

TECHNICAL REPORT  
NATICK/TR-06/004

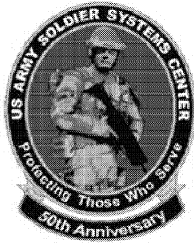

AD\_\_\_\_\_

# PERSONAL NAVIGATION SYSTEM

by  
**Peter Sherman**  
and  
**Steven Holmes**

**Draper Laboratory**  
**Cambridge, MA 02130**

October 2005

Final Report  
June 2002 – April 2005

**Approved for public release; distribution is unlimited**

Prepared for  
**U.S. Army Research, Development and Engineering Command**  
**Natick Soldier Center**  
**Natick, Massachusetts 01760-5056**

## DISCLAIMERS

The findings contained in this report are not to be construed as an official Department of the Army position unless so designated by other authorized documents.

Citation of trade names in this report does not constitute an official endorsement or approval of the use of such items.

## DESTRUCTION NOTICE

### For Classified Documents:

Follow the procedures in DoD 5200.22-M, Industrial Security Manual, Section II-19 or DoD 5200.1-R, Information Security Program Regulation, Chapter IX.

### For Unclassified/Limited Distribution Documents:

Destroy by any method that prevents disclosure of contents or reconstruction of the document.

**REPORT DOCUMENTATION PAGE***Form Approved*  
**OMB No. 0704-0188**

Public reporting burden for this collection of information is estimated to average 1 hour per response, including the time for reviewing instructions, searching data sources, gathering and maintaining the data needed, and completing and reviewing the collection of information. Send comments regarding this burden estimate or any other aspect of this collection of information, including suggestions for reducing this burden to Washington Headquarters Service, Directorate for Information Operations and Reports, 1215 Jefferson Davis Highway, Suite 1204, Arlington, VA 22202-4302, and to the Office of Management and Budget, Paperwork Reduction Project (0704-0188) Washington, DC 20503.

**PLEASE DO NOT RETURN YOUR FORM TO THE ABOVE ADDRESS.**

<b>1. REPORT DATE (DD-MM-YYYY)</b> 10/31/05		<b>2. REPORT TYPE</b> FINAL		<b>3. DATES COVERED (From - To)</b> June 2002 – April 2005	
<b>4. TITLE AND SUBTITLE</b> PERSONAL NAVIGATION SYSTEM				<b>5a. CONTRACT NUMBER</b> DAAD16-02-C-0040	
				<b>5b. GRANT NUMBER</b>	
				<b>5c. PROGRAM ELEMENT NUMBER</b>	
<b>6. AUTHOR(S)</b> Peter Sherman and Steven Holmes				<b>5d. PROJECT NUMBER</b>	
				<b>5e. TASK NUMBER</b>	
				<b>5f. WORK UNIT NUMBER</b>	
<b>7. PERFORMING ORGANIZATION NAME(S) AND ADDRESS(ES)</b> Draper Laboratory 555 Technology Square Cambridge, MA 02130				<b>8. PERFORMING ORGANIZATION REPORT NUMBER</b>	
<b>9. SPONSORING/MONITORING AGENCY NAME(S) AND ADDRESS(ES)</b> U.S. Army Research, Development and Engineering Command Natick Soldier Center ATTN: AMSRD-NSC-TP-S (H. Girolamo) Kansas St., Natick, MA 01760-5056				<b>10. SPONSOR/MONITOR'S ACRONYM(S)</b>	
				<b>11. SPONSORING/MONITORING AGENCY REPORT NUMBER</b> NATICK/TR-06/004	
<b>12. DISTRIBUTION AVAILABILITY STATEMENT</b> Approved for public release; distribution is unlimited.					
<b>13. SUPPLEMENTARY NOTES</b>					
<b>14. ABSTRACT</b> The U.S. Army has a need to provide an affordable navigation system to meet the multi-mission needs of the warfighter. Recent advances in Micro-Electro Mechanical System (MEMS) inertial instruments, Global Position System (GPS) receivers, GPS anti-jam technologies and state-of-the-art processing allow the development of a low cost GPS/INS-based Personal Navigation System (PNS) that will meet the expected power, size, weight, cost and performance needs of the Ground Soldier System (formerly Future Force Warrior and Objective Force Warrior) program. The Personal Navigation System Program was executed in two phases. This Final Report focuses on Phase II activities and results. Activities which are solely Phase I tasks are summarized in the Appendix.					
<b>15. SUBJECT TERMS</b> GLOBAL POSITIONING SYSTEM    DOPPLER SYSTEMS    COST-EFFECTIVE    PERFORMANCE TESTS AUTONOMOUS NAVIGATION    SIGNALS    WARFIGHTER    PROTOTYPES PERSONAL NAVIGATION    INTEGRATION    JAMMING    SENSORS					
<b>16. SECURITY CLASSIFICATION OF:</b>			<b>17. LIMITATION OF ABSTRACT</b>	<b>18. NUMBER OF PAGES</b>	<b>19a. NAME OF RESPONSIBLE PERSON</b>
a. REPORT	b. ABSTRACT	c. THIS PAGE	SAR	52	Henry Girolamo, Program Manager
U	U	U			<b>19b. TELEPHONE NUMBER (include area code)</b> 508-233-5483



## TABLE OF CONTENTS

List of Figures.....	iv
List of Tables.....	v
Preface.....	vi
1.0 SUMMARY.....	1
2.0 TECHNOLOGY EVALUATION.....	4
3.0 SIMULATION ANALYSES.....	11
4.0 PHASE II PROTOTYPE SYSTEM & HWIL.....	16
5.0 PHASE II/JOINT TEST RESULTS.....	23
6.0 TECHNOLOGY ROADMAP.....	33
APPENDIX PHASE I FINAL REPORT OVERVIEW.....	37
LIST OF ACRONYMS.....	44

## LIST OF FIGURES

<u>Figure</u>	<u>Page</u>
Figure 1. Conceptualized GPS-Challenged Environment .....	1
Figure 2. Technology Path for Deep Integration Guidance and Navigation Unit .....	6
Figure 3. Inertial vs. Magnetic Heading .....	7
Figure 4. Satellite Visibility Statistics .....	12
Figure 5. Performance Improvement with Velocimeter Aiding .....	14
Figure 6. Performance Improvement with Intermittent vs No GPS .....	15
Figure 7. Deep Integration Satellite Control.....	17
Figure 8. Deep Integration Re-acquisition after Complete Loss of Lock.....	17
Figure 9. CSIM Block Diagram.....	20
Figure 10. HWIL Block Diagram .....	21
Figure 11. HWIL Physical Configuration.....	21
Figure 12. PNS Prototype Software System Integration Environment.....	22
Figure 13. Canyon Walk (1 March 2005).....	24
Figure 14. Joint Field Test Data Sets.....	25
Figure 15. Test Area Looking East .....	26
Figure 16. Ground Truth .....	26
Figure 17. Segment and Cumulative Error Statistics for March 1st 05 Data Set .....	27
Figure 18. GPS Visibility in Urban Canyon .....	29
Figure 19. Histogram of Usable Satellite Visibility.....	29
Figure 20. Deep Integration Tracking.....	30
Figure 21. Indoor Navigation Summary .....	32
Figure 22. Navigation System Power Outlook .....	34
Figure 23. Personal Navigation System Roadmap .....	36
Figure A-1. Navigation Core .....	38
Figure A-2. PNS Concept .....	39
Figure A-3. PNS Phase I Prototype System.....	39
Figure A-4. PNS Phase I Test Apparatus.....	40
Figure A-5. Smaller Urban Course .....	41

## LIST OF TABLES

<u>Table</u>	<u>Page</u>
1. Table MEMS IMU Performance Evolution.....	5
2. Table Urban Canyon Data Summary.....	27
3. Table Indoor Test Summary .....	31
4. Table Technology Requirements for Personal Navigation.....	33
Table A-1. Phase I Results.....	43

## PREFACE

This report summarizes the effort conducted for the U.S. Army Research, Development and Engineering Command (RDECOM) in support of contract DAAD16-02-C-0040, "Personnel Navigation System". The U.S. Army has a need to provide an affordable navigation system to meet the multi-mission needs of the warfighter. Recent advances in Micro-Electro Mechanical System (MEMS) inertial instruments, GPS receivers, GPS anti-jam technologies and state-of-the-art processing allow the development of a low cost GPS/INS-based Personal Navigation System (PNS) that will meet the expected power, size, weight, cost and performance needs of the Ground Soldier System (formerly Future Force Warrior and Objective Force Warrior) program.

The work was performed under Congressional Award, during the period of June 2002- April 2005.

The citation of trade names in this report does not imply endorsement or other approval of such product.



# PERSONAL NAVIGATION SYSTEM

## 1.0 SUMMARY

The U.S. Army has a need to provide an affordable navigation system to meet the multi-mission needs of the warfighter. Recent advances in Micro-Electro Mechanical System (MEMS) inertial instruments, Global Position System (GPS) receivers, GPS anti-jam technologies and state-of-the-art processing allow the development of a low cost GPS/INS based Personal Navigation System (PNS) that will meet the expected power, size, weight, cost and performance needs of the Ground Soldier System (formerly Future Force Warrior and Objective Force Warrior) program.

Over the course of the PNS program, Draper Laboratory has developed a prototype Personal Navigation System (PNS). This prototype contains the following sensors: GPS receiver; Micro-Electro Mechanical System (MEMS) Inertial Measurement Unit (IMU), Doppler radar, magnetometer and a baro-altimeter. A suite of complementary sensors is necessary as no single sensor will provide an accurate and reliable navigation solution throughout the range of environments in which the warfighter will be deployed. A particular emphasis has been placed on providing a navigation solution in environments where the GPS signal may be degraded due to obscuration, weak signal, and/or multipath (Figure 1.). Draper's prototype includes Deep Integration (DI) tracking algorithms which will allow the GPS signal to be retained for longer periods of time as the GPS signal weakens (e.g., entering a building) or suffers from intentional (e.g., jamming) or environmental interference.

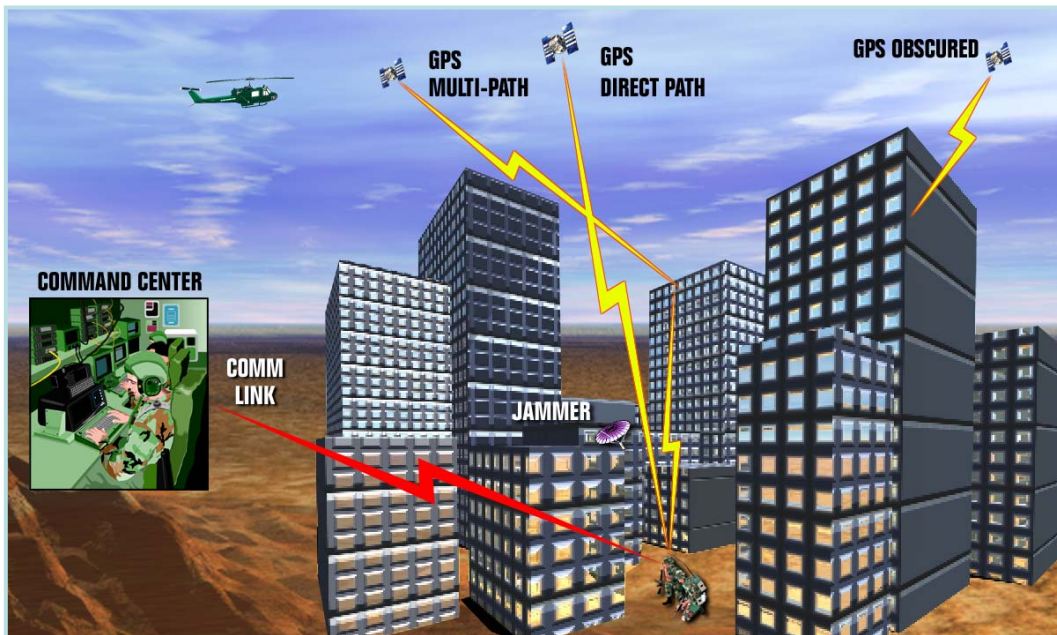

Figure 1. Conceptualized GPS-Challenged Environment

The PNS Program has successfully achieved its primary goals. The major focus of this program has been to identify applicable technologies for dismounted soldier precision navigation systems and to raise the Technology Readiness Level (TRL) for the application of these technologies in this area. The field tests demonstrated the capabilities of prototype hardware for navigation in GPS-denied and significantly challenged environments.

Two technologies, developed at Draper with this application in mind, were a focus of both the system trade studies and prototype field demonstrations. The first, tactical grade MEMS (micro electro mechanical systems) inertial sensors, is the result of over a decade of development at Draper. These sensors were successfully tested in several GPS/inertial guided munitions programs. Production fabrication of these devices has been transitioned to industry partners. The challenge for the Personal Navigator program, one that was successfully met, was to demonstrate MEMS inertial sensor utility in a very different application domain.

Deep Integration GPS tracking is the other Draper-developed technology incorporated into the PNS design. This also was developed for missile and munition guidance and focused on tracking under poor signal to noise conditions associated with intentional interference of the GPS signal. For the warfighter, Deep Integration gives significant anti-jam capability through algorithm enhancements and requires no specific anti-jam hardware. Deep Integration was perceived to have relevance in two additional areas. First is improved receiver sensitivity for indoor and jungle navigation. It also provides optimal satellite tracking under conditions where buildings and mountains intermittently block the view of the satellite. During a run down a hallway, as an example, the satellite may only be in view for a second while the soldier passes a doorway. The PNS program fielded a real-time embedded implementation of Deep Integration that demonstrated prompt reacquisition of satellites in a challenging Urban Canyon test course.

Looking forward, there is a clear need to support missions over extended periods of time by reducing power and size, and also improving system performance. Key areas that need to be addressed include:

- Decreasing power usage of MEMS inertial sensors and on-board velocimeters
- Improving sensor performance and/or adding additional low cost/low power sensors to support longer missions with high reliability
- Implementing GPS multipath rejection techniques that are consistent with position accuracy requirements of 1-3 meters.
- Implementing size effective and affordable anti-jam hardware and algorithms
- Aggressively reducing package size
- Demonstrating that active sensor technologies have no fit or interference issues with other equipment on the soldier.

The hierarchy in deriving system and subsystem specifications is performance, power, size, and cost. Precision navigation for the urban warfighter is *mission critical*, both for position location and targeting. Performance specifications look to geo-locate to a hallway, a room, and a floor inside buildings. Specifications of one to three meters spherical error probable at the 95% level (SEP 95%) have been proposed.

A key lesson learned from this program, derived both from trade studies and test of the prototype system, was the need for a system of sensor systems architecture that supported integrity checking and cross-sensor calibrations. Every navigation-sensing subsystem has instrument drift, data drop-outs, and/ or data corruption. This application requires *depth* in the on-board

sensor suite to achieve robust performance. An active area of future work is in low-power augmentation sensors.

Power requirements for a navigation system are driven by the need to support a 24 hour mission. The system won't need to operate at peak power at all times – either the full system can be transitioned to sleep mode or select subsystems can be powered down. An aggressive system power goal is 2W peak including a SAASM GPS Receiver. Operating at this peak value for 24 hours requires a 48W-hour battery, comparable to the size of a computer laptop battery. Power management techniques are capable of significantly reducing required battery size and weight.

Affordability and allocation go hand in hand. There is a clear need for low-power precision navigators. A robust but expensive solution won't see wide distribution. The key to designing in affordability is selection of sensors developed for large-scale production in either the military or commercial arena. Navigation system customization costs could be further reduced for the military if a parallel systems for the police, firefighter, urban and cave search and rescue communities were developed. This is a realistic goal. Requirements will be somewhat different for these non-military users but a core system can be developed serving both military and *First Responders*.

The Personal Navigation System Program was executed in two phases. This Final Report focuses on Phase II activities and results. Activities which are solely Phase I tasks are summarized in the Appendix.

Section 2 of this report provides thumbnail critical evaluations of technologies relevant to dismounted soldier battlefield position location. These focus both on benefits as well as outstanding technical issues. Section 3 describes covariance simulations used to assess the performance of different navigation sensor mixes and different performance levels of these sensors under GPS challenged and fully denied conditions. Section 4 describes the migration of the algorithms and error models in these simulations initially to a Hardware-in-the-Loop test environment that provided GPS RF signals modeling urban canyon and indoor navigation signal environments. The subsequent system development was a Personal Navigation System prototype that replaced simulations of the inertial and other sensors with physical sensors. Section 5 shows data collected with this system during a Joint Test conducted in collaboration with a team from the U.S. Army/CERDEC. This Joint Test was the culmination of the Phase II activities. Finally, Section 6 discusses the technology areas requiring development to move forward from a lab prototype to a usable soldier system.

## 2.0 TECHNOLOGY EVALUATION

The sections below summarize technologies that Draper believes to be particularly relevant for the PNS Program. During Phase I, Draper conducted additional technology evaluations. Summaries can be found in Appendix I of the Final Report for PNS Phase I (Draper Document 414105; Dated 6 January 2004).

### *Tactical Grade MEMS Inertial Sensors*

MEMS Inertial Sensors have been transformational for precision guidance of small munitions. Sensors developed for this application by Draper Laboratory have been licensed to Honeywell and are now in production. The Common Guidance Inertial Measurement Unit (CGIMU) Program is continuing to fund the Honeywell/Draper team, investing both in production ramp-up and sensor performance improvements.

This defined technology path and the growing military market make these sensors attractive for use in a personal navigation system. Functionally, MEMS inertial sensors have relatively large drifts and thus cannot provide long term autonomous position aiding. The drifts, however, are stable, and so the short term body dynamics sensed by a MEMS IMU is faithful to the actual physical motion. Other navigation sensing systems experience dropouts and anomalies that result in unavailable or incorrect data. The function of MEMS inertial sensors in a personal navigation system is to provide attitude and position information during these dropouts, to detect anomalies and incorrect data from other system sensors (*e.g.*, Doppler radar velocity sensors and magnetometers) and as part of the system of navigation sensors, to provide an accurate tracking aid to the GPS receiver.

In addition to the military market, there is a large market for automotive gyros and accelerometers. A cost/performance tradeoff can be made – the penalty for use of a lower performance automotive gyro is significantly less tolerance for dropouts on the other sensors. Simulations showing this effect are presented in Section 4 below.

Power consumption is the area where both military and automotive inertial sensors fail to meet the requirements of the dismounted soldier. The power issue is solvable, but requires a focused development effort.

Table 1 surveys the evolution in performance of MEMS gyros and accelerometers. The commercial device is based on an Analog Devices sensor and the custom and CGIMU columns are based on Draper Laboratory's tuning fork gyro (TFG) and high performance accelerometer (HPA).

Table 1. MEMS IMU Performance Evolution

Source	Units	Commercial (2002)	Custom HW (2002)	CGIMU Goals (2005)
<b>Gyro Stability Errors (<math>1\sigma</math>)</b>				
<b>In-run Bias</b>	$^{\circ}/\text{hr}$	<b>100</b>	<b>1</b>	<b>0.3</b>
<b>In-run Scale Factor</b>	<b>PPM</b>	<b>500</b>	<b>100</b>	<b>33</b>
<b>Turn-on Bias</b>	$^{\circ}/\text{hr}$	<b>100</b>	<b>3.3</b>	<b>0.3</b>
<b>Turn-on Scale Factor</b>	<b>PPM</b>	<b>500</b>	<b>170</b>	<b>33</b>
<b>IA Alignment</b>	<b>mrads</b>	<b>0.03</b>	<b>0.03</b>	<b>0.03</b>
<b>Angle Random Walk</b>	$^{\circ}/\text{rt-hr}$	<b>1</b>	<b>0.06</b>	<b>0.003</b>
<b>Accelerometer Stability Errors (<math>1\sigma</math>)</b>				
<b>In-run Bias</b>	<b>milli-g</b>	<b>3.3</b>	<b>1</b>	<b>0.3</b>
<b>In-run Scale Factor</b>	<b>PPM</b>	<b>130</b>	<b>100</b>	<b>50</b>
<b>Turn-on Bias</b>	<b>milli-g</b>	<b>3.3</b>	<b>3.3</b>	<b>0.3</b>
<b>Turn-on Scale Factor</b>	<b>PPM</b>	<b>200</b>	<b>170</b>	<b>50</b>
<b>IA Alignment</b>	<b>mrads</b>	<b>0.03</b>	<b>0.03</b>	<b>0.03</b>
<b>Velocity Random Walk</b>	<b>m/s/rt-hr</b>	<b>0.05</b>	<b>0.02</b>	<b>0.002</b>

***Augmented GPS/INS: Deep Integration Receiver Aiding***

Basic Deep Integration Architecture: IMU aiding allows the navigation system to estimate, under high dynamics and poor signal conditions, both satellite doppler shift and range, so that tracking loops can stay within the range of the receiver’s correlators. Draper’s Deep Integration (DI) feedback architecture takes the raw in-phase and quadrature (I and Q) power levels output from these correlators as inputs to the navigation estimation filter. The filter in turn estimates the carrier and code phase delay for the receiver’s tracking loops. In the presence of strong signal, the receiver measurement uncertainty is low and the satellite measurement dominates the navigation solution. With low carrier-to-noise ratio ( $C/N_0$ ), the inertial sensors maintain the quality of the solution and feed this back to the receiver to maintain track.

Augmentation Sensors: In a personal navigation system, augmentation sensors, in addition to the MEMS inertial sensors, contribute to the estimation of replica code phase that is fed back to the receiver. Use of measurements from additional sensors increases the length of time the receiver can maintain track under poor signal conditions.

The advantages of a Deep Integration approach for personal navigation are

- Optimal tracking under poor signal conditions (indoor, forest, jamming)
- Prompt reacquisition of satellites undergoing intermittent urban or indoor obscuration
- Optimal range aiding under the common urban condition where fewer than the four satellites needed for a self-contained GPS solution are in view.

Clock Drift and Reacquisition: When no satellite is in direct view, the ability of Deep Integration to promptly reacquire is limited by the quality of the receiver’s oscillator. If the combination of unmodeled clock drift and position uncertainty is larger than the correlator’s

capture range, DI is no longer able to reacquire. Under these conditions all satellite channels are handed back to the receiver's native reacquisition section. Handback to Deep Integration after reacquisition requires moding through some form of explicit pseudorange aiding. Clearly better oscillators reduce the need to access this handover mode.

Packaging Evolution: Figure 2 below shows the evolution in form factor and performance of a miniature GPS/INS system (DI-GNU) scheduled for production in 2005. Development of this integrated system is funded under the Common Guidance program. Both packaging and power utilization were designed for high launch shock, short time-of-flight munitions applications. Customization of this system is needed to make this usable for the dismounted soldier.

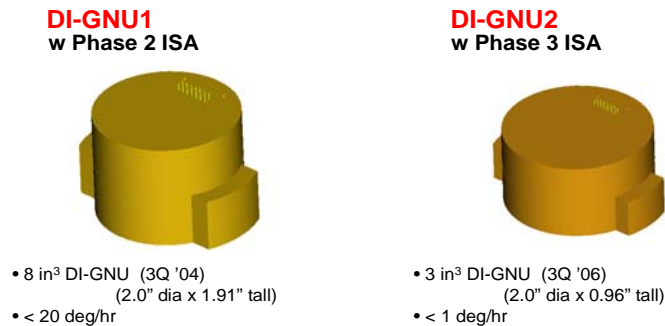

Figure 2. Technology Path for Deep Integration Guidance and Navigation Unit

***Magnetic Compass Aiding***

Magnetic compasses are a traditional and historic component of dead reckoning systems. As a recent example, the Land Warrior navigation system is based on a combination of pedometry and a magnetic compass and provides specified accuracy of 2% distance traveled.

The experience in this program has been that earth field magnetic measurements are problematic for precision dismounted navigation both in indoor and urban outdoor environments. The plots in Figure 3 show traces of inertial heading (red) and magnetic heading (blue). The top plot shows data from an open field athletic track; the middle plot depicts an Urban Canyon area, and bottom plot represents indoors in a metal frame building. The vertical scales in all three are the same, 45°/division. Unsurprisingly, the progression shows increasing magnetic anomalies going from open field to indoors.

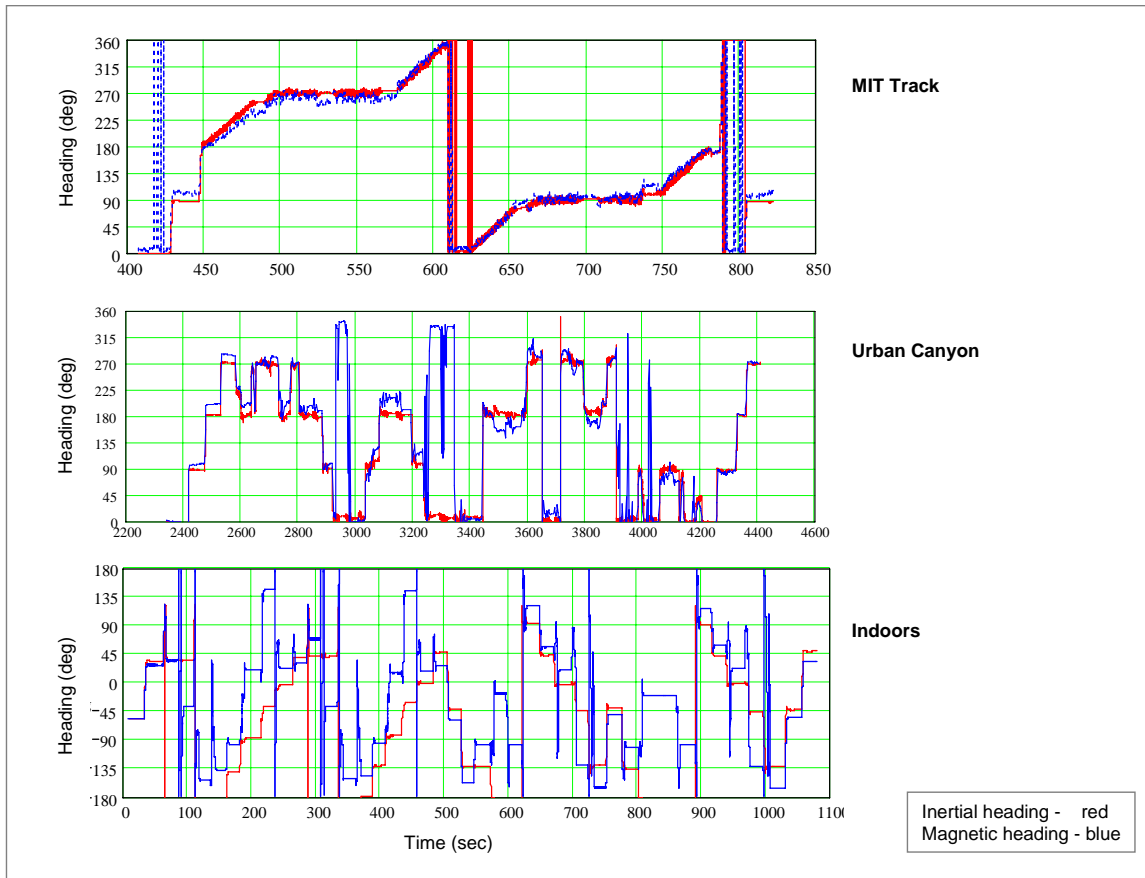

Figure 3. Inertial vs. Magnetic Heading

Magnetometer aiding is compromised both by spatial and temporal field variations. For a moderate length GPS dropout (several minutes), most *geomagnetic* field variations are not a severe problem and drive attitude errors to less than one degree. On the other hand, short range field variations from ferrous metal objects or electric motors can significantly distort the heading and hence drive errors in the integration of on-track position.

If these variations have persistence, measurements from GPS as well as on-board sensors can calibrate the local magnetic field direction. Our observation is that this is a difficult task, particularly indoors. In a battlefield environment additional field variations are sourced by vehicles and by the soldier's weapon. When the soldier is moving, a hand-held or body-strapped weapon will be in proximity to the magnetic sensor. The relative motion between the weapon and sensor will be synchronized to the soldier's gait. This correlated motion can rectify the integration of position along forward track into cross-track position error.

### ***Zero Velocity Updates***

Zero velocity updates are a theoretically powerful method of bounding inertial sensor drift. This measurement is a particular category of vector velocity aiding and can bound drift both in accelerometers and in the roll and pitch gyros. For optimal effectiveness the measurement should be available often enough compared to the characteristic drift times of the inertial sensors.

One way to ensure a frequent update rate is to mount both the inertial instruments and a contact sensor on the foot, allowing a measurement to be taken at each footfall. There are both soldier-fit and system-performance issues here. The fit problem derives both from the weight of the inertial package in the boot and the need for a power and communication channel from the boot to the body.

The performance issue has two parts. The first is that on certain terrain (mud, sand) there could be significant slip at each step – this puts a bound on accuracy of the zero velocity measurement. Secondly, the boot sees significant body motion unrelated to change in position of the body center of mass. This motion, through scale factor errors or asymmetries could degrade performance with respect to a mid-body mounted sensor suite.

All of these are solvable problems. A very high degree of miniaturization of MEMS inertial sensors is technically feasible and would make this approach more appealing.

### ***Doppler Velocity Sensors***

This technology leverages sensor development for automotive collision avoidance and intelligent cruise control radars. The sensors provide a three dimensional velocity vector using short-range, low-power transceivers. They can be spoofed by reflection from moving objects and require other acceleration or velocity aids to discriminate against spurious data. The technology is expected to evolve to a single multi-element transceiver using beam-steering to provide vector velocity.

### ***Gait Recognition and Stride Modeling / Pedometry***

The Land Warrior dead reckoning system mentioned above combines gait recognition with magnetic heading measurements. It is unlikely this category of system can navigate accurately and reliably in urban areas and indoors. Issues are both the magnetic variations mentioned earlier and also variations in stride length modeling with terrain, level of fatigue, and load. Following earlier examples, if this scale factor error has a persistence then GPS and on-board sensors can recalibrate the gait timing/stride length relationship.

A stride measurement will be available intermittently. In a house-to-house operation, for example, there may be few periods where a regular gait is discernable. It makes sense to use stride measurements only during periods of clear characterizable gait and rely on other subsystems to maintain position during the dropouts.

### ***Network-Assisted GPS***

There are a number of commercial GPS-based self-location technologies. Three of these – RadioTrac, SnapTrac, and Global Locate share concepts with a deployable military system but require fixed infrastructure that may not be available on the battlefield. They all rely on C/A code and thus are susceptible to spoofing.

In a battlefield environment, network aids can improve the sensitivity and shorten re-acquisition time for a soldier-mounted receiver. They can be transmitted through urban canyons or indoors more effectively than the native satellite signal. These aids include ephemerides from all satellites in potential view, clock synchronization signals, iono/tropospheric corrections, and differential corrections. For a company or small unit deployed over a limited area of engagement, one or more vehicles can be fitted with P(Y) code receivers and larger beam steering A/J antennas and serve as a base for transmitted aids over a local tactical radio channel.

This approach is appealing to the GPS community in that it “solves” the indoor navigation problem by adding communications to a modified GPS receiver. An insertion path for this



technology exists – Future Force Warrior has plans for integration of software GPS receivers into multi-channel tactical radios.

There are two weak links here. The first is indoor multipath. In an urban environment, the GPS signal is subject to obscuration and reflection from surrounding buildings. Inside a building there is additional blocking and reflections from walls and ceiling. The high-sensitivity receiver built around network GPS assistance can track these low-power signals. However, the derived range measurements can be seriously corrupted by both flavors of multipath. Other on-board sensors are still needed to support integrity checking of these measurements.

The second problem is communication dropouts. Signal penetration indoors in a function of site geometry, transmitter power, and for soldier-to-soldier mediated communications, the density of active units in the operation.

Network-assisted GPS extends the range of GPS measurements to indoor operations with very little hardware cost. It is unlikely that it can serve as a *stand-alone* augmentation to traditional GPS for precision indoor navigation.

### ***RF Ranging and Positioning***

RF ranging piggybacks on local tactical communications networks for both relative and absolute positioning of members of a small unit of operation. This was the design approach of the SUO-SAS (Small Unit of Operation Situational Awareness System). Absolute geo-location is aided by ranging to unit members who have access to full sky GPS or a vehicle navigation system. Alternatively a grid of surveyed beacons can provide absolute position directly to all members of the team. Ultra wide band (UWB) technology is especially promising as a low-power, low probability of intercept system with good penetration indoors.

UWB ranging is complementary to urban GPS, providing similar time sequenced range measurements. Like GPS, obscuration and multipath are significant problems to a UWB system. For absolute positioning, site obscuration can drive a need for a high density of beacons to give units a reliable fix. If the overall navigation system is designed in a way so that only occasional fixes are necessary, then beacon geometry requirements could be relaxed.

For multipath, shortest time delay screening can minimize but not eliminate the errors. Again, similar to GPS, the hardest case to integrity check is when the direct path is not observable. Raising signal power to increase indoor penetration also increases multipath errors.

### ***Commercial Self-Locating/TDOA Technologies***

In addition to the GPS based technologies mentioned above, two commercial systems have been proposed for indoor navigation.

AM radio signal navigation – Trilateration from AM radio towers uses carrier phase as a measure of distance. Limitations to the system accuracy are driven by wavelength, (175-550m), poor transmitter frequency stability, and ground wave propagation uncertainties.

Digital TV signal navigation – This system uses the synch bit from digital TV signals with ranging to digital TV towers. This technique is limited both by the lack of widespread availability of digital TV and also by the ability to shut these signals down in battlefield conditions. It is potentially useful for search and rescue in developed areas.

### ***Mapping and Digital Imaging***

*Real-time digital imaging* as a navigation aid tracks the motion of objects in the focal plane of the optics with respect to a body mounted camera. Low cost miniature cameras are available and

can be customized to this application. The challenge is in sorting through the information contained in the frame-to-frame changes in the image, using an acceptable level of computation, in order to derive a navigation aid.

In broad terms, the system tracks either high contrast objects in the field of view or performs frame-to-frame correlations of the entire image. The tracked image can contain both stationary and moving objects. Motion with respect to these objects is due both to relative translation (*i.e.*, delta range per frame period) and rotation (*i.e.*, attitude change per frame period) of the body. Inertial and other on-board sensors, in the context of an estimation filter, can provide a reference to separate rotation from translation. The filter incorporates the optical measurements and computes optimal estimates of attitude, velocity, and instrument biases.

*Mapping* provides a database of features with which to test and correct the accuracy of position estimates. The challenge is to acknowledge the cognitive load on the soldier in battle and design a fully *autonomous* system for traditional landmark navigation. The difficult derivative problem is to associate bird's-eye features from available geo-registered aerial photos with real-time ground-level images from the soldier's camera.

*Simultaneous localization and mapping* (SLAM), developed principally in the robotics community, uses sequential (single observer) and collaborative (multiple observer) observations of a mix of unsurveyed features and surveyed landmarks to refine the position of both the observer and the features.

The most successful methods to date use a probabilistic approach and Monte Carlo sampling, where the probability densities are modeled using a set of particles. Propagation between measurements is accomplished by sampling from a transition density based on a specified dynamical model. Measurement updating is accomplished by updating each particle according to a set of importance weights using a bootstrap resampling technique. In scenarios where there are many uncertain features (e.g., unsurveyed features and uncertain landmark locations), computation requirements can often be reduced significantly without significant loss of accuracy by using Gaussian densities for the features. This method solves the measurement data association problem by carrying estimates of the features along with each particle. These estimates are also updated at a measurement. Several methods are available for selecting the most likely measurement/feature identity pair at each measurement.

The application of this technique to small unit geo-location combines navigation sensors on each soldier and autonomous vehicles with a soldier-to-soldier RF ranging system. An "unsurveyed" feature can be a target – this technique has application to rapid, precision small unit collaborative target location.

### 3.0 SIMULATION ANALYSES

The primary objective of the simulation effort was to assess the contribution of each sensor to the quality of the overall navigation solution. These simulations demonstrated both the value of precision velocity sensors and of intermittent range measurements to the navigator when fewer than four GPS satellites are available. Navigation solutions in urban canyon and indoor locations were examined. The simulation environment was also used to refine the configuration of a vector Doppler velocimeter.

The section below describes this simulation in detail and shows sample results.

**Trajectories:** Trajectories were developed to model a two square block walk through a sequence of connected urban canyons. The model was based on the Technology Square area of Cambridge, Massachusetts. A second trajectory was an outdoor initialized multi-floor walk modeled on a section of Draper's Technology Square facility.

**Sensor Configurations:** A test matrix was developed in collaboration with CERDEC. For each trajectory, both variations in sensor mix as well as sensor quality within the mix were run. The intent was to develop an understanding of the time development of sensor error states as a function of sensor mix, quality, and environment. Plans for additional combinations of sensors were added to the matrix including RF ranging, Network Assisted GPS, and pedometry. This work was not completed in the base program but is planned as a follow-on activity.

**Initialization** – Initialization CONOPS were simulated with an *initial* occasional full sky view of GPS satellites. This was used to calibrate magnetic field variations, baro-altimeter bias, and IMU turn-on errors. A quality position fix was implemented and used for initial calibration of pseudo range biases.

**Framework:** The simulation framework was developed in MatLab. This included a trajectory generator, sensor models, inertial navigation integrations, and Kalman filter. Outputs showed truth vs. estimated navigated path, state estimates plotted with covariances, and histograms showing the error spread for each configuration run over each trajectory.

#### *Approach*

Instrument models were created for each sensor contained within the Personal Navigation System. This includes GPS, MEMS IMU, baro-altimeter, magnetometer, and a three-axis Doppler radar system.

A detailed GPS obscuration mask for the Draper/Cambridge area was derived analytically based on building laydown and satellite almanac information. This calculation showed excellent match with the statistics for satellite availability measurements made with the Rockwell NavStorm receiver in the PNS demonstration system. In Figure 4 the gray and red bars represent data from keyed and un-keyed runs, respectively. Blue columns are the simulation output. Note the dominance of measurements with only two satellites in view. The explicit set of satellites changes as the simulation trajectory turns a corner. *Instantaneous* geometry is poor with these mostly high elevation two satellite fixes but the overall *time-lapse* geometry is much better. This is the basis for the expectation that intermittent Urban Canyon range measurements are important navigation aids.

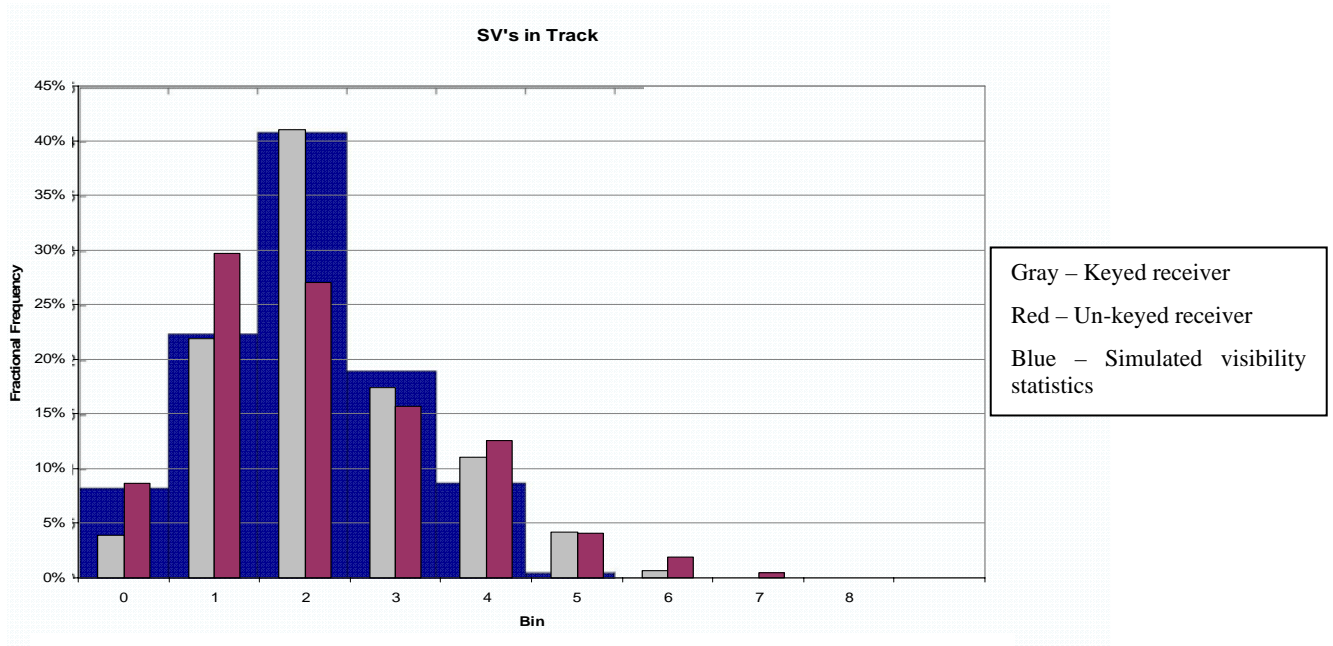

Figure 4. Satellite Visibility Statistics

The initial plan had been to start the urban canyon simulations with a 100-second walk with a least four satellites in view. To keep a sense of operational reality, it was decided to base the navigation system initialization only on the set of satellites observable in the plaza outside Draper Laboratory. This is a conservative operational environment – four satellites are rarely in view during this initialization period.

### ***Urban Canyon Simulations***

Urban Canyon simulations were run with four separate scenarios. These scenarios are summarized below:

- a) GPS in full view for 100 seconds only, no GPS aiding thereafter. IMU + baro aiding,
- b) As above, but with Doppler velocity aids,
- c) GPS in full view for 100 seconds only, no GPS aiding thereafter. IMU + baro aiding + Doppler aiding,
- d) Sensors suite from c) but GPS intermittent for entire time.

### ***Urban Canyon GPS Multipath Model***

Urban canyon multipath was modeled as a random Markov process with errors scaled to a few meters. This scaling is now believed, both by site geometry considerations and with experimental data back-up, to be closer to 50 meter p-p. The data was derived from a least squares fit solution of satellite range measurements when more than four satellites are in view. Under these conditions, the solution is over-determined and the error of each satellite's range from the best fit can be calculated. Simulation examples shown below were run with the lower scaling.

Example 1 - Velocimeter Aiding – In the first three straightline legs of the tracks in Figure 5 below, GPS satellites are completely visible and are fully blocked thereafter. The left hand trace

shows the clear and expected divergence of the pure inertial navigation solution. Addition of a quality velocimeter, red trace on the right brought the average position errors to less than three meters.

Example 2 – Intermittent GPS Range Aids - In a similar way, the trajectory on the left hand side of Figure 6 is derived from a full sky view of GPS. The inertial system is of poorer quality than that in Figure 5. The Doppler aided inertial solution is significantly improved over a pure inertial system but does show significant errors. On the right hand side, intermittent GPS aiding is turned on for the full trajectory. The improvement in performance is clear.

### ***Indoor Simulations***

Simulations were developed for indoor scenarios using appropriate models for each PNS sensor. GPS visibility models were augmented to account for blockage from ceilings and interior walls as well as nearby buildings. Indoor multipath was modeled as a Markov Process with a few meters scaling. Random dropouts were added to simulate Raleigh fading of the RF signal. The prediction of these simulations, borne out by data from the PNS prototype, was that a velocimeter and baro-altimeter aided tactical grade MEMS inertial system could navigate accurately with little or no GPS aiding.

### ***Doppler Model Variations***

Simulations were run to support trades on the physical configuration of the vector Doppler radar velocimeter. In one set the forward pointing radar was dropped with a goal of reducing the physical size of the radar transceiver. The combination of the 2-D velocity aid with baro-altimeter bounding of the vertical channel did appear to perform well. The reliability of this configuration is clearly sensitive to baro-altimeter errors. These are still being evaluated.

The second simulation kept three beams but decreased the bore-sight angle of the side radars to  $\pm 15^\circ$  from  $\pm 30^\circ$ . No significant change in performance was seen. The narrower beam spread is easier to implement with phased array beam steering and allows the transceiver to be mounted flush with the PNS package.

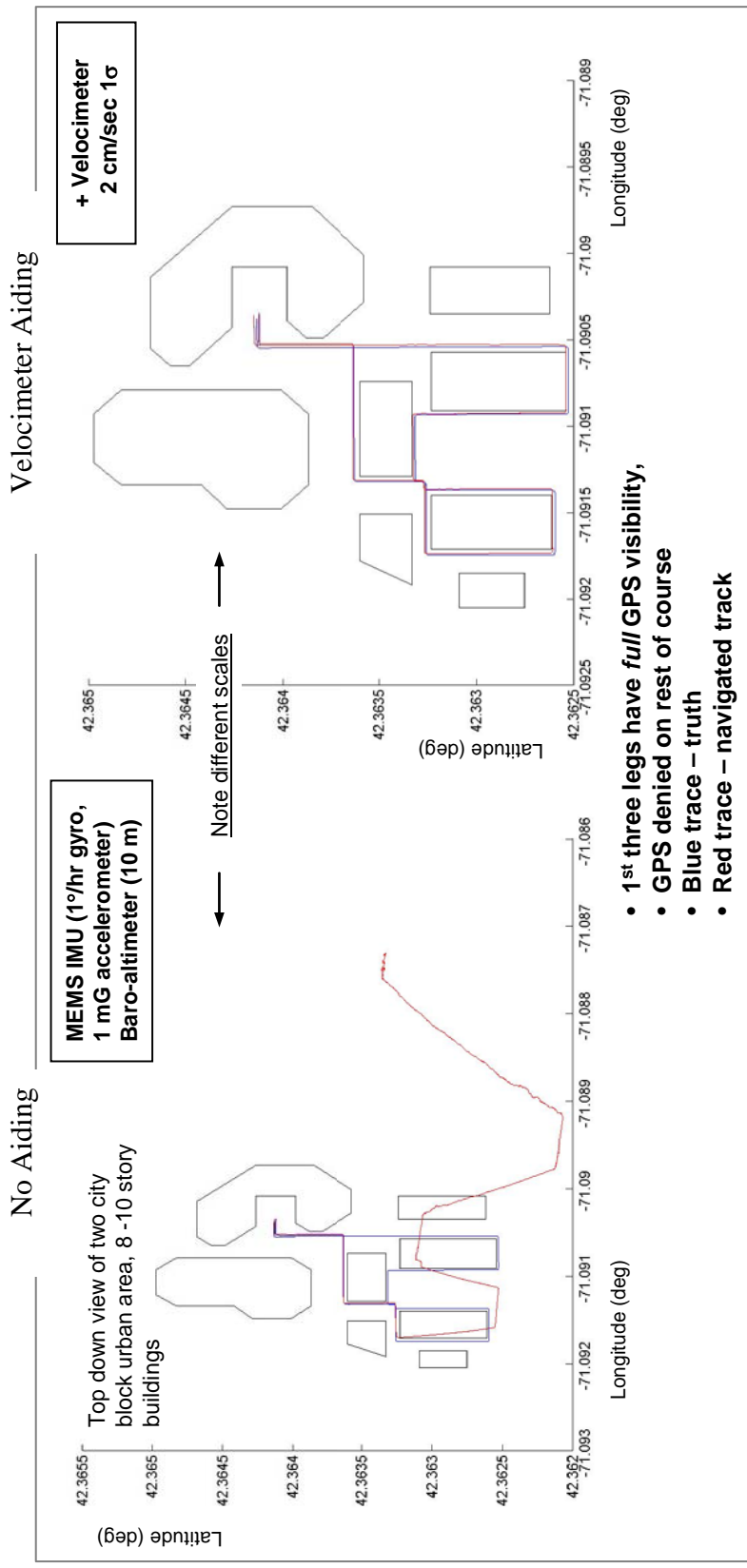

Figure 5. Performance Improvement with Velocimeter Aiding

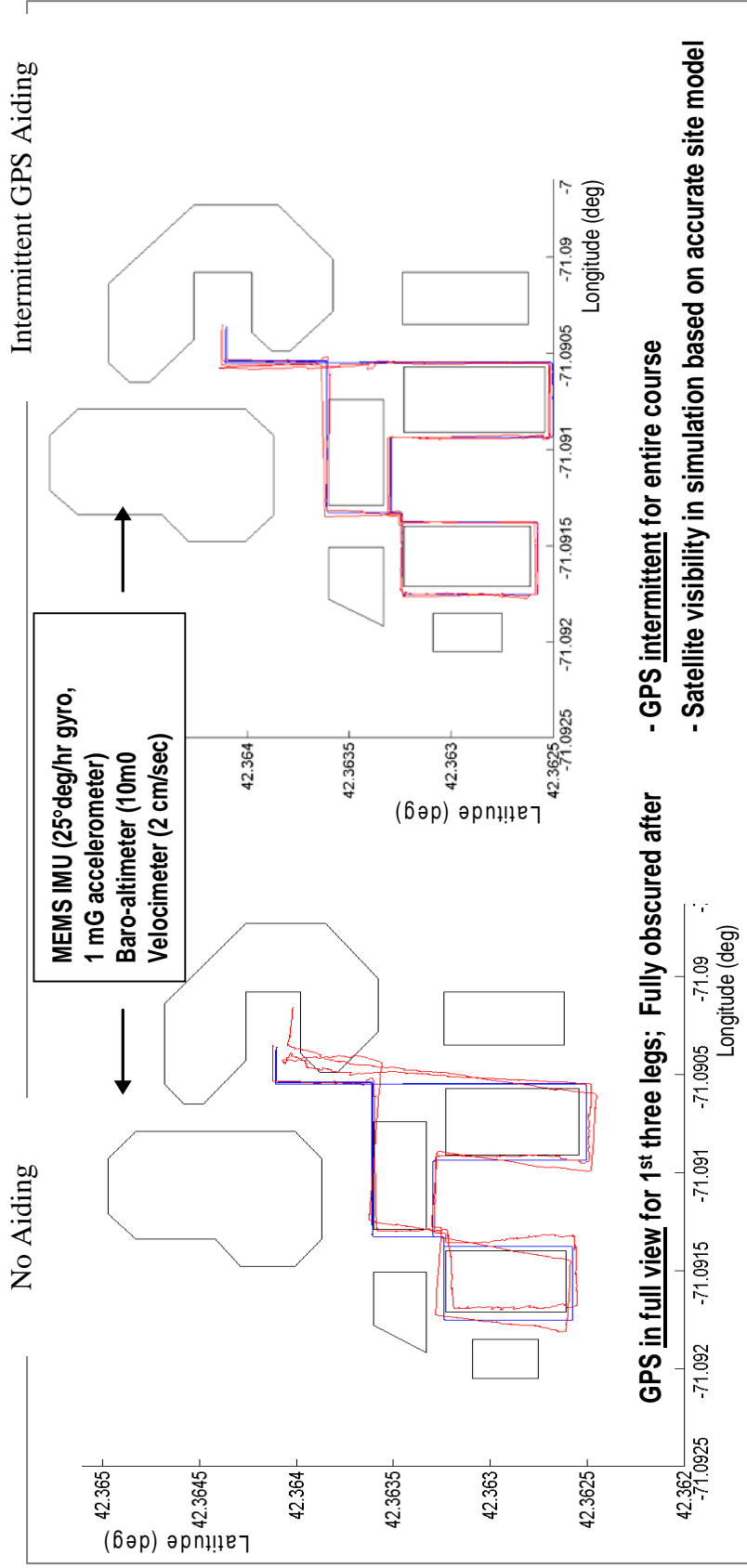

Figure 6. Performance Improvement with Intermittent vs. No GPS

## 4.0 PHASE II PROTOTYPE SYSTEM & HWIL

The Phase II Prototype System builds in a modest way on the *hardware* baseline developed in Phase I. For *software*, the program invested significant resources in developing real-time navigation and GPS tracking algorithms. Both the software and its development environment heavily leveraged existing work on the Deep Integration Guidance and Navigation Unit (DIGNU) and the Low Cost Guidance Electronics Unit (LCGEU) programs. Both of these programs targeted missile and small munitions applications. The focus of the PNS Phase II program was to customize this base to the very different application domain of aided GPS navigation on the ground.

This section outlines specific areas where algorithms were modified and also describe the development environment itself.

### *Algorithm & Software Modifications for PNS*

**All-in-View Tracking:** Previous programs, designed for short time-of-flight missile tests, provided Deep Integration tracking control on a fixed set of four satellites. As part of the PNS program, Draper developed interfaces and logic to support all-in-view tracking.

**Satellite Switching:** The “on-the-ground” urban environment exhibits highly dynamic satellite visibility. This drives a requirement to accurately track and promptly acquire satellites of opportunity. Typically, in the area around Draper Laboratory, two or three satellites are in direct view. The specific set of two or three satellites will change as the user turns a corner. If the person is walking quickly or running and passes an open area between two buildings, it is likely that an additional satellite will momentarily “pop” into view.

The approach taken was to use an integrated mix of native GPS receiver acquisition and Deep Integration Tracking. This is shown in the mode diagrams Figures 7 and 8.

The first mode diagram describes the hand-back of a satellite under Deep Integration control to the GPS receiver after it has disappeared from view for an extended period of time. In the PNS prototype this period of time is set for two minutes. This means Deep Integration will continue to provide to the receiver phase commands for two minutes even though there is no received RF on this channel. The payoff is that if the satellite reappears in this window, its signal will be close to center on the receiver correlators and no time will be lost in a reacquisition search. If it doesn’t reappear, the PNS software tells the receiver to drop the satellite into its search pool.

The second diagram shows moding necessary after *all* satellites have been handed back to the receiver. The transition back to Deep Integration requires at least one satellite to reappear. Pseudorange measurements from the satellite are used to estimate receiver clock parameters. Handoff back to Deep Integration follows.



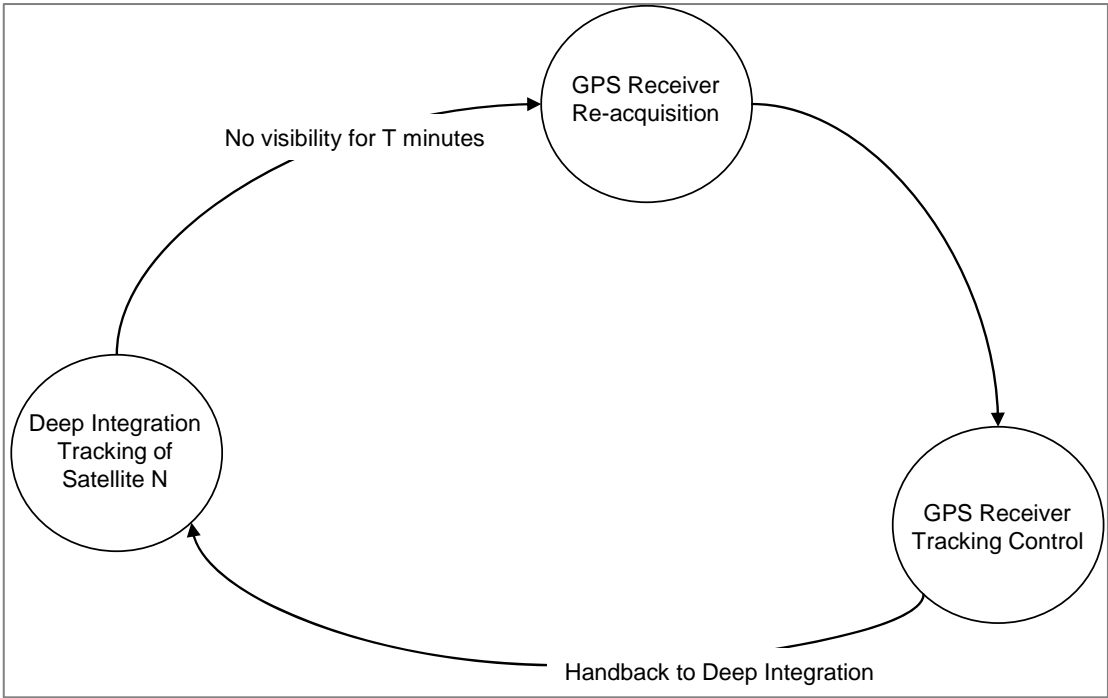

Figure 7. Deep Integration Satellite Control

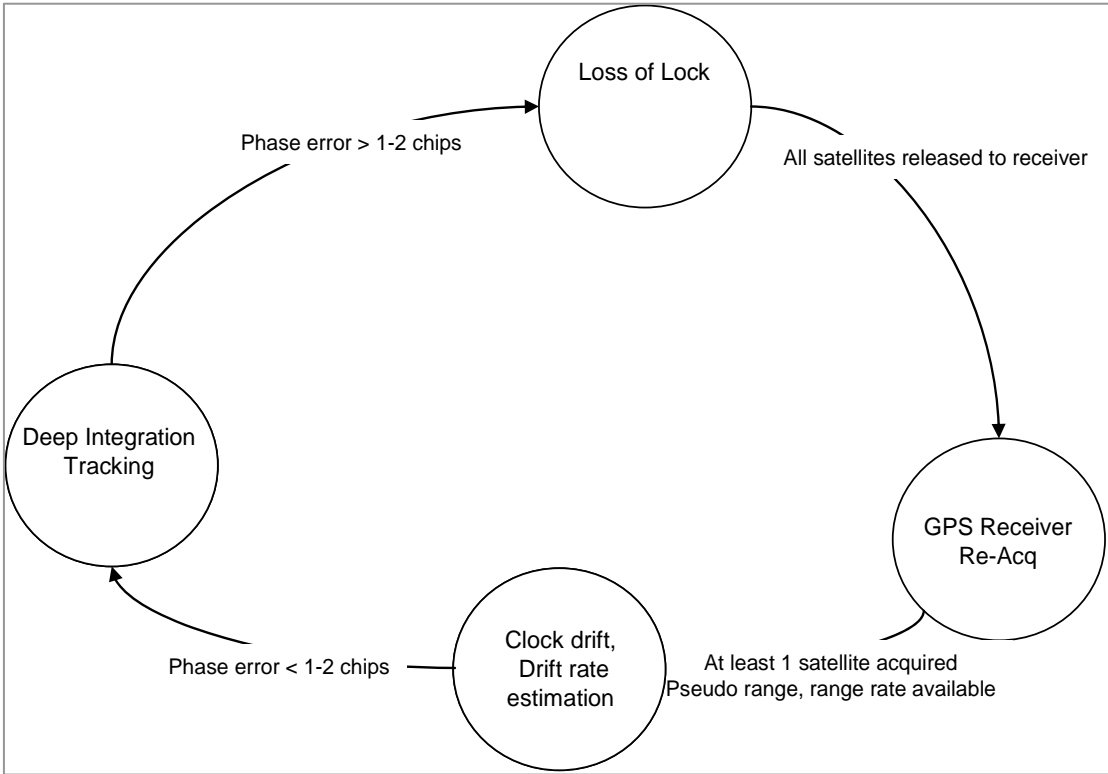

Figure 8. Deep Integration Re-acquisition after Complete Loss of Lock

**Support for Augmentation Sensors:** PNS unique sensors were a 3-axis Doppler Radar, Baro-altimeter, and a 3-axis magnetometer.

**Integrity Checking:** Algorithms were developed and integrated for integrity checking of selected measurements. Doppler Radar was tested for body interference, GPS for multi-path errors, and baro-altimeter for reasonableness.

**Bluetooth Interface:** The PNS prototype was modified to emulate small portable Bluetooth enabled GPS receivers. A stream of standard NMEA messages that can be displayed with standard PDA tracking software is transmitted by the Personal Navigation System. This interface was also investigated for use as the primary telemetry port. The data rate of the interface appears to be marginal for this application. Higher bandwidth Bluetooth interfaces do exist and could be integrated in the future.

**PDA Software:** A high resolution ‘gaming’ PDA was chosen to host map and floor plan displays. Custom software was developed to show, in real-time, the development of the navigated track overlaid on the maps. Console buttons were programmed for zooming and panning the display. Some effort was given to organizing the map and floor plan images in memory to allow rapid switching between scenes. The logical follow-on is to use building perimeter coordinates and altitude information to automate scene switching.

**Telemetry:** A data stream from the software to an on-board Compact Flash (CF) memory was implemented. Data included position, attitude, GPS tracking information, and estimation filter state values and variances. After each operational test the CF was removed from the chassis, placed into a standard memory reader, and had its contents transferred to a PC. PC software sorted the data and converted it to a Matlab readable format. A set of Matlab scripts were developed to generate “quicklook” plots. A full suite of plots were available about 15 minutes after the conclusion of each test.

A “mature real-time software baseline” is more than a library of code. It is an environment that allows staged algorithm development and test, subsystem integration, and system test. The components of this environment, described in more detail in the next section, are:

- Covariance Simulator – System trades, subsystem error budgets, development of environmental models
- Workstation hosted C language test environment – Algorithm development
- Hardware in the Loop (HWIL) – Laboratory environment for embedded software evaluation
- Personal Navigation System Prototype – Operational test with embedded software and sensor suite
- Operational Test Evaluation – System for prompt and in-depth look at test data.

The environment encourages spiral development. Operational testing allows for validation of environmental models and subsystem error budgets. In this program, these tests clearly pointed out algorithm shortcomings that were not stressed sufficiently through HWIL testing.

The architecture of this environment is open in the sense that the cost for integrating measurement algorithms and hardware from emerging position sensing systems is relatively low.

There are interfaces both in the development environment and in the software that make this insertion relatively straightforward. Because of this, it is expected that the Personal Navigation System real-time software development environment will be an important venue for Position Location technology integration and test.

### ***System Algorithm Software Development***

This section describes in detail the progression from pure software simulation to increasing levels of hardware insertion and operational reality.

The development flow starts with trial sensor configurations. A sensitivity analysis is run, using covariance simulations with variations on subsystem performance specifications of each sensor. Error budgets as well as the environmental models were derived from Phase I prototype experiments.

Instrument and environmental models developed for the covariance simulations are the algorithm base for C language code targeted for the embedded processor in the PNS prototype. The initial development environment, *CSIM*, shown in Figure 9, provides simulated sensor and GPS receiver inputs. A simulated model of the receiver's correlators is used to test Deep Integration tracking loops with the true code phase delay of the satellite computed from a knowledge of true ground and satellite positions. The Deep Integration tracking loops estimate this code phase and feed it back to the correlator model. The simulation then models correlator output power based on the phase difference between the "truth" and estimated replicate code phases.

The same C language algorithm code is then recompiled to the embedded target, a TMS320VC33 digital signal processor (DSP), shown in Figure 10. The correlator simulation is replaced with the *physical* GPS receiver. The trajectory generator now simultaneously drives the sensor models and a Nortel GPS simulator. Output of the Nortel is a multi-channel RF stream. The simulator can control the number of satellites in view at any time as well as their power. The system has the capability, not exercised here, to simulate multipath and RF jamming effects.

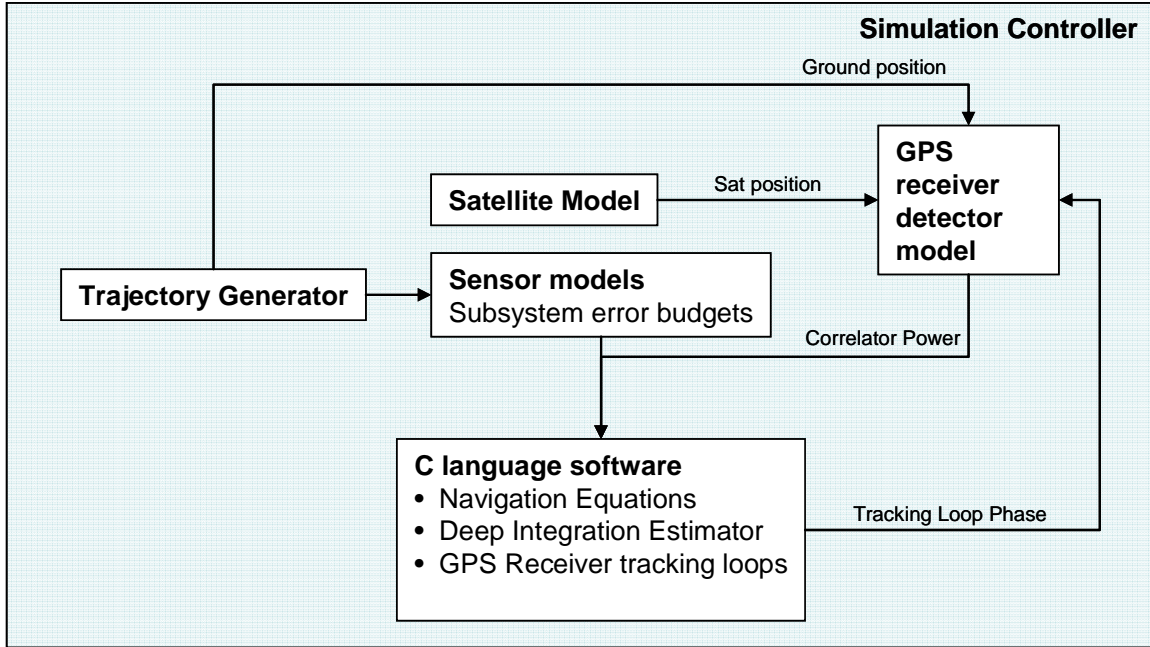

Figure 9. CSIM Block Diagram

The physical configuration of the Hardware in the Loop facility is shown in Figure 11. The box in the upper left shows the components of the Simulation Controller, built around a Silicon Graphics workstation. As part of the Personal Navigation System Program, Draper built a custom PCI to LVDS bridge based on a commercial PCI card purchased from Protoboard. This bridge was both the hardware interface for simulated sensor data input to the signal processor and also for the outbound telemetry stream.

For the PNS Prototype Software System Integration, Figure 12, simulated sensor models are replaced by physical sensors. The Nortel receiver is used to test the software for the most basic *standing still* trajectory, a non-trivial test since the satellites are moving in their orbits. It is also useful for in-building operational navigation sequence: GPS position initialization, handover to Deep Integration tracking, GPS-denied navigation, and finally satellite reacquisition.

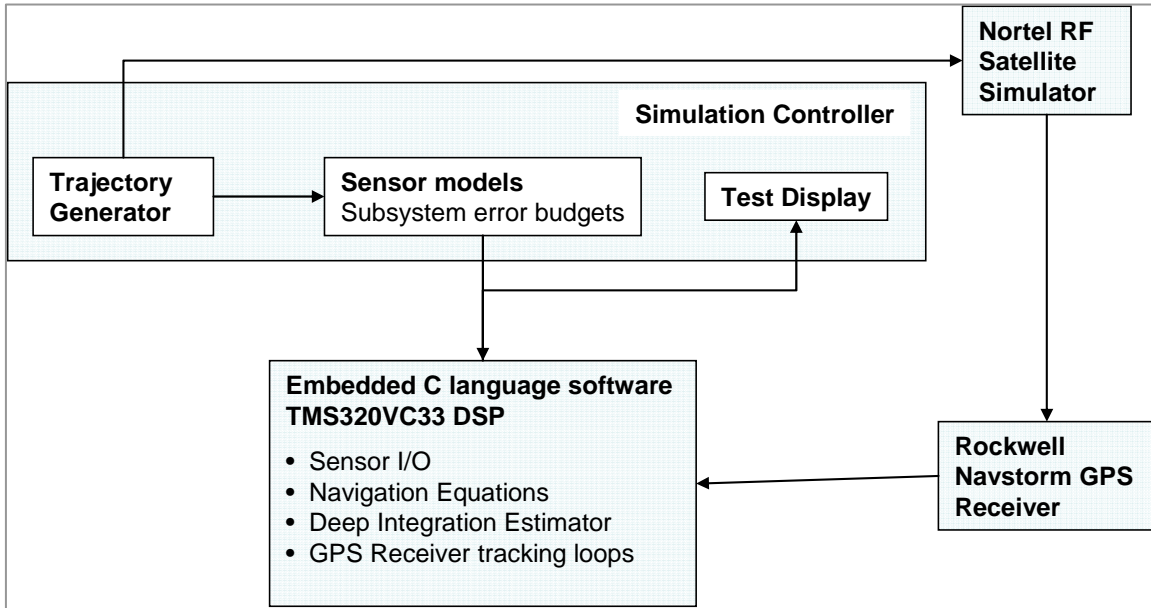

Figure 10. HWIL Block Diagram

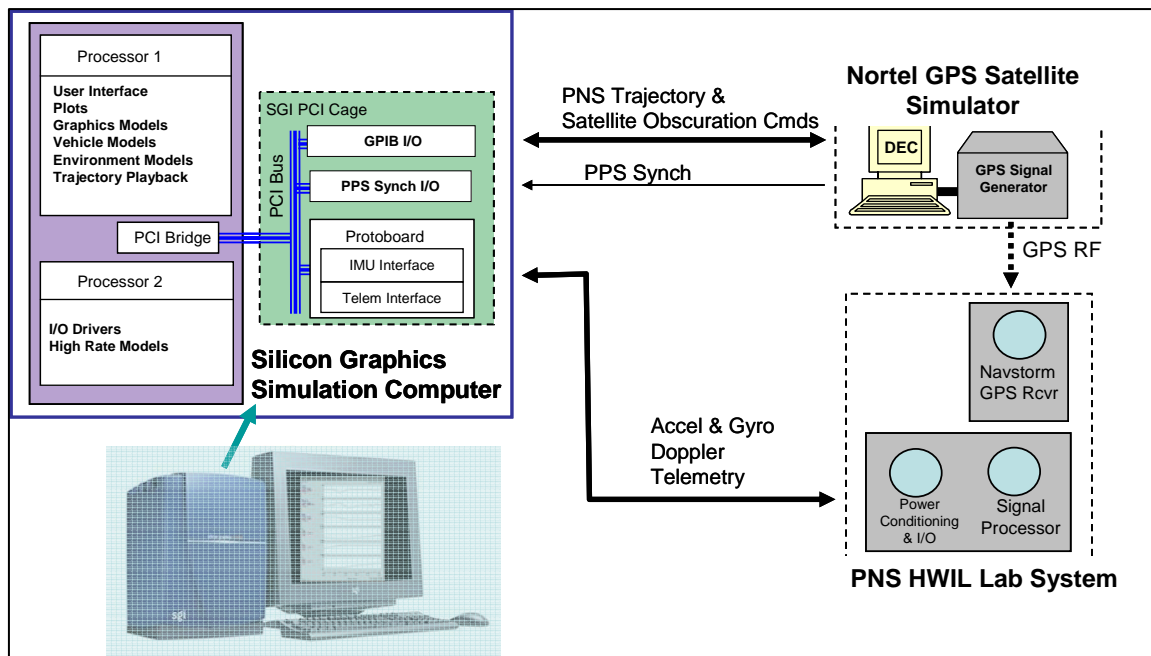

Figure 11. HWIL Physical Configuration

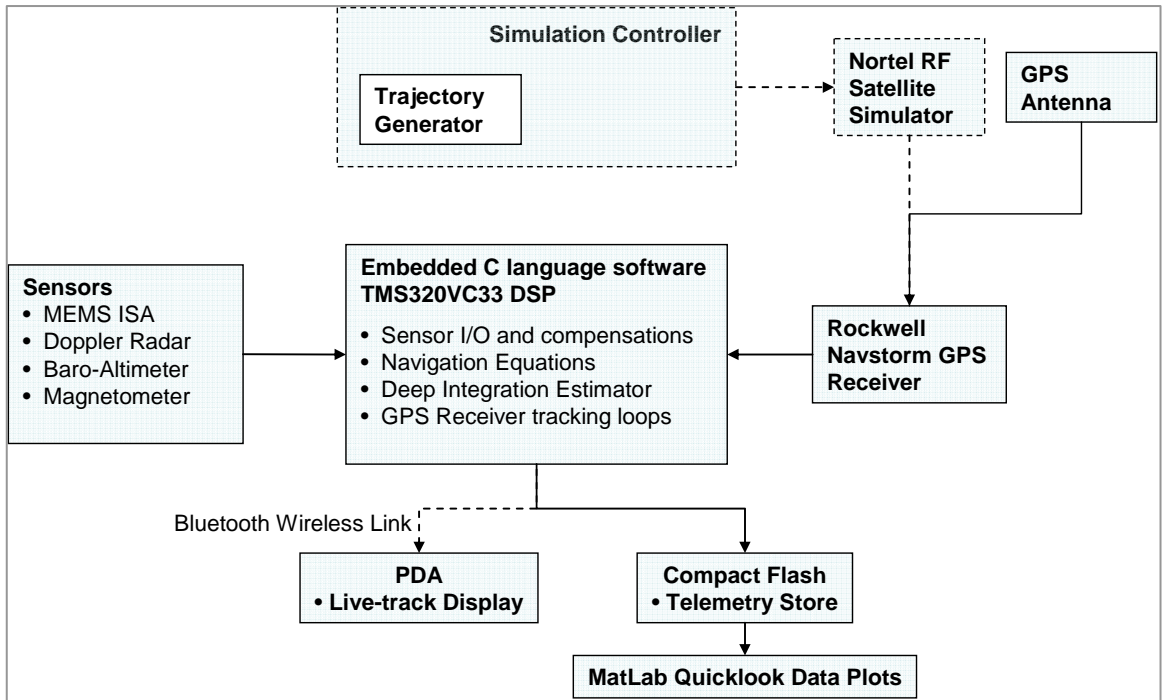

Figure 12. PNS Prototype Software System Integration Environment

## 5.0 PHASE II/JOINT TEST RESULTS

In early March 2005 representatives from the US Army/CERDEC and US Army/Natick Soldier Center were at Draper Laboratory in Cambridge, Massachusetts to conduct Joint Tests and evaluate four position/navigation systems. These systems were Draper's Personal Navigation System (PNS); Point Research's *DRM-V*; two PLGRs and two DAGRs. The PLGR and DAGR are existing GPS Receivers which are in wide use in the military. The PLGRs and DAGRs were tested in both keyed and unkeyed modes. This section will present PNS data obtained during the Joint Tests as well as in the few days prior to this test.

### *Systems Under Test (Other Than PNS)*

**DRM-V:** Point Research's developmental extension of an existing product includes a GPS Receiver, magnetic compass, and intelligent pedometry. This system has been designed to discriminate between forward, backward, and side stepping gaits as well as crawling and running. The DRM-V also provides a real-time position solution which is output via an RS-232 connection.

**PLGR & DAGR:** The PLGR is a self-contained, hand-held, five-channel, single frequency (L1), PPS capable GPS receiver. The Defense Advanced GPS Receiver, or DAGR, is a smaller hand-held GPS receiver, also PPS capable. The DAGR is dual frequency (L1/L2) and has twelve channels.

### *Test Courses*

Two test courses were identified. One was an all outdoor, urban environment course which included areas where satellite obscuration and GPS signal multi-path would be an issue. The course also exhibited magnetic anomalies. Groups of people walking by the testers could potentially cause anomalies in the Doppler radar output.

The second course modeled an outdoor-indoor-outdoor MOUT exercise. The course started with an initialization sequence on a nearby rooftop. The GPS satellites in view during this sequence provided initial position, and during the walk across the roof, refined the heading estimate as well as calibrated sensors. The course descended into a plaza where GPS data is corrupted by multipath, and then went indoors. Three separate floors within Draper Laboratory's Duffy Building were each traversed twice. Tests were run in New England winter. One of the environmental challenges in this series was a greater than 50°F differential between indoor and outside temperatures.

The goal of this second test, met successfully, was to demonstrate the ability to geo-locate to a floor within a building and navigate staircases. Significant magnetic and Doppler clutter issues were also present in this test environment. The indoor portion of each indoor test lasted approximately fifteen minutes.

Some of the tests conducted on these courses included gait variations such as side-stepping, walking backwards and running. No crawling tests were performed. All systems under test observed the identical GPS signal. A single GPS antenna was placed on the shoulder of the

tester and an amplified splitter then provided all systems with the same GPS signal. The PNS and DRM-V were worn by a single tester. This ensured these two systems were exposed to the same body motions. The PLGRs and DAGRs were worn by a separate tester, but since these systems are not impacted by body motions, this did not have an impact on the ability to make comparisons.

**Results and Discussion: Urban Canyon Tests**

A four lap, three kilometer data set taken the day before the test is shown in Figure 13. The traces represent the full set of real-time navigation position data from the system. Data is co-plotted with a geo-registered aerial photo of the roughly two city block test site. Three data sets, taken during the Joint Test are shown, side-by-side in Figure 14. These runs lasted 20-25 minutes for the GPS challenged part and covered 1.5 kilometers.

The test in Figure 13 has a rooftop start, followed by a descent to the plaza and entry to the significantly GPS challenged area. Building heights in that area are between four and ten stories. A photo looking east from the area is shown in Figure 15 and gives a feel for the site geometry. The orientation of this photo is called out in the center of Figure 13.

Performance on each data set was analyzed by measuring the average error on each straight segment of the course. This number was then weighted by the fractional length of the segment to the overall course length. An integrated fractional error was then computed and plotted. Points for 50%, 67%, and 95% error bounds were then extracted from the plots. Lines indicating ground truth are shown in Figure 16. Figure 17 contains a representative graph of the error statistics, for the data shown in Figure 13. Each diamond represents a single segment error that contributes to the overall run statistics. Lastly, Table 2 has a summary of the errors from these four runs. ***For these Urban Canyon tests, the nominal circular error probable was approximately six meters, the best case value is about four and one-half meters.***

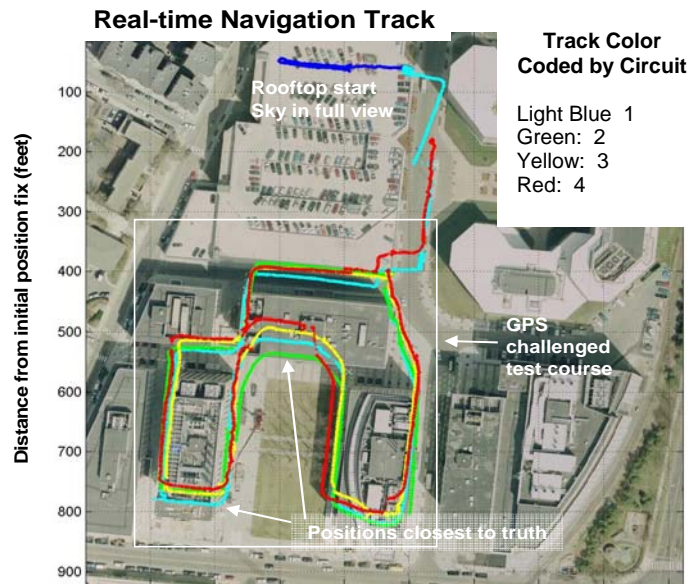

Figure 13. Canyon Walk (1 March 2005)



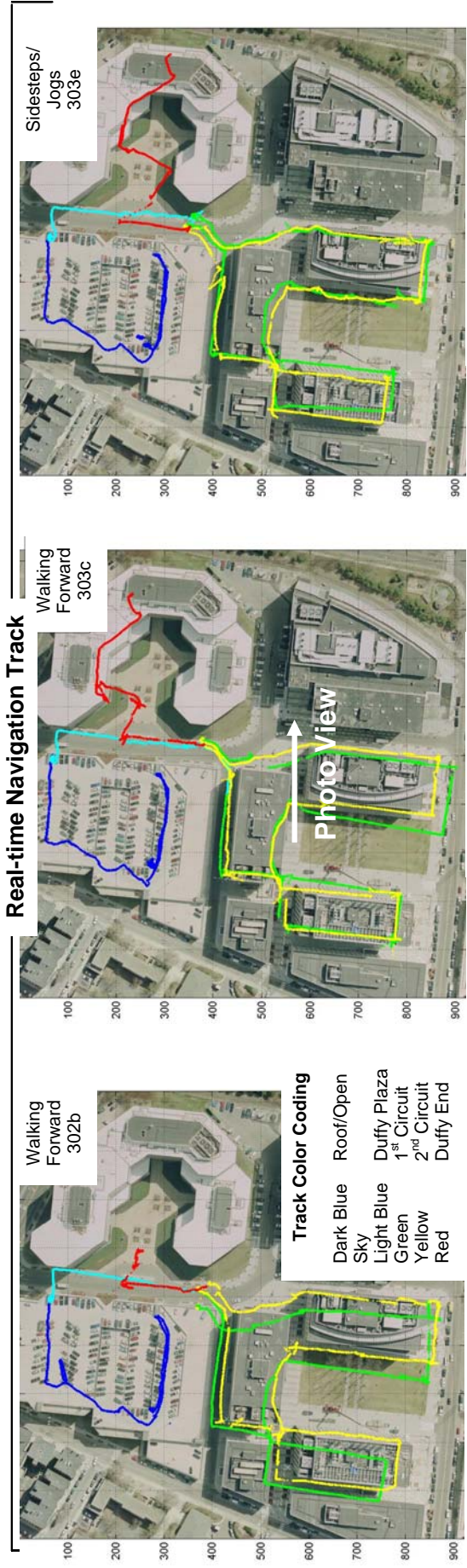

Figure 14. Joint Field Test Data Sets



Figure 15. Test Area Looking East



Figure 16. Ground Truth

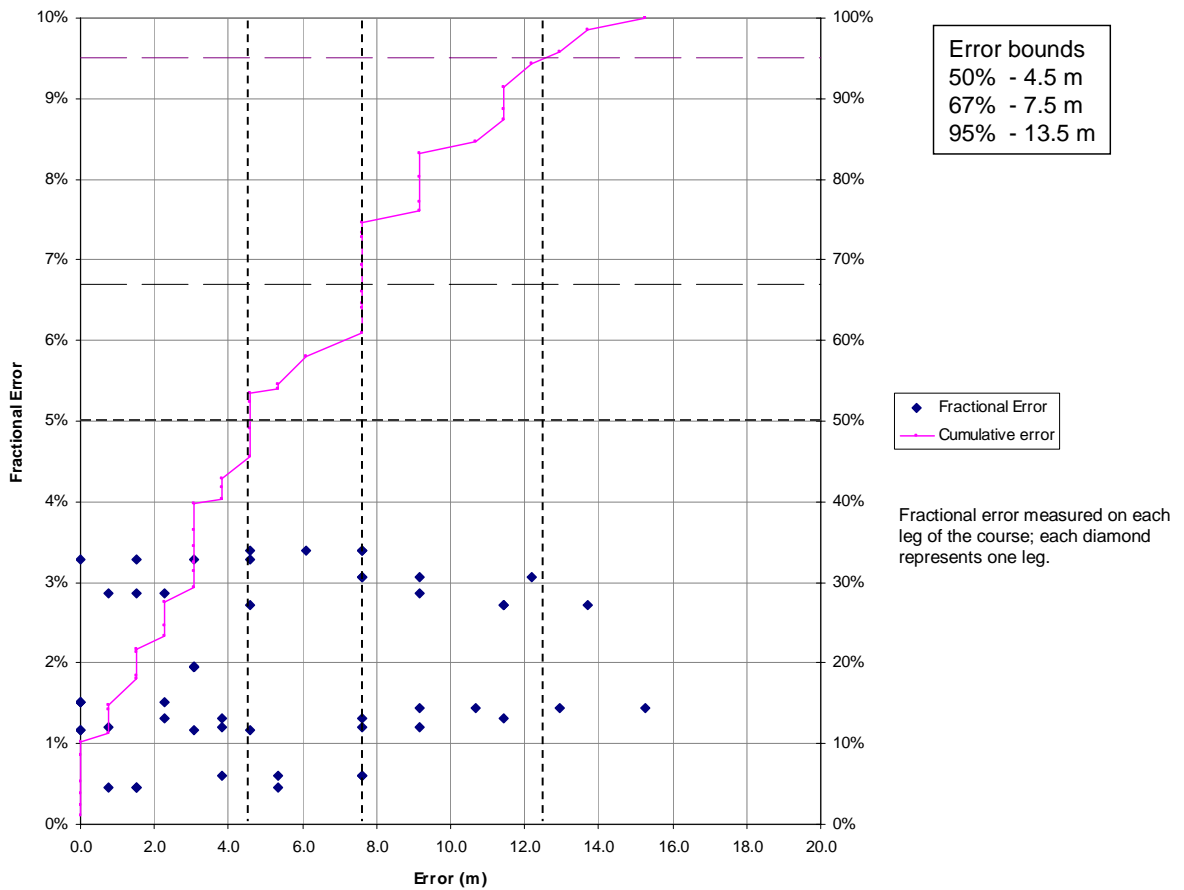

Figure 17. Segment and Cumulative Error Statistics for March 1<sup>st</sup> 05 Data Set

Table 2. Urban Canyon Data Summary

<b>Draper - CERDEC- Natick Soldier Center - Joint Test 2-5 March 2005</b>			
<b>Data File</b>	<b>CEP</b>	<b>Max Error</b>	<b>Time GPS challenged</b>
<b>Technology Square Course</b>	<b>-- meters --</b>		<b>minutes</b>
hw_03.02_b_uc	6.2	18.5	24
hw_03.03_c_UC_roof	6	13	26
hw_03.03_e_roofuc_gait	5	17	24
hw_03.03_f_roofuc	4	10	20
<b>Pretests</b>			
hw_0301_b_uc	4.5	15	30

### *GPS Satellite Visibility in the Urban Canyon*

This report addressed how GPS can be a challenged measurement system in an urban environment. The urban area where the PNS was tested rarely has four or more satellites simultaneously in view. For parts of the course, certain satellites are only seen via their images reflected from buildings. The receiver will track these multi-path signals. They are generally lower in power than direct view signals, but a carefully designed, high sensitivity receiver can effectively track them. This is the case for the Deep Integration coupled with Rockwell NavStorm GPS system contained in the Personal Navigation System.

The approach taken to reject multipath relies primarily on received signal power screening. Satellites in direct view generally have much higher power signals than those observed through a reflection. Analyses of test data from Phase I of this program showed that as the power threshold on GPS signals was raised, the navigated path shape more closely approached truth. This approach requires the system to have an awareness of the local environment – thresholds will be different under canopy or indoors. Making this awareness evident to the system is challenging and makes this approach less than satisfactory. Other screening methods are being evaluated.

With screening, the number of satellites in view decreases. Figure 18 replots the same data as in Figure 13 but with a color coding that shows the number of “usable” satellites in view; that is the number of satellites providing quality data to the estimation filter. A histogram of this usable satellite visibility is shown below in Figure 19. For this run, two or fewer satellites are providing data for 80% of the run.

The lessons learned include:

- Quality urban Position Location accuracy is achievable with very limited access to satellite data.
- It is important to rigorously throw away all suspect satellite range data.
- Screening of multipath errors to achieve 1-3m position accuracy with high reliability remains a challenging problem.



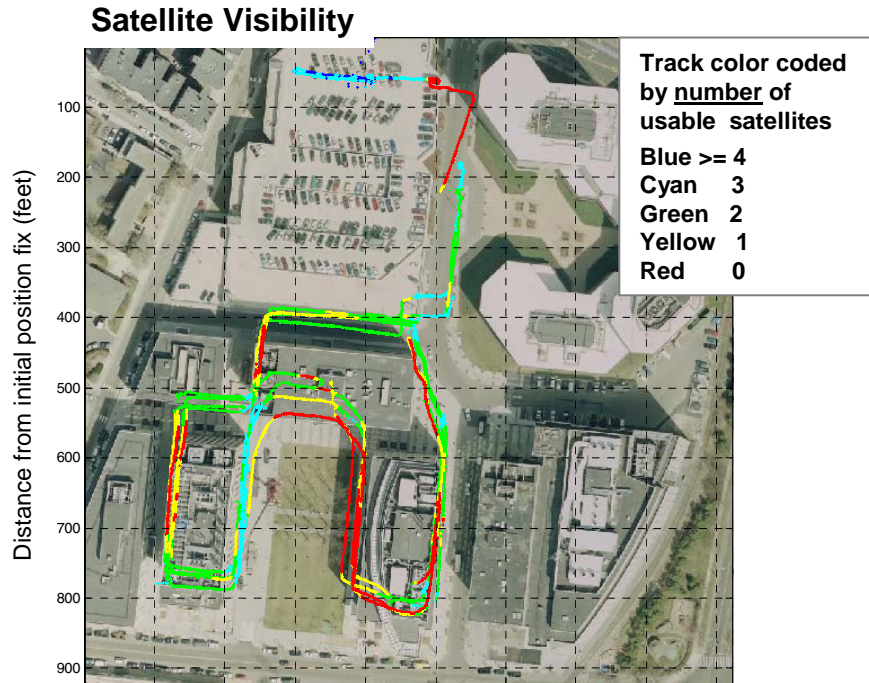

Figure 18. GPS Visibility in Urban Canyon

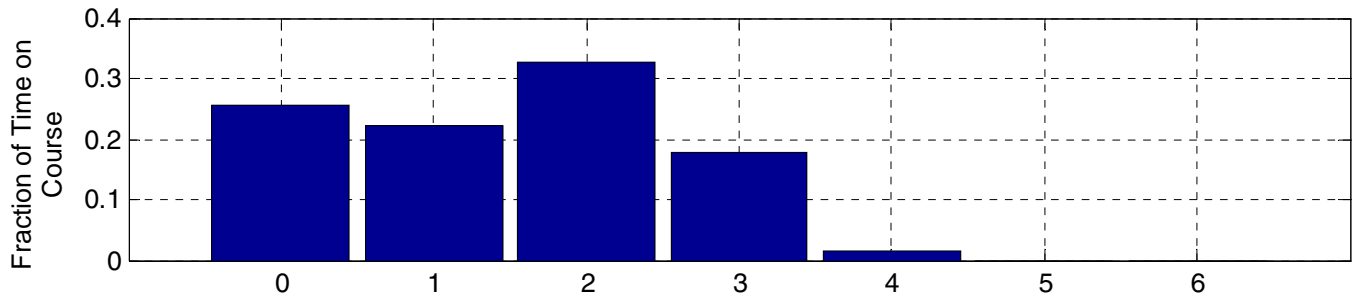

Figure 19. Histogram of Usable Satellite Visibility

### *GPS Tracking in the Urban Canyon*

The challenge for tracking satellites in this environment is being able to derive range data from satellites of opportunity. The GPS subsystem’s tracking loops need to promptly acquire the new satellite and extract a range measurement before it is obscured again.

This scenario, along with low indoor signal and anti-jam considerations, drove Draper to a Deep Integration implementation in the PNS prototype. Satellites that are acquired by the receiver, through a relatively time consuming search procedure are handed off to Deep Integration, as described in the “Prototype System and HWIL” Section of this document. The PNS will currently hold track on a satellite for up to two minutes after its signal has disappeared. This threshold was set conservatively. The issue is how accurately, with at least one satellite in track,

the navigation system can estimate position. When this position error grows beyond the capture range of the receiver's correlators, Deep Integration will no longer be able to reacquire the signal.

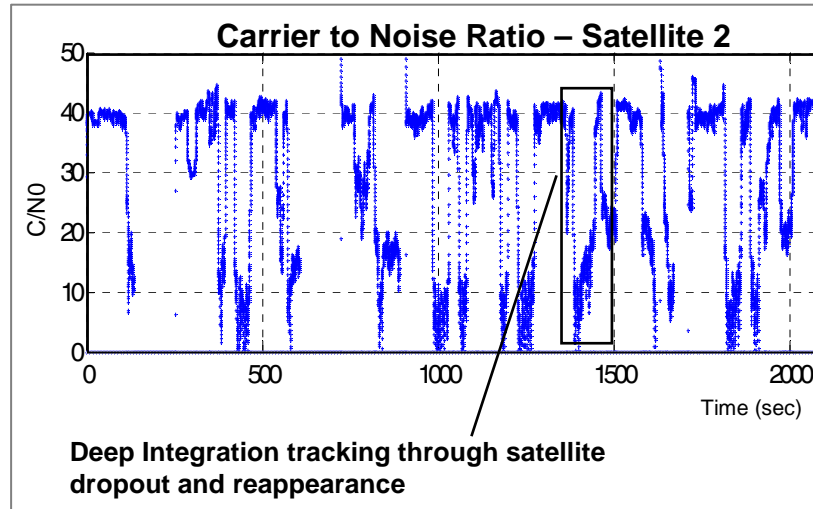

Figure 20. Deep Integration Tracking

Figure 20 shows the variation in received signal power for one of the satellites tracked in the test from Figure 13. The callout in this figure highlights a rapid drop-off in signal power followed by a slow recovery. This sequence, and others like it in the same trace, demonstrates the effectiveness of this Deep Integration implementation in promptly reacquiring the satellite signal.

For the tracking problem alone, a tight coupling implementation might perform as well. The advantage of Deep Integration is a mathematically optimal use of receiver correlator information in the multi-sensor estimation filter, optimal tracking control, and much stronger performance than tight coupling in jammed and low signal environments.

The prototype system did not include an optimized the GPS receiver configuration. Receivers designed for rapid P(Y) code acquisition implement, with a cost in system power, multiple correlators to each search channel. Once the software Deep Integration algorithm takes over the tracking and reacquisition function, much of this extra hardware can be powered down. *A receiver customized for this kind of assisted tracking can operate at lower power than receivers designed for unaided operation since the acquisition hardware is needed less frequently.*

### ***Results and Discussion: Outdoor-Indoor-Outdoor Tests***

The sequence tested here is intended to model a MOUT scenario with system initialization under open sky followed by entry to the operational area. This area has a GPS challenged Urban Canyon as well as extended periods of time indoors with little or no GPS signal at all. On exit from the building, the system needs to promptly reacquire and correct any instrument drifts built up during the period of GPS denial.

The composite below, Figure 21, is a good illustration of precise indoor navigation. The 3-D trace in the upper right is the full set of real-time navigation position estimates. It shows a system

initialization period on a nearby rooftop where position, heading, and instrument biases are set. The trace winds down an indoor staircase, traverses a plaza, and enters the building. Inside, the track includes two circuits each on the 2<sup>nd</sup>, 5<sup>th</sup>, and 8<sup>th</sup> floors.

*This data demonstrates performance close to the goal of geo-location to a hallway and a room.* Plots on the left side of Figure 21 show an overlay of the navigated trace onto geo-registered floor plans. There is a discernable rotation of the track between the 2<sup>nd</sup> and 8<sup>th</sup> floors due to uncompensated gyro drift. *The data also demonstrates geo-location to a floor.* The plot in the lower right corner of Figure 21 shows crisp separation of the building floors as well as the landings in the stairwells.

The rotation of the track between the 2<sup>nd</sup> and 8<sup>th</sup> floors is somewhat larger than expected for the MEMS gyro in the system and points to a need to assess how good a job the multi-sensor filter is doing in estimating in-run drift. Improvement of this performance will likely require a combination of better instruments and more sophisticated turn-on calibration procedures. A clear technology path exists for this performance improvement. The latter is both an exercise in filter tuning and also initialization algorithm design.

As mentioned earlier, a challenge on this course was outdoor to indoor temperature differentials of >50°F. The system showed *no* dramatic response to this variation.

A summary of indoor performance data in the Joint Test is given in Table 3. Position error is broken into two components. The first piece is *relative* to the position on entry to the building; the second is the *absolute* position error at the point of entry. It is clear there has been error injection between the rooftop position initialization and building entry. This error is likely due to GPS signal multipath during the traverse of the urban canyon plaza. Vertical performance is very good – between 2 and 3 meters.

The 2<sup>nd</sup> column in the Table 3, “Gait”, indicates whether the test used a steady forward walking gait or a separate protocol that mixed in long sidestep sequences and for the urban canyon course, jogs. This protocol was designed to stress the gait recognition software in the pedometer based system and also presented somewhat higher bandwidth body motions to the PNS prototype. The prototype system showed mixed performance with this protocol. The right hand side of Figure 14 depicts a relatively successful outdoor test which included these gait variations. Table 3 shows the real and repeatable indoor performance degradation with these motions.

The likely cause of the degradation is timing synchronization between Doppler velocity and inertial measurements excited by the higher bandwidth body motions. Further testing is necessary to verify this assertion.

Table 3. Indoor Test Summary

	Gait	Horizontal			Vertical	Time GPS denied or challenged minutes
		CEP relative to entry	Max Relative Error	Position error at entry	Entry to exit meters	
<b>Draper Indoor Course</b>		-- meters --			<b>meters</b>	
hw_03.04_g_ind_gait	Gaits		5-15 m outside building		3	13.5
hw_03.05_a_ind_duffy	Forward	11*	3	10	2	13.5
hw_03.05_c_ind	Forward	4	10	6	2.5	13.5
<b>Pretests</b>						
hw_0228_a_indoor_roof_init	Forward	4 25*	8	<1	2	15

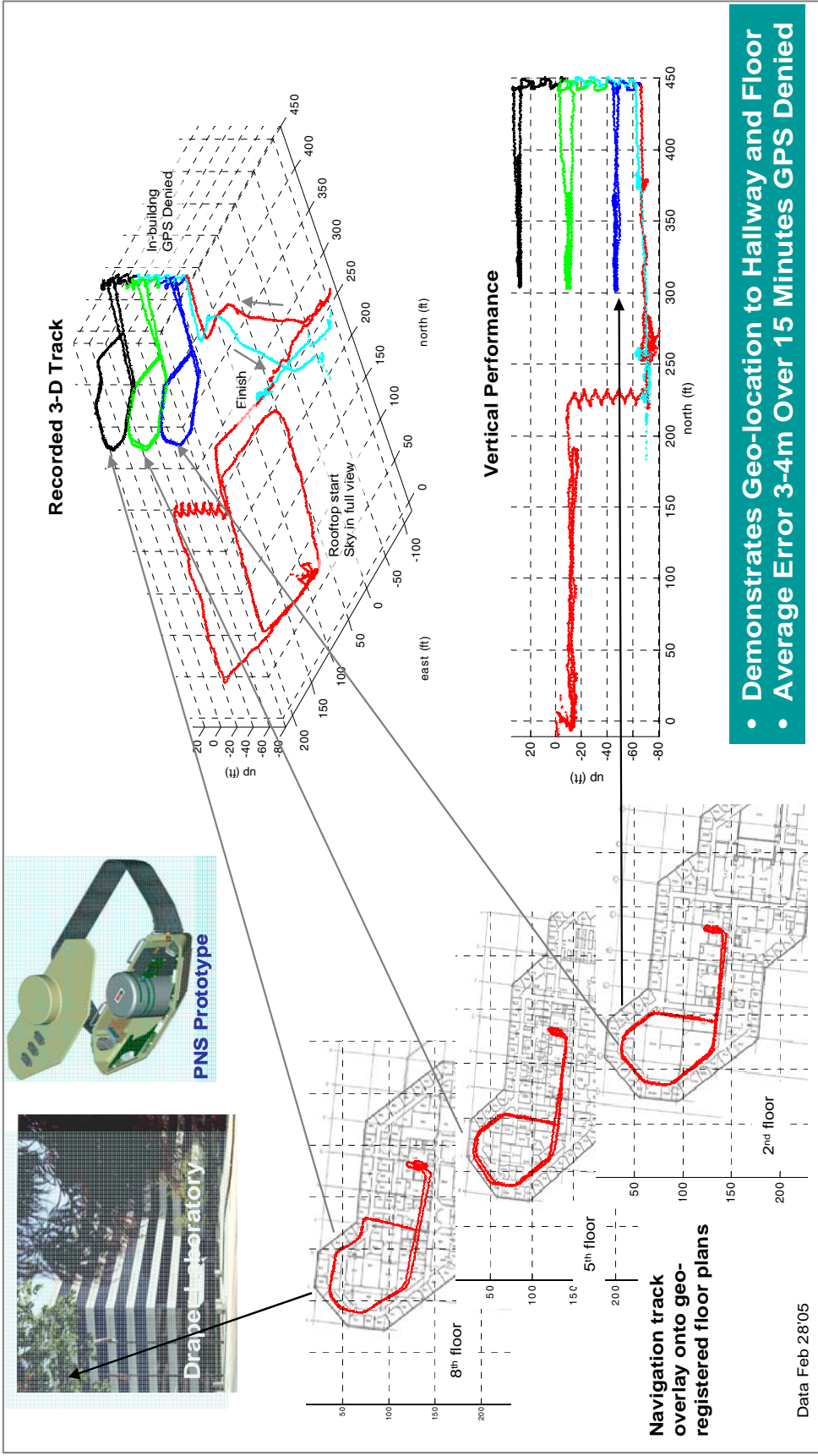

Figure 21. Indoor Navigation Summary



## 6.0 TECHNOLOGY ROADMAP

The PNS prototype successfully demonstrated the system concept; *however* work is needed to reduce power and size, to improve accuracy, and support longer duration missions. Several technologies are applicable but do need to be focused onto this problem. The chart below, Table 4, gives a thumbnail view of the improvements in power and performance needed to provide reliable position location for mission times greater than one day with periods of full GPS denial over one hour.

Table 4 Technology Requirements for Personal Navigation

Technology	Personal Navigator Need
MEMS Inertial	Decrease power, improve accuracy, shrink package size
Radars	Decrease power, shrink antenna size
Optical Sensors	Design low power hardware & efficient, robust algorithms
Pedometry	Demonstrate "algorithm fusion" consistent with 1-3m accuracy over extended missions
Navigation Processor	Decrease power - Leverage PDA/ Cell Phone technology
Algorithms	Analyze performance vs throughput tradeoffs for different filter implementations ( <i>e.g.</i> , single filter vs federated, Kalman vs Particle)
Battlefield Infrastructure	Demonstrate & insert UWB ranging & Network assistance to improve indoor performance
GPS	Adapt receiver & S/W for GPS modernization ( <i>e.g.</i> new signals, Block III insertion) and for Galileo satellite access. Develop very low power, compact RF interference architecture
System Integration	Design in mission aware/ environment aware power management, Improve cross-sensor data fusion

### *Navigation System Power Roadmap*

The technical path to reliable and accurate Position Location relies on a system of sensor systems approach. The roadmap to a low power solution requires both power reductions in each subsystem and a power management architecture that

- Minimizes processor and sensor idle power
- Explicitly powers down subsystems based on mission need for precision location and on signal quality both for GPS and the other measurement systems.

Figure 6-1 below shows a realistic projection of system power reduction that can be realized in a three year time frame. The blue column is the summed subsystem power *inboard* of the system's

power conversion electronics while the maroon/center columns show power draw at the “wall plug”. The chart assumes that conversion efficiency will improve about 10% over the near term. Lastly, the yellow columns show a rough estimate of the power savings using power management strategies. The usefulness of power management is highly mission dependent.

The take-home from the chart is that dominant decreases in power come from programs that focus on optimizing subsystem power draw. These net result of these decreases move the technology to the realm where battery and navigation system weight are commensurate. Improvements in power supply efficiency and power management are important as well. For a 1½ watt system, power management effectiveness of 25% translates to several hundred mW, a very large number in this application.

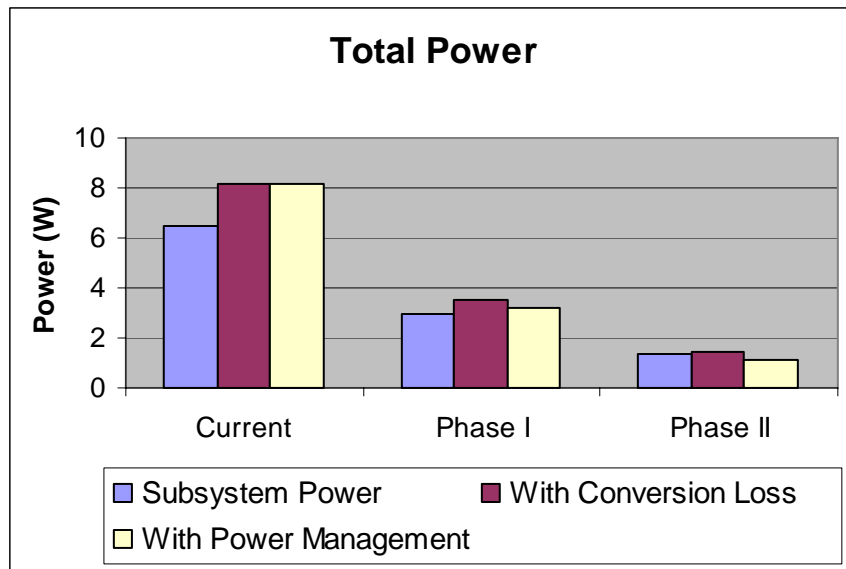

Figure 22. Navigation System Power Outlook

***Navigation System Near-Term Roadmap***

Figure 23 shows two separate system concepts derived from the current PNS prototype. The intent of Concept 1 is to repackage the system to facilitate operationally realistic testing. Package size and power are decreased and performance is modestly increased versus the existing prototype. A key element for this decrease package size is reduction in both area and volume of the Doppler radars. Size reductions are technically feasible. The greatest risks to this concept are the degree of size and power reduction. Concept 1 has been shaped based on feedback from the U.S. Army and is designed for integration with the Ground Soldier System Program. Estimated cost for this concept is approximately \$3M. It has a two-year duration and would include the fabrication of ten systems.

Concept 2 does require significant technology investment. This investment will result in an order of magnitude improvement in MEMS inertial performance over Common Guidance Phase III goals coupled with an order of magnitude decrease in inertial sensor power draw. Concept 2 would require approximately three years to complete, would include the fabrication of in excess of thirty prototypes.

### ***System Cost***

The system architecture needed to provide mission critical precise positioning for the dismounted soldier requires quality sensors and a redundant, integrity checking sensor mix. This approach drives a higher system cost that can be mitigated through insertion of dual/multiple use sensors. Tactical MEMS inertial sensors are being inserted into smart munitions at increasingly high production rates. As their costs decrease, insertion of this technology into a wider class of munitions becomes possible. Broadening the consumer base for MEMS inertial first to the dismounted soldier and then to the *First Responder* community should accelerate the cost drop. With this large base, it should be possible to drive the recurring cost of the navigation system, exclusive of the GPS receiver, well below \$1,000.



<b>Existing PNS</b>	
<u>Attributes</u>	
<b>Size:</b>	~140 in <sup>3</sup>
<b>Power:</b>	8.5 Watts
<b>Weight:</b>	3.5 Pounds
<u>Performance</u>	
Inside: < 5 Meters (20 Minutes)	
Urban: 6 Meters	
<u>Characteristics</u>	
Real-Time Navigation	
Deep Integration	
5 Sensor Suite	

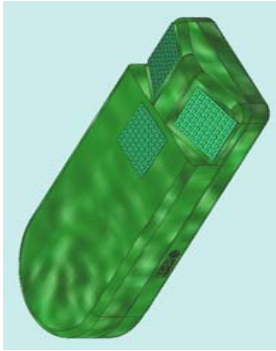

<b>Concept #1</b>	
<u>Attributes</u>	
<b>Size:</b>	~15 in <sup>3</sup>
<b>Power:</b>	~3 W-Peak (w/o GPS)
<b>Weight:</b>	0.5 Pounds
<u>Performance</u>	
Inside: < 3 Meters (30 Minutes)	
Urban: 5 Meters	
<u>Characteristics</u>	
Robust to Gait Changes	
Improved Reliability	
Improved Ruggedization	

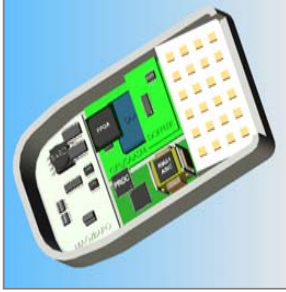

<b>Concept #2</b>	
<u>Attributes</u>	
<b>Size:</b>	~10 in <sup>3</sup>
<b>Power:</b>	~1.1 W-Peak (w/GPS)
<b>Weight:</b>	<0.5 Pounds
<u>Performance</u>	
Inside: < 3 Meters (1 Hour)	
Urban: 3 Meters	
<u>Characteristics</u>	
Significant Power Reduction	
Beam Steering – Single Antenna	
Improved Performance	
Chip Scale Atomic Clock Insertion	

Figure 23 Personal Navigation System Roadmap

This document reports research undertaken at the U.S. Army Research, Development and Engineering Command, Natick Soldier Center, Natick, MA, and has been assigned No. NATICK/TR-06/004 in a series of reports approved for publication

APPENDIX  
FINAL REPORT OVERVIEW

## APPENDIX PHASE I FINAL REPORT OVERVIEW

This appendix provides a summary of the Phase I Final Report. Additional information concerning Phase I testing and results can be found in the Phase I Final Report. This report was submitted to the U.S. Army/Natick Soldier Center in January 2004 (Draper Document Number: 414105).

### *Phase I Prototype System*

The PNS Phase I System consisted of a five sensors: GPS; MEMS IMU, baro-altimeter, magnetometer and three-axis Doppler radar. The GPS Receiver and the MEMS IMU are part of the Navigation Core. The navigation core is a cylindrical piece of hardware which includes “slices” for the GPS receiver, processor, power conditioning electronics, accelerometer and gyro modules. The gyro and accelerometer modules make up the MEMS IMU sensor. The explosion of the Navigation Core is depicted in Figure A-1. The design for the modules contained within the Navigation core was developed as part of the Low Cost Guidance Electronics Unit (LCGEU) and Common Guidance IMU (CGIMU) programs. The GPS Receiver is a Rockwell Collins NavStorm device.

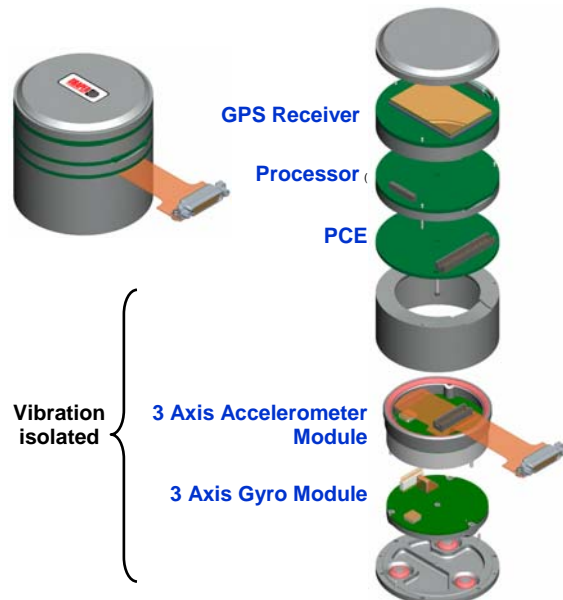

Figure A-1. Navigation Core

In addition to the navigation core, the PNS Phase I hardware included a three axis Doppler radar system developed by Epsilon Lambda. This radar system includes an antenna, a transceiver and an interface board for each axis. The baro-altimeter (Motorola Model MPXA4115A) and magnetometer (Honeywell model HMC1023) have been integrated onto a single board. Also resident in the Phase I hardware design is a compact flash device which will be used for data storage. This data was post-processed in Phase I to determine the navigation solution. Switches and LEDs on the top of the Personal Navigation System provide status information to the user and allow the user to enter zero velocity updates (ZUPTs). A lithium manganese dioxide battery provides ten hours of continuous power to the Personal Navigation System. This battery is non-rechargeable. The Phase I hardware concept is depicted in Figure A-2. Figure A-3 contains a photograph of the actual Phase I hardware.

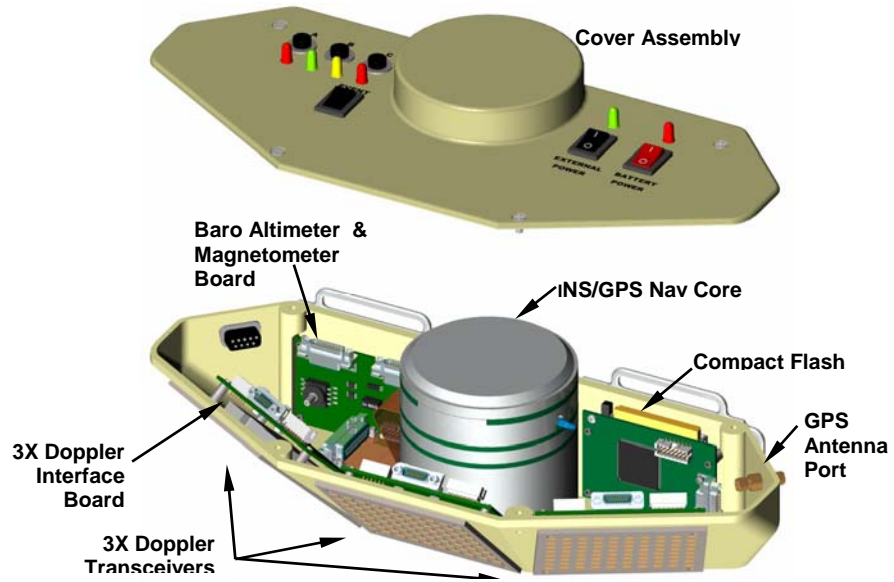

Figure A-2. PNS Concept

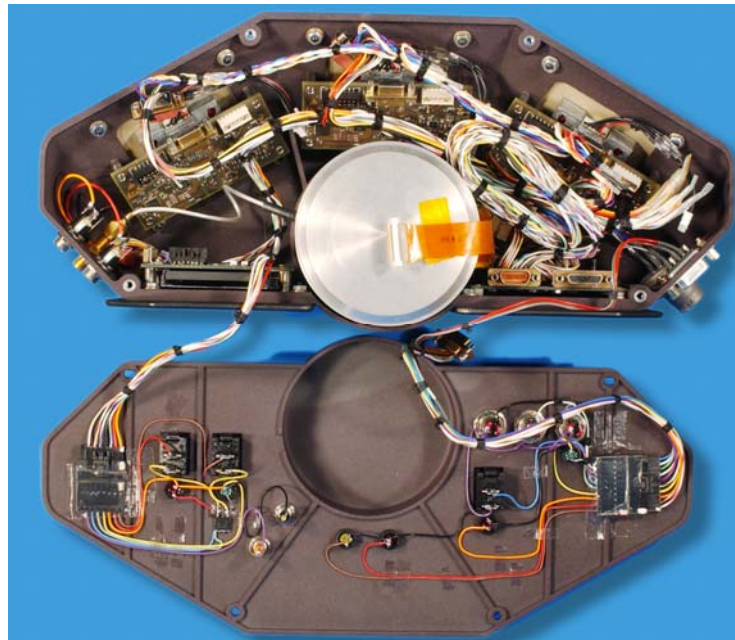

Figure A-3. PNS Phase I Prototype System

## *Phase I Results*

### *Objective*

The overall objective of the PNS Phase I testing was to acquire, post-process, and analyze collected sensor data in order to assess and refine the PNS architecture. The emphasis on post processing, rather than demonstration of a point design, reflects the program's commitment to a spiral development approach consisting of system concept, experimentation, analysis, and system refinement. Data post processing also provides a high degree of flexibility by enabling multiple scenarios to be envisioned and analyzed from a single collected dataset.

The primary test objective was to quantify and verify navigation performance predictions of the PNS in a variety of realistic operating environments. These quantifiable measures allow us to determine if our approach/architecture provides an accurate enough navigation solution, and serves as a benchmark for comparing proposed advanced system concepts and methods for increasing PNS performance.

### *System Description*

Phase I testing was conducted using prototype hardware developed for this program. Figure A-4 illustrates the device and the baseline location for placement on the body. The primary sensors include a Draper MEMS Inertial Measuring Unit (IMU), a 3-axis Doppler velocity sensor, a magnetometer, and a barometric pressure transducer. In addition, the system included an embedded microprocessor and a compact flash card for storing the collected data. More detailed information about the Phase I Final Report

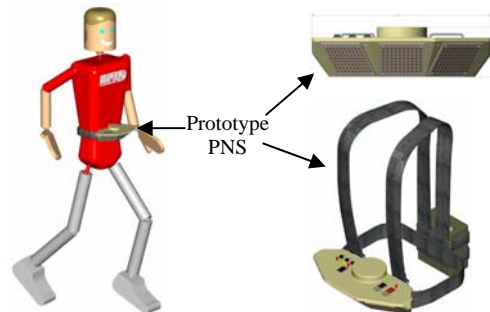

Figure A-4. PNS Phase I Test Apparatus

### *Test Description/Scenarios: Laboratory Checkouts*

Before field-testing, a number of indoor laboratory tests were performed with the integrated PNS for general system checkout and validation of proper operation. Two types of laboratory tests were conducted: 1) Instrumented cart tests and 2) Hallway walk-around tests. Instrumented cart tests consist of firmly attaching the PNS to a laboratory cart in order to eliminate the noise and dynamic signature from an operator walking with the device. This allows better assessment of the intrinsic INS/Doppler performance properties of the PNS. Post-processed data assess system sensors synchronization, calibration, and EMI noise characteristics to ensure the system meets design specifications. Cart tests also permit a final validation of the post-processing software. The cart was pushed down corridors and in and out of rooms throughout Draper, visiting several floors through rides in elevators. Following cart tests, hallway walk-around tests were conducted, and were the first opportunities to collect data with the PNS being worn by an



operator. This test course included several floors of the Draper's Duffy Building, this time using stairwells for transitioning between floors.

***Test Description/Scenarios: Open Field Control Experiments***

The system was first wrung out in relatively benign conditions, that is, in an open field with solid GPS coverage and minimal multi-path. A closed course was pre-surveyed over an area approximately the size of a football field, such that one circuit loop will cover approximately one quarter mile in distance. The survey was conducted with both aerial photos and GPS. These experiments represent a control data set of how well the system performs under favorable conditions.

***Test Description/Scenarios: Urban Canyon Experiments***

A number of experiments were planned in and around an urban canyon. The test site is designed to exercise anticipated MOUT environments including tall buildings, streets with varying geometry, and open areas representing fields or courtyards. Urban sites challenge the PNS in terms of GPS obscuration, multi-path, and local magnetic field distortions. For each test case, GPS performance was monitored in terms of number of received satellites and their corresponding signal to noise ratio.

The route includes narrow canyons and prominent overhangs where GPS is essentially unavailable. Test experiments comprised of walking through urban areas along pre-surveyed routes, stopping briefly (few seconds) at designated waypoints to signal the system of a waypoint revisit. Brief stops for ZUPT signaling also occurred every few minutes (2-5 min) and lasted on the order of a few seconds before moving on. These were performed at surveyed landmarks so that post-processing could employ either ZUPT or waypoint aiding.

A block-sized urban area was selected from which test routes were constructed to exercise the PNS. Working initially in a smaller area permits a more closely measured and characterized area for specifically assessing GPS fading and multi-path, and magnetic compass degradation. Figure A-5 depicts the test site; the Technology Square complex adjoining the Draper Laboratory facility.

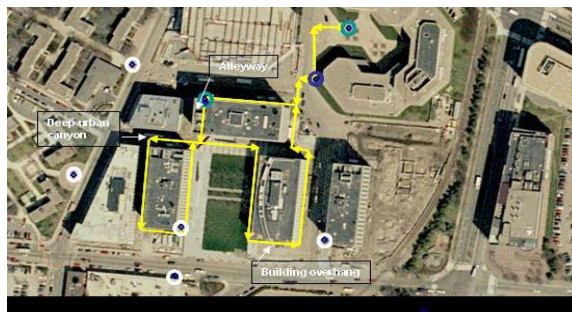

Figure A-5. Smaller Urban Course

True position was measured using the Massachusetts State aerial survey (MassGIS) with 0.5m resolution. Aerial survey positions were verified with averaged GPS readings taken in parts of the area where SV visibility was clear. Agreement was within three meters. The path itself, shown as yellow lines in the figure, was chosen to include alleyways, narrow canyons between buildings, and prominent roof overhangs. White circles represent aerial survey landmarks, green circles were verified with GPS, and the blue circle is a surveyed marker outside Draper Laboratory.

***Test Description/Scenarios: Natick Outdoor-Indoor MOUT Experiment***

An experiment was conducted at Natick Laboratory simulating a MOUT operation. The experiment consisted of initializing the system outdoors, with GPS, followed by entering one of the two entrances and walking the length of each floor of the building. The user then exited from the other building access point to the outdoors where a final GPS update was acquired before terminating the experiment. Floor plans of the building were made available to us and give the length of the interior walk at five hundred feet or a little over one hundred fifty-two meters.

***Test Description/Scenarios: Obstacle Course***

In Hudson, MA the U.S. Army has an obstacle course training facility dedicated to training military personnel in the kind of physical obstacles they may need to negotiate during an operation. Ideally, the PNS should provide accurate navigation throughout complex user motion expected during engagement of obstacles encountered in the battlefield. With the data that is collected, we can monitor the effect of large amplitude correlated body motion on quality of navigation solution. Obstacles found in this course included: a fence climb; log walk; tire walk; walking through a field of poles; tunnel crawling; over/under cross bars and descending into a six foot man-hole.

***Post-Processing Methodology***

The principal tool used for data reduction and analysis is a 59-state Kalman filter, backfilter, and smoother. The architecture of the backfilter is essentially identical to that of the forward filter, but data is sorted in reverse time order before processing, and the dynamics is run backwards in time from the end of the data to the beginning. There are minor differences in the state dynamics for states (such as Markov states) whose dynamics are not time-reversal-invariant.

Each set of collected data can be processed in a variety of ways, with or without Doppler velocity measurements, with or without GPS (or even with some satellites and not others), with or without the magnetometer, and with or without ZUPTs and waypoint measurements. Runs that include frequent stops for ZUPTs and many crossings can be post-processed with as few or as many of the ZUPTs and crossings as desired to determine the sensitivity of the accuracy of the solution to the frequency of ZUPTs and crossings.

Note: Detailed information concerning Post-Processing Methodologies for Phase I testing can be found in the Phase I Final Report.

***Results***

Field testing of the Personal Navigation System (PNS) occurred at the MIT track, on an urban course laid out around buildings near Draper Laboratory, inside Draper, at the Natick Soldier Center and at the Hudson obstacle course. Table A-1 and the bullets below this table summarize these results. Additional information concerning Phase I Test Results can be found in the Phase I Final Report.

Table A-1. Phase I Results

<b>Course</b>	<b>Course Length</b>	<b>Elapsed Time</b>	<b>Average Error</b>	<b>80% of Errors</b>	<b>95% of Errors</b>	<b>Max Error</b>
Urban Canyon (w/o GPS)	1,460 m		<10 m	< 12 m	< 19 m	
Urban Canyon (w/GPS)	1,460 m		< 9 m	< 13 m	< 20 m	
MIT Track	400 m	10 min				3 m
Natick	620 m	15 min				8 m
Urban/Kendall	550 m	15 min				18 m

- Best MIT track data shows average error ~ 1-2 meters over 400 meters without GPS aiding. Net error at end of track is about 5 meters or 1% of distance traveled. The elapsed time without aids was 7 minutes. This result backs-up assertions made earlier in this report that the unaided PNS can hold position accurately un-aided for at least several minutes.
- Natick Soldier Center corridor data shows 1.5 meter error over 152 meter indoor travel, again about 1% of distance traveled.
- The data from all of the tests were post-processed as forward navigation solutions. Path accuracy depends only on sensor performance and the sequential application of waypoint or zero velocity aids. Errors in the navigation solution grow between application of each aid. This differs from route reconstruction processing that minimizes the overall path error independent of the sequence of the aids. Route reconstruction is applicable to surveying and gives a more accurate track profile. The emphasis here is on real-time navigation.
- Instrument failures and dropouts prevented the analysis from accounting for all of the sensors in the system design.
  - Two magnetometer axes failed and one gyro sensor degraded during the test suite. Erratic behavior of the roll gyro drove distortions in the path shape of the forward navigation solution.
  - To work around the sensor failures, a “simple navigation” analysis was performed with the assumption of zero roll and pitch. This is adequate on level ground, in more serious error on stairs, and inappropriate on the obstacle course. Only the azimuth gyro was used for attitude and Doppler sensors and the baro-altimeter for velocity and position. This analysis gave overall very good replication of the shape of complex paths and isolated the performance issue to the roll gyro.

## LIST OF ACRONYMS

A/J	Anti-Jam
AM	Amplitude Modulation
ASIC	Application Specific Integrated Circuit
C/A	Coarse Acquisition
C/N	Carrier Signal to Noise Ratio
CEP	Circular Error Probable
CF	Compact Flash
CGIMU	Common Guidance IMU
DAGR	Defense Advanced GPS Receiver
D/I	Deep Integration
DTED	Digital Terrain Elevation Data
ECCM	Electronic Counter Counter Measure
FM	Frequency Modulation
FOM	Figure of Merit
GPS	Global Positioning System
FFW	Future Force Warrior
HWIL	HardWare In the Loop
HPA	High Performance Accelerometer
IMU	Inertial Measurement Unit
JTRS	Joint Tactical Radio System
LCGEU	Low Cost Guidance Electronics Unit
LED	Light Emitting Diode
LVDS	Low Voltage Digital Signal
MEMS	Micro Electro-Mechanical System
MIT	Massachusetts Institute of Technology
MOUT	Military Operations on Urban Terrain
OFW	Objective Force Warrior
PLGR	Precision Lightweight GPS Receiver
PNS	Personal Navigation System
PPS	Precise Positioning Service
RF	Radio Frequency
SAASM	Selective Availability Anti-Spoofing Module
SEP	Spherical Error Probable
SV	Satellite Vehicle
SWAP	Size, Weight And Power
TDOA	Time Difference of Arrival
TFG	Tuning Fork Gyro
TRL	Technology Readiness Level
TV	Television
UWB	Ultra Wide Band Radar
ZUPT	Zero Velocity Update

