



# LMT

## Critical Design Review

### Ring Panels 1- 4

### Part 3 – Mechanical Strength Analysis

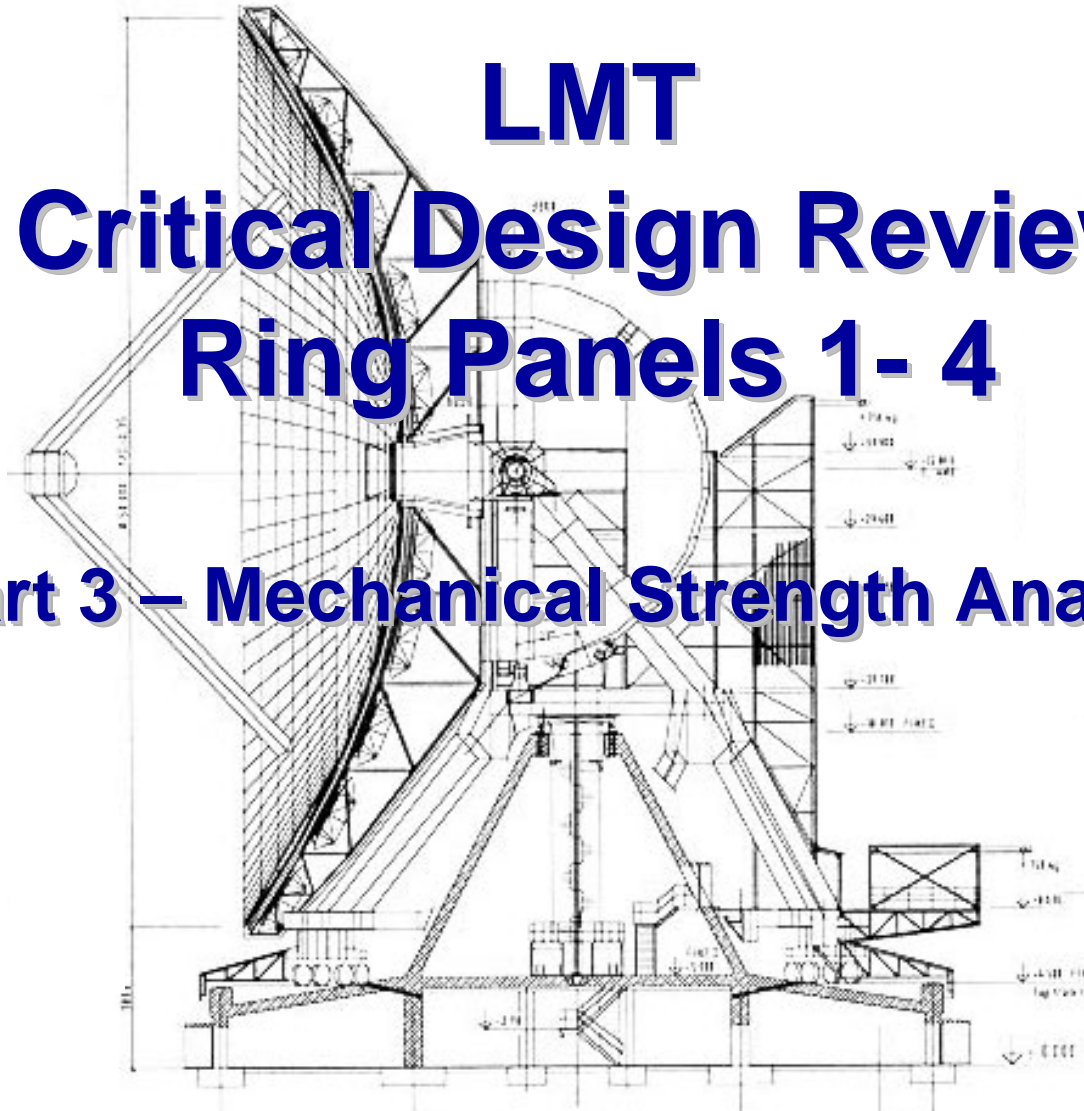

**December 11, 2003**

# Report Documentation Page

*Form Approved*  
*OMB No. 0704-0188*

Public reporting burden for the collection of information is estimated to average 1 hour per response, including the time for reviewing instructions, searching existing data sources, gathering and maintaining the data needed, and completing and reviewing the collection of information. Send comments regarding this burden estimate or any other aspect of this collection of information, including suggestions for reducing this burden, to Washington Headquarters Services, Directorate for Information Operations and Reports, 1215 Jefferson Davis Highway, Suite 1204, Arlington VA 22202-4302. Respondents should be aware that notwithstanding any other provision of law, no person shall be subject to a penalty for failing to comply with a collection of information if it does not display a currently valid OMB control number.

1. REPORT DATE <b>11 DEC 2003</b>	2. REPORT TYPE <b>N/A</b>	3. DATES COVERED <b>-</b>			
4. TITLE AND SUBTITLE <b>LMT - Critical Design Review Ring Panels 1 - 4 Part 3 Mechanical Strength Analysis</b>		5a. CONTRACT NUMBER			
		5b. GRANT NUMBER			
		5c. PROGRAM ELEMENT NUMBER			
6. AUTHOR(S)		5d. PROJECT NUMBER			
		5e. TASK NUMBER			
		5f. WORK UNIT NUMBER			
7. PERFORMING ORGANIZATION NAME(S) AND ADDRESS(ES) <b>Composite Optics, Inc. - an Alliant Techsystems Affiliate 9617 Distribution Avenue San Diego, California 92121</b>		8. PERFORMING ORGANIZATION REPORT NUMBER			
		10. SPONSOR/MONITOR'S ACRONYM(S)			
9. SPONSORING/MONITORING AGENCY NAME(S) AND ADDRESS(ES)		11. SPONSOR/MONITOR'S REPORT NUMBER(S)			
		12. DISTRIBUTION/AVAILABILITY STATEMENT <b>Approved for public release, distribution unlimited</b>			
13. SUPPLEMENTARY NOTES <b>See also ADM001773, Large Millimeter Telescope Project. , The original document contains color images.</b>					
14. ABSTRACT					
15. SUBJECT TERMS					
16. SECURITY CLASSIFICATION OF:			17. LIMITATION OF ABSTRACT <b>UU</b>	18. NUMBER OF PAGES <b>39</b>	19a. NAME OF RESPONSIBLE PERSON
a. REPORT <b>unclassified</b>	b. ABSTRACT <b>unclassified</b>	c. THIS PAGE <b>unclassified</b>			

**LMT**

**Critical Design Review**

**Rings Panels 1-4**

**Structural Analysis**

**Prepared by:**  
**ATA Engineering, Inc.**  
Kurt Knutson  
Brian Mooney

# Mechanical Strength Analysis

- ◆ **Finite Element Model descriptions and documentation (typical model Ring 3)**
  - » Updates to the Ring 3 design from 2002 FEM
  - » Ring 3 Model and Structural Components
  - » Ring 3 Model Integrated with Subframe
- ◆ **Materials and Allowables**
- ◆ **Load Cases and Configurations**
- ◆ **Ring 3, No Subframe**
  - » Stress and Margin of Safety Results for All Mechanical Load Cases
- ◆ **Ring 1, 2, 4 No Subframe**
  - » Load case 9 and 10 Results only

# Ring 3 FEM Updates from 2002 FEM

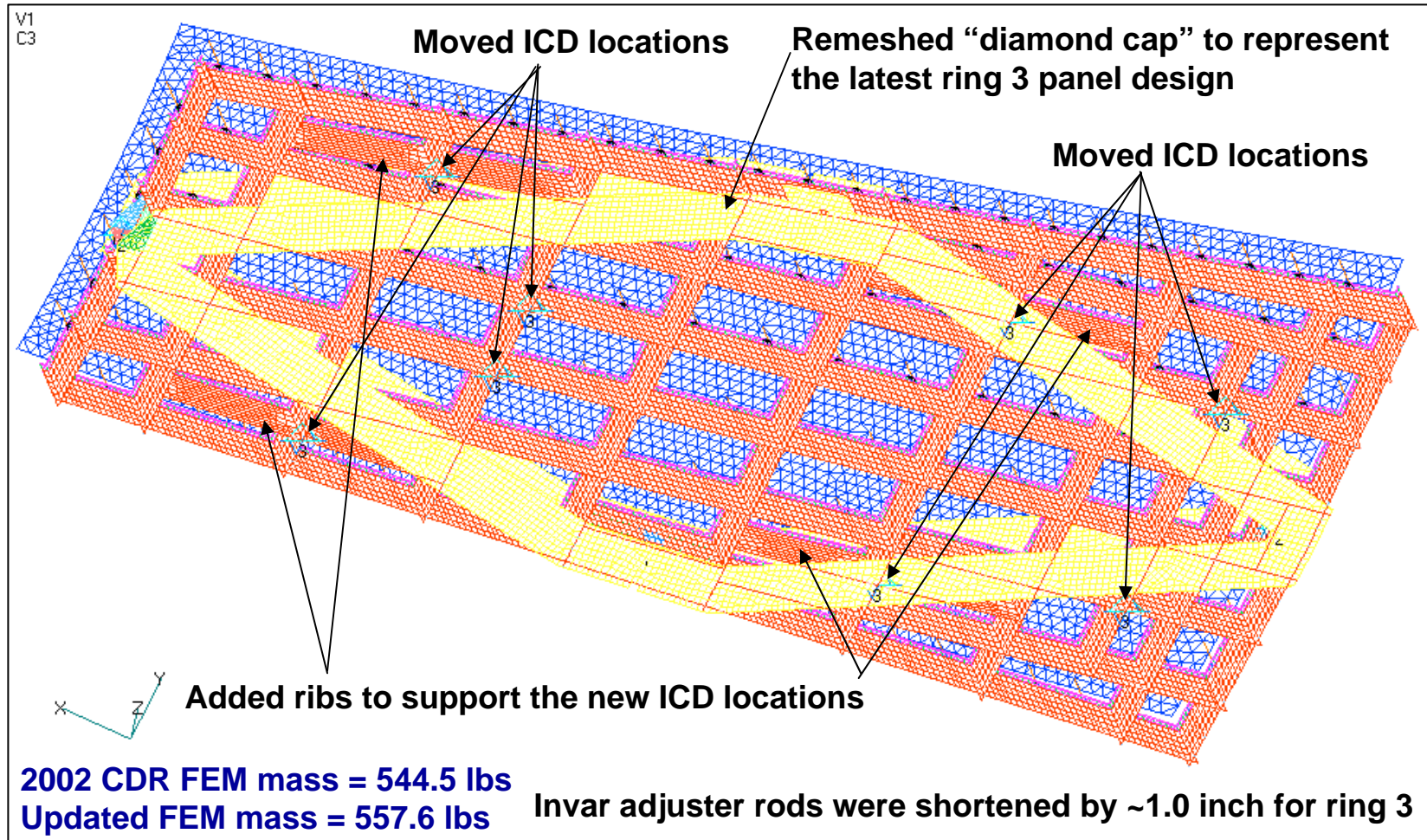

# Ring 3 FEM Description & Materials

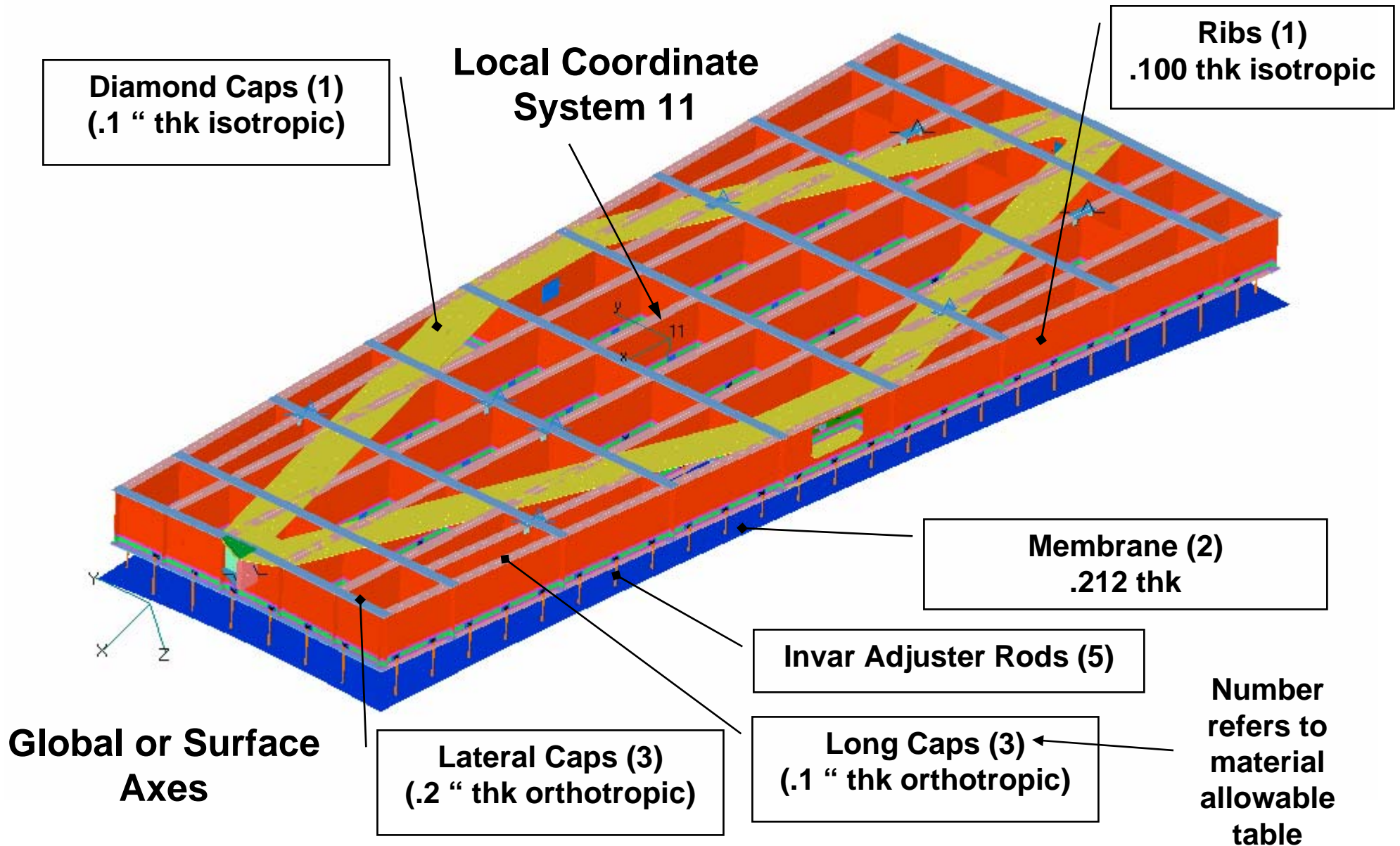

# Ring 3 Model Aft View

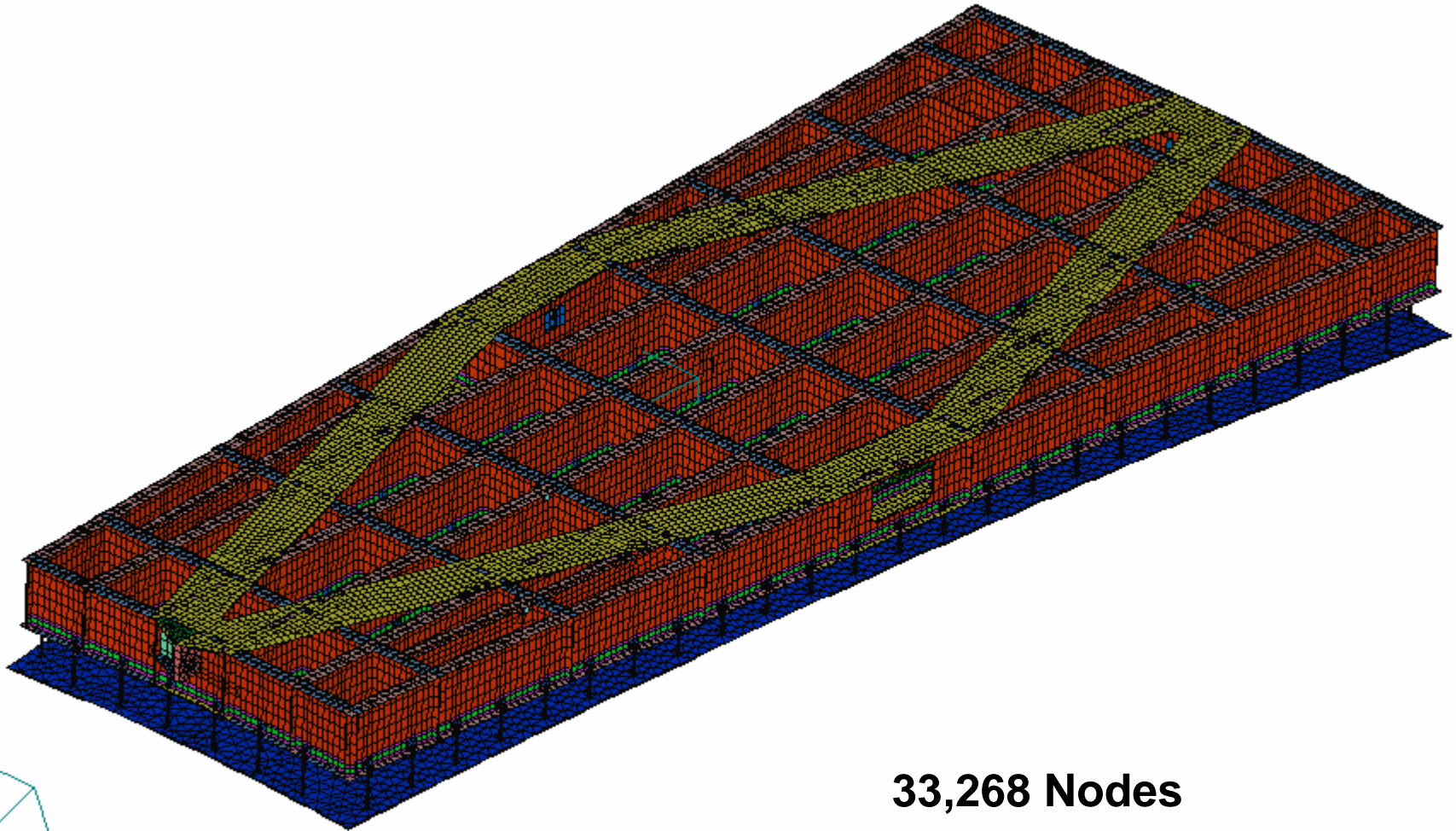

**33,268 Nodes**

**41,332 Elements**

# Ring 3 Model Front View

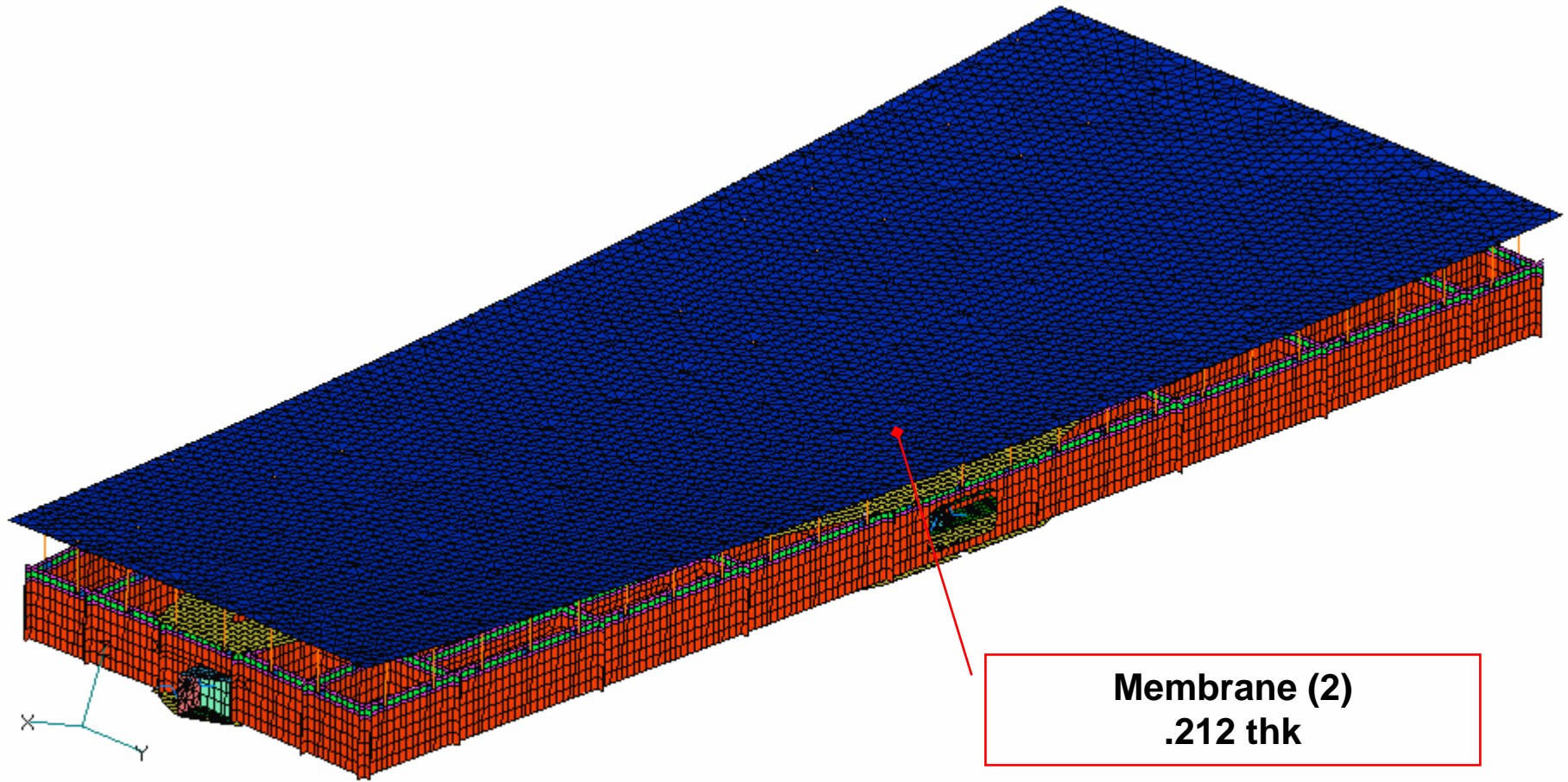

**Membrane (2)  
.212 thk**



# Ring 3 Model Front View (Membrane Removed from View)

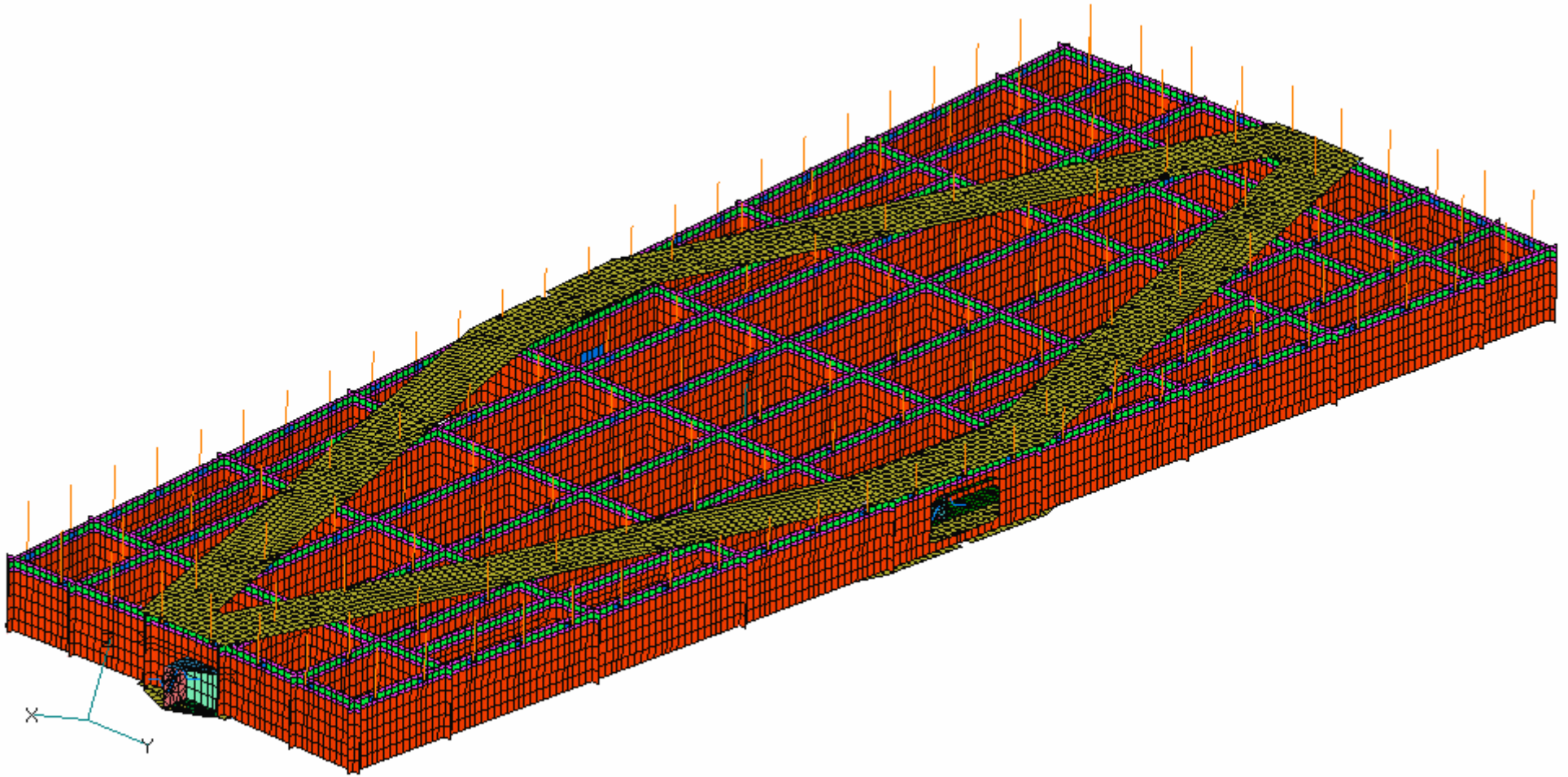

# Ring 3 Model Front View Steel Regions

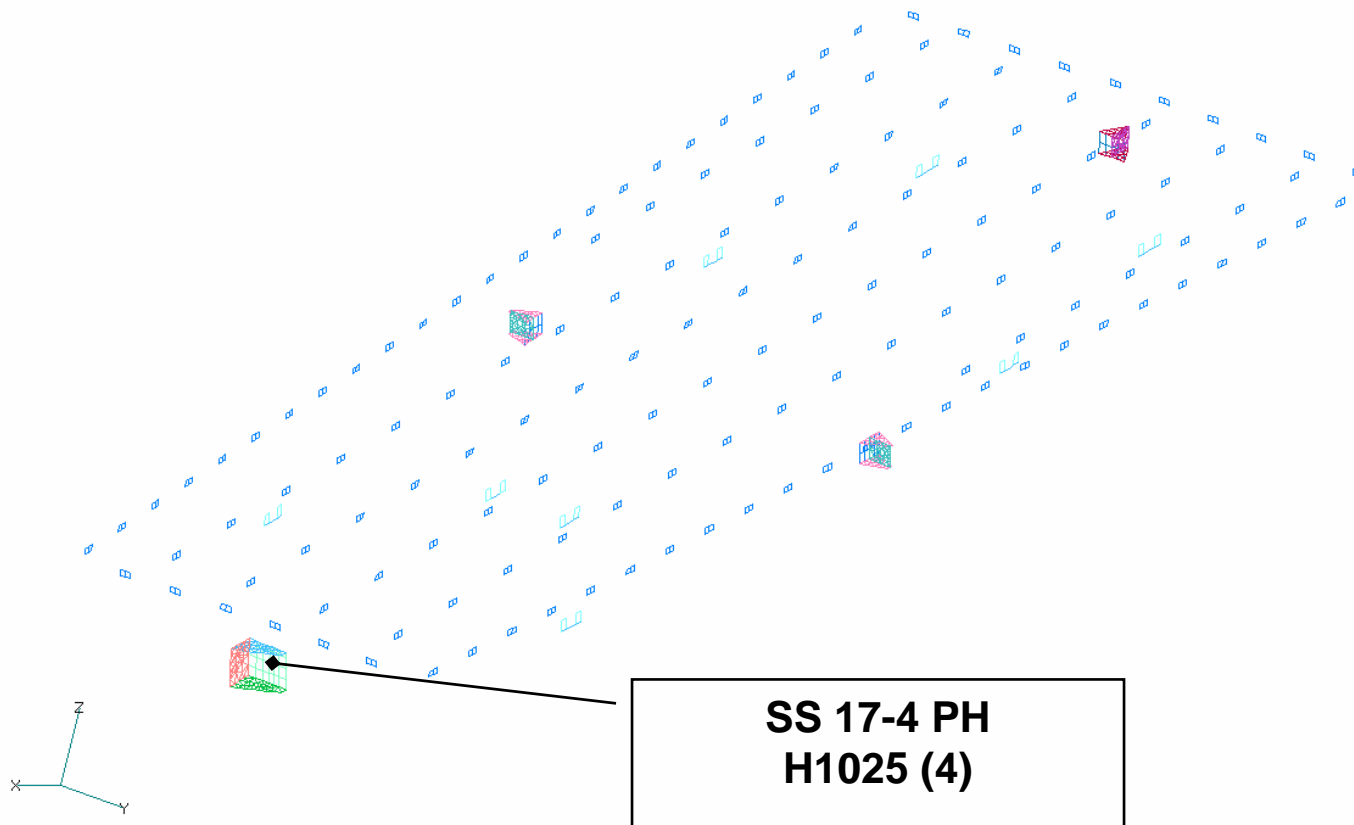

# Ring 3 Model Front View Invar Adjusters

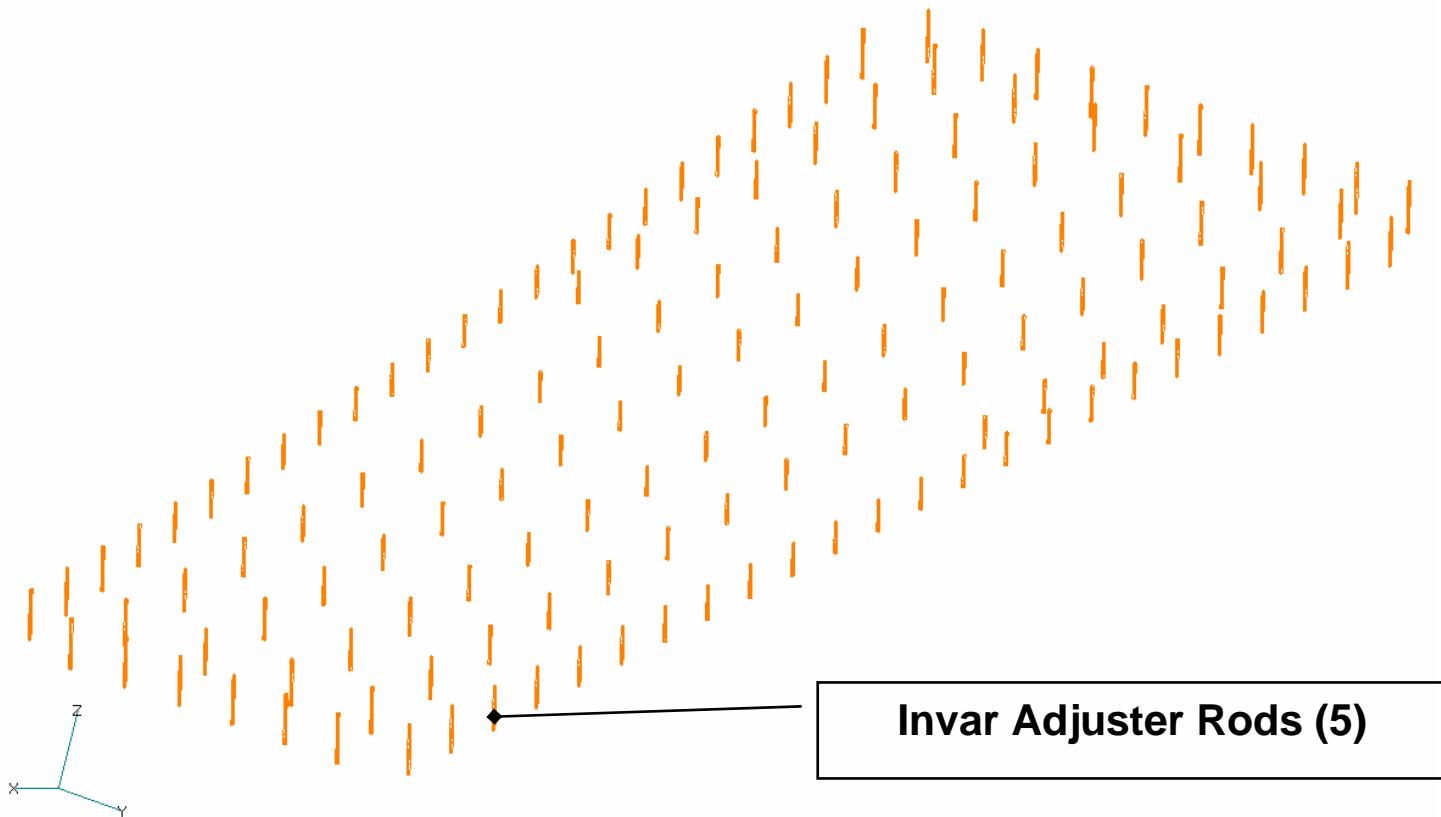

# Ring 3 Model Front View Integrated with Subframe

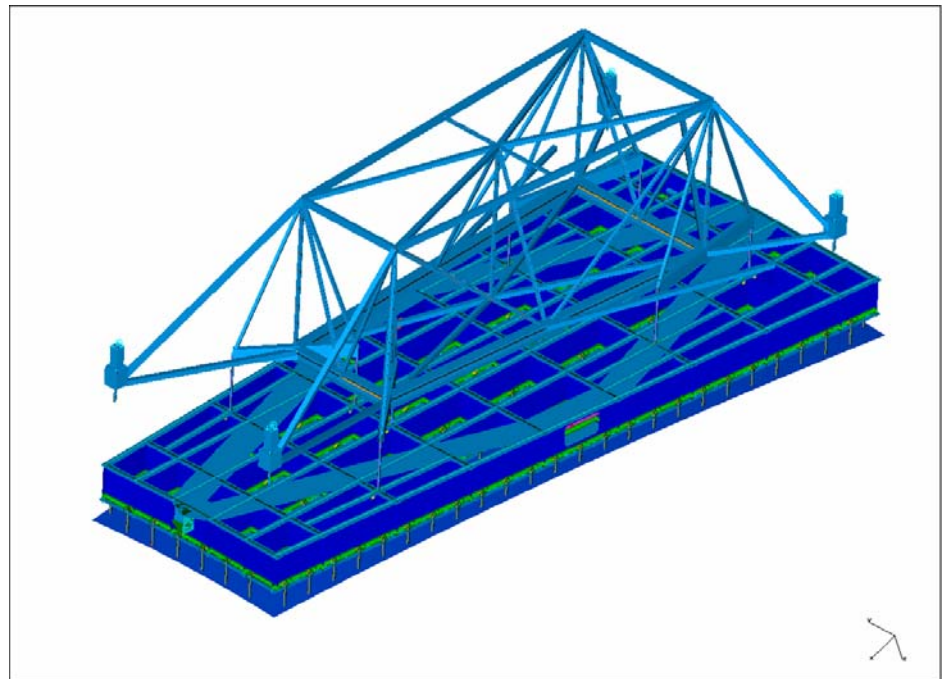
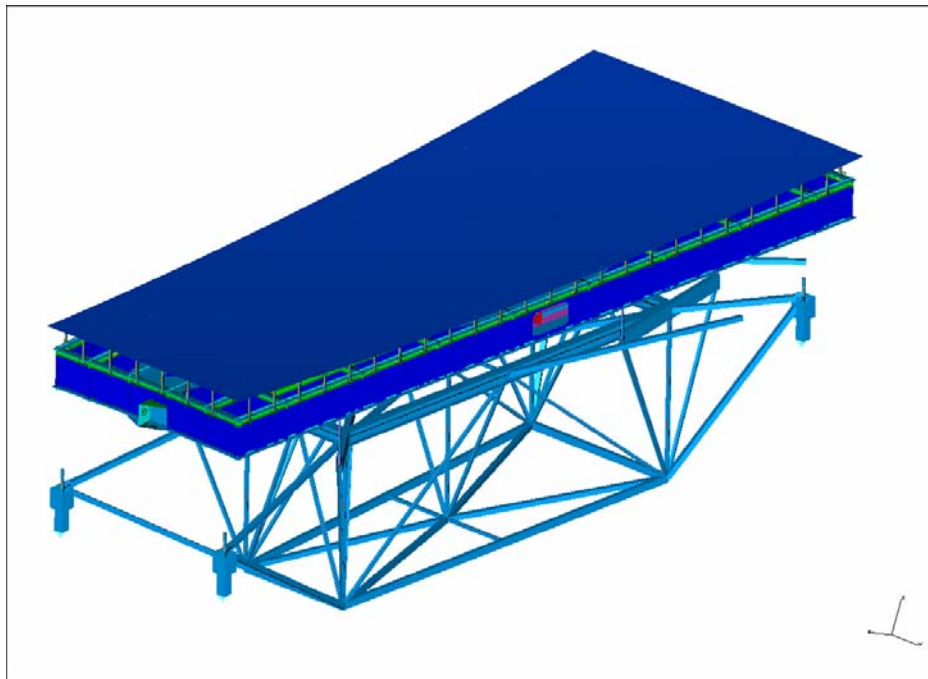

# Mechanical Strength Analysis

- ◆ **Mechanical Strength Analysis Requirements**
- ◆ **Load Cases and Configurations**
- ◆ **Materials and Allowables**
- ◆ **Ring 3, No Subframe**
  - » **Stress and Margin of Safety Results for All Mechanical Load Cases**
- ◆ **Ring 1, 2, 4 No Subframe**
  - » **Load case 9 and 10 Results only**

# Mechanical Strength Analysis Requirements

- ◆ Evaluate for survival loading conditions in stow position

- » Component Stresses

- » Component Margins of Safety

- ◆ Stress Margins calculated as: 
$$\text{margin of safety} = \frac{\text{Allowable Stress}}{\text{Actual Stress}} - 1.0$$

- ◆ Bond Margins calculated as:

- » Ft is Factored Tensile Force

- » At is Tensile Allowable

- » Fs is Factored Shear Force

- » As is Shear Allowable

$$\text{bond margin of safety} = \frac{1.0}{\sqrt{\left(\left(\frac{F_t}{A_t}\right)^2 + \left(\frac{F_s}{A_s}\right)^2\right)}} - 1.0$$

# Load Cases for Mechanical Stress Analysis

14 Load Case Combinations from Specification	
1	1.35*Gravity (+X) + 0.75*Wind (+) + 1.5*Ice Load (+X)
2	1.35*Gravity (-X) + 0.75*Wind (+) + 1.5*Ice Load (-X)
3	1.35*Gravity (+X) + 0.75*Wind (-) + 1.5*Ice Load (+X)
4	1.35*Gravity (-X) + 0.75*Wind (-) + 1.5 *Ice Load (-X)
5	1.35*Gravity (+X) + 1.5 *Wind (+) + 0.75 *Ice Load (+X)
6	1.35*Gravity (-X) + 1.5 *Wind (+) + 0.75 *Ice Load (-X)
7	1.35*Gravity (+X) + 1.5 *Wind (-) + 0.75 *Ice Load (+X)
8	1.35*Gravity (-X) + 1.5 *Wind (-) + 0.75 *Ice Load (-X)
9	1.35*Gravity (+Y) + 0.75 *Wind (+) + 1.5 *Ice Load (+Y)
10	1.35*Gravity (+Y) + 0.75 *Wind (-) + 1.5 *Ice Load (+Y)
11	1.35*Gravity (+Y) + 1.5 *Wind (+) + 0.75 *Ice Load (+Y)
12	1.35*Gravity (+Y) + 1.5 *Wind (-) + 0.75 *Ice Load (+Y)
13	1.35*Gravity (+Z) + 1.5 *Wind (+) + 0.75 *Ice Load (+Z)
14	1.35*Gravity (+Z) + 1.5 *Wind (-) + 0.75 *Ice Load (+Z)

**Temperature Soak (20 C) & Gradient (5 C) superimposed with each combination**

**All load cases analyzed for each boundary condition (BC2 & BC3) for a total of 28 mechanical stress analyses**

# Boundary Conditions, No Subframe

## Arrangement 2:

- 8 points at bottom of reaction structure constrained in Z-direction
- 2 points at middle of long sides constrained in X-direction
- 1 point at middle of short side constrained in Y-direction

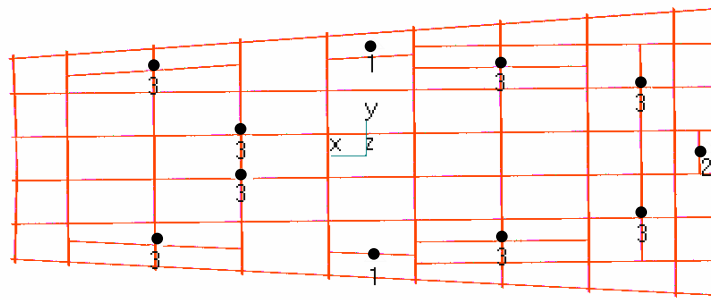

## Arrangement 3:

- 8 points at bottom of reaction structure constrained in Z-direction
- 1 point at middle of long side constrained in X-direction
- 2 points at middle of short sides constrained in Y-direction

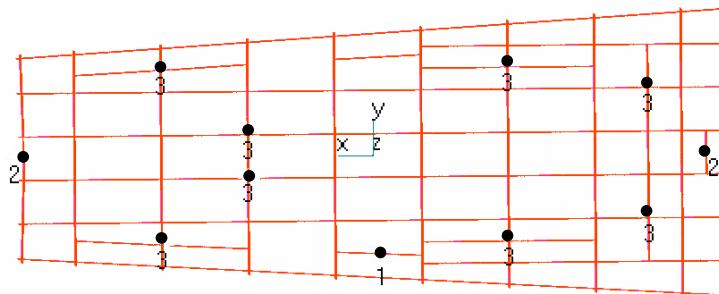

All constraints  
specified in the local  
coordinate system 11  
(shown)



# Materials and Allowables

Property	Composite Ribs (1)	Material Composite Membrane (2)	Composite Caps (3)	SS 17-4PH H1025 (4)	Invar (5)	Reaction Structure(6)
Modulus of Elasticity (MSI)	7.33	6.16	17.42	29	21	NA
Shear Modulus (MSI)	2.5	2.128	1.26	11.2	8.1	NA
Poisson's Ratio	0.31	0.307	0.663	0.32	0.3	NA
CTE (PPM/deg F)	1.65	2.08	-0.329	8.3	0.7	NA
Density (Lb/cu-in)	0.066	0.066	0.066	0.286	0.291	NA
Strength – Compression (KSI)	56.8	54.5	102.2	155	75	NA
Strength – Shear (KSI)	32.1	30.2	24.5	95	37	NA
Strength – Yield (KSI)	NA	NA	NA	145	45	NA
Edge Bond Tension Strength (KSI)	NA	NA	NA	NA	NA	
Edge Bond Shear Strength (KSI)	NA	NA	NA	NA	NA	
Lap Shear Bond Strength (KSI)	NA	NA	NA	NA	NA	3.19

## Notes

- (1) T300/Epoxy, Isotropic
- (2) T300/Epoxy, Isotropic + 0.003” Thick Al foil + 0.003” E-Glass on each side
- (3) T300/Epoxy, (0/15/-15/0)s

# Ring 3

## Mechanical Strength Analysis Results

# Ring 3 No Subframe: Maximum Stress in Reaction Structure Laminates

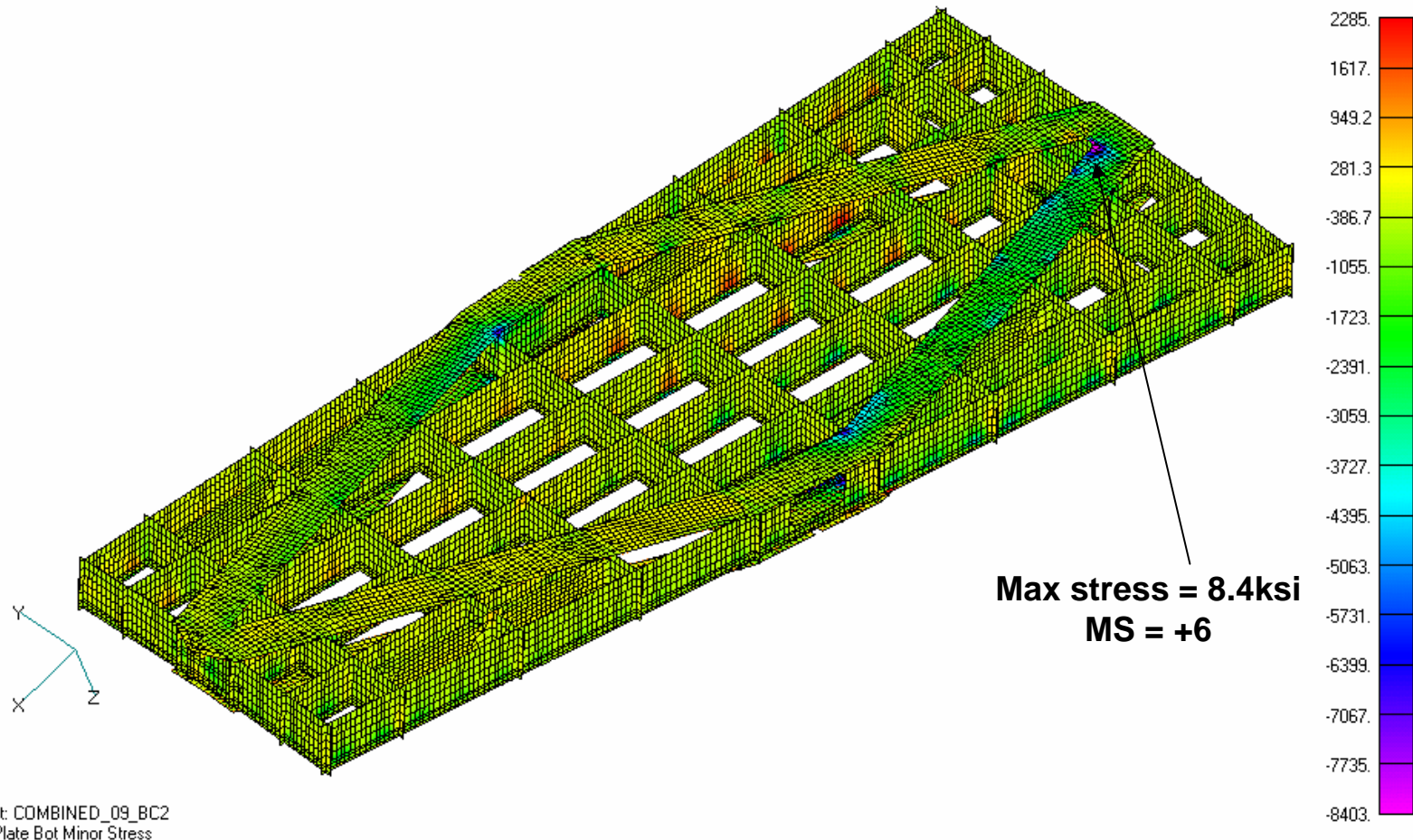

**Load Case 9: 1.35\*Gravity (+Y) + 0.75 \*Wind (+) + 1.5 \*Ice Load (+Y)**  
**Boundary Condition: Arrangement 2**

# Ring 3 No Subframe: Stresses in Reaction Structure Laminates - BC2, BC3

## BC2

Load Combination No.	Max Abs. (Major/Minor)		Max Shear Stress	
	Stress (PSI) (56.8 ksi allowable)	Margin of Safety	Stress (PSI) (32.1 ksi allowable)	Margin of Safety
1	3821	14	1747	17
2	3606	15	1526	20
3	3826	14	1753	17
4	4283	12	1664	18
5	3568	15	1485	21
6	3935	13	1523	20
7	3639	15	1510	20
8	3920	13	1523	20
9	8403	6	4452	6
10	8402	6	4452	6
11	5189	10	2682	11
12	5149	10	2681	11
13	3353	16	1499	20
14	3357	16	1499	20

## BC3

Load Combination No.	Max Abs. (Major/Minor)		Max Shear Stress	
	Stress (PSI) (56.8 ksi allowable)	Margin of Safety	Stress (PSI) (32.1 ksi allowable)	Margin of Safety
1	5442	9	2523	12
2	4114	13	1959	15
3	5475	9	2538	12
4	5744	9	2339	13
5	3921	13	1855	16
6	4433	12	1771	17
7	3807	14	1572	19
8	4402	12	1749	17
9	4795	11	2538	12
10	4794	11	2544	12
11	3566	15	1944	16
12	3554	15	1939	16
13	3478	15	1460	21
14	3477	15	1463	21

# Ring 3 No Subframe: Maximum Stress in Steel Plate Regions

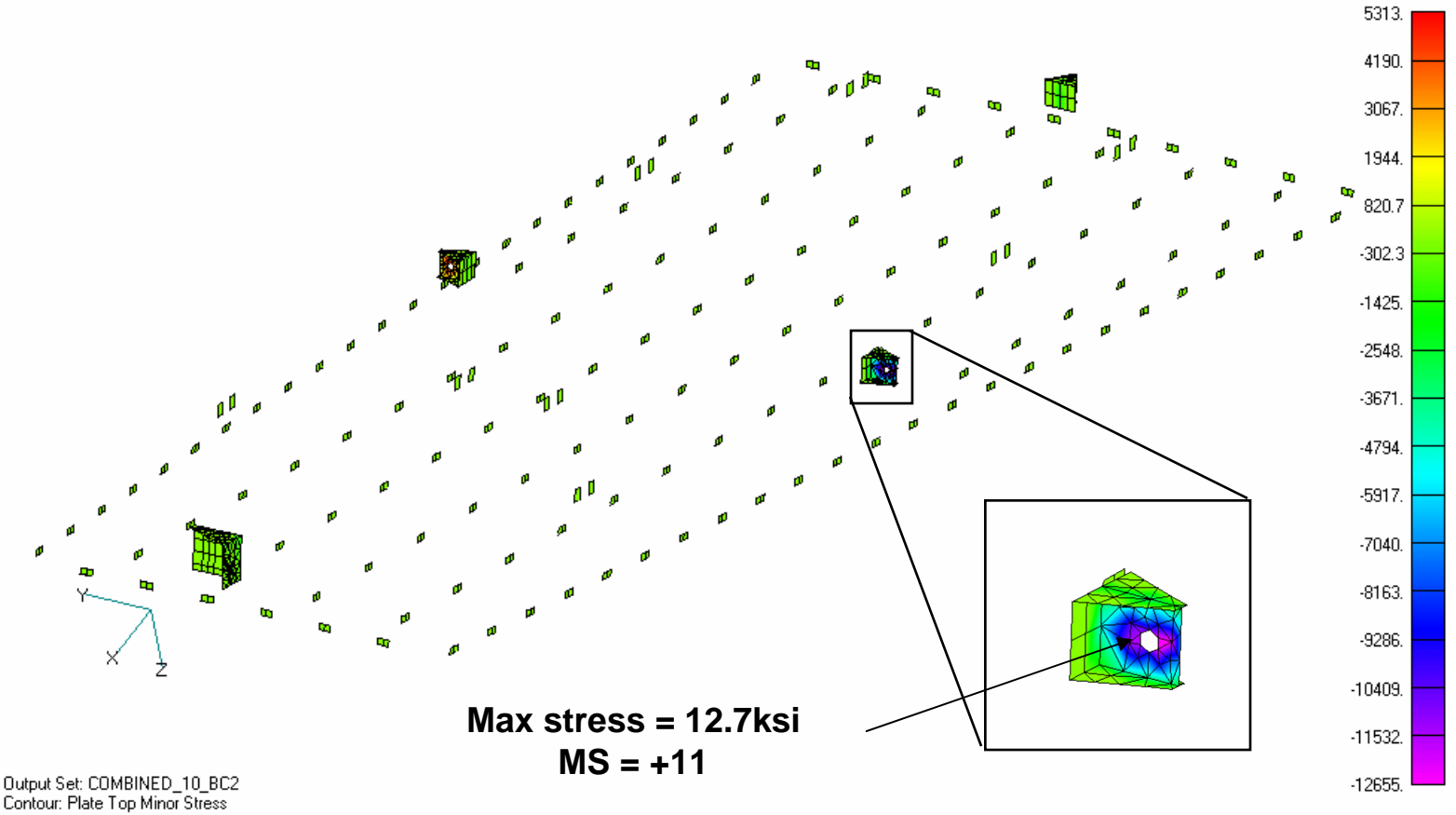

**Load Case 10: 1.35\*Gravity (+Y) - 0.75 \*Wind (+) + 1.5 \*Ice Load (+Y)**  
**Boundary Condition: Arrangement 2**

# Ring 3 No Subframe: Stresses in Steel Plate Regions– BC2

Load Combination No.	Max Abs. (Major/Minor)		Max Shear Stress		Max Yield Stress	
	Stress (PSI) (155 ksi allowable)	Margin of Safety	Stress (PSI) (95 ksi allowable)	Margin of Safety	Stress (PSI) (145 KSI allowable)	Margin of Safety
1	4657	32	2124	44	4251	33
2	4563	33	2116	44	4238	33
3	4696	32	2125	44	4266	33
4	4576	33	2111	44	4228	33
5	4556	33	2123	44	4248	33
6	4572	33	2112	44	4230	33
7	4563	33	2121	44	4244	33
8	4573	33	2113	44	4230	33
9	12623	11	4854	19	11445	12
10	12655	11	4869	19	11479	12
11	7426	20	2861	32	6738	21
12	7484	20	2888	32	6793	20
13	4586	33	2122	44	4250	33
14	4587	33	2122	44	4250	33

# Ring 3 No Subframe: Stresses in Steel Plate Regions– BC3

Load Combination No.	Max Abs. (Major/Minor)		Max Shear Stress		Max Yield Stress	
	Stress (PSI) (155 ksi allowable)	Margin of Safety	Stress (PSI) (95 ksi allowable)	Margin of Safety	Stress (PSI) (145 KSI allowable)	Margin of Safety
1	9034	16	3480	26	8197	17
2	5895	25	2278	41	5352	26
3	9112	16	3510	26	8266	17
4	8892	16	3419	27	8064	17
5	5303	28	2161	43	4816	29
6	5308	28	2074	45	4818	29
7	4560	33	2106	44	4231	33
8	5154	29	2075	45	4678	30
9	7357	20	3617	25	7296	19
10	7337	20	3607	25	7277	19
11	4736	32	2367	39	4725	30
12	4696	32	2351	39	4686	30
13	4589	33	2133	44	4260	33
14	4590	33	2134	44	4261	33

# Ring 3 No Subframe: Stresses in Steel Bar Regions– BC2, BC3

## BC2

Load Combination No.	Max Abs. Stress (bending & axial)	
	Stress (PSI) (145 ksi allowable)	Margin of Safety
1	12248	11
2	12150	11
3	12221	11
4	11959	11
5	12222	11
6	12041	11
7	12084	11
8	11985	11
9	15645	8
10	15635	8
11	13868	9
12	13848	9
13	11509	12
14	11454	12

## BC3

Load Combination No.	Max Abs. Stress (bending & axial)	
	Stress (PSI) (145 ksi allowable)	Margin of Safety
1	13446	10
2	12714	10
3	13448	10
4	11872	11
5	12569	11
6	11889	11
7	12021	11
8	11834	11
9	13658	10
10	13635	10
11	12824	10
12	12773	10
13	11582	12
14	11534	12



# Ring 3 No Subframe: Maximum Stress in Invar Adjusters

Max stress = 42.4 ksi  
MS = +0.06

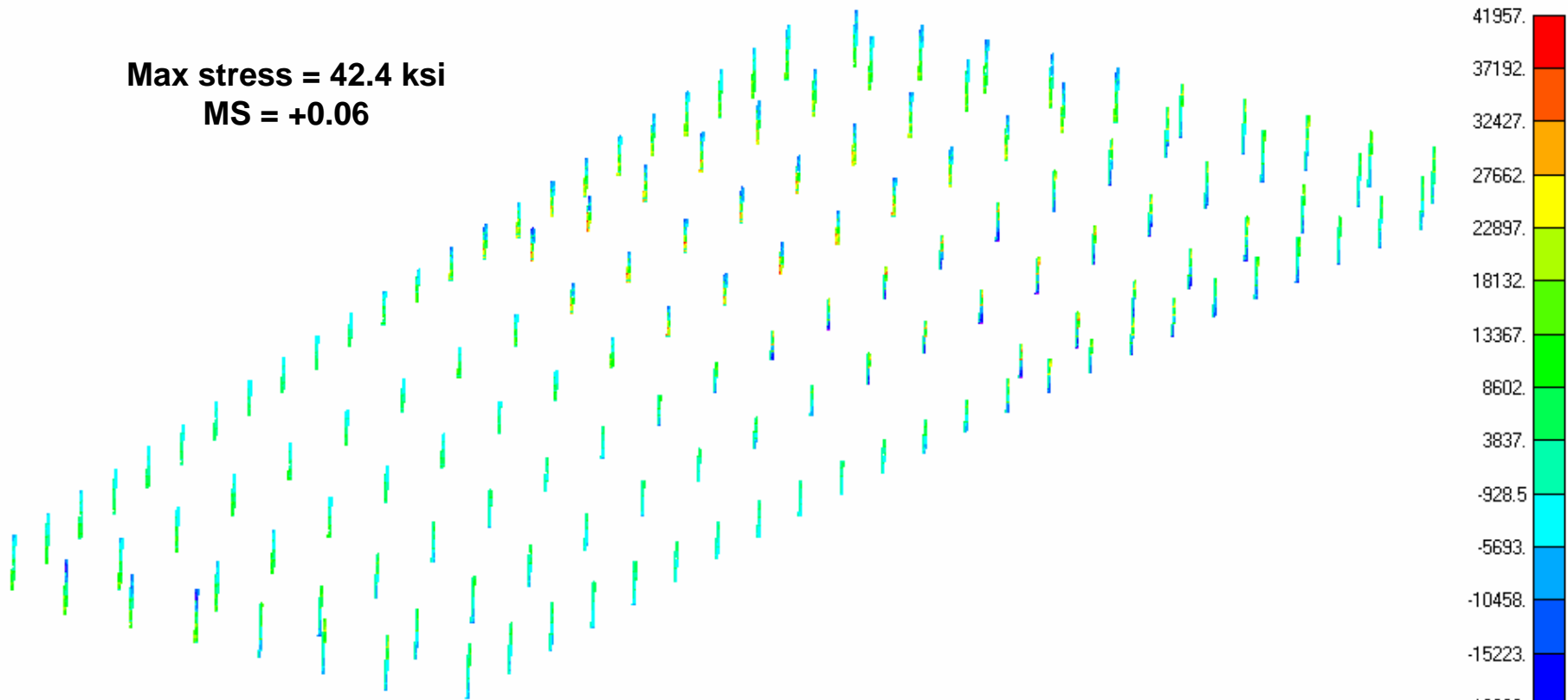

**Load Case 9: 1.35\*Gravity (+Y) + 0.75 \*Wind (+) + 1.5 \*Ice Load (+Y)**  
**Boundary Condition: Arrangement 2**

Output Set: COMBINED\_09\_BC2  
Contour: Bar EndB Pt2 Bend Stress

# Ring 3 No Subframe: Stresses in Invar Adjusters – BC2 & BC3

## BC2

Load Combination No.	Max Abs. Stress (bending & axial)	
	Stress (PSI) (45 ksi allowable)	Margin of Safety
1	34474	0.31
2	29111	0.55
3	34430	0.31
4	33349	0.35
5	18987	1.37
6	18069	1.49
7	12591	2.57
8	18058	1.49
9	42419	0.06
10	42372	0.06
11	23967	0.88
12	23893	0.88
13	4074	10.05
14	4540	8.91

## BC3

Load Combination No.	Max Abs. Stress (bending & axial)	
	Stress (PSI) (45 ksi allowable)	Margin of Safety
1	41340	0.09
2	33187	0.36
3	41383	0.09
4	40513	0.11
5	22978	0.96
6	22350	1.01
7	14093	2.19
8	22220	1.03
9	28513	0.58
10	28606	0.57
11	15623	1.88
12	15628	1.88
13	4508	8.98
14	5018	7.97

# Ring 3 Reaction Structure Rib to Rib Edge Bond Margins of Safety Plot – BC2

Single element margin = - 0.19

Load case 9, 10

LMT  
Ring 3: Rib to Rib Bonds  
Minimum Margins of Safety  
Load Cases 1-14

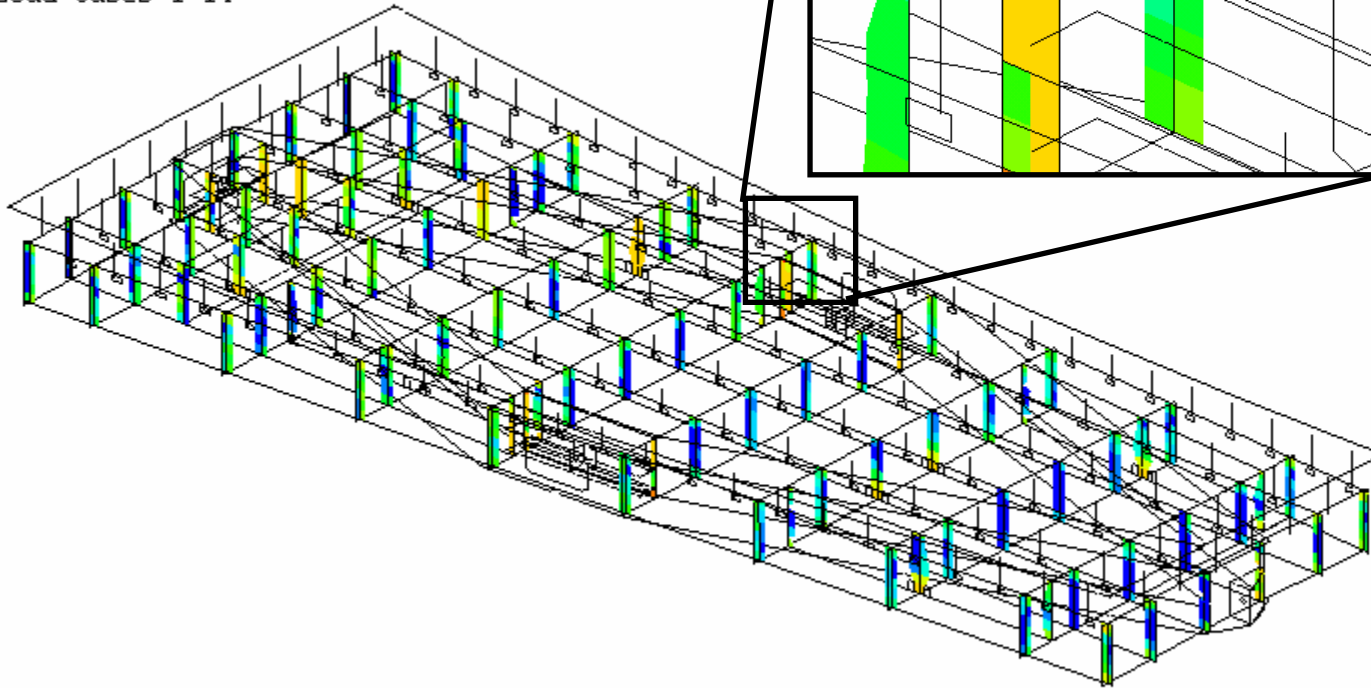

Dimensionless

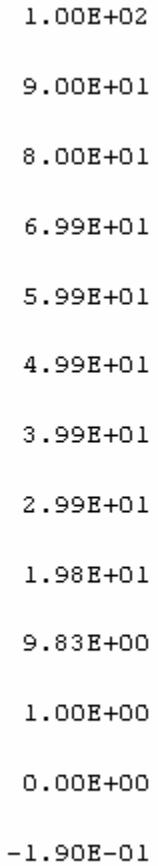

# Ring 3 No Subframe: Reaction Structure Edge Bond Strength Rib to Rib Bonds– BC2

Ring 3, BC2, Rib to Rib Minimum Bond Margins				
Load Combination	Tension (Allowable = 469.3 lb/in ) Force (lb/in)	Shear (Allowable = 568.3 lb/in) Force (lb/in)	Margin of Safety	
1	93.69	109.08	2.60	
2	92.39	120.86	2.50	
3	93.69	109.13	2.60	
4	92.42	120.90	2.40	
5	92.82	111.71	2.60	
6	91.50	118.19	2.50	
7	92.81	111.80	2.60	
8	91.56	118.28	2.50	
9	531.67	270.97	-0.19	
10	531.21	270.64	-0.19	
11	297.11	152.99	0.45	
12	315.18	179.63	0.35	
13	92.14	116.62	2.50	
14	92.13	116.71	2.50	

# Ring 3 No Subframe: Reaction Structure Edge Bond Strength Rib to Diamond Cap Bonds– BC2

Ring 3, BC2, Rib to Diamond Cap Minimum Bond Margins				
Load Combination	Tension (Allowable = 469.3 lb/in ) Force (lb/in)	Shear (Allowable = 568.3 lb/in) Force (lb/in)	Margin of Safety	
1	156.15	107.17	1.60	
2	156.88	105.59	1.60	
3	156.15	107.16	1.60	
4	156.88	105.58	1.60	
5	156.24	106.94	1.60	
6	156.80	105.83	1.60	
7	156.23	106.92	1.60	
8	156.79	105.81	1.60	
9	0.00	301.07	0.89	
10	0.00	301.39	0.89	
11	155.97	104.01	1.60	
12	0.00	240.03	1.40	
13	156.14	104.86	1.60	
14	156.13	104.84	1.60	

# Ring 3 No Subframe: Reaction Structure Edge Bond Strength Rib to Rib Bonds– BC3

Ring 3, BC3, Rib to Rib Minimum Bond Margins				
Load Combination	Tension (Allowable = 469.3 lb/in ) Force (lb/in)	Shear (Allowable = 568.3 lb/in) Force (lb/in)	Margin of Safety	
1	249.39	147.78	0.69	
2	243.64	138.36	0.74	
3	251.91	149.20	0.67	
4	241.77	137.31	0.76	
5	133.64	79.61	2.20	
6	128.74	75.35	2.30	
7	138.68	82.45	2.00	
8	125.00	73.24	2.40	
9	141.40	79.03	2.00	
10	141.20	79.37	2.00	
11	107.63	72.11	2.80	
12	174.39	101.53	1.40	
13	90.56	121.56	2.50	
14	90.40	122.12	2.50	

# Ring 3 No Subframe: Reaction Structure Edge Bond Strength Rib to Diamond Cap Bonds– BC3

Ring 3, BC3, Rib to Diamond Cap Minimum Bond Margins				
Load Combination	Tension (Allowable = 469.3 lb/in ) Force (lb/in)	Shear (Allowable = 568.3 lb/in) Force (lb/in)	Margin of Safety	
1	151.96	104.59	1.70	
2	161.06	114.31	1.50	
3	151.92	104.56	1.70	
4	161.02	114.23	1.50	
5	153.79	105.41	1.70	
6	159.26	110.59	1.60	
7	153.72	105.34	1.70	
8	159.18	110.42	1.60	
9	167.34	126.62	1.40	
10	167.30	126.53	1.40	
11	162.88	117.75	1.50	
12	159.18	110.04	1.60	
13	155.40	104.35	1.60	
14	155.32	104.29	1.60	

# Ring 3 No Subframe: Reaction Structure Fitting Lap Shear Bond Strength – BC2, BC3

## BC2

Load Combination Number	Adjuster's Base Area = 1.16 in <sup>2</sup>		Axial (Z) Fittings Area = 2.1 in <sup>2</sup>		Lateral (X,Y) Fittings Area = 12.5 in <sup>2</sup>	
	Force (lb)	Margin of Safety	Force (lb)	Margin of Safety	Force (lb)	Margin of Safety
1	6	640	107	61	2115	18
2	5	743	89	74	1374	28
3	5	689	100	66	2133	18
4	6	635	159	41	2085	18
5	4	1002	79	84	1236	31
6	4	907	124	53	1243	31
7	3	1129	81	82	466	85
8	4	955	99	67	1207	32
9	32	115	569	11	5767	6
10	33	112	554	11	5783	6
11	17	213	354	18	3389	11
12	19	190	325	20	3410	11
13	21	173	454	14	374	106
14	24	152	494	13	410	96

## BC3

Load Combination Number	Adjuster's Base Area = 1.16 in <sup>2</sup>		Axial (Z) Fittings Area = 2.1 in <sup>2</sup>		Lateral (X,Y) Fittings Area = 12.5 in <sup>2</sup>	
	Force (lb)	Margin of Safety	Force (lb)	Margin of Safety	Force (lb)	Margin of Safety
1	7	551	248	26	4124	9
2	6	662	180	36	2681	14
3	7	563	229	28	4159	9
4	7	549	349	18	4064	9
5	4	873	148	44	2411	16
6	5	820	213	30	2422	15
7	3	1066	145	45	908	43
8	5	779	244	26	2352	16
9	21	178	397	16	2308	16
10	22	170	382	17	2313	16
11	11	343	254	25	1355	28
12	13	287	224	29	1364	28
13	21	172	478	13	730	54
14	24	151	520	12	801	49



# Ring 1,2,4

## Mechanical Strength Analysis Results

# Ring 1,2,4 No Subframe: Stresses in Reaction Structure Laminates - BC2, BC3

**BC2**

Ring	Load Combination No.	Max Abs. (Major/Minor)		Max Shear Stress	
		Stress (PSI) (56.8 ksi allowable)	Margin of Safety	Stress (PSI) (32.1 ksi allowable)	Margin of Safety
1	9	5446	9	2528	12
	10	5444	9	2528	12
2	9	7105	7	3184	9
	10	7105	7	3185	9
4	9	8701	6	5640	5
	10	8703	6	5641	5

**BC3**

Ring	Load Combination No.	Max Abs. (Major/Minor)		Max Shear Stress	
		Stress (PSI) (56.8 ksi allowable)	Margin of Safety	Stress (PSI) (32.1 ksi allowable)	Margin of Safety
1	9	4788	11	2258	13
	10	4788	11	2258	13
2	9	5443	9	2664	11
	10	5443	9	2663	11
4	9	7264	7	3084	9
	10	7288	7	3084	9

# Rings 1,2,4 No Subframe: Stresses in Steel Plate Regions– BC2, BC3

## BC2

Ring	Load Combination No.	Max Abs. (Major/Minor)		Max Shear Stress		Max Yield Stress	
		Stress (PSI) (155 ksi allowable)	Margin of Safety	Stress (PSI) (95 ksi allowable)	Margin of Safety	Stress (PSI) (145 KSI allowable)	Margin of Safety
1	9	7350	20	3049	30	6811	20
	10	7350	20	3049	30	6811	20
2	9	10060	14	4339	21	9445	14
	10	10060	14	4339	21	9445	14
4	9	10785	13	4560	20	10056	13
	10	10785	13	4560	20	10056	13

## BC3

Ring	Load Combination No.	Max Abs. (Major/Minor)		Max Shear Stress		Max Yield Stress	
		Stress (PSI) (155 ksi allowable)	Margin of Safety	Stress (PSI) (95 ksi allowable)	Margin of Safety	Stress (PSI) (145 KSI allowable)	Margin of Safety
1	9	6228	24	2592	36	5778	24
	10	6229	24	2593	36	5778	24
2	9	7233	20	3124	29	6784	20
	10	7232	20	3124	29	6785	20
4	9	6383	23	2517	37	5747	24
	10	6383	23	2517	37	5747	24

# Rings 1,2,4 No Subframe: Stresses in Steel Bar Regions– BC2, BC3

**BC2**

Ring	Load Combination No.	Max Abs. Stress (bending & axial)	
		Stress (PSI) (145 ksi allowable)	Margin of Safety
1	9	14116	9.3
	10	14116	9.3
2	9	13257	9.9
	10	13220	10.0
4	9	13377	9.8
	10	13356	9.9

**BC3**

Ring	Load Combination No.	Max Abs. Stress (bending & axial)	
		Stress (PSI) (145 ksi allowable)	Margin of Safety
1	9	13743	10
	10	13736	10
2	9	13148	10
	10	13126	10
4	9	12216	11
	10	12196	11

# Rings 1,2,4 No Subframe: Stresses in Invar Adjusters – BC2 & BC3

## BC2

Ring	Load Combination No.	Max Abs. Stress (bending & axial)	
		Stress (PSI) (45 ksi allowable)	Margin of Safety
1	9	34548	0.30
	10	34547	0.30
2	9	45878	-0.02
	10	45901	-0.02
4	9	46754	-0.04
	10	46783	-0.04

## BC3

Ring	Load Combination No.	Max Abs. Stress (bending & axial)	
		Stress (PSI) (45 ksi allowable)	Margin of Safety
1	9	30910	0.46
	10	30910	0.46
2	9	38487	0.17
	10	38506	0.17
4	9	38775	0.16
	10	38804	0.16

# Ring 1,2,4 No Subframe: Reaction Structure Edge Bond Strength Load Cases 9, 10– BC2

Ring 1,2,4, BC2, Rib to Rib Minimum Bond Margins					
Ring	Load Combination	Tension (Allowable = 469.3 lb/in )		Shear (Allowable = 568.3 lb/in )	
		Force (lb/in)		Force (lb/in)	
Margin of Safety					
1	9		76.73	188.83	1.70
	10		76.74	188.81	1.70
2	9		217.03	151.69	0.87
	10		216.86	151.46	0.87
4	9		264.13	266.41	0.37
	10		264.08	266.38	0.37

Ring 1,2,4, BC2, Rib to Diamond Cap Minimum Bond Margins					
Ring	Load Combination	Tension (Allowable = 469.3 lb/in )		Shear (Allowable = 568.3 lb/in )	
		Force (lb/in)		Force (lb/in)	
Margin of Safety					
1	9		0.00	217.91	1.60
	10		0.00	217.94	1.60
2	9		0.00	229.00	1.50
	10		0.00	229.02	1.50
4	9		0.00	319.30	0.78
	10		0.00	319.33	0.78

# Ring 1,2,4 No Subframe: Reaction Structure Edge Bond Strength Load Cases 9, 10– BC3

Ring 1,2,4, BC3, Rib to Rib Minimum Bond Margins				
Ring	Load Combination	Tension (Allowable =	Shear (Allowable =	Margin of Safety
		469.3 lb/in ) Force (lb/in)	568.3 lb/in) Force (lb/in)	
1	9	74.07	164.65	2.00
	10	74.07	164.65	2.00
2	9	106.13	176.71	1.60
	10	106.13	176.72	1.60
4	9	143.83	148.05	1.50
	10	143.79	148.02	1.50

Ring 1,2,4, BC3, Rib to Diamond Cap Minimum Bond Margins				
Ring	Load Combination	Tension (Allowable =	Shear (Allowable =	Margin of Safety
		469.3 lb/in ) Force (lb/in)	568.3 lb/in) Force (lb/in)	
1	9	0.00	191.51	2.00
	10	0.00	191.55	2.00
2	9	0.00	169.01	2.40
	10	0.00	169.03	2.40
4	9	0.00	200.93	1.80
	10	0.00	200.96	1.80

# Rings 1,2,4 No Subframe: Reaction Structure Fitting Lap Shear Bond Strength – BC2, BC3

**BC2**

Ring	Load Combination Number	Adjuster's Base Area = 1.16 in <sup>2</sup>		Axial (Z) Fittings Area = 2.1 in <sup>2</sup>		Lateral (X,Y) Fittings Area = 12.5 in <sup>2</sup>	
		Force (lb)	Margin of Safety	Force (lb)	Margin of Safety	Force (lb)	Margin of Safety
1	9	12	305	N/A	N/A	3562	10
	10	12	313	N/A	N/A	3562	10
2	9	23	161	411	15	4231	8
	10	24	153	406	16	4231	8
4	9	27	134	N/A	N/A	5305	7
	10	28	129	N/A	N/A	5305	7

**BC3**

Ring	Load Combination Number	Adjuster's Base Area = 1.16 in <sup>2</sup>		Axial (Z) Fittings Area = 2.1 in <sup>2</sup>		Lateral (X,Y) Fittings Area = 12.5 in <sup>2</sup>	
		Force (lb)	Margin of Safety	Force (lb)	Margin of Safety	Force (lb)	Margin of Safety
1	9	12	321	N/A	N/A	3011	12
	10	11	329	N/A	N/A	3011	12
2	9	19	196	350	18	2991	12
	10	20	185	345	18	2991	12
4	9	22	169	N/A	N/A	2958	12
	10	23	162	N/A	N/A	2958	12