

Wavelets and Affine Distributions

A Time-Frequency Perspective

Franz Hlawatsch

Institute of Communications and Radio-Frequency Engineering
Vienna University of Technology



OUTLINE

- The notion of time-frequency analysis
- Linear and quadratic time-frequency analysis
- Short-time Fourier transform and wavelet transform; spectrogram and scalogram
- Constant-bandwidth analysis vs. constant-Q analysis
- The affine class
- Affine time-frequency smoothing
- Hyperbolic time-frequency localization

Report Documentation Page

Form Approved
OMB No. 0704-0188

Public reporting burden for the collection of information is estimated to average 1 hour per response, including the time for reviewing instructions, searching existing data sources, gathering and maintaining the data needed, and completing and reviewing the collection of information. Send comments regarding this burden estimate or any other aspect of this collection of information, including suggestions for reducing this burden, to Washington Headquarters Services, Directorate for Information Operations and Reports, 1215 Jefferson Davis Highway, Suite 1204, Arlington VA 22202-4302. Respondents should be aware that notwithstanding any other provision of law, no person shall be subject to a penalty for failing to comply with a collection of information if it does not display a currently valid OMB control number.

1. REPORT DATE 07 JAN 2005	2. REPORT TYPE N/A	3. DATES COVERED -	
4. TITLE AND SUBTITLE Wavelets and Affine Distributions A Time-Frequency Perspective		5a. CONTRACT NUMBER	
		5b. GRANT NUMBER	
		5c. PROGRAM ELEMENT NUMBER	
6. AUTHOR(S)		5d. PROJECT NUMBER	
		5e. TASK NUMBER	
		5f. WORK UNIT NUMBER	
7. PERFORMING ORGANIZATION NAME(S) AND ADDRESS(ES) Institute of Communications and Radio-Frequency Engineering Vienna University of Technology		8. PERFORMING ORGANIZATION REPORT NUMBER	
9. SPONSORING/MONITORING AGENCY NAME(S) AND ADDRESS(ES)		10. SPONSOR/MONITOR'S ACRONYM(S)	
		11. SPONSOR/MONITOR'S REPORT NUMBER(S)	
12. DISTRIBUTION/AVAILABILITY STATEMENT Approved for public release, distribution unlimited			
13. SUPPLEMENTARY NOTES See also ADM001750, Wavelets and Multifractal Analysis (WAMA) Workshop held on 19-31 July 2004., The original document contains color images.			
14. ABSTRACT			
15. SUBJECT TERMS			
16. SECURITY CLASSIFICATION OF:			17. LIMITATION OF ABSTRACT
a. REPORT unclassified	b. ABSTRACT unclassified	c. THIS PAGE unclassified	UU
			18. NUMBER OF PAGES 27
			19a. NAME OF RESPONSIBLE PERSON

OUTLINE

- **The notion of time-frequency analysis**
- Linear and quadratic time-frequency analysis
- Short-time Fourier transform and wavelet transform; spectrogram and scalogram
- Constant-bandwidth analysis vs. constant-Q analysis
- The affine class
- Affine time-frequency smoothing
- Hyperbolic time-frequency localization

The notion of time-frequency (TF) analysis

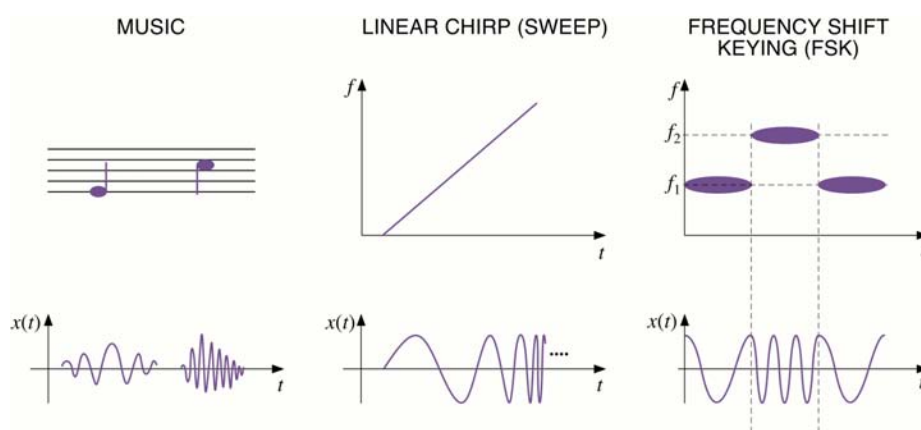

Auditory perception as TF analysis

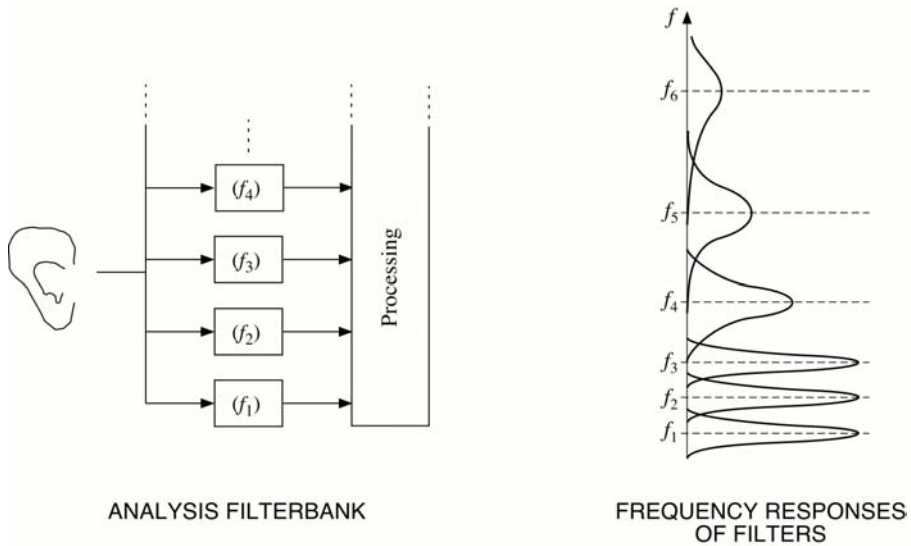

WAMA-04 Cargèse, France

- 5 -

The TF plane

- Visualize time-frequency location/concentration of signal $x(t)$:

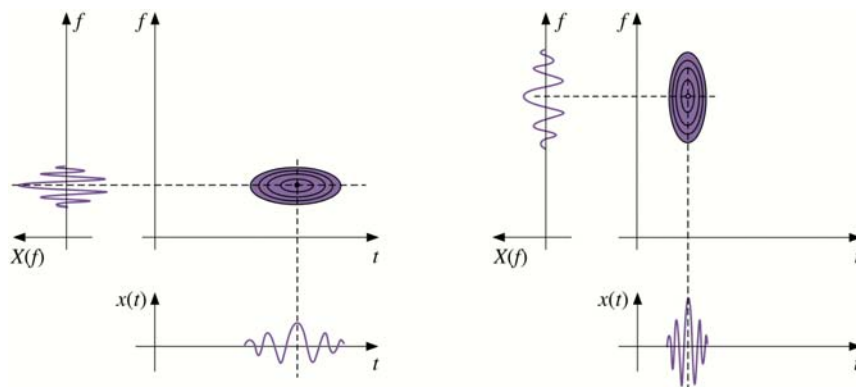

WAMA-04 Cargèse, France

- 6 -

OUTLINE

- The notion of time-frequency analysis
- **Linear and quadratic time-frequency analysis**
- Short-time Fourier transform and wavelet transform; spectrogram and scalogram
- Constant-bandwidth analysis vs. constant-Q analysis
- The affine class
- Affine time-frequency smoothing
- Hyperbolic time-frequency localization

Linear TF analysis

- **TF analysis:** Measure contribution of TF point (t_0, f_0) to signal $x(t)$
- **General approach:** Inner product of $x(t)$ with “test signal” or “sounding signal” $\psi_{t_0, f_0}(t)$ located about (t_0, f_0) :

$$\text{LTFR}_x(t_0, f_0) := \langle x, \psi_{t_0, f_0} \rangle = \int_{-\infty}^{\infty} x(t) \psi_{t_0, f_0}^*(t) dt$$

LTFR = Linear TF Representation

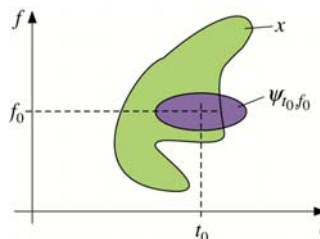

Linear TF synthesis

- **TF synthesis (inversion of LTFR):** Recover (“synthesize”) signal $x(t)$ from $LTFR_x(t_0, f_0)$

- **General approach:**

$$x(t) = \int_{-\infty}^{\infty} \int_{-\infty}^{\infty} LTFR_x(t_0, f_0) \tilde{\psi}_{t_0, f_0}(t) dt_0 df_0$$

$x(t)$ is represented as superposition of TF localized signal components, weighted by “TF coefficient function” $LTFR_x(t_0, f_0)$

- **Problem:** How to construct test (analysis) functions $\psi_{t_0, f_0}(t)$ and synthesis functions $\tilde{\psi}_{t_0, f_0}(t)$?

Quadratic TF analysis

- **TF analysis:** Measure “energy contribution” of TF point (t_0, f_0) to signal $x(t)$

- **Simple approach:**

$$\begin{aligned} QTFR_x(t_0, f_0) &:= |LTFR_x(t_0, f_0)|^2 = |\langle x, \psi_{t_0, f_0} \rangle|^2 \\ &= \int_{-\infty}^{\infty} \int_{-\infty}^{\infty} x(t_1) x^*(t_2) \psi_{t_0, f_0}^*(t_1) \psi_{t_0, f_0}(t_2) dt_1 dt_2 \end{aligned}$$

QTFR = Quadratic TF Representation

- Want QTFR to distribute signal energy E_x over TF plane:

$$\int_{-\infty}^{\infty} \int_{-\infty}^{\infty} QTFR_x(t, f) dt df = E_x \quad \text{“TF energy distribution”}$$

- **Problem:** How to construct test (analysis) functions $\psi_{t_0, f_0}(t)$?

Construction of analysis/synthesis functions

- **Problem:** Construct family of analysis functions $\{\psi_{t_0, f_0}(t)\}$ such that $\psi_{t_0, f_0}(t)$ is localized about TF point (t_0, f_0)
- **Systematic approach:** $\psi_{t_0, f_0}(t)$ derived from “prototype function” $\psi(t)$ via unitary “TF displacement operator” U_{t_0, f_0} :

$$\psi_{t_0, f_0}(t) := (U_{t_0, f_0} \psi)(t)$$

- Same for synthesis functions $\{\tilde{\psi}_{t_0, f_0}(t)\}$:

$$\tilde{\psi}_{t_0, f_0}(t) := (U_{t_0, f_0} \tilde{\psi})(t)$$

- **Two classical definitions of U_{t_0, f_0} :**
 - TF shift
 - TF scaling (compression/dilatation) + time shift

Two classical definitions of operator U

- **TF shift:**

$$\begin{aligned} \psi_{t_0, f_0}(t) &= (U_{t_0, f_0} \psi)(t) \\ &= \psi(t - t_0) e^{j2\pi f_0 t} \end{aligned}$$

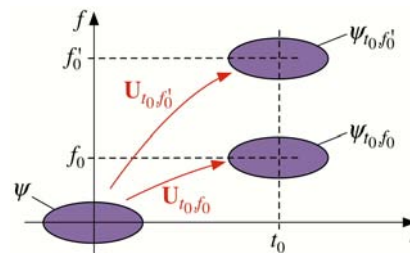

- **TF scaling + time shift:**

$$\begin{aligned} \psi_{t_0, f_0}(t) &= (U_{t_0, f_0} \psi)(t) \\ &= \sqrt{\frac{f_0}{f_\psi}} \psi\left(\frac{f_0}{f_\psi}(t - t_0)\right) \\ &= \frac{1}{\sqrt{a}} \psi\left(\frac{t - t_0}{a}\right) \Big|_{a=f_\psi/f_0} \end{aligned}$$

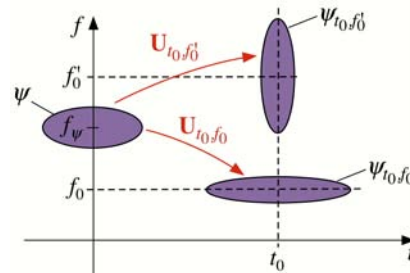

OUTLINE

- The notion of time-frequency analysis
- Linear and quadratic time-frequency analysis
- **Short-time Fourier transform and wavelet transform; spectrogram and scalogram**
- Constant-bandwidth analysis vs. constant-Q analysis
- The affine class
- Affine time-frequency smoothing
- Hyperbolic time-frequency localization

Short-Time Fourier Transform (STFT)

- Recall TF shift:

$$\psi_{t_0, f_0}(t) = (\mathbf{U}_{t_0, f_0} \psi)(t) = \psi(t - t_0) e^{j2\pi f_0 t}$$

- \Rightarrow LTFR = **STFT**:

$$\text{STFT}_x(t_0, f_0) = \langle x, \mathbf{U}_{t_0, f_0} \psi \rangle = \int_{-\infty}^{\infty} x(t) \psi^*(t - t_0) e^{-j2\pi f_0 t} dt$$

STFT = FT of local (windowed) segment of $x(t)$:

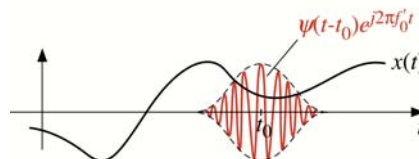

STFT signal synthesis

- Recall STFT analysis:

$$\text{STFT}_x(t_0, f_0) = \langle x, \mathbf{U}_{t_0, f_0} \psi \rangle = \int_{-\infty}^{\infty} x(t) \psi^*(t-t_0) e^{-j2\pi f_0 t} dt$$

- STFT signal synthesis:

$$\begin{aligned} x(t) &= \int_{-\infty}^{\infty} \int_{-\infty}^{\infty} \text{STFT}_x(t_0, f_0) (\mathbf{U}_{t_0, f_0} \tilde{\psi})(t) dt_0 df_0 \\ &= \int_{-\infty}^{\infty} \int_{-\infty}^{\infty} \text{STFT}_x(t_0, f_0) \tilde{\psi}(t-t_0) e^{j2\pi f_0 t} dt_0 df_0 \end{aligned}$$

$x(t)$ is weighted superposition of TF shifted versions of $\tilde{\psi}(t)$

Wavelet Transform (WT)

- Recall TF scaling + time shift:

$$\psi_{t_0, f_0}(t) = (\mathbf{U}_{t_0, f_0} \psi)(t) = \sqrt{\frac{f_0}{f_\psi}} \psi\left(\frac{f_0}{f_\psi}(t-t_0)\right)$$

- \Rightarrow LTFR = WT:

$$\text{WT}_x(t_0, f_0) = \langle x, \mathbf{U}_{t_0, f_0} \psi \rangle = \int_{-\infty}^{\infty} x(t) \sqrt{\frac{f_0}{f_\psi}} \psi^*\left(\frac{f_0}{f_\psi}(t-t_0)\right) dt$$

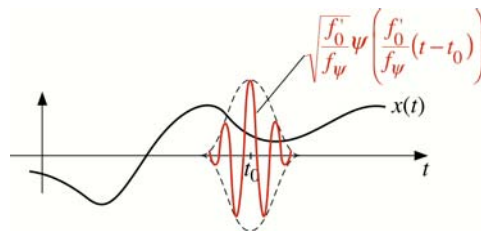

WT signal synthesis

- Recall WT analysis:

$$\text{WT}_x(t_0, f_0) = \langle x, \mathbf{U}_{t_0, f_0} \psi \rangle = \int_{-\infty}^{\infty} x(t) \sqrt{\frac{f_0}{f_\psi}} \psi^* \left(\frac{f_0}{f_\psi} (t - t_0) \right) dt$$

- WT signal synthesis:

$$\begin{aligned} x(t) &= \int_0^{\infty} \int_{-\infty}^{\infty} \text{WT}_x(t_0, f_0) (\mathbf{U}_{t_0, f_0} \tilde{\psi})(t) dt_0 df_0 \\ &= \int_0^{\infty} \int_{-\infty}^{\infty} \text{WT}_x(t_0, f_0) \sqrt{\frac{f_0}{f_\psi}} \tilde{\psi} \left(\frac{f_0}{f_\psi} (t - t_0) \right) dt_0 df_0 \end{aligned}$$

$x(t)$ is weighted superposition of TF scaled and time shifted versions of $\tilde{\psi}(t)$

Spectrogram and scalogram

- Recall LTFR \rightarrow QTFR:

$$\text{QTFR}_x(t_0, f_0) = |\text{LTFR}_x(t_0, f_0)|^2 = |\langle x, \mathbf{U}_{t_0, f_0} \psi \rangle|^2$$

- STFT \rightarrow spectrogram:

$$\text{SPEC}_x(t_0, f_0) := |\text{STFT}_x(t_0, f_0)|^2 = \left| \int_{-\infty}^{\infty} x(t) \psi^*(t - t_0) e^{-j2\pi f_0 t} dt \right|^2$$

- WT \rightarrow scalogram:

$$\text{SCAL}_x(t_0, f_0) := |\text{WT}_x(t_0, f_0)|^2 = \left| \int_{-\infty}^{\infty} x(t) \sqrt{\frac{f_0}{f_\psi}} \psi^* \left(\frac{f_0}{f_\psi} (t - t_0) \right) dt \right|^2$$

OUTLINE

- The notion of time-frequency analysis
- Linear and quadratic time-frequency analysis
- Short-time Fourier transform and wavelet transform; spectrogram and scalogram
- **Constant-bandwidth analysis vs. constant-Q analysis**
- The affine class
- Affine time-frequency smoothing
- Hyperbolic time-frequency localization

STFT and constant-BW filterbank: analysis

- STFT analysis as convolution:

$$\begin{aligned} \text{STFT}_x(t_0, f_0) &= \int_{-\infty}^{\infty} x(t) \psi^*(t-t_0) e^{-j2\pi f_0 t} dt \\ &= [x(t) * \psi^*(-t) e^{j2\pi f_0 t}] \cdot e^{-j2\pi f_0 t} \Big|_{t=t_0} \end{aligned}$$

- \Rightarrow Filterbank interpretation/implementation:

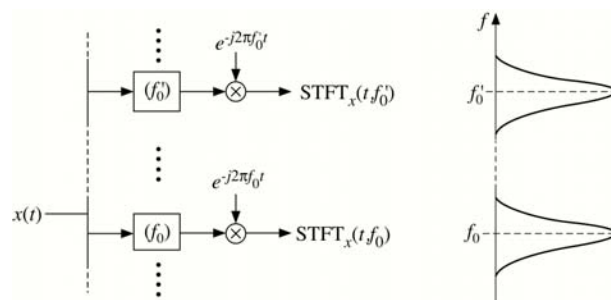

STFT and constant-BW filterbank: synthesis

- STFT synthesis as convolution:

$$x(t) = \int_{-\infty}^{\infty} \int_{-\infty}^{\infty} \text{STFT}_x(t_0, f_0) \tilde{\psi}(t-t_0) e^{j2\pi f_0 t} dt_0 df_0$$

$$= \int_{-\infty}^{\infty} \left[\text{STFT}_x(t_0, f_0) e^{j2\pi f_0 t_0} * \tilde{\psi}(t-t_0) e^{j2\pi f_0 t_0} \right]_{t_0=t} df_0$$

- \Rightarrow Filterbank interpretation/implementation:

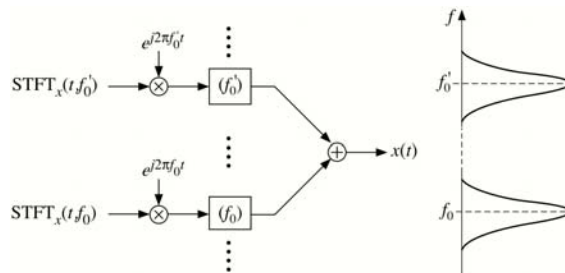

Spectrogram analysis as constant-BW filterbank

- Spectrogram analysis as convolution:

$$\text{SPEC}_x(t_0, f_0) = |\text{STFT}_x(t_0, f_0)|^2 = \left| [x(t) * \psi^*(-t) e^{j2\pi f_0 t}]_{t=t_0} \right|^2$$

- \Rightarrow Filterbank interpretation/implementation:

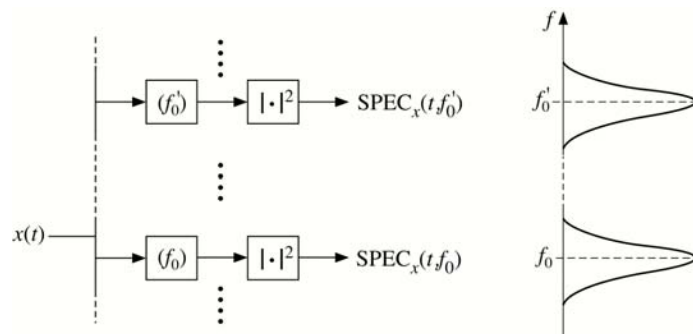

STFT / spectrogram: example

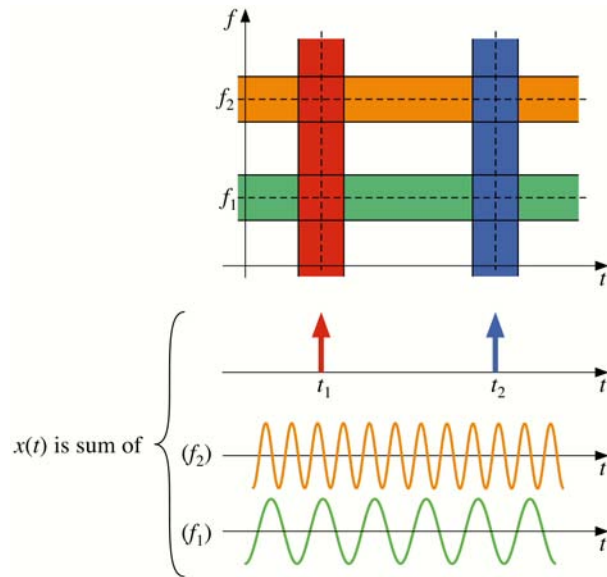

WAMA-04 Cargèse, France

- 23 -

WT and constant-Q filterbank: analysis

- WT analysis as convolution:

$$\begin{aligned} \text{WT}_x(t_0, f_0) &= \int_{-\infty}^{\infty} x(t) \sqrt{\frac{f_0}{f_\psi}} \psi^* \left(\frac{f_0}{f_\psi} (t - t_0) \right) dt \\ &= \left[x(t) * \sqrt{\frac{f_0}{f_\psi}} \psi^* \left(-\frac{f_0}{f_\psi} t \right) \right]_{t=t_0} \end{aligned}$$

- \Rightarrow Filterbank interpretation/implementation:

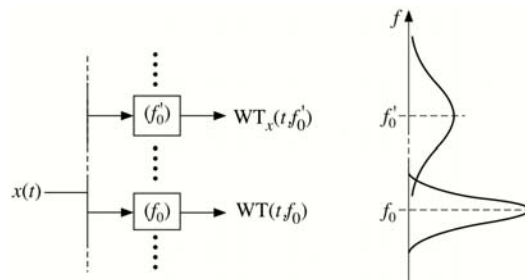

WAMA-04 Cargèse, France

- 24 -

WT and constant-Q filterbank: synthesis

- WT synthesis as convolution:

$$x(t) = \int_0^{\infty} \int_{-\infty}^{\infty} \text{WT}_x(t_0, f_0) \sqrt{\frac{f_0}{f_\psi}} \tilde{\psi}\left(\frac{f_0}{f_\psi}(t-t_0)\right) dt_0 df_0$$

$$= \int_0^{\infty} \left[\text{WT}_x(t_0, f_0) * \sqrt{\frac{f_0}{f_\psi}} \tilde{\psi}\left(\frac{f_0}{f_\psi} t_0\right) \right]_{t_0=t} df_0$$

- \Rightarrow Filterbank interpretation/implementation:

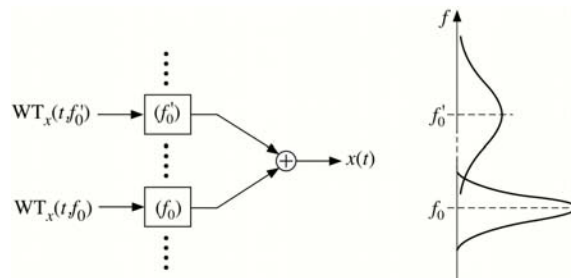

Scalogram analysis as constant-Q filterbank

- Scalogram analysis as convolution:

$$\text{SCAL}_x(t_0, f_0) = |\text{WT}_x(t_0, f_0)|^2 = \left| \left[x(t) * \sqrt{\frac{f_0}{f_\psi}} \psi^*\left(-\frac{f_0}{f_\psi} t\right) \right]_{t=t_0} \right|^2$$

- \Rightarrow Filterbank interpretation/implementation:

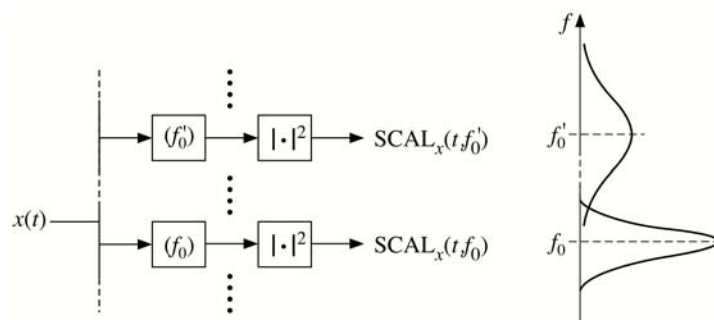

WT / scalogram: example

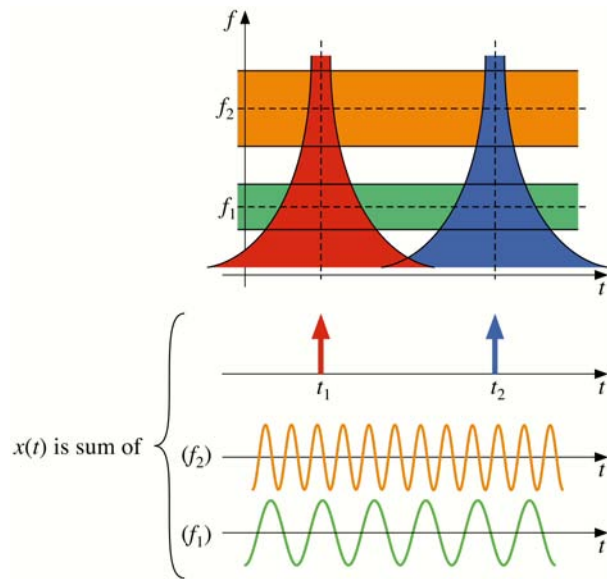

WAMA-04 Cargèse, France

- 27 -

STFT / spectrogram vs. WT / scalogram

STFT / spectrogram

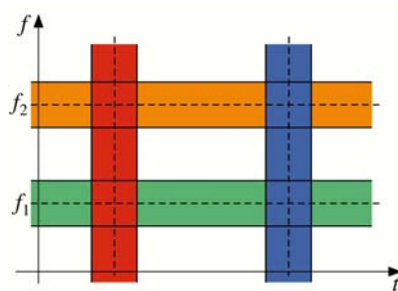

WT / scalogram

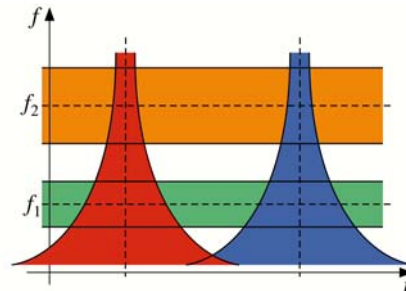

WAMA-04 Cargèse, France

- 28 -

Good-bye and hello

- Good-bye to:
 - STFT
 - spectrogram
 - constant-BW analysis
- Hello to:
 - affine class of QTFRs
 - Wigner distribution and Bertrand distribution
 - hyperbolic TF localization

OUTLINE

- The notion of time-frequency analysis
- Linear and quadratic time-frequency analysis
- Short-time Fourier transform and wavelet transform; spectrogram and scalogram
- Constant-bandwidth analysis vs. constant-Q analysis
- ***The affine class***
- Affine time-frequency smoothing
- Hyperbolic time-frequency localization

Axiomatic (covariance-based) definition of WT

- Generic LTFR expression:

$$\text{LTFR}_x(t, f) = \int_{-\infty}^{\infty} x(t') K(t'; t, f) dt'$$

- **Covariance** of LTFR to TF scalings + time shifts:

$$y(t) = \frac{1}{\sqrt{a}} x\left(\frac{t-\tau}{a}\right) \leftrightarrow Y(f) = \sqrt{a} X(af) e^{-j2\pi\tau f}$$

$$\Rightarrow \text{LTFR}_y(t, f) = \text{LTFR}_x\left(\frac{t-\tau}{a}, af\right)$$

- Can show that **covariant LTFRs are given by WT**

$$\text{WT}_x(t, f) = \int_{-\infty}^{\infty} x(t') \sqrt{\frac{f}{f_\psi}} \psi^*\left(\frac{f}{f_\psi}(t'-t)\right) dt' = \sqrt{f} \int_{-\infty}^{\infty} x(t') \phi(f(t'-t)) dt'$$

Axiomatic (covariance-based) definition of the affine class of QTFRs

- Generic QTFR expression:

$$\text{QTFR}_x(t, f) = \int_{-\infty}^{\infty} \int_{-\infty}^{\infty} x(t_1) x^*(t_2) K(t_1, t_2; t, f) dt_1 dt_2$$

- **Covariance** of QTFR to TF scalings + time shifts:

$$y(t) = \frac{1}{\sqrt{a}} x\left(\frac{t-\tau}{a}\right) \leftrightarrow Y(f) = \sqrt{a} X(af) e^{-j2\pi\tau f}$$

$$\Rightarrow \text{QTFR}_y(t, f) = \text{QTFR}_x\left(\frac{t-\tau}{a}, af\right)$$

- Can show that **covariant QTFRs are given by**

$$\text{AC}_x(t, f) = f \int_{-\infty}^{\infty} \int_{-\infty}^{\infty} x(t_1) x^*(t_2) \phi(f(t_1-t), f(t_2-t)) dt_1 dt_2$$

AC = Affine Class

The affine class of QTFRs

- Affine class of QTFRs:

$$AC_x(t, f) = f \int_{-\infty}^{\infty} \int_{-\infty}^{\infty} x(t_1) x^*(t_2) \phi(f(t_1-t), f(t_2-t)) dt_1 dt_2$$

- 2-D “kernel” $\phi(\alpha_1, \alpha_2)$ specifies QTFR of the AC
- Scalogram is a member of the AC; its kernel is *separable*:

$$\phi(\alpha_1, \alpha_2) = \frac{1}{f_\psi} \psi^*\left(\frac{\alpha_1}{f_\psi}\right) \psi\left(\frac{\alpha_2}{f_\psi}\right)$$

- Expression of AC QTFRs in terms of signal's FT:

$$AC_x(t, f) = \frac{1}{f} \int_0^{\infty} \int_0^{\infty} X(f_1) X^*(f_2) \Phi\left(\frac{f_1}{f}, \frac{f_2}{f}\right) e^{j2\pi(f_1-f_2)t} df_1 df_2$$

Affine class and affine group

- TF scaling + time shift:

$$(\mathbf{U}_{a,\tau} x)(t) = \frac{1}{\sqrt{a}} x\left(\frac{t-\tau}{a}\right) = \sqrt{\beta} x(\beta t + \gamma) =: (\tilde{\mathbf{U}}_{\beta,\gamma} x)(t)$$

- Affine time transformation $t \rightarrow \beta t + \gamma$ (“clock change”)
- Composition of clock changes is another clock change:

$$\tilde{\mathbf{U}}_{\beta_2,\gamma_2} \tilde{\mathbf{U}}_{\beta_1,\gamma_1} = \tilde{\mathbf{U}}_{\beta_1\beta_2,\gamma_1+\beta_1\gamma_2}$$

- $\Rightarrow \tilde{\mathbf{U}}_{\beta,\gamma}$ is unitary representation of the **affine group**:

- Set: $(\beta, \gamma) \in \mathbb{R}^+ \times \mathbb{R}$
- Group operation: $(\beta_1, \gamma_1) \circ (\beta_2, \gamma_2) = (\beta_1\beta_2, \gamma_1 + \beta_1\gamma_2)$
- Neutral element: $(\beta_0, \gamma_0) = (1, 0)$

OUTLINE

- The notion of time-frequency analysis
- Linear and quadratic time-frequency analysis
- Short-time Fourier transform and wavelet transform; spectrogram and scalogram
- Constant-bandwidth analysis vs. constant-Q analysis
- The affine class
- **Affine time-frequency smoothing**
- Hyperbolic time-frequency localization

The Wigner-Ville Distribution (WVD)

- Prominent member of the AC: the WVD

$$\text{WVD}_x(t, f) = \int_{-\infty}^{\infty} x\left(t + \frac{\tau}{2}\right) x^*\left(t - \frac{\tau}{2}\right) e^{-j2\pi f\tau} d\tau$$

- Properties of the WVD:
 - Covariant to TF scaling and time shift (of course)
 - Covariant to frequency shift \Rightarrow **not constant-Q**
 - Real for any (real or complex) signal $x(t)$
 - Marginal properties: e.g., $\int_{-\infty}^{\infty} \text{WVD}_x(t, f) dt = |X(f)|^2$
 - Localization properties: e.g., $\text{WVD}_x(t, f) = \delta(f - f_0)$ for $x(t) = e^{j2\pi f_0 t}$
 - Many more...

Interference terms in the WVD

$$\begin{aligned} \text{WVD}_{x_1+x_2}(t, f) &= \text{WVD}_{x_1}(t, f) + \text{WVD}_{x_2}(t, f) \\ &\quad + \underbrace{2 \operatorname{Re}\{\text{WVD}_{x_1, x_2}(t, f)\}}_{\text{Interference/cross term}} \end{aligned}$$

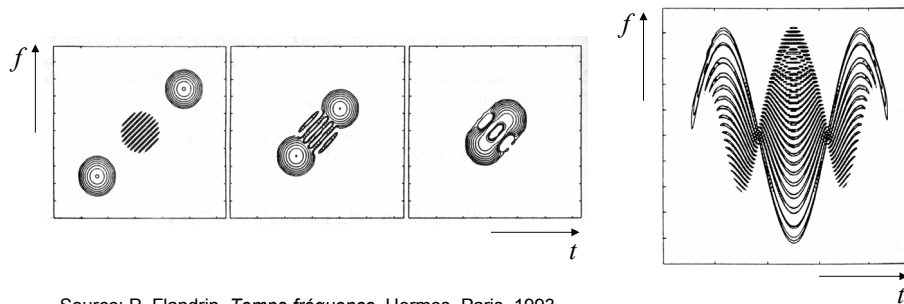

Source: P. Flandrin, *Temps-fréquence*. Hermes, Paris, 1993

Constant-BW smoothing of the WVD

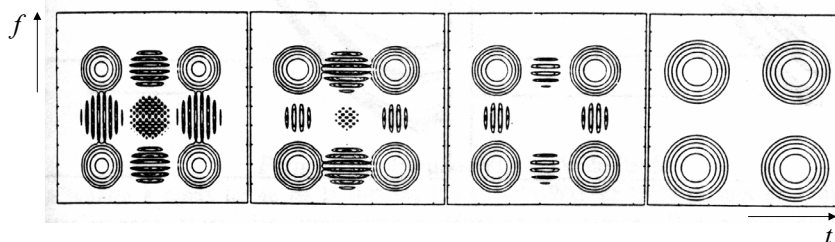

Smaller/less interference terms
 →
 Poorer TF resolution

Source: P. Flandrin, *Temps-fréquence*. Hermes, Paris, 1993

AC expression in terms of WVD

- Any QTFR of the AC can be expressed in terms of the WVD:

$$AC_x(t, f) = \int_0^{\infty} \int_{-\infty}^{\infty} WVD_x(t', f') \sigma\left(f(t'-t), \frac{f'}{f}\right) dt' df'$$

where $\sigma(\alpha, \beta)$ is related to $\phi(\alpha_1, \alpha_2)$ and $\Phi(\beta_1, \beta_2)$ by FTs

- If $\sigma(\alpha, \beta)$ is a *smooth* function, then $AC_x(t, f)$ is a **smoothed version** of $WVD_x(t, f)$
- Smoothing causes...**
 - smaller/less interference terms
 - poorer TF resolution

Affine (constant-Q) smoothing, different from constant-BW smoothing shown on previous slide!

Affine (constant-Q) smoothing of the WVD

- Recall: $AC_x(t, f) = \int_0^{\infty} \int_{-\infty}^{\infty} WVD_x(t', f') \underbrace{\sigma\left(f(t'-t), \frac{f'}{f}\right)}_{\text{Smoothing function}} dt' df'$

- Smoothing function $\sigma\left(f(t'-t), \frac{f'}{f}\right)$ at various TF positions:

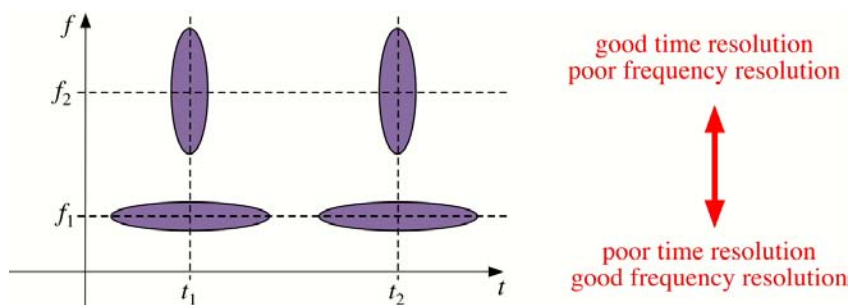

Affine smoothing: example

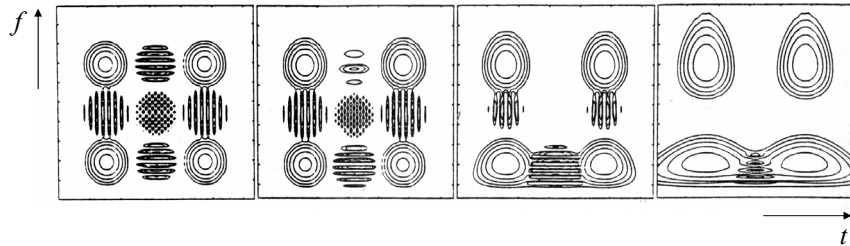

Smaller/less interference terms

Poorer TF resolution

Source: P. Flandrin, *Temps-fréquence*. Hermes, Paris, 1993

Scalogram as smoothed WVD

- Recall scalogram:

$$\text{SCAL}_x(t, f) := |\text{WT}_x(t, f)|^2 = \left| \int_{-\infty}^{\infty} x(t') \sqrt{\frac{f}{f_\psi}} \psi^* \left(\frac{f}{f_\psi} (t' - t) \right) dt' \right|^2$$

- Expression of scalogram as smoothed WVD:

$$\text{SCAL}_x(t, f) = \int_0^{\infty} \int_{-\infty}^{\infty} \text{WVD}_x(t', f') \underbrace{\text{WVD}_\psi \left(\frac{f}{f_\psi} (t' - t), \frac{f'}{f/f_\psi} \right)}_{\text{Smoothing function is WVD of wavelet:}} dt' df'$$

$$\sigma(\alpha, \beta) = \text{WVD}_\psi \left(\frac{\alpha}{f_\psi}, f_\psi \beta \right)$$

Affine WVD smoothing and constant-Q analysis

- Scalogram as smoothed WVD:

$$\begin{aligned} \text{SCAL}_x(t, f) &= \int_0^\infty \int_{-\infty}^\infty \text{WVD}_x(t', f') \text{WVD}_\psi\left(\frac{f}{f_\psi}(t'-t), \frac{f'}{f/f_\psi}\right) dt' df' \\ &= \left| \int_{-\infty}^\infty x(t') \sqrt{\frac{f}{f_\psi}} \psi^*\left(\frac{f}{f_\psi}(t'-t)\right) dt' \right|^2 \end{aligned}$$

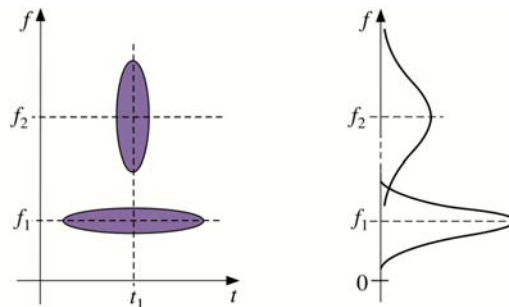

WAMA-04 Cargèse, France

- 43 -

Constant-BW vs. affine (constant-Q) smoothing

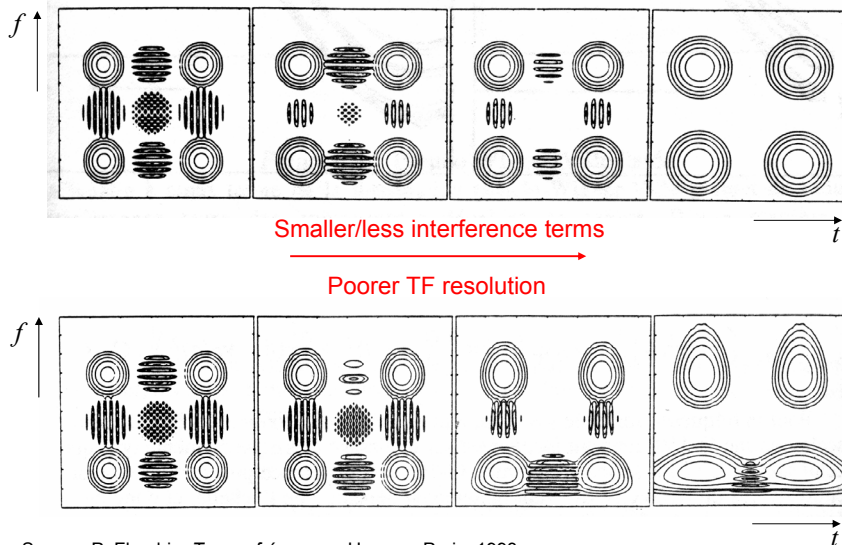

Source: P. Flandrin, *Temps-fréquence*. Hermes, Paris, 1993

WAMA-04 Cargèse, France

- 44 -

OUTLINE

- The notion of time-frequency analysis
- Linear and quadratic time-frequency analysis
- Short-time Fourier transform and wavelet transform; spectrogram and scalogram
- Constant-bandwidth analysis vs. constant-Q analysis
- The affine class
- Affine time-frequency smoothing
- **Hyperbolic time-frequency localization**

Doppler-tolerant signals

- TF scaling / Doppler effect:

$$(C_a x)(t) = \frac{1}{\sqrt{a}} x\left(\frac{t}{a}\right) \leftrightarrow \sqrt{a} X(af)$$

- “Doppler-tolerant” signal = eigenfunction of C_a :

$$(C_a x)(t) = \lambda_a x(t)$$

- Solution: “hyperbolic impulse”

$$X(f) = H_c(f) = \frac{1}{\sqrt{f}} e^{-j2\pi c \ln(f/f_r)}, \quad f > 0, \quad c \in \mathbb{R}$$

- Group delay:

$$\tau(f) = -\frac{1}{2\pi} \frac{d}{df} \arg\{H_c(f)\} = \underbrace{\frac{c}{f}}$$

Hyperbola in the TF plane

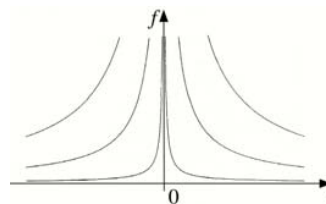

Example: Bat sonar signals

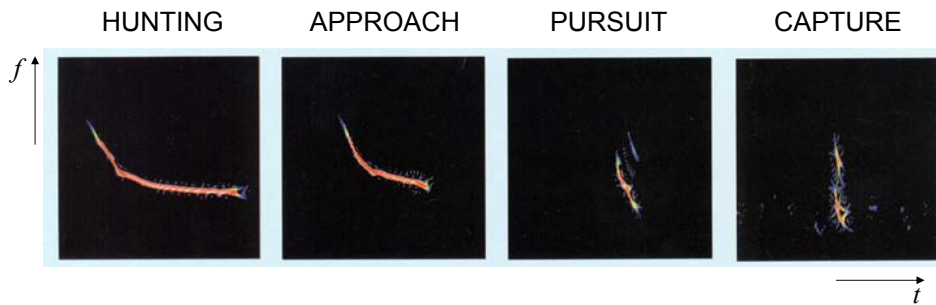

Source: P. Flandrin

WAMA-04 Cargèse, France

- 47 -

Hyperbolic TF localization

- Want AC QTFR to satisfy **hyperbolic TF localization property**:

$$X(f) = \frac{1}{\sqrt{f}} e^{-j2\pi c \ln(f/f_r)} \Rightarrow AC_x(t, f) = \frac{1}{f} \delta\left(t - \frac{c}{f}\right)$$

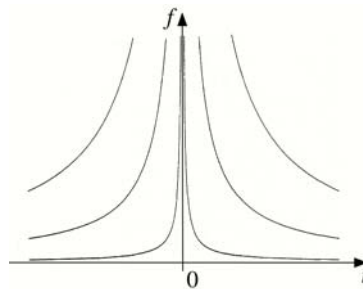

- *Not* satisfied by WVD !

WAMA-04 Cargèse, France

- 48 -

The Bertrand P_0 distribution

- The hyperbolic TF localization property is satisfied by the (unitary) **Bertrand P_0 distribution**

$$\text{BER}_x(t, f) = f \int_{-\infty}^{\infty} X(f \lambda(u)) X^*(f \lambda(-u)) e^{j2\pi f t u} \mu(u) du, \quad f > 0$$

with

$$\lambda(u) = \frac{e^{u/2} u/2}{\sinh(u/2)}, \quad \mu(u) = \frac{u/2}{\sinh(u/2)}$$

- The Bertrand P_0 distribution is a **central member of the AC**. It satisfies several important properties (besides the hyperbolic TF localization property).

Bertrand P_0 distribution as generator of the AC

- Any QTFR of the AC can be expressed in terms of the Bertrand P_0 distribution:

$$\text{AC}_x(t, f) = \int_0^{\infty} \int_{-\infty}^{\infty} \text{BER}_x(t', f') \tilde{\sigma}\left(f(t'-t), \frac{f'}{f}\right) dt' df',$$

where $\tilde{\sigma}(\alpha, \beta)$ is related to $\sigma(\alpha, \beta)$

- Special case: **scalogram**

$$\text{SCAL}_x(t, f) = \int_0^{\infty} \int_{-\infty}^{\infty} \text{BER}_x(t', f') \underbrace{\text{BER}_\psi\left(\frac{f}{f_\psi}(t'-t), \frac{f'}{f/f_\psi}\right)}_{\text{Smoothing function is BER of wavelet}} dt' df'$$

$$\tilde{\sigma}(\alpha, \beta) = \text{BER}_\psi\left(\frac{\alpha}{f_\psi}, f_\psi \beta\right)$$

Mellin transform and hyperbolic marginals

- Recall *hyperbolic impulse* $H_c(f) = \frac{1}{\sqrt{f}} e^{-j2\pi c \ln(f/f_r)}$

- Mellin transform:

$$M_x(c) = \langle X, H_c \rangle = \int_0^{\infty} X(f) e^{j2\pi c \ln(f/f_r)} \frac{df}{\sqrt{f}}$$

- Hyperbolic marginal property:

$$\int_0^{\infty} \underbrace{AC_x\left(\frac{c}{f}, f\right)}_{\text{Integrate } AC_x(t,f) \text{ over TF hyperbola } t=cf} \frac{df}{f} = |M_x(c)|^2$$

Integrate $AC_x(t, f)$ over TF hyperbola $t=cf$

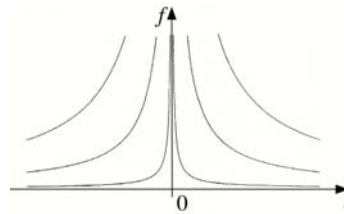

- Not satisfied by WVD... but satisfied by Bertrand P_0 distribution !

Application: TF analysis of gravitational wave

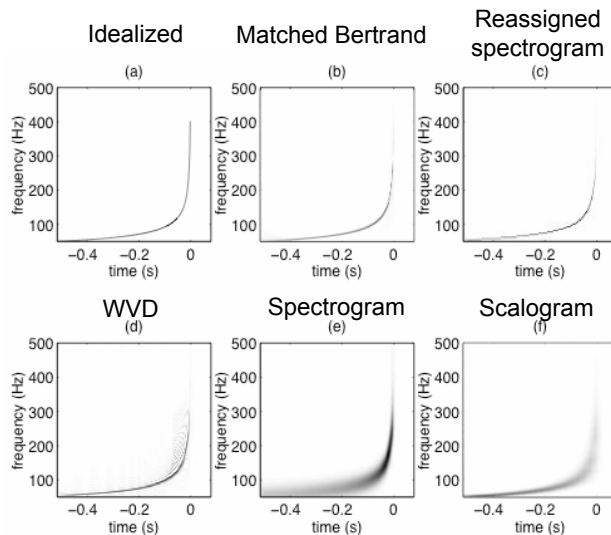

Source: E. Chassande-Mottin and P. Flandrin, On the time-frequency detection of chirps. *Appl. Comp. Harm. Anal.*, 6(9): 252-281, 1999.

Conclusion

- Linear and quadratic TF analysis
- Short-time Fourier transform and spectrogram
- Wavelet transform and scalogram
- Filterbank interpretation: constant-BW analysis versus constant-Q analysis
- Scaling/shift covariance and affine class of QTFRs
- Wigner-Ville distribution and affine smoothing
- Doppler tolerance and hyperbolic impulses
- Hyperbolic TF localization and Bertrand P_0 distribution
- Mellin transform and hyperbolic marginal property

WARNING

YOU ARE LEAVING THE
TIME-FREQUENCY PLANE