

Scaling in Heartbeat Rate Variability

Malvin Carl Teich

Boston University and Columbia University

<http://people.bu.edu/teich>

Colleagues:

- **Conor Heneghan, University College Dublin**
- **Steven Lowen, Harvard Medical School**
- **Robert Turcott, Stanford Medical School**
- **Markus Feurstein, Wirtschaftsuniversität Wien**
- **Stefan Thurner, Allgemeines Krankenhaus Wien**

Report Documentation Page

Form Approved
OMB No. 0704-0188

Public reporting burden for the collection of information is estimated to average 1 hour per response, including the time for reviewing instructions, searching existing data sources, gathering and maintaining the data needed, and completing and reviewing the collection of information. Send comments regarding this burden estimate or any other aspect of this collection of information, including suggestions for reducing this burden, to Washington Headquarters Services, Directorate for Information Operations and Reports, 1215 Jefferson Davis Highway, Suite 1204, Arlington VA 22202-4302. Respondents should be aware that notwithstanding any other provision of law, no person shall be subject to a penalty for failing to comply with a collection of information if it does not display a currently valid OMB control number.

1. REPORT DATE 07 JAN 2005		2. REPORT TYPE N/A		3. DATES COVERED -	
4. TITLE AND SUBTITLE Scaling in Heartbeat Rate Variability				5a. CONTRACT NUMBER	
				5b. GRANT NUMBER	
				5c. PROGRAM ELEMENT NUMBER	
6. AUTHOR(S)				5d. PROJECT NUMBER	
				5e. TASK NUMBER	
				5f. WORK UNIT NUMBER	
7. PERFORMING ORGANIZATION NAME(S) AND ADDRESS(ES) Boston University; Columbia University				8. PERFORMING ORGANIZATION REPORT NUMBER	
9. SPONSORING/MONITORING AGENCY NAME(S) AND ADDRESS(ES)				10. SPONSOR/MONITOR'S ACRONYM(S)	
				11. SPONSOR/MONITOR'S REPORT NUMBER(S)	
12. DISTRIBUTION/AVAILABILITY STATEMENT Approved for public release, distribution unlimited					
13. SUPPLEMENTARY NOTES See also ADM001750, Wavelets and Multifractal Analysis (WAMA) Workshop held on 19-31 July 2004., The original document contains color images.					
14. ABSTRACT					
15. SUBJECT TERMS					
16. SECURITY CLASSIFICATION OF:			17. LIMITATION OF ABSTRACT	18. NUMBER OF PAGES	19a. NAME OF RESPONSIBLE PERSON
a. REPORT unclassified	b. ABSTRACT unclassified	c. THIS PAGE unclassified			



POINT PROCESSES

a) POINT PROCESS $dN(t)$

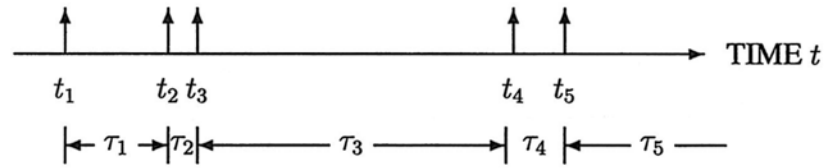

b) COUNTING PROCESS $N(t)$

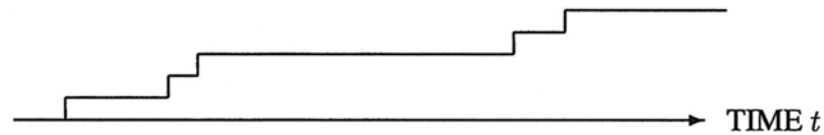

c) GENERATION OF COUNT SEQUENCE

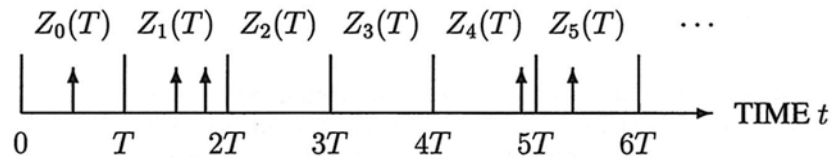

d) COUNT SEQUENCE $\{Z_k(T)\}$

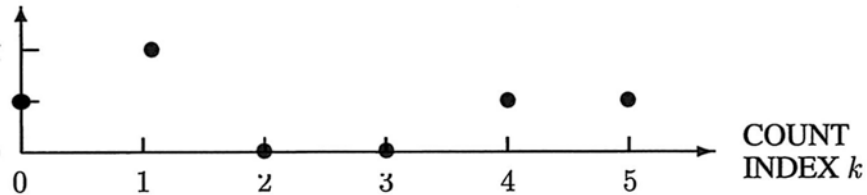

e) INTERVAL SEQUENCE $\{\tau_k\}$

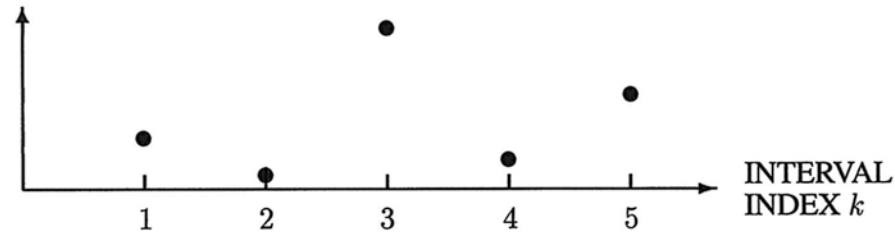



FRACTAL-BASED POINT PROCESSES

- Fractal point processes
- Fractal-rate point processes

S. B. Lowen and M. C. Teich, *Fractal-Based Point Processes*
(Wiley Series in Probability and Statistics, Hoboken, NJ, 2005)
ALMOST DONE!

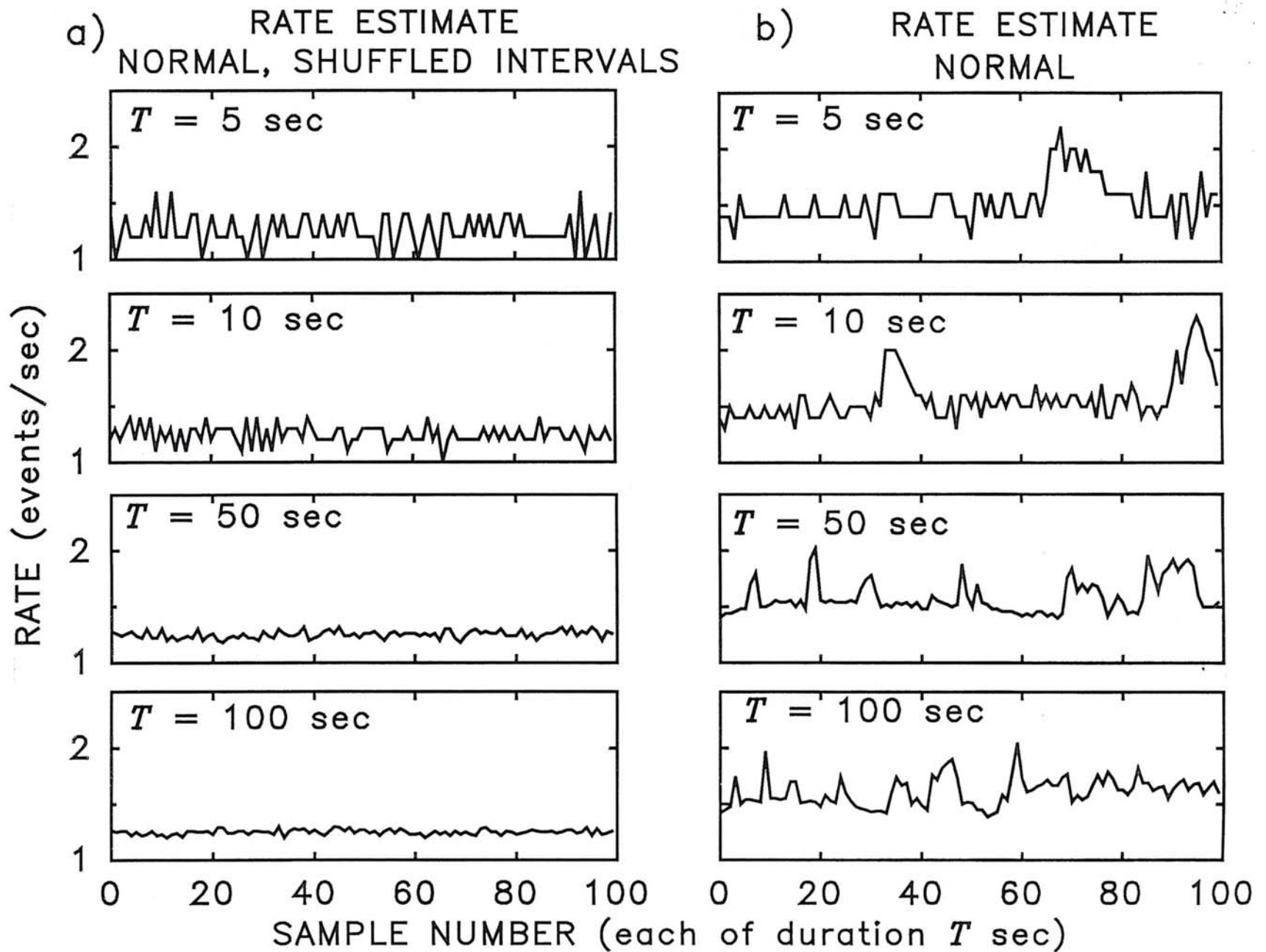



INTERVAL-BASED MEASURES

CONGESTIVE HEART FAILURE

INABILITY OF HEART TO INCREASE CARDIAC OUTPUT IN PROPORTION TO METABOLIC DEMANDS

Symptom complex:

Many different presentations and etiologies

Typical symptoms:

- Shortness of breath
- Swelling in legs
- General fatigue and weakness

Clinical diagnostics:

- Ascultate heart
- Carotid pulse
- Electrocardiogram
- Chest radiograph

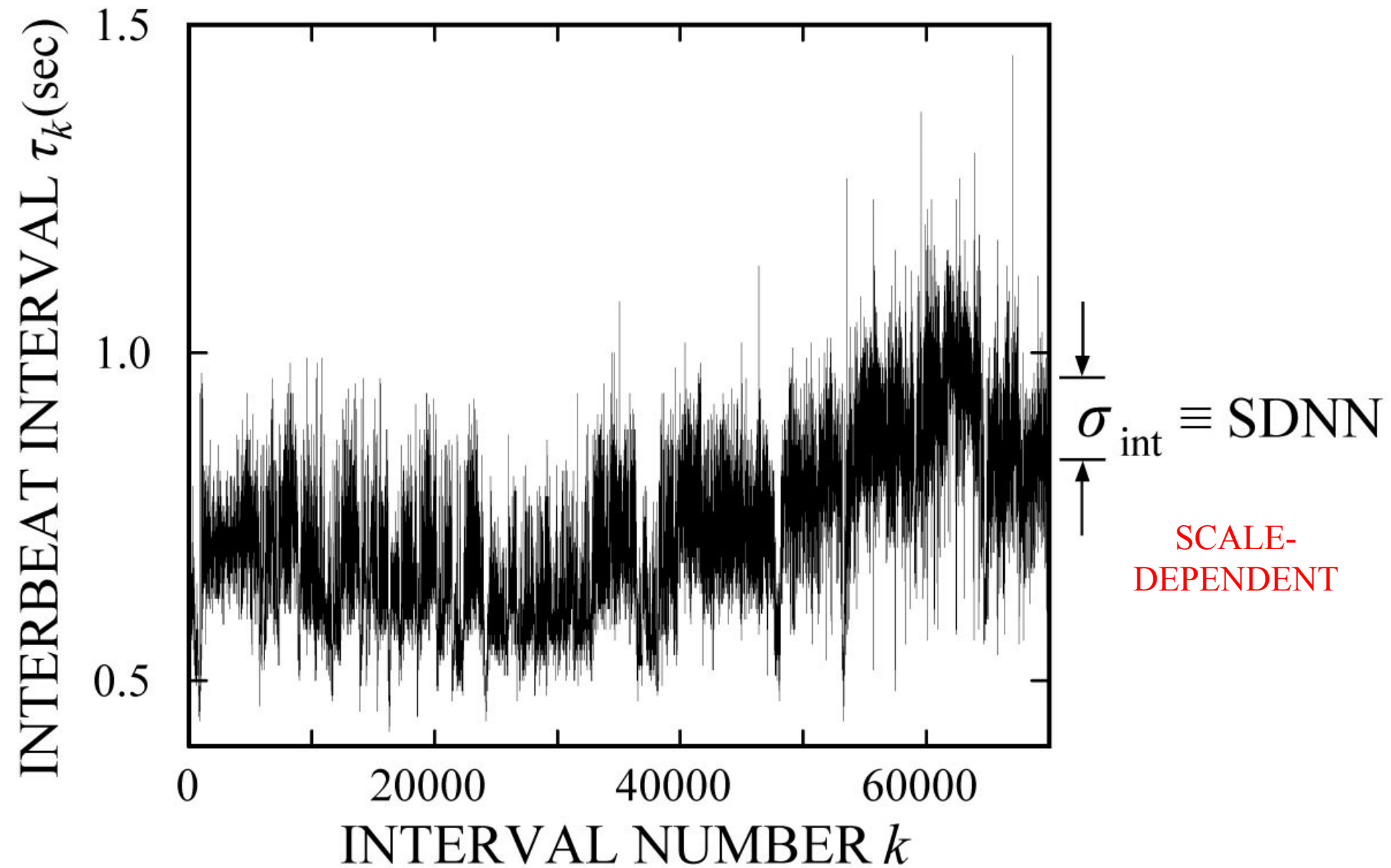

INTEREVENT-INTERVAL HISTOGRAM

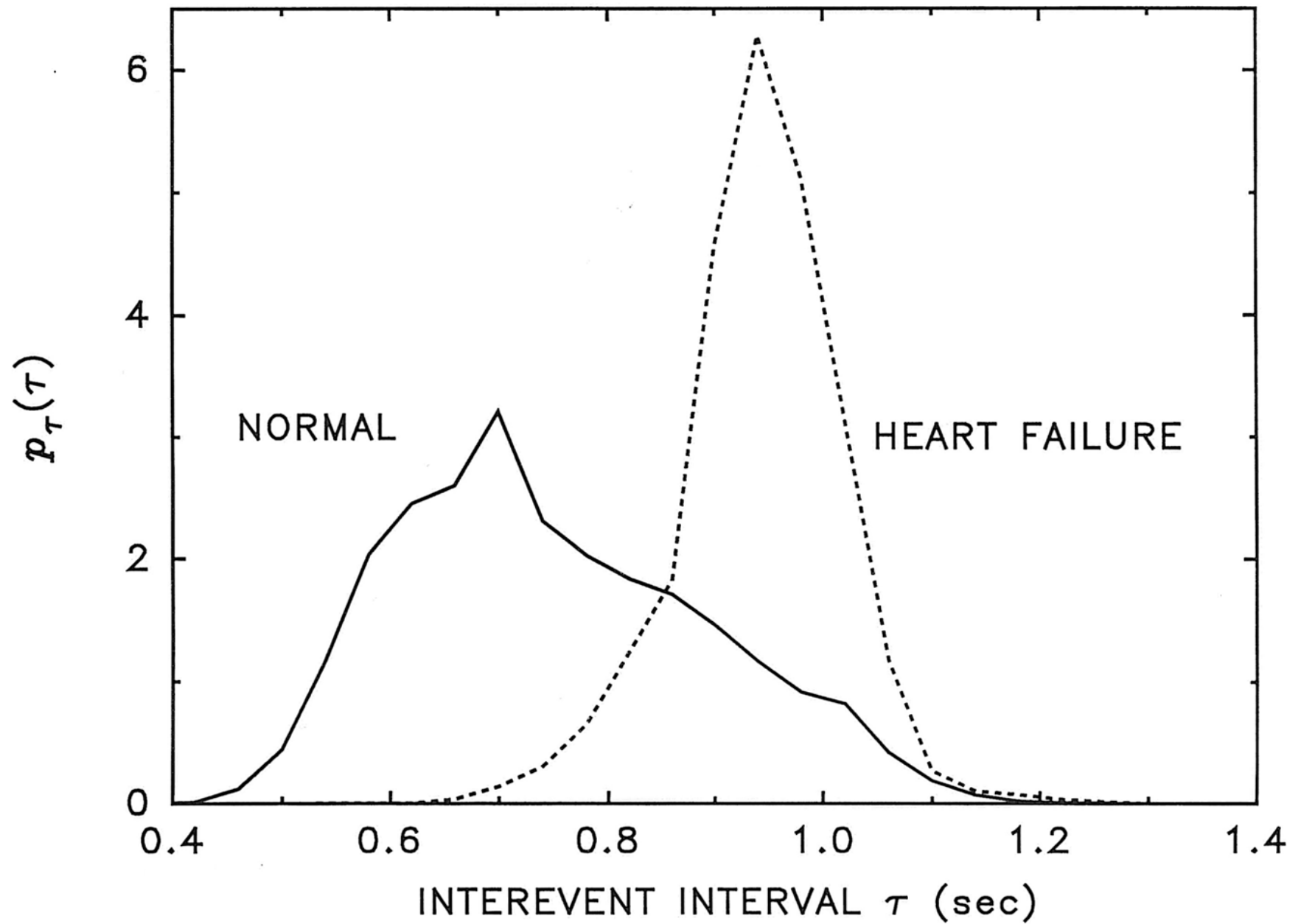

RESCALED RANGE ANALYSIS (R/S)

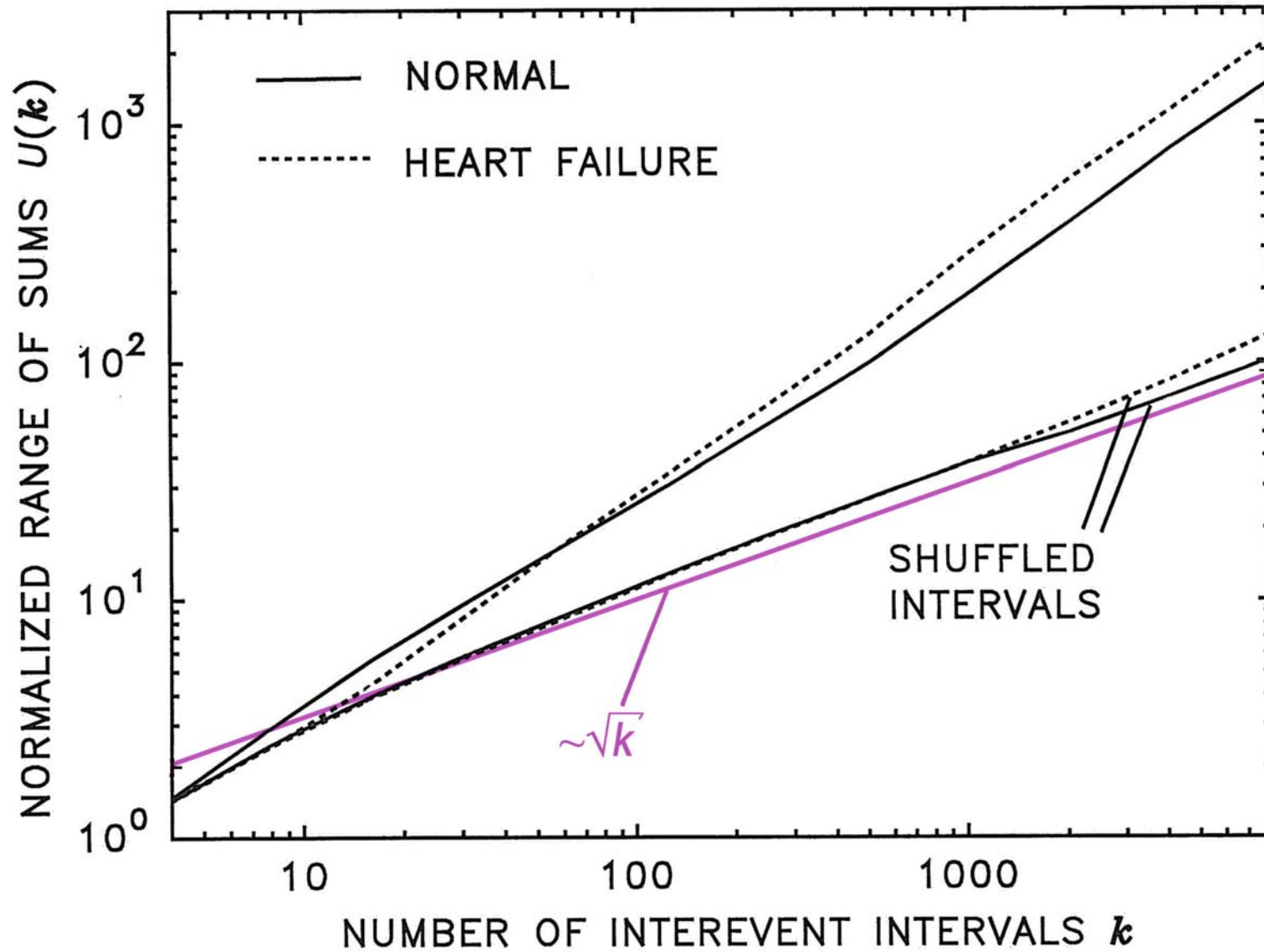

SPECTRAL ANALYSIS

INTERVAL-BASED PERIODOGRAM

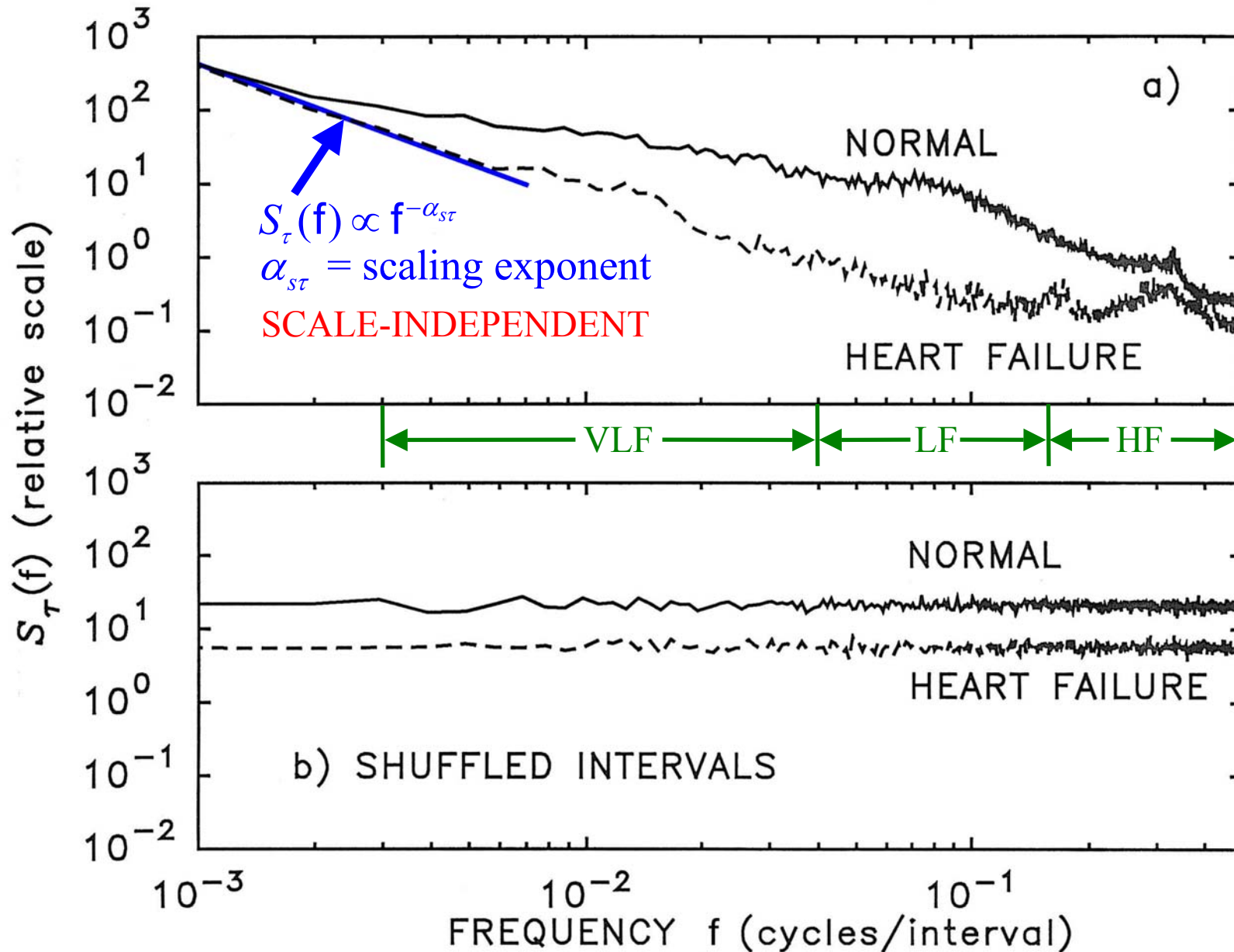

TIME-SCALE ANALYSIS

DISCRETE WAVELET TRANSFORM

EXAMINES ALL SCALES

MITIGATES AGAINST NONSTATIONARITIES

m = scale index; 2^m = scale

$$W_{\psi, \tau}^{\text{wav}}(m, i) = \sum_k 2^{-m/2} \psi(2^{-m} k - i) \tau_k$$

$$\sigma_{\text{wav}}^2 \equiv \text{Var} \left[W_{\psi, \tau}^{\text{wav}}(m, i) \right] = 2^{-m} \sum_k \sum_l \psi(2^{-m} k - i) \psi(2^{-m} l - i) R_{\tau}(l - k)$$

$$A_{\tau}(k) \equiv \text{Var} \left[W_{\psi, \tau}^{\text{wav}}(m, i) \right] / E^2[\tau]$$

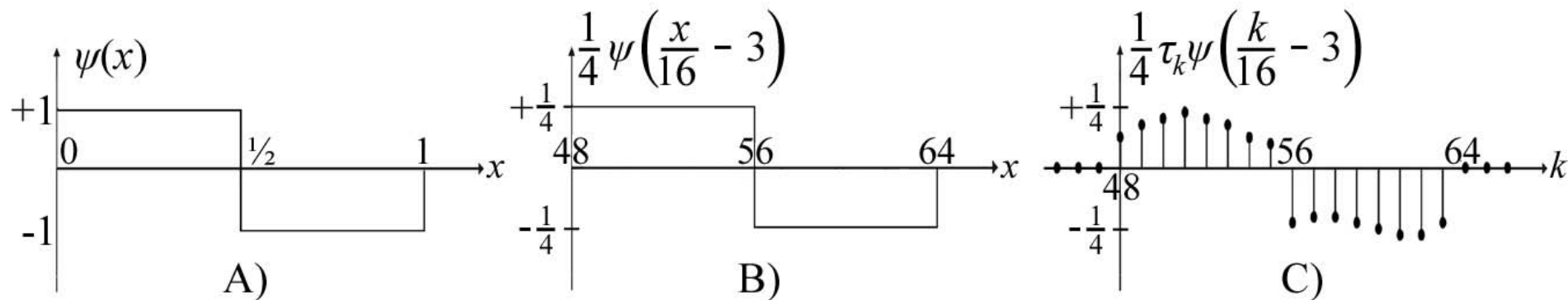

After Teich, Lowen, Jost, Vibe-Rheymer & Heneghan,
in *Nonlinear Biomedical Signal Processing*, vol II, M. Akay, Ed.
(IEEE Press, NY, 2001), pp. 159-213.

NORMAL

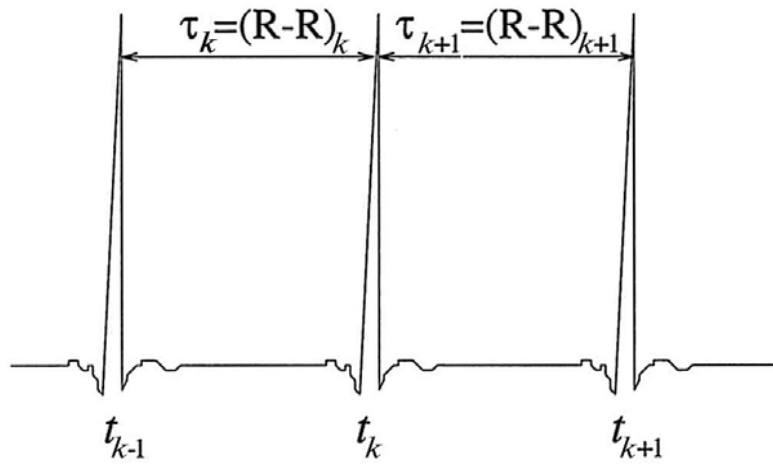

a)

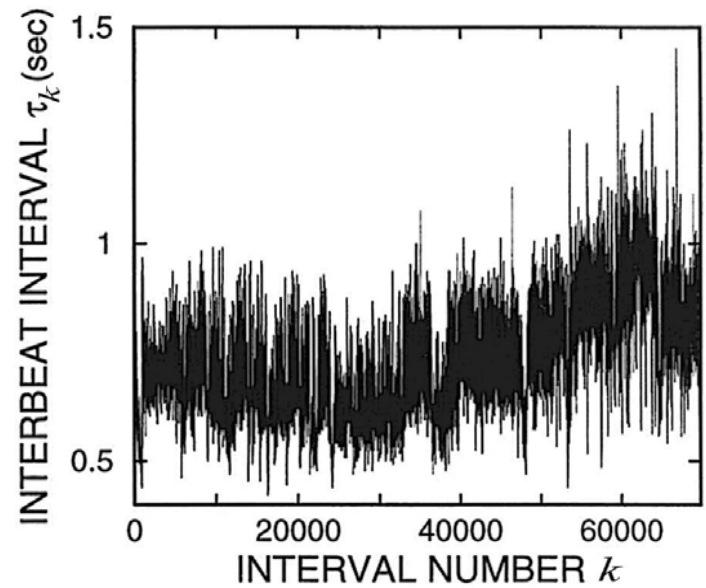

b)

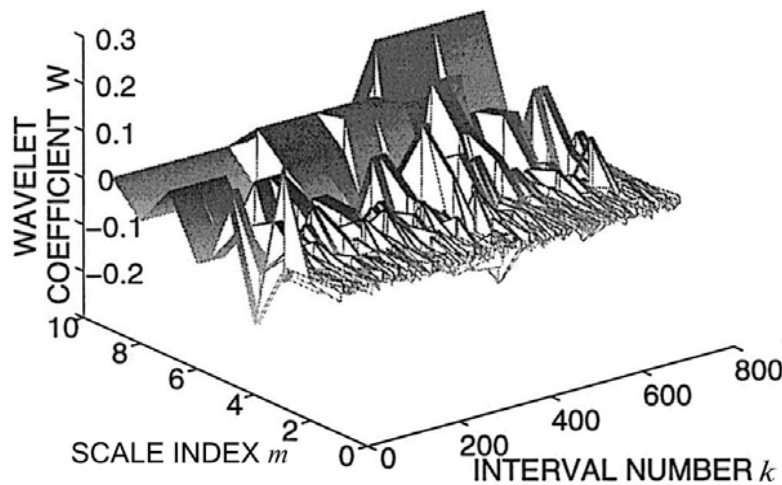

c)

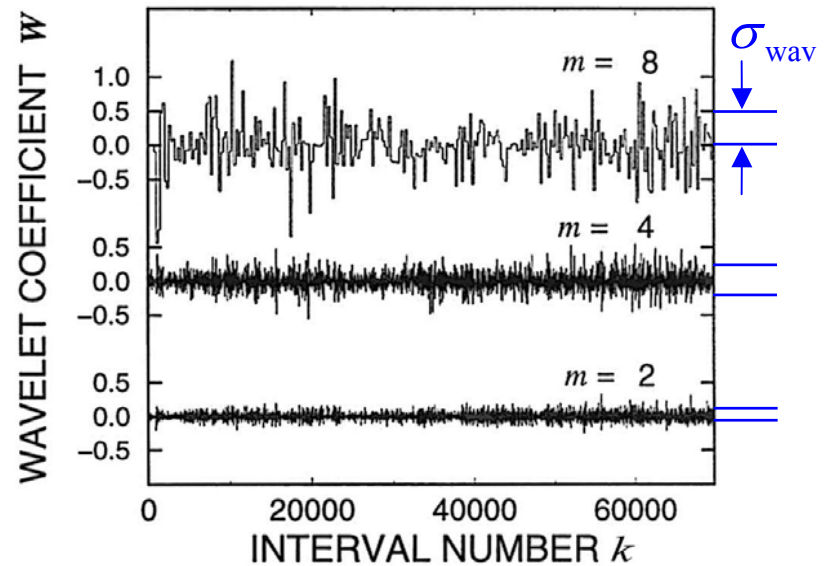

d)

WAVELET COEFFICIENT W

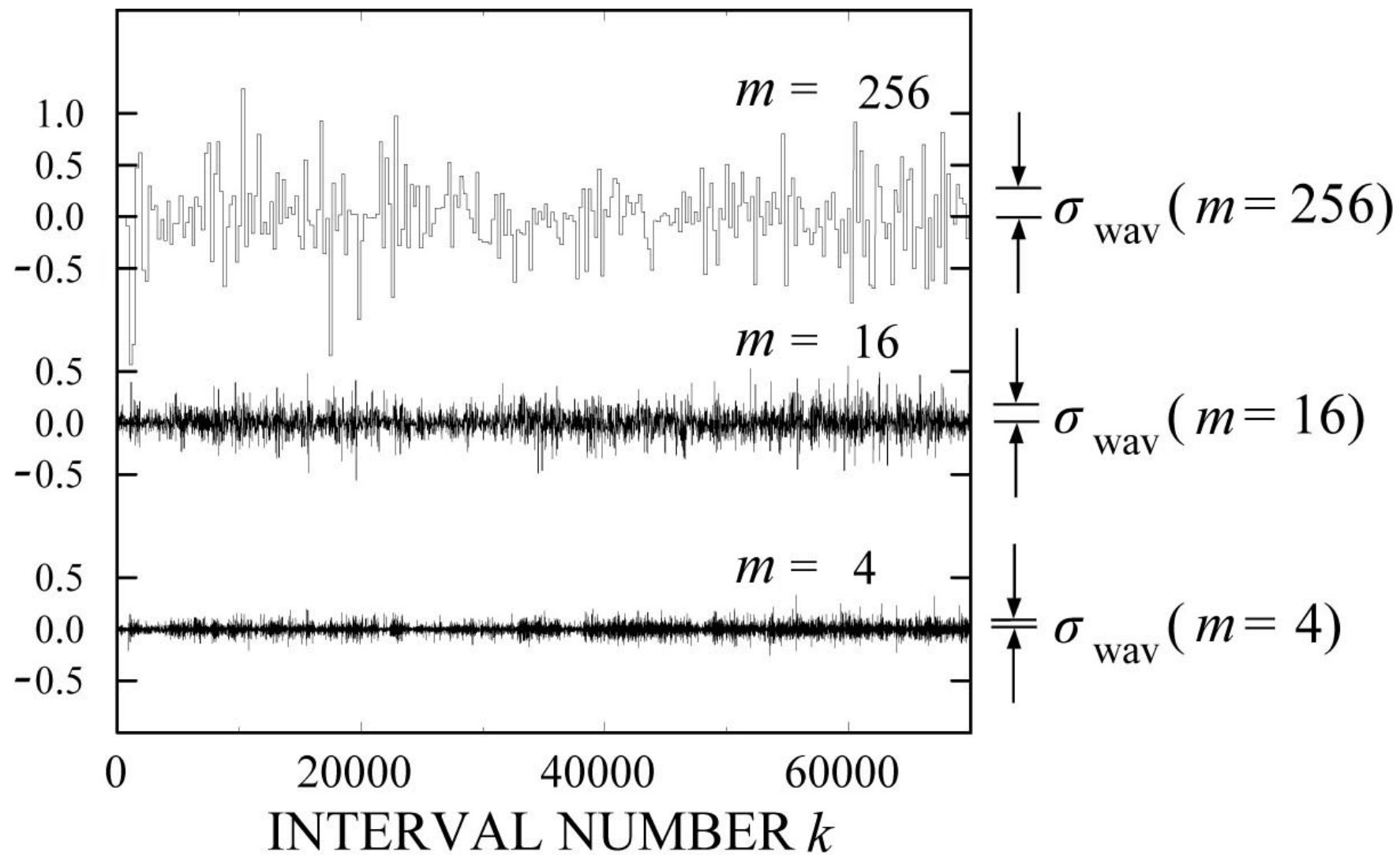

HEART-FAILURE

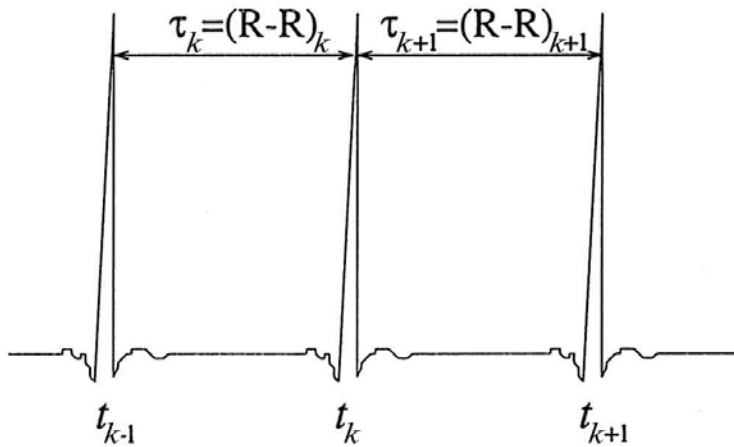

a)

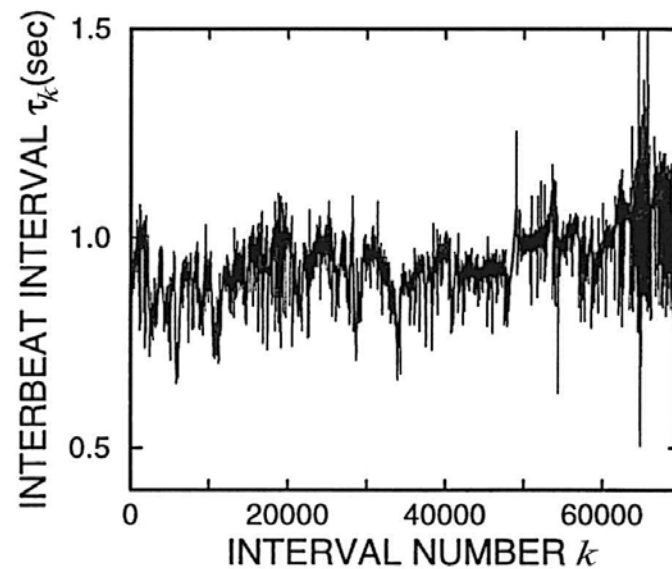

b)

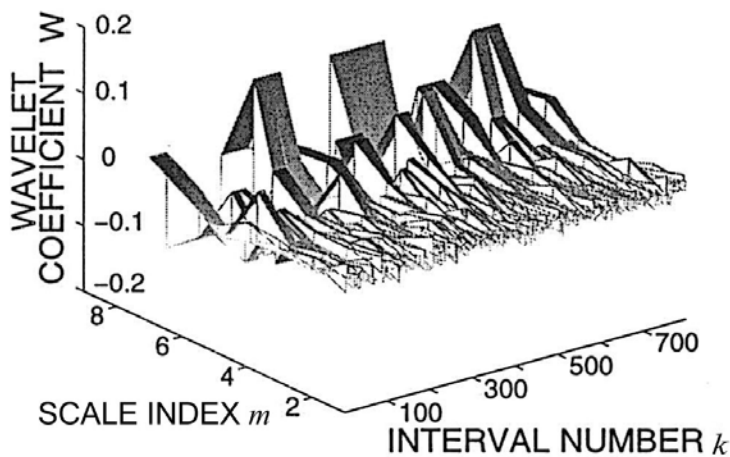

c)

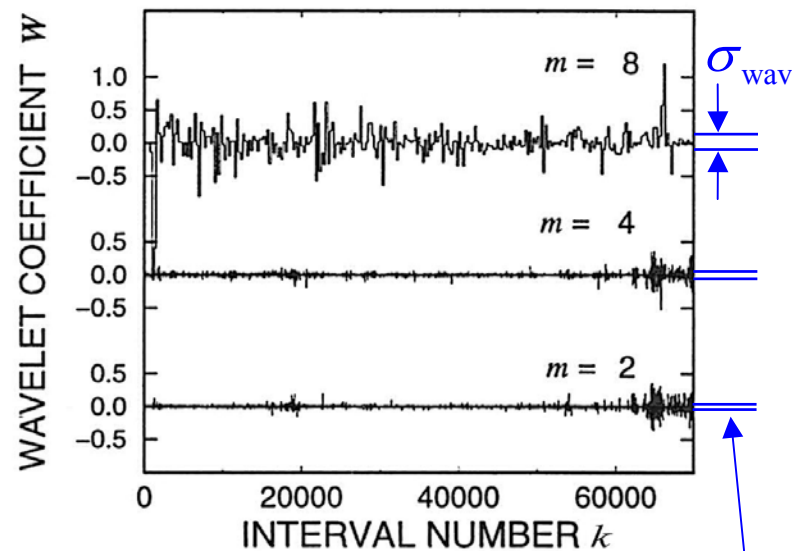

d)

SMALLER VALUES
OF σ_{wav} THAN FOR
NORMAL SUBJECTS

$$\sigma_{\text{wav}}^2(T) \propto T^{\alpha_{A\tau}}$$

$\alpha_{A\tau}$ = scaling exponent

SCALE-INDEPENDENT

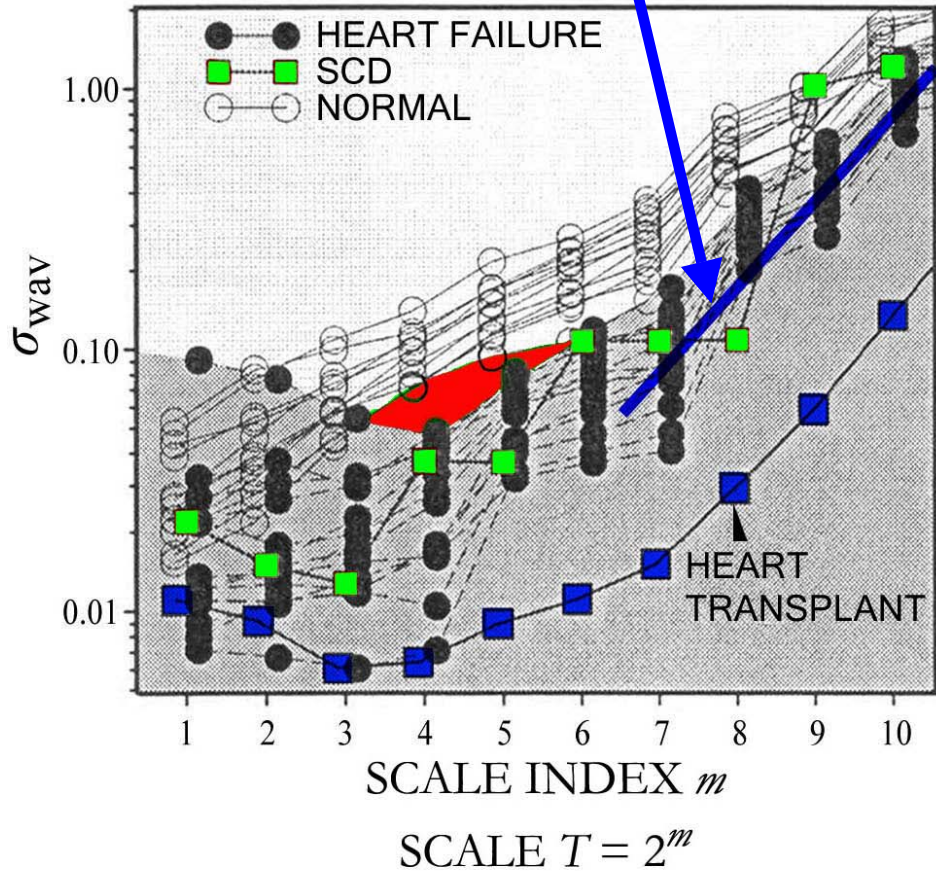

After Teich, *Proc. Int. Conf. IEEE Eng. Med. Biol. Soc.* **20**, 1136-1141 (1998).

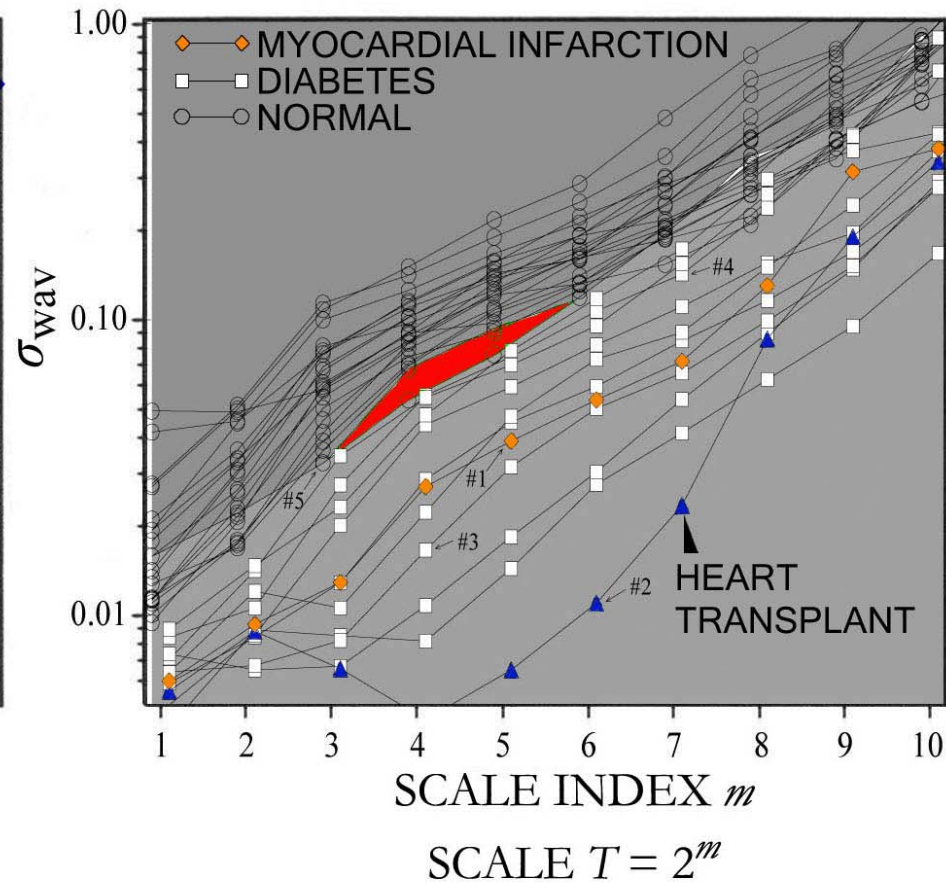

After Ashkenazy *et al.*, *Fractals* **6**, 197-203 (1998).

ROBUSTNESS WITH WAVELET FORM

Haar wavelet

Daubechies 10-tap wavelet

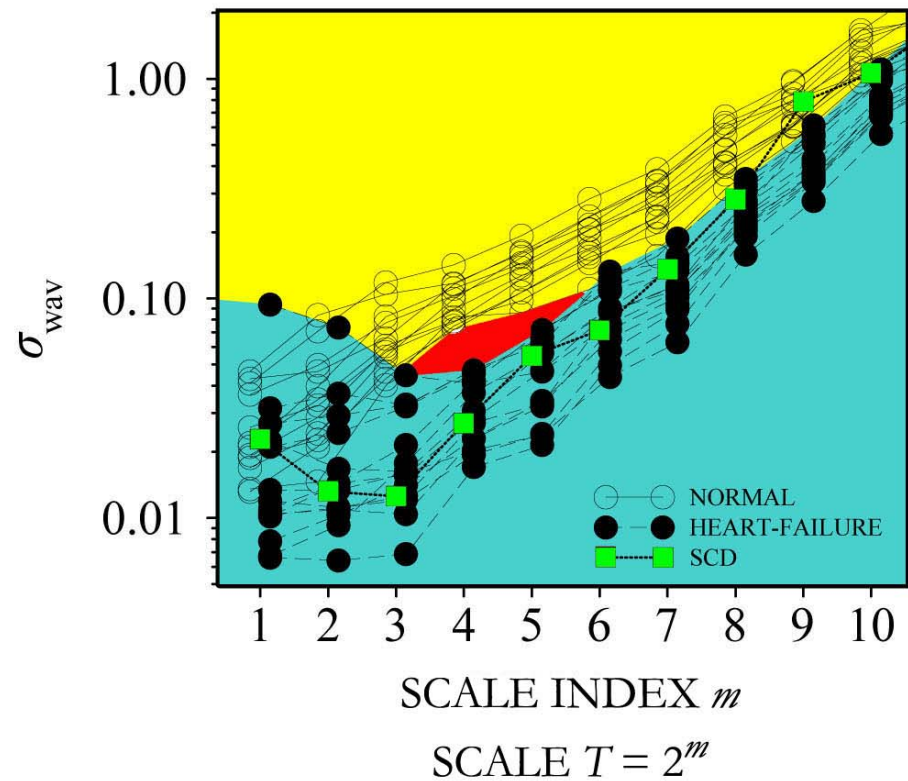
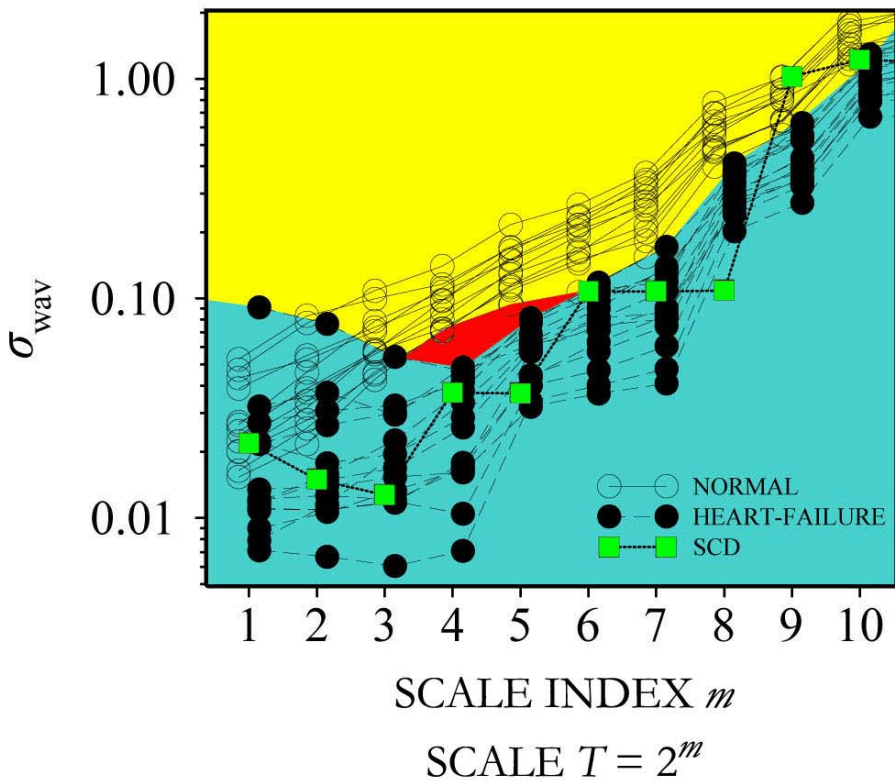

After Thurner, Feurstein & Teich, *Phys. Rev. Letters* **80**, 1544-1547 (1998).

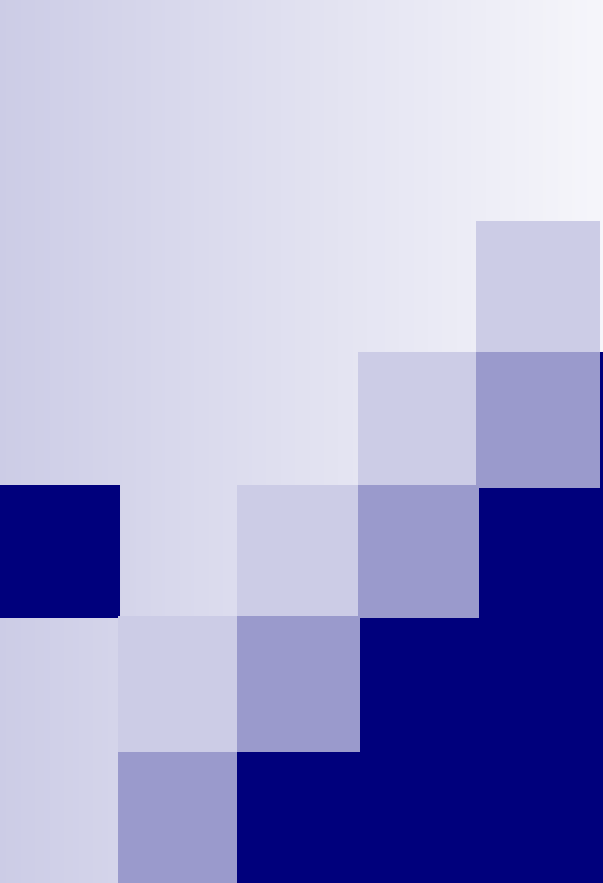

COUNT-BASED MEASURES

SPECTRAL ANALYSIS

GENERALIZED-RATE-BASED PERIODOGRAM

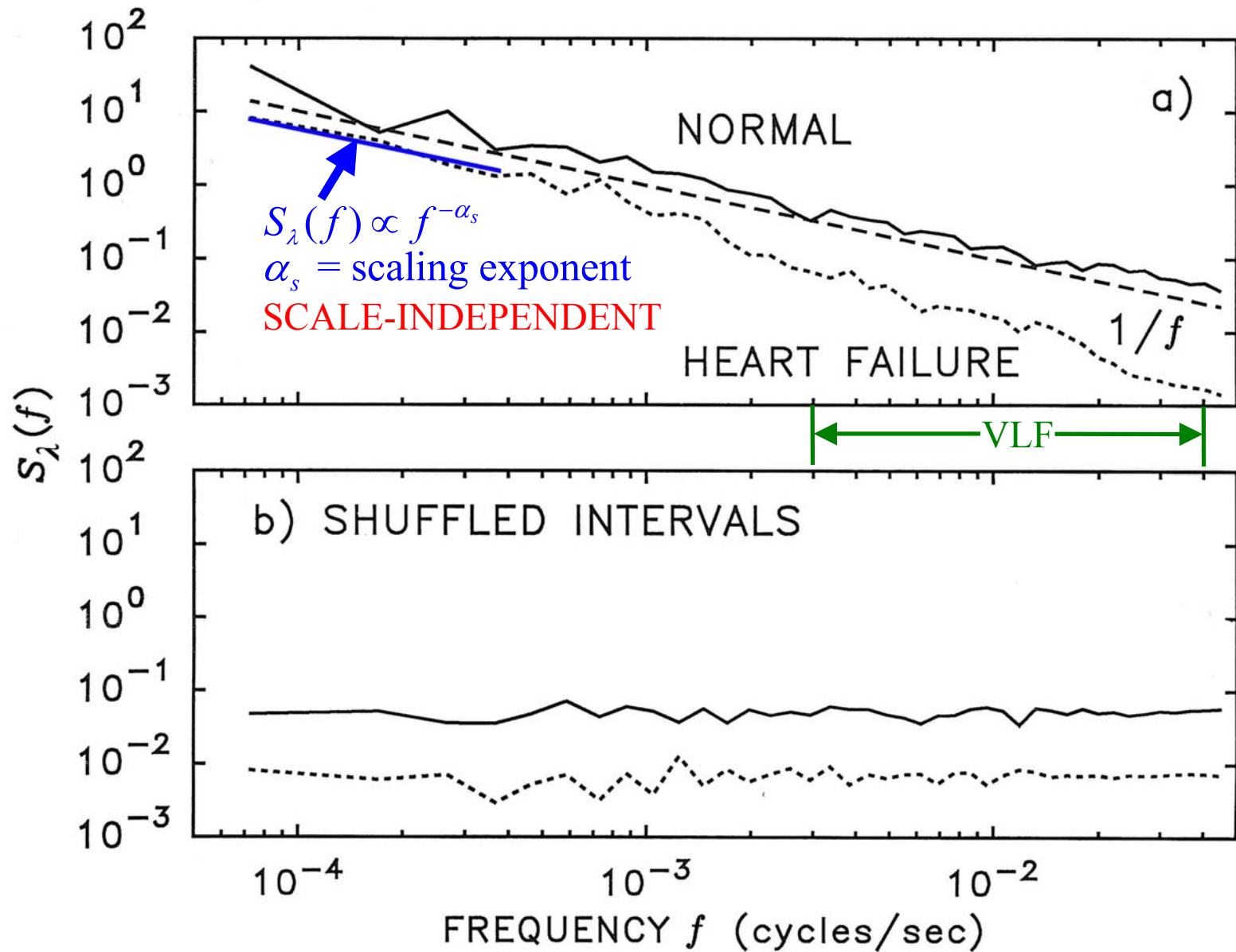

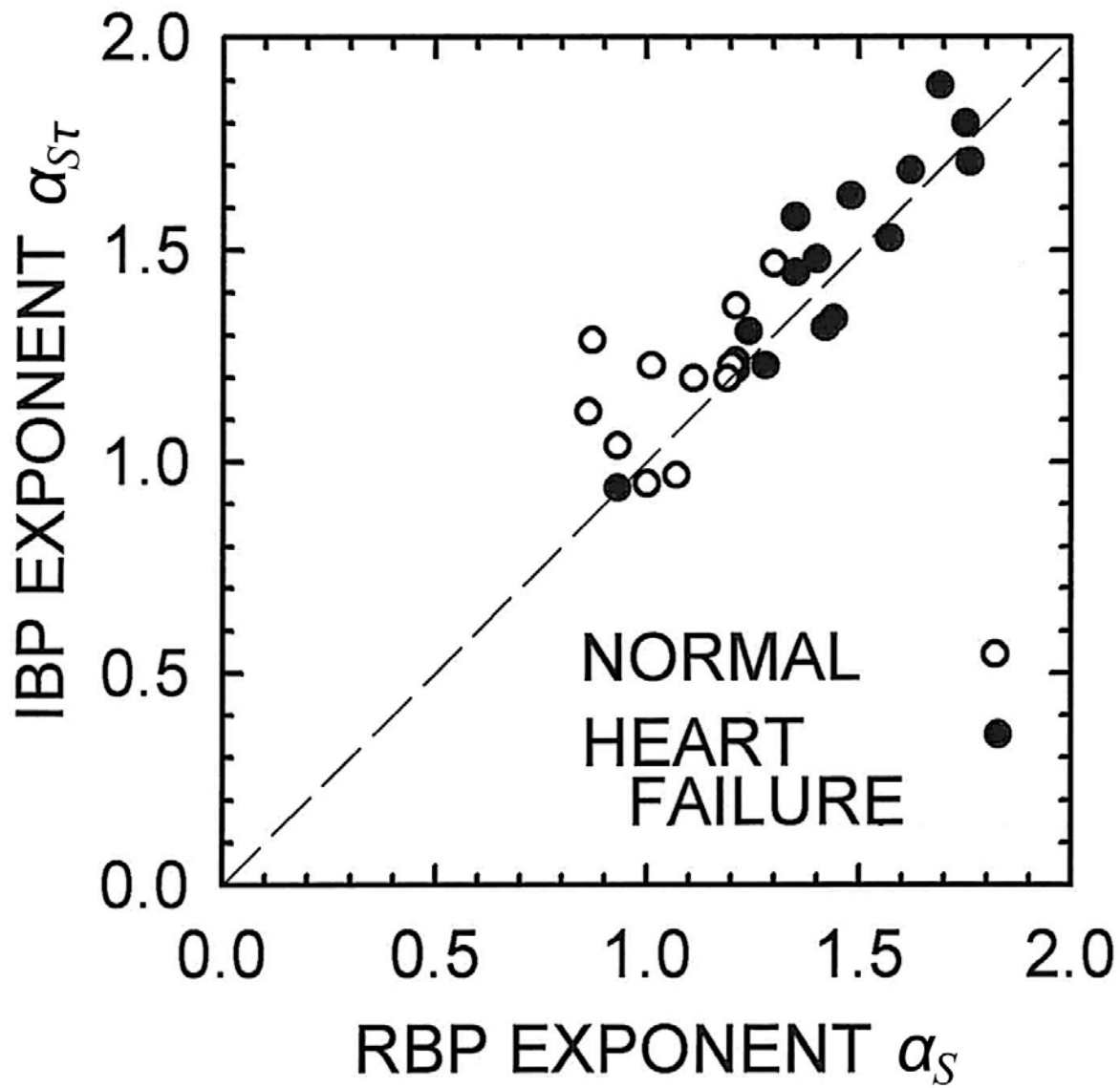

TIME-SCALE ANALYSIS

DISCRETE WAVELET TRANSFORM

a) CONSTRUCTION OF NORMALIZED VARIANCE $F(T)$

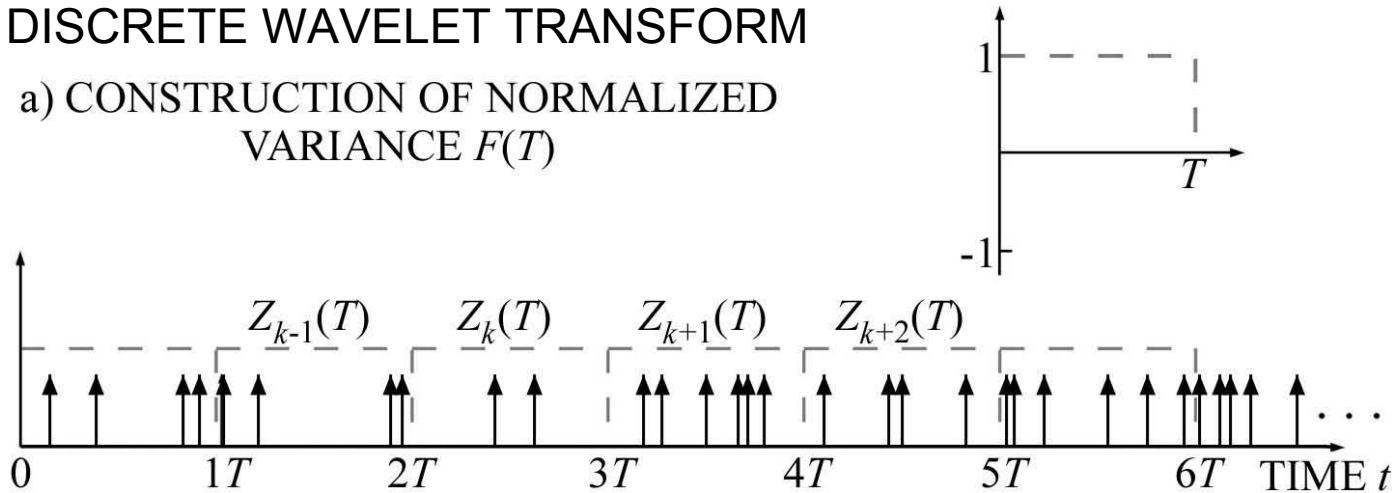

b) CONSTRUCTION OF NORMALIZED HAAR-WAVELET VARIANCE $A(T)$

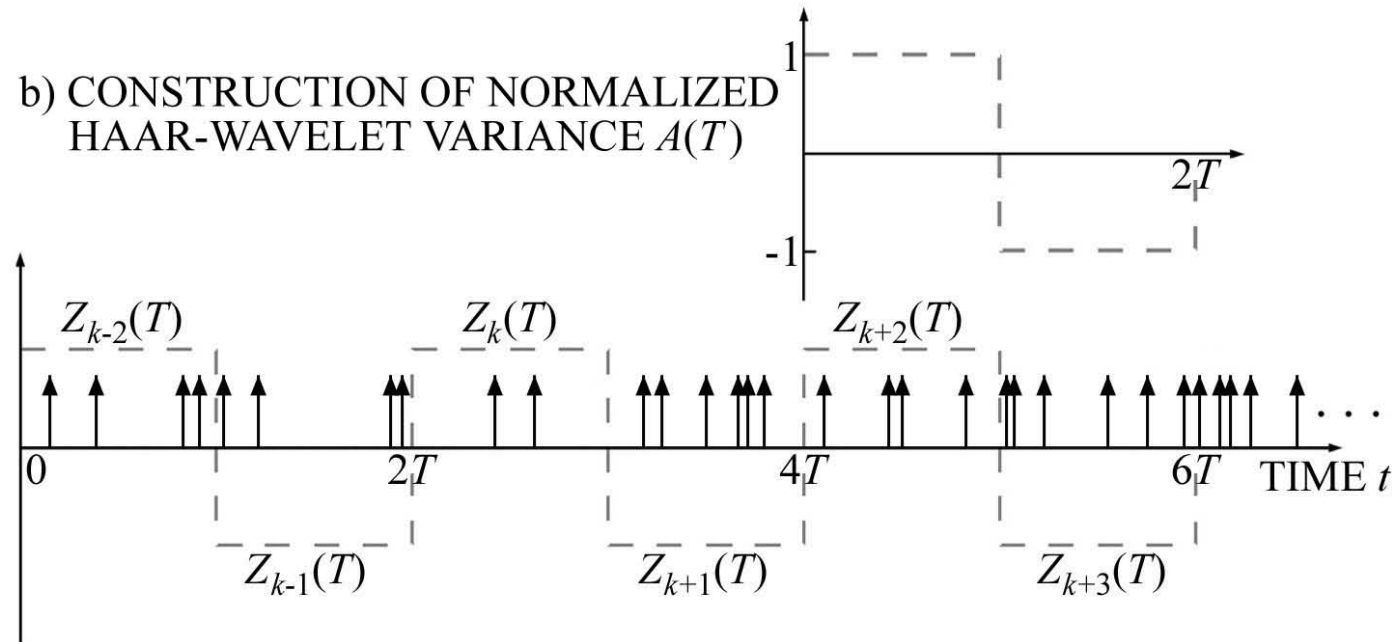

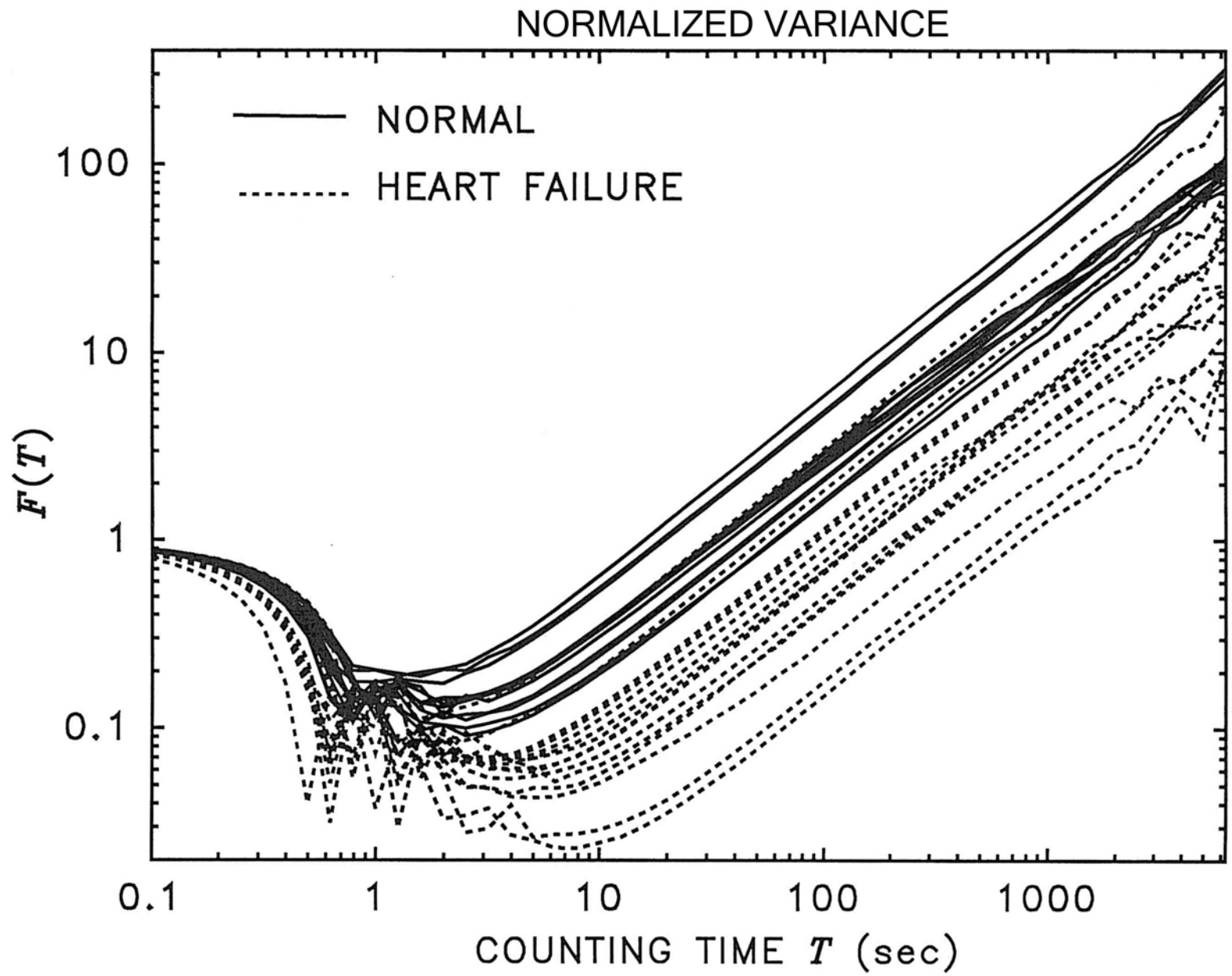

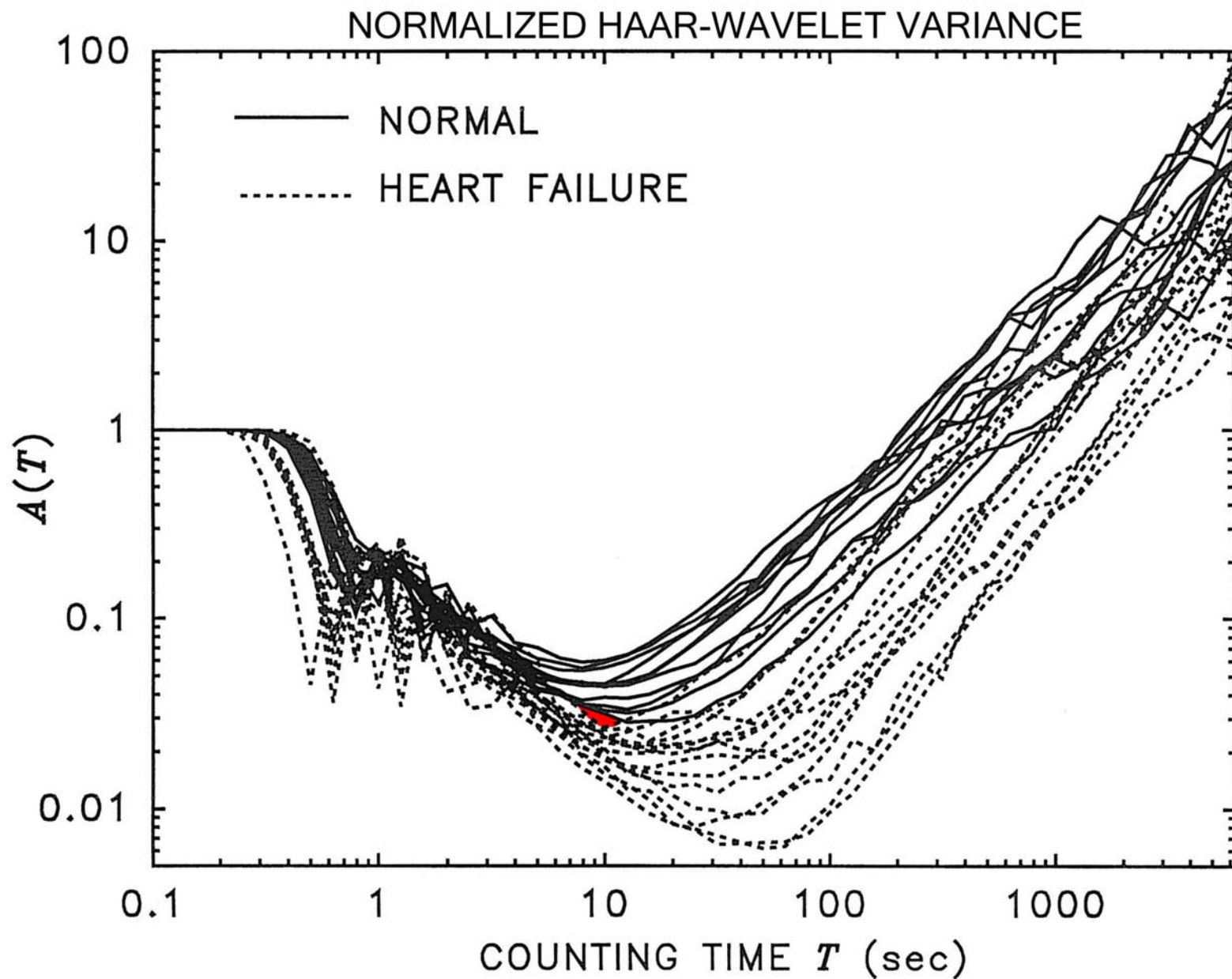

NHWV: NORMALIZED COUNTING TIME

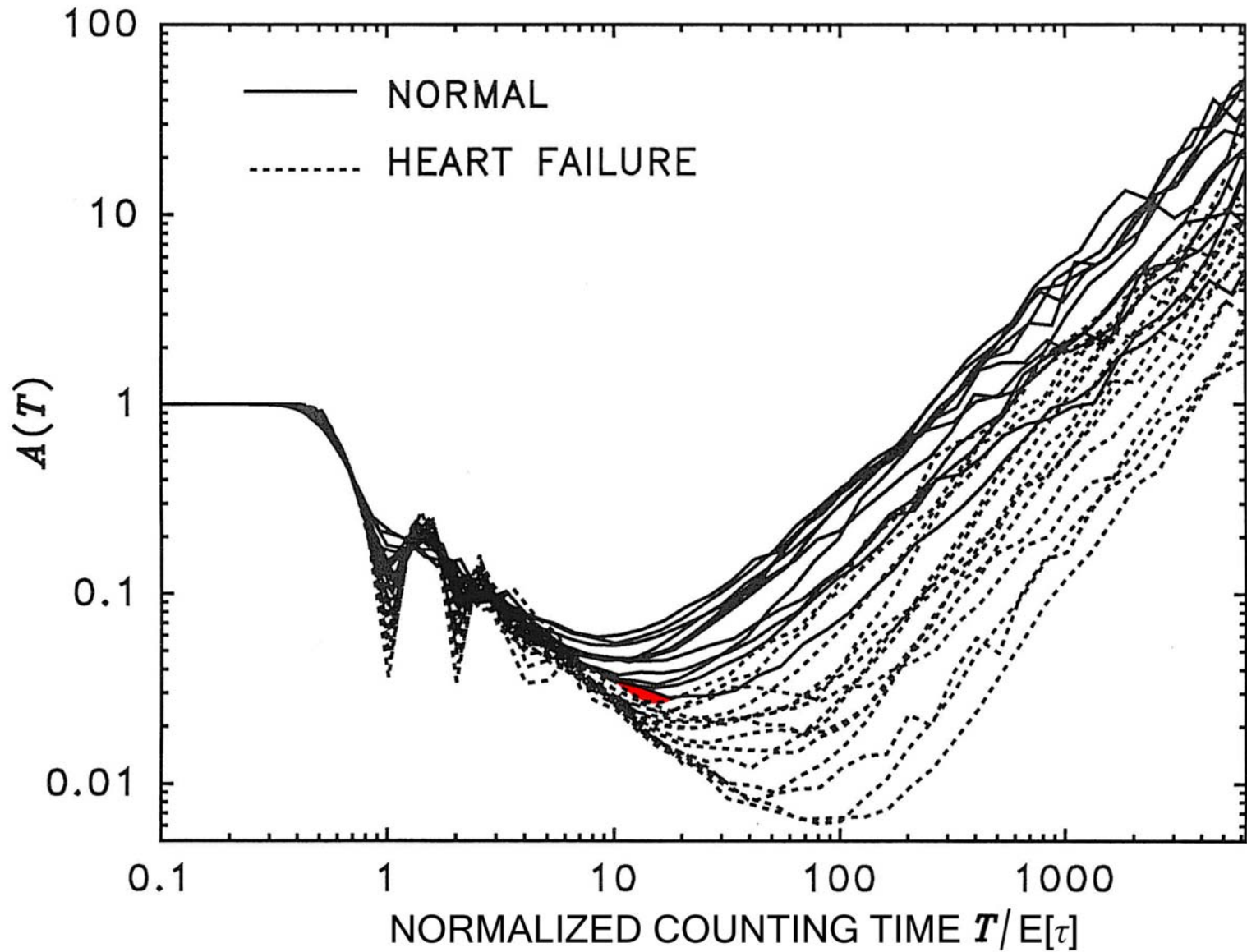

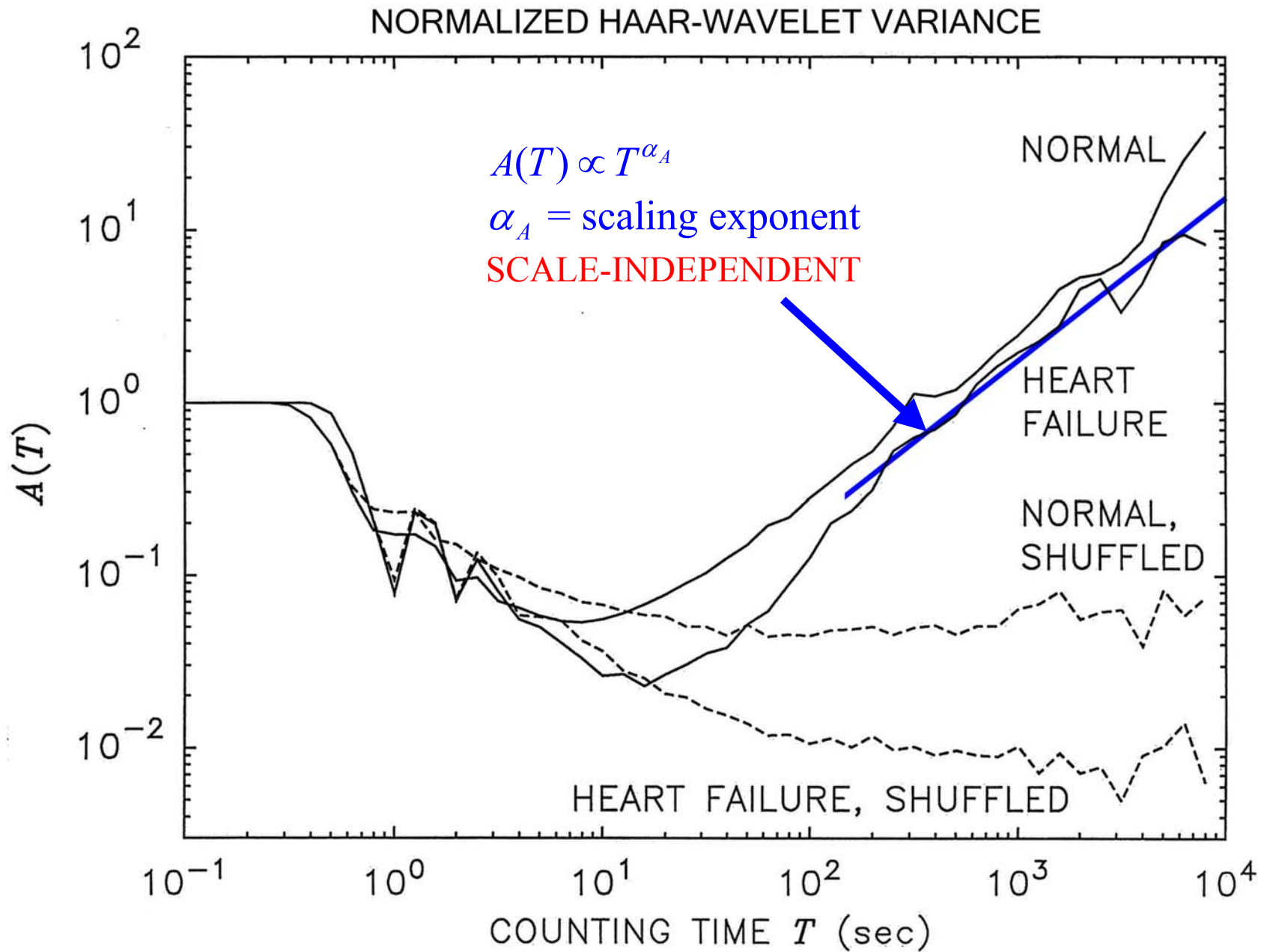

FRACTAL-EXPONENT ESTIMATORS

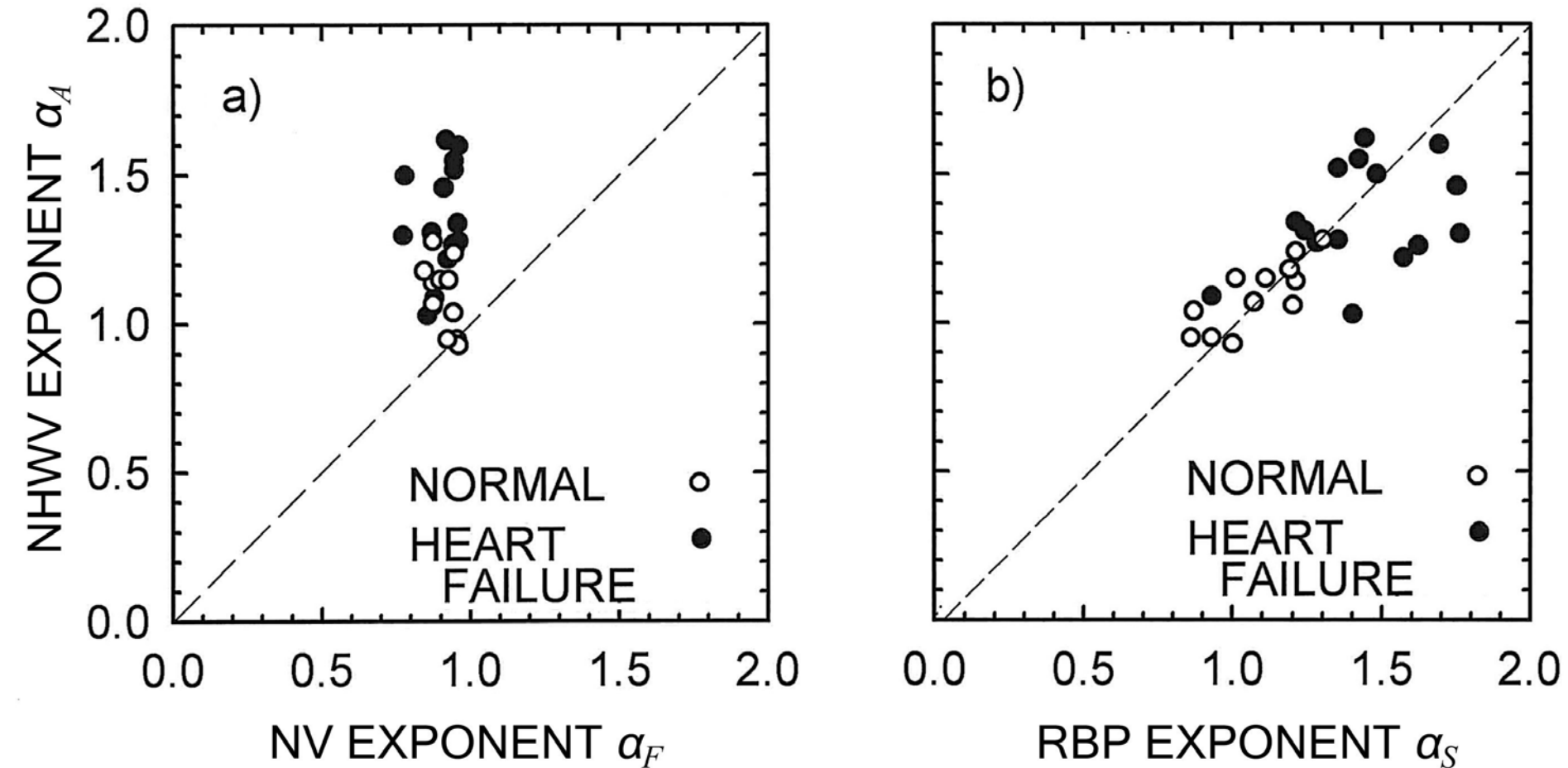

NORMALIZED DAUBECHIES-WAVELET VARIANCE

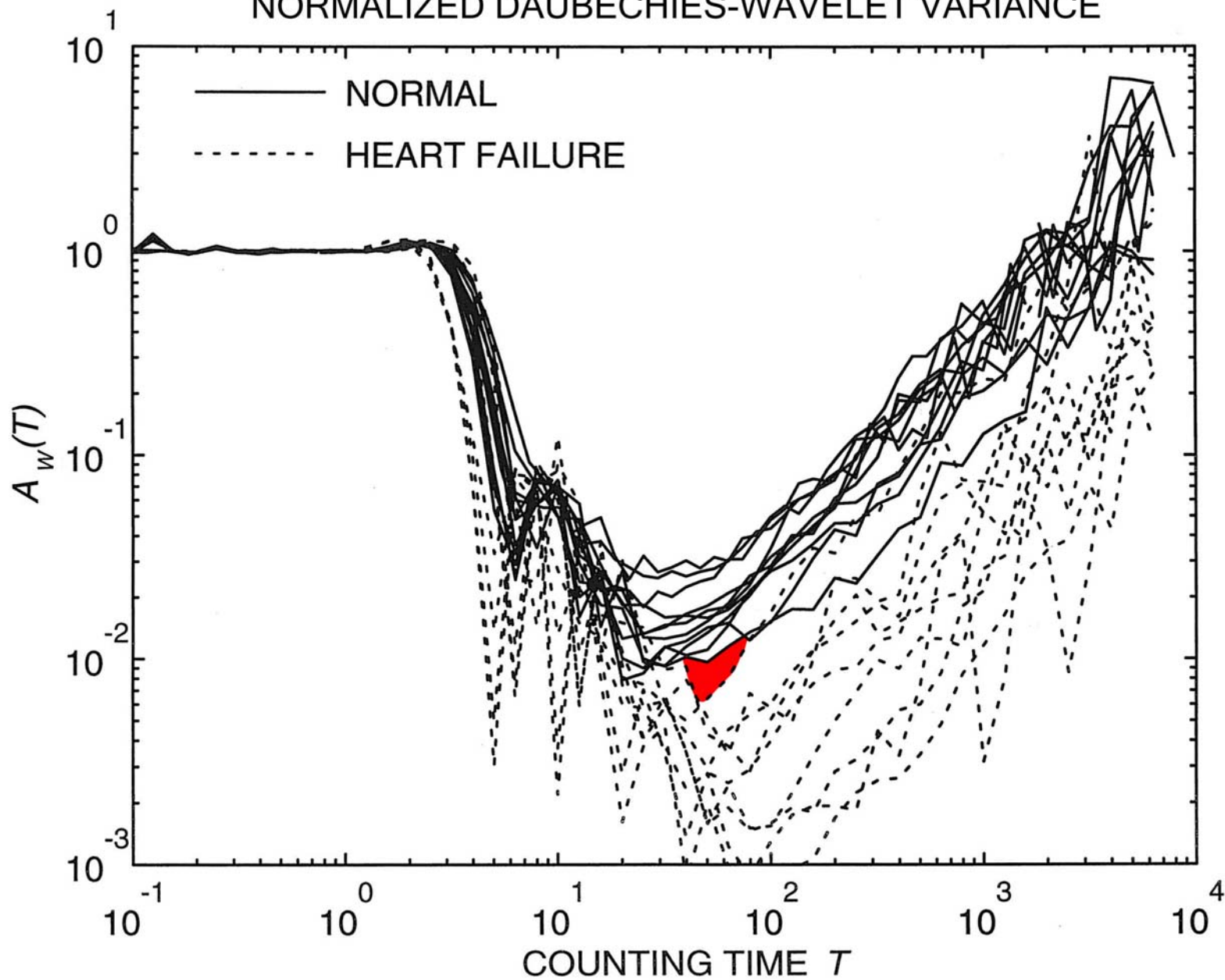

After Teich, *Proc. 18th Intern. Conf. IEEE Eng. Med. Biol. Soc.* **18**, 1128-1129 (1996).



IDENTIFYING PATIENTS WITH CARDIAC DYSFUNCTION

MEASURES OF STATISTICAL SIGNIFICANCE

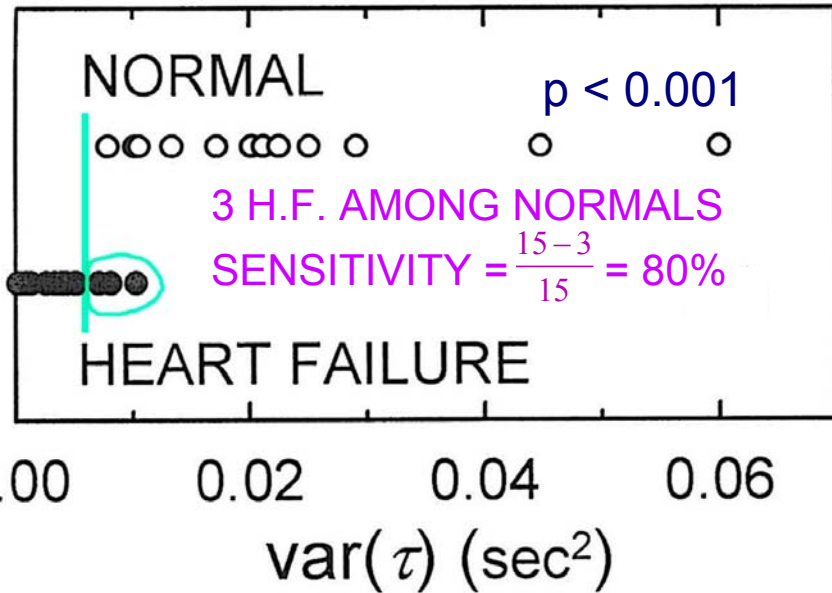

SCALE-DEPENDENT

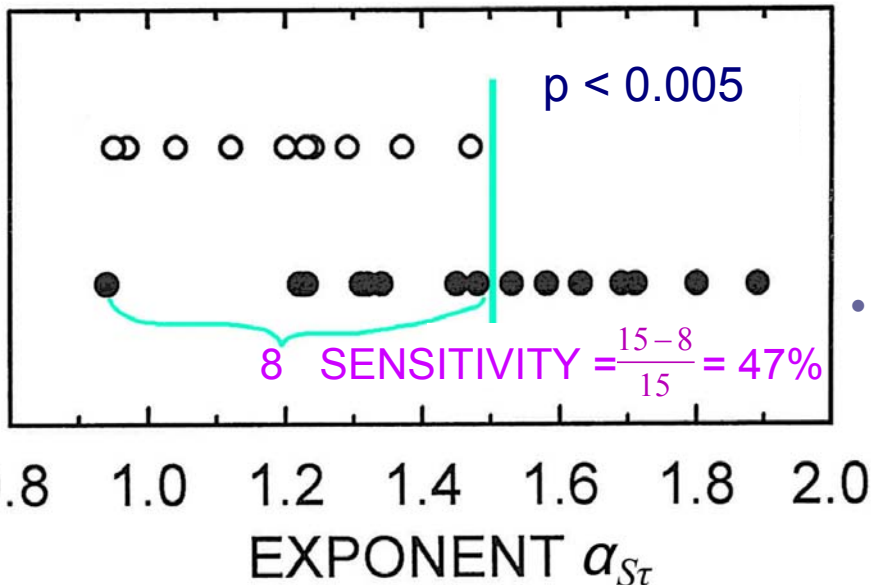

SCALE-INDEPENDENT

- p VALUE, d', AND VARIANTS (rely on Gaussian assumption)

- SENSITIVITY/SPECIFICITY MEASURES OF CLINICAL SIGNIFICANCE (distribution free)

SENSITIVITY \equiv proportion of heart-failure patients that are properly identified

e.g., Hypothesis that all normal patients are so identified \equiv 100% SPECIFICITY

- ROC CURVES & AREA UNDER ROC

After Turcott & Teich,
Ann. Biomed. Eng. **24**, 269-293 (1996)

M. C. Teich 2004

ROC CURVES & AREA UNDER ROC

SCALE-DEPENDENT σ_{wav} (32)

SCALE-INDEPENDENT $\alpha_{A\tau}$

HAAR WAVELET

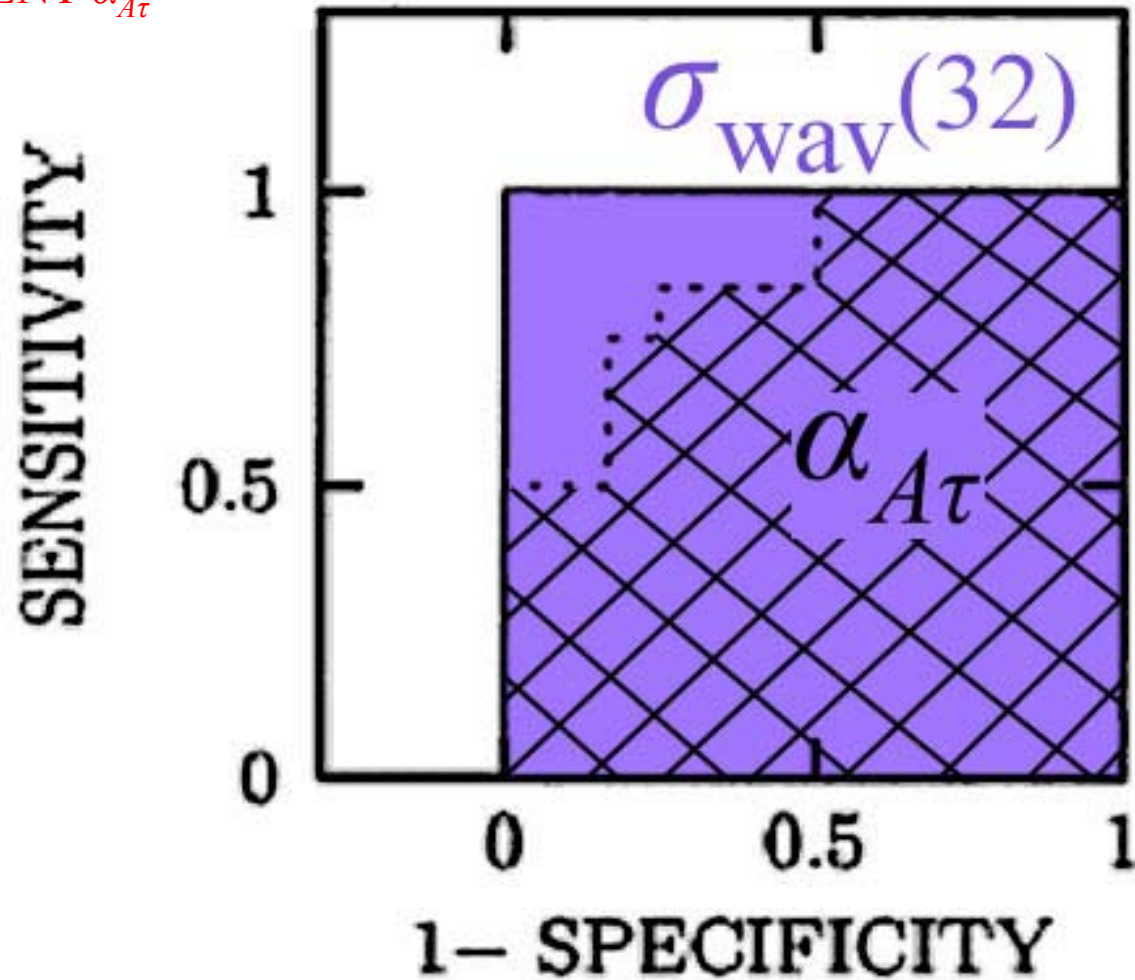

After Thurner, Feurstein, Lowen & Teich,
Phys. Rev. Letters **81**, 5688-5691 (1998).

M. C. Teich 2004

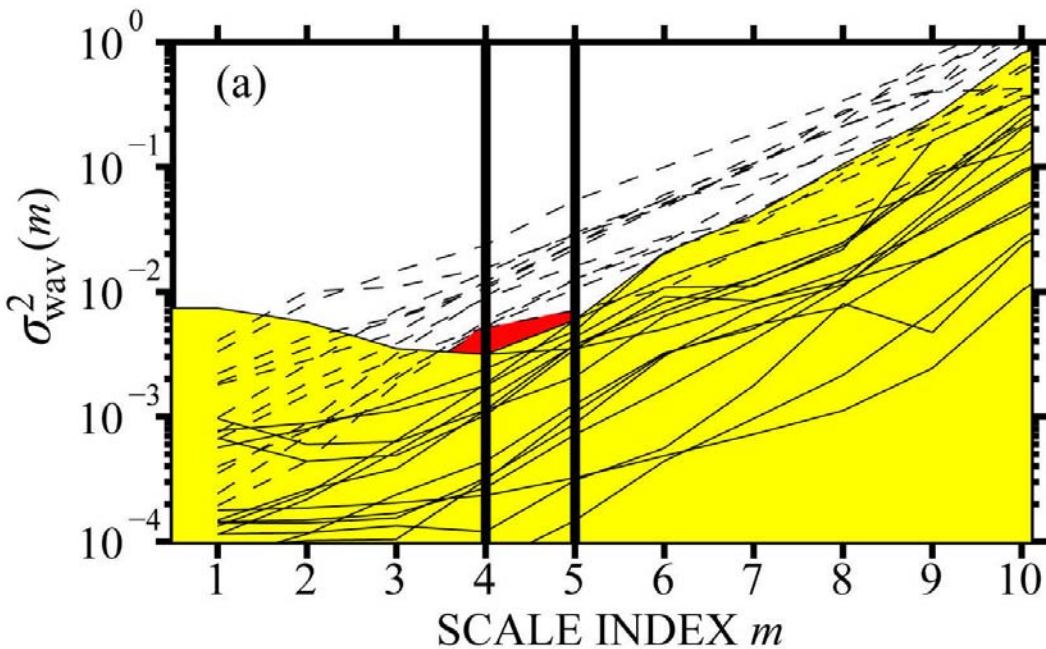

$$16 \leq 2^m \text{ (scale)} \leq 32$$

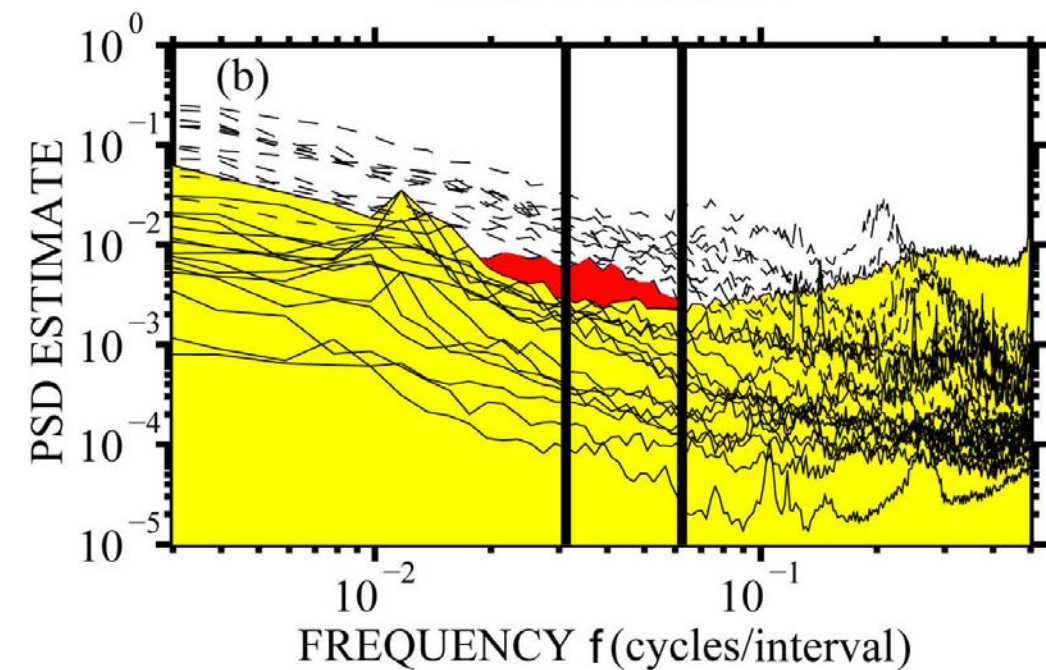

$$\frac{1}{32} < f \text{ (cycles/interval)} < \frac{1}{16}$$

After Heneghan, Lowen, & Teich
Proc. 1999 ICASSP (Phoenix, AZ)
paper SPTM-8.2.

INDIVIDUAL VALUES: DATA

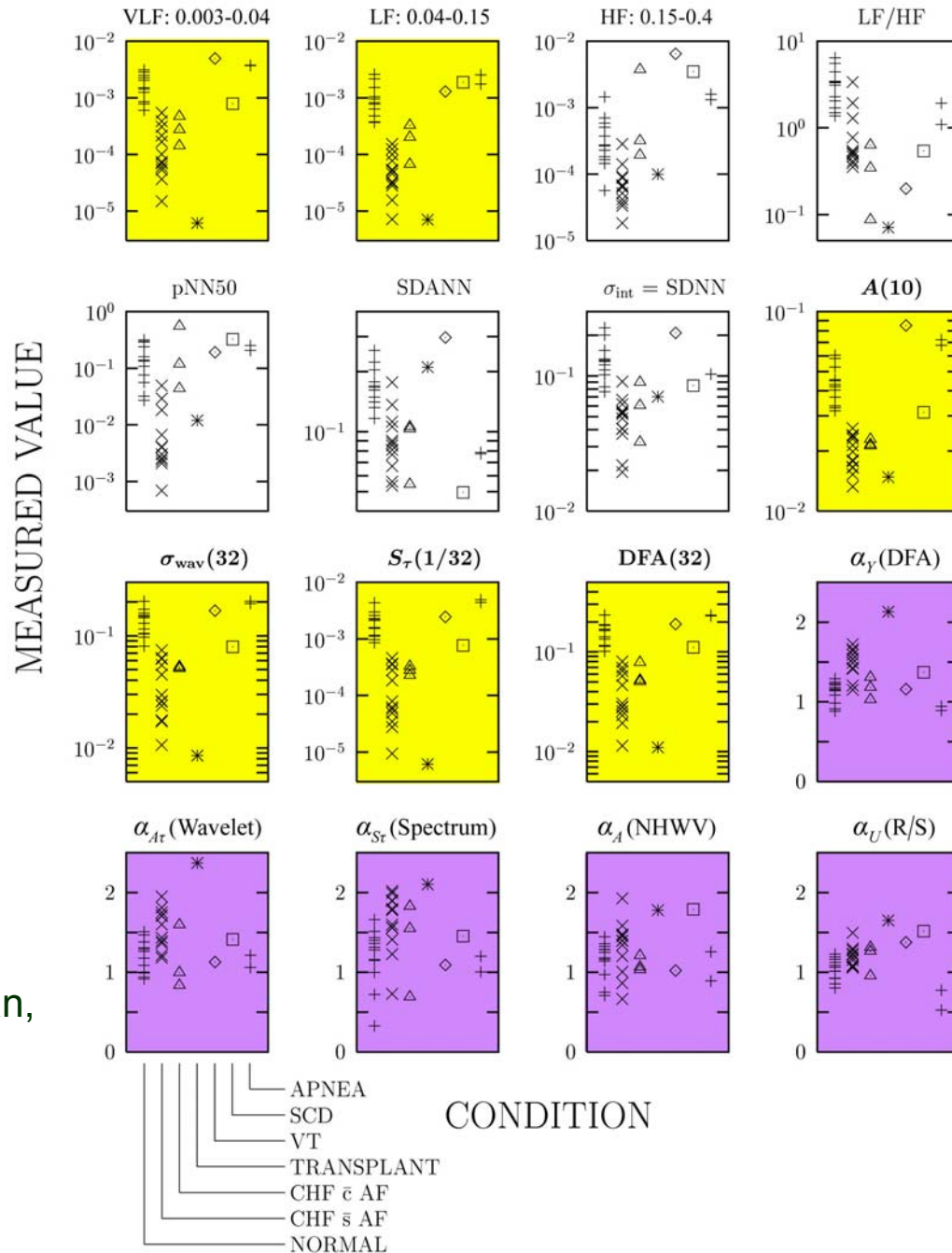

After Teich, Lowen, Jost, Vibe-Rheymer & Heneghan, in *Nonlinear Biomedical Signal Processing*, vol II, M. Akay, Ed. (IEEE Press, NY, 2001), pp. 159-213.

ROC CURVES: NORMAL AND CHF DATA (\bar{S} AF; 75821 intervals)

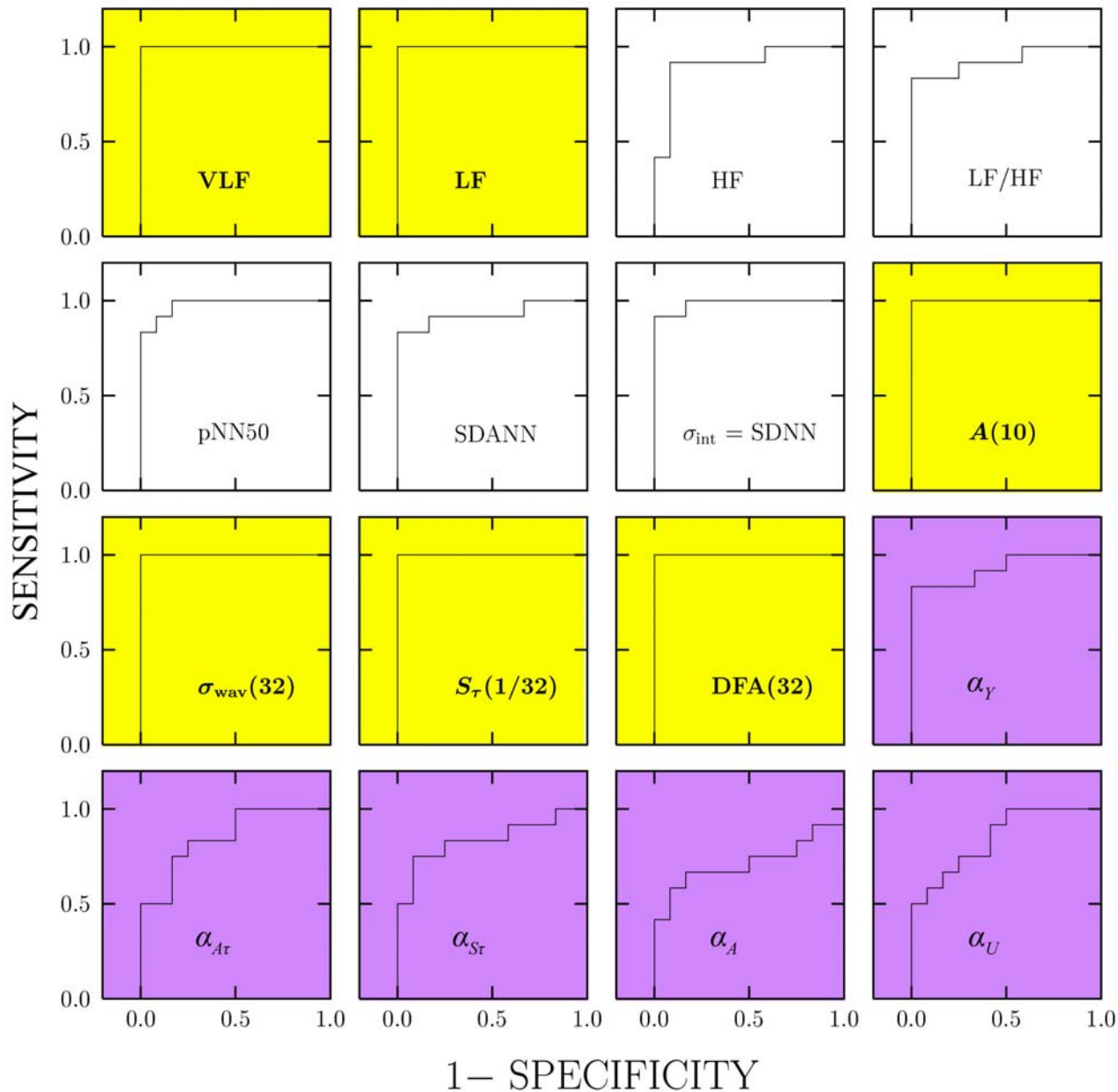

ROC-AREA CURVES: NORMAL AND CHF DATA

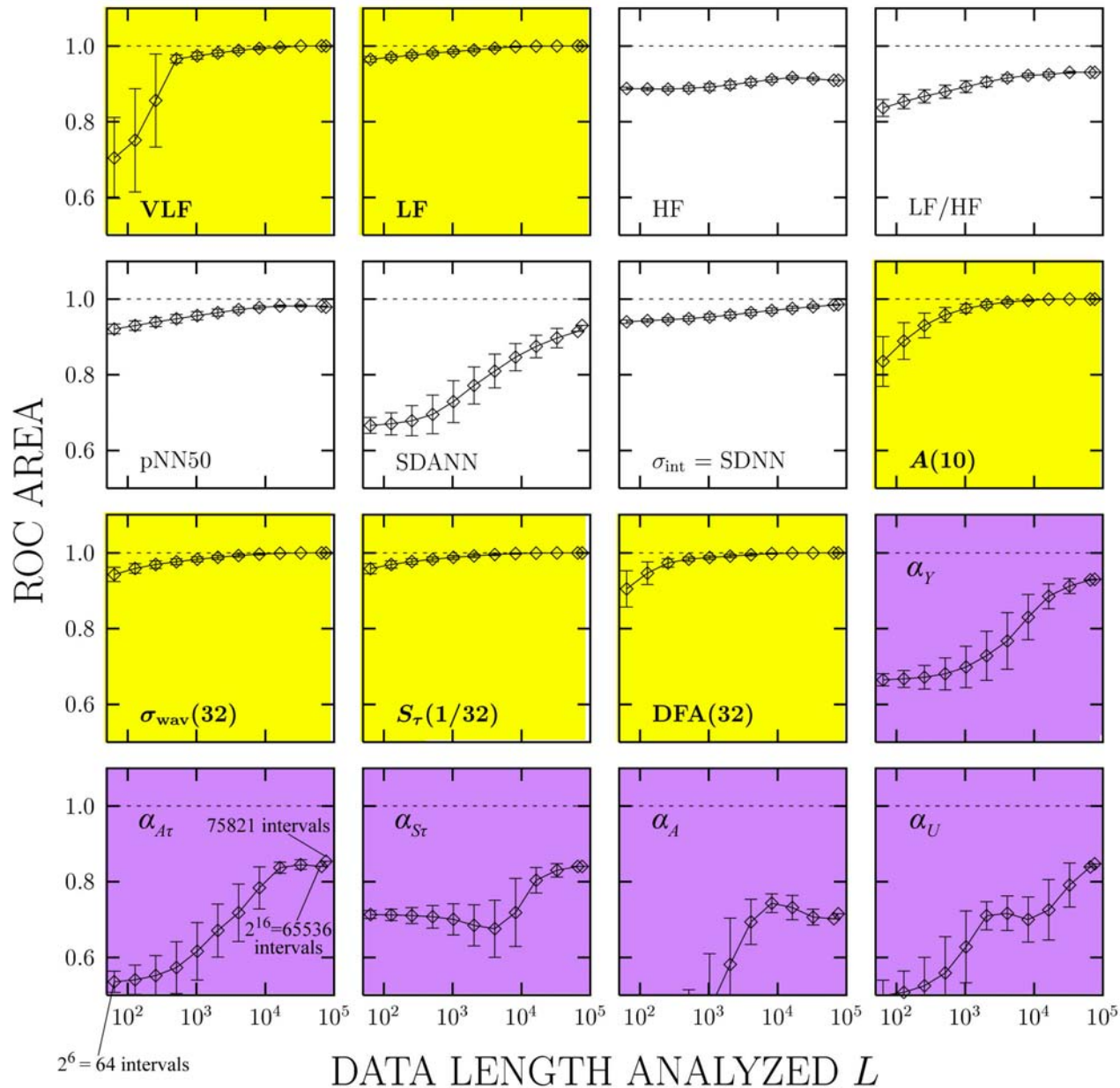

After Teich, Lowen, Jost, Vibe-Rheymer & Heneghan, in *Nonlinear Biomedical Signal Processing*, vol II, M. Akay, Ed. (IEEE Press, NY, 2001), pp. 159-213.

M. C. Teich 2004

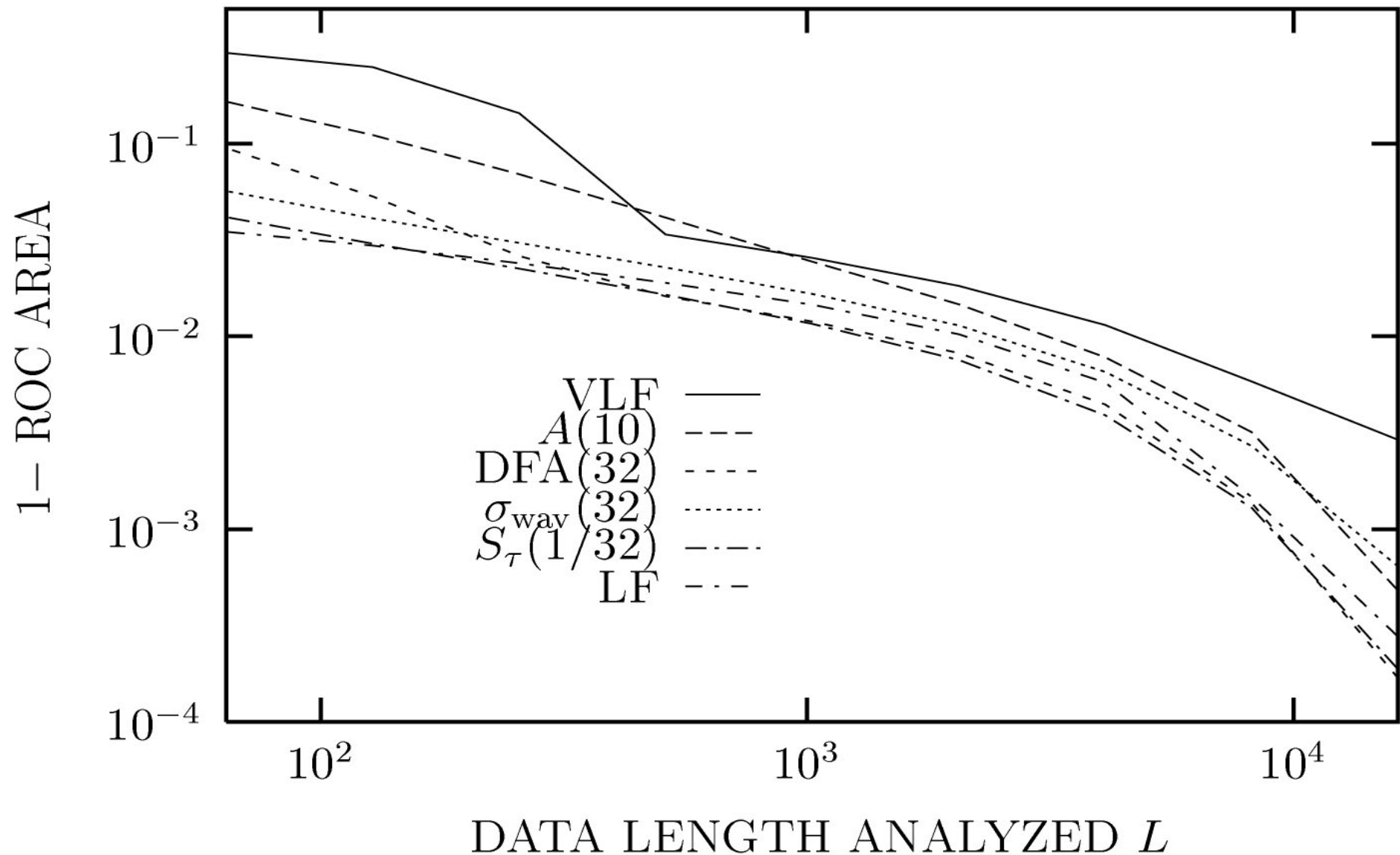

After Teich, Lowen, Jost, Vibe-Rheymer & Heneghan,
 in *Nonlinear Biomedical Signal Processing*, vol II, M. Akay, Ed.
 (IEEE Press, NY, 2001), pp. 159-213.

Measure	Execution Time (msec)
VLF, LF, HF, and LF/HF	330
pNN50	40
SDANN	160
σ_{int}	190
$A(10)$	160
$\sigma_{\text{wav}}(32)$	20
$S_{\tau}(1/32)$	60
DFA (32)	650,090
α_{γ}	650,110
$\alpha_{A\tau}$	220
$\alpha_{S\tau}$	920
α_A	610
α_U	570

After Teich, Lowen, Jost, Vibe-Rheymer & Heneghan,
in *Nonlinear Biomedical Signal Processing*, vol II, M. Akay, Ed.
(IEEE Press, NY, 2001), pp. 159-213.

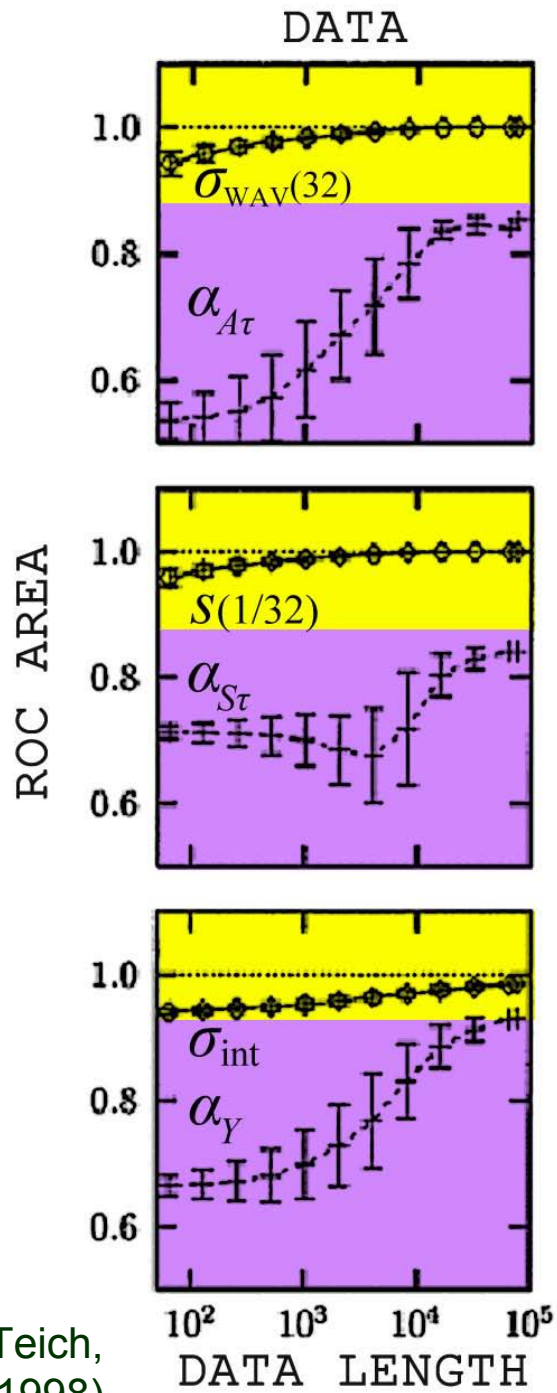

After Thurner, Feurstein, Lowen & Teich,
Phys. Rev. Letters **81**, 5688-5691 (1998).



THEORY

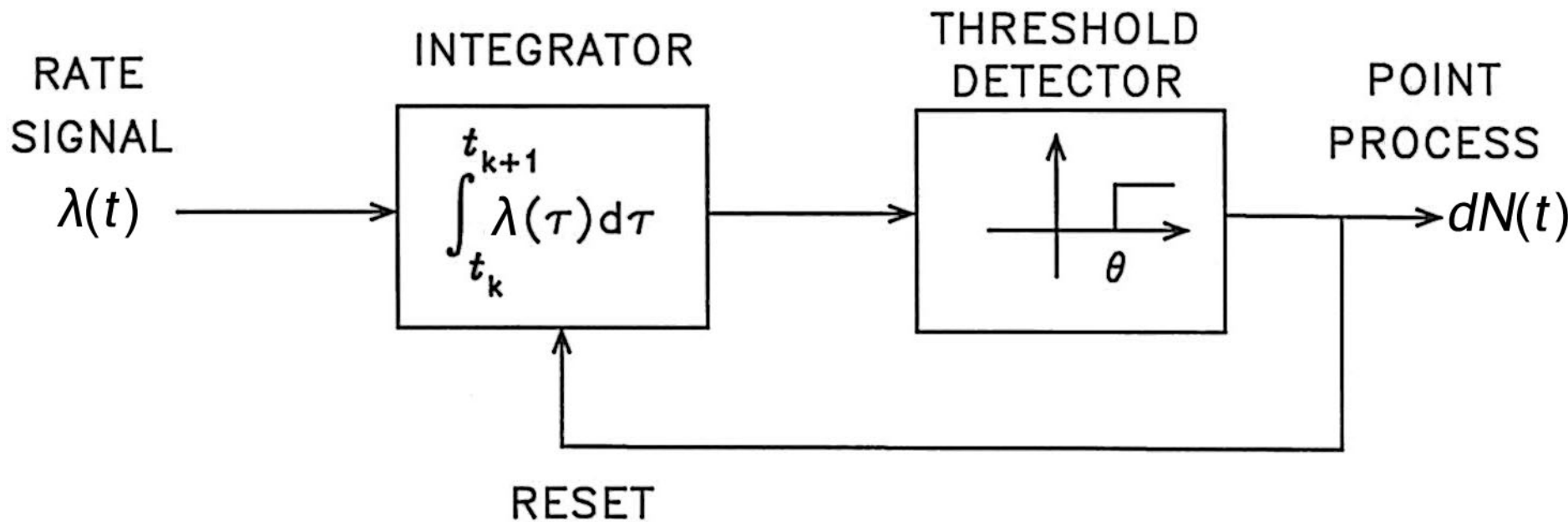

FREQUENCY-DOMAIN REPRESENTATION OF BANDLIMITED FRACTIONAL GAUSSIAN NOISE (FGN)

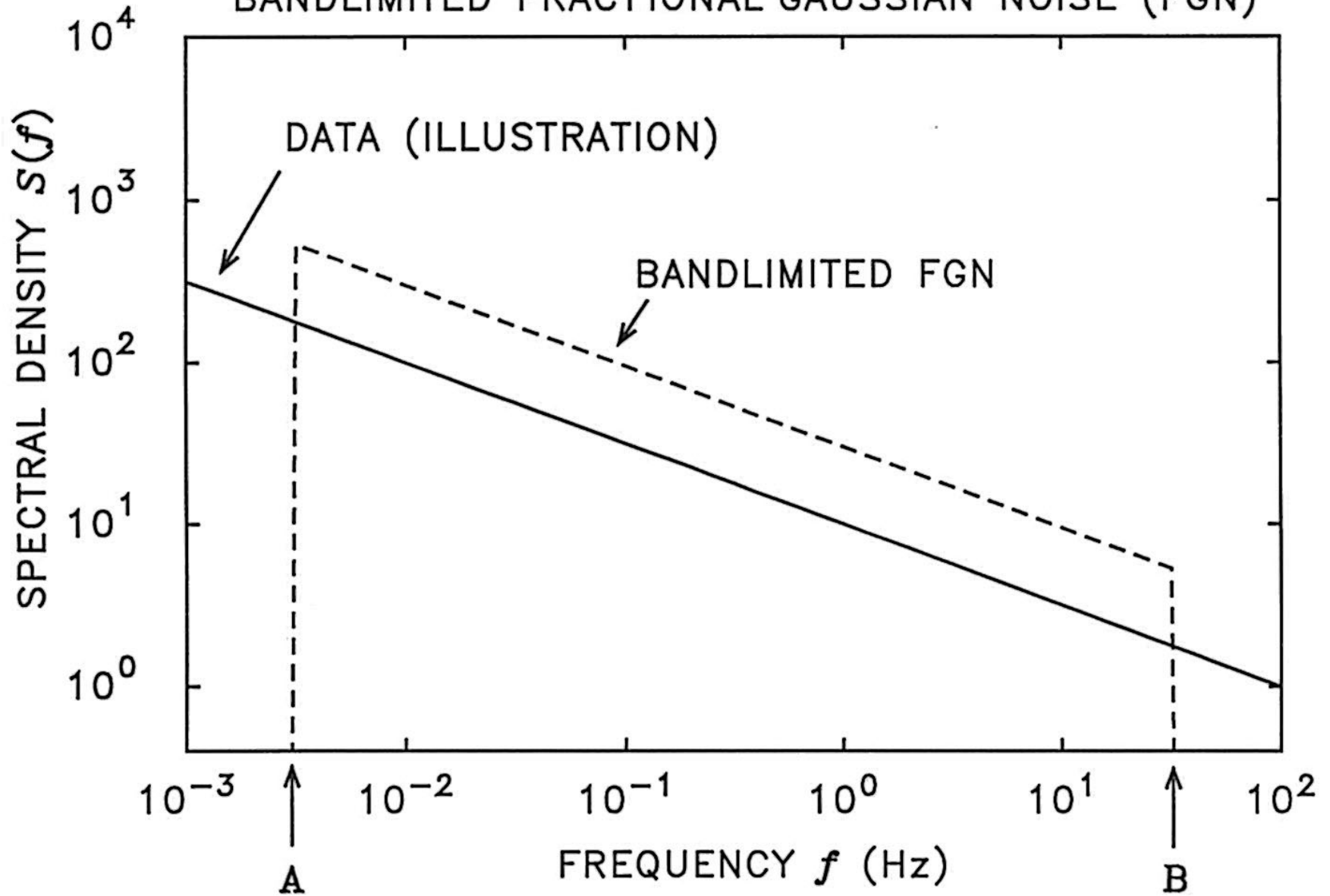

INTEREVENT-INTERVAL HISTOGRAM

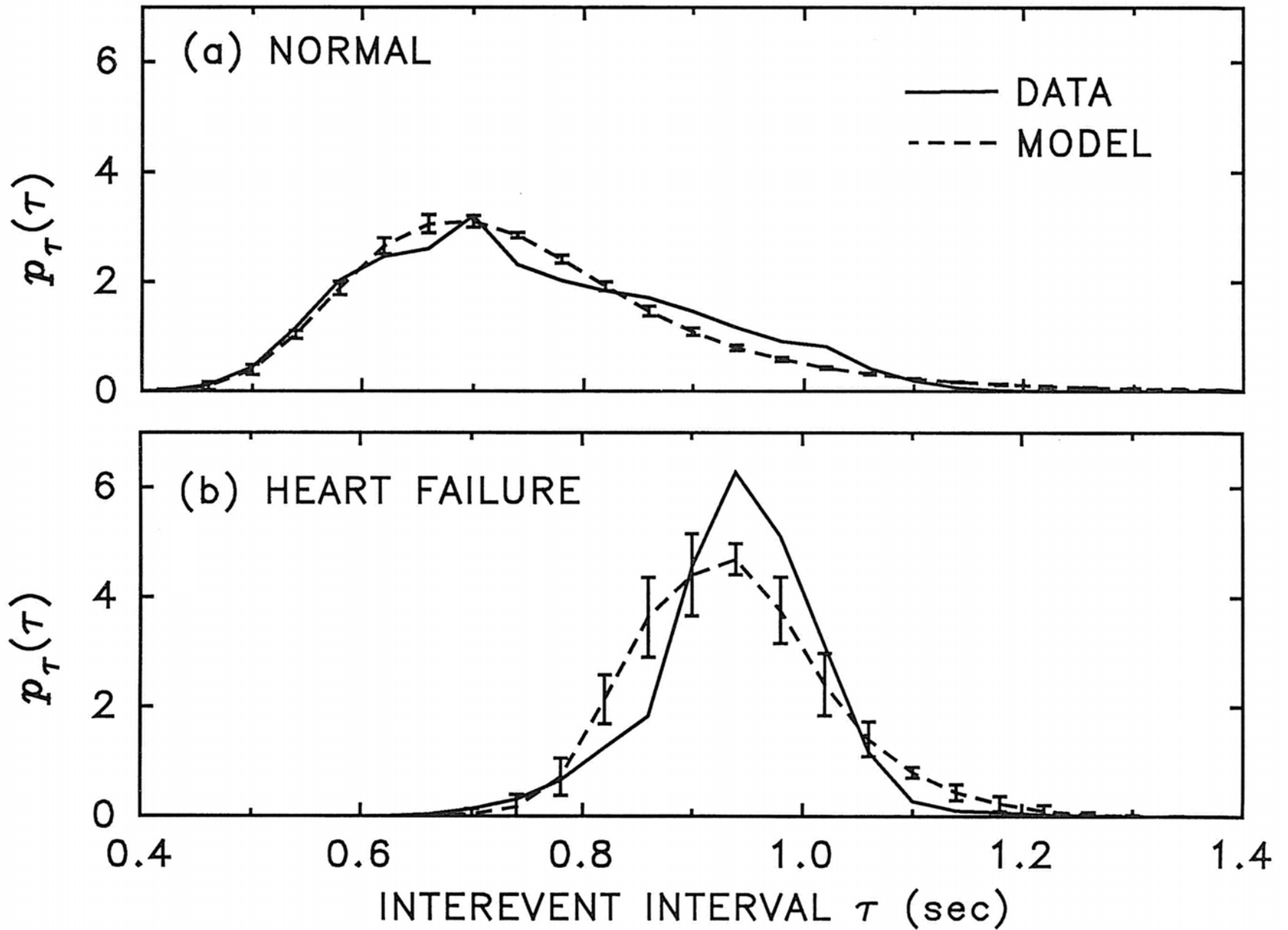

INTERVAL-BASED PERIODOGRAM

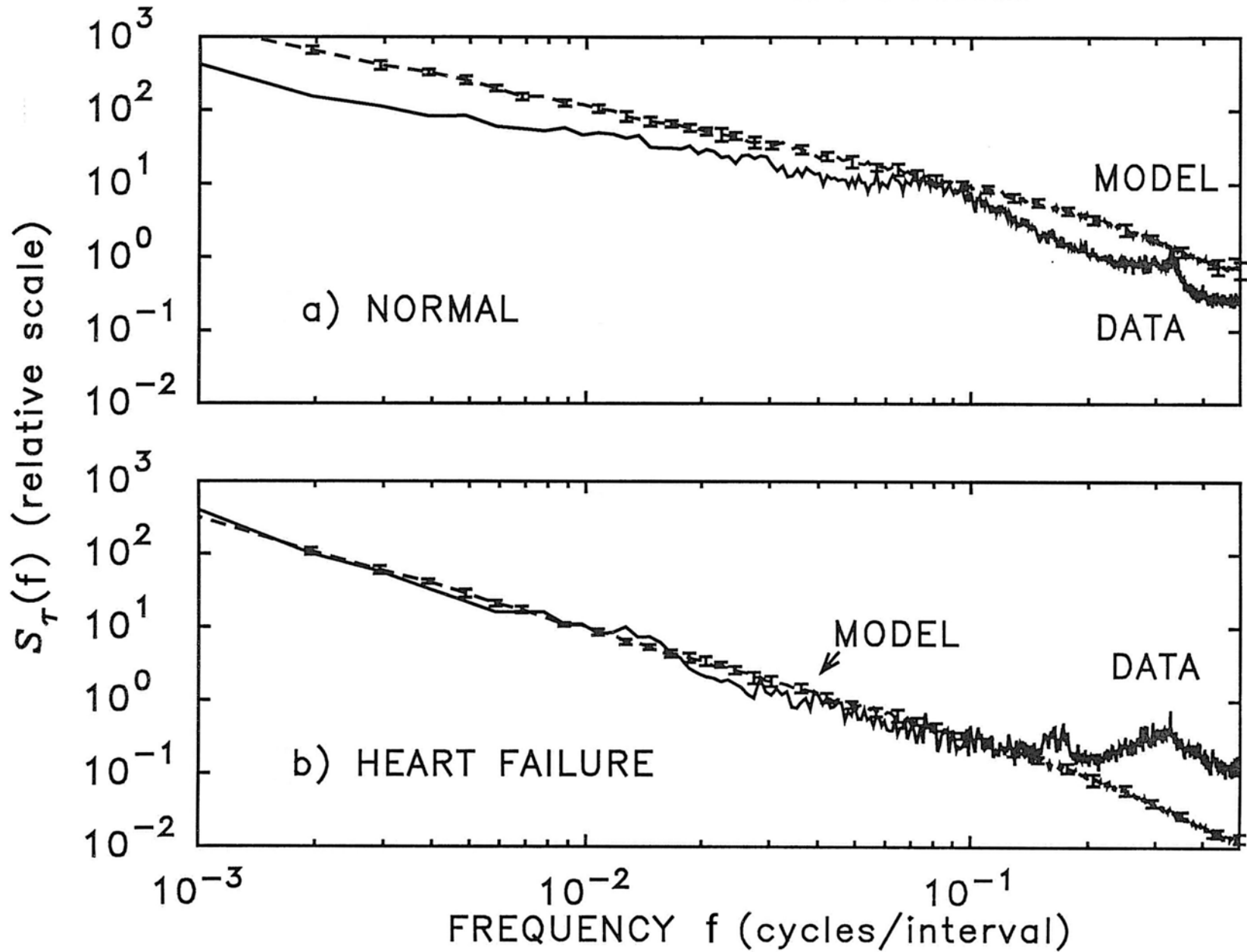

GENERALIZED-RATE-BASED PERIDOGRAM

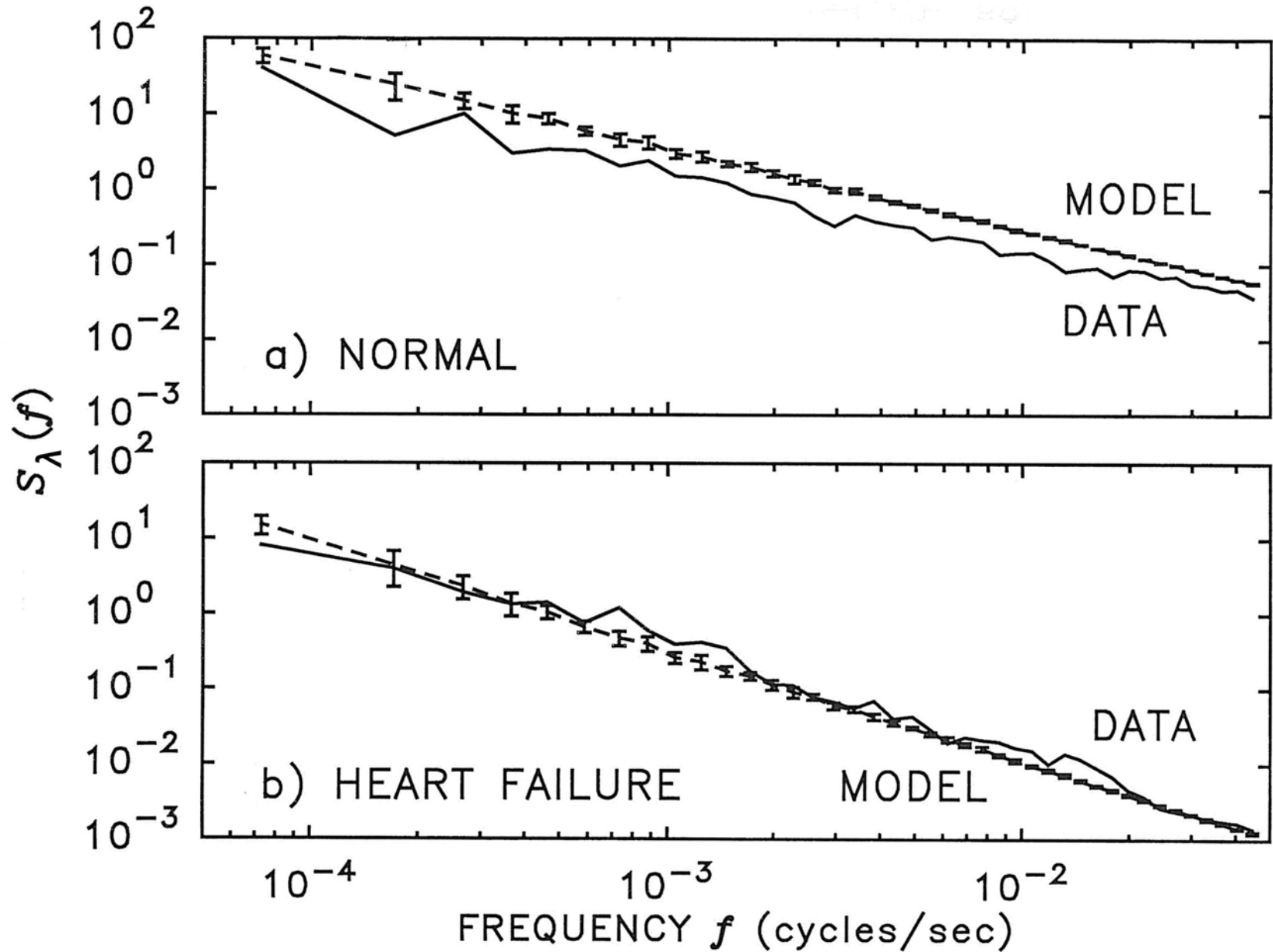

NORMALIZED HAAR-WAVELET VARIANCE

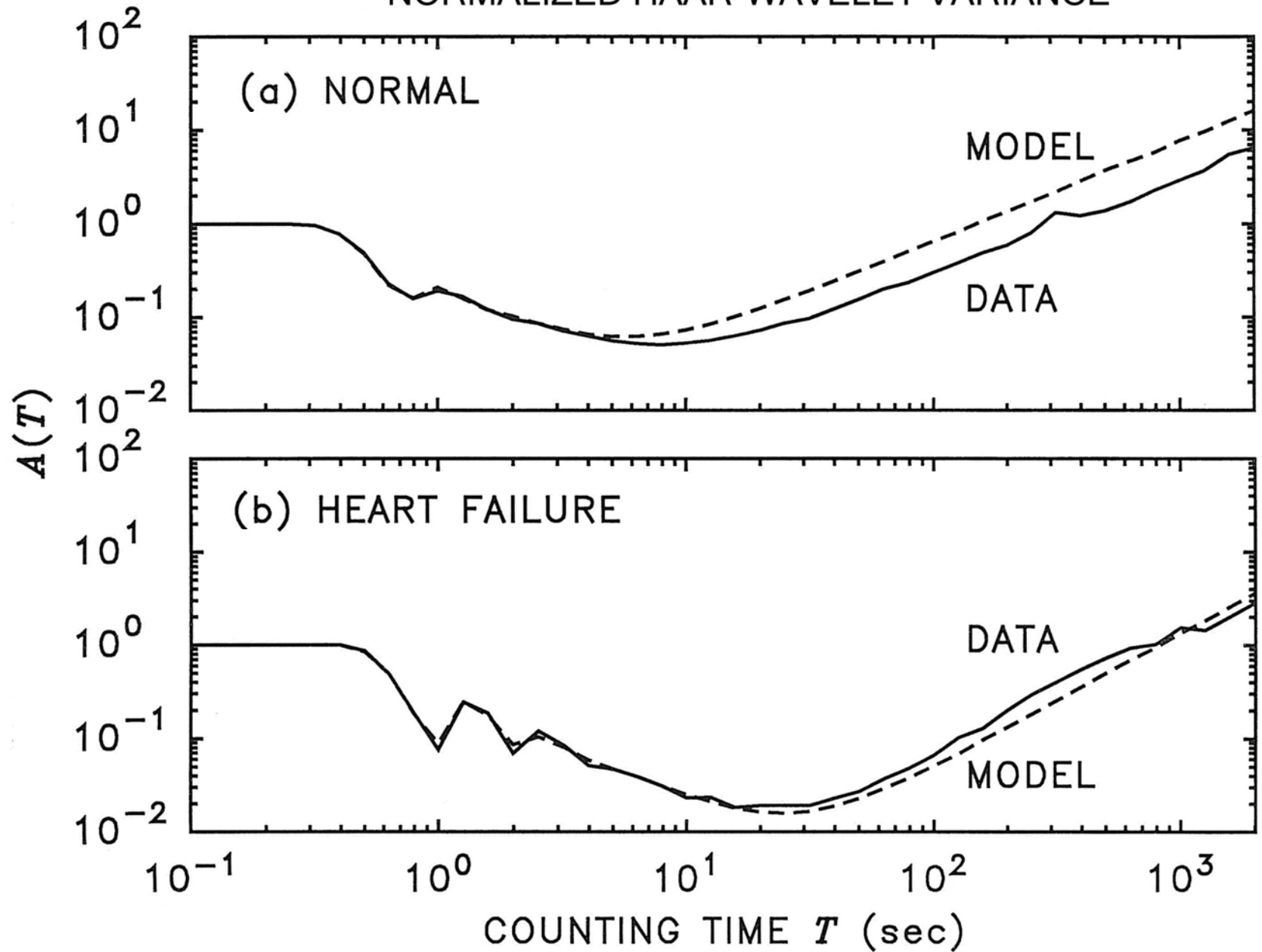

ROC-AREA CURVES: SIMULATION

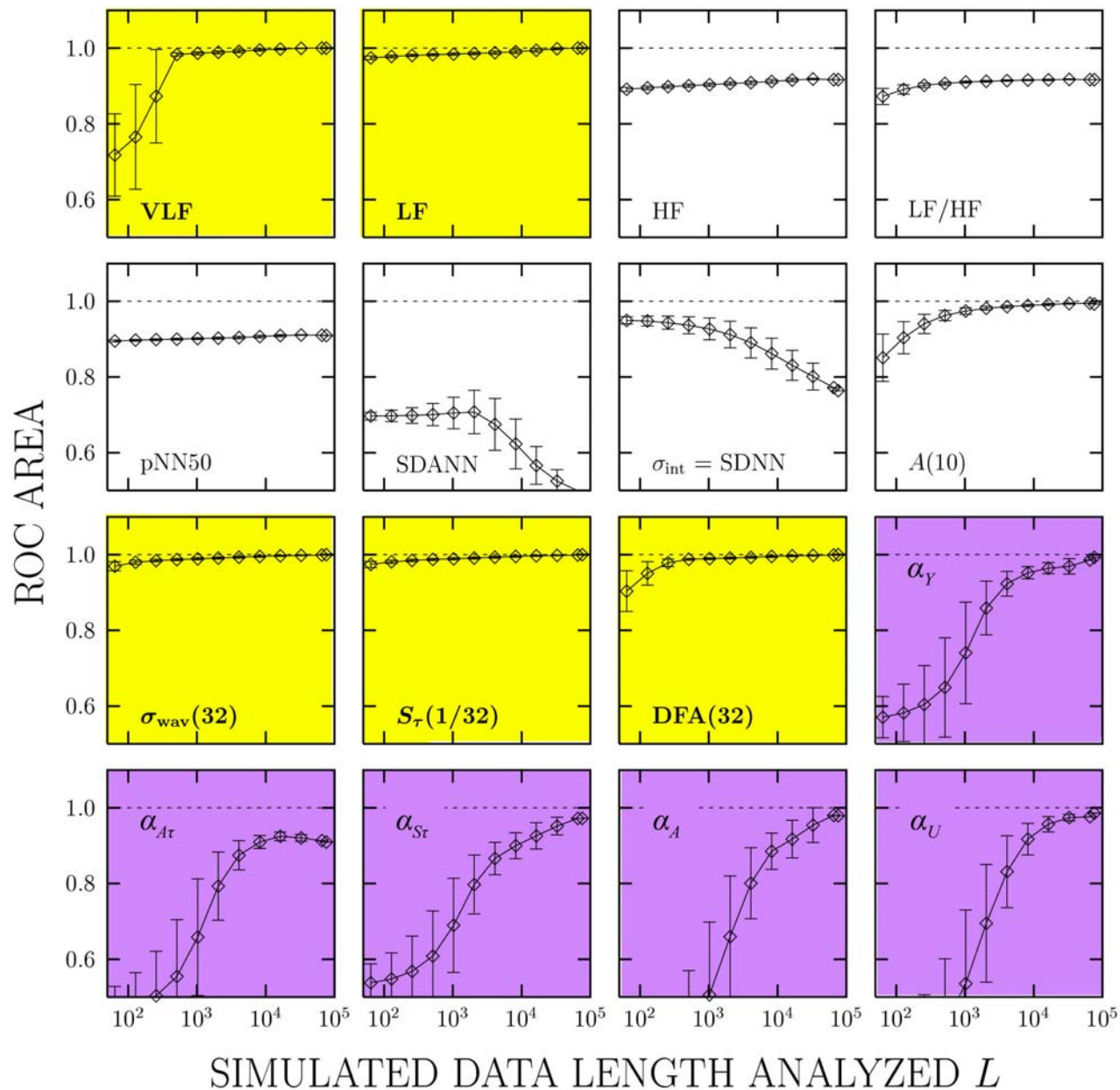

After Teich, Lowen, Jost, Vibe-Rheymer & Heneghan, in *Nonlinear Biomedical Signal Processing*, vol II, M. Akay, Ed. (IEEE Press, NY, 2001), pp. 159-213.

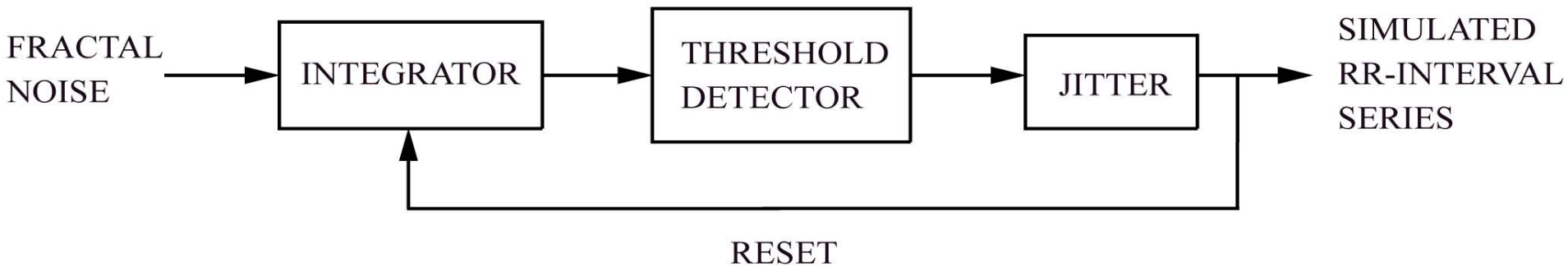

After Teich, Lowen, Jost, Vibe-Rheymer & Heneghan,
in *Nonlinear Biomedical Signal Processing*, vol II, M. Akay, Ed.
(IEEE Press, NY, 2001), pp. 159-213.

NORMAL

HEART FAILURE

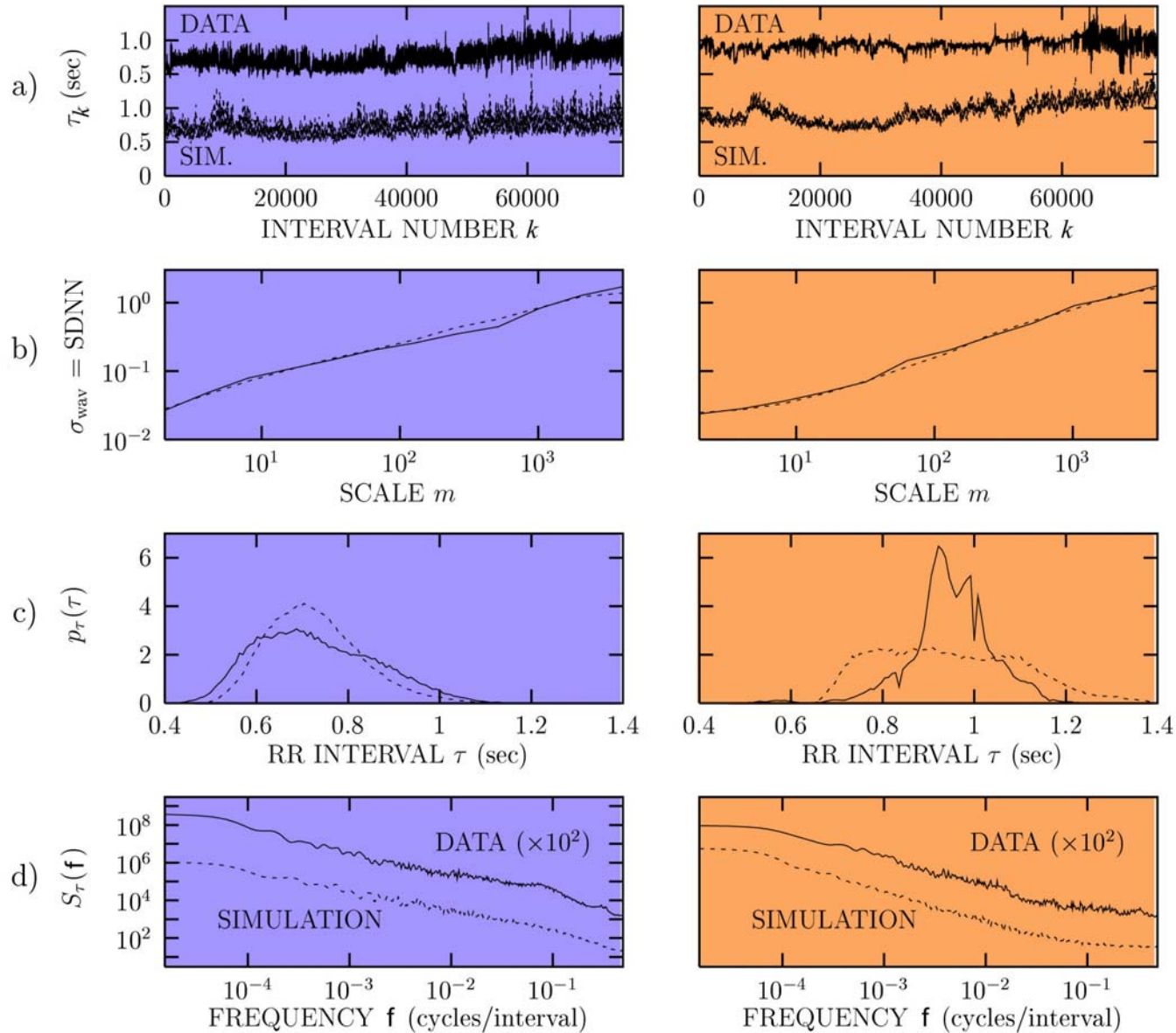

SIMULATION ACCURACY

SIMULATION

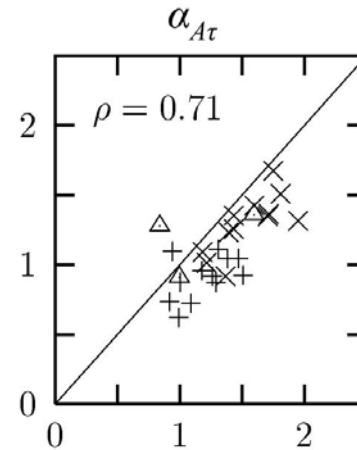
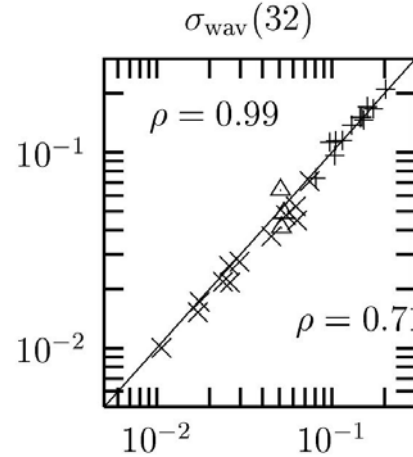
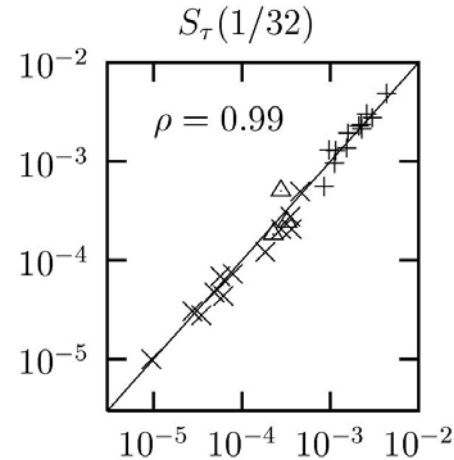
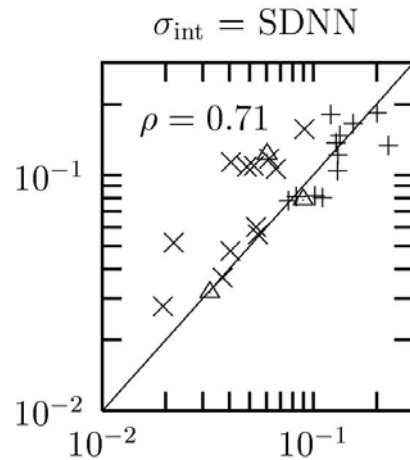

DATA

NORMAL +
 HEART FAILURE \bar{s} AF ×
 HEART FAILURE \bar{c} AF △



DOES THE HEARTBEAT REFLECT DETERMINISTIC CHAOS?

NORMAL

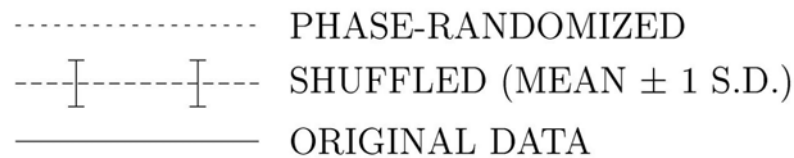
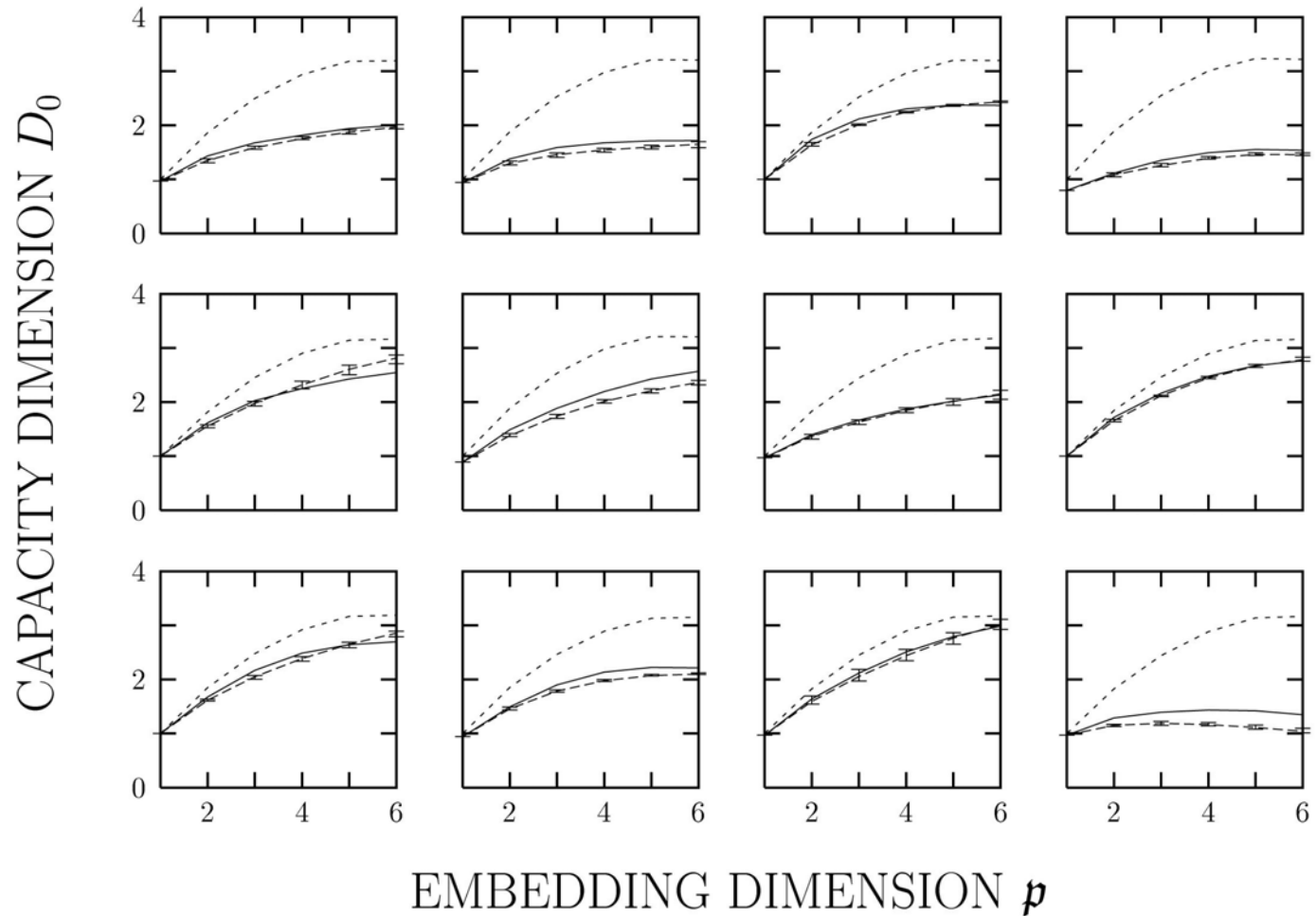

HEART FAILURE \bar{s} AF

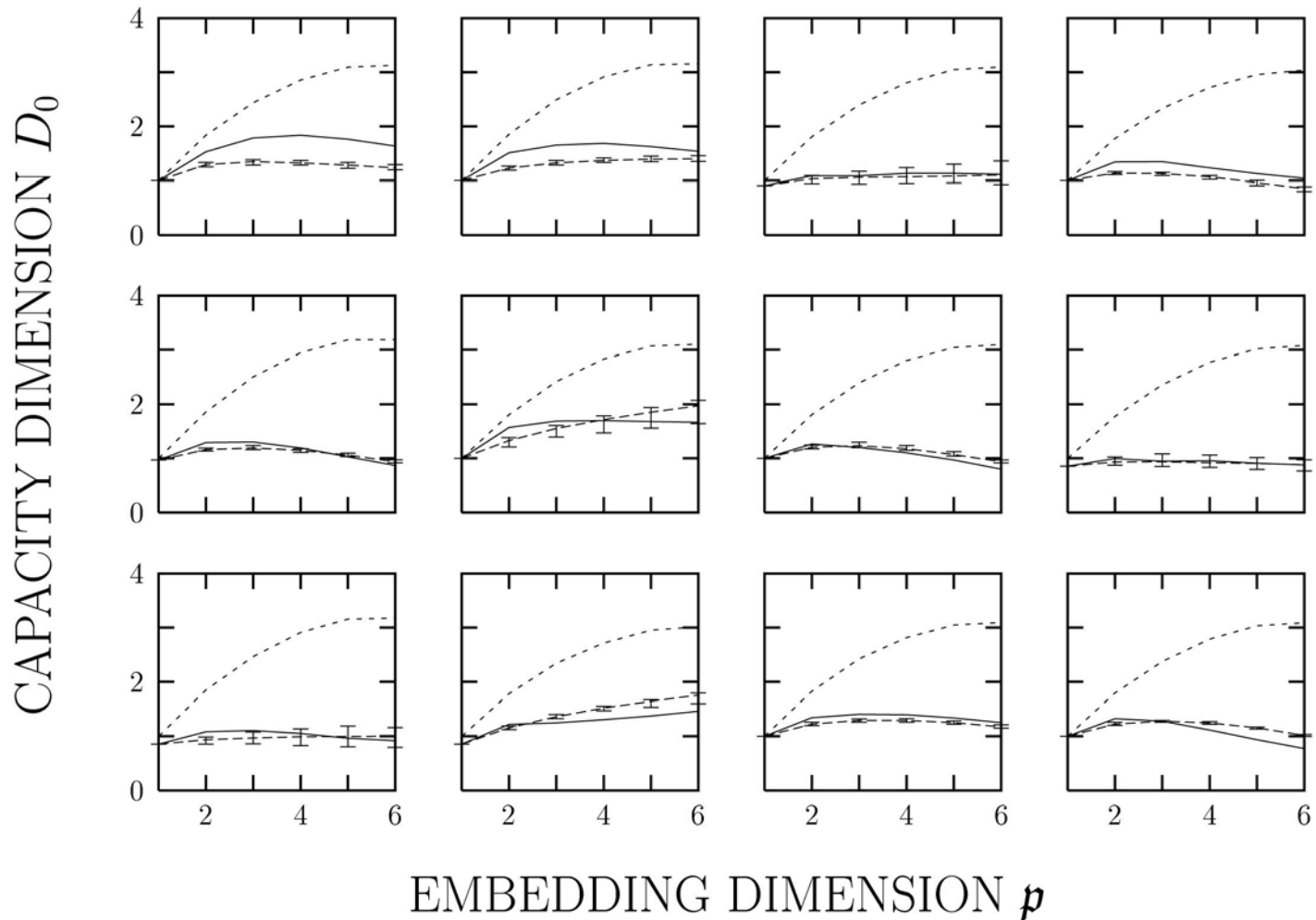

- PHASE-RANDOMIZED
- |-|-|- SHUFFLED (MEAN \pm 1 S.D.)
- _____ ORIGINAL DATA

OTHER PATHOLOGIES

CAPACITY DIMENSION D_0

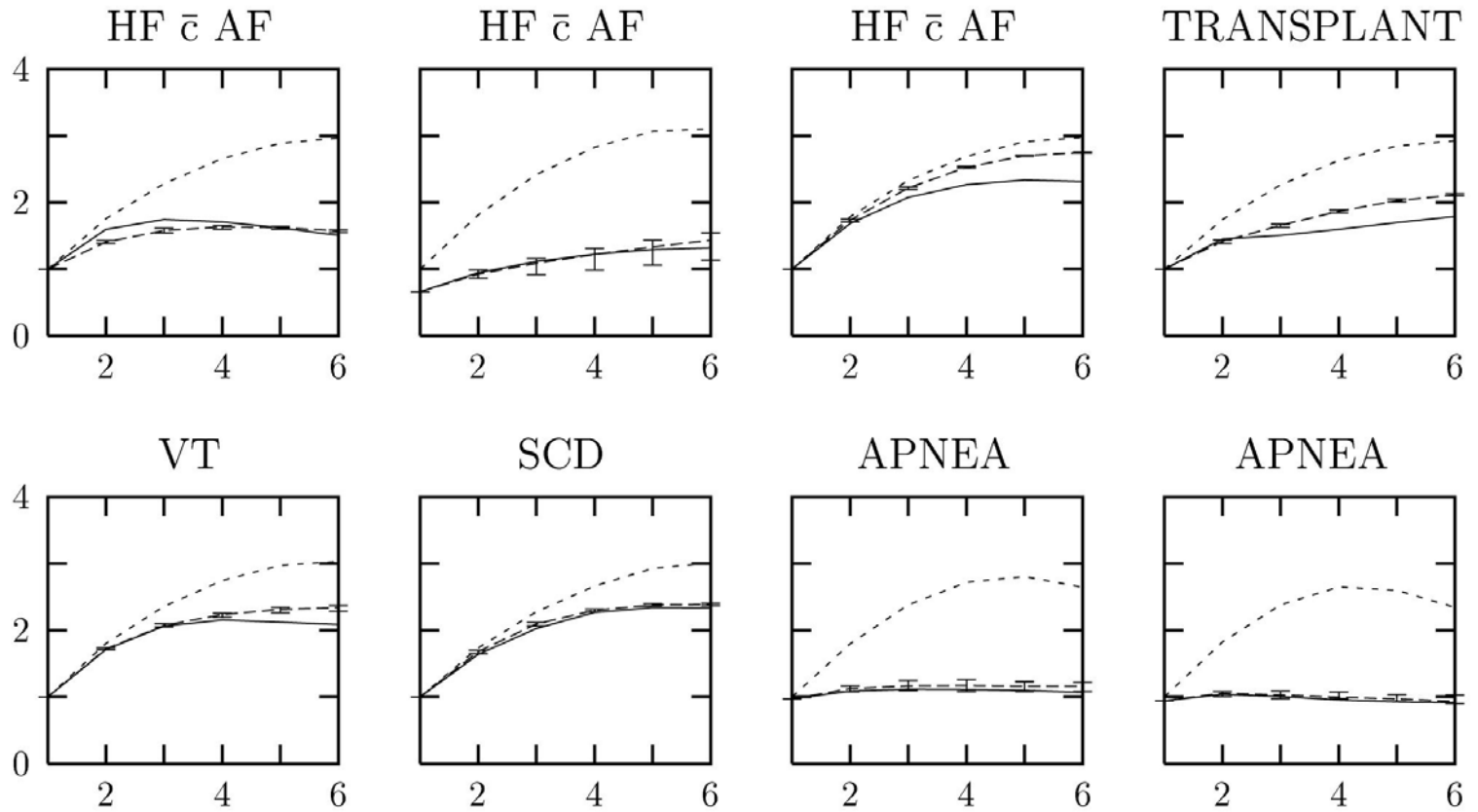

EMBEDDING DIMENSION p



GENERALIZED-RATE-BASED PHASE-SPACE RECONSTRUCTION

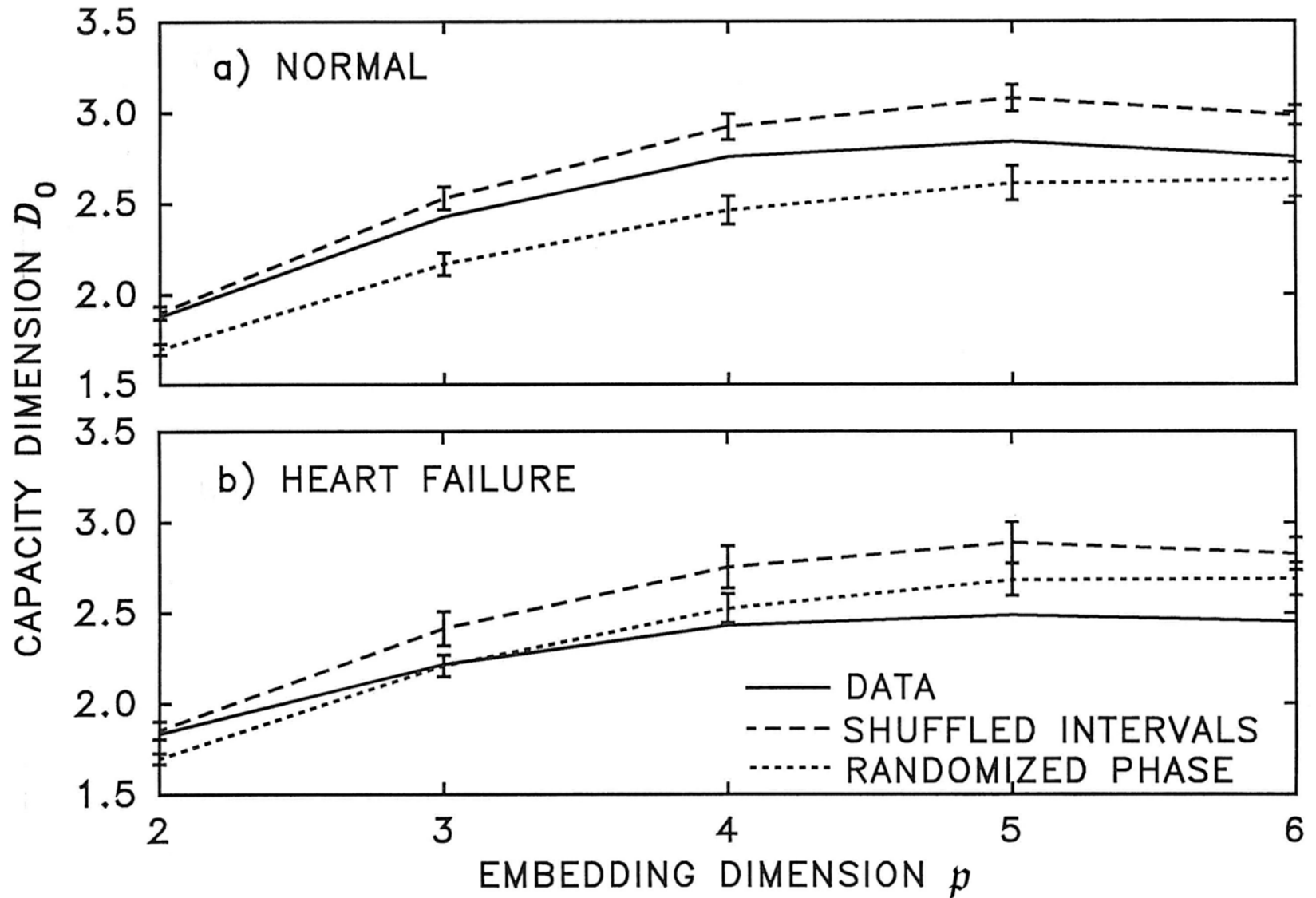

GENERALIZED-RATE-BASED PHASE-SPACE RECONSTRUCTION

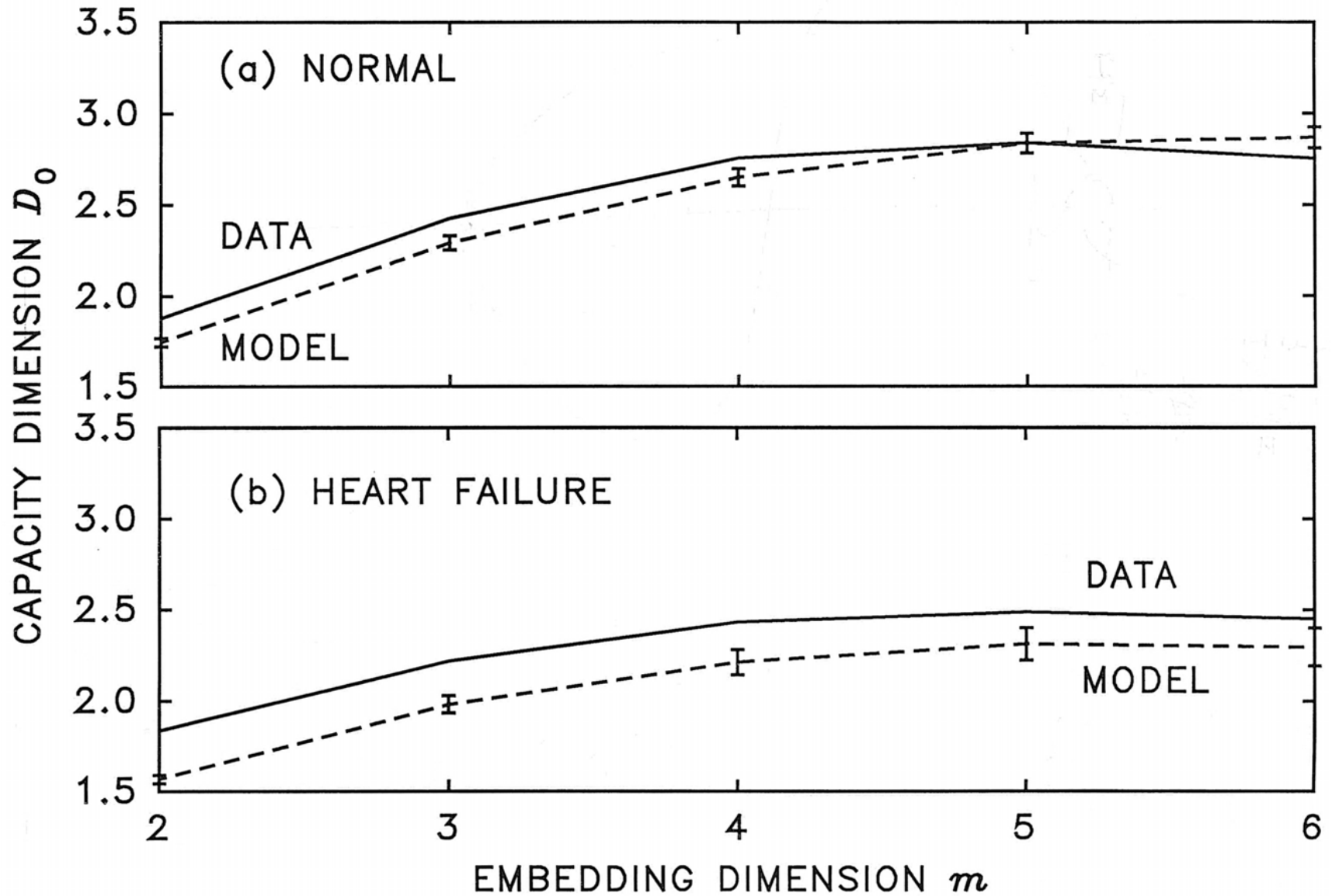

References

- R. G. Turcott and M. C. Teich, "Long-Duration Correlation and Attractor Topology of the Heartbeat Rate Differ for Healthy Patients and Those with Heart Failure," *Proc. SPIE* **2036** (Chaos in Biology and Medicine), 22-39 (1993).
- R. G. Turcott and M. C. Teich, "Fractal Character of the Electrocardiogram: Distinguishing Heart-Failure and Normal Patients," *Ann. Biomed. Eng.* **24**, 269-293 (1996).
- M. C. Teich, "Fractal Behavior of the Electrocardiogram: Distinguishing Heart-Failure and Normal Patients Using Wavelet Analysis," *Proc. 18th Intern. Conf. IEEE Eng. Med. Biol. Soc.* **18**, 1128-1129 (1996).
- S. Thurner, S. B. Lowen, M. Feurstein, C. Heneghan, H. G. Feichtinger, and M. C. Teich, "Analysis, Synthesis, and Estimation of Fractal-Rate Stochastic Point Processes," *Fractals* **5**, 565-595 (1997).
- M. C. Teich, "Multiresolution Wavelet Analysis of Heart-Rate Variability for Heart-Failure and Heart-Transplant Patients," *Proc. Int. Conf. IEEE Eng. Med. Biol. Soc* **20**, 1136-1141 (1998).
- S. Thurner, M. C. Feurstein, and M. C. Teich, "Multiresolution Wavelet Analysis of Heartbeat Intervals Discriminates Healthy Patients from Those with Cardiac Pathology," *Phys. Rev. Lett.* **80**, 1544-1547 (1998).
- S. Thurner, M. C. Feurstein, S. B. Lowen, and M. C. Teich, "Receiver-Operating-Characteristic Analysis Reveals Superiority of Scale-Dependent Wavelet and Spectral Measures for Assessing Cardiac Dysfunction," *Phys. Rev. Lett.* **81**, 5688-5691 (1998).
- C. Heneghan, S. B. Lowen, and M. C. Teich "Analysis of Spectral and Wavelet-Based Measures Used to Assess Cardiac Pathology," in *Proc. 1999 IEEE International Conference on Acoustics, Speech, and Signal Processing (ICASSP)* (Phoenix, AZ, 1999), paper SPTM-8.2.
- M. C. Teich, S. B. Lowen, B. M. Jost, K. Vibe-Rheymer, and C. Heneghan, "Heart Rate Variability: Measures and Models," in *Nonlinear Biomedical Signal Processing, Vol. II*, edited by M. Akay (IEEE Press, New York, 2001), pp. 159-213.