

Naval Research Laboratory

Washington, DC 20375-5320 NRL/PU/5211--03-456 November 2002



NRL FACT BOOK

Report Documentation Page

*Form Approved
OMB No. 0704-0188*

Public reporting burden for the collection of information is estimated to average 1 hour per response, including the time for reviewing instructions, searching existing data sources, gathering and maintaining the data needed, and completing and reviewing the collection of information. Send comments regarding this burden estimate or any other aspect of this collection of information, including suggestions for reducing this burden, to Washington Headquarters Services, Directorate for Information Operations and Reports, 1215 Jefferson Davis Highway, Suite 1204, Arlington VA 22202-4302. Respondents should be aware that notwithstanding any other provision of law, no person shall be subject to a penalty for failing to comply with a collection of information if it does not display a currently valid OMB control number.

1. REPORT DATE NOV 2002	2. REPORT TYPE N/A	3. DATES COVERED -		
4. TITLE AND SUBTITLE NRL Fact Book		5a. CONTRACT NUMBER		
		5b. GRANT NUMBER		
		5c. PROGRAM ELEMENT NUMBER		
6. AUTHOR(S)		5d. PROJECT NUMBER		
		5e. TASK NUMBER		
		5f. WORK UNIT NUMBER		
7. PERFORMING ORGANIZATION NAME(S) AND ADDRESS(ES) Naval Research Laboratory Washington, DC 20375-5320		8. PERFORMING ORGANIZATION REPORT NUMBER		
9. SPONSORING/MONITORING AGENCY NAME(S) AND ADDRESS(ES)		10. SPONSOR/MONITOR'S ACRONYM(S)		
		11. SPONSOR/MONITOR'S REPORT NUMBER(S)		
12. DISTRIBUTION/AVAILABILITY STATEMENT Approved for public release, distribution unlimited				
13. SUPPLEMENTARY NOTES The original document contains color images.				
14. ABSTRACT				
15. SUBJECT TERMS				
16. SECURITY CLASSIFICATION OF:			17. LIMITATION OF ABSTRACT	
a. REPORT unclassified	b. ABSTRACT unclassified	c. THIS PAGE unclassified	UU	18. NUMBER OF PAGES 135
				19a. NAME OF RESPONSIBLE PERSON

The *NRL Fact Book* is a reference source for information about the Naval Research Laboratory (NRL). It is updated and placed on NRL's Web site (<http://www.nrl.navy.mil/>) annually. It is printed every other year. To provide additional information to the reader, a point of contact is listed for each activity.

NRL has a continuing need for physical scientists, mathematicians, engineers, and support personnel. Vacancies are filled without regard to age, race, creed, sex, or national origin. Information concerning current vacancies is furnished on request. Address all such inquiries to:

Human Resources Office
 Personnel Operations Branch (Code 1810)
 Naval Research Laboratory
 Washington, DC 20375-5320

Cover photos:

Inspection of the Starshine 3 satellite prior to its flight acceptance vibration test

WindSat is a polarimetric microwave radiometer developed for measuring ocean surface wind speed and direction

Virtual Information Command Center

NIKE Laser Facility's propagation bay

**NRL
 Washington, DC**

NRL's URL: <http://www.nrl.navy.mil/>

Quick Reference Telephone Numbers

	NRL WASHINGTON	NRL- SSC	NRL- MONTEREY	NRL CBD	NRL FSD Patuxent River
Hotline	(202) 767-6543	(202) 767-6543	(202) 767-6543	(202) 767-6543	(202) 767-6543
Personnel Locator	(202) 767-3200	(228) 688-3390	(831) 656-4721	(410) 257-4000	(301) 342-4926
DSN	297- or 754-	828	878	—	342
Direct-in-Dialing	767- or 404-	688	656	257	342
Public Affairs	(202) 767-2541	(228) 688-5328	(831) 656-4758	—	(301) 342-4926

Additional telephone numbers are listed on pages 144 and 145.

NRL

FACT

BOOK

**NAVAL RESEARCH LABORATORY
WASHINGTON, DC 20375-5320**

Contents

1	INTRODUCTION TO THE NAVAL RESEARCH LABORATORY
1	Mission
3	The Naval Research Laboratory in the Department of the Navy
4	NRL Functional Organization
5	Current Research
8	Major Research Capabilities and Facilities
14	NRL Sites and Facilities
15	EXECUTIVE DIRECTORATE
17	Executive Directorate - Commanding Officer and Director of Research
20	Executive Council
21	Research Advisory Committee
25	Office of Technology Transfer
26	Office of Program Administration and Policy Development
27	Office of Counsel
28	Command Support Division
30	Military Support Division
32	Flight Support Detachment
34	Human Resources Office
37	BUSINESS OPERATIONS DIRECTORATE
40	Associate Director of Research for Business Operations
42	Contracting Division
44	Financial Management Division
46	Supply Division
48	Research and Development Services Division
51	SYSTEMS DIRECTORATE
54	Associate Director of Research for Systems
57	Signature Technology Office
58	Technical Information Division
60	Radar Division
62	Information Technology Division
64	Optical Sciences Division
66	Tactical Electronic Warfare Division
69	MATERIALS SCIENCE AND COMPONENT TECHNOLOGY DIRECTORATE
72	Associate Director of Research for Materials Science and Component Technology
75	Laboratory for Structure of Matter
76	Chemistry Division
78	Materials Science and Technology Division
80	Laboratory for Computational Physics and Fluid Dynamics
82	Plasma Physics Division
84	Electronics Science and Technology Division
86	Center for Bio/Molecular Science and Engineering

89	OCEAN AND ATMOSPHERIC SCIENCE AND TECHNOLOGY DIRECTORATE
92	Associate Director of Research for Ocean and Atmospheric Science and Technology
94	Office of Research Support Services
96	Acoustics Division
98	Remote Sensing Division
100	Oceanography Division
102	Marine Geosciences Division
104	Marine Meteorology Division
106	Space Science Division
109	NAVAL CENTER FOR SPACE TECHNOLOGY
112	Director of Naval Center for Space Technology
114	Space Systems Development Department
116	Spacecraft Engineering Department
119	TECHNICAL OUTPUT, FISCAL, AND PERSONNEL INFORMATION
121	Technical Output
122	Fiscal
126	Personnel Information
127	PROFESSIONAL DEVELOPMENT
129	Programs for NRL Employees
133	Programs for Non-NRL Employees
135	GENERAL INFORMATION
137	Maps
144	Key Personnel

Photos on opposite page - top to bottom

The Naval Research Laboratory is located in Washington, DC, on the east bank of the Potomac River.

The NRL Marine Meteorology Division is located in Monterey, California (NRL-MRY).

The Naval Research Laboratory Detachment is located at Stennis Space Center, Bay St. Louis, Mississippi (NRL-SSC).

Introduction to the Naval Research Laboratory

Mission

To conduct a broadly based multidisciplinary program of scientific research and advanced technological development directed toward maritime applications of new and improved materials, techniques, equipment, systems, and ocean, atmospheric, and space sciences and related technologies.

The Naval Research Laboratory

- Provides primary in-house research for the physical, engineering, space, and environmental sciences
- Provides broadly based exploratory and advanced development programs in response to identified and anticipated Navy and Marine Corps needs
- Provides broad multidisciplinary support to the Naval Warfare Centers
- Provides space and space systems technology development and support
- Assumes responsibility as the Navy's corporate laboratory



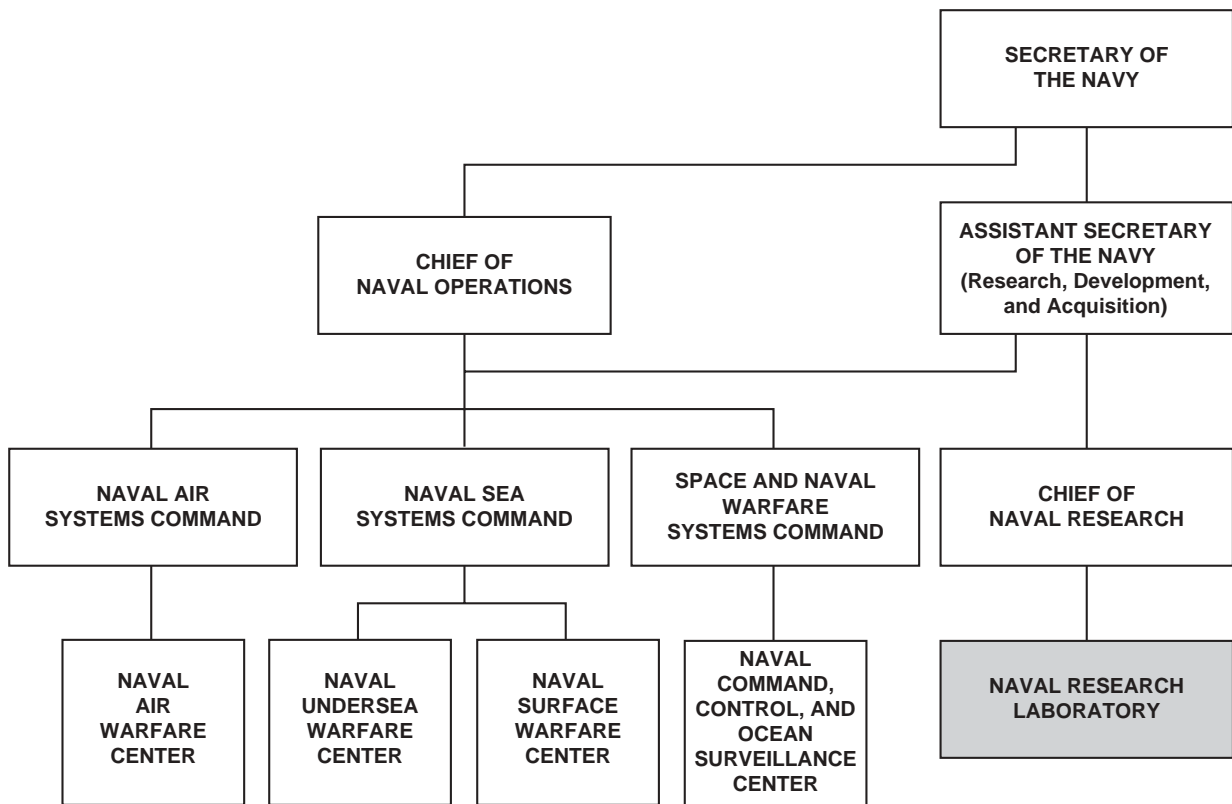



The Naval Research Laboratory in the Department of the Navy

The Naval Research Laboratory is the Department of the Navy's corporate laboratory; it is under the command of the Chief of Naval Research. As the corporate laboratory of the Navy, NRL is the principal in-house component in the Office of Naval Research's (ONR) effort to meet its science and technology responsibilities.

NRL has had a long and fruitful relationship with industry as a collaborator, contractor, and most recently in Cooperative Research and Development Agreements (CRADAs). NRL values this linkage and intends for it to continue to develop.

NRL is an important link in the Navy Research, Development, and Acquisition (RD&A) chain. Through NRL, the Navy has direct ties with sources of fundamental ideas in industry and the academic community throughout the world and provides an effective coupling point to the R&D chain for ONR.

NRL Functional Organization

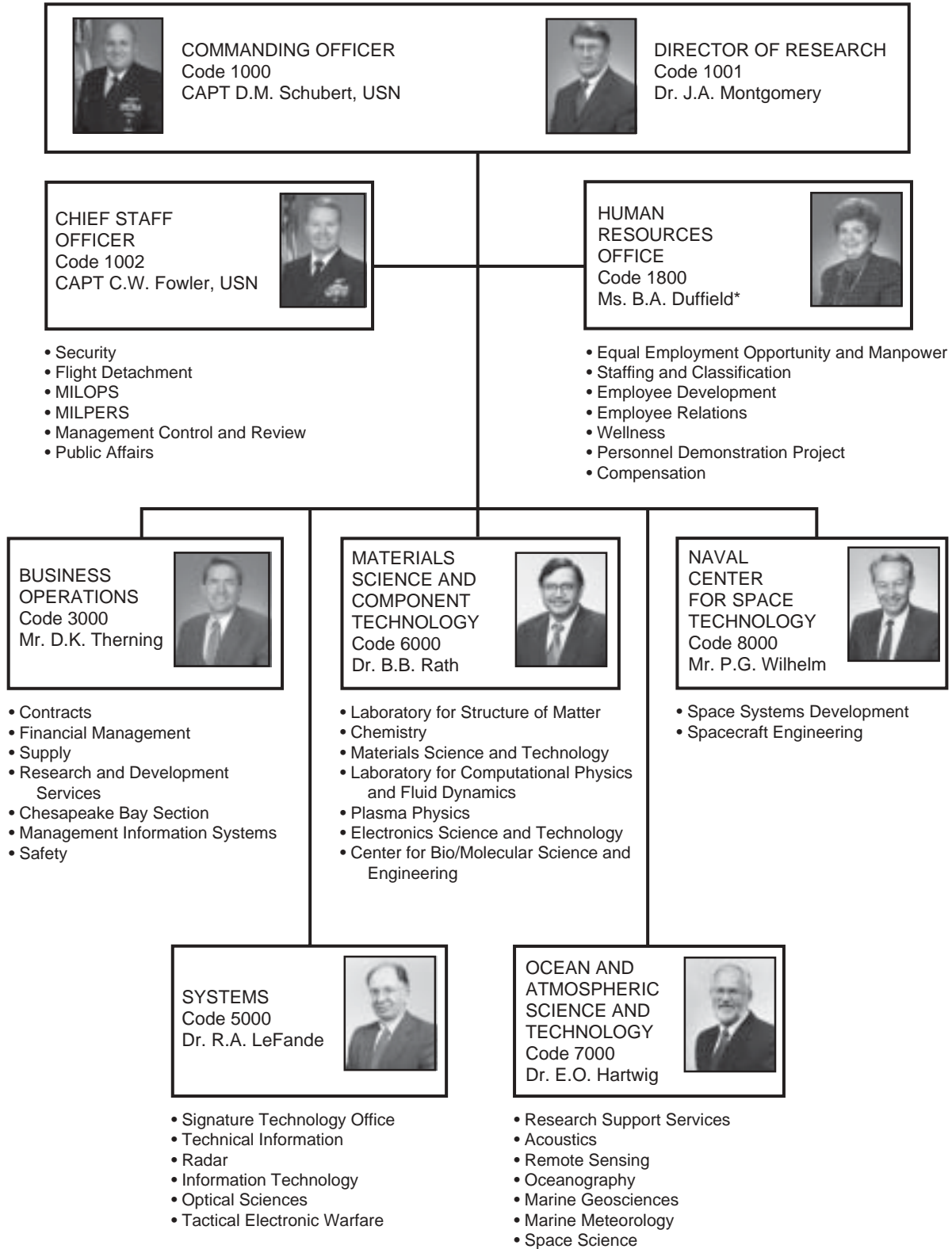

*Acting

Current Research

The following areas represent broad fields of NRL research. Under each, more specific topics that are being investigated for the benefit of the Navy and other sponsoring organizations are listed. Some details of this work are given in the *NRL Review*, published annually. More specific details are published in reports on individual projects provided to sponsors and/or presented as papers for professional societies or their journals.

Advanced Radio, Optical, and IR Sensors

- Advanced optical sensors
- EM/EO/meteorological/oceanographic sensors
- Satellite meteorology
- Precise space tracking
- Radio/infrared astronomy
- Infrared sensors and phenomenology
- UV sensors and middle atmosphere research
- Image processing
- VLBI/astrometry
- Optical interferometry
- Imaging spectrometry
- Liquid crystal technology

Computer Science and Artificial Intelligence

- Standard computer hardware, development environments, operating systems, and run-time support software
- Methods of specifying, developing, documenting, and maintaining software
- Human-computer interaction
- Intelligent systems for resource allocation, signal identification, operational planning, target classification, and robotics
- Parallel scientific libraries
- Algorithms for massively parallel systems
- Digital progressive HDTV for scientific visualization
- Adaptive systems: software and devices
- Advanced computer networking
- Simulation management software for networked high performance computers
- Interactive 3-D visualization tools and applications
- Distributed modeling and simulation (e.g., HLA, and FOM development)
- Real-time parallel processing
- Scalable, parallel computing
- Processing graph method for parallel processing
- Teraflop scalable shared memory, massively parallel computer architectures

Directed Energy Technology

- High-energy lasers
- Laser propagation
- Solid-state and fiber lasers
- High-power microwave sources
- RAM accelerators
- Pulse detonation engines
- Charged-particle devices

- Pulse power
- DE effects

Electronic Electro-optical Device Technology

- Integrated optics
- Radiation-hardened electronics
- Nanotechnology
- Microelectronics
- Microwave and MM wave technology
- Hydrogen masers for GPS
- Aperture syntheses
- Electric field coupling
- Vacuum electronics
- Focal plane arrays
- Infrared sensors
- Radiation effects and satellite survivability
- Molecular engineering

Electronic Warfare

- EW/C2W/IW systems and technology
- COMINT/SIGINT technology
- EW decision aids and planning/control systems
- Intercept receivers, signal processing, and identification systems
- Passive direction finders
- Decoys and offboard CM (RF and IR)
- Expendable autonomous vehicles/UAVs
- Repeaters/jammers and EO/IR active countermeasures and techniques
- Platform signature measurement and management
- Threat and EW systems computer modeling and simulations
- Visualization
- Hardware-in-the-loop and flyable ASM simulators
- Missile warning infrared countermeasures
- RF environment simulators
- EO/IR multispectral/hyperspectral surveillance

Enhanced Maintainability, Reliability, and Survivability Technology

- Coatings
- Friction/wear reduction
- Water additives and cleaners
- Fire safety
- Laser hardening
- Satellite survivability
- Corrosion control
- Automation for reduced manning
- Radiation effects

- Mobility fuels
- Chemical and biological sensors
- Environmental compliance

Environmental Effects on Naval Systems

- Meteorological effects on communications
- Meteorological effects on weapons, sensors, and platform performance
- Air quality in confined spaces
- Electromagnetic background in space
- Solar and geomagnetic activity
- Magnetospheric and space plasma effects
- Nonlinear science
- Ionospheric behavior
- Oceanographic effects on weapons, sensors, and platforms
- EM, EO, and acoustic system performance/optimization
- Environmental hazard assessment
- Contaminant transport
- Biosensors
- Microbially induced corrosion

Imaging Research/Systems

- Remotely sensed signatures analysis
- Real-time signal and image processing algorithms/systems
- Image data compression methodology
- Image fusion
- Automatic target recognition
- Scene/sensor noise characterization
- Image enhancement/noise reduction
- Scene classification techniques
- Radar and laser imaging systems studies
- Coherent/incoherent imaging sensor exploitation
- Remote sensing simulation
- Hyperspectral imaging
- Microwave polarimetry

Information Technology

- High performance, all-optical networking
- Antijam communication links
- Next generation, signaled optical network architectures
- Integrated voice and data
- Information security (INFOSEC)
- Voice processing
- High performance computing
- High performance communications
- Requirement specification and analysis
- Real-time computing
- Wireless mobile networking
- Natural environments for distributed simulation
- Collaborative engineering environments
- Information filtering and fusion
- Integrated internet protocol (IP) and asynchronous transfer mode (ATM) multicasting
- Reliable multicasting
- Wireless networking with directional antennas

- Sensor networking
- Communication network simulation
- Bandwidth management (quality of service)
- High assurance software
- Distributed network-based battle management
- High Performance Computing (HPC) supporting uniform and nonuniform memory access with single and multithreaded architectures
- Distributed, secure, and mobile information infrastructures
- Virtual engineering
- Simulation-based virtual reality
- Advanced distributed simulation
- High-end, progressive HDTV imagery processing and distribution
- Defensive information warfare
- Virtual reality/mobile augmented reality
- Motion adaptation and vestibular research
- 3-D multimodal interaction
- Model integration/physical, environmental, biological, psychological) for simulation
- Synthetic natural environments for distributed simulation
- Command decision support
- Data fusion

Marine Geosciences

- Marine seismology, including propagation and noise measurement
- Geoacoustic modeling in support of acoustic performance prediction
- Geomagnetic modeling in support of nonacoustic system performance prediction
- Static potential field measurement and analysis (gravity and magnetic) in support of navigation and geodesy
- Geotechnology/sediment dynamics affecting mine warfare and mine countermeasures
- Foreshore sediment transport
- Geospatial information, including advanced seafloor mapping, imaging systems, and innovative object-oriented digital mapping models, techniques, and databases

Materials

- Superconductivity
- Magnetism
- Biological materials
- Materials processing
- Advanced alloy systems
- Solid free-form fabrication
- Environmental effects
- Energetic materials/explosives
- Aerogels and underdense materials
- Nanoscale materials
- Nondestructive evaluation
- Ceramics and composite materials
- Thin film synthesis and processing
- Electronic and piezoelectric ceramics

Thermoelectric materials
Metamorphic materials/smart structures
Computational material science
Paints and coatings
Flammability
Chemical/biological materials
Spintronic materials and half metals
Biomimetic materials

Meteorology

Global, theater, tactical-scale, and on-scene numerical weather prediction
Data assimilation and physical initialization
Atmospheric predictability and adaptive observations
Adjoint applications
Marine boundary layer characterization
Air/sea interaction; process studies
Coupled air/ocean/land model development
Tropical cyclone forecasting aids
Satellite data interpretation and application
Aerosol transport modeling
Meteorological applications of artificial intelligence and expert systems
On-scene environmental support system development/nowcasting
Tactical database development and applications
Meteorological tactical decision aids
Meteorological simulation and visualization

Ocean Acoustics

Underwater acoustics, including propagation, noise, and reverberation
Fiber-optic acoustic sensor development
Deep ocean and shallow water environmental acoustic characterization
Undersea warfare system performance modeling, unifying the environment, acoustics, and signal processing
Target reflection, diffraction, and scattering
Acoustic simulations
Tactical decision aids
Sonar transducers
Dynamic ocean acoustic modeling

Oceanography

Oceanographic instrumentation
Open ocean, littoral, polar, and nearshore oceanographic forecasting
Shallow water oceanographic effects on operations
Modeling, sensors, and data fusion
Bio-optical and fine-scale physical processes
Oceanographic simulation and visualization
Coastal scene generation
Waves, tides, and surf prediction
Coupled model development

Coastal ocean characterization
Oceanographic decision aids
Global, theater, and tactical scale modeling
Remote sensing of oceanographic parameters
Satellite image analysis

Space Systems and Technology

Space systems architectures and requirements
Advanced payloads and optical communications
Controllers, processors, signal processing, and VLSI
Precision orbit estimation
Onboard autonomous navigation
Satellite ground station engineering and implementation
Tactical communication systems
Spacecraft antenna systems
Launch and on-orbit support
Precise Time and Time Interval (PTTI) technology
Atomic-time/frequency standards/instrumentation
Passive and active ranging techniques
Design, fabrication, and testing of spacecraft and hardware
Structural and thermal analysis
Attitude determination and control systems
Reaction control
Propulsion systems
Navigation, tracking, and orbit dynamics
Spaceborne robotics applications

Surveillance and Sensor Technology

Point defense technology
Imaging radars
Surveillance radars
Multifunction RF systems
High-power millimeter-wave radar
Target classification/identification
Airborne geophysical studies
Fiber-optic sensor technology
Undersea target detection/classification
EO/IR multispectral/hyperspectral detection and classification
Sonar transducers
Electromagnetic sensors—gamma ray to rf wavelengths
SQUID for magnetic field detection
Low observables technology
Ultrawideband technology
Interferometric imagery
Microsensor system
Digital framing reconnaissance canvas
Biologically based sensors
Digital radars and processors

Undersea Technology

Autonomous vehicles
Bathymetric technology
Anechoic coatings
Acoustic holography
Unmanned undersea vehicle dynamics
Weapons launch 

Major Research Capabilities and Facilities

(Listed alphabetically by organizational unit)

Acoustics Division (Code 7100)

Large, sandy-bottom, holographic pool facility for investigating echo characteristics of underwater buried/near-bottom targets and sediment acoustics

Multichannel programmable acoustic signal processing system

Containerized data processing for acoustic array processing at remote sites and aboard ship

One million gallon, vibration-isolated underwater holographic/3-D laser vibrometer facility for studying structural acoustic phenomena for submarine, mine countermeasure, and torpedo systems

In-air structural acoustics facility with high spatial density nearfield acoustic holography and 3-D laser vibrometer measurements and processing systems for diagnosing large structures, including aircraft interiors and rocket payload fairings

High-powered sound source array

Moored acoustic array with satellite telemetry channels for measuring directional noise

Multiple-towed acoustic arrays with up to 144 acoustic channels for measuring directional noise

Twin underwater towers supporting sources and hydrophone arrays to measure high-frequency propagation, volume, and boundary scattering in shallow water

High-speed maneuverable towed body with MK-50 and synthetic aperture sonars to measure high-frequency boundary scattering and coherence

Tactical oceanography simulation laboratory

Digital Acoustic Buoy Systems (DABS), which can autonomously record data from vertical and/or horizontal acoustic arrays, providing the capability to (1) make long-term ambient noise measurements uncontaminated by the noise of a nearby ship and (2) make single ship propagation measurements

Acoustic Communications Simulation Laboratory

20-ft by 20-ft by 10-ft deep above-ground saltwater acoustic tank facility with environmental control and substantial optical access

Center for Bio/Molecular Science and Engineering (Code 6900)

Optical equipment

- Confocal fluorescent microscope
- CW fluorimeter and microscope
- Excimer laser projection exposure system
- Dektak surface profilometer
- Optical and fluorescence microscopes
- Photon correlation spectrometer
- Picosecond dye laser system
- Raman spectrometers

Scanning and transmission electron microscope

SLM fluorimeter (visible through near IR)

Time resolved fluorimeter (nanosecond)

UV-visible absorption spectrophotometers

Analytical instruments

- Atomic force/scanning tunnelling microscope
- Capillary electrophoresis unit
- Contact angle goniometer
- Differential scanning calorimeter
- GC/MASS spectrometer
- DNA synthesizer; DNA sequencer
- HPLC
- Patch clamp microelectrodes
- Potentiometer for electrochemistry

General facilities

- Class 100 clean room
- Cold room for storage and preparation
- Controlled shelf temperature lyophilizer
- Silicon Graphics IRIS workstation
- Freeze-fracture apparatus
- High-speed ultracentrifuges
- Inert atmosphere dry box
- NMR
- FTIR
- Ellipsometer

Titration calorimeter

Differential scanning calorimeter

Chemistry Division (Code 6100)

Synthesis/processing facilities

- Paint formulation and coating
- Functional polymers/elastomers
- Langmuir-Blodgett film
- Surface cleaning
- Thin film deposition/etching with in-situ control

Marine Corrosion Facility (at Key West, Florida)

Characterization facilities

- General purpose chemical analysis
- Surface diagnostics
- Nanometer scale composition/structure/properties
- Magnetic resonance NDI
- Tribology
- Polymer structure/function

Special purpose capability

- Environmental monitoring/remediation
- Combustion and fire research
- Alternate and petroleum-derived fuels

Simulation/modeling

- Synchrotron radiation beam lines (at NSLS, Brookhaven, NY)

Electronics Science and Technology Division (Code 6800)

Nano- and microelectronics characterization and processing facilities
Electron-beam nanowriter
High-resolution transmission electron microscope
Scanning tunneling microscopy and electro-optical analysis
Crystal growing facilities including bulk growth, molecular beam epitaxy, and organometallic chemical vapor deposition
Optical and electrical characterization of materials
Electronic testing and analysis facilities
Vacuum electronics engineering facility
Femtosecond laser facility

Information Technology Division (Code 5500)

Internet technology lab
JTF WARNET testbed
Mobile networking lab
General purpose equipment test lab
Brandywine antenna range
Pommonkey test range
CBD Ship Motion Simulator
Signal analysis laboratory
Artificial intelligence computer network
HCI laboratory
Spatial audio and immersive simulation
Fleet Information System Security Technology Laboratory
Virtual reality laboratory
DOD High Performance Computing Modernization Program (HPCMP) Distributed Center (DC)
High-speed ATM network (backbone and to the desktop)
ATDnet Washington area POP for high performance, multigigabit optical streams
Distributed file systems with authentication (Andrew File System/Multi-Resident Andrew File System (AFS/MRAFS))
Labwide network, NICE net, providing computer communications, video services, and gateways to networks and computer systems worldwide
Satellite dishes for video and data reception
File server/archiver system for central file storage of labwide data
Visualization laboratory
Navy engagement warfare assessment and virtual engineering (NEWAVE) research center

Laboratory for Computational Physics and Fluid Dynamics (Code 6400)

Eighteen processor SGI Power Challenge
Eight processor SGI Origin 2000
Thirty-two processor SGI Origin 2000
Sixty-four processor SGI Origin 2000

Twenty-eight processor SGI Origin 3800
Sixty-four processor Alpha Cluster
Sixteen processor Athlon Cluster
256 processor Pentium 4 Cluster
Over sixty SGI, Apple, and Intel workstations
Three-fourths terabyte RAID Disk Storage Systems
All computers and workstations have network connections to NICENET and ATDnet allowing access to the NRL CCS facilities (including the DOD HPC resources) and many other computer resources both internal and external to NRL.

Laboratory for Structure of Matter (Code 6030)

Two area detector systems
Two X-ray diffractometers
Zymark robotics
Four Silicon Graphics IRIS workstations
Protein and peptide chromatography
Atomic force microscope

Marine Geosciences Division (Code 7400)

Airborne gravimetry, magnetics, and topographic measurements suite coupled with differential GPS yielding position accuracies of < 1.0 meter
100 and 500 kHz sidescan sonar with 2-12 kHz chirp profiler and C_s magnetometer for seafloor characterization/imaging and shallow subbottom profiling
Deep-towed acoustic geophysical system operating at 220-1000 Hz characterizes subseafloor structure including gas clathrate accumulations and dissociation of methane hydrates
Acoustic seafloor classification system operating at 8-50 kHz provides underway, real-time prediction of sediment type and physical properties
Seafloor probes for measuring sediment pore water pressures, permeability, electrical resistivity, acoustic compressional and shear wave velocities and attenuations, and dynamic penetration resistance
100 and 300 kV transmission electron microscopes with environmental cell for study of sediment fabric, especially impact of organic matter
Object-oriented digital cartographic modeling techniques and databases with internet access
Map data formatting facility compresses map information onto compact disk-read only memory media for masters for use in aircraft digital moving map systems
Positioning, navigation, and timing laboratory
Comprehensive geotechnical and geoaoustics laboratory capability
Airborne ElectroMagnetic (AEM) bathymetry system
Ocean bottom magnetometer system
3-D, multispectral, subbottom swath imaging system
Ocean bottom seismographs (OBS)

In-Situ Sediment Acoustic Measurement System (ISSAMS)
 Instrumented mine shapes to measure hydrodynamics of free-fall in the water column, dynamics of deceleration in seafloor sediments, and rates and depths of scour burial
 Hydrothermal plume imaging data acquisition and analysis system
 Integrated digital databases analysis and display system for bathymetric, meteorological, oceanographic, geoacoustic, and acoustic data
 Stereometric video image processing system for use in foreshore morphology measurement
 Sediment gas-content sampler
 Acoustic tomographic probes for surf zone sands and gassy muds

Marine Meteorology Division (Code 7500)

Naval Integrated Tactical Environmental Subsystem (NITES) for fielding regional and shipboard METOC applications
 AN/SMQ-11 shipboard antenna system for retrieving polar-orbiting satellite data
 Geostationary satellite data direct readout and processing center
 Supercomputer for numerical weather prediction systems development
 Master Environmental Library (MEL) implemented on superworkstations for archiving and distributing real-time and historical atmosphere/ocean databases
 Bergen Data Center for extensive file serving and research data backup/archival capability
 Data visualization center for developing shipboard briefing tools, displaying observations and model output, and integrating meteorological parameters into tactical simulations
 Classified radar and satellite data processing facility

Materials Science and Technology Division (Code 6300)

Hot isostatic press
 Cold isostatic press
 High-energy, dispersive X-ray analytical system
 Electron microprobe, SEM, SAM, and STEM systems
 Quantitative metallography
 Computer-controlled multiaxial loading and SCC measurement systems
 Computer-interactive, nonlinear, multimode fracture measurement system
 Computer-aided, experimental stress analysis
 Crystallite Orientation Distribution Function (CODF)
 Thermoelectric parametric measurement system
 Class 1000 clean room; processing metallic film
 Elevated temperature and structural characterization laboratory
 Closed-loop, low- and high-cycle fatigue systems
 Metallic film deposition systems
 Magnetometry

Mossbauer spectroscopy
 Cryogenic facilities
 High-field magnets
 High-resolution analytical electron microscope
 Isothermal heat treating facility
 Vacuum arc melting facility
 Vacuum induction melting facility
 3-MeV tandem Van de Graaff accelerator
 200-keV ion-implantation facility
 Microwave test facility
 Excimer laser film deposition facility
 Bomen infrared spectrometer facility
 Diffuse light scattering facility
 Femtosecond laser facility
 Semiconductor assessment facility
 Surface characterization facility

Oceanography Division (Code 7300)

Towed sensor and advanced microstructure profiler systems for studying upper ocean fine and microstructure
 Integrated absorption cavity and optical profiler systems for studying ocean optical characteristics
 Environmental scanning electron microscope and confocal laser scanning microscope for detailed studies of biocorrosion in naval materials
 Self-contained bottom-mounted upwardlooking acoustic profilers for measuring ocean variability
 Acoustic Doppler profiler for determining ocean currents while underway
 Data visualization center for displaying ocean model output
 Remotely operated underwater vehicle (ROV)
 Bottom-mounted acoustic Doppler profilers
 Towed hyperspectral optical array
 SCI processing facility
 Satellite receiving stations for AVHRR, SeaWiFS, and DMSP Ocean Color Processing Facility

Optical Sciences Division (Code 5600)

Short-pulse excitation apparatus for kinetic mechanisms investigations
 IR laser facility for optical characterization of semiconductors
 Mobile, high-precision optical tracker
 Facilities for synthesis and characterization of optical glass compositions and for the fabrication of optical fibers
 Optical and digital image processing facilities
 Silica and IR fluoride/chalcogenide fiber fabrication facilities
 Facilities for fabricating and testing integrated optical devices
 Optical probes laboratory to study viscoelastic, structural, and transport properties of molecular systems
 Computer IR/EO technology/systems simulation center

Laser-diode pumped solid-state lasers
 Field-qualified EO/IR measurement devices
 Focal plane array evaluation facility
 Mid-IR, low-phonon crystal growth facility
 Multispectral image processing facility
 Indoor IR test range
 NRL P-3 aircraft sensor pallet
 EO/IR high-resolution reconnaissance/surveillance sensors
 RF and laser data links
 Infrared countermeasure techniques laboratory
 Multi- and hyperspectral sensors and processing
 Environmental testing of fiber sensors (acoustic, magnetic, electric field, etc.)
 High-speed, high-power, photodetector characterization
 Communication link characterization to >100 Gbps
 RF phase noise, noise figure, and network analysis
 Ultrahigh-speed A/O convertors

Plasma Physics Division (Code 6700)

PAWN, 1-MJ compact inductive storage facility
 Gamble II high-voltage pulsed power generators
 HAWK, 1 MA inductive storage facility
 PHAROS III, two-beam neodymium-glass laser and target facility
 Table-Top Terawatt (T³) laser system
 NIKE krypton fluoride laser facility
 Large volume space chamber (2 m × 5 m)
 Large-area plasma processing system
 Microwave facility for processing of advanced materials (2.45, 35, 94, and 60-120 GHz)
 ELECTRA, test bed for high-rep 5 Hz KrF laser

Radar Division (Code 5300)

Shipboard radar research and development test beds:

1. Senrad wideband air surveillance radar facility
2. Volume surveillance radar test bed
3. Ship self-defense surveillance and engagement demonstration systems
4. AN/SPS-49

Airborne research radar facility, including advanced profile high-resolution imaging radar and P-3 (1998) with APS-145 Group 2 and CEC
 High-power 94 GHz radar system
 Ultrahigh resolution radar system (microwave microscope)
 Ship radar cross-section computer prediction facility
 Electromagnetic numerical computation facility
 Compact range antenna measurement laboratory and nearfield scanner
 Space-time adaptive processing (STAP) laboratory
 Electronic computer-aided design facility
 Clutter research radar
 Jet Engine Modulation (JEM) laboratory
 Microwave and RF instrumentation laboratory

Cryogenic microwave and RF measurement facility
 High-bandwidth, high-capacity data recording system

Remote Sensing Division (Code 7200)

Polar ozone and aerosol monitor space sensor
 Ground-based stratospheric water-vapor monitoring system
 SAR processing facility
 SCI processing facility
 SEALAB
 SAIL
 Hyperspectral imaging, sensors, and processing
 Optical remote sensing calibration lab/facility
 Navy prototype optical interferometer
 NRL/NRAO 74 MHz very large array
 Free surface hydrodynamics laboratory
 SSM/I processing facility
 STEMS system
 Volume imaging lidar system
 Aerosol and field measurement facility
 Airborne Polarimetric Microwave Imaging Radiometer (APMIR)
 NRL RP-3A aircraft sensors
 Airborne lidar
 MMW imagers
 DMSP SSM/I simulator
 PRT-5 IR radiometer
 Imaging real-aperture radar (RAR)
 Flight-level meteorological sensors
 Hyperspectral sensor systems (PHILLS)
 Ultrawideband SAR (NUSAR)

Research and Development Services Division (Code 3500)

Military construction
 Research support engineering
 Planning
 Full range of facility contracting, including construction, architect/engineering services, facilities support, and reserved parking
 Transportation
 Telephone services
 Maintenance and repair of buildings, grounds, and communication and alarm systems
 Shops for machining, sheet metal, welding, and plating

Spacecraft Engineering Department (Code 8200)

Chambers:
 Thermal-vacuum
 Acoustic reverberation
 Facilities:
 Shock and vibration test
 Cleanrooms
 Spacecraft-fabrication and assembly

- Fuels testing
- Autoclave
- Robotics engineering and controls laboratory
- Dynamic motion simulator
- CAD/CAM
- Propulsion system welding
- Static loads test
- Star tracker characterization
- Spacecraft spin balance
- Modal analysis
- Computational astrodynamics simulation and visualization

Space Science Division (Code 7600)

- E.O. Hulburt Center for Space Research
- Development and test facilities for spaceborne instruments to perform astrophysical, solar, high-atmospheric, and space-environment sensing
- Cleanroom facilities
- Extensive computer-assisted data manipulation and interpretive capability for space-data imaging and modeling
- Backgrounds Center of Expertise (BCoE)
- Ballistic Missile Defense Organization (BMDO)
- Synthetic Scene Generation Model (SSGM)
- Backgrounds Data Center for analysis of BMDO-relevant natural backgrounds
- Special Sensor Ultraviolet Limb Imager (SSULI) calibration facility
- Ultraviolet remote sensing data center
- Low-temperature laboratory
- Gamma Ray Observatory (OSSE) operations and data analysis center
- Solar instrument test facility
- Solar Ultraviolet Spectral Irradiance Monitor (SUSIM) operations and data analysis center
- Large Angle Spectrometric Coronagraph (LASCO) operation and data analysis
- Extreme-ultraviolet Imaging Telescope (EIT)
- Middle Atmosphere High Resolution Spectrograph Investigation (MAHRSI) to measure OH and NO in middle atmosphere

Space Systems Development Department (Code 8100)

- Payload test facility and processor development laboratory
- Spacecraft high-reliability electronic and electrical production facility
- Spacecraft electronic systems integration and test facility
- Spacecraft electrical power systems and battery laboratories
- Laser communications and electro-optics laboratories
- Tactical Technology Development Laboratory (TTDL)

- Electromagnetic interference/electromagnetic compatibility (EMI/EMC) screen room test facility
- Precision oscillator (clock) test facility
- Radio frequency (RF) system development facility
- RF microcircuit fabrication cleanroom facility
- Large tapered horn RF anechoic chamber facility
- RF payload development laboratory with anechoic chamber
- Precision high-frequency RF compact range anechoic chamber facility
- Transportable ground station development, assembly, and test facility
- Multiplatform FPGA/ASIC/VLSI Development Laboratory
- Satellite telemetry, tracking, and control facilities
- Pomomoy Field Site/large antenna, space communications, and research facility
- Midway Research Center/space communications and research facility
- Optical Telescope Facility

Tactical Electronic Warfare Division (Code 5700)

- Mobile infrared signature measurement and simulation facility
- Mobile ESM laboratory
- Hybrid RF/IR missile-seeker simulation facility
- Central target simulation facility for developing, testing, and evaluating EW systems and techniques, using real-time, hardware-in-the-loop models
- RF simulation laboratory and signal simulators
- Radar cross-section measurement facility (at CBD)
- Search radar ECM simulator
- Advanced tactical EW environment simulator
- Electronic warfare coordination test bed
- Scale-model analysis facility
- Wind tunnel for performance measurements of low Reynolds number vehicles
- Optical integration laboratory
- Tempest signal-processing laboratory
- Simulated ship-mast facility
- Secure supercomputer facility
- Vehicle development laboratory
- Visualization laboratory

Technical Information Division (Code 5200)

- History Office
- Ruth H. Hooker Research and Technical Information Center:
 - Online catalog of unclassified publications
 - LAN-based catalog of classified and unclassified publications
 - Web-access to journals, reports, press releases, and NRL publications
 - Digital library projects with association, commercial, and government publishers

Consortial relationship with NIST, NASA
Goddard Space Flight Center, and NSA
Writing, editing, and publication services
Graphic design and printing services
Imaging Center
Photographic laboratory
NRL Exhibit Program: display, design, production
Multimedia design and production
Video editing suite

Scientific and technical photography
Auditorium services
Video teleconferencing services
Mail handling services
Correspondence review and archives services
Forms Supply Store
Electronic forms and forms design 

NRL Sites and Facilities

SITE	ACREAGE		BUILDINGS/ STRUCTURES
	LAND OWNED/LEASED	EASEMENT/ LICENSE- PERMIT	
District of Columbia NRL and Artificial Intelligence Center at Bolling AFB	131/0	0/10.24	107/25
Virginia Midway Research Center Quantico	162/0		9/1
Maryland NRL Flight Support Detachment, NAS Patuxent River*	Tenant		
Chesapeake Bay Section and Dock Facility Chesapeake Beach*	157/0	0/0.60	62/87
Multiple Research Site Tilghman Island*	2/0		3/3
Radio Astronomy Observatory Maryland Point*	24/0		10/16
Radio Antenna Range USAF Receiver Site Brandywine*	0/0	0/22.98	1/0
Free Space Antenna Range Pomonkey*	56/0	28.40/0	9/11
Florida Marine Corrosion Facility Key West	Tenant		
California NRL Monterey Monterey*	Tenant		
Mississippi Stennis Space Center Bay St. Louis*	Tenant		
Alabama Ex-USS <i>Shadwell</i> (LSD-15) Mobile Bay	Tenant		
	Decommissioned	457-ft vessel	used for fire research

PROPERTY

Land:		Buildings:		Replacement Costs:	
Owned	556 acres	RDT&E	3,167,125 ft ²	Real property – current	
Leased	0 acres	Administrative	225,812 ft ²	Replacement value	\$964.5 million
		Other	422,367 ft ²	Equipment	\$186.7 million

*See maps in the General Information section (page 137).

**Executive
Directorate**

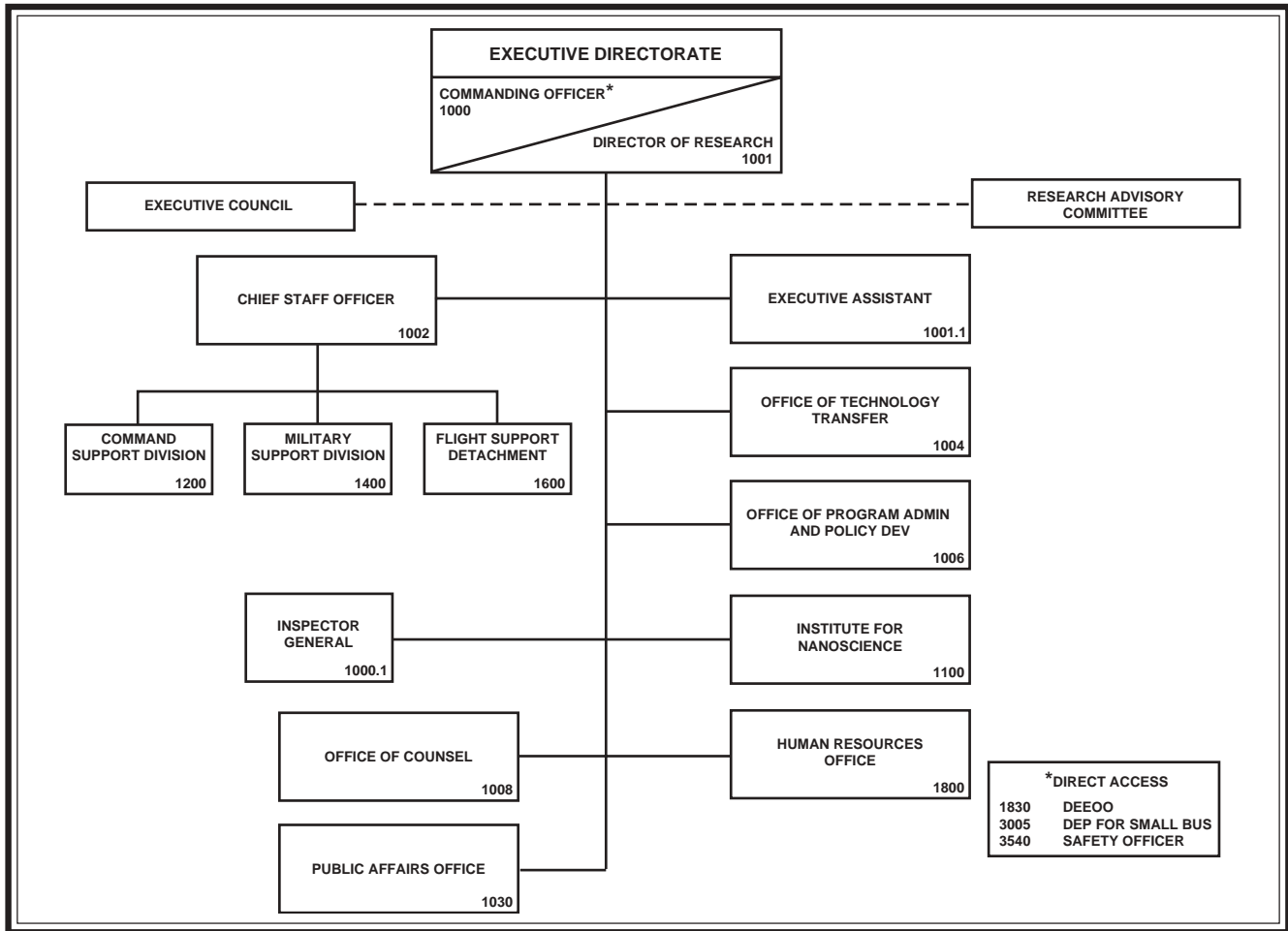

Key Personnel

Name	Title	Code
CAPT D.M. Schubert, USN	Commanding Officer	1000
Dr. J.A. Montgomery	Director of Research	1001
Mr. D.J. DeYoung	Executive Assistant	1001.1
CAPT C.W. Fowler, USN	Chief Staff Officer/Inspector General	1002/1000.1
CAPT C.W. Fowler, USN	Head, Command Support Division	1200
Mr. J.T. Miller	Deputy Head, Command Support Division/ Deputy Inspector General	1000.11
Ms. B.L. Peters	Command Management Review	1000.12
Dr. C.M. Cotell	Head, Office of Technology Transfer	1004
Mrs. L.T. McDonald	Head, Office of Program Administration and Policy Development	1006
Mr. J.N. McCutcheon	Head, Office of Counsel	1008
Mr. R.L. Thompson	Head, Public Affairs Branch	1030
CDR R.B. Grimm, USN	Head, Military Support Division	1400
CDR T.M. Munns, USN	Officer in Charge, Flight Support Detachment	1600
Ms. B.A. Duffield**	Director, Human Resources Office	1800
Ms. D.E. Erwin	Deputy Equal Employment Opportunity Officer	1830
Ms. M.H. Nicholl	Deputy for Small Business	3005
Mr. K.J. Pawlovich**	Head, Safety Branch	3540

**Acting

EXECUTIVE DIRECTORATE

Code 1000 and Code 1001

The Commanding Officer (Code 1000) and the Director of Research (Code 1001) share executive responsibility for the management of the Naval Research Laboratory. In accordance with Navy requirements, the Commanding Officer is responsible for the overall management of the Laboratory and exercises the usual functions of command including compliance with legal and regulatory requirements, liaison with other military activities, as well as the general supervision of the quality, timeliness, and effectiveness of the technical work and of the support services.

The Commanding Officer delegates line authority and assigns responsibility to the Director of Research for the technical program, its planning, conduct, and staffing; evaluation of the technical competence of personnel; liaison with the scientific community; selection of subordinate technical personnel; exchange of technical information; and the effective execution of the NRL mission.

Within the limits of Navy regulations, the Commanding Officer and the Director of Research share authority and responsibility for the internal management of the Laboratory. The Commanding Officer retains all authority and responsibility specifically assigned to him by higher authority.

The mission of the Laboratory is carried out by three science and technology directorates and the Naval Center for Space Technology, supported by the Business Operations Directorate and the Executive Directorate. In addition, the Laboratory's operating staffs provide assistance in their special fields to the Commanding Officer and to the Director of Research. The operating staffs are listed on the following pages of this publication.

Commanding Officer

Captain David M. Schubert, USN, is a native of Detroit, Michigan. He is a 1977 honors graduate of the United States Naval Academy where he was a Trident Scholar, and received a Bachelor of Science Degree in Physics. Once commissioned, he reported to the Naval Research Laboratory, where he participated in a summer internship program testing thin line acoustic arrays. In March 1979 following completion of nuclear power and submarine training, he reported to USS *Hammerhead* (SSN 663) where he served as Communications Officer, Damage Control Assistant, and Operations Officer. During this period, the ship deployed to the Mediterranean Sea, the North Atlantic, and the Indian Ocean, and earned two Battle Efficiency “E” awards.

From April 1982 to March 1984, Captain Schubert served as an instructor at Nuclear Power School in Orlando, Florida. He then served as the Engineer of USS *Chicago* (SSN 721) during the ship’s initial construction and shakedown period. In 1988 he was selected for the MIT/Woods Hole Joint Oceanography program, where he received a Masters Degree in Physical Oceanography.

In October 1990, Captain Schubert reported as Executive Officer on USS *Stonewall Jackson* (SSBN 634) (GOLD) where he completed three strategic deterrent patrols and earned another Battle “E” award. From August 1992 to August 1994, he served on the Joint Staff (J3) as Operations Officer for the National Military Command Center.

Captain Schubert returned to USS *Chicago* as her Commanding Officer from May 1995 to July 1997. During this tour, the ship had a very successful deployment to the Arabian Gulf with the USS *Independence* Carrier Battle Group. The USS *Chicago* was also the first submarine to control a Predator unmanned aerial vehicle during an exercise off Southern California in June 1996.

From August 1997 to July 1999, Captain Schubert served as the Assistant for Plans, Liaison and Assessments for the Submarine Warfare Division of the Navy Staff. He then moved to COMSUBLANT as the Assistant Chief of Staff for Warfare Requirements, Planning and Assessments. In these assignments, Captain Schubert was instrumental both in firmly establishing the current need for submarines, and for developing the vision for the Navy’s future in undersea warfare.

From July 1999 to May 2002, Captain Schubert served as the Assistant Chief of Naval Research. By promoting interaction between the technology and acquisition communities, and in finding science and technology solutions to current Fleet problems, he was instrumental in establishing ONR’s Future Naval Capabilities program.

Captain Schubert assumed command of the Naval Research Laboratory in May 2002.

Captain Schubert’s awards include the Legion of Merit, the Defense Meritorious Service Medal, the Meritorious Service Medal, the Navy Commendation Medal, and the Navy Achievement Medal.

He is married to the former Pamela Smith of Basking Ridge, New Jersey. They have two daughters, Helen, 20, and Karen, 19.



Director of Research

Dr. John A. Montgomery received his Bachelor of Science degree in Physics from North Texas State University in 1967 and his Masters degree, also in Physics, in 1969. He received his PhD in Physics from the Catholic University of America in 1982. Dr. Montgomery is presently the Director of Research at the Naval Research Laboratory, where he oversees research and development expenditures of approximately \$800 million per year.

Dr. Montgomery joined the Naval Research Laboratory (NRL) in 1968 as a research physicist in the Advanced Techniques Branch of the Electronic Warfare Division, where he conducted research on a wide range of Electronic Warfare (EW) topics. In 1980, he was selected to head the Off-Board Countermeasures Branch. In 1985, he was appointed to the Senior Executive Service and was selected as Superintendent of the Tactical Electronic Warfare Division. He has been responsible for numerous systems that have been developed/approved for operational use by the Navy and other services. He has had great impact through the application of advanced technologies to solve unusual or severe operational deficiencies noted during world crises, most recently in the Persian Gulf, the Kosovo campaign, in Afghanistan, and for Homeland Defense. During his career, Dr. Montgomery has contributed more than 60 publications, papers, symposia presentations, and lectures.

Dr. Montgomery received the Department of Defense Distinguished Civilian Service Award in 2001. He was recognized by the Department of the Navy Distinguished Civilian Service Award in 1999 and by the Department of the Navy Meritorious Civilian Service Award in 1986. As a member of the Senior Executive Service, he received the Presidential Rank of Distinguished Executive award in 1991, and the Presidential Rank of Meritorious Executive award in 1988, and again in 1999. He also received the 1997 Dr. Arthur E. Bisson Prize for Naval Technology Achievement, awarded by the Chief of Naval Research in 1998. Further, he has received the Association of Old Crows (Electronic Defense Association) Joint Services Award in 1993. He was an NRL Edison Scholar, and is a member of Sigma Xi. He has served as the U.S. National Leader of The Technical Cooperation Program's multinational Group on Electronic Warfare since 1987, and served as its Executive Chairman.



Executive Council



The Executive Council consists of executive, management, and administrative personnel. Executive Council members include:

- Commanding Officer, Chairperson
- Director of Research
- Associate Directors of Research
- Chief Staff Officer
- Director, Naval Center for Space Technology
- Heads of Divisions
- Head, Laboratory for Structure of Matter
- Head, Laboratory for Computational Physics and Fluid Dynamics
- Head, Center for Bio/Molecular Science and Engineering
- Director, Human Resources Office
- Public Affairs Officer
- Deputy Equal Employment Opportunity Officer
- Head, Office of Program Administration and Policy Development
- Safety Officer
- Head, Office of Counsel
- Head, Office of Technology Transfer

Research Advisory Committee



The Research Advisory Committee advises the Commanding Officer and the Director of Research on scientific programs and the administration of the Laboratory. The committee assists in planning the long-range scientific program, coordinating the scientific work, reviewing the budget, accepting or modifying problems, considering personnel actions, and initiating such studies as may be necessary or desirable. The membership consists of the following:

- Director of Research, Chairperson
- Commanding Officer
- Associate Directors of Research
- Chief Staff Officer (Observer)

Chief Staff Officer/Inspector General Code 1002/1000.1/1200



CAPT C.W. FOWLER, USN

The Chief Staff Officer serves as the Deputy to the Commanding Officer and acts for the Commanding Officer in his absence. The Command Support Division (Code 1200), the Military Support Division (Code 1400), and the Flight Support Detachment (NAS Patuxent River, MD, Code 1600) report directly to the Chief Staff Officer. When directed, the Laboratory's Inspector General investigates, inspects, and/or inquires into matters that affect the operation and efficiency of NRL. These matters include but are not limited to: effectiveness, efficiency, and economy; management practices; and fraud and waste. He serves as principal advisor to the Commanding Officer on all inspection matters and audits and is the principal point of contact and liaison with all agencies outside NRL.

Public Affairs Officer Code 1030



MR. R.L. THOMPSON

The Public Affairs Officer (PAO) advises the Commanding Officer and Director of Research on public affairs matters, including external and internal relations, community outreach, and serves as the Commanding Officer's principal assistant in the area of public affairs. To do this, the PAO plans and directs a program of public information dissemination on official NRL activities. The PAO coordinates responses to requests from the news media and the public for unclassified information or materials dealing with the Laboratory, coordinates participation in community relations activities, and directs the NRL history and internal information programs. The PAO is also responsible for coordinating all actions within the Laboratory that respond to requirements of the Freedom of Information Act (FOIA).

Deputy Equal Employment Opportunity Officer Code 1830



MS. D.E. ERWIN

The Deputy Equal Employment Opportunity Officer (DEEEO) is the EEO program manager and the advisor to the Commanding Officer on all EEO matters. The DEEEO manages the discrimination complaint process and directs the Laboratory's affirmative action plans and special emphasis programs (Federal Women's, Hispanic Employment, African American Employment, Asian-Pacific Islanders, American Indian Employment, Individuals with Disabilities, including Disabled Veterans). The DEEEO recruits quality candidates for those areas when underrepresentation exists. Duties also include reviewing, coordinating, and monitoring implementation of EEO policies and developing local guidance, directives, and implementation procedures for the EEO programs.

Safety Officer Code 3540



MR. K.J. PAWLOVICH*

The Head of the Safety Branch acts as the Safety Officer and is the program manager for Occupational Safety and Health, Explosives Safety, Industrial Hygiene, Hazardous Material Control and Management, Radiological Safety, Non-Ionizing Radiation Safety, and Environmental Protection. The Safety Branch must ensure that the development, implementation, and maintenance of comprehensive safety and environmental compliance programs, in support of the Laboratory's unique areas of research and development, comply with the appropriate federal, state, Navy, and NRL regulations.

*Acting

Office of Technology Transfer

Code 1004



DR. C.M. COTELL

Basic Responsibilities

The Office of Technology Transfer is responsible for coordinating NRL's implementation of the Federal Technology Transfer Act. The Office of Technology Transfer facilitates the transitioning of NRL's innovative technologies for use in products and services to benefit the public. Technology Transfer Office personnel draft Cooperative Research and Development Agreements (CRADAs) under which NRL scientists and engineers work together with industry, academia, state or local governments, or other Federal agencies to develop NRL technologies for government and/or commercial applications. The Technology Transfer Office is also responsible for negotiating patent licensing agreements (PLAs) whereby NRL grants licensees the right to use NRL technologies in products for commercial sale. In addition to promoting NRL technologies through CRADAs, PLAs, and educational marketing mechanisms, the Office of Technology Transfer serves as a resource for NRL scientists and engineers to assist them with all steps toward transitioning their technologies for government or commercial use.

Personnel: 3 full-time civilian

Key Personnel

Name	Title	Code
Dr. C.M. Cotell	Head	1004
Dr. C. I. Merzbacher	Technology Transfer Officer	1004

Point of contact: Dr. C.M. Cotell, Code 1004, (202) 767-7230

Office of Program Administration and Policy Development

Code 1006



MRS. L.T. McDONALD

Basic Responsibilities

The Office of Program Administration and Policy Development provides managerial, technical, and administrative support to the Director of Research (DOR) in such areas as program and policy development, intra-Navy and inter-Service Science and Technology (S&T) program coordination; liaison with other Navy, DOD, and government activities on matters of mutual concern; and support to the Executive Directorate in planning and directing NRL's S&T (6.1, 6.2) program. Specific functions include: monitoring and providing background information on technical and policy matters that come under the purview of the DOR; representing NRL, ONR, and/or the Navy on tri-Service or DOD-wide coordination matters; performing special studies or chairing ad hoc study groups regarding program decisions or policy positions; performing special studies involving major NRL programs and resource issues; providing administrative support in the areas of personnel, budget, facilities, equipment, and security; provides executive management information and analyses for various aspects of the S&T program effort; coordinating VIP visits to NRL; managing the NRL directives system; administering the NRL response to Congressional requests; maintaining the NRL R&D achievements file; developing the S&T guidance for monitoring and reporting the NRL S&T program; administering NRL's various postdoctoral fellowship programs; and managing the Facility Modernization Program.

Personnel: 19 full-time civilian

Key Personnel

Name	Title	Code
Mrs. L.T. McDonald	Head	1006
Ms. L.S. Herrin	Head, Program Administration Staff	1006.1
Ms. L.R. Renfro	Head, GLSIP Program	1006.17
Ms. M.E. Dixon	Administrative Officer	1006.2
Mrs. L.T. McDonald*	Head, Management Information Staff	1006.3
Mr. M.G. Kosky	Head, NRL Facilities Staff	1006.4
Ms. M.E. Barton	Head, Directives Staff	1006.5

Point of contact: Ms. M.E. Dixon, Code 1006.2, (202) 767-3082

*Acting

Office of Counsel

Code 1008



Mr. J.N. McCutcheon

Basic Responsibilities

The Office of Counsel is responsible for providing legal services to NRL's management in all areas of general, administrative, intellectual property, and technology transfer law. The Office reviews all procurement-related actions; reviews NRL scientific papers prior to publication; prepares patent applications and prosecutes the applications through the Patent and Trademark Office; defends against contract protests, other contract litigation, and personnel cases; and advises on other legal matters relating to technology transfer, personnel, fiscal, and environmental law.

NRL Counsel also serves as legal advisor to the Commanding Officer and Director of Research.

Personnel: 25 full-time civilian

Key Personnel

Name	Title	Code
Mr. J.N. McCutcheon	Head, Office of Counsel	1008
Mr. C.G. Steenbuck	Associate Counsel/General Law	1008.1
Mr. J.J. Karasek	Associate Counsel/Intellectual Property	1008.2
Mr. A.R. Beede	Associate Counsel/SSC Legal Matters	1008.3

Point of contact: Ms. K.Y. Head, Code 1008A, (202) 767-7606

Command Support Division

Code 1200 Staff Activity Areas

- Security
- Fire Protection



Security monitoring



Incoming visitor's reception area



CAPT C.W. FOWLER, USN

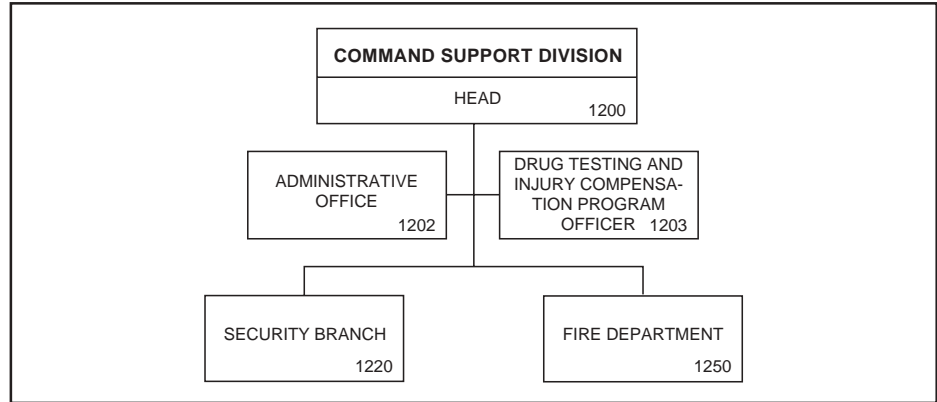

Basic Responsibilities

The Command Support Division provides civilian staff to the Commanding Officer and to the Director of Research. The Division is responsible for the Laboratory’s physical, personnel, information, industrial and ADP security programs; communications service; and fire protection. It provides intelligence support and support for international cooperative agreements in technology. The Division also coordinates the Laboratory’s Management Control Program and provides liaison and coordination for all audit and inspection teams. In addition, administrative/budget supervision over the Military Operations Branch and the Patuxent River Flight Support Detachment is provided.

The Head of the Command Support Division is also the Deputy Inspector General. The Deputy Inspector General is responsible for day-to-day functioning of the office and its staff; program planning and execution, and provides interface with outside agencies concerning inspections and audits conducted or to be conducted by NRL. These include Inspector General representatives from ONR, Navy, DOD, and GAO.

Personnel: 81 full-time civilian

Key Personnel

Name	Title	Code
CAPT C.W. Fowler, USN	Head	1200
Ms. M.A. Sepety	Administrative Officer	1202
Ms. R.E. Drake	Drug Testing/Injury Compensation Program Office	1203
Dr. J.T. Miller	Head, Security Branch	1220
Mr. J.E. Sohlke	Head, Information Security Services	1221
Mr. J.W. Dennis	Head, Physical Security Services	1222
Ms. J.A. Gray	Head, Special Security Services	1223
Ms. L. Fortner	Head, Personnel Security Services	1224
Mr. E. Stillwell	Fire Chief	1250

Point of contact: Ms. M.A. Sepety, Code 1202, (202) 767-3204

Military Support Division

Code 1400 Staff Activity Areas

- Operations
- Administrative Operations



P-3 airborne research facility



Administration



CDR R.B. GRIMM, USN

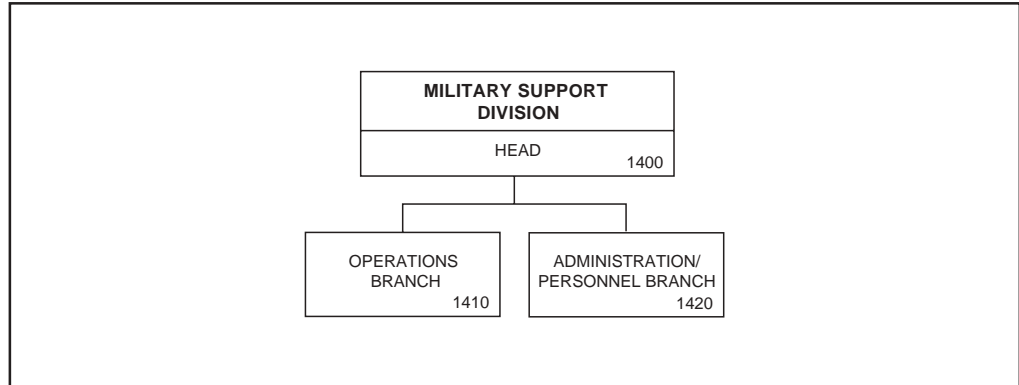

Basic Responsibilities

The Military Support Division provides military operational and administrative services to NRL.

The Operations Branch assists NRL Research Directorates in planning and executing project flight missions, develops deployment schedules and military operational and training objectives, and coordinates the Research Reserve Program within NRL.

The Military Administration Branch is responsible for the coordination and efficient functioning of all military administrative operations for NRL (including site detachments). These duties specifically include: personnel actions, maintenance of personnel records, performance evaluations, awards and training; advising the Chief Staff Officer on manpower matters and organization issues; and preparing and administering the military operational budget.

Personnel: 1 full-time civilian; 10 military

Key Personnel

Name	Title	Code
CDR R.B. Grimm, USN	Head	1400
LT J.D. Morgan, USN	Assistant Military Operations Officer	1410
LT T.A. Voltz, USN	Assistant Military Operations Officer	1410
LT M.A. Torreano, USN	Assistant Military Operations Officer	1410
LT R.E. Kane, USN	Assistant Military Operations Officer	1410
LT B.T. Le, USN	Military Administration and Personnel	1420

Point of contact: YN2 R.A. Wilson, USN, Code 1420B, (202) 767-0554

Flight Support Detachment

Code 1600 Staff Activity Areas

- Operations
- Administrative Operations
- Aircraft Maintenance
- Safety/NATOPS



P-3 airborne research facility



Flight Support Detachment hangar



Administration



Aircraft maintenance



CDR T.M. MUNNS, USN

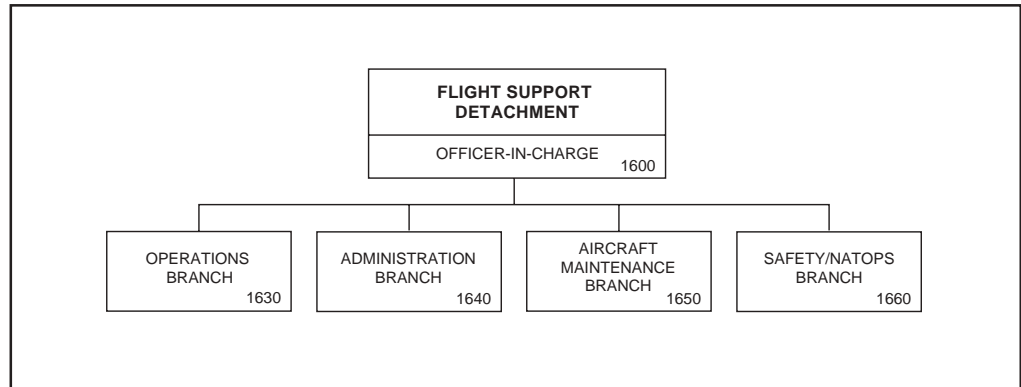

Basic Responsibilities

The Flight Support Detachment located at NAS Patuxent River, Maryland, operates and maintains five uniquely configured P-3 Orion aircraft. The men and women of the detachment provide the Naval Research Laboratory with airborne research platforms, conducting flights worldwide in support of a wide spectrum of projects and experiments. These include magnetic variation mapping, hydroacoustic research, bathymetry, electronic countermeasures, gravity mapping, and radar research. The detachment annually logs 2,000 flight hours, and in its 34 years the Flight Support Detachment has amassed 55,000 hours of accident-free flying.

Personnel: 5 full-time civilian; 95 military

Key Personnel

Name	Title	Code
CDR T.M. Munns, USN	Officer in Charge	1600
LCDR B.K. Choy, NOAA	Assistant Officer in Charge	1600.1
ATCS R.W. Zweimiller, USN	Senior Enlisted Advisor	1600.2
Mrs. B.J. Walter	Executive Secretary	1600.4
LCDR S.D. Ostoin, USN	Operations Officer	1630
LT F.S. Strazzulla, USN	Administrative Officer	1640
LT G.W. Ford, USN	Maintenance Officer	1650
ADCS S.E. Lenharr, USN	Maintenance/Material Control Officer	1650.1
LT A.M. Girimonte, USN	Head, Safety/NATOPS Branch	1660

Point of contact: Mrs. B.J. Walter, Code 1640, (301) 342-3751; DSN 342-3751

Human Resources Office

Code 1800 Staff Activity Areas

- Personnel Operations (Staffing, Classification, and Employee Development)
- Employee Relations
- Equal Employment Opportunity and Manpower
- Compensation, Reports, and Demonstration Project
- Information Technology and Reports



Employee Relations Branch



EEO and Manpower Branch



Personnel Operations Branch

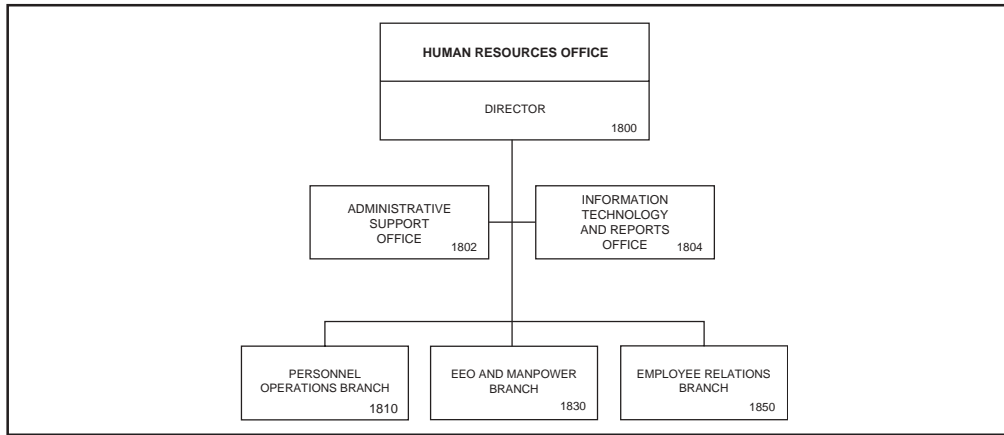

Basic Responsibilities

The Human Resources Office (HRO) provides civilian personnel, manpower, and Equal Employment Opportunity (EEO) services to the Naval Research Laboratory. The Human Resources Program provides the full range of operating civilian personnel management in the staffing and placement, position classification, employee relations, labor relations, employee development, EEO functional areas, manpower management, and morale, welfare, and recreation programs.

The HRO at NRL-main site in Washington, DC services approximately 3,000 employees as well as provides a centralized capability to perform various managerial, service, and advisory functions in support of field office operations. These include such items as issuance of policy and procedural directives; development, design, and maintenance of automated systems; and monitoring and evaluating product effectiveness to develop and maintain efficient, cost-effective, service-oriented methods.

Personnel: 30 full-time civilian

Key Personnel

Name	Title	Code
Ms. B.A. Duffield*	Director	1800
Ms. R.A. Ward*	Administrative Officer	1802
Ms. B.A. Duffield*	Head, Information Technology and Reports Branch	1804
Ms. C.L. Downing	Head, Personnel Operations Branch	1810
Ms. D.E. Erwin	Head, Equal Employment Opportunity and Manpower Branch	1830
Ms. J.L. Walker	Head, Employee Relations Branch	1850

Point of contact: Ms. R.A. Ward, Code 1802, (202) 404-2797

*Acting

**Business
Operations
Directorate**

BUSINESS OPERATIONS DIRECTORATE

Code 3000

The Business Operations Directorate provides executive management, policy development, and program administration for business programs needed to support the activities of the scientific directorates. This support is in the areas of financial management, supply management, contracting, research and development services, and management information systems support.

Associate Director of Research for Business Operations



Mr. D.K. Therning was born in Modesto, California, on August 29, 1960. He graduated from Washington State University with a bachelor's degree in finance in 1983 and earned a master's degree in business administration from George Mason University in 1993.

Mr. Therning has accumulated extensive experience in the financial business management of research, development, test, and evaluation (RDT&E) activities within the Department of Navy (DoN) beginning at the Naval Weapons Center, China Lake, California, where he served as a budget analyst in the Public Works Department and then in the Weapons Department.

In 1984, he became the Financial Management Advisor to the Ordnance Systems Department. In 1985, under the auspices of the Naval Scientist Training and Exchange Program, he was selected for a one-year assignment in the Office of the Director of Naval Laboratories (DNL), Washington, DC. He remained on the DNL staff as a budget analyst until 1987, when he was appointed Budget Officer of the DNL's seven Navy Industrial Fund R&D laboratories.

As the DoN reorganized the R&D laboratories and T&E activities, Mr. Therning oversaw the financial reorganization of the DNL labs with other activities into the Naval warfare centers. Upon the disestablishment of DNL, Mr. Therning remained in the Space and Naval Warfare Systems Command as the Director of the Defense Business Operations Fund (DBOF) Resources Management Division, with collateral duty as the Financial Manager of the Naval Command, Control, and Ocean Surveillance Center (NCCOSC). During this time, he managed the conversion of nine appropriated fund engineering activities to DBOF and the financial consolidation of these activities with NCCOSC.

In 1995, Mr. Therning served as Head of the Revolving Funds Branch of the Office of the Assistant Secretary of the Navy (Financial Management and Controller), where he was responsible for the budget formulation and execution processes of all DoN DBOF activities, which includes the RDT&E activities, shipyards, aviation depots, ordnance centers, and supply centers.

Mr. Therning was appointed Head, Financial Management Division/Comptroller of NRL in July 1996. Since that time, his responsibilities have increased in the Business Operations Directorate. In October 1996, in addition to leading the Financial Management Division, he assumed responsibilities for the Management Information Systems office. In January 1999, as an additional duty to his role as Comptroller, Mr. Therning was appointed to the newly established position of Deputy Associate Director of Research for Business Operations to assist in the management and administration of the Business Operations Directorate.

Mr. Therning was Acting Associate Director of Research for Business Operations from April 1999 until March 2000, when he was appointed the Associate Director of Research for Business Operations.

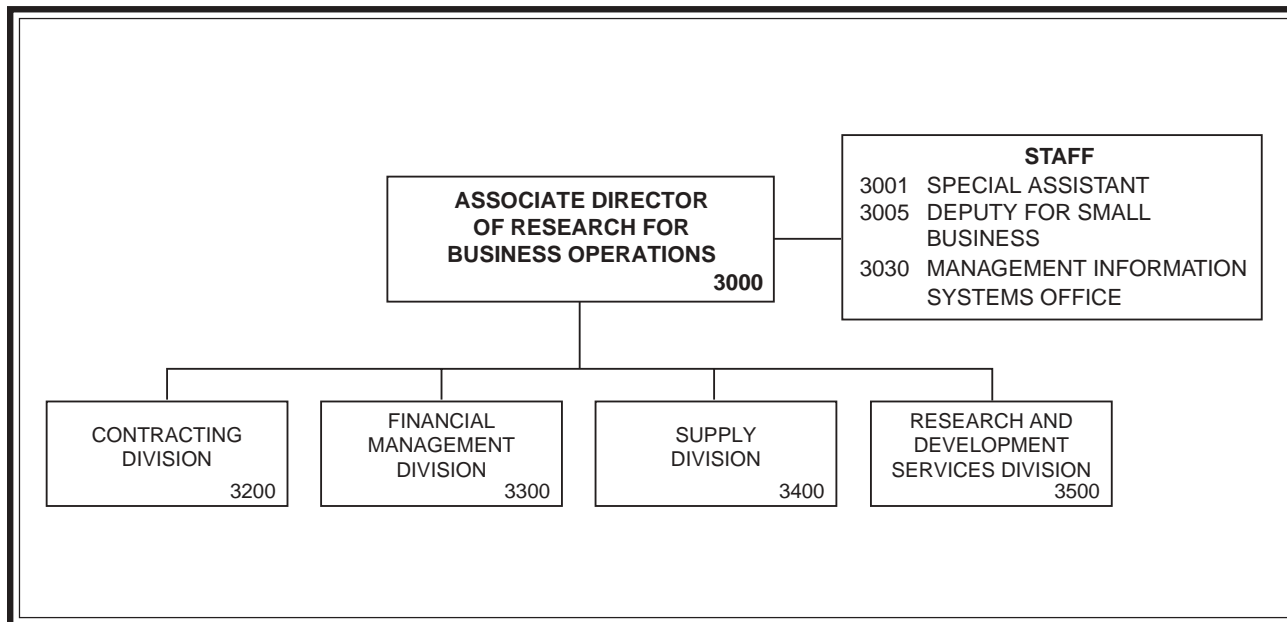

Key Personnel

Name	Title	Code
Mr. D.K. Therning	Associate Director of Research for Business Operations	3000
Vacant	Special Assistant	3001
Ms. M.H. Nicholl	Deputy for Small Business	3005
Ms. P.W. Lowery	Head, Management Information Systems Office	3030
Mr. J.C. Ely	Head, Contracting Division	3200
Mr. S.A. Birk	Head, Financial Management Division	3300
Ms. C. Hartman	Head, Supply Division	3400
Mr. S.D. Harrison	Director, Research and Development Services Division	3500

Point of contact: Mrs. D. Mayo, Code 3000A, (202) 404-7461

Contracting Division

Code 3200

- Advance Acquisition Planning
- Acquisition Strategies
- Acquisition Training
- Contract Negotiations
- Contractual Execution
- Contract Administration
- Acquisition Policy Interpretation and Implementation

Procurement Technician and Contracting Officer review contracts for closeout



Contract Specialist consults with PIPS Hotline representative



Procurement Technician prepares contract documents in PIPS



Division Head conducts staff meeting



Mr. J.C. ELY

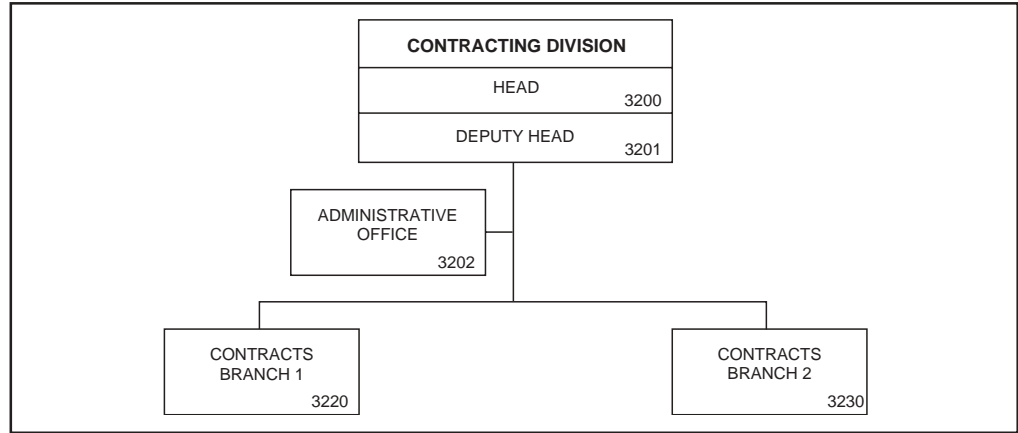

Basic Responsibilities

The Contracting Division is responsible for the acquisition of major research and development, materials, services, and facilities where the value is in excess of \$100,000. It also maintains liaison with the ONR Procurement Directorate on procurement matters involving NRL. Specific functions include: providing consultant and advisory services to NRL division personnel on acquisition strategy, contractual adequacy of specifications, and potential sources; reviewing procurement requests for accuracy and completeness; initiating and processing solicitations for procurement; awarding contracts; performing contract administration and post-award monitoring of contract terms and conditions, delivery, contract changes, patents, etc., and taking corrective actions as required; providing acquisition-related training to division personnel; and interpreting and implementing acquisition-related Federal Department of Defense and Navy regulations.

Personnel: 40 full-time civilian

Key Personnel

Name	Title	Code
Mr. J.C. Ely	Head	3200
Ms. M.A. Carpenter	Deputy Head	3201
Ms. K.P. Best	Administrative Officer	3202
Ms. W.C. Cosby	Head, Contracts Branch 1	3220
Mr. J.W. Adams	Head, Contracts Branch 2	3230
Ms. P.A. Lewis	Head, Contracts Section, SSC	3235

Point of contact: Ms. K.P. Best, Code 3202, (202) 767-3749

Financial Management Division

Code 3300

- Budget
- Reports and Statistics
- Accounting
- Travel Services
- Payroll Liaison



The Budget Branch prepares various financial analyses, reports, and studies in response to external data calls and/or management requests



The Financial Services Section coordinates efforts with DFAS to complete payment transactions related to NRL business, such as payroll and travel expenses



Mr. S.A. Birk

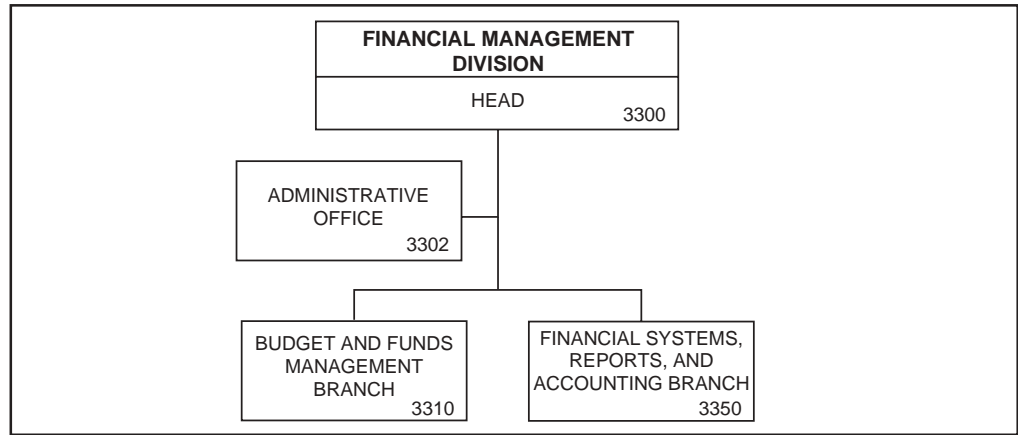

Basic Responsibilities

The Financial Management Division (FMD) develops, coordinates, and maintains an integrated system of financial management that provides the Comptroller, Commanding Officer, the Director of Research, and other officials of NRL the information and support needed to fulfill the financial and resource management aspects of their responsibilities. FMD translates the NRL program requirements into the financial plan, formulates the NRL budget, monitors and evaluates performance with the budget plan, and provides recommendations and advice to NRL management for corrective actions or strategic program adjustments. FMD maintains the accounting records of NRL's financial and related resources transactions and prepares reports, financial statements, and other documents in support of NRL management needs and/or to comply with external reporting requirements. FMD provides financial management guidance, policies, advice, and documented procedures to ensure that NRL operates in compliance with Navy and DOD regulations and with economy and efficiency. FMD coordinates efforts with the Defense Finance and Accounting Service (DFAS) to complete payment transactions related to NRL business (e.g., the payment of NRL personnel for payroll and travel expenses and the payment to NRL's contractors and vendors for goods and services purchased by NRL). Additionally, FMD develops, operates, and maintains automated business and management information systems supporting the lab-wide administrative and business processes, including financial management, procurement and contracting, stores and inventory, asset management, human resources, facilities, and security.

Personnel: 67 full-time civilian

Key Personnel

Name	Title	Code
Mr. S.A. Birk	Head, Financial Management Division	3300
Ms. R.A. Smith	Administrative Officer	3302
Mr. T.Y. Kim	Head, Budget and Funds Management Branch	3310
Ms. H.M. McCauley	Head, Corporate Budget Unit	
Ms. M. Macquade	Head, Internal Budget Unit	
Mr. J.V. Thomas	Head, Financial Systems, Reports, and Accounting Branch	3350
Mr. M.C. Mills	Head, Cost Accounting Section	3351
Ms. J. Jones	Head, Contracts and Credit Cards Unit	3351.1
Ms. L.V. Pollard	Head, Small Purchases and Miscellaneous Docs Unit	3351.2
Ms. M. Gibbons	Head, Financial Services Section	3352
Ms. A.C. Cutchember	Head, Payroll Services Unit	3352.1
Ms. T.D. Frye	Head, Travel Services Unit	3352.2
Ms. D.K. Edwards	Head, Asset Management Unit	3352.3
Ms. S.L. Weber	Head, Accounting Systems and Reports	3353

Point of contact: Ms. R.A. Smith, Code 3302, (202) 767-2950

Supply Division

Code 3400

- Disposal and Storage
- Store Material Issues
- Customer Liaison
- Automated Inventory Management System
- Purchasing
- Receipt Control
- Material Control
- Technical

Head of the Purchasing Branch reviews purchase order folder



Customer and employee at the Supply store



Woodworkers prepare boxes for shipping



Disposal and Storage in building 49



Ms. C. HARTMAN

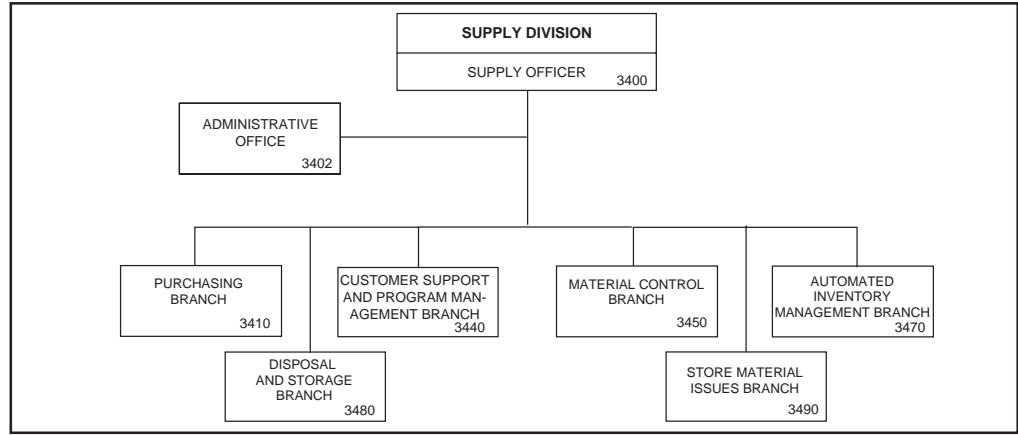

Basic Responsibilities

The Supply Division provides the Laboratory and its field activities with contracting, supply management, and logistics services. Specific functions include: procuring required equipment, material, and services; receiving, inspecting, storing, and delivering material and equipment; packing, shipping, and traffic management; surveying and disposing of excess and unusable property; operating various supply issue stores and performing stock inventories; providing technical and counseling services for the research directorates in the development of specifications for a complete procurement package; and obtaining and providing guidance in the performance stages of contractual services.

Personnel: 75 full-time civilian

Key Personnel

Name	Title	Code
Ms. C. Hartman	Supply Officer	3400
Ms. A. Olson	Administrative Officer	3402
Ms. M. Smith	Head, Purchasing Branch	3410
Ms. P. Carter	Head, Customer Support and Program Management Branch	3440
Mr. W. Myers	Head, Material Control Branch	3450
Ms. L. Brown	Head, Automated Inventory Management Branch	3470
Ms. L. Marshall*	Head, Disposal and Storage Branch	3480
Mr. M. Clark	Head, Store Material Issues Branch	3490

Point of contact: Ms. A. Olson, Code 3402, (202) 767-3871

*Acting

Research and Development Services Division

Code 3500

- Technical/Support Services
- Operations
- Shop Services
- Chesapeake Bay Section
- Customer Liaison
- Safety
- Environmental



Service Desk – processing service calls

Telephone Office – processing service calls



Machine Shop – fabricating radar pedestal for shipboard operation



Mr. S.D. HARRISON

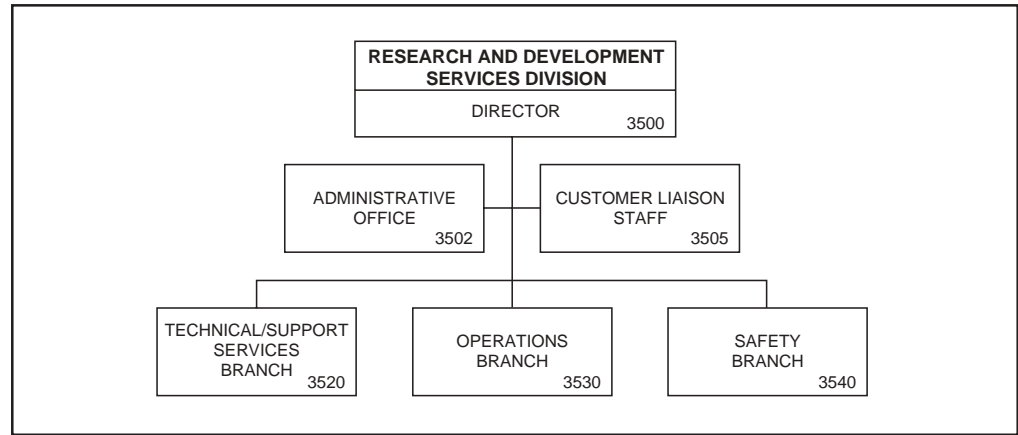

Basic Responsibilities

The Research and Development Services Division is responsible for the physical plant of the Naval Research Laboratory and subordinate field sites. The responsibilities include military construction, engineering, and coordination of construction; facility support services, planning, maintenance/repair/operation of all infrastructure systems; transportation; and occupational safety, health and industrial hygiene, and environmental safety.

The Division provides engineering and technical assistance to research divisions in the installation and operation of critical equipment in support of the research mission.

Personnel: 155 full-time civilian

Key Personnel

Name	Title	Code
Mr. S.D. Harrison	Director	3500
Ms. L.Y. Jones	Administrative Officer	3502
Vacant	Head, Customer Liaison Staff	3505
Mr. T.K. Hull, Jr.	Head, Technical/Support Services Branch	3520
Mr. S.B. Daulat	Head, Engineering Section	3521
Ms. T.M. Downing	Head, Chesapeake Bay Section	3522
Mr. J.E. Headley	Head, Shop Services Section	3523
Mr. F.W. Regalia	Head, Operations Branch	3530
Mr. J.M. Schultz	Head, Production Control Section	3531
Mr. K.J. Pawlovich*	Head, Safety Branch	3540
Mr. S. Goldman	Occupational Safety and Health/Industrial Hygiene	3541
Ms. K. Edwards	Explosives Safety	3542
Mr. K.J. Pawlovich	Health Physics	3544
Ms. K. Edwards*	Environmental	3546

Point of contact: Ms. L.Y. Jones, Code 3502, (202) 767-2168

*Acting

**Systems
Directorate**

SYSTEMS DIRECTORATE

Code 5000

The Systems Directorate applies the tools of basic research, concept exploration, and engineering development to expand operational capabilities and to provide materiel support to Fleet and Marine Corps missions. Emphasis is on technology, devices, systems, and know-how to acquire and move war-fighting information and to deny these capabilities to the enemy. Current activities include:

- New and improved radar systems to detect and identify ever smaller targets in the cluttered littoral environment;
- Optical sensors and related materials to extract elusive objects in complex scenes when both processing time and communications bandwidth are limited;
- Unique optics-based sensors for detection of biochemical warfare agents and pollutants, for monitoring structures, and for alternative sensors;
- Advanced electronic support measures techniques for signal detection and identification;
- Electronic warfare systems, techniques, and devices including quick-reaction capabilities;
- Innovative concepts and designs for reduced observables;
- Techniques and devices to disable and/or confuse enemy sensors and information systems;

- Small “intelligent”/autonomous land, sea, or air vehicles to carry sensors, communications relays, or jammers; and

- High-performance/high-assurance computers with right-the-first-time software and known security characteristics despite commercial off-the-shelf components and connections to public communications media.

Many of these efforts extend from investigations at the frontiers of science to the support of deployed systems in the field, which themselves provide direct feedback and inspiration for applied research and product improvement and/or for quests for new knowledge to expand the available alternatives.

In addition to its wide-ranging multidisciplinary research program, the Directorate provides support to the corporate laboratory in shared resources for high performance computing and networking, technical information collection and distribution and in coordination of Laboratory-wide efforts in signature technology, counter-signature technology, Theater Missile Defense, and the Naval Science Assistance Program.

Associate Director of Research for Systems



Dr. R.A. LeFande was born on Staten Island, New York on February 8, 1941. He attended the Brooklyn Technical High School and obtained his undergraduate degree in physics from the University of Rhode Island in 1962. After a brief tour as a telephone equipment engineer with Western Electric Company in New York City, he returned to academic pursuits, earning a Master's degree in physics from the Rutgers University in 1965.

In July of 1965, Dr. LeFande joined the Naval Research Laboratory as a research physicist in the Satellite Communications Branch. He worked on a variety of projects related to the

design of waveforms for Naval applications, calibration of antennas and path losses by methods borrowed from radio astronomy, and on the design and acquisition of satellite communication terminals for shipboard and submarine use. By drawing on this work for a thesis topic, he obtained his Ph.D. from the University of Maryland in 1973, in the areas of astronomy and astrophysics.

In 1976, Dr. LeFande became Head of the Special Communications Branch where he nurtured and encouraged an NRL team of scientists and engineers in the development of satellite communications terminals that are now being deployed in the Fleet, and in establishing the scientific understanding and practical design principles that contributed to the selection of waveforms for MILSTAR and other systems.

From 1979 to 1981, Dr. LeFande was Technical Director and System Engineer of the Special Communication Project of the Naval Electronic Systems Command. He oversaw several research and acquisition programs related to submarine communications, which covered the spectrum from extremely low frequencies through optics and included the maintenance and operation of a worldwide network of radio transmitter facilities. After termination of the project and a brief tour as Deputy Director, Research and Technology Group, Dr. LeFande returned to NRL as Superintendent of the Aerospace Systems Division. Here he guided a diverse program of basic and applied research in Wide Area Surveillance Systems, Space Warfare, and in related areas of physical science, materials, and device technology. From 1983 to 1990, Dr. LeFande served as Associate Deputy Assistant Secretary of the Navy (C³I and Space), providing technical and philosophical advice to eight assistant and deputy assistant secretaries. In this capacity, he took a keen interest in the issues of acquisition management reform and of the appropriate roles and missions of the Laboratory and the other Centers in the acquisition process. During this tour, Dr. LeFande was selected as a Legis Fellow and served on the staff of Representative Byron for six months in 1989, working on a variety of issues and legislation related to the armed services, science and technology, foreign affairs, and other matters.

Dr. LeFande returned to the Laboratory in October 1990, where he served on the staff of the Director of Research. He was designated Acting Associate Director of Research in February 1991, and Associate Director of Research in February 1992.

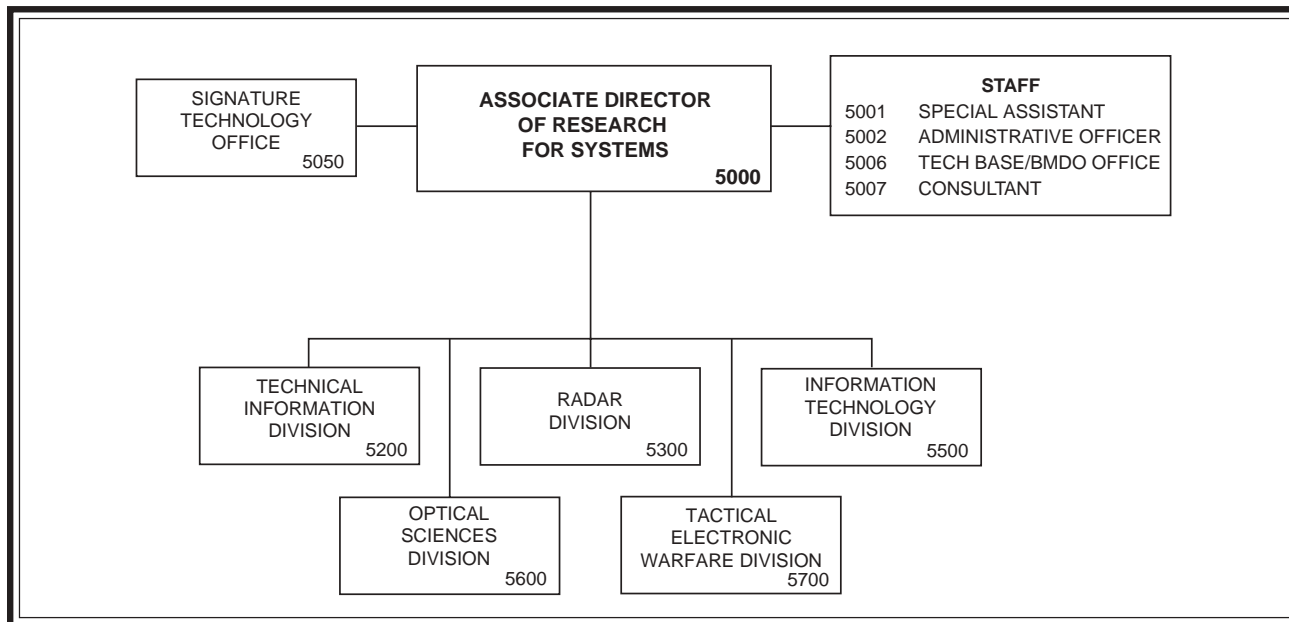

Key Personnel

Name	Title	Code
Dr. R.A. LeFande	Associate Director of Research for Systems	5000
Ms. B.J. Turner	Special Assistant	5001
Ms. D. Ernst	Administrative Officer	5002
Dr. S. Sacks	Head, Technology Base/Ballistic Missile Defense Office	5006
Dr. M.I. Skolnik	Consultant	5007
Dr. D.W. Forester	Head, Signiateure Technology Office	5050
Dr. R.A. LeFande*	Head, Technical Information Division	5200
Mr. P. Hughes II*	Superintendent, Radar Division	5300
Dr. J.D. McLean*	Superintendent, Information Technology Division	5500
Dr. T.G. Giallorenzi	Superintendent, Optical Sciences Division	5600
Dr. F.J. Klemm*	Superintendent, Tactical Electronic Warfare Division	5700

Point of contact: Ms. S.S. Harris, Code 5000A, (202) 767-3324

*Acting

**Technology Base/Ballistic Missile Defense
(BMD) Office
Code 5006**



DR. S. SACKS

The Head of the Technology Base/BMD Office carries out program management activities pertaining to the Navy BMD, SBIR, critical technology, and other technology efforts. Mission activities include assurance of technical quality and program relevance, technology philosophy, orientation of the program to priority needs and transition opportunities, and overall coordination of NRL efforts. He is the Laboratory point of contact with the Program Offices for this work.



DR. M.I. SKOLNIK

**Consultant
Code 5007**

The radar consultant provides expert advice, historical perspectives, analyses, and investigations in the field of radar, related systems, phenomenology, and applications to the Systems Directorate, NRL, the Navy, and other DOD organizations as requested.

Signature Technology Office

Code 5050



DR. D.W. FORESTER

- Electromagnetic Scattering Fundamentals
- Low Observables Materials
- Multidisciplinary Program Management
- Technology Transfer

Basic Responsibilities

The NRL Signature Technology Office (STO) performs research and manages/coordinates an integrated, comprehensive research and development program at NRL addressing all aspects of signature control and countersignature control as they apply to Navy weapons systems. The STO monitors and evaluates signature control technology development efforts within government and industry and facilitates the incorporation of advanced signature control technologies into present and future Navy systems. It provides a central point of contact for outside agencies on matters concerning the STO program.

Personnel: 15 full-time civilian

Key Personnel

Name	Title	Code
Dr. D.W. Forester	Research Physicist	5050

Point of contact: Ms. N.A. Carpenter, Code 5050A, (202) 767-3116

Technical Information Division

Code 5200

- NRL Historian
- Research Library and Technical Information Center
- Publications, Graphic Design, and Printing Services
- Photographic, Video, and Imaging Services
- Exhibits/Multimedia
- Auditorium Services
- Administrative Services

Printout of a collection of images from NRL's 75th Anniversary exhibit on TID's new color, wide-format Novajet printer.



Mail clerks sort mail by directorate and file into bins by organizational codes. Mail is bundled and delivered once a day.

The Library uses a 3.24 GB SPARC Storage RAID array to cache PDF files of the more than 160 journals it networks to NRL/



ONR researchers through its Web-based TORPEDO system. In addition, TORPEDO, as the centerpiece of the Library's Digital Library Initiative, provides access to about 5,000 research reports, reprints of publications by NRL authors, and NRL press releases.



The Publications Services Section staff reviews press sheets for one of NRL's publications



DR. R.A. LEFANDE*

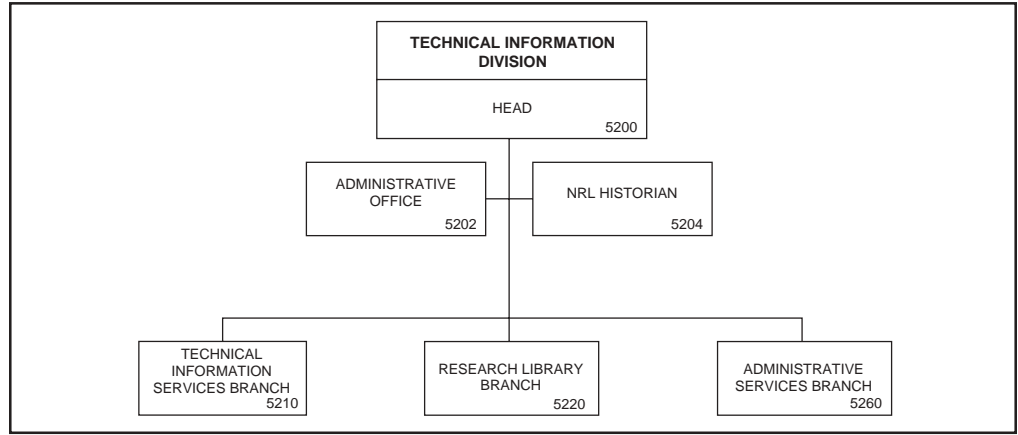

Basic Responsibilities

The Technical Information Division (TID) provides centralized support to the Laboratory, and sometimes the Office of Naval Research, by collecting, retaining, processing, publishing, presenting, and distributing information in various forms to many audiences.

TID supports the Laboratory by providing a full range of library services; by editing and publishing reports and publications; by performing specialized scientific and general photographic services, illustration and graphic design services, imaging support, scientific composition, and special projects graphics; and by providing photographic and video data-gathering and editing services.

Personnel: 64 full-time civilian

Key Personnel

Name	Title	Code
Dr. R.A. LeFande*	Head	5200
Ms. D.L. Gibson	Administrative Officer	5202
Dr. D. van Keuren	NRL Historian	5204
Ms. K.M. Parrish*	Head, Technical Information Services Branch	5210
Mr. R.J. King*	Head, Research Library Branch	5220
Ms. L. Warder	Head, Administrative Services Branch	5260

Point of contact: Ms. D.L. Gibson, Code 5202, (202) 767-3370

*Acting

Radar Division

Code 5300

Staff Activity Areas

AEGIS coordination
Marine Corps/IFF coordination

Electromechanical design
Multifunction RF systems

High-power millimeter wave radar

Research Activity Areas

Radar Analysis

Target signature prediction
Electromagnetics and antennas
Airborne early-warning radar (AEW)
Inverse synthetic aperture radar (ISAR)
Space-time adaptivity

Advanced Radar Systems

High-frequency over-the-horizon radar
Signal analysis
Signal processing and equipment
Computer Aided Design (CAD)
Electromagnetic Compatibility/Electromagnetic Interference (EMC/EMI)

Mark XII IFF improvements
Future identification technology

Surveillance Technology

Shipboard surveillance radar
Ship self-defense
Electronic counter-countermeasures
Target signature recognition
Digital T/R modules
Sea clutter characterization
Ultrawideband technology

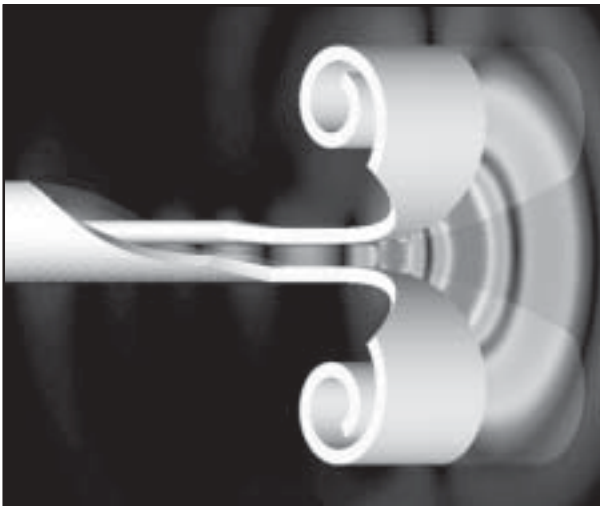

The radiation pattern at a point in time following introduction of a pulse of electromagnetic energy at the feed terminals of the element. This is an output of the electromagnetic computational capabilities of the Radar Division. It allows a researcher to investigate and perfect the performance of a design prior to actually building the element and testing it in an experiment setup, significantly shortening the development cycle.



Some of the experimental radar systems built and employed by the Radar Division. In the right center of the picture are the antenna and trailers of the AN/SPQ-9B Advanced Development Radar. To the left of the antenna are precision mounts used in a variety of experimental setups. In the upper right corner is the antenna mounting platform for the Engagement system, which currently is investigating means of implementing low-cost phased array radar system.



P.K. HUGHES II

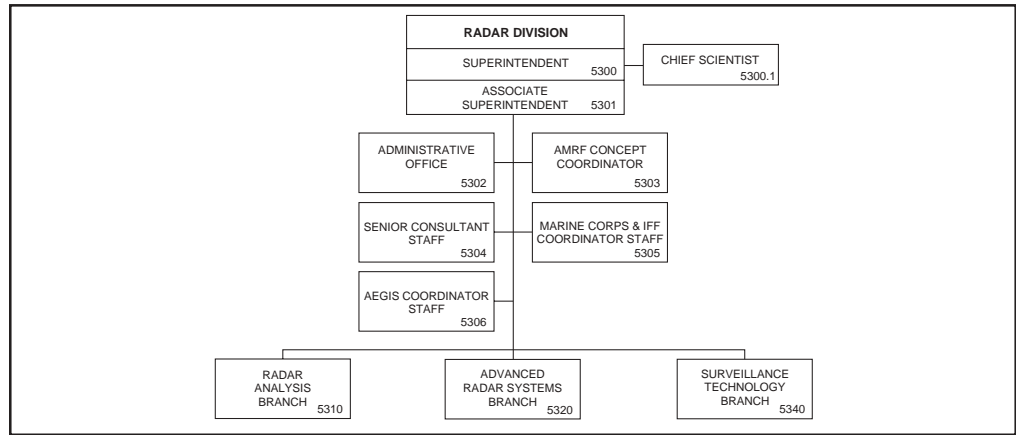

Basic Responsibilities

The Radar Division conducts research on basic physical phenomena of importance to radar and related sensors, investigates new engineering techniques applicable to radar, demonstrates the feasibility of new radar concepts and systems, performs related systems analyses and evaluation of radar, and provides special consultative services. The emphasis is on new and advanced concepts and technology in radar and related sensors that are applicable to enhancing the Navy's ability to fulfill its mission.

Personnel: 101 full-time civilian

Key Personnel

Name	Title	Code
Mr. P.K. Hughes II	Superintendent	5300
Dr. B.H. Cantrell	Chief Scientist	5300.1
Dr. J. Choe	Associate Superintendent	5301
Ms. J.C. Rohde	Administrative Officer	5302
Mr. G.C. Tavik	AMRF Concept Coordinator	5303
Mr. E.E. Maine, Jr.	Senior Consultant Staff	5304
Mr. J.A. Pavco	Marine Corps and IFF Coordinator	5305
Mr. V. Gregers-Hansen	AEGIS Coordinator	5306
Dr. W.P. Pala	Head, Radar Analysis Branch	5310
Mr. J.P. Letellier	Head, Advanced Radar Systems Branch	5320
Dr. E.L. Mokole	Head, Surveillance Technology Branch	5340

Point of contact: Mr. P.K. Hughes II, Code 5300, (202) 404-2700

*Acting

Information Technology Division

Code 5500 Research Activity Areas

Navy Center for Applied Research in Artificial Intelligence

Case-based reasoning
Natural language inter-
faces
Intelligent software agents
Machine learning
Robotics software and
computer vision
Neural networks
Novel devices/techniques
for HCI
Spatial Audio
Immersive Simulation

Mobile robots are used in
experiments at the Navy Center
for Applied Research in Artificial
Intelligence to study sensor-based
control and adaptive behavior



Transmission Technology

Arctic communication
Communication system architecture
Communication antenna/propagation technology
Communications intercept systems
Signal analysis systems
Virtual engineering

Center for High Assurance Computer Systems

Security architecture
Formal specification/verification of system
security
COMSEC application technology
Secure networks
Secure databases
Software engineering for secure systems
Key management and distribution
Certification and Infosec Engineering
Formal methods for requirements specification
and verification
Security product development

Communication Systems

Communication system engineering
Mobile, wireless networking
Bandwidth management (quality of service)

Reliable multicast protocols and applications
Integrated IP and ATM multicasting
Communication network simulation
Networking protocols for directional antennas
Policy-based network management
Tactical voice-over IP
Sensor networks
Fastlane and Taclane crypto testing

Advanced Information Technology

Command decision support
Scalable parallel computing
Joint C4ISR and operational M&S systems
Data fusion
3-D multi-modal interaction
Real-time parallel processing
Distributed modeling and simulation (e.g., HLA,
FDM development)
Processing graph method
Virtual reality/mobile augmented reality
Natural environments for distributed simulation
Collaborative engineering environment
Model integration (physical, environmental, biologi-
cal, psychological) for simulation
Motion adaptation and vestibular research

Center for Computational Science

Transparent optical network research and design
Parallel computing
Scalable high performance computing for Navy and DOD
Distributed computing environments
Scientific visualization
Advanced networking streams
High-definition video technology
End user support for information technology and
operational networks
Lab-wide support for web, email, and other infor-
mation services



Center for Computational
Science meta-computer
facility



Dr. J.D. McLEAN*

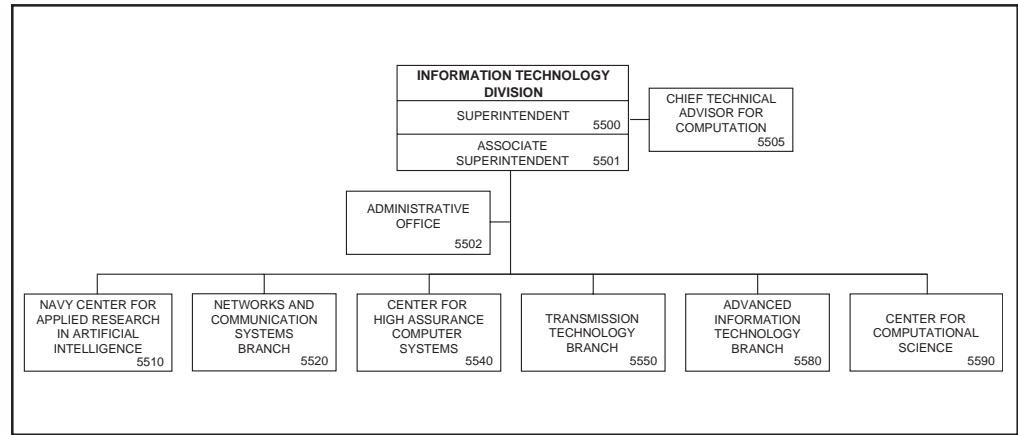

Basic Responsibilities

The Information Technology Division conducts research and development programs in the collection, transmission, and processing of information to provide a basis for improving the conduct of military operations. The organization of the Division is directed toward addressing the technologies and subsystems necessary to develop architectures and system designs for the next-generation battleforce warfare systems.

Personnel: 180 full-time civilian

Key Personnel

Name	Title	Code
Dr. J.D. McLean*	Superintendent	5500
Mr. W.D. Long	Associate Superintendent	5501
Ms. J. Saunders	Administrative Officer	5502
Dr. H. Dardy	Chief Technical Advisor for Computation	5505
Dr. A.L. Meyrowitz	Director, Navy Center for Applied Research in Artificial Intelligence	5510
Mr. E.L. Althouse	Head, Networks and Communication Systems Branch	5520
Dr. J.D. McLean	Director, Center for High Assurance Computer Systems	5540
Mr. E.J. Kennedy	Head, Transmission Technology Branch	5550
Dr. S.K. Numrich	Head, Advanced Information Technology Branch	5580
Mr. J.B. Root	Director, Center for Computational Science	5590

Point of contact: Mr. W.D. Long, Code 5501, (202) 767-2954

*Acting

Optical Sciences Division

Code 5600 Staff Activity Areas

Program analysis and development
Special systems analysis
Technical study groups

Technical contract monitoring
Theoretical studies
Navy Science Assistance Program (NSAP)

Research Activity Areas

Infrared Materials and Chemical Sensors

Advanced infrared glasses and fibers
IR fiber-optic materials and devices
IR fiber chemical sensors
Fiber environmental sensors

Optical Physics

Laser materials diagnostics
Nonlinear frequency conversion
Optical instrumentation and probes
Optical interactions in semiconductor superlattices and organic solids
Laser-induced reactions
Organic light emitting devices
Nano optical and electrical research

Applied Optics

Detection signal processing studies
Optical and IR countermeasures
Optical technology
Ultraviolet component development and UV countermeasures
Multispectral sensors and processing
Missile warning sensor technology
UV, visible, and IR imager development
Framing reconnaissance sensors
Micro UAV sensors

Photonics Technology

Diode laser applications
Fiber and solid-state laser/sources
High-speed (<100 fs) optical probing
High-power fiber amplifier
High-speed optical networks
Antenna remoting
RF filters and processes
Photonic control of phased arrays
Photonic analog to digital conversion

Advanced Concepts

IR Range Facility
IR low observables
Multispectral/hyperspectral/detection algorithms
EO/IR systems analysis
Airborne IR search and track technology
Atmospheric IR measurements
Ship IR signatures

Optical Techniques

Radiation effects
Fiber lasers/sources and amplifiers
Fiber-optic materials and fabrication
Fiber Bragg grating sensors/systems for smart structures
Fiber-optic sensors/systems (acoustic, magnetic, gyroscopes)
Integrated optics
Optical sources for sensors



The Focal Plane Array Evaluation Facility consists of the optical sources and electronics required to evaluate monolithic or hybrid infrared focal plane arrays that use charge-coupled device, charge-injection device, direct readout, or charge-imaging matrix technologies



The Missile Seeker Evaluation Facility is a computerized facility that is used to evaluate optical countermeasures to infrared missile seekers and infrared imaging sensors



DR. T.G. GIALLORENZI

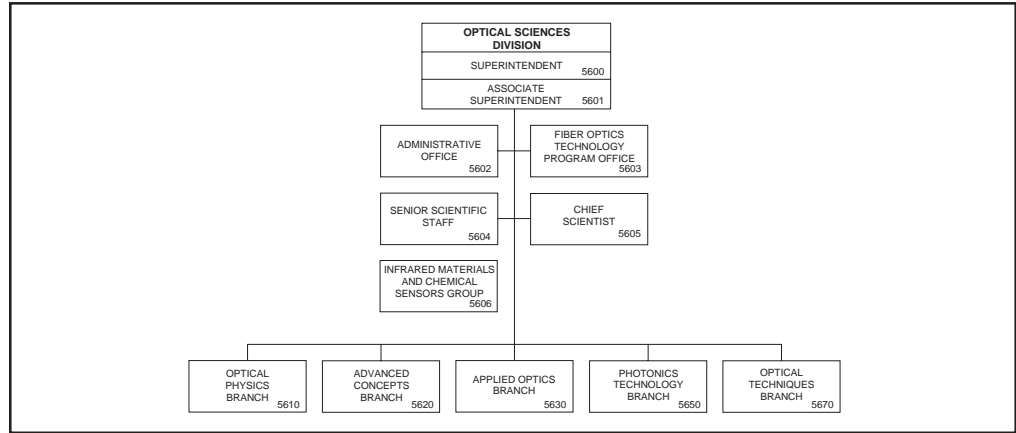

Basic Responsibilities

The Optical Sciences Division carries out a variety of research, development, and application-oriented activities in the generation, propagation, detection, and use of radiation in the wavelength region between near-ultraviolet and far-infrared wavelengths. The research, both theoretical and experimental, is concerned with discovering and understanding the basic physical principles and mechanisms involved in optical devices, materials, and phenomena. The development effort is aimed at extending this understanding in the direction of device engineering and advanced operational techniques. The applications activities include systems analysis, prototype system development, and exploitation of R&D results for the solution of optically related military problems. In addition to its internal program activities, the Division serves the Laboratory specifically and the Navy generally as a consulting body of experts in optical sciences. The work in the Division includes studies in quantum optics, laser physics, optical waveguide technologies, laser-matter interactions, atmospheric propagation, optical technology, holography, optical warfare, optical data processing, fiber-optic sensor systems, optical systems, optical materials, radiation damage studies, IR surveillance and missile seeker technologies, IR signature measurements, optical recording materials, and optical diagnostic techniques. A significant portion of the effort is devoted to developing, analyzing, and using special optical materials. Various field measurement programs on optical problems of specific interest are also conducted.

Personnel: 137 full-time civilian

Key Personnel

Name	Title	Code
Dr. T.G. Giallorenzi	Superintendent	5600
Dr. C. Hoffman	Associate Superintendent	5601
Ms. M. Webb	Administrative Officer	5602
Mr. G. Cogdell	Head, Fiber Optics Technology Program Office	5603
Dr. J. Reintjes*	Head, Senior Scientific Staff	5604
Vacant	Chief Scientist	5605
Dr. I. Aggarwal	Head, Infrared Materials and Chemical Sensors Group	5606
Dr. A.J. Campillo	Head, Optical Physics Branch	5610
Dr. J.C. Kershenstein	Head, Advanced Concepts Branch	5620
Dr. R.A. Patten	Head, Applied Optics Branch	5630
Dr. K. Williams	Head, Photonics Technology Branch	5650
Dr. A. Dandridge	Head, Optical Techniques Branch	5670

Point of contact: Ms. M. Webb, Code 5602, (202) 767-6986

*Acting

Tactical Electronic Warfare Division

Code 5700 Staff Activity Areas

EW Strategic Planning
Information Warfare Technology Program
EW Lead Laboratory Coordinator

Navy Science Assistance Program (NSAP)
Effectiveness of Naval EW Systems (ENEWS)

Research Activity Areas

Offboard Countermeasures

Expendable technology and devices
Unmanned air vehicles
Offboard payloads
Decoys

Airborne Electronic Warfare Systems

Air systems development
Penetration aids
Power source development
Jamming and deception
Millimeter-wave technology
Communications CM

Ships Electronic Warfare Systems

Ships systems development
Jamming technology
Deception techniques
EW antennas

Electronic Warfare Support Measures

Intercept systems and direction finders
RF signal simulators
Systems integration
Command and control interfaces
Signal processing

Advanced Techniques

Analysis and modeling simulation
New EW techniques
Experimental systems
EW concepts
Infrared technology

Integrated EW Simulation

Hardware-in-the-loop simulation
Data management technology
Flyable ASM seeker simulators
Foreign military equipment exploitation



Using the latest composite, MMIC, and processing technologies, the Tactical Electronic Warfare Division has developed a small, lightweight, and inexpensive ESM receiving system for use on frigates, Coast Guard vessels, and various patrol aircraft

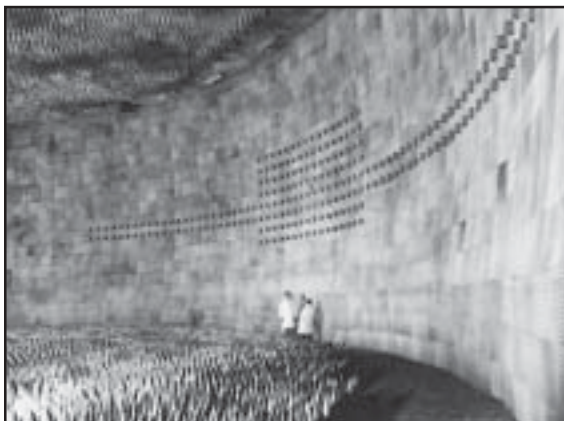

The Central Target Simulator (CTS) Programmable Array is part of a large hardware-in-the-loop simulation facility whose purpose is to test and evaluate electronic warfare systems and techniques used to counter the radar guided missile threat to Navy forces



DR. F.J. KLEMM*

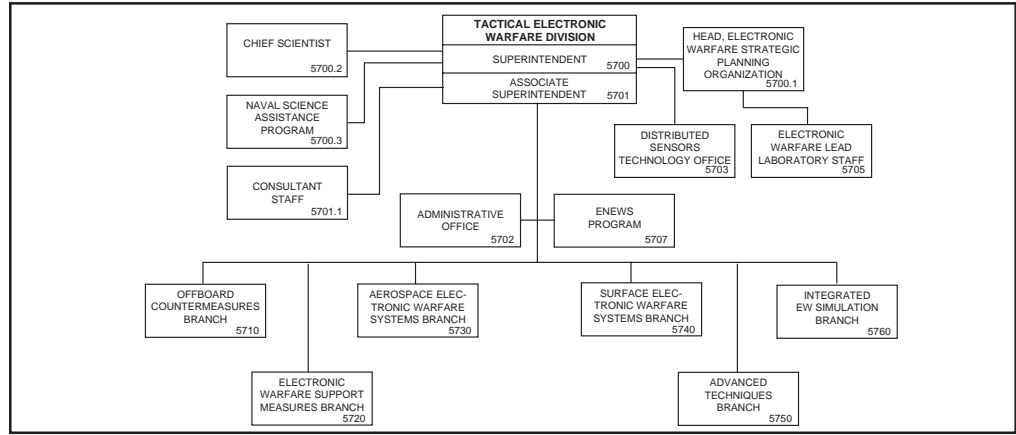

Basic Responsibilities

The Tactical Electronic Warfare Division (TEWD) is responsible for research and development in support of the Navy's tactical electronic warfare requirements and missions. These include electronic warfare support measures, electronic countermeasures, and supporting counter-countermeasures, as well as studies, analyses, and simulations for determining and improving the effectiveness of these systems.

Personnel: 237 full-time civilian

Key Personnel

Name	Title	Code
Dr. F.J. Klemm*	Superintendent	5700
Vacant	Head, Electronic Warfare Strategic Planning Organization	5700.1
Dr. W.E. Howell	Chief Scientist	5700.2
Mr. D.R. Starkston	Head, Naval Science Assistance Program	5700.3
Mr. A.A. DiMattesa	Associate Superintendent	5701
Mr. A.A. DiMattesa [†]	Consultant Staff	5701.1
Ms. J.C. Johnson	Administrative Officer	5702
Dr. J. Heyer*	Head, Distributed Sensors Technology Office	5703
Mr. T.J. Jesswein	Head, Electronic Warfare Lead Laboratory Staff	5705
Mr. A.A. DiMattesa*	Manager, ENEWS Program	5707
Vacant	Head, Offboard Countermeasures Branch	5710
Mr. R.D. Oxley	Head, Electronic Warfare Support Measures Branch	5720
Dr. G.A.H. Cowart	Head, Aerospace Electronic Warfare Systems Branch	5730
Dr. P.W. Grounds	Head, Surface Electronic Warfare Systems Branch	5740
Dr. R.H. Evans	Head, Advanced Techniques Branch	5750
Mr. B.W. Edwards	Head, Integrated EW Simulation Branch	5760

Point of contact: Mr. A.A. DiMattesa, Code 5701, (202) 767-5974

*Acting

[†]Additional duty

**Materials
Science and
Component
Technology
Directorate**

MATERIALS SCIENCE AND COMPONENT TECHNOLOGY DIRECTORATE

Code 6000

The Materials Science and Component Technology Directorate carries out a multidisciplinary research program whose objectives are the discovery, invention, and exploitation of new improved materials, the generation of new concepts associated with materials behavior, and the development of advanced components based on these new and improved materials and concepts. Theoretical and experimental research is carried out to determine the scientific origins of materials behavior and to develop procedures for modifying these materials to meet important naval needs for advanced platforms, electronics, sensors, and photonics. The program includes investigations of a broad spectrum of materials including insulators, semiconductors, superconductors, metals and alloys, optical materials, polymers, plastics, and artificially structured bio/molecular materials and composites, which are used in important naval devices, components, and systems. New techniques are developed for producing, processing, and fabricating these materials for crucial naval applications.

The synthesis, processing, properties, and limits of performance of these new and improved materials in natural or radiation environments, components under deleterious conditions such as those associated with the marine environment, neutron or directed energy beam irradiation, or extreme temperatures and pressures, are established. For new materials design, emphasis is placed on protection of the environment.

Additionally, major thrusts are directed in advanced sensing, detection, reactive flow physics, computational physics, and plasma sciences. Areas of particular emphasis include nanoscience and technology, fluid mechanics and hydrodynamics, nuclear weapon effects simulations, high-energy density materials including fuels, propellants, explosives, and storage devices, interactions of various types of radiation with matter, survivability of materials and components, and directed energy devices.

Associate Director of Research for Materials Science and Component Technology



Dr. **B.B. Rath** was born in Banki, India, on October 28, 1934. He received a B.S. degree in physics and mathematics from Utkal University, an M.S. in metallurgical engineering from Michigan Technological University, and a Ph.D. from the Illinois Institute of Technology.

Dr. Rath was Assistant Professor of Metallurgy and Materials Science at Washington State University from 1961 to 1965. From 1965 to 1972, he was with the staff of the Edgar C. Bain Laboratory for fundamental research of the U.S. Steel Corporation. From 1972 to 1976, he headed the Metal Physics Research Group of the McDonnell Douglas Research Laboratories in St.

Louis, Missouri, until he came to NRL as Head of the Physical Metallurgy Branch. During this period, he was adjunct Professor at the Carnegie-Mellon University, the University of Maryland, and the Colorado School of Mines. Dr. Rath served as Superintendent of the Materials Science and Technology Division from 1982 to 1986, when he was appointed to his present position.

Dr. Rath is recognized in the fields of solid-state transformations, grain boundary migrations, and structure-property relationships in metallic systems. He has published over 160 papers in these fields and edited several books and conference proceedings.

Dr. Rath serves on several planning, review, and advisory boards for both the Navy and the Department of Defense, as well as for the National Materials Advisory Board of the National Academy of Sciences, Carnegie-Mellon University, University of Virginia, Colorado School of Mines, University of Pittsburgh, University of Connecticut, University of Maryland, Carnegie-Mellon University, and Florida Atlantic University. He serves as the Navy representative and as the Executive Chair to the Materials and Structures Group of The Technical Cooperation Program (TTCP) countries and the Indo-U.S. Joint Commission on Science and Technology.

Dr. Rath is a Fellow of the Minerals, Metals, and Materials Society (TMS), American Society for Materials-International (ASM), Washington Academy of Sciences, Indian Academy of Engineering, British Institute of Materials (IOM), and Materials Research Society of India. For his contributions to Materials Research, he has received the 1991 George Kimball Burgess Memorial Award, TMS Leadership Award, the Charles S. Barrett Medal, the Chandrasekhar Medal and Award in 1998, the Presidential Rank Award in 1999, Presidents' Meritorious Executive Award, Distinguished Lecture in Materials and Society Award, Distinguished ASM Life Member Award, THERMEC-2000 Distinguished Award, and The National Materials Advancement Award. He has served as chairperson of several technical committees of TMS, ASM, and AAES, and serves in the editorial boards of three international materials research journals. He is a member of the Board of Trustees of ASM-International and the Federation of Engineering Societies, and Board of Directors of The Materials Society (TMS).

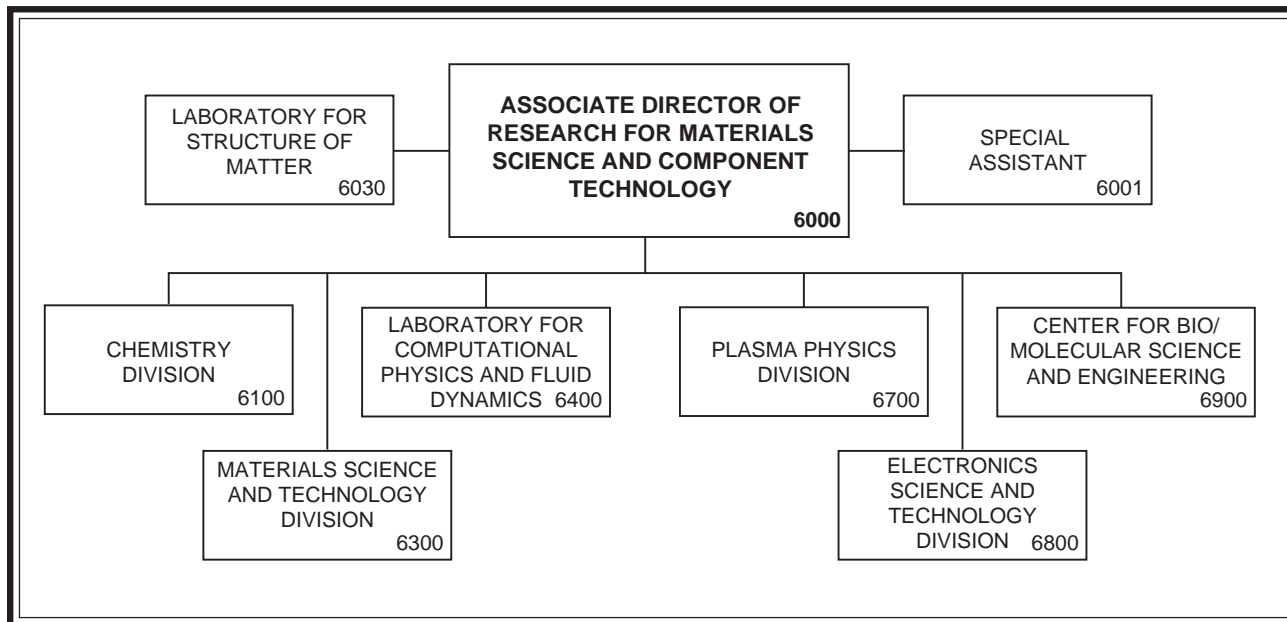

Key Personnel

Name	Title	Code
Dr. B.B. Rath	Associate Director of Research for Materials Science and Component Technology	6000
Mr. S.J. Gill	Special Assistant	6001
Dr. J. Karle	Chief Scientist, Laboratory for Structure of Matter	6030
Dr. J.S. Murday	Superintendent, Chemistry Division	6100
Dr. D.U. Gubser	Superintendent, Materials Science and Technology Division	6300
Dr. J.P. Boris	Chief Scientist and Director, Laboratory for Computational Physics and Fluid Dynamics	6400
Dr. S.L. Ossakow	Superintendent, Plasma Physics Division	6700
Dr. G.M. Borsuk	Superintendent, Electronics Science and Technology Division	6800
Dr. J.M. Schnur	Director, Center for Bio/Molecular Science and Engineering	6900

Point of contact: Mrs. J.E. Smithwick, Code 6000A, (202) 767-2538

**Dr. Jerome Karle recipient of
1985 Nobel Prize in Chemistry**



Dr. Jerome Karle's research has been concerned with diffraction theory and its application to the determination of atomic arrangements in various states of aggregation, gases, liquids, amorphous solids, fibers, and macromolecules. This research has resulted in new techniques for structure determination and a broad variety of applications. His work in crystal structure analysis was recognized by the 1985 Nobel Prize in Chemistry.

Dr. Karle is a Fellow of the American Physical Society, a member of the National Academy of Sciences, and the American Philosophical Society. He has served as president of the International Union of Crystallography, and is a member of a number of other professional societies. He has been chairman of the Chemistry Section of the National Academy of Sciences. Some time ago, he was a Professorial Lecturer in the University College of the University of Maryland and a Visiting Professor at the University of Kiel in Germany. He has also lectured at many international schools and symposia and has served on a number of international scientific organizations.

Laboratory for Structure of Matter

Code 6030



DR. J. KARLE

Basic Responsibilities

The Laboratory for Structure of Matter carries out experimental and theoretical investigations of the atomic, molecular, glassy, and crystalline structures of materials. The methods of X-ray, electron, and neutron diffraction are used in a broad program of structural studies that can form the basis for understanding and interpreting the results of research investigations in a wide variety of scientific disciplines. Structural investigations relate structure to function, facilitate industrial syntheses and the creation of new materials with improved properties, and provide foundation information for numerous associated disciplines and studies. Applications are made, for example, to propellants, explosives, dense energetic materials, absorptive carbons, metallic glasses, device materials, ion carriers, antibiotics, analgesics, reversible oxygen carriers, and synthetic reaction intermediates and final products.

Personnel: 10 full-time civilian

Key Personnel

Name	Title	Code
Dr. J. Karle	Chief Scientist	6030

Point of contact: Mrs. M. Williams, Code 6030, (202) 767-3496

Chemistry Division

Code 6100 Staff Activity Areas

The Environment and Biotechnology Program Manager

Research Activity Areas

Chemical Diagnostics

- Optical diagnostics of chemical reactions
- Kinetics of gas phase reactions
- Trace analysis
- Atmosphere analysis and control
- Ion/molecule processes
- Environmental chemistry

Materials Chemistry

- Synthesis and evaluation of innovative polymers
- Functional organic coatings
- Polymer characterization
- Quality control methodology
- Degradation and stabilization mechanisms
- High-temperature resins
- OMCVD materials
- Corrosion prevention
- Mobility fuels

Center for Corrosion Science and Engineering

- Materials failure analysis
- Marine coatings
- Cathodic protection
- Corrosion Science
- Environmental fracture and fatigue
- Corrosion control engineering



The NRL National Synchrotron Light Source research station for materials and surface research

Surface/Interface Chemistry

- Tribology
- Surface properties of materials
- Surface/interface analysis
- Chemical microdetectors
- Surface reaction dynamics
- Diamond films
- Beam-enhanced chemistry
- Electrochemistry
- X-ray sources, optics, and detectors
- X-ray analysis of materials—composition and structure
- Synchrotron radiation applications
- Radiation detection and measurement
- UV optical properties of materials

Safety and Survivability

- Combustion dynamics
- Fire protection and suppression
- Personnel protection
- Modeling and scaling of combustion systems
- Chemical and biological defense



The Key West site of the NRL Center for Corrosion Science and Engineering specializes in understanding and modeling of the marine environments impact on Naval materials. A complete laboratory for the study of corrosion control technologies provides sponsors with prototypical seawater exposure of their systems.



Dr. J.S. MURDAY

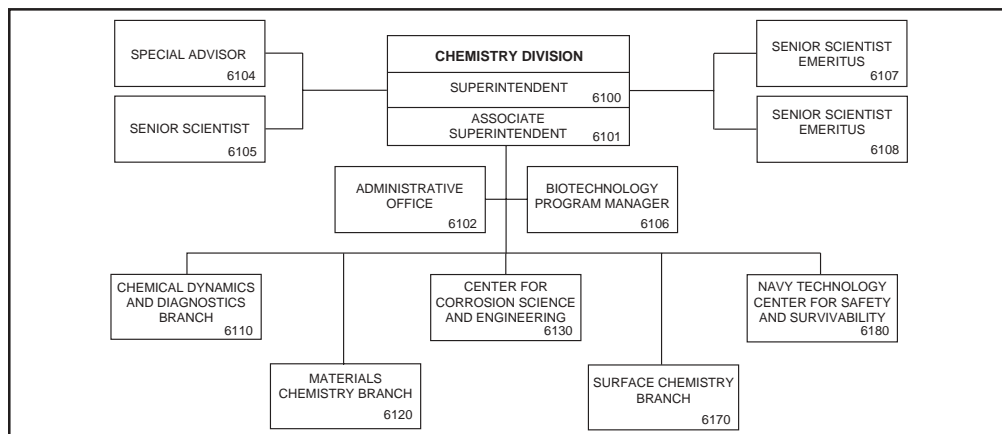

Basic Responsibilities

The Chemistry Division conducts basic research, applied research, and development studies in the broad fields of chemical/structural diagnostics, reaction rate control, materials chemistry, surface and interface chemistry, corrosion passivation, environmental chemistry, and ship safety/survivability. Specialized programs within these fields include chemical vapor precursors, coatings, functional polymers/elastomers, clusters, controlled release of energy, physical and chemical characterization of surfaces, electrochemistry, assembly, and properties of nanometer structures, tribology, chemical vapor deposition/etching, atmosphere analysis and control, environmental protection/reclamation, prevention/control of fires, mobility fuels, modeling/simulation, and miniaturized sensors for chemical, biological, nuclear, and radiation hazards.

To enhance protection of Navy personnel and platforms from damage and injury in peace and wartime, the Navy Technology Center for Safety and Survivability performs RDT&E on fire and personnel protection, fuels, chemical defense, submarine atmospheres, and damage control aspects of ship and aircraft survivability; supports Navy and Marine Corps requirements in these areas; and acts as a focus for technology transfer in safety and survivability.

Personnel: 106 full-time civilian; 4 full-time military; 4 part-time

Key Personnel

Name	Title	Code
Dr. J.S. Murday	Superintendent	6100
Dr. W.W. Schultz	Associate Superintendent	6101
Ms. M.R. Roderick	Administrative Officer	6102
Dr. R.W. Holst	Special Advisor	6104
Vacant	Senior Scientist	6105
CDR A. Churilla, MSC, USN	Biotechnology Program Manager	6106
Dr. D.L. Venezky	Senior Scientist Emeritus	6107
Dr. H.W. Carhart	Senior Scientist Emeritus	6108
Dr. B.J. Spargo	Head, Chemical Dynamics and Diagnostics Branch	6110
Dr. L.J. Buckley	Head, Materials Chemistry Branch	6120
Mr. K.E. Lucas	Head, Center for Corrosion Science and Engineering	6130
Dr. R.J. Colton	Head, Surface Chemistry Branch	6170
Dr. F.W. Williams	Head, Navy Technology Center for Safety and Survivability	6180

Point of contact: Ms. M.R. Roderick, Code 6102, (202) 767-2460

Materials Science and Technology Division

Code 6300 Research Activity Areas

Physical Metallurgy

- Ferrous and intermetallic alloys
- Synthesis/processing of metals
- Welding technology
- Micro-/nanostructure characterization

Complex Systems Theory

- Computational condensed matter physics and materials science
- Applications or electronic structure theory to solids and clusters
- Molecular dynamics
- Quantum many-body theory
- Theory of alloys
- Superconductivity theory
- Theoretical studies of phase transitions
- Atomic physics theory

Directed Energy Effects

- Laser-hardened materials and systems
- Laser point defense
- Nanostructure optics
- High-power laser interactions with materials and systems
- Atomic and molecular interactions with surfaces and interfaces
- Spectroscopy of superconductors

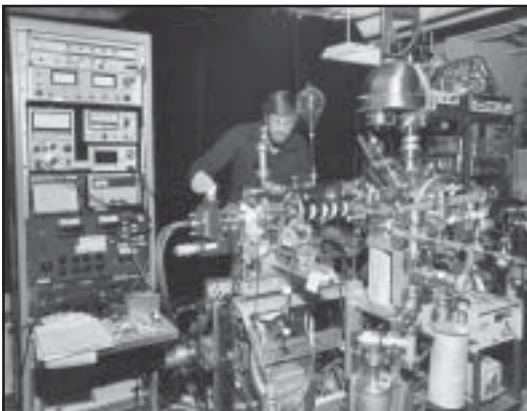

The growth of single crystal magnetic films on semiconductor substrates for electronic applications is observed

Surface Modification

- Thin film deposition
 - Pulsed laser deposition
 - Ion-beam-assisted deposition
 - Variable balance magnetron sputtering
- Ion engineering
 - Ion implantation
 - Reactive ion etching
- Functional materials
 - Optoelectronics
 - Electroceramics
 - Chemical sensors
- Analysis
 - Surface analysis by accelerator techniques
 - Trace element accelerator mass spectrometry
 - Mechanical loss spectroscopy

Material Physics

- Superconducting materials
- Magnetic materials
- Thermoelectric materials
- Nonlinear (chaotic) phenomena

Multifunctional Materials

- Mechanics of metallic and ceramic materials
- Nondestructive evaluation
- Smart materials/structures
- Synthesis and processing of ceramic materials

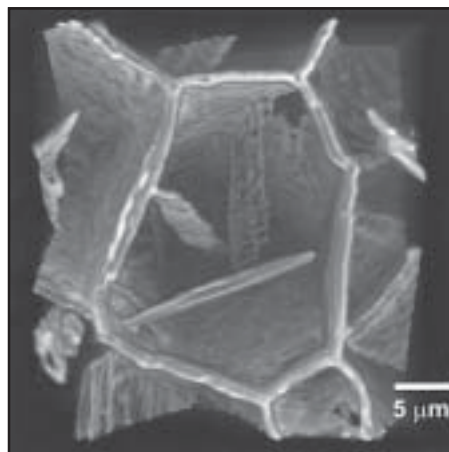

3D reconstruction of cementite precipitates in an austenite grain



DR. D.U. GUBSER

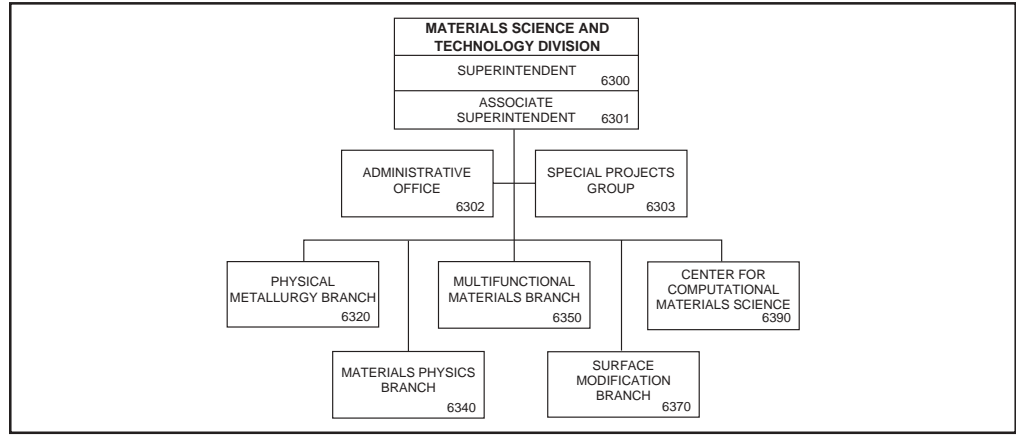

Basic Responsibilities

The Materials Science and Technology Division conducts basic and applied research and engages in exploratory and advanced development of materials having substantive value to the Navy. R&D programs encompass the intrinsic behavior of metals, insulators, composites, and ceramics, including efforts in ferrous alloys, intermetallic compounds, superconducting, dielectric, and magnetic materials, films and coatings, and multifunctional materials systems. The programs encompass advanced synthesis and processing techniques as well as postprocessing techniques to fabricate sensors, devices, structures, and components. A variety of state-of-the-art characterization tools are used to probe the atomic and microstructure nature (composition and structure) of the materials as well as to delineate the fundamental properties of the material or material system. Response of materials and material systems to a variety of external influences (mechanical, chemical, optical, electromagnetic radiation, high-power lasers, temperature, etc.) is integral to the division's programs as well as performances and reliability projections for military service lifetime. The program includes strong theoretical, computational, and simulation efforts to predict, guide, and explain the behavior of materials and materials systems. Studies conducted in the division will provide guidance for the selection, design, certification, and life-cycle management of material in naval vehicles and systems. The diversity of R&D programs in the division is carried out by multidisciplinary teams of materials scientists, metallurgists, ceramists, physicists, chemists, and engineers using the most advanced testing facilities and diagnostic techniques.

Personnel: 140 full-time civilian

Key Personnel

Name	Title	Code
Dr. D.U. Gubser	Superintendent	6300
Dr. A.C. Ehrlich	Associate Superintendent	6301
Mr. M.R. Shepherd	Administrative Officer	6302
Dr. D.U. Gubser*	Head, Special Projects Group	6303
Dr. E.A. Metzbower	Head, Physical Metallurgy Branch	6320
Dr. V.G. Harris	Head, Materials Physics Branch	6340
Dr. P. Matic	Head, Multifunctional Materials Branch	6350
Dr. G. Huber	Head, Surface Modification Branch	6370
Dr. D.A. Papaconstantopoulos	Head, Center for Computational Materials Science	6390

Point of contact: Ms. J. Schoch, Code 6300A, (202) 767-2926

*Acting

Laboratory for Computational Physics and Fluid Dynamics

Code 6400 Research Activity Areas

Reactive Flows

- Fluid dynamics in combustion
- Turbulence in compressible flows
- Multiphase flows
- Turbulent jets and wakes
- Turbulence modeling
- Computational hydrodynamics
- Propulsion systems analysis
- Contaminant transport modelling

Computational Physics Developments

- Laser plasma interactions
- Inertial confinement fusion
- Solar physics modeling
- Dynamical gridding algorithms
- Advanced graphical and parallel processing systems
- Electromagnetic and acoustic scattering
- Microfluidics
- Fluid structure interaction
- Shock and blast containment



Olive (32P) and Snuffy (24P) — Origins at work

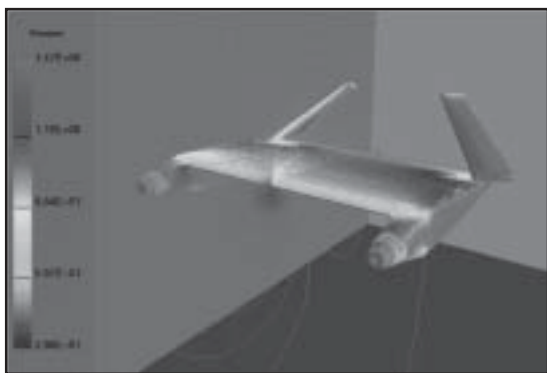

Simulation of flow past a Micro Air Vehicle. Computational Fluid Dynamics is being used to evaluate the aerodynamic performance of alternative concepts. This figure shows the pressure contours on the surface of the vehicle and a symmetry plane.

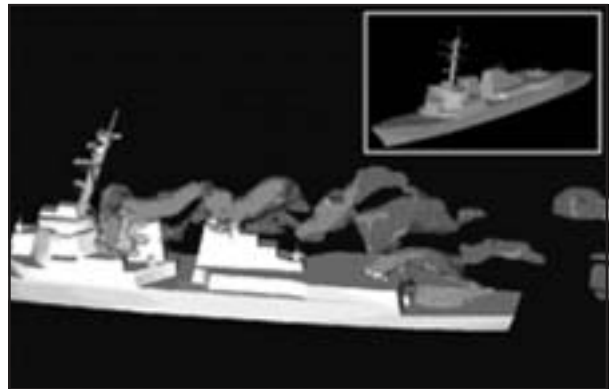

Simulations of temperature isocontours from unsteady airwake simulations over the DDG-51 destroyer were performed in a joint effort with NRL's Tactical Electronic Warfare Division (TEWD).

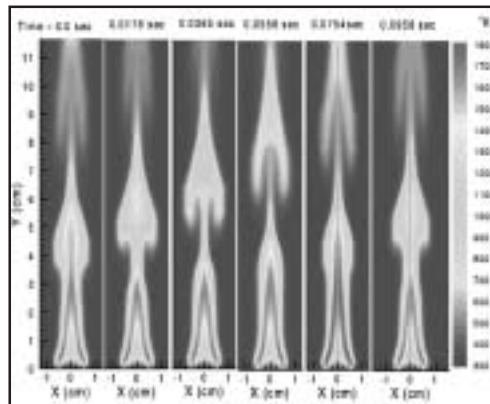

Temperature distributions from an unsteady simulation of a methanol liquid pool fire. Water mist suppression of such fires and the mechanisms involved have been elucidated using detailed reactive flow simulations.



Dr. J.P. Boris

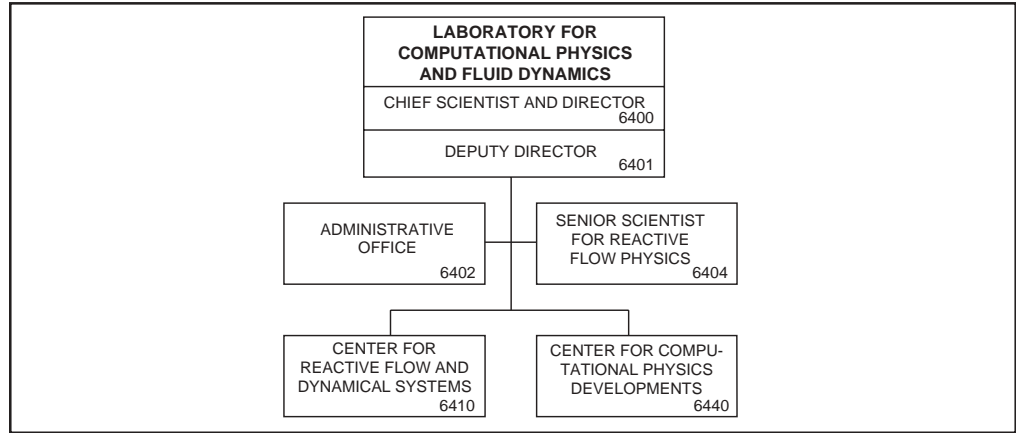

Basic Responsibilities

The Laboratory for Computational Physics and Fluid Dynamics is responsible for the research leading to and the application of advanced analytical and numerical capabilities that are relevant to Navy, DOD, and other programs of national interest. This research is pursued in the fields of compressible and incompressible fluid dynamics, reactive flows, fluid/structure interaction including submarine and aerospace applications, atmospheric and solar geophysics, magnetoplasma dynamics for laboratory and space applications, application of parallel processing to large-scale problems such as unstructured grid generation for complex flows and target tracking and correlation for battle management, and in other disciplines of continuum and quantum computational physics as required to further the overall mission of the Naval Research Laboratory. The specific objectives of the Laboratory for Computational Physics and Fluid Dynamics are to develop and maintain state-of-the-art analytical and computational capabilities in fluid dynamics and related fields of physics; to establish in-house expertise in parallel processing for large-scale scientific computing; to perform analyses and computational experiments on specific relevant problems using these capabilities; and to transfer this technology to new and ongoing projects through cooperative programs with the research divisions at NRL and elsewhere.

Personnel: 26 full-time civilian

Key Personnel

Name	Title	Code
Dr. J.P. Boris	Chief Scientist and Director	6400
Dr. W.C. Sandberg	Deputy Director	6401
Mrs. C. Adams	Administrative Officer	6402
Dr. E.S. Oran	Senior Scientist for Reactive Flow Physics	6404
Dr. K. Kailasanath	Head, Center for Reactive Flow and Dynamical Systems	6410
Mr. J.H. Gardner, Jr.	Head, Center for Computational Physics Developments	6440

Point of contact: Mrs. C. Adams, Code 6402, (202) 767-6581

Plasma Physics Division

Code 6700

Research Activity Areas

Radiation Hydrodynamics

- Pulsed-power radiation source and power-flow development
- Gas laser kinetics
- Dense plasma atomic structure, processes, and equations of state
- Radiation hydrodynamics of dense Z-pinch and laser-produced plasmas
- Plasma-radiation diagnostics
- Plasma discharge physics
- Numerical simulation of high-density plasma

Laser Plasma

- Nuclear weapons stockpile stewardship
- Laser fusion, inertial confinement
- Megabar high-pressure physics
- Rep-rate KrF laser development
- Strongly coupled plasmas
- Laser fusion technology

Charged Particle Physics

- Electrodeless plasma discharges for lighting
- Applications of modulated electron beams
- Rocket, satellite, and shuttle-borne natural and active experiments
- Laboratory simulation of space plasma processes
- Large-area plasma processing sources
- Atmospheric and ionospheric GPS sensing
- Ionospheric effects on communications

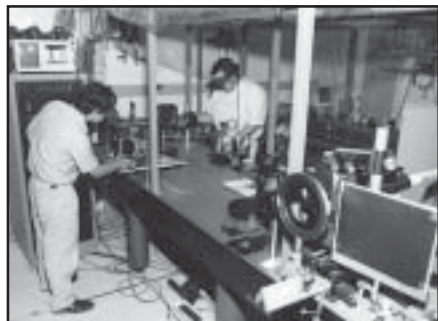

The NRL Table-Top-Terawatt (T^3) Laser Facility. The T^3 laser currently operates at 0.4 ps, 2.5 TW and 5×10^{18} W/cm² and provides a facility to conduct research in intense laser-plasma interactions, intense laser-electron beam interactions, and intense laser-matter interactions.

Pulsed Power Physics

- Production, focusing, and propagation of intense electron and ion beams
- High-power, pulsed radiography
- Plasma radiator and bremsstrahlung diode source development
- Capacitive and inductive energy storage
- Nuclear weapons effects simulation
- Electromagnetic launchers
- Ion-beam inertial confinement fusion

Beam Physics

- Advanced accelerators and radiation sources
- Microwave, plasma, and laser processing of materials
- Microwave sources: Magnicons and gyrotrons
- Nonlinear dynamics
- Ultrahigh intensity laser-matter interactions
- Free electron lasers and laser synchrotrons
- Theory and simulation of space and solar plasmas
- Ionospheric modification
- Space weather modeling
- Rocket and space diagnostics
- Damage effects from laser-generated X rays
- Laser propagation in the atmosphere

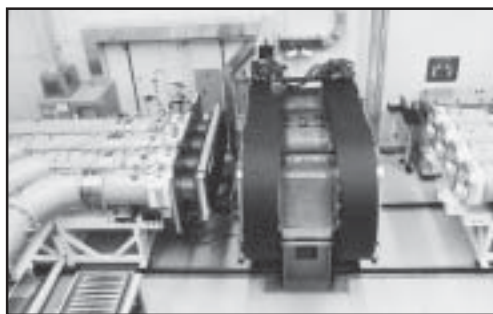

The NIKE Krypton Fluoride (KrF) Laser is in operation to study the physics issues of Direct Drive Inertial Confinement Fusion (ICF) for defense

and energy applications. Direct Drive with a KrF laser is a very attractive approach to ICF owing to its simplicity, inherent high efficiency, and very high-beam uniformity. The NIKE laser illuminates a flat target with intensities of up to 10^{14} W/cm² and beam nonuniformities of less than 0.25%. This photograph shows the largest amplifier in the laser. Light enters and exits the amplifier cell through the square aperture near the center of the photo. Amplification is achieved by exciting the krypton/fluorine mixture gas in the cell with two large-area electron beams. One of the electron beam emitters (cathode) is in an exposed position to the left of the cell. The amplifier produces a 248 nm laser beam with total energy of 4-5 kJ.



Dr. S.L. OSSAKOW

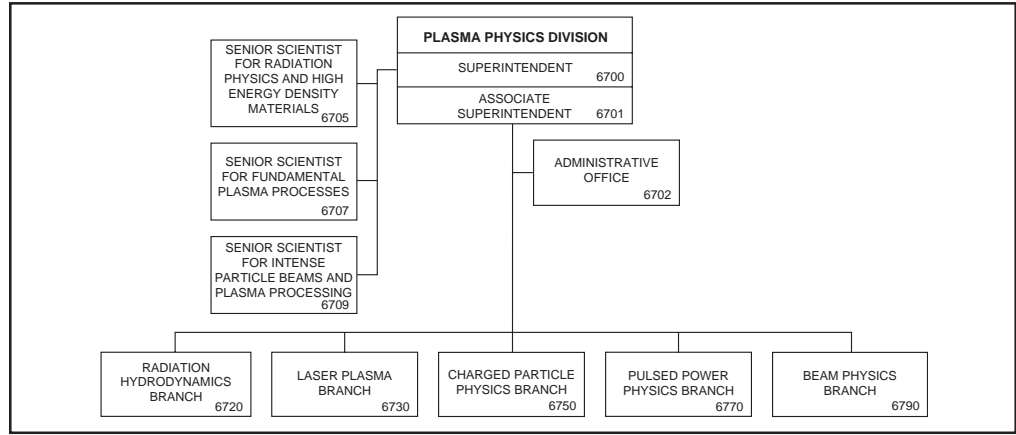

Basic Responsibilities

The Plasma Physics Division conducts a broad theoretical and experimental program of basic and applied research in plasma physics, laboratory discharge, and space plasmas, intense electron and ion beams and photon sources, atomic physics, pulsed power sources, laser physics, advanced spectral diagnostics, and nonlinear systems. The effort of the Division is concentrated on a few closely coordinated theoretical and experimental programs. Considerable emphasis is placed on large-scale numerical simulations related to plasma dynamics; ionospheric, magnetospheric, and atmospheric dynamics; nuclear weapons effects; thermonuclear plasma confinement; atomic physics; plasma processing; nonlinear dynamics and chaos; free electron lasers and other advanced radiation sources; and advanced accelerator concepts. Areas of experimental interest include: laser-plasma, laser-electron beam, and laser-matter interactions, laser shock hydrodynamics, thermonuclear fusion, electromagnetic wave generation, the generation of intense electron and ion beams, large-area plasma processing sources, high-frequency microwave processing of ceramic materials, high-intensity electrodeless discharge lamps, advanced accelerator development, inductive energy storage, laboratory simulation of space plasma phenomena, and in-situ and remote sensing space plasma measurements.

Personnel: 115 full-time civilian

Key Personnel

Name	Title	Code
Dr. S.L. Ossakow	Superintendent	6700
Dr. V.L. Patel	Associate Superintendent	6701
Ms. T. Santos	Administrative Officer	6702
Dr. J. Davis	Senior Scientist, Radiation Physics and High Energy Density Materials	6705
Dr. W. Manheimer	Senior Scientist, Fundamental Plasma Processes	6707
Dr. M. Lampe	Senior Scientist, Intense Particle Beams and Plasma Processing	6709
Dr. J. Davis	Head, Radiation Hydrodynamics Branch	6720
Dr. S.P. Obenschain	Head, Laser Plasma Branch	6730
Dr. R.A. Meger	Head, Charged Particle Physics Branch	6750
Dr. G. Cooperstein	Head, Pulsed Power Physics Branch	6770
Dr. P. Sprangle	Head, Beam Physics Branch	6790

Point of contact: Dr. V.L. Patel, Code 6701, (202) 767-2997

Electronics Science and Technology Division

Code 6800 Research Activity Areas

Electronic Materials

- Preparation and development of magnetic, dielectric, optical, and semiconductor materials
- Electrical, optical, and magneto-optical studies of semiconductor microstructures and nanostructures, surfaces, and interfaces
- Impurity and defect studies
- Structural and electronic properties of amorphous semiconductors
- Condensed matter theory
- High magnetic field phenomena

Surface and Interface Sciences

- Metal organic chemical vapor deposition
- Surface and interface physics
- Vacuum surface research
- Processing research for nanometric electronics
- Growth and characterization of micro- and nano-surfaces and interface structures
- High-temperature superconductors

Microwave Technology

- Microwave, millimeter-wave, and submillimeter-wave component and circuit research
- Millimeter-wave and millimeter-wave integrated circuits
- Surface acoustic wave devices
- High-frequency device design, simulation, and fabrication
- Ion implantation technology
- Reliability and failure physics of electronic devices and circuits

Radiation Effects

- Space experiments
- Single event effects
- Radiation tolerant ultralow-power microelectronics
- Ultrafast charge collection
- Environmental hazard remediation
- Advanced photovoltaic technologies
- Femtosecond laser research
- Radiation effects in microelectronics and photonics
- Material and device damage and hardening
- Satellite survivability

Solid State Devices

- Solid state optical sensors
- Radiation effects/hardening of electronic devices, circuits, and optoelectronic sensors
- Microelectronics device research and fabrication
- Solid state circuits research
- Signal processing research

Vacuum Electronics

- Microwave and millimeter power amplifier research and development
- Cathode research and development
- Thermionic energy conversion
- Field emission arrays
- Vacuum electronic devices
- Tube fabrication and support technology

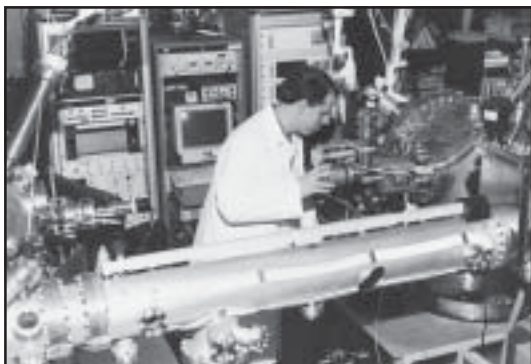

The EPICENTER specializes in molecular beam epitaxial growth of nanostructures created by alternating layers of narrow bandgap materials made available from four ultrahigh vacuum chambers. These structures are expected to improve the performance of far-infrared detectors, mid-wave lasers, and superhigh frequency transistors and resonant tunneling diodes. Here a scientist in the Electronics Science and Technology Division is shown creating a structure using high vacuum, chamber-to-chamber sample transfer.



Dr. G.M. BORSUK

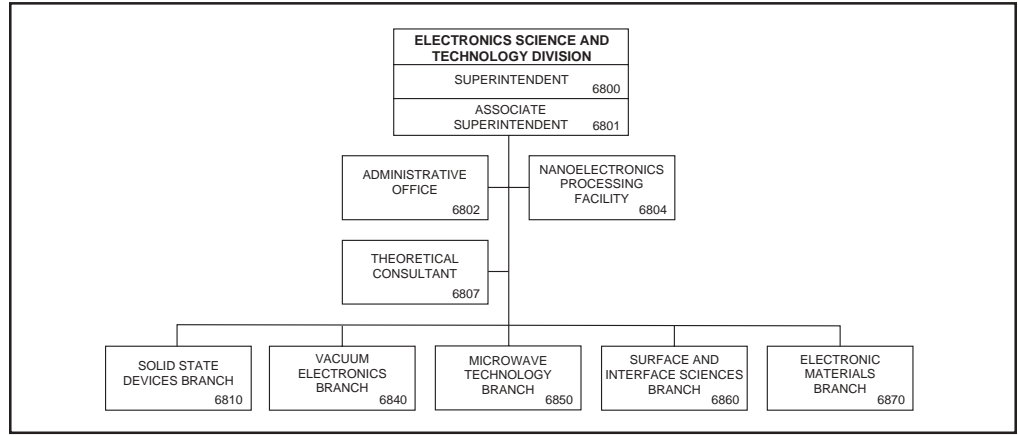

Basic Responsibilities

The Electronics Science and Technology Division conducts programs of basic science and applied research and development in materials growth and properties, surface physics, micro- and nano- structure electronics, microwave techniques, microelectronic device research and fabrication, vacuum electronics, high-power microwave generation, and cryoelectronics, including superconductors. The activities of the Division couple device research both to basic materials investigations and to systems research and development needs.

Personnel: 105 full-time civilian

Key Personnel

Name	Title	Code
Dr. G.M. Borsuk	Superintendent	6800
Dr. K.J. Sleger	Associate Superintendent	6801
Mrs. B.L. Murphy	Administrative Officer	6802
Dr. C.R.K. Marrian	Head, Nanoelectronics Processing Facility	6804
Dr. K.L. Ngai	Theoretical Consultant	6807
Dr. A.B. Campbell	Head, Solid State Devices Branch	6810
Dr. R.K. Parker	Head, Vacuum Electronics Branch	6840
Dr. D.C. Webb	Head, Microwave Technology Branch	6850
Dr. M. Peckerar	Head, Surface and Interface Sciences Branch	6860
Dr. B.V. Shanabrook	Head, Electronic Materials Branch	6870

Point of contact: Dr. K.J. Sleger, Code 6801, (202) 767-3894

Center for Bio/Molecular Science and Engineering

Code 6900 Research Activity Areas

Biologically Derived Microstructures

Self-assembly, molecular machining
Synthetic membranes, molecular printing
Nanocomposites
Tailored electronic materials
Low observables
Molecular engineering, biomimetic materials

Biosensors

Binding polypeptides
Cell-based biosensor
DNA biosensor
Fiber-optic biosensor
Flow immunosensor
Array-based sensors

Environmental Quality

Soil/groundwater explosives detection
Antifouling paint, controlled release

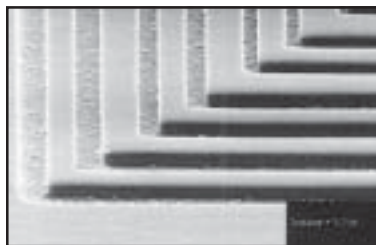

Injection molded patterned micro-textured biopolymers are being fabricated from silicon templates, using lithographic tools. These biomaterials are being explored for use in devices, that incorporate biomolecules (antibodies and DNA) and biological cells for sensor and tissue engineering applications.

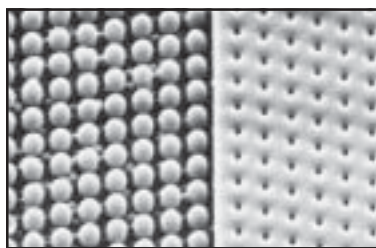

Polyurethanase degradation
Heavy metal detection
Heavy metal cleanup
Hazardous waste neutralization

Polymers and Liquid Crystals

Ferroelectric liquid crystals
Advanced materials/information processing
Flexible displays, noninvasive alignment technique

Surfaces and Interfaces

Uncooled IR detectors/imagers
Submicron resists and microlithography
Specifically activated thin films
Neuronal patterning

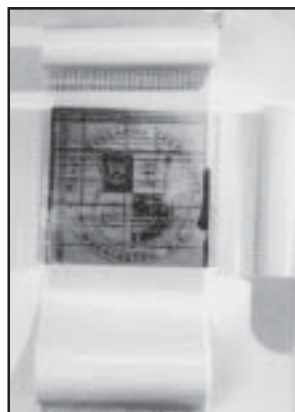

NRL logo shown on a Flexible Liquid Crystal display. The resolution of the image is 100 dpi. The display is rugged, portable, and light weight. The applications being considered include handheld map reader and curved displays for cockpits.



Portable flow immunosensor developed for on-site analysis of environmental contaminants in groundwater and soil

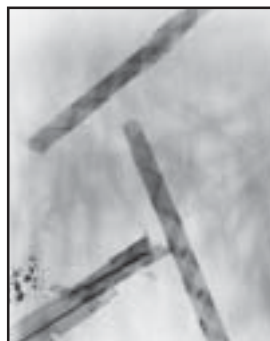

Electron micrograph of lipid tubules, showing one complete lipid bilayer surrounded by a helically wrapped partial bilayer. These self-assembled microstructures have applications that include controlled release, field emitting cathodes, and electronic obscurers for low observables.



Dr. J.M. SCHNUR

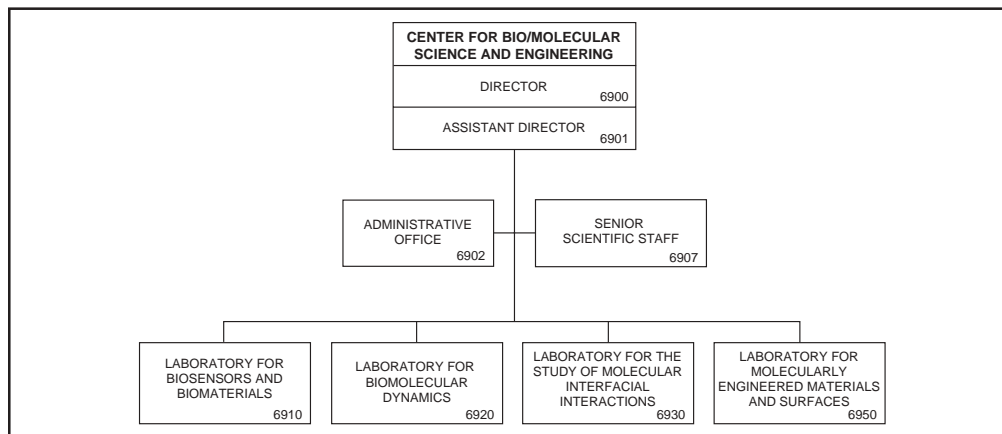

Basic Responsibilities

The Center for Bio/Molecular Science and Engineering is using the tools of modern biology, physics, chemistry, and engineering to develop advanced materials and sensors. The long-term research goal is first to gain a fundamental understanding of the relationship between molecular architecture and the function of materials, then apply this knowledge to solve problems for the Navy and DOD community. The key theme is the study of complex bio/molecular systems with the aim of understanding how “nature” has approached the solution of difficult structural and sensing problems. Technological areas currently being studied include molecular and microstructure design, molecular biology, self-assembly, controlled release and encapsulation, and surface patterning and modification. Much of the research deals with the self-assembly of lipids, proteins, and liquid crystals into complex microstructures for use in advanced material applications, and the harnessing of the recognition functions of proteins and cells for the development of advanced sensors. A highly multidisciplinary staff is required to pursue these research and development programs. The Center provides a stimulating environment for cross-disciplinary programs in the areas of immunology, biochemistry, electrochemistry, inorganic and polymer chemistry, microbiology, microlithography, photochemistry, biophysics, spectroscopy, advanced diagnostics, organic synthesis, and electro-optical engineering.

Personnel: 42 full-time civilian

Key Personnel

Name	Title	Code
Dr. J.M. Schnur	Director	6900
Ms. A.W. Kusterbeck	Assistant Director	6901
Ms. M.A. Shorb	Administrative Officer	6902
Dr. J.M. Schnur	Head, Senior Scientific Staff	6907
Dr. F.S. Ligler	Head, Laboratory for Biosensors and Biomaterials	6910
Dr. J.J. Pancrazio	Head, Laboratory for Biomolecular Dynamics	6920
Dr. B.P. Gaber	Head, Laboratory for the Study of Molecular Interfacial Interactions	6930
Dr. R. Shashidhar	Head, Laboratory for Molecularly Engineered Materials and Surfaces	6950

Point of contact: Ms. M.A. Shorb, Code 6902, (202) 404-6015

**Ocean and
Atmospheric
Science and
Technology
Directorate**

OCEAN AND ATMOSPHERIC SCIENCE AND TECHNOLOGY DIRECTORATE

Code 7000

The Ocean and Atmospheric Science and Technology Directorate performs research and development in the fields of acoustics, remote sensing, oceanography, marine geosciences, marine meteorology, and space science. Areas of emphasis in acoustics include advanced acoustic concepts and computation, acoustic signal processing, physical acoustics, acoustic systems, ocean acoustics, and acoustic simulation and tactics. Areas of emphasis in remote sensing include radio, infrared, and optical sensors, remote sensing physics and hydrodynamics, remote sensing simulation, and imaging systems. Areas of emphasis in oceanography include coastal and open ocean dynamics and prediction, coastal and open ocean processes, and remote sensing applications to oceanography. Areas of emphasis in marine geosciences include marine physics, seafloor sciences, and

geospatial information science and technology mapping, charting, and geodesy. Areas of emphasis in marine meteorology include atmospheric dynamics for theater-wide, tactical scale prediction systems and forecast support, and meteorological applications development. Areas of emphasis in space science include ultraviolet measurements, middle and upper atmospheric physics, gamma, cosmic and X-ray astronomy, solar physics, and solar terrestrial relationships. Senior naval officers are assigned as military advisors to help maintain the directorate focus on operational Navy and other DOD requirements in these areas of emphasis. The directorate is responsible for administrative and technical support to major activities in Washington, DC; Stennis Space Center, Mississippi; and Monterey, California.

Associate Director of Research for Ocean and Atmospheric Science and Technology



Dr. E.O. Hartwig was born in Cincinnati, Ohio on November 22, 1946. He obtained his B.S. degree in biological sciences from the University of Texas at El Paso in 1968, and his Ph.D. from Scripps Institution of Oceanography in 1974. After completing his graduate studies, Dr. Hartwig accepted a position as a researcher at the Scottish Marine Biological Association (SMBA) in Oban, Scotland, where he established a seagoing experimental marine microbiological effort.

In 1975, Dr. Hartwig returned to the U.S., accepting a position at the Chesapeake Bay Institute of Johns Hopkins University. His shallow water research concentrated on the Chesapeake Bay and its outflow region, in active collaboration with many

institutions and scientists. The efforts sought to understand the biological dynamics associated with the Bay's flow regimes, and studied the underlying water column and benthic biological processes resulting in the onset of the seasonal summer anoxia of the bay.

In 1978, Dr. Hartwig accepted a position at Marine Ecological Consultants (MEC), where his research centered on understanding the "before operations" environment at a nuclear generating station. In 1980, Dr. Hartwig accepted a position at the Lawrence Berkeley Laboratory (LBL) at the University of California at Berkeley to head up the biological component of a research team studying the concept of a proposed Ocean Thermal Energy Conversion (OTEC) plant. His work involved extensive interactions with engineers on the operating characteristics of the plant and physical oceanographers modeling flow regimes around the plant and to be generated by the plant.

Following his research at LBL, Dr. Hartwig joined the Office of Naval Research in 1982 as a scientific officer in the Oceanic Chemistry/Biology Program. When the program was split into an Oceanic Chemistry and Oceanic Biology Program, Dr. Hartwig became Program Manager of the Oceanic Biology Program. Here, Dr. Hartwig developed several major interdisciplinary research initiatives for the Navy.

In 1987, Dr. Hartwig was selected as Director of Ocean Sciences at ONR. He enhanced both university interactions with Ocean Sciences and the stature of ONR Ocean Science scientific officers and program managers in the Federal Government. Dr. Hartwig, working with the Oceanographer of the Navy, developed and implemented the Navy's academic research vessel rebuild program, which has resulted in fewer, more capable oceanographic vessels for the next millennium.

Dr. Hartwig joined NRL in October 1992 as Associate Director of Research for Ocean and Atmospheric Science and Technology. In 1996, Dr. Hartwig was presented the Presidential Rank Award of Meritorious Executive in the Senior Executive Service (SES). In 2000, Dr. Hartwig was elected to be President of The Oceanography Society, an international scientific organization.

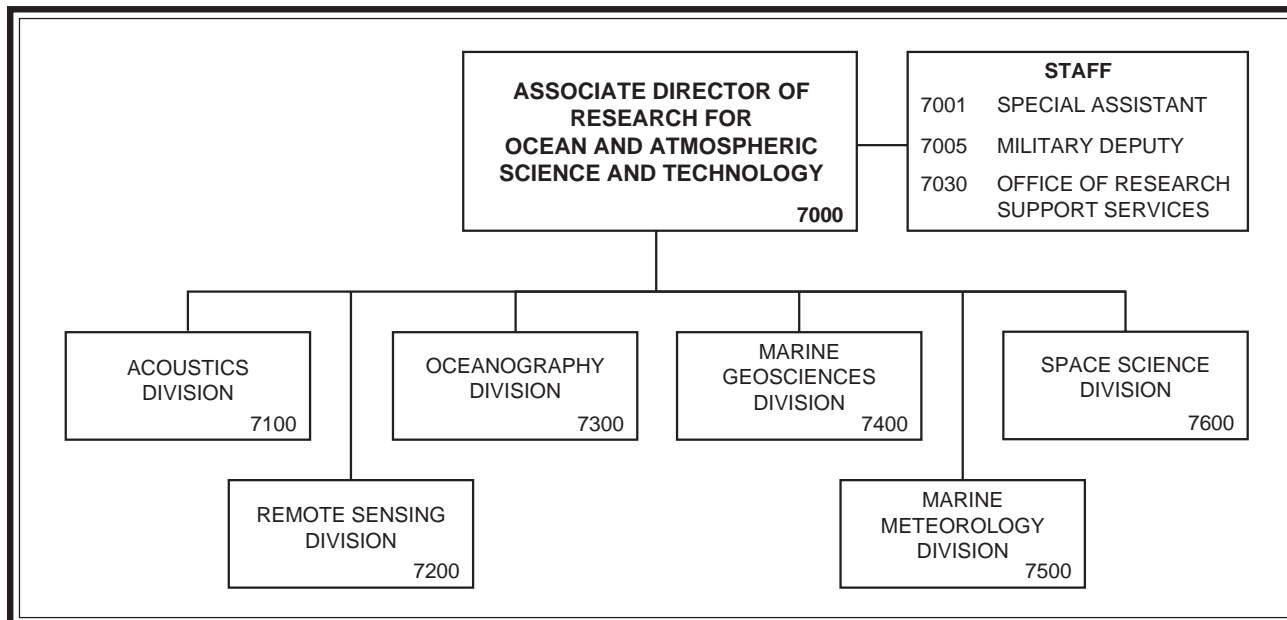

Key Personnel

Name	Title	Code
Dr. E.O. Hartwig	Associate Director of Research for Ocean and Atmospheric Science and Technology	7000
Mrs. P.A. Dixon	Special Assistant	7001
CDR D.J. Groters, USN	Military Deputy	7005
Mr. G.R. Bower	Head, Office of Research Support Services	7030
Dr. E.R. Franchi	Superintendent, Acoustics Division	7100
LTjg J. Bruch, USN	Naval Science (Acoustic) Research Coordinator	7105
Dr. P.R. Schwartz	Superintendent, Remote Sensing Division	7200
LCDR P.M. Klein, USN	Military Deputy	7205
Dr. W.J. Jobst	Superintendent, Oceanography Division	7300
CAPT B. Garrett, USN	Military Deputy	7305
Dr. H.C. Eppert, Jr.	Superintendent, Marine Geosciences Division	7400
LCDR T. Teadt, USN	Military Deputy	7405
Ms. P.A. Phoebus*	Superintendent, Marine Meteorology Division	7500
CDR G. Cooper, USN	Military Deputy	7505
Dr. H. Gursky	Superintendent, Space Science Division	7600

Point of contact: Ms. L.M. Trader, Code 7000A, (202) 404-8174

*Acting

Office of Research Support Services

Code 7030 Staff Activity Areas

Office of Research Support

- Conference coordination, video teleconferencing
- Data communications
- Data networking
- Computer network maintenance

Security Office

- Information security
- Physical security
- Industrial security
- AIS security
- Personnel security
- Classification
- SCIF management
- Security investigations
- Navy message center
- Classified material control

Facilities/Administrative Information Office

- Directives, reports, forms
- Mail management
- Facilities planning
- Vehicles
- Shipment via FedEx and common carriers

HPC Management Office

- Supercomputing interface management

Safety/Environmental Office

- Industrial/laboratory safety
- Specialized safety training
- Hazard abatement
- Mishap prevention
- Hazardous materials program
- Hazardous waste disposal

Public Affairs Office

- Community relations
- News releases
- Exhibits
- Information
- Freedom of Information Act



DR. H.C. EPPERT, JR.

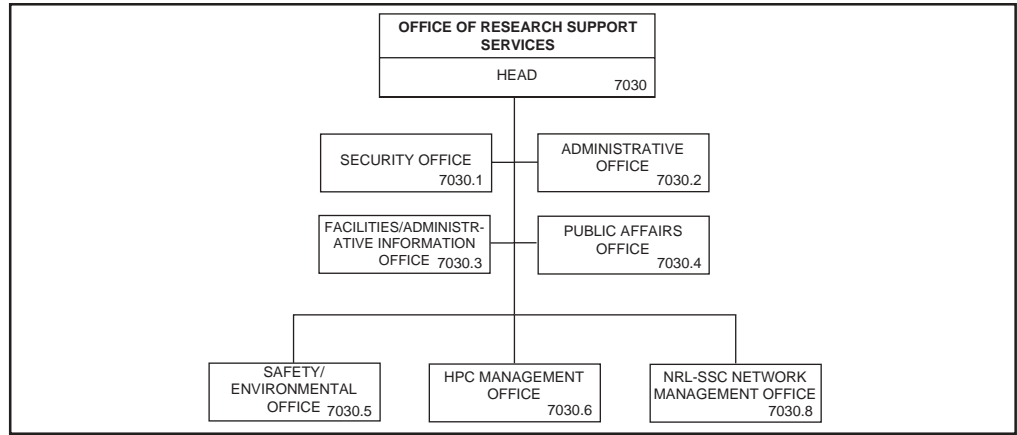

Basic Responsibilities

The Office of Research Support Services is responsible for the operational and management support necessary for the day-to-day operations at NRL Stennis Space Center, Mississippi (NRL-SSC). The Head of NRL-SSC acts for the Commanding Officer in dealing with local Naval, Federal, and civil activities and personnel on matters relating to NRL-SSC support activities and facilities, community and multicommand issues, and safety and disaster control measures.

Support functions include security, public affairs, safety, high-performance computer management, and support services to include management, administration, and facilities.

Personnel: 13 full-time civilian

Key Personnel

Name	Title	Code
Dr. H.C. Eppert, Jr.	Head	7030
Mr. R.H. Swanton	Head, Security Office	7030.1
Ms. C.L. Gilroy	Administrative Officer	7030.2
Mr. W.B. Eslick	Head, Facilities/Administrative Information Office	7030.3
Ms. M.P. Rotundo	Public Affairs Office	7030.4
Mr. M.L. Reinholtz	Safety/Environmental Officer	7030.5
Ms. M.B. Frommeyer	HPC Management Office	7030.6
Mr. K.O. Davis	NRL-SSC Network Management Office	7030.8

Point of contact: Dr. H.C. Eppert, Jr., Code 7030, (228) 688-4010; DSN 828-4010

Acoustics Division

Code 7100 Staff Activity Areas

Special programs management
System concepts and studies

USN Journal of Underwater Acoustics

Research Activity Areas

Acoustic Signal Processing

Random media propagation
Limits of acoustic array performance
Underwater acoustic communications
Undersea noise signal characterization and modeling
Surf zone noise generation
Shallow water acoustic surveillance methods
Fish absorption of acoustic signals
Geophysical inversion
Matched field processing and inversion
High-frequency acoustic flow visualization

Physical Acoustics

Structural acoustics
Active sound control
Fiber-optic acoustic sensors
Acoustics of coatings
Dynamics of complex structures
Target strength/radiation modeling
Acoustic transduction
Inverse scattering
Nanomicrostructure dynamics

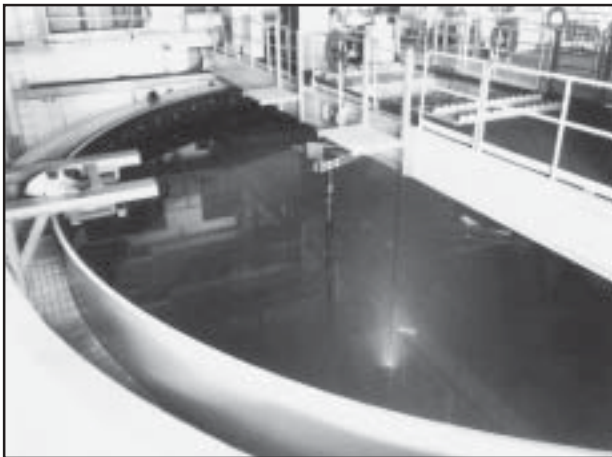

Structural acoustic studies in the one-million gallon Acoustic Holographic Pool Facility

Acoustic Systems

Ocean boundary scattering
Shallow water active classification
Statistical characterization of reverberation
Active sonar performance modeling
Matched field processing
Acoustic inversion techniques
Acoustic propagation
Nonlinear signal propagation
Acoustics of bubbly media

Acoustic Simulation, Measurements, and Tactics

Coupled dynamic ocean and acoustic modeling
Ocean acoustic propagation and scattering models
Ocean ambient noise models and simulation
Superconductor and scalable acoustic models
Fleet application acoustic models
Environmental acoustic assessments and characterizations
High-frequency seafloor and ocean acoustic measurements
Coastal acoustic measurements and studies
Biologic ocean volume reverberation measurements
Multisensor system optimization
Tactical oceanography simulations and databases
Warfare effectiveness studies and optimizations

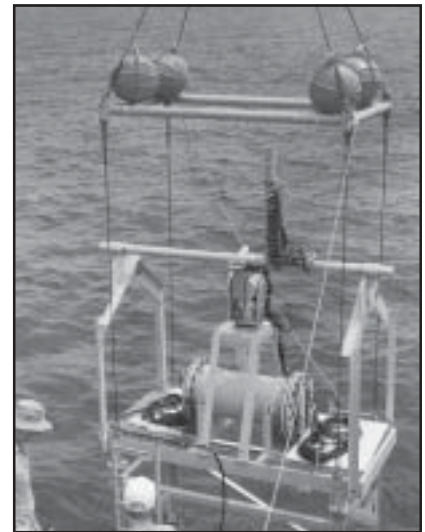

Deployment of high-frequency acoustics tower



DR. E.R. FRANCHI

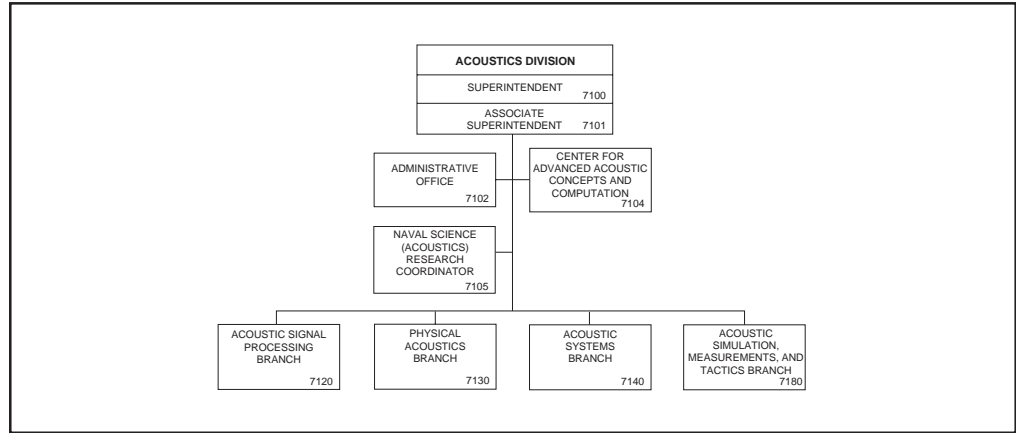

Basic Responsibilities

The Acoustics Division conducts basic and applied research in undersea physics. The basic research areas are signal processing; ocean acoustics and the associated description of the ocean environment as it impacts advanced systems; and physical acoustics. The applied spectrum includes developing and proving system concepts; signal processing for active and passive detection, tracking, and classification of underwater targets; echo strength; structural acoustics; large area assessment techniques; and development of processing systems and techniques. Also included are basic and applied research in simulations and tactics as influenced by the environment. The Division program is interactive with the ONR Contract Research Program and other research laboratories, both U.S. and foreign.

Personnel: 104 full-time civilian; 1 full-time military

Key Personnel

Name	Title	Code
Dr. E.R. Franchi	Superintendent	7100
Vacant	Associate Superintendent	7101
Mr. J.R. Tomlinson	Administrative Officer	7102
Vacant	Head, Center for Advanced Acoustic Concepts and Computation	7104
LTjg J. Bruch, USN	Naval Science (Acoustics) Research Coordinator	7105
Dr. M.H. Orr	Head, Acoustic Signal Processing Branch	7120
Dr. J.A. Bucaro	Head, Physical Acoustics Branch	7130
Mr. J.S. Perkins*	Head, Acoustic Systems Branch	7140
Dr. S.A. Chin-Bing	Head, Acoustic Simulation, Measurements, and Tactics Branch	7180

Point of contact: Dr. E.R. Franchi, Code 7100, (202) 767-3482

*Acting

Remote Sensing Division

Code 7200 Research Activity Areas

Remote Sensing

Sensors

- SAR
- Imaging RAR
- Passive microwave imagers
- CCDs and focal plane arrays
- Fabry-Perot spectrometers
- Imaging spectrometers
- Radio interferometers
- Optical interferometers
- Lidar
- Spaceborne and airborne systems

Areas

- Radiative transfer modeling
- Coastal oceans
- Marine ocean boundary layer
- Polar ice
- Middle atmosphere
- Global ocean phenomenology
- Environmental change
- Ocean surface wind vector
- Ionosphere

Astrophysics

- Optical interferometry
- Radio interferometry
- Fundamental astrometry and reference frames
- Fundamental astrophysics
- Star formation
- Stellar atmospheres and envelopes
- Interstellar medium, interstellar scattering
- Pulsars
- Low-frequency astronomy

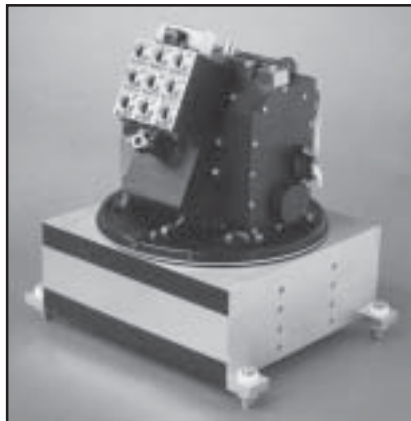

Optical Head Assembly (OHA) of the Polar Ozone and Aerosol Measurement (POAM-II) experiment payload

Physics of Atmospheric/Ocean Interaction

- Mesoscale, fine-structure, and microstructure
- Aerosol and cloud physics
- Mixed layer and thermocline applications
- Sea-truth towed instrumentation techniques
- Turbulent jets and wakes
- Nonlinear and breaking ocean waves
- Stratified and rotating flows
- Turbulence modeling
- Boundary layer hydrodynamics
- Marine hydrodynamics
- Computational hydrodynamics

Imaging Research/Systems

- Remotely sensed signatures analysis/simulation
- Real-time signal and image processing algorithm/systems
- Image data compression methodology
- Image fusion
- Automatic target recognition
- Scene/sensor noise characterization
- Image enhancement/noise reduction
- Scene classification techniques
- Radar and laser imaging systems studies
- Coherent/incoherent imaging sensor exploitation
- Numerical modeling simulation
- Environmental imagery analysis

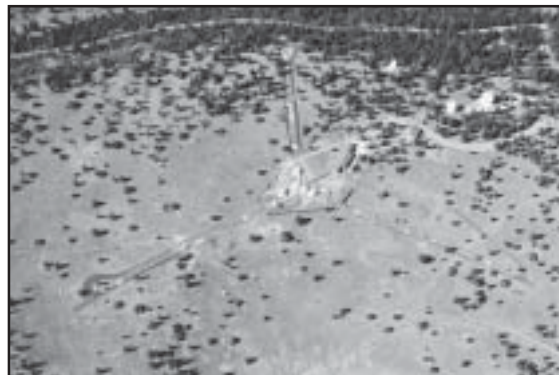

The Navy Prototype Optical Interferometer produces the highest angular resolution images ever made at optical wavelengths. Its four astrometric elements (the rectangular huts) provide extremely precise star positions for use by the U.S. Naval Observatory in navigation and time keeping. The imaging elements are mounted on piers extending out the "Y" configuration. Light from all the telescopes is carried down evacuated pipes and combined in the optics laboratory to produce images of stellar surfaces.



DR. P.R. SCHWARTZ

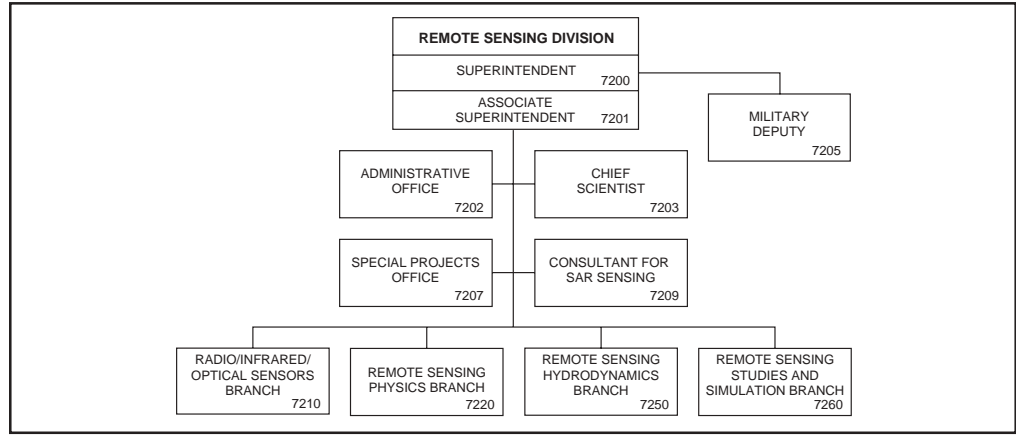

Basic Responsibilities

The Remote Sensing Division conducts a program of basic research, science, and applications aimed at the development of new concepts for sensors and imaging systems for objects and targets on the Earth, in the near-Earth environment, and in deep space. The research, both theoretical and experimental, deals with discovering and understanding the basic physical principles and mechanisms that give rise to target and background emission and to absorption and emission by the intervening medium. The accomplishment of this research requires the development of sensor systems technology. The development effort includes active and passive sensor systems to be used for the study and analysis of the physical characteristics of phenomena that give rise to naturally occurring background radiation, such as that caused by the Earth's atmosphere and oceans, as well as man-made or induced phenomena such as ship/submarine hydrodynamic effects. The research includes theory, laboratory, and field experiments leading to ground-based, airborne or space systems for use in such areas as remote sensing, astrometry, astrophysics, surveillance, nonacoustic ASW, and improved meteorological support systems for the operational Navy. Special emphasis is given to developing space-based platforms and exploiting existing space systems.

Personnel: 96 full-time civilian; 1 full-time military

Key Personnel

Name	Title	Code
Dr. P.R. Schwartz	Superintendent	7200
Mr. C.W. Hoffman	Associate Superintendent	7201
Mrs. M.K. Smith	Administrative Officer	7202
Dr. C.O. Davis	Chief Scientist	7203
LCDR P. Klein, USN	Military Deputy	7205
Dr. D.T. Chen	Head, Special Projects Office	7207
Dr. S.A. Mango	Consultant for SAR Sensing	7209
Dr. L.J. Rickard	Head, Radio/Infrared/Optical Sensors Branch	7210
Dr. R.M. Bevilacqua	Head, Remote Sensing Physics Branch	7220
Dr. R.P. Mied	Head, Remote Sensing Hydrodynamics Branch	7250
Dr. Dr. R.L. Fiedler	Head, Remote Sensing Studies and Simulation Branch	7260

Point of contact: Dr. P.R. Schwartz, Code 7200, (202) 767-2351

Oceanography Division

Code 7300 Staff Activity Areas

Special studies

Research Activity Areas

Ocean Dynamics and Prediction

- Ocean prediction
 - Large scale
 - Arctic
 - Shipboard
 - Data assimilation
 - Coastal and semi-enclosed sea
- Ocean observing system simulation
- Coastal scene generation

Ocean Sciences

- Dynamical processes
 - Coastal current systems
 - Waves and bubbles
- Coupled systems
 - Air/ocean/acoustic coupling
 - Biodynamics
- Remote sensing applications
 - Color/hyperspectral signatures
 - Ocean optics



Optical mooring equipment for shallow water showing attenuation and absorption meters and irradiance sensors

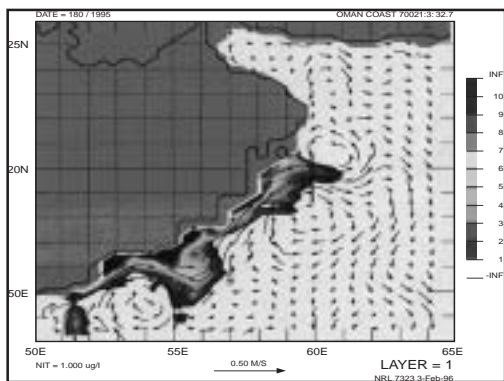

Gulf of Mexico NOAA AVHRR Sea Surface Temperature Image illustrating the mesoscale and shelf processes. The position of the warm Loop current (dark) is shown in the eastern gulf. NRL collects and processes all AVHRR and SeaWifs imagery to understand the dynamics and evolution of oceanographic events that affect our coastal waters. Imagery can be viewed on the NRL SSC website.

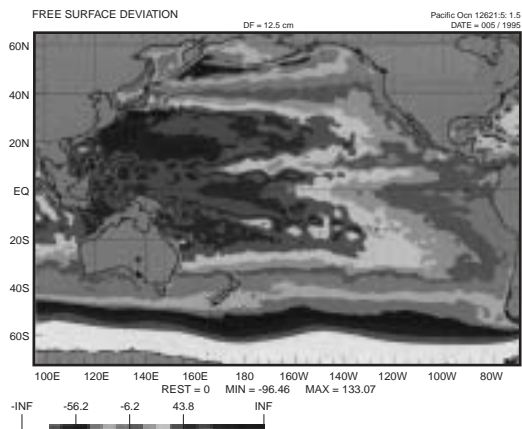

NRL layered ocean model output of sea surface height for Pacific Ocean, 5 January 1995. This model has been transitioned to NAVOCEANO.

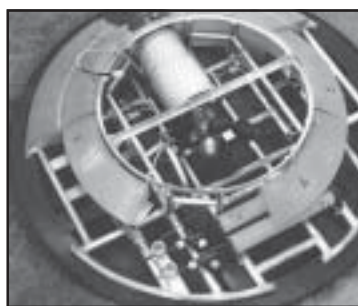

NRL's ten 300 kHz ADCPs are matched with trawl-resistant bottom mounts. This photo shows a bottom mount with its exterior fiberglass shell and some internal buoyancy segments removed. The internal recording instruments collect frequent profiles of horizontal current for intervals of up to several months. A wave and tide gauge may also be included in the housing. With an operating depth of 300 m, the instruments permit operations nearly everywhere on the world's continental shelves.



DR. W.J. JOBST

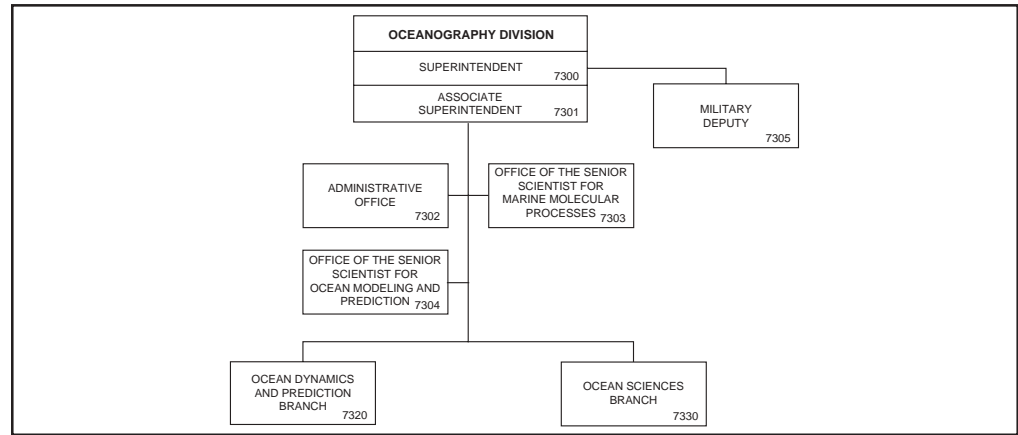

Basic Responsibilities

The Oceanography Division conducts basic and applied research in biological, physical, and dynamical processes and their description and modeling in open ocean, coastal, and semi-enclosed seas; exploiting satellite and airborne sensors for environmental information; investigation and application of microbiological processes to Navy problems. The oceanographic research is both theoretical and experimental in nature and is focused on understanding and modeling ocean, coastal, and littoral area hydro/thermodynamics, circulation, waves, ice dynamics, air-sea exchange, optics, and small and microscale processes. Analytical methods and algorithms are developed to provide quantitative retrieval of geophysical parameters of Navy interest from state-of-the-art sensor systems. The Division work includes analysis of biological processes that mediate and control bioluminescence distributions in the oceans, coastal, and littoral regions and microbially induced corrosion/metal microbe interaction. The Division programs are designed to be responsive to and to anticipate Naval needs. Transition of Division products to the Department of Defense (DOD), Navy systems developers, operational Navy, and civilian (dual use) programs is a primary goal. The Division's programs are coordinated and interactive with other NRL programs and activities, ONR's research programs, and other government agencies involved in oceanographic activities. The Division also collaborates and cooperates with scientists from the academic community and other U.S. and foreign laboratories.

Personnel: 76 full-time civilian; 1 full-time military

Key Personnel

Name	Title	Code
Dr. W.J. Jobst	Superintendent	7300
Mr. S.W. Payne	Associate Superintendent	7301
Mrs. I.S. DeSpain	Administrative Officer	7302
Dr. B.J. Little	Office of the Senior Scientist for Marine Molecular Processes	7303
Dr. H.E. Hurlburt	Office of the Senior Scientist for Ocean Modeling and Prediction	7304
CAPT B. Garrett, USN	Military Deputy	7305
Dr. G.A. Jacobs	Head, Ocean Dynamics and Prediction Branch	7320
Mr. R.A. Arnone	Head, Ocean Sciences Branch	7330

Point of contact: Mrs. I.S. DeSpain, Code 7302, (228) 688-4114; DSN 828-4114

Marine Geosciences Division

Code 7400 Research Activity Areas

Marine Geology

- Sedimentary processes
- Foreshore sediment transport
- Sediment microstructure
- Pore fluid flow
- Diapirism, volcanism, faulting, mass movement
- Biogenic and thermogenic methane
- Hydrate distribution, formation and dissociation

Marine Geophysics

- Seismic wave propagation
- Earthquake seismology
- Physics of low-frequency acoustic propagation
- Acoustic energy interaction with topography and inhomogeneities
- Gravimetry and geodesy
- Geomagnetic modeling

Marine Geotechnique

- Acoustic seafloor characterization
- Geoacoustic modeling
- Geotechnical properties and behavior of sediments
- Measurement and modeling of high-frequency acoustic propagation and scattering
- Mine burial processes
- Marine biogeochemistry
 - Animal-microbe-sediment interactions
 - Early sediment diagenesis

- Sedimentary microbial respiration of manganese and iron
- Whole-cell bioluminescent reporter strain construction

Mapping and Charting

- Digital database design
- Digital product analysis and standardization
- Data compression techniques and exploitation
- Hydrographic survey techniques
- Bathymetry extraction techniques from remote and acoustic imagery
- Utility software development for digital mapping databases
- Observation and modeling of nearshore morphodynamics

In Situ and Laboratory Sensors

- High-resolution subseafloor 2-D and 3-D seismic imaging
- Laser/hyperspectral bathymetry/topography
- Swath acoustic backscatter imaging
- Sediment pore water pressure, permeability, and undrained shear strength
- Compressional and shear wave velocity and attenuation
- Airborne geophysics, gravity, and magnetics
- Seafloor magnetic fluctuation
- Sediment microfabric change with pore fluid and/or gas change
- Instrumented mine shapes
- Bottom currents and pressure fluctuations

Lattice Fringe Comparison by EC-TEM

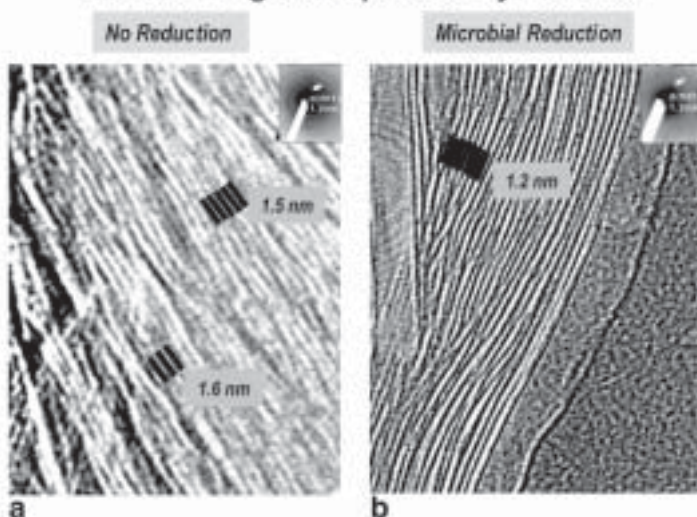

An image taken by NRL scientists using an environmental cell transmission electron microscope. The images demonstrate the effect of microbially mediated iron reduction on the crystal structure of clay minerals in marine environments (a, non-reduced; b, microbially reduced). The physiochemical properties of clays are important because they influence contaminant bioremediation, and acoustical and optical properties in marine sediments.



DR. H.C. EPERT, JR.

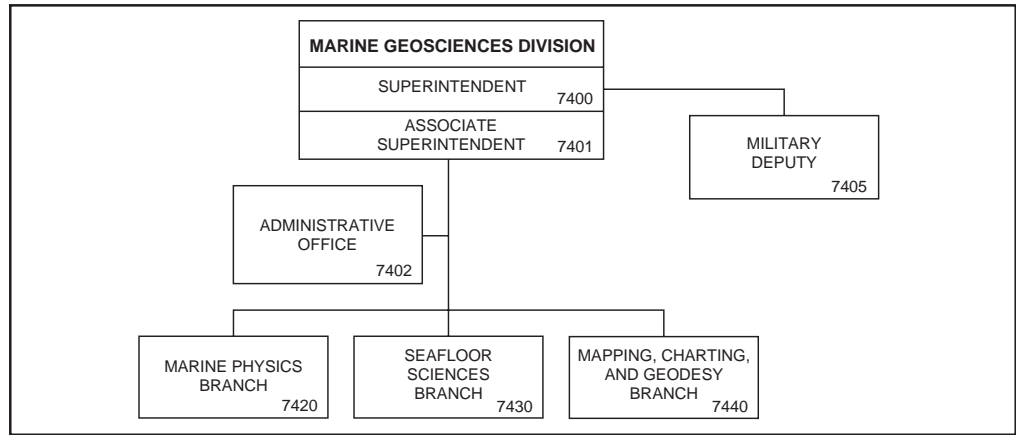

Basic Responsibilities

The Marine Geosciences Division has responsibility for planning and executing a broad spectrum research, development, and technology program in marine geology, geophysics, geoacoustics, geotechniques, and geospatial information and systems (GIS). The program is designed to provide necessary digital data-bases, geoacoustic and geophysical models, and simulations to support training, system design, performance prediction, and operational needs of the Navy.

The applied portion of the program is directed toward (1) quantitatively predicting the effects of the seafloor and associated geophysical, geomorphological, and geoacoustic variability on performance of present and emerging naval systems, operations, and plans, and (2) developing technology and techniques to rapidly acquire, process, and analyze MC&G (such as gravity, magnetics, and bathymetry) and other types of geological, geophysical, and geoacoustic information to meet existing digital database requirements of the Chief of Naval Operations (CNO), National Image and Mapping Agency (NIMA), and system commands.

The Division serves as the focal point in the Navy and Marine Corps for assessing and identifying MC&G requirements, including prototype digital MC&G products and product coordination. The program is keyed to and responsive to priorities identified by NRL, Office of Naval Research, CNO, the System Commands, NIMA, and Federal Homeland Defense programs. Close coordination and interaction with the Warfare Centers is essential to the success of this program with transition of Division products to system developers and the operational Navy a primary goal. The Division program is coordinated and interactive with other NRL programs and activities, ONR's Research Program Department, NOAA, USGS, NSF, and other government agencies involved in seafloor activities. The Division collaborates and cooperates with scientists from the academic community, other U.S. and foreign laboratories, and industry.

Personnel: 82 full-time civilian; 1 full-time military

Key Personnel

Name	Title	Code
Dr. H.C. Eppert, Jr.	Superintendent	7400
Dr. P.J. Valent	Associate Superintendent	7401
Ms. C.L. Gilroy	Administrative Officer	7402
LCDR T. Teadt, USN	Military Deputy	7405
Mr. H.S. Fleming	Head, Marine Physics Branch	7420
Dr. M.D. Richardson	Head, Seafloor Sciences Branch	7430
Mr. M.M. Harris	Head, Mapping, Charting, and Geodesy Branch	7440

Point of contact: Ms. M.B. Gill, Code 7400, (228) 688-4650; DSN 828-4650

Marine Meteorology Division

Code 7500 Research Activity Areas

Numerical Weather Prediction

- Global
- Mesoscale
- On-scene
- Large eddy simulation
- Boundary layer
- Coastal
- Massively parallel computing
- Coupled ocean/atmosphere/wave
- Tropical cyclones
- Aerosols
- Topographically forced flow
- Predictability

Data Assimilation

- Optimum interpolation
- 3D to 4D variational analysis
- Quality control
- Synthetic soundings
- Remotely sensed data
- Physical initialization
- Direct radiance assimilation
- Radar data assimilation
- Targeted observations

Shipboard Support

- Naval Integrated Tactical Environmental Subsystem
- Data fusion
- Nowcasting
- Visualization
- Port studies
- Typhoon havens
- Forecaster handbooks
- Expert systems
- CD-ROMs

Satellite Data/Imagery

- Automated cloud classification
- Satellite imagery analysis
- Case study development
- Multisensor data fusion
- Tropical cyclone intensity
- Water vapor-tracked winds
- Cloud-tracked winds
- Dust/aerosols
- Rain rate

Decision Aids

- Refractivity
- Ceiling/visibility
- Fog/turbulence/icing
- Electromagnetic
- Electro-optical
- Tropical cyclones

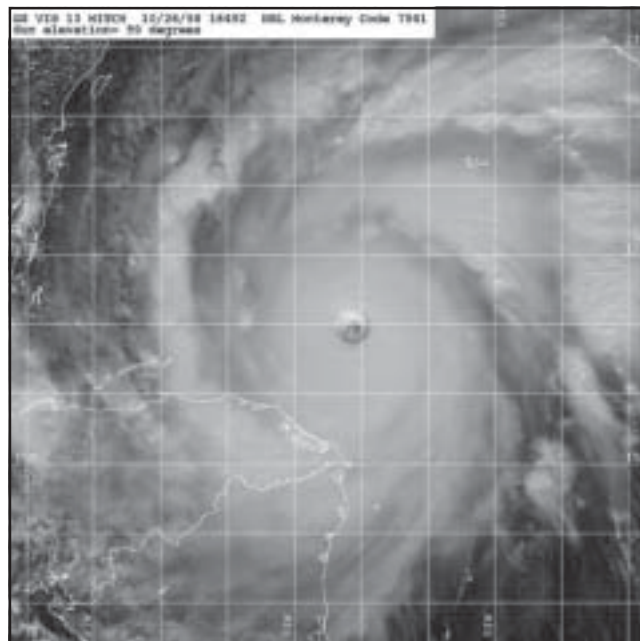

Visible image for Hurricane Mitch on October 26, 1998 at 1645Z



Ms. P.A. PHOEBUS*

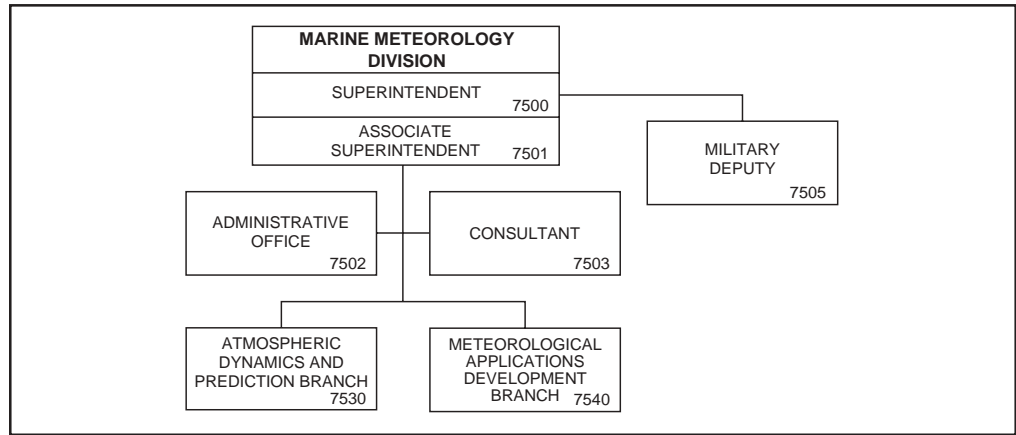

Basic Responsibilities

The Marine Meteorology Division conducts a basic and applied research and development program designed to improve the basic understanding of atmospheric processes that impact Fleet operations and to develop information systems that analyze, simulate, predict, and interpret the structure and behavior of these processes and their effect on naval weapons systems. Basic research includes work in air-sea interaction, orographic and fetch-limited flow, atmospheric predictability, targeted observations, advanced data assimilation, and atmospheric physics. Applied research spans the gamut from development of both central-site and on-scene analysis/forecast systems to the development of tactical decision aids for operations support. NRL-Monterey (NRL-MRY) is co-located with the Fleet Numerical Meteorology and Oceanography Center (FNMOC) and has developed and transitioned to FNMOC the data assimilation global and mesoscale forecast models and satellite applications products that form the backbone of the Navy's worldwide weather forecasting capability. In addition, NRL is forging new ground by transitioning similar products and capabilities to the Navy's regionalized meteorology and oceanography centers around the globe. Specialties of the Division include numerical weather prediction, data assimilation and quality control, marine boundary layer processes, on-scene atmospheric environment assessment, environmental decision aids, database management, and satellite data interpretation and application.

Personnel: 65 full-time civilian; 2 full-time military

Key Personnel

Name	Title	Code
Ms. P.A. Phoebus*	Superintendent	7500
Ms. P.A. Phoebus	Associate Superintendent	7501
Ms. B.A. Burrows	Administrative Officer	7502
Vacant	Consultant	7503
CDR G. Cooper, USN	Military Deputy	7505
Dr. R.M. Hodur	Head, Atmospheric Dynamics and Prediction Branch	7530
Dr. T.L. Tsui	Head, Meteorological Applications Development Branch	7540

Point of contact: Ms. P.A. Phoebus, Code 7500, (831) 656-4721; DSN 878-4721

*Acting

Space Science Division

Code 7600 Research Activity Areas

Space Weather and Atmospheric Physics

Remote sensing of the ionosphere and thermosphere
Middle atmospheric investigations
Global modeling
Upper atmospheric physics

Space Astronomy

X-ray observation, analysis, and theory of space astronomical sources
Gamma-ray astrophysics, solar-flare gamma rays, and space cosmic ray particle environment
Gamma-ray Large Area Space Telescope (GLAST) NASA space mission

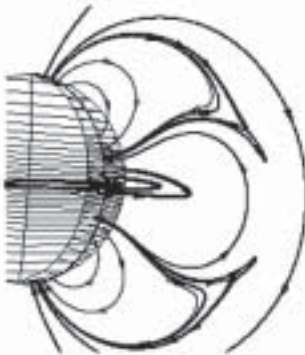

The Solar Theory Group has simulated the overall magnetic field in the Sun's corona and demonstrated the formation of coronal mass ejections following field reconnection

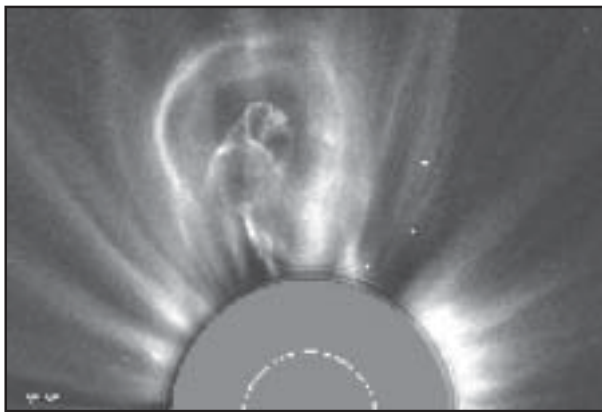

A coronal mass ejection emerging from the Sun as a large, spherical region of hot gas and entrapped magnetic field

Solar Physics

Solar ultraviolet and visible light spectroscopy and photometry from rockets, satellites, and the Space Shuttle
Extreme-ultraviolet Imaging Spectrometer (EIS)
Sun Earth Connection Coronal and Heliospheric Investigation (SECCHI) for the Stereo Mission

Solar-Terrestrial Relationships

Solar X-ray/EUV plasma diagnostics; coronal effects on Earth



SHIMMER being readied for flight on the Space Shuttle. SHIMMER, a Michelson Interferometer, will map the globe in atmospheric trace compounds.



A Black Brand rocket being readied for flight at the White Sands Missile Range. The rocket is carrying NRL's advanced spectrometer for studying stars at soft X-ray wavelengths.



DR. H. GURSKY

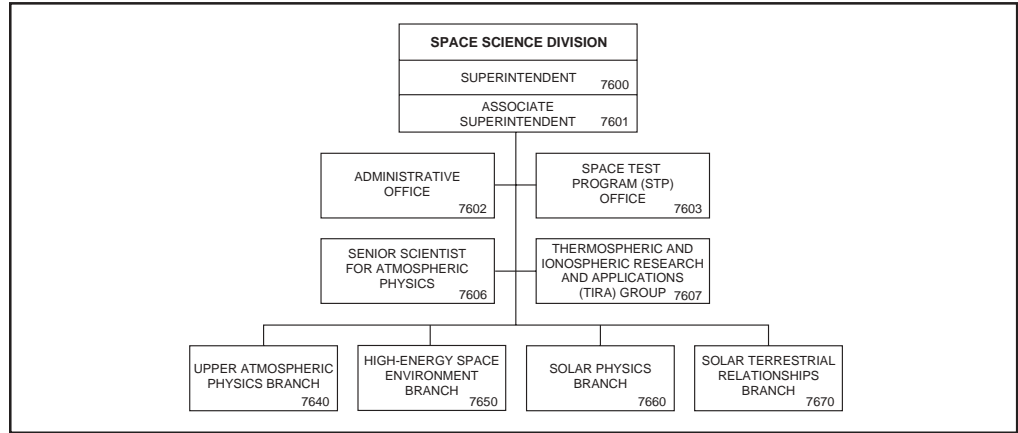

Basic Responsibilities

The Space Science Division conducts research in the fields of astronomy and astrophysics, solar-terrestrial physics, and atmospheric science. Satellites, rockets, and ground-based facilities are used to obtain information on radiation from the Sun and celestial sources, and to study the behavior of the ionosphere and high atmosphere. Research results are of importance to radio communications, to use of the space environment, to weather prediction, and to the fundamental understanding of natural radiation and geophysical phenomena. The Superintendent also acts as Chief Scientist of the E.O. Hulburt Center for Space Research, created to provide research opportunities in space science to appointees from universities.

Personnel: 80 full-time civilian

Key Personnel

Name	Title	Code
Dr. H. Gursky	Superintendent	7600
Dr. F.J. Giovane	Associate Superintendent	7601
Mrs. B.M. Shea	Administrative Officer	7602
LT P. Travis, USN	Space Test Program Officer, Kirtland AFB, NM	7603
Dr. R.R. Meier	Senior Scientist for Atmospheric Physics	7606
Dr. K.F. Dymond	Thermospheric and Ionospheric Research and Applications (TIRA) Group	7607
Dr. D.E. Siskind	Head, Upper Atmospheric Physics Branch	7640
Dr. J.D. Kurfess	Head, High-Energy Space Environment Branch	7650
Dr. R.A. Howard	Head, Solar Physics Branch	7660
Dr. G.A. Doschek	Head, Solar Terrestrial Relationships Branch	7670

Point of contact: Mrs. B.M. Shea, Code 7602, (202) 767-3631

**Naval Center
for Space
Technology**

NAVAL CENTER FOR SPACE TECHNOLOGY

Code 8000

In its role to preserve and enhance a strong space technology base and provide expert assistance in the development and acquisition of space systems that support naval missions, the Naval Center for Space Technology activities extend from basic and applied research through advanced development in all areas of interest to the Navy space program. These activities include developing spacecraft, systems using these spacecraft, and ground command and control stations. Principal functions of the Center include understanding and clarifying requirements, recognizing and prosecuting promising research and development, analyzing and testing systems to quantify their capabilities, developing operational concepts

that exploit new technical capabilities, system engineering to allocate design requirements to subsystems, and engineering development and initial operation to test and evaluate selected spacecraft subsystems and systems. The Center is a focal point and integrator for those divisions at NRL whose technologies are used in space systems. The Center also provides systems engineering and technical direction assistance to system acquisition managers of major space systems. In this role, technology transfer is a major goal and motivates a continuous search for new technologies and capabilities and the development of prototypes that demonstrate the integration of such technologies.

Director of Naval Center for Space Technology



Mr. P.G. Wilhelm was born in New York City on July 26, 1935. He attended Purdue University, where he received a B.S.E.E. degree in 1957. By 1961, he had completed all the course work for an M.S.E. degree from George Washington University.

From 1957 to 1959, Mr. Wilhelm served as an electrical engineer with Stewart Warner Electronics where he was assigned to a project to redesign the UPM-70, a Navy radar test set. In March 1959, he joined the Naval Research Laboratory as an electrical scientist in the Electronics Division. In December 1959, he joined the Satellite Techniques Branch. In 1961, he became Head of the Satellite Instrument Section; in 1965, he

became Head of the Satellite Techniques Branch; and in 1974, Head of the Spacecraft Technology Center. In these positions, he performed satellite system design, equipment development, environmental testing, launch operations, and orbital data handling. In 1981, he was named the Superintendent of the Space Systems and Technology Division, the Navy's principal organization, or lead Laboratory, for space. He is credited with contributions in the design, development, and operation of more than 85 scientific and Fleet-support satellites. He has been awarded five patents. In October 1986, he was appointed Director of the newly established Naval Center for Space Technology. The Center's mission is to "preserve and enhance a strong space technology base and provide expert assistance in the development and acquisition of space systems which support naval missions."

Mr. Wilhelm has been recognized with numerous awards including the Navy's Meritorious Civilian Service Award, the DOD Distinguished Civilian Service Award, the Presidential Meritorious Executive Award, the Presidential Distinguished Rank Award, the Institute of Electrical and Electronics Engineers Aerospace and Electronic Systems Group Man of the Year Award, the NRL E.O. Hulburt Annual Science and Engineering Award, the Dexter Conrad Award, the Rotary National Stellar Award, and in May 1999, Mr. Wilhelm received the American Institute of Aeronautics and Astronautics (AIAA) Goddard Astronautics Award. He also has been elected a Fellow of the Washington Academy of Sciences and a Fellow of the American Institute of Aeronautics and Astronautics, and was elected to the National Academy of Engineering. Mr. Wilhelm is also the first recipient of the R.L. Easton Award for excellence in engineering.

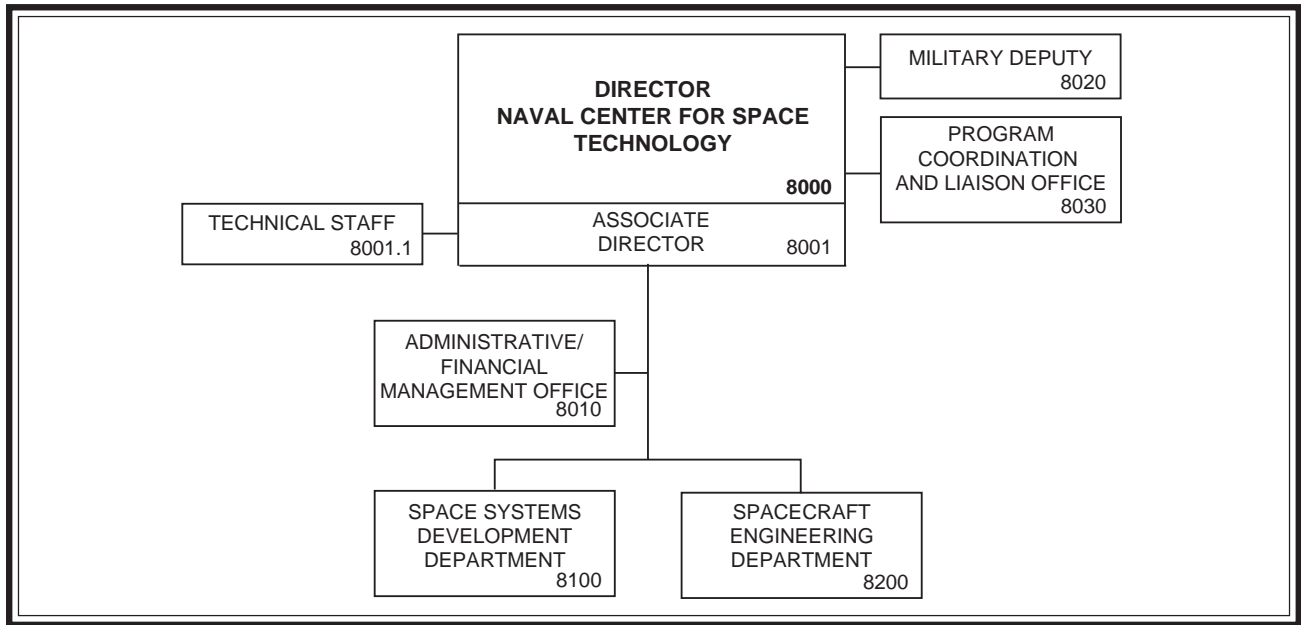

Key Personnel

Name	Title	Code
Mr. P.G. Wilhelm	Director, Naval Center for Space Technology	8000
Mr. F.V. Hellrich	Associate Director	8001
	Technical Staff	8001.1
Mrs. B.L. Fleming	Head, Administrative/Financial Management Office	8010
Vacant	Military Deputy	8020
Mr. P.A. Regeon	Head, Program Coordination and Liaison Office	8030
Mr. R.E. Eisenhauer	Superintendent, Space Systems Development Department	8100
Mr. H.E. Senasack, Jr.	Superintendent, Spacecraft Engineering Department	8200

Point of contact: Mr. F.V. Hellrich, Code 8001, (202) 767-6549

Space Systems Development Department

Code 8100

Research Activity Areas

Advanced Space Systems Technologies

- Space systems architectures and requirements
- Advanced payloads and optical communications
- Controllers, processors, signal processing, and VLSI
- Data management systems and equipment
- Embedded algorithms and software
- Satellite laser ranging

Astrodynamics

- Precision orbit estimation
- Onboard autonomous navigation
- Star catalog development
- Onboard orbit propagation
- GPS space navigation
- Satellite coverage and mission analysis
- Geolocation systems
- Orbit dynamics
- Interplanetary navigation

Command, Control, Communications, Computers, and Intelligence

- Communications theory and systems
- Tracking, telemetry, and control systems
- Satellite ground station engineering and implementation
- Transportable and fixed ground antenna systems
- High-speed fixed and mobile ground data collection, processing, and dissemination systems
- Tactical communication systems



The Joint Combat Information Terminal (JCIT) uses advanced RF and digital technology to provide unprecedented battlefield connectivity and combat information

processing in a compact, modular, on-the-fly reconfigurable unit with an open system architecture. The JCIT contains up to eight multiband transceivers, embedded INFOSEC, message processing, date storage, crypto key management, GPS, and power supplies in a 19" rack mount or three-fourths ATR chassis weighing less than 50 lbs. It can simultaneously transmit, receive, encrypt, decrypt, and process voice and video. The system is software reprogrammable to support a variety of mission scenarios to achieve functionality and diversity. The design of the JCIT permits interoperability with legacy systems, interservice, international, and coalition partner systems. Designed for airborne platforms, the JCIT is fully qualified for land, sea, and subsea applications.

Space Electronic Systems Development

- Space system concept definition, design, and implementation including hardware and software
- Detailed electrical/electronic design of electronic and electromechanical systems and components
- Implementation of real-time flight software and embedded command, control, and telemetry software
- Design and verification of real-time embedded multiprocessor software
- Spacecraft antenna systems
- Space systems fabrication, test, and integration
- Launch and on-orbit support
- Space test systems and electronic launch support equipment

Space Electronic Warfare

- Design criteria for counter-surveillance and counter-targeting
- Data search, analysis, and synthesis of information related to special sensor performance

Space Mission Development

- Mission development and requirements definition
- Systems engineering and analysis
- Concepts of operations and mission simulations
- Mission evaluation and performance assessments

Space Surveillance, Navigation, and Time

- Advanced navigation satellite technology
- Precise Time and Time Interval (PTTI) technology
- Atomic-time/frequency standards/instrumentation
- Passive and active ranging techniques
- Detection and precision tracking of orbiting objects from space and ground



The "ICEBOX" is a transportable satellite communications and relay station that has been deployed around the world in support of Naval operations. ICEBOX is transportable via a C141 Aircraft and can provide satellite communications and in-theater monitoring capabilities for a number of situations. ICEBOX has a number of innovative features that include remote operations and troubleshooting, automatic transmit and

receive, multifunctional antennas, and innovative processing techniques.



Mr. R.E. Eisenhauer

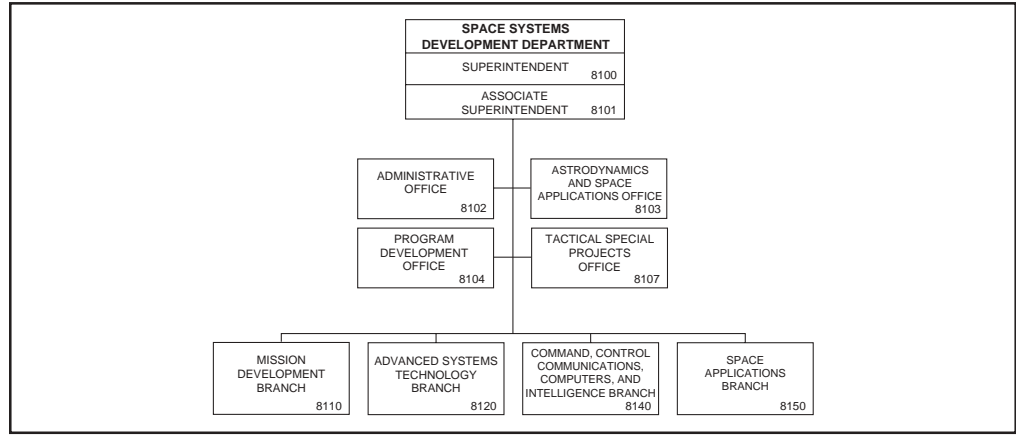

Basic Responsibilities

The Space Systems Development Department (SSDD) is the space and ground support systems research and development organization of the Naval Center for Space Technology. The primary objective of the SSDD is to develop space systems to respond to Navy, DOD, and national mission requirements with improved performance, capacity, reliability, efficiency, and/or life cycle cost. The Department must derive system requirements from the mission, develop architectures in response to these requirements, and design and develop systems, subsystems, equipment, and implementation technologies to achieve the optimized, integrated operational space and ground system. These development responsibilities extend across the entire space/ground spectrum of hardware, software, and advanced technologies, including digital processing and control, analog systems, power, communications, command and telemetry, radio frequency, optical, payload, and electromechanical systems, as well as systems engineering.

Personnel: 233 full-time civilian

Key Personnel

Name	Title	Code
Mr. R.E. Eisenhauer	Superintendent	8100
Mr. W.R. Webster*	Associate Superintendent	8101
Ms. M.R. Hudson	Administrative Officer	8102
Mr. J.W. Middour	Head, Astrodynamics and Space Applications Office	8103
Mr. B.J. Lamb	Head, Program Development Office	8104
Mr. M.T. Powell	Head, Tactical Special Projects Office	8107
Mr. D.L. Pettit*	Head, Mission Development Branch	8110
Mr. W.R. Webster	Head, Advanced Systems Technology Branch	8120
Mr. R.E. Eisenhauer*	Head, Command, Control, Communications, Computers, and Intelligence Branch	8140
Mr. R.L. Beard	Head, Space Applications Branch	8150

Point of contact: Ms. M.R. Hudson, Code 8102, (202) 767-0432

*Acting

Spacecraft Engineering Department

Code 8200 Research Activity Areas

Design, Test, and Processing

Design, fabrication, and testing of spacecraft and hardware:

- Preliminary and detailed design
- Fabrication
- Testing
- Integration onto launch vehicle
- Systems engineering for new spacecraft proposals
- Start-to-finish responsibility for NCST spacecraft mechanical systems



The Spacecraft Robotics Engineering and Controls Laboratory employs two six degree-of-freedom robotic manipulators to perform realistic orbital and attitude motion simulations for proximity operations of spacecraft. This facility enables hardware-in-the-loop testing of machine vision systems, capture mechanisms and autonomous guidance, navigation, and control algorithms. The resulting technologies will benefit future DOD space missions involving autonomous rendezvous and capture.

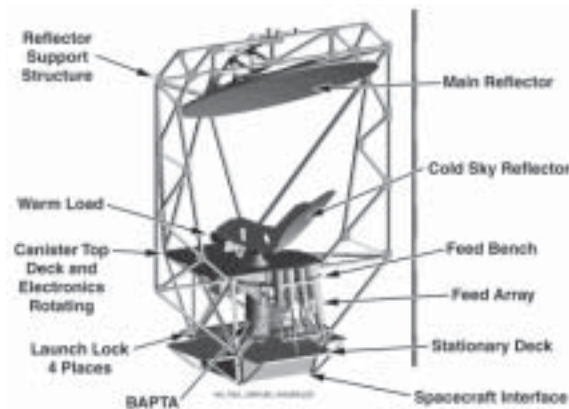

WindSat demonstrates the use of Passive Microwave Polarimetry from space to measure the full ocean surface wind field (wind speed and direction).

Systems Analysis

Research and development in spacecraft technology
Conceptual design trade studies
Integrated engineering design and analysis
Structural and thermal analysis
Development and transition of prototype hardware
Development and integration of experimental payloads

Control Systems

Attitude determination and control systems
Reaction control
Precision pointing
Optical line-of-sight stabilization
Propulsion systems
Analytical design and mission planning
Navigation, tracking, and orbit dynamics
Expert systems
Flight operations support
Computer simulation
Computer animation
Robotics engineering and control
Spaceborne robotics applications
Autonomous rendezvous and capture

Naval Earth Map Observer (NEMO) will provide hyperspectral technology applications for coastal ocean and littoral imaging, resource monitoring, and mineral mapping.

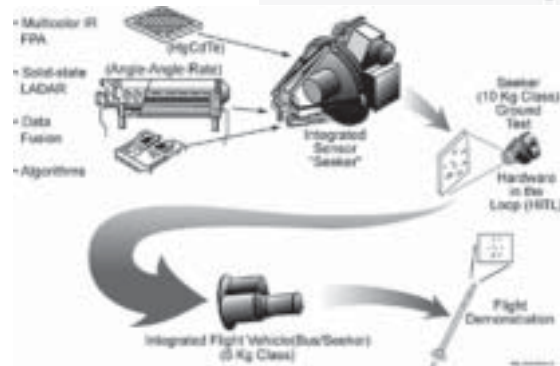
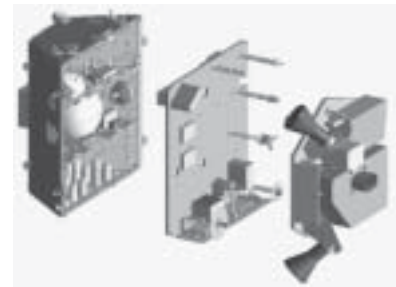

Discriminating Interceptor Technology (DITP) demonstrates technologies traceable to NMD and TMD applications to include miniaturized IR and ladar sensors and sensor fusion processing hardware.



Mr. H.E. SENASACK, JR.

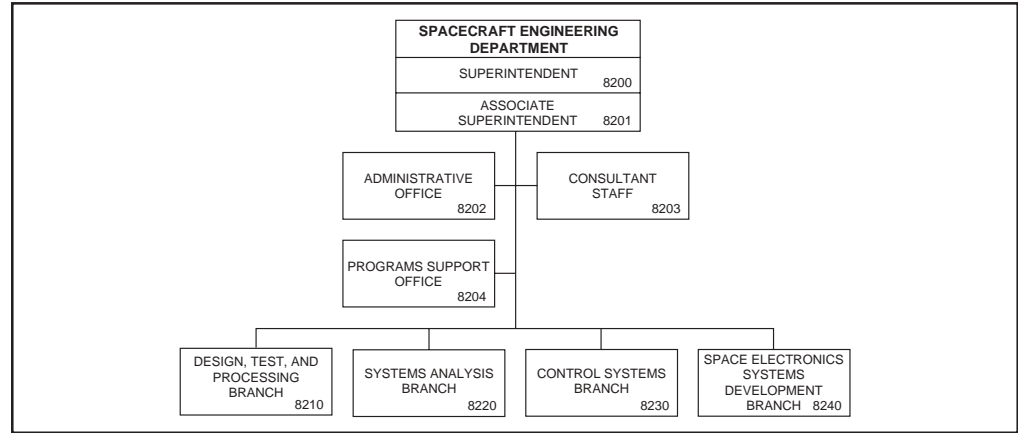

Basic Responsibilities

The Spacecraft Engineering Department (SED) is the focal point for the Navy’s capability to design and build spacecraft. Activities range from concept and feasibility planning to on-orbit IOC for the NRL’s space systems.

The SED provides spacecraft bus expertise for the Navy and maintains an active in-house capability to develop satellites; manages Navy space programs through engineering support and technical direction; in concert with the Space Systems Development Department, designs, assembles and tests spacecraft and space experiments, including all aspects of space, launch, and ground support; analyzes and designs structures, mechanisms, and a variety of control systems, including attitude, propulsion, reaction, and thermal; integrates satellite designs, launch vehicles, and satellite-to-boost stages; functions as a prototype laboratory to ensure that designs can be transferred to industry and incorporated into subsequent satellite hardware builds; and consults with the Navy Program Office on technical issues involving spacecraft architecture, acquisition, and operation.

Personnel: 93 full-time civilian

Key Personnel

Name	Title	Code
Mr. H.E. Senasack, Jr.	Superintendent	8200
Mr. J.P. Schaub	Associate Superintendent	8201
Ms. C.A. Gross	Administrative Officer	8202
Mr. A.L. Hull	Consultant Staff	8203
Vacant	Head, Programs Support Office	8204
Mr. J.A. Hauser II	Head, Design, Test, and Processing Branch	8210
Mr. A.B. Jacoby	Head, Systems Analysis Branch	8220
Dr. A. Bosse	Head, Control Systems Branch	8230
Mr. G.E. Flach	Head, Space Electronics Systems Development Branch	8240

Point of contact: Mr. H.E. Senasack, Jr., Code 8200, 767-6411

**Technical
Output,
Fiscal, and
Personnel
Information**

Technical Output

Publications, Presentations, and Patents

The Navy continues to be a pioneer in initiating new developments and a leader in applying these advancements to military requirements. The primary means of informing the scientific and engineering community of the advances made at NRL is through the Laboratory's technical output—reports, articles in scientific journals, contributions to books, papers presented to scientific societies, and topical conferences, patents, and inventions.

The figures for calendar years 2000 and 2001 presented below represent the output of NRL facilities in Washington, DC; Bay St. Louis, Mississippi; and Monterey, California.

In addition to the output listed, NRL scientists made more than 1,257 oral presentations during 2000 and 678 oral presentations during 2001.

In 1986, Congress enacted the Federal Technology Transfer Act in an effort to encourage the commercial use of technology developed in Federal laboratories. The Act allows Government inventors and the laboratories where they work to share the royalties generated by commercial licensing of their inventions. Also, the Act encourages the establishment of cooperative research and development agreements between laboratories such as NRL and nonfederal entities such as state and local governments, universities, and business corporations. Such cooperative R&D agreements can include the allocation in advance of patent rights on any inventions made under the joint research effort.

The 1986 Act has given additional impetus to the Laboratory's efforts to patent important inventions arising out of its various research programs.

Calendar Year 2000

Type of Contribution	Unclassified	Classified	Total
Articles in periodicals, chapters in books, and papers in published proceedings	1,014	9	1,023*
NRL Formal Reports	20	10	30
NRL Memorandum Reports	94	7	101
Books	0	0	0
Patents granted			80
Statutory Invention Registrations (SIRs)			3

Calendar Year 2001

Type of Contribution	Unclassified	Classified	Total
Articles in periodicals, chapters in books, and papers in published proceedings	1,018	3	1,021**
NRL Formal Reports	13	10	23
NRL Memorandum Reports	83	3	86
Books	2	0	2
Patents granted			86
Statutory Invention Registrations (SIRs)			4

*This is a provisional total based on information available to the Ruth H. Hooker Research Library and Technical Information Center on January 25, 2001. Additional publications carrying a 2000 publication date are anticipated.

**This is a provisional total based on information available to the Ruth H. Hooker Research Library and Technical Information Center on January 16, 2002. Additional publications carrying a 2001 publication date are anticipated.

FY 2000/2001 Sources of New Funds (Actual)

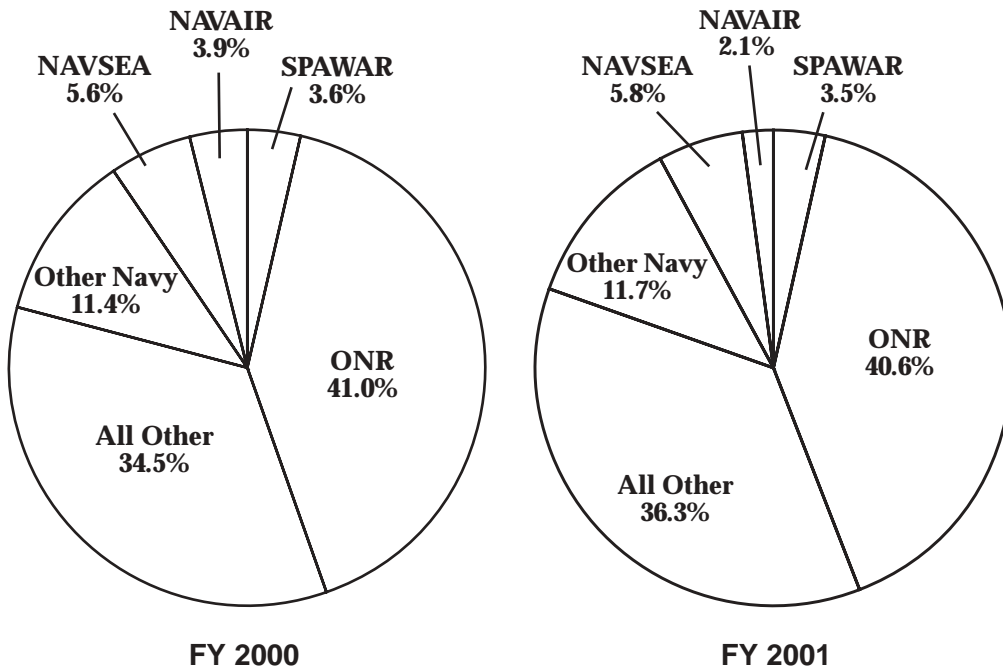

Source of Funds (%)

FY 2000	\$M		Total
	Reimbursable	Direct Cite	
Office of Naval Research (ONR)	248.8	63.8	312.6
Naval Sea Systems Command (NAVSEA)	25.2	17.8	43.0
Space and Naval Warfare Systems Command (SPAWAR)	17.4	10.2	27.6
Naval Air Systems Command (NAVAIR)	9.7	19.9	29.6
Other Navy	49.0	37.9	86.9
All Other	<u>179.6</u>	<u>83.0</u>	<u>262.6</u>
Total Funds	529.7	232.6	762.3

FY 2001	\$M		Total
	Reimbursable	Direct Cite	
Office of Naval Research (ONR)	255.4	58.9	314.3
Naval Sea Systems Command (NAVSEA)	24.8	20.1	44.9
Space and Naval Warfare Systems Command (SPAWAR)	17.8	9.1	26.9
Naval Air Systems Command (NAVAIR)	4.1	11.8	15.9
Other Navy	54.1	36.4	90.5
All Other	<u>184.6</u>	<u>97.1</u>	<u>281.7</u>
Total Funds	540.8	233.4	774.2

FY 2002 Sources of New Funds (Plan)

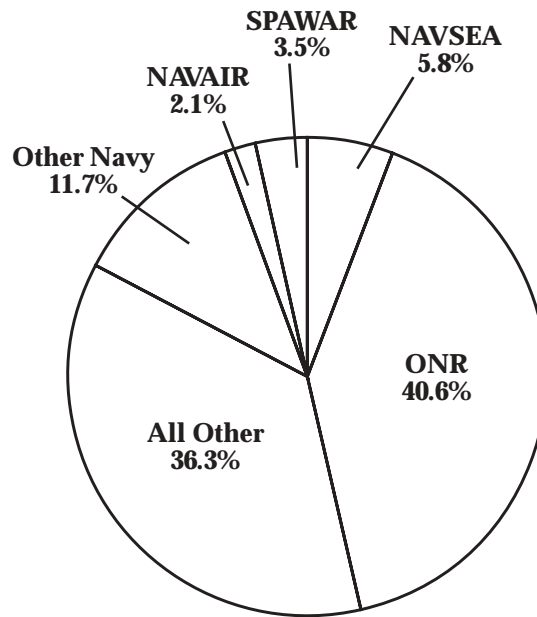

Source of Funds (%)

FY 2002	\$M		Total
	Reimbursable	Direct Cite	
Office of Naval Research (ONR)	252.4	58.0	310.4
Naval Sea Systems Command (NAVSEA)	24.5	19.8	44.3
Space and Naval Warfare Systems Command (SPAWAR)	17.6	9.0	26.6
Naval Air Systems Command (NAVAIR)	4.1	11.6	15.7
Other Navy	53.4	35.9	89.3
All Other	<u>182.5</u>	<u>95.7</u>	<u>278.2</u>
Total Funds	534.5	230.0	764.5

FY 2002 Distribution of New Funds (Plan)

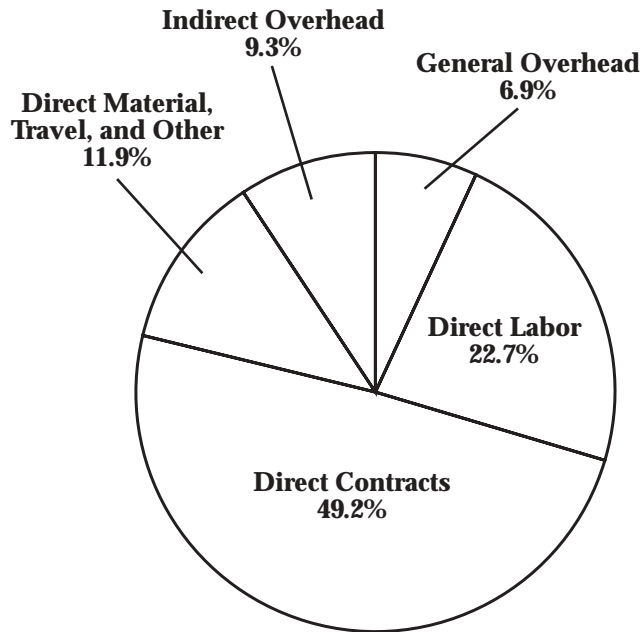

Distribution of Funds (%)

	\$M
Direct Labor	173.5
General Overhead	52.8
Indirect Overhead	70.8
Direct Material, Travel, and Other	90.9
Direct Contracts*	<u>376.5</u>
Total Funds	764.5

*Direct contracts include reimbursable and direct citation funding.

FY 2002 Reimbursable New Funds by Category (Plan)

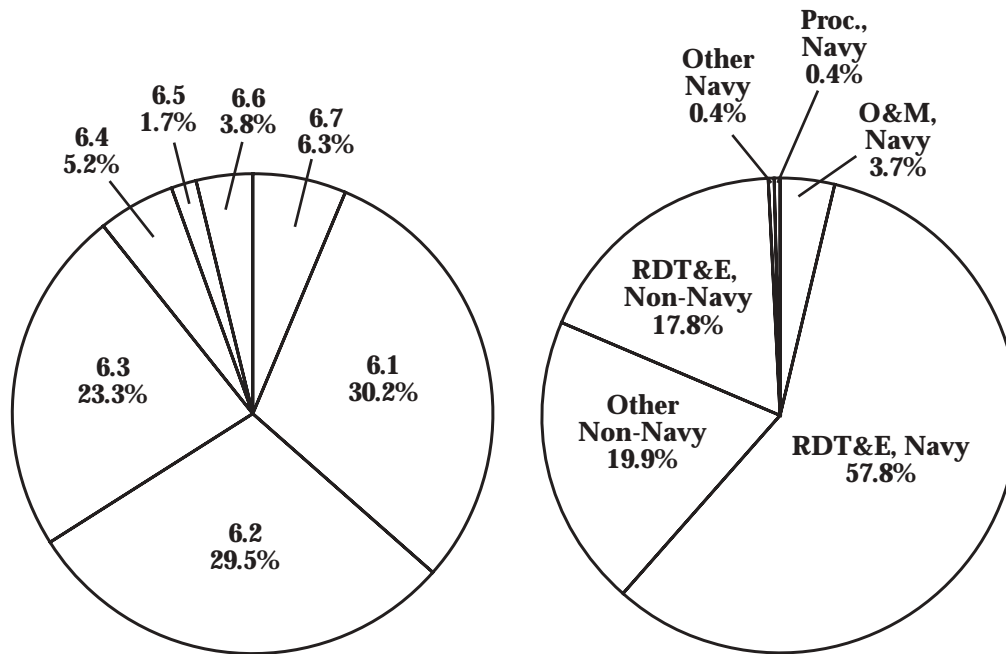

Distribution of RDT&E, Navy (%)
(\$308.9)

Distribution of Reimbursable (%)
(\$534.5)

Category	\$M		
	Navy	Non-Navy	Total
6.1 Basic Research	93.4	4.2	97.6
6.2 Applied Research	91.1	20.6	111.7
6.3 Advanced Technology Development	72.1	52.8	124.9
6.4 Demonstration and Validation	16.0	2.4	18.4
6.5 Engineering and Manufacturing Development	5.2	0.7	5.9
6.6 RDT&E Management Support	11.7	4.2	15.9
6.7 Operational System Development	<u>19.4</u>	<u>10.3</u>	<u>29.7</u>
Subtotal RDT&E	308.9	95.2	404.1
Operations and Maintenance	19.8	2.7	22.5
Procurement	2.1	18.8	20.9
Other	<u>2.4</u>	<u>84.6</u>	<u>87.0</u>
Total Reimbursable Funds	333.2	201.3	534.5

Personnel Information*

Civilian

Full-Time, Permanent (FTP)	
Graded	2,412
Ungraded	<u>109</u>
Total	2,521

Temporary, Part-Time, Intermittent (TPTI)	
TPTI	<u>310</u>

Total Civilian 2,831

FTP Breakdown	
Scientific/Engineering Professional	1,521
Scientific/Engineering Technical	107
Administrative Specialist/Professional	379
Administrative Support	318
Senior Executive Service	26
Scientific or Professional	17
General Schedule	<u>44</u>
Total	2,412

Civilian Budgeted
End-Strength 2,626

Military

Officers	33
Enlisted	<u>75</u>

Total Military On-Board 108
Military Allowance 125

On-Board	Total Military	Total Civilian	FTP	TPTI	FTP Ungraded	FTP Graded
2,939	108	2,831	2,521	310	109	2,412

Annual Civilian Turnover Rate (%) (permanent employees only)

	1997	1998	1999	2000	2001
Research divisions	8.7	9.1	11.62	10.02	10.9
Nonresearch areas	8.6	12.3	18.14	10.85	9.0
Entire Laboratory	8.7	9.8	12.89	10.18	10.5

Highest Academic Degrees Held by Permanent Employees

Bachelors	530
Masters	360
Doctorates	820

*Military numbers are current as of 23 October 2002; figures include all NRL sites.
Numbers are current as of 31 May 2002; figures include all NRL sites.
Civilian Budgeted End-Strength number is for FY 2002.

**Professional
Development**

Professional Development

NRL has established programs for the professional and personal development of its employees so that they may better serve the needs of the Navy. These programs develop and retain talented people and keep them abreast of advanced technology and management skills. Graduate assistantships, fellowships, sabbatical study programs, cooperative education programs, individual college courses, and short courses for personal improvement contribute to professional development.

Programs also exist for non-NRL employees. These programs enhance research efforts by providing means for non-NRL professionals to work at the Laboratory, thereby improving the interchange of ideas, meeting critical short-term technical requirements, and providing sources of new scientists and engineers. The programs include two-year graduate fellowships, faculty and professional interchanges, undergraduate work, and introducing gifted and talented high school students to the world of technology.

Programs for NRL Employees

NRL employees participate in hundreds of individual training events throughout the year. Many of these are presented under the auspices of the Human Resources Office as in-house courses on diverse technical subjects, computer software, and management techniques.

One common study procedure is for employees to work full time at the Laboratory while taking job-related scientific courses at universities and schools in the Washington area. The training ranges from a single course to full graduate-level programs. Tuition for training is paid by NRL. The formal programs offered by NRL are described below.

Graduate Programs

- The **Advanced Graduate Research Program** (formerly the Sabbatical Study Program, which began in 1964) enables selected professional employees to devote full time to research or pursue work in their own or a related field for one year at an institution or research facility of their choice without the loss of regular salary, leave, or fringe benefits. NRL pays all educational costs, travel, and moving expenses for the employee and dependents. Criteria for eligibility include professional stature consistent with the applicant's opportunities and experience, a satisfactory program of study, and acceptance by the facility selected by the applicant. The program is open to paraprofessional (and above) employees who have completed six years of Federal service, four years of which are required at NRL.

- The **Edison Memorial Graduate Training Program** enables employees to pursue advanced studies in their fields at local universities. Participants in this program work 24 hours each work-week and pursue their studies during the other 16 hours. The criteria for eligibility include a minimum of one year of service at NRL, a bachelor's or master's degree in an appropriate field, and profes-

sional standing in keeping with the candidate's opportunities and experience.

- To be eligible for the **Select Graduate Training Program**, employees must have a college degree in an appropriate field and must have demonstrated ability and aptitude for advanced training. Students accepted in this program devote a full academic year to graduate study. While attending school, they receive one half of their salary; NRL pays for tuition, books, and laboratory expenses.

- The **Naval Postgraduate School (NPS)**, located in Monterey, California, provides graduate programs to enhance the technical preparation of Naval officers and civilian employees who serve the Navy in the fields of science, engineering, operations analysis, and management. It awards a master of arts degree in national security affairs and a master of science degree in many technical disciplines.

NRL employees desiring to pursue graduate studies at NPS may apply for a maximum of six quarters away from NRL, with thesis work accomplished at NRL. Specific programs are described in the NPS catalog. Participants will continue to receive full pay and benefits during the period of study.

- Research conducted at NRL may be used as thesis material for an advanced degree.

This original research is supervised by a qualified employee of NRL who is approved by the graduate school. The candidate should have completed the required course work and should have satisfied the language, residence, and other requirements of the graduate school from which the degree is sought. NRL provides space, research facilities, and supervision but leaves decisions on academic policy to the cooperating schools.

Professional Development

NRL has programs, professional society chapters, and informal clubs that enhance the professional growth of employees. Some of these are listed below.

- The **Congressional Fellowship Program**, sponsored by the American Political Science Association, provides an opportunity for some of the most promising young, technically oriented Federal executives to participate in a variety of assignments designed to develop their knowledge and understanding of Congressional operations. These Fellows share activities with other members of the Congressional Fellowship Program who come mainly from journalism, law, and college teaching.

- The **LEGIS Fellows Program** provides assignments for personnel whose current or prospective positions may require working knowledge of the operations of the Congress. The Fellows receive instruction and hands-on experience in a Congressional office through training/developmental activities such as seminars, intensive briefings, and assignments on the staff of a member, committee, or support agency of the Congress in Washington, DC.

- The **Counseling Referral Service (C/RS)** helps employees to achieve optimal job performance through counseling and resolution of problems such as family, stress and anxiety, behavioral, emotional, and alcohol- or drug-related problems that may adversely impact job performance.

C/RS provides confidential assessments and short-term counseling, as well as training workshops and referrals to additional resources in the community. (Contact Dr. Ralph Surette at (202) 767-6857, NRL Washington, DC; (228) 688-5726, NRL Stennis Space Center; 1-800-523-5668, NRL Monterey).

- The **NRL Women in Science and Engineering (WISE) Network** is an open-membership network group of scientists and engineers who meet periodically to discuss issues of common interest, host speakers, address and sponsor projects to

benefit NRL's S&T community. The primary goals of the NRL WISE network, a merger of the NRL Women's S&T Network and the NRL WISE Chapter, are to encourage and promote professional growth among NRL scientists and engineers. One of the most successful projects initiated and sponsored by this group is the Mentor Program, which was institutionalized to provide an environment for personal and professional growth at NRL. The most recent project adopted by the **NRL WISE Network** group has focused on addressing issues concerning the quality of life for scientists and engineers at NRL. The idea was suggested by one of the invited speakers, Ms. Welch, who was DOD's Chief of Human Resources. The **NRL WISE Network** jointly with the NRL Mentor Program has launched a new seminar series focused on NRL, Navy, and DOD research organizations. A reception, hosted by the **NRL WISE Network** group, immediately follows the seminar and is held at the science lounge in building 222.

Members of the **NRL WISE Network** meet regularly at noon on the first Friday of each month (September through June) at the Science Lounge in building 222. These brown bag luncheon meetings are open to all NRL female and male scientists and engineers, including contractors and postdoctoral associates. If you would like to join the group and/or be on the electronic mailing list in order to be notified of events and topics of interest, please contact Dr. Ellen Goldman, **NRL WISE Network** secretary, at erg@cbmse.nrl.navy.mil or (202) 404-6052. For inquiry and further information, the president of the **NRL WISE Network**, Dr. Rhonda Stroud, can be reached at stroud@nrl.navy.mil or (202) 404-4143.

- **Sigma Xi**, the Scientific Research Society, encourages and acknowledges original investigation in scientific research. As an honor society for research scientists, individuals who have demonstrated the ability to perform original research are elected to membership in local chapters. The NRL-Edison Chapter, comprised of several hundred members, recognizes leadership research at NRL by presenting awards annually in pure and applied science to outstanding NRL staff members. This year the chapter has initiated a Young Investigator Award to be presented to an outstanding young NRL researcher. The NRL-Edison Chapter also sponsors lectures at NRL on a wide range of scientific topics for the entire NRL community. These lectures are delivered by scientists from all over the nation and the world. The highlight of the Sigma Xi lecture series is the Edison Memorial Lecture, traditionally featuring a Nobel laureate. (Contact Dr. Mark Pederson at (202) 767-6577.)

- The **NRL Mentor Program** was established to provide an innovative approach to professional and career training and an environment for personal and professional growth. It is open to all NRL employees in all job series and at all sites. Mentorees are matched with successful, experienced colleagues with more technical and/or managerial experience, who can provide them with the knowledge and skills needed to maximize their contribution to the success of their immediate organization, to NRL, to the Navy, and to their chosen career fields. The ultimate goal of the program is to increase job productivity, creativity, and satisfaction through better communication, understanding, and training. NRL Instruction 12400.1 established the NRL Mentor Program, and it provides the policy and procedures for the program. (Contact Dawn Brown at (202) 767-2957.)

- The Charlotte Moore-Sitterly Chapter of **Federally Employed Women, Inc.** (FEW) was chartered at NRL in 1993. FEW is an international organization of federally employed women and men whose purpose is to eliminate sex discrimination and sexual harassment and enhance career opportunities for women in government. FEW works closely with other Federal agencies and organizations, including the Office of Personnel Management, Equal Employment Opportunity Commission, and Federal Women's Program subcommittees. (Contact Maria Ferrell at (202) 767-3846.)

- Employees interested in developing effective self-expression, listening, thinking, and leadership potential are invited to join either of two NRL chapters of **Toastmasters International**, the Thomas Edison Club or the Forum Club. Members of these clubs, who possess diverse career backgrounds and talents, learn to communicate not by rules but by practice in an atmosphere of understanding and helpful fellowship. NRL's Commanding Officer and the Director of Research endorse Toastmasters. (Thomas Edison Club: contact Jim Waldenfels at (202) 767-3003 or at his e-mail address, waldenfels@contracts.nrl.navy.mil; Forum Club: contact George Arthur at (202) 767-4389 or at his e-mail address, arthur@kingcrab.nrl.navy.mil.

Continuing Education

NRL employees take government sponsored college courses (undergraduate and graduate) in order to improve their skills and keep abreast of current developments in their fields.

- The Human Resources Office (HRO) at NRL offers to all employees **short courses** in certain program areas that are not available at local schools; Laboratory employees may attend these courses at nongovernment facilities as well. Interagency

courses in management, personnel, finance, supervisory development, clerical skills, and other areas are also available.

Other Programs

- The **Brookings Institution** offers a variety of seminars and conferences devoted to research, education, and publication on important issues of domestic and foreign policy.

- OPM's **Management Development Center** offers one- and two-week courses in intensive policy and management training for government managers and executives.

- The **Excellence in Government Fellows Program** is an extensive, year-long leadership development opportunity to build the capacity of mid-level federal managers to lead organizations and produce results. As part of their fellowship year, participants develop strategies for meeting the complex challenges facing their organizations.

Technology Base

- The **Scientist-to-Sea Program** (STSP) provides increased opportunities for Navy R&D laboratory/center personnel to go to sea for several days to gain first-hand insight into operational factors affecting system design, performance, and operations on a variety of ships.

For further information on the Technology Base Programs, contact Dr. Stephen Sacks, Code 5006, (202) 767-3666.

Equal Employment Opportunity (EEO) Programs

Equal Employment Opportunity is a fundamental NRL policy for all persons, regardless of race, color, sex, religion, national origin, age, or physical/mental disability. The EEO office's major functions include affirmative action in employment, discrimination complainant process, EEO training, advice and guidance to management on EEO policy, and the following special emphasis programs: the Federal Women's Program, the Hispanic Employment Program, the African-American Employment Program, the Individuals with Disabilities Employment Program, the Asian-American/Pacific Islander Employment Program, and the American Indian-Alaskan Native Employment Program.

The management and planning of diversity issues and the special emphasis programs are accomplished through the NRL Diversity Committee. The Diversity Committee serves as an advisory committee to the Commanding Officer and recommends policies, programs and activities, that encourage advancement and self-improvement for

all employees. The committee educates NRL employees on diversity issues by sponsoring awareness programs and special workshops on quality of life issues pertaining to women, minorities, and persons with disabilities. They also aid in Community Outreach efforts. (Contact the EEO Office at (202) 767-2486 for all EEO programs.)

In addition, the EEO Office handles the Federal Employment Opportunity Recruitment Program (FEORP). The FEORP is designed to establish, maintain, and update targeted recruitment programs to reduce the conspicuous absence or manifest imbalance categories of NRL employees through innovative internal and external recruitment. Furthermore, it fosters relationships with minority and women's institutions and organizations.

Other Activities

- The **Community Outreach Program** traditionally has used its extensive resources to foster programs that provide benefits to students and other community citizens. Volunteer employees assist with and judge science fairs, give lectures, tutor, mentor, coach, and serve as classroom resource teachers. The program also sponsors African-American History Month art and essay contests for local schools, student tours of NRL, a student Toastmasters Youth Leadership Program, an annual holiday party for neighborhood children, and an annual book drive to support school librar-

ies. Through this program NRL has active partnerships with four District of Columbia and three Aberdeen, Maryland public schools. (Contact the Public Affairs Office at (202) 767-2541.)

- Other programs that enhance the development of NRL employees include four computer user groups (**IBM PC**, **Mac**, **NeXT**, and **Sun**). The **Amateur Radio Club** is devoted to amateur and related radio communications and is open to licensed radio operators as well as others interested in radio. The wide spectrum of club activities range from vintage radio to satellite communications. A club station is available for use by all members. The club conducts annual nationally coordinated Field Day (simulated emergency) operations. The **Recreation Club** accommodates the varied interests of NRL's employees with its numerous facilities, such as a 25-yard, 6-lane indoor swimming pool; basketball and volleyball courts; a weight room; an exercise room; table tennis; a meeting room; basketball leagues; hot tubs; saunas; and classes in five different types of martial arts, aerobics exercise, swimming, water aerobics, and water walking. The **Showboaters**, a nonprofit drama group that presents live theater for the enjoyment of NRL and the community, performs two major productions each year in addition to occasional performances at Laboratory functions and benefits for local charities. Though based at NRL, membership in Showboaters is not limited to NRL employees. 🏠

Programs for Non-NRL Employees

Several programs have been established for non-NRL employees. These programs encourage and support the participation of visiting scientists and engineers in research of interest to the Laboratory. Some of the programs may serve as stepping-stones to federal careers in science and technology. Their objective is to enhance the quality of the Laboratory's research activities through working associations and interchanges with highly capable scientists and engineers and to provide opportunities for outside scientists and engineers to work in the Navy laboratory environment. Along with enhancing the Laboratory's research, these programs acquaint participants with Navy capabilities and concerns.

Recent Ph.D., Faculty Member, and College Graduate Programs

- The **National Research Council (NRC)/NRL Cooperative Research Associateship Program** selects associates who conduct research at NRL in their chosen fields in collaboration with NRL scientists and engineers. The tenure period is two years.

- The **American Society for Engineering Education (ASEE) Postdoctoral Fellowship Program** aims to increase the involvement of highly trained scientists and engineers in disciplines necessary to meet the evolving needs of naval technology. Appointments are for one year (renewable for a second and sometimes a third year). These competitive appointments are made by ASEE.

- The **Consortium for Oceanographic Research and Education (CORE) Postdoctoral Fellowship Program**. Administered in much the same way as the other two, this program selects associates to conduct research in ocean and atmospheric sciences only. The aim is to recruit more scientists and engineers in these specialized areas.

- The American Society for Engineering Education also administers the **Navy/ASEE Summer Faculty Research Program** for university faculty members to work for ten weeks with professional peers in participating Navy laboratories on research of mutual interest.

- The **NRL/United States Naval Academy (USNA) Cooperative Program for Scientific Interchange** allows faculty members of the U.S. Naval Academy to participate in NRL research. This collaboration benefits the Academy by providing the opportunity for USNA faculty members to work on research of a more practical or applied nature. In turn, NRL's research program is strengthened by the available scientific and engineering expertise of the USNA faculty.

- The **National Defense Science and Engineering Graduate Fellowship Program** helps U.S.

citizens obtain advanced training in disciplines of science and engineering critical to the U.S. Navy. The three-year program awards fellowships to recent outstanding graduates to support their study and research leading to doctoral degrees in specified disciplines such as electrical engineering, computer sciences, material sciences, applied physics, and ocean engineering. Award recipients are encouraged to continue their study and research in a Navy laboratory during the summer.

For further information about these six programs, please contact Mrs. Lesley Renfro at (202) 404-7450.

- The **Professional Development Program for Ensigns** assigns newly commissioned ensigns who are awaiting future training to NRL, working in areas of their own choosing commensurate with their academic qualifications. These young officers provide a fruitful summer of research assistance while gaining valuable experience in the Navy's R&D program.

For more information, contact the Military Administrative Office, LT Paul Simmons at (202) 767-7511.

Professional Appointments

- **Faculty Member Appointments** use the special skills and abilities of faculty members for short periods to fill positions of a scientific, engineering, professional, or analytical nature.

- **Consultants and experts** are employed because they are outstanding in their fields of specialization, or because they possess ability of a rare nature and could not normally be employed as regular civil servants.

- **Intergovernmental Personnel Act Appointments** temporarily assign personnel from state or local government or an educational institution to the federal government (or vice versa) to improve public services rendered by all levels of government.

High School/Undergraduate/Graduate College Student Programs

The student programs are tailored to the undergraduate and graduate students to provide employment opportunities and work experience in naval research. These programs are designed to attract applicants for student and full professional employment in fields such as engineering, physics, mathematics, and computer science. The student employment programs are designed to help students and the educational institutions gain a better understanding of NRL's research, its challenges, and its opportunities. The employment programs for college students include the following:

- The **Student Career Experience Program** (formerly known as Cooperative Education Program) employs students in study-related occupations. The program is conducted in accordance with a planned schedule and a working agreement between NRL, the educational institution, and the student. Primary focus is on students pursuing bachelor degrees in engineering, computer science, or the physical sciences.

- The **Student Temporary Employment Program (STEP)** enables students to earn a salary while continuing their studies and offers them valuable work experience.

- The **Student Employment Program** employs students for the summer in paraprofessional and technician positions in engineering, physical sciences, computer sciences, and mathematics.

- The **Student Volunteer Program** helps students gain valuable experience by allowing them to voluntarily perform educationally related work at NRL.

For additional information on these undergraduate and graduate student programs, contact (202) 767-8313.

High School Programs

- The **DOD Science & Engineering Apprenticeship Program (SEAP)** employs high school juniors and seniors to serve for eight weeks as junior research associates. Under the direction of a mentor, students gain a better understanding of research, its challenges, and its opportunities through participation in scientific programs. Criteria for eligibility are based on science and mathematics courses completed and grades achieved; scientific motivation, curiosity, and capacity for sustained hard work; a desire for a technical career; teacher recommendations; and achievement test scores. The NRL program is the lead program and the largest in DOD.

Prospective mentors desiring additional information on this program, please contact Dawn Brown at (202) 767-2957.

Students desiring additional information on this program may call the George Washington University SEAP Coordinator's Office at (202) 994-2234. 🏢

General Information

Naval Research Laboratory (Washington, DC)

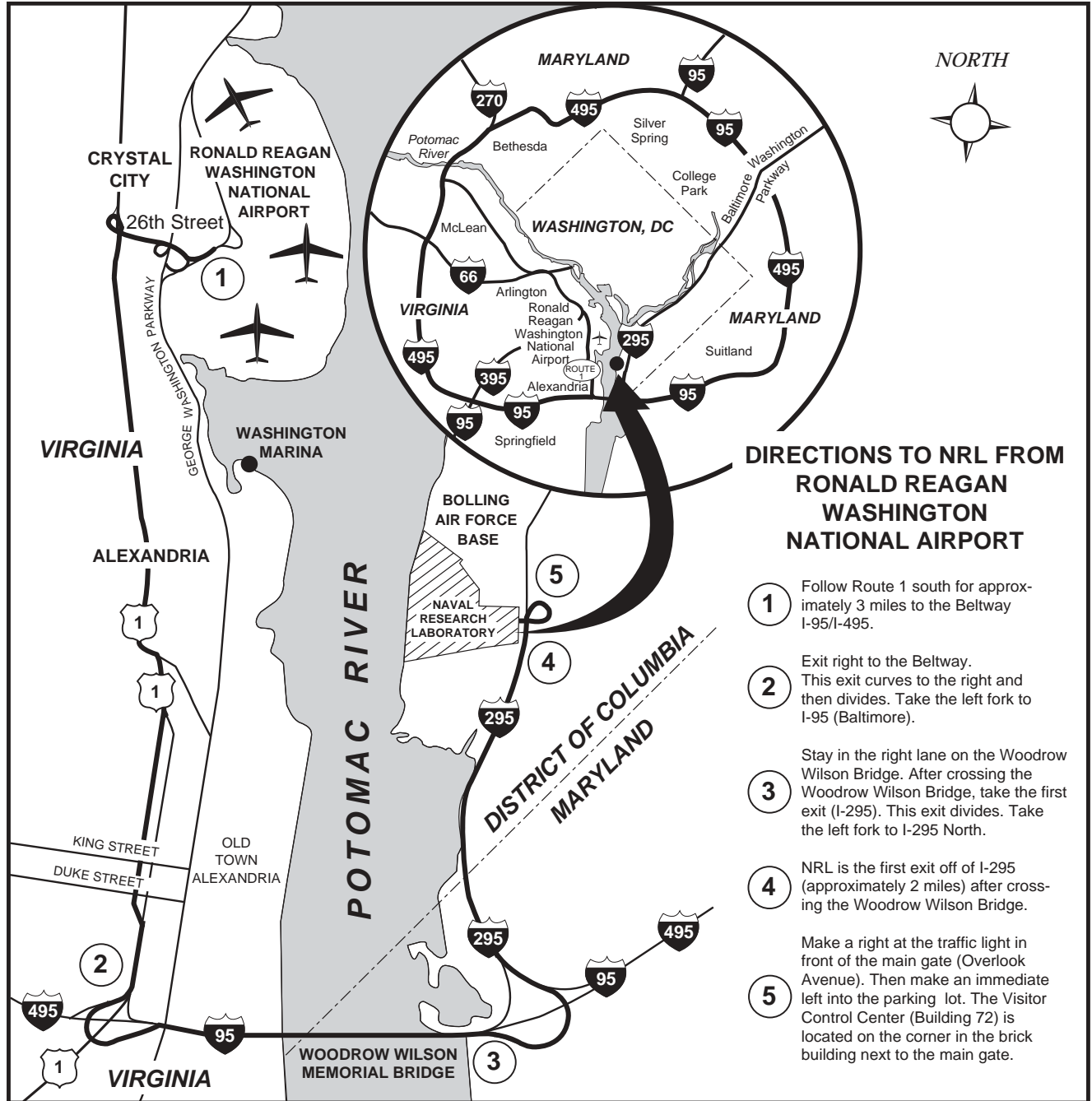

Naval Research Laboratory
4555 Overlook Avenue, SW
Washington, DC 20375-5320
(202) 767-3200 – DSN 297-3200

Location of Field Sites in the NRL Washington Area

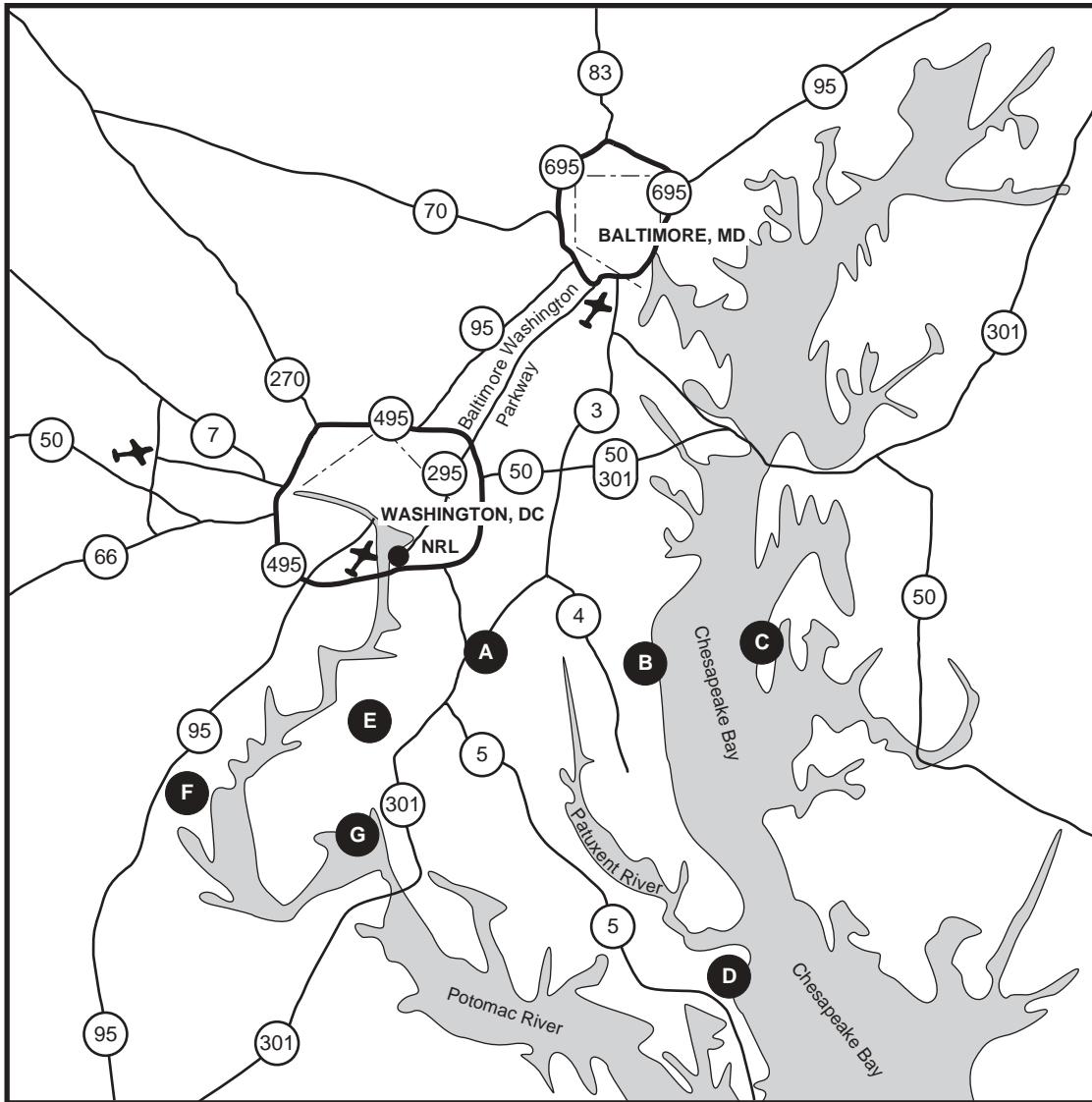

<u>Location</u>	<u>Approximate Mileage from NRL Washington</u>	<u>Cognizant Code</u>
A - Brandywine, MD	28	3500
B - Chesapeake Bay Section, Chesapeake Beach, MD	40	3522
C - Tilghman Island, MD	110	3522
D - Patuxent River (MD) Naval Air Station	64	1600
E - Pomonkey, MD	20	8124
F - Midway Research Center, Quantico, VA	38	8140
G - Blossom Point, MD	40	

Chesapeake Bay Section (Chesapeake Beach, Maryland)

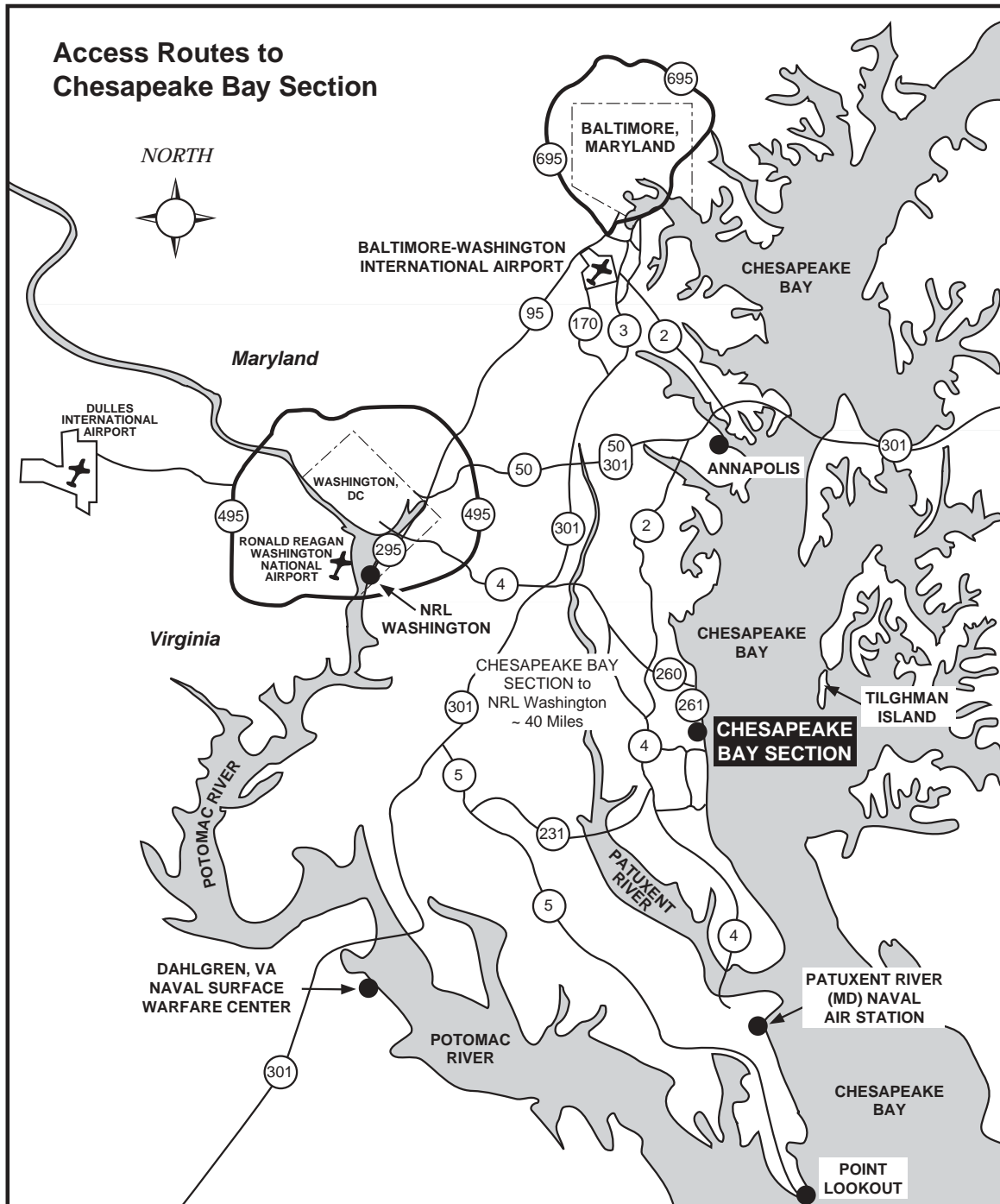

Naval Research Laboratory
 Chesapeake Bay Section
 5813 Bayside Road
 Chesapeake Beach, MD 20732
 (301) 257-4002

John C. Stennis Space Center (Stennis Space Center, Mississippi)

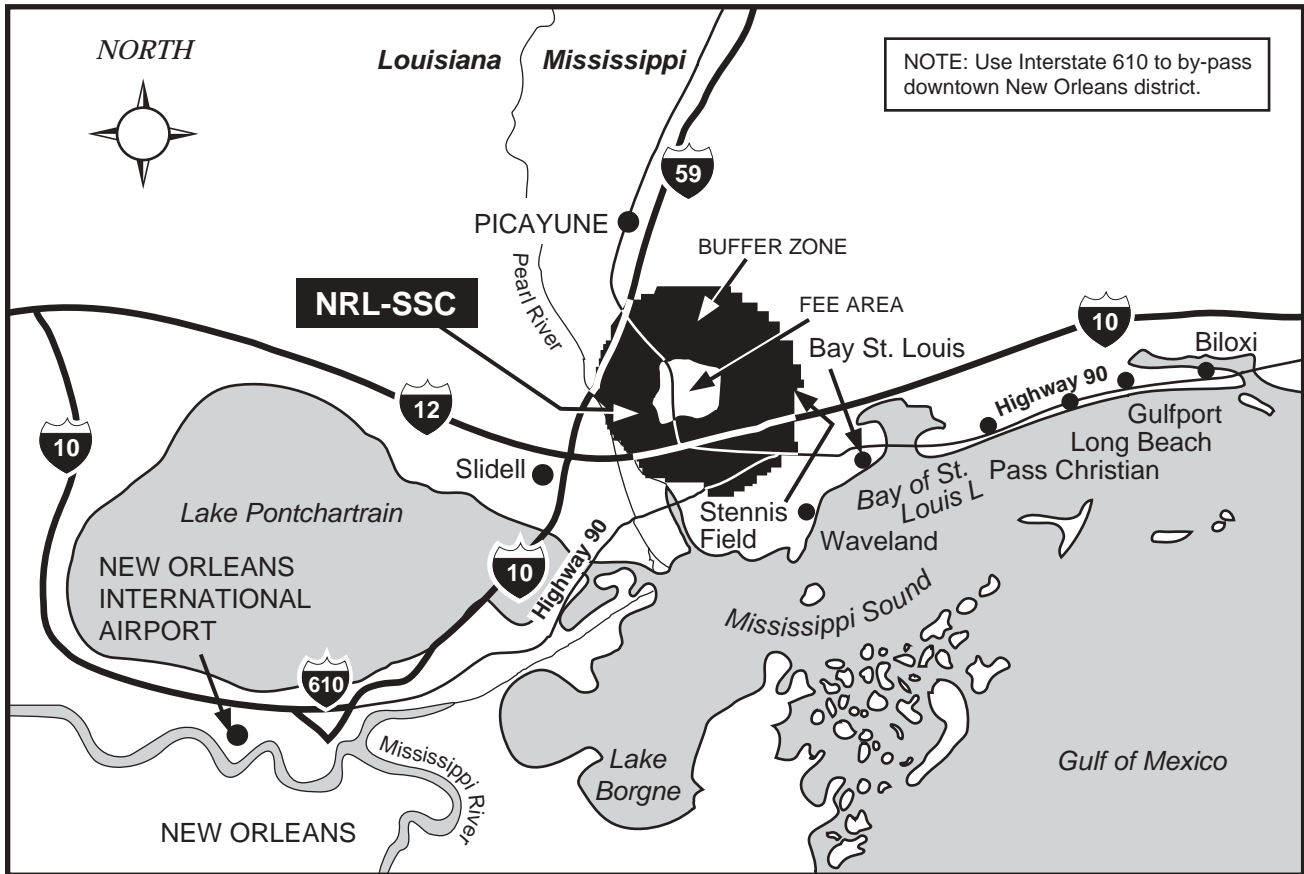

Naval Research Laboratory
John C. Stennis Space Center
Stennis Space Center, MS 39529-5004
(228) 688-3390

Naval Research Laboratory Monterey (Monterey, California)

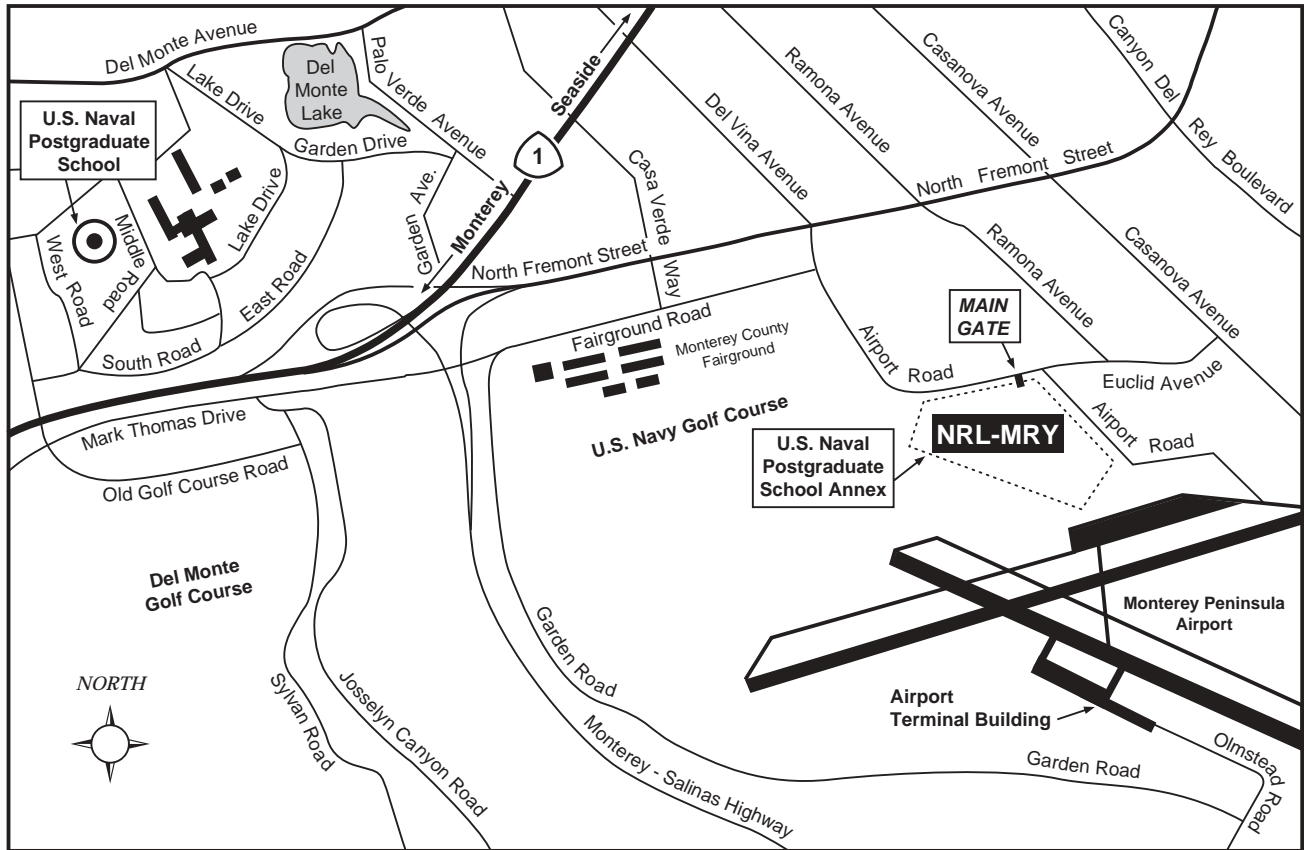

Naval Research Laboratory
Marine Meteorology Division
7 Grace Hopper Avenue
Monterey, CA 93943-5502
(831) 656-4721

Key Personnel

**DSN: NRL Washington 297- or 754-; NRL/SSC 828-; NRL/Monterey 878-;
NRL FSD/Patuxent River 342**

Code **Telephone**

EXECUTIVE DIRECTORATE

1000	Commanding Officer	CAPT D.M. Schubert, USN	(202) 767-3403
1000.1	Inspector General	CAPT C.W. Fowler, USN	(202) 767-3621
1001	Director of Research	Dr. J.A. Montgomery	(202) 767-3301
1001.1	Executive Assistant	Mr. D.J. DeYoung	(202) 767-2445
1002	Chief Staff Officer	CAPT C.W. Fowler, USN	(202) 767-3621
1004	Head, Office of Technology Transfer	Dr. C.M. Cotell	(202) 404-8411
1006	Head, Office of Program Administration and Policy Development	Mrs. L.T. McDonald	(202) 767-3091
1008	Head, Office of Counsel	Mr. J.N. McCutcheon	(202) 767-2244
1030	Head, Public Affairs Branch	Mr. R.L. Thompson	(202) 767-2541
1200	Head, Command Support Division	CAPT C.W. Fowler, USN	(202) 767-3621
1220	Head, Security Branch	Dr. J.T. Miller	(202) 767-0793
1400	Head, Military Support Division	CDR R.B. Grimm, USN	(202) 767-2273
1600	Officer-in-Charge, Flight Support Detachment (PAX River NAS)	CDR T.M. Munns, USN	(301) 342-3751
1800	Director, Human Resources Office	Ms. B.A. Duffield*	(202) 767-3421
1830	Deputy Equal Employment Opportunity Officer	Ms. D.E. Erwin	(202) 767-5264
3005	Deputy for Small Business	Ms. M.H. Nicholl	(202) 767-6263
3540	Head, Safety Branch	Mr. K.J. Pawlovich*	(202) 767-2232

BUSINESS OPERATIONS DIRECTORATE

3000	Associate Director of Research for Business Operations	Mr. D.K. Therning	(202) 767-2371
3005	Deputy for Small Business	Ms. M.H. Nicholl	(202) 767-6263
3030	Head, Management Information Systems Office	Ms. P.W. Lowery	(202) 404-3659
3200	Head, Contracting Division	Mr. J.C. Ely	(202) 767-5227
3300	Head, Financial Management Division	Mr. S.A. Birk	(202) 767-3405
3400	Head, Supply Division	Ms. C. Hartman	(202) 767-3446
3500	Director, Research and Development Services Division	Mr. S.D. Harrison	(202) 767-3697

SYSTEMS DIRECTORATE

5000	Associate Director of Research for Systems	Dr. R.A. LeFande	(202) 767-3324
5006	Head, Technology Base/Ballistic Missile Defense (BMD) Office	Dr. S. Sacks	(202) 767-3666
5007	Consultant	Dr. M.I. Skolnik	(202) 404-4004
5050	Head, Signature Technology Office	Dr. D.W. Forester	(202) 767-3955
5200	Head, Technical Information Division	Dr. R.A. LeFande*	(202) 767-2187
5300	Superintendent, Radar Division	Mr. P.K. Hughes II	(202) 404-2700
5500	Superintendent, Information Technology Division	Dr. J.D. McLean*	(202) 767-2903
5600	Superintendent, Optical Sciences Division	Dr. T.G. Giallorenzi	(202) 767-3171
5700	Superintendent, Tactical Electronic Warfare Division	Dr. F.J. Klemm*	(202) 767-6278

MATERIALS SCIENCE AND COMPONENT TECHNOLOGY DIRECTORATE

6000	Associate Director of Research for Materials Science and Component Technology	Dr. B.B. Rath	(202) 767-3566
6030	Chief Scientist, Laboratory for Structure of Matter	Dr. J. Karle	(202) 767-2665
6100	Superintendent, Chemistry Division	Dr. J.S. Murday	(202) 767-3026
6300	Superintendent, Materials Science and Technology Division	Dr. D.U. Gubser	(202) 767-2926
6400	Chief Scientist and Director, Laboratory for Computational Physics and Fluid Dynamics	Dr. J.P. Boris	(202) 767-3055
6700	Superintendent, Plasma Physics Division	Dr. S.L. Ossakow	(202) 767-2723
6800	Superintendent, Electronics Science and Technology Division	Dr. G.M. Borsuk	(202) 767-3525
6900	Director, Center for Bio/Molecular Science and Engineering	Dr. J.M. Schnur	(202) 404-6000

*Acting

Code

Telephone

OCEAN AND ATMOSPHERIC SCIENCE AND TECHNOLOGY DIRECTORATE

7000	Associate Director of Research for Ocean and Atmospheric Science and Technology	Dr. E.O. Hartwig	(202) 404-8690
7005	Military Deputy	CDR D.J. Groters, USN	(202) 404-8162
7030	Head, Office of Research Support Services	Mr. G.R. Bower	(228) 688-4010
7100	Superintendent, Acoustics Division	Dr. E.R. Franchi	(202) 767-3482
7105	Naval Science (Acoustics) Research Coordinator	LCDR S.A. Akahoshi, USN	(202) 767-3643
7200	Superintendent, Remote Sensing Division	Dr. P.R. Schwartz	(202) 767-2351
7205	Military Deputy	LCDR C.A. Weddle, USN	(202) 767-4132
7300	Superintendent, Oceanography Division	Dr. W.J. Jobst	(228) 688-4670
7305	Military Deputy	CDR R.M. Robichaud, Jr., USN	(228) 688-4013
7400	Superintendent, Marine Geosciences Division	Dr. H.C. Eppert, Jr.	(228) 688-4650
7405	Military Deputy	Vacant	(228) 688-5404
7500	Superintendent, Marine Meteorology Division	Ms. P.A. Phoebus*	(831) 656-4721
7505	Military Deputy	CDR K.F. Bedell, USN	(831) 656-4782
7600	Superintendent, Space Science Division	Dr. H. Gursky	(202) 767-6343

NAVAL CENTER FOR SPACE TECHNOLOGY

8000	Director, Naval Center for Space Technology	Mr. P.G. Wilhelm	(202) 767-6547
8100	Superintendent, Space Systems Development Department	Mr. R.E. Eisenhauer	(202) 767-0410
8200	Superintendent, Spacecraft Engineering Department	Mr. H.E. Senasack, Jr.	(202) 767-6411



*Acting

Technical Information Division Production Staff



Editor

Saul Oresky

Coordination, Design, and Layout

Jan D. Morrow

Photography

***Gayle R. Fullerton, James Marshall, and
Michael A. Savell***

The cooperation and assistance of others on the staffs of the Technical Information Services Branch and the Central Mail Processing Unit are also acknowledged and appreciated.

REVIEWED AND APPROVED

NRL/PU/5211--03-456

November 2002

A handwritten signature in black ink, which appears to read "DM Schubert".

David M. Schubert, Captain, USN
Commanding Officer

NRL **FACT BOOK**

<http://www.nrl.navy.mil>