



**NAVAL  
POSTGRADUATE  
SCHOOL**

**MONTEREY, CALIFORNIA**

---

**MBA PROFESSIONAL REPORT**

---

**Cost Effective Analysis Comparing the Small Diameter Bomb and the  
Joint Standoff Weapon (A+ Variant)**

---

**By: Brian P. Kelly, Major, USMC  
Brett Stevens, Lieutenant Commander, USN  
Sean D. Hayes, Major, USMC  
December 2004**

**Advisors: William Gates, Professor  
Thom Crouch, LTC USA**

*Approved for public release; distribution is unlimited.*

THIS PAGE INTENTIONALLY LEFT BLANK

<b>REPORT DOCUMENTATION PAGE</b>			<i>Form Approved OMB No. 0704-0188</i>	
Public reporting burden for this collection of information is estimated to average 1 hour per response, including the time for reviewing instruction, searching existing data sources, gathering and maintaining the data needed, and completing and reviewing the collection of information. Send comments regarding this burden estimate or any other aspect of this collection of information, including suggestions for reducing this burden, to Washington headquarters Services, Directorate for Information Operations and Reports, 1215 Jefferson Davis Highway, Suite 1204, Arlington, VA 22202-4302, and to the Office of Management and Budget, Paperwork Reduction Project (0704-0188) Washington DC 20503.				
<b>1. AGENCY USE ONLY (Leave blank)</b>		<b>2. REPORT DATE</b> December 2004	<b>3. REPORT TYPE AND DATES COVERED</b> MBA Professional Report	
<b>4. TITLE AND SUBTITLE:</b> Cost Effective Analysis Comparing the Small Diameter Bomb and the Joint Standoff Weapon (A+ Variant)			<b>5. FUNDING NUMBERS</b>	
<b>6. AUTHOR(S)</b> Brian P. Kelly, Brett Stevens, Sean D. Hayes				
<b>7. PERFORMING ORGANIZATION NAME(S) AND ADDRESS(ES)</b> Naval Postgraduate School Monterey, CA 93943-5000			<b>8. PERFORMING ORGANIZATION REPORT NUMBER</b>	
<b>9. SPONSORING / MONITORING AGENCY NAME(S) AND ADDRESS(ES)</b> N/A			<b>10. SPONSORING / MONITORING AGENCY REPORT NUMBER</b>	
<b>11. SUPPLEMENTARY NOTES</b> The views expressed in this report are those of the author(s) and do not reflect the official policy or position of the Department of Defense or the U.S. Government.				
<b>12a. DISTRIBUTION / AVAILABILITY STATEMENT</b> Approved for public release; distribution is unlimited			<b>12b. DISTRIBUTION CODE</b>	
<b>13. ABSTRACT (maximum 200 words)</b>  This MBA project investigated and analyzed the cost effectiveness of implementing the Joint Standoff Weapon A+ (JSOW A+) variant versus the Small Diameter Bomb (SDB). The primary goal was to compare the "cost per kill" for each weapon system in its intended operational environment against an existing target set. The secondary goal was to determine most cost effective optimum mix of weapons that would destroy the given target set. The optimum mix was determined using either the SDB or the JSOW A+ in combination with the current family of JSOW weapons, and was calculated based upon each weapons' cost-effectiveness. A computer model generated the cost-effectiveness of each weapon system by dividing weapon cost by weapon effectiveness. During the process of answering our research questions we discovered different scenarios identifying JSOW A+ as comparatively more, and in several scenarios comparatively less cost-effective than the SDB. The scenarios and results are subject to the assumptions and limitations defined within this report. This project explores the different scenarios to provide the acquisition program manager with the relevant data to make informed decisions concerning the direction of their program.				
<b>14. SUBJECT TERMS</b> Cost Effectiveness analysis, Joint Standoff Weapon (JSOW), Small Diameter Bomb (SDB), Cost-Per Kill, Optimum Mix			<b>15. NUMBER OF PAGES</b> 145	
			<b>16. PRICE CODE</b>	
<b>17. SECURITY CLASSIFICATION OF REPORT</b> Unclassified	<b>18. SECURITY CLASSIFICATION OF THIS PAGE</b> Unclassified	<b>19. SECURITY CLASSIFICATION OF ABSTRACT</b> Unclassified	<b>20. LIMITATION OF ABSTRACT</b> UL	

THIS PAGE INTENTIONALLY LEFT BLANK

**Approved for public release; distribution is unlimited**

**COST EFFECTIVE ANALYSIS COMPARING THE SMALL DIAMETER BOMB  
AND THE JOINT STANDOFF WEAPON (A+ VARIANT)**

Brian P. Kelly, Major, United States Marine Corps  
Brett Stevens, Lieutenant Commander, United States Navy  
Sean D. Hayes, Major, United States Marine Corps

Submitted in partial fulfillment of the requirements for the degree of

**MASTER OF BUSINESS ADMINISTRATION**

from the

**NAVAL POSTGRADUATE SCHOOL  
December 2004**

Authors:

\_\_\_\_\_  
Brian P. Kelly

\_\_\_\_\_  
Brett Stevens

\_\_\_\_\_  
Sean D. Hayes

Approved by:

\_\_\_\_\_  
William Gates, Professor, Lead Advisor

\_\_\_\_\_  
Thom Crouch, LTC, USA, Support Advisor

\_\_\_\_\_  
Douglas A. Brook, Dean  
Graduate School of Business and Public Policy

THIS PAGE INTENTIONALLY LEFT BLANK

# **COST EFFECTIVE ANALYSIS COMPARING THE SMALL DIAMETER BOMB AND THE JOINT STANDOFF WEAPON (A+ VARIANT)**

## **ABSTRACT**

This MBA project investigated and analyzed the cost effectiveness of implementing the Joint Standoff Weapon A+ (JSOW A+) variant versus the Small Diameter Bomb (SDB). The primary goal was to compare the “cost per kill” for each weapon system in its intended operational environment against an existing target set. The secondary goal was to determine most cost effective optimum mix of weapons that would destroy the given target set. The optimum mix was determined using either the SDB or the JSOW A+ in combination with the current family of JSOW weapons, and was calculated based upon each weapons’ cost-effectiveness. A computer model generated the cost-effectiveness of each weapon system by dividing weapon cost by weapon effectiveness. During the process of answering our research questions we discovered different scenarios identifying JSOW A+ as comparatively more, and in several scenarios comparatively less cost-effective than the SDB. The scenarios and results are subject to the assumptions and limitations defined within this report. This project explores the different scenarios to provide the acquisition program manager with the relevant data to make informed decisions concerning the direction of their program.

THIS PAGE INTENTIONALLY LEFT BLANK



# TABLE OF CONTENTS

<b>EXECUTIVE SUMMARY .....</b>	<b>1</b>
<b>I. INTRODUCTION.....</b>	<b>3</b>
<b>II. LITERATURE REVIEW .....</b>	<b>7</b>
<b>A. MILITARY REFERENCES.....</b>	<b>7</b>
1. Cost/Benefit of Integrating JSOW A+ into the JSOW Inventory.....	7
2. Program Executive Officer Review, Small Diameter Bomb.....	7
3. Conventional Strike Weapon Comparison.....	7
4. TOPGUN Manual .....	8
5. Small Diameter Bomb ( <i>A Miniature Munitions Capability</i> ) Command, Control, Communications, Computers, and Intelligence (C4I) Support Plan.....	8
6. Operational Requirements Document for Miniature Munitions and Carriage System.....	9
7. Joint Operational Requirements Document for Joint Standoff Weapon (JSOW) System .....	9
<b>B. OTHER REFERENCES .....</b>	<b>10</b>
1. Cost-Effectiveness, A Primer .....	10
2. Cost-Effectiveness Analysis, New Approaches in Decision-Making .....	10
3. Cost-Benefit Analysis, Concepts and Practice.....	10
<b>III. BACKGROUND .....</b>	<b>11</b>
<b>A. ANALYTICAL FRAMEWORKS.....</b>	<b>11</b>
1. Cost-Feasibility Analysis .....	11
2. Cost-Utility Analysis .....	12
3. Cost-Benefit Analysis.....	12
4. Cost Effectiveness Analysis .....	13
<b>B. JOINT STAND-OFF WEAPON (JSOW) FAMILY OF WEAPONS .....</b>	<b>15</b>
1. JSOW A (AGM-154A) Description.....	16
2. JSOW B (AGM-154B) Description .....	17
3. JSOW C (AGM-154C) Description.....	18
4. JSOW A+ Description .....	18
<b>C. SMALL DIAMATER BOMB.....</b>	<b>19</b>
1. Smart Carriage System .....	20
2. The Weapon.....	21
3. System Development.....	22
4. Accuracy Support Infrastructure (ASI) .....	22
<b>D. TARGETING, TARGET SET, AND WEAPONNEERING .....</b>	<b>22</b>
1. Targeting.....	22
2. Target Set.....	23

3.	<b>Weaponeering</b> .....	24
a.	<i>Error Budget Concept</i> .....	24
E.	<b>ACQUISITION LIFECYCLES</b> .....	25
1.	<b>JSOW A</b> .....	25
2.	<b>JSOW B</b> .....	26
3.	<b>JSOW C</b> .....	26
4.	<b>SDB</b> .....	26
IV.	<b>SCOPE AND METHODOLOGY</b> .....	29
A.	<b>OVERVIEW</b> .....	29
1.	<b>Objective</b> .....	29
2.	<b>Research Questions</b> .....	29
a.	<i>Primary Research Question</i> .....	29
b.	<i>Secondary Research Question</i> .....	29
3.	<b>Scenarios</b> .....	29
4.	<b>Model</b> .....	30
a.	<i>Overview</i> .....	30
b.	<i>Variables</i> .....	31
c.	<i>Model Logic</i> .....	32
V.	<b>ANALYSIS AND RESULTS</b> .....	37
A.	<b>SCENARIO ONE</b> .....	37
1.	<b>Observations and Results</b> .....	39
2.	<b>Analysis</b> .....	40
B.	<b>SCENARIO TWO</b> .....	40
1.	<b>Observations and Results</b> .....	43
2.	<b>Analysis</b> .....	44
C.	<b>SCENARIO THREE</b> .....	45
1.	<b>Observations and Results</b> .....	46
2.	<b>Analysis</b> .....	50
VI.	<b>CONCLUSION AND RECOMMENDATIONS</b> .....	53
	<b>APPENDIX A: SCENARIO ONE</b> .....	57
A.	<b>TABLE OVERVIEW</b> .....	57
B.	<b>COST PER KILL</b> .....	58
C.	<b>COST OF OPTIMUM MIX</b> .....	59
D.	<b>DATA FOR SCENARIO 1</b> .....	60
	<b>APPENDIX B: SCENARIO TWO</b> .....	85
A.	<b>TABLE OVERVIEW</b> .....	85
B.	<b>COST PER KILL</b> .....	86
C.	<b>COST OF OPTIMUM MIX</b> .....	87
D.	<b>DATA FOR SCENARIO 2</b> .....	88
	<b>APPENDIX C: SCENARIO THREE</b> .....	113
A.	<b>TABLE OVERVIEW</b> .....	113
B.	<b>COST PER KILL</b> .....	113
C.	<b>DATA FOR SCENARIO 3</b> .....	115

D.	DATA FOR SCENARIO 3; BREAKEVEN POINTS .....	120
APPENDIX D:	(SEE PMA 201) .....	125
A.	TARGET SET LIST .....	125
B.	NUMBER OF AIM POINTS PER TARGET .....	125
C.	SSPK FOR EACH WEAPON AT EACH CEP .....	125
D.	REQUIRED $P_D$ .....	125
LIST OF REFERENCES	.....	127
INITIAL DISTRIBUTION LIST	.....	129

THIS PAGE INTENTIONALLY LEFT BLANK

## LIST OF FIGURES

Figure 1	JSOW Dimensions (From TOPGUN MANUAL Chapter 33).....	15
Figure 2	JSOW A components (From TOPGUN MANUAL Chapter 33).....	16
Figure 3	BLU-97 bomblet (From TOPGUN MANUAL Chapter 33).....	17
Figure 4	BLU-108 Canister / Skeet (From TOPGUN MANUAL Chapter 33).....	17
Figure 5	SDB carriage system (From Conventional Strike Weapon Presentation Dec 2003).....	21
Figure 6	SDB in flight (From Conventional Strike Weapon Presentation Dec 2003)...	21
Figure 7	Average Number of Targets Targeted Per Weapon System, Scenario One ....	38
Figure 8	Average Cost Per Kill, Scenario One .....	38
Figure 9	Average Total Cost, Scenario One.....	39
Figure 10	Average Number of Targets Targeted Per Weapon System, Scenario Two....	41
Figure 11	Average Cost Per Kill, Scenario Two.....	42
Figure 12	Average Total Cost, Scenario Two.....	43
Figure 13	Optimum Mix of Weapons, Scenario Three .....	47
Figure 14	22m CEP Break-Even, Scenario Three.....	48
Figure 15	1.5m Break Even Aim Points, Scenario Three .....	49
Figure 16	4m aim point/weapon break-even point, Scenario Three .....	50

THIS PAGE INTENTIONALLY LEFT BLANK

## LIST OF TABLES

Table 1	Model Example 1 .....	33
Table 2	Model Example 2 .....	33
Table 3	Model Example 2a .....	35
Table 4	Model Example 2b .....	35
Table 5	Cost Per Kill Scenario1, Trial 1 .....	58
Table 6	Cost Per Kill Scenario1, Trial 2 .....	58
Table 7	Cost Per Kill Scenario1, Trial 3 .....	58
Table 8	Cost Per Kill Scenario1, Trial 4 .....	58
Table 9	Total Cost of Optimum Mix Per Trial 1 and 2 at Each CEP: .....	59
Table 10	Total Cost of Optimum Mix Per Trial 3 and 4 at Each CEP: .....	59
Table 11	Cost Per Kill Scenario 2, Trial 1 .....	86
Table 12	Cost Per Kill Scenario 2, Trial 2 .....	86
Table 13	Cost Per Kill Scenario 2, Trial 3 .....	86
Table 14	Cost Per Kill Scenario 2, Trial 4 .....	86
Table 15	Total Cost of Optimum Mix Per Trial 1 and 2 at Each CEP: .....	87
Table 16	Total Cost of Optimum Mix Per Trial 3 and 4 at Each CEP: .....	87
Table 17	Scenario 3, Trial 1: SDB at 1.5m .....	113
Table 18	Scenario 3, Trial 2: SDB at 3m .....	113
Table 19	Scenario 3, Trial 3: SDB at 5m .....	114
Table 20	Scenario 3, Trial 4: SDB at 8m .....	114
Table 21	Scenario 3, Trial 5: SDB at 13m .....	114
Table 22	Scenario 3, Trial 6: SDB at 22m .....	114
Table 23	SDB @ 1.5m Accuracy in conjunction with JSOW A & JSOW C .....	121
Table 24	JSOW A+ in conjunction with JSOW A & JSOW C .....	122
Table 25	SDB @ 4m Accuracy in conjunction with JSOW A & JSOW C .....	123
Table 26	JSOW A+ in conjunction with JSOW A & JSOW C .....	124

THIS PAGE INTENTIONALLY LEFT BLANK



## EXECUTIVE SUMMARY

Scenarios One and Two demonstrated that the average cost per kill of the SDB was significantly less than that of the JSOW A+ if the accuracies of the weapons compared to their combat effectiveness were averaged. In Scenario One, considering only one aim point per target, the cost per kill of the SDB was an average of 50.7% less than the JSOW A+ when looking at each weapon individually. Also, the total cost to kill the target set was 60% less when the SDB was included with the JSOW A and JSOW C. When the SDB was used instead of the JSOW A+, the total cost to kill the target set was reduced by 51%. In Scenario Two, considering all aim points within the target set, the cost per target kill when the SDB was utilized was an average of 50.7% less than the JSOW A+. The subsequent cost to kill the entire target set when utilizing the SDB was reduced by 63% compared to the utilization of just the JSOW A and JSOW C. Also, the total cost to kill the target set when the SDB replaced the JSOW A+ was reduced by 49%.

This information lends insight to the relative destructive capabilities of the weapons but does not speak directly to the realistic combat effectiveness experienced when total system accuracies are included and compared specifically. Therefore, we investigated several “break-even” points.

The system accuracy, or CEP, break-even point was investigated to determine if there was a SDB total system accuracy at which the SDB is never considered the most cost-effective weapon system in comparison to the JSOW A+ at its specification CEP. With accuracies of 22m, the SDB was still selected as a cost effective weapon for approximately 33% of the target set. The point at which the JSOW A+ entirely replaces the SDB as the cost-effective was not discovered because it lies above the 22m-accuracy level and that data is not available. As the accuracies of the SDB improve to approximately 11.5m or better, the SDB entirely replaces the JSOW A+ as the most cost effective weapon.

The second break-even point discussed was the weapon quantity break-even point. This point identified the number of number of weapons at which the SDB is the most cost effective weapon of choice 100% of the time. With SDB accuracies of 4m, we

observed that the weapon break-even point was approximately 1,662 weapons. This equated to approximately 6.1% of the target set. With SDB accuracies of 1.5m, the weapon break-even point was approximately 1,641 weapons or 6% of the target set. Each of these break-even points represents the point at which either the SDB or the JSOW A+ becomes the most cost effective weapon. The conclusion being that if approximately 1,700 or more SDBs were purchased and employed against this target set with SDB accuracies of 4m or less then it would be more cost effective to utilize the SDB.

Overall, we conclude that there are a myriad of possible combinations of weapons that can cost effectively prosecute our given target set. Each possibility is greatly influenced by the number of aim points, the cost of each weapon, associated integration and support costs, and the accuracies inherent to each system. With this in mind, our research demonstrated that the SDB was selected as the most cost effective weapon an overwhelming majority of the time when compared to the JSOW A+. However, there were instances where the JSOW A+ was selected as the most cost effective weapon and, no matter how seldom this occurred, the situations that dictated this course of action must be considered when making decisions on which weapon is best for Naval aviation.

## I. INTRODUCTION

In 1986, the Navy started a program called the Advanced Interdiction Weapon System (AIWS). This program was designed to develop a new precision guided standoff weapon system to replace the current laser guided weapons like the Paveway series guided bombs and the AGM-65E Maverick. In June of 1992, Texas Instruments, now Raytheon, won the AIWS competition for the AGM-154A. That same year, the AIWS program was combined with the Air Force standoff program and the Joint Standoff Weapon (JSOW) program was formed.

Since Initial Operational Capability (IOC) was reached in 1999, the JSOW has been used by the F-16, F/A-18, B-2, B-1 and B-52 aircraft, and used in Operation Southern Watch, NATO Operation Allied Force, Operation Enduring Freedom, and Operation Iraqi Freedom. With a proven record in combat situations, the standoff weapon technology is a valuable asset to the United States (U.S.) arsenal of weapons. As with all the military weapon systems of today, given that current conflict scenarios and modern battlefields are moving into a more urban environment, more precision is needed to help minimize collateral damage and increase weapons effectiveness. As well, there is an ever-increasing requirement for all government military programs to get the most out of every funding dollar. In order to meet these ever changing requirements, weapon systems have to evolve and change with the times.

To meet this changing environment, the Air Force has started to develop a new miniature munitions (MM) program. This program is being developed to provide an increased number of kills per pass, improve combat effectiveness in adverse weather, minimize collateral damage, enhance weapon standoff ranges, and reduce logistic footprints and aircraft generation times. The MM has two components. The first component is the Small Diameter Bomb (SDB), which is a smaller conventional bomb with a 250 lb warhead. The SDB is currently to be developed in two increments. Increment I consists of an all-up-round designed to give standoff capability against stationary and fixed targets, while Increment II consists of an all-up-round designed to give standoff capability against moving targets. An all-up-round is defined as being a

complete weapon, from the bomb body to the bomb warhead and all the components that make up the weapon. The other component of the MM program is the SDB carriage system. This carriage system is being designed to carry four combat capable SDBs per available station.

The Navy, seeing the need for a weapon such as the SDB, has developed the concept of the JSOW A+. The JSOW A+ is being developed as the Navy's answer to the SDB Increment I using current JSOW A technology. Realizing the benefits of the SDB, the Navy has committed to develop the SDB Increment II, in conjunction with the Air Force, by authorizing funding to aid the Air Force in Increment II testing and development. With funding tight for all new programs and the SDB Increment I already being funded, the Joint Requirements Oversight Council (JROC) and the Defense Acquisition Board (DAB), will need substantial evidence proving that the Navy and Department of Defense will benefit from the JSOW A+ program.

Our goal, at the request of Naval Air Systems Command, Conventional Strike Weapons Program Office (PMA-201), was to conduct an independent cost effectiveness analysis, examining the cost of implementing and fielding the JSOW A+ Navy variant versus the Air Force SDB Increment I. This study was conducted to aid PMA-201 in their decision as to whether or not they should peruse the development of the JSOW A+.

In conducting this analysis, we will compare the "cost per kill" of each weapon system against a realistic target set PR05-Non Nuclear Ordnance Requirements (NNOR). The target set consists of over 100 different targets, but was reduced down by PMA-201 to a representative set of twenty-six targets. Due to limitations encountered during our study we were forced to selectively remove 9 targets from the original twenty-six-target subset, leaving us with a target set consisting of seventeen representative targets. This target set was chosen because it represents the type of targets being used by the SDB and JSOW program offices during initial system testing. The PR05 target set is accepted as the primary representative sample of targets that would be engaged in a South East Asia Area of Operation. Once the "cost per kill" data has been collected, we will determine the optimum mix of weapons for each weapon system that will minimize cost and maximize combat capability for that same target set. To conduct this analysis, techniques

for Cost Effectiveness Analysis (CEA) described in Chapter 17 of Cost-Benefit Analysis, Concepts and Practice<sup>1</sup>, were used through the construction of a CEA model using Microsoft Excel.

This MBA project report is divided into five chapters. The first chapter consists of this introduction; the next chapter is a literature review of all of the major resources used in developing this report. Chapter III gives background information on the JSOW family, SDB, target selection, and an analytical framework as well as the acquisition strategy for both weapon systems. Chapter IV contains the CEA along with a sensitivity analysis of the final results. Chapter V is our final conclusions and recommendation as to which weapon system has proven to be more cost effective.

THIS PAGE INTENTIONALLY LEFT BLANK

## **II. LITERATURE REVIEW**

### **A. MILITARY REFERENCES**

#### **1. Cost/Benefit of Integrating JSOW A+ into the JSOW Inventory**

This reference was a PowerPoint presentation prepared in April 2004 by the Naval Air Systems Command, China Lake, California. The presentation highlighted the cost-effectiveness of incorporating the JSOW A+ into the JSOW inventory. The presentation stated that the JSOW A+ was less expensive, yet nearly equally as effective as the current family of JSOW weapons. In fact, the presentation listed JSOW A+ as the weapon-of-choice for greater than 70% of the target set when compared to the existing family of JSOW weapons. The presentation concluded by asserting that adding the JSOW A+ to the JSOW mix of weapons would indeed enhance overall performance.

#### **2. Program Executive Officer Review, Small Diameter Bomb**

This reference was a PowerPoint presentation prepared in March 2004 by the Small Diameter Bomb Program Manager at Eglin Air Force Base in Florida. It provided an overview of the program, and included the current financial status of the program; integration issues; and notional configuration of the second increment of the SDB. The presentation also provided some detail regarding the status of the Accuracy Support Infrastructure as it relates to the SDB.

#### **3. Conventional Strike Weapon Comparison**

This reference was a PowerPoint presentation prepared in December 2003 by the Naval Air Systems Command, China Lake, California. This presentation compared the basic capabilities and costs of conventional strike weapon options to support planning for the Navy's SDB acquisition decision. Among the weapon systems compared were JSOW A, JSOW A+, JSOW C and SDB. As part of the comparison, extensive lethality

data was provided. The presentation also noted the cost savings associated with using the SDB, and attributed this savings to the reduced number of sorties required to deliver the weapon.

#### **4. TOPGUN Manual**

The TOPGUN manual contains in-depth information on virtually all aspects of strike-fighter weapons and employment. It is the source document for strike-fighter tactics for the United States Navy and the United States Marine Corps.

Chapter 33 of the TOPGUN Manual, pages 21-44, is the chapter that contains information on the JSOW. This chapter gives a general description of the JSOW then goes into a more detailed description of the hardware associated with the weapon system, the different variants of the JSOW family, the different munitions associated with each weapon variant, target planning associated with each weapon variant, and any employment considerations that govern weapons delivery.

This manual is a key source of information for all Navy and Marine aviators when learning about and learning how to employ the JSOW family of weapons.

#### **5. Small Diameter Bomb (*A Miniature Munitions Capability*) Command, Control, Communications, Computers, and Intelligence (C4I) Support Plan**

The C4ISP is an Air Force acquisition document, which was written during the system development phase of the Small Diameter Bomb (SDB) by Program Manager, Colonel James R. McClendon, Lethal Strike Joint Program Office. This document identifies the C4ISPs, including: operational, system, and technical architectures; intelligence, connectivity, and interoperability requirements; and communications and information manpower and training shortfalls and solutions associated with the SDB.

This manual is divided into five major sections that describe the Small Diameter Bomb and any relevant issues. Section one, Introduction, describes the authority and purpose of the SDB and the C4ISP. Section two, System Description, provides a pre-milestone B description of the Small Diameter Bomb. Section three, Operational



Employment, sets the stage for defining the support requirements by describing the overall operational environment in which the SDB will be used. Section four, Derived C2 and ISR Support Requirements, describes the strategy-to-task methodology used to derive the C2 and ISR requirements. Section five, Potential C4I Support Shortfalls and Proposed Solutions, identifies potential C2 and ISR shortfalls and possible solutions.

## **6. Operational Requirements Document for Miniature Munitions and Carriage System**

The Operational Requirement Document (ORD) for the Miniature Munitions and Carriage System helped to lay the foundation for why the Small Diameter Bomb (SDB) was being developed. This document discussed the requirements, the specific mission areas, the different planned phases, the threat specifics, the required capabilities, and the scheduling considerations related to the Miniature Munitions program. The document also helped to highlight any existing system and C4I architecture shortcomings. This document was vitally important for the research team to understand the Miniature Munitions (SDB) and Carriage System program.

## **7. Joint Operational Requirements Document for Joint Standoff Weapon (JSOW) System**

The Operational Requirements Document (ORD) for the Joint Standoff Weapon (JSOW) System defined the requirements for each JSOW variant (A, B, and C). This document described the components involved with each variant and provided a foundation for the type of target each variant would be used against. The document also described the mission needs statement, the current capabilities, the shortcomings of the existing systems and C4ISR architectures, and the key performance parameters associated with the JSOW family of weapons. This document proved to be instrumental in helping the research team understand the current family of JSOW weapons within the United States arsenal, and motivating the need to develop the JSOW A+.

## **B. OTHER REFERENCES**

### **1. Cost-Effectiveness, A Primer**

This reference helped establish an analytical framework, and identifying the problem and alternatives. This reference provided useful insight into the appropriateness of various methods of evaluation and analysis. For example, in situations where alternative benefits can be expressed in terms of cost, the cost-benefit analysis is the most useful approach to determining courses of action. Other circumstances, however, might dictate a different approach, such as when costs cannot (or should not) be assigned to various outcomes. In such cases, a cost-effectiveness analysis is appropriate. In all, four related, but different, forms of analysis were introduced and discussed.

### **2. Cost-Effectiveness Analysis, New Approaches in Decision-Making**

This reference provided additional background information pertaining to the cost-effectiveness analytical framework. Specifically, it made clear the scope of cost-effectiveness analyses and discussed common problems and limitations. Finally, this reference conveyed the relevance of this type of analysis (i.e., cost-effectiveness analysis) to the subject of our study (a comparison of one weapon system versus another).

### **3. Cost-Benefit Analysis, Concepts and Practice**

This reference was particularly useful in its discussion of cost-effectiveness ratios and technical efficiency. This reference also provided additional background information that assisted us in selecting an analytical framework.

### **III. BACKGROUND**

#### **A. ANALYTICAL FRAMEWORKS**

Cost analysis is a fundamental component of decision-making among alternatives. If this was not true, and budgets were unlimited, selection of the best alternative in any given situation would merely involve the option that delivered the most capability. This not being the case within the government, an approach that quantifies benefits in relation to costs is necessary. Therefore, the government utilizes an entire array of different, but related cost-analysis approaches in evaluation and decision-making. The different analytical frameworks include cost-feasibility, cost-utility, cost-benefit and cost-effectiveness analyses. Each is characterized by important differences that make it appropriate to specific applications. The purpose of this next section will be to introduce each analytical framework, to describe and illustrate differences, and finally to discuss each method's applicability to the cost analysis performed as part of this study.

##### **1. Cost-Feasibility Analysis**

The first cost analysis method used is also the simplest form of analysis. Cost-feasibility analysis refers to the methodology of estimating only the costs of an alternative in order to ascertain whether or not it can be considered<sup>2</sup>. In this manner, if the cost of any alternative exceeds resources available, no further consideration is warranted. To illustrate where this methodology might be useful, consider a situation in which the government is providing disaster relief in the form of financial grants to a particular community ravaged by natural disaster. If the grant amounted to \$1,000 per community citizen, and a decision was being sought as to what material to buy to repair damaged housing, only those options that cost \$1,000 or less could realistically be considered. That is, building material exceeding the \$1,000 per community citizen (assuming no personal funds were being used to offset differences) would be infeasible solutions.

This methodology is not particularly well suited to the data comprising our study because, as with most Department of Defense procurements, tradeoffs are involved, such

that a more costly option can realistically be pursued if it is deemed important enough (albeit at the cost of a lesser important project). Furthermore, it would be decidedly inappropriate to say, for example, that the government should not consider a particular alternative simply because it exceeded a certain dollar threshold. Such limited thinking would effectively stymie the robust and innovative culture needed to produce advanced weaponry.

## **2. Cost-Utility Analysis**

The next cost analysis method is cost-utility analysis, which refers to the evaluation of alternatives by comparing costs and the estimated utility or value of their outcomes<sup>3</sup>. Situations lacking quantitative data and relying instead on subjective evaluations of utility and the probability of alternative solutions are appropriate situations in which to use cost-utility analysis.

One drawback to this type of analysis is its highly subjective nature. Since analysis is based on qualitative techniques, interpretation varies according to how each decision-maker assigns utilities and probabilities. If, for example, one decision maker is particularly well versed in one proposed solution, and not as well versed in another, bias may be introduced into the decision making process. To alleviate this problem, it might be possible to get a more representative panel of users or experts to set both subjective probabilities and the values of those outcomes. But doing so presents its own problems, such as the difficulties encountered when taking the utility assessments of individuals and aggregating them to obtain a “social utility” approach<sup>4</sup>.

Accordingly, cost-utility analysis is best left to situations where data are less stringent, and where supporting information is less precise. Since our data are derived from (reasonably) precise weapons system testing and cost information, the cost-utility analysis is not particularly efficacious.

## **3. Cost-Benefit Analysis**

A third analytical framework to aid decision makers is cost-benefit analysis. In broad terms, cost-benefit analysis compares alternatives’ costs and benefits, when each is

measured in monetary terms. Since each alternative is assessed in terms of its benefits, each alternative can be examined on its own merits to see if it is worthwhile. To be considered for selection, an alternative must show benefits in relationship to costs. To be selected from among alternatives, a particular alternative must demonstrate relative superiority in terms of its ratio of costs to benefits, or benefits to costs. In the former, a lower number is better; in the latter, a higher number is better.

The ability to judge whether an alternative is worthwhile (where benefits equal or exceed costs) is indeed a useful property of cost-benefit analysis, and makes it unique in that regard. Comparatively speaking, none of the other analytical frameworks introduced thus far enable the decision maker to reach such a determination. Furthermore, cost-benefit analysis enables a rank order comparison among alternatives. Cost-utility analysis also enables such an ordering, but is justifiable only to the extent of the analyst's judgment since interpretation of qualitative data tends to be more subjective.

In the context of our study, however, cost-benefit analysis will not work, since the data are not expressed entirely in pecuniary terms. Rather, our data is comprised of two different metrics, namely, cost and effectiveness. As is often the case, it is not possible to assess benefits in monetary terms, for this would mean assigning a monetary value to the weapon system's single shot probability of kill.

#### **4. Cost Effectiveness Analysis**

The final analytical framework is also the one selected for our study. Cost-effectiveness analysis evaluates alternatives according to both their costs and their effects with regard to producing some outcome or set of outcomes<sup>5</sup>. Cost-effectiveness analysis is appropriate when it is neither possible, nor desirable, to convert each decision-making variable to monetary terms. In our study, for example, it would be difficult (and inappropriate) to reduce the effectiveness of each weapon system being considered to a monetary value. Practically speaking, that would require assigning a dollar figure to the single shot probability of kill of each weapon system being considered, a tricky problem tantamount to assigning a dollar figure to lives saved or tons of air pollutants eliminated.

Fortunately, cost-effectiveness analysis obviates the need for such a move by comparing ratios. Essentially, one can derive two versions of the same story, depending on which cost-effectiveness ratio is selected. The first ratio is a measure of technical efficiency, and describes alternatives in terms of the amount of effectiveness achieved per unit of cost. Since our study involved different weapon systems, our effectiveness measure was the single shot probability of kill, or SSPk for each weapon system. And, since our study involved the effectiveness of different weapon systems against multiple target types, the effectiveness measure for each weapons system varied according to target type. Therefore, for each target type, cost-effectiveness was computed using the following formula:

$$CE_i = C_i / E_i$$

where  $C_i$  is the cost of each alternative weapon system  $i$ , and  $E_i$  is the effectiveness against each alternative target type  $i$

Accordingly, this information, allows us to rank alternatives in terms of their cost-effectiveness. In the context of our study, that means ranking the most cost-effective alternative (smallest cost-effectiveness ratio) as the best alternative, since it gives the user the most bang for the buck. Cost-effectiveness analysis yields useful information in terms of the relative efficiency of alternatives. Programs that cost less per unit of SSPk are comparatively more efficient.

Another ratio useful for comparing of alternatives is the effectiveness-cost ratio, computed using the following formula:

$$EC_i = E_i / C_i$$

Where  $E_i$  is the effectiveness against each alternative target type  $i$ , and  $C_i$  is the cost of each alternative weapon system  $i$

The information thus derived is useful in drawing conclusions about the average effectiveness per unit of cost.

## B. JOINT STAND-OFF WEAPON (JSOW) FAMILY OF WEAPONS

The JSOW family of weapons is an INS/GPS glide weapon designed for standoff attacks against a wide variety of targets. The JSOW bomb body is designed to accommodate different payloads, allowing the JSOW to be adapted to specific target types. Currently there are three variants of the JSOW: The JSOW A that dispenses 145 BLU-97 B/B combined effects bomblets; the JSOW B that dispenses six BLU-108/B sensor fuzed weapons (SFW) canisters, each with four IR sensing skeet warheads; the JSOW C has a unitary BROACH 500-lb warhead. Launch platforms for the weapons are as follows: The JSOW A platforms include the United States Navy (USN) F/A-18, the United States Air Force (USAF) F-16, B-2A, B-52H and the United States Marine Corps (USMC) F/A-18 and potentially the AV-8B; the JSOW B platforms include the USN F/A-18, the USAF F-16, B-52, B-1, and potentially the F-15E, and the USMC F/A-18 and potentially the AV-8B; the JSOW C platform includes only the USN F/A-18.

“The basic weapon consists of an aerodynamically efficient airframe with folding wings and non-folding fixed and movable tail surfaces”<sup>6</sup>. The JSOW has a length of 160 inches and a wingspan of 106 inches when fully deployed as seen in Figure 1. A fully assembled weapon weighs approximately 1,065 pounds.

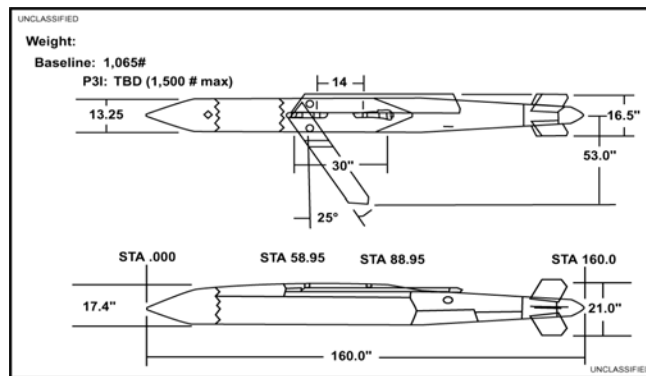

Figure 1 JSOW Dimensions (From TOPGUN MANUAL Chapter 33)

All JSOW weapons were designed to provide a standoff launch capability of greater than 40 nm at high altitudes and greater than 15 nm at low altitudes. The type of target will determine the variant that is used.

## 1. JSOW A (AGM-154A) Description

The JSOW A (baseline), as shown in Figure 2, is the fundamental platform that is used by all JSOW variants.

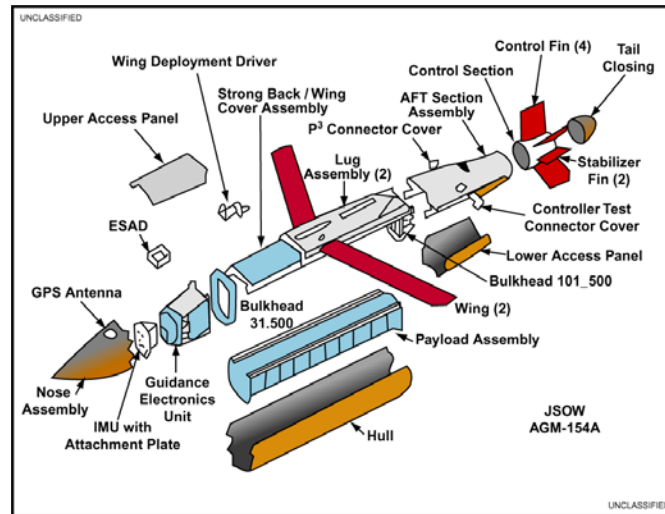

Figure 2 JSOW A components (From TOPGUN MANUAL Chapter 33)

The payload for the JSOW A is 145 BLU-97 bomblets. The BLU-97 is a six and a half inch long by two and a half inch wide diameter submunition that weighs about three and a half pounds. The BLU-97 has a shaped charge for direct blast effects and a zirconium ring for incendiary effects. The normal blast footprint for the BLU-97 bomblets is 248 ft x 137 ft. A depiction of the BLU-97 can be seen in Figure 3. The JSOW A variant is primarily used as a firepower or mobility kill against armored type targets.



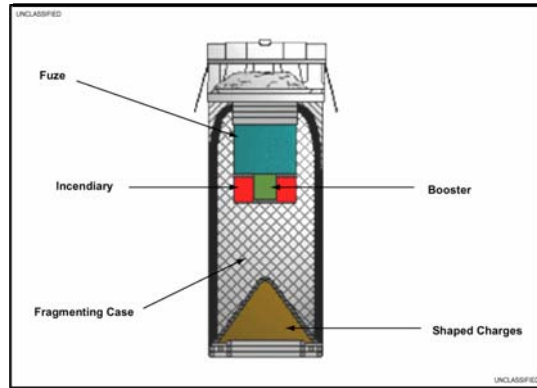

Figure 3 BLU-97 bomblet (From TOPGUN MANUAL Chapter 33)

## 2. JSOW B (AGM-154B) Description

The JSOW B smart, wide area coverage munition, shares the common airframe with the JSOW A. The payload for the JSOW B is six internally held BLU-108 canisters. Attached to each canister there are four IR sensing skeet. Figure 4 shows the BLU-108 canister and its associated skeet. When employed the six BLU-108 canisters are dispensed consecutively in one string.

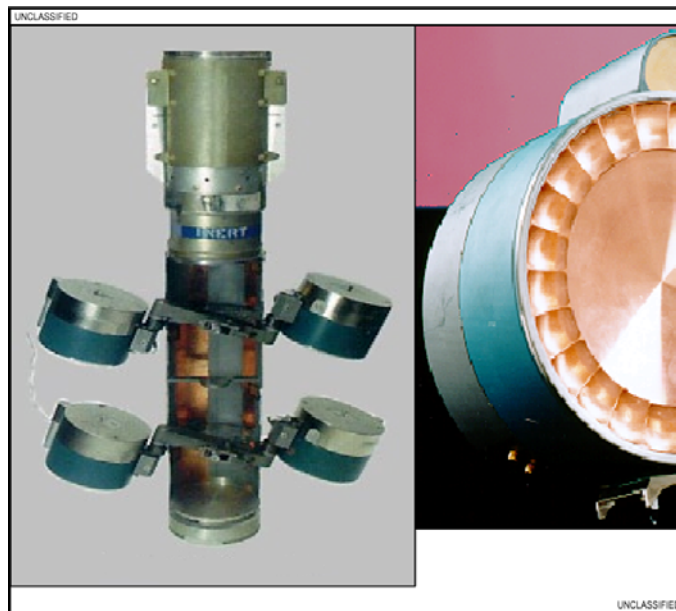

Figure 4 BLU-108 Canister/Skeet (From TOPGUN MANUAL Chapter 33)

Once dispensed, each canister fires a solid propellant rocket motor causing the canister to climb. At the apex of the canister's climb, four skeet per canister are ejected. Once ejected the skeet start looking to detect IR energy. When an IR energy source is detected the skeet fire a liquid metal projectile conducting a top-down attack. The BLU-108 footprint is approximately 1,600 ft x 800 ft. The JSOW B variant is primarily used as a multiple kill weapon against land combat armored vehicle targets.

### **3. JSOW C (AGM-154C) Description**

The JSOW C uses the baseline JSOW A body and incorporates a mid-wavelength IR seeker. The JSOW C was originally proposed as a 500 lb unitary warhead. Since its inception, a BROACH warhead has been developed giving the weapon a penetration capability of 4 –5 ft through 2,000-psi reinforced concrete.

The weapon uses a single plane IR seeker during the guidance phase of launch. An IR template is downloaded from the aircraft during the targeting flight phase, prior to weapon release. During the terminal flight phase, the weapon matches the IR picture it receives and compares it to the downloaded image. If the match is made, the weapon guides to the specific aim point; if a match is not made, the weapon will simply guide using GPS data only.

### **4. JSOW A+ Description**

The JSOW A+ is a conceptual weapon system developed by the JSOW program office at Naval Air Systems Command (NAVAIR), Conventional Strike Weapons Program Office in Patuxent River, Maryland. Seeing the need for a weapon with the SDB capabilities that will fill the future needs of the combatant commander, NAVAIR developed the concept for the JSOW A+.

The JSOW A+ will replace all of the existing Navy JSOW family of weapons, with the exception of the JSOW C variant. The JSOW A+ will use the existing JSOW A bomb body and components, as seen in Figures 1 and 2, the only difference being that the JSOW BLU-97 warhead will be replaced with the BLU-11 warhead. The BLU-11 is a

500 lb general-purpose warhead that is currently being used in all MK-82 series bombs. The guidance system of the JSOW A+ will be the GPS/INS stabilized system that is currently being used in the JSOW A variant.

The concept of the JSOW A+ takes existing proven technology, which is already integrated into the Navy's arsenal of aircraft, with off-the-shelf items, the BLU-111 warhead, and produces a replacement for the SDB Increment I. Essentially, the JSOW A+ will accomplish the same results as the SDB Increment I, which is to engage fixed and stationary targets from a standoff distance, using an already proven weapon system. By using the JSOW A+, the Navy believes it will achieve significant cost savings by eliminating integration and significant research and development costs. The Navy also sees the JSOW A+ as a weapon system that can be developed right now and fielded without delay. The Navy also sees benefits in developing the SDB weapon system and is currently allocating funds to aid the Air Force in developing the SDB Increment II weapon system.

### **C. SMALL DIAMATER BOMB**

In October 1997, the USAF identified a number of war fighting needs that could be addressed by a miniature munitions (MM) weapon system<sup>7</sup>. These needs included: increasing the number of kills per pass; improving combat effectiveness in adverse weather; minimizing collateral damage; achieving battlefield effects against targets covered, concealed, hardened, or moving; providing autonomous target attack; enhancing weapon standoff range; providing weapon penetration capability; reducing logistic footprints and aircraft generation times<sup>8</sup>. The Small Diameter Bomb (SDB), along with the smart multiple ejector rack, are the two components that comprise the USAF's MM weapons system program.

The initial SDB phase (Increment I) consists of an all-up round (AUR) munition and carriage system that provides fighter and bomber aircraft with a standoff attack capability against fixed and stationary targets<sup>9</sup>. The weapon system will provide a day/night, adverse weather, and standoff capability to be used against fixed and stationary

targets using target coordinates. It is during this initial phase that the carriage system will be developed.

The SDB follow-on phase (Increment II) will possess all the attributes of the initial weapon (effective, day/night, adverse weather, standoff capability), but will have the capability to attack moving targets across the future combat arena, from open desert to urban terrain.

The proposed launch aircraft are the F-15E, F/A-22, F-35, UCAV, F-16, F-117, A-10, MQ-9, B-1, B-2, and B-52. The threshold aircraft, threshold meaning the developmental host platform, is to be the F-15E. All other aircraft are labeled as objective aircraft, meaning that the weapon must still be integrated into the platform when funded.

### **1. Smart Carriage System**

The SDB smart carriage system will provide the power, control, and digital data multiplexing required to carry the SDB on one MIL-STD-1760 weapon station. The carriage system will be designed to accommodate four SDBs, increasing the weapon load out per aircraft. This aspect of the MM program is crucial to provide an enhanced combat capability per aircraft. The carriage system will be designed to carry SDB weapons and will be common across all threshold and objective launch platforms<sup>10</sup>.

The miniature munitions stores interface (MMSI) between the carriage system and SDB weapons will enable the aircrew to accomplish individual targeting, fuze programming, and gather weapon status data for each munition loaded on an aircraft. Additionally, the MMSI will initialize weapons release and support weapon mission software reprogramming. The carriage system will safely release SDBs individually or in multiple pairs against one or more targets. Figure 5 shows the SDB carriage system attached to a MIL-STD 1760 weapons station of an F-15E.



Figure 5 SDB carriage system (From Conventional Strike Weapon Presentation Dec 2003)

## 2. The Weapon

The SDB weapon is a GPS-aided INS guided glide munition. The SDB has wing and fin control surfaces, which deploy and help guide the weapon to target impact upon weapon release. The warhead is a 250 lb unitary warhead designed to reduce collateral damage. Figure 6 is a conceptual depiction of the SDB weapon with wings deployed.



Figure 6 SDB in flight (From Conventional Strike Weapon Presentation Dec 2003)

The SDB could be launched from 15,000 feet above ground level (AGL) up to 50,000 feet mean sea level (MSL)<sup>11</sup>. As previously mentioned, the initial phase weapon can be launched at fixed and stationary targets in day/night, adverse weather conditions to include ceilings as low as zero feet AGL, forward visibility as low as zero nautical miles, and surface winds up to 30 knots.

### **3. System Development**

Increment I of the SDB program is currently in the System Development and Demonstration phase of the acquisition cycle. Increment II research has been significantly reduced, with delays being encountered in Aug 2003 due to recent funding issues within the Technology Demonstration phase.

### **4. Accuracy Support Infrastructure (ASI)**

Of particular interest to this system is the fact that there has to be a system fielded in the operation area that “enhances” the GPS data. The system consists of ground-based sensors and communication equipment that transmits and communicates corrected GPS data to the releasing aircraft or to the munition itself after release. This is currently the only way that the SDB system will be able to achieve its intended delivery accuracy. Without the ASI the accuracy is expected to be on the order of 4 meters. At the time of this report, the necessary ASI equipment is expected to cost approximately \$700,000 per operating area.

## **D. TARGETING, TARGET SET, AND WEAPONING**

### **1. Targeting**

The targeting process is an analytical, systematic approach that focuses targeting efforts on supporting operational planning and facilitates force employment. Targeting recommends the best means to attain a goal. Ideally it integrates intelligence information about the threat, the target system, and target characteristics with operations data on friendly force posture, capabilities, weapons effects, objectives, rules of engagement, and

doctrine. Targeting matches objectives and guidance with inputs from intelligence and operations to identify the forces necessary to achieve the objectives<sup>12</sup>.

As we embarked upon this study, we had to limit the depth with which targeting, as defined above, was analyzed by relying on previously generated targeting information. This information allowed for the construction of a viable and realistic target set through which we were able to perform our research. Also, one of the main limitations and artificial boundaries set within this report was the fact that weapons cost and munitions effectiveness were the only variables utilized in determining a weapon's use in a tactical scenario. Different results might be achieved if other considerations were taken into account while determining and solidifying our target set.

## **2. Target Set**

The original target set utilized in this study was a relevant sample, or subset, of targets derived from the PR05-Non Nuclear Ordnance Requirements (NNOR) document. The NNOR document prescribes the Navy's requirement for conventional ordnance and reflects the full requirement for meeting Defense Planning Guidance scenarios; it is the basis for ordnance procurement programs<sup>13</sup>. The requirement for conventional ordnance is established as the sum of combat and non-combat requirements<sup>14</sup>. Combat requirements for those weapons included in the NNOR process are computed annually by the Director, Naval Warfare Analysis, Assessment and Force Level Plans Division, based upon inputs from the Navy and Marine Corps Headquarters and field staffs. The non-combat expenditure requirements process, under the direction of the Tactical Readiness Division, computes non-combat requirements.

The PR05-NNOR target set consists of over 100 different targets. The overall target set utilized for testing was originally reduced to a representative set of twenty-six targets. This target set is accepted as the primary representative sample of targets that would be engaged by the weapons studied here in a South East Asia Area of Operation. The original target subset incorporated the total number of aim points associated with each target, i.e. a target could be a tank and within the area of operations where it has been assessed that there are 400 tanks. The term "target" used in this study can refer to

400 tanks in this case or only a single tank. The aim points depend on the scenario in which the target is being included. The targets are also consistent with those used by both the SDB and JSOW program offices during initial system testing. The different target samples include single point targets, area targets, maritime targets, hardened structures, buildings, and bridges. Further discussion concerning this follows in the description of the scenarios and trials.

Due to limitations encountered during our study, we were forced to selectively remove nine targets from the original twenty-six-target subset, leaving a set consisting of seventeen representative targets and associated aim points. Applicable weapons effectiveness data against the nine removed targets was not available. The subsequent calculation of the cost per kill for each weapon system, optimum mix and total target set costs without this data provide partial and preliminary results. Throughout this study, all calculations were performed using the seventeen representative targets. We will henceforth refer to the seventeen targets as our target set.

The methodology used for evaluating the effectiveness of each weapon system was to compare the prescribed required NNOR probability of destruction (Pd) for each target and each weapon's single shot probability of kill (SSPk).

### **3. Weaponeering**

Weaponeering is the process of estimating the quantity of a specific type weapon required to achieve a specific level of damage to a given target, considering target vulnerability, weapon effects, munition delivery errors, damage criteria, probability of kill, weapon reliability, etc<sup>15</sup>. This process supports our premises and methodology of using a cost-effectiveness analysis to compare the SDB and JSOW A+.

#### ***a. Error Budget Concept***

Total system accuracy may be viewed as an "error budget" when considering how each source contributes to the total system error. Conceptually, the Circular Error Probability, or CEP (defined later) "error budget" is a set of systematically defined error sources, each of which contributes some identifiable portion to total system



inaccuracy<sup>16</sup>. The SSPK at each specific CEP for each individual weapon utilizes this “error budget” concept and reflects the effectiveness of the system with the overall stated system accuracy.

## **E. ACQUISITION LIFECYCLES**

### **1. JSOW A**

JSOW A is a Navy-led joint Navy/Air Force program. Raytheon Systems, of Tucson, Arizona, was awarded the initial JSOW A contract in June 1992. The JSOW baseline variant (JASO A) completed engineering, manufacturing and development testing, including initial operational testing, with a success rate of 91.3% (52 of 57) in July 1997. Full rate production commenced in the first quarter of fiscal year 1999, and initial operational capability was achieved during the second quarter of fiscal year 1999. JSOW A is well into its production, fielding, deployment and operational support phase of its acquisition lifecycle.

No fiscal year 2001 production contract for the JSOW A was awarded to complete an engineering change proposal to the control section. In fiscal year 2002, the control section engineering change proposal successfully completed its critical design review, and production resumed. Since June 2002, four additional JSOW A production contracts have been awarded, divided evenly between the Navy and the Air Force (two in fiscal year 2003 and two in fiscal year 2004). There are two additional production contracts for the JSOW A planned for late in the first quarter of fiscal year 2005 (one each for the Navy and Air Force).

The JSOW A baseline variant (AGM-154A) has a total planned procurement inventory of 11,800 weapons. The Navy and Marine Corps have a planned inventory of 8,800 weapons, and the Air Force has a planned inventory of 3,000 weapons.

## **2. JSOW B**

The JSOW B development lagged slightly behind the JSOW A, and operational testing was not completed before 2001. The Air Force pulled out of the JSOW B program because it selected another weapon system as its future standoff anti-armor weapon (it chose the CBU-105/B Wind-Corrected Munitions Dispenser). The Navy, unable to afford the program on its own, subsequently dropped the JSOW B program (source: astronautix.com). Consequently, there are no Milestone III, Initial Operational Capability and/or Full Operational Capability dates planned for the JSOW B. However, JSOW B is still considered a contingency capability that the Department of the Navy may procure should it become a weapon of choice for future threats.

## **3. JSOW C**

JSOW C is completing the engineering, manufacturing and development stage of its acquisition lifecycle. JSOW C awarded its low rate initial production contract during the fourth quarter of fiscal year 2003. Operational test and live fire test and evaluation are scheduled to be completed during the fourth quarter of fiscal year 2004, with a Milestone III decision expected in the first quarter of fiscal year 2005. Full rate production begins in early fiscal year 2005. The Navy's planned inventory is 3,000 weapons.

## **4. SDB**

SDB (increment II) achieved Milestone A in the fourth quarter of fiscal year 2001. Increment II upgrades the capabilities inherent with the original SDB by giving it the capability to attack moving targets. Following Milestone A, two contractors were selected for the 24-month Component Advanced Development (CAD) phase using firm fixed price contracts. CAD tasks included monitoring the design definition for the SDB and carriage system, and a study to better define Navy and Marine Corps applications of the weapon system. Down selection was completed in the fourth quarter of fiscal year 2003, with Boeing receiving the final contract award. On October 17, 2003, the Under Secretary of Defense issued an Acquisition Decision Memorandum to the Secretaries of

the Air Force and Navy directing additional carrier suitability studies and risk reduction activity to ensure the SDB design does indeed satisfy unique Navy requirements. These studies, along with ongoing advanced development of the autonomous target recognition and seeker sub-systems, will take place during the risk reduction and technical development phase in fiscal years 2004 – 2006.

Milestone B is scheduled for the first quarter of fiscal year 2007. Following this is a 24-month System Development and Demonstration phase. Milestone C is currently scheduled for the end of fiscal year 2009, with full rate production 12 months thereafter.

THIS PAGE INTENTIONALLY LEFT BLANK

## IV. SCOPE AND METHODOLOGY

### A. OVERVIEW

#### 1. Objective

The best way to examine and analyze our proposed research questions is to construct a computer model.

#### 2. Research Questions

##### *a. Primary Research Question*

What is cost per kill of the JSOW A+ variant and the Small Diameter Bomb?

##### *b. Secondary Research Question*

What is the optimum mix of weapons that minimizes cost and maximizes effectiveness?

#### 3. Scenarios

We divided our research into several different scenarios. Each scenario had various trials associated with it. The first scenario focused on calculating the cost per kill relevant to a particular weapon system and a total cost to kill the target set once an optimum mix was calculated. These calculations were conducted with reference to our target set including only one aim point per target. This scenario did not include the “relevant costs” associated with incorporating the SDB into the arsenal (i.e., primarily the Accuracy Support Infrastructure). The trials conducted within the first scenario examined different combinations of weapons to gain insight on the baseline costs and optimum mixes among the weapon systems.

The second scenario also focused on calculating the cost per kill relevant to a particular weapon system once an optimum mix was calculated. The scenario included the SDB “relevant cost” figure and all aim points associated with each target. This was

done to identify how the cost per SDB unit, the cost per kill for each weapon, and the total cost to kill the target set were affected once the “relevant cost” figure was spread across the targets determined to be most cost effectively destroyed by the employment of SDB.

During the third Scenario, we wanted to determine the cost effectiveness of the SDB in relationship to the other weapons at their specification Circular Error Probabilities (CEPs). We utilized the model to generate this data and subsequently determined the break-even number of weapons at which point the JSOW A+ or the SDB would be considered the weapon of choice at different CEPs. This number corresponded to a percentage of the total target set and can be considered a break-even weapon quantity if taken in context with the limitations and specifics of each scenario. A major limitation during this study was that each target was considered equal in terms of relevance and importance. In actuality, the importance of each target will vary as a combat scenario changes.

Scenario three also generated two break-even CEP figures that identified the minimum total system accuracy, or CEPs, above which only the JSOW A+, compared to the SDB, would be selected as the most cost effective weapon. The model also determined a maximum total system accuracy CEP below which only the SDB was identified as the most cost effective weapon. While determining break-even points, it is important to note that each break-even point represents a cutoff where either the SDB or the JSOW A+ is selected, providing a figure that equates to having to chose one or the other weapon not both.

## **4. Model**

### ***a. Overview***

The model developed here was able to generate a cost per kill for each weapon system and then utilized that figure to compute an optimum mix of weapons. The computed optimum mix of weapons identifies the most cost effective means by which a given target set could be “killed”. A total cost to “kill” the given target set could

then be computed. Our methodology allowed us to examine different scenarios that contained different combinations of weapon systems and different quantities of aim points per target. This allowed us to compute different “break-even” points that ultimately determined the point at which the SDB became a viable cost effective weapon within the given scenario.

***b. Variables***

The model considered all the appropriate variables, including: cost per unit, the Probability of Kill ( $P_k$ ) of each specific weapon, the Probability of Destruction ( $P_d$ ) required for each specific aim-point, and a “relevant cost” variable that allows us to incorporate costs that will be incurred if the SDB weapon system is purchased and employed.

The  $P_d$  required to effectively “kill” a particular aim point reflects data provided by PMA-201 and is based on the Joint Munitions Effectiveness Manual (JMEM). The  $P_k$  figures, particular to 6 different and specific Circular Errors of Probability (CEP) utilized during this study, were derived either from actual performance data, in the case of the JSOW A and JSOW C weapons, or modeled based on comparable warhead performance in the case of the SDB and the JSOW A+.

The  $P_k$  figures determine the relevant combat effectiveness of each weapon at various CEPs, ranging from 1 meter to twenty-two meters. These CEP numbers represent the total system accuracy or “error budget” for a particular weapon. The figure derived and labeled the “cost per kill” in this study represents the dollar cost required to effectively “kill” a target, whether there is one or multiple aim points associated with the target.

The “relevant cost” estimate is an adjustable dollar amount that includes the costs associated with procuring the SDB weapon system and integrating it into the F/A-18 System Configuration Set (SCS). This figure also includes the procurement costs of other equipment required to deploy the SDB weapon system. This required equipment is primarily the Accuracy Support infrastructure (ASI) for the Differential Global Positioning System (Differential GPS) that allows the weapon to achieve the required

accuracies. It is therefore, for all intents and purposes, a subset of the SDB weapon system. Without this system, the SDB would not be a viable weapon because of its relatively smaller destructive capability and its failure to attain specific ORD requirements. The model does not consider the costs associated with such things as logistical efforts, training, inventory costs, or supportability costs.

*c. Model Logic*

Even though there are different scenarios and various trials, our model allows us to use the same methodology throughout the study. This was done to maintain a consistent baseline throughout. The model generated the number of each type weapon required to satisfy the “kill” criteria of the associated targets and aim points within the target set. The “kill” criterion is referred to as the  $P_d$  required to attain the desired results for each of the seventeen targets used in our model. During our study, as previously described, we maintained the same target set while changing the number of aim points associated with each target. In both scenarios the model was then able to determine how many weapons were required to “kill” the target, by comparing the effectiveness of each weapon, or the Single Shot Probability of Kill ( $SSP_k$ ), to the required destructive power to kill each aim point, ( $P_D$ ). This is calculated by utilizing the formula;

$$\ln(1 - \text{required } P_d) / \ln(1 - SSP_k).$$

If the estimated number of weapons required to destroy a target involves a fraction, the number is rounded up to a whole number. These calculations were conducted for each weapon and target associated with the given scenarios and trials.

(1) Example 1



Target	Pd Required	SSPk/Weapons Effectiveness "A"	SSPk/Weapons Effectiveness "B"	SSPk/Weapons Effectiveness "C"	# of "A" Weapons required	# of "B" Weapons required	# of "C" Weapons required
1	0.7	0.6	0.22	0.81	2	5	1
2	0.6	0.67	0.29	0.83	1	3	1
3	0.7	0.77	0.47	0.91	1	2	1
4	0.7	0.6	0.5	0.88	2	2	1

**Note:** One aim point associated with each target

Table 1 Model Example 1

Once we were able to determine the number of weapons required to destroy a target, as illustrated in Table 1, the model computed the cost incurred destroying each target and aim point with each particular weapon, Table 2. The model then selected the smallest dollar value for each target, whether there was one aim point or multiple aim points. The smallest dollar value identifies the weapon that costs the least and thus is referred to as the most cost effective weapon to "kill" the aim-point(s) and thus the target. This was computed for the entire target set within the different scenarios and an optimum weapons mix was generated for each.

(2) Example 2; Scenario 1

Weapon	Unit Cost	"Relevant Cost"	Number of weapons required based on $P_d$ and $SSP_k$			Cost \$ to Kill		
			Target # 1	Target # 2	Target #3	Target # 1	Target # 2	Target #3
			A	10	0	1	2	1
B	8	0	2	2	1	16	16	8
C	5	0	3	2	1	15	10	5

Table 2 Model Example 2

Table 2 is a simple example illustrating the logic contained within our model. We have assumed that the weapons required for each target have already been calculated using the method previously described. Given the total number of

weapons required, the model computes the total cost to kill each target by multiplying the total number of weapons needed and the unit cost of the weapon. Finally, the model selects the most cost-effective weapon (the least expensive weapon that meets or exceeds the effectiveness required to kill the target), and is able to derive an optimum mix of weapons against the target set, and its associated cost. The optimum mix to destroy the target set in this example is one A weapon, zero B weapons, and three C weapons. The total cost is twenty-five dollars, the sum of the highlighted figures in Table 2. There is no “relevant cost” figure utilized in this example. The first scenario is based on this methodology, with the number of weapons required to destroy each target being derived from the combat effectiveness of each weapon at various CEPs and the required  $P_d$ . Notice that weapon B was never selected. This aptly demonstrates conditions found to be true when using actual data; certain weapons were never included in the optimal mix due to their relatively inferior cost effectiveness.

Using the logic described above, we modeled scenario one using zero relevant costs and only one aim point from each of the 17 targets. In scenario two, however, we included all of the SDB relevant costs and all of the aim points for each of the 17 targets. The optimum mix was computed utilizing the same methodology and once this figure was determined we included the “relevant costs” figure. The addition of this figure increased the total weapon costs, the cost per unit, and the total costs incurred destroying the target set.

This figure was introduced under the assumption that there were no further integration, testing or operational “costs” associated with the JSOW A and C variants. Also, we assume that there are negligible costs associated with introducing the JSOW A+ variant into the arsenal.

As the SDB relevant costs were integrated into the model, we again identified the most cost effective weapon per target and the mix of weapons that would destroy the entire target set for the lowest price. This figure would be unrealistic if the target set included only one aim point per target, so we utilized the total number of aim points associated with each target detailed. During additional scenarios and trials, we altered the number of aim points to test different theories and to find certain break-

even points; but the methodology by which the cost per unit, total cost, and optimum mix were generated remains the same and is detailed as follows.

(3) Example 2; Scenario 2

Weapon	Unit Cost	"Relevant Cost"	Number of weapons required based on $P_d$ and $SSP_k$			Cost \$ to Kill		
			Target # 1	Target # 2	Target #3	Target # 1	Target # 2	Target #3
A	10	0	20	15	5	200	150	50
B	8	0	24	30	10	192	240	80
C	5	100	30	25	15	150	125	75

**Note:** This example assumes multiple aim points per target and includes SDB "relevant cost" figure.

Table 3 Model Example 2a

In this example, the optimum mix the model computed was 55 C weapons, 0 B weapons and 5 A weapons, with a total cost of \$325 dollars. After this was computed, the "relevant cost" figure was then spread out over the appropriate targets destroyed by the associated weapon; in this case, weapon C carries the "relevant cost" and the appropriate targets to be included in further computations are targets # 1 and # 2 consisting of 55 weapons.

Weapon	Unit Cost	"Relevant Cost"	Number of weapons required based on $P_d$ and $SSP_k$			Cost \$ to Kill		
			Target # 1	Target # 2	Target #3	Target # 1	Target # 2	Target #3
A	10	0	NA	NA	5	NA	NA	50
B	8	0	NA	NA	NA	NA	NA	NA
C	5	100	30	25	NA	205	170	NA

Table 4 Model Example 2b

After including the “relevant cost” figure, the cost to destroy targets #1 and # 2 with weapon C totals \$375 vice the originally computed figure of \$275 and the added cost per unit is \$1.82 making the total cost per unit C to be \$6.82 vice the original \$5.00 per unit cost. The total cost to destroy the entire target set has now been computed to be \$425.

During the trials in this and other scenarios we utilize multiple aim points because it is impossible to realistically spread the “relevant cost” figure, approximately 175 million dollars, across a target set that only requires 25 of that particular weapon. It is impossible to compute a realistic cost per unit and subsequent cost per “kill” without using multiple aim points. Again, this is a simplistic example but the processes by which the model computes the appropriate information is consistent throughout this scenario.

## V. ANALYSIS AND RESULTS

### A. SCENARIO ONE

Scenario one included four trials. The resulting data is contained in Appendix A. Trial 1, Table 5 was the baseline trial that only included the JSOW A and JSOW C. Trial 2, Table 6 included the JSOW, the JSOW A and the JSOW C. Trial 3, Table 7 compared the SDB, JSOW A and JSOW C. Finally, Trial 4, Table 8 considered all four weapons systems discussed in this study. In each trial, we computed *an average number of targets targeted per weapon system*, a *cost per kill*, and an *average total cost of the optimum mix*. One aim point for each target within the target set was used during this scenario. Relevant costs, totaling \$175M were not incorporated into this scenario. We decided that the “relevant cost” figure was not applicable in this scenario because the costs that make up this figure can not be realistically absorbed by so few aim points and subsequently weapons.

In Scenario One, we ignored the inherent capability of each weapon system, and based our computations on the average performance of each weapon at all six system accuracies (CEPs equal to 1.5m, 3m, 5m, 8m, 13m, 22m) as though each weapon system performed equally well at each CEP. Imposing such a constraint is not technically correct since each weapon has an associated CEP at which it best performs, but doing so allowed us to generally compare the performance of each weapon system.

The model determined the most cost effective weapon per target at each specific CEP. It then totaled the number required for each type of weapon where identified as the most cost effective. The model also totaled the number of applicable targets associated with each cost effective weapon. The average number of targets targeted per weapon system was produced by averaging the number of targets destroyed by each cost effective weapon within each trial, Figure 7.

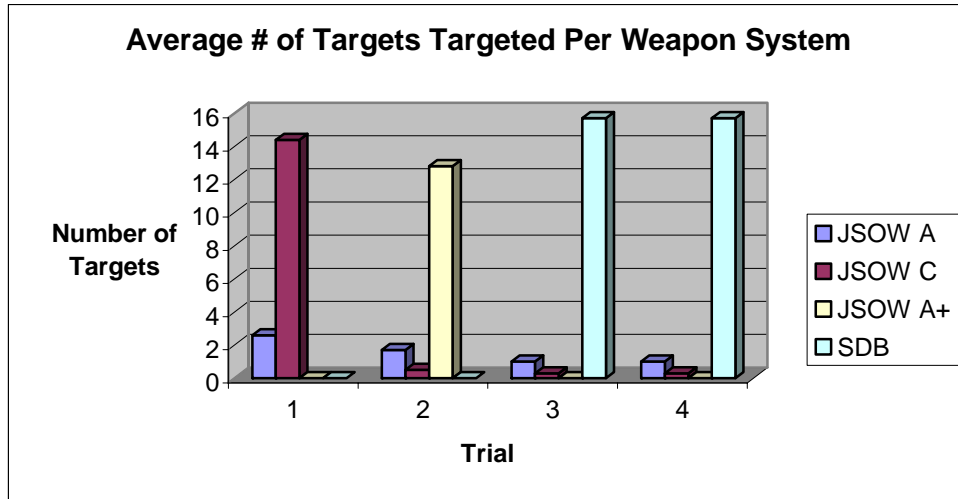

Figure 7 Average Number of Targets Targeted Per Weapon System, Scenario One

The average cost per kill per target was determined using the previously calculated total cost of each required weapon and dividing it by the average number of targets targeted per weapon system (as computed above). Appendix A, Table 5 through Table 8 contain the results of the cost per kill calculations for trials 1 through 4; the findings are summarized in Figure 8.

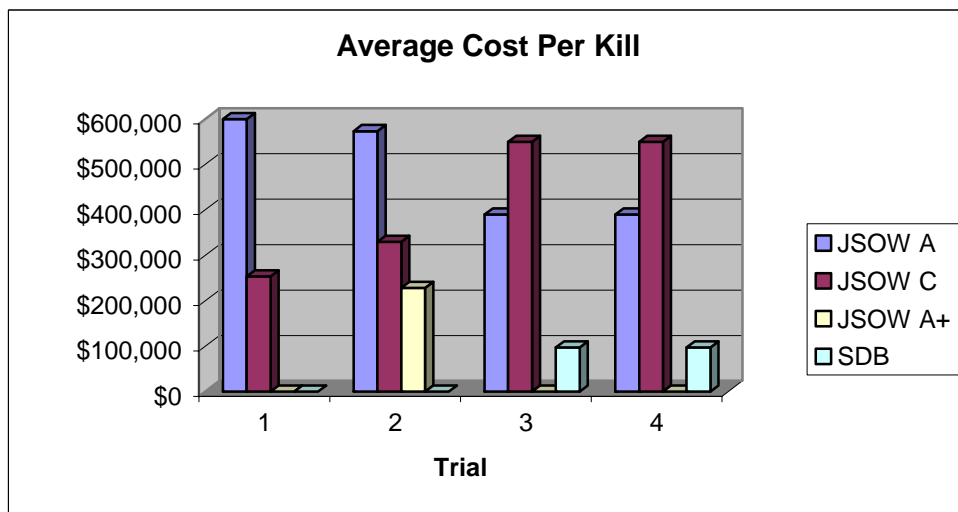

Figure 8 Average Cost Per Kill, Scenario One

Finally, the average total cost of the optimum mix was determined using the sum of the total cost of each cost effective weapon required to destroy the target set (an output of our model). The cost of each weapon system needed to destroy the target was an average of all six CEPs (1.5m, 3m, 5m, 8m, 13m and 22m) for each trial and then the costs associated with each weapon were summed to derive a total average cost per trial. Appendix A, Table 9 and Table 10 contain the results of the averaged total cost of the optimum mix, and a summary of our findings is contained in Figure 9.

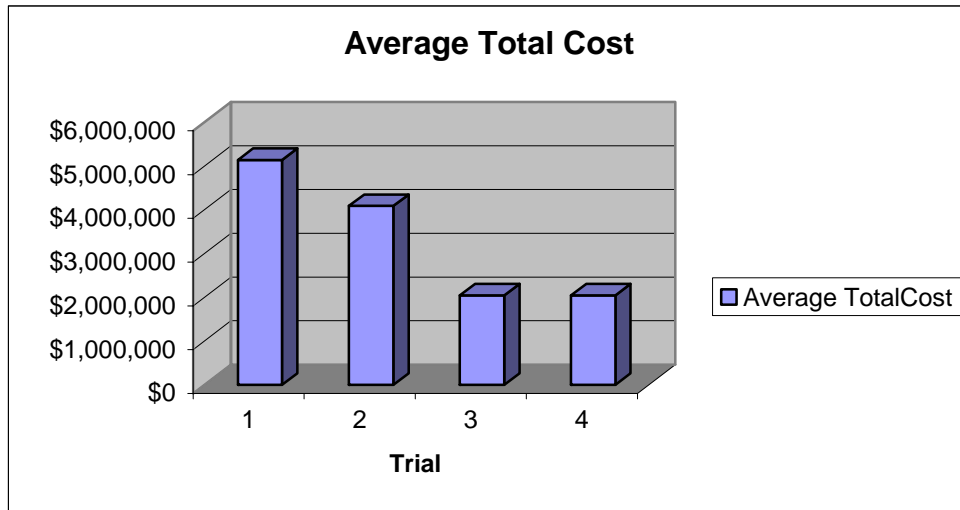

Figure 9 Average Total Cost, Scenario One

**1. Observations and Results**

Trial 1 indicated that the average cost per kill using the JSOW A and JSOW C was \$600,000 and \$253,846 respectively. Trial 2 demonstrated that the average cost per kill of each weapon changed to \$573,529 for the JSOW A, \$330,000 for the JSOW C and \$228,594 for the JSOW A+. Trial 3 exchanged the SDB for the JSOW A+ and produced an average cost per kill of each weapon system of \$390,000 for the JSOW A, \$550,000 for the JSOW C and \$97,452 for the SDB. Finally, considering all four weapon systems in trial 4, the average cost per kill was the same as computed in trial 3.

Trial 1, Table 9, produced an average cost for the optimum mix of \$5.1M. Trial 2, also contained in Table 9, produced an average cost of for the optimum mix of \$4.0M. In Table 10, Trial 3, the total average cost using JSOW A, JSOW C and SDB amounted to \$2.0M. Finally, Table 10, Trial 4, yielded the same result as that in Trial 3.

## **2. Analysis**

Comparing the average cost per kill of the JSOW A+ (\$228,594) to the average cost per kill of the SDB (\$97,452), the SDB offers an average savings of 50.7% over the JSOW A+ in combination with the JSOW A and C variants. This savings will become more apparent in the following discussion.

Considering Trial 1 (JSOW A and JSOW C) as the baseline trial, we observe that it will cost \$5.1M, on average, to destroy the target set. Adding the JSOW A+ into the equation reduces the average cost to destroy all of the aim points within the target set to \$4.1M (Table 10, Trial 2). This decrease in cost amounts to a savings of 20% and reflects that the JSOW A+ is comparatively equal to the JSOW A in terms of effectiveness, yet is less expensive (\$133,000 per unit for the JSOW A+ versus \$195,000 per unit for the JSOW A).

In Table 11, Trial 3, when the JSOW A+ is replaced by the SDB, it will cost, on average, \$2.0M to destroy the target set. Therefore, utilizing the SDB instead of the JSOW A+ and retaining the option to use the JSOW A and C generates approximately a 51% and a 60% savings when compared to using the JSOW A, C and A+, or just the JSOW A and C, respectively.

This large savings can be explained by the fact that the per-unit cost of the SDB is a fraction of the JSOW A+, \$30,000 for the SDB versus \$133,000 for the JSOW A+. Table 11, trial 4, with all weapons included, yielded the same results as Table 11, trial 3. This reflects that the JSOW A+ was never chosen as the most cost-effective weapon at any CEP in trial 4.

## **B. SCENARIO TWO**

Scenario Two contained four trials, as listed in Appendix B. Each trial was conducted in the same manner as in Scenario One, except that Scenario Two considered all aim points listed in Appendix D. In Scenario Two, Trial 1 was the baseline trial, considering the JSOW A and JSOW C. Trial 2 added JSOW A+, so that the alternatives



included the JSOW A, JSOW C and A+. In Trial 3, JSOW A+ was replaced by the SDB, so that the weapons included were the SDB, JSOW A and JSOW C. Finally, all four weapons were considered in Trial 4: the SDB, JSOW A, JSOW C and JSOW A+. Like Scenario One, Scenario Two computed the *average number of targets targeted per weapon system*, the *cost per kill*, and an *total average cost of the optimum mix* required to destroy the target set.

We ignored the inherent capability of each weapon system (as we did in Scenario One), and based our computations on the average performance of each weapon at all six system accuracies (CEP equal to 1.5m, 3m, 5m, 8m, 13m, 22m) as though each weapon system performed equally well at each CEP. Imposing such a constraint is not technically correct (since each weapon has an associated CEP at which it best performs), but doing so allowed us to compare the performance of each weapon system in general.

The model determined the most cost effective weapon per target at each specific CEP. It then calculated the number required and type of weapon computed as the most cost effective. The model also totaled the number of applicable targets associated with each cost effective weapon. The average number of targets targeted per weapon system was determined by averaging the number of targets destroyed by each cost effective weapon within each trial, Figure 10.

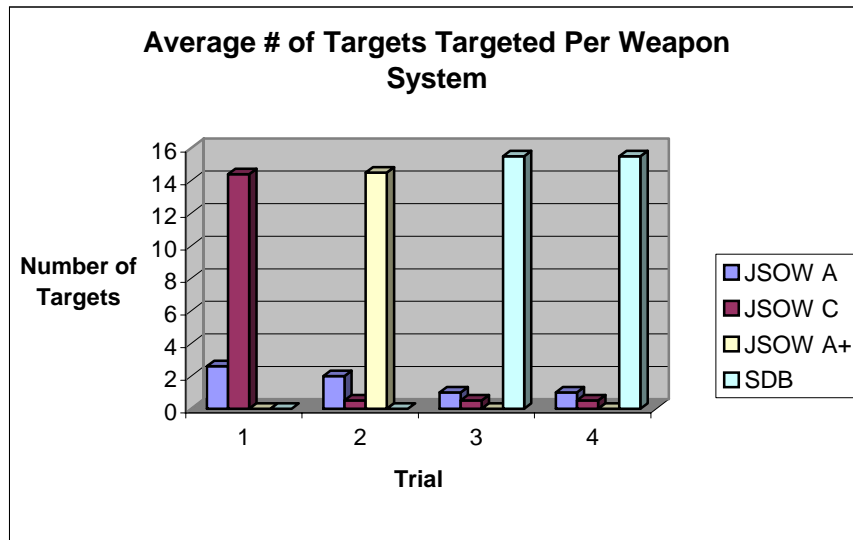

Figure 10 Average Number of Targets Targeted Per Weapon System, Scenario Two

The average cost per kill per target was determined using the previously calculated total cost of each required weapon and dividing it by the average number of targets targeted per weapon system (as computed above). Recall that Scenario 2 included all of the aim points within the target set. The corresponding cost per kill per target, including multiple aim points, is comparatively larger than that contained in Scenario One which only considered a single aim point per target. Appendix B, Table 11 through Table 14 contain the results of the cost per kill calculations for Trials 1 through 4; the findings are summarized in Figure 11.

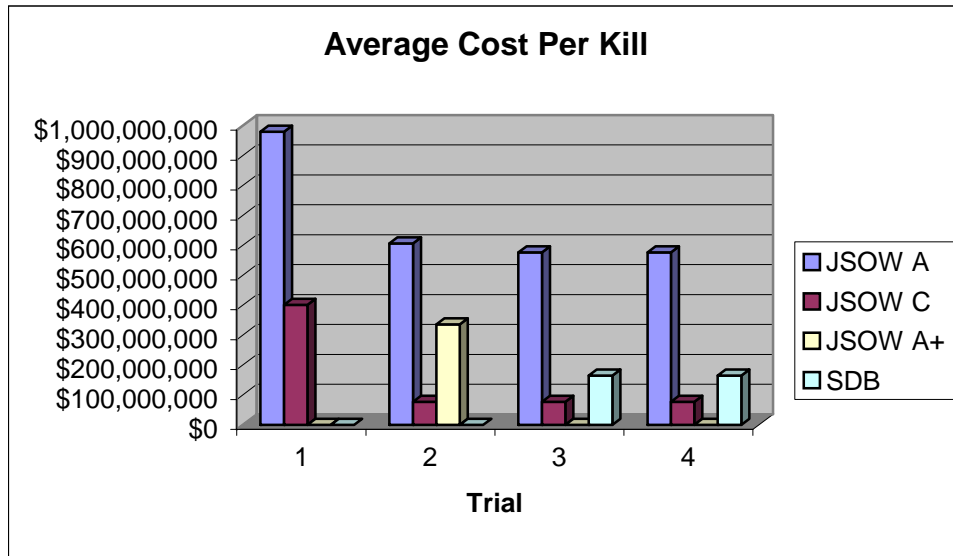

Figure 11 Average Cost Per Kill, Scenario Two

Note that Scenario Two generated the average cost per kill of each weapon system by first calculating the optimum mix of cost effective weapons required then distributing the “relevant costs” evenly per SDB required in the calculations. “Relevant costs” included the costs associated with integrating this weapon into the F/A-18 E/F Hornet and the accuracy support infrastructures costs. These rough orders of magnitude figures total \$175M and are unique to the SDB. Knowing that these “relevant costs” represent fixed costs that must be incurred if the SDB is selected, we opted to evenly

spread these costs over the number of SDBs after the optimum mix was determined. This allows the inherent cost effectiveness of each weapon to be compared and used as a basis for selection.

Finally, the average total cost of the optimum mix was determined using the sum of the total cost of each cost effective weapon required to destroy the target set (an output of our model). The cost of each weapon system needed to destroy the target was an average over all six CEPs (1.5m, 3m, 5m, 8m, 13m and 22m) for each trial, then the costs associated with each weapon were summed to derive a total average cost per trial. Appendix B, Table 15 and Table 16 show the optimum mix of weapons, and the average total cost of this optimum mix is summarized in Figure 12.

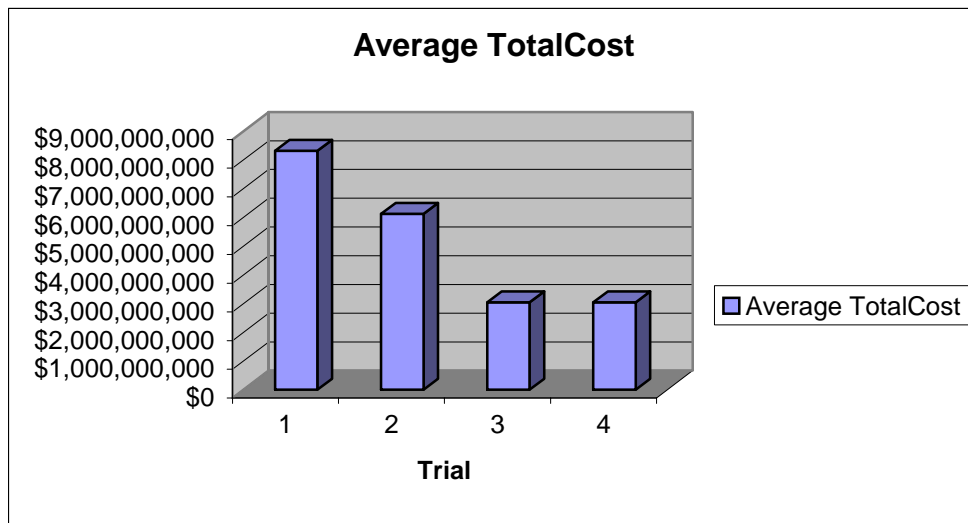

Figure 12 Average Total Cost, Scenario Two

**1. Observations and Results**

Considering all the aim points within the target set, Appendix B, Table 11, Trial 1 indicated that the average cost per kill using the JSOW A and JSOW C was \$980M and \$400M, respectively. In Table 12, Trial 2, JSOW A+ was introduced and the average cost per kill of each weapon changed to \$606M for the JSOW A, \$77M for the JSOW C and \$337M for the JSOW A+. In Table 13, Trial 3, the SDB was introduced into the mix and the average cost per kill of each weapon changed to \$576M for the JSOW A, \$77M for the JSOW C and \$165M for the SDB. Finally, in Table 14, Trial 4, all four weapon

systems were considered; the average cost per kill of each weapon system did not change from that computed in Trial 3 (\$576M for JSOW A, \$77M for JSOW C and \$165M for SDB). The model never selected the JSOW A+ in Trial 4 due to its relatively low cost-effectiveness.

Another observation made as a result of Scenario Two involves the total average cost required to destroy the target set. In Table 15, Trial 1, the total cost averaged across all six specific CEPs considering only the JSOW A and JSOW C was \$8.3B. In Table 15, Trial 2, using the JSOW A, JSOW C and JSOW A+, the total average cost fell to \$6.1B. In Table 16, Trial 3, using the JSOW A, JSOW C and SDB, the total average cost fell further to \$3.1B. Finally, Table 16, Trial 4, yielded the same result as that in Trial 3 (\$3.1B).

## **2. Analysis**

With only the JSOW A and JSOW C combining to make up the potential mix of weapons, it will cost, on average, \$8.3B to destroy all of the aim points within the target set. Adding JSOW A+ to the equation reduces the average cost to destroy all of the aim points within the target set to \$6.1B. This reduction in cost amounts to a 26% savings and is primarily due to the fact that the JSOW A+ is comparatively equal to JSOW A in terms of effectiveness, yet is less expensive (\$133,000 per unit for the JSOW A+ versus \$195,000 per unit for the JSOW A).

When the mix of weapons includes SDB, JSOW A and JSOW C, it will cost on average \$3.1B to destroy all of the aim points within the target set. Therefore, replacing the JSOW A+ with the SDB in this scenario provides a 49% savings; a 63% savings is achieved when compared to the mix containing only the JSOW A and JSOW C. This large savings can be explained by the fact that the per-unit cost of the SDB is a fraction of JSOW A+ (\$34,082 for the SDB versus \$133,000 for the JSOW A+), even though we factored in \$175M in relevant costs for the SDB. Interestingly, the unit price of the SDB only increased slightly, from \$33,000 per unit to \$34,082 per unit, when compared to the unit cost used in Scenario One. This extra cost per unit reflects the total \$175M of

relevant costs being spread among all weapons needed to destroy all of the aim points for all of the targets in the target set.

Both weapon system cost and effectiveness are reflected in average cost per target kill. Comparing the average cost per target kill of the JSOW A+ (\$336,279,034) to the SDB (\$165,279,034) shows an average savings of 50.7% from using the SDB as opposed to the JSOW A+.

### **C. SCENARIO THREE**

The primary intent of Scenario Three was to investigate if the optimum mix of cost effective weapons changed with varying SDB accuracies or if there was any other relevant changes such as total cost or average cost per kill, etc

In this Scenario, six trials were performed, and the results are contained in Appendix C. In each trial, we computed an *average cost per kill*; a *total cost per weapon*; an *optimum mix of weapons* (comprised only of the weapons within each trial); and two *break-even points*. Within each trial the approximate specification CEPs for the JSOW A (13m), JSOW C (1.5m), and JSOW A+ (8m) were compared to the SDB at 1.5m, 3m, 5m, 8m, 13m, and 22m CEPs, respectively. The comparisons yielded results similar to Scenarios One and Two in that the model computed the most cost-effective weapon for each trial. The major difference is that the CEPs and effectiveness for the JSOW family of weapons remained constant at their approximate specification CEP, while the CEPs and effectiveness for the SDB varied with each trial. For Scenario Three, all aim points for each target within the target set contained within Appendix D were used.

The average cost per kill per target was determined by dividing the total cost of each weapon system needed to destroy the targets by the average number of targets targeted per weapon system in each scenario. Appendix C, Tables 17 through 22 contains the results of the cost per kill calculations for Trials 1 through 6.

The total cost per weapon was computed by multiplying the cost of each weapon by the number of weapons selected by the model in each trial. Appendix C, Part 3 contains the results of the cost per weapon calculations.

Our model determined the optimum mix by selecting the most cost-effective alternative among the weapons in each trial. The results of these computations are contained in Appendix C. With regards to “relevant costs”, Scenario Three utilized the same methodology as Scenario Two. The “relevant cost” figure associated with the SDB (\$175M) was not included when determining the optimum mix of weapons for each trial. Only after the optimum number weapons for each trial was determined were the “relevant costs” associated with the SDB spread evenly over the optimum number of SDBs within each trial.

Finally, Scenario Three determined a CEP break-even point, defined as the accuracy at which SDB was no longer selected as the most cost-effective alternative and was excluded from the optimum mix, and the weapons quantity break-even point, defined as the minimum quantity of weapons required to make SDB the more cost-effective alternative. That is the cost savings between choosing the SDB over the JSOW A+ was greater than the \$175M “relevant cost”. Appendix C, Tables 23 through 26 contain the results of the break-even analysis.

## **1. Observations and Results**

Within each trial, the JSOW family of weapons was considered at their approximate specification CEP, and the SDB was considered at CEPs of 1.5m, 3m, 5m, 8m, 13m and 22m (e.g., in Trial 1, SDB is considered at 1.5m CEP and the JSOW family of weapons is considered at their respective approximate specification CEPs; in Trial 2, SDB is considered at 3m CEP and the JSOW family of weapons is again considered at their respective approximate specification CEP; etc.). The average cost per kill of each weapon was determined

Similar to Scenarios One and Two, the optimum mix of weapons in Scenario Three includes the weapons that represent the most cost-effective alternative. Appendix

C contains the total number of weapons required to destroy the target set, as well as the target set optimum mix total cost. The total number of weapons within each trial is as follows:

- Trial 1, 27,353 SDBs and 2,956 JSOW A
- Trial 2, 27,586 SDBs and 2,956 JSOW A
- Trial 2, 32,762 SDBs and 2,956 JSOW A
- Trial 4, 38,663 SDBs, 2,956 JSOW A and 1,443 JSOW C
- Trial 5, 62,410 SDBs, 2,956 JSOW A, 2,305 JSOW C and 1,242 JSOW A+
- Trial 6, 5,288 SDBs, 2,956 JSOW A, 2,742 JSOW C and 23,273 JSOW A+

A summary of the results can be seen below in Figure 13.

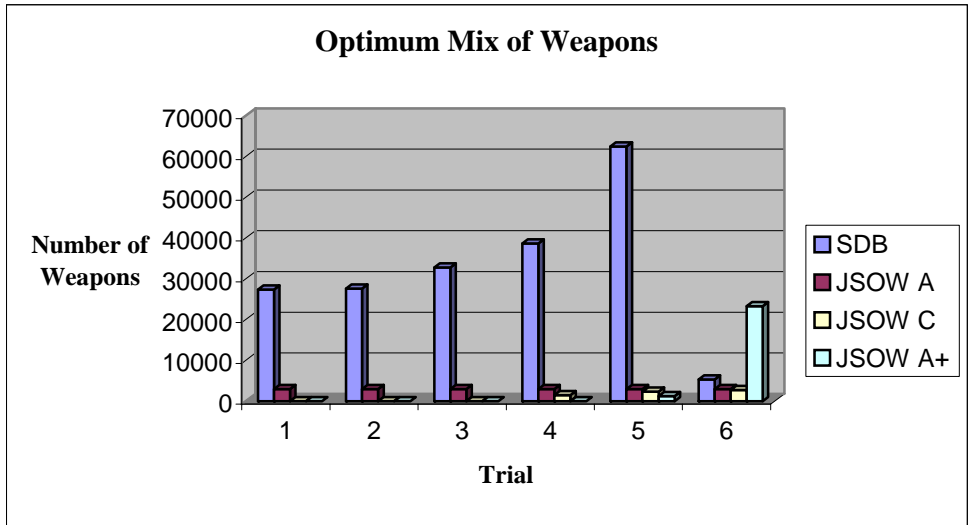

Figure 13 Optimum Mix of Weapons, Scenario Three

The data generated in this trial allowed us to investigate several break-even points. The first break-even point computed was the accuracy or CEP break-even point, defined as the accuracy at which SDB is no longer selected as the most cost-effective alternative. The largest CEP for which we have data (22m) is contained in Appendix C,

Trial 6. Even at this large CEP, our model still selects 5,288 SDBs in the optimum mix. This is a significant decrease from the 62,410 SDBs selected by our model in Trial 5 (Appendix C), but does not provide us with a true break-even CEP. There is a point at which the JSOW A+ becomes the sole cost effective weapon, but that point is where the SDB has total system accuracies in excess of 22m.

What was discovered was that as the accuracy of the SDB gets better and its CEP reduces in size, the SDB starts to replace the JSOW A+ as the most cost effective weapon of choice. Considering the data from Table 20, trial 4, and Table 21, trial 5, this replacement occurs somewhere between 13m and 8m's. Based on our results, we believe that the SDB completely replaces the JSOW A+ as the most cost effective weapon of choice at approximately 11.5m. The summary of the above mentioned observations can be seen below in Figure 14.

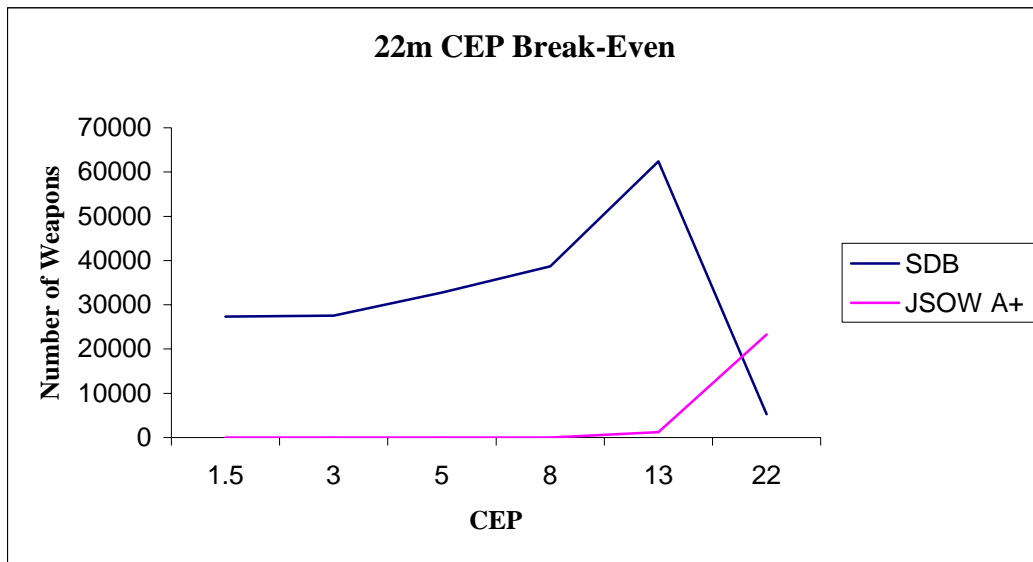

Figure 14 22m CEP Break-Even, Scenario Three

The second break-even point identified in this scenario involves a weapon break-even point. This break-even focused on the SDB with accuracies of 1.5m and 4m's and the JSOW family of weapons set at their specification CEPs. The target weapon break-even point indicates the quantities of weapons above which only one, SDB or JSOW A+, is selected as part of the optimum mix and below which the other weapon is selected.



The weapon break-even point with SDB having accuracies of 1.5m is 1641 weapons or 6% of all aim points contained in the target set. The break-even point with SDB accuracies of 4m is 1662 weapons or 6.1% of all aim points contained within this study. Figures 15 and 16 below summarize these results.

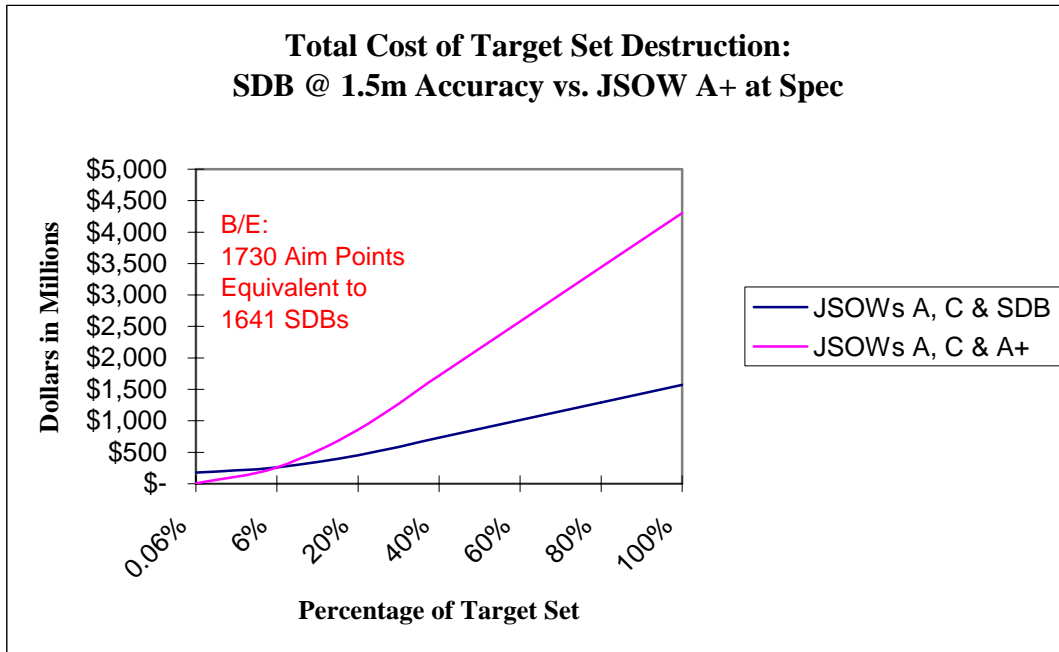

Figure 15 1.5m Break Even Aim Points, Scenario Three

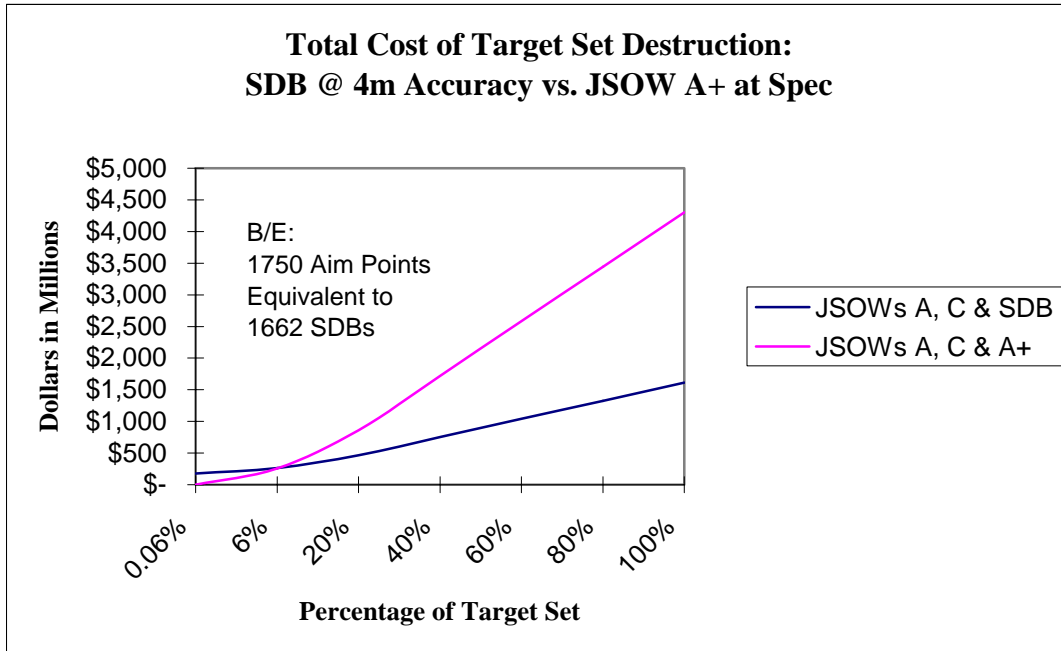

Figure 16 4m aim point/weapon break-even point, Scenario Three

## 2. Analysis

The optimum mix of weapons identified in Scenario Three, and shown in Figure 13 above, reveal that the SDB is more cost-effective than JSOW A+ up until trial 4. That For CEPs of 1.5m, 3m, 5m and 8m, SDB's comparatively higher cost-effectiveness prevented JSOW A+ from being included in the optimum mix. We found this to be interesting, since the JSOW family of weapons (and not the SDB) was being considered at their approximate specification CEPs. At approximately 11.5m, however, we find that the relative cost-effectiveness of the JSOW A+ allows it to enter the mix as a cost-effective alternative. At larger CEPs, it takes comparatively more SDBs to destroy the same number of aim points because it contains a smaller warhead. Therefore, its cost-effectiveness starts to decline. In trial 5, this decline in cost-effectiveness becomes more pronounced until ultimately, in trial 6, the JSOW A+ is selected significantly more than the SDB as the weapon of choice.

The system accuracy, or CEP, break-even point, shown in Figure 14, was investigated to determine if there was a SDB total system accuracy at which the SDB is never considered a more cost-effective weapon system than the JSOW A+ at its

specification CEP. With the SDB accuracies of 22m, the SDB was still selected as a cost effective weapon for approximately 33% of the target set. The point at which the JSOW A+ entirely replaces the SDB was not discovered because it lies above the 22m-accuracy level and that data is not available. As the accuracies of the SDB improve to approximately 11.5m (or better) the SDB entirely replaces the JSOW A+ as the most cost effective weapon.

The second break-even point discussed was the weapon quantity break-even point. This point identified the number of number of weapons, at which the SDB is more cost effective than the JSOW A+ 100% of the time. With SDB accuracies of 4m, we observed that the weapon break-even point was approximately 1,662 weapons, as shown in Figure 15. This equated to approximately 6.1% of the target set. With SDB accuracies of 1.5m, the weapon break-even point was approximately 1,641 weapons, or 6% of the target set, as shown in Figure 16. Each of these break-even points represents the point at which either the SDB or the JSOW A+ becomes the most cost effective weapon. The conclusion being that if approximately 1,700 or more SDBs were purchased and employed against this target set with SDB accuracies of 4m or less then it would be more cost effective to utilize the SDB.

THIS PAGE INTENTIONALLY LEFT BLANK

## VI. CONCLUSION AND RECOMMENDATIONS

Scenarios One and Two demonstrated that the average cost per kill of the SDB was significantly less than that of the JSOW A+ if the accuracies of the weapons compared to their combat effectiveness were averaged. In Scenario One, considering only one aim point per target, the cost per kill of the SDB was an average of 50.7% less than the JSOW A+, looking at each weapon individually. The total cost to kill the target set was 60% less when the SDB was included with the JSOW A and JSOW C. When the SDB was used instead of the JSOW A+, the total cost to kill the target set was reduced by 51%. In Scenario Two, considering all aim points within the target set, the cost per target kill for the SDB was an average of 50.7% less than the JSOW A+. The cost to kill the entire target set when utilizing the SDB was reduced 63% compared to just the JSOW A and JSOW C, and 49% when the SDB replaced the JSOW A+.

The SDB is a cost-effective solution relative to the JSOW A+, and achieves significant cost savings when added to the optimum mix. This information lends insight to the relative cost effectiveness of the weapons but does not speak directly to the realistic combat effectiveness experienced when total system accuracies are included and compared. Therefore, we wanted to examine the relationship among the weapons using their proven and theorized specification CEPs.

The system accuracy, or CEP, break-even point was investigated to determine if there was a SDB total system accuracy at which the SDB is never considered the most cost-effective weapon system compared the JSOW A+ at its specification CEP. With the SDB accuracies of 22m, the SDB was still selected as a cost effective weapon for approximately 33% of the target set. The point at which the JSOW A+ entirely replaces the SDB as the cost-effective was not discovered because it lies above the 22m-accuracy level and that data is not available. As the accuracies of the SDB improve to approximately 11.5m or better, the SDB entirely replaces the JSOW A+ as the most cost effective weapon. Under conditions within this scenario, the SDB is a more cost effective weapon than the JSOW A+ 100% of the time if the SDB's total error budget produces accuracies of 11.5m or less.

The second break-even point discussed was the weapon quantity break-even point. This point identified the number of weapons at which the SDB is more cost effective than the JSOW A+ 100% of the time. With SDB accuracies of 4m, we observed that the weapon break-even point was approximately 1,662 weapons. This equated to approximately 6.1% of the target set. With SDB accuracies of 1.5m, the weapon break-even point was approximately 1,641 weapons, or 6% of the target set. Each of these break-even points represents the point at which either the SDB or the JSOW A+ becomes the most cost effective weapon. This implies that if approximately 1,700 or more SDBs were purchased and employed against this target set, with SDB accuracies of 4m or less, it would be cost effective to utilize the SDB rather than the JSOW A+.

Overall we conclude that there are a myriad of possible combinations of weapons that can cost effectively prosecute our given target set. Each possibility is greatly influenced by the number of aim points, the cost of each weapon, associated integration and support costs, and the accuracies inherent to each system. With this in mind, our research demonstrated that the SDB was selected as the most cost effective weapon an overwhelming majority of the time when compared to the JSOW A+. However, there were instances where the JSOW A+ was selected as the most cost effective weapon. No matter how seldom this occurred, the situations that dictated this course of action must be considered when making decisions on which weapon is best for Naval aviation.

We recommend the following for further work associated with this project. First, to better understand the relative prioritization among targets within the target set, it would be useful to develop a weighting scheme for each target such that the most important targets received greater emphasis in determining the optimum mix of weapons. With approximately 29,000 aim points, there most likely exists a logical gradation in target prioritization; these gradations could subsequently be assigned different weights.

Next, further analysis would be beneficial in determining a more accurate weapon system cost. A more holistic approach might also consider: logistics costs (shipping and handling, shipboard storage, etc.); sortie costs; training costs; personnel; and the opportunity costs associated with purchasing one weapon system over the other.

Finally, further research as to the validity and accuracy of the target set might yield results different from those contained in this study. Specifically, it would be prudent to reassess the current target set (and associated aim points) to verify whether they accurately represent current, real-world threats. Moreover, replacing the modeled effectiveness data with accurate operational or test data for the SDB and JSOW A+ would further refine the results contained within this study.

THIS PAGE INTENTIONALLY LEFT BLANK



## APPENDIX A: SCENARIO ONE

### A. TABLE OVERVIEW

The tables below contain the relevant figures computed for each trial. A brief description is necessary to understand what each column represents. Column 1 summarizes the weapon systems that are included in that trial. Column 2 provides the average number of weapons required in the optimum mix for in the given scenario. Column 3 shows the cost of each weapon unit. Column 4 calculates the average total cost per weapon system across all CEPs. Column 5 provides the average number of targets targeted per weapon system. The sum of Column 5 will always equal 17, which represents the number of targets in our target set. Finally, Column 6 calculates the average cost per kill per target.

An example of the calculations will be stepped through using results from Table 5 Trial 1. Using the row of information associated with JSOW A we see that the average number of weapons required in the optimum mix is 8. The cost per JSOW A is contained in Column 3: \$195,000. Multiplying Column 2 by Column 3 calculates the average total cost of \$1,560,000 in Column 4. Dividing the results in Column 4 by the average number of targets destroyed, Column 5, yields the average cost per kill per target found in Column 6 (\$600,000). \$600,000 is the average cost per kill per target, considering the weapon's cost and effectiveness at the 6 specific accuracies for the JSOW A. Each result within each Table listed below was derived using the same methodology.

**B. COST PER KILL**

1	2	3	4	5	6
JSOW A	8	\$195,000	\$1,560,000	2.6	\$600,000
JSOW C	22	\$165,000	\$3,630,000	14.4	\$253,846

Table 5 Cost Per Kill Scenario1, Trial 1

1	2	3	4	5	6
JSOW A	5	\$195,000	\$975,000	1.7	\$573,529
JSOW C	1	\$165,000	\$165,000	0.5	\$330,000
JSOW A+	22	\$133,000	\$2,926,000	12.8	\$228,594

Table 6 Cost Per Kill Scenario1, Trial 2

1	2	3	4	5	6
SDB	51	\$30,000	\$1,530,000	15.7	\$97,452
JSOW A	2	\$195,000	\$390,000	1	\$390,000
JSOW C	1	\$165,000	\$165,000	0.3	\$550,000

Table 7 Cost Per Kill Scenario1, Trial 3

1	2	3	4	5	6
SDB	51	\$30,000	\$1,530,000	15.7	\$97,452
JSOW A	2	\$195,000	\$390,000	1	\$390,000
JSOW C	1	\$165,000	\$165,000	0.3	\$550,000
JSOW A+	0	\$133,000	\$0	0	\$0

Table 8 Cost Per Kill Scenario1, Trial 4

**Legend**

Column 1: Weapon System

Column 2: Average Number of Weapons (within the optimum mix)

Column 3: Cost Per Unit

Column 4: Average Total Cost Per Weapon System

Column 5: Average Number of Targets Targeted Per Weapon System

Column 6: Average Cost Per Kill Per Target

**C. COST OF OPTIMUM MIX**

The total cost of for each CEP within the optimum mix tables are the individual results the computer model generated for each trial. The data from each trial run by the computer model yielded the optimum or most cost effective mix of weapons for each CEP: 1.5 through 22m. The average cost number is calculated by adding all of the results within each trial at each CEP and then dividing by six. For example the numbers for each CEP in Trial 1 equal \$30,810,000. Dividing this number by six yields an average cost of the optimum mix per trial of \$5,135,000. The same methodology was used throughout each trial.

Trial 1:	CEP	Total Cost	Trial 2:	CEP	Total Cost
	1.5m	\$3,030,000		1.5m	\$2,518,000
	3m	\$3,030,000		3m	\$2,518,000
	5m	\$3,360,000		5m	\$2,651,000
	8m	\$4,515,000		8m	\$3,215,000
	13m	\$6,465,000		13m	\$4,967,000
	22m	\$10,410,000		22m	\$8,651,000
	Average Cost	\$5,135,000		Average Cost	\$4,086,667

Table 9 Total Cost of Optimum Mix Per Trial 1 and 2 at Each CEP:

Trial 3:	CEP	Total Cost	Trial 4:	CEP	Total Cost
	1.5m	\$870,000		1.5m	\$870,000
	3m	\$900,000		3m	\$900,000
	5m	\$1,140,000		5m	\$1,140,000
	8m	\$1,545,000		8m	\$1,545,000
	13m	\$2,790,000		13m	\$2,790,000
	22m	\$4,995,000		22m	\$4,995,000
	Average Cost	\$2,040,000		Average Cost	\$2,040,000

Table 10 Total Cost of Optimum Mix Per Trial 3 and 4 at Each CEP:

**D. DATA FOR SCENARIO 1**

**Scenario 1, Trial 1**

1.5M	Target	JSOW A	JSOW C
	1	\$975,000	\$165,000
	2	\$585,000	\$165,000
	3	\$390,000	\$165,000
	4	\$390,000	\$165,000
	5	\$390,000	\$165,000
	6	\$2,340,000	\$165,000
	7	\$390,000	\$165,000
	8	\$195,000	\$165,000
	9	\$195,000	\$165,000
	10	\$195,000	\$165,000
	11	\$195,000	\$165,000
	12	\$1,560,000	\$165,000
	13	\$195,000	\$165,000
	14	\$195,000	\$165,000
	15	\$390,000	\$165,000
	16	\$390,000	\$990,000
	17	\$2,535,000	\$165,000
Target Set			
Optimum Mix		2	16
Weapon Unit			
Cost		\$195,000	\$165,000
Weapon Total			
Cost		\$390,000	\$2,640,000
Target Set			
Optimum Mix			
Total Cost			\$3,030,000

**Scenario 1, Trial 1**

3M	Target	JSOW A	JSOW C
	1	\$975,000	\$165,000
	2	\$585,000	\$165,000
	3	\$390,000	\$165,000
	4	\$390,000	\$165,000
	5	\$390,000	\$165,000
	6	\$2,340,000	\$165,000
	7	\$390,000	\$165,000
	8	\$195,000	\$165,000
	9	\$195,000	\$165,000
	10	\$195,000	\$165,000
	11	\$195,000	\$165,000
	12	\$1,560,000	\$165,000
	13	\$195,000	\$165,000
	14	\$195,000	\$165,000
	15	\$390,000	\$165,000
	16	\$390,000	\$990,000
	17	\$2,535,000	\$165,000
Target Set			
Optimum Mix		2	16
Weapon Unit			
Cost		\$195,000	\$165,000
Weapon Total			
Cost		\$390,000	\$2,640,000
Target Set			
Optimum Mix			
Total Cost			\$3,030,000

**Scenario 1, Trial 1**

5M	Target	JSOW A	JSOW C
	1	\$975,000	\$165,000
	2	\$585,000	\$165,000
	3	\$390,000	\$165,000
	4	\$390,000	\$165,000
	5	\$390,000	\$165,000
	6	\$2,340,000	\$165,000
	7	\$390,000	\$165,000
	8	\$195,000	\$165,000
	9	\$195,000	\$165,000
	10	\$195,000	\$165,000
	11	\$195,000	\$165,000
	12	\$1,560,000	\$495,000
	13	\$195,000	\$165,000
	14	\$195,000	\$165,000
	15	\$390,000	\$165,000
	16	\$390,000	\$990,000
	17	\$2,535,000	\$165,000
Target Set			
Optimum Mix		2	18
Weapon Unit			
Cost		\$195,000	\$165,000
Weapon Total			
Cost		\$390,000	\$2,970,000
Target Set			
Optimum Mix			
Total Cost			\$3,360,000

**Scenario 1, Trial 1**

8M	Target	JSOW A	JSOW C
	1	\$975,000	\$330,000
	2	\$585,000	\$165,000
	3	\$390,000	\$165,000
	4	\$390,000	\$165,000
	5	\$390,000	\$330,000
	6	\$2,340,000	\$165,000
	7	\$390,000	\$165,000
	8	\$195,000	\$165,000
	9	\$195,000	\$165,000
	10	\$195,000	\$165,000
	11	\$195,000	\$165,000
	12	\$1,560,000	\$1,155,000
	13	\$195,000	\$165,000
	14	\$195,000	\$165,000
	15	\$390,000	\$165,000
	16	\$390,000	\$1,155,000
	17	\$2,535,000	\$330,000
Target Set			
Optimum Mix		2	25
Weapon Unit			
Cost		\$195,000	\$165,000
Weapon Total			
Cost		\$390,000	\$4,125,000
Target Set			
Optimum Mix			
Total Cost			\$4,515,000

**Scenario 1, Trial 1**

13M	Target	JSOW A	JSOW C
	1	\$1,170,000	\$495,000
	2	\$585,000	\$330,000
	3	\$585,000	\$330,000
	4	\$390,000	\$330,000
	5	\$390,000	\$660,000
	6	\$2,730,000	\$330,000
	7	\$390,000	\$330,000
	8	\$195,000	\$165,000
	9	\$195,000	\$165,000
	10	\$195,000	\$165,000
	11	\$195,000	\$165,000
	12	\$1,560,000	\$2,805,000
	13	\$390,000	\$330,000
	14	\$195,000	\$165,000
	15	\$390,000	\$165,000
	16	\$390,000	\$990,000
	17	\$2,925,000	\$660,000
Target Set			
Optimum Mix		12	25
Weapon Unit			
Cost		\$195,000	\$165,000
Weapon Total			
Cost		\$2,340,000	\$4,125,000
Target Set			
Optimum Mix			
Total Cost			\$6,465,000



**Scenario 1, Trial 1**

22M	Target	JSOW A	JSOW C
	1	\$1,365,000	\$990,000
	2	\$780,000	\$660,000
	3	\$780,000	\$495,000
	4	\$585,000	\$660,000
	5	\$585,000	\$1,650,000
	6	\$4,485,000	\$495,000
	7	\$585,000	\$660,000
	8	\$195,000	\$330,000
	9	\$390,000	\$330,000
	10	\$195,000	\$330,000
	11	\$195,000	\$330,000
	12	\$2,340,000	\$11,385,000
	13	\$390,000	\$495,000
	14	\$390,000	\$330,000
	15	\$390,000	\$330,000
	16	\$390,000	\$1,155,000
	17	\$3,510,000	\$1,320,000
Target Set			
Optimum Mix		28	30
Weapon Unit			
Cost		\$195,000	\$165,000
Weapon Total			
Cost		\$5,460,000	\$4,950,000
Target Set			
Optimum Mix			
Total Cost			\$10,410,000

**Scenario 1, Trial 2**

1.5M	Target	JSOW A	JSOW C	JSOW A+
	1	\$975,000	\$165,000	\$133,000
	2	\$585,000	\$165,000	\$133,000
	3	\$390,000	\$165,000	\$133,000
	4	\$390,000	\$165,000	\$133,000
	5	\$390,000	\$165,000	\$133,000
	6	\$2,340,000	\$165,000	\$133,000
	7	\$390,000	\$165,000	\$133,000
	8	\$195,000	\$165,000	\$133,000
	9	\$195,000	\$165,000	\$133,000
	10	\$195,000	\$165,000	\$133,000
	11	\$195,000	\$165,000	\$133,000
	12	\$1,560,000	\$165,000	\$133,000
	13	\$195,000	\$165,000	\$133,000
	14	\$195,000	\$165,000	\$133,000
	15	\$390,000	\$165,000	\$133,000
	16	\$390,000	\$990,000	\$665,000
	17	\$2,535,000	\$165,000	\$133,000
Target Set				
Optimum Mix		2	0	16
Weapon Unit				
Cost		\$195,000	\$165,000	\$133,000
Weapon Total				
Cost		\$390,000	\$0	\$2,128,000
Target Set				
Optimum Mix				
Total Cost				\$2,518,000

**Scenario 1, Trial 2**

3M	Target	JSOW A	JSOW C	JSOW A+
	1	\$975,000	\$165,000	\$133,000
	2	\$585,000	\$165,000	\$133,000
	3	\$390,000	\$165,000	\$133,000
	4	\$390,000	\$165,000	\$133,000
	5	\$390,000	\$165,000	\$133,000
	6	\$2,340,000	\$165,000	\$133,000
	7	\$390,000	\$165,000	\$133,000
	8	\$195,000	\$165,000	\$133,000
	9	\$195,000	\$165,000	\$133,000
	10	\$195,000	\$165,000	\$133,000
	11	\$195,000	\$165,000	\$133,000
	12	\$1,560,000	\$165,000	\$133,000
	13	\$195,000	\$165,000	\$133,000
	14	\$195,000	\$165,000	\$133,000
	15	\$390,000	\$165,000	\$133,000
	16	\$390,000	\$990,000	\$798,000
	17	\$2,535,000	\$165,000	\$133,000
Target Set				
Optimum Mix		2	0	16
Weapon Unit				
Cost		\$195,000	\$165,000	\$133,000
Weapon Total				
Cost		\$390,000	\$0	\$2,128,000
Target Set				
Optimum Mix				
Total Cost				\$2,518,000

**Scenario 1, Trial 2**

5M	Target	JSOW A	JSOW C	JSOW A+
	1	\$975,000	\$165,000	\$133,000
	2	\$585,000	\$165,000	\$133,000
	3	\$390,000	\$165,000	\$133,000
	4	\$390,000	\$165,000	\$133,000
	5	\$390,000	\$165,000	\$133,000
	6	\$2,340,000	\$165,000	\$133,000
	7	\$390,000	\$165,000	\$133,000
	8	\$195,000	\$165,000	\$133,000
	9	\$195,000	\$165,000	\$133,000
	10	\$195,000	\$165,000	\$133,000
	11	\$195,000	\$165,000	\$133,000
	12	\$1,560,000	\$495,000	\$266,000
	13	\$195,000	\$165,000	\$133,000
	14	\$195,000	\$165,000	\$133,000
	15	\$390,000	\$165,000	\$133,000
	16	\$390,000	\$990,000	\$798,000
	17	\$2,535,000	\$165,000	\$133,000
Target Set				
Optimum Mix		2	0	17
Weapon Unit				
Cost		\$195,000	\$165,000	\$133,000
Weapon Total				
Cost		\$390,000	\$0	\$2,261,000
Target Set				
Optimum Mix				
Total Cost				\$2,651,000

**Scenario 1, Trial 2**

8M	Target	JSOW A	JSOW C	JSOW A+
	1	\$975,000	\$330,000	\$133,000
	2	\$585,000	\$165,000	\$133,000
	3	\$390,000	\$165,000	\$133,000
	4	\$390,000	\$165,000	\$133,000
	5	\$390,000	\$330,000	\$266,000
	6	\$2,340,000	\$165,000	\$266,000
	7	\$390,000	\$165,000	\$133,000
	8	\$195,000	\$165,000	\$133,000
	9	\$195,000	\$165,000	\$133,000
	10	\$195,000	\$165,000	\$133,000
	11	\$195,000	\$165,000	\$133,000
	12	\$1,560,000	\$1,155,000	\$532,000
	13	\$195,000	\$165,000	\$133,000
	14	\$195,000	\$165,000	\$133,000
	15	\$390,000	\$165,000	\$133,000
	16	\$390,000	\$1,155,000	\$798,000
	17	\$2,535,000	\$330,000	\$266,000
Target Set				
Optimum Mix		2	1	20
Weapon Unit				
Cost		\$195,000	\$165,000	\$133,000
Weapon Total				
Cost		\$390,000	\$165,000	\$2,660,000
Target Set				
Optimum Mix				
Total Cost				\$3,215,000

**Scenario 1, Trial 2**

13M	Target	JSOW A	JSOW C	JSOW A+
	1	\$1,170,000	\$495,000	\$266,000
	2	\$585,000	\$330,000	\$266,000
	3	\$585,000	\$330,000	\$266,000
	4	\$390,000	\$330,000	\$266,000
	5	\$390,000	\$660,000	\$399,000
	6	\$2,730,000	\$330,000	\$399,000
	7	\$390,000	\$330,000	\$266,000
	8	\$195,000	\$165,000	\$133,000
	9	\$195,000	\$165,000	\$133,000
	10	\$195,000	\$165,000	\$133,000
	11	\$195,000	\$165,000	\$133,000
	12	\$1,560,000	\$2,805,000	\$1,197,000
	13	\$390,000	\$330,000	\$133,000
	14	\$195,000	\$165,000	\$133,000
	15	\$390,000	\$165,000	\$133,000
	16	\$390,000	\$990,000	\$798,000
	17	\$2,925,000	\$660,000	\$399,000
	Target Set			
	Optimum Mix	4	2	29
	Weapon Unit			
	Cost	\$195,000	\$165,000	\$133,000
	Weapon Total			
	Cost	\$780,000	\$330,000	\$3,857,000
	Target Set			
	Optimum Mix			
	Total Cost			\$4,967,000

**Scenario 1, Trial 2**

22M	Target	JSOW A	JSOW C	JSOW A+
	1	\$1,365,000	\$990,000	\$532,000
	2	\$780,000	\$660,000	\$399,000
	3	\$780,000	\$495,000	\$399,000
	4	\$585,000	\$660,000	\$532,000
	5	\$585,000	\$1,650,000	\$665,000
	6	\$4,485,000	\$495,000	\$798,000
	7	\$585,000	\$660,000	\$532,000
	8	\$195,000	\$330,000	\$266,000
	9	\$390,000	\$330,000	\$266,000
	10	\$195,000	\$330,000	\$266,000
	11	\$195,000	\$330,000	\$266,000
	12	\$2,340,000	\$11,385,000	\$3,059,000
	13	\$390,000	\$495,000	\$266,000
	14	\$390,000	\$330,000	\$266,000
	15	\$390,000	\$330,000	\$133,000
	16	\$390,000	\$1,155,000	\$798,000
	17	\$3,510,000	\$1,320,000	\$931,000
	Target Set			
	Optimum Mix	20	3	32
	Weapon Unit			
	Cost	\$195,000	\$165,000	\$133,000
	Weapon Total			
	Cost	\$3,900,000	\$495,000	\$4,256,000
	Target Set			
	Optimum Mix			
	Total Cost			\$8,651,000

**Scenario 1, Trial 3**

1.5M	Target	SDB	JSOW A	JSOW C
	1	\$30,000	\$975,000	\$165,000
	2	\$30,000	\$585,000	\$165,000
	3	\$30,000	\$390,000	\$165,000
	4	\$30,000	\$390,000	\$165,000
	5	\$30,000	\$390,000	\$165,000
	6	\$30,000	\$2,340,000	\$165,000
	7	\$30,000	\$390,000	\$165,000
	8	\$30,000	\$195,000	\$165,000
	9	\$30,000	\$195,000	\$165,000
	10	\$30,000	\$195,000	\$165,000
	11	\$30,000	\$195,000	\$165,000
	12	\$30,000	\$1,560,000	\$165,000
	13	\$30,000	\$195,000	\$165,000
	14	\$30,000	\$195,000	\$165,000
	15	\$30,000	\$390,000	\$165,000
	16	\$1,530,000	\$390,000	\$990,000
	17	\$30,000	\$2,535,000	\$165,000
Target Set				
Optimum Mix		16	2	0
Weapon Unit				
Cost		\$30,000	\$195,000	\$165,000
Weapon Total				
Cost		\$480,000	\$390,000	\$0
Target Set				
Optimum Mix				
Total Cost				\$870,000



**Scenario 1, Trial 3**

3M	Target	SDB	JSOW A	JSOW C
	1	\$30,000	\$975,000	\$165,000
	2	\$30,000	\$585,000	\$165,000
	3	\$30,000	\$390,000	\$165,000
	4	\$30,000	\$390,000	\$165,000
	5	\$30,000	\$390,000	\$165,000
	6	\$60,000	\$2,340,000	\$165,000
	7	\$30,000	\$390,000	\$165,000
	8	\$30,000	\$195,000	\$165,000
	9	\$30,000	\$195,000	\$165,000
	10	\$30,000	\$195,000	\$165,000
	11	\$30,000	\$195,000	\$165,000
	12	\$30,000	\$1,560,000	\$165,000
	13	\$30,000	\$195,000	\$165,000
	14	\$30,000	\$195,000	\$165,000
	15	\$30,000	\$390,000	\$165,000
	16	\$1,530,000	\$390,000	\$990,000
	17	\$30,000	\$2,535,000	\$165,000
Target Set				
Optimum Mix		17	2	0
Weapon Unit				
Cost		\$30,000	\$195,000	\$165,000
Weapon Total				
Cost		\$510,000	\$390,000	\$0
Target Set				
Optimum Mix				
Total Cost				\$900,000

**Scenario 1, Trial 3**

5M	Target	SDB	JSOW A	JSOW C
	1	\$60,000	\$975,000	\$165,000
	2	\$30,000	\$585,000	\$165,000
	3	\$30,000	\$390,000	\$165,000
	4	\$60,000	\$390,000	\$165,000
	5	\$60,000	\$390,000	\$165,000
	6	\$90,000	\$2,340,000	\$165,000
	7	\$60,000	\$390,000	\$165,000
	8	\$30,000	\$195,000	\$165,000
	9	\$30,000	\$195,000	\$165,000
	10	\$30,000	\$195,000	\$165,000
	11	\$30,000	\$195,000	\$165,000
	12	\$90,000	\$1,560,000	\$495,000
	13	\$30,000	\$195,000	\$165,000
	14	\$30,000	\$195,000	\$165,000
	15	\$30,000	\$390,000	\$165,000
	16	\$1,530,000	\$390,000	\$990,000
	17	\$60,000	\$2,535,000	\$165,000
Target Set				
Optimum Mix		25	2	0
Weapon Unit				
Cost		\$30,000	\$195,000	\$165,000
Weapon Total				
Cost		\$750,000	\$390,000	\$0
Target Set				
Optimum Mix				
Total Cost				\$1,140,000

**Scenario 1, Trial 3**

8M	Target	SDB	JSOW A	JSOW C
	1	\$90,000	\$975,000	\$330,000
	2	\$60,000	\$585,000	\$165,000
	3	\$60,000	\$390,000	\$165,000
	4	\$90,000	\$390,000	\$165,000
	5	\$120,000	\$390,000	\$330,000
	6	\$180,000	\$2,340,000	\$165,000
	7	\$60,000	\$390,000	\$165,000
	8	\$30,000	\$195,000	\$165,000
	9	\$30,000	\$195,000	\$165,000
	10	\$60,000	\$195,000	\$165,000
	11	\$30,000	\$195,000	\$165,000
	12	\$180,000	\$1,560,000	\$1,155,000
	13	\$30,000	\$195,000	\$165,000
	14	\$30,000	\$195,000	\$165,000
	15	\$30,000	\$390,000	\$165,000
	16	\$1,530,000	\$390,000	\$1,155,000
	17	\$90,000	\$2,535,000	\$330,000
Target Set				
Optimum Mix		33	2	1
Weapon Unit				
Cost		\$30,000	\$195,000	\$165,000
Weapon Total				
Cost		\$990,000	\$390,000	\$165,000
Target Set				
Optimum Mix				
Total Cost				\$1,545,000

**Scenario 1, Trial 3**

13M	Target	SDB	JSOW A	JSOW C
	1	\$180,000	\$1,170,000	\$495,000
	2	\$120,000	\$585,000	\$330,000
	3	\$90,000	\$585,000	\$330,000
	4	\$180,000	\$390,000	\$330,000
	5	\$240,000	\$390,000	\$660,000
	6	\$330,000	\$2,730,000	\$330,000
	7	\$150,000	\$390,000	\$330,000
	8	\$60,000	\$195,000	\$165,000
	9	\$60,000	\$195,000	\$165,000
	10	\$90,000	\$195,000	\$165,000
	11	\$60,000	\$195,000	\$165,000
	12	\$510,000	\$1,560,000	\$2,805,000
	13	\$60,000	\$390,000	\$330,000
	14	\$60,000	\$195,000	\$165,000
	15	\$60,000	\$390,000	\$165,000
	16	\$1,530,000	\$390,000	\$990,000
	17	\$150,000	\$2,925,000	\$660,000
	Target Set			
	Optimum Mix	80	2	0
	Weapon Unit			
	Cost	\$30,000	\$195,000	\$165,000
	Weapon Total			
	Cost	\$2,400,000	\$390,000	\$0
	Target Set			
	Optimum Mix			
	Total Cost			\$2,790,000

**Scenario 1, Trial 3**

22M	Target	SDB	JSOW A	JSOW C
	1	\$390,000	\$1,365,000	\$990,000
	2	\$330,000	\$780,000	\$660,000
	3	\$210,000	\$780,000	\$495,000
	4	\$450,000	\$585,000	\$660,000
	5	\$510,000	\$585,000	\$1,650,000
	6	\$690,000	\$4,485,000	\$495,000
	7	\$330,000	\$585,000	\$660,000
	8	\$120,000	\$195,000	\$330,000
	9	\$120,000	\$390,000	\$330,000
	10	\$180,000	\$195,000	\$330,000
	11	\$90,000	\$195,000	\$330,000
	12	\$690,000	\$2,340,000	\$11,385,000
	13	\$150,000	\$390,000	\$495,000
	14	\$120,000	\$390,000	\$330,000
	15	\$90,000	\$390,000	\$330,000
	16	\$1,530,000	\$390,000	\$1,155,000
	17	\$330,000	\$3,510,000	\$1,320,000
Target Set				
Optimum Mix		137	2	3
Weapon Unit				
Cost		\$30,000	\$195,000	\$165,000
Weapon Total				
Cost		\$4,110,000	\$390,000	\$495,000
Target Set				
Optimum Mix				
Total Cost				\$4,995,000

**Scenario 1, Trial 4**

1.5M	Target	SDB	JSOW A	JSOW C	JSOW A+
	1	\$30,000	\$975,000	\$165,000	\$133,000
	2	\$30,000	\$585,000	\$165,000	\$133,000
	3	\$30,000	\$390,000	\$165,000	\$133,000
	4	\$30,000	\$390,000	\$165,000	\$133,000
	5	\$30,000	\$390,000	\$165,000	\$133,000
	6	\$30,000	\$2,340,000	\$165,000	\$133,000
	7	\$30,000	\$390,000	\$165,000	\$133,000
	8	\$30,000	\$195,000	\$165,000	\$133,000
	9	\$30,000	\$195,000	\$165,000	\$133,000
	10	\$30,000	\$195,000	\$165,000	\$133,000
	11	\$30,000	\$195,000	\$165,000	\$133,000
	12	\$30,000	\$1,560,000	\$165,000	\$133,000
	13	\$30,000	\$195,000	\$165,000	\$133,000
	14	\$30,000	\$195,000	\$165,000	\$133,000
	15	\$30,000	\$390,000	\$165,000	\$133,000
	16	\$1,530,000	\$390,000	\$990,000	\$665,000
	17	\$30,000	\$2,535,000	\$165,000	\$133,000
Target Set					
Optimum Mix		16	2	0	0
Weapon Unit					
Cost		\$30,000	\$195,000	\$165,000	\$133,000
Weapon Total					
Cost		\$480,000	\$390,000	\$0	\$0
Target Set					
Optimum Mix					
Total Cost					\$870,000

**Scenario 1, Trial 4**

3M	Target	SDB	JSOW A	JSOW C	JSOW A+
	1	\$30,000	\$975,000	\$165,000	\$133,000
	2	\$30,000	\$585,000	\$165,000	\$133,000
	3	\$30,000	\$390,000	\$165,000	\$133,000
	4	\$30,000	\$390,000	\$165,000	\$133,000
	5	\$30,000	\$390,000	\$165,000	\$133,000
	6	\$60,000	\$2,340,000	\$165,000	\$133,000
	7	\$30,000	\$390,000	\$165,000	\$133,000
	8	\$30,000	\$195,000	\$165,000	\$133,000
	9	\$30,000	\$195,000	\$165,000	\$133,000
	10	\$30,000	\$195,000	\$165,000	\$133,000
	11	\$30,000	\$195,000	\$165,000	\$133,000
	12	\$30,000	\$1,560,000	\$165,000	\$133,000
	13	\$30,000	\$195,000	\$165,000	\$133,000
	14	\$30,000	\$195,000	\$165,000	\$133,000
	15	\$30,000	\$390,000	\$165,000	\$133,000
	16	\$1,530,000	\$390,000	\$990,000	\$798,000
	17	\$30,000	\$2,535,000	\$165,000	\$133,000
Target Set					
Optimum Mix		17	2	0	0
Weapon Unit					
Cost		\$30,000	\$195,000	\$165,000	\$133,000
Weapon Total					
Cost		\$510,000	\$390,000	\$0	\$0
Target Set					
Optimum Mix					
Total Cost					\$900,000

**Scenario 1, Trial 4**

5M	Target	SDB	JSOW A	JSOW C	JSOW A+
	1	\$60,000	\$975,000	\$165,000	\$133,000
	2	\$30,000	\$585,000	\$165,000	\$133,000
	3	\$30,000	\$390,000	\$165,000	\$133,000
	4	\$60,000	\$390,000	\$165,000	\$133,000
	5	\$60,000	\$390,000	\$165,000	\$133,000
	6	\$90,000	\$2,340,000	\$165,000	\$133,000
	7	\$60,000	\$390,000	\$165,000	\$133,000
	8	\$30,000	\$195,000	\$165,000	\$133,000
	9	\$30,000	\$195,000	\$165,000	\$133,000
	10	\$30,000	\$195,000	\$165,000	\$133,000
	11	\$30,000	\$195,000	\$165,000	\$133,000
	12	\$90,000	\$1,560,000	\$495,000	\$266,000
	13	\$30,000	\$195,000	\$165,000	\$133,000
	14	\$30,000	\$195,000	\$165,000	\$133,000
	15	\$30,000	\$390,000	\$165,000	\$133,000
	16	\$1,530,000	\$390,000	\$990,000	\$798,000
	17	\$60,000	\$2,535,000	\$165,000	\$133,000
Target Set					
Optimum Mix		25	2	0	0
Weapon Unit					
Cost		\$30,000	\$195,000	\$165,000	\$133,000
Weapon Total					
Cost		\$750,000	\$390,000	\$0	\$0
Target Set					
Optimum Mix					
Total Cost					\$1,140,000



**Scenario 1, Trial 4**

8M	Target	SDB	JSOW A	JSOW C	JSOW A+
	1	\$90,000	\$975,000	\$330,000	\$133,000
	2	\$60,000	\$585,000	\$165,000	\$133,000
	3	\$60,000	\$390,000	\$165,000	\$133,000
	4	\$90,000	\$390,000	\$165,000	\$133,000
	5	\$120,000	\$390,000	\$330,000	\$266,000
	6	\$180,000	\$2,340,000	\$165,000	\$266,000
	7	\$60,000	\$390,000	\$165,000	\$133,000
	8	\$30,000	\$195,000	\$165,000	\$133,000
	9	\$30,000	\$195,000	\$165,000	\$133,000
	10	\$60,000	\$195,000	\$165,000	\$133,000
	11	\$30,000	\$195,000	\$165,000	\$133,000
	12	\$180,000	\$1,560,000	\$1,155,000	\$532,000
	13	\$30,000	\$195,000	\$165,000	\$133,000
	14	\$30,000	\$195,000	\$165,000	\$133,000
	15	\$30,000	\$390,000	\$165,000	\$133,000
	16	\$1,530,000	\$390,000	\$1,155,000	\$798,000
	17	\$90,000	\$2,535,000	\$330,000	\$266,000
Target Set					
Optimum Mix		33	2	1	0
Weapon Unit					
Cost		\$30,000	\$195,000	\$165,000	\$133,000
Weapon Total					
Cost		\$990,000	\$390,000	\$165,000	\$0
Target Set					
Optimum Mix					
Total Cost					\$1,545,000

**Scenario 1, Trial 4**

13M	Target	SDB	JSOW A	JSOW C	JSOW A+
	1	\$180,000	\$1,170,000	\$495,000	\$266,000
	2	\$120,000	\$585,000	\$330,000	\$266,000
	3	\$90,000	\$585,000	\$330,000	\$266,000
	4	\$180,000	\$390,000	\$330,000	\$266,000
	5	\$240,000	\$390,000	\$660,000	\$399,000
	6	\$330,000	\$2,730,000	\$330,000	\$399,000
	7	\$150,000	\$390,000	\$330,000	\$266,000
	8	\$60,000	\$195,000	\$165,000	\$133,000
	9	\$60,000	\$195,000	\$165,000	\$133,000
	10	\$90,000	\$195,000	\$165,000	\$133,000
	11	\$60,000	\$195,000	\$165,000	\$133,000
	12	\$510,000	\$1,560,000	\$2,805,000	\$1,197,000
	13	\$60,000	\$390,000	\$330,000	\$133,000
	14	\$60,000	\$195,000	\$165,000	\$133,000
	15	\$60,000	\$390,000	\$165,000	\$133,000
	16	\$1,530,000	\$390,000	\$990,000	\$798,000
	17	\$150,000	\$2,925,000	\$660,000	\$399,000
	Target Set				
	Optimum Mix	80	2	0	0
	Weapon Unit				
	Cost	\$30,000	\$195,000	\$165,000	\$133,000
	Weapon Total				
	Cost	\$2,400,000	\$390,000	\$0	\$0
	Target Set				
	Optimum Mix				
	Total Cost				\$2,790,000

**Scenario 1, Trial 4**

22M	Target	SDB	JSOW A	JSOW C	JSOW A+
	1	\$390,000	\$1,365,000	\$990,000	\$532,000
	2	\$330,000	\$780,000	\$660,000	\$399,000
	3	\$210,000	\$780,000	\$495,000	\$399,000
	4	\$450,000	\$585,000	\$660,000	\$532,000
	5	\$510,000	\$585,000	\$1,650,000	\$665,000
	6	\$690,000	\$4,485,000	\$495,000	\$798,000
	7	\$330,000	\$585,000	\$660,000	\$532,000
	8	\$120,000	\$195,000	\$330,000	\$266,000
	9	\$120,000	\$390,000	\$330,000	\$266,000
	10	\$180,000	\$195,000	\$330,000	\$266,000
	11	\$90,000	\$195,000	\$330,000	\$266,000
	12	\$690,000	\$2,340,000	\$11,385,000	\$3,059,000
	13	\$150,000	\$390,000	\$495,000	\$266,000
	14	\$120,000	\$390,000	\$330,000	\$266,000
	15	\$90,000	\$390,000	\$330,000	\$133,000
	16	\$1,530,000	\$390,000	\$1,155,000	\$798,000
	17	\$330,000	\$3,510,000	\$1,320,000	\$931,000
	Target Set				
	Optimum Mix	137	2	3	0
	Weapon Unit				
	Cost	\$30,000	\$195,000	\$165,000	\$133,000
	Weapon Total				
	Cost	\$4,110,000	\$390,000	\$495,000	\$0
	Target Set				
	Optimum Mix				
	Total Cost				\$4,995,000

THIS PAGE INTENTIONALLY LEFT BLANK

## **APPENDIX B: SCENARIO TWO**

### **A. TABLE OVERVIEW**

The tables below contain the cost per kill results for each trial. The data within each table was calculated using the same methodology as presented in scenario one. The numbers are comparatively larger however, since all aim points and all “relevant costs” were incorporated.

**B. COST PER KILL**

1	2	3	4	5	6
JSOW A	13,065	\$195,000	\$2,547,675,000	2.6	\$979,875,000
JSOW C	34,977	\$165,000	\$5,771,205,000	14.4	\$400,778,125

Table 11 Cost Per Kill Scenario 2, Trial 1

1	2	3	4	5	6
JSOW A	6,219	\$195,000	\$1,212,705,000	2	\$606,352,500
JSOW C	233	\$165,000	\$38,445,000	0.5	\$76,890,000
JSOW A+	36,662	\$133,000	\$4,876,046,000	14.5	\$336,279,034

Table 12 Cost Per Kill Scenario 2, Trial 2

1	2	3	4	5	6
SDB	75,099	\$34,082	\$2,559,524,118	15.5	\$165,130,588
JSOW A	2,956	\$195,000	\$576,420,000	1	\$576,420,000
JSOW C	233	\$165,000	\$38,445,000	0.5	\$76,890,000

Table 13 Cost Per Kill Scenario 2, Trial 3

1	2	3	4	5	6
SDB	75,099	\$34,082	\$2,559,524,118	15.5	\$165,130,588
JSOW A	2,956	\$195,000	\$576,420,000	1	\$576,420,000
JSOW C	233	\$165,000	\$38,445,000	0.5	\$76,890,000
JSOW A+	0	\$133,000	0	0	0

Table 14 Cost Per Kill Scenario 2, Trial 4

**Legend**

Column 1: Weapon System

Column 2: Average Number of Weapons Required Across All CEPs Per Target

Column 3: Cost Per Unit

Column 4: Average Total Cost Per Weapon System

Column 5: Average Number of Targets Targeted Per Weapon System

Column 6: Average Cost Per Kill Per Target

### C. COST OF OPTIMUM MIX

As in Scenario One, the model generated the total cost of the optimum mix for each specific CEP. Each unique trial within the scenario produced data that yielded the optimum mix (i.e., the most cost-effective mix) for CEPs 1.5m through 22m. Results are shown in Table 15 and Table 16 below.

Trial 1:	CEP	Total Cost	Trial 2:	CEP	Total Cost
	1.5m	\$5,089,665,000		1.5m	\$4,214,369,000
	3m	\$5,089,665,000		3m	\$4,214,369,000
	5m	\$5,488,965,000		5m	\$4,375,299,000
	8m	\$6,645,450,000		8m	\$4,874,988,000
	13m	\$11,187,810,000		13m	\$6,945,629,000
	22m	\$16,411,755,000		22m	\$12,138,061,000
Average Cost:		\$8,318,885,000	Average Cost:		\$6,127,119,167

Table 15 Total Cost of Optimum Mix Per Trial 1 and 2 at Each CEP:

Trial 3:	CEP	Total Cost	Trial 4:	CEP	Total Cost
	1.5m	\$1,572,014,494		1.5m	\$1,572,014,494
	3m	\$1,579,005,584		3m	\$1,579,005,584
	5m	\$1,734,294,604		5m	\$1,734,294,604
	8m	\$2,167,567,553		8m	\$2,167,567,553
	13m	\$3,747,573,380		13m	\$3,747,573,380
	22m	\$7,456,562,426		22m	\$7,456,562,426
Average Cost:		\$3,042,836,340	Average Cost:		\$3,042,836,340

Table 16 Total Cost of Optimum Mix Per Trial 3 and 4 at Each CEP:

**D. DATA FOR SCENARIO 2**

**Scenario 2, Trial 1**

1.5M	Type of Target	JSOW A	JSOW C
	1	\$865,800,000	\$146,520,000
	2	\$3,906,630,000	\$1,101,870,000
	3	\$33,930,000	\$14,355,000
	4	\$131,040,000	\$55,440,000
	5	\$336,180,000	\$142,230,000
	6	\$545,220,000	\$38,445,000
	7	\$7,020,000	\$2,970,000
	8	\$111,540,000	\$94,380,000
	9	\$49,920,000	\$42,240,000
	10	\$19,110,000	\$16,170,000
	11	\$15,015,000	\$12,705,000
	12	\$1,887,600,000	\$199,650,000
	13	\$2,957,760,000	\$2,502,720,000
	14	\$76,440,000	\$64,680,000
	15	\$23,010,000	\$9,735,000
	16	\$576,420,000	\$1,463,220,000
	17	\$1,062,165,000	\$69,135,000
Target Set Optimum Mix		2956	27353
Weapon Unit Cost		\$195,000	\$165,000
Weapon Total Cost		\$576,420,000	\$4,513,245,000
Target Set Optimum Mix Total Cost			\$5,089,665,000



**Scenario 2, Trial 1**

3M	Type of Target	JSOW A	JSOW C
	1	\$865,800,000	\$146,520,000
	2	\$3,906,630,000	\$1,101,870,000
	3	\$33,930,000	\$14,355,000
	4	\$131,040,000	\$55,440,000
	5	\$336,180,000	\$142,230,000
	6	\$545,220,000	\$38,445,000
	7	\$7,020,000	\$2,970,000
	8	\$111,540,000	\$94,380,000
	9	\$49,920,000	\$42,240,000
	10	\$19,110,000	\$16,170,000
	11	\$15,015,000	\$12,705,000
	12	\$1,887,600,000	\$199,650,000
	13	\$2,957,760,000	\$2,502,720,000
	14	\$76,440,000	\$64,680,000
	15	\$23,010,000	\$9,735,000
	16	\$576,420,000	\$1,463,220,000
	17	\$1,062,165,000	\$69,135,000
	Target Set Optimum Mix	2956	27353
	Weapon Unit Cost	\$195,000	\$165,000
	Weapon Total Cost	\$576,420,000	\$4,513,245,000
	Target Set Optimum Mix Total Cost		\$5,089,665,000

**Scenario 2, Trial 1**

<b>5M</b>	<b>Type of Target</b>	<b>JSOW A</b>	<b>JSOW C</b>
	1	\$865,800,000	\$146,520,000
	2	\$3,906,630,000	\$1,101,870,000
	3	\$33,930,000	\$14,355,000
	4	\$131,040,000	\$55,440,000
	5	\$336,180,000	\$142,230,000
	6	\$545,220,000	\$38,445,000
	7	\$7,020,000	\$2,970,000
	8	\$111,540,000	\$94,380,000
	9	\$49,920,000	\$42,240,000
	10	\$19,110,000	\$16,170,000
	11	\$15,015,000	\$12,705,000
	12	\$1,887,600,000	\$598,950,000
	13	\$2,957,760,000	\$2,502,720,000
	14	\$76,440,000	\$64,680,000
	15	\$23,010,000	\$9,735,000
	16	\$576,420,000	\$1,463,220,000
	17	\$1,062,165,000	\$69,135,000
Target Set Optimum Mix		2956	29773
Weapon Unit Cost		\$195,000	\$165,000
Weapon Total Cost		\$576,420,000	\$4,912,545,000
Target Set Optimum Mix Total Cost			\$5,488,965,000

**Scenario 2, Trial 1**

8M	Type of Target	JSOW A	JSOW C
	1	\$865,800,000	\$293,040,000
	2	\$3,906,630,000	\$1,101,870,000
	3	\$33,930,000	\$14,355,000
	4	\$131,040,000	\$55,440,000
	5	\$336,180,000	\$284,460,000
	6	\$545,220,000	\$38,445,000
	7	\$7,020,000	\$2,970,000
	8	\$111,540,000	\$94,380,000
	9	\$49,920,000	\$42,240,000
	10	\$19,110,000	\$16,170,000
	11	\$15,015,000	\$12,705,000
	12	\$1,887,600,000	\$1,397,550,000
	13	\$2,957,760,000	\$2,502,720,000
	14	\$76,440,000	\$64,680,000
	15	\$23,010,000	\$9,735,000
	16	\$576,420,000	\$1,707,090,000
	17	\$1,062,165,000	\$138,270,000
Target Set Optimum Mix		2956	36782
Weapon Unit Cost		\$195,000	\$165,000
Weapon Total Cost		\$576,420,000	\$6,069,030,000
Target Set Optimum Mix Total Cost			\$6,645,450,000

**Scenario 2, Trial 1**

13M	Type of Target	JSOW A	JSOW C
	1	\$1,038,960,000	\$439,560,000
	2	\$3,906,630,000	\$2,203,740,000
	3	\$50,895,000	\$28,710,000
	4	\$131,040,000	\$110,880,000
	5	\$336,180,000	\$568,920,000
	6	\$636,090,000	\$76,890,000
	7	\$7,020,000	\$5,940,000
	8	\$111,540,000	\$94,380,000
	9	\$49,920,000	\$42,240,000
	10	\$19,110,000	\$16,170,000
	11	\$15,015,000	\$12,705,000
	12	\$1,887,600,000	\$3,394,050,000
	13	\$5,915,520,000	\$5,005,440,000
	14	\$76,440,000	\$64,680,000
	15	\$23,010,000	\$9,735,000
	16	\$576,420,000	\$1,463,220,000
	17	\$1,225,575,000	\$276,540,000
	Target Set Optimum Mix	14,360	50,834
	Weapon Unit Cost	\$195,000	\$165,000
	Weapon Total Cost	\$2,800,200,000	\$8,387,610,000
	Target Set Optimum Mix Total Cost		\$11,187,810,000

**Scenario 2, Trial 1**

22M	Type of Target	JSOW A	JSOW C
	1	\$1,212,120,000	\$879,120,000
	2	\$5,208,840,000	\$4,407,480,000
	3	\$67,860,000	\$43,065,000
	4	\$196,560,000	\$221,760,000
	5	\$504,270,000	\$1,422,300,000
	6	\$1,045,005,000	\$115,335,000
	7	\$10,530,000	\$11,880,000
	8	\$111,540,000	\$188,760,000
	9	\$99,840,000	\$84,480,000
	10	\$19,110,000	\$32,340,000
	11	\$15,015,000	\$25,410,000
	12	\$2,831,400,000	\$13,775,850,000
	13	\$5,915,520,000	\$7,508,160,000
	14	\$152,880,000	\$129,360,000
	15	\$23,010,000	\$19,470,000
	16	\$576,420,000	\$1,707,090,000
	17	\$1,470,690,000	\$553,080,000
	Target Set Optimum Mix	52,207	37,766
	Weapon Unit Cost	\$195,000	\$165,000
	Weapon Total Cost	\$10,180,365,000	\$6,231,390,000
	Target Set Optimum Mix Total Cost		\$16,411,755,000

**Scenario 2, Trial 2**

1.5M	Target	JSOW A	JSOW C	JSOW A+
	1	\$865,800,000	\$146,520,000	\$118,104,000
	2	\$3,906,630,000	\$1,101,870,000	\$888,174,000
	3	\$33,930,000	\$14,355,000	\$11,571,000
	4	\$131,040,000	\$55,440,000	\$44,688,000
	5	\$336,180,000	\$142,230,000	\$114,646,000
	6	\$545,220,000	\$38,445,000	\$30,989,000
	7	\$7,020,000	\$2,970,000	\$2,394,000
	8	\$111,540,000	\$94,380,000	\$76,076,000
	9	\$49,920,000	\$42,240,000	\$34,048,000
	10	\$19,110,000	\$16,170,000	\$13,034,000
	11	\$15,015,000	\$12,705,000	\$10,241,000
	12	\$1,887,600,000	\$199,650,000	\$160,930,000
	13	\$2,957,760,000	\$2,502,720,000	\$2,017,344,000
	14	\$76,440,000	\$64,680,000	\$52,136,000
	15	\$23,010,000	\$9,735,000	\$7,847,000
	16	\$576,420,000	\$1,463,220,000	\$982,870,000
	17	\$1,062,165,000	\$69,135,000	\$55,727,000
	Target Set Optimum Mix	2,956	0	27,353
	Weapon Unit Cost	\$195,000	\$165,000	\$133,000
	Weapon Total Cost	\$576,420,000	\$0	\$3,637,949,000
	Target Set Optimum Mix Total Cost			\$4,214,369,000

**Scenario 2, Trial 2**

3M	Target	JSOW A	JSOW C	JSOW A+
	1	\$865,800,000	\$146,520,000	\$118,104,000
	2	\$3,906,630,000	\$1,101,870,000	\$888,174,000
	3	\$33,930,000	\$14,355,000	\$11,571,000
	4	\$131,040,000	\$55,440,000	\$44,688,000
	5	\$336,180,000	\$142,230,000	\$114,646,000
	6	\$545,220,000	\$38,445,000	\$30,989,000
	7	\$7,020,000	\$2,970,000	\$2,394,000
	8	\$111,540,000	\$94,380,000	\$76,076,000
	9	\$49,920,000	\$42,240,000	\$34,048,000
	10	\$19,110,000	\$16,170,000	\$13,034,000
	11	\$15,015,000	\$12,705,000	\$10,241,000
	12	\$1,887,600,000	\$199,650,000	\$160,930,000
	13	\$2,957,760,000	\$2,502,720,000	\$2,017,344,000
	14	\$76,440,000	\$64,680,000	\$52,136,000
	15	\$23,010,000	\$9,735,000	\$7,847,000
	16	\$576,420,000	\$1,463,220,000	\$1,179,444,000
	17	\$1,062,165,000	\$69,135,000	\$55,727,000
	Target Set			
	Optimum Mix	2,956	0	27,353
	Weapon Unit			
	Cost	\$195,000	\$165,000	\$133,000
	Weapon Total			
	Cost	\$576,420,000	\$0	\$3,637,949,000
	Target Set			
	Optimum Mix			\$4,214,369,000
	Total Cost			

**Scenario 2, Trial 2**

5M	Target	JSOW A	JSOW C	JSOW A+
	1	865800000	146520000	118104000
	2	3906630000	1101870000	888174000
	3	33930000	14355000	11571000
	4	131040000	55440000	44688000
	5	336180000	142230000	114646000
	6	545220000	38445000	30989000
	7	7020000	2970000	2394000
	8	111540000	94380000	76076000
	9	49920000	42240000	34048000
	10	19110000	16170000	13034000
	11	15015000	12705000	10241000
	12	1887600000	598950000	321860000
	13	2957760000	2502720000	2017344000
	14	76440000	64680000	52136000
	15	23010000	9735000	7847000
	16	576420000	1463220000	1179444000
	17	1062165000	69135000	55727000
	Target Set Optimum Mix	2,956	0	28,563
	Weapon Unit Cost	\$195,000	\$165,000	\$133,000
	Weapon Total Cost	\$576,420,000	\$0	\$3,798,879,000
	Target Set Optimum Mix Total Cost			\$4,375,299,000



**Scenario 2, Trial 2**

8M	Target	JSOW A	JSOW C	JSOW A+
	1	\$865,800,000	\$293,040,000	\$118,104,000
	2	\$3,906,630,000	\$1,101,870,000	\$888,174,000
	3	\$33,930,000	\$14,355,000	\$11,571,000
	4	\$131,040,000	\$55,440,000	\$44,688,000
	5	\$336,180,000	\$284,460,000	\$229,292,000
	6	\$545,220,000	\$38,445,000	\$61,978,000
	7	\$7,020,000	\$2,970,000	\$2,394,000
	8	\$111,540,000	\$94,380,000	\$76,076,000
	9	\$49,920,000	\$42,240,000	\$34,048,000
	10	\$19,110,000	\$16,170,000	\$13,034,000
	11	\$15,015,000	\$12,705,000	\$10,241,000
	12	\$1,887,600,000	\$1,397,550,000	\$643,720,000
	13	\$2,957,760,000	\$2,502,720,000	\$2,017,344,000
	14	\$76,440,000	\$64,680,000	\$52,136,000
	15	\$23,010,000	\$9,735,000	\$7,847,000
	16	\$576,420,000	\$1,707,090,000	\$1,179,444,000
	17	\$1,062,165,000	\$138,270,000	\$111,454,000
	Target Set Optimum Mix	2,956	233	32,031
	Weapon Unit Cost	\$195,000	\$165,000	\$133,000
	Weapon Total Cost	\$576,420,000	\$38,445,000	\$4,260,123,000
	Target Set Optimum Mix Total Cost			\$4,874,988,000

**Scenario 2, Trial 2**

13M	Target	JSOW A	JSOW C	JSOW A+
	1	\$1,038,960,000	\$439,560,000	\$236,208,000
	2	\$3,906,630,000	\$2,203,740,000	\$1,776,348,000
	3	\$50,895,000	\$28,710,000	\$23,142,000
	4	\$131,040,000	\$110,880,000	\$89,376,000
	5	\$336,180,000	\$568,920,000	\$343,938,000
	6	\$636,090,000	\$76,890,000	\$92,967,000
	7	\$7,020,000	\$5,940,000	\$4,788,000
	8	\$111,540,000	\$94,380,000	\$76,076,000
	9	\$49,920,000	\$42,240,000	\$34,048,000
	10	\$19,110,000	\$16,170,000	\$13,034,000
	11	\$15,015,000	\$12,705,000	\$10,241,000
	12	\$1,887,600,000	\$3,394,050,000	\$1,448,370,000
	13	\$5,915,520,000	\$5,005,440,000	\$2,017,344,000
	14	\$76,440,000	\$64,680,000	\$52,136,000
	15	\$23,010,000	\$9,735,000	\$7,847,000
	16	\$576,420,000	\$1,463,220,000	\$1,179,444,000
	17	\$1,225,575,000	\$276,540,000	\$167,181,000
	Target Set Optimum Mix	4,680	466	44,783
	Weapon Unit Cost	\$195,000	\$165,000	\$133,000
	Weapon Total Cost	\$912,600,000	\$76,890,000	\$5,956,139,000
	Target Set Optimum Mix Total Cost			\$6,945,629,000

**Scenario 2, Trial 2**

22M	Target	JSOW A	JSOW C	JSOW A+
	1	\$1,212,120,000	\$879,120,000	\$472,416,000
	2	\$5,208,840,000	\$4,407,480,000	\$2,664,522,000
	3	\$67,860,000	\$43,065,000	\$34,713,000
	4	\$196,560,000	\$221,760,000	\$178,752,000
	5	\$504,270,000	\$1,422,300,000	\$573,230,000
	6	\$1,045,005,000	\$115,335,000	\$185,934,000
	7	\$10,530,000	\$11,880,000	\$9,576,000
	8	\$111,540,000	\$188,760,000	\$152,152,000
	9	\$99,840,000	\$84,480,000	\$68,096,000
	10	\$19,110,000	\$32,340,000	\$26,068,000
	11	\$15,015,000	\$25,410,000	\$20,482,000
	12	\$2,831,400,000	\$13,775,850,000	\$3,701,390,000
	13	\$5,915,520,000	\$7,508,160,000	\$4,034,688,000
	14	\$152,880,000	\$129,360,000	\$104,272,000
	15	\$23,010,000	\$19,470,000	\$7,847,000
	16	\$576,420,000	\$1,707,090,000	\$1,179,444,000
	17	\$1,470,690,000	\$553,080,000	\$390,089,000
	Target Set Optimum Mix	20,809	699	59,887
	Weapon Unit Cost	\$195,000	\$165,000	\$133,000
	Weapon Total Cost	\$4,057,755,000	\$115,335,000	\$7,964,971,000
	Target Set Optimum Mix Total Cost			\$12,138,061,000

**Scenario 2, Trial 3**

1.5M	Target	SDB	JSOW A	JSOW C
	1	\$32,321,278	\$865,800,000	\$146,520,000
	2	\$243,064,747	\$3,906,630,000	\$1,101,870,000
	3	\$3,166,612	\$33,930,000	\$14,355,000
	4	\$12,229,673	\$131,040,000	\$55,440,000
	5	\$31,374,934	\$336,180,000	\$142,230,000
	6	\$8,480,696	\$545,220,000	\$38,445,000
	7	\$655,161	\$7,020,000	\$2,970,000
	8	\$20,819,562	\$111,540,000	\$94,380,000
	9	\$9,317,846	\$49,920,000	\$42,240,000
	10	\$3,566,988	\$19,110,000	\$16,170,000
	11	\$2,802,633	\$15,015,000	\$12,705,000
	12	\$44,041,381	\$1,887,600,000	\$199,650,000
	13	\$552,082,372	\$2,957,760,000	\$2,502,720,000
	14	\$14,267,952	\$76,440,000	\$64,680,000
	15	\$2,147,472	\$23,010,000	\$9,735,000
	16	\$2,261,340,000	\$576,420,000	\$1,463,220,000
	17	\$15,250,693	\$1,062,165,000	\$69,135,000
	Target Set Optimum Mix	27,353	2,956	0
	Weapon Unit Cost	\$36,398	\$195,000	\$165,000
	Weapon Total Cost	\$995,594,494	\$576,420,000	\$0
	Target Set Optimum Mix Total Cost			\$1,572,014,494

**Scenario 2, Trial 3**

3M	Target	SDB	JSOW A	JSOW C
	1	\$32,273,292	\$865,800,000	\$146,520,000
	2	\$242,703,880	\$3,906,630,000	\$1,101,870,000
	3	\$3,161,910	\$33,930,000	\$14,355,000
	4	\$12,211,516	\$131,040,000	\$55,440,000
	5	\$31,328,354	\$336,180,000	\$142,230,000
	6	\$16,936,210	\$545,220,000	\$38,445,000
	7	\$654,188	\$7,020,000	\$2,970,000
	8	\$20,788,652	\$111,540,000	\$94,380,000
	9	\$9,304,012	\$49,920,000	\$42,240,000
	10	\$3,561,692	\$19,110,000	\$16,170,000
	11	\$2,798,472	\$15,015,000	\$12,705,000
	12	\$43,975,995	\$1,887,600,000	\$199,650,000
	13	\$551,262,722	\$2,957,760,000	\$2,502,720,000
	14	\$14,246,769	\$76,440,000	\$64,680,000
	15	\$2,144,284	\$23,010,000	\$9,735,000
	16	\$2,261,340,000	\$576,420,000	\$1,463,220,000
	17	\$15,228,051	\$1,062,165,000	\$69,135,000
	Target Set Optimum Mix	27,586	2,956	0
	Weapon Unit Cost	\$36,344	\$195,000	\$165,000
	Weapon Total Cost	\$1,002,585,584	\$576,420,000	\$0
	Target Set Optimum Mix Total Cost			\$1,579,005,584

**Scenario 2, Trial 3**

5M	Target	SDB	JSOW A	JSOW C
	1	\$62,766,600	\$865,800,000	\$146,520,000
	2	\$236,010,899	\$3,906,630,000	\$1,101,870,000
	3	\$3,074,715	\$33,930,000	\$14,355,000
	4	\$23,749,524	\$131,040,000	\$55,440,000
	5	\$60,928,839	\$336,180,000	\$142,230,000
	6	\$24,703,746	\$545,220,000	\$38,445,000
	7	\$1,272,295	\$7,020,000	\$2,970,000
	8	\$20,215,369	\$111,540,000	\$94,380,000
	9	\$9,047,437	\$49,920,000	\$42,240,000
	10	\$3,463,472	\$19,110,000	\$16,170,000
	11	\$2,721,299	\$15,015,000	\$12,705,000
	12	\$128,289,841	\$1,887,600,000	\$598,950,000
	13	\$536,060,694	\$2,957,760,000	\$2,502,720,000
	14	\$13,853,889	\$76,440,000	\$64,680,000
	15	\$2,085,151	\$23,010,000	\$9,735,000
	16	\$2261,340,000	\$576,420,000	\$1,463,220,000
	17	\$29,616,222	\$1,062,165,000	\$69,135,000
	Target Set Optimum Mix	32,762	2,956	0
	Weapon Unit Cost	\$35,342	\$195,000	\$165,000
	Weapon Total Cost	\$1,157,874,604	\$576,420,000	\$0
	Target Set Optimum Mix Total Cost			\$1,734,294,604

**Scenario 2, Trial 3**

8M	Target	SDB	JSOW A	JSOW C
	1	\$90,071,776	\$865,800,000	\$293,040,000
	2	\$451,576,065	\$3,906,630,000	\$1,101,870,000
	3	\$5,883,066	\$33,930,000	\$14,355,000
	4	\$34,081,212	\$131,040,000	\$55,440,000
	5	\$116,579,385	\$336,180,000	\$284,460,000
	6	\$41,940,000	\$545,220,000	\$38,445,000
	7	\$1,217,186	\$7,020,000	\$2,970,000
	8	\$19,339,736	\$111,540,000	\$94,380,000
	9	\$8,655,546	\$49,920,000	\$42,240,000
	10	\$6,626,902	\$19,110,000	\$16,170,000
	11	\$2,603,426	\$15,015,000	\$12,705,000
	12	\$245,465,875	\$1,887,600,000	\$1,397,550,000
	13	\$512,841,102	\$2,957,760,000	\$2,502,720,000
	14	\$13,253,805	\$76,440,000	\$64,680,000
	15	\$1,994,833	\$23,010,000	\$9,735,000
	16	\$2,261,340,000	\$576,420,000	\$1,707,090,000
	17	\$42,500,083	\$1,062,165,000	\$138,270,000
	Target Set Optimum Mix	45,923	2,956	233
	Weapon Unit Cost	\$33,811	\$195,000	\$165,000
	Weapon Total Cost	\$1,552,702,553	\$576,420,000	\$38,445,000
	Target Set Optimum Mix Total Cost			\$2,167,567,553

**Scenario 2, Trial 3**

13M	Target	SDB	JSOW A	JSOW C
	1	\$178,757,606	\$1,038,960,000	\$439,560,000
	2	\$896,203,671	\$3,906,630,000	\$2,203,740,000
	3	\$8,756,707	\$50,895,000	\$28,710,000
	4	\$67,638,013	\$131,040,000	\$110,880,000
	5	\$231,364,949	\$336,180,000	\$568,920,000
	6	\$81,380,954	\$636,090,000	\$76,890,000
	7	\$3,019,554	\$7,020,000	\$5,940,000
	8	\$38,381,888	\$111,540,000	\$94,380,000
	9	\$17,177,908	\$49,920,000	\$42,240,000
	10	\$9,863,877	\$19,110,000	\$16,170,000
	11	\$5,166,793	\$15,015,000	\$12,705,000
	12	\$690,135,876	\$1,887,600,000	\$3,394,050,000
	13	\$1,017,791,052	\$5,915,520,000	\$5,005,440,000
	14	\$26,303,672	\$76,440,000	\$64,680,000
	15	\$3,958,971	\$23,010,000	\$9,735,000
	16	\$2,261,340,000	\$576,420,000	\$1,463,220,000
	17	\$70,288,510	\$1,225,575,000	\$276,540,000
	Target Set			
	Optimum Mix	97,310	2,956	466
	Weapon Unit			
	Cost	\$31,798	\$195,000	\$165,000
	Weapon Total			
	Cost	\$3,094,263,380	\$576,420,000	\$76,890,000
	Target Set			
	Optimum Mix			\$3,747,573,380
	Total Cost			



**Scenario 2, Trial 3**

22M	Target	SDB	JSOW A	JSOW C
	1	\$355,517,024	\$1,212,120,000	\$879,120,000
	2	\$2,262,263,477	\$5,208,840,000	\$4,407,480,000
	3	\$18,755,186	\$67,860,000	\$43,065,000
	4	\$155,215,333	\$196,560,000	\$221,760,000
	5	\$451,294,740	\$504,270,000	\$1,422,300,000
	6	\$160,770,000	\$1,045,005,000	\$115,335,000
	7	\$6,097,745	\$10,530,000	\$11,880,000
	8	\$70,462,834	\$111,540,000	\$188,760,000
	9	\$31,535,814	\$99,840,000	\$84,480,000
	10	\$18,108,456	\$19,110,000	\$32,340,000
	11	\$7,114,036	\$15,015,000	\$25,410,000
	12	\$857,071,967	\$2,831,400,000	\$1,377,585,000
	13	\$2,335,621,200	\$5,915,520,000	\$7,508,160,000
	14	\$48,289,215	\$152,880,000	\$129,360,000
	15	\$5,451,015	\$23,010,000	\$19,470,000
	16	\$2,261,340,000	\$576,420,000	\$1,707,090,000
	17	\$141,941,958	\$1,470,690,000	\$553,080,000
	Target Set Optimum Mix	219,658	2,956	699
	Weapon Unit Cost	\$30,797	\$195,000	\$165,000
	Weapon Total Cost	\$6,764,807,426	\$576,420,000	\$115,335,000
	Target Set Optimum Mix Total Cost			\$7,456,562,426

**Scenario 2, Trial 4**

1.5M	Tgt	SDB	JSOW A	JSOW C	JSOW A+
	1	\$32,321,278	\$865,800,000	\$146,520,000	\$118,104,000
	2	\$243,064,747	\$3,906,630,000	\$1,101,870,000	\$888,174,000
	3	\$3,166,612	\$33,930,000	\$14,355,000	\$11,571,000
	4	\$12,229,673	\$131,040,000	\$55,440,000	\$44,688,000
	5	\$31,374,934	\$336,180,000	\$142,230,000	\$114,646,000
	6	\$8,480,696	\$545,220,000	\$38,445,000	\$30,989,000
	7	\$655,161	\$7,020,000	\$2,970,000	\$2,394,000
	8	\$20,819,562	\$111,540,000	\$94,380,000	\$76,076,000
	9	\$9,317,846	\$49,920,000	\$42,240,000	\$34,048,000
	10	\$3,566,988	\$19,110,000	\$16,170,000	\$13,034,000
	11	\$2,802,633	\$15,015,000	\$12,705,000	\$10,241,000
	12	\$44,041,381	\$1,887,600,000	\$199,650,000	\$160,930,000
	13	\$552,082,372	\$2,957,760,000	\$2,502,720,000	\$2,017,344,000
	14	\$14,267,952	\$76,440,000	\$64,680,000	\$52,136,000
	15	\$2,147,472	\$23,010,000	\$9,735,000	\$7,847,000
	16	\$2,261,340,000	\$576,420,000	\$1,463,220,000	\$982,870,000
	17	\$15,250,693	\$1,062,165,000	\$69,135,000	\$55,727,000
	Target Set Optimum Mix	27,353	2,956	0	0
	Weapon Unit Cost	\$36,398	\$195,000	\$165,000	\$133,000
	Weapon Total Cost	\$995,594,494	\$576,420,000	\$0	\$0
	Target Set Optimum Mix Total Cost				\$1,572,014,494

**Scenario 2, Trial 4**

3M	Tgt	SDB	JSOW A	JSOW C	JSOW A+
	1	\$32,273,292	\$865,800,000	\$146,520,000	\$118,104,000
	2	\$242,703,880	\$3,906,630,000	\$1,101,870,000	\$888,174,000
	3	\$3,161,910	\$33,930,000	\$14,355,000	\$11,571,000
	4	\$12,211,516	\$131,040,000	\$55,440,000	\$44,688,000
	5	\$31,328,354	\$336,180,000	\$142,230,000	\$114,646,000
	6	\$16,936,210	\$545,220,000	\$38,445,000	\$30,989,000
	7	\$654,188	\$7,020,000	\$2,970,000	\$2,394,000
	8	\$20,788,652	\$111,540,000	\$94,380,000	\$76,076,000
	9	\$9,304,012	\$49,920,000	\$42,240,000	\$34,048,000
	10	\$3,561,692	\$19,110,000	\$16,170,000	\$13,034,000
	11	\$2,798,472	\$15,015,000	\$12,705,000	\$10,241,000
	12	\$43,975,995	\$1,887,600,000	\$199,650,000	\$160,930,000
	13	\$551,262,722	\$2,957,760,000	\$2,502,720,000	\$2,017,344,000
	14	\$14,246,769	\$76,440,000	\$64,680,000	\$52,136,000
	15	\$2,144,284	\$23,010,000	\$9,735,000	\$7,847,000
	16	\$2,261,340,000	\$576,420,000	\$1,463,220,000	\$1,179,444,000
	17	\$15,228,051	\$1,062,165,000	\$69,135,000	\$55,727,000
Target Set					
Optimum		27,586	2,956	0	0
Mix					
Weapon					
Unit Cost		\$36,344	\$195,000	\$165,000	\$133,000
Weapon					
Total Cost		\$1,002,585,584	\$576,420,000	\$0	\$0
Target Set					
Optimum					
Mix Total					\$1,579,005,584
Cost					

**Scenario 2, Trial 4**

5M	Tgt	SDB	JSOW A	JSOW C	JSOW A+
	1	\$62,766,600	\$865,800,000	\$146,520,000	\$118,104,000
	2	\$236,010,899	\$3,906,630,000	\$1,101,870,000	\$888,174,000
	3	\$3,074,715	\$33,930,000	\$14,355,000	\$11,571,000
	4	\$23,749,524	\$131,040,000	\$55,440,000	\$44,688,000
	5	\$60,928,840	\$336,180,000	\$142,230,000	\$114,646,000
	6	\$24,703,746	\$545,220,000	\$38,445,000	\$30,989,000
	7	\$1,272,296	\$7,020,000	\$2,970,000	\$2,394,000
	8	\$20,215,369	\$111,540,000	\$94,380,000	\$76,076,000
	9	\$9,047,438	\$49,920,000	\$42,240,000	\$34,048,000
	10	\$3,463,472	\$19,110,000	\$16,170,000	\$13,034,000
	11	\$2,721,300	\$15,015,000	\$12,705,000	\$10,241,000
	12	\$128,289,842	\$1,887,600,000	\$598,950,000	\$321,860,000
	13	\$536,060,695	\$2,957,760,000	\$2,502,720,000	\$2,017,344,000
	14	\$13,853,889	\$76,440,000	\$64,680,000	\$52,136,000
	15	\$2,085,152	\$23,010,000	\$9,735,000	\$7,847,000
	16	\$2,261,340,000	\$576,420,000	\$1,463,220,000	\$1,179,444,000
	17	\$29,616,222	\$1,062,165,000	\$69,135,000	\$55,727,000
Target Set Optimum Mix		32,762	2,956	0	0
Weapon Unit Cost		\$35,342	\$195,000	\$165,000	\$133,000
Weapon Total Cost		\$1,157,874,604	\$576,420,000	\$0	\$0
Target Set Optimum Mix Total Cost					\$1,734,294,604

**Scenario 2, Trial 4**

8M	Tgt	SDB	JSOW A	JSOW C	JSOW A+
	1	\$90,071,776	\$865,800,000	\$293,040,000	\$118,104,000
	2	\$451,576,065	\$3,906,630,000	\$1,101,870,000	\$888,174,000
	3	\$5,883,066	\$33,930,000	\$14,355,000	\$11,571,000
	4	\$34,081,212	\$131,040,000	\$55,440,000	\$44,688,000
	5	\$116,579,385	\$336,180,000	\$284,460,000	\$229,292,000
	6	\$41,940,000	\$545,220,000	\$38,445,000	\$61,978,000
	7	\$1,217,186	\$7,020,000	\$2,970,000	\$2,394,000
	8	\$19,339,736	\$111,540,000	\$94,380,000	\$76,076,000
	9	\$8,655,546	\$49,920,000	\$42,240,000	\$34,048,000
	10	\$6,626,902	\$19,110,000	\$16,170,000	\$13,034,000
	11	\$2,603,426	\$15,015,000	\$12,705,000	\$10,241,000
	12	\$245,465,875	\$1,887,600,000	\$1,397,550,000	\$643,720,000
	13	\$512,841,102	\$2,957,760,000	\$2,502,720,000	\$2,017,344,000
	14	\$13,253,805	\$76,440,000	\$64,680,000	\$52,136,000
	15	\$1,994,833	\$23,010,000	\$9,735,000	\$7,847,000
	16	\$2,261,340,000	\$576,420,000	\$1,707,090,000	\$1,179,444,000
	17	\$42,500,083	\$1,062,165,000	\$138,270,000	\$111,454,000
	Target Set Optimum Mix	45,923	2,956	233	0
	Weapon Unit Cost	\$33,811	\$195,000	\$165,000	\$133,000
	Weapon Total Cost	\$1,552,702,553	\$576,420,000	\$38,445,000	\$0
	Target Set Optimum Mix Total Cost				\$2,167,567,553

**Scenario 2, Trial 4**

13M	Tgt	SDB	JSOW A	JSOW C	JSOW A+
	1	\$178,757,606	\$1,038,960,000	\$439,560,000	\$236,208,000
	2	\$896,203,671	\$3,906,630,000	\$2,203,740,000	\$1,776,348,000
	3	\$8,756,707	\$50,895,000	\$28,710,000	\$23,142,000
	4	\$67,638,013	\$131,040,000	\$110,880,000	\$89,376,000
	5	\$231,364,949	\$336,180,000	\$568,920,000	\$343,938,000
	6	\$81,380,954	\$636,090,000	\$76,890,000	\$92,967,000
	7	\$3,019,554	\$7,020,000	\$5,940,000	\$4,788,000
	8	\$38,381,888	\$111,540,000	\$94,380,000	\$76,076,000
	9	\$17,177,908	\$49,920,000	\$42,240,000	\$34,048,000
	10	\$9,863,877	\$19,110,000	\$16,170,000	\$13,034,000
	11	\$5,166,793	\$15,015,000	\$12,705,000	\$10,241,000
	12	\$690,135,876	\$1,887,600,000	\$3,394,050,000	\$1,448,370,000
	13	\$1,017,791,052	\$5,915,520,000	\$5,005,440,000	\$2,017,344,000
	14	\$26,303,672	\$76,440,000	\$64,680,000	\$52,136,000
	15	\$3,958,971	\$23,010,000	\$9,735,000	\$7,847,000
	16	\$2,261,340,000	\$576,420,000	\$1,463,220,000	\$1,179,444,000
	17	\$70,288,510	\$1,225,575,000	\$276,540,000	\$167,181,000
Target Set					
Optimum		97,310	2956	466	0
Mix					
Weapon					
Unit Cost		\$31,798	\$195,000	\$165,000	\$133,000
Weapon					
Total Cost		\$3,094,263,380	\$576,420,000	\$76,890,000	\$0
Target Set					
Optimum					
Mix Total					\$3,747,573,380
Cost					

**Scenario 2, Trial 4**

22M	Tgt	SDB	JSOW A	JSOW C	JSOW A+
	1	\$355,517,024	\$1,212,120,000	\$879,120,000	\$472,416,000
	2	\$2,262,263,477	\$5,208,840,000	\$4,407,480,000	\$2,664,522,000
	3	\$18,755,186	\$67,860,000	\$43,065,000	\$34,713,000
	4	\$155,215,333	\$196,560,000	\$221,760,000	\$178,752,000
	5	\$451,294,740	\$504,270,000	\$1,422,300,000	\$573,230,000
	6	\$160,770,000	\$1,045,005,000	\$115,335,000	\$185,934,000
	7	\$6,097,745	\$10,530,000	\$11,880,000	\$9,576,000
	8	\$70,462,834	\$111,540,000	\$188,760,000	\$152,152,000
	9	\$31,535,814	\$99,840,000	\$84,480,000	\$68,096,000
	10	\$18,108,456	\$19,110,000	\$32,340,000	\$26,068,000
	11	\$7,114,036	\$15,015,000	\$25,410,000	\$20,482,000
	12	\$857,071,967	\$2,831,400,000	\$13,775,850,00	\$3,701,390,000
	13	\$2,335,621,200	\$5,915,520,000	\$7,508,160,000	\$4,034,688,000
	14	\$48,289,215	\$152,880,000	\$129,360,000	\$104,272,000
	15	\$5,451,015	\$23,010,000	\$19,470,000	\$7,847,000
	16	\$2,261,340,000	\$576,420,000	\$1,707,090,000	\$1,179,444,000
	17	\$141,941,958	\$1,470,690,000	\$553,080,000	\$390,089,000
Target Set Optimum Mix		219,658	2,956	699	0
Weapon Unit Cost		\$30,797	\$195,000	\$165,000	\$133,000
Weapon Total Cost		\$6,764,807,426	\$576,420,000	\$115,335,000	\$0
Target Set Optimum Mix Total Cost					\$7,456,562,426

THIS PAGE INTENTIONALLY LEFT BLANK



## APPENDIX C: SCENARIO THREE

### A. TABLE OVERVIEW

The tables that follow contain the resulting data for each trial and the most cost effective solution for each trial. The tables were constructed in the same fashion as those tables listed in Scenarios One and Two.

### B. COST PER KILL

1	2	3	4	5	6
SDB	27353	\$36,398	\$995,594,494	16	\$62,224,656
JSOW A	2956	\$195,000	\$576,420,000	1	\$576,420,000
JSOW C	0	\$165,000	\$0	0	\$0
JSOW A+	0	\$133,000	\$0	0	\$0

Table 17 Scenario 3, Trial 1: SDB at 1.5m

1	2	3	4	5	6
SDB	27586	\$36,344	\$1,002,585,584	16	\$62,661,599
JSOW A	2956	\$195,000	\$576,420,000	1	\$576,420,000
JSOW C	0	\$165,000	\$0	0	\$0
JSOW A+	0	\$133,000	\$0	0	\$0

Table 18 Scenario 3, Trial 2: SDB at 3m

1	2	3	4	5	6
SDB	32762	\$35,342	\$1,157,874,604	16	\$72,367,163
JSOW A	2956	\$195,000	\$576,420,000	1	\$576,420,000
JSOW C	0	\$165,000	\$0	0	\$0
JSOW A+	0	\$133,000	\$0	0	\$0

Table 19 Scenario 3, Trial 3: SDB at 5m

1	2	3	4	5	6
SDB	38663	\$34,526	\$1,334,878,738	14	\$95,348,481
JSOW A	2956	\$195,000	\$576,420,000	1	\$576,420,000
JSOW C	1443	\$165,000	\$238,095,000	2	\$119,047,500
JSOW A+	0	\$133,000	\$0	0	\$0

Table 20 Scenario 3, Trial 4: SDB at 8m

1	2	3	4	5	6
SDB	62410	\$32,804	\$2,047,300,000	10	\$204,730,000
JSOW A	2956	\$195,000	\$576,420,000	1	\$576,420,000
JSOW C	2305	\$165,000	\$380,325,000	3	\$126,775,000
JSOW A+	1242	\$133,000	\$165,186,000	3	\$55,062,000

Table 21 Scenario 3, Trial 5: SDB at 13m

1	2	3	4	5	6
SDB	5288	63,094	\$333,641,072	5	\$66,728,214
JSOW A	2956	\$195,000	\$576,420,000	1	\$576,420,000
JSOW C	2724	\$165,000	\$449,460,000	4	\$112,365,000
JSOW A+	23273	\$133,000	\$3,095,309,000	7	\$442,187,000

Table 22 Scenario 3, Trial 6: SDB at 22m

**Legend**

Column 1: Weapon System

Column 2: Number of Weapons Required Across All CEPs Per Target

Column 3: Cost Per Unit / SDB with ASI cost spread over optimum #'s

Column 4: Total Cost Per Weapon System

Column 5: Number of Targets Targeted Per Weapon System

Column 6: Cost Per Kill Per Target

**C. DATA FOR SCENARIO 3**

**Scenario 3, Trial 1**

1.5M	Target	SDB	JSOW A	JSOW C	JSOW A+
	1	\$32,321,278	\$1,038,960,000	\$146,520,000	\$118,104,000
	2	\$243,064,747	\$3,906,630,000	\$1,101,870,000	\$888,174,000
	3	\$3,166,612	\$50,895,000	\$14,355,000	\$11,571,000
	4	\$12,229,673	\$131,040,000	\$55,440,000	\$44,688,000
	5	\$31,374,934	\$336,180,000	\$142,230,000	\$229,292,000
	6	\$8,480,696	\$636,090,000	\$38,445,000	\$61,978,000
	7	\$655,161	\$7,020,000	\$2,970,000	\$2,394,000
	8	\$20,819,562	\$111,540,000	\$94,380,000	\$76,076,000
	9	\$9,317,846	\$49,920,000	\$42,240,000	\$34,048,000
	10	\$3,566,988	\$19,110,000	\$16,170,000	\$13,034,000
	11	\$2,802,633	\$15,015,000	\$12,705,000	\$10,241,000
	12	\$44,041,381	\$1,887,600,000	\$199,650,000	\$643,720,000
	13	\$552,082,372	\$5,915,520,000	\$2,502,720,000	\$2,017,344,000
	14	\$14,267,952	\$76,440,000	\$64,680,000	\$52,136,000
	15	\$2,147,472	\$23,010,000	\$9,735,000	\$7,847,000
	16	\$2,261,340,000	\$576,420,000	\$1,463,220,000	\$1,179,444,000
	17	\$15,250,693	\$1,225,575,000	\$69,135,000	\$111,454,000
	Target Set				
	Optimum Mix	27353	2956	0	0
	Weapon Unit				
	Cost	\$36,398	\$195,000	\$165,000	\$133,000
	Weapon Total				
	Cost	\$995,594,494	\$576,420,000	\$0	\$0
	Target Set Optimum Mix Total				
	Cost				\$1,572,014,494

**Scenario 3, Trial 2**

3M	Target	SDB	JSOW A	JSOW C	JSOW A+
	1	\$32,273,292	\$1,038,960,000	\$146,520,000	\$118,104,000
	2	\$242,703,880	\$3,906,630,000	\$1,101,870,000	\$888,174,000
	3	\$3,161,910	\$50,895,000	\$14,355,000	\$11,571,000
	4	\$12,211,516	\$131,040,000	\$55,440,000	\$44,688,000
	5	\$31,328,354	\$336,180,000	\$142,230,000	\$229,292,000
	6	\$16,936,210	\$636,090,000	\$38,445,000	\$61,978,000
	7	\$654,188	\$7,020,000	\$2,970,000	\$2,394,000
	8	\$20,788,652	\$111,540,000	\$94,380,000	\$76,076,000
	9	\$9,304,012	\$49,920,000	\$42,240,000	\$34,048,000
	10	\$3,561,692	\$19,110,000	\$16,170,000	\$13,034,000
	11	\$2,798,472	\$15,015,000	\$12,705,000	\$10,241,000
	12	\$43,975,995	\$1,887,600,000	\$199,650,000	\$643,720,000
	13	\$551,262,722	\$5,915,520,000	\$2,502,720,000	\$2,017,344,000
	14	\$14,246,769	\$76,440,000	\$64,680,000	\$52,136,000
	15	\$2,144,284	\$23,010,000	\$9,735,000	\$7,847,000
	16	\$2,261,340,000	\$576,420,000	\$1,463,220,000	\$1,179,444,000
	17	\$15,228,051	\$1,225,575,000	\$69,135,000	\$111,454,000
	Target Set				
	Optimum				
	Mix	27586	2956	0	0
	Weapon Unit				
	Cost	\$36,344	\$195,000	\$165,000	\$133,000
	Weapon Total				
	Cost	\$1,002,585,584	\$576,420,000	\$0	\$0
	Target Set Optimum Mix Total				
	Cost				\$1,579,005,584

**Scenario 3, Trial 3**

5M	Target	SDB	JSOW A	JSOW C	JSOW A+
	1	\$62,766,600	\$1,038,960,000	\$146,520,000	\$118,104,000
	2	\$236,010,899	\$3,906,630,000	\$1,101,870,000	\$888,174,000
	3	\$3,074,715	\$50,895,000	\$14,355,000	\$11,571,000
	4	\$23,749,524	\$131,040,000	\$55,440,000	\$44,688,000
	5	\$60,928,840	\$336,180,000	\$142,230,000	\$229,292,000
	6	\$24,703,746	\$636,090,000	\$38,445,000	\$61,978,000
	7	\$1,272,296	\$7,020,000	\$2,970,000	\$2,394,000
	8	\$20,215,369	\$111,540,000	\$94,380,000	\$76,076,000
	9	\$9,047,438	\$49,920,000	\$42,240,000	\$34,048,000
	10	\$3,463,472	\$19,110,000	\$16,170,000	\$13,034,000
	11	\$2,721,300	\$15,015,000	\$12,705,000	\$10,241,000
	12	\$128,289,842	\$1,887,600,000	\$199,650,000	\$643,720,000
	13	\$536,060,695	\$5,915,520,000	\$2,502,720,000	\$2,017,344,000
	14	\$13,853,889	\$76,440,000	\$64,680,000	\$52,136,000
	15	\$2,085,152	\$23,010,000	\$9,735,000	\$7,847,000
	16	\$2,261,340,000	\$576,420,000	\$1,463,220,000	\$1,179,444,000
	17	\$29,616,222	\$1,225,575,000	\$69,135,000	\$111,454,000
Target Set					
	Optimum Mix	32762	2956	0	0
Weapon Unit					
	Cost	\$35,342	\$195,000	\$165,000	\$133,000
Weapon Total					
	Cost	\$1,157,874,604	\$576,420,000	\$0	\$0
Target Set Optimum Mix Total Cost					\$1,734,294,604

**Scenario 3, Trial 4**

8M	Target	SDB	JSOW A	JSOW C	JSOW A+
	1	\$91,978,040	\$1,038,960,000	\$146,520,000	\$118,104,000
	2	\$461,133,146	\$3,906,630,000	\$1,101,870,000	\$888,174,000
	3	\$6,007,575	\$50,895,000	\$14,355,000	\$11,571,000
	4	\$34,802,502	\$131,040,000	\$55,440,000	\$44,688,000
	5	\$119,046,652	\$336,180,000	\$142,230,000	\$229,292,000
	6	\$41,940,000	\$636,090,000	\$38,445,000	\$61,978,000
	7	\$1,242,946	\$7,020,000	\$2,970,000	\$2,394,000
	8	\$19,749,039	\$111,540,000	\$94,380,000	\$76,076,000
	9	\$8,838,731	\$49,920,000	\$42,240,000	\$34,048,000
	10	\$6,767,153	\$19,110,000	\$16,170,000	\$13,034,000
	11	\$2,658,524	\$15,015,000	\$12,705,000	\$10,241,000
	12	\$217,800,000	\$1,887,600,000	\$199,650,000	\$643,720,000
	13	\$523,694,786	\$5,915,520,000	\$2,502,720,000	\$2,017,344,000
	14	\$13,534,306	\$76,440,000	\$64,680,000	\$52,136,000
	15	\$2,037,051	\$23,010,000	\$9,735,000	\$7,847,000
	16	\$2,261,340,000	\$576,420,000	\$1,463,220,000	\$1,179,444,000
	17	\$43,399,548	\$1,225,575,000	\$69,135,000	\$111,454,000
Target Set					
Optimum Mix		38663	2956	1443	0
Weapon Unit					
Cost		\$34,526	\$195,000	\$165,000	\$133,000
Weapon Total					
Cost		\$1,334,878,738	\$576,420,000	\$238,095,000	\$0
Target Set Optimum Mix Total					
Cost					\$2,149,393,738

**Scenario 3, Trial 5**

13M	Target	SDB	JSOW A	JSOW C	JSOW A+
	1	\$159,840,000	\$1,038,960,000	\$146,520,000	\$118,104,000
	2	\$876,261,458	\$3,906,630,000	\$1,101,870,000	\$888,174,000
	3	\$8,561,854	\$50,895,000	\$14,355,000	\$11,571,000
	4	\$60,480,000	\$131,040,000	\$55,440,000	\$44,688,000
	5	\$206,880,000	\$336,180,000	\$142,230,000	\$229,292,000
	6	\$76,890,000	\$636,090,000	\$38,445,000	\$61,978,000
	7	\$2,700,000	\$7,020,000	\$2,970,000	\$2,394,000
	8	\$37,527,819	\$111,540,000	\$94,380,000	\$76,076,000
	9	\$16,795,667	\$49,920,000	\$42,240,000	\$34,048,000
	10	\$9,644,387	\$19,110,000	\$16,170,000	\$13,034,000
	11	\$5,051,822	\$15,015,000	\$12,705,000	\$10,241,000
	12	\$617,100,000	\$1,887,600,000	\$199,650,000	\$643,720,000
	13	\$995,143,291	\$5,915,520,000	\$2,502,720,000	\$2,017,344,000
	14	\$25,718,366	\$76,440,000	\$64,680,000	\$52,136,000
	15	\$3,870,876	\$23,010,000	\$9,735,000	\$7,847,000
	16	\$2,261,340,000	\$576,420,000	\$1,463,220,000	\$1,179,444,000
	17	\$68,724,459	\$1,225,575,000	\$69,135,000	\$111,454,000
Target Set					
Optimum Mix		62410	2956	2305	1242
Weapon Unit					
Cost		\$32,804	\$195,000	\$165,000	\$133,000
Weapon Total					
Cost		\$2,047,300,000	\$576,420,000	\$380,325,000	\$165,186,000
Target Set					
Optimum Mix					
Total					
Cost					\$3,169,231,000

**Scenario 3, Trial 6**

22M	Target	SDB	JSOW A	JSOW C	JSOW A+
	1	\$346,320,000	\$1,038,960,000	\$146,520,000	\$118,104,000
	2	\$2,203,740,000	\$3,906,630,000	\$1,101,870,000	\$888,174,000
	3	\$18,270,000	\$50,895,000	\$14,355,000	\$11,571,000
	4	\$151,200,000	\$131,040,000	\$55,440,000	\$44,688,000
	5	\$439,620,000	\$336,180,000	\$142,230,000	\$229,292,000
	6	\$160,770,000	\$636,090,000	\$38,445,000	\$61,978,000
	7	\$5,940,000	\$7,020,000	\$2,970,000	\$2,394,000
	8	\$144,358,608	\$111,540,000	\$94,380,000	\$76,076,000
	9	\$64,608,048	\$49,920,000	\$42,240,000	\$34,048,000
	10	\$17,640,000	\$19,110,000	\$16,170,000	\$13,034,000
	11	\$14,574,667	\$15,015,000	\$12,705,000	\$10,241,000
	12	\$834,900,000	\$1,887,600,000	\$199,650,000	\$643,720,000
	13	\$2,275,200,000	\$5,915,520,000	\$2,502,720,000	\$2,017,344,000
	14	\$98,931,074	\$76,440,000	\$64,680,000	\$52,136,000
	15	\$11,167,602	\$23,010,000	\$9,735,000	\$7,847,000
	16	\$2,261,340,000	\$576,420,000	\$1,463,220,000	\$1,179,444,000
	17	\$138,270,000	\$1,225,575,000	\$69,135,000	\$111,454,000
	Target Set				
	Optimum Mix	5288	2956	2724	23273
	Weapon Unit				
	Cost	\$63,094	\$195,000	\$165,000	\$133,000
	Weapon Total				
	Cost	\$333,641,072	\$576,420,000	\$449,460,000	\$3,095,309,000
	Target Set Optimum Mix Total				
	Cost				\$4,454,830,072

**D. DATA FOR SCENARIO 3; BREAKEVEN POINTS**

The charts provided below are a breakdown of the costs and number of weapons generated during the construction of our Scenario three breakeven points.



% of Target Set 28831	# Aim Points	# SDB	# JSOW A	# JSOW C	# JSOW A+	Total # Weapons	Total Cost
		# TGTS	# TGTS	# TGTS	# TGTS		
		Cost Per Unit	Cost Per Unit	Cost Per Unit	Cost Per Unit		
0.06%	17	16 16 \$10,967,500	2 1 \$195,000	0 0 NA	0 0 NA	18	\$175,870,000
6.00%	1730	1641 16 \$136,631	177 1 \$195,000	0 0 NA	0 0 NA	1819	\$258,820,600
20.00%	5766	5471 16 \$61,989	591 1 \$195,000	0 0 NA	0 0 NA	6062	\$454,402,000
40.00%	11532	10941 16 \$45,995	1182 1 \$195,000	0 0 NA	0 0 NA	12123	\$733,720,000
60.00%	17299	16412 16 \$40,663	1774 1 \$195,000	0 0 NA	0 0 NA	18186	\$1,013,290,000
80.00%	23065	21882 16 \$37,997	2365 1 \$195,000	0 0 NA	0 0 NA	24247	\$1,292,635,000
100.00%	28831	27353 16 \$36,398	2956 1 \$195,000	0 0 NA	0 0 NA	30309	\$1,572,010,000

Table 23 SDB @ 1.5m Accuracy in conjunction with JSOW A & JSOW C

<i>% of Target Set</i> 28831	<i># Aim Points</i>	<i># SDB</i> <i># TGTS</i> <i>Cost Per Unit</i>	<i># JSOW A</i> <i># TGTS</i> <i>Cost Per Unit</i>	<i># JSOW C</i> <i># TGTS</i> <i>Cost Per Unit</i>	<i># JSOW A+</i> <i># TGTS</i> <i>Cost Per Unit</i>	<i>Total # Weapons</i>	<i>Total Cost</i>
0.06%	17	0 0 NA	2 1 \$195,000	4 4 \$165,000	12 12 \$133,000	18	\$2,646,000
6.00%	1730	0 0 NA	177 1 \$195,000	163 4 \$165,000	1478 12 \$133,000	1819	\$258,092,220
20.00%	5766	0 0 NA	591 1 \$195,000	545 4 \$165,000	4926 12 \$133,000	6062	\$860,328,000
40.00%	11532	0 0 NA	1182 1 \$195,000	1090 4 \$165,000	9852 12 \$133,000	12124	\$1,720,656,000
60.00%	17299	0 0 NA	1774 1 \$195,000	1634 4 \$165,000	14777 12 \$133,000	18185	\$2,580,881,000
80.00%	23065	0 0 NA	2365 1 \$195,000	2179 4 \$165,000	19703 12 \$133,000	24247	\$3,441,209,000
100.00%	28831	0 0 NA	2956 1 \$195,000	2724 4 \$165,000	24629 12 \$133,000	30309	\$4,301,537,000

Table 24 JSOW A+ in conjunction with JSOW A & JSOW C

<i>% of Target Set</i> 28831	<i># Aim Points</i>	<i># SDB</i> <i># TGTS</i> <i>Cost Per Unit</i>	<i># JSOW A</i> <i># TGTS</i> <i>Cost Per Unit</i>	<i># JSOW C</i> <i># TGTS</i> <i>Cost Per Unit</i>	<i># JSOW A+</i> <i># TGTS</i> <i>Cost Per Unit</i>	<i>Total # Weapons</i>	<i>Total Cost</i>
0.06%	17	18 16 \$9,752,222	2 1 \$195,000	0 0 NA	0 0 NA	20	\$175,930,000
6.00%	1730	1727.76 16 \$131,287	177.36 1 \$195,000	0 0 NA	0 0 NA	1905	\$261,418,000
20.00%	5766	5759.2 16 \$60,386	591.2 1 \$195,000	0 0 NA	0 0 NA	6350	\$463,060,000
40.00%	11532	11518.4 16 \$45,193	1182.4 1 \$195,000	0 0 NA	0 0 NA	12701	\$751,120,000
60.00%	17299	17277.6 16 \$40,129	1773.6 1 \$195,000	0 0 NA	0 0 NA	19051	\$1,039,180,000
80.00%	23065	23036.8 16 \$37,597	2364.8 1 \$195,000	0 0 NA	0 0 NA	25402	\$1,327,240,000
100.00%	28831	28796 16 \$36,077	2956 1 \$195,000	0 0 NA	0 0 NA	31752	\$1,615,300,000

Table 25 SDB @ 4m Accuracy in conjunction with JSOW A & JSOW C

<i>% of Target Set</i>	<i># Aim Points</i>	<i># SDB</i>	<i># JSOW A</i>	<i># JSOW C</i>	<i># JSOW A+</i>	<i>Total #</i>	<i>Total Cost</i>
<i>28831</i>		<i># TGTS</i>	<i># TGTS</i>	<i># TGTS</i>	<i># TGTS</i>	<i>Weapons</i>	
		<i>Cost Per Unit</i>	<i>Cost Per Unit</i>	<i>Cost Per Unit</i>	<i>Cost Per Unit</i>		
0.06%	17	0 0 NA	2 1 \$195,000	4 4 \$165,000	12 12 \$133,000	18	\$2,646,000
6.00%	1730	0 0 NA	177 1 \$195,000	163 4 \$165,000	1478 12 \$133,000	1819	\$258,092,220
20.00%	5766	0 0 NA	591 1 \$195,000	545 4 \$165,000	4926 12 \$133,000	6062	\$860,328,000
40.00%	11532	0 0 NA	1182 1 \$195,000	1090 4 \$165,000	9852 12 \$133,000	12124	\$1,720,656,000
60.00%	17299	0 0 NA	1774 1 \$195,000	1634 4 \$165,000	14777 12 \$133,000	18185	\$2,580,881,000
80.00%	23065	0 0 NA	2365 1 \$195,000	2179 4 \$165,000	19703 12 \$133,000	24247	\$3,441,209,000
100.00%	28831	0 0 NA	2956 1 \$195,000	2724 4 \$165,000	24629 12 \$133,000	30309	\$4,301,537,000

Table 26 JSOW A+ in conjunction with JSOW A & JSOW C

**APPENDIX D: (SEE PMA 201)**

- A. TARGET SET LIST**
- B. NUMBER OF AIM POINTS PER TARGET**
- C. SSPK FOR EACH WEAPON AT EACH CEP**
- D. REQUIRED  $P_D$**

THIS PAGE INTENTIONALLY LEFT BLANK

## LIST OF REFERENCES

1. Boardman, Greenberg, Vining, Weimer, Cost Benefit Analysis, Concepts and Practice. 2001 Prentice Hall, Inc., Uppersaddle River, N.J. pp. 437-453
2. Levin, Henry M. Cost-Effectiveness A Primer. London: Sage Publications, 1983. 30.
3. Levin, Henry M. Cost-Effectiveness A Primer. London: Sage Publications, 1983. 29.
4. Levin, Henry M. Cost-Effectiveness A Primer. London: Sage Publications, 1983. 17.
5. Cost-Effectiveness Analysis: New Approaches in Decision-Making. Ed. Thomas A. Goldman. New York: Frederick A. Praeger, 1969. 20.
6. Boone, LT John, Smith, LT Shannon, TOPGUN MANUAL Vol III Chapter 33 - GPS/JSOW/JDAM, May 2002. P. 21
7. Jumper, General John P., CAF OPERATIONAL REQUIREMENTS DOCUMENT for MINATURE MUNITIONS and CARRAGE SYSTEM, Chapter 1, P. 1
8. Jumper, General John P., CAF OPERATIONAL REQUIREMENTS DOCUMENT for MINATURE MUNITIONS and CARRAGE SYSTEM, Chapter 1, P. 1
9. McClendon, Colonel James R., SMALL DIAMETER BOMB A MINATURE MUNITIONS CAPABILITY, Chapter 2, P. 19
10. McClendon, Colonel James R., SMALL DIAMETER BOMB A MINATURE MUNITIONS CAPABILITY, Chapter 2, P. 20
11. McClendon, Colonel James R., SMALL DIAMETER BOMB A MINATURE MUNITIONS CAPABILITY, Chapter 2, P. 21
12. AIR FORCE PAMPHLET 14-210, 1 FEBRUARY 1998, Intelligence; USAF INTELLIGENCE TARGETING GUIDE
13. OPNAVINST 4850.1B, 20 Feb 01.
14. OPNAVINST 8011.9A, 11 Aug 89.

15. AIR FORCE PAMPHLET 14-210, 1 FEBRUARY 1998, Intelligence; USAF INTELLIGENCE TARGETING GUIDE
16. AIR FORCE PAMPHLET 14-210, 1 FEBRUARY 1998, Intelligence; USAF INTELLIGENCE TARGETING GUIDE



## INITIAL DISTRIBUTION LIST

1. Defense Technical Information Center  
Fort Belvoir, Virginia
2. Dudley Knox Library  
Naval Postgraduate School  
Monterey, California
3. Marine Corps Representative  
Naval Postgraduate School  
Monterey, California
4. Director, Training and Education, MCCDC, Code C46  
Quantico, Virginia
5. Director, Marine Corps Research Center, MCCDC, Code C40RC  
Quantico, Virginia
6. Marine Corps Tactical Systems Support Activity (Attn: Operations Officer)  
Camp Pendleton, California
7. Bill Gates  
Associate Dean for Research, GB/Gt  
Naval Postgraduate School,  
Monterey, California
8. Thom Crouch  
Lecturer, GB  
Naval Postgraduate School  
Monterey, California