



**AIR FORCE HANDBOOK 11-203, VOLUME 1  
1 MARCH 1997**

**Flying Operations**

***WEATHER  
FOR  
CREWS***

**DEPARTMENT OF THE AIR FORCE**

# Report Documentation Page

Form Approved  
OMB No. 0704-0188

Public reporting burden for the collection of information is estimated to average 1 hour per response, including the time for reviewing instructions, searching existing data sources, gathering and maintaining the data needed, and completing and reviewing the collection of information. Send comments regarding this burden estimate or any other aspect of this collection of information, including suggestions for reducing this burden, to Washington Headquarters Services, Directorate for Information Operations and Reports, 1215 Jefferson Davis Highway, Suite 1204, Arlington VA 22202-4302. Respondents should be aware that notwithstanding any other provision of law, no person shall be subject to a penalty for failing to comply with a collection of information if it does not display a currently valid OMB control number.

1. REPORT DATE <b>01 MAR 1997</b>		2. REPORT TYPE <b>N/A</b>		3. DATES COVERED <b>-</b>	
4. TITLE AND SUBTITLE <b>Weather For Aircrews - Air Force Handbook 11-203, Volume I</b>				5a. CONTRACT NUMBER	
				5b. GRANT NUMBER	
				5c. PROGRAM ELEMENT NUMBER	
6. AUTHOR(S)				5d. PROJECT NUMBER	
				5e. TASK NUMBER	
				5f. WORK UNIT NUMBER	
7. PERFORMING ORGANIZATION NAME(S) AND ADDRESS(ES) <b>Secretary Of The Air Force Washington, DC</b>				8. PERFORMING ORGANIZATION REPORT NUMBER	
9. SPONSORING/MONITORING AGENCY NAME(S) AND ADDRESS(ES)				10. SPONSOR/MONITOR'S ACRONYM(S)	
				11. SPONSOR/MONITOR'S REPORT NUMBER(S)	
12. DISTRIBUTION/AVAILABILITY STATEMENT <b>Approved for public release, distribution unlimited</b>					
13. SUPPLEMENTARY NOTES					
14. ABSTRACT					
15. SUBJECT TERMS					
16. SECURITY CLASSIFICATION OF:			17. LIMITATION OF ABSTRACT <b>UU</b>	18. NUMBER OF PAGES <b>186</b>	19a. NAME OF RESPONSIBLE PERSON
a. REPORT <b>unclassified</b>	b. ABSTRACT <b>unclassified</b>	c. THIS PAGE <b>unclassified</b>			



**WEATHER FOR AIRCREWS**



This handbook familiarizes the aircrew member with fundamentals of weather. It serves as a text for undergraduate pilot and navigator training programs, all USAF instrument refresher training and flight instruction programs, and various unit and individual flying training programs. It is issued to each flying unit and to each instructor and student involved in UPT and other aircrew training courses. This handbook, when used with related flight directives and publications, provides weather guidance for visual and instrument flight under most circumstances. It is not a substitute for sound judgment.

**Paragraph**

**Chapter 1 - The Earth's Atmosphere**

Introduction .....	1.1.
The Sun .....	1.2.
Structure and Composition .....	1.3.
Troposphere .....	1.4.
Stratosphere .....	1.5.
Aircrew Environment .....	1.6.

**Chapter 2 - Moisture**

Introduction .....	2.1.
Changes of State .....	2.2.
Water Vapor Content .....	2.3.
Relative Humidity .....	2.4.
Dew Point, Dew, and Frost .....	2.5.
Condensation and Sublimation Processes .....	2.6.
Clouds and Fog .....	2.7.
Precipitation .....	2.8.

**Chapter 3 - Temperature**

Introduction .....	3.1.
Heat Energy Measurement .....	3.2.
Temperature Measurement .....	3.3.
Daily Range of Temperature .....	3.4.
Temperature Distribution .....	3.5.
Temperature Variation with Altitude .....	3.6.
Inversion Aviation Hazards .....	3.7.



**Chapter 4 - Atmospheric Pressure and Altimetry**

Introduction .....	4.1.
Definition .....	4.2.
Mercurial Barometer .....	4.3.
Digital Barometer Altimeter Setting Indicator (DBASI) .....	4.4.
Aneroid Barometer .....	4.5.
Pressure Units .....	4.6.
Pressure Distribution .....	4.7.
Station Pressure and Mean Sea Level (MSL) Pressure .....	4.8.
Pressure Variation .....	4.9.
Pressure Patterns .....	4.10.
Standard Atmosphere .....	4.11.
Altimetry .....	4.12.

**Chapter 5 - Wind**

Introduction .....	5.1.
General Circulation .....	5.2.
Factors Influencing Circulation .....	5.3.
Wind Direction .....	5.4.
Coriolis Force .....	5.5.
Other Deflective Forces .....	5.6.
Pressure Gradient Force .....	5.7.
Effects of Friction and Gravity .....	5.8.
Large Wind Systems .....	5.9.
Local Winds .....	5.10.
Windshear .....	5.11.

**Chapter 6 - Clouds**

Introduction .....	6.1.
Cloud Composition .....	6.2.
Types of Clouds .....	6.3.
Cloud Formation and Structure .....	6.4.
Low Clouds .....	6.5.
Middle Clouds .....	6.6.
High Clouds .....	6.7.
Clouds with Extensive Vertical Development .....	6.8.
Altostratus Standing Lenticular (ACSL) .....	6.9.
Rotor Clouds .....	6.10.
Special Topics .....	6.11.

**Chapter 7 - Air Masses**

Introduction .....	7.1.
Source Regions .....	7.2.
Air Mass Classification .....	7.3.
Air Mass Modification .....	7.4.

**Chapter 8 - Fronts**

Introduction .....	8.1.
Definition of Fronts .....	8.2.
Cold Fronts .....	8.3.
Warm Fronts .....	8.4.
Stationary Fronts .....	8.5.
Frontal Wave Process .....	8.6.

**Chapter 9 - Turbulence**

Introduction .....	9.1.
Categories of Turbulence Intensity .....	9.2.
Convective Turbulence .....	9.3.

Mechanical Turbulence .....	9.4.
Mountain Wave Turbulence .....	9.5.
High Altitude Turbulence-Tropopause .....	9.6.
Jet Stream .....	9.7.
Clear Air Turbulence (CAT) .....	9.8.
Wake Turbulence .....	9.9.
Medical and Human Factors of Turbulence .....	9.10.

### Chapter 10 - Low Level Windshear

Introduction .....	10.1.
Definition .....	10.2.
Performance Decreasing Shear .....	10.3.
Performance Increasing Shear .....	10.4.
Microbursts .....	10.5.
Weather Causing Low Level Windshear .....	10.6.
Fronts .....	10.7.
Low Level Jet at Top of Radiation Inversion .....	10.8.
Funneling Winds and Mountain Waves .....	10.9.
Cloud Clues .....	10.10.
Other Causes of Low Level Wind Shear .....	10.11.
Lessons Learned from Windshear Encounters .....	10.12.
Encounter During Takeoff-After Liftoff .....	10.13.
Encounter During Takeoff-On Runway .....	10.14.
Encounter on Approach .....	10.15.
Windshear Effects on Systems - Vertical Speed Indicators .....	10.16.
Runway Windshear Detection Systems .....	10.17.
SIGMETs .....	10.18.
PIREPs .....	10.19.

### Chapter 11 - Icing

Introduction .....	11.1.
Structural Icing .....	11.2.
Types of Structural Icing .....	11.3.
Intensities of Structural Icing .....	11.4.
Ice Formation on Fixed Wing Aircraft .....	11.5.
Ice Formation on Rotary Wing Aircraft .....	11.6.
Induction Icing .....	11.7.
Weather Conducive to Aircraft Icing .....	11.8.
Frontal Zones .....	11.9.
Seasons .....	11.10.
Terrain .....	11.11.
Procedures to Avoid or Minimize Icing Effects .....	11.12.

### Chapter 12 - Visibility And Ceilings

Introduction .....	12.1.
Visibility-Definition .....	12.2.
Night Vision Goggles .....	12.3.
Weapons Systems "Visibility" .....	12.4.
Ceiling .....	12.5.
Climatological Ceiling/Visibility .....	12.6.
Fog .....	12.7.
Low Stratus .....	12.8.
Haze .....	12.9.
Smoke/Smog .....	12.10.
Blowing Sand/Blowing Dust .....	12.11.
Blowing Snow .....	12.12.
Drizzle .....	12.13.
Rain .....	12.14.

**Chapter 13 - Thunderstorms And Associated Hazards**

Introduction .....	13.1.
Factors Necessary for Thunderstorm Development .....	13.2.
Thunderstorm Cell Life Cycle .....	13.3.
Tropopause .....	13.4.
Thunderstorm Types-Frontal Thunderstorms .....	13.5.
Thunderstorm Weather Hazards .....	13.6.
Aviator Corrective Actions .....	13.7.

**Chapter 14 - Tropical Weather**

Introduction .....	14.1.
Oceanic Tropical Weather .....	14.2.
Continental Tropical Weather .....	14.3.
Island and Coastal Tropical Weather .....	14.4.
Subtropical Jet Stream .....	14.5.
Tropical Easterly Jet Stream .....	14.6.
Equatorial Trough .....	14.7.
Tropical Waves .....	14.8.
Shear Lines .....	14.9.
Monsoon .....	14.10.
Tropical Cyclones .....	14.11.

**Chapter 15 - Arctic Weather**

Introduction .....	15.1.
Polar Physical Geography and Climatic Influences .....	15.2.
Polar Weather Peculiarities .....	15.3.
Polar Weather and Aviation Operations .....	15.4.

**Chapter 16 - Volcanic Ash**

Introduction .....	16.1.
Hazards to Aircraft .....	16.2.
Flight Operations in Volcanic Ash .....	16.3.
Ash is Worse than Sand for Jets .....	16.4.
Efforts to Improve Safety .....	16.5.

**Figures**

1-1. Earth's Rotation, Axis Tilt, and Orbit.....	10
1-2. Composition of Atmosphere.....	10
1-3. Atmospheric Layers.....	11
1-4. Troposphere Characterized by Decrease in Temperature with Height .....	13
2-1. Hydrologic Cycle.....	14
2-2. Factors Affecting Hydrologic Cycle.....	14
2-3. Changes of State of Water.....	15
2-4. Evaporation and Condensation.....	16
2-5. Saturation of Air Depends on its Temperature.....	16
2-6. Relative Humidity and Dew Point.....	17
2-7. Dew Point and Temperature Spread.....	18
2-8. Causes of Condensation.....	18
2-9. Precipitation Products.....	19
2-10. Growth of Raindrops by Collision of Cloud Droplets.....	20
3-1. Land has Greater Temperature Variance than Water.....	21
3-2. Temperature Conversion Methods.....	21
3-3. Surface Temperature Distribution for January and July.....	23
3-4. Effect of Nonstandard Temperature on Pressure and Density.....	24
3-5. Lapse Rates May Vary from Layer to Layer.....	24
3-6. Lapse Rate Temperature Reversals are Called Inversions.....	25
4-1. Normal Atmospheric Pressure at Sea Levels Supports a Column of Mercury 29.92 Inches High.....	26
4-2. Digital Barometer Altimeter Setting Indicator (DBASI).....	27

4-3. Aneroid Barometer Inner View .....	27
4-4. Average Global Sea Level Pressure in January and July .....	28
4-5. Station Pressure. ....	29
4-6. Mean Sea Level Pressure (MSL). ....	29
4-7. Adjusting Barometric Pressure to MSL Pressure. ....	30
4-8. Pressure Rate Decrease with Height Varies with Temperature .....	30
4-9. Surface Pressure Chart. ....	31
4-10. Upper Air Chart. ....	32
4-11. Comparison of Isobars and Contours. ....	32
4-12. Aneroid Altimeter. ....	33
4-13. Effects of Temperature on True and Indicated Altitude. ....	34
4-14. Altitude Pressure Conversion Table (From FLIP). ....	35
4-15. Barometric Readings Conversion Table, Inches to HectoPascals or Millibars. ....	36
4-16. Density Altitude. ....	37
4-17. Density Altitude Chart. ....	38
4-18. True Altitude Error Due to Nonstandard Temperatures Aloft (D-Value). ....	39
5-1. Theoretical Basic Air Movement. ....	40
5-2. Worldwide Surface Pressure Distribution. ....	41
5-3. Coriolis Force. ....	42
5-4. Coriolis Force Affects Circulation Patterns. ....	42
5-5. Patterns of Atmospheric Circulation. ....	44
5-6. Effect of Pressure Gradient and Coriolis Force on Wind Direction. ....	45
5-7. Pressure Gradient Versus Wind Speed. ....	45
5-8. Surface Winds are Deflected Across Isobars Toward Lower Pressure. ....	46
5-9. Wind Direction Around Contours (Aloft). ....	46
5-10. Air Flow Aids in Exchange of Heat Between Latitudes. ....	47
5-11. Land and Sea Breezes. ....	47
5-12. Valley Wind and Mountain Breeze. ....	48
5-13. Chinook Wind. ....	49
5-14. Fall Wind. ....	49
5-15. Horizontal Wind Shear Turbulence. ....	50
6-1. Basic Cloud Types. ....	51
6-2. Cloud Heights. ....	52
6-3. Various Factors Affecting Cloud Types. ....	54
6-4. Stratus Becoming Stratocumulus and Cumulus at Coast Line. ....	54
6-5. Stratus Clouds (ST). ....	55
6-6. Stratocumulus Clouds (SC). ....	55
6-7. Cumulus Clouds (CU). ....	55
6-8. Altostratus Clouds (AS). ....	56
6-9. Altcumulus Clouds (AC). ....	57
6-10. Nimbostratus Clouds (NS). ....	57
6-11. Cirrus Clouds (CI). ....	58
6-12. Cirrostratus Clouds (CS). ....	58
6-13. Cirrocumulus Clouds (CC). ....	58
6-14. Towering Cumulus Clouds (TCU). ....	59
6-15. Cumulonimbus Cloud (CB). ....	59
6-16. Tornado. ....	60
6-17. Altcumulus Standing Lenticular Clouds (ACSL). ....	60
6-18. Rotor Clouds. ....	61
6-19. Virga. ....	61
6-20. Contrails. ....	62
7-1. Typical Air Mass Source Regions. ....	63
7-2. Heating from Below Causes Instability. ....	64
7-3. Heating Moist Air from Below. ....	64
7-4. Heating Cold, Dry Air from Below Causing Lake Effect Snowshowers. ....	65
7-5. Cooling from Below Improves Stability. ....	65
7-6. Warm, Moist Air Trapped, Cooled from Below Causing Air Stagnation. ....	66
7-7. Warm, Moist Air Cooled from Below Causing Gulf Stratus. ....	67



7-8. Arctic Inversion Stable Layer.....	67
7-9. Sinking Air (Subsidence) Increases Stability.....	67
7-10. Air Mass Weather Characteristics Based on Stability and Moisture.....	68
8-1. Frontal Zone.....	68
8-2. Satellite Imagery of a Front in the Gulf of Alaska.....	69
8-3. Symbols for Various Types of Fronts.....	69
8-4. Polar Front Follows Low Pressure Trough.....	71
8-5. Fast-Moving Cold Front Runs Under Warmer Air.....	71
8-6. Cold Front As Depicted on Surface Weather Charts.....	72
8-7. Fast-Moving Cold Front and Squall Line.....	72
8-8. Slow-Moving Cold Front and Stable Air.....	73
8-9. Slow-Moving Cold Front and Unstable Air.....	73
8-10. Formation of a Squall Line.....	74
8-11. Windshifts Associated with Flight Level Cold Frontal Boundaries.....	75
8-12. Warm Front and Moist Stable Air.....	75
8-13. Warm Front and Moist Unstable Air.....	76
8-14. Precipitation Types in Wintertime Warm Frontal Zones.....	76
8-15. Stationary Front as Shown on Surface Weather Chart.....	77
8-16. Frontal Wave and Occlusion.....	79
8-17. Cold Frontal Occlusion.....	80
9-1. Strength of Convective Currents Vary with Composition of Surface.....	82
9-2. Updrafts May Cause Pilots to Overshoot.....	82
9-3. Downdrafts May Cause Pilots to Undershoot.....	82
9-4. Avoid Convective Currents by Flying Above Cumulus Clouds.....	83
9-5. Surface Obstructions Cause Eddies and Other Irregular Wind Movements.....	83
9-6. Buildings Near Landing Area May Cause Turbulence.....	84
9-7. Wind Flow over Mountain Ranges Produces Turbulence.....	84
9-8. In a Valley or Canyon, Safest Path is on Upslope Wind Side.....	85
9-9. Avoid Downwind Side of Narrow Gorge.....	85
9-10. Winds Funneled through Mountain Valleys Create High Winds.....	86
9-11. The Low-Level Nocturnal Jet Stream.....	86
9-12. Vertical Cross-Section of the Low-Level Jet.....	87
9-13. Typical Cloud Formation. Main Downdraft and Updraft in Mountain Wave.....	88
9-14. Mountain Waves Photographed from a Manned Spacecraft.....	88
9-15. Rotor Clouds.....	89
9-16. Standing Lenticular Clouds Associated with a Mountain Wave.....	90
9-17. Location of Polar and Subtropical Jet Streams in Relation to Tropopause.....	90
9-18. The Polar Front Jet Stream.....	91
9-19. Areas of Probable Turbulence in Jet Stream.....	92
9-20. Examples of Multiple Structure of Jet Stream.....	92
9-21. Wind Patterns Associated with High-Level CAT.....	93
9-22. Counter-Rotating Vortices.....	94
9-23. Induced Roll.....	94
9-24. Relative Span.....	94
9-25. Vortex Generation.....	95
9-26. Vortex Circulation.....	95
9-27. Vortex Sink Rate.....	96
9-28. Vortex Movement in Ground Effect (No Wind).....	96
9-29. Vortex Movement In Ground Effect (Cross Wind).....	97
9-30. Vortex Movement Forward of Touchdown Zone (Tail Wind).....	97
9-31. Helicopter Vortices.....	97
10-1. Performance Decreasing Shear.....	99
10-2. Performance Increasing Shear.....	100
10-3. Thunderstorm Windshear Hazard Zones.....	101
10-4. Windshear Associated with Thunderstorm Downdraft.....	102
10-5. Approach and Takeoff can be Dangerous in Rapidly Changing Shear Conditions.....	102
10-6. Windshear in a Warm Front.....	103
10-7. Windshear During Radiation Inversion.....	103

10-8. A Wind Funneling Condition.....	104
10-9. Windshear Encounter During Takeoff After Liftoff.....	104
10-10. Windshear Effects on Flight Path.....	106
10-11. Pitch Controls on Flight Path.....	106
10-12. Time Available to Respond to Windshear Encounter.....	107
10-13. Windshear Encounter During Takeoff on Runway.....	107
10-14. Windshear Effects on Liftoff. Microburst Reduces Airspeed and Lift.....	108
10-15. Windshear Encounter During Approach.....	109
10-16. Windshear Effects on Flight Path on Approach.....	109
10-17. Vertical Speed Indicator (VSI) Error During Takeoff Windshear Encounter.....	110
11-1. Clear Ice Can Be Smooth or Rough.....	112
11-2. Rime Ice is Milky, Opaque, and Granular.....	113
11-3. Frost on Exposed Surfaces of Parked Aircraft.....	114
11-4. Ice Accumulation Disrupts Air Flow.....	114
11-5. Effects of Icing are Cumulative, Causing Stalling Speed to Increase.....	115
11-6. Propeller Icing.....	115
11-7. Pitot Tube Icing.....	116
11-8. Main Rotor Head Icing.....	117
11-9. Main Rotor Blade Icing.....	117
11-10. Engine Air Intake Screen Icing.....	118
11-11. Carburetor Icing.....	118
11-12. Jet Engine Induction Icing.....	119
11-13. Cold Front Icing Zone.....	120
11-14. Warm Front Icing Zone.....	120
11-15. Icing over Mountains.....	121
12-1. Day/Night Visibility Observer Check Point Diagram.....	122
12-2. Typical ASOS Combined Sensor Group Layout.....	123
12-3. Distance to Objects on the Horizon at Sea (Nautical Miles).....	125
12-4. Moonrise/Moonset and Percent Illumination.....	126
12-5. Nautical Twilight, Civil Twilight, and Sunrise/Sunset.....	127
12-6. Hours of Solar Darkness, Moonlight, and Total Darkness Percent Lunar Illumination.....	128
12-7. Seasonal Restrictions to Visibility.....	129
12-8. Visibility with Cloud or Obscured Ceiling Condition.....	129
12-9. Ground Fog.....	130
12-10. Stratus and Fog Off West Coast of United States.....	131
12-11. Precipitation-Induced Fog.....	131
12-12. Upslope Fog.....	132
12-13. Haze and Smog.....	132
12-14. Aerial Photograph of Blowing Dust.....	132
12-15. Blowing Sand.....	133
13-1. Average Number of Days with Thunderstorms Each Year.....	134
13-2. Average Number of Days with Thunderstorms During Spring.....	134
13-3. Average Number of Days with Thunderstorms During Summer.....	135
13-4. Average Number of Days with Thunderstorms During Fall.....	135
13-5. Average Number of Days with Thunderstorms During Winter.....	136
13-6. Lifting Mechanisms for Thunderstorm Development.....	137
13-7. Stages of a Thunderstorm.....	137
13-8. Prolonged Mature Stage.....	138
13-9. Thunderstorm with a Well Developed Anvil.....	138
13-10. Warm Front Thunderstorm.....	139
13-11. Cold Front Thunderstorm.....	139
13-12. Squall Line.....	140
13-13. Squall Line Thunderstorms.....	140
13-14. Air Mass Thunderstorm.....	141
13-15. Orographic Thunderstorm.....	141
13-16. Typical Location of Thunderstorm Turbulence.....	142
13-17. First Gust Hazards.....	143
13-18. Aircraft Icing.....	143

13-19. Large Hail.....	144
13-20. Hail Damage to Aircraft.....	144
13-21. Lightning Variations.....	145
13-22. Lightning "Bolt out of the Blue".....	145
13-23. FB-111 Pitot Tubes after Being Struck by Lightning.....	145
13-24. Major Aircraft Structural Damage Resulting from Lightning Strike.....	146
13-25. Jet Fuel Characteristics.....	146
13-26. Tornado.....	147
13-27. Funnel Clouds.....	147
13-28. Waterspout.....	147
13-29. Anatomy of a Funnel Cloud.....	148
13-30. Funnel Convergence.....	149
13-31. Thunderstorm Wind Shear Hazard Zones.....	149
14-1. The Tropical Zone.....	153
14-2. C-130 Ingesting Sand During Engine Run-Up.....	153
14-3. Satellite Picture of Clouds Associated with the Equatorial Trough.....	154
14-4. Vertical Structure of Convergence Zone.....	155
14-5. Well-Developed Easterly Wave.....	155
14-6. Shear Line Resulting from Polar Front Invasion.....	156
14-7. General Monsoon Region.....	156
14-8. Monsoon Flow (Summer And Winter) over Southeast Asia.....	157
14-9. Principal Regions of Tropical Cyclone Formation and Favored Direction of Movement.....	157
14-10. Saffir-Simpson Scale of Hurricane Intensity.....	158
14-11. Hurricane Movement in Northern Hemisphere.....	158
14-12. Cross Section of Hurricane Eye and Spiral Bands.....	159
14-13. Radar Photograph of Hurricane Showing Spiral Rain Pattern and Eye.....	159
14-14. Satellite Picture of a Hurricane.....	160
15-1. Arctic Circle.....	161
15-2. Duration and Angle of Incidence of Sun's Rays upon Arctic.....	162
15-3. Number of Hours Sun is Above or Below Horizon.....	162
15-4. Arctic Physical Features and Typical Air Mass Source Regions.....	163
15-5. Average Number of Days Each Year with Temperatures Above Freezing.....	164
15-6. Average Number of Days Per Month on which Cloudy Conditions Occur.....	164
15-7. Equivalent Wind Chill Index.....	165
15-8. Aurora Borealis.....	166
15-9. Whiteout Conditions.....	166
15-10. Blowing Snow.....	167
15-11. Visibility Reduced in Blowing Snow.....	168
16-1. Mount St. Helens Eruption, May 1980.....	169
16-2. Ash Cloud Trajectory Product.....	172
<b>Attachment</b>	
Glossary of Abbreviations, Acronyms and Terms.....	173

## Chapter 1

### THE EARTH'S ATMOSPHERE

**1.1. Introduction.** Benjamin Franklin aptly remarked: "Some people are weatherwise but most are otherwise." He wisely understood that weather affects all facets of life. Virtually all of our activities are affected by weather, but none is affected more than aviation. Aviation weather can be as uneventful as a "clear and a million" day or as challenging as descending through a solid deck of nimbostratus clouds with moderate rime icing and embedded thunderstorms. Aviators can narrow the uncertainty surrounding weather with a well-rounded understanding of weather processes. Aviators can anticipate and avoid potential or existing hazardous weather conditions, and can take advantage of favorable conditions such as tail winds and clearing weather behind a cold front.

**1.1.1.** This handbook explains basic meteorological concepts and common weather problems. Aviators can use this knowledge to ask weather forecasters critical questions such as the expected movement of reported severe thunderstorms or the length of time the visibility is to stay below 1/4 mile. Perhaps mission planners want to know how the anticipated weather conditions will affect their sensors if doing Night Vision Goggle (NVG) testing. What adjustments must be made if forecast target weather is marginal? Will low-level jet stream winds affect the paratroops drop over the dropzone? You may only have a phone number to a remote weather briefing site to retrieve weather information. Furthermore, once in the air, you may not be able to consult with a forecaster or see updated weather maps when confronted with unexpected changes. The Hazardous Inflight Weather Advisory Service (HIWAS) may not be updated. At any rate, the better you understand weather, the safer your flight will be.

**1.2. The Sun.** The sun is the Earth's only source of heat and energy and the cause of all the weather and atmospheric changes on Earth. With an estimated surface temperature of 11,000°F, the sun radiates energy in all directions. The Earth captures a very small amount of this electromagnetic radiation, but this very small amount of captured energy provides our source of heat and light.

**1.2.1. Basic Motions.** The earth has two basic motions within the solar system in relation to the sun (Figure 1-1). The first motion is the daily rotation of the earth about its axis. A complete rotation of the earth about its axis takes about 24 hours, so each hour represents 15 degrees rotation, a distance of 1,030.62 miles at the equator. Rotation produces numerous weather effects and a predictable effect on the flow of wind on the surface, as we shall see in Chapter 5.

**1.2.2.** The other crucial basic motion is its slightly elliptical, revolving orbit about the sun. It takes  $365\frac{1}{4}$  days to complete one revolution around the sun. The plane of the earth's orbit around the sun is called the plane of the ecliptic. Since the earth's axis is tilted about  $23\frac{1}{2}^\circ$  degrees from the vertical to the plane of the ecliptic, we experience the seasons of summer, fall, winter, and spring.

**1.2.3.** The sun's most intense energy is concentrated between  $23\frac{1}{2}^\circ$  N and S latitudes. As a result, the uneven heating of the earth's surface coupled with the earth's rotation about its axis, its revolving around the sun, and the earth's varied topographical features, are all major factors why our weather changes. Lets take a closer look at the earth's structure and composition.

**1.3. Structure and Composition.** The atmosphere is the gaseous envelope covering the earth and held in place by gravity. Comparing the earth to a baseball, the atmosphere, in perspective, would be about as thick as the baseball's cover. This envelope of air rotates with the earth. The atmosphere also has motions relative to the earth's surface called circulations. Circulations are caused primarily by the large temperature difference between the tropics and the polar regions, with other significant factors such as the uneven heating of land and water areas by the sun.

**1.3.1.** The atmosphere consists of a mixture of various gases. Pure, dry air is composed of approximately 78 percent nitrogen, 21 percent oxygen, and a 1 percent mixture of other gases, mostly argon (Figure 1-2). One of the most important factors of the atmosphere is water vapor, which varies in amounts from 0 to 5 percent by volume. It is present in three physical states, in a gaseous, liquid, and solid. The maximum amount of gaseous water vapor the air can hold is temperature dependent; the higher the temperature, the more water vapor it can hold. Water vapor remains invisibly suspended in varying amounts in the air until, through condensation, it grows to sufficient droplet or ice crystal size to form clouds or precipitation.

**1.3.2.** Even when the atmosphere is apparently clear, it contains variable amounts of impurities, such as dust, smoke, volcanic ash, and salt particles. Concentrations of these impurities can lower visibility resulting in hazy skies and blurring of long distance visual cues.

**1.3.3.** The depth of the atmosphere is commonly accepted as being 300,000 feet or up to 22 miles thick (Figure 1-3). Roughly half of it, by weight, lies below 18,000 feet due to gravity. This creates a blanket of dense air at the earth's surface upon which other forces act, as we will see in subsequent chapters.

**1.4. Troposphere.** The atmosphere is divided into layers, or *spheres*, each having certain properties and characteristics. The indistinct upper boundaries of these spheres are referred to as *pauses*. Since most weather and flying is in the troposphere and stratosphere, we will restrict our discussions to these two layers.

**1.4.1.** The *troposphere* is the layer adjacent to the earth. It varies in depth from an average of 60,000 feet over the equator to about 30,000 feet over the poles, with greater depth in summer than in winter. Some principal characteristics include:

**1.4.1.1.** Generally decreasing temperatures with height (Figure 1-4)

**1.4.1.2.** Increasing wind speeds with height

**1.4.1.3.** Most active atmospheric phenomena called *weather*.

**1.4.2.** The top of the troposphere is the *tropopause* which serves as the boundary between the troposphere and the stratosphere. The location of the tropopause is usually characterized by a pronounced increase of temperature with an increase of altitude.

Figure 1-1. Earth's Rotation, Axis Tilt, and Orbit.

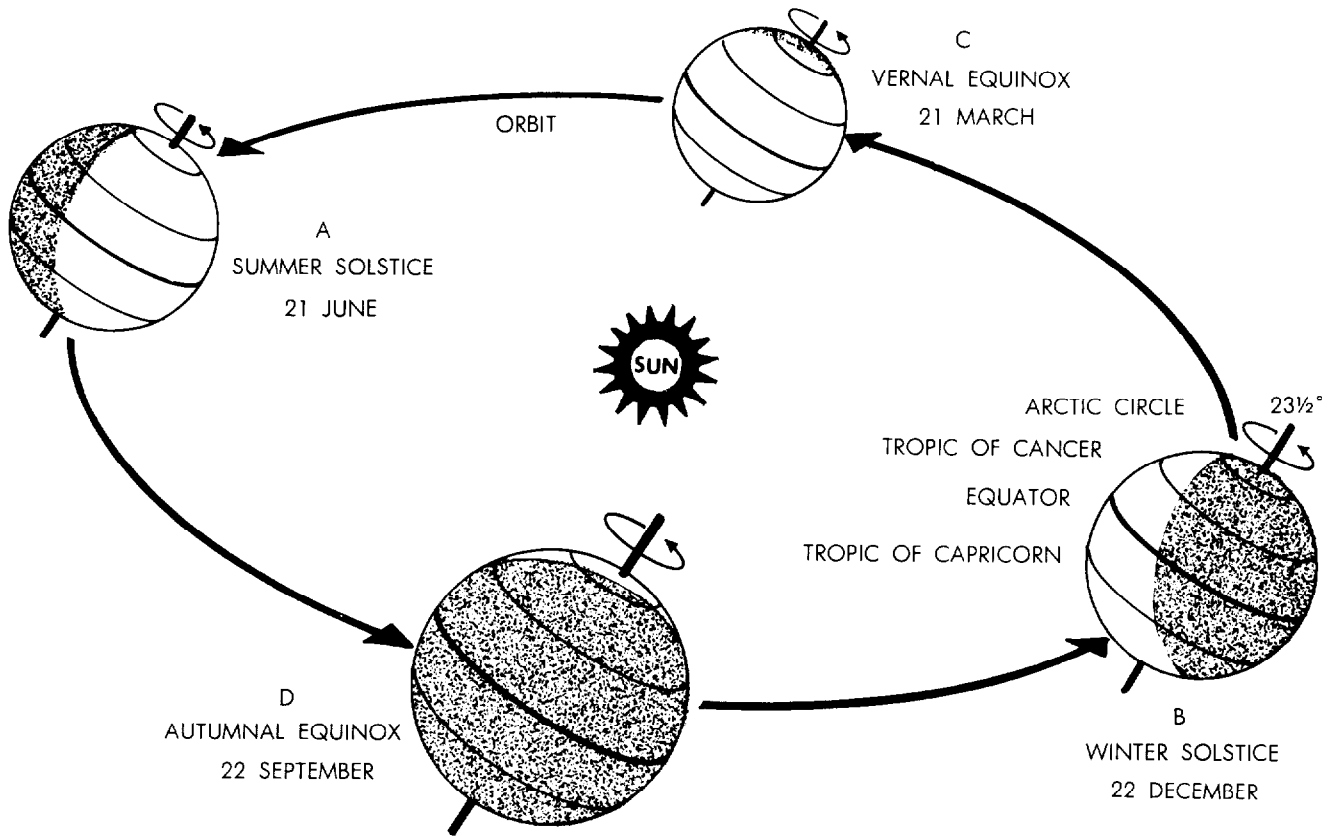


Figure 1-2. Composition of Atmosphere.

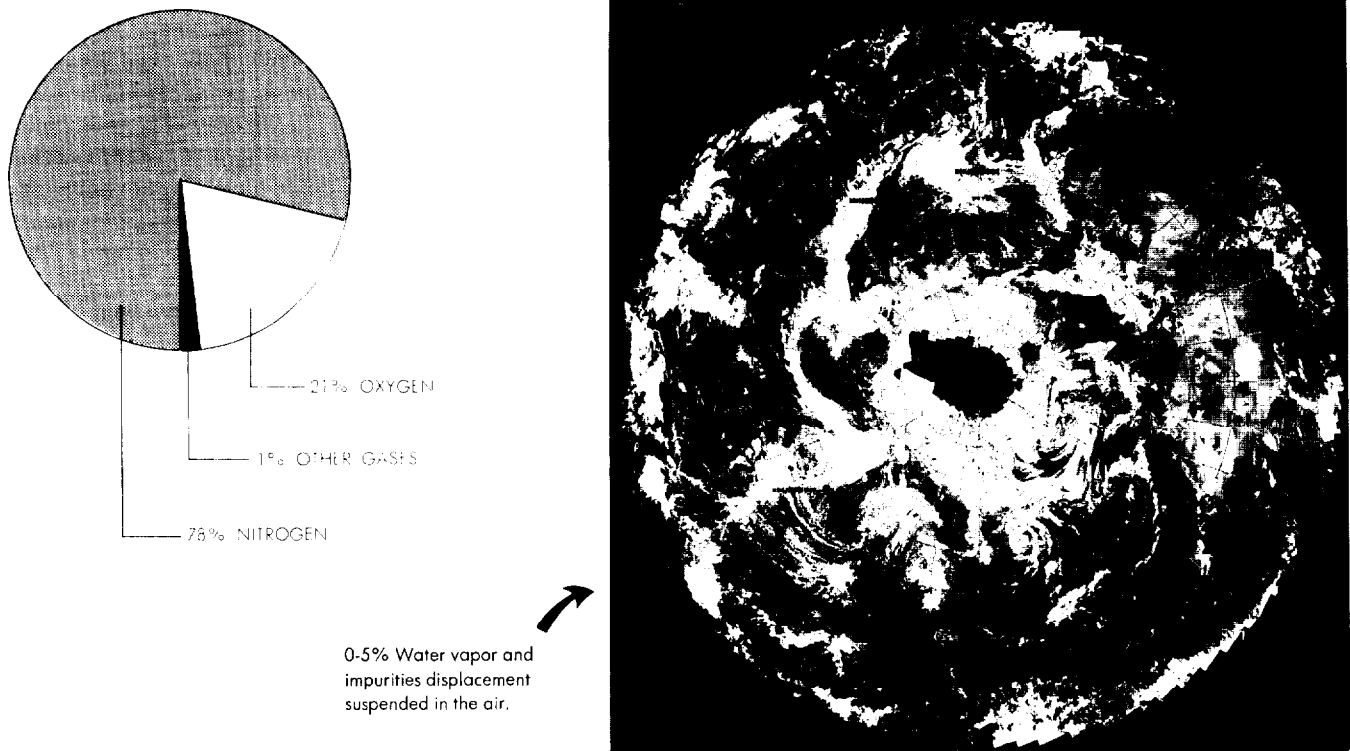
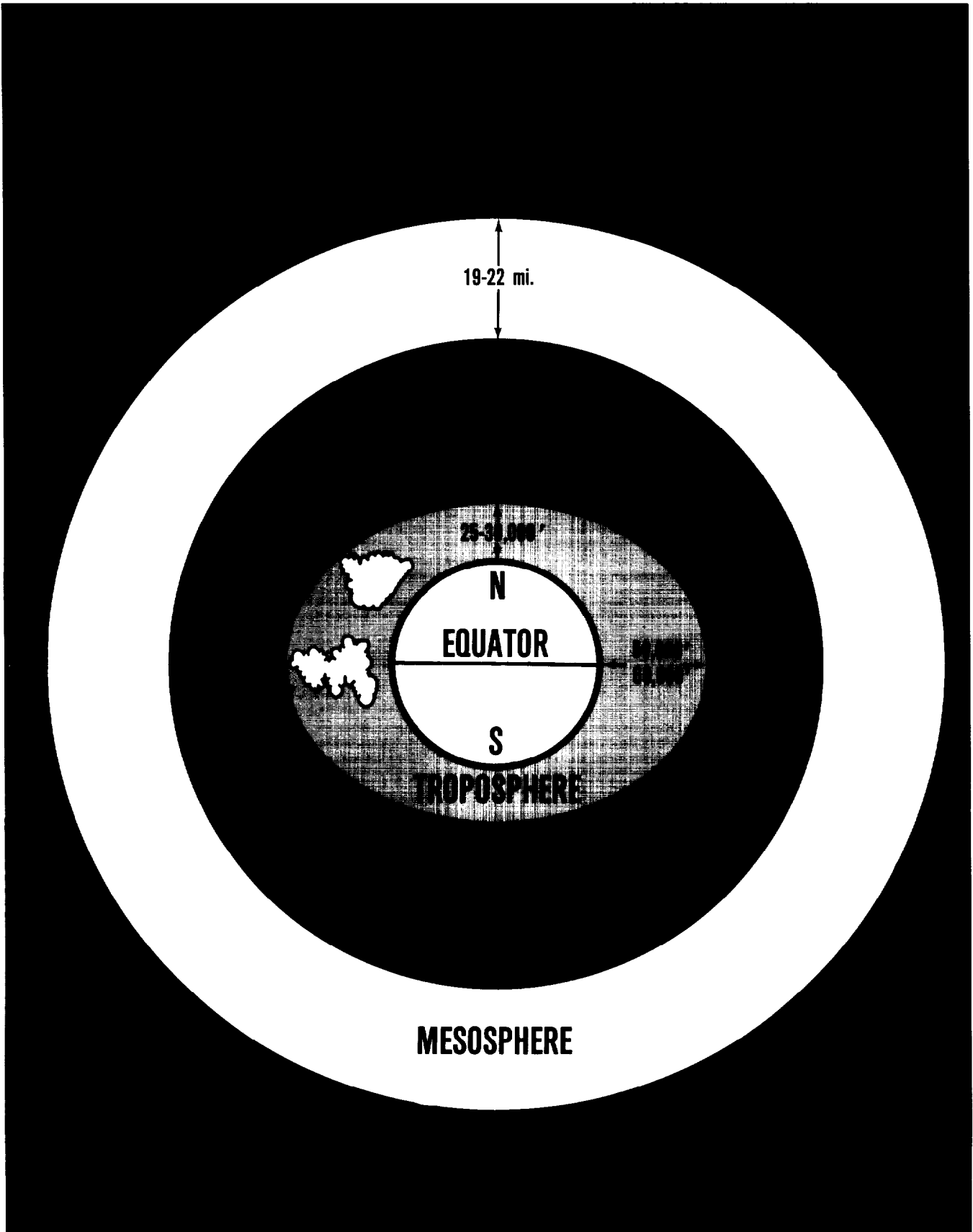


Figure 1-3. Atmospheric Layers.



**1.4.3.** The tropopause acts like a "lid" in that it resists the exchange of air between the troposphere and the atmosphere above. This explains why almost all water vapor is found in the troposphere. This also explains why the tops of thunderstorms rarely exceed the tropopause level. Above the tropopause are the stratosphere, the mesosphere, and the thermosphere (Figure 1-3). We will only discuss the stratosphere as an influence on weather above the troposphere.

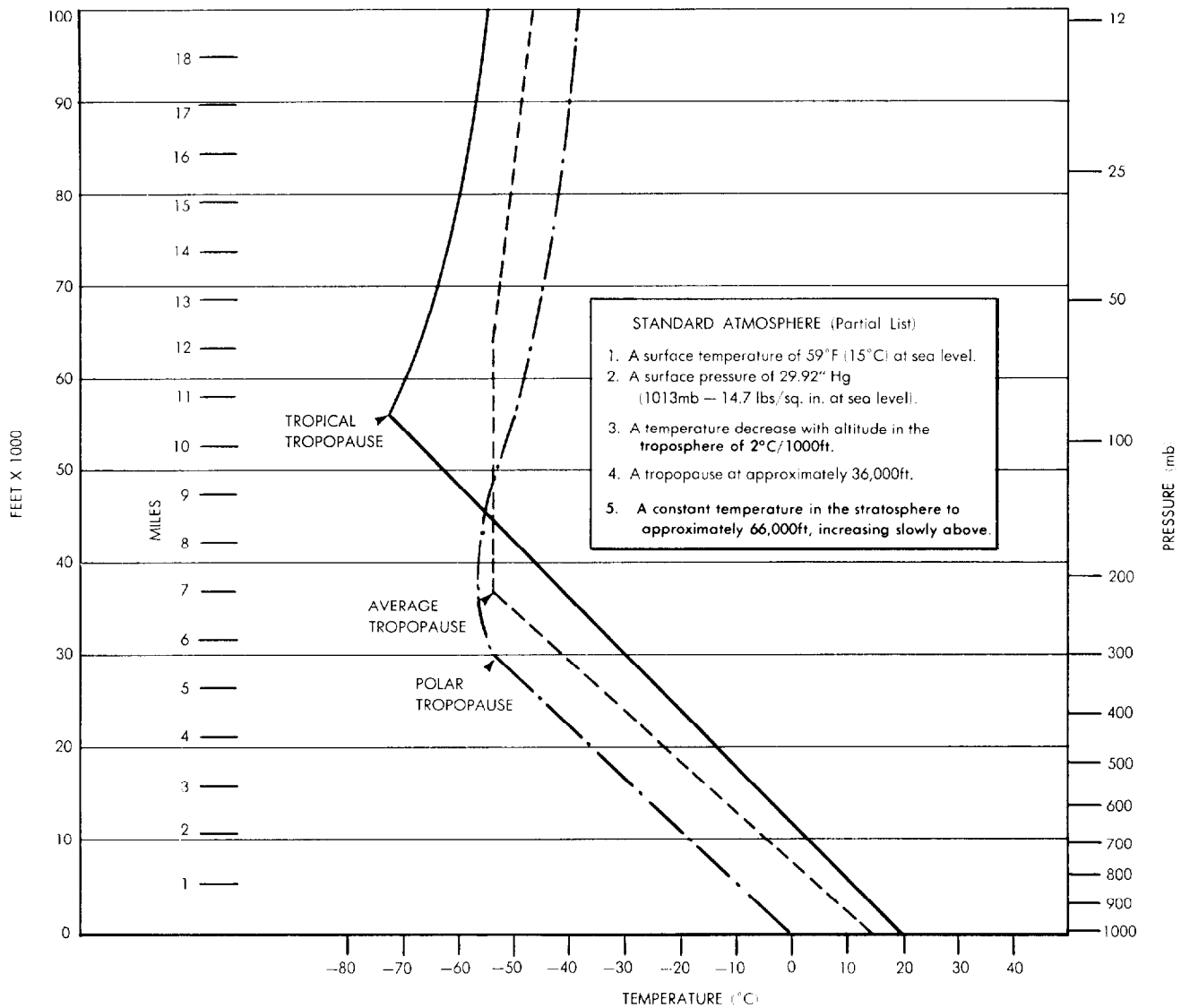
**1.5. Stratosphere.** The atmospheric layer just above the tropopause is the *stratosphere*. The average altitude of the top of this layer is 30 miles. Characteristics of this layer are a slight *increase* in temperature with height (as opposed to the *decrease* encountered in the troposphere) and the near absence of water vapor and clouds.

**1.5.1.** Except for a substantial increase in the amount of ozone, the composition of the stratosphere is the same as the troposphere. Ozone is important because it absorbs most of the deadly ultraviolet rays from the sun. The maximum temperatures associated with the absorption of the sun's ultraviolet radiation occur at the *stratopause*. Ozone also has a corrosive effect on certain metals and has become increasingly important as supersonic aircraft operate in the regions of higher ozone concentration. Aircrews flying through areas of higher ozone concentration may experience irritation to eyes, nose, and mouth, or coughing symptoms associated with ozone sickness.

**1.6. Aircrew Environment.** Because the atmosphere contains 21 percent oxygen, the pressure oxygen exerts is about one-fifth of the total air pressure at any one given level. This is important to aircrews because the rate at which the lungs absorb oxygen depends upon the oxygen pressure. The average person is accustomed to absorbing oxygen at a pressure of about 3 pounds per square inch (psi). Since air pressure decreases with increasing altitude, oxygen pressure also decreases. Prolonged high altitude flight without supplemental oxygen usually produces a feeling of exhaustion, then vision impairment, and finally unconsciousness; all symptoms of hypoxia.

**1.6.1.** Since the first effects of hypoxia can occur without the person realizing it, auxiliary oxygen must be used during prolonged flights above 10,000 feet, or when flying above 12,000 feet for even short periods of time. When the atmospheric pressure falls below 3 pounds per square inch (approximately 40,000 feet), a system of environmental pressurization becomes essential.

Figure 1-4. Troposphere--Decrease in Temperature with Height.



## Chapter 2

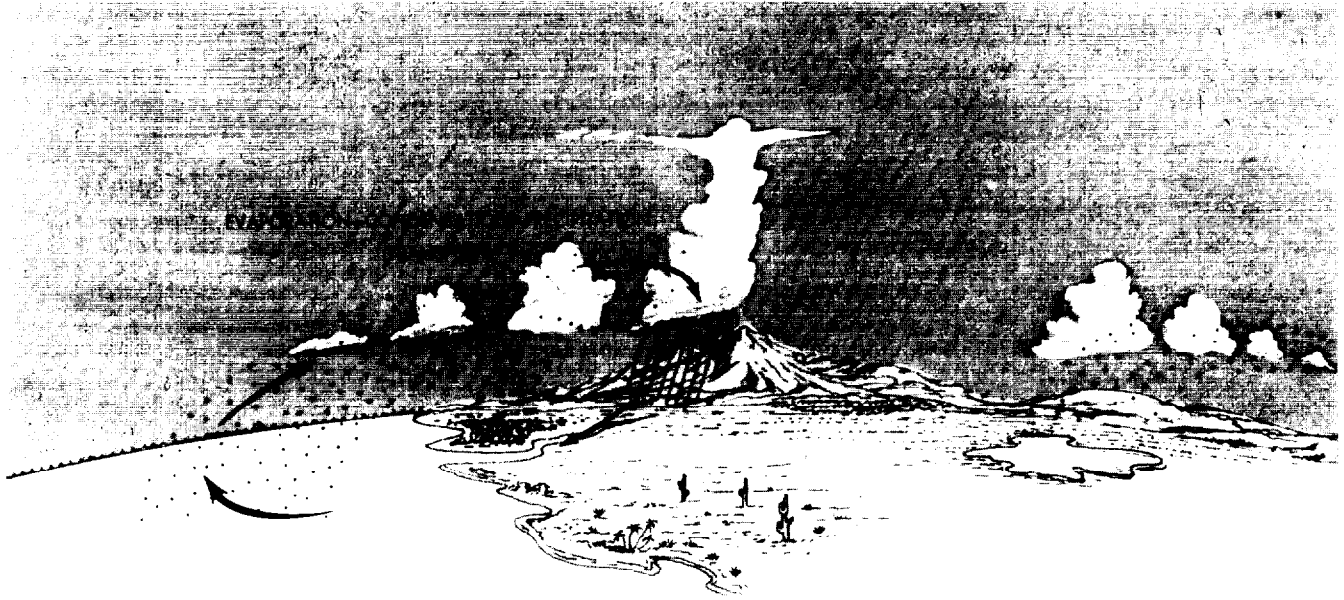
### MOISTURE

**2.1. Introduction.** Water covers more than two-thirds of the earth's surface. Water from this extensive source is in a constant state of transformation, in which the three most important stages are evaporation, condensation, and precipitation. This continuous process is called the hydrologic cycle (Figure 2-1). It keeps the atmosphere supplied with moisture and helps produce temperature and pressure changes (Figure 2-2). Most of the atmosphere's moisture is concentrated in the lower troposphere, and only rarely is found in significant amounts above the tropopause.

**2.1.1.** The remaining third of the earth's surface is land with elevation contrasts and vegetation differences. A good working knowledge of local and regional terrain variations is very important to understanding local weather effects. Terrain varies from sharply contrasting mountain ranges to vast stretches of flat plains and plateaus. Each type of terrain significantly influences low level wind flow, moisture availability, and temperatures. The weather can be cloudy and rainy on the west side of a mountain range and cloudless and dry on the eastern side. Knowledge of terrain features can help you anticipate favored precipitation areas characterized by instrument flight rules (IFR) weather conditions.



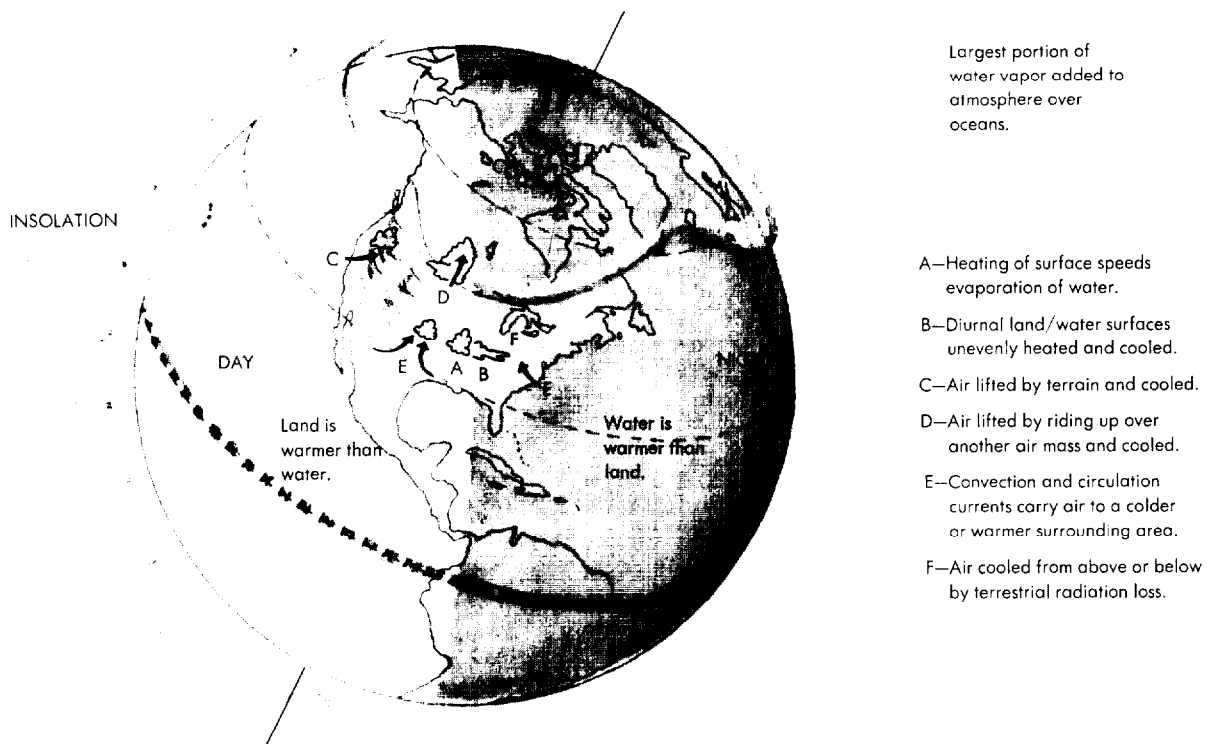
Figure 2-1. Hydrologic Cycle.



2.1.2. Water in the atmosphere exists in three states: vapor, liquid, and solid. Water vapor is water in the gaseous state and is not visible. In the liquid state, it forms as rain, drizzle, fog, and as small water droplets which form clouds. In its solid state, it forms as snow, hail, ice pellets, ice-crystal clouds, and ice-crystal fog.

2.1.3. The oceans provide the primary source of water for the atmosphere. To a lesser extent, moisture sources also include lakes, rivers, swamps, moist soil, snow, ice fields, and vegetation. As moisture evaporates into its vapor state, the wind may carry moisture great distances before it changes states into liquid or solid precipitation.

Figure 2-2. Factors Affecting Hydrologic Cycle.



**2.2. Changes of State.** Evaporation, condensation, sublimation, and deposition are changes of state. When water changes from a liquid to a gas, molecules escape from the liquid's surface and enter the air as water vapor. Their escape rate increases with temperature. This is a simplified explanation of *evaporation*, the process through which water vapor enters the atmosphere from liquid water. *Condensation* is the change of state from a gas to a liquid. Condensation takes place when an air parcel reaches its saturation point. *Sublimation* is the change of state directly from a solid to a gas. The reverse is called *deposition* (sometimes used interchangeably with sublimation) and is the change directly from a gas to a solid. Two other familiar changes of state are *melting* and *freezing*.

**2.2.1.** Any change of state involves heat exchange. Energy, in the form of heat, is absorbed or released. Figure 2-3 illustrates the heat exchanges between the different states of water. During evaporation, escaping water molecules absorb energy (heat) to break away from the attraction of the other molecules. This cools the remaining liquid since it has less heat. Heat required for evaporation is not lost, but remains hidden or latent in the water vapor. When the vapor condenses to liquid water or depositions directly to ice, this heat is released to the atmosphere as illustrated in Figure 2-4, and the surrounding air becomes warmer. As an example, the amount of heat given off in a thunderstorm during the process of precipitating one-half inch of rain over a square mile is 17 trillion calories. The energy released by the atomic bomb dropped on Hiroshima was 20 trillion calories. Melting, freezing, and sublimation all involve the exchange of heat in a similar manner.

**2.3. Water Vapor Content.** *Water vapor* is water molecules in its gaseous, invisible state. A parcel of air's capacity to hold water vapor is determined by the temperature of the parcel. When a parcel of air contains the maximum amount of water vapor for a given temperature, the air becomes *saturated*. The warmer the air, the more water vapor it can hold before reaching saturation and condensation (Figure 2-5). For approximately every 20°F (11°C) increase in temperature, the capacity of a volume of air to hold water vapor doubles. Conversely, as a parcel cools, the dew point is eventually reached; the point when the temperature and dew point temperature are the same and the relative humidity is 100%. Further cooling forces some water vapor to visibly condense as fog, clouds, or precipitation. The relative humidity and dew point concepts are expanded during the next few paragraphs.

Figure 2-3. Changes of State of Water.

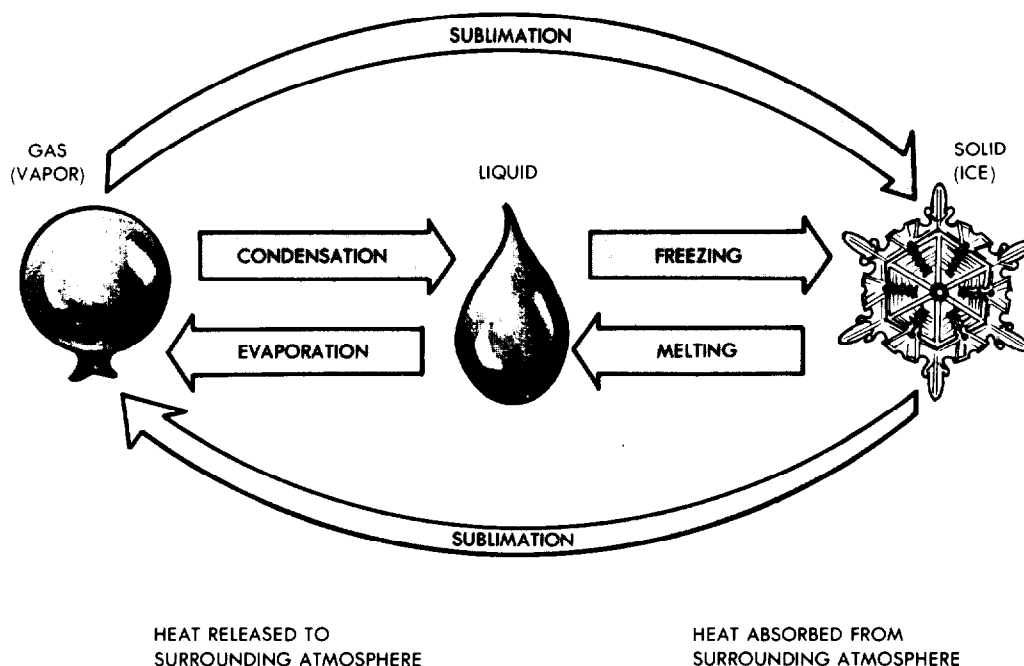


Figure 2-4. Evaporation and Condensation.

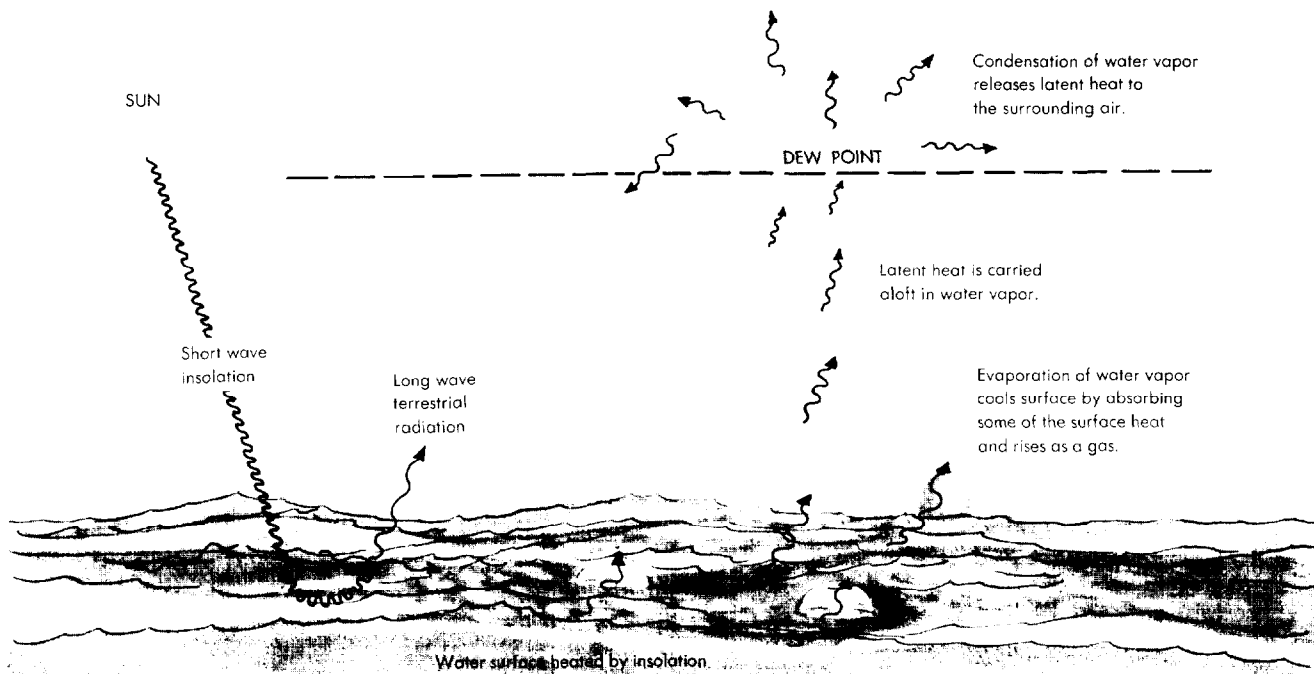
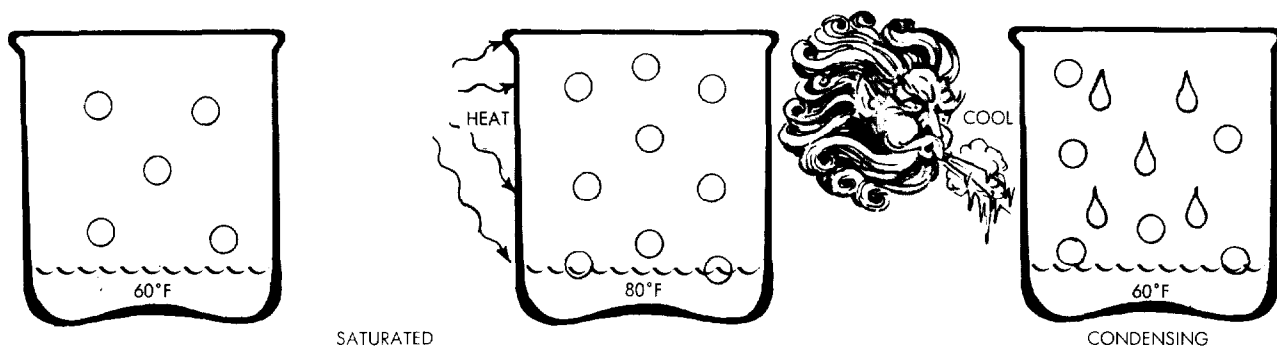


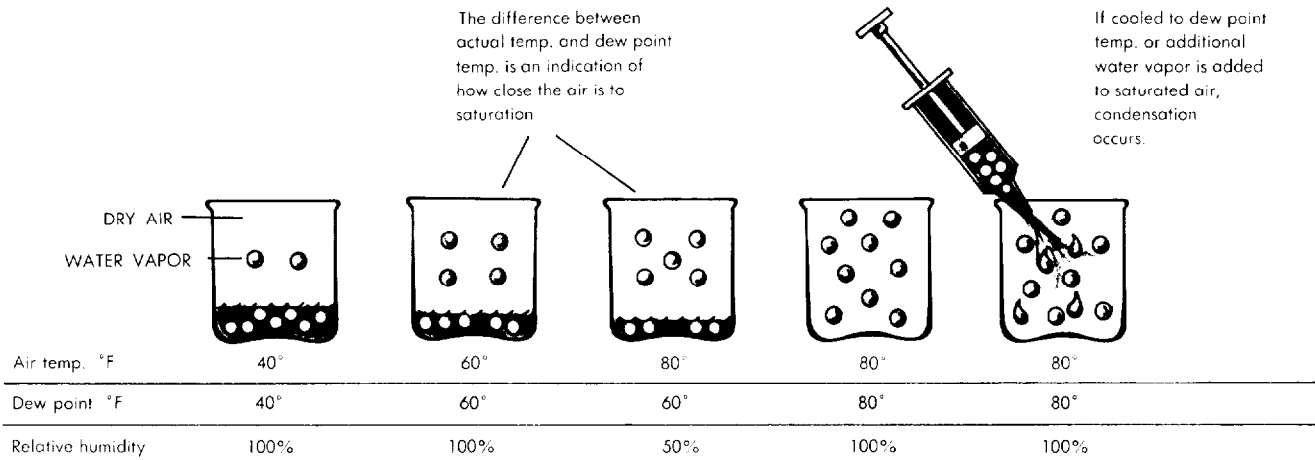
Figure 2-5. Saturation of Air Depends on its Temperature.



**2.4. Relative Humidity.** Humidity is measured in grams of water per kilogram of air. *Relative humidity* is the ratio of the actual humidity to the humidity that the air would contain if saturated. The ratio of two ratios is expressed as a percentage. When a given air sample contains all the water vapor possible at a given temperature, the relative humidity is 100 percent (Figure 2-6). A relative humidity value of 50 percent means the air contains half the water vapor it is capable of holding at that temperature.

**2.4.1.** Practically speaking, on a cold day with a temperature of 35°F and a dew point of 30°F, the relative humidity is 84 percent. On a hot day with a temperature of 95°F and the same dew point of 30°F, the relative humidity is only 10 percent. The dew point temperature is the same, but the relative humidity is quite different. If on the same hot day the temperature was 95°F with a sticky dewpoint of 74°F, the relative humidity will feel high because it feels so humid but the relative humidity is 50%!

Figure 2-6. Relative Humidity and Dew point.



**2.5. Dew Point, Dew, and Frost.** The *dew point* is the temperature air must be cooled to become saturated (Figure 2-6). When this temperature is below freezing, it is sometimes called the *frost point*. The difference between the actual air temperature and the dew point temperature is an indication of how close the air is to becoming saturated. This temperature difference is commonly called the *spread*, or *dew point depression*. Relative humidity increases as the temperature spread (dew point depression) decreases until the relative humidity becomes 100 percent when the dew point spread is 0°. Aviation hourly weather reports regularly include the dew point temperature.

**2.5.1.** Be alert for fog or low cloud formation any time the surface air temperature is within 4°F of the dew point, and the spread between the two is decreasing (Figure 2-7). Generally this condition is optimal during late night and early morning hours. On the other hand, when the difference between the two temperatures is increasing, existing fog and low clouds will likely dissipate because water vapor is evaporating into the warming air. This is often true in the morning hours, when air temperature is increasing as the day progresses. Be aware, however, that fog and low clouds may form 2 to 3 hours after sunrise if there is a layer of moist air in the first few hundred feet above the surface.

**2.5.2.** During clear, still nights, aircraft surfaces often cool by radiation to a temperature equal to the dew point of the adjacent air. The moisture or *dew* collects on the airframe surface just as it does on a pitcher of ice water in a warm room. The moisture comes from the air in direct contact with the cool surface. Often heavy dew is observed on grass or plants when there is none on the pavements or on large solid objects. Since large objects absorb so much heat during the day, their temperature falls slowly, and their temperature may not cool below the dew point of the surrounding air during the night.

**2.5.3. Frost** forms much the same way as dew. The difference is that the dew point of the surrounding air must be colder than freezing. Water vapor then sublimates directly as ice crystals or frost rather than condensing as dew. Sometimes dew forms and later freezes, but frozen dew is easily distinguishable from frost since it is transparent and frost is opaque. Aircrews should not underestimate the dangers associated with frost formation. Frost forming on airframes results in increased drag and decreased lift. Remove *all* frost from the aircraft before takeoff.

**2.6. Condensation and Sublimation Processes.** *Condensation* occurs if moisture is added to the air after saturation has been reached, or if cooling of the air reduces the temperature to the saturation point. As shown in Figure 2-8, the most frequent cause of condensation is cooling of the air and often results when: (a) air moves over a colder surface, (b) air is lifted (cooled by expansion), or (c) air near the ground is cooled at night as a result of radiational cooling.

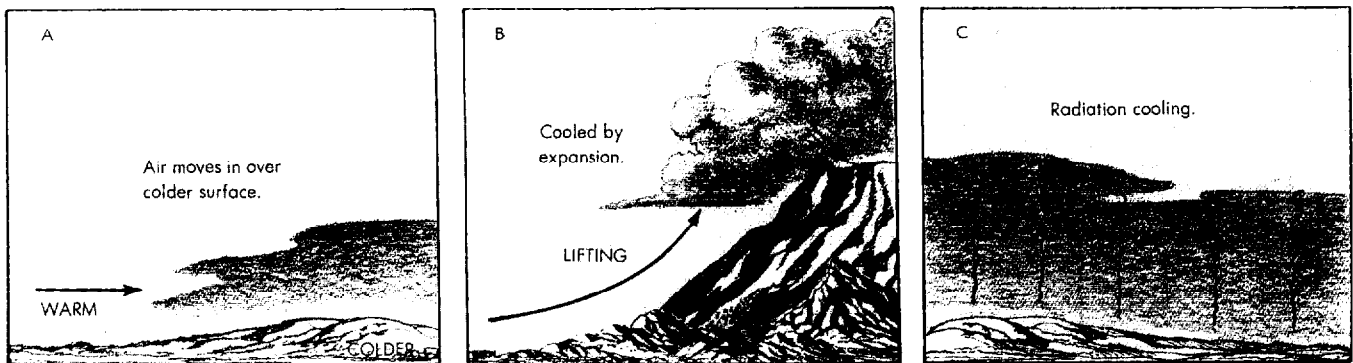
**2.6.1. Sublimation** is the change of state from a solid to a gas without an intermediate liquid stage. This is where ice changes directly into water vapor without becoming a liquid and is why snow will disappear with temperatures below freezing.

**2.7. Clouds and Fog.** Clouds and fog form in air that has become supersaturated, with respect to liquid water or ice. Clouds and fog are composed of very small droplets of water which collect on microscopic water-absorbent particles called *condensation nuclei*. These aerosols include sea salts, dust, industrial pollution particles, volcanic ash, and a variety of other sources. They are so small their size is measured in microns (millionths of a meter). Clouds generally form when the air becomes saturated.

Figure 2-7. Dew Point and Temperature Spread.



Figure 2-8. Causes of Condensation.

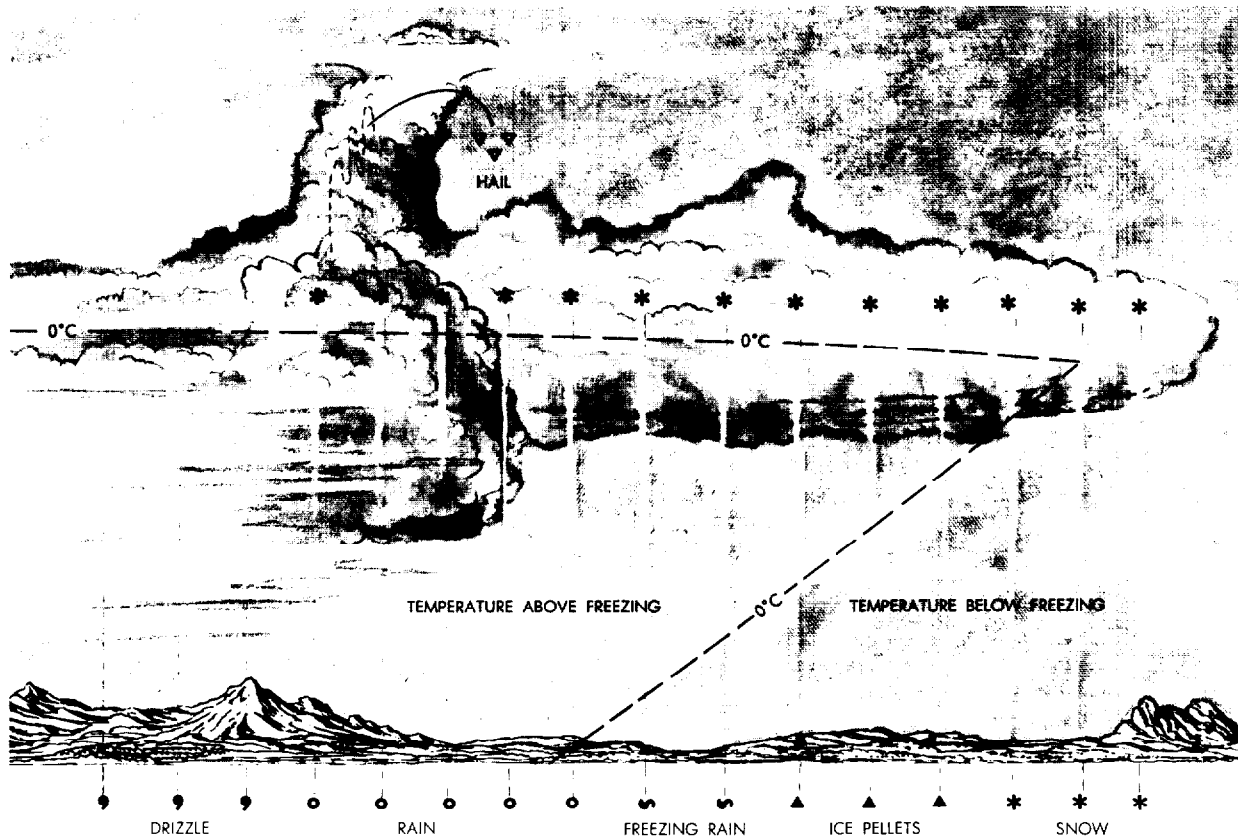


**2.7.1.** Clouds and fog which form at temperatures well below freezing ( $-20^{\circ}\text{C}$  or lower) are usually composed of ice crystals, which form directly from water vapor through the deposition process. However, liquid water droplets are frequently observed in the atmosphere at temperatures much lower than the freezing point, and have been observed at  $-40^{\circ}\text{C}$ . These supercooled water droplets are prevalent in clouds to a temperature of about  $-20^{\circ}\text{C}$ . Aircraft penetrating supercooled clouds are likely to encounter icing because the impact of the aircraft may induce freezing of the supercooled droplets upon contact.

**2.8. Precipitation.** *Precipitation* is liquid or solid moisture that falls from the atmosphere in the form of rain, freezing rain, drizzle, freezing drizzle, ice pellets, snow, hail, or combinations of them. As shown in Figure 2-9, the form of precipitation is largely dependent upon temperature conditions and the degree of turbulence present.

**2.8.1.** The main precipitation process uses ice crystals as a starting point. Initially, suspended minute ice crystals grow through collisions with other ice crystals while traveling through moving air currents. The growing ice crystal attains a fall-speed which exceeds the upward air current velocities. As the ice crystal travels through the freezing point into warmer air, it becomes a raindrop. Gravity accelerates the raindrops toward the earth's surface, colliding with other, slower traveling raindrops and becomes larger. Raindrop size is largely dependent upon the amount of turbulence in the cloud.

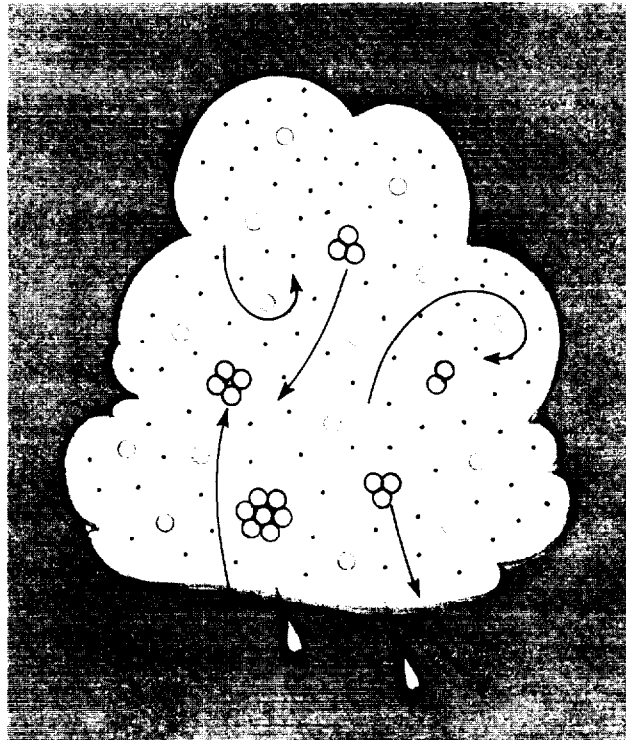
Figure 2-9. Precipitation Products.



**2.8.2.** In clouds with no freezing level and the presence of minute droplets, collision of variable sized water droplets produces precipitation. Vertical air currents cause the droplets to collide and assist in the growth of clouds by carrying water droplets to higher altitudes (Figure 2-10). Gentle ascending air currents will produce light precipitation and less thick clouds. For turbulent air currents, precipitation will be heavier, have larger droplet sizes and clouds will be more than 4,000 feet thick. Usually precipitation of light intensity falls from stable stratus type clouds less than 4,000 feet thick.

**2.8.3.** Precipitation can change its state as its environmental temperature varies. For example, during the winter, descending snow can change to rain as the precipitation goes through warmer layers of air, and the rain can descend further into colder air (below freezing point) refreezing into ice pellets before reaching the ground. This situation can happen frequently in the vicinity of warm fronts during the winter when an aircraft can cross the freezing level several times while ascending or descending.

**2.8.4. Virga.** Not all precipitation reaches the earth. On many occasions, it evaporates completely in dry air beneath the cloud base. This phenomenon is known as *virga* and is a relatively common occurrence in hot, dry areas such as the western United States. As the precipitation evaporates, the cooled air is colder than the surrounding air and rapidly sinks to the surface. The cooled air forms a strong downdraft and poses a wind shear threat to aircraft.

**Figure 2-10. Growth of Raindrops by Collision.**

## Chapter 3

### TEMPERATURE

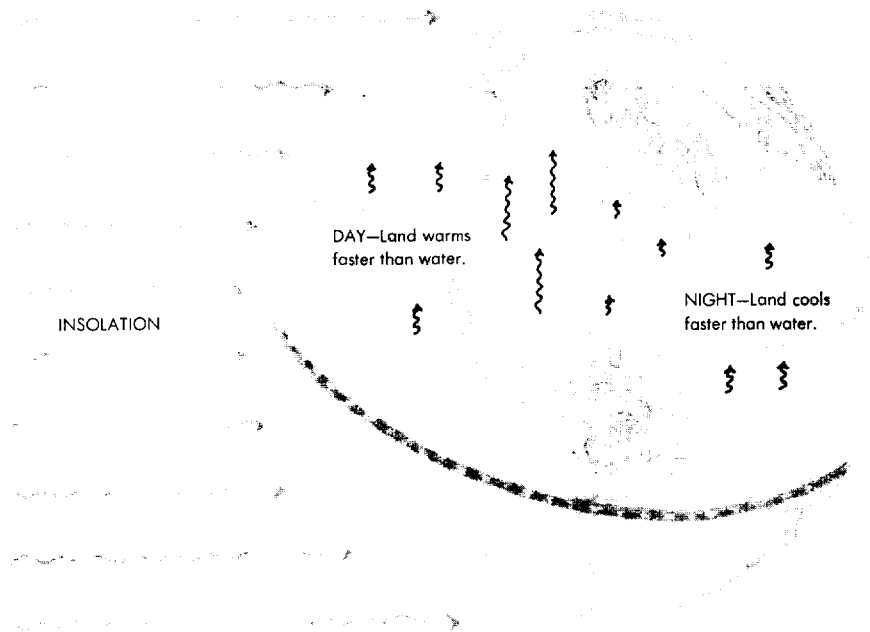
**3.1. Introduction.** Temperature is important to the aircrew because it enters into the computation of most aircraft performance parameters. Aircrews can use the information to determine load capacities and takeoff roll information. In some cases, aircraft cannot take off in hot weather conditions unless the temperature and pressure altitude conditions are favorable. This chapter relates heat and temperature, describes commonly used temperature scales, and surveys temperature variations both at the surface and aloft.

**3.2. Heat Energy Measurement.** Temperature is a measurement of heat energy and expresses the degree of molecular activity. Since different substances have different molecular structures, equal amounts of heat applied to two different objects of equal mass usually results in one object getting hotter than the other. For example, a land surface becomes hotter than a water surface when equal amounts of heat are added to each (Figure 3-1).

**3.2.1.** The sun's radiation heats the earth's surface during the day. However, direct solar radiation accounts for only a small portion of the heat absorbed by the atmosphere. Most radiative heating of the atmosphere is the result of re-radiated energy from the earth's surface. Absorption of radiated energy is partially dependent upon the temperature of the emitting body--the hotter the body, the shorter the wavelength of the emitted energy.

**3.2.2.** Solar radiation is concentrated in the short-wave spectrum (ultraviolet) and is called *insolation*. Since the earth is a significantly cooler body, the earth's radiation is limited to the longer, infrared wavelengths. Heat re-radiated from the earth by outgoing or long-wave radiation, is called *terrestrial radiation*. Cooling results at night as terrestrial radiation continues and insolation ceases. The heating of the earth and its atmosphere depends on the ability of the individual masses involved to absorb and emit the two types of radiation.

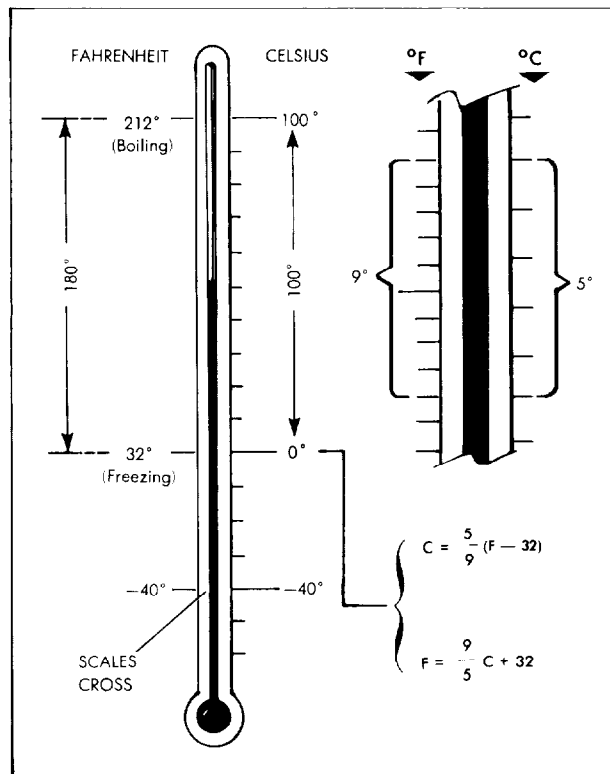
**Figure 3-1. Land has Greater Temperature Variance than Water.**



- The various surfaces absorb, retain, and radiate heat and determine the daily surface air temperature to 4000ft.

- Practically no daily temperature variance occurs in the free air above 4000ft.

**Figure 3-2. Temperature Conversion Methods.**



**3.3. Temperature Measurement.** Fahrenheit and Celsius (centigrade) are the names given to the two temperature scales important to the aircrew member. On the Fahrenheit (F) scale, the freezing point is at 32 degrees and the boiling point at 212



degrees -- a difference of 180 degrees (Figure 3-2). On the Celsius (C) scale, the freezing point is at 0 degree and the boiling point at 100 degree -- a difference of 100 degrees. The ratio between degree F and degree Celsius is, therefore, 180 to 100, or 9 to 5. This means that a temperature difference of 9 degrees F is equal to a difference of 5 degrees C. This ratio is used in converting from one scale to another as shown in Figure 3-2.

**3.3.1.** The measurement of outside air temperatures with the typical aircraft thermometer is influenced by several factors (such as radiation, air compression, and friction) which tend to decrease the accuracy of these observations. Such effects may cause the reading to differ from the true free-air temperature by 25 degrees F (14 degrees C) or more, except where careful engineering has been provided. Most flight manuals contain a temperature correction chart to obtain true air temperature.

**3.4. Daily Range of Temperature.** *Diurnal variation* is the daily change in temperature from day to night. During the day, incoming solar radiation exceeds outgoing terrestrial radiation and the surface becomes warmer. The daily temperature maximum usually lags behind the maximum solar insolation, occurring during the mid-afternoon hours. At night, solar radiation ceases, but terrestrial radiation continues and the surface cools. The same temperature lag process explains why the minimum temperature usually occurs just after sunrise. The continued nighttime cooling process lags a bit even after sunrise and is one reason fog can form shortly after sunrise.

**3.4.1.** The range of temperature between night and day varies considerably, both with season and location. This daily variation ranges as much as 30 to 50 Fahrenheit degrees in arid areas to 15 to 20 Fahrenheit degrees in most mid-latitude locations. It is greater near the surface of barren high-level places, over sand, plowed fields, and rocks, while it is much smaller over thick vegetation and deep water surfaces. Practically no daily temperature change occurs in the free air 4,000 feet or more above the surface within the troposphere. The daytime vertical temperature mixing process rarely extends to above 4,000 feet above ground level (AGL).

**3.4.2.** The temperature (and resultant air density) at and near the surface greatly affects aircraft allowable gross weights for both takeoff and landing. An aircraft taking off during night or early morning in cooler, denser air has more allowable gross weight (all other factors being equal) than it would have in the early afternoon when the air is warmed and becomes less dense.

**3.5. Temperature Distribution.** The temperature distribution over the earth's surface largely depends on the seasons and on the composition and distribution of land/sea surfaces. Figure 3-3 shows the surface temperature distribution for January and July representing both hemispheres' winter and summer respectively, and clearly illustrates the influence of topography on the temperature. The following pertinent information can be noted:

- The ocean areas between latitudes 40 degrees N and 40 degrees S show very little temperature changes from summer to winter.
- The land areas are warmer than the adjacent water areas at the same latitude during summer.
- The water areas are warmer than the adjacent land areas at the same latitude during winter.
- Both the warmest and coldest temperatures are found over the land areas.

**3.6. Temperature Variation with Altitude.** Temperature normally decreases with increasing altitude throughout the troposphere. This decrease of temperature with altitude is called the *lapse rate*, expressed in degrees per thousand feet. The *standard lapse rate* in the troposphere is 2 degrees C (3.6 degrees F) per 1,000 feet. This value serves as the basis for calibrating aircraft instruments and preparing performance charts. Figure 3-4 shows nonstandard temperature effects on pressure and density.

**3.6.1. Temperature Inversions.** Variation in the lapse rate may change with altitude itself (Figure 3-5). At a given time and place, the vertical temperature might decrease at a rate of 3 degrees C per 1,000 feet from the ground to an altitude of 5,000 feet, at a rate of 1 degrees C per 1,000 feet between 5,000 and 7,000 feet, and at 2 degrees C per 1,000 feet above 7,000 feet until the tropopause is reached. Rarely does the temperature decrease at an orderly rate. In fact, temperature inversions are the norm with sometimes two or three inversions present from surface to 30,000 feet.

**3.6.2.** Many times there is a layer within the troposphere characterized by an increase of temperature with altitude. It is called an *inversion*, because the usual decrease in temperature with altitude is inverted. Inversions are usually confined to a relatively shallow layer, several hundred feet thick but can be up to a few thousand feet in depth. The three main types of inversions are the radiation, subsidence and frontal.

**3.6.3.** The most common inversion over land, the *radiation* or *nocturnal* inversion, is produced immediately above the ground on a clear, relatively still night. Since air is a poor conductor, the ground loses heat rapidly through terrestrial radiation, cooling the layer and creating a temperature inversion. The coldest air is adjacent to the earth's surface with the amount of cooling decreasing rapidly with altitude. The air temperature a few hundred feet above the ground is affected very little or not at all. Terrestrial radiation thus causes the lowest layer of air to be colder than the air just above that layer. If skies are overcast, nighttime cooling is reduced, thus reducing the likelihood of a radiation inversion formation.

Figure 3-3. Surface Temperature Distribution.

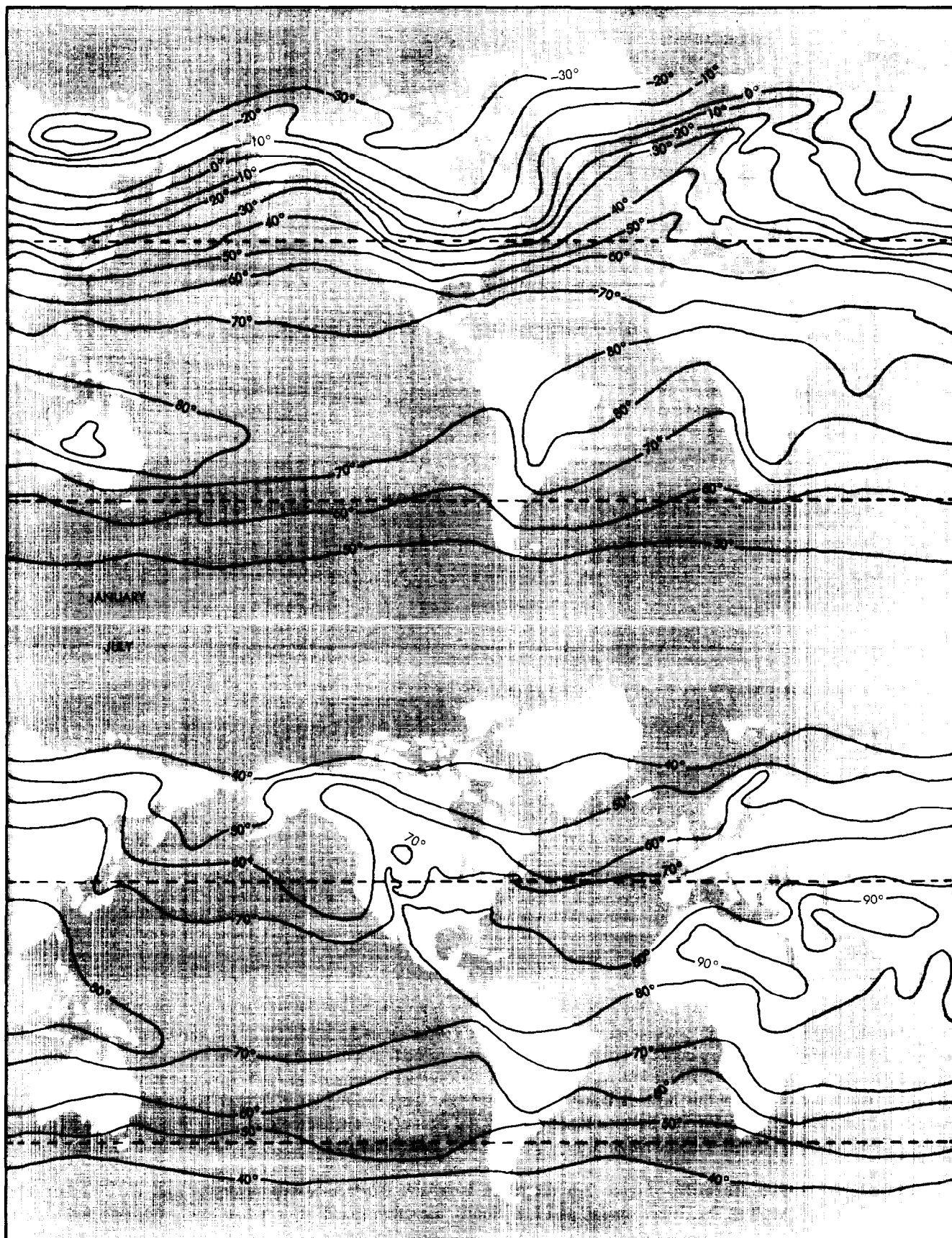


Figure 3-4. Effect of Nonstandard Temperature on Pressure and Density.

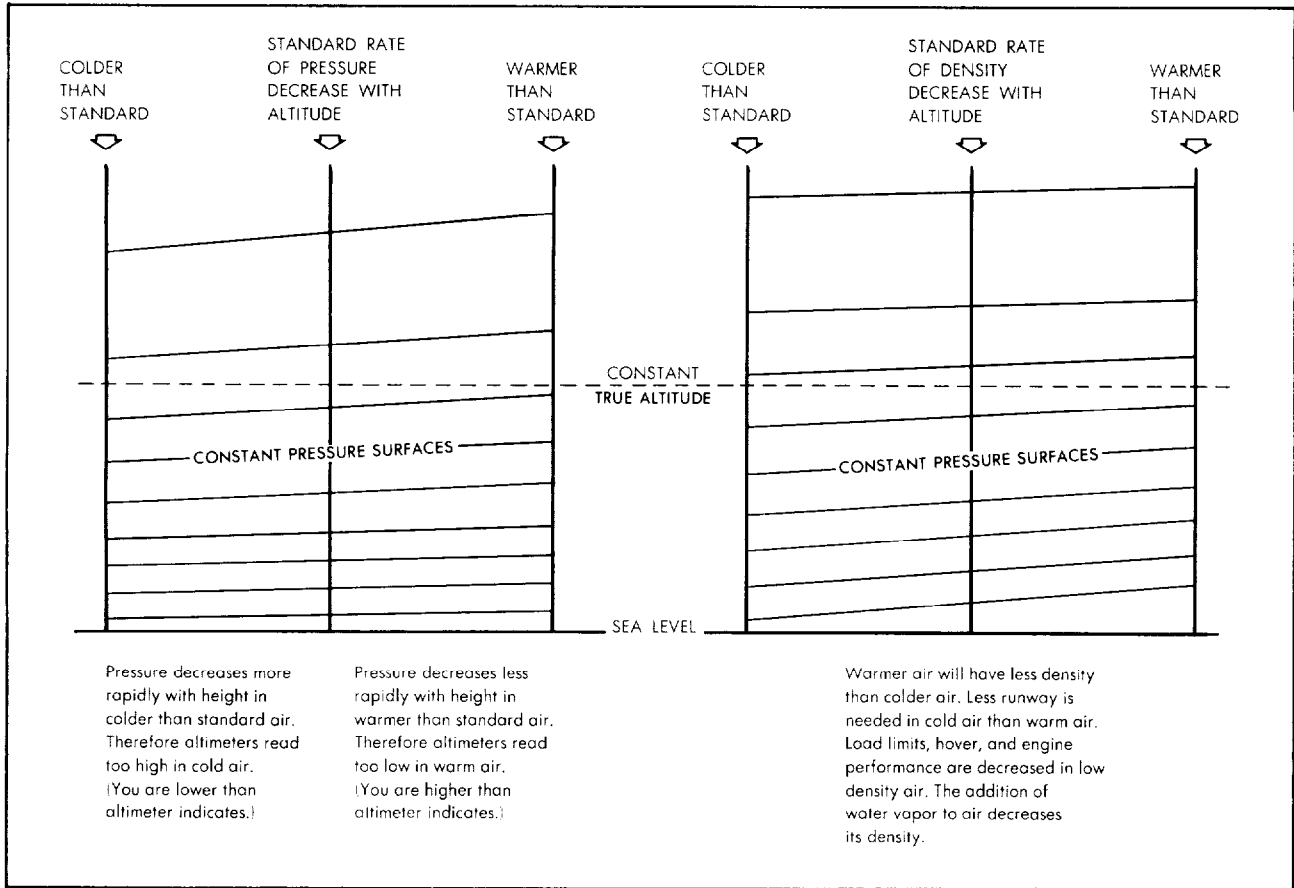
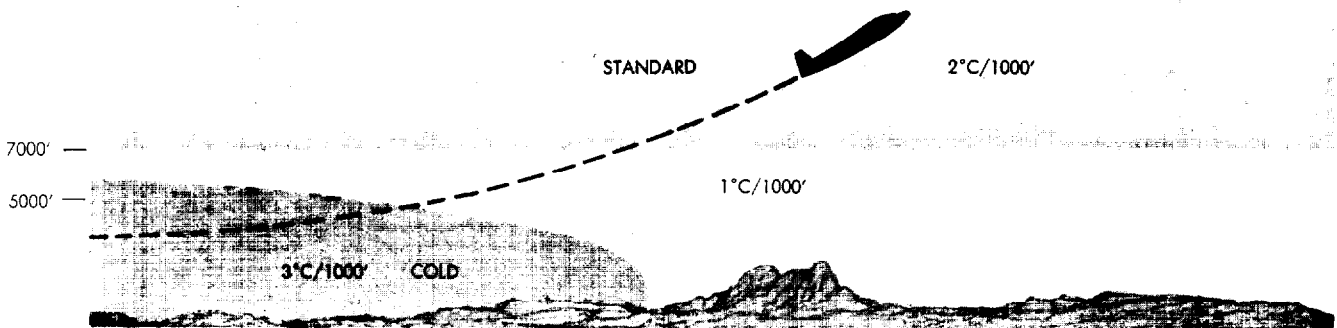


Figure 3-5. Lapse Rates May Vary from Layer to Layer.



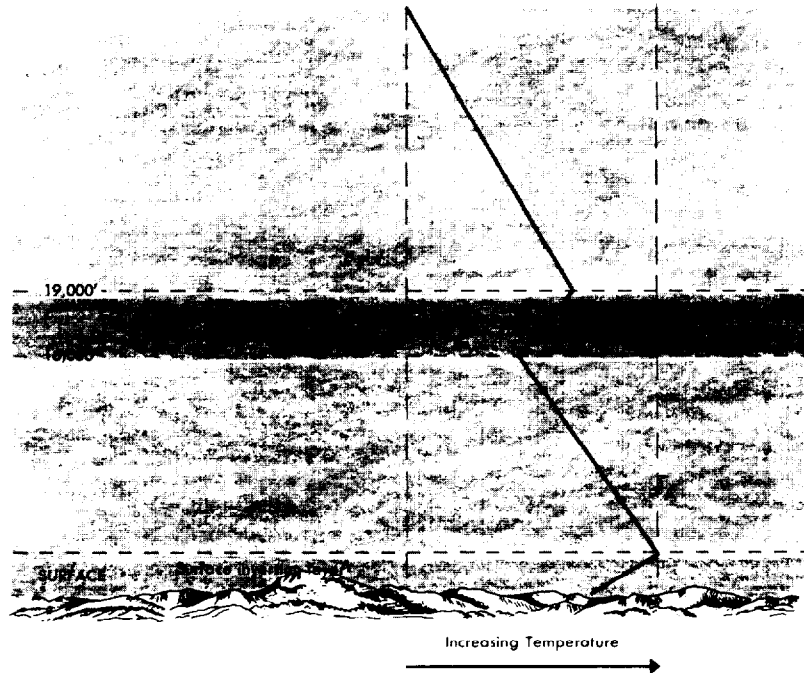
3.6.4. Inversions are also found in association with movement of colder air under warm air or the movement of warm air over cold air. Such inversions are often called *frontal inversions*. Their formation will be discussed in the chapter on fronts.

3.6.5. A *subsidence* inversion sometimes forms as a result of widespread sinking of air (subsidence) within a relatively thick layer aloft, while the air below this layer is essentially unchanged. This sinking air is heated by compression, and it may become warmer than the air below it. Subsidence inversions are commonly encountered in areas affected by high pressure weather. Sometimes an aircraft will encounter more than one subsidence inversion.

3.7. **Inversion Aviation Hazards.** Figure 3-6 illustrates a ground (surface-based) inversion and an inversion aloft. Restrictions to vision, such as fog, haze, smoke, and low clouds, are often found in or below low inversions and in layers

through which there is only a small change in temperature. The air in these layers is usually very smooth; however, light turbulence may be expected when flying through inversion flight levels.

**Figure 3-6. Lapse Rate Temperature Reversals are Called Inversions.**



**3.7.1. Low Level Inversions.** Inversions often form the boundary between altitudes of widely varying wind speeds and directions. In the Midwest, a summertime radiation inversion often divides the light and variable surface winds from the low level jet winds. The wind speed difference can be 40 knots within a few hundred feet, causing wind shear and turbulence in the lower levels. The low level radiation inversion and associated wind shear/turbulence is most common in the lowest 2,000 feet of the atmosphere.

## Chapter 4

### ATMOSPHERIC PRESSURE AND ALTIMETRY

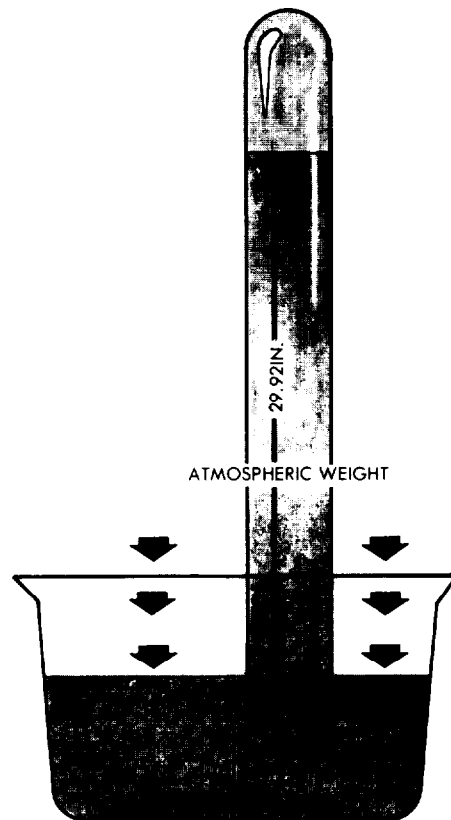
**4.1. Introduction.** Atmospheric pressure is one of the most important weather parameters that aviators need to understand. Aviators need to know the differences between the altimeter setting, sea level pressure, pressure altitude, density altitude, and constant pressure values. All of these different pressures operationally impact aviators in significantly different ways. A "QNH" altimeter setting used by most countries represents a pressure reading quite different than a "QFE" pressure reading used by a few. The following sections will discuss the important pressure concepts and their impact upon flying operations.

**4.2. Atmospheric Pressure-Definition.** *Atmospheric pressure* is the force-per-unit area exerted by the weight of a column of air extending directly above a given fixed point. As a result of constant and complex air movements and changes in air mass characteristics, the weight of this air column is continually fluctuating. These changes in air weight, and therefore air pressure, are measured with pressure-sensitive instruments called *barometers*. Most military weather stations use two barometers for barometric pressure readings: the Aneroid Barometer and the Digital Barometer Altimeter Setting Indicator (DBASI). Some civilian weather stations, both domestic and overseas, still use the mercurial barometer. Air Force crew members should be familiar with all three barometric pressure instruments.

**4.3. Mercurial Barometer.** The mercurial barometer, shown in Figure 4-1, consists of an open dish of mercury into which is placed the open end of an evacuated glass tube. Mercury is used because it is one of the heaviest liquids at normal temperatures. The mercury barometer was used as the standard for deriving pressure readings for many years and still is used as the measuring standard at many civilian overseas locations.

**4.3.1.** Atmospheric pressure forces mercury to rise in the tube. In an ideal or standardized atmosphere at sea level, a column of mercury rises to a height of 29.92 inches or 760 millimeters. In other words, a column of mercury measuring 29.92 inches represents the weight of a column of air having the same cross section as the column of mercury and extending from sea level to the top of the atmosphere. Changes in mercury height measures differences in air pressure at that location.

**Figure 4-1. Normal Atmospheric Pressure at Sea Level.**



**4.4. The Digital Barometer Altimeter Setting Indicator (DBASI).** Most military and all fixed Air Force Weather observing sites use the Digital Barometer Altimeter Setting Indicator (DBASI) as the primary pressure measurement device. The aneroid barometer is used as a backup instrument. The DBASI is a highly sensitive and precise pressure instrument which has replaced the mercurial barometer. The DBASI continuously displays the altimeter setting and can display station pressure when needed. It digitally displays pressure readings in either inches or millibars. Figure 4-2 shows the front display of a DBASI.

**4.5. The Aneroid Barometer.** The necessity for a more convenient and sturdy pressure instrument resulted in the Aneroid Barometer. This barometer doesn't use fluid to measure pressure. Instead the internal workings has a cell, made of thin metal to make it flexible, operating in a partially evacuated environment so it responds more readily to changes in atmospheric pressure (Figure 4-3). One end of the cell is fixed, while the other end is coupled to a pointer on a dial marked with pressure readings expressed in feet. The coupling itself magnifies the movement of the free end of the cell so as to express its calibration of 1,000 feet of altitude to each 1 inch of barometric pressure change. This approximates the rate of pressure change found in the lowest 10,000 feet of the atmosphere.

**4.6. Pressure Units.** Barometric pressure is expressed in many ways throughout the world. The three most common units are inches of mercury (Hg), millibars (mb), and hectopascals (hPa). Since the Kollsman window of altimeters in United States aircraft is calibrated for settings in inches of mercury, United States military and civil weather agencies express altimeter settings in inches of mercury.

**4.6.1.** However, inches of mercury do not directly express pressure in terms of *force-per-unit area*. The most common unit of pressure that does is the millibar (mb), a unit of measurement equal to a force of 1,000 dynes per square centimeter. Many foreign nations use the millibar for altimeter settings. Crew members flying in these countries can consult the Flight Information Handbook, Conversion Tables, Section D, for a table of millibars to inches of mercury and vice versa. The standard atmospheric pressure at sea level is 1013.25 mb, which corresponds to 29.92 inches of mercury.

Figure 4-2. Digital Barometer Altimeter Setting Indicator (DBASI).

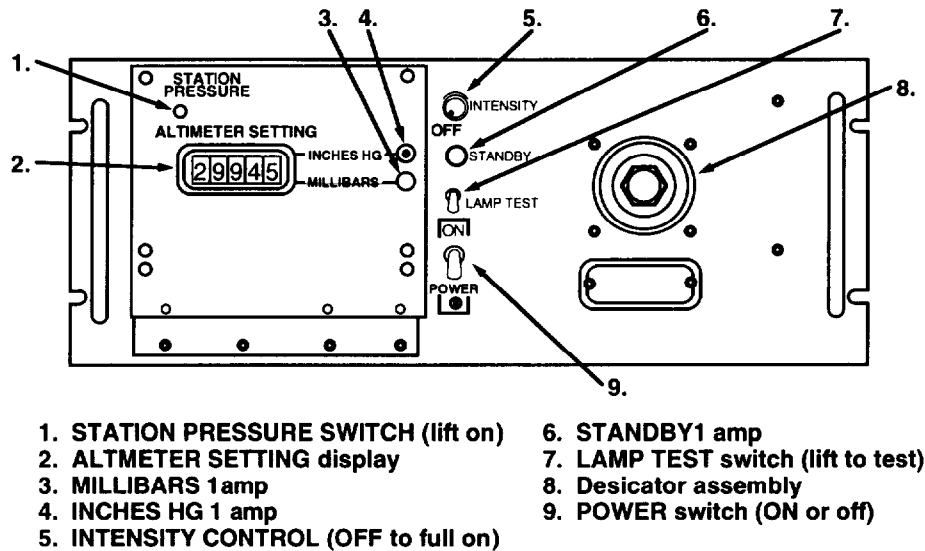
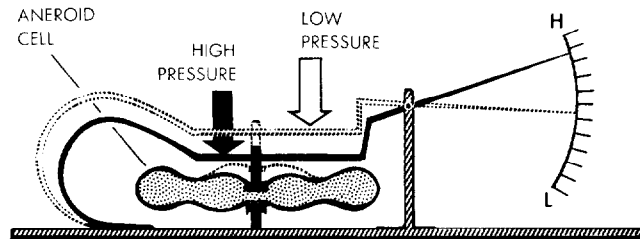


Figure 4-3. Aneroid Barometer Inner View.

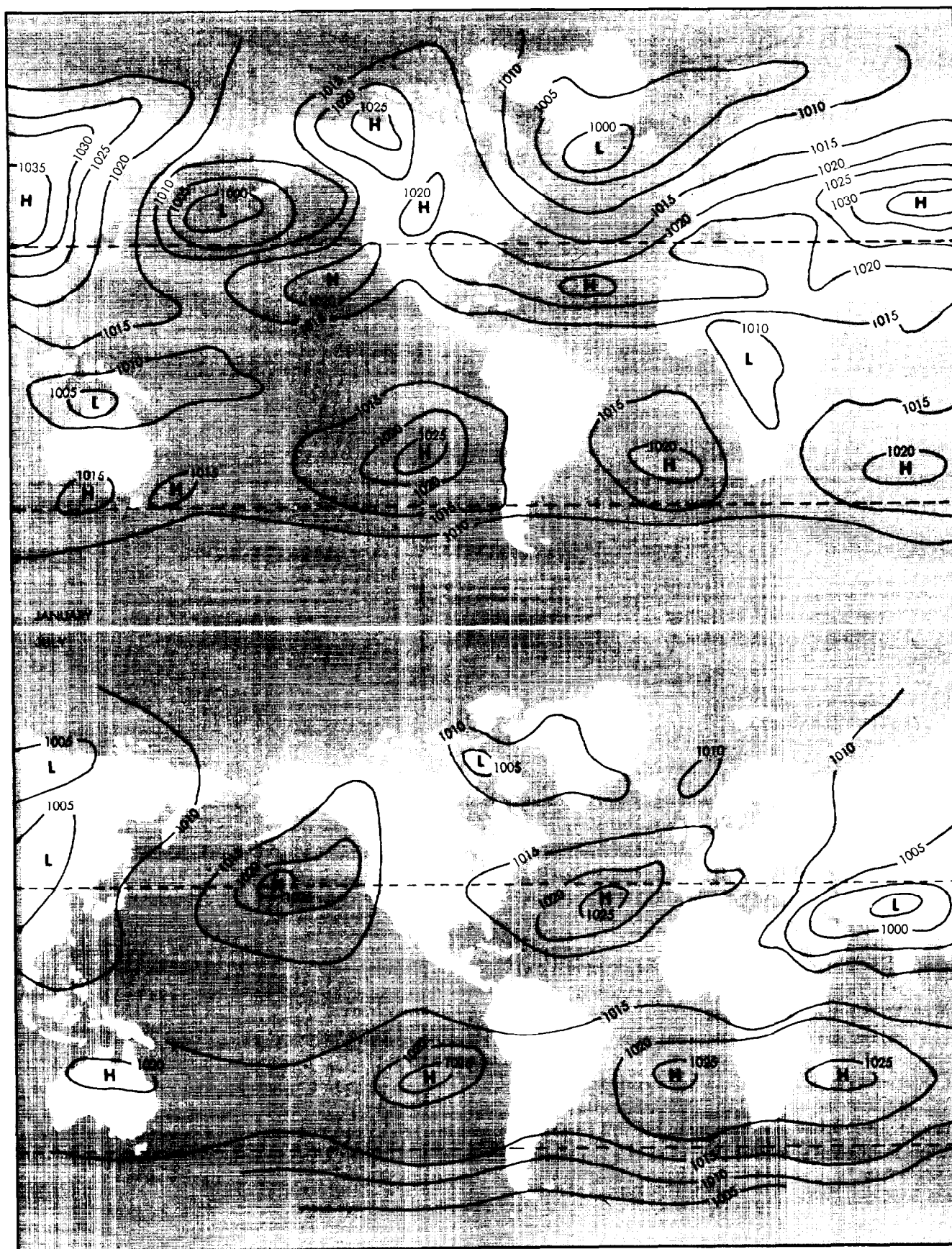


**4.7. Pressure Distribution.** Figure 4-4 shows the average worldwide distribution of sea level pressure in millibars for the months of January and July, representing Northern Hemisphere winter and summer respectively. Some of the more important features are listed below:

- The semi-permanent belt of high pressure located in the subtropical ocean regions of both hemispheres ( $20^{\circ}$  to  $30^{\circ}$  latitude) is usually present during both January and July.
- The subtropical belt of high pressure normally extends northward into Siberia and continental North America during July and disappears in January.
- In January, deep lows are normally present in the Northern Pacific Ocean (the Aleutian Low) and off the coast of Greenland in the North Atlantic Ocean (the Icelandic Low).
- In January, cold high pressure centers are prevalent over Northern Hemisphere continents. The two most common ones are the Siberian High and the Canadian High.
- Low pressure dominates land areas of the Southern Hemisphere during both January and July.

**4.8. Station Pressure and Mean Sea Level (MSL) Pressure.** When the pressure is measured at an airport, it is the weight of the air above the airport that is measured. This is called station pressure (Figure 4-5). Pressure usually decreases with height so the pressure at a high elevation will be less than pressure at a lower elevation. To analyze weather maps, the pressure at different observing stations must be compared. Since station pressure varies with the station elevation, all station pressures must be adjusted to some common level to make the comparison (Figure 4-6). The commonly reduced level used is Mean Sea Level (MSL).

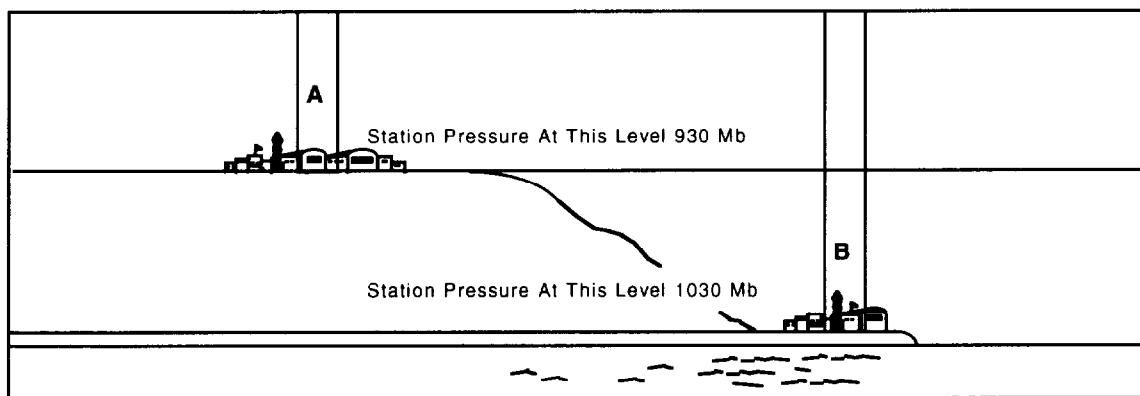
Figure 4-4. Average Global Sea Level Pressure in January and July.



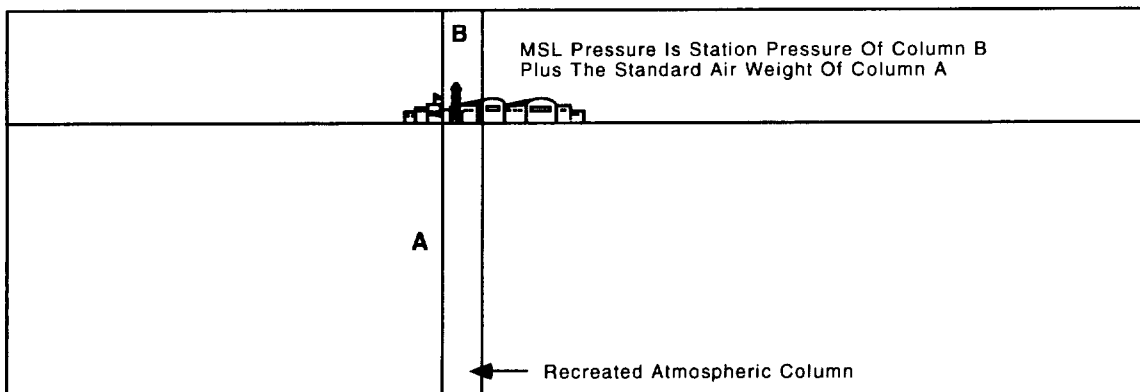
**4.8.1. MSL Pressure.** The biggest change in barometric pressure comes with height. Within the lower few thousand feet of the troposphere, where most of the atmosphere is concentrated because of gravity, the change amounts roughly to 1 inch of mercury for each 1,000 feet of altitude. In Figure 4-7, we illustrate this concept by using two reported barometric pressures at Denver and New Orleans in an assumed standard atmosphere. The observer at Denver, located at 5,000 feet above sea level, will read approximately 24.92 inches on the barometer. The observer at New Orleans will read approximately 29.92 inches. Since all stations are not at the same elevation and conditions vary, the *observed station pressure is adjusted to mean sea level pressure (MSL) for pressure reporting purposes*. If this correction was not applied, Denver would almost always report a lower barometric pressure than New Orleans.

**4.9. Pressure Variation.** Pressure variations are continually occurring at any given location at any given time. There are diurnal, seasonal, frontal, and occasional abrupt pressure changes. Abrupt changes occur due to frontal passages, thunderstorms, and the movement of high and low pressure systems. Passages of well-developed pressure systems (either highs or lows) are often accompanied by a large change in pressure, sometimes one inch or more, with the changes occurring over a several hour period. The more gradual variations occur on a weekly, monthly, and seasonal basis. But pressure varies most with vertical altitude changes and corresponding air temperature changes.

**Figure 4-5. Station Pressure.**



**Figure 4-6. Mean Sea Level Pressure (MSL).**



**4.9.1. Temperature.** Air expands as it becomes warmer and contracts as it cools. Figure 4-8 shows three columns of air--one colder than standard, one at standard temperature, and one warmer than standard. Air pressure is equal at the bottom of each column and at the top of each column but the volume of each air column differs with respect to temperature.

**4.9.2.** Vertical expansion of the warm column makes it higher than the column at standard temperature. Contraction of the cold column makes it shorter. Since pressure decrease is the same in each column, the rate of decrease of pressure with height in warm air is less than standard. The rate of decrease of pressure with height in cold air is greater than standard.

**4.10. Pressure Patterns.** Atmospheric pressure readings are used quite extensively by meteorologists and aircrew members alike. Analyzed weather chart pressure patterns give insight to observed weather and forecasted weather changes. The relationship between pressure systems and weather is complicated, and only a trained meteorologist is expected to understand the complex relationship. However, there are numerous pressure patterns that aircrews can learn to recognize on weather



charts because they frequently happen and are associated with numerous flying hazards. A clear sky does not guarantee an absence of turbulence!

Figure 4-7. Adjusting Barometric Pressure to MSL Pressure.

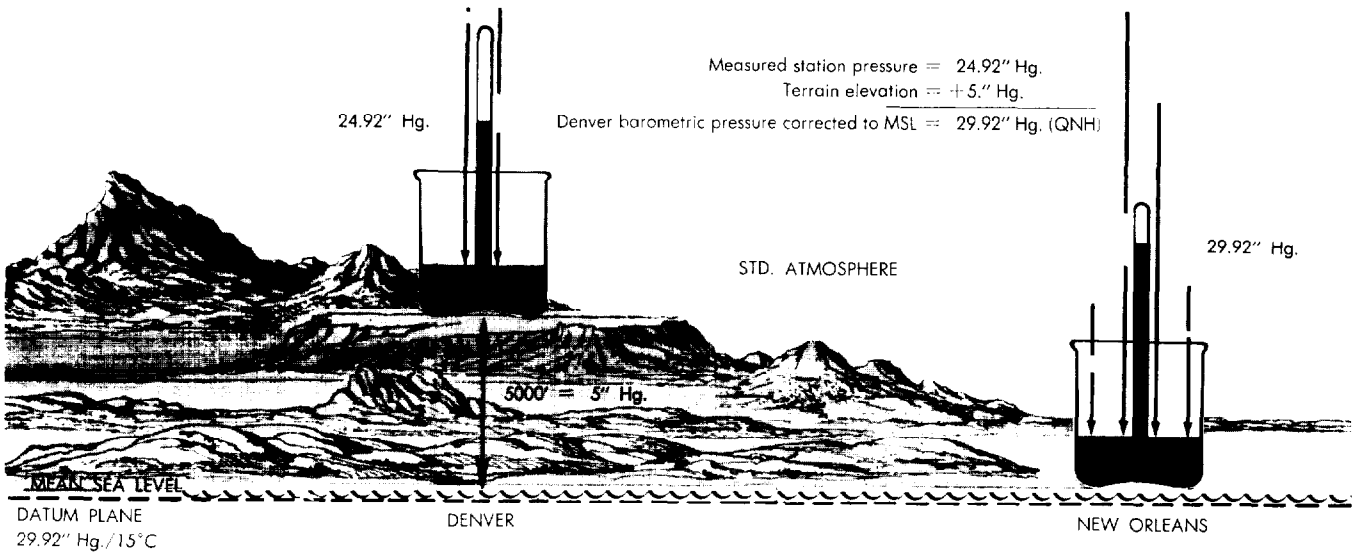
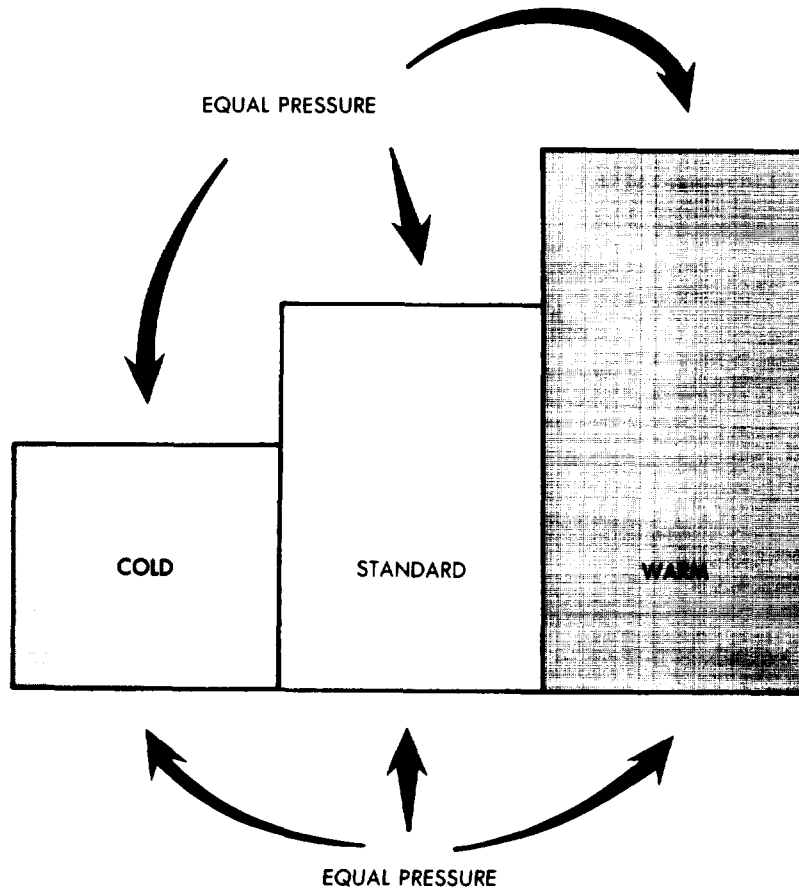


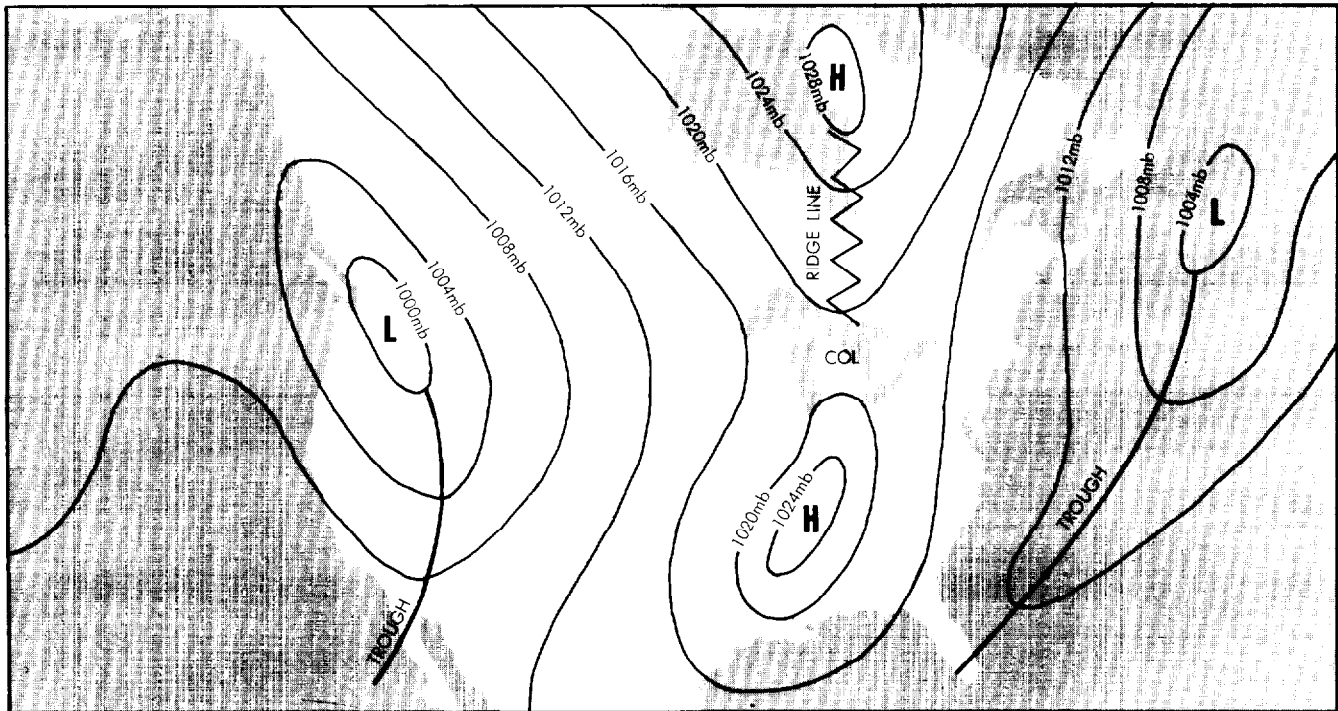
Figure 4-8. Pressure Rate Decrease with Height Varies with Temperature.



**4.10.1. Winds.** There is a direct relationship between pressure systems and air flow (wind). In general, high pressure areas are typically regions of favorable weather conditions, while lows are often associated with bad weather. Pressure variations also affect the atmosphere's density, and therefore they affect flight. The most noticeable effects of decreased pressure due to increased elevation are higher required true air speed for takeoffs and landings, increased takeoff and landing distances, decreased rate of climb, and higher stall true air speeds.

**4.10.2. Surface Pressure Isobars.** To provide a visual portrayal of the pressure patterns across the country, the MSL pressures from the observing stations are plotted on a surface weather map. Lines connecting stations of equal pressure are called *isobars* (expressed in millibars). They are usually drawn at 4 millibar (mb) intervals. These isobars form a pressure "topographic" map. In many cases, isobaric patterns yield clues to possible weather conditions. Lower pressure values usually indicate bad weather while high pressure indicates good weather (Figure 4-9). Tightly compacted isobars indicate quickly changing weather and strong winds. Loosely aligned isobars indicate light winds and generally fair or static weather conditions.

**Figure 4-9. Surface Pressure Chart.**



**4.10.3. Upper Air Contours.** Above the earth's surface, the convention is to use constant pressure charts, with lines called *contours* depicting the varying height of the pressure surface. Thus, contours are lines of equal altitude (Figure 4-10) and are expressed in meters. Figure 4-11 shows a comparison of isobars and contours. Analyzed contour patterns can indicate the relative strength of upper level winds much the same as the isobars on the surface weather map. The tighter the contours, the stronger the winds. This is because the rapidly changing pressure is correlated with strong winds. Common surface pressure and upper air chart symbols are explained below:

- Low--An area of low pressure surrounded on all sides by higher pressure (as outlined by isobars on surface charts) or an area of low true altitude surrounded by higher true altitudes (as shown by contours on upper air charts); also called a cyclone.
- High--An area of high pressure surrounded on all sides by lower pressure (as outlined by isobars on surface charts) or an area of high true altitude surrounded by lower true altitudes (as shown by contours on upper air charts); also called an anticyclone.
- Trough--An elongated area of low pressure with the lowest pressure along a line called a "trough line" which marks the place of maximum curvature in the isobars or contours.
- Ridge--An elongated area of high pressure with the highest pressure along a line called a "ridge line" which marks the place of maximum curvature in the isobars or contours.
- Col--The neutral area between two highs and two lows.

Figure 4-10. Upper Air Chart.

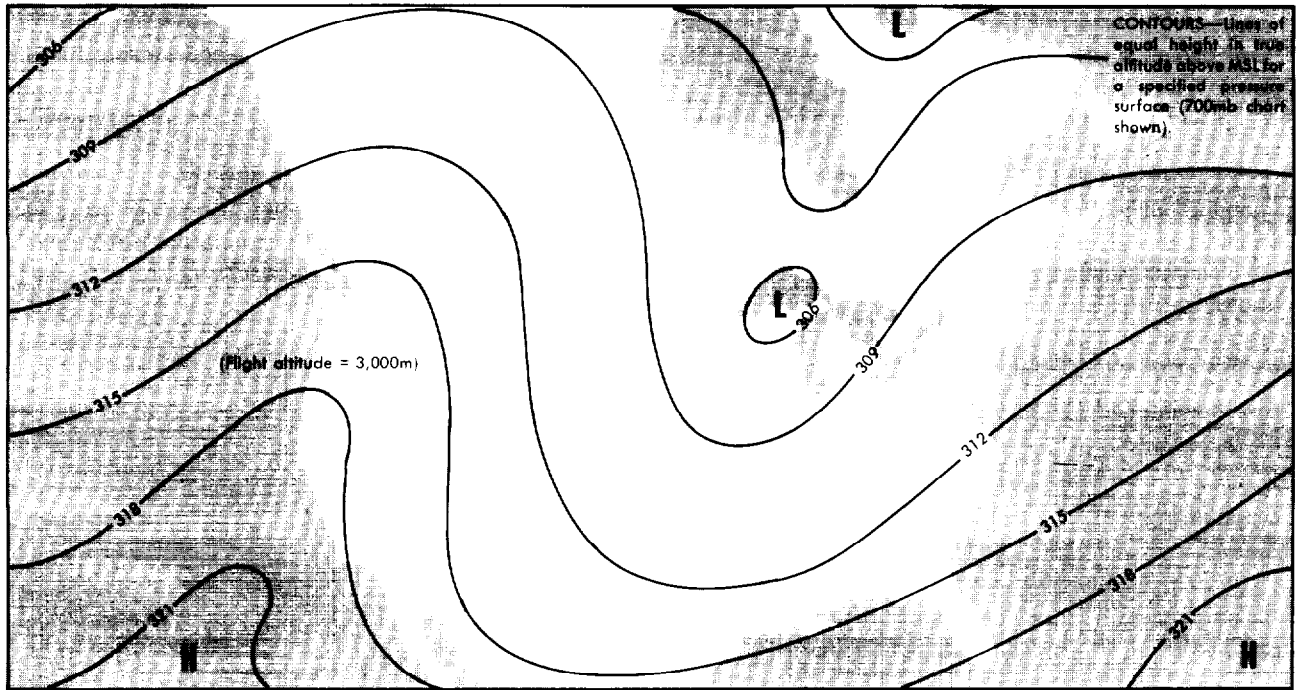
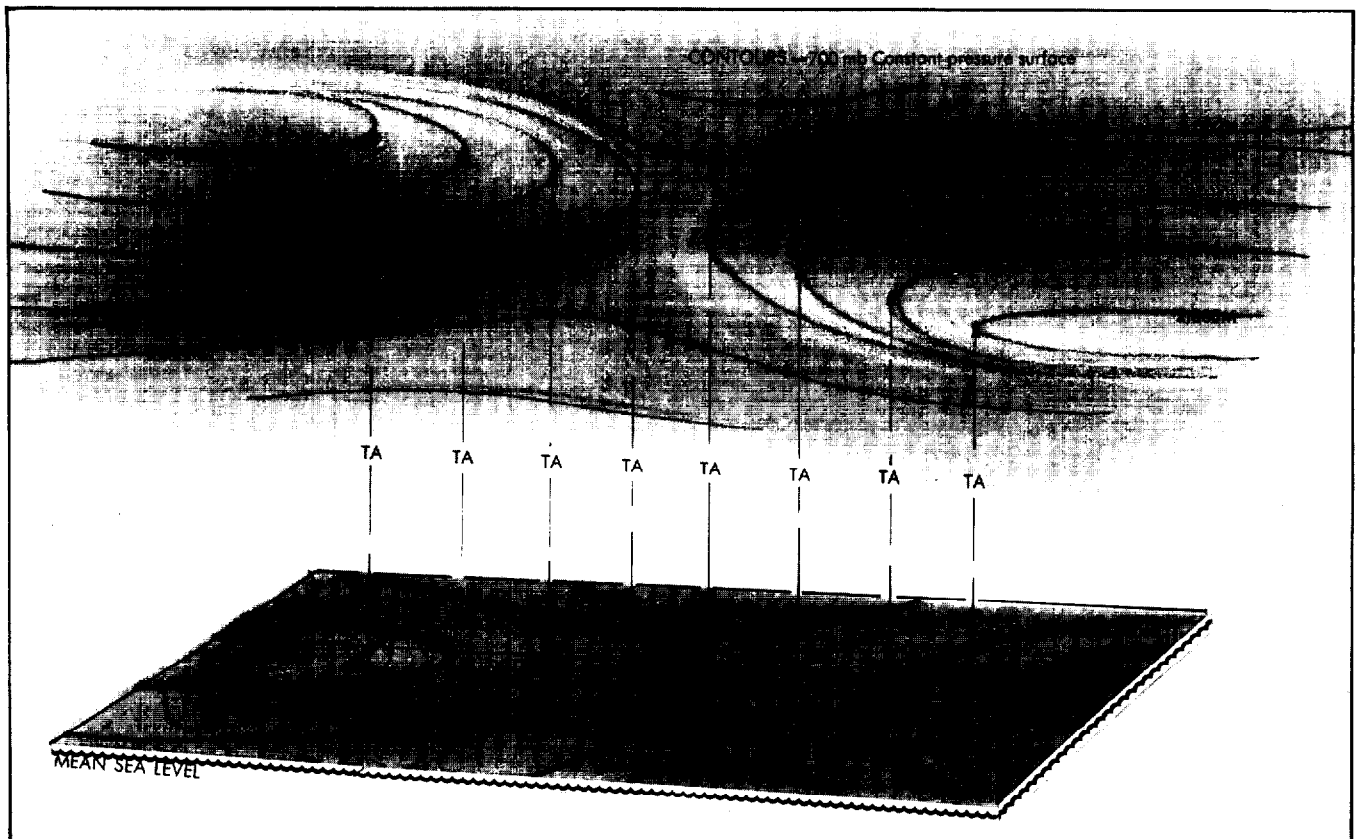


Figure 4-11. Comparison of Isobars and Contours.



**4.11. Standard Atmosphere.** Since the vertical distribution of both temperature and pressure changes with time and place, some convenient vertical structure of the atmosphere, representing average conditions, had to be assumed to obtain fixed reference points. The International Civil Aviation Organization (ICAO) determined a year-round average of pressure/height/temperature soundings what is now considered the standard atmosphere for use in calibrating the aneroid barometer.

**4.11.1.** Here is a partial list of conditions assigned by ICAO that make up the standard atmospheres:

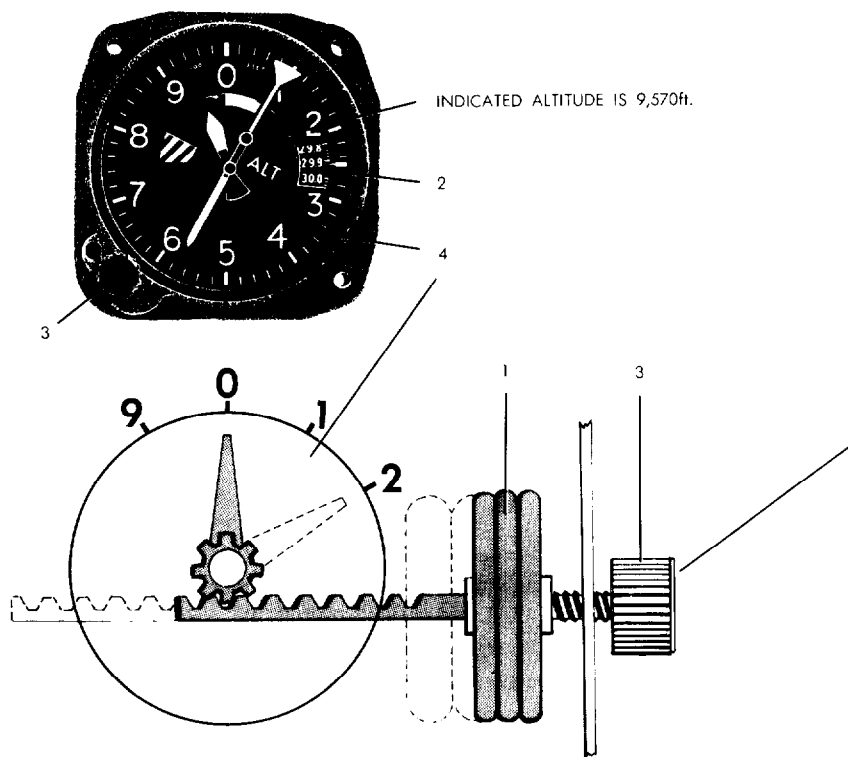
- A surface temperature of 15°C (59°F) at sea level.
- A surface pressure of 29.92 inches of mercury (1013.2 millibars, 14.7 pounds per square inch) at sea level.
- A lapse rate within the troposphere of approximately 2°C per 1,000 feet up to the tropopause.
- A tropopause at approximately 36,000 feet.
- A lapse rate of 0°C in the stratosphere to approximately 82,000 feet.

**4.12. Altimetry.** The advent of aviation early in this century brought about a search for an accurate method of measuring the altitude at which an aircraft was flying. Barometric pressure was ideal for several reasons, chiefly the fact that pressure change with altitude is approximately 10,000 times greater than that found in equivalent horizontal distances. The rate of change in vertical heights in the lower atmosphere is about 1 inch for every 1,000 feet of altitude.

**4.12.1. Aircraft Altimeter.** An aircraft altimeter (Figure 4-12) is essentially an aneroid barometer calibrated to indicate altitude in feet instead of pressure. This altitude is independent of the terrain below. An altimeter reads accurately only in a standard atmosphere and when properly adjusted altimeter settings are used. Remember, an altimeter is *only* a pressure-measuring device. It *indicates* 10,000 feet with 29.92 set in the Kollsman window, and the pressure is 697 millibars, whether or not the altitude is actually 10,000 feet.

**4.12.2.** The effect is important since in the lowest 15,000 feet of the atmosphere a deviation of the true mean temperature from the assumed standard temperature of 2.8°C will cause about a 1 percent error in the altimeter reading. For example, if an aircraft with a correct altimeter setting is flying at an indicated altitude of 10,000 feet but the air below flight level is 11°C warmer than the standard atmosphere temperature of 2.8°C, the altimeter will read about 4 percent too low. The aircraft will be flying at a true altitude of 10,400 feet (400 feet higher than indicated). Carefully study Figures 4-8 and 4-13 to visually see the effects of temperature on aircraft indicated and true altitudes.

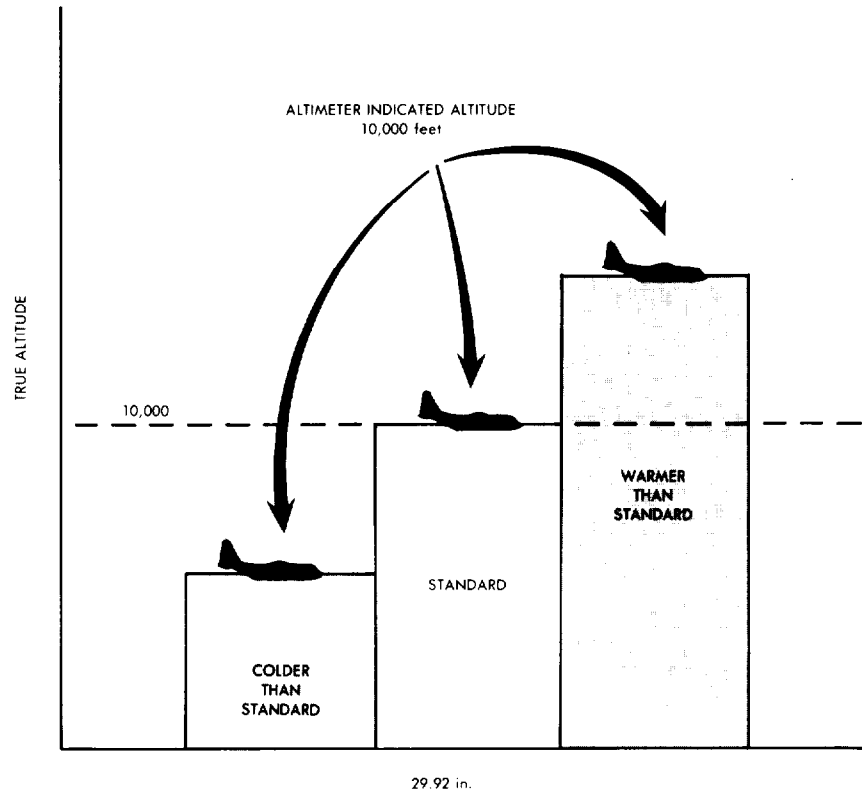
**Figure 4-12. Aneroid Altimeter.**



1. Aneroid cell expands in low pressure to indicate altitude in feet above MSL in standard atmosphere with reported station pressure set into Kollsman window.
2. Barometric scale.
3. Barometric pressure set knob.
4. Altitude indication scale.

- Because surface pressures are always changing, a means of changing the altimeter reference is necessary. A barometric set knob is provided to change the reference shown on the barometric scale and is designed to change the altimeter indication approximately 10 feet for each .01" Hg change on the scale. This approximates the rate of pressure change found in the first 10,000 feet of atmosphere, i.e., 1" Hg for each 1,000 feet.
- Increasing the barometric setting will cause the altitude indication to increase, while decreasing the value on the barometric scale will cause the altitude indication to decrease. The majority of altimeters have mechanical stops at or just beyond the barometric scale limits (28.10 to 31.00).  
NOTE: At some northern latitude locations, the local altimeter setting may exceed these limits. Procedures for handling these situations are contained in AFM 51-37, "Instrument Flying".

Figure 4-13. Effects of Temperature on True and Indicated Altitude.



**4.12.3. Pressure Altitude.** In the standard atmosphere, sea level pressure is 29.92 inches Hg or 1013.2 millibars. This is called the standard datum plane. Pressure falls at a fixed rate upward through this hypothetical atmosphere. Pressure altitude is the altitude above that standard datum plane. Therefore, crew members can easily determine pressure altitude from the aircraft altimeter whether in flight or on the ground. Simply set the altimeter to the standard altimeter pressure setting of 29.92 inches, and the altimeter will indicate pressure altitude. Block 7 of Flight Weather Briefing, DD Form 175-1, is for pressure altitude calculations furnished by AF Weather personnel. If you get a forecast or actual altimeter setting, you can use Figure 4-14 to find the corresponding pressure altitude. If you receive a reading in millibars or hectoPascals, use Figure 4-15 to convert to inches.

**4.12.4. Density Altitude.** Density altitude is pressure altitude corrected for nonstandard temperature. Since standard atmospheric conditions are seldom encountered, the density altitude for an airfield may vary several thousand feet from the actual mean sea level elevation of the field.

**4.12.4.1.** On a hot day, the air becomes "thinner," and its density at the field is equivalent to a higher altitude in the standard atmosphere. The field then has a high (+) density altitude. An example of this would be a field located 5,000 feet above mean sea level with a density altitude of 10,000 feet (Figure 4-16). An aircraft flying at this field would then be operating in air normally found in the standard atmosphere at 10,000 feet. Conversely, on a cold day the air becomes heavy. Its density is the same as that at an altitude in the standard atmosphere lower than the field elevation. The density altitude is then lower (-) than normal.

**4.12.4.2.** The efficiency of aircraft performance is greatly affected by the varying densities of the atmosphere. Low density altitude increases aircraft performance. High density altitude, however, can be a hazard since it reduces aircraft performance, especially if the aircraft is critically loaded. The lift of the wing or blade is affected by the speed of the air around it and the density of the air through which it moves. In areas of high density altitude, additional engine power is required to compensate for the thin air. Takeoff and landing rolls are lengthened, and rates of climb and service ceiling are reduced.

**4.12.4.3. Density Altitude Chart.** Figure 4-17 illustrates how to find the density altitude if the temperature and pressure altitude are known. For example, if the outside temperature is  $-15^{\circ}\text{C}$  and the pressure altitude is 6,000 feet, follow the  $-15\text{C}$  value vertically until it intersects the slanted pressure altitude value of 6,000 feet. Follow the horizontal density altitude value to the left of the graph for the density altitude in thousands of feet. In this case, the density altitude is 4,000 feet.

Figure 4-14. Altitude Pressure Conversion Table (From FLIP).

ALTITUDE PRESSURE TABLE - INCHES FEET										
Inches	0.00	0.01	0.02	0.03	0.04	0.05	0.06	0.07	0.08	0.09
28.0	1824	1814	1805	1795	1785	1776	1766	1756	1746	1737
28.1	1727	1717	1707	1698	1688	1678	1668	1659	1649	1639
28.2	1630	1620	1610	1601	1591	1581	1572	1562	1552	1542
28.3	1533	1523	1513	1504	1494	1484	1475	1465	1456	1446
28.4	1436	1427	1417	1407	1398	1388	1378	1369	1359	1350
28.5	1340	1330	1321	1311	1302	1292	1282	1273	1263	1254
28.6	1244	1234	1225	1215	1206	1196	1186	1177	1167	1158
28.7	1148	1139	1129	1120	1110	1100	1091	1081	1072	1062
28.8	1053	1043	1034	1024	1015	1005	995	986	976	967
28.9	957	948	938	929	919	910	900	891	881	872
29.0	863	853	844	834	825	815	806	796	787	777
29.1	768	758	749	739	730	721	711	702	692	683
29.2	673	664	655	645	636	626	617	607	598	589
29.3	579	570	560	551	542	532	523	514	504	495
29.4	485	476	467	457	448	439	429	420	410	401
29.5	392	382	373	364	354	345	336	326	318	308
29.6	298	289	280	270	261	252	242	233	224	215
29.7	205	196	187	177	168	159	149	140	131	122
29.8	112	103	94	85	75	66	57	47	38	29
29.9	20	10	+1	-8	-17	-26	-36	-45	-54	-63
30.0	-73	-82	-91	-100	-110	-119	-128	-137	-146	-156
30.1	-165	-174	-183	-192	-202	-211	-220	-229	-238	-248
30.2	-257	-266	-275	-284	-293	-303	-312	-321	-330	-339
30.3	-348	-358	-367	-376	-385	-394	-403	-412	-421	-431
30.4	-440	-449	-458	-467	-476	-485	-494	-504	-513	-522
30.5	-531	-540	-549	-558	-567	-576	-585	-594	-604	-613
30.6	-622	-631	-640	-649	-658	-667	-676	-685	-694	-703
30.7	-712	-721	-730	-740	-749	-758	-767	-776	-785	-794
30.8	-803	-812	-821	-830	-839	-848	-857	-866	-875	-884
30.9	-893	-902	-911	-920	-929	-938	-947	-956	-965	-974
31.0	-983	-992	-1001	-1010	-1019	-1028	-1037	-1046	-1055	-1064

**4.12.4.4. Density Altitude Formula.** Temperature variation is incorporated into a formula for obtaining density altitude from a known pressure altitude. Each 1 degree C variation from standard temperature changes the density altitude approximately 120 feet. If the actual temperature is below standard, the density altitude is lowered.

**4.12.4.5.** Block 8 of the Flight Weather Briefing, DD Form 175-1, is for density altitude calculations. The base weather station has the ability to calculate this value for you. In addition, they should be able to calculate these values for your destination, target regions, low-level routes, or drop zones.

**4.12.5. Altimeter Settings.** There are three different altimeter settings. Listed below are comparisons of the three altimeter settings:

SETTING	AT AIRPORT	IN THE AIR
Standard QNE 29.92 Hg 1013.25 mb	Variable elevation reading above or below actual elevation.	Positive separation by pressure level but at varying altitudes.
QNH	Actual elevation above MSL reading when aircraft on ground.	Altitude above MSL (without consideration of temperature).
QFE	Zero elevation reading when aircraft on ground.	Height above ground indicated (without consideration of temperature.)

Figure 4-15. Barometric Readings Conversion Table--Inches to Millibars.

BAROMETRIC READINGS FROM INCHES TO HECTOPASCALS OR MILLIBARS										
Inches	0.00	0.01	0.02	0.03	0.04	0.05	0.06	0.07	0.08	0.09
Hectopascals or Millibars										
28.0-	948.2	948.5	948.9	949.2	949.5	949.9	950.2	950.6	950.9	951.2
28.1-	951.6	951.9	952.3	952.6	952.9	953.3	953.6	953.9	954.3	954.6
28.2-	955.0	955.3	955.6	956.0	956.3	956.7	957.0	957.3	957.7	958.0
28.3-	958.3	958.7	959.0	959.4	959.7	960.0	960.4	960.7	961.1	961.4
28.4-	961.7	962.1	962.4	962.7	963.1	963.4	963.8	964.1	964.4	964.8
28.5-	965.1	965.5	965.8	966.1	966.5	966.8	967.2	967.5	967.8	968.2
28.6-	968.5	968.8	969.2	969.5	969.9	970.2	970.5	970.9	971.2	971.6
28.7-	971.9	972.2	972.6	972.9	973.2	973.6	973.9	974.3	974.6	974.9
28.8-	975.3	975.6	976.0	976.3	976.6	977.0	977.3	977.6	978.0	978.3
28.9-	978.7	979.0	979.3	979.7	980.0	980.4	980.7	981.0	981.4	981.7
29.0-	982.1	982.4	982.7	983.1	983.4	983.7	984.1	984.4	984.8	985.1
29.1-	985.4	985.8	986.1	986.5	986.8	987.1	987.5	987.8	988.1	988.5
29.2-	988.8	989.2	989.5	989.8	990.2	990.5	990.9	991.2	991.5	991.9
29.3-	992.2	992.5	992.9	993.2	993.6	993.9	994.2	994.6	994.9	995.3
29.4-	995.6	995.9	996.3	996.6	997.0	997.3	997.6	998.0	998.3	998.6
29.5-	999.0	999.3	999.7	1000.0	1000.3	1000.7	1001.0	1001.4	1001.7	1002.0
29.6-	1002.4	1002.7	1003.0	1003.4	1003.7	1004.1	1004.4	1004.7	1005.1	1005.4
29.7-	1005.8	1006.1	1006.4	1006.8	1007.1	1007.4	1007.8	1008.1	1008.5	1008.8
29.8-	1009.1	1009.5	1009.8	1010.2	1010.5	1010.8	1011.2	1011.5	1011.9	1012.2
29.9-	1012.5	1012.9	1013.2	1013.5	1013.9	1014.2	1014.6	1014.9	1015.2	1015.6
30.0-	1015.9	1016.3	1016.6	1016.9	1017.3	1017.6	1017.9	1018.3	1018.6	1019.0
30.1-	1019.3	1019.6	1020.0	1020.3	1020.7	1021.0	1021.3	1021.7	1022.0	1022.3
30.2-	1022.7	1023.0	1023.4	1023.7	1024.0	1024.4	1024.7	1025.1	1025.4	1025.7
30.3-	1026.1	1026.4	1026.8	1027.1	1027.4	1027.8	1028.1	1028.4	1028.8	1029.1
30.4-	1029.5	1029.8	1030.1	1030.5	1030.8	1031.2	1031.5	1031.8	1032.2	1032.5
30.5-	1032.8	1033.2	1033.5	1033.9	1034.2	1034.5	1034.9	1035.2	1035.6	1035.9
30.6-	1036.2	1036.6	1036.9	1037.2	1037.6	1037.9	1038.3	1038.6	1038.9	1039.3
30.7-	1039.6	1040.0	1040.3	1040.6	1041.0	1041.3	1041.7	1042.0	1042.3	1042.7
30.8-	1043.0	1043.3	1043.7	1044.0	1044.4	1044.7	1045.0	1045.4	1045.7	1046.1
30.9-	1046.4	1046.7	1047.1	1047.4	1047.7	1048.1	1048.4	1048.8	1049.1	1049.4

DA = PA + (120 x Vt) where:

DA is the density altitude

PA is the pressure altitude

120 is the temperature constant (120 feet per 1 °C)

Vt is the variation of the actual air temperature from standard at the pressure altitude.

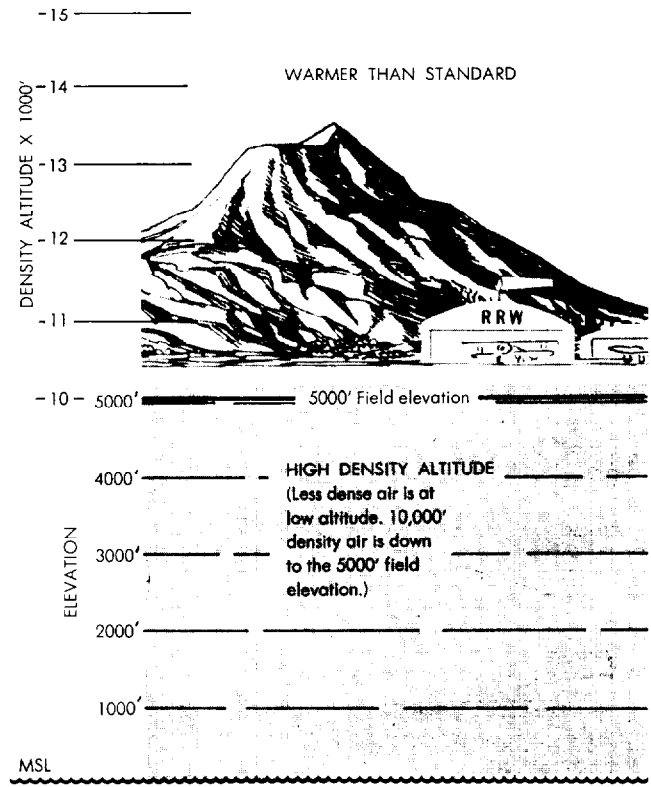
**4.12.5.1. QNE Altimeter Setting.** QNE is always 29.92" Hg and results in the altimeter indicating height above the standard datum plane or *pressure altitude*. This altimeter setting is used above the transition altitude (18,000 feet MSL in the United States).

**4.12.5.2. QNH Altimeter Setting.** The QNH altimeter setting is a pressure reading which, when set in the aircraft altimeter Kollsman window, will cause the instrument to read its true height above MSL. Although QNH is the standard altimeter setting throughout most of the world, some locations may give it in units of a millibar. If pressure data cannot be obtained in inches, use the conversion table in Figure 4-15 or the Flight Information Handbook, Section D, to convert them.

**4.12.5.3. QFE Altimeter Setting.** A QFE altimeter setting (used by a few nations) is the actual surface pressure and is not corrected to sea level. If QFE is set, the altimeter indicates actual elevation above the field, but does not ensure terrain clearance. Aircrews must exercise extreme caution if conducting operations at a location using QFE.

**4.12.5.4.** An altimeter correctly set is good for aircraft traffic separation because any atmospheric pressure or temperature deviation is common to all aircraft in the area. It is also useful for landing, since a ground-level pressure variation would diminish to zero. *But the pressure altimeter will not automatically show exact actual height when in flight.* It is still the aircrew's responsibility to ensure terrain avoidance.

Figure 4-16. Density Altitude.



**Example**

The field elevation is 1,500 feet with a current altimeter setting of 29.41. Surface temperature is 30°C.

Pressure altitude variation (PAV) = (29.92 - 29.41) x 1,000 = 510 feet

PA = field elevation + PAV = 1,500 + 510 = 2,010 feet

The standard temperature for 2,010 feet is 11°C

$V_t = 30^\circ\text{C} - 11^\circ\text{C} = 19^\circ\text{C}$

DA = 2,010' + (120 x 19) = 4,290 feet

Density altitude can also be determined by using a dead reckoning (DR) computer or a conversion chart found in aircraft T.O.s. If you know the ambient temperature and the pressure altitude, you can use a simple conversion chart as illustrated in Figure 4-17 to find the density altitude.

**4.12.6. Altimetry Errors.** There are three factors that determine indications of the pressure altimeter.

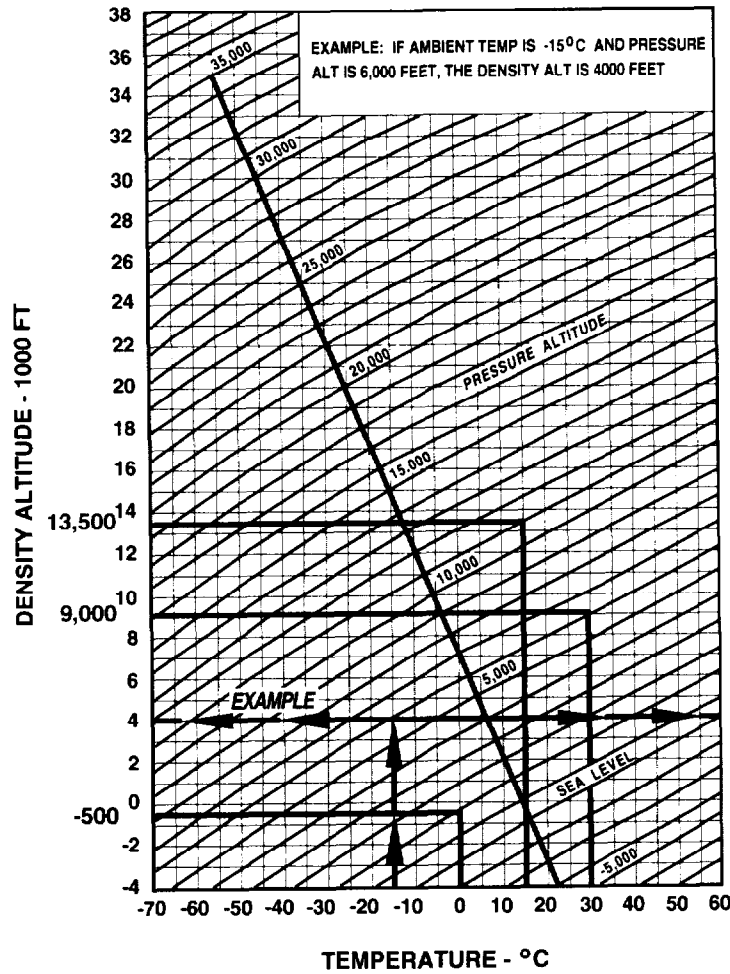
- The atmospheric pressure level which the instrument is measuring.
- The mechanical displacement of the indicator needles; the altimeter setting.
- Instrument error. (Determined for each individual altimeter.)

**4.12.6.1.** Aside from the possible instrument error, it is easy to anticipate the effects of the other two variables by understanding the meteorological factors: first, the variation of sea level pressure from that assumed in the standard atmosphere, and second, the deviation of the vertical temperature distribution from that assumed in the standard atmosphere.

**4.12.6.2. Pressure Error.** At and above the transition altitude (18,000 feet MSL in the US), aircraft altimeters must be set to the standard altimeter setting 29.92 inches Hg. The pilot flying above the transition level must adjust the altimeter to the QNH setting when descending through the transition level for operation below that altitude. This will provide proper air traffic and terrain separation. When flying below the transition altitude, the altimeter must be adjusted to the surface pressure setting (QNH) of the nearest ground reporting station.

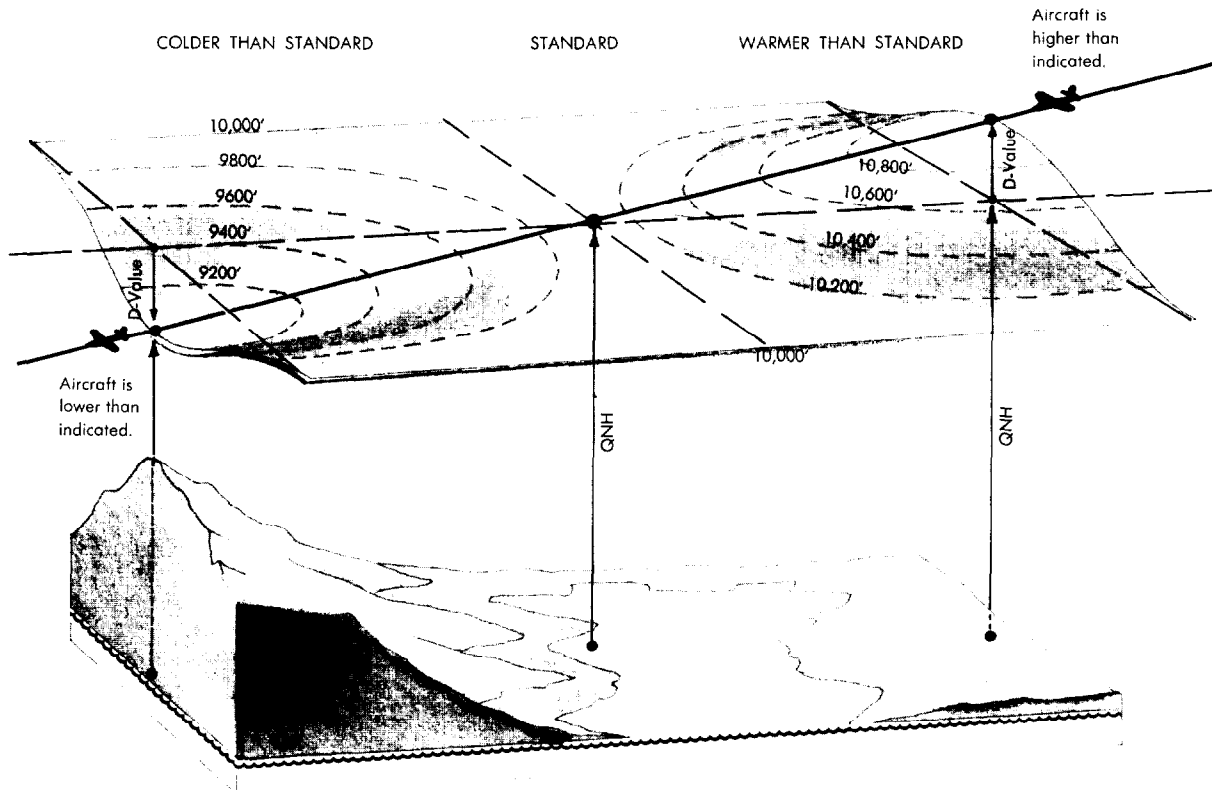


Figure 4-17. Density Altitude Chart.



**4.12.6.3. Temperature Error.** Even when sea level pressure does not change along a route of flight, incorrect altitude indications may result from temperature changes. If the air is much colder than the standard atmosphere, the actual aircraft altitude will be lower than the altimeter indicates; if the air is warmer, the aircraft will be higher than the altimeter indicates (Figure 4-18). It is important that crew members understand these errors so that when flying in cold weather and operating in mountainous regions at minimum en route altitudes (MEA), they do not have difficulty maintaining terrain clearance.

Figure 4-18. Altitude Error Due to Nonstandard Temperatures Aloft (D-Value).



## Chapter 5

### WIND

**5.1. Introduction.** Wind is moving air, and while normally referred to as "wind," in certain geographic locations the wind has different names. The Mediterranean has its *mistral*, the Rocky Mountain region has the *Chinook*, Southern California has the *Santa Ana*, and northern Africa has their hot, dry, *sirocco* wind. Whatever it is called, the aviator is concerned with wind on every flight. Winds near the surface are important in takeoff, en route, and landing conditions. Knowledge of the winds is essential for navigation, fuel management, and flight safety purposes.

**5.1.1.** Atmospheric pressure and temperature variations cause the air to move in two ways: ascending and descending currents (vertical motions) and the horizontal flow of air known as wind. Both of these air motions affect the weather. Wind transports water vapor and therefore plays an important role in the formation of clouds, fog, and precipitation. This chapter will discuss mainly the horizontal flow of air. The vertical motion of air and its impact upon weather is treated in later chapters.

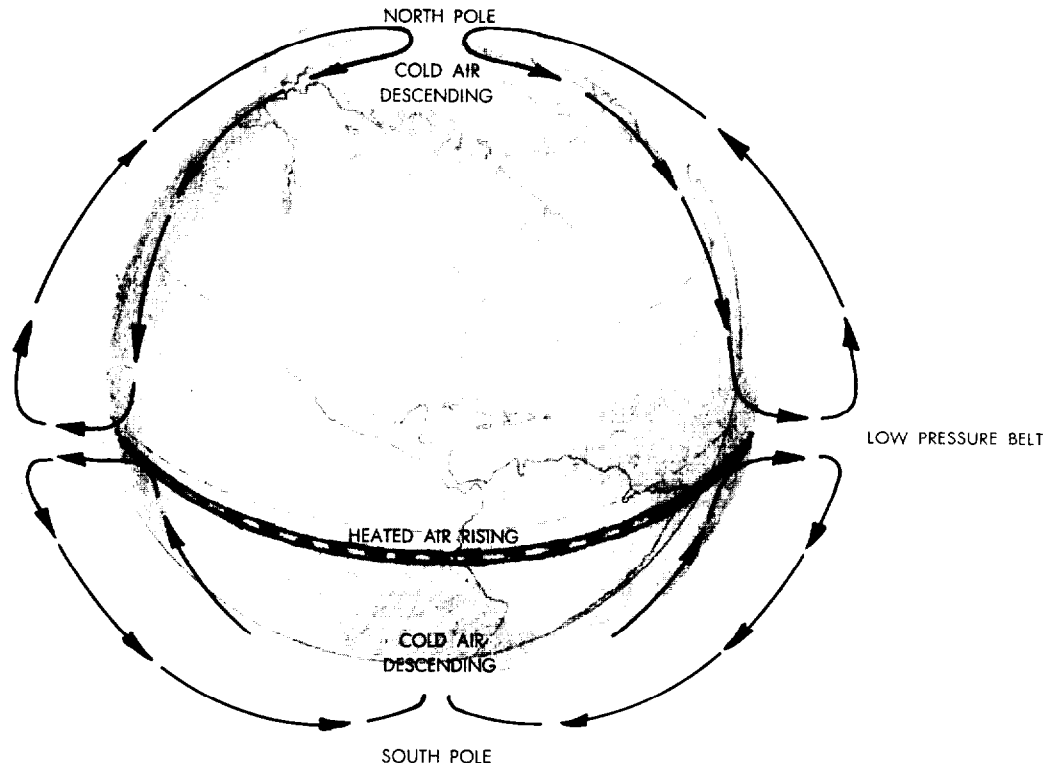
**5.2. General Circulation.** General circulation describes observed patterns of winds and pressure which persist throughout the year. General circulation patterns redistribute the unequal heating of the earth's surface allowing large scale migrations of warmer and cooler air. The circulations form semipermanent pressure systems, steer any migratory pressure systems and also determine where tropical storms may track. Also the general circulation uniquely balances many controlling factors such as angular momentum and the Coriolis force.

**5.2.1.** The key driver of atmospheric circulation is uneven heating of the earth's surface by the sun. The most direct rays strike the earth near the equator, heating equatorial regions much more than polar regions. Equatorial regions retain more of the sun's heat, while the reverse is true at the poles. Yet the equatorial regions do not get hotter and hotter, nor the polar regions become colder and colder because the general circulations transport heat from one latitude to another.

**5.3. Factors Influencing Circulation.** Because the earth rotates, and its surface is not even or uniform in heat capacity, we must examine the more important modifications to the simple circulation pattern in Figure 5-1. This circulation is considerably modified by:

- the irregular distribution of oceans and continents
- irregular terrain
- daily variation in temperature
- seasonal changes.

**Figure 5-1. Theoretical Basic Air Movement.**



**5.3.1.** These factors lead to the establishment of semipermanent regions of high and low pressure which control the general atmospheric movements in their regions. Refer to Figure 5-2 for the normal positions in January and July of these principal surface high and low pressure areas.

**5.3.2.** The semipermanent highs and lows are important to our basic understanding of the atmosphere's circulation and useful to aircrews during flight planning. However, of far greater significance are the moving lows (migrating cyclones) and highs (migrating anticyclones) associated with the rapid changes in weather characteristics of the middle latitudes.

**5.4. Wind Direction.** Migrating air masses are the sources of our surface winds, but not necessarily their direction. In some cases, air flow is direct. This occurs when the flow from a high (colder, denser air masses) displaces warmer, less dense air masses (lows), in a comparatively short distance.

**5.4.1.** As distances lengthen, other forces affecting the wind direction take effect. These forces include Coriolis force, pressure gradient force, friction, and gravity. For brevity, we will describe all activity as it occurs in the Northern Hemisphere; remember, in the Southern Hemisphere, these forces affect wind in the opposite direction.

**5.5. Coriolis Force.** The earth rotates from west to east at a set speed much the same as a phonograph record on a turntable. Although the revolutions per minute (rpm) are the same, the outward rim of the phonograph record (the equator, in the case of the earth) has more distance to cover over one complete revolution than any of the inner points of the record (comparable to the higher latitudes on earth) and is therefore traveling faster. Gravity brings our atmosphere along at the same relative speeds at each latitude. When a migrating parcel of air moves toward another latitude, either northward or southward, a phenomenon takes place known as the *Coriolis force* (Figure 5-3). If the parcel of air moves northward from a lower latitude to a higher latitude, it will move ahead (to the right) of the point directly north of its initial starting point due to its greater speed.

Figure 5-2. Worldwide Surface Pressure Distribution.

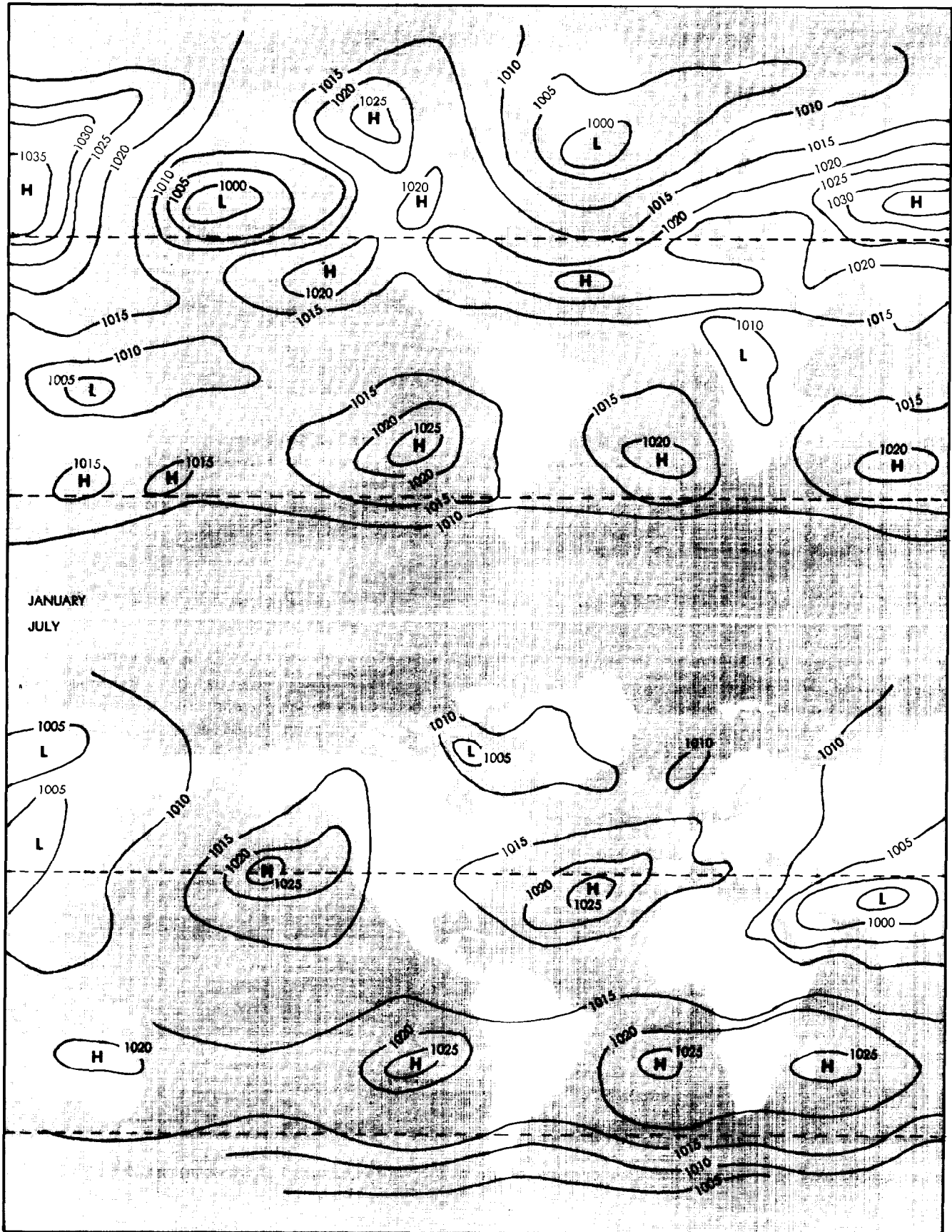
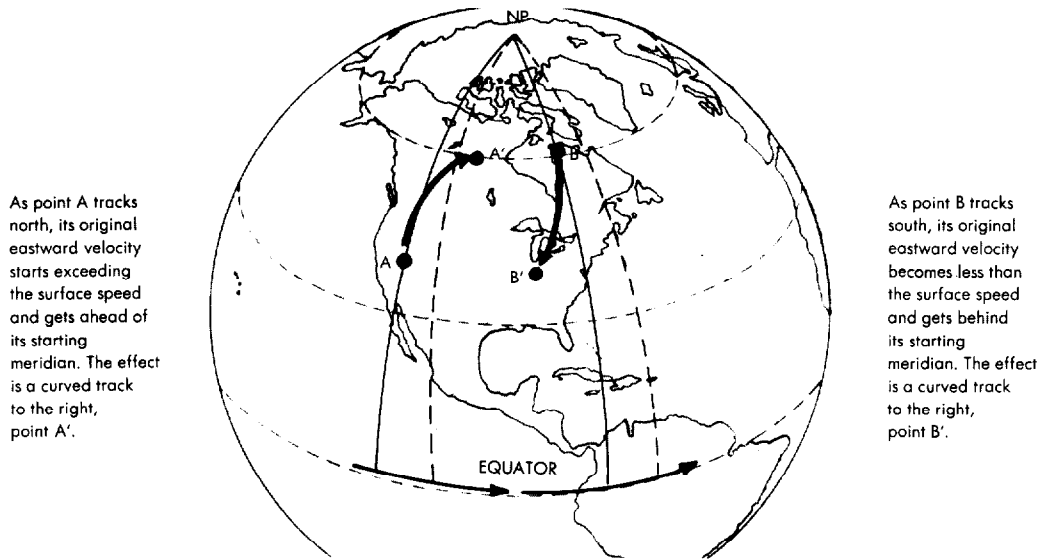


Figure 5-3. Coriolis Force.



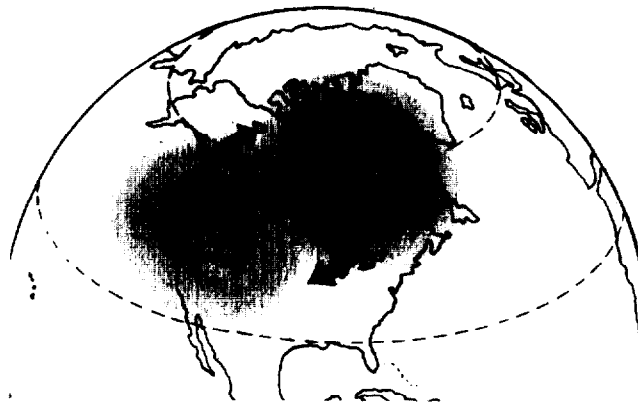
**5.5.1** A parcel of air moving from north to south, from an area with a smaller circumference to an area with a larger one, encounters a lag because it enters a plane with a greater rim speed than the plane it left. Therefore, because of the lag, the air parcel would also deflect to the right.

**5.5.2.** From this, we observe that if the only force at work is the rotation of the earth, parcels of air moving north or south over considerable distances deflect to the right in the Northern Hemisphere (Figure 5-4). Therefore, if a parcel of air migrates from north to south, the parcel will deflect to the west.

**5.6. Other Deflective Forces.** Two other elements produce similar wind deflections, the origins of which are of an east-west nature. The earth's rotation produces a centrifugal force, felt strongest at the equator. The other element is gravity, which has a stronger effect at the poles due to the lessened influence of centrifugal force.

**5.6.1.** These two forces, gravity and centrifugal force, tend to neutralize each other as long as the earth maintains its rotational speed. Without centrifugal force, free-moving bodies on the earth are drawn toward the poles. By the same token, without gravity's poleward component, centrifugal force draws free bodies toward the equator. The conclusion is that the speed of a moving body traveling from west to east (along with the rotation of the earth) would add to the rotational speed of the earth resulting in an increase in centrifugal force. This would draw that body (in this case a parcel of air) toward the equator (to the right in the Northern Hemisphere).

Figure 5-4. Coriolis Force Affects Circulation Patterns.



**5.6.2.** A body moving in the opposite direction (from east to west against the rotation of the earth) would subtract from the speed of the rotation of the earth, lessening the effects of centrifugal force and turning that body toward the pole, to the right in the Northern Hemisphere. Notice how all deflective motion is approximately  $90^\circ$  to the right of its source of origin in the

Northern Hemisphere and to the left in the Southern Hemisphere. The Coriolis force is strongest at the poles and decreases to zero at the equator. The stronger the wind, the stronger the deflective force.

**5.6.3. Pattern of Circulation.** Let's apply Coriolis force to the simplified pattern of circulation (Figure 5-5A). For brevity, we will again confine movement to the Northern Hemisphere. As air is forced to rise (Figure 5-5B) and move northward from the equator, it is deflected toward the east. By the time it has traveled about a third of the distance to the pole, it is no longer moving northward, but eastward. This causes the air to pile up in the so-called "horse latitudes" (around 30°N latitude) producing a high pressure area. At the surface, air moving southward out of the horse latitudes, deflects toward the west, producing the northeast trade winds.

**5.6.4.** In the polar regions, a similar process operates, with southward-moving polar air deflected toward the west becoming an east wind. Air forced northward from the high pressure area near 30° latitude, deflects toward the east to become a west wind, producing the prevailing westerlies of the middle latitudes. When this air meets the colder polar air, it moves over the colder air, producing an accumulation in the upper latitudes. The cold air periodically breaks loose from under this accumulation with a portion migrating southward reducing the accumulated pressure. This is called a polar outbreak or cold wave. The boundary zone between the wedge of cold, polar air and the warmer air of the prevailing westerlies is called the polar front. The polar front is strongest in the winter and weakest in the summer.

**5.7. Pressure Gradient Force.** In the Northern Hemisphere, air flows clockwise around high pressure areas and counterclockwise around low pressure areas. This circulation pattern is referred to as cyclonic for a low and anticyclonic for a high. In briefings and forecasts, you will often encounter the term "pressure gradient" or just "gradient." *Pressure gradient* is the rate change of pressure or height of a pressure surface (such as 850mb) with horizontal distance between high and low pressure areas. The greater the difference in pressure between two horizontal points, the greater the pressure gradient between those points. On surface and upper air charts, closer spacing of the isobars and contours indicate greater differences in pressure over a given distance. The closer the spacing, the faster air flows to equalize the pressure difference, therefore indicating higher wind speeds.

**5.7.1.** The reason for this begins when a parcel of air from the higher pressure area starts moving toward the low pressure area (Figure 5-6). As it does, the Coriolis force begins to swing the parcel of air to the right. The force initiating the horizontal movement (pressure gradient) still exerts its pull, now to the left. When the pressure gradient balances the Coriolis force, the air blows parallel to the isobars or contours. As this parcel of air enters these "lanes" between isobars or contours, it is virtually squeezed through the more narrow channels formed by greater pressure gradient, and shown on the surface chart by a closer spacing of the isobars. Thus the moving parcel of air, channeled into a more narrow corridor, picks up speed. If it enters an area where the isobars indicate less pressure gradient (by being spaced farther apart), the wind will lose speed.

**5.7.2.** Without Coriolis force, a parcel of air would move directly across the isobars from high to the lower pressure until the pressure equalized. This attempt to equalize pressure initiates the movement of the parcel of air from the higher to lower pressure area. As air evacuates the low, an equalizing parcel of air drawn from the high pressure area takes its place.

**5.7.3.** Using Figure 5-7, measure the perpendicular distance between the two adjoining isobars for the region under discussion. The difference between A and B, and C and D is 4 mb. However, the 4 mb difference between A and B occurs over a shorter distance, making the pressure gradient stronger than that between C and D. Pressure gradients may be described as either steep, strong, flat, or weak. From a practical standpoint, it is sufficient to remember that the gradient (and wind) is strongest where the isobars or contours are closest.

**5.7.4.** Applied to pressure areas with curved isobars, air moves clockwise about a center of high pressure and counterclockwise about a center of low pressure. If you need to get away from high velocity pressure gradient winds, the quickest route is to fly perpendicular to the winds with the wind flowing right to left. (to fly with the wind flowing left to right will guide you toward the center of the low and toward higher winds).

**5.8. Effects of Friction and Gravity.** Surface friction slows air movement. Since the Coriolis force varies with wind speed, a reduction in the wind speed by friction means a reduction in the Coriolis force. This results in a disruption of the balance between the Coriolis and pressure gradient forces. When the new balance, including friction, is reached, the air blows at an angle across the isobars from high to low pressure. This angle varies from 10° over the oceans to as much as 45° over rugged terrain.

**5.8.1.** Friction effects on the air are greatest near the ground, but the effects are also carried aloft by ascending currents. Surface friction slows winds up to about 2,000 to 3,000 feet AGL (Figure 5-8). Above this level, friction effects decrease rapidly and are negligible for all practical purposes. Therefore, air about 3,000 feet or more AGL tend to flow parallel to the isobars and contours. Figure 5-9 illustrates the flow of air around high and low pressure areas above the surface friction layer. As a result of changing pressure patterns with height, the wind at higher levels may be entirely different than indicated on the surface chart. It is quite possible for the surface wind to be light and variable, while the 30,000 foot wind has a speed of over 100 knots. In forecasting winds at flight level, the forecaster uses the constant pressure chart nearest that level, instead of the surface chart.

Figure 5-5. Patterns of Atmospheric Circulation.

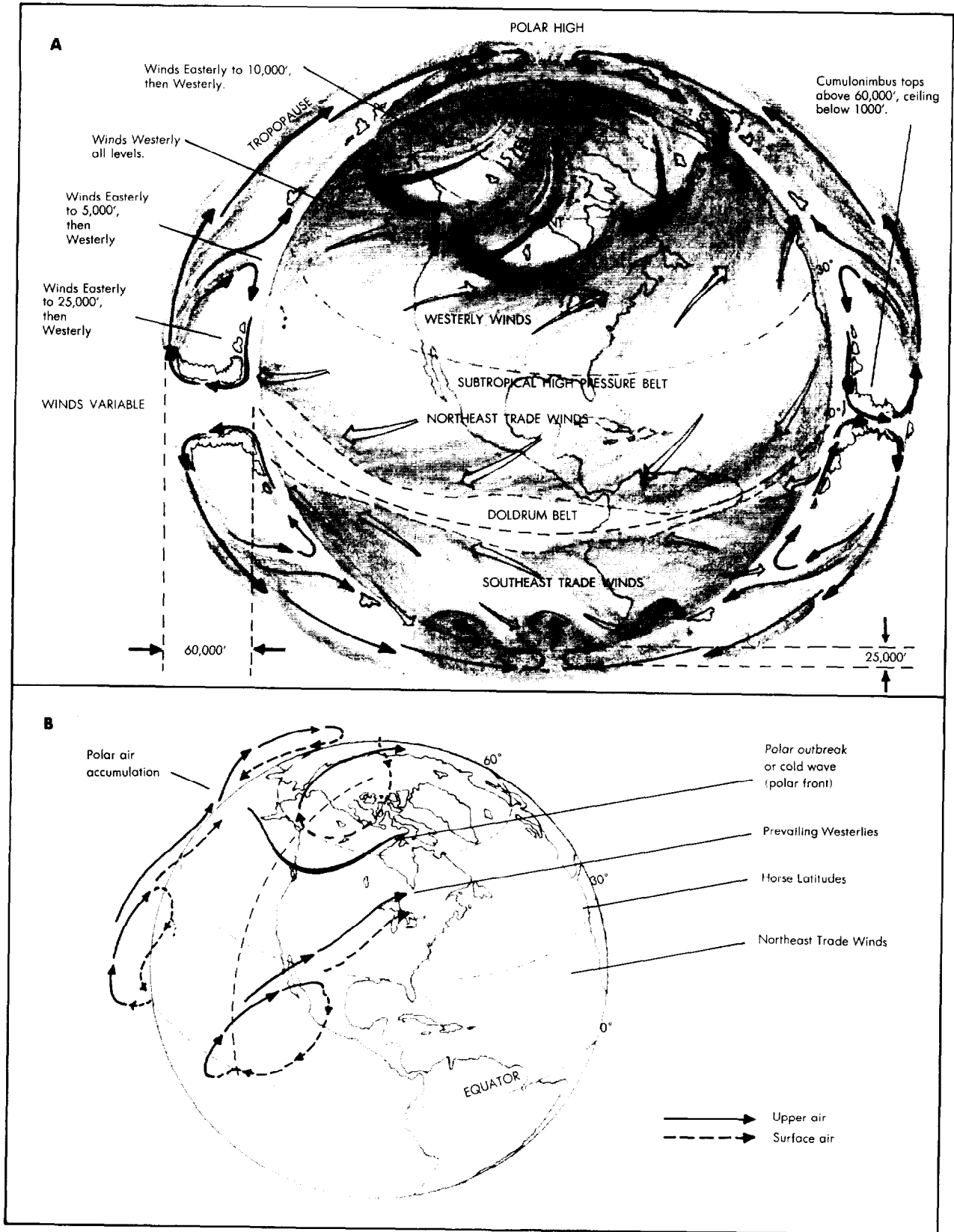


Figure 5-6. Effect of Pressure Gradient and Coriolis Force on Wind Direction.

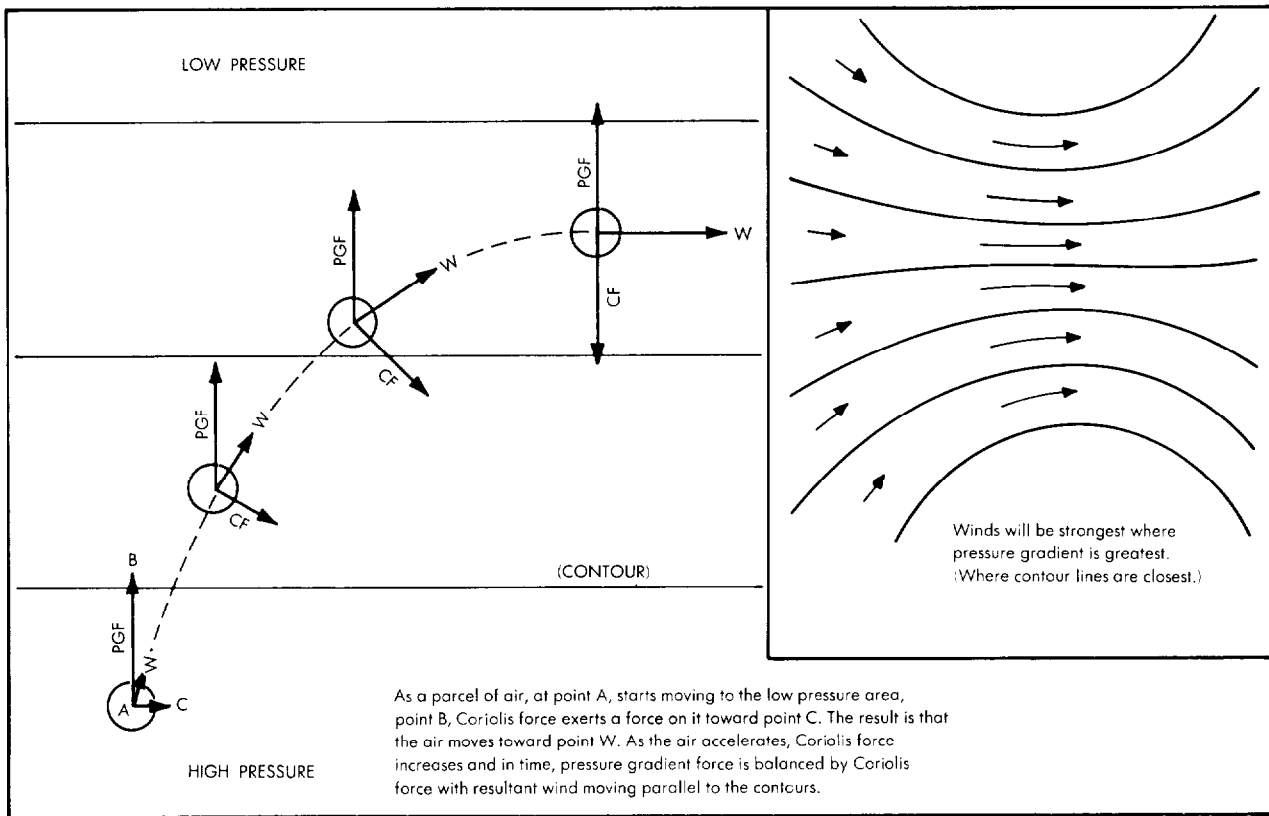
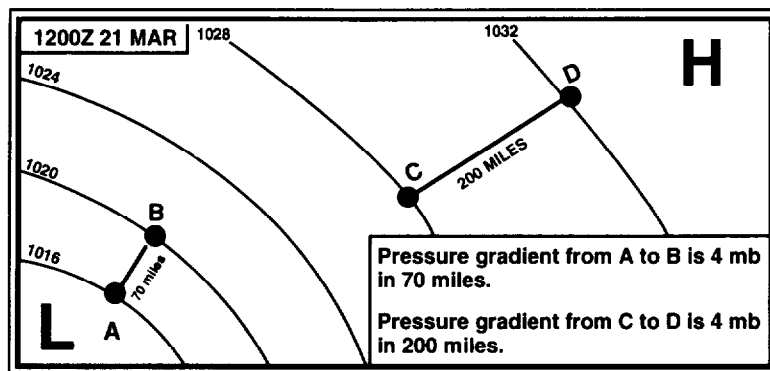


Figure 5-7. Pressure Gradient Versus Wind Speed.



**5.9. Large Wind Systems.** People living in the temperate zone and farther north know that their weather changes almost constantly with the alternate passage of cyclones (low pressure systems) and anticyclones (high pressure systems). These migrating systems usually move from west to east with the prevailing westerly winds. They are accompanied by wind shifts, rapid changes in temperature, and broad areas of precipitation. Migrating cyclones and anticyclones are the primary means for the heat exchange between high and low latitudes (Figure 5-10).

**5.9.1. Lows and Highs.** Lows (cyclones) are usually a few hundred miles in diameter. Highs (anticyclones) are generally larger and more elongated, the longer axis sometimes extending over 2,000 miles.

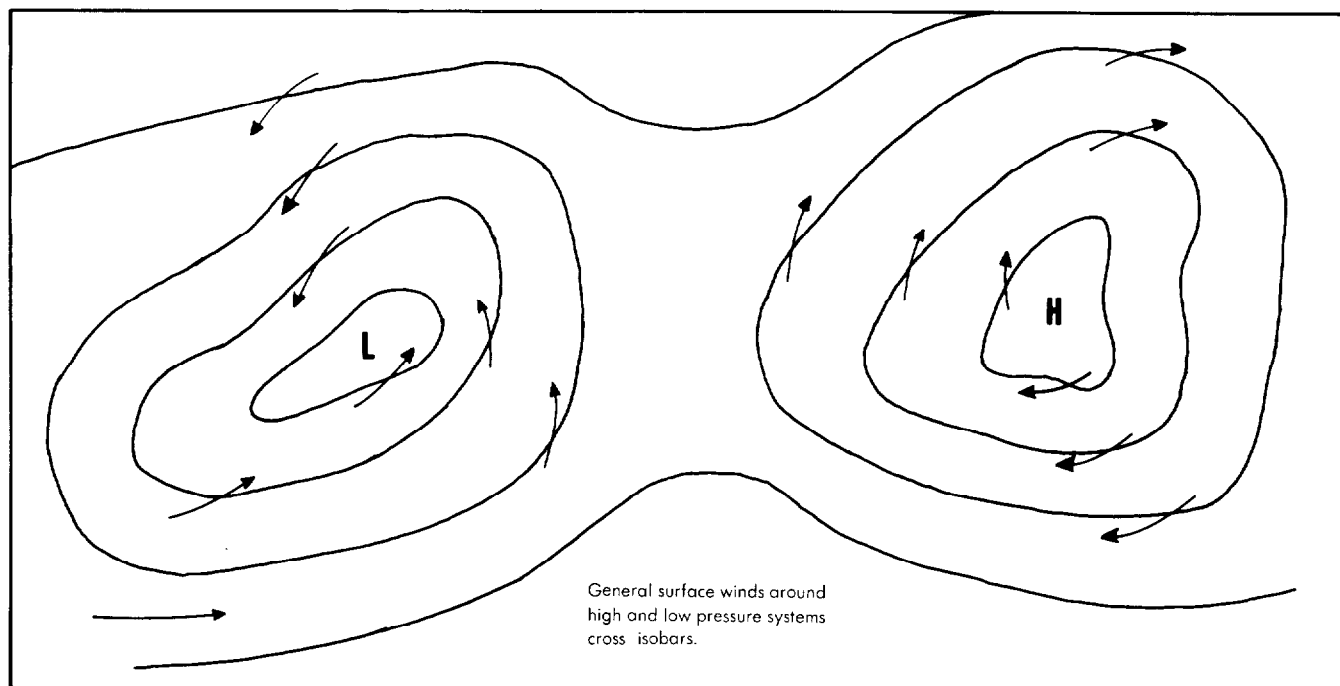
**5.9.2. Hurricanes, Typhoons, and Cyclones.** Hurricanes originate over the Atlantic Ocean, the Caribbean Sea, the Gulf of Mexico, and the eastern Pacific along the coasts of Central America and Mexico. In the tropical areas of the western Pacific Ocean, they are called "typhoons." In the Indian Ocean near the east coast of Africa, and in the Southern Hemisphere, they are called "tropical cyclones." The extremely low pressure, very strong winds, torrential rains, and other characteristics of



hurricanes, typhoons, and cyclones, make them adaptable for discussion in several chapters of this manual. Their treatment in detail is reserved for Chapter 14, Tropical Weather, since these phenomena originate in the tropics.

**5.9.3. Jet Streams.** A discussion of large scale wind systems is incomplete without some mention of the *jet stream*. Winds generally increase with height through the troposphere, reaching a maximum near the tropopause. Within the long, meandering belt of high winds, the jet stream, are concentrated packets of the strongest winds within the jet stream. The jet stream maxima or jet stream cores are most responsible for vertical motions of air and are a major factor in the development of low pressure systems. Chapter 9 discusses this in more detail.

**Figure 5-8. Surface Winds are Deflected Across Isobars Toward Lower Pressure.**



**Figure 5-9. Wind Direction Around Contours (Aloft).**

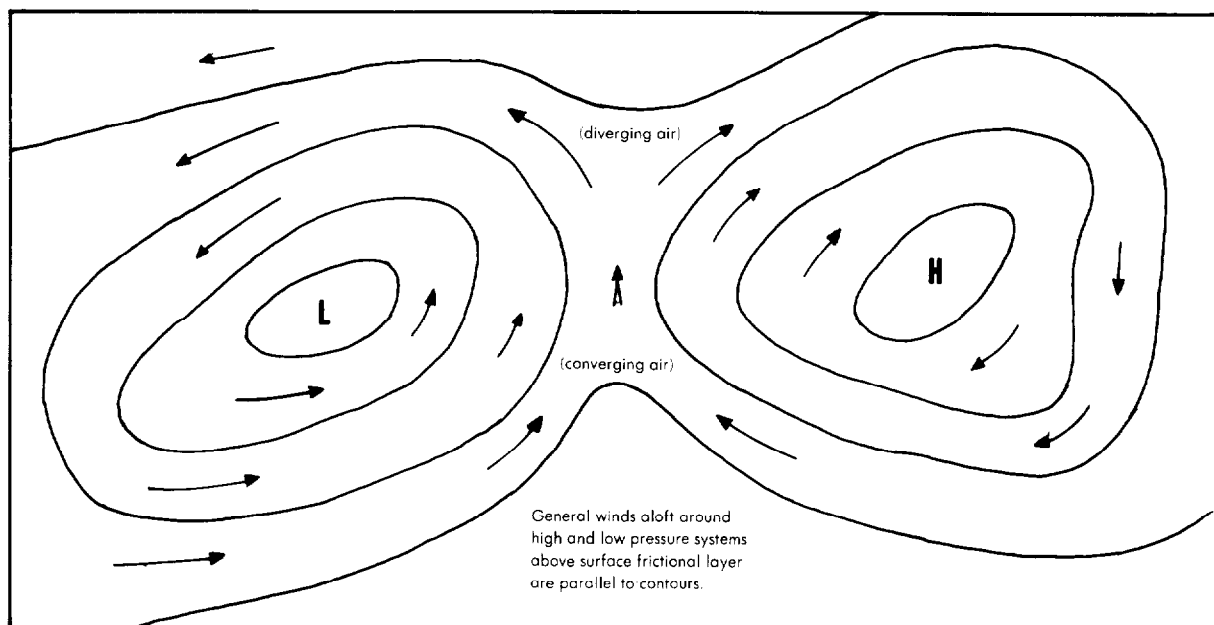
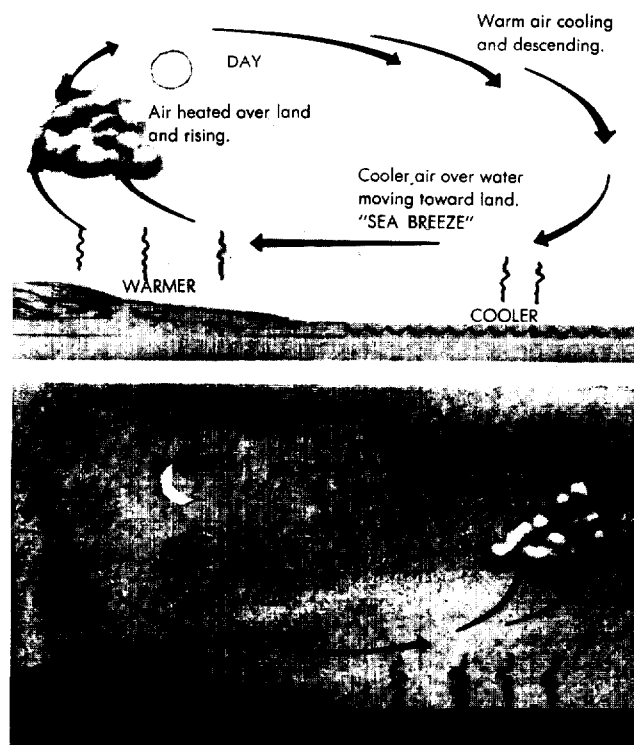


Figure 5-10. Air Flow Aids in Exchange of Heat Between Latitudes.



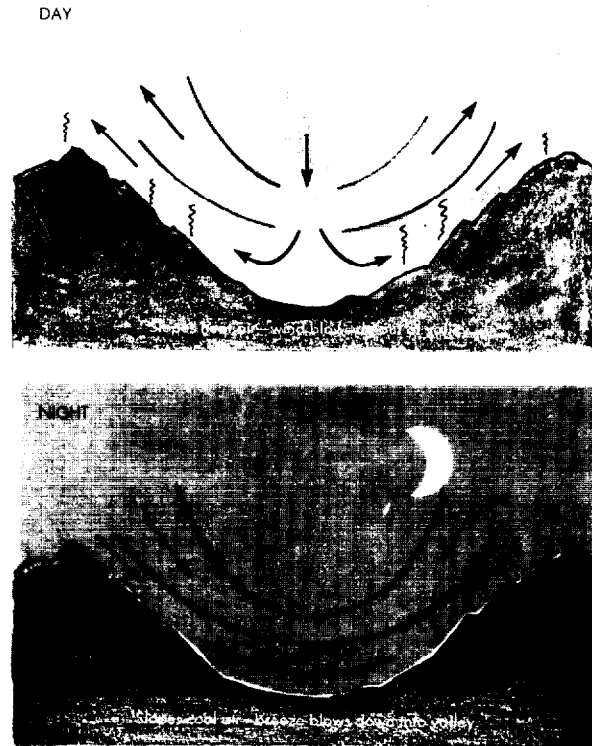
Figure 5-11. Land and Sea Breezes.



**5.10. Local Winds.** Superimposed on the general wind systems are local wind systems created by the area's geography. These local systems usually cause significant changes in the area's weather. The term "local," in the case of wind systems, applies to areas whose sizes range from affected regions in the tens of miles range to regions which are long, geographically thin areas which will favor development of local winds. In any case, local geographical differences determine the size and degree of local wind development.

**5.10.1. Land and Sea Breezes.** Land surfaces warm and cool more rapidly than water surfaces through insolation and terrestrial radiation. Therefore, the land is normally warmer than the sea during the day and colder at night. This difference in temperature is more noticeable during the summer months and when there is little horizontal transport of air in the low levels. In coastal areas, this difference of temperature between the land and water produces a corresponding difference in pressure (a pressure gradient). During the day the pressure over the warm land is lower than over the colder water. The cool air over the water moves toward the lower pressure, forcing the warm air over land upward. The resulting onshore wind is a "sea breeze."

Figure 5-12. Valley Wind and Mountain Breeze.



**5.10.1.1.** At night the circulation reverses so that the air movement is from land to sea, producing an offshore wind called a "land breeze." The sea breezes are usually stronger than land breezes, but they seldom penetrate far inland. Both land and sea breezes (Figure 5-11) are shallow in depth. Ten to twenty knot sea breezes are common.

**5.10.2. Mountain and Valley Winds.** In the daytime air next to a mountain slope heats by contact with the ground as it receives radiation from the sun. This air becomes warmer than the surrounding air farther away from the slope. Colder, denser air in the surrounding areas settles downward and forces the warmer air near the ground up the mountain, producing the *valley wind*, so called because the air flows up out of the valley (Figure 5-12). These winds are of particular importance for light aircraft, helicopter, and low-level operations. At night the air in contact with the mountain slope cools by outgoing terrestrial radiation and becomes denser than the surrounding air. It sinks along the slope, producing the *mountain wind*. In mountainous areas where the performance of some fixed wing aircraft or helicopters is marginal, the location of upslope and downslope winds can be critical.

**5.10.3. Katabatic Winds.** A *Katabatic wind* is any wind blowing down an incline. The mountain breeze, therefore, is a type of Katabatic wind. If the downslope wind is warm relative to the air in the valley or plain below, it is called a foehn. If the downslope wind is cold, it is called either a fall wind or a gravity wind.

**5.10.3.1. Foehn or Chinook Winds.** Many Katabatic winds recurring in local areas have been given colorful names due to their dramatic effect. Two examples of warm, dry, downslope winds are the Chinook and the foehn winds. For example, the warm wind located along the eastern slopes of the Rockies is called a *Chinook* (Figure 5-13). As air rises it cools and its moisture condenses out during ascent on the western slopes. The same parcel heats more quickly than it cooled by a compression process as it flows downhill from the high elevations. A Chinook can raise the temperature at the base of a mountain 30°F in a few minutes. Another example is the Santa Ana wind, a *foehn* wind which descends from the Sierra Nevada Mountains into the Santa Ana Valley of California. This hot, dry wind is noted for its high speeds and extremely low humidities.

**5.10.3.2. Fall Winds.** *Fall winds* are found in very cold plateau regions (Figure 5-14). In southeastern Alaska there is a fall wind known as the Taku, while in the Alps there is one known as the Bora. Because the cold air is heavy, it flows downhill due to gravity, resulting in a shallow wind sometimes attaining high speeds. These winds usually affect a rather large area and may occur during the day or night. Fall winds are usually stronger at night, though, because radiational cooling of the ground further cools the air.

Figure 5-13. Chinook Wind.

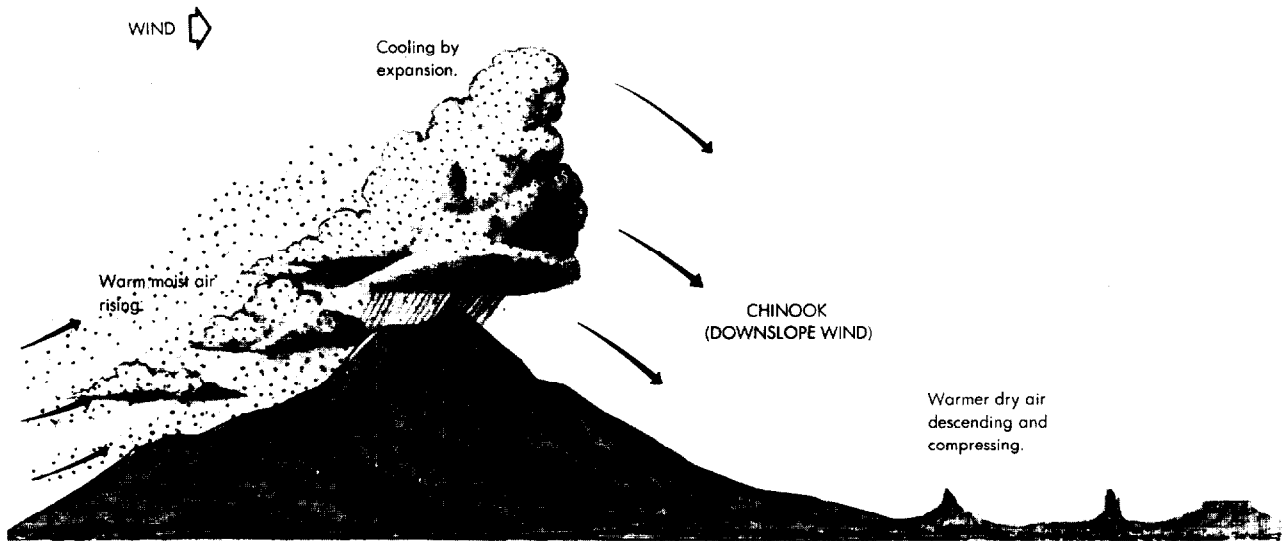
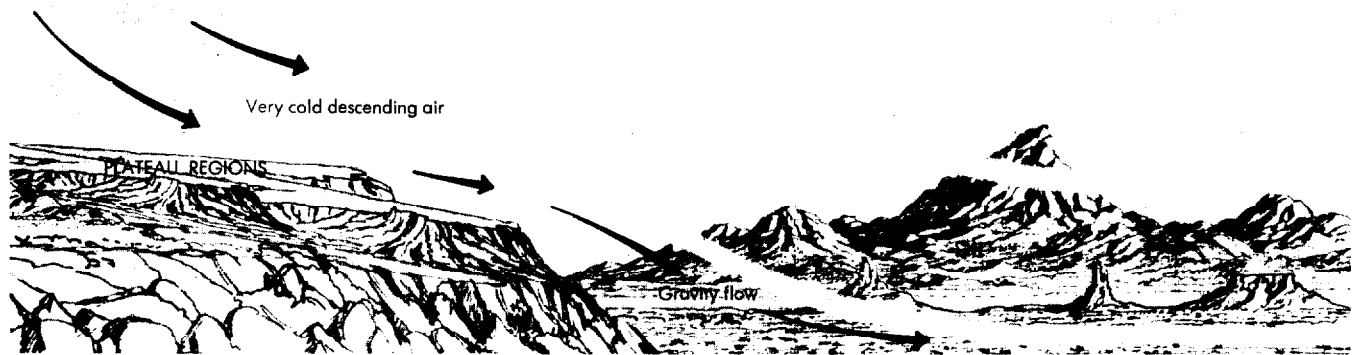


Figure 5-14. Fall Wind.



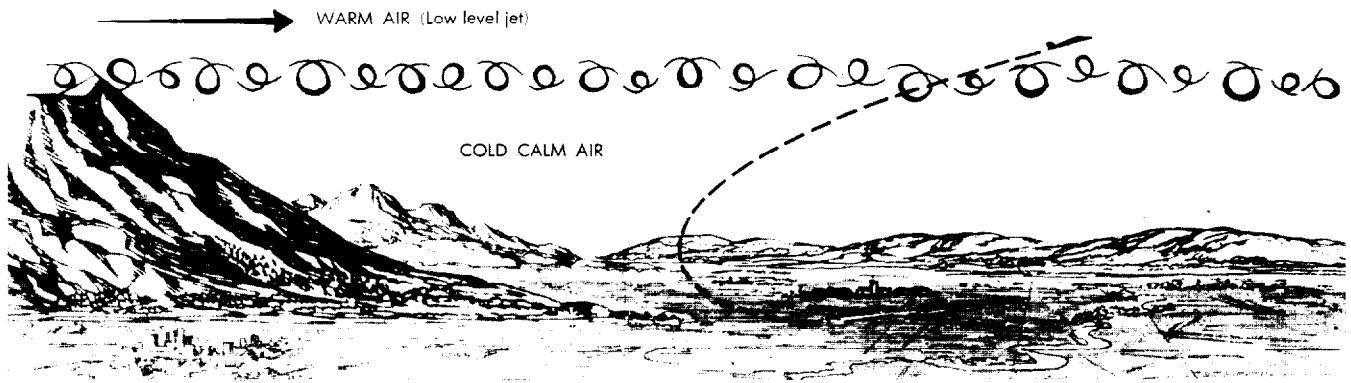
**5.10.3.3. Upslope Winds.** *Upslope winds* flow up a slope or a valley during the day. Air adjacent to a slope facing the sun becomes warmer and less dense than the air at the same level some distance from the slope. The warm air becomes buoyant and floats up the slope. Surface heating, a frequent ingredient of thunderstorm development, develops instability which causes the flow to be turbulent. The depth of the upslope wind increases with height, and the air can become very turbulent at the top of the hill or ridge. For the same reason, air tends to flow up a valley during the day rather than along isobars. In these situations there will be an upslope wind on the sunny side of the valley and a downslope wind on the shaded side.

**5.10.3.4. Downslope Winds.** A *downslope wind* may consist of either a warm or cold flow of air down a slope and may develop into an extremely strong wind with dangerous shears. Air cooled by radiational cooling at night becomes dense and is pulled by gravity down the natural pathways of hills and mountains to collect in the valleys; then it flows down the valleys out onto the plains or oceans. The flow tends to be shallow and streamlined.

**5.10.3.5. Glacier Winds.** The *glacier wind* is a form of downslope wind which can develop to hazardous proportions if the cooling is extreme. This can occur over glaciers where shallow winds of 80 knots or more can form. Because the cooling in this case is caused by the underlying ice, the winds blow downhill both day and night. At times the flow is pulsating with the cold air building up to a critical point and then being released in a rush down the slope.

**5.11. Wind Shear.** Friction results when you place two objects together, and move one along the surface of the other. A similar process occurs between two bodies of air of differing velocities and causes *wind shear*. Friction creates a mixing zone of eddies between the bodies called a shear zone. Figure 5-15 shows two adjacent bodies of air moving at different velocities with their accompanying shear zone. Shear, either vertical or horizontal, is further discussed in Chapters 9 and 10.

Figure 5-15. Horizontal Wind Shear Turbulence.



**5.11.1. Winds and Altimeters.** Since the wind at any level blows according to the pressure system at that level, there is a definite connection between wind and altimeter error. If you are flying at 10,000 feet and are experiencing a direct headwind or tailwind, you must be flying parallel to the isobars. There is no pressure change to affect the accuracy of your altimeter. If during flight you experience a marked drift to the left, you will be approaching an area of higher pressure. If the drift is to the right, you are approaching an area of lower pressure.

**5.11.2.** During a flight at higher levels, the observed wind will indicate the pressure pattern at flight level, which may not be the same as the pressure pattern at the surface. If you are flying at a constant pressure level, a marked left-hand drift indicates the aircraft is gradually gaining altitude and a marked right-hand drift indicates the aircraft is gradually losing altitude, although in both cases the altimeter reading would remain unchanged. Therefore, winds determined during flight can be of great value in assessing altimeter errors due to pressure.

## Chapter 6

### CLOUDS

**6.1. Introduction.** Clouds display a wealth of information about present and forthcoming weather. They provide visible evidence of atmospheric motions, water content, and stability. A good working knowledge of cloud types enables fliers to reasonably understand what flying weather to expect.

**6.1.1.** Clouds are classified by their height and appearance. Puffy cumulus clouds are the "fair weather clouds" while the nimbostratus clouds "look like rain." Altocumulus standing lenticular clouds usually indicate mountain wave turbulence while large, cumulonimbus clouds mean trouble! Since there is such a variety of clouds, meteorologists have simplified cloud identification by using ten cloud genera defined by the World Meteorological Organization (WMO).

**6.1.2.** This chapter will introduce cloud formation processes and cloud composition. The chapter will further explain the cloud types, typical heights, and specific characteristics of each type. Cloud pictures will help identify the different cloud types. The chapter will conclude by looking at special cloud formations and topics.

**6.2. Cloud Composition.** Chapter 2 indicated that clouds are composed of minute liquid water droplets and/or ice crystals, depending on the cloud's temperature. When the outside air temperature is between 0 degrees C and -20 degrees C, clouds are largely composed of supercooled water droplets, and usually contain some ice particles. Ice crystals *usually* predominate at temperatures lower than -20 degrees C. However, supercooled water droplets can exist at temperatures as low as -40 degrees C.

**6.2.1. Cloud Particles.** Cloud particles have an average radius of 10 to 100 microns and are clustered together closely enough to make them visible. If the cloud droplets become large enough, they are no longer buoyant and they begin to slowly fall as supercooled or naturally occurring water droplets. The droplets stick together or *coalesce* and fall faster eventually becoming precipitation. Water droplets grow to 500 microns for drizzle and up to 5,000 microns for raindrops. The cloud temperature and atmospheric stability determines the precipitation type. A stable atmosphere favors precipitation droplets of a more uniform size.

**6.2.2. Condensation Nuclei.** *Condensation nuclei*, such as windblown dusts, sea-salt, and combustion by-products, compose the centers of cloud particles. The presence of condensation nuclei is necessary for the formation of water droplets. Most nuclei is found within the first few kilometers of the ground. Within higher elevations, complex cloud physics processes

allow condensation nuclei to grow and gradually overcome gravity. The type of condensation nuclei also is a determining factor of how fast a precipitation particle will grow. Cloud formation theories are not completely understood and are the subject of ongoing studies.

**6.3. Types of Clouds.** The forms, species, and varieties of clouds have always challenged those whose livelihoods depended upon the weather. Aircrews can also learn the language of clouds and use the information. Although the weather field has become highly technological and computerized, basic cloud knowledge will still reap dividends for aircrews.

**6.3.1. Basic Cloud Types.** For our purpose, aircrews should be concerned with only the basic cloud types, which are divided into four "families." The basic cloud types are low clouds, middle clouds, high clouds, and clouds with extensive vertical development (Figure 6-1). The average heights of middle and high clouds varies with latitude, time of year, and with the tropopause height. Low cloud altitudes vary little with latitude.

**6.3.2.** Low, middle, and high cloud families are further classified according to the way they are formed. Clouds formed by vertical currents of unstable air are called cumulus, meaning "accumulation" or "heap." They are characterized by their lumpy, billowy appearance. Turbulent flying conditions are usually found in and around the vicinity of cumuliform clouds. Clouds formed by the cooling of a stable layer are called stratus, meaning "spread out" and appear layered. They are characterized by their uniform, sheet-like appearance. Flight within stratified clouds is relatively smooth.

**Figure 6-1. Basic Cloud Types.**

ALTITUDE OF BASE	CLOUD TYPE	ABBREVIATION
Bases of High Clouds Usually Above 16,000 Feet (AGL)	CIRRUS	CI
	CIRROCUMULUS	CC
	CIRROSTRATUS	CS
20,000 FEET		
Bases of Middle Clouds Range From 6,500 Feet (AGL) To 20,000 Feet (AGL)	ALTOCUMULUS	AC
	ALTOSTRATUS	AS
	NIMBOSTRATUS	NS
6,500 FEET		
Bases of Low Clouds Range From Surface To 6,500 Feet (AGL)	*CUMULUS	CU
	*CUMULONIMBUS	CB
	STRATOCUMULUS	SC
	STRATUS	ST
SURFACE		

\*Cumulus and Cumulonimbus are clouds with vertical development. Their base is usually below 6,500 feet but may be slightly higher. The tops of the cumulonimbus sometimes exceed 60,000 feet.

NOTE: Divisions between middle and high clouds can overlap and their limits may vary with latitude and season.

**6.3.3.** In addition to cloud family descriptions, different prefixes and suffixes are added to create descriptions of combination-type clouds. For example, the prefix *nimbo* or the suffix *nimbus*, meaning raincloud, is added to the name of precipitation producing clouds. Thus a rain-producing, horizontal cloud is called nimbostratus, while a developing cumulus growing into a thunderstorm is referred to as cumulonimbus. Heights of the various cloud types are illustrated in Figure 6-2.

**6.4. Cloud Formation and Structure.** The degree of the air's stability largely determines cloud type. Cumuliform clouds, due to associated vertical air currents, always have some degree of turbulence within and beneath them. Stratiform clouds, having little or no vertical motion, experience little or no turbulence.

**6.4.1.** Cloud structures formed from air forced to ascend depend almost entirely on the air's stability prior to the lifting. For example, stable air forced up a mountain slope remains sufficiently stable to prevent appreciable vertical development. Associated clouds will be layered, with little or no turbulence. However, if the air forced upward is initially unstable, the mountain slope itself increases the tendency for vertical development and cumuliform clouds may grow considerably.

**6.4.2.** Sometimes stratiform clouds will partly change to cumuliform clouds and/or stratocumulus as a result of heat introduction either from surface heating, warmer air moving from another location, or other heating processes. Heat reflecting from the tops of altostratus clouds can form altocumulus. Heating and cooling processes determine stability which, in turn, determines whether a cloud will become a stratiform or cumuliform cloud (Figure 6-3).

**6.4.3.** Forced ascension of an entire layer produces similar conditions if the air is even slightly unstable. This transition in cloud formation is sometimes noticeable when flying over a relatively smooth cloud deck with cumulus-like clouds beginning to project upward. Sometimes these projections appear as only random puffs and at other times in groups or in lines. Lines of cumuliform clouds projecting upward out of a horizontal cloud deck sometimes indicate a frontal zone (the boundary between different air masses). A similar cloud pattern often occurs at a coastline (Figure 6-4) resulting from the temperature difference between the land and water. Mountain ranges, oriented with a perpendicular component to the air flow, produce lines of cumuliform clouds within what is otherwise a horizontal stratus cloud layer.

**6.5. Low Clouds.** Low clouds consists of stratus, stratocumulus, and cumulus. Cloud bases range from the surface to about 6,500 feet AGL. Clouds forming below 50 feet and extending to the surface are classified as fog. During the summer, low clouds are almost entirely water droplets. During colder weather, these clouds may consist of ice crystals or supercooled water droplets and may therefore cause icing conditions hazardous to aircraft. A brief description of each low cloud follows.

Figure 6-2. Cloud Heights.

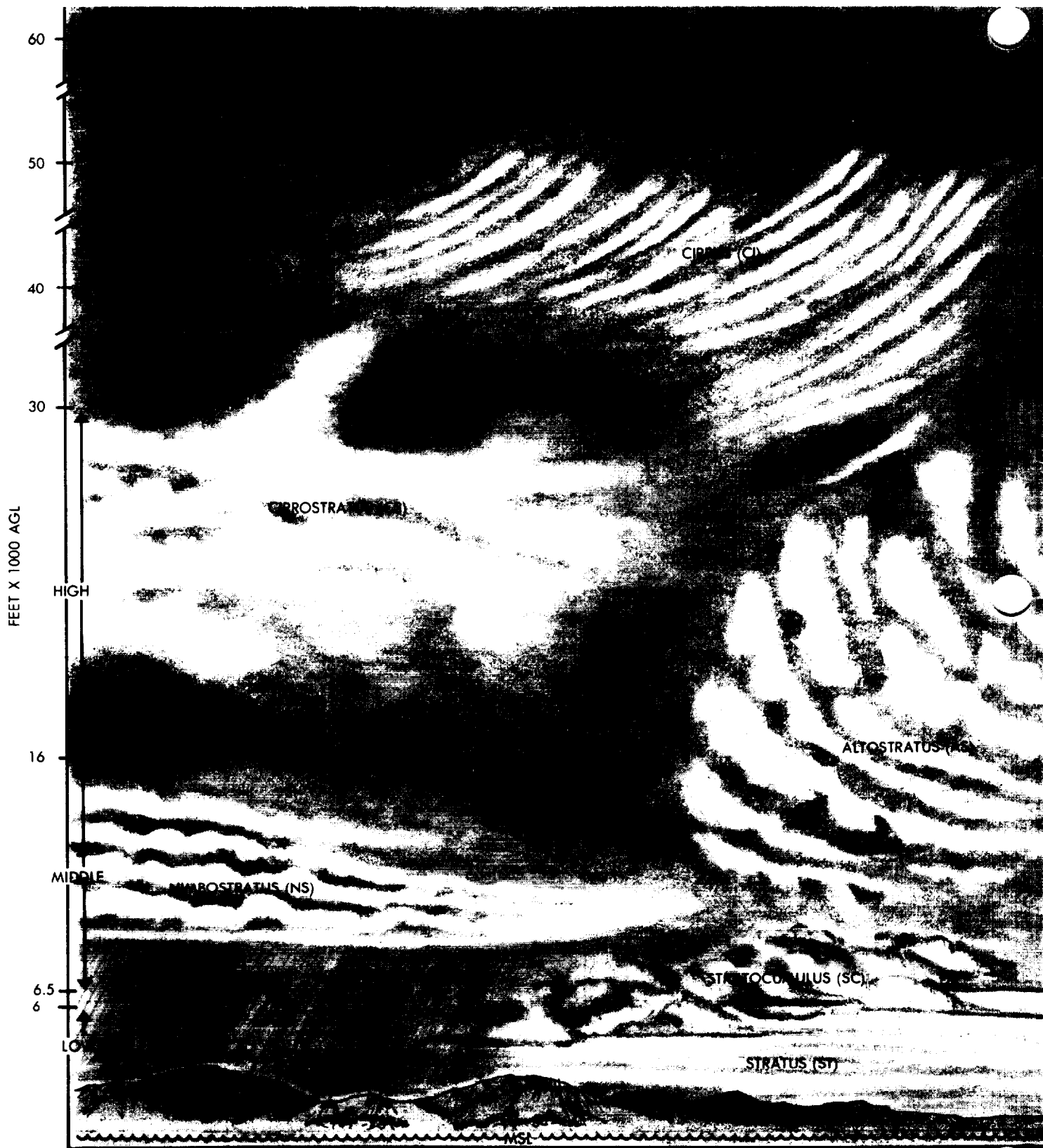


Figure 6.2. Continued.





Figure 6-3. Various Factors Affecting Cloud Types.

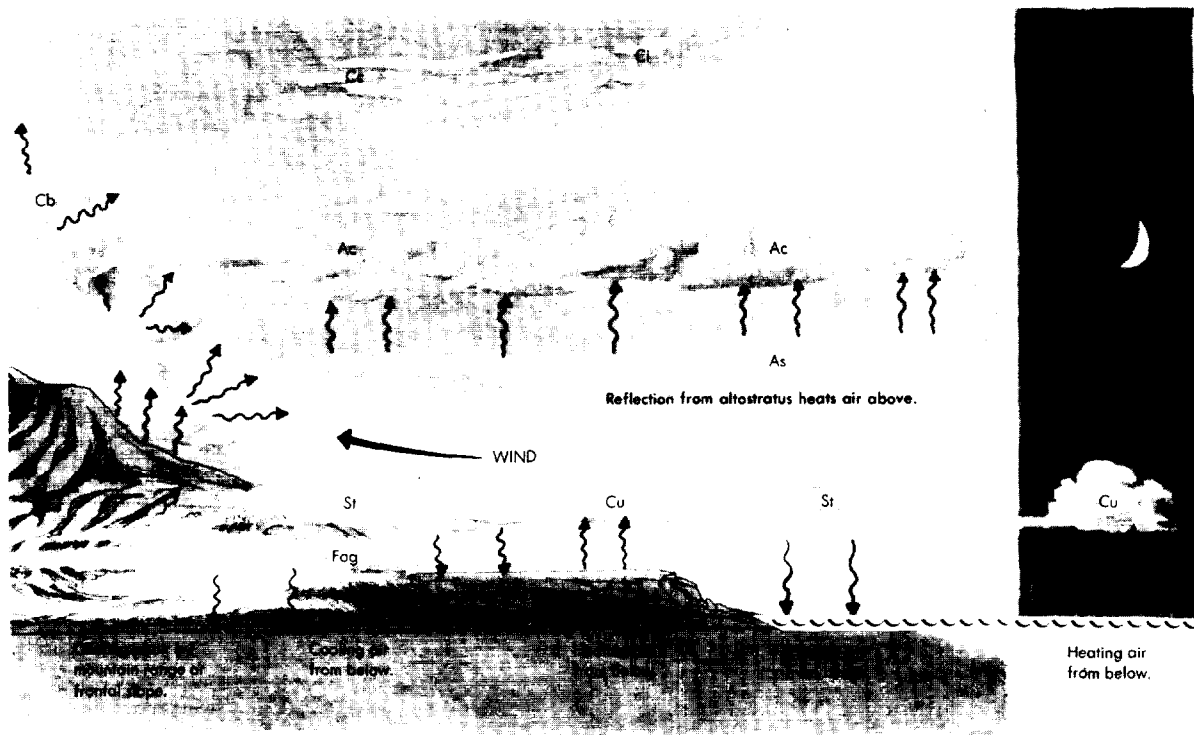


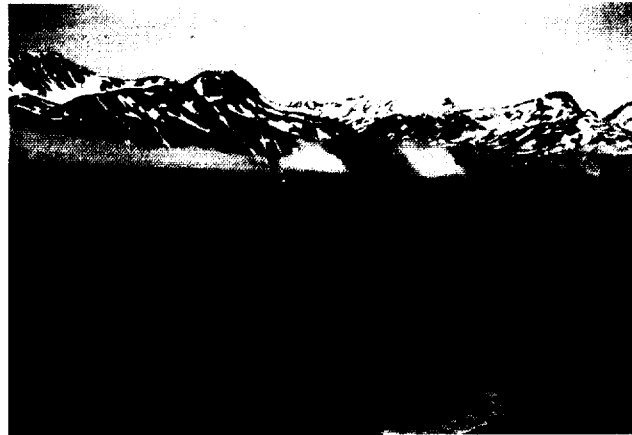
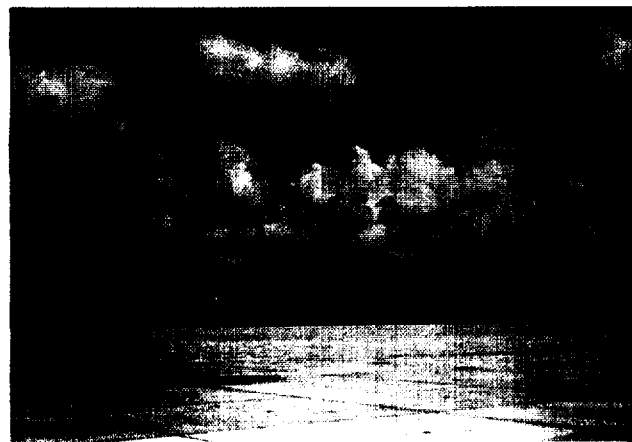
Figure 6-4. Stratus Becoming Stratocumulus and Cumulus at Coast Line.



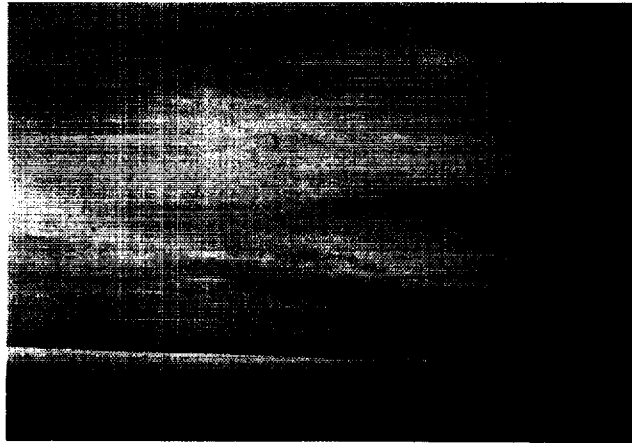
**6.5.1. Stratus (ST).** *Stratus* is a low, uniform, sheet-like cloud (Figure 6-5). Stratus clouds tend to be between a couple hundred to thousands of feet thick and produces only drizzle, ice prisms, or ice crystals. When associated with fog or heavier precipitation, stratus clouds often become mixed with nimbostratus clouds, which are discussed later. Stratus clouds often present problems by causing low ceilings and restricted visibilities. A slowly lifting fog layer often becomes stratus clouds before dissipation. Finally, fog formed over water bodies and driven inland by onshore winds, becomes stratus. While stratus clouds indicate stable flying conditions, extended flying through stratus clouds with temperatures below freezing can cause hazardous icing conditions.

**6.5.2. Stratocumulus (SC).** *Stratocumulus* clouds appear as large, globular masses or rolls which look like dirty gray cotton balls (Figure 6-6). They often result from a layer of stable air lifted and mixed by wind blowing over rough terrain. Stratocumulus also form from the breaking up of a stratus layer and from the spreading out of cumulus clouds. Ceilings and visibilities are usually better with stratocumulus than in stratus.

**6.5.3. Cumulus (CU).** *Cumulus* clouds form as warmed "blobs" of air rise and visibly condense. They can also form as a cold air mass warms as it passes over a warmer surface. Relatively flat bases, dome-shaped tops, and a cauliflower appearance characterize cumulus (Figure 6-7). Fair weather cumulus indicates a shallow layer of instability. Expect some light turbulence and no significant icing or precipitation. If cumulus clouds continue to vertically develop, they become towering cumulus and can eventually become cumulonimbus clouds.

**Figure 6-5. Stratus Clouds (ST).****Figure 6-6. Stratocumulus Clouds (SC).****Figure 6-7. Cumulus Clouds (CU).**

**6.6. Middle Clouds.** In the middle cloud family are altostratus, altocumulus, and nimbostratus clouds. In the middle latitudes, middle cloud bases range from about 6,500 feet to about 20,000 feet AGL. These clouds may be composed of ice crystals, water droplets, and/or supercooled water droplets. The middle cloud family has the most variation of the four families and contains a few of the most dangerous clouds, notably the altocumulus standing lenticular and rotor clouds which indicate the likelihood of moderate to severe turbulence. Therefore, accurate recognition can be crucial to flight safety.

**Figure 6-8. Altostratus Clouds (AS).**

**6.6.1. Altostratus (AS).** *Altostratus* are relatively uniform gray to blue sheets covering the entire sky (Figure 6-8). Altostratus will signal the arrival of a warm front or approaching storm by appearing as a thinly veiled, whitish-gray sheet. The sunlight dimly shines through this higher altostratus cloud deck as though shining through frosted glass. The altostratus usually becomes thicker or lowers until the sun gradually disappears and assumes a grayer, uniform appearance. Light precipitation usually will form in lower altostratus clouds. Aircraft experience little or no turbulence but may experience moderate icing in this type of cloud.

**6.6.2. Altcumulus (AC).** *Altcumulus* are white or gray patches of solid cloud (Figure 6-9). Altcumulus also can be composed of both water and ice crystals of varying compositions. These clouds are associated with many types of approaching frontal systems and often signal a change in the weather in the next few hours. Altcumulus develops from dissolving altostratus or lifted cumulus. Altcumulus clouds can appear as layered cells and also be encountered at differing altitudes.

**6.6.2.1.** Altcumulus clouds aligned in rows parallel with mountainous terrain usually signal turbulence. Aligned altcumulus cloud patterns can be spotted on visible satellite imagery and should be treated with utmost respect. A particularly dangerous variety of altcumulus is the altcumulus standing lenticular (ACSL). It is discussed in the Special Cloud Types section of this chapter.

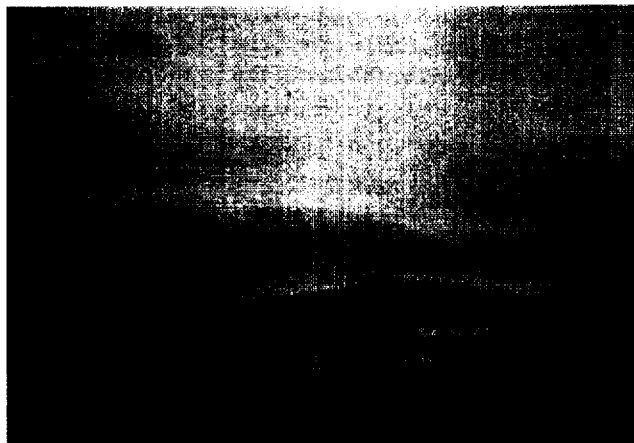
**6.6.3. Nimbostratus (NS).** *Nimbostratus* is a gray or dark, extensive cloud layer accompanied by continuous precipitation (Figure 6-10). This cloud is classified as a middle-cloud, although it generally extends downward into the low cloud ranges. Nimbostratus appear as dense threatening clouds, and often produce nearly continuous periods of precipitation. When precipitation becomes heavy, the bases of nimbostratus clouds become obscured and affect cloud measuring equipment. Nimbostratus clouds can vertically extend in a continuous cloud layer from a couple hundred feet AGL up to 20,000 or more. Flight visibility is considerably reduced in heavy precipitation. Ragged cloud shreds underneath nimbostratus clouds are called *stratus fractus*. This particular variety of stratus often accompanies strong low level wind conditions.

**6.7. High Clouds.** Cirrus, cirrostratus, and cirrocumulus--the cirriform clouds--are the most common upper level clouds. These cloud bases range from about 16,000 to 45,000 feet in mid-latitudes. The upper limit of these clouds may be as high as 60,000 feet in the tropics. Since cirriform clouds are composed of ice crystals, they do not present a significant icing hazard. Thick cirriform clouds can affect air refueling operations by restricting in-flight visibilities.

**6.7.1. Cirrus (CI).** *Cirrus* clouds are thin, feathery clouds in patches or narrow bands (Figure 6-11). Clouds arranged in bands or connected with cirrostratus or altostratus, may be a sign of approaching bad weather. Wispy cirrus appearing to have trailing tails or looking like "mares tails" indicates upper level wind direction and relative speed. The tail is formed by precipitating ice crystals falling into slower moving, lower level winds thus forming the "tail" appearance.

**6.7.1.1.** Cirriform clouds can also indicate the presence of a jet stream (see Chapter 9). Cirrus clouds often evolve from the upper part of thunderstorms or cumulonimbus clouds. They can blow away from the main cloud, or the main portion of the cloud may evaporate, leaving only the ice crystal top portion. Cirrus clouds herald incoming bad weather or indicate that stormy weather is still several hundreds of miles away.

**6.7.2. Cirrostratus (CS).** *Cirrostratus* clouds are thin, whitish cloud layers appearing as a sheet or veil (Figure 6-12). The ice crystals composing cirrostratus may produce halos. Sunshine will appear slightly dimmed through cirrostratus clouds. Gradually thickening cirrostratus will eventually transition into high level altostratus clouds. Classic cirrostratus usually signal the approach of a warm front by 12 to 24 hours. Since cirrostratus occur only in stable layers, expect little to no turbulence. Icing, if any, is light and normally poses no significant hazards.

**Figure 6-9. Altocumulus Clouds (AC).****Figure 6-10. Nimbostratus Clouds (NS).**

**6.7.3. Cirrocumulus (CC).** *Cirrocumulus* clouds are thin, closely-spaced, individual elements, appearing as small cotton balls (Figure 6-13). This cloud may result from the lifting of a shallow unstable layer, but more often develops from a layer of cirrostratus and consists primarily of ice crystals. Heat loss by radiation occurs from the top of the cirrus layer, and the cooler air sinks into the cloud, setting up shallow convective currents within the layer. Large layers of cirrocumulus can form the so-called "mackerel sky." Cirrocumulus signals upper level instability and can precede thunderstorms by up to 12 hours. Expect some turbulence in cirrocumulus.

**6.8. Clouds with Extensive Vertical Development.** Clouds in this family are towering cumulus and cumulonimbus. Their bases range from the low to middle categories and their tops up through the high category. These cloud types are treated separately because of their significance to flying operations.

**6.8.1. Towering Cumulus (TCU).** *Towering cumulus* (TCU) is an important variety of the cumulus cloud. It is a transition type cloud between the fair weather cumulus and the eventual cumulonimbus (CB) cloud. Not all towering cumulus clouds become cumulonimbus but towering cumulus does indicate the potential for further vertical development (Figure 6-14). Towering cumulus clouds signal changes in atmospheric stability from stable to unstable. Carefully watch for rapidly growing towering cumulus clouds. Rapidly growing TCU indicate an unstable atmosphere with thunderstorms probable within minutes. The towering cumulus is usually accompanied by turbulence and icing. TCUs are significant enough to be reported by weather observers in their official observations.

Figure 6-11. Cirrus Clouds (CI).



Figure 6-12. Cirrostratus Clouds (CS).

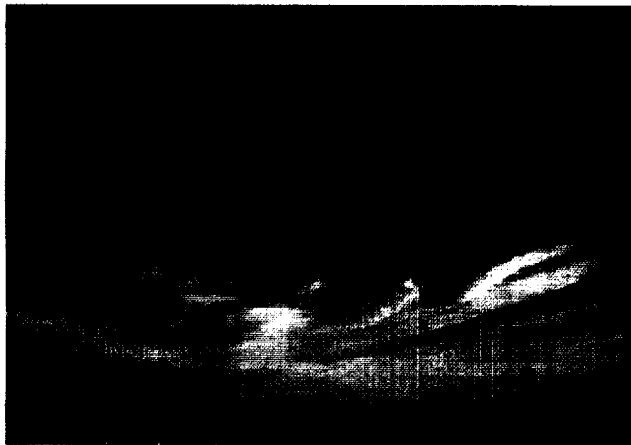
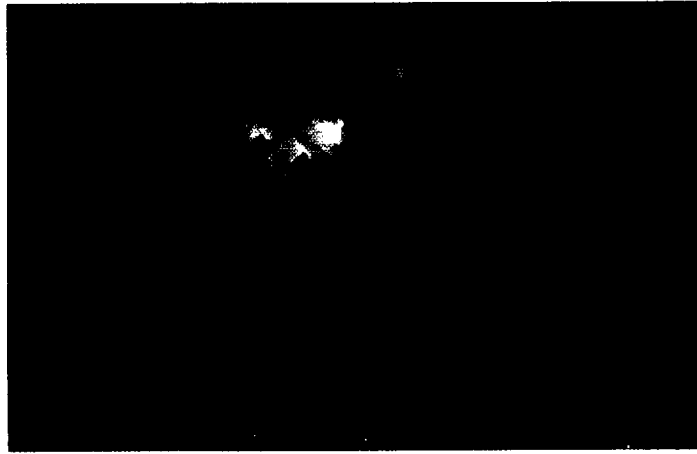


Figure 6-13. Cirrocumulus Clouds (CC).



**Figure 6-14. Towering Cumulus Clouds (TCU).**

**6.8.2. Cumulonimbus (CB).** *Cumulonimbus*(CB) clouds are large, dense, towering clouds with cauliflower-like tops. The mature cumulonimbus' top portion is often flattened into the classic anvil shape or consists of a cirrus formation (Figure 6-15). Water droplets form the major portion of cumulonimbus, but ice crystals appear in the upper portions.

**6.8.2.1.** Cumulonimbus and thunderstorm are synonymous terms. Cumulonimbus result in strong winds, lightning, and potentially heavy rains. A well developed cumulonimbus can spawn hail and tornadoes (Figure 6-16). Dangerous wind shears are often encountered with strong updrafts and downdrafts associated with thunderstorm activity. An expanded review of this well respected cloud is treated in Chapter 13.

**6.8.3. Flight Conditions Associated with Vertically Developed Clouds.** Isolated towering cumulus or cumulonimbus seldom present a flight problem since these clouds can be circumnavigated. But when these clouds rapidly develop into groups or lines of cumulonimbus, they become great flying hazards and difficult to circumnavigate. They may also become embedded and hidden in stratiform clouds, resulting in hazardous instrument flight conditions. Associated turbulence and icing dangers always may affect safety of flight. Avoid flying near or under cumulonimbus. (See Chapter 13, Thunderstorms, Lightning, and Associated Hazards).

**6.9. Altocumulus Standing Lenticular (ACSL).** *Altocumulus Standing Lenticular* clouds form on the crests of waves created by barriers in the wind flow (Figure 6-17). Condensation in the wave's ascending portion forms the cloud. In the wave's descending portion, the cloud evaporates. Thus, the cloud appears not to move although very strong winds can blow through it. Avoid these clouds, since their presence is a good indicator of severe turbulence. (See Chapter 9, Mountain Wave Turbulence.)

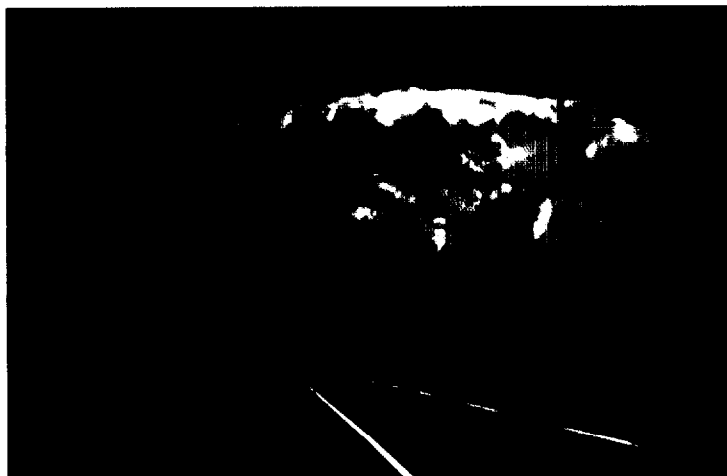
**Figure 6-15. Cumulonimbus Cloud (CB).**

Figure 6-16. Tornado.



Figure 6-17. Altocumulus Standing Lenticular (ACSL).



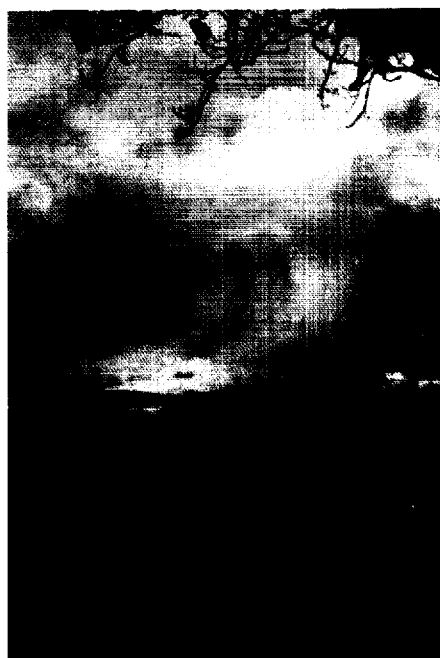
**6.10. Rotor Clouds.** *Rotor clouds* form on the lee side of mountains. Rotor clouds look like a line of small cumulus clouds parallel to the mountain (Figure 6-18). The rotor cloud gives visible clues to probable turbulence associated with mountain wave activity. Aircrews may encounter extreme turbulence in the vicinity of rotor clouds. Chapter 9, Mountain Wave Turbulence contains further descriptions.

**6.11. Special Topics--Virga.** *Virga* appears as wisps or streaks of water or ice attached to the bottom of a cloud but not reaching the surface (Figure 6-19). Precipitation falling from these high-based clouds evaporates before reaching the ground. The evaporation process cools the air. This cooler, denser air sinks creating a downdraft. If the virga reaches the ground, it's reported as precipitation. However, if the virga continuously evaporates, it can form *microbursts*, which are intense small scale downdrafts.

Figure 6-18. Rotor Clouds.



Figure 6-19. Virga.



**6.11.1. Microbursts.** Microbursts are another hazard warranting further discussion in Chapter 10. In fact, several fatal aircraft accidents have been attributed to wind shear caused by microbursts. Therefore, recognizing virga helps you avoid the microburst and dangerous strong downdrafts associated with high-based thunderstorm activity.

**6.11.2. Condensation Trails (CONTRAILS).** *Contrails* are clouds formed (Figure 6-20) in an aircraft's wake when the moisture content of the air at a particular temperature exceeds a critical amount. This condition can be attained by two methods: (1) adding water vapor from an external source, or (2) changing the temperature and pressure of the air so that the resulting mixture is saturated.

**6.11.2.1. Contrail Formation.** Jet aircraft disturb the environment in two important ways. First, a jet engine consumes large quantities of fuel and emits a large amount of water vapor. This forms the *engine exhaust* contrails. Second, the rapid movement of air over the wings and body of the aircraft generates vortices that persist until their energy dissipates. This forms the *aerodynamic* contrails.

**6.11.2.2. Engine Exhaust Contrails.** Engine exhaust contrails form when water vapor in the exhaust gas mixes with and saturates the air in which the aircraft flies. The maximum period of exhaust contrail formation is the winter season. In very cold arctic air, contrails may form at the surface. A change in altitude or power setting may eliminate exhaust contrails.

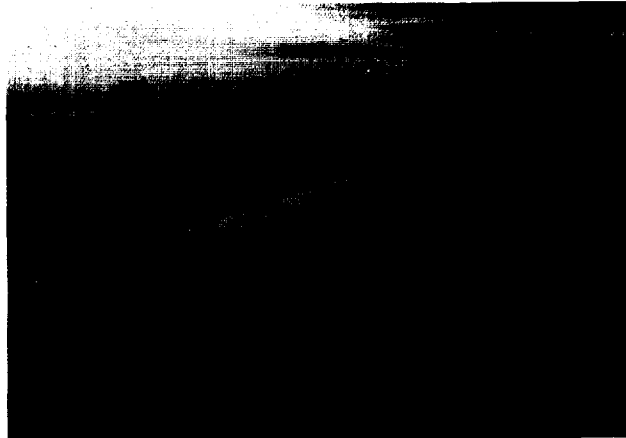
**6.11.2.3. Aerodynamic Contrails.** If the aircraft is flying through a dry, stable environment, the water vapor by-product will form a short-lived contrail or none at all. The reduction of air pressure when air flows at high speed over an airfoil causes the



aerodynamic contrails. These contrails are of short duration. A small change in altitude, attitude or airspeed usually stops their formation.

**6.11.2.4.** In a tactical environment, contrails highlight an aircraft's position. Of course, this seriously degrades the effectiveness of aircraft missions during combat operations. During mission planning, ask the forecaster about the likelihood of contrail formation and the altitudes expected for contrail formation. Reporting contrails on a pilot report (PIREP) alerts other aviators to their existence.

**Figure 6-20. Contrails.**




---

## Chapter 7

### AIR MASSES

**7.1. Introduction.** An understanding of air masses helps aircrews anticipate certain kinds of flying weather associated with particular air masses. Certain air masses are more prone to develop persistent cloudiness and shower activity while other air masses generally have clear skies and few flying hazards. For example, if an air mass is of Arctic origin, it will usually have little moisture content and have strong temperature inversions relatively close to the earth's surface. Summertime continental polar air masses from Canada are quite refreshing after an extended bout of maritime tropical "hazy, hot, and humid" weather. Tropical air masses have a much higher moisture content and higher average temperatures from the surface to the tropopause. Whether an air mass forms in a dry desert region or a moist maritime region also determines flying weather conditions. Collisions between two differing air masses result in a variety of weather along fronts. Lets examine air masses in closer detail.

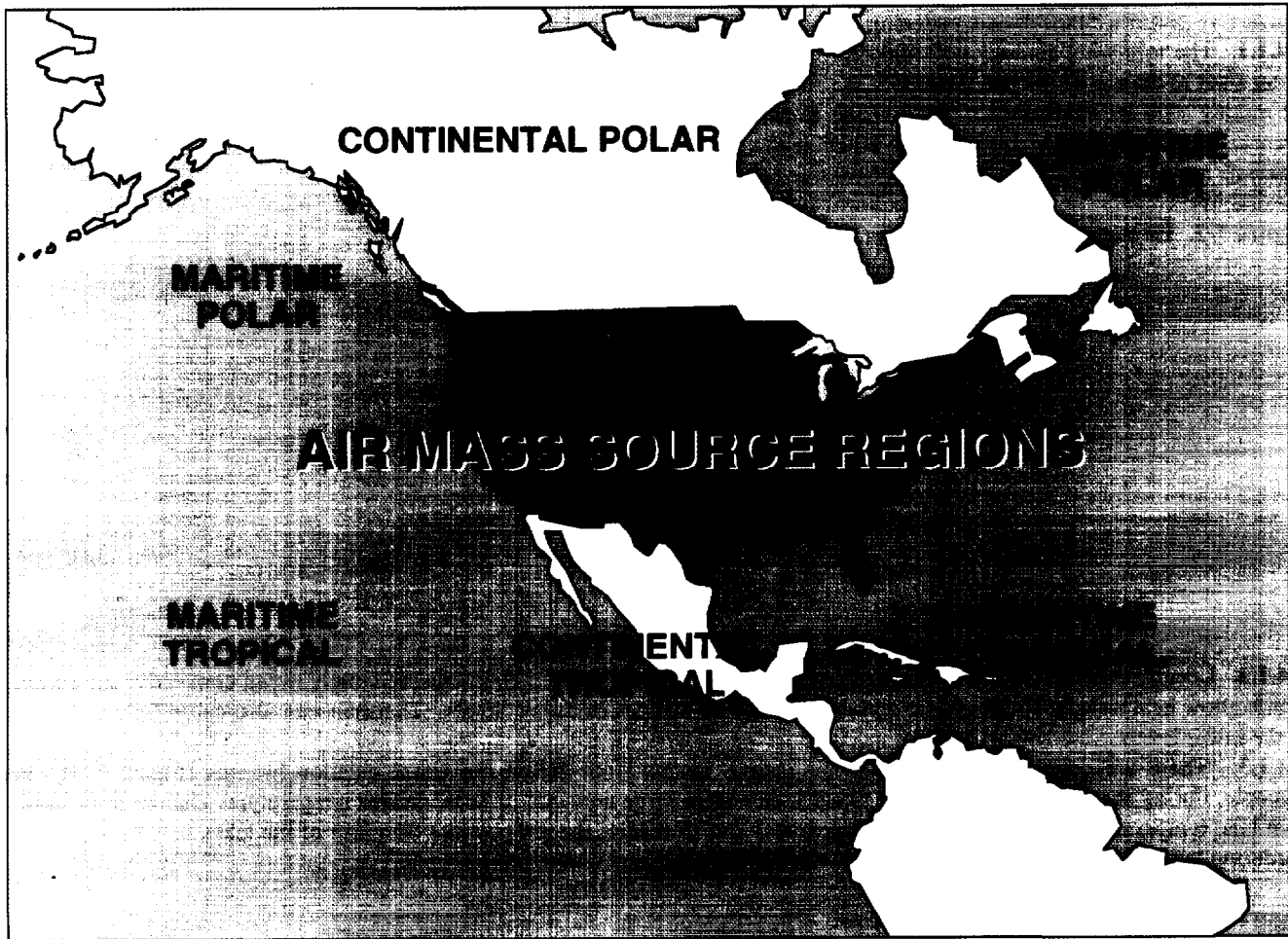
**7.2. Source Regions.** The *source region* is where an air mass acquires its characteristic temperature and moisture attributes. The ideal source region has uniform characteristics: a uniform land or water surface, uniform temperature, and little air movement. In general, the best source regions are large land or ocean areas with little topographic relief and temperature differences.

**7.2.1.** Good air mass breeding grounds include deserts, high plateaus, snowy or ice covered tundra, and oceans with uniform surface temperatures. Source regions also have quasi-stationary pressure systems which allow little active weather. Midlatitudes are poor source regions because weather systems seldom stagnate long enough to acquire uniform characteristics.

**7.2.2.** Once an air mass starts moving from its source region, frontal zones will develop as air mass differences become more pronounced. Frontal zones separate two air masses and can be active or inactive. Some frontal zones, such as the polar front, separate two distinct air masses almost all year round. The polar front is stronger in the winter than during the summer and separates the continental polar air from the maritime tropical air. We will talk more about the polar front in Chapter 8.

**7.2.3.** Figure 7-1 shows the source regions for air masses affecting North America. These regions include the plains of northern Canada, the polar ice cap, the North Atlantic, the North Pacific, the Atlantic and Pacific near 30°N latitude, the Gulf of Mexico, and the arid regions of the southwestern United States and northern Mexico.

Figure 7-1. Typical Air Mass Source Regions.



**7.3. Air Mass Classification.** A detailed worldwide air mass analysis is beyond the scope and space of this manual. This section presents a general description of common air masses affecting the continental United States. The same kinds of source region conditions also characterize air masses which affect Europe and Asia.

- Continental polar (cP): Air stagnating over northern continental regions forms continental polar or continental arctic (cA) air masses. They are cold and dry, with little moisture. Their source region is very stable.
- Maritime polar (mP): Form over northern oceanic areas. Generally, they are not as cold as cP air masses (especially in winter), have a higher moisture content, and are either stable or unstable.
- Maritime tropical (mT): Form over warm oceanic areas near 30°N latitude in the high-pressure cells. Has a high moisture content and is stable in its source region. When moving over land, maritime Tropical air becomes unstable typically resulting in hot, and humid conditions with thunderstorm activity during the summer. Maritime Tropical air will tend to stabilize while moving over land during the winter resulting in cloudy, foggy conditions.
- Continental tropical (cT): Forms over desert or high plateau regions. These air masses are hot, dry, and unstable. Due to the absence of water vapor, they produce few showers. When precipitation forms, it tends to be high-based thunderstorms with virga and/or short, intense showers which can cause flash flooding and strong, damaging winds.

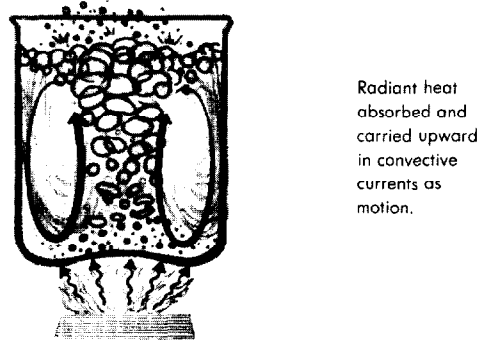
**7.4. Air Mass Modification.** Just as an air mass tends to take on the temperature and moisture properties of its source region, it also modifies when moving to a new location. The modification processes affects air mass moisture and stability and ultimately determines the predominant air mass weather. The degree of air mass modification is dependent on the following factors:

- The speed at which it travels.
- The terrain of the region it moves over.
- The temperature difference between the new surface and the air mass.
- The depth of the air mass.

**7.4.1. Warming from Below.** When a cold air mass flows over a warmer surface, heat flows from the ground to the air. Convective currents carry the heat to higher and higher levels. This results in the air mass becoming more unstable. The convective process mixes the air, reducing the temperature differences between the land surface and the air mass.

**7.4.1.1.** The following analogy will illustrate the convective process. If a large pan of water is heated on a stove, the heated water rises to the top of the pan (Figure 7-2). As long as direct heat is applied to the pan, the heated water distributes the heat by mixing with its environment while rising to the water surface. The warmer water has become unstable and will rise because the rising water is attempting to equalize the pan water temperature. The locally warmed pockets of rising water are *thermals* and closely simulate the atmosphere's actions.

**Figure 7-2. Heating from Below Causes Instability.**

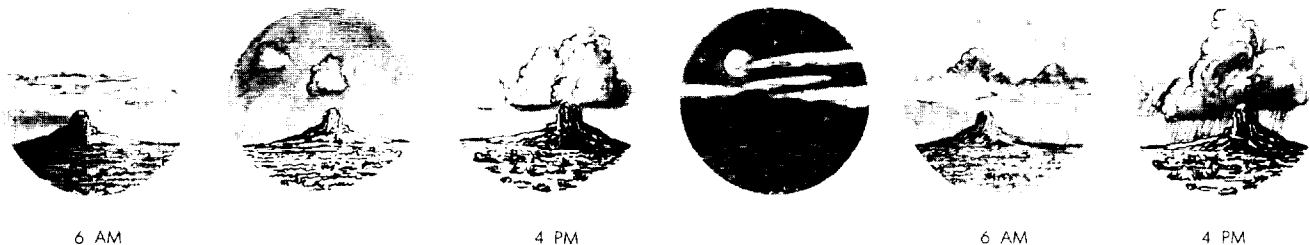


**7.4.1.2.** Locally warmed parcels of air will rise also producing thermals. Thermals are simply rising convective air currents which allow heat transfer to take place and can visually be seen as cumulus clouds. Thermals can also cause light turbulence in the lower levels.

**7.4.1.3.** There are certain situations when air masses heated from below can cause aviation hazards (Figure 7-3). For example, during the summer months, the Great Lakes store large amounts of heat. Water temperatures change more slowly than land temperatures. Therefore, as summer transitions to winter, the temperature decrease of the lakes lags far behind the bordering land, making the water temperature warmer than the land temperature.

**Figure 7-3. Heating Moist Air from Below.**

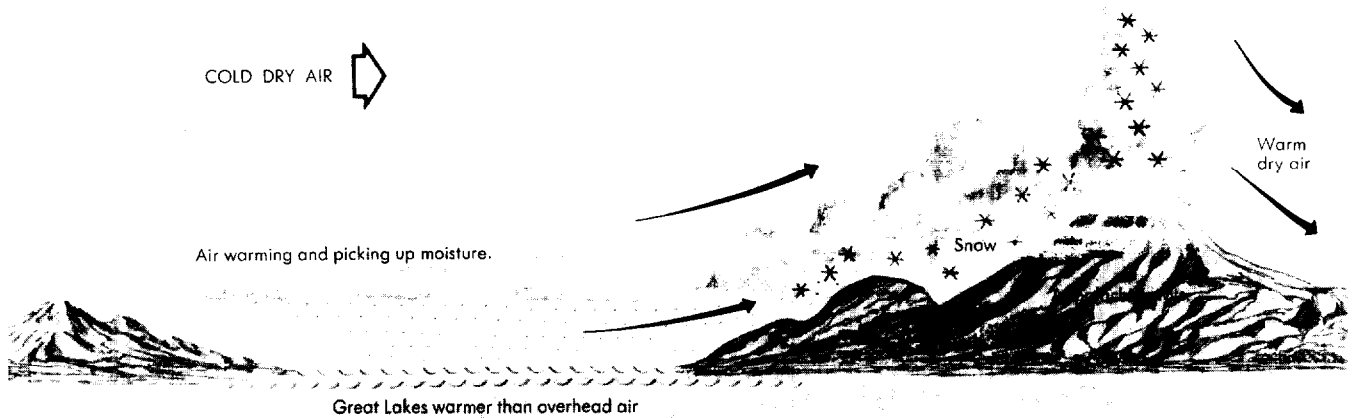
Instability builds when night cooling does not nullify day heating.



**7.4.1.4. Lake Effect Snowshowers.** Figure 7-4 shows a cold air outbreak from the north flowing over the lake, creating a large temperature difference between the air and the lake's surface which considerably warms the lower levels of the air. As the lake heats the lower air mass levels, additional moisture is also being added. The result is instability, with snow showers forming over the lake and spreading downwind over adjacent land areas. Heavy snow showers can quickly drop ceilings and visibilities to below field minimums. Snow showers and snow squalls can last from a few minutes to a few hours. In addition, many lake effect snow showers are accompanied with gusty surface winds and low level turbulence.

**7.4.1.5.** These "lake effect" snows can accumulate over an inch per hour and accumulate over several feet before ending while lasting intermittently over several days. Lake effect snows commonly blanket the eastern shores of the Great Lakes affecting western New York, western Pennsylvania, northern Ohio, Indiana, Illinois, and various parts of lower and upper Michigan. If the winds are just right, eastern Minnesota will also be affected by Lake Superior. Heavy snows from colder air moving over warmer waters also affect the west coast of Korea and many northern Japanese islands.

Figure 7-4. Heating Cold, Dry Air from Below Causing Lake Effect Snowshowers.

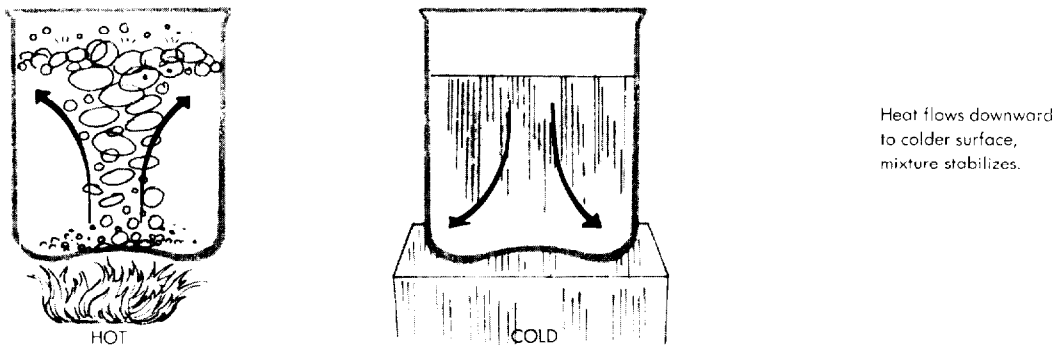


7.4.1.6. During winter months, aircrews flying adjacent to the Atlantic coastline between New England and Bermuda nearly always report cumulus clouds just off shore of the United States. The cumulus activity is the result of warm ocean temperatures of the Gulf Stream interacting with the colder air from the continental United States. Many times the clouds are aligned in "cloud streets." Expect light turbulence when flying in the vicinity of cloud streets, principally in low level flying operations.

7.4.2. **Cooling from Below.** When an air mass flows over a colder surface, heat transfers from the air to the ground. This cooling from below increases the air mass's stability. If the air cools to its dew point, stratus and/or fog forms. Compare this (Figure 7-5) to placing a pan of boiling water on a block of ice. As the liquid cools from below, it stops boiling and stabilizes. The cooler water will stay at the bottom of the pan and will have no reason to circulate through the rest of the pan. No convective process can take place. Basically, the same process happens when an air mass is becoming cooled from below.

7.4.2.1. **Haze, Fog, Smog.** One important thing to remember in this situation is that there is no limit to how stable an air mass can become. Prolonged cooling in the lower layers sometimes sets up conditions so stable that daytime heating cannot overcome the extreme stability therefore there will not be any convective currents. Haze, fog, stratus, and smog hazards become more prevalent over time.

Figure 7-5. Cooling from Below Improves Stability.

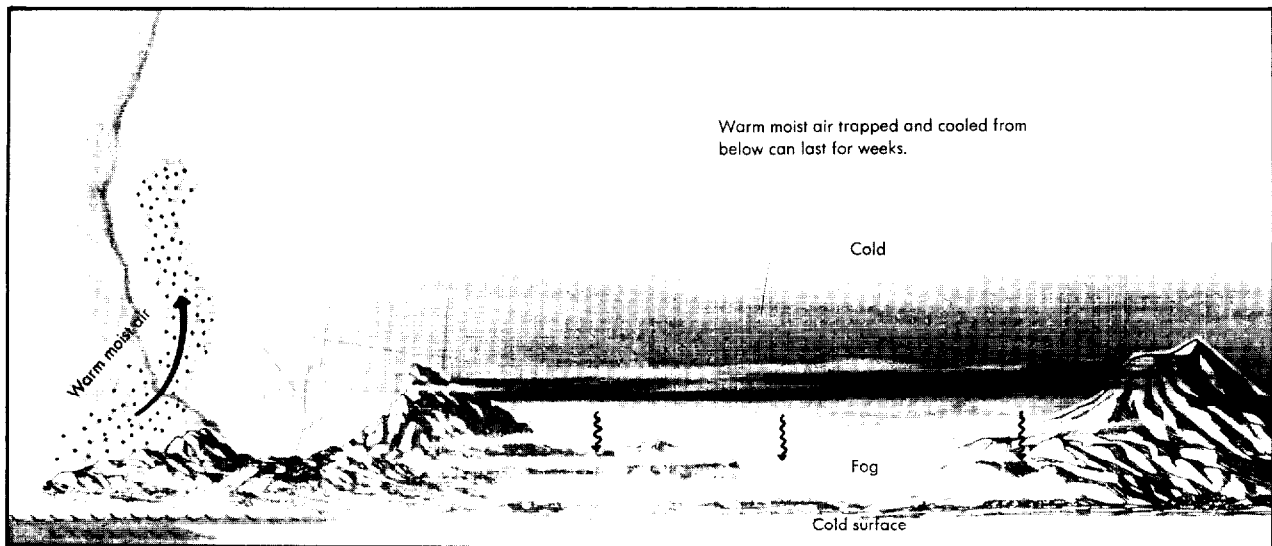


7.4.2.2. Many locations in the United States are favorable for stable air to become entrenched and stagnate. Local topography helps maintain stability by trapping stable air and not allowing circulation or drainage. Fog and stratus can form in the cooled air and restricted ceilings and visibilities can remain for weeks. A few notorious western locations are the Sacramento and San Joaquin Valleys of California and Oregon's Medford Valley.

**7.4.2.3. Air Stagnation.** Some of the worst air pollution cases have also resulted from air stagnation. The Los Angeles basin, industrial cities in England, and some Mediterranean cities are favorable for thick smog formation. Normal upward convective currents cannot penetrate the inversion, so smoke, automobile exhaust, and other pollutants spread out laterally butting against the mountains. Extreme cases of air stagnation can reduce slant visibilities to 1/2 mile or so with horizontal visibilities not much better (Figure 7-6).

**7.4.2.4. Advection Stratus and Fog.** Another common situation develops when advection stratus and fog forms in the cooling, stable air. Advection stratus and fog forms over the water source and moves over land areas. Many parts of England, Newfoundland, and southeast coast of China experience this fog problem. In the United States, it frequently happens along much of the Pacific Coast and sometimes in the southeastern United States, and along the lee shores of the Great Lakes and other large water bodies.

**Figure 7-6. Warm, Moist Air Trapped, Cooled from Below Causing Air Stagnation.**



**7.4.2.5. Gulf Coast Stratus.** When the Bermuda high pressure cell affects the southeastern United States, the resulting circulation makes a wide sweep over the Atlantic Ocean where it picks up moisture. As the air moves over the Gulf of Mexico and funnels inland along the Appalachian Mountains and coastal plains, the colder land cools the moist, warmer air causing widespread stratus and fog often called "Gulf Stratus." In early spring or fall, as shown in Figure 7-7, it is not uncommon to see most of the eastern United States covered with low stratus. The balance between sufficient heating to keep the air clear and cooling to allow condensation within a stable air mass is sometimes so delicate that minor temperature changes can cause clouds and fog to develop or dissipate.

**7.4.2.6.** The persistent Pacific coastal stratus and fog results from warmer maritime tropical air being gradually cooled by the colder Pacific Ocean currents. The prevailing westerly surface winds force the fog ashore during the late afternoon/early evening and fog persists well into the next day. This common late spring, summer, and early autumn phenomenon results in widespread IFR ceilings and visibilities.

**7.4.2.7. Arctic Inversions.** The long Arctic nights are responsible for the formation of strong low level inversions in Alaska's interior. Inversion temperatures can be up to 50°F warmer than the surface temperatures (Figure 7-8). Sound is greatly amplified and carries farther than normal distances. Light rays are bent as they pass through the arctic inversion at low angles causing objects below the horizon to appear to be above the horizon. This effect, known as "looming," is a mirage. Mirages distort the shape of the moon, sun, and potential targets.

**7.4.3. Other Air Mass Modifying Causes.** Geographical terrain changes will modify an air mass within a relatively short distance. Water vapor can be added to the lower layers of an air mass from evaporation of water surfaces, lakes, rivers, swampy terrain, falling liquid precipitation, or sublimation from ice or snow surfaces. Elevation differences can deplete air moisture as the air is forced up the sloping terrain. The sharpness of terrain differences determines the extent of air mass modification.

**7.4.3.1. Orographically Lifted Air.** Air can be orographically forced up higher terrain and will be modified as condensation processes occur. Gently forced air, such as moist air circulating northward from the Gulf of Mexico into Texas and Oklahoma, can produce extensive stratus cloud shields. The stratus cloud shields can gradually move north until reaching as

far as eastern Nebraska and Kansas, Iowa, Illinois, and southern Minnesota. Under certain conditions, a nocturnal low-level jet stream can form (see Chapter 9) and rapidly move this gulf stratus northward into the central US.

Figure 7-7. Warm, Moist Air Cooled from Below Causing Gulf Stratus.

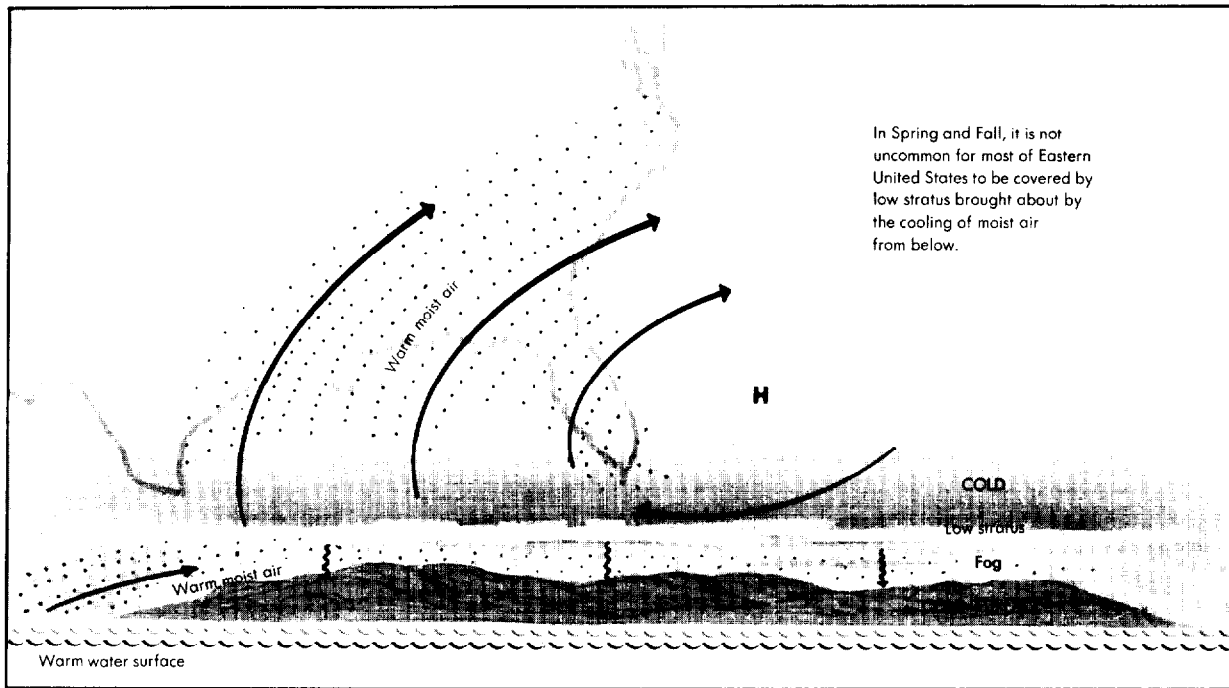


Figure 7-8. Arctic Inversion Stable Layer.

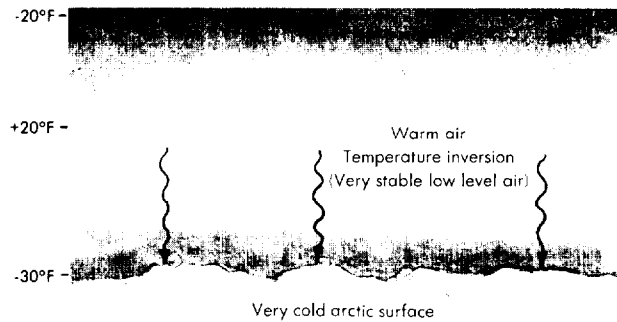
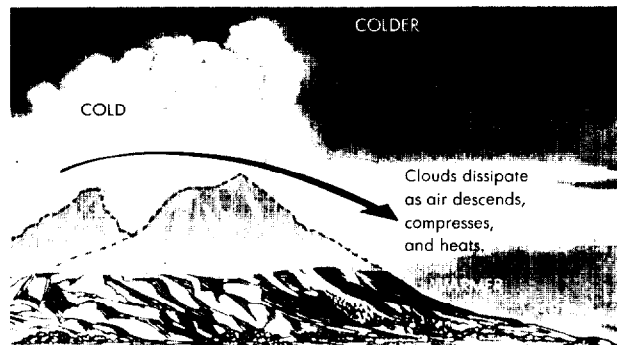


Figure 7-9. Sinking Air Increases Stability.



7.4.3.2. Orographically forced air up mountain slopes often results in clouds on the windward side obscuring mountain peaks. Precipitation and cloud cover amounts widely vary from the windward side of mountains compared with the leeward side. On

the windward side, as air condenses releasing moisture, the unstable air eventually rises on its own and is forced downslope on the leeward side (Figure 7-9). The air, heated by compression, is much warmer and drier resulting in a cloud free area. The persistent cloud free areas on the leeward side of mountain ranges is called the *rain shadow* effect.

**7.4.4. Stability.** An air mass's stability determines its typical weather characteristics. Assuming that sufficient moisture is available, Figure 7-10 lists typical characteristics of stable and unstable air masses.

**Figure 7-10. Air Mass Weather Characteristics Based on Stability and Moisture.**

Stable Air Mass	Unstable Air Mass
Stratiform clouds and fog	Cumuliform clouds
Continuous precipitation	Showery precipitation
Smooth air	Rough air (turbulence)
Fair to poor visibility	Good visibility (except in precipitation blowing sand or snow)

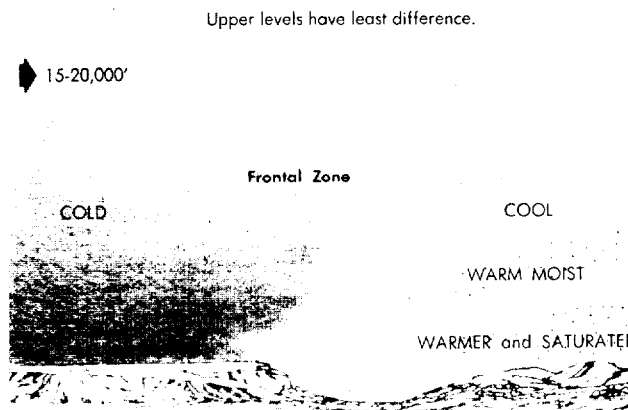
## Chapter 8

### FRONTS

**8.1. Introduction.** When most people think of weather, they think of common weatherman terms such as cold fronts, warm fronts, high and low pressure systems, with the associated weather. Weather programs focus on frontal weather for good reason. This is where the active weather is concentrated, along fronts! The term "front" was coined in the early 1920's by Scandinavian meteorologists who found it advantageous to discuss active weather using the military analogy of opposing armies meeting at the battle front. The concept of fronts and air masses and weather chart analysis of fronts still forms an important part of practical meteorology today.

**8.2. Definition of Fronts.** *Fronts* are boundaries between air masses with temperature and density differences (Figure 8-1). The boundary or contrast zone between two differing air masses is called a *front* with the air mass on the earth's surface called the *surface front*. The frontal zone shape is determined by the frontal zone type and the extent of air mass differences. Most active weather is focused along and on either side of a surface front and frontal zone. Likewise, most aviation weather hazards are also found in the vicinity of fronts. In the mid-latitudes, fronts usually form between tropical and polar air masses.

**Figure 8-1. Frontal Zone.**



**8.2.1. Frontal Zones.** *Frontal zones*, normally many miles in width, are most easily detected when the air masses have vastly different properties (e.g., cold, dry air from Canada colliding with warm, moist air from the Gulf of Mexico). Frontal zones are more difficult to locate over data sparse regions like the ocean and between highly modified air masses. Advances in satellite imagery processes and interpretation have helped meteorologists better locate frontal systems. Meteorological satellite imagery is virtually indispensable in data sparse regions. If a flying unit is deployed to a data sparse region, the meteorologist may use satellite imagery as the only tool to locate fronts and other active weather boundaries. Figure 8-2 shows an excellent example of a frontal system sprawling thousands of miles from the parent low pressure system located in the Gulf of Alaska.

Figure 8-2. Satellite Picture of a Front in the Gulf of Alaska.



**8.2.2. Front Types.** There are four basic types of fronts: *warm*, *cold*, *stationary*, and *occluded*. Warm and cold fronts are classified according to how the temperature of the air mass compares to the surface temperature over which the air mass passes. A stationary front generally occurs between two high pressure systems and normally is a former moving front which lost momentum and stalled. Occluded fronts result from either a faster moving warm or cold front overtaking a slower moving front with the surface-based colder air forcing the warmer air aloft.

**8.2.3. Front Symbols.** On a surface analysis chart, fronts are designated with color-coded lines: red for warm fronts, blue for cold fronts, and purple for occluded fronts. Designs (pips) on the line indicate the front type and point in the direction the front is moving. Triangle shaped pips designate cold fronts while half-circle shaped pips designate warm fronts. Mixtures of the pip arrangements indicate either stationary or occluded fronts with stationary fronts designated with alternating blue/red pips on both sides of a front. Occluded fronts use purple colored pips only on one side of the front. Air Force Weather personnel use standard color schemes when processing weather charts on the Automated Weather Distribution System (AWDS) or any other polychromatic source of weather information (Figure 8-3).

Figure 8-3. Symbols for Various Types of Fronts.

Type of Fronts	Color Scheme (If Used)	Symbolized Lines
Cold Front	Blue	Line with triangles pointing towards the front
Warm Front	Red	Line with semi-circles pointing towards the front
Occluded Front	Purple	Line with triangles and semi-circles on opposite sides
Stationary Front	Alternately Blue and Red	Line with alternating triangles and semi-circles on opposite sides
Trough Line	Black (AWS) Brown (NWS)	Solid line (AWS) Dashed line (NWS)
Ridge Line	Black (AWS) Yellow (NWS)	Solid line (AWS) Wavy line (NWS)
Squall Line	Black (AWS) Purple (NWS)	Solid line (AWS) Dashed line (NWS)



**8.2.3.1.** Often typical or "classic" weather patterns precede and follow fronts as they move through an area. Approaching warm fronts are often preceded with an orderly procession of high clouds, middle clouds, and finally the extensive lower clouds. Additionally, weather typically associated with particular fronts may vary according to geographic location. For example, the northernmost portion of a wintertime cold front can have snow showers while the southern portion of the same front can spawn severe thunderstorms. We'll discuss the typical properties associated with the various types of fronts.

**8.2.4. Temperature.** *Temperature* change is one of the most easily recognized features when locating a front because it changes the most. When flying through a front, aircrews notice significant changes in temperature, especially at lower altitudes. The rate of temperature change is an indicator of a front's intensity. Abrupt and sizable temperature changes often accompany strong (narrow) fronts. Gradual and minor changes characterize weak or diffused fronts. Also temperature changes are more pronounced in the lower levels than the upper levels. Thus, for flight safety reasons, update the altimeter setting as often as practical when flying near a front. Chapter 4 discussed the effect of temperature changes on aircraft altimeters.

**8.2.5. Dew Point.** The *dew point* temperature gives a practical measure of an air masses' moisture content. The dew point is valuable because this temperature is readily available on an hourly surface weather observation. The dew point and temperature/dew point difference varies across a front. The "difference," often called the *temperature/dew point spread*, is the difference between the free air temperature and the dew point values. This valuable dew point spread helps identify the front and gives a clue to the potential for cloudiness and fog. The smaller the difference, the more likely for condensation to occur. The higher the dew point, the more moisture an air mass possesses.

**8.2.6. Temperature and Dewpoint Frontal Clues.** Both temperatures and dewpoints are higher behind warm fronts and often result in considerable cloudiness and restrictions to visibility. In the summer, high dew points are a good indicator of shower and potentially strong thunderstorm potential. When monitoring a potentially explosive thunderstorm situation, weather forecasters often focus on the dew point temperature. Generally, if the value is above 65°F, the potential is quite high for strong thunderstorm development. In wintertime, higher dew points indicate the potential for snow, freezing rain, ice pellets, and rain. Higher dew points aloft indicate a potential for icing hazards with air mass stability determining the type and severity of icing.

**8.2.7. Wind.** Frontal passage is evidenced by marked changes in wind direction and speed at the earth's surface and aloft. Wind speed is often variable and usually higher and gustier behind a cold front. Other times, the wind speed may approach calm until the actual frontal surface passes through your location. Steady southeasterly, southerly, or southwesterly winds precede cold frontal passage with the strongest pre-frontal winds observed just before cold frontal passage. Cold fronts are accompanied with gusty westerly, northwesterly, to northerly winds. Again wind strength is a function of the pressure gradient and differences in the air mass densities. The greater the contrasts, the stronger the winds. When flying from warm to cold air, the wind speed increases abruptly since wind speeds are generally greater in a cold air mass.

**8.2.7.1. Rough Terrain Flying.** Be extremely cautious when flying in the vicinity of rough terrain around frontal boundaries. Surface-based directional and speed changes can be quite abrupt, dramatic, and terrain dependent. For instance, surface winds funneled down valleys result in stronger than expected wind speeds when the winds spill out over a nearby airfield. Strong winds moving perpendicular to mountain tops will enhance mountain wave turbulence conditions during and after frontal passage.

**8.2.7.2. Wind Shear.** Be especially alert for *wind shear*. Rapid changes in wind speed and/or direction create wind shear, which is extremely hazardous especially when departing or approaching an airfield. For example, winds at 220 degrees at 10 knots immediately ahead of cold front may be displaced by winds 330 degrees at 20 knots gusting to 30 knots behind the cold front. Wind shear is further discussed in Chapter 10.

**8.2.7.3. Crosswinds.** *Crosswinds* are another hazard frequently accompanied with frontal passage. Runway orientation is the key in determining whether or not you will experience sudden crosswinds such as in our previous example. Momentary or sustained crosswinds are often a problem during strong frontal passage. Be careful! An in-depth discussion on wind hazards follows in Chapter 9, Turbulence.

**8.2.8. Pressure.** A front lies in a *pressure trough*, an area of lowest surface barometric pressure, with the pressure higher on either side of the trough (Figure 8-4). Thus, the pressure usually decreases when a front approaches and rises after the front moves through. The rate of barometric pressure change often accelerates as a front moves through. The change rate can be quite dramatic, up to 0.10" Hg change per hour or more, especially when flying in the vicinity of strong winter storms! Keep an eye on your altimeter and make sure its current!

**8.3. Cold Fronts.** A *cold front* is the leading edge of an advancing cold air mass. Colder air overtakes and wedges underneath the warmer air forcing the warmer air aloft. Surface friction slows the air in contact with the surface, creating a bulge in the frontal slope. This tends to give the front a steep slope near its leading edge (Figure 8-5). Cold frontal slopes average about 1:80 miles. This means that 80 miles behind the front's surface position, the frontal boundary is about one mile above the ground. A steep sloped front (1:40), results in a narrow band of active weather while a shallower sloped front (1:100), results in a wide band of weather.

Figure 8-4. Polar Front Follows Low Pressure Trough.

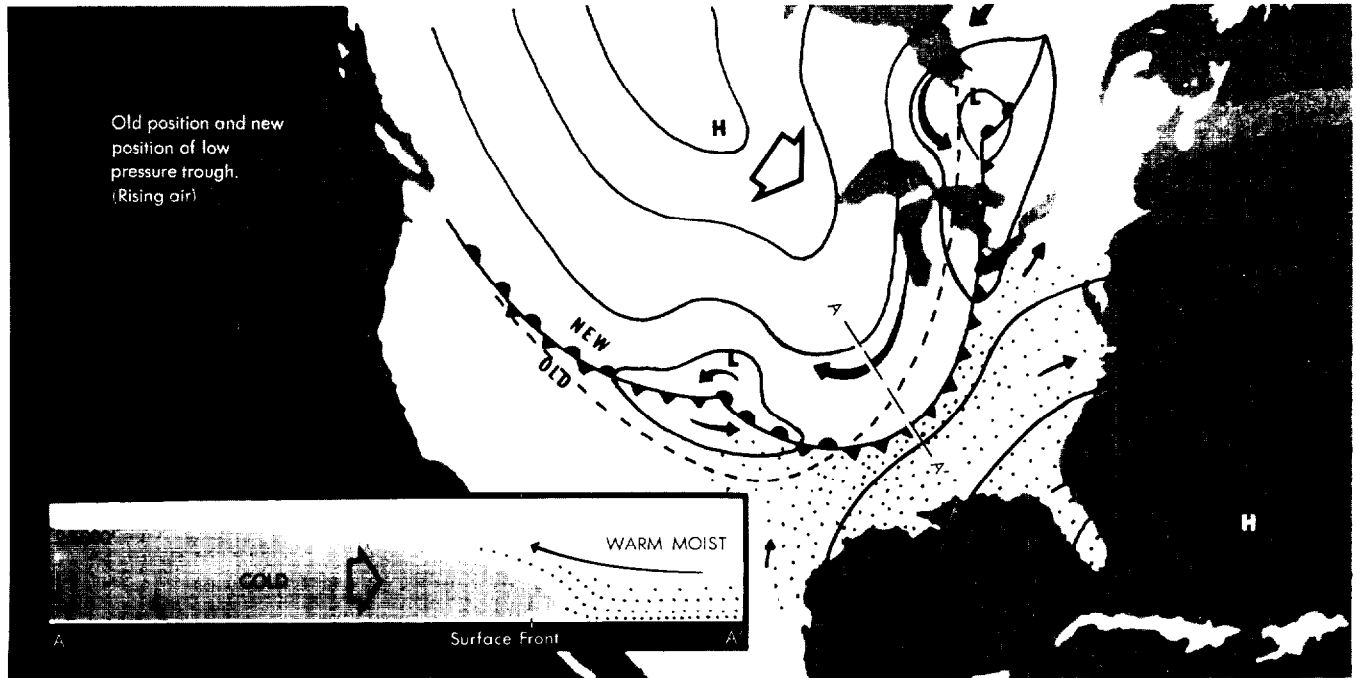
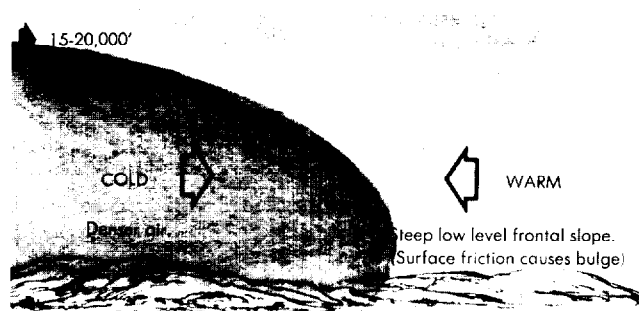


Figure 8-5. Fast Moving Cold Front Runs Under Warmer Air.



**8.3.1. Classic Cold Front.** Cold fronts may be accompanied by dramatic weather changes and hazardous flying weather. Figure 8-6A shows how surface weather charts depict cold fronts. Figure 8-6B shows a cross section of the same front. Note that the vertical dimensions of the front, correctly shown in Figure 8-6C, are exaggerated. For clarity, all illustrations maintain the exaggeration of the frontal structure.

**8.3.2. Cold Fronts: Two Types.** There are two types of cold fronts: fast moving and slow moving. In extreme cases, fast moving cold fronts can move at 50 kts, but normally average between 25-35 kts. The slow moving cold fronts average 10-20 kts. Cold fronts usually move faster in winter than in summer and is dependent upon the jet stream strength and movement for surface speed.

**8.3.2.1. Fast Moving Cold Fronts.** Rapidly moving cold fronts force the air upward in the area ahead of the front's surface position (Figure 8-7). Therefore, most of the thick cumuliform cloudiness and showery precipitation is located just ahead of the front where the opposing air currents meet. The severity of weather is determined by the instability of the warm air ahead of the cold front and clashing air mass differences. If the preceding warm air has a high dew point and strong southerly winds, the potential exists for severe weather. Sometimes if the cold front has a steep slope (1:40) and is quickly moving, a squall line may also form.

**8.3.2.2. Slow Moving Cold Fronts.** When a cold front moves slowly (20 kts or less), there is an upgliding of warm air over the frontal surface. This results in a rather broad cloud pattern in the warm air, with clouds extending well behind the front's surface position. Figure 8-8 shows warm, stable air creating stratiform clouds. Slow cold fronts can affect local flying weather for 12 to 18 hours with slow improvement. If an airfield is located close to rough terrain, the front may momentarily

stall in the higher terrain and affect the local airfield even longer. In the CONUS, this happens in the vicinity of the Pacific coastal mountain ranges and the Appalachian Mountains near the east coast. In the summer, cumuliform clouds and garden variety thunderstorms, as shown in Figure 8-9, develop if the warm air is moist and unstable. This favors periods of snow or snow showers in the winter.

Figure 8-6. Cold Front as Depicted on Surface Weather Charts.

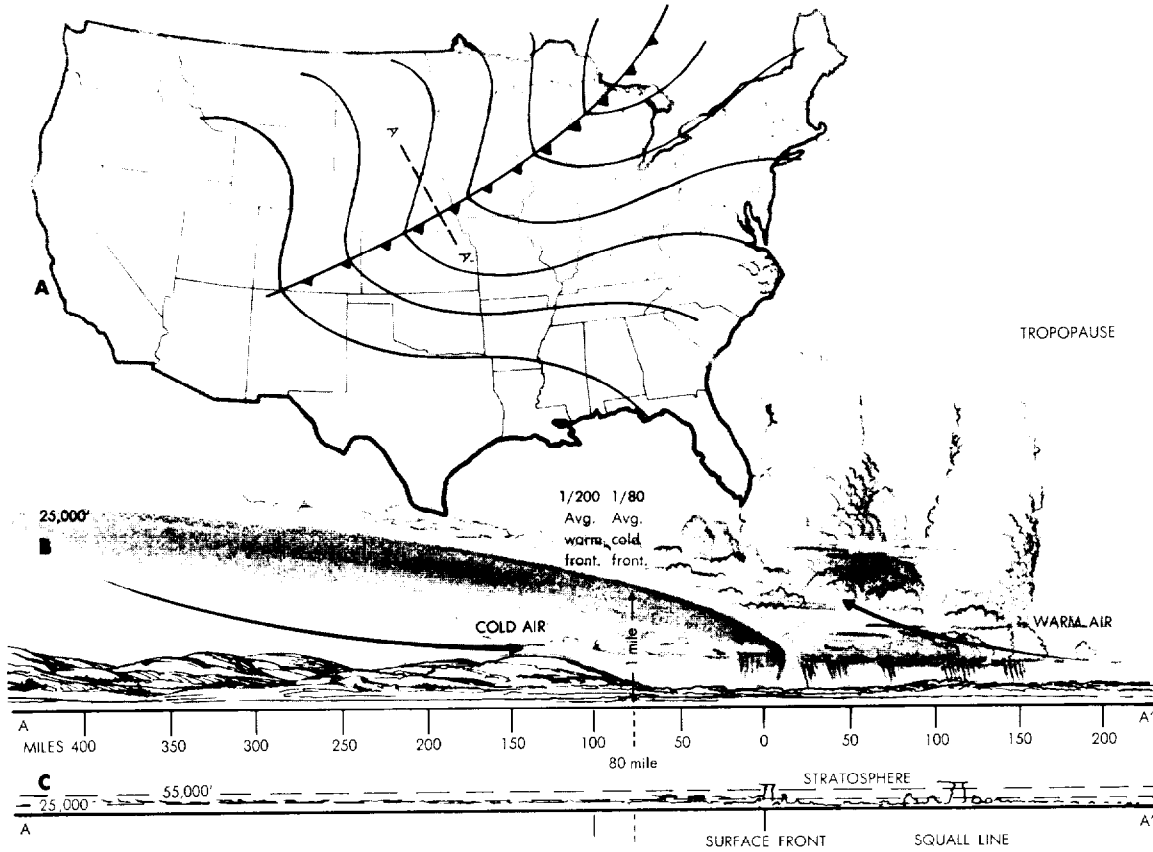


Figure 8-7. Fast Moving Cold Front and Squall Line.

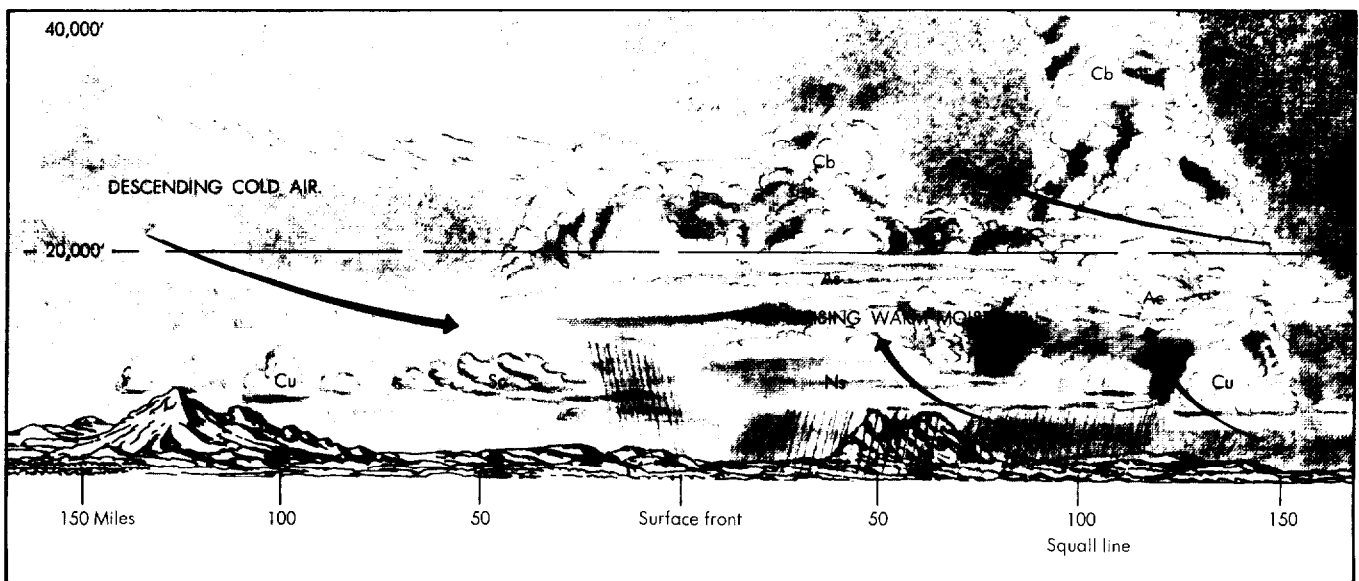


Figure 8-8. Slow-Moving Cold Front and Stable Air.

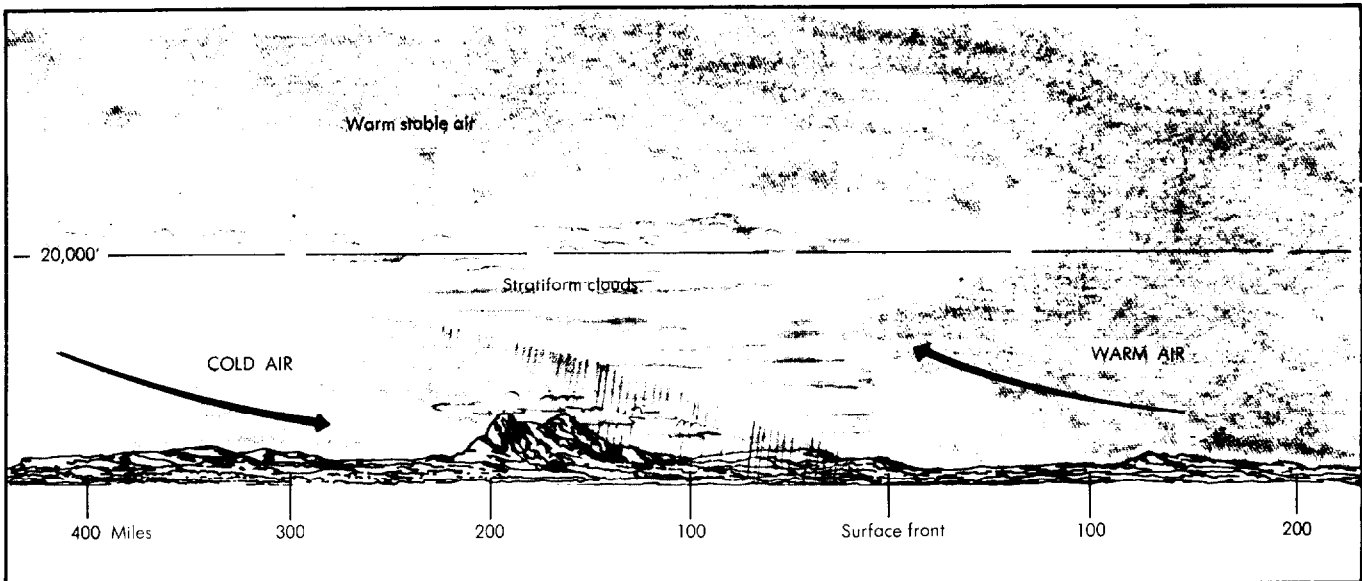
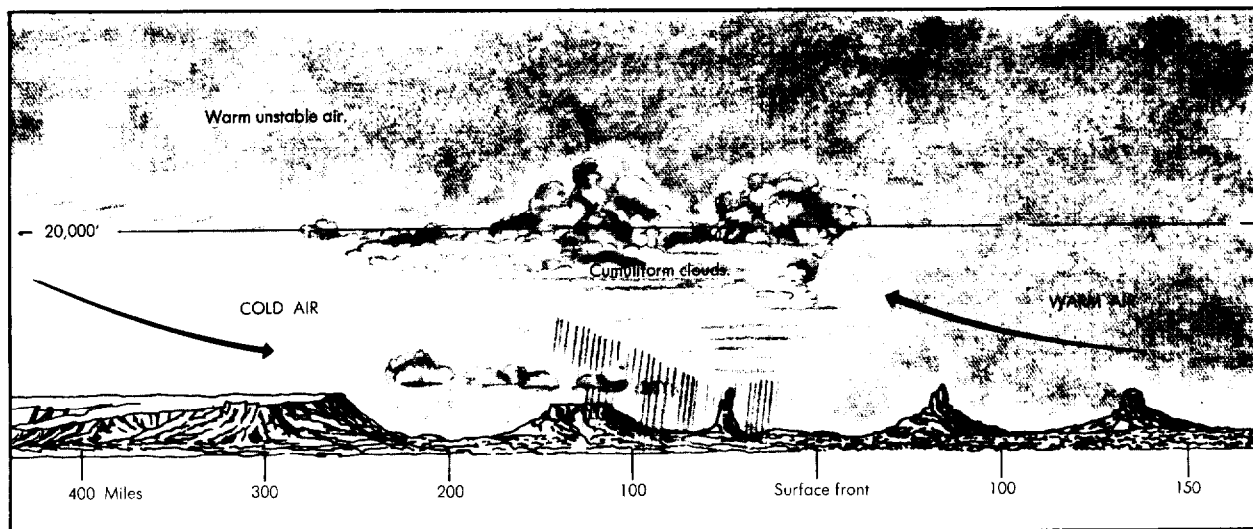


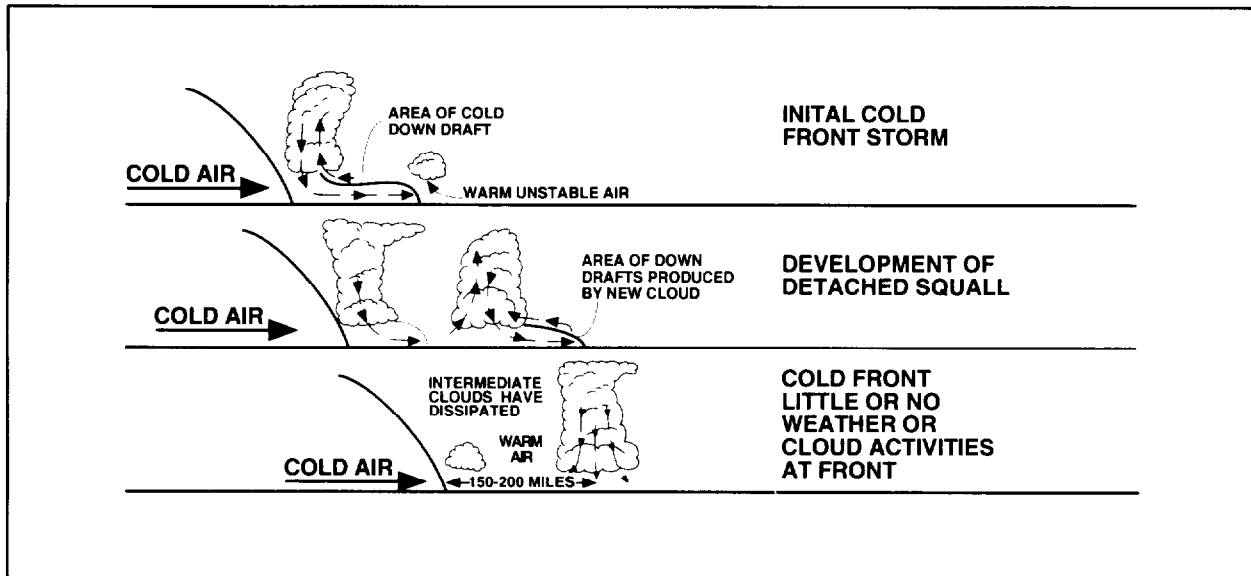
Figure 8-9. Slow Moving Cold Front and Unstable Air.



**8.3.3. Cold Front/Squall Line Weather Hazards.** Under certain atmospheric conditions, a *squall line* composed of thunderstorms may develop 50 to 200 NM ahead of and parallel to a fast moving cold front (Figure 8-7). If a squall line does develop, little activity usually occurs at the cold front. Thunderstorms along a squall line are frequently similar to those along a cold front, but may be more violent. The cloud bases are often lower and the tops higher than with most other thunderstorms. The most severe conditions (large hail, damaging winds, tornadoes) are generally associated with squall line thunderstorms. Squall lines are usually most intense during the late afternoon and early evening hours just after maximum daytime heating.

**8.3.3.1. Squall Line Formation.** Squall lines usually form rapidly, and sometimes a series will develop ahead of the cold front. Squall lines form when cold air downdrafts flowing ahead of the cold air lift the warm, unstable air. The uplifted air develops its own updrafts and downdrafts and starts the thunderstorm development cycle. As the thunderstorms continue development, a squall line will form, often moving quickly attaining forward speeds of up to 50 knots. Eventually the squall line loses its momentum and energy and dissipates after a several hour life cycle. Sometimes a new squall line reforms and moves through approximately the same location of the dissipating one. Figure 8-10 illustrates the squall line formation process.

Figure 8-10. Formation of a Squall Line.



**8.3.3.2.** While squall lines frequently accompany cold fronts, the existence of a front is not a prerequisite. Squall lines may accompany low pressure troughs or lines where sea breezes converge against mountain barriers. Other factors being favorable, squall line thunderstorms are most likely to develop in areas where there is a convergence of wind flow in the lower atmospheric levels, regardless of the cause of the converging flow.

**8.3.3.3. Aviation Hazards.** Squall line flying hazards include turbulence (possibly extreme), wind shear, thunderstorms, lightning, heavy rain, hail, icing, and possibly tornadoes. Other hazards are the strong, variable, gusty, low level winds (wind shear) at the surface, around and under the thunderstorms and sudden altimeter setting changes. The altimeter can change 0.06 to 0.12" Hg in a matter of minutes.

**8.3.4. Snowshowers.** During winter, the cold front will dramatically affect those airfields in the vicinity of water bodies downwind from the front. As a cold front with its colder, drier air, picks up moisture from the unfrozen water bodies, the lower-level, moisture-laden air will precipitate as snow as the air is forced to climb higher terrain. The "lake effect" snowshowers were covered previously in Chapter 7.

**8.3.5. Wind Shifts.** When you are flying through a cold frontal surface, the wind shift may be abrupt, and some form of heading change is generally required. The wind shift occurs at the location of the frontal surface rather than at the front. Cold fronts slope "back" towards colder air. This means that when you're flying through a frontal surface, frontal passage will not be apparent at the same place it would be if you were on the ground (Figure 8-11). If you use the standard frontal slope ratio of 1:80, you will be approximately 80 miles on the cold air side of the surface front before encountering the cold air 1 mile up in the atmosphere. This means if you are flying directly towards the cold front from the "back" side of the front, you will pass through the upper cold front approximately 80 miles before you pass over the surface front.

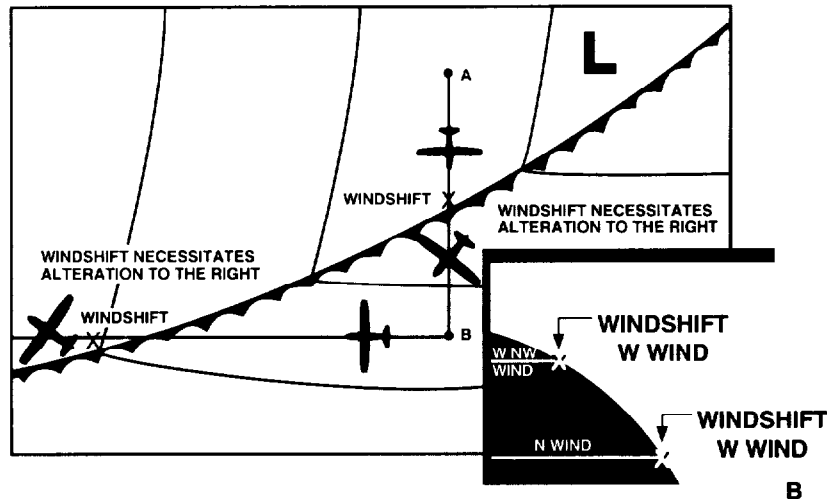
**8.3.6. Ceilings, Visibilities, and Precipitation.** When cold fronts move with moderate or rapid speed, the active weather band is generally less than 50 miles. Ceilings and visibilities will quickly decrease usually coinciding with the onset of precipitation. If the front is a slow-moving cold front, the area of low ceilings and visibility may be extensive enough to seriously affect flight operations for several hours. Even with slow moving cold fronts, the frontal precipitation band is usually relatively narrow (as compared to a warm front). This is particularly true if the precipitation is showery in character. Refer to Figures 8-7, 8-8, and 8-9 for typical cloud patterns associated with the various kinds of cold fronts.

**8.4. Warm Fronts.** A *warm front* is the edge of an advancing warm air mass; that is, warmer air overtaking and replacing colder air. Since cold air is denser than warm air, the cold air is slow to retreat in advance of the overriding warm air. This produces a warm frontal slope that extends ahead of the surface front and has a more gradual slope. Warm frontal slopes usually average about 1:200.

**8.4.1.** If the advancing warm air is moist and stable, stratiform clouds develop as shown in Figure 8-12. Precipitation increases gradually with the approach of this type of warm front and usually continues until it passes.

**8.4.2.** If the advancing warm air is moist and unstable, as shown in Figure 8-13, altocumulus and cumulonimbus are embedded in the cloud masses normally accompanying the front. The presence of thunderstorms is often unknown to aircrews until encountered. Precipitation in advance of the front is usually showery with periods of steady light rain.

Figure 8-11. Windshifts Associated with Flight Level Cold Frontal Boundaries.



**8.4.3. Classic Warm Front.** Whether you fly through a warm front with stable or unstable air, the clouds gradually descend from near 20,000 feet to 6,500 feet or lower. At first, the sun or moon will be seen dimly through the thin leading edge of the altostratus deck of clouds but as the cloud deck thickens and the bases lower, celestial bodies will disappear from sight. From the thick altostratus clouds, intermittent light precipitation may be encountered. If the altostratus deck is still quite high, this precipitation may not reach the ground. As flight is continued, the altostratus-altocumulus deck will lower and the precipitation will increase in intensity. Passage into the warm air mass will be indicated by a rise in temperature and a wind shift, even though the magnitude of this wind shift will be fairly small above 10,000 feet.

**8.4.3.1. Ceiling and Visibility.** The widespread precipitation ahead of a warm front is often accompanied by low stratus and fog. In this case, the precipitation raises the moisture content of the cold air until saturation is reached. This produces low ceilings and poor visibility covering thousands of square miles. When rain begins to fall from warmer air above the front into the colder air below the frontal surface, ragged clouds (stratus fractus) form in the cold air. These ominous looking clouds can cause very low ceilings and often obscure higher terrain. Steady precipitation will provide a constant source of moisture allowing the low stratus clouds to continuously form. Ceilings are often in the 300 to 900-foot range during steady, warm frontal rain situation. Just before the warm front passes your station, ceilings and visibilities can drop to zero with drizzle and fog. The worst conditions often occur in the winter when the ground is cold and the air is warm; the best scenario for dense fog and low ceilings.

Figure 8-12. Warm Front and Moist Stable Air.

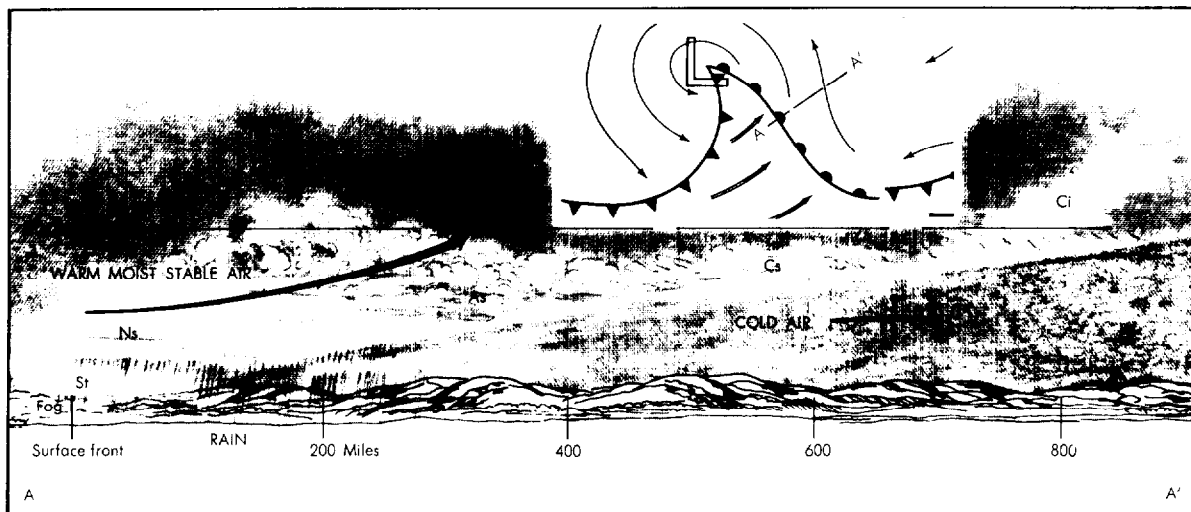
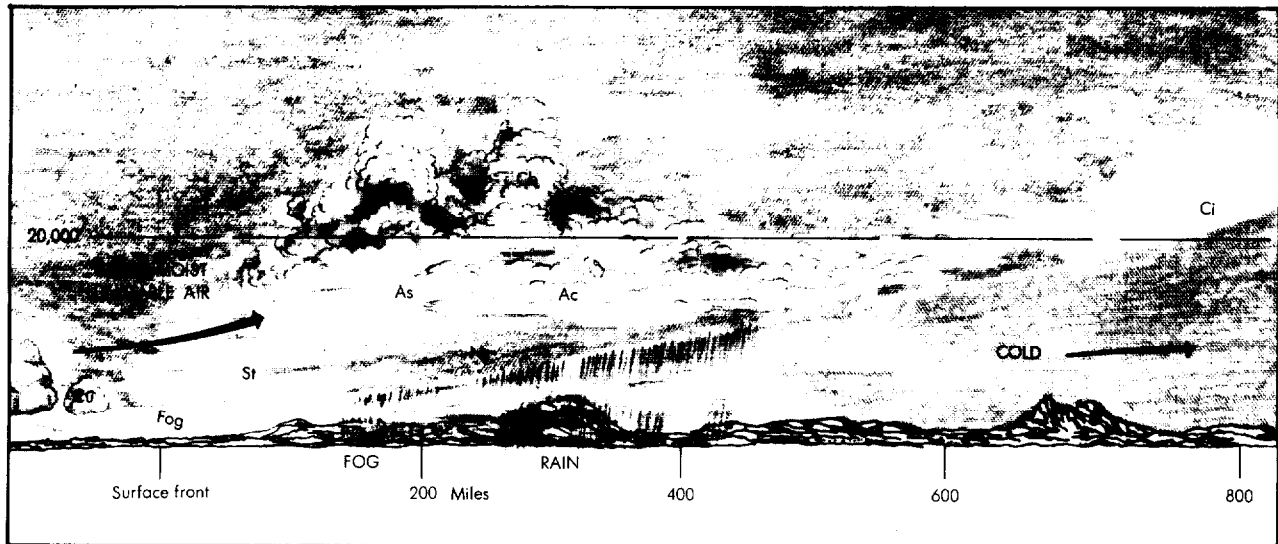


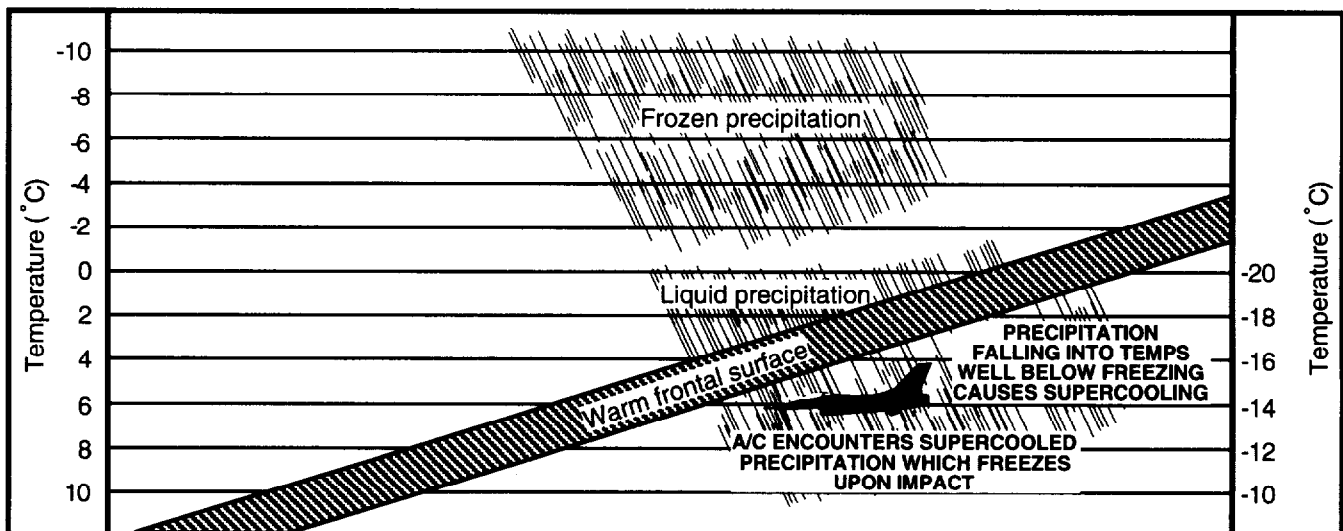
Figure 8-13. Warm Front and Moist Unstable Air.



8.4.3.2. If the cold air under the warm air has below freezing temperatures and the surface layer is thick enough, precipitation will be freezing rain, freezing drizzle, and/or ice pellets. If the freezing layer is thick enough, snow will form. Wintertime warm fronts produce the widest or greatest variety of precipitation types. Figure 8-14 shows the various precipitation types in a wintertime warm front when temperatures are near freezing.

8.4.3.3. **Snowstorms.** Some of the heaviest snowstorms form when warm air glides over the colder air as a warm front approaches. With a strong low pressure system, the pressure gradient is strong enough to force large scale movements of air in both the vertical and horizontal directions. As warmer, moist air rises and condenses heavy snowfalls can result, often lasting for several hours. Many an airport has been closed for long periods of time due to heavy snowstorms associated with and in advance of warm fronts.

Figure 8-14. Precipitation Types in Wintertime Warm Frontal Zone.



8.4.3.4. **Precipitation Transition Zone.** If the warm front is warm enough and advances close to your location, the heavy snow will gradually transition to ice pellets and rain before changing to all rain. Aloft, conditions are ripe for formation of moderate to severe clear icing and rime icing. On the ground, conditions may be favorable for extended bouts of freezing rain reducing braking action runway condition readings (RCR) readings to "06" or less! Obtain the freezing level from your

weather briefer and be observant when flying around and above the freezing level. The weather forecaster can generally forecast when icing potential is likely. Unfortunately, pinpointing exact locations of icing formation is very difficult.

**8.4.3.5. Multiple Freezing Levels Aloft and Precipitation Types.** In Figure 8-14, you will see snow is falling from the part of the warm air cloud that is below freezing temperatures. Rain will fall from the portion of the cloud which is above freezing temperatures, but as it falls through the cold air it becomes supercooled and will freeze on contact with any cold object. As you fly through this region, the type of precipitation you experience in the air will not necessarily match that falling on the ground. The form of the precipitation reaching the ground depends on the thickness or depth of the cold air and warm layers above that point on the ground.

**8.4.3.6. Icing.** There is a relatively narrow transition zone between the snow and the freezing rain area. In the upper portion of this zone there is a mixture of freezing rain and snow, in the lower levels there is a mixture of snow and ice pellets. Therefore, when flying toward the front in the lower levels of the cold air mass, you may meet snow, snow and ice pellets mixed, and then freezing rain, in succession. At higher levels, but still in the cold air, you will not encounter ice pellets. The sequence of precipitation will be reversed if you are flying from the warm to the cold air mass. Warm front icing conditions and other icing scenarios are covered in Chapter 11, Icing.

**8.4.3.7. Thunderstorms.** While flight through the lower levels of warm front is rarely smooth, a turbulence problem arises when cumulonimbus clouds are embedded in the mainly nimbostratus cloud deck. The flight planning difficulty is that embedded thunderstorms may be scattered throughout the seemingly solid cloud decks (Figure 8-13) and you have no way of knowing exactly when or where you will encounter storms. If you must fly through IMC weather, use all available resources (ATC, on board radar, etc.) to avoid embedded thunderstorms.

**8.4.3.8. Wind Shift.** The wind shift will occur at the frontal boundary, which aloft may not coincide with the surface frontal position. Warm frontal wind shift and its effects on your flight are as follows:

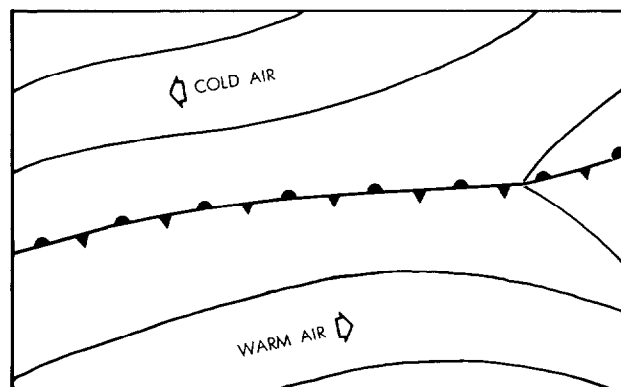
- The outside air temperature rises when you have passed through the frontal surface from the cold air side to the warm air side.
- The wind shift requires an alteration to the right, no matter which way you are flying through the front.
- The wind shift will be most noticeable in the lower levels, especially below 5,000 feet.

**8.4.3.9. Wind Shear.** Warm fronts have a very shallow slope of approximately 1:200 and the air mass generally doesn't extend as far up in the atmosphere as a cold air mass. The time to be concerned about warm frontal wind shear is 6 to 12 hours prior to a warm frontal passage (while the airfield is still in the cold air) and an hour after warm frontal passage.

**8.4.3.10.** On the north side of warm frontal surfaces, especially in the vicinity of low pressure centers, low level convergence can cause surface winds to exceed 20 to 40 knots. When flying south through the warm frontal slope, winds can shift to the south-southwest with speeds up to 40 to 50 knots, usually from near ground level to approximately 5,000 feet AGL. If the pressure gradient is strong, the transition from northerly component winds to southerly component winds can be abrupt. This strong low level wind pattern is called the "low level jetstream." This is the same wind pattern which is often associated with a potential for severe weather. When penetrating this low level jetstream, you can experience large changes in headwind or tailwind components below 1,000 feet AGL. Often low level significant weather charts will forecast light to moderate turbulence with this situation.

**8.5. Stationary Fronts.** Sometimes, opposing forces exerted by adjacent air masses are such that the frontal surface between them shows little or no movement. In such cases, surface winds tend to blow parallel to the front rather than against or away from it. This is called a stationary front, since it does not move and neither air mass replaces the other. Figure 8-15 depicts a stationary front on the surface weather chart.

**Figure 8-15. Stationary Front as Shown on Surface Weather Chart.**





**8.5.1. Classic Stationary Front.** Although there is no movement of the surface position of the stationary front, there still is movement of air toward the front from either side of it. Warmer air will move towards it generally from the south while colder air from the north will also move towards the front. The clash of the two air masses will cause an active weather band to develop. The stronger air mass controls the angle of the air flow in relation to the front's surface position, the strength of the upgliding wind, and determines the inclination of the frontal slope. Fronts moving less than 5 kts are called either quasi-stationary or stationary.

**8.5.2.** Weather conditions occurring with stationary fronts are similar to those found with warm fronts but are usually less intense. One annoying feature of the stationary front is that the weather pattern may persist and hamper flights for several days. Stationary fronts can also be the focus of heavy precipitation events and can result in local flooding over a period of time.

**8.6. Frontal Wave Process.** *Frontal waves* are primarily the result of the interaction of two air masses; they usually form on slow-moving cold fronts or stationary fronts. During stage A of Figure 8-16, the winds on both sides of the front blow parallel to the front. Small disturbances in the wind pattern, as well as uneven local heating and irregular terrain, may start a wave-like bend in the front (B). These disturbances are not obvious on the weather chart. If this tendency persists and the wave increases in size, a counterclockwise (cyclonic) circulation starts to form.

**8.6.1. Circulation Centers Develop.** One section of the front begins moving as a warm front, while the section next to it begins moving as a cold front (C). This deformation area is called a *frontal wave*. As the pressure at the peak of the frontal wave falls, a low-pressure center forms. The cyclonic circulation strengthens, and the winds begin moving the fronts. The cold front moves faster than the warm front (D).

**8.6.2. Occlusion Process.** When the cold front catches up with the warm front, the two of them occlude (close together). The result is called an *occlusion* (E). This is the time of maximum intensity for the wave cyclone. The occluded front exhibits characteristics from both the cold front and warm front. That is why the weather symbol depicting an occlusion is a combination of the symbols and colors of warm and cold fronts. As the occlusion continues to grow in length, the low pressure area weakens and the frontal movement slows (F). At this point, a new frontal wave may begin to form on the long westward-trailing portion of the cold front. In the final stage, the two fronts are a single stationary front again. The low center with its remnant of the occlusion is disappearing (G).

**8.6.3. Occluded Front Type.** There are two types of occluded fronts; warm and cold occlusions. The portion of the occluded front which intersects the earth's surface determines whether the occlusion is a cold or warm occluded front. Figure 8-17 shows an example of a cold frontal occlusion with the warm front forced aloft. The Figure also shows the relative positions of the cold air, cool air, and warm air portions of the occlusion.

**8.6.4. Occlusion Weather.** The location of the occlusion is significant to aircrews because the most severe weather (including low ceilings and visibilities) is generally located in an area 100 NM south to 300 NM north of the frontal intersection. Since occlusions result from one frontal system overtaking another, occlusions combine the weather of both warm and cold fronts into one extensive system. A line of showers and thunderstorms typical of cold fronts merges with the warm front's low ceilings. Precipitation and low visibilities are widespread on either side of the occlusion's surface position. In addition, strong winds occur around an intense low pressure center at the occlusion's northern end.

**8.6.4.1.** Aircrews should be aware of rapidly changing weather conditions in occlusions and that changes are most dramatic during the initial stages of development. If you are flying toward an approaching occlusion, the cloud pattern is very similar to that of a warm front. However, the weather is more complex because part of the occluded weather is characteristic of a cold front. If you approach an occlusion from behind, the cloud structure may resemble a cold front, but the effects on flight are different. In addition to the problems associated with a cold front, there are the problems of the extensive cloud deck which may lie ahead of the base of the warm air. If flight is conducted through the system at such an altitude that you pass below the base of the trough, you would expect one wind shift. If you fly at higher altitudes, there will be two wind shifts because you must pass through two frontal surfaces (Figure 8-17).

Figure 8-16. Frontal Wave and Occlusion.

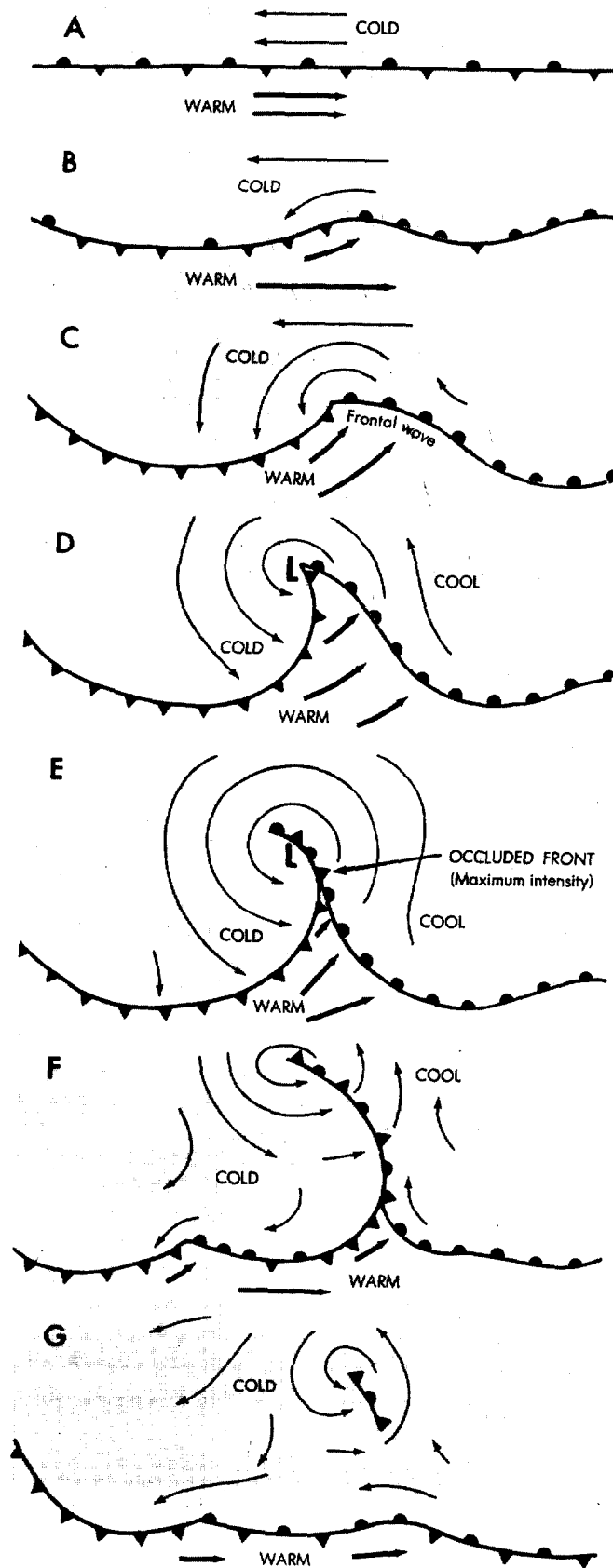
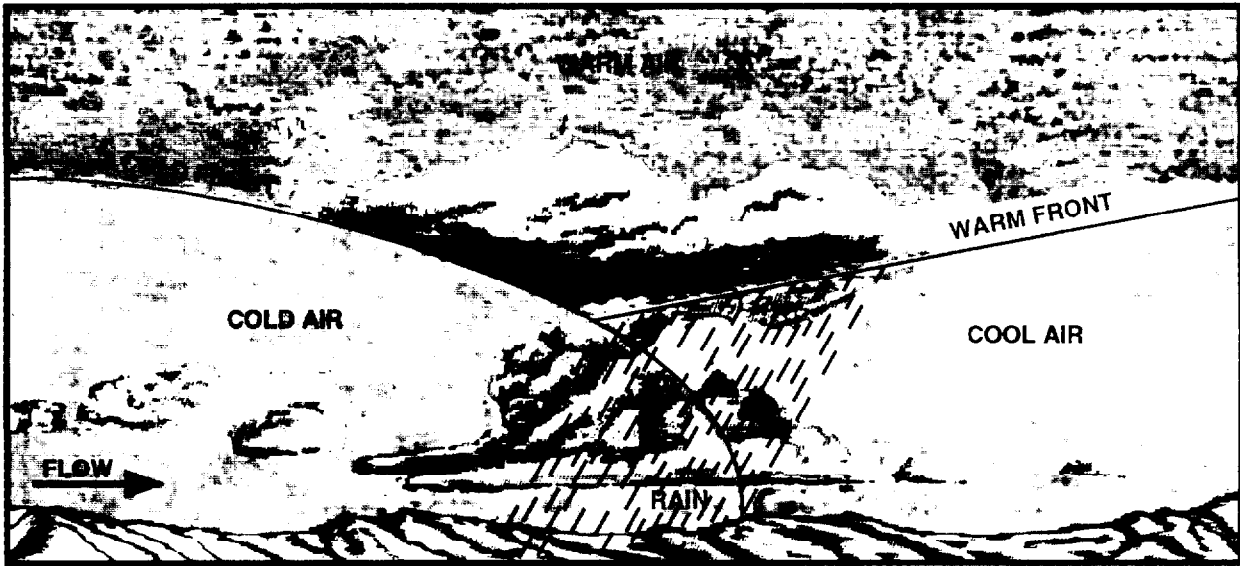


Figure 8-17. Cold Frontal Occlusion.



## Chapter 9

### TURBULENCE

**9.1. Introduction.** Turbulence is one of the most unexpected aviation hazards to fly through and also is one of the most difficult hazards to forecast. Severe and extreme turbulence has been known to cause extensive structural damage to B-52s, with lesser cases resulting in compressor stalls, flameouts, and injury to crew members and passengers. From minor bumps to severe mountain wave turbulence, turbulence comes in many forms and is usually worst during the winter months. It's estimated that turbulence causes \$30 million damage annually to aviation assets.

**9.1.1. Definition.** Turbulence is caused by *abrupt, small-scale variations in wind speed and direction*. Upper level turbulence is mainly found in curved jet stream segments associated with troughs, ridges, closed upper level lows, and rapidly developing surface lows. Turbulence usually is associated with the variations in the jet stream winds.

**9.1.2. Jet Stream.** A *jet stream* is a meandering region of concentrated, higher wind speeds which circles the earth. In the wintertime, there are often two or three predominant jet streams: the polar jet stream, the subtropical and the arctic jet streams. The main and best known jet stream is the polar jet stream which frequently enhances major weather system development. Unfortunately, many of the world's busiest military and civilian air routes are concentrated in the mid-latitudes, the favored location of the polar jet stream and turbulence.

**9.1.3.** Classifying turbulence intensity is difficult and is often a function of a pilot's flying experience level and how much the pilot has been exposed to turbulence. In addition, the flier's assessment of turbulence is influenced by the length of time and the severity of the turbulence during flight. Most of all, the type of aircraft and the aircraft's speed and weight determines to what extent a crew will experience turbulence. Severe turbulence reported by a C-172 may be light to occasional moderate when experienced by a C-5 crew.

**9.1.4. Pilot Reports (PIREPs).** The above problem is further complicated because air turbulence clues aren't plentiful, occur at infrequent intervals, and are reported often at widely separated locations. Thus, forecasters are very dependent on timely, accurate pilot reports (PIREPs). In fact, it may be your turbulence report which triggers a weather service turbulence advisory for your fellow fliers. Always include your aircraft location, time, turbulence intensity, flight level, aircraft type, and duration of turbulence when providing a PIREP.

**9.2. Categories of Turbulence Intensity.** Turbulence is categorized as *light, moderate, severe, and extreme*. Each category is defined in terms which are perceived by the pilot in term of effects on the aircraft and its occupants. Weather forecasters use the same four categories when forecasting turbulence on their significant weather charts (sig wx). The weather community intends for turbulence reports to be used in two important ways: (1) pilot reports of turbulence received from one type of aircraft are to be used to predict how the pilot of another similar aircraft will experience the same turbulence and (2)

Air Force weather briefers are to brief forecasted turbulence in a manner that will allow briefers to present these same turbulence categories to the pilot. This allows consistency in transmitting turbulence information and allows aviators to anticipate a particular level of forecasted turbulence.

**9.2.1. Turbulence Category Definitions.** Because of the different effects of turbulence on different types of aircraft, the DoD Flight Information Handbook, Section C, lists turbulence reporting categories. The tables are based on intensity, aircraft reaction, and the reaction within the aircraft. Take a moment to learn the categories of turbulence listed below.

**9.2.2. Definitions:**

- Light turbulence: Momentarily causes slight, erratic changes in altitude and/or attitude (pitch, roll, yaw).
- Light chop: Slight, rapid and somewhat rhythmic bumpiness without appreciable changes in altitude or attitude.
- Moderate turbulence: Similar to light turbulence but of greater intensity. Changes in altitudes and/or attitude occur but the aircraft remains in positive control at all times. It usually causes variations in indicated airspeed.
- Moderate chop: Turbulence similar to light chop but of greater intensity and which causes rapid bumps or jolts without appreciable changes in aircraft altitude or attitude.
- Severe turbulence: Causes large abrupt changes in altitude and/or attitude. It usually causes large variation in indicated airspeed. Aircraft control becomes very difficult.
- Extreme turbulence: Aircraft violently tossed around with control virtually impossible. Large, sudden changes in altitude and/or attitude. Extreme turbulence may cause structural damage.

**9.2.3. Turbulence Causes.** Knowledge of turbulence causes and favored formation locations help you to minimize your exposure to turbulence or avoid it altogether. This chapter discusses the following turbulence types:

- Convective Turbulence: Caused by alternating currents of warm air rising and cooler air descending.
- Mechanical Turbulence: Caused by wind flowing over irregular terrain or obstructions, or by a marked change in wind speed or direction over a short distance.
- Mountain Wave Turbulence: Caused by air blowing perpendicular across the top of a mountain range.
- High Altitude Turbulence: Variations in wind speed and direction principally in the vicinity of the jet stream and occurs above 10,000 feet. Commonly called clear air turbulence (CAT) because of scant, visible evidence of its existence.
- Vortex Wave Turbulence: Generated by every aircraft in flight at its wing tips.

**9.3. Convective Turbulence.** Convective currents usually cause turbulence, especially at low altitudes. These currents are localized vertical air movements, both ascending and descending. For every rising current, there is a compensating downward current. The downward currents occur over a broader area than the rising currents, therefore having a slower vertical speed than the rising currents.

**9.3.1.** Convective currents are most active on warm summer afternoons with light winds. Heated surface air rises creating a shallow, unstable layer. As surface heating increases, convection increases in strength and rises to greater heights. Barren surfaces such as sandy or rocky wasteland and plowed fields become hotter than open water or ground covered with vegetation (Figure 9-1). Uneven surface heating results in favored locations for rising and sinking air currents.

**9.3.2. Effects.** Because of this, the strength of the convective currents varies considerably within short distances. Figures 9-2 and 9-3 illustrate this effect on an aircraft approaching an airport. Winds and light turbulence that develop in hilly and mountainous terrain due to differential heating are of particular importance for light aircraft, helicopters, and low-level operations. In mountainous areas where the performance of some fixed wing aircraft or helicopters is marginal, the location of upslope and downslope winds can be critical.

**9.3.3.** As air moves upward, it cools by expansion. A convective current continues upward, continually cooling, until it reaches a level where its temperature is the same as the surrounding air. If it cools to saturation, a cloud forms. Aircrews should associate cumulus and cumulonimbus clouds with thermal turbulence. Turbulence may be light to moderate in or beneath the clouds, but the air is generally smooth above them (Figure 9-4). If the air is too dry, aircrews may have no turbulence indications until they encounter it. Just be aware of convective turbulence during sunny, hot, dry days.

**9.3.4. Aircraft Response.** Aircraft response to turbulence varies with turbulence intensity and aircraft characteristics such as airspeed, weight, design, wing loading, and pilot technique. At higher speeds, turbulence places more stress on aircraft and aircrew alike. At slower airspeeds, aircraft control is reduced and becomes more sluggish. To minimize the effects of convective turbulence, fly above the turbulent layer, tighten your seat belt and shoulder harness, and fly the turbulence airspeed recommended by your Dash 1.

**9.4. Mechanical Turbulence.** *Mechanical turbulence* occurs when air near the surface flows over rough terrain or other obstructions. Obstacles such as trees, buildings, hills, and mountains transform the normal wind flow into a complicated snarl of eddies (Figure 9-5). These eddies are carried along with the general wind flow; their size and extent affects the flying characteristics of aircraft.

Figure 9-1. Strength of Convective Currents vary with Composition of Surface.

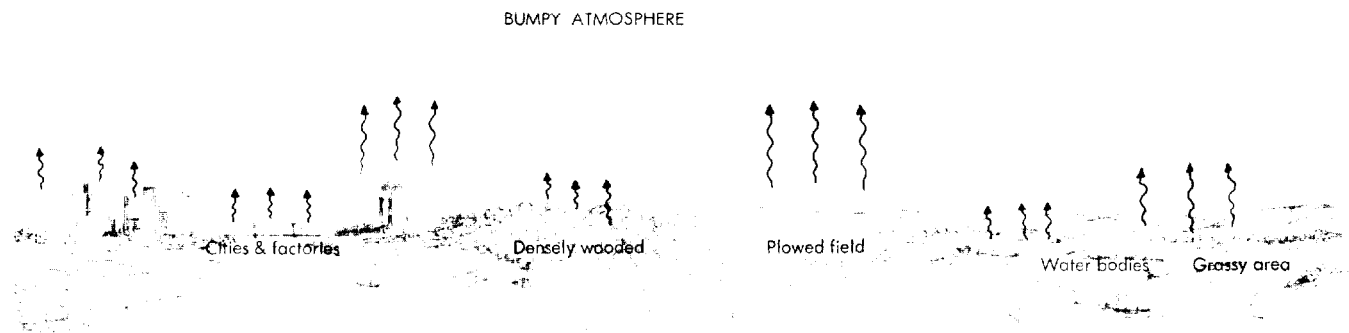


Figure 9-2. Updrafts May Cause Pilots to Overshoot.

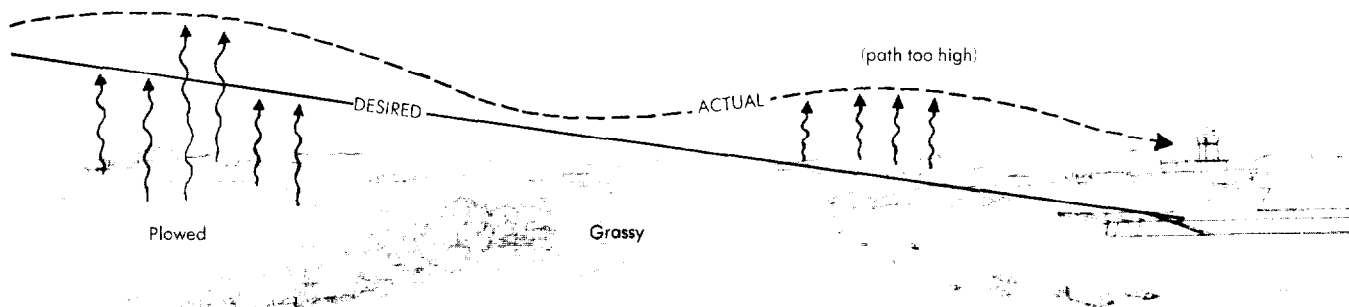
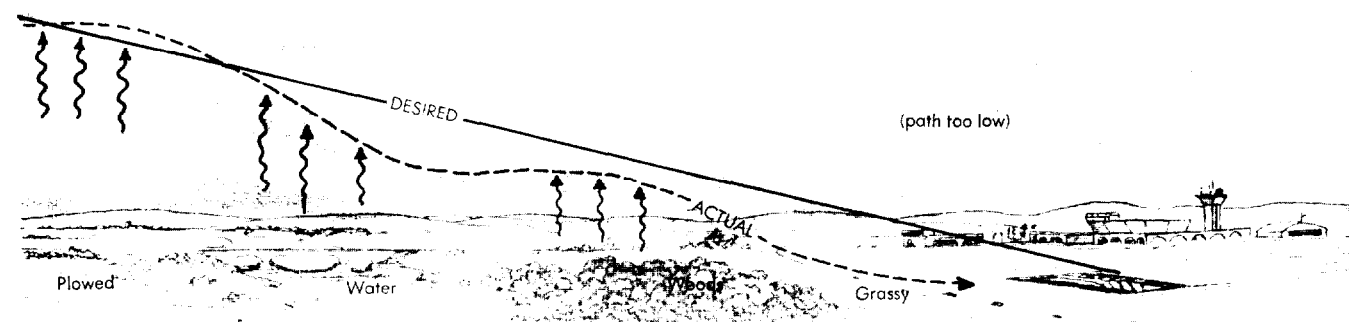


Figure 9-3. Downdrafts May Cause Pilots to Undershoot.



**9.4.1. Degree of Mechanical Turbulence.** The degree of mechanical turbulence depends on the roughness of the terrain or obstructions, wind speed, and air mass stability. The higher the wind speed or the rougher the surface, the greater the turbulence intensity. Unstable air allows larger eddies to form than in stable air; but the instability breaks up the eddies more quickly, while in stable air they dissipate slowly.

**9.4.2. Wind Variability.** Wind variability near the ground is an extremely important consideration during takeoff and landing, especially for light aircraft. Strong, gusty winds have caused many aircraft accidents. Aircrews landing at airports where large hangars or other buildings are located near the runways should be alert for formation of turbulent wind eddies as shown in Figure 9-6. If the wind is light, eddies tend to remain as rotating pockets of air near the windward and leeward sides of the buildings. If the wind speed exceeds about 20 knots, the flow may be broken up into irregular eddies which are carried a sufficient distance downstream to create a hazard in the landing area. The IFR en-route supplement should describe

crosswind and turbulence problems as appropriate in the remarks section of the airfield entry. For example, Offutt AFB has in their remarks section "apch end turbulence and hi variable crosswinds dur S to SW sfc winds."

Figure 9-4. Avoid Convective Currents by Flying Above Cumulus Clouds.

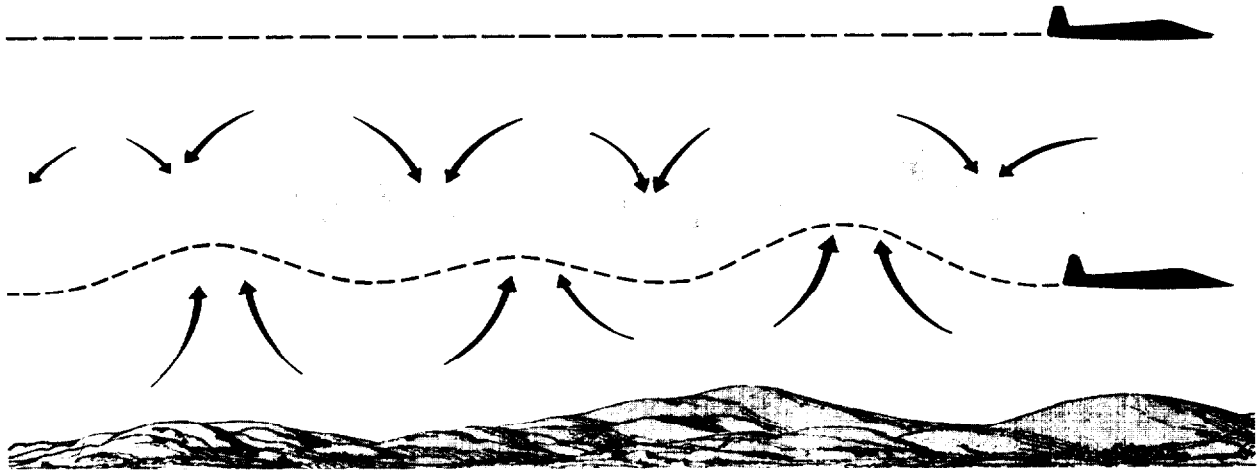
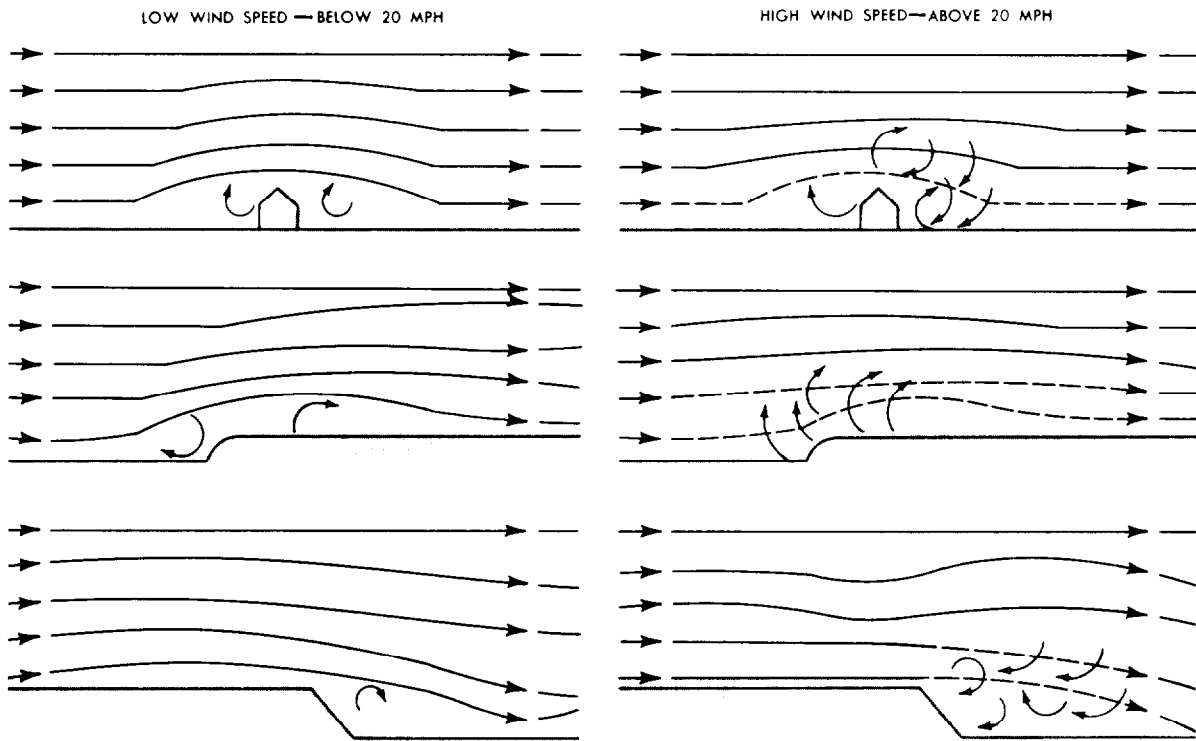
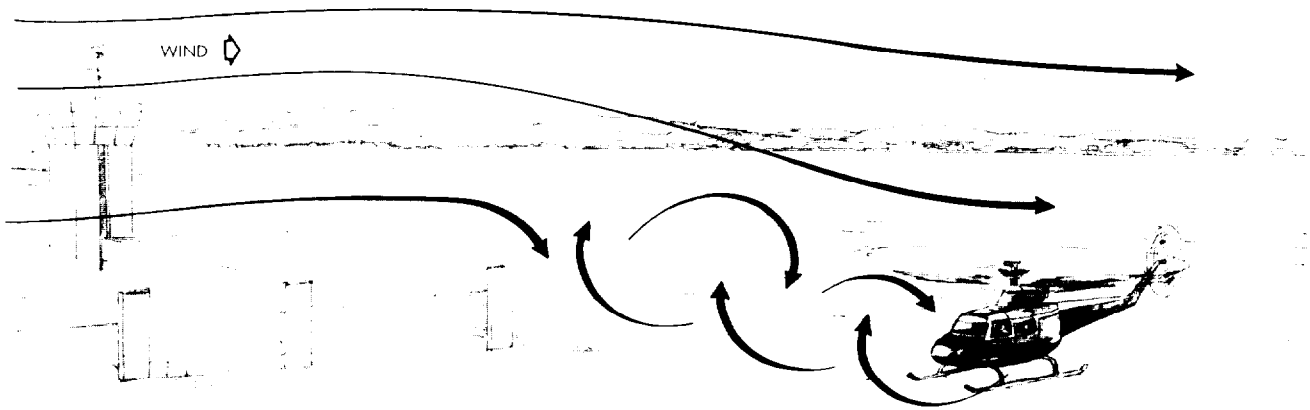


Figure 9-5. Surface Obstructions Cause Eddies and Other Irregular Wind Movements.



**9.4.3. Rugged Terrain Effects.** When winds blow across rugged hills or mountains, the resulting turbulence may increase as the wind speed increases. Exercising caution is necessary when crossing mountain ranges under strong wind conditions. Severe downdrafts can be expected on the lee side as illustrated in Figure 9-7. These downdrafts can be dangerous and can place an aircraft in a position from which it may not be able to recover. Aircrews should allow for this condition when approaching mountain ridges against the wind. If the wind is strong and the ridges pronounced, pilots should cross obstructions at higher than normal altitudes.

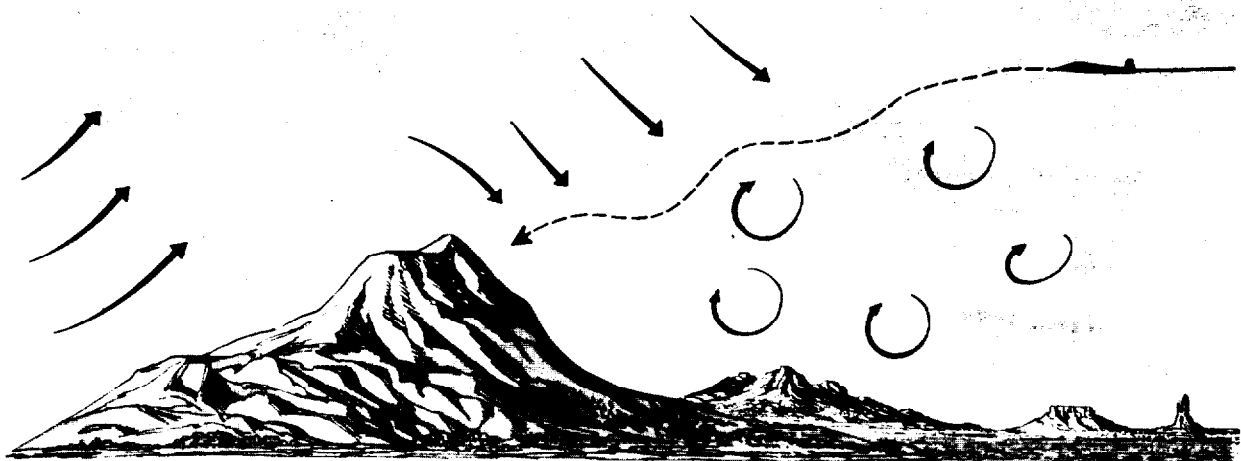
Figure 9-6. Buildings Near Landing Area May Cause Turbulence.



**9.4.4. Aviator Corrective Action.** It is important to climb to the crossing altitude well before reaching the mountains to avoid having to climb (or, what is worse, trying unsuccessfully to climb) in a persistent downdraft. Attempting to cross at a lower altitude will also subject the aircraft to much greater turbulence and sudden crosswinds caused by winds blowing suddenly parallel to the valley instead of the prevailing direction. When the wind blows across a valley or canyon, a downdraft occurs on the lee side, while an updraft results on the windward side (Figure 9-8). If flight through the canyon is required, the safest path is to fly near the side of the pass or canyon which affords an upslope wind, since additional lift is provided.

**9.4.5. Turbulence Associated with Narrow Canyons and Gorges.** If the wind blows across a narrow canyon or gorge, it will veer down into the canyon (Figure 9-9). Turbulence will be found near the middle and downward side of the canyon or gorge. Aircrews should exercise caution during flight on the downwind side of narrow canyons, because winds may cause rates of descent which exceed the aircraft's ability to outclimb.

Figure 9-7. Wind Flow over Mountain Ranges Produces Turbulence.



**9.4.6. Funnel Winds.** The mountains funnel winds into passes and valleys, thus increasing wind speeds and intensifying turbulence. *Funnel winds* flow out of mountain valleys and toward flat areas, reaching speeds of up to 80 knots and creating hazardous shear and turbulent conditions. Figure 9-10 illustrates the funnel wind effect. In this case, the terrain is such that the wind is channeled through a narrow space where it is accelerated and then spills out into the flight path of aircraft as happens at Hill AFB, UT. This creates low-level wind shear that is different in origin from the wind shear associated with downbursts and microbursts.

Figure 9-8. In a Valley or Canyon, Safest Path is on Upslope Wind Side.

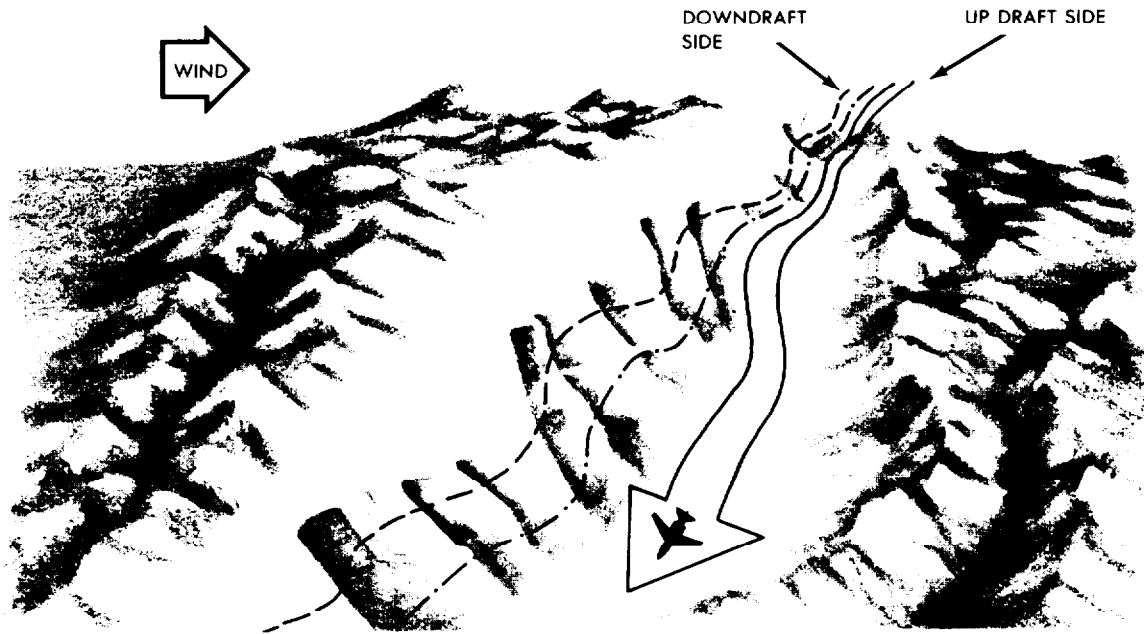


Figure 9-9. Avoid Downwind Side of Narrow Gorge.



**9.4.7. Low Level Jet Streams.** In general, jet streams will be discussed later in this chapter, but low-level jet streams are most evident to the pilot when low level wind shear or turbulence are encountered (Figure 9-11). As a radiation inversion develops, the wind near the top of the inversion increases to speeds much greater than that indicated by the isobar spacing on a weather map. The low level winds decouple from the surface winds as the radiation inversion forms shortly after sundown. The wind reaches its maximum speed just before sunrise and then decreases in the morning (usually by 10 AM local time) as daytime heating destroys the inversion. The wind below the inversion is often light or near calm. But the dramatic difference in wind speeds above and below the inversion height causes the wind shear and resultant low level turbulence.



Figure 9-10. Winds Funneled through Mountain Valleys Create High Winds.

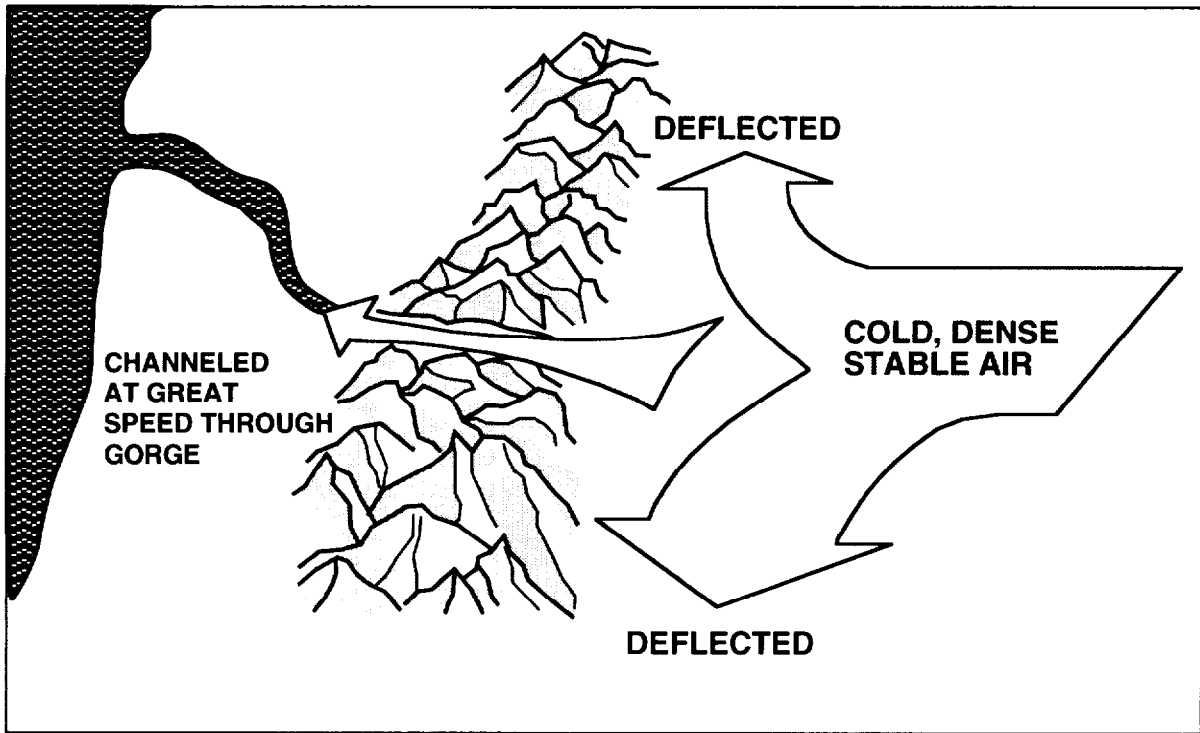
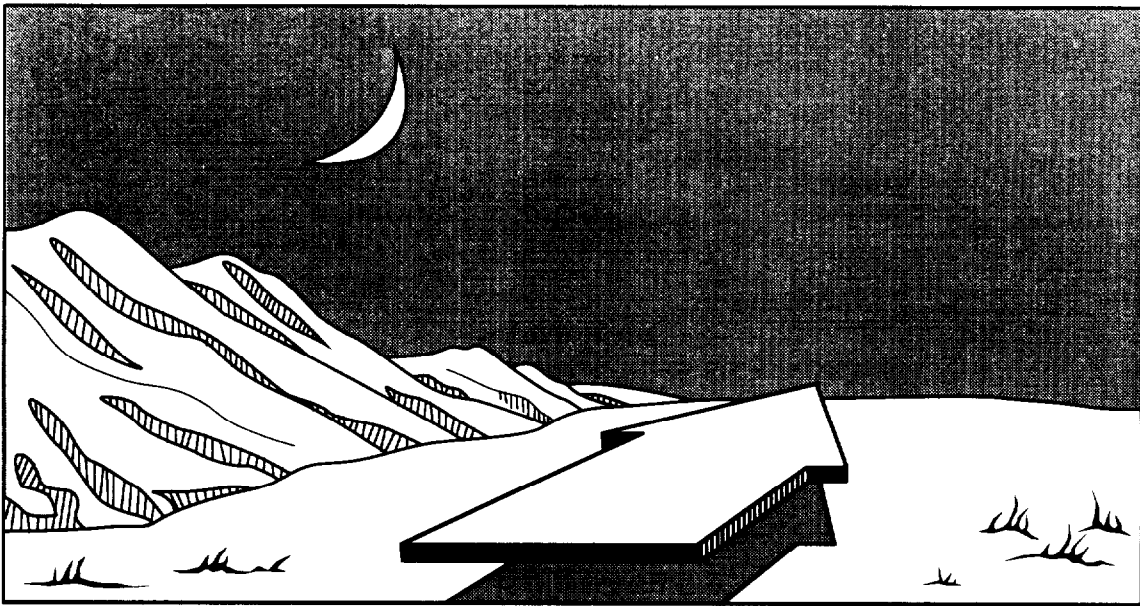
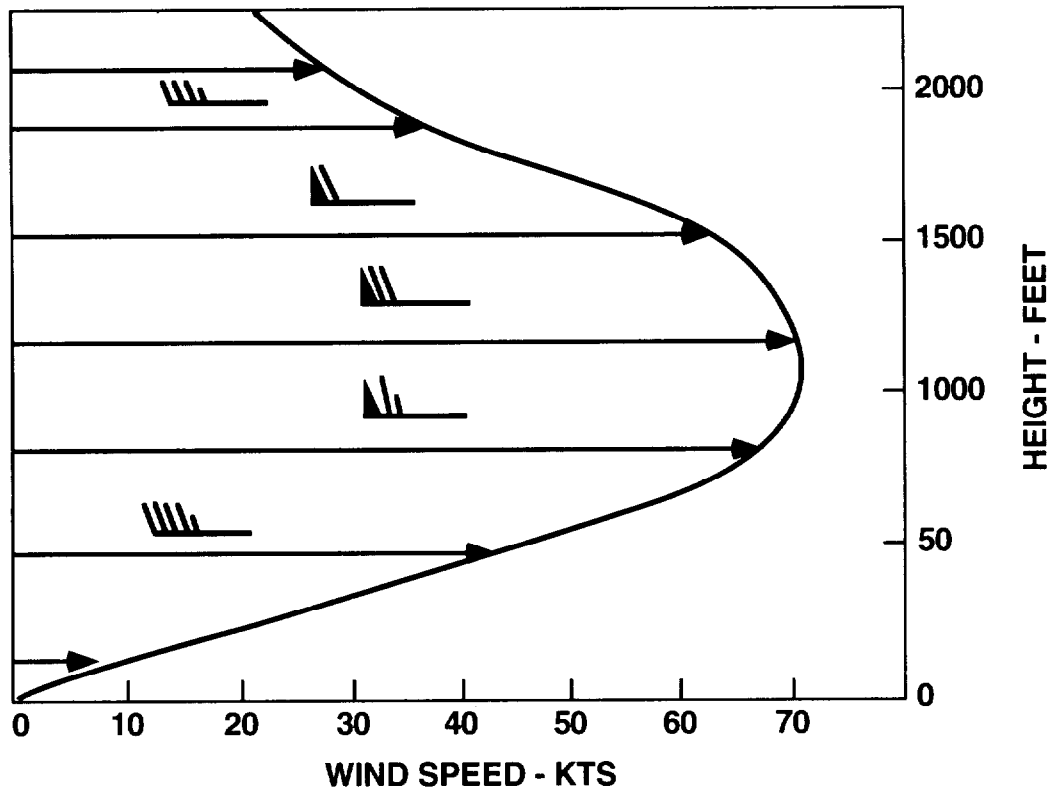


Figure 9-11. The Low Level Nocturnal Jet Stream.



**9.4.7.1. Low Level Jet Characteristics.** A low level jet stream is a "sheet" of strong winds sometimes a thousand miles long, hundreds of miles wide and hundreds of feet thick. It generally forms over large expanses of flat terrain and develops in response to a strong pressure gradient. The favored US location is in the Midwest and Great Plains when a High pressure cell is over the east coast and a Low pressure system forms on the east side of the Rocky Mountains. Winds are usually from the south to southwest with velocities up to 60 knots at only 2000 to 6000 feet AGL. Once again, it's the difference in wind speeds above and below the inversion that causes the wind shear and turbulence.

Figure 9-12. Vertical Cross-Section of the Low Level Jet.



**9.4.7.2. Low Level Jet Stream Max Locations.** The level of maximum wind varies from about 700 feet to 2,000 feet above the ground (Figure 9-12). Wind speeds typically vary from 0-8 knots at ground level to 25-40 knots at the jet maximum, dropping to the wind speeds normally expected (15-30 knots) 1,000 feet or so above the maximum wind. Low level jets are one of the main causes of hazardous low level wind shear. In extreme cases, the maximum winds can be in excess of 65 knots with shears of 10 knots or more per 100 feet just above and below the jet core. At times when the morning inversion breaks, these strong winds that were just above the inversion, lower to the surface very quickly.

**9.5. Mountain Wave Turbulence.** When *stable* (non-convective) air blows across a mountain range, a phenomenon known as a *mountain wave turbulence* may occur. A wave condition usually develops when a component of wind flowing perpendicular to the top of the mountain exceeds 25 knots and an inversion exists within 2,000 feet of the mountain top. Although the actual wind direction can vary somewhat and still cause a wave, the strongest waves occur with a strong, perpendicular flow. The waves, which resemble ripples formed downstream from a rock in a swiftly flowing river, remain nearly stationary while the wind blows through them. The characteristics of a typical mountain wave are shown in Figure 9-13. Waves such as these are commonly associated with high mountain ranges, but it has been established that any mountain range or ridge line is capable of producing wave phenomena.

**9.5.1. Dangerous Features.** The most dangerous features of the mountain wave are the extreme turbulence and very high velocity updrafts and downdrafts on the lee side of the mountain range. In some cases, associated areas of updrafts and downdrafts may extend up to 70,000 feet and as far as 300 miles downstream from the mountain range (Figure 9-13). The amplitude and intensity of the waves decrease the further downstream they occur.

**9.5.1.1.** While clouds are usually present to warn aircrews of mountain wave activity, it is possible for wave action to take place when the air is too dry to form clouds. Key wave turbulence cloud types are cap clouds, rotor clouds, and standing lenticular clouds. Characteristic cloud forms, peculiar to wave action, still provide the best means for identifying the presence of the wave. The weather forecaster can use satellite imagery to locate visible turbulence cloud signatures such as those evident in Figure 9-14. Clouds aligned parallel with mountain ranges often signal the presence of turbulence and extend hundreds of miles downstream.

Figure 9-13. Typical Cloud Formation. Main Updraft and Downdraft in Mountain Wave.

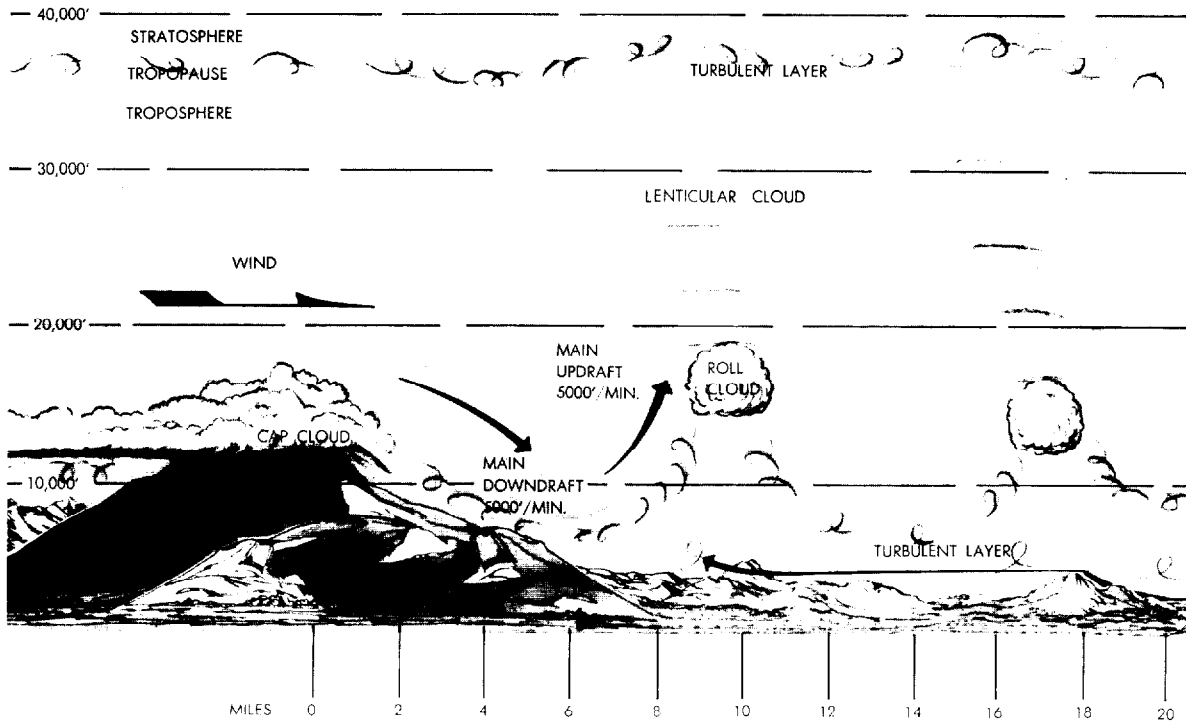


Figure 9-14. Mountain Waves Photographed from a Manned Spacecraft.

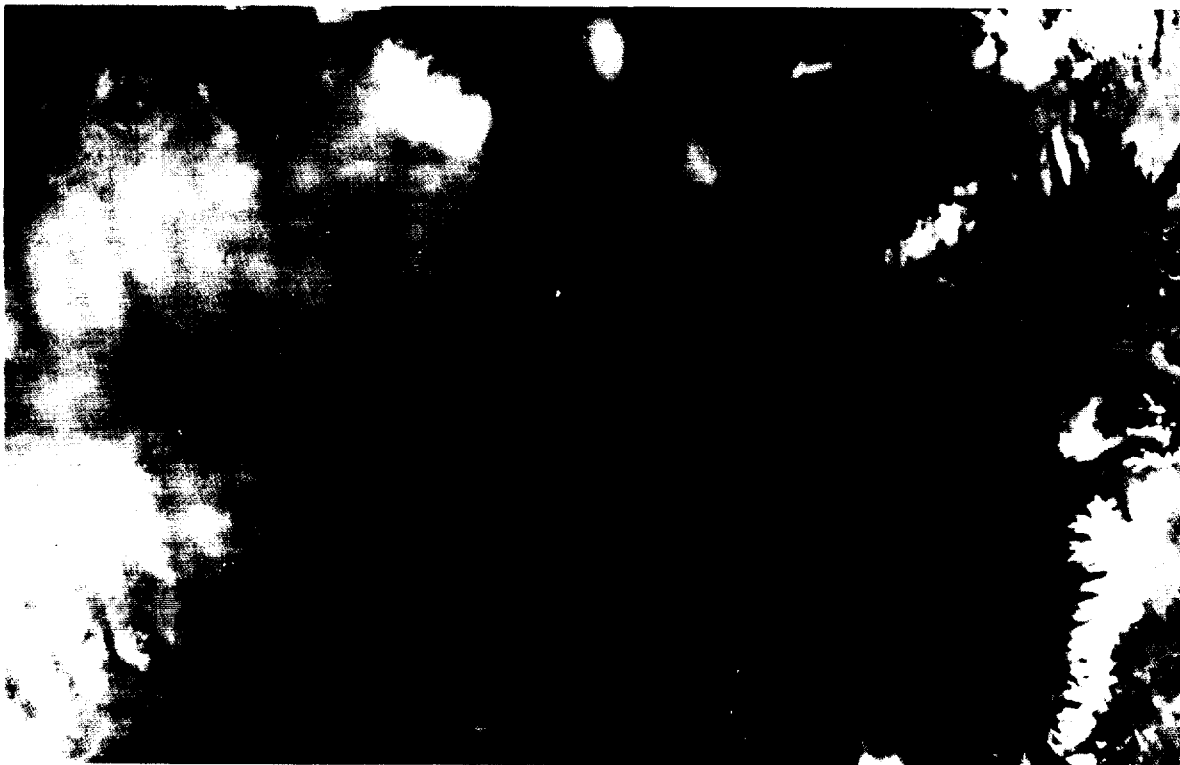


Figure 9-15. Rotor Clouds.



**9.5.2. Cap Cloud.** The *cap cloud* is a low hanging cloud with its base near the mountain top and at times obscuring the mountain peak. Most of the cloud is on the windward side, while on the leeward side, the cloud looks like a wall hanging over the edge with fingers pointing down the slope (Figure 9-13).

**9.5.3. Rotor Cloud.** The *rotor cloud* gives a visible appearance of turbulence. The rotor cloud looks like a line of cumulus clouds parallel to the ridge line (Figure 9-15). The cloud is usually stationary and is constantly forming and dissipating on the lee side with updrafts and downdrafts of up to 5,000 feet per minute. The rotation of the cloud may not be apparent to the crew member. The most dangerous features of mountain waves are the turbulence in and below the rotor clouds and the downdrafts just to the lee of the mountain ridges and to the lee of the rotor clouds.

**9.5.4. Standing Lenticular Cloud.** The *standing lenticular cloud* is lens-shaped and is probably the most frequent cloud associated with mountain waves (Figure 9-16). The lenticular cloud, like the rotor, is stationary, and constantly forms in bands parallel to the mountain at fairly regular-spaced intervals on the leeward side. The standing lenticular cloud is usually found above 14,000 feet and can form multiple layers at differing heights. The lenticular cloud is usually turbulent, regardless if they are smooth or ragged in appearance.

**9.5.5. Altimeter Error.** Barometric pressure is considerably lowered in the mountain wave because of the Venturi effect of high winds over an obstruction. Therefore, significant pressure altimeter errors are associated with the mountain wave. The maximum error can be as much as 2,500 feet if a strong wave is in progress. Therefore, the altimeter may indicate as much as 2,500 feet higher than the actual aircraft altitude.

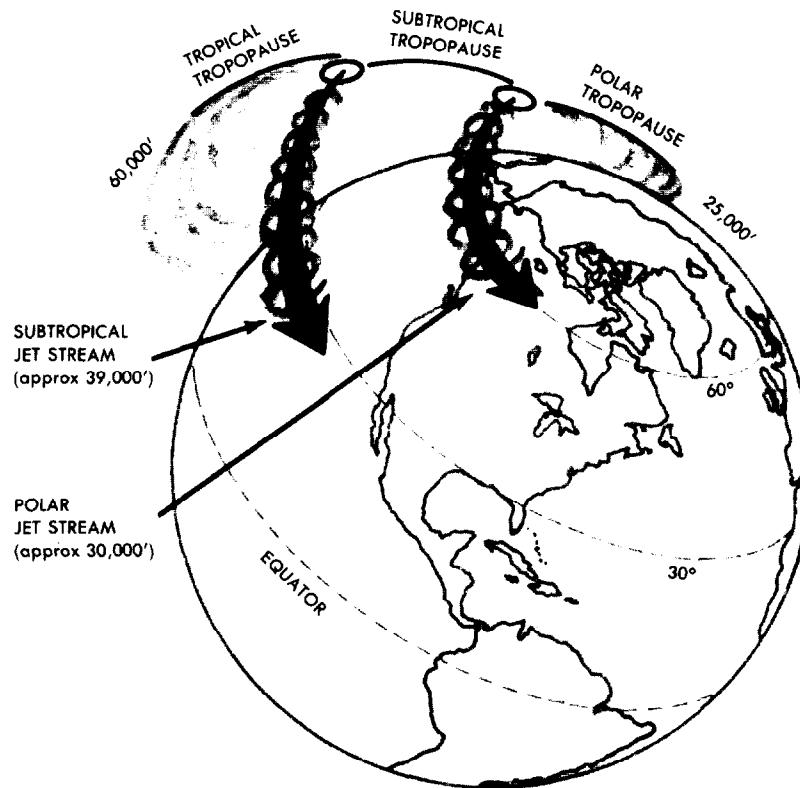
**9.5.6. Mountain Wave Precautions.** Aircrews should avoid flight into areas of suspected mountain wave conditions. If flight into the area must be made, the following safeguards should be followed:

- Avoid the cap, rotor, and lenticular clouds since they can often contain severe to extreme turbulence.
- As a minimum, fly at a level which is at least 50 percent higher than the height of the mountain range. This procedure will not keep the aircraft out of turbulence, but provides a margin of safety if a strong downdraft is encountered.
- Approach the mountain range at a 45° angle, so that a quick turn can be made away from the ridge if a severe downdraft is encountered.

Figure 9-16. Standing Lenticular Clouds Associated with a Mountain Wave.



Figure 9-17. Location of Polar/Subtropical Jet Streams in Relation to Tropopause.

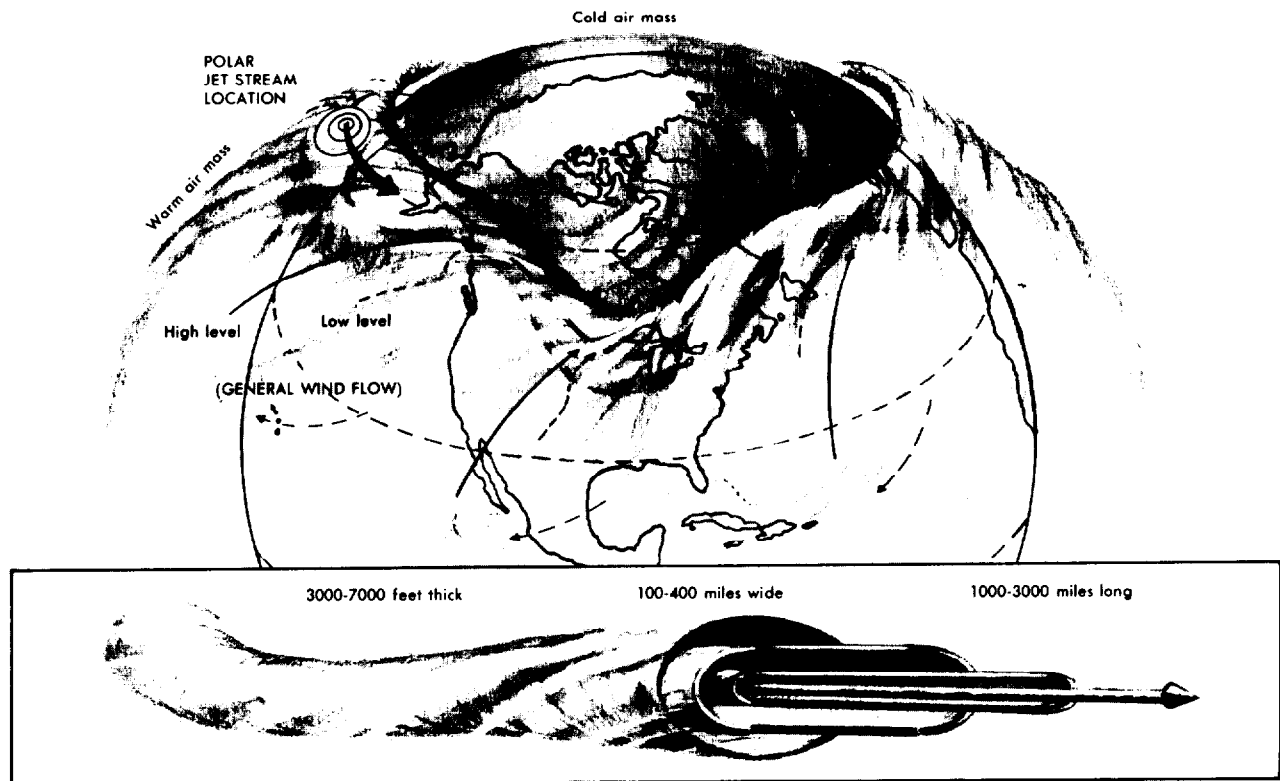


- Suspect pressure altimeter errors. *Altimeters may indicate 2,500 feet higher than actual altitude.*
- Follow additional Dash 1 procedures concerning flight speeds and control settings.

**9.6. High Altitude Turbulence-Tropopause.** The tropopause is often a region of turbulence because of the marked variations in vertical motions which occur in, at, or below the tropopause. The tropopause is often devoid of clouds, so that turbulence encountered there will frequently be classified as clear air turbulence.

**9.6.1.** Earlier we discussed the tropopause is higher at the equator than at the poles. However, there are generally two breaks in the tropopause—one between the arctic and polar air masses, and one between the polar and tropical air masses (Figure 9-17). It is where these breaks in the tropopause appear that a very important flight factor can be found--the *jet stream*.

Figure 9-18. The Polar Front Jet Stream.



**9.7. Jet Stream.** Jet streams are characteristic of both the Northern and Southern Hemispheres; however, this discussion will be limited to Northern Hemisphere jet streams. The jet stream, as illustrated in Figure 9-18, is a narrow, shallow band of strong, generally westerly winds of 50 kts or more which meanders vertically and horizontally around the hemisphere in wave-like patterns.

**9.7.1. Polar Jet Stream.** Polar jet streams are generally found parallel to and on the "poleward" (cold) side of surface frontal systems, generally in the neighborhood of 30,000 feet; but, they can be above or below this level depending on the latitude and the season. As you look downwind into the jet stream, you will notice that the air in a jet core slowly rotates in a counterclockwise direction. If the air is moist, the ascending air on the warm air side will cause cirrus clouds to form. Strong vertical wind shear may be evident from the windswept appearance of the trailing ice crystals of hook-shaped cirrus. Very dense cirrostratus clouds form with an abrupt "poleward" edge near the jet core.

**9.7.1.1. Wind Speeds.** Wind speeds in the jet stream may sometimes reach 300 kts but generally are between 100 and 150 knots. Since the jet stream is stronger in some places than at others, it rarely encircles the entire hemisphere as a continuous river of wind. More frequently it is found in segments from 1,000 to 3,000 miles in length, 100 to 400 miles in width, and 3,000 to 7,000 feet in depth.

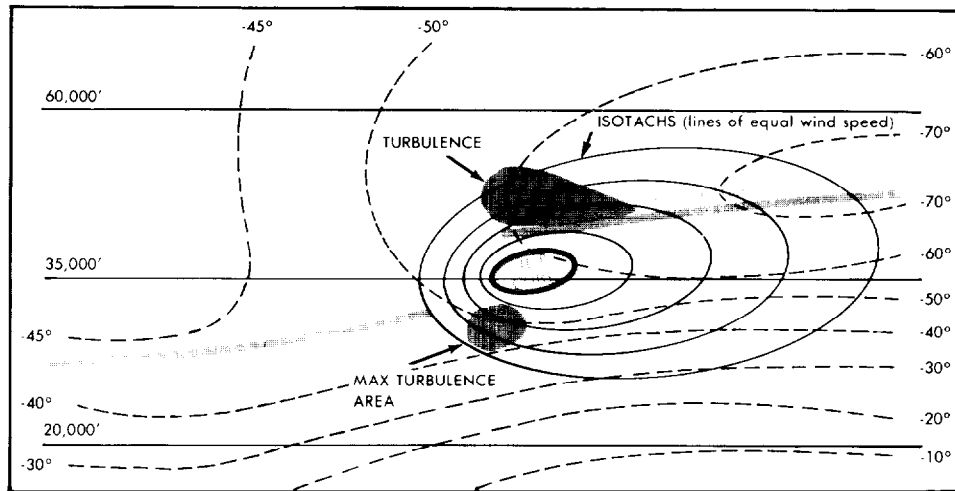
**9.7.2. Life Cycle.** The polar jet stream has a life cycle of formation, intensification, movement, and dissipation related to the polar front. The strength of the jet stream is greater in winter than in summer. The mean position of the polar jet stream shifts south in winter and north in summer moving with the seasonal migration of the polar front. As the jet stream moves southward, its core rises to higher altitudes, and on the average, its speed increases. The core of strongest winds is generally found between 25,000 feet and 40,000 feet, depending on latitude and season.

**9.7.2.1.** In Figure 9-19, notice that the highest wind speeds and probable associated turbulence in the polar front jet stream is found about 5,000 feet below the tropical tropopause and near the end of the polar tropopause. Also notice that the rate of decrease of wind speed is much greater on the polar side than on the equatorial side. Therefore, the magnitude of the wind shear is greater on the polar side than on the equatorial side. If a polar front jet becomes indistinct, another reforms in an interval of a few days or so, and more than one jet can exist at the same time. Likewise, one polar front jet follows another, and as illustrated in Figure 9-20 over Canada, two or more may exist simultaneously. There is hardly a day in the colder months without at least one jet stream, and often two or more, meandering over the United States.

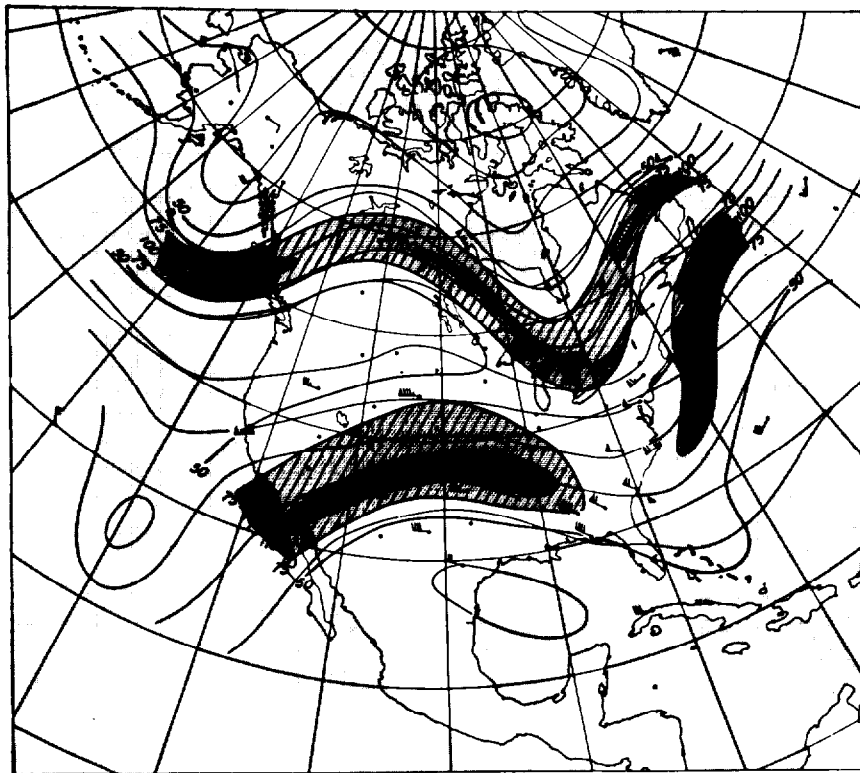
**9.7.2.2.** The existence of jet streams at operational altitudes requires additional aircrew flight planning consideration. The greater headwind component for westbound aircraft will increase fuel consumption and may require additional alternates

along the route. Wind shear associated with the jet stream may also cause turbulence, forcing the aircrew to change altitude or course.

**Figure 9-19. Areas of Probable Turbulence in Jet Stream.**



**Figure 9-20. Examples of Multiple Structure of Jet Stream.**



**9.8. Clear Air Turbulence (CAT).** The term *clear air turbulence* (CAT) is commonly used to denote the rough, washboard-like bumpiness which ranges from a few annoying bumps to severe jolts capable of causing structural damage to airframes and injury to passengers. CAT is not restricted to cloud-free air. It occurs in cirrus clouds and haze layers with no visual warnings. Studies show that only about 75 percent of all CAT encounters are in clear air.

**9.8.1. Characteristics.** Clear air turbulence differs from convective and mechanical turbulence in that it is more rhythmic in nature rather than random. CAT is usually found above 15,000 feet, outside of cumuliform cloudiness, in association with a marked change in wind speed or temperature, either with height (vertical wind shear) and/or in the horizontal (horizontal wind shear). Not all CAT is associated with jet streams, but the most likely location of CAT, and especially the more severe cases,

is considered to be as indicated in Figure 9-19. Favored geographical areas for the strongest upper level jet stream and coincident CAT areas are depicted in Figure 9-20.

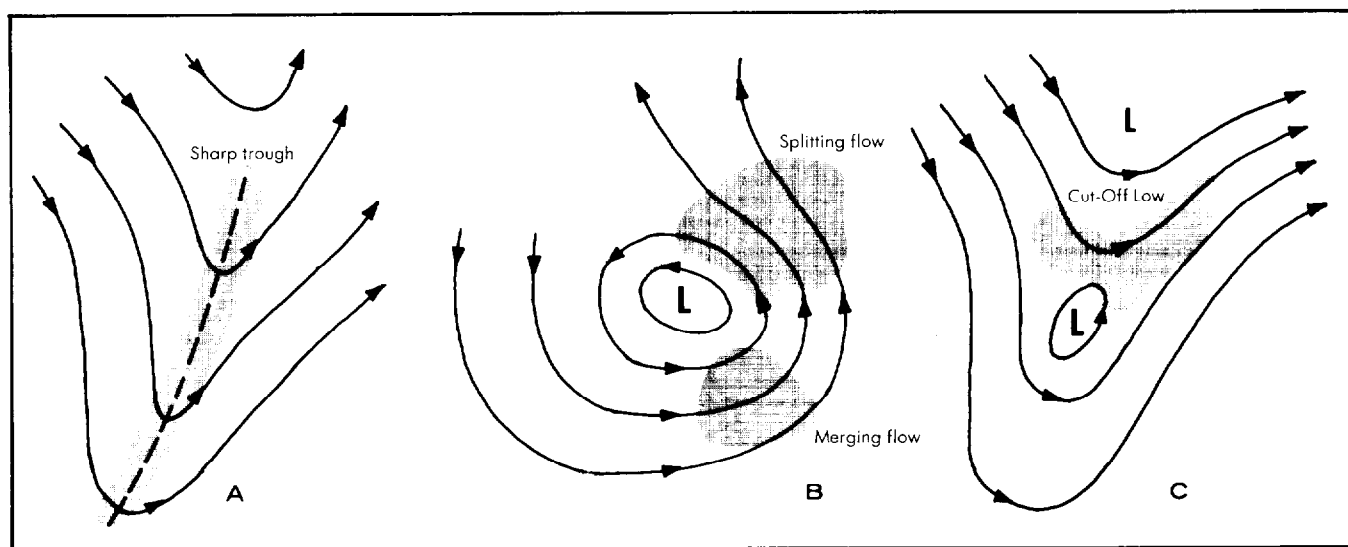
**9.8.1.1.** The rapid change of wind speed within a short distance of the jet core is particularly significant. The vertical shear is generally close to the same intensity both above and below the core, and it may be many times stronger than the horizontal shear. The horizontal shear on the cold air side of the core is stronger than on the warm air side. You can use this information to adjust your flight to obtain an increased tail wind or a decreased head wind. If jet stream turbulence is encountered with direct tail winds or head winds, a turn to the south in the northern hemisphere will place the aircraft in a more favorable area. If a turn is not feasible because of airway restrictions, a climb or descent to the next flight level will usually result in smoother air. Jet stream CAT often occurs in patches averaging 2,000 feet deep, 20 miles wide, and 50 miles long.

**9.8.2. Upper Wind Patterns with CAT.** The occurrence of CAT can extend to levels in excess of 60,000 feet, and can be associated with other windflow patterns which produce shears. A sharp trough aloft, especially one moving at a greater speed than 20 kts, can have clear air turbulence in or near the trough, even though wind speeds can be rather low as compared with the speeds near the jet stream. However, the winds on opposite sides of the trough can have a difference of 90° or more in direction (Figure 9-21A). CAT can occur in the circulation around a closed low aloft, particularly if the flow is merging or splitting (Figure 9-21B) and is to the northeast of a cutoff low aloft (Figure 9-21C).

**9.8.3. Aviator Corrective Actions.** If jet stream turbulence is encountered in a crosswind, it is not so important to change course or flight level. However, if it is desired to traverse the CAT area more quickly, either climb or descend after watching the temperature gauge for a minute or two. *If the temperature is rising--climb; if it is falling--descend.* This maneuver will prevent following the sloping tropopause or frontal surface and thereby staying in the turbulent area. If the temperature remains the same, you can either climb or descend.

**9.8.3.1.** When anticipating or encountering CAT, fly the recommended turbulence-penetration airspeed for your aircraft and tighten your seat belt and shoulder harness. Ordinarily, this will reduce the effect of turbulence. However, if the intensity of the turbulence requires further action, climb, descend, and/or change course to exit the turbulent zone, using the information provided by the weather forecaster during the preflight weather briefing or pilot-to-metro services. Make very gradual climbs, descents, and turns to minimize additional stress on the aircraft. Finally, give PIREPs as soon as practical to alert fellow aviators of CAT and other dangerous weather.

**Figure 9-21. Wind Patterns Associated with High Level CAT.**



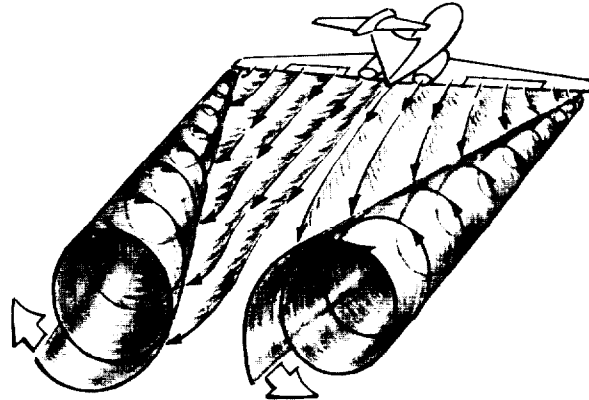
**9.9. Wake Turbulence.** Every aircraft in flight generates a pair of counter-rotating vortices trailing from the wing tips (Figure 9-22). Many large jets generate vortices exceeding the roll capability of smaller aircraft. Further, turbulence generated within the vortices can damage aircraft components and equipment if encountered at close range. The strength of the vortex is governed primarily by the weight, speed, and wing shape of the generating aircraft. The basic factor is weight, and vortex strength increases with increases in weight and span loading. The greatest vortex strength occurs when the aircraft is HEAVY, CLEAN, and SLOW. Vortex tangential velocities have been recorded up to 130 kts.

**9.9.1. Induced Roll.** A serious wake encounter could result in structural damage. The primary hazard is loss of control because of induced roll (Figure 9-23). The capability of counteracting this roll depends on the span and counter-control responsiveness of the encountering aircraft. Where the wing span and ailerons of larger aircraft extend beyond the vortex,

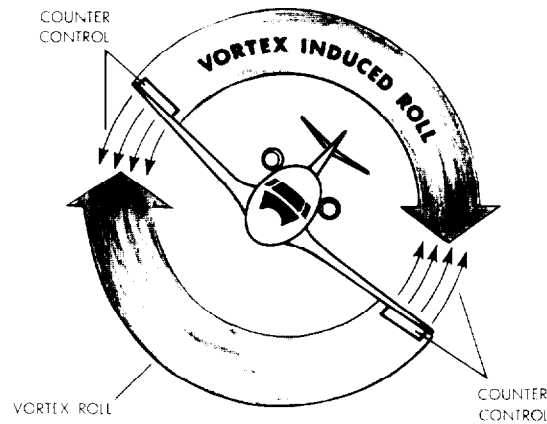


counter-control is usually effective and the induced roll is minimal. The significant factor in induced roll is the *relative span* of the encountering aircraft (Figure 9-24) as compared to the generating aircraft.

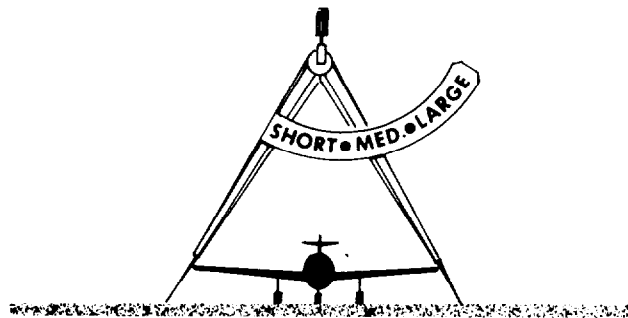
**Figure 9-22. Counter Rotating Vortices.**



**Figure 9-23. Induced Roll.**



**Figure 9-24. Relative Span.**

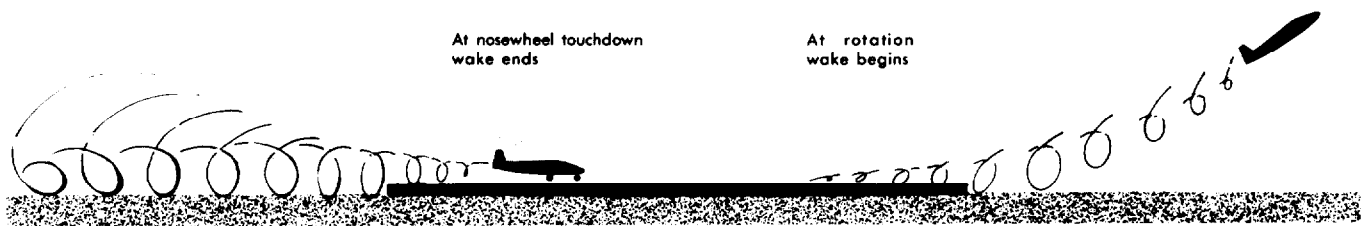


**9.9.2. Wake Vortex Characteristics.** Trailing vortex wakes have certain characteristics which the aircrew can use to visualize their location and avoid them:

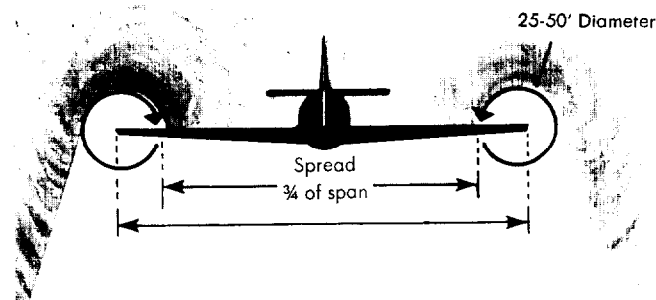
- Vortex generation starts with rotation when the nose-wheel lifts off and ends when the nose-wheel touches down on landing (Figure 9-25).
- Vortex circulation is outward, upward, and around the wing tip. Core sizes range from 25 to 50 feet and stay close together until dissipation (Figure 9-26).

- Vortices sink immediately at a rate of 400 to 500 feet/minute and level off 800 to 900 feet below the flight path (Figure 9-27). Pilots should fly at or above a preceding aircraft's flight path.
- When vortices sink into ground effect, they move laterally on the ground at a speed of about 5 kts (Figure 9-28).
- Cross-winds will influence the lateral movement of the upwind vortex and increase movement of the downwind vortex (Figure 9-29). Aircrews should be alert to heavy jets upwind.
- Tail-wind conditions can move the vortices forward into the touchdown zone (Figure 9-30).
- Vortices persist longer during inversions. When such conditions exist, aircrews should request additional aircraft separation.

**Figure 9-25. Vortex Generation.**



**Figure 9-26. Vortex Circulation.**



**9.9.3. Helicopters.** Helicopter-hovering can generate a down-wash from its main rotor(s) similar to the prop-blast of conventional aircraft. In forward flight, this energy is transformed into a pair of trailing vortices similar to wing tip vortices of fixed wing aircraft (Figure 9-31). However, the vortex circulation is outward, upward, around, and away from the main rotor(s) in all directions. Pilots of small aircraft and helicopters should avoid both the vortices and down-wash of a heavy helicopter.

**9.9.4. Air Traffic Controller/Aviator Corrective Actions.** Airfield traffic controllers will separate IFR aircraft from heavy jets or large aircraft, but VFR aircraft must provide their own separation from heavy/large aircraft. But, ultimately, it is the aircrew's responsibility to anticipate and avoid areas of possible vortex wake turbulence. The following vortex avoidance procedures are recommended for the various situations:

- Enroute--fly at or above a large aircraft's flight path.
- Ensure adequate distance exists behind landing heavies, or land beyond the heavies touchdown point if sufficient runway remains.
- Landing or departing behind a departing large aircraft--land or rotate prior to the heavy aircraft's rotation point.

**9.10. Medical and Human Factors of Turbulence.** Turbulence causes a variety of effects on aircraft ranging from gentle jostling to structural damage. Another important aspect about turbulence is that it can produce adverse effects on the aircrew. Aviation medicine and human factor research has shown that a severe turbulence environment can cause a compromise of aircrew performance in the following ways:

- Causes a startled reaction.

- Delays decision time.
- Produces involuntary control movements which may not be obvious to the aircrew.
- Produces sensory illusion. Makes reading instruments difficult.

Figure 9-27. Vortex Sink Rate.

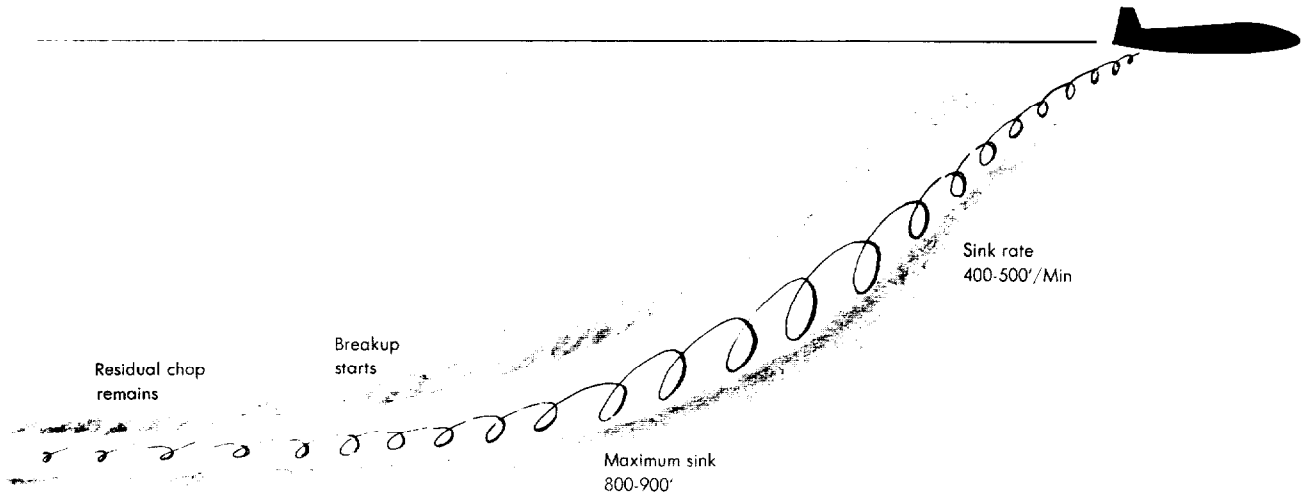


Figure 9-28. Vortex Movement in Ground Effect (No Wind).

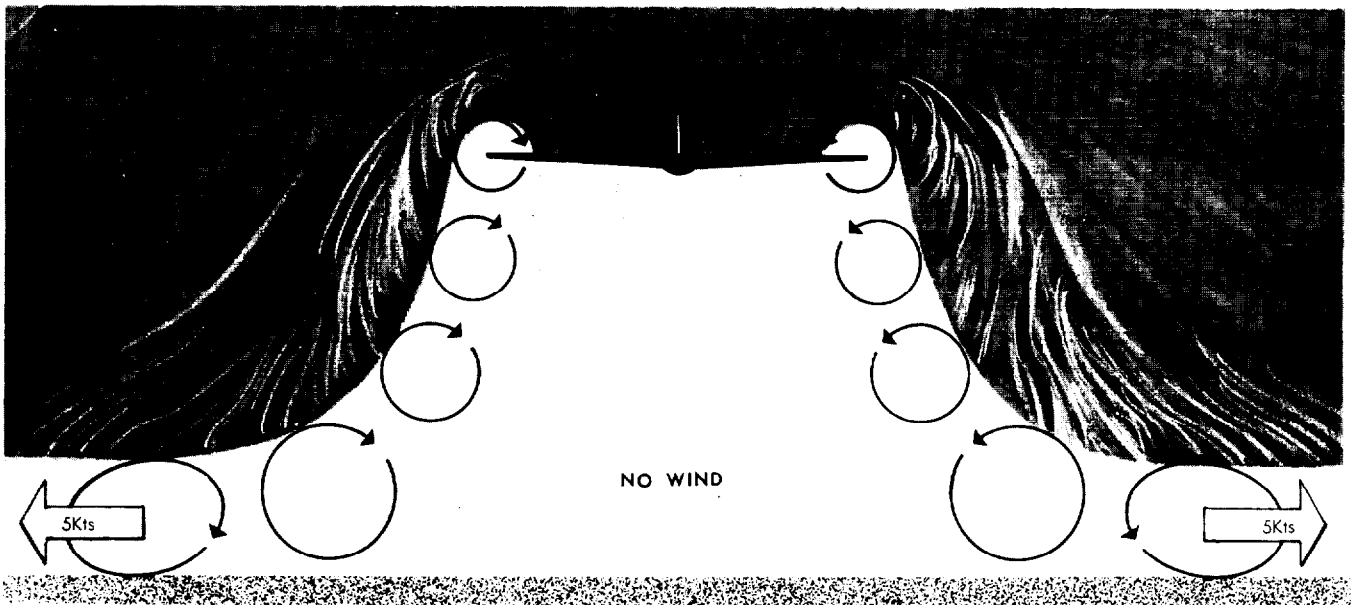


Figure 9-29. Vortex Movement in Ground Effect (Cross Wind).

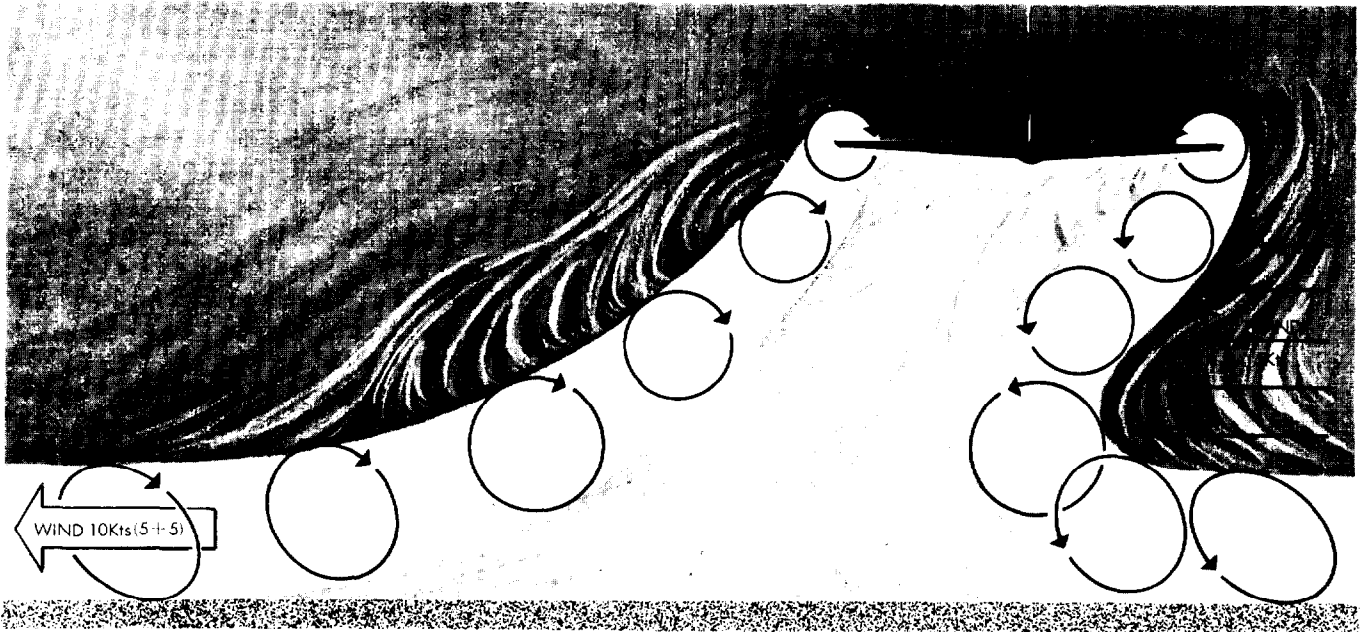


Figure 9-30. Vortex Movement Forward of Touchdown Zone (Tail Wind).

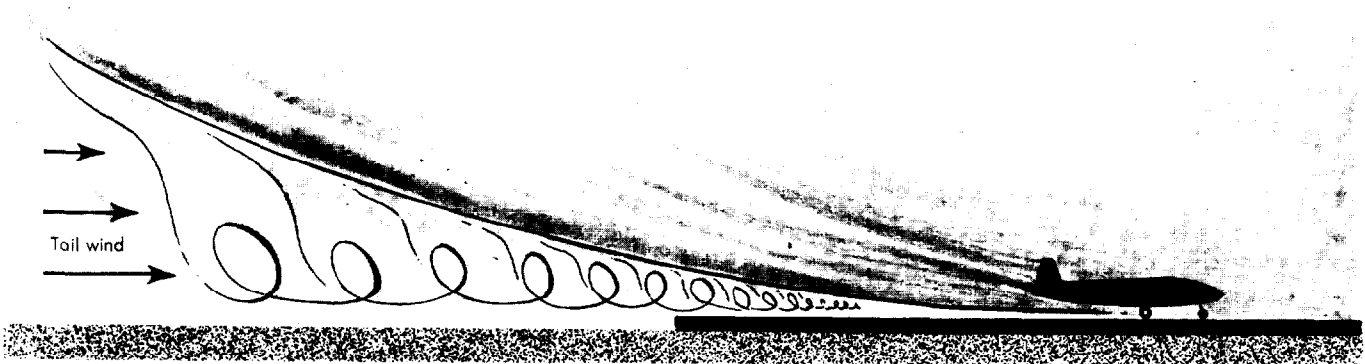
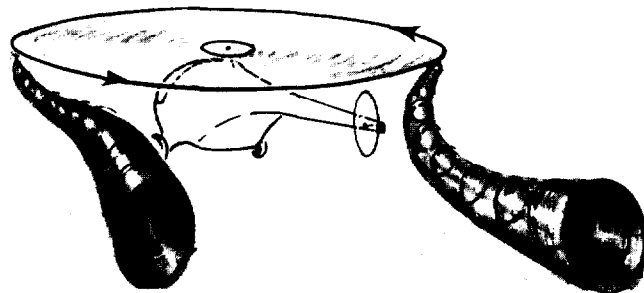


Figure 9-31. Helicopter Vortices.



## Chapter 10

### LOW LEVEL WINDSHEAR

**10.1. Introduction.** During the period from 1964 to 1986, at least 32 accidents and incidents occurred in which windshear was identified as a contributing factor. These accidents and incidents resulted in over 600 fatalities. Flight crews must gather all available information to assist them in making informed decisions when flying in windshear environments. Recognizing windshear, using available cockpit instruments, and using effective crew coordination procedures are the first steps in handling this potentially lethal situation. This chapter will arm you with the basic knowledge to handle a windshear situation.

**10.1.1. Background.** Windshear was first identified by Dr. Fujita in the early 1970's as a factor in aircraft accidents. The prominent University of Chicago meteorologist identified thunderstorm fan shaped debris patterns as caused by sudden downrushes of strong winds. He coined the phrase "*downburst*" which became known as the "*microburst*" and attributed microbursts to causing the Eastern Flight 66 crash at JFK airport on 24 Jun 75 and the Continental Flight 426 which crashed at Denver on 7 Aug 75. On 1 Aug 83, a severe microburst event at Andrews AFB, MD had an indicated headwind/tailwind differential velocity near 200 knots! The primary lesson learned is that aviators should always avoid dangerous windshear situations. Windshears can exist which are beyond the capability of any pilot or airplane.

**10.2. Definition.** *Windshear* is any rapid change in wind direction or speed. Severe windshear is a rapid change in wind direction or speed causing airspeed changes greater than 15 knots or vertical speed changes greater than 500 feet per minute. Although windshear occurs at all altitudes, it is particularly hazardous when it happens within 2,000 feet of the ground.

**10.2.1. Hazards.** On approach and departure, aircraft operate only slightly above stall speed, and a sudden change in wind velocity can lead to a loss of lift. If the loss is great enough, and the power response inadequate, a high descent rate results. The altitude at which the encounter occurs, the pilot reaction time, and the aircraft response capability determine if the descent can be stopped in time to prevent an accident.

**10.2.2.** The time factor and low level windshear (LLWS) can be illustrated by example. Suppose an aircraft is straight and level at 180 KIAS flying into a 30 kt headwind. Over the next hour, the winds change to a 30 knot tailwind. The only effect on the aircraft was a groundspeed change from 150 to 210 knots. The aircraft effectively accelerated with the accelerating air mass without a power adjustment by the pilot. However, if the same change occurs over five to ten seconds, the air mass accelerates away from the aircraft, causing a rapid reduction below 180 KIAS. The crew would have to react quickly to accelerate and prevent a critical loss of airspeed. Unfortunately, not all aircraft respond fast enough to safely fly through sudden windshear environments. This is especially true for jet aircraft with engines that respond slowly to changes in power settings.

**10.3. Performance Decreasing Shear.** When an aircraft enters into a decreasing headwind over a short time period, the relative velocity of air over the wings decreases and the indicated airspeed decreases. Since lift is dependent upon relative velocity of air over the wings, lift decreases with an associated increase in the vertical speed indicator (VSI) readout. The decreasing headwind shear condition is therefore *performance decreasing*.

**10.3.1.** The hazard associated with performance decreasing windshear during approach and takeoff is a significant loss of airspeed and therefore lift. An aircraft operating at low speeds and low altitudes in a high drag configuration cannot afford a sudden decrease in airspeed (Figure 10-1A). When the shear is encountered, the aircraft experiences a drop in airspeed and a loss in altitude. The pilot must be ready to add power when indicated airspeed starts to decrease. Once speed and glide path are regained, thrust must be reduced to remain at the appropriate approach speed. It will now require less thrust and a greater rate of descent to maintain the proper profile in the decreased headwind. If the initial corrections of increased thrust and pitch are not promptly removed after regaining glide path and airspeed, a long landing at high speed may result (Figure 10-1B).

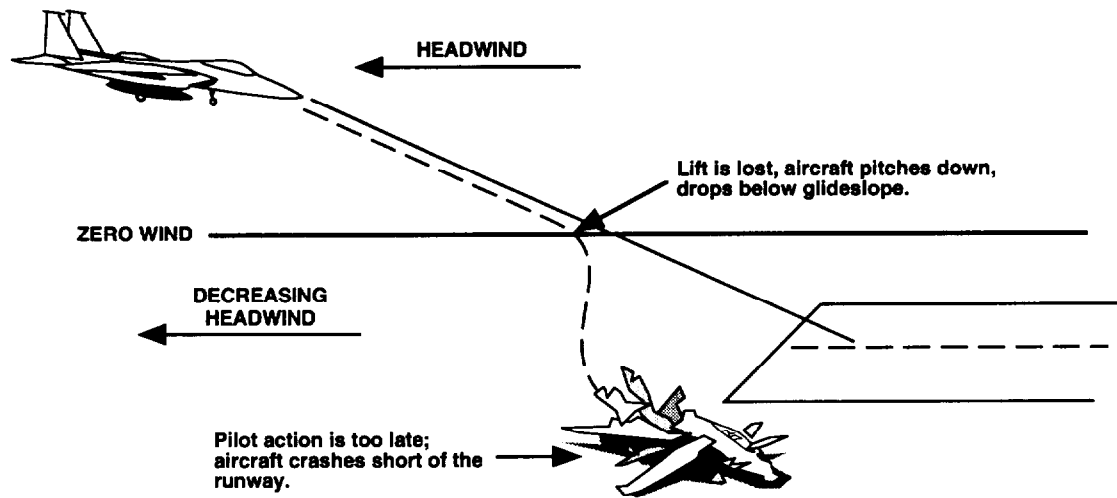
**10.4. Performance Increasing Shear.** When an aircraft traverses from a tailwind to a headwind over a short time span, the air's relative velocity over the wings increases. The aircraft's inertia causes an increase in lift, with an initial increase in airspeed and reduced VSI indications. This windshear condition is *performance increasing*.

**10.4.1.** Long landings are an obvious hazard of performance increasing windshear (Figure 10-2A). However, a more critical hazard exists. When an aircraft on approach experiences wind shear during an approach at approach speeds, the aircraft will experience a sudden increase in airspeed and a reduction in the descent rate. The pilot's normal reaction will be to reduce power and lower pitch to compensate. Moments later, after the aircraft's inertia dissipates, the indicated airspeed (IAS) will drop resulting in a loss of lift. The aircraft will now be below approach speed at a higher descent rate and most likely descending through the glidepath--all at a reduced power setting. If this type of shear occurs close to the ground, the tendency is for the aircraft to land short of the runway (Figure 10-2B). Therefore, it is critical for the pilot to understand what is

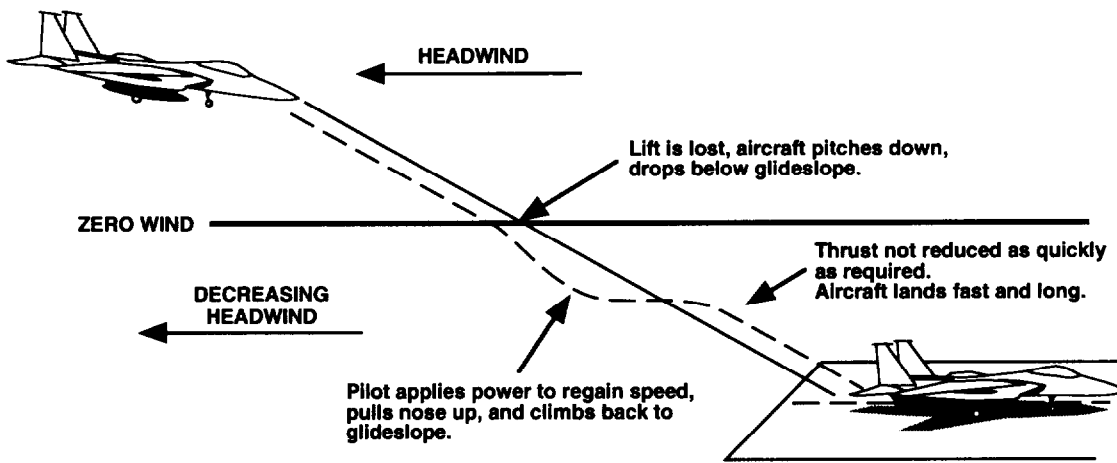
happening to the aircraft in order to successfully transit the shear. Corrections to pitch and power must be positive and aggressive. But avoid going to idle where engine spool up time could be excessive.

**10.5. Microbursts.** A *microburst* is short lived, powerful downdraft associated with convective activity. Observations show that approximately five percent of all thunderstorms produce a microburst. Downdrafts associated with a microburst are typically only a few hundred to 3,000 feet across. When a microburst contacts the ground, it fans out in a radial pattern typically producing headwind to tailwind speed differences greater than 50 kts. The outflow region is typically 6,000 to 12,000 feet across.

Figure 10-1. Performance Decreasing Shear.

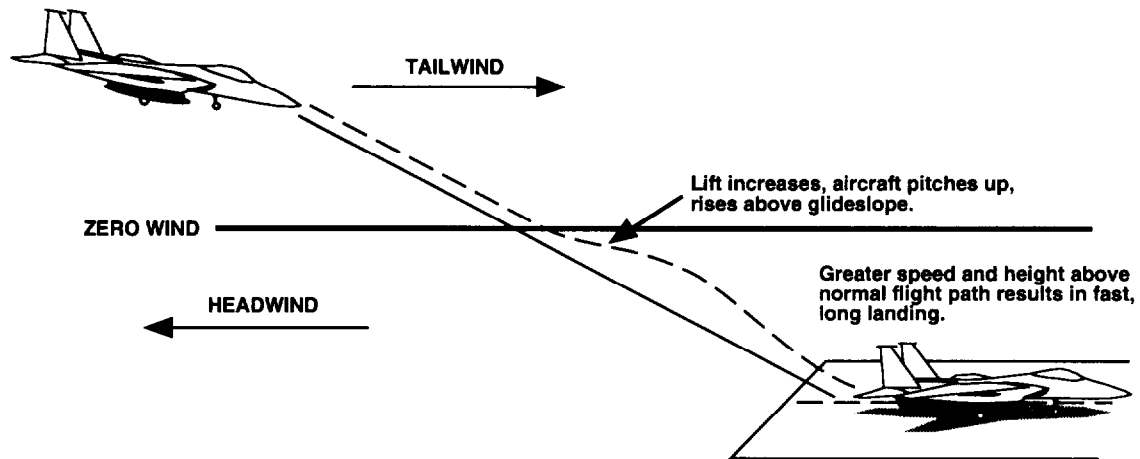


A. Performance decreasing shear at an altitude too low for recovery

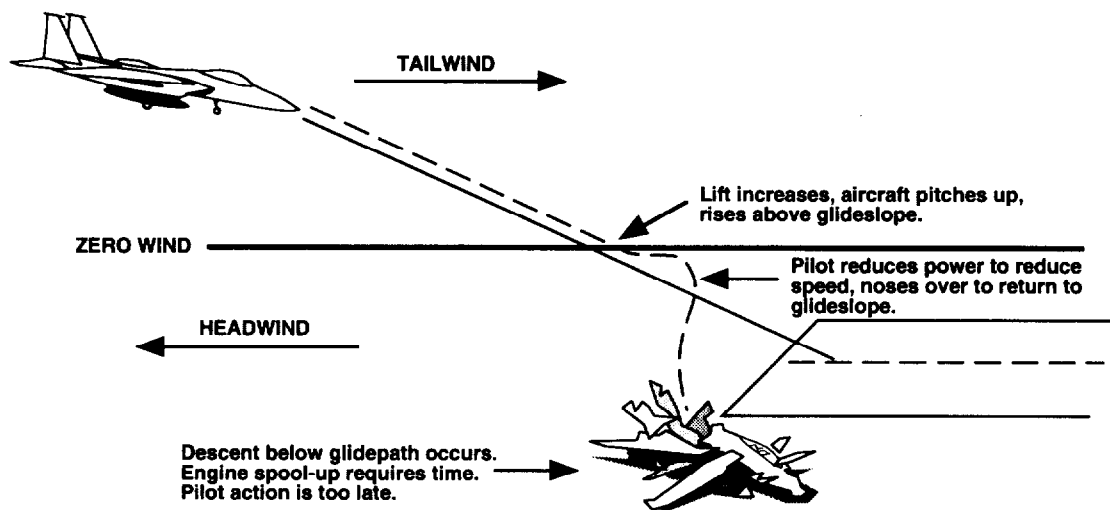


B. Performance decreasing shear where over-correction results in a long landing

Figure 10-2. Performance Increasing Shear.



A. Performance increasing shear resulting in a long landing



B. Performance increasing shear where over-correction results in impact short of runway

**10.5.1. Hazards.** They are extremely dangerous because their small size and rapidly changing wind pattern over short distances results in extreme windshears. Characteristically, microburst winds intensify for about 5 minutes after ground contact and typically dissipate after about 10 to 20 minutes. Since the phenomenon is short lived, this makes the "If he made it, so can I" theory or PIREPs invalid.

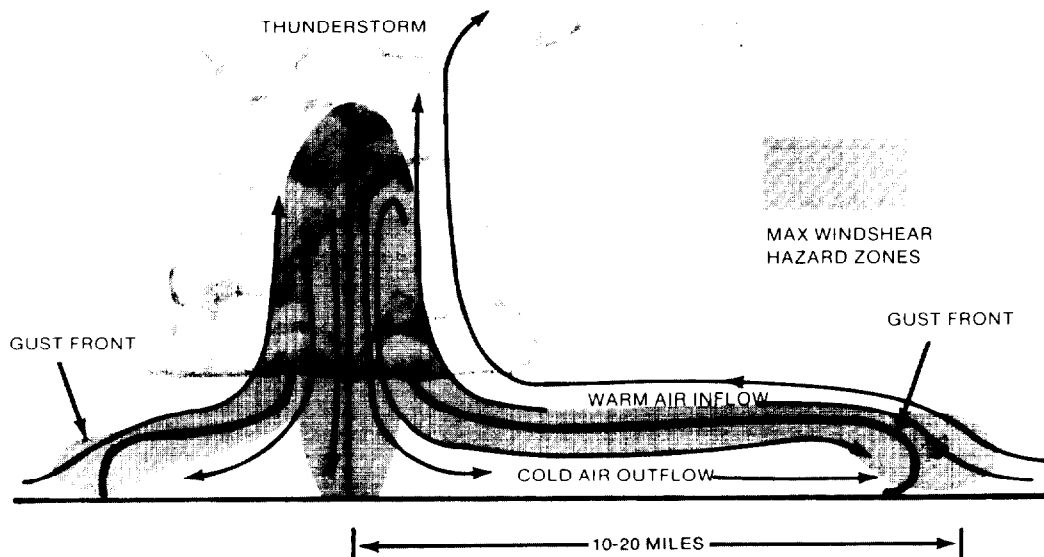
**10.5.2.** When penetrating a microburst, an aircraft experiences a headwind followed rapidly by a strong downdraft and then a tailwind. This results in a dramatic loss of airspeed and a large decrease in angle of attack. This all adds up to very high sink rate. If the shear is large enough and the altitude low, inadvertent ground contact may occur regardless of pilot actions. Several major aircraft accidents have been attributed to microburst windshear.

**10.5.3. Microburst Recognition.** One type of microburst (wet) typically occurs in conjunction with thunderstorms and is often embedded in heavy precipitation. Another type (dry) frequently develops under benign-appearing showers or virga (see Clouds, Figure 6-19). Both types produce extremely dangerous shears occurring with little or no warning. Most military airfields are not equipped with sensors to detect the onset of microburst windshear; therefore, timely PIREPs to tower or air traffic control agencies are essential. Due to rapidly changing conditions typical of microbursts, a PIREP from the aircraft directly ahead may not accurately describe the severity of windshear you may encounter.

**10.6. Weather Causing Low Level Windshear.** Several weather phenomena produce low level windshear. These include thunderstorms, microbursts, fronts, sea breezes, low level jets at the top of a radiation inversion, topographic conditions, and mountain waves.

**10.6.1. Thunderstorms.** Thunderstorms are responsible for two out of every three windshear events. Thunderstorms are also responsible for the most hazardous form of windshear, the microburst. Frontal thunderstorms are usually associated with weather systems like fronts, converging winds, and troughs aloft. The thunderstorm downdraft is fairly large, about one to five miles in diameter. Resultant outflows may produce large changes in wind speed (Figure 10-3). Downdrafts exiting the base of a thunderstorm spread outward upon reaching the surface and form an area of gustiness near the thunderstorm. The *gust front* is the outer limit of this gusty area.

**Figure 10-3. Thunderstorm Windshear Hazard Zones.**



**10.6.2. Gust Front.** The *gust front* frequently extends 10 to 20 miles from the thunderstorm. Across the gust front, vertical shears of 10 kts per 100 feet of altitude and horizontal shears of 40 kts per mile have been recorded. In addition to the tremendous speed shears reached, most severe thunderstorms produce directional shears of  $90^\circ$  to  $180^\circ$ . The thunderstorm downdraft may produce the most dangerous shear conditions associated with the outflow of a thunderstorm. For example, in Figure 10-4A, an aircraft passing through the gust front and downdraft would encounter not only a rapid change in the horizontal windfield but also a downward vertical motion. The downward vertical motion can add or subtract 2,000 feet per minute or more to the descent or ascent rate of the aircraft. In Figure 10-4B, the departing aircraft experiences both a downdraft and tailwind while still near the ground. The resulting loss of lift could prove disastrous to the aircrew.

**10.6.3.** Windshear associated with thunderstorms is by far the most hazardous due to the complexity and multiplicity of the shears produced. Prevailing low level winds are forced up over the gust front; currents feeding into the storm are present, and more than one gust front may be encountered due to multiple downdrafts. In addition, extreme downdrafts may occur beneath the central regions of the storm. Avoid approaches or departures in an environment of rapidly changing wind directions and speed since this can be disastrous (Figure 10-5).

**10.7. Fronts.** Winds can be significantly different in the two air masses meeting to form a front. Fronts most conducive to significant windshear are fast moving (30 kts or more) or have at least a  $5^\circ\text{C}$  ( $9^\circ\text{F}$ ) temperature differential.

**10.7.1. Cold Front Windshear.** Low level windshear occurs with a cold front after the front passes the aerodrome. Because cold fronts have a greater slope and normally move faster than warm fronts, the duration of low level windshear at a station is usually less than 2 hours.

**10.7.2. Warm Front Windshear.** Windshear associated with a warm front is more dangerous to aerodrome operations. Strong winds aloft, associated with the warm front, may cause a rapid change in wind direction and speed where warm air overrides the cold, dense air near the surface (Figure 10-6). Warm frontal windshear may persist 6 hours or more over an



Figure 10-4. Windshear Associated with Thunderstorm Downdraft.

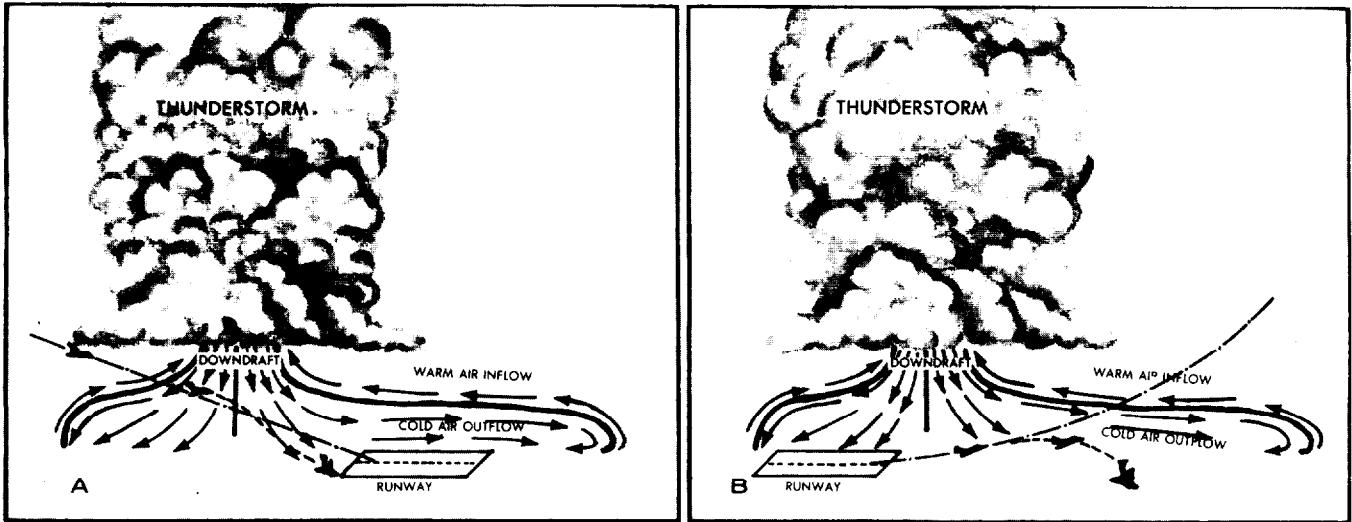


Figure 10-5. Approach and Takeoff can be Dangerous in Rapidly Changing Shear Conditions.

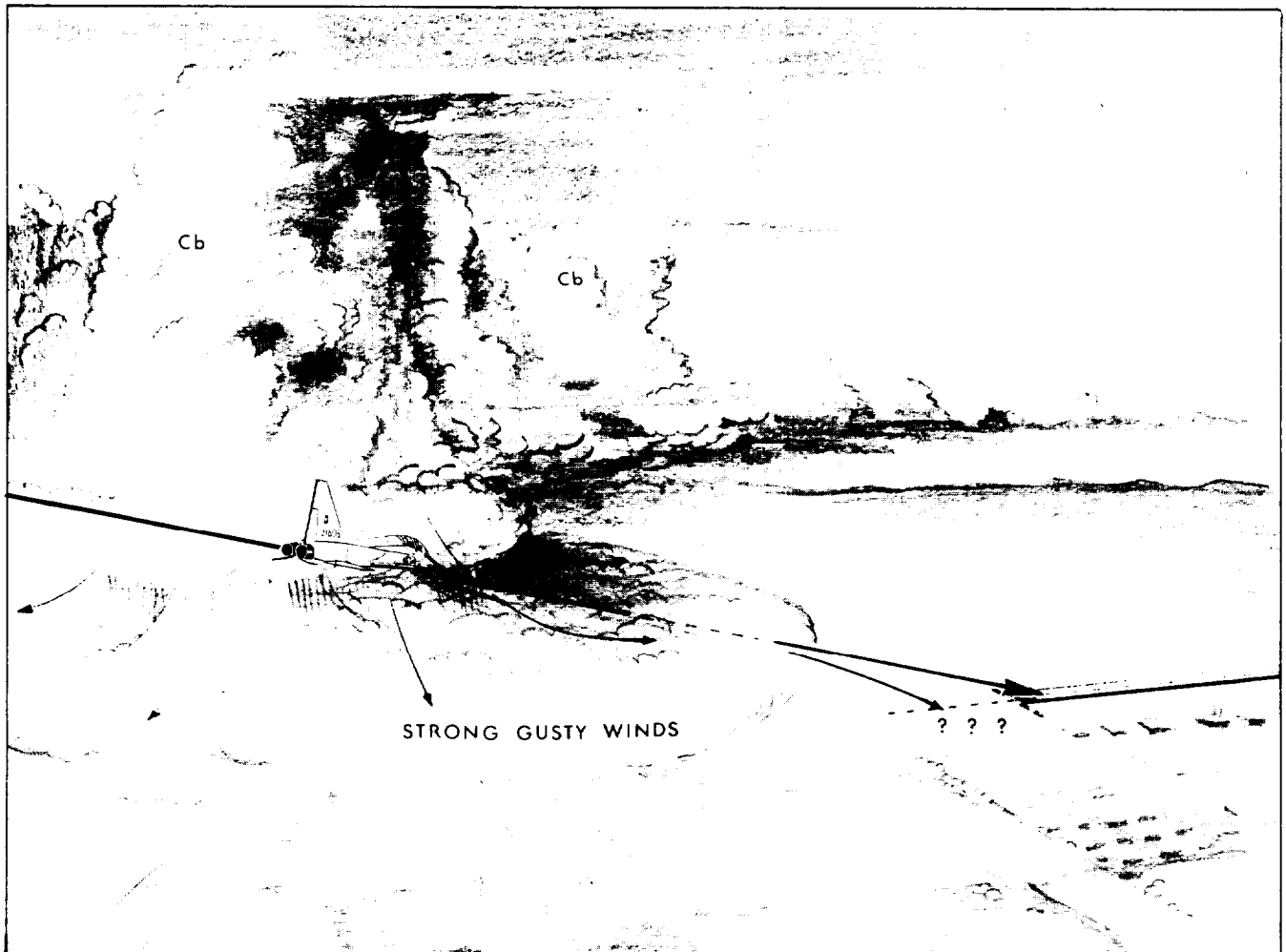
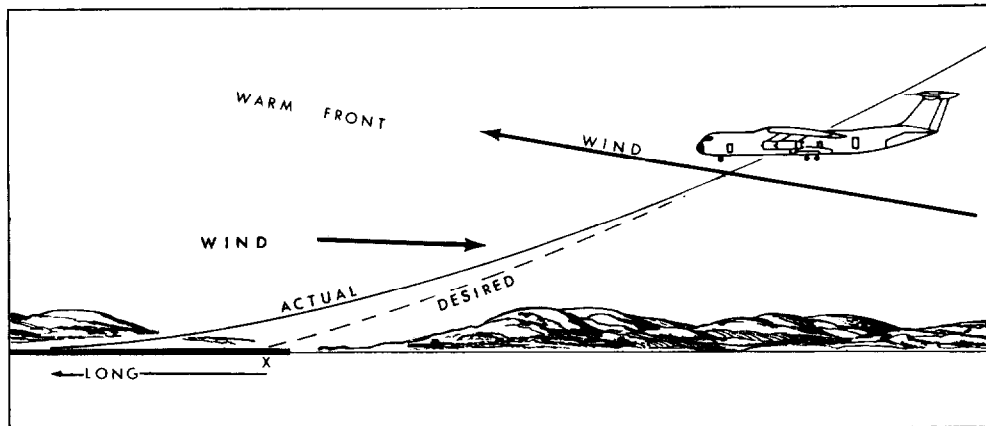


Figure 10-6. Windshear in a Warm Front.

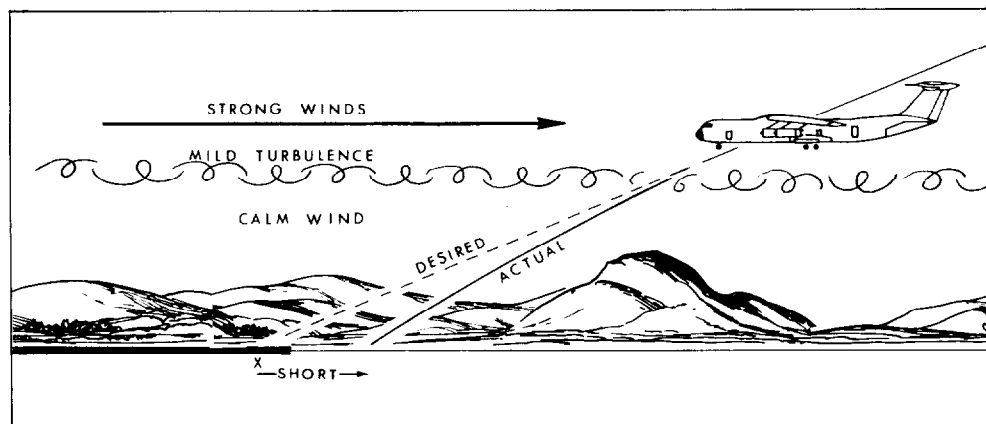


airfield ahead of the front because of the front's shallow slope and slow movement. Additionally, low ceilings and visibilities frequently associated with warm fronts may compound aircrew problems.

**10.8. Low Level Jet at Top of Radiation Inversion.** The low level jet often forms just above a radiation inversion. It starts to form at sundown, reaches maximum intensity just before sunrise, and is destroyed by daytime heating (usually by 10 AM local time). The low level jet can occur anywhere in the world during the entire year. In the United States it's common in the Great Plains and central states. As the earth cools, it creates a calm, stable dome of cold air 300-1,000 feet thick, called an inversion layer (see Chapter 9). The low level jet occurs just above the top of the inversion layer, and while speeds of 30 kts are common, wind speeds in excess of 60 kts have been reported. Anytime a radiation inversion is present, low level windshear is possible (Figure 10-7).

**10.9. Funneling Winds and Mountain Waves.** Some aerodromes are notorious for their frequent treacherous winds. These winds are caused by funneling, i.e., the terrain forces the prevailing winds to channel through a narrow space (such as a canyon) where it accelerates and spills out into an aircraft's flight path. These winds can sometimes reach 80 kts or more. Use caution when conducting operations near mountains or along straits and channels (Figure 10-8).

Figure 10-7. Windshear During Radiation Inversion.



**10.10. Cloud Clues.** Mountain waves (see Chapter 9) often create low level windshear at aerodromes lying downwind of the wave. While not a prerequisite, altocumulus standing lenticular (ACSL) clouds usually indicate the presence of mountain waves, and are clues to anticipate strong shears.

**10.11. Other Causes of Low Level Windshear.** Two less prominent sources of low level windshear deserve a brief discussion: gusty or strong surface winds and land/sea breezes. Fluctuations of 10 kts or more from the mean sustained wind speed or strong winds blowing past buildings and structures near a runway can produce localized shear. This type of shear is

Figure 10-8. A Wind Funneling Condition.

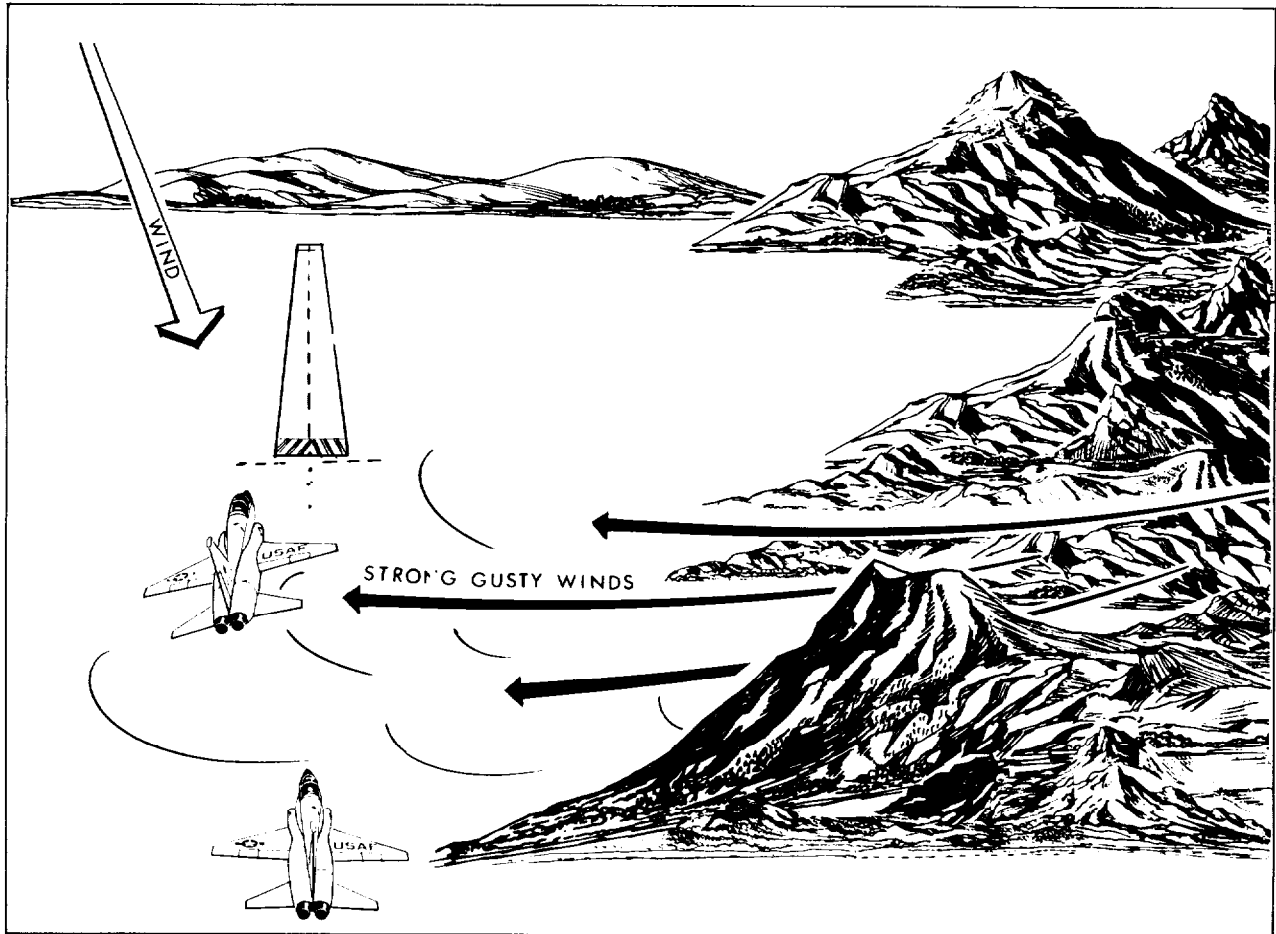
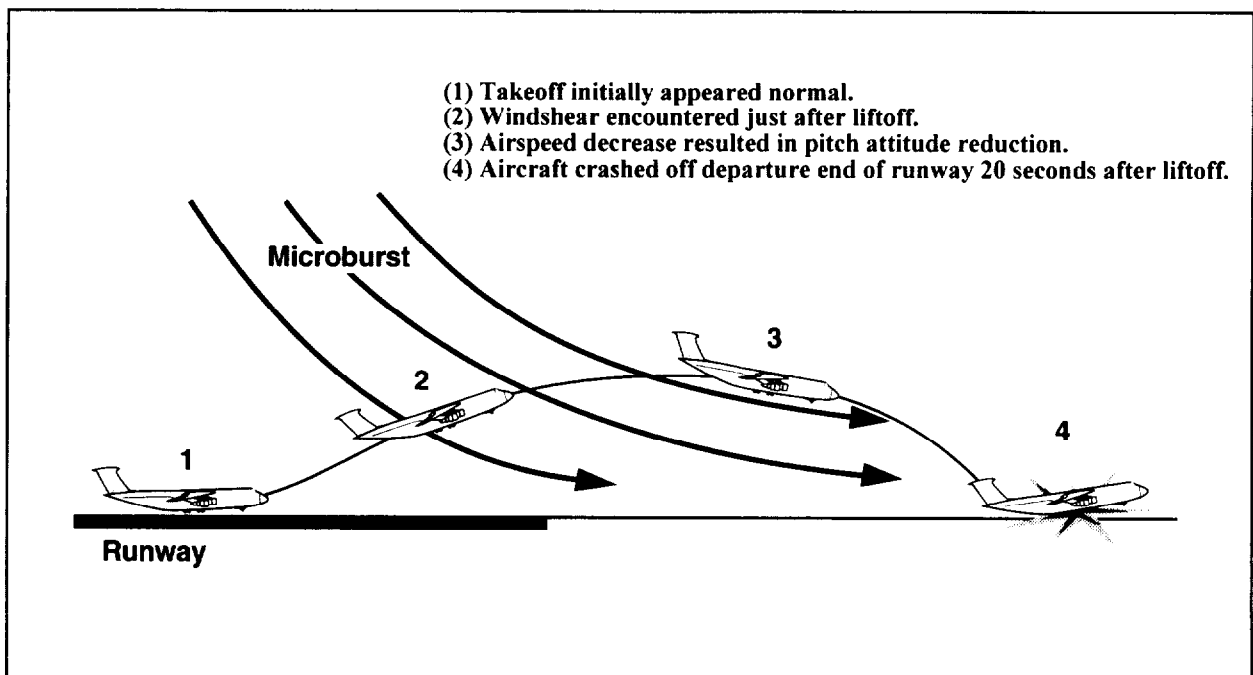


Figure 10-9. Windshear Encounter During Takeoff After Liftoff.



particularly hazardous to light aircraft. Observing the local terrain and requesting PIREPs of conditions near the runway are the best means for anticipating windshear from this source.

**10.11.1. Land and Sea Breezes.** Land and sea breezes commonly occur near large bodies of water (see Chapter 5). Differential heating and cooling of land and water causes this air flow. There is a windshear boundary present between the lower land/sea breeze with the prevailing upper level winds present just above the land/sea breeze boundary. If the upper and lower winds are from the same direction, windshear isn't much of a problem; but if the winds are from opposite directions, windshear can be as high as 40 knots! The sea breeze is primarily a daytime phenomenon. It's a small scale frontal boundary with prevailing wind speeds of 15 to 20 kts, and moves inland 10 to 20 miles. The depth of the sea breeze is approximately 2,000 feet. Land breezes occur at night when the land becomes cooler than the water. Land breezes are not as strong as sea breezes and are little threat to flying safety.

**10.12. Lessons Learned From Windshear Encounters.** Analysis of past windshear accidents and incidents has taught valuable lessons regarding windshear recognition and flight path control. Engineering studies and flight simulator evaluations have been conducted to gather additional information.

**10.12.1. Avoidance--Best Technique.** The primary lesson learned is that the best defense against windshear is to avoid it altogether. This is important because shears will exist which are beyond the capability of any pilot or airplane. In most windshear accidents, several clues, Low Level Wind Shear Alerts, weather reports, visual signs, were present that would have alerted the aircrew.

**10.12.2. Windshear Recognition.** Recognition of windshear is difficult and is usually accompanied by marginal weather. The time available for recognition and recovery is short, in some instances as little as 5 seconds. Flight crew coordination is essential for prompt windshear recognition and recovery. Pilots can control flight path with pitch attitude. Lower than normal airspeed may have to be accepted to counter loss of lift. Three main windshear situations and suggested pilot techniques are presented below.

**10.13. Encounter During Takeoff--After Liftoff.** In a typical accident studied, the airplane encountered an increasing tailwind shear shortly after lifting off the runway (Figure 10-9). For the first 5 seconds after liftoff, the takeoff appeared normal, but the aircraft crashed off the end of the runway about 20 seconds after liftoff.

**10.13.1. Early Trends.** In many events, early trends in airspeed, pitch attitude, vertical speed and altitude appeared normal. In this example, the aircraft encountered windshear before stabilized climb was established which caused difficulty in detecting onset of shear. As the airspeed was decreased, pitch attitude was reduced to regain airspeed (Figure 10-10). By reducing pitch attitude, available performance capability was not utilized and the airplane lost altitude. As terrain became a factor, recovery to initial pitch attitude was initiated. This required unusually high stick force. Corrective action was too late to prevent ground contact since the downward flight path was well established.

**10.13.2. Successful Recovery.** Reducing pitch attitude to regain lost airspeed, or allowing attitude to decrease in response to lost airspeed, is the result of past training emphasis on airspeed control. Successful recovery from an inadvertent windshear encounter requires maintaining or increasing pitch attitude and accepting lower than usual airspeed. Unusual and unexpected control inputs may be required to counter natural airplane pitching tendencies due to airspeed and lift loss. To counter the loss of airspeed and angle of attack, pitch attitude must be increased above the normal range. Only by properly controlling angle of attack (AOA) through pitch attitude and accepting a reduced airspeed can flight path degradation be prevented (Figure 10-11). Once the airplane begins to deviate from the intended flight path and high descent rates develop, it takes additional time and altitude to change flight path direction.

**10.13.3. Response Time.** In the windshear scenario just described, available aircraft performance capability may not have been used because of two factors: lack of timely recognition and inappropriate or inadequate response. Rapidly deteriorating climb performance may not be apparent to the crew unless all appropriate vertical flight path instruments are closely monitored. Only 5 to 10 seconds may be available to recognize and respond to the shear (Figure 10-12). It's imperative that a windshear encounter be recognized as soon as possible. Timely windshear recognition requires effective crew coordination and appropriate callouts by the pilot not flying.

**10.14. Encounter During Takeoff--On Runway.** Analysis of a typical accident where an increasing tailwind shear was encountered during takeoff ground roll showed that initial indications appeared normal. Due to increasing tailwind shear, the airplane didn't reach rotational speed ( $V_r$ ) until nearing the end of the runway. As the aircraft lifted off, the tailwind continued increasing, preventing any further airspeed increase. The airplane encountered an obstacle off the departure end of the runway (Figure 10-13).

**10.14.1. Difficulties Recognizing Tailwind Shear.** An additional factor is the difficulty of recognizing deteriorating aircraft performance. Timely recognition of a windshear encounter on the runway may be difficult since the only indication may be slower than normal acceleration. The presence of gusts may mask abnormal airspeed build-up. Time available to respond effectively may be as little as 5 seconds.

Figure 10-10. Windshear Effects on Flight Path.

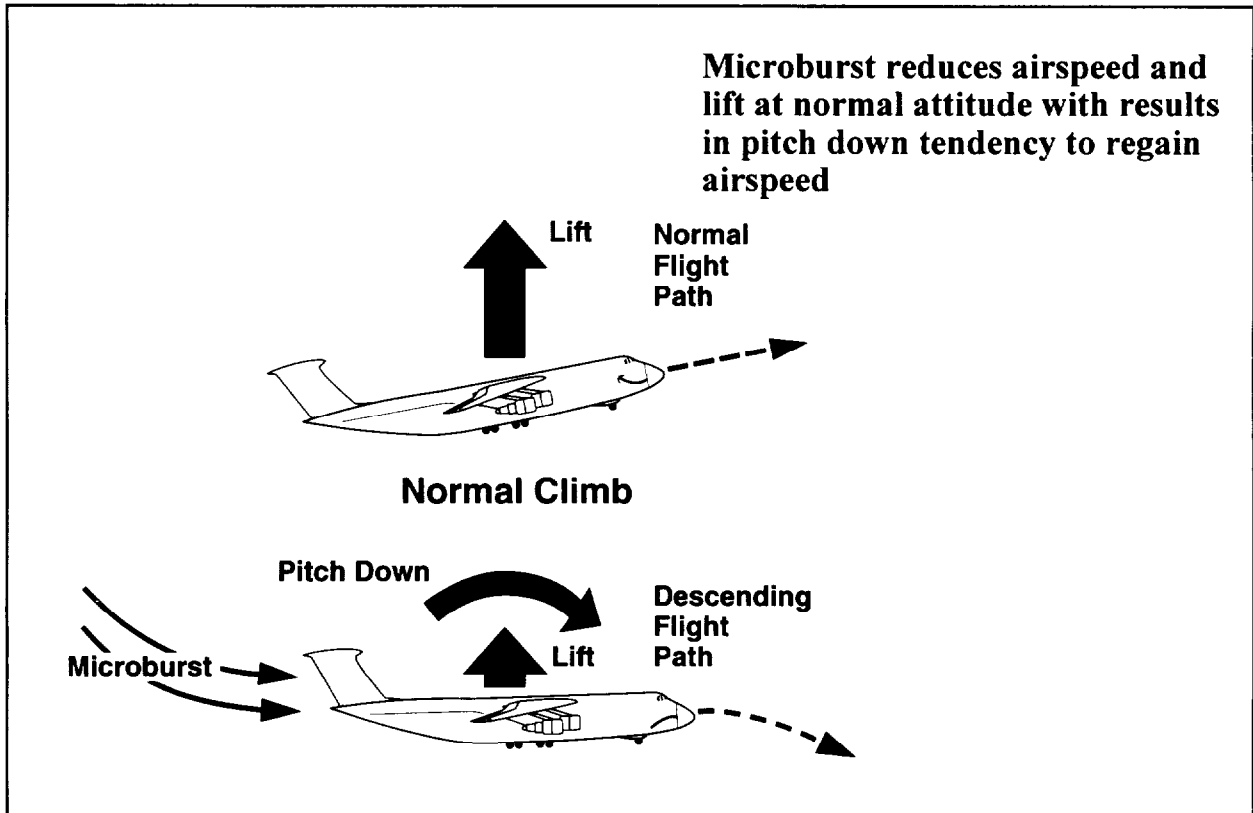
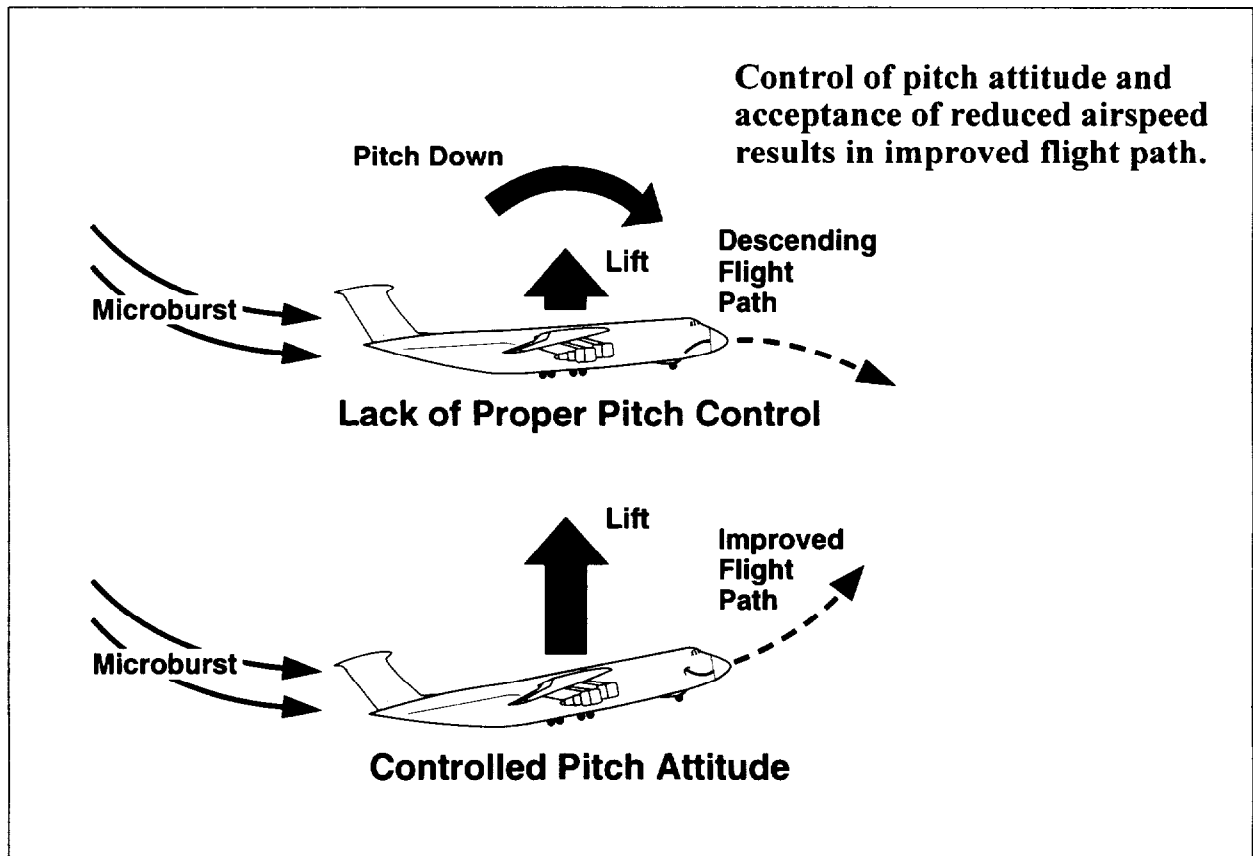


Figure 10-11. Pitch Controls on Flight Path.



**10.14.2. Successful Recovery.** Full thrust may be required to provide additional performance, particularly if reduced thrust takeoff procedures have been used. If there is insufficient runway left to accelerate to normal takeoff speed, and inadequate runway to stop, liftoff and safe climb may require rotation at speeds less than normal  $V_L$ . In this case, additional pitch attitude may be required to achieve sufficient lift (Figure 10-14). Rotation to higher than normal pitch attitude at lower than normal airspeed may be required to lift off the remaining runway which may result in aft body contact. To deal with an inadvertent windshear encounter, the pilot must be prepared to apply techniques which differ from those ordinarily used.

Figure 10-12. Time Available to Respond to Windshear Encounter.

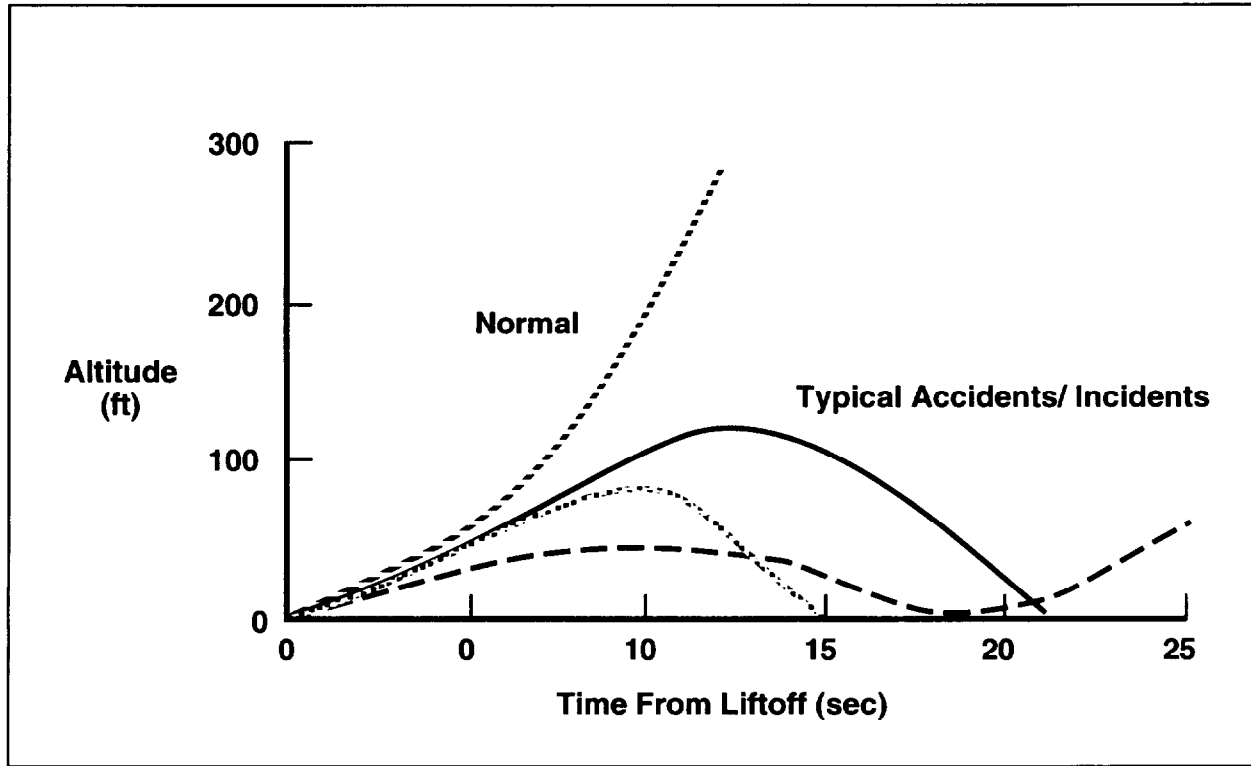
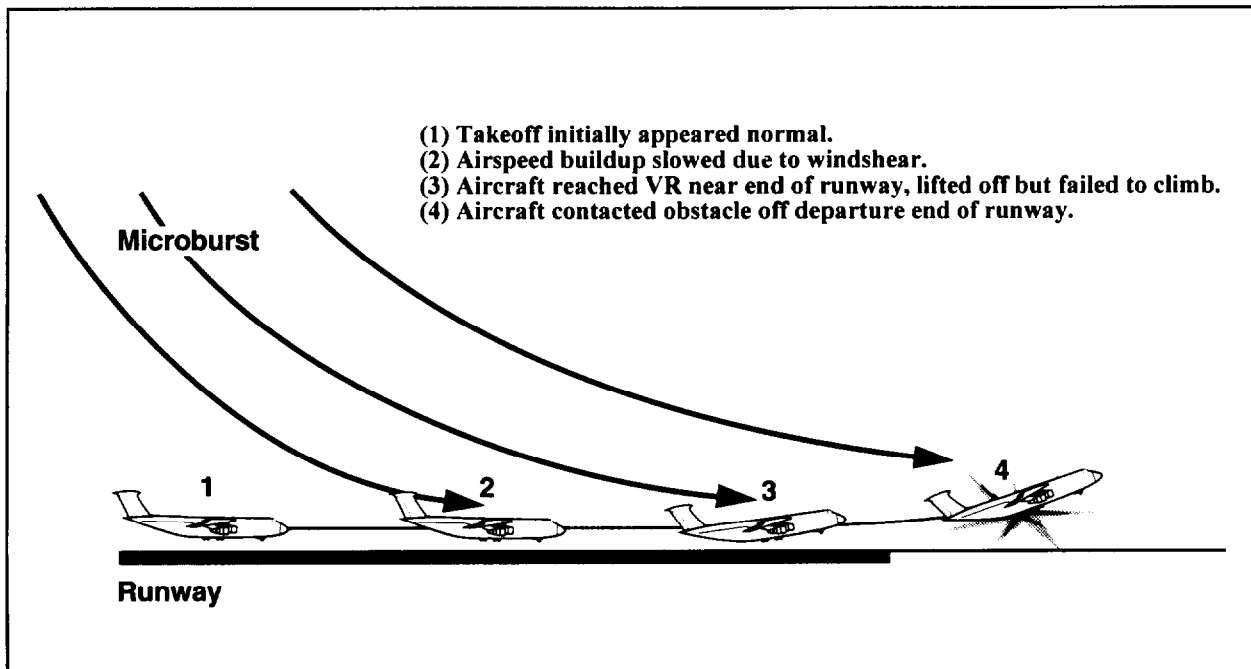
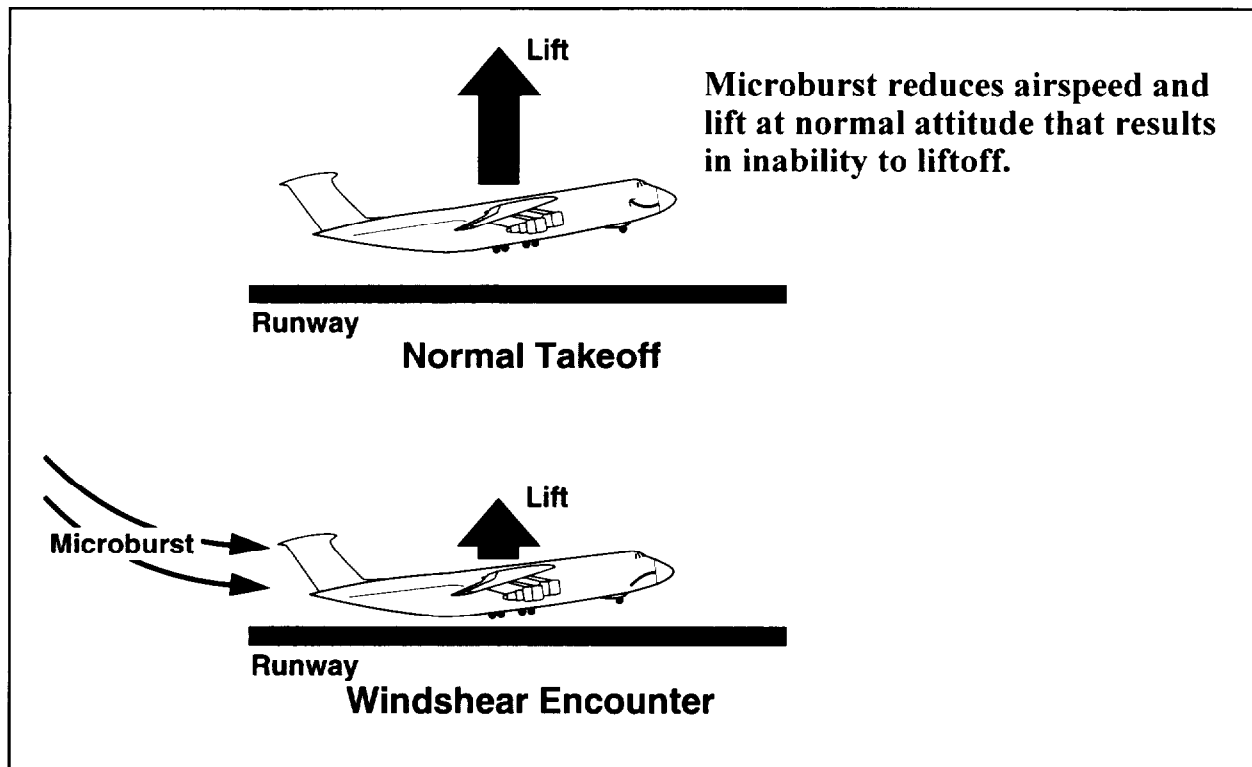


Figure 10-13. Windshear Encounter During Takeoff on Runway.



**10.15. Encounter on Approach.** Analysis of typical windshear encounters on approach yields that the aircrew can expect increased downdrafts and tailwinds along the approach flight path (Figure 10-15). The aircraft will lose airspeed, drop below the target glideslope, and contact the ground short of the runway threshold. Reduced airspeed and AOA, as the aircraft encounters the windshear, results in decreased lift. This loss of lift increases the descent rate (Figure 10-16). The natural nose-down pitch response of the aircraft to low airspeed causes additional altitude loss.

**Figure 10-14. Windshear Effects on Liftoff.**



**10.15.1. Recognition and Successful Recovery.** Lack of clues and limited recognition time will delay recovery initiation. Gradual application of thrust during approach may mask the initial decreasing airspeed trend. Poor weather conditions will cause additional workload and complicate the approach. Transition from instruments to exterior visual reference may detract from instrument scan. A stabilized approach with clearly defined callouts is essential to aid in recognition of unacceptable flight trends and the need to initiate recovery.

**10.15.2. Pilot Corrective Action.** As soon as you recognize that you have flown into a microburst, you must push the power all the way up. You will be in for a scary ride and will need all the energy you can muster. Do not change your configuration. You are about to fly right on the verge of a stall! and any configuration change may put you over the edge. If your gear is down, you should leave it down in case you contact the ground.

**10.15.3.** After that, it will be all finesse with the controls. Pull the nose up until you get the stall warning or reach maximum performance AOA and hold it there. Fly off the AOA or stall warning system. You must compensate for the relative wind change that will occur from the downdraft, and AOA is the only thing that matters at this point. The whole maneuver will result in an extremely nose high attitude. This will feel completely wrong, but it is critical that you maintain maximum performance AOA so that the wings can produce lift and slow your descent rate. Once you get to the other side of the microburst, you will need to lower the nose to maintain your AOA as the winds start spreading along the ground again. Eventually you should return to level flight and can get back your pre-microburst configuration and resume level flight and normal airspeed.

**10.16. Windshear Effects on Systems--Vertical Speed Indicators.** The vertical speed indicator (VSI) should not be solely relied upon to provide accurate vertical speed information. Due to instrument lags, indications may be several seconds behind actual aircraft rate of climb/descent and, in some situations, may indicate a climb after the aircraft has started descending (Figure 10-17). Vertical speed indicators driven by an Inertial Reference Unit (IRU) show significant improvement over other type instruments but still have some lag. In addition, gust-induced pitot static pressure variations within the microburst

may introduce further VSI inaccuracies. Due to such lags and errors, all vertical flight path instruments should be cross-checked to verify climb/descent trends.

Figure 10-15. Windshear Encounter During Approach.

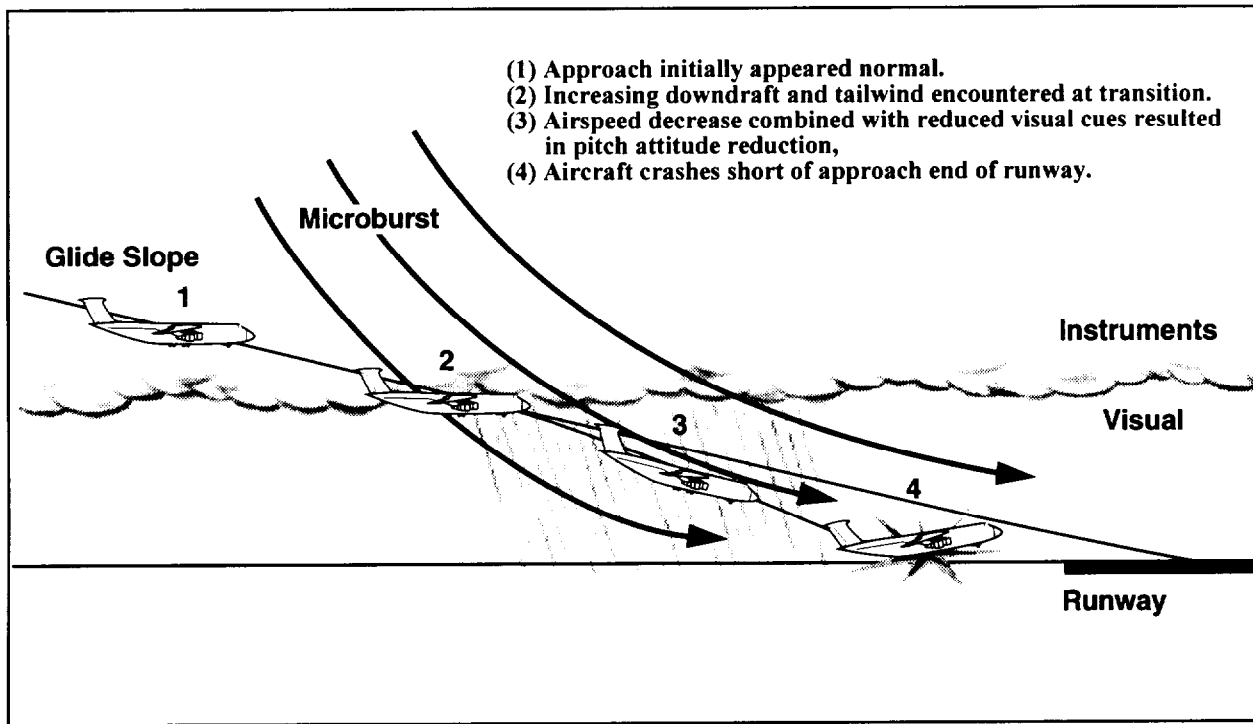


Figure 10-16. Windshear Effects on Flight Path during Approach.

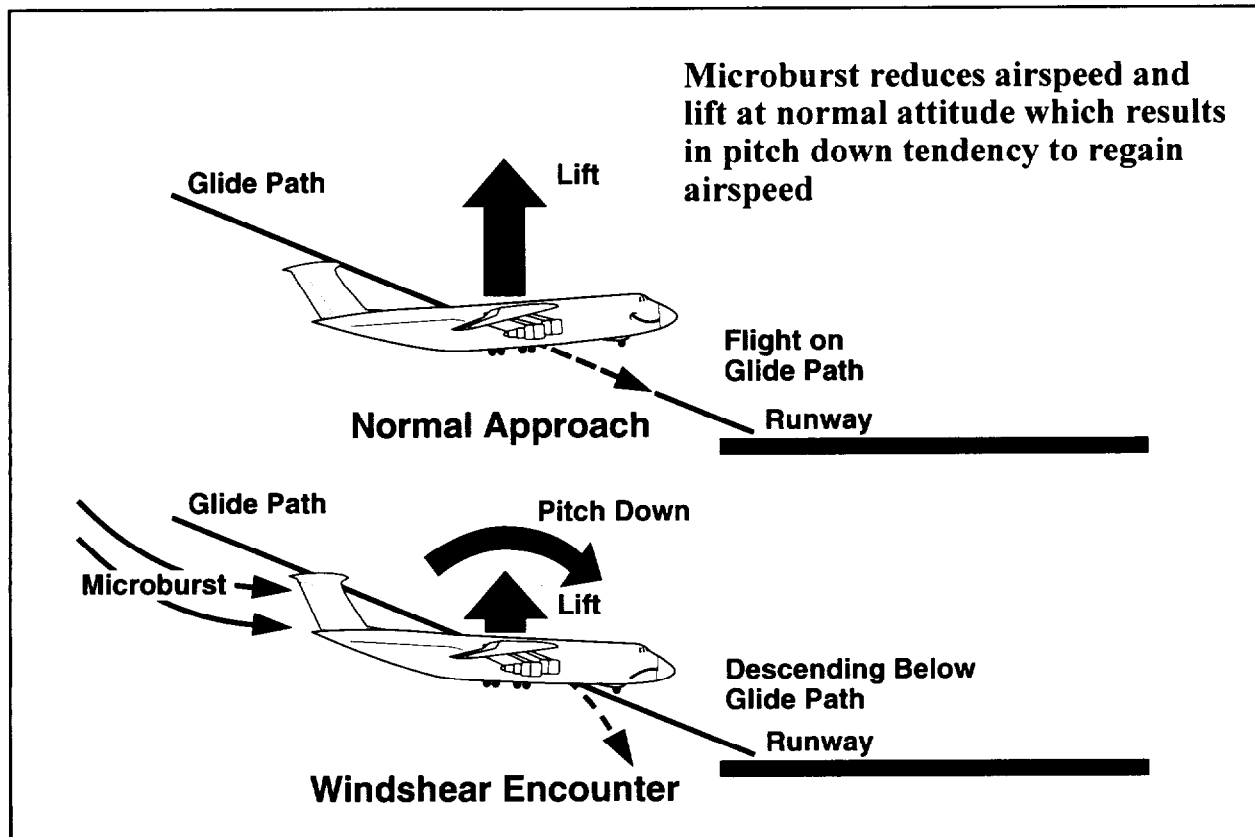
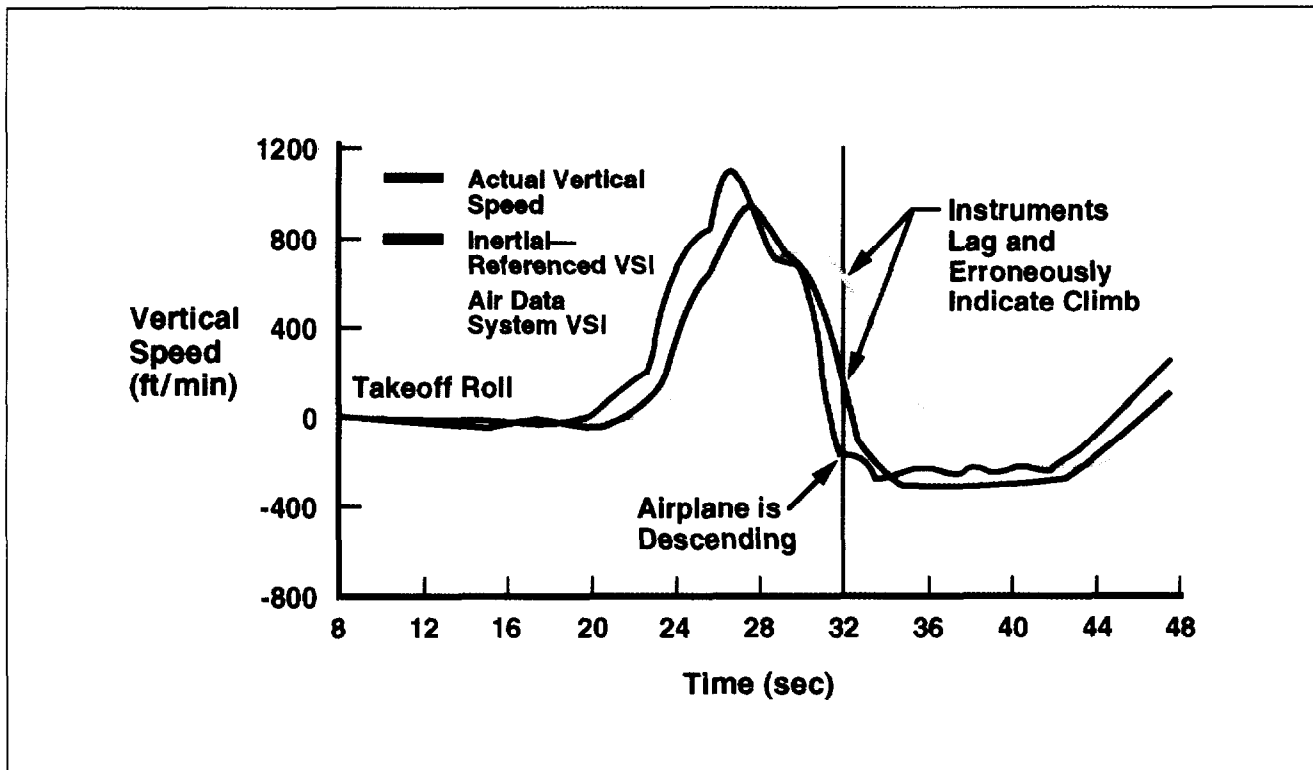




Figure 10-17. Vertical Speed Indicator Error During Takeoff Windshear Encounter.



**10.16.1. Stick Shaker.** Stick shaker is activated by angle of attack. Consequently, rapidly changing vertical winds or maneuvering will vary the attitude and airspeed at which stick shaker occurs. With a properly functioning stall warning system and undamaged alpha vanes, stick shaker will normally activate below the stall angle of attack, thus providing a warning prior to stall.

**10.16.2. Cockpit Angle of Attack Indicators.** Angle of attack indicators do provide useful indications of margin to stick shaker and can show variations in relative wind. However, in an actual windshear encounter where rapidly changing vertical winds cause rapid angle of attack fluctuations independent of pilot input, the lack of direct control over angle of attack limits its usefulness as a guiding parameter.

**10.16.3. Altimeters.** During callouts and instrument scan in a windshear, use of barometric altimeters must be tempered. The barometric altimeter may provide distorted indications due to pressure variations within the microburst.

**10.17. Runway Windshear Detection Systems.** Many civilian airfields have, or are installing windshear detection systems such as Low Level Windshear Alert Systems (LLWAS) and Terminal Doppler Weather Radars (TDWR). Currently there isn't instrumentation on Air Force runways to detect and measure windshear, and there are no foolproof procedures for dealing with it. Awareness and coordination are crucial for timely windshear recognition and recovery.

**10.18. SIGMETs.** A SIGMET, particularly a CONVECTIVE SIGMET, may provide essential clues. In the following example, the CONVECTIVE SIGMET warns of scattered embedded thunderstorms, some reaching level 5 intensity, indicating a potential for windshear.

ATTENTION ALL AIRCRAFT, CONVECTIVE SIGMET CHARLIE ONE FROM THE VICINITY OF ELMIRA TO PHILLIPSBURG, SCATTERED EMBEDDED THUNDERSTORMS MOVING EAST AT ONE ZERO KNOTS. A FEW INTENSE LEVEL FIVE CELLS, MAXIMUM TOPS FLIGHT LEVEL FOUR FIVE ZERO.

**10.19. PIREPs.** PIREPs are extremely important indicators in microburst windshear situations. Reports of sudden airspeed changes in the airport approach or landing corridors provide indication of the presence of windshear. In international weather reports, windshear observations may be included at the end of routine and/or special aviation weather observations.

ANDREWS TOWER, PIREP, TRACK 21 ENCOUNTERED WINDSHEAR ON THREE MILE FINAL, LOSS OF 20 KNOTS AT 300 FEET.

## Chapter 11

### AIRCRAFT ICING

**11.1. Introduction.** Aircraft icing is a major weather hazard to aviation. Many aircraft accidents and incidents have been attributed to aircraft icing. In fact, many icing-related mishaps have occurred when the aircraft was not deiced before takeoff attempt. Most of the time, ground deicing and anti-icing procedures will adequately handle icing formation. But there are times when you may be caught unaware of dangerous ice buildup. This chapter will help you understand icing formation processes and what you can do if suddenly caught in an icing situation.

**11.1.1. Hazards.** Icing formation on either fixed or rotary wing aircraft disrupts the flow of air over the airfoils increasing weight and stalling speed. Test data indicates that icing reduces wing lift by up to 30 percent and increases drag by 40 percent. The accumulation of ice on exterior movable surfaces also affects the control of the aircraft. If ice begins forming on a propeller's blades, the propeller's efficiency decreases and requires further power to maintain flight. Another significant hazard comes from ice accumulation on rotors and propellers resulting in disastrous vibrations. Ice can also form in an engine's intake, robbing the engine of air needed to support combustion, or ice may break off and may be ingested into the engine, causing foreign object damage (FOD). Other icing effects include loss of proper operation of control surfaces, brakes, and landing gear, reduction or loss of aircrew's outside vision, false flight instrument indications, and loss of radio communication.

**11.1.2. Icing Classifications.** Aircraft icing is classified into two main groups: structural and induction. We will discuss these icing groups in detail to include conditions contributing to ice formation, icing intensities, icing types, and where icing is most likely found.

**11.2. Structural Icing.** Two conditions must be met for structural ice to form on an aircraft. First, the air and aircraft's surface temperatures must be at or below freezing. Second, supercooled, visible water droplets (liquid water droplets at subfreezing temperatures) must be present or high humidity must exist.

**11.2.1. Free-Air Temperature.** Wind tunnel experiments reveal that saturated air flowing over a stationary object may form ice on the object when the air temperature is as high as 4 degrees C. The object's temperature cools by evaporation and pressure changes in the moving air currents. Conversely, friction and water droplet impacts heat the object. When an aircraft travels at about 400 kts true airspeed, the cooling and heating effects tend to balance. Structural ice may form when the free-air temperature is 0 degrees C or colder. Ice is seldom encountered at below -40 degrees C.

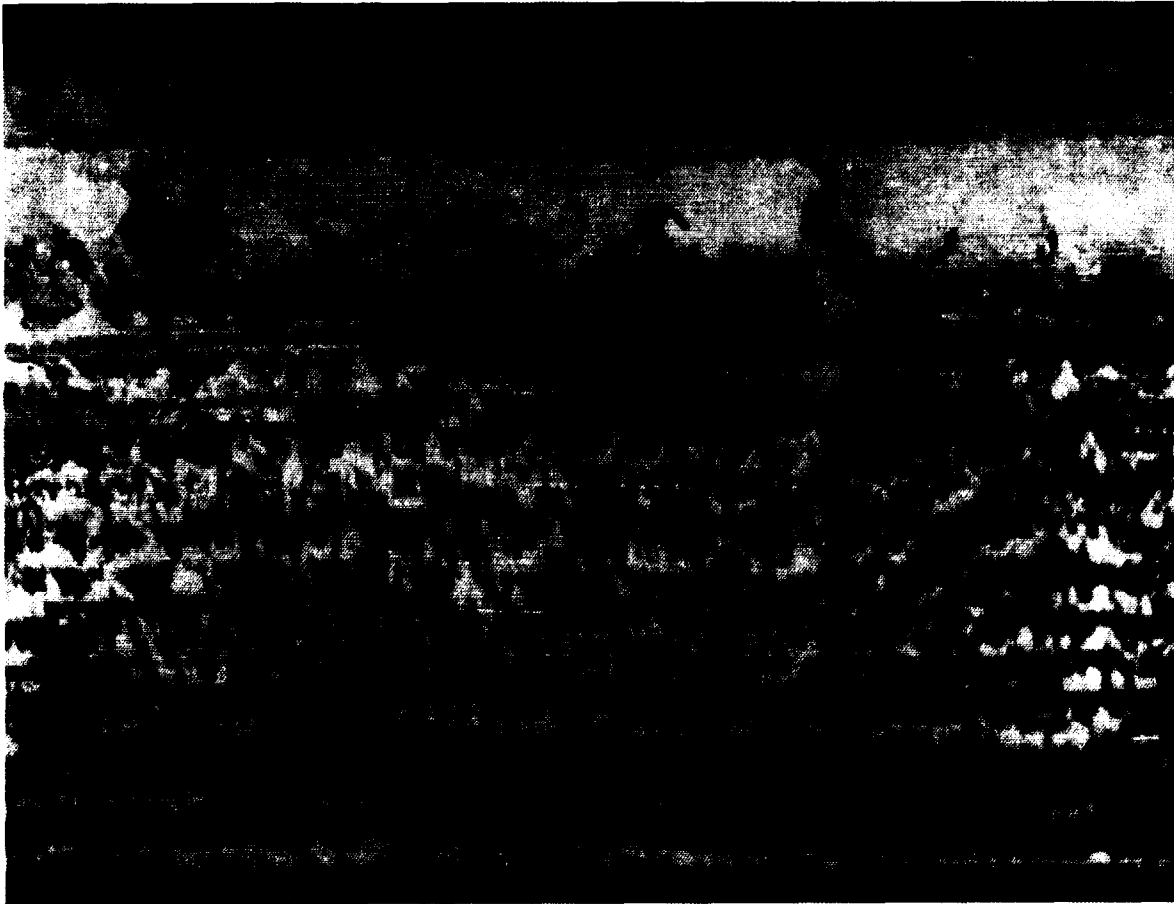
**11.2.2. Supercooled Visible Liquid Water and High Humidity.** Clouds are the most common forms of visible liquid water. Water droplets in the free air, unlike bulk water, do not freeze at 0 degrees C. Instead, their freezing temperature varies from -10 degrees C to -40 degrees C. The smaller the droplets, the lower the freezing point. As a general rule, serious icing is rare in clouds with temperatures below -20 degrees C since these clouds are almost completely composed of ice crystals. However, be aware that icing is possible in any cloud when the temperature is 0 degrees C or below. In addition, frost may form on an aircraft in clear, humid air if the aircraft skin temperature is below freezing.

**11.2.3.** Freezing rain and drizzle, sometimes found in the clear air below a cloud deck, are other forms of visible liquid moisture causing icing. Freezing precipitation is the most dangerous of all icing conditions. It can build hazardous amounts of ice in a few minutes and is extremely difficult to remove. A review of freezing rain and drizzle environments is found in Chapter 8, Fronts.

**11.3. Types of Structural Icing.** Aircraft structural icing consists of three basic types: *clear, rime, and frost*. Also, mixtures of clear and rime are common. The type of icing that will form depends primarily upon the water droplet size and temperature.

**11.3.1. Clear Ice.** *Clear ice* is a glossy ice identical to the glaze forming on trees and other objects as freezing rain strikes the earth. Clear ice is the most serious of the various forms of ice because it adheres so firmly to the aircraft. Conditions most favorable for clear ice formation are high water content, large droplet size, and temperature slightly below freezing. Clear ice normally forms when temperatures are between 0 degrees and -10 degrees C, but can be encountered in cumulonimbus clouds in temperatures as low as -25 degrees C. It is most frequently encountered in cumuliform clouds and freezing precipitation.

Figure 11-1. Clear Ice can be Smooth or Rough.



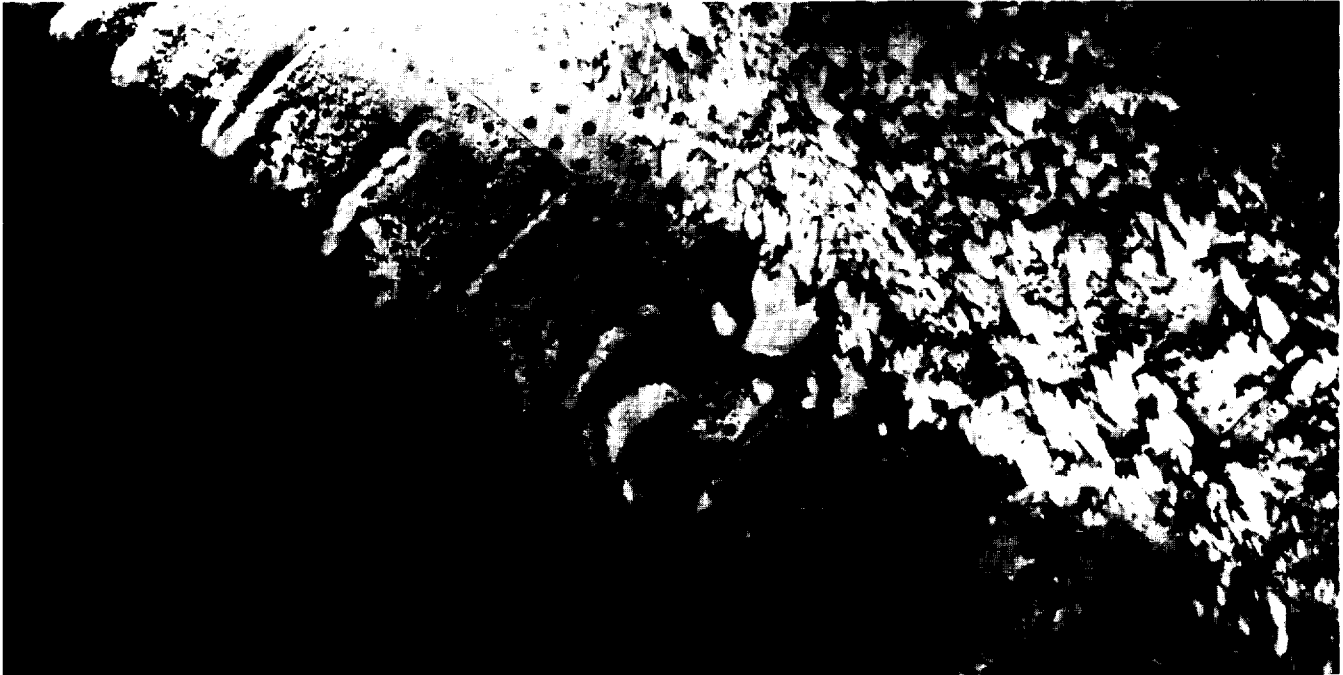
**11.3.1.1. Clear ice can be smooth or rough.** It is smooth when deposited from large, supercooled cloud droplets or raindrops that spread, adhere to the surface of the aircraft and slowly freeze. If mixed with snow, ice pellets or small hail, it is rough, irregular, and whitish (Figure 11-1). The deposit then becomes very blunt-nosed with rough bulges building out against the airflow. Clear ice is hard, heavy, and tenacious. Its removal by deicing equipment is especially difficult.

**11.3.2. Rime Ice.** *Rime ice* is a milky, opaque, and granular deposit with a rough surface (Figure 11-2). It forms by the instantaneous freezing of small, supercooled water droplets as they strike the aircraft. This instantaneous freezing traps a large amount of air, giving the ice its opaqueness and making it very brittle. It is most likely to accumulate when temperatures are between  $0^{\circ}$  and  $-20^{\circ}\text{C}$  but can be expected in thunderstorms as cold as  $-40^{\circ}\text{C}$ . Rime ice is most frequently encountered in stratiform clouds but also occurs in cumulus clouds. Rime ice is lighter in weight than clear ice and its weight is of little significance. Rime ice is brittle and more easily removed than clear ice.

**11.3.3. Mixed Clear and Rime Icing.** *Mixed icing* forms when water drops vary in size or when liquid drops are intermingled with snow or ice particles. It can form rapidly. Ice particles become embedded in clear ice, building a very rough accumulation sometimes in a mushroom shape on leading edges.

**11.3.4. Frost.** *Frost* is deposited as a thin layer of crystalline ice (Figure 11-3). It forms on the exposed surfaces of parked aircraft when the temperature of the exposed surface is below freezing (although the air temperature may be above freezing). The deposit forms during night radiational cooling in the same way the formation of frost found on the ground. Frost may also form on aircraft in flight when a cold aircraft moves from a zone of subzero temperatures to a warmer, moist layer. Contact with the cold aircraft suddenly chills the air to below freezing temperatures and sublimation (formation of ice crystals directly from water vapor) occurs. Frost can cover the windshield or canopy and completely restrict outside vision. It also affects the aircraft's lift to drag ratio and can be a hazard during takeoff. Remove all frost from the aircraft prior to departure.

Figure 11-2. Rime Ice is Milky, Opaque, and Granular.



**11.4. Intensities of Structural Icing.** The amount of ice an aircraft accumulates depends considerably on the characteristics of that particular aircraft. Therefore, general intensity classifications for reporting icing are given in the "Meteorological Information" section of the Flight Information Handbook (FIH) and are described below.

- Trace--Ice becomes perceptible. Rate of accumulation slightly greater than rate of sublimation. It is not hazardous even though de-icing/anti-icing equipment is not used, unless encountered for an extended period of time (over one hour).
- Light--The rate of accumulation may create a problem if flight is prolonged in this environment (over one hour). Occasional use of de-icing/anti-icing equipment removes/prevents accumulation. It does not present a problem if the de-icing/anti-icing equipment is used.
- Moderate--The rate of accumulation is such that even short encounters become potentially hazardous and use of de-icing/anti-icing equipment or diversion is necessary.
- Severe--The rate of accumulation is such that de-icing/anti-icing equipment fails to reduce or control the hazard. Immediate diversion is necessary.

**11.5. Ice Formation on Fixed Wing Aircraft.** The relatively thick wings, canopies, and other features of conventional aircraft have a smaller collection potential than those of the trimmer and faster turbojet aircraft. However, the actual hazard of icing for conventional aircraft tends to be greater than for jets because of less aerodynamic heating at lower airspeed. Conventional aircraft are subjected to icing conditions over longer periods and operate at altitudes more conducive to icing.

**11.5.1. Wing and Tail Surfaces.** Ice accumulations on wing and tail surfaces disrupt the air flow around these airfoils (Figure 11-4). This results in a loss of lift, an increase in drag, and causes higher than normal stall speeds (Figure 11-5). The weight of the ice deposit presents less danger, but may become important when too much lift and thrust are lost.

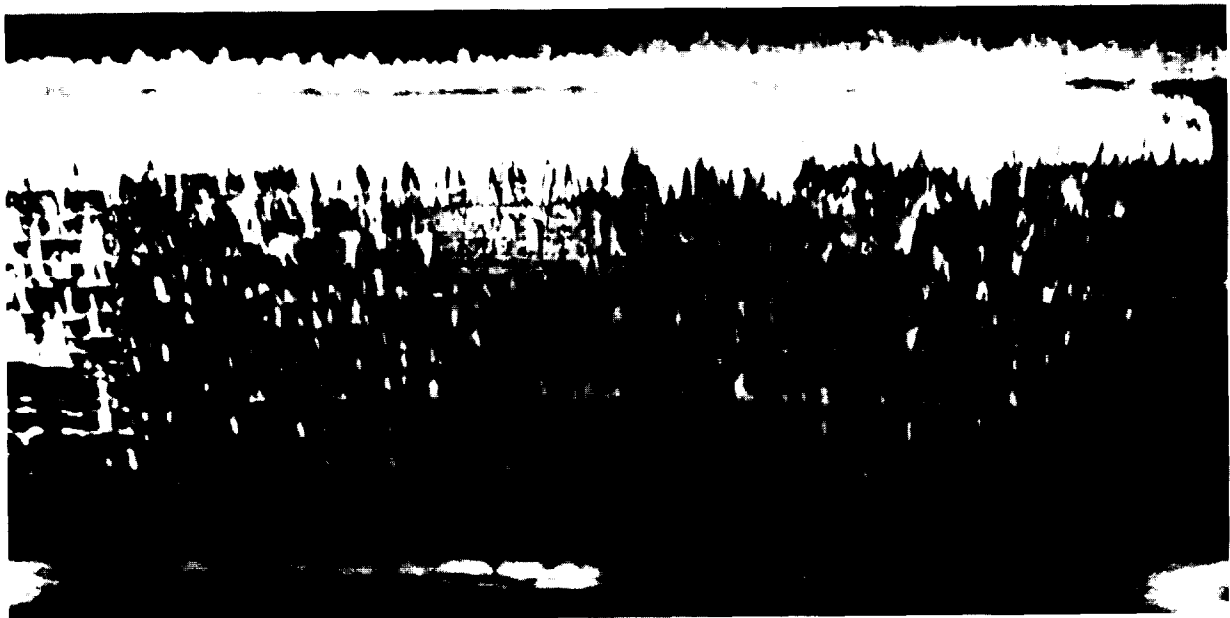
**11.5.1.1.** Experiments have shown that a ½ inch ice deposit on the leading edge of airfoils on some aircraft reduce their lift by as much as 50 percent and increases drag on the aircraft by the same amount, which greatly increases the stall speed. The serious consequences of these effects are obvious. Remember that ½ inch or more of ice can accumulate in a minute or two.

**11.5.2. Propellers.** Ice accumulation on the propeller hub and blades (Figure 11-6) reduces the propeller's efficiency, which reduces thrust. Increased power settings consume more fuel and may fail to produce sufficient thrust to maintain altitude. An even greater hazard is the vibration of the propeller, caused by the uneven distribution of ice on the blades. A propeller is very delicately balanced, and even a small amount of ice creates an imbalance. The resulting vibration places dangerous stress on the engine mounts as well as the propeller itself. Propellers with low RPM are more susceptible to icing than those with high RPM. Ice usually forms faster on the propeller's hub because the blade's differential velocity causes a temperature increase from the hub to the propeller tip.

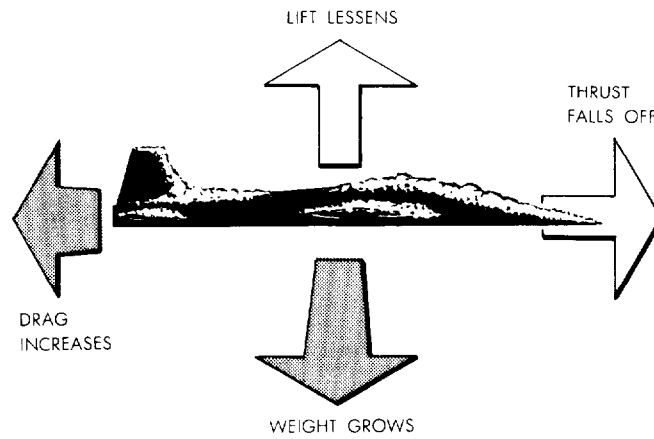
Figure 11-3. Frost on Exposed Surfaces of Parked Aircraft.



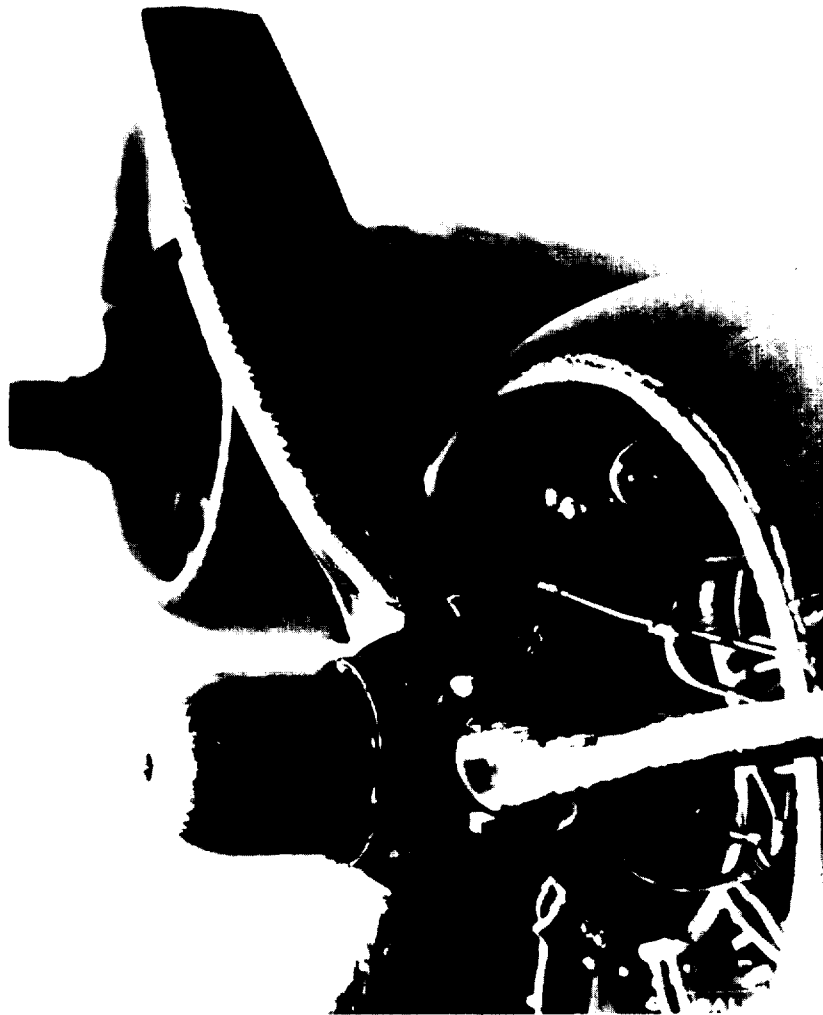
Figure 11-4. Ice Accumulation Disrupts Air Flow.



**Figure 11-5. Effects of Icing are Cumulative Causing Stall Speed to Increase.**



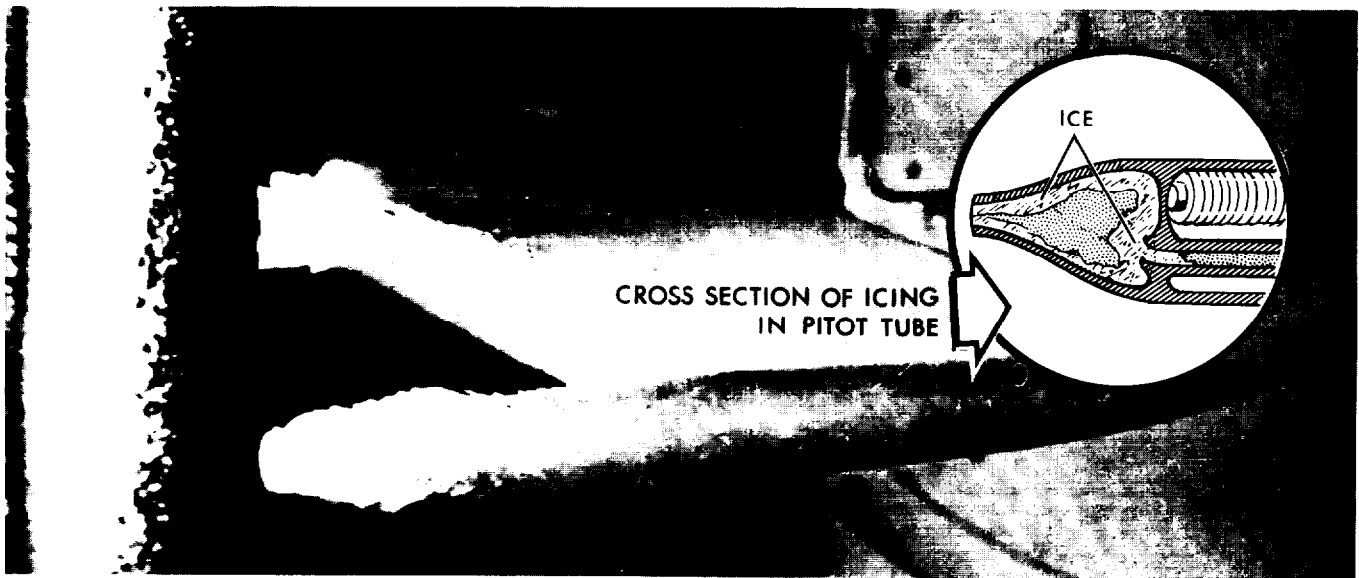
**Figure 11-6. Propeller Icing.**



**11.5.3. Pitot Tube and Static Pressure Ports.** Icing of the pitot tube (Figure 11-7) and static pressure ports is dangerous because it causes inaccurate indications on the altimeter, airspeed, and VSI. When icing is observed on the aircraft, remember that the pitot tubes accumulate ice as fast or faster than other areas of the aircraft.

**11.5.4. Radio Antenna.** The principal danger of ice accumulating on the aircraft's radio antenna is the probable loss of radio communication. Antennas are usually one of the first items on a aircraft to collect ice. Other parts of the aircraft will also begin to accumulate ice if the antennas start icing up. Ultimately, aircrews lose their ability to request altitude or course changes to get out of the icing zone.

**Figure 11-7. Pitot Tube Icing.**



**11.5.5. Windshield.** Ice or frost formation on an aircraft's windshield is most hazardous during takeoffs and landings. Small frost particles on the windshield prior to takeoff may act as sublimation nuclei during takeoff and reduce visibility to near zero. On approach, windshield icing may prevent visual contact with the runway. In large helicopters, windshield icing is a good indication that main rotor head and rotor blade icing is well underway.

**11.5.6. Engines.** Reciprocating engines experience icing on air scoops, scoop inlets (ducts), carburetor inlet screens, and other induction system protuberances. All surfaces of the engine exposed to water droplets may collect ice.

**11.6. Ice Formation on Rotary Wing Aircraft.** Icing on rotary wing aircraft is related to those involving wings and propellers. Rotor icing is slightly different from propeller icing due to the rotors' lower rotational speed. Ice accumulation on rotor blades differs from the fixed wings of conventional aircraft due to the smaller scale of the helicopter wing, the variation of airspeed with rotor blade span, the cyclic pitch change, and the cyclic variation of airspeed at any given point on the blade in forward flight.

**11.6.1. Rotor Systems.** Ice formation on the helicopter main rotor system or antitorque rotor system may produce serious vibration, loss of efficiency or control, and can significantly deteriorate the available RPM to a level where safe landing cannot be assured. Although the slow forward speed of the helicopter reduces ice build-up on the fuselage, the rotational speed of main and tail rotor blades produces a rapid growth rate on certain surface areas:

**11.6.2. Main Rotor Head Assembly.** Ice accumulation on the swashplates, push-pull rods, bell cranks, hinges, scissors assemblies, and other mechanisms of the main rotor head assembly interferes with collective and cyclic inputs (Figure 11-8).

**11.6.3. Main Rotor Blades.** Several factors tend to reduce ice accretion on the main rotor blades, such as the centrifugal force of rotation, blade flexing during rotation, the slow rotational speed of the blades near the rotor head, and the fast rotational speed near the blade tips. However, in a hover, a 3/16 inch coating of ice is sufficient to prevent some helicopters from maintaining flight. A critical icing hazard can, therefore, form rapidly on the center two-thirds of the main rotor blades (Figure 11-9). The uneven accretion or asymmetrical shedding of ice produces severe rotor vibration.

**11.6.4. Tail Rotor.** Ice accumulation on either the antitorque rotor head assembly or blades produces the same hazards as those associated with the main rotor. The centrifugal force of rotation and the blade angle of incidence relative to the clouds help to reduce ice build-up on the tail rotor blades, but the shedding of ice from the blades may result in structural damage or FOD to the fuselage, rotors or engines, and injury to ground personnel. This particular hazard appears to be more threatening to large, tandem rotor system aircraft.

Figure 11-8. Main Rotor Head Icing.



Figure 11-9. Main Rotor Blade Icing.



**11.6.5. Air Intake Screens.** Ice accumulation on the engine and transmission air intake screens (Figure 11-10) is more rapid than on the rotor systems. This results in inadequate cooling of the engine and transmission. On some helicopters, a loss of manifold pressure concurrently with air intake screen icing may force an immediate landing. Freezing water passing through the screens also coats control cables and may produce limited throttle movement and other control problems.

**11.7. Induction Icing.** In addition to the hazards created by structural icing, aircraft are frequently subjected to icing of the power plant itself. The affected components supply the engine with the proper fuel and air mixture for efficient combustion. Induction icing occurs under a wide range of weather conditions and is most common in the air induction system but may also be found in the fuel system. Carburetor icing in carburetor equipped piston engines is actually a combination of the two.

**11.7.1. Carburetor Icing.** Carburetor icing is treacherous. It frequently causes complete engine failure. It may form under conditions in which structural ice could not possibly form. If the air drawn into the carburetor has a high relative humidity, ice can form inside the carburetor in cloudless skies with temperatures as high as 22 degrees C (72 degrees F). It sometimes forms with outside air temperatures as low as -10 degrees C (14 degrees F).

**11.7.2.** Carburetor ice forms during fuel vaporization, combined with the air expanding as it passes through the carburetor. Temperature drop in the carburetor can be as much as 40 degrees C but is usually 20 degrees C or less. With enough available moisture, ice will form in the carburetor passages (Figure 11-11) if the temperature inside the carburetor cools down to 0 degrees C or below. Ice may form at the discharge nozzle, in the Venturi, on or around the butterfly valve, or in the passages from the carburetor to the engine.



Figure 11-10. Engine Air Intake Screen Icing.

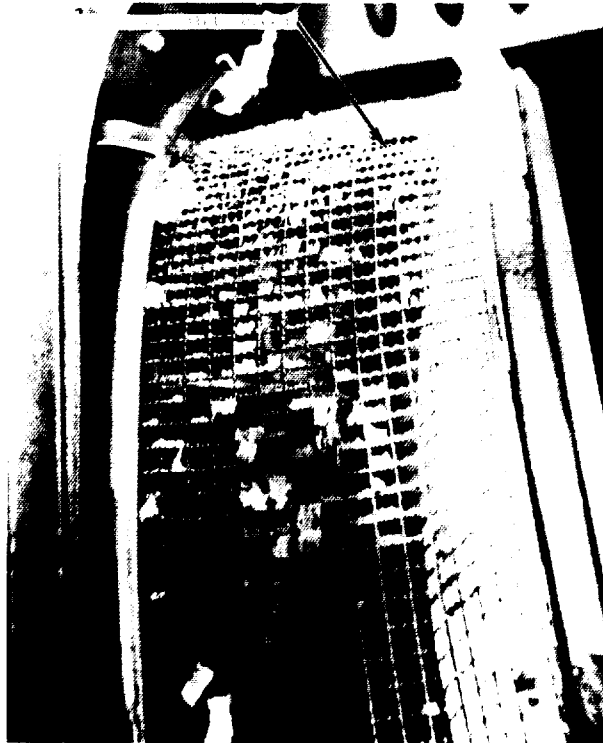
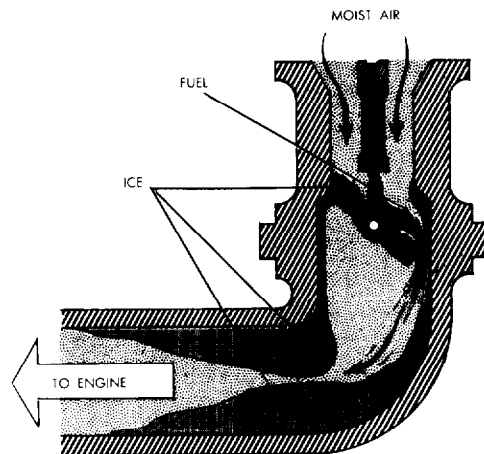


Figure 11-11. Carburetor Icing.



**11.7.3.** The carburetor heater is an anti-icing device which heats the air before it reaches the carburetor, melting any ice or snow entering the intake, and keeping the mixture above the freezing point. The heater usually prevents icing, but it cannot always clear out ice already formed. Since carburetor heating adversely affects aircraft performance, use it only as specified in your flight manual. The fuel absorbs considerable amounts of water when the humidity is high. Occasionally, enough water is absorbed to create icing in the fuel system when the fuel temperature is at or below 0 degrees C.

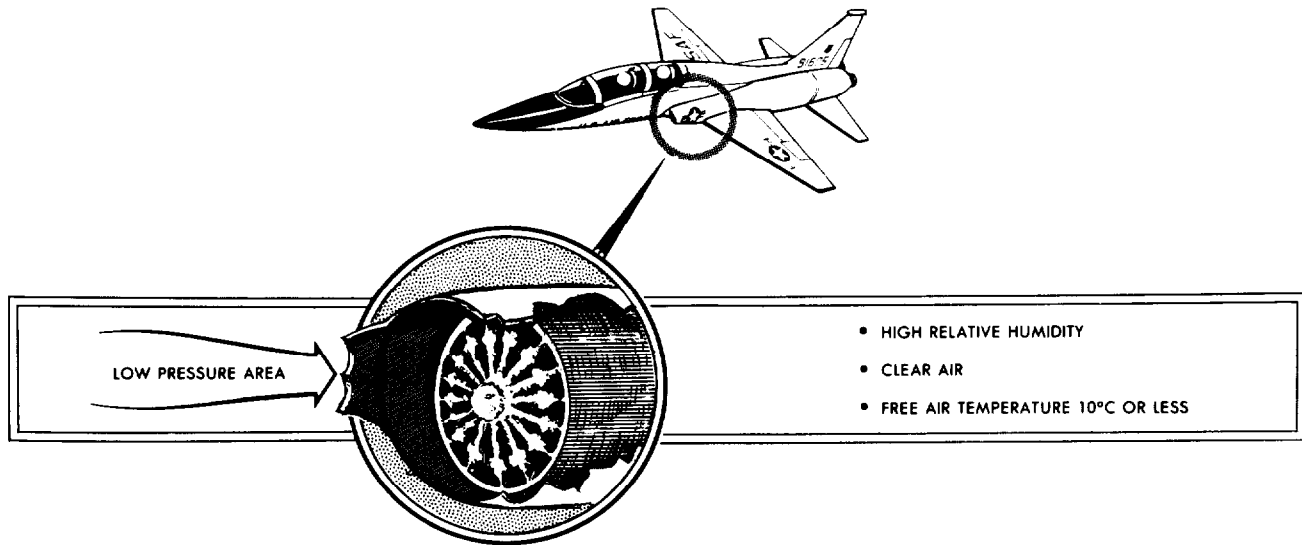
**11.7.4.1. Induction System.** Ice forms in the induction system when atmospheric conditions are favorable for structural icing (visible liquid moisture and freezing temperatures). Induction icing can form in clear air with a high relative humidity (small temperature/dewpoint spread) and temperatures anywhere from 22 degrees C (72 degrees F) to 10 degrees C (14 degrees F).

**11.7.4.2. Air Intake Ducts.** In flights through clouds containing supercooled water droplets, air intake duct icing is similar to wing icing. However, duct icing may occur with clear skies and above freezing temperatures. While taxiing, and on departure, reduced pressures exist in the intake system (Figure 11-12). This lowers temperatures to the point where

condensation or sublimation takes place, resulting in ice formation which decreases the radius of the duct opening and limits air intake.

**11.7.4.3.** The temperature change varies considerably with different types of engines. Therefore, if the air temperature is 10 degrees C or less (especially near the freezing point) and the relative humidity is high, the possibility of induction icing definitely exists.

**Figure 11-12. Jet Engine Induction Icing.**



**11.7.5. Inlet Guide Vanes.** Icing occurs when supercooled water droplets in the atmosphere strike the guide vanes and freeze. As ice build-up increases, air flow to the engine decreases, which results in a loss of thrust and eventual engine flameout. Also, ingestion of ice shed ahead of the compressor inlet may cause severe engine damage.

**11.8. Weather Conducive to Aircraft Icing.** Potential icing zones in the atmosphere are mainly a function of temperature and cloud structure. These factors vary with altitude, location, weather pattern, season, and terrain.

**11.8.1. Temperature.** Generally, aircraft icing is limited to the atmospheric layer lying between 0 degrees C and -20 degrees C. However, icing reports at temperatures colder than -40 degrees C occur in the upper parts of cumulonimbus and other clouds. The types of icing in cumuliform clouds are associated with the following temperature ranges:

- - 0 degrees C to -10 degrees C, clear
- -10 degrees C to -15 degrees C, mixed clear and rime
- -15 degrees C to -20 degrees C, and colder, rime.

**11.8.2. Stratiform Clouds.** Icing in middle and low level stratiform clouds is confined, on the average, to a layer between 3,000 and 4,000 feet thick. Icing intensity generally ranges from a trace to light, with the maximum values occurring in the cloud's upper portions. Both rime and mixed are found in stratiform clouds. The main hazard lies in the great horizontal extent of these cloud decks. High-level stratiform clouds are composed mostly of ice crystals and give little icing.

**11.8.3. Cumuliform Clouds.** The icing zone in cumuliform clouds is smaller horizontally but greater vertically than in stratiform clouds. Icing is more variable in cumuliform clouds because many of the factors conducive to icing depend on the particular cloud's stage of development. Icing intensities may range from a trace in a small cumulus to severe in a large towering cumulus or cumulonimbus. Although icing occurs at all levels above the freezing level in a building cumulus, it is most intense in the upper half of the cloud. Icing in a cumuliform cloud is usually clear or mixed with rime in the upper levels.

**11.8.4. Cirriform Clouds.** Aircraft icing rarely occurs in cirrus clouds although some do contain a small portion of water droplets. However, light icing has been reported in the dense, cirrus anvils of cumulonimbus, where updrafts maintain considerable amounts of water at rather low temperatures.

**11.9. Frontal Zones.** Of all icing conditions reported, 85 percent occurs in the vicinity of fronts. This icing may be in relatively warm air above the frontal surface or in the cold air beneath (Figures 11-13 and 11-14).

**11.9.1. Icing Above Frontal Surface.** For significant icing to occur above the frontal surface, the warm air must be lifted and cooled to saturation at temperatures below freezing, making it contain supercooled water. If the warm air is unstable,

icing may be sporadic; if it is stable, icing may be continuous over an extended area. Icing may form in this manner over either a warm or a shallow cold frontal surface. A line of showers or thunderstorms along a surface cold front may produce icing, but only in a comparatively narrow band along the front.

**11.9.2. Icing Below Frontal Surface.** Icing below a frontal surface outside of clouds occurs most often in freezing rain or drizzle. Precipitation forms in the relatively warm air above the frontal surface at temperatures above freezing. It falls into the subfreezing air below the front, supercools, and freezes on impact with the aircraft. Freezing drizzle and rain occur with both warm and shallow cold fronts. Icing in freezing precipitation is especially hazardous since it often extends horizontally over a broad area and downward to the surface.

Figure 11-13. Cold Front Icing.

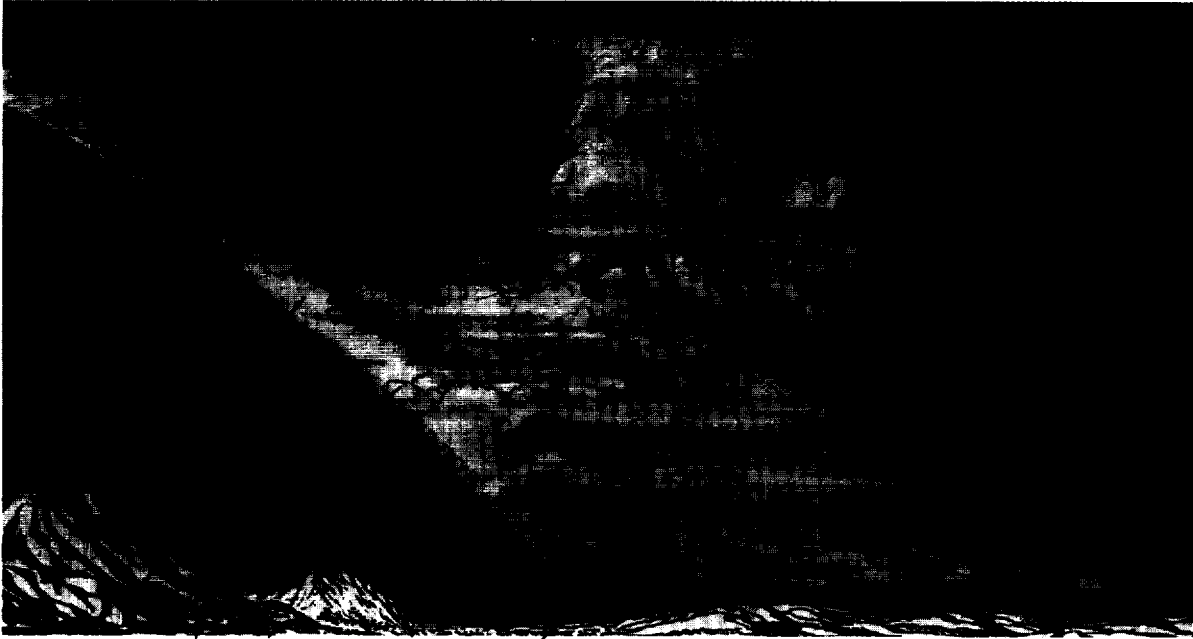


Figure 11-14. Warm Front Icing.

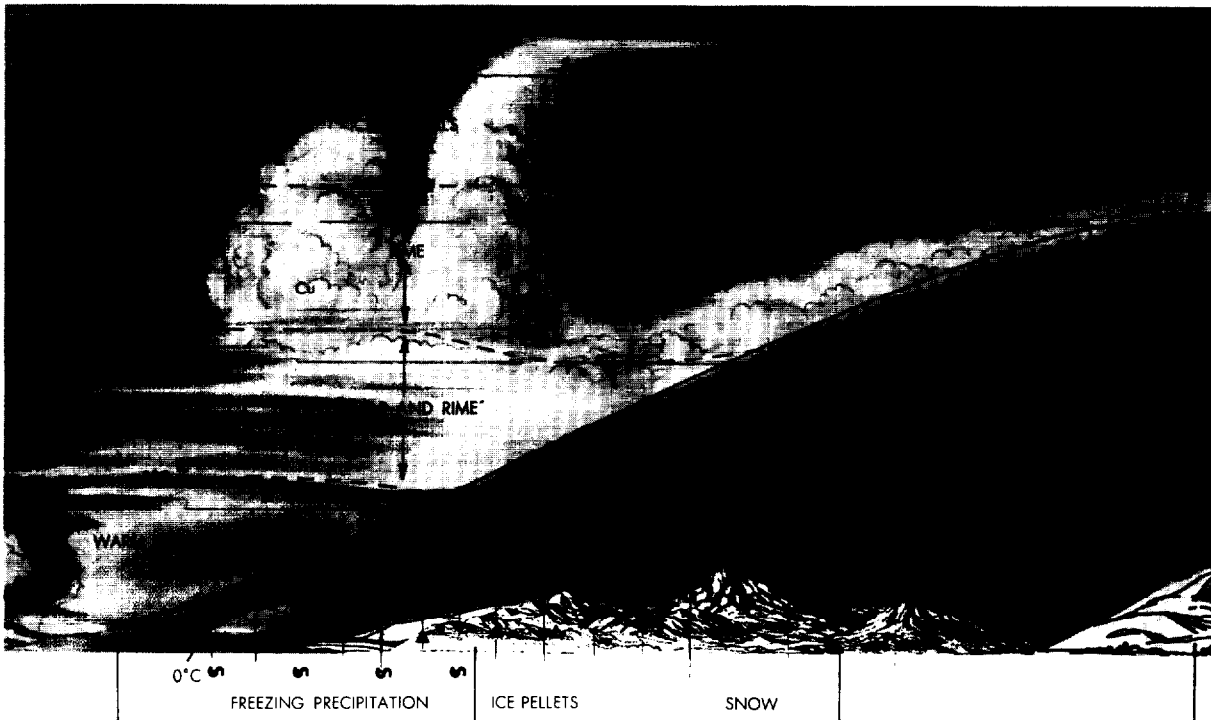
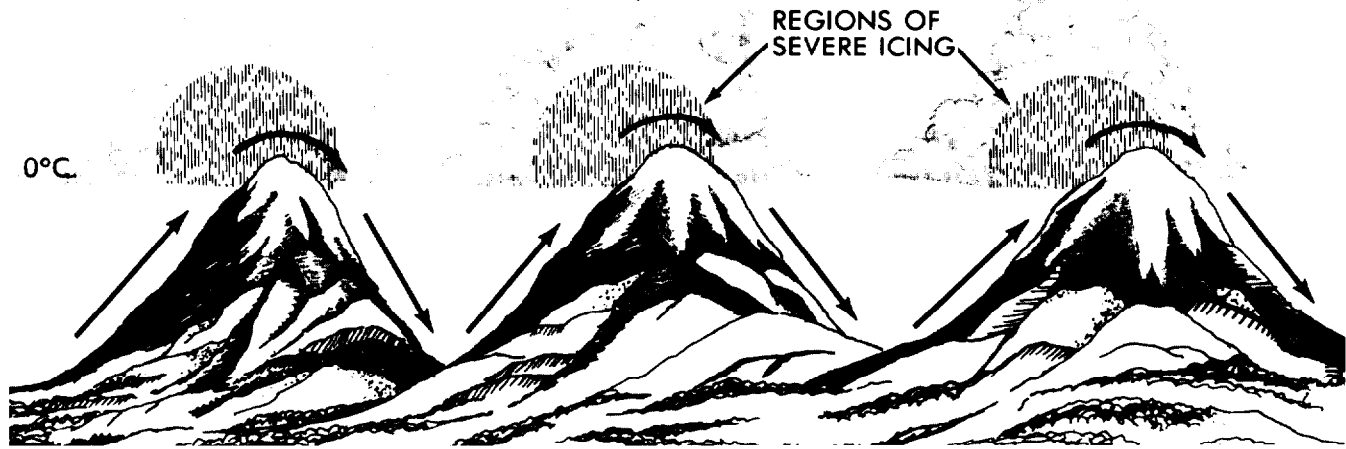


Figure 11-15. Icing Over Mountains.



**11.10. Seasons.** Icing may occur during any season of the year, but in temperate climates, such as in most of the United States, it is most frequent in winter. The freezing level is nearer to the ground in winter than in summer, leaving a smaller low level layer of airspace free of icing conditions. Frontal activity is also more frequent in winter and the resulting cloud systems more extensive.

**11.10.1.** Regions at higher latitudes, such as Canada and Alaska, generally have the most severe icing conditions in spring and fall. In winter, the polar regions are normally too cold to contain heavy concentrations of moisture necessary for icing, and most cloud systems are stratiform and composed of ice crystals.

**11.11. Terrain.** Icing is more likely and more severe in mountainous regions than over other terrain. Mountain ranges cause upward air motions on their windward side. These vertical currents support large water droplets normally falling as rain over level terrain. The movement of a frontal system across a mountain range combines the normal frontal lift with the mountains' upslope effect to create extremely hazardous icing zones.

**11.11.1.** The most severe icing occurs above the crests and on the ridges' windward side (Figure 11-15). This zone usually extends to about 5,000 feet above the mountain tops but can extend much higher if cumuliform clouds develop.

**11.12. Procedures to Avoid or Minimize Icing Effects.** Always be prepared to avoid or escape icing. The following procedures will help reduce icing effects on your aircraft:

- Remove all ice and snow from the aircraft before takeoff.
- Use anti-ice and de-ice equipment.
- Avoid clouds when the temperature is between  $0^{\circ}\text{C}$  and  $-20^{\circ}\text{C}$ .
- If icing is encountered, climb or descend to an altitude where the temperature is warmer than  $0^{\circ}\text{C}$  or colder than  $-20^{\circ}\text{C}$ .
- Give PIREPs when encountering icing or if it is forecast and not encountered.

## Chapter 12

### VISIBILITY AND CEILINGS

**12.1. Introduction.** Historically, low ceilings and poor visibilities have contributed to many aircraft accidents. Fog, heavy snow, heavy rain, blowing sand, blowing dust all restrict visibility and can result in low ceilings. Adverse weather conditions causing widespread low ceilings and visibilities can restrict flying operations for days. Since ceiling and visibility is so important to operational flying, it's imperative that a pilot understand the strict meanings of the two terms. There are many different kinds of "visibility", slant, sector, and prevailing visibility. But you're concerned with the "prevailing visibility."

You also need to know how a ceiling is determined and what constitutes a "scattered" versus a "broken" deck of clouds. This chapter explains the concepts of ceiling and visibility and their impacts upon operational flying.

**12.2. Visibility--Definition.** *Visibility* is the horizontal distance determined by human or instrument evaluations measuring the *opacity* or translucence of the atmosphere. By day, manual visibility is the greatest distance selected objects are seen and identified by unaided eyes. At night, manual visibility is the greatest distance at which unfocused lights of moderate intensity (about 25 candlepower) can be seen and identified.

**12.2.1. Prevailing Visibility.** *Prevailing visibility* is the greatest horizontal visibility observed throughout at least half of the horizon circle and is considered representative of conditions *6 feet above the ground* at the observation point. It need not be continuous throughout 180 consecutive degrees. Prevailing visibility determines whether flights are conducted under VFR or IFR. Also, circling approaches must use prevailing visibility. Prevailing visibility is the only forecast visibility value and is observed and reported by the base weather station. Figure 12-1 is an example of a visibility check point diagram from the weather observer's viewpoint. Air Traffic Controllers have a similar visibility check point diagram in the tower.

**12.2.2. Tower Prevailing Visibility.** At times the prevailing visibility from the tower vantage point may differ significantly from the weather observer's manual, surface-based visibility. To alert aviators to this condition, the tower controller determines the *tower prevailing visibility*. The tower visibility value is disseminated by the weather observer in the weather observation and appears as a "tower visibility remark," (e.g., TWR VIS 1/2 or TWR VIS 3200). It is important to note that the *lower reported visibility controls the airfield*.

**12.2.3. Automated Visibility Determination.** Automated Surface Observing Stations (ASOS) and other automated weather stations use a calibrated sensor which is located approximately 10 feet above the ground. The sensor samples a small volume

Figure 12-1. Day/Night Visibility Observer Check Point Diagram.

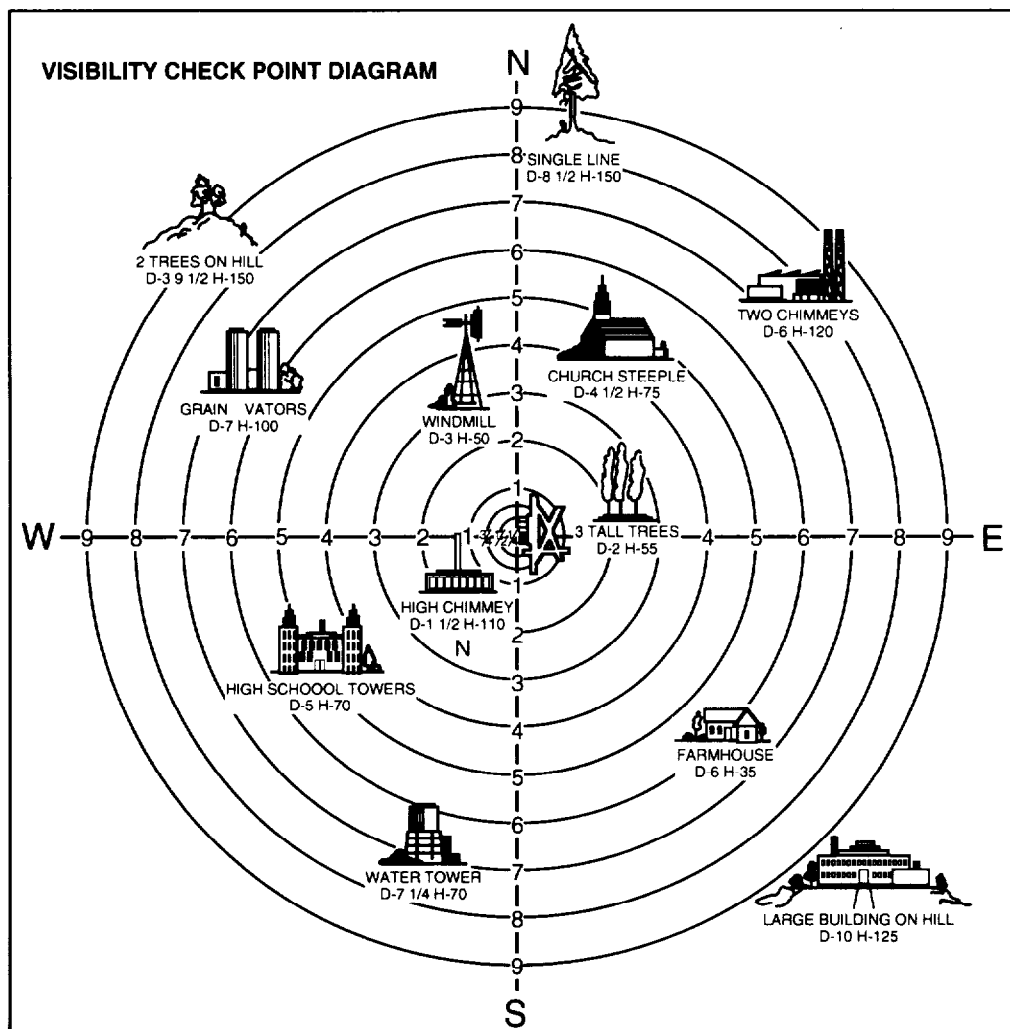
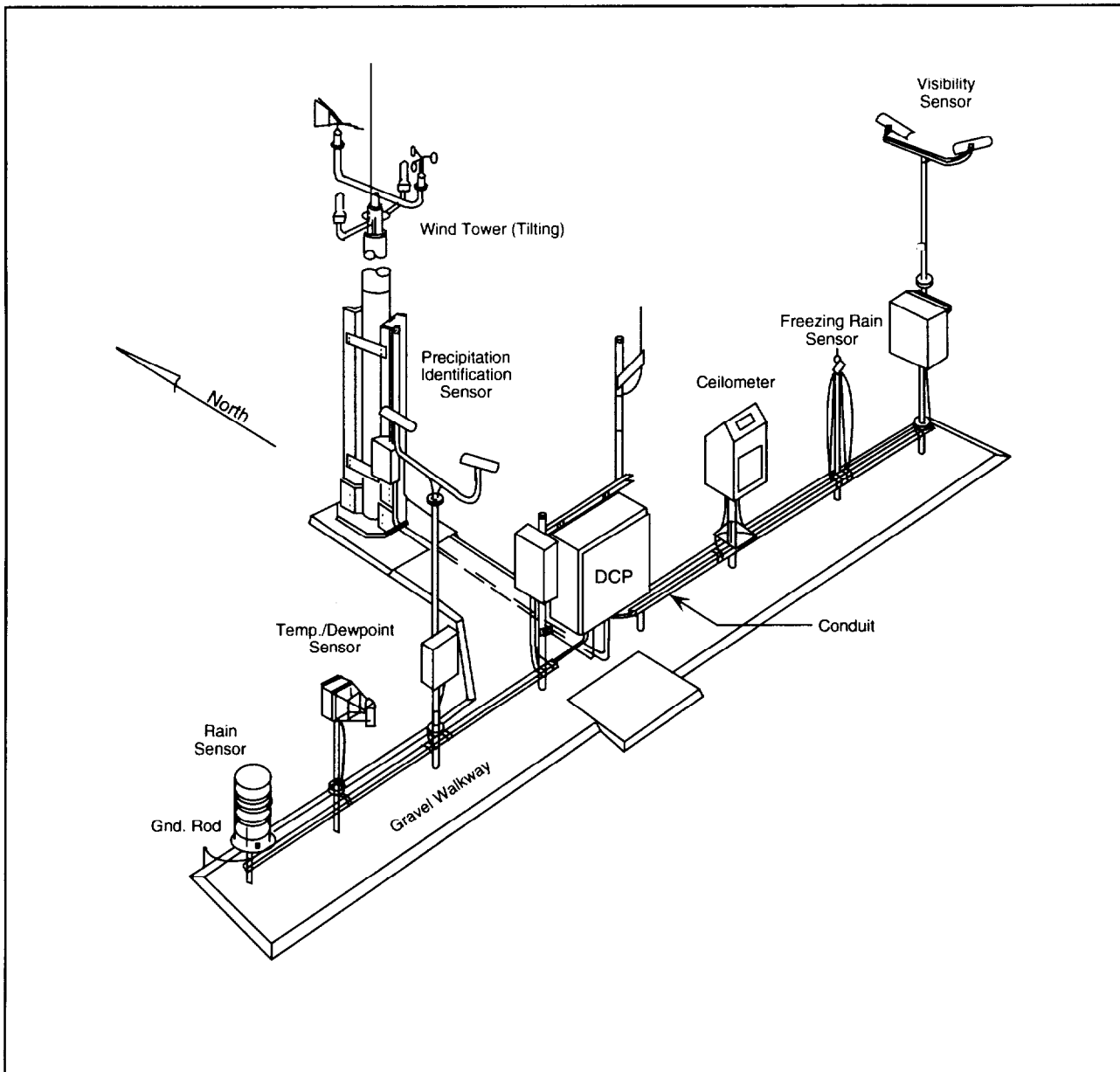


Figure 12-2. Typical ASOS Combined Sensor Group Layout.



area and extrapolates the sampled value to become the prevailing visibility value. The sensor is usually located near the touchdown zone of the primary designated runway. Figure 12-2 displays a typical ASOS combined sensor group layout.

**12.2.4. Sector Visibility.** *Sector visibility* is the visibility within a specified 45 degree arc (NE, SE, SW, NW, etc.) of the horizon circle having essentially uniform visibility. Sector visibility is reported when manually-derived visibility is not uniform in all horizontal directions.

**12.2.5. Slant Range Visibility.** *Slant range visibility* is the angle from which you view an airfield or target from an "above ground" vantage point. Slant range visibility is often lower than the surface prevailing visibility. Weather observers observe visibility horizontally, while airborne aircrews view the ground from their aircraft at an angle. Slant range visibility is not reported by a weather observer.

**12.2.6. Runway Visual Range (RVR).** *Runway Visual Range (RVR)* is an instrumentally derived value based on standard calibrations which is used to determine the field condition for takeoffs and straight-in approaches to that runway. RVR is calculated by a transmissometer near the touchdown point of the instrument runway and is calculated from visibility, ambient light level, and runway light intensity. The RVR sensors are located alongside and about 14 feet higher than the center line of the runway. RVR gives the horizontal distance pilots see down the runway from the approach end during periods of reduced

visibility. It is based on the sighting of either high intensity runway lights or on the visual contrast of visual targets, whichever yields the greatest visual range.

**12.2.7. RVR Reporting Standards.** RVR is reported when the prevailing visibility is one statute mile or less and/or the RVR for the designated runway is 6,000 feet/1830 meters or less. RVR data is read on digital displays inside the weather station. RVR is reported in either feet or meters as determined by country.

**12.2.8. Day Visibility Discrepancies.** Although the day observed horizontal visibility may be unrestricted, the pilot's slant range visibility frequently is restricted to less than 7 statute miles (SM). In some cases the slant range visibility can be as little as one-half of the reported horizontal visibility. This frequently happens when looking through fog, smoke, precipitation, dust, and haze because the suspended particles scatter the sun's rays. If a purely visual approach is being attempted with no attention being given to the instruments, glare often results in disguised sink rates and other illusions. Under these conditions, instruments should be cross-checked closely to ensure that optical illusions don't occur. To improve the slant range visibility, it is advisable to land with the sun to your back. These same problems may exist in a target region due to smoke from burning targets, blowing sand, etc. To help minimize this problem, the weather forecaster can provide sun angle and azimuth for any target location.

**12.2.9. Night Visibility Discrepancies.** Slant range visibility is also a problem at night. Generally, a night flier will not see as far as a surface based observer because nighttime visibility markers are easier to see than daytime markers. This is especially true in fog and light rain. Situations vary so you will have to depend on the weather observer, the tower controller, or your own experience.

**12.2.10. Visibility Differences.** Aircrews should keep in mind that the prevailing visibility, slant range visibility, and RVR will differ from each other on many occasions. The weather observer's ability to take representative observations is restricted at some airfields because one or both ends of the runway are not visible from the observing site or buildings or other obstructions may restrict the observer's view. The tower controller assists the weather observer by taking a visibility observation when the two observing locations significantly differ in their visibility values. Your local weather station and tower controllers keep visibility charts which they use to assess visibility values.

**12.2.11. Overseas Visibility Criteria.** Countries other than the US and Canada, and US overseas bases, may use different criteria in determining prevailing visibility. Some countries use the worst sector visibility value as the prevailing visibility value. If this is the practice of the host country and their weather observations are the official airfield observations, you must operate under their criteria. If US military observers are transmitting official observations at that airfield, then the US visibility definitions are used. In addition to different reporting criteria, different units of measure may also be used. Overseas observations report visibility in meters while stateside reports use statute miles. In either case, if the visibility falls halfway between two reportable values, the value is rounded down for flight safety reasons.

**12.2.12. Vertical Visibility.** *Vertical visibility* is the distance (in hundreds of feet) a weather observer can see in an upward direction when the sky is totally obscured. This distance is usually determined by weather instruments, but may be estimated by the observer if the equipment is inoperative. If the sky is partially obscured, no vertical visibility value is reported. If the sky is totally obscured, the vertical visibility is reported with a numerical value in hundreds of feet.

**12.2.13. Long Range Visibility.** Aircrews sometimes wonder how long they can "hide" below the horizon to keep from being seen by someone/something on the ground. The chart in Figure 12-3 shows how to determine the distance you (and they) can see targets at sea, based on height. Surface-based radar can generally see about 15 percent farther than the eye. The chart can be reversed to determine how far away an aircraft (height of object above sea level) can see a target on the horizon (height of observer's eyes above sea level).

**12.3. Night Vision Goggles.** Aircrews using night vision goggles (NVGs) are heavily dependent on the percent of moon illumination. Each weather station has the capability of running light programs that calculate the beginning and end of nautical and civil twilight, sunrise and sunset data, and the percent of moon illumination. This information can be calculated for any geographic location and for any length of time (number of days). This information is available for targets and destinations anywhere in the world. Figures 12-4 through 12-6 are a sampling of the light programs available through your base weather station. Restrictions to normal vision may be detrimental to NVGs as well. Certainly, rainfall, snowfall, fog, clouds, smoke, haze, etc., will have some effect. Follow manufacturer's guidance in anticipating the magnitude of reduction in night vision.

**12.4. Weapon Systems "Visibility."** Weather forecasters are frequently tasked to provide acquisition or lock-on ranges for state-of-the-art weapons systems. Pilots want to know how far away the weapon can "see" or acquire/lock-on the target. Infrared and TV guided systems are affected by the same weather conditions that affect NVGs and normal vision. Weather effects on electro-optic sensors are based on atmospheric effects on the propagation of electromagnetic energy. Accurate information is based upon the actual contrast between targets and backgrounds both in the visible and infrared spectrums. The base weather forecaster can assist by using Electro-Optic (E-O) computer aided guidance to furnish aircrews with "E-O" information.

Figure 12-3. Distance to Objects on the Horizon at Sea (Nautical Miles).

Height of observer's eyes above sea level (feet)	HEIGHT OF OBJECT ABOVE SEA LEVEL (FEET)														
	0*	10	20	30	40	60	80	100	150	200	300	400	600	800	1,000
10.....	3.8	7.2	8.7	9.9	10.8	12.5	13.9	15.1	17.7	19.8	23.5	26.5	31.6	36.0	39.8
15.....	4.6	8.0	9.5	10.7	11.6	13.3	14.7	15.9	18.5	20.6	24.3	27.3	32.4	36.8	40.6
20.....	5.4	8.7	10.2	11.4	12.3	14.0	15.4	16.6	19.2	21.3	25.0	28.0	33.1	37.5	41.3
25.....	6.0	9.3	10.8	12.0	12.9	14.6	16.0	17.2	19.8	21.9	25.6	28.6	33.7	38.1	41.9
30.....	6.6	9.9	11.4	12.6	13.5	15.2	16.6	17.8	20.4	22.5	26.2	29.2	34.3	38.7	42.5
35.....	7.1	10.4	11.9	13.1	14.0	15.7	17.1	18.3	20.9	23.0	26.7	29.7	34.8	39.2	43.0
40.....	7.6	10.8	12.3	13.5	14.4	16.1	17.5	18.7	21.3	23.4	27.1	30.1	35.2	39.6	43.4
45.....	8.0	11.3	12.8	14.0	14.9	16.6	18.0	19.2	21.8	23.9	27.6	30.6	35.7	40.1	43.9
50.....	8.5	11.7	13.2	14.4	15.3	17.0	18.4	19.6	22.2	24.3	28.0	31.0	36.1	40.5	44.3
60.....	9.3	12.5	14.0	15.2	16.1	17.8	19.2	20.4	23.0	25.1	28.8	31.8	36.9	41.3	45.1
70.....	10.0	13.2	14.7	15.9	16.8	18.5	19.9	21.1	23.7	25.8	29.5	32.5	37.6	42.0	45.8
80.....	10.7	13.9	15.4	16.6	17.5	19.2	20.6	21.8	24.4	26.5	30.2	33.2	38.3	42.7	46.5
90.....	11.4	14.5	16.0	17.2	18.1	19.8	21.2	22.4	25.0	27.1	30.8	33.8	38.9	43.3	47.1
100.....	12.0	15.1	16.6	17.8	18.7	20.4	21.8	23.0	25.6	27.7	31.4	34.4	39.5	43.9	47.7
*Horizon															

**12.4.1. Electro-Optics Information.** When the aircrew desires E-O information, it's necessary for the aircrew to provide the forecaster with as much information about the target as possible. This information includes, but may not be limited to: time over target (TOT), run-in heading, flight level, target size (height, width, and length), target composition (concrete, steel, glass, etc.), heated/not, type of weapon being used, and method of launching and steering the weapon. With this information, the weather forecaster should be able to provide the acquisition and lock-on range, sun elevation and azimuth at time over target, length of shadows around target, "what's hot, what's not" in the target picture, percent moon illumination, probability of line-of-sight, and target area weather forecast.

**12.5. Ceiling.** The *ceiling* is the height above the earth's surface of the lowest (thin or opaque) layer reported as broken or overcast, or the vertical visibility into a surface-based total obscuration. In this case, this ceiling is referred to as an *indefinite ceiling*. The ceiling can be composed of interconnected layers or composed of a layer with numerous detached elements. Figure 12-7 shows the average percentage of time the ceiling/visibility is less than 1000/3 by season.

**12.5.1. Summation Principle.** In the US and Canada, the ceiling is determined by using the *summation principle*. The summation principle states that the sky cover at any level is equal to the summation of the sky cover of the lowest layer plus the additional sky cover present at all successively higher layers up to and including the layer being considered. A layer is clouds or obscuring phenomena whose bases are approximately at the same level.

**12.5.2. Determination of Aviation Routine Weather Report (METAR) Ceiling Layer.** The METAR code does not use ceiling designator letters. Unlike the old Surface Aviation Observations (SAO), there is no "E" for estimated or "M" for measured associated with the ceiling layer. Instead, the lowest cloud layer prefixed with the contraction "BKN" for broken or "OVC" for overcast designates the ceiling. When the sky is totally obscured, "VV" will be encoded for the amount and the vertical visibility is measured in feet.

**12.5.3. Sky Cover Classifications.** The following terms are used to reflect the degree of cloudiness in sky condition evaluations. In METAR code the basic classification terms are:

- CLR or SKC--The absence of layers of clouds or other obscuring phenomena. Transmitted as "SKC" at manual weather stations. Transmitted as "CLR" at automated stations when no clouds are at or below 12,000 feet.
- FEW--Means "few" and is greater than 0/8 up to 2/8 cloud coverage.
- SCT--Means "scattered" and is 3/8 to 4/8 cloud coverage.
- BKN--Means "Broken" and is 5/8 to 7/8 cloud coverage.
- OVC--Means "Overcast" and the sky is totally covered with clouds (8/8).



Figure 12-4. Moonrise/Moonset and Percent Illumination Data.

AIR FORCE LUNAR DATA			
Moonrise/Noonset and Percent Illumination			
For: RANDOLPH AFB, TX			
Latitude: 29 deg 32 min N Longitude: 98 deg 17 min W			
Flying Altitude: 0			
JANUARY 1991			
ALL TIMES ARE GREENWICH MEAN TIME			
PERCENT ILLUMINATION IS GIVEN FOR 00 LST			
DAY	MOON RISE	MOON SET	% ILLUM
1	****	1420	100
2	0104	1506	97
3	0214	1545	91
4	0320	1620	84
5	0422	1652	75
6	0522	1722	65
7	0619	1753	55
8	0716	1824	45
9	0812	1859	35
10	0909	1937	26
11	1004	2020	19
12	1058	2107	12
13	1149	2159	6
14	1236	2254	3
15	1318	2350	0
16	1356	****	0
17	1431	0048	2
18	1502	0145	5
19	1533	0242	11
20	1602	0339	18
21	1633	0437	26
22	1707	0537	36
23	1744	0640	47
24	1828	0746	58
25	1919	0853	69
26	2019	1001	79
27	2126	1106	88
28	2237	1203	94
29	2348	1254	99
30	****	1337	100
31	0057	1414	99

**12.5.4. Partial Obscuration.** The portion of sky cover hidden by weather phenomena in contact with the surface shall be the amount of the partial obstruction. In the old SAO code, it was reported as "-X." In METAR it's reported as "FEW000, SCT000, or BKN000." The partial obscuration is clarified in remarks such as "FG FEW000," "FU SCT000," or "DU BKN000."

**12.5.5. Overseas Ceiling Differences.** As with visibility, some countries have established different criteria regarding the amount of sky cover required to constitute a ceiling. When flying in a foreign country using their weather conditions, aircrews must ask the local weather office to determine exactly what ceiling criteria is used.

**12.5.6. Obscured Sky.** To be classified as obscuring phenomena, precipitation, smoke, haze, fog, or other visibility restricting conditions must extend upward from the surface. An obscured sky occurs when the sky is totally hidden from an observer on the ground. The ceiling will be reported as the vertical visibility from the ground upward into the obstruction. For example, when the sky is totally hidden by fog and the ground observer can see upward for 600 feet, the ceiling will be reported as "indefinite at 600 feet" using the proper coding format.

**12.5.6.1. Obstruction Ceiling and Cloud Ceiling Differences.** It is important to note the difference between the obstruction ceiling of 600 feet and a cloud ceiling of 600 feet. With a low cloud ceiling, the aircrew normally can expect to see the ground and the runway after descending to a level below the cloud base. However, with an obscured ceiling, the obscuring phenomenon restricts visibility between the aircraft altitude and the ground, and the slant range visibility is greatly reduced. Aircrews will not normally be able to see the runway or approach lights clearly, even after penetrating the level of the reported obstruction ceiling. Figure 12-8 illustrates the difference in the two ceilings.

Figure 12-5. Nautical Twilight, Civil Twilight and Sunrise/Sunset.

SOLAR DATA						
Nautical Twilight, Civil Twilight, and Sunrise/Sunset						
For: RANDOLPH AFB, TX						
Latitude: 29 deg 32 min N Longitude: 98 deg 17 min W						
Flying Altitude: 0						
JANUARY 1991						
ALL TIMES ARE GREENWICH MEAN TIME						
DAY	BMNT	BMCT	SUN RISE	SUN SET	EECT	EENT
1	1233	1302	1328	2345	0011	0040
2	1233	1302	1329	2346	0011	0041
3	1233	1302	1329	2346	0012	0042
4	1233	1303	1329	2347	0013	0042
5	1233	1303	1329	2348	0013	0043
6	1234	1303	1329	2349	0014	0044
7	1234	1303	1329	2350	0015	0044
8	1234	1303	1330	2350	0016	0045
9	1234	1303	1330	2351	0016	0046
10	1234	1303	1330	2352	0017	0047
11	1234	1303	1330	2353	0018	0047
12	1234	1303	1330	2354	0019	0048
13	1234	1303	1330	2354	0019	0049
14	1234	1303	1329	2355	0020	0050
15	1234	1303	1329	2356	0021	0050
16	1234	1303	1329	2357	0022	0051
17	1234	1303	1329	2358	0023	0052
18	1234	1303	1329	2359	0023	0053
19	1234	1303	1329	****	0024	0053
20	1234	1303	1328	0000	0025	0054
21	1233	1302	1328	0001	0026	0055
22	1233	1302	1328	0001	0027	0056
23	1233	1302	1327	0002	0027	0057
24	1233	1301	1327	0003	0028	0057
25	1232	1301	1327	0004	0029	0058
26	1232	1301	1326	0005	0030	0059
27	1232	1300	1326	0006	0031	0100
28	1231	1300	1325	0007	0031	0101
29	1231	1259	1325	0007	0032	0101
30	1231	1259	1324	0008	0033	0102
31	1230	1258	1324	0009	0034	0103

<b>BMNT-Beginning Morning Nautical Twilight</b>	<b>EENT-Ending Evening Nautical Twilight</b>
<b>BMCT-Beginning Morning Civil Twilight</b>	<b>EECT-Ending Evening Civil Twilight</b>

**12.5.6.2. Partial Obscured Sky** With a partially obscured sky, clouds or part of the sky can be seen above the obscuring phenomenon. A partial obstruction does not define a ceiling. However, a cloud layer above a partial obstruction may constitute a ceiling. Partial obscured skies also present a slant range visibility problem for aircrews on approach, but usually to a lesser degree than a total obstruction. From directly overhead, the aircrew may be able to see the runway clearly, whereas the slant range visibility on final approach could be poor.

**12.6. Climatological Ceiling/Visibility.** Figure 12-7 shows the percentage of hours when the ceiling is below 1,000 feet and/or the visibility is less than 3 miles in the CONUS for the four seasons.

**12.7. Fog.** Fog is one of the most common and persistent weather hazards encountered in aviation, and the most frequent cause of prevailing visibility less than three miles. Since fog occurs at the surface, it is primarily a hazard during takeoff and landing. Above fog, flight visibility is generally good.

Figure 12-6. Hours of Solar Darkness, Moonlight, and Total Darkness Percent Lunar Illumination.

<b>DARKNESS DATA</b>										
<b>Hours of Solar Darkness, Moonlight, and Total Darkness Percent Lunar Illumination (at Moonrise/Moonset during Solar Darkness)</b>										
For: RANDOLPH AFB, TX										
Latitude: 29 deg 32 min N Longitude: 98 deg 17 min W										
Flying Altitude: 0										
JANUARY 1991										
ALL TIMES ARE GREENWICH MEAN TIME										
DAY	EENT	FMT	FMI	LMI	LMT	BMNT	DAY	DD	HM	HNM
2	0041	0104	98	96	1233	1233	2	1152	1129	0023
3	0042	0214	92	90	1233	1233	3	1151	1019	0132
4	0042	0320	85	82	1233	1233	4	1151	0913	0238
5	0043	0422	76	73	1233	1233	5	1150	0811	0339
6	0044	0522	66	63	1234	1234	6	1150	0712	0438
7	0044	0619	55	53	1234	1234	7	1150	0615	0535
8	0045	0716	45	43	1234	1234	8	1149	0518	0631
9	0046	0812	35	34	1234	1234	9	1148	0422	0726
10	0047	0909	26	25	1234	1234	10	1147	0325	0822
11	0047	1004	18	17	1234	1234	11	1147	0230	0917
12	0048	1058	11	11	1234	1234	12	1146	0136	1010
13	0049	1149	6	6	1234	1234	13	1145	0045	1100
14	0050	****	***	***	****	1234	14	1144	0000	1144
15	0050	****	***	***	****	1234	15	1144	0000	1144
16	0051	****	***	***	****	1234	16	1143	0000	1143
17	0052	0052	1	2	1234	1234	17	1142	1142	0000
18	0053	0053	4	4	0145	1234	18	1141	0052	1049
19	0053	0053	9	9	0242	1234	19	1141	0149	0952
20	0054	0054	15	16	0339	1234	20	1140	0245	0855
21	0055	0055	23	25	0437	1233	21	1138	0342	0756
22	0056	0056	33	35	0537	1233	22	1137	0441	0656
23	0057	0057	43	47	0640	1233	23	1136	0543	0553
24	0057	0057	54	58	0746	1233	24	1136	0649	0447
25	0058	0058	65	70	0853	1232	25	1134	0755	0339
26	0059	0059	76	81	1001	1232	26	1133	0902	0231
27	0100	0100	85	89	1106	1232	27	1132	1006	0126
28	0101	0101	93	96	1203	1231	28	1130	1102	0028
29	0101	0101	98	99	1231	1231	29	1130	1130	0000
30	0102	0102	100	100	1231	1231	30	1129	1129	0000
31	0103	0103	99	98	1230	1230	31	1127	1127	0000
1	0104	0203	95	93	1230	1230	1	1126	1027	0059

<b>EENT-Ending Evening Nautical Twilight</b>	<b>BMNT-Beginning Morning Nautical Twilight</b>
<b>FMT-First Moonlight at or after EENT</b>	<b>LMT-Last Moonlight at or after BMNT</b>
<b>FMI-Percent Illumination at FMT</b>	<b>LMI-Percent Illumination at LMT</b>
<b>DD-Duration of Solar Darkness</b>	<b>HM-Hours of Moonlight</b>
<b>HNM-Hours with No Moon (Total Darkness)</b>	

**12.7.1. Fog Definition.** Fog is a surface-based cloud composed of either water droplets or ice crystals. Since fog normally forms in very stable air, there are few collisions between the droplets or ice crystals, and the particles remain extremely small. Therefore, before significantly reducing visibility, a large number of suspended particles must be present.

**12.7.2. Fog Conditions.** Ideal atmospheric conditions for fog formation are:

- small temperature dew point spread (4° F or less)
- abundant condensation nuclei
- light surface wind
- cooling land surfaces, warmer air above

Figure 12-7. Seasonal Restrictions to Visibility.

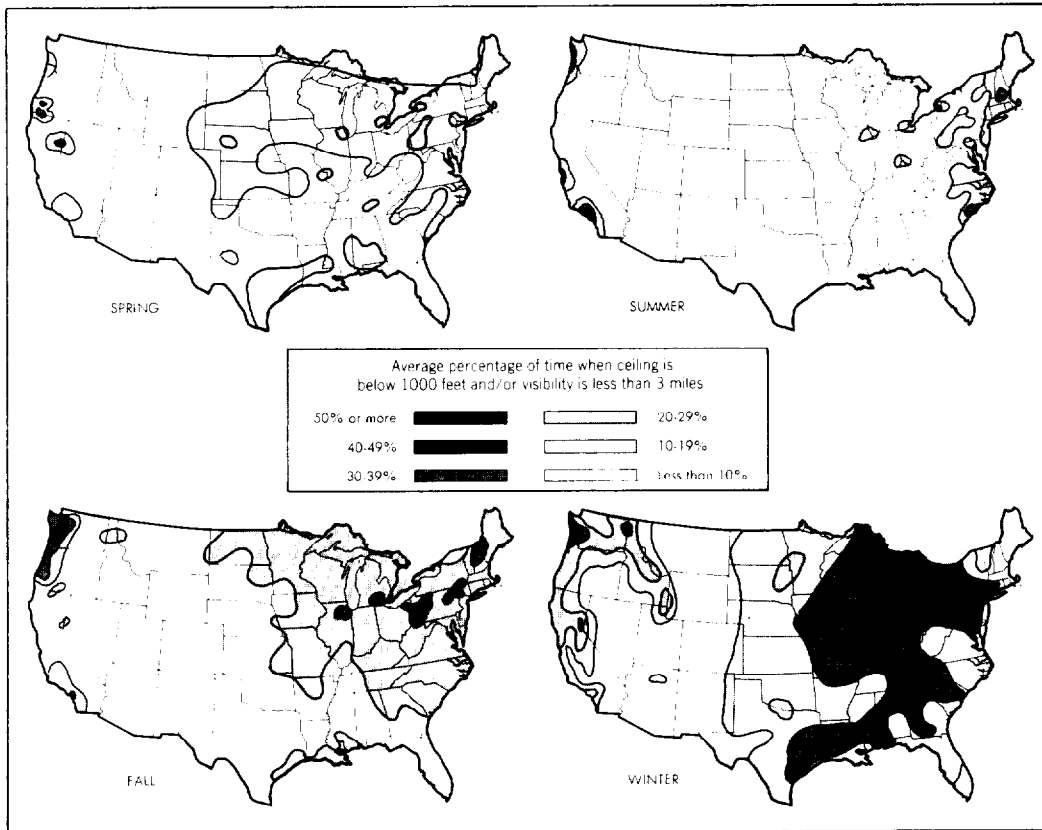
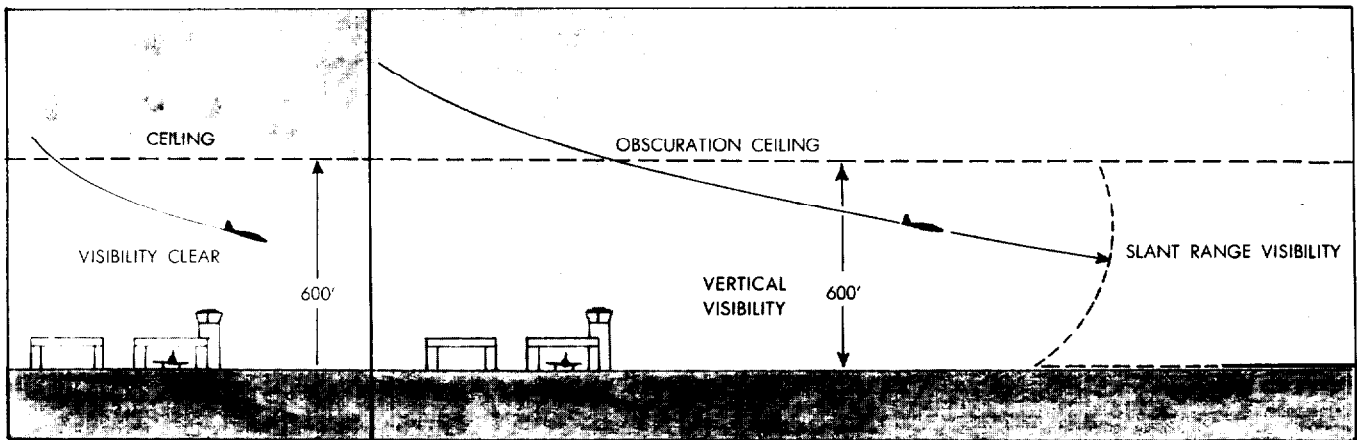


Figure 12-8. Visibility with Cloud or Obscured Ceiling Condition.



Consequently, fog is prevalent in coastal areas where moisture is abundant and in industrial areas where combustion products provide a high concentration of water-attracting condensation nuclei. Fog occurs more frequently in the colder months, but the season and frequency of occurrence varies from one area to another. Fog may form by cooling air to its dew point or by adding moisture to the air near the ground. Names of various fogs are based upon the way they form.

**12.7.3. Radiation Fog.** Radiation fog is a relatively shallow fog resulting from radiational cooling of the ground on clear, calm nights. The ground cools the air in contact with it to the dew point temperature. Ground fog (Figure 12-9.) is a form of radiation fog. Radiation fog is restricted to land areas because water areas do not vary much in temperature. It forms almost exclusively at night or in the early morning and usually disappears a few hours after sunrise. Radiation fog is very shallow when there is no wind. Light wind, usually less than 5 kts, produces a slight mixing of the air. This tends to deepen the fog by spreading the cooled air through a deeper layer. Stronger winds disperse the fog or mix the air through a still deeper layer with stratus forming at the top of the mixing layer.

Figure 12-9. Ground Fog.



**12.7.4. Advection Fog.** Common along coastal areas, *advection fog* forms when moist air moves over colder ground or water. When it forms over a large water body, it is called sea fog. It also forms as radiation fog which is then advected by the prevailing wind over surrounding areas. Advection fog deepens with increasing wind speed (up to about 15 kts). Winds stronger than 15 kts usually lift the fog into a layer of low stratus or stratocumulus. Advection fog can stay over water for weeks moving over land late in the day and moving over the water the next morning.

**12.7.4.1. Favored Locations.** The west coast of the United States is quite vulnerable to advection fog and stratus. This common fog forms offshore, largely as a result of upwelling--very cold water rising from the ocean depths to the surface (Figure 12-10). The resulting cold air is carried inland by the wind as stratus or fog. Advection fog over the southeastern United States and along the Gulf Coast results from moist tropical air moving over cold ground. For this reason, it is more frequent in winter than summer. Airfields located downwind from cold, freshwater lakes can experience frequent bouts with advection fog during the summer months.

**12.7.5. Other Types of Fog.** When relatively warm rain or drizzle falls through cool air, evaporation from the precipitation saturates the air and forms fog (Figure 12-11). *Precipitation induced fog* can become quite dense and extend over large areas. It may form rapidly and continue for an extended period of time.

**12.7.5.1. Upslope Fog.** Moist, stable air, cooling as it moves up sloping terrain, forms *upslope fog* (Figure 12-12). It is often quite dense and extends to high elevations.

**12.7.5.2. Ice Fog.** *Ice fog* occurs when the temperature is below freezing and water vapor sublimates as ice crystals. Conditions favorable for formation are the same as for radiation fog except that the temperature usually is colder than 32°F. Ice fog frequently forms very rapidly in the exhaust gasses of aircraft engines. If there is little or no wind, it is possible for an aircraft to generate enough ice fog during takeoff or landing to cover the runway, halting further aircraft operations. Ice fog may persist for periods which vary from a few minutes to several days.

**12.8. Low Stratus.** Like fog, stratus clouds are composed of extremely small water droplets or ice crystals suspended in the air. Stratus differs from fog by being a layer above the ground and not reducing the horizontal visibility at the surface. As a portion of the sun's energy warms the earth's surface, the fog lifts into an elevated low stratus layer. Because of the reduction in upward visibility, the observer on the ground recognizes the condition as stratus. Both slant range visibility and flight visibility may approach zero in stratus, depending on the cloud's density and depth.

**12.9. Haze.** *Haze* is a concentration of suspended salt or dust particles. It occurs in stable air and is usually only a few thousand feet thick, but may sometimes extend as high as 15,000 feet. A haze layer often has a well defined top and good horizontal visibility above. However, downward visibility from above a haze layer is poor, especially on a slant. Visibility in haze varies greatly, depending upon whether the aircrew is facing into or away from the sun. Landing or taking off into the sun is often hazardous if haze is present.

**12.10. Smoke/Smog.** *Smoke* concentrations form primarily in industrial areas in stable air. *Smog* is when smoke and fog occur together. Smog also causes very poor visibility (Figure 12-13). Large scale air stagnation is required for smog formation. Some geographic areas chronically suffer from reduced visibilities due to smog and smoke. The aerosols cannot disperse through the atmosphere because an inversion prevents smog dissipation. Severe smog conditions can reduce prevailing visibilities to less than one mile.

Figure 12-10. Stratus and Fog off the West Coast of the United States.

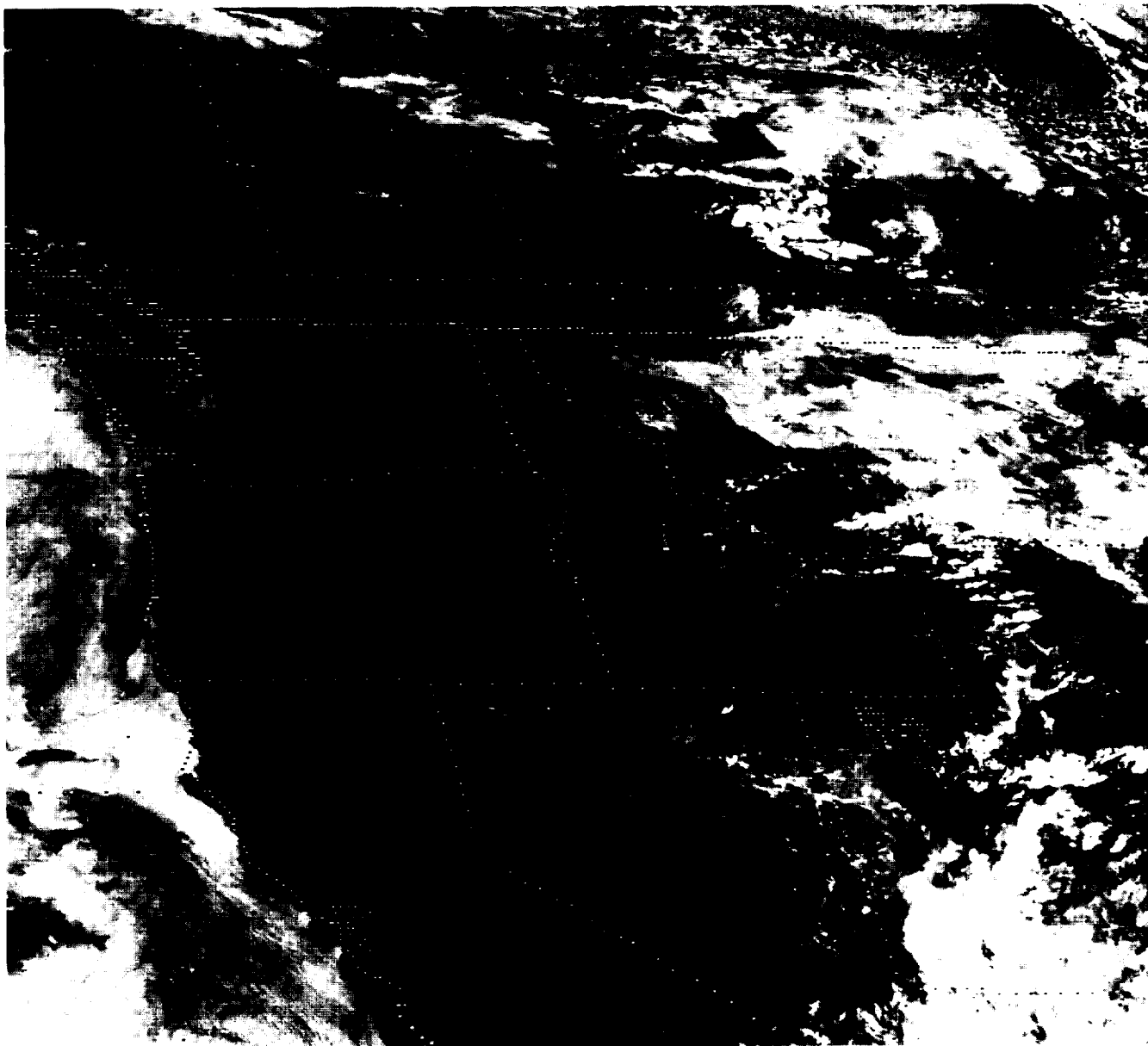


Figure 12-11. Precipitation-Induced Fog.

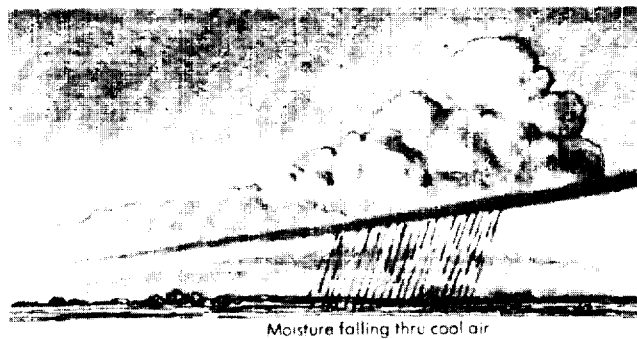


Figure 12-12. Upslope Fog.



Figure 12-13. Haze and Smog.

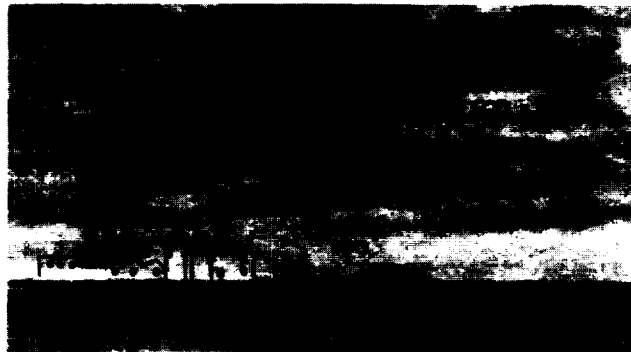
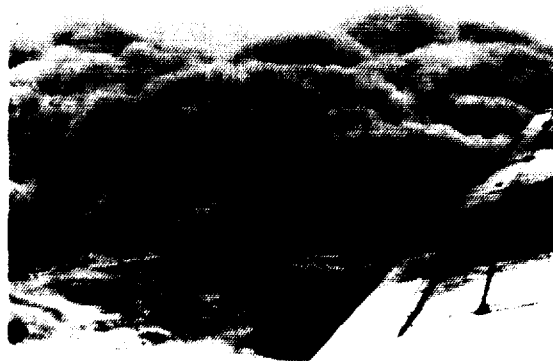


Figure 12-14. Aerial Photograph of Blowing Dust.



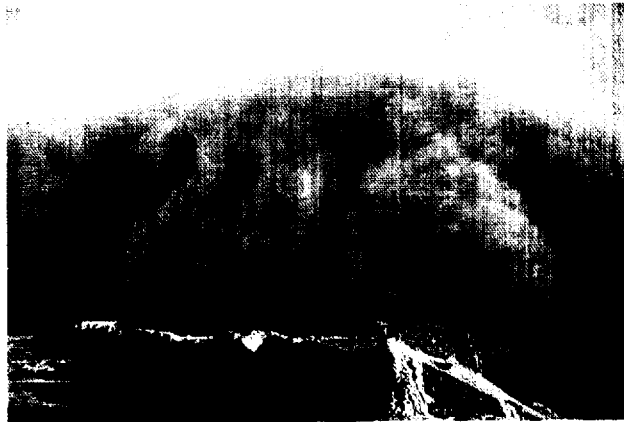
**12.11. Blowing Sand/Blowing Dust.** In areas with loose dry soil, blowing dust occurs in strong winds and unstable air (Figure 12-14). The wind and vertical currents may spread the dust over a wide area and often lifts it to great heights. Once airborne, very small dust particles may remain suspended for several days. Both blowing dust and suspended dust reduce surface, flight, and slant visibility ranges to very low values. Blowing sand is more local than blowing dust. It occurs in deserts where the wind lifts loose sand and blows it about in clouds or sheets. In its extreme form, blowing sand may become a sandstorm and restrict visibility to near zero (Figure 12-15).

**12.12. Blowing Snow.** *Blowing snow* is also troublesome. Strong winds keep the snow suspended up to 50 feet or so reducing visibility at ground level to near zero. When the snow is blowing to great heights, the sky can become partially obscured. Blowing snow, falling snow, and strong winds makes for a tricky combination and can reduce visibilities for hours in a heavy snow or lake effect snowshower situation. Ceilings and visibilities can vary quite rapidly in snow situations.

**12.13. Drizzle.** *Drizzle* usually restricts visibility to a greater degree than rain. Drizzle falls in stable air and usually is accompanied by fog. When drizzle changes to light rain, visibility usually improves and the droplet size increases. The droplet size increase means there are less droplets per unit area thus improving the visibility.

**12.14. Rain.** Rain by itself seldom reduces surface visibility below one mile, except in brief, heavy showers, but rain does limit cockpit visibility. When rain streams over the aircraft windshield, freezes on it, or fogs over the inside surface, it greatly reduces the aircrew's visibility.

**Figure 12-15. Blowing Sand.**




---

## Chapter 13

### THUNDERSTORMS AND ASSOCIATED HAZARDS

**13.1. Introduction.** Thunderstorms contain the most severe weather hazards to flight. Many are accompanied by strong winds, severe icing and turbulence, frequent lightning, heavy rain, and hazardous windshear. If all of these are not enough, consider the possibility of large hail, microbursts and even tornadoes. Thunderstorms are quite powerful. The latent heat released by a moderate thunderstorm is equivalent to the energy of a nuclear explosion of 400 kilotons! This chapter presents hazards a pilot must consider when flying in the vicinity of, or actually entering a thunderstorm. Being familiar with these factors will help you better understand what is going on both inside and outside the cockpit.

**13.1.1. Avoid Thunderstorms.** The best advice if thunderstorms are forecasted or have already formed is: **DON'T FLY IN OR NEAR THEM!** Unfortunately, with about 44,000 thunderstorms occurring daily over the surface of the earth, almost every aircrew can expect to encounter one occasionally. There are flights when you simply cannot avoid flying in the vicinity of thunderstorms, especially when widespread thunderstorms form over large areas. Knowledge of thunderstorm characteristics and the application of tested procedures will help aircrews fly more safely when thunderstorms are present.

**13.1.2. Thunderstorm Information.** The weather forecaster is the best source for obtaining thunderstorm information during the preflight weather briefing. During flight, enroute thunderstorm avoidance can sometimes be provided by the Air Route Traffic Control Center (ARTCC). Many enroute information sources are periodically updated to reflect the latest thunderstorm advisories and warnings in effect. The Automatic Terminal Information Service (ATIS), Transcribed Weather Broadcast (TWEB), and Hazardous Inflight Advisory Service (HIWAS) are a few such weather sources. Aircraft weather radar can be used to avoid thunderstorms but should not be used to determine thunderstorm intensity. Therefore, it is advisable to obtain weather information from a weather station that has a pilot-to-metro service (PMSV) capability.

**13.1.3. Formation.** Thunderstorms can form in any weather environment which favors their formation. This means they can develop during any season at any latitude if the main weather ingredients are present. In some tropical regions, thunderstorms occur year round. In the mid-latitudes, they develop most frequently in spring, summer, and fall. Thunderstorms can even form in the Arctic regions during their summer months. Figure 13-1 shows the average annual number of days with thunderstorms in the United States. Note they are most frequent in the south-central and southeastern states with Florida having the greatest number of thunderstorms. The number of days a thunderstorm occurs varies with the season as shown in Figures 13-2 through 13-5.

**13.2. Factors Necessary for Thunderstorm Development.** The basic requirements for thunderstorm formation (cumulonimbus) are moisture, unstable air, and some type of lifting action.

**13.2.1. Moisture.** Lifted warm air does not always result in thunderstorm activity. Air may be lifted to a point where the moisture condenses and clouds form, but these clouds may not grow significantly unless the air parcel reaches a point where it



Figure 13-1. Average Number of Days with Thunderstorms Each Year.

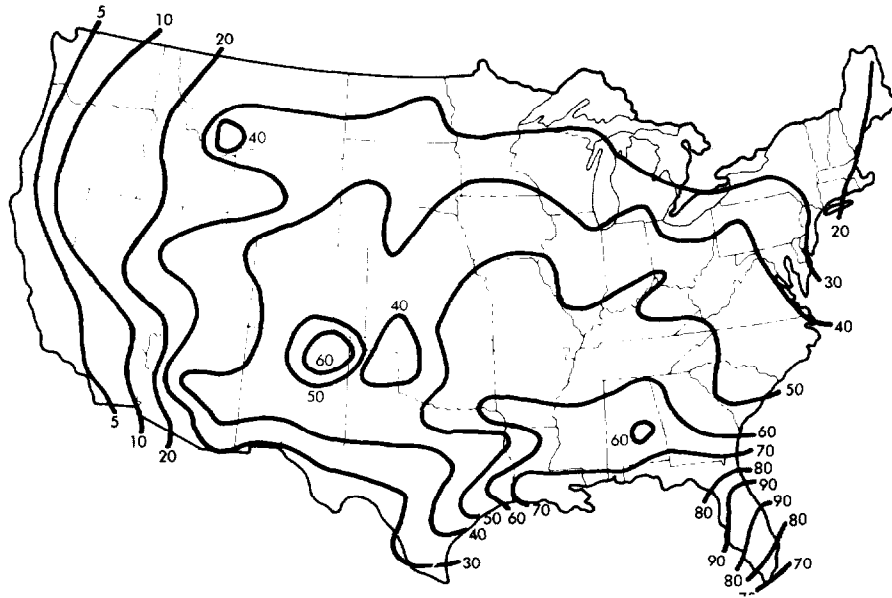


Figure 13-2. Average Number of Days with Thunderstorms During Spring.

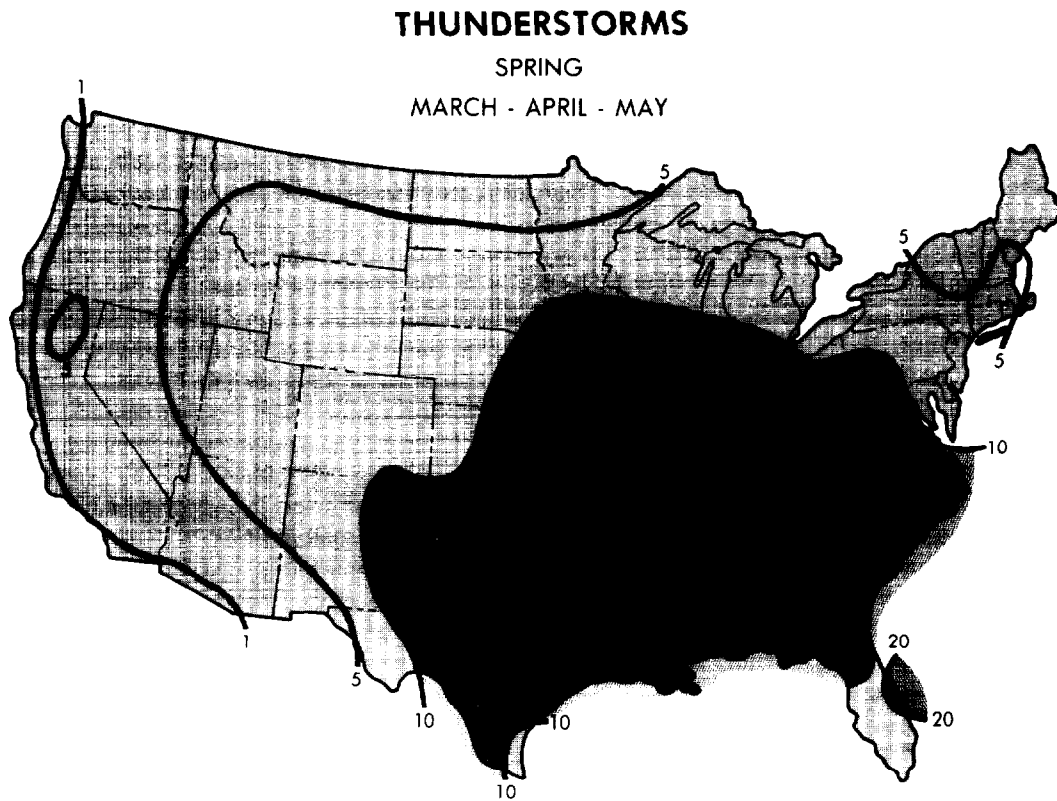


Figure 13-3. Average Number of Days with Thunderstorms During Summer.

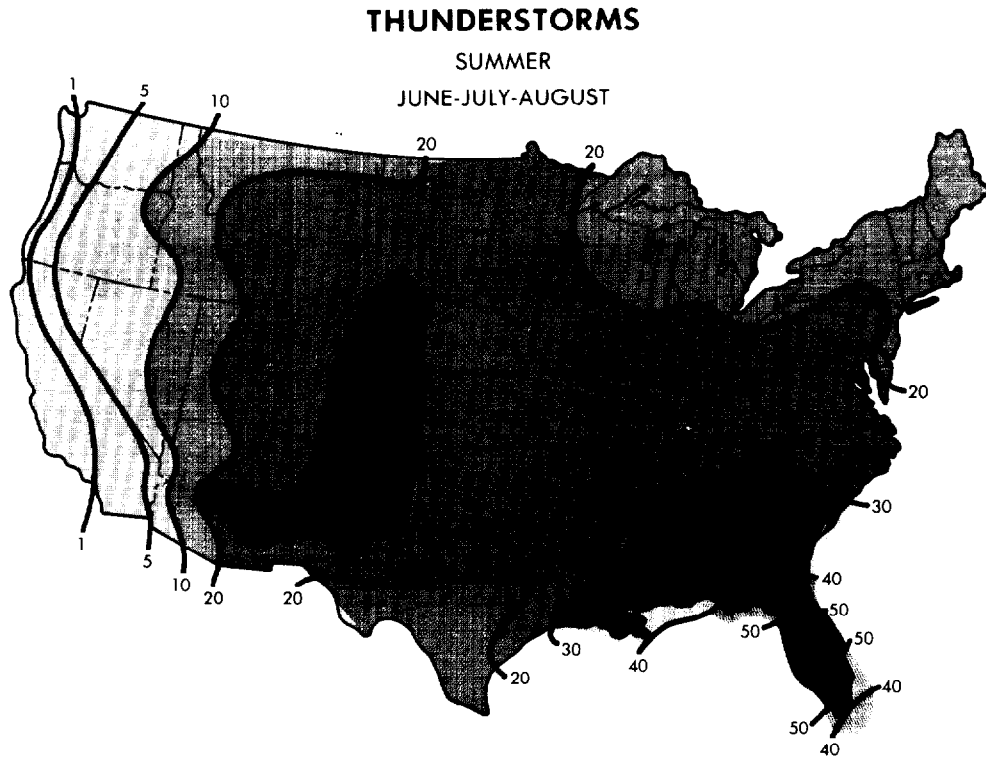


Figure 13-4. Average Number of Days with Thunderstorms During Fall.

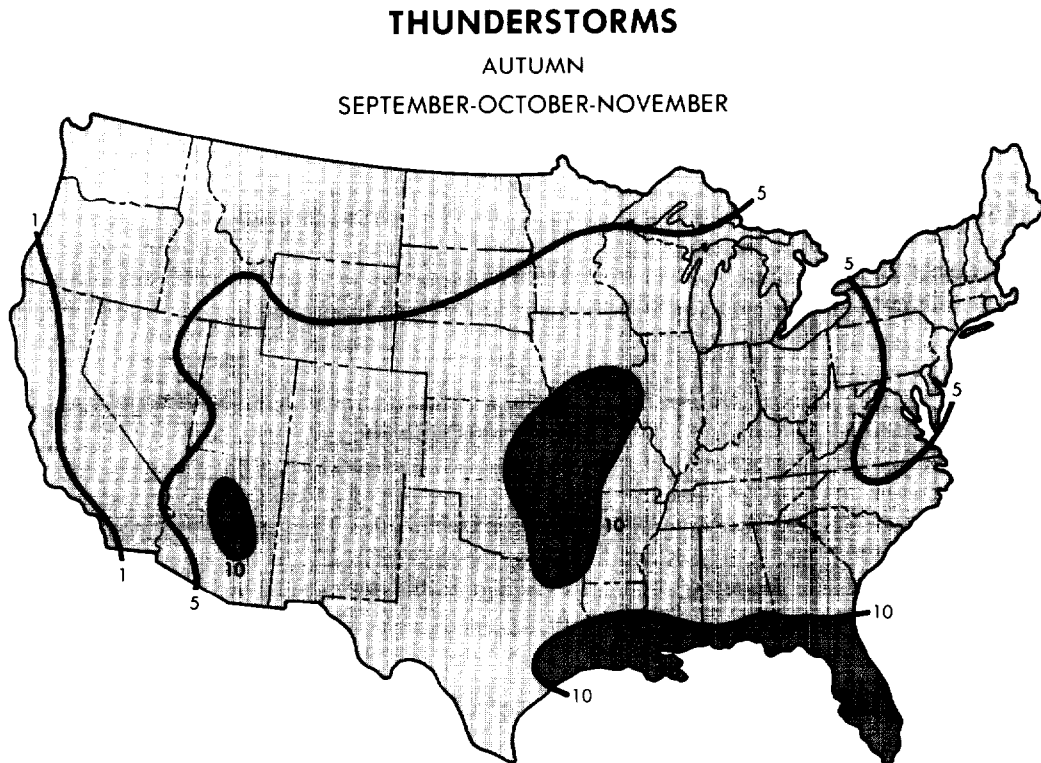
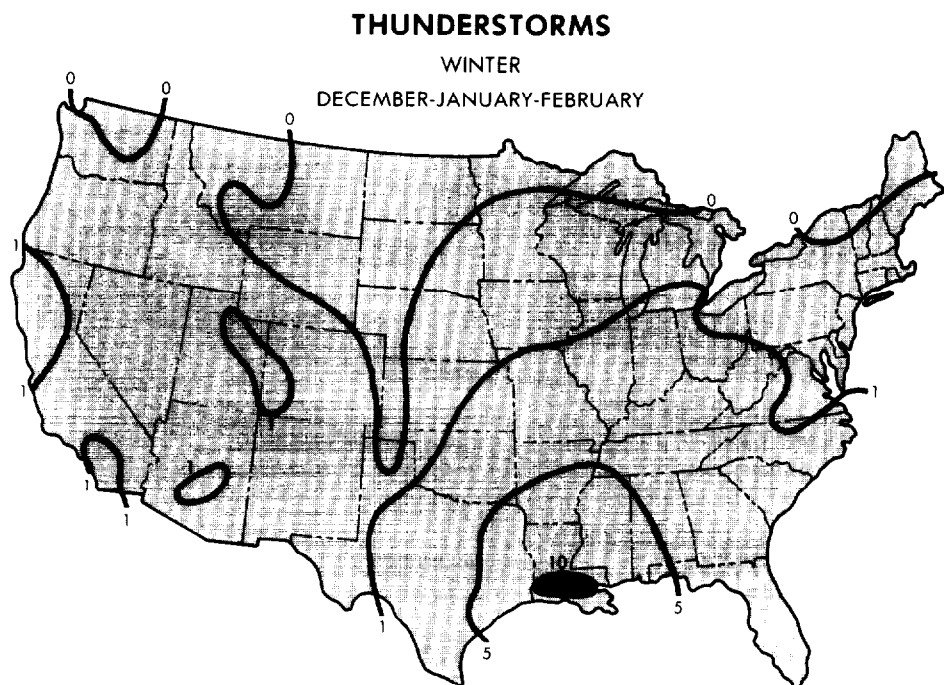


Figure 13-5. Average Number of Days with Thunderstorms During Winter.



will continue to rise freely (the level of free convection or LFC). This happens when the condensing air produces a locally warmer air pocket than its surrounding area. When the warmer air rises on its own, the air has become unstable. The higher the moisture content, the easier the LFC is reached.

**13.2.2. Unstable Air.** Once a cloud forms, the released heat caused by the changing state from vapor to liquid tends to make the cloud area warmer than its surrounding air environment. This forms an *unstable air* environment. When the warmed air is much warmer than its surrounding environment, the rapidly rising unstable air quickly forms towering cumulus and eventual cumulonimbus clouds. The degree of vertical cloud growth often indicates the potential severity of the thunderstorm. Rapidly growing thunderstorms indicate very unstable conditions and can develop into severe thunderstorms. As it rises, the warmed unstable air cools but at a slower rate than its surrounding environment. Eventually the air parcel reaches an altitude where it becomes the same temperature as its surroundings. The air parcel slows vertical development reaching an equilibrium level where the air parcel temperature and its surrounding environment temperature are the same.

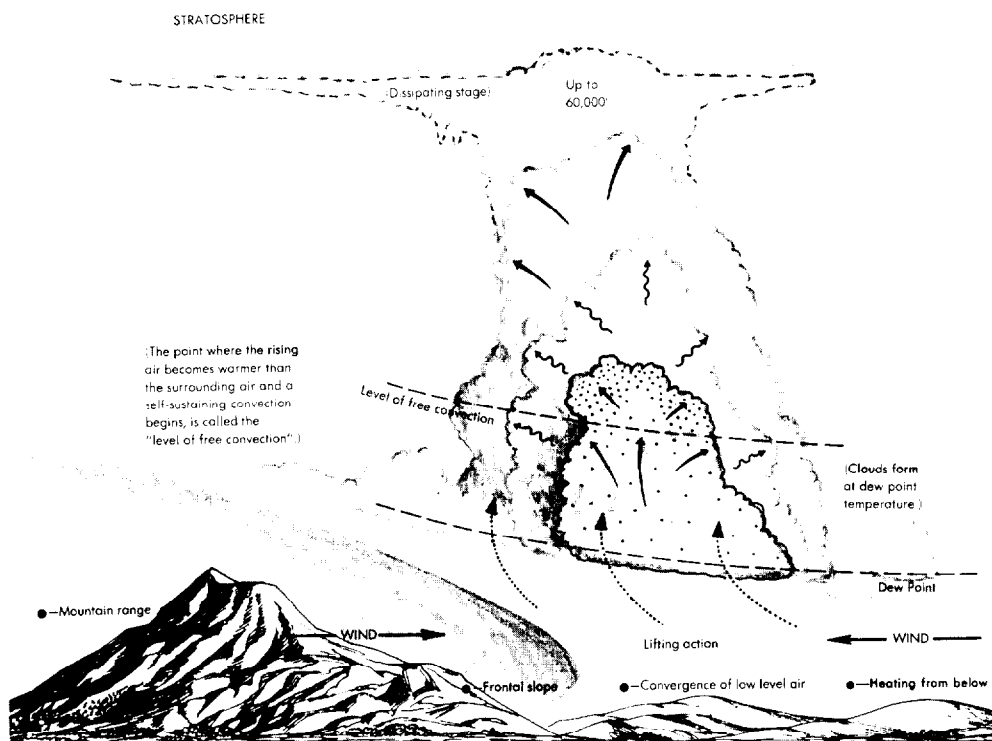
**13.2.3. Lifting Action.** Some type of lifting action is necessary to force warmer air from its lower level to a level where the warmed air will continue to rise freely. Normally, mountainous terrain, fronts, heating from below, or convergence (upward vertical motions associated with air coming together from different directions) provides the necessary lifting action. Once the necessary lifting action allows towering cumulus to form, many towering cumulus clouds start through the thunderstorm life cycle (Figure 13-6).

**13.3. Thunderstorm Cell Life Cycle.** During its life cycle, a thunderstorm progresses through three stages: cumulus (growth), mature, and dissipating. All thunderstorms progress through this life cycle with some progressing through all three stages in a half hour or less while other storms can last several hours. Furthermore, a thunderstorm may often consist of a cluster of cells each in different stages of the life cycle giving the appearance of a continuous, long-lasting single storm.

**13.3.1. Cumulus Stage--Updrafts.** All thunderstorms start out in the cumulus cloud stage. The main feature of the cumulus stage (Figure 13-7A) is the *updraft* which may extend from near the surface to several thousand feet above the visible cloud top. In the latter part of this stage, the greatest updraft occurs at higher altitudes and may reach 3,000 feet or more per minute. As the cloud forms, water vapor changes to liquid and/or frozen cloud particles. This releases heat providing energy to the developing cloud. After other forces form the cloud, this continuous heat release process helps the cumulus cloud to rise and grow.

**13.3.1.1.** During this early period, cloud droplets are very small but grow into raindrops as the cloud builds. In the upper levels, snow and ice particles exist, although in the updraft, raindrops remain liquid to heights far above the freezing level, sometimes reaching 40,000 feet. Since ascending air currents carry or suspend raindrops and ice particles, there is usually no precipitation during this stage.

Figure 13-6. Lifting Mechanisms for Thunderstorm Development.



**13.3.2. Mature Stage.** A cumulus cloud forming into a towering cumulus (TCU) and eventual CB is entering the mature stage. The *mature stage* is characterized by updraft and downdraft development. When updrafts can no longer support the raindrops and ice particles in the cloud, a downdraft develops and precipitation and/or hail begins falling from the cloud base. By this time, the average cell has grown to 25,000 feet, has crossed the freezing level, and has developed lightning. Empirical studies have shown that when a thunderstorm vertically develops above the  $-20^{\circ}\text{C}$  isotherm, lightning formation is likely.

**13.3.2.1. Downdrafts.** As rain starts falling, evaporation cools the surrounding air and the air parcel begins to sink. Since it is unstable, the cold, dense air accelerates, forming a *downdraft* which may reach 2,500 feet per minute (Figure 13-7B). The downdraft spreads outward near the surface, producing a sharp temperature drop and strong, gusty, surface winds. The leading edge of this wind is called the gust front and often pushes ahead of the thunderstorm by several miles. The gust front is characterized by gusty winds, sharp temperature drops, low level windshear, and turbulence. In the early mature stage, remaining updrafts continue increasing in speed and may exceed 4,500 feet per minute. Updrafts and downdrafts occur near each other creating strong, vertical shear and turbulence. The mature stage marks the maximum intensity of the thunderstorms. If severe weather develops, it will most likely form during this stage.

Figure 13-7. Stages of a Thunderstorm.

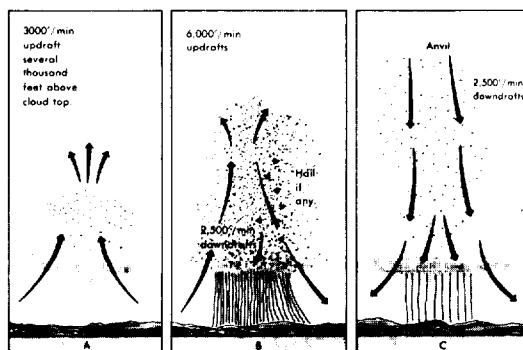
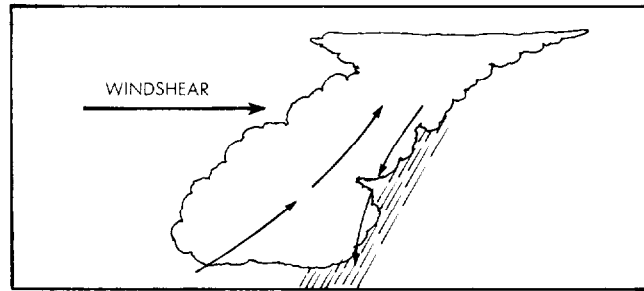


Figure 13-8. Prolonged Mature Stage.



**13.3.2.2. Prolonged Mature Stage.** Occasionally, severe thunderstorms do not dissipate through the classic mature stage. Instead strong upper level winds prolong the mature stage and a considerable tilt develops in the updraft/downdraft couplet within the cloud. In this situation, precipitation falls through only a small portion of the rising air and later falls through the relatively still air near the updraft, or perhaps completely outside the cloud (Figure 13-8). This tilted configuration keeps the falling precipitation and downdrafts from cutting off the warm, moist inflow necessary to sustain the storm. In this situation, prolonged, much stronger, updrafts and downdrafts enable the storm to achieve a virtual "Steady State" stage. "Steady State" thunderstorms often form severe weather and should be avoided. Sometimes "Steady State" storms can form a massive storm complex covering portions of several states (called Mesoscale Convective Complexes) and last 6 to 8 hours or more. These storm complexes typically form at night and last into the following day. They often trigger flash flooding events.

**13.3.3. Dissipation Stage.** Throughout the mature stage, downdrafts strengthen while updrafts weaken. The storm's cooled air rushes downward resulting in the entire thunderstorm cell becoming an area of downdrafts (Figure 13-7c). The cooled, stable air advances into formerly warm, moist air environments effectively cutting off the storm's supply of energy. Since updrafts are necessary to produce condensation and latent heat energy, the thunderstorm begins to dissipate. If severe weather has formed, the severe weather will also dissipate during this stage. Maximum tornado intensity, the strongest surface winds and largest hail are experienced during the first part of the dissipation stage. Strong winds aloft may form the upper levels of the CB into the familiar anvil shape (Figure 13-9).

**13.4. Tropopause.** The height of the *tropopause* is important when analyzing potential severity of a thunderstorm. The tropopause height will vary with latitude and the season of the year. The tropopause height is higher in summer, and lower in winter. The height is also higher at the equator and lower at higher latitudes. The tropopause acts as a barrier to resist the exchange of air between the troposphere and the stratosphere.

**13.4.1. Tropopause Penetration.** The tropopause will stop a thunderstorm from continuing to build, acting as a lid on further vertical development. That is why forecasters and aviators can key on the tropopause height. Powerful storms penetrate the tropopause because the rapidly rising updrafts have enough kinetic energy to penetrate the tropopause before cooling and slowing down. Remember that the tropopause height does seasonally and regionally change. A summertime 50,000-foot midwest thunderstorm is potentially as deadly as a 30,000-foot thunderstorm in Germany. There is a rough correlation between the degree of tropopause penetration and thunderstorm severity. The greater the tropopause penetration, the more severe the storm.

Figure 13-9. Thunderstorm with a Well Developed Anvil.

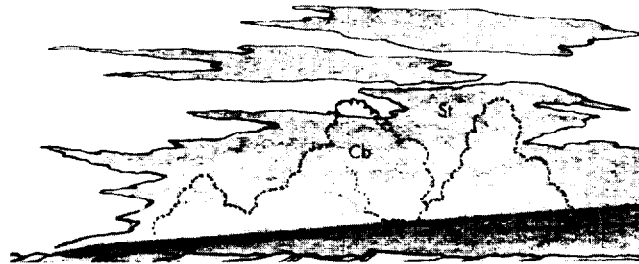


**13.5. Thunderstorms Types--Frontal Thunderstorms.** Thunderstorms can occur with any type of front; warm, cold, stationary, or occluded. Frontal surfaces provide the lifting mechanism to force air upward. Warm, moist, unstable air lifted over a frontal surface causes *frontal* thunderstorms. Thunderstorms may also occur many miles ahead of rapidly moving cold fronts with squall lines.

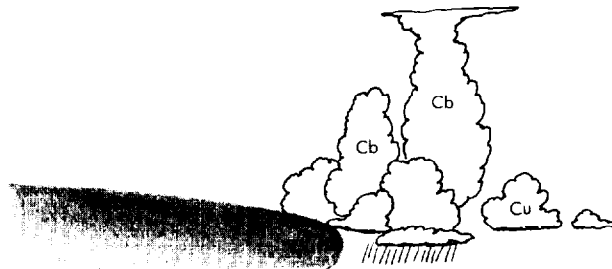
**13.5.1. Warm Frontal Thunderstorms.** Stratiform clouds usually accompany warm fronts due the shallowness of the frontal slope. This may obscure thunderstorms unless aircrews fly above the stratiform layer. If flying at low levels, aircrews may be forewarned of such conditions by loud crashes of static in their headsets. Because of the front's shallow slope, warm frontal thunderstorms are usually the least severe of all frontal thunderstorms (Figure 13-10).

**13.5.2. Cold Frontal Thunderstorms.** Thunderstorms associated with cold fronts are the most severe found, except for those found in squall lines. The cold frontal surface wedges the warm unstable air upward until the forced air rises on its own. Often cold frontal thunderstorms form into a continuous line and are easy to recognize. These storms usually form the classic thunderstorms and are often connected with cold frontal passage (Figure 13-11).

**Figure 13-10. Warm Front Thunderstorm.**



**Figure 13-11. Cold Front Thunderstorm.**

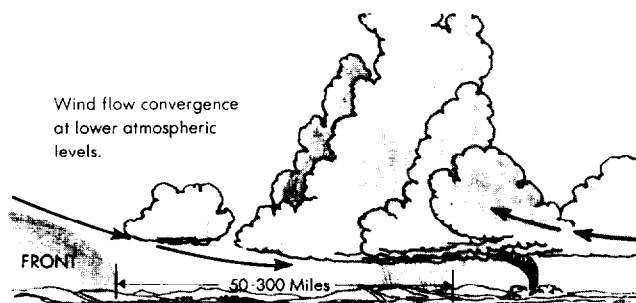


**13.5.3. Stationary Frontal Thunderstorms.** Occasionally, thunderstorms develop along a stationary front, where they are usually scattered. These thunderstorms can form in the same areas for days dumping heavy rains and causing flooding. Stationary frontal storms usually move slowly and can plague an airfield for hours with inclement weather.

**13.5.4. Occluded Frontal Thunderstorms.** Thunderstorms associated with occluded fronts are particularly dangerous to aircrews since they are often embedded in stratiform clouds and difficult to see. Occluded frontal thunderstorms form along the mixed frontal surfaces with the overlapping frontal surfaces forcing the unstable air aloft. The forced air eventually reaches the height where the air rises on its own and goes through the thunderstorm development cycle. Occluded frontal thunderstorms can achieve the same severity as their cold front cousins.

**13.5.5. Squall Line Thunderstorms.** A squall line is a non-frontal, narrow band of active, occasionally violent, thunderstorms. Squall lines often develop 50 to 300 miles ahead of rapidly moving cold fronts in moist, unstable air (Figure 13-12), but the existence of a front is not a prerequisite. The squall line may be too long to easily detour and too wide or severe to penetrate. Remember from Chapter 8 that squall lines have moderate to extreme turbulence, strong windshear, frequent lightning, possible hail and tornadoes. They can achieve forward speeds of 50 knots or more. Figure 13-13 provides a vivid aerial look of an advancing squall line.

Figure 13-12. Squall Line.



**13.5.6. Air Mass Thunderstorms.** Air mass thunderstorms form within a warm, moist, unstable air mass not associated with a front. They are generally isolated or widely scattered over a large area with no apparent organized activity. These thunderstorms receive their necessary lift by surface heating (convection), convergence of low level winds, or winds forcing the moist, unstable air up mountain slopes (Figure 13-14). Since they are caused by surface heating and convergence, they reach maximum intensity and frequency over land during middle and late afternoon. Along coastal regions they reach a maximum during the night and early morning when the warmer water heats the cool air flowing off the land, causing thunderstorms to form a short distance offshore.

**13.5.7. Orographic Thunderstorms.** Orographic thunderstorms will form on the windward side of a mountain when the prevailing wind forces moist, unstable air up the slope. The storm activity is usually scattered along the individual mountain peaks, but occasionally there will be a long, unbroken line of thunderstorms. The storms frequently enshroud the mountain peaks and adjacent lower terrain (Figure 13-15). Orographic stationary thunderstorms can have dangerous flash flooding as evidenced by the Big Thompson Canyon Flood, Colorado, in July 1976. These orographically stationary storms topped 60,000 feet and dumped an estimated 10 inches of rain in a 2 hour period.

Figure 13-13. Squall Line Thunderstorms.

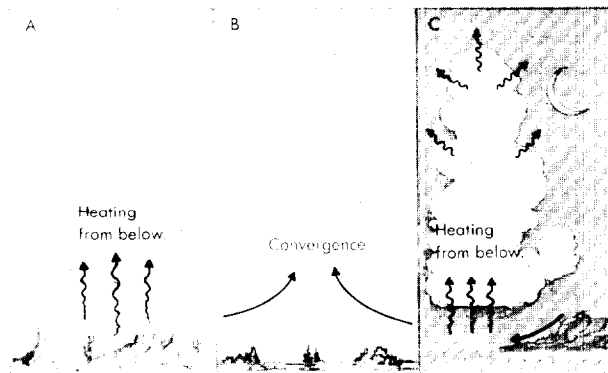


**13.6. Thunderstorm Weather Hazards.** Severe turbulence and icing, heavy precipitation, lightning, windshear, and gusty surface winds may accompany thunderstorms. These hazards are so common they appear on the front of every DD Form 175-1, Flight Weather Briefing. Severe thunderstorms may produce large hail, damaging winds, and sometimes tornadoes.

**13.6.1. Turbulence.** Hazardous turbulence is present in all thunderstorms, and in a severe thunderstorm it can damage the airframe and cause serious injury to passengers and crew. The most violent turbulence occurs in the shear between updrafts and downdrafts. Outside the cloud, shear turbulence has been encountered several thousand feet above and as much as 20 miles from a severe storm. Severe turbulence can occur in the anvil 15 to 30 miles downwind (Figure 13-16). Remember, the storm cloud is only the visible portion of a turbulent system. Updrafts and downdrafts often extend outside the storm proper.

**13.6.1.1. Shear Zone or Gust Front.** The *shear zone* between the cold air downdraft and surrounding air forms a low level turbulent area. When the shear zone reaches the surface and spreads out laterally ahead of the storm, it's called a *gust front* (Figure 13-17). It often occurs 20 or more miles ahead of a mature storm. Thunderstorms with multiple downdrafts may form second or third gust fronts between the first and the cloud base. On the average, horizontal wind direction changes 40 percent across the gust front, and wind speed may increase 50 percent between the surface and 1,500 feet. Thus, surface observations may not give a true estimate of the actual wind just above the surface.

**Figure 13-14. Air Mass Thunderstorm.**



**Figure 13-15. Orographic Thunderstorm.**



**13.6.1.2. Roll Cloud.** Often a *roll cloud* on the leading edge of a storm marks the eddies associated with this shear (Figure 13-17). The roll cloud is most prevalent with cold front or squall line thunderstorms and indicates an extremely turbulent zone. The first gust causes a rapid and sometimes drastic change in surface wind ahead of an approaching storm.

**13.6.2. Aircraft Icing.** Where the free air temperatures are at or below freezing, icing should be expected (Figure 13-18). In general, icing is associated with temperatures from 0°C to -20°C. The most severe icing occurs from 0°C to -10°C, while the heaviest icing conditions usually occur just above the freezing level. Since the freezing level is also the zone where heavy rainfall and turbulence most frequently occur, this particular altitude appears to be the most hazardous.

**13.6.3. Hail.** Hail is solid spheres of ice or irregular frozen conglomerates originating in the updraft/downdraft couplet of thunderstorms. The most prolific hailstorms result from the formation of supercells in a thunderstorm whose enormous updrafts permit large hailstones to grow by accretion over periods of many minutes. Hailstones can be spherical, conical, or quite irregular in shape (Figure 13-19). Often hailstones are tossed out of the chimney-effect updraft into downdrafts when the ice commences its descent as a potentially damaging missile. Baseball and softball sized hail is often reported with severe thunderstorms. Hailstorms have been known to precipitate hail measured over a foot deep. As a general rule, the larger the





Figure 13-17. First Gust Hazards.

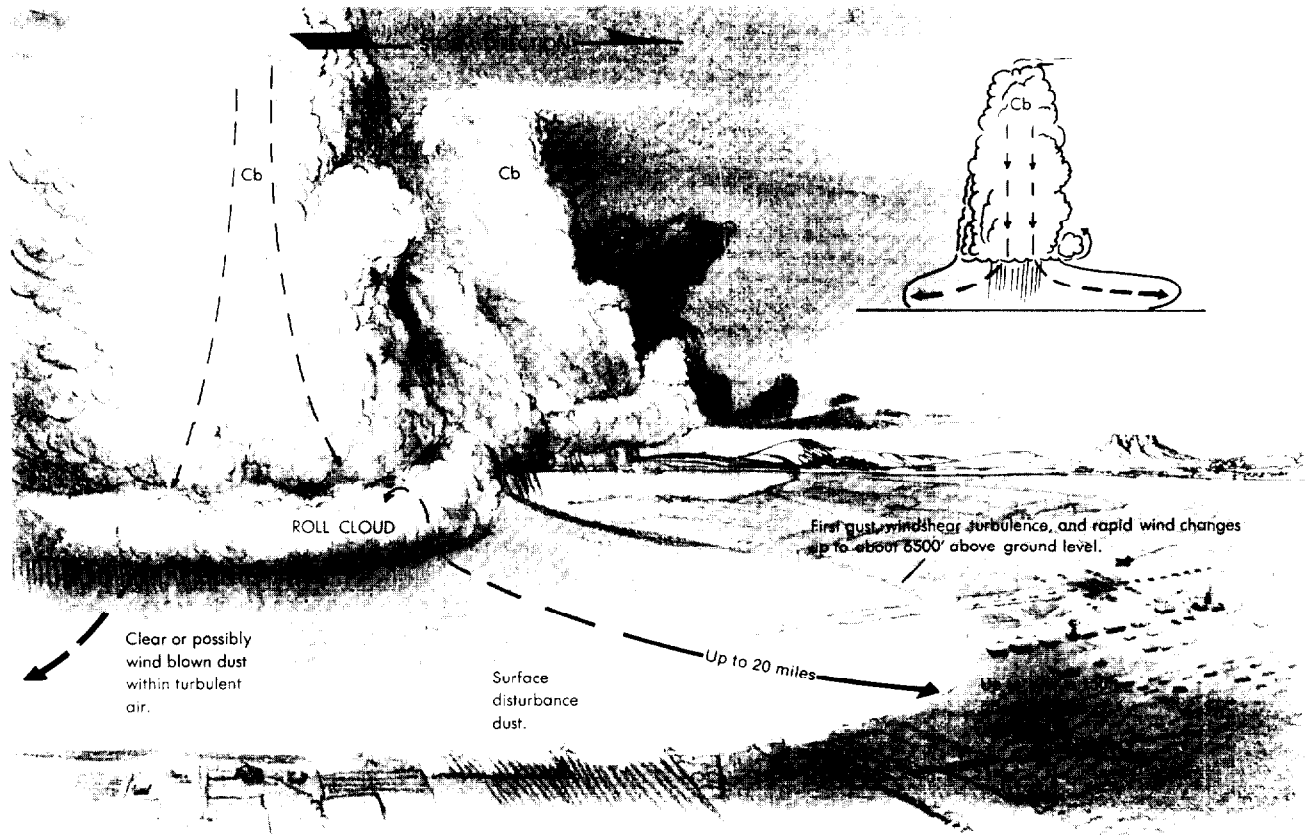
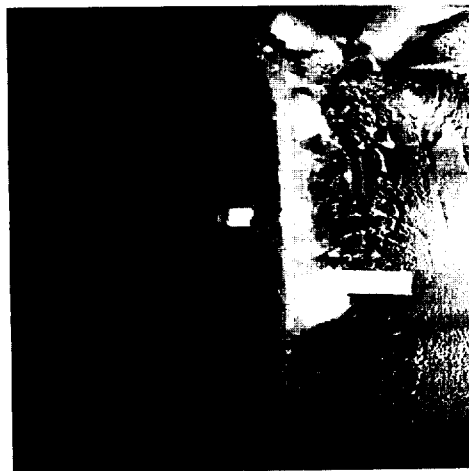


Figure 13-18. Aircraft Icing.



**13.6.4.4. Lightning Strike--Aircraft Effects.** Lightning strikes and electrostatic discharges have varied effects on aircraft and aircrews. Usually, structural damage is minor (Figure 13-23), but sometimes severe structural damage can occur (Figure 13-24). Damage to aircraft electrical systems, instruments, avionics, and radar is also possible. Transient voltages and currents induced in the aircraft electrical systems, as well as direct lightning strikes, have caused bomb doors to open, activated wing folding motors, and made the accuracy of electronic flight control navigational systems questionable. After an electrostatic discharge or a lightning strike, consider all instruments invalid until proper operation is verified.

Figure 13-19. Large Hail.



Figure 13-20. Hail Damage to Aircraft.

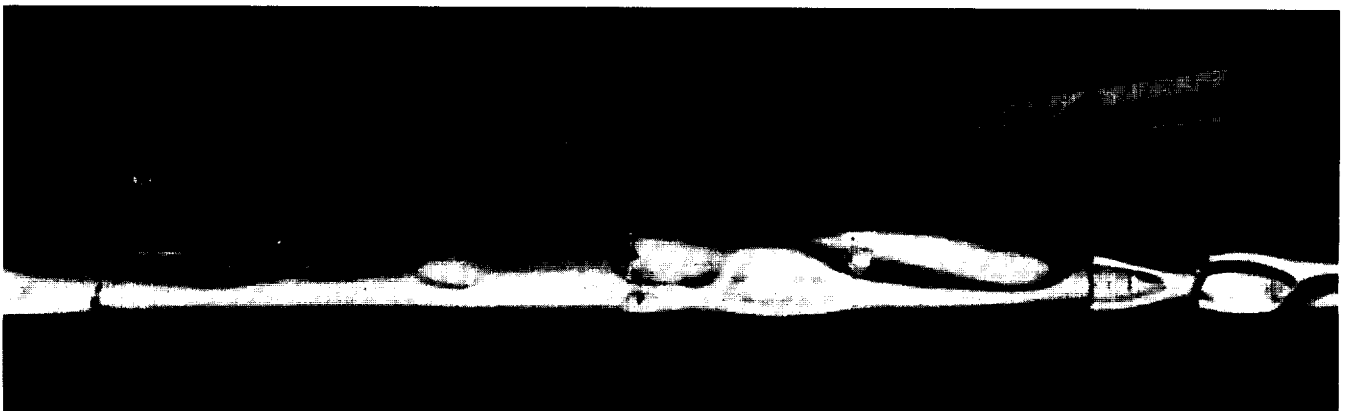


Figure 13-21. Lightning Variations.

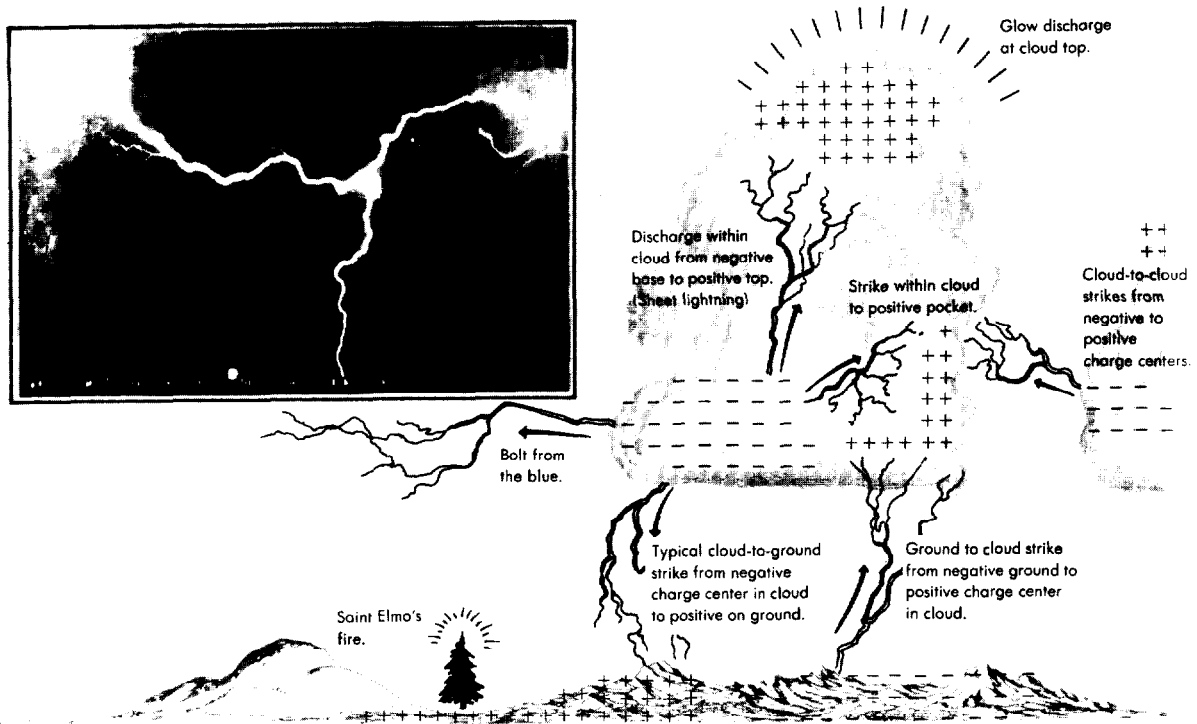
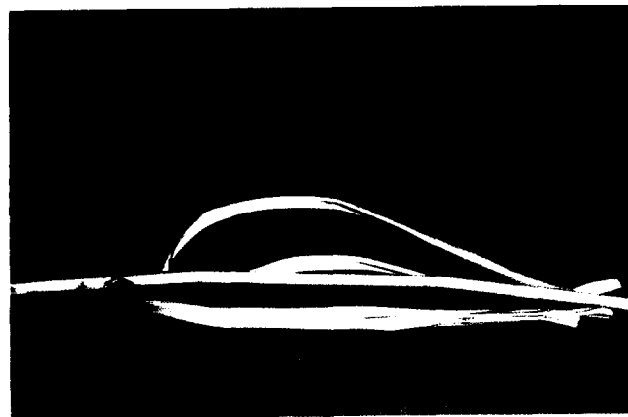


Figure 13-22. Lightning Bolt "Out of the Blue."

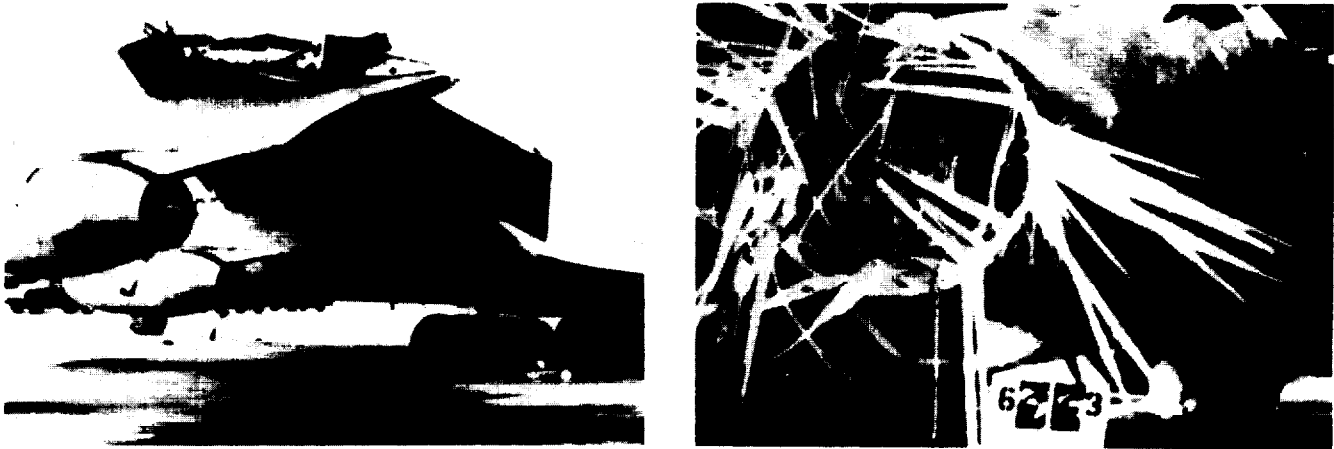


Figure 13-23. FB-111 Pitot Tubes after being Struck by Lightning.



**13.6.4.5. Lightning Strike--Aircrew Effects.** Aircrews are not immune to the effects of lightning strikes. Flash blindness can last up to 30 seconds, and the shock wave can cause some temporary hearing loss, if headphones or hearing loss protection gear are not worn. Some aircrews report electric shock and minor burns.

**Figure 13-24. Major Structural Damage Resulting from Lightning Strike.**



**13.6.4.6. Lightning-Induced Fuel Ignition.** Catastrophic fuel ignition can occur under certain conditions. In non-pressurized fuel tanks, a mixture of vaporized fuel and air fills the space above the liquid fuel. The proper ratio of fuel vapor to air can form a highly explosive mixture. Figure 13-25 shows various fuel grades with their corresponding flash points and freeze points. Notice that JP-8 (currently used in most routine Air Force flying operations) is considerably less volatile than the formerly used JP-4. In fact, JP-4 was actually more dangerous at the colder temperatures routinely experienced at flight level. JP-8 is much more stable at these colder temperatures. You may experience more difficult engine starts in extremely cold climates such as Alaska or the Antarctic, but the trade-off for increased safety is well worth it.

**Figure 13-25. Jet Fuel Characteristics.**

FUEL GRADE	FLASH POINT (°F)	FREEZE POINT (°F)
JP-4	-20	-72
JP-5 (Navy)	140	-51
JP-7	140	-46
JP-8	100	-58

**13.6.5. Tornadoes.** *Tornadoes* are violent, rotating columns of air that descend from cumulonimbus clouds (Figure 13-26) in funnel-like or tube-like shapes. If the circulation does not reach the surface, it is called a *funnel cloud* (Figure 13-27); if it touches water, it is called a *waterspout* (Figure 13-28). A tornado vortex is normally several hundred yards wide and have been measured up to 1 1/2 miles wide. Within the tornado's funnel-shaped circulation, winds can reach 300 miles per hour, while the forward speed of the tornado averages 30-40 kts.

**13.6.5.1. Location Within Thunderstorm.** Observed as appendages of the main cloud, families of tornadoes or tornadic vortices may extend 20 miles from the lightning and precipitation areas (Figure 13-29). They may last from a few minutes to 6 hours. These vortices usually occur on the storm's southern or south western flank. Innocent looking cumulus trailing the thunderstorm may mask tornadic vortices and the vortex may not be visible to alert unwary aircrews. The invisible vortices may be revealed only by swirls in the cloud base or dust whirls boiling along the ground, but may be strong enough to cause severe structural damage to the aircraft.

**13.6.5.2.** Airborne radar isn't much help in spotting tornadoes. It returns echoes of significant precipitation but doesn't display a spinning column of air for your guidance while flying around the thunderstorms. It must be emphasized that just plain eyeballing and radar scanning a line of CBs won't tell you which thunderstorm is hiding a tornado. Be cautious on approach and departure, under or through lines of thunderstorms. The hazards tend to increase with altitude in the clouds because of the convergence of the vortices upward in the cloud line (Figure 13-30). The effect upon the aircraft may range from a thump to catastrophic airframe failure in major encounters.

**13.6.6. Thunderstorm Effect on Altimeters.** Pressure usually falls rapidly with approaching thunderstorms, rises sharply with the onset of the gust front and rain showers, and returns to normal as the storm moves on. This pressure change cycle can occur in 15 minutes. If the altimeter setting is not corrected, the indicated altitude may be in error by hundreds of feet.

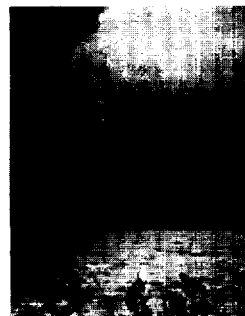
Figure 13-26. Tornado.



Figure 13-27. Funnel Clouds.



Figure 13-28. Waterspout.



**13.6.7. Precipitation Static.** Precipitation static is a steady, high level of noise in radio receivers caused by intense, continual corona discharges from sharp metallic points and edges of flying aircraft. It is often encountered in the vicinity of thunderstorms. When an aircraft flies through an area containing clouds, precipitation, or a concentration of solid particles (ice, sand, dust, and such), it accumulates a charge of static electricity. The electricity discharges onto a nearby surface, or into the air, causing a noisy disturbance at lower radio frequencies. Precipitation static does not usually interfere with reception on UHF.

**13.6.8. Telltale Cloud Warning Signs.** The *mammatus* cloud (cottage cheese) formation often precedes severe activity, generally as a part of the underside the thunderstorm anvil in front of the storm. Mammatus clouds often precede severe thunderstorms and act as a good clue. The lower-based *roll cloud* is in advance of the thunderstorm and appears as a dark, ominous, boiling, cloud mass. The roll cloud area often contains severe turbulence and signal the leading edge of the thunderstorm gust frontal boundary (Figure 13-31).

**13.7. Aviator Corrective Actions.** If conditions won't permit you to circumnavigate a thunderstorm, you have only two alternatives; divert to the closest unaffected airfield (and wait until the storm passes) or go through the thunderstorm, but only as a last resort if required by your mission. Ask yourself, "Is going through the thunderstorm worth losing the aircraft; or my life?"

**Figure 13-29. Anatomy of a Funnel Cloud.**

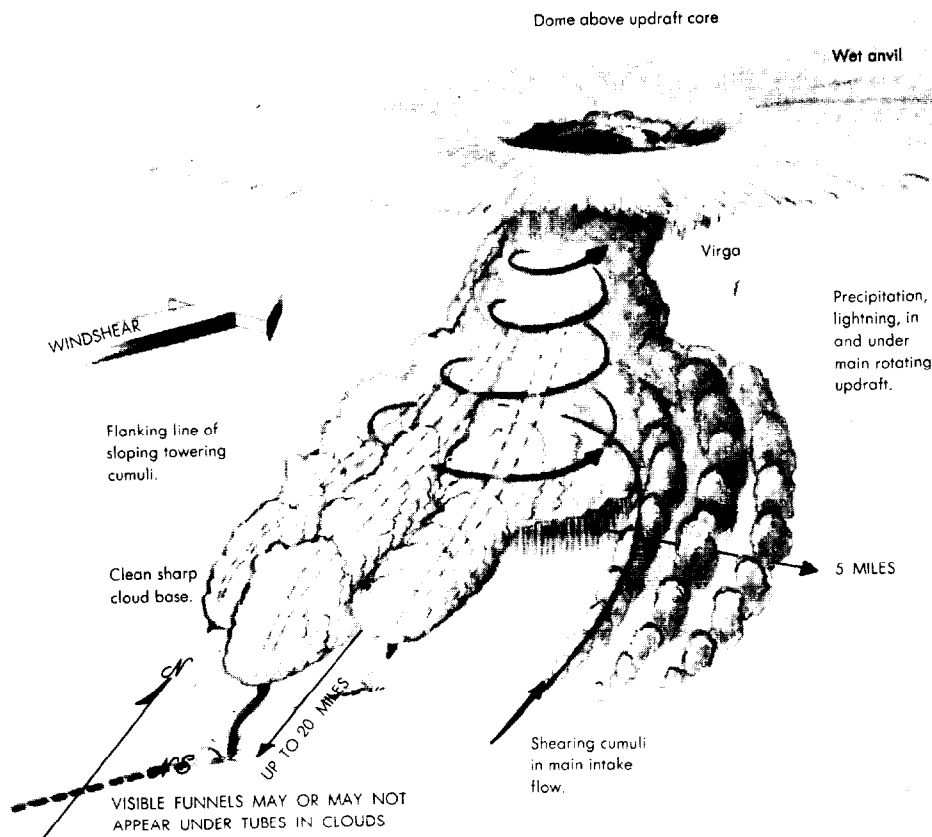


Figure 13-50. Funnel Convergence.

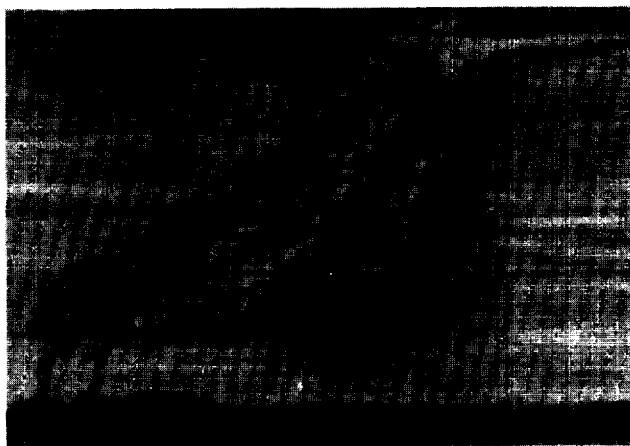
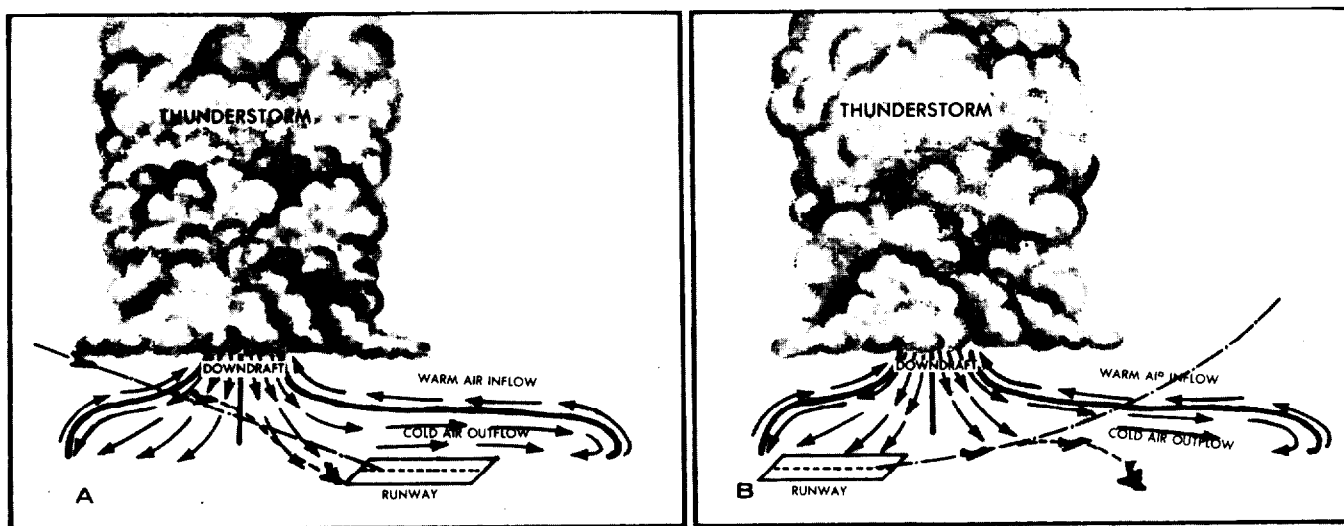


Figure 13-31. Thunderstorm Wind Shear Hazard Zones.



**WARNING:** The following guidance is not to be construed as a recommendation to fly through, under, over, or near a thunderstorm. It is given to provide information only in case your mission is so critical to national defense that it warrants the very real risk of losing the aircraft and personnel on board, or, as happens in some cases, you encounter a thunderstorm that is embedded in other clouds.

**13.7.1. Flying Around Thunderstorms.** The method you use to get past a thunderstorm depends on the following considerations. Therefore, as you approach a thunderstorm, take your time and size up the situation to ensure the method you attempt (based on the rules of thumb and the techniques found below) will be the proper one and you won't have to do any second-guessing once you are on your way.

**13.7.2. Analyzing Situation.** In estimating the situation, you must analyze the nature of the terrain, altitude of the base of the storm, altitude of the top, number of storms in the area and their location in relation to each other, size and intensity of these storms, direction and velocity of the movement of the storm, location of your destination and an alternate airport, and type of aircraft you are flying. (Including its service ceiling, and range).

**13.7.3. Thunderstorm Rules of Thumb.** When you expect to fly over a storm, obtain your altitude before approaching it, so you are on top of the cloud shelf around the storm and can inspect the storm line before selecting your course. A rule of thumb is to fly an additional 1,000 feet higher for every 10 knots of wind speed at cloud top level. This rule doesn't, however, guarantee your safety. Remember, if the storm is in its growth stage, your altitude may not be sufficient to clear the storm as it continues its rapid growth.

**13.7.4.** The altitude necessary to fly around the tops or over the saddlebacks between thunderstorms will vary with the season and the latitude in which you encounter the storm. In higher latitudes (north of 60°), 25,000 feet may be sufficient,



but remember the 25,000-foot storm in upper latitudes can be as violent as the 50,000-foot storm close to the equator. In the tropics, the height of the saddlebacks may be above the service ceiling of your aircraft.

**13.7.5.** If you inadvertently enter a thunderstorm, don't turn around. If you do, you'll fly through the same hazards again. Hold your original course. Use your airborne radar to determine the shallowest or weakest part of the storm. Heavy precipitation may attenuate (absorb) your radar energy, making you believe you are safe when you are actually headed into the most violent part of the storm.

**13.7.6. Tips:**

- Maintain turbulence-penetration airspeed before entering a thunderstorm.
- If lightning threatens to blind you temporarily, turn your cockpit or thunderstorm lights to full power. Keep your eyes on the instrument panel and consider lowering your seat.
- If St. Elmo's fire (static electricity) forms on the windshield, the wings and the periphery of the engines, reduce your airspeed and the fire will usually go away. Always follow flight manual procedures to maintain your flight safety margin. St. Elmo's fire may appear in various colors such as reddish and bluish (reddish for a positive charge and bluish for a negative charge). It may appear outside or even inside the aircraft as a small dot of static electricity or large areas of "electrical arcing." Some pilots have even reported it as large peacock feathers arcing off the nose of the aircraft. (St. Elmo's fire is not a hazard to flight, but may interfere with radio communication in the form of static.) St. Elmo's fire is also a warning sign of a potential static discharge or lightning strike.

**13.7.7. Circumnavigating a Thunderstorm--The Preferred Method:** Isolated air mass thunderstorms and orographic thunderstorms (those created by updrafts around rough terrain) are usually local and should be flown around. The added mileage and time are usually of little consequence. Thunderstorms can be circumnavigated at low, high, or intermediate levels, depending upon the set of circumstances they present. In any case, it is vital to determine the direction in which a line of storms is moving and to fly between the storm centers, heading in at a right angle. For individual cells, you should fly with the rotation of the storm. Since most storms rotate counterclockwise in the Northern Hemisphere, if you are traveling eastward, fly on the south side of the storm; if you are flying westward, fly on the north side of the storm. Remember, storms generally move from southwest to northeast in the Northern Hemisphere. Therefore, if you are flying on the north side of the storm, be sure to give it a wide berth to compensate for its movement.

**13.7.7.1.** At intermediate levels, keep either blue sky or light spots in the clouds in sight ahead of you. This may cause you to alter course a little from time to time to miss the storm centers, but don't wander around. In circumnavigating at intermediate levels, it is a good plan to stay on top of intermediate clouds where you can keep the structure of the main cloud well in view.

**13.7.7.2.** Once you have entered the storm area, if the hole closes up ahead of you and you have to go on instruments, don't change course. Stick to your original right angle course and go through. Don't alter your course on account of turbulence, rain, or hail because you may find yourself flying through the same hazards again.

**13.7.8. Flying Underneath a Thunderstorm.** If the terrain is flat or you are over the open sea, flying underneath the storm may seem to be one of the easiest ways to negotiate a thunderstorm, but it's one of the most dangerous methods because of violent downdrafts, microbursts, wind shear, icing, and hail. Familiarity with thunderstorm dynamics is essential, especially where you will encounter updrafts and downdrafts (Figure 13-7). If your fuel range is short and/or your service ceiling is low, this may be the only method open to you if your divert base is on the other side of the storm. The "Underneath" method should not be attempted in mountainous country.

**13.7.9. Flying Over the Top of a Thunderstorm:** If your equipment permits, fly over the top of the main body of a thunderstorm or between the saddlebacks. To elect this method, you must be sure of your aircraft, sure of your knowledge of the storm, and sure of yourself. Remember, you should clear the top by at least 1,000 feet of altitude for each 10 knots of wind speed at the cloud top. Flying over the top is preferable to flying underneath; however, this may exceed the service ceiling of your aircraft.

**13.7.9.1.** You must know the intensity of the storm, its extent, and the direction in which it is moving. You must also know that your fuel supply is adequate, and the service ceiling of your aircraft is sufficient to get you as high as you need to go. Some storms develop higher than 60,000 feet in the mid-latitudes and tropics.

**NOTE:** Most thunderstorms build faster than an aircraft can climb. Attempting to out-climb one can be deadly, especially since you won't know the climb capability of the thunderstorm until you try to "race" it. Obviously this has a good possibility of putting you into a dangerous position with potentially few escape options. By flying close to the thunderstorm you are also increasing your chances of a lightning strike or damage from hail thrown out the top of the thunderstorm.

**13.7.9.2.** In flying over the saddlebacks or around the anvils, remember that the higher you go, the less turbulence you will encounter. The thunderstorm anvil is created as the jet stream shears off the top of the thunderstorm. Winds are generally strong there, and hailstones can be carried as much as 20 miles downstream--in the clear air! Do not fly in, under, or downwind of the anvil top; this is a favorite place for hailstones.

**13.7.10. Flying Through a Thunderstorm.** If you have no alternative but to fly through a thunderstorm, try to avoid the center of the storm or area where the most violent turbulence is apparent. Select a course where the thunderstorm is visibly least turbulent and where there will be the least possibility of hail; slow the aircraft to turbulence penetration airspeed (hopefully, you are already at this speed); don't change course!

**13.7.10.1. Entering the Storm.** When entering the front of a thunderstorm, you will encounter updrafts and downdrafts. Prepare yourself by going in with enough altitude to keep from being forced into the ground during a downdraft. Your minimum penetration altitude should be 4,000 to 6,000 feet AGL above the highest terrain in the area. The flight manual for each type of aircraft gives the correct turbulence penetration speed. In the absence of this information, a good rule of thumb is to fly about 50 percent above stall speed.

**13.7.10.2. Inside the Storm.** Once inside the storm, let the plane ride out the updrafts and downdrafts and concentrate on maintaining a level attitude. The attitude gyro is the primary attitude instrument because rapidly changing pressure conditions within the storm will result in erratic variations in altitude, airspeed, and rate of climb, which cause unreliable readings. Since the attitude gyro is independent of the pitot static system, its indications should be considered valid. If using autopilot, disengage the altitude hold mode and speed hold mode. (If used, they will increase aircraft maneuvers and structural stress.)

**WARNING: When you fly through a thunderstorm, the hazards that face you are extreme. You will be betting the aircraft, your life, and the lives of your crew members on the forces of nature. This must be the only remaining alternative!**

**13.7.11. Thunderstorm Do's and Don'ts Checklist.** If you must penetrate a storm area, comply with thunderstorm avoidance rules and follow the general flight procedures listed below:

- Don't try and circumnavigate thunderstorms covering 6/10 or more of an area.
- Don't fly into or under the cirrus anvil. Severe hail damage can result.
- Don't turn around. Attempting to do so will keep you in the storm longer, increase stress on the aircraft, increase the possibility of stall and may result in spatial disorientation and/or an unusual attitude.
- Don't penetrate in close formation.
- Do avoid, by at least 20 miles, any thunderstorm identified as severe or giving an intense radar echo. This is especially true under the anvil of a large cumulonimbus.
- Do get your aircraft ready for thunderstorm penetration prior to entry by setting instrument and cockpit lights full bright, pitot heat on, and safety belts and shoulder harnesses tightened and locked.
- Do change power settings to establish turbulence penetration airspeed. This airspeed reduces the hazard of exceeding stress limitations.
- Do choose a heading minimizing travel time in the storm.
- Do try to maintain a constant attitude, but ride out the updrafts and downdrafts. Trying to maintain an exact altitude during strong updrafts and downdrafts increases stress on your aircraft.
- Do penetrate the storm below the freezing level or above -15 degrees C to avoid severe icing hazards.

## Chapter 14

### TROPICAL WEATHER

**14.1. Introduction.** The tropics include a vast region of the earth situated between the Tropic of Cancer (23½ degrees N latitude) and the Tropic of Capricorn (23½ degrees S latitude) as shown in Figure 14-1. However, typical tropical weather may occur more than 45 degrees of latitude on both sides of the Equator. This is especially true for the east coasts of continents during the summer. The tropics contain both the wettest and driest regions of the world.

**14.1.1.** Lower pressure systems predominate in the tropics, and pressure gradients are ordinarily weak except in tropical cyclones. Since there are no well defined surface pressure systems in this region, except in cyclones, local pressure variations are frequently due only to daily heating and cooling. The main difference between tropical weather and weather in the middle and high latitudes is the relative absence of fronts. Rarely are fronts strong enough to move into the tropics. Almost all fronts which do reach the tropics produce rain showers, some wind shift, and a small temperature reduction.

**14.1.2.** Most active tropical weather results from interaction between the lower and upper level wind flows. When low level convergent flow combines with upper level divergent flow, vertical motion results. This combination in the tropics almost always results in towering cumulus and heavy rain.

**14.1.3.** Typically, weather occurring over the tropical oceans differs from weather over the continental areas. Along coastal regions and over islands, a combination of these two types (land and ocean) usually results. This chapter examines typical weather regimes found over land and the oceans.

**14.2. Oceanic Tropical Weather--Clouds.** Over oceans, cloud cover varies from clear to scattered outside the equatorial trough region. Cloud bases are usually about 2,000 feet. Cloud top heights vary greatly, with maximum tops generally around 8,000 feet. Often, cumulus will parallel the windflow, forming "cloud streets." Scattered rainshowers are common from these cumulus clouds with ceilings periodically lowering to 1,000 to 1,500 feet in precipitation.

**14.2.1. Visibility.** Visibility is usually good. The chief restriction outside of showers is haze caused by suspended sea salt concentrations in the lower levels. The salt particles cannot penetrate the inversion hence visibility is good above the inversion level. The temperature inversion is more pronounced over the eastern parts of oceans due to cooling from below from colder ocean currents. Sometimes a stratus layer will develop beneath the inversion and last for several days with little vertical variation in layer depth and in ceiling heights.

**14.2.2. Temperatures.** Temperatures closely approximate adjacent sea-surface temperatures, averaging about 80°F with a daily variation only about 5-8 degrees or so. Dew points stay almost constant in the oceanic tropics. There are some seasonal changes based on whether the monsoon season is in progress. But the temperature variation is small from month to month. The freezing level is usually between 15,000 and 18,000 feet throughout the year.

**14.3. Continental Tropical Weather.** The weather over interior continental areas is subject to extreme climatic variation. The chief climatic controlling factor is terrain differences. Other factors such as prevailing pressure patterns, wind flow, orientation and height of coastal mountain ranges, altitude of the continental area, also affects tropical land masses. Various combinations of these factors produce tropical weather ranging from the hot, humid climate of the Amazon and Congo river basins, to the arid Sahara Desert, and to the snow-capped mountains of South America and Africa.

**14.3.1. Arid Tropical Weather.** Typically, the climate of land areas to the lee of mountain ranges or on high plateaus is hot and dry. Examples of this climate regime are found in the rain shadow of the Andes Mountains, South America and the Sahara Desert in Africa. In the flat desert areas, afternoon temperatures may exceed 100 degrees F while night temperatures can drop into the 50's and 60's. There is strong convection during the day, but low surface humidity keeps the cumuliform cloud bases above 10,000 feet. Occasional high-based thunderstorms will produce precipitation which often evaporates before reaching the ground. These "dry" thunderstorms produce gusty winds and may cause severe dust or sandstorms. Severe turbulence aloft and restricted ceiling and visibility accompanied by gusts and squalls near the ground present hazards to aircrews.

**14.3.1.2. Duststorms and Sandstorms.** Sometimes a strong pressure gradient forms which triggers dust and sandstorms which cover large areas and last for days. There is little relief from the prolonged dust and sandstorms and obviously challenge aircrews to minimize damage to their aircraft. Aircraft engine damage often is caused by sand or dust ingestion (Figure 14-2).

**14.3.2. Humid Tropical Weather.** Where high terrain or mountains are not present to obstruct the onshore flow of maritime air, the warm, moist air influences wide continental areas. Cloudiness and precipitation are at a maximum over the jungles and tropical rain forests. In humid tropical climates, the wind's daily variation in direction and speed determines the daily variations in cloudiness, temperature, and precipitation. Clouds are mostly cumuliform with afternoon cumulonimbus. The average daytime cloud coverage is approximately 60 percent throughout the year, with maximum cloud coverage during the day.

**14.3.3. Temperatures.** The annual range in temperatures for jungle stations may be less than 2 degrees F, but the daily range is often 30 degrees F or more. When afternoon showers occur, the descending cold air may produce nights with temperatures in the 60's. These rains are very heavy and produce low clouds that may reduce ceilings and visibilities to near zero.

**14.4. Island and Coastal Tropical Weather.** Weather conditions are similar along coastal areas and over the various mountainous tropical islands. During the day, as the inland terrain lifts warm, moist air, large cumulus may develop. While these clouds are common in coastal areas, moist air lifted on the windward side of mountainous islands also produces towering cumulus. These clouds are frequently seen from long distances, indicating the presence of an island.

**14.4.1. Island Precipitation.** Islands, especially mountainous islands, can have dramatic effects on rainfall. The almost constant trade winds result in a predominantly onshore wind on one side of an island, while the opposite side has an offshore wind. Precipitation and cloudiness are considerably heavier on the windward side than on the leeward. On the island of Kauai, Hawaii, Mount Waialeale receives the highest average annual rainfall of all rain gages in the world (460 inches), yet only 10 miles away, sugar cane plantations need irrigation.

Figure 14-1. The Tropical Zone.

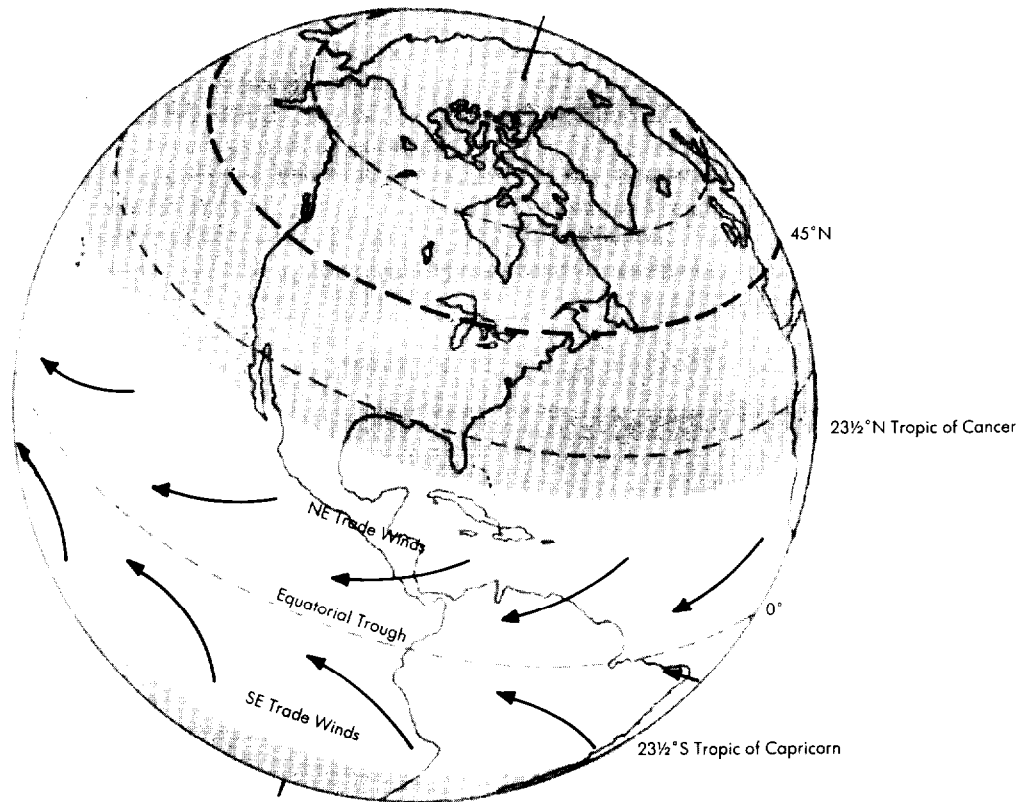


Figure 14-2. C-130 Ingesting Sand During Engine Run-Up.



**14.5. Subtropical Jet Stream.** *Subtropical jet streams* are a persistent feature of the tropical general circulation. A detailed study of the Northern Hemisphere subtropical jet stream during winter shows it to be a simple broadscale current with very high wind speeds. The subtropical jet stream is continuous around the world and speeds of 150 to 200 knots are not uncommon. Maximum wind speeds are generally located over the east coasts of Asia, North America, and in the Middle East. The mean latitude ranges from 20 to 35 degrees North with the average core speed of 140 knots located around 40,000 feet.

**14.6. Tropical Easterly Jet Stream.** The *tropical easterly jet stream* is a persistent feature over extreme southern Asia and northern Africa during the northern hemispheric summer. The tropical easterly jet extends over the layer from 35,000 to 50,000 feet in the latitude belt 5 to 20 degrees North. It is remarkably persistent in its position, direction, and intensity.

**14.7. Equatorial Trough.** The equatorial trough is known by a variety of names. You may have heard meteorologists refer to the Intertropical Convergence Zone (ITCZ) or a zone of Intertropical Confluence (ITC). The equatorial trough is a broad area of relatively low pressure and light winds which separates the northeast trade winds of the Northern Hemisphere and the southeast trade winds of the Southern Hemisphere. This zone of confluence can have active weather along the zone extending thousands of miles or have a series of short disturbances. The equatorial trough migrates northward during the Northern Hemisphere's summer season and southward during the Southern Hemisphere's summer. Due to the light wind flow, land and sea breezes become the predominant wind for extended periods along coastal areas and near islands in this belt.

**14.7.1. Active Weather.** Convergence of the northeast and southeast winds is always present to some degree and in the trough, some unsettled convective weather is found at all times (Figure 14-3). When the zone of convergence intensifies, thunderstorms are very likely to develop. Severe turbulence and icing is likely in these thunderstorms, especially above 15,000 feet (average freezing level). Precipitation reaches its maximum just before dawn with the minimum occurring late in the morning through the early afternoon hours.

**Figure 14-3. Satellite Picture of Clouds Associated with the Equatorial Trough.**



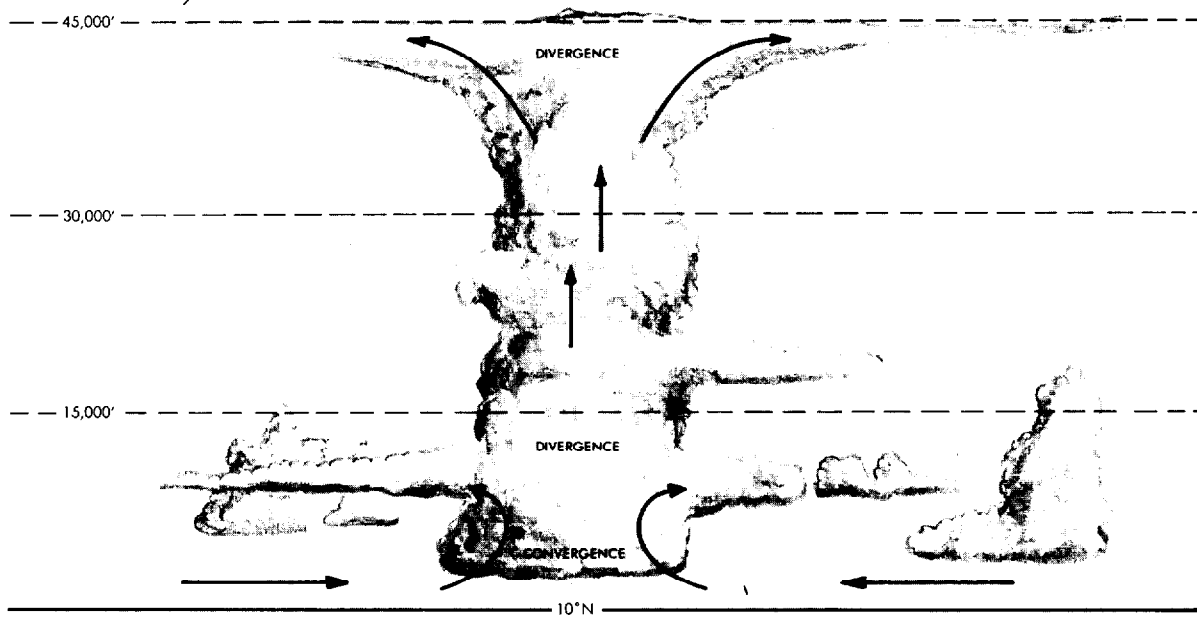
**14.7.2.** Disturbances move from east to west and can move poleward and develop into tropical storms. Low-level cyclonic wind shear is present over large areas. Figure 14-4 illustrates the vertical structure of this convergence zone.

**14.8. Tropical Waves.** There are numerous tropical waves found in the lower levels in the tropics. Many times these are reflections of an upper level trough which may be the remnants of a former midlatitude frontal system. Extensive weather may be associated with these waves, with the level of intensity dependent on the upper level flow. The most common of these tropical waves is the easterly wave.

**14.8.1. Easterly Wave.** The *easterly wave* is a low level, tropical weather disturbance occurring in the trade wind belt. Easterly waves occurring in the Northern Hemisphere have advance winds somewhat more northerly (NE or NNE) than the usual trade wind direction as shown in Figure 14-5. The wind shifts to the east as the line passes. Very good weather precedes a typical wave, but is followed by extensive cloudiness, low ceilings, rain, and thunderstorms. The weather activity is found in roughly a north-south line. Easterly waves are more numerous and stronger during summer and early fall. Their effects occasionally reach as far north as the Gulf Coast and Florida. They are commonly observed in the Greater and Lesser Antilles of the Caribbean Sea.

**14.9. Shear Lines.** A line of wind shear, simply called a "shear line," is found in the tropics at the southern edge of a strong polar front which has moved unusually far south. The front gradually weakens leaving only a wind shift and a small temperature discontinuity across the former front. Strong areas of convection develop and are oriented parallel to the shear line. The average height of the shear lines is 10,000 to 15,00 feet. The associated low ceilings and rainfall along the line can cause poor terminal weather conditions. Figure 14-6 illustrates a shear line which is on the southern edge of a dissipating cold front. Strong winds due to convergence along the shearline or funneling effects caused by local terrain as shearlines pass can exceed 90 knots such as in the Gulf of Tehuantepec.

Figure 14-4. Vertical Structure of Convergence Zone.



**14.10. Monsoon.** A *monsoon* is a seasonal shift in the surface wind. More technically this wind shift is the result of a wind reversal from one persistent circulation system to another. This type of regime is found from Central Africa across South Asia and the Indian Ocean to Southeast Asia (Figure 14-7). There is no simple correlation between the wind direction and rainfall. For instance in Southeast Asia during the northeast monsoon, some sectors are wet and others are very dry. Generally, the classic heavy rains result from landward moving, moisture-laden ocean air coming in contact with the summer-heated land. Intense, persistent convection develops and lasts for literally weeks as the monsoon circulation moves northward or southward. In India, the heaviest rains are enhanced by a low level convergent wind flow between the monsoon circulation and another wind system (Figure 14-8). The monsoon circulations affect weather as far north as Korea, China, and Japan.

**14.10.1. United States Desert Southwest.** You may also hear the term *monsoon* used to describe thunderstorm season in the deserts of the southwestern United States. Here, by early July the upper wind pattern typically changes from a familiar westerly direction (prevailing westerlies) to a more easterly or southeasterly flow which can often extend from near surface upward through 30,000 to 40,000 feet. This flow reversal is due to the northward migration of the Bermuda High—a subtropical semi-permanent high pressure system which affects a large portion of the southern United States during the summer months. Over a period of several weeks, this easterly flow transports moisture from the Gulf of Mexico region into New Mexico, Arizona, and sometimes as far west as the deserts of southern California. Combined with intense surface heating already in place, this moisture influx results in high-based thunderstorms which can produce very strong winds and impressive, often dangerous lightning events. This monsoonal setup typically persists through the middle of September.

Figure 14-5. Well-Developed Easterly Wave.

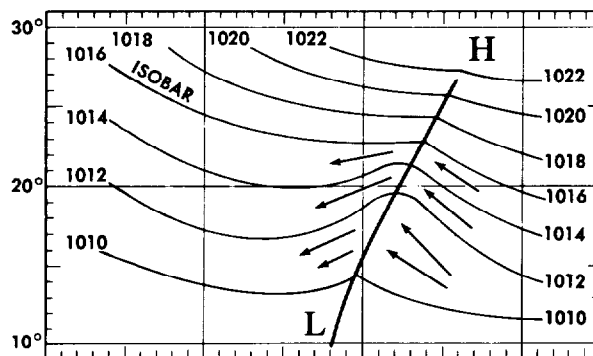
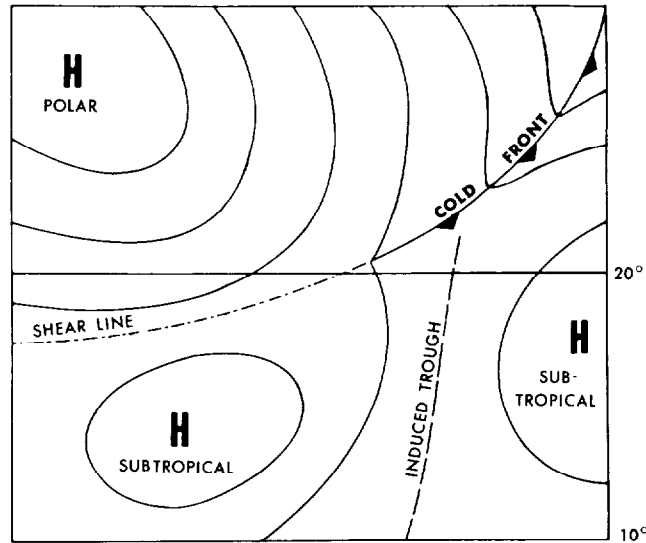


Figure 14-6. Shear Line Resulting from Polar Front Invasion.



**14.11 Tropical Cyclones.** *Tropical cyclone* is a general term for any low originating over tropical oceans. In the North Atlantic, the central and eastern North Pacific, and the Caribbean they are known as *hurricanes*; the western Pacific Ocean as *typhoons*; and in the Indian Ocean and Australia they are termed *tropical cyclones*. The exact formation process is not known. We do know they form in certain areas characterized by high temperatures, high moisture content, and instability. They form in low pressure troughs where there are large areas of warm, rising air. Many times they form from easterly waves or other tropical wave disturbances. Tropical cyclones have caused thousands of deaths and should be treated with utmost respect.

**14.11.1. Formation Regions.** Tropical cyclones affecting the United States originate over the warm tropical waters of the Atlantic Ocean, the Caribbean Sea, the Gulf of Mexico, the coasts of Central America and Mexico, and the eastern part of the North Pacific Ocean. Figure 14-9 indicates the principal regions of the world where tropical cyclones form and their usual direction of movement. Note that most tropical systems form between 5 and 15° latitude.

Figure 14-7. General Monsoon Region.

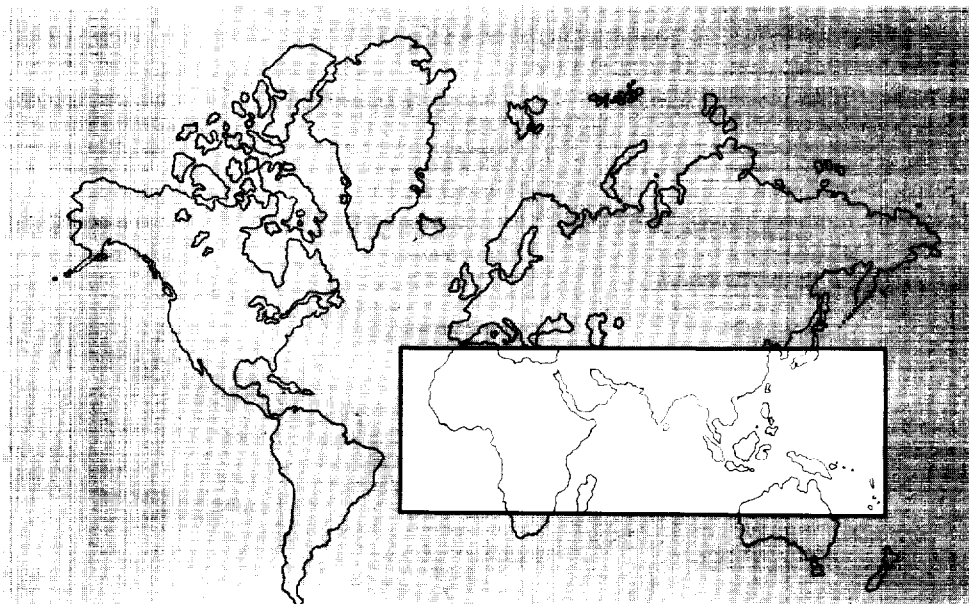
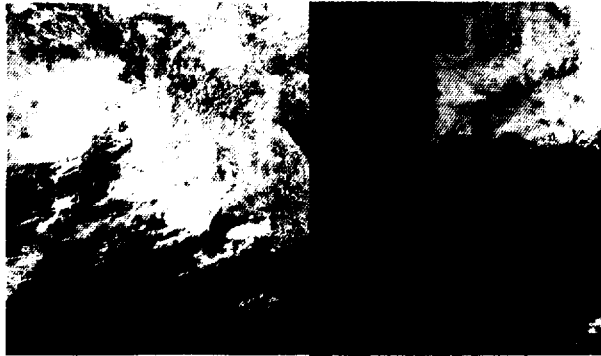
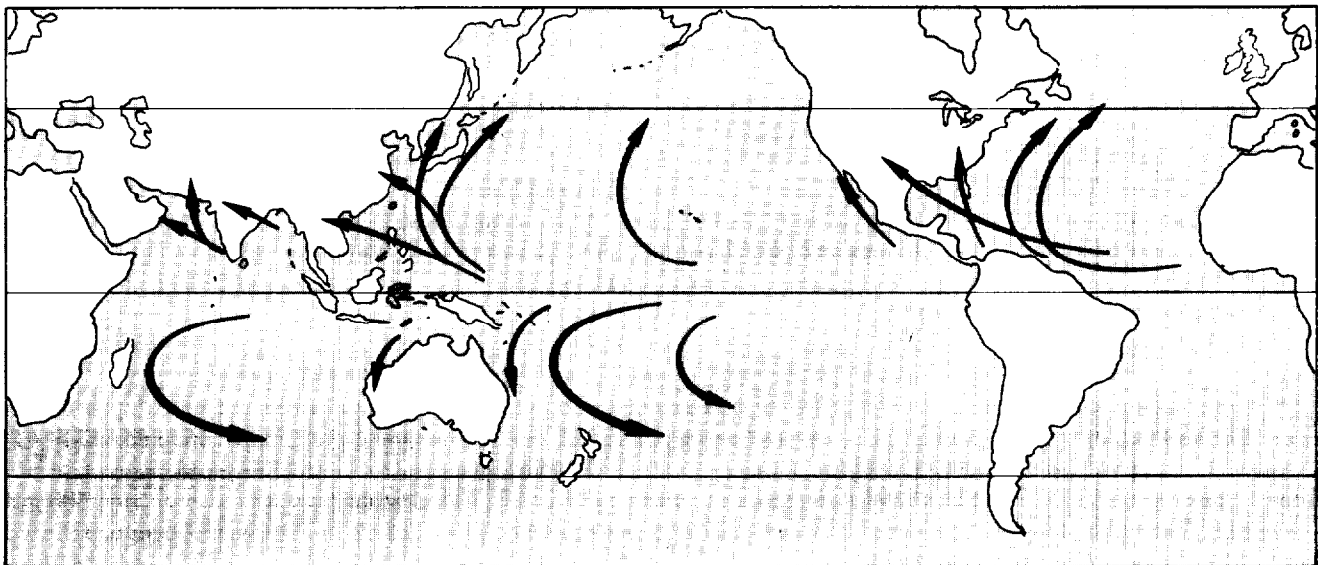


Figure 14-8. Monsoon Flow (Summer and Winter) over Southeast Asia.



**14.11.2. Development.** In the formative stage, the system is called a *tropical depression*. By definition, a depression's sustained wind speeds are 33 kts or less. Tropical depressions are numbered and when sustained winds reach speeds between 34 and 63 knots, they become named *tropical storms*. When the tropical storm winds exceed 63 knots, the storm becomes a hurricane, typhoon, or tropical cyclone. Sustained winds associated with hurricanes frequently exceed 100 kts near the center. In August 1992, Hurricane Andrew, a "category 4" storm, struck Homestead AFB, FL with sustained winds in excess of 130 knots with gusts to 155 knots. In super-typhoons, found in the western Pacific Ocean, sustained winds exceed 150 kts, with gusts in excess of 200 knots. The North Atlantic tropical cyclone season is from June through October. Forecasters often use the "Saffir-Simpson Scale of Hurricane Intensity" to assess and forecast tropical storm strength (Figure 14-10).

Figure 14-9. Principal Regions of Tropical Cyclone Formation and Favored Direction of Movement.



**14.11.3. Movement.** The progressive movement of hurricanes while in the tropics averages only 10 to 12 kts. In the Northern Hemisphere, the direction of movement is usually westward or northwestward until they reach  $25^{\circ}$  to  $30^{\circ}$ N latitude. At roughly this point, they often begin to recurve and move in a north to east direction (Figure 14-11). Following recurvature, they usually move with rapidly increasing speed, sometimes faster than 50 kts. After recurvature, the cyclone usually starts to weaken as it travels over cooler water.

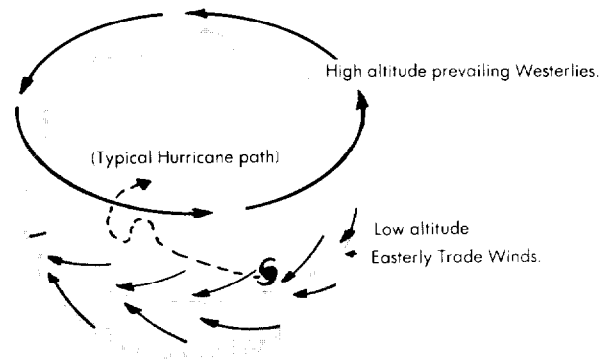
**14.11.4. Eye.** Most hurricanes have a relatively clear area in the center, 12 to 25 miles across, called the *eye* (Figures 14-12, 14-13 and 14-14). The sky in the storm center is often so clear that the sun or stars become visible, and the wind is comparatively calm. Around this eye is an encircling wall of violent hurricane-force winds. When the eye passes over any location, winds of great violence from one direction precede the calm center followed by violent winds from the opposite direction. Central barometric pressure is lowest in the eye of the storm. The Florida Keys' 1935 Labor Day Hurricane measured a central pressure of 892mb and Hurricane Andrew measured 922mb.



Figure 14-10. Saffir-Simpson Scale of Hurricane Intensity.

Saffir-Simpson Scale of Hurricane Intensity			
Category	Central pressure (mb)	Storm surge (feet)	Mean wind (m.p.h.)
1 Weak	>980	4-5	74-95
2 Moderate	965-979	6-8	96-110
3 Strong	945-964	9-12	111-130
4 Very Strong	920-944	13-18	131-155
5 Devastating	<920	18-	156-

Figure 14-11. Hurricane Movement in Northern Hemisphere.



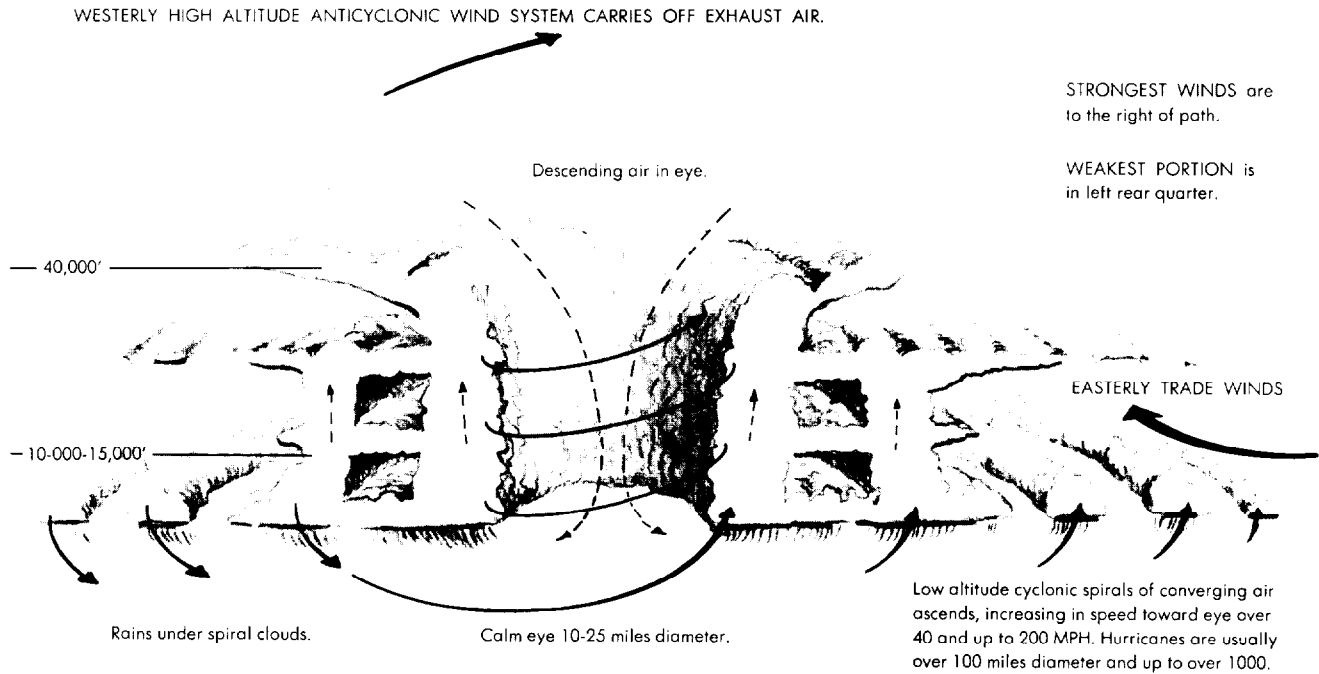
**14.11.5. Rainfall.** The rainfall pattern revealed in the radar photograph shown in Figure 14-13 is typical of a mature hurricane. The characteristic *spiral band* of rainfall distributed about a hurricane is evident in the white areas of the photograph. Individual convective showers and thunderstorms align in this pattern about the center of the storm. The heaviest rainfall is ordinarily found in a semi-circle to the right of the hurricane's direction of movement, where accumulations have exceeded 40 inches in a 24-hour period.

**14.11.6. Hurricane Damage.** Torrential rainfall, high winds, and occasional tornadoes associated with hurricanes cause tremendous destruction. The greatest loss of life and property results from extensive flooding along coastal areas. The raised water level, called a *storm surge*, is superimposed on normal tides, and in turn, wind-driven waves are superimposed on the surge. The build-up of water levels can cause severe flooding on islands and coastal areas, particularly when the storm surge is superimposed upon high tide. Hurricanes (including typhoons and cyclones) cause the most widespread destruction of all storms. Some of the larger hurricanes have diameters up to about 1,000 miles, with destructive winds over an area 500 miles in diameter. The worst storms have claimed thousands of lives. In September 1900, Galveston, Texas, lost over 6,000 people due to a storm surge associated with a hurricane.

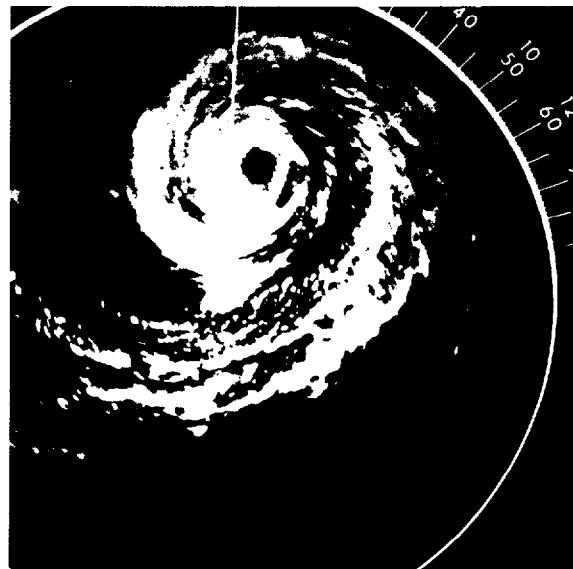
**14.11.7. Decay of Tropical Storms and Hurricanes.** Cooler surface temperatures, loss of moisture, interaction with the polar jet stream, and increased surface friction cause tropical storms and hurricanes to decay. When the storm curves toward the north or east in the Northern Hemisphere, it usually begins to lose its tropical characteristics and acquires the characteristics of low pressure systems normally found in middle and high latitudes. The latter type of low pressure system is called extratropical, meaning "outside the tropics." Weather reconnaissance aircrews have found the roughest flying weather in storms during the transition between tropical and extratropical due to cold air entrained into the low, middle, and upper altitudes.

**14.11.8. Detection and Warning of Tropical Cyclones.** The National Weather Service maintains a constant watch for the formation and development of tropical cyclones in the North Atlantic Ocean, Caribbean Sea, Gulf of Mexico, and the North Pacific Ocean eastward of 180°. From 180° westward to the African coast, the Joint Typhoon Warning Center (JTWC) located in Guam, is responsible for the detection and warning of developing cyclones.

**Figure 14-12. Cross Section of Hurricane Eye and Spiral Bands.**



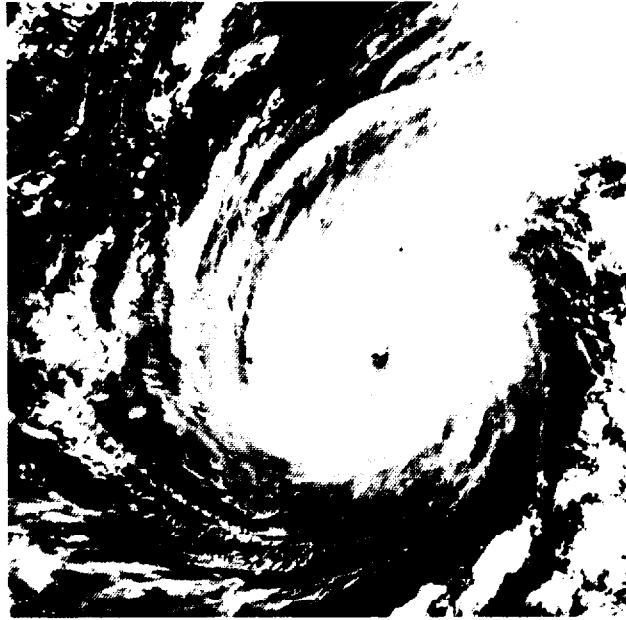
**Figure 14-13. Radar Photograph of Hurricane Showing Spiral Rain Pattern and Eye.**



**14.11.8.1.** Initial detection is made by analyzing cloud patterns from weather satellite imagery (Figure 14-14) and by analyzing wind reports from ships at sea. Specially equipped weather reconnaissance aircraft are dispatched on demand to some areas where forecasters suspect a tropical cyclone exists or may be forming. When tropical cyclones approach foreign nations, we advise the countries of the storm's existence and location.

**14.11.9. Tropical Cyclones and Hazards to Aircrews.** All aircrews, except those specially trained to explore tropical storms and hurricanes, should avoid these dangerous cyclones. The data gathered by weather research aircraft, flying at 35,000 to 43,000 feet in the tops of hurricanes, shows that in well developed hurricanes, you should expect severe to occasionally extreme turbulence. For low-flying aircraft, circumnavigation may be accomplished by keeping the storm center to the left of the flight path (in the Northern Hemisphere). In this way, the aircraft experiences a tailwind component around the storm.

Figure 14-14. Satellite Picture of a Hurricane.



**14.11.9.1. Winds.** Typically, hurricane winds are strongest at low levels and decrease with altitude. Research aircraft frequently find winds in excess of 100 kts at 18,000 feet. Winds become significantly lighter above 30,000 feet.

**14.11.9.2. Turbulence.** Some of the most severe turbulence encountered is in the edge of the surrounding eyewall. Other turbulent areas are found within the spiral rain bands. Flight at low levels, 500 to 3,000 feet AGL, results in exposure to sustained pounding turbulence due to the surface friction of the fast moving air.

**14.11.9.3. Icing.** Critical icing conditions may be encountered in the mid levels of the storm. Between 15,000 and 25,000 feet, severe clear icing may render aircraft de-ice and anti-ice equipment ineffective while dramatically decreasing the aircraft's performance.

---

## Chapter 15

### ARCTIC WEATHER

**15.1. Introduction.** Flights in polar regions present special problems for aircrews. Most weather phenomena of special significance occur at low altitudes or at the surface. Challenging terminal weather conditions such as extreme cold temperatures and persistent snow packed and icy runways are serious hazards in polar flight operations. Obstructions to visibility and depth perception make takeoffs and landings difficult. Mechanical turbulence becomes a problem with strong low level winds. These and other flight problems will be examined after a discussion of some general polar features.

**15.2. Polar Physical Geography and Climatic Influences.** The polar regions, strictly speaking, are the areas north of the Arctic Circle (66½ degrees N latitude) and south of the Antarctic Circle (66½ degrees S latitude). Since both polar regions have similar weather hazards, we will confine our discussion to Arctic weather (Figure 15-1). We will also include information on Alaskan weather, even though much of the state lies south of the Arctic Circle.

**15.2.1. Arctic Climate Factors.** The amount of energy received from the sun largely determines an area's climate. The heat an area obtains from the sun depends upon (1) the duration of sunlight, (2) the angle of incidence of the sun's rays, and (3) the average cloud cover. Figure 15-2 shows that much of the Arctic receives little or no direct heat from the sun during the winter. During the prolonged night, there is a continual heat loss by radiation. This radiative heat loss is a prolonged and continual phenomenon each winter. Notice in Figure 15-3 how much more sunlight the southern latitudes receives during the winter.

**15.2.2.** The climate is not completely determined by energy from the sun. Other weather variations are attributed to land and water distribution, the land's physical features, and ocean currents. Combined, these features influence the characteristics of

the air masses affecting this region. Some Arctic locations such as the eastern shores of Greenland have the fiercest weather in the Northern Hemisphere with steady wind velocities averaging 40 knots for days.

**15.2.3. Water Features.** The Arctic Ocean and parts of the North Atlantic and North Pacific Oceans comprise the principal water areas of the Arctic. A large portion of the water area encircling the North Pole is covered throughout the year by a deep layer of ice known as the permanent ice pack (Figure 15-1). This ice cover becomes larger during the winter months. In summer, the ice pack is crisscrossed by cracks and open leads.

**Figure 15-1. Arctic Circle.**



**15.2.3.1.** Even when ice covered, the water bodies act as temperature moderators since the ice and water below retain more heat than the surrounding cold land. Since the water moderates the temperatures, the Arctic summertime temperatures are still quite cool. Oceanic and coastal areas have a milder climate during winter than would be expected and a cool climate in summer.

**15.2.4. Land Features.** Land areas in the Arctic (also shown in Figure 15-1) include the northern portions of Europe and Asia (Eurasia), the Canadian Archipelago, parts of Alaska, most of Greenland, and the Svalbard Archipelago of Norway.

**15.2.4.1.** The Arctic mountain ranges of Siberia, North America, and Greenland significantly contribute to the climatic and air mass characteristics of the region since these ranges are effective barriers to air movement. During periods of weak pressure gradient, air blocked by the mountains, becomes stagnant. The stagnant air acquires the temperature and moisture characteristics of the underlying surface and becomes an air mass source region. But when the pressure gradient becomes quite strong during the winter, the winds blow quite strong in certain Arctic regions. The strongest winds are found on the eastern shores of Greenland and other lower lying areas downwind from frozen, higher terrain areas. Strong pressure gradients enable strong winds to blow from high pressure found in the interior land areas to low pressure found over the large water areas. Figure 15-4 shows Arctic physical features and source regions.

**15.2.5. Temperatures--Winter.** The Arctic is usually very cold in winter with maritime locations warmer than the inland areas. Temperatures are usually well below zero in the northern part of the continental interior. During the long hours of darkness, temperatures range from -20 degrees F to -40 degrees F or colder. Verkhoyansk in north central Siberia has the record for the lowest officially recorded temperature in the Northern Hemisphere of -90 degrees F. Snag, in the Yukon Territory of Canada, holds the North American record of -81 degrees F. Arctic coastal areas in the winter usually average about 20 degrees F warmer than the interior due to the modifying effect of water and ice.

Figure 15-2. Duration and Angle of Incidence of Sun's Rays upon Arctic.

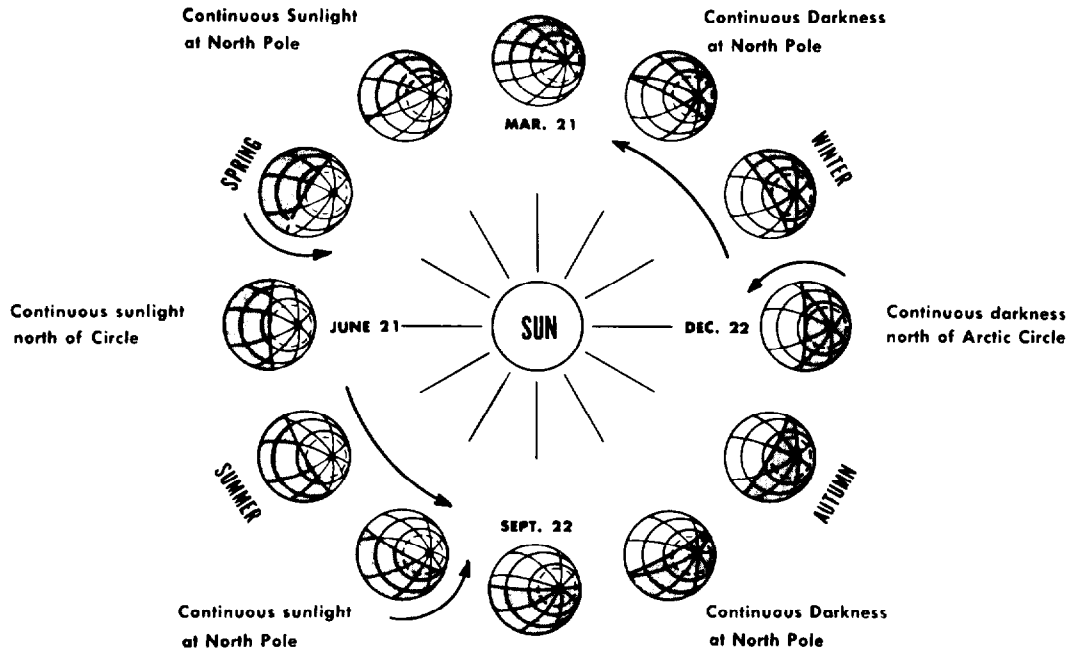
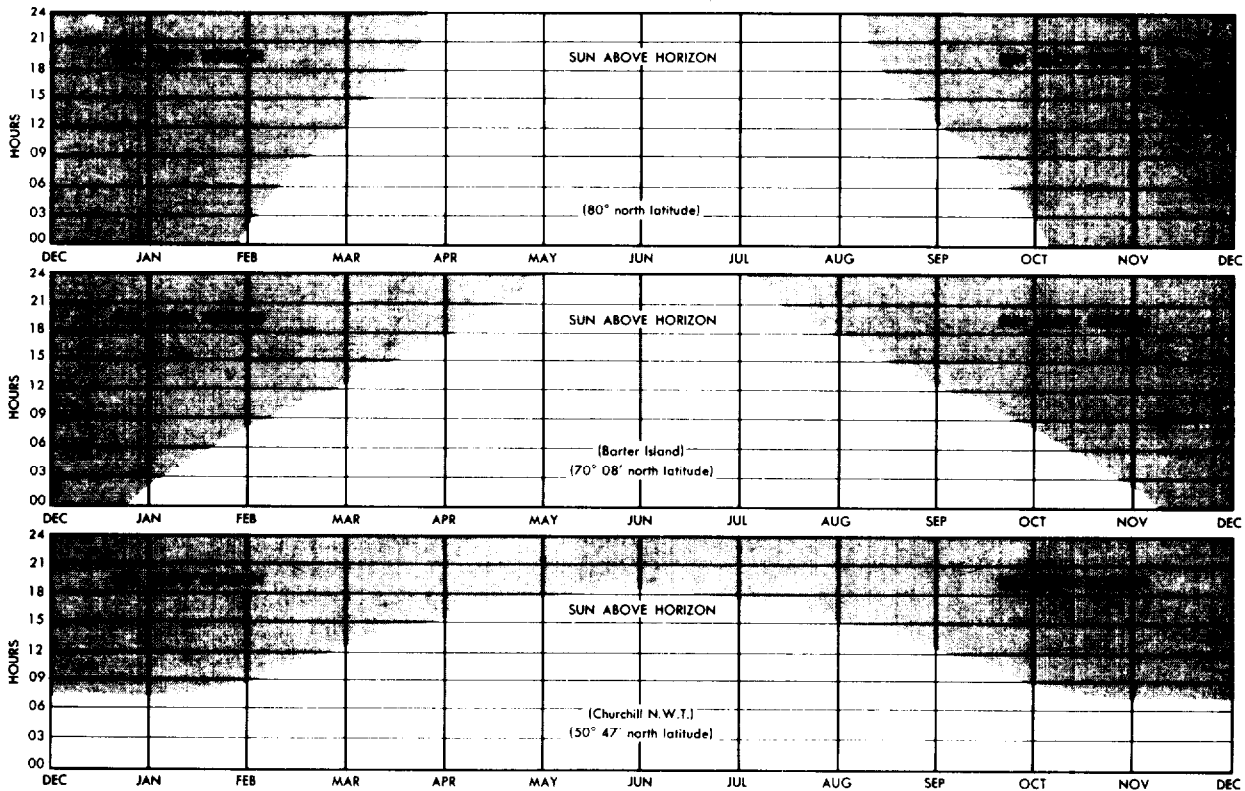


Figure 15-3. Number of Hours Sun is Above or Below Horizon.



**15.2.5.1. Temperatures--Summer.** During summer, some areas are surprisingly warm. The interior areas have pleasantly warm summers with many hours of sunshine each day. Figure 15-5 shows the average number of days each year with above freezing temperatures. Continental interior temperatures sometimes rise to the high 70s or 80s and occasionally into the 90s. Fort Yukon, located just north of the Arctic Circle, has recorded 100°F; Verkhoyansk has recorded 94°F. Arctic coastal areas have cool, short summers tempered by the persistent onshore winds and abundant cloudiness. Summer high temperatures

occasionally reach the 60s with low temperatures consistently dipping below freezing. For example, during July, Barrow Point in northern Alaska has an average temperature of 40°F.

**Figure 15-4. Arctic Physical Features and Typical Air Mass Source Regions.**



**15.2.6. Clouds and Precipitation.** Cloudiness over the Arctic is at a minimum in winter and at a maximum in summer and fall. Figure 15-6 shows the average number of cloudy days at selected locations for the cold and warm seasons. Coastal locations are particularly affected by prolonged periods of stratocumulus ceilings during the summer and early fall because of onshore flow from the Arctic Ocean. Scattered cumulus clouds form over interior regions during warm summer afternoons. Occasionally the interior experiences low-topped thunderstorms with the typical associated thunderstorm aviation hazards. Even a tornado or two has been observed in the vicinity of the Arctic Circle although they are extremely rare.

**15.2.6.1. Precipitation** (usually snow) in the Arctic is generally light. Annual amounts over the ice pack and along the coastal area are only 3 to 7 inches. Coastal areas with sharp, rising terrain and the interior areas are somewhat wetter, with annual amounts of 5 to 15 inches, mostly consisting of summer rain.

**15.2.7. Winds.** Strong winds are more frequent during the fall and winter, especially along the coastal areas. A number of coastal stations have recorded wind speeds greater than 70 kts. Along the coast of Greenland, winds in excess of 90 kts are not uncommon in winter. Strong downslope (fall) winds are very hazardous to aircrews. As these cold winds drain from high plateau or mountain areas down to lower elevations, their speed increases abruptly and may exceed 100 kts. With the lack of vegetation, the winds blow constantly at many locations with the speed averaging between 10 and 20 knots.

**15.2.7.1. Wind Chill Temperatures.** Strong winds combined with low temperatures make the Arctic very uncomfortable for human activity. The combination produces *equivalent chill temperatures (ECT)* of -100°F or colder. This is computed according to the average wind speed without gusts with the free air temperature. The ECT temperature is the sensed temperature on the human body taking into account the additional cooling effect of wind on the human body. It is the temperature that equates the same rate of cooling under calm wind conditions. Figure 15-7 is a chart used in computing equivalent chill factors.

**15.3. Polar Weather Peculiarities--Effects of Temperature Inversions.** The rapid increase in temperature with height at low levels over the polar regions during much of the winter causes interesting phenomena. Sound tends to carry great distances under these inversions. Light rays are bent as they pass through the inversion at low angles. This may cause the appearance of objects that are actually below the horizon. This effect, known as looming, is a mirage. Mirages that distort the apparent shape of the sun, moon, and other objects are common with these inversions.

Figure 15-5. Average Number of Days Each Year with Temperatures above Freezing.



Figure 15-6. Average Number of Days Per Month on which Cloudy Conditions Occur.

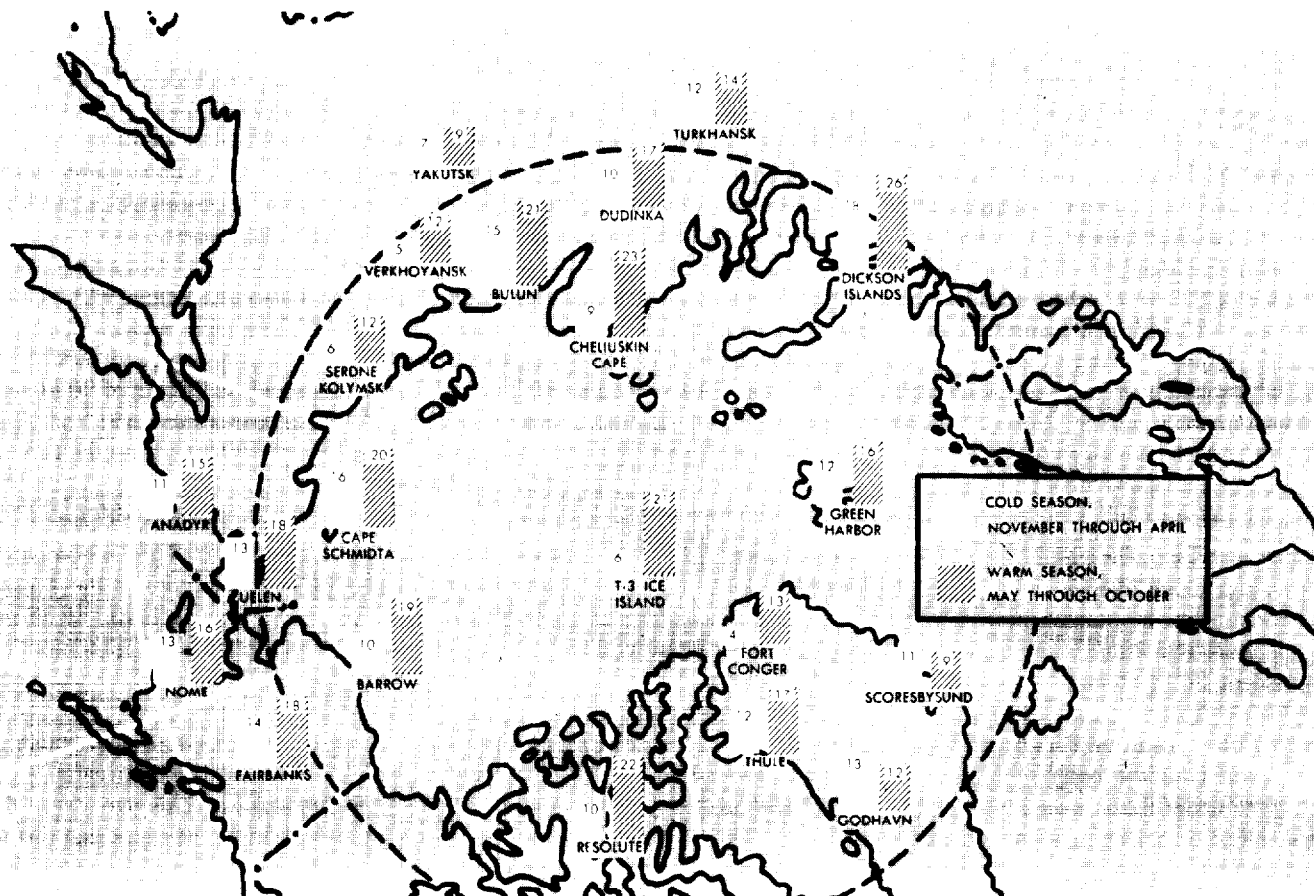


Figure 15-7. Equivalent Wind Chill Index.

COOLING POWER OF WIND EXPRESSED AS "EQUIVALENT CHILL TEMPERATURE"																						
WIND SPEED		TEMPERATURE (°F)																				
CALM	CALM	40	35	30	25	20	15	10	5	0	-5	-10	-15	-20	-25	-30	-35	-40	-45	-50	-55	-60
KNOTS	MPH	EQUIVALENT CHILL TEMPERATURE																				
3 - 6	5	35	30	25	20	15	10	5	0	-5	-10	-15	-20	-25	-30	-35	-40	-45	-50	-55	-65	-70
7 - 10	10	30	20	15	10	5	0	-10	-15	-20	-25	-35	-40	-45	-50	-60	-65	-70				
11 - 15	15	25	15	10	0	-5	-10	-20	-25	-30	-40	-45	-50	-60	-65	-70						
16 - 19	20	20	10	5	0	-10	-15	-25	-30	-35	-45	-50	-60	-65								
20 - 23	25	15	10	0	-5	-15	-20	-30	-35	-45	-50	-60	-65									
24 - 28	30	10	5	0	-10	-20	-25	-30	-40	-50	-55	-65	-70									
29 - 32	35	10	5	-5	-10	-20	-30	-35	-40	-50	-60	-65										
33 - 36	40	10	0	-5	-15	-20	-30	-35	-45	-55	-60	-70										
WINDS ABOVE 40 HAVE LITTLE ADDITIONAL EFFECT.		LITTLE DANGER					INCREASING DANGER (Flesh may freeze within 1 minute)					GREAT DANGER (Flesh may freeze within 30 seconds)										
DANGER OF FREEZING EXPOSED FLESH FOR PROPERLY CLOTHED PERSONS																						

**15.3.1. Aurora.** Disturbances on the sun spew out bursts of energy particles, a portion of which eventually reach the earth. The high-energy particles strike the earth's magnetic field and are carried along the magnetic field lines of the earth where they tend to lower and converge near the geomagnetic poles. The electrons pass through rarefied gases of the outer atmosphere, illuminating similarly as a fluorescent lamp. The illuminated gases, more commonly known as the northern lights, the *aurora borealis* (Figure 15-8) has its counterpart in the Antarctic, where it is termed the *aurora australis* or southern lights.

**15.3.2.** While the northern lights are frequently observed in the Arctic region, they have been seen as far south as Florida. Displays of aurora vary from a faint glow to that of a full moon. The lights frequently change shape and form. The most predominant color is pale green, but yellow, white, red, blue, and violet are sometimes observed.

**15.3.3. Effects on Communications.** When auroras are active, high frequency (HF) radio communications may experience increased noise levels. At times, the noise levels are severe enough to totally degrade HF radio reception. The interference, which sounds like continuous static, lasts from 30 minutes to a few hours.

**15.3.4. Light Reflection by Snow-Covered Surfaces.** Snow-covered surfaces reflect much more light than darker surfaces. Snow often reflects Arctic sunlight sufficiently to blot out shadows. This markedly decreases the contrast between objects, and it becomes very difficult to distinguish between them. The landscape may merge into a featureless grayish-white field. Dark mountains in the distance may be easily recognized, but a crevasse normally directly in view may be undetected due to lack of contrast.

**15.3.4.1.** Illumination from the stars creates visibility far beyond that found elsewhere. Only during heavy overcasts does the Arctic night begin to approach the degree of darkness in lower latitudes. There are often long periods of moonlight, with the moon staying above the horizon for several days at a time.



Figure 15-8. Aurora Borealis.



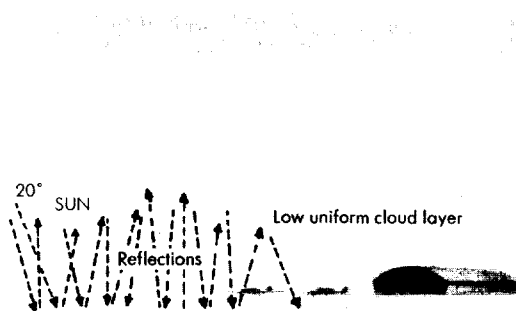
**15.4. Polar Weather and Aviation Operations.** For the most part, fewer and less severe weather hazards exist in the polar regions for aircraft at flight altitudes than in other regions. But parts of Greenland compete with the Aleutian islands for the world's worst weather. During winter, many coastal and adjacent inland locations are frequently affected by synoptic storms which originate from the Gulf of Alaska and other similar semi-permanent low pressure areas. The interior isn't quite as affected because of the dryness of the air and more stable dominant air masses. Expect turbulence especially in mountainous areas and flat areas adjacent to mountainous areas subject to strong pressure gradients. Strong channeled winds can cause moderate to severe low level turbulence below 5,000 feet.

**15.4.1. Icing.** Most Arctic air masses exhibit a pronounced dryness in all but the lowest layers. Occasionally, moisture works its way into the upper levels in maritime polar air masses. This, in turn, sets the stage for icing conditions. Icing can be encountered when passing through seemingly safe clouds of thin consistency. Rime icing is the dominant form of icing with some mixed icing forming along coastal mountain areas.

**15.4.2. Whiteout.** *Whiteout* is a visibility-restricting phenomenon occurring in the polar regions when a uniformly overcast layer of clouds overlies a snow or ice covered surface. Most whiteouts occur when the cloud deck is relatively low and the sun is about 20° above the horizon.

**15.4.2.1. Depth Perception Loss.** The parallel rays from the sun are broken up and diffused when passing through the cloud layer so that they strike the snow surface from many angles (Figure 15-9). This diffused light reflects back and forth countless times between the snow and clouds until all shadows are eliminated. The result is a loss of depth perception. Low level flight and landings on snow surfaces become dangerous. Several disastrous aircraft crashes have occurred where whiteout conditions may have been a factor.

Figure 15-9. Whiteout Condition.



**15.4.3. Arctic Haze.** Aircrews in flight over polar regions sometimes experience reduced visibility in the horizontal and in looking at surface objects at an angle other than from directly above. Color effects suggest that extremely small ice particles cause this condition. It is also called Arctic mist when near the ground.

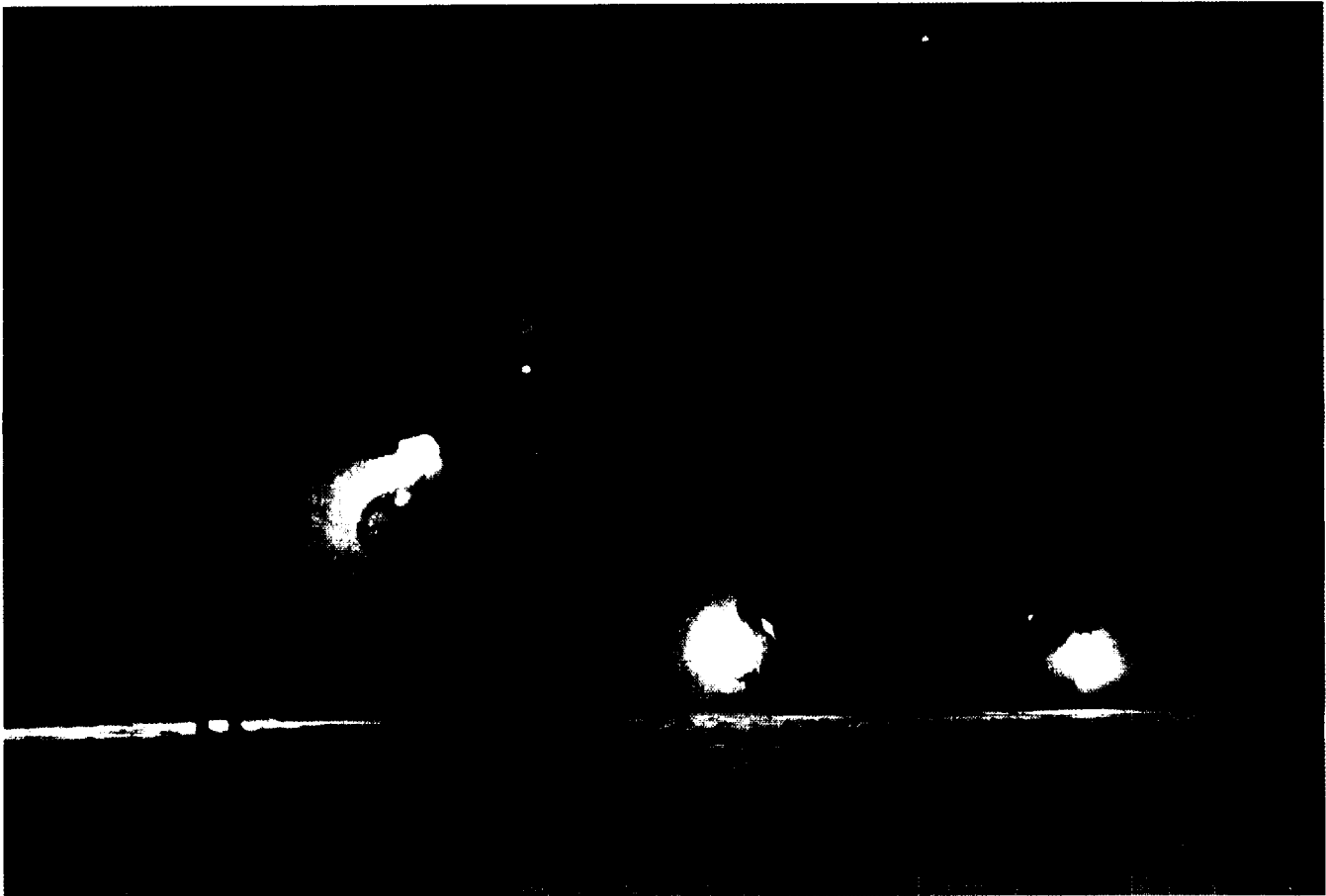
**15.4.4. Fog.** Fog limits takeoff and landing in the polar regions more than any other visibility restriction. Water droplet fog is the main hazard to aircraft operators in coastal areas during the summer. It is a potential source of aircraft icing when temperatures are below freezing.

**15.4.5. Ice Fog.** *Ice fog*, a major operational hazard, is common in polar areas in winter. It forms in moist air during extremely cold weather. Combustion of aircraft fuel in air -20°F (-29°C) and colder produces the ice fog most frequently

affecting aircraft operations. In supersaturated conditions, routine aircraft engine running or movement can supply enough exhaust impurities and moisture to cause sublimation. The resulting ice fog may restrict visibilities enough to halt aircraft operations at the airfield for hours.

**15.4.6. Blowing and Drifting Snow.** Blowing snow is a greater hazard to flying operations in polar regions than in mid-latitudes because the snow is dry and fine and is easily picked up by light winds (Figure 15-10). Winds may raise the snow 1,000 feet AGL and produce drifts more than 30 feet deep, obscuring objects such as runway markers. Under certain conditions, a frequent and sudden increase in surface winds may cause visibility to drop from unlimited to near zero within a few minutes (Figure 15-11). Blowing snow is deceptive to inexperienced aircrews since the shallowness of the snow layer may permit good vertical visibility at the same time that the horizontal visibility within the layer is very poor.

**Figure 15-10. Blowing Snow.**



**15.4.7. Temperature Inversion.** In winter, temperatures may increase from  $-60^{\circ}\text{F}$  at the surface to  $0^{\circ}\text{F}$  only 1,500 feet above the ground. Such a strong temperature inversion will dramatically decrease the climb performance of an aircraft. Anticipate them and be alert when the weather forecaster briefs the magnitude of the inversion. Then follow procedures listed in your flight manual for cold weather operation.

**15.4.8. Altimeter Errors.** Strong winds over rough terrain and very low temperatures are sometimes responsible for large errors in altimetry. Chapter 4 and the following sections discuss the cause and effect of these errors.

**15.4.8.1. Standard Deviation Versus Actual Temperature Deviation.** Aircrews should allow for an ample safety margin in selecting flight altitudes over mountainous terrain. Be alert when flying over extremely cold areas where the total air column is dramatically colder than a standard column of air. The actual temperature deviation will be dramatically different than the standard temperature

**15.4.8.2. Vertical Separation.** When the mean actual temperature is much colder than a standard column of air, the distance between two flight levels will be less than the indicated altitude difference. Since the colder air shrinks the distance between two pressure levels, the actual vertical difference can be 80% of the distance when compared to a standard air column. For example, when the vertical separation distance is expected to be 2,000 feet in a standard atmosphere, in extremely cold temperatures, the vertical distance can shrink to 1,600 feet.

Figure 15-11. Visibility Reduced in Blowing Snow.



**15.4.8.3. Terrain Clearance.** Safe terrain clearance is adversely affected by cold temperatures. The magnitude of this difference can become quite large during cold, winter conditions when flight is undertaken over mountains in cases where the altimeter setting is obtained from a station whose elevation is well below that of the highest peak to be crossed by an aircraft. The altimeter setting reported by a station at the base of the mountain will be higher than the actual altimeter setting on top of the mountain.

**15.4.8.4. Altimeter Corrections--Cold Temperatures.** If flying in the vicinity of a mountain top and you have your altimeter setting adjusted to a station setting at the base of the mountain, and the actual mean temperature is below the standard mean temperature, the indicated altitude shown by the aircraft instrument will be **higher** than the true altitude. This is a dangerous situation. The indicated altimeter setting can read as much as 1,500 feet too high.

**15.4.8.5. Altimeter Corrections--Warm Temperatures.** When the actual mean temperature exceeds that of a standard air column, then the altimeter setting at the mountain top will be higher than that of the station altimeter setting at the base of the mountain. The indicated altitude shown by the aircraft instrument will be **lower** than the true altitude.

**15.4.9. Temperature Corrected Altitude.** In some parts of the United States such as the western plateau areas of Colorado, Montana, Idaho, Utah, and Wyoming, minimum temperatures of  $-30^{\circ}\text{F}$  have been observed while in Alaska surface cold temperatures can be  $-50^{\circ}\text{F}$ . It is not uncommon for weather stations to be located along the side of mountain peaks or ridges whose tops rise from 5,000 to 9,000 feet above the elevation of the stations. In some regions such as Greenland, the air traffic controller will issue a *temperature corrected altitude* for aircraft flying in the region during extreme cold temperature situations.

## Chapter 16

### VOLCANIC ASH

**16.1. Introduction.** Volcanic activity was not generally considered a severe threat to aircraft until the beginning of the 1980's. However, the first recorded volcanic eruption which had any appreciable impact on aviation occurred 22 March 1944 when Mount Vesuvius in Italy did more damage on an Allied airfield than would have likely happened from an enemy raid. The American 340th Bombardment Group's entire fleet of 88 North American B-25 Mitchells had their fabric control surfaces burned off and all Plexiglas pitted. The weight of ash which fell on the aircraft at their field near Naples, tipped them onto their tails. All 88 were severely damaged. It would be 36 years until another volcano would have a significant impact on

aviation. Why such a long time? Simply because we entered a period of about three decades in which there were very few explosive eruptions of the world's volcanoes. According to Decker and Decker in their book *Volcanoes*, there are about 40 subduction volcanoes (the type most often explosive) erupting each year. But during this period the earth's volcanoes were uncharacteristically quiet. Check aircraft operation manuals for these decades and you will not likely find any reference to volcanic ash, how it might be encountered, or what to do about repairing ash damage.

**16.2. Hazards to Aircraft.** Since the early 1980's there have been several major volcanic eruptions around the world. These eruptions have given aircraft manufacturers and aviators more than they bargained for. Beginning in 1980 with the eruption of Mount Saint Helens in Washington state (Figure 16-1), a new chapter began in the story of "aviation versus volcanoes." The decade held at least two major aviation encounters with volcanic ash which almost resulted in loss of life near Indonesia and adversely affected numerous flying operations in Alaska. Take a moment to re-live the following aircraft encounter with a dangerous volcanic ash cloud. Unfortunately this is but one incident; there have been many others. After reading the next few paragraphs, your concern and respect for volcanic phenomenon should be greatly enhanced.

**Figure 16-1. Mount St Helens, May 1980.**



**16.2.1.** In early summer of 1982, a British Airways B-747 with 247 passengers and 16 crew members was enroute from Kuala Lumpur, Malaysia to Perth, Australia. It was cruising at 37,000 feet. The onboard radar was painting nothing unusual. The captain had left the flight deck.

**16.2.2.** The eerie blue glow of St. Elmo's Fire on windscreens and engine nacelles (coverings) was the first sign of trouble. The crew turned on anti-ice and ignitors on all engines and switched on the seat belt lights in the passenger compartment as a precaution. Turning on the landing lights, the first officer peered out into the darkness. It seemed to him the plane was passing through a continuous, thin cloud.

**16.2.3.** The captain was called to return to the cockpit. Soon the crew noticed what seemed to be a bluish smoke on the flight deck and the acrid smell of ozone. A thin shaft of light projecting forward of the plane's four Rolls-Royce RB.211 engines appeared, somewhat similar to a flashlight's beam. Passengers began noticing the blue smoke in their cabin and became uneasy. Back in the cockpit, a light glowed on the flight engineer's panel indicating the number four engine's air supply was down. Within a short time the engine's rpm and pressure ratio began to drop and it wound to a halt. The crew began the engine fire checklist for number four but as it was completed, the number two engine also began to run down. The remaining two engines did the same. Now, all four engines were out! The plane was 80 nautical miles from land, 180 miles from a suitable runway.

**16.2.4.** All of aviation is based on redundancy of systems. If one system fails, another should be available to take its place. Very seldom is such redundancy not possible. The odds against all four engines failing at the same time in a modern commercial aircraft are astronomical. For all practical purposes, losing all four engines just never happens. But now it had. Jakarta air traffic control also found this situation hard to grasp and it took a second radio message from the crew before controllers understood that the plane was powerless.

**16.2.5** To attempt to restart the engines would require the crew to maintain an indicated airspeed of 250 to 270 knots. At the same time, the aircraft was descending at a rate of 2,000 feet per minute. That meant a water landing in 18 minutes, time to glide perhaps halfway to Jakarta, Indonesia. Naturally the flight engineer worked continuously to restart the engines. By this time the plane was vibrating vigorously and flames were issuing from the tailpipes due to the restart attempts. In the cabin, passengers were listening to emergency ditching instructions.

**16.2.6** Eight minutes after the first engine failure, as the plane descended through 13,000 feet, the number four engine relit. That helped save the day, because if just one engine stayed operational, the plane could slow its descent rate or maybe even maintain altitude. Over the next 5 minutes, the crew was able to get the remaining three engines relit and start a climb. At 15,000 feet however, the St. Elmo's fire was again observed and the crew began another descent. The number two engine surged again and was shut down. The plane proceeded on to Jakarta on three engines and made an uneventful landing. The front windshields were so badly scratched and the landing lights rendered so useless that the crew requested the plane be towed off the runway after landing.

**16.2.7** This incident was the result of a cloud of volcanic ash from Java's Galunggung volcano which had erupted about an hour before the B-747 left Kuala Lumpur. Analyzing the flight data recorders, engineers learned that the four engines had begun to lose power imperceptibly about 5 minutes before the shutdowns began. The plane gradually lost speed and the autopilot increased the pitch angle to maintain the assigned altitude until the first engine failure and long descent began. Inspection of the engines revealed light erosion of the cowl leading edges and pieces of fused volcanic ash debris in the tailpipes. After being torn down, the engines were found to have various degrees of erosion. In the hot sections, fused volcanic dust had built up on the walls and blades. Outside the plane, sandblasting (ash-blasting) had eroded the central portions of the windshields and frosted over the landing lights. This harrowing experience is a good example of hazards faced by aircrews resulting from unreported volcanic events and from resulting ash clouds which often cannot be detected.

**16.3 Flight Operations in Volcanic Ash (from AIM/FAR, 1996).** Most important is to avoid any encounter with volcanic ash. The ash plume may not be visible, especially in instrument conditions or at night, and even if visible it is difficult to distinguish between ash cloud and ordinary weather cloud. Volcanic ash clouds are not displayed on airborne or Air Traffic Control (ATC) radar. In fact, radar reflectivity of volcanic ash is roughly a million times less than that of a cumuliform cloud. Pilots must rely on reports from controllers and other pilots to determine the location of the ash cloud and use that information to remain well clear of the area. You should make every attempt to remain on the upwind side of the volcano. Flightcrews who have encountered volcanic ash clouds provided the following indicators to help you recognize this hazard.

- Smoke or dust appearing in the cockpit.
- An acrid odor similar to electrical smoke.
- At night, St. Elmo's fire or other static discharges accompanied by a bright orange glow in the engine inlets.
- At night, or in dark clouds, landing lights cast dark distinct shadows in ash clouds, unlike the fuzzy, indistinct shadows cast against weather clouds.
- Multiple engine malfunctions, such as compressor stalls, increasing exhaust gas temperatures, torching from tailpipes and flameouts.
- A fire warning in forward cargo areas.

**16.3.1. Recommended Actions.** It is recommended that pilots encountering an ash cloud immediately reduce thrust to idle (altitude permitting) and reverse course in order to escape from the cloud. Ash clouds may extend for hundreds of miles so pilots should not attempt to fly through or climb out of the cloud. The following procedures are recommended. Some of these may not apply to your particular aircraft.

- Disengage the autothrottle if engaged. This will prevent the autothrottle from increasing engine thrust.
- Turn on continuous ignition.

- Turn on all accessory airbleeds including all air conditioning packs, nacelles, and wing anti-ice. This will provide an additional engine stall margin by reducing engine pressure.

- It may become necessary to shut down and then restart engines to prevent exceeding engine temperature limits. Also, volcanic ash may block the pitot system resulting in unreliable airspeed indications.

**16.3.2. Reporting.** If you see a volcanic eruption and have not been previously notified of it, you may be the first person to observe it--especially in remote locations. In this case, immediately contact ATC personnel and alert them to the hazard. Remember, you are the most important link in volcano observation and warning programs for aviators.

**16.3.3. Airfield Environment.** When landing at airports where volcanic ash has been deposited on the runway, be aware that even a thin layer of dry ash can be detrimental to braking action. Wet ash can also impair your braking action. It is recommended that reverse thrust be limited to minimum practical to lessen the possibility of reduced visibility and engine ingestion of airborne ash. When departing from affected airfields, you should avoid operating in visible airborne ash. It is also recommended that flap extension be delayed until initiating the before takeoff checklist and that a rolling takeoff be executed to avoid blowing ash back into the air.

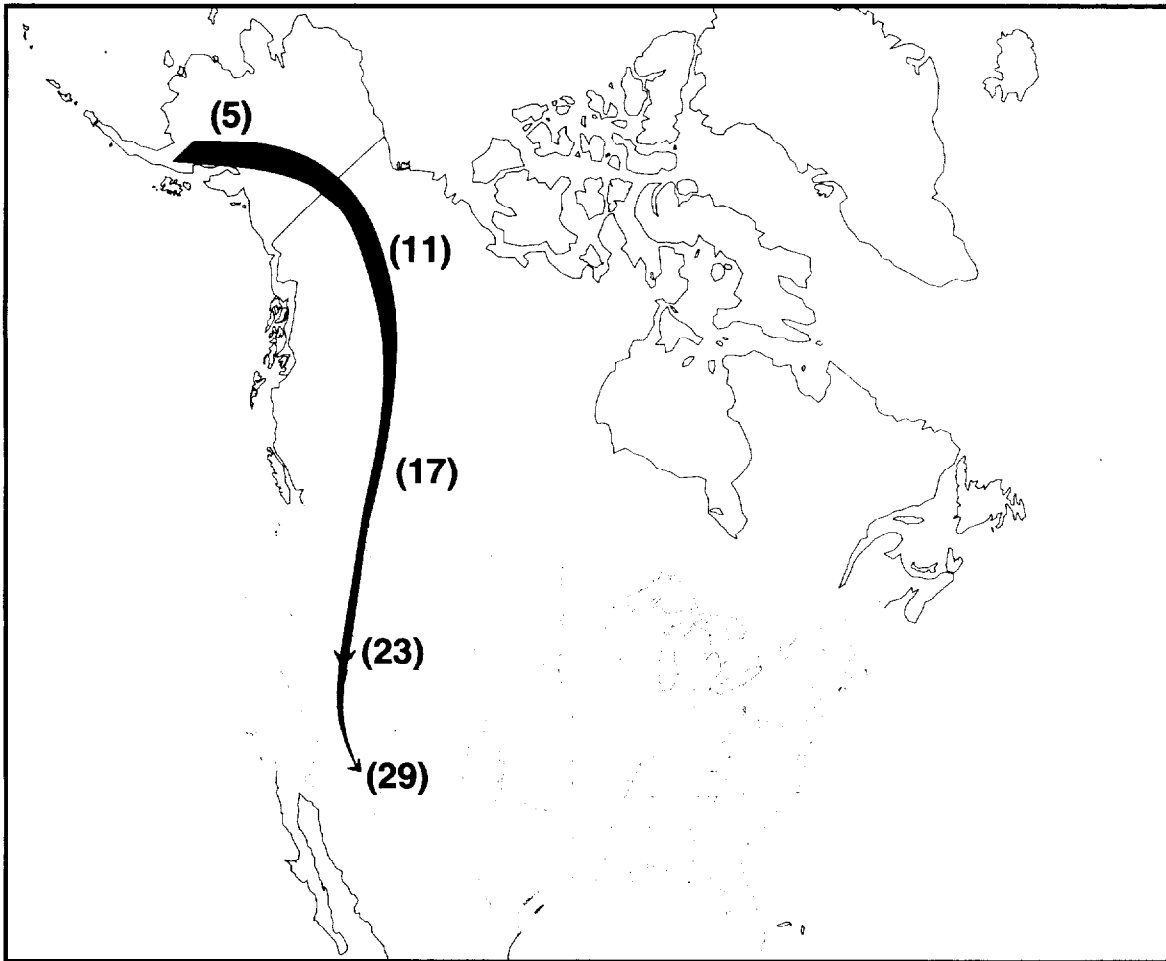
**16.4. Ash is Worse than Sand for Jets.** What happens to a turbo jet engine which causes such severe and costly damage? After all, these engines have a long history of operating in desert areas such as the American Southwest where high levels of dust in the atmosphere is commonplace. In Kuwait, and area of frequent airline operations, fine-grained dust layering is said to exist suspended in the atmosphere up to 15,000 feet. The usual experience is that such dust causes slow erosion of the engine's compressor blades but no case of major engine failure is known to have resulted from these conditions.

**16.4.1. Damaging Effects.** Volcanic dust can cause rapid erosion and damage to the internal components of engines. As it builds up, blockage of the high pressure turbine nozzle guide vanes and high pressure turbine cooling holes can cause surge, loss of thrust and/or high exhaust gas temperature. Because the greatest constituent of volcanic ash is silicon, it forms a glazing on the hot turbine components. The ash is also highly abrasive and may cause serious damage not only to the engines, but to leading wing edges, windshields, and landing lights as well. The ash may also block the pitot static system causing unreliable airspeed indications.

**16.5. Efforts to Improve Safety.** Since 1982, the International Civil Aviation Organization (ICAO) has worked to address the volcanic threat to aviation safety worldwide. In the United States, the US Geological Survey is the principle federal agency with responsibility for assessing volcanic hazards and monitoring active volcanoes. This work is carried out primarily from observatories in Hawaii, Alaska, California, and Washington. The National Oceanic and Atmospheric Administration (NOAA) and the FAA also have responsibilities for dealing with the hazard of volcanic ash clouds that affect aviation operations in the United States.

**16.5.1. Methods of Assessment and Warning.** Methods used for assessing volcanic activity include analysis of data from satellites, upper-air wind sensors, lightning detection systems, pilot reports, and even specialized radars. Computer models have been developed to help forecast the trajectory of volcanic ash clouds so that Significant Meteorological Phenomena Reports (SIGMETs) and other timely products may be issued to warn aviators of this potentially lethal hazard. Figure 16-2 is one such product showing the estimated trajectory of the ash cloud from the December 1989 eruption of Mt. Redoubt in Alaska. Time in hours after the eruption is shown in parentheses. Notice the ash cloud passed across the major airline routes of the western United States and Canada in less than 30 hours.

Figure 16-2. Ash Cloud Trajectory Product.



JOHN P. JUMPER, Lt General, USAF  
DCS/Plans and Operations

## GLOSSARY OF ABBREVIATIONS, ACRONYMS AND TERMS

## Abbreviations and Acronyms

ACSL	Altostratus
AFFSA	Air Force Flight Standards Agency
AFGWC	Air Force Global Weather Center, Offutt AFB NE
AFW	Air Force Weather
AGL	Above Ground Level
AIRMET	Airman's Meteorological Information
ARTCC	Air Route Traffic Control Center
AS	Altostratus
ASI	Altimeter Setting Indicator
ASOS	Automatic Surface Observation System
ATC	Air Traffic Control
ATIS	Automatic Terminal Information Service
AWDS	Automated Weather Distribution System
AWOS	Automated Weather Observation System
AWS	Air Weather Service
BKN	Broken
BL	Blowing (Only used with DU, SA, SN, and PY)
BR	Mist
BWS	Base Weather Station
CAT	Clear Air Turbulence
CAVOK	Ceiling and Visibility OK
CB	Cumulonimbus
CBMAM	Cumulonimbus Mammatus
CC	Cirrocumulus
CI	Cirrus
CONUS	Continental United States
cP	Continental Polar
CS	Cirrostratus
cT	Continental Tropical
CU	Cumulus
CWW	Continuous Weather Watch
DA	Density Altitude
DBASI	Digital Barometer Altimeter Setting Indicator
DR	Drifting or Dead Reckoning
DS	Duststorm
DU	Dust
DZ	Drizzle
ECT	Equivalent Chill Temperature
E-O	Electro-optic
FAA	Federal Aviation Administration
FC	Funnel Cloud
FG	Fog
FIH	Flight Information Handbook
FLIP	DoD Flight Information Publication
FOD	Foreign Object Damage
FU	Smoke
FZ	Freezing
GOES	Geostationary Operational Environmental Satellite
GR	Hail
Ha	Field Elevation
Hg	Mercury
HIWAS	Hazardous In-flight Weather Advisory
Hp	Station Pressure
hPa	Hectopascal



HZ	Haze
ICAO	International Civil Aviation Organization
IFR	Instrument Flight Rules
IRU	Inertial Reference Unit
ITC	Intertropical Confluence
ITCZ	Intertropical Convergence Zone
JTWC	Joint Typhoon Warning Center
KIAS	Knots Indicated Airspeed
LFC	Level of Free Convection
LST	Local Standard Time
LLWS	Low Level Wind Shear
LLWAS	Low Level Wind Shear Alerts
MAJCOM	Major Command
Mb	Millibar
MEA	Minimum En route Altitude
METAR	Aviation Routine Weather Report
MOCA	Minimum Obstruction Clearance Altitude
mP	Maritime Polar
mT	Maritime Tropical
MSL	Mean Sea Level
NEXRAD	Next Generation Weather Radar (also known as WSR-88D)
NOAA	National Oceanic and Atmospheric Administration
NOTAM	Notice to Airmen
NS	Nimbostratus
NVG	Night Vision Goggle
NWS	National Weather Service
OVC	Overcast
PA	Pressure Altitude
PAV	Pressure Altitude Variation
PIREP	Pilot Report
PMSV	Pilot to Metro Service
PV	Prevailing Visibility
PY	Spray
QFE	Station Pressure
QFF	Sea Level Pressure
QNE	Pressure Altitude
QNH	Altimeter Setting
RA	Rain
RAREP	Radar Report
RCR	Runway Condition Reading
RNO	RVR Not Available
RSC	Runway Surface Condition
RVR	Runway Visual Range
SC	Stratocumulus
SCT	Scattered
SH	Showers
SIGMET	Significant Meteorological Information
SKC	Sky Clear (TAF Term)
SM	Statute Mile
SPECI	Special Observation
SQ	Squall
SS	Sandstorm
ST	Stratus
TAF	Aerodrome Forecast
TCU	Towering Cumulus
TDWR	Terminal Doppler Weather Radar
TDZ	Touchdown Zone
T.O.	Technical Order

TOT	Time Over Target
TS	Thunderstorm
TWEB	Transcribed Weather Broadcast
UTC	Coordinated Universal Time
VC	Vicinity
VFR	Visual Flight Rules
V <sub>R</sub>	Rotational Speed
VSI	Vertical Speed Indicator
VV	Vertical Visibility
WMO	World Meteorological Organization
WSR-88D	Weather Surveillance Radar 1988 Doppler
WX	Weather

### *Terms*

**Absorption.** The process in which radiant energy is retained by a substance.

**Advection fog.** A fog resulting from the transport of warm, humid air over a cold surface.

**Air mass.** An extensive body of air with essentially uniform temperature and moisture in a horizontal plane.

**Altimeter setting.** That pressure value to which an aircraft altimeter scale is set so that it will indicate the altitude above mean sea-level of an aircraft on the ground at the location for which the value was determined.

**Atmospheric pressure.** The pressure exerted by the atmosphere at a given point.

**Anticyclone.** An area of high pressure having a closed, anticyclonic (clockwise) circulation in the Northern Hemisphere and counterclockwise in the Southern Hemisphere.

**Attenuation.** The weakening of a radar signal caused by the presence of precipitation, clouds, dust, and atmospheric gases.

**Aurora australis.** Auroras of the southern latitudes. See aurora borealis.

**Aurora borealis.** Sporadic radiant emission from the upper atmosphere due to molecular and atomic excitation from charged particles of the solar wind. Borealis refers to auroras of the northern latitudes.

**Barometer.** An instrument for measuring atmospheric pressure; the three principal types are the DBASI, aneroid, and mercurial barometers. The mercurial barometer is used for calibration purposes.

**Blowing.** A descriptor used to amplify observed weather phenomena whenever the phenomena is raised to a height of 6 feet or more above the ground.

**Broken layer.** A layer covering whose summation amount of sky cover is 5/8ths through 7/8ths.

**CAVOK.** An ICAO acronym for Ceiling and Visibility OK. In a forecast this means no clouds below 5,000 feet, no CB, visibility 10 km or greater, and no precipitation, thunderstorm, or shallow fog.

**Ceiling.** The height above the earth's surface of the lowest non-surface based cloud layer that is reported as broken or overcast, or the vertical visibility into an indefinite ceiling.

**Circulation.** The continuous motion of the atmosphere relative to the earth's surface.

**Clear Air Turbulence (CAT).** Turbulence above 15,000 feet normally encountered in cloud-free air.

**Clear ice.** A glossy, transparent ice formed by the relatively slow freezing of large supercooled water droplets.

**Climate.** The statistical collective of weather conditions of a point or area during a specified period of time.

**Cloud layer.** An array of clouds whose bases are at approximately the same level.

**Col.** The neutral area between two highs and two lows.

**Cold front.** The leading edge of an advancing cold air mass.

**Condensation.** The physical process by which water vapor becomes liquid water.

**Condensation trail (Contrail).** A cloud-like streamer frequently observed to form behind aircraft flying in clear, cold, humid air.

**Contour.** A line on constant pressure upper air charts connecting points of equal height.

**Contrast.** The difference between the radiance of a target and the radiance of its background.

**Convective turbulence.** Aircraft turbulence caused by vertical motions in the atmosphere.

**Convergence.** Air coming together from different directions. Areas of low level convergent winds are regions favorable to the occurrence of clouds and precipitation.

**Coriolis Force.** An apparent deflective force resulting from the earth's rotation. It acts to the right of the wind direction in the Northern Hemisphere and to the left in the Southern Hemisphere.

**Cumulonimbus.** An exceptionally dense and vertically developed cloud, occurring either isolated or as a line or wall of clouds with separated upper portions. These clouds appear as mountains, and/or as huge towers, at least a part of the upper portions of which are usually smooth, fibrous, or striated. Well developed cumulonimbus have a characteristic anvil-shaped cloud top.

**Cyclone.** A low pressure area with a closed cyclonic (counterclockwise) circulation in the Northern Hemisphere, clockwise in the Southern Hemisphere.

**D-Value.** The difference between the actual height of any given pressure surface in the atmosphere and the height of that pressure surface in the standard atmosphere.

**Density altitude.** The altitude which a given density would be found in the standard atmosphere.

**Deposition.** Change of state from water vapor to solid (ice) without intermediate liquid state.

**Dew point.** The temperature air must be cooled to become saturated.

**Diurnal.** Daily. A cycle completed every 24-hour period.

**Divergence.** Condition of winds that exists within a given area such that there is a net horizontal flow of air outward from the region. Low level divergent regions are areas unfavorable to the occurrence of clouds and precipitation.

**Emissivity.** A measure of the total radiant energy emitted per unit time per unit area of the emitting surface.

**Equatorial trough.** A quasi-continuous belt of low pressure lying between the subtropical high-pressure belts of the Northern and Southern Hemispheres; sometimes referred to as the Intertropical Convergence Zone (ITCZ).

**Equinox.** The time at which the sun passes directly over the equator. This happens twice a year; the vernal equinox in spring and the autumnal equinox in fall.

**Equivalent wind chill temperature (ECT).** The apparent temperature sensed by the human body which incorporates the cooling effects produced by the combination of wind and free air temperature.

**Evaporation.** The process through which water vapor enters the atmosphere from liquid water.

**Fall wind.** A strong, cold, downslope wind.

**Few.** A layer whose summation amount of sky cover is 1/8th through 2/8ths.

**Foehn.** A warm, dry, wind descending the lee side of mountains.

**Fog.** A visible aggregate of minute water droplets which are based at the earth's surface and reduce horizontal visibility to less than 5/8 statute mile and, unlike drizzle, it does not fall to the ground.

**Freezing precipitation.** Any form of precipitation what freezes upon impact and forms a glaze on the ground or exposed objects.

**Front.** The boundary between two air masses with different densities.

**Frontal inversion.** Inversion resulting from movement of colder air under warm air or the movement of warm air over cold air.

**Frontal wave.** A cyclone which forms and moves along a front. The circulation about the cyclone center tends to produce a wave-like deformation of the front.

**Frost.** Ice crystal deposits formed by sublimation on exposed surfaces when the temperature of the exposed surface is below freezing.

**Frozen precipitation.** Any form of precipitation that reaches the ground in solid form (snow, small hail and/or snow pellets, snow grains, ice pellets, and ice crystals).

**Funnel cloud.** A rotating, funnel-shaped cloud typically associated with severe thunderstorms extending downward but not reaching the earth's surface. Often precedes tornadic or waterspout activity.

**Glaze ice.** Ice formed by freezing precipitation covering the ground or exposed objects.

**Gravity wind.** See Katabatic wind.

**Ground fog.** A fog concealing less than 0.6 tenths of the sky and not extending to the base of any clouds.

**Gust front.** The outward limit of gusty, low level winds extending 10 to 20 miles from the base of a thunderstorm.

**Hail.** Precipitation in the form of small balls or other pieces of ice falling separately or frozen together in irregular lumps.

**Haze.** A concentration of small dust or salt particles suspended in the air.

**High (anticyclone).** An area of high barometric pressure on a surface chart or a maximum of height (closed contours) on a constant pressure upper air chart.

**Hurricane.** A severe tropical cyclone in the North Atlantic Ocean, Caribbean Sea, Gulf of Mexico, and off the west coast of Mexico. Maximum sustained windspeed must be 64 kts or greater.

**Hydrologic cycle.** The composite picture of the interchange of water between the earth, the atmosphere and the seas.

**Ice fog.** A type of fog composed of suspended particles of ice, usually occurring at temperatures of -20°F or colder.

**Indefinite (ceiling designator).** The ceiling applied when the reported ceiling value represents the vertical visibility upward into a surface-based obstruction.

**Indicated altitude.** Altitude above mean sea level indicated on a pressure altimeter set at current local altimeter setting.

**Insolation.** Incoming solar radiation falling upon the earth and its atmosphere.

**Inversion.** Layer within the atmosphere characterized by an increase in temperature with altitude.

**Isobar.** Line connecting points of equal barometric pressure.

**Isotach.** Line drawn connecting points of equal windspeed.

**Jet Stream.** Strong winds concentrated in a narrow stream in the atmosphere.

**Katabatic wind.** Any wind blowing downslope. Same as gravity wind.

**Land breeze.** A local coastal breeze blowing from land to sea, caused by the temperature difference between a sea surface warmer than the adjacent land.

**Lapse rate.** The rate of decrease of an atmospheric variable with height; most commonly refers to decrease of temperature with height.

**Layer amount.** The amount of sky cover reported for each layer based on the summation layer amount for that layer. All layers are reported in ascending order up to the first overcast layer.

**Local dissemination.** The transmission or delivery of a weather report to individuals or groups of users near the weather station.

**Long-line dissemination.** The transmission of a weather report by a communication media to a group of users on a regional, national, or international scale.

**Low (cyclone).** An area of low barometric pressure on a surface chart or a minimum of height (closed contours) on a constant pressure upper air chart.

**Mechanical turbulence.** Turbulence originating from air displaced by surface features.

**METAR/SPECI.** An evaluation of select weather elements from a point or points on or near the ground according to a set of procedures. It may include the type of report, station identifier, date and time group of report, a report modifier, wind, visibility, runway visual range, weather and obstructions to vision, sky condition, temperature and dew point, altimeter setting, and Remarks.

**Microburst.** A small scale, short-lived intense downdraft that produces hazardous low altitude wind shear.

**Millibar (mb).** A pressure unit of 1,000 dynes per square centimeter convenient for reporting atmospheric pressure.

**Mirage.** A phenomena where the image of some object appears displaced from its true position.

**Mist.** A hydrometeor consisting of an aggregate of microscopic and more-or-less hygroscopic water droplets or ice crystals suspended in the atmosphere that reduces visibility to less than 7 statute miles but greater than or equal to 5/8 statute mile.

**Monsoon.** A seasonal shift in the prevailing wind direction.

**Mountain breeze.** The wind that descends a mountain at night.

**Mountain wave turbulence.** Turbulence in the form of waves in the atmosphere. Formed by wind blowing across mountains.

**Northern lights.** See aurora borealis.

**Obstructions to vision.** Any phenomena of particles in contact with the earth's surface dense enough to be detected from the surface of the earth. Also, any phenomena producing a layer in the atmosphere.

**Occlusion.** The result of one frontal system overtaking a previously formed frontal system.

**Orographic.** Of, pertaining to, or caused by mountains, as in orographic lift.

**Polar front.** The zone which separates the polar and tropical air masses.

**Precipitation.** Liquid or solid moisture falling from the atmosphere.

**Pressure altitude.** Altitude indicated when altimeter is set to 29.92 inches; altimeter indicates height above the standard datum plane.

**Pressure gradient.** Rate of horizontal pressure change.

**Prevailing visibility (PV).** Greatest horizontal visibility observed throughout at least half the horizon circle, not necessarily continuous.

**QFE (altimeter setting).** Actual surface pressure. Altimeter indicates zero feet regardless of field elevation.

**QNE (altimeter setting).** 29.92 inches, results in altimeter indicating height above standard datum plan or pressure altitude.

**QNH (altimeter setting).** Altimeter setting which results in altimeter indicating height above mean sea level.

**Radiance.** A measure of the intrinsic electromagnetic radiation emitted by a body.

**Radiation fog.** Fog produced over land when radiation cooling reduces the air temperature near the ground to or below its dew point. Usually occurs on clear nights with light winds.

**Radiation inversion.** Inversion near surface of land caused when ground loses heat rapidly through terrestrial radiation, cooling the air next to it.

**Reflection.** A process by which a surface turns back a portion of incident radiation.

**Ridge.** An elongated area of high pressure with the highest pressure along a line called a "ridge line."

**Rime ice.** Rough, milky, opaque ice formed by the instantaneous freezing of small supercooled water droplets.

**Runway Visual Range (RVR).** An instrumentally-derived value representing the horizontal distance an aircrew will see down the runway from the approach end.

**Saddlebacks.** At flight-level, the relatively cloud-free areas between thunderstorm tops, especially when the storm cells are arranged in a line.

**Saint Elmo's Fire.** A luminous discharge of electricity from protruding objects on aircraft.

**Saturation.** The condition existing when air, at a given temperature and pressure, holds the maximum possible water vapor content.

**Scattered.** A layer whose summation amount of sky cover is 3/8ths through 4/8ths.

**Scattering.** The process by which particles in the air diffuse a portion of incident radiation in all directions.

**Sea breeze.** A coastal local wind blowing from sea to land, caused by the temperature difference between a sea surface colder than the adjacent land.

**Sector visibility.** The visibility in a specified direction that represents at least a 45 degree arc of the horizon circle.

**Shear.** A variation of direction or velocity in space.

- Slant visibility (approach visibility).** The distance from which the aircrew on final approach can see landing aids on the ground.
- Source region.** The surface area over which an air mass originates.
- Southern lights.** See aurora australis.
- Squall.** A strong wind characterized by a sudden onset in which the wind speed increases at least 16 knots and is sustained at 22 knots or more for at least one minute.
- Squall line.** Any line or narrow band of organized, active thunderstorms.
- Stability.** Atmospheric resistance to vertical motion.
- Standard atmosphere.** A hypothetical vertical distribution of the atmospheric temperature, pressure, and density, which by international agreement is considered to be representative of the atmosphere for pressure-altimeter calibrations and other purposes (29.92INS or 1013hPa).
- Stationary front.** A front which is stationary or nearly so. A front which is moving at a speed of less than 5 kts.
- Stratosphere.** The atmospheric layer above the tropopause, having an average altitude of base and top of 7 and 22 miles respectively.
- Sublimation.** A change of state from ice to water vapor, by-passing the liquid state.
- Subsidence.** Widespread sinking of air in the atmosphere.
- Summation principle.** Used to evaluate sky cover, this principle states that the sky cover at any level is equal to the summation of the sky cover of the lowest layer plus the additional sky cover provided at all successively higher layers up to and including the layer being considered.
- Supercooled water.** Liquid water at subfreezing temperatures.
- Temperature.** The degree of hotness or coldness of a substance.
- Terrestrial radiation.** Heat radiated from the earth by outgoing radiation.
- Thermal current.** A relatively small-scale convective current rising from the ground. Produced from locally heated air near the earth's surface.
- Thunderstorm.** A local storm produced by a cumulonimbus (CB) cloud always accompanied by lightning and thunder, and usually associated with strong gusts, heavy rain, severe icing and turbulence, and sometimes hail.
- Tornado.** A violent, rotating column of air extending from a cumulonimbus cloud and touching the ground. It starts out as a funnel cloud and it generates a loud roaring noise and highly destructive winds.
- Tropics.** The area of the earth which lies between the Tropic of Cancer ( $23\frac{1}{2}^{\circ}$  N latitude) and the Tropic of Capricorn ( $23\frac{1}{2}^{\circ}$  S latitude).
- Tropical cyclone.** A general term for any low originating over tropical oceans.
- Tropical depression.** A tropical cyclone with maximum sustained winds of 33 kts or less.
- Tropical storm.** A tropical cyclone with maximum sustained winds between 34 to 63 kts.
- Tropopause.** The next layer above the troposphere, marking the boundary between the troposphere and the stratosphere.

**Troposphere.** The portion of the atmosphere from the earth's surface to the tropopause. The lowest 6-12 miles of atmosphere.

**Trough.** An elongated area of low pressure along a line called a "trough line."

**True altitude.** Actual altitude above mean sea level.

**Turbulence.** A condition of the atmosphere in which air currents vary greatly over short distances.

**Typhoon.** A severe tropical cyclone in the western Pacific; maximum sustained windspeed must be 64 kts or greater.

**Valley wind.** Warm air near the ground which rises out of a valley up a mountain slope during daytime.

**Vertical visibility.** A subjective or instrumental evaluation of the vertical distance into a surface-based obstruction that an observer would be able to see.

**Virga.** Visible wisps or strands of precipitation falling from clouds that evaporate before reaching the surface.

**Visibility.** The greatest horizontal distance selected objects can be seen and identified or its equivalent derived from instrumental measurements.

**Vortex wake turbulence.** Aircraft turbulence generated by an aircraft's passage through the atmosphere.

**Warm front.** The leading edge of an advancing warm air mass.

**Waterspout.** A tornado over water.

**Weather Flimsy.** Local weather briefing form used in lieu of DD Form 175-1. Most often used when several aircraft depart in the same time frame.

**Whiteout.** An optical phenomena in which the observer appears to be engulfed in a uniformly white glow.

**Wind.** Air in motion relative to the surface of the earth; generally used to denote horizontal movement.

**Wind chill.** See equivalent wind chill temperature.

**Wind shear.** A change in windspeed and/or direction, resulting in a tearing or shearing action.



—

—

—



---

For sale by the U.S. Government Printing Office  
Superintendent of Documents, Mail Stop: SSOP, Washington, DC 20402-9328  
ISBN 0-16-049015-4

