



**A LIFE CYCLE ASSESSMENT AND ECONOMIC  
ANALYSIS OF WIND TURBINES USING  
MONTE CARLO SIMULATION**

THESIS

Edward J. Liberman, Captain, USAF

AFIT/GEE/ENV/03-16

**DEPARTMENT OF THE AIR FORCE  
AIR UNIVERSITY**

**AIR FORCE INSTITUTE OF TECHNOLOGY**

---

---

**Wright-Patterson Air Force Base, Ohio**

APPROVED FOR PUBLIC RELEASE; DISTRIBUTION UNLIMITED.

The views expressed in this thesis are those of the author and do not reflect the official policy or position of the United States Air Force, Department of Defense, or the United States Government.

AFIT/GEE/ENV/03-16

A LIFE CYCLE ASSESSMENT AND ECONOMIC ANALYSIS OF WIND  
TURBINES USING MONTE CARLO SIMULATION

THESIS

Presented to the Faculty

Department of Systems and Engineering Management

Graduate School of Engineering and Management

Air Force Institute of Technology

Air University

Air Education and Training Command

In Partial Fulfillment of the Requirements for the  
Degree of Master of Science in Engineering and Environmental Management

Edward J. Liberman, BS

Captain, USAF

March 2003

APPROVED FOR PUBLIC RELEASE; DISTRIBUTION UNLIMITED.

A LIFE CYCLE ASSESSMENT AND ECONOMIC ANALYSIS OF WIND  
TURBINES USING MONTE CARLO SIMULATION

Edward J. Liberman, BS  
Captain, USAF

Approved:

// SIGNED //

4 Mar 03

---

Major Peter T. LaPuma, PhD  
Chairman, Advisory Committee

---

date

// SIGNED //

4 Mar 03

---

Lieutenant Colonel Alfred E. Thal, Jr., PhD  
Member, Advisory Committee

---

date

// SIGNED //

4 Mar 03

---

Dr. Charles A. Bleckmann  
Member, Advisory Committee

---

date

## **Acknowledgments**

I would like to express my sincere appreciation to my faculty advisor, Major Peter LaPuma, for his guidance, support, and encouragement throughout the course of this thesis endeavor. His enthusiasm and understanding are greatly appreciated. I would also like to thank my wife and children for their love and patience, and for the sacrifices that they made during my tour at AFIT. Most importantly, I would like to thank God for being my source of strength and for helping me persevere through the trials at AFIT.

Edward J. Liberman

## Table of Contents

	Page
Acknowledgments .....	iv
List of Figures .....	viii
List of Tables .....	x
Abstract .....	xi
I. Introduction .....	1
Problem Statement .....	1
Background .....	1
Air Emissions .....	3
Federal Government as an Electricity Consumer .....	4
Wind Energy .....	5
Life Cycle Assessment .....	8
Monte Carlo Simulation .....	9
Research Objectives .....	10
II. Literature Review .....	12
Introduction .....	12
Executive Guidance .....	12
Executive Order 13123 .....	12
National Energy Policy .....	13
Wind Turbine Technology .....	14
Review of Wind Energy Life Cycle Analyses .....	17
Energy Content and Emission Factors of Materials .....	19
Life Cycle Analysis Methods .....	21
Analysis Scope .....	24
Application of Monte Carlo Simulation to Wind Energy .....	25
III. Methodology .....	27
Overview .....	27
Scope of Analysis .....	29
Selected Wind Turbine Models: Assumptions and Data Collection .....	30
Meteorological Data Collection .....	32
Expected Energy Output .....	34
Wind Speed .....	35
Air Density .....	37

	Page
General Method for Assigning Probability Distributions .....	39
Life Cycle Cost Analysis .....	41
Electricity Prices .....	43
Wind Turbine Energy and Emissions Intensity .....	46
Process Analysis .....	47
Economic Input/Output Analysis .....	51
Raw Materials .....	53
Transportation .....	54
Construction .....	55
Overhead and Profit .....	56
Manufacturing .....	57
Calculating Energy Consumption and Indirect Emissions .....	57
 IV. Results and Analysis .....	 60
Data Interpretation .....	60
Wind Turbine Selection .....	60
Life Cycle Cost Analysis .....	63
Life Cycle Assessment Results .....	69
Energy Intensity .....	69
Emissions Analysis .....	72
Relative Impact of Life Cycle Stages .....	79
 V. Discussion .....	 81
Model Validation .....	83
Utility of the Model .....	85
Ideas for Further Research .....	86
Conclusion .....	88
 Appendix A. Data Excerpt from Lenzen and Munksgaard (2002) .....	 90
Appendix B. Computed Expected Annual Energy Output (MWh) .....	93
Appendix C. Average State Electricity Prices (cents/kWh) (2000) .....	102
Appendix D. Wind Turbine Mass Composition (excluding foundation) .....	103
Appendix E. Initial Economic Payback Output (yrs) for 24 Selected Sites .....	109
Appendix F. Economic Payback Results .....	113
Appendix G. Energy Intensity Results .....	119

	Page
Appendix H. CO <sub>2</sub> Intensity Results .....	125
Appendix I. SO <sub>x</sub> Intensity Results .....	131
Appendix J. NO <sub>x</sub> Intensity Results .....	137
Bibliography.....	143
Vita.....	149



## List of Figures

Figure	Page
1. U.S. Net Electricity Generation by Source, 2001 .....	2
2. Schematic of a Typical Wind Turbine .....	6
3. Growth of U.S. Installed Wind Capacity .....	7
4. Methodology Flow Diagram.....	27
5. Scope of Analysis Flow Diagram .....	29
6. Nordex N-60 Power Curve .....	34
7. Annual Electricity Price Decline.....	45
8. Cost Allocation for Economic I/O Analysis .....	52
9. Frequency Chart for Simple Economic Payback of the NM 48 Wind Turbine at Sioux Falls, SD.....	60
10. Economic Payback for 11 Wind Turbines at Sioux Falls, SD .....	61
11. Economic Payback at Selected Locations.....	64
12. Sensitivity Graph for Economic Payback.....	66
13. Scatterplot of Economic Payback vs. Expected Energy Output .....	68
14. Frequency Distribution for Economic Payback at Medford, OR.....	69
15. Energy Intensity at Selected Locations.....	70
16. Sensitivity Graph for Energy Intensity .....	72
17. CO <sub>2</sub> (eq) Intensity at Selected Locations .....	73
18. SO <sub>x</sub> Intensity at Selected Locations .....	74
19. NO <sub>x</sub> Intensity at Selected Locations .....	75
20. Sensitivity Graph for CO <sub>2</sub> (eq) Intensity.....	77

Figure	Page
21. Sensitivity Graph for SO <sub>x</sub> Intensity .....	77
22. Sensitivity Graph for NO <sub>x</sub> Intensity .....	78
23. Contribution of Life Stages to Energy Input and Emissions.....	80

## List of Tables

Table	Page
1. Wind Turbine Model Characteristics .....	31
2. Methodology for Assigning Probability Distributions.....	40
3. Assignment of Probability Distributions for Life Cycle Cost Analysis.....	42
4. Assignment of Probability Distributions for Process Analysis.....	49
5. Assignment of Probability Distributions for Economic I/O Analysis .....	52
6. Unit Prices for Wind Turbine Materials.....	53
7. Economic Input/Output Factors .....	59
8. Assignment of Life Cycle Stages to Economic Sectors.....	59
9. Comparison of LCA Results to Previous Studies .....	84

**Abstract**

The United States depends heavily on nonrenewable fossil fuels to generate electricity. Using renewable energy sources, such as wind, could reduce air emissions and fossil fuel dependency. Previous studies have examined the life cycle costs and environmental impacts of using wind to generate electricity, but results have varied due to inconsistent modeling assumptions. This research uses Monte Carlo simulation to conduct an economic payback analysis and life cycle assessment of 11 modern, utility-scale wind turbines. Hourly meteorological data was used to evaluate 239 U.S. locations. For each location, the wind turbine with the shortest median payback period was assumed to be the economically preferred turbine model.

This simulation demonstrates that variance in the model output is primarily caused by differences in location-specific climate data (wind speed, air density). Depending on the location, the median economic payback periods ranged from 2 to 132 years. 41% of the locations had median payback periods less than 10 years, and 63% less than 15 years. Considering a typical turbine lifespan of 15-30 years, wind turbines are not economically viable at all locations. At locations with favorable wind resources, wind turbines are likely to be superior to electricity production using natural gas or coal.

For the preferred wind turbine, the median life cycle energy intensities at all 239 locations ranged from 0.05-0.54 (KWh energy inputs/KWh outputs), compared to 2.3 for natural gas and 2.6-3.5 for coal-fired electricity generation. The median CO<sub>2</sub> (eq) intensity values range from 13-156 g-CO<sub>2</sub> (eq)/kWh for the preferred wind turbine, compared to 585 g-CO<sub>2</sub> (eq)/kWh for natural gas and 757-1042 g-CO<sub>2</sub> (eq)/kWh for coal-fired power plants. SO<sub>x</sub> and NO<sub>x</sub> intensity values range from 0.04-0.50 g-SO<sub>x</sub>/kWh and 0.05-0.66 g-NO<sub>x</sub>/kWh for the preferred wind turbine, compared to 0.32 g-SO<sub>x</sub>/kWh and 0.57 g-NO<sub>x</sub>/kWh for natural gas and 0.72-6.70 g-SO<sub>x</sub>/kWh and 0.54-3.35 g-NO<sub>x</sub>/kWh for coal power plants.

# A LIFE CYCLE ASSESSMENT AND ECONOMIC ANALYSIS OF WIND TURBINES USING MONTE CARLO SIMULATION

## **I. Introduction**

### **Problem Statement**

The United States (U.S.) largely depends upon nonrenewable fossil and nuclear fuels to generate electricity. To meet electricity needs and reduce dependence on nonrenewable fuels, technologies have been developed to harness the energy in renewable resources such as wind power. Previous studies have compared the life cycle impacts and cost of wind energy with traditional energy sources such as coal and natural gas. However, these studies have relied on point estimates (deterministic methods) that do not account for the variability or uncertainty in the estimates. The results of these previous studies vary considerably. Life cycle assessment and economic analysis using Monte Carlo simulation will provide a more comprehensive evaluation of wind energy by accounting for the variability in the estimates.

### **Background**

The annual consumption of energy resources in the United States is at an all-time high and is projected to increase through 2020. In 2001, the U.S. consumed 97.0 quadrillion British thermal units (BTUs) of energy (DOE, 2002a:5). Over 94% of the energy consumed was from nonrenewable fossil or nuclear energy. The U.S. Department of Energy (DoE) projects that between 2000 and 2020, consumption will increase at an

average 1.4% annually to 130.9 quadrillion BTUs in 2020 (DOE, 2001a:3). This is a 32% increase in primary energy consumption over 2000 levels.

The electricity generation sector consumed more energy than any other sector in the U.S. economy. In 2001, electricity generation accounted for 38.6 quadrillion BTUs, or 39.8% of the total U.S. energy consumption (DOE, 2002a:219). This constitutes a total net generation of 3,719 billion kilowatt-hours (kWh) of electricity, generated mostly by nonrenewable energy sources (DOE, 2002a:220). As seen in Figure 1, U.S. electricity generation relies heavily on coal, nuclear material, and natural gas as sources of fuel. Considering both utility and nonutility generation, nonrenewable sources (including nuclear) accounted for 92.3% of all electricity generated in the U.S. in 2001 (DOE, 2002a:224). Hydroelectric power accounted for 5.6%, and all other renewable sources accounted for only 2.1%.

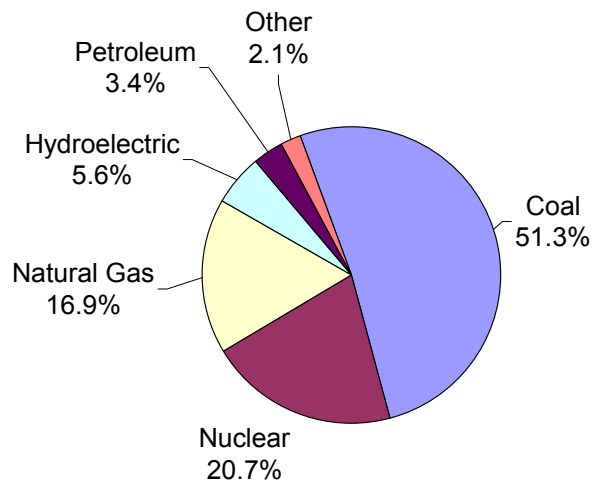

Figure 1. U.S. Net Electricity Generation by Source, 2001 (DOE, 2002a:224)

U.S. demand for electricity is projected to grow faster than that of overall energy demand. Electricity demand is projected to grow at an annual rate of 1.8% between 2000

and 2020 (DOE, 2001a:72). Much of this growth can be attributed to the increasing number of U.S. households, increased use of electric appliances, and general expansion of the economy (DOE, 2001a:72). This suggests that electricity generation will account for an increasingly larger percentage of national energy consumption in future years.

As electricity demand has grown, nonrenewable sources have accounted for most of the new capacity. In the year 2000, an additional 23,510 megawatts (MW) of generating capacity was added to the U.S. power grid. Nonrenewable sources accounted for 99.8% (23,470 MW) of this increase, while hydroelectric and other renewable sources contributed only 0.2% (40 MW) (DOE, 2001b:6-7). Natural gas alone accounted for 94.6% of the capacity increase. Over the next 20 years, nonrenewable fuels, predominantly natural gas and coal, are predicted to remain the primary energy sources for electricity generation (DOE, 2001a:73).

It is apparent that if current trends continue, the U.S. will remain reliant upon nonrenewable sources for future energy needs. The fact that these sources can be depleted over time emphasizes the need to develop sustainable sources to meet future energy demands. Wind power and other renewable sources have the potential to make a significant contribution to U.S. energy demands without increasing the use of nonrenewable resources.

### **Air Emissions**

Renewable resources will also reduce the quantity of pollutants emitted into the air per kilowatt-hour of electricity generated. The federal government regulates six air pollutants under the National Ambient Air Quality Standard program of the Clean Air

Act: sulfur dioxide (SO<sub>2</sub>), nitrogen dioxide (NO<sub>2</sub>), particulate matter, carbon monoxide (CO), ozone (O<sub>3</sub>), and lead (Pb). These pollutants are released in significant quantities during the combustion of fossil fuels and have a negative impact on public health, welfare, and the environment (Sullivan, 2001:194). Sulfur oxides (SO<sub>x</sub>) and nitrogen oxides (NO<sub>x</sub>) are known to cause “acid deposition.” NO<sub>x</sub> also increases ground level ozone concentrations, which can lead to upper respiratory disorders (De Nevers, 1995:456). This research will focus on SO<sub>x</sub> and NO<sub>x</sub> emissions because of these negative impacts and because they are emitted in large quantities from coal fired power plants.

Another environmental impact of concern is the release of carbon dioxide (CO<sub>2</sub>) during the combustion of fossil fuels. The atmospheric concentration of CO<sub>2</sub> has steadily increased over the past century and is thought to contribute to “global warming” (De Nevers, 1995:442-453). Other gases such as methane (CH<sub>4</sub>), nitrous oxide (N<sub>2</sub>O), and chlorofluorocarbons (CFCs) are released during industrial and commercial processes that support electricity generation. These gases, collectively referred to as “greenhouse gases,” have differing potential to contribute to global warming and are often expressed as an equivalent concentration of carbon dioxide (CO<sub>2</sub> (eq)).

### **Federal Government as an Electricity Consumer**

The federal government is a large energy consumer and has a major influence on energy management policy and the national energy market. In 2001, the federal government consumed 58.3 billion kilowatt-hours of electricity. The Department of Defense accounted for 30.8 billion kilowatt-hours, or 53% of federal electricity consumption (DOE, 2002a:28). As the nation’s largest energy consumer, the federal



government can promote the development of renewable energy technologies such as wind power by fostering an environment where renewable energy sources are competitive with traditional, nonrenewable sources.

## **Wind Energy**

Wind is a promising source of renewable energy that is relatively undeveloped in the U.S. Wind turbines capture the kinetic energy in wind 40-100 meters above ground. As wind passes by a turbine's blades, it produces aerodynamic lift, which turns a rotor. The rotor shaft is connected to an electric generator inside the nacelle, which generates electricity (Figure 2) (DWTMA, 2002).

The amount of energy available in wind for conversion to electricity depends upon the air density and wind speed. At higher elevations, wind is less influenced by the resistance caused by trees and other obstructions at ground level. As a result, wind speed generally increases with height above the ground. Therefore, taller wind turbines are able to produce a larger energy output (DWTMA, 2002). The actual amount of energy that a particular turbine is able to convert to electricity depends upon the turbine's hub height, the swept area of the turbine blades and the efficiency of the turbine.

Wind energy is largely untapped in the U.S. A 1993 study by the DoE estimates the total accessible wind resources in the U.S. to be 5,046 quadrillion BTUs (DOE, 1993:3). This represents the total amount of wind energy that could be accessed with 1993 wind technology, regardless of the cost to extract it. Compared to the 97 quadrillion BTUs of energy consumed by the U.S. in 2001, the accessible wind resources are roughly 50 times greater than U.S. annual energy consumption. Although these vast

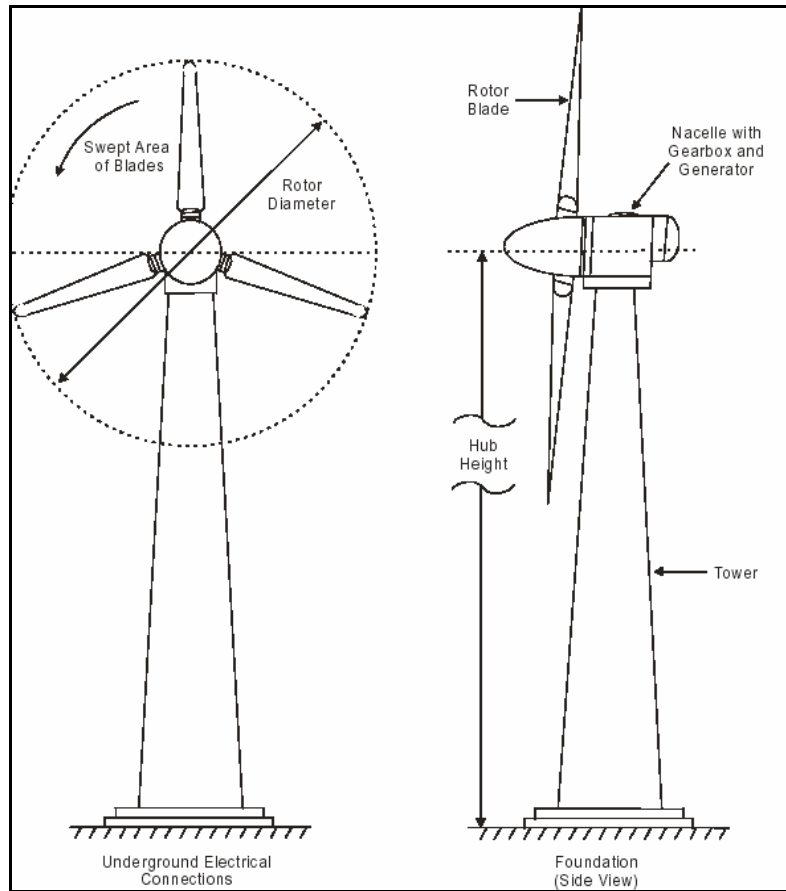

Figure 2. Schematic of a Typical Wind Turbine (DOE, 2001c:81)

resources are available, historically the cost of wind energy technology has limited its application and shifted the preference to less expensive fossil fuels and uranium (DOE, 1993:5). Actual U.S. wind energy production in 2001 was 0.059 quadrillion BTUs, representing only 0.0008% of the total energy produced in 2001 (DOE, 2002a:7).

The installed wind power capacity in the U.S. remained relatively constant throughout the early 1990s; however, in the past five years, a sizable growth has occurred. During the mid-1990s, the installed wind power capacity in the U.S. declined from 1,975 MW in 1991 to a low of 1,579 MW in 1997 (Figure 3) (DOE, 2001c:10;

AWEA, 2002:2). It was not until 1998 that a period of renewed wind energy development began. During the three years from 1998-2001, the net installed capacity increased 251% to 4,261 megawatts.

Renewed interest is due in part to an extension of the federal production tax credit. The production tax credit, which originally expired on June 30, 1999, provided a 1.5 cent/kWh tax credit for the first 10 years of renewable energy electricity projects operating by June 30, 1999. The tax credit was reinstated in December 1999 and provides the 1.5 cent/kWh tax credit for projects operating by the end of 2001. More importantly though, the cost to produce electricity by wind energy has declined to a point where it is more competitive with fossil fuel sources (DOE, 2001c:73).

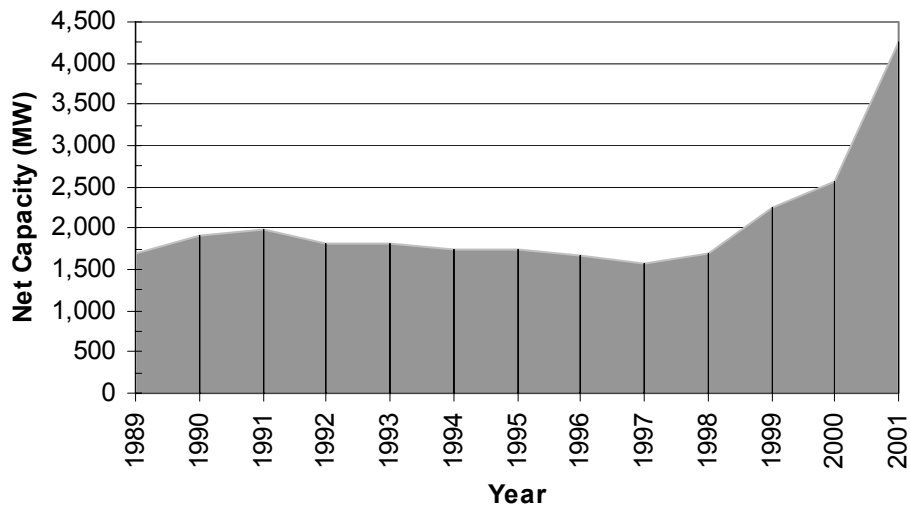

Figure 3. Growth of U.S. Installed Wind Capacity (DOE, 2001c:10; AWEA, 2002c:2)

Wind energy shows promise as an economically viable source of renewable energy. Since the 1980s, the cost of wind energy is reported to have dropped from approximately \$0.25 per kWh to \$0.04 - \$0.06 per kWh (Parsons, 1998:4). With

advances in turbine technology, modern wind turbines are able to capture a greater portion of the wind energy at lower costs. The current trend in turbine design is towards more efficient systems with larger power output (DOE, 2001c:78-83). Larger, more efficient systems are able to produce electricity at costs comparable to traditional fossil fuel sources over the life span of the system.

### **Life Cycle Assessment**

The life cycle assessment (LCA) is an environmental accounting tool that measures the inputs and outputs of a product, process, or activity (Aumonier, 1998:295). Inputs and outputs typically include energy, materials, and emissions into the environment. As defined by the U.S. Environmental Protection Agency,

LCA is a technique to assess the environmental aspects and potential impacts associated with a product, process, or service by compiling an inventory of relevant energy and material inputs and environmental releases; evaluating the potential environmental impacts associated with identified inputs and releases; and interpreting the results to help make a more informed decision (EPA and SAIC., 2002:4).

In the case of electricity production, primary energy and raw materials are inputs into the system and secondary energy (electricity in this case) and air emissions are outputs. The LCA differs from other analysis tools in that it evaluates the impacts of an alternative over its entire life cycle. This includes raw materials extraction, system manufacture, use, maintenance, and final disposal (EPA and SAIC, 2002:4-5). Rather than focusing on a single life stage, such as power plant operations, the entire life cycle is evaluated.

LCA is an appropriate tool for comparing the costs and benefits of different electricity generation alternatives (Aumonier, 1998:301). It can provide an energy manager or decision maker with insight about potential environmental impacts resulting

from a particular electricity-generating technology. More importantly, it provides a comprehensive picture of a decision's impacts that may extend beyond the boundaries of the decision maker (e.g., facility manager).

The LCA is not intended to be the sole source of information from which an energy decision should be made. Rather, it provides the decision maker with information that is not typically considered in an economic model. It presents a cradle-to-grave perspective of the environmental impacts of an alternative. When combined with economic and other considerations, it allows for a more informed decision to be made (Aumonier, 2002:302).

### **Monte Carlo Simulation**

LCAs have been conducted on wind turbines using deterministic methods that do not account for natural variability and uncertainty (henceforth the term variability will include uncertainty). Previous LCA results differ among studies, due primarily to inconsistent assumptions. This is often the case with deterministic methods, where only one value is selected for each input, resulting in a single value for each output. Because there is often variability associated with any input, the outputs are strongly influenced by the assumed value for each input. Because deterministic methods do not account for variability in input values, no insight is gained about the variability that may occur in output values. Monte Carlo simulation allows the assignment of a distribution of values for each input variable to account for the variability in each input.

Monte Carlo simulation allows a researcher to represent inputs into a spreadsheet model as variables with a range of possible values, rather than as single values. Each

variable is represented by a distribution type with a characteristic shape (such as a uniform, triangular or normal distribution), and in some cases minimum, maximum, and most likely values. During a Monte Carlo simulation run, the model randomly selects values for each input according to the specified probability distribution and computes an output. After several thousand runs are conducted, the range of possible outcomes for each output variable produces a frequency distribution (Crystal Ball, 2000:58-59,113).

Analysis using Monte Carlo simulation provides valuable insight that cannot be gleaned from deterministic methods. From the output frequency distribution, one can determine the range of possible outcomes of a model. More importantly, the probability of an outcome occurring within a specified range can be determined. Also, sensitivity analysis of the LCA model can identify the variables that most significantly impact the results.

### **Research Objectives**

Monte Carlo simulation will be used in this thesis to evaluate the life cycle energy and emissions, as well as the economic payback period, of modern utility-scale wind turbines. Specific research objectives are:

1. Conduct a life cycle cost analysis for wind turbines at various locations across the U.S. to determine the economic payback period for each location.
2. Conduct a life cycle energy analysis for each location to determine the energy intensity ( $\text{kWh}_{\text{in}}/\text{kWh}_{\text{out}}$ ) of each wind turbine model. The energy intensity is the energy inputs divided by the energy outputs over the life of the wind turbine.

Compare results to the energy intensity of coal and natural gas electricity generation.

3. Conduct a life cycle air emission analysis for CO<sub>2</sub> (equivalent), SO<sub>x</sub>, and NO<sub>x</sub> at each location, and compare results to the life cycle emissions intensity of coal and natural gas electricity generation.

## **II. Literature Review**

### **Introduction**

This literature review begins with a summary of the executive guidance that directs federal agencies to use renewable energy sources such as wind energy. This is followed by a discussion of the wide range of LCA results in previous wind energy studies. Lastly, it concludes with examples of how Monte Carlo simulation has been used in wind turbine research and how it can benefit the analysis of a wind turbine life cycle.

### **Executive Guidance**

Historically, the federal government has promoted renewable energy technologies by offering financial incentives, sponsoring research and development, and issuing regulatory mandates (DOE, 2001c:89-92). Executive Order (EO) 13123 and the National Energy Policy are two such mandates that promote renewable energy within federal agencies (Clinton, 1999; Bush, 2001).

#### ***Executive Order 13123***

On June 3, 1999, President Clinton issued Executive Order (EO) 13123, “Greening the Government Through Efficient Energy Management”. EO 13123 encourages the government to reduce energy costs, choose energy sources that are environmentally friendly, and conserve natural resources. To make progress in these areas, EO 13123 establishes seven goals for federal facilities. Two goals that apply



directly to this research are expanding the use of renewable energy and reducing energy-related greenhouse gas emissions.

EO 13123 directs federal agencies to implement renewable energy projects and to purchase electricity from renewable energy sources when it is cost-effective. Renewable energy is explicitly defined as energy produced by wind, solar, geothermal, or biomass power. To determine cost-effectiveness, EO 13123 repeatedly emphasizes the use of life cycle cost (LCC) analysis. LCC analysis accounts for the costs of investment, capital, installation/construction, energy, operations, maintenance, and disposal over the lifetime of a project. In applying the life cycle cost perspective, federal agencies should adopt renewable energy sources when they show the least overall cost to the government.

Additionally, EO 13123 directs federal agencies to purchase electricity from clean, high-efficiency technologies. Federal agencies should consider the emissions intensity of the generating source and seek to minimize the greenhouse gas intensity of purchased electricity (Clinton, 1999:30856). This implies the use of life cycle energy and emissions analysis. The electricity can either be purchased from a renewable source generator or produced by the federal agency. Regardless, federal agencies must consider both the economics of the source and its impact to the environment.

### ***National Energy Policy***

The National Energy Policy (NEP) encourages the use of sustainable energy sources such as wind power (Bush, 2001). According to the NEP, the U.S. lacks adequate infrastructure and production capacity to meet future energy needs. The U.S. must increase national energy supplies, but capacity must be added in ways that protect

and improve the environment. It is difficult to accomplish both a capacity increase and an emissions reduction using traditional fossil-fuel technologies. Since electricity production from fossil fuels is a significant source of air pollution, simply expanding the capacity of existing energy sources will likely increase the quantity of air emissions.

Wind power is a sustainable source of energy that meets the intent of the National Energy Policy—that is, a clean source of domestic energy. Wind power is abundant in the U.S. and has the potential to diversify our nation’s energy profile. Wind energy is sustainable in that it does not require significant use of nonrenewable energy during operation. As a result, wind power adds production capacity without the air emissions resulting from fossil fuel combustion.

### **Wind Turbine Technology**

The use of wind energy for grid-connected electricity generation gained attention in the U.S. in the late 1970s. Early wind turbines experienced relatively poor performance due to a number of technical problems, including blade failures and difficulties in regulating power output (Ackermann and Söder, 2002:72). However, as technological challenges were addressed, wind turbines became more reliable, efficient, and cost-effective. Since the 1970s, wind turbine technology has become increasingly more sophisticated. Over the past decade, wind technology has focused on increasing the electrical output and conversion efficiency of turbines while reducing the capital investment costs (Bourillon, 1999:951; Thresher, *et al.*, 2002).

One of the most noticeable developments in wind technology is the increasing amount of energy that can be captured by a single turbine. The power in wind is

proportional to air density, the rotor swept area, and the cube of the wind velocity  
(Ackermann and Söder, 2002:83):

$$\text{Power (watts)} = \frac{\rho A v^3}{2} \quad [1]$$

where:  $\rho$  = air density ( $\text{kg/m}^3$ )  
 $A$  = swept area of the wind turbine rotor ( $\text{m}^2$ )  
 $v$  = wind speed ( $\text{m/s}$ )

Turbines with a larger swept rotor area are able to capture considerably more energy than smaller units. Available energy also increases as wind speed increases. As mentioned earlier, wind speed generally increases with height above the ground. Therefore, wind turbines with a taller hub height (distance from ground to the rotor hub) are able to capture more energy than shorter units. Wind manufacturers have taken advantage of these relationships, and it is reflected in the development of wind turbines with taller hub heights and larger swept areas. As recently as 1992, a wind turbine with a capacity of 500 kW and a 37-m swept rotor diameter was considered state-of-the-art (Ackermann and Söder, 2002:70). By 2002, the capacity of the largest wind turbines had reached 2 MW, with rotor diameters of nearly 100 m. There are even 4-5 MW wind turbine prototypes under development.

At the component level, wind turbine technology has changed substantially over the past decade. Developments have occurred in blade design and manufacturing materials. Turbine blades are now typically made of lightweight plastic resins that are reinforced with fiberglass matting. This is generically referred to as glass fiber reinforced

plastic (GRP). GRP flexes to tolerate the stresses caused by wind turbulence, thus reducing the likelihood of blade failure (Baldwin, 2002:64).

Power control technologies have enhanced the amount of wind power that is converted to electricity. For example, stall and active stall technologies use the aerodynamic design of a turbine blade to prevent the rotor from “over-spinning” under high wind conditions. Where other wind turbines had to be stopped under these conditions, turbines using stall regulation can continue generating electricity near maximum capacity. Pitch regulation is another power regulation technology that performs a similar function. Pitch regulation allows the turbine blades to rotate in response to changing wind conditions. Under low wind conditions, the pitch can be adjusted to maximize contact area between the blade and the wind, so as to increase power capture. Under high wind conditions, the pitch can be adjusted to reduce contact area and prevent damage to the turbine (Thresher, *et al.*, 2002).

Also, wind turbine drive/generator combinations have been improved to allow for increased energy capture at moderate and low wind speeds. Generators with large power output, while able to produce more electricity, require higher wind speeds to rotate the drive shaft and begin generation. Consequently, the generator has a higher “start-up” speed and is unable to produce electricity in low wind conditions. Smaller generators require less torque on the drive shaft to begin generating and have lower start-up speeds. As a result, wind turbines with smaller generators are more suited for lower wind profiles. These developments reflect a trend towards specializing wind turbines for high or low wind profiles.

## **Review of Wind Energy Life Cycle Assessments**

Since the early 1980s, more than 70 LCAs have been conducted on wind turbines. Previous studies exhibit notable differences, including the design and rated output of wind turbines studied, the life cycle methodology employed, and the resulting conclusions about wind energy. These studies used deterministic methods where single values were chosen for inputs. For example, the input energy required to extract and refine steel has typically been selected as a discrete value. In reality, the input energy varies depending on the method of refinement (i.e., electric arc furnace or blast furnace), the type of steel product (i.e., plate steel versus rebar or galvanized coil), and the country of manufacture. This variability has led to energy input values in previous studies that range from 20.7 to 55 megajoules per kilogram of steel (MJ/kg) (Schleisner, 2000:281; Voorspools, *et al.*, 2000:311). Assuming discrete values for other parameters, such as the lifespan of a wind turbine, air emissions from various life stages, and apportionment of life cycle costs, also contributed to variability in the results of previous studies.

Lenzen and Munksgaard (2002) presented a comprehensive analysis of 72 life cycle assessments conducted on wind energy between 1977 and 2001. They identify the primary causes of variability in life cycle input energy and CO<sub>2</sub> (eq) emissions from wind energy LCAs. Their data reveals that the results from wind turbine LCAs vary significantly (Appendix A). Turbine rated capacities range from 0.3 to 6,600 kW. Hub heights range from 11.6 m to 100 m. Basic turbine designs include two and three-blade rotors, upwind and downwind configurations, and onshore and offshore installation. Rotor diameter, expected lifespan, and the assumed load factor are other factors that varied.

The LCA analysis method and the study scope also caused considerable differences among the studies. For example, 40 of 72 studies used process analysis methods, while the remaining 32 used input/output techniques or variations thereof. (These methods are discussed briefly in the “Life Cycle Analysis Methods” section of this chapter.) Regarding the scope of analysis, some studies adopted very narrow scopes, focusing only on specific stages of a turbine life cycle, such as manufacturing. Others considered the entire life cycle, from raw material extraction to turbine recycling.

In these studies, energy intensity is defined as the amount of input energy consumed over the life cycle of a wind turbine per unit of electrical output ( $\text{kWh}_{\text{in}}/\text{kWh}_{\text{out}}$ ). Likewise,  $\text{CO}_2$  (eq) intensity is the amount of  $\text{CO}_2$  (eq) emitted over the life cycle of a wind turbine per unit of electrical output ( $\text{g-CO}_2$  (eq)/ $\text{kWh}_{\text{out}}$ ). The values of energy intensity in past studies ranged from 0.014 to 1.016  $\text{kWh}_{\text{in}}/\text{kWh}_{\text{out}}$ , and the values for  $\text{CO}_2$  intensity ranged from 7.9 to 123.7  $\text{g-CO}_2$  (eq)/ $\text{kWh}_{\text{out}}$ . These ranges, spanning nearly two orders of magnitude, reflect the variability in LCA results and illustrate the impact of using discrete values for inputs.

To investigate the causes of this variance, Lenzen and Munksgaard (2002) analyzed the intensity values using statistical regression. They observed considerable scatter within the data, and deduced that the scatter is primarily caused by three factors:

1. Values of input energy and emissions assumed for each material
2. Use of process analysis verses input/output methods
3. Analysis scope (the specific life cycle stages that were analyzed)

These factors and their impact on output variability are discussed in more detail.

## **Energy Content and Emission Factors of Materials**

The energy content and emission factors of materials used to construct wind turbines can greatly affect the energy and emissions intensity of wind power. Energy inputs are needed for the extraction and refining of raw materials and manufacture of wind turbine components. These energy inputs are referred to as “embodied energy,” or “indirect energy,” because they do not directly contribute to electricity generation by a wind turbine. In contrast, the energy in wind that is captured by a wind turbine is a direct energy source because it contributes directly to electricity generation. Other life cycle phases of a wind turbine, such as transportation and construction, will also produce CO<sub>2</sub> (eq), sulfur oxides (SO<sub>x</sub>), and nitrous oxides (NO<sub>x</sub>), among other regulated air pollutants. These are referred to as “indirect emissions,” as they are emitted during the non-operational life cycle stages of the wind turbine.

A wide range of values for material energy content and emission factors has been used in previous LCAs. For example, in summarizing the values from eleven studies, Lenzen and Munksgaard (2002:353) found that a wide range of values has been used for the energy content of copper. The values averaged 86.2 megajoules of input energy per kilogram of copper produced (MJ/kg); however, the standard deviation of these values is 65.5. This suggests that a range of energy content values from 20.7-151.7 MJ/kg copper represents one standard deviation from the average. Wide ranges were also found for the energy content of steel, concrete, and GRP.

The input energy and indirect emissions of a wind turbine depend largely on its material composition, the country in which it is manufactured, and recycling of materials (Norton, 1999:7). Modern wind turbines consist predominantly of steel, concrete, and

glass fiber reinforced plastic (Schleisner, 2000:284), although other materials are present in relatively smaller quantities. Most of the material mass used in a wind turbine is found in the tower and foundation. Turbine towers are almost exclusively constructed of steel, although there is some limited use of concrete towers (Lenzen and Munksgaard, 2002:349). Foundations are typically reinforced concrete, and account for the majority of the mass of a wind turbine. Lenzen and Munksgaard (2002:353) indicate the tower accounts for 23.3% of the total turbine mass (on average). The foundation may account for nearly three times as much, or 60.3% of the total mass (on average). Because steel and concrete account for such a large portion of the mass, selecting discrete values for the energy content and emission factors of these materials can lead to significant variances in the results of an LCA.

Assumptions about the recycling of materials can also affect LCA results. Recycling can impact input energy and indirect emissions at either end of the life cycle: during raw materials extraction/refining or during wind turbine decommissioning. The use of recycled materials in turbine manufacturing results in less input energy and emissions because the energy consumed and emissions resulting from the recycled material are less than that of virgin material. Likewise, recycling material at the end of the wind turbine's life cycle reduces the amount of input energy and emissions resulting from future use of the material. If applied as a credit to LCA results, this can save a substantial amount of input energy and avoid associated air emissions. Given a scenario where wind turbine materials are recycled to the maximum extent practical, recycling can result in avoiding nearly 20% of the life cycle energy input of a wind turbine (Krohn, 1997:6). Lenzen and Munksgaard (2002:351) also report that recycling 75-100% of the



material in a wind turbine can result in an energy savings of 12.5-31.9% of the total input energy requirement. Previous studies assume varying degrees of recycling, and consequently energy intensities vary. This study assumes no recycling, which presents a worst-case scenario for wind power (from an energy-intensity perspective).

### **Life Cycle Analysis Methods**

Just as the energy content and emissions factors for materials are sources of output variability, the method of analysis can also result in output variability. There are two primary methods for conducting LCAs: process analysis (PA) and input-output (I/O) analysis. Both techniques have been applied in wind energy LCAs, and as shown by Lenzen and Munksgaard (2002:342-345), previous studies are split almost evenly between the two methods. Although both methods are valid, each has inherent differences and drawbacks that can affect the life cycle energy and emissions balance of a wind turbine.

PA is a bottom-up approach to account for the embodied energy and emissions in materials (Voorspools, *et al.*, 2000:309-310). Using PA, each material in a wind turbine is traced back to its manufacturing process. The energy input required to produce each material and the emissions resulting from the production are assessed. The mass of each material is then multiplied by the appropriate energy and emission factor. In the final life cycle assessment, the energy consumed and emissions resulting from each material are summed over the entire turbine system.

PA is a practical method that allows a researcher to analyze specific systems based on the materials unique to the system. Nevertheless, it has shortcomings that must

be recognized. PA estimates the direct energy requirements and emissions from the production of basic materials; however, the PA method is complicated by boundary truncation decisions due to system complexity (Lenzen and Dey, 2000:577-578). Boundary truncation occurs when the entire life cycle is not analyzed, resulting in an incomplete LCA. For example, higher-order processes such as transportation or engineering services that support the turbine manufacture are excluded. As a result, values of energy and emissions intensity calculated using PA are typically smaller than values calculated using I/O analysis (Lenzen and Dey, 2000:584).

I/O analysis differs from PA in that it is a top-down approach. I/O analysis is a macro-economic method that assesses the economic inputs and environmental emissions of an entire sector of the economy (Norton, 1999:7; Lenzen and Dey, 2000:578). National input-output tables are compiled by relating the energy use and emissions resulting from a sector of the economy to the monetary value of products developed in that sector. In this manner, the life cycle energy and emissions of a wind turbine can be calculated by equating the monetary value added during a life cycle stage to the energy and emissions of a particular economic sector. For example, the NO<sub>x</sub> emissions resulting from wind turbine transport can be identified by determining the monetary value of transporting the turbine and multiplying this cost by the NO<sub>x</sub> emissions per dollar value (NO<sub>x</sub>/\$) of the U.S. transportation economic sector.

I/O analysis is more comprehensive than PA, which evaluates only the raw material inputs to a product. I/O includes the impacts from higher order activities such as management, transportation and construction. This broader analysis leads to a more consistent definition of the system boundary (Joshi, 2000:97). However, I/O analysis is

subject to several limitations, the most recognized of which is the lack of detail and specificity (Lenzen and Dey, 2000:578). Because I/O analysis considers each economic sector as a whole, it assumes each sector produces one “average” product (Proops, *et al.*, 1996:230). In reality, each sector encompasses several products, different quality grades of each product, and differently priced products. For example, the price difference between two automobiles may be large (i.e., Ford Taurus vs. Porsche), but the emissions resulting from manufacturing the cars may be similar. Additionally, input-output tables are restricted to a limited number of economic sectors (Voorspools, *et al.*, 2000:314). For instance, the U.S. Department of Commerce input-output tables divide the U.S. economy into 485 sectors. The wind turbine industry is not included in the I/O tables; therefore, it is necessary to allocate the various costs of producing wind turbines to other similar economic sectors.

Because of the inherent limitations of PA and I/O analysis, Lenzen and Munksgaard (2002:340) advocate the use of a hybrid analysis technique. A hybrid technique integrates the two methods by filling the “gaps” in PA data with data from I/O analysis. Treloar, *et al.*, (2000:8) propose a hybrid LCA methodology such that the most significant life cycle pathways are extracted from an I/O analysis and substituted with system-specific data derived via PA. In effect, the hybrid technique is a process analysis assessment where higher-order processes are estimated from input-output tables. The use of hybrid techniques in wind energy assessments allows specific wind turbines to be assessed while maintaining a broad system boundary.

## Analysis Scope

Aside from the boundary truncation that may occur with PA, boundary truncation may also occur when a researcher selects a narrow scope of study. This presents another source of variability between the results of previous LCA/LCC studies. In this context, scope refers to the definition of specific life cycle stages that are included or excluded from an LCA (SETAC, 1999:5). The scope of a wind turbine LCA may include all life stages from cradle to grave, or it may be streamlined to include select stages that require the greatest energy input or cause the greatest air emissions.

From Lenzen and Munksgaard's (2002:342-345) data, there is significant variance in the selected LCA scope. From the 72 life cycle assessments identified, Lenzen and Munksgaard identified eight unique life stages. However, the percentage of studies that consider each life stage varies considerably. As shown below, all 72 studies consider wind turbine manufacture but only 2 of the 72 studies consider engineering or business management.

- 100 % - Manufacture: raw material extraction/refining, component production and assembly
- 69 % - Construction: site preparation, foundation and erecting the wind turbine
- 56 % - Operation maintenance and repair of the wind turbine
- 38 % - Transportation from the manufacturing plant to the wind farm site
- 22 % - Connection to the local power grid
- 19 % - Decommissioning of the wind turbine
- 3 % - Engineering: design, research, and development
- 3 % - Business management: planning, financial, and administrative requirements

According to the Society of Environmental Toxicology and Chemistry, LCAs should initially consider all life stages of a system under study. This is necessary to gain a system-wide perspective and to assess the numerous materials and processes that

impact a product. Under certain circumstances, it is appropriate to “streamline” an assessment by reducing the scope. Life stages should be eliminated only when they are inconsistent with the goals of the study or when the impact of their energy and emissions becomes insignificant (SETAC, 1999:8-9).

In the case of wind energy LCAs, there is significant variation among study scopes to conclude that a commonly accepted scope has not been found. This variation can lead to differing energy intensity and air emission results. Logically, a broad scope considers more life cycle impacts than a narrow scope. A broad scope results in a more comprehensive assessment of the energy input requirements and air emissions resulting from a wind turbine. Therefore, to gain the most complete understanding possible of the life cycle impacts of a wind turbine, it is appropriate to adopt a broad scope of analysis.

In summary, Lenzen and Munksgaard (2002:340) and Treloar, *et al.*, (2000:8) propose the use of a hybrid analysis technique. Additionally, SETAC’s (1999:8-9) guidelines recommend adopting a broad scope of study in which all life cycle stages are initially considered. These recommendations serve as the basis for an assessment technique in this study.

### **Application of Monte Carlo Simulation to Wind Energy**

Current literature reveals that material energy content and emissions factors, the life cycle assessment method, and the analysis scope are significant sources of variance in wind energy LCAs. This variance makes data interpretation difficult. Using a probabilistic analysis technique such as Monte Carlo simulation accounts for the variability that exists in model parameters. Monte Carlo simulation allows factors such

as the energy content and emissions of wind turbine materials to be assigned probability distributions. As a result, model output consists of a range of values and associated probabilities of occurrence, rather than single values obtained by deterministic methods.

Monte Carlo simulation has been used extensively in many fields of study, including finance, physics, environmental risk, and energy systems research. A limited number of wind turbine studies have applied Monte Carlo techniques to account for variability of the wind resource and uncertainty associated with system reliability and energy conversion efficiency. Desrochers et al. (1986:51-53) used Monte Carlo techniques to generate hourly wind speed and load values from constructed distributions, thus simulating the hour-by-hour operations of a wind energy system (Desrochers, *et al.*, 1986:50). Crosby (1987:330) used Monte Carlo simulation to randomly select wind turbine design variables such as the number of turbines in a cluster, blade diameter, tower height, and turbine spacing (Crosby, 1987:335).

Monte Carlo simulation has been used in a limited capacity for wind research. It has been used to optimize the design of wind turbines and the placement of turbines in wind farms. Many studies have focused on the life cycle energy, emissions, and economics of wind turbines; however, Monte Carlo simulation has not been applied in an LCA/LCC analysis to date. Wind turbine LCAs can benefit from the use of Monte Carlo simulation by accounting for the variability and uncertainty that occurs in model inputs. Factors that exhibit a wide range of possible values, such as the energy content and emission factors of materials, can be assessed in a probabilistic manner. Likewise, the uncertainty in factors such as the lifespan of a wind turbine can be addressed using these techniques.

### III. Methodology

#### Overview

This thesis evaluates the life cycle costs, energy intensity, and emissions intensity of eleven modern, utility-scale wind turbines at 239 locations across the United States and its territories (Guam and Puerto Rico). Monte Carlo simulation will be used to accomplish the analysis. A flow diagram (Figure 4) displays the methodology used to develop the simulation model. On the diagram, boxes represent collected data; unshaded ovals represent intermediate calculations; shaded ovals represent model output. Dashed

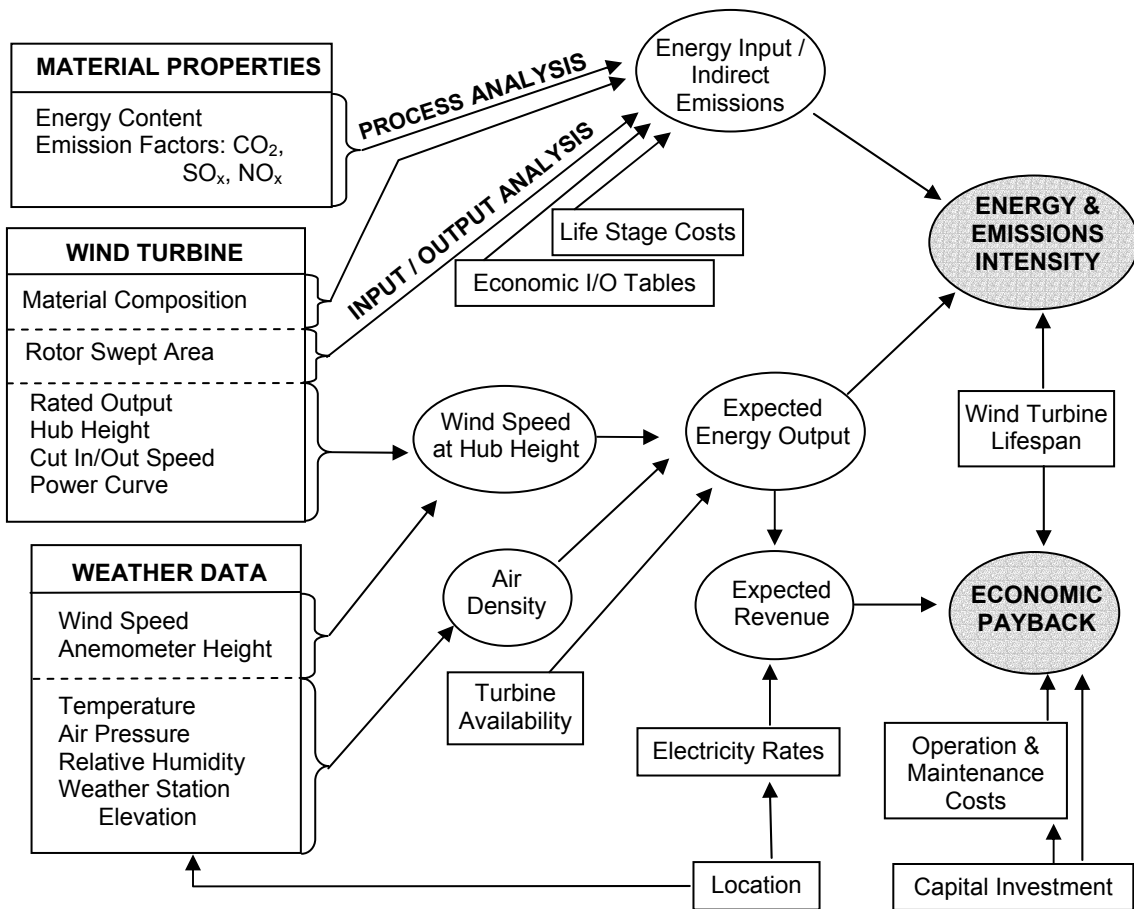

Figure 4. Methodology Flow Diagram

lines are used to group collected data according to intermediate calculation inputs.

Initial data collection includes historical weather data for each location and model-specific wind turbine characteristics. Wind speed is calculated at the wind turbine hub height, and air density is calculated at the site elevation. These values are calculated for each hour of a typical year at a given location. The wind speed for each hour is related to power output using the turbine power curve. Hourly power output values are then summed over the year, resulting in the expected annual energy output for each wind turbine at each location. Expected annual energy output values and economic inputs such as location-specific electricity costs are used to calculate the economic payback for each turbine model. The wind turbine model with the shortest economic payback is selected as the preferred model at a given location.

Once the economically-preferred model is selected for each location, the PA and I/O methods are used to determine the distributions of life cycle energy intensity, CO<sub>2</sub> intensity, SO<sub>x</sub> intensity, and NO<sub>x</sub> intensity. The PA method requires collecting values of material-specific energy content and emission factors, and assessing the material mass composition of the wind turbine. The I/O method is used to determine the values of energy input and emissions for higher-order life stages. This requires assessing the costs associated with various life cycle stages and applying the costs to economic input-output tables in order to derive the resulting energy inputs and emissions. The distributions of energy and emissions intensity values are calculated for each location by summing the energy inputs and air emissions over all life stages included in the study scope. These



results are displayed on a per-kWh output basis and compared against a baseline of coal and natural gas electricity generation.

### Scope of Analysis

To obtain the most holistic life cycle assessment of wind energy, a broad scope of analysis was adopted. Nine life cycle stages of a wind turbine were identified, as shown in Figure 5. Those stages that are addressed in this analysis are represented as shaded boxes. Grid connection was excluded from the analysis because at a given location the need to connect the generator to the local power grid is the same, regardless of the type of electricity generation technology used at the power plant. Therefore, when comparing energy sources, excluding the grid connection stage does not affect the relative energy inputs and air emissions. Additionally, grid connection requirements are dependent upon

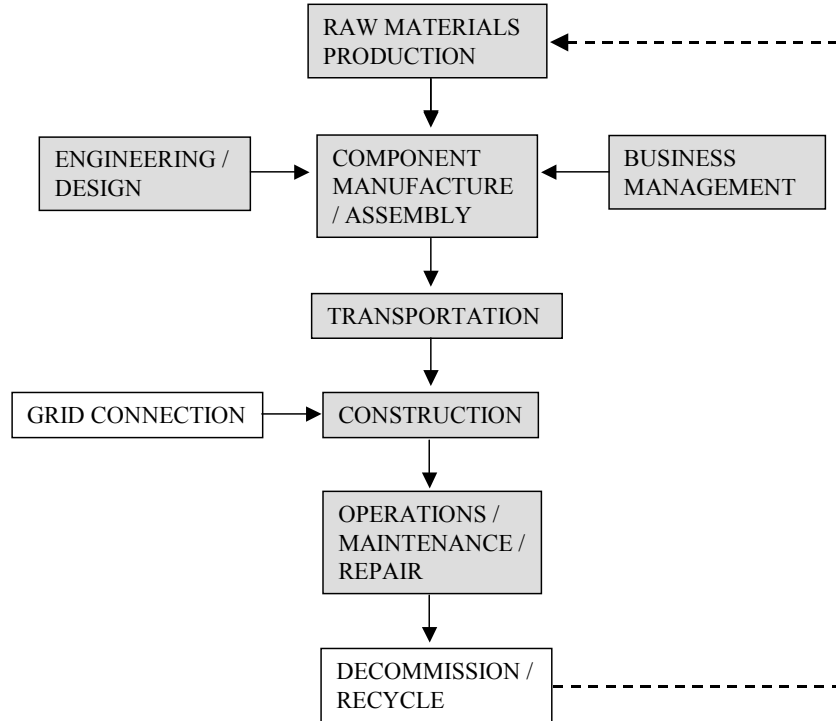

Figure 5. Scope of Analysis Flow Diagram

the proximity of the generator to the local power grid and the availability of a nearby power substation, which is driven by many site-specific factors such as aesthetics, terrain, land ownership, etc. This introduces many external factors that are not impacted by the type of electricity generation system. Therefore, grid connection is excluded from the model scope in accordance with the SETAC (1999) guidelines for LCA streamlining.

Wind turbine decommissioning and recycling are also excluded from the analysis model. Although previous studies identified recycling as a factor that significantly affects the energy and emissions intensity of a wind turbine (Krohn, 1997:6; Lenzen and Munksgaard, 2002:351), there is insufficient data on the feasibility or practicality of recycling wind turbine materials. Therefore, this study assumes no recycling of wind turbine materials at the end of its life cycle. In effect, no energy or emission reductions gained from recycling are applied to the energy and emissions intensities calculated in this study. Generally, if recycled materials are used to manufacture a turbine or any turbine materials are recycled, the emissions and energy consumption will likely be reduced.

### **Selected Wind Turbine Models: Assumptions and Data Collection**

The focus of this study is utility-scale, on-shore wind turbines that are offered for purchase in the U.S. Utility-scale turbines, typically used at large-scale wind farms, are generally regarded as turbines with a rated capacity of 500 kW or higher. On-shore applications were selected since they represent nearly all wind turbine applications in the U.S. This study also assumes that a wind turbine is operated as a single unit, as opposed

to part of a wind farm with multiple turbines. This avoids the added complexity introduced when wind turbines are subject to wake effects caused in a wind farm.

Four major manufacturers were identified that sell utility-scale wind turbines in the U.S.: GE Wind, NEG-Micon, Nordex, and Vestas. Each manufacturer was contacted and requested to provide turbine-specific design and cost information. Table 1 provides

Mfg.	Model*	Rated Power Output (kW)	Hub Height (m)	Rotor Diameter (m)	Rotor Swept Area (m <sup>2</sup> )	Cut-in Wind Speed (m/s)	Cut-out Wind Speed (m/s)
NEG-Micon	NM 48	750	55	48.2	1,824	4	25
	NM 52 (49)	900	49	52.2	2,140	3.5	25
	NM 52 (72.3)	900	72.3	52.2	2,140	3.5	25
	NM 54	950	72.3	54.5	2,333	3.5	25
	NM72C (70)	1,500	70	72	4,072	4	25
	NM72C (80)	1,500	80	72	4,072	4	25
NORDEX	N-60 (46)	1,300	46	60	2,828	3 - 4	25
	N-60 (60)	1,300	60	60	2,828	3 - 4	25
	N-60 (80)	1,300	80	60	2,828	3 - 4	25
	N-62 (60)	1,300	60	62	3,020	3 - 4	25
	N-62 (69)	1,300	69	62	3,020	3 - 4	25
Vestas	V47-660 (48)	660	48	47	1,735	~ 4	25
	V47-660 (50)	660	50	47	1,735	~ 4	25
	V80-1.8 (67)	1,800	67	80	5,027	~ 4	25
	V80-1.8 (78)	1,800	78	80	5,027	~ 4	25
GE Wind Energy**	750i	750	55/65	46	1,662	4.5	29
		750	55/65	48	1,810	3.5	29
		750	55/65	50	1,963	3	29
	900	900	60/70	52	2,124	3	25
	900 s	900	60/70	55	2,376	3	25
	900 sl	900	60/70	57	2,552	3	25
	1.5 s	1,500	65-100	70.5	3,902	3	25
1.5 sl	1,500	65-100	77	4,657	3	20	
* models where multiple tower heights are available are considered separate models in this analysis; hub heights are indicated in parentheses ** multiple rotor/tower combinations offered							

Table 1. Wind Turbine Model Characteristics

details about the wind turbine models on which information was requested. NEG-Micon and Nordex provided information with sufficient detail to develop the spreadsheet model. GE Wind and Vestas responded; however, their information lacked sufficient detail to be included in this study.

All turbines analyzed were 3-blade, horizontal-axis, up-wind rotors with tubular steel towers. This configuration currently dominates the utility-scale turbine market. Other configurations (horizontal-axis, downwind rotors and vertical-axis rotors) and tower designs (concrete pillar and steel lattice) are mentioned in the literature and are used in small-scale wind applications, but they are not offered in the U.S. by the four manufacturers contacted.

### **Meteorological Data Collection**

Estimating the wind resource at a location requires either having data on meteorological conditions at each location or assuming a wind speed profile. Since the power in wind is proportional to the cube of the wind speed (equation 1), slight changes in wind speed can greatly affect the power that is available to a wind turbine for capture. (Ackermann and Söder, 2002:83):

$$\text{Power (watts)} = \frac{\rho A v^3}{2} \quad [1]$$

where:  $\rho$  = air density ( $\text{kg/m}^3$ )  
 $A$  = swept area of the wind turbine rotor ( $\text{m}^2$ )  
 $v$  = wind speed ( $\text{m/s}$ )

Many wind studies assume a probability distribution (eg., Weibull distribution) for wind in a given area to compute power output. In this research, hourly meteorological data at

each location is used because it more accurately reflects the natural variability of the wind speed fluctuations in a given area.

Hourly meteorological data for each of the 239 locations was collected from the Typical Meteorological Year 2 (TMY) data set produced by the National Renewable Energy Laboratory (NREL, 1995). The TMY data set consists of hourly values of meteorological conditions such as temperature, wind speed, barometric pressure, and relative humidity, which were collected at National Weather Service (NWS) monitoring stations. The data set considers weather observations at each location for a 30-year period (1961-1990) and compiles this data into a “typical meteorological year” (TMY) for each location (NREL, 1995:1-6).

A TMY represents hourly weather conditions that are deemed most typical for a location during a 1-year period. In developing the TMY data set, each calendar month was reviewed independently to determine the most typical weather patterns. For example, the data for all 30 January months was reviewed, and the hourly measurements for the most typical January were selected to be included in the TMY. This process was repeated for all months to form a complete TMY for each location.

The TMY data set contains weather data at a given location for all 8,760 hours in a typical year. This captures not only hourly variability in weather conditions, such as wind speed, humidity, and barometric pressure, but it also captures diurnal and seasonal patterns (Justus, 1978:9-18). Extreme weather patterns, which are rare, are not represented in the TMY. This more closely reflects expected wind energy at a given location.

## Expected Energy Output

The expected energy output of a wind turbine at a given wind speed is obtained from the manufacturer's power curve. A power curve relates the wind speed at hub height to the expected power output of the wind turbine. Power curves are specific to a particular wind turbine model and account for the design and power conversion efficiency of the turbine. In this study, power output computations were done by correlating each hourly wind speed value with the corresponding power output for the turbine. For example, Figure 6 displays the power curve provided for the Nordex N-60 turbine. If on Jan 1 at 01:00 the wind speed is 6 m/s, the expected power output at 6 m/s for this wind turbine is 131 kW. Therefore, the energy output for that hour is 131 kilowatt-hours (kWh). Then, if the wind speed at 02:00 changes to 8 m/s, the energy output is 376 kWh. The energy output for all 8,760 hours of the TMY is then summed to

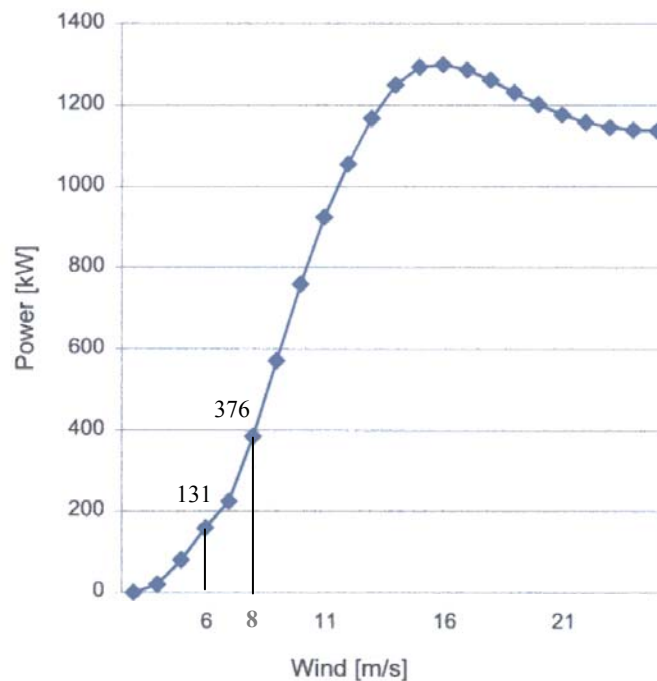

Figure 6. Nordex N-60 Power Curve

compute the expected annual energy output for a given turbine model in a given location.

Using the power curve to determine expected power output, it is assumed that the wind turbine rotor is facing directly into the wind at all times. Most modern wind turbines incorporate a yaw mechanism that continuously adjusts the rotor position so it is facing into the wind. This allows the greatest area of contact between the wind and the blade surface. Although instantaneous changes in the wind direction will result in less than optimal rotor positioning, it is believed these effects are relatively small. To obtain the expected power output from the power curve, it is necessary to calculate the hourly wind speed at the wind turbine hub height and the air density. These calculations are explained in further detail in the following discussion.

### ***Wind Speed***

To calculate the wind speed at hub height, it is necessary to address the effects of wind shear. Wind shear is the decrease in wind speed near ground level that is caused by friction between wind and terrain. As a result, wind speed generally increases with height above ground level. Accounting for the effects of wind shear requires knowing the anemometer height at which the TMY wind speed measurements were taken, the wind turbine hub height, and an approximation of surface roughness conditions for each site.

Over the 30-year period that is used to compile the TMY data there are often changes in anemometer heights at NWS stations. This is due to changing anemometer technologies and revised NWS standards for anemometer height and placement. Changery (1978) provides a historical account of changes in anemometer height at U.S.

weather monitoring stations from the 1900s thru 1978. During the early 1960s, many monitoring stations had anemometers positioned to measure wind speed 6-7 meters above ground. In the mid 1980s, Twidell and Weir (1986:231) note that it was common for meteorological wind speed measurements to be taken at a height of 10 m. Since slight changes in elevation above ground (3-4 m change) have little impact on the adjusted wind speed, the anemometer height is assumed to be a constant 8.5 m above ground (halfway between 7 and 10 m) for all 239 locations.

Wind speed at hub height is calculated using the power law equation (Johnson, 1985:49):

$$v(h_2) \cong v(h_1) \cdot \left( \frac{h_2}{h_1} \right)^\alpha \quad [2]$$

where:  $h_1$  = anemometer height (m)  
 $h_2$  = wind turbine hub height (m)  
 $v(h_1)$  = wind speed at anemometer height (m/s)  
 $v(h_2)$  = wind speed at hub height (m/s)  
 $\alpha$  = power law exponent

The power law exponent ( $\alpha$ ) is empirically derived and accounts for the surface roughness at a location. It has been observed that  $\alpha$  varies with parameters such as elevation, time of day, season, nature of the terrain, wind speed, and temperature (Manwell *et al.*, 2002:45). From measurements around the world, it has been found that  $\alpha$  is highly variable, but on average equals 1/7. Thus the power law is sometimes referred to as the 1/7<sup>th</sup> power law. Although the power law is not a theoretically exact calculation of the effects of wind shear, literature indicates that it yields satisfactory results. In general,  $\alpha = 1/7$  is acceptable for sites with low surface roughness or when no other site-specific data is available (Johnson, 1985:49; Johansson *et al.*, 1993:127; Twidell and



Weir, 1986:231-2). Since NWS monitoring stations are typically located in open areas with few obstructions and smooth terrain,  $\alpha = 1/7$  is assumed to be an acceptable approximation for this research. This also points out that surface roughness is an important parameter in site selection of wind farms. Fewer obstructions or less surface roughness are desirable to maximize wind energy at a given location.

### ***Air Density***

Manufacturers typically develop power curves for application at mean sea level with a standard air density of  $1.225 \text{ kg/m}^3$ . Because air density differs with site elevation and meteorological conditions, it is necessary to correct the expected power output from the power curve for differences in air density. Air density is calculated for each hourly interval of the TMY using the ideal gas law (De Nevers, 1995:78; Johnson, 1985:25):

$$\rho = \frac{M \cdot P}{1000 \cdot R \cdot T} = \frac{M \cdot P}{8.314 T} \quad [3]$$

where:  $\rho$  = air density ( $\text{kg/m}^3$ )  
 $M$  = molecular weight of air ( $\text{g/mol}$ )  
 $P$  = atmospheric pressure ( $\text{kPa}$ )  
 $T$  = Temperature ( $\text{K}$ )  
 $R \equiv$  Universal Gas Constant =  $\left( 0.008314 \frac{\text{m}^3 \cdot \text{kPa}}{\text{mol} \cdot \text{K}} \right)$

Equation 3 assumes air is a perfect gas with a molecular weight of  $28.964 \text{ g/mol}$ . To account for the effects of water content in air on air density, De Nevers (1995:79) cites a correction to the calculation of the molecular weight of air:

$$M_{\text{avg}} \approx 28.964 - 0.253 (\text{RH}) \quad [4]$$

where:  $M_{avg}$  = average molecular weight of air (g/mol)  
 RH = relative humidity, expressed as a decimal

Combining these equations, the air density can be calculated as follows:

$$\rho \cong \frac{[28.964 - 0.253 (RH)] P}{8.314 \cdot T} \quad [5]$$

Equation 5 is used to calculate the air density at the point of measurement, which is near ground level. Although there are minor differences between the air density near ground level and at hub height (46-80 m), the differences are insignificant in comparison to the other parameters. This calculation accounts for the majority of the difference between the air density at mean sea level (standard conditions) and at each location.

Equation 1, which defined the power in wind, can be adapted to define the power captured by a wind turbine by incorporating the turbine coefficient of performance,  $C_p$ .  $C_p$  reflects the energy conversion efficiency of a wind turbine and varies based on the specific wind turbine model and the wind speed. From the resulting relationship (equation 6), it is apparent that air density is linearly proportional to the power captured by a turbine (Twidell and Weir, 1986:204):

$$P_T = C_P A \cdot \frac{\rho \cdot v^3}{2} \quad [6]$$

where:  $P_T$  = Power extracted by a wind turbine (watts)  
 $C_P$  = Coefficient of performance (unitless)  
 $A$  = Swept area of the wind turbine rotor ( $m^2$ )  
 $\rho$  = air density ( $kg/m^3$ )  
 $v$  = wind speed at hub height (m/s)

Therefore, the power output extracted from the power curve is proportionally scaled to the calculated hourly air density at each location. This is accomplished for each hourly observation by applying equation 7:

$$P_{Adj} = \frac{P_T \cdot \rho}{\rho_{Std}} \quad [7]$$

where:  $P_{Adj}$  = Expected hourly power output (kW), adjusted for air density  
 $P_T$  = Power Output (kW), obtained from power curve  
 $\rho$  = air density ( $\text{kg}/\text{m}^3$ ), calculated for each hourly observation  
 $\rho_{Std}$  = air density at standard conditions ( $1.225 \text{ kg}/\text{m}^3$ )

Since the adjusted power output (kW) is calculated at hourly intervals, the calculated value also equals the expected hourly energy output (kWh). As a result, the expected annual energy output can be calculated by summing the hourly power output values over the 8,760 hourly observations in the TMY. Appendix B lists the calculated values of the expected annual energy output used in the life cycle cost, energy, and emissions analysis.

### **General Method for Assigning Probability Distributions**

The general methodology shown in Table 2 was developed to guide the process of assigning probability distributions to inputs used in the Monte Carlo simulation.

Depending upon the number of data points collected and the confidence in the data, a distribution was assigned to each input variable. Although this methodology is somewhat subjective, it provides a guide to assign probability distributions to variables in the Monte Carlo simulation model.

In instances where one data point was collected, a uniform distribution was applied. By using the uniform distribution, each value in the range of possible values

Number of Data Points	Level of Confidence	Distribution	Method of Assigning Distribution
1	High	Uniform	Value $\pm$ 10%
	Medium	Uniform	Value $\pm$ 25%
2	High or Medium	Uniform	High/low values form endpoints
3	High or Medium	Triangular	High/low values form endpoints; middle value is the peak
>3	High or Medium	Uniform	High/low values form endpoints; no apparent density
	High or Medium	Triangular	High/low values form endpoints; center of density is the peak

Table 2. Methodology for Assigning Probability Distributions

receives an equal probability of occurrence between a minimum and maximum value.

The minimum and maximum endpoints were either  $\pm$  10% or  $\pm$  25% depending on the degree of confidence in the data. A uniform distribution was also applied when two data points were collected. The two points were assumed to be the minimum and maximum endpoints and all values between are given an equal probability of occurrence.

When three data points were collected, the triangular distribution was applied. Using the triangular distribution, the minimum and maximum values are the endpoints, and the middle data point is the “peak” of the triangle. Rather than assigning an equal probability of occurrence to all values between the minimum and maximum, the triangular distribution places a heavier emphasis on values near the peak data point and less emphasis near the end points.

To assign a distribution to an input with more than three data points, a judgment was made based on the scatter of the data points. If the data points were spread evenly over the range or displayed no apparent patterns or areas of density, a uniform distribution was applied. If there appeared to be a grouping of data points, the grouped

values were averaged to determine the peak value of the triangular distribution. In either case, the lowest and highest values were assigned as the minimum and maximum endpoints for the distribution.

### **Life Cycle Cost Analysis**

LCC analysis focuses on the costs incurred during the lifespan of a wind turbine and estimates the economic payback period, or the time needed to payback the investment. Payback considers the initial capital investment to purchase and install a wind turbine, the annual operating expenses, and revenue received from the sale of the electricity generated. It does not consider the impact of financial arrangements or other business investments. To calculate payback and circumvent the complexities added from the time-value of money, all expenses and revenue are expressed in nominal 2000 dollars. Data is gathered from recent literature and wind turbine manufacturers. Probability distributions are then assigned to model parameters. Table 3 lists these parameters and the associated probability distributions used in the Monte Carlo simulation of life cycle costs.

Capital investment and annual operating expenses are assessed directly from available literature and product information. Capital investment is typically expressed as a cost per kW of installed generating capacity. A rough estimate for the cost of a wind turbine is \$1,000 per kilowatt installed, so a 1.5 MW wind turbine would cost roughly \$1,500,000. In this manner, the capital investment cost for a particular wind turbine is determined by multiplying the capital investment rate (\$/kW) by the wind turbine rated capacity (kW). In this model, the capital investment rate is given a triangular distribution











Parameter	Assumed Distribution		Ref.
Power Curve Deviation (%)		Mean = 0.00 Std dev = 2.00	c,n
Turbine Availability (%)		Min = 95.75 Peak = 97.83 Max = 100.00	n
Wind Turbine Life (years)		Min = 15.0 Peak = 22.5 Max = 30.0	b,i,k,l,m,o,p,q, r,s,u
Annual Electricity Price Decline (%)		Min = 0.07 Max = 0.53	d
Electricity Price (\$/kWh)		Min, Peak, & Max values are state-dependent	e,j
Capital Investment Rate (\$/kW installed)		Min = 765 Peak = 1000 Max = 1250	a,g,h,i,n,t,u
Annual O&M Expense (% of capital invested)		Min = 1.0 Max = 2.5	a,f,i,l,m,n,s,u
 Normal Distribution  Triangular Distribution  Uniform Distribution			
a (Bourillon, 1999:950)	h (AWEA, 2002b)	o (Nadal and Girardin, 2001:88)	
b (AWEA, 2002a)	i (El-Kordy et al., 2002:321)	p (Nomura et al., 2001:216)	
c (DWTMA, 2002)	j (EIA, 2002)	q (Norton, 1999:8)	
d (DOE, 2001a:7,153)	k (Kemmoku et al., 2002:16)	r (Schleisner, 2000:285-286)	
e (DOE, 2002b:12)	l (Krawiec, 1981:73)	s (Tande, 1995:634)	
f (DOE, 2001c:86)	m (Krohn, 1997:2)	t (Wieland, 2002)	
g (Derrick, 2002)	n (Michaelsen, 2002)	u (NWCC, 1997)	

Table 3. Assignment of Probability Distributions for Life Cycle Cost Analysis

with a peak at \$1000/kW and the end points being \$765/kW to \$1250/kW to account for variability caused by installation complexity, design differences, etc. In a similar manner, the annual operating and maintenance (O&M) expense (\$/yr) is expressed as a percentage of the capital investment cost (uniform distribution from 1-2.5%). For example, if during one iteration the simulation selects a capital investment rate of \$1,100/kW for the 1.5 MW turbine and 2% for the annual O&M expense, the capital costs would be \$1.65 million (1,500 kW \* \$1,100/kW) and the O&M expenses would be \$33,000/yr (2% \* \$1.65 million).

To calculate the annual revenue from the sale of electricity, it is necessary to adjust the annual energy output for minor deviations. The actual power output from a wind turbine may deviate from the power curve by as much as  $\pm 5\%$  due to short-term variability in the wind (i.e. gusts of wind) (Michaelson, 2002). Under “gusty” conditions, some wind energy is absorbed by flexure in the rotor blades, which results in more or less power output than that anticipated from the power curve. Because power curves are developed from or validated with empirical data, it is believed a normal distribution represents deviations from the power curve expected values more accurately than the triangular distribution. To account for this source of variability, the expected annual power output is multiplied by a power curve deviation factor (normal distribution, mean = 0%, std dev = 2%). A standard deviation of 2% results in a probability distribution that spans approximately  $\pm 5\%$  from the power curve value.

To calculate annual revenue, it is also necessary to adjust the annual energy output for turbine down-time. The wind turbine may be off-line as much as 5% of the time for routine or unscheduled maintenance and repair. Therefore, the amount of time the turbine is operating and generating electricity ranges from 95% to nearly 100%. To account for turbine availability, the expected annual energy output is multiplied by a turbine availability correction factor, which is the fraction of time the turbine is operational (triangular distribution, 95.75% to 100%, peak = 97.8%).

### ***Electricity Prices***

Annual revenue is calculated by multiplying the adjusted annual energy output of each turbine by the average price of electricity in a particular U.S. state. Since electricity

prices tend to fluctuate and are to some degree location-dependent, they will be assigned a triangular probability distribution. Electricity price data are obtained from the Energy Information Administration historical data website (EIA, 2002) and *Electric Sales and Revenue 2000* (DOE, 2002b:12). Values are displayed in Appendix C. The annual average revenue per kWh of electricity sold in a state in 2000 is the peak value. The endpoint values of the triangular distribution are represented by the minimum and maximum values of the monthly average revenue per kWh electricity sold in 2000. Minimum and maximum monthly averages were used to dampen the more extreme daily shifts in electricity prices but still estimate price volatility for a given state.

Because the wind turbine lifespan is assumed to be 15 to 30 years in this model, it is necessary to address the change in electricity prices over time. The Department of Energy projects that between 2000 and 2020, U.S. electricity prices (expressed in nominal 2000 dollars) will decline on average 0.3% annually (DOE, 2001a:7,153). This represents the DoE's reference case for annual price decline. Under scenarios of high or low economic growth, the actual annual price decline may range from 0.07-0.53% (2000 baseline). Due to the uncertainty associated with predicting future electricity prices, annual electricity price decline is assigned a uniform probability distribution from 0.07% to 0.53%. The effect of the annual electricity price decline is illustrated in the following example.

Given a hypothetical scenario where the electricity price in a given state is \$0.10/kWh in 2000 (Figure 7), the price at the end of a 30-year lifespan could decline to \$0.085-\$0.098/kWh (nominal 2000 dollars), based on a 0.07%-0.53% annual price decline. Of course, these are just estimates and the actual price of electricity averaged



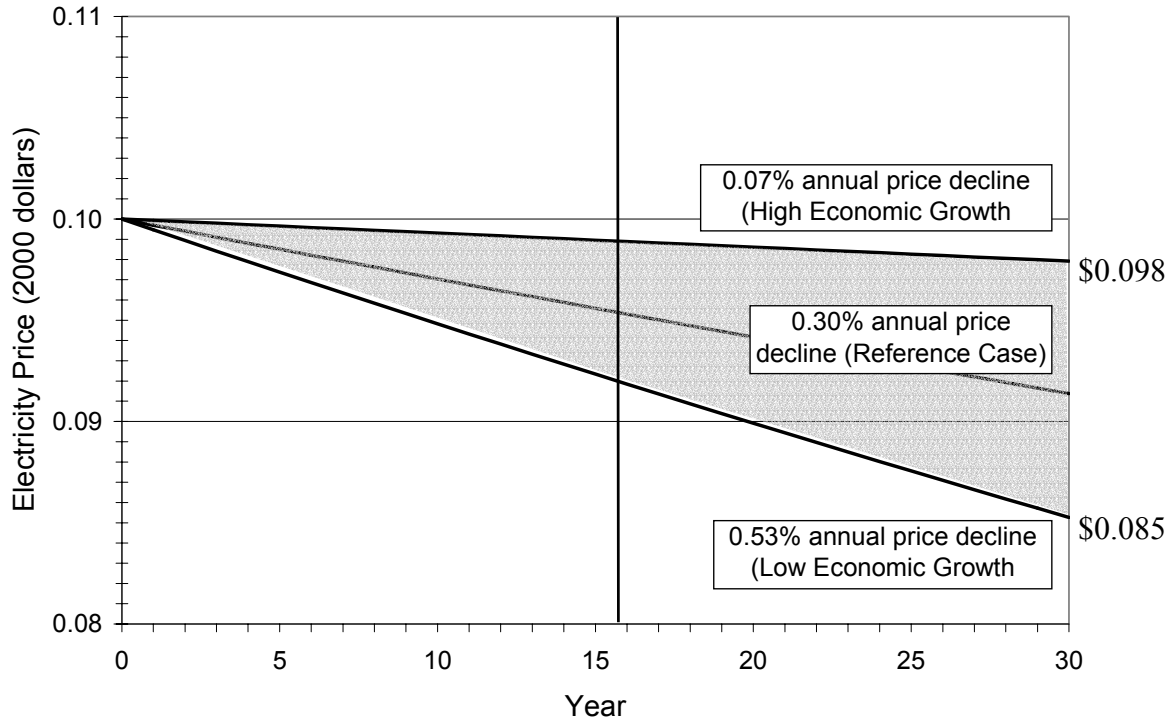

Figure 7. Annual Electricity Price Decline (DOE, 2001a:7,153)

over the next 15-30 years could be much higher. In that case, the annual revenue would increase and the payback for an installed wind turbine would decrease proportionally.

To correct for the decline in electricity prices, the minimum, peak, and maximum values of the state electricity price distribution are corrected as follows:

$$AP = IP \cdot (1 - DCF)^{(1/2) \cdot LS} \quad [7]$$

where: AP = Adjusted Price (\$/kWh)(in 2000 dollars)  
 IP = Initial Price (\$/kWh)(in 2000 dollars)  
 DCF = Declination Correction Factor (%)  
 LS = Wind Turbine Lifespan (years)

Since the price decline over the turbine lifespan is roughly linear, the price at 1/2 the wind turbine lifespan is used as an average price to calculate annual revenue. The adjusted

prices (minimum, peak, and maximum) form the triangular distribution from which Monte Carlo simulation selects a state-specific electricity price. For example, assume the “most likely” price in a given state is \$0.10/kWh and the minimum and maximum are \$0.09/kWh and \$0.13/kWh, respectively. If the Monte Carlo simulation selects an annual price decline of 0.3% and a lifespan of 30 years, the assumed price distribution after 15 years is \$0.086/kWh, \$0.096/kWh, and \$0.124/kWh (minimum, peak, and maximum values, respectively).

Given the previous calculations of capital investment cost, annual operating expense, and annual revenue, the simple economic payback is calculated:

$$\text{Payback} = \frac{\text{Cap Inv}}{(\text{Revenue} - \text{O\&M})} \quad [8]$$

where: Payback = economic payback (years)  
 Cap Inv = capital investment (\$)  
 Revenue = annual revenue (\$/yr)  
 O&M = annual operations & maintenance expense (\$/yr)

As previously mentioned, economic payback is used to select the most advantageous wind turbine model for each location. The model with the shortest median payback period is assumed to be the most advantageous.

### **Wind Turbine Energy and Emissions Intensity**

Energy and emissions intensity relate the environmental impacts of a wind turbine to the electricity generated over its lifespan. The energy and emissions intensity of the economically-preferred wind turbine model is calculated for each location using equations 9 and 10:

$$\text{Energy Intensity} = \frac{\text{Total Input Energy (kWh)}}{\text{Lifetime Electricity Production (kWh)}} \quad [9]$$

$$\text{Emissions Intensity} = \frac{\text{Total Indirect Emissions (g)}}{\text{Lifetime Electricity Production (kWh)}} \quad [10]$$

In equation 10, “total indirect emissions” refers to CO<sub>2</sub> (eq), SO<sub>x</sub>, or NO<sub>x</sub> emissions.

Values for total input energy and total indirect emissions are calculated for each life stage using PA and I/O analysis and are then summed for all life stages. Energy and emissions intensity values provide a basis for comparing wind turbines to other sources of electricity generation such as coal and natural gas. Energy sources that exhibit smaller energy and emissions intensity values are considered more favorable from an environmental impact perspective.

### **Process Analysis**

Process Analysis is conducted to determine the input energy consumed and the indirect emissions resulting from the production of raw materials used in a wind turbine. Data required to perform the analysis includes a material mass composition of each wind turbine under study and energy content and emission factors for each material. Mass composition data was obtained from NEG-Micon and Nordex for each wind turbine. The most prevalent materials (excluding concrete for the foundation) are steel and GRP. Copper and oil products are found in relatively small amounts. Appendix D lists the material composition of each turbine. Excluding the material in the turbine foundation, steel comprises 79.2-88.2% of the mass in the eleven turbines analyzed. Glass fiber-

reinforced plastic comprises 10.3-18.0% of the turbine mass, followed by copper and oil products, which together account for only 1.5-2.8%.

From literature and discussions with turbine manufacturers, it was determined that the mass of concrete and steel rebar used in a foundation can vary significantly based on soil conditions at a particular site and foundation design preferences. Because of the uncertainty in these factors, historical project records and general design guidelines were used to assign probability distributions. Concrete was assigned a uniform distribution from 100-600 metric tons (mt). This represents the maximum and minimum mass of concrete actually used for the foundation of a single wind turbine in previous installations. The mass of steel rebar used in the foundation is represented by a concrete-to-rebar ratio. From a review of previous wind turbine applications, the mass of concrete ranges from 21.8 to 41.5 times the mass of rebar. Therefore, the concrete-to-rebar ratio is assigned a uniform distribution from 21.8 to 41.5.

Data for the energy content and emission factors of the five primary materials (steel, GRP, concrete, copper, and oil products) was gathered, and probability distributions were assigned based on the general methodology discussed earlier. The distribution assigned to the CO<sub>2</sub> (eq) emission factor for concrete is an exception to the general methodology. Four data points were gathered for the CO<sub>2</sub> (eq) emission factor for concrete; three were relatively close in value (150, 180, and 200 g-CO<sub>2</sub> (eq)/kg) and the fourth was significantly larger (835 g-CO<sub>2</sub> (eq)/kg). The three smallest values were assigned a uniform distribution, tapering toward the maximum value. This assigns the greatest probability of occurrence and an equal probability of occurrence to values between 150 and 200 g-CO<sub>2</sub> (eq)/kg. The assigned distributions are listed in Table 4.

Given the mass of each material and the energy content and emission factors, the input energy and indirect emissions are calculated for each material in the wind turbine:

$$\text{Energy} = \text{Mass} \cdot \text{Energy Content} \quad [11]$$

$$\text{Emissions} = \text{Mass} \cdot \text{Emission Factor} \quad [12]$$

where:

- Energy = Energy input to manufacture the raw material (MJ)
- Mass = Mass of the material (kg)
- Energy Content = input energy content of the material (MJ/kg)
- Emissions = Indirect emissions (CO<sub>2</sub> (eq), SO<sub>x</sub>, or NO<sub>x</sub>) resulting from production of the raw material (g pollutant)
- Emission Factor = indirect emissions resulting from raw material extraction/refining per unit mass (g pollutant / kg material)

The total input energy and emissions resulting from the manufacture of raw materials can then be summed over all materials in the turbine.







Matl.	Parameter	Assigned Distribution	Ref.
Steel	Energy Content (MJ/kg)		Min = 5.00 Peak = 30.00 Max = 55.30 a,b,c, e,f,h
	CO <sub>2</sub> Emissions Factor (g-CO <sub>2</sub> (eq)/kg)		Min = 153 Peak = 2,500 Max = 7,000 a,b,d, e,f,h
	SO <sub>x</sub> Emissions Factor (g-SO <sub>x</sub> /kg)		Min = 0.34 Max = 17.00 e,f
	NO <sub>x</sub> Emissions Factor (g-NO <sub>x</sub> /kg)		Min = 0.53 Max = 11.00 e,f
Glass Fiber Reinforced Plastic (GRP)	Energy Content (MJ/kg)		Min = 24.50 Max = 106.00 a,b,c, f,h
	CO <sub>2</sub> Emissions Factor (g-CO <sub>2</sub> (eq)/kg)		Min = 1,500 Peak = 3,000 Max = 4,000 a,b,d, f,h
	SO <sub>x</sub> Emissions Factor (g-SO <sub>x</sub> /kg)		Min = 17.18 Max = 28.64 f
	NO <sub>x</sub> Emissions Factor (g-NO <sub>x</sub> /kg)		Min = 11.03 Max = 18.39 f

Table 4. Assignment of Probability Distributions for Process Analysis







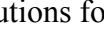











Concrete	Energy Content (MJ/kg)		Min = 1.30 Peak = 3.00 Max = 5.10	a,c,f, h
	CO <sub>2</sub> Emissions Factor (g-CO <sub>2</sub> (eq)/kg)		Min = 150 Middle = 200 Max = 835	a,d,f, h
	SO <sub>x</sub> Emissions Factor (g-SO <sub>x</sub> /kg)		Min = 0.01 Max = 0.60	f
	NO <sub>x</sub> Emissions Factor (g-NO <sub>x</sub> /kg)		Min = 2.14 Max = 3.56	f
	Mass of concrete in foundation (mt)		Min = 100 Max = 600	i
	Concrete-to-rebar ratio		Min = 21.8 Max = 41.5	i
Copper	Energy Content (MJ/kg)		Min = 20.70 Peak = 85.00 Max = 151.70	a,b,c, f,h
	CO <sub>2</sub> Emissions Factor (g-CO <sub>2</sub> (eq)/kg)		Min = 5,000 Peak = 6,329 Max = 8,983	a,b,d, f,h
	SO <sub>x</sub> Emissions Factor (g-SO <sub>x</sub> /kg)		Min = 26.71 Max = 44.51	f
	NO <sub>x</sub> Emissions Factor (g-NO <sub>x</sub> /kg)		Min = 17.39 Max = 28.99	f
Oil Products	Energy Content (MJ/kg)		Min = 8.22 Max = 10.04	g
	CO <sub>2</sub> Emissions Factor (g-CO <sub>2</sub> (eq)/kg)		Min = 1,300 Max = 1,588	g
	SO <sub>x</sub> Emissions Factor (g-SO <sub>x</sub> /kg)		Min = 11.52 Max = 14.08	g
	NO <sub>x</sub> Emissions Factor (g-NO <sub>x</sub> /kg)		Min = 3.15 Max = 3.85	g
 Triangular Distribution  Uniform (2 data points)				
 Uniform (1 data point +/- 25%)  Uniform (1 data point +/- 10%)				
 Uniform/Triangular				
a (Blanchard and Reppe, 1998:12-13) b (Kemmoku, et al., 2002:16-17) c (Lenzen and Munksgaard, 2002:353) d (Norton, 1999:7) e (Price, 2002)		f (Schleisner, 2000:281-282) g (Sheehan, et al., 1998:208-238) h (Voorspools, et al., 2000:311) i Assessed from review of previous wind turbine applications		

Table 4 (cont.). Assignment of Probability Distributions for Process Analysis

## **Economic Input/Output Analysis**

Economic I/O analysis is performed to quantify the life cycle energy and emissions of higher-order wind turbine life cycle stages. To conduct this analysis, the Economic Input-Output Life Cycle Assessment (EIOLCA) model is used. The EIOLCA model, developed by the Green Design Initiative at Carnegie Mellon University, relates the value of products in each of 485 U.S. commodity sectors to the environmental impacts of the sector (CMU-GDI, 2002). Environmental impacts include the emissions of CO<sub>2</sub> (eq), SO<sub>x</sub> and NO<sub>x</sub>, and the energy consumed by each sector. An underlying premise of the EIOLCA model is that economic sectors vary in their energy and emissions intensity.

To apply the EIOLCA model, it is necessary to apportion the capital investment cost of a wind turbine to its various cost components. The capital investment cost was determined to consist of the following major components:

- Manufacturing
- Raw materials
- Transportation
- Construction
- Overhead
- Profit

Profit is not associated with a life stage, but it is deemed a significant cost that must be considered in the model. Each of these components is needed to estimate the energy and emissions from higher order processes in the I/O analysis. Manufacturing costs are the most difficult to estimate, therefore the remaining unallocated capital investment cost is assigned to manufacturing (Figure 8).

The capital investment cost breakdown for each major component is based on probability distributions shown in Table 5. Once determined, each component cost is multiplied by an economic input/output factor to determine the energy consumption and

emissions resulting from that component. A discussion of the development of the major cost components and economic input/output factors follows.

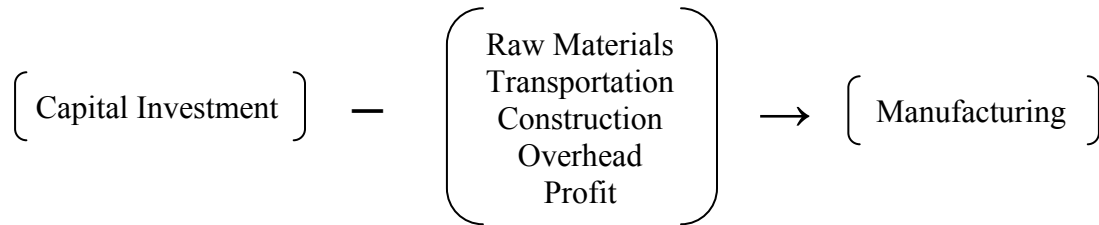

Figure 8. Cost Allocation for Economic I/O Analysis

Parameter	Assumed Distribution		Ref.
Cost of Glassfiber-Reinforced Plastic (\$/mt)	■	Min = 1,900 Max = 3,100	b,e
Cost of Concrete (\$/mt)	■	Min = 44 Max = 53	h
Cost of Transportation (% of capital investment)	■	Min = 5.0 Max = 12.0	d,l
Cost of Foundation Construction (% of capital investment)	■	Min = 5.0 Max = 9.0	c
Cost of Erecting/Commissioning (\$/m <sup>2</sup> swept area)	■	Min = 10 Max = 20	c
Cost of Engineering/Planning (% of capital investment)	■	Min = 4.0 Max = 6.0	c
Gross Profit Margin (% of capital investment)	■	Min = 5.0 Max = 15.0	a,f,g,j
■ Uniform Distribution (2 data points)			
a (Bonus, 2002)	f (NEG-Micon, 2003:3)		
b (Cairns and Skramstad, 2000:1-2)	g (Nordex, 2003:2)		
c (Harrison, et al., 2000:126-129,156-163)	h (RS Means, 2002:111)		
d (Lenzen and Munksgaard, 2002:350)	l (Wieland, 2002)		
e (Mandall, et al., 2002:43)	j (Vestas, 2003:9)		

Table 5. Assignment of Probability Distributions for Economic I/O Analysis



### ***Raw Materials***

To determine the major cost components, the cost of the raw materials used in a wind turbine is subtracted from the capital investment costs. The raw material costs are computed by multiplying the mass of each material by an assumed unit price. Unit prices are listed in Table 6. Costs for steel, copper, and oil products are obtained from U.S. Census Bureau reports on manufacturing sectors (DOC, 2000:6-2,7,35,36; DOC, 2001:159). Turbine data provided by the manufacturers had sufficient detail to differentiate the mass of individual steel components. Therefore, to account for the variability in steel products and prices, the mass of steel in each turbine is further divided into steel castings, plate, and wire rods. This assumes that the turbine tower consists of plate steel, the foundation rebar is wire rod, and the remaining steel components in the nacelle are cast steel. Values for steel, copper, and oil products are obtained by dividing total U.S. shipments of each material by the total value of these shipments. Thus, the unit prices for steel, copper, and oil products represent national averages.

<b>Material</b>	<b>Price/Unit (\$/mt)</b>	<b>Year of Estimate</b>	<b>[Ref]</b>
Copper and copper-base alloy	\$ 6,340	1998	b
Steel castings	\$ 2,196	1998	b
Carbon steel, plate, cut lengths	\$ 488	1998	b
Carbon steel, wire rods	\$ 387	1998	b
Lubricating oils	\$ 340	1997	c
GRP*	\$ 1900-3100	2001	a,d
Concrete*	\$ 44-53	2002	e
* Uniform distribution assigned to unit price			
a (Cairns and Skramstad, 2000:1-2)			
b (DOC, 2000:6-2,7,35,36)			
c (DOC, 2001:159)			
d (Mandall, Samborsky, and Cairns, 2002:43)			
e (RS Means, 2002:111)			

Table 6. Unit Prices for Wind Turbine Materials

Unlike unit prices for steel, copper, and oil, the unit prices of concrete and GRP are assigned probability distributions to reflect variability in the material composition. Because concrete mixes vary in their compressive strength, the unit price of concrete is assigned a uniform probability distribution from \$44-\$53/mt (RS Means, 2002:111). These prices correspond to 4000 pound-per-square-inch (psi) and 6000-psi concrete, which are typical compressive strengths used for concrete foundations.

In a similar manner, the unit price of GRP was assigned a uniform probability distribution from \$1,900-\$3,100/mt. GRP is a composite material that varies with the specific plastic resin used and the proportion of resin and fiberglass fabric used (Cairns and Skramstad, 2000:1-2; Mandall, *et al.*, 2002:43). The most commonly used method for constructing wind turbine blades involves the use of a polyester resin, reinforced with fiberglass fabric (Cairns and Skramstad, 2000:1-2). Therefore, the unit price of polyester resin is assumed to be representative of the unit price of GRP.

### ***Transportation***

Transportation cost varies with the mode of transport and distance transported, and it is expressed as a percentage of the capital investment. Due to the subcontracting of wind turbine components, it is difficult to determine a specific transport distance/mode from a manufacturer. Some components, such as the generator or tower may be subcontracted and assembled at the wind farm location. Other components, such as the transformer or foundation materials may be purchased on the local market near the construction site. To account for this uncertainty, transportation cost is assigned a uniform distribution from 5-12% of the capital cost (Lenzen and Munksgaard, 2002:350;

Wieland, 2002). Since NEG-Micon and Nordex turbines are primarily manufactured in Europe (Denmark and Germany, respectively), the model assumes 50% of the transportation cost is incurred by sea freight from Europe to the U.S., and 50% from trucking within the U.S.

### ***Construction***

The cost to construct a wind turbine encompasses the costs of site preparation, foundation construction, erection/commissioning, and installation of a remote monitoring system. Site preparation, turbine erection/commissioning, and remote monitoring costs are proportionate to the size of the wind turbine. Harrison et al. (2000:157-158) express these costs in units of euros (EUR) as a function of the rotor swept area (EUR/m<sup>2</sup>). Based on currency exchange rates, values expressed in euros are assumed to be equal to U.S. dollars. Site preparation and remote monitoring are each assigned a cost of 5 EUR/m<sup>2</sup>. Likewise, Harrison et al. (2000:157) indicate the cost of turbine erection and commissioning may be on the order of 10-20 EUR/m<sup>2</sup>. Since two data points are available for the erection/commissioning cost and there is no indication of a most likely value, a uniform distribution from 10-20 EUR/m<sup>2</sup> is assigned.

Foundation construction is expressed as a percentage of the capital investment. Because foundation size and design depend upon site-specific soil conditions, the amount of foundation material (and the corresponding foundation construction cost) appears independent of the size of the wind turbine. From a review of 13 U.S. wind farm projects constructed by Enron Wind (now GE Wind) and NEG-Micon, and foundation design guidance from Nordex, it was found that large wind turbines may in some conditions

have relatively small foundations, and small wind turbines may have relatively large foundations. It is reasonable to assume that this is due to local soil conditions.

Harrison et al. (2000:157) indicate that the foundation cost is on average about 5-9% of the total capital investment. Because of the uncertainty of soil conditions at each location, foundation construction is assigned a uniform distribution of 5-9% of the capital investment. Because the energy and emissions resulting from the foundation raw materials (concrete and rebar) are already accounted for in the process analysis, the cost of these raw materials is deducted from the cost of foundation construction.

### ***Overhead and Profit***

The costs of the wind turbine manufacturer's overhead and profit are expressed as percentages of the capital investment. Overhead, which was attributed entirely to the planning and engineering services that support turbine manufacture, may account for 4-6% of the capital investment cost (Harrison, *et al.*, 2000:158). The manufacturer's profit margin was assessed by reviewing the 2001 annual financial reports of Bonus, NEG-Micon, Nordex, and Vestas. From these reports, the corporate gross profit was used as a proxy for the profit margin of each wind turbine model. Gross profit of each manufacturer accounts for other product lines and other financial transactions. Because it is an average profitability across each company, actual wind turbine profit margins may be higher or lower than these values. However, it provides an estimate of the profitability of the wind turbine industry. From the 2001 annual financial reports, gross profit margin ranged from a high of 15% (Vestas in 2000) to a low of 5% (Nordex in 1998/1999).

Because gross profit varies from year-to-year, profit margin is assigned a uniform distribution from 5-15% of the capital investment.

### ***Manufacturing***

Manufacturing cost represents the cost to the company to manufacture a wind turbine. The cost of manufacturing is divided among three primary manufacturing sectors: mechanical power transmission equipment, fabricated steel plate work, and plastics. Power transmission equipment in the wind turbine nacelle accounts for roughly 60% of the wind turbine's cost. Plastics and metal plate work account for roughly 20% each (Krohn, 1997:3).

Manufacturing costs are generally confidential. Therefore, the remaining capital investment costs that were not attributed to other cost components were attributed to manufacturing. This may result in over-allocating the manufacturing cost; however, this can be viewed as a worst-case scenario for wind energy. Because manufacturing is more energy and emissions-intensive than other life stages, attributing all remaining costs to manufacturing may result in elevated energy and emissions intensity values.

### **Calculating Energy Consumption and Indirect Emissions**

To complete the I/O analysis for the higher order LCCs (excluding raw materials and profit), each cost was adjusted to 1992 dollars using the Producers' Price Index (PPI) for total manufacturing industries. The PPI is a statistical index that measures the average change in prices received by producers of all commodities in the U.S. (DOC, 2002:449). This is necessary because the EIOLCA model was constructed using the 1992 Department of Commerce commodity-by-commodity input-output model. As a

result, all energy and emissions factors in the EIO/LCA model are referenced to 1992 prices.

Cost components are then assigned to an appropriate economic sector in the EIO/LCA model and multiplied by the corresponding energy and emission factors for that sector. As a result, during each Monte Carlo simulation run, specific quantities of input energy and SO<sub>x</sub>, NO<sub>x</sub>, and CO<sub>2</sub> (eq) emissions are calculated. Table 7 lists the EIO/LCA economic sectors used and their energy and emissions factors. Table 8 summarizes the percentage of each cost component that is attributed to a particular EIO/LCA economic sector, as discussed previously. For example, of the capital investment cost that was attributed to manufacturing, 60% is multiplied by the “mechanical power transmission equipment” input/output factors, 20% by the “fabricated plate work” factors, and 20% by the “plastic materials and resins” factors. It should be noted that the impact of raw materials production was assessed previously in the process analysis, and therefore is not assigned to an economic sector. Likewise, profit margin is not assessed because it results in no environmental impact.

<b>Economic Sector</b>	<b>SO<sub>x</sub> Emissions (g/\$)</b>	<b>NO<sub>x</sub> Emissions (g/\$)</b>	<b>CO<sub>2</sub> (eq) Emissions (g/\$)</b>	<b>Energy Consumption (MJ/\$)</b>
Trucking and Courier Services (excluding air)	2.18	28.38	2,413	31.85
Water Transportation	9.68	8.72	3,150	41.69
Plastics Materials and Resins	6.62	6.66	2,073	31.94
Fabricated Plate Work (Boiler shops)	4.85	3.54	1,167	16.31
Mechanical Power Transmission Equipment	3.39	2.62	864	11.66
Other New Construction	1.97	3.64	535	7.11
Engineering, Architectural, and Surveying Services	0.74	0.67	210	2.59
Other Repair and Maintenance Construction	1.90	3.73	534	7.13

Table 7. Economic Input/Output Factors

<b>Cost Component</b>	<b>% Cost Attributed to</b>	<b>EIOLCA Economic Sector</b>
Manufacturing	60%	Mechanical Power Transmission Equipment
	20%	Fabricated Plate Work (Boiler shops)
	20%	Plastics Materials and Resins
Transportation	50%	Trucking and Courier Services (excluding air)
	50%	Water Transportation
Construction	100%	Other New Construction
Overhead	100%	Engineering, Architectural, and Surveying
Operations & Maintenance	100%	Other Repair and Maintenance Construction

Table 8. Assignment of Life Cycle Stages to Economic Sectors.

## IV. Results and Analysis

### Data Interpretation

Each Monte Carlo simulation run consisted of 10,000 iterations and resulted in a frequency distribution of output values for a given wind turbine at a given location. As an example, Figure 9 illustrates a typical frequency chart generated by Crystal Ball for the NM 48 wind turbine model at Sioux Falls, SD. The 2.5th, 25th, 50th, 75th, and 97.5th percentile values were extracted from the frequency distribution at each location. In this case, the 50<sup>th</sup> percentile value (median) for payback is 8.7 years.

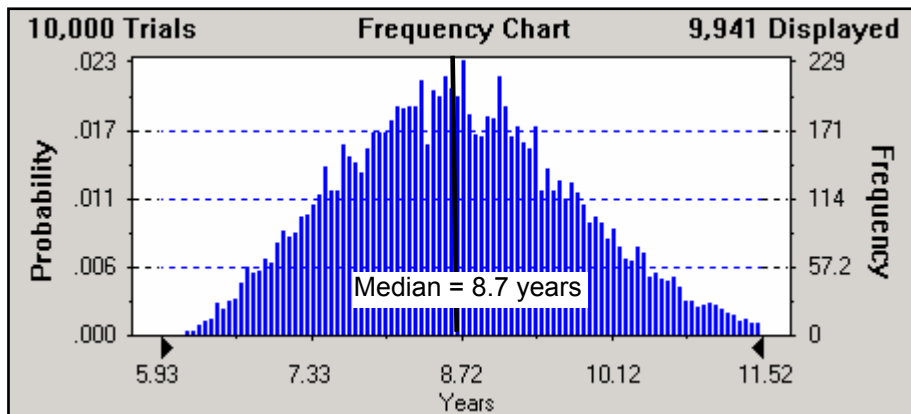

Figure 9. Frequency Chart for Simple Economic Payback of the NM 48 Wind Turbine at Sioux Falls, SD

### Wind Turbine Selection

Due to the volume of data, a preliminary LCC analysis was conducted using a sample of 24 locations to determine the preferred wind turbine model. Monte Carlo simulations were performed for 24 locations as a representative cross-section of the U.S. (10% of the 239 locations). Economic analysis was performed for each wind turbine



model to determine the model with the lowest median (50th percentile) value of economic payback for each location. Figure 10 depicts the compiled results for Sioux Falls as a series of box-and-whiskers diagrams. Each box-and-whiskers diagram presents the extracted percentiles for a wind turbine model. The upper and lower boundaries of the “box” represent the 75th and 25th percentiles, respectively. The bold line inside the box represents the 50th percentile, and the “whiskers” represent the 97.5th and 2.5th percentiles.

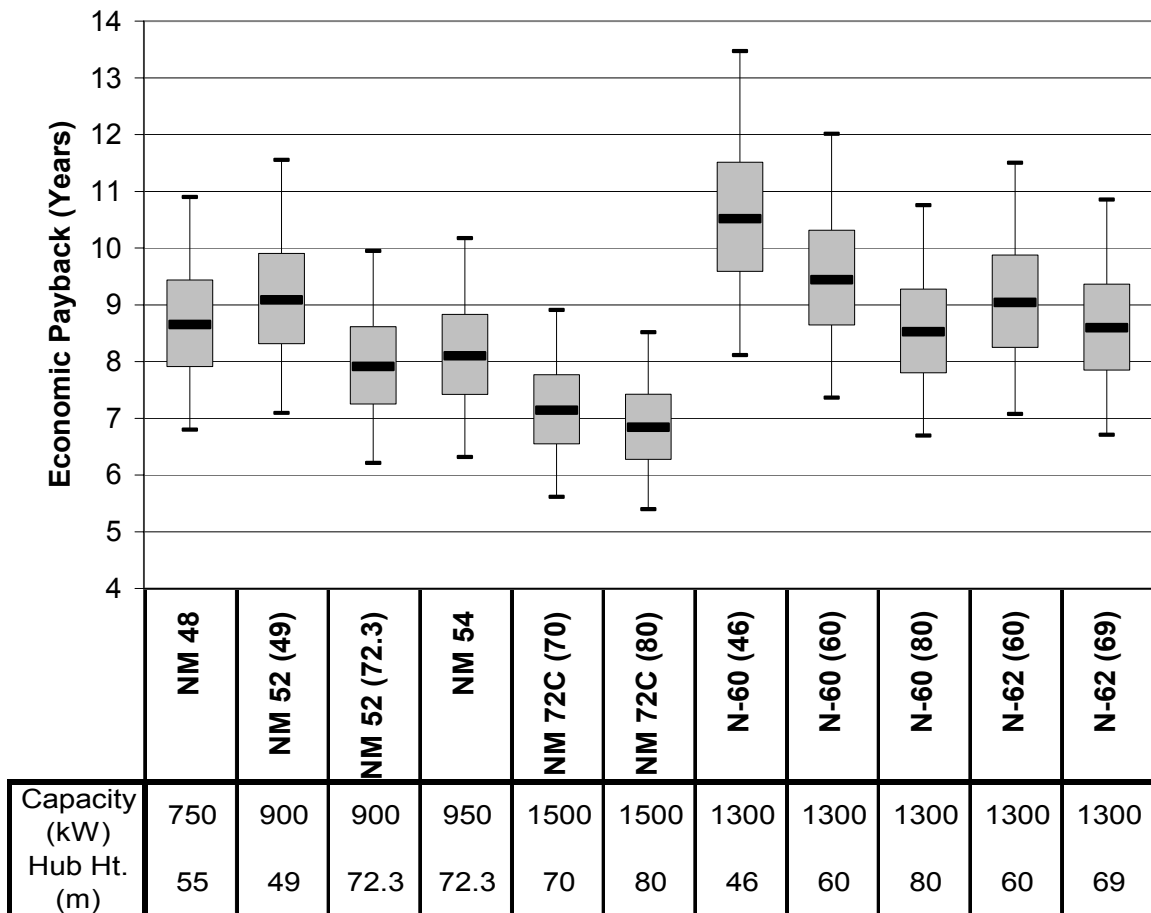

Figure 10. Economic Payback for 11 Wind Turbines at Sioux Falls, SD

From Figure 10, it can be seen that the wind turbine model selected can make a large difference in the length of the payback period. Comparing turbine models, 95% of the payback values for the best wind turbine (NM 72C (80)) range from 5.4 to 8.5 years, versus 8.1 to 13.5 years for the turbine with the longest payback period (N-60 (46)). Also, note that the simulation illustrates considerable variability in the economic payback of each wind turbine. The time between the 2.5<sup>th</sup> and the 97.5<sup>th</sup> percentile values for each turbine ranges from 3.1 to 5.4 years. When comparing the same wind turbine model at different tower heights, models with taller hub heights generally had shorter payback periods. This trend is expected, since wind energy increases with height above ground elevation, thus increasing the amount of electricity generated and the associated revenue.

Generally, wind turbines with larger rated capacity and taller hub heights have shorter payback times than smaller turbine models. Within the NEG-Micon product line, the larger NM 72C series experienced shorter payback durations than the smaller NM 48, 52, and 54 series. Likewise, within the Nordex product line, turbine models with taller hub heights experienced shorter payback durations. (Recall that all five Nordex models under study each have a rated capacity of 1,300 kW.)

On the basis of the shortest median payback period of 6.8 years, the NM 72C (80) is the preferred wind turbine for Sioux Falls. In fact, for all 24 locations the NM 72C (80) is the economically preferred model. Payback data for the 24 locations is presented in Appendix E. Because the NM 72C (80) consistently displayed the shortest median payback duration, it is used exclusively for the LCC and LCA for all 239 locations.

## **Life Cycle Cost Analysis**

The LCC analysis was accomplished for all 239 locations using the economically-preferred wind turbine model (NM 72C (80)). Figure 11 displays the economic payback output for 50 locations, which corresponds to the 20 sites with the longest median paybacks, the middle 10 paybacks, and the 20 shortest paybacks. Median payback values range from a minimum of 2.1 years for St. Paul Island, AK, to a maximum of 132.3 years for Medford, OR. Output data for all 239 locations is presented in Appendix F.

Even with variability embedded into the inputs, there are significant differences in the payback periods, depending on location. This suggests that the expected annual energy output based on the locations' TMY data and cost of electricity contribute significantly to the payback period. Six of the ten sites with the shortest median paybacks (St. Paul Island, Cold Bay, Kahului, Kotzebue, Barrow, and Bethel) also rank among the top ten sites for expected annual energy output. Additionally, five of the ten sites with the shortest median paybacks are located in states (HI and NY) where the mean cost of electricity ranks among the three most expensive states. Since expected energy output and cost of electricity are the only factors in this model that distinguish one location from another, shorter paybacks are most heavily influenced by higher power output (linked to wind and air density of the location) and higher electricity costs.

The results in Figure 11 also suggest that the payback frequency distribution becomes more variable as the median economic payback of a site increases. In other words, as median economic payback increases, the length of the box and whiskers also increases. The 20 locations with the shortest paybacks have less than one year between

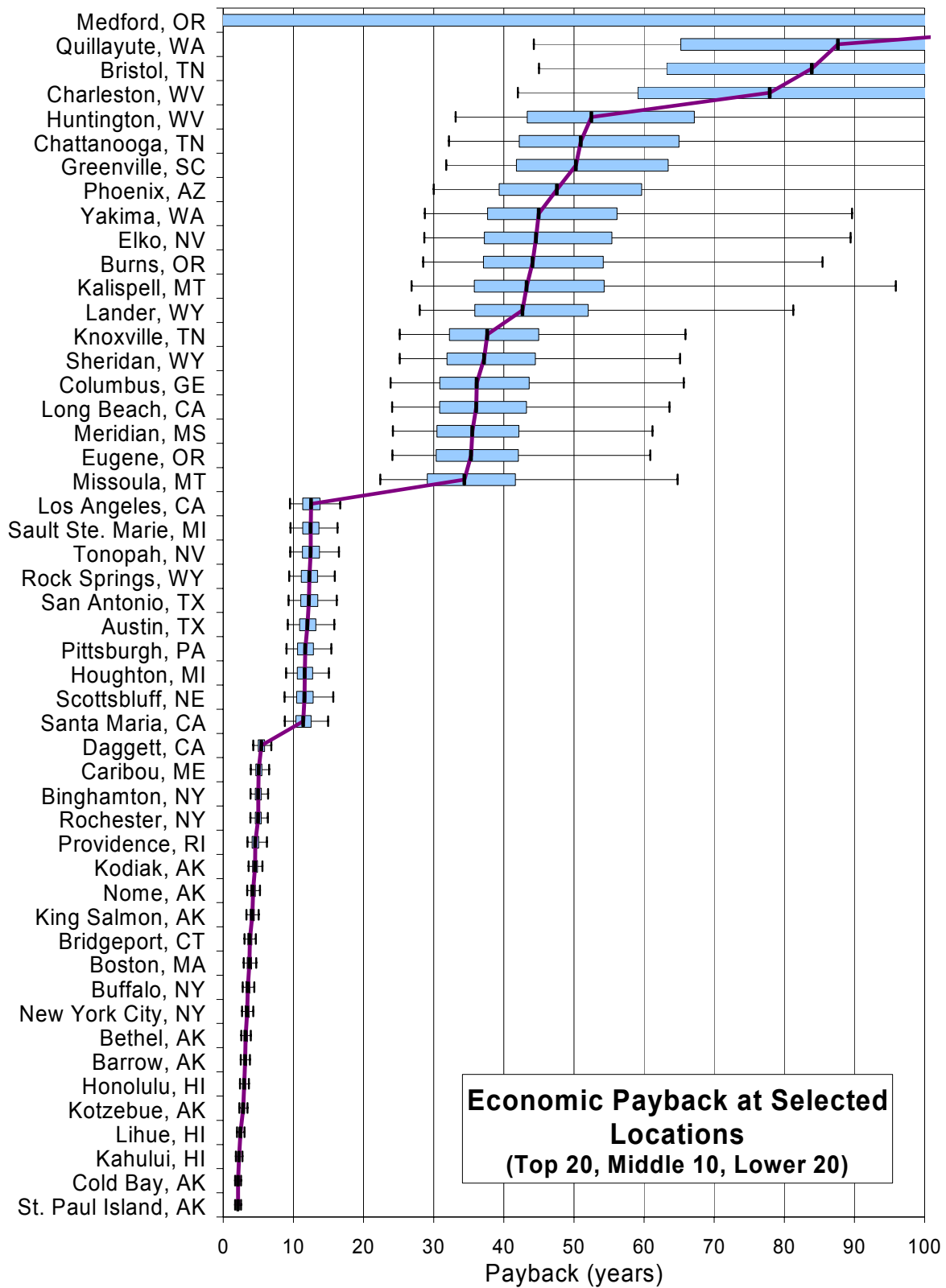

Figure 11. Economic Payback at Selected Locations

the 25<sup>th</sup> and 75<sup>th</sup> percentiles, versus the 20 longest payback locations with a range of 12.6-71.2 years. This demonstrates that the payback variability at most locations is not very large, especially compared to the differences between locations.

Analyzing the average increase in variability is another way to view the payback results. Given all locations with a median payback of less than 15 years (150 locations), the average increase from the 50<sup>th</sup> % to the 97.5<sup>th</sup> % payback value is 29% with a standard deviation of only 5%. But for the other 89 sites with median payback values greater than 15 years, the average difference from 50<sup>th</sup> to 97.5<sup>th</sup> is 88% with a standard deviation of 190%. However, there are a few locations that heavily influence the variability of this group, such as Medford, OR. Medford has the lowest expected energy output of the 239 locations. In fact, if the four locations with the longest median paybacks are eliminated from the highest 89 locations (payback > 15 years), the average increase from the 50<sup>th</sup> to 97.5<sup>th</sup> is only 57% (from 88%) with a standard deviation of 22% (from 190%).

Output variability was analyzed using sensitivity analysis. In LCC analysis, various factors such as the capital investment cost and electricity rates influence the calculation of economic payback. Based on the probability distribution assigned and the influence on the payback calculation, some input variables will have more impact on the output variability than others. For example, an input variable that can assume a wide range of values in the Monte Carlo simulation may account for most of the output variability, whereas an input with a narrow distribution range may have little impact. Sensitivity analysis calculates the contribution of each probabilistic input factor to the variance of the output--in this case payback.

The four most influential variables that contribute to the variance of economic payback are illustrated in Figure 12. Figure 12 captures the range of influence for all 239 sites. For example, the capital investment is generally the most influential variable, with a median percent contribution to variance of 72%. This means that for half the sites, capital investment contributes more than 72% of the payback variance, while at the other sites it contribute less than 72%. Capital investment is followed by annual O&M expense (13% median value), cost of electricity (7% median value), and power curve deviation (2.5% median value). Interestingly, the influence of cost of electricity is relatively small, possibly due to the narrow range of minimum and maximum values that resulted from using average costs. A larger range of electricity prices would likely have a greater influence on payback variability.

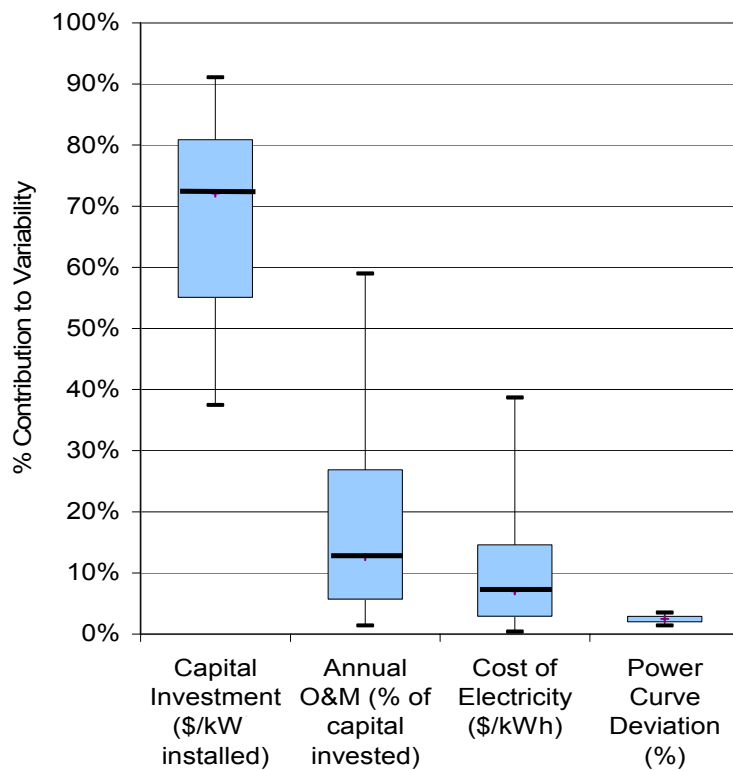

Figure 12. Sensitivity Graph for Economic Payback

Overall, capital investment is the most influential of the probabilistic input factors, although expected energy output is really more influential. Because each location was modeled separately, the influence of the location-specific wind profile will not appear in this sensitivity analysis. Figure 11 demonstrates that even with the capital investment, annual O&M expense, and electricity price varied in the model, their influence on variability is really dwarfed by the influence of expected energy output.

In this model, the trend in payback variability (shown in Figure 11) is driven by the variability of capital investment and its influence on how economic payback is calculated. Recall from equation 8 that economic payback is a function of the capital investment, annual revenue, and annual O&M expense.

$$Payback = \frac{Cap\ Inv}{(Revenue - O\&M)} \quad [8]$$

where: *Payback* = simple economic payback (years)  
*Cap Inv* = capital investment (\$)  
*Revenue* = annual revenue (\$/yr)  
*O&M* = annual operations & maintenance expense (\$/yr)

Since capital investment and annual O&M expenses are not site-specific in this model, annual revenue (energy output \* cost of electricity) determines the difference in payback results at different locations. At locations where revenue is relatively high, the denominator of equation 8 becomes large, thus dampening the effect of capital investment on the variability of results. However, at sites where annual revenue is low and approaches the cost of O&M expenses, the denominator becomes relatively small, and the effect of capital investment variability becomes more pronounced.

Mathematically, this has the effect of amplifying the variability of payback results. This observation is illustrated in Figure 13, where median values of payback are most variable at locations where expected energy output is lowest.

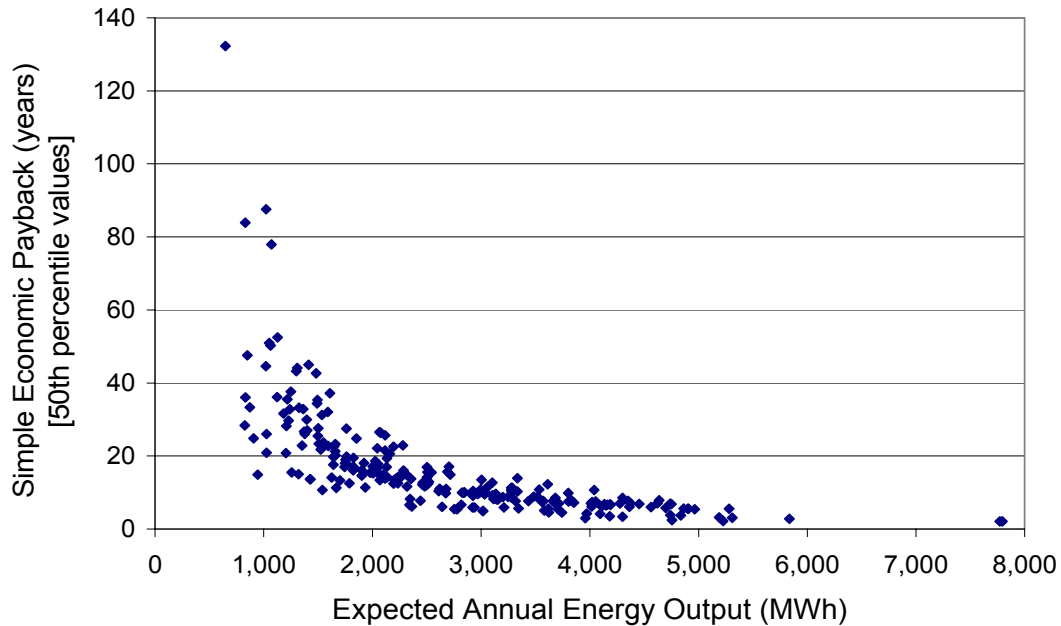

Figure 13. Scatterplot of Economic Payback vs. Expected Energy Output

This observation offers insight into the extreme variability at Medford, Oregon. Medford has the lowest expected annual energy output of the 239 locations, and the 6<sup>th</sup> lowest mean electricity rate of the 50 U.S. states. This causes the calculated annual revenue distribution to approach the annual O&M cost distribution. As a result, in some simulation iterations, the combination of variables causes the annual revenue to be less than the annual O&M cost. Therefore, a negative payback value is calculated, which implies that the turbine costs more to operate than the revenue it generates each year. This results in a bimodal frequency distribution (Figure 14), where the negative values represent  $O\&M > Revenue$ , and the positive values represent  $Revenue > O\&M$ . In



summary, wide variability and some negative payback values will occur at locations where site conditions are not favorable for wind power.

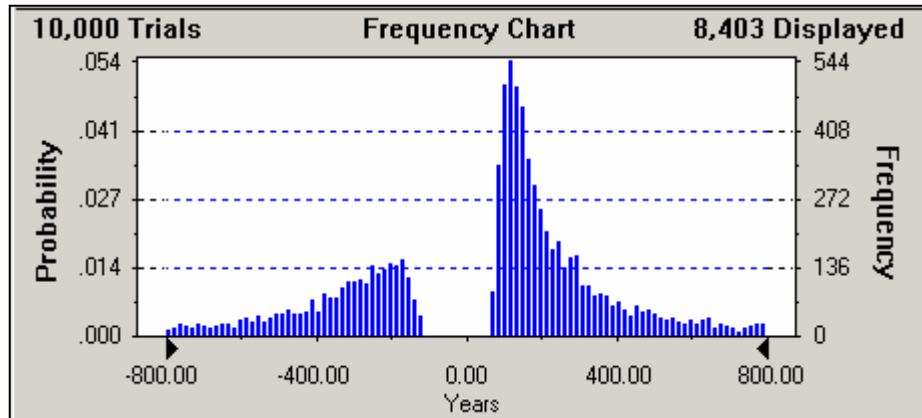

Figure 14. Frequency Distribution for Economic Payback at Medford, OR

## Life Cycle Assessment Results

### *Energy Intensity*

Energy intensity data for the 239 locations is displayed in Appendix G. The median energy intensity values ( $\text{kWh}_{\text{in}}/\text{kWh}_{\text{out}}$ ) range from 0.05 at St. Paul Island, AK to 0.54 at Medford, OR (Figure 15). The values observed confirm that wind turbines can vary considerably based on location. An energy intensity of 0.05 means that the wind turbine would generate 20 times the energy that it consumes over its lifespan, while a value of 0.5 implies that it will produce twice the energy that it consumes.

Compared to baselines of natural gas and coal power production, wind energy appears much less energy intensive than nonrenewable sources of energy. All energy intensity calculations for this analysis assume that the input energy is from nonrenewable energy sources (except for wind energy, in the case of wind turbines). In other words,

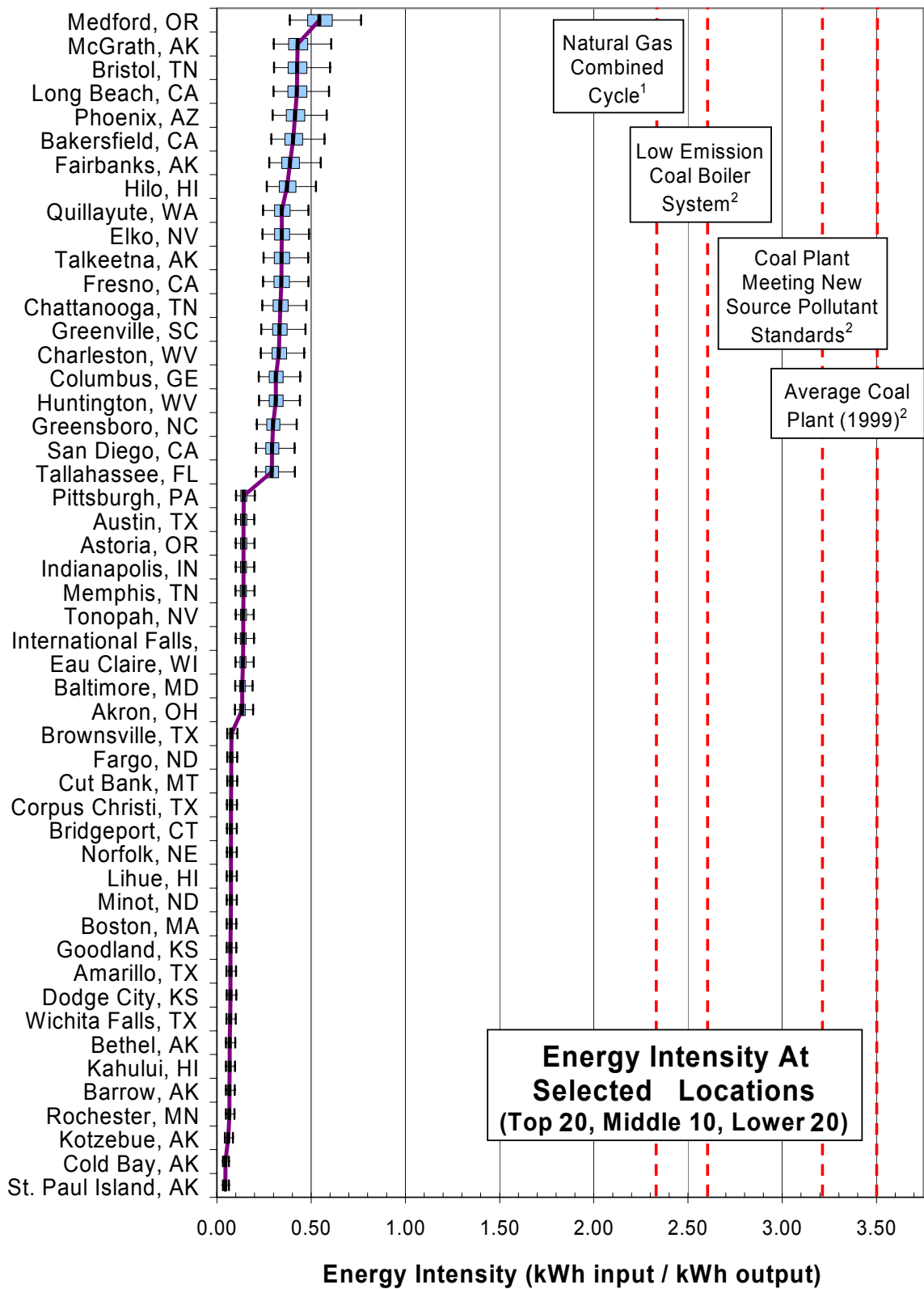

Figure 15. Energy Intensity at Selected Locations  
 Sources: <sup>1</sup>(Spath and Mann, 2000:17) <sup>2</sup>(Spath, *et al.*, 1999:31,B-9,B-19)

because wind energy is “renewable” energy, it is not counted in the input energy.

However, fossil fuels consumed during the operational phase of natural gas and coal power production are nonrenewable, and are thus counted as energy inputs.

It should be noted that the baselines for natural gas and coal-fired electricity generation are obtained from studies that used deterministic methods. Although these baselines do not convey the variability of energy intensity results for natural gas and coal electricity generation, they do provide a general “feel” for how wind energy compares to traditional sources of electricity generation. Additionally, when calculating these baselines, Spath and Mann (2000) and Spath, *et al.* (1999) used a methodology that accounts for material and energy inventories. Although unclear, this methodology appears similar to the process analysis LCA method. Therefore, baselines for natural gas and coal may not account for the energy input due to higher-order life stages.

Energy intensity frequency distributions display trends similar to those observed during the analysis of economic payback. As with economic payback, the trend in variability can be attributed to how energy intensity is calculated in this model. Because input energy is not site dependent, the expected electricity generated distinguishes one location from another. Therefore, sites with large expected annual energy outputs display less variable energy intensity results.

Figure 16 illustrates the sensitivity analysis for energy intensity at all 239 locations. The wind turbine lifespan contributes 46-49% of the variability of energy intensity. Lifespan impacts the amount of output energy that can be generated, and thus the energy intensity of a wind turbine. It is followed by the capital investment cost (22-25%) and the energy intensity of steel (15-17%). Again, however, the location dependent

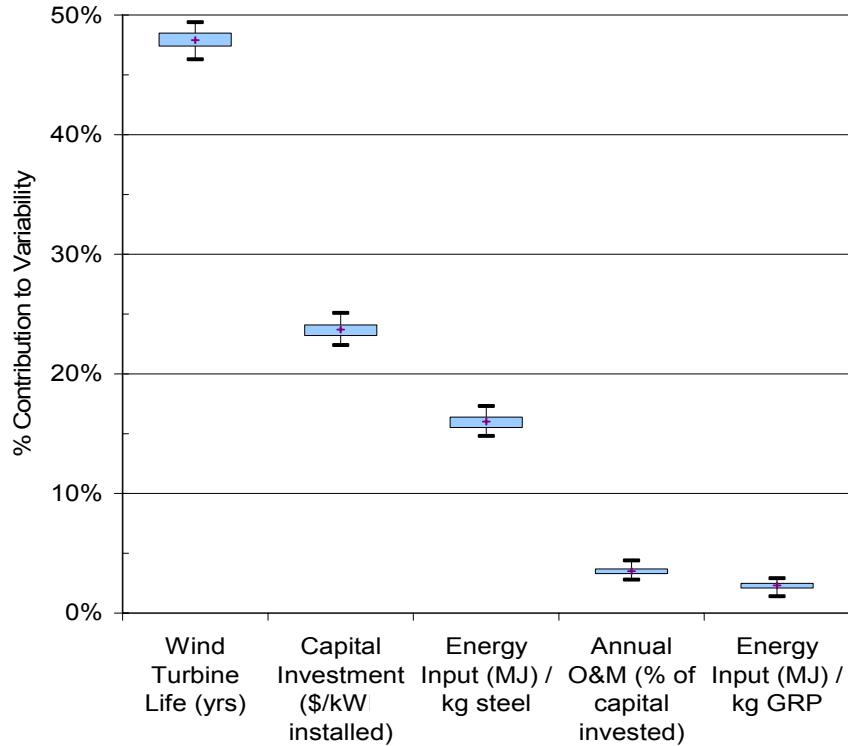

Figure 16. Sensitivity Graph for Energy Intensity

variables are not modeled in the sensitivity analysis, and Figure 15 demonstrates that there is a strong location-dependent influence on energy intensity.

### ***Emissions Analysis***

Frequency distributions for CO<sub>2</sub> (eq), SO<sub>x</sub>, and NO<sub>x</sub> intensity were calculated for each of the 239 locations. Results for selected locations along with emission baselines for natural gas and coal plants are displayed in Figures 17-19. Data for all 239 locations are presented in Appendices H, I, and J.

Overall, air emission results have trends similar to the payback and energy intensity results. Median values for CO<sub>2</sub> (eq) intensity range from 13 g-CO<sub>2</sub> (eq)/kWh output in St. Paul, AK, to 156 g-CO<sub>2</sub> (eq)/kWh in Medford, OR (Figure 17). In

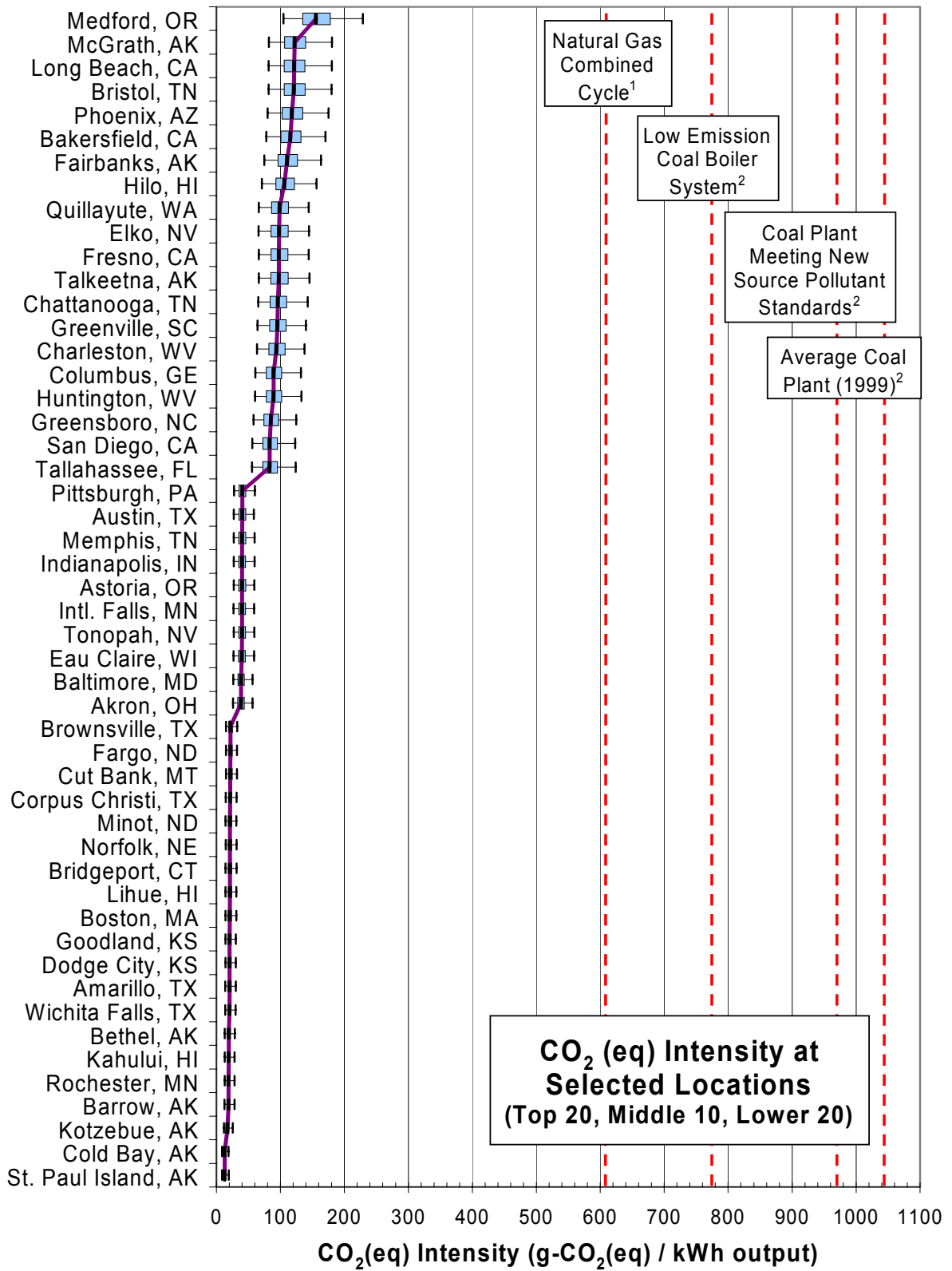

Figure 17. CO<sub>2</sub> (eq) Intensity at Selected Locations  
 Sources: <sup>1</sup>(Spath and Mann, 2000:14) <sup>2</sup>(Spath, *et al.*, 1999:36,40)

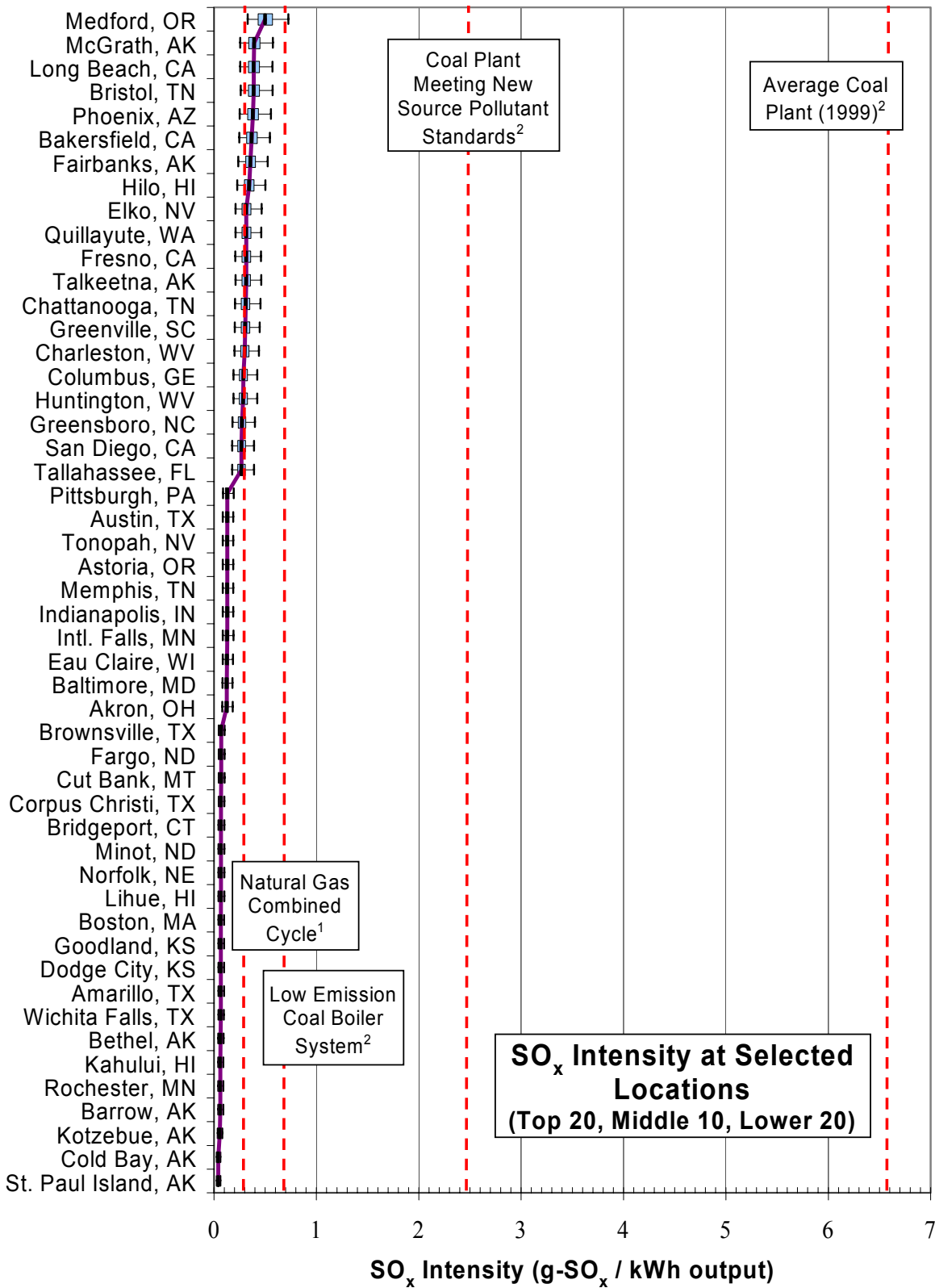

Figure 18. SO<sub>x</sub> Intensity at Selected Locations  
 Sources: <sup>1</sup>(Spath and Mann, 2000:16) <sup>2</sup>(Spath, *et al.*, 1999:35)

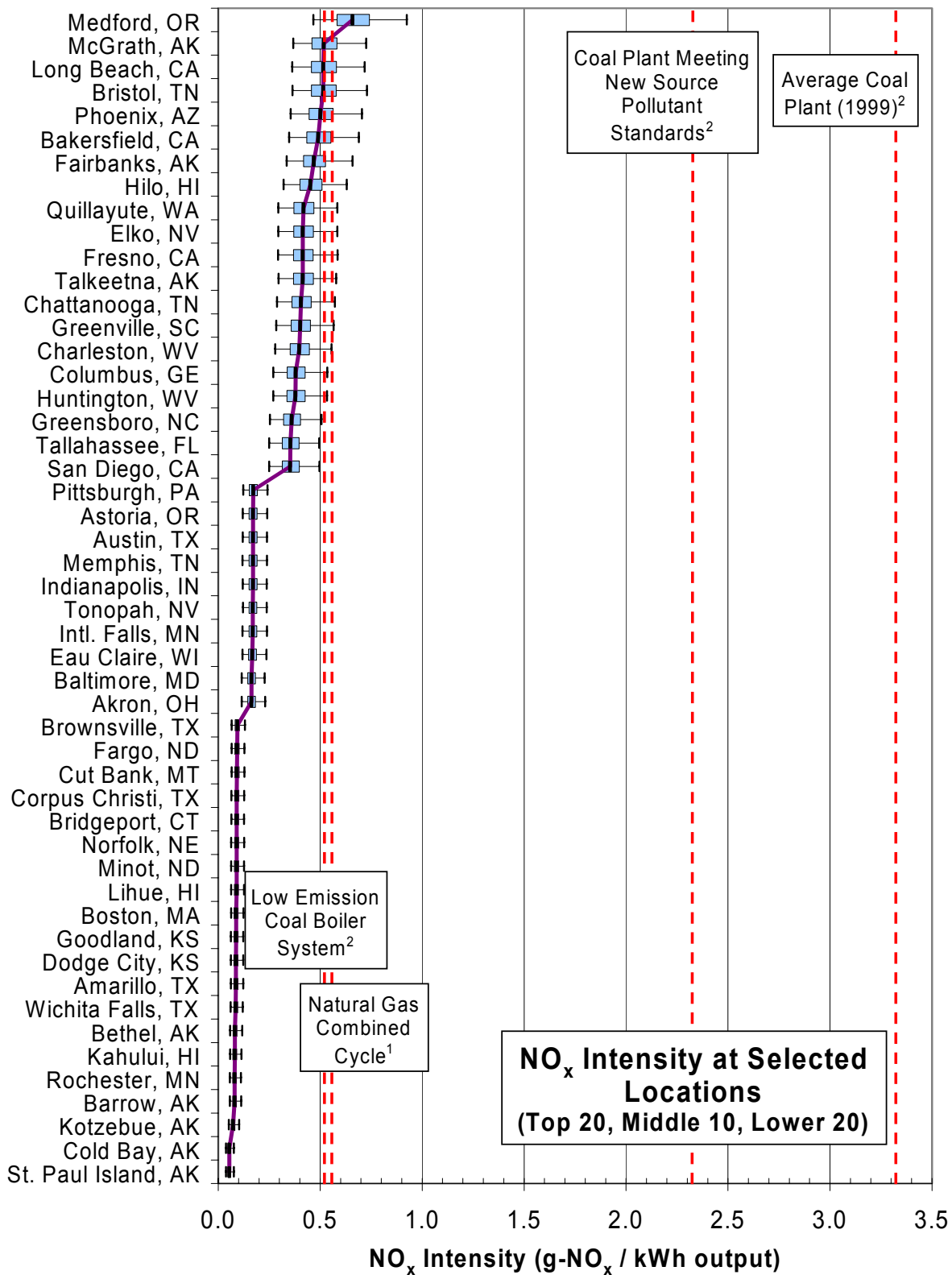

Figure 19. NO<sub>x</sub> Intensity at Selected Locations  
 Sources: <sup>1</sup>(Spath and Mann, 2000:16) <sup>2</sup>(Spath, *et al.*, 1999:35)

comparison to natural gas and coal (ranging from 585-1,042 g-CO<sub>2</sub> (eq)/kWh), the variability in the CO<sub>2</sub> (eq) intensity of wind energy is insignificant.

Results for SO<sub>x</sub> and NO<sub>x</sub> intensity are similar to those seen with CO<sub>2</sub> (eq) intensity. However, at times the combined cycle natural gas system and the low emission coal boiler system display values comparable to those of wind turbines. Median values for SO<sub>x</sub> intensity range from 0.04 – 0.50 g-SO<sub>x</sub>/kWh output. Median values for NO<sub>x</sub> intensity range from 0.05 – 0.66 g-NO<sub>x</sub>/kWh output. Wind turbines are still less SO<sub>x</sub> and NO<sub>x</sub> intensive overall, but the difference between wind and coal or natural gas generation is not as prominent as with CO<sub>2</sub> (eq) intensity.

Figures 20-22 present sensitivity charts for the factors influencing emissions intensity. Sensitivity analysis on CO<sub>2</sub> (eq), SO<sub>x</sub>, and NO<sub>x</sub> intensity reveals that five probabilistic factors each contribute at least 10% to the variability of emissions intensity values.

- Wind Turbine Life (yrs)
- Capital Investment (\$/kW installed)
- CO<sub>2</sub> Intensity of Steel (g-CO<sub>2</sub> (eq) / kg steel)
- SO<sub>x</sub> Intensity of Steel (g-SO<sub>x</sub> / kg steel)
- NO<sub>x</sub> Intensity of Steel (g-NO<sub>x</sub> / kg steel)

Wind turbine lifespan is repeatedly one of the major contributors to emissions intensity variability, contributing on average 37% to CO<sub>2</sub> (eq) intensity, 34% to SO<sub>x</sub> intensity, and 40% to NO<sub>x</sub> intensity. This can be attributed to the large degree of uncertainty about how long a particular wind turbine will operate before it is decommissioned, which is assumed to be 15-30 years in this model. Since most indirect



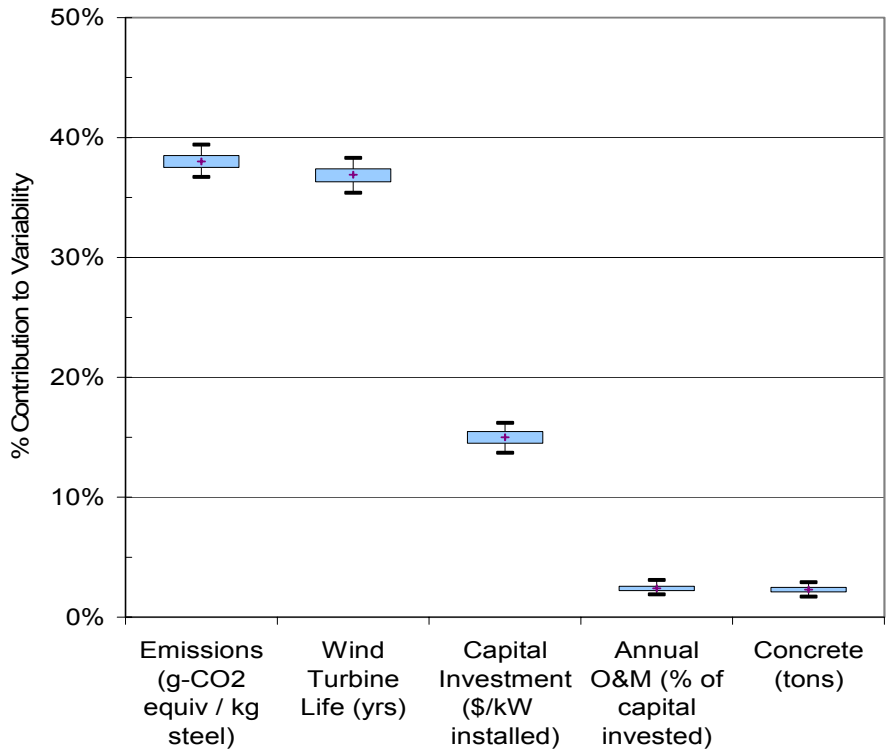

Figure 20. Sensitivity Graph for CO<sub>2</sub> (eq) Intensity

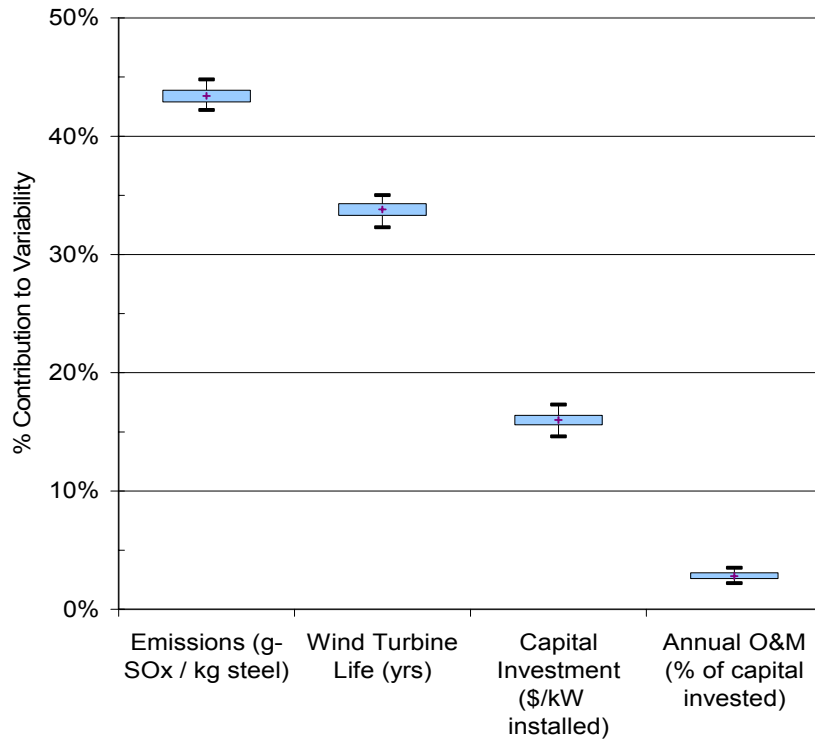

Figure 21. Sensitivity Graph for SO<sub>x</sub> Intensity

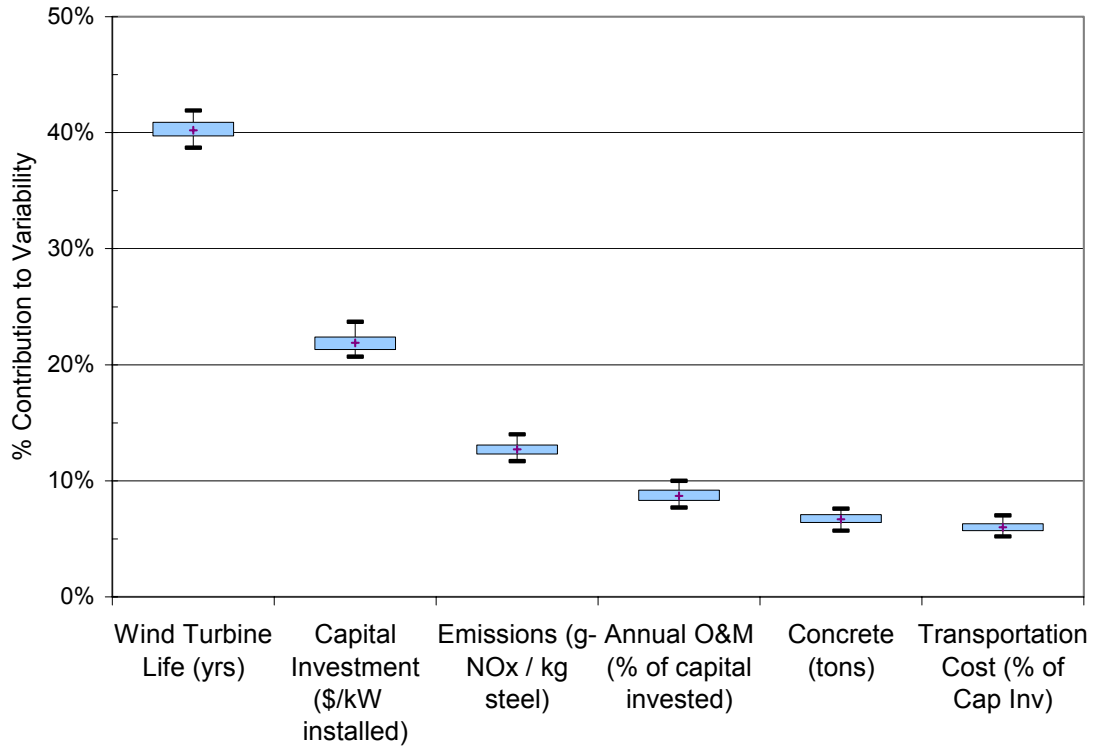

Figure 22. Sensitivity Graph for NO<sub>x</sub> Intensity

emissions occur in life stages before a wind turbine begins operating, a longer lifespan will reduce the emissions intensity of the turbine.

Capital investment cost is generally the 2<sup>nd</sup> or 3<sup>rd</sup> ranked contributing factor. The impact of capital investment on the variability of emissions intensity results from the use of economic input-output methods. Because economic input-output factors relate the value added by an economic sector to emissions resulting from that sector, changing the cost allocation also changes the emission estimates. As the capital investment amount changes, the dollar value attributed to each higher-order stage also changes. This results in changing emissions estimates for each life stage.

The CO<sub>2</sub> (eq), SO<sub>x</sub>, and NO<sub>x</sub> emissions from steel manufacture contribute the majority of the remaining variability. The CO<sub>2</sub> (eq) intensity of steel contributes 38% of the variability of overall CO<sub>2</sub> (eq) intensity. Likewise, the SO<sub>x</sub> intensity of steel contributes 43% of the SO<sub>x</sub> intensity variability. The large impact of steel is likely attributed to the wide emission factor distributions assigned to steel in the Monte Carlo simulation. Additionally, steel is a major material component of wind turbines, second in mass only to concrete. Therefore, any variability in the steel emission factors is magnified by the sheer tonnage of steel. Interestingly, although the mass of concrete was assigned a very wide distribution range (100-600 tons) and contributes a great deal of material mass, it is a minor contributor to the sensitivity of emissions intensity. This is because concrete on average is much less emission intensive than steel for NO<sub>x</sub>, SO<sub>x</sub> and CO<sub>2</sub>. Only in the case of NO<sub>x</sub> intensity is the variability caused by the mass of concrete comparable to that of the steel emission intensity.

### **Relative Impact of Life Cycle Stages**

Figure 23 illustrates the wind turbine energy and emissions intensity data broken down by life cycle stage. The values shown represent the average values of the medians from all locations. Because the median values across all locations had a relatively narrow range, only the averages are illustrated. For example, the input energy for O&M ranged from 13.0% to 13.2%; therefore, all values were rounded to the nearest whole number. Raw materials extraction/refining and product manufacture together account for most input energy (67%), CO<sub>2</sub> (eq) emissions (69%), and SO<sub>x</sub> emissions (72%).

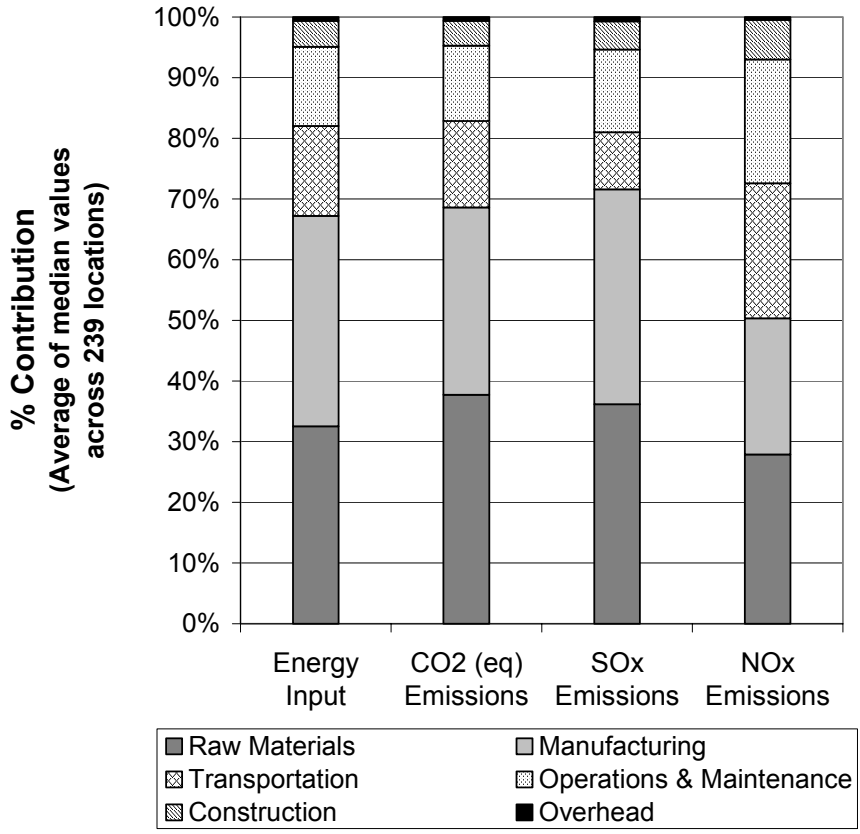

Figure 23. Contribution of Life Stages to Energy Input and Emissions

The contribution of the raw materials life stage should be noted, because it was accomplished using process analysis. The other life stages were assessed using economic input-output techniques. This observation suggests that conducting the LCA by using process analysis alone would only capture approximately 28-38% of the energy and emissions impacts (on average) of a wind turbine. Higher-order life cycle stages assessed via I/O analysis contribute the majority of the energy and emissions impacts of wind turbines.

## V. Discussion

This research used Monte Carlo simulation to provide insight into wind power and demonstrate how variability of input factors results in differing energy and emissions intensity results. Analysis of 239 locations and 11 wind turbine models revealed that the location-specific meteorological data is the most significant factor influencing the economic and environmental success of a wind turbine. Meteorological data is most significant because, even with other model inputs varied, the differences in payback period, energy intensity, and emissions intensity results from location to location were significantly different as illustrated in Figures 11, 15, and 17-19.

This thesis demonstrates the importance of using location-specific TMY data, combined with wind turbine power curves, to more accurately reflect wind turbine power output. Expected annual energy output for the economically preferred turbine model ranged from as much as 7,795 MWh/yr (St. Paul Island, AK) to as little as 609 MWh/yr (Medford, OR). Locations with high expected annual energy output generally had shorter payback periods, lower energy and emission intensities, and less variability than areas with low expected energy output.

Analyzing the sensitivity of the Monte Carlo simulation model revealed that the capital investment cost, wind turbine lifespan, and emissions factors for steel accounted for the majority of output variability for a given location. Larger capital investment costs increase the time needed to payback the initial investment and increase the O&M costs, since they are calculated as a percentage of capital costs. Though it should be noted that the higher capital cost associated with selecting a larger turbine design is worth the added

cost, since the turbine with the shortest payback period (at the 24 selected sites) was shown to be the turbine with the largest capacity (1.5 MW). It is likely that as technology advancements increase the turbine rated capacity, larger systems would have shorter payback periods.

Wind turbine lifespan affects the total amount of electricity generated by the turbine. Shorter lifespan values result in less electricity generated. Once a turbine is commissioned, most life cycle energy consumption and air emissions have already occurred. Therefore, at this point electricity generated during the operational life stage becomes the primary influence on overall energy and emissions intensity. Thus, a shorter lifespan will increase the energy and emissions intensity values.

Emission factors for steel present another significant source of variability in energy and emissions intensity values. Although the mass of concrete (100-600 tons) in a wind turbine application is generally greater than the mass of steel (181-206 tons for the economically preferred turbine), the energy content and emission factors for steel contribute more to the overall variability of energy and emissions intensity. For example, the energy content of steel ranges from 5.0-55.3 MJ/kg steel, whereas values for concrete range from 1.3-5.1 MJ/kg. Likewise, the indirect CO<sub>2</sub> (eq) emissions for steel range from 153-7,000 g-CO<sub>2</sub> (eq)/kg steel, whereas values for concrete range from 150-835 g-CO<sub>2</sub> (eq)/kg. SO<sub>x</sub> and NO<sub>x</sub> emission factors display similar results. As a result of wide distribution ranges, variations in steel input factors have significantly more impact on the energy and emissions variability even though there is generally more concrete than steel.

## **Model Validation**

The Monte Carlo simulation model is validated by comparing LCC and LCA results to output from previous wind energy studies. From LCC analysis using Monte Carlo simulation, the median payback values for the 239 locations range from 2.1 to 132.3 years. Krawiec (1981:74) found payback periods ranging from 6 to 39 years. (This was the only study found which addresses the economic payback of wind turbines.) Results from Monte Carlo simulation and Krawiec's study suggest that a wide range of payback values is possible. Locations with favorable wind resources can experience payback periods as short as 2-6 years, whereas locations lacking adequate wind resources will not reach the payback point during the expected turbine life span (15-30 years).

It should be noted that Krawiec's study focused on 10 kW wind turbines commercially available in 1980, as opposed to the 1,500 kW economically preferred turbine analyzed in this study. Also, Krawiec assumed a range of annual energy outputs from 4.8 to 13.5 MWh/yr, rather than calculating the expected energy output at specific locations. This study calculated expected energy outputs (ranging from 263 to 7,795 MWh/yr) based on site-specific meteorological data. Differences in the annual energy output and in life cycle costs occurring over the past 20 years likely influence the payback period, thereby making it difficult to compare these studies. Therefore, these factors should be considered when comparing Krawiec's (1981) payback results to those obtained from Monte Carlo simulation.

LCA results obtained in this study by using Monte Carlo simulation are compared to the results of nine previous studies. Table 9 lists the range of median energy and emissions intensity outputs and the values calculated in previous studies. Generally, the

range of values obtained by Monte Carlo simulation encompasses the values obtained in previous studies. This is expected due to the use of a probabilistic technique instead of deterministic methods and due to the large number of locations that were analyzed. It should be noted that previous studies occasionally do not specify the location analyzed, or it is unclear from the literature how expected energy output is determined. Therefore, LCA results may differ because of the influence of the site-specific energy output.

In several instances, studies referenced in Table 9 obtained smaller values than the lower limit of the range of median values found in this study. For example, three studies reported energy intensity values of 0.01 (Krohn, 1997:7; Lenzen and

[Ref]	Energy Intensity (kWh <sub>IN</sub> /kWh <sub>OUT</sub> )	CO <sub>2</sub> (eq) Intensity (g-CO <sub>2</sub> (eq)/kWh)	SO <sub>x</sub> Intensity (g-SO <sub>x</sub> /kWh)	NO <sub>x</sub> Intensity (g-NO <sub>x</sub> /kWh)
<b>Monte Carlo Simulation*</b>	0.05 - 0.54	13 - 156	0.04 - 0.50	0.05 - 0.66
a	---	18.1	0.02	0.06
b	0.02	7.8	---	---
c	0.01 - 0.02**	---	---	---
d	0.01 - 1.02***	7.9 - 123.7	---	---
e	---	46	---	---
f	---	39	0.05	0.11
g	---	6.5 - 9.1	0.02 - 0.09	0.02 - 0.36
h	0.01 - 0.02**	9.7	0.02	0.03
i	0.03 - 0.10	9.2 - 27	---	---
* Range of median values				
** Energy payback period converted to energy intensity assuming 15-30 yr life span				
*** Mean = 0.062				
a	(El-Kordy, <i>et al.</i> , 2002:323)		f	(Nomura, <i>et al.</i> , 2001:221)
b	(Kemmoku, <i>et al.</i> , 2002:17)		g	(Norton, 1999:11)
c	(Krohn, 1997:7)		h	(Schleisner, 2000:286)
d	(Lenzen and Munksgaard, 2002:347)		i	(Voorspools, <i>et al.</i> , 2000:318)
e	(Nadal and Girardin, 2001:90)			

Table 9. Comparison of LCA Results to Previous Studies



Munksgaard, 2002:347; Schleisner, 2000:286). The smallest median energy intensity value found in this study was 0.05. Smaller values found in previous studies may be caused by truncating the system boundary, which can result in excluding the impact of higher-order life cycle stages. Alternately, values obtained by the Monte Carlo simulation model may be larger due to over-allocating the manufacturing portion of wind turbine capital costs. The effects of recycling and the use of I/O tables from other countries could also cause differences in results. Studies that accounted for the recycling of wind turbine components, such as Krohn (1997), would obtain smaller values than those studies that did not consider recycling. Likewise, I/O tables developed for less energy- or emission-intensive countries will result in smaller LCA values.

Values found in previous studies tend to fall in the lower end of the range of values obtained from Monte Carlo simulation. This is expected, since many previous studies were based on empirical data from operating wind turbines. It is reasonable to assume that existing wind turbines have been sited in locations with favorable wind resources. Therefore, LCA results would display relatively small values of energy and emissions intensity.

### **Utility of the Model**

This Monte Carlo simulation model used meteorological data from 239 locations in order to provide a broad picture of the possible impacts of wind power. The model is useful to the decision maker in that it provides a range of wind power results that can be compared to traditional sources of electricity generation. However, it should be noted that the meteorological data used in this model provides generalities, but actual

conditions may vary even with subtle changes in terrain or altitude relative to the weather station sites. Therefore, site-specific wind speed and air density data are necessary to estimate the potential wind resource at a location. This study also provides a general guide as to which locations are more favorable for wind turbine use.

### **Ideas for Further Research**

Several simplifying assumptions were made to narrow the focus of this study. Wind turbines selected for analysis were limited to utility-scale, grid-connected applications with rated capacities of 750 to 1,500 kW. Additionally, all turbines selected were 3-blade/upwind-rotor/horizontal-axis models. These design characteristics represent many wind turbines in use and in production today, but do not encompass all wind turbine applications. LCA analysis was also limited to analyzing the life cycle air emissions of CO<sub>2</sub> (eq), SO<sub>x</sub>, and NO<sub>x</sub>. These assumptions, while focusing on issues of interest in wind energy, are not all-inclusive, and therefore leave other opportunities for future research:

1. Wind turbines of a sub-utility scale (rated capacity < 500 kW) are frequently used as stand-alone or supplemental power supplies in rural areas. Stand-alone systems are not connected to the electricity grid, and require storage batteries or a backup generator to maintain a constant supply of electricity. As a result, stand-alone systems may have longer payback periods due to the added expense of battery or backup systems.
2. Utility-scale wind turbines vary in their ability to capture the wind resource. Optimizing the turbine selection for maximum wind energy capture, rather than

- shortest economic payback period, presents an alternate strategy to employing wind energy.
3. Downwind-rotor/horizontal-axis and vertical-axis are alternate wind turbine configurations that may experience renewed interest in the future. Downwind-rotor/horizontal axis turbines benefit from lighter, more flexible rotors. Small downwind-rotor turbines may also be built without a yaw mechanism. Vertical axis turbines benefit because a yaw mechanism is not required and the generator and gearbox are at ground level. These design variations result in differing material mass compositions and efficiencies of energy capture, which affects the energy and emissions intensity of wind power.
  4. Costs and emissions from raw materials extraction and higher-order life stages (such as transportation and construction) depend on location-specific factors. Expanding the Monte Carlo simulation model to include location-specific factors for I/O analysis may reveal greater insight into the model output.
  5. Analyzing CO<sub>2</sub> (eq), SO<sub>x</sub>, and NO<sub>x</sub> air emissions presents one aspect of the environmental impacts caused by wind turbines. Other impacts such as emissions of volatile organic compounds and migratory bird kills result from wind turbine manufacture and operations.
  6. Natural gas and coal-fired electric plants were used as baselines to compare wind energy in this study. However, the baselines were calculated using deterministic input values. A probabilistic LCA of coal and natural gas electricity generation using Monte Carlo simulation will provide a sense for variability in the current electricity-generation technologies to compare to wind energy.

7. The TMY database represents the most typical meteorological measurements at a location over a 30-year period. Computing the expected power output for each year of the 30-year period will provide insight into the variability of the wind resource over a several-year period and will identify the impact of extreme weather conditions on energy output.
8. In this study, the distribution of electricity prices for each state was determined using average monthly and annual values for 2000. Electricity prices are often unpredictable and subject to short-term fluctuations and long-term trends. Analyzing the impacts of electricity price fluctuation at specific locations over time may provide greater insight into the expected payback duration for wind turbines.

## **Conclusion**

Monte Carlo simulation is proven an effective tool for analyzing the variability of the economic payback and environmental impacts of wind turbines. This research shows that at most locations wind energy results in less energy consumption per kWh generated than natural gas or coal-fired electricity generation. All median energy intensity values were less than one, which implies that the wind turbine will produce more energy than it consumes over its lifespan. In contrast, the energy intensity baselines for natural gas and coal (2.33-3.49) suggest that roughly 2-4 times more fossil energy is consumed in generating electricity than is actually converted to electricity.

Likewise, emissions intensity results for wind energy are generally less than those resulting from natural gas and coal-fired power plants. At all 239 locations, median CO<sub>2</sub>

(eq) values for wind energy are less than baselines for coal and natural gas plants. At all but 1 location the median NO<sub>x</sub> intensity values for wind energy are lower than the natural gas and coal baselines, and at all but 8 locations wind energy is preferred based on median SO<sub>x</sub> intensity values. Although results at 8 locations indicate that natural gas or low-emissions coal systems are less emissions-intensive than wind energy, these locations are unlikely candidates for wind turbines due to their low expected energy output and high payback periods.

Using Monte Carlo simulation, this study shows that wind energy meets the intent of the National Energy Policy and EO 13123—that is, a renewable source of electricity that reduces dependence on fossil fuels and reduces air emissions. Wind turbines are generally less energy and emission intensive, and for 150 of 239 sites the median time to payback the capital investment and operation of the system is less than 15 years. However, site selection is an important factor in deciding where to locate wind farms, and detailed site conditions should be thoroughly evaluated before installation.

## Appendix A. Data Excerpt from Lenzen and Munksgaard (2002)

Year of Study	Location	Energy Intensity (kWh <sub>in</sub> / kWh <sub>el</sub> )	CO <sub>2</sub> Intensity (gCO <sub>2</sub> / kWh <sub>el</sub> )	Power Rating (kW)	Life Time (years)	Load Factor (%)	Analysis Type	Scope as stated in reference	Turbine Type	Rotor Diameter (m)	Hub Height (m)	Rated Wind Speed (m/s)	Remarks
1977	USA <sup>c</sup>	0.023		1500	30	50.4	I/O	BCENT	2-bl	~60	~50	10.5	Steel truss tower
1980	UK <sup>c</sup>	0.080		1000	25	18.3	I/O	CM		46		18.4	On-shore farm (5)
		0.165		1000	25	18.3	I/O	CM		46		18.4	
1981	USA <sup>o</sup>	1.016		3	20	26.8	I/O	CMO		4.3	20	10.1	Excl. storage
1983	Germany <sup>o</sup>	~0.43		2	15	45.7	AEI	CM					Average values
		~0.29		6	15	45.7	AEI	CM					Average values
		~0.20		12.5	15	45.7	AEI	CM					Average values
		~0.12		32.5	15	45.7	AEI	CM					Average values
		~0.79		3000	20	45.7	AEI	CM	2-bl	100	100		
1990	Denmark <sup>o</sup>	0.014		95	20	25.2	PA	M (C)	3-bl	19	22.6		On-shore farm (6)
1990	Denmark <sup>o</sup>	0.021	8.81	150	25	30.1	PA	M					
1990	Germany <sup>o</sup>	0.031		300	20	28.9	PA	CMT	3-bl	32	34	11.5	Enercon-32
1991	Japan <sup>o</sup>	0.252	71.7 <sup>e</sup>	100	20	31.5	I/O	CMT					
1991	Germany <sup>o</sup>	0.085		30	20	14.4	PA	CGMOT	2-bl	12.5	14.8	13	Hsw-30
		0.049		33	20	29.4	PA	M	2-bl	14.8	22	11	MAN-Aeromann
		0.068		95	20	20.5	PA	CGMT	3-bl	19	22.6		On-shore farm (6)
		0.051		95	20	20.5	PA	M	3-bl	19	22.6		Tellus 95
		0.060		100	20	20.9	PA	M	2-bl	34	24.2	8	Hutter 100
		0.049		150	20	25.6	PA	M	3-bl	23	30	13	AN-Bonus 150
		0.037		165	20	23.2	PA	M	3-bl	25	32	13.5	Adler 25
		0.053		200	20	21.0	PA	M	3-bl	26	30	13	Adler 26
		0.064		265	20	19.0	PA	M	2-bl	52	30.5	8.5	Voith 52/265.8
		0.048		450	20	20.0	PA	GM	3-bl	35	36	18	AN-Bonus 450
0.065		3000	20	30.4	PA	GM	2-bl	100	100	12	GROWIAN I		
1991	Germany <sup>o</sup>	0.053		45	20	33.5	PA	M		12.5			
		0.031		225	20	39.9	PA	M		27			
		0.037		300	20	39.9	PA	M		32			
		0.045		3000	20	34.2	PA	M		80			

Year of Study	Location	Energy Intensity (kWh <sub>in</sub> / kWh <sub>el</sub> )	CO <sub>2</sub> Intensity (gCO <sub>2</sub> / kWh <sub>el</sub> )	Power Rating (kW)	Life Time (years)	Load Factor (%)	Analysis Type	Scope as stated in reference	Turbine Type	Rotor Diameter (m)	Hub Height (m)	Rated Wind Speed (m/s)	Remarks
1992	Japan <sup>o</sup>	0.345	95.6 <sup>e</sup>	100	20	31.5	I/O	CMOT					10% auxiliary power
1992	Germany <sup>o</sup>	0.089 0.027		0.3 300	20 20	38.8 41.9	PA PA	CDMOT CDGMOT	3-bl 3-bl	1.5 32	11.6 34	9.0	75% recycling 75% recycling
1992	Japan <sup>o</sup>	0.033 0.054	33.7	100 100	30 30	28.0 40.0	I/O I/O	CMOT CMOT	1983	30 30		13 10	Upwind propeller Downwind propeller
1993	Germany <sup>o</sup>	0.046	11 <sup>e</sup>	300	20	22.8	PA	CDMOT					Recycling
1994	Germany <sup>o</sup>	0.068	8.1	500	20	36.5	PA	M	2/3-bl	39	41		
1994	Germany <sup>o</sup>	0.022		300	20	22.8	PA	MO(D)					O calculated with AEI
1994	Germany <sup>o</sup>		18.2 <sup>e</sup>	500	20	27.4	I/O	CM					Incl. factory buildings
1995	UK <sup>o</sup>	0.042	9.1	350	20	30.0	PA	M	3-bl	30	30	~15	
1996	Germany <sup>o</sup>	0.120 0.035	17 10	100 1000	20 20	31.4 36.2	PA PA	CMO CMO	3-bl 3-bl	20 60	30 50		
1996	Japan <sup>o</sup>	0.436	123.6 <sup>e</sup>	100	30	20.0	I/O	CMO					Downwind propeller
1996	Switzerland <sup>o</sup>	0.321 0.202	52 28	30 150	20 20	7.9 7.6	PA PA	CDGMOT CDGMOT	2-bl 3-bl	12.5 23.8	22 30	11.4	Simplon Grenchenberg
1996	Japan <sup>o</sup>	0.456 0.171 0.118 0.088	123.7 <sup>e</sup> 47.4 <sup>e</sup> 34.9 <sup>e</sup> 24.1 <sup>e</sup>	100 170 300 400	20 20 20 20	18.0 22.5 18.0 18.0	I/O I/O I/O I/O	CMO CMO CMO CMO	1984	30 27 28 31			Demonstration plant Mitsubishi-2 Mitsubishi-1 MICON
1996	Germany <sup>o</sup>		14 <sup>e</sup> 22 <sup>e</sup>	1000 1000	20 20	18.5 18.5	PA I/O	CMO CMO	3-bl 3-bl	54 54	55 55		HSW 1000 HSW 1000
1996	UK <sup>o</sup>		~25	6600	20	29.0	I/O	CDMO					System not specified
1997	Denmark <sup>o</sup>	0.120 0.123 0.100 0.066 0.037 0.030		15 22 30 55 600 1500	20 20 20 20 20 20	20.5 19.9 19.0 20.6 26.5 38.4	I/O I/O I/O I/O I/O I/O	CMO CMO CMO CMO BCDEGMO CMO	1980 1980 1980 1980 3-bl 3-bl	10 10.5 11 16 47 64	18 18 19 20 ~50 55	15 17	Vintage model Vintage model Vintage model Vintage model Off-shore
1997	Denmark <sup>o</sup>	0.020	15.9	400	20	22.8	PA	M(O)					Excl. imports

Year of Study	Location	Energy Intensity (kWh <sub>in</sub> / kWh <sub>el</sub> )	CO <sub>2</sub> Intensity (gCO <sub>2</sub> / kWh <sub>el</sub> )	Power Rating (kW)	Life Time (years)	Load Factor (%)	Analysis Type	Scope as stated in reference	Turbine Type	Rotor Diameter (m)	Hub Height (m)	Rated Wind Speed (m/s)	Remarks
1998	Germany <sup>o</sup>	0.042		500	20	29.6	PA	CGMOT	3-bl	40.3	44		Enercon E-40
		0.065		500	20	29.6	I/O	CGMOT	3-bl	40.3	44		Enercon E-40
		0.046		1500	20	31.0	PA	CGMOT	3-bl	66	67		Enercon E-66
		0.071		1500	20	31.0	I/O	CGMOT	3-bl	66	67		Enercon E-66
1998	Argentina <sup>c</sup>	~0.17	~42	2.5	20	22.0	PA	CMT (O)	2/3-bl				Incl. storage
		0.120	~29	30	20	22.0	PA	CMT (O)	2/3-bl				
		~0.08	~18	225	20	22.0	PA	CMT(O)	2/3-vl				
1999	Germany <sup>c</sup>	0.038		1500	20	31.0	PA	CDGMOT		66	67		no gear box
	India <sup>c</sup>	0.032		1500	20	45.9	PA	CDGMOT		66	67		E-66; Transp. D -> India
2000	Denmark <sup>o</sup>	0.033	9.7	500	20	25.1	PA	M(DT)	3-bl		41.5		On-shore farm (18)
		0.047	16.5	500	20	28.5	PA	GM(DT)	3-bl	39	40.5	16	Off-shore farm (10)
2000	Belgium <sup>o</sup>	0.033	9.2 <sup>e</sup>	600	20	34.2	PA	DM(O)					
		0.036	7.9 <sup>e</sup>	600	20	34.2	I/O	DM(O)					1980 I/O tables
2001	Japan <sup>o</sup>	0.160	39.4	100	25	34.8	I/O	CMT		30	30		NO <sub>x</sub> & So <sub>x</sub> calculated
2001	Brazil <sup>o</sup>	0.069		500	20	29.6	I/O	CGMOT	3-bl	40.3	44		E-40; Transp. D -> Brazil

Notes: AEI = method of multiplying total cost with a national average energy intensity, <sup>c</sup> = conceptual, bl = blades, B = Business management, C = Construction, D = Decommissioning, <sup>e</sup> = CO<sub>2</sub> equivalents including CH<sub>4</sub> and N<sub>2</sub>O, E = Engineering, G = Grid connection, h = Tower height, I/O = Input-output-based hybrid analysis, M = Manufacture, <sup>o</sup> = operating, O = Operation, PA = Process Analysis, T = Transport, ( ) = partly covered.



## Appendix B. Computed Expected Annual Energy Output (MWh/yr)

WBAN	STATE	CITY	NEG-MICON					NORDEX					
			WIND TURBINE MODEL	NM 48	NM 52 (49)	NM 52 (72.3)	NM 54	NM72C (70)	NM72C (80)	N-60 (46)	N-60 (60)	N-60 (80)	N-62 (60)
13876	AL	Birmingham	591	696	818	841	1,410	1,500	823	928	1,054	964	1,023
03856	AL	Huntsville	851	992	1,145	1,181	2,025	2,130	1,211	1,348	1,508	1,404	1,481
13894	AL	Mobile	815	953	1,107	1,141	1,940	2,050	1,148	1,286	1,447	1,337	1,414
13895	AL	Montgomery	529	623	734	753	1,244	1,324	736	831	945	863	916
26451	AK	Anchorage	669	780	909	932	1,579	1,667	942	1,055	1,189	1,101	1,163
25308	AK	Annette	1,209	1,404	1,581	1,638	2,808	2,922	1,786	1,950	2,138	2,012	2,105
27502	AK	Barrow	2,211	2,536	2,822	2,949	5,133	5,310	3,282	3,564	3,876	3,701	3,851
26615	AK	Bethel	2,186	2,523	2,789	2,913	5,021	5,189	3,300	3,561	3,849	3,666	3,804
26533	AK	Bettles	533	634	751	772	1,236	1,320	738	837	956	866	922
26415	AK	Big Delta	1,273	1,470	1,617	1,690	2,853	2,939	1,943	2,089	2,251	2,137	2,211
25624	AK	Cold Bay	3,465	4,011	4,253	4,475	7,668	7,771	5,553	5,815	6,078	5,854	5,990
26411	AK	Fairbanks	368	433	512	523	853	907	513	580	662	600	638
26425	AK	Gulkana	588	681	769	794	1,375	1,429	859	940	1,033	974	1,022
25503	AK	King Salmon	1,688	1,949	2,181	2,267	3,943	4,094	2,503	2,724	2,975	2,816	2,938
25501	AK	Kodiak	1,580	1,831	2,023	2,105	3,619	3,744	2,397	2,580	2,788	2,639	2,739
26616	AK	Kotzebue	2,531	2,921	3,162	3,313	5,699	5,836	3,928	4,174	4,439	4,255	4,385
26510	AK	McGrath	333	397	472	483	774	825	461	524	602	541	579
26617	AK	Nome	1,663	1,925	2,136	2,226	3,835	3,970	2,502	2,701	2,931	2,777	2,889
25713	AK	St. Paul Island	3,449	4,016	4,257	4,473	7,671	7,795	5,544	5,782	6,051	5,807	5,942
26528	AK	Talkeetna	410	484	571	582	965	1,027	570	645	734	669	711
25339	AK	Yakutat	572	674	786	807	1,348	1,426	809	906	1,023	939	996
03103	AZ	Flagstaff	531	623	725	746	1,281	1,353	747	838	945	871	924
23183	AZ	Phoenix	354	424	507	517	792	850	490	558	642	574	615
23184	AZ	Prescott	674	789	912	939	1,558	1,641	962	1,070	1,198	1,108	1,170
23160	AZ	Tucson	775	908	1,050	1,084	1,805	1,902	1,106	1,231	1,377	1,277	1,349

WBAN	STATE	CITY	NEG-MICON					NORDEX						
			WIND TURBINE MODEL	NM 48	NM 52 (49)	NM 52 (72.3)	NM 54	NM72C (70)	NM72C (80)	N-60 (46)	N-60 (60)	N-60 (80)	N-62 (60)	N-62 (69)
13964	AR	Fort Smith		541	645	767	786	1,307	1,394	749	851	976	881	942
13963	AR	Little Rock		658	775	912	935	1,560	1,659	914	1,032	1,172	1,074	1,141
24283	CA	Arcata		646	755	879	898	1,541	1,625	913	1,022	1,152	1,063	1,125
23155	CA	Bakersfield		355	426	512	523	812	872	487	557	645	573	615
23161	CA	Daggett		1,536	1,772	1,979	2,067	3,571	3,707	2,279	2,479	2,705	2,559	2,666
93193	CA	Fresno		407	487	583	595	957	1,026	558	639	738	659	705
23129	CA	Long Beach		336	403	484	497	773	831	459	524	606	543	582
23174	CA	Los Angeles		707	832	972	1,001	1,686	1,789	999	1,120	1,266	1,157	1,225
23232	CA	Sacramento		678	795	924	947	1,613	1,700	960	1,074	1,207	1,115	1,181
23188	CA	San Diego		487	580	688	709	1,125	1,204	671	761	872	789	843
23234	CA	San Francisco		1,488	1,712	1,919	1,997	3,486	3,619	2,190	2,390	2,615	2,482	2,592
23273	CA	Santa Maria		790	917	1,044	1,081	1,854	1,935	1,150	1,267	1,402	1,312	1,377
23061	CO	Alamosa		740	860	969	1,006	1,693	1,762	1,094	1,197	1,314	1,232	1,290
94018	CO	Boulder		650	760	878	908	1,512	1,594	928	1,033	1,156	1,069	1,128
93037	CO	Colorado Spring		980	1,138	1,285	1,337	2,256	2,354	1,440	1,575	1,731	1,628	1,703
23063	CO	Eagle		497	580	670	689	1,180	1,241	709	789	884	818	863
23066	CO	Grand Junction		626	733	851	879	1,467	1,550	885	989	1,111	1,027	1,086
93058	CO	Pueblo		948	1,100	1,236	1,285	2,179	2,265	1,406	1,534	1,679	1,582	1,652
94702	CT	Bridgeport		1,953	2,248	2,515	2,625	4,570	4,742	2,884	3,141	3,430	3,259	3,399
14740	CT	Hartford		939	1,092	1,259	1,299	2,233	2,346	1,335	1,487	1,660	1,551	1,635
13781	DE	Wilmington		1,077	1,253	1,437	1,488	2,553	2,677	1,551	1,716	1,911	1,781	1,876
12834	FL	Daytona Beach		880	1,032	1,198	1,233	2,117	2,236	1,244	1,391	1,563	1,448	1,533
13889	FL	Jacksonville		728	849	983	1,010	1,731	1,823	1,034	1,153	1,292	1,201	1,267
12836	FL	Key West		1,629	1,881	2,141	2,214	3,933	4,108	2,343	2,587	2,864	2,707	2,845
12839	FL	Miami		1,153	1,337	1,540	1,590	2,784	2,924	1,639	1,823	2,037	1,904	2,009
93805	FL	Tallahassee		477	566	671	687	1,132	1,209	657	746	854	775	828
12842	FL	Tampa		691	812	954	980	1,640	1,744	960	1,083	1,228	1,129	1,198
12844	FL	West Palm Beach		1,248	1,443	1,649	1,706	2,990	3,128	1,792	1,981	2,199	2,068	2,176

WBAN	STATE	CITY	NEG-MICON					NORDEX						
			WIND TURBINE MODEL	NM 48	NM 52 (49)	NM 52 (72.3)	NM 54	NM72C (70)	NM72C (80)	N-60 (46)	N-60 (60)	N-60 (80)	N-62 (60)	N-62 (69)
13873	GA	Athens		544	645	764	781	1,289	1,370	755	856	977	889	950
13874	GA	Atlanta		888	1,036	1,203	1,240	2,103	2,224	1,251	1,399	1,572	1,456	1,538
03820	GA	Augusta		603	707	824	848	1,425	1,507	846	949	1,070	989	1,048
93842	GA	Columbus		443	529	631	646	1,049	1,123	611	695	801	719	769
03813	GA	Macon		605	713	842	861	1,440	1,532	840	950	1,081	988	1,050
03822	GA	Savannah		693	817	959	987	1,652	1,753	967	1,089	1,236	1,133	1,204
21504	HI	Hilo		389	469	565	576	881	945	538	615	712	630	678
22521	HI	Honolulu		1,559	1,798	2,053	2,114	3,786	3,958	2,236	2,473	2,743	2,589	2,724
22516	HI	Kahului		2,171	2,480	2,755	2,881	5,059	5,225	3,224	3,499	3,805	3,637	3,784
22536	HI	Lihue		1,858	2,148	2,450	2,528	4,550	4,755	2,676	2,960	3,282	3,089	3,252
24131	ID	Boise		833	970	1,120	1,155	1,974	2,078	1,186	1,320	1,477	1,374	1,450
24156	ID	Pocatello		1,391	1,598	1,783	1,856	3,220	3,334	2,065	2,246	2,446	2,328	2,424
94846	IL	Chicago		1,388	1,604	1,823	1,888	3,286	3,435	2,009	2,213	2,445	2,302	2,416
14923	IL	Moline		1,433	1,661	1,884	1,949	3,415	3,564	2,090	2,297	2,531	2,383	2,500
14842	IL	Peoria		1,241	1,436	1,646	1,699	2,975	3,117	1,771	1,963	2,185	2,056	2,164
94822	IL	Rockford		1,462	1,685	1,922	1,984	3,518	3,676	2,099	2,319	2,571	2,429	2,553
93822	IL	Springfield		1,505	1,738	1,969	2,042	3,563	3,715	2,188	2,404	2,648	2,506	2,626
93817	IN	Evansville		852	990	1,142	1,177	2,027	2,134	1,210	1,347	1,506	1,405	1,481
14827	IN	Fort Wayne		1,308	1,511	1,728	1,785	3,129	3,276	1,871	2,070	2,299	2,164	2,280
93819	IN	Indianapolis		1,012	1,178	1,351	1,395	2,390	2,507	1,452	1,608	1,789	1,675	1,763
14848	IN	South Bend		1,314	1,521	1,737	1,799	3,137	3,286	1,887	2,086	2,316	2,175	2,287
14933	IA	Des Moines		1,432	1,656	1,873	1,945	3,374	3,518	2,088	2,290	2,522	2,380	2,494
14940	IA	Mason City		1,749	2,012	2,260	2,353	4,112	4,276	2,562	2,802	3,071	2,906	3,036
14943	IA	Sioux City		1,574	1,810	2,032	2,118	3,677	3,820	2,306	2,520	2,760	2,622	2,740
94910	IA	Waterloo		1,560	1,798	2,025	2,105	3,682	3,828	2,285	2,501	2,746	2,599	2,720
13985	KS	Dodge City		2,031	2,330	2,592	2,708	4,739	4,902	3,013	3,271	3,556	3,396	3,538
23065	KS	Goodland		1,994	2,291	2,554	2,663	4,699	4,863	2,954	3,210	3,493	3,331	3,472
13996	KS	Topeka		1,305	1,506	1,713	1,773	3,111	3,248	1,881	2,075	2,295	2,167	2,274

WBAN	STATE	CITY	NEG-MICON						NORDEX					
			WIND TURBINE MODEL	NM 48	NM 52 (49)	NM 52 (72.3)	NM 54	NM72C (70)	NM72C (80)	N-60 (46)	N-60 (60)	N-60 (80)	N-62 (60)	N-62 (69)
03928	KS	Wichita		1,727	1,988	2,226	2,315	4,037	4,190	2,549	2,777	3,034	2,883	3,009
93814	KY	Covington		908	1,062	1,231	1,271	2,159	2,280	1,285	1,435	1,611	1,493	1,579
93820	KY	Lexington		848	990	1,152	1,184	2,004	2,116	1,191	1,333	1,502	1,393	1,476
93821	KY	Louisville		814	953	1,109	1,142	1,953	2,064	1,148	1,286	1,448	1,338	1,416
13970	LA	Baton Rouge		602	710	835	858	1,435	1,525	836	944	1,073	984	1,048
03937	LA	Lake Charles		879	1,023	1,183	1,221	2,090	2,201	1,245	1,389	1,557	1,448	1,529
12916	LA	New Orleans		751	882	1,031	1,063	1,796	1,903	1,050	1,180	1,335	1,231	1,306
13957	LA	Shreveport		695	817	957	986	1,648	1,748	971	1,092	1,237	1,137	1,207
14607	ME	Caribou		1,479	1,705	1,914	1,992	3,447	3,580	2,179	2,378	2,602	2,467	2,576
14764	ME	Portland		973	1,133	1,307	1,345	2,322	2,441	1,386	1,541	1,723	1,609	1,698
93721	MD	Baltimore		1,059	1,229	1,407	1,453	2,492	2,610	1,524	1,686	1,871	1,754	1,843
14739	MA	Boston		1,958	2,257	2,540	2,640	4,651	4,836	2,870	3,140	3,443	3,268	3,418
94746	MA	Worcester		1,154	1,341	1,521	1,579	2,699	2,817	1,683	1,849	2,037	1,915	2,008
94849	MI	Alpena		806	948	1,110	1,142	1,953	2,068	1,128	1,269	1,434	1,324	1,405
94847	MI	Detroit		1,335	1,546	1,760	1,825	3,168	3,316	1,930	2,129	2,355	2,214	2,323
14826	MI	Flint		1,241	1,439	1,647	1,704	2,971	3,114	1,778	1,969	2,189	2,052	2,160
94860	MI	Grand Rapids		1,254	1,455	1,670	1,720	3,007	3,155	1,789	1,985	2,209	2,075	2,187
94814	MI	Houghton		908	1,070	1,249	1,290	2,187	2,318	1,273	1,430	1,616	1,488	1,579
14836	MI	Lansing		1,265	1,464	1,667	1,723	3,006	3,142	1,828	2,016	2,232	2,098	2,205
14840	MI	Muskegon		1,617	1,863	2,110	2,182	3,855	4,017	2,346	2,577	2,841	2,690	2,823
14847	MI	Sault Ste. Marie		864	1,012	1,178	1,211	2,076	2,194	1,214	1,362	1,534	1,420	1,504
14850	MI	Traverse City		1,035	1,214	1,412	1,452	2,528	2,674	1,459	1,635	1,841	1,696	1,798
14913	MN	Duluth		1,393	1,616	1,843	1,903	3,328	3,484	2,011	2,219	2,457	2,311	2,429
14918	MN	International Fal		995	1,160	1,344	1,386	2,388	2,519	1,405	1,568	1,760	1,637	1,732
14922	MN	Minneapolis		1,418	1,640	1,862	1,928	3,375	3,523	2,054	2,261	2,497	2,358	2,473
14925	MN	Rochester		2,177	2,499	2,785	2,901	5,100	5,280	3,229	3,510	3,820	3,640	3,792
14926	MN	Saint Cloud		799	940	1,098	1,125	1,939	2,050	1,123	1,261	1,425	1,314	1,395
03940	MS	Jackson		655	769	900	927	1,551	1,646	914	1,028	1,163	1,071	1,136

WBAN	STATE	CITY	NEG-MICON					NORDEX						
			WIND TURBINE MODEL	NM 48	NM 52 (49)	NM 52 (72.3)	NM 54	NM72C (70)	NM72C (80)	N-60 (46)	N-60 (60)	N-60 (80)	N-62 (60)	N-62 (69)
13865	MS	Meridian		479	565	667	682	1,143	1,216	664	752	858	782	832
03945	MO	Columbia		1,176	1,365	1,567	1,621	2,788	2,926	1,680	1,863	2,075	1,942	2,048
03947	MO	Kansas City		1,178	1,376	1,597	1,641	2,880	3,042	1,658	1,858	2,088	1,937	2,047
13995	MO	Springfield		1,251	1,448	1,659	1,714	2,992	3,135	1,788	1,982	2,203	2,072	2,182
13994	MO	St. Louis		1,203	1,399	1,603	1,659	2,854	2,998	1,724	1,910	2,122	1,988	2,091
24033	MT	Billings		1,554	1,791	2,017	2,100	3,654	3,803	2,274	2,486	2,730	2,587	2,708
24137	MT	Cut Bank		1,986	2,288	2,500	2,620	4,517	4,638	3,045	3,259	3,491	3,338	3,451
94008	MT	Glasgow		1,448	1,670	1,883	1,957	3,398	3,536	2,119	2,320	2,550	2,412	2,525
24143	MT	Great Falls		1,831	2,111	2,315	2,419	4,183	4,300	2,783	2,990	3,207	3,072	3,181
24144	MT	Helena		757	878	1,001	1,035	1,773	1,854	1,097	1,209	1,339	1,256	1,320
24146	MT	Kalispell		530	622	715	739	1,234	1,299	765	847	945	874	921
24036	MT	Lewistown		1,104	1,277	1,450	1,498	2,601	2,716	1,603	1,765	1,950	1,832	1,923
24037	MT	Miles City		1,267	1,469	1,667	1,730	2,968	3,103	1,841	2,024	2,234	2,100	2,201
24153	MT	Missoula		606	702	804	831	1,424	1,490	873	966	1,074	1,002	1,055
14935	NE	Grand Island		1,792	2,064	2,309	2,404	4,195	4,353	2,650	2,885	3,150	2,994	3,125
14941	NE	Norfolk		1,998	2,302	2,534	2,650	4,601	4,738	3,029	3,259	3,509	3,352	3,476
24023	NE	North Platte		1,364	1,574	1,758	1,832	3,163	3,278	2,030	2,205	2,403	2,278	2,374
94918	NE	Omaha		1,344	1,555	1,753	1,819	3,146	3,277	1,972	2,158	2,369	2,236	2,340
24028	NE	Scottsbluff		1,272	1,473	1,649	1,715	2,945	3,060	1,889	2,054	2,240	2,118	2,210
24121	NV	Elko		409	480	562	577	964	1,020	575	646	731	670	710
23154	NV	Ely		996	1,158	1,321	1,372	2,352	2,465	1,438	1,587	1,759	1,647	1,730
23169	NV	Las Vegas		940	1,090	1,234	1,280	2,149	2,241	1,378	1,508	1,661	1,560	1,633
23185	NV	Reno		572	662	750	774	1,344	1,399	837	918	1,011	952	997
23153	NV	Tonopah		1,029	1,195	1,355	1,407	2,402	2,512	1,495	1,645	1,813	1,702	1,781
24128	NV	Winnemucca		666	781	906	935	1,571	1,656	947	1,057	1,188	1,096	1,158
14745	NH	Concord		617	719	833	858	1,461	1,538	876	977	1,097	1,015	1,073
93730	NJ	Atlantic City		1,293	1,501	1,709	1,769	3,071	3,211	1,873	2,064	2,284	2,146	2,255
14734	NJ	Newark		1,343	1,555	1,777	1,839	3,188	3,343	1,929	2,131	2,367	2,221	2,337

WBAN	STATE	CITY	NEG-MICON					NORDEX						
			WIND TURBINE MODEL	NM 48	NM 52 (49)	NM 52 (72.3)	NM 54	NM72C (70)	NM72C (80)	N-60 (46)	N-60 (60)	N-60 (80)	N-62 (60)	N-62 (69)
23050	NM	Albuquerque		885	1,025	1,155	1,201	2,030	2,114	1,303	1,425	1,564	1,472	1,538
23048	NM	Tucumcari		1,073	1,243	1,419	1,466	2,541	2,660	1,542	1,703	1,890	1,775	1,868
14735	NY	Albany		1,111	1,289	1,474	1,524	2,651	2,778	1,599	1,768	1,964	1,842	1,938
04725	NY	Binghamton		1,197	1,393	1,602	1,655	2,873	3,017	1,706	1,895	2,115	1,977	2,087
14733	NY	Buffalo		1,725	1,988	2,229	2,321	4,031	4,184	2,545	2,774	3,033	2,879	3,007
94725	NY	Massena		924	1,082	1,254	1,293	2,213	2,342	1,301	1,459	1,638	1,510	1,594
94728	NY	New York City		1,713	1,979	2,253	2,331	4,119	4,302	2,467	2,722	3,012	2,846	2,991
14768	NY	Rochester		1,224	1,421	1,617	1,677	2,883	3,015	1,776	1,955	2,162	2,030	2,130
14771	NY	Syracuse		1,111	1,288	1,472	1,522	2,630	2,754	1,599	1,767	1,960	1,841	1,935
03812	NC	Asheville		870	1,006	1,140	1,179	2,033	2,120	1,269	1,393	1,536	1,447	1,516
93729	NC	Cape Hatteras		1,669	1,933	2,188	2,267	3,974	4,148	2,430	2,668	2,942	2,775	2,911
13881	NC	Charlotte		494	584	691	708	1,152	1,228	685	776	885	805	857
13723	NC	Greensboro		474	562	668	684	1,106	1,182	653	742	850	771	822
13722	NC	Raleigh		660	776	909	933	1,547	1,640	927	1,042	1,179	1,081	1,146
13748	NC	Wilmington		791	929	1,086	1,120	1,893	2,005	1,105	1,242	1,404	1,296	1,375
24011	ND	Bismarck		1,383	1,593	1,783	1,854	3,214	3,334	2,046	2,228	2,433	2,308	2,408
14914	ND	Fargo		1,917	2,208	2,457	2,560	4,463	4,622	2,857	3,094	3,367	3,203	3,337
24013	ND	Minot		1,950	2,242	2,508	2,607	4,578	4,749	2,875	3,134	3,419	3,253	3,391
14895	OH	Akron		1,033	1,205	1,395	1,433	2,483	2,618	1,461	1,632	1,831	1,701	1,798
14820	OH	Cleveland		1,284	1,488	1,699	1,759	3,054	3,199	1,845	2,040	2,263	2,128	2,236
14821	OH	Colombus		853	994	1,152	1,186	2,028	2,138	1,206	1,347	1,511	1,404	1,485
93815	OH	Dayton		1,160	1,346	1,545	1,590	2,769	2,906	1,661	1,842	2,050	1,918	2,019
14891	OH	Mansfield		1,427	1,652	1,884	1,945	3,414	3,572	2,052	2,267	2,513	2,368	2,490
94830	OH	Toledo		1,121	1,304	1,504	1,546	2,711	2,848	1,593	1,775	1,981	1,855	1,958
14852	OH	Youngstown		1,182	1,372	1,579	1,631	2,829	2,971	1,681	1,868	2,085	1,953	2,062
13967	OK	Oklahoma City		1,823	2,096	2,350	2,442	4,293	4,452	2,683	2,927	3,200	3,045	3,181
13968	OK	Tulsa		1,486	1,715	1,946	2,018	3,527	3,682	2,148	2,365	2,612	2,466	2,587
94224	OR	Astoria		1,015	1,182	1,352	1,396	2,388	2,501	1,470	1,623	1,805	1,682	1,770

WBAN	STATE	CITY	NEG-MICON					NORDEX						
			WIND TURBINE MODEL	NM 48	NM 52 (49)	NM 52 (72.3)	NM 54	NM72C (70)	NM72C (80)	N-60 (46)	N-60 (60)	N-60 (80)	N-62 (60)	N-62 (69)
94185	OR	Burns		517	611	718	739	1,231	1,308	723	814	925	845	898
24221	OR	Eugene		593	704	831	852	1,404	1,494	826	935	1,066	968	1,033
24225	OR	Medford		263	312	370	378	609	647	372	420	481	430	458
24284	OR	North Bend		1,235	1,429	1,619	1,681	2,877	3,002	1,795	1,972	2,176	2,047	2,145
24155	OR	Pendleton		899	1,044	1,185	1,226	2,070	2,160	1,316	1,445	1,596	1,493	1,567
24229	OR	Portland		849	989	1,124	1,163	1,955	2,045	1,244	1,366	1,509	1,408	1,476
24230	OR	Redmond		698	821	960	980	1,663	1,760	982	1,104	1,248	1,144	1,215
24232	OR	Salem		640	750	872	900	1,505	1,589	907	1,013	1,139	1,052	1,112
		Pacific												
41415	Islands	Guam		1,020	1,194	1,388	1,432	2,501	2,640	1,430	1,604	1,807	1,676	1,779
14737	PA	Allentown		1,172	1,358	1,533	1,592	2,724	2,838	1,726	1,886	2,072	1,949	2,039
04751	PA	Bradford		772	912	1,066	1,097	1,862	1,980	1,078	1,214	1,375	1,257	1,334
14860	PA	Erie		1,785	2,050	2,303	2,398	4,201	4,363	2,613	2,856	3,130	2,976	3,110
14751	PA	Harrisburg		710	833	970	995	1,674	1,772	1,003	1,125	1,266	1,162	1,226
13739	PA	Philadelphia		1,140	1,325	1,519	1,571	2,689	2,825	1,634	1,810	2,013	1,884	1,981
94823	PA	Pittsburgh		988	1,149	1,324	1,364	2,358	2,481	1,407	1,565	1,746	1,631	1,718
14777	PA	Wilkes-Barre		716	844	994	1,017	1,724	1,828	997	1,126	1,280	1,172	1,248
14778	PA	Williamsport		874	1,019	1,175	1,208	2,110	2,217	1,246	1,386	1,548	1,444	1,524
		Puerto												
11641	Rico	San Juan		925	1,076	1,244	1,279	2,245	2,362	1,307	1,459	1,637	1,523	1,610
14765	RI	Providence		1,457	1,685	1,917	1,986	3,466	3,622	2,105	2,321	2,567	2,416	2,535
13880	SC	Charleston		900	1,054	1,227	1,263	2,160	2,286	1,266	1,418	1,596	1,477	1,563
13883	SC	Columbia		542	637	748	767	1,285	1,362	754	850	963	885	939
03870	SC	Greenville		427	507	603	615	999	1,063	595	675	773	697	745
14936	SD	Huron		1,551	1,791	2,018	2,091	3,660	3,805	2,278	2,491	2,731	2,587	2,705
24025	SD	Pierre		1,725	1,987	2,219	2,307	4,038	4,187	2,556	2,780	3,032	2,880	3,003
24090	SD	Rapid City		1,734	2,009	2,187	2,291	3,906	4,012	2,678	2,855	3,051	2,908	3,003
14944	SD	Sioux Falls		1,682	1,937	2,178	2,259	3,978	4,134	2,467	2,696	2,954	2,804	2,932

WBAN	STATE	CITY	NEG-MICON					NORDEX						
			WIND TURBINE MODEL	NM 48	NM 52 (49)	NM 52 (72.3)	NM 54	NM72C (70)	NM72C (80)	N-60 (46)	N-60 (60)	N-60 (80)	N-62 (60)	N-62 (69)
13877	TN	Bristol		334	395	467	478	779	829	465	526	600	546	581
13882	TN	Chattanooga		415	489	578	591	987	1,051	576	652	743	676	719
13891	TN	Knoxville		505	595	696	714	1,181	1,250	713	800	905	828	877
13893	TN	Memphis		989	1,154	1,335	1,375	2,373	2,502	1,400	1,563	1,750	1,629	1,720
13897	TN	Nashville		803	938	1,090	1,121	1,918	2,026	1,133	1,268	1,427	1,320	1,396
13962	TX	Abilene		1,682	1,931	2,182	2,262	3,999	4,161	2,439	2,680	2,949	2,800	2,933
23047	TX	Amarillo		2,041	2,344	2,600	2,714	4,748	4,907	3,050	3,302	3,581	3,417	3,554
13958	TX	Austin		1,002	1,167	1,339	1,386	2,376	2,496	1,436	1,592	1,772	1,654	1,742
12919	TX	Brownsville		1,864	2,138	2,396	2,486	4,403	4,564	2,741	2,992	3,272	3,113	3,254
12924	TX	Corpus Christi		1,933	2,213	2,474	2,580	4,540	4,699	2,848	3,103	3,386	3,233	3,372
23044	TX	El Paso		687	802	914	944	1,585	1,661	1,002	1,102	1,221	1,135	1,192
03927	TX	Fort Worth		1,247	1,444	1,647	1,705	2,968	3,106	1,794	1,981	2,197	2,066	2,173
12960	TX	Houston		804	944	1,106	1,136	1,931	2,048	1,123	1,263	1,428	1,318	1,399
23042	TX	Lubbock		1,575	1,818	2,041	2,126	3,705	3,853	2,316	2,529	2,770	2,625	2,743
93987	TX	Lufkin		539	641	761	779	1,287	1,377	741	844	967	871	930
23023	TX	Midland		1,503	1,732	1,947	2,027	3,525	3,664	2,209	2,413	2,644	2,506	2,618
12917	TX	Port Arthur		1,176	1,366	1,568	1,617	2,814	2,953	1,679	1,864	2,076	1,946	2,051
23034	TX	San Angelo		1,310	1,514	1,726	1,787	3,133	3,276	1,883	2,081	2,306	2,171	2,283
12921	TX	San Antonio		971	1,137	1,319	1,362	2,329	2,460	1,371	1,532	1,722	1,594	1,688
12912	TX	Victoria		1,221	1,417	1,618	1,672	2,896	3,031	1,763	1,945	2,158	2,024	2,130
13959	TX	Waco		1,465	1,693	1,928	2,000	3,505	3,663	2,111	2,329	2,580	2,428	2,552
13966	TX	Wichita Falls		2,042	2,344	2,617	2,728	4,794	4,965	3,020	3,287	3,585	3,416	3,562
93129	UT	Cedar City		869	1,001	1,127	1,170	2,019	2,098	1,274	1,394	1,530	1,447	1,513
24127	UT	Salt Lake City		881	1,023	1,159	1,204	2,025	2,118	1,289	1,413	1,556	1,461	1,526
14742	VT	Burlington		1,063	1,238	1,426	1,471	2,559	2,692	1,515	1,686	1,883	1,755	1,850
13733	VA	Lynchburg		507	599	705	724	1,183	1,257	708	799	907	828	881
13737	VA	Norfolk		1,614	1,857	2,107	2,178	3,855	4,022	2,329	2,564	2,830	2,682	2,813
13740	VA	Richmond		719	850	998	1,027	1,720	1,825	1,008	1,135	1,289	1,177	1,252



		WIND TURBINE MODEL	NM 48	NM 52 (49)	NM 52 (72.3)	NM 54	NM72C (70)	NM72C (80)	N-60 (46)	N-60 (60)	N-60 (80)	N-62 (60)	N-62 (69)
WBAN	STATE	CITY											
13741	VA	Roanoke	813	949	1,092	1,124	1,905	2,003	1,167	1,294	1,443	1,341	1,413
93738	VA	Sterling	774	901	1,043	1,074	1,825	1,922	1,097	1,223	1,371	1,274	1,345
24227	WA	Olympia	595	699	816	839	1,416	1,499	834	937	1,059	976	1,035
94240	WA	Quillayute	407	485	577	592	956	1,022	561	638	733	659	705
24233	WA	Seattle	871	1,018	1,186	1,220	2,072	2,193	1,225	1,372	1,547	1,429	1,512
24157	WA	Spokane	1,116	1,294	1,466	1,524	2,587	2,704	1,627	1,786	1,968	1,849	1,936
24243	WA	Yakima	595	698	803	828	1,345	1,413	863	955	1,064	983	1,037
13866	WV	Charleston	429	506	598	615	1,006	1,071	595	672	766	699	743
13729	WV	Elkins	611	714	825	852	1,457	1,534	869	968	1,083	1,008	1,064
03860	WV	Huntington	457	541	641	655	1,057	1,128	633	717	820	742	790
14991	WI	Eau Claire	999	1,166	1,351	1,392	2,411	2,544	1,407	1,574	1,768	1,643	1,737
14898	WI	Green Bay	1,318	1,524	1,737	1,800	3,138	3,280	1,900	2,098	2,323	2,185	2,296
14920	WI	La Crosse	919	1,070	1,238	1,273	2,197	2,313	1,300	1,453	1,628	1,513	1,597
14837	WI	Madison	1,183	1,374	1,579	1,626	2,856	2,997	1,688	1,875	2,089	1,957	2,063
14839	WI	Milwaukee	1,648	1,901	2,143	2,226	3,895	4,053	2,410	2,640	2,897	2,749	2,874
24089	WY	Casper	1,855	2,128	2,345	2,455	4,246	4,375	2,801	3,017	3,257	3,114	3,230
24018	WY	Cheyenne	1,712	1,984	2,180	2,279	3,919	4,040	2,614	2,807	3,017	2,869	2,971
24021	WY	Lander	611	715	819	844	1,412	1,483	888	981	1,090	1,008	1,058
24027	WY	Rock Springs	1,529	1,759	1,941	2,027	3,501	3,611	2,309	2,490	2,687	2,565	2,660
24029	WY	Sheridan	664	772	884	914	1,536	1,609	959	1,060	1,178	1,098	1,154

### Appendix C. Average State Electricity Prices (cents/kWh) (2000)

STATE	MINIMUM	PEAK	MAXIMUM
Alaska	9.6	10.1	10.5
Alabama	5.0	5.6	6.4
Arkansas	5.2	5.8	6.3
Arizona	6.3	7.3	7.9
California	7.8	8.5	9.5
Colorado	5.4	5.9	7.0
Connecticut	8.9	9.5	9.8
District of Columbia	6.2	7.5	9.2
Delaware	5.5	6.1	7.7
Florida	6.7	6.9	7.1
Georgia	5.5	6.2	7.3
Pacific Islands	10.9	10.9	10.9
Hawaii	13.2	14.0	15.1
Iowa	5.2	5.9	6.7
Idaho	3.9	4.2	4.6
Illinois	6.0	6.9	7.5
Indiana	4.9	5.2	5.3
Kansas	5.8	6.3	7.1
Kentucky	3.7	4.2	4.8
Louisiana	5.4	6.5	7.9
Massachusetts	8.1	9.5	10.6
Maryland	5.7	6.7	8.2
Maine	8.1	9.7	10.7
Michigan	6.8	7.1	7.3
Minnesota	5.4	5.9	6.5
Missouri	4.9	6.0	7.5
Mississippi	5.6	5.9	6.3

STATE	MINIMUM	PEAK	MAXIMUM
Montana	3.9	5.0	5.9
North Carolina	6.2	6.5	7.0
North Dakota	5.1	5.4	5.8
Nebraska	4.7	5.3	6.1
New Hampshire	11.1	11.3	11.9
New Jersey	8.5	9.5	9.6
New Mexico	6.3	6.6	7.2
Nevada	5.6	6.2	6.7
New York	10.0	11.4	13.0
Ohio	6.2	6.4	6.9
Oklahoma	4.5	5.9	7.0
Oregon	4.5	4.9	5.1
Pennsylvania	6.1	6.6	7.1
Puerto Rico	12.0	12.0	12.0
Rhode Island	8.1	10.2	12.7
South Carolina	5.1	5.6	5.9
South Dakota	6.0	6.3	6.5
Tennessee	5.4	5.6	5.7
Texas	5.8	6.5	6.9
Utah	4.5	4.8	5.0
Virginia	5.7	5.9	6.3
Vermont	9.0	10.3	11.7
Washington	4.0	4.3	5.0
Wisconsin	5.5	5.7	6.2
West Virginia	5.0	5.1	5.2
Wyoming	4.2	4.3	4.5

## Appendix D. Wind Turbine Mass Composition (excluding foundation)

	Wind Turbine Component	NM 48 NEG-MICON			NM 52 (49) NEG-MICON		
		Mass (tons)	Unit	Material	Mass (tons)	Unit	Material
<b>Nacelle</b>	Cover	5.0	tons	Glass fibre-reinforced plastic (GRP)	4.0	tons	Glass fibre-reinforced plastic (GRP)
	Bed / Main Frame	5.5	tons	welded steel plate or cast	6.5	tons	EN-GJS-400-18U-LT (steel)
	Rotor Shaft	2.3	tons	34CrNiMo6V (steel)	2.4	tons	34CrNiMo6V - QT (steel)
	Gearbox Type I	4.7	tons	cast iron	6.5	tons	cast iron
	Gear Oil (Type I)	160	L	Mobilgear SHC XMP 320	170	L	Mobilgear SHC XMP 320
	Gearbox Type II	5.5	tons	cast steel	5.8	tons	cast iron
	Gear Oil (Type II)	90	L	Mobilgear SHC XMP 320	150	L	Tribol 1710/320
	Gearbox Type III	5.5	tons	cast steel			
	Gear Oil (Type III)	100	L	Tribol 1710/320			
	Gearbox Type IV	5.6	tons	welded steel			
	Gear Oil (Type IV)	80	L	Tribol 1710/320			
	Hydraulic Oil (mechanical brake)	2.5	L	Mobil SHC 524	10	L	Mobil SHC 524
	Hydraulic Oil (blade tip air brakes)	3	L	Mobil AERO HF	7.5	L	Mobil AERO HF
	Hydraulic Oil (rotor)						
	Hydraulic Oil (yaw brake)						
	Generator	3.24	tons	steel	4.14	tons	steel
	0.36	tons	copper	0.46	tons	copper	
Hydraulic System (in general)							
Yaw Drive							
<b>Rotor</b>	Blades (type I)	10.56	tons	Glasfiber-PE/Carbon fibre-epoxy	12.6	tons	Glasfiber-UP/Carbon fibre-epoxy
	Blades (type II)	9	tons	Glasfiber-polyester/wood-epoxy			
	Blade Bearings						
	Hub	2.7	tons	Meehanite SFF 400 (steel)	3.5	tons	EN-GJS-400-18U-LT (steel)
	Hub spinner	0.3	tons	fiberglass	0.3	tons	fiberglass
<b>Tower</b>	Conical Tube Steel	48	tons	welded steel plate	63	tons	welded steel plate
	Controller / Power Panel	0.8	tons	steel	0.9	tons	steel
	Transformer	2	tons	steel	2	tons	steel
		1	tons	copper	1	tons	copper
		1	tons	transformer oil	1	tons	transformer oil

	Wind Turbine Component	NM 52 (72.3) NEG-MICON			NM 54 NEG-MICON		
<b>Nacelle</b>	Cover	4.0	tons	Glass fibre-reinforced plastic (GRP)	4.0	tons	Glass fibre-reinforced plastic (GRP)
	Bed / Main Frame	6.5	tons	EN-GJS-400-18U-LT (steel)	6.5	tons	EN-GJS-400-18U-LT (steel)
	Rotor Shaft	2.4	tons	34CrNiMo6V - QT	2.4	tons	34CrNiMo6V - QT (steel)
	Gearbox Type I	6.5	tons	cast iron	6.5	tons	cast iron
	Gear Oil (Type I)	170	L	Mobilgear SHC XMP 320	155	L	
	Gearbox Type II	5.8	tons	cast iron			
	Gear Oil (Type II)	150	L	Tribol 1710/320			
	Gearbox Type III						
	Gear Oil (Type III)						
	Gearbox Type IV						
	Gear Oil (Type IV)						
	Hydraulic Oil (mechanical brake)	10	L	Mobil SHC 524	10	L	Mobil SHC 524
	Hydraulic Oil (blade tip air brakes)	7.5	L	Mobil AERO HF			
	Hydraulic Oil (rotor)				15	L	Mobil SHC 524
	Hydraulic Oil (yaw brake)						
	Generator	4.14	tons	steel	4.14	tons	steel
		0.46	tons	copper	0.46	tons	copper
Hydraulic System (in general)							
Yaw Drive							
<b>Rotor</b>	Blades (type I)	12.6	tons	Glasfiber-UP/Carbon fibre-epoxy	10.8	tons	Wood Epoxy/Glass fibre epoxy
	Blades (type II)						
	Blade Bearings				1.8	tons	steel
	Hub	3.5	tons	EN-GJS-400-18U-LT (steel)	4.2	tons	EN-GJS-400-18U-LT (steel)
	Hub spinner	0.3	tons	fiberglass	0.3	tons	fiberglass
<b>Tower</b>	Conical Tube Steel	98.3	tons	welded steel plate	98.3	tons	welded steel plate
	Controller / Power Panel	0.9	tons	steel	0.9	tons	steel
	Transformer	2	tons	steel	2	tons	steel
		1	tons	copper	1	tons	copper
		1	tons	transformer oil	1	tons	transformer oil

	Wind Turbine Component	NM72C (70) NEG-MICON			NM72C (80) NEG-MICON		
<b>Nacelle</b>	Cover	9.3	tons	Glass fibre-reinforced plastic (GRP)	9.3	tons	Glass fibre-reinforced plastic (GRP)
	Bed / Main Frame	8.5	tons	EN-GJS-400-18U-LT (steel)	8.5	tons	EN-GJS-400-18U-LT (steel)
	Rotor Shaft	6.2	tons	34CrNiMo8QT (steel)	6.2	tons	34CrNiMo8QT (steel)
	Gearbox Type I	13	tons	cast iron	13	tons	cast iron
	Gear Oil (Type I)	225	L	Mobilgear SHC XMP 320	225	L	Mobilgear SHC XMP 320
	Gearbox Type II						
	Gear Oil (Type II)						
	Gearbox Type III						
	Gear Oil (Type III)						
	Gearbox Type IV						
	Gear Oil (Type IV)						
	Hydraulic Oil (mechanical brake)	1.5	L	Mobil AERO HFE	1.5	L	Mobil AERO HFE
	Hydraulic Oil (blade tip air brakes)						
	Hydraulic Oil (rotor)						
	Hydraulic Oil (yaw brake)	8	L	Mobil AERO HFE	8	L	Mobil AERO HFE
	Generator	5.4	tons	steel	5.4	tons	steel
		0.6	tons	copper	0.6	tons	copper
Hydraulic System (in general)							
Yaw Drive							
<b>Rotor</b>	Blades (type I)	20.4	tons	Fibre Glass/PE/carbon fibre/epoxy	20.4	tons	Fibre Glass/PE/carbon fibre/epoxy
	Blades (type II)						
	Blade Bearings	3.6	tons	steel	3.6	tons	steel
	Hub	14.35	tons	EN-GJS-400-18U-LT (steel)	14.35	tons	EN-GJS-400-18U-LT (steel)
	Hub spinner	1.65	tons	fiberglass	1.65	tons	fiberglass
<b>Tower</b>	Conical Tube Steel	115	tons	welded steel plate	123.5	tons	welded steel plate
	Controller / Power Panel	1.1	tons	steel	1.1	tons	steel
	Transformer	2.5	tons	steel	2.5	tons	steel
		1.25	tons	copper	1.25	tons	copper
		1.25	tons	transformer oil	1.25	tons	transformer oil

	Wind Turbine Component	N-60 (46) NORDEX			N-60 (60) NORDEX		
<b>Nacelle</b>	Cover	9.7	tons	Glass fibre-reinforced plastic (GRP)	9.7	tons	Glass fibre-reinforced plastic (GRP)
	Bed / Main Frame	15.45	tons	cast iron	15.45	tons	cast iron
	Rotor Shaft	6.8	tons	42 CrMo4V (steel)	6.8	tons	42 CrMo4V (steel)
	Gearbox Type I	10.9	tons	steel	10.9	tons	steel
	Gear Oil (Type I)	280	L	VG 320	280	L	VG 320
	Gearbox Type II						
	Gear Oil (Type II)						
	Gearbox Type III						
	Gear Oil (Type III)						
	Gearbox Type IV						
	Gear Oil (Type IV)						
	Hydraulic Oil (mechanical brake)						
	Hydraulic Oil (blade tip air brakes)						
	Hydraulic Oil (rotor)						
	Hydraulic Oil (yaw brake)						
	Generator	6.66	tons	steel	6.66	tons	steel
		0.74	tons	copper	0.74	tons	copper
Hydraulic System (in general)	60	L	VG 32	60	L	VG 32	
Yaw Drive	1.15	tons	42 CrMo4 (steel)	1.15	tons	42 CrMo4 (steel)	
<b>Rotor</b>	Blades (type I)	14.4	tons	Glass fibre-reinforced plastic (GRP)	14.4	tons	Glass fibre-reinforced plastic (GRP)
	Blades (type II)						
	Blade Bearings						
	Hub	7.1	tons	cast iron	7.1	tons	cast iron
	Hub spinner						
<b>Tower</b>	Conical Tube Steel	73	tons	welded steel plate	97.9	tons	welded steel plate
	Controller / Power Panel	2	tons	steel	2	tons	steel
	Transformer	2.5	tons	steel	2.5	tons	steel
		1.25	tons	copper	1.25	tons	copper
		1.25	tons	transformer oil	1.25	tons	transformer oil

	Wind Turbine Component	N-60 (80) NORDEX			N-62 (60) NORDEX		
<b>Nacelle</b>	Cover	9.7	tons	Glass fibre-reinforced plastic (GRP)	9.7	tons	Glass fibre-reinforced plastic (GRP)
	Bed / Main Frame	15.45	tons	cast iron	15.45	tons	cast iron
	Rotor Shaft	6.8	tons	42 CrMo4V (steel)	6.8	tons	42 CrMo4V (steel)
	Gearbox Type I	10.9	tons	steel	10.9	tons	steel
	Gear Oil (Type I)	280	L	VG 320	280	L	VG 320
	Gearbox Type II						
	Gear Oil (Type II)						
	Gearbox Type III						
	Gear Oil (Type III)						
	Gearbox Type IV						
	Gear Oil (Type IV)						
	Hydraulic Oil (mechanical brake)						
	Hydraulic Oil (blade tip air brakes)						
	Hydraulic Oil (rotor)						
	Hydraulic Oil (yaw brake)						
	Generator	6.66	tons	steel	6.66	tons	steel
		0.74	tons	copper	0.74	tons	copper
Hydraulic System (in general)	60	L	VG 32	60	L	VG 32	
Yaw Drive	1.15	tons	42 CrMo4 (steel)	1.15	tons	42 CrMo4 (steel)	
<b>Rotor</b>	Blades (type I)	14.4	tons	Glass fibre-reinforced plastic (GRP)	21.3	tons	Glass fibre-reinforced plastic (GRP)
	Blades (type II)						
	Blade Bearings						
	Hub	7.1	tons	cast iron	7.1	tons	cast iron
	Hub spinner						
<b>Tower</b>	Conical Tube Steel	154.7	tons	welded steel plate	86.7	tons	welded steel plate
	Controller / Power Panel	2	tons	steel	2	tons	steel
	Transformer	2.5	tons	steel	2.5	tons	steel
		1.25	tons	copper	1.25	tons	copper
		1.25	tons	transformer oil	1.25	tons	transformer oil

	Wind Turbine Component	N-62 (69) NORDEX		
<b>Nacelle</b>	Cover	9.7	tons	Glass fibre-reinforced plastic (GRP)
	Bed / Main Frame	15.45	tons	cast iron
	Rotor Shaft	6.8	tons	42 CrMo4V (steel)
	Gearbox Type I	10.9	tons	steel
	Gear Oil (Type I)	280	L	VG 320
	Gearbox Type II			
	Gear Oil (Type II)			
	Gearbox Type III			
	Gear Oil (Type III)			
	Gearbox Type IV			
	Gear Oil (Type IV)			
	Hydraulic Oil (mechanical brake)			
	Hydraulic Oil (blade tip air brakes)			
	Hydraulic Oil (rotor)			
	Hydraulic Oil (yaw brake)			
	Generator	6.66	tons	steel
	0.74	tons	copper	
Hydraulic System (in general)	60	L	VG 32	
Yaw Drive	1.15	tons	42 CrMo4 (steel)	
<b>Rotor</b>	Blades (type I)	21.3	tons	Glass fibre-reinforced plastic (GRP)
	Blades (type II)			
	Blade Bearings			
	Hub	7.1	tons	cast iron
	Hub spinner			
<b>Tower</b>	Conical Tube Steel	105.8	tons	welded steel plate
	Controller / Power Panel	2	tons	steel
	Transformer	2.5	tons	steel
		1.25	tons	copper
		1.25	tons	transformer oil



## Appendix E. Initial Economic Payback Output (yrs) for 24 Selected Sites

WBAN	CITY, STATE	%	NEG-MICON					NORDEX					
			NM 48	NM 52 (49)	NM 52 (72.3)	NM 54	NM 72C (70)	NM 72C (80)	N-60 (46)	N-60 (60)	N-60 (80)	N-62 (60)	N-62 (69)
13876	Birmingham, AL	2.5%	26.2	26.7	21.6	22.3	20.9	19.1	35.4	29.8	25.1	28.1	26.2
		25.0%	33.9	34.7	27.6	28.5	26.1	24.1	48.1	39.4	32.4	37.1	33.8
		50.0%	40.2	41.2	31.9	33.0	30.3	27.6	60.3	47.7	38.2	44.4	40.0
		75.0%	49.1	50.5	37.8	39.3	35.7	32.1	81.0	60.3	46.3	55.3	48.8
		97.5%	77.1	79.0	54.3	57.5	49.7	43.5	165.3	102.2	70.9	90.0	75.6
25624	Cold Bay, AK	2.5%	1.9	2.0	1.9	1.9	1.7	1.7	2.1	2.0	1.9	2.0	1.9
		25.0%	2.2	2.3	2.2	2.2	2.0	1.9	2.4	2.3	2.2	2.2	2.2
		50.0%	2.4	2.5	2.3	2.3	2.1	2.1	2.6	2.5	2.3	2.4	2.4
		75.0%	2.6	2.7	2.5	2.5	2.3	2.3	2.8	2.6	2.5	2.6	2.6
		97.5%	2.9	3.0	2.8	2.8	2.6	2.5	3.1	3.0	2.8	2.9	2.9
25339	Yakutat, AK	2.5%	13.5	13.8	11.6	11.9	11.1	10.4	17.3	15.0	13.0	14.5	13.4
		25.0%	16.2	16.6	13.7	14.2	13.2	12.4	21.1	18.2	15.7	17.4	16.1
		50.0%	18.1	18.6	15.3	15.7	14.6	13.7	23.9	20.3	17.4	19.5	18.0
		75.0%	20.3	20.8	16.9	17.4	16.2	15.1	27.2	22.9	19.4	21.9	20.2
		97.5%	25.1	26.0	20.6	21.3	19.6	18.1	35.1	28.7	23.8	27.5	24.9
93193	Fresno, CA	2.5%	24.6	25.0	19.8	20.7	20.1	18.4	34.2	28.3	23.4	27.2	24.8
		25.0%	31.6	31.9	24.5	25.8	25.1	22.8	45.8	36.8	29.5	35.2	31.7
		50.0%	36.9	37.4	28.1	29.6	28.9	26.1	56.5	43.7	34.4	41.8	37.0
		75.0%	44.4	45.4	32.6	34.8	33.6	30.1	74.1	54.0	40.9	51.0	44.5
		97.5%	65.6	67.2	45.0	47.4	46.5	39.8	143.7	87.0	59.0	80.3	66.9
23063	Eagle, CO	2.5%	29.6	31.1	25.4	26.3	23.6	22.0	39.2	33.6	28.8	32.0	29.7
		25.0%	39.5	41.2	33.1	34.2	30.5	28.1	55.0	45.4	37.8	43.4	39.4
		50.0%	47.8	50.2	39.1	40.7	35.8	32.8	70.6	56.6	45.6	53.0	47.9
		75.0%	61.1	64.3	47.5	49.7	43.0	39.1	100.5	74.6	57.0	68.4	60.4
		97.5%	105.4	114.8	72.1	78.7	63.6	56.7	264.2	146.0	95.1	126.5	103.1
93805	Tallahassee, FL	2.5%	27.2	27.6	22.0	23.0	21.8	20.0	37.7	31.2	26.2	29.8	27.2
		25.0%	34.9	35.5	27.6	29.0	27.2	24.7	50.8	40.9	33.3	38.7	34.9
		50.0%	41.3	42.0	31.8	33.2	31.2	28.2	63.8	49.4	38.8	46.2	41.1
		75.0%	49.9	51.3	37.2	39.1	36.4	32.5	86.6	62.3	47.1	57.5	50.1
		97.5%	76.4	78.7	52.0	54.4	50.4	43.3	176.6	106.1	70.8	92.6	76.1

WBAN	CITY, STATE	%	NEG-MICON					NORDEX					
			NM 48	NM 52 (49)	NM 52 (72.3)	NM 54	NM 72C (70)	NM 72C (80)	N-60 (46)	N-60 (60)	N-60 (80)	N-62 (60)	N-62 (69)
22521	Honolulu, HI	2.5%	3.1	3.2	2.8	2.9	2.5	2.4	3.7	3.4	3.0	3.2	3.0
		25.0%	3.5	3.7	3.2	3.3	2.9	2.8	4.3	3.9	3.5	3.7	3.5
		50.0%	3.8	4.0	3.5	3.6	3.1	3.0	4.7	4.2	3.8	4.0	3.8
		75.0%	4.2	4.3	3.8	3.9	3.4	3.2	5.1	4.6	4.1	4.4	4.1
		97.5%	4.7	5.0	4.3	4.4	3.8	3.7	5.8	5.2	4.6	5.0	4.7
93817	Evansville, IN	2.5%	18.8	19.5	16.5	17.0	15.3	14.4	24.5	21.1	18.4	20.1	18.8
		25.0%	23.4	24.1	20.1	20.8	18.5	17.4	30.8	26.3	22.6	24.9	23.2
		50.0%	26.5	27.7	22.6	23.5	20.7	19.4	35.9	30.1	25.6	28.4	26.3
		75.0%	30.5	31.9	25.6	26.7	23.3	21.8	42.9	35.4	29.4	32.9	30.2
		97.5%	40.2	42.6	32.9	34.4	29.5	27.2	61.5	48.3	38.9	44.6	40.0
13996	Topeka, KS	2.5%	8.6	9.1	7.9	8.1	7.1	6.8	10.7	9.6	8.5	9.1	8.6
		25.0%	10.3	10.8	9.3	9.5	8.4	8.0	12.8	11.4	10.1	10.9	10.3
		50.0%	11.4	11.9	10.2	10.5	9.3	8.8	14.3	12.6	11.2	12.0	11.3
		75.0%	12.6	13.2	11.3	11.6	10.2	9.7	15.8	14.0	12.4	13.3	12.5
		97.5%	15.0	15.9	13.4	13.7	11.9	11.4	19.2	16.8	14.7	15.8	14.9
14764	Portland, ME	2.5%	7.7	7.9	6.8	7.0	6.3	5.9	9.5	8.4	7.5	8.1	7.5
		25.0%	9.1	9.5	8.0	8.3	7.5	7.1	11.5	10.2	8.9	9.7	9.0
		50.0%	10.1	10.4	8.9	9.1	8.2	7.8	12.8	11.3	9.9	10.7	10.0
		75.0%	11.1	11.5	9.7	10.1	9.1	8.5	14.2	12.4	10.9	11.8	11.1
		97.5%	13.4	13.9	11.6	12.0	10.8	10.1	17.5	15.1	13.0	14.4	13.4
14840	Muskegon, MI	2.5%	6.2	6.5	5.7	5.8	5.1	4.9	7.5	6.8	6.1	6.5	6.2
		25.0%	7.2	7.6	6.6	6.7	6.0	5.7	8.8	7.9	7.1	7.6	7.2
		50.0%	7.9	8.3	7.2	7.3	6.5	6.2	9.7	8.7	7.8	8.3	7.8
		75.0%	8.6	9.0	7.8	8.0	7.0	6.7	10.6	9.5	8.5	9.0	8.5
		97.5%	9.9	10.4	9.0	9.2	8.1	7.7	12.3	10.9	9.7	10.4	9.9
03945	Columbia, MO	2.5%	9.8	10.2	8.7	8.8	8.0	7.6	12.3	10.9	9.6	10.4	9.7
		25.0%	12.1	12.5	10.7	10.9	9.8	9.3	15.3	13.5	11.8	12.8	12.0
		50.0%	13.6	14.1	11.9	12.3	11.0	10.4	17.4	15.2	13.3	14.4	13.5
		75.0%	15.4	16.0	13.4	13.9	12.4	11.7	19.9	17.3	15.0	16.4	15.3
		97.5%	19.6	20.5	16.9	17.4	15.4	14.6	26.1	22.1	19.0	21.0	19.4

WBAN	CITY, STATE	%	NEG-MICON						NORDEX				
			NM 48	NM 52 (49)	NM 52 (72.3)	NM 54	NM 72C (70)	NM 72C (80)	N-60 (46)	N-60 (60)	N-60 (80)	N-62 (60)	N-62 (69)
24036	Lewistown, MT	2.5%	13.6	14.3	12.4	12.6	11.2	10.7	17.0	15.2	13.4	14.6	13.5
		25.0%	17.1	17.9	15.3	15.7	14.0	13.2	21.7	19.0	16.7	18.0	16.9
		50.0%	19.4	20.5	17.4	17.9	15.8	14.9	25.0	21.7	19.0	20.6	19.3
		75.0%	22.4	23.7	19.8	20.3	17.9	16.9	29.1	25.2	21.9	23.7	22.3
		97.5%	30.1	31.9	25.8	26.5	23.2	21.5	40.8	34.3	29.3	31.8	29.8
23169	Las Vegas, NV	2.5%	13.3	13.9	11.9	12.3	11.4	10.8	16.3	14.6	13.0	14.1	13.3
		25.0%	16.1	16.7	14.4	14.7	13.7	12.9	20.0	17.7	15.7	17.0	16.0
		50.0%	17.9	18.8	16.0	16.4	15.2	14.3	22.5	19.9	17.5	19.1	17.9
		75.0%	20.1	21.1	17.9	18.3	16.9	15.9	25.6	22.5	19.6	21.5	20.1
		97.5%	24.9	26.4	21.9	22.4	20.7	19.3	33.1	28.2	24.5	27.2	25.2
04725	Binghamton, NY	2.5%	5.0	5.1	4.4	4.5	4.1	3.9	6.2	5.5	4.9	5.2	4.9
		25.0%	5.9	6.0	5.2	5.3	4.8	4.6	7.3	6.5	5.7	6.2	5.8
		50.0%	6.4	6.6	5.7	5.8	5.3	5.0	8.0	7.1	6.3	6.8	6.4
		75.0%	7.1	7.3	6.2	6.4	5.7	5.5	8.8	7.8	6.9	7.4	7.0
		97.5%	8.3	8.6	7.3	7.5	6.7	6.4	10.4	9.1	8.1	8.7	8.2
13722	Raleigh, NC	2.5%	19.1	19.5	16.1	16.7	15.7	14.6	25.0	21.5	18.3	20.4	19.0
		25.0%	23.6	24.2	19.5	20.4	19.0	17.7	31.7	26.7	22.6	25.6	23.5
		50.0%	26.9	27.5	22.0	22.9	21.4	19.8	37.2	30.8	25.6	29.2	26.7
		75.0%	31.1	32.0	25.0	26.1	24.2	22.2	44.6	36.0	29.5	33.7	30.8
		97.5%	41.1	42.7	31.9	33.4	30.6	27.9	64.8	49.7	39.0	45.6	40.8
94830	Toledo, OH	2.5%	10.2	10.6	9.0	9.3	8.3	7.8	12.8	11.4	10.0	10.8	10.2
		25.0%	12.2	12.7	10.6	11.0	9.7	9.2	15.4	13.6	11.9	12.8	12.0
		50.0%	13.4	14.0	11.7	12.1	10.6	10.0	17.2	15.0	13.1	14.2	13.3
		75.0%	14.8	15.4	12.9	13.3	11.6	11.0	19.2	16.6	14.5	15.7	14.7
		97.5%	17.8	18.5	15.3	15.9	13.8	12.9	23.5	20.2	17.3	18.7	17.7
24229	Portland, OR	2.5%	20.6	21.1	18.1	18.5	17.1	16.3	25.3	22.3	19.9	21.6	20.2
		25.0%	25.5	26.4	22.2	22.8	20.9	19.7	32.4	28.1	24.5	27.0	25.2
		50.0%	29.1	30.4	25.2	25.8	23.7	22.1	37.9	32.6	27.9	31.1	28.9
		75.0%	33.8	35.5	28.9	29.7	27.0	25.2	45.8	38.4	32.4	36.5	33.6
		97.5%	46.0	49.2	37.9	39.5	35.2	32.5	67.9	53.9	43.5	50.2	45.5

WBAN	CITY, STATE	%	NEG-MICON						NORDEX				
			NM 48	NM 52 (49)	NM 52 (72.3)	NM 54	NM 72C (70)	NM 72C (80)	N-60 (46)	N-60 (60)	N-60 (80)	N-62 (60)	N-62 (69)
14777	Wilkes-Barre, PA	2.5%	17.0	17.5	14.3	14.9	13.6	12.7	22.4	19.3	16.5	18.3	17.0
		25.0%	21.0	21.4	17.2	18.0	16.4	15.3	28.2	23.9	20.1	22.6	20.7
		50.0%	23.7	24.2	19.3	20.2	18.4	17.0	32.4	27.2	22.7	25.7	23.4
		75.0%	26.9	27.7	21.8	22.8	20.6	19.1	38.5	31.4	25.7	29.5	26.7
		97.5%	35.3	36.4	27.1	28.8	25.7	23.4	54.1	42.0	33.2	38.7	34.8
14944	Sioux Falls, SD	2.5%	6.8	7.1	6.2	6.3	5.6	5.4	8.1	7.4	6.7	7.1	6.7
		25.0%	7.9	8.3	7.3	7.4	6.5	6.3	9.6	8.6	7.8	8.2	7.8
		50.0%	8.7	9.1	7.9	8.1	7.1	6.8	10.5	9.4	8.5	9.0	8.6
		75.0%	9.4	9.9	8.6	8.8	7.8	7.4	11.5	10.3	9.3	9.9	9.4
		97.5%	10.9	11.6	9.9	10.2	8.9	8.5	13.5	12.0	10.8	11.5	10.9
12924	Corpus Christi, TX	2.5%	5.6	5.9	5.3	5.3	4.7	4.6	6.7	6.1	5.6	5.9	5.6
		25.0%	6.6	7.0	6.2	6.3	5.5	5.3	7.9	7.2	6.5	6.9	6.5
		50.0%	7.2	7.6	6.7	6.8	6.0	5.8	8.7	7.9	7.2	7.5	7.2
		75.0%	7.9	8.3	7.3	7.4	6.6	6.3	9.5	8.6	7.8	8.2	7.8
		97.5%	9.1	9.6	8.5	8.6	7.6	7.3	11.1	10.0	9.1	9.5	9.1
12912	Victoria, TX	2.5%	9.4	9.8	8.4	8.6	7.8	7.4	11.6	10.3	9.2	9.9	9.3
		25.0%	11.2	11.6	10.0	10.2	9.2	8.7	13.9	12.4	10.9	11.8	11.1
		50.0%	12.3	12.9	11.0	11.2	10.0	9.5	15.4	13.7	12.1	13.0	12.2
		75.0%	13.6	14.2	12.0	12.3	11.0	10.4	17.2	15.2	13.3	14.4	13.5
		97.5%	16.3	17.1	14.2	14.7	13.0	12.3	21.0	18.3	15.8	17.3	16.1
93738	Sterling, VA	2.5%	17.5	18.2	15.2	15.6	14.4	13.5	22.5	19.8	17.1	18.8	17.4
		25.0%	21.5	22.3	18.4	19.1	17.4	16.3	28.3	24.4	20.9	23.0	21.4
		50.0%	24.4	25.3	20.7	21.4	19.4	18.1	32.6	27.8	23.6	26.1	24.2
		75.0%	27.9	29.1	23.3	24.3	21.8	20.3	38.4	32.1	26.8	30.0	27.7
		97.5%	36.5	38.1	29.4	30.7	27.2	25.1	53.5	43.4	34.4	39.8	35.8
14898	Green Bay, WI	2.5%	9.6	10.1	8.7	8.8	7.9	7.5	12.1	10.6	9.5	10.2	9.6
		25.0%	11.5	12.0	10.3	10.5	9.4	8.9	14.3	12.7	11.2	12.1	11.4
		50.0%	12.6	13.2	11.3	11.5	10.3	9.8	15.9	14.0	12.4	13.4	12.6
		75.0%	13.9	14.6	12.4	12.7	11.3	10.7	17.7	15.5	13.6	14.7	13.8
		97.5%	16.7	17.4	14.7	15.0	13.2	12.5	21.4	18.6	16.3	17.6	16.5

## **APPENDIX F. Economic Payback Results**

Results for the NM72C (80) – 1,500 kW turbine with 80 m hub height  
239 Locations arranged alphabetically by State/City  
Box-and-whiskers diagrams represent 2.5<sup>th</sup>, 25<sup>th</sup>, 50<sup>th</sup>, 75<sup>th</sup>, and 97.5<sup>th</sup> percentiles

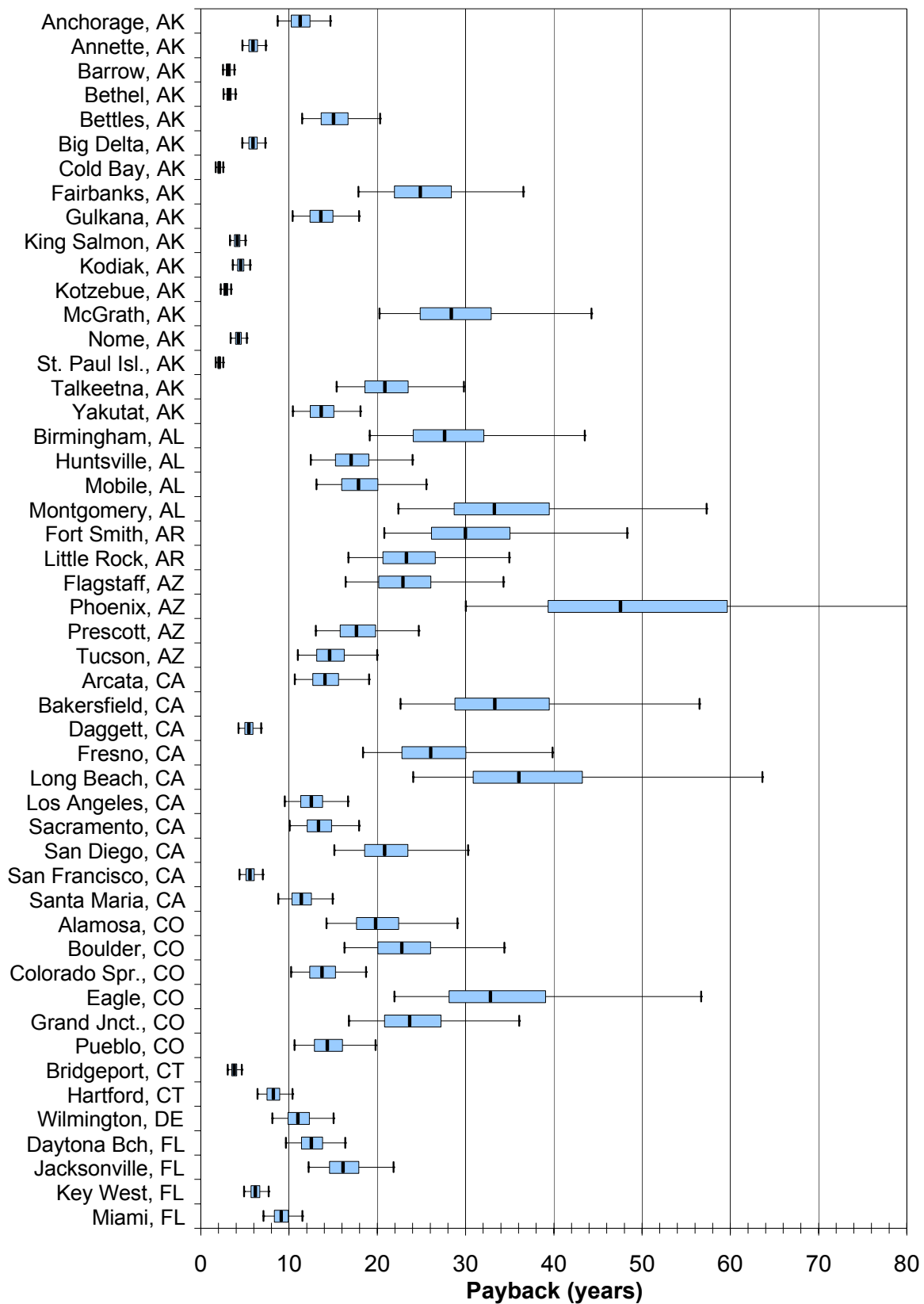

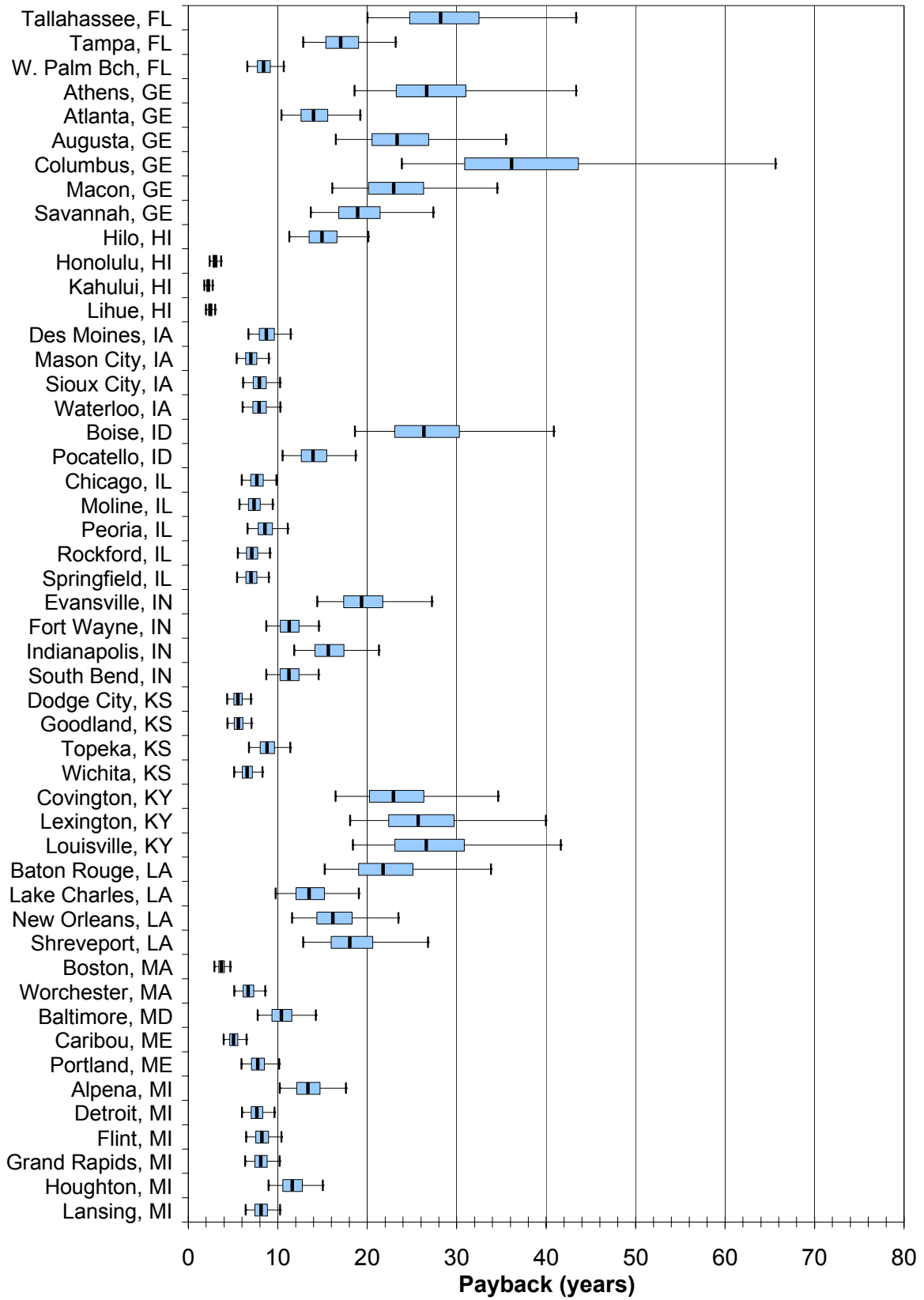

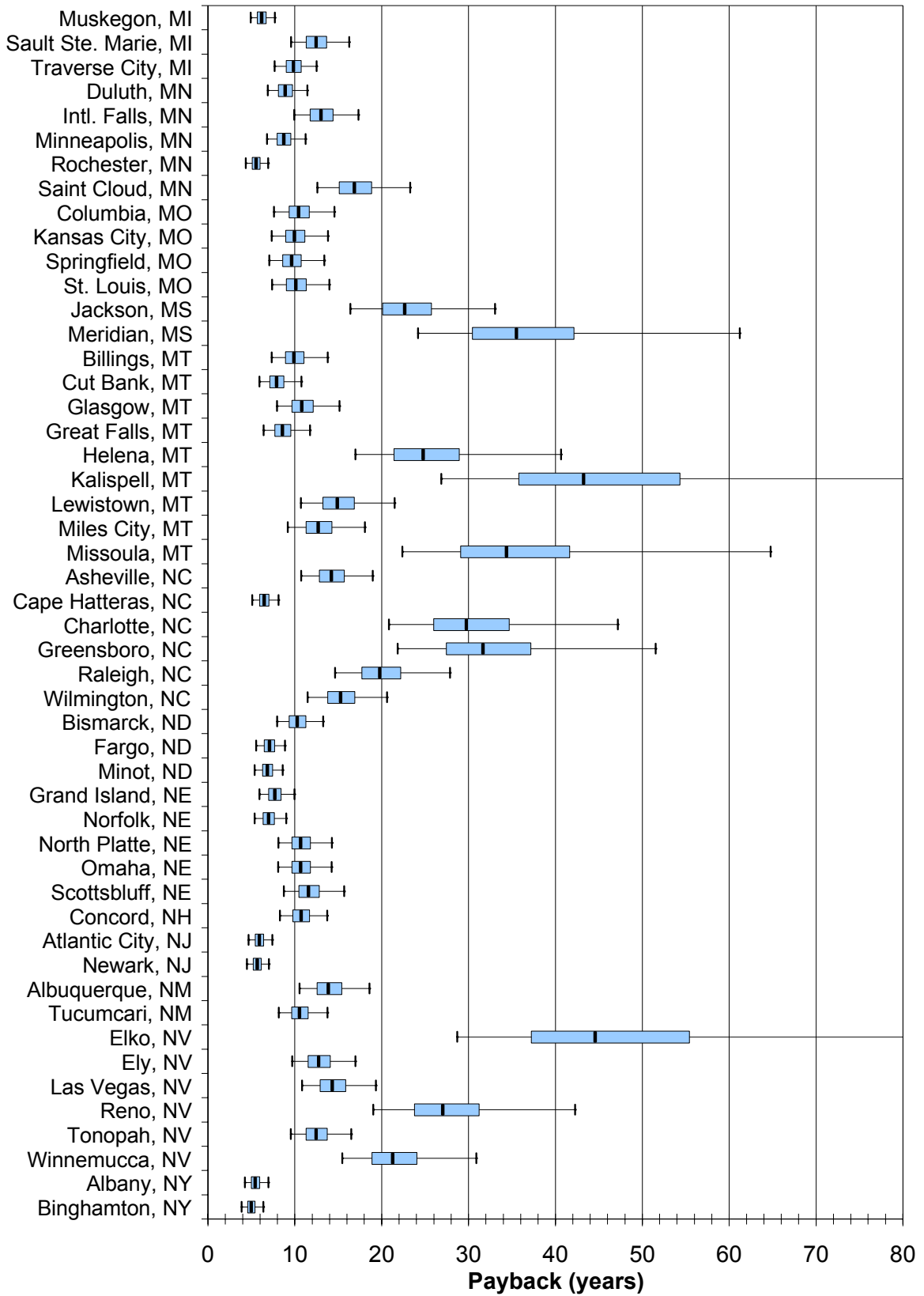



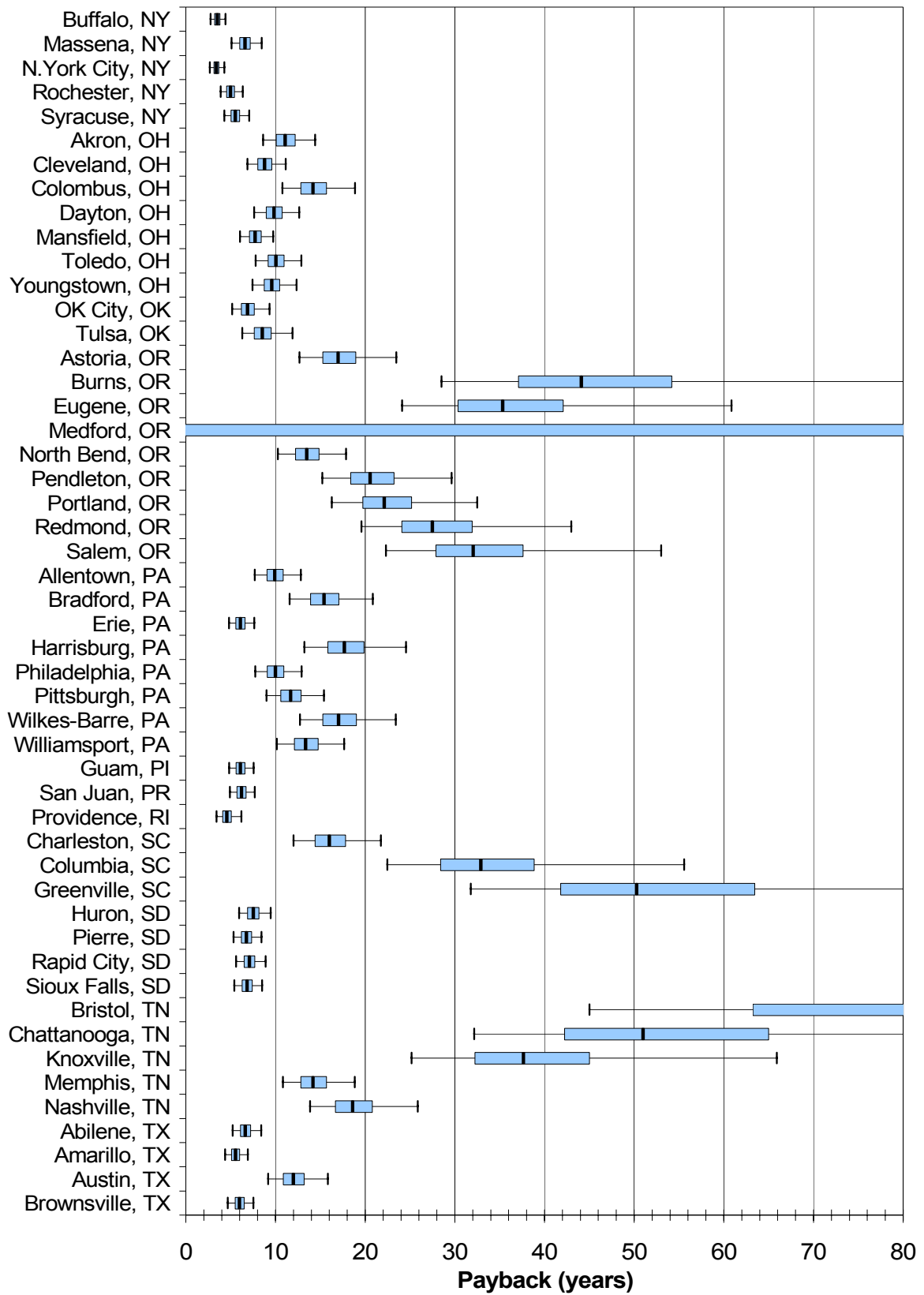

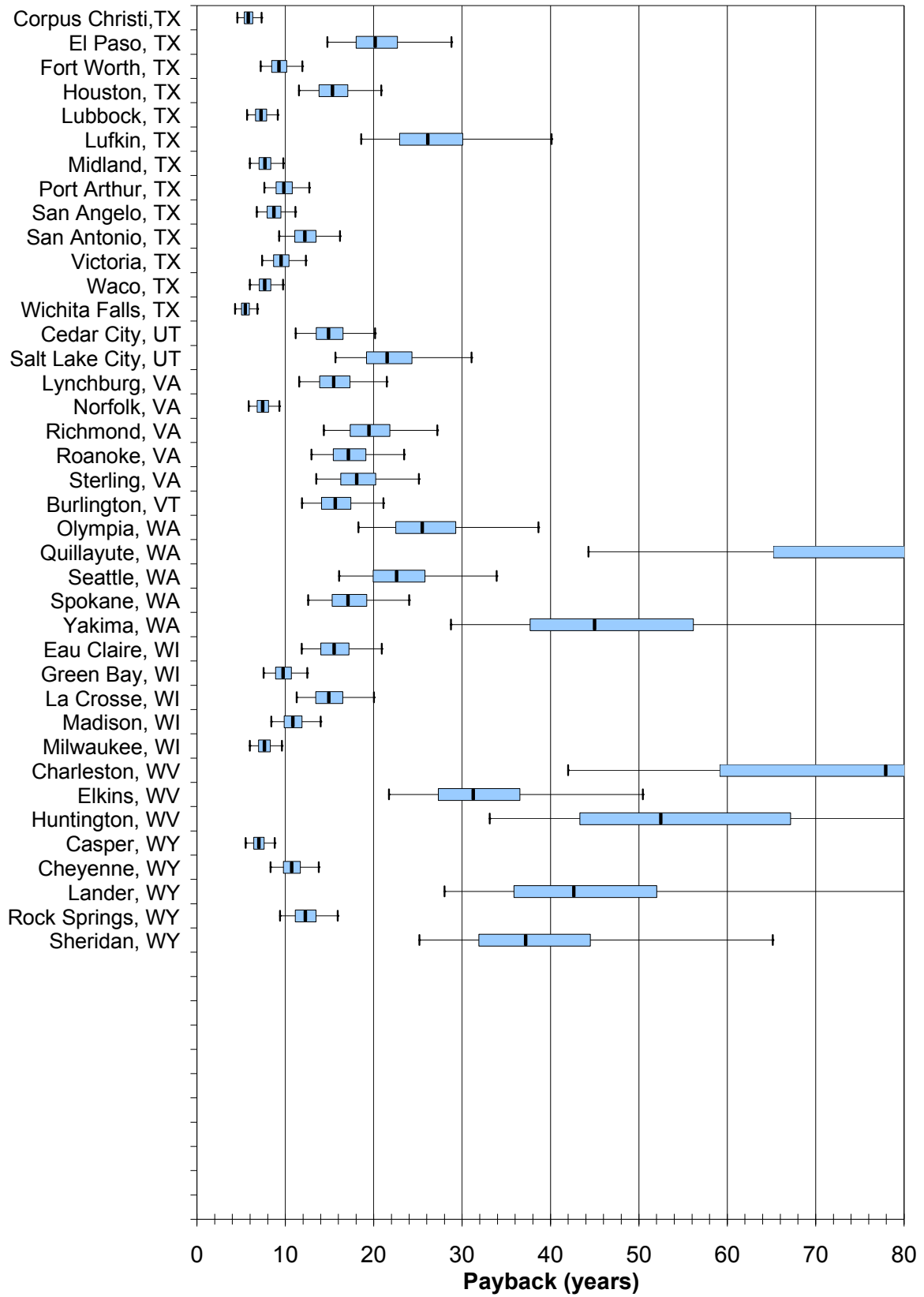

## **APPENDIX G. Energy Intensity Results**

Results for the NM72C (80) – 1,500 kW turbine with 80 m hub height  
239 Locations arranged alphabetically by State/City  
Box-and-whiskers diagrams represent 2.5<sup>th</sup>, 25<sup>th</sup>, 50<sup>th</sup>, 75<sup>th</sup>, and 97.5<sup>th</sup> percentiles

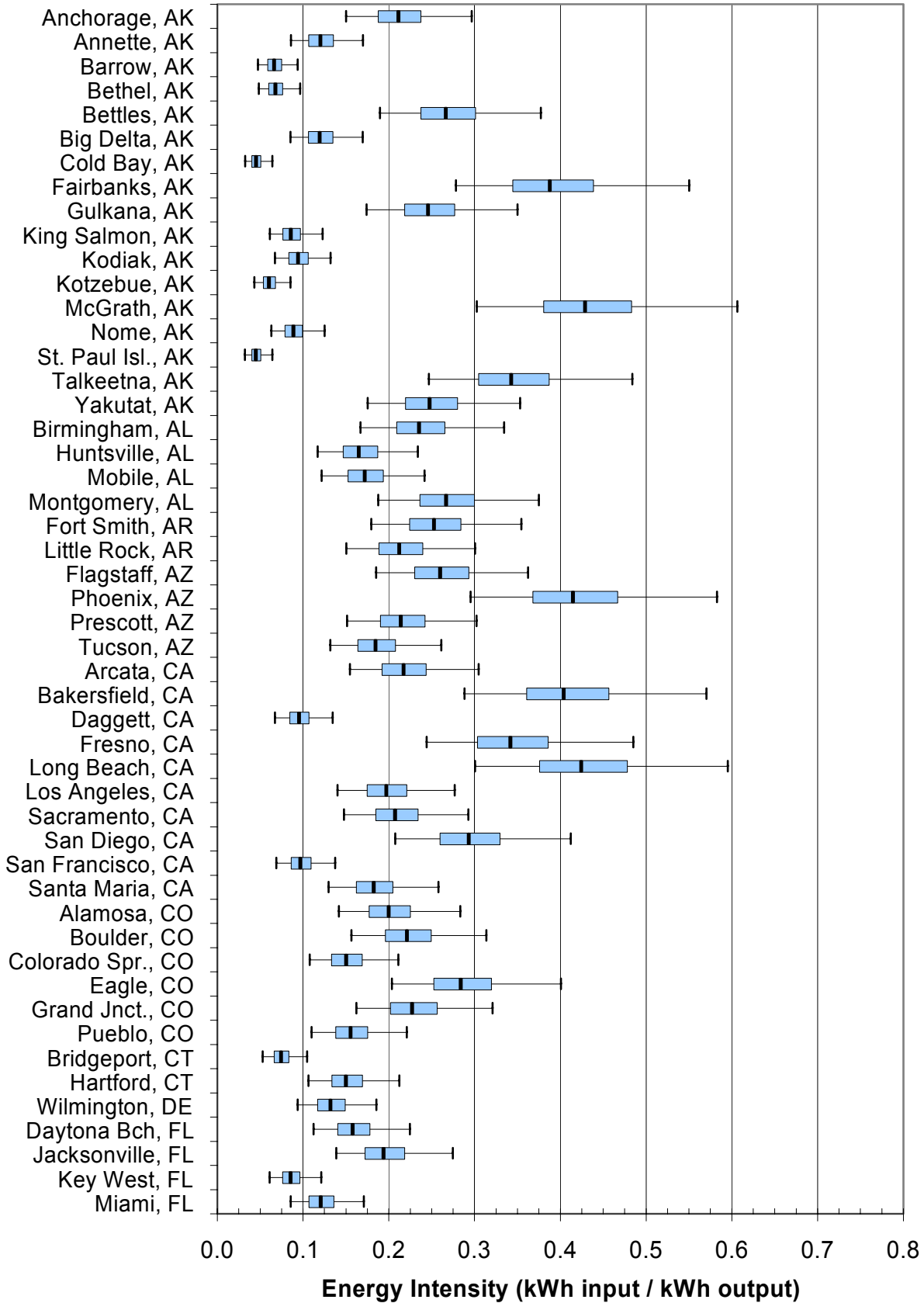

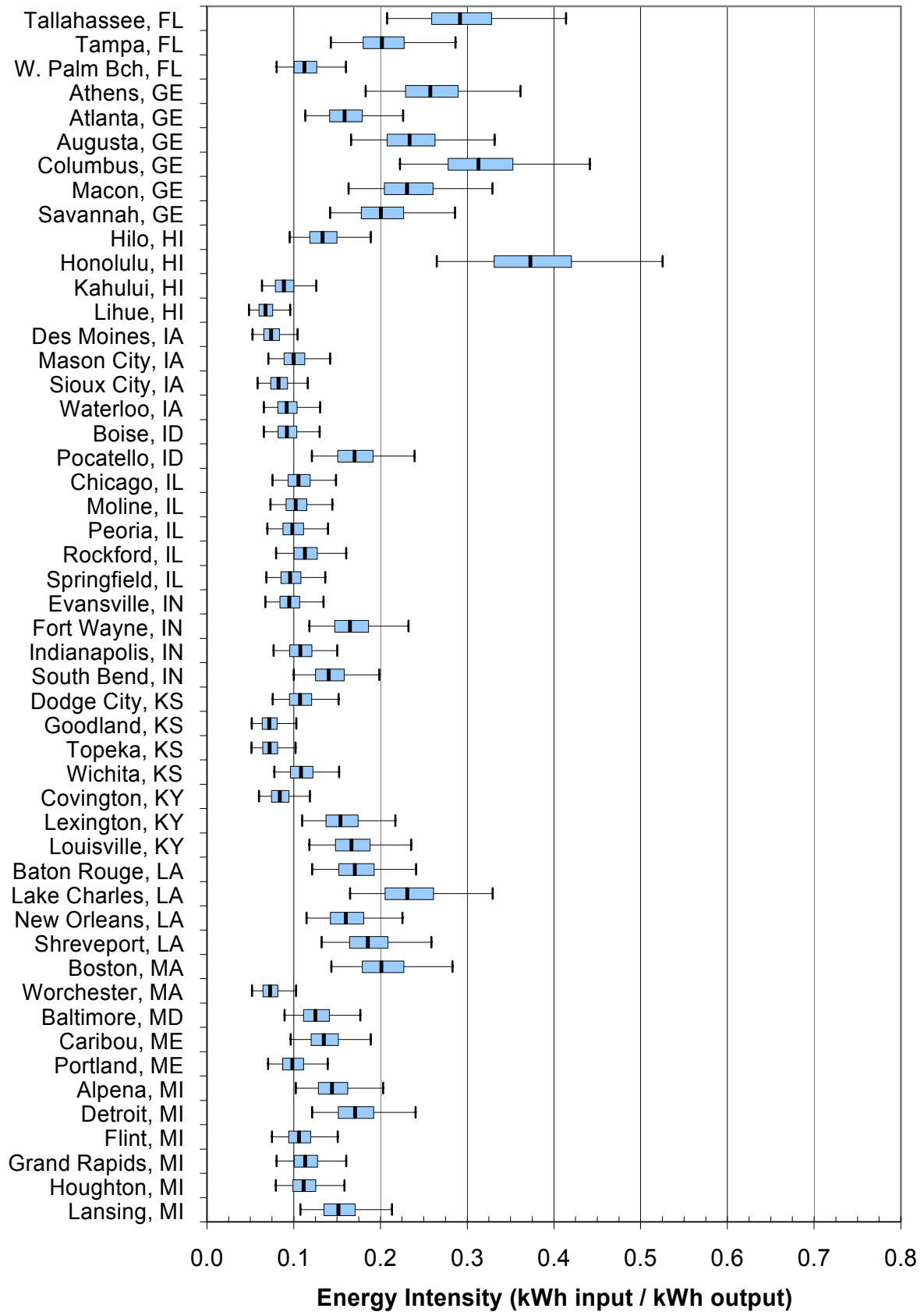

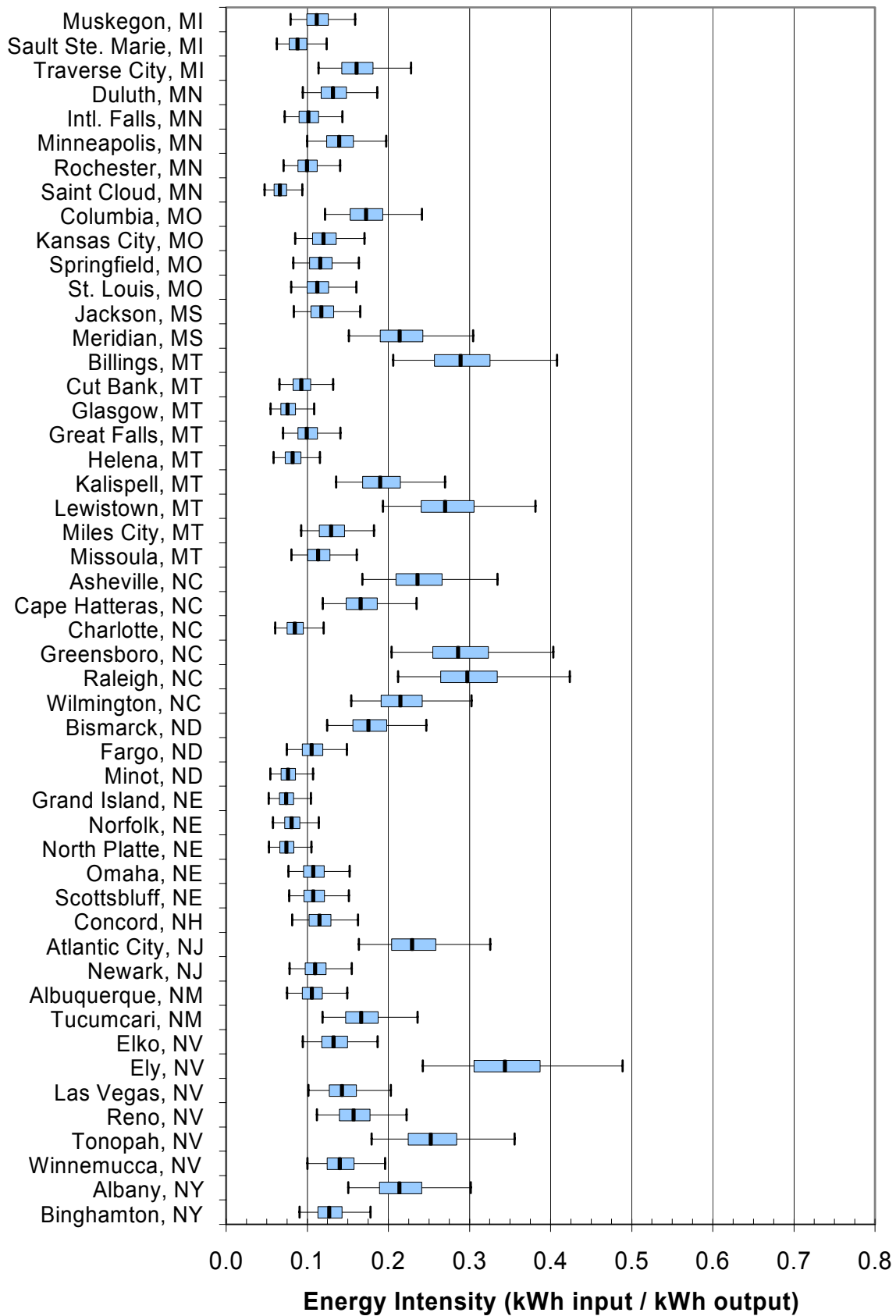

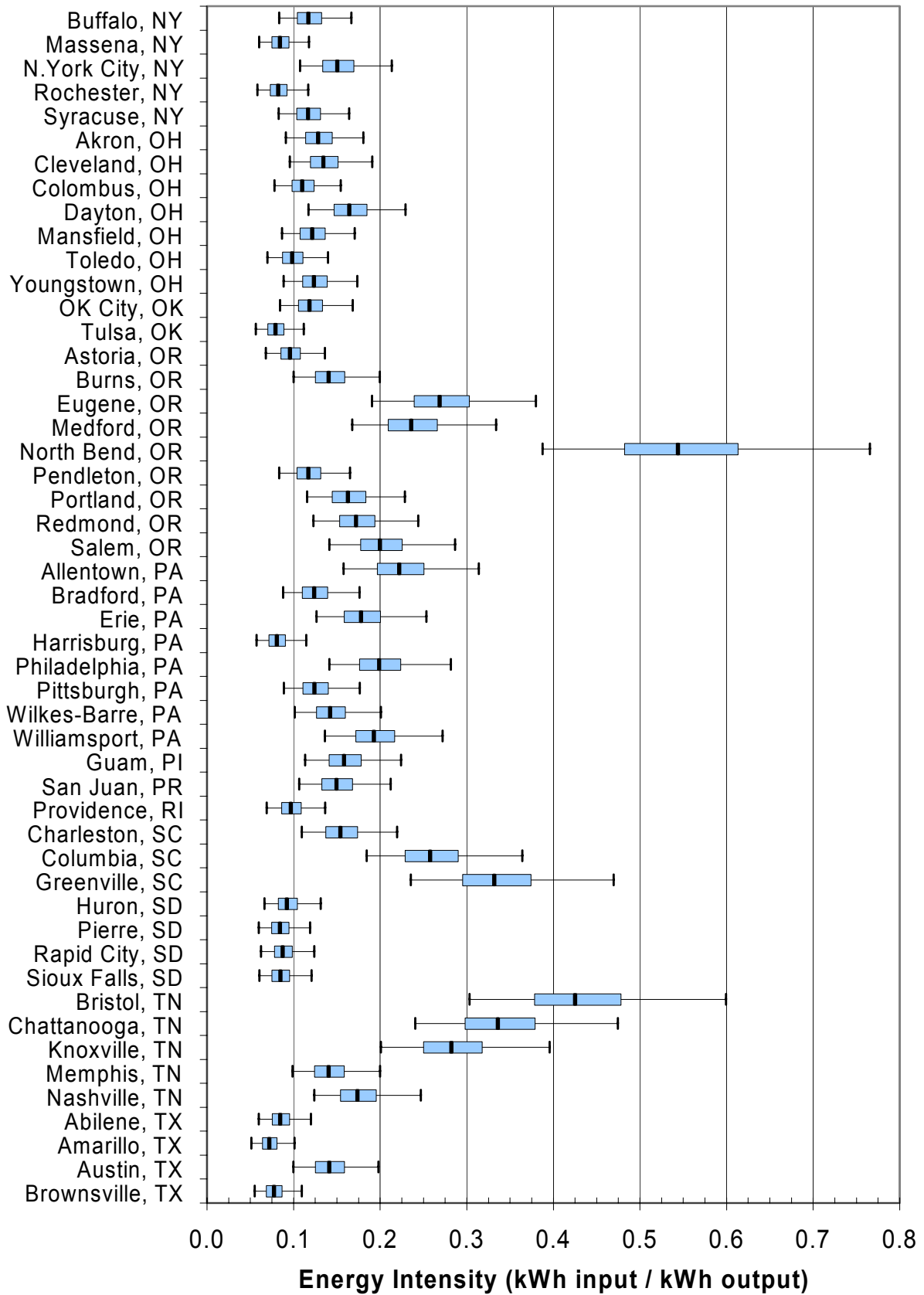

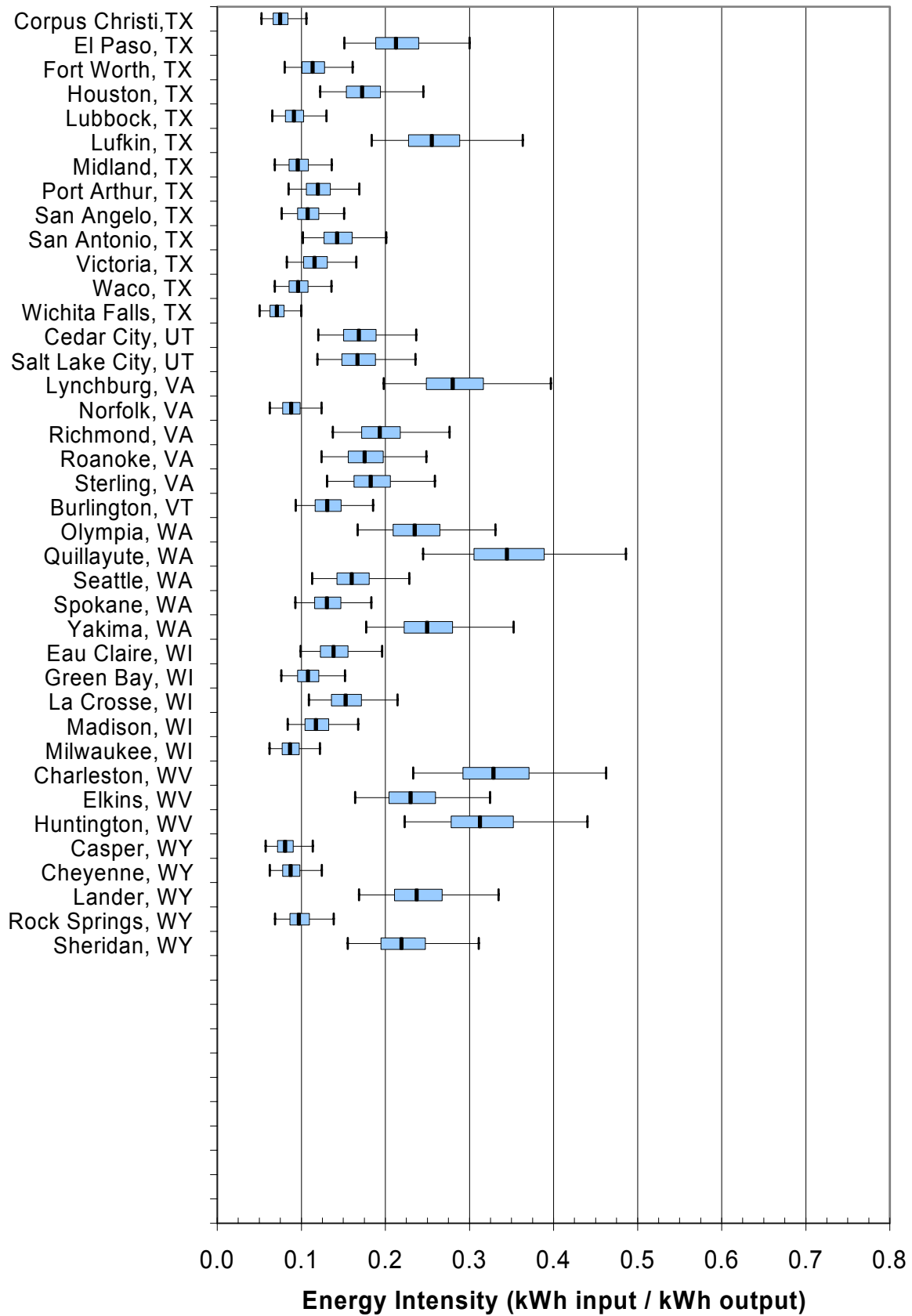



## **APPENDIX H. CO<sub>2</sub> (eq) Intensity Results**

Results for the NM72C (80) – 1,500 kW turbine with 80 m hub height  
239 Locations arranged alphabetically by State/City  
Box-and-whiskers diagrams represent 2.5<sup>th</sup>, 25<sup>th</sup>, 50<sup>th</sup>, 75<sup>th</sup>, and 97.5<sup>th</sup> percentiles

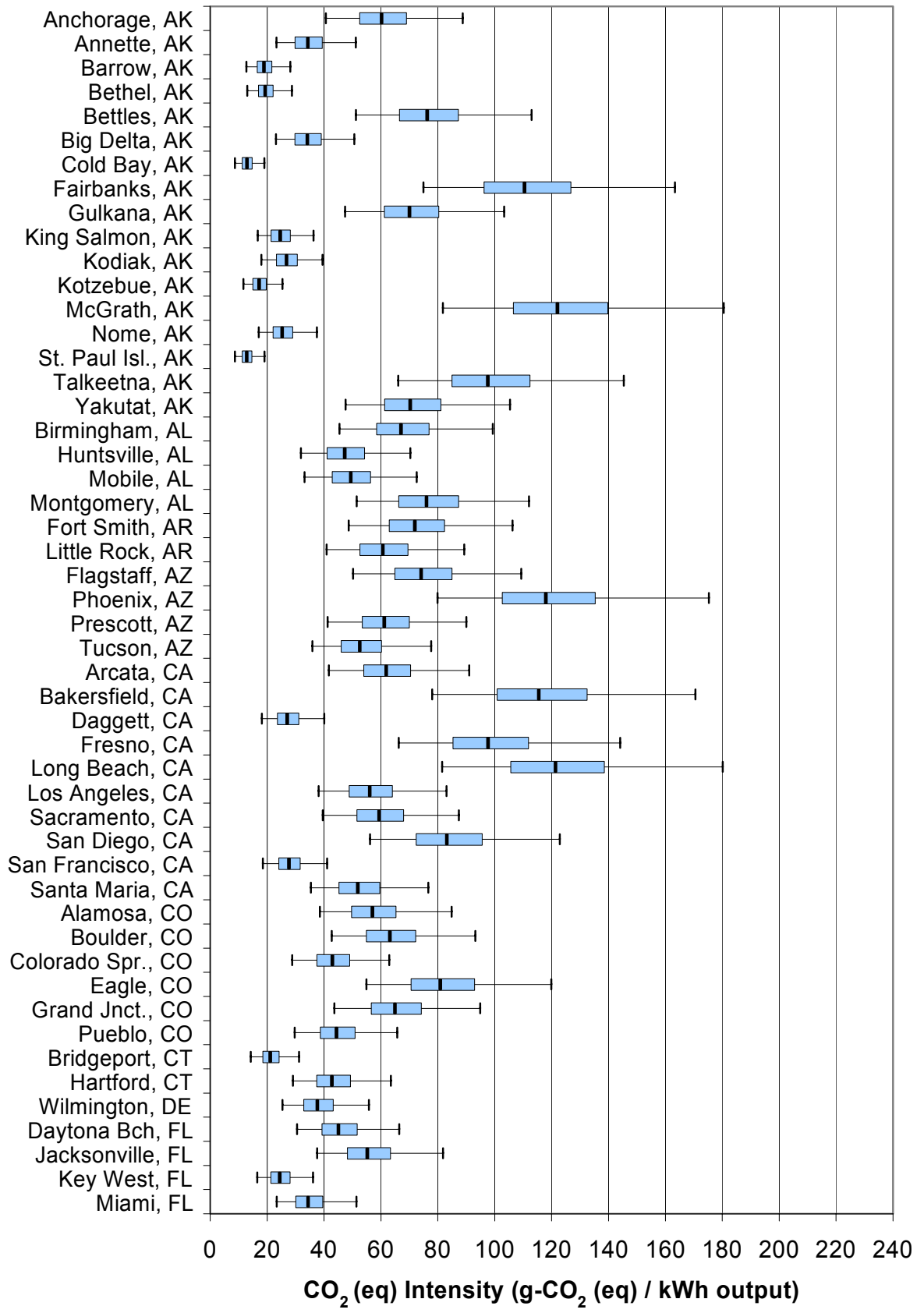

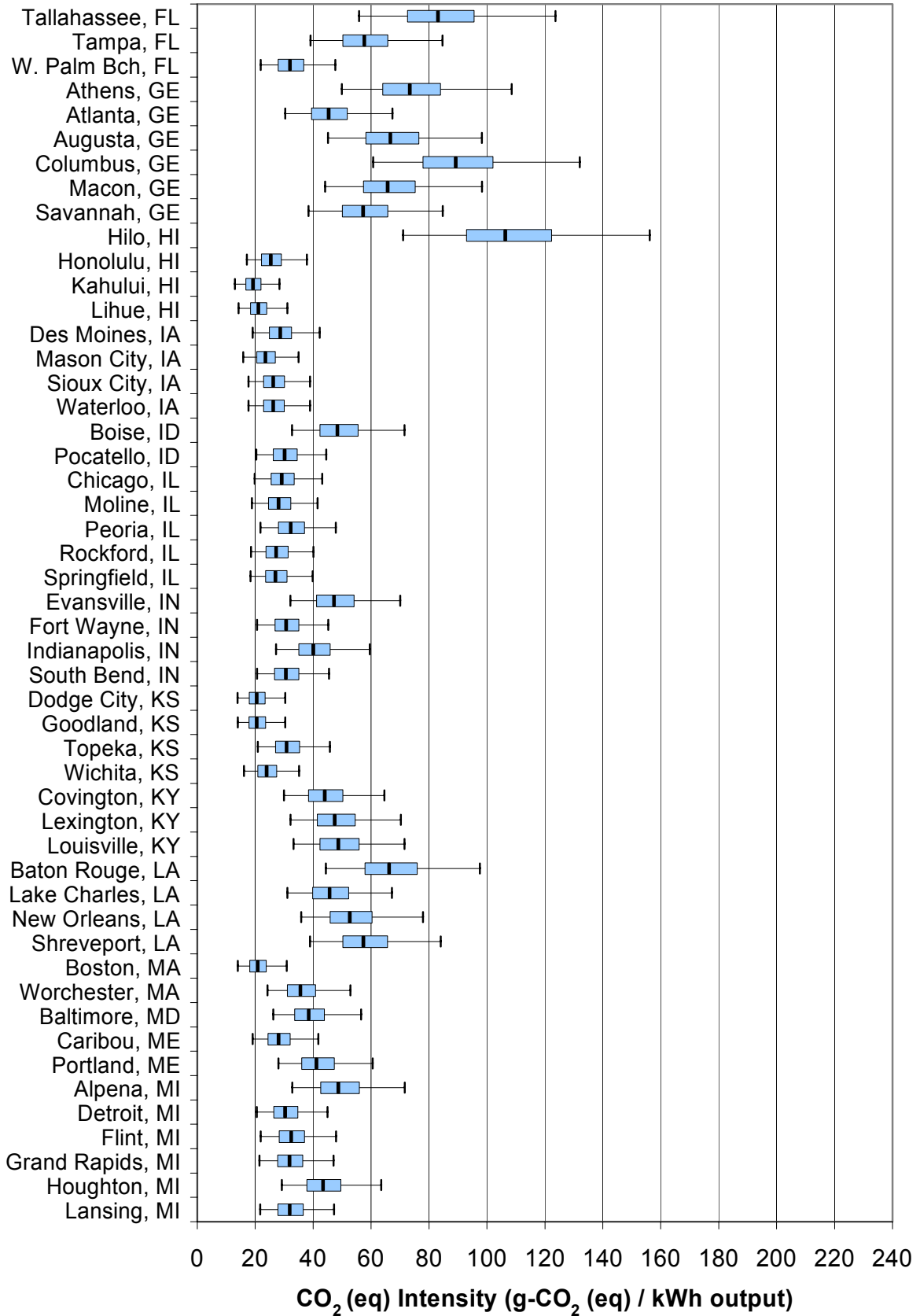

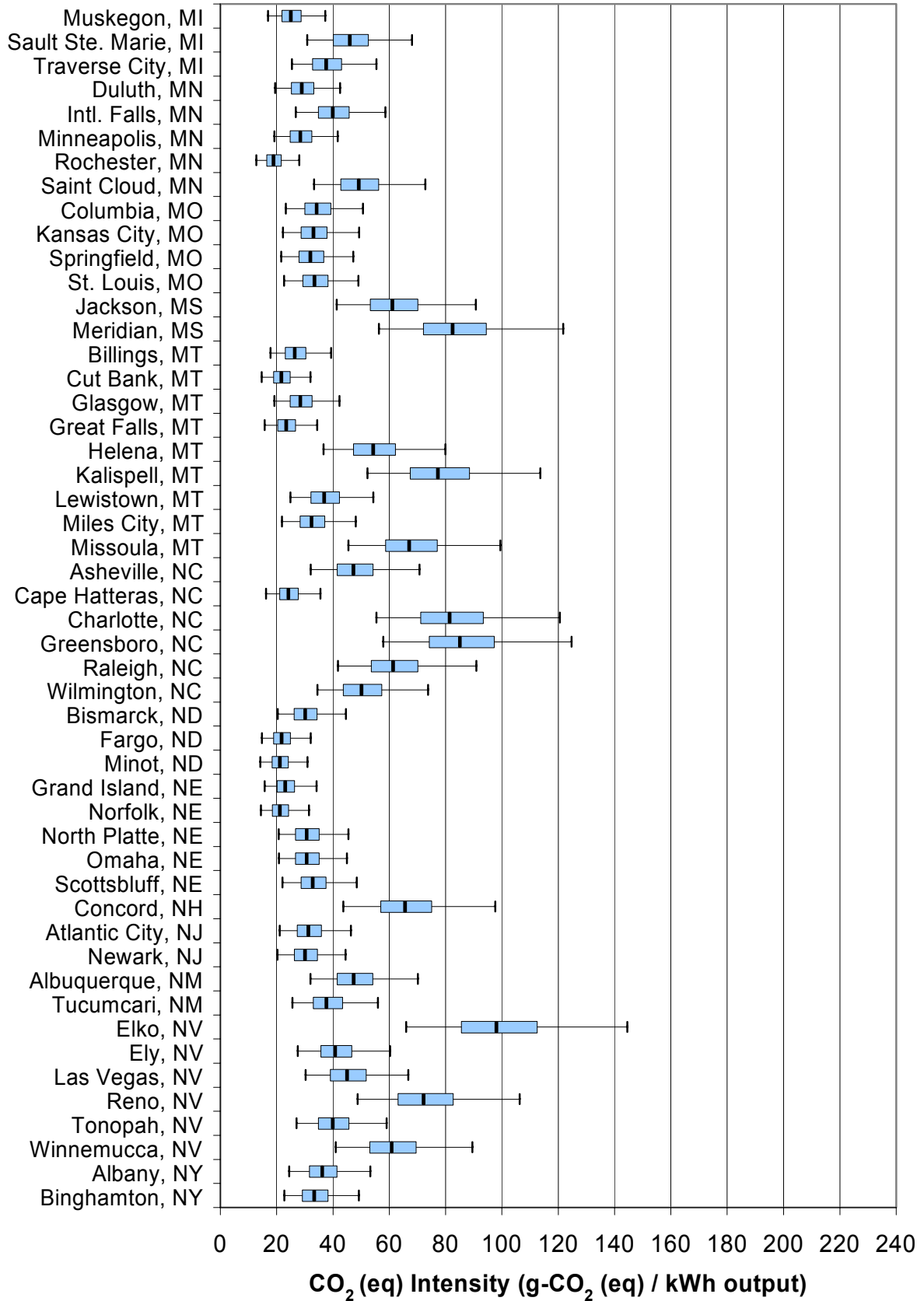

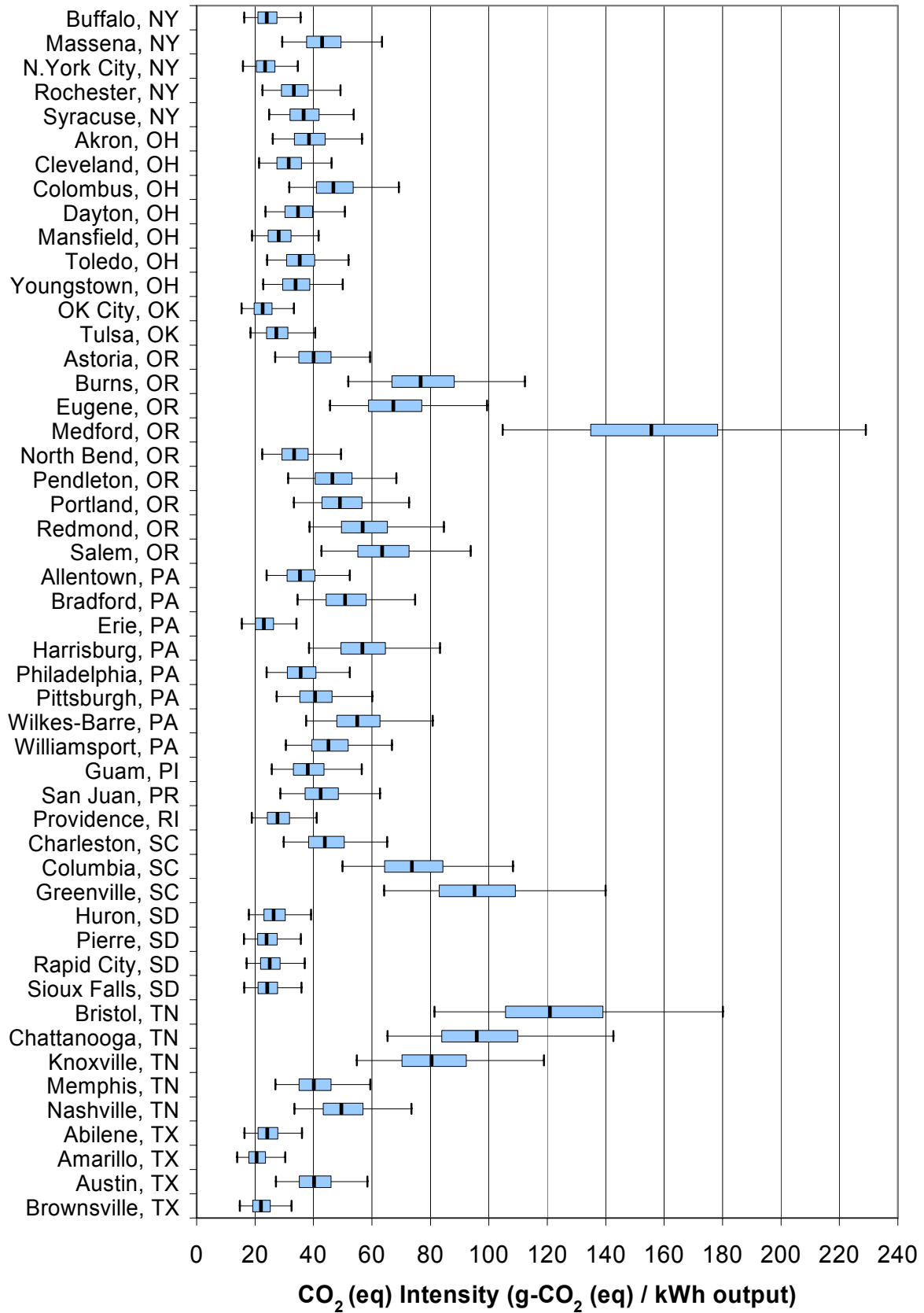

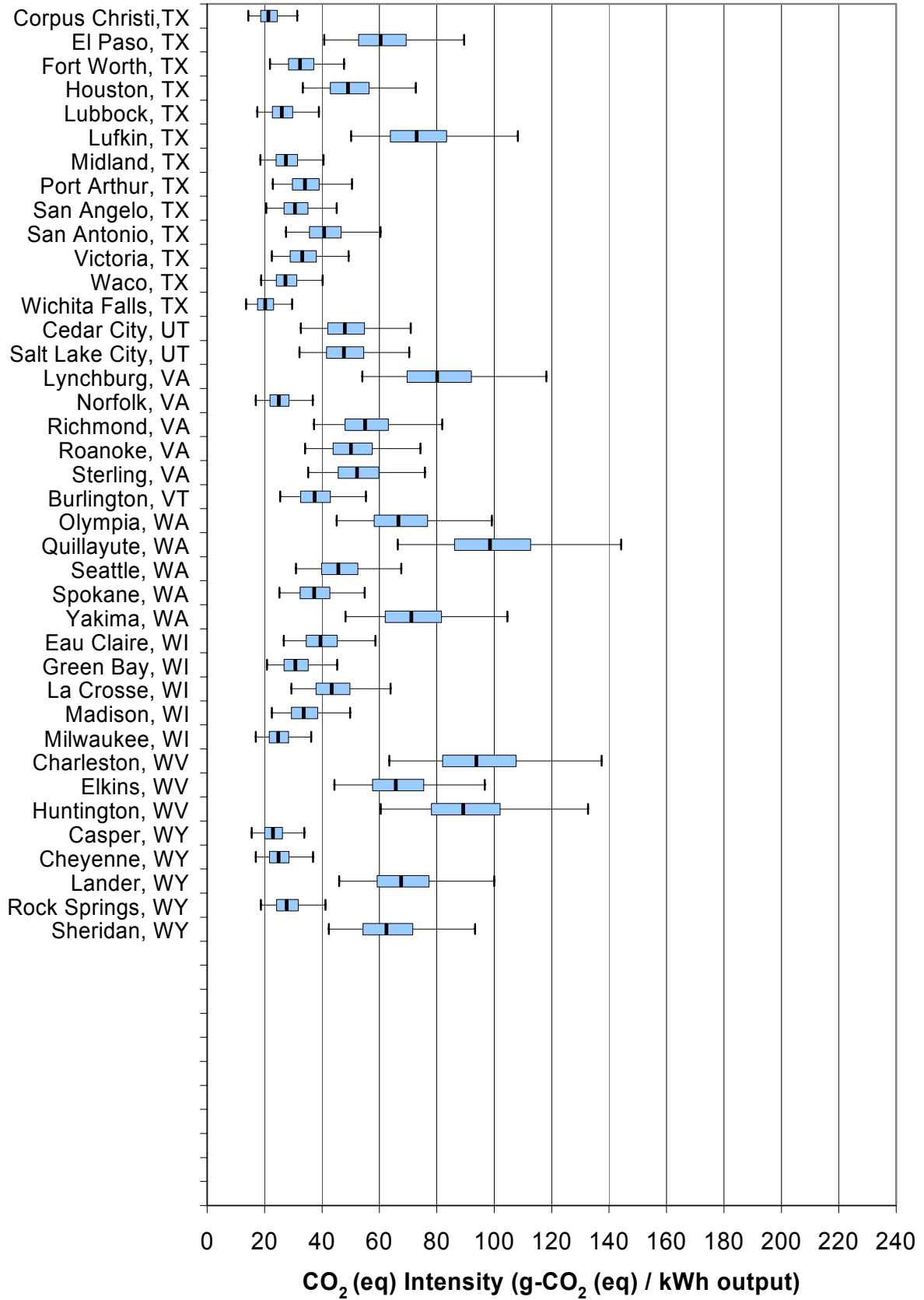

## **APPENDIX I. SO<sub>x</sub> Intensity Results**

Results for the NM72C (80) – 1,500 kW turbine with 80 m hub height  
239 Locations arranged alphabetically by State/City  
Box-and-whiskers diagrams represent 2.5<sup>th</sup>, 25<sup>th</sup>, 50<sup>th</sup>, 75<sup>th</sup>, and 97.5<sup>th</sup> percentiles

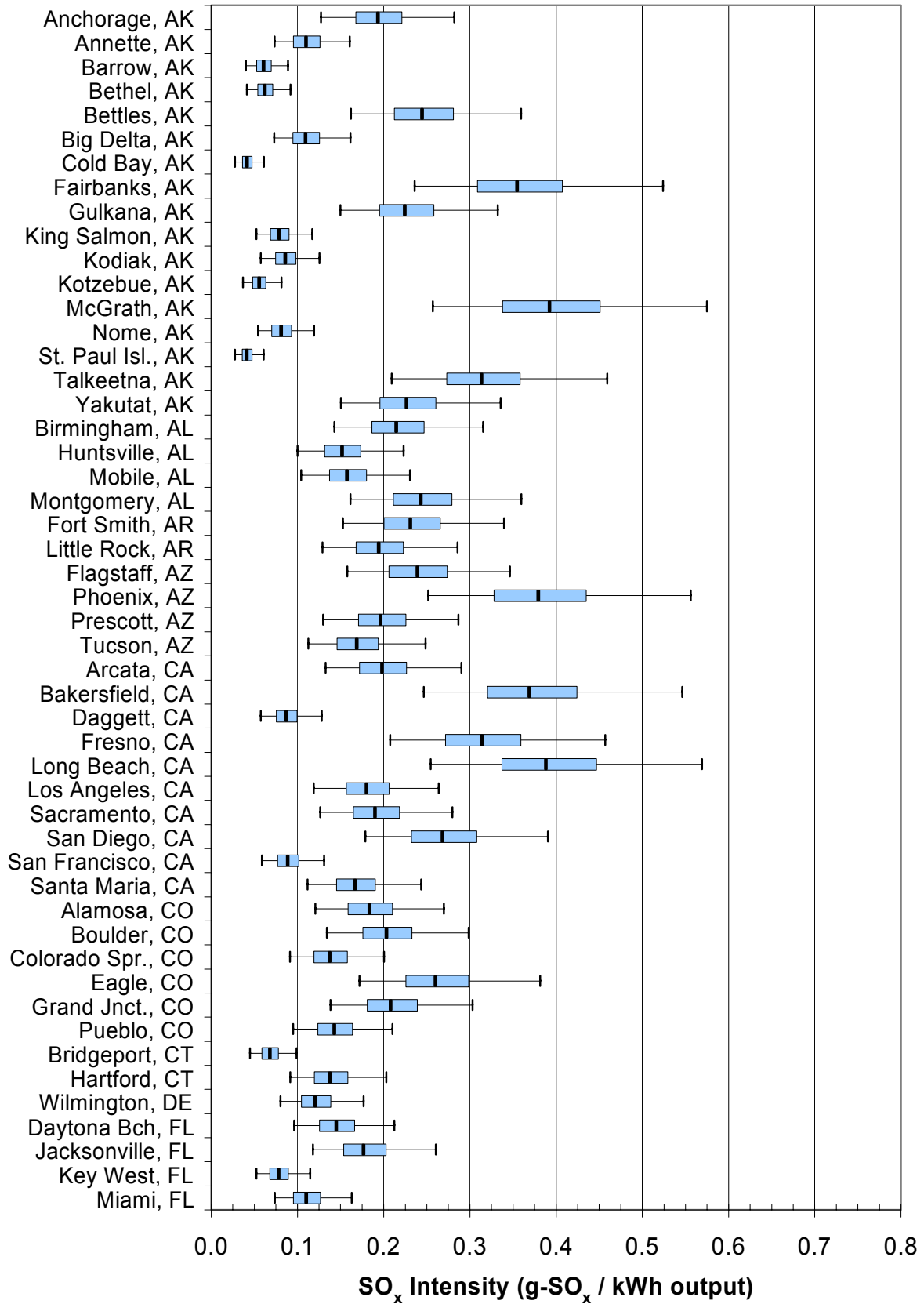



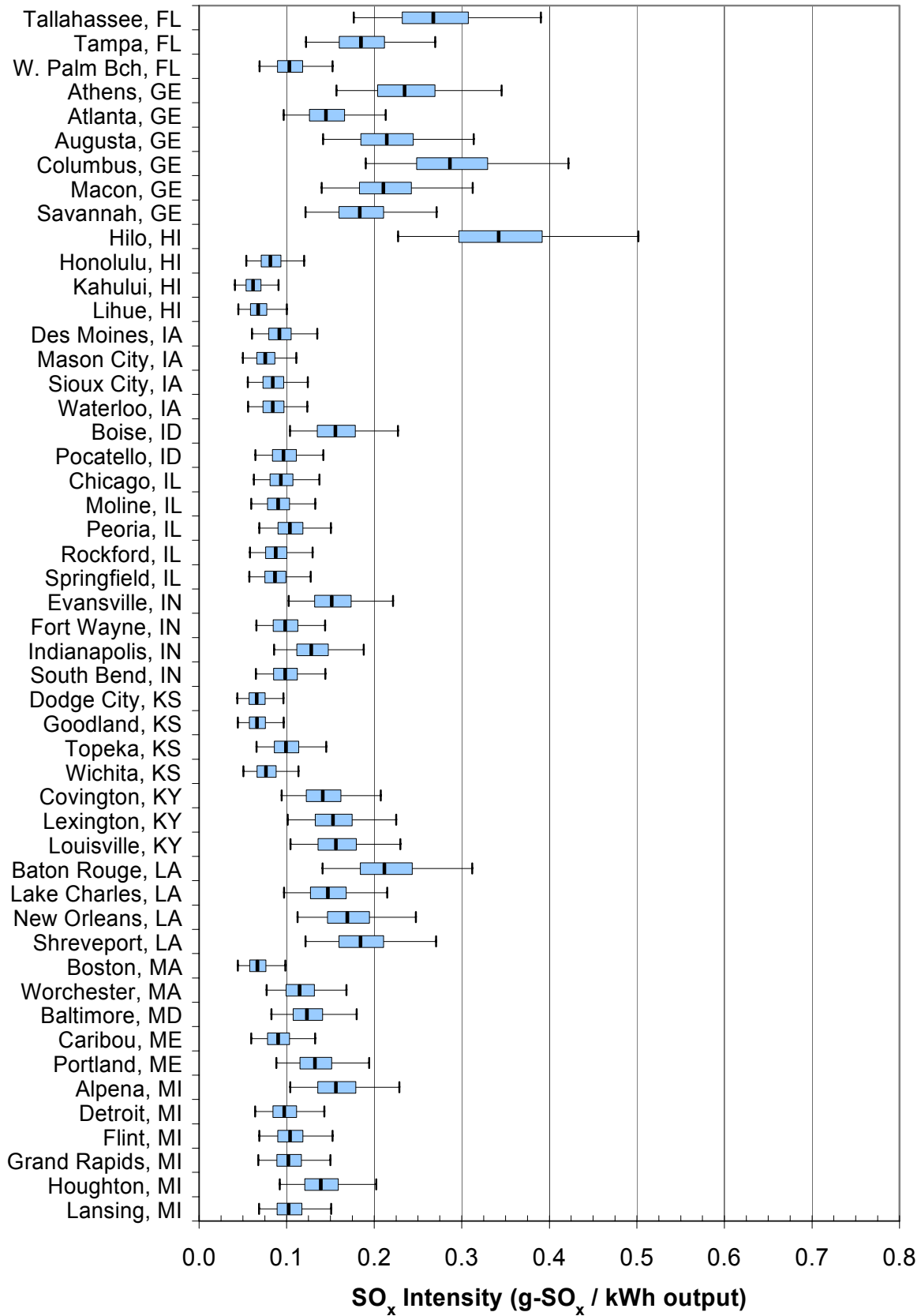

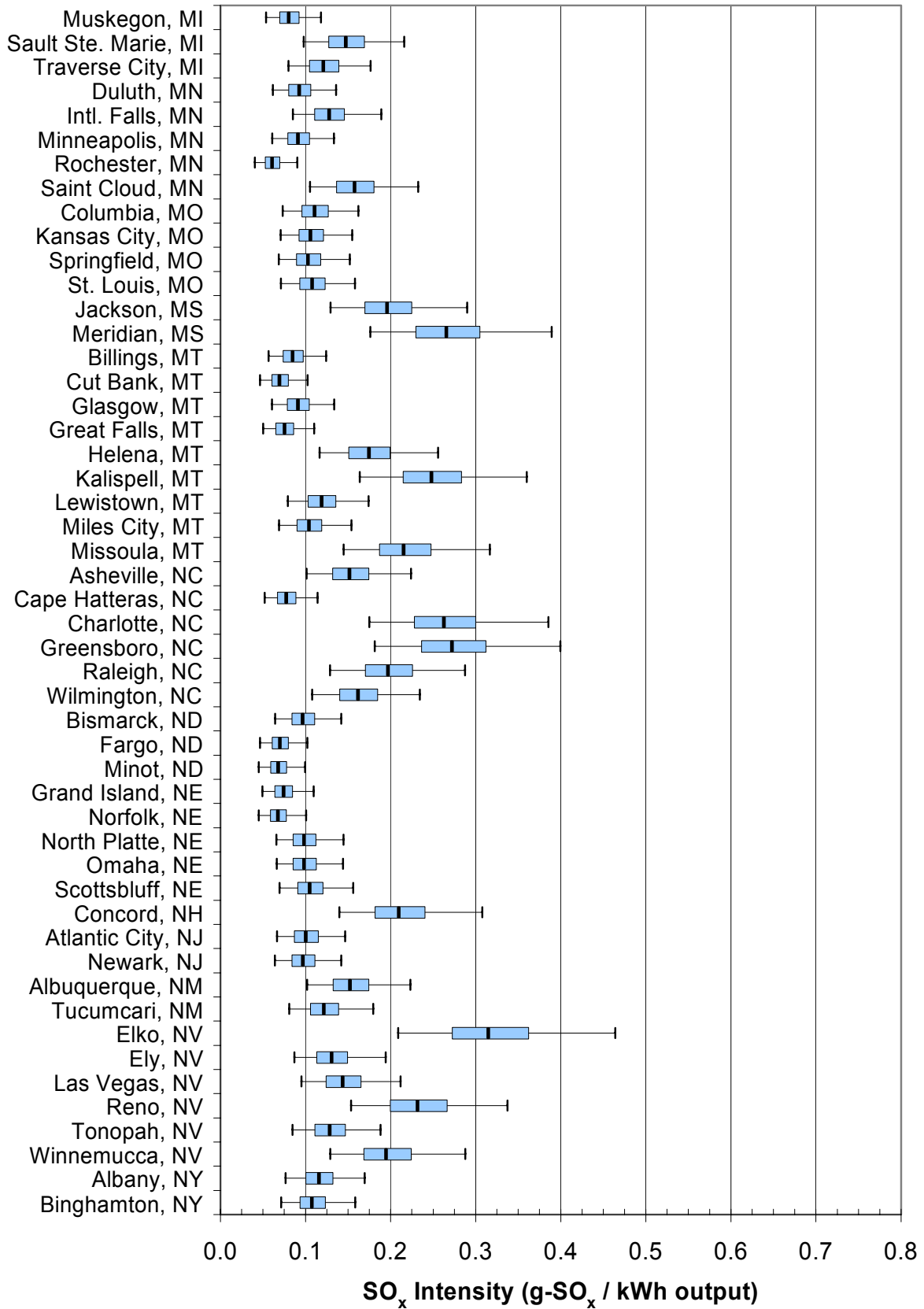

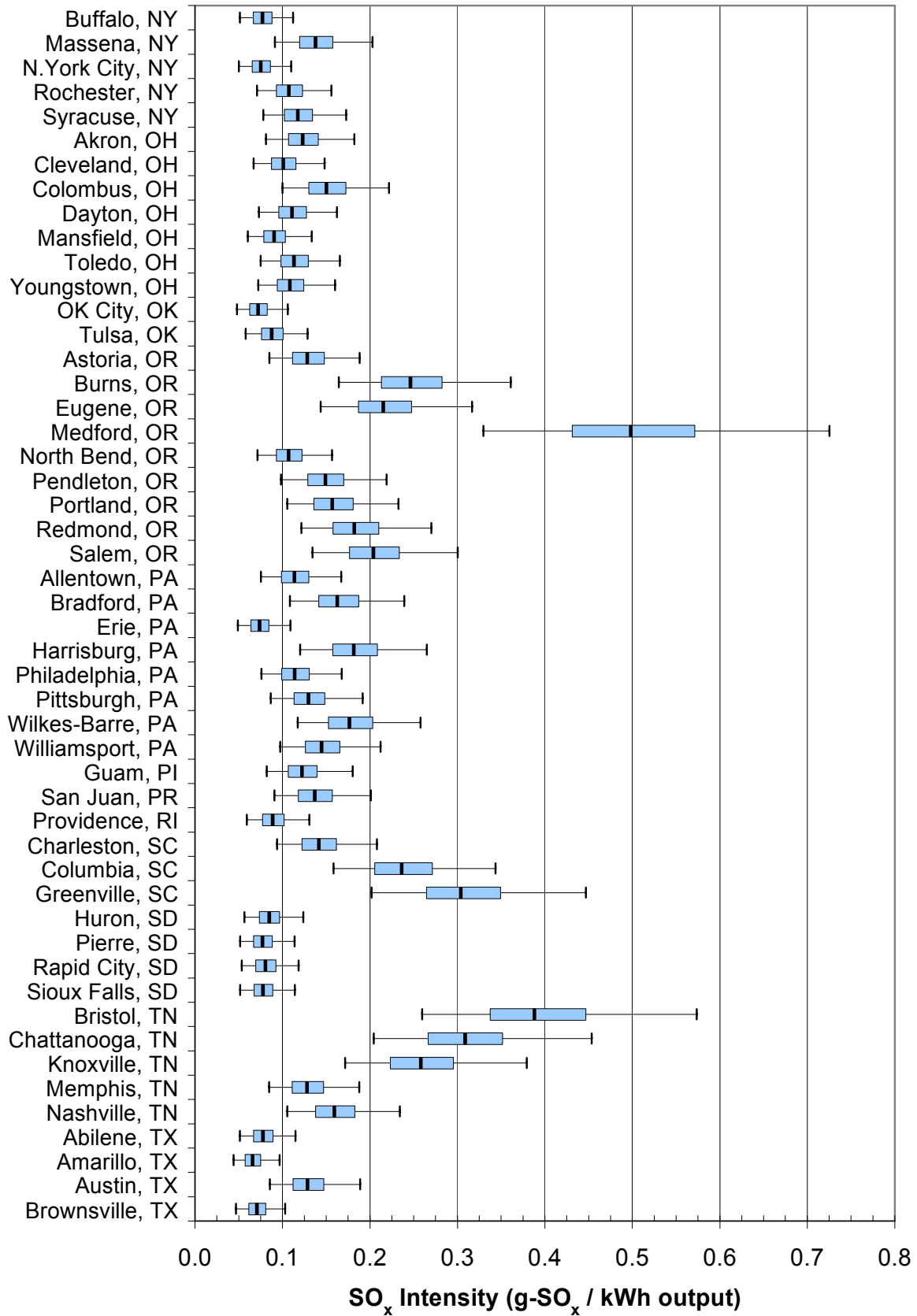

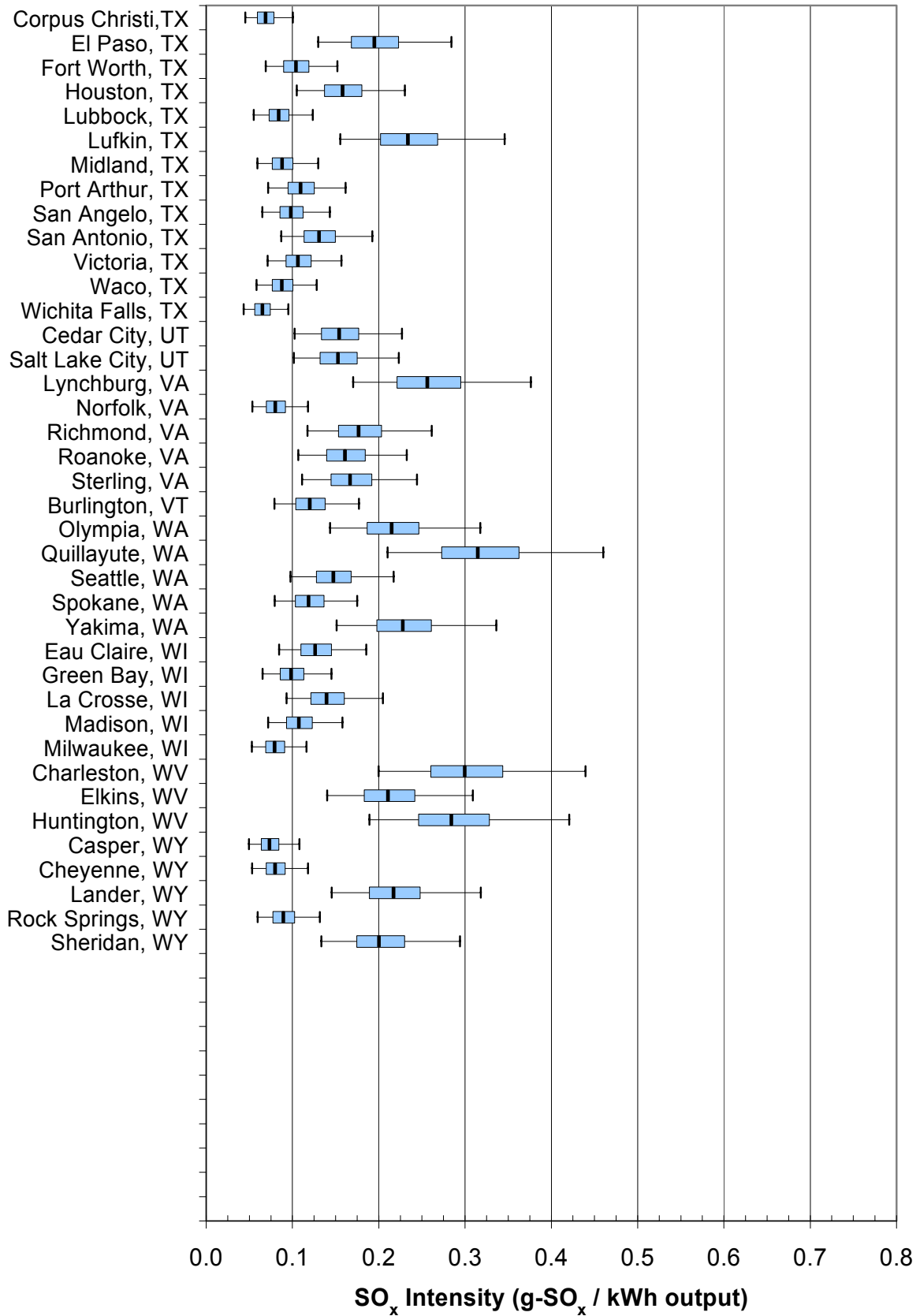

## **APPENDIX J. NO<sub>x</sub> Intensity Results**

Results for the NM72C (80) – 1,500 kW turbine with 80 m hub height  
239 Locations arranged alphabetically by State/City  
Box-and-whiskers diagrams represent 2.5<sup>th</sup>, 25<sup>th</sup>, 50<sup>th</sup>, 75<sup>th</sup>, and 97.5<sup>th</sup> percentiles

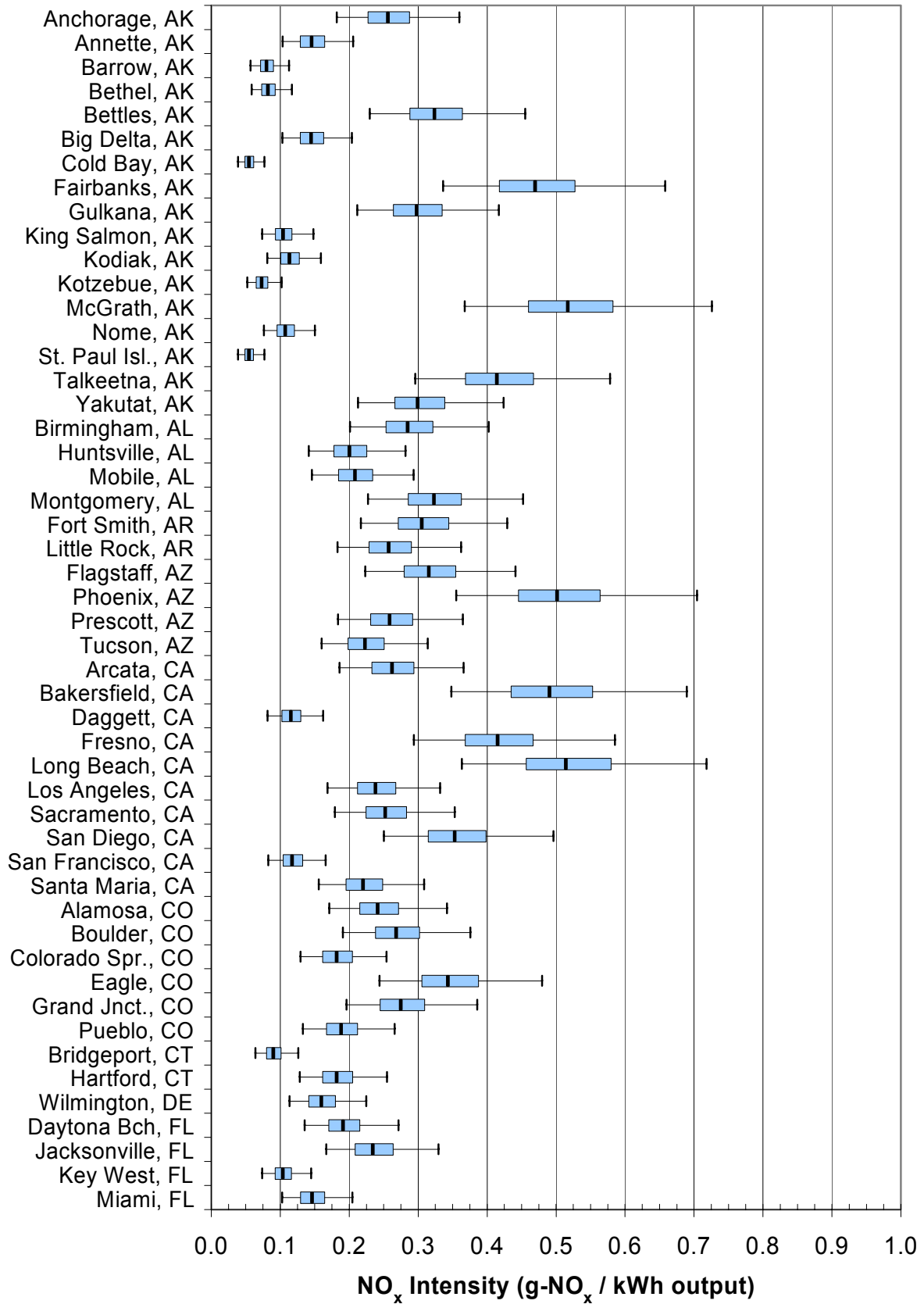

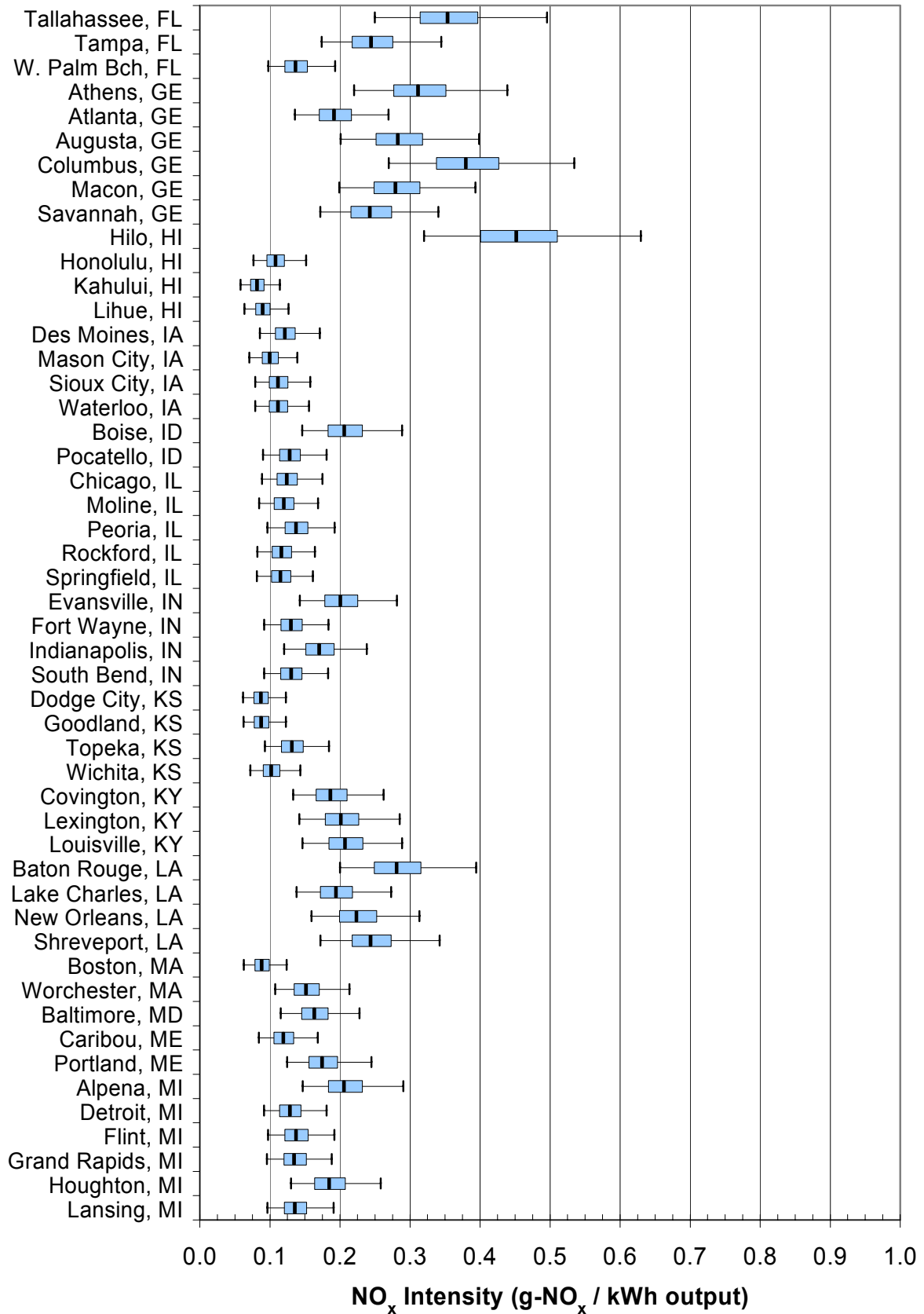

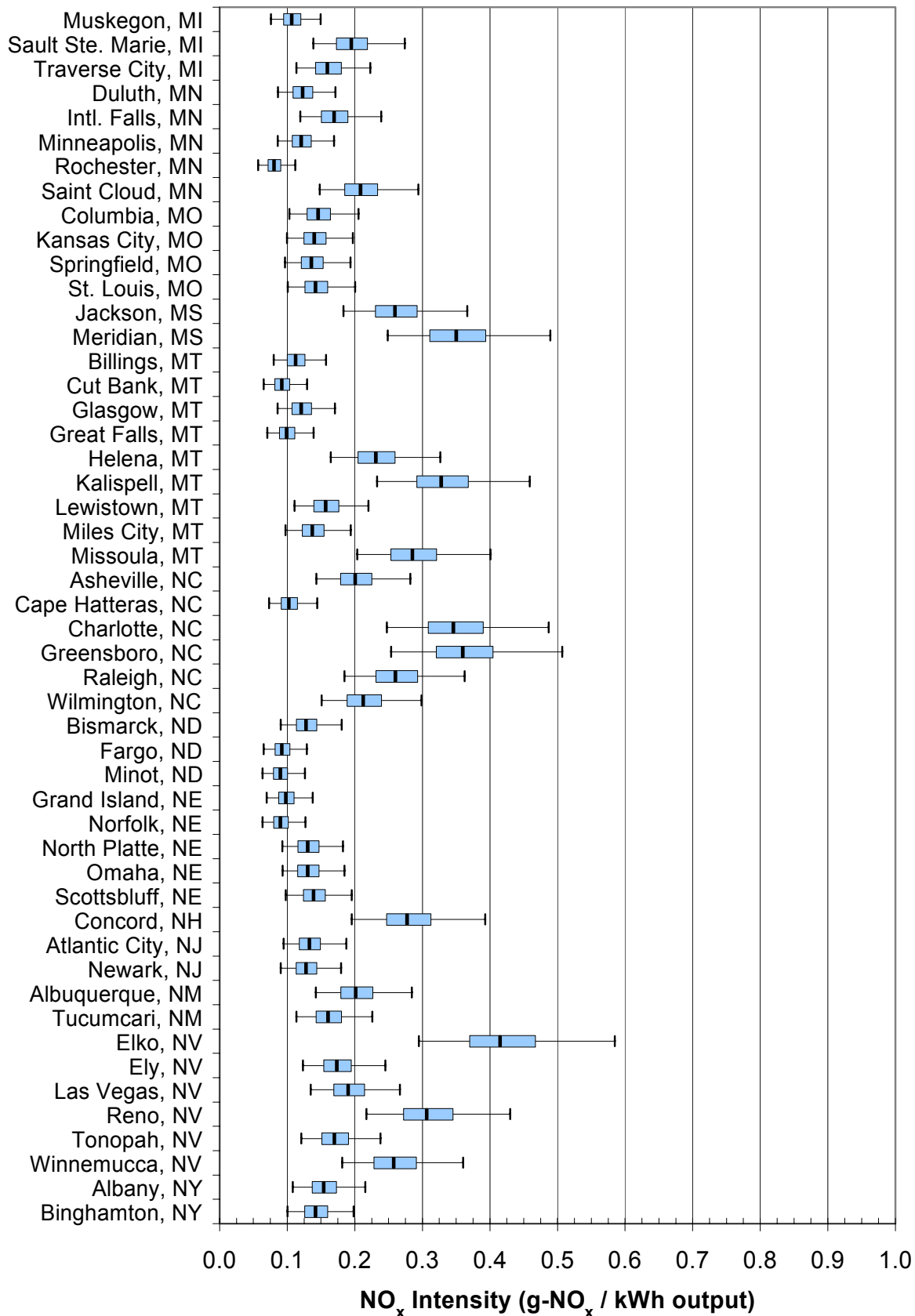



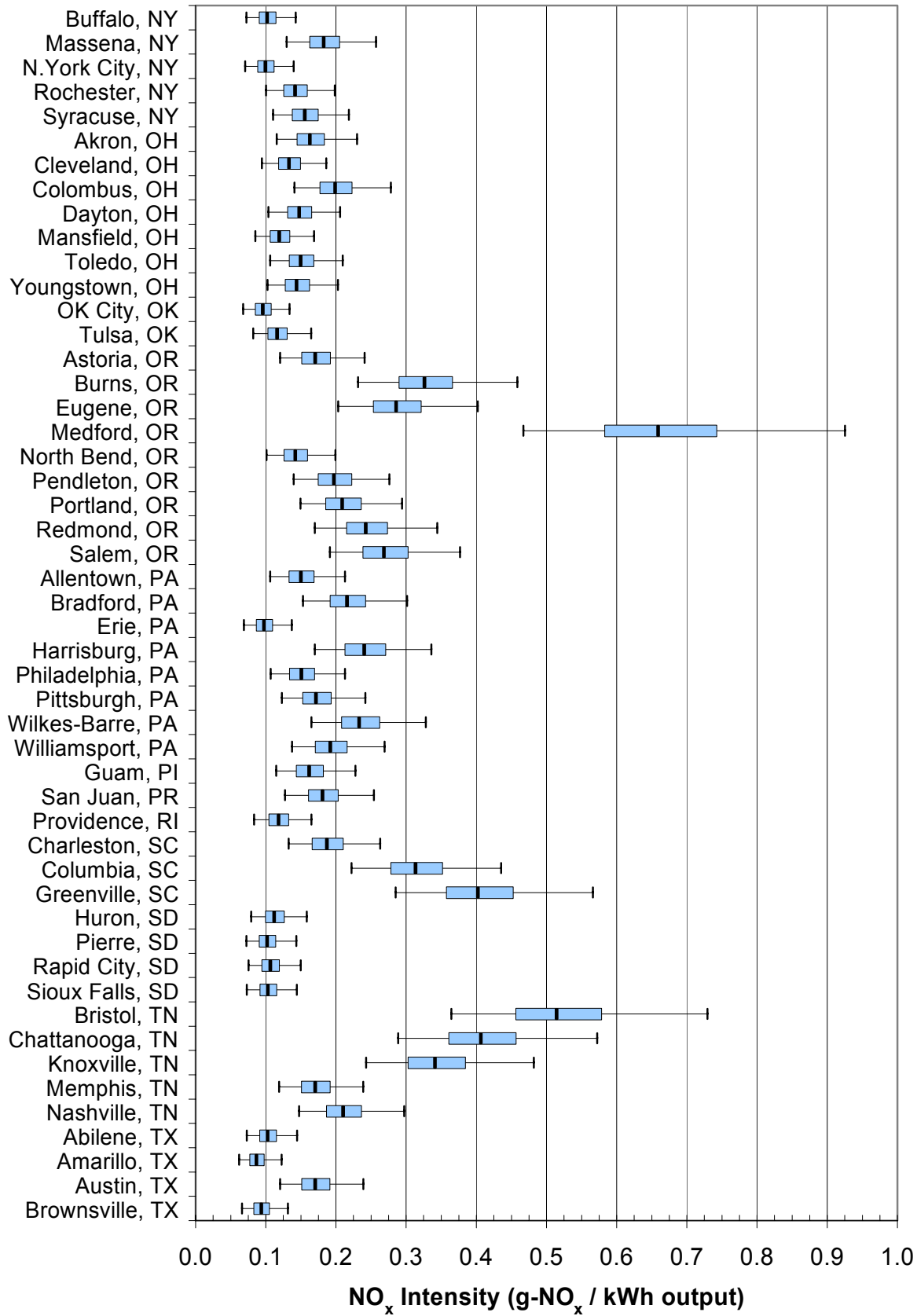

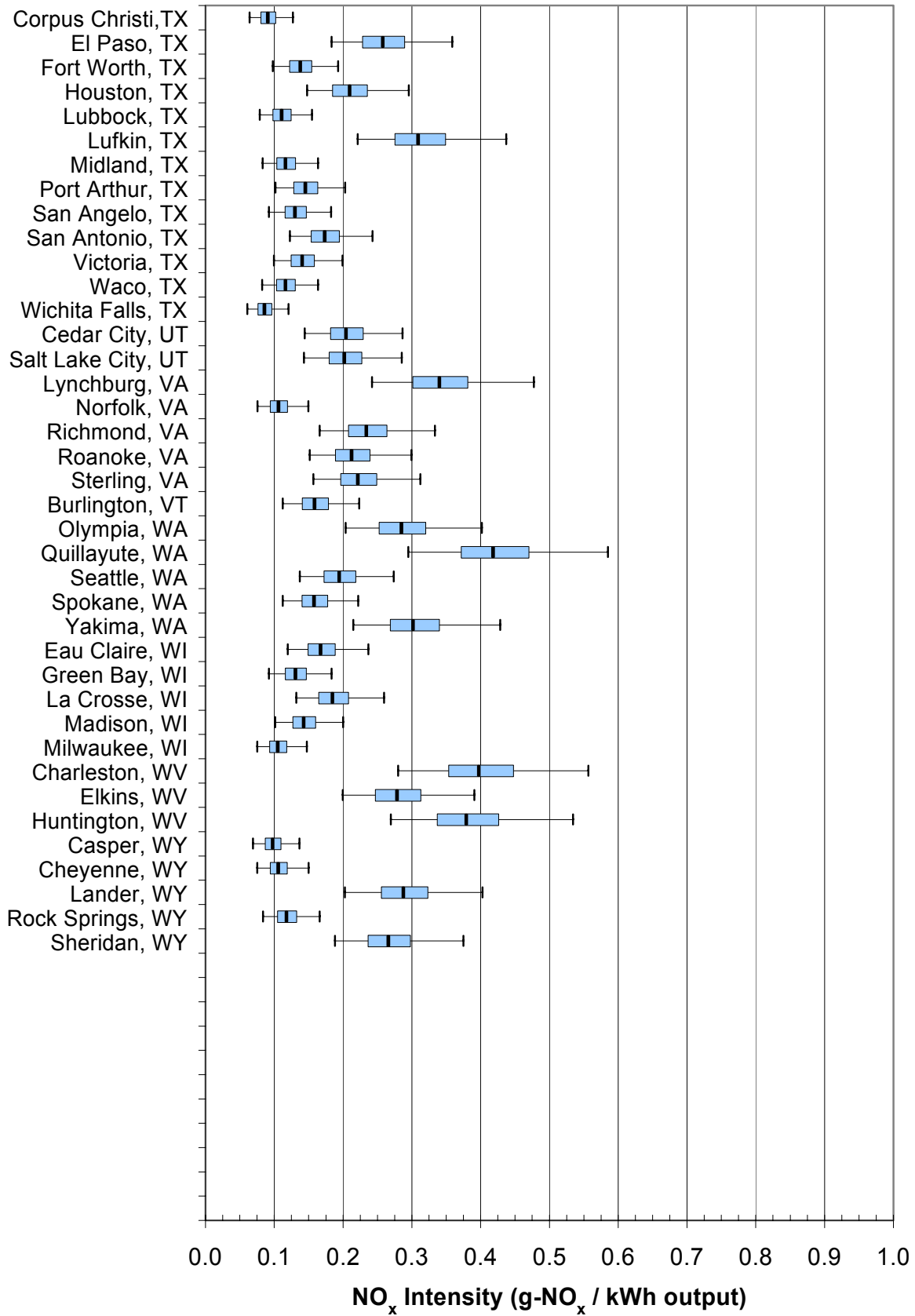

## Bibliography

- Ackermann, Thomas and Lennart Söder. "An Overview of Wind Energy – Status 2002," *Renewable & Sustainable Energy Reviews*, 6:67-128 (2002).
- American Wind Energy Association (AWEA). "Comparative Cost of Wind and Other Energy Sources." Factsheet. n. pag.  
<http://www.awea.org/pubs/factsheets/Cost2001.pdf>. 24 June 2002a.
- . "Economics of Wind Energy," Factsheet. n. pag.  
<http://www.awea.org/pubs/factsheets/EconomicsofWind-March2002.pdf>.  
24 June 2002b.
- . "Global Wind Energy Market Report," Online report.  
<http://www.awea.org/pubs/documents/GlobalWEMarket2002.pdf>. March 2002c.
- Aumonier, S. "Life Cycle Assessment, Electricity Generation and Sustainability," *Nuclear Energy*, 37:295-302 (October 1998).
- Baldwin, Samuel F. "Renewable Energy: Progress and Prospects," *Physics Today*, 55:62-67 (April 2002).
- Blanchard, Steven and Peter Reppe. "Life Cycle Analysis of a Residential Home in Michigan." Unpublished Report No. CSS98-05. Center for Sustainable Systems, University of Michigan, Ann Arbor MI, September 1998.  
[http://css.snre.umich.edu/css\\_doc/css98-0](http://css.snre.umich.edu/css_doc/css98-0).
- Bonus Energy A/S. Financial figures. <http://www.bonus.dk/uk/nyheder/index.html>.  
18 November 02
- Bourillon, Christophe. "Wind Energy – Clean Power for Generations," *Renewable Energy*, 16:948-953 (January-April 1999).
- Bush, George W. *National Energy Policy: Reliable, Affordable, and Environmentally Sound Energy for America's Future*. Report of the National Energy Policy Development Group, May 2001.
- Cairns, Douglas S. and Jon D. Skramstad. "Evaluation of Hand Lay-Up and Resin Transfer Molding in Composite Wind Turbine Blade Manufacturing, Sandia National Laboratory Report SAND2000-1425 (June 2000).
- Carnegie Mellon University Green Design Initiative (2002). Economic Input-Output Life Cycle Assessment (EIO-LCA) model [Internet], <http://www.eiolca.net>.  
14 November 2002.

- Changery, Michael J. *National Wind Data Index: Final Report*. Report HCO/T1041-01; UC-60. Asheville NC: National Climatic Center, Department of Commerce, December 1978.
- Clinton, William J. *Executive Order 13123—Greening the Government Through Efficient Energy Management*. Federal Register page and date: 64 CFR 109: 30851-30860, 8 June 1999. <http://www.nara.gov/fedreg/eo.html>
- Crosby, P.A. “Application of a Monte Carlo Optimization Technique to a Cluster of Wind Turbines,” *Journal of Solar Energy Engineering*, 109:330-336 (1987).
- Crystal Ball 2000. Decisioneering Inc., Computer software user’s manual. 2000.
- Danish Wind Turbine Manufacturer’s Association (DWTMA). “Guided Tour on Wind Energy.” n. pag. <http://www.windpower.org>. March 2002.
- De Nevers, Noel. *Air Pollution Control Engineering*. New York: McGraw-Hill, Inc., 1995)
- Department of Commerce (DOC). *Manufacturing Profiles: 1998*, Current Industrial Reports, US Census Bureau, Report MP/98, December 2000
- . *1997 Economic Census, Manufacturing Subject Series*, US Census Bureau, Report EC97M31S-PS, October 2001.
- . *2001 Statistical Abstract of the US: The National Data Book*. US Census Bureau online report. <http://www.census.gov/prod/2002pubs/01statab/stat-ab01.html>. 13 November 2002.
- Department of Energy (DOE). *Annual Energy Outlook 2002*. Energy Information Administration, U.S. Department of Energy, December 2001a (DOE/EIA-0383(2002)). [http://www.eia.doe.gov/oiaf/aeo/pdf/0383\(2002\).pdf](http://www.eia.doe.gov/oiaf/aeo/pdf/0383(2002).pdf).
- . *Annual Energy Review 2001*. Energy Information Administration, U.S. Department of Energy, November 2002a (DOE/EIA-0384(2001)). <http://www.eia.doe.gov/aer/>.
- . *Electric Power Annual 2000, Volume I*. Energy Information Administration, U.S. Department of Energy, August 2001b (DOE/EIA-0348(2000)/1). <http://www.eia.doe.gov/cneaf/electricity/epav1/epav1.pdf>.
- . *Electric Sales and Revenue 2000*. Energy Information Administration, U.S. Department of Energy, January 2002b (DOE/EIA-0540(00)). <http://www.eia.doe.gov/cneaf/electricity/esr/esr.pdf>

- . *Renewable Energy 2000: Issues and Trends*. Energy Information Administration, U.S. Department of Energy, February 2001c (DOE/EIA-0628(2000)).  
[http://www.eia.doe.gov/cneaf/solar.renewables/rea\\_issues/rea\\_issues\\_sum.html](http://www.eia.doe.gov/cneaf/solar.renewables/rea_issues/rea_issues_sum.html).
- . *Renewable Resources in the U.S. Electricity Supply*. Energy Information Administration, U.S. Department of Energy, February 1993 (DOE/EIA-0561(92)).  
[http://www.eia.doe.gov/cneaf/electricity/pub\\_summaries/renew\\_es.html](http://www.eia.doe.gov/cneaf/electricity/pub_summaries/renew_es.html).
- Derrick, Timothy. Commercial Associate, GE Wind Energy, Tehachapi CA. Telephone Interview. July 2002.
- Desrochers, G., M. Blanchard, and S. Sud. "A Monte Carlo Simulation Method for the Economic Assessment of the Contribution of Wind Energy to Power Systems," *IEEE Transaction on Energy Conversion*, EC-1:50-56 (December 1986).
- El-Kordy, M.N., M.A. Badr, K.A. Abed, and Said M.A. Ibrahim. "Economical Evaluation of Electricity Generation Considering Externalities," *Renewable Energy*, 25:317-328 (2002).
- Energy Information Administration (EIA). Historic information database.  
<http://www.eia.doe.gov/neic/historic/helectricity.htm>. 28 Oct 2002.
- Environmental Protection Agency (EPA) and Science Applications International Corporation (SAIC). *LCAccess – LCA 101*.  
<http://www.epa.gov/ORD/NRMRL/lcaccess/lca101.htm>. 29 June 2002.
- Harrison, Robert, Erich Hau, and Herman Snel. "Large Wind Turbines: Design and Economics," John Wiley & Sons, 2000.
- Johansson, Thomas B., Henry Kelly, Amulya K.N. Reddy, and Robert H. Williams. *Renewable Energy: Sources for Fuels and Electricity*. Washington DC: Island Press, 1993.
- Johnson, Gary L. *Wind Energy Systems*. Englewood Cliffs NJ: Prentice Hall, Inc., 1985.
- Joshi, Satish. "Product Environmental Life-Cycle Assessment Using Input-Output Techniques," *Journal of Industrial Ecology*, 3:95-120 (2000).
- Justus, C.G. *Winds and Wind System Performance*. Philadelphia: Franklin Institute Press, 1978.
- Kemmoku, Yoshishige, Keiko Ishikawa, Shigeyasu Nakagawa, Teru Kawamoto, and Tateki Sakakibara. "Life Cycle CO<sub>2</sub> Emissions of a Photovoltaic/Wind/Diesel Generating System," *Electrical Engineering in Japan*, 138:14-23 (2002).

- Krawiec, Stella. "Economics of Selected WECS Dispersed Applications," *Journal of Energy*, 5:72-8 (1981).
- Krohn, S. "The Energy Balance of Modern Wind Turbines," *Wind Power Note*, 16:1-16 (December 1997). <http://www.windpower.org/publ/index.htm>.
- Lenzen, Manfred and Christopher Dey. "Truncation Error in Embodied Energy Analysis of Basic Iron and Steel Products," *Energy*, 25:577-585 (2000).
- Lenzen, Manfred and Jesper Munksgaard. "Energy and CO<sub>2</sub> Life Cycle Analyses of Wind Turbines—Review and Applications," *Renewable Energy*, 26:339-362 (July 2002).
- Mandall, John F., Daniel D. Samborsky, and Douglas S. Cairns. "Fatigue of Composite Materials and Substructures for Wind Turbine Blades," Sandia National Laboratory Report SAND2002-0771 (March 2002).
- Manwell, J.F., J.G. McGowan, and A.L. Rogers. *Wind Energy Explained: Theory, Design and Application*. West Sussex, England: John Wiley & Sons Ltd., 2002.
- Michaelsen, Jesper J. Sales Associate, NEG Micon USA, Inc., Rolling Meadows IL. Electronic Message and product information. Sep/Oct 2002.
- Nadal, Gustavo and Osvaldo L. Girardin. "Economic Impact of the Valuation of Life Cycle CO<sub>2</sub> Emissions from Renewable and Fossil Energy Systems," *International Journal of Global Energy Issues*, 15:84-96 (2001).
- National Renewable Energy Laboratory (NREL). *User's Manual for TMY2s: Typical Meteorological Years Derived from the 1961-1990 National Solar Radiation Data Base*. NREL/SP-463-7668. Golden CO: NREL, June 1995.
- National Wind Coordinating Committee (NWCC). "Wind Energy Costs," Wind Energy Series No. 11, January 1997. n. pag. <http://www.nationalwind.org/pubs/wes/wes11.htm>.
- NEG-Micon. *Annual Report 2001*. [http://www.neg-micon.com/Upload/files/UserFiles/UK\\_00\\_2001.pdf](http://www.neg-micon.com/Upload/files/UserFiles/UK_00_2001.pdf). 21 January 2003.
- Nomura, Noboru, Atsushi Inaba, Yutaka Tonooka, and Makoto Akai. "Life-cycle Emission of Oxidic Gases from Power-Generation Systems," *Applied Energy*, 68:215-227 (2001).
- Nordex. *Annual Report 2000/2001*. [http://www.nordex-online.com/\\_e/online\\_service/download/\\_dateien/annual\\_report\\_00\\_01.pdf](http://www.nordex-online.com/_e/online_service/download/_dateien/annual_report_00_01.pdf). 21 January 2003.

- Norton, Brian. "Renewable Electricity – What is the True Cost?" *Power Engineering Journal*, 13:6-12 (1999).
- Parsons, Brian. "Grid-Connected Wind Energy Technology: Progress and Prospects." National Wind Technology Center, November 1998 (NREL/CP-500-25692).
- Price, Edward. Manager LCA, International Iron and Steel Institute. Electronic Message. 2 October 2002.
- Proops, John L.R., Philip W. Gay, Stefan Speck, and Thomas Schröder. "The Lifetime Pollution Implications of Various Types of Electricity Generation," *Energy Policy*, 24:229-237 (1996).
- RS Means. *Building Construction Cost Data*, 60<sup>th</sup> Annual Edition. Kingston MA: 2002.
- Schleisner, L. "Life Cycle Assessment of a Wind Farm and Related Externalities," *Renewable Energy*, 20:279-288 (2000).
- Sheehan, John, Vince Camobreco, James Duffield, Michael Graboski, and Housein Shapouri. "Life Cycle Inventory of Biodiesel and Petroleum Diesel for Use in an Urban Bus." Unpublished Report No. NREL/SR-580-24089. National Renewable Energy Laboratory, Golden CO, May 1998.
- Society of Environmental Toxicology and Chemistry (SETAC). "Streamline Life-Cycle Assessment: A Final Report from the SETAC North America Streamlined LCA Workgroup," July 1999.
- Spath, Pamela L. and Margaret K. Mann. *Life Cycle Assessment of a Natural Gas Combined-Cycle Power Generation System*. National Renewable Energy Laboratory Report NREL/TP-570-27715. Golden CO: NREL, September 2000.
- Spath, Pamela L., Margaret K. Mann, and Dawn R. Kerr. *Life Cycle Assessment of Coal-fired Power Production*. National Renewable Energy Laboratory Report NREL/TP-570-25119. Golden CO: NREL, June 1999.
- Sullivan, Thomas F.P. and others. *Environmental Law Handbook* (16<sup>th</sup> Edition). Rockville MD: Government Institutes, ABS Group Inc., 2001.
- Tande, John Olav. "Assessing High Wind Energy Penetration," *Renewable Energy*, 6:633-637 (1995).
- Thresher, Robert W., Susan M. Hock, Ronald R. Loose, and Peter Goldman. "Wind Technology Development: Large and Small Turbines." National Wind Technology Center unpublished report. n. pag. [http://www.nrel.gov/wind/wind\\_turbines.html](http://www.nrel.gov/wind/wind_turbines.html). 25 March 2002.

Treloar, G.J., P.E.D. Love, O.O. Faniran and U. Iyer-Raniga. "A Hybrid Life Cycle Assessment Method for Construction," *Construction Management and Economics*, 18:5-9 (2000).

Twidell, John, and Tony Weir. *Renewable Energy Resources*. Cambridge: University Press, 1986.

Vestas. *Annual Report 2001*.

[http://www.vestas.com/investor/finans/UK/reportuk/2002/ves\\_profile\\_uk.pdf](http://www.vestas.com/investor/finans/UK/reportuk/2002/ves_profile_uk.pdf).  
21 January 2003

Voorspools, Kris R., Els A. Brouwers, and William D. D'haeseleer. "Energy Content and Indirect Greenhouse Gas Emissions Embedded in 'Emission-Free' Power Plants: Results For the Low Countries," *Applied Energy*, 67:307-330 (2000).

Wieland, Steve. Sales Associate, Nordex USA, Inc., Grand Prairie TX. Personal Correspondence. 30 September 2002.



## Vita

Captain Edward J. Liberman graduated from Arrowhead Union High School in Hartland, Wisconsin in 1992. He entered undergraduate studies at Michigan Technological University in Houghton, Michigan, where he graduated Summa Cum Laude with a Bachelor of Science degree in Environmental Engineering in May 1996. He was commissioned through Air Force Reserve Officer Training Corps Detachment 400 at Michigan Technological University in May 1996.

In June 1996 he was assigned to the 47<sup>th</sup> Civil Engineer Squadron, Laughlin AFB, Texas, where he served as an Environmental Engineer and as Readiness Flight Commander. While stationed at Laughlin AFB, he completed the Civil Engineer officer-training course, where he was recognized as a Distinguished Graduate. Additionally he deployed overseas in May 1998 to spend four months at Eskan Village, Saudi Arabia as the 4409<sup>th</sup> Civil Engineer Squadron (Provisional) Readiness Flight Commander.

In February 1999, he was assigned to the 5<sup>th</sup> Civil Engineer Squadron, Minot AFB, North Dakota, where he served as Chief of Construction Management and as Contract Programmer. While serving at Minot AFB, he deployed overseas in March 2000 to spend three months at Prince Sultan Air Base, Saudi Arabia as a Project Engineer for the 363<sup>rd</sup> Expeditionary Civil Engineer Squadron.

In September 2000, he entered the Graduate School of Engineering and Management at the Air Force Institute of Technology. Upon graduation, he will be assigned to the 65<sup>th</sup> Civil Engineer Squadron, Lajes Air Field, Azores (Portugal).

<b>REPORT DOCUMENTATION PAGE</b>				<i>Form Approved</i> OMB No. 074-0188	
The public reporting burden for this collection of information is estimated to average 1 hour per response, including the time for reviewing instructions, searching existing data sources, gathering and maintaining the data needed, and completing and reviewing the collection of information. Send comments regarding this burden estimate or any other aspect of the collection of information, including suggestions for reducing this burden to Department of Defense, Washington Headquarters Services, Directorate for Information Operations and Reports (0704-0188), 1215 Jefferson Davis Highway, Suite 1204, Arlington, VA 22202-4302. Respondents should be aware that notwithstanding any other provision of law, no person shall be subject to a penalty for failing to comply with a collection of information if it does not display a currently valid OMB control number. <b>PLEASE DO NOT RETURN YOUR FORM TO THE ABOVE ADDRESS.</b>					
<b>1. REPORT DATE (DD-MM-YYYY)</b> 25-03-2003		<b>2. REPORT TYPE</b> Master's Thesis		<b>3. DATES COVERED (From - To)</b> Jan 2002 - Mar 2003	
<b>4. TITLE AND SUBTITLE</b>  A LIFE CYCLE ASSESSMENT AND ECONOMIC ANALYSIS OF WIND TURBINES USING MONTE CARLO SIMULATION				<b>5a. CONTRACT NUMBER</b>	
				<b>5b. GRANT NUMBER</b>	
				<b>5c. PROGRAM ELEMENT NUMBER</b>	
<b>6. AUTHOR(S)</b>  Lieberman, Edward, J., Captain, USAF				<b>5d. PROJECT NUMBER</b>	
				<b>5e. TASK NUMBER</b>	
				<b>5f. WORK UNIT NUMBER</b>	
<b>7. PERFORMING ORGANIZATION NAMES(S) AND ADDRESS(S)</b> Air Force Institute of Technology Graduate School of Engineering and Management (AFIT/EN) 2950 P Street, Building 640 WPAFB OH 45433-7765				<b>8. PERFORMING ORGANIZATION REPORT NUMBER</b>  AFIT/GEE/ENV/03-16	
<b>9. SPONSORING/MONITORING AGENCY NAME(S) AND ADDRESS(ES)</b> HQ AFCESA/CESM Attn: Mr. Mike Santoro 139 Barnes Drive Suite 1 Tyndall AFB FL 32403      e-mail: Mike.Santoro@tyndall.af.mil				<b>10. SPONSOR/MONITOR'S ACRONYM(S)</b>	
				<b>11. SPONSOR/MONITOR'S REPORT NUMBER(S)</b>	
<b>12. DISTRIBUTION/AVAILABILITY STATEMENT</b>  APPROVED FOR PUBLIC RELEASE; DISTRIBUTION UNLIMITED.					
<b>13. SUPPLEMENTARY NOTES</b>					
<b>14. ABSTRACT</b> Renewable energy sources, such as wind, have the potential to reduce air emissions and U.S. fossil fuel dependency. Monte Carlo simulation was used to assess the life cycle impacts and economic payback of 11 modern utility-scale wind turbines. Hourly meteorological data was used to evaluate 239 U.S. locations. For the economically preferred wind turbine, 40.6% of locations had median payback periods less than 10 years, and 62.8% less than 15 years. Process Analysis and Input-Output Analysis techniques were combined to compute life cycle energy consumption and indirect emissions of CO <sub>2</sub> (equivalent), SO <sub>x</sub> , and NO <sub>x</sub> . Median values for energy intensity (kWh energy inputs/kWh outputs) ranged from 0.05-0.54 for the preferred wind turbine, compared to 2.3 for natural gas and 2.6-3.5 for coal-fired electricity generation. Median emissions intensity values ranged from 13-156 g-CO <sub>2</sub> (eq)/kWh, 0.04-0.50 g-SO <sub>x</sub> /kWh and 0.05-0.66 g-NO <sub>x</sub> /kWh. Compared to results for natural gas and coal-fired electricity generation, wind turbines are less energy and emissions intensive at more than 96% of locations analyzed. Depending on site-specific climate conditions, wind energy is likely to be superior to electricity generation using fossil fuels.					
<b>15. SUBJECT TERMS</b> wind, energy, wind turbine, electricity generation, Monte Carlo simulation, probabilistic, life cycle assessment, life cycle costs, economic payback, renewable energy, energy intensity, air emissions					
<b>16. SECURITY CLASSIFICATION OF:</b>			<b>17. LIMITATION OF ABSTRACT</b>  UU	<b>18. NUMBER OF PAGES</b>  162	<b>19a. NAME OF RESPONSIBLE PERSON</b> Peter T. LaPuma, Maj, USAF (ENV)
a. REP ORT U	b. ABSTRACT U	c. THIS PAGE U			<b>19b. TELEPHONE NUMBER (Include area code)</b> (301) 319-6951; e-mail: plapuma@usuhs.mil