

# TURNING CHARACTERISTICS AND STABILITY OF MANUAL WHEELCHAIRS ON A SLOPE

H. Ohnabe<sup>1</sup> and F. Mizuguchi<sup>2</sup>

<sup>1</sup> Department of Biocybernetics, Faculty of Engineering, Niigata University, Ikarashi, Niigata, Japan

<sup>2</sup> Department of Mechanical Engineering, Japan Coast Guard Academy, Kure shi, Hiroshima, Japan

*Abstract-* Wheelchairs will be in ever greater demand in a rapidly aging society. Because of the special needs of aging users, due to frailty and reduced reflexes in many cases, it is important to give careful consideration to rather fundamental design properties. Inter alia it is very important to define, clarify and design running, turning and stability properties of the highest standards in manual wheelchairs. In particular we discuss these matters in regard to wheelchair behavior on sloping surfaces. In the present paper we report on an analytical model for a 4 wheel manual wheelchair which shows good correlation with the existing experimental data relating to torque and speed when the wheelchair is moving on a level plane and when climbing a 3 degree slope. The rolling stability of the wheel chair on a slope is also discussed.

*Keywords -* Wheelchair, Dynamic characteristics, Stability

## I. INTRODUCTION

In a rapidly aging society, wheelchairs are used a lot as support devices for independent movement. The environment where they are used is not necessarily free of barriers. Many roads have a slope in Japan. Some roads are a plane but others are designed also to rise from the curb towards the center. This design feature is for improved drainage. Such roads have to be crossed and also have to be used up and down their length for any journey. Accordingly it is important to clarify the dynamic characteristics and stability properties of manual wheelchairs from the point of users and providers. Yoneda etc. [1] and Tanaka etc. [2] have undertaken a lot of empirical research in this area.

In the present study, the dynamic characteristics of manual wheelchairs were studied from a theoretical point of view based on Shung etc. [3], for powered wheelchairs. The models fitted the existing experimental results for 4 wheelchairs on a level plane and on a downhill slope. Cooper's work [4]-[6] on the stability of wheelchairs on a downhill slope was also considered.

The authors considered the stability conditions for a violent fall and the direction hold stability of the wheelchair on a downhill slope.

On the stability conditions for a violent fall, the influence of the center of gravity of the rider/wheelchair system is greater before than an axle line is considered and the stable judgement equation is proposed.

Furthermore, we studied the direction hold stability on a downhill slope in relation to torque, pitch and drive distance in a search for the relationship between necessary torque and slope angle, to travel in a straight line, because it is difficult to travel in a straight line where there is a slope affecting pitch.

## II. METHODOLOGY

Although the modeling of the wheelchair on a down hill slope is based on a powered wheelchair of Shung [3], the following points are changed and simplified to clarify the principles.

- (a) A surface of a slope is assumed to be flat.
- (b) The coordinate system of the wheelchair on a slope depends on at least the properties shown in Figure 1.
- (c) The moving direction is defined as a positive irrespective of an ascent or a descent.

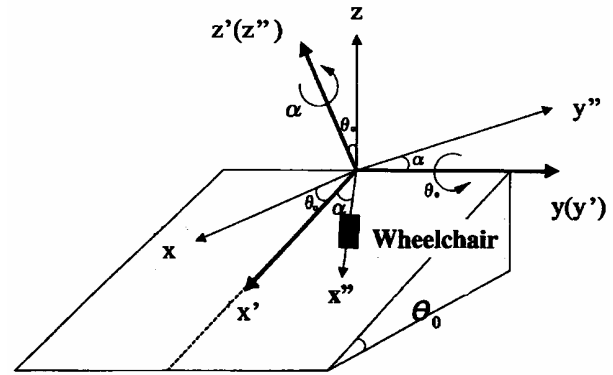

Fig. 1 Coordinate system for wheelchair characteristic and stability analysis

where  $x, y, z$ : the coordinate system fixed on the earth,  $x', y', z'$ ; the coordinate system fixed on the wheelchair rotated  $\theta$  in the  $y$  axis along a slope turning a wheelchair toward the inclination of a slope,  $x'', y'', z''$ ; the coordinate system fixed on the wheelchair rotated  $\alpha$  in the  $z'$  axis  $z$  from the inclination direction of a slope.  $\theta_0$  shows the gradient of a slope,  $\alpha$  a conversion start angle,  $\theta$  wheelchair moving direction of a slope.

### II-1. Model while travelling

The ball bearing resistance and rolling resistance acting on a wheelchair always work in opposite directions. If those resistance exceed the driving force, a wheelchair will stop.

The resistance force changes the direction as the driving mode of a wheelchair changes from positive rotation, stationary state and reversal in this way. In turn the governing equation will also changes.

In the present study the driving mode of positive rotation is studied, that is

$$v_R > 0, \quad v_L > 0 \quad (1)$$

where  $v_L, v_R$  are the velocity of the right and left wheel(m/s).

## Report Documentation Page

<b>Report Date</b> 25 Oct 2001	<b>Report Type</b> N/A	<b>Dates Covered (from... to)</b> -
<b>Title and Subtitle</b> Turning Characteristics and Stability of Manual Wheelchairs on a Slope	<b>Contract Number</b>	
	<b>Grant Number</b>	
	<b>Program Element Number</b>	
<b>Author(s)</b>	<b>Project Number</b>	
	<b>Task Number</b>	
	<b>Work Unit Number</b>	
<b>Performing Organization Name(s) and Address(es)</b> Department of Biocybernetics Faculty of Engineering Niigata University Ikarashi, Niigata, Japan	<b>Performing Organization Report Number</b>	
<b>Sponsoring/Monitoring Agency Name(s) and Address(es)</b> US Army Research, Development & Standardization Group (UK) PSC 802 Box 15 FPO AE 09499-1500	<b>Sponsor/Monitor's Acronym(s)</b>	
	<b>Sponsor/Monitor's Report Number(s)</b>	
<b>Distribution/Availability Statement</b> Approved for public release, distribution unlimited		
<b>Supplementary Notes</b> Papers from 23rd Annual International Conference of the IEEE Engineering in Medicine and Biology Society, October 25-28, 2001, held in Istanbul, Turkey. See also ADM001351 for entire conference on cd-rom., The original document contains color images.		
<b>Abstract</b>		
<b>Subject Terms</b>		
<b>Report Classification</b> unclassified	<b>Classification of this page</b> unclassified	
<b>Classification of Abstract</b> unclassified	<b>Limitation of Abstract</b> UU	
<b>Number of Pages</b> 4		

The wheel bearing and rolling resistance are able to be considered as a main torque loss resource [8]. The following equations are obtained from the figure of the free body of a left side wheel on the slope as shown in Fig. 2.

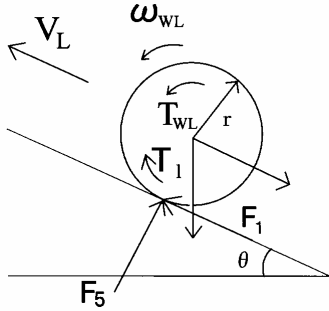

Fig.2 Left wheel free body on a slope

Rotary motion of the right and left circle

$$T_{WR} - T_r - F_3 r = J_w \dot{\omega}_{WR}, \quad T_{WL} - T_l - F_1 r = J_w \dot{\omega}_{WL} \quad (2)$$

where

$T_{WL}, T_{WR}$ : the torque transferred to the left, right wheel from the arm (N m)

$T_l, T_r$ : the torque loss by friction(Nm)

$F_1, F_3$ : the force acting on the direction on the rear wheel(N)

$\omega_{WL}, \omega_{WR}$ : the angular velocity of the left, the right wheel (rad/s)

$J_w$ : the polar moment of inertia of the rear wheel of the wheelchair (kg m<sup>2</sup>)

Also,

$$T_l = \beta_c (\omega_{WL})^{\frac{2}{3}} + F_5 f r, \quad T_r = \beta_c (\omega_{WR})^{\frac{2}{3}} + F_6 f r \quad (3)$$

$\beta_c$ : the bearing constant (mNs<sup>2/3</sup>)

$f$ : the rolling friction coefficient

$F_5, F_6$ : the force of vertical z' direction acting on a rear wheel on the slope(N)

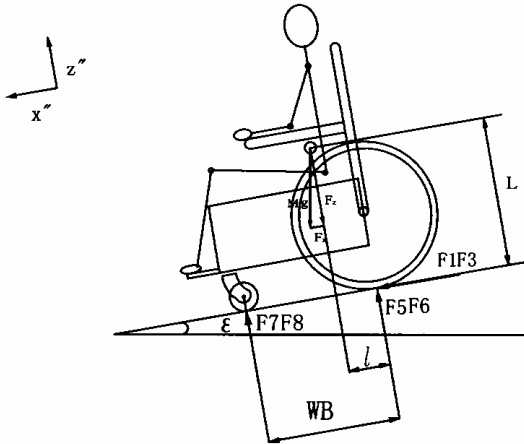

Fig. 3 Wheelchair on a down hill slope

Because torque loss is positive in the right and left wheel, the angular velocity of the wheels are

$$\omega_{WL} = \frac{v_L}{r}, \quad \omega_{WR} = \frac{v_R}{r} \quad (4)$$

where the acceleration of the wheelchair of x'', y'' direction are , making D half the track width of the wheelchair and l the distance from a rear axle to the center of gravity

$$\dot{v}_x = \frac{1}{2}(\dot{v}_R + \dot{v}_L) - \frac{(v_R - v_L)^2}{4D^2} l, \quad \dot{v}_y = \frac{l(v_R - v_L)}{2D} + \frac{(v_R - v_L)^2}{4D} \quad (5)$$

Acceleration of the wheelchair of the right and left are

$$\dot{v}_R = \frac{(A+B)}{2}, \quad \dot{v}_L = \frac{(A-B)}{2} \quad (6)$$

Putting M as the total mass of the wheelchair and rider system, the components of gross weight are

$$F_x = Mg \cos \alpha \sin \theta, \quad F_y = Mg \sin \alpha \sin \theta, \quad F_z = Mg \cos \theta \quad (7)$$

From the relation of the balance of power

$$M \frac{dv_x}{dt} = F_x + C_x + F_1 + F_3$$

$$M \frac{dv_y}{dt} = -F_y - C_y + F_2 + F_4 \quad (8)$$

$$F_5 + F_6 + F_7 + F_8 = F_z$$

Putting WB as the distance between a front and rear wheel and L as the center of gravity height, the equations of the moment balance from Fig. 3 are

$$(F_5 + F_7)D + (F_2 + F_4)L - (F_6 + F_8)D = 0 \quad (9)$$

$$(F_5 + F_6)l - (F_7 + F_8)(WB - l) - (F_1 + F_3)L = 0$$

$$I_z \frac{d\omega_z}{dt} = -(F_1 - F_3)D - (F_2 + F_4)l$$

$F_2, F_4$ : force acts on the y'' direction of a rear wheel

$F_7, F_8$ : force acts on the vertical z'' direction of a front wheel on the slope

Solving these equations simultaneously, we obtain

$$A = \frac{(T_{WR} + T_{WL}) - \beta_c \left\{ (\omega_{WR})^{\frac{2}{3}} + (\omega_{WL})^{\frac{2}{3}} \right\} - \frac{fr}{WB} (WB - l) F_z + r \left( \frac{fL}{WB} + 1 \right) \left\{ F_x + \frac{Ml}{2D^2} (v_R - v_L)^2 \right\}}{\frac{J_w}{r} + \frac{rM}{2} \left( \frac{fL}{WB} + 1 \right)} \quad (10)$$

$$B = \frac{(T_{WR} - T_{WL}) - \beta_c \left\{ (\omega_{WR})^{\frac{2}{3}} - (\omega_{WL})^{\frac{2}{3}} \right\} - \frac{r}{D} (fL + l) \left\{ F_y + \frac{M}{2D} v_R (v_R - v_L) \right\}}{\frac{J_w}{r} + \frac{r}{2D^2} \{ I_z + Ml(fL + l) \}}$$

However, here we are strictly concerned only with the case of a wheelchair that turns with keeping forward velocity. It is considered to be unstable if a wheelchair goes into reverse or stops contrary to the driver's intention.

## II-2. Downhill slope stability

There is a potential or the wheelchair to fall over due to the centrifugal force at the turn. There is also the direction hold stability defined by whether or not direction can be held,

towards a specific goal, by intentionally by overcoming the influence of a slope.

### II-2-1. Stability for falling over

The factors that relate to wheelchair falling over are the component  $F_y$  of weight  $Mg$  and the component  $C_y$  of centrifugal force on the  $y''$  direction. The direction of  $F_y$  is assumed to occur on the side of inclination direction. In the present study we consider the case that it always turns to the left.

Whether a wheelchair is stable or not is determined by whether or not the moment of force component  $F_z$  of weight on the  $z'$  direction is bigger or smaller than the moments of force of the two factors.

The stability condition, i.e., the condition does not fall down is

$$F_z D \geq C_y L + F_y L \quad (11)$$

where

$$F_y = Mg \sin \alpha \sin \theta_0, \quad F_z = Mg \cos \theta_0$$

$$C_y = \frac{M}{4D} (v_R^2 - v_L^2) \quad (12)$$

Although  $F_z$  is constant irrespective of the attitude of a wheelchair,  $F_y$  changes. However, it is good enough to determine whether a wheelchair fall over or not.

The  $x''$  velocity component of a wheelchair is

$$v_x = \frac{1}{2} (v_R + v_L) \quad (13)$$

The turn angular velocity of a wheelchair

$$\omega_z = \frac{v_R - v_L}{2D} \quad (14)$$

and substituting the above relation to the equations (11)

$$\text{where } \omega_z v \sqrt{1 - (l/\rho)^2} \leq g \left( \frac{D}{L} \cos \theta_0 - \sin \theta_0 \sin \alpha \right) \quad (15)$$

$$v = \sqrt{v_x^2 + v_y^2}$$

but  $l$  shows the distance from an axle center to the center of gravity.

In the case that turn radius ( $\rho$ ) is large, putting here  $(l/\rho)^2 \ll 1$

$$\omega_z v \leq g \left( \frac{D}{L} \cos \theta_0 - \sin \theta_0 \sin \alpha \right) \quad (16)$$

### II-2-2. Direction hold stability

The ability to use a wheelchair varies widely, depending on sex, age, the degree of disability of arm, etc. It may not be possible to go forward to the direction of a goal due to the inclination of a slope.

It should be  $\dot{\alpha} (= \omega_z) = 0$  to stay on course.

As turn angular velocity  $\dot{\alpha}$  is expressed with  $\dot{\alpha} = (v_R - v_L)/2D$ , substituting equations (6),  $B = 0$  must be satisfied to hold a steady course.

If the necessary torque required to go straight ( $\omega_{WR} = \omega_{WL}$ ) on a down hill slope is applied to only the right side wheel ( $T_{WL} = 0$ ), from the equation (10)<sub>2</sub>.

the right side torque is expressed as follows:

$$T_{WR} = \frac{r}{D} (fL + l) F_y \quad (17)$$

Substituting equation (7)<sub>2</sub> into equation (17) and if it is shown with non-dimensional form

$$\frac{T_{WR}}{Mgr} = T_\theta \sin \alpha \quad (18)$$

$$\text{where } T_\theta = \frac{1}{D} (fL + l) \sin \theta$$

The  $x'$ ,  $y'$  components of non-dimensional torque to go straight toward the  $\alpha$  direction are

$$x' = \frac{T_\theta}{2} \sin 2\alpha \quad (19)$$

$$y' = \frac{T_\theta}{2} (1 - \cos 2\alpha)$$

Eliminating  $\alpha$  from both equations,

$$x'^2 + (y' - \frac{T_\theta}{2})^2 = (\frac{T_\theta}{2})^2 \quad (20)$$

the locus of necessary non-dimensional torque to go straight on the plane  $x'y'$  is obtained.

## III. CALCULATIONS AND DISCUSSION

As an example of a simulation, we calculated the locus and stability to turn 90 degrees, 180 degrees and 360 degrees, putting a torque to the right hand rim only on the plane and on the slope in the case of running on the equal torque.

The wheelchair dimensions are  $WB=0.3238$  m.,  $l=0.04857$  m,  $L=0.505$  m,  $D=0.235$  m,  $r=0.3025$  m. The following values are from [3],  $I_z = 7.5 \text{ kgm}^2$ ,  $J_w = 0.017 \text{ kgm}^2$ ,  $\beta_c = 0.14 \text{ mNs}^{-2/3}$ ,  $f=0.02$ ,  $M=100$  kg,  $T_p$  the drive pitch: 50 times/min (=1.2 sec),  $S_0$  drive period length: 0.47 m,  $T_w$ : drive torque: 9.8 Nm as standard value and it is changed due to inclination angle of slope  $\theta$ , conversion start angle  $\alpha$  of wheelchair speed.

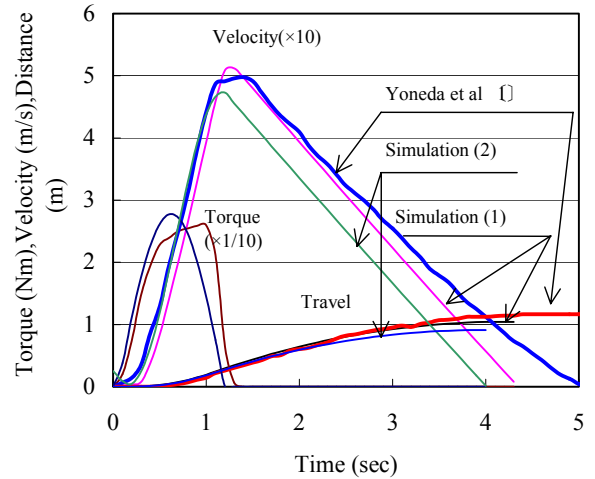

Fig.4 Comparison between the present simulation and existing experimental results

For confirmation of the present simulation, using the measured torque, we have obtained the relationship between the velocity versus the time and the distance. This simulation (Simulation (1) in Fig. 4) shows good agreement with the experimental results[1]. Even assuming the torque has a sinusoidal shape, we obtain a relatively good correlation as shown in Fig. 4 (see Simulation (2)). Then using this assumed sinusoidal shape of torque, we obtained the relationship between the maximum torque and the speed and compared this with existing experimental data [2] in Fig. 5. Good correlation between both of them were again found.

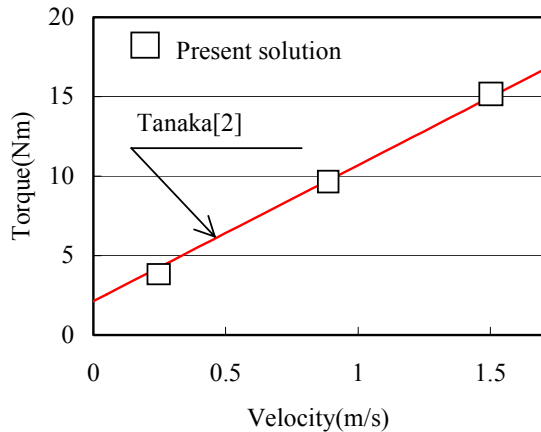

Fig.5 Comparison between the present simulation and experimental results on torque vs. speed

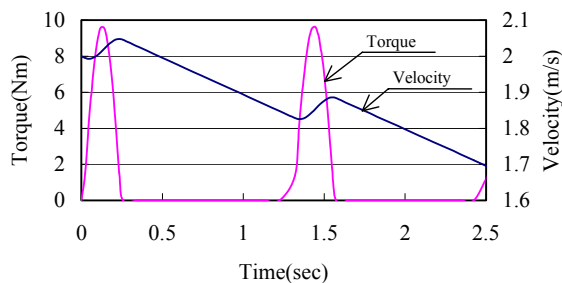

Fig.6 Torque and speed of wheelchair

Figure 6 represents a velocity change with time under a constant amplitude of driving torque, starting with the initial velocity 2.0 m/sec, the maximum torque 9.8Nm in one side, the pitch 50 times/min. and the distance 0.47m. Referring to Hildebrandt et al. [7], and making comparisons with the experimental work of Tanaka [2] the difference on the amount of power required was 1 %.

Figure 7 represents equation (20) with a angle  $\theta$  of slope as a parameter in the case of running on a slope. The figure shows the necessary uniform torque to go straight on the slope with an optional slope angle ( $\theta$ ) from the inclination direction to the optional angle ( $\alpha$ ).

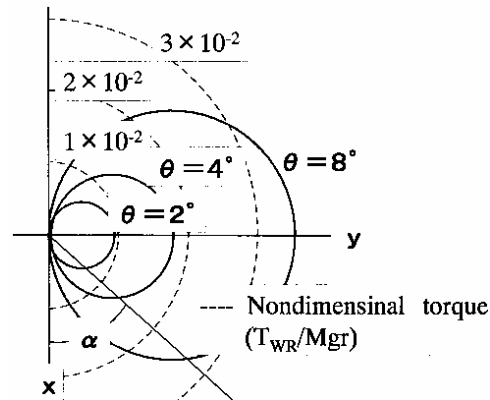

Fig. 7. Necessary non-dimensional torque ( $T_{WR}/Mgr$ ) for a straight running on a  $\theta$  slope with  $\alpha$  direction

#### IV. CONCLUSION

The simulation of dynamic characteristics of manual wheelchairs was studied and it gave a good correlation with existing experimental results. Stability of the wheelchair on a down hill slope was also discussed from the position (1) the stability against falling over due to the centrifugal force at the turn and also (2) the direction hold stability. A stability chart for a wheelchair on a down hill slope has been proposed.

#### ACKNOWLEDGMENT

H. Ohnabe thanks partly for the grant of Japan Society for the Promotion of Science, Basic Reserch(B)(T) (No. 12574002).

#### REFERENCES

- [1] I. Yoneda, T. Hashizume, F. Fujiki, Y. Fujioka, M. Kawata and H. Kawai, Research for Characteristics of Wheelchair's Running Performance, Proc.(1) of 74<sup>th</sup> Conf. JSME Ordinary General meeting, No.97-1, pp.344-345 (Japanese).
- [2] M. Tanaka, Necessary Capabilities for Wheelchair Movement, J. Society of Biomechanisms Japan, Vol. 5, No. 1, 1981, pp.26-34 (Japanese).
- [3] J. B. Shung, G. Stout, M. Tomizuka, D.M. Auslander, Dynamic Modeling of a Wheelchair on a Slope, Journal of Dynamic Systems, Measurement, and Control, Vol. 105, pp. 101-106.
- [4] R. A. Cooper and M. MacLeish, Racing wheelchair roll stability while turning: A simple model, Journal of Rehabilitation Research and Development Vol. 29 No.2, 1992, pp.23-30.
- [5] R. Cooper, Stability of a Wheelchair Controlled by a Human Pilot, Tran. Rehabilitation Engineering, Vol. 1, No. 4. Dec. 1993, pp.193-206.
- [6] R. Cooper, Rehabilitation Engineering – Applied to Mobility and Manipulation, Institute of Physics Publishing, 1995.
- [7] Hildebrandt, G. et al. "Energy Costs of Propelling Wheelchair at Various Speeds-Cardiac Response and Effect on Steering Accuracy, Arch. Phys. Med. Rehabil., 51, 1970, pp. 131-136.
- [8] Thacker, J., "Wheelchair Dynamics", University of Virginia REC Annual Report-1978, pp.41-44.