

Administration

# **Planning, Programming, Budgeting, and Execution System**

Headquarters  
Department of the Army  
Washington, DC  
30 January 1994

**Unclassified**

## Report Documentation Page

<b>Report Date</b> 30 Jan 1994	<b>Report Type</b> N/A	<b>Dates Covered (from... to)</b> -
<b>Title and Subtitle</b> Administration: Planning, Programming, Budgeting, and Execution System	<b>Contract Number</b>	
	<b>Grant Number</b>	
	<b>Program Element Number</b>	
<b>Author(s)</b>	<b>Project Number</b>	
	<b>Task Number</b>	
	<b>Work Unit Number</b>	
<b>Performing Organization Name(s) and Address(es)</b> Department of the Army Headquarters Washington, DC	<b>Performing Organization Report Number</b>	
<b>Sponsoring/Monitoring Agency Name(s) and Address(es)</b>	<b>Sponsor/Monitor's Acronym(s)</b>	
	<b>Sponsor/Monitor's Report Number(s)</b>	
<b>Distribution/Availability Statement</b> Approved for public release, distribution unlimited		
<b>Supplementary Notes</b>		
<b>Abstract</b>		
<b>Subject Terms</b>		
<b>Report Classification</b> unclassified	<b>Classification of this page</b> unclassified	
<b>Classification of Abstract</b> unclassified	<b>Limitation of Abstract</b> UU	
<b>Number of Pages</b> 50		

# ***SUMMARY of CHANGE***

AR 1-1

Planning, Programming, Budgeting, and Execution System

This revision describes an enhanced Army Planning, Programming, and Budgeting, and Execution System (PPBES) that responds to the following--

- o The new biennial cycle that began with the Program Objective Memorandum (POM) for fiscal years (FY) 1990-1994 (para 1-5).
- o Implementation of the DOD Reorganization Act of 1986 (Act of 1 October 1986, Public Law 99-433, volume 100, US Statutes at Large, p.992), and later organizational changes (para 1-5).
- o Implementation of recommendations of the President's Blue Ribbon Commission on Defense Management adopted into law (section 2436, title 10, United States Code) (para 1-5).
- o A 1987 statutory requirement to submit to Congress the Future Years Defense Program (FYDP) underlying the President's Budget (section 221, Title 10, United States Code) (para 1-5). (Beginning in 1990, the new 6-year Future Years Defense Program replaced the former Five-Year Defense Program) (para 2-2).
- o Initial actions from the Defense Management Review directed by the President in February 1989 (paras 2-3 through 2-6 and 3-2 through 3-6).
- o Change in which:
  - Army major commands (MACOMS) and other operating agencies (now including program executive offices (PEOs)), submit operating requirements using field POMs instead of Program Analysis and Resource Reviews (PARRS) used before the FY 1992-1997 PPBES cycle (para 2-16 and chap 4).
  - The Headquarters, Department of the Army (HQDA) staff uses appropriation-based Program Evaluation Groups (PEGs) instead of functional panels to help build the Army program (POM), which then, unlike the functional panels, remain in operation throughout the PPBES cycle to track the program through budget analysis, program and budget defense, and execution (paras 2-15, 4-8, and 5-9).
  - Commands and agencies submit a Command Budget Estimate (CBE) in the even year and Resource Management Update (RMU) in the odd year replacing yearly submission of a Command Operating Budget (COB) (para 6-7).

Administration

Planning, Programming, Budgeting, and Execution System

By Order of the Secretary of the Army:

GORDON R. SULLIVAN  
General, United States Army  
Chief of Staff

Official:

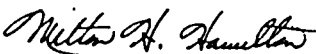
  
MILTON H. HAMILTON  
Administrative Assistant to the  
Secretary of the Army

**History.** This UPDATE printing publishes a revision of this publication. Because the publication has been extensively revised, the changed portions have not been highlighted.

**Summary.** The regulation defines responsibilities for managing the Army Planning, Programming, Budgeting, and Execution System (PPBES) and performing its operational tasks. The regulation sets system policy, outlines the organizational framework within

which the system operates, and describes the phase-by-phase PPBES process. The regulation implements DODD 7045.14 and DODI 7045.7, which cover the parent DOD Planning, Programming, and Budgeting System (PPBS).

**Applicability.** This regulation applies to the Active Army, the Army National Guard, and the U.S. Army Reserve.

**Proponent and exception authority.** The proponent of this regulation is the Director of the Army Staff (DAS). The proponent has the authority to approve exceptions to this regulation that are consistent with controlling law and regulation. Proponents may delegate this approval authority, in writing, to a division chief under their supervision within the proponent agency who holds the grade of colonel or the civilian equivalent.

**Army management control process.** This regulation is not subject to the requirements of AR 11-2. It does not contain internal control provisions.

**Supplementation.** Supplementation of this regulation and establishment of command

and local forms are prohibited without prior approval from HQDA (DACS-DPD), WASH, DC 20310-0103.

**Interim changes.** Interim changes to this regulation are not official unless they are authenticated by the Administrative Assistant to the Secretary of the Army. Users will destroy interim changes on their expiration dates unless sooner superseded or rescinded.

**Suggested improvements.** Users are invited to send comments and suggested improvements on DA Form 2028 (Recommended Changes to Publications and Blank Forms) directly to HQDA (DACS-DPD), WASH DC 20310-0200.

**Distribution.** Distribution of this publication is made in accordance with DA Form 12-09-E, block number 2001, intended for command level D for Active Army, Army National Guard, and U.S. Army Reserve.

**Contents** (Listed by paragraph and page number)

**Chapter 1**

**Introduction, page 1**

*Section I*

*Overview, page 1*

Purpose • 1-1, *page 1*

References • 1-2, *page 1*

Explanation of abbreviations and terms • 1-3, *page 1*

System and procedure • 1-4, *page 1*

*Section II*

*System Responsibilities, page 1*

Oversight and system management • 1-5, *page 1*

Secretarial oversight • 1-6, *page 1*

System management • 1-7, *page 1*

*Section III*

*Planning, Programming, Budgeting, and Execution Responsibilities, page 2*

Deputy Chief of Staff for Operations and Plans • 1-8, *page 2*

Director of Program Analysis and Evaluation • 1-9, *page 2*

Assistant Secretary of the Army (Financial Management) • 1-10, *page 2*

Assistant Secretary of the Army (Manpower and Reserve Affairs) • 1-11, *page 3*

Assistant Secretary of the Army (Research, Development, and Acquisition) • 1-12, *page 3*

Deputy Chief of Staff for Intelligence • 1-13, *page 3*

Deputy Chief of Staff for Logistics • 1-14, *page 3*

Deputy Chief of Staff for Personnel • 1-15, *page 3*

Chief, National Guard Bureau (CNGB) • 1-16, *page 3*

Chief, Army Reserve (CAR) • 1-17, *page 3*

Other principal officials • 1-18, *page 3*

Commanders of major Army commands and other operating agencies • 1-19, *page 3*

Commanders of major Army commands serving as Army component commanders • 1-20, *page 4*

Staff managers and sponsors for congressional appropriations • 1-21, *page 4*

**Chapter 2**

**System Description, page 9**

*Section I*

*The Department of Defense Planning, Programming, and Budgeting System, page 9*

The DOD PPBS concept • 2-1, *page 9*

The Future Years Defense Program • 2-2, *page 9*

\* This regulation supersedes AR 1-1, 9 July 1986, and DA Pam 5-9, 1 August 1986.

## Contents—Continued

Roles of core DOD managers • 2–3, *page 10*  
DOD Executive Committee • 2–4, *page 10*  
Defense Resources Board • 2–5, *page 10*  
Program Review Group • 2–6, *page 10*  
Defense Acquisition Board and Joint Requirements Oversight Council • 2–7, *page 10*

### Section II

*The Army Planning, Programming, Budgeting, and Execution System, page 11*

The PPBES: the Army's primary resource management system • 2–8, *page 11*

The Army PPBES concept • 2–9, *page 11*

PPBES objectives • 2–10, *page 11*

Control of planning, programming, and budgeting documents • 2–11, *page 11*

Management Decision Packages • 2–12, *page 12*

Adjusting program and budget resources • 2–13, *page 12*

Principal PPBES committees • 2–14, *page 13*

Other committees • 2–15, *page 13*

Program Evaluation Groups • 2–16, *page 13*

Process and structure • 2–17, *page 14*

## Chapter 3

### Planning Phase, *page 14*

#### Section I

*PPBS Planning, page 14*

OSD and joint strategic planning • 3–1, *page 14*

Joint strategic planning • 3–2, *page 14*

Joint Strategy Review • 3–3, *page 14*

JSPS documents and plans • 3–4, *page 14*

Special assessments • 3–5, *page 14*

OSD planning products • 3–6, *page 15*

#### Section II

*PPBES Planning, page 15*

Army Planning • 3–7, *page 15*

Role of long-range planning • 3–8, *page 15*

Army Long-Range Planning Guidance • 3–9, *page 15*

Army Modernization Plan • 3–10, *page 15*

Enhanced Concept Based Requirements System • 3–11, *page 15*

Long-Range Research, Development, and Acquisition Plan • 3–12, *page 15*

The Army Plan (TAP) • 3–13, *page 15*

Force development and Total Army Analysis • 3–14, *page 16*

Force management • 3–15, *page 16*

#### Section III

*Operational Planning Link to the PPBES, page 17*

Operational planning • 3–16, *page 17*

Missions and tasks • 3–17, *page 17*

OPLAN development and review • 3–18, *page 17*

## Chapter 4

### Programming Phase, *page 17*

Army programming • 4–1, *page 17*

Defense Planning Guidance • 4–2, *page 17*

Army Program Guidance • 4–3, *page 17*

Program administrative instructions • 4–4, *page 17*

Program and Budget Guidance • 4–5, *page 17*

Transition from planning • 4–6, *page 18*

Program development • 4–7, *page 18*

Program development process • 4–8, *page 18*

Army program reviews • 4–9, *page 19*

POM preparation and submission • 4–10, *page 19*

OSD program review • 4–11, *page 19*

Program Decision Memorandum • 4–12, *page 19*

## Chapter 5

### Budgeting Phase, *page 19*

#### Section I

*Army Budgeting, page 19*

Budget process • 5–1, *page 19*

Budget guidance • 5–2, *page 19*

Defense Business Operations Fund: a recent managerial initiative • 5–3, *page 19*

#### Section II

*Formulation, page 20*

Command budget submissions • 5–4, *page 20*

Other budget submissions by MACOMs • 5–5, *page 20*

Acquisition reviews • 5–6, *page 20*

Final adjustments • 5–7, *page 20*

Review and approval • 5–8, *page 20*

OSD-OMB budget review • 5–9, *page 20*

President's Budget • 5–10, *page 20*

#### Section III

*Justification, page 21*

Budget hearings • 5–11, *page 21*

Legislative approval and enactment • 5–12, *page 21*

Continuing resolution authority • 5–13, *page 21*

## Chapter 6

### Execution Phase, *page 21*

#### Section I

*Budget Execution, page 21*

Execution • 6–1, *page 21*

Financial management • 6–2, *page 21*

Apportionment, allocation, and allotment • 6–3, *page 21*

Funds control • 6–4, *page 21*

Obligation and outlay plans • 6–5, *page 21*

Financing unbudgeted requirements • 6–6, *page 21*

#### Section II

*Program Performance and Review, page 21*

Program implementation • 6–7, *page 21*

Formal program performance evaluation • 6–8, *page 22*

OSD execution review • 6–9, *page 22*

### Appendix A. References, *page 23*

#### Table List

Table 1–1: Army managers for manpower and force structure issues, *page 2*

Table 1–2: Army appropriation and fund managers, *page 6*

Table 1–3: Budget activity management structure for operation and maintenance appropriations, *page 7*

Table 1–3: Budget activity management structure for operation and maintenance appropriations—continued, *page 8*

Table 1–4: Program Evaluation Groups listing proponent agency and areas of activity, *page 9*

Table 1–5: Composition of Program Evaluation Groups, *page 9*

Table 2–1: Major force programs, *page 9*

#### Figure List

Figure 2–1: Future Years Defense Program, *page 10*

Figure 2–2: Fiscal year structure of resources in a Management Decision Package (MDEP) reflecting the FY 1994–1999 Program Objective Memorandum (POM), *page 12*

**Contents—Continued**

Figure 2-3: Fiscal year structure of resources in a Management Decision Package (MDEP) reflecting the President's FY 94-95 budget, *page 12*

Figure 5-1: Fiscal year structure of resources, *page 20*

**Glossary****Index**

**RESERVED**

## Chapter 1 Introduction

### Section I Overview

#### 1-1. Purpose

*a.* This regulation describes the Army Planning, Programming, Budgeting, and Execution System (PPBES). It explains how an integrated Secretariat and Army Staff, with the full participation of major Army commands (MACOMs), Program Executive Offices (PEOs), and other operating agencies—

(1) Plan, program, budget, and then allocate and manage approved resources.

(2) Provide the commanders in chief (CINCs) of United States unified and specified commands with the best mix of Army forces, equipment, and support attainable within available resources.

*b.* The regulation assigns responsibilities and describes policy and procedures for using the PPBES to:

(1) Establish the Army long-range plan, midterm plan and program, and near-term budget.

(2) Identify resource requirements of the approved program.

(3) Request and justify resources from the Office of the Secretary of Defense (OSD) and Congress.

(4) Monitor the use of appropriated funds and authorized manpower to achieve intended purposes.

#### 1-2. References

Required and related publications and prescribed and referenced forms are listed in appendix A.

#### 1-3. Explanation of abbreviations and terms

Abbreviations and special terms used in this regulation are explained in the glossary.

#### 1-4. System and procedure

Sections II and III assign responsibilities for system oversight, management, and operation. Chapters 2 through 6 describe system policy and procedure.

### Section II System Responsibilities

#### 1-5. Oversight and system management

The responsibilities assigned in sections II and III reflect new ways in which the Army oversees, manages, and operates the PPBES in which—

*a.* The Department of Defense (DOD) now—

(1) Plans, programs, and budgets on a biennial cycle.

(2) Submits to Congress the 6-year Future Years Defense Program (FYDP) underlying the President's Budget (section 221, title 10, United States Code (10 USC 221)).

*b.* The CINCs now play a greater role in Service and DOD resource decisions affecting Service components assigned to the CINC. Several new measures stress support of CINC warfighting capabilities:

(1) Each Army component command (ACC) integrates the CINC's operational requirements with other missions of the command.

(2) Headquarters, Department of the Army (HQDA) presents a formal briefing to each CINC on the resource status of the CINC's issues in the Army program submitted to OSD.

(3) HQDA coordinates directly with each CINC on major budget issues affecting the CINC's resource requirements.

*c.* The Army Secretariat has assumed overall responsibility for executing selected functions formerly carried out by the Army Staff. The Secretariat now exercises sole responsibility for auditing, inspector general functions, legislative affairs, and public affairs. Concerning functions that figure prominently in the PPBES, the Secretariat now has sole responsibility for acquisition, financial

management, and information management. The Army Staff, meanwhile, retains overall responsibility for determining requirements. Also, with functional cohorts from the Army Secretariat, the Staff prepares The Army Plan (TAP), develops the Army program, and tracks Army program performance. Related to the changes—

(1) A designated Army Acquisition Executive (AAE), PEOs, and program and project managers (PMs) now operate under the policy of a designated Defense Acquisition Executive (DAE) (section 2436, title 10, United States Code (10 USC 2436)).

(2) The Assistant Secretary of the Army (Financial Management) (ASA(FM)) now supervises and directs preparation of Army budget estimates and financial execution of the congressionally approved budget.

#### 1-6. Secretarial oversight

*a.* *PPBES oversight and Armywide policy development.* The ASA(FM) will oversee—

(1) The PPBES and the development and promulgation of Armywide PPBES policy.

(2) All Army appropriations and will serve as the sponsor for all appropriations except Army National Guard (ARNG) and U.S. Army Reserve (USAR) appropriations.

*b.* *Functional oversight.* Principal officials of the Office of the Secretary of the Army (OSA) will oversee operation of the PPBES process within assigned functional areas and will provide related policy and direction.

#### 1-7. System management

The ASA(FM), with the Director of Program Analysis and Evaluation (DPAE), will manage the overall PPBES. As provided in *a* through *d*, below, the Deputy Chief of Staff for Operations and Plans (DCSOPS), DPAE, and ASA(FM) will manage functional phases of the system, each establishing and supervising policies and procedures necessary to carry out phase functions.

*a.* *Planning.* The DCSOPS will manage the PPBES planning phase and will—

(1) Administer the Army Planning System (APS) to meet and complement the demands of the Joint Strategic Planning System (JSPS) and the Joint Operational Planning and Execution System (JOPES).

(2) Validate CINC requirements and provide CINC linkage to the U.S. Army Training and Doctrine Command (TRADOC) to make sure CINC required warfighting capabilities receive consideration in developing Army doctrine.

(3) Integrate the views of HQDA principal officials on Army missions and capabilities consonant with national security objectives and DOD guidance. Based on the integrated view, recommend Army priorities to the Chief of Staff, U.S. Army (CSA) for approval by the Secretary of the Army (SA).

*b.* *Programming.* The DPAE will manage the PPBES programming phase and will—

(1) Provide the SA and CSA with independent assessments of program alternatives and priorities.

(2) Serve as the authoritative source of the FYDP resource position for the Army as a whole and, specifically, for CINC issues.

(3) Exercise HQDA staff responsibility over the Program Objective Memorandum (POM) and the FYDP to include interaction with OSD and the Joint Staff.

*c.* *Budgeting.* The ASA(FM) will manage the PPBES budgeting phase and will supervise and direct preparation of Army budget estimates, as well as incorporating the budgets of the ARNG and USAR.

*d.* *Execution.*

(1) The ASA(FM) will manage the PPBES execution phase and will—

(a) Apply funds appropriated by Congress to carry out authorized programs to include apportioning, allocating, and allotting funds, obligating and disbursing them.

(b) Track and report on budget execution and help in reviews of program performance.

(2) The DPAE will coordinate the evaluation of overall program



performance to make sure that total resources are applied to achieve approved objectives and to gain feedback for adjusting resource requirements.

### Section III Planning, Programming, Budgeting, and Execution Responsibilities

#### 1-8. Deputy Chief of Staff for Operations and Plans

The DCSOPS will:

*a.* Determine force-related requirements of the Total Army— Active Army, ARNG, and USAR.

(1) Through TRADOC, integrate CINC requirements and those developed through the JSPS and JOPES into the Enhanced Concept Based Requirements System (ECBRS).

(2) Integrate required capabilities identified through the ECBRS into Army planning.

(3) Develop near-, mid-, and long- term force requirements. Develop requirements for organization, force structure, personnel, materiel, command and control, mobilization, facilities, and training devices.

*b.* Prepare Army Long Range Planning Guidance (ALRPG).

*c.* Document in the TAP policy set by the senior Army leadership and leadership priorities for force-related resource requirements, midterm objectives for long term functional goals, and approved base force levels.

*d.* Develop the preliminary program force.

*e.* Exercise staff supervision of joint matters and assign, coordinate, and review Joint Staff actions.

*f.* Provide the operational link between HQDA, the Joint Staff, and, through ACCs, the CINCs.

*g.* Participate with DPAAE in preparing—

(1) Army input to the OSD Program Projection and Army comments on the Defense Planning Guidance (DPG) directed in 1-9 *b* , below.

(2) Briefings on resource status of CINC issues directed in 1-9 *j* , below.

*h.* Participate with ASA(FM) in coordinating CINC major budget issues directed in 1-10 *d* , below.

*i.* Serve as Army manager for force structure issues (table 1-1), and perform programming and budgeting assignments listed in tables 1-2, 1-3, and 1-5 (para 1-21).

(2) Review CINC integrated priority lists (IPLs) and MACOM-PEO POMs.

*d.* Serve as HQDA executive agent for OSD Execution Review of selected Army programs.

*e.* During the programming phase, guide and integrate the work of Program Evaluation Groups (PEGs) (tables 1-4 and 1-5 (para 1-21) and para 2-15). With the PEG chair, translate and recommend resource levels for the overall Army program.

*f.* Direct the review and analysis of Army programming actions, perform selected studies, and develop alternatives for resource planning and programming.

*g.* Review Reserve component programming actions to make sure they are coordinated before interacting with the Army Secretariat.

*h.* Manage the Management Decision Package (MDEP) architecture.

*i.* Make sure that the force structure and manpower information included in FYDP submissions to OSD matches the positions in the force structure and accounting data bases for the Active Army, ARNG, USAR, and civilian work force. (Data in the FYDP and in the force structure and manpower data bases must match before the FYDP can be provided to OSD.)

*j.* With DCSOPS and ACCs, brief each CINC on the resource status of the CINC's issues after the submission of each POM.

*k.* With ASA(FM)—

(1) Maintain the data architecture of the Army Management Structure (AMS) to meet management needs for each phase of the PPBES and to support FYDP submissions (including annexes).

(2) Maintain a resource management architecture to support the integration of PPBES processes and systems.

(3) Maintain the data base architecture for the PPBES Data Management System (PROBE), including managing data entry into PROBE, making sure that PROBE data elements are consistent both internally and with AMS and FYDP reporting requirements (including annexes).

(4) Maintain the official data base for submitting the Army portion of the FYDP.

(5) Produce the FYDP resource position in paper and machine-readable form for periodic issue of Program and Budget Guidance (volume II).

(6) Generate machine-readable data in support of Army budget estimates.

*l.* With appropriate HQDA principal officials develop automated management systems, decision support systems, and predictive models to support program development and management through program and budget execution.

**Table 1-1  
Army managers for manpower and force structure issues**

<i>Issue</i>	<i>Manager</i>
Force Structure	DCSOPS
Active Military Manpower	DCSPER
Army Reserve Manpower	CAR
Army National Guard Manpower	CNGB
Civilian Manpower	DCSPER
Army Management Headquarters Activities (AMHA)	ASA(MRA)
Joint and Defense Accounts	DCSPER

#### 1-9. Director of Program Analysis and Evaluation

The DPAAE will—

*a.* With DCSOPS, develop programming guidance for incorporation in the TAP.

*b.* Develop guidance for, and with functional proponents, prepare responses to, OSD program guidance documents.

*c.* With functional proponents—

(1) Develop and defend the Army program, manage its codification in the POM, and monitor program execution.

#### 1-10. Assistant Secretary of the Army (Financial Management)

The ASA(FM) will—

*a.* With functional proponents, prepare the Army budget from the approved Army program.

*b.* Review and consolidate the ARNG and USAR budgets with the Active Army budget for submission to OSD and Congress.

*c.* During the budgeting phase, guide and integrate the work of designated PEGs (tables 1-4 and 1-5 (para 1-21) and para 2-16).

*d.* With DCSOPS, coordinate with each CINC on major budget issues affecting the CINC's resource requirements.

*e.* Supervise and direct financial execution of the congressionally approved budget.

*f.* Develop and approve the Independent Cost Estimate (ICE) to check the reasonableness of the Baseline Cost Estimate (BCE) for selected major weapon and information systems and establish the Army Cost Position (ACP) that certifies or modifies the BCE as appropriate.

*g.* Validate economic analyses supporting new programs.

*h.* Maintain the HQDA Program Performance and Budget Execution Review System (PPBERS).

*i.* Oversee policy and guidance to account for and report on Army managed funds.

*j.* Oversee accounting for and reporting on use of Army managed funds to OSD and Congress by appropriation. As applicable to each

appropriation include FYDP program, program element (PE), project number, budget line item number (BLIN), budget activity (BA), budget activity group (BAG), budget subactivity (BSA), element of resource (EOR), and financing data. Also as applicable to an appropriation, account for and report on the use of manpower by manpower category.

*k.* Develop and maintain nonstandard Army systems in support of financial review and analysis and implement nonstandard Army systems in support of fund distribution, accounting, and reporting of funds. Oversee the development and maintenance of standard Army systems, such as the Standard Army Financial Inventory Accounting and Reporting System (STARFIARS) in support of financial analysis; and oversee implementation of the same standard Army systems in support of distribution, accounting, and reporting of funds.

*l.* With DPAA, perform the system and data management functions directed in 1-9 *k*, above.

*m.* Issue before each PROBE update resource controls for authorized or projected levels of total obligation authority (TOA), manpower, and force structure.

*n.* Perform budget and appropriation sponsor assignments listed in tables 1-2, 1-3, and 1-5 (para 1-21).

#### **1-11. Assistant Secretary of the Army (Manpower and Reserve Affairs)**

The Assistant Secretary of the Army (Manpower and Reserve Affairs) (ASAMRA) will—

*a.* Approve policy for, and oversee, manpower, force structure, and personnel activities conducted throughout the Army.

*b.* Oversee development and promulgation of ARNG and USAR policy.

*c.* Perform PPBES functions and responsibilities outlined in AR 10-5 and related functions affecting manpower, including review of proposed manpower levels before approval by the SA and CSA.

*d.* Serve as Army manager for Army Management Headquarters Activities (AMHA) (table 1-1, para 1-8, above), and perform programming and budgeting assignments listed in table 1-5 (para 1-21).

#### **1-12. Assistant Secretary of the Army (Research, Development, and Acquisition)**

The Assistant Secretary of the Army (Research, Development, and Acquisition) (ASARDA) will—

*a.* Perform Army acquisition management activities as the designated AAE and will—

(1) Represent the Army on the Defense Acquisition Board (DAB), The Nuclear Weapons Council Standing Committee, and the Conventional Systems Committee.

(2) Advise the Secretary of the Army on matters of acquisition management.

(3) With the Vice Chief of Staff, Army, co-chair the Army Systems Acquisition Review Council (ASARC).

*b.* Manage the Army Baseline Program and make sure that baseline documentation reflects the current Army cost position.

*c.* Integrate the development and acquisition of materiel into all phases of the PPBES process and will—

(1) Exercise responsibility for the research, development, and procurement (RDA) appropriations in formulating, presenting, and executing the budget and in related data base areas as outlined in the Memorandum of Understanding between ASA(FM) and ASARDA.

(2) With the ASA(FM), prepare and justify budget estimates for the RDA appropriations.

(3) Perform programming and budgeting assignments listed in tables 1-2, 1-3, and 1-5 (see para 1-21).

#### **1-13. Deputy Chief of Staff for Intelligence**

The Deputy Chief of Staff for Intelligence (DCSINT) will—

*a.* Prepare, justify, and submit the program and budget for the Army portion of the National Foreign Intelligence Program (NFIP)

per the policy, resource, and administrative, guidance of the Director of Central Intelligence and DOD NFIP Program Managers.

*b.* Perform programming and budgeting assignments listed in tables 1-2, 1-3, and 1-5 (para 1-21).

#### **1-14. Deputy Chief of Staff for Logistics**

The Deputy Chief of Staff for Logistics (DCSLOG) will—

*a.* Review the program and budget for its capability to sustain the force.

*b.* Perform programming and budgeting assignments listed in tables 1-2, 1-3, and 1-5 (para 1-21).

#### **1-15. Deputy Chief of Staff for Personnel**

The Deputy Chief of Staff for Personnel (DCSPER) will—

*a.* Manage the individuals' account for Active Army military manpower not included in Army operating strength.

*b.* Allocate Active Army military and civilian end strength and civilian workyears to MACOMs, PEOs, and other operating agencies.

*c.* Collect for reimbursable manpower allocated to revolving funds and non-Army agencies.

*d.* Serve as Army manager for manpower issues as assigned in table 1-1, paragraph 1-8 above, and perform programming and budgeting assignments listed in tables 1-2, 1-3, and 1-5 (para 1-21).

#### **1-16. Chief, National Guard Bureau (CNGB)**

The Chief, National Guard Bureau (CNGB) will—

*a.* Prepare and justify the budget for ARNG appropriations and perform operational tasks listed in paragraph 1-21, below.

*b.* Serve as Army manager for ARNG manpower issues as listed in table 1-1, paragraph 1-8 above, and perform programming and budgeting assignments listed in tables 1-2, 1-3, and 1-5 (para 1-21).

#### **1-17. Chief, Army Reserve (CAR)**

The Chief, Army Reserve (CAR) will—

*a.* Prepare and justify the budget for USAR appropriations.

*b.* Serve as Army manager for USAR manpower issues as listed in table 1-1, paragraph 1-8 above, and perform programming and budgeting assignments listed in tables 1-2, 1-3, and 1-5 (para 1-21).

#### **1-18. Other principal officials**

Other HQDA principal officials, as assigned, will serve as Army managers for manpower issues (table 1-1, para 1-8 above) and will perform programming and budgeting assignments listed in tables 1-2, 1-3, and 1-5 (para 1-21).

#### **1-19. Commanders of major Army commands and other operating agencies**

MACOM commanders, PEOs, and heads of other operating agencies will—

*a.* Plan, program, and budget for assigned missions, responsibilities, and functions.

*b.* Document manpower in their subordinate organizations per allocated manpower levels.

*c.* Execute the approved MACOM or agency program within allocated resources, applying the inherent flexibility allowed by law and regulation.

*d.* Assess MACOM or agency program performance and budget execution and will—

(1) Account for and report on use of allocated funds by appropriation and MDEP. As applicable to each appropriation, include FYDP program and subprogram, Army Management Structure Code (AMSCO), PE, project number, BLIN, BAG, and EOR. Also account for and report on use of allocated manpower by unit identification code (UIC).

(2) Use manpower data (especially the Civilian Employment

Level Plan (CELP)) and financial data from budget execution in developing future requirements.

#### **1-20. Commanders of major Army commands serving as Army component commanders**

MACOM commanders serving as ACC commanders will identify and integrate with their other missions and operational requirements the requirements of the CINC.

#### **1-21. Staff managers and sponsors for congressional appropriations**

Separate resource allocation structures for congressional appropriations and the FYDP are essential to obtaining Army resources. Table 1-1, above, assigns staff managers for manpower and force structure issues. Tables 1-2 and 1-3 assign staff managers and sponsors for Army appropriations and funds and 0-1 level budget activities of the Operation and Maintenance appropriations. Table 1-5 shows PEG assignments for these managers and sponsors. The responsibilities of the designated staff managers and sponsors are as outlined below:

*a. Manager for manpower and force structure issues.* The manager for manpower issues and the manager for force structure issues will work together to maintain a continuous exchange of information and collaboration. As appropriate, they will—

(1) Coordinate instructions to the field, and the processing of requests from the field, for manpower or force changes.

(2) Align and balance manpower and unit information among the Structure and Manpower Allocation System (SAMAS), The Army Authorization Documents System (TAADS), PROBE, and the FYDP.

(3) Provide lead support to the PEG chair on manpower issues

*b. Manager for requirements determination.* The manager for requirements determination will—

(1) Determine the scope, quantity, and qualitative nature of functional requirements for planning, programming, and budgeting.

(2) Check how commands and agencies apply allocated manpower and dollars to be sure their use fulfills program requirements.

(3) Review unresourced programs submitted by MACOMs, PEOs, and other operating agencies.

(4) Resolve conflicts involving unresourced requirements or decrements on which MACOMs, PEOs, and other operating agencies fail to reach agreement in developing the program or budget.

(5) Recommend to the Program and Budget Committee (PBC) (para 2-14 *c*, below) the allocation of available resources, unresourced programs, and offsetting decrements.

(6) During program and budget reviews, and throughout the process, coordinate resource changes with agencies having proponentcy for affected MDEPs.

*c. Manager for program and performance.* The manager for program and performance will—

(1) Represent the functional program and monitor its performance.

(2) As required, act with the appropriation sponsor or help the appropriation sponsor perform the duties listed in *d* (1) through (5), below.

(3) Translate budget decisions and approved manpower and funding into program changes and make sure that data transactions update affected MDEPs.

(4) Check budget execution from the functional perspective.

(5) For investment appropriations—

*(a)* Operate and maintain data bases in support of PROBE.

*(b)* During budget formulation, determine how changes in fiscal guidance affect budget estimates and review and approve the documentation of budget justification.

*(c)* During review of the budget by OSD and Office of Management and Budget (OMB) and by Congress, serve as appropriation advocate, help prepare the Army response to OSD program budget decisions (PBDs), and prepare congressional appeals.

*(d)* During execution determine fund recipients, monitor execution, perform decrement reviews, plan reprogrammings, and control below threshold reprogrammings. On RDA matters and otherwise as required, testify before OSD and Congress.

*d. Appropriation sponsor.* The appropriation sponsor will—

(1) Control the assigned appropriation or fund.

(2) Serve as Army spokesperson for appropriation resources.

(3) Help resource claimants solve manpower and funding deficiencies.

(4) Issue budget policy, instructions, and fiscal guidance.

(5) Prepare supplemental budgets.

(6) During budget formulation

*(a)* Provide lead support to the PEG chair.

*(b)* Bear responsibility for PROBE updates.

*(c)* Prepare and justify budget estimates.

(7) During budget justification testify before Congress.

(8) During budget execution manage financial execution of the appropriation and reprogram allocated manpower and funds to meet unforeseen contingencies.

Table 1-2  
Army appropriation and fund managers

<b>Resource Identifica- tion code</b>	<b>Appropriation (fund)<sup>1</sup></b>	<b>Manager for requirements determination</b>	<b>Manager for program and performance</b>
<b>Investment</b>			
<b>RDTE</b>	Research, Development, Test, and Evaluation, Army	DCSOPS	ASA(RDA)
<b>ACFT (APA)</b>	Aircraft Procurement, Army	DCSOPS	ASA(RDA)
<b>MSLS (MIPA)</b>	Missile Procurement, Army	DCSOPS	ASA(RDA)
<b>WTCV</b>	Procurement of Weapons and Tracked Combat Vehicles, Army	DCSOPS	ASA(RDA)
<b>AMMO (PAA)</b>	Procurement of Ammunition, Army	DCSOPS	ASA(RDA)
<b>OPA</b>	Other Procurement, Army	DCSOPS	ASA(RDA)
	OPA 1	DCSOPS	ASA(RDA)
	OPA 2	DCSOPS	ASA(RDA), DISC4
	OPA 3	DCSOPS	ASA(RDA)
<b>MCA</b>	Military Construction, Army	ACSIM	ACSIM
<b>MCNG</b>	Military Construction, Army National Guard	CNGB	CNGB
<b>MCAR</b>	Military Construction, Army Reserve	CAR	CAR
<b>AFHC</b>	Family Housing, Army (Construction)	ACSIM	ACSIM
<b>Operations</b>			
<b>OMA</b>	Operation and Maintenance, Army	Table 1-3	Table 1-3
<b>OMNG</b>	Operation and Maintenance, Army National Guard <sup>2</sup>	CNGB	CNGB
<b>OMAR</b>	Operation and Maintenance, Army Reserve <sup>2</sup>	CAR	CAR
<b>MPA</b>	Military Personnel, Army	DCSPER	DCSPER
<b>NGPA</b>	National Guard Personnel, Army	CNGB	CNGB
<b>RPA</b>	Reserve Personnel, Army	CAR	CAR
<b>AFHO</b>	Family Housing, Army (Operation)	ACSIM	ACSIM
<b>NBRP</b>	National Board for the Promotion of Rifle Practice, Army	DCSOPS	DCSOPS
<b>DBOF</b>	Business Operations Fund	ASA(FM)	ASA(FM)
<b>DM</b>	Depot Maintenance	DCSLOG	ASA(FM)
<b>SMA</b>	Supply Management, Army	DCSLOG	DCSLOG
<b>CAWCF</b>	Army Conventional Ammunition Working Capital Fund	ASA(RDA)	ASA(RDA)
<b>IMET</b>	International Military Education and Training Transfer Appropriation	DCSLOG	DCSLOG
<b>FMF</b>	Foreign Military Financing Program	DCSLOG	DCSLOG
<b>FMS</b>	Foreign Military Sales Program	DCSLOG	DCSLOG
<b>HOA</b>	Home Owners Assistance Fund, Defense	COE	COE
<b>ATF</b>	Department of the Army Trust Funds	ASA(FM)	ASA(FM)

**Notes:**

<sup>1</sup> ASA(FM) serves as appropriation sponsor for all appropriations (funds) except ARNG and USAR appropriations, whose sponsors are the Chief, National Guard Bureau and Chief, Army Reserve, respectively.

<sup>2</sup> See table 1-3.

Table 1-3  
Budget activity management structure for operation and maintenance appropriations

**Operation and Maintenance, Army**

**I. Army manpower and total obligation authority**

nxx Budget activity (BA)  
 nnx 01 level  
 nnn Budget subactivity  
 Records resources for Army Management Structure  
 Code (AMSCO) nnnxx, where nnn designates  
 budget subactivity.

Code	Description	Manager <sup>1</sup>
<b>BA 1: Operating forces</b>		
11	Land forces	DCSOPS
111	Combat units	DCSOPS
112	Tactical support	DCSOPS
113	Theater defense	DCSOPS
114	Force related training/special activities	DCSOPS
115	Force communications	DISC4
116	JCS exercises	DCSOPS
117	Base support	ACSIM
118	Depot maintenance	DCSLOG
<b>BA 2: Mobilization</b>		
21	Mobility operations	DCSOPS
211	Strategic mobility	DCSLOG
212	War reserves	DCSLOG
213	Industrial preparedness	DCSLOG
214	POMCUS	DCSLOG
<b>BA 3: Training and recruiting</b>		
31	Accession training	DCSOPS
311	Officer acquisition	DCSOPS
312	Recruit training	DCSOPS
313	One station unit training	DCSOPS
314	Reserve Officers' Training Corps (ROTC)	DCSOPS
315	Service academy base support	ACSIM
<b>BA 4: Training and recruiting</b>		
32	Basic skill and advanced training	DCSOPS
321	Specialized skill training	DCSOPS
322	Flight training	DCSOPS
323	Professional development education	DCSOPS
324	Training support	DCSOPS
325	Base support	ACSIM
<b>BA 5: Recruiting, and other training and education</b>		
33	Recruiting, and other training and education	DCSOPS
331	Recruiting and advertising	DCSPER
332	Examining	DCSPER
333	Off-duty and voluntary education	DCSPER
334	Civilian education and training	DCSPER
335	Junior ROTC	DCSPER
336	Base support—recruiting & examining	ACSIM

Code	Description	Manager
<b>BA 4: Administration and servicewide activities</b>		
41	Security programs	
411	Security programs	DCSINT
42	Logistics operations	
421	Servicewide transportation	DCSLOG
422	Central supply activities	DCSLOG
423	Logistic support activities	DCSLOG
424	Ammunition management	DCSLOG
<b>BA 5: Servicewide support</b>		
43	Administration	Shared <sup>2</sup>
431	Administration	DISC4
432	Servicewide communications	DCSPER
433	Manpower management	DCSPER
434	Other personnel support	DCSOPS
435	Other service support	TJAG
436	Army claims activities	DCSLOG
437	Real estate management	ACSIM
438	Base support	ACSIM
439	Defense Environmental Restoration Account (DERA)	ACSIM
<b>BA 6: Support of other nations</b>		
44	Support of other nations	
441	International military headquarters	DCSOPS
442	Miscellaneous support of other nations	DCSOPS

**II. Manpower-only activity structure**

PROBE generates categories 8 and 9 below to meet  
 manpower reporting requirements.  
 Category 8 records resources for AMSCO 84nxxx,  
 where n=1, 6, 7, or 9 designates the budget sub-  
 activity. Category 9 records resources for AMSCO  
 9nxxx, where n=1, 2, 3, or 4 designates the 0-1  
 level structure.

Code	Description	Manager
<b>Category 8: Medical activities, manpower only—reimbursable labor</b>		
84	Medical manpower—reimbursable	TSG
841	Examining activities	
846	Training—medical spaces	
847	Care in Army medical centers	
849	Defense medical spaces	
<b>Category 9: Other—manpower only</b>		
91	Special operations forces manpower—reimbursable	DCSOPS
92	Defense agency manpower (military only)	DCSPER
93	Outside Department of Defense	DCSPER
94	Transients, holdees, and operating strength deviation	DCSPER

Continued—

Table 1-3  
Budget activity management structure for operation and maintenance appropriations—continued

**Operation and Maintenance, Army—continued**

<b>III. Base support</b>		<b>Account</b>	<b>Manager</b>
Provides installation support functions for budget subactivities, 117, 315, 325, 336, and 438. Includes former accounts for base operations (BASOPS) (AMSCO xxxx98), real property maintenance (RPM) (AMSCO xxxx78 in account L and AMSCO xxxx76 in account K), and environmental compliance (AMSCO xxx56). Adds functions listed.		<b>N.</b> Command element, special staff, headquarters commandant	ACSIM
		<b>R.</b> Automation activities	DISC4
		<b>Q.</b> Reserve component support	ACSIM
		<b>S.</b> Community and morale support activities	ACSIM
		<b>T.</b> Preservation of order/counterintelligence operations	DCSOPS
		<b>U.</b> Resource management	ASA(FM)
		<b>W.</b> Contracting operations	ASA(RDA)
		<b>Y.</b> Records management, publications	DISC4
		Environmental compliance, pollution prevention, and conservation programs (summary account)	ACSIM
<b>Account</b>	<b>Manager</b>	<b>Added function</b>	<b>Manager</b>
<b>A.</b> Real estate leases	ACSIM	Base communications	DISC4
<b>B.</b> Installation supply operations	DCSLOG	AMSCO xxxx95	
<b>C.</b> Direct and general support (DS/GS) maintenance of nontactical equipment	DCSLOG	Audio visual	DISC4
<b>D.</b> Transportation services	DCSLOG	AMSCO xxxx90	
<b>E.</b> Laundry and dry cleaning services	DCSLOG	Youth services, family programs	ACSIM
<b>F.</b> The Army food services program	DCSLOG	AMSCO 315819 and 315820 (for USMA resources) and AMSCO xxx719 and xxx720 (where xxx is 117, 325, or 438 depending on the command owning the resources)	
<b>G.</b> Personnel support	DCSPER		
<b>H.</b> Unaccompanied personnel housing operation	ACSIM		
<b>J.</b> Operation of utilities	ACSIM		
<b>K.</b> Maintenance and repair of real property	ACSIM		
<b>L.</b> Minor construction	ACSIM		
<b>M.</b> Engineer support	ACSIM		

**Operation and Maintenance—Army National Guard, U.S. Army Reserve**

**Army National Guard**

**U.S. Army Reserve**

Records resources for AMSCO 5nxxxx, where n=1 or 4 designates the 0-1 level structure.

Records resources for AMSCO 5nxxxx, where n=1 or 4 designates the 0-1 level structure.

<b>Code</b>	<b>Description</b>	<b>Manager</b>	<b>Code</b>	<b>Description</b>	<b>Manager</b>
	<b>BA 1: Operating forces</b>	CNGB		<b>BA 1: Operating forces</b>	CAR
<b>51</b>	<b>Mission operations</b>		<b>51</b>	<b>Mission operations</b>	
	Training operations			Training operations	
	Recruiting and retention			Recruiting and retention	
	Medical support			Medical support	
	Depot maintenance			Depot maintenance	
	Base support <sup>3</sup>			Base support <sup>3</sup>	
	<b>BA 4: Administration &amp; servicewide activities</b>	CNGB		<b>BA 4: Administration &amp; servicewide activities</b>	CAR
<b>54</b>	<b>Administration &amp; servicewide activities</b>		<b>54</b>	<b>Administration &amp; servicewide activities</b>	
	Information management			Information management	
	Public affairs			Public affairs	
	Personnel administration			Personnel administration	
	Staff management			Staff management	

Notes: <sup>1</sup> Manager for requirements determination and for program and performance.

<sup>2</sup> Manager responsibilities shared by various functional proponents.

<sup>3</sup> Follows support recording structure used for Operation and Maintenance, Army.

Table 1-4  
 Program Evaluation Groups listing proponent agency and areas of activity

<b>Title</b>	<b>Proponent</b>	<b>Area of activity</b>
<b>Manpower and Force Structure</b>	DCSOPS	Active Army and reserve component modified table of organization and equipment (MTOE) and table of distribution (TDA) units; Individuals Account (TTHS: trainees, transients, holdees, and students); force manning decisions, civilian and military. <sup>1 2</sup>
<b>General Purpose Forces</b>	DCSOPS	Program 2, General Purpose Forces; Program 10, Support of Other Nations.
<b>Information Management (Sustaining)</b>	DISC4	Service-wide Communications; Information Systems for Command and Control, Communications, and Computers (C4); Automation MDEPs (including MSxx, MUxx, and Information Management PEO MDEPs).
<b>Intelligence</b>	DCSINT	Program 3 (Intelligence) (Operation and Maintenance, Army (OMA), Budget Subactivity 411—Security Programs).
<b>Army National Guard (ARNG)</b>	CNGB	Military Construction, Army National Guard (MCNG); Operation and Maintenance, Army National Guard (OMNG); National Guard Personnel, Army (NGPA).
<b>U.S. Army Reserve (USAR)</b>	CAR	Military Construction, Army Reserve (MCAR); Operation and Maintenance, Army Reserve (OMAR); Reserve Personnel, Army (RPA).
<b>Modernization (Battlefield)</b>	DCSOPS ASA(RDA)	Research, Development, Test, and Evaluation, Army (RDTE); procurement appropriations; fielding support costs. <sup>1 2</sup>
<b>Supply and Maintenance</b>	DCSLOG	OMA Budget Activity (BA) 1, Operating Forces (Depot Maintenance); BA 2, Mobilization (War Reserves, Industrial Preparedness); BA 4, Administrations and Service-wide Activities (Service-wide Transportation, Central Supply Activities, Logistic Support Activities, Ammunition Management, Miscellaneous Support of Other Nations); and Defense Business Operations Fund (DBOF).
<b>School and Institutional Training</b>	DCSOPS	OMA BA 3, Training and Recruiting (Training).
<b>Medical</b>	TSG	Army health care program.
<b>Personnel Activities</b>	DCSPER	Personnel Activities, OMA Budget Subactivities 331-335, 433, and 434; Military Personnel, Army (MPA).
<b>Administrative</b>	AASA	Program 9, Administration and Associated Activities and other subprograms within OMA.
<b>Base Operations (BASOPS)</b>	ACSIM	Base support functions in OMA Budget Subactivities 117, 315, 325, 336, and 438. (See Base Support, fig 1-3.)
<b>Construction and Housing</b>	ACSIM	Military Construction, Army (MCA); Army Family Housing (AFH); Home Owners Assistance (HOA)

**Notes:**

<sup>1</sup> The Manpower and Force Structure PEG and Modernization PEG address fundamental, strategy driven operational requirements. Remaining PEGs address functional requirements to sustain the force and to maintain readiness and the support base.

<sup>2</sup> The Manpower and Force Structure PEG administers unit counts and end strength for the Active Army, without dollars. The Modernization PEG deals with equipment quantities and dollars. Other PEGs deal with manpower and dollars.

Table 1-5  
Composition of Program Evaluation Groups

Title and proponent	Membership <sup>1 2</sup>			
	Manager for requirements determination	Manager for program and performance	Appropriation sponsor	OSA member
Manpower and Force Structure	DCSOPS	DCSPER CNGB, CAR	ASA(FM) <sup>3</sup>	ASA(MRA)
General Purpose Forces	DCSOPS	DCSOPS	ASA(FM)	ASA(MRA)
Information Management (Sustaining)	DISC4	DISC4	ASA(FM)	ASA(FM), DISC4
Intelligence	DCSINT	DCSINT	ASA(FM)	ASA(MRA)
Army National Guard (ARNG)	CNGB	CNGB	CNGB	CNGB, ASA(MRA)
U.S. Army Reserve (USAR)	CAR	CAR	CAR	CAR, ASA(MRA)
Modernization (Battlefield)	DCSOPS	ASA(RDA) DISC4	ASA(FM)	ASA(RDA)
Supply and Maintenance	DCSLOG	DCSLOG	ASA(FM)	ASA(ILE)
School and Institutional Training	DCSOPS	DCSOPS	ASA(FM)	ASA(MRA)
Medical	TSG	TSG	ASA(FM)	ASA(MRA)
Personnel Activities	DCSPER	DCSPER	ASA(FM)	ASA(MRA)
Administrative	AASA	AASA	ASA(FM)	ASA(MRA)
Base Operations (BASOPS)	ACSIM	ACSIM	ASA(FM)	ASA(ILE)
Construction and Housing	ACSIM	ACSIM	ASA(FM)	ASA(ILE)

**Notes:**

<sup>1</sup> A program integrator representing the director of Program Analysis and Evaluation (DPAE) serves as an additional core member of the Program Evaluation Group (PEG). The manager for requirements determination chairs the PEG.

<sup>2</sup> Other representatives from offices and agencies of the Secretariat and Army Staff may attend PEG meetings according to subjects considered. The additional representatives provide oversight or act in behalf of functional interests. For example, a DCSLOG member of the Information Management PEG might represent DCSLOG's proponentry of tactical logistics systems. An open door policy invites attendance by major Army commands (MACOMs) and Program Executive Offices (PEOs).

<sup>3</sup> The Manpower and Force Structure PEG administers unit counts and end strength. It affects appropriations indirectly only.

## Chapter 2 System Description

### Section I The Department of Defense Planning, Programming, and Budgeting System

#### 2-1. The DOD PPBS concept

The DOD Planning, Programming, and Budgeting System (PPBS) is the primary system for managing the department's military functions. It is also the parent system of the Army's PPBS. The purpose of the PPBS is to produce a plan, a program, and finally the defense budget.

#### 2-2. The Future Years Defense Program

*a.* The term Future Years Defense Program (FYDP) replaces the term Five-Year Defense Program used through the FY '91 President's Budget. The FYDP officially summarizes the programs developed within the PPBS and approved by the Secretary of Defense (SECDEF). The FYDP exists in machine readable form, which lists resources by program element (PE), resource identification code, fiscal year (FY), and value. The FYDP exists also in

paper form, which sums resource data in various management arrays.

*b.* The FYDP has two dimensions. Its first dimension specifies 11 major force programs (table 2-1). Constructed from PE building blocks, the programs offer an output or mission-oriented structure, within which each PE represents an organizational or functional entity and its associated resources. DOD uses the structure for internal program review. In its second dimension, the FYDP records program decisions on dollars and manpower applying the input-oriented appropriation structure of congressional budget requests (table 1-2). The FYDP includes separately published annexes for procurement; construction; and research, development, test, and evaluation.

**Table 2-1  
Major force programs**

Program	Title
1	Strategic forces
2	General purpose forces
3	Intelligence and communications
4	Airlift and sealift



**Table 2-1**  
**Major force programs —Continued**

Program	Title
5	Guard and Reserve forces
6	Research and development
7	Central supply and maintenance
8	Training, medical, and other general personnel activities
9	Administration and associated activities
10	Support of other nations
11	Special operations forces

c. The FYDP identifies and accounts for the total of all resources programmed by DOD. Assigning resources to specific major force programs, the FYDP shows fiscal year totals for forces, manpower, and dollars. For example, the FYDP for the FY 1994-1995 Budget (fig 2-1) would—

**fiscal years**

PY	CY	BY	BY	1	2	3	4	5	6	7
92	93	94	95	96	97	98	99	00	01	02

**STOA & manpower**

**forces**

**Figure 2-1. Future Years Defense Program**

(1) Give totals for each resource group by prior year (PY), current year (CY), and the FY 1994-1995 budget years (BYs).

(2) Extend TOA and manpower totals 4 years beyond the FY 1995 BY to FY 1999.

(3) Extend force totals 7 years beyond the FY 1995 BY to FY 2002.

d. The FYDP gets updated at least three times during the biennial PPBES cycle.

(1) In the even years, updates occur when defense components submit their POMs to OSD about 1 April and budget estimates about 15 September.

(2) In the odd years (and, when appropriate, for an even year amendment) a FYDP update coincides with the President's Budget submitted to Congress in January.

**2-3. Roles of core DOD managers**

The SECDEF relies on a core of key DOD officials to help manage DOD. Those serving in that capacity are as follows:

a. *Deputy Secretary of Defense.* The Deputy Secretary of Defense (DEPSECDEF) helps the SECDEF in overall leadership of the department. He exercises authority delegated by the SECDEF and conducts the day-to-day operation of DOD.

b. *Chairman of the Joint Chiefs of Staff.* Existing outside the military chain of command, the Chairman of the Joint Chiefs of Staff (CJCS) functions within the chain to transmit communications from the President and the SECDEF to the CINCs. The CJCS serves as the principal military advisor to the President and SECDEF. Shouldering responsibilities for planning, advising, and policy formulation, the CJCS participates in DOD's senior councils. There, the CJCS speaks for the Joint Chiefs of Staff (JCS) and CINCs. The Vice Chairman of the JCS is the second ranking member of the Armed Forces. He acts for the Chairman in the Chairman's absence.

c. *Service Secretaries.* The SA and other Service Secretaries convey the Service perspective on defense matters to the SECDEF

and DEPSECDEF and, as key advisors, provide them with candid personal views.

d. *Under Secretary of Defense for Acquisition.* The Under Secretary of Defense for Acquisition (USD(A)) exercises responsibility for acquisition matters DOD-wide and performs as the DAE.

e. *Under Secretary of Defense for Policy.* The Under Secretary of Defense for Policy (USD(P)) represents DOD on foreign relations and arms control matters. The USD(P) also serves as primary advisor to the DEPSECDEF for the PPBS planning phase.

**2-4. DOD Executive Committee**

The DOD Executive Committee (EXCOM), serves as the key, senior deliberative and decisionmaking body within DOD for all major defense issues. The SECDEF and, in his absence, the DEPSECDEF chair the committee, whose other members consist of the core group of managers just described. The DOD General Counsel serves the EXCOM as legal advisor, and the Special Assistant to the SECDEF and DEPSECDEF serves as the executive secretary. Attendance is limited to the members and the committee's legal advisor and executive secretary except that the chairman may invite others to attend a particular meeting. Convening at the call of the chair, the forum exists to allow the SECDEF to receive in confidence and with candor the advice, opinions, and judgments of the Secretary's senior advisors.

**2-5. Defense Resources Board**

The SECDEF uses a Defense Resources Board (DRB) to help manage the PPBS and make major program decisions.

a. The SECDEF and, in his absence, the DEPSECDEF, chair the DRB. Members include the CJCS, VCJCS, JCS, and the Service Secretaries. Members from within OSD include the USD(A), ASD (Personnel and Readiness), and the Comptroller, DOD. The chairman also invites other OSD principals to participate when necessary. The Director for Program Analysis and Evaluation serves as the executive secretary.

b. The DRB helps promote long-range planning and stability in the defense program. Among other functions, the DRB—

(1) Considers broad policy and develops guidance on high-priority objectives.

(2) Reviews guidance for planning and programming.

(3) Examines high priority programs.

(4) Considers the effect of resource decisions on baseline cost, schedule, and performance of major acquisition programs and aligns the programs with the PPBS.

(5) Helps tie the allocation of resources for specific programs and forces to national policies.

(6) Reviews the program and budget.

(7) Reviews execution of selected programs.

(8) Advises the SECDEF on policy, PPBS issues, and proposed decisions.

**2-6. Program Review Group**

The SECDEF uses a Program Review Group (PRG) to identify major issues, analyze them, and develop decision options for presentation to the DRB. The USD(A) chairs the group, with the VCJCS serving as the vice chair. Members include Military Department representatives, ASD (Strategy, Requirements, and Resources), ASD (Personnel and Readiness), ASD (Reserve Affairs), and Comptroller, DOD. The chairman also invites others to participate when necessary. The Director for Program Analysis and Evaluation serves as the executive secretary.

**2-7. Defense Acquisition Board and Joint Requirements Oversight Council**

a. As chair and vice chair, respectively, the USD(A) and VCJCS direct the efforts of the Defense Acquisition Board (DAB). The DAB oversees defense system acquisition, providing discipline through review of major programs. At each milestone in the system life cycle, the Board assures that programs have met performance requirements, including program-specific exit criteria.

b. Helping the DAB and USD(A) is the Joint Requirements

Oversight Council (JROC) chaired by the VCJCS. The JROC explains military needs and validates performance goals and program baselines at successive milestones for each DAB program.

c. The USD(A), with the DAB and JROC, helps link the acquisition process to planning, programming, and budgeting. Serving as a key advisor to the SECDEF and DEPSECDEF, the USD(A) participates in all resource decisions affecting the baselines of major acquisition programs.

## Section II

### The Army Planning, Programming, Budgeting, and Execution System

#### 2-8. The PPBES: the Army's primary resource management system

The PPBES is the Army's primary resource management system. A major decisionmaking process, the PPBES interfaces with OSD and joint planning and links directly to OSD programming and budgeting. It develops and maintains the Army portion of the defense program and budget. It supports Army planning, and it supports program development and budget preparation at all levels of command. It supports execution of the approved program and budget by both headquarters and field organizations. During execution, it provides feedback to the planning, programming, and budgeting processes.

#### 2-9. The Army PPBES concept

a. The PPBES ties strategy, program, and budget together. It helps build a comprehensive plan in which budgets flow from programs, programs from requirements, requirements from missions, and missions from national security objectives. The patterned flow from end purpose to resource cost defines requirements in progressively greater detail.

(1) Long range planning creates a vision of the Army 10 to 20 years into the future. In the 2- to 15-year midterm, long range macro estimates give way to a specified size, composition, and quality of divisional and support forces. Derived from joint strategic planning and intermediate objectives to achieve long range goals, this base force provides the planning foundation for program requirements.

(2) Guided by base force requirements and still in the midterm, programming distributes available resources. It seeks to support priorities and policies of the senior Army leadership while achieving balance among Army organizations, systems, and functions.

(3) In the 0- to 2-year near term, budgeting converts program requirements into requests for manpower and dollars. When enacted into appropriations and manpower authorizations, these resources become available to carry out approved programs.

(4) Formally adding execution to traditional emphasis on planning, programming, and budgeting emphasizes Army concern for how well program performance and financial execution apply allocated resources to meet requirements.

b. Documents produced within the PPBES support defense decisionmaking, and the review and discussion that attend their development help shape the outcome. The following are examples.

(1) The Army helps prepare the DPG and planning documents produced by the JSPS. The participation influences policy, strategy, and force objectives considered by the SECDEF and the JCS, including policies for development, acquisition, and other resource allocation issues.

(2) MACOM commanders similarly influence positions and decisions taken by the SA and CSA. They develop and submit force-structure, procurement, and construction requirements; command programs; and budget estimates. They also make their views known through periodic commander's conferences held by the CSA on the proposed plan, program, and budget.

(3) The CINC's influence Army positions and decisions through MACOM commanders serving as ACC commanders, who integrate CINC operational requirements into their POMs. They also highlight

pressing requirements in an integrated priorities list (IPL) that receives close review during program development.

#### 2-10. PPBES objectives

The objectives of the PPBES are:

a. During all phases of the PPBES, to provide an essential focus on Departmental policy and priorities for Army functional activities.

b. Through planning, to size, structure, man, equip, and train the Army force to support the national military strategy.

c. Through programming, to distribute available manpower, dollars, and materiel among competing requirements per Army resource allocation policy and priorities.

d. Through budgeting, to convert program decisions on dollars and manpower into requests for congressional authorization and appropriations.

e. Through program execution, to—

(1) Apply resources to achieve approved program objectives.

(2) Adjust resource requirements based on execution feedback.

f. Through program and budget execution, to manage and account for funds to carry out approved programs.

#### 2-11. Control of planning, programming, and budgeting documents

a. Papers and associated data sponsored by the DOD PPBS give details of proposed programs and plans. The proposals state candidate positions and competing options that remain undecided until final approval.

(1) Access to the material by persons other than those directly involved in planning and allocating resources would frustrate the candor and privacy of leadership deliberations.

(2) Access by private firms seeking DOD contracts would imperil competition and pose serious ethical, even criminal, problems for those involved.

b. For reasons in a (1) and (2), above, DOD closely controls documents produced through the DOD PPBS and its supporting data bases. Thus, OSD restricts access to DOD and other governmental agencies directly involved in planning, programming, and budgeting defense resources, primarily OMB. The list that follows cites major documents illustrative of but not limiting PPBS-sponsored material requiring restricted access.

(1) Planning phase. Defense Planning Guidance (DPG).

(2) Programming phase.

(a) Fiscal guidance.

(b) Program Objective Memorandum (POM).

(c) Future Years Defense Program (FYDP) documents for the POM, including procurement annex and RDT&E annex.

(d) Program review proposals.

(e) Issue papers (for example, major issue papers, tier II issue papers, cover briefs).

(f) Proposed military department program reductions (or program offsets).

(g) Tentative issue decision memoranda.

(h) Program Decision Memorandum (PDM).

(3) Budgeting phase.

(a) Future Years Defense Program (FYDP) documents for the September budget estimates submission and President's Budget, including procurement, RDT&E, and construction annexes classified P-1, R-1, and C-1.

(b) Program Budget Decisions (PBDs) and Defense Management Review (DMR) Decisions.

(c) Reports Generated by the Automated Budget Review System (BRS).

(d) DD 1414 Base for Reprogramming.

(e) DD 1416 Report of Programs.

(f) Congressional data sheets.

c. Exceptions to the limitation of b, above, require SECDEF approval. After coordination with the General Counsel, an Army proponent may request an exception, but only for compelling need. The Select Committee (SELCOM) (para 2-14) will consider requests on a case-by-case basis. Statutes and other procedures govern

disclosure of information to Congress and the General Accounting Office (GAO).

## 2-12. Management Decision Packages

a. Early in the PPBES process, the resource management architecture distributes program and budget resources to MDEPs by appropriation and program element. MDEPs serve as a resource management tool used internally by the Army. Taken collectively, MDEPs account for all Army resources. They describe the capability of the Total Army—Active, Guard, and Reserve. Individually, an MDEP describes a particular organization, program, or function. It also records the resources associated with the intended output. An individual MDEP applies uniquely to one of the following six management areas:

- (1) Missions of MTOE units.
- (2) Missions of TDA units and Army-wide standard functions.
- (3) Missions of standard installation organizations (SIOs).
- (4) Acquisition, fielding, and sustainment of weapon and information systems. (Linkage to units exists through HQDA decision support systems, such as Force Builder, Single Army Battlefield Requirements Evaluator, and Logistics DSS.)
- (5) Special visibility programs (SVPs).
- (6) Short term projects (STPs).

b. Maintained in the PROBE data base, each MDEP records manpower and total obligation authority over 9 fiscal years. (System MDEPs also show item quantities over the same period.) Resources recorded in the MDEP shift forward each January as follows.

(1) A 2-year shift forward occurs in MDEP resources each even (or POM submission) year. PROBE drops the 2 earliest years from the data base and adds 2 new years. The MDEP then displays the 6 years of the new program and the 3 preceding years (fig 2-2.). The first of the preceding years is the prior fiscal year (PY). It records resources spent in executing the budget the year before the current fiscal year (CY). The CY shows resources in the budget being executed. The last preceding year is called the budget year (BY). It lists resources requested in the President's Budget being reviewed by Congress.

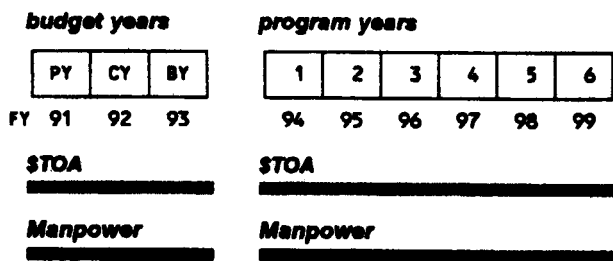

Figure 2-2. Fiscal year structure of resources in a Management Decision Package (MDEP) reflecting the FY 1994-1999 Program Objective Memorandum (POM)

(2) Another shift occurs in the odd year (the year in which the President submits the next 2-year defense budget). The shift leaves each year's resources intact but changes their relative position in the program or budget process as shown in figure 2-3. Budget years 91 and 92 both become prior years; budget year 93 becomes the current year; and the first 2 program years both become budget years 94 and 95. The last 4 years (years 96 through 99) remain program years.

c. During programming, MDEPs provide useful visibility. They help Army managers, decisionmakers, and leaders assess program worth, confirm compliance, and rank resource claimants. During budgeting, MDEPs help convey approved programs and priorities into budget estimates. Providing the vehicle for data entry, MDEPs also help PEGs post program changes caused by budget decisions and approved funding. During execution, the posted MDEPs help HQDA principal officials, MACOM commanders, PEOs, and heads

of other operating agencies track program and financial performance. The financial data they get as feedback help determine future requirements.

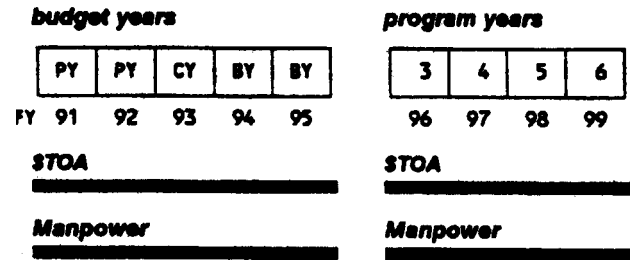

Figure 2-3. Fiscal year structure of resources in a Management Decision Package (MDEP) reflecting the President's FY 94-95 budget

## 2-13. Adjusting program and budget resources

### a. Recurring changes.

(1) Changes in resources occur throughout the PPBES process. HQDA staff agencies update MDEPs through their respective feeder systems to reflect the position of the last program or budget event. During programming, competition may reduce programmed amounts originally recorded. Decisions during OSD POM and budget reviews will further alter amounts initially approved. Sometimes the decisions affect requests in the President's Budget already before Congress, as do authorization and appropriation decisions by Congress. Budget execution often results in different rates and quantities from those planned, and at times it results in different purposes.

(2) The changes require that resource managers continually weigh how the stream of program and budget actions—

- (a) Change MDEP resource levels.
- (b) Shift resources between years.
- (c) Affect resources in related MDEPs.

b. *Manpower and fund flexibility.* Flexibility in managing Army manpower and funds differs depending on whether the resources apply to the program or budget.

(1) In the program or POM years, manpower is restricted by total end strength for military and civilians rather than by operation and maintenance appropriation or budget subactivity. Similarly program dollars are restricted by TOA only, rather than by individual appropriations within TOA. The distinctions give the Army latitude in redistributing previously programmed manpower and dollars to meet changing requirements. In later POM or budget submissions, for example, the Army can, as needed, move program year resources between MDEPs, appropriations, and PEs.

(2) In contrast, tight controls govern the redesignation of manpower and funding once the President's Budget has gone to Congress.

(a) The Army can reallocate previously budgeted manpower and dollars between MDEPs or operating agencies but not between 0-1 level budget activities or appropriations. Once the budget goes to Congress, the Army must leave budget manpower and dollars unchanged until current year appropriations become law.

(b) Some flexibility during execution allows financing unbudgeted requirements to meet unforeseen needs or changes in operating conditions. Even so, congressional rules and specified dollar thresholds severely restrict spending for purposes other than those originally justified and approved. Also during execution, military and civilian manpower transfer within 0-1 level budget activities and appropriations may occur without a corresponding transfer of funds.

c. *Investment accounts.* For investment accounts (RDA and construction), managers first allocate program and budget resources by AMSCO, PE, project number, and BLIN. They then distribute the resources to MDEPs within the six management areas.

## 2-14. Principal PPBES committees

### a. Select Committee.

(1) The SELCOM is co-chaired by the Vice Chief of Staff, Army (VCSA) and the Under Secretary of the Army. The SELCOM convenes either as a full committee or an Executive SELCOM.

(2) Members of the full SELCOM consist of the following:

(a) From the Secretariat—Assistant Secretaries, the General Counsel, the Administrative Assistant, DISC4, Inspector General, Deputy Under Secretary of the Army (Operations Research), Chief of Legislative Liaison, Chief of Public Affairs, Comptroller of the Army, Military Deputy to ASA(RDA), and Deputy Assistant Secretary of the Army for Army Budget (DAB).

(b) From the Army Staff—Director of the Army Staff; Deputy Chiefs of Staff; Assistant Chief of Staff for Installation Management; Chief of Engineers; The Surgeon General; Chief, National Guard Bureau; Chief, Army Reserve; The Judge Advocate General; Director of Management; and Director of Program Analysis and Evaluation.

(c) As required—representatives from other offices and agencies of the Army Secretariat and Staff, the Commander of the U.S. Army Strategic Defense Command, and liaison and advisory representatives from other MACOMs and PEOs.

(3) The SELCOM functions as HQDA's senior committee. The forum helps the Army leadership review, coordinate, and integrate PPBES actions. The SELCOM considers and interprets guidance from the SECDEF, SA, and CSA. It reviews Army policy, plans, programs, and budgets. It reviews program performance and budget financial execution. When possible, the SELCOM disposes of actions on its own. It refers issues of major importance or other special management interest to the SA and CSA, presenting, as appropriate, alternatives and recommendations for decision.

(4) As needed, the chair convenes the Executive SELCOM as an ad hoc group to consider matters of narrow interest inappropriate for a full session. SELCOM minutes inform the full membership on decisions and recommendations made in executive sessions.

### b. Strategy and Planning Committee.

(1) The Strategy and Planning Committee (SPC) is chaired by the Assistant DCSOPS (ADCSOPS). Alternate chair for international activities is the ADCSOPS (Joint Affairs). Members consist mainly of officials responsible for planning in the various Army Staff agencies and offices of the Army Secretariat. Membership includes the DPAE and DAB.

(2) The SPC provides an integrating forum for Army planning. It considers guidance and analyses related to strategy and planning and makes recommendations to the SELCOM. The SPC—

(a) Recommends force structure guidance to SA and CSA for approval.

(b) Monitors force development to be sure the program force meets requirements identified through the ALRPG and ECBRS and those related to CINC IPLs.

(c) Serves as coordinating body for TAP.

### c. Program and Budget Committee.

(1) The Program and Budget Committee (PBC) is co-chaired by the DPAE and DAB. Either presides, depending on the subject. PBC members consist mainly of officials responsible for programming or budgeting in the various offices and agencies of the Army Secretariat and Staff.

(a) The PBC oversees the programming, budgeting, and execution phases of the PPBES, including information feedback among the phases. The PBC serves in both a coordinating and executive-advisory role. It provides a continuing forum in which program and budget managers review, adjust, and decide issues. An aim of the PBC is to make sure of the internal consistency and support of Army policy.

(b) The PBC may return the results of committee deliberations to the Army Staff or Secretariat for action. It may pass them to the SELCOM for review or approval and later presentation to the SA and CSA.

(2) The PBC may set up standing committees or working groups

to resolve difficulties in managing the program or budget. An example is the Transportation Working Group formed to develop priorities and controls for managing transportation. An example of a standing committee is the PBC Systems Subcommittee. This subcommittee consists of general officers and members of the Senior Executive Service (SES). It is co-chaired by representatives of the DPAE and DAB. It broadly represents the Army Staff and Secretariat and includes appropriate representation from the field. The subcommittee reviews program, budget, and cost estimates for the life cycle of major weapon and information systems. It assigns agency responsibilities for issues needing further review and follows up on the action taken. As appropriate, the subcommittee presents the results of its deliberations to the PBC.

### d. Prioritization Steering Group.

(1) The Prioritization Steering Group (PSG) serves as another PPBES deliberating body. The DCSOPS chairs the PSG. Members consist of the Director of the Army Staff and other primary Army Staff principals. Membership includes the DPAE and DAB and, when requested by DCSOPS, extends to selected representatives of the Army Secretariat.

(2) The PSG, as required—

(a) Reviews unresourced programs submitted by MACOMs and PEOs and proposed decrements recommended by the PBC.

(b) Resolves differences involving unresourced requirements or decrements on which the PBC fails to reach agreement during program or budget development.

(c) Reviews prioritized and integrated lists of unresourced programs and decrements against fiscal and manpower constraints imposed by OSD.

(d) Makes recommendations on unresourced programs and proposes off-setting decrements to the SELCOM.

## 2-15. Other committees

The following additional committees meet as required to handle specific needs within their areas of responsibility.

a. Army System Acquisition Review Council (ASARC).

b. Materiel Acquisition Review Board (MARB).

c. Army Major Automated Information Systems Review Council (MAISRC).

d. Study Program Coordination Committee (SPCC).

e. Construction Requirements Review Committee (CRRC).

f. Stationing and Installations Planning Committee (SIPC).

g. Installation Management Steering Committee (IMSC).

h. Army Defense DBOF Board of Directors.

## 2-16. Program Evaluation Groups

a. HQDA supports planning, programming, and budgeting using PEGs sponsored by designated principal officials. PEGs help build TAP and Army program and help convert the program into budget-level detail. The Modernization PEG functions during the programming phase only, its core members being convened as required during other PPBES phases by DCSOPS for planning, DAB for budgeting and financial execution, and DPAE for program execution. Other PEGs remain in operation throughout the PPBES cycle.

b. PEGs help maintain program consistency during planning and program review, and later during budget analysis and defense. During execution, PEGs track program and budget performance. Typically, within assigned functional areas, PEGs—

(1) Set the scope, quantity, and qualitative nature of functional requirements.

(2) Review CINC IPLs and MACOM-PEO POMs to develop the Army program for the assigned functional area and incorporate the program in the POM, to include:

(a) Reconciling conflicts involving unresourced requirements or decrements on which commands fail to reach agreement.

(b) Recommending the allocation of available resources and off-setting decrements to support approved unresourced programs.

(3) Help prepare the Army budget from the approved program.

(4) During execution, check how commands apply allocated manpower and dollars to be sure their use fulfills program requirements.

(5) During program and budget reviews, and throughout the planning, programming, and budgeting process, coordinate resource changes with HQDA staff agencies having proponentcy for affected MDEPs. Translate budget decisions and approved manpower and funding into program changes and make sure that data transactions update affected MDEPs.

c. Tables 1-4 and 1-5 list the PEGs and give their composition and focus.

## 2-17. Process and structure

a. Figure 2-4 shows the organizational framework within which the PPBES operates. Figures 2-5 and 2-6 show the sequence and interrelationship of events of the biennial cycle, providing a doctrinal baseline typically subject to cycle-specific changes. Figures 2-4, 2-5, and 2-6 appear at the end of this publication. In citing the month of a baseline event, the discussion specifies whether the event occurs in an odd or even calendar year. A larger display appears as DA Poster 1-1 receiving the same storage and distribution as this publication.

b. The system has four formal phases. Three it shares with the DOD PPBS: planning, programming, and budgeting. The fourth, execution, applies uniquely to the Army as a distinct system phase. PPBES cycles overlap as do the four phases within each cycle. Chapters 3 through 6 explain the phases.

## Chapter 3 Planning Phase

### Section I PPBS Planning

#### 3-1. OSD and joint strategic planning

a. OSD and joint strategic planning make up PPBS planning. The planning—

(1) Examines the military posture of the United States in comparison with national security objectives and resource limitations.

(2) Develops the national military strategy.

(3) Identifies force levels to achieve the strategy.

b. OSD and joint strategic planning provides a framework of requirements, priorities, and risk. OSD uses the framework to give each CINC the best mix of forces, equipment, and support attainable within defined fiscal constraints.

#### 3-2. Joint strategic planning

a. Joint strategic planning examines the global security situation. It develops national military strategy to achieve national security objectives and sets related force requirements. It also prepares strategic and contingency plans, prepares supporting joint logistic and mobility plans, and conducts capability assessments.

b. Joint strategic planning helps the CJCS discharge the functions prescribed by 10 USC 153 (a) and 10 USC 163 (b) (2). Specifically, joint strategic planning underlies the military advice the Chairman gives to help the President and SECDEF—

(1) Provide strategic direction to the armed forces.

(2) Form defense policy, programs, and budgets.

c. Led by the Joint Staff, joint strategic planning involves each of its directorates and the Defense Intelligence Agency. Moreover, it entails close consultation with the combatant commands, Services, and other defense agencies.

d. Joint strategic planning takes place within the context of the Joint Strategic Planning System (JSPS). Featuring a continuous review of the national military strategy (para 3-3), the JSPS yields four principal products (para 3-4). The products help the joint community relate strategic planning to both the Joint Operation Planning and Execution System (JOPES) and PPBS.

#### 3-3. Joint Strategy Review

a. The Joint Strategy Review (JSR) lies at the core of JSPS. The

review helps the Joint Staff integrate strategy, operational planning, and program assessments. It covers the short-, mid-, and long-range periods: 0-2, 2-10, and 10-20 years in the future.

b. A continuous process, the JSR assesses the global strategic setting for issues affecting the national military strategy.

(1) The Joint Staff, with the Services, combatant commands, and defense agencies develop issue papers highlighting how changed conditions affect current strategy. Key judgments, if not earlier acted on, appear in the next JSR Annual Report.

(2) Provided to the CJCS, Chiefs of Services, and CINCs, the report, when approved by the Chairman, becomes guidance for maintaining or revising the NMS and other JSPS products.

c. As needed the JSR produces a long-range vision paper addressing plausible strategic settings 10-20 years in the future.

#### 3-4. JSPS documents and plans

As mentioned, the JSPS generates four products. Shown in figures 2-5 and 2-6, they are described below.

a. *National Military Strategy*. The CJCS approves and issues the National Military Strategy (NMS). The strategy advises the SECDEF and, after SECDEF review, the President and National Security Council on the strategic direction of the armed forces. A standing document changed when needed, the NMS applies to program years, 2-8 years in the future. The NMS—

(1) Summarizes the global strategic setting from the JSR.

(2) Recommends military foundations and strategic principles to support national security objectives.

(3) Provides a strategy and force levels that conform with NCA Fiscal Guidance.

b. *Joint Planning Document*. The Joint Planning Document (JPD) derives from the NMS. Prepared by the Joint Staff with the Service Chiefs and the CINCs, the document exists as seven stand-alone volumes. Each volume advises the SECDEF on requirements and programming priorities in a specific functional area. Published in September in the odd year, the JPD receives distribution in time to influence the biennial DPG (para 3-6 a ).

c. *Joint Strategic Capabilities Plan*.

(1) The Joint Strategic Capabilities Plan (JSCP) underlies the capabilities-based military advice the CJCS gives the President and SECDEF. Another standing document, the JSCP, undergoes revision as needed, receiving formal review early each even year.

(2) Covering the 2-year, near term planning period, the JSCP—

(a) Gives strategic guidance to the CINCs, JCS members and heads of defense agencies.

(b) Apportions resources to the CINCs.

(c) Tasks the CINCs to develop major and lesser regional plans to employ the force resulting from completed program and budget actions (para 3-16).

d. *Chairman's Program Assessment*. The Chairman's Program Assessment (CPA) checks the balance and capabilities of composite force and support levels recommended by the Service POMs. It compares the recommended capabilities and levels with priorities posed by U.S. strategic plans and requirements of the CINCs. Completed about 45 days after the Services submit their POMs, the document helps the SECDEF make program decisions.

#### 3-5. Special assessments

a. Four related assessments shown in figure 2-5 support the JSPS documents and plans. One is the Joint Military Net Assessment (JMNA). Closely involving the CINCs and other members of the JCS, the CJCS prepares the JMNA. The document compares defense capabilities and programs of the United States and its Allies with those of potential adversaries. The SECDEF reviews and approves the JMNA, then sends it to Congress with the defense budget per 10 USC 1139 (i) (1).

b. Included among three other assessments is the Logistics Sustainability Analysis (LSA). The analysis considers logistics capabilities and limiting factors of individual OPLANs prepared by the CINCs. Another, the Chairman's Preparedness Assessment Report (PAR), checks the ability of the combatant commands to carry out

assigned missions. Still another, the Chairman's Contingency Capabilities Assessment, considers the effect of critical deficiencies faced in contingency planning.

### 3-6. OSD planning products

Two SECDEF documents influence products of the JSPS. One is Defense Planning Guidance (DPG), the other Contingency Planning Guidance (CPG).

*a. Defense Planning Guidance.* The SECDEF places responsibility and authority for program execution with the Services and other DOD components but maintains central direction. Serving this central purpose, the DPG presents the SECDEF's strategic plan for developing and employing future forces. Prepared by OSD and published by 1 October in the odd year, the DPG is a principal product of OSD planning. It reflects—

- (1) Military advice and information recommended by the CJCS.
- (2) Service long-range plans and positions on policy and other matters advanced by Service Secretaries.
- (3) CINC appraisals of major issues and problems bearing on command missions.

*b. Contingency Planning Guidance.* The CPG provides the CJCS written policy guidance for preparing and reviewing contingency plans. Focusing NMS and DPG guidance on contingency planning, the CPG bears directly on the JSCP. The SECDEF prepares the document annually in coordination with the Joint Staff. Then, on approval by the President, the SECDEF provides guidance to the Chairman.

## Section II PPBES Planning

### 3-7. Army Planning

Army, or PPBES, planning responds to and complements OSD and joint strategic planning. PPBES planning—

- a.* Helps the senior Army leadership determine force requirements and objectives and set priorities.
- b.* Provides the basis for positions and comments supporting Army participation in OSD and joint processes.
- c.* Lays the planning basis for the Army program.

### 3-8. Role of long-range planning

Long-range planning looks 10-20 years ahead. In the process, the senior Army leadership creates a vision of the future Army. Fleshing out the design, commands and agencies develop long-range plans in their respective mission and functional areas. Long-range planning guides the midterm vision to develop the force and set program requirements.

### 3-9. Army Long-Range Planning Guidance

*a.* Distributed in October in the even year, the ALRPG records the vision of the senior Army leadership. The ALRPG—

- (1) Describes a framework for defining future requirements.
- (2) Examines national security objectives against a range of potential requirements.
- (3) Lays out long-range planning assumptions and objectives.
- (4) Lists underlying conditions likely to hold over the 10-20 year period.

*b.* The ALRPG goes on to examine political, military, economic, and technological events. Its examination—

- (1) Identifies trends and determines a range of possible results that bound the future operating environment.
- (2) Draws implications for future missions and for achieving required capabilities.

*c.* The biennial document helps commands and agencies translate leader vision into long-range plans. Command and agency long-range plans, in turn, help fashion the midterm vision by setting goals and strategies to get the capabilities to meet future requirements. Together, the ALRPG and command and agency long-range plans guide the preliminary TAP (para 3-13). Released in December

in the odd year, the preliminary TAP sets the course for requirements determination and force development for the next PPBES cycle. For the draft and final TAP published in the base cycle, the ALRPG updates guidance given the cycle before.

### 3-10. Army Modernization Plan

The Army Modernization Plan (AMP) outlines the vision for modernizing the future force and provides a strategy for near- to mid-term force development and long-term evolution. The AMP codifies required capabilities programmed through the PPBES and assesses the impact of required capabilities remaining to be programmed. Its modernization objectives guide program prioritization at HQDA. Interacting with the ALRPG, the AMP provides a starting point for developing the Long Range Research, Development, and Acquisition Plan (LRRDAP) (para 3-12). It supports also the approved POM (para 4-10). As does the ALRPG, the document receives distribution in October in the even year.

### 3-11. Enhanced Concept Based Requirements System

The ALRPG and AMP interact with TRADOC's ECBRS. Through a biennial process known as Warfighting Lens Analysis (WFLA), the ECBRS considers warfighting needs using insights from Louisiana Maneuvers and analyses from Army branches, proponents, and TRADOC Battle Labs. Defined for the long-term, each capability required to meet a warfighting need falls within one of several functional domains: doctrine, training, leader development, organization, or materiel, all of which focus on the soldier. Two products emerge from the process. One is TRADOC's WFLA, the other, a corresponding Science and Infrastructure Support Analysis (SISA), prepared by the U.S. Army Materiel Command (AMC). Prioritizing materiel solutions and optimizing dollars spent on modernization programs, the WFLA and SISA provide the analytical underpinning for the LRRDAP. Required capabilities for all five ECBRS domains receive consideration during program development and the next Total Army Analysis (TAA) (para 3-14).

### 3-12. Long-Range Research, Development, and Acquisition Plan

One of eight functional and special area long-range plans, the LRRDAP plays a key role. It maps the effort to develop and produce technology and equipment for the Army's modernization program. In the process it focuses research, development, and acquisition programs on solving battlefield needs derived from warfighting requirements.

*a.* LRRDAP development begins with the AMP, followed by the LRRDAP Guidance document prepared by DCSOPS and ASA(-RDA) with TRADOC and AMC. HQDA issues the document in the spring of the odd year.

*b.* TRADOC and AMC with the PEOs and ISC consider LRRDAP Guidance and required capabilities identified through the ECBRS. Jointly, these agencies prioritize required capabilities to get the best return for dollars spent under the LRRDAP and record the results in the WFLA and SISA.

*c.* HQDA then reviews and integrates the WFLA and SISA. On approval by the senior Army leadership, the issues recorded in the two documents, as amended, become the Army LRRDAP. Responding to force structure and sustainability guidance, the LRRDAP informs the TAA process of RDA programs planned for the Army modernization program. Information concerning the early planning years forms the basis of the RDA portion of the POM.

### 3-13. The Army Plan (TAP)

*a.* TAP documents policy of the senior Army leadership and gives resource guidance. TAP concurrently documents force levels stabilized initially through force requirements planning and then refined through objectives planning that features—

(1) TAA used to develop for each program year a proposed program force that:

*(a)* Meets projected mission requirements within expected end strength and equipment levels.

*(b)* Considers unalterable earlier decisions.

(2) Force Integration Analysis (FIA) (para 4-6 *b* ), used to make sure that the force is affordable and executable in each program year.

*b.* TAP covers the midterm (or POM period). It distills Army missions and coalesces information from such sources as the DPG, JSPS planning products, ALRPG, and other guidance, including HQDA and MACOM-PEO interaction. TAP also captures long-range objectives from the long-range plans (LRPs) of Army functional proponents. It links them to supporting midterm objectives, which, to be achieved, require resources during program development.

*c.* DCSOPS drafts TAP in coordination with the HQDA staff, MACOMs, and PEOs. Preparation occurs in three stages:

(1) A preliminary TAP, in December of the odd year, guides the developing and updating of the TAA base force. As a minimum, the preliminary TAP codifies planning assumptions and sets parameters for modeling and structuring the program force.

(2) About 1 year later, in January of the next odd year, a draft TAP records the base force update and revises planning assumptions given in the preliminary TAP as a basis for a following FIA. Published as the resource section of TAP, draft Army Program Guidance (APG) (paras 4-3 *a* and 4-6) translates planning objectives into an initial plan of what the Army hopes to achieve in the next POM. (3) TAP, in its final version, appears the following August, after the FIA. The final TAP documents the preliminary program force approved by the SA and CSA. Together with its included Army Program Guidance (paras 4-3 *b* and 4-6), TAP—

(*a*) Provides early direction to the programming, budgeting, and execution phases of the PPBES.

(*b*) Outlines national military strategy and security policy for the Army.

(*c*) Summarizes the existing view of the current force, the POM force at the end of the 6th program year, and the projected force 10 years beyond.

(*d*) Introduces midrange planning objectives, derived from long-range plans, into the POM development and prioritization process.

(*e*) Links programming guidance to midrange planning objectives.

(*f*) States the Army's priorities within expected resource levels.

### 3-14. Force development and Total Army Analysis

*a.* The thrust of PPBES planning is to develop an achievable force structure for the Total Army that supports the national military strategy. The approach centers on TAA, a computer-aided force development process that gets under way about January of the even year.

*b.* Led by DCSOPS, TAA receives HQDA agency and MACOM-PEO participation. It draws guidance from the TAP and other sources and generates requirements for manpower and equipment. The TAA helps assess force capabilities and helps determine, verify, and justify Army requirements. For each program year, TAA develops a base force that meets projected mission requirements within expected end strength and equipment levels.

*c.* A related FIA gets under way in January of the odd year. It determines executability of the TAA base force by examining projected resources and developing force structure alternatives. The decision of the CSA, after reviewing the alternatives, establishes a preliminary program force (para 4-6 *b* ).

*d.* DCSOPS issues the final TAP in August of the odd year, documenting the decision and making the preliminary program force the force structure basis for the Army program.

### 3-15. Force management

Detailed integration and documentation of the force centers on the management of change (MOC) window which occurs the first and third quarter of each calendar year (fig 2-6). The Army uses the semiannual periods to create MTOE and TDA documents. These documents officially record decisions on missions, organizational structure, and requirements and authorizations for personnel and

equipment. The updated MTOE and TDA apply for the current year through the first program year.

*a.* The process begins with the Command Plan (CPLAN) Guidance message released by HQDA (DCSOPS) at the start of the MOC window. CPLAN guidance directs MACOM reprogramming and provides force structure allowances (FSA). MACOMs and other operating agencies then submit a proposed troop list at unit (UIC) level. Proposed CPLANs incorporate force decisions reflected in HQDA guidance, including the program force approved in TAP and the Troop Program Guidance. CPLANs reflect the current and projected force structure of each command and show both military and civilian manpower. After HQDA review, DCSOPS publishes a Master Force (M-Force) reflecting the approved CPLAN. The M-Force provides the basis for documenting personnel and equipment in MTOE and TDA.

*b.* The Army Authorization Document System (TAADS) applies to the Total Army—Active Army, Army National Guard, Army Reserve, and civilian work force. The Army uses the system to record changes in requirements and authorizations that result from changes in unit missions, organizational structure, and equipment.

(1) TAADS defines requirements for MTOE units at various levels of organization using data from the Tables of Organization and Equipment System (TOE).

(2) TAADS uses data from the Basis of Issue Plan (BOIP) to identify quantitative and qualitative requirements for new items of equipment, including the personnel requirements needed to accommodate them.

(3) Requirements for TDA derive from manpower surveys and a manpower standard application.

*c.* The Structure and Manpower Allocation System (SAMAS) serves as the force development database that records the authorized level of manpower and force structure for the Army program and budget. SAMAS has two primary files. One is a force file, which reflects the approved and documented force structure position. The force file produces the M-Force. The second file is a budget file, which reflects the approved CPLAN force structure plus additional budgeting assumptions. The budget file produces a Manpower Addendum to the Program and Budget Guidance (PBG) document that provides resource guidance to MACOMs and other operating agencies.

(1) HQDA submits TAADS to OSD as the Army's billet file, a file that must accord with the manpower and force structure of the Army's programmed and budgeted force by unit, PE, and military and civilian identity.

(2) Toward this end, the Automatic Update Transaction System (AUTS) compares the CPLAN M-Force against the TAADS documents submitted by MACOMs and other operating agencies. When discrepancies are discovered, the TAADS documents are corrected to reflect the approved CPLAN force structure. The comparison occurs within a month of the close of each MOC window (31 March and 30 September). After matching the CPLAN M-Force and TAADS documents, HQDA approves the TAADS documentation for use by the field and SACS (*d*, below). HQDA also publishes a new M-Force showing which units have corresponding TAADS documents. This latest M-Force provides the basis for updating the Personnel Management Authorization Document (PMAD) and Army Stationing and Installation Plan (ASIP).

*d.* The Structure and Composition System (SACS) produces the Army's time-phased demands for personnel and equipment over the current, budget, and program years. SACS consists of a series of computational programs that combine information from SAMAS, TOE, BOIP, and TAADS data.

(1) A key output is the Personnel Structure and Composition System (PERSACS). PERSACS summarizes time-phased requirements and authorizations for personnel, specifying grade and branch as well as areas of concentration (AOC) and military occupational specialty (MOS).

(2) Another key product is the Logistics Structure and Composition System (LOGSACS). LOGSACS summarizes time-phased requirements and authorizations for equipment by line item number (LIN).

(3) PERSACS and LOGSACS form the requirements and authorizations base used by other personnel and logistics systems. The Total Army Equipment Distribution Plan (TAEDP), for example, uses equipment requirements and authorizations from LOGSACS to plan equipment distribution throughout the program years.

### Section III Operational Planning Link to the PPBES

#### 3-16. Operational planning

*a.* Operational planning addresses the 0-2 year short-range planning period. It takes place under JOPEs and the counterpart Army Mobilization and Operations Planning and Execution System (AMOPES).

*b.* Through JOPEs, the CINCs and their Service component commands develop concept plans (CONPLANS) and operation plans (OPLANS).

*c.* Capabilities based, the plans employ the current force to carry out military tasks assigned in the JSCP (para 3-4 *c*). Plan preparation and review return information about shortfalls and limiting factors for consideration in current planning, programming, and budgeting.

#### 3-17. Missions and tasks

The JSCP carries out the NMS through unified command OPLANS. Its accompanying intelligence estimate assesses potential threats and their impact on available U.S. forces. Based on the assessment, the document assigns missions and planning tasks to the CINCs. It also apportions the combat forces expected to be available. Annexes amplify guidance, capabilities, and tasks in specified functional areas.

#### 3-18. OPLAN development and review

*a.* HQDA provides ACCs, supporting MACOMs, and reserve components additional guidance through AMOPES. AMOPES provides planning assumptions, policy, and procedures. It applies both to mobilization and to military operations before the involuntary call up of reserve component forces.

(1) AMOPES Annex A describes the availability of Army combat, combat support, and combat service support units for developing Time-Phased Force and Deployment Data (TPFDD).

(2) AMOPES Annex S (will supersede AMOPS Volume V in early 1994) guides planning to—

*(a)* Survive a nuclear attack on the United States.

*(b)* Recover and reconstitute essential HQDA missions and functions.

*b.* ACC TPFDDs specify arrival priorities for force augmentation, resupply, and troop replacement. TPFDD review and later logistics and transportation assessments help refine the priorities to accord with CINC OPLANS. Issues remaining after negotiation become the subject of a force conference in December of the even year and logistics and transportation conferences the following August. ACCs, supporting MACOMs, and HQDA agencies participate in these deliberations. The participants bring information about current shortfalls and limitations to bear on future requirements through the FIA and program development processes.

*c.* In July (odd year), the CINCs submit their OPLANS for final JCS review and approval. The OPLANS provide a basis for CINC IPLs, which influence program development, their earlier drafts having influenced the ECBRS process and MACOM POM development.

### Chapter 4 Programming Phase

#### 4-1. Army programming

*a.* Army programming helps the senior Army leadership distribute resources to support Army roles and missions. Programming,

translates planning decisions, OSD programming guidance, and congressional guidance into a comprehensive allocation of forces, manpower, and funds. In the process, the PPBES integrates and balances centrally managed programs for manpower; operations; research, development, and acquisition; and stationing and construction. Concurrently, the PPBES incorporates requirements stated by MACOMs and PEOs for manpower, operation and maintenance, housing, and construction.

*b.* The result is the Army POM. The POM presents the Army's proposal for a balanced allocation of its resources within specified constraints. OSD reviews the POM and issues a Program Decision Memorandum (PDM) to reflect SECDEF program decisions.

*c.* The program, as approved by the SECDEF, provides the basis for preparing Army Budget Estimates.

*d.* During execution (chap 6), program reviews help HQDA, MACOMs, PEOs, and other operating agencies make sure that financial allocations support approved program objectives.

#### 4-2. Defense Planning Guidance

The DPG (para 3-6 *a*) provides programming direction from the SECDEF.

#### 4-3. Army Program Guidance

*a.* Army Program Guidance (APG) guides program development. HQDA issues a draft of the document (para 4-6 *a*) with the draft TAP in January of the even year. It issues a final version para 4-7 *a*) the following August, also included as part of TAP.

*b.* The format of the APG parallels that of the POM, whose standard topics are:

- (1) Force structure.
- (2) Force deployment and prepositioning.
- (3) Modernization and investment.
- (4) Force readiness and sustainability.
- (5) Facilities, construction, and maintenance.
- (6) Manpower.
- (7) Information management.
- (8) Reconstitution.
- (9) Unified and specified commands.
- (10) International agreements.

#### 4-4. Program administrative instructions

*a.* *MACOM POM Development Instructions.* HQDA issues MACOM POM Development Instructions (MPDI) in August of the odd year. The document gives administrative instructions to guide MACOMs and PEOs in preparing their program submission and to MACOMs for submitting CINC high priority warfighting needs.

*b.* *Army POM Preparation Instructions.* HQDA issues the Army POM Preparation Instructions (APPI) in January of the even year. For HQDA staff agencies, the document augments OSD's PPI.

#### 4-5. Program and Budget Guidance

*a.* The PBG provides resource guidance to MACOMs, PEOs, and other operating agencies. The document covers—

- (1) The force structure and associated manpower.
- (2) Appropriations of immediate MACOM and PEO interest, such as:

*(a)* Operation and Maintenance, Army (OMA) and Army Reserve (OMAR).

*(b)* Military Construction, Army (MCA) and Army Reserve (MCAR).

*(c)* Army Family Housing (Operation and Maintenance) (AFHO) and (Construction) (AFHC).

(3) Construction, using trust funds for commissary construction and nonappropriated funds (NAF) for morale, welfare, and recreation (MWR) construction.

*b.* HQDA typically publishes a PBG five times during the biennial PPBES cycle.

(1) In the odd years it issues a PBG after the President's Budget goes to Congress in January and after the draft TAP and APG. The issue reflects the President's Budget and preliminary program force and guides agency program development. It also guides preparation



of the Resource Management Update (RMU), refining the Command Budget Estimate (CBE) submitted the previous even year. Later, a PBG update follows publication of the final TAP and APG in August. The issue reflects the preliminary program force approved by the SA and CSA. It also records the result of the July RMU submissions and publishes probable fiscal guidance for MACOM and PEO use in completing the field POMs submitted in late November.

(2) In even years, the President usually submits an amended budget. When this occurs, soon after the budget goes to Congress, HQDA will issue a PBG for the information of MACOMs and PEOs. A PBG follows submission of the POM to OSD in April. Reflecting the new program, it guides preparation of CBEs. A PBG update in the fall reflects Army Budget Estimates submitted to OSD in September.

#### 4-6. Transition from planning

The new program cycle for the next POM begins in the fall of the even year. It occurs after OSD program review and near the end of the even-year TAA process. In this early stage of the cycle, planning and programming at HQDA centers on publishing the draft TAP which includes preliminary programming guidance. The activity continues at HQDA with an FIA to establish the preliminary program force.

*a. Army Program Guidance.* HQDA publishes the draft APG in January of the odd year as the resource section of the draft TAP. The draft APG translates planning objectives into an initial plan of what the Army hopes to achieve in the POM. It conveys CSA directions for future programs. It applies constrained resources for building an integrated and balanced Army program to achieve Army goals. The document whose guidance reflects the President's Budget applies to HQDA, MACOMs, PEOs, and other operating agencies.

(1) The draft APG reflects the base force updated through the TAA process and the planning goals and objectives set in TAP. It considers positions taken by Congress in its review of near-year programs. It incorporates program adjustments from the OSD PDM.

(2) The draft APG projects the availability of manpower and dollars as the resource base for developing the program. Economic assumptions in the draft APG cover such issues as the rate of real growth, amount of a projected pay raise, and estimates of foreign currency changes for each year of the new POM.

(3) The draft APG describes preliminary program guidance. It typically covers the following—

- (a) Base force proposed for the program period.
- (b) Military end strength.
- (c) Force readiness goals.
- (d) Equipment modernization.
- (e) Secondary item levels.
- (f) Base operations support levels.
- (g) Unit training goals.
- (h) Forces stationing.
- (i) Other key program areas.

*b. Force Integration Analysis.* From January through the end of August, DCSOPS conducts an FIA of the TAA base force. Serving as a link between midterm planning and projections for the availability of resources, the FIA develops and costs major force alternatives. From these alternatives, the SA and CSA select and lock the preliminary program force.

(1) The analysis examines the affordability of each alternative of the TAA base force, adjusting the force to reflect applied resource constraints. It concurrently examines the capability of force units to perform assigned missions in support of CINC operational requirements.

(2) The objective of the analysis is to answer such questions as: Can the force be equipped, manned, and trained? Can the force be sustained and provided facilities? Mobilized and deployed?

(3) Considerations include the following—

- (a) Effect of deliveries from earlier budget and execution cycles on the first 2 years of the program.
- (b) Execution and current production rates.

(c) Program impacts resulting from OSD budget review.

(d) Fiscal guidance issued by OSD following submission of the President's Budget to Congress.

#### 4-7. Program development

Army program development formally gets under way when HQDA publishes the final TAP and its included APG in August of the odd year, nearly 1 year before submitting the POM to OSD. Reflecting affordability analyses from the FIA process, TAP and the APG lock in the preliminary program force and stabilize manpower and key equipment requirements for program development. The provisions of the TAP and APG apply to HQDA, MACOMs, PEOs, and other operating agencies.

*a.* Work in developing the APG section of TAP serves as the program baseline for the following—

(1) An Army Force Posture Statement submitted earlier to SECDEF on 1 April.

(2) The LRRDAP POM years.

(3) ACC, other MACOM, and PEO POM requirements submitted to HQDA in late November.

*b.* The APG directs HQDA agencies to prepare alternative programs to support the preliminary program force. An alternative, for example, might vary the distribution of resources to readiness and sustainability. Such alternatives provide insights on various ways to apply resources to achieve Army goals and flexibility to adapt to variations in resource levels (and since they are presented in MDEP structure, the alternatives readily convey to management information system data bases.)

#### 4-8. Program development process

Using the MDEP as a building block, program development applies information from the APG published in August of the odd year to refine and extend the program of the previous PPBES cycle.

*a.* Program development by MACOMs, PEOs, and other operating agencies gets under way early in the odd year. The resource position reflected in the FYDP for the President's Budget and related PBG serve as the base for developing program requirements. On publication of the APG in August, MACOMs, PEOs, and other operating agencies adjust requirements to respond to its guidance and related PBG. They then prepare and present to HQDA—

(1) RMUs submitted in July, updating even-year CBEs.

(2) Command plans validating the latest force structure changes or requesting internal reprogramming to meet them.

(3) MACOM and PEO POMs submitted about 1 November.

(4) A validated economic analysis for the POM years when a program is first funded, prepared per AR 11-18 and instructions in the PBG.

*b.* Information for the early years of the approved LRRDAP serves as the RDA program equivalent to MACOM and PEO POMs.

*c.* HQDA agencies, guided by the APG, collect and review program information. They study the existing program considering new requirements, determine program needs and, then, begin preparing their functional programs.

(1) Under DPAE lead, the agencies incorporate program requirements into POM alternatives directed by the APG and constructed to achieve programmatic balance. Key considerations include—

(a) Resource assessments and new requirements submitted by MACOMs, PEOs, and other operating agencies.

(b) CINC IPLs and ACC-developed requirements supporting them.

(c) DPG.

(d) Final Army fiscal guidance provided by OSD on 30 November.

(2) Proponent agency PEGs guided by DPAE (paras 1-9 *e* and 2-16), build the Army program. Coordinating as required with MDEP proponents, DPAE assigns each MDEP to a particular PEG based largely on the MDEP's main fiscal appropriation. PEGs review resources contained in assigned MDEPs from a functional or program perspective. In building the PEG portion of the overall program, each PEG rank orders unresourced programs submitted by

MACOM, PEO, and other agency POMs. The PEG also reviews command and agency zero-sum realignments, which reallocate programmed resources to meet existing shortfalls and changed requirements. The purpose of the review is to make sure that proposed reallocations—

- (a) Conform to legal restrictions and Army policy and priorities.
- (b) Avoid imprudently high risk.
- (c) Do not cause a mandatory program or subprogram to become inexecutable.

#### 4-9. Army program reviews

The program undergoes review by the senior Army leadership in January and February of even years.

a. *Army Commanders' Conference.* The Army Commanders' Conference scheduled during this period provides field commanders with the chance to review and influence program alternatives.

b. *SELCOM.* The SELCOM then reviews program alternatives, incorporating views expressed at the Army Commanders' Conference. The SELCOM recommends program alternatives to the SA and CSA.

c. *SA and CSA reviews.* Throughout January and February, the SA and CSA hold a series of in-process reviews. Then, after the joint SELCOM has completed its work, the SA and CSA decide on the Army program.

#### 4-10. POM preparation and submission

HQDA prepares the POM in March each even year. The POM reflects program actions fleshed out by the HQDA staff with DPAE. It also documents the program decision of the SA and CSA. Sent to OSD in April, the POM submits the Army program for OSD review.

#### 4-11. OSD program review

a. Also known as the summer issue cycle, the OSD program review begins early in April and continues until late July.

b. The review features Program Review Proposals (PRPs) that recommend alternatives to POM submitted programs. PRPs are two- or three-page issue papers that fully describe the proposed alternative and give evidence for its adoption.

c. PRPs arise early in the process. They develop from review by members of the DRB and nonmember Assistant Secretaries of Defense who manage specific programs. Each reviewer prepares a set of PRPs that offsets recommended program additions with recommended reductions. Submitted to the DEPSECDEF, the balanced sets remain within manpower and fiscal levels originally programmed, thus leaving program costs unchanged. CINCs also may submit PRPs but need not balance theirs.

d. PRPs divide into three tiers, which determine their treatment—

(1) *Tier I—major issues* Tier I topics and issues become major issues. The DRB deliberates these issues in a series of meetings throughout May and August. Tier I major issues typically fall into one of the following groups:

- (a) CINC issues.
- (b) Policy and risk assessment.
- (c) Nuclear forces.
- (d) Conventional forces.
- (e) Modernization and investment.
- (f) Readiness and logistics.
- (g) Manpower.
- (h) Intelligence.
- (i) Management.
- (j) Special Defense agency issues.

(2) *Tier II—issue papers.* Tier II topics become individual issue papers. As a topic surfaces, ASD(PA&E) staffs it within OSD and with the Services and defense agencies. In late June, members of the DRB review the topics along with the results of staffing. Members then submit written comments and a recommended course of action for decision by the DEPSECDEF. The DEPSECDEF entertains reclaims, provided reductions offset additions, and convenes the DRB if required.

(3) *Tier III—budget items.* Tier III topics become items for later budget review sent to the Comptroller of the DOD with possible options.

e. DPAE serves as executive agent for the OSD review, interacting primarily with the Joint Staff. As issues arise, representatives of HQDA principal officials meet with their OSD counterparts. The Army representatives present the Army position and try to clarify issues. If possible, they resolve the issue. An issue resolved outside the DRB becomes known as an “out-of-court” settlement. Such settlements require the signature of responsible officials, both Army and OSD.

f. The principal official primarily responsible for the subject matter reviews each issue and helps DPAE prepare and coordinate a recommended Army position.

(1) Recommended positions for unresolved Tier II issues go to the VCSA or the Under Secretary of the Army for review. Following the review, the DPAE briefs the SA and CSA for their decision.

(2) A shorter response time for Tier I topics requires abbreviating the procedure. Normally, the DPAE and proponent jointly draft the Army position for decision by the SA and CSA without intermediate review.

(3) Approved positions become the basis for Army participation in DRB discussions, if required.

#### 4-12. Program Decision Memorandum

In mid- to late-July, after the DRB has debated all outstanding issues, the DEPSECDEF signs the PDM. The PDM approves the POM with specific changes as the program basis for Army Budget Estimates submitted to OSD.

## Chapter 5 Budgeting Phase

### Section I Army Budgeting

#### 5-1. Budget process

Army budgeting proceeds in three stages: formulation, justification, and execution. Budget formulation converts into Army Budget Estimates the first 2 years of the program approved by the DEPSECDEF's PDM. Budget justification, presents the estimates to Congress and defends them before that body. Budget execution applies congressionally approved resources consisting of authorized manpower and appropriated funds to carry out approved programs.

#### 5-2. Budget guidance

Adding to a DOD budget guidance manual and OSD budget call memorandum, ASA(FM) administrative instructions guide HQDA in preparing Army Budget Estimates. The President's Budget and POM PBG guide MACOMs and PEOs in preparing their CBEs.

#### 5-3. Defense Business Operations Fund: a recent managerial initiative

a. Two initiatives by OSD change the way DOD components program and budget for designated support functions. To increase cost visibility, in August 1989 DOD adopted a financial management system based on cost per output or unit cost. Then, beginning at the outset of fiscal year 1992, DOD instituted the Defense Business Operations Fund (DBOF), to further improve tools available to managers of DOD support functions.

b. DBOF expands the current revolving fund concept to finance the business operations of defense industrial, commercial, and support activities. It provides a structure for each included business area to identify the products or services produced and the total cost of operations. DBOF incorporates the Army Industrial Fund; Army Stock Fund; Surcharge Collections, Sales of Commissary Stores, Army; and other selected DOD funds.

(1) DBOF is essentially a business-type financial system. For each activity providing support through the fund, DBOF captures

the total costs of doing business, accounting for both operating and capital costs.

(a) Operating costs include the usual administrative, supply, and material expenses. They also include personnel costs associated with operating and maintaining a support activity. Moreover, depreciation costs for plant and equipment are included in the operating budget.

(b) Capital costs include the cost of minor construction over \$15,000 with a life expectancy greater than 2 years. They also include the costs of developing information systems and procuring equipment.

(2) DBOF recovers the support activity's cost of operations through stabilized prices that it charges customers receiving support. Fixed prices remaining throughout the year protect customers from unforeseen inflationary pressures and other cost uncertainties. The fund shows the true cost implication of management decisions to both the providers of support and supported operating forces.

## Section II Formulation

### 5-4. Command budget submissions

a. In the even years, MACOMs and PEOs develop their CBEs based on the latest PBG, which reflects fiscal levels approved for the POM. MACOMs and PEOs submit their CBEs to HQDA in July. Projected for the coming budget, fiscal years of the CBE typically cover the current (or execution) year through the 4 program outyears (fig 5-1).

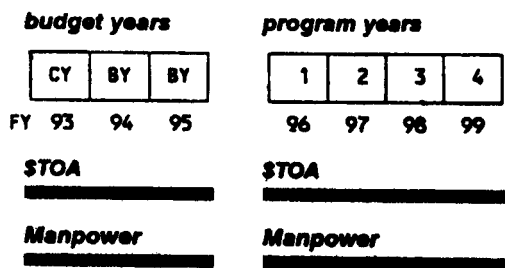

Figure 5-1. Fiscal year structure of resources

b. A major aim during budgeting and execution is to maintain consistency with the program. Acceptance of any change to program levels in the approved POM requires determining program tradeoffs to achieve a zero-sum change. That is, adjustments during budget formulation must remain within the levels approved for Army TOA. Proposed program changes submitted in the CBE receive review from functional proponents and appropriation sponsors. Changes accepted by the PBC and SELCOM make their way into the budget.

c. Used in support of the Army budget submission to OSD, CBE schedules have the most impact on the 2 budget years. This is because CBE changes make a difference in the request that will go to Congress as the President's Budget. (Changes in the coming execution year must be met within the limits of the congressional appropriation or manpower authorization, essentially by reprogramming either within the MACOM and PEO or at DA level.)

d. In July in the odd years, MACOMs and PEOs forward RMUs to HQDA. The RMUs refine budget estimates and selected schedules of the CBE submitted the previous year.

### 5-5. Other budget submissions by MACOMs

Certain other budget submissions and processes parallel those for the CBE. They apply to appropriate MACOMs for RDTE, procurement, and military construction resources as well as for National Guard and Reserve resources.

### 5-6. Acquisition reviews

Matériel development and procurement programs undergo evaluation during acquisition reviews held in the spring and summer. The

reviews consider recent execution experience in pricing and projected program changes by PE, project number, and BLIN. Major issues failing to receive required resources at these levels go to the PBC and SELCOM for review. If necessary, they go to the SA and CSA for decision.

### 5-7. Final adjustments

On receipt of the PDM, the DPAE, with the Army Staff and Secretariat, adjusts the program. The DPAE then forwards the result to the DAB. The DAB, through appropriation sponsors—

a. Develops budget estimates from POM dollar and manpower levels as adjusted by the PDM.

b. Revises the estimates to incorporate changes determined through review of CBEs and centralized programs for the RDTE, procurement, construction, and military personnel appropriations.

c. Adjusts budget estimates to conform to changes required by pending authorization and appropriation legislation.

### 5-8. Review and approval

a. Appropriation sponsors (table 1-2) present their proposed revisions to the PBC and SELCOM.

b. After the SELCOM review, the ASA(FM) presents the budget to the SA and CSA for approval. Once proposed estimates receive approval, appropriation sponsors, aided by managers for program and performance, prepare detailed justification books and furnish update tapes reflecting the CBE. The DAB prepares the executive summary of the budget and a forwarding letter from the SA to the SECDEF. Separately, the DAB submits the justification books by appropriation to OSD, and the DPAE submits an update tape for the FYDP.

### 5-9. OSD-OMB budget review

a. Members of OSD and OMB jointly review Army Budget Estimates. Also called the fall review, the joint review focuses on proper pricing, reasonableness, and executability.

b. Recommendations developed during the review usually include alternative courses of action. The DEPSECDEF reviews recommended adjustments and forwards approved alternatives to the Army as PBDs. The DAB incorporates PBD changes in the developing budget estimate while the DPAE uses the PBDs to adjust or revalidate the program.

c. During the PBD cycle, each Service identifies certain pending decrements as major budget issues (MBIs). Army MBIs center on decrements to specific initiatives that would significantly impair ability to achieve program intentions. An MBI addresses the adverse impact that would occur if the decrement were to prevail. An MBI affecting a combatant command undergoes coordination to get CINC comments and, if appropriate, CINC support. At the end of the PBD process, the SA and CSA meet with the SECDEF and DEPSECDEF on major unresolved issues. The SECDEF decides whether a meeting with the President to request fund restoration or recommend other action is necessary.

d. The DAB supervises the PBD and MBI processes. The DAB also:

(1) Maintains coordination between the Comptroller of the DOD and HQDA.

(2) Makes sure that adjustments to fiscal and manpower controls are correct on all records for each PBD.

(3) Gives special attention to any PBD under appeal, since the DEPSECDEF may revise the pending adjustments on review.

### 5-10. President's Budget

a. In late November or early December, at the end of the PBD cycle, OSD issues a final PBD incorporating any changes from MBI deliberations.

b. Completing the review phase, OSD-OMB and the Military Departments submit required budget information in the form of the President's Budget. The budget covers prior year obligations and updated resource estimates for the current year. It also covers estimates of total obligation authority for the budget year and budget year plus 1.

c. The DPAE uses these controls to update the FYDP to reflect the President's Budget submission. (As mentioned, a 1987 statutory change (10 USC 221) requires DOD each year to submit to Congress the FYDP coinciding with the President's Budget.)

d. Managers for program and performance and appropriation sponsors update their internal systems and the PROBE data base. Their action reflects changes resulting from budget review and approval. Under the guidance and direction of DPAE, PEGs translate the changes into program changes, posting MDEPs as required.

### **Section III Justification**

#### **5-11. Budget hearings**

a. During budget justification, the Army presents and defends its portion of the President's program before Congress. The process proceeds formally and informally under the staff supervision of the Chief of Legislative Liaison and ASA(FM).

b. After the President formally submits the budget, the Army provides detailed budget justification to the authorizing and appropriations committees. First, however, appropriation sponsors will have prepared material in Army justification books to conform with decisions of the President and SECDEF and congressional requirements for formats and supporting information. Justification books undergo internal Army review under ASA(FM) and are then sent to OSD for final review.

c. The authorizing and appropriation committees hold formal hearings to discuss the issues in the budget request. The SA and the CSA normally testify first. ASA(FM) and Chief of Legislative Liaison help appropriation managers in presenting and defending the details of the budget.

d. The Omnibus Budget Reconciliation Act of 1990, as codified in section 901, title 2, United States Code (2USC 901) significantly changed the congressional budget process of the preceding 5 years. The Act—

(1) Replaced the automatic spending cuts under the Gramm-Rudman antideficit law by three discrete sequesters.

(2) Set discretionary spending caps for defense and also for foreign aid and domestic spending for fiscal years 1992 and 1993.

(3) Provided for triggering the first sequester only if the discretionary spending caps are exceeded.

#### **5-12. Legislative approval and enactment**

Budget justification ends when the President signs the authorization and appropriation bills for the coming fiscal year. Enacted into law, Army appropriations provide the legal authority to incur obligations and make payments.

#### **5-13. Continuing resolution authority**

When Congress fails to pass an appropriation by 30 September, it may pass a continuing resolution. Continuing resolution authority (CRA) derives from emergency legislation that authorizes the funding of Government operations in the absence of appropriations. A temporary measure, the CRA usually restricts funding to the prior year level and prohibits new initiatives. HQDA separately publishes specific policy on how the Army will operate under the CRA.

## **Chapter 6 Execution Phase**

### **Section I Budget Execution**

#### **6-1. Execution**

a. During execution the Army—

(1) Manages and accounts for funds and manpower to carry out approved programs.

(2) Checks how well HQDA, MACOMs, PEOs, and other operating agencies use allocated resources to carry out approved programs.

(3) Adjusts resource requirements based on execution feedback.

b. This section describes budget execution. Section II, below, addresses program performance and review.

#### **6-2. Financial management**

Budget execution applies the funds appropriated by Congress to carry out approved programs. The procedure entails:

a. Apportioning, allocating, and allotting funds; obligating and disbursing them; and associated reporting and review.

b. Financing unbudgeted requirements caused by changed conditions unforeseen when submitting the budget and having higher priority than the requirements from which funds have been diverted.

#### **6-3. Apportionment, allocation, and allotment**

a. An apportionment distributes funds by making specified amounts available for obligation. Appropriation sponsors request apportionment from OMB by submitting justification through the DAB and OSD at the time of budget review. OMB approves the requests, returning apportionments through OSD.

b. Guided by appropriation (and fund) sponsors at HQDA, the Defense Finance and Accounting Services Center (DFAS) allocates apportioned funds to operating agencies. Operating agencies, in turn, make funds available to subordinate commands and installations by an allotment. Allotments authorize users to place orders and award contracts for products and services to carry out approved programs. Installations obligate funds as orders are placed and contracts awarded. They make payments as materiel is delivered or as service are performed.

#### **6-4. Funds control**

a. The Army must receive OSD program authorizations and provide them to executing agencies before any funds can be obligated.

b. OSD controls procurement accounts through program releases that specify the quantity of an authorized item that may be bought. Similarly, program releases control the obligation and expenditure of RDTE funds by program elements and construction funds by construction project.

c. Authorization controls for OMA apply quarterly. However, they impose few restrictions on budget programs and activities funded by operating accounts. Instead, OSD sets dollar thresholds that govern rates of expenditure. Within these thresholds, execution focuses on meeting changes in pricing and in adjusting command priorities.

#### **6-5. Obligation and outlay plans**

a. Early in the fiscal year, DAB prepares initial obligation and outlay plans. The obligation plans address unexpired funds for all Army appropriations. The outlay plans address unexpired, and expired funds. After an appropriation act passes, DAB and appropriation sponsors revise the plans based on MACOM and PEO estimates of annual obligations.

b. The ASA(FM) sends completed obligation and outlay plans to the Comptroller of the DOD. The plans are tied to obligations and outlays as defined in President's Budget.

#### **6-6. Financing unbudgeted requirements**

Congress recognizes the need for flexibility during budget execution to meet unforeseen requirements or changes in operating conditions. Congress accepts that rigid adherence to program purposes and amounts originally budgeted and approved would jeopardize businesslike performance. Thus, within stated restrictions and specified dollar thresholds, Congress allows Federal agencies to reprogram existing funds to finance unbudgeted requirements.

## **Section II**

### **Program Performance and Review**

#### **6-7. Program implementation**

MACOMs, PEOs, and other operating agencies carry out the approved program within manpower and funds provided. They review budget execution, account for, and report on use of allocated funds by appropriation and MDEP. As applicable to each appropriation they include the 0-1 level budget activity, AMSCO, PE, project number, BLIN, BAG, and EOR. They also account for use of allocated manpower by UIC. The manpower and financial data obtained help MACOMs and agencies develop future requirements.

#### **6-8. Formal program performance evaluation**

*a. Selected Army programs.*

(1) HQDA conducts a quarterly management review of selected Army programs under the Program Performance and Budget Execution Review System (PPBERS). The review compares actual program performance with objectives set by the SA and CSA at the beginning of the fiscal year. It then takes corrective action to improve goal accomplishment.

(2) The PBC receives the quarterly PPBERS presentations, from which it selects topics for further presentation to the SELCOM.

*b. Reviews of selected Army systems.* Means for checking system program performance include the following—

(1) Milestone reviews of designated acquisition programs by the Army Systems Acquisition and Review Council conducted by ASA(RDA).

(2) Milestone and in-process reviews (IPRs) of designated automated information systems by the MAISRC conducted by DISC4.

#### **6-9. OSD execution review**

*a.* OSD has introduced a biennial execution review of selected programs as a scheduled event in the DOD PPBS process. The measure focuses exclusively on execution of the defense program. It gives the senior leadership a chance to assess the effect of program and policy initiatives.

*b.* The review considers subjects selected by the DEPSECDEF from candidates nominated by OSD principals, the Services, and CINCs. OSD uses review findings to influence future DOD policy and the Defense program. For example, the findings help decide DPG content, topics for OSD summer program review, and need for special studies. The findings also lead to new guidance for conducting current efforts.

## **Appendix A References**

### **Section I Required Publications**

**AR 10-5**  
Headquarters, Department of the Army. (Cited in para 1-11.)

**AR 10-87**  
Major Army Commands in the Continental United States

**AR 11-18**  
The Cost and Economic Analysis Program. (Cited in para 4-8.)

### **Section II Related Publications**

**AR 37-1**  
Army Accounting and Fund Control.

**Section III  
Prescribed Forms**  
There are no entries for this section.

**Section IV  
Referenced Forms**  
There are no entries for this section.

## Glossary

### Section I Abbreviations

#### AAE

Army Acquisition Executive

#### AASA

Administrative Assistant to the Secretary of the Army

#### ACC

Army component command

#### ACFT

Aircraft Procurement, Army (appropriation)

#### ACP

Army Cost Position

#### ACSIM

Assistant Chief of Staff for Installation Management

#### ADC SOPS

Assistant Deputy Chief of Staff for Operations and Plans

#### AFH

Army Family Housing

#### AFHC

Army Family Housing (Construction)

#### AFHO

Army Family Housing (Operations)

#### ALRPG

Army Long Range Planning Guidance

#### AMC

U.S. Army Materiel Command

#### AMHA

Army Management Headquarters Activities

#### AMMO

Procurement of Ammunition, Army (appropriation)

#### AMOPES

Army Mobilization, Operations Planning, and Execution System

#### AMOPS

Army Mobilization and Operations Planning System

#### AMP

Army Modernization Plan

#### AMP

Army Modernization Plan

#### AMS

Army Management Structure

#### AMSCO

Army Management Structure Code

#### AOC

area of concentration

#### AOL

authorized organization level

#### APA

See ACFT

#### APG

Army Program Guidance

#### APPI

Army POM Preparation Instructions

#### APS

Army Planning System

#### AR

Army Regulation

#### ARNG

Army National Guard

#### ASA(CW)

Assistant Secretary of the Army (Civil Works)

#### ASA(FM)

Assistant Secretary of the Army (Financial Management)

#### ASA(ILE)

Assistant Secretary of the Army (Installations, Logistics, and Environment)

#### ASA(MRA)

Assistant Secretary of the Army (Manpower and Reserve Affairs)

#### ASA(RDA)

Assistant Secretary of the Army (Research, Development, and Acquisition)

#### ASARC

Army Systems Acquisition Review Council

#### ASD(PA&E)

Assistant Secretary of Defense (Program Analysis and Evaluation)

#### ASIP

Army Stationing and Installation Plan

#### ATF

Department of the Army Trust Funds

#### AUTS

Automatic Update Transaction System

#### BA

budget activity

#### BAG

budget activity group

#### BASOPS

base operations

#### BCE

Baseline Cost Estimate

#### BES

Budget Estimates Submission

#### BLIN

budget line item number

#### BOIP

Basis of Issue Plan

#### BRS

automated budget review system

#### BSA

budget subactivity

#### BY

budget year

#### C4

command and control, communications, and computers

#### CAR

Chief, Army Reserve

#### CAWCF

Army Conventional Ammunition Working Capital Fund

#### CBE

Command Budget Estimate

#### CBO

Congressional Budget Office

#### CC

Chief of Chaplains

#### CCA

Chairman's Contingency Capabilities Assessment

#### CELP

Civilian Employment Level Plan

#### CG

Chairman's Guidance

#### CIDC

U.S. Army Criminal Investigation Command

#### CINC

commander in chief, unified or specified command

#### CINCSOC

Commander in Chief, U.S. Special Operations Command

#### CJCS

Chairman of the Joint Chiefs of Staff

#### CLL

Chief, Legislative Liaison

#### CNGB

Chief, National Guard Bureau

#### COE

Chief of Engineers

<b>CPA</b> Chief of Public Affairs; Chairman's Program Assessment	<b>DM</b> Depot Maintenance (Ordnance) (Other); Director of Management	<b>FYDP</b> Future Years Defense Program
<b>CPG</b> Contingency Planning Guidance	<b>DMR</b> Defense Management Review	<b>GAO</b> General Accounting Office
<b>CPLAN</b> command plan	<b>DOD</b> Department of Defense	<b>GS</b> general support
<b>CRA</b> continuing resolution authority	<b>DODD</b> Department of Defense Directive	<b>HAC</b> House Appropriations Committee
<b>CRRC</b> Construction Requirements Review Committee	<b>DODI</b> Department of Defense Instruction	<b>HASC</b> House Armed Services Committee
<b>CSA</b> Chief of Staff, U.S. Army	<b>DPAE</b> Director, Program Analysis and Evaluation	<b>HBC</b> House Budget Committee
<b>CSPAR</b> CINC's Preparedness Assessment Report	<b>DPG</b> Defense Planning Guidance	<b>HOA</b> Home Owners Assistance
<b>CY</b> current year	<b>DRB</b> Defense Resources Board	<b>HQDA</b> Headquarters, Department of the Army
<b>DA</b> Department of the Army	<b>DS</b> direct support	<b>HSC</b> U.S. Army Health Services Command
<b>DAB</b> Deputy Assistant Secretary of the Army for Army Budget; Defense Acquisition Board	<b>DSADBU</b> Director, Office of Small and Disadvantaged Business Utilization	<b>ICE</b> Independent Cost Estimate
<b>DAE</b> Defense Acquisition Executive	<b>DSS</b> decision support system	<b>IMET</b> International Military Education and Training Program
<b>DARNG</b> Director of Army National Guard	<b>ECAP</b> Environmental Compliance Achievement Program	<b>IMSC</b> Installation Management Steering Committee
<b>DAS</b> Director of the Army Staff	<b>ECBRS</b> Enhanced Concept Based Requirements System	<b>INSCOM</b> U.S. Army Intelligence & Security Command
<b>DBOF</b> Defense Business Operations Fund	<b>EOR</b> element of resource	<b>IPL</b> integrated priority list
<b>DCSINT</b> Deputy Chief of Staff for Intelligence	<b>EUSA</b> Eighth U.S. Army	<b>IPR</b> in process review
<b>DCSLOG</b> Deputy Chief of Staff for Logistics	<b>EXCOM</b> DOD Executive Committee	<b>ISC</b> U.S. Army Information Systems Command
<b>DCSOPS</b> Deputy Chief of Staff for Operations and Plans	<b>FAS</b> Force Accounting System	<b>JCS</b> Joint Chiefs of Staff
<b>DCSPER</b> Deputy Chief of Staff for Personnel	<b>FIA</b> Force Integration Analysis	<b>JMNA</b> Joint Military Net Assessment Planning
<b>DEPSECDEF</b> Deputy Secretary of Defense	<b>FMF</b> Foreign Military Financing Program	<b>JOPEs</b> Joint Operations Planning and Execution System
<b>DERA</b> Defense Environmental Restoration Account	<b>FMS</b> Foreign Military Sales Program	<b>JPD</b> Joint Planning Document
<b>DFAS</b> Defense Finance and Accounting Service	<b>FORSCOM</b> Forces Command, a specified command	<b>JPD</b> Joint Planning Document
<b>DISC4</b> Director of Information Systems for Command, Control, Communications, and Computers	<b>FY</b> fiscal year	<b>JSCP</b> Joint Strategic Capabilities Plan
		<b>JSPS</b> Joint Strategic Planning System



<b>JSR</b> Joint Strategy Review	<b>MPA</b> Military Personnel, Army (appropriation)	<b>OSD</b> Office of the Secretary of Defense
<b>LIN</b> line item number	<b>MPDI</b> MACOM POM Development Instructions	<b>PAA</b> Procurement of Ammunition, Army (appropriation)
<b>LOGSACS</b> Logistics Structure and Composition System	<b>MS-3</b> Manpower Staffing Standards System	<b>PAR</b> Chairman's Preparedness Assessment Report
<b>LRP</b> long-range plan	<b>MSA</b> Manpower Standards Application	<b>PBC</b> Program and Budget Committee
<b>LRRDAP</b> Long Range Research, Development, and Acquisition Plan	<b>MSLS</b> Missiles Procurement, Army (appropriation)	<b>PBD</b> Program Budget Decision
<b>LSA</b> Logistic Sustainability Analysis	<b>MTMC</b> Military Traffic Management Command	<b>PBG</b> Program and Budget Guidance
<b>LSA</b> Logistics Sustainability Analysis	<b>MTOE</b> modified table of organization and equipment	<b>P/BS</b> Program/Budget System
<b>M-Force</b> Master Force	<b>MWR</b> morale, welfare, and recreation	<b>PDM</b> Program Decision Memorandum
<b>MACOM</b> major Army command	<b>NAF</b> nonappropriated fund	<b>PE</b> program element
<b>MAISRC</b> Army Major Automated Information Review Committee	<b>NBRP</b> National Board for the Promotion of Rifle Practice	<b>PEG</b> Program evaluation group
<b>MARB</b> Materiel Acquisition Review Board	<b>NCA</b> national command authorities	<b>PEO</b> Program executive officer; program executive office
<b>MARC</b> Manpower Requirements Criteria	<b>NFIP</b> National Foreign Intelligence Program	<b>PERSACS</b> Personnel Structure and Composition System
<b>MBI</b> major budget issue	<b>NGB</b> National Guard Bureau	<b>PM</b> Project/product manager
<b>MCA</b> Military Construction, Army (appropriation)	<b>NGPA</b> National Guard Personnel, Army (appropriation)	<b>PMAD</b> Personnel Management Authorization Document
<b>MCAR</b> Military Construction, Army Reserve (appropriation)	<b>NMS</b> national military strategy	<b>POC</b> point of contact
<b>MCNG</b> Military Construction, Army National Guard (appropriation)	<b>OMA</b> Operation and Maintenance, Army (appropriation)	<b>POM</b> Program Objective Memorandum
<b>MDEP</b> Management Decision Package	<b>OMAR</b> Operation and Maintenance, Army Reserve (appropriation)	<b>PPBERS</b> Program Performance and Budget Execution Review System
<b>MDW</b> U.S. Army Military District of Washington	<b>OMB</b> Office of Management and Budget	<b>PPBES</b> Planning, Programming, Budgeting, and Execution System
<b>MILCON</b> military construction	<b>OMNG</b> Operation and Maintenance, Army National Guard (appropriation)	<b>PPBS</b> Planning, Programming, and Budgeting System
<b>MIPA</b> See MSLS	<b>OPA</b> Other Procurement, Army (appropriation)	<b>PPI</b> POM Preparation Instructions
<b>MOC</b> management of change	<b>OPLAN</b> operation plan	<b>PRG</b> Program Review Group
<b>MOS</b> military occupational specialty	<b>OSA</b> Office of the Secretary of the Army	<b>PROBE</b> PPBES Data Management System

<b>PRP</b> Program review proposal	<b>SPC</b> Strategy and Planning Committee	<b>USAISC</b> U.S. Army Information Systems Command
<b>PSG</b> Prioritization Steering Group	<b>SPCC</b> Study Program Coordination Committee	<b>USAR</b> U.S. Army Reserve
<b>PY</b> prior year	<b>STP</b> short term project	<b>USAREUR</b> U.S. Army Europe
<b>RDA</b> research, development, and acquisition	<b>STARFIARS</b> Standard Army Financial Inventory Accounting and Reporting System	<b>USARLANT</b> U.S. Army Atlantic
<b>RDT&amp;E</b> Research, Development, Test and Evaluation	<b>SVP</b> special visibility program	<b>USARPAC</b> U.S. Army Pacific
<b>RDTE</b> Research, Development, Test and Evaluation, Army (appropriation)	<b>SSN</b> standard study number	<b>USARSO</b> U.S. Army South
<b>RMU</b> resource management update	<b>TAA</b> Total Army Analysis	<b>USARSPACECOM</b> U.S. Army Space and Strategic Defense Command
<b>ROTC</b> Reserve Officers' Training Corps	<b>TAADS</b> The Army Authorization Documents System	<b>USASOC</b> U.S. Army Special Operations Command
<b>RPA</b> Reserve Personnel, Army (appropriation)	<b>TAEDP</b> Total Army Equipment Distribution Program	<b>USCENTCOM</b> U.S. Central Command
<b>RPM</b> Real Property Maintenance	<b>TAP</b> The Army Plan	<b>USD(A)</b> Under Secretary of Defense for Acquisition
<b>SA</b> Secretary of the Army	<b>TDA</b> table of distribution and allowances	<b>USD(P)</b> Under Secretary of Defense for Policy
<b>SAC</b> Senate Appropriations Committee	<b>TIG</b> The Inspector General	<b>USEUCOM</b> U.S. European Command
<b>SACS</b> Structure and Composition System	<b>TJAG</b> The Judge Advocate General	<b>USFJ</b> U.S. Forces Japan
<b>SAMAS</b> Structure and Manpower Allocation System	<b>TOA</b> total obligational authority	<b>USFK</b> U.S. Forces Korea
<b>SASC</b> Senate Armed Services Committee	<b>TOE</b> table(s) of organization and equipment, Tables of Organization and Equipment System	<b>USLANTCOM</b> U.S. Atlantic Command
<b>SBC</b> Senate Budget Committee	<b>TPFDD</b> Time-Phased Force Deployment Data	<b>USPCACOM</b> U.S. Pacific Command
<b>SECDEF</b> Secretary of Defense	<b>TRADOC</b> U.S. Army Training and Doctrine Command	<b>USSOCOM</b> U.S. Special Operations Command
<b>SELCOM</b> Select Committee	<b>TSG</b> The Surgeon General	<b>USSOUTHCOM</b> U.S. Southern Command
<b>SES</b> senior executive service	<b>TTHS</b> trainees, transients, holdees, and students	<b>USSPACECOM</b> U.S. Space Command
<b>SIO</b> standard installation organization	<b>TUSA</b> Third U.S. Army	<b>USTRANSCOM</b> U.S. Transportation Command
<b>SIPC</b> Stationing and Installations Planning Committee	<b>UIC</b> unit identification code	<b>VCSA</b> Vice Chief of Staff, U.S. Army
<b>SISA</b> Science and Infrastructure Support Analysis	<b>USA</b> Under Secretary of the Army	<b>WFLA</b> Warfighting Lens Analysis
<b>SMA</b> Supply Management, Army (business area)	<b>USACE</b> U.S. Army Corps of Engineers	

**WTCV**

Procurement of Weapons and Tracked Combat Vehicles, Army (appropriation)

**Section II****Terms****Army leadership**

See senior Army leadership.

**HQDA**

The executive part of the Department of the Army at the seat of Government. Consists of the Office of the Secretary of the Army and the Army Staff.

**HQDA principal officials**

A designated member of the Army Secretariat or Army Staff.

**Major Army commands**

Major Army commands (MACOMs) consist of the command organizations of Army Forces in the continental United States (other than HQDA), the Army components of unified commands, and one Army specified command.

**Military Traffic Management Command (MTMC), assigned to U.S. Transportation Command (USTRANSCOM)****National command authorities**

The President and Secretary of Defense or their duly authorized alternates or successors.

**Operating agency**

A command, headquarters, or agency assigned a code designation for consolidating fiscal data for budgetary analysis. (See AR 37-1, paragraph 3-9.)

**Principal official**

See HQDA principal official.

**Program (budget) execution**

Act of carrying out the approved program (budget).

**Program planning**

Act of working out beforehand how to develop the program.

**Senior Army leadership**

The Secretary of the Army; Chief of Staff, Army; Undersecretary of the Army; and Vice Chief of Staff, Army.

**Section III****Special Abbreviations and Terms**

## Index

This index is organized alphabetically by topic and subtopic. Topics and subtopics are identified by paragraph number, selected topics by table number.

**Acquisition reviews, 2-7, 5-6, 6-8**

**Appeals of Program Budget Decisions (PBDs), 5-9**

**Allocation, 6-2, 6-3**

**Allotment, 6-2, 6-3**

**Apportionment, 6-2, 6-3**

**Appropriation(s)**

And funds, list of, table 1-2

As representing program requirements, 2-10

Bills, 5-12

For Reserve Components, responsibility for, table 1-2

Included in Program and Budget Guidance, 4-5

Justification books for, 5-8, 5-11

Management latitude in changing, 2-13

Manager assignments for, tables 1-2, 1-3, and 1-5

Manager for program and performance 1-21c

Manager for requirements determination 1-21b

Of immediate interest to major Army commands, 4-5

Sponsor assignments for, tables 1-2, 1-3 and 1-5

**Appropriation sponsor, 1-21d**

**Army Acquisition Executive (AAE), 1-5c, 1-12**

**Army Budget Estimates**

Cover first 2 years of Army program, 5-1  
Administrative instructions for preparing, 5-2

**Army Long Range Planning Guidance (ALRPG)**

Considered by Strategy and Planning Committee, 2-14

Described, 3-9

Use of, by The Army Plan, 3-13

**Army Major Automated Information Systems Review Council (MAISRC), 2-15, 6-8**

**Army Modernization Plan (AMP), 3-10**

**Army Plan. See The Army Plan (TAP)**

**Army planning. See PPBES planning**

**Army Program Guidance (APG), 3-13, 4-3, 4-6, 4-7**

**Army POM Preparation Instructions (APPI), 4-4**

**Army PPBES. See PPBES**

**Army Systems Acquisition and Review Council (ASARC), 2-15, 6-8**

**Authorization**

Bill, 5-12

Controls, 6-4

**Automatic Update Transaction System (AUTS), 3-15**

**Basis of Issue Plan (BOIP), 3-15**

**Budget execution. See also funding**

Described, 6-1

Financing unbudgeted requirements, 6-6

Program Performance and Budget Execution Review System (PPBERS), 6-8

Use of obligation and outlay plans, 6-5

**Budget formulation. See budget preparation; budget review**

**Budget justification**

Budget hearings, 5-11

Legislative approval and enactment, 5-12

**Budget preparation**

Guidance for, 5-2

Incorporates final adjustments, 5-7

President's Budget, 5-10

Program and Budget Guidance, 5-2

Reviewed by PBC and SELCOM, 5-8

**Budget process as budget formulation, justification, and execution, 5-1**

**Budget review**

By HQDA, 5-8

By OSD-OMB, 5-9

**Candor and privacy of leadership deliberations during PPBES process, 2-11**

**Chairman's Guidance (CG), 3-3b**

**Chairman's Program Assessment (CPA), 3-4d**

**CINC requirements**

Briefings on status of, 1-9j

Influence program development as integrated priority lists (IPLs), 3-18c

Integration of, into programs of major Army commands, 1-20

Linkage of, to U.S. Training and Doctrine Command (TRADOC), 1-7a(2)

Validated by Deputy Chief of Staff for Operations and Plans, 1-7a(2)

**Command plan, 3-15**

**Continuing resolution authority, 5-13**

**Control of planning, programming, and budgeting documents, 2-11**

**DBOF. See Defense Business Operations Fund**

**Defense Acquisition Board (DAB), 2-7**

**Defense Business Operations Fund (DBOF), 5-3, table 1-2**

**Defense Resources Board (DRB), 2-5**

**Defense Planning Guidance (DPG), 3-6a**

**DOD**

Core managers of, 2-3

Executive Committee (EXCOM) of, 2-4

**DOD PPBS**

Concept of, 2-1

Role of Defense Resources Board (DRB) in, 2-5

**Enhanced Concept Based Requirements System (ECBRS), 3-11**

**Fall budget review. See budget review**

**Financing unbudgeted requirements, 2-13b, 6-6**

**Force development, 3-14. See also PPBES planning**

**Force documentation, 3-15**

**Force Integration Analysis (FIA), 3-13, 3-14, 4-6b, 4-7**

**Funding. See also appropriations; authorization; funding authority**

Controls, 2-13, 6-4

Through allocation, 6-3

Through allotment, 6-3

Through apportionment, 6-3

Of unbudgeted requirements, 6-6

**Funding authority, continuing resolution, 5-13**

**Future Years Defense Program (FYDP)**

Data for, must match data in force structure and manpower databases, 1-9i

Described, 2-2

Director of Program Analysis and Evaluation point of contact for, 1-7b

Submitted to Congress, 1-5, 2-2, 5-10

**FYDP. See Future Years Defense Program (FYDP)**

**Gramm-Rudman-Hollings (GRH) anti deficit law, 5-11**

**Hearings**

Congressional, 5-11

OSD-OMB, 5-9

**HQDA principal officials**

Functional oversight by, 1-6

Functional tasks of, 1-8 through 1-18

Views of, considered in assessing Army missions and capabilities, 1-7a

**Integrated priority lists (IPLs). See CINC requirements**

**Issue papers, 4-11, 5-9**

**Joint Military Net Assessment (JMNA), 3-5a**

**Joint Requirements Oversight Council (JROC), 2-7c**

**Joint Strategic Capabilities Plan (JSPS), 3-4c, 3-17**

**Joint Strategic Planning System (JSPS)**

Products produced by, 3-4

Supported by PPBES planning, 3-7

**Joint Strategy Review (JSR), 3-3**

**Logistics Structure and Composition System (LOGSACS), 3-15**

**Long-Range Research, Development, and Acquisition Plan (LRRDAP), 3-12, 4-7, 4-8**

**MACOM POM Development Instructions (MPDI), 4-4**

**Major defense programs, 2-2**

**Major issues, 4-11, 5-9**

**Management Decision Package (MDEP)**

Described, 2-12

Each assigned to a specific Program Evaluation Group, 4-8

Posted by Program Evaluation Groups (PEGs) to reflect budget decisions and approved funding, 5-10d

Use of, required by commanders to track and report on program and financial performance, 1-19d, 6-7

Use of, as building block in developing Army program, 4-8

**Management of change (MOC) window, 3-15**

**Manager for manpower and force structure issues, table 1-1**

**Manpower standard application, 3-15**

**Materiel acquisition reviews. See acquisition reviews**

**National Military Strategy (NMS), 3-4a**

**Objectives of PPBES, 2-10**

**Obligation and outlay plans, 6-5**

**Omnibus Budget Reconciliation Act of 1990, 5-11**

**Operational planning**  
 Described, 3-16  
 Guided by Joint Strategic Capabilities Plan (JSCP), 3-17  
 Operation plans (OPLANs), a product of, 3-16, 3-18

**OSD-OMB budget review, 5-9**

**OSD program authorizations, 6-4**

**OSD program review, 4-11**

**Out-of-court settlements, 4-11**

**PBC. See Program and Budget Committee (PBC)**

**PBC Systems Subcommittee, 2-14**

**Personnel Structure and Composition System (PERSACS), 3-15**

**Planning, Programming, and Budgeting System (PPBS). See DOD PPBS.**

**POM. See Program Objective Memorandum (POM)**

**POM Preparation Instructions (PPI), 4-4**

**PPBES. See also DOD PPBS**  
 Baseline events of, 2-17  
 Changes in, 1-5  
 Concept of, 2-9  
 How used, 1-1  
 Objectives of, 2-10  
 Organizational framework for, 2-17  
 Phases of, 2-17  
 Principal committees for, 2-14  
 Related committees, 2-15  
 Responsibilities for managing operation of, 1-7  
 Responsibilities for performing functional tasks of, 1-8 through 1-21  
 Serves as Army's primary resource management system, 2-8

**PPBES planning, 3-7. See also PPBS planning**

**PPBS planning, 3-1. See also PPBES planning**

**President's Budget, 5-10**

**Principal officials. See HQDA principal officials**

**Prioritization Steering Group, 2-14**

**Privacy and candor, preserving during leadership deliberations, 2-11**

**Program and Budget Committee (PBC)**  
 Described, 2-14  
 Review of budget, 5-8  
 Review of performance of selected Army programs, 6-8  
 Review of program, 4-9  
 Review of program changes proposed by command budget estimates, 5-4  
 Systems Subcommittee of, 2-14

**Program and Budget Guidance (PBG)**  
 As budget guidance, 5-2  
 As program guidance, 4-5

**Program Budget Decision (PBD), 5-9**

**Program Decision Memorandum (PDM), 4-12**

**Program development**  
 Guidance for, 4-2 through 4-7  
 Described, 4-7 through 4-12  
 Latitude in adjusting resources during, 2-13  
 Use of Program Evaluation Groups (PEGs) in, 2-16, 4-8

**Program Evaluation Groups (PEGs)**  
 Composition and focus of, 2-16, tables 1-4 and 1-5

Role of, in program development, 4-8  
 Use of, to translate adjustments from budget review and approval into program change, 5-10

**Program Objective Memorandum (POM)**  
 Approved by Program Decision Memorandum (PDM), 4-12  
 Format of, 4-3  
 Preparation of, 4-10  
 Product of Army programming, 4-1  
 Review of, by OSD, 4-12  
 Submits Army program for OSD review, 4-10

**Program Performance and Budget Execution Review System (PPBERS), 6-8**

**Program review by Army, 4-9**

**Program review by OSD**  
 Classifies issues in three tiers, 4-11  
 Out-of-court settlements during, 4-11  
 Program Decision Memorandum (PDM) issued at completion of, 4-12  
 Program Review Group, 2-6  
 Program Review Proposals, 4-11

**Reprogramming. See financing unbudgeted requirements**

**Requirements for manpower and equipment considered during Total Army Analysis, 3-14**

**Resources, changes in during programming and budgeting, 2-13**

**Resource management architecture, 2-12**

**Responsibilities**  
 For Armywide policy development and oversight of the PPBES, 1-6  
 For functional oversight of the PPBES, 1-6  
 For managing the PPBES, 1-7  
 For PPBES functional tasks, 1-8 through 1-21

**Science and Infrastructure Support Analysis (SISA), 3-11, 3-12**

**SELCOM. See Select Committee**

**Select Committee (SELCOM)**  
 Described, 2-14  
 Review of acquisition issues during budgeting, 5-6  
 Review of program, 4-9  
 Review of program changes proposed by Command Budget Estimates, 5-4  
 Review of budget, 5-8, 5-9, 5-11  
 Review of performance of selected Army programs, 6-8

**Strategy and Planning Committee (SPC), 2-14**

**Structure and Composition System (SACS), 3-15**

**Structure and Manpower Allocation System (SAMAS), 3-15**

**Summer issue cycle. See program review**

**Systems Subcommittee of PBC, 2-14**

**Table of Organization and Equipment System (TOE), 3-15**

**The Army Authorization Document System (TAADS), 3-15**

**The Army Plan (TAP), 3-13, 4-6, 4-7**

**Total Army Analysis (TAA), 3-14**

**Warfighting Lens Analysis (WFLA), 3-11, 3-12**

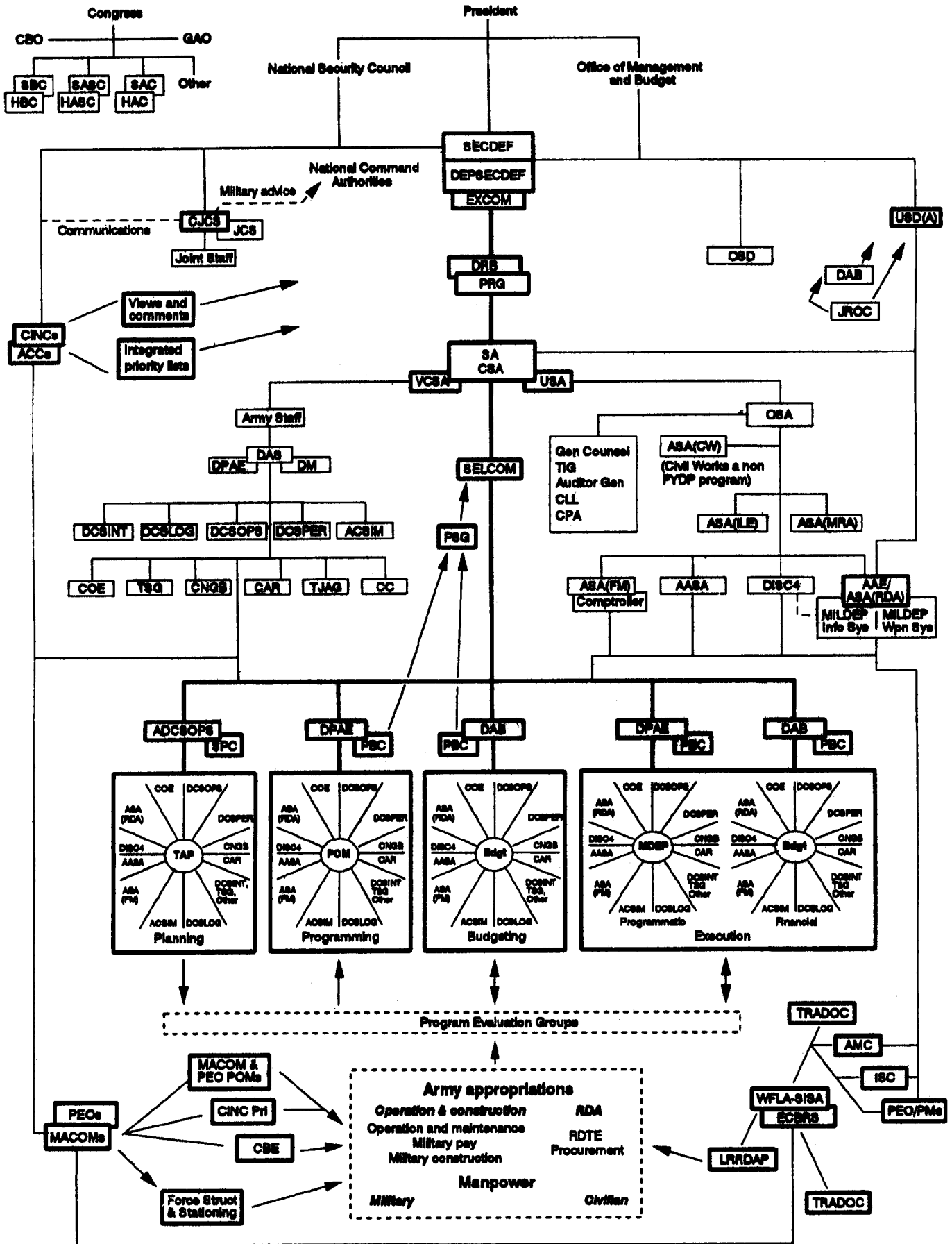



<b>AAE</b>	Army Acquisition Executive	<b>FYDP</b>	Future Years Defense Program
<b>AASA</b>	Administrative Assistant to the Secretary of the Army	<b>GAO</b>	General Accounting Office
<b>ACC</b>	Army component command	<b>Gen</b>	general
<b>ACSIM</b>	Assistant Chief of Staff for Installation Management	<b>HAC</b>	House Appropriations Committee
<b>ADCSOPS</b>	Assistant DCSOPS	<b>HASC</b>	House Armed Services Committee
<b>AMC</b>	U.S. Army Materiel Command	<b>HBC</b>	House Budget Committee
<b>ASA</b>	Assistant Secretary of the Army	<b>HQDA</b>	Headquarters Department of the Army
<b>ASA(CW)</b>	ASA (Civil Works)	<b>ISC</b>	U.S. Army Information Systems Command
<b>ASA(FM)</b>	ASA (Financial Management)	<b>ISR</b>	Infrastructure Support Requirements
<b>ASA(ILE)</b>	ASA (Installations, Logistics, and Environment)	<b>JCS</b>	Joint Chiefs of Staff
<b>ASA(MRA)</b>	ASA (Manpower and Reserve Affairs)	<b>JROC</b>	Joint Requirements Oversight Council
<b>ASA(RDA)</b>	ASA (Research, Development and Acquisition)	<b>LRRDAP</b>	Long Range Research, Development, and Acquisition Plan
<b>BIP</b>	Battlefield Initiatives Program	<b>MACOM</b>	major Army command
<b>CAR</b>	Chief, Army Reserve	<b>MILCON</b>	military construction
<b>CBE</b>	Command budget estimate	<b>OSA</b>	Office of the Secretary of the Army
<b>CBO</b>	Congressional Budget Office	<b>OSD</b>	Office of the Secretary of Defense
<b>CC</b>	Chief of Chaplains	<b>PBC</b>	Program and Budget Committee
<b>CINC</b>	commander in chief, unified or specified command	<b>PEO</b>	Program Executive Officer
<b>CJCS</b>	Chairman, Joint Chiefs of Staff	<b>PM</b>	project/product manager
<b>CLL</b>	Chief, Legislative Liaison	<b>POM</b>	Program Objective Memorandum
<b>CNGB</b>	Chief, National Guard Bureau	<b>pri</b>	priority
<b>COE</b>	Chief of Engineers	<b>PRG</b>	Program Review Group
<b>CPA</b>	Chief of Public Affairs	<b>PSG</b>	Prioritization Steering Group
<b>CSA</b>	Chief of Staff, U.S. Army	<b>RDTE</b>	Research, Development, Test, and Evaluation, Army (appropriation)
<b>DAB</b>	Defense Acquisition Board, Deputy Assistant Secretary of the Army for Army Budget	<b>SA</b>	Secretary of the Army
<b>DAS</b>	Director of the Army Staff	<b>SAC</b>	Senate Appropriations Committee
<b>DCS</b>	Deputy Chief of Staff	<b>SASC</b>	Senate Armed Services Committee
<b>DCSINT</b>	DCS for Intelligence	<b>SBC</b>	Senate Budget Committee
<b>DCSLOG</b>	DCS for Logistics	<b>SECDEF</b>	Secretary of Defense
<b>DCSOPS</b>	DCS for Operations and Plans	<b>SELCOM</b>	Select Committee
<b>DCSPER</b>	DCS for Personnel	<b>SPC</b>	Strategy and Planning Committee
<b>DEPSECDEF</b>	Deputy SECDEF	<b>TIG</b>	The Inspector General
<b>DISC4</b>	Director of Information Systems for Command, Control, Communications, and Computers	<b>TJAG</b>	The Judge Advocate General
<b>DM</b>	Director of Management	<b>TRADOC</b>	U.S. Army Training and Doctrine Command
<b>DPAE</b>	Director of Program Analysis and Evaluation	<b>TSG</b>	The Surgeon General
<b>DRB</b>	Defense Resources Board	<b>USA</b>	Under Secretary of the Army
<b>EXCOM</b>	Executive Committee	<b>USD(A)</b>	Under Secretary of Defense for Acquisition
<b>ECBRB</b>	Enhanced Concept Based Requirements System	<b>VCBA</b>	Vice Chief of Staff, U.S. Army





- Legend**
- ACC Army component command
  - ALRPG Army Long Range Planning Guidance
  - AMC U.S. Army Materiel Command
  - AMP Army Modernization Plan
  - amend amendment (to)
  - AMOPES Army Mobilization, Operations Planning, and Execution System
  - APG Army Program Guidance
  - APPI Army POM Preparation Instructions
  - apppn appropriation
  - apppx appropriation
  - AUTS Automatic Update Transaction System
  - bdg budget
  - BES Budget Estimates Submission
  - BOIP Basis of Issue Plan
  - brfs briefings
  - CBE command budget estimate
  - CCA Chairman's Contingency Capabilities Assessment
  - chgs changes
  - CINC commander in chief, unified or specified command
  - CG Chairman's Guidance
  - cmi comment
  - concurr concurrent
  - comd command
  - conf conference
  - congr congressional
  - CPA Chairman's Program Assessment
  - CPG Contingency Planning Guidance
  - CSPAR CINC's Preparedness Assessment Report
  - DOD Department of Defense
  - DPG Defense Planning Guidance
  - DPRB Defense Planning and Resources Board
  - ECBR3 Enhanced Concept Based Requirements System
  - eq equipment
  - FIA Force Integration Analysis
  - frc force(s)
  - FYDP Future Years Defense Program
  - gd guidance
  - HQDA Headquarters Department of the Army
  - hrgs hearings
  - instr instructions
  - IPL integrated priority list
  - ISC U.S. Army Information Systems Command
  - JMNA Joint Military Net Assessment
  - JPD Joint Planning Document
  - JSCP Joint Strategic Capabilities Plan
  - JSR Joint Strategy Review
  - jt joint
  - L/T logistics/transportation
  - log logistics
  - LOGSACS Logistics Structure and Composition System
  - LRP long range plan
  - LRRDAP Long Range Research, Development, and Acquisition Plan
  - LSA Logistics Sustainability Analysis
  - M-Force Master Force
  - MACOM major Army command
  - MARC Manpower Requirements Criteria
  - MILCON military construction
  - MOC management of change
  - MPDI MACOM POM Development Instructions
  - mpr manpower
  - NCA National Command Authorities
  - NMS national military strategy
  - OMB Office of Management and Budget
  - OSD Office of the Secretary of Defense
  - OPLAN operation plan(s)
  - PAR Chairman's Preparedness Assessment Report
  - PBD Program Budget Decision
  - PBG Program and Budget Guidance
  - PDM Program Decision Memorandum
  - PEO program executive office(r)
  - PERSACS Personnel Structure and Composition System
  - plng planning
  - POM Program Objective Memorandum
  - PPBERS Program Performance and Execution Review System
  - PPBES Planning, Programming, Budgeting, and Execution System
  - PPI POM Preparation Instructions
  - prelim preliminary
  - prep preparation
  - Pres President
  - prog program
  - proj projection
  - quan quantity
  - rcmdtms recommendations
  - rcv review
  - RMU resource management update
  - rqmts requirements
  - rsln resolution
  - SACS Structure and Composition System
  - SAMAS Structure and Manpower Allocation System
  - SECDEF Secretary of Defense
  - SELCOM Select Committee
  - SISA Science and Infrastructure Support Analysis service
  - svc service
  - TAA Total Army Analysis
  - TAADS The Army Authorization Document System
  - TAEDP Total Army Equipment Distribution Program
  - TAP The Army Plan
  - TOE Tables of Organization and Equipment System
  - TPFDD Time Phased Force Deployment Data
  - TRADOC U.S. Army Training and Doctrine Command
  - trans transportation
  - WFLA Warfighting Lens Analysis

**Congress**

**President**

**Joint Staff**

**CINCs**

**ACCs**

**OSD**

**HQDA**

**MACOMs**

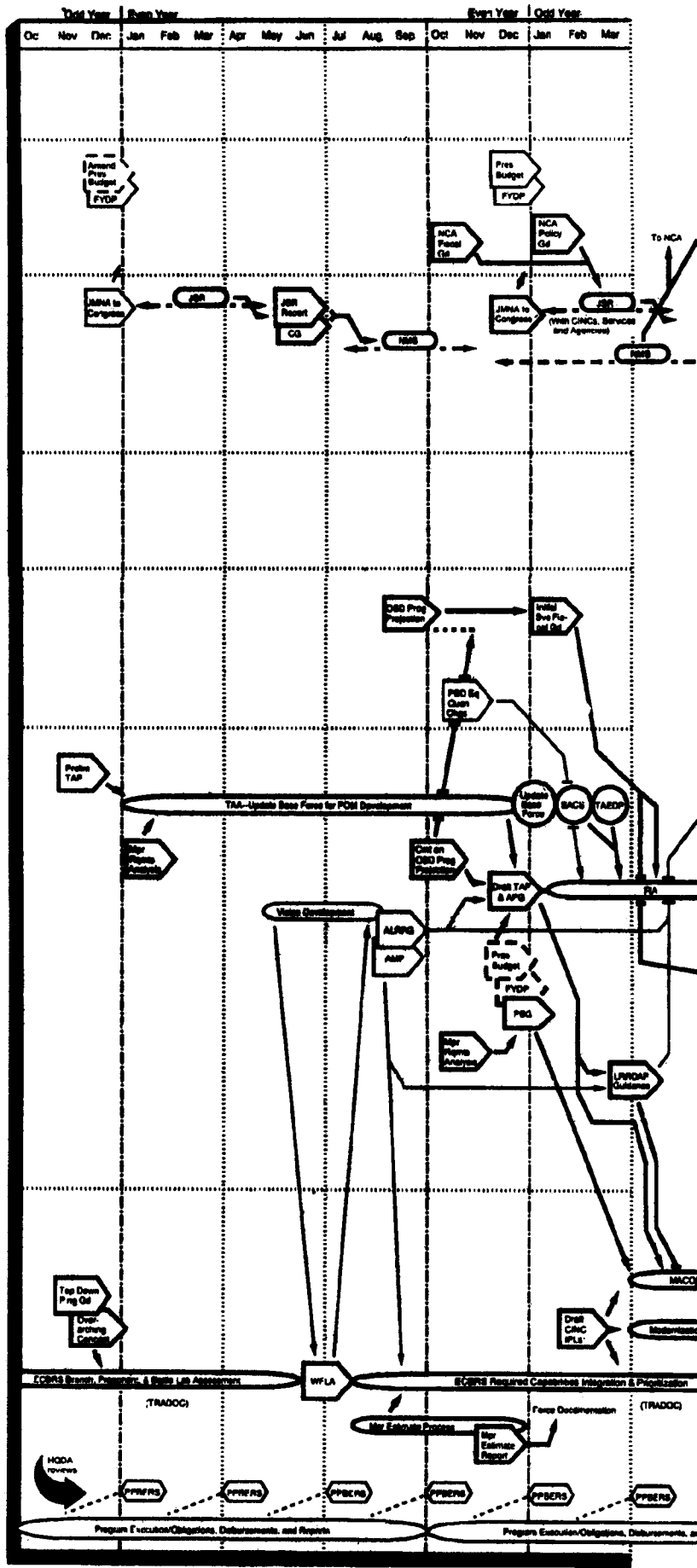



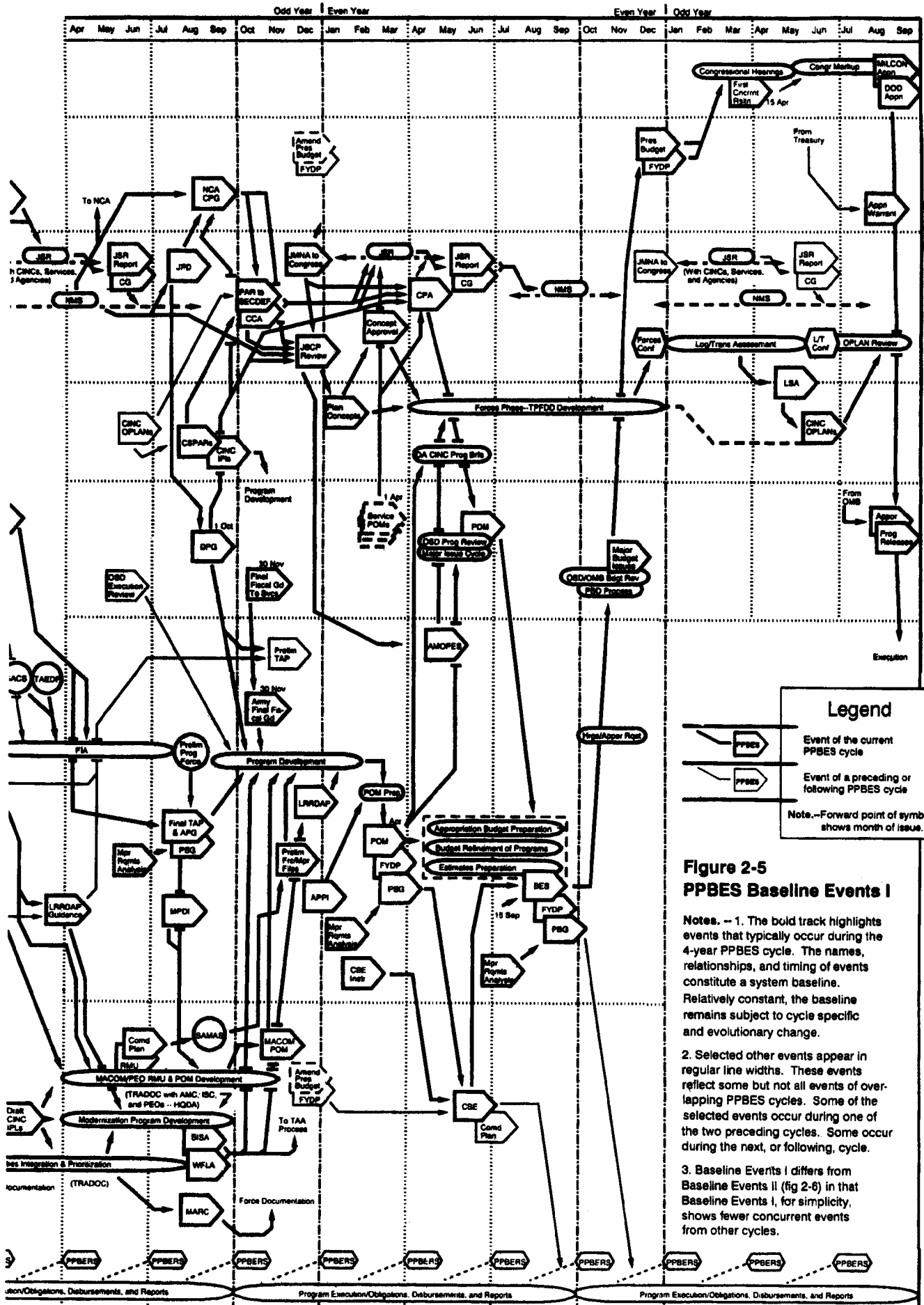

**Figure 2-5  
PPBES Baseline Events I**

**Notes.** -- 1. The bold track highlights events that typically occur during the 4-year PPBES cycle. The names, relationships, and timing of events constitute a system baseline. Relatively constant, the baseline remains subject to cycle specific and evolutionary change.

2. Selected other events appear in regular line widths. These events reflect some but not all events of overlapping PPBES cycles. Some of the selected events occur during one of the two preceding cycles. Some occur during the next, or following, cycle.

3. Baseline Events I differs from Baseline Events II (fig 2-6) in that Baseline Events I, for simplicity, shows fewer concurrent events from other cycles.



- Legend**
- ACC Army component command
  - ALRPG Army Long Range Planning Guidance
  - AMC U.S. Army Materiel Command
  - AMP Army Modernization Plan
  - AMP/OPS Army Mobilization, Operations Planning, and Executive System
  - APG Army Program Guidance
  - APPI Army POM Preparation Instructions
  - apppr appropriation
  - apppr approval
  - AUTS Automatic Update Transaction System
  - bdgt budget
  - BES Budget Estimates Submission
  - BOIP Basis of Issue Plan
  - brfs briefings
  - CCA command budget estimate
  - CCA Chairman's Contingency Capabilities Assessment
  - chgs changes
  - CINC commander in chief, unified or specified command
  - CG Chairman's Guidance
  - cmnt comment
  - cnctnt concurrent
  - cmd command
  - cnfrnc conference
  - cong congressional
  - CPA Chairman's Program Assessment
  - CPG Contingency Planning Guidance
  - CSPAR CINC's Preparedness Assessment Report
  - DOD Department of Defense
  - DPG Defense Planning Guidance
  - DFRB Defense Planning and Resources Board
  - ECBRs Enhanced Concept Based Requirements
  - System
  - eq equipment
  - FIA Force Integration Analysis
  - fc force(s)
  - FYDP Future Years Defense Program guidance
  - HODA Headquarters Department of the Army
  - hrng hearings
  - instr instructions
  - IPL integrated priority list
  - JSC U.S. Army Information Systems Command
  - JMNA Joint Military Net Assessment
  - JPD Joint Planning Document
  - JSCP Joint Strategic Capabilities Plan
  - JSR Joint Strategy Review
  - jt joint
  - L/T logistics/transportation
  - log logistics
  - LOGSACS Logistics Structure and Composition System
  - LRP long range plan
  - LRRDAP Long Range Research, Development, and Acquisition Plan
  - LSA Logistics Sustainability Analysis
  - M-Force Master Force
  - MACOM major Army command
  - MARC Manpower Requirements Criteria
  - MILCON military construction
  - MOC management of change
  - MPDI MACOM POM Development Instructions
  - mpr manpower
  - NCA National Command Authorities
  - national military strategy
  - OMB Office of Management and Budget
  - OSD Office of the Secretary of Defense
  - OPLAN operation plan(s)
  - PAR Chairman's Preparedness Assessment Report
  - PBD Program Budget Decision
  - PBG Program and Budget Guidance
  - PDM Program Decision Memorandum
  - PBO program executive office(s)
  - PERSACS Personnel Structure and Composition System
  - plng planning
  - POM Program Objective Memorandum
  - PPBERS Program Performance and Execution Review System
  - PPBES Planning, Programming, Budgeting, and Execution System
  - PPI POM Preparation Instructions
  - prelim preliminary
  - prep preparation
  - Pres President
  - prog program
  - proj projection
  - quan quantity
  - recomd recommendations
  - rev review
  - RMU resource management update
  - rgmts requirements
  - rsln resolution
  - SACS Structure and Composition System
  - SAMAS Structure and Manpower Allocation System
  - SECDEF Secretary of Defense
  - SELCOM Select Committee
  - SISA Science and Infrastructure Support Analysis
  - svc service
  - TAA Total Army Analysis
  - IAADS The Army Authorization Document System
  - TAEDP Total Army Equipment Distribution Program
  - TAP The Army Plan
  - TOE Tables of Organization and Equipment System
  - TPFDD Time Phased Force Deployment Data
  - TRADOC U.S. Army Training and Doctrine Command
  - trans transportation
  - WFLA Warfighting Lens Analysis

**Congress**

**President**

**Joint Staff**

**CINCs**

**ACCs**

**OSD**

**HQDA**

**MACOMs**

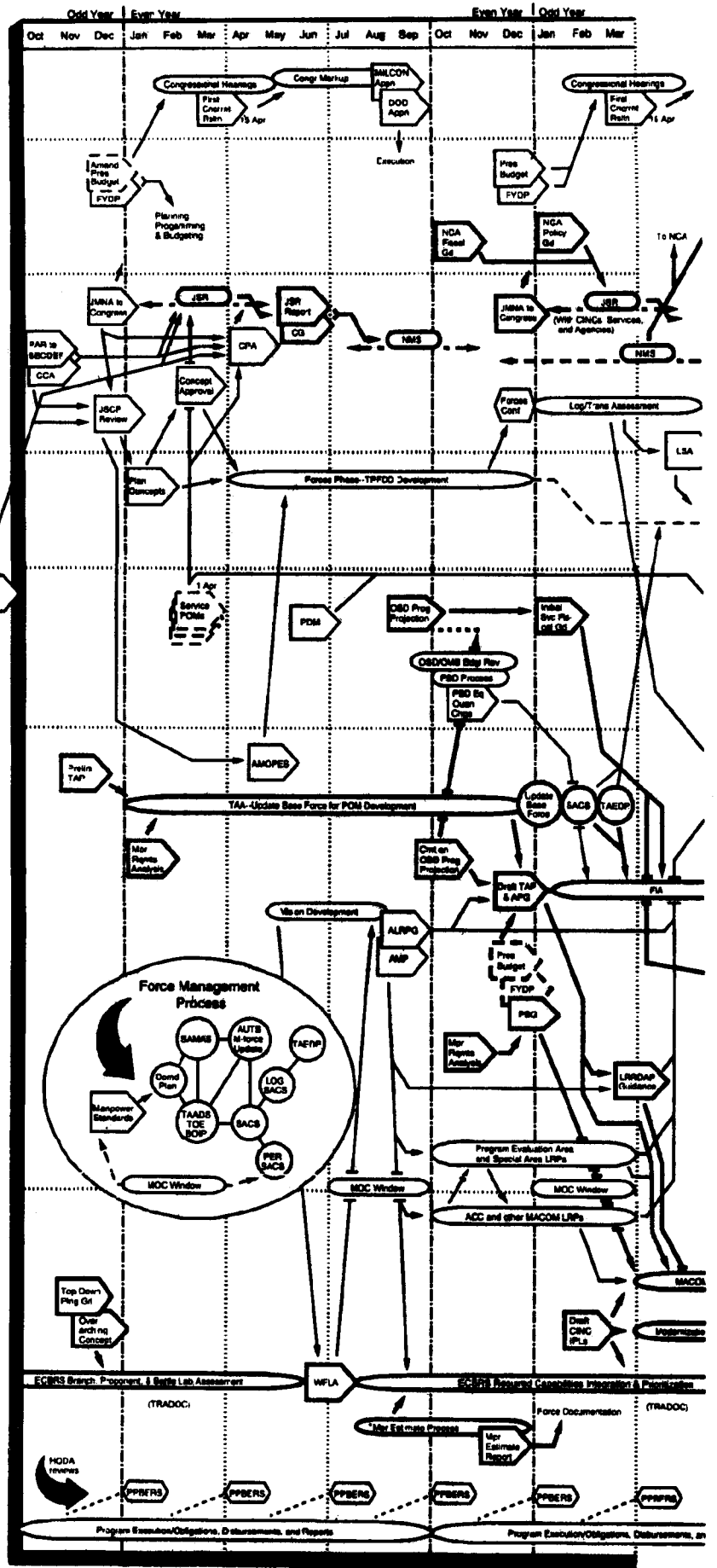



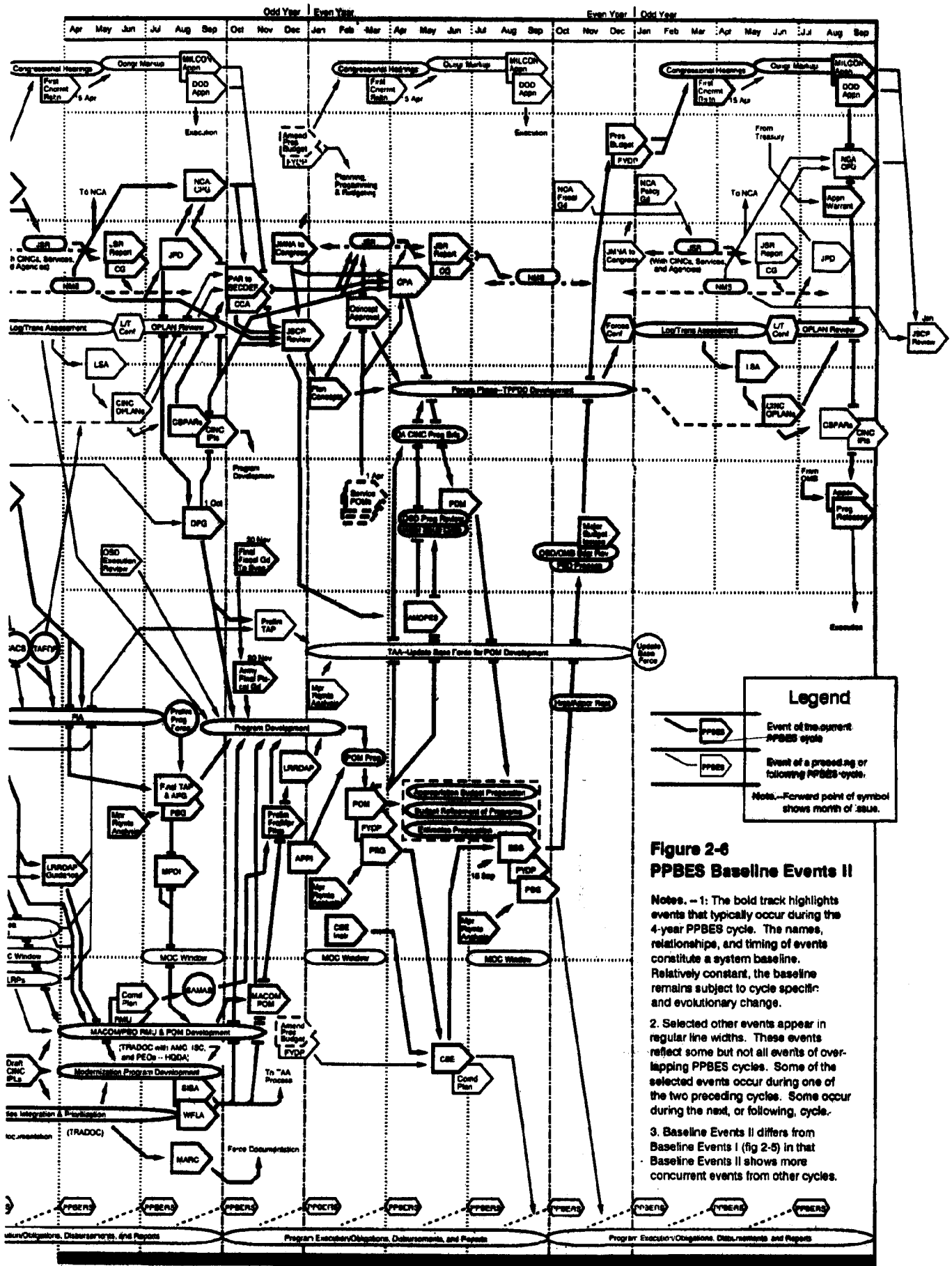

**Figure 2-6  
PPBES Baseline Events II**

**Notes.** - 1: The bold track highlights events that typically occur during the 4-year PPBES cycle. The names, relationships, and timing of events constitute a system baseline. Relatively constant, the baseline remains subject to cycle specific and evolutionary change.

2. Selected other events appear in regular line widths. These events reflect some but not all events of overlapping PPBES cycles. Some of the selected events occur during one of the two preceding cycles. Some occur during the next, or following, cycle.

3. Baseline Events II differs from Baseline Events I (fig 2-5) in that Baseline Events II shows more concurrent events from other cycles.





**Unclassified**

PIN 000207-000

# USAPA

ELECTRONIC PUBLISHING SYSTEM  
TEXT FORMATTER ... Version 2.45

PIN: 000207-000

DATE: 09-15-98

TIME: 15:53:56

PAGES SET: 44

---

DATA FILE: s304.fil

DOCUMENT: AR 1-1

DOC STATUS: NEW PUBLICATION