

DEPARTMENT OF THE ARMY
U.S. Army Corps of Engineers
Washington, DC 20314-1000

CECW-EG

ETL 1110-2-544

Technical Letter
No. 1110-2-544

31 July 1995

Engineering and Design
GEOTECHNICAL ANALYSIS BY THE FINITE
ELEMENT METHOD

Distribution Restriction Statement

Approved for public release; distribution is unlimited.

Report Documentation Page

Report Date 31 Jul 1995	Report Type N/A	Dates Covered (from... to) -
Title and Subtitle Engineering and Design: Geotechnical Analysis by the Finite Element Method	Contract Number	
	Grant Number	
	Program Element Number	
Author(s)	Project Number	
	Task Number	
	Work Unit Number	
Performing Organization Name(s) and Address(es) Department of the Army U.S. Army Corps of Engineers Washington, DC 20314-1000	Performing Organization Report Number	
Sponsoring/Monitoring Agency Name(s) and Address(es)	Sponsor/Monitor's Acronym(s)	
	Sponsor/Monitor's Report Number(s)	
Distribution/Availability Statement Approved for public release, distribution unlimited		
Supplementary Notes		
Abstract		
Subject Terms		
Report Classification unclassified	Classification of this page unclassified	
Classification of Abstract unclassified	Limitation of Abstract UU	
Number of Pages 42		

CECW-EG

Technical Letter
No. 1110-2-544

31 July 1995

**Engineering and Design
GEOTECHNICAL ANALYSIS BY THE FINITE
ELEMENT METHOD**

1. Purpose

This engineer technical letter (ETL) provides guidance on the use of the finite element method in the analysis of problems in geotechnical engineering. This ETL is intended for engineers who are unfamiliar with the method, but who are interested in understanding its potential use in geotechnical engineering.

2. Applicability

This ETL applies to all HQUSACE elements and USACE commands having responsibilities for the design of civil works projects.

3. References

See Appendix A.

4. Background

a. Numerical technique. The finite element method (FEM) is a numerical technique which can be used to solve problems in geotechnical engineering. Computer codes based on the FEM have been developed to solve problems involving soil structure interaction, embankment construction, seepage, and soil dynamics.

b. Traditional methods of analysis. Traditional methods of analysis often times use techniques that are based on assumptions that oversimplify the problem at hand. These methods lack the ability to account for all of the factors and variables the design engineer faces and may severely limit the accuracy of the solution. The finite element method can overcome many of these shortcomings, thereby

offering many advantages over the conventional approaches. Accordingly, the FEM accounts for complex geometries, a variety of loading conditions, nonlinear material behavior, nonhomogeneous material distribution, and soil-structure interaction effects that are not accounted for in the simpler procedures. Unfortunately, the FEM is an underutilized technology in the design process because engineers believe its application is time consuming, expensive, and complicated. However, with recent advances in the hardware and software associated with modern digital computers, a properly conducted FEM analysis can be conducted rapidly and at a relatively low cost.

5. Objective

The objective of this ETL is to provide a basis for understanding what can be learned from finite element analyses, what skills are required for its application, and what resources in terms of time, effort, and cost are involved. The emphasis is on practical applications of the method. Appendix A contains information as to how the FEM can be used in soil-structure interaction, embankment construction, and seepage analysis. Appendix A includes discussions on the details of finite element modeling, case histories, and a section which will help interested engineers find further information on how the FEM can help in the analysis of their problems.

FOR THE DIRECTOR OF CIVIL WORKS

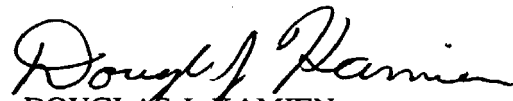
DOUGLAS J. KAMIEN
Acting Chief, Engineering Division
Directorate of Civil Works

CECW-EG

Technical Letter
No. 1110-2-544

31 July 1995

**Engineering and Design
GEOTECHNICAL ANALYSIS BY THE FINITE
ELEMENT METHOD**

Table of Contents

Subject	Paragraph	Page	Subject	Paragraph	Page
Appendix A			Case History: Sheet-pile Wall		
Geotechnical Analysis by the Finite Element Method			Analysis	2-9	A-10
 Chapter 1			 Chapter 3		
Introduction			Embankment Construction Problems		
Background	1-1	A-1	Results and Use of Embankment		
Types of Problems	1-2	A-1	Construction Analysis	3-1	A-15
What Can be Learned from Finite			Important Features of Embankment		
Element Analyses	1-3	A-1	Construction Analysis	3-2	A-15
Information Required for Finite			Case History: Birch Dam	3-3	A-17
Element Analyses	1-4	A-2	Case History: New Melones Dam	3-4	A-18
Skills Required for Geotechnical					
Finite Element Analyses	1-5	A-3	 Chapter 4		
Required Effort and Cost	1-6	A-3	Seepage Problems		
Finite Element Codes Used on			Results and Uses of Seepage		
Corps' Projects	1-7	A-3	Analyses	4-1	A-26
			Types of Seepage Analyses	4-2	A-26
 Chapter 2			Constitutive Law and Material		
Static Soil Structure Interaction Problems			Properties	4-3	A-26
Results and Use of SSI Analysis	2-1	A-4	Case History: S. A. Murray		
Important Features of SSI Analysis	2-2	A-4	Hydroelectric Plant	4-4	A-27
Material Behavior Models	2-3	A-4	Case History: Cerrillos Dam	4-5	A-28
Stress-Strain Material Property					
Values	2-4	A-5	 Chapter 5		
Finite Element Mesh	2-5	A-5	Sources for Further Information		
Construction Sequence	2-6	A-6	Finite Element Codes Used in		
Calibration of the Entire Model	2-7	A-6	the Analysis of Past Corps of		
Case History: Retaining Wall			Engineers Geotechnical Projects	5-1	A-35
at Bonneville Navigation			References	5-2	A-35
Locks	2-8	A-6			

APPENDIX A: GEOTECHNICAL ANALYSIS BY THE FINITE ELEMENT METHOD

Chapter 1 Introduction

1-1. Background

a. *Purpose.* The purpose of this engineering technical letter (ETL) is to provide guidance to engineers who are unfamiliar with the finite element method, but who are interested in understanding its potential for use in geotechnical engineering. The emphasis is on practical applications. The objective is to provide a basis for understanding what can be learned from finite element analyses, what skills are required for its application, and what resources in terms of time, effort, and cost are involved.

b. *Use of finite element method.* Use of the finite element method for geotechnical engineering began in 1966, when Clough and Woodward used it to determine stresses and movements in embankments, and Reyes and Deer described its application to analysis of underground openings in rock. Many research studies and practical applications have taken place in the intervening 30 years. During this period, considerable advances have been made in theory and practice, and the cost of computers has diminished to a small fraction of the cost 30 years ago. This report emphasizes the practical lessons learned in the past 30 years, that together define the current state of practice with regard to finite element analyses.

c. *Emphasis.* The theory of the finite element method is not covered in this report. Instead, emphasis is placed on the types of geotechnical problems to which the method has been applied and the options available to engineers who wish to use it for analysis of their problems.

1-2. Types of Problems

a. *Sequence of real events.* Almost all geotechnical finite element analyses are performed in steps that simulate a sequence of real events, such as the successive stages of excavation of a braced or unbraced cut, or placement of fill on an embankment. Performing the analyses in steps has two important advantages for geotechnical problems:

(1) The geometry can be changed from one step to the next to simulate excavation or fill placement, by removing elements or adding elements to the mesh.

(2) The properties of the soil can be changed from one step to the next to simulate the changes in behavior that result from changes in the stresses within the soil mass.

b. *Types of problems.* The finite element method has been applied to a wide variety of geotechnical engineering problems where stresses, movements, pore pressures, and groundwater flow were of interest. The types of problems analyzed include:

- Anchored walls used to stabilize landslides
- Building foundations
- Cellular cofferdams
- Embankment dams
- Excavation bracing systems
- Long-span flexible culverts
- Offshore structures
- Plastic concrete seepage cutoff walls
- Reinforced embankments
- Reinforced slopes
- Retaining walls
- Seepage through earth masses
- Slurry trench seepage barriers
- Tunnels
- U-frame locks
- Unbraced excavations

This list is representative, but not exhaustive. It is clear that the finite element method can be used to calculate stresses, movements, and groundwater flow in virtually any conditions that arises in geotechnical engineering practice. Limitations on the use of the method usually stem from limitations on resources to define problems and to perform analyses, rather than inherent limitations of the method itself.

1-3. What Can Be Learned from Finite Element Analyses?

a. *Analysis by finite element methods.* For analysis by the finite element method, the region to

be analyzed is divided into a number of elements connected at their common nodal points. A finite element mesh used in the seismic analysis of the Mormon Island Dam of the Folsom Reservoir Project is shown in Figure 1. This mesh contains a total of 297 elements and 332 nodal points. By means of the finite element method, it is possible to calculate the complete state of stress in each element and the horizontal and vertical movements of each nodal point at each stage in the analysis. The analyses thus provides a very detailed picture of stresses, strains, and movements within the region analyzed. This information has been used to evaluate several aspects of behavior, including:

- Earth pressures within earth masses and on retaining structures
- Earthquake response of embankments and foundations
- Local failure in slopes, embankments, and foundations
- Pore pressures and seepage quantities in steady and nonsteady flow conditions
- Pore pressures induced by loading under undrained conditions
- Potential for cracking in embankment dams
- Potential for hydraulic fracturing in embankment dams
- Potential for hydraulic separation between concrete and soil
- Settlements and horizontal movements

b. Comparing results. The finite element method complements field instrumentation studies very well because each stage in the analysis represents an actual condition during or following construction. By comparing the results of the finite element analyses with measured behavior, the accuracy of the analyses can be assessed. If the calculated values are close enough to the measured values to give confidence in the analytical results, the analyses can be used to infer information about aspects of the behavior that are not shown directly by the

instrumentation. Finite element analyses thus extend the value of instrumentation studies by filling out the picture of behavior that can be derived from the field measurements. Finite element analyses have also proved very useful for planning instrumentation studies by showing where instruments can be located to best advantage. In addition, the process of comparing calculated and measured results fits very well into the use of the observational method, which offers one of the most reliable approaches for unusual and difficult problems.

1-4. Information Required for Finite Element Analyses

a. Nonlinear stress strain behavior. Almost all geotechnical finite element analyses represent the nonlinear stress-strain behavior of the soil, because this is almost always a significant factor. To model nonlinear behavior, it is necessary to estimate:

- The initial stresses (before construction)
- The strength and nonlinear stress-strain behavior of the soils
- The sequence of construction operations of other loading conditions to be represented by the analysis

b. Stresses in the soil. These three things are needed because the stress-strain behavior of soil depends on the stresses in the soil. The higher the confining pressure, the stiffer the soil (all else being equal), and the higher the deviator stress, the less stiff the soil (all else being equal). Also, since the soil is inelastic, the strains and displacements that occur depend on the sequence of changes in load as well as the load magnitudes. Despite the complexities of soil behavior, the data required for a finite element analysis can be obtained from a more detailed study of the same type tests as those required for conventional settlement or stability analysis.

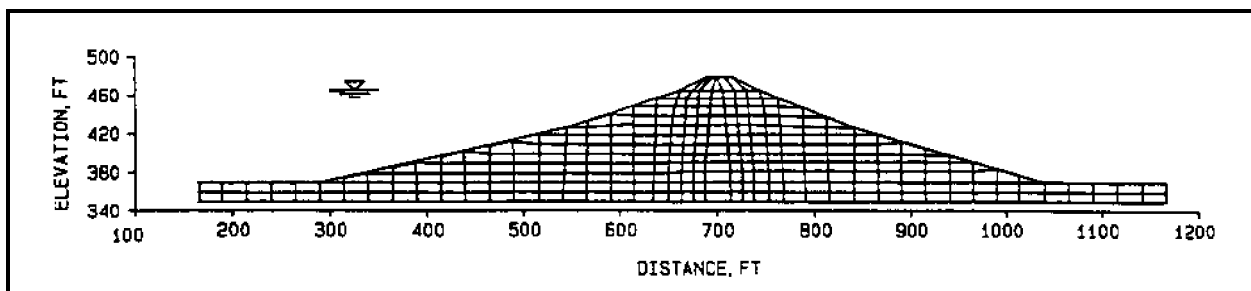

Figure 1. Finite element mesh for Mormon Island Dam

c. *Parameters.* The parameters required for most of the soil stress-strain models that are used in finite element analyses can be determined from the results of conventional soil laboratory tests, such as triaxial tests or direct shear tests used in combination with consolidation tests. The results of in situ tests (SPT, CPT, or PMT) can be used, together with data for similar soils, to estimate stress-strain parameters when results of tests on undisturbed tests are not available.

1-5. Skills Required for Geotechnical Finite Element Analyses

By far the most important skill required for geotechnical finite element analyses is a firm understanding of the geotechnical engineering aspects of the problem being analyzed, most particularly the physical behavior of soils and rocks. It is also necessary to understand the principles of mechanics and numerical analyses that form the basis for the finite element method. An engineer with a solid background in geotechnical engineering and mechanics can become effective in using the finite element method within a few weeks or months. The time required to become skilled in using the method is shortened considerably by the opportunity to work with and learn from an engineer who has already achieved mastery of the method. When weeks or months to learn to apply the method are not available or affordable, the alternative is to engage an engineer who is already an expert with this method. The examples summarized in subsequent sections of this report include suggestions for further study and for possible sources of expert assistance that may be of use in either case.

1-6. Required Effort and Cost

a. *Minimum time and effort.* The amounts of effort and time required for finite element analyses vary over a wide range, depending on the purpose of the analysis and the complexity of the problem analyzed. An example of the minimum time and effort would be a simple analysis performed to estimate possible settlements within an embankment during construction. If the geometry of the embankment was simple, if the foundation was rock or firm soil that

would not contribute to settlements, if the anticipated constructions sequence was simple, and if the properties of the embankment materials could be estimated using available data for similar soils, a geotechnical engineer experienced in performing finite element analyses might be able to develop the mesh, select the soil parameter values, perform the analysis, and summarize the results in 1 or 2 days. Computer costs would be negligible, because this type of analysis could be performed readily on a 486 computer.

b. *Dynamic analyses.* If the conditions analyzed or the objectives of the analysis are more complex, considerably more time may be required to perform finite element analyses. Among the most time-consuming analyses are dynamic analyses of earthquake response, analyses of consolidation that model elasto-plastic soil stress-strain behavior, and three-dimensional (3-D) analyses. An example of a very complex series of analyses are the 3-D analyses performed to estimate the movements, earth pressures, and pore pressures in New Melones Dam, California. These analyses (which had a research component because they were unprecedented at the time) required a total of about 4,000 hours of effort. About one-fourth of this time was needed to evaluate the stress-strain characteristics needed for analyses, which used both hyperbolic and Cam Clay properties.

c. *Costs.* Costs of finite element analyses have decreased in the past few years because the cost of computers has decreased so dramatically. New computer programs are now available that use graphical preprocessors and postprocessors to reduce the amount of time required to prepare input, to interpret, and to plot output.

1-7. Finite Element Codes Used on Corps' Projects

a. *Corps of Engineers' experience.* The Corps of Engineers has extensive experience in the use of the finite element method for the analysis of geotechnical projects. A list of the most commonly used codes is provided in Chapter 5. Chapter 5 also includes an extensive bibliography that can be used to obtain further information on the finite element method.

Chapter 2 Static Soil Structure Interaction Problems

Soil structure interaction (SSI) problems are those where earth pressures depend on structure movements or deflections and structure movements or deflections depend on earth pressures. To analyze these problems, the foundation soil, the structure, and the back-fill or retained soil must be considered. Examples of SSI problems include: anchored walls to stabilize landslides, cellular cofferdams, excavation bracing systems, long-span flexible culverts, reinforced slopes and embankments, retaining walls, U-frame locks, and tunnels.

2-1. Results and Use of SSI Analyses

a. Principal results. The principal results that can be obtained from an SSI analysis using finite elements are the stresses and displacements of the structure and the soil. In most real design problems, the stresses and displacements of the soil and structure can only be calculated using a numerical method like a finite element analysis. Conventional limit equilibrium methods, which do not predict displacements, are adequate for design where there is a sufficient base of experience. When there is less experience, or when displacements are critical, SSI analyses may be needed.

An SSI analysis can be used as a design tool in the following ways:

(1) Calculated values. Stresses and deformations of the structure and/or the soil can be calculated, and the calculated values can be compared to allowable values. If necessary, changes in the system configuration or the constructed component stiffnesses can be made, and the SSI analysis can be repeated until the calculated stresses and deformations are acceptable.

(2) Questions that arise. The “what if” questions that arise during the design process can be addressed in a rational manner. For example, due to subsurface heterogeneity and limited budgets for exploratory work and laboratory testing, significant uncertainty can exist in characterizing subsurface conditions. This uncertainty can create questions concerning the reliability of performance predictions.

Such questions can often be addressed by performing parameter studies. Parameter studies on material property values are relatively easy to perform once an SSI model has been set up. If reasonable variations of material property values result in acceptable values of calculated stresses and deformations, further field and/or laboratory work may not be necessary. On the other hand, if reasonable variations of material property values result in unacceptable stresses or deformations, it may be necessary to modify the proposed construction in some way or to expend further effort to characterize subsurface conditions. In the latter case, the effort can be focused on those aspects of the problem that have been found by SSI analysis to be critical to performance.

b. Efficient application. In addition to its usefulness for predicting performance before construction, an SSI analysis using finite elements can contribute to efficient application of the observational method. The analysis results can be used to identify both representative and critical locations of installation of instrumentation that will be used to monitor performance during construction. Field measurements obtained from the instrumentation during early phases of construction can be used to calibrate the finite element model. The calibrated model can then be used to make more reliable predictions of final displacements and stresses and to evaluate whether specific contingency plans should be implemented.

2-2. Important Features of SSI Analysis

The following paragraphs describe several of the most important features and considerations for development of a good finite element model for an SSI analysis.

2-3. Material Behavior Models

a. Linear elasticity. Structural components in SSI analyses are most frequently modeled using linear elasticity. Rock units in the foundation are also frequently modeled using linear elasticity. Soil behavior, on the other hand, is usually more complex.

b. Confining pressure. As described in the introduction of this ETL, the stress-strain behavior of soil is nonlinear and inelastic. For all cases except saturated soil under undrained conditions, the stress-strain behavior of soil is dependent on confining

pressure. These aspects of soil behavior are encountered in most geotechnical engineering projects, including projects where SSI is important. Consequently, it is important that the material model be capable of tracking these aspects of soil behavior.

c. *Material models.* Many material models, such as the hyperbolic model of Duncan and Chang (1970) and the Cam-Clay model (Roscoe and Burland 1968), do capture these characteristics of soils. The hyperbolic model uses a confining pressure-dependent, nonlinear elastic formulation, with an inelastic component introduced, because the value of the unload-reload modulus is larger than the value of the virgin loading modulus. The Cam-Clay model uses a plasticity formulation that also yields reduced modulus values as the soil strength becomes mobilized and increased modulus values as the confining pressure increases. One of the key benefits of plasticity is that it can model plastic strains that occur in directions other than the direction of the applied stress increment. This feature becomes especially important when a soil mass is near failure. In such a case, the application of a load increment in one direction can cause large displacements of the soil in another direction if large forces had been previously applied in that other direction. For well-designed structures in which failure of large masses of soil is not imminent, modeling this aspect of failure can become less important.

2-4. Stress-Strain Material Properties Values

a. *Material property values.* Selection of appropriate stress-strain material property values is often the most important step in performing SSI analyses. There are four methods to obtain material property values:

(1) Sampling and laboratory testing. For foundation soils, relatively undisturbed samples should be obtained. For embankment or backfill materials, laboratory compacted specimens can be prepared. In either case, the specimens should be tested in the laboratory in an appropriate manner to obtain the necessary parameter values for the material model that will be used. Typical laboratory tests for obtaining these values are one-dimensional (1-D) consolidation tests, isotropic consolidation tests, triaxial compression tests, and direct, simple shear tests.

(2) Field testing. Some *in situ* tests, e.g., the borehole pressuremeter tests, can be performed to obtain material property values.

(3) Correlations with index property values. Stress-strain material property values for several soils have been published together with index property values for the same soils, e.g., Duncan et al. (1980). These published values, together with judgment and experience, can be used to estimate appropriate stress-strain material property values based on index property test results for the soils of interest.

(4) Calibration studies. In many cases, designers have experience with local soils and are skilled at calculating 1-D consolidation settlements using conventional procedures. It is good practice in such cases to develop a 1-D column of finite elements that models the soil profile at the site of interest. The 1-D column can be loaded and the resulting settlements compared to those calculated using conventional procedures. The material property values for the finite element analyses can be adjusted until a match is obtained. Similarly, if an independent estimate of the lateral load response, i.e., the Poisson effect, can be made, the material property values can be adjusted until the 1-D column results match the independent estimate. Ideally, one set of material property values would be found that provides a match to both the compressibility and the lateral load response over the range of applied loads in the SSI problem to be analyzed.

b. *Selection of method.* The selection of a method to obtain material property values depends, of course, on the type of information available. The above methods are most effective when used in combination.

2-5. Finite Element Mesh

a. *Finite element mesh.* The finite element mesh for an SSI analysis should reflect the geometry of the structure, the stratigraphy in the foundation, and the configuration of any excavations and/or fills that are part of the work. In addition, the mesh should have sufficient refinement that deformations and stress gradients are smoothed as one moves from element to element in areas of interest.

b. Known boundary condition. The mesh should also extend beyond the area of interest until a known boundary condition is encountered (e.g., bed-rock can often be represented as a fixed boundary condition) or for a sufficient distance that conditions at the boundary do not significantly influence the calculated stresses and deformations in the area of interest.

The finite element mesh for an SSI analysis can include several different types of elements:

(1) Two-dimensional (2-D) elements. 2-D elements for the soil and concrete portions of plane-strain and axisymmetric analyses.

(2) 3-D brick elements. 3-D brick elements for the soil and concrete portions of 3-D analyses (although it should be pointed out that 3-D analyses of geotechnical engineering problems are rare because of the great cost and time necessary for setting up the problem and interpreting the results, as well as due to the fact that many important aspects of 3-D problems can be modeled using 2-D meshes).

(3) Beam or shell elements. Beam or shell elements for sheet-pile walls, cellular cofferdams, and other structural components.

(4) Bar elements. Bar elements for struts and tiebacks.

(5) Interface elements. Interface elements to allow for slip between dissimilar materials such as between backfill soil and a concrete retaining wall.

2-6. Construction Sequence

a. Construction sequence. As described in the introduction, it is important to model the construction sequence in soil-structure interaction problems for two reasons: 1) soil response is nonlinear, and 2) the geometry can change during construction, e.g., fill placement.

b. Initial in situ stresses. Because of the non-linear stress-strain behavior of soils, it is almost always necessary to first calculate the initial *in situ* stresses in the foundation materials. Perhaps the only exception occurs when a rock foundation is being modeled as linear elastic. In addition, it is necessary to model the following types of construction operations in steps:

excavation, fill placement, placement and removal of structural components, and application of loads and pressures. Less often it can be important to model other sources of load, such as thermal strains in structural elements and compaction-induced lateral earth pressures, for example.

2-7. Calibration of the Entire Model

a. Consider factors. As can be seen from the foregoing, there are several factors that must be carefully considered to develop a good finite element model of the SSI problem. It is important to successful application of the method to calibrate the entire process against instrumented case histories. Fortunately, several such comparisons have been published (See Reference list in Chapter 5).

b. View results with caution. Whenever the method is applied in an unprecedented way, the results should be viewed with caution until confirmation by comparison with an instrumented case history can be established.

2-8. Case History: Retaining Wall at Bonneville Navigation Locks

a. Project description. A temporary tieback wall was built to retain the excavation for construction of a new navigation lock at Bonneville Dam on the Columbia River between Oregon and Washington. The geologic profile at the site, slide debris and man-made fill overlying rock units, is shown in Figure 2. The landslide occurred in the Pleistocene, and previous stability analyses had shown the landslide to be stable in its preconstruction configuration. Figure 2 also shows excavation and a railroad line relocation that took place prior to constructing the tieback wall. An important objective of the construction was to limit the magnitude of movements that would take place at the railroad line during excavation for the new navigation lock.

The 440-ft-long wall consists of a series of reinforced concrete panels. Each panel was excavated by rock chisel and clamshell, with the excavation supported by a bentonite-water slurry. After excavation of each panel, reinforcement was placed and the excavation was backfilled with concrete. The heights of the panels range from 20 to 110 ft. Following completion of the wall panels, excavation for the navigation lock

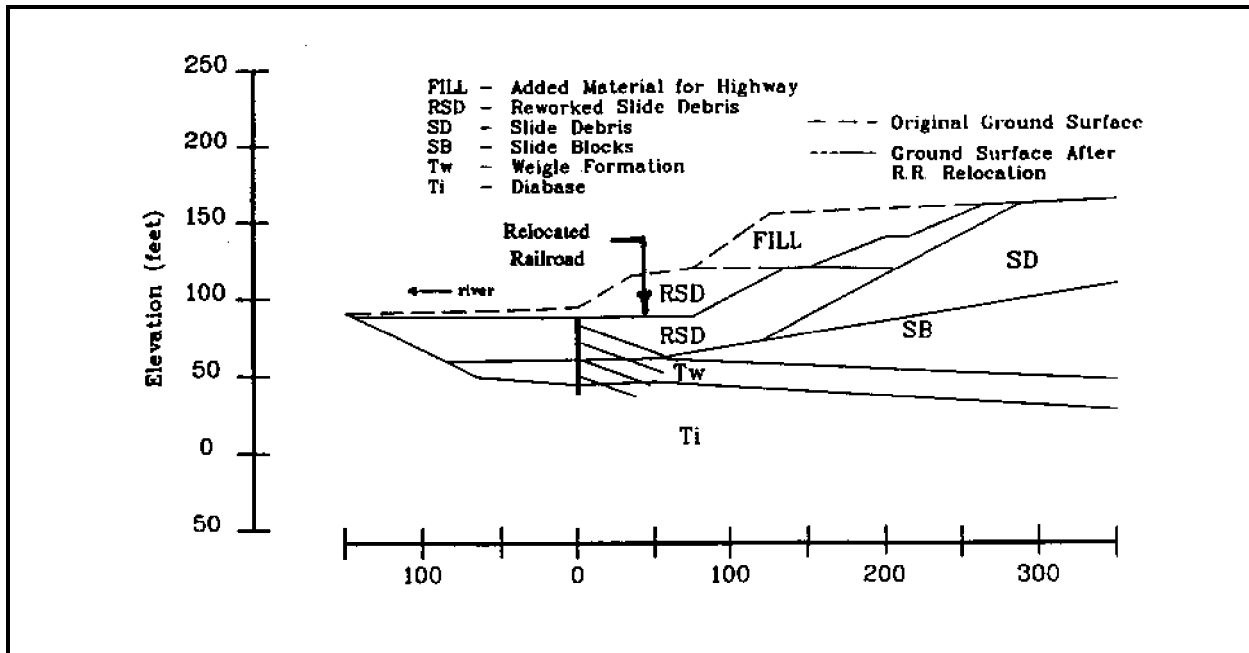

Figure 2. Geologic profile for analysis of Bonneville tieback wall

commenced, and tiebacks were installed at a grid spacing of approximately 10 ft by 10 ft.

b. *Purposes of the SSI analysis.* SSI analysis of the tieback wall were performed by Mosher and Knowles (1990) for three principal purposes:

- (1) To confirm previous design studies based on limit equilibrium procedures and beam on elastic foundation analyses.
- (2) To predict wall performance during excavation and tieback installation.
- (3) To assist in the interpretation of instrumentation results.

c. *Material behavior model and property values.* The hyperbolic model (Duncan and Chang 1970) as implemented in SOILSTRUCT (Clough and Duncan 1969, and Ebeling et al. 1990) was selected for the soil and rock units at the site. Material property values were obtained from interpretation of laboratory test results. Structural materials were assumed to behave in a linear elastic manner.

d. *Mesh details.* The finite element mesh used for the analyses is shown in Figure 3. The mesh

has 395 elements and 389 nodes, and it extends a considerable distance away from the wall. Two-dimensional elements were used to model the soil and rock units and the reinforced concrete wall. Bar elements were used to represent the tie-backs. Bar elements were also employed as "strain gages" on either side of the wall so that extreme fiber stresses and bending moments could be calculated in post-processing. Interface elements were used to allow slip between the wall and adjacent materials.

e. *Construction sequence modeling.* A series of analysis steps were used to develop the initial *in situ* stresses prior to construction. These steps included a gravity turn-on analysis followed by several steps to establish the initial ground surface slope. The displacements were set to zero at this point to represent the zero displacement condition prior to beginning construction.

The construction sequence was then modeled as follows:

- (1) Excavate to the level of the top of the wall and the railroad grade.
- (2) Excavate and place concrete for the retaining wall.

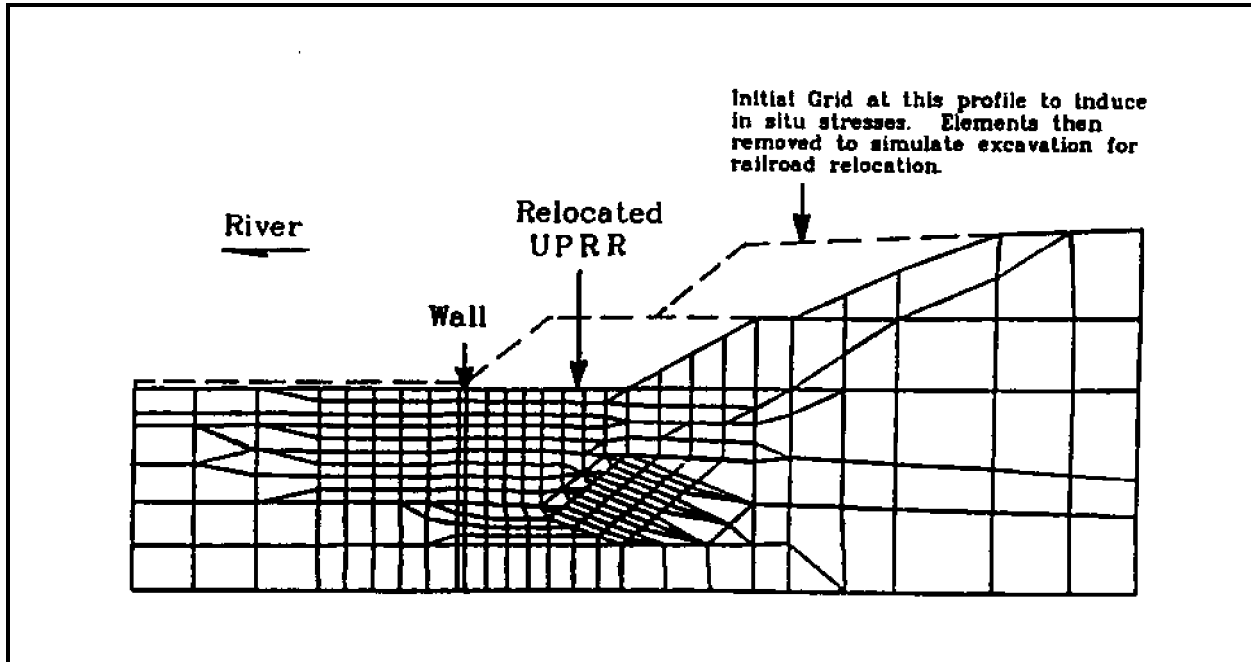

Figure 3. Finite element mesh for Bonneville tieback wall

- (3) Excavate in front of the wall to the depth necessary for installing the uppermost tieback.
- (4) Apply the tieback proof load.
- (5) Reduce the tieback load to the lockoff load.
- (6) Add the stiffness of the tieback to the mesh and excavate to the level of the next tieback.

Steps 4 through 6 were repeated until the bottom of the excavation was reached. These construction steps are illustrated in Figure 4 for four levels of tieback.

f. Results. The results of the analyses included values of wall deflections and moments, lateral earth pressures on the wall, ground surface movements behind the wall (including movement of the relocated railroad line), and soil stresses in the ground behind the wall.

Some of the results are shown in Figure 5. The calculated wall deflections at the end of the excavation are away from the excavation and toward the railroad line. This occurs because the large tierod reload forces pulled the wall toward the railroad line. The maximum calculated deformation is a small amount, 0.67 in. The calculated vertical movement of the ground surface at the railroad track

alignment was 0.08 in. of heave. Figure 6 shows the calculated lateral earth pressure distribution on the wall at the end of construction in comparison to the lateral earth pressure distribution assumed during earlier design studies. The design earth pressures are larger than the calculated earth pressure at the top of the wall and smaller at the bottom of the wall. The undulations in the calculated pressure diagram result from the concentrated tieback reload forces that were applied.

g. Parameter studies during design. Parameter studies were performed during design to investigate the effects of reduction of the soil stiffness and the consequences of failure of the top anchor at the end of construction. The SSI analysis of the wall was repeated using values of soil stiffness equal to one-half of those obtained from laboratory tests. This change caused wall deflections to increase by about 65 percent, wall bending moments to increase by about 40 percent, and heave of the railroad line to increase by about 60 percent. The analysis of tierod failure resulted in a wall movement of about 1.45 in. toward the excavation, to a position 0.78 in. past the vertical. This lateral movement of the wall was accompanied by a 0.14-in. drop of the ground surface at the railroad line location, to a level of 0.06 in. below the original ground level.

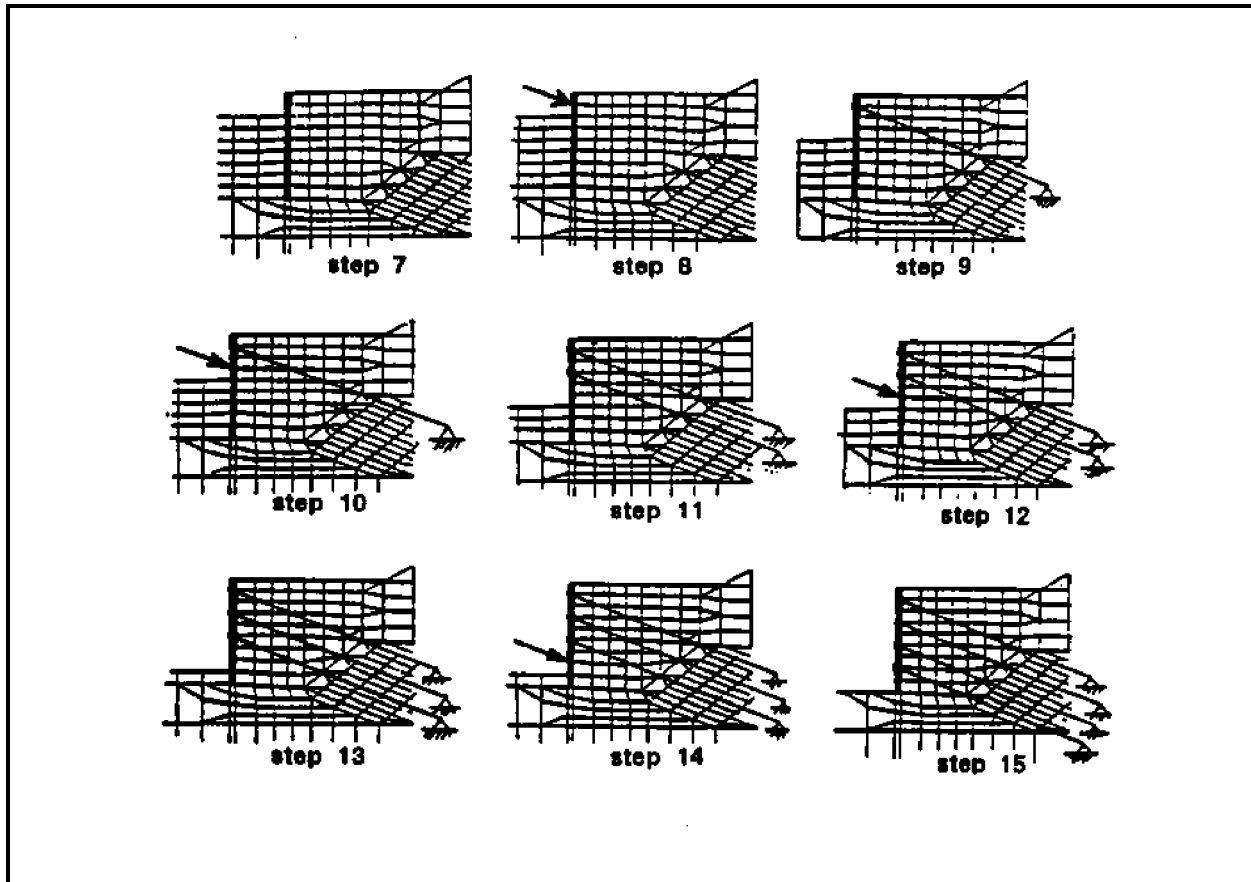

Figure 4. Finite element mesh for steps 7 through 15

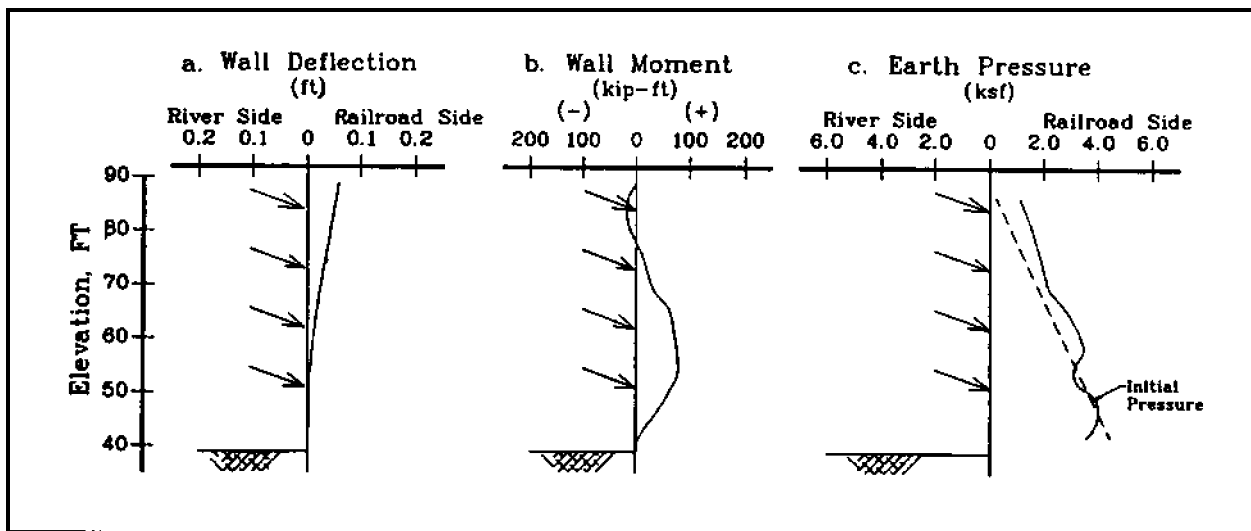

Figure 5. Wall deflections, moments, and lateral earth pressures after final excavation to elevation 39 ft with fourth anchor locked off

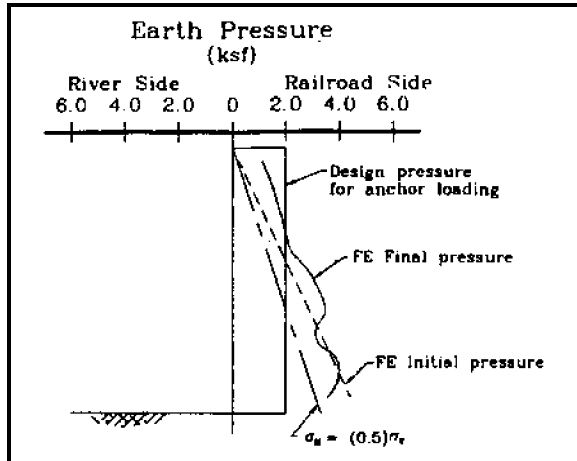

Figure 6. Earth pressures on tieback wall

h. Comparison with measurements. The wall was instrumented with inclinometer casings and strain gages. Figures 7 and 8 show the comparisons between calculated and measured deflections and bending moments. In both cases, the curve marked "Initial" represents the calculated values from the SSI analysis when the soil stiffness obtained from the laboratory tests was used in the analyses. The calculated deflections and moments exceeded the measured values.

i. Parameter studies performed after making field measurements. After the field measurements were obtained, additional parameter studies were performed in an attempt to better match observed behavior. By tripling the soil stiffness obtained from laboratory test data, a reasonably good match could be obtained. Figures 7 and 8 show the comparison. This result is in agreement with the experience on other projects that laboratory data frequently underestimate *in situ* soil stiffness.

The calibrated model could be used, if necessary, to calculate the response of the system to further loadings, such as surcharges or additional excavation.

2-9. Case History: Sheet-pile Wall Analysis

a. Project description. Sheet-pile walls are used for both flood protection along the Mississippi and Atchafalaya Rivers and hurricane protection along the Gulf of Mexico. The cost of the walls depends on the sheet-pile section and the depth of

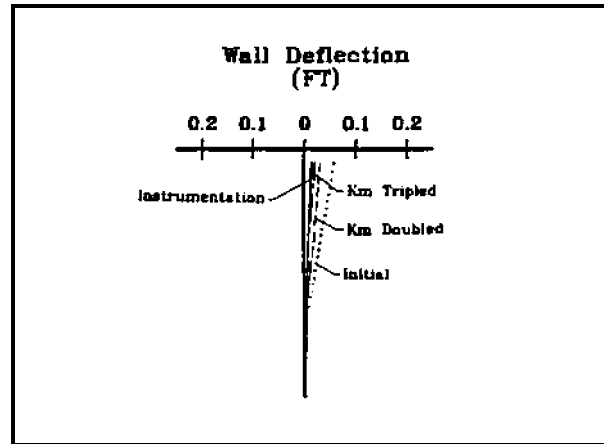

Figure 7. Calculated and measured wall deflections

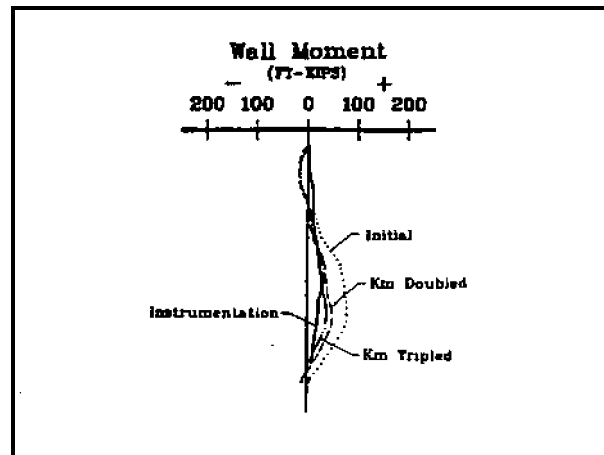

Figure 8. Calculated and measured bending moments

penetration required for stability. Conventional design practice incorporates both a limit equilibrium program and a beam-spring program to predict the stability of the system and the deflections of the sheet pile to determine if a given layout will meet design criteria. A full-scale test program and finite element analysis were performed as part of this study to investigate the effectiveness of the current design procedures.

b. Purposes. This study had three primary purposes:

- (1) To demonstrate the applicability of the finite element method to sheet-pile wall design in soft clays by analysis of the full-scale E-99 test section sheet-pile wall.

(2) To determine which factors have the greatest influence in the performance of the sheet-pile wall through a parametric study with the finite element method. Variations in soil properties, loadings, sheet-pile type, and depth of penetration were considered in this study.

(3) To develop recommendations for a sheet pile design procedure that overcomes some of the inconsistencies in the current methods.

c. Material behavior model, property values, and finite element code. The hyperbolic model (Duncan and Chang 1970) implemented in SOILSTRUCT (Clough and Duncan 1969, and Ebeling 1990) was selected for this problem. Soil material properties were determined from laboratory tests and back analysis of the observational data retrieved from the E-99 test section. The sheet piles were treated as linear elastic materials.

d. Modifications to finite element code. The finite element code, SOILSTRUCT, was modified during the course of the study to ease the input of material parameters for soils and to improve the means of computing the bending moments in the sheet-pile wall. These modifications included:

(1) Implementation of a (S_u/p) model to ease the input of shear strength parameters.

(2) Determination of the initial tangent modulus of soils, E_i , as a function of the undrained shear strength of the soil using the relationship

$$E_i = K \times S_u \quad (1)$$

where K is a unitless parameter between 250 and 1,000 as determined from previous experience.

(3) Improving the bending elements representing the sheet piles so that the bending moments could be directly computed.

e. Mesh details. The mesh used to model the E-99 test section is shown in Figure 9. The mesh consists of 281 solid elements and 322 nodes and models the foundation between elevations (el) + 6.5 to -35 ft. Sheet-pile elements are attached to soil elements by 19 interface elements. Water loads are applied to the soil surface and pile as linearly varying distributed loads in increments corresponding to

water levels of 4.0, 6.0, 7.0, 8.0, and 9.0 ft. A second mesh was used in this study for the purpose of performing a parametric analysis. This mesh, presented in Figure 10 and based on the E-105 test section, was used to investigate design implications of soft foundation behavior.

f. Construction sequence modeling. The basic construction/loading sequence employed in the finite element analyses of both the E-99 test section and in the parametric studies was:

(1) Computation of the initial stresses based on an elastic gravity turn on analysis.

(2) Insertion of the sheet pile.

(3) Application of water loads in 1-ft increments.

(4) Application of wave loads.

The stresses determined in (1) were used to determine S_u and the E_i for each element in the mesh. The insertion of the sheet-pile wall was accomplished by changing the material of the elements representing the sheet-pile wall from soil to steel during the first step. Water loads were simulated through the application of the appropriate pressure to surface nodes in contact with the floodwaters.

g. Results of the E-99 test section. Field data obtained from the E-99 test section was used to establish and validate the FEM for the analysis of the sheet-pile walls. A PZ-27 sheet pile was simulated in the analysis. Water loads were applied to simulate water levels of elevations 4.0, 6.0, 7.0, 8.0, and 9.0 ft. Soil material properties for analysis were obtained from "Q-tests" and field classifications. Three shear strength profiles obtained from test data, used in design, and used in the finite element analysis are shown in Figure 11. The soil stiffness in all finite element runs of the E-99 test section were made on the assumption that K was the same for all soils. Two runs were made with $K = 500$ and $K = 1,000$. Leavell et al. (1989) concluded from the SOILSTRUCT analysis that:

(1) Wall-versus-head relationship. The displacement at the top of the wall-versus-head relationship is predicted fairly well as shown in Figure 12. The ability of the analysis to predict the larger displacements as the head approached 8.0 ft is particularly important because it implies that the limit

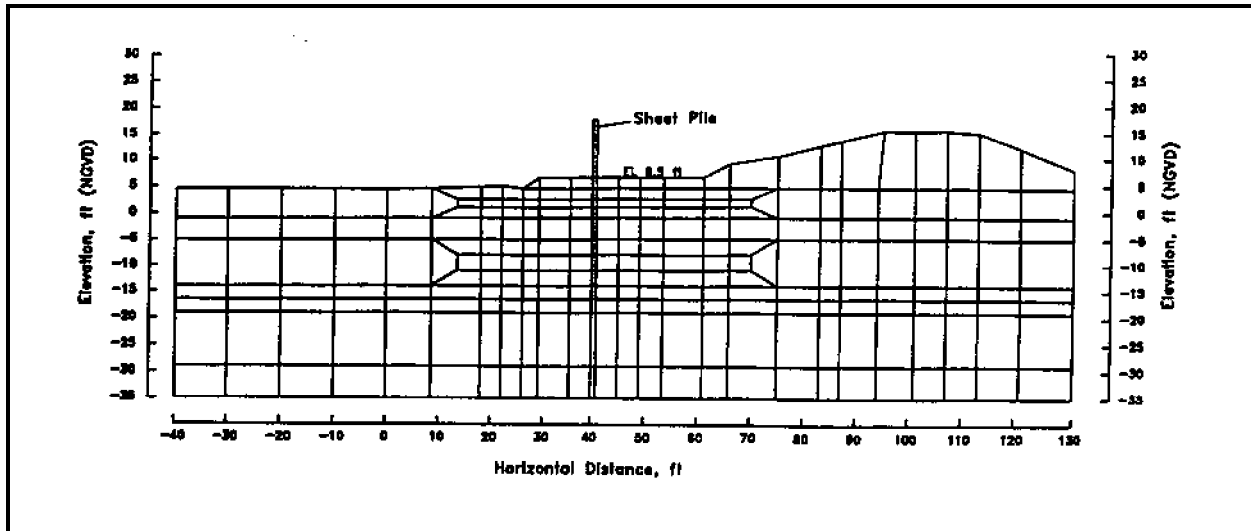

Figure 9. Finite element mesh for E-99 test section

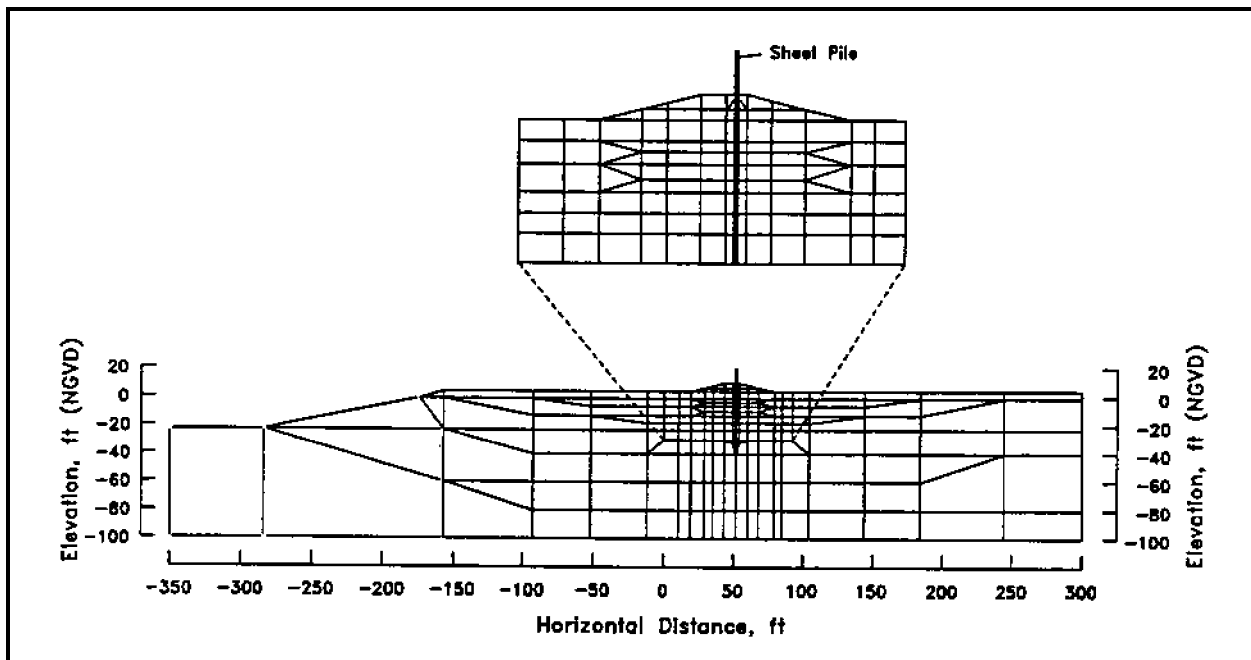

Figure 10. Finite element mesh for E-105 levee section

load can be computed accurately with the finite element method.

(2) Distribution along the wall. The displacement distribution along the wall is predicted well as shown in Figure 13. The ability to predict displacements near the pile tip is significant because in the

soft-soil foundation deep-seated movements can control the displacements of the pile-levee system.

(3) Computed maximum moments. The computed maximum moments and their location agreed well with those measured in the field as shown in Figure 14.

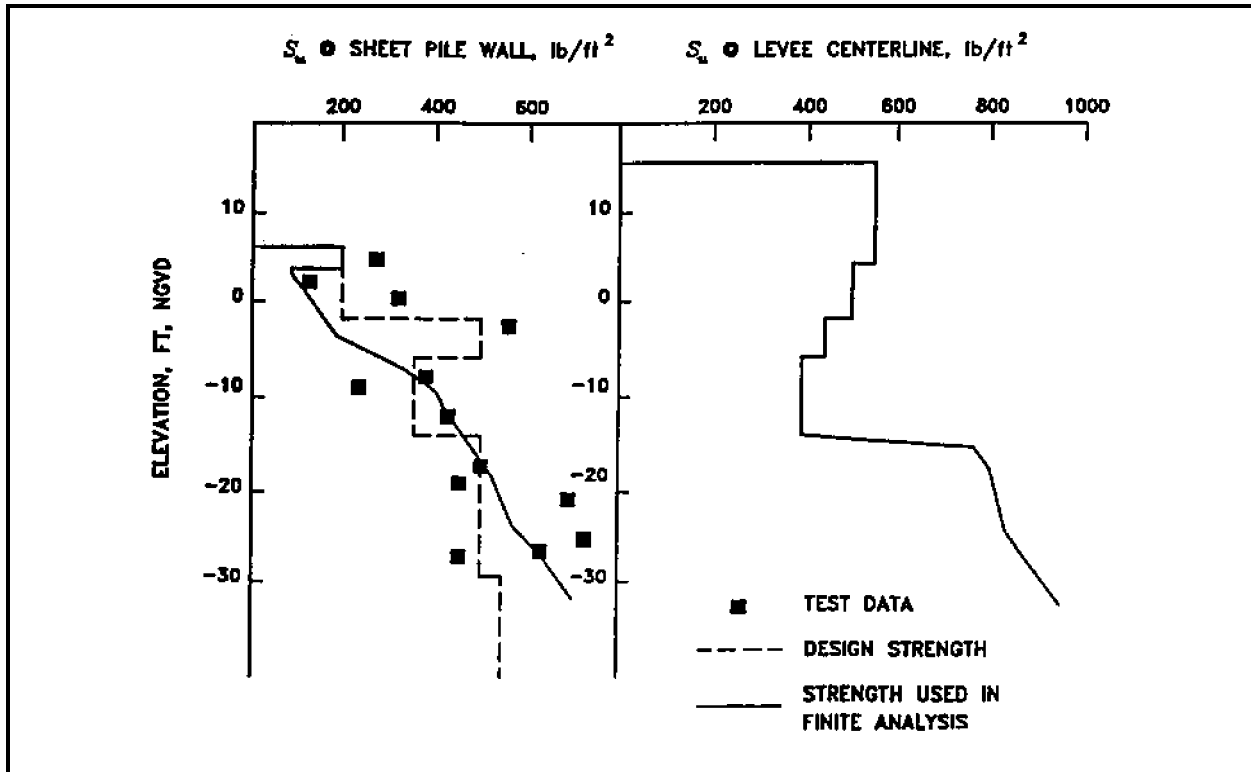

Figure 11. Undrained shear strength profile for Section E-99

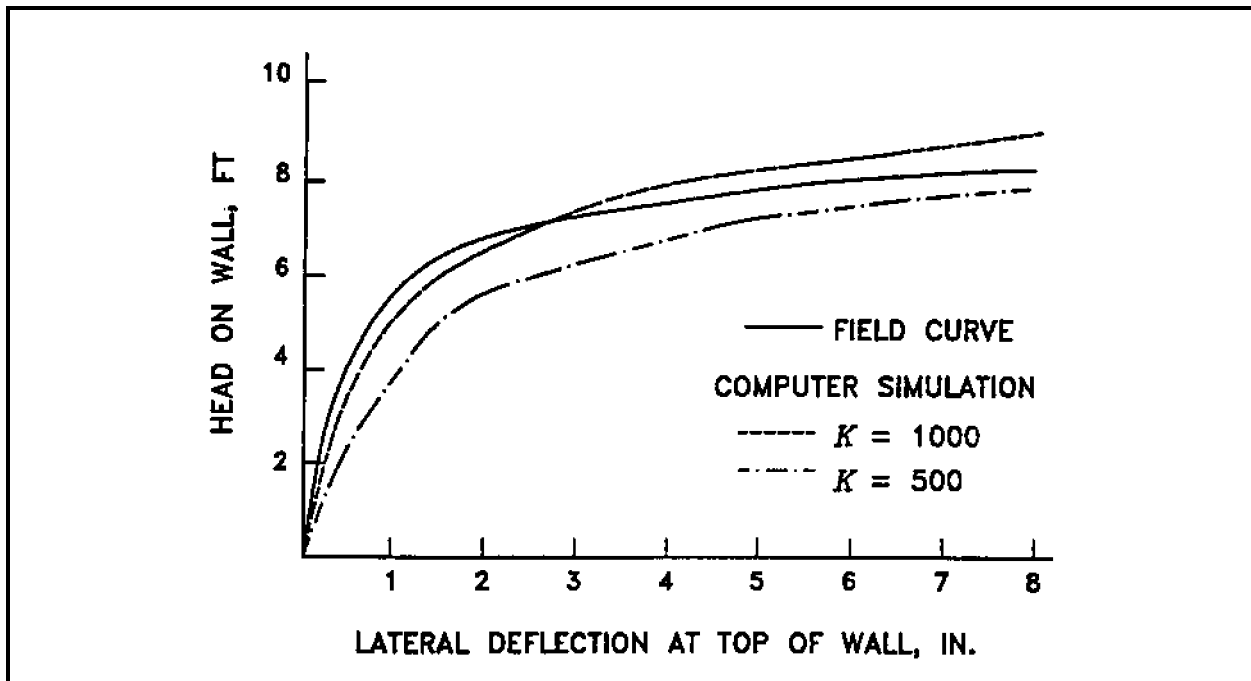

Figure 12. Computed and measured deflections at top of wall versus head for section E-99

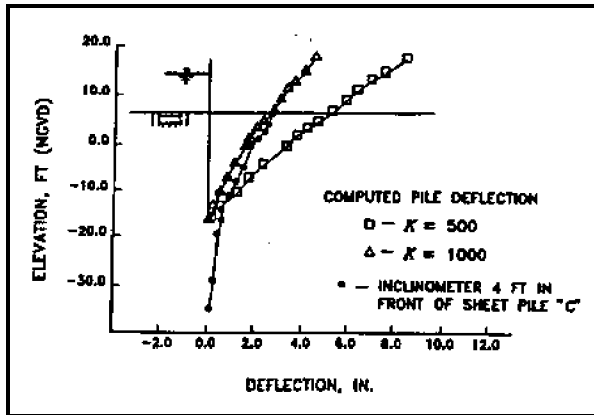

Figure 13. Computed and measured deflections of sheet-pile wall

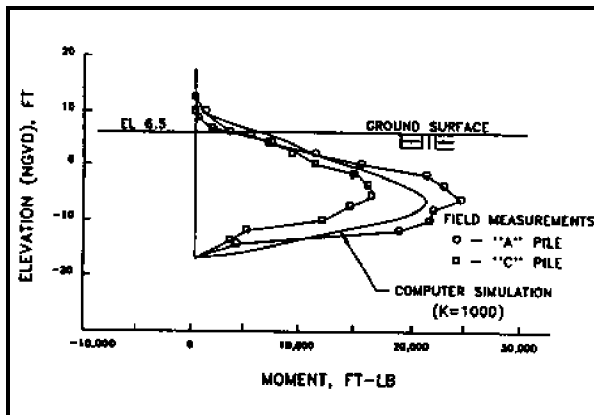

Figure 14. Computed and measured bending moments in sheet-pile wall

h. Results of the parametric analysis. The parameter study was designed to evaluate the effects of pile embedment depth, soil strength, and pile type on the performance of the system at various water levels. The finite element analyses were performed in conjunction with a limit equilibrium analysis to establish a link between the displacements computed with the FEM and the safety factor computed with the limit equilibrium method. Some of the key findings of the parametric analysis include:

(1) Deep-seated movements. Deep-seated movements in the levee foundation controlled the magnitude of sheet-pile deflection, particularly in soft soils. As a result, the height of water loading that can be sustained by a particular wall is controlled by the

stability of the foundation, as determined by a slope stability analysis.

(2) Stability of the levee. The stability of the levee implied by the displacements is consistent with the safety factor computed by the limit-equilibrium method. This is shown in Figure 15 where the sheet-pile wall movements are sensitive to safety factors less than about 1.3.

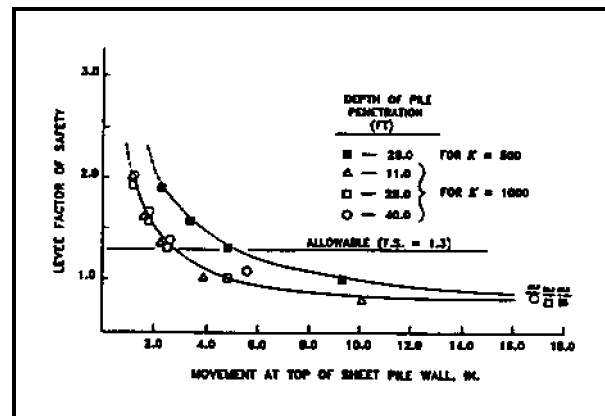

Figure 15. Displacement computed by the finite element method versus factor of safety computed by limit equilibrium method

(3) Increased pile penetration. Increased pile penetration does not improve the stability of the levee.

(4) Pile stiffness. Pile stiffness has little effect on the total displacements.

(5) Deflection of sheet-pile wall. Deflection of the sheet-pile wall, as determined with conventional design programs, is a poor criterion for design of sheet-pile walls because movements are caused by shear deformations in the foundation and not the cantilever action of the pile.

Based on the findings of the parametric analysis, Leavell et al. (1989) were able to successfully develop a design procedure based on the finite element for sheet-pile design. The procedure gives designers charts for making a "correction" to the displacements computed with the conventional design programs. This correction accounts for the effect of the deep-seated movements on the pile deflections.

Chapter 3 Embankment Construction Problems

The analysis of embankment construction involves the estimation of stresses and movements in embankments and their foundations both during and after construction. The construction of embankments generally involves both excavation and filling in some specified order. The finite element method offers an ideal way to perform such an analysis because of its ability to handle complex geometries, construction sequences, and nonlinear soil behavior. Some examples of embankment construction problems include those in embankment dams, levees, and highway embankments. Additionally, a static finite element analysis is often performed as part of the evaluation of liquefaction potential of foundation soils beneath an embankment as the cyclic strength of soil depends on the state of stress in the soil (Wahl et al. 1987).

3-1. Results and Use of Embankment Construction Analysis

a. Embankment and foundation system. The stresses and movements obtained from the analysis can be used to evaluate the expected performance of the embankment-foundation system against pre determined performance standards. The finite element analysis should be used in conjunction with a conventional slope stability program to ensure that both give the same results with respect to the stability of the system.

b. Finite element analysis. The finite element analysis can be a useful tool during the design process of an embankment. Parametric studies can be performed for the purpose of dealing with uncertainty in the foundation conditions and material properties. The results of these studies can provide a range of values for stresses and movements which can be compared with allowable values to help ensure the adequacy of the design.

c. Construction process. The finite element analysis of an embankment can also be useful in the construction process, since it can serve as an aid in the selection of the types and locations of instrumentation systems that monitor performance both during and after construction. This type of analysis can also provide insight into the interpretation of movements and distribution of stress in the

embankment-foundation system based on data collected from settlement gages, slope indicators, pore pressure transducers, etc.

3-2. Important Features of Embankment Construction Analysis

The following paragraphs describe several items and considerations necessary for the performance of a good finite element model for embankment construction:

a. Material behavior models. Soil is the primary material of construction in embankment construction problems. As described in the introduction of this ETL, the stress-strain behavior of soil is nonlinear and inelastic. For all cases except saturated soil under undrained conditions, the stress-strain behavior of soil is dependent on confining pressure. These aspects of soil behavior are encountered in most geotechnical engineering projects, including projects involving the construction of embankments. Consequently, it is important that the material model be capable of tracking these aspects of soil behavior. Many material models, such as the hyperbolic model of Duncan and Chang (1970) and the Cam-Clay model (Roscoe and Burland 1968), do capture these characteristics of soils. The hyperbolic model uses a confining pressure-dependent, nonlinear elastic formulation, with an inelastic component introduced, because the value of the unload-reload modulus is larger than the value of the virgin loading modulus. The Cam-Clay model uses a plasticity formulation that also yields reduced modulus values as the soil strength becomes mobilized and increased modulus values as the confining pressure increases. One of the key benefits of plasticity is that it can model plastic strains that occur in directions other than the direction of the applied stress increment. This feature becomes especially important when a soil mass is near failure. In such a case, the application of a load increment in one direction can cause large displacements of the soil in another direction if large forces had been previously applied in that other direction. For well-designed structures, in which failure of large masses of soil is not imminent, modeling this aspect of failure can become less important.

b. Stress-strain material properties values. Selection of appropriate stress-strain material property values is often the most important step in performing SSI analyses. There are four methods to obtain material property values:

(1) Sampling and laboratory testing. For foundation soils, relatively undisturbed samples should be obtained. For embankment or backfill materials, laboratory compacted specimens can be prepared. In either case, the specimens should be tested in the laboratory in an appropriate manner to obtain the necessary parameter values for the material model that will be used. Typical laboratory tests for obtaining these values are 1-D consolidation tests, isotropic consolidation tests, triaxial compression tests, and direct simple shear tests.

(2) Field testing. Some *in situ* tests, e.g., the borehole pressuremeter tests can be performed to obtain material property values.

(3) Correlations with index property values. Stress-strain material property values for several soils have been published together with index property values for the same soils, e.g., Duncan et al. (1980). These published values, together with judgment and experience, can be used to estimate appropriate stress-strain material property values based on index property test results for the soils of interest.

(4) Calibration studies. In many cases, designers have experience with local soils and are skilled at calculating 1-D consolidation settlements using conventional procedures. It is good practice in such cases to develop a 1-D column of finite elements that models the soil profile at the site of interest. The 1-D column can be loaded and the resulting settlements compared to those calculated using conventional procedures. The material property values for the finite element analyses can be adjusted until a match is obtained. Similarly, if an independent estimate of the lateral load response, i.e., the Poisson effect, can be made, the material property values can be adjusted until the 1-D column results match the independent estimate. Ideally, one set of material property values would be found that provides a match to both the compressibility and the lateral load response over the range of applied loads in the problem to be analyzed. The selection of a method to obtain material property values depends, of course, on the type of information available. These methods are most effective when used in combination.

c. Finite element mesh. The finite element mesh should reflect the geometry of the embankment, both

with respect to the external surface geometry and the distribution of materials in the embankment and underlying foundation. Additionally, the mesh should reflect the configuration of any excavations or filling operations performed as part of construction. Most embankment construction problems are either 2-D plane-strain or 3-D type analyses. Levees or embankment dams constructed across broad alluvial valleys are good candidates for 2-D plane strain analysis, whereas embankment dams constructed within narrow canyons are good candidates for a 3-D finite element analysis. The mesh should also extend beyond the area of interest until a known boundary condition is encountered (e.g., bedrock can often be represented as a fixed boundary condition) or for a sufficient distance that conditions at the boundary do not significantly influence the calculated stresses and deformations in the area of interest.

d. Construction sequence. It is important to model the construction sequence in embankment problems for two reasons:

- (1) Soil response is nonlinear.
- (2) Geometry can change during construction, e.g., fill placement.

Because the nonlinear stress-strain behavior of soils depends on the confining pressure, it is almost always necessary to first calculate the initial *in situ* stresses in the foundation materials. Perhaps the only exception occurs when a rock foundation is being modeled as linear elastic. In addition, it is necessary to model the following types of construction operations in steps: excavation, fill placement, placement and removal of structural components, and application of loads and pressures. The construction steps should be modeled in the actual order in which they are to be carried out.

e. Calibration of the entire model. As can be seen from the foregoing, there are several factors that must be carefully considered to develop a good finite element model of an embankment construction problem. It is important to successful application of the method over the years to calibrate the entire process against instrumented case histories. Fortunately, several such comparisons have been published. Several of these are listed among the references in Chapter 4.

3-3. Case History: Birch Dam

a. *Project description.* Birch Dam, built across Birch Creek between 1974 and 1976, has a maximum height of 70 ft and a crest length of 3,200 ft. The embankment was constructed across alluvial soil deposits which vary in thickness from 10-ft near the abutments to a maximum of 37-ft near the center of the valley. A cross-sectional view of the embankment is shown in Figure 16. The foundation was primarily composed of compressible silts and clays with numerous lenses of silty and clayey sands. The core and cutoff trench contain materials which classify as a CL (according to the Unified Soil Classification System). The upstream and downstream shells contain coarser and less plastic materials which classify as ML's. The finite element analysis of Birch Dam was reported by Soriano, Duncan, and Simon in 1976.

b. *Purposes.* The finite element study of Birch Dam was performed to predict the stresses and movements in the embankment and foundation during construction, at the end of construction, and after filling of the reservoir. The finite element analysis of Birch Dam was reported by Soriano et al. (1976).

c. *Material model, properties, and finite element Code.* The hyperbolic model as implemented into ISBILD (predecessor to FEADAM), was used for the analysis of Birch Dam. The parameters for the

soil model were obtained from the interpretation of tests performed in the drained and undrained triaxial tests, respectively. All time dependent stresses and movements were computed *indirectly* since ISBILD is a statics program which does not account for consolidation. Separate finite element analyses were performed to model the construction sequence for both *drained* and *undrained* conditions. These are extreme conditions in which the analysis is carried out assuming that there is no dissipation of pore pressure at all times for the undrained case and complete dissipation of porewater pressures for the drained case. In this study, the authors contrived a scheme based on Terzaghi's theory of consolidation to weight the drained and undrained cases to determine the displacements and stresses in the embankment at any time.

d. *Mesh details.* The mesh used for both the drained and undrained analyses is shown in Figure 17. Only half of the mesh upstream of the centerline was modeled in the analysis due to the symmetrical geometry of the cross section. A full mesh was used to model the filling of the reservoir because of the asymmetry of the loading conditions. Seepage forces were determined from a seepage analysis and applied as concentrated forces to the appropriate nodal points in the full mesh. The resulting movements and stresses were then calculated.

e. *Construction sequence.* The construction schedule is presented in Figure 18. Both the drained

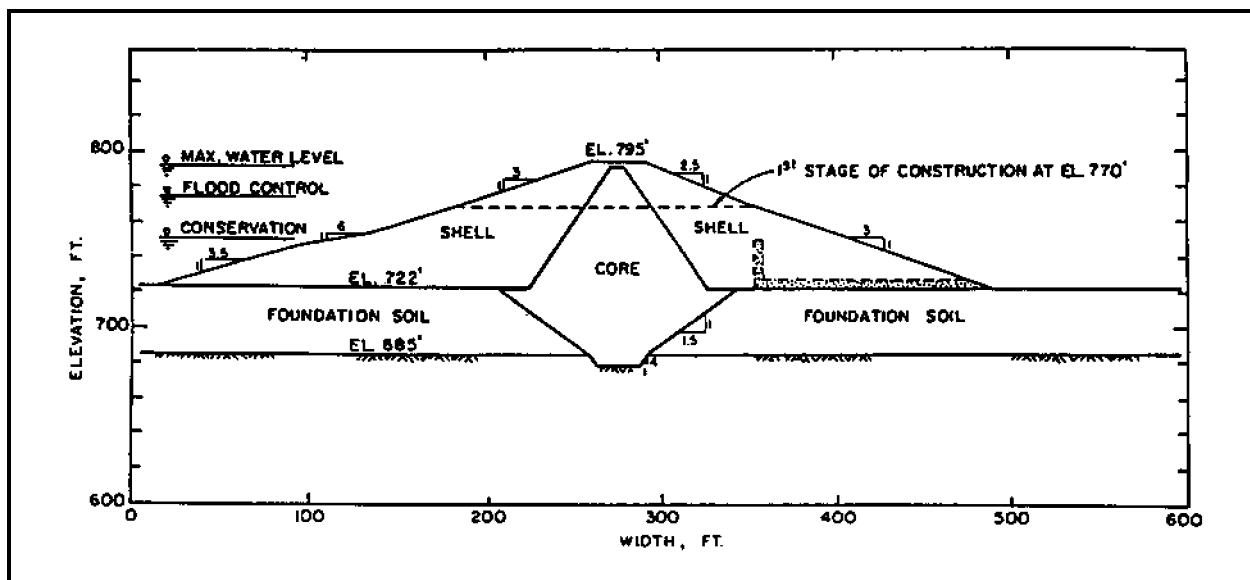

Figure 16. Cross-sectional view of Birch Dam

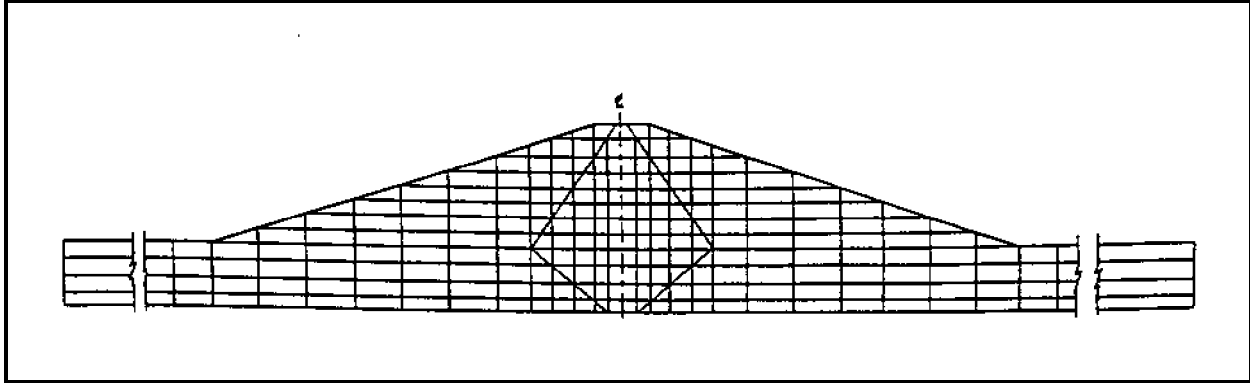

Figure 17. Finite element mesh of Birch Dam

and undrained analyses proceeded according to this schedule. Level ground conditions were presumed to exist just prior to the start of Stage I. The core trench was presumed to be in place at this time as excavation and filling of the core trench were not modeled. As shown in Figure 18, Stage I was modeled in five load steps by placement of the bottom five rows of elements and Stage II was modeled in three load steps by the top three rows of the embankment. Movements and stresses in the embankment and foundation were desired at the following times from the output:

- (1) Start of construction, $t = 0$ months.
- (2) End of Stage I, $t = 4$ months.
- (3) End of the waiting period between Stages I and II, $t = 13.5$ months.
- (4) End of Stage II, $t = 16.5$ months.
- (5) After construction had been completed for 13.5 months, $t = 30$ months.
- (6) After reservoir filling.

f. Results. A vector plot showing the displacements at various times with consideration of the effects of consolidation is shown in Figure 19. The percentage of the available shear strength mobilized in the cross section for the undrained and drained cases is shown in Figures 20 and 21, respectively. Also shown in these figures is the safety factor of the critical circles from a conventional limit equilibrium analyses. Figure 20 shows that the results for the undrained finite element method analysis agree with those from the slope stability analysis. In these analyses, the critical circle (whose factor of safety equals 1.25)

passes through the zone of foundation materials where 100 percent of the available shear strength is mobilized. Similar results are shown in Figure 21 for the drained case where the limit equilibrium analysis showed the safety factor to be 2.33. The estimated horizontal and vertical movements in the embankment and foundation with consolidation taken into account are shown in Figures 22 and 23 at the indicated times. These results are presented in a form consistent with that of data to be collected from instrumentation.

3-4. Case History: New Melones Dam

a. Project description. A second example of a finite element analysis of the construction and performance of an embankment dam was reported by Chang and Duncan (1977) for New Melones Dam. New Melones Dam was constructed by the U.S. Army Engineer District, Sacramento, on the Stanislaus River to create a multipurpose reservoir capable of impounding 2.4 million acre-ft of water. The dam, built in a canyon, has a maximum height of 625 ft above the streambed and a length of 1,600 ft. Plan and cross-sectional views of New Melones Dam are shown in Figures 24 and 25.

b. Purpose. The purpose of the analysis was to provide insight into three important questions related to the consolidation of the core and behavior of zoned embankment dams. The questions were:

- (1) What is the nature of expected movements in a zoned dam during the consolidation of the core?
- (2) How do the stresses in the embankment change during consolidation?

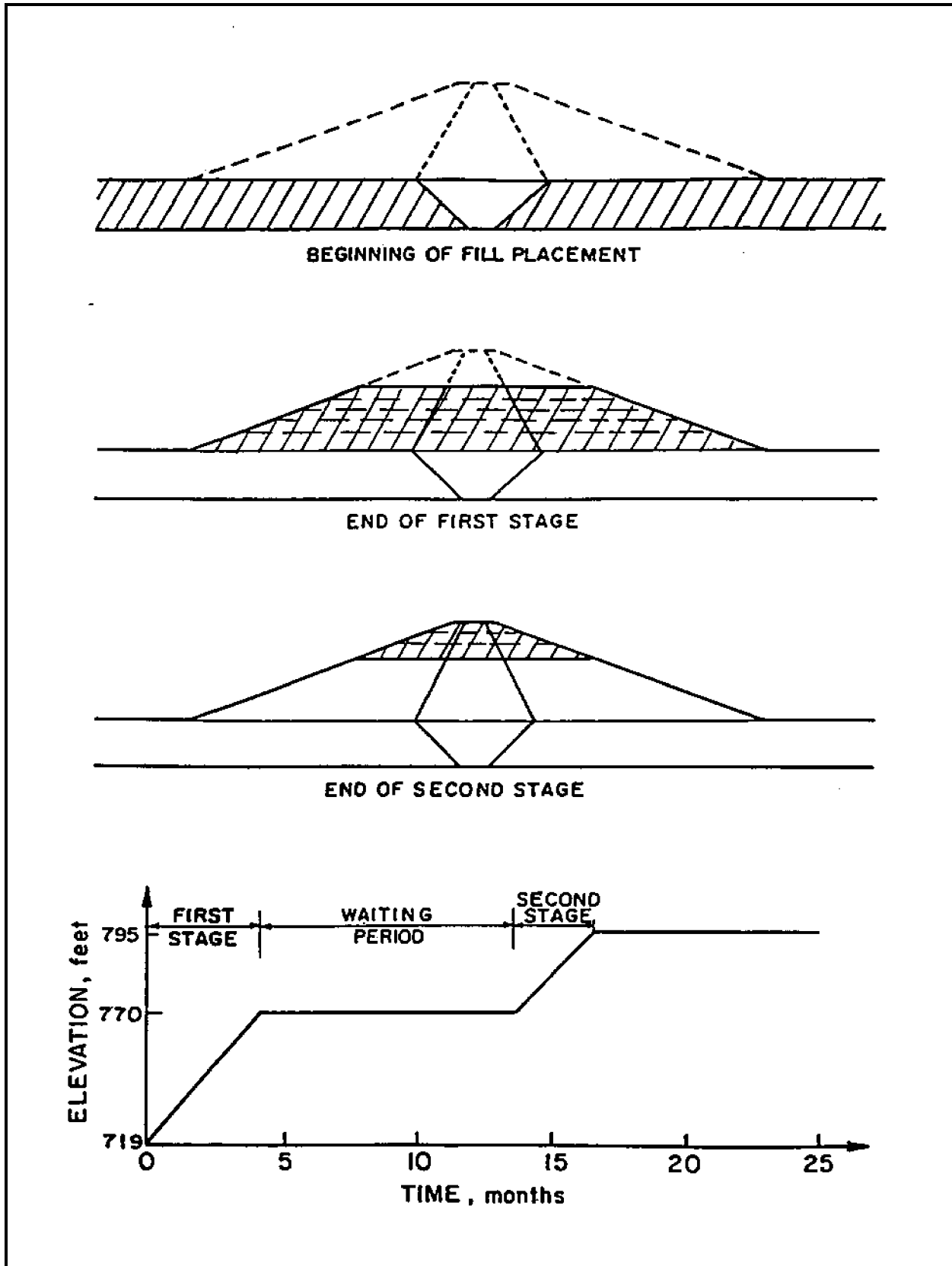

Figure 18. Construction sequence for Birch Dam

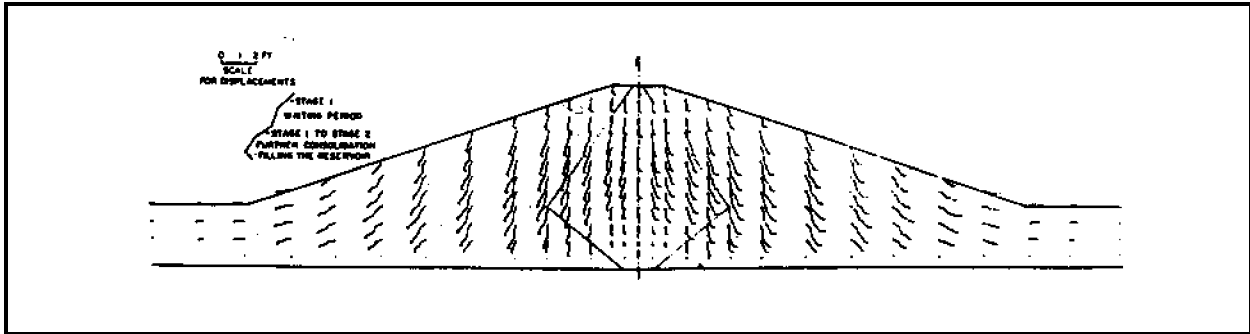

Figure 19. Displacements at selected times

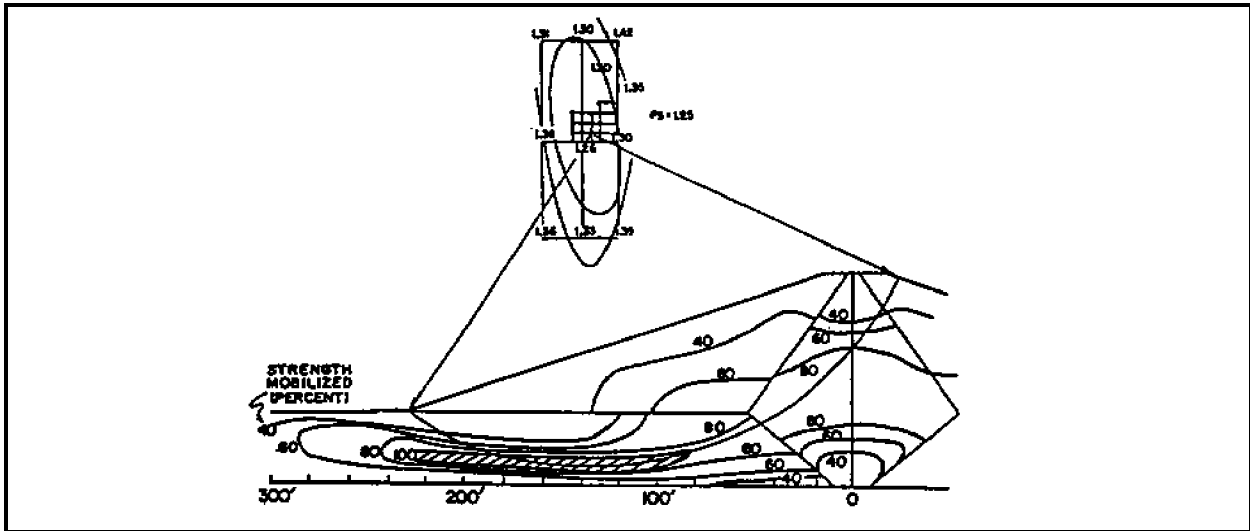

Figure 20. Percentages of mobilized shear strength for undrained case

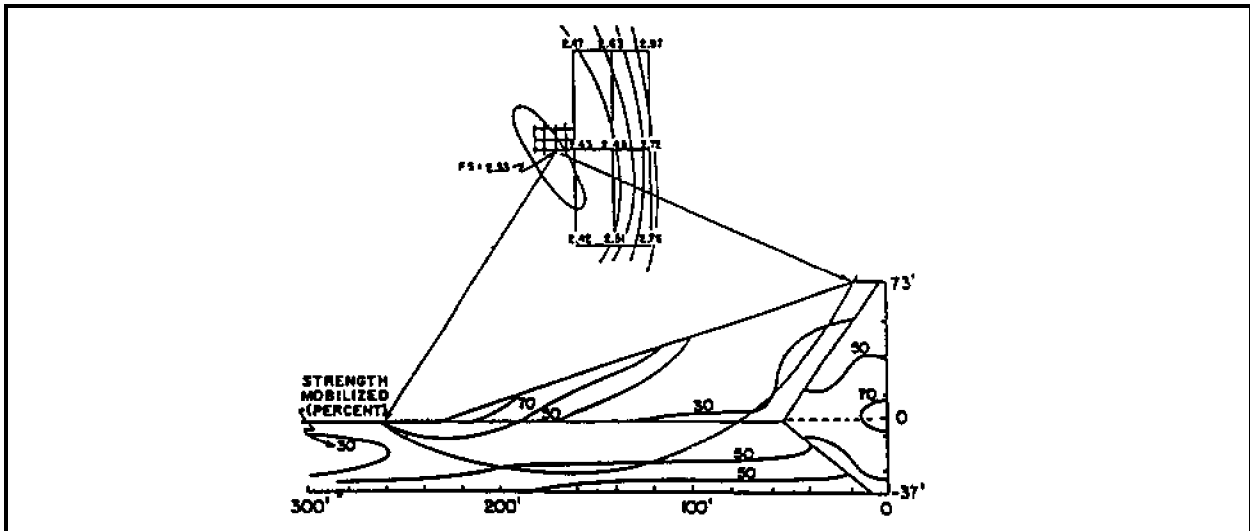

Figure 21. Percentages of mobilized shear strength and critical circle for drained analysis

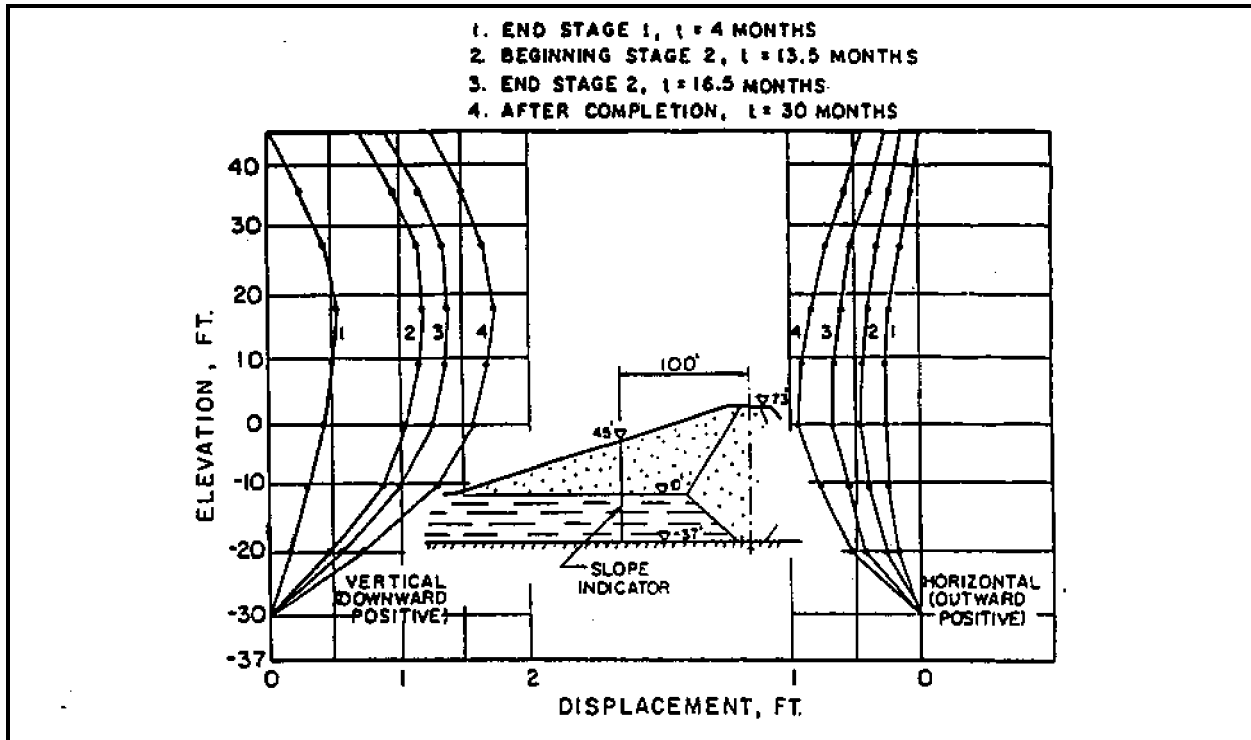

Figure 22. Estimated vertical and horizontal movements of slope indicators at selected times

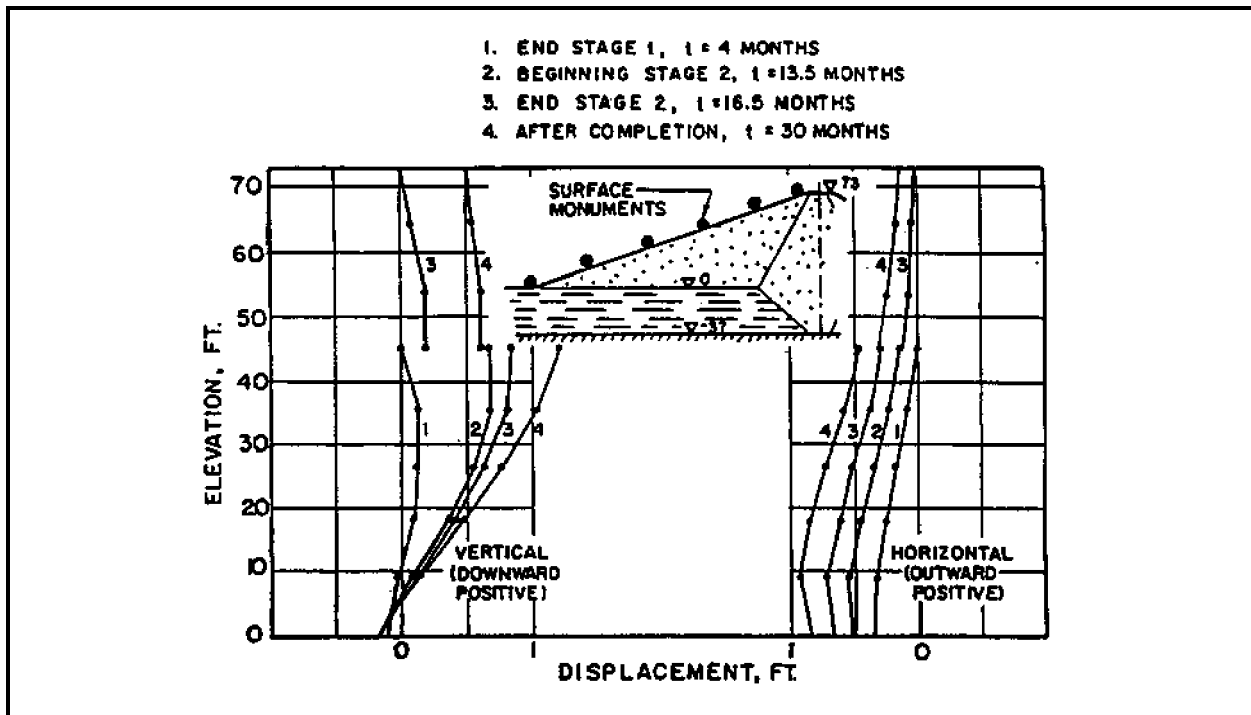

Figure 23. Estimated vertical and horizontal movements of the surface monuments at selected times

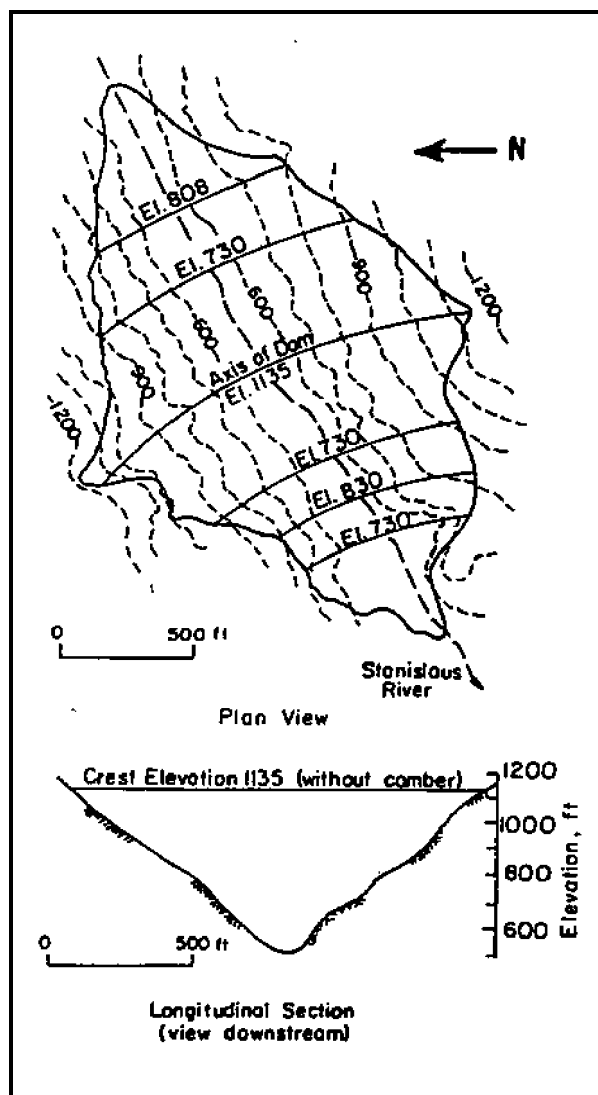

Figure 24. Plan and longitudinal views of New Melones Dam

(3) Are the long-term stresses, calculated assuming slow construction and assuming no excess pore water pressure, the same as those calculated taking into account the effects of consolidation?

c. *Material model, properties, and finite element code.* The finite element code used in this analysis was CON2D, and it has the ability to directly account for the effects of consolidation. In the study, it was assumed that a plane-strain analysis would serve as a reasonable approximation of the performance of the dam in the center of the valley. The mesh is shown in

Figure 26. Nonlinear stress-strain behavior was simulated using the Modified Cam-Clay model. Also, in the analysis, the permeability of the shell (rockfill) was very high compared to that of the core ($k = 10^{-7}$ cm/sec). The consolidation of partially saturated soils in the core was simulated using a "homogenized" pore fluid to account for the effects of water and air in the void spaces. Separate analyses were conducted for two different core conditions to account for the variations in water content and dry density which may occur during construction. These analyses accounted for a "stiff" core (corresponding to 95 percent relative compaction as determined by the Standard AASHTO compaction test and 1 percent dry of the optimum water content) and a "soft" core (corresponding to 90 percent relative compaction and optimum moisture content at the time of placement).

d. *Construction sequence.* The analysis was performed in three principal stages: (1) construction, (2) reservoir filling, and (3) long-term seepage. The construction represented a timespan of 3.5 years. The construction of the cofferdam was accomplished by introducing elements 1 through 16 as fill in two layers (Figure 26). The remainder of the dam was constructed by the addition of five layers of additional "fill elements." The construction was an undrained analysis as it was assumed that excess pore water pressures did not dissipate during the construction process due to the relatively short timespan of the construction period. The filling of the reservoir was modeled by the application of the water pressures of the full reservoir at the interfaces between the upstream and the core and the impervious soil in the cofferdam zone. The reservoir was assumed to be filled to elevation 990 ft. Forces were applied to nodes connected to "shell" elements to account for buoyancy due to submergence. The application of these pressures and forces is illustrated in Figure 27. Dissipations of excess porewater pressures during reservoir filling were also neglected because it was presumed that the reservoir would be filled within a relatively short period. During the third stage, the long-term seepage stage, fluctuations in the pool level were ignored as it was assumed that the elevation of the pool remained at 990 ft. During this stage, as steady seepage was approached, deformations within the dam were influenced by the dissipation of excess porewater pressures and seepage through the dam. In the analysis, stresses, strains, and porewater pressures were calculated 5, 15, 50, and 80 years after the reservoir was filled.

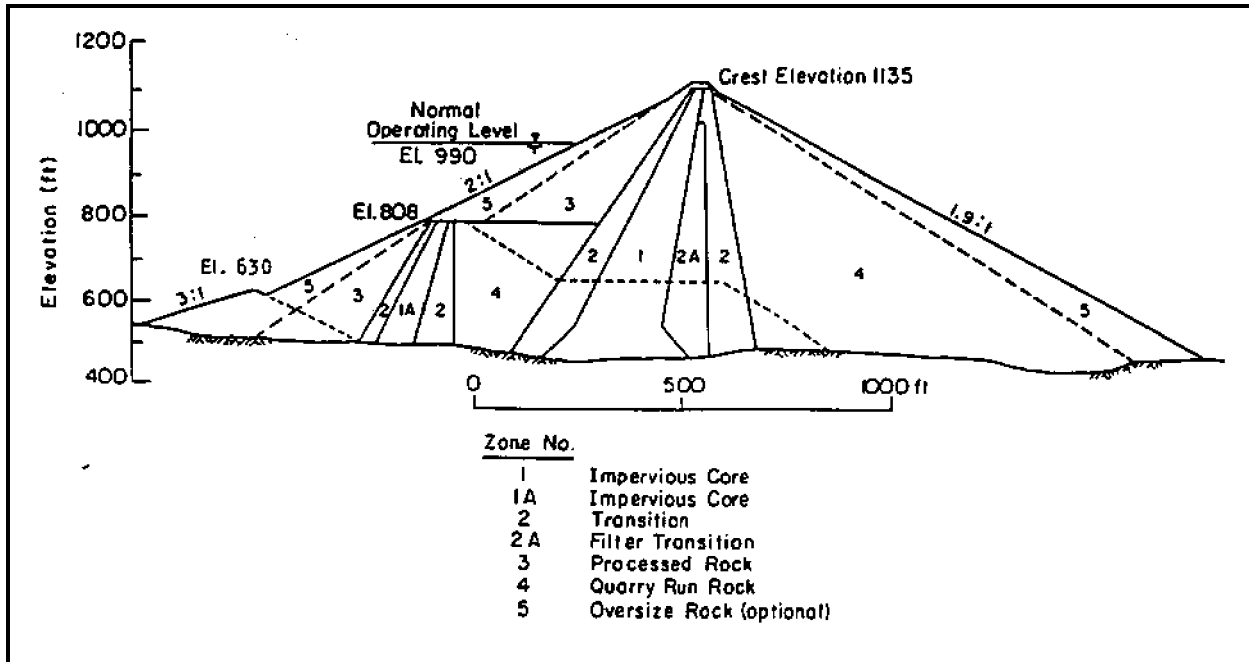

Figure 25. Cross-sectional view of New Melones Dam

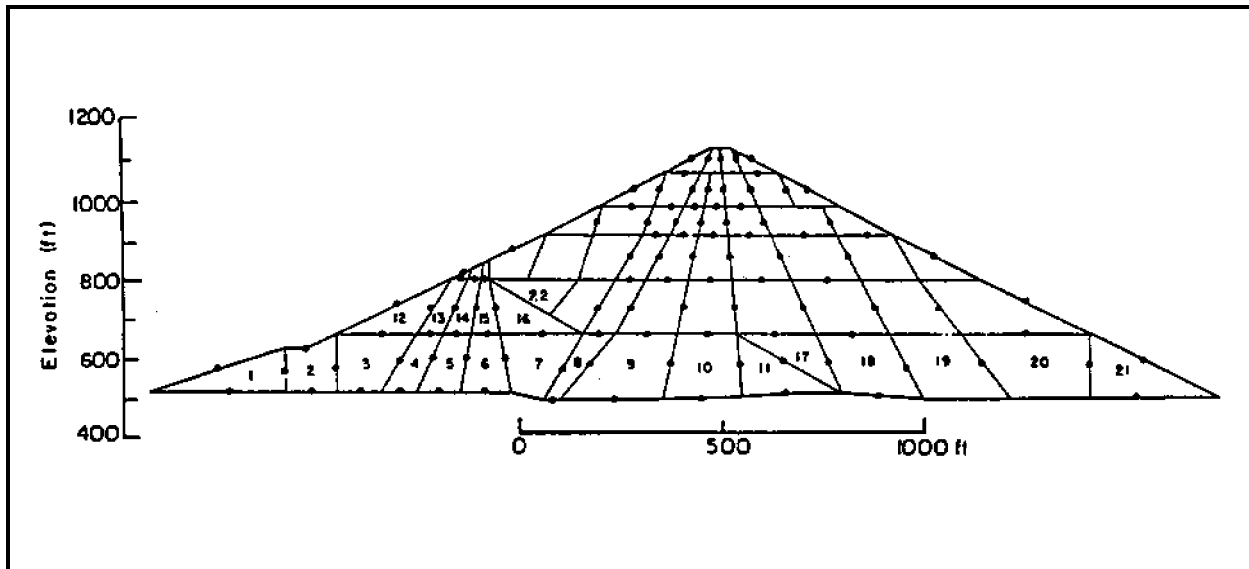

Figure 26. Finite element mesh of New Melones Dam

e. *Results.* The analysis was summarized providing answers to the three primary questions posed earlier as reasons for performing the study. Figures 28 and 29 show that the expected horizontal movements for the "stiff" and "soft" cores show that the maximum calculated horizontal movements during the development of steady state seepage was about 0.6 ft toward the downstream. The analysis

indicated that some upward movement (rebound) might occur due to the effects of buoyancy. Upward movement (rebound) in the upstream shell may occur due to the effects of buoyancy as the upstream shell becomes submerged. However, it was reasoned that other effects such as creep or secondary compression which were not accounted for in the analysis would contribute to a net

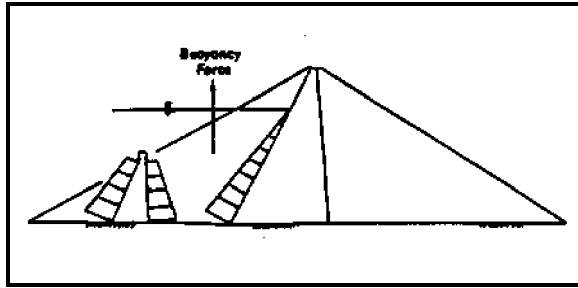

Figure 27. Treatment of upstream shell during reservoir filling

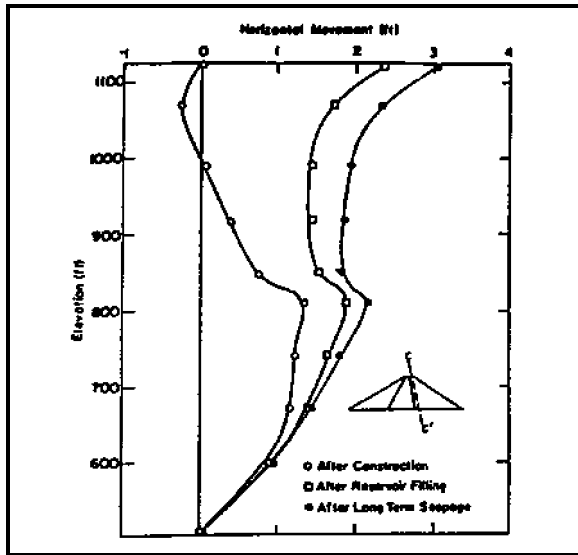

Figure 28. Horizontal movements for "stiff" core FE analysis

settlement rather than an uplift movement. The maximum and minimum principal stresses in the embankment for the "stiff" core case are shown in Figures 30 and 31, respectively. For both cases, the maximum and minimum principal effective stresses in the upstream shell decreased due to the effect of submergence. The maximum principal effective stress in the downstream shell decreased a small amount, and the minimum effective principal stress increased during consolidation and the development of long-term seepage in the core. As part of another finite element calculation, the long-term stresses were calculated using the hyperbolic constitutive model under the assumption that the construction was slow enough so as not to induce excess porewater pressures during the placement of fill.

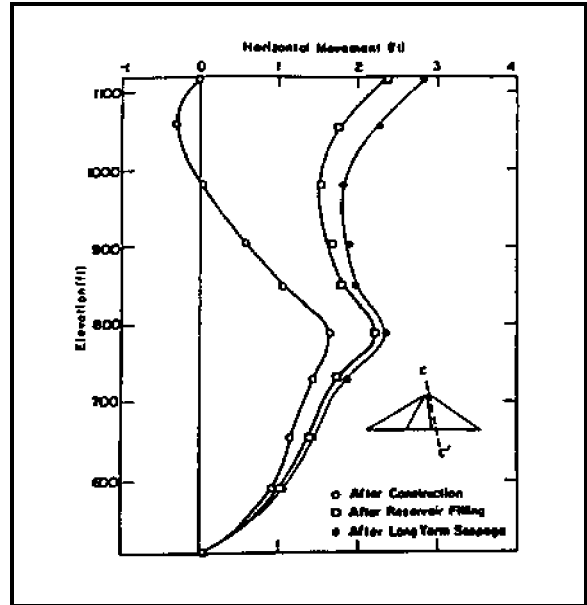

Figure 29. Horizontal movements for "soft" core FE analysis

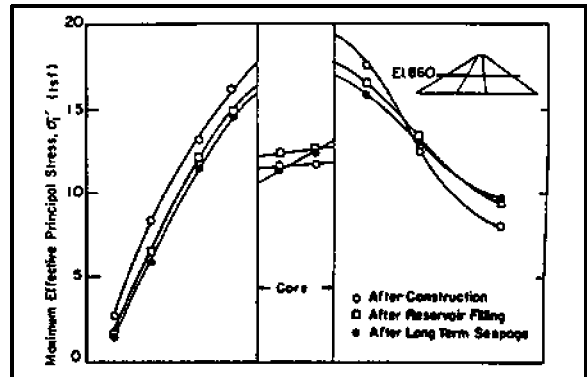

Figure 30. Maximum principal stress for "stiff" core analysis

These stresses were compared with the long-term stresses computed using the CON2D model in Figure 32. The results show that the stresses are nearly the same for this case. Overall, the movements in the embankment were considered small for the range of compaction conditions considered in the analysis. It was speculated that the movements would have been larger had the core been treated as a wetter and softer material. Additionally, the difference between the long-term stresses computed with the hyperbolic model and the consolidation model might also have been greater for the wetter and softer core.

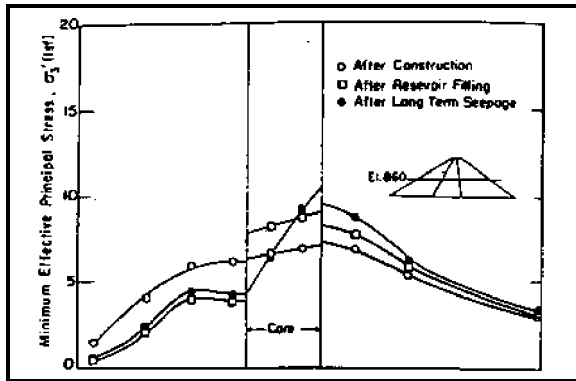

Figure 31. Minimum principal stress for "stiff" core analysis

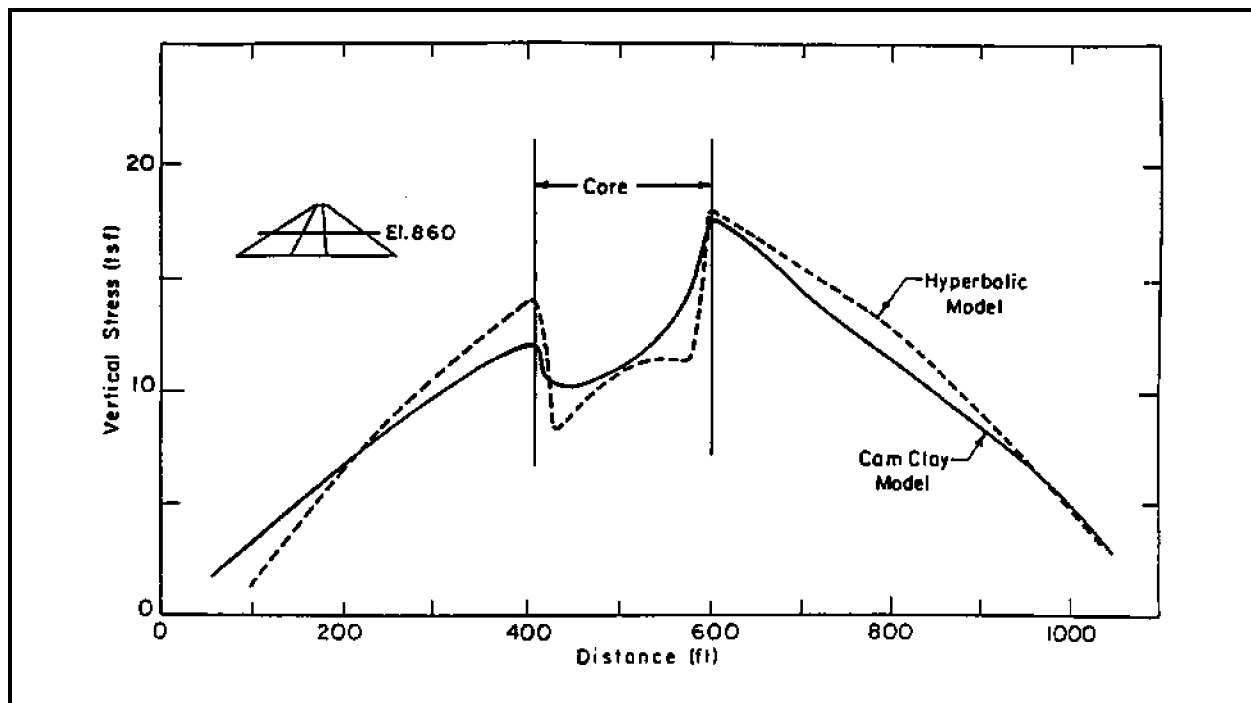

Figure 32. Comparison of long-term stresses for "drained" analysis with those for consolidation analysis

Chapter 4 Seepage Problems

Seepage problems involve the analysis of the flow of groundwater through porous media such as soil and rock. Geotechnical engineers typically perform seepage analyses as part of the design process for embankment dams, levees, and river structures such as locks and dams.

4-1. Results and Uses of Seepage Analyses

The principal quantity solved for in a finite element solution of a seepage problem is the pressure head at each nodal point in the finite element mesh. All flow is assumed to occur through the pore spaces of a rigid soil skeleton. From these heads, the quantity and velocity of flow, and hydraulic gradients at any point in the system can be determined. Flow nets can be constructed from the finite element results to help the design engineer interpret the results.

4-2. Types of Seepage Analyses

a. Seepage problems. Seepage problems can be classified according to the type of flow conditions presumed to exist for the analysis. The analyses of most seepage problems for engineering projects are performed under the assumption of *steady-state* flow conditions. This assumption implies that all conditions affecting the flow of water through the system are the same at all times, hence the solution is independent of time. In contrast, *transient* solutions to seepage problems, performed less frequently, are time-dependent as factors such as changing headwater and tailwater levels and the flow of water into partially saturated soils can be accounted for in this type of analysis.

b. Confined or unconfined seepage problems. Seepage problems can also be classified as confined or unconfined depending on the boundary conditions presumed to exist. In confined flow problems, the locations of all boundaries are known and fixed. Unconfined flow problems must have at least one impervious boundary and a free surface boundary. The location of the free surface boundary (phreatic surface) is unknown and must be determined as part of the solution. Boundary conditions are presumed to be impervious to flow.

4-3. Constitutive Law and Material Properties

a. Darcy's law. The constitutive relationship in most finite element codes is based on Darcy's law. Darcy's law states that the velocity of the fluid is proportional to the hydraulic gradient. The constant of proportionality in this relationship is termed the coefficient of permeability. This coefficient is a parameter which is material dependent. Most finite element codes are capable of handling materials having anisotropic permeabilities.

The coefficient of permeability is typically estimated in three different ways:

(1) Sampling and laboratory testing. Sampling and laboratory testing where samples retrieved from a field exploration program are sent to the laboratory where permeability tests can be performed. The two most common types of laboratory permeability tests are the constant head and falling head types of tests.

(2) Correlations with grain-size distribution. For example, the Lower Mississippi Valley Division of the Corps of Engineers has correlated the grain-size distribution of sands in the Lower Mississippi Valley to the coefficient of permeability. This relationship is shown in Figure 33.

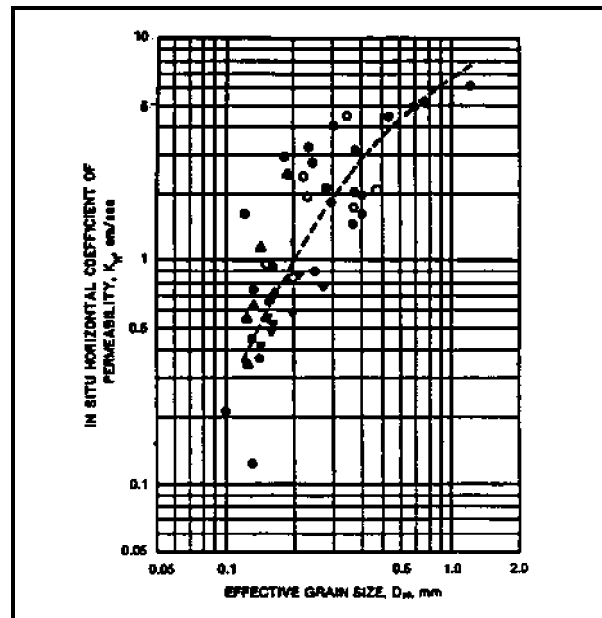

Figure 33. Relationship between in situ horizontal permeability and effective size

(3) Field tests. Permeability can be estimated from field pump tests and falling head tests performed in boreholes.

b. *Documented reference.* Engineer Manual EM 1110-2-1901 entitled "Seepage Analysis and Control for Dams" contains more detailed information on the methods for determining the coefficient of permeability.

4-4. Case History: S. A. Murray Hydroelectric Plant

a. *Project description.* A 2-D plan view seepage analysis of the S. A. Murray, Jr. Hydroelectric Station was reported by Knowles (1992). The power plant is adjacent to the Mississippi River just upstream from the Old River Control Structure.

Plan and cross-sectional views of the site are shown in Figures 34 and 35. The powerplant is founded in a medium to very dense layer of fine to medium

sand, approximately 100 ft deep. Below this sand layer is hard tertiary clay. A channel was cut from the Mississippi River through the mainline levee to divert flow to the powerplant. An exit channel leads flow away to auxiliary overflow channels. The entire site is surrounded by a levee system which ties into the mainline levee and the natural levee and backswamp deposits.

b. *Purpose of analysis.* As shown in Figure 34, the powerplant receives flow from the Mississippi River through a diversion channel and could experience differential hydraulic heads up to 26 ft from project flood conditions and 41 ft under extreme conditions. These heads cause seepage to occur under the structure and subject it to uplift pressures. Seepage control measures include concrete cutoff walls and a drainage system. These cutoff walls under the structure extend through the sand layer to the tertiary deposits. The analysis was performed to determine the seepage and associated uplift pressure beneath the powerplant and other structural features (e.g. concrete channel linings) and to study the effect of the cutoff walls on the seepage.

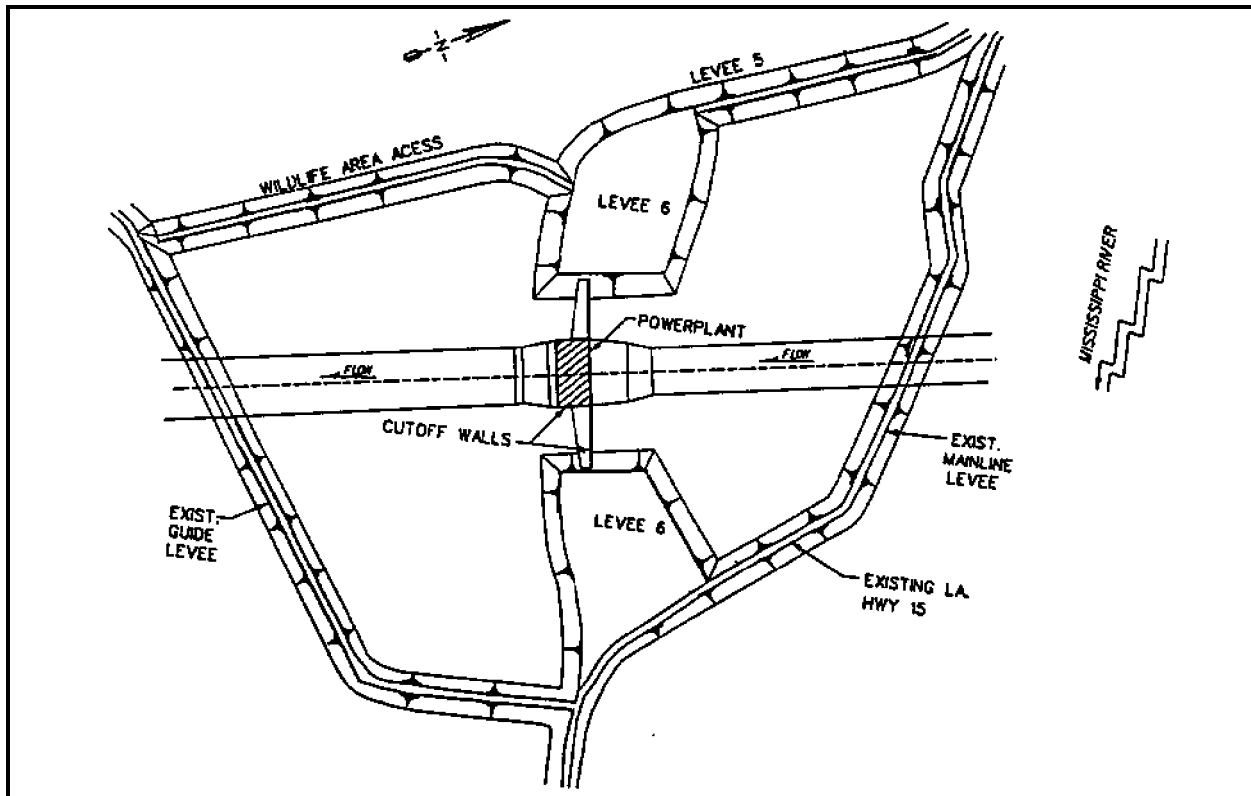

Figure 34. Plan view of S. A. Murray Hydroelectric Plant

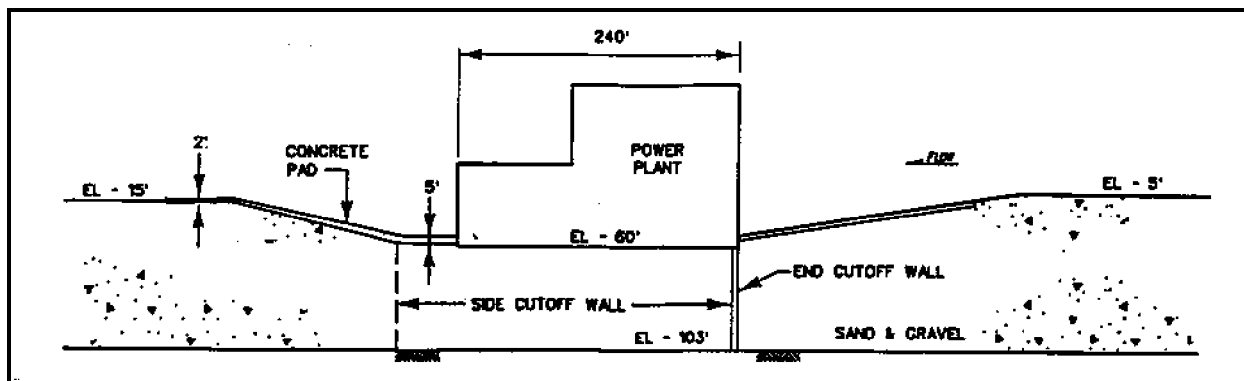

Figure 35. Section view through centerline of powerplant

c. *Finite element model, code, and material properties.* The program CSEEP (Tracy 1983) was to assess the uplift pressure on the structure from a plan view model. Two simplifying assumptions were made so that the problem could be solved as a 2-D problem. First, it was assumed to be a confined flow problem. The ground surface adjacent to the structure and channels is covered by a natural clay and silt blanket or by a man-made clay blanket. These make the surface of the surrounding area highly impermeable, therefore, water will flow mainly from the upstream channel and the surrounding subsurface stratum under the structure to the downstream channel. The second assumption is that the seepage occurs in one uniformly thick layer having a constant permeability. Figure 36 shows the finite element mesh used in the analysis. The boundaries were chosen so they would not unduly influence the seepage pattern around the power plant. The boundary conditions (shown in Figure 36) were selected to represent a piezometric level equal to the water level of the Mississippi River. The extreme differential hydraulic head conditions, 41 ft, were applied in these analyses. The soil is considered to be homogeneous and isotropic with a permeability of 0.14 ft/min. The design permeability for the cutoff wall was 2×10^{-6} ft/min. The effect of the cutoff walls on the seepage was of particular interest with respect to the resulting uplift pressures under the powerplant and downstream lining. Several analyses were performed in which the permeability of the cutoff walls was varied from 10^{-6} to 10^{-2} ft/min to determine the range of effectiveness of the cutoff walls in controlling uplift pressures.

d. *Results.* Figure 37 shows a vector plot of flow for the case of the cutoff walls having a permeability of 2×10^{-6} ft/min. Most flow occurs around the cutoff walls from upstream to downstream with

little under the structure itself. Contours of total head for this case are shown in Figure 38. Most head drop occurs along the walls outside of the powerplant structure and downstream channel lining. The uplift pressure distribution along the centerline of the structure is plotted in Figure 39 for this case. Uplift pressures resulting from the various cutoff wall permeabilities used in the parametric study are shown in Figure 40. At the highest permeability of 10^{-2} ft/min, the distribution of head is nearly linear under the structure. Another analysis performed in which the cutoff wall was modeled as impervious (zero permeability) gave results which were almost identical to the results for 10^{-6} ft/min. The results of the analysis clearly display the influence of the cutoff wall on the uplift under the structure. The design permeability makes the cutoff wall act as a relatively impervious barrier causing water to flow around the structure resulting in a longer flow path and reduced uplift pressures under the structure. Conversely, with the highest permeability, 10^{-2} ft/min, the wall hardly impedes flow at all because this value is near the same order of permeability as the surrounding soil, 10^{-1} ft/min.

4-5. Case History: Cerrillos Dam

a. *Project description.* Palmerton (1993) reported on a 3-D steady-state seepage analysis of Cerrillos Dam near Ponce, Puerto Rico, for the U.S. Army Engineer District, Jacksonville. Cerrillos Dam is 323 ft high and has a crest length of 1,555 ft. The dam consists of a central clay core, a grout curtain extending to a depth of 200 ft, and upstream and downstream rockfill shells with the appropriate transition zones. The geologic structure near the dam is characterized by steeply dipping planar and parallel

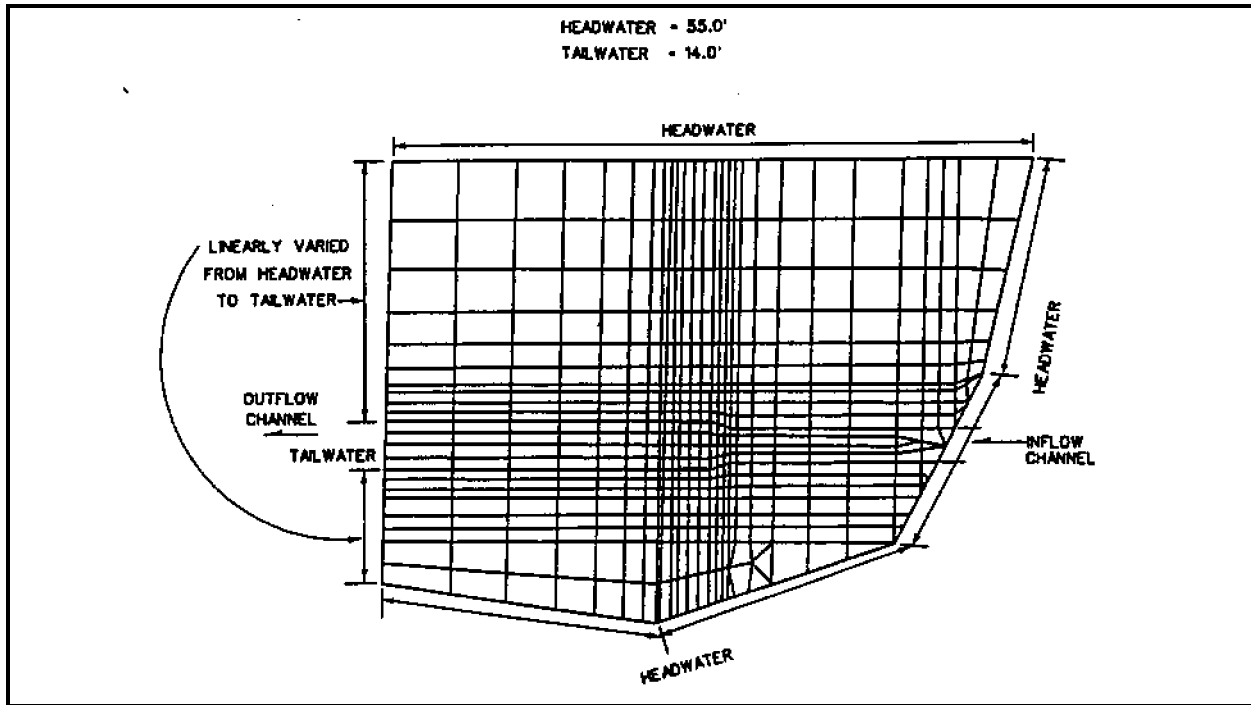

Figure 36. Grid generated for plan view model of S. A. Murray Hydroelectric Plant

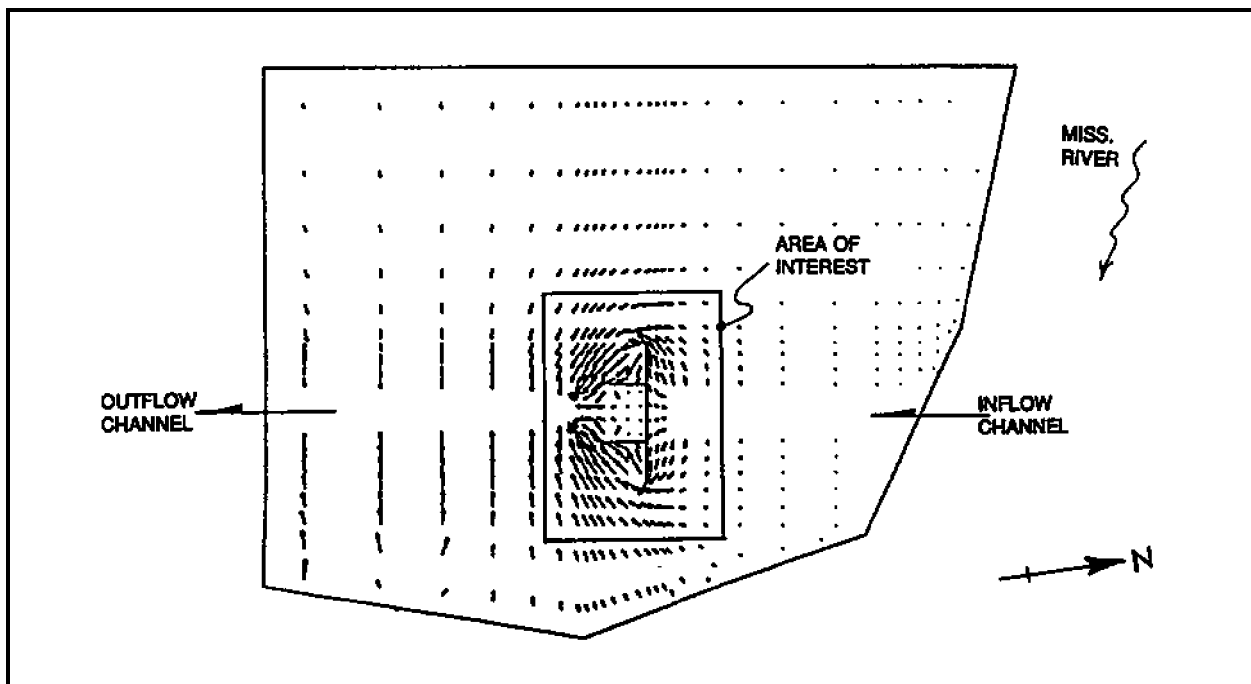

Figure 37. Flow velocity vectors with the cutoff wall at a permeability of 2×10^{-6} ft/min

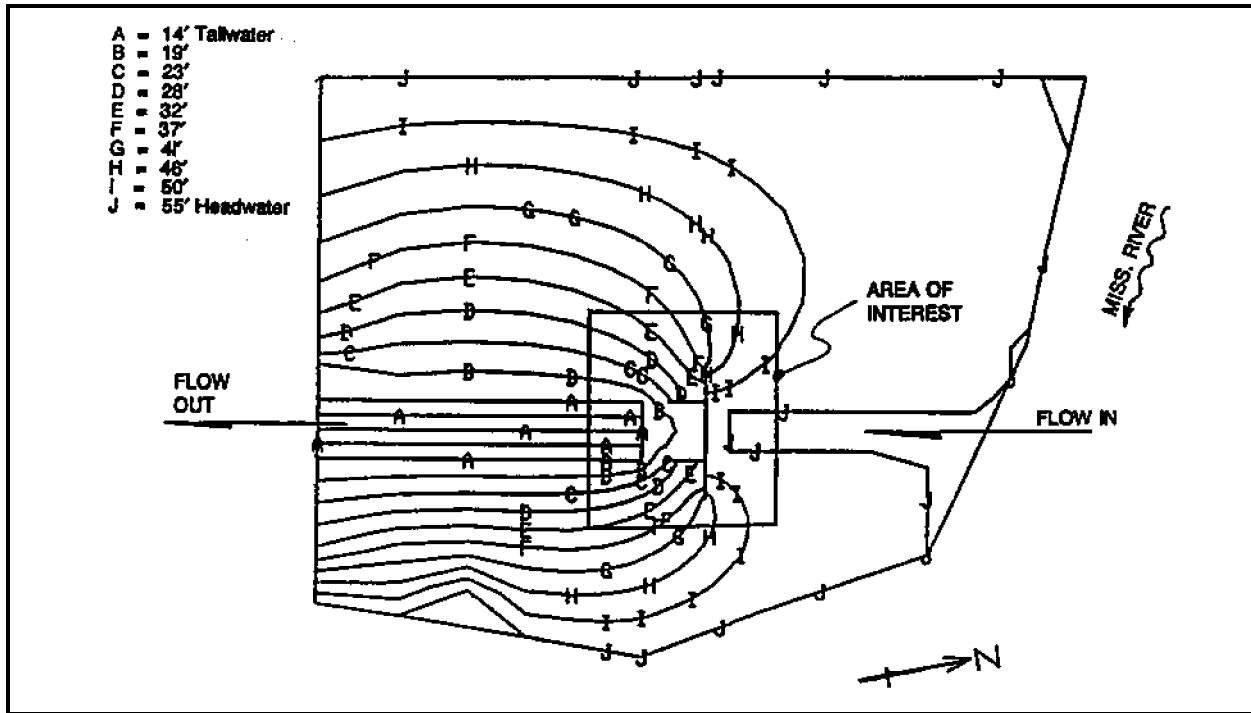

Figure 38. Total head contours with cutoff wall at a permeability of 2×10^{-6} ft/min

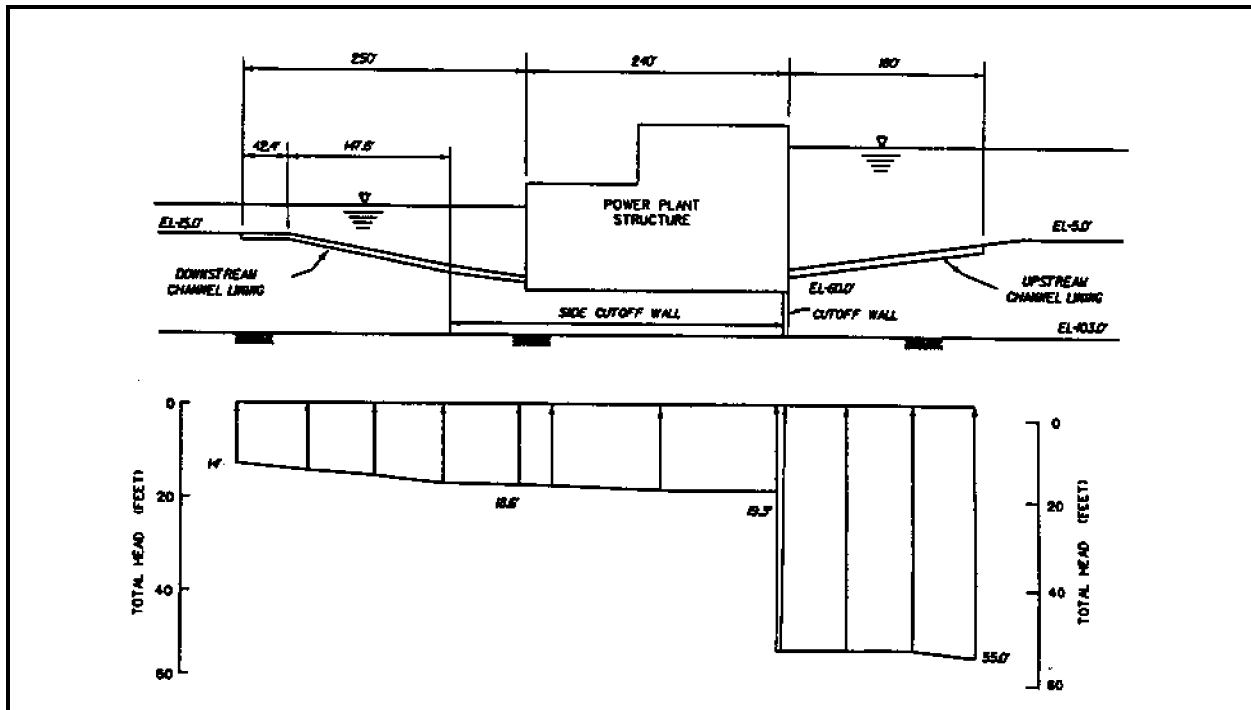

Figure 39. Uplift at centerline of powerplant with cutoff wall permeability of 2×10^{-6} ft/min

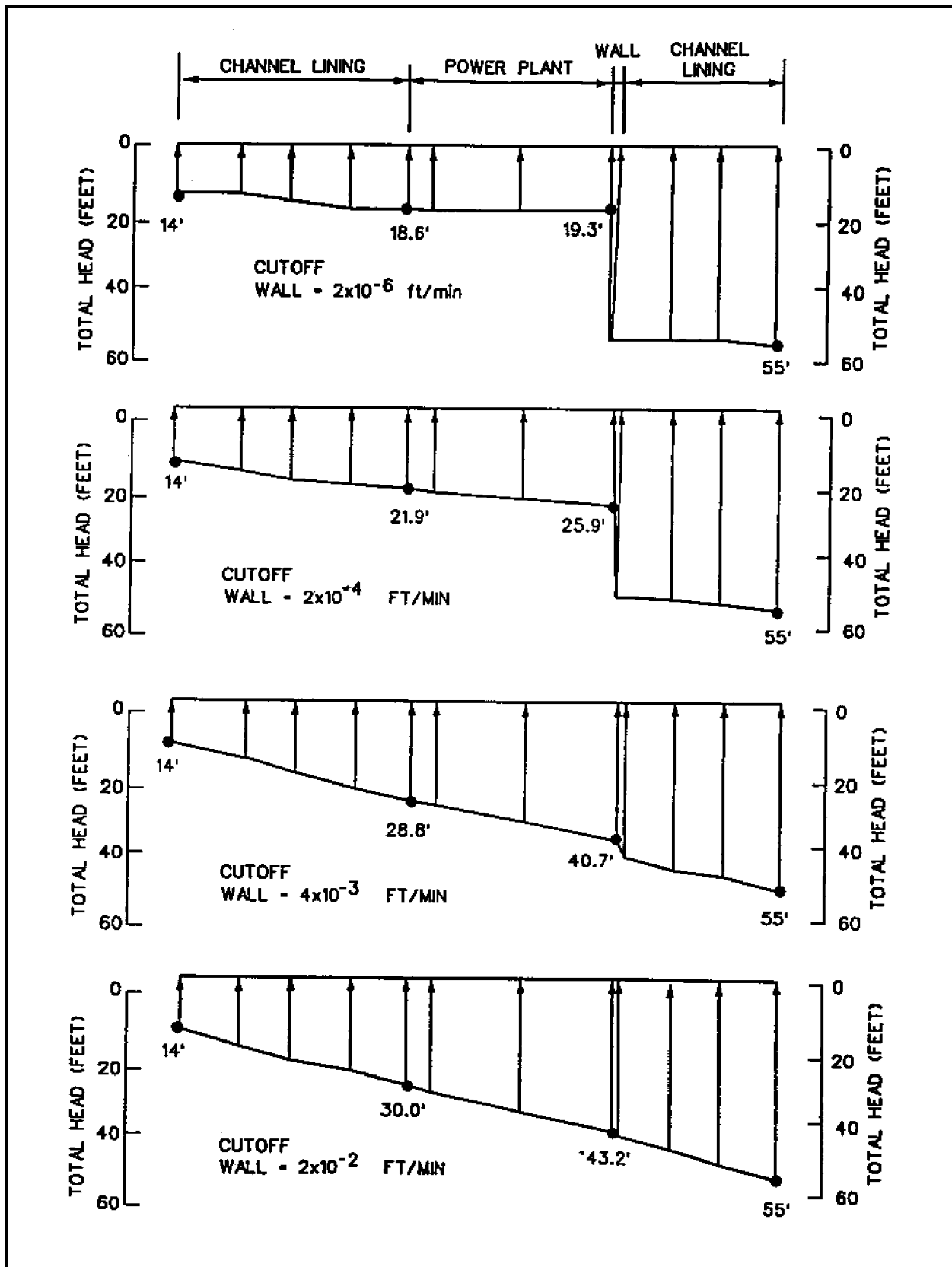

Figure 40. Uplift at centerline of powerplant and channel linings for a range of cutoff wall permeabilities

units of limestone, siltstones, and tuff. Of these, the Ridge Limestone Unit is the most pervious. The Ridge Limestone Unit outcrops on the left valley wall at the dam's abutment. The 3-D spatial relationships between the Ridge Limestone Unit and the components of the embankment dam are shown in Figures 41 and 42. These figures show that at the left abutment different portions of the Ridge Limestone Unit are exposed or are in contact with the upstream rockfill shell, the impervious core, and the grout curtain. Water from the reservoir was believed to enter the Ridge Limestone Unit on the left abutment where it moved beneath the grout curtain and into the seepage collection system located on the downstream side of the dam.

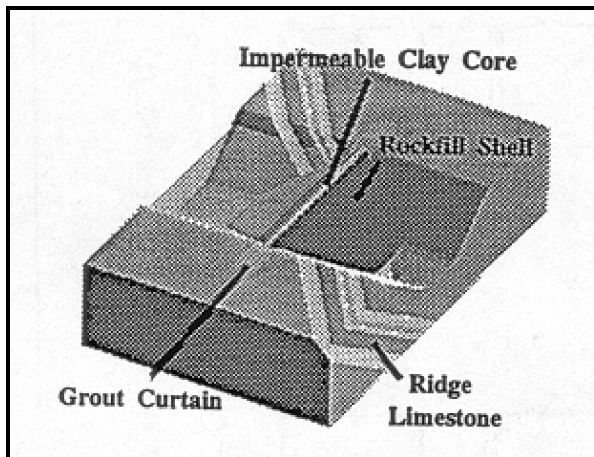

Figure 41. Simplified 3-D model dam, grout curtain, and Ridge Limestone

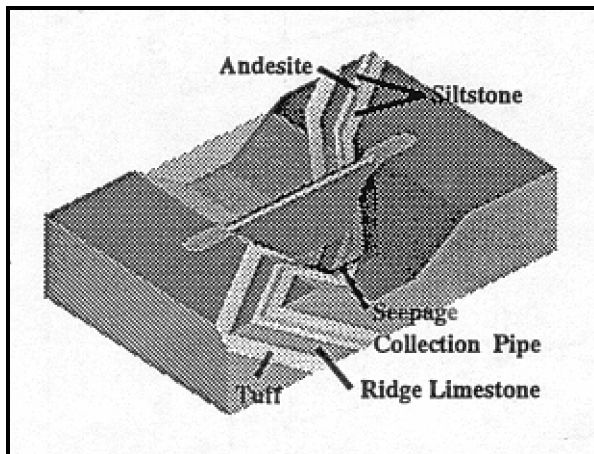

Figure 42. View showing geology at Cerrillos Dam (rockfill shells are transparent)

b. *Purpose.* The 3-D finite element analyses was performed because the quantity of seepage, 4 cfs, after the first reservoir filling when the pool was at el 495 (depth of 200 ft) exceeded the design estimate of 1 cfs. The initial estimate was based on a 2-D hand drawn flow net analysis which was not able to account for the complex geological conditions at the site. The 3-D analysis was performed to overcome this limitation and gain an improved understanding of the flow conditions. After validating the 3-D model against the observed flow quantities the model was used to predict seepage quantities at different pool elevations and evaluate the effectiveness of potential remedial measures.

c. *Finite element model.* Palmerton used the 3-D finite element code, CSEEP3D, developed by Tracy (1991) to perform his analysis. The problem was treated as a steady-state unconfined flow problem. The methods developed for pre- and post-processing for this problem were critical to the success of this study due to the large size of the finite element simulation. A grid generator program was written specifically for this study to develop the mesh shown in Figure 43 as the task of manually constructing the 3-D mesh for a problem of this size would be overwhelming. Different finite element meshes were used depending upon the pool elevation made for a particular run. For example, for the case where the pool is 350 ft deep, the generated mesh contained 8,282 elements and 10,810 nodal points. All meshes for this study were based on the idealized section shown in Figure 44. The output file from the finite

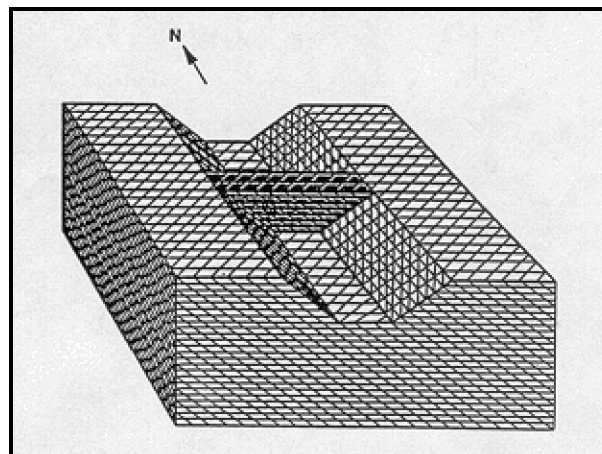

Figure 43. 3-D finite element mesh

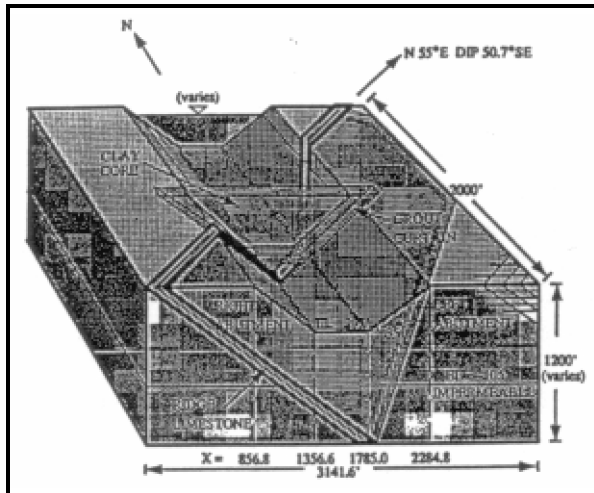

Figure 44. Pertinent dimensions and features of 3-D finite element mesh

element runs were very extensive. Computer routines were developed to extract piezometric heads, flows, and the position of the phreatic surface from the output of the 3-D seepage code. The permeabilities used in this analysis are listed in Table 1.

Table 1. Permeabilities of Materials for Cerrillos Dam

Material	Permeability (cm/sec)
Grout Curtain	1.0×10^{-6} cm/sec
Impermeable clay core of dam	6.4×10^{-7} cm/sec
Ridge Limestone Unit	5.0×10^{-3} cm/sec
All other foundation rock units above el -105 ft	1.0×10^{-4} cm/sec
All foundation rock units below el -105 ft	Impermeable

Palmerton concluded that 3-D finite element solutions offer an effective engineering approach toward the evaluation of proposed corrective measures for reducing or controlling seepage under and through embankment dams where conditions warrant accounting for

3-D effects. Additionally, he recommended the use of 2-D finite element analysis for 2-D situations because of the limitations and oversimplifications

inherent in the conventional flow net analysis which is performed manually. Palmerton noted that for "situations where multiple zones and anisotropic permeability must be included, a numerical model is, for all practical purposes, mandated."

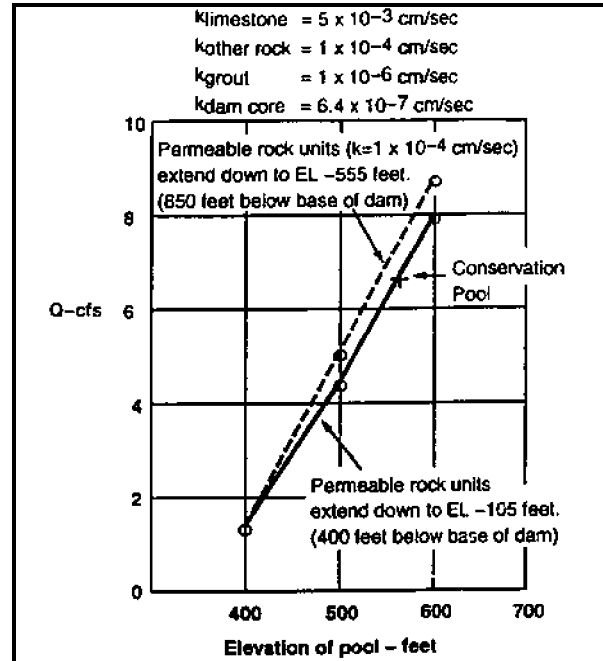

Figure 45. Predicted seepage discharges for various pool levels from 3-D FE analysis

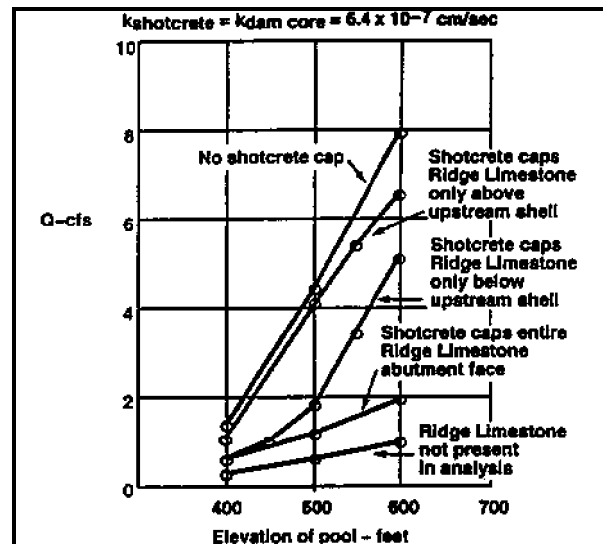

Figure 46. Effect of shotcrete placement on left valley wall

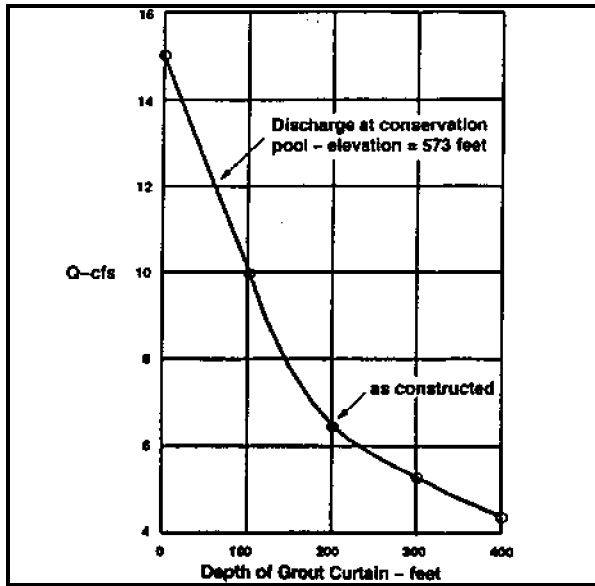

Figure 47. Effect of deepening grout curtain

Chapter 5 Sources of Further Information

5-1. Finite Element Codes Used in the Analysis of Past Corps of Engineers Geotechnical Projects

Table 2 lists the finite element codes which have been used in the past on Corps' projects. The table also lists the applications and office symbols at the Waterways Experiment Station where further information can be obtained about each code.

5-2. References

A list of selected references has been compiled in the bibliography for purposes of assisting design engineers with their finite element analyses. The list is by no means intended to be complete but is intended to provide finite element users with places to go to get started with applying the finite element method to a given problem in geotechnical engineering. The list was compiled with a focus toward the collection of sample problems to aid a designer in becoming

familiar with the methods used by other analysts to solve similar problems. The list is divided into seven categories which includes selected references on:

- a) Text books and general references.
- b) Embankment dams.
- c) Constitutive models.
- d) Seepage analysis.
- e) Soil-structure interaction analysis.
- f) Reinforced earth analysis.
- g) Consolidation.
- h) Dynamic analysis of embankment dams.

a. *Text books and general references.*

Bathe, K. J. (1982). *Finite Element Procedures in Engineering Analysis*. Prentice-Hall, Englewood Cliffs, NJ.

Desai, C. S., and Christian, J. T. (1977). *Numerical Methods in Geotechnical Engineering*. McGraw-Hill, New York.

Hinton, E., and Owen, D. R. J. *Finite Element Programming*. Academic Press, San Diego, CA.

Table 2. Finite Element Codes Used In Analysis of Corps Geotechnical Projects

Code Name	Geometry	Applications	Source/s for further Information
STUBBS	Plane strain Axisymmetric	Statics, Soil-structure Interaction, Consolidation, Transient Seepage	CE-WES-GS-GC
SOILSTRUCT	Plane strain	Statics, Soil-structure interaction	CE-WES-IM-DI
FEADAM	Plane strain	Static analysis of earth embankments	CE-WES-IM-DI
FLUSH	Plane strain	Earthquake analysis, dynamic soil structure interaction	CE-WES-GS-GC
TARA	Plane strain	Earthquake analysis	CE-WES-GG-H
CSEEP	Plane flow Plan view flow Axisymmetric	Steady state seepage	CE-WES-IM-DI
CSEEP3D (Tracy 1991)	3-D flow	Steady state seepage	CE-WES-IM-DI CE-WES-GS-R

Hughes, T. J. R. (1987). *The Finite Element Method, Linear Static and Dynamic Finite Element Analysis*. Prentice-Hall, Englewood Cliffs, NJ.

Lewis, R. W., and Schrefler, B. A. (1987). *The Finite Element Method in the Deformation and Consolidation of Porous Media*. Wiley, New York.

Zienkiewicz, O. C. (1977). *The Finite Element Method*. 3rd ed., McGraw Hill, New York.

b. *Embankment dams.*

Chang, C. S., and Duncan, J. M. (1977). "Analysis and Consolidation of Earth and Rockfill Dams," Volumes 1 and 2, Contract Report S-77-4, U.S. Army Engineer Waterways Experiment Station, Vicksburg, MS.

Clough, R. W., and Woodward, R. J. (1967). "Analysis of Embankment Stress and Deformations," Proceedings Paper 5329, *Journal of Soil Mechanics and Foundations Division, ASCE* 93(SM4), 529-549.

Duncan, J. M., Seed, R. B., Wong, K. S., and Mabry, P. (1984). "FEADAM84: A Computer Program for the Finite Element Analysis of Dams," Research Report No. SU/GT/84-03, Stanford University, Stanford, CA.

Kulhawy, F. H., and Duncan, J. M. (1972). "Stresses and Movements in Oroville Dam," *Journal of Soil Mechanics and Foundations Division, ASCE* 98(SM7), New York.

Kulhawy, F. H., Duncan, J. M., and Seed, H. B. (1969). "Finite Element Analysis of Stresses and Movements in Embankments During Construction," Geotechnical Engineering Report TE-69-4, Berkeley, CA; also U.S. Army Engineer Waterways Experiment Station Contract Report S-69-8, Vicksburg, MS.

Lefebvre, G., and Duncan, J. M. (1971). "Three Dimensional Finite Element Analysis of Dams," Contract Report S-71-6, U.S. Army Engineer Waterways Experiment Station, Vicksburg, MS.

Nobari, E. S., Lee, K. L., and Duncan, J. M. (1973). "Hydraulic Fracturing in Zoned Earth and Rockfill Dams," Contract Report S-73-2, U.S. Army Engineer Waterways Experiment Station, Vicksburg, MS.

Reyes, S. F., and Deene, D. K. (1966). "Elastic Rustic Analysis of Underground Openings by the Finite Element Method," *Proceedings of the 1st Congress of the International Society of Rock Mechanics*, Lisbon, 477-486.

Skermmer, N. A. (1973). "Finite Element Analysis of El Infiernillo Dam," *Canadian Geotechnical Journal* 10(2), 129-144.

Soriano, A., Duncan, J. M., Wong, K., and Simon, J. (1976). "Finite Element Analyses of Stresses and Movements in Birch Dam," Contract Report S-76-2, U.S. Army Engineer Waterways Experiment Station, Vicksburg, MS.

c. *Constitutive models.*

Duncan, J. M., Byrne, P., Wong, K. S., and Mabry, P. (1980). "Strength, Stress-Strain and Bulk Modulus Parameters for Finite Element Analyses of Stresses and Movements in Soil Masses," Geotechnical Engineering Research Report No. UCB/GT/80-01, Department of Civil Engineering, University of California, Berkeley, CA.

Duncan, J. M., and Chang, C. Y. (1970). "Nonlinear Analysis of Stress and Strain in Soils," *Journal of Soil Mechanics and Foundations Division, ASCE* 96(SM5), 1629-1653.

Finn, W. D. L., Lee, K. W., and Martin, G. R. (1977). "An Effective Stress Model for Liquefaction," Proceedings Paper 13008, *Journal of Geotechnical Engineering Division, ASCE* 103(GT6), 517-533.

Irmay, S. (1954). "On the Hydraulic Conductivity of Unsaturated Soils," EOS Transactions of the American Geophysical Union, 35.

Peters, J. F., and Valanis, K. C. (1992). "Computational Aspects of Endochronic Plasticity." *Modern Approaches to Plasticity*, Horton, Greece.

Roscoe, K. H., and Schofield, A. N. (1963). "Mechanical Behavior of an Idealized 'Wet Clay'." *Proceedings of the Second European Conference on Soil Mechanics*, Wiesbaden I, 47-54.

Roscoe, K. H., Schofield, A. N., and Thurairajah, A. (1963). "Yielding of Clays in States Wetter Critical," *Geotechnique* 13(3), 211-240.

Roscoe, K. H., and Burland, J. B. (1968). "On the Generalized Stress-Strain Behavior of 'Wet' Clay," *Engineering Plasticity*, J. Heyman and F. A. Leckie, ed., Cambridge University Press, Cambridge, MA, 535-609.

Valanis, K. C., and Peters, J. F. (1988). "Thermodynamics of Frictional Materials: Constitutive Theory of Soils with Dilatant Capability—Report 1," Technical Report GL-88-20, U.S. Army Engineer Waterways Experiment Station, Vicksburg, MS.

Valanis, K. C., and Peters, J. F. (1991). "An Endochronic Plasticity Theory with Shear-Volumetric Coupling," *International Journal for Numerical and Analytical Methods in Geotechnical Engineering* 15, 77-102.

d. *Seepage analysis.*

Cedergren, H. R. (1967). *Seepage, Drainage, and Flow Nets*. Wiley, New York.

Department of the Army. (1986). "Engineering and Design: Seepage Analysis and Control for Dams," Engineer Manual 1110-2-1901, Washington, DC.

Knowles, V. R. (1992). "Applications of the Finite Element Seepage Analysis Corps Program CSEEP(X8202)," Technical Report ITL-92-6, U.S. Army Engineer Waterways Experiment Station, Vicksburg, MS.

Mosher, R. L., and Noddin, V. R. (1987a). "Finite Element Seepage Analysis of Cofferdam Embankment for Dewatering the Old River Control Structure Stilling Basin," Letter Report, U.S. Army Engineer Waterways Experiment Station, Vicksburg, MS.

Mosher, R. L., and Noddin, V. R. (1987b). "Seepage Analysis for the S.A. Murray, Jr., Hydroelectric Station," Letter Report, U.S. Army Engineer Waterways Experiment Station, Vicksburg, MS.

Pace, M. E. (1983). "Explanation of 2-D FEM Seepage Analysis of Unconfined Flow Through an Earthen Dam," unpublished paper, U.S. Army Engineer Waterways Experiment Station, Vicksburg, MS.

Palmerton, J. B. (1993). "Cerrillos Dam, 3-D Seepage Analysis," Miscellaneous Paper GL-93-25, U.S. Army Waterways Experiment Station, Vicksburg, MS.

Strohm, W. (1990). "Analysis of Drainage System, Trapezoidal Channel," Letter Report, Burns Engineering, Inc., Geotechnical Consultants, Jackson, MS.

Tracy, F. T. (1977a). "An Interactive Graphics Postprocessor for Finite Element Method Results," Miscellaneous Paper K-77-4, U.S. Army Engineer Waterways Experiment Station, Vicksburg, MS.

Tracy, F. T. (1977b). "An Interactive Graphics Finite Element Method Grid Generator for Two-Dimensional Problems," Miscellaneous Paper K-77-5, U.S. Army Engineer Waterways Experiment Station, Vicksburg, MS.

Tracy, F. T. (1983). "User's Guide for a Plane and Axisymmetric Finite Element Program for Steady-State Seepage Problems," Instruction Report K-83-4, U.S. Army Engineer Waterways Experiment Station, Vicksburg, MS.

Tracy, F. T. (1991). "Application of Finite Element, Grid Generation, and Scientific Visualization Techniques to 2-D and 3-D Seepage and Groundwater Modeling," U.S. Army Engineer Waterways Experiment Station, Technical Report ITL-91-3, Vicksburg, MS.

Wolff, T. F. (1989). "Appendix G: Finite Element Analyses of Gravel Layer and Scour Effects," Letter Report, Department of Civil and Environmental Engineering, Michigan State University, East Lansing, MI.

e. *Soil-structure interaction analysis.*

Clough, G. W., and Duncan, J. M. (1969). "Finite Element Analysis of Port Allen and Old River Locks," Report No. TE 69-3, College of Engineering, Office of Research Services, University of California, Berkeley, CA.

Clough, G. W., and Duncan, J. M. (1971a). "Finite Element Analysis of Retaining Wall Behavior," *Journal of Soil Mechanics and Foundations Division, ASCE* 97(SM12).

Clough, G. W., and Duncan, J. M. (1971b). "Finite Element Analysis of Port Allen Lock," *Journal of Soil Mechanics and Foundations Division, ASCE* 97(SM12).

Clough, G. W., and Tsui, Y. (1974). "Performance of Tied Back Walls in Clay," *Journal of Geotechnical Engineering Division, ASCE* 100(GT12), 1259-1274.

Ebeling, R. M. (1990). "Review of Finite Element Procedures for Earth Retaining Structures," Miscellaneous Paper ITL-90-5, U.S. Army Engineer Waterways Experiment Station, Vicksburg, MS.

Ebeling, R. M., Clough, G. W., Duncan, J. M., and Brandon, T. L. (1992). "Methods of Evaluating the Stability and Safety of Gravity Earth Retaining Structures Founded on Rock," Technical Report REMR-CS-29, U.S. Army Engineer Waterways Experiment Station, Vicksburg, MS.

Ebeling, R. M., Peters, J. F., and Clough, G. W. (1990). "User's Guide for the Incremental Construction Soil-Structure Interaction Program Soilstruct," Technical Report ITL-90-6, U.S. Army Engineer Waterways Experiment Station, Vicksburg, MS.

Goodman, R. E., Taylor, R. L., and Brekke, T. L. (1968). "A Model for the Mechanics of Jointed Rock," *Journal of Soil Mechanics and Foundations Division, ASCE* (SM 3).

Leavell, D. A., Peters, J. F., Edris, E. V., and Holmes, T. V. (1989). "Development of Finite Element Based Design Procedure for Sheet Pile Walls," Technical Report GL-89-14, U.S. Army Engineer Waterways Experiment Station, Vicksburg, MS.

Mosher, R. L. (1992). "Three-Dimensional Finite Element Analysis of Sheet-Pile Cellular Cofferdams," Technical Report ITL-92-1, U.S. Army Engineer Waterways Experiment Station, Vicksburg, MS.

Mosher, R. L., Bevins, T. L., and Neeley, B. D. (1991). "Structural Evaluation of Eisenhower and Snell Locks, Saint Lawrence Seaway, Massena, New York," Technical Report ITL-91-4, U.S. Army Engineer Waterways Experiment Station, Vicksburg, MS.

Mosher, R. L., and Knowles, V. R. (1990). "Finite Element Study of Tieback Wall for Bonneville Navigation Lock," Technical Report ITL-90-4, U.S. Army Engineer Waterways Experiment Station, Vicksburg, MS.

Torrey, V. H., III. (1993). "Williamson, WV, Central Business District, Local Flood Protection Project," Completion and Evaluation Report, U.S. Army Engineer Waterways Experiment Station, Vicksburg, MS.

f. Reinforced earth analysis.

Ebeling, R. M., Mosher, R. L., Abraham, K., and Peters, J. F. (1993). "Soil-Structure Interaction Study of Red River Lock and Dam No. 1 Subjected to Sediment Loading," Technical Report ITL-93-3, U.S. Army Engineer Waterways Experiment Station, Vicksburg, MS.

Ebeling, R. M., Peters, J. F., and Wahl, R. E. (1991a). "Prediction of Reinforced Sand Wall Performance." *Proceedings of the International Symposium on Geosynthetic-Reinforced Soil Retaining Walls*, Balkema Publishing Company, Rotterdam, The Netherlands.

Ebeling, R. M., Peters, J. F., and Wahl, R. E. (1991b). "Lessons Learned from Deformation Analysis of Wall Experiment," *Proceedings of the International Symposium on Geosynthetic-Reinforced Soil Retaining Walls*, Balkema Publishing Company, Rotterdam, The Netherlands.

Fowler, J., Leach, R. E., Peters, J. F., and Horz, R. C. (1983). "Mohicanville Reinforced Dike #2 - Design Memorandum," U.S. Army Engineer Waterways Experiment Station, Vicksburg, MS.

Rowe, R. K., Maclean, M. D., Soderman, K. L. (1983). "Analysis of Geotextile-Reinforced Embankment Constructed on Peat," *Canadian Geotechnical Journal* 21(3), 563-576.

Rowe, R. K., and Mylleville, B. L. J. (1990). "Implications of Adopting an Allowable Geosynthetic Strain in Estimating Stability," *Proceedings of the 4th International Conference on Geotextiles, Geomembranes, and Related Products*, The Hague, 131-136.

Rowe, R. K., and Soderman, K. L. (1987). "Stabilization of Very Soft Soils Using High Strength Geosynthetics: The Role of the Finite Element Analyses," *Geotextiles and Geomembranes* 6(1), 53-80.

Soderman, K. L. (1986). "Behaviour of Geotextile Reinforced Embankments," Dissertation submitted to the faculty of University of Western Ontario, Canada.

g. Consolidation.

Biot, M. A. (1941). "General Theory of Three-Dimensional Consolidation," *Journal of Applied Physics* 12, 426-430.

Biot, M. A. (1956). "General Solutions of the Equations of Elasticity and Consolidation for a Porous Material: Transactions," *Journal of Applied Mechanics, ASME* 78, 91-96.

Christian, J. T., and Boehmer, J. W. (1970). "Plane Strain Consolidation by Finite Elements," *Journal of Soil Mechanics and Foundation Division, ASCE* 96(SM4), 1,435-1,457.

Davis, E. H., and Poulos, H. G. (1972). "Rate of Settlement under Two- and Three-Dimensional Conditions," *Geotechnique* 12(1), 95-114.

Hwang, C. T., Morgenstern, N. R., and Murray, D. T. (1971). "On Solutions of Plane Strain Consolidation Problems By the Finite Element Method," *Canadian Journal of Geotechnical Engineering* 8(1).

Sandhu, R. S., and Pister, K. S. (1970). "A Variational Principle for Linear, Coupled Field Problems in Continuum Mechanics," *International Journal of Science* 8, 989-999.

Sandhu, R. S., and Wilson, E. L. (1969). "Finite Element Analysis of Flow of Saturated Porous Elastic Media," *Journal of Engineering Mechanics Division, ASCE*.

h. Dynamic analysis of embankment dams.

Hynes, M. E., Wahl, R. E., Donaghe, R. T., and Tsuchida, T. (1987). "Seismic Stability Evaluation of Folsom Dam and Reservoir Project - Report 4 - Mormon Island Auxiliary Dam - Phase I," Technical Report GL-87-14, U.S. Army Engineer Waterways Experiment Station, Vicksburg, MS.

Lysmer, J., Udaka, T., Tsai, G. F, and Seed, H. B. (1973). "FLUSH: A Computer Program for Approximate 3-D Analysis of Soil-Structure Interaction Problems," Report No. EERC 75-30, Earthquake Engineering Research Center, University of California, Berkeley, CA.

Quigley, D. W., Duncan, J. M., Caronna, S., Moroux, P. J., and Chang, C. S. (1976). "Three-Dimensional Finite Element Analysis of New Melones Dam," Geotechnical Engineering Report, Department of Civil Engineering, University of California, Berkeley, CA.

Seed, H. B., Lee, K. L., Idriss, I. M., and Makdisi, F. (1973). "Analysis of the Slides of in the San Fernando Dams During the Earthquakes of February 9, 1971," Earthquake Engineering Research Center Report EERC-73-2, Berkeley, CA.

Sykora, D. W., Koester, J. P., and Hynes, M. E. (1991). "Seismic Stability Evaluation of Ririe Dam and Reservoir Project," Technical Report GL-91-22, Reports 1 and 2, U.S. Army Engineer Waterways Experiment Station, Vicksburg, MS.

Wahl, R. E., and Bluhm, P. F. (1992). "Seismic Stability Evaluation of Alben Barkley Dam - Volume 1 - Summary Report," Technical Report 86-7, U.S. Army Engineer Waterways Experiment Station, Vicksburg, MS.

Wahl, R. E., Crawforth, S. G, Hynes, M. E, Comes, G. D., and Yule, D. E. (1987). "Seismic Stability Evaluation of Folsom Dam and Reservoir Project - Report 8-Mormon Island Auxiliary Dam - Phase II," Technical Report GL-87-14, U.S. Army Engineer Waterways Experiment Station, Vicksburg, MS.