



Open Systems Development Initiative (OSDI)
Open Systems Project Engineering Conference (OSPEC)
FY 98 Status Review
29 April - 1 May 1998

John T. Paul
Naval Air Warfare Center - Weapons Division
China Lake, CA

REPORT DOCUMENTATION PAGE

Form Approved OMB No.
0704-0188

Public reporting burden for this collection of information is estimated to average 1 hour per response, including the time for reviewing instructions, searching existing data sources, gathering and maintaining the data needed, and completing and reviewing this collection of information. Send comments regarding this burden estimate or any other aspect of this collection of information, including suggestions for reducing this burden to Department of Defense, Washington Headquarters Services, Directorate for Information Operations and Reports (0704-0188), 1215 Jefferson Davis Highway, Suite 1204, Arlington, VA 22202-4302. Respondents should be aware that notwithstanding any other provision of law, no person shall be subject to any penalty for failing to comply with a collection of information if it does not display a currently valid OMB control number. PLEASE DO NOT RETURN YOUR FORM TO THE ABOVE ADDRESS.

1. REPORT DATE (DD-MM-YYYY) 29-04-1998	2. REPORT TYPE Briefing	3. DATES COVERED (FROM - TO) 29-04-1998 to 01-05-1998
---	----------------------------	--

4. TITLE AND SUBTITLE Open Systems Development Initiative (OSDI) Unclassified	5a. CONTRACT NUMBER
	5b. GRANT NUMBER
	5c. PROGRAM ELEMENT NUMBER

6. AUTHOR(S) Paul, John T. ;	5d. PROJECT NUMBER
	5e. TASK NUMBER
	5f. WORK UNIT NUMBER

7. PERFORMING ORGANIZATION NAME AND ADDRESS Naval Air Warfare Center Weapons Division China Lake, CAxxxxx	8. PERFORMING ORGANIZATION REPORT NUMBER
--	--

9. SPONSORING/MONITORING AGENCY NAME AND ADDRESS Open Systems Joint Task Force (OSJTF) 1931 Jefferson Davis Highway Crystal Mall 3, Suite 104 Arlington, VA22202	10. SPONSOR/MONITOR'S ACRONYM(S)
	11. SPONSOR/MONITOR'S REPORT NUMBER(S)

12. DISTRIBUTION/AVAILABILITY STATEMENT
A PUBLIC RELEASE

13. SUPPLEMENTARY NOTES

14. ABSTRACT
See Report.

15. SUBJECT TERMS

16. SECURITY CLASSIFICATION OF:	17. LIMITATION OF ABSTRACT	18. NUMBER OF PAGES	19. NAME OF RESPONSIBLE PERSON
a. REPORT Unclassified	Public Release	24	http://www.acq.osd.mil/osjtf/library/library_alpha.html (blank) lfenster@dtic.mil
b. ABSTRACT Unclassified			19b. TELEPHONE NUMBER
c. THIS PAGE Unclassified			International Area Code Area Code Telephone Number 703767-9007 DSN 427-9007



Open Systems Development Initiative

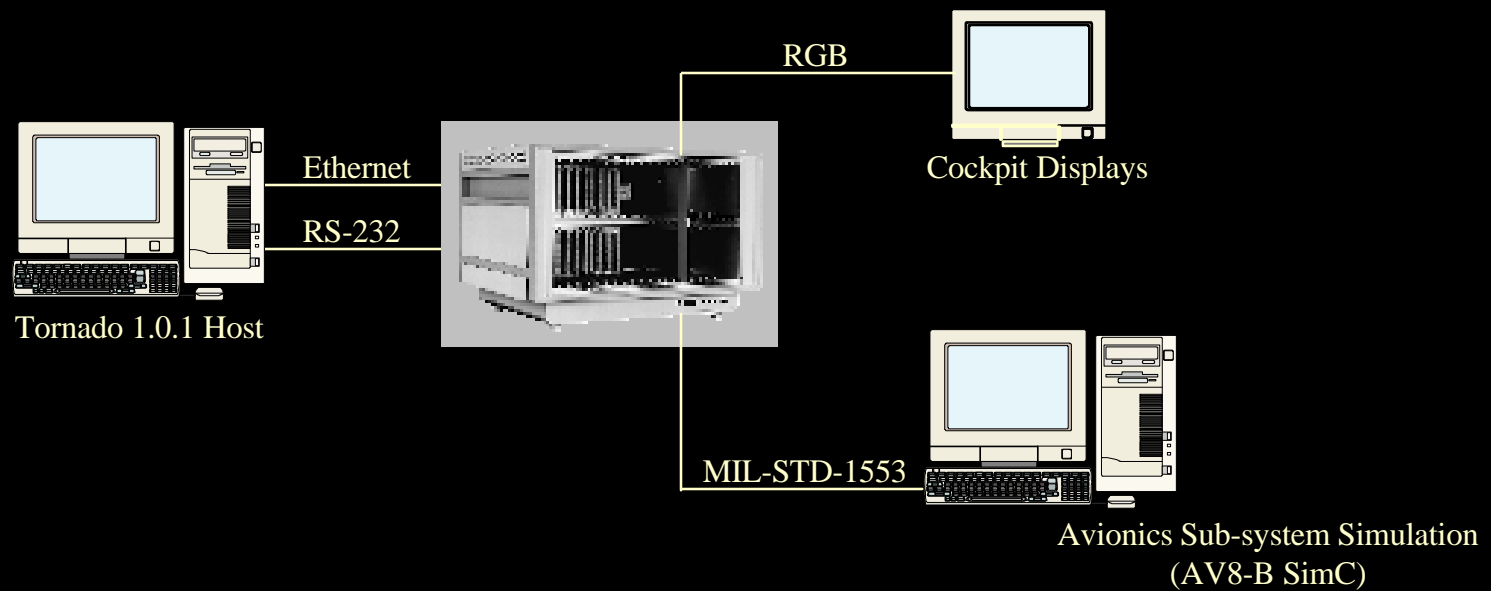



Goals

COTS technology

Object Oriented S/W

AV8B OSCAR

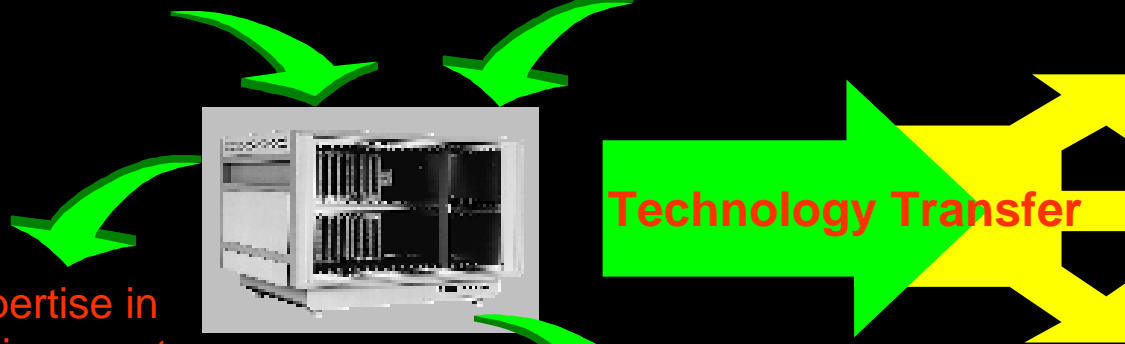

Technology Transfer

F/A-18 AMC&D

OTHERS

Hands-on expertise in a low risk environment

Plug & Play capabilities
Performance Characteristics

In-house OS expertise



OSDI Relationships

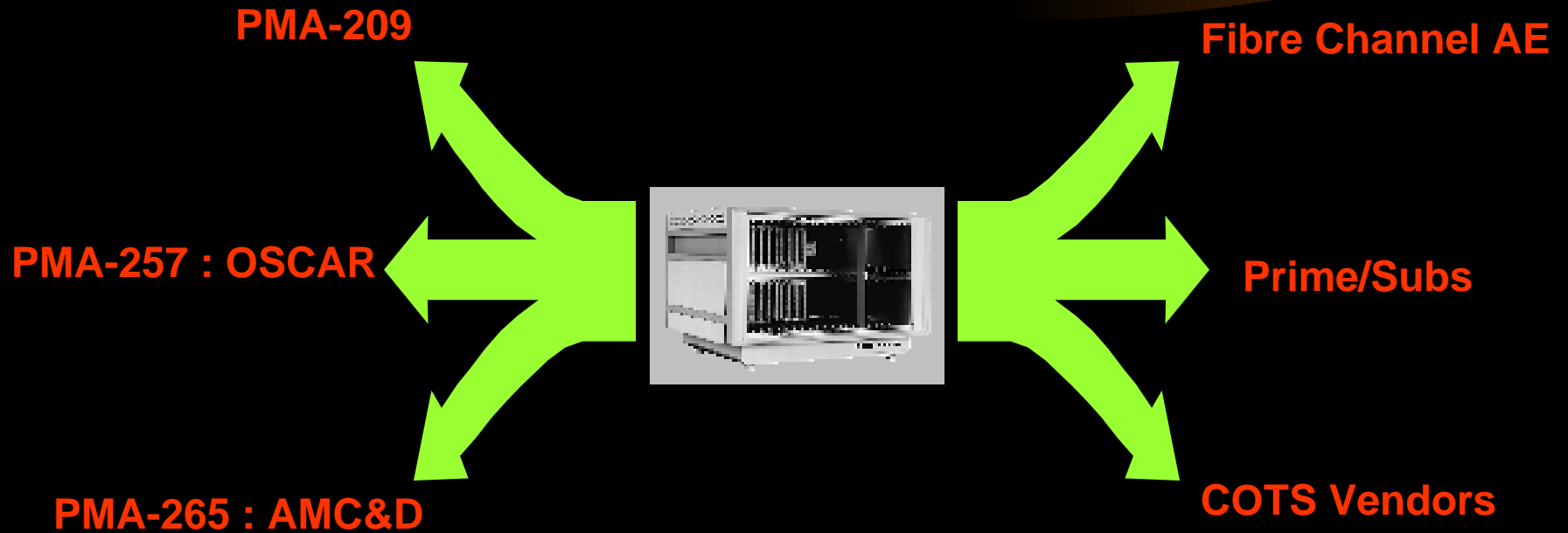



Architecture

- Operational Architecture - Description of the operational elements, assigned tasks, and information flows.
- Systems Architecture - Defines the physical connection, location and identification of key components, circuits, networks etc., and specifies system and component performance parameters.
- Technical Architecture - Identifies the services, interfaces, standards, and their relationships.



OSDI System Architecture

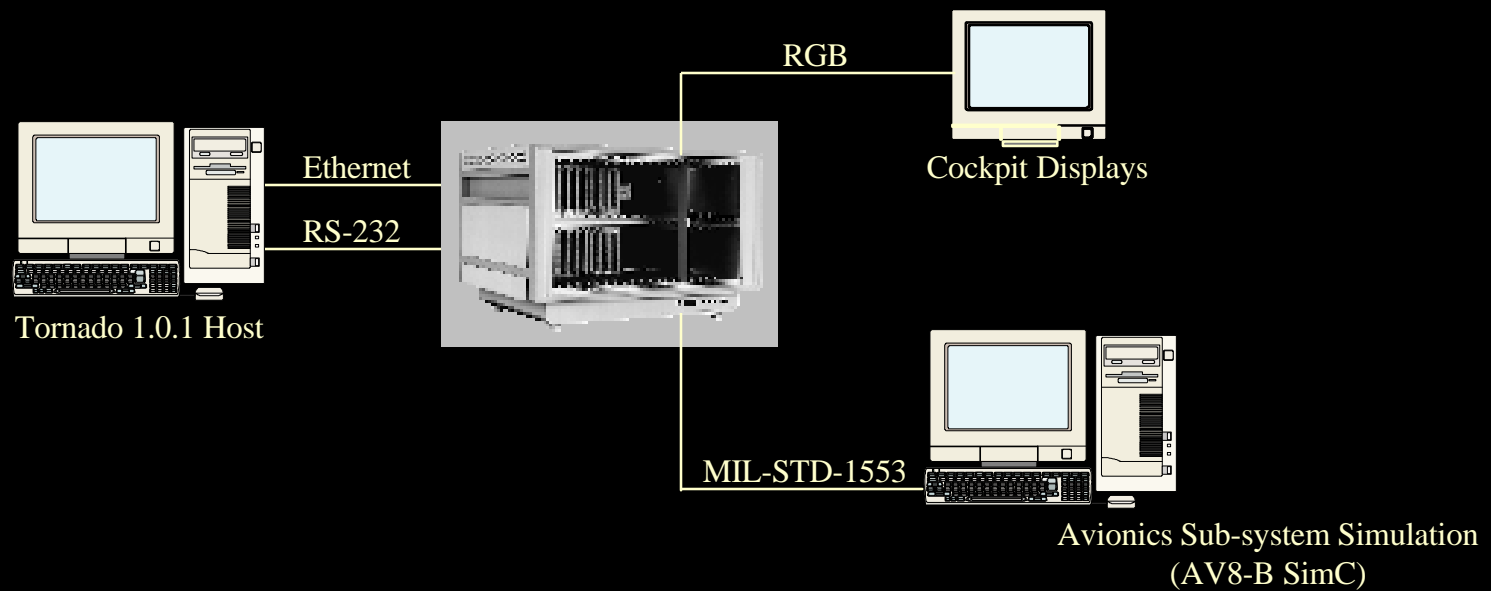



OSDI Technical Architecture

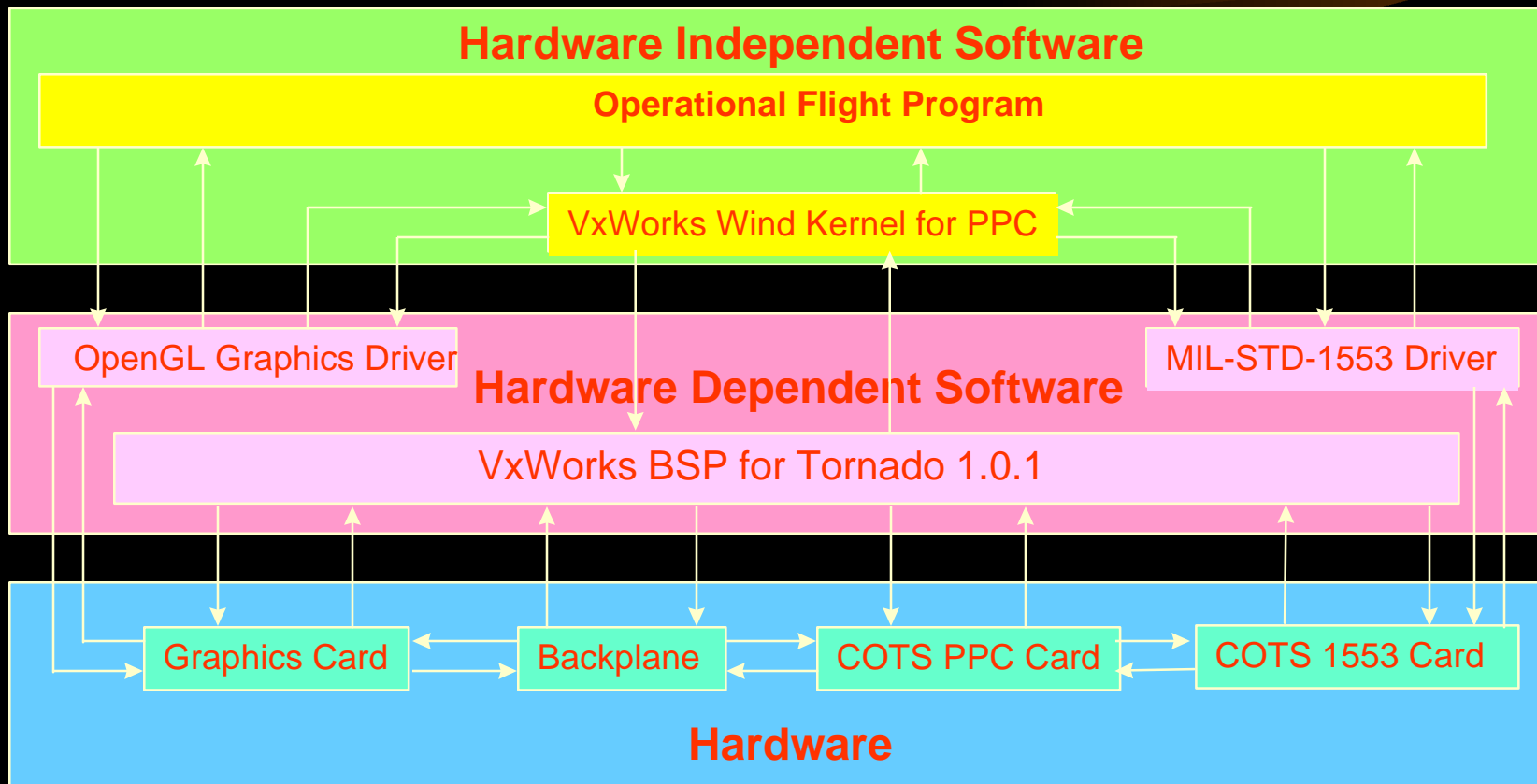



OSDI S/W Architecture

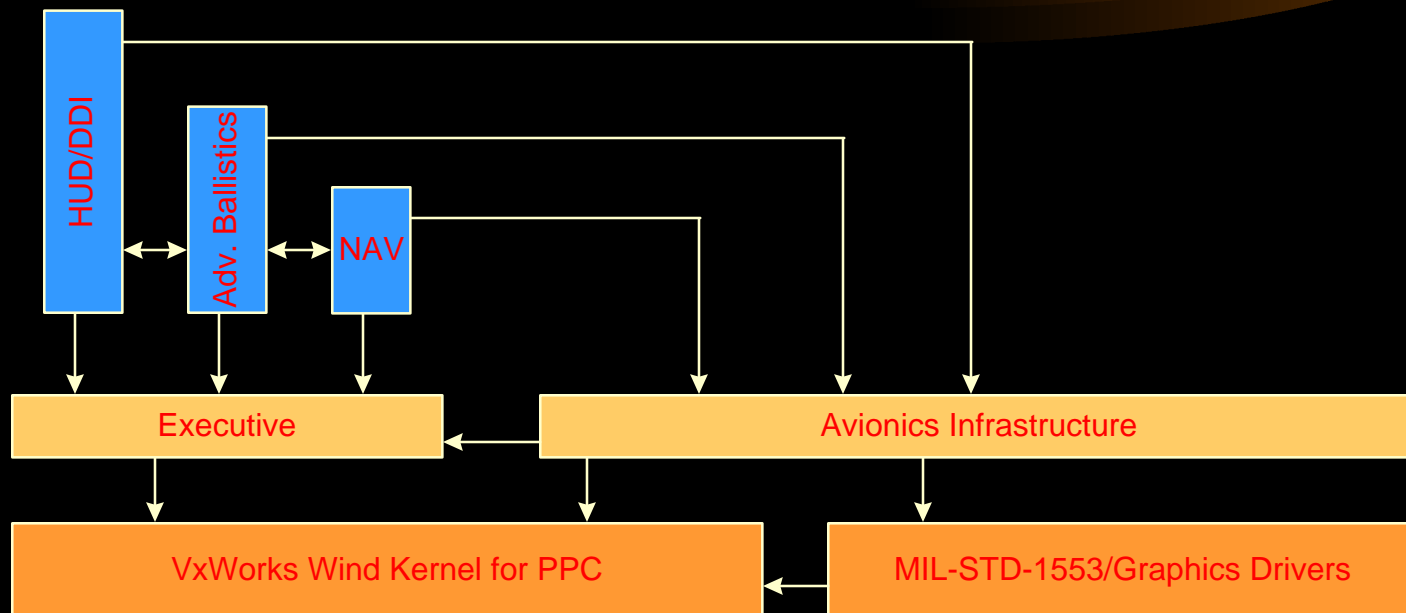



OSDI Components

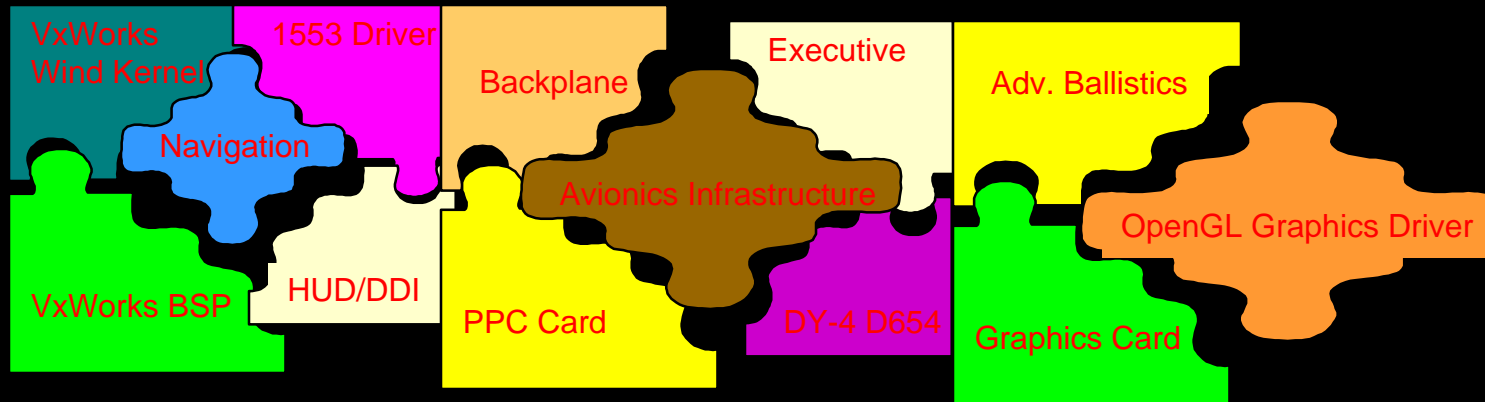



Standards & Conformance

Standards

- National Body
- Company Proprietary
- Non-Standard
- Implementation

Conformance

- Strict
- Conforming
- Conforming with extensions
- Non-conforming



Identify Interfaces

	VxWorks Kernel	VxWorks BSP	1553 Driver	Backplane	DY-4 SVME-171	DY-4 D654	Executive	Avionics Infr.	Navigation	Adv. Ballistics	HUD/DDI	Graphics Card	Graphics Driver
VxWorks Kernel		X	X				X	X					X
VxWorks BSP	X			X	X	X							
1553 Driver	X							X					
Backplane		X			X							X	
DY-4 SVME-171		X		X		X							
DY-4 D654		X			X								
Executive	X							X	X	X	X		
Avionics Infr.	X		X				X		X	X	X		X
Navigation							X	X		X			
Adv. Ballistics							X	X	X		X		
HUD/DDI							X	X		X			
Graphics Card				X									X
Graphics Driver	X							X				X	



Identify Key Interfaces

	VxWorks Kernel	VxWorks BSP	1553 Driver	Backplane	DY-4 SVME-171	DY-4 D654	Executive	Avionics Infr.	Navigation	Adv. Ballistics	HUD/DDI	Graphics Card	Graphics Driver
VxWorks Kernel		X(1)	X(2)				X(3)	X					X
VxWorks BSP				X(4)	X(5)	X							
1553 Driver								X(6)					
Backplane					X(7)							X(8)	
DY-4 SVME-171						X(9)							
DY-4 D654													
Executive								X(10)	X(11)	X(12)	X(13)		
Avionics Infr.									X(14)	X(15)	X(16)		X(17)
Navigation										X(18)			
Adv. Ballistics											X(19)		
HUD/DDI													
Graphics Card													X
Graphics Driver													



Key Open Standard Interfaces

	VxWorks Kernel	VxWorks BSP	1553 Driver	Backplane	DY-4 SVME-171	DY-4 D654	Executive	Avionics Infr.	Navigation	Adv. Ballistics	HUD/DDI	Graphics Card	Graphics Driver
VxWorks Kernel		X(1)	POSIX				POSIX	X					X
VxWorks BSP				VME	EABI	X							
1553 Driver								X(6)					
Backplane					VME							VME	
DY-4 SVME-171						MaxPack							
DY-4 D654													
Executive								X(10)	X(11)	X(12)	X(13)		
Avionics Infr.									X(14)	X(15)	X(16)		OpenGL
Navigation										X(18)			
Adv. Ballistics											X(19)		
HUD/DDI													
Graphics Card													X
Graphics Driver													



The KOSI List

	KOSI Component	Standard/Non-Standard	Conformance Level	Responsibility
X(1)	VxWorks Kernel - VxWorks BSP	Non-Standard		DY-4
X(2)	VxWorks Kernel - 1553 Driver	POSIX	IEEE Strict	DY-4
X(3)	VxWorks Kernel - OFP Executive	POSIX	IEEE Strict	OSDI/DY-4
X(4)	VxWorks BSP - Backplane	1101.2 VME	IEEE Strict	DY-4
X(5)	VxWorks BSP - DY-4 SVME-171	EABI	ANSI Strict	DY-4
X(6)	1553 Driver - Avionics Infrastructure	Non-Standard		???
X(7)	Backplane - DY-4 SVME-171	1101.2 VME	IEEE Strict	DY-4
X(8)	Graphics Card - Backplane	1101.2 VME	IEEE Strict	Radstone
X(9)	DY-4 SVME-171 - D654	MaxPack	Proprietary/Unknown	DY-4
X(10)	OFP Executive - Avionics Infrastructure	.h(implementation)		OSDI
X(11)	OFP Executive - Navigation	.h (implementation)		OSDI
X(12)	OFP Executive - Advanced Ballistics	.h (implementation)		OSDI
X(13)	OFP Executive - HUD/DDI	.h (implementation)		OSDI



The KOSI List

	KOSI Item	Standard/Non-Standard	Conformance Level	Responsibility
X(14)	Avionics Infrastructure - Navigation	.h (implementation)		OSDI
X(15)	Avionics Infrastructure - Adv. Ballist.	.h (implementation)		OSDI
X(16)	Avionics Infrastructure - HUD/DDI	.h (implementation)		OSDI
X(17)	Avionics Infrastructure - Graphics Drv	OpenGL	ANSI Strict	Radstone
X(18)	Navigation - Advanced Ballistics	BANav.h(impl.)		OSDI
X(19)	Advanced Ballistics - HUD/DDI	.h (implementation)		OSDI

Note: Header files are facades(a design pattern) that define critical software interfaces.



Benefits of KOSI Analysis

- Understand key interfaces & standards
- Non-conforming interfaces
- Standardization Vs. Optimization
- KOSI based product selection
- Valuable tool for system engineers



Benefits of KOSI Analysis

- Promotes technology insertion for increased throughput and memory requirements
- Reduced time-to-market
- KOSI based system is scalable, portable, interoperable, & plug & play compatible
- System kept “open” indefinitely



Recommendation #1

- Every new open system procured for the DoD shall have KOSI analysis as a SOW requirement
- KOSI analysis shall be performed by a joint team of prime, subs and DoD
- KOSI analysis shall be controlled and changes tracked through the life of the system



OSDI Technical Architecture

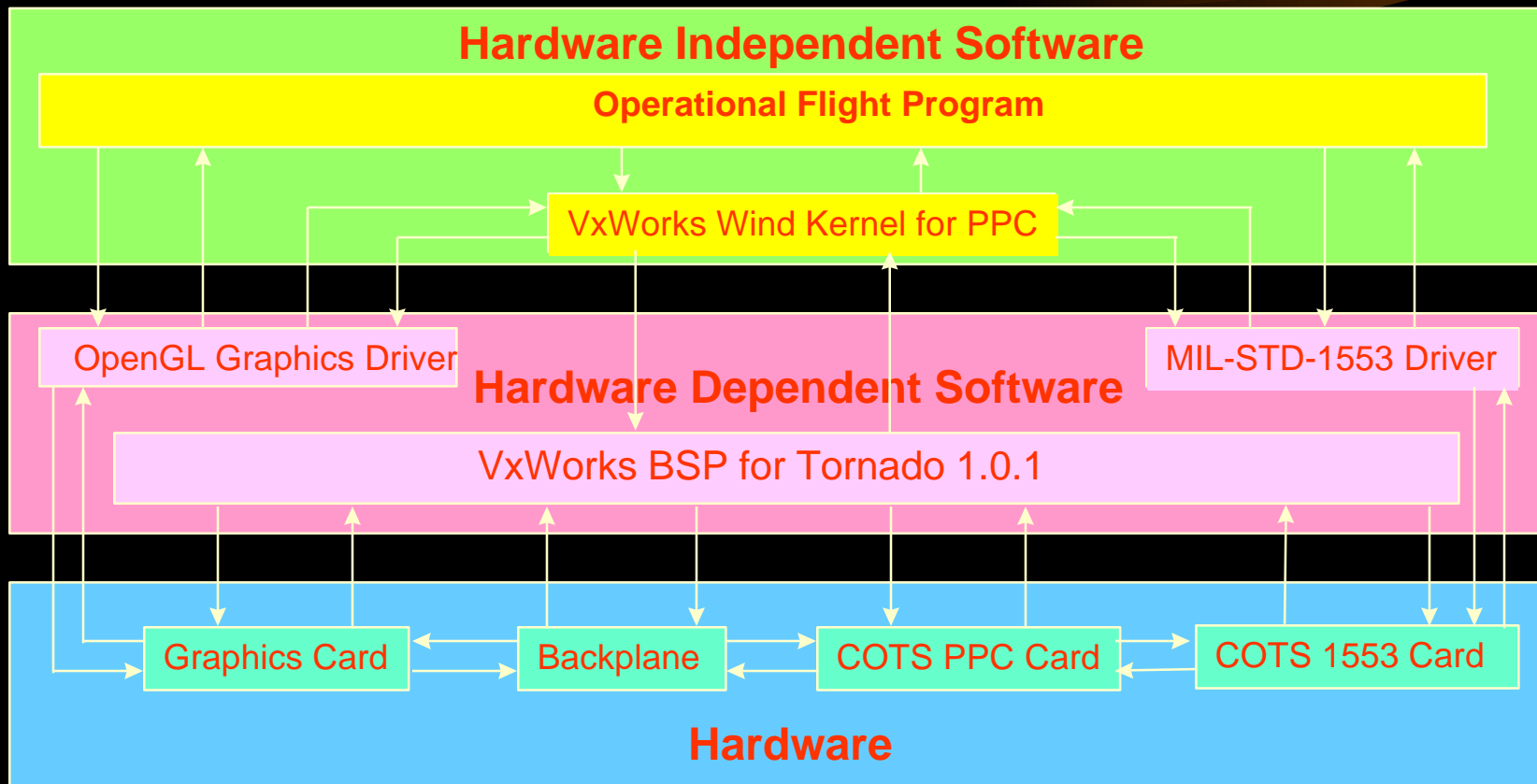



Typical OS Technical Architecture

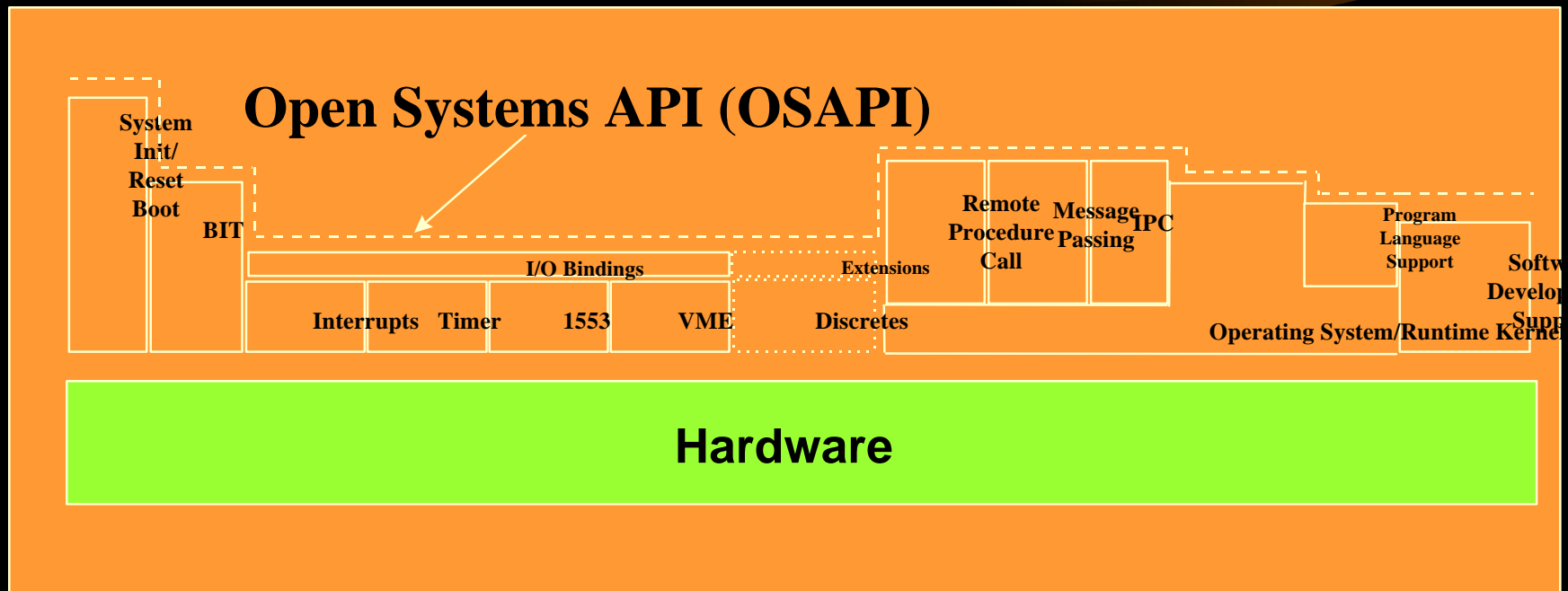



Generic API Services

- System Initialization & Boot Loader
- Built-In Test (BIT)
- Device Drivers
 - Interrupt
 - Timers
 - Backplane (VME)
 - Legacy I/O (1553)
 - High Speed I/O (Fibre Channel, PCI, SCI)
 - Discrete I/O
 - Bindings
- Operating system/Kernel
- Programming Language Runtime Support
- Software Development Interface



OSMC API - A Joint Venture

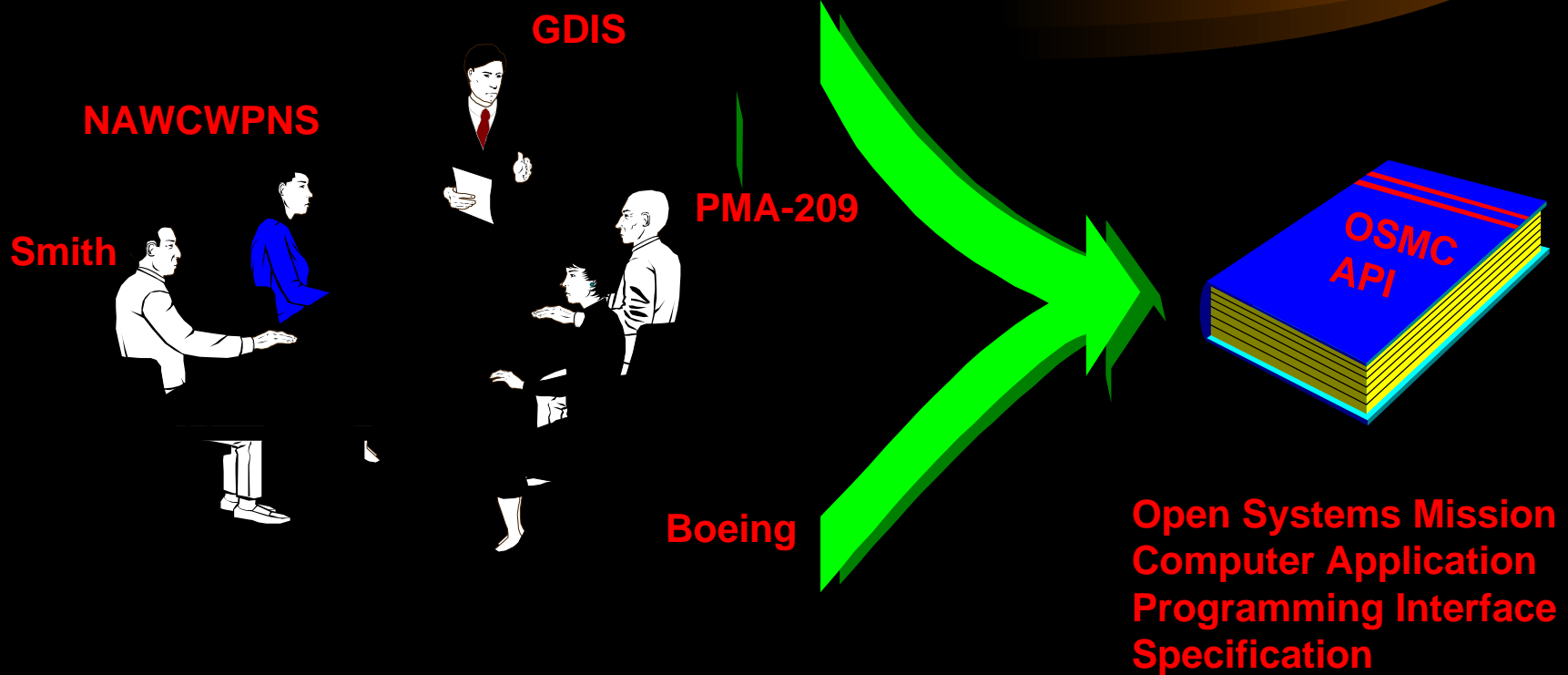



Recommendation #2

- Joint Review of OSMC API
- Develop OSAPI Specification
- Encourage vendors to voluntarily embrace OSAPI
- Validate COTS product conformance to OSAPI



Questions

It Depends