

NORTH ATLANTIC TREATY ORGANISATION



RESEARCH AND TECHNOLOGY ORGANISATION

BP 25, 7 RUE ANCELLE, F-92201 NEUILLY-SUR-SEINE CEDEX, FRANCE

RTO TECHNICAL REPORT 45

Design Loads for Future Aircraft

(Les charges de calcul pour de futurs aéronefs)

Work performed by the RTO Applied Vehicle Technology Panel (AVT) TG 024.

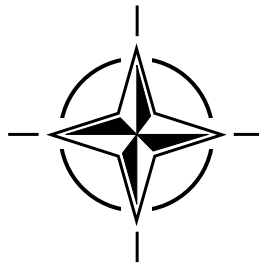

REPORT DOCUMENTATION PAGE

Form Approved OMB No.
0704-0188

Public reporting burden for this collection of information is estimated to average 1 hour per response, including the time for reviewing instructions, searching existing data sources, gathering and maintaining the data needed, and completing and reviewing this collection of information. Send comments regarding this burden estimate or any other aspect of this collection of information, including suggestions for reducing this burden to Department of Defense, Washington Headquarters Services, Directorate for Information Operations and Reports (0704-0188), 1215 Jefferson Davis Highway, Suite 1204, Arlington, VA 22202-4302. Respondents should be aware that notwithstanding any other provision of law, no person shall be subject to any penalty for failing to comply with a collection of information if it does not display a currently valid OMB control number. PLEASE DO NOT RETURN YOUR FORM TO THE ABOVE ADDRESS.

1. REPORT DATE (DD-MM-YYYY) 01-02-2002	2. REPORT TYPE	3. DATES COVERED (FROM - TO) xx-xx-2002 to xx-xx-2002
4. TITLE AND SUBTITLE Design Loads for Future Aircraft Unclassified		5a. CONTRACT NUMBER
		5b. GRANT NUMBER
		5c. PROGRAM ELEMENT NUMBER
6. AUTHOR(S)		5d. PROJECT NUMBER
		5e. TASK NUMBER
		5f. WORK UNIT NUMBER
7. PERFORMING ORGANIZATION NAME AND ADDRESS Research and Technology Organisation North Atlantic Treaty Organisation BP 25, 7 rue Ancelle F-92201 Neuilly-sur-Seine Cedex, Francexxxxx		8. PERFORMING ORGANIZATION REPORT NUMBER
9. SPONSORING/MONITORING AGENCY NAME AND ADDRESS NATO Research and Technology Organization BP25, Rue Ancelle F-92201 Neuilly-Sur-Seine Cedex, Francexxxxx		10. SPONSOR/MONITOR'S ACRONYM(S)
		11. SPONSOR/MONITOR'S REPORT NUMBER(S)
12. DISTRIBUTION/AVAILABILITY STATEMENT APUBLIC RELEASE		
13. SUPPLEMENTARY NOTES		
14. ABSTRACT This RTO Task Group reviewed the requirements which regular flight and manoeuvring will put as design loads on the structure of future NATO aircraft, addressing also safety aspects, structural weight, elastic effects and influence of the control system. Treated are: load critical flight manoeuvres as well as external loads such as induced by turbulence. Existing specifications are reviewed and procedures for establishing design loads are presented. Metal and composite structures are treated, and the analysis pertains to main structures as well as critical subassemblies. Under operational aspects the monitoring of loads and of structural fatigue are treated and some actual failure cases are analysed. The request for NATO agreements on relevant design criteria is mentioned.		
15. SUBJECT TERMS Aerodynamic loads Flight manoeuvres Aircraft design; Gust loads Airframes; Load monitoring systems Aviation safety; NATO agreements Composite structures; Procedures Design loads; RTO Task Group Dynamic loads; Specifications Failure analysis; Structural analysis Fatigue (materials); Structural weight Flight control; Turbulence Flight loads		
16. SECURITY CLASSIFICATION OF:	17. LIMITATION OF ABSTRACT Same as Report (SAR)	18. NUMBER OF PAGES 300
a. REPORT Unclassified	b. ABSTRACT Unclassified	c. THIS PAGE Unclassified
		19. NAME OF RESPONSIBLE PERSON Fenster, Lynn lfenster@dtic.mil
		19b. TELEPHONE NUMBER International Area Code Area Code Telephone Number 703767-9007 DSN 427-9007
		Standard Form 298 (Rev. 8-98) Prescribed by ANSI Std Z39.18

This page has been deliberately left blank



Page intentionnellement blanche

NORTH ATLANTIC TREATY ORGANISATION



RESEARCH AND TECHNOLOGY ORGANISATION

BP 25, 7 RUE ANCELLE, F-92201 NEUILLY-SUR-SEINE CEDEX, FRANCE

RTO TECHNICAL REPORT 45

Design Loads for Future Aircraft

(Les charges de calcul pour de futurs aéronefs)

Work performed by the RTO Applied Vehicle Technology Panel (AVT) TG 024.



The Research and Technology Organisation (RTO) of NATO

RTO is the single focus in NATO for Defence Research and Technology activities. Its mission is to conduct and promote cooperative research and information exchange. The objective is to support the development and effective use of national defence research and technology and to meet the military needs of the Alliance, to maintain a technological lead, and to provide advice to NATO and national decision makers. The RTO performs its mission with the support of an extensive network of national experts. It also ensures effective coordination with other NATO bodies involved in R&T activities.

RTO reports both to the Military Committee of NATO and to the Conference of National Armament Directors. It comprises a Research and Technology Board (RTB) as the highest level of national representation and the Research and Technology Agency (RTA), a dedicated staff with its headquarters in Neuilly, near Paris, France. In order to facilitate contacts with the military users and other NATO activities, a small part of the RTA staff is located in NATO Headquarters in Brussels. The Brussels staff also coordinates RTO's cooperation with nations in Middle and Eastern Europe, to which RTO attaches particular importance especially as working together in the field of research is one of the more promising areas of initial cooperation.

The total spectrum of R&T activities is covered by the following 7 bodies:

- AVT Applied Vehicle Technology Panel
- HFM Human Factors and Medicine Panel
- IST Information Systems Technology Panel
- NMSG NATO Modelling and Simulation Group
- SAS Studies, Analysis and Simulation Panel
- SCI Systems Concepts and Integration Panel
- SET Sensors and Electronics Technology Panel

These bodies are made up of national representatives as well as generally recognised 'world class' scientists. They also provide a communication link to military users and other NATO bodies. RTO's scientific and technological work is carried out by Technical Teams, created for specific activities and with a specific duration. Such Technical Teams can organise workshops, symposia, field trials, lecture series and training courses. An important function of these Technical Teams is to ensure the continuity of the expert networks.

RTO builds upon earlier cooperation in defence research and technology as set-up under the Advisory Group for Aerospace Research and Development (AGARD) and the Defence Research Group (DRG). AGARD and the DRG share common roots in that they were both established at the initiative of Dr Theodore von Kármán, a leading aerospace scientist, who early on recognised the importance of scientific support for the Allied Armed Forces. RTO is capitalising on these common roots in order to provide the Alliance and the NATO nations with a strong scientific and technological basis that will guarantee a solid base for the future.

The content of this publication has been reproduced directly from material supplied by RTO or the authors.

Published February 2002

Copyright © RTO/NATO 2002
All Rights Reserved

ISBN 92-837-1077-0



Printed by St. Joseph Ottawa/Hull
(A St. Joseph Corporation Company)
45 Sacré-Cœur Blvd., Hull (Québec), Canada J8X 1C6

Design Loads for Future Aircraft

(RTO TR-045 / AVT-024)

Executive Summary

The selection of design loads and requirements is defining the structural weight of airplanes and their safety. Therefore the definition of requirements should be performed very critically by the customer and structural weight should be assessed based on sensitivity analysis of the total aircraft which includes flight manoeuvre simulation, flight control system, aerodynamics and elastic effects introduced by finite elements. To produce these analyses is the job of the aircraft companies.

After selection of most load critical flight manoeuvres (pull up manoeuvres, initiation of roll manoeuvres etc.) the calculation of airloads and inertia loads must include the flight control system and its failure cases because it affects the motion of the control surfaces and therefore the aircraft.

With the advent of carbon fibre composite structures discrete loads are the predominant limiting design conditions but it should be emphasised that most structures are of a hybrid nature with metal frame which are still susceptible to fatigue loads. For airplanes designed to civil requirements such as transport airplanes, tankers etc. the definition of continuous turbulence and inclusion of FCS failure cases and nonlinearities such as control surface angles is extremely important.

There was a long way from load assumptions used by the Wright Brothers who designed their Flyer to a 5g limit to the load limiting capabilities of the care free handling flight control system of the Eurofighter. Also the US-Airforce Mil-Specifications which were used to design NATO airplanes such as Tornado, F16 and F18 in the 1970's are obsolete today and the MIL-A-87221 (USAF) is only a frame without the essential quantitative material. All these issues are addressed in this manual including comparisons of regulations and descriptions of new specifications. Complete procedures how to establish design loads are presented which should help for the design of new airplanes.

The importance of dynamic phenomena which produce design loads for various aircraft parts such as intakes, leading edges etc. is also highlighted. Loads monitoring systems are necessary to prove calculated loads and monitor fatigue loads to establish the remaining structural life. There is a description of a modern system.

For transport type aircraft gust load cases are the most critical for strength design and they are also the main fatigue loading source for the major part of the structure. Methods for discrete and continuous gust loading cases are presented together with nonlinear example calculations.

In the appendix there is a description of failure cases and their effect on loads for transport aircraft and a specification of a landing gear which could be used as an example how to specify the whole structure as a system. The military use of this manual is to establish procedures to build the lightest structure for the military requirements. Agreement on requirements and design loads within the NATO countries could standardise pilot training, aircraft usage, increase aircraft life and reduce maintenance. Since the search of the best usage of the aircraft for its military purpose will continue to integrate structure and avionics such as fire and flight control systems as an example there will be a continuous need for future work.

Les charges de calcul pour de futurs aéronefs

(RTO TR-045 / AVT-024)

Synthèse

Le choix des charges théoriques et des spécifications détermine la masse structurale des aéronefs et leur sécurité. C'est pourquoi la définition des spécifications doit être réalisée de façon très rigoureuse par le client, la masse structurale étant, dans ce cas, évaluée à partir d'une étude de sensibilité de l'aéronef dans son ensemble, couvrant une simulation d'évolution en vol, un système de commandes de vol, des considérations aérodynamiques et d'éventuels effets élastiques introduits par des éléments finis. Il incombe aux avionneurs d'effectuer ces études.

Après avoir défini les évolutions en vol les plus critiques en termes de charges (ressource, tonneau, etc.), le calcul des charges aérodynamiques et des charges d'inertie doit également inclure le système de commande de vol et ses défaillances potentielles car il a une incidence sur le mouvement des gouvernes et par conséquent sur l'aéronef.

Avec l'avènement des structures composites en fibre de carbone, les charges discrètes sont devenues les principales conditions restrictives pour la conception, mais il est à noter que la plupart des structures sont hybrides avec une cellule métallique et restent vulnérables aux charges de fatigue. En ce qui concerne les aéronefs conçus selon des spécifications civiles, tels que les avions de transport, les avions ravitailleurs, etc., la définition de la turbulence continue et l'inclusion des cas de pannes du système de commandes de vol (FCS) et des non-linéarités, tels que les angles de gouverne, sont extrêmement importantes.

Un long chemin sépare les hypothèses de charge retenues par les frères Wright, qui ont conçu leur "Flyer" pour un facteur de charge limite de 5g, et les caractéristiques de limite de charge du système de commandes de vol à pilotage sécurisé de l'Eurofighter. De même, les spécifications MIL de l'US-Airforce, utilisées dans les années 70 pour la conception des avions de combat de l'OTAN, tels que le Tornado, le F16 et le F18, sont aujourd'hui obsolètes et la spécification MIL-A-87221 (USAF) ne représente qu'un cadre, dénué du matériau quantitatif essentiel. L'ensemble de ces questions est abordé dans le présent manuel avec la comparaison des règlements et des descriptions de nouvelles spécifications. Des procédures complètes permettant de définir des charges de calcul sont présentées, ce qui devrait faciliter la conception des nouveaux aéronefs.

L'importance des phénomènes dynamiques, qui génèrent des charges de calcul s'appliquant à différents éléments de l'aéronef, tels que les entrées d'air, les bords d'attaque etc. est également soulignée. Des systèmes de surveillance des charges sont nécessaires pour justifier les charges calculées et surveiller les charges de fatigue en vue d'établir la durée de vie structurale restante. La description d'un système moderne est donnée.

Pour les aéronefs de transport, les charges de rafale sont l'élément le plus critique en ce qui concerne les calculs de résistance, et elles sont également la principale source de charges de fatigue pour la majeure partie de la structure. Les méthodes relatives aux cas de charges de rafale continues et discontinues sont présentées avec des calculs d'exemple non linéaires.

L'annexe présente une description des cas de panne et de leurs effets sur les charges pour les avions de transport, ainsi que la spécification d'un train d'atterrissage qui pourrait être utilisée comme exemple pour établir la spécification de l'ensemble de la structure en tant que système. Ce manuel permet de mettre au point des procédures pour la fabrication de structures les plus légères répondant aux spécifications militaires. Un accord portant sur les spécifications et les charges de calcul en vigueur dans les pays de l'OTAN pourrait conduire à la standardisation de la formation des pilotes et de l'exploitation des aéronefs, associée à l'accroissement de la durée de vie des aéronefs et à l'allègement de la maintenance. En conclusion, étant donné que la recherche de l'exploitation optimale d'un aéronef à des fins militaires continuera d'intégrer la structure et l'avionique, tel que par exemple les systèmes de commandes de vol et de tir, la demande de travaux de recherche sera maintenue.

Contents

	Page
Executive Summary	iii
Synthèse	iv
Publications of the RTO Applied Vehicle Technology Panel	ix
Task Group Members	xi
1 Introduction	1
2 Loads Requirements Review	1
2.1 The development of maneuver load criteria for agile aircraft	1
2.1.1 Introduction	1
2.1.2 Status of present Criteria	1
2.1.3 The influence of piloting technique	6
2.1.4 The influence of advanced control systems	7
2.1.5 Conclusion	8
2.1.6 References	9
2.2 Changes in USAF Structural Loads Requirements	9
2.2.1 Introduction	9
2.2.2 Structural Loading Condition	9
2.2.3 Flight Loading Conditions	10
2.2.4 Ground Loading Conditions	10
3 Maneuver Loads	18
3.1 Classical Approach	18
3.1.1 Definitions	18
3.1.2 Limit Load Concept	19
3.1.3 Safety Factors Review	20
3.2 Non Classical Approach	21
3.2.1 Maximum Load Concept	21
3.2.2 Operational Flight Parameter Approach	26
3.2.3 Determination and Verification of Operational Maneuver Parameters and Time Histories	27
3.2.4 Flight Loads derived from Operational Maneuvers	36
3.2.5 Flight Parameter Envelopes Approach	40
3.3 Dynamic Loads	52
3.3.1 Introduction	52
3.3.2 Types of Dynamically Acting Loads	52
3.3.3 Prediction Process & Methods	56
3.3.4 Design Assumptions, Criteria and Certification	59
3.3.5 Developments	59
3.3.6 Summary	60
3.3.7 Acknowledgements	61
3.3.8 References	61
3.4 Managing the Technical Risk - Dynamic Loads in-flight Monitoring	62
3.4.1 Dynamic Loads Monitoring System	62
3.4.2 Dynamic Loading Phenomena Monitored	63
3.4.3 Dynamic Loads Monitoring System Implementation	63
3.5 Airframe Certification Against Birdstrike Threats	68
3.5.1 Certification via Empirical Testing	68
3.5.2 References	69

4	Gust loads	70
4.1	Introduction	70
4.1.1	Discrete Gusts	70
4.1.2	Continuous Gusts	71
4.1.3	Gust Load Requirements	71
4.2	Overview of Gust Requirements	72
4.2.1	Draft NPRM on Continuous Turbulence	72
4.3	Comparison of Methods to calculated Continuous Turbulence Design Loads for Non-Linear Aircraft	72
4.3.1	Analyses made by NLR	73
4.3.2	Analyses made by the University of Manchester	74
4.4	Conclusions & Recommendations	76
4.5	References	76
4.6	Appendix A4.1	85
4.6.1	Stochastic Methods	85
4.6.2	Deterministic Methods	87
4.7	Appendix A4.2 Description of Aircraft Models	91
5	A More Global Approach	96
5.1	Why a more global approach	96
5.2	Limit Loads	96
5.2.1	Basic principles of the “more global approach” for limit loads	96
5.2.2	“Maximum Loads” through “Load Severity Indicators”	96
5.2.3	“Maximum Loads Expected in Service”	97
5.2.4	Application to design of “fly by wire” aircraft	97
5.3	Ultimate load definition and Safety Factors for multiphysical effects	97
5.4	Safety factors evolution with innovations	98
5.4.1	The particular case of fly by wire aircraft	98
5.4.2	Towards probabilistic approaches	98
Appendix A The Impact of Electronic Flight Control System (EFCS) Failure Cases on Structural Design Loads		99
A.1	Introduction	101
A.2	Certification Requirements	102
A.3	EFCS Failures	103
A.4	Procedure to Handle Failure Cases in Loads	104
A.5	Consequences on Design	105
A.6	OFIS, Approaches to OFC Detection	107
A.7	Conclusion	108
A.8	References	108
Appendix B The NATO Aircraft Landing Gear Design Specification		111
B.1	Introduction	113
B.2	Scope	113
B.3	Application	113
B.3.1	Program	113
B.3.2	Aircraft	113
B.3.3	Landing Gear Structure	114
B.3.4	Use	114
B.3.5	Structure	114
B.3.6	Instructional Handbook	114
B.3.7	Deviations	114
B.4	Applicable Documents	114

B.5	Requirements	114
B.5.1	Detailed Structural Design Requirements	114
B.5.2	General Parameters	117
B.5.3	Specific Design and Construction Parameters	160
B.5.4	Structural Loading Conditions	177
B.5.5	Vibration	188
B.5.6	Strength	189
B.5.7	Durability	194
B.5.8	Damage Tolerance	200
B.5.9	Durability and Damage Tolerance Control	206
B.5.10	Sensitivity Analysis	208
B.5.11	Force Management	208
B.5.12	Production Facilities, Capabilities, and Processes	211
B.5.13	Engineering Data Requirements	211
B.6	Verification	212
B.6.1	Detailed Structural Design Requirements	212
B.6.2	General Parameters	214
B.6.3	Specific Design and Construction Parameters	224
B.6.4	Structural Loading Conditions	226
B.6.5	Vibration	232
B.6.6	Strength	236
B.7	Definitions	265
B.7.1	Acoustic Environment	265
B.7.2	Aerial Delivery	265
B.7.3	Aeroacoustic Fatigue	265
B.7.4	Aeroacoustic Load	265
B.7.5	Aircraft	265
B.7.6	Airframe	265
B.7.7	Air Transport	265
B.7.8	Air Vehicle	265
B.7.9	Auxiliary Systems	265
B.7.10	Container Delivery System (CDS)	265
B.7.11	Damage Tolerance	265
B.7.12	Damping Coefficient (G)	265
B.7.13	Degree of Inspectability	265
B.7.14	Discipline	266
B.7.15	Divergence	266
B.7.16	Durability	266
B.7.17	Durability Service Life	266
B.7.18	Factor Of Uncertainty	266
B.7.19	Fail-Safe Crack Arrest Structure	266
B.7.20	Critical Parts	266
B.7.21	Frequency of Inspection	267
B.7.22	Hardness	267
B.7.23	Initial Quality	267
B.7.24	Load Factor	267
B.7.25	Margin of Safety	267
B.7.26	Minimum Assumed Initial Damage Size	267
B.7.27	Minimum Assumed In-Service Damage Size	267
B.7.28	Minimum Period of Unrepaired Service Usage	267
B.7.29	Multiple Load Path — Fail-Safe Structure	267
B.7.30	Operational Needs	267
B.7.31	Pallet	267
B.7.32	Personnel Ear Protection	267
B.7.33	Pure Tone or Narrow Band	267
B.7.34	Reported Sound Pressure Level	267
B.7.35	Safety of Flight Structure	268
B.7.36	Slow Crack Growth Structure	268

B.7.37 Sound Pressure Levels	268
B.7.38 Special Mission Aircraft	268
B.7.39 Speeds	268
B.7.40 Store	268
B.7.41 Structure	268
B.7.42 Structural Integrity	268
B.7.43 Structural Operating Mechanisms	268
B.7.44 Survivability	268
B.7.45 Vulnerability	268
B.7.46 Key Process Characteristics	268
B.7.47 Key Product Characteristics	269
B.7.48 Key Production Process	269
B.7.49 Process Capability Index (Cp)	269
B.7.50 Production	269
B.7.51 Production Control	269
B.7.52 Production Process	269
B.7.53 A-Basis Allowable	269
B.7.54 B-Basis Allowable	269

Publications of the RTO Applied Vehicle Technology Panel

MEETING PROCEEDINGS (MP)

Unmanned Vehicles (UV) for Aerial, Ground and Naval Military Operations

MP-052, January 2002

Active Control Technology for Enhanced Performance Operational Capabilities of Military Aircraft, Land Vehicles and Sea Vehicles

MP-051, June 2001

Design for Low Cost Operation and Support

MP-37, September 2000

Gas Turbine Operation and Technology for Land, Sea and Air Propulsion and Power Systems (Unclassified)

MP-34, September 2000

Aerodynamic Design and Optimization of Flight Vehicles in a Concurrent Multi-Disciplinary Environment

MP-35, June 2000

Structural Aspects of Flexible Aircraft Control

MP-36, May 2000

New Metallic Materials for the Structure of Aging Aircraft

MP-25, April 2000

Small Rocket Motors and Gas Generators for Land, Sea and Air Launched Weapons Systems

MP-23, April 2000

Application of Damage Tolerance Principles for Improved Airworthiness of Rotorcraft

MP-24, January 2000

Gas Turbine Engine Combustion, Emissions and Alternative Fuels

MP-14, June 1999

Fatigue in the Presence of Corrosion

MP-18, March 1999

Qualification of Life Extension Schemes for Engine Components

MP-17, March 1999

Fluid Dynamics Problems of Vehicles Operation Near or in the Air-Sea Interface

MP-15, February 1999

Design Principles and Methods for Aircraft Gas Turbine Engines

MP-8, February 1999

Airframe Inspection Reliability under Field/Depot Conditions

MP-10, November 1998

Intelligent Processing of High Performance Materials

MP-9, November 1998

Exploitation of Structural Loads/Health Data for Reduced Cycle Costs

MP-7, November 1998

Missile Aerodynamics

MP-5, November 1998

EDUCATIONAL NOTES (EN)

Supercavitating Flows

EN-010, January 2002

Aging Aircraft Fleets: Structural and Other Subsystem Aspects

EN-015, March 2001

Aging Engines, Avionics, Subsystems and Helicopters

EN-14, October 2000

Measurement Techniques for High Enthalpy and Plasma Flows

EN-8, April 2000

Development and Operation of UAVs for Military and Civil Applications

EN-9, April 2000

Planar Optical Measurements Methods for Gas Turbine Engine Life

EN-6, September 1999

High Order Methods for Computational Physics, Published jointly with Springer-Verlag, Germany

EN-5, March 1999

Fluid Dynamics Research on Supersonic Aircraft

EN-4, November 1998

Integrated Multidisciplinary Design of High Pressure Multistage Compressor Systems

EN-1, September 1998

TECHNICAL REPORTS (TR)

Ice Accretion Simulation Evaluation Test

TR-038, November 2001

NATO East-West Workshop on Magnetic Materials for Power Applications

TR-031, August 2001

Verification and Validation Data for Computational Unsteady Aerodynamics

TR-26, October 2000

Recommended Practices for Monitoring Gas Turbine Engine Life Consumption

TR-28, April 2000

A Feasibility Study of Collaborative Multi-facility Windtunnel Testing for CFD Validation

TR-27, December 1999

Task Group Members

Chairman

Mr. Claude Perron
Bombardier Inc. Canada
Military Aircraft Division
10,000 Cargo Road A-4, Montreal International Airport
Mirabel, Quebec J7N 1H3
em: claude.perron@defence.bombardier.com

Co-Chairman

Prof. Dr. O. Sensburg
European Aeronautic Defence and Space Company - EADS
Military Aircraft MT2
Postfach 80 11 60, 81663 Munich, Germany
em: aeroelastic@t-online.de

BELGIUM

Prof. Dr. J. Vantomme
Royal Military Academy (RMA)
Department of Civil Engineering
avenue de la renaissance, 30
B-1000 Brussels
em: jvt@cobo.rma.ac.be

CANADA

Mr. William Glaser
De havilland Inc., 123 Garratt Blvd
Downsview, Ontario M3K 1Y5

FRANCE

Mr. C. Petiau
Aviation Marcel Dassault
78, quai Marcel Dassault
Cedex 300
92552 St. Cloud Cedex
em: christian.petiau@dassault-aviation.fr

GERMANY

Mr. K. Fuellhas
European Aeronautic Defence and Space
Company - EADS
Postfach 80 11 60
81663 Munich
em: konrad.fuellhas@m.dasa.de

Mr. W. Luber
European Aeronautic Defence and Space
Company - EADS
Military Aircraft MT24
P.O. Box 80 11 60
81663 Munich, Germany
em: wolfgang.luber@m.dasa.de

Mr. M. Spieck
DLR - Institute of Aeroelasticity
Vehicle Systems Division
Muenchner Strasse 20
82230 Wessling
em: martin.spieck@dlr.de

Mr. Horst Struck
Wangeroogerstrasse, 13
D-27755 Delmenhorst
em: h.r.struck@web.de

THE NETHERLANDS

Ir. J.B. De Jonge
National Aerospace Lab.
P.O. Box 153
8300 Ad Emmeloord
em: dejonge@nlr.nl

UNITED KINGDOM

Mr. R. Chapman
Aerodynamics Department
British Aerospace, Military Aircraft Div. Warton
Aerodrome, Preston, Lancs

Mr. J. E. Cooper
School of Engineering
University of Manchester
Oxford Road
Manchester, M13 9PL
em: jecooper@man.ac.uk

UNITED STATES

Mr. D. Gibson
Weapons System Design Center
Analysis Branch, Lockheed Martin
Tactical Aircraft Systems
P.O. Box 748, Fort Worth
Texas 76101
em: david.h.gibson@imco.com

Mr. W. Krabacher
AFRL/VACM, Building 31
1981 Fifth Street
Wright Patterson AFB
OH 45433-7202
em: william.krabacher@va.wpafb.af.mil

EDITORS

Prof. Dr. O. Sensburg
European Aeronautic Defence and Space Company - EADS
Military Aircraft MT2
Postfach 80 11 60
81663 Munich, Germany
em: otto.sensburg@m.eads.net

Mr. W. Luber
European Aeronautic Defence and Space Company - EADS
Military Aircraft MT24
P.O. Box 80 11 60
81663 Munich, Germany
em: wolfgang.luber@m.eads.net

Mr. Claude Perron
Bombardier Inc. Canada
Military Aircraft Division
10,000 Cargo Road A-4
Montreal International Airport
Mirabel, Quebec J7N 1H3
em: claud.perron@defence.bombardier.com

1 Introduction

During the past few years there has been an increased interest of the aircraft community on design loads for aircraft. Consequently there was a workshop in 1996 SC73 on "Loads and Requirements for Military Aircraft" (AGARD Report 815). Elastic effects on design loads were presented at a Workshop: "Static Aeroelastic Effects on High Performance Aircraft."

Also an Agadograph was written on Gust Loads: AGARDograph 317: "Manual on the Flight of Flexible Aircraft in Turbulence." All these topics are covered in this manual.

With the increased use of active control systems on aircraft, there is currently a strong need to revisit some concepts used for conventional aircraft and to identify the correction to be brought forward to existing procedures to compute the several loads affecting a military aircraft and the effect of the active control system. Special attention has been given to cover these items.

This report contains the following:

Maneuver Loads

Under this topic, design loads derivation covers the following aspects:

- Aerodynamic/inertia loads
- Aeroservoelastic effects
- Effects of control system failure on design envelope
- Dynamic loads

Gust loads

Although not a major concern for fighter aircraft, gust loads play an important role on aircraft that are designed under civil requirements. A complete description of the methods used is presented along with recommendations on their use. The effect of control system failure is described for the case of gust alleviation systems in Appendix A.

Aircraft/Landing Gear Loads

The specification of a landing gear as a system is shown in the Appendix B.

Limit Loads Concept

Limit load concepts and design loads criteria are explored for actively controlled aircraft.

CONCLUSIONS

In this manual several approaches are presented how to calculate design loads for existing and future aircraft. There is a description of requirements included with some historical background.

It very soon becomes clear that for fly by wire, agile, inherently unstable aircraft, these requirements as far as manoeuvres are concerned are obsolete.

Therefore, an approach as described for the Eurofighter, where flight parameters are restricted and care free handling of the aircraft is provided, is a possible solution.

Gust loads are also presented with some very interesting comparisons of methods dealing with non-linear aircraft.

There is also an extensive compendium of dynamic loads which may be designing the aircraft structure.

A more global approach is also shown which tries to avoid insufficiencies of classical load regulations.

It is hoped that this manual can be helpful for aircraft designers to produce realistic flight loads which will result in optimum weight structures.

2 Loads Requirements Review

The design of modern fighter aircraft is becoming an increasingly complex process, and the establishment of design criteria is an extremely important element in that process. The Structures and Materials Panel of AGARD have noted with concern that the existing design maneuver load regulations in the NATO nations a) are not uniform in content and b) do not generally reflect the actual service experience of the aircraft.

Therefore an AGARD manual was prepared which tries to put together the latest requirement and methods which have been used for the design of recent modern airplanes. As an introduction to the present situations two contributions to military requirements are given. The first one gives a suggestion how maneuver loads criteria could be developed for modern agile aircraft.

In the second one the changes in the USAF Structural Load Requirements are presented which show the evolution of general load criteria valid for every aircraft to a specific document which is part of the overall specification.

Similarly a specification for undercarriage is shown in the Appendix B. The third set of specifications is for civil airplanes and is laid down in JAR25 (not included in this report).

2.1 The development of maneuver load criteria for agile aircraft

Max Hacklinger
Munich, FRG
AGARD Report 746, May 1987

2.1.1 Introduction

The flight maneuver loads are major design criteria for agile aircraft (aerobatics, trainer, fighter aircraft), because large portions of their airframe are sized by these loads. They also belong traditionally to the most elusive engineering criteria and so far engineers never succeeded in precisely predicting what pilots will eventually do with their machines. One extreme solution to this problem would be to put so much strength into the structure that the aerodynamic and pilot tolerance capabilities can be fully exploited by maneuvering without failure. This is more or less the case with aerobatics aircraft, but modern fighters would grow far too heavy by this rule.

To keep things lucid in this overview, I shall try to generalize or simplify the Problems but retain the essential interrelations. Fig. 1 serves to illustrate this:

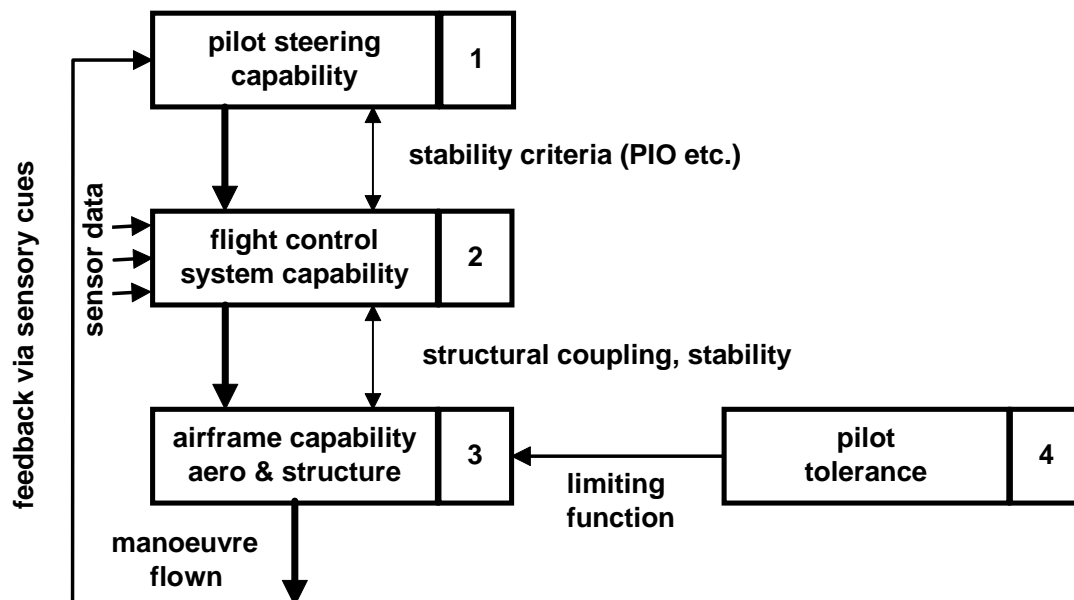

Figure 1

Box 1 contains the pilot's sensomotoric capabilities, that is, his production of time, force and frequency dependent inputs into the aircraft controls.

Box 2 resembles the complete flight control system function from the sensors down to powered actuators. It has to satisfy not only aircraft stability but also man-machine stability criteria among others.

Box 3 stands for the airframe with its aerodynamic and structural capabilities to produce and withstand maneuver loads.

Box 4 contains the physiological limitations of the pilot - his tolerance of high g, angular acceleration etc. Box 4 acts as a single limiting function on box 3 and can be treated independently, but all other boxes are strongly coupled with multiple feedback paths.

In the course of an aircraft development programme, box 4 is given a priori, and apart from special training effects, box 1 is also given at the start in average form. Box 3 is frozen relatively early by definition of the aircraft configuration and so is the architecture of box 2. But then for a long period of simulation and flight testing the functions of 2 are optimized, not only for the clean aircraft but for a variety of external stores. To a lesser degree corrections are also possible in this period for box 3. This optimization process concerns both handling qualities and maneuver loads, but the approaches are different. The handling specialist has to analyze the whole spectrum of possible flight maneuvers with main emphasis an stability and achievement of performance. Design load investigations are a search for maximal and an experienced loads analyst can narrow down the vast spectrum of possible flight cases to relatively few which become load critical. However, this process is becoming increasingly difficult with modern active control systems and the control system departments have to live with a new burden - the responsibility for causing exotic loads.

As a basis for a return to safe ground when the following discussions of advanced maneuver systems leads us too far astray, the next chapter gives a summary of the present status of maneuver load regulations for agile aircraft.

2.1.2 Status of present Criteria

The easiest way of obtaining maneuver loads is to assume abrupt control surface movement to the stops, limited only by pilot or actuator force, and to derive the resulting airloads without aircraft motion analysis. This cheap method is still in use for certification of some civil aircraft but all the military regulations now require sequences of pilot control inputs to initiate load critical maneuvers. The following regulations will be summarized here:

- MIL-A-008861 A (USAF) 1971 for the US Air Force
- MIL-A-8861 B (AS) 1986 for the US Navy
- DEF-STAN 00-970 1983 for the UK
- AIR 2004 E 1979 for France.

The US situation at the moment is curious. (A) used to be the main US specification for flight loads over many years. It has been replaced for the Air Force in 1985 by MIL-A-87221 (USAF), but this new specification is only a frame without the essential quantitative material and as such no great help for the designer. The US Navy on the other hand, who traditionally used to have their own and different specification, have now adopted the old USAF Spec. (A) and updated and amplified it for application to modern control system technology, including direct force control, thrust vectoring etc. Thus (B) seems to be the most up-to-date specification available now. Although modern fighter tactics use combined control inputs in several axes, for a starting basis we prefer to treat them separately as pitching, rolling and yawing maneuvers.

2.1.2.1 Pitching manoeuvres

US Air Force

Fig. 2 shows the longitudinal control inputs for a checked maneuver required in (A) to rapidly achieve high load factors. Table 1 gives the corresponding boundary conditions. Case (a) requires to pull maximum positive g by a triangular control input; if the maximum is not achievable by this, then the pilot shall pull to the stops and hold for such time that max. g is attained. Case (b) is similar to (a) but control displacement and holding time t_3 shall be just sufficient to achieve max. g at the end of the checking movement. Case (c) is similar to (b) but with control movement not only back to zero but $1/2$ of the positive amplitude into the negative direction.

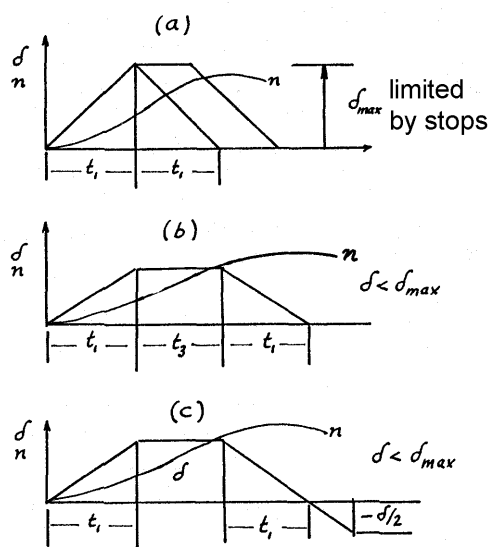

Fig. 2 Stick Inputs for pitching cases of 8861A

Aircraft class	Limit load factor					t_1 [sec]
	Basic design mass		All masses	Max design mass		
	Max	Min at V_H	Min at V_L	Max	Min at V_H	
A,F,T 1)	8.0	-3.0	-1.0	4.0	-2.0	0.2
A,F,T 2)	6.5	-3.0	-1.0	4.0	-2.0	0.2
O	6.0	-3.0	-1.0	3.0	-1.0	0.3
U	4.0	-2.0	0	2.5	-1.0	0.3

- 1) subsonic
2) supersonic

Table 1: Symmetrical maneuver parameters of 8861 A

These theoretical maneuvers are certainly not exactly what pilots will do with modern fighters, but as long as we can not use the vast amount of combat simulation results as an all embracing envelope for flight loads, they provide at least a design basis – and they have historically produced reasonable maneuver loads, particularly tail loads.

US Navy:

(B) has adopted these 3 cases with slightly changed boundary conditions, see Table 2,

Aircraft class	Limit load factor					t_1 [sec]
	Basic design mass		All masses	Max design mass		
	Max	Min at V_H	Min at V_L	Max	Min at V_H	
F, A	7.5	-3.0	-1.0	5.5	-2.0	0.2
T	7.5	-3.0	-1.0	4.0	-2.0	0.2
O	6.5	-3.0	0	3.0	-1.0	0.3
U	4.0	-2.0	0	2.5	-1.0	0.3

Table 2: Symmetrical maneuver parameters of 8861 B

(d) maximum control authority in the negative direction shall be applied until maximum stabilizer or wing load has been attained. This can mean more than $-\delta/2$ in case (c).

(e) is a special case for "computer control", fly-by-wire, active control, stability augmentation, the direct lift control, or other types of control system where the pilot control inputs do not directly establish control surface position" which we shall call here generically ACT systems. This case requires that aircraft strength shall also be sufficient to cover modifications of cases (a) to (c) caused by ACT systems partially failed (transients, changed gains etc.), a requirement which is easier stated than proven.

UK

In the UK, pitching maneuvers have traditionally been covered by airplane response calculations after the Czaykowski method which assumed an exponential function for elevator movement and no checking. This was an expedient way to obtain tail loads but the new UK specification (C) advises that pilot control inputs should be used now. It does not specify any details of these.

France

The French specification (D) is very similar to case (a) of (A), with two differences: it has other load factors, see Table 3, and it allows a slower stick return to neutral in time t_2 ; for servo controls $t_1 = t_2$ shall be derived from maximum control surface rate under zero load. It does not require checking into the negative region as (A) and (B). (see Fig. 3)

Aircraft class	Limit load factor		T_1 [sec]	T_2 [sec]
	Max	min		
III	n_1^*	$-0.4 n_1$	0.2	0.3
II	4.0	-1.6	0.2	0.3
I	2.5	-1.0	0.3	0.3

Table3: Symmetrical maneuver parameters of AIR 2004E
* n_1 defined in the aircraft specification

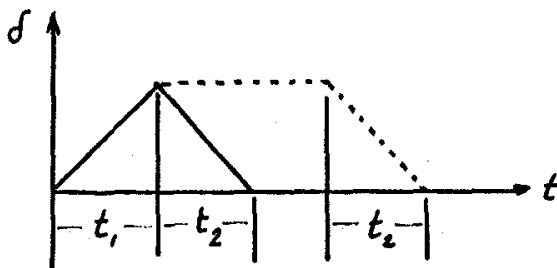

Fig. 3 Control Inputs of AIR 2004 E

2.1.2.2 Rolling maneuvers (with pitching)

US Air Force

The rolling cases of (A) assume rapid control inputs and reversal (checked maneuvers), see Fig. 4. With 267 N force the stick shall be moved sideways in 0.1 sec, held until the specified bank angle is attained and then reverted to neutral in 0.1 sec. If a roll rate greater than 270°/s would result, control position may be lessened to just achieve this value, but the roll rates shall never be lower than those necessary to achieve the time to bank criteria in the handling qualities specification ($T_{360} = 2.8$ sec gives $P_{max} \approx 150^\circ/\text{sec}$).

Fast 180° rolls are required starting from level flight with -1 to +1g.

Fast 360° rolls are required starting from $n=1$.

Rolling pull out is required to start from steady level turns with load factors from 1 to 8 n_1 (for a typical 8 g airplane this is 1 to 6.4 g).

By application of rapid lateral control (Fig. 4) the aircraft shall be rolled through twice the initial bank angle. In our typical example this would be a bank angle change of 162°. Longitudinal control may be used to prevent exceeding 0.8 n_1 during maneuver.

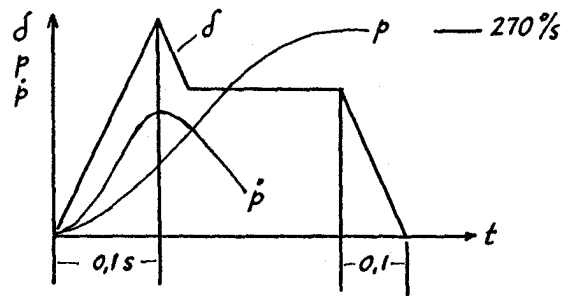

Fig. 4 Stick Input of rolling cases of 8861 A

US Navy

The US Navy has in (B) adopted the rolling criteria of (A) but with significant additions: for ACT aircraft the Pilot force is replaced by "maximum control authority". The reference to roll performance requirements is removed - probably because this criterion used to be less stringent than the 270 °/sec in most cases. Important is the explicit reference to external store configurations; the rolling cases of (A) have often been met in the clean configuration only. But most important is the addition of a new case for ACT aircraft. It states that the aircraft shall be designed for maximum abrupt pilot inputs in all three axes. But it also states that these inputs shall in no case lead to higher rates and load factors than the conventional cases.

This paragraph is remarkable in several respects. It describes a control system which would digest the wildest pilots Inputs into control outputs which are tailored to just achieve the old load maximum. It shows clearly the dilemma of the rule maker in the face of rapid technical development. This is the dream of the now

much advertised carefree (foolproof) handling system. In reality control systems are primarily optimized for actual maneuver performance and not for achievement of some theoretical load cases. On the positive side this criterion recognizes the need to retain some reference to proven maneuver design load practice.

Another addition in (B) is the requirement that the structure shall also be designed to withstand the demonstration requirements of MIL-D-87088 (AS), which apparently is not obvious.

UK

In the UK a wider envelope of initial conditions is required for the rolling cases, including a negative g roll reversal: -1.5 to 7.2 g. For the maximum roll rate several limits are given: at least 1 1/3 of the roll performance

criteria in the handling specification which amounts to about 200 °/sec; 200 °/sec for ground attack and 250 °/sec for aerial combat maneuvers. The control input time history is roughly as in (A).

France

The French specification also requires negative initial conditions for the rolling cases:

-1.6 to 6.4 g. (D) has control inputs similar to (A), but with $t_1 = 0.2$ and $t_3 = 0.3$ or maximum servo capability. The roll limits are more severe, i.e., a full 360° roll and $p_{max} \approx 300$ °/sec. (C) and (D) may reflect the experience that US pilots tend to avoid negative g maneuvers in contrast to their European colleagues:

Table 4 summarizes the rolling parameters for a typical 8 g airplane.

(A)	(B)	(C)	(D)
MIL-A-8861 A	MIL-A-8861-B	DEF STAN 970	AIR 2004 E
180° roll -1 to +1 g 360° roll at 1g rolling pull out from 1 to 6.4 g, $t_1 = t_2 = 0.1$ sec, $p_{max} = 270$ °/sec	Same as A plus ACS fool proof ness with maximum control authority plus demonstration requirements	Rolling pull out from -1.5 to 7.2 g, $p_{max} = 1.33 p$ handling ≈ 200 °/sec Ground attack 200°/sec Aerial combat 250°/sec No t_1 , but maximum servo capability	360 ° roll, $p_{max} = 360$ °/sec rolling pull out from -1.6 to 6.4 g $t_1 = 0.2$ sec $t_2 = 0.3$ sec or max servo capability under zero load and $t_1 = t_2$

Table 4: Comparison of rolling parameters (8g airplane)

2.1.2.3 Yawing Maneuvers

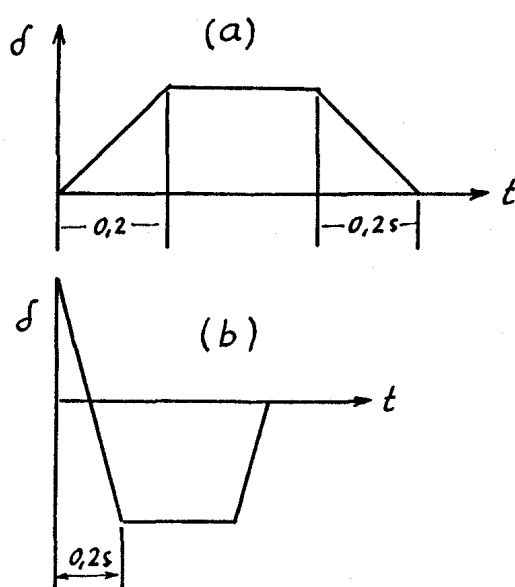

Fig. 5 Rudder Inputs of 8861 A

US Air Force

Apart from the usual engine failures cases, (A) specifies low and high speed rudder reversal.

Fig. 5a shows the rudder for maneuvers from straight and level flight. At low speed 1334 N pedal force are required, at high speed 800 N.

Fig. 5b shows the rudder input for the reversal case; from maximum steady sideslip a fast recovery to zero yaw shall be made.

US Navy

(B) has adopted these design cases and amplified them with three new ones:

- for aircraft with direct side force control, strength shall be provided for abrupt application of control authority up to a maximum side load factor of $n_y = 3$.
- for aircraft with lateral thrust vectoring capability, all maneuvers specified in the handling and stability criteria shall also be covered in the loads analysis.

- it is general practice that evasive maneuvers such as jinking, missile break etc. shall be considered in the loads analysis.

UK

(C) requires a rudder kick with 667 N pedal force or maximum output of the control system at all speeds. It also requires the traditional British fishtail maneuver: starting from straight level flight, the rudder is moved sinusoidal for 1 1/2 periods of the Dutch Roll frequency with an amplitude corresponding to 445 N pedal force or 2/3 of the actuator maximum.

France

(D) has a rudder reversal case very similar to Fig. 5 b and a rudder kick without reversal, but both slightly slower than (A) due to $t_1 = 0,3$ sec.

Spinning is somewhat marginal for our theme of pilot controlled maneuvers but it deserves mentioning that it can cause rather high loads. (B) has now increased the yawing velocity of agile aircraft with fuselage mounted engines from the 200 °/sec in (A) to 286 °/sec. This is a severe requirement for long fuselages.

The following figures show typical load maneuvers resulting from application of the current US Mil-Specs. to an aircraft with moderate amount of ACT (Tornado).

Fig. 6 gives time histories of response quantities in a rapid pitching maneuver with the control input specified in Fig. 2, case (a). displacement δ_{max} and holding time are just sufficient to achieve $n_{z,max}$ '

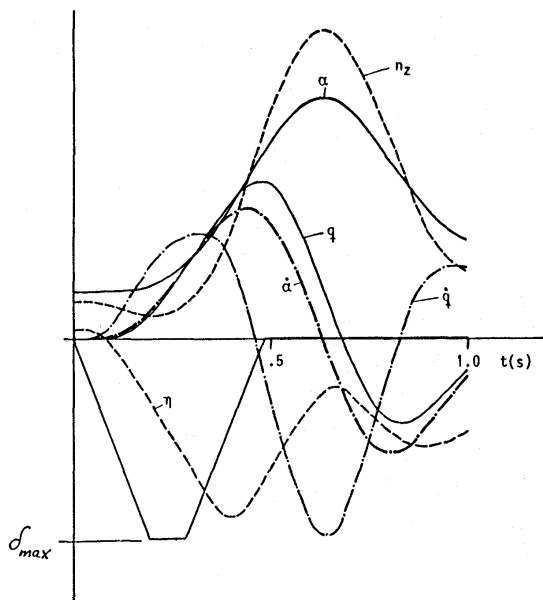

Fig. 6 Tornado rapid pitch, case(a) $M=0.9$, 1000ft, full CSAS

Fig. 7 is a time history of response quantities resulting from the control input of case c in Fig. 2 which is critical for taileron bending moment BM.

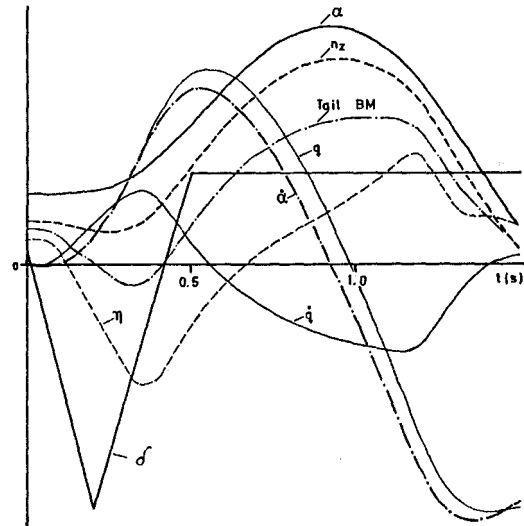

Fig. 7 Tornado rapid pitch, case (c), $M = 0.92$, 22500 ft, full CSAS

Fig. 8 corresponds to the rolling pull out maneuver with initial load factor $0,8 n_1$. This is another critical case for taileron loads.

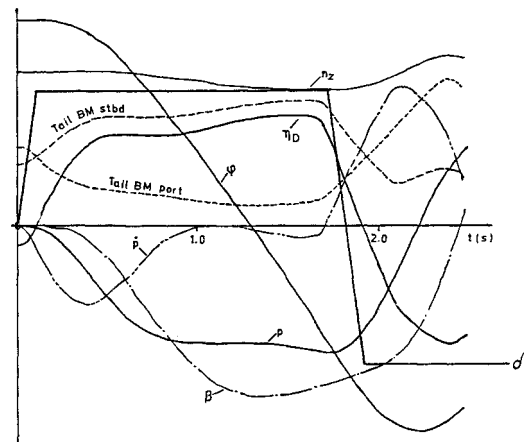

Fig.8 Tornado rolling pull out $M=0.92$, 19100ft, full CSAS

2.1.3 The influence of piloting technique

Having set the scene of present structural maneuver criteria, the next step is to review how realistic they are in a changed tactical environment with different piloting techniques. Mohrman has given a good account of these changes in [1], describing engagement rolls, turn reversal with push down to increase roll rate, jinking maneuvers etc. From the fact that these maneuvers are only weakly correlated with the specification maneuvers one might be tempted to conclude that the old specifications should be abandoned altogether in favor of realistic simulation of combat maneuvers. Before deciding upon radical cut however, several arguments need to be considered.

Even for the old-fashioned aircraft without ACT the specified control inputs were never fully representative of actual pilot handling. They came closest for a control system with a solid stick directly connected to tail surfaces without sophisticated tabs, but they were only engineering simplifications of nature - like a $(1 - \cos)$ gust which does exist nowhere but is used to produce reasonable loads.

Pilots are quite inventive in finding new techniques for combat maneuvering - in fact this is part of the selection process (survival of the fittest). For this reason and due to changed tactical scenarios, most aircraft later in their service life are used differently from the way projected at the design stage. If a sophisticated simulated combat maneuver is used to derive critical design loads this case may be overtaken by evolution after a few years in service. ACT gives the possibility of late adjustments of the limiting functions, ideally by software changes only, but this is equally true for an aircraft designed to the old criteria.

Perhaps the major difference between the old criteria and the new piloting techniques lies in the longer sequences of combined maneuvers and not so much in the short elementary inputs (stick to the stops, maximum pilot force).

If so, it would be easier to adapt an aircraft designed to the old criteria to changed operational practice than one with sizing load cases derived from specific complex simulated maneuvers.

An important difference to the old criteria exists in the absolute level of maneuver loads. Improved g-suits, increased aircraft performance and improved control systems with load limitation - all these factors have led pilots to pull limit loads more often and for longer duration. There is also indication for an increased application of negative g in jinking maneuvers. This general tendency goes so far that high performance aircraft are now more frequently crashed due to pilot incapacitation (GLC).

The increased overall load level certainly necessitates adjustment of the old fatigue strength criteria (e.g. MIL-8866); whether it also requires expansion of the design g-envelope, is debatable. Following the rationale which has been the basis of our airworthiness criteria for many years now, it would be sound engineering practice to increase design strength if the overall load level has statistically increased. Other people argue however, that the load limiting capability of ACT does not only justify staying with the old design loads, but even reducing the factor of safety.

Whilst designers are confronted with a very real increase in the overall level of the symmetrical load cases, the situation is more obscure with the unsymmetrical loads. Due to various scheduled interconnects between rudder, taileron, aileron or spoilers, the pilot now is rarely aware of the effect his commands have on the aircraft control surfaces. The only real limitation of unsymmetrical maneuvers is probably the pilot's tolerance to lateral acceleration which is far less than in the vertical direction. Turning to Fig. 1 again, this control function is executed via the feedback path between boxes 3 and 1.

At this point it is well to remember that the results of any ground based simulation are severely limited by the absence of realistic motion cues to the pilot - nevertheless these simulations have become an indispensable development tool.

2.1.4 The influence of advanced control systems

The cockpit environment has drastically changed in recent years with the rapid development of flight control systems. For many decades pilots had to move large controls against inertia and air forces to keep their machines under control. Most of the aircraft in service now have still control movement but artificial feel to provide some indication of the flight conditions. Now sidestick controllers are being introduced which are very sensitive and require almost no motion. Although man is basically a motion sensitive animal, pilots seem to have adapted to this type of control. But from our viewpoint of aircraft loads, we should keep in mind that many natural limitations which used to prevent the pilot from commanding critical flight situations, do not exist with ACT-aircraft. The conventional type of control is essentially a low pass filter. With sidestick controllers many high frequency inputs, some of them unintentional, can make the FCS nervous.

Several loading cases in the existing criteria are based on maximum pilot forces. The attempt in (B) to replace this for ACT-aircraft by "maximum pilot authority" is not convincing. What is this pilot authority? The phrase "maximum deflection of motivators" in (C) does not resolve the problem either. This is just another case where we have lost an engineering yardstick which used to work well in the past.

More important than changes at the input side are changes in the main FCS functions. Traditionally, flight control systems have been optimized for handling qualities, with a few loads related functions like roll rate limitation incorporated separately. So the problem was to provide maximum maneuverability with sufficient flight stability to prevent loss of control. This task requires high authority and strong control outputs. Now ACT systems have a new basic function, load limitation, which requires low authority and mild control outputs. Thus FCS optimization has become a much more demanding task to unite two conflicting targets.

The FCS-certification effort has also increased drastically with automatic load limitation since the FCS is now a direct component of the proof of structural integrity. Where it was previously efficient to show that consecutive failures in the FCS led to degraded handling but still preserved a minimum get-you-home capability, the load limiting function of the FCS is directly safety critical and must therefore satisfy severe criteria for failure rates, redundancy etc.. To a degree this is reflected in (B) by the requirement that the loading cases shall also include different failure states of the FCS. The associated problems are severe and can only be touched upon: Sensor redundancy, -disparity, software qualification, load distribution and a. o.

It is clear that proof of airworthiness of ACT aircraft would be incomplete with consideration of the deterministic loads cases only the ACT part needs to be treated statistically and this can be a cumbersome journey through the woods of failure trees. Quantitative guidance can be taken from [2]

The overall failure rates given there are still applicable to new designs.

Let us return now to the "carefree handling" concept which appears to offer great possibilities for loads control and which Air Staffs are all too ready to specify because it would reduce pilots workload significantly and free them for tactical tasks. In our context of maneuver loads such a control system ideally would limit all flight loads to the design values so that neither pilot nor designer need to worry about exceeding the structural capability of the airframe. This requires a large number of reliable inputs - air data, flight path coordinates, but also continuous complete knowledge of the aircraft mass status, including external stores partially released (speed limits would probably still have to be observed by the pilot).

The central problem of such a system however, is the fact that good handling qualities and reliable load limitation have conflicting tendencies in the FCS optimization. So at best, a compromise can be achieved where due to the load limiting functions the handling envelopes are reduced, particularly in the upper left hand corner.

Load distribution is another complicating factor for an ACT aircraft the same flight condition can often be achieved with a variety of aircraft configurations, depending on foreplane position, maneuver flap scheduling and perhaps vectored thrust. Assessment of those cases is even more difficult because airload distribution is already a great problem on modern agile aircraft due to non-linearities, elastic structure, fuselage lift, dynamic lift etc.

It appears unlikely that we shall see comprehensive carefree handling control systems in operational use which would also effect complete load limitation. More realistic is the selection of a few single parameters such as symmetric g, roll rate and perhaps sideslip which are controlled automatically. After all, who wants a formula 1 racing car with a carefree handling control system?

One of the great benefits of ACT is its flexibility. Where previously adjustment of the handling characteristics during development was very limited to changes of springs, bobweights and control surface tabs, it is now possible to tailor handling qualities over a wide range during flight testing without large hardware changes. Also greater changes in operational usage can be accommodated later on by ACT. This has consequences for the loads; they are subject to larger changes during the aircraft life. On the other hand development of modern aircraft takes so long that the basic configuration must be frozen long before the final loads situation is known with confidence.

In consequence, the certification process needs to be changed too. It is futile from the start trying to find structural maneuver load criteria which cover all eventualities. What we can do is to keep our feet on proven ground initially, that is to use the updated

conventional criteria for the basic design. Then, for a long period of simulation and flight testing, adjustments are made whenever weak areas are discovered. This requires an integrated approach by the FCS and loads departments. The certification process must recognize this by not aiming at the usual final operational clearance, but over many years providing preliminary clearances which reflect the temporary state of knowledge about tested maneuver loads and the related build standard of the FCS.

In summary, the maneuver loads part of aircraft design has evolved from a relatively clean-cut, predetermined analysis to a long iterative process which gradually utilizes flight test information to expand the flight envelopes; a process which is also much more demanding because it involves the reliability of the FCS in proving structural integrity.

2.1.5 Conclusion

Design maneuver load regulations in the NATO nations have evolved from crude assumptions of single control surface movement to relatively complicated series of Pilot inputs in all three axes. These inputs need to be standardized to permit the assessment of structural loads with reasonable effort, but with the advent of active control technology the hiatus between standardized control inputs for load assessment and actual pilot practice with agile aircraft is rapidly increasing. A solution of this dilemma may be to design flight control systems such that they provide "carefree handling", that is a system which even for the wildest pilot inputs does not lead to structural damage. But this solution has also disadvantages:

- a) structural designers lose the wealth of experience contained in previous design practice and with it their basis for initial dimensioning of the airframe. This affects a large portion of the aircraft mass and later re-design may be impossible.
- b) Structural safety becomes crucially dependent on the functioning of black boxes and their connections. As long as we have no technically feasible direct load sensing and controlling system, a compromise is proposed: Use the best combination of the old criteria for initial design but allow for a long development period flight control system adjustments of load critical functions to fully exploit the maneuver capability of the aircraft without structural damage. This will require a flexible system of operational clearances where the user can not have a complete definition of the maneuver capabilities at the start of a program.

We have no consistent set of airworthiness criteria which fully covers maneuver loads of agile aircraft.

Attempts to update the existing criteria to embrace the vast possibilities of ACT are only partially successful.

Proof of airworthiness of aircraft with ACT has become more demanding since the load influencing functions of the FCS are directly safety critical and must be analyzed for failure to the same quantitative criteria as the structure itself.

The existing criteria can and should still be used for initial design to define the airframe. Certification needs to

become adaptive to reflect a long period of testing and FCS changes .

2.1.6 References:

- (A) MIL-A-008861 A (USAF) 31.03.1971
Airplane Strength and Rigidity, Flight Loads
- (B) MIL-A-8861 D (AS) 07.02.1986
Airplane Strength and Rigidity, Flight Loads
- (C) DEF STAN 00-970 October 1985
Design and Airworthiness Requirements for
Service Aircraft, Volume 1 Airplanes,
Part 2 Structural Strength and Design for Flight
- (D) AIR 2004 E Resistance des Avion 08.03.1979
- [1] Mohrman, R.:
Selecting Design Cases for Future Aircraft
AGARD-Report 730, 1986
- [2] Hacklinger , M.:
Airworthiness Criteria for Operational Active
Control Systems.
Paper for DGLR panel Aeroelastics and
Structural Dynamics 1979 (translation)

2.2 Changes in USAF Structural Loads Requirements

Daniel Sheets and Robert Gerami
Loads and Dynamic Branch
Aeronautical System Division
ASD/ENFL, Wright Patterson Air force Base OH, 45433-
6503, USA
AGARD Report 746 , May 1987

The new General Specification for Aircraft Structures, MIL-A-87221 (USAF), does not establish the traditional, fixed requirements, but instead it presents the current tailored approach to establishing structural loads requirements. In most cases the previous specifications set arbitrary load levels and conditions to be used in aircraft design. These requirements were based upon historical experience, without consideration of future potential needs or capabilities brought about by technology advances. Instead, the new philosophy requires that loading conditions be established rationally for each weapon system based on anticipated usage. Also, compliance with each condition must be verified by analysis, model test, or full scale measurement.

2.2.1 Introduction

During the late 1970s, several conditions came together that caused the US Air Force to develop new aircraft structural specifications. While the USAF has always had a policy of reviewing, revising, and upgrading existing specifications, there were factors favoring a new

approach. The contracting and legal authorities believed that the existing system of many layers of specifications needed to be simplified. Also, rapidly advancing structural technologies, coupled with new realms of performance and control capabilities, demanded that the structural specifications address much wider range of conditions while using an ever widening mix of technologies. The new military specification for aircraft structures, MIL-A-87221 (USAF), is a major deviation from past requirement practices. It establishes weapon system uniquely tailored structural performance and verification requirements for airframes based on an in-depth consideration of operational needs and anticipated usage. In the past, specifications set arbitrary conditions, levels, and values to be used in the design of broad categories of aircraft.

Various sources have alleged that design requirements have not kept pace with current usage practices; especially in the area of flight combat maneuvers. These allegations ignore the new requirement philosophy and are wrong for several reasons. The specification, MIL-A-87221 (USAF), does not preclude the consideration of any type of loading situation. The new specification actually requires the consideration of any loading condition that can be identified for either analysis, model testing, or full scale measurement. Therefore, if a loading condition is overlooked, the fault is not with MIL-A-87221 since it is not a set of rigid, pre-determined requirements.

Thus, this new approach does place a greater reliance on the designer's insight and ability to correctly anticipate the actual service loads. The term designer represents a broad spectrum of individuals associated with the USAF, System Contractor, and not just from the System Project Office which manages system development for the USAF. Anyone attempting to use the specification must understand that this one document covers all types of aircraft; from light observation, to the largest transport, to the fastest fighters, to any of the most advanced flight vehicles. Therefore, any application of this new specification must be tailored to the specific type of aircraft under design. It should also be understood that no two aircraft designs, even of the same general type, will have identical anticipated usage. Therefore, not only must the detail design specification be tailored to a specific type or category of aircraft, but it must also reflect the specific anticipated usage of the aircraft being designed and performance capabilities brought about by technology improvements in aerodynamics, control system integration, materials, and human factors.

2.2.2 Structural Loading Condition

The general organization of MIL-A-87221 is shown in figure 1. Structural loading requirements are developed through the application of section 3.4 of the appendix. The verification of these requirements is established by the use of section 4.4, also of the appendix. This procedure when incorporated into the new specification gives the user the best features of both a checklist approach and total design freedom. The loading requirement section 3.4, is divided into flight and ground conditions as shown in figure 2. The flight and ground

conditions are divided into subsections as shown in figures 2a and 2b respectively. Each of the many subsections contain various specific load sources which the designer can either accept or modify as appropriate. During aircraft design, particular care must be exercised in defining both the structural loading conditions and the associate distributions used to design the airframe, which in turn directly influences the performance and reliability of the aircraft. No single section of the specification can be addressed independently. All requirements pertaining to all technologies must be considered as one unified entity. Both flight and ground operating conditions must be based on the anticipated usage, unique to a specific aircraft design effort. These conditions reflect the operational usage from which design loads shall evolve.

Even though this new approach gives the designer considerable flexibility, the designer is not abandoned to establishing all requirements without guidance or assistance. In both the requirement and verification sections, numerous possibilities are presented for consideration. The applicability or non-applicability of Bach suggested requirement or verification can be indicated by inserting either "APP" or "N/A" in a blank provided with Bach one. For those that are considered applicable, either the requirement or verification procedure is then fully defined. Additionally, unique requirements can be added as a direct product of the tailoring process.

2.2.3 Flight Loading Conditions

The flight conditions (subsection of 3.4) consists of thirteen categories, from the Standard symmetrical maneuvers, to missile evasion, to the all inclusive "Other" category which is the one that both frees the designer from rigid requirements and simultaneously burdens him with the need to better define anticipated usage. The maneuver load category suggests a minimum of five sub-categories for consideration. There is, of course, the usual symmetric maneuver envelope, figure 3. However, due to current usage, various maneuvers such as extreme yaw, jinking, or missile lock evasion are suggested for design consideration. Any maneuver which is possible for an anticipated aircraft and its usage, must be considered for design purposes.

Other changes can be found in the area of turbulence analysis. Historically, gust loading conditions have been analyzed by a discrete approach. However, the current procedure is to employ an exceedence distribution calculation. In order to establish the exceedence distribution, various parameters are needed. Fortunately, the new specification does suggest values for these terms; figure 4 is an example from the specification. Also, historically, maneuver and gust loading were considered independent and non-concurrent of each other except for aircraft engaged in low altitude missions. However, MIL-A-87221 actually suggests the designer rationally consider various conditions where gust and maneuver loads are combined because they concurrently affect the aircraft.

A very different type of load condition occurs during in-flight refueling. While some services use the probe and drogue system, a few others use the flying boom approach; a few use both types of in-flight refueling

systems. This specification provides guidance in both these areas to establish appropriate design conditions.

Since the very beginning of aircraft pressurization, specifications have addressed its loading effects. However, this new specification addresses pressurization in a more inclusive manner than in the past. Usually, pressurization concerns have been focused on cockpits or crew compartments. In contrast, the new specification addresses all portions of the aircraft structure subject to a pressure differential. The requirements to consider pressurization even apply to such areas as fuel tanks, avionics bays, or photographic compartments. The broad application of this section of the specification requires constant and capable vigilance by the designer to include all pertinent structure.

Since this specification does not presume to directly address all possible loading phenomena, a special category is reserved for any unique situations. This category is called "other" and is available so the designer can completely define all anticipated aircraft flight loading conditions. The important aspect of this category is that the designer is free to include any flight loading condition derived from operational requirements that can be appropriately defined for analysis

2.2.4 Ground Loading Conditions

While aircraft ground operations are not as glamorous as flight performance, they can be the source of significant loading conditions. Unlike flight conditions, there have been very few changes to ground operating conditions in recent years. In some cases the loading levels have been decreased due to improved civil engineering capabilities; improved runways, taxiways, ramps, etc. Ground loading conditions include all ground operations (taxi, landing, braking, etc.) and maintenance operations (towing, jacking, hoisting, etc.).

2.2.4.1 Ground Operations

Since the earliest days of aircraft, ground operations have changed very little. Most of these changes have been in the area of load magnitude, not in the type or source of load. Before takeoff, an aircraft normally needs to taxi, turn, pivot, and brake. Various combinations of these operations must be considered in order to fully analyze realistic ground operations. The resultant loads are highly dependent on the operating conditions, which are in turn dependent on the aircraft type and anticipated mission.

2.2.4.2 Takeoff and Landing.

Usually takeoffs and landings are performed on hard smooth surfaces which are of more than adequate length. However, in some situations the surface is not of adequate length, hardness, or smoothness. Therefore, takeoff specifications must either anticipate all possible situations or allow the designer to establish specific takeoff and landing requirements for each system. For example, consideration is given to rough semi-prepared

and unprepared surfaces. Even rocket and catapult assisted launch is included in the specification. However, the designer is free to consider devices such as ski-jumps, if they are appropriate to the aircraft and missions involved. Since takeoffs are addressed; so too are landings. Various surfaces, arrestment devices and deceleration procedures are included for consideration as possible load producing conditions. The designer and eventual user must work together to correctly establish landing requirements, since they can vary greatly depending on the final usage of the aircraft.

2.2.4.3 Towing

Since the beginning of aviation, it has been necessary to tow aircraft. While the designer is free to define his own towing conditions and associated loads, he must also to verify the legitimacy of these conditions. In this category the new specification comes close to the previous Air Force criteria specifications by providing the values given in figures 5 and 6. One should remember that these towing conditions are very much result of years of empirical experience. Justifying and verifying new towing load conditions could be a very difficult task.

2.2.4.4 Crashes

Unfortunately not all flights are successful; some end in crashes. Different types of aircraft require various types of design considerations for crash loads, depending on their inherent dangers due to mission and general configuration. For example, fighters pose crash problems with respect to seats, fuel tanks, or cockpit equipment, but definitely not litters or bunks. However, the design of a transport would most assuredly involve crash load considerations for cargo, litters, bunks, or even temporary fuel tanks in the cargo compartment. The new specification suggests various combinations of on-board equipment. These suggested values, figure 7, are very similar to the historic ones which in the past were firm requirements. Today a designer can use factors other than the suggested ones, as long as the alternate load factors can be substantiated.

2.2.4.5 Maintenance

Even daily maintenance actions can impose various loading conditions on aircraft. Many maintenance operations require towing, jacking, or hoisting which subject the aircraft to abnormal and unusual loading combinations that must be considered during aircraft design. General data is supplied for these conditions, see figure 8. However, following the tailoring in MIL-A-87221 (USAF), the designer is free to define any level of maintenance induced loading which can be substantiated.

2.2.4.6 CONCLUSIONS

The new specification, MIL-A-87221, will allow design requirements to be more closely tailored to the anticipated use of the aircraft. In this way the final product will be more efficient, with less wasted, unneeded, and unused capabilities. This will lead in turn to reduce costs of ownership for Air Force weapon systems. This specification has been applied to the definition of requirements for the Advanced Tactical Fighter. This process is now taking place.

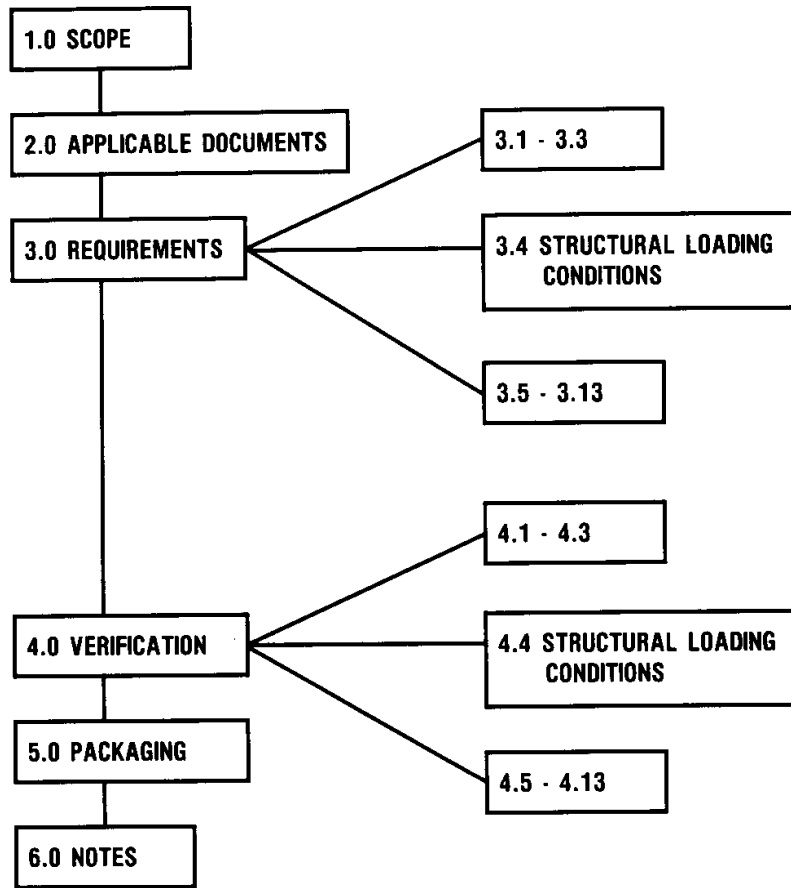

FIG. 1 ORGANIZATION OF MIL-A-87221 (USAF)

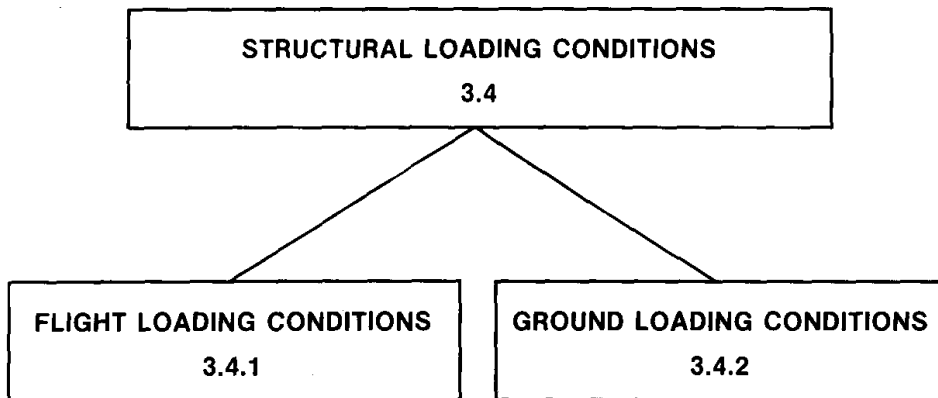

FIG. 2 ORGANIZATION OF "STRUCTURAL LOADING CONDITIONS"

FLIGHT LOADING CONDITIONS**3.4.1**

- 3.4.1.1 SYMMETRIC MANEUVERS**
- 3.4.1.2 ASYMMETRIC MANEUVERS**
- 3.4.1.3 DIRECTIONAL MANEUVERS**
- 3.4.1.4 EVASIVE MANEUVERS**
- 3.4.1.5 OTHER MANEUVERS**
- 3.4.1.6 TURBULENCE**
- 3.4.1.7 AERIAL REFUELING**
- 3.4.1.8 AERIAL DELIVERY**
- 3.4.1.9 SPEEDS AND LIFT CONTROL**
- 3.4.1.10 BRAKING WHEELS IN AIR**
- 3.4.1.11 EXTENSION AND RETRACTION OF LANDING GEAR**
- 3.4.1.12 PRESSURIZATION**
- 3.4.1.13 OTHER FLIGHT LOADING CONDITIONS**

FIG. 2A FLIGHT LOADING CONDITIONS**GROUND LOADING CONDITIONS****3.4.2**

- 3.4.2.1 TAXI**
- 3.4.2.2 TURNS**
- 3.4.2.3 PIVOTS**
- 3.4.2.4 BRAKING**
- 3.4.2.5 TAKEOFF**
- 3.4.2.6 LANDINGS**
- 3.4.2.7 SKI EQUIPPED AIR VEHICLES**
- 3.4.2.8 MAINTENANCE**
- 3.4.2.9 GROUND WINDS**
- 3.4.2.10 CRASHES**
- 3.4.2.11 OTHER GROUND LOADING CONDITIONS**

FIG. 2B GROUND LOADING CONDITIONS

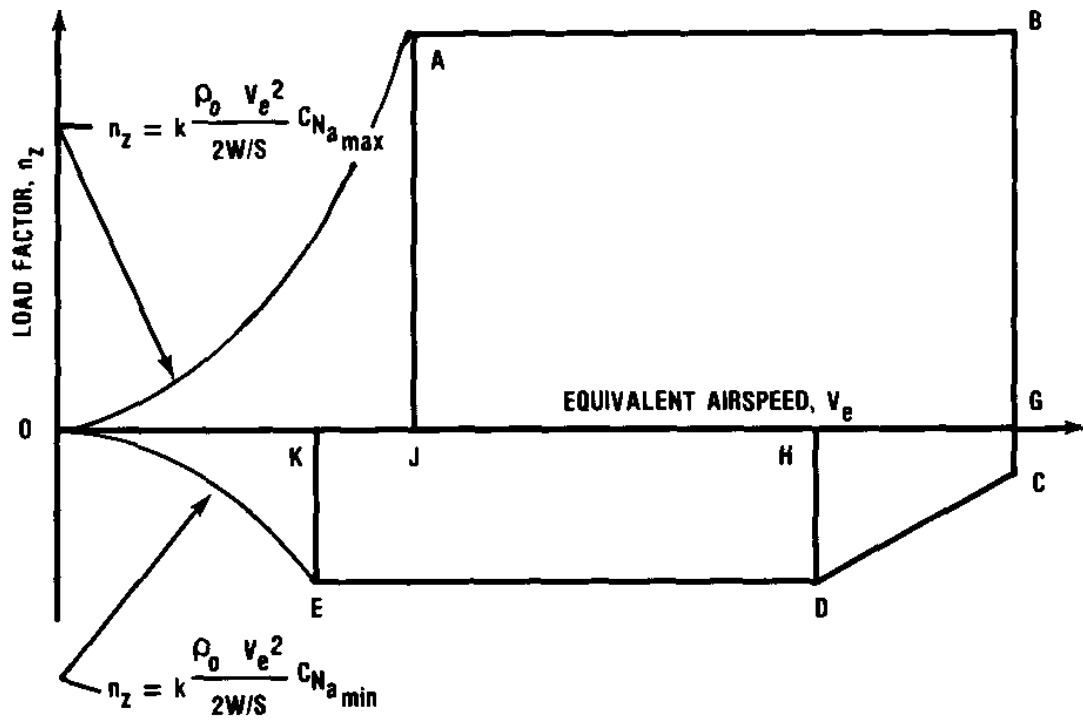

NOTES:

1. JA = GB = VALUE SPECIFIED IN PARAGRAPH 3.2.9
2. GC = VALUE SPECIFIED IN PARAGRAPH 3.2.9
3. HD = KE = VALUE SPECIFIED IN PARAGRAPH 3.2.9
4. OH = V_H AS SPECIFIED IN PARAGRAPH 3.2.7
5. OG = V_D OR V_L AS SPECIFIED IN PARAGRAPH 3.2.7

FIG. 3 V - n DIAGRAM FOR SYMMETRICAL FLIGHT AS PRESENTED IN MIL-A-87221 (USAF)

ALTITUDE (FT)	MISSION SEGMENT	DIRECTION ^{1/}	P ₁	b ₁ (FT/SEC)	P ₂	b ₂ (FT/SEC)	L (FT) ^{2/}
0 - 1,000	LOW LEVEL CONTOUR	VERTICAL	1.00	2.70	10 ⁻⁵	10.65	500
0 - 1,000	LOW LEVEL CONTOUR	LATERAL	1.00	3.10	10 ⁻⁵	14.06	500
0 - 1,000	CLIMB, CRUISE, DESCENT	VERT & LAT	1.00	2.51	.005	5.04	500
1,000 - 2,500	CLIMB, CRUISE, DESCENT	VERT & LAT	.42	3.02	.0033	5.94	1750
2,500 - 5,000	CLIMB, CRUISE, DESCENT	VERT & LAT	.30	3.42	.0020	8.17	2500
5,000 - 10,000	CLIMB, CRUISE, DESCENT	VERT & LAT	.15	3.59	.00095	9.22	2500
10,000 - 20,000	CLIMB, CRUISE, DESCENT	VERT & LAT	.062	3.27	.00028	10.52	2500
20,000 - 30,000	CLIMB, CRUISE, DESCENT	VERT & LAT	.025	3.15	.00011	11.88	2500
30,000 - 40,000	CLIMB, CRUISE, DESCENT	VERT & LAT	.011	2.93	.000095	9.84	2500
40,000 - 50,000	CLIMB, CRUISE, DESCENT	VERT & LAT	.0046	3.28	.000115	8.81	2500
50,000 - 60,000	CLIMB, CRUISE, DESCENT	VERT & LAT	.0020	3.82	.000078	7.04	2500
60,000 - 70,000	CLIMB, CRUISE, DESCENT	VERT & LAT	.00088	2.93	.000057	4.33	2500
70,000 - 80,000	CLIMB, CRUISE, DESCENT	VERT & LAT	.00038	2.80	.000044	1.80	2500
ABOVE 80,000	CLIMB, CRUISE, DESCENT	VERT & LAT	.00025	2.50	0	0	2500

- NOTES: ^{1/} PARAMETER VALUES LABELED VERT & LAT ARE TO BE USED EQUALLY IN BOTH THE VERTICAL AND LATERAL DIRECTIONS.
- ^{2/} FOR ALTITUDES BELOW 2,500 FT, THE SCALE OF TURBULENCE, L, CAN BE ASSUMED TO VARY DIRECTLY WITH ALTITUDE.

FIG. 4 SAMPLE OF TURBULENCE FIELD PARAMETERS

CONDITION	TOWING LOAD		ROTATION OF AUXILIARY WHEEL RELATIVE TO NORMAL POSITION	TOW POINT
	DIRECTION FROM FORWARD, DEGREES	MAGNITUDE		
1	0	0.75 T		AT OR NEAR EACH MAIN GEAR
2	± 30			
3	180			
4	± 150			
5	0	T	0	AT AUXILIARY GEAR OR NEAR PLANE OF SYMMETRY
6	180	T	180	
7	0			
8	180	0.5 T	MAXIMUM ANGLE	
9	MAXIMUM ANGLE			
10	MAXIMUM ANGLE PLUS 180	0.5 T	MAXIMUM ANGLE PLUS 180	
11	MAXIMUM ANGLE			
12	MAXIMUM ANGLE PLUS 180			

FIG. 5 SUGGESTED TOWING CONDITION

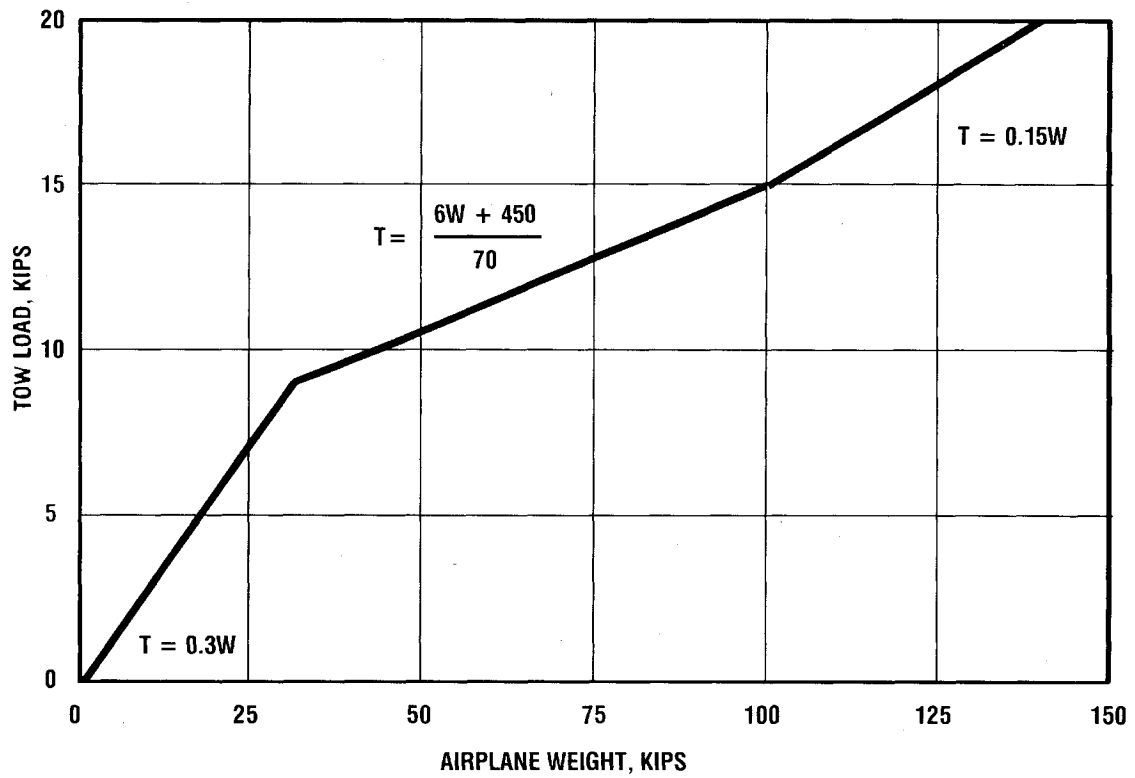

FIG. 6 SUGGESTED RELATIONSHIP BETWEEN AIRCRAFT WEIGHT AND TOW LOAD

BASIC MISSION SYMBOLS	LOAD FACTORS				APPLICABLE ITEMS
	LONGITUDINAL		VERTICAL	LATERAL (LEFT AND RIGHT)	
	FORWARD	AFT			
ALL AIRPLANES EXCEPT CARGO (C)	40	20	10 UP 20 DOWN	14	APPLICABLE TO ALL ITEMS
CARGO (C)	20	10	10 UP 20 DOWN	10	APPLICABLE TO ALL ITEMS EXCEPT STOWABLE TROOP SEATS
CARGO (C)	10	5	5 UP 10 DOWN	10	APPLICABLE TO STOWABLE TROOP SEATS

FIG. 7 SAMPLE SEAT CRASH LOAD FACTORS SHOWN IN MIL-A-87221 (USAF)

COMPONENT	LANDING GEAR 3-POINT ATTITUDE	OTHER JACK POINTS LEVEL ATTITUDE
VERTICAL	1.35 F	2.0 F
HORIZONTAL	0.4 F	0.5 F
F IS THE STATIC VERTICAL REACTION AT THE JACK POINT.		

FIG. 8 SAMPLE JACKING LOADS GIVEN IN MIL-A-87221 (USAF)

3 Maneuver Loads

Design maneuver load regulations in the NATO nations have evolved from crude assumptions of single control surface movement to relatively complicated series of pilot inputs in all three axes. These inputs need to be standardized to permit the assessment of structural loads with reasonable effort, but with the advent of active control technology the hiatus between standardized control inputs for load assessment and actual pilot practice with agile aircraft is rapidly increasing.

The flight maneuver loads are major design criteria for agile aircraft (aerobatics, trainer, fighter aircraft), because large portions of their airframe are sized by these loads. They also belong traditionally to the most elusive engineering criteria and so far engineers have never succeeded in precisely predicting what pilots will eventually do with their machines. One extreme solution to this problem would be to put so much strength into the structure that the aerodynamic and pilot tolerance capabilities can be fully exploited by maneuvering without failure. This is more or less the case with aerobatics aircraft. But modern fighters would grow far too heavy by this rule.

So the history of maneuver load criteria reflects a continuous struggle to find a reasonable compromise between criteria which do not unduly penalize total aircraft performance by overweight and a tolerable number of accidents caused by structural failure.

Several approaches are presented in the next sections which have been used for the design of the most recent fighter airplanes.

3.1 Classical Approach

3.1.1 Definitions

Loads External Loads on the structure

Limit Load

- Military Specification (MIL-Spec.):
Maximum loads which can result from authorized flight and ground use of the aircraft including certain maintenance and system failures
Requirement: The cumulative effects of elastic, permanent or thermal deformations resulting from limit loads shall not inhibit or degrade the mechanical operations of the airplane.

- Civil Requirements (FAR,JAR):

Maximum loads to be expected in service.
Requirement: Without detrimental permanent deformation of the structure. The deformation may not interfere with safe operation.

Ultimate Load

- Military Specification:
Limit Load multiplied by a factor of safety.
Requirement: No structural failure shall occur

- Civil Requirements:
Limit Load multiplied by a factor of safety.

Requirement: No failure of the structure for at least 3 seconds.

Factor of Safety

- Military Specification:
The Factor of Safety shall be 1.5.

- Civil Requirements:
A Factor of Safety of 1.5 must be applied to the prescribed Limit Load, which are considered external loads on the structure.

General Definition:

Safety Factors are used in aircraft structural design to prevent failures when the structure is subjected to various indeterminate uncertainties which could not be properly accessed by the technological means, such as:

- the possible occurrences, during flight or ground operations, of load levels higher than the limit load
- uncertainties in the theoretical or experimental determinations of stresses
- scatter in the properties of structural materials, and inaccuracies in workmanship and production
- deterioration of materials during the operational life of the aircraft.

Static Loads

Airframe static loads are considered to be those loads that change only with flight condition: i. e. airspeed, altitude, (angle of incidence, sideslip, rotation rates, ..) etc. with a loads / loads-parameter oscillating below 2 Hz. These loads can be considered to be in a steady non oscillating state (rigid body motion).

Dynamic Loads

Dynamic loads are considered to be those loads which arise from various oscillating elastic or aeroelastic excitation which frequencies above 2 Hz. The loads are to be determined by dynamic loads approaches, depending on the sources of excitation and would include:

- Atmospheric turbulence / Gusts
- Buffet / Buffeting / Buzz
- Stores Release and Jettison
- Missile Firing
- Hammershock
- Ground Operations
- Birdstrike
- etc.

Maximum Load = Maximum external Load (general used as classical definition)

- resulting from authorized flight use (Mil. Specification)
- expected in service (FAR/ JAR – Requirement)
- derived by the Maximum Load Concept Approach
- limited by the Flight Control System, applying Flight Parameter Envelope Approach
- derived from operational flight monitoring applying Operational Flight Parameter Approach

- derived from load spectra (cumulative occurrences of loads) applying Extreme Value Distribution

Maximum Load = the structure is capable to support (used in More Global Approach)

- Maximum load case which produces the maximum value of at least 1 failure strength criterion, integrating Load Severity Indicators.

3.1.2 Limit Load Concept

Strength requirements are specified in terms of

• **Limit Loads**

- Military Specifications:
MIL-A-8860 (ASG),
MIL-A-008860 A (USAF),
AFGS-87221 A

is the maximum load normally authorized for operations.

- Federal Aviation Regulations:
Part 23,
Part 25

is the maximum load to be expected in service.

• **Ultimate Loads**

is limit loads multiplied by prescribed factors of safety.

The basic premise of the Limit Load Concept is to define that load, or set of loads, which the structure should be capable of withstanding without permanent deformation, interference or malfunctions of devices, degradation of performance, or other detrimental effects.

At any load up to limit loads, the deformation may not interfere with safe operation. The structure must be able to support ultimate loads without failure for at least 3 seconds. The limit loads, to be used in the design of the airframe subject to a deterministic design criteria, shall be the most critical combination of loads which can result from authorized ground and flight use of the aircraft.

3.1.2.1 Conventional Aircraft

A limit load or limit load factor which establishes a strength level for design of the airplane and components is the maximum load factor normally authorized for operations.

The determination of the limit loads is largely specified in the regulations (MIL, FAR, Def., etc) and is independently of the missions / maneuvers actually performed in operation. Worst case conditions are usually selected as a conservative approach.

Safety factors were introduced into the design of the structure to take care of uncertainties which could not be

properly assessed by the technological means of that time, such as:

- the possible occurrence of load levels higher than the limit load
- uncertainties in the theoretical or experimental determination of stresses
- scatter in the properties of structural materials, and inaccuracies in workmanship and production
- deterioration of the strength of materials during the operational life of the aircraft

3.1.2.2 Actively Controlled Aircraft

For actively controlled aircraft the limit loads are to be determined taking into account the flight control system (fly by wire, load alleviation) for:

- normal operating conditions, without system failures
- conditions due to possible system failures

The resulting loads have to be considered for design respectively proof of the structure.

For civil aircraft required by recent regulations (FAR, JAR):

- **for normal operating systems**
as limit loads, ultimate loads applying the prescribed safety factor (1.5)
- **for failure conditions**
the safety factor is determined by the failure probability distinctive:
 - active failure (at time of failure)
 - passive failure (after failure for continuation of flight)

The purpose for the integration of an active control system is to enhance maneuver performance while not eroding structural reliability, safety, and service life. The application is described in Ref. (1)

Reasons for applying other Approaches

For conventionally controlled aircraft the regulations gives unequivocal deterministic criteria for the determination of the most critical combination of loads.

e.g. for flight maneuvers, the regulations (Mil-A-8861) prescribe the time history of the control surface deflections and numerically define several essential maneuver – load parameter for the determination of design load level.

Obviously with the introduction of active control technology, as well as care free maneuvering features, recent specifications no longer define the control surface deflections but rather provide the cockpit displacements of the controls in the cockpit (Mil-A-8861).

This means that existing design load regulations and specifications based on conventional aircraft configurations, structural design concepts and control systems technologies, may not be adequate to give unequivocal criteria for the determinations of design loads and ensure the structural integrity of future aircraft using novel control methods.

To cope with using the limit load concept for **actively controlled aircraft** several approaches have been applied:

- **Maximum load concept**
Background and suggested models are described in 3.2.1.

An example of application:

- The flight control system for a naturally unstable aircraft is designed with the feature to feed in maneuver parameter boundaries (load factors, rates, accelerations) in such a way that limit design loads are not exceeded.

This approach could lead to a reduction of the safety factor for flight maneuver loads keeping the structural safety at least as for conventional aircraft e.g. from 1.5 to 1.4 for EFA.

The application is described in Ref. (2).

Flight Parameter Envelope Approach

The loads process is described in 3.2.5

Probabilistic determination of limit load

Operational Flight Parameter Approach

The procedure is described in 3.2.2

3.1.2.3 References

[1] H.-M. Besch, H.-G. Giessler, J. Schuller
AGARD Report 815,
Impact of Electronic Flight Control System (EFCS)
Failure Cases on Structural Design Loads

[2] Sensburg O., Bartsch O., Bergmann H.
Journal of Aircraft, Vol.24, No.11, Nov. 1987
Reduction of the Ultimate Factor by applying a
Maximum Load Concept.

3.1.3 Safety Factors Review

3.1.3.1 History

The present - day safety factor for aircraft structures, as applied to manned aircraft, dates back 70 years. During

the last 30 years considerable progress has been made in the fields of structural materials, semi finished products and testing methods. Furthermore advances in aerodynamic and aeroelasticity, combined with developments in electronic data processing, facilitate a more precise prediction of structural loads and structural analysis.

A reappraisal of the safety factor would therefore seem to be in order, not with the intention of lowering the level of safety, but with the aim for examining the various safety requirements in the light of present knowledge. This, together with the fact that there exists a lack of a rational basis for the factors of safety concept presently applied to the design of air vehicles, brought up a discussion of changing the structural safety concept and the factors involved within AGARD-SMP in 1977. The Structural and Materials Panel formed an ad hoc Group to conduct this discussion. Three pilot papers contained in Ref.(1) addressed the different aspects to be envisaged, and show up inconsistencies of the present concept as well as means and methods for permissible changes.

The result of the discussion following the presentations before the Sub - Committee was, that it would not be appropriate at the present time to change the concept, but it was found worthwhile to have a collection and evaluation of all those factors concerning structural safety including the philosophies which back up the application of these factors.

The Sub - Committee found it most suitable to collect all pertinent data and back up information by means of a questionnaire, which was drafted by two coordinators (one for North America, one for Europe) and reviewed by the members of the Sub - Committee.

This questionnaire was distributed to the addressed Airworthiness Authorities of the NATO - Nations with a request for cooperation. The replies of the questionnaire were summarized and evaluated by the coordinators and presented before the Sub - Committee. The answers given, including the results of personal discussions between coordinators and nominated representatives of the authorities, are condensed published in Ref.(2).

From the evaluation it may be concluded that there exists a considerable amount of agreement with respect to the Factors of Safety and their application. On the other hand, some disagreements and interpretations have resulted. Thus, this report forms a basis for discussing the disagreements in order to achieve a higher degree of conformity between the authorities of NATO - Countries with a regard to structural safety and reliability.

At that time the present concept and the Factors of Safety were in general regarded as satisfactory with the intention to review the Safety Concept till such time as more knowledge and experience in application of new technologies are available;

e.g.

- Improvement of knowledge about flight and ground loads occurring in service (operational loads) to know the margin between the design conditions and the operational conditions.

- Introduction of new technologies, which are not included in the scope of the existing design requirements
 - active control
 - behavior of new materials (composites)

3.1.3.2 REFERENCES

[1] AGARD - Report No. 661
Factors of Safety , Historical Development , State of the Art and Future Outlook.

[2] AGARD - Report No. 667
Factors of Safety , Related to Structural Integrity .
A Review of Data from Military Airworthiness Authorities.

3.1.3.3 Possible Methods for Splitting of Safety Factors

In the mean time significant progress and experiences in load determination for conventional aircraft and for actively controlled aircraft have been made as well as determinations of load conditions have been applied for cases which are not covered by the several existing airworthiness regulations; e.g. as special conditions. Therefore it is time to take up the review of the Safety Factor Concept. Factors of safety can be rationalized by splitting into Loads (FSI) and structural / material uncertainties (FSs).

The present - day safety factor covers the uncertainties as a global factor mainly applied for

- possible exceedances of loads in relation to the design loads
- uncertainties in structural analysis

without realizing the particular uncertainties of loads and structural analysis separately i.e. the global factor is applied as the same value for both. This application of the same factor of safety for loads determination and for structural analysis can lead to an apparent margin of safety which is higher or lower than the global factor is intended to cover.

By splitting the factor into two parts, as suggested by the Study Group Structures of AECMA (see chapter 3.2.1.1) for loads and for structural analysis, a clear relation of the safety margin is determined.

- FSI for loads uncertainties
- FSs for structure uncertainties

The product of both factors is known, keeping the approved total factor of 1.5 .

$$FS = FSI \times FSs = 1.25 \times 1.20 = 1.50$$

Another suggestion from US (D. Gibson) is to divide the Factor of Safety into three terms

- U1 uncertainty related to loads computation
- U2 " " to operational environment
- U3 " " to structural analysis

In this proposal U1 and U3 are the same as FSI and FSs. U2 for predicting the actual operational environment might be applied using deterministic criteria. The proposed values for all terms are 1.15.

$$\text{e.g. } U1 \times U2 \times U3 = 1.15 \times 1.15 \times 1.15 = 1.52$$

For aircraft which apparently will not be able to exceed design loads during operations e.g.

- applying operational maneuver models for deriving or updating of design loads (see chapter 3.2.4)
- applying flight parameters envelope approach for limiting specified response parameters (see chapter 3.2.5)

The value of U2 might be 1.0 resulting in a final Factor of Safety

$$FS = 1.15 \times 1.15 = 1.32$$

3.2 Non Classical Approach

3.2.1 Maximum Load Concept

3.2.1.1 Background

The Airworthiness Committee of the international Civil Aviation Organization (ICAO) discussed, among other things, the subject of maximum load concept in the period from 1957 to 1970. It was decided in Montreal in late 1970 not to pursue this concept for the time being as a possible basis for airworthiness regulations. Several proposals however, were made to improve structural safety. This subject was also discussed by the Study Group Structures of the AECMA (Association Européenne des Constructeurs de Material Aérospatial) in the context of the Joint Airworthiness Requirement (JAR). These deliberations led to the suggestion to split the proven safety factor of 1.5 into two parts, in a rational fashion, one for uncertainties in the loading (determination of loads), the other for uncertainties in strength analysis including scatter of material properties and inaccuracies in construction.

Allowable loads are defined as those load values that will only be exceeded by expected loads with a prescribed small probability. These loads are then referred to as maximum loads.

Gust or landing loads are strongly influenced by random physical or human characteristics. But also in these cases safety could be much better defined by extrapolation of loads from statistical data, rather than the application of a safety factor of 1.5 for all cases. Furthermore, loads that are limited naturally by the ability of the aircraft to produce them, or by internal aircraft systems, (load alleviation, flight control systems) could be regarded as maximum loads to which a safety factor need not be applied. The determination of maximum loads with a small probability of being exceeded is entirely possible for modern fighters which are limited in their maneuvers, or for control configured vehicles (CCV) which are in any case equipped with an active flight control system (fly-by-wire). As a principle the prescribed design boundaries and the corresponding safety factor should not be applied separately, i.e. the entire design philosophy should be considered. Therefore a mixed application of various regulations to a single project is not advisable. Up to now the safety factor has been reduced in only a few cases. Within the pertinent regulations only the case of the American MIL-A-8860 (ASG) issue is known, where no safety margin is required for the undercarriage and its supporting structure.

It may be supposed that with the consent of the appropriate authorities the safety factor or the load level could be reduced in the following cases:

- in emergencies, such as emergency landings into an arresting net or cable
- for transient phenomena (hammer shock pressure in aircraft inlets)
- where actuators are power-limited and large loads cannot be produced

3.2.1.2 Suggested Models

The following models are proposed for the application of the Maximum Load Concept.

Semi-statistical / semi deterministic

In the past operational loads were predominantly checked by measurement of the main load parameters, in the form of cumulative frequencies or load - parameter - spectra (Ref. 1).

They are:

- the normal load factor, in flight and on the ground
- the angle of sideslip and/or the transverse load factor
- the rolling velocity in flight
- the bank angle during landing

On the basis of these load - parameter - spectra a probability of occurrence of the main load parameters is defined for each type of mission and maneuver, and the maximum value of the main load parameter can be determined from this.

If, for instance, an aircraft is designed for air-to-air combat, a maximum load factor of 9.0 may be derived from the statistical cumulative frequency distribution for every tenth aircraft after 4000 flight hours. This value is taken to be maximum main load parameter. For this load parameter the loads produced by the maneuvers specified in the pertinent regulations are determined by means of a deterministic calculation such that the maximum value of the main load parameter is just attained, but not exceeded. An example is the loads as a function of time produced by the actuation of cockpit controls according to MIL-A-008861.

A recent approach for active controlled aircraft has been applied to the European Fighter (EFA) for the determination of the design loads, called Flight Parameter Envelope Approach. (Description see 3.2.5)

Semi-statistical / semi empirical

It has been known for years that VG and VGH measurements do not suffice for the definition of criteria for structural design.

In order to obtain statistically supported design criteria, a special NACA Sub-Committee on Aircraft Loads recommended (1954) to expand statistical load programs to the extent that they included measurements of time histories of eight parameters, three linear accelerations (x, y, z.), three angular accelerations (p, q, r.), airspeed (V) and altitude (H).

The first measurement of this kind where made with the F 105 D Fighter with the aim to develop a maneuver load concept which was to predict design loads (Ref. 2). All data were processed to calculate time histories of loads, with peaks called "observed loads". The data oscillogramms were examined in order to define 23 recognizable types of maneuver. Assuming that for every type of maneuver the same sequence of aircraft motion occurs with the exception of differences in amplitude and duration, the measured parameters were normalized with respect to amplitude and time.

Finally, to determine the loads, the normalized parameters were denormalized in order to get the load peak distribution for the wing, the fuselage, and the empennage. The good agreement between the observed and predicted load peak distribution demonstrated the feasibility of the maneuver model technique for the F-105 D aircraft. The F-106 Fighter was selected to demonstrate this model, thereby determining the model's usefulness on another aircraft. The detailed results of 3770 flight test hours made it possible to apply the maneuver model technique i.e. the empirical calculation of component loads as compared to F-106 design loads (Ref. 3).

The results in the form of cumulative occurrence of the loads for wing, elevon, and vertical tail made it possible to determine the design load for a given cumulative occurrence.

A recent approach has been elaborated in the Working Group 27 of AGARD-SMP called Operational Maneuver Model. The demonstration of the feasibility is reported in AGARD Advisory Report 340 Evaluation of Loads from operational Flight Maneuvers (Ref. 4).

(Description see 3.2.2 Operational Flight Parameter Approach)

Statistical: Extreme Value Distribution

As a rule, load spectra are produced with the objective of determining magnitude and frequency of operational loads. These, in turn, are used in fatigue tests to determine the corresponding fatigue life of structure. Loads spectra like these are derived from relatively short time records, compared to the actual operational life time; they do not contain those maximum values that might be expected to occur during the entire operational life of the structure, i.e. a knowledge of which is necessary for the design.

Determination of Extreme Value Distribution

In cases where the range, the maximum value, and scatter of the spectrum may be safely assumed, an extreme - value distribution can be established, describing extreme values of loads / load parameters by its magnitude and related probability of exceedences (suggested by Prof. O. Buxbaum, (Ref. 5)). By means of extreme load distributions the derivation of extreme loads is feasible for determinate probabilities of exceedences, and thereby the design load can be determined.

Examples of applications

- Maximum rolling moments on horizontal tail derived from in - flight measurement with C160 Military Transport Aircraft, AGARD Report No. 661, page 9

Fig. 1 shows the extreme – value distribution

- Maximum loads on vertical tail derived from in - flight measurements with F-106 Fighter Aircraft AIAA - Paper No. 70-948, page 8

Fig. 2 shows the cumulative occurrences

3.2.1.3 References

- [1] J. Taylor, Manual of Aircraft Loads, AGARDograph 83 (1965)
- [2] Larry E. Clay and Heber L. Short, Statistical predicting Maneuver Loads from eight-channel Flight Data Report No. TL 166-68-1 (1/1968) NASA CR-100152
- [3] James D. Jost and Guin S. Johnson, Structural Design Loads for Strength Fatigue computed with a multi-variable Load Environment Model AIAA - Paper No. 70 - 948
- [4] AGARD ADVISORY REPORT 340 Evaluation of Loads from Operational Flight Maneuvers Final Working Group Report of Structures and Materials Panel Working Group 27
- [5] O. Buxbaum, Verfahren zur Ermittlung von Bemessungslasten schwingbruchgefährdeter Bauteile aus Extremwerten von Häufigkeitsverteilungen LBF - Bericht Nr. FB - 75 (1967)

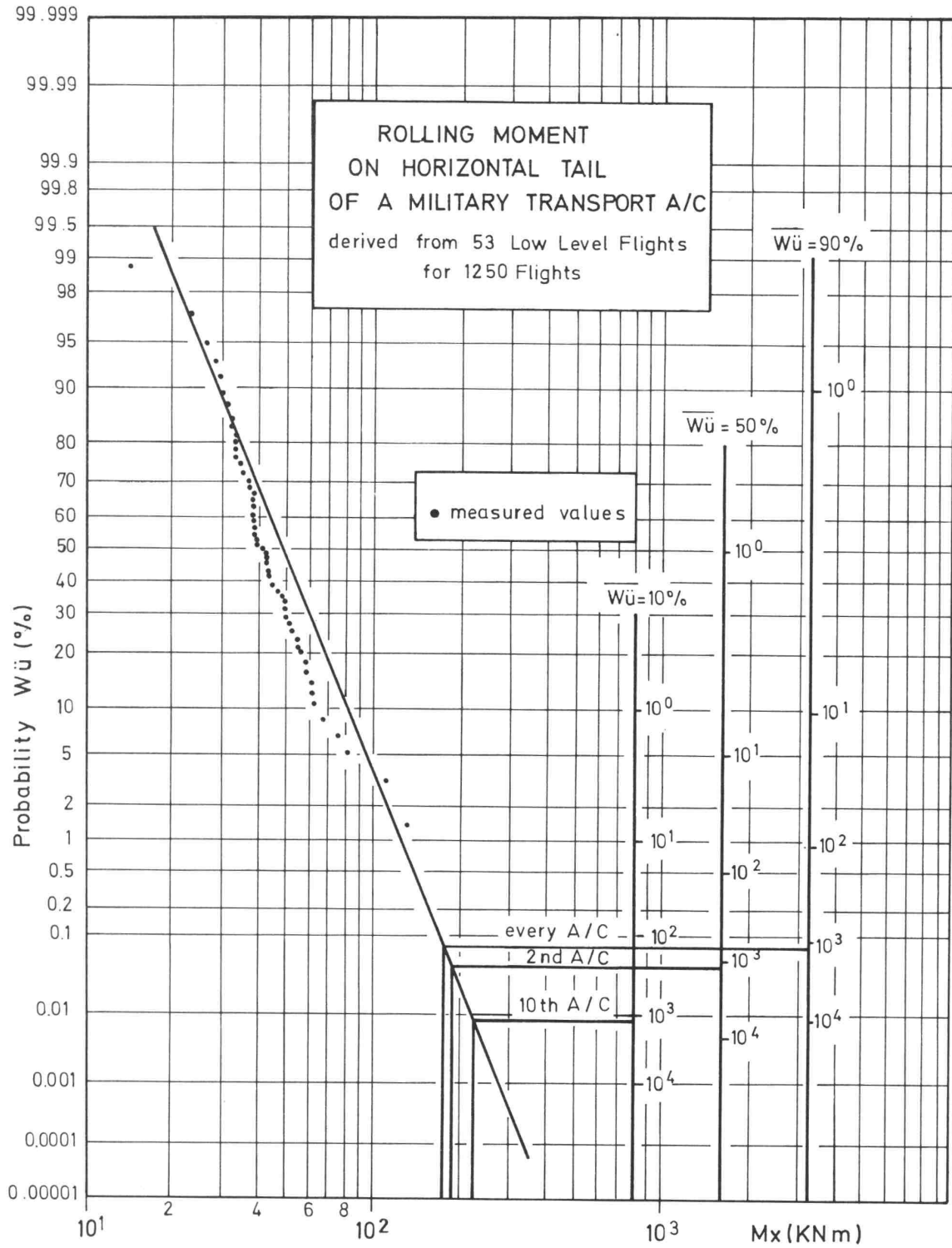

FIG. 1 EXTREME - VALUE DISTRIBUTION

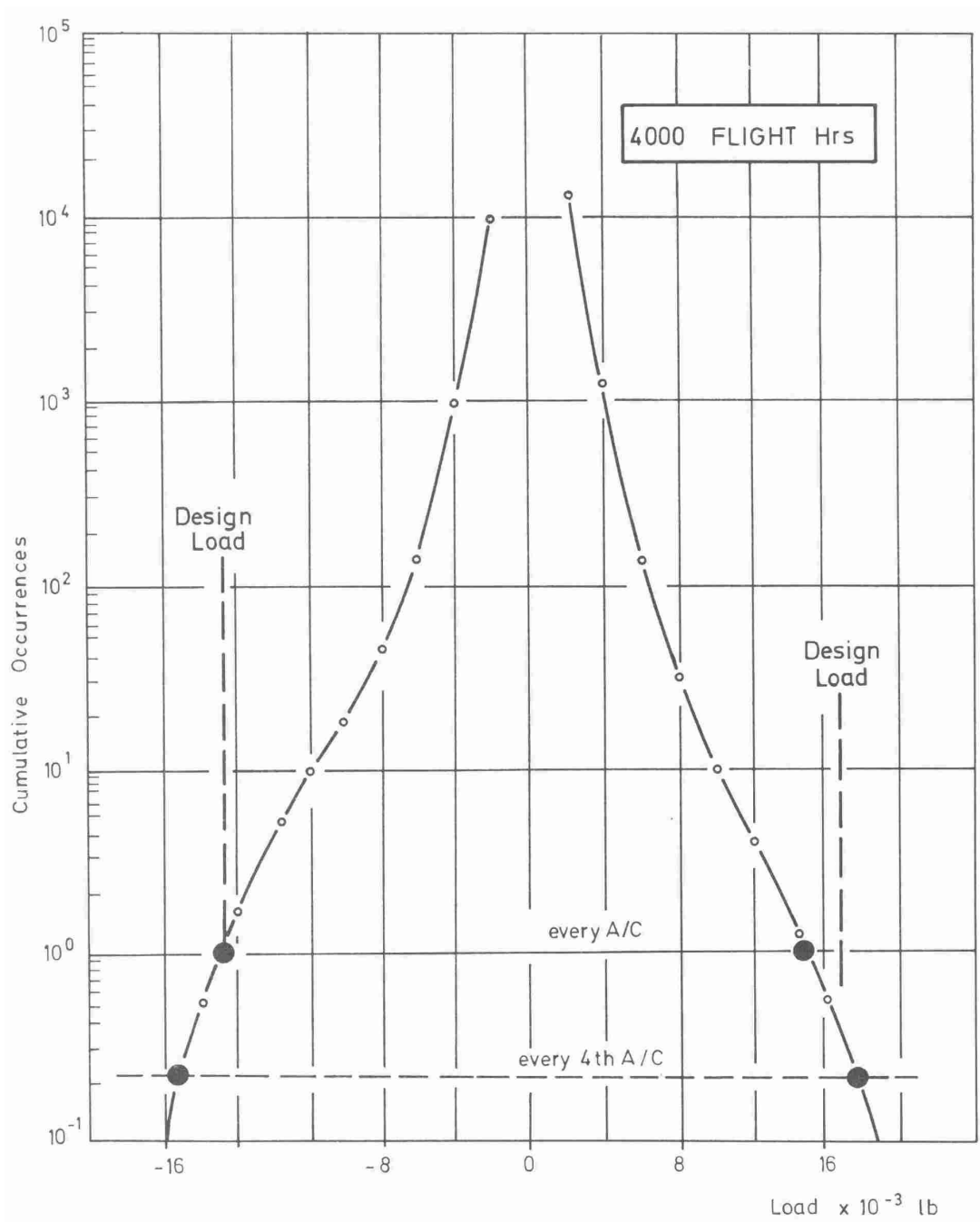

FIG. 2 CUMULATIVE OCCURANCES OF VERTICAL STABILIZER LOADS

3.2.2 Operational Flight Parameter Approach

3.2.2.1 Introduction

The determination of the design maneuver loads is largely specified in regulations independently of the maneuvers or missions actually performed in operation. For conventionally controlled aircraft the regulations give the time history of the control surface deflections and numerically define several essential maneuver – load parameters for the determination of the design load level. Obviously with the introduction of the fly-by-wire and/or active control technology, as well as care free maneuvering features, recent specifications no longer define the control surface deflections but rather provide the cockpit displacements of the controls in the cockpit. This means that existing design load regulations and specifications based on conventional aircraft configurations, structural design concepts and control system technologies, may not be adequate to ensure the structural integrity of future military aircraft configurations using novel control methods, structural concepts and combat tactics.

In service, maneuvers, especially combat maneuvers, are flown in accordance with practiced rules that lead to specified motions of the aircraft in the sky. An evaluation of operational flight maneuvers has been made for several aircraft types flown by the USAF, CF and GAF with the aim of deriving operational loads by applying parameters measured in operational flights.

This approach is based on the assumption that maneuvers trained and flown by the NATO Air Forces can be standardized.

The standardized maneuver time history is the replacement as a quasi unit maneuver, for all operational maneuvers of the same type.

The Standardized Maneuver is obtained by normalization of parameter amplitudes and maneuver time to make the parameters independent of mass configurations, intensity of the maneuver, flight condition, flight control system, and of the aircraft type.

The goal is to find a standardized time history for each type of maneuver, which is independent of the extreme values of the relevant parameters and aircraft type.

One promising approach is to derive design loads from a careful analysis of operational maneuvers by current fighters to extract critical parameters and their range of values. To investigate this approach, Working Group 27 “Evaluation of Loads from Operational Flight Maneuver” was formed, AGARD involvement was particularly relevant since it allowed the expansion of the types of aircraft and the control systems considered in the study. The Working Group formulated a set of activities that addressed the fundamental premises of a method to generate operational loads from flight parameters by determination of Standard Maneuvers independent of the aircraft type and the control system.

The flow chart in Figure 1 presents the general data flow and indicates the major phases of the procedure. These operational loads can be statistically evaluated for use in static design and for fracture assessment.

In the first part of the procedure the verification of the Operational Maneuver Parameter Time Histories is described in boxes with black frames, Fig 3.2.3.

The steps of the verification are:

- Recording and Evaluation of Operational Parameters
- Identification of the Maneuver Types
- Normalization of the Parameters
- Determination of the Standard Maneuver Types

In the second part the Derivation of Operational Flight Loads is described in boxes with red frames in 3.2.4 applying the Maneuver Model in the steps:

- Selection of the Standard Maneuver Type to be considered
- Definition of the Boundary Condition as design criteria
- Calculation of the Control Deflections necessary to perform the Operational Maneuver
- Response Calculation and Verification of the parameter time history
- Determination of Structural Loads

The evaluation of this procedure done by the Working Group (WG 27) has demonstrated the feasibility of determining loads from operational flight maneuvers (Ref. 1)

This Operational Flight Maneuver Approach can be used for:

- The judgment of the operational load level for aircraft already designed with regard to the design level (static and fatigue) as specified in the regulations.
- That means the margin between design loads and the extreme operational loads is known.
- The determination of the load level for static and fatigue design due to operation for new aircraft to be developed.

3.2.2.2 References

- (1) AGARD ADVISORY REPORT 340
Structures and Materials Panel, Working Group 27 on Evaluation of Loads from Operational Flight Maneuvers.
- (2) AGARD REPORT 815
Loads and Requirements for Military Aircraft, Page 3 –1, and Page 4 – 1

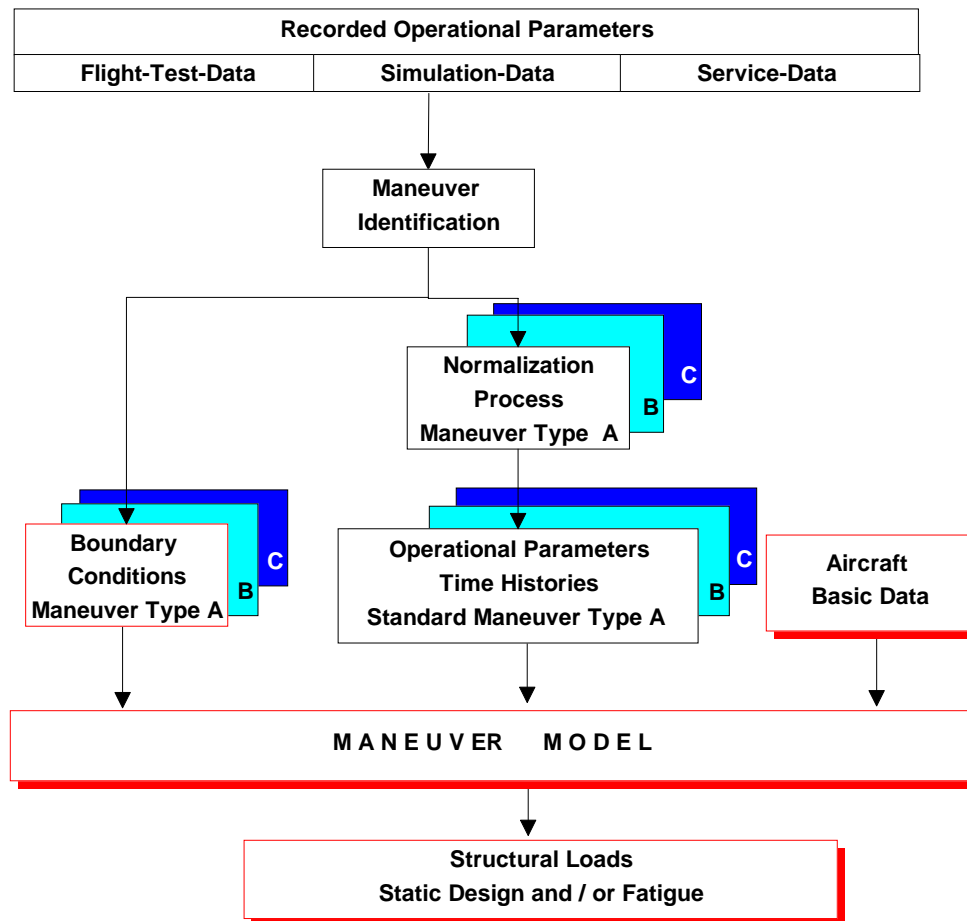

Fig. 1: Procedure Overview

3.2.3 Determination and Verification of Operational Maneuver Parameters and Time Histories

3.2.3.1 Verification Performed

Based on the hypothesis that all operational maneuvers performed in service can be verified as standard maneuvers (normalized parameter time histories for each independent maneuver type) the determination of operational loads is feasible applying the Operational Flight Parameter Approach. The verification of this approach to generate operational loads from flight parameters by determination of a set Standard Maneuvers consisting of normalized operational parameter time histories is described.

The Standard Maneuver procedure is shown in figure 2 as a flow chart.

For each type of Standard Maneuvers the normalized motion parameters are to be validated independent of aircraft type, mass configuration and flight control system.

For the evaluation of operational parameters, the following data were made available and have been judged as applicable.

- Flight test data by GAF Test Center for specific operational maneuvers on three aircraft (Alpha Jet, F – 4 F, Tornado)
- Data from simulations by GAF for specific operational maneuvers recorded on Dual Flight Simulator for two aircraft (F – 4, JF – 90)
- Service data by USAF recorded on the F-16 (selected subset from over 300 sorties from 97 aircraft)
- Service data by CF recorded on the CF-18 fleet monitoring) (selected subset of CF-18 fleet monitoring)

Taking all data available, which have been found to be suitable for separation into maneuver types, the data base is about 13 maneuver types.

For two maneuver types, High - g – turn and Barrel roll, more than 60 maneuvers for each maneuver type have been considered as applicable for evaluation.

The actively controlled aircraft (Tornado, F-16, CF-18) fit in the same scatter band as the conventional controlled aircraft. This means the hypothesis that the operational maneuvers are performed in the same way, i.e. performing the same normalized parameter time history, can be considered as confirmed.

The result is, that the Operational Standard Maneuver independent of the aircraft type is applicable as unit input for calculation of the movement of a specific aircraft by reconstitution of the real aircraft configuration and flight condition.

3.2.3.2 OPERATIONAL PARAMETERS

The number of parameters defining the aircraft motion should be chosen in such a way that recording and evaluation cause minimal expense. This can be achieved by using parameters available from existing systems of the aircraft. Each aircraft motion must be represented by a data set of relevant parameter time histories.

The following operational parameters are necessary:

Ma	Mach-number
Alt	Altitude
n(x)	Longitudinal Load Factor
n(y)	Lateral Load Factor
n(z)	Normal Load Factor
p	Roll Rate
q	Pitch Rate
r	Yaw Rate
t	Maneuver Time

the Eulerian Angles, if available:

ϕ	Bank Angle
θ	Pitch Altitude
Ψ	Heading

and additional parameters only for the verification process:

α (alpha)	Angle of Attack
β (beta)	Angle of Sideslip
ξ (xi)	Aileron / Flaperon Deflection
η (eta)	Elevator Deflection
ζ (zeta)	Rudder Deflection

3.2.3.3 STANDARD MANEUVER PROCEDURE

Provided the operational parameter time histories of the basic parameter are available in correct units, this procedure includes several steps:

- (1) Maneuver type identification
- (2) Normalization of relevant parameter time histories for a number of identified maneuvers of the same maneuver type for comparison
- (3) Determination of the mean values for each relevant parameter time history of the same maneuver type
- (4) Idealization and tuning of the parameter time histories
- (5) Determination of the standard maneuver time histories

The result of this procedure is a data set of standardized parameter time histories. The parameters are roll rate, pitch rate and yaw rate of the selected maneuver type. See Figure 2.

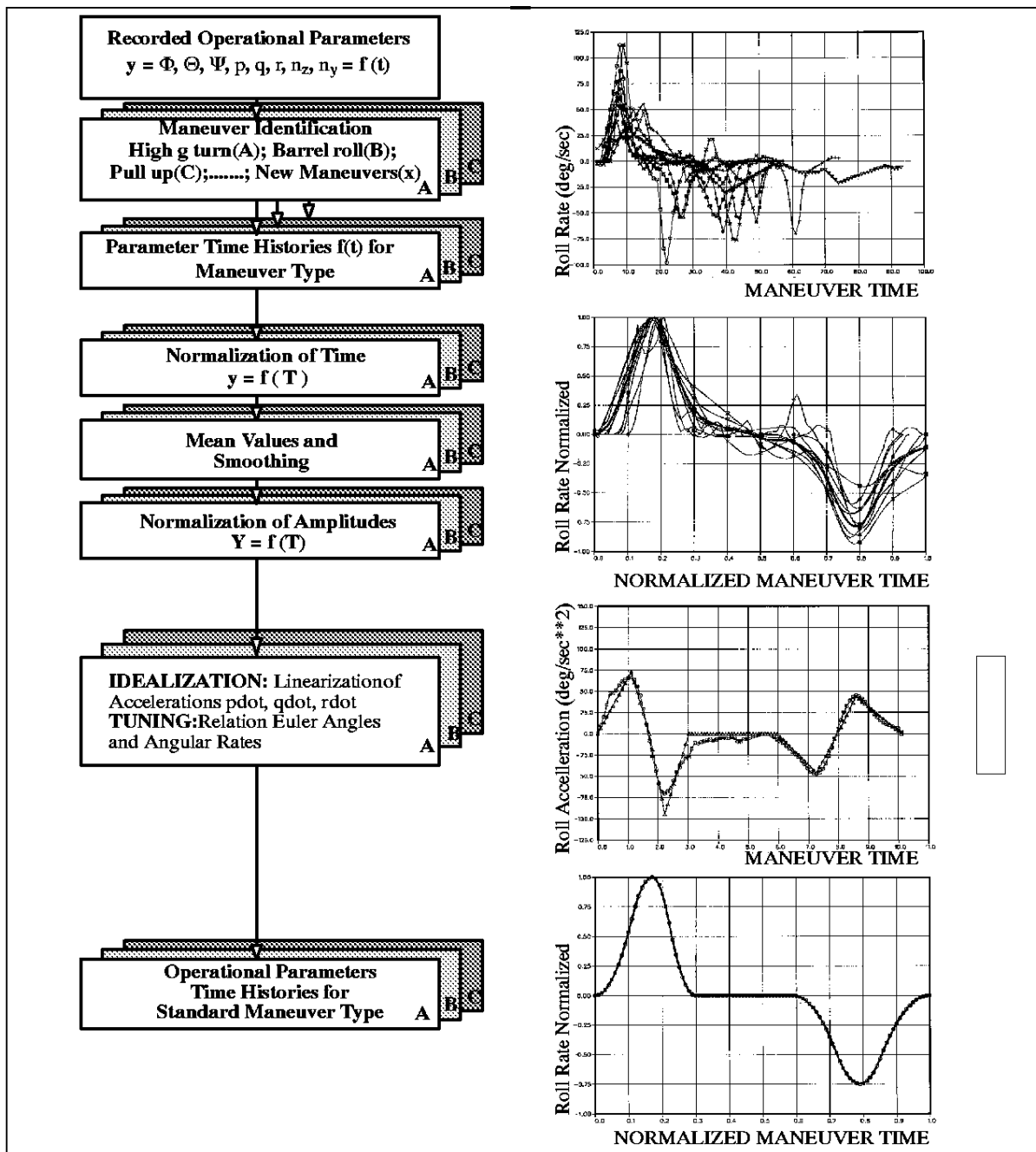

FIG 2: Standard Maneuver Procedure

3.2.3.4 MANEUVER IDENTIFICATION

The goal of the maneuver identification is to select the relevant maneuver segments from the recorded operational data base. A maneuver is identified by comparing the observed data with the predefined maneuver characteristics as described in the Maneuver Type Description of selected maneuvers:

Turn

$N(z) \leq 2, p \geq \pm 20^\circ/\text{sec}, \phi \approx 40 \div 90^\circ$

Roll steady to bank angle, pull, the bank angle is held as long as desired, opposite roll back to level

Roll rates of opposite sign before and after g peak.

High g Turn

$N(z) > 2$

Turn Maneuver

Break

$N(z) > 3$

High g Turn Maneuver with g peak during initial maneuver time.

Scissors

A series of High g Turn Maneuvers

Roll Reversal

$N(z) > 2, p > \pm 20^\circ/\text{sec}, \phi \approx 20 \div 90^\circ$

Roll steady to bank angle, directly opposite roll back to level.

High g Rolls / Barrel Rolls

$N(z) > 1.5, p > \pm 20^\circ/\text{sec}, \phi (\text{max}) \approx 360^\circ$

Roll steady in one direction

Barrel Roll over top θ rise to a peak value . Barrel roll underneath θ descend to a negative peak value.

Pull sym.

$N(z) > 1.5 \Delta \phi < 10^\circ$

From $\approx 1g$ to $\approx 1g$

The maneuver identification parameters are mainly load factor $n(z)$, roll rate p and bank angle ϕ .

First:

The data are checked for completeness and suitability for separating them into missions and maneuver types.

Second:

The start and end time of each maneuver type are identified when the roll rate is near zero and the g is approximately 1.

The bank angle also indicates the type of maneuver, i. e. full roll $\phi \approx 360^\circ$, half roll $\phi \approx 180^\circ$, turn $< 90^\circ$

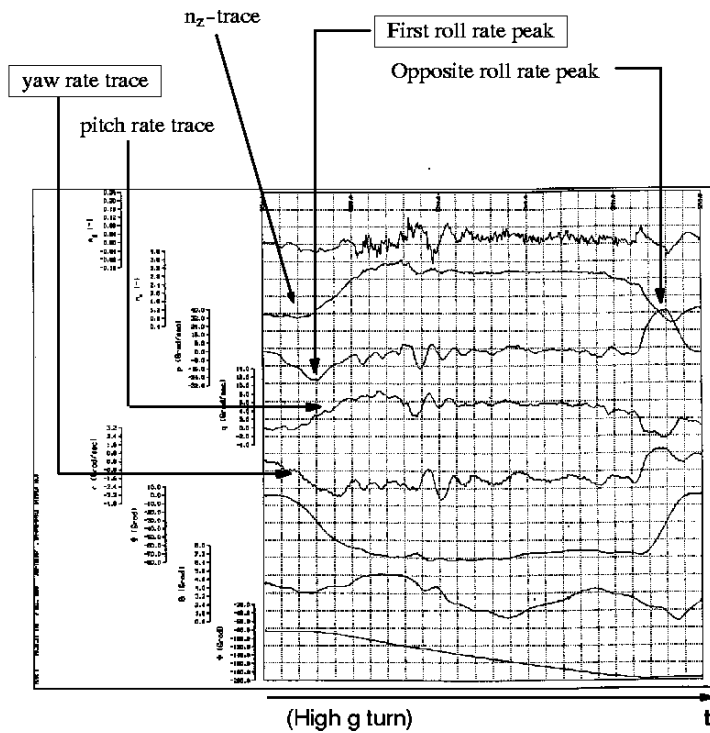

Figure3 :Identified Time Histories of Correlated Operational Parameters

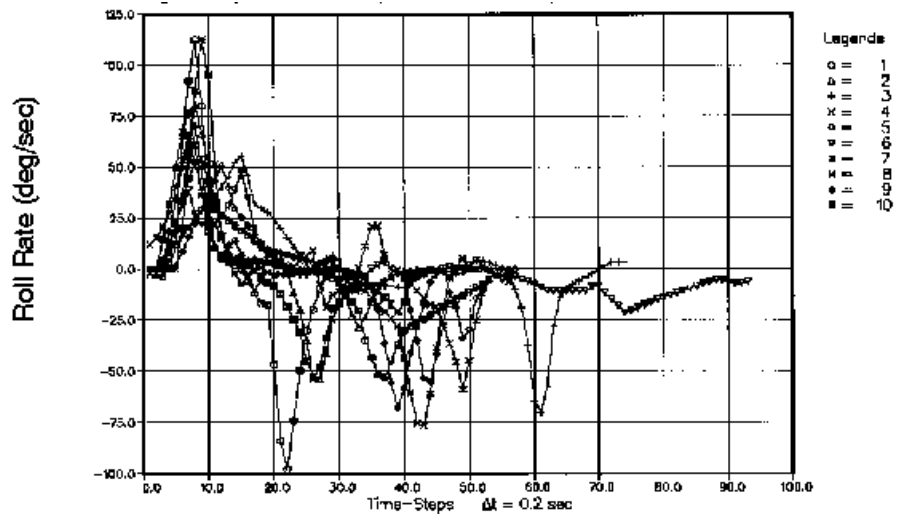

FIG 4: Unified Roll Directions

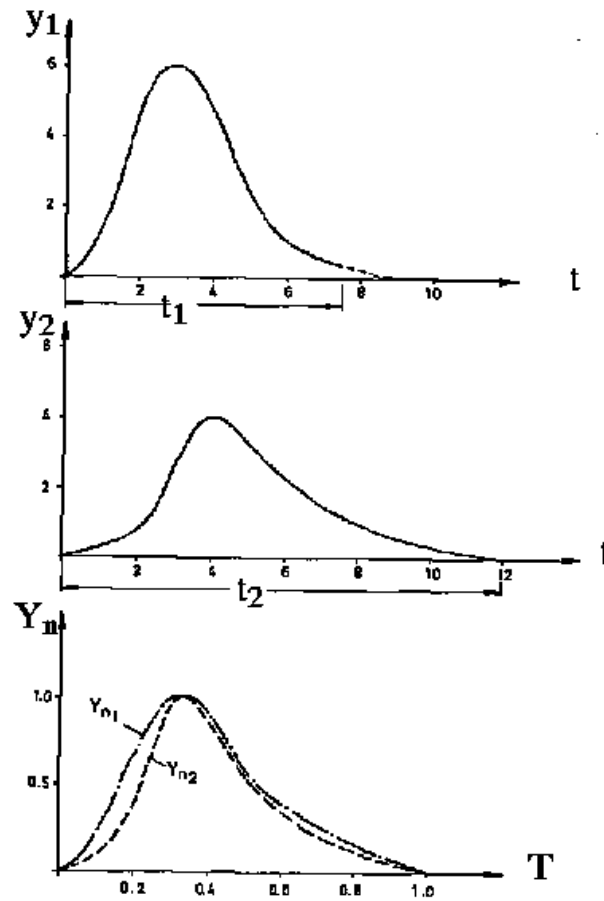

FIG 5: Normalisation of Parameters

Figure 3 shows as an example for the identification of a High g Turn Maneuver. In this case the roll rate trace primarily defines the maneuver length.

The pilot first rolls the aircraft in the direction of the turn and finally rolls it back to the wings level position. In parallel, the g rises to a peak value. The peak is held as long as desired. The g drops down from its peak as the aircraft is rolled back to the wings level.

The start and the end of the maneuver are determined as follows: the maneuver starts when the first negative / positive deflection of the roll rate trace starts and the maneuver finishes after recovering i.e. the opposite deflection of the trace, decreased to zero.

The Eulerian angles ϕ , θ , Ψ , give the aircraft orientation with respect to the earth's coordinate system.

The bank angle values indicate the type of maneuver as defined in Maneuver Type Description.

All recorded parameters are time related.

3.2.3.5 NORMALIZATION

Normalization is necessary because several maneuvers of the same type are different in roll direction , amplitude of motion and in maneuver time. For the calculation of loads from operational maneuvers it not important to separate the maneuver types into different roll directions.

Therefore, maneuvers of the same type are transformed into a unified roll direction. See Figure 4.

For a requisite comparison, a two – dimensional normalization is necessary.

Figure 5 illustrates the basic procedure of normalization.

The ordinate presents one of the parameters of motion : $y= n(y), n(z), p, \dots\dots$ for several maneuvers of the same type : $y(1), y(2), \dots\dots y(n)$.

These parameters are normalized by relating them to the maximum values (absolute derivation from zero) which have occurred. This means the maximum value of each normalized parameter becomes in this case:

$$Y = \frac{y(1)}{y(1)_{max}} = \frac{y(2)}{y(2)_{max}} = + 1.0$$

The time is presented by the abscissa t , where by the maneuver executing time is marked by $t(1), t(2), \dots\dots t(n)$ for several maneuvers.

The normalization is accomplished in that way that:

- firstly, the maneuver time is chosen as the value 1.0 i. e. $t(1) = t(2) = T = 1.0$
- secondly, the extreme values of the relevant parameters is chosen at the same normalized time.

The time scale normalization factor for all correlated parameters: $n(y), n(z), p, q, r, \phi, \theta, \Psi$, within, fore example, a High g Turn was derived from the roll rate trace. See Figure 6

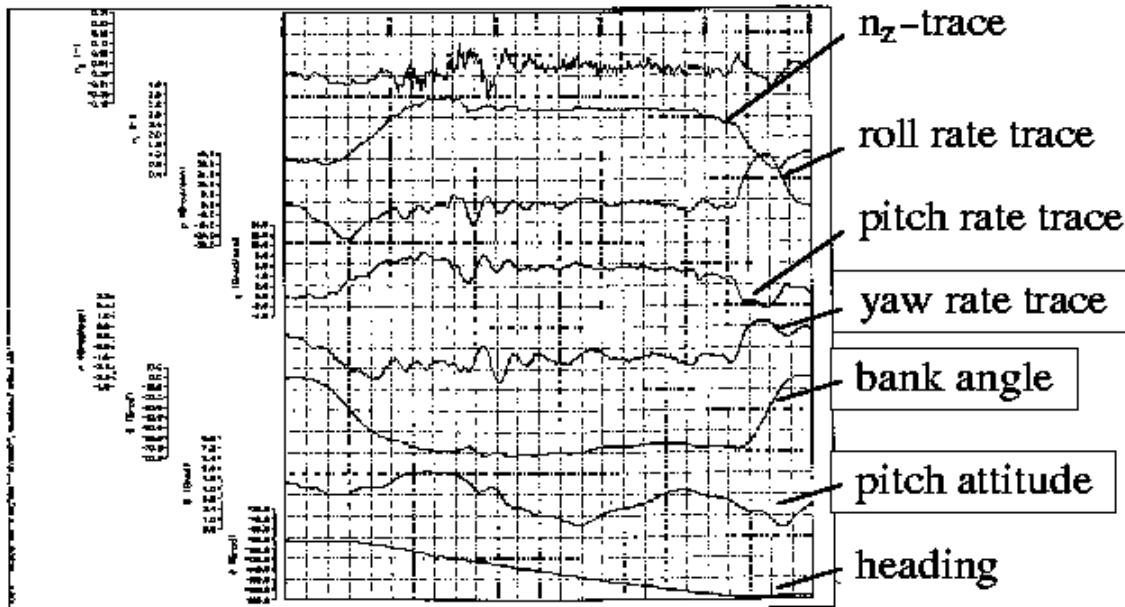

FIG 6: Correlated Parameters

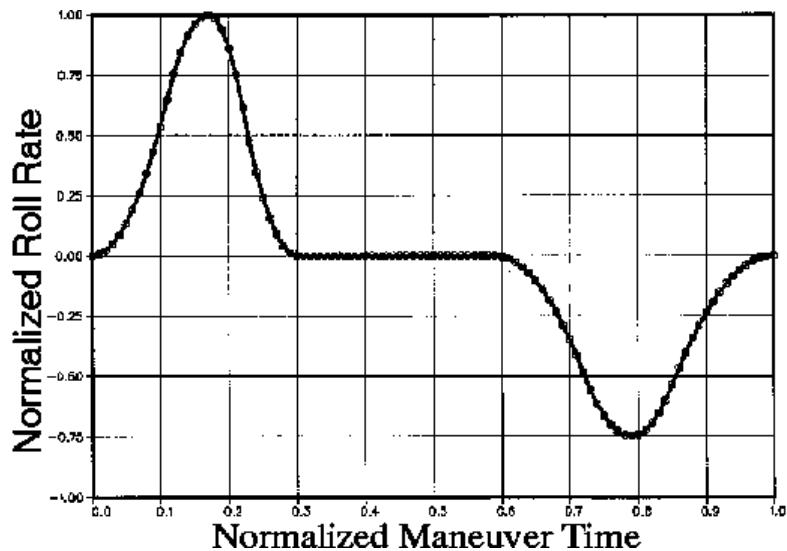

FIG 7: Normalized Roll Rate Trace

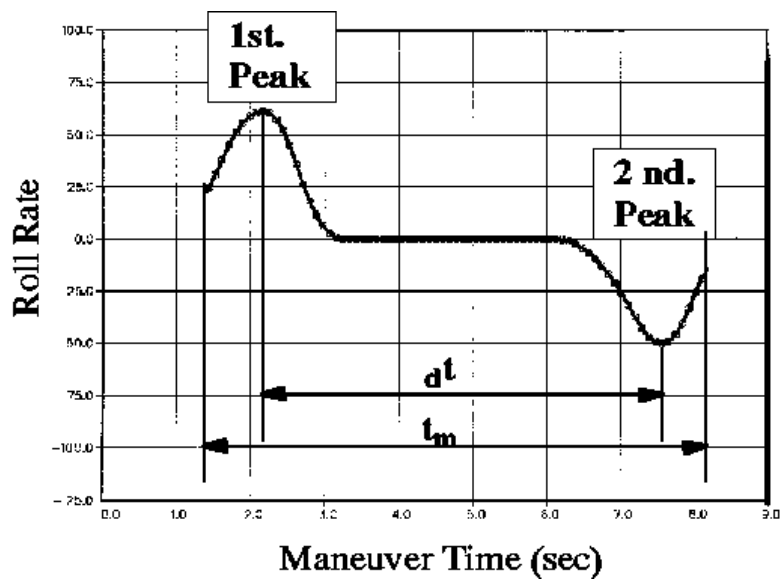

FIG 8: Time Ratio

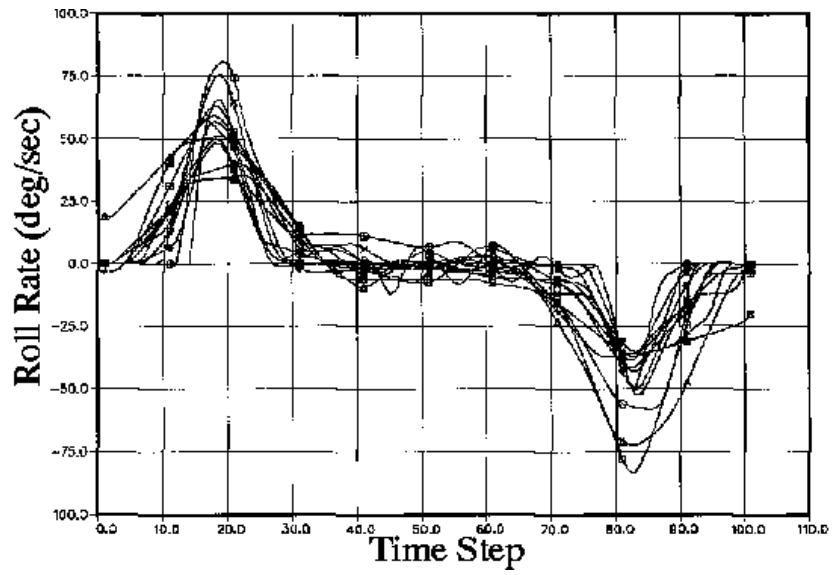

Fig.9 Shifted Roll Rate Traces

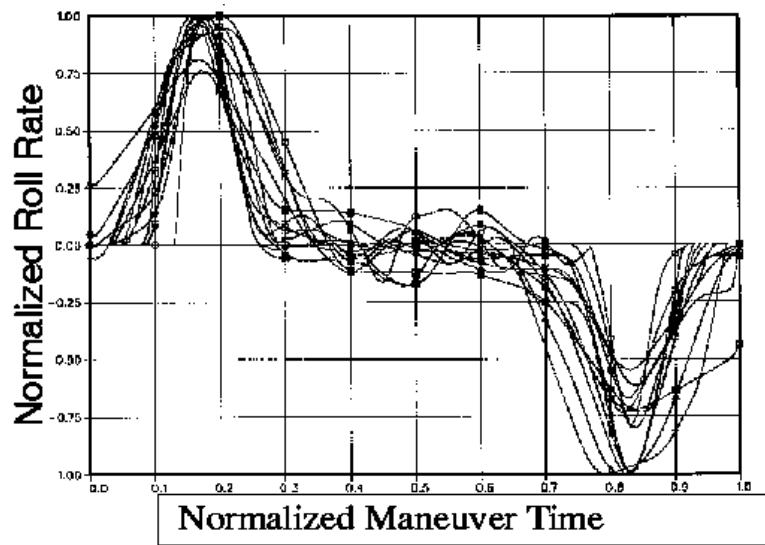

Fig. 10 Comparison of Normalized Rate Traces

In the normalized time scale, $T=0$ corresponds to the time when the roll rate trace first goes negative or positive (start of the maneuver), and $T=1$ corresponds to the time when the roll rate trace is back to zero after the opposite roll rate peak (finish of the maneuver). Figure 7 shows the normalized roll rate trace (positive roll direction).

This normalization procedure is dependent on the accurate maneuver start value. ($p \approx 0$)

In several cases the start values of the available time slices are very poor. One reason is the low sample rate of e.g. 1 or 2/sec. Recordings from flight tests are sampled 24 times per second.

An other reason is the selected parameter threshold values of the data reduction and maneuver identification process, combined with a low sample rate.

For these cases an upgraded normalization procedure, derived from the basic procedure, is used.

The estimated time of a High g Turn $t(m)$ had a very high correlation with the difference between the time of the first and the second roll rate peak. See Figure 8. This time ratio is very important for the normalization procedure

The time transformation from real time into normalized time requires several steps:

1. Determination of time ratio. The time ratio is defined by $\tau(1) = dt/t(m)$

2. Harmonization For the comparison of the parameter traces, a harmonization of the maneuver time ratio is necessary.

$$t'_1 * sf_1 = t'_2 * sf_2 = t'_3 * sf_3 = \dots = t'_n * sf_n$$

sf_n = scale factor

3. Shifting A new interpolation of a similar number of time steps for each of the correlated parameters for all maneuver of the same type is necessary. Then the roll rate traces were shifted in a way, that all selected first peaks coincided at the same time step.

All correlated parameters are shifted parallel in the similar way.

Figure 9 presents the comparison of the shifted roll rate traces versus normalized time for the selected High g Turn maneuvers.

The amplitudes of the traced are normalized individually. Each value of the trace is divided by its absolute deviation value from zero, therefore, all normalized amplitudes will fall between ± 1.0 .

Figure 10 shows the result of the “peak to peak” normalization procedure.

The application of the two-dimensional normalization procedure is very helpful for the comparison of maneuver time histories. In this normalized form, all parameter time histories are independent of the aircraft type.

3.2.3.6 MEAN VALUES

After normalization of the maneuver time, for all selected maneuvers of the same type, the typical values of the relevant parameters – in this case the peaks of the roll rate – coincide at the same normalized time. Each parameter time history contains the similar number of time steps, independent of its individual maneuver length. This is the basis for calculating the arithmetic mean values for each of the time steps.

Figure 9 presents the comparison of the non-normalized roll rate traces versus normalized time for the selected High g Turn maneuvers. The roll rate is a good example for all relevant parameters.

Note: The amplitudes for the mean value calculation are not normalized.

The mean value is defined by:

$$y_m(j) = \frac{\sum_{i=1}^n y_i(j)}{n}$$

n = number of maneuver of the same type

j = time step

$y_i(j)$ = relevant parameter

$y_m(j)$ = mean value

The mean values of all parameters have been formed in combination by smoothing of the time history.

For plot comparison, a normalization of the amplitude is necessary.

3.2.3.7 IDEALIZATION

The mean value traces represent a good estimation of the relationship between the selected parameters during a maneuver (e.g. High g Turn).

For the compensation of any minor errors by the mean value calculation and for reasons of compatibility, the mean values have to be idealized and tuned.

The interpretation of “idealized and tuned” as follows:

To cover the most extreme peaks of the control surface deflections possible, the most extreme accelerations in roll (p), pitch (q), and yaw (r) are used.

These values are obtained by linearization of the acceleration time history in a way that the same response of the aircraft is obtained.

For the idealization, the calculation is performed in three steps.

In the first step, the following parameters were calculated:

The three angular accelerations \dot{p} , \dot{q} and \dot{r} by differentiating the three angular rates p (roll), q (pitch) and r (yaw) with respect to maneuver time.

The differentiation was given by $\dot{y} = \frac{\Delta y}{\Delta x}$

In the second step, the acceleration traces \dot{p} , \dot{q} , \dot{r} , were replaced by linearized traces

With respect to the zeros of the traces and extreme values of \dot{p} , \dot{q} , \dot{r} and the corresponding extreme values of roll -, pitch- and yaw rate.

Figure 11 presents the comparison of derived roll acceleration trace and idealized trace versus maneuver time for a High g Turn Maneuver.

In the third step, the three angular rates (roll, pitch, yaw) were recalculated
By integrating the idealized values of the three angular accelerations (\dot{p} , \dot{q} , \dot{r}).

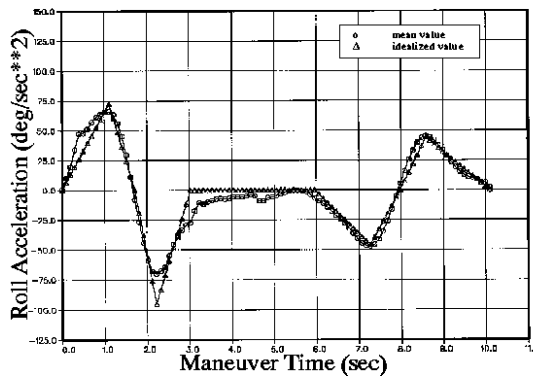

FIG 11 : Idealization Traces

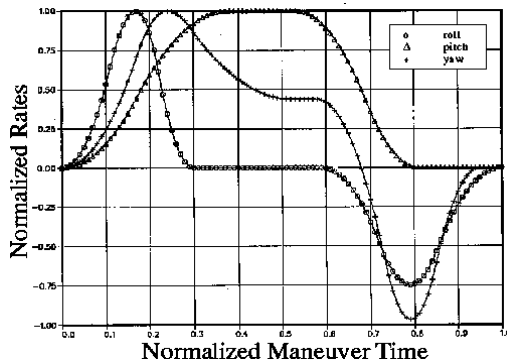

FIG 12: Standard Maneuver

For the reasons of compatibility, the idealized data have to be tuned, that means the relation between the three

$$p = \dot{\Phi} - \dot{\Psi} * \sin \Theta$$

Eulerian angles Φ , Θ , Ψ and the angular rates p , q , r is verified with the equations:

The result is the standardized maneuver.

$$r = -\dot{\Theta} * \sin \Phi + \dot{\Psi} * \cos \Phi * \cos \Theta$$

$$q = \dot{\Theta} * \cos \Phi + \dot{\Psi} * \sin \Phi * \cos \Theta$$

Figure 12 presents the idealized and tuned “standardized” traces of the three angular rates for a High g Turn maneuver.

For each type of standardized maneuver the normalized motion parameters are independent of aircraft type, mass configuration and flight control system.

3.2.4 Flight Loads derived from Operational Maneuvers

The determination of operational loads is considered as feasible applying an Operational Maneuver Model. The essential input for the Operational Maneuver Model is a set of Operational Standard Maneuvers consisting of normalized operational parameter time histories, as determined in 3.2.3.

The operational loads can be determined by introducing aircraft basic data, flight condition and boundary conditions for the maneuver to be considered.

3.2.4.1 Application of the Operational Maneuver Model

The application of the Operational Maneuver Model is feasible for the determination of loads in general.

- for Extreme Operational Loads / Limit Loads taking into account the boundary conditions for design
- for Fatigue Loads by building a usage spectrum made up of reconstituted Operational Standard Maneuvers
- for Loads related to recorded parameters taking into account the recorded parameters directly without application of standardization procedure (normalization, mean values, tuning, idealization) and without tailoring by boundary conditions

Aircraft Basic Data

Aircraft basic data is the main input for the Operational Maneuver Model and is required to perform the reconstitution from the standardized maneuvers.

For calculation of the control deflections necessary to generate the operational parameter time history, the following data are needed:

- Aircraft configuration
- geometric data
- operational mass
- inertia properties

- Aerodynamic data set for the aircraft $C_l, C_m = f(\alpha), C_y, C_l, C_n = f(\alpha, \beta)$

- Flight Control System data
- for conventionally controlled aircraft: mechanical gearing / limits

- for active controlled aircraft: flight control law (EFCS)

- Engine data- thrust

- Flight Condition- airspeed, M_a - altitude

3.2.4.2 For calculation of structural loads on aircraft components the following data are needed:

- aerodynamic data set for the components to be considered (wing, tailplane)
- mass data for the components to be considered

3.2.4.3 Boundary Conditions as Design Criteria

Boundary Conditions have to be considered as the main input for defining the load level. This is necessary for the determination of the extreme operational maneuvers and consequently for the verification of design loads.

The boundary parameters to be defined for an operational maneuver are:

→ Design Maneuvers

- the shortest maneuver time ($T_{man} = \text{minimum}$)
- realizable by the control system and the aerodynamic limits
- the maximum vertical load factor (n_z)
- the maximum lateral load factor (n_y)
- the maximum bank angle (ϕ) for the maneuver to be considered

These boundary condition parameters can be derived from spectra of main load parameters by applying extreme value distributions, an example is shown in Figure 13.

If no spectra are available the main load parameters stated in the Design Requirements (MIL – Spec.) can be applied.

→ Fatigue Maneuvers

All the main load parameters can be taken from related spectra available.

The procedure of Operational Maneuver Model is shown in Figure 14 as a flow chart.

Using the Standardized Operational Parameters the reconstitution into real time is performed.

For these operational parameters time histories in real time the control deflections necessary to generate the operational maneuver can be determined as follows:

→ roll control ξ by applying roll and yaw equations

→ pitch control η using the pitch equation, taking into account the symmetrical aileron deflections

→ yaw control ζ by applying sideslip and yaw equations

Using these control deflections the response calculation is done for real time conditions, but for the purpose of checking the results with respect to the standardized maneuvers, the response parameters are normalized.

In a comparison of the parameters between input and output, the standardization is checked. In case of confirmation of the conformity of the main response parameters with the standardized parameters, the output parameters are considered to be verified. These verified data represent the model parameters for load calculation.

The calculation of the Operational Loads is performed in the conventional manner applying the verified model parameters in particular the control deflections determined for the Operational Maneuver to be considered.

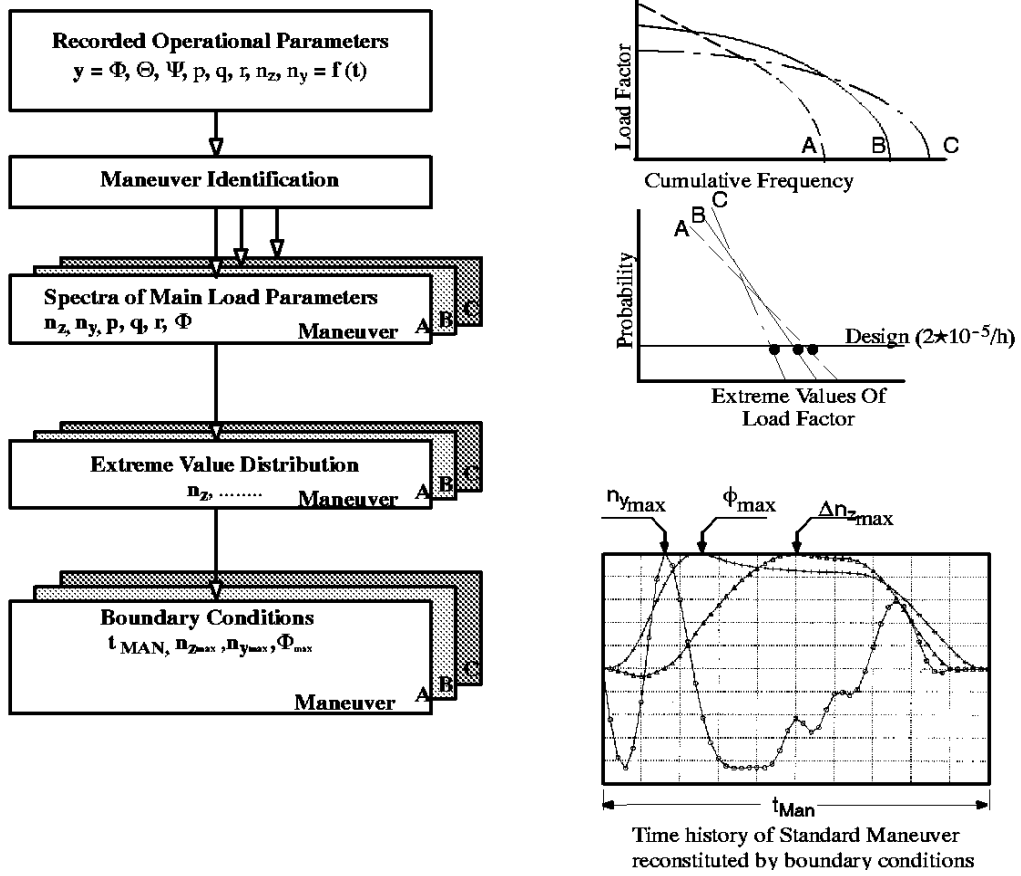

FIG 13 : Boundary Conditions for Design Maneuvers

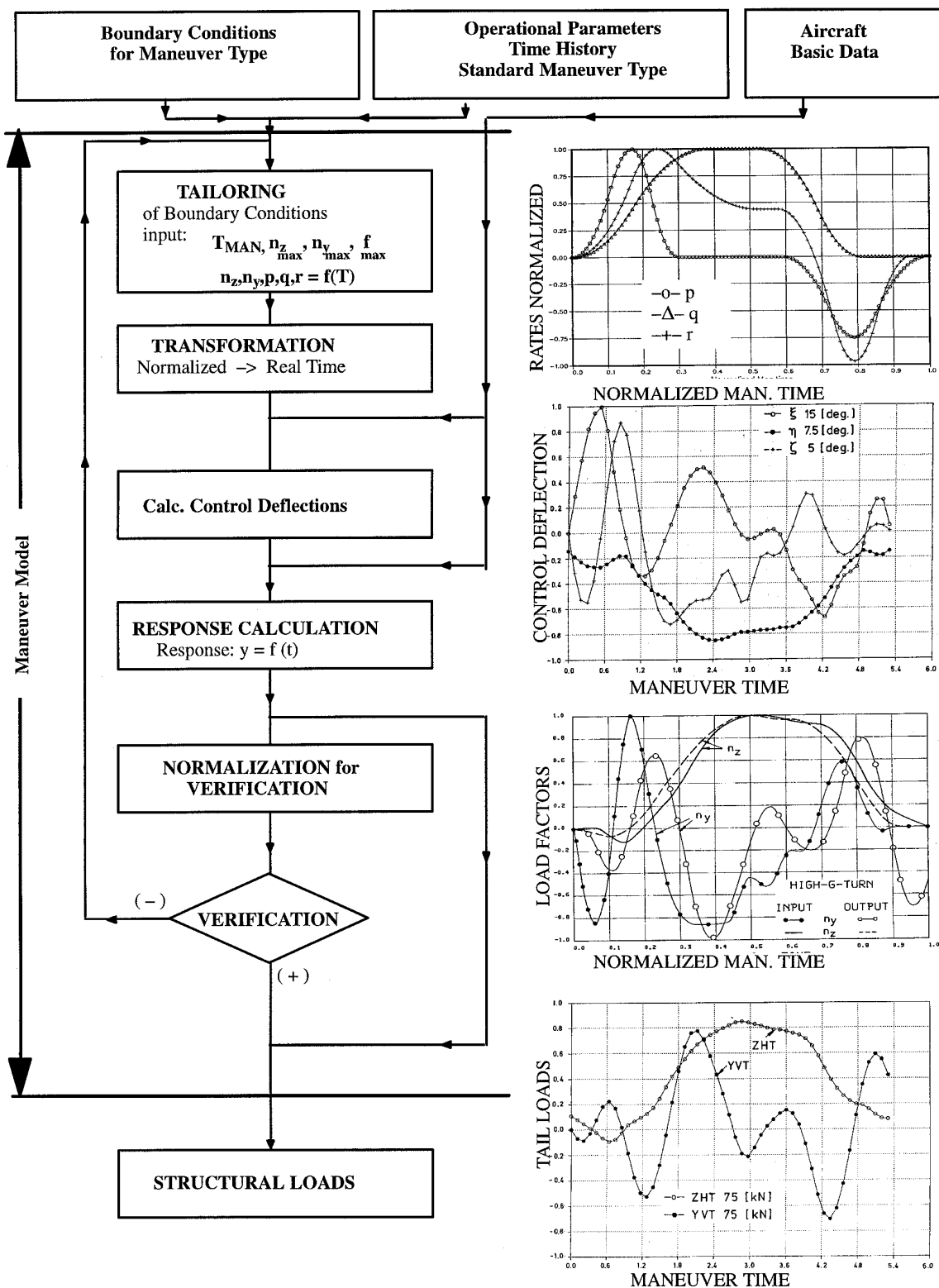

FIG 14 : Procedure of the Operational Maneuver Model

3.2.5 Flight Parameter Envelopes Approach

Abstract

This part of the manual will explain in detail the Flight Parameter Envelope Approach:

A new method to determine the critical flight design loads for a modern control configured fighter aircraft. The way from the initial design phase up to the Final Operational Clearance (FOC) will be examined.

The Flight Parameter Envelope Approach has to be seen in conjunction with the new design tools (i.e. Loads Model) and the modern digital Flight Control Systems with carefree handling and load limiting procedures. The definition of Flight Parameter Envelopes will then be useful and feasible if computer tools are available to do extensive load investigations for the total aircraft under balanced aircraft conditions and if the FCS will limit the aircraft responses (carefree handling) and with it the aircraft loads (load limiting system).

The definition of Flight Parameter Envelopes may be a problem for new aeroplanes where in the beginning of the aircraft development only limited information about the aircraft responses from previous or similar aircraft is available. New techniques, such as thrust vectoring for high angle of attack maneuvering in combination with higher dynamic pressures may cause new problems. But the poststall flight conditions up to now known are only loads critical locally because the dynamic pressures in the flown poststall regime is low.

However for aircraft like the Eurofighter generation the definition of Flight Parameter Envelopes is a useful and feasible approach to determine the critical flight design loads and to overcome the additional problem that Military Specifications became more and more obsolete for aircraft design.

List of Symbols

A/C	Aircraft
ALE	Allowable Loads Envelope
CFC	Carbon Fibre Composites
DOF	Degree of Freedom
FCS	Flight Control System
FOC	Final Operational Clearance
HISSS	Aerodynamic Program - Higher Order Panel Sub- and Supersonic Singularity Method
IFTC	Initial Flight Training Clearance
MAST	Major Airframe Static Test
MAFT	Major Airframe Fatigue Test
MLA	Maneuver Load Alleviation
RF	Structural Reserve Factor
f_{limit}	Limit Load Factor
$f_{\text{ult.}}$	Ultimate Load Factor
F_x, F_y, F_z	Forces

M_x, M_y, M_z	Moments
c. g.	center of gravity
q_{dyn}	dynamic pressure
n_x, n_y, n_z	load factors
p	roll velocity
q	pitch velocity
r	yaw velocity
p_{dot}	roll acceleration
q_{dot}	pitch acceleration
r_{dot}	yaw acceleration
α	angle of attack
β	sideslip angle
$\beta * q_{\text{dyn}}$	product of sideslip angle and dynamic pressure
$\eta_{\text{F/P}}$	foreplane deflection angle
$\eta_{\text{T/E}}$	trailing edge deflection angle
δ_R	rudder deflection angle

3.2.5.1 Introduction

When starting with feasibility studies for a new fighter aircraft in the beginning of the eighties indications from an aircraft designed in the early seventies were confirmed that a change of the applications of Military Specifications for the aircraft design would be necessary. This was also valid for the evaluation of aircraft design loads (e.g. MIL-A-08861A).

The increase in new technologies e.g.

increase of computer capacity

digital flight control systems (FCS)

new materials – e.g. Carbon Fibre Composites (CFC)

better and more efficient design tools – e.g. Structural Optimization Tool, Loads Model, etc.

led to a change of the design and performance requirements for a new fighter generation.

The high work load of the pilots should be reduced in contrast to the increase of the tasks of the aircraft such as performance, agility, etc.. The consequence was to design

an aerodynamic unstable aircraft - increase of agility with a digital Flight Control System (FCS)

The requirement to reduce the workload of the pilot could be fulfilled by a carefree handling and automatic load limiting procedure in the FCS control laws. With it the control function of the pilot for the instrument panel in the cockpit is reduced to a minimum and eyes out of the cockpit whilst maneuvering is possible.

To overcome the new situation for calculation of critical design loads for modern fighter aircraft the so called Flight Parameter Envelope Approach was developed and will be described here for an aerodynamically unstable aircraft with foreplanes (see Fig. 1) featuring:

- artificial longitudinal stability
- extensive control augmentation throughout the flight envelope
- carefree maneuver capability with automatic load protection achieved by careful control of maneuver response parameters

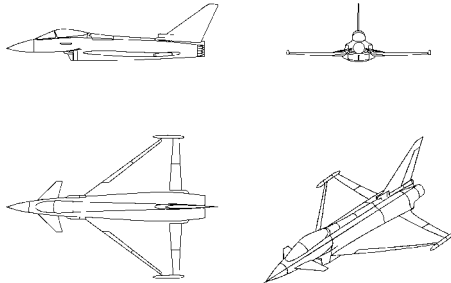

Fig. 1 - “Demonstrator Aircraft” for Flight Parameter Envelope Approach

The main problem is to realize an agile and carefree load limiting FCS. Therefore a robust structural design of the airframe is necessary including an appropriate growth potential for possible changes of the FCS control laws covering aircraft role changes which may influence the design loads and with it the aircraft structure. To make sure that the airframe and the FCS are harmonized: aircraft structure and FCS control laws have to be developed concurrently.

In comparison to earlier aircraft like Tornado the design loads for the new FCS controlled fighter aircraft have to be defined without a detailed knowledge of the final standard of the FCS because

a very limited understanding of the FCS- control laws is available in the initial design phase.

This problem can be solved by the definition of new Structural Design Criteria where among other design conditions the principal flight maneuver requirements for the aircraft have to be defined. In this case the FCS dependent loads critical Flight Parameter Envelopes (s. Fig. 2) are defined by:

- translatory accelerations (n_y, n_z)
- rotational velocities (p, r)
- rotational accelerations ($\dot{p}, \dot{q}, \dot{r}$)
- sideslip conditions ($\beta \cdot q_{dyn}$)
- etc.

To take into consideration all requirements of the different aircraft design disciplines the Flight Parameter Envelopes have to be defined in not only considering FCS but also

- Flightmechanics
- Aerodynamics
- Structural Dynamics
- Loads

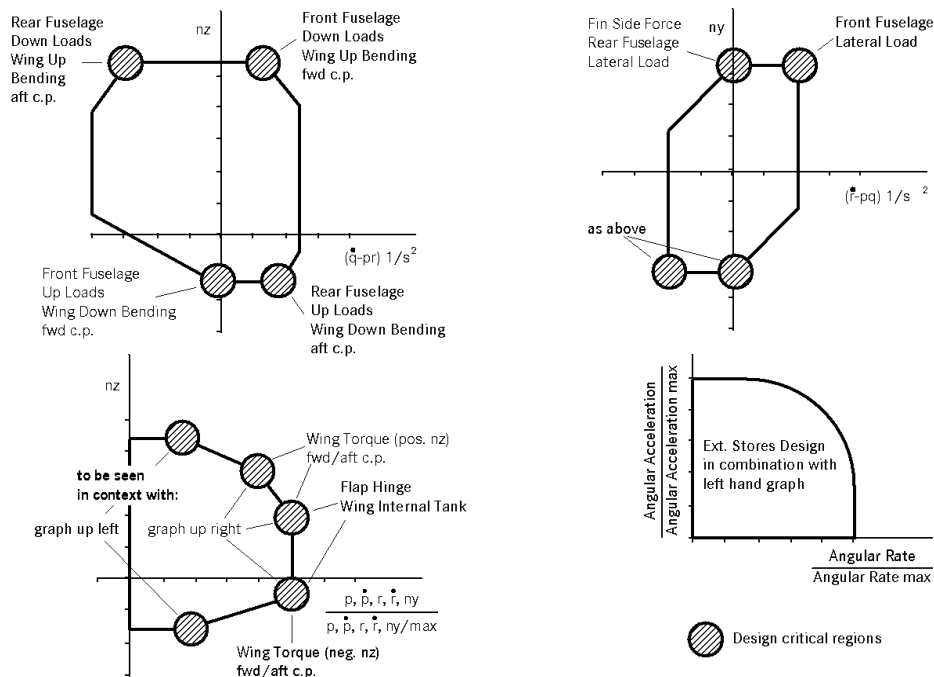

Fig. 2 – Loads Critical Flight Parameter Envelopes for the Loads Model – Interdependence between the Flight Parameter Envelopes and Critical Design Load Cases for Main A/C- Components

The calculation of aircraft design loads will be done with a modern computer tool the so called Loads Model and the Flight Parameter Envelopes are a part of this tool.

3.2.5.2 The Flight Parameter Envelope Approach and the Loads Model

Both the FCS dependent Flight Parameter Envelopes (Fig. 2) and the Loads Model (Fig. 3) result in a highly efficient computer tool for aircraft design load calculations:

- the maneuver requirements of the aircraft controlled by the FCS are indirectly defined by the Flight Parameter Envelopes and the Loads Model contains all the important aircraft mass and aerodynamic information's which have to be known to calculate the critical design loads for the aircraft

3.2.5.3 Description of the Loads Model

The today's computer capacities allow extensive load investigations considering:

- all mass information's (masses, c.g.'s, moments-of-inertia, mass distributions) for the total aircraft and specific aircraft components
- the corresponding aerodynamic information (aerodynamic pressures, aerodynamic coefficients/derivatives) for the total aircraft and the defined aircraft components for different Mach numbers
- the static aeroelastic input (flexibility factors and increments for total aircraft and aircraft

components) to correct the rigid aerodynamics (aerodynamic pressures, aerodynamic coefficients/derivatives) for defined Mach numbers.

The mass- and aerodynamic data have to be stated for different loads critical aircraft configurations.

The idea of the Loads Model is to calculate the critical aircraft component design loads (aircraft component loads envelopes) to get balanced load cases for the total aircraft. That means the total sum of the aircraft component forces and moments is zero (equilibrium) for each load case:

$$\Sigma F_{x,y,z} = 0 \quad \Sigma M_{x,y,z} = 0$$

These balanced load cases (Fig. 4) are the basis for the calculation of nodal point loads for the total aircraft Finite Element Model (FE-Model) and for the stress analysis.

Simplified the Loads Model is a combination of big input and output data files and a number of computer programs (Fig. 3). The input data sets contain all information which is necessary for load calculations while the output data sets contain the results of the load calculations as load case conditions, forces, moments, aircraft component load envelopes, etc..

The computer programs of the Loads Model can be classified into two different groups

- programs to establish and to handle the required data sets
- programs to compute the critical aircraft component loads (balanced load cases, loads envelopes)

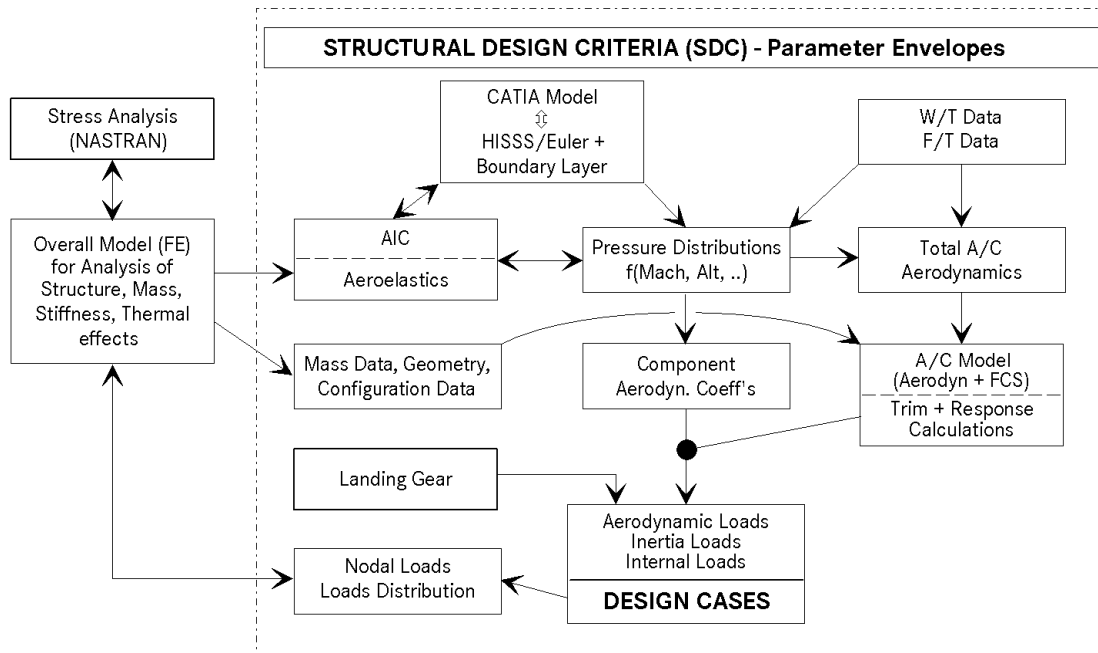

Fig. 3 – Loads Model - Overall View

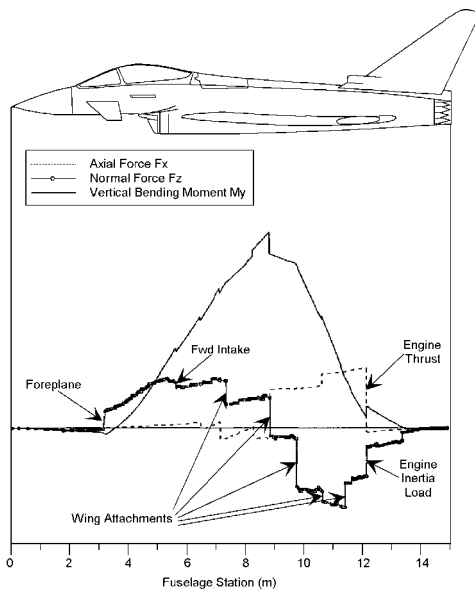

Fig. 4 – Total Aircraft – Balanced Load Case

To use the Loads Model efficiently the structural design rules including the flight maneuver requirements have to be defined for the new aircraft. This will be done in the SDC.

3.2.5.4 Structural Design Criteria (SDC)

Because more and more the Military Specifications (e.g. MIL-A-08861A) are getting obsolete for the design of modern fighter aircraft it becomes important to define the new structural design rules in the Structural Design Criteria.

The following conditions have to be defined in the Structural Design Criteria:

Design Flight Envelope- Mach/altitude

$n_{z-max./min.}$ vs. Mach

$f_{limit}, f_{ult.}$ - limit/ultimate load factor

Loads critical aircraft configurations with and without stores – key configurations

Aircraft design masses:

Basic Flight Design Mass, Maximum Design Mass, Minimum Flying Mass, Landing Design Mass, etc.

Gust conditions:

gust design speeds in combination with aircraft speeds, gust lengths

Temperatures:

maximum recovery temperature

maximum stagnation temperature

Ground Loads Criteria:

sink rate, crosswind, arresting, repaired runway, etc.

Departure and Spin

Hammershock conditions

Bird strike conditions

Static aeroelastic requirements

Flutter/divergence requirements

Fatigue conditions:

safe life or fail save philosophy

g-spectrum, scatter factor, aircraft service life, etc.

etc.

Additional to the above described design conditions also

the principal flight manoeuvre requirements for the aircraft

have to be defined.

3.2.5.5 Flight Parameter Envelopes for Structural Design

The application of the single axis pitch, roll or yaw maneuvers (MIL-A-08861A) is no longer sufficient for the definition of design loads (Fig. 5 and Fig. 6).

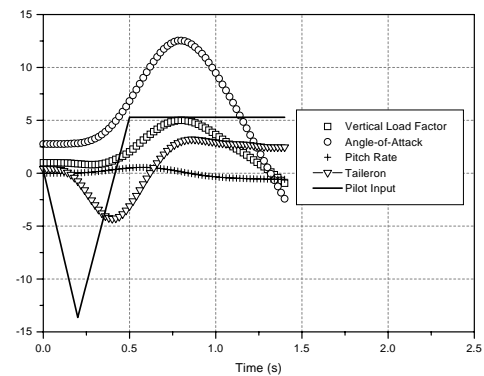

Fig. 5 – MIL - Pull-Push Maneuver

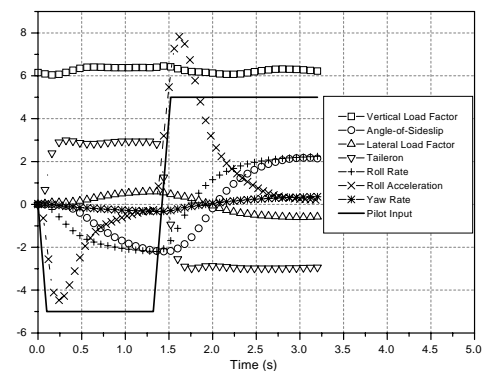

Fig. 6 – MIL - Rolling Pull Out Maneuver

The carefree maneuver capability with automatic load protection allows the superposition of combined pilot control inputs in roll, pitch and yaw and with it numerous different operational maneuvers which have to be taken under consideration to find the critical design loads. Some typical pilot stick inputs for flight clearance maneuvers are shown in Fig. 7.

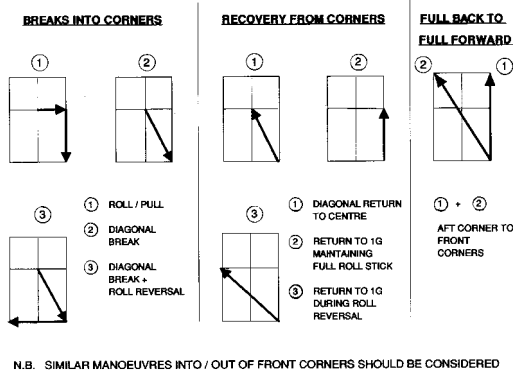

Fig. 7 – Typical Pilot Stick Input

The following Flight Parameter Envelopes have to be defined (s. Fig. 2):

$$n_z = f(q_{\dot{d}})$$

$$n_y = f(r_{\dot{d}})$$

$$n_z = f(p, p_{\dot{d}}, r, r_{\dot{d}}, n_y, \beta^*q_{\text{dyn}})$$

$$p, r \text{ vs. } p_{\dot{d}}, r_{\dot{d}}$$

As it can be seen mainly the inertia dominated parameters as the translatory accelerations (n_z , n_y) and the rotational velocities (p , r) and rotational accelerations ($p_{\dot{d}}$, $q_{\dot{d}}$, $r_{\dot{d}}$) have to be defined while only one aerodynamic parameter is β^*q_{dyn} (sideslip angle * dynamic pressure). The sideslip angle β is well controllable by the FCS and with it the product β^*q_{dyn} . β^*q_{dyn} can be defined under consideration of the gust requirements for the aircraft.

Important for the definition of the Flight Parameter Envelopes for the structural design of an aircraft are also the possible tolerances of the flight parameters (s. Fig. 8). These have to be defined

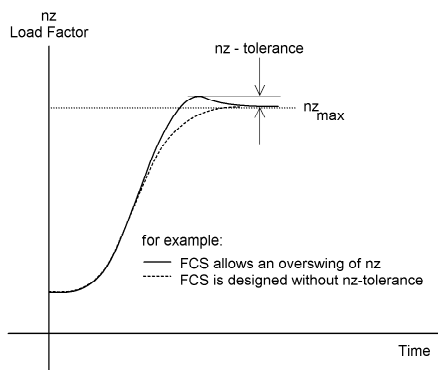

Fig. 8 – Flight Control System Design - Tolerance of Flight Parameter

- For example:

to define $n_{z\text{max./min.}}$ for the most important Flight Parameter Envelopes

$$n_z = f(q_{\dot{d}})$$

$$n_z = f(p, p_{\dot{d}}, r, r_{\dot{d}}, n_y, \beta^*q_{\text{dyn}})$$

it should be known how exact the FCS controls the vertical load factor n_z (s. Fig. 8):

$$n_z = n_{z\text{max./min.}} \pm \Delta n_z$$

If in this case the defined tolerances are too small an increase of the n_z overshoot ($\pm\Delta n_z$) may cause problems, because the load limiting procedure of the FCS can become uncertain therefore or on the other hand an increase of the critical aircraft loads has to be accepted for which the aircraft structure has to be checked for.

These Flight Parameter Envelopes will be used now to determine the design load and the load envelopes for the aircraft main components – see Para. 3.2.5.8.

The interdependence between the Flight Parameter Envelopes and critical design load cases for the different aircraft components can be seen on Fig. 2.

3.2.5.6 Total Aircraft and Component Aerodynamics

To get “balanced load cases” the total aircraft aerodynamic as well as the corresponding component aerodynamic is integrated in the Loads Model regarding all loads critical aerodynamic influences. The result must fulfil the condition:

- sum of component aerodynamics = total aircraft aerodynamics

The following aerodynamic data sets are part of the Loads Model:

- aerodynamic pressures of the total aircraft for all aerodynamic influences (α , β , control surface deflections, p , q , r , etc.) for different Mach numbers
- the corresponding aerodynamic coefficients/derivatives of the aircraft components - result of aerodynamic pressure integration – for all defined monitor stations (Fig. 9)
- the corresponding aerodynamic coefficients/derivatives of the total aircraft – sum of component coefficient/derivatives
- the static aeroelastic corrections of the aerodynamic pressures for all aerodynamic influences as

$$\alpha, \beta, \text{ control deflections, } p, q, r, \text{ etc.}$$

and the aerodynamic pressures of aeroelastic inertia effects and the corresponding integration results (coefficients/derivatives) for

$$n_z, n_y, p_{\dot{d}}, q_{\dot{d}}, r_{\dot{d}}$$

together with the correction factors and increments for the aerodynamic coefficients/derivatives for the aircraft components and the total aircraft

- the corrected flexible aerodynamic pressures including the corresponding flexible total aircraft aerodynamics and the flexible aircraft component aerodynamics

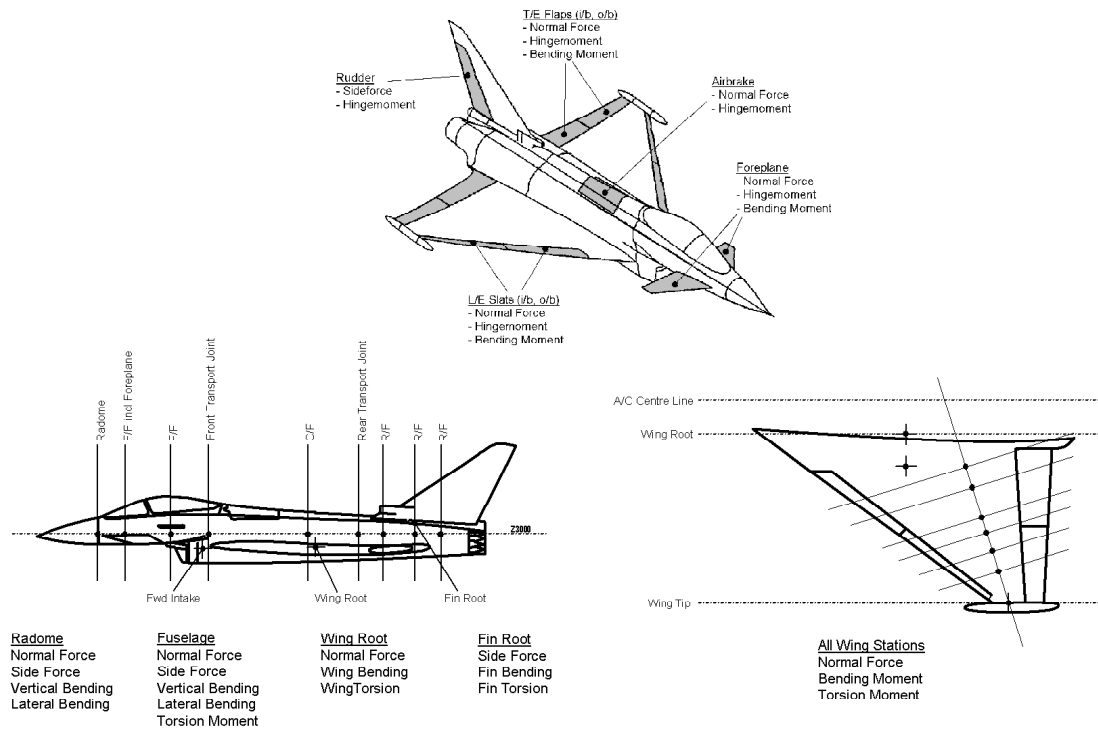

Fig. 9 - Load Monitor Stations for "Demonstrator Aircraft" and Corresponding Main Loads Components

The main programs for establishing the required aerodynamic data sets and for data set handling are:

- a theoretical aerodynamic program (e.g. the Dasa HISSS program – higher order panel method) to calculate the rigid aerodynamic pressures for the above described loads relevant aerodynamic influences.

In Fig. 10 it is shown how starting from a CATIA model the HISSS panel model will be derived.

- a correlation and integration program to compare and correct the theoretical total aircraft aerodynamic results up to first total aircraft wind tunnel measurements and with it to correct the aerodynamic

- pressures and the aerodynamic coefficients /derivatives for the aircraft and the aircraft components

- a static aeroelastic program to calculate the aeroelastic pressure increments for the correction of the rigid pressure distributions and to calculate the correction factors and increments for the aerodynamic coefficients/derivatives for the aircraft components and the total aircraft to establish the flexible aerodynamic data set.

an aerodynamic pressure summation program to summarize the aerodynamic pressures due to

$$\alpha, \beta, \text{ control deflections, } p, q, r, \text{ etc.}$$

for the selected critical load cases to calculate the aerodynamic nodal point loads for the FE- Model.

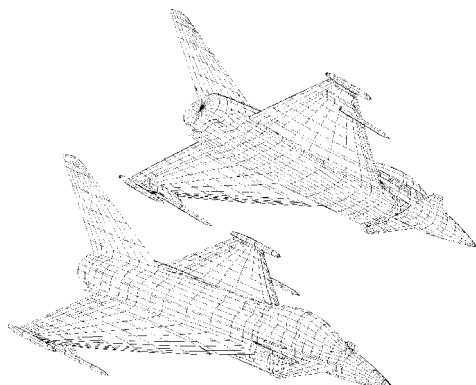

Fig. 10 – HISSS Panel Model of "Demonstrator Aircraft" – Calculation of Aerodynamic Pressures for Total Aircraft

3.2.5.7 Total Aircraft- and Component Masses

For the calculation of "balanced load cases" the mass conditions for the defined design masses (Basic Flight Design Mass, Maximum Design Mass, Minimum Flying Mass, Landing Design Mass, etc.) for the total aircraft as

aircraft mass

aircraft c.g.

aircraft moments of inertia

as well as the corresponding component mass conditions have to be integrated into the Loads Model.

- Sum of component masses = total aircraft mass

The following mass data sets are part of the Loads Model:

- the aircraft component masses, component c.g.'s and moments of inertia including the corresponding internal fuel states and external stores (Fig. 9 – A/C Monitor Stations)
- the total aircraft mass, c.g., moments of inertia including the internal fuel states and external stores as sum of the above described aircraft component masses

3.2.5.8 Aircraft Loads Monitoring

The calculation of critical design load cases (loads monitoring) for the aircraft components (monitor stations) can be started when the required input data sets for the Loads Model are established. The outcome of the aircraft loads monitoring are Loads Envelopes (Fig. 11) for the defined monitor stations.

The computer program which will be used for the calculation of critical load cases under consideration of the defined Flight Parameter Envelopes is the so called “Balance Program”. The loads analysis for the monitor stations (Fig. 9) will be performed by means of user defined dynamic equilibrium points (time steps of a time dependent flight simulation):

- The user has to define for each load case the following flight parameters
 Mach number, altitude, n_z , n_y , p , p_{dot} , q , q_{dot} , r , r_{dot}
 respecting the Flight Parameter Envelopes (Fig. 2) and as a special case for this “demonstrator” aircraft
 the foreplane deflection (η_{FP}) and trailing edge deflection ($\eta_{T/E-sym.}$)
 under consideration of the foreplane schedule

- The Balance Program will define the remaining ones:

$$\alpha, \beta, \eta^{-T/E-sym.} \text{ or } \eta^{-F/P}, \eta^{-T/E-unsym.}, \delta_R$$

and n_x and the thrust level

if required. In a second step the corresponding air-, inertia- and net- loads for all monitor stations are computed for the selection of critical design loads to establish the loads envelopes for the defined aircraft components

To be sure that the defined requirements will be fulfilled the program also checks

- the derived control surface deflection angles compared to the max. deflection angles
- the derived hinge moments for the control surfaces compared to the max. defined hinge moments if necessary
- the user defined flight parameters compared to the Flight Parameter Envelopes

It seems to be useful to establish a program for loads calculations which can be used for different degrees of freedom (DOF):

- 6 DOF – balance of $F_x, F_y, F_z, M_x, M_y, M_z$
- 5 DOF - without F_x balance (tangential force)
- 3 DOF – balance of F_x, F_z, M_y for pure symmetric conditions
- 2 DOF – balance of F_z, M_y for pure symmetric conditions without F_x balance

It should also be possible later on in the aircraft clearance phase when the carefree handling and load limiting FCS is available to use a flight simulation program to do time dependent loads critical flight simulations and to calculate the corresponding flight load time histories (air-, inertia-, net- loads for all time steps) for the aircraft monitor stations with the Loads Model.

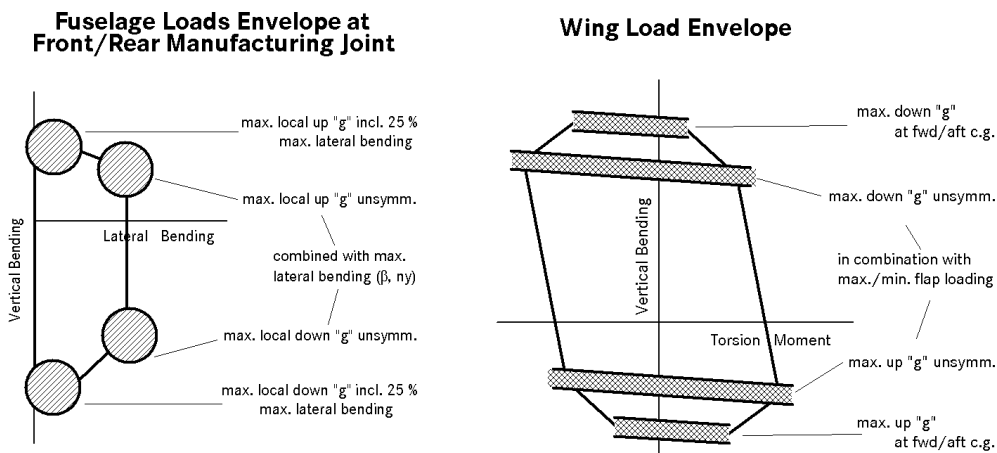

Fig. 11 – Example of Loads Envelopes for Monitor Stations – Design Load Cases

To fulfil the above described additional program check functions the following margins have to be defined:

- max. deflection angles for control surfaces versus Mach number
- max. allowable hinge moments for the control surfaces respective max. normal forces if necessary - as result of structural optimization of wing, fin and foreplane
- engine thrust conditions if necessary
- Maneuver Load Alleviation (MLA) concept if the FCS will have a MLA procedure – to reduce the wing bending moment – respective the other in Para. 3.2.5.13 described load reducing FCS rules
- as a special case for this “demonstrator” aircraft the foreplane trim schedule including possible tolerances because the foreplane and the trailing edge flaps will be used for symmetric flight control

3.2.5.9 Loads Process, Aircraft Design and Clearance Phases

After the feasibility studies respective definition phase the normal development process of an aircraft structure has three phases:

- Design Phase
- Check Stress Phase
- Structural Clearance Phase

For these three development phases the accuracy of the input data (aircraft masses, aerodynamic, etc.) for the Loads Model differs and with it the accuracy of the load calculations. But as explained before the standard of the input data for the Loads Model is relatively high even at the beginning of the aircraft development due to modern computer tools (i.e. theoretical aerodynamic programs) and the possible crossreading to other similar aircraft.

But more important is that with the Flight Parameter Envelopes the principal flight maneuver requirements for the aircraft can be defined very early and with it the interaction of FCS and the aircraft loads. During the development of the aircraft structure the Flight Parameter Envelopes have to be checked in line with the FCS development.

3.2.5.10 Design Phase

Before starting loads calculations with the 1st flexible Loads Model in the Design Phase the in Para. 3.2.3.8 described prerequisites have to be settled additional to the Flight Parameter Envelopes to be sure that the loads are the critical ones and are not maximized:

- A structural optimization has to be done and with it an optimization of the control surface efficiencies under consideration of aeroelastic influences, failure conditions and deflection rates (Fig. 12). Based on these optimization studies the critical hinge moments respective normal forces for the control surfaces can be defined. The result of optimization is “configuration freeze”.

- The max. deflection angles versus Mach number and the maneuver conditions for the control surfaces have to be defined – for example the foreplane trim schedule.
- A maneuver load alleviation (MLA) concept should be defined if necessary under consideration of
 - the required reduction of wing root bending moment for high g conditions
 - the trailing edge split flap schedule as function of g respective α
 - the foreplane trim schedule.

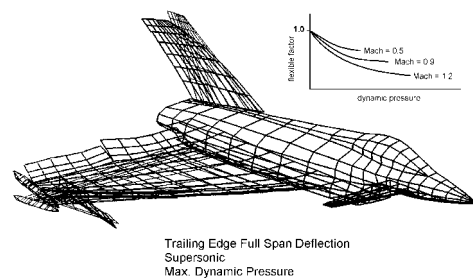

Fig. 12 – Flexible Loads Model - Static Aeroelastic Influences

If all these prerequisites are defined and integrated in the Loads Model the load investigation can start.

During the Design Phase the Loads Model consists of theoretical linear aerodynamics compared with first windtunnel test results and corrected if necessary. The flexible aerodynamic data set includes all important static aeroelastic corrections for selected Mach/altitude points (Fig. 13).

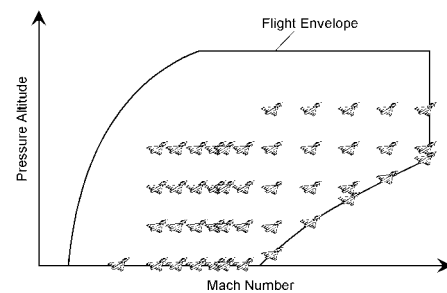

Fig. 13 – Flight Envelope Mach-Altitude Points for Flexible Loads Model – Flexible Aerodynamic Data Set

The main benefit to do the load investigations with the first flexible Loads Model is

- the loads for the aircraft components can be calculated for total aircraft balanced conditions for different aerodynamic configurations (with and without stores) and different aircraft masses (fuel, external stores) under consideration of the FCS requirements (Flight Parameter Envelopes).

3.2.5.11 Check Stress Phase

The Check Stress Phase is the second development phase. The design loads have to be checked and updated with the updated Loads Model for the design of the production aircraft structure:

- the panel model for the theoretical aerodynamic calculations has to be updated (configuration changes, external stores, etc.)
- the new theoretical linear aerodynamic has to be updated by comparing and correcting it to the latest windtunnel tests (configuration changes, additional store configurations, mass flow, etc.)
- first windtunnel based store aerodynamic increments can be available (store balances) and can be included in the Loads Model
- the static aeroelastic corrections have to be updated by using the updated structure (FE- Model) and the updated aerodynamic pressures
- the aircraft masses have to be updated for production aircraft standard
- the foreplane trim schedule and the tolerances for the trim schedule have to be updated
- the MLA concept has to be checked and updated if necessary
- the max. hinge moments for the control surfaces have to be checked and updated if necessary
- if required additional monitor stations have to be included in the Loads Model
- the Flight Parameter Envelopes have to be checked and updated in line with the FCS development. That means in detail that the flight control laws have to be reviewed during all design phases to check their function as a load limiting system. For example the defined tolerances of the Flight Parameter Envelopes have to be checked, e.g. the n_z tolerances:

$$n_{z \text{ max./min.}} \pm \Delta n_z$$

as explained in Para. 3.2.5.5.

As for the Design Phase the load calculations have to be done by using the Balance Program and the updated Flight Parameter Envelopes. The up to now available FCS has only a check function because the carefree handling and load limiting procedures are not finally agreed (preliminary carefree handling). The load investigation should be expanded and additional Mach/altitude points should be considered.

The revised aircraft component design load cases (balanced load cases, load envelopes) from the Check Stress Phase are the basis for the stress analysis for the production aircraft and with it for the structural clearance activities in the Clearance Phase.

3.2.5.12 Structural Clearance Phase

The aircraft clearance will be done in different steps from the first flight clearance for the prototypes up to the Initial Flight Training Clearance (IFTC) and the Final Operational Clearance (FOC - 100% load level) for the production aircraft.

The aircraft structure has to be cleared for the conditions defined in the Structural Design Criteria as there are:

- design flight envelope (Ma/altitude)
- critical aircraft configurations
- limit/ultimate load factor
- aircraft design masses
- $n_{z\text{-max./min.}}$ vs. Mach
- etc.

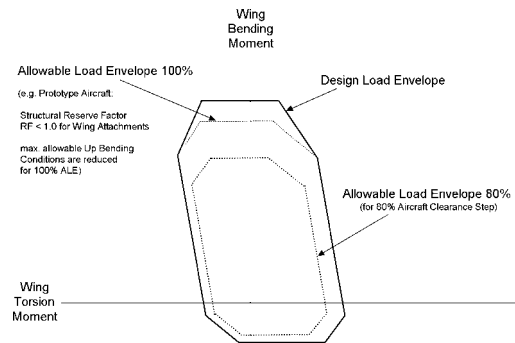

Fig. 14 – Allowable Load Envelope for Aircraft Clearance Phases – Structural Reserve Factors < 1.0 are considered

For the clearance of the aircraft structure so called Allowable Loads Envelopes (ALE) will be used. The ALE's (Fig. 14) contain the structural information of the prototypes respective of the production aircraft. The ALE's have to be defined by the stress office based on the design load envelopes of the aircraft components and under consideration of the results from the stress analysis and structural tests. To be on the severe side during the clearance activities (flight test) only structural Reserve Factors (RF) < 1.0 have to be considered in the ALE's.

The prerequisites to increase the clearance level are :

- Major Airframe Static Test (MAST) to limit, ultimate, failure load condition and other aircraft component tests - to check the aircraft structure
- FCS updates – from preliminary carefree handling to full carefree handling to check the load limiting procedure of the FCS
- Validation of the Loads Model via the Flight Load Survey to update the data basis for loads monitoring and to proof also the load limiting procedure of the FCS

The first Loads Model for the structural clearance of the aircraft consists of non-linear aerodynamic data based on wind tunnel pressure plotting measurements. The validation of this non-linear Loads Model will be done by the Flight Load Survey. The Flight Load Survey will be performed for selected primary aircraft configurations (clean aircraft and external store configurations). During the Flight Load Survey aerodynamic pressures of the surfaces (wing, foreplane, fin) and the fuselage will be

measured (Fig. 15). The integrated pressures (aerodynamic coefficients for the total aircraft and for aircraft components) will be correlated against the load predictions from the non-linear Loads Model. The Loads Model will be then corrected where significant discrepancies exist. Finally the flight validated Loads Model for the primary aircraft configurations is available and should be used for the Final Operational Clearance (FOC) – 100 % load level and production FCS.

During the Structural Clearance Phase at all clearance levels the confidence that the load level will not be exceeded has to be shown by the loads monitoring of loads critical flight simulations using the current FCS and the validated Loads Model. Some typical pilot stick inputs for the flight simulations (flight clearance maneuvers) are shown on Fig. 7.

The loads from the simulated flight maneuvers have to be compared to the Allowable Loads Envelopes for each monitor station. If the loads monitoring shows that the loads are inside the ALE's the clearance step is fulfilled. If not:

- the areas have to be defined where control law changes are required to maintain acceptable loads
- or
- modifications may be necessary to improve the aircraft structure for higher loads

3.2.5.13 Load Optimized Maneuvers

In the past the aircraft were optimized mainly to aerodynamic performance conditions (drag, etc.) and the design loads were the result of the aerodynamic configuration, the aircraft mass conditions and the application of single axis pitch, roll or yaw maneuvers (e.g. MIL-A-08861A).

A new possibility for the latest high performance fighter aircraft generation like Eurofighter are load optimized maneuvers because the FCS can be used in some cases for load reduction under the consideration that the aircraft performance is not prejudiced.

Three examples for load optimized maneuvers controlled by the FCS are given below:

1. Load optimized foreplane/trailing edge deflection schedule as a special case for the “demonstrator” aircraft described in this paper:

- a) reduction of front fuselage loads

The front fuselage loads are normally dominated by the inertia loads. To reduce the front fuselage loads (F_z -normal force and M_y - vertical bending moment) the foreplane has to be deflected in that way that the aerodynamic foreplane loads are acting against the front fuselage inertia loads (s. Fig.16). In this case the aircraft has to be controlled by the trailing edge flaps.

- b) reduction of trailing edge flap loads - e.g. hinge moments.

For low g conditions (1g) where the maximum roll performance of the aircraft is required the trailing edge flaps can be zero loaded for the aircraft trim conditions by trimming the aircraft only with the foreplane. The trailing edge flap itself has to be deflected in that way that the α influence on the flap will be compensated:

$$\eta_{T/E-symm(nz=1.0)} = f(\alpha, \text{Mach}, A/C-cg)$$

With it the flap hinge moments can be reduced and the roll efficiency of the aircraft can be increased in some cases.

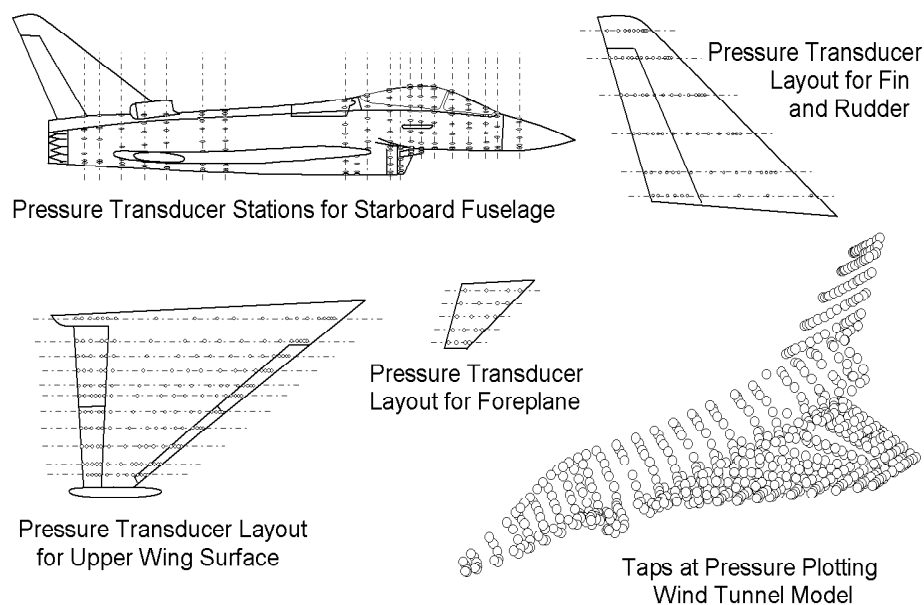

Fig. 15 – Flight Load Survey - Pressure Transducers at the Prototype of “Demonstrator Aircraft”

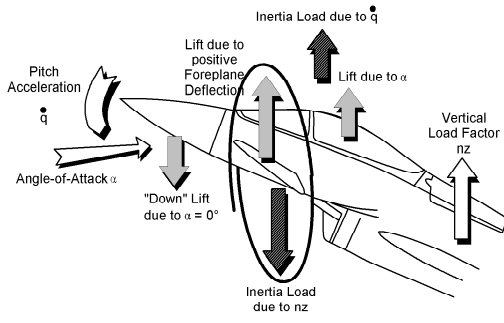

Fig. 16 – Front Fuselage - Load Reduction Load Optimized Foreplane/Trailing Edge Schedule

Procedure a) may be used only for the front fuselage loads critical flight conditions as high g's turns at low aircraft masses (minimum flying mass) where the normal aerodynamic discharge for the front fuselage is a minimum and with it the net load is a maximum. In this case the trailing edge flap loading is relatively low compared to the maximum aircraft rolling conditions and can be used therefore for exclusive aircraft control in the pitch axis. In all other cases the aircraft performance will be more important.

Procedure b) is a possible solution for hinge moment reduction if the control surface loads are increasing and the size of the flap actuators cannot be changed.

2. Maneuver Load Alleviation - MLA (differential trailing edge flap deflection of i/b- o/b- flap):

the shift of the aerodynamic center of pressure towards the wing root reduces the wing root bending moment and with it the wing attachment load conditions

In this case the i/b- flap has to be deflected downwards to increase the wing lift in the inboard wing area while the o/b- flap has to be deflected upwards to reduce the lift in the outboard wing area under the condition that the total wing lift has not to be changed (s. Fig. 17). This differential trailing edge flap deflection has to be superimposed to the full span trailing edge flap trim condition. The small effect on the aircraft trim conditions by using the MLA-system has to be corrected by a full span trailing edge deflection itself or by the foreplane.

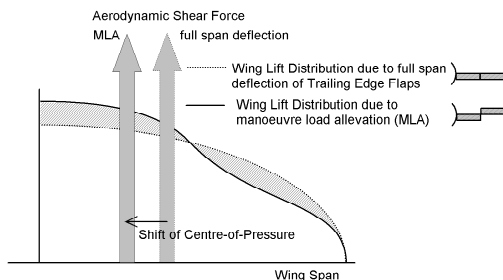

Fig. 17 – Maneuver Load Alleviation (MLA) Change of Wing Lift Distribution and Shift of Center of Pressure

The MLA- system could be important at high g's and high dynamic pressure in the lower α -region (elliptical wing lift distribution, linear aerodynamics).

At higher α there may be a natural shift of the center of pressure to the wing root because the wing lift distribution becomes more and more a triangle due to non linear aerodynamics. (s. Fig. 18).

Spanwise Normal Force Distribution - Subsonic

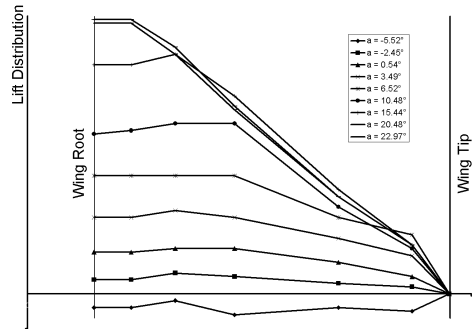

Fig. 18 – Spanwise Normal Force Distribution Natural Shift of Center of Pressure to the Wing Root

The MLA- system can be important for the critical wing up bending conditions at max. g's for the static design respective the most critical g's (mean proportional g's) for fatigue design because the aerodynamic design often didn't allow to increase the lever arm of the wing root attachment to carry over the wing bending moment by a couple of forces (s. Fig. 19).

3. Prevention of overswing of control surfaces (deflection angles):

to prevent load peaks on the control surfaces during rapid aircraft maneuvers (e.g. rapid rolling) an overswing of the control surfaces should be avoided. An example for the trailing edge flap is shown on Fig. 20. In this case the overswing of the flap is optimized by a small change of the T90 condition and with it the flap loads (hinge moments) are reduced significantly.

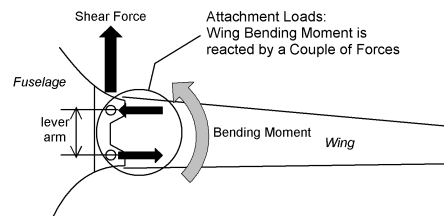

Fig. 19 – Wing Root – Carry Over of Wing Bending Moment

The above described maneuvers can be defined for the critical static design loads as well as for fatigue loads which becomes more and more important for the structural design of the aircraft.

In all these cases it must be decided whether the load optimized maneuvers sacrifice aircraft performance or whether the benefit (i.e. mass saving) is big enough to compensate the loss of performance!

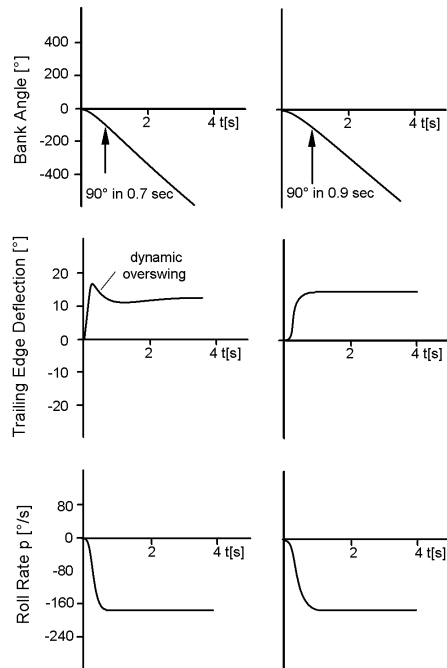

Fig. 20 – Dynamic Overswing of Trailing Edge Flaps
– Change of T-90 Conditions

One way to assess this question is to evaluate required operational maneuvers with respect to extreme or fatigue maneuvers as evaluated by the former AGARD-WG 27 (AGARD AR 340). For further information see Chapter 3.2.2 – Operational Flight Parameter Approach.

On the other hand the $\beta \cdot q_{\text{dyn}}$ requirement defined in the flight parameter envelopes (s. Fig. 2) is also a load limiting condition controlled by the FCS as explained in Para. 3.2.5.5. With it the Fin loads and the side force and side bending moment of the rear and front fuselage can be limited.

3.2.5.14 Ultimate Load Factors

Historically a reduction of the ultimate load factor f_{ult} was done several times down to $f_{\text{ult}}=1.5$ now which was for a long time seen as the lowest possible limit.

The situation was changed for FCS controlled aircraft with carefree handling and load limiting procedures.

Based on the assumption that the aerodynamic and inertia flight loads for the aircraft are limited by the FCS by controlling the important flight parameters

$$\beta, p \text{ and } n_z \text{ respective } \alpha$$

directly the ultimate load factor can be reduced for example from

$$f_{\text{ult}}=1.5 \text{ to } f_{\text{ult}}=1.4$$

(as agreed with the British-, German-, Italian- and Spanish- authorities for the Eurofighter)

But as explained in Para. 3.2.5.12 an extensive Flight Load Survey has to be done to verify the load limiting procedure of the FCS and to proof the reduction of the ultimate load factor.

For FCS independent loads (e.g. landing gear loads, Hammershock pressures, etc.) the ultimate load factor will still be 1.5.

For further information about the ultimate load factor see Chapter 3.1.3 – Safety Factor Review.

3.2.5.15 Conclusion

The calculation of aircraft loads under consideration of Flight Parameter Envelopes is useful and practicable for modern high performance fighter aircraft with a carefree handling and load limiting FCS.

As demonstrated for the Eurofighter:

- the integrated design of FCS and aircraft structure is possible
- the carefree handling and load limiting procedure of the FCS is working
- the defined design loads by using the Flight Parameter Envelopes are acceptable and leading to a robust but not to conservative design of the aircraft structure - compared to the loads evaluated with the FCS (time dependent flight load simulations) later on in the A/C- Clearance Phase the design loads are well
- the reduction of the ultimate load factor from $f_{\text{ult}} = 1.5$ to $f_{\text{ult}} = 1.4$ based on the FCS- load limiting function is useful and leads to a lighter aircraft structure

On the other hand the enormous increase in system complexity for a modern high performance fighter aircraft with a carefree handling and load limiting FCS leads to extensive investigations:

- the flight control laws have to be reviewed during all design phases to check their function as a load limiting system
- the necessary careful and accurate load investigations during all design phases are very extensive
- an extensive Flight Load Survey has to be done for Loads Model validation and with it to proof the load limiting procedure of the FCS and additional if necessary to proof the reduction of the ultimate load factor
- the ALE concept has to be verified by detailed stress analysis, static test and possible restrengthening of the aircraft structure

As explained above the permanent monitoring of the structural design parameters as Flight Parameter Envelopes, ALE's, etc., is indispensable to minimize the risk of a non optimal structural design of the aircraft.

Therefore it should be emphasized once more that various disciplines as Loads, Aeroelastics, Flightmechanics, Flight Control, Stress, Aerodynamics, Flight Test have to cooperate in a very close manner, the so called concurrent aircraft engineering.

3.3 Dynamic Loads

3.3.1 Introduction

The intention of this chapter is to discuss the prediction of unsteady loads arising as a result of pilot actions (as opposed to atmospheric turbulence, say). Gusts and ground loads are treated in separate chapters. Loads due to buffet and buffeting, hammershock, gunfire and store ejection/release loads are mentioned. The aim is met by briefly describing the background, prediction processes and calculation methods, and certification issues. Consideration of the latter is essential, even at the design stage. In addition, the likely way forward for this "technology" is noted. A table is provided as a guide for consideration of dynamic loading sources and their effects on an airframe.

In addition, examples of dynamic load analyses and testing for validation purposes are given in section 3.4, whilst birdstrike is discussed in 3.5. The latter does not strictly come within the terms of this chapter, but is classified under 'threats'. However, it is such a significant source of aircraft in-service incidents, and hence a driver of future designs, that it is included here.

In the course of the item, reference is made to some specific papers and work known to the author. However, it should be noted that hundreds of technical papers relating to the overall subject are available world-wide. Since there are several approaches documented, this chapter does not make prescriptive statements regarding the "correct" approach. Rather, readers are encouraged to adopt information and data applicable and appropriate to their own specific technical challenges. The aim is to raise awareness, not define methods in detail.

The airframe static load can be thought of as one that changes only with flight condition e.g. airspeed, angle of incidence, altitude etc. For the purposes of this report, the airframe dynamic load component can be considered to be the oscillating part of the load which has a frequency in the range 2 - 100Hz. This is not a hard and fast rule. However, loads oscillating below 2Hz can be considered to be due to 'rigid body' motion. Above 100Hz, the load is unlikely to be adversely affecting a major structural item, more likely to be a localized effect e.g. an acoustic, stores or equipment environmental effect.

There are many sources of dynamic loads on a military combat aircraft. Traditionally, combat aircraft were not designed and optimized to the degree that is expected today. Dynamic effects were therefore included in the early design phases of an aircraft project by applying a factor to the static design loads (which were usually maneuver defined for combat aircraft). The pessimism that this introduced could be tolerated and covered the majority of dynamic loading effects. It was only when structural or equipment problems emerged during project development, or even in-service, that dynamic loads were considered in more detail. This situation was compounded by an absence of advanced unsteady response prediction tools.

The performance of modern military combat aircraft has increased, taking the airframe into situations where the

airflow over the structure becomes separated and oscillatory. The unsteady environment to which a modern airframe is subjected has therefore become increasingly harsh. At the same time, a requirement exists to reduce the factors applied to the design loads to drive down structural mass. The need to predict the unsteady load component more accurately, to ensure safety, has therefore become correspondingly more important. To that end, modern military combat aircraft are designed to withstand the worst static and dynamic load cases which they are likely to encounter in-service. This has led to some regions of modern combat aircraft structures being designed by dynamic load cases.

3.3.2 Types of Dynamically Acting Loads

3.3.2.1 Buzz

Buzz is a single degree of freedom flutter whereby limited amplitude oscillations of surface panels or control surfaces occur due to a loss in aerodynamic damping and may involve the local resonance of such surfaces. This loss is attributed to boundary layer and shock wave induced instabilities in the surrounding flow field. Examples of such instabilities include oscillations of shock waves over a control surface and separated flow caused by an upstream shock wave.

Although the limited amplitudes of oscillation associated with buzz phenomena do not cause catastrophic structural failure, as can happen with a two (or more) degree of freedom flutter, structural fatigue can arise. Common solutions to reduce the adverse effects of buzz phenomena include manipulation of the flow field (e.g. using vortex generators) to reduce instabilities and stiffening of the control surface hinges to reduce freeplay.

3.3.2.2 Buffet and Buffeting

Buffet is an excitation caused by the separation of air flow over a surface. This can be separation in an unsteady manner causing excitation of the surface from which it is separating, or separation from upstream components such that the resulting unsteady flow impinges upon a downstream surface. This is worse at high angles of attack. Buffeting is the associated airframe structural response. Buffet and buffeting are phenomena that are unavoidable in highly maneuverable combat aircraft.

For many years fighter aircraft have had to penetrate into the buffeting region of the flight envelope in order to gain maximum turn performance. With conventional control systems, the buffet onset was in many ways a useful feature because it provided the pilot with a clear warning that he was approaching the limits of aircraft controllability. Increasing buffet penetration, for instance by increasing angle of attack, is also accompanied by related characteristics such as wing-rock and nose slice.

With the advent of complex, active flight control systems, modern aircraft can remain controllable well beyond traditional boundaries, and even into post-stall conditions. This has implications upon structural design due to the potentially greater time spent in unsteady flow

conditions (fatigue implications) and the large magnitude of these unsteady loading actions (strength). Consequently, the ability to predict these flows has assumed a far greater importance in aircraft design.

Another consequence of active flight control systems is the potential for affecting the structural response under unsteady loading conditions. If the system interprets structural response as aircraft response and tries to correct it by driving the controls, then there is a potential for increasing the loads on the structure. This area of expertise is known as Aero-servo-elasticity (ASE) or Structural Coupling. A well-designed flight control system (FCS) will not exhibit such adverse characteristics. **It is not a design driver** when assessing loads, but an awareness of the total system (aircraft + FCS) characteristics is required for flight clearance work.

Ways of using active control for reducing structural response to unsteady loading, like buffet, are under consideration. A view of this is given in reference 1.

The above is applicable to combat aircraft. However, buffet also occurs due to impingement of vortical and wake flow on downstream surfaces, separated flow over control surfaces, and flow interaction between adjacent stores (or engines), their pylons and other airframe structure, to name a few generic examples. These are not restricted to highly maneuverable aircraft. Indeed, straight and level flight at transonic conditions, on any class of aircraft, can lead to complex shock-boundary layer interactions, which induce separated flow and hence buffet, i.e. a forced response.

Further 'buffet inducers' include excrescence and cavities. Examples of the former include blade aeriels, chaff/flare dispensers, auxiliary cooling system intakes and exhausts. Flow separation occurs from these unless they are carefully designed, and faired-in specifically to avoid this phenomenon. The result is unsteady pressure fluctuations on surrounding, external paneling and surfaces. The risk here is that surface panel modal frequencies can be excited which can lead to rapid fatiguing of the affected structure.

Flow spillage from cavities can have similar effects. The cavities can be those occurring when the landing gear is deployed, or when internally carried weapons are released. The latter is likely to be much more of a problem due to the wider range of flight conditions at which it may occur.

Further, there is much potential for adversely affecting the internal and back-up structure of the weapons bay due to acoustic effects. Similarly, stores and equipment installed in the bay will have difficult environmental

clearance issues to overcome. Control of such acoustic environments is a major study area.

3.3.2.3 Hammershock

Hammershock (H/S) is an event whereby an aircraft engine surges, sending a pressure pulse upstream, opposing the direction of airflow that would exist during normal engine operation. This results in a loss of engine performance, the possibility of a flame-out and/or permanent engine damage.

H/S events can occur anywhere within a combat aircraft flight envelope but are more significant at the envelope extremities. They have many causes. These include:

- over-fuelling;
- bird strike;
- foreign object ingestion and
- disturbed intake airflow (e.g. wake ingestion).

A single surge may occur or a series of pressure pulses may be generated if the surge becomes 'locked-in' i.e. conditions are such that repeated surges occur.

The pressure pulse created impinges on the engine intake and on the forward fuselage. Both of these items must have sufficient strength to withstand a H/S event. This is particularly critical for aircraft which have foreplanes located in the path of the pulse. The concern here is that a locked-in surge may occur with a pulse frequency close to a fundamental foreplane vibration mode. If an item of structure is excited at a frequency near one of its natural vibration modes (i.e. a resonant frequency), the resulting amplitudes of vibration and hence load are large.

Realistic prediction of the excitation can be achieved by deliberately surging an engine on the ground and measuring the resultant pressure pulse amplitudes in the intake duct, splitter plate/lip regions and forward of the intake. Account can then be taken of airspeed, altitude etc. to derive excitation throughout the desired flight envelope. Wind tunnel testing is an alternative approach, but scale effects are significant, and can lead to major over-prediction if not accounted for adequately.

H/S was considered during the development of EAP (shown in Figure 1). This resulted in the foreplanes being modified to prevent them 'tuning' with the predicted pulse H/S frequency. This proved to be overly cautious. The actual pressure pulses dissipated more quickly than was anticipated or had been measured in the wind-tunnel. This experience, of course, can be used on future aircraft projects.



Figure 1 : EAP Technology Demonstrator

3.3.2.3.1 Influence on inlet duct design

Examples of load cases on the inlet duct include maneuver 'g'-loads, steady state pressures and hydrostatic pressures of neighboring fuel tanks. However, the pressure loads acting on the inlet duct caused by the propagation of the high velocity pressure wave(s) associated with surge phenomena is the predominant design factor for combat aircraft.

The majority of modern combat aircraft utilize rectangular, or other non-circular, shaped inlets with a gradual longitudinal change into a circular shape duct in order to merge effectively with the engine face. The H/S loads become critical for such variable duct geometry due to complex load paths in the throat region and stress distributions around the corners of, say, a rectangular inlet. The H/S loads associated with the circular duct sections produce hoop tension and are less critical.

From reference 2, two aspects of H/S phenomena which are of importance to the dynamic response of the intake duct structure are (i) magnitude of the pressure wave and (ii) the rise time to positive and negative peaks. It should be noted that the negative peak is caused by the reflected

H/S pressure wave at the forward intake. Figure 2 shows a typical example of a H/S excitation time history in which the vertical axis represents the ratio of incremental H/S pressure to maximum incremental H/S pressure and the horizontal axis corresponds to the H/S pulse duration (τ).

The characteristics of H/S loading as described above leads to the consideration of dynamic magnification of loads during duct design, especially when taking into account of 'locked in' surges. This is due to the potential of a pulse sequence having repetition frequencies which could coincide with the natural frequencies of the duct paneling.

Conventional approaches of designing ducts to cope with H/S loads include increasing duct skin thickness and employing additional ring stiffeners around the duct in between the frames. Furthermore, special attention is made to the local design of frames and stiffeners in the rectangular sections of the duct as well as axial fastener and bond peel strengths which could result in localized structural strengthening. Approaches such as these serve to increase duct weight: an undesirable trend.

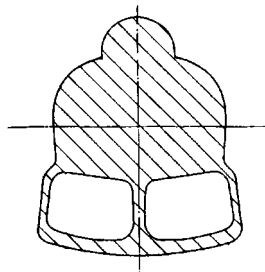

Rectangular inlet

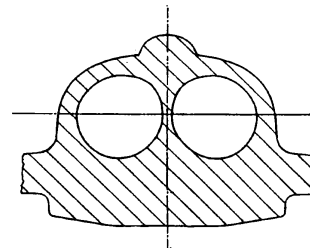

Circular duct at engine face

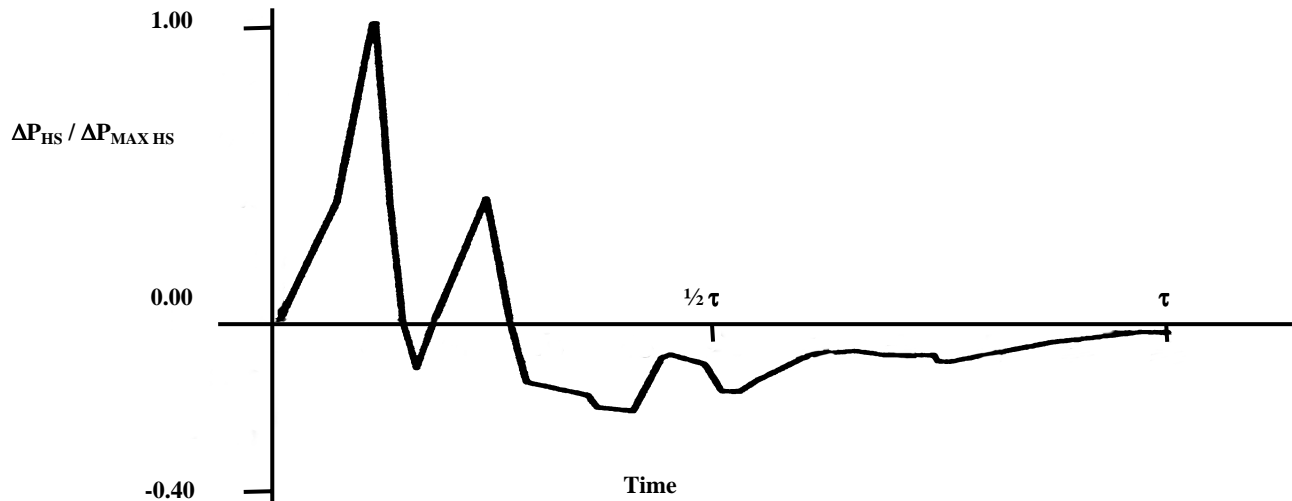

Figure 2 Characteristics of Hammershock loading

Another aspect of duct design in relation to H/S phenomena is the attenuation of pressure waves. Attenuation is key to the reduction of pressure loads acting throughout the duct, particularly in critical areas such as frontal inlet region. Two processes (detailed discussion provided in reference 3) which can relieve pressures are (i) airflow bleed through a bypass exit which reduces diffuser volume and (ii) ramp edge leakage to the plenum allowing pressure transmissions at sonic velocity. However, trade-off studies must be conducted to determine the feasibility of duct weight reduction due to the alleviation of pressure loads, against the losses in intake efficiency during operation of the bleed / leakage processes, and the weight increases due to implementation of the more complex mechanisms involved.

3.3.2.4 Gunfire

This is an obvious source of high energy, short duration dynamic loading. Attention is traditionally given to designing structure to absorb recoil forces transmitted to it, whether from an internal or pod-mounted installation. Conventional metallic structure, with its joints and fastenings, tends to absorb energy (via damping and friction) better than extensively bonded designs. Hence, transmission of loading is limited. With bonded structures the recoil effects can affect a much larger part of the airframe. This gives the potential for tuning with modal frequencies, and hence loading problems.

Muzzle/exhaust blast could increase this effect if transmitted through a significant part of the airframe. It could be possible for some parts to be loaded by both the recoil forces and the blast effects. Even if this is not the case, the blast effects on localized external structure should be assessed. Again, tuning with panel modal frequencies is a possibility given the current range of

gunfire rates. From the blast impingement point of view, pod mounted guns are usually better. Almost by definition, they are mounted such that the gun muzzle will be further away from the aircraft. This would be expected to allow some dissipation of the blast energy before hitting the nearest parts of the airframe.

3.3.2.5 Store Release / Jettison / Missile Firing

Stores release can vary from jettison of fuel tanks to missile firing activities. Stores release design cases are few and far between, but the possibility must be considered. The effects of store release during extreme maneuvers must be assessed.

Excitation of the airframe arises from the 'kick' provided by the loss of mass during release, this effect being directly in line with the mass of the store, and also from the ejector release units which push the store away from the aircraft. Unlike buffet, gunblast and H/S excitation, the point of application of a release 'impulse' to the structure is more localized. However, the effect can be just as global if significant transmission through the airframe is possible, as discussed in the previous section on gunfire.

Special design consideration must be given to 'ripple' store releases i.e. multiple stores released in rapid succession. This may be required to give a wide munitions coverage of the target or as part of an emergency stores jettison sequence. As with H/S events, the proximity of release 'pulses' could have an excitation frequency close to a major airframe vibration mode. The result would be large structural oscillations. This implies large structural loads but would also affect 'dumb' store delivery accuracy.

3.3.3 Prediction Process & Methods

3.3.3.1 Loads Prediction and Simulation

The main emphasis here is about primary lifting surfaces undergoing general bending and torsional responses due to a dynamic loading action, eg. buffet excitation. Localized loads use similar principles, but may not need a full aero-structural simulation. This depends upon the needs of the technical problem being addressed.

There are 2 major approaches. The first is empirical, and assumes that the new design is similar in general nature to a previous project for which there exists an adequate database of information.

The second approach can be classed as the theoretical approach although it does not yield an exact solution; the accuracy being dependant upon the quality of the input data, and the inherent assumptions regarding linearity of characteristics.

3.3.3.1.1 Empirical Approach

An example of a successful use of an empirical approach is that of designing EAP to account for fin buffeting. Figure 3 illustrates how an initial prediction of structural response can be carried out. From Tornado measured characteristics, an estimate of EAP fin response was made. It assumes that the dominant parameters affecting the fin response are wing sweep angle, incidence, and dynamic pressure.

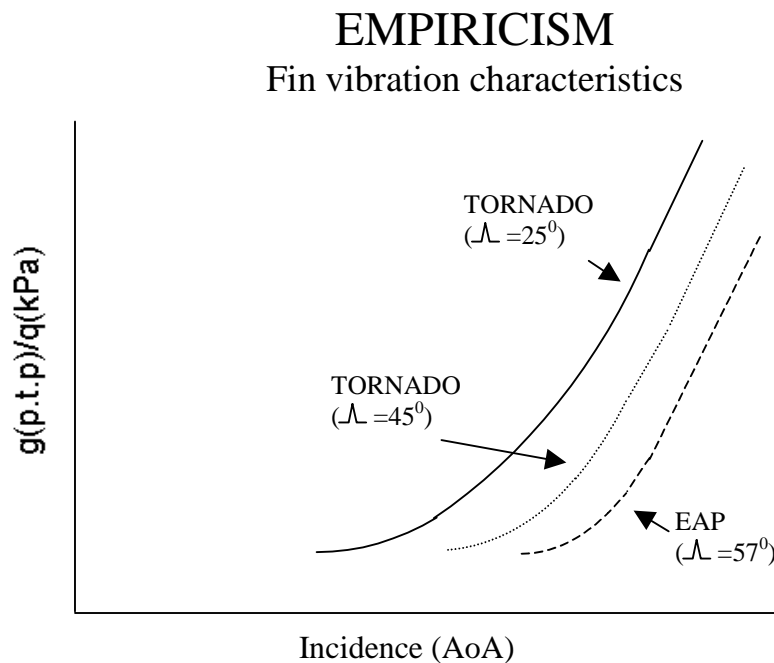

FIGURE 3. Fin Vibration Characteristics

Actual numbers on the axes are removed to preserve the unclassified nature of this document. However, use of the original plot will lead to the response on the EAP fin for a given flight condition. Assuming a detailed knowledge of the fin structural characteristics, then the internal structural loads can be derived. This was successful because of the large amount of information generated, and hence available, in the course of studying fin buffeting on Tornado.

As stated before, there is a large amount of publicly available information which could allow derivation of empirical methods for other projects. The example given would not, of course, be applicable to twin fin designs, or if the new fin structure (and, hence, modal response) was radically different.

3.3.3.1.2 Theoretical Approach

This approach requires a numerical model of the structure (inertia, damping and stiffness), numerical representation of the oscillatory aerodynamics (damping and stiffness)

and numerical representation of the forcing function (eg. buffet excitation).

The mathematical equation to be solved is of the following form

$$A\ddot{x} + \sqrt{\sigma}V_E B\dot{x} + V_E^2 Cx + D\dot{x} + Ex = F(t)$$

where

- A = generalized inertia matrix
- B = generalized aerodynamic damping matrix
- C = generalized aerodynamic stiffness matrix
- D = generalized structural damping matrix
- E = generalized structural stiffness matrix
- V_E = equivalent airspeed
- x = generalized co-ordinates
- σ = relative air density
- $F(t)$ = generalized forcing function

Post-processing of the output from the response solution leads to derivation of loads at defined points on the structure. The process is shown diagrammatically in figure 4.

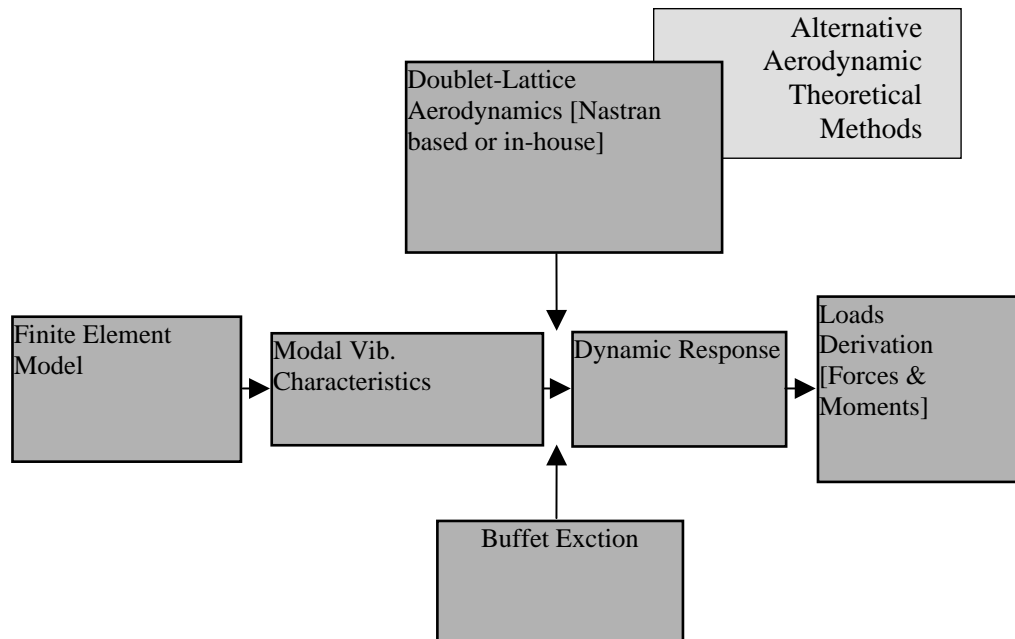

Figure 4 : Buffeting Response Calculation Process
(Generalise from fig. 16 of Ref. 3)

NASTRAN, or In-Company developed alternative, is used as the analytical tool for the calculation technique shown above.

There are several points to note. In current practice, the unsteady aerodynamics and structural models are linear approximations. Development of improved, advanced aerodynamic methods is discussed later. For early design information there is unlikely to be detailed structural and mass data available. In addition, the excitation function may well be derived from existing databases pending availability of wind tunnel test data.

For the detailed design and clearance phases of a project the response model is likely to be the same as that used for Flutter assessments. During the clearance phases of a project, it should be possible to include a structural model matched to reflect GVT data. The excitation data will probably be based on wind tunnel testing of the finalized project lines. However, it will still be subject to scaling from wind-tunnel to full scale, as well as normal wind

tunnel accuracies. This is for a rigid wind tunnel model and is illustrated in figure 5.

An interesting, but less used variation of the above, is to create a dynamically scaled, flexible wind tunnel model. This involves scaling the full size structural characteristics to the model, but does mean that the surface forces and moments can be measured directly. There is still the problem of then re-scaling to full size in order to derive the full scale loads.

The first approach is likely to be used earlier in the design cycle. Unless the new aircraft is a development of an existing type, detailed structural information will not be available for manufacture of the flexible wind tunnel model. The latter is also likely to be more expensive because, in addition to increased model manufacturing costs, a dedicated set of test runs will be required. The rigid data can possibly be acquired on a ride-along basis with other testing.

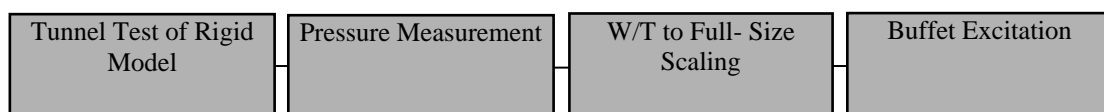

Figure 5 : Development of Buffet Excitation

A useful guide to the ‘state-of-the-art’ for numerical aeroelastic simulation techniques is reference 4.

3.3.3.1.3 Hybrid W/T - CFD Techniques

Reference 5 is experimentally based and gives a good summary of the aerostructural buffet problem. As it points out, testing is expensive. Ideally, given the advances in computing power in recent years, increasing maturity of steady CFD techniques and accelerating interest in unsteady CFD, then it should be possible to replace some of the wind tunnel testing essential to reference 5 and generally improve accuracy of the aerodynamic predictions.

Researchers are now beginning to develop these approaches. Until unsteady CFD techniques are more mature, a pragmatic approach is needed to allow the engineer (as opposed to the researcher) a means of addressing buffet and buffeting early in the design process. Hence, a combination of steady CFD analysis with unsteady pressure measurements from wind tunnel testing is a realistic approach. There are still some problems, most notably prediction of aerodynamic damping levels during buffeting at higher incidences.

3.3.3.1.4 Superposition of Steady and Unsteady Loading

The above treatment relates to derivation of the unsteady excitation. However, it is the total response, and hence loading, that we are interested in from the structural design and clearance point of view.

An aircraft operating on the ground or in flight encounters two distinct types of loading - static and dynamic. Of course, the airframe structure itself cannot distinguish between the two loads. It is subject to the combination of them, the total load.

Design activities are affected by available prediction tools and techniques. It is common practice, for the purposes of aircraft design and clearance activities, that the two ‘types’ of loads are calculated discretely. These are then combined to give total predicted load. Figure 6 shows the principle diagrammatically.

It is important to ensure a coherent approach. There are different ways of achieving the same result by assuming that the principle of superposition holds (see table below).

DYNAMIC LOADS - A DEFINITION

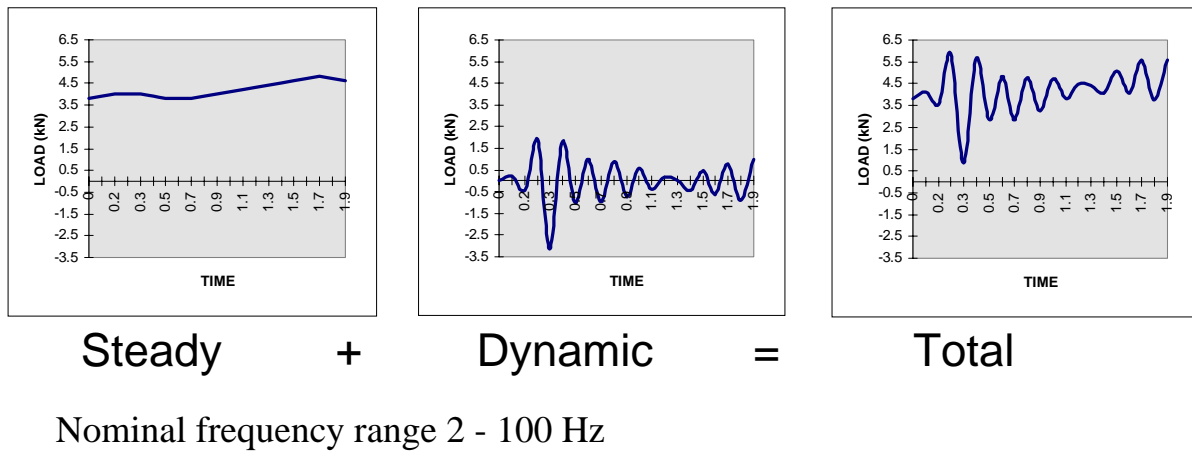

Figure 6: Superposition of Steady and Unsteady Loads

	Quasi-Steady Loads Simulation Methods	Dynamics Simulation Methods
1.	Time varying throughout manoeuvre ie. ‘rigid body’ steady manoeuvre loads	Incremental loads due to unsteady effects on a flexible structure
2.	Constant loads from starting point of manoeuvre	Incremental loads due to time varying ‘rigid body’ motion + Incremental loads due to unsteady effects on a flexible structure
3.	-	Total loads due to time varying ‘rigid body’ motion + loads due to unsteady effects on a flexible structure + FCS

These approaches are driven by pragmatic applications of available methods and tools. It is a recognition that not all organizations have the latest available technology and computing power. Indeed, the third approach above is only recently becoming more common as 'tool sets' and design processes become more integrated. For instance, formerly it might have been necessary to have separate methods for development and analysis of structural, aerodynamic and FCS models. If consideration of other 'disciplines' was necessary, each would probably model the others in its' own home environment. This led to a number of notionally similar numerical models being developed - each needing extensive quality assurance and checking, and none of them fully compatible.

As stated before, there is no definitive method. Readers must judge the appropriate way forward for their own particular projects. However, it should be noted that some aspects of 1 and 2 above are favourable because the quasi-steady loads can be based upon more mature, speedier, theoretical methods (CFD) than unsteady loading. In addition, for similar reasons there are likely to be more extensive wind tunnel test data available.

3.3.4 Design Assumptions, Criteria and Certification

Reference 6, gives a very brief overview of important dynamic loading phenomena that should be considered during the design of combat aircraft. It notes, however, that specific design and certification criteria/guidelines are few.

This can lead to lengthy discussions with Customers and Certification Authorities about what should be addressed in design and certification of a given aircraft project. Experience has shown that an open-minded approach at the design stage, which can include work that positively eliminates a phenomenon from consideration, will ensure a smoother progression, later in the project cycle, to flight clearance and qualification. In short, at present there are no hard rules governing consideration of dynamic loading in structural design, other than that it should be taken into account!

As engineers, we are bound to consider these loading actions because they can be significant. This is illustrated by the technical papers covering fin and tail buffeting on F-18, and similar aircraft, which are numerous (e.g. references 5, 7, 8, 9 and 10 picked nearly at random from a wide choice). Wing buffeting is a well known phenomenon, and also well documented. It is clear that buffeting must be examined in the early stages of design for aircraft with significant maneuver capability. The problem for other areas is deciding what is an acceptably low risk for a given set of circumstances. Often, there are little data available which can be analyzed effectively.

It is stressed that the reader must decide what is appropriate for his particular work. It must be clear what the latest design criteria are, and what is applicable to a given project. If standards change through the life of an aircraft project, this can lead to a very complex documentation trail!

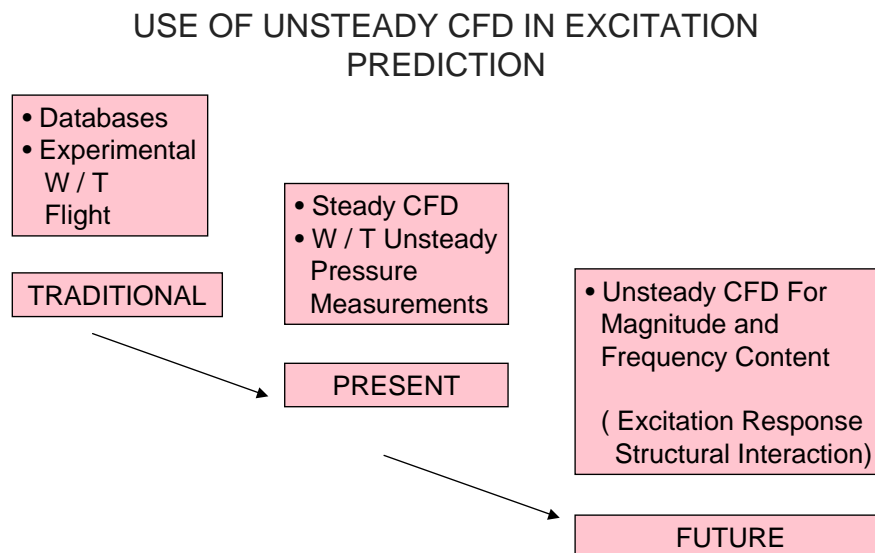

Figure 7: Use of Unsteady CFD in Excitation Prediction

3.3.5 Developments

The above figure illustrates the changing approach to the use of CFD in the prediction and simulation of dynamic loading phenomena. The overall thrust has been to be able to use CFD to replace/supplement wind tunnel measurements for prediction of buffet, and other,

unsteady excitation. In addition, use of CFD for improved response aerodynamics (particularly damping) increasingly allows assessment of aerodynamically non-linear effects. Key to this capability on the response side is the unsteady CFD/structural modeling interfacing methods. This is available at research and academic

levels, but is not yet sufficiently robust or rapid for production application.

Reference 11 gives an outline of some work done in the UK to address the shorter term requirements of engineers. It reports on the combination of an extensive set of wind tunnel tests with the aim of providing insight into the aerodynamic phenomena associated with novel wing planforms. These planforms impact both steady and unsteady aerodynamics.

The wind tunnel tests have produced steady pressure distributions, overall forces and moments, surface oil flow patterns and unsteady surface pressure frequency spectra. The steady flow results have been compared with output from converged Reynolds Averaged Navier-Stokes (RANS) CFD solutions.

The work has enabled a design tool to be proposed for use early in the design process. For an arbitrary wing planform, at maneuvering conditions, steady CFD can be used to establish mean flow topology, including tracking of vortex shear layers. Empirical representations of the characteristic buffet frequencies can then identify the dominant frequencies of the dynamic loads. When coupled with relatively simple finite element models, predictions of buffeting response are expected to be sufficiently accurate to enable meaningful evaluation and comparison of different wing planforms.

3.3.6 Summary

The above discussions are aimed at raising awareness of dynamic loading effects, and their prediction, which is advisable to consider at the design stage of an aircraft project. Historically, this has not been so prevalent, but is necessary now due to the requirements to more effectively optimize structures, from both a strength and fatigue point of view. Indeed, active control of structural response (due to buffeting, say) is under very energetic research and must now also be considered as a possible option at the design stage of an aircraft project.

Because of the immense breadth of the subject, there are no definitive statements here. Readers are required to formulate their own approach to their own particular technical challenges.

It is apparent that wind tunnel and CFD methods are vital to future prediction techniques, particularly of non-linear aerodynamic effects. However, examination of non-linear structural effects (e.g. control surface backlash characteristics) as part of the overall aero-structural system are dependant upon more robust and rapid techniques for coupling CFD with a FEM than are available at present.

The table below is intended as an aide memoir. It summarizes different types of dynamic loading and which parts of an aircraft they affect. It includes gusts and ground operations for completeness, although these are described in different chapters.

SOURCE OF LOADING	COMPONENTS AFFECTED	TYPES OF AIRCRAFT / COMMENTS
ATMOSPHERIC TURBULENCE / GUSTS	WING FORE / TAIL PLANE FIN FUSELAGE CREW EQUIPMENT STORES & PYLONS SENSORS & PROBES	HIGH SPEED AIRCRAFT WITH RELATIVELY LOW WING LOADING
BUFFET / BUFFETING / BUZZ	WING FORE / TAIL PLANE FIN STORES & PYLONS LOCALISED EFFECTS eg. Excrescences Panels Sensors & Probes Airbrake	ALL TYPES, BUT PARTICULARLY THOSE WITH SIGNIFICANT AoA AND MANOEUVRING CAPABILITY Bluff shaped excrescences mounted on large panels
STORES RELEASE & JETTISON	WING FUSELAGE PYLONS ATTACHMENTS & BACK-UP STRUCTURE	ALL TYPES
MISSILE FIRING	As above + PLUME EFFECTS on Local panels Control surfaces Tailplane etc.	ALL TYPES
HAMMERSHOCK	INTAKE & DUCT FOREPLANES FRONT FUSELAGE SENSORS & PROBES	CANARD CONFIGURATIONS WITH CHIN INTAKES AFT OF FOREPLANES
GROUND OPERATIONS	WING FORE / TAIL PLANE FIN FUSELAGE CREW EQUIPMENT STORES & PYLONS SENSORS & PROBES	ALL TYPES BUT WORSE FOR CARRIER-BORNE & VSTOL Any extreme action that can be achieved by the pilot
BIRDSTRIKE	NOSE CONE COCKPIT / TRANSPARENCY FOREPLANE WING LEADING EDGE INLET FACE Plus any other forward facing sections of the airframe	ALL TYPES Other hazards include airborne and ground debris

3.3.7 Acknowledgements

Thanks are due for the assistance of Mr. S Samarasekera, BAE SYSTEMS Aerodynamic Technology, and to Mr. C Bingham, BAE SYSTEMS Structural Technology.

3.3.8 References

1. PAPER PRESENTED AT RTO CONFERENCE – OTTAWA OCT 1999
NASA LANGLEY RESEARCH CENTER'S Contributions to international active buffet alleviation programs,
R. W. MOSES, OCTOBER 1999

2. AGARD-R-815
THE IMPACT OF DYNAMIC LOADS ON THE DESIGN OF MILITARY AIRCRAFT
Papers presented at 83rd Meeting of the AGARD Structures and Materials Panel, held in Florence, Italy, 4-5 September 1996 Published February 1997
3. REVIEW OF HAMMERSHOCK PRESSURES IN AIRCRAFT INLETS
L C YOUNG and W D BEAULIEU
Rockwell International, Los Angeles, California
JANUARY 1975
4. AGARD-R-822
Numerical Unsteady Aerodynamic and Aeroelastic Simulation
Papers presented at Workshop in Aalborg, Denmark, OCTOBER 1997 Published March 1998
5. AGARD-CP-483 paper 11
PREDICTIONS OF F-111 TACT AIRCRAFT BUFFET RESPONSE
AM CUNNINGHAM jr., CF COE APRIL 1990
6. AGARD-R-815 paper 9
DYNAMIC LOADING CONSIDERATIONS IN DESIGN OF MODERN COMBAT AIRCRAFT
R CHAPMAN SEPTEMBER 1996
7. AGARD-CP-483 paper 2
A UNIFIED APPROACH TO BUFFET RESPONSE OF FIGHTER AIRCRAFT EMPENNAGE
MA FERMAN et al APRIL 1990
8. AIAA paper 91-1049
SOME BUFFET RESPONSE CHARACTERISTICS OF A TWIN-VERTICAL-TAIL CONFIGURATION
SW MOSS et al APRIL 1991
9. AIAA paper 92-2127
BUFFET LOAD MEASUREMENTS ON AN F/A-18 VERTICAL FIN AT HIGH-ANGLE-OF-ATTACK
BHK LEE, FC TANG JANUARY 1992
10. AGARD-R-815 paper 6
A COMPARISON OF PRESSURE MEASUREMENTS BETWEEN A FULL-SCALE AND 1/6 SCALE F/A-18 TWIN TAIL DURING BUFFET
RW MOSES, E PENDLETON
SEPTEMBER 1996
11. BATH UNIVERSITY, UK Ph.D. Thesis
AN INVESTIGATION OF BUFFET OVER LOW OBSERVABLE PLANFORMS
M I WOODS 1999

3.4 Managing the Technical Risk – Dynamic Loads in-flight Monitoring

The principle adopted throughout design and clearance of combat aircraft with respect to dynamic loads is one of caution, due to the known deficiencies in prediction techniques. Each design could be over-engineered and every clearance might be unduly restrictive if the approximations remain un-quantified. To try to minimize

this risk, dynamic loading predictions are validated against flight test measurements during envelope expansion flying within the development phase of the project.

The flight test envelope expansion process for modern combat aircraft is a rapid one. To be able to keep pace with this programme whilst ensuring that in-flight dynamic loads are on the safe side of predictions, a high level of visibility of aircraft response amplitudes and trends is required. In addition, for really rapid turn-around and test-conduct these data need to be presented to the monitoring engineer in real time. In this way, should response trends appear to be worse or response amplitudes greater than predictions, the testing can be halted, or modified, before safety is compromised. Further, due to the data visibility, in-depth evaluation of any discrepancies can then be carried out post-flight more effectively.

Real-time unsteady response monitoring is achieved at BAE Systems, Warton, via the 'Dynamic Loads Monitoring System'. The low cost system described here, commissioned at BAE Systems, Warton, has been used for the EF2000 Project. It is currently undergoing modernization.

3.4.1 Dynamic Loads Monitoring System

The Dynamic Loads Monitoring System comprises a series of pen recorders which display up to 24 real-time acceleration time-histories for various defined locations on the aircraft. Figure 1 shows a typical instrumentation layout for vibration monitoring on a military aircraft (EAP). In addition, a VAX-based, in-house developed software package displays the following in real-time:

- fin acceleration/dynamic pressure at a defined fin location vs. incidence angle. These data are compared with a predicted fin buffet trend which takes into account, if required, airbrake operation;
- fin acceleration at a defined location vs. incidence angle. These data can be compared with a user-defined maximum allowable acceleration;
- wing accelerations for up to 3 defined wing locations. These data are compared with user-defined maximum allowable accelerations;
- wing acceleration/dynamic pressure at a defined wing location vs. incidence angle. These data are compared with a predicted wing buffeting trend.

A typical example of the software output is shown in figure 2.

It is worth noting at this stage that airframe loads are monitored, by implication, via acceleration levels i.e. it is assumed that, if unsteady acceleration predictions are consistent with measurements, then the airframe dynamic loads will also match predictions. Two outputs are therefore required from the load prediction models mentioned earlier. The first, for design and clearance purposes, is actual loading information. The second, for loads monitoring purposes, is acceleration response data.

Strain-gauges could be used to measure load 'directly'. There are, however, a number of problems associated with their use, namely:

- suitable calibrations being available to convert gauge signal to load;
- reliability of the gauges and the signals that they produce;
- strain gauge signals vary with temperature;
- the gauge is measuring structural load in a highly localized area, making prediction more difficult to do accurately. Measured accelerations give a more global picture of structural response.

3.4.2 Dynamic Loading Phenomena Monitored

In an ideal world, the dynamic loads engineer would be able to monitor all regions of an aircraft for all types of unsteady phenomenon. This would, of course, bring with it the problem of how to display such a volume of data in a usable form. Unfortunately (or fortunately), there is a limit to the amount of instrumentation which can be fitted to a given test aircraft. Priorities must be decided as to which dynamic loading effects are to be monitored, but never to the detriment of flight safety. This decision may be made easier if loading predictions for a given effect are small compared to available structural strength and can therefore be safely disregarded.

The monitoring system at Warton is used to assess the dynamic response induced by:

- gust loading and flutter test induced dynamic loads via acceleration time-histories displayed on the pen recorders;
- fin and wing buffet loads via acceleration amplitudes and trends with incidence angle, displayed using the VAX-based monitoring software.

3.4.3 Dynamic Loads Monitoring System Implementation

Figure 3 shows how the Dynamic Loads Monitoring System is implemented at Warton.

Accelerometer data from various locations on the airframe is transmitted to the Monitoring System (via a Ground Station) at a rate of 512 samples per second. Using the Nyquist Theorem, this allows the monitoring engineer to observe vibration response having a maximum theoretical frequency of 256Hz. This frequency range is sufficient for the dynamic phenomena being monitored, as defined earlier. In addition, a selection of aircraft data (Mach no., incidence angle, dynamic pressure and time) are transmitted to the system at 32 samples per second.

The (digital) accelerometer data to be displayed using the pen recorders is converted to an analogue signal and is plotted throughout the flight. This provides a useful data quality check in addition to displaying response amplitudes. The pens used for this have a transfer

function such that signals with frequencies up to around 80Hz are not attenuated.

The VAX-based software component of the monitoring system is only used for certain flight test points - those where significant wing and/or fin buffet is likely to occur e.g. wind-up turn maneuvers. The fin and wing buffet accelerometer data are conditioned as follows:

- high and low-pass filtered to remove any DC signal component and to include only the response frequencies of interest. This is limited to only those frequencies associated with the first few fundamental aircraft vibration modes (the modes most likely to cause structural damage in the case of buffet monitoring).
- data 'drop-outs' are checked for and any data 'spikes' are suppressed.

Buffet analysis is initiated and terminated by the monitoring engineer. Conditioned data is captured by the system over one second and the requisite analysis performed to obtain zero-to-peak acceleration levels and zero-to-peak acceleration levels normalized by dynamic pressure. These data are then plotted to the monitor screen (vs. incidence angle where applicable) using the lower rate aircraft data. This process is repeated until the system is commanded to stop. The plot presented to the user is therefore continually updated as a given maneuver progresses. This process is summarized in figure 4.

The data acquired during monitoring are saved to disk for post-flight analysis, if required.

Figure 5 shows an example of the wing buffet data available to a monitoring engineer during a wind-up-turn (WUT) maneuver. The acceleration time-history for a wing parameter is shown (W3). It can be seen that as the WUT progresses, the vibration amplitude increases and then attenuates as the turn is completed and straight and level flight resumed. Peak acceleration amplitudes for this and two other accelerometers (W1, W2 and W3) are plotted for comparison with user-defined maximum allowable vibration levels at 1 second intervals. In addition, the trend of peak g/dynamic pressure is plotted against incidence angle for comparison with the predicted trend.

Figure 5 shows that whilst an acceleration time-history is useful as a data quality check, the software based monitoring system provides a quick way of verifying that the dynamic loading on the aircraft is within prescribed limits. Simplification of the loads monitoring task is welcome in the high-pressure flight test environment.

Figure 5 shows that, for this test point at least:

- wing buffet trend predictions are well matched by flight measurements and
- amplitudes of vibration at the wing accelerometer locations are well within allowable limits.

As such, with respect to buffeting response, this test has been flown safely. It should be noted that these results are for a single test point. To form any sensible conclusions about the predictive techniques used, a more extensive survey of results would have to be performed.

• Accelerometer Locations

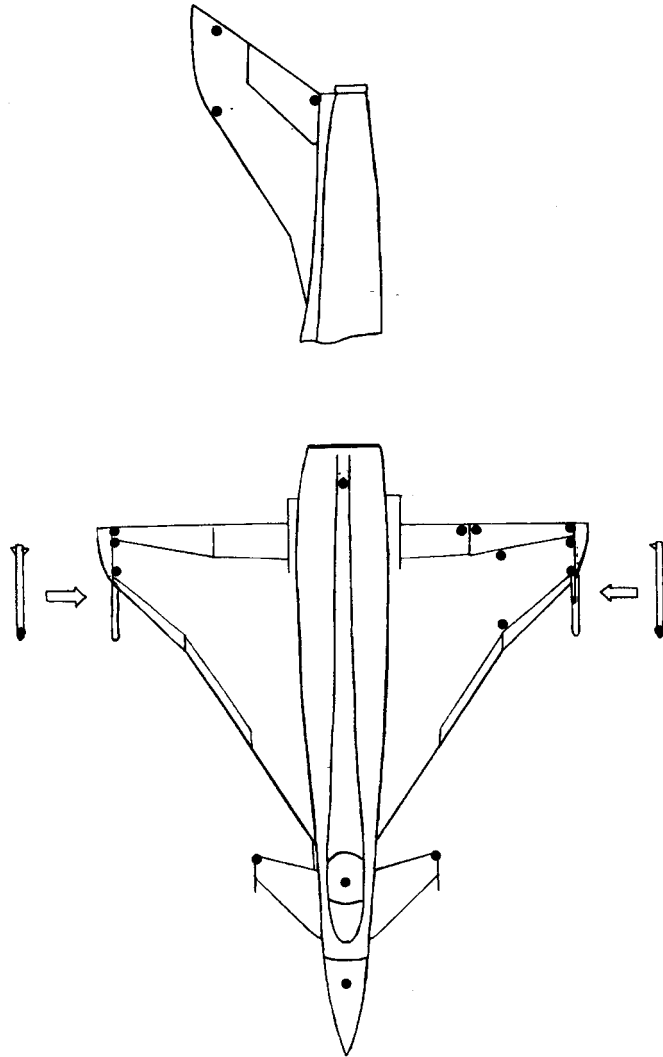

FIGURE 1 - Typical Accelerometer Layout on Military Aircraft (EAP)

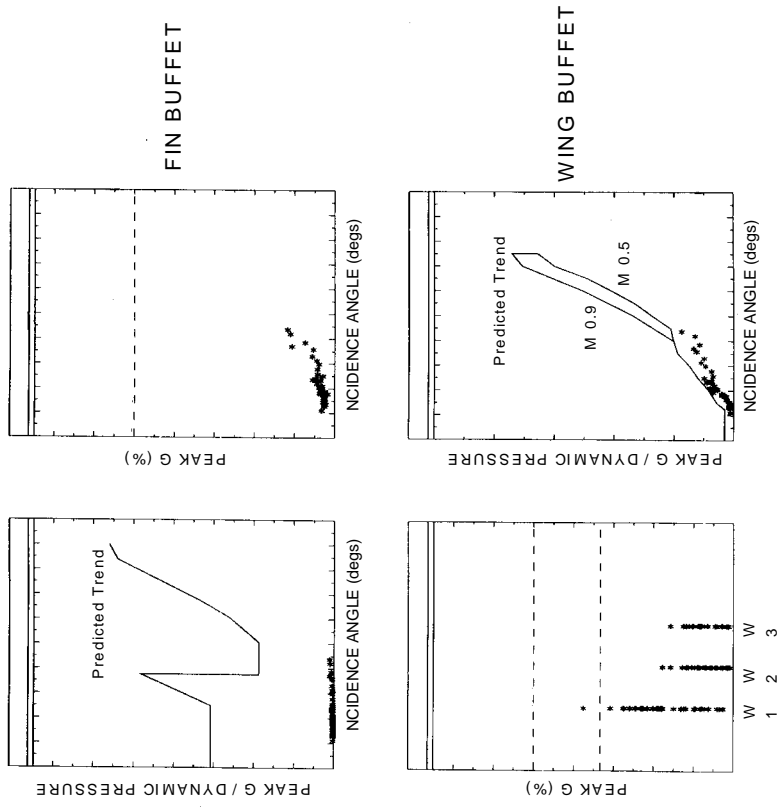

FIGURE 2 - Monitoring System Example Data Plots

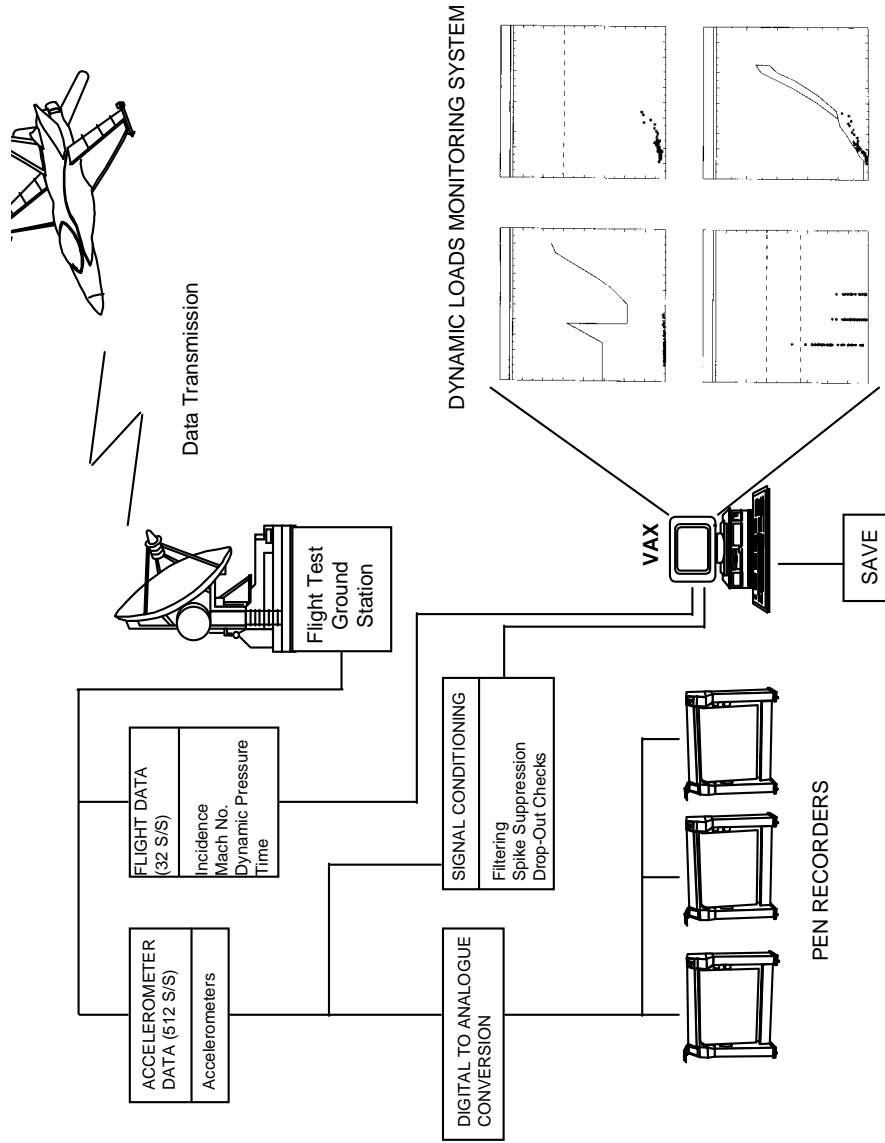

FIGURE 3 - Dynamic Loads Monitoring System General Layout

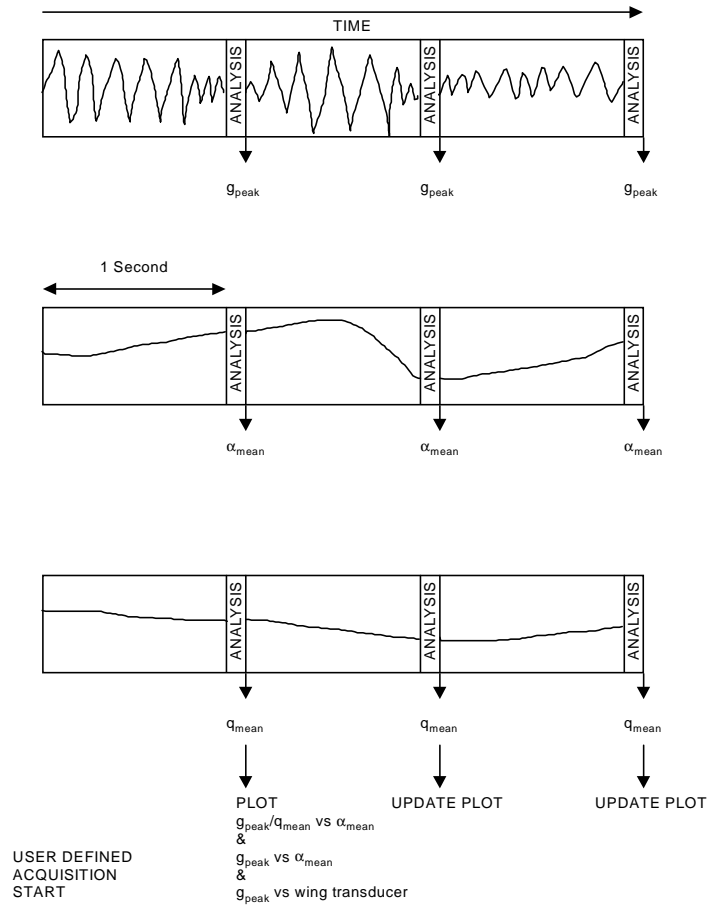

FIGURE 4 - Calculation of Trends With Aircraft Incidence

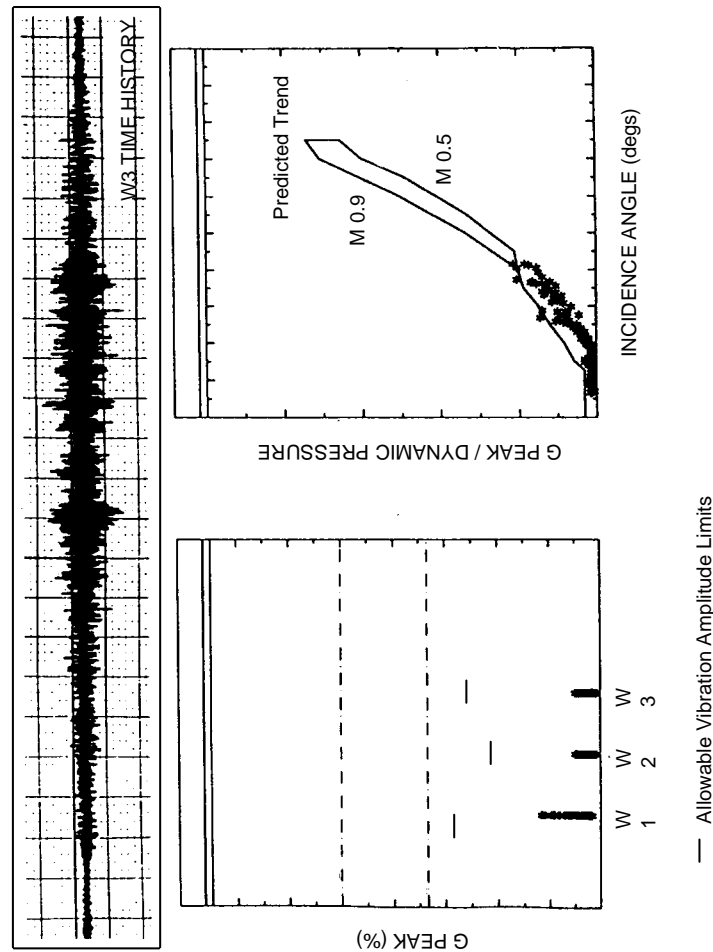

FIGURE 5 - Monitoring System Example Wing Buffeting Output

3.5 Airframe Certification Against Birdstrike Threats

The phenomena of birdstrikes requires serious assessment during the design stages of an aircraft. Over the last decade there has been an increase in fatal accidents due to birdstrikes on military aircraft. Furthermore, it is the single greatest cause of military aircraft loss in peace time.

To certify the airframe against birdstrikes, resistance to representative impulse loads acting on all leading edge and forward facing sections of the airframe must be considered early in the design phase. The design work would involve predictions of stress levels associated with such loads in both the skin and sub-structure of the frontal airframe region. To prevent stress levels exceeding the allowable limit, high strain rate performance, yield strength and fracture toughness may be critical factors in determining material selection.

Furthermore, past testing has revealed that structural components with sharp leading edges (i.e. leading edge radius less than bird diameter) leads to a significant increase in the impact velocity required to cause structural damage, due to higher local stiffness levels inherent in smaller radii. Therefore, design specifications of leading edges for forward facing regions of the airframe can be influenced by birdstrike phenomena, in addition to aerodynamic, structural and manufacturing aspects.

3.5.1 Certification via Empirical Testing

Chapter 209 of Ref. 1 specifies the minimum requirements for the resistance of airframes to damage caused by birdstrike ;

- A 1kg bird with an impact velocity of 480 knots must not penetrate the structure.

- A 1kg bird with an impact velocity of 366 knots must not cause structural damage.

The latter specification reflects the need to reduce the cost of repair after lower kinematics energy impacts. Currently, meeting this specification is an expensive and time consuming procedure, primarily due to model manufacture and test set up costs.

The standard approach is to fire real (dead) birds using compressed air in a gas gun. The birds are fired at varying projectile velocities (up to high subsonic Mach No.'s) onto the frontal area of the airframe, i.e. nose cone, transparency, intake lips, foreplane, wing leading edges etc. Testing considers birdstrikes head on to the airframe and angles up to 15 - 17 degree azimuth from the nose direction. Maximum deflections of the structure are recorded and the impacted structure is inspected for damage and evidence of penetration. This data may be supported by strain gauge information, high speed photography and deflection time history data from laser measuring devices. Due to the difficulties involved in firing real birds, the inherent variability in the bird structure, the difficulty in controlling the centre of gravity location and the bird orientation, tests are notoriously prone to high levels of variability.

Empirical design rules are available for metallic structures however equivalent methods are not available for composites making the potential role of analysis more important. A single test that fails the structure may not provide much information for a successful redesign to be produced, particularly in the light of other design considerations that may apply.

Current Developments

In an attempt to alleviate costs involved with standard birdstrike testing, one approach that has been accepted in the civil aerospace industry is to certify aircraft against birdstrikes using 'generic analysis' (Ref. 2). However, it may be some time yet before military aircraft would be allowed to be certified in this way.

The idea behind the generic analysis approach is that if you have designed and tested a similar component before, and if the analytical method has proven accuracy, clearance of a new 'generic' component can be achieved by analysis alone. Generic analysis requires comprehensive understanding of mechanical properties and failure modes of the airframe structure and bird behaviour under impact. Bird impacts above a certain velocity threshold has been shown to be essentially fluidic. The modelling of an event which incorporates both fluidic and structural behaviour, with strong

interaction, presents significant challenges to the available codes and analysis techniques.

Coupled Euler-Lagrange and 'smooth particle hydrodynamic' codes are now being developed that will significantly improve the modelling capability in the future. Current analytical techniques attempt to represent the bird behaviour in the best possible manor in a Lagrangian approach.

The failure behaviour of structures under high velocity impact and the representation of these events in the codes is also subject to on going research and development. This is particularly significant in the area of composite materials where there are many complex failure modes and particular problems in including these effects into the codes.

To address these issues and improve the analytical capability several working groups and research activities have been set up in industry. These include programs that have established bird biometrics and flocking behaviour, investigated the use of more consistent artificial birds, investigated the high rate failure behaviour of composites and assessed the on-going developments in the available codes.

The results of one (FE based) birdstrike prediction tool is shown in Figure 6 below. The figure shows a strain map of a leading edge after impact and allows direct comparisons with strains measured from experiment.

Upon extensive validation of birdstrike FE prediction tools, some form of certification of airframes against birdstrikes by analysis could become feasible, although it is envisaged that empirical testing will never be fully eradicated from a combat aircraft's developmental programme.

3.5.2 References

1. DEFENCE – STANDARD 00-970 MINISTRY OF DEFENCE
DESIGN AND AIRWORTHINESS
REQUIREMENTS FOR SERVICE AIRCRAFT
VOLUME 1 – AEROPLANES, BOOK 1
2. S351 IMechE SEMINAR PAPER 1
DEVELOPMENT OF A BIRDSTRIKE
CLEARANCE PHILOSOPHY
C H EDGE
Published in 'Foreign Object Impact and Energy
Absorbing Structure' MARCH 1998

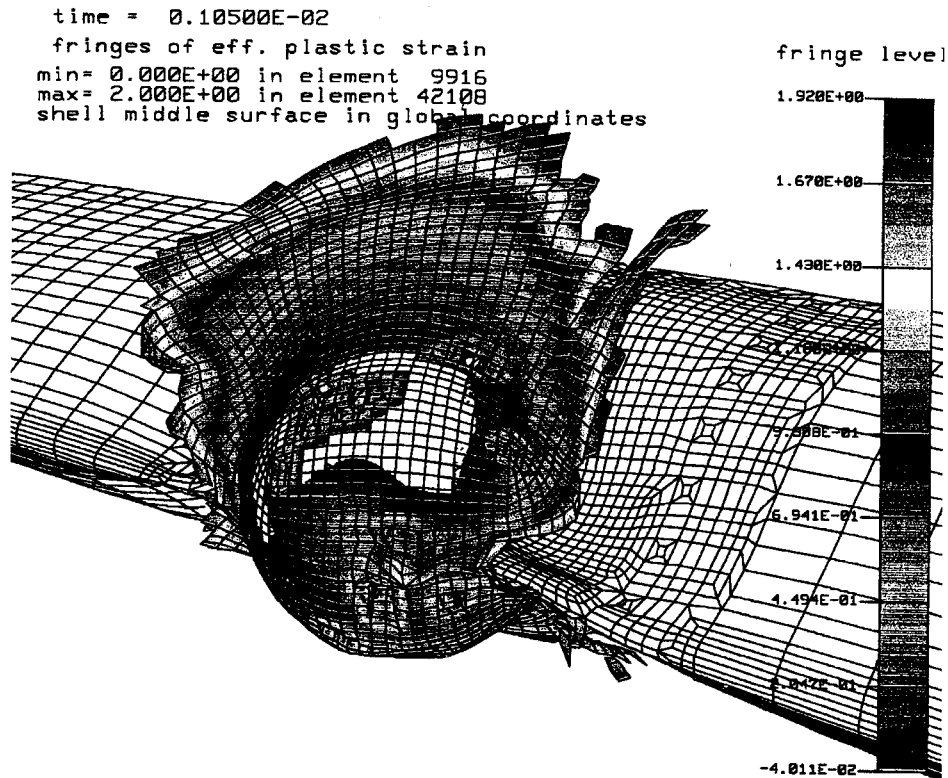

Figure 6: Birdstrike FE-Prediction

4 Gust loads

4.1 Introduction

Aircraft are often subjected to abrupt movements of air in the form of turbulence or gusts. These gusts can impose considerable loads on aircraft. Gusts may come from all directions. Vertical gusts load the wing, fuselage and horizontal tail. In the case of horizontal gusts we distinguish lateral or “side” gusts, loading the fuselage, vertical tail and pylons and longitudinal or “head-on” gusts which may cause important loads on flap structure.

For transport type aircraft, gust load cases are the most critical for strength design, and gust loads are the main fatigue loading source for the major part of the structure. Combat type aircraft structures are generally manoeuvre load critical, but for specific parts of the structure like thin outer wing sections and pylons, gusts may determine critical design load cases¹. Since the recognition that turbulence produced significant loads (around 1915) gust design criteria have been formulated, which have evolved over the years and are still under development^{2,3}.

All major current Airworthiness Codes include two sets of gust criteria, based on a “Discrete Gust” concept and a “Continuous Gust” concept. In the following, the main aspects of these two concepts will be briefly explained.

4.1.1 Discrete Gusts

The basic loading mechanism of gusts is schematically illustrated in fig 4.1. An aircraft flying with speed V entering an upward gust with velocity w experiences a sudden change in angle of attack $\Delta\alpha=w/V$. This gives rise to an additional air load

$$\Delta L = \frac{1}{2} \rho V^2 S C_{L\alpha} \frac{w}{V}$$

It will be clear, however, that the abrupt or “sharp-edged” gust indicated in figure 4.1 is physically impossible; it implies an instantaneous change in lift and a real gust must have some distance over which its effect builds up. Additionally, due to so-called aerodynamic inertia, a sudden change in angle of attack does not immediately result in a proportional change in lift. Hence, the load felt by the structure is modified by this effect. The resulting load depends upon the size and shape of the gust and the response characteristics of the aircraft. Different “Discrete Gust” shapes have been assumed in gust criteria, ranging from the simple “sharp-edged” shape shown in figure 4.1 (in the early twenties), through the “ramp type” gust used in e.g. the former BCAR Requirements to the “1-cos” gust shape included in almost all current airworthiness codes.

Essentially, the Discrete Gust Criterion consists of a “design gust” of specified shape and magnitude U_{ds} (which is a function of altitude). The design value Y_{des} of any load quantity y is to be found by calculating the time response $y(t)$ to the gust, and taking the maximum of $y(t)$ as Y_{des} . For many years, the main Airworthiness Codes included simplifying assumptions with regard to the length of the gust (e.g. a (1-cos)-gust of 25 wing chords) and allowed the assumption of an aircraft response in plunge only (“in the absence of a more rational investigation”), resulting in very simple gust-response expressions as given e.g. by the well known “Pratt Formula”³.

With the growing size and increasing flexibility of aircraft these assumptions became more and more unacceptable. Hence, the major Airworthiness Codes currently demand for a full dynamic response calculation, including all rigid and all relevant elastic modes. As the length of the gust has a direct effect on the structural response, a range of gust lengths has to be considered. The one giving the highest design load (the “Tuned Discrete Gust”) must be assumed, up to a defined level of severity e.g. the minimum gust distance is specified.

4.1.2 Continuous Gusts

The discrete gust concept assumes an atmosphere where separate and independent “gust bumps” occur that may hit the aircraft. Measurements in gusty conditions, however, revealed a pattern more resembling a process of continuous turbulence. This notion led in the early sixties to the development of a completely new gust concept and a set of additional Design Criteria, known as the “Continuous Turbulence Concept” and the PSD (Power Spectral Density) Gust Design Criteria.

In this concept, the loading action is described as a continuous process of random turbulence. Over shorter periods of time this process may be considered as stationary with Gaussian properties and standard deviation σ_w . In the longer term, the standard deviation or gust intensity is not a constant, but varies randomly with a given probability function. The turbulence is characterized by the “von Karman” type Power Spectral Density function, describing how the energy in the process is distributed with frequency.

On the basis of this turbulence concept, two design methods were developed referred to as the “Mission Analysis” and the “Design Envelope” Concepts⁵. The “Mission Analysis Concept”, which is of a purely statistical nature, has the virtue of elegance. It is, however, difficult to apply and may lead to unconservative predictions if the actual “Mission Profile” of an aircraft changes and starts to deviate from design assumptions. Hence, the criterion is seldom applied and it is expected that in the near future it will be deleted from the Airworthiness Codes.

The “Design Envelope” criterion shows a resemblance to the Discrete Gust Criterion in that it also specifies a “design gust strength” U_σ as a function of altitude the design value Y_{des} of any load quantity y is found from

$$Y_{des} = \bar{A}_r * U_\sigma$$

The response parameter \bar{A}_r , which is actually the ratio of the standard deviations of the load output y and gust input w in stationary Gaussian turbulence, may be considered as defining an “average weighted” response;

\bar{A}_r is calculated by integrating the product of load transfer function squared and the turbulence PSD function over all gust frequencies. Thus, \bar{A}_r defines essentially an “average response”, taking into account for which frequencies the load is sensitive (as defined by the transfer function) and also which gust frequencies (or “gust lengths”) occur in the atmosphere.

Comparing now the PSD- gust criterion and the Discrete gust criterion, we notice the difference and the reason why both criteria are included in our design procedures. The PSD criterion is based on a rational and consistent model of the atmospheric turbulence; it defines design loads that are based on an average response, considering all possible gust lengths that prevail in random turbulence. The Discrete Gust Criterion is typically a “worst case” criterion; the highest load resulting from a discrete bump with most adverse length must be taken. The Discrete Gust cases are included and maintained in airworthiness codes to safeguard against sudden more or less “stand alone” gust outbursts that have been observed to occur in practice.

4.1.3 Gust Load Requirements

Gust load requirements have been, and are subject to, a process of continuous change due to the experience gained from previous aircraft, changes in aircraft design philosophy and advances in analysis techniques. Section 4.2 gives an overview of the gust requirements in the principal civil and military requirements prevailing today. The military requirements tend to lag behind compared to FAR/JAR 25, due to a lack of available flight data as well as the lower criticality of gust loads for military aircraft. In FAR 25 and JAR 25, major changes have been included over the last few years with regard to the discrete gust cases and a major change of the continuous gust criteria is in preparation. A relevant part of the associated NPRM (Notice on Proposed Rule Making) is included in Paragraph 4.2.

These developments have prepared by the ARAC Loads and Dynamic Handling Working Group, supported by the Committee of International Gust Specialists. Airworthiness Requirements tend to be put in rather general “legal” terms, which may be subject to different interpretation. Additional documents, describing acceptable means and methods to comply with the requirements may be very helpful. Such information may be contained in ACJ’s (Acceptable means of Compliance to JAR) in the case of JAR requirements, or in Advisory Circulars in the case of FAR requirements.

Traditionally, the calculation of aircraft response has been made assuming linearity. With the advent of nonlinear active control systems, aircraft are becoming increasingly nonlinear and the assumption of linearity is becoming more and more unacceptable for accurate load prediction. The calculation of the response to a discrete gust for a nonlinear aircraft may be time-consuming but offers no fundamental problem. Three deterministic type methods are considered here: Matched Filter Theory, the

Noback (or IDPSD) method and the Spectral Gust (Brink-Spalink) method.

The existing PSD gust design criteria, however, are fundamentally based on linear response behaviour. Current Airworthiness Codes do not contain explicit rules how to determine PSD-gust loads for non-linear aircraft, but the NPRM presented in paragraph 4.2 foresees in this shortcoming. In case of significant non-linearities, one approach towards determining the PSD design loads is to calculate the aircraft response in the time domain of the aircraft to a patch of stationary random turbulence with an rms. value equal to 0.4 times the design gust velocity U_{σ} . This procedure is known as the "Stochastic Simulation method", is physically well founded, straightforward and relatively easy to apply but very computer time consuming and hence expensive. The alternative Probability Exceedence Criterion (PEC) method is also considered. A further approach is the Statistical Discrete Gust method, which attempts to combine both discrete and stochastic methodologies. Full details about the methods can be found in Appendix A4.1. There is a need to assess, validate and compare these methods before they can be accepted for Certification purposes.

Section 4.3 presents a comparison of the above methods for design load calculations using various aircraft models with different nonlinearities. Two different institutes carried out these calculations and comparative results are given. Concluding remarks are presented in section 4.4.

4.2 Overview of Gust Requirements

4.2.1 Draft NPRM on Continuous Turbulence.

The Discrete Gust Criteria in FAR25 and JAR25 have been changed a few years ago, but the Continuous Gust Requirements in these codes have not been changed since the late sixties.

A Draft NPRM (Notice on Proposed Rule Making) has been prepared recently, proposing changes in the FAR25. It is expected that these proposed changes will also be adopted in the JAR 25 Code.

The proposed requirement includes a revision to the gust intensity model used in the design envelope method to continuous turbulence on the basis of more recent statistical data (including CAADRP data). The mission analysis method will be eliminated and a new requirement included for considering combined vertical and lateral turbulence. Provisions for treating non-linearities will also be included.

A summary of the most relevant changes that are proposed for paragraph 25.341 are:

(b) *Continuous Turbulence criteria:*

(3) The limit turbulence intensities U_{σ} , in feet per second true airspeed required for compliance with paragraph are –

(i) At speed from V_B to V_C :

$$U_{\sigma} = U_{\sigma ref} F_g$$

Where –

$U_{\sigma ref}$ is the turbulence intensity that varies linearly with the altitude from 90 fps (TAS at sea level to 79 fps (TAS) at 24000 feet and is then constant at 79 fps (TAS) up to an altitude of 50000 feet.

F_g is the flight profile alleviation factor defined in paragraph (a)(6) of this section;

- (ii) At speed V_D : U_{σ} is equal to ½ the values obtained under subparagraph (3)(i) of this paragraph.
- (iii) At speeds between V_C and V_D : U_{σ} is equal to a value obtained by linear interpolation.
- (iv) At all speeds both positive and negative continuous turbulence must be considered.
- (4) When an automatic system affecting the dynamic response of the airplane is included in the analysis, the effects of system non-linearities on loads must be taken into account in a realistic or conservative manner.
- (5) If necessary for the assessment of loads on airplanes with significant non-linearities, it must be assumed that the turbulence field has a root-mean square velocity equal to 0.4 times the U_{σ} values specified in subparagraph (3). The value of limit load is that load with the same probability of exceedence in the turbulence field as a velocity of U_{σ} .
- (6) The resultant combined stresses from both the vertical and lateral components of turbulence must be considered when significant. The stresses must be determined on the assumption that the vertical and lateral components are uncorrelated.

4.3 Comparison of Methods to calculated Continuous Turbulence Design Loads for Non-Linear Aircraft

This section presents results of comparative studies to evaluate methods for the calculation of design loads. The simulations were carried out by the National Aerospace Laboratory NLR N and the University of Manchester UK, using the same aircraft models. A number of different methods were considered:

Stochastic Methods

- Stochastic Simulation (SS)
- Probability of Exceedence Criterion (PEC)
- Power Spectral Density (PSD) [only for the linear cases]

Deterministic Methods

- Matched Filter Based method (MFB), both 1-dimensional and Multidimensional
- Indirect Deterministic Power Spectral Density Method (IDPSD)
- Spectral Gust procedure (SG)

Stochastic-Deterministic Methods

- Statistical Discrete Gust (SDG)

A brief description of these methods is given in Appendix A4.1.

The following nonlinear aircraft models were used:

- Noback model: 2 DOF large transport aircraft with load alleviation through ailerons.
- F100 model: medium-sized transport with "Fokker-100-like" characteristics with load alleviation through ailerons.
- A310 model: an A310 model with load alleviation through ailerons and spoilers.

A description of these models is given in Appendix A4.2. Nonlinearity is introduced in these models by limits on the control surface deflections. The A310 model control surfaces can only deflect upward (max. 10 deg.) in the nonlinear version, so that a non-symmetrical nonlinearity is introduced. Analysis could be performed using either the linear or non-linear versions of these models.

4.3.1 Analyses made by NLR

The NLR investigation⁴ compared the three Deterministic methods with the Stochastic Simulation methods and the PSD technique for the linear cases. For linear aircraft models, these Deterministic PSD methods and Stochastic Simulation result in design and correlated load values y_d and z_c that are equal to the "standard" PSD loads:

$$y_d = \bar{A}_y U_\sigma \quad z_c = \rho_{yz} \bar{A}_z U_\sigma.$$

For nonlinear aircraft models, the standard PSD method cannot be applied, because the model transfer functions are then dependent on the input signal. The Stochastic Simulation method has been proposed for the definition of design and correlated loads in nonlinear cases. This method is based on the probability of exceedence of load levels. The Deterministic methods aim to comply with this Stochastic Simulation procedure in nonlinear calculations.

By showing results of calculations for these three aircraft models it was demonstrated that the Deterministic and the Stochastic Simulation procedures effectively lead to correct PSD loads in linear cases. The results for three nonlinear aircraft models obtained with the Deterministic methods are presented, and the degree of compliance of the Deterministic methods with Stochastic Simulation was investigated.

In Appendix A4.1 it is explained that the Deterministic methods follow a more or less similar scheme. An essential part in the procedures is the so-called gust filter. The Power Spectral Density of the gust filter response to a pulse input should have the von Karman power spectrum shape. The impulse response power spectrum can be calculated directly from the frequency-domain representation of the gust filter $G(jf)$:

$$\Phi(f) = \frac{G(jf)G^*(jf)}{T}$$

where T = length of impulse response.

The gust filter impulse response for the IDPSD filter gives by definition exactly the von Karman Spectrum. Comparing the original MFB gust filter ("NASA"), and a new MFB gust filter that has been taken from Hoblit⁵, it appears that the Hoblit filter clearly approaches the von Karman PSD better than the original NASA filter. The Hoblit gust filter has therefore been implemented in the present MFB procedure, which resulted in correct PSD loads in linear cases, contrary to MFB with the original NASA gust filter, where slight deviations from AU_σ were found.

The bar-charts in figures 4.2 - 4.7 show the results of the calculations for the three aircraft models and five calculation methods. The notation in the axis labels of these figures is as follows:

y,des	=	design load value of load quantity y.
y,cor z	=	correlated value of y if z has its design value.
nonlin	=	closed loop system, nonlinear (limited) load alleviation.
nolim	=	closed loop system, linear (unlimited) load alleviation.
nocon	=	open loop system (linear).
Stoch. Simul.	=	Stochastic Simulation result.
PSD	=	standard PSD result.
POS	=	"positive" design load case (A310 model only).
NEG	=	"negative" design load case (A310 model only).

Note that correlated load values in some cases are given with opposite sign, indicated by a minus sign in the legend. The results for the linear and nonlinear versions of the A310 model are given in separate figures, because there is a difference between "positive" and "negative" nonlinear design load cases, due to the fact that ailerons and spoilers can only deflect upward in the nonlinear version of this model.

These bar charts demonstrate that the three Deterministic methods comply with the standard PSD results in linear cases, so it may be concluded that all Deterministic procedures lead to correct results for linear aircraft models. Figure 4.2 for the linear A310 model shows standard PSD results and Deterministic PSD results together with Stochastic Simulation results. It can be seen that the Stochastic Simulation procedure gives design loads close to the standard PSD values, and correlated loads may deviate a few percent (of the design load value) from the theoretical value, see for instance the correlated bending for the uncontrolled A310 model.

In nonlinear conditions, where controller actions are limited, the Stochastic and Deterministic methods lead to different results. MFB and IDPSD do not differ much, but the correlated load values are different in some cases. A second optimization loop could have been added to MFB/IDPSD, calculating outputs at e.g. four more k/K_{eq} values around the optimum found, and find a higher maximum output with somewhat different correlated load values. An even more rigorous search routine, the "multi-dimensional search", might also be applied. As it is believed, on the basis of NASA investigations, that such a routine would change the design conditions by a very small amount in respect to the one-dimensional search, such calculations were not performed.

MFB and IDPSD both approach the Stochastic Simulation results reasonably in figure 4.3; only the correlated value of Δn for the nonlinear F100 model is really very incorrect (wrong sign) for both methods, see figure 4.4. The corresponding MFB/IDPSD design levels of the bending moment in figure 4.5 differ more than 10 % from the Stochastic Simulation value. The SG procedure design loads and correlated loads can both deviate appreciably from Stochastic Simulation results. Similar findings were obtained for the Noback model, figures 4.6-4.7, where the major differences occur in the correlated y values.

The ailerons and spoilers of the A310 model can only deflect upward in the nonlinear version, so that different gust design loads will occur in positive and negative directions. In the IDPSD and MFB procedures, negative gust cases are created by reversing the sign of the gust inputs to the "first system". In the SG procedure the sign of a design load is determined, by calculating the sign of:

$$\int_0^{\infty} y|y|dt$$

where y is the load quantity response to an SG input.

It can be seen in figure 4.3 that the positive and negative design load cases of wing bending do not differ significantly, but the negative torsion design load is considerably lower than the positive design load in the results of Stochastic Simulation, MFB, and IDPSD. It is a good point for MFB and IDPSD that they appear to represent this effect in the same way as the Stochastic Simulation method.

With regard to the required computational times the following observations could be made. The SG method is very fast, because only four time responses are calculated. The IDPSD method takes some more calculation time than MFB, because the "first system" response in IDPSD is twice as long as in MFB. Stochastic Simulation takes much more time than the other methods (14 times the MFB time), mainly due to the counting procedures for finding design levels and correlated loads.

The following conclusions can be drawn from this comparison of Deterministic methods with the Stochastic Simulation and "standard" PSD methods:

- With the Hoblit gust filter, MFB is equivalent to IDPSD and "standard" PSD in linear cases.
- The results of MFB and IDPSD are reasonably similar in nonlinear cases; correlated loads may deviate somewhat.
- MFB and IDPSD reasonably approach Stochastic Simulation results in nonlinear cases, but this is not enough for design load calculations.
- The SG method deviates significantly from the other methods in nonlinear cases.
- Stochastic Simulation takes much more calculation time than the Deterministic methods.

4.3.2 Analyses made by the University of Manchester

The following methods were investigated at the University of Manchester:

- IDPSD: Indirect Deterministic Power Spectral Density
- MFB 1-D: Matched Filter Based 1-Dimensional
- MFB Multi-D: Matched Filter Based Multi-Dimensional
- PEC: Probability of Exceedence Criteria
- SS: Stochastic Simulation
- SDG: Statistical Discrete Gust

The description of the methods can be found in Appendix 4.1. The methods were applied to the simple 2-dof and A310 aircraft. Since the absolutely correct design load cannot be obtained for a nonlinear system, one of the methods was to be used as a benchmark. In this case, the benchmark was chosen to be the Matched Filter Based 1-Dimensional search method. This choice was dictated by the relative simplicity of the method and by the fact that it is less computationally expensive than the other methods. However, the term "benchmark" does not imply that the design loads predicted by the MFB 1-D method are taken to be the best estimates.

The graphical comparisons between the methods presented in this section are based on the following figures (unless otherwise stated).

- Figures 4.8 and 4.9 show a direct comparison of maximum and correlated loads obtained by the methods for the Noback aircraft model.
- Figures 4.10 and 4.11 show a direct comparison of maximum and correlated loads obtained by the methods for the A310 aircraft model.
- Figures 4.12 and 4.13 Load variation with time and critical gust shape for Noback aircraft load 2 and A310 load 3

4.3.2.1 Stochastic Simulation Method

The figures show a very good agreement between results using the SS method and those from the two deterministic methods. Figure 4.12 shows the load variation with time and the critical gust shape for the Noback aircraft as predicted by the MFB, SS and IDPSD methods. It can be seen that, even though there is some differences between the three gust shapes, the load variations are in very good agreement with each other. This phenomenon highlights the main difficulty in predicting gust loads and worst-case gusts for nonlinear aircraft i.e. that there is not one single solution.

The good agreement between the two deterministic methods and the SSB however, heavily depends on the choice of the value of the turbulence intensity, σ_g . The authors of reference 6 suggest that, in order to compare the two methods, the value of the turbulence intensity used with the MFB scheme should be

$$\sigma_g = U_\sigma$$

where U_σ is the design gust velocity. For the SSB method, the suggested value is

$$\sigma_g = U_\sigma / 3$$

The turbulence intensity used during the course of this work was

$$\sigma_g = U_\sigma / 2.5$$

This value was preferred⁴ to $U_\sigma / 3$ because it agrees more closely with the representative, σ_{wr} , value at normal civil aircraft cruising altitudes.

4.3.2.2 PEC method

The design and correlated loads obtained by the PEC method are in considerable agreement with those obtained by the SSB method, which is logical since both methods are stochastic approaches applied to the same simulated patches of turbulence.

The comments made in the previous paragraph about turbulence intensity also apply to the PEC approach.

4.3.2.3 SDG method

The SDG method is the approach that yields loads which are in least agreement with those obtained from the other techniques. For the Noback aircraft, the SDG yields the most conservative design load for load 1 and the least conservative one for load 2. For the A310, the SDG estimate for load 3 is in good agreement with those obtained from the DPSD procedures but, for load 4 the SDG again provides the least conservative design loads. This discrepancy is caused by the fact that the SDG methodology, being based on a search through families of discrete gusts, is significantly different to the other four methodologies (see Appendix 4.1).

4.3.2.4 IDPSD method

The agreement between the IDPSD and the MFB 1-D methods is, generally, very good. For the particular case of the worst-case gust for Load2 of the Noback aircraft (figure 4.12), the agreement breaks down to a certain extent. The figure shows that the gust shape estimated using the IDPSD lies between the SSB and MFB 1-D gusts. Nevertheless the resulting maximum loads are still comparable.

Since both the Noback and MFB 1-D methods are deterministic methods, estimating worst-case gusts there is no problem with scaling the turbulence intensity value in order to get agreement between the two methods.

4.3.2.5 MFB Multi-Dimensional Search

Table 4.1 shows a comparison of results from the 1-dimensional and the multi-dimensional MFB searches, obtained from the Noback and A310 models. The table confirms previous findings^{7,8} that the 1-dimensional search provides a very good estimate of the design load. The design loads for the Noback model have been improved upon by the MFB M-D method by up to 6.8%. However, for the A310 model, the improvement is almost

negligible. The fact that the multi-dimensional search is much more computationally expensive but only delivers a small improvement in the final result suggests that the 1-dimensional search is more suitable, especially in the case of the gust-load prediction for a full aircraft, where the design loads need to be predicted at a very large number of stations over the whole aircraft.

% Improvement
6.8
6.7
0.1
0.2

Load	MFB 1-D	MFB M-D
Noback Load 1	10.73 m/s ²	11.46 m/s ²
Noback Load 1	6.55 m/s ²	7.02 m/s ²
A310 load 2	2.8242x10 ⁶ lb.ft	2.8261x10 ⁶ lb.ft
A310 load 3	2.3736x10 ⁵ lb.ft	2.3793x10 ⁵ lb.ft

Table 4.1: Comparison of design loads by the MFB M-D and MFB 1-D methods for the Noback and A310 models

4.3.2.6 Comparative Results

The IDPSD method tends to predict slightly more conservative results than the MFB 1-D method. In the case of the Noback model the IDPSD results are closest to those obtained from the MFB M-D method. Since the SSB and PEC are stochastic, their design load predictions change slightly every time the calculations are performed. Consequently, there is no definitive way of determining whether these predictions are generally more or less conservative than the results obtained with the other two methods.

Another important conclusion is that the design load predictions of the methods agree more closely with each other than the correlated load predictions. In reference 4 this phenomenon is also noted. Additionally, Vink⁴ shows the cause of the phenomenon to be that the theoretical standard deviation of the design load will generally be smaller than the theoretical standard deviation of the correlated loads.

In many cases the methods predict very different worst-case gust shapes but quite similar design loads. Table 4.1 shows the worst-case gusts and resulting load variations calculated from the SSB, MFB and IDPSD methods for the A310 wing torsion load. It can be clearly seen that three considerably different worst-case gust shapes yield very similar load variations and, hence, maximum loads. Again, this phenomenon is caused by the nonlinearity of the aircraft under investigation.

Table 4.2 compares the computational expense of the SSB, MFB 1-D, PEC and IDPSD methods. Neither the CPU time nor the number of floating point operations (*flops*) figures are absolute. CPU time depends on the computer used, the software installed. The number of flops performed depends on the programming and on the routine that counts the flops. Nevertheless there is a clear pattern to the results in the tables. The least computationally expensive method is the MFB 1-D and the most computationally expensive one is the SSB, with

the IDPSD and PEC methods lying somewhere in between. The CPU time and number of flops for the multi-dimensional MFB and SDG methods are labelled "variable" in the table since the method relies on a directed random search. Hence, the duration of the calculations is different every time the procedure is applied, but always much longer than the duration of any of the other methods.

Method	CPU time
IDPSD	24.45
MFB 1-D	18.73
MFB M-D	Variable*
PEC	100.93
SDG	Variable*
SSB	274.85

Table 4.2: Comparison of computational expense of the methods (applied to the A310 model) * Variable times are caused by optimization procedures

4.4 Conclusions & Recommendations

This report has provided a brief historical background and an overview of the current state of the airworthiness regulations as regards to gust loadings. In the future, certification regarding the effects of non-linearities on the gust loading of aircraft will become increasingly important. A number of the most promising gust load prediction methods, including both stochastic and deterministic techniques, have been described and compared analytically.

The nature of non-linear systems means that the principle of superposition does not hold and large amount of computation is required to determine the design gust loads. Even then, there is no guarantee that a maximum has been achieved. The computation can be performed either via a stochastic approach that considers a large amount of turbulent data, or a deterministic procedure whereby some type of search is undertaken to find the maximum loads.

Two comparative studies were carried out using three different non-linear aircraft models. Gust loads obtained using the different methods were compared. It was found that most of the analysis techniques gave similar estimates, although some variation in results was found using the version of the Statistical Discrete Gust method employed for this work, and also the Spectral Gust method. There is not enough evidence however to categorically say one method is better, or worse, than the others. The deterministic methods require less computation.

There is a requirement for the research community to develop new analysis methods that are able to predict design gust loads without resorting to large amounts of computation. The test cases used in this study should be employed as benchmark test cases for future comparative work.

4.5 References

- 1 *Various authors: Loads and Requirements for Military Aircraft. Papers presented at the 83rd Meeting of the AGARD SMP, Florence, September 1996. AGARD Report 815, February 1997.*
- 2 *Flomenhoft, H.I., 'Brief History of Gust Models for Aircraft Design' J. Aircraft v31 n5 pp1225 - 1227 1994.*
- 3 *Fuller. J.R., 'Evolution of Airplane Gust Loads Design Requirements' J Aircraft v32 n2 pp 235 - 246. 1995.*
- 4 *Vink, W.J.; A stochastic simulation procedure compared to deterministic methods for PSD gust design loads. NLR TP 98240, 1998.*
- 5 *Hoblit, F.M.; Gust loads on aircraft: concepts and applications, AIAA, Inc., 1988*
- 6 *R.C. Scott, A.S. Pototzky, and B. Perry III, Matched-Filter and Stochastic-Simulation-Based methods of gust loads prediction, Journal of Aircraft, 32(5):1047--1055, 1995*
- 7 *P.J. Goggin, Comparison of stochastic and deterministic nonlinear gust analysis methods to meet continuous turbulence criteria. Report 798, AGARD, May 1994.*
- 8 *R.C. Scott, A.S. Pototzky, and B. Perry III, Computation of maximized gust loads for nonlinear aircraft using Matched-Filter-Based schemes. J.Aircraft, 30(5):763--768, 1993.*
- 9 *R.Noback, S.D.G., P.S.D. and the nonlinear airplane, TP 88018 U, NLR, National Aerospace Laboratory, Holland, 1988*
- 10 *J.G. Jones, Statistical-Discrete-Gust Method for predicting aircraft loads and dynamic response, Journal of Aircraft, 26(4):382-392, 1989.*
- 11 *D.L. Hull, Design limit loads based upon statistical discrete gust methodology, Report 798, AGARD, May 1994.*
- 12 *G.W. Foster & J.G. Jones, Analysis of atmospheric turbulence measurements by spectral and discrete-gust methods, Aeronautical Journal, pp 162-176, 1989.*
- 13 *E.Aarst & J.Korst, Simulated annealing and Boltzman machines, John Wiley & Sons, 1989.*
- 14 *R.C. Scott, A.S. Pototzky, & B.Perry III, Similarity between methods based on matched filter theory and on stochastic simulation, AIAA-92-2369-CP, 1992.*
- 15 *A.S. Pototzky & T.A. Zeiler, Calculating time-correlated gust loads using matched filter and random process theories. Journal of Aircraft, 28(5):346-352, 1991.*
- 16 *R.C. Scott, A.S. Pototzky, & B.Perry III, Computation of maximized gust loads for nonlinear aircraft using Matched-Filter-Based schemes, Journal of Aircraft, 30(5):763-768, 1993.*
- 17 *J.E. Cooper & G.Dimitriadis, Prediction of maximum loads due to turbulent gusts using nonlinear system identification, In Proceedings of the CEAS International Forum on Aeroelasticity and Structural Dynamics, Volume II, pages 71-78, Rome, Italy, June 1997*

- 18 *J.G. Jones*, Formulation of Design Envelope criterion in terms of Deterministic Spectral Procedure, *J. Aircraft*, 30(1):137-139, 1993.
- 19 *G.Rosenberg, D.A.Cowling, & M.Hockenull*, The deterministic spectral procedure for gust response analysis of nonlinear aircraft models. *Intl Forum on Aeroelasticity and Structural Dynamics*. pp 339–358. 1993
- 20 *R.C. Scott, A.S. Pototzky, and B. Perry III*, Maximized gust loads for a nonlinear airplane using matched filter theory and constrained optimization. NASA TM 104138, 1991.
- 21 *R.Noback*, The Deterministic Power-Spectral-Density method for nonlinear systems, TP 92342 U, NLR, National Aerospace Laboratory, Holland, 1992.
- 22 *R.Noback*. The Deterministic Power-Spectral-Density method for linear systems. TP 92062 U, NLR, National Aerospace Laboratory, Holland, 1992.

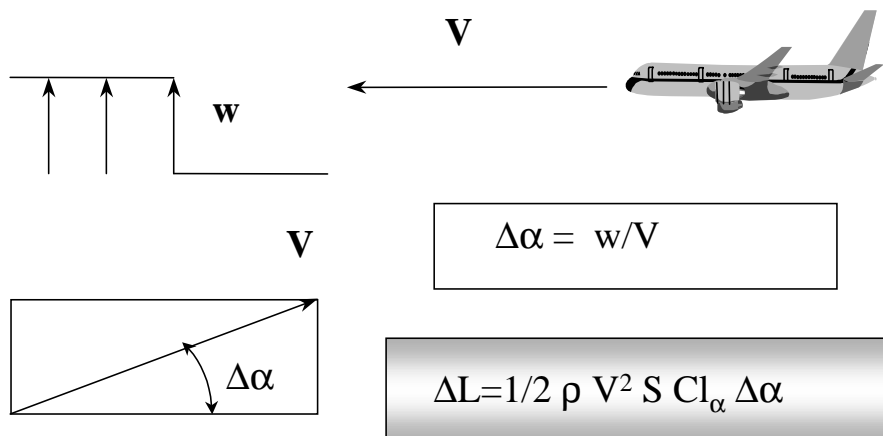

Figure 4.1. Basic Gust Loading Mechanism

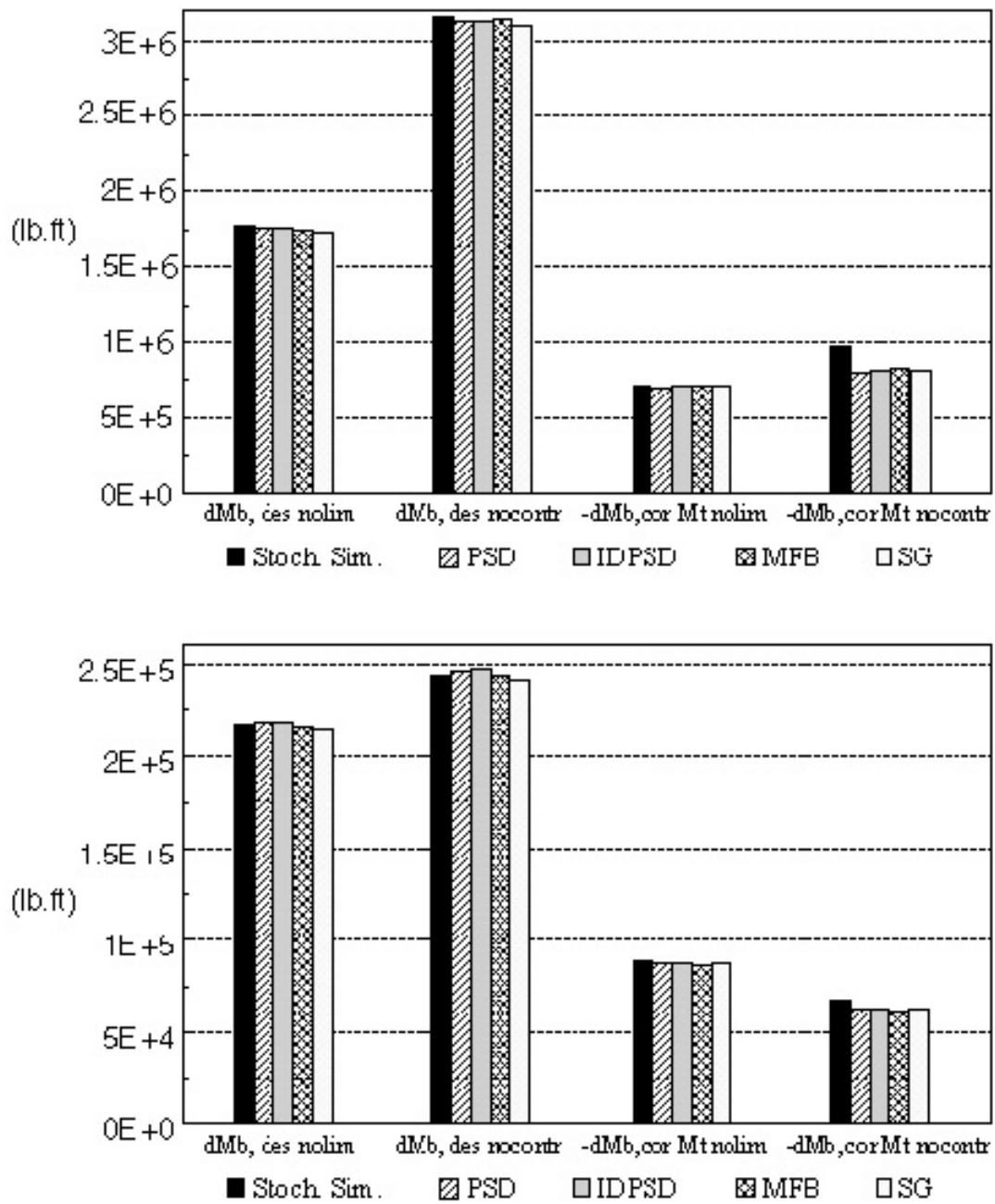

Figure 4.2 Bending and Torsion Loads. Linear A310.

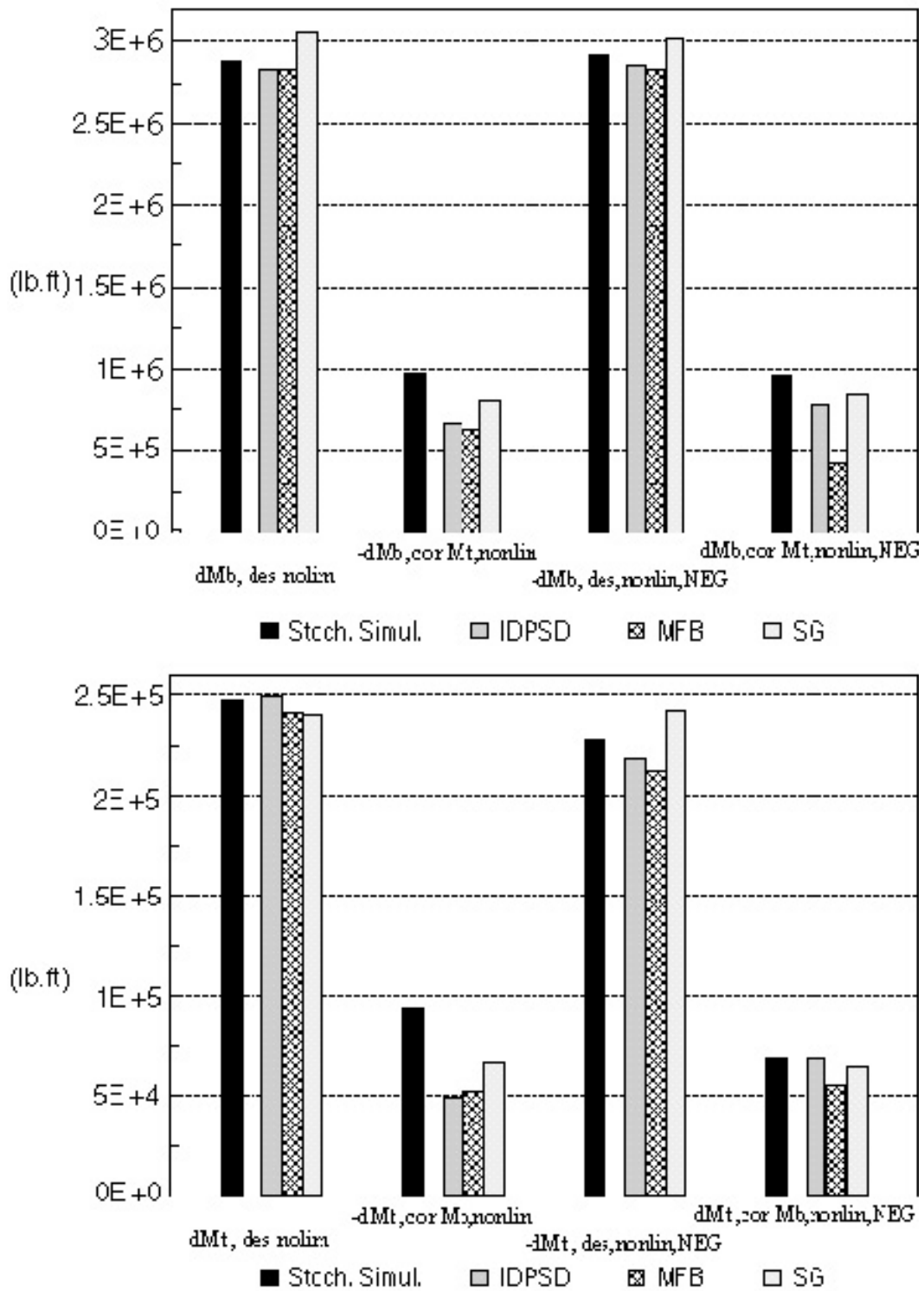

Figure 4.3 Bending and Torsion Loads. Non-Linear A310.

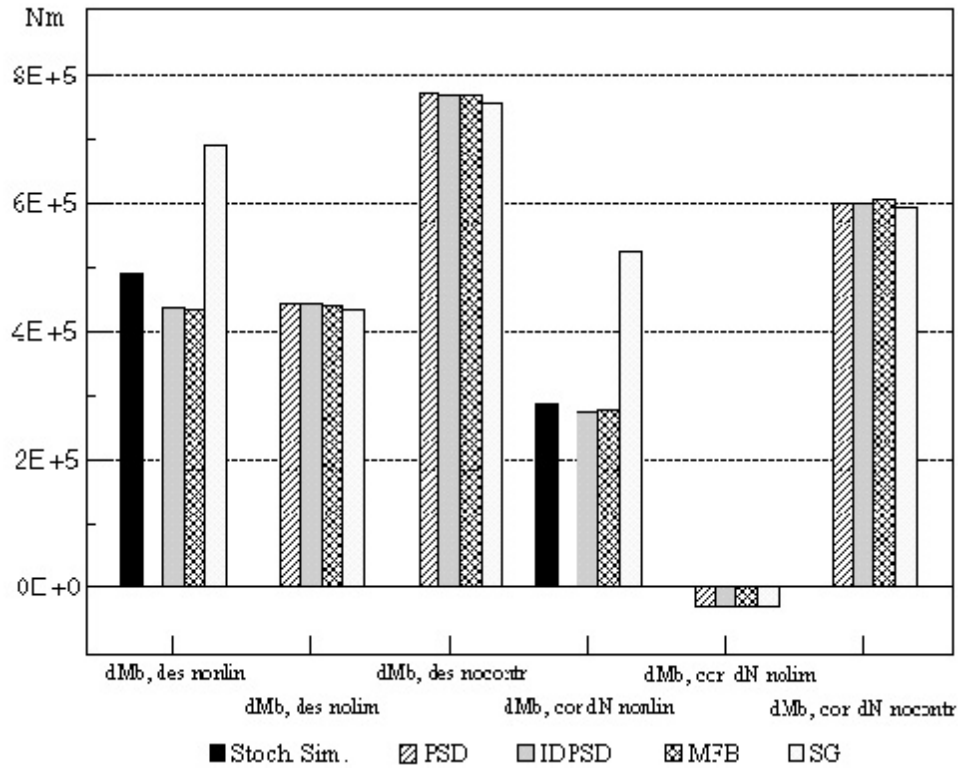

Figure 4.4 F-100 Design and Correlated Loads

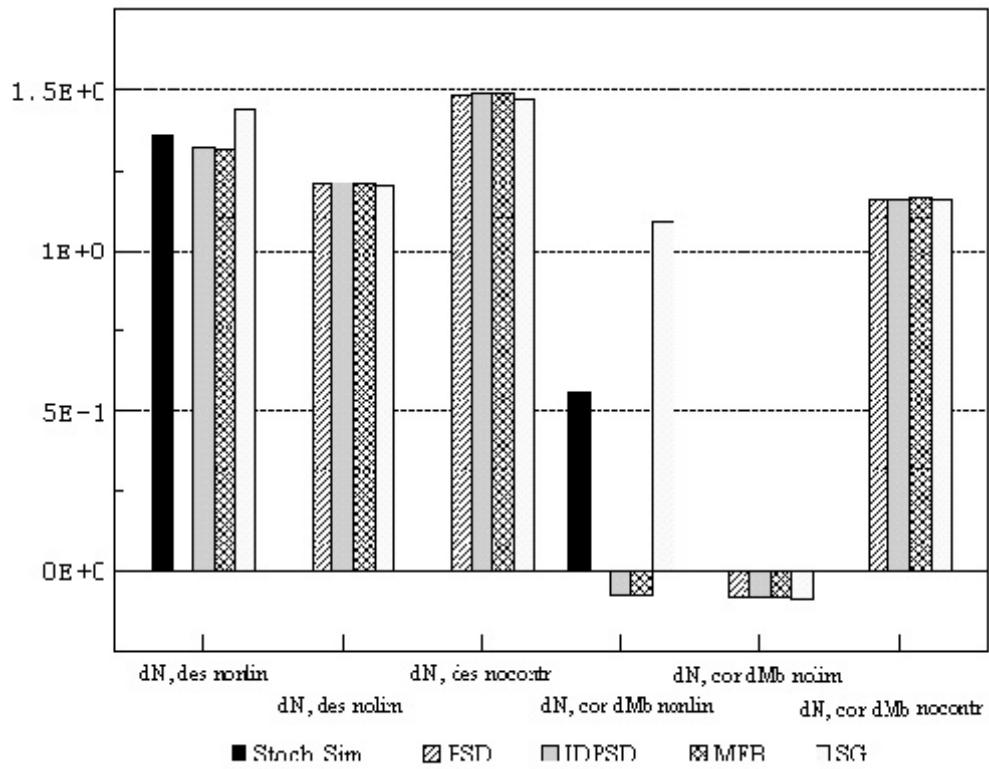

Figure 4.5: F-100 Design and Correlated Loads

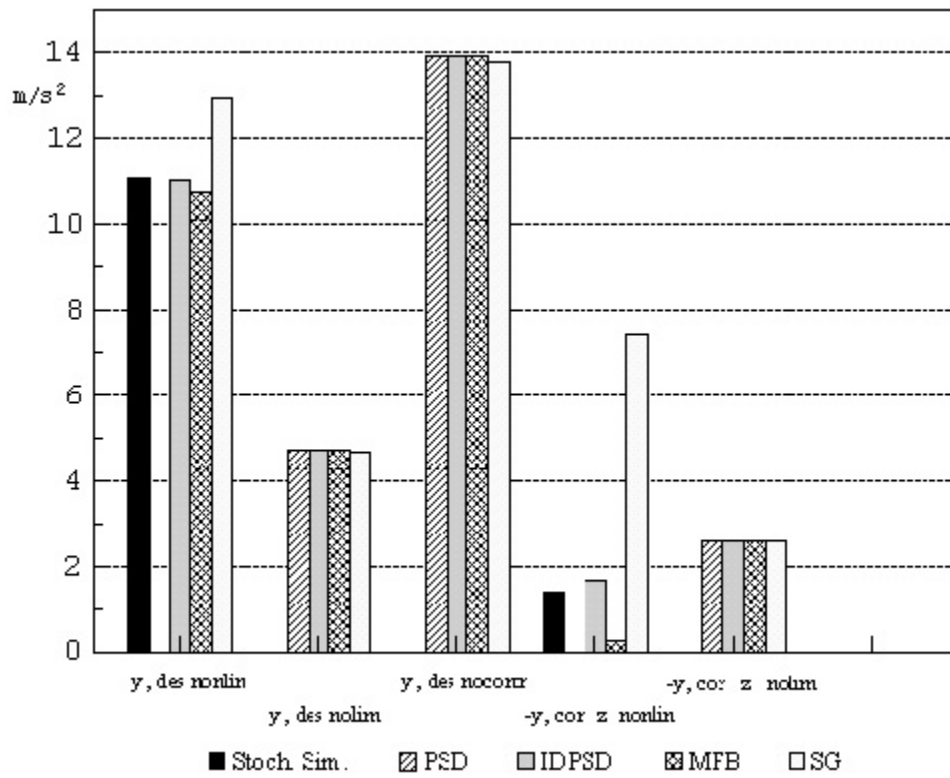

Figure 4.6 Noback Aircraft c/g Acceleration

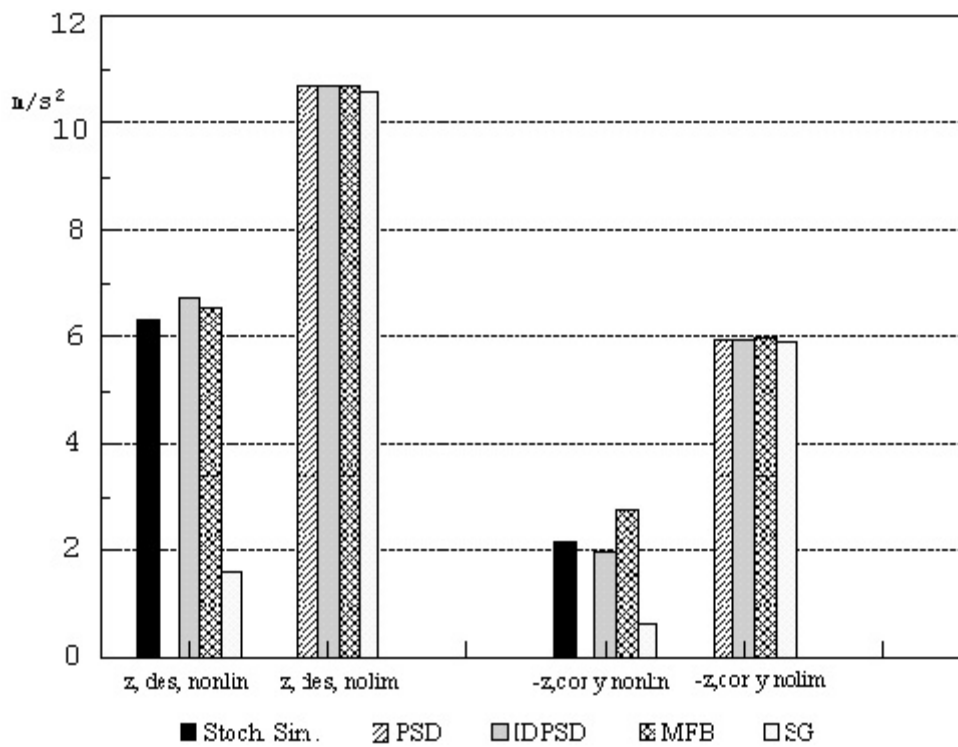

Figure 4.7 Noback Model c/g Acceleration by Aileron

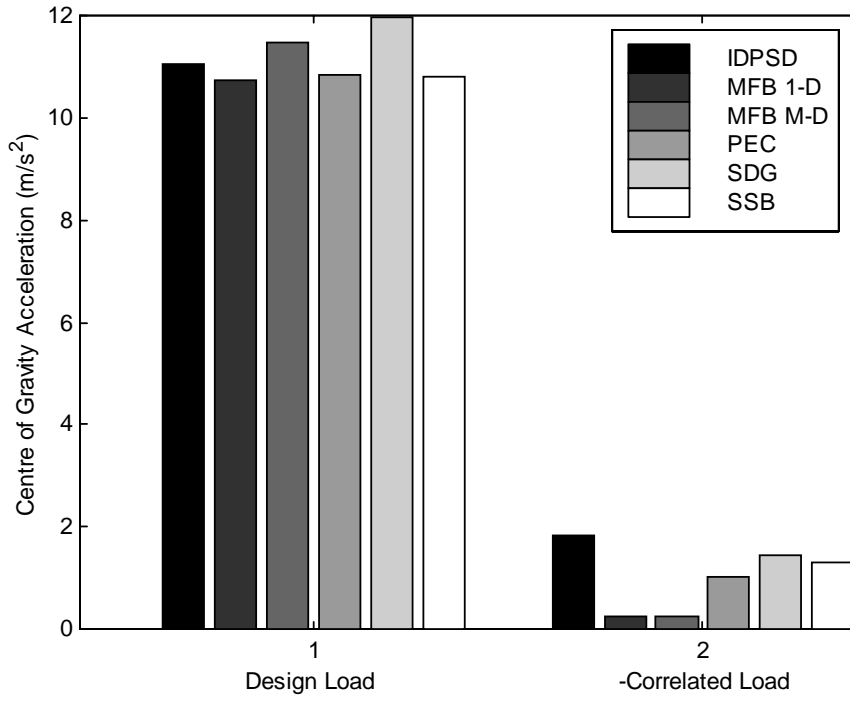

Figure 4.8: Results for Noback model, centre of gravity acceleration

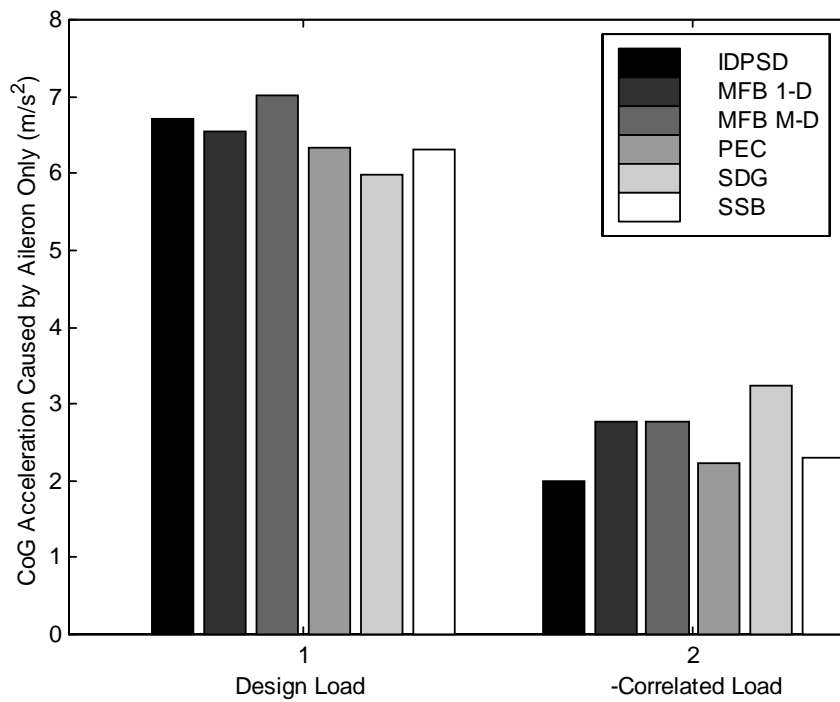

Figure 4.9: Results for Noback model, centre of gravity acceleration caused by aileron only

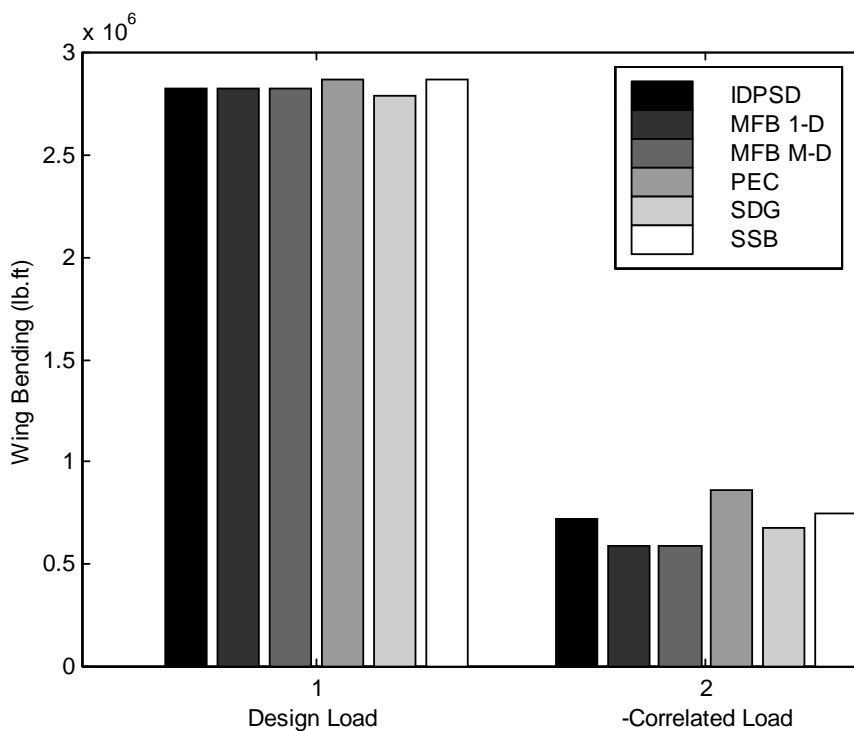

Figure 4.10: Results for A310 model, wing bending

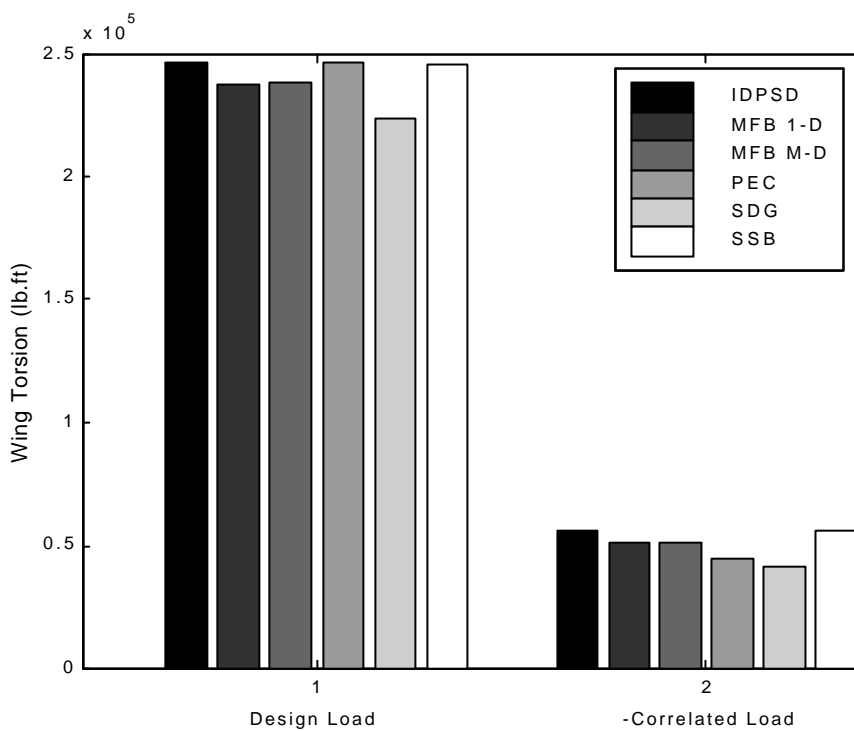

Figure 4.11: Results for A310 model, wing torsion

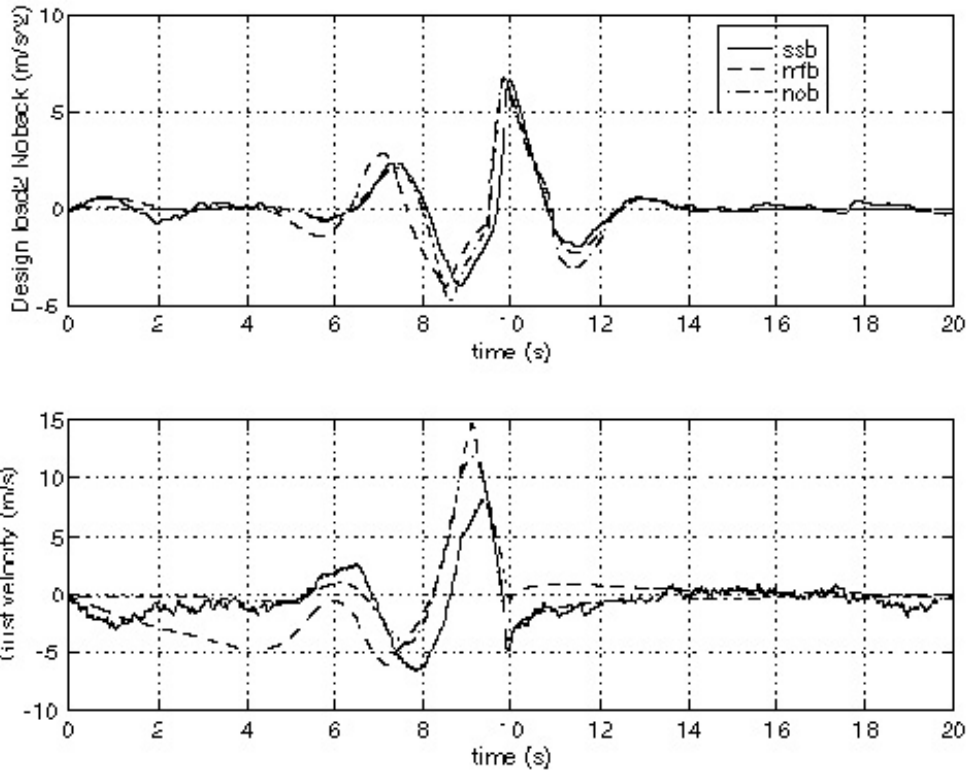

Figure 4.12: Comparison between SSB, MFB 1-D and IDPSD (labeled 'nob') for Noback a/c load 2 (design load and gust shape)

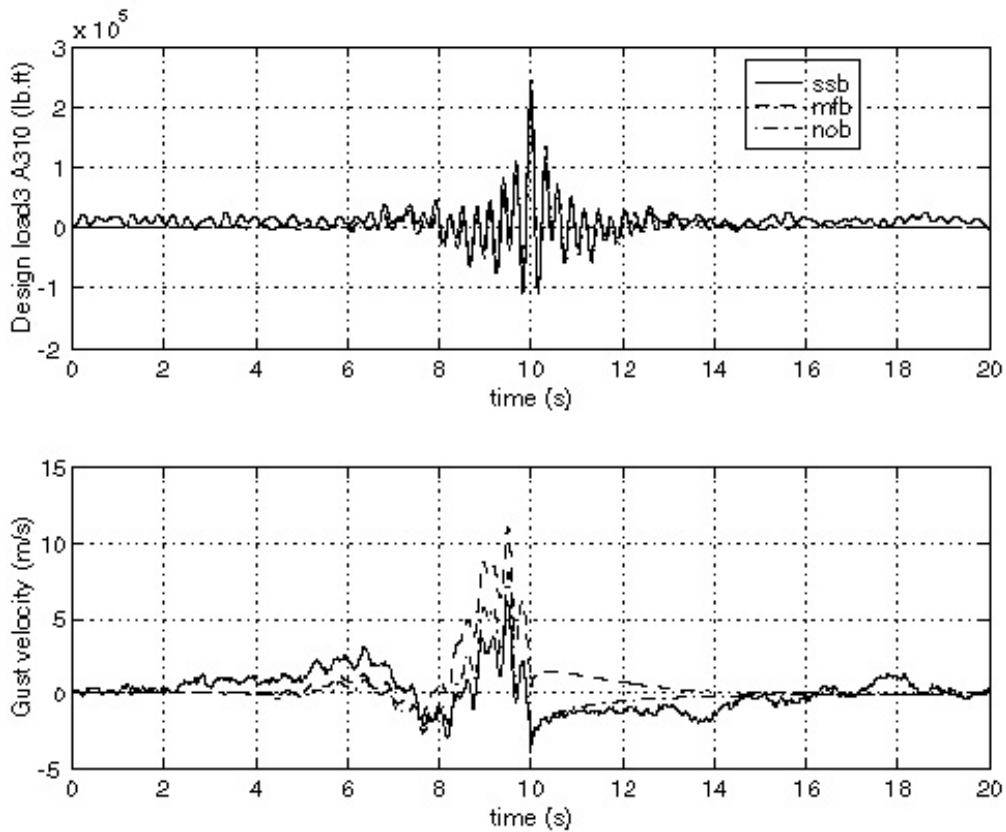

Figure 4.13: Comparison between SSB, MFB 1-D and IDPSD (labeled 'nob') for A310 wing torsion (design load and gust shape)

4.6 APPENDIX A4.1

Methods for design gust load prediction for nonlinear aircraft

This appendix gives a brief description of the methods considered in this chapter. They have been categorized as either Stochastic or Deterministic methods, although arguably the Statistical Discrete Gust methods could be in their own section. Further details can be found in the references.

4.6.1 Stochastic Methods

4.6.1.1 Probability of Exceedence Criteria

The Probability of Exceedence Criteria (PEC) method⁹ is an extension of the Power Spectral Density method (PSD) for nonlinear aircraft. The PEC is stochastic and attempts to calculate design loads. The procedure is as follows^{7,9}:

1. The flight conditions at which the design loads are to be evaluated are prescribed and values of U_σ and b_2 are determined from the airworthiness requirements. b_2 is a coefficient used in the expression for the probability that the load will exceed the design load - its variation with altitude can be found in reference 5.
2. A representative value of the rms gust intensity, σ_{wr} , is computed using

$$\sigma_{wr} = b_2 \sqrt{\frac{1 + \sqrt{1 + 4(U_\sigma / b_2)^2}}{2}}$$

3. An input white noise signal with σ_{wr} is generated, passed through a gust pre-filter and fed into the nonlinear aeroelastic model. The resulting load time history for load y is used to calculate the probability that the design load will be exceeded in a turbulent flow-field of intensity σ_{wr} using

$$P(y > y_d, \sigma_{wr}) = \frac{1}{\sqrt{2\pi}} \bar{A} \sigma_{wr} \int_{y_d}^{\infty} \exp\left(-\frac{y^2}{2\bar{A}^2 \sigma_{wr}^2}\right) dy d\sigma_{wr}$$

where $\bar{A} = \sigma_y / \sigma_{wr}$

4. The design load is defined as the value of the load for which

$$P(y > y_d, \sigma_{wr}) = \frac{1}{2} \operatorname{erfc}\left(\frac{U_\sigma}{\sqrt{2}\sigma_{wr}}\right)$$

where erfc is the error function complement.

Instead of calculating the probability distribution of load y , it is possible to obtain the design load by estimating the number of exceedences, N , of this load given by⁴

$$N = \frac{T_{\text{tot}}}{dt} P(y > y_d, \sigma_{wr})$$

where T_{tot} is the total length of the simulation (in seconds) and dt is the time step. Then, the array containing the load response y is sorted from higher to lower values and the design load is the N th element of the sorted array. If N is not an integer, linear interpolation can be used to obtain the design load.

$$\exp\left(-\frac{\sigma_w^2}{2b_2^2}\right) \operatorname{erfc}\left(\frac{U_\sigma}{\sqrt{2}\sigma_w}\right)$$

This procedure only gives an estimate of the nonlinear design load which may be substantially different to the real value⁹. The estimate can be improved by repeating the procedure for two values of σ_w at which the value of the following quantity is the same

Then, the design loads obtained for these two values of gust intensity can be combined with the initial estimate such that

$$y_d = 0.5y_d(\sigma_{wr}) + 0.25y_d(\sigma_{w1}) + 0.25y_d(\sigma_{w2})$$

It has been suggested⁴ that, instead of three simulations with three different values of σ_w , only one simulation with $\sigma_w = U_\sigma / 2.5$ can be performed. The results will be adequate in the altitude range of 22,000ft-35,000ft since, in this range, the value of σ_{wr} is very close to $U_\sigma / 2.5$. This latter approach is also adopted in the present work since it is suggested that increasing the total simulation length at one value of σ_w improves the quality of the design load predictions by a larger amount than increasing the number of simulations at different values of σ_w .

The correlated loads can be obtained using

$$P(z > z_c | y = y_d) = 0.5$$

i.e. the probability of load z to be higher than the correlated load, z_c , when load y assumes its design value is 0.5. This is implemented by extracting the value of z at all the time instances where $y=y_d$. The probability distribution of these values is then calculated and the correlated load is obtained as the load whose probability is 0.5. As with the design load, the correlated loads can be obtained using the number of exceedences instead of the probability distribution.

Since the PEC input to an aeroelastic model is stochastic turbulence, modelled as white noise, in order for the method to work accurately, long simulation times are needed so that the variance of the input is as close as

possible to σ_w and its mean is almost zero. However, the advantage that this method has over some of the less computationally demanding discrete gust methods is that the airworthiness requirements concerned are more uniformly defined⁵.

4.6.1.2 Statistical Discrete Gust Method

The Statistical Discrete Gust Method (SDG) has been introduced as a method that employs a better description of atmospheric turbulence than the Power Spectral Density method for extreme gusts on linear aircraft^{10,11}. This description is based on families of discrete 1-cosine ramp gusts. The present implementation of the SDG methodology is based on a similar implementation⁹. It should be noted that the method was developed as an attempt to bridge the gap between continuous turbulence and discrete gusts methodologies and is being continuously refined, most recently with the use of wavelets. The SDG calculates design loads.

Figure A4.1 shows a single discrete gust, as used by the SDG method. Initially, its velocity increases in a 1-cosine fashion until, at a distance H , it levels out to the value U which is given by

$$U = U_0 H^{1/3}$$

if H is less than L , the length-scale of turbulence, and

$$U = U_0 L^{1/3}$$

if $H \geq L$. The value of U_0 is decided by the equivalence of the design value of σ_g in the continuous turbulence PSD analysis to the SDG analysis as¹¹

$$U_0 = \frac{\sigma_g}{10.4}$$

where σ_g is obtained from the airworthiness requirements⁵.

For extreme turbulence the scaling of equation the gust velocity equation changes to

$$U = U_0 H^{1/6}$$

This is how the SDG methodology bridges the gap between continuous turbulence and discrete gusts. Continuous turbulence is assumed to be self-similar, which is where the 1/3 scaling law comes from. Self-similarity can be modelled as a stretching transformation. In the time-domain, if the time axis is stretched by a certain amount, h , the dependent variable, say $y(t)$, will be stretched by $h^{-\lambda}$. The similarity parameter λ can be chosen such that the function $h^{-\lambda} y(ht)$ is statistically independent of h . This value for λ can be obtained by considering the spectrum, $\Phi(\omega)$ of the process $y(t)$, when stretched by h , which in reference is shown¹² to satisfy

$$h^{-(2\lambda+1)} \Phi(\omega/h) = \Phi(\omega)$$

In the special case where the process $y(t)$ is turbulent, the Von Karman spectrum applies, i.e.

$$\Phi_{11}(\omega) = \sigma_g^2 \frac{L}{\pi} \frac{1}{\left(1 + \left(1.339\omega \frac{L}{V}\right)^2\right)^{5/6}}$$

$$\Phi_{22}(\omega) = \Phi_{33}(\omega) = \sigma_g^2 \frac{L}{2\pi} \frac{1 + \frac{8}{3} \left(1.339\omega \frac{L}{V}\right)^2}{\left(1 + \left(1.339\omega \frac{L}{V}\right)^2\right)^{11/6}}$$

Simple algebra shows that the limit of both $\Phi_{11}(\omega)$ and $\Phi_{22}(\omega)$ as ω tends to infinity (which defines the inertial subrange where self-similarity applies) is

$$\lim_{\omega \rightarrow \infty} \Phi = A \omega^{-5/3}$$

where A is a proportionality constant. Consequently

$$h^{-(2\lambda+1)} A \left(\frac{\omega}{h}\right)^{-5/3} = A \omega^{-5/3}$$

For this expression to be satisfied, h must vanish from the left-hand-side, or

$$-2\lambda - 1 = -\frac{5}{3}$$

Hence for continuous, self-similar turbulence, $\lambda=1/3$.

Discrete gusts are extreme events for which self-similarity breaks down. They are larger-scale and more ordered events than the background turbulence within which they are contained. The similarity parameter for such events is given by¹⁰

$$\lambda = \frac{1}{3} - \frac{3-D}{3}$$

where D is termed the active volume of turbulence and has values $2 < D \leq 3$. For $D=3$ the standard self-similar value, $\lambda=1/3$, is obtained. For a value of $D=2.5$, the extreme turbulence similarity parameter is obtained, $\lambda=1/6$. Hence, with a simple change in the scaling law, the SDG method can be made also applicable to extreme turbulent events like discrete gusts.

At a particular value for the gust-length, H , the nonlinear aeroelastic system under consideration will exhibit a maximum load response. The maximum value of this maximum response, $\bar{\gamma}_1$ is an estimate for the design load, y_{d1} . A second estimate is obtained using a pair of gusts as shown in figure A4.2. Here, there are three parameters that govern the gust shape, H_1 , H_2 and the spacing between the two gusts, S . The values of these parameters are varied until the maximum, $\bar{\gamma}_2$, is obtained. Another two estimates for the design load are

calculated using two pairs of gusts and four pairs of gusts. Finally, four design loads are calculated using

$$\begin{aligned} y_{d1} &= p_1 \bar{\gamma}_1 U_0 \\ y_{d2} &= p_2 \bar{\gamma}_2 U_0 \\ y_{d3} &= p_3 \bar{\gamma}_3 U_0 \\ y_{d4} &= p_4 \bar{\gamma}_4 U_0 \end{aligned}$$

with $p_1=1.0$, $p_2=0.81$, $p_3=0.57$ and $p_4=0.40$. For highly damped systems the first two design values are more important, for slightly damped ones the last two design values predominate.

For linear systems, estimating the maximum response due to SDG gusts is simple since superposition can be employed. For nonlinear systems this estimation can only be performed by means of an optimization scheme, especially for the longer gust-shapes. The optimization scheme chosen for this study was Simulated Annealing¹³.

4.6.1.3 Stochastic Simulation

The Stochastic Simulation method (SS) models continuous turbulence as a white noise input with a Von Karman spectrum, in the same way as the PEC method. Hence, the SSB is stochastic and can calculate design loads, correlated loads and worst-case gusts, given a target value for the design load. The procedure is as follows¹⁴:

1. A Gaussian white noise signal with unity variance is generated and fed through a gust pre-filter, such as

$$G(s) = \sigma_g \sqrt{\frac{L}{\pi V}} \frac{\left(1 + 2.618 \frac{L}{V} s\right) \left(1 + 0.1298 \frac{L}{V} s\right)}{\left(1 + 2.083 \frac{Ls}{V}\right) \left(1 + 0.823 \frac{Ls}{V}\right) \left(1 + 0.0898 \frac{Ls}{V}\right)}$$

The output of the filter is a time history of continuous turbulence data. The object is to identify segments of this time history that lead up to peak loads.

2. A number of long time-domain simulations are performed
3. The load time histories obtained from the simulations are analysed. Instances in time are isolated where the load exhibits a peak near a prescribed value or within a specified range. Then standard durations of time data leading up to the peak values are extracted, lined up in time and averaged. The result is 'averaged-extracted' time-histories of the excitation waveform (input to the gust filter), gust profile (section of turbulence data) and load. These have been shown to be directly equivalent to results obtained by the MFB methods¹⁴, if the value of the turbulence intensity σ_g is selected appropriately.

To ensure that there is an adequate number of extracted samples so that the final waveforms are as smooth as possible, very long simulations are required (1000

seconds has been suggested¹⁴). Long simulation times also ensure that the white noise input has a variance very close to unity and a mean very close to zero. Finally, the extraction and averaging process must take place separately for positive and negative peak load values.

The stochastic simulation method, as outlined here cannot be used on its own since it requires a target load to be specified, around which it will search for peaks in the load response. This target load value can be supplied by another method. The authors of ref. 14 used the MFB multi-dimensional search procedure to obtain the target design load value and picked peaks in the SSB load output within $\pm 8\%$ of that value. Of course, the object of their work was to show that the MFB results are equivalent to stochastic results. In a straightforward design loads calculation it would be extremely wasteful to use two of the most computationally expensive methods to produce the same results twice.

However, it is suggested here that the SSB method can be used to supplement results obtained by the Probability of Exceedence Criteria method. As mentioned earlier, the PEC method will only produce values for the design and correlated loads. It will not calculate time-variations of the loads or the gust velocity. The SSB, on the other hand can produce design and correlated load responses and critical gust waveforms. Hence, the PEC method can be used to yield a target value for the design load to be subsequently used with the SSB method.

4.6.2 Deterministic Methods

Figure A4.3 and table A4.1 summarize the Deterministic procedures. An input signal to the "first aircraft system", H_1 , is generated by feeding a pulse through a (von Karman) gust filter G , with $G(jf) = [\Phi''_{wv}(jf)]^2$. The power spectrum of the input to the first system will thus have the shape of the von Karman spectrum. The pulse strength k is variable in the MFB method, and constant in the IDPSD ($k=U_\sigma$) and SG ($k=U_\sigma \sqrt{T}$, where T = length of gust input) methods. It should be noted, that the gust filter in the MFB method is only an approximation of the von Karman spectrum, and in the version used in this report it is the Hoblit approximation.

The first aircraft system, H_1 , represents the non-linear aircraft equations of motion in MFB and SG. In IDPSD, H_1 is a linearized version of the non-linear aircraft, by replacing the non-linearity by a linear element with an "equivalent gain", K_{eq} . K_{eq} is a multiplication factor to the original gain in the feedback loop, with $0 \leq K_{eq} \leq 1$

For nonlinear systems, the three Deterministic methods apply different procedures:

- MFB varies the strength k of the input pulse to the first gust filter.
- IDPSD varies the value of the equivalent gain that represents the nonlinearity in the first system.
- SG varies the phase relation of the gust filter, which is limited to only four different phase relations.

4.6.2.1 Matched Filter Based 1-Dimensional search

Matched Filter Theory (*MFT*) was originally developed as a tool used in radar technology¹⁵. The main objective of the method is the design of a filter such that its response to a known input signal is maximum at a specific time, which makes it suitable for application to gust response problems. The method can only be applied to linear systems because it makes use of the principle of superposition, which does not apply to nonlinear systems. However, by applying a search procedure, it can be adapted to provide results for nonlinear aircraft. The method is deterministic.

The technique is quite simple and consists of the following steps^{15,16} :

1. A unit impulse of a certain strength K_g is applied to the system.
2. The unit impulse passes through a pre-filter describing gust turbulence (usually the Von Karman Gust pre-filter).
3. The pre-filtered input is fed into the aircraft model and the response of the various loads is obtained (e.g. wing root bending and torsional moments).
4. The response of the load whose design value is to be estimated is isolated, reversed in time, normalized by its own energy and multiplied by U_σ , the design gust velocity (which is determined by airworthiness requirements⁵).
5. The resulting signal is the input that maximizes the response of the chosen load for this particular impulse strength, K_g . It is then fed back into the system (first the Gust pre-filter, then the aircraft model) in order to obtain the response of the load whose design value is to be estimated and also the responses of the other loads (which are termed the correlated loads).
6. The procedure is repeated from step 1 with a different K_g .

The characterization of the method as one-dimensional refers to the variation of K_g . The end result is a graph of peak load versus initial impulse strength. The maximum of this function is the design load and the gust input that causes it is termed the Matched Excitation Waveform. It must be mentioned at this point that the method does not guarantee that the maximum load for a nonlinear aircraft will be obtained. As was found in refs. 7 and 17, the variation of peak load with initial impulse strength for some types of nonlinearities (e.g. freeplay and bilinear stiffness) does not display a global maximum (instead it slowly asymptotes to a certain value).

4.6.2.2 Deterministic Spectral Procedure

This method was first proposed by Jones¹⁸. In its most general form it is based on the assumption that there exists a single deterministic input function that causes a maximum response in an aircraft load. It states that a design load on an aircraft can be obtained by evaluating the load response to a family of deterministic gust inputs with a prescribed constraint. In practice, this implies a search for the worst case gust, subject to the constraint that the energy of the gusts investigated is constant. The

method is deterministic. The procedure consists of the following steps:

1. A model input shape in the time-domain is generated.
2. The input shape is parameterized to produce a set of describing coefficients
3. The coefficients are used to generate the input waveform
4. The energy of the input is constrained by dividing the signal by its rms value
5. The constrained waveform is fed into a turbulence pre-filter and next through the nonlinear aircraft system
6. The aircraft load response is assessed. If it has not been maximized the coefficients that generate the input are changed and the process is repeated from step 3.

This iterative procedure requires a constrained optimization scheme, to ensure that the maximum load has been obtained, and a model input shape. The optimization scheme proposed originally¹⁸ was simulated annealing. Another approach¹⁶ is to convert the constrained optimization problem to an unconstrained one by means of the Kreisselmeier-Steinhauser function.

As for the generation of the initial input shape, two approaches have been proposed. In ref. 19 a white noise gust model is used. The problem with this approach is that it is more difficult to parameterize a random signal than a deterministic one. Alternatively¹⁶, the MFB 1-dimensional search results are proposed as the input to the DSP loop, which results in what is called the MFB multi-dimensional search procedure.

The parameterization process is probably the most crucial aspect of the DSP method. Input waveforms have to be described by a minimum number of coefficients to minimize computational cost but this description has to be as accurate as possible. Again, two popular procedures can be found in the literature. The first¹⁹ is to fit the waveform by a number of half-sinusoid (or cosinusoid) functions. The other approach is to fit the waveform using a set of Chebyshev polynomials¹⁶. In the same reference, a Fourier series approach was considered but it was found to be much more computationally expensive.

The most common implementation of the DSP method is the Multi-Dimensional Matched Filter Based method which is described next.

4.6.2.3 Multi-Dimensional Matched Filter Based Method

The Multi-Dimensional Matched Filter Based (*MFB Multi-D*) method^{16,20} for gust load prediction for nonlinear aircraft is a practical application of the Deterministic Spectral Procedure. It was designed to provide a more computationally efficient alternative to the Stochastic Simulation Based approach. Reference 16 shows how the method provides almost identical results to those obtained by use of the SSB but with less computational effort. The method is deterministic.

The MFB Multi-D approach revolves around the fact that the usual design envelope analysis can be reformulated as an exactly equivalent time-domain worst-case analysis. In other words, the search for a worst-case gust load in the presence of a turbulence field of prescribed intensity is equivalent to the search for a design load¹⁹. Hence, the simplest possible procedure for determining the worst-case load is to simulate very long patches of turbulence and to look within the load response of the aeroelastic system in question for the design load. This is the stochastic simulation approach that requires significant amounts of computation.

The worst-case load problem can be simplified by noting that the significant part of a long turbulent signal that causes the maximum load is short and can be approximated as a discrete gust. Hence the MFB Multi-D method searches for the single discrete worst-case gust waveform thus avoiding the need for long simulation times.

The implementation of the method is as follows, also depicted graphically in figure A4.4:

1. An initial guess for the worst-case gust waveform (or *matched excitation waveform*) is obtained by use of the 1-dimensional MFB procedure.
2. The initial guess is parameterized. In the present application the parameterization scheme used is Chebyshev Polynomials.
3. The values of the various parameters are changed and the resulting waveform is fed into the aeroelastic system (including a turbulence pre-filter as described earlier).
4. The resulting maximum load is compared to the previous value for the worst-case gust load and is accepted or rejected according to some optimization procedure. The optimization procedure used for the present application is Simulated Annealing. The procedure is repeated, i.e. the parameters are changed again resulting in a new gust waveform which is then used as an input to the system, until the worst-case gust load is obtained.

4.6.2.4 Indirect Deterministic Power Spectral Density Method

The Indirect Deterministic Power Spectral Density method (*IDPSD*)^{20,21}, is derived from the Design Envelope Analysis⁵ of the continuous Power Spectral Density method. For linear aircraft it yields design loads equal to those obtained by the PSD method but using a deterministic input, in a similar way to the linear MFT method. For nonlinear systems it can be extrapolated to a 1-dimensional search procedure, equivalent to the MFB 1-D search but involving a linearized representation of the system. The method is deterministic.

The IDPSD procedure is very similar to the MFB 1-D method with two main differences. Firstly, the IDPSD method uses a different gust filter and, secondly, the initial excitation is applied to a linearised version of the system whose output is then reversed, normalized and fed into the nonlinear system. Hence, the MFB 1-D method consists of a filtered impulse of variable strength fed into the nonlinear system, the resulting gust waveform being fed into the same system. In the IDPSD method, an initial input of constant strength is fed into a linearised system, called the first system, whose nonlinear element has been

replaced by a variable gain. The resulting waveform forms the input to the nonlinear system, called the second system. The search procedure consists of varying the linear gain until the response of the second system is maximized.

The input to the first system is given by $U_\sigma V(t)$, where U_σ is the design gust velocity and $V(t)$ is the Fourier Transform of the two-sided Von Karman Spectrum, $\Phi_{ww}(\omega)$, given by

$$\Phi_{ww}(\omega) = \frac{L}{V} \frac{1 + \frac{8}{3} \left(1.339 \omega \frac{L}{V} \right)^2}{\left(1 + \left(1.339 \omega \frac{L}{V} \right)^2 \right)^2}$$

where ω is the radial frequency, L is the turbulence length-scale and V is the aircraft velocity²². This input can be alternatively defined as the Auto-Correlation function pertaining to $\Phi_{ww}(\omega)$, i.e.

$$V(t) = R_{22}(t) = \frac{1}{2\pi} \int_{-\infty}^{\infty} \Phi_{ww}(\omega) e^{j\omega t} d\omega$$

The Von Karman Spectrum can be expressed in a more practical form as the Auto-Correlation function of the filtered MFB impulse,

$$V(t) = \frac{\overline{u_g(\tau) u_g(\tau + t)}}{u_g(\tau)^2}$$

where u_g is the MFB filtered impulse gust velocity, the overbars denote averaging and τ is an integration variable. The solid line is the Fourier Transform result and differs from the Auto-Correlation result (dotted line) in that it takes negative values away from the peak. As a consequence the Auto-Correlation result was preferred for the present work.

The IDPSD Method procedure is as follows:

1. $U_\sigma V(t)$ is formed, say using equation (6).
2. The input is fed into the linearized aircraft model with linear gain K and the response of the various loads is obtained (e.g. wing root bending and torsional moments).
3. The response of the load whose design value is to be calculated is isolated, convoluted by $V(t)$, normalized by its own energy and multiplied by U_σ , the design gust velocity.
4. The resulting signal is the input that maximizes the response of the chosen load for this particular linearised gain, K . The signal is then fed into the nonlinear system in order to obtain the response of the load whose design value is to be calculated and also the responses of the correlated loads.
5. The procedure is repeated from step 2 with a different K .

Reference 21 suggests that the values of the linearized gain should be between 0 and 1.

Table A4.1 Elements of Deterministic Methods⁴

Element	Matched filter (Scott e.a.)	IDPSD (Noback)	Spectral Gust (Brink-Spalink e.a.)
Impulse Strength k	k <u>variable</u>	$k = U_\sigma$	$k = U_\sigma \cdot \sqrt{T}$
Gust Prefilter $G(jf)$	$ G(jf) \approx \sqrt{\Phi^n(f)}$ One set $\varphi(f)$	$ G(jf) = \sqrt{\Phi^n(f)}$ One set $\varphi(f)=0$ For <u>all</u> f	$ G(jf) = \sqrt{\Phi^n(f)}$ four sets $\varphi(f)$
Aircraft System $H_1(y)$	(Nonlinear) set of equations for output y	<u>Linearized</u> Equations; <u>Variable</u> "equivalent gain"	Nonlinear set of equations for output y
Calculation y -norm:	$y_{\text{norm}} = \left[\int_{-\infty}^{\infty} s^2(t) dt \right]^{1/2}$ $= \left[\int_{-\infty}^{\infty} s(jf) s^*(jf) df \right]^{1/2}$ <p>-----</p> <p>For <u>linear</u> system:</p> $y_{\text{norm}} = \left[k^2 \int_{-\infty}^{+\infty} H_1 \cdot H_1^* G \cdot G^* df \right]^{1/2} = k \bar{A}_y$ <p>if $k = U_\sigma \rightarrow y_{\text{norm}} = y_{\text{des}}$</p>		
" <u>Critical</u> <u>gust</u> <u>profile</u> " $w(t)$	For linear systems same profile for matched filter and IDPSD		SG stops here: <u>Four values</u> for y_{norm} ,
Aircraft System $H_2(y)$	Nonlinear set of equations		$y_{\text{des}} = \frac{y_{\text{norm}}(\text{max})}{\sqrt{T}}$
Y_{des}	<u>Variable</u> k $y_{\text{des}} = [y_t]_{\text{max}}$	<u>Variable gain</u> of $H_1(y)$ $y_{\text{des}} = [y_t]_{\text{max}}$	

4.7 Appendix A4.2 Description of Aircraft Models

Three symmetrical aircraft models have been considered in this research. The first one is a simple model of a large transport aircraft with two degrees of freedom, pitch and plunge, and a load alleviation system that feeds back the centre of gravity acceleration to aileron deflection. The model is shown in figure A4.5. The functions $C(s)$ and $D(s)$ are the transformed Wagner - and Küssner functions representing unsteady aerodynamic loads. Output y in the figure is the centre of gravity acceleration, and output z is the centre of gravity acceleration caused by aileron action only. This model is called the Noback-model in this report.

The second model represents an aircraft with "Fokker-100-like" characteristics. This model has the two rigid degrees of freedom pitch and plunge, and ten symmetric flexible degrees of freedom. This flexibility is represented by the first ten natural modes of the aircraft structure. Aerodynamic forces are calculated with strip theory, and unsteady aerodynamics is accounted for by Wagner - and Küssner functions. The wing has 27 strips and the tail 13; the fuselage is considered as one lifting surface. The Wagner - and Küssner functions are calculated at 3 locations on the wing and at 1 location on the horizontal tail.

The gust penetration effect and the time delay of the downwash angle at the tail with respect to the wing are included. Taking these two effects into account, makes it necessary to apply time delays to the gust input, and to the state variables (because the angle of incidence at the reference point on the wing is a function of all states) respectively. Especially the latter considerably increases the total number of system states.

A Load Alleviation System is implemented in the model that feeds back the load factor to a (symmetrical) aileron deflection. Figure A4.6 shows the aircraft system with the feedback loop to the aileron input. The configuration of the Fokker 100 model used in this report is:

$$m_{a/c} = 40,000 \text{ kg} \quad I_y = 1.782 \cdot 10^6 \text{ kgm}^2$$

$$V = 220 \text{ m/s, altitude} = 7000 \text{ m}$$

centre of gravity location at 25 % mean-aerodynamic-chord.

The third model has been distributed at the Gust Specialists Meeting of March 1995. It represents an A310 aircraft, containing plunge, pitch, and 3 symmetric flexible degrees of freedom. Unsteady response is assumed instantaneous, and gust penetration is not represented. The aircraft with control system is depicted in figure A4.7. The centre of gravity acceleration is fed back to both the ailerons and the spoilers through a feedback gain of 30 degrees per g load factor. Ailerons and spoilers have the same authority: deflections between 0 and 10 degrees. This means that the nonlinearity in this control system is "non-symmetric"; the control surfaces can only deflect upward. The load quantity outputs of this system are the increments of:

- Engine lateral acceleration [g].
- Wing bending moment [lb.ft].
- Wing torque [lb.ft].
- Load factor [g].

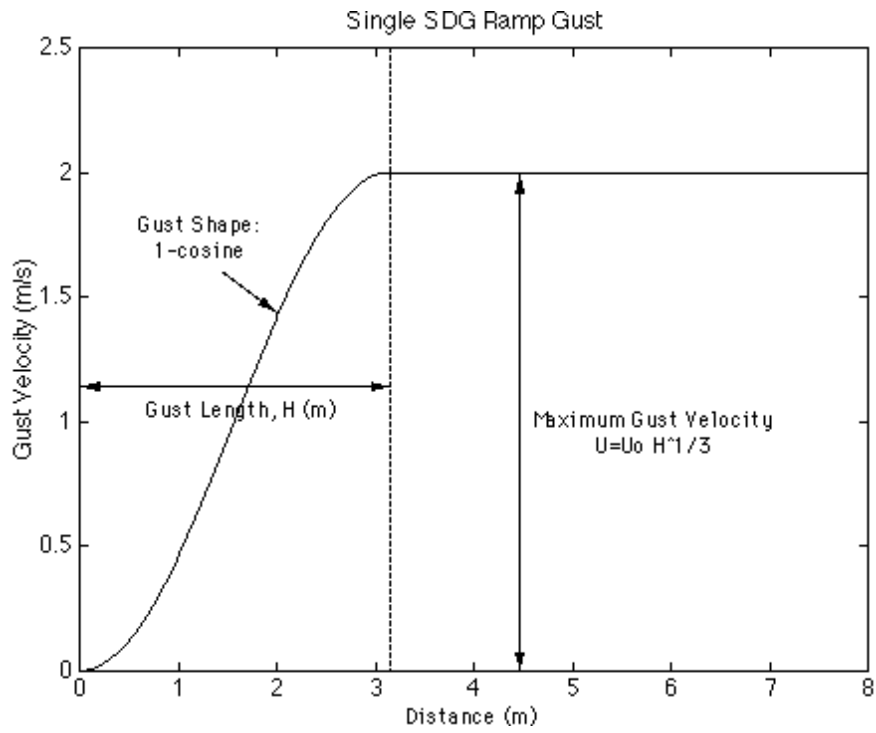

Figure A4.1 Single SDG Gust

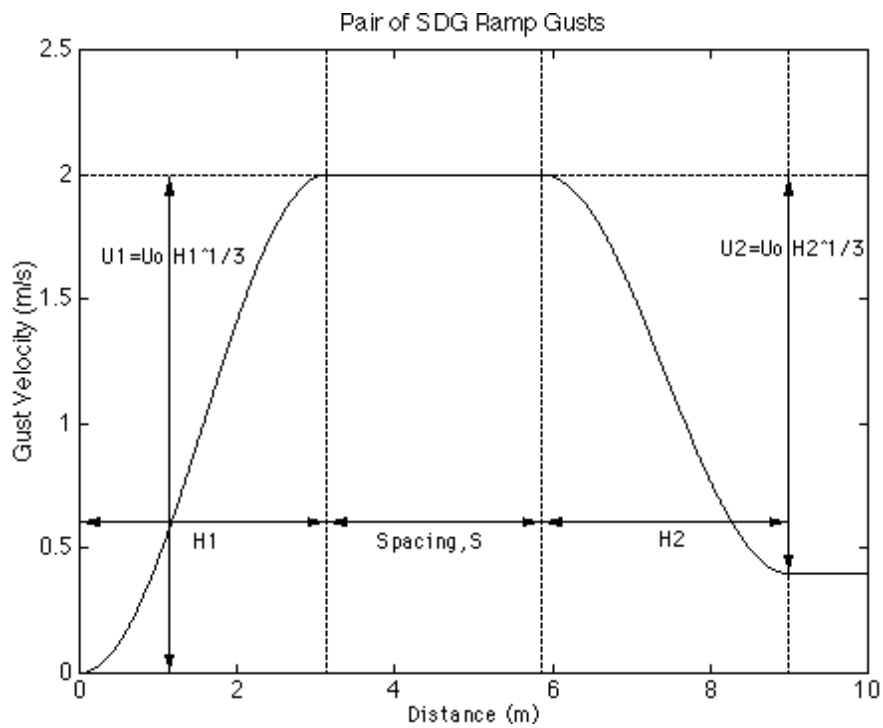

Figure A4.2 Pair of Statistical Discrete Gusts

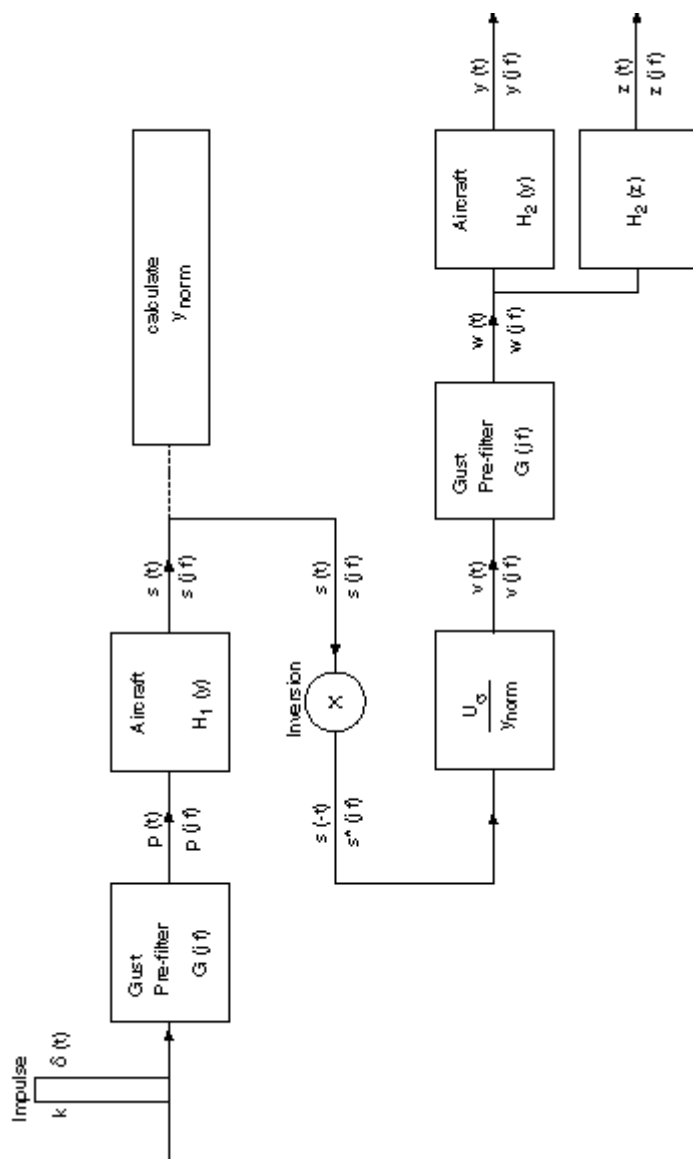

Figure A4.3 Process for Deterministic Methods

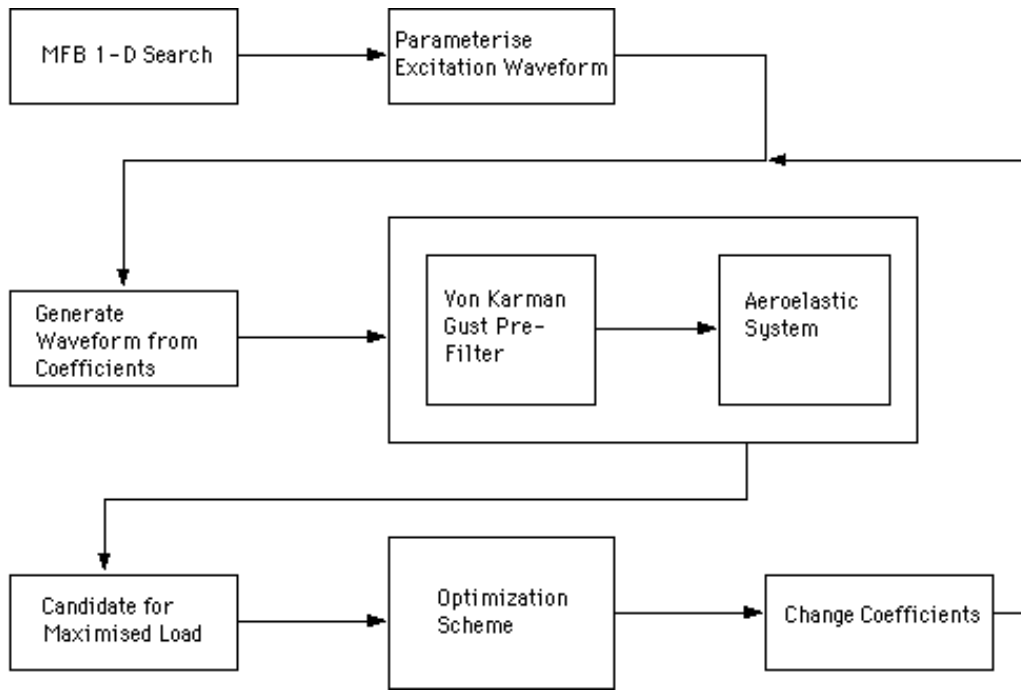

Figure A1.4: Graphical description of MFB Multi-D procedure

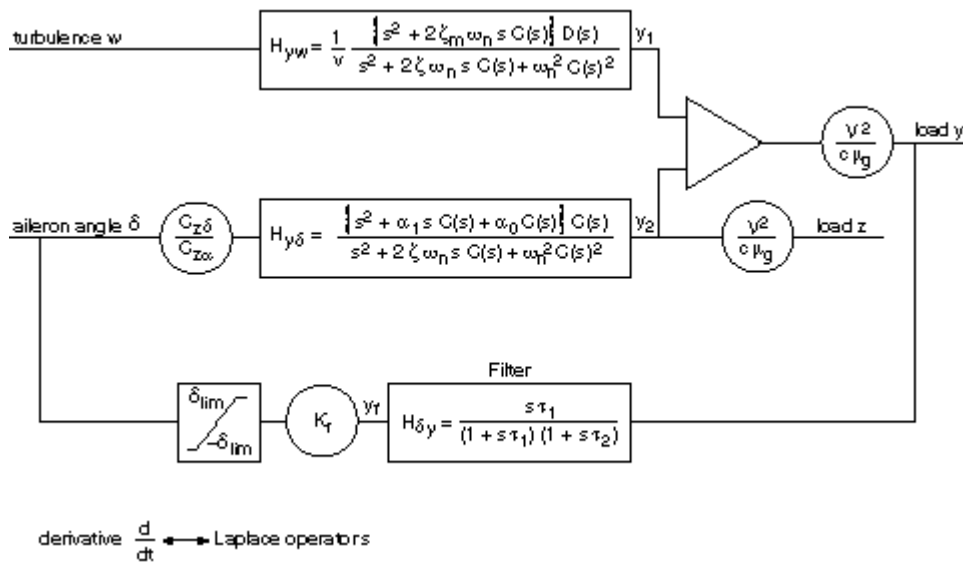

Figure A4.5 Noback Aircraft Model

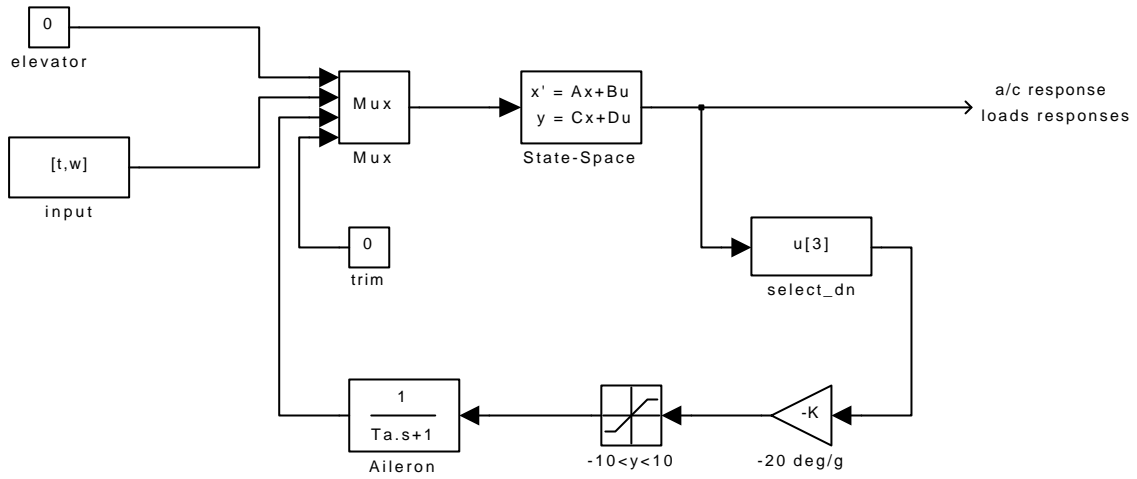

Figure A4.6 Fokker-100 Model

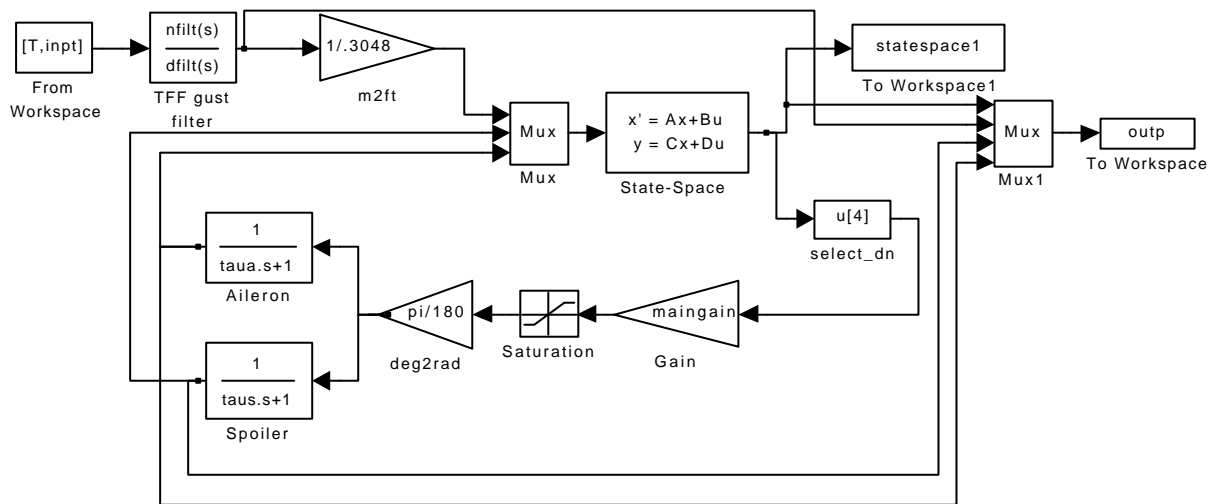

Figure A4.7 A310 Model

5 A More Global Approach

5.1 Why a more global approach

It comes from the necessity to get rid of insufficiencies of classical load regulations, the main lines of these regulations being:

- Limit loads are defined as "maximum loads" expected in service.
- Regulations prescribe the set of loading conditions (ex.: manoeuvres), or directly the computation procedure (gust, ground loads), to be considered for finding these "maximum loads".
- Ultimate loads result from multiplication of limit loads by a prescribe safety factor.

The sources of difficulties are principally:

- The chronic lack of exhaustively of regulation loading conditions set up from flight experience of past programme.

Already with conventionally controlled aircraft manufacturers had to add "company" design load cases, for instance to cover countered maneuvers where the pilot, remaining inside limit values of "official" load factors and control surface deflections, could easily make severe structural loading.

Matters worsen when new technologies come, which has been met, in particular with:

- the design of fly by wire combat aircraft and the associated concept of care free piloting, where "maximum loads" can be reached every day as result of extremely complex and various dynamic maneuvers, far from regulation maneuvers.
- the design of re-entry vehicles with their "hot structures", where limit conditions result from combinations of mechanical, thermal loads, and aging conditions, closely depending on structural design.

- The need to clarify the meaning of the word "maximum loads" ; its have been often restricted to loading conditions corresponding to maximum values of "general load" components, notion becoming insufficient when "long beam theory" is not relevant (e.g. delta wings), where local structural failure modes are not only led by "general loads".

Still more severe difficulties occur when thermal loads, or any physical or chemical environmental conditions, or aging and fatigue effects, must be considered in addition to mechanical loads.

- The safety factors philosophy
 - first it is a need to clarify the present safety factor rules when other physical effects (thermal, environmental, aging/fatigue, ...) are added to mechanical loads, where several components of safety factor must appear, corresponding to each physical effects.

- more fundamentally we have to open the debate of safety factor evolutions with innovation, with the progress both of design solutions and of analysis process, knowing that we are to day unable to quantify, inside the present global safety factor, separated contributions of loads, manufacturing, strength, ..., or of any other uncertain elements.

Faced with these questions since the mid 70ies with MIRAGE 2000 programme and after with RAFALE, DASSAULT AVIATION have developed and experienced the "more global approach", already presented to AGARD SMP in 1984 and 1996 (ref. 1 and 2) and reminded hereafter to be proposed now to the RTO community.

To note that this approach, including extensions to thermal loads, have been carried by ESA and CNES for design loads of HERMES space shuttle .

5.2 Limit Loads

5.2.1 Basic principles of the "more global approach" for limit loads

They are:

- To keep (even to reinforce) the limit load definition of classical regulations:

Limit loads are the maximum loads expected in service .

- To consider that it is not necessary to prescribe any particular set of loading conditions within regulations.

"Maximum loads" must come from scenario analyses of missions/flight conditions/ environments, suited to the designed product.

In practice, this don't prevent aircraft designer from building a set of

"reference design load cases",

under his responsibility and to demonstrate that these "reference design loads" envelop the maximum loads expected in service.

- To clearly define the meaning of the sentence :

"Maximum loads expected in service" ,

and to propose a practical process for their determination (see hereafter).

5.2.2 "Maximum loads" through "Load Severity Indicators"

The notion of "maximum Loads" has a meaning only through the effects of loads induced on the structure:

A load case is referred to as a maximum load case as soon as it produces the maximum value of at least 1 failure mode strength criterion.

Which need in theory :

- To identify of all structure failure modes liable to occur under mechanical loading (local stress - or strain - induced ruptures, local or general buckling, non-allowable overall deflections, ...), and more generally under all other physical effects (thermal, aging, ...).
- To allocate to each one of these failure modes of a **scalar strength criterion** calculable in function of the loading conditions and of the structure design. When necessary the strength criteria may take into account thermomechanical and aging effects.
- To sweep all "expected" loading conditions (see 6.2.3) calculating each of these strength criteria.

To reduce the effort of monitoring thousands of local strength criteria, we have introduced the notion of :

"Load Severity Indicators".

Which are few tens to few hundreds of scalar indicators standing in monotonic relation to a structure area strength criteria, whatever the loading.

As "load severity indicators" are generally chosen:

- components of stress or strain in pilot points,
- internal reactions (e.g. : loads on the wing or control surface attachment bearings),
- classical "general loads" components (shear force, bending moment ...) on particular sections.*

Computation management will be simplified if the severity indicators remain linear functions of the loads ; they can then be calculated at low cost in function of flight parameters, starting from a matrix of "**load severity indicator operators**" giving the relation with flight mechanics state vector, this table being built prior to maneuver computations.

The strain gauge distribution of flight test aircraft will attempt to reflect the choice of load severity indicators, thereby providing for calibration and validation of the operators and thus, of the whole load computation process.

Once "load Severity Indicator operators" are built/calibrated/validated, the computer cost of maximum load case selection comes cheap, corresponding to linear combinations of "load severity indicator operators", downstream sweeping of:

- flight mechanics simulations, (numerical simulations / real time flight simulator),
- environmental aircraft responses (gust, turbulence, ...),
- ground load conditions,
- etc... ,

marking as limit load case conditions where maximal of "load severity indicators" are reached,

and/or :

checking that these maximal remain under the level of "reference design loads" chosen a priori.

5.2.3 "Maximum Loads Expected in Service"

That means that we have to sweep all possible scenario, during an aircraft life, of missions / maneuvers / environments / ..., computing previous Load Severity Indicators, and selecting, as design load cases, loading conditions where load severity indicators are maximal.

When relevant, it can correspond to probabilistic analyses in the spirit of Continuous Turbulence regulations(e.g. FAR 25, appendix G)

- to determine from mission analysis **limit value of "load severity indicators"**, corresponding to **1 average exceeding per aircraft life** .
- to ensure that the limit load set (or the "reference design load" set of the manufacturer) envelop these limit values.

5.2.4 Application to design of "fly by wire" aircraft

It have been detailed in reference 2, the principle is to integrate the designs of structure and of Flight Control System via the following iterative process :

- Start from a first set of "reference design loads"
 - from aircraft manufacturer experience
 - reflecting flight quality requirements
- Design of airframe
 - supported by F.E./Aeroelasticity analyses / optimizations
 - delivering "load severity indicators" operators and their associated limit values
- Design of F.C.S.
 - to maintain "load severity indicator" responses below their limit values for all possible scenario of missions / maneuvers / environments,
 or
 - to define new limit load cases (→ airframe design iteration).

5.3 Ultimate load definition and Safety Factors for multiphysical effects

When limit loads contain only "mechanical effects" the definition could remain "as is" :

Ultimate loads result of multiplication of limit loads by a prescribed safety factor.

When others physical effects (thermal, aging, ...) occur in limit conditions, **specific safety factors must be applied successively and separately on each of these effects** (the others remaining at their limit values) ; for instance:

- **on heat fluxes or on parts of heat fluxes or on resulting temperature fields.**
- **on life duration for fatigue/aging loads.**
- **for each kind of other physical/chemical environmental conditions.**

The nature and the levels of these specific safety factor must be adapted for each type of vehicle liable to meet these special physical effects, levels could result from probabilistic considerations (see § 6.4.2) .

Another requirement for these multiphysical effect safety factors is **to keep possible a verification test in the ultimate conditions**; it leads to avoid safety factors on "calculation beings" physically inseparable by test conditions as with the present thermal stress safety factor of AIR2004-E and other regulations.

5.4 Safety factors evolution with innovations

5.4.1 The particular case of fly by wire aircraft

Knowing that the flight control system, with a "care free piloting functions, can protect against limit load overshoots, a debate may arise as to the pertinence of a change to the safety factor (currently 1.5) ; such discussions come up against great difficulties :

- The current safety factor covers aspects other than the occurrence of load conditions that are severer than the limits ; they involve, amongst others :
- ✓ potential flaws in the load computation models (force fields applied to the airframe) in function of loading conditions (flight mechanics state vector).
- ✓ every unknown differences between the airframes in service and the one that was qualified (non-detected manufacturing or material defects, various non-detected corrosion-, fatigue- or impact-induced damage types, etc...).
- For all of these factors, there are non sufficiently conclusive probability models available that give the load or structure strength overshoot statistical distributions ; we do not know how to quantify these factors separately within the global safety factor.
- The global safety factor of 1.5 can be justified quantitatively only by the acquirements of

experience, based on observation over half a century of a globally satisfactory structural strength of aircraft in service ; but this safety factor cannot be decorrelated from the rest of the environment of the used construction techniques, analysis methods and verification process. Any partial change that occurred in the technical environment requires a demonstration to establish that there is no regression in Safety (cf. qualification rules for composite materials), although this would not mean that any likely gain in one point can be exchanged against a reduction of the margin in another point.

A further element for debate bears on the advantages that might be drawn from a potential safety factor reduction:

- For new projects, the potential gain in terms of structure mass is likely to be slim, the safety factor-to-mass exchange ratio will remain far below proportionality (fatigue sizing of metallic parts, design to technological minimal for large areas, areas with design-sizing aeroelasticity constraints, ...).
- The discussion is somewhat more open, for existing and proven by flight service airframes, when considering any specific or circumstance-related maneuver performance characteristics improvement.

5.4.2 Towards probabilistic approaches

At long range a complete reconstruction of structural analysis process would be required , to get out of the above mentioned piling of safety margins, resulting from ignorance of the part, within present global safety factor, assigned to any innovation of design solution or of analysis method .

This long range research could be founded on a full probabilistic approach, considering all items of airframe qualification : loads, types of design ,calculation and test process , manufacturing process, flight service use, fatigue & corrosion and any other aging effects, control plan , ..., and human error possibilities everywhere inside the process .

It is a subject in itself, which could be proposed to further RTO discussions .

References :

1. C. PETIAU, M. DE LA VIGNE Analyse Aéroélastique et Identification des Charges en Vol AGARD conference proceedings No 373 - "operational load data" - Sienne 1984 .
2. C. PETIAU Evolution de la philosophie des charges de dimensionnement des avions militaires .AGARD report No 815 - "Loads and requirements for military aircraft" - Florence 1996

Appendix A

The Impact of Electronic Flight Control System (EFCS) Failure Cases on Structural Design Loads

H.-M. Besch¹, H.-G. Giessler², J. Schuller³
Daimler-Benz Aerospace Airbus GmbH Hamburg
Structural Dynamics, Loads Department

¹ H.-M. Besch, Dipl.-Ing., Head of Loads Department, Member of AIAA

² H.-G. Giessler, Dipl.-Phys., OFIS Project Leader

³ J. Schuller, Dipl.-Ing., Project Engineer System Failures in Loads

This page has been deliberately left blank



Page intentionnellement blanche

Abstract

For structural design loads, the most relevant benefits of the advent of fly-by-wire and digital flight control system are drawn from more sophisticated control of the aircraft and from the flight envelope protection functions. In parallel, rarely recognized even by the engineering community, the number of failure cases to be considered in A/C design is significantly increasing due to the growing complexity of the systems, eroding the aforementioned benefits. The monitoring system, designed to detect and to trigger removal of failure cases, can ease but not nullify the impact of failure cases on loads.

Experience gained in the structural design of an A/C with fly-by-wire and digital flight control system is summarized, highlighting the necessity to cover system failures in calculating structural design loads.

The current requirements for structural design of EFCS A/C are explained. By giving several examples of system failures of the new EFCS technology, it will be demonstrated how the requirements are met, whereby the influence on structural loads is especially emphasized.

Generic system-failure cases (software/ hardware) having an influence on structural loads, are runaway, jamming and oscillation of control surface(s), the latter we call Oscillatory Failure Cases (OFC). OFC cause significant component loads and can cause resonance phenomena which may generate excessive loads for poorly damped rigid body and flexible modes. This motivated the research programme Oscillatory Failure Case Identification System (OFIS) which, as a future component of the common Monitoring Systems, aims at detection of OFC in time. We describe the current status of OFIS that exploits the specific properties of OFC for detection enhancement.

Furthermore, by investigating the inverse effect, namely, that structure loads have an influence on system layout (or modification), this presentation will underline the necessity, mentioned above, of co-operation between all disciplines in modern aircraft design.

List of Symbols

A/C	Aircraft
AFC	Automatic Flight Control
ALE	Adaptive Line Enhancer
AP	Autopilot
ASP	Adaptive Signal Processing
CoF	Continuation of Flight
Conf	Confirmation, issues true when input is true for a confirmation time
DO/OFIS	OFIS based on Deflections-Only measurement
DRP/OFIS	OFIS based on Detection of Resonance Phenomena
EFCS	Electronic Flight Control System, esp. control laws and protection functions
FBW	Fly-By-Wire
FC	Flight Control

FCC	Flight Control Computer
Fh	Flight hour
FIR	Finite Impulse Response
FSF/OFIS	OFIS based on Fault Sensitive Filter approach
FUL	Failure Ultimate Loads
HQ	Handling Quality
IPB	Innovation Process Based
FAR	Federal Aviation Requirements
FDI	Fault Detection and Isolation
JAR	Joint Aviation Requirements
KF	Kalman Filter
LAF	Load Alleviation Function
MLA	Manoeuvre Load Alleviation
MMEL	Master Minimum Equipment List
MS	Monitoring System
NFUL	Non-Failure Ultimate Loads
NOP	Normal Operation
OFC	Oscillatory Failure Case
OFIS	Oscillatory Failure Identification System
P _{Fh}	Probability of failure per flight hour
PIO	Pilot Induced Oscillations
q	Probability of being in failure state
RF	Reserve Factor
SF	Safety Factor
SSA	System Safety Assessment
t _{fail}	Mean time spent in failure state
TLU	(Rudder) Travel Limitation Unit
TFM/OFIS	OFIS based on Transfer Function Monitoring
ToO	Time of Occurrence

A.1 INTRODUCTION

Introduction of EFCS has a profound effect on all disciplines involved in civil A/C design. From Loads point of view, three main interactions with system failure cases exist:

Firstly, the structural design is substantially affected by special functions implemented in the EFCS (via software) to reduce structural design loads (e.g. Manoeuvre Load Alleviation Function).

Secondly, EFCS control laws and active flight envelope protection modify the response of the A/C due to any disturbance, and thus have an effect on design inputs as well [1].

And consequently, thirdly, faults or loss of functions enter design conditions, and influence loads level and (if no provision is taken) the level of safety. This is the issue of this paper.

In order to show and to prove that the required safety standard is maintained even in failure condition [2], it is

necessary to investigate system failure cases for their influence on structural loads, which requires more effort as for conventional A/C.

Failure case investigations show, that structural design conditions do not cover all system failure conditions. If no provisions were taken, these system failures would become design conditions which is a situation to be avoided. In the course of this presentation we will investigate whether this desideratum can still be met in the new generation of A/C and arrive at what will be, we trust, a convincing conclusion.

In addition, we will demonstrate the influence of EFCS failures on structural design, emphasizing the necessity of co-operation among the different disciplines involved in civil A/C design (here HQ/Systems/Loads/Stress). Further, the new requirement situation arising from this context is discussed and interpreted with special considerations of how the safety level can be maintained for such an A/C.

We treat in some detail the problematic class of oscillatory failure cases and shortly describe our monitoring solution OFIS.

A.2 CERTIFICATION REQUIREMENTS

Loads certification of A/C is reached when it can be shown that the structure complies with all relevant requirements which are JAR-25 [3] and FAR-25 [4].

These requirements specify manoeuvre, gust and ground loads condition, which, via simulation (using an adequate modelling of A/C and systems) and subsequent envelope forming, result in limit loads.

Definition: Limit Load

The maximum load to be expected in service. The structure must be able to support limit loads without detrimental permanent deformation. •

For standard design tasks, a safety factor of normally 1.5 is applied to the limit loads resulting in ultimate loads.

Definition: Ultimate Load

This is limit load multiplied by a prescribed factor of safety, for static design conditions this factor is 1.5. The structure must be able to support ultimate loads without failure for at least 3 seconds. •

This accounts for uncertainties in the design process and for scatter in material properties and manufacturing.

In addition to the non-failure static design, the influence of flight control system failures on structural design has to be investigated showing compliance with the Notices of Proposed Amendment to JAR-25 (NPA 25C-199 - Interaction of Systems and Structure), which resulted from harmonization of JAR and FAR. The regulations have been established in co-operation between industry and authorities during A320 and A330/A340 design phases.

Definition: Flight Control System Failures

Flight Control System Failures are specified either in terms of control surface movement as a direct consequence of the failure case (runaway or oscillating) or by describing the failure case itself (loss of limiter). For each failure case a probability of failure per flight

hour p_{Fh} and a duration of the failure case t_{fail} is specified. •

The following two definitions affect the way the failure case is to be investigated.

Definition: Time of Occurrence (ToO)

ToO is the time a transient or a permanent failure with influence on loads occurs by faulty movement of one or more controls including pilot corrective action. •

Definition: Continuation of Flight (CoF)

CoF refers to the time after occurrence of the failure, lasting until the end of the flight or until the failure condition is removed. •

These definitions replace the former active and passive part of a failure case.

We give examples for ToO and CoF problems: ToO: For failure cases which are likely to become critical at ToO, the conditions as given in the failure case definition are to be simulated resulting in "manoeuvres" not included in the standard design conditions, for instance asymmetrical elevator runaway or oscillatory surface movements (OFC). CoF: For failure cases which remain undetected by the MS or cannot be removed otherwise (pilot action, inspection ...) simulation of design condition with AC in failed state must be done.

The failure limit loads envelope is to be multiplied by a failure case dependent safety factor in order to result in failure ultimate loads. Two different formulas for deriving the safety factor for ToO and CoF respectively have to be applied:

At Time of Occurrence

Given the probability of failure per flight hour p_{Fh} for a specific failure case, the safety factor to be applied to the ToO loads simulation outcomes is given by

$$SF_{ToO} = SF_{ToO}(p_{Fh}) \quad (1)$$

using Fig. 1 :

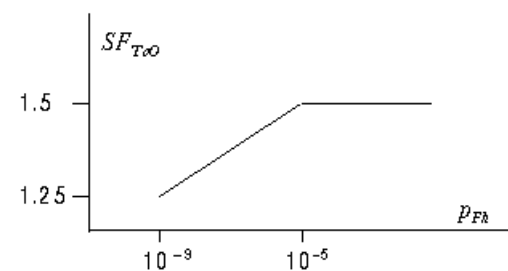

Fig. 1 Safety factor for ToO versus probability of failure per flight hour p_{Fh}

For Continuation of the Flight

Given the probability of failure per flight hour p_{Fh} for a specific failure case and t_{fail} , the average time the A/C is operating in failure condition, the safety factor to be applied to the CoF loads simulation outcomes is given by

$$SF_{CoF} = \begin{cases} 1.5 & p_{Fh} \geq 10^{-3} \\ SF *_{CoF}(p_{Fh} t_{fail}) & else \end{cases} \quad (2)$$

using Fig. 2

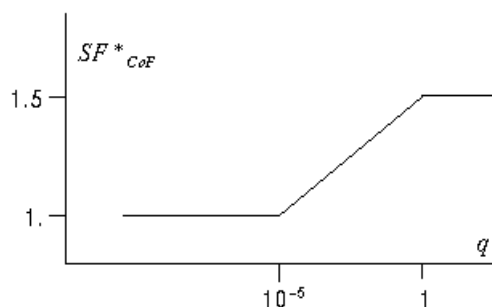

Fig. 2 Contribution to Safety factor for CoF versus probability of being in failure state $q = p_{Fh} t_{fail}$, the product of p_{Fh} and time spent in failure state t_{fail}

Summarizing we have to show for ToO, that the structure can withstand the loads due to system failure cases. For CoF we have to show, that in addition to loads due to the persisting system failure case, the structure can withstand loads resulting from design criteria on top.

For system failures that can be shown to be extremely improbable, i.e. $p_{Fh} < 10^{-9}$, no investigation is required.

A.3 EFCS FAILURES

The basic rule for System Failure Cases in A/C design is to show, that the standard level of safety is maintained during the incident itself and for the completion of the flight.

A catastrophic consequence has to be shown to be extremely improbable and is thereafter not considered for the structure. This evokes the following requirements:

- the flight handling of the A/C with systems in failure state must not overload the crew's ability to counteract the possible A/C reaction and to complete the flight, and
- the A/C structure must not be overstressed by the incident itself or during the completion of the flight.

To meet these requirements, a justification is carried out as done for all large transport A/C and is documented in the so called System Safety Assessment (SSA) established by the System Departments. A lot of defined failure cases consist of single cases which are comprised to a worst case scenario. Each of these defined system failures has to be analyzed for its impact on the structural loads.

All possible failure cases are investigated in detail by establishing fault trees and performing an analysis on the

probability of each failure. The total work is summarized in the SSA mentioned above.

Two main lists of system failures have been drawn up:

- automatic flight control (AFC) failures (autopilot (AP))
- flight control (FC) failures.

AFC-failures are not considered here as they are well known for conventional A/C. Their influence on the structure is of minor importance except those involving oscillatory failure cases which are treated in connection with the FC-failures.

FC-failures (above all, those of structural relevance) are all failures affecting any control surface, its control unit (jacks, servo valves etc.) or the associated computers. These failures may be indicated in the following as failures of the EFCS.

All further discussions are restricted to failures having their origin in a computer error.

Before giving types of EFCS-failures, something shall be said about the "Monitoring System" (MS), which keeps the EFCS under surveillance. This MS checks the computer output (and all control surface deflections/rates) for their compatibility with the A/C flight condition (configuration, pilot command etc.) and controls the computer operation itself.

For example during normal operation Flight Control Computer 1 (FCC1) is on line where Flight Control Computer 2 (FCC2) is in stand-by mode. When FCC 1 fails, FCC 2 takes over the job after being initiated by the MS.

If the MS has recognized an error within the air data computers, the loss of the normal control laws is the consequence, and the alternate ones come on line, again initiated by the MS.

EFCS-failures having an influence on structural loads are mainly as follows:

- unintended runaway of any control surface by computer error or mechanical damage
- loss of control over any control surface by disconnection or during change from one computer to another
- unintended retraction of any control surface
- loss of limitations (e.g. rudder travel limiter)
- oscillation of control surfaces
- degradation of rate of deflection (e.g. because of low hydraulic pressure)
- loss of special functions (load alleviation).

In the next chapter, several system failures are described and their consequences on the structure are demonstrated as basic examples for the complete failure case analysis process. The complete work of system failure case analysis requires an extended (and iterative) effort, and is far beyond the scope of this presentation.

Before concluding this chapter, an economic aspect should be mentioned. Up until now, all system failures described have been Normal Dispatch Cases. But there is

also the approach of dispatching the A/C under known system failures.

Airlines are interested in being able to fly the A/C to the next maintenance center without repairing the A/C at a remote airport lacking facilities. Furthermore, it might be allowed to operate the A/C under some restrictions up to the next planned maintenance check.

The minimum system (hardware or software) required for dispatching the A/C, that is which have to be in normal operating mode, are laid down in the so called Master Minimum Equipment List (MMEL). Two kinds of MMEL-dispatch cases are distinguishable:

- Failures, which allow dispatch of the A/C under MMEL and
- subsequent failures after the A/C has been dispatched under MMEL-conditions.

The second item is of especial importance for the level of safety because the A/C no longer retains its original redundancy of the EFCS. Thus it is more likely that any further subsequent failure will have consequences. This is expressed by the higher probability of the MMEL failures. The MMEL approach is used particularly for failures affecting the LAF/MLA, because this function reduces the loads in severe turbulence but has - for some failure states - no effect on A/C handling. An example is given in the next but one chapter.

A.4 PROCEDURE TO HANDLE FAILURE CASES IN LOADS

As mentioned above, possible system failures are summarized in the SSA. Each item of the SSA is to be processed according to Fig. 3 which we are going to describe now.

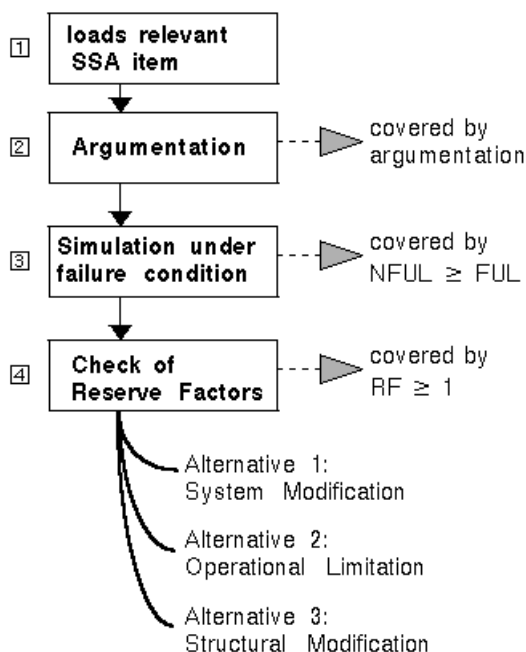

Fig. 3 Investigation of SSA items

The first step 1 of the investigation of system failures having an influence on the structure is to select the loads-relevant failure cases from all failures of the SSA. The co-operation between System and Loads Department starts at this point. Both Systems and Loads derive a scenario for each selected case which generally includes the worst conditions in order to have a pessimistic approach for the impact on structural loads.

For many cases it may be sufficient to cover the failure loads by argumentation 2 and therefore satisfy the requirements.

If it is not possible to solve a case by arguing (i.e. failure loads expected to be close to or greater than the design envelope loads) a loads calculation has to be carried out 3. For each affected component the ultimate loads under failure conditions (FUL-Failure Ultimate Loads) are calculated according to the requirements and then compared with the non-failure ultimate loads envelope (NFUL-Non Failure Ultimate Loads).

It should be noted, that the non-failure ultimate loads are obtained by multiplying the limit loads by a SF depending for time of occurrence on the probability of occurrence of the failure and for continuation of flight on the probability of being in failure state.

If the failure loads are below the non failure ultimate loads $NFUL \geq FUL$, the investigation for this case is finished.

If, however, the FUL exceed the $NFUL$, there is a problem. Fortunately, there are also several ways to solve it. Especially at this stage of the failure case investigation, good-working co-operation between the different involved disciplines becomes of particular importance.

One possibility is to use structural margins 4. The structure can stand the design ultimate loads at the least. This means that it can often stand higher loads. The proportion between the ultimate loads level and the real capability of the structure is figured in the Reserve Factor (RF).

If the RF for loads under failure condition is greater than 1. the investigation is finished; however this special failure case has now become a design case which must be considered in all later stress calculations. This is an undesirable situation.

To avoid this or in case of a RF being less than 1., the following alternatives remain:

- Alt.1: System Modification: This can lead directly to a decrease of failure loads or can result in a reduction of the probability of occurrence (the system is now more reliable), so that a lower required safety factor can be applied. Another way is to apply system modifications that change the parameters defining the failure case in a way favorable for loads.
- Alt. 2: Introduction of appropriate flight limitation to reduce loads.
- Alt. 3: Reinforcement of structure.

The selection of the alternatives will be done in the light of timing, cost and feasibility.

A.5 CONSEQUENCES ON DESIGN

In the following, some basic examples of system failures are given to demonstrate how they influence the structure and/or how they may affect system design.

The first example is an antisymmetrical runaway of elevators caused by a computer error, Fig. 4 .

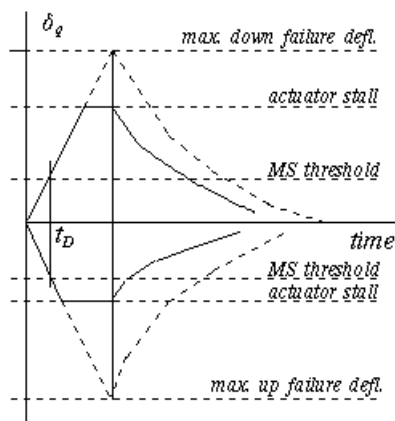

Fig. 4 Supervision of antisymmetrical elevator runaway (δ_q) detected by MS at t_D

The elevators are signalled to deflect up to the stops if not limited by the aerodynamic hinge moment. The MS recognizes the sudden full command as a fault and holds up the surface at a certain position. Then a stand-by computer device takes over control of the surfaces, moving them back to the originally commanded position using the manual normal pitch law of AP pitch law. The probability of occurrence of, say, $p_{Fh}^{ToC}=10^{-5}$ requires using a SF of 1.5 to obtain the ultimate failure loads for this failure that is critical at ToO. The component affected mainly by this failure is horizontal tailplane (HTP) and the associated structure (attachments, rear fuselage).

Resulting FUL caused by this runaway exceed the total NFUL envelope applying the normal design condition. Due to the fact that the system can not be modified at this late stage, a stress check is required with the aim of using structural margins. The responsible stress offices have to show that the HTP-structure as dimensioned can sustain the high failure loads. But, at this point we should emphasize, that a failure case has now become one of the design cases for the HTP and reserve factors are not fully usable for further A/C versions.

Another type of failures is the group of control law reconfiguration failures. Table 1 shows the different combinations of pitch and lateral control law degradations with their appropriate probabilities.

Pitch Lateral	Normal	Alternate with Static Stability	Alternate without Static Stability	Direct	Mechanical Back-up
Normal	1	Extremely Improb.	Extremely Improb.	Extremely Improb.	Extremely Improb.
Roll Direct with Alternate Yaw Damper	Extremely Improb.	10^{-5}	10^{-8}	Extremely Improb.	Extremely Improb.
Roll Direct without Alternate Yaw Damper	Extremely Improb.	10^{-7}	10^{-7}	10^{-8}	Extremely Improb.
Yaw Mechanical Back-up	Extremely Improb.	Extremely Improb.	Extremely Improb.	Extremely Improb.	Extremely Improb.

Table 1 Typical probabilities of Control Law Reconfigurations

Pitch and yaw mechanical back-up laws normally are extremely improbable ($p_{Fh}<10^{-9}$), therefore it is not required to investigate consequences on A/C structure.

The remaining five cases (roll direct laws and pitch alternate laws) have to be investigated only for continuation of flight (CoF) because the effect on loads during reversion to another law (ToO) is neglectable which has to be demonstrated. Here all relevant design conditions have to be calculated using the different control laws. Due to the low safety factor which has to be applied for these probabilities for CoF these failure cases have always been covered by the non-failure design loads envelope.

A third failure demonstrates the behavior of the transition from a computer which has failed to a standby one.

Again we have a runaway of control surfaces, this time of the ailerons, Fig. 5 , limited by the aerodynamic loads or the stops. The rate of deflection is the maximum allowed by the electrical rate limiter of the control law. After a certain time while the electrically actuated valve is signalled with the maximum input, the MS detects (threshold) the failure automatically and gives a stop command to the valve. Having done this, the function of the faulty FCC1 is transferred to a standby FCC2. During this transition time, Fig. 5 , no control of ailerons is present: they automatically go to zero hinge moment and simultaneously - as always when not powered - return to damping mode.

After the standby computer has been initiated by the MS with aid of the air data computer etc., A/C control is resumed and the control surfaces are commanded to the original flight conditions: that is the aileron is not frozen.

This system scenario has to be investigated for loads at all A/C stations in detail. The result must show that all failure loads are covered by the non-failure ultimate loads envelope.

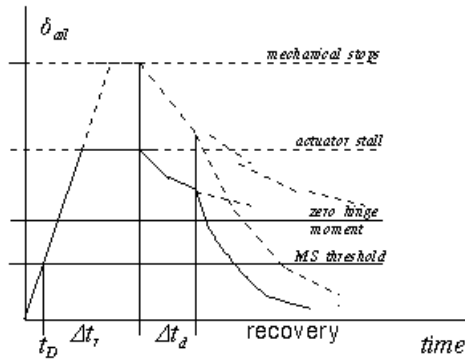

Fig. 5 Supervision of aileron runaway (\square_{aail}) detected by MS at t_D , \square_r is runaway time, \square_d is time spent in damping mode

The next example describes, how the solution of a failure case problem was achieved by modifying the system.

It is a failure concerning the rudder with its so-called rudder travel limitation unit (TLU). The TLU limits the maximum allowed rudder deflection for structural purposes as a function of the speed VCAS (Fig. 6).

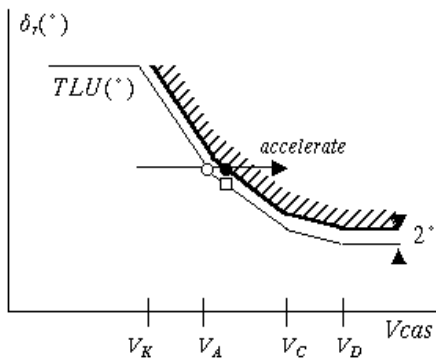

Fig. 6 Limitation of rudder deflection (\square_r) by TLU, solid line is 2° jamming detection threshold.
 o occurrence of TLU jamming,
 • detection of TLU jamming
 □ commanded TLU value

In case of TLU failure the TLU immobilizes at the last commanded rudder position. If the failure occurs at low speed with a higher commanded rudder deflection than the TLU allows at high speeds, it might be dangerous for the structure if the A/C operates at increased speed.

In the beginning of this failure case investigation, it was found that this failure was not detected by any system (e.g. MS) and therefore not reported to the crew. Thus, we were confronted with the unpleasant fact that rudder deflections at high speed, producing loads at fin and rear fuselage which could not be sustained by the structure, were possible. After many solutions had been discussed and a lot of additional calculations had been done, the only economic way of covering this failure and maintaining the required level of safety was to perform a system modification.

It was decided to implement an additional function in the MS which would detect the failure as soon as the commanded position of the TLU decreased to 2° below the jammed position providing a warning on the crew's warning display "AUTO FLT RUD TRV LIM SYS" with the additional remark to use the rudder with care, Fig. 6.

The fifth interesting example of a severe system failure case with consequences for both system and structure design is the oscillatory failure case (OFC), leading to oscillation of one or more control surfaces as a consequence of a system failure. Potential locations of OFC sources are shown in Fig. 7.

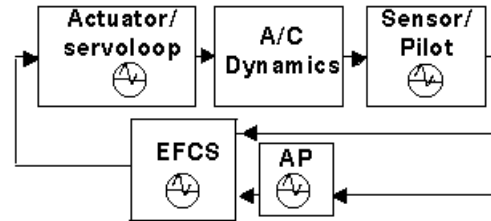

Fig. 7 Potential Location of sources of OFC indicated by ⓐ

The OFC may manifest itself as liquid or solid at the control surface. In liquid OFC, the OFC signal adds to the normal operation (NOP) signal issued by the EFCS and the control surface(s) deflects according to the superimposition. In solid OFC the control surface executes a pure periodic motion.

Solid OFC of control surface occurs, when OFC of actuator/servoloop is solid or when we have an upstream OFC in the EFCS, AP or in the sensor system with no pilot input or feedbacks from the control system. Upstream OFC (i.e. OFC that occur in the EFCS or AP or even in the sensor system) in general manifest itself as liquid at the control surface, because feedbacks from different paths can add. Solid OFC is most severe, because the oscillating control surface cannot execute any damping action that can ease the impact of the OFC on the structure.

OFC frequencies are uniformly distributed over the frequency range where the structure responds to excitation. Amplitudes are determined by A/C and control law dynamics. They are limited by the capability of the associated hydraulic jacks or by the detection levels of the MS.

The requirement demands investigation of the full frequency range, i.e. from the lowest body mode (rigid or elastic) up to the highest elastic mode. However frequencies below 0.2 Hz need not be regarded [5].

The determination of loads is carried out as follows:

The complete, full flexible A/C model from design load calculations in dynamic response analysis is the basis for OFC simulation. A harmonic disturbance is used to analyze the structural A/C response whereby the frequency is varied over the entire range, and the amplitude is kept at unit (1 degree). Thus the transfer functions for unit control surface deflections for different critical stations at all relevant A/C components over frequency are determined. The transfer functions show several peaks for different frequencies, characterizing the eigenvalues (eigenfrequencies) of the A/C structure.

It must be demonstrated, that loads due to OFC with amplitudes as high as the detection level of the MS can be sustained by the structure. This is tested using Fig. 8 : the dashed line is the MS detection level (or, if lower, the actuator performance curve); the solid line represent

allowed angles. They are constructed by dividing the non-failure design loads by the unit load per degree, i.e. allowed angles would generate design loads when used in OFC simulation.

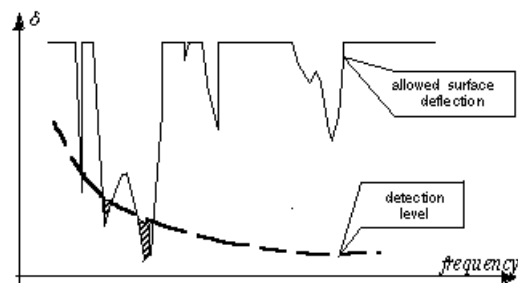

Fig. 8 Allowed Control Surface Deflection

As can be seen from Fig. 8, some peak values of allowed angle fall below the detection level. Thus, loads due to oscillating for this frequency are not covered by the design loads at this station.

Since it may not be possible to reinforce the structure at that time, and since it is not economical to do this for a small frequency range, another solution has to be chosen. There are several options:

- a structural filter to avoid critical frequency
- system modification (e.g. rate limiter in the respective frequency region)
- more restrictive motoring: a special OFC detection device (see Oscillatory Failure Case Identification System (OFIS) below).

A final solution to the problem of OFC is obtained only, when OFIS can be put into practice: occurrence of OFC must be detected by the MS before the loads on the A/C can damage the structure.

When the OFC is such that design loads will ultimately be exceeded, detection must be very fast in order to neutralize the OFC before design loads are reached. This defines the ToO problem.

If OFC remains undetected or cannot be cut-off before completion of flight, then simultaneous occurrence of OFC and standard design conditions must not exceed ultimate loads level. This defines the CoF problem. Even if this can be achieved, an undetected OFC can cause severe fatigue problems even (when small amplitudes) which is due to the relatively large frequency of loads cycles and to the long inspection intervals. This is the fatigue problem associated with OFC.

A.6 OFIS, APPROACHES TO OFC DETECTION

Process monitoring is an indispensable prerequisite for the design of reliable, fault tolerant systems. The realm of Fault Detection and Isolation (FDI) ranges from simple voting systems to the concept of model based FDI or analytical redundancy which is recommended in situations where replication of hardware becomes

prohibitively expensive. Model based FDI with deep roots in Decision Theory and Estimation Theory is currently the subject of extensive research. As mentioned above current A/C are equipped with a MS, but we believe that it can be improved with respect to OFC detection performance - the add-on system we call OFIS, Oscillatory Failure Identification System. In the literature on FDI, the problem of OFC seems to be rather unknown and the procedures there were not readily applicable. For OFIS, we utilize some classical approaches for FDI, but also introduced new ones (Adaptive Signal Processing (ASP) and resonance condition monitoring).

The different types and sources of OFC lead to a family concept for OFIS, which up to now has four members, Fig. 9. The underlying algorithms are based partly on Kalman Filtering and on Adaptive Signal Processing and adaption procedures developed there, but also on the observation of basic properties of response characteristics of a harmonic oscillator. We explain now the working principle for the different members, more details are given in [14].

FSF/OFIS: In [7] the Fault Sensitive Filter (FSF) was proposed as a fast responding detector for the ToC problem of liquid actuator/servoloop OFC. Roughly speaking, the FSF/OFIS is based on a comparison of actuator/servoloop input with output, approximately taking into account the actuator/ servoloop dynamics. More precisely, a Kalman Filter is used to estimate the states of a simple model of the actuator/servoloop plus additional failure states that respond in case of OFC. A subsequent detection state examines the failure state and derives a quantity to be subject to threshold test. It is clear, that this procedure can only detect OFC that occurs inside the actuator/ servoloop (or, more generally between input/output (I/O) measurement points). First results were given in [8] while [9] addresses the false alarm issue of FSF. Improvements of the present day MS (smaller detection levels in the most critical frequency regions) shifted our interest to CoF and Fatigue problem area which was the genesis of [10], where Adaptive Signal Processing (ASP) for detection of sinusoids in noise was involved, working either on the states of the FSF or on the Innovation Process (i.e. prediction error) of a KF (without failure model).

DRP/OFIS: In order to cover upstream OFC we gave a procedure for "Detection of OFC causing Resonance Phenomena", which was offered as an extension to OFIS [12][13]. DRP/OFIS is confined to frequency ranges, where a couple can be found showing resonance. To fix ideas, think of the dutch roll frequency range and the couple rudder deflection and sideslip response. From an ongoing forced oscillation we conclude, that OFC has occurred. We found an easy way to monitor the forcing condition by investigating the sense of rotation in a phase plane plot of sideslip versus rudder. As we detect forcing conditions in general, we note, that there might be a chance of applying this procedure to the phenomena of Pilot Induced Oscillation (PIO) too, although it was not designed for it.

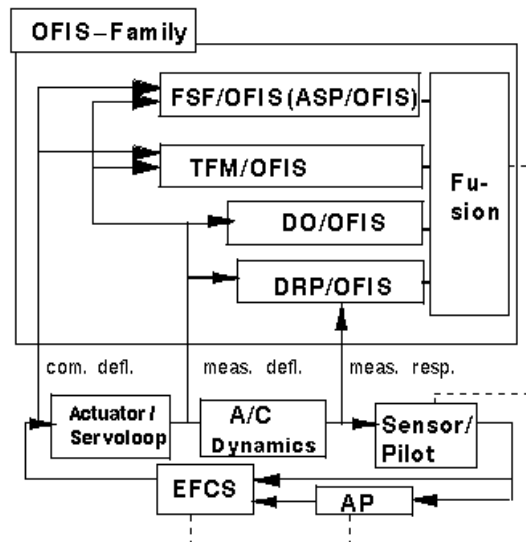

Fig. 9 OFIS-Family

DO/OFIS: The variation of OFC types: actuator/servoloop-OFC, upstream OFC, liquid OFC, solid OFC and the experience we gained within our part in the Loads Certification Loop leads us to pursue an alternate approach, the "Deflections Only-" component of OFIS [12]. This is an Innovation Process Based method using Kalman Filtering and Adaptive Filtering, processing only deflection measurements of the control surface to be supervised. It is directed towards detection of solid OFC in specific frequency ranges (no resonance of structure needed) that turned out to be critical during our certification work. The main assumption is, that there exist frequency regions in which a sustained periodic signal is neither commanded nor desired and thus is indicative of OFC. From Adaptive Signal Processing, we borrow the Adaptive Line Enhancer (ALE) concept, which adapts a FIR (all zero) filter to become a prediction filter for the deflection measurement. In case of Solid OFC, the Innovation Process of the ALE becomes a minimum, because of the splendid predictability of periodic processes. The low power in the innovation process and a 'system active criteria' is used to decide on occurrence or absence of OFC.

TFM/OFIS: The realm of application of Transfer Function Monitoring OFIS is the same as that for FSF/OFIS. But it utilizes ASP algorithms, which, this time, are cast into a system identification algorithm, used on-line in order to monitor the occurrence of oscillations between points where input/output measurements are taken. Presence of OFC will result in extra large gains at the respective frequency of the OFC and can be detected by comparing the continuously updated system transfer function with an envelope of the transfer function of the healthy system. As the TFM/OFIS adapts a FIR filter to match the transfer function of the system to be supervised (in Fig. 9 this is the actuator/servoloop) using various ASP algorithm, the model of the healthy system (transfer function envelope) can be identified and must not be provided a priori. Clearly, this approach also can be applied to any part of the controlled A/C where I/O measurements are available.

We note, that the individual members of the OFIS-Family are designed to do their own job and not all of them are needed in order to remove the impact of the most severe OFC on A/C design. However, a subsequent fusion step,

as indicated in Fig. 9, can enhance the overall performance and even add new features to the scheme which are not displayed by the single OFIS member itself.

A.7 CONCLUSION

The development of A320 and A330/A340 has shown that system failure cases for EFCS controlled A/C have an increasing influence on structural loads investigation.

In the past for non-EFCS A/C, apart from some failures of lesser importance, it always could be demonstrated for conventional A/C that no system failure case would become a design condition for any part of the structure.

From system failure case analysis for EFCS A/C, we have learned that this must no longer be true; now several system failures do affect the design of A/C structure and, vice versa, structural loads do influence the system layout. This has shown how important close co-operation among all disciplines involved in A/C design has become.

The increasing complexity of flight control systems leads to a rising number of failure cases with the tendency of becoming a structural design condition.

This calls for a continuous improvement of the monitoring system.

Especially for oscillatory failures the current monitoring systems have turned out to border on. Therefore an additional oscillatory failure identification system - OFIS has been created.

A family concept for OFIS has been developed tailored for detection and identification of OFC in modern FBW/EFCS AC, the current status of which was sketched. The basic working principles of the various OFIS-Family members are presented. The methods are based on Kalman Filtering, Adaptive Signal Processing (ASP) and "Detection of Resonance Phenomena". While ASP is widely used in other areas, to our knowledge the application in the framework of fault detection is new, and so is the specific approach to resonance detection. Our conjecture is, that the ladder method also presents a solution to the PIO problem, which will be investigated in parallel.

OFIS is offered as a potential part of EFCS and MS providing the basis for system reconfiguration after occurrence of OFC, which are OFC detection and estimation of OFC amplitude and OFC frequency range.

A.8 REFERENCES

- (1) Influence of EFCS-Control Laws on Structural Design of Modern Transport Aircraft, M. Besch, C.L. Tanck, Messerschmitt-Bölkow-Blohm GmbH ICAS-86-2.1.2
- (2) Is it Safe? The Safety Assessment of Aircraft Systems, W. Tye, T. Lloyd, Aircraft Engineering, Jan. - May 1981
- (3) Joint Airworthiness Requirements JAR-25
- (4) Federal Airworthiness Requirements FAR-25
- (5) Joint Airworthiness Requirements JAA ACJ 25.1329. § 5.4.1 and IM S-17

- (6) Besch, H.-M., Schuller J. 1988: Influence of EFCS-Failure on Structural Design of Modern Transport Aircraft, 16th ICAS Congress Jerusalem/Israel ICAS-88-1.72
- (7) Besch, H.-M., Giessler H.-G. 1991: OFIS, Oscillatory Failure Identification System, Proposal for application of Failure Detection Methods in Dynamical Systems to the Problem of Control Surface Oscillation, Deutsche Airbus EF 32 -18/91
- (8) Besch, H.-M., Giessler H.-G. 1991: OFIS Progress Report A.1: First Results from OFIS simulation: Performance of Fault Sensitive Filter operating on artificial I/O, Deutsche Airbus EF 32 - 35/91
- (9) Besch, H.-M., Giessler H.-G. 1992: Progress Report A.3: Towards a Robust OFIS: Reduction of False Alarm Rate Due to Low Frequency Mismatch of System Model, Deutsche Aerospace Airbus EF 322 - 41/92
- (10) Besch, H.-M., Giessler H.-G. 1992: Progress Report B.1: Adaptive Signal Processing (ASP) for detection of sinusoids and frequencies, directed to solve the OFIS very low amplitude detection problem P2/3 Deutsche Aerospace, Airbus EF 322 - 35/92
- (11) Besch, H.-M., Giessler H.-G. 1992: OFIS Oscillatory Failure Identification System, Proposal for Detection of Forced Oscillations Causing Resonance Phenomena, Deutsche Aerospace Airbus EF 322 - 36/92
- (12) Besch, H.-M., Giessler H.-G. 1992: Progress Report B.2: Daimler-Benz Aerospace Airbus EF 322 - 35/94
- (13) Besch, H.-M., Giessler H.-G. 1992: Progress Report X.2: Daimler-Benz Aerospace Airbus EF 322 - 35/94
- (14) Besch, H.-M., Giessler H.-G. 1995: The Oscillatory Failure Identification System OFIS, 36th AIAAS/ASME/ASCE/AHS/ASC Structures, Structural Dynamics and Materials Conference and AIAA/ASME Adaptive Structures Forum New Orleans, LA April 10-13 1995

This page has been deliberately left blank



Page intentionnellement blanche

Appendix B

The NATO Aircraft Landing Gear Design Specification

(Attention: please note that all references to sections in the Appendix itself exclude the prefix B).

This page has been deliberately left blank



Page intentionnellement blanche

B.1 INTRODUCTION

This landing gear design specification defines the high level landing gear design requirements. The high level requirements are mainly focused on the landing gear interface with the airframe. In developing these requirements a very broad brush approach was taken in developing the requirements, requirements rationale, requirement guidance, requirements lessons learned, verification methods, verification rationale, verification guidance, and verification lessons learned.

The spirit of the development activity was to incorporate anything that might have an impact on the landing gear design or aircraft backup structure. Some readers may feel that some of the requirements and verification methods may not be appropriate for their procuring activity. This document was written to be a general guideline and the individual procuring activities are free to customize the document to suit their needs.

In various places the word "airframe" or "aircraft" is used. While these are general terms the meaning in mind when using these terms is the sense of using these terms in how they relate to landing gear and gear backup structure specifically. Any meaning attached to general terms that is not directly translatable into landing gear and gear backup structure is incorrect.

B.2 SCOPE

This guide establishes the joint structural performance and verification requirements for the landing gear. These requirements are derived from operational and maintenance needs and apply to the landing gear structure which is required to function, sustain loads, resist damage and minimize adverse operational and readiness impacts during usage for the entire service life.

This usage pertains to both land and ship based operations including take-off, catapult, landing, arrestment, ground handling, maintenance, and testing. This specification also provides for trade studies and analyses to identify and establish certain structural design parameters and criteria which, as a minimum, are necessary to enable the landing gear to meet these structural performance requirements, consistent with the program acquisition plan for the force level inventory and life cycle cost.

B.3 APPLICATION

B.3.1 PROGRAM

This specification applies to _____.

REQUIREMENT RATIONALE

This paragraph identifies the program, primary management responsibility, structural engineering responsibility, and level of structural engineering change required.

REQUIREMENT GUIDANCE

Identify the weapon system program. Identify the agency or agencies primarily responsible for the program, and the organization(s) responsible for structural engineering. If structural modifications are involved, identify the level of structural change.

REQUIREMENT LESSONS LEARNED

Programs involving significant structural modifications have been confused with programs involving minor changes. This resulted in delay and added expense when it became clear that structural changes required engineering review and evaluation before flight clearances could be validated. Care should be exercised to assure that all modification and change programs are properly identified and controlled by competent authority.

B.3.2 AIRCRAFT

This specification applies to _____.

REQUIREMENT RATIONALE

This paragraph is needed to identify the type of aircraft, in general descriptive terms, to which the specification applies.

REQUIREMENT GUIDANCE

Describe briefly the type of aircraft. The specification applies to power driven aircraft only; however, the aircraft may be manned or unmanned, possess fixed or adjustable fixed wings, and V/STOL with similar structural characteristics of those above. For example: "This specification applies to a manned, power-driven aircraft with fixed wings." Further, the following statement or parts thereof should be included to identify those sub-systems to which the specification is not applicable: "'Propulsion systems, engines, power generators, avionics, helicopters, and helicopter-type power transmission systems, including lifting and control rotors, and other dynamic machinery are not covered by this specification."

REQUIREMENT LESSONS LEARNED

None.

B.3.3 LANDING GEAR STRUCTURE

This specification applies to metallic and nonmetallic landing gear structures. The landing gear structure consists of all components that make up the total landing gear and backup support structure, carrier related apparatus/devices, structural operating mechanisms, and structural provisions for stowage or gear. It also includes _____.

REQUIREMENT RATIONALE

This paragraph is needed to identify and define the parts and components of the air vehicle structure (airframe) to which the specification is applicable.

REQUIREMENT GUIDANCE

Include in the list of airframe items, those assemblies or components which are applicable to the particular air vehicle being acquired. For example, permanently installed external fuel tanks and chemical tanks, peculiar radomes and pods, and add-on skis.

REQUIREMENT LESSONS LEARNED

None.

B.3.4 USE

This specification cannot be used for contractual purposes without supplemental information relating to the structural performance of the landing gear structure.

B.3.5 STRUCTURE

The supplemental information required is identified by blanks within the specification.

B.3.6 INSTRUCTIONAL HANDBOOK

This specification is broken into two sections. The first main section contains all the requirements. The second main section contains all of the verifications procedures. The requirements section is of the format (1) Requirement, (2) Requirement Rationale, (3) Requirement Guidance, and (4) Requirement Lessons Learned. The verification section is of the format, (1) Verification, (2) Verification Rationale, (3) Verification Guidance, and (4) Verification Lessons Learned. The guidance sections under each requirement and verification informs the reader on how to go about filling the blanks, if the requirement or verification has any blanks.

B.3.7 DEVIATIONS

Prior to contract award, prospective contractors are encouraged to submit to the acquisition activity cost effective changes, substitutions, and improvements to the requirements of this specification. Incorporation will depend upon the merits of the proposed change and the needs of the program. After contract award, changes will be accomplished in accordance with

applicable contract specification change notice (SCN) procedures.

B.4 APPLICABLE DOCUMENTS

The appropriate applicable documents can all be found in U. S. Air Force Joint Services Specification Guidance (JSSG) 2006 and the English and French Specifications.

B.5 REQUIREMENTS

(The instructional handbook provides the rationale for specified requirements, guidance for inclusion of supplemental information, a lessons learned repository, and _____. This specification is meant to be tailored by filling in the blank elements according to the particular landing gear's performance requirements and characteristics, with appropriate supporting engineering justification. In the absence of such justification and acceptance, the recommendations in the handbook shall be used to fill in the blanks of this specification. In addition, specific paragraphs may be tailored by deletion or not applicable, by inserting "N/A" in parentheses following the number and title, or by rewriting of the paragraph by inserting "REWRITE" in parentheses following number and title.)

B.5.1 DETAILED STRUCTURAL DESIGN REQUIREMENTS

The requirements of this specification reflect operational and maintenance needs and capabilities and are stated in terms of parameter values, conditions, and discipline (loads, etc.) requirements. The landing gear and backup structure shall have sufficient structural integrity to meet these requirements, separately and in attainable combinations.

REQUIREMENT RATIONALE

This requirement is needed to ensure that all applicable structural design requirements are defined in engineering quantities in the specification to ensure that the landing gear and backup structure properly functions during the intended usage and that the structural integrity of the landing gear and backup structure is maintained. This requirement establishes the starting point for the design of the landing gear and backup structure and the conduct of the engineering analyses and tests to verify the adequacy of the design.

REQUIREMENT GUIDANCE

The aim of this requirement is the conversion of the operational and maintenance needs of the landing gear and backup structure in the specific structural design requirements that will drive the selection of the structural design criteria, structural designs, materials, fasteners, fabrication methods, etc. All expected operational and maintenance needs must be evaluated to ensure that the specific structural design requirements are complete and of sufficient detail to

enable the design, analyses, fabrication, and testing of the landing gear and backup structure to be undertaken.

The selection of each specific structural design requirement must be carefully made so that the landing gear and backup structure designed, built, and maintained to meet these requirements will have adequate structural integrity, acceptable economic cost of ownership, and acceptable structural performance in terms of aircraft performance capabilities and weight. Although in many cases past experience will provide the basis for the selection of the specific requirements, each selection must consider the impact of new design approaches, new materials, new fabrication methods, unusual aircraft configurations, unusual usage, planned aircraft maintenance activities, and past lessons learned.

There is a clear distinction between design requirements and design criteria. Design requirements establish a capability that the landing gear and backup structure must possess. Design criteria establish the engineering standards to be used to enable the landing gear and backup structure to achieve the required capability. For example, the factor of uncertainty is a design criteria and not a design requirement. The requirement is to have adequate ultimate load capability. The factor of uncertainty is one engineering method for achieving this requirement. Care should be taken to distinguish between design requirements and design criteria.

REQUIREMENT LESSONS LEARNED

Prior to the 1950 time period, the service life expectancy of medium and heavy bomber aircraft was on the order of 1000-5000 flight hours. The missions' requirements were maximum range/payload high altitude weapon delivery. These requirements led to the use of new high strength aluminum alloys at relatively high stress levels. Very little emphasis was given to structural durability and damage tolerance.

When mission requirements for these aircraft changed to include high-speed low level operation over a much longer service life, many kinds of structural problems began to occur. Fatigue cracking initiated in areas of high stress concentration. The high strength alloys were susceptible to stress corrosion cracking and had a low tolerance for fatigue cracking or other defects because of low fracture toughness.

Structural modifications to these aircraft that were designed to meet more severe load environment and extended service life have been verified by extensive testing, analysis, and service experience. Materials with higher fracture toughness, reduction of stress concentrations, and use of durability and damage tolerance design concepts were incorporated in these life extension modifications.

B.5.1.1 DETERMINISTIC DESIGN CRITERIA

The deterministic structural design criteria stated in this specification are, as a minimum, those necessary to ensure that the landing gear and backup structure shall meet the detailed structural design requirements established in this specification. These criteria are also based on the requirements derived from the inherent operational, maintenance, engineering, and test needs of the landing gear. Each individual criterion established herein has been selected based upon historical experience with adjustments made to account for new design approaches, new materials, new fabrication methods, unusual landing gear configurations, unusual usage, planned landing gear maintenance activities, and any other significant factors. Trade studies and analyses supporting the substantiation of the adequacy of these criteria in meeting the specified and inherent design requirements, and their use in design details, shall be documented in accordance with the verification requirements in 5.6.1.1.

REQUIREMENT RATIONALE

This requirement is needed to ensure that the specific structural design criteria required to enable the landing gear and backup structure to achieve the operational, maintenance, engineering, and test needs are completely defined and are rationally related to the structural design requirements.

REQUIREMENT GUIDANCE

The structural design criteria is the statement of the engineering standards that will be used to meet the structural design requirements and achieve the needed operational, maintenance, engineering, and test capabilities. These criteria are derived from and directly relatable to the specific design requirements. They provide critical information to the engineer on how to design, analyze, build, and test the landing gear and backup structure. It is important that the historically used criteria be thoroughly reviewed and, as appropriate, be updated to reflect the use of new design methods, new materials, new fabrication methods, unusual aircraft configurations, unusual usage, planned aircraft maintenance activities, and past lessons learned. The substantiation of the adequacy of the selected criteria is normally documented in the structural design criteria report.

REQUIREMENT LESSONS LEARNED

None

B.5.1.2 PROBABILITY OF DETRIMENTAL DEFORMATION AND STRUCTURAL FAILURE

Only where deterministic values have no precedence or basis, a combined load-strength probability analysis shall be conducted to predict the risk of detrimental structural deformation and structural failure, subject to the approval of the procuring activity. For the design requirements stated in this specification, the landing gear and backup structure shall not experience any detrimental structural deformations with a probability of occurrence equal to or greater than _____ per flight. Also, for these design requirements, the landing gear shall not experience the loss of adequate structural rigidity or proper structural functioning such that safety is affected or suffer structural failure leading to the loss of the air vehicle with a probability of occurrence equal to or greater than _____ per flight. Shipboard landings are per the multi-variate distribution of landing impact conditions of _____.

REQUIREMENT RATIONALE

This requirement establishes the maximum acceptable frequency of occurrence of detrimental deformation and structural failures that are used in conjunction with combined load-strength probability analyses.

REQUIREMENT GUIDANCE

In some instances, historically based deterministic criteria are not applicable to the specific combination of design approaches, materials, fabrication methods, usage, and maintenance for the structural element being designed. In these instances, it may not be possible to rationally arrive at an alternative deterministic criteria and a combined load-strength probability analysis is conducted to establish that the risks of detrimental structural deformation and structural failure are acceptable. The selection of the maximum acceptable frequency of occurrence of detrimental structural deformation, loss of structural functioning, or structural failure can be made by examining relevant historical repair and failure rates. A maximum acceptable frequency of permanent structural deformations would be 1×10^{-5} occurrences per flight. A maximum acceptable frequency of the loss of adequate structural rigidity or proper structural functioning, or structural failure leading to the loss of the air vehicle would be 1×10^{-7} occurrences per flight.

In most cases, a combined load-strength probability analysis is only selectively used in the analysis of the structural elements for which historically based deterministic criteria are not appropriate. In these cases, a probability analysis of a highly loaded representative structural element is performed. This analysis would address all of the significant variations in load, material properties, dimensions, etc. Once the design of the element has been completed by these probabilistic means, it is usually possible to develop a set of modified deterministic criteria which, when

combined with the appropriate limit and ultimate loads, would yield the same final element design. This updated criteria can then be used to design similar structural elements. In addition to establishing new design criteria, the conduct of the probability analysis also aids in gaining an increased understanding of the more important design drivers and enables an improved design to be produced.

If combined load-strength probability analyses are not used, insert N/A (not applicable) in the first blank.

REQUIREMENT LESSONS LEARNED

None

B.5.1.3 STRUCTURAL INTEGRITY

The landing gear shall meet the structural integrity requirements of this specification. These integrity requirements shall apply to all parts of the landing gear including actuators, seals, films, coatings, etc. Critical parts may have additional requirements designed to control their quality, durability, and/or damage tolerance.

B.5.1.3.1 PARTS CLASSIFICATION

All landing gear parts and components shall be classified for criticality.

B.5.1.3.2 FATIGUE/FRACTURE CRITICAL PARTS

Fatigue/fracture critical parts shall meet the requirements of durability 5.5.11, damage tolerance 5.5.12, and the control processes of durability and damage tolerance control 5.5.13.

B.5.1.3.3 MAINTENANCE CRITICAL PARTS

Maintenance critical parts shall meet the requirements of durability 5.5.11 and damage tolerance 5.5.12.

B.5.1.3.4 MISSION CRITICAL PARTS

In addition to the requirements of this specification, mission critical parts shall have special design criteria developed to meet the requirements of the landing gear specification. In addition, special controls on quality, processes, and inspections may be required.

B.5.1.3.5 FATIGUE/FRACTURE CRITICAL TRACEABLE PARTS

Fatigue/fracture critical traceable parts shall meet the requirements of durability 5.5.11, damage tolerance 5.5.12, and damage tolerance control 5.5.13.

REQUIREMENT RATIONALE (For 5.5.1.3 through 5.5.1.3.5)

None

REQUIREMENT GUIDANCE
(For 5.5.1.3 through 5.5.1.3.5)

None

REQUIREMENT LESSONS LEARNED
(For 5.5.1.3 through 5.5.1.3.5)

None

B.5.2 GENERAL PARAMETERS

The landing gear shall have sufficient structural integrity to meet the required operational and maintenance capabilities reflected in the parameters of 5.5.2 and subparagraphs and attainable combinations of the parameters. These parameters are to be used in conjunction with the conditions and discipline requirements of this specification.

REQUIREMENT RATIONALE

This set of general requirements is needed to collectively define conditions of usage that are mutually applicable to the following discipline requirements, 5.5.4, Structural Loading Conditions. Further, the operational and maintenance capability required of the landing gear and backup structure from a strength, rigidity, and aeroelasticity viewpoint are to be identified and established in measurable engineering terms and parameters.

REQUIREMENT GUIDANCE

The general parameters of this paragraph are to be used in conjunction with the other requirements of this specification to define the total structural requirements for the landing gear and backup structure. Before the hardware exists and in particular, before the contract for the hardware is written, it is impossible to select the one combination of the specification parameters which will be the worst strength, rigidity, and aeroelasticity conditions to be experienced by the landing gear and backup structure during its usage. If one such condition could be defined, it would greatly reduce the time and cost of designing, developing, testing, and verifying the landing gear and backup structure. Note that a conservative condition could be chosen, however, it would not be experienced by the landing gear and backup structure during usage and hence this structure would be over-designed and probably weigh and cost more than it should. Also, an unconservative condition could be chosen, but this would result in higher maintenance and repair costs and higher attrition rates. Therefore, it is necessary to define each of the specification parameters to the extend possible and assess the contribution to the required landing gear and backup structural integrity of each attainable combination of those parameters.

REQUIREMENT LESSONS LEARNED

Not all usage of the landing gear and backup structure during flight operations needs to be covered by the parameters and conditions of the specification. For

example, a fighter collided with a 1190-foot tall television transmitter tower approximately 100 feet below its top. The aircraft was on an annual tactical qualification check flight as lead of a three ship wedge formation. Numbers two and three were flying 3,000 feet abreast, 1-1/2 nautical miles (NM) in trail. Number three saw a puff of smoke and the top section of the tower fall. Visual inspection revealed the loss of the left drop tank and left wing tip, as well as two deep gashes in the leading edge of the left wing. The aircraft was recovered. It would not be prudent to design all low flying aircraft for collisions with towers because it does not happen that often. However, it is prudent to design them for collisions with birds since experience shows impacts with birds occur at significant levels of probability or occurrence, whereas impacts with towers occur very, very infrequently.

B.5.2.1 AIRFRAME CONFIGURATIONS

The airframe configurations shall encompass those applicable to ship-based and ground based conditions and reflect authorized usage of the air vehicle.

REQUIREMENT RATIONALE

This requirement is needed to assure that the airframe structure can operate satisfactorily during all specified operating/maneuvering conditions while in the most considered/expected configuration for each condition. Configurations might include basic, landing approach, takeoff, external loading, etc.

REQUIREMENT GUIDANCE

All configurations that the airframe can be put into must be considered in conjunction with other operational requirements to ensure adequate structural integrity exists. Sometimes the configurations of concern are the different combinations of selected missiles or other airborne stores.

REQUIREMENT LESSONS LEARNED

An analytical and test program was conducted for a fighter airframe to determine the airframe's capability with many variations of air-to-air missiles. The importance to landing gear here is the spread of weight, inertia, centers of gravity considered for that program.

B.5.2.2 EQUIPMENT (____)

The landing gear shall support and react the loads and motions of payloads required and expected to be carried by the air vehicle. This equipment includes _____.

REQUIREMENT RATIONALE

The intent of this requirement is to ensure that all equipment, including government furnished equipment, is adequately supported and their loads and motion have been considered.

REQUIREMENT GUIDANCE

Equipment mass properties and loads frequently change during development. They must be constantly monitored and the analysis of the airframe adjusted as necessary. The equipment list should include contractor furnished equipment, government furnished equipment, and equipment installed after delivery.

REQUIREMENT LESSONS LEARNED

Typical engineering approaches involve the identity of larger vehicles for which space and mass are a primary concern, identity of maximum dual and single wheel axle loadings, identity of maximum running loads for tracks and pallets, and the use of running loads and volumetric block loadings to address the multitude of palletized and loose supplies. Careful attention to the off center loadings permitted is required.

Cargo listed may be in the design/development phase. There is a risk that the vehicle design parameters could change during its development phase and thereby exceed the airframe's parameters, which were based on the original air vehicle parameters. Close coordination between the air vehicle developer and airframe system program office is required to reduce this risk, and insure that the most up-to-date vehicle parameters are used.

B.5.2.3 PAYLOADS(____)

The landing gear shall support and react the loads and motions of payloads required and expected to be carried by the air vehicle. These payloads include _____.

REQUIREMENT RATIONALE

When a payload is carried, the weapon system is to carry and deliver that payload without inducing failure or damage to the aircraft or payload.

REQUIREMENT GUIDANCE

Identify those documents, figures, tables, etc. which define the payload to be carried by the air vehicle. Payloads include such items as passenger, passenger baggage, cargo (vehicles, crated and palletized equipment or freight, etc.) stores (bombs, rockets, etc.), ammunition flare, chaff, and disposable fuel tanks. External fuel tanks intended to be routinely returned to base should be accounted for in operating weight.

REQUIREMENT LESSONS LEARNED

Typical engineering approaches involve the identification of the larger vehicles for which space and mass are a primary concern, identification of maximum dual and single wheel axle loading, identification of maximum running loads for tracks and pallets, and the use of running loads and volumetric block loading to address the multitude of palletized and loose supplies. Careful attention to the permitted, off center loading is required.

Payload listed may be in the design/development phase. There is a risk that the payload design parameters could change during its development phase and thereby exceed the airframe's parameters which were based on the original air vehicle parameters. Close coordination between the air vehicle developer and air vehicle systems program office is required to reduce this risk, and insure that the most up-to-date vehicle parameters are used.

B.5.2.4 WEIGHT DISTRIBUTION

The air vehicle weight distributions shall be those required for operations and maintenance use.

REQUIREMENT RATIONALE

Weight distributions need to be known since they effect all aspects of usage of the air vehicle, including performance, aircraft balance, handling qualities, loads, structural responses, stresses, etc.

REQUIREMENT GUIDANCE

Weight variations of individual mass items are included as part of this requirement, particularly if large variations in weight of an item can exist. Other aspects to consider, especially when one air vehicle system is or will be sold to many different countries, includes establishment of the actual center of gravity margins for all versions; definition of the limits of pilot and associated equipment weights; determination of configurations most critical for forward and aft center of gravity conditions; and definition of minimum ballast required.

REQUIREMENT LESSONS LEARNED

Weight and weight distributions can and will become a real problem if many configurations are sold to many customers/countries and if a weight control program is not initiated. In 1975 a potentially critical problem developed in the application of pilot weight criteria for the design of ballast weights. The inconsistent application of the light (150 lbs), nominal (240 lbs), and heavyweight (280 lbs) pilot weight (along with other variables such as fuel density, ie. JP-4 or JET A-1) coupled with the highly critical center of gravity could produce couplings and loadings in excess of values based on nominal assumptions. A mutually agreeable policy between the system program office and the contractor concerning the application of the various weights noted above was

established. The policy decision was, "For future design, analysis testing, and qualification the most adverse combinations of pilot weight, fuel weight, and ballast shall be considered. The maximum pilot weight need not exceed a combined weight a combined weight of 200 pounds for the pilot, personal items, parachute, and survival vest. The minimum pilot weight need not be less than a combined weight of 150 pounds for the pilot, personal items, and parachute. Variable ballast shall be considered in a rational manner. For formal weight reports, weight reference sheets and Prime Item Development Specifications, a nominal combined pilot weight of 240 pounds including personal gear and parachute will be required along with the fuel weight for the prime fuel used. For maximum and minimum weight conditions, informal weight reports, weight reference sheets, and Prime Item Development Specifications, use the most adverse combinations of fuel weight, variable ballast, and pilot weight."

B.5.2.5 WEIGHTS

The weights to be used in conducting the design, analysis, and test of the landing gear are derived combinations of the operating weights, the defined payload, and fuel configuration. These weights shall be the expected weight at Initial Operation Capability (IOC).

REQUIREMENT RATIONALE

Requirements which define the ranges of weight which the air vehicle will experience during its usage are needed since these weights directly influence the structural performance of the airframe.

REQUIREMENT GUIDANCE

In each of the subparagraphs, provide the definition of the configuration of the air vehicle that corresponds to the weight (not the number) starting with the operating weight and adding the required payload and useable fuel. Operating weight is defined in MIL-W-25140. A weight growth factor is to be applied in each weight definition to predict an IOC weight (see Lessons Learned). For modification programs, provide growth in relation to the modification weight only. Care should be taken in the placement of the growth weight. The effect of the weight placement could affect control surfaces. The actual baseline weight of the aircraft to be modified shall be validated.

The actual air vehicle weights corresponding to the weight configurations defined in this specification are usually defined in the structural design criteria report.

REQUIREMENT LESSONS LEARNED

Experience has shown that aircraft weight will grow between source selection or contract signing and IOC for a variety of reasons. It will also grow after IOC as

witnessed by the U. S. Air Force multi-role fighter as a pound a day. The primary reason for the initial weight growth is because requirements may not be well defined. That is, the geometry may change (spars, bulkheads, skin thicknesses, etc.) equipment ('black boxes', hydraulics, etc.) may have changed due to better understanding of the mission, loads may have been optimistic, the government furnished equipment (like engines) weight may have matured, the material properties may have been optimistic, and other such reasons. Other reasons for weight growth are optimism in the weights estimates, insufficient schedule for development, lack of funds and the lack of management support for mass properties. All services have experienced aircraft weight growth in this period. Using IOC weights for analysis eliminated the iteration of analysis each time weight changes took place during the development process.

There is a need to combat weight growth to protect the advertised performance, to protect the required structural integrity, and to restore political confidence in the acquisition process. There are many ways to combat weight growth. One of the best ways is to remove the optimism in the weight prediction. A weight reconciliation process in which the contractor and the government compare weights and agree on what the weight should be may help to reduce over-optimistic weight estimates. But that should only be part of the solution to minimize the weight growth. Other methods may be strong configuration management, a weight margin, zero weight growth development, adequate performance margins, incentive fee program, or a combination of the above. A good mass properties management and control process is required.

A fighter plane basic landing weight (BLW) is 15,000 pounds for all configurations. This weight is a deviation from existing requirements which would have required a BLW of 17,418 pounds. But because the primary mission was 85 percent air-to-air and performance was not to be degraded by any alternate mission, the 15,000 pound value was not changed. The wheel jacking weight was established in accordance with MIL-A-008862 and no problems have occurred in this area.

The strong consideration toward lightweight design of a large transport resulted in the selection of lightweight wiring and electronic controls using hybrid driver circuits. The weight savings were significant. Some areas of the aircraft developed maintenance problems. The landing gear actuation controls were particularly susceptible to intermittent failures and difficult to evaluate and were redesigned and replaced. A total of 311,000 feet of the wire has performed with reasonable success for over 10 years, but later versions of the aircraft using similar insulation on heavier gauge wire are being substituted to avoid future maintenance problems. Careful consideration of where new technology can be successfully used must be evaluated during initial design to avoid costly rework.

Aircraft wire weights. In a bomber development it was found that the contractor's design practice for wire bundles was to provide extra wires to allow for broken wires and subsystem growth. No trades to evaluate the wire impact and maintenance advantages were made to validate this practice or to optimize the number of extra wires.

B.5.2.5.1 OPERATING WEIGHT

The operating weight is the weight empty plus oil, crew, useable fuel, and _____.

REQUIREMENT RATIONALE

The operating weight is used as the basis for all weight definitions in this specification.

REQUIREMENT GUIDANCE

See MIL-W-25140 – includes guns, other fixed useful load items, and special mission equipment (weapon racks, pylons, tie down equipment, etc.) as per MIL-STD-1374.

REQUIREMENT LESSONS LEARNED

None

B.5.2.5.2 MAXIMUM ZERO FUEL WEIGHT

The maximum zero fuel weight shall be the highest required weight of the loaded air vehicle without any useable fuel and is specified as the operating weight plus _____.

REQUIREMENT RATIONALE

This requirement defines the highest aircraft weight without useable fuel.

REQUIREMENT GUIDANCE

The normal definition for maximum zero fuel weight is operating weight plus maximum payload.

REQUIREMENT LESSONS LEARNED

None

B.5.2.5.3 LANDPLANE LANDING WEIGHT

The landplane landing weight shall be the highest landing weight for the maximum landbased sink rate and is specified as the operating weight plus _____.

REQUIREMENT RATIONALE

This requirement defines the highest weight which is to be used in combination with the maximum sink speed consistent with the intended use of the weapon system.

REQUIREMENT GUIDANCE

The normal definition of landplane landing weight is:

- a. For observation, trainers, and utility aircraft, the maximum flight weight minus all payload items expected to be expended, all external fuel, and 25 percent internal fuel.
- b. For cargo aircraft, the maximum flight weight minus all external fuel and 50 percent internal fuel.
- c. For bombers, attack, and fighter aircraft, the maximum flight weight minus all external fuel plus 60 percent internal fuel.

REQUIREMENT LESSONS LEARNED

None

B.5.2.5.4 MAXIMUM LANDING WEIGHT

The maximum landing weight shall be the highest weight required for any landing and is specified as the operating weight plus _____.

REQUIREMENT RATIONALE

This requirement defines the highest landing weight required for design purposes.

REQUIREMENT GUIDANCE

The normal definition of maximum landing weight is the maximum flight weight minus assist-takeoff fuel, droppable fuel tanks, items expended during routine take-off, and fuel consumed or dumped during one ground or 3.0 minutes, whichever results in the minimum amount of fuel.

REQUIREMENT LESSONS LEARNED

None.

B.5.2.5.5 MAXIMUM GROUND WEIGHT

The maximum ground weight shall be the highest weight required for ramp, taxiway, and runway usage and is specified as the operating weight plus _____.

REQUIREMENT RATIONALE

This requirement defines the highest ground weight required for design purposes.

REQUIREMENT GUIDANCE

This weight is frequently referred to as maximum ramp weight. It is used for ground handling, jacking, taxiing, and runway usage. It is usually higher than the maximum take-off weight by the amount of fuel used in taxiing the aircraft for take-off.

REQUIREMENT LESSONS LEARNED

None

B.5.2.5.6 MAXIMUM TAKEOFF WEIGHT

The maximum takeoff weight shall be the highest required weight for flight usage at the time of lift-off and is specified as the operating weight plus _____.

REQUIREMENT RATIONALE

This requirement defines the heaviest take-off weight for design purposes.

REQUIREMENT GUIDANCE

The maximum take-off weight is normally defined as the weight of the aircraft with the maximum internal and external loads and full fuel except for fuel used during taxi and warm-up.

REQUIREMENT LESSONS LEARNED

None

B.5.2.5.7 MAXIMUM LANDING GEAR JACKING WEIGHT

The maximum landing gear jacking weight shall be the highest weight required for landing gear jacking and is specified as the operating weight plus _____.

REQUIREMENT RATIONALE

This requirement defines, for design purposes, the highest weight that can be jacked at the landing gear for purposes of wheel or brake changes.

REQUIREMENT GUIDANCE

The maximum landing gear jacking weight is normally the maximum ground weight since it is desired not to offload fuel and payload when a tire change is required.

REQUIREMENT LESSONS LEARNED

None

B.5.2.5.8 MAXIMUM CATAPULT DESIGN GROSS WEIGHT (____)

The maximum catapult design gross weight shall be the maximum catapult launch weight to be used to determine maximum tow force and in determining maximum launch constant selector valve (CSV) settings and is specified as the operating weight plus _____.

REQUIREMENT RATIONALE

This requirement defines the highest weight at which the maximum catapult tow force will be determined for design purposes.

REQUIREMENT GUIDANCE

The weight of the airplane with maximum internal fuel and maximum external load for which provision is required, without any reduction permitted for fuel used during pre-launch operations.

REQUIREMENT LESSONS LEARNED

This weight, which is used to determine the limit tow force loads, is normally the maximum mission weight plus an anticipated weight growth factor (IOC plus 10% weight empty). Almost every current U. S. Navy carrier aircraft has experienced significant weight growth and without a pre-design growth capability, the ship speed and available wind over deck would be insufficient, within the structural design to provide the required launch end speed. The maximum launch tow force resulting from this weight will be used to determine the maximum CSV setting in the launch bulletins to preserve static demonstrated strength.

B.5.2.5.9 MAXIMUM CATAPULT WEIGHT (____)

The maximum catapult weight shall be the maximum launch weight for which shipboard launch is required within the structural limits of the airframe, wind over deck (WOD) capability and launch end speed of the ship system and is specified as the operating weight plus _____.

REQUIREMENT RATIONALE

This requirement defines the highest weight at which the aircraft can be safely launched based on the design tow force, most capable catapult, maximum ship speed, and wind over deck.

REQUIREMENT GUIDANCE

Based on ship speed, wind over deck, and maximum catapult end speed, the maximum launch weight can be determined. This weight should be used to determine airframe strength limits.

REQUIREMENT LESSONS LEARNED

Rather than determine gear stretch capability/limitations, based on improved catapult energy capability and increased weight growth after the aircraft is fielded and contractor support and flight test support is no longer available, this determination should be provided during EMD.

B.5.2.5.10 PRIMARY CATAPULT MISSION WEIGHT (____)

The primary catapult mission weight is the minimum weight used to determine the maximum horizontal acceleration used in setting launch bulletin limits and is specified as the operating weight plus _____.

REQUIREMENT RATIONALE

This requirement defines the weight at which the maximum N_X (horizontal load factor) will be determined, based on maximum tow force and maximum thrust.

REQUIREMENT GUIDANCE

This weight corresponds to the primary mission for each catapult separately.

REQUIREMENT LESSONS LEARNED

The N_X value is used to determine both mass item design requirements resulting from minimum weight launches and to establish catapult/weight CSV setting limitations.

B.5.2.5.11 CARRIER LANDING DESIGN GROSS WEIGHT (____)

The carrier landing design gross weight shall be the maximum aircraft weight at which shipboard recovery can be initiated and shall be based on the ability to perform ____ passes and fly ____ nautical miles with ____ payload.

REQUIREMENT RATIONALE

This requirement defines the highest weight at which shipboard landings/arrestments and shore-based FCLP (Field Carrier Landing Practices), and U. S. Navy Field Landings will be determined for design purposes.

REQUIREMENT GUIDANCE

This weight is the maximum weight of a fully loaded aircraft (stores, ammunition, pylons, racks, launchers, ejectors, empty fuel tanks, pods, etc.) minus the weight of all allowable expendables, minus the weight of all useable fuel plus the specified bring-back payload (fuels and stores).

REQUIREMENT LESSONS LEARNED

This weight is used to determine the maximum recovery bulletin shipboard landing weight and airframe shipboard design loads and energy absorption requirements.

B.5.2.5.12 BARRICADE DESIGN GROSS WEIGHT (____)

The maximum weight at which shipboard barricade recovery can be initiated and is specified as the operating weight plus _____.

REQUIREMENT RATIONALE

This requirement defines the highest weight at which emergency shipboard barricade engagements are required for design purposes.

REQUIREMENT GUIDANCE

This weight is the normal equivalent to the carrier landing design gross weight, and along with engaging speed, is used to set barricade recovery limits, based on results of shore-based barricade tests.

REQUIREMENT LESSONS LEARNED

This weight and the allowable MK-7 MOD 2 Barricade characteristics will determine the strap loads to be used for on-center and off-center ultimate loads, and the resultant airframe design requirements resulting from this condition. Airframe design configuration should be such that propeller placement or sharp leading edges will not damage the barricade straps. Also based on location of external stores, strap loads will impinge on them causing load conditions for configuration/design consideration.

B.5.2.5.13 OTHER WEIGHT

The air vehicle, fuel, and payload configuration to be used in determining the design weights for other conditions and the corresponding design conditions are as follows: _____.

REQUIREMENT RATIONALE

This requirement defines all other weights used in the design such as limiting wing fuel allowable weight, in-flight system failures, ground system failures, etc.

REQUIREMENT GUIDANCE

These weights are usually defined in word definition form. They are used to define special air vehicle weight configurations other than those defined above which are critical in the designing the air vehicle. For example, Limiting Wing Fuel Allowable Gross Weight is the weight above which any additional load must be fuel carried in the wing.

REQUIREMENT LESSONS LEARNED

None

B.5.2.6 THE CENTER OF GRAVITY

The center of gravity envelopes shall be commensurate with the requirements in the detailed specification and all the weights in 5.5.2.5 plus and minus a tolerance to account for manufacturing variations, addition of planned equipment, variations in payload, flight attitudes, density of fuel, fuel system failures (see system failures 5.5.2.22) and _____.

- a. The tolerance is _____.
- b. The envelope is _____.

REQUIREMENT RATIONALE

Depending upon the type of airframe program, a requirement for tolerance is necessary since no airframe can be built that does not vary somewhat from the drawings and experience variations in loadings with usage. For example, a small modification program may not require a large tolerance. As a general rule, any time a change is made to the airframe, the weight goes up and the center of gravity goes aft. This is an application of Murphy's law. Failure to provide for rational tolerances and loadings can result in ballast requirements which result in additional weight.

REQUIREMENT GUIDANCE

Provide the center of gravity tolerance which is compatible with the type of air vehicle. Evaluate the applicability of the historical 1.5 percent of the mean aerodynamic chord prior to using it as a requirement. Rigorous evaluation of the effects of fuel redistribution at extreme attitudes has been used as an alternative to arbitrary center of gravity tolerances for some aircraft.

REQUIREMENT LESSONS LEARNED

Loads calculations for a fighter model change were based on center of gravity positions in the 30 degree nose down attitude. Additionally, 1.5 percent further aft tolerance on the center of gravity positions in the 30 degrees nose up attitude was used. It was not felt necessary to calculate or determine loads with a 1.5 percent forward tolerance.

Fuel/center of gravity management system. Failure of monitoring systems which allow differences between primary and secondary systems without alerting the aircrew will degrade safety and mission performance requirements and could result in an unstable aircraft. The FCGMS failure monitoring system for a swing wing bomber allows differences between the primary and secondary system center of gravity calculations without alerting the pilots. This becomes critical, when, unknown to the pilot, incorrect input data is utilized by the system in control. The result is that the center of gravity computation/control will be in error and could drive the aircraft out of limits. The condition will also exist where the center of gravity calculation would not warn the pilots that a selected

weapon release will cause the aircraft to immediately exceed limits. The aircraft specification required that under any operational condition a single failure of the fuel system shall not prevent the weapon system from completing its mission. A central test system and internal software checks were designed into the FCGMS to detect computer error, but not to compare systems. Undetected failure of the FCGMS monitoring system will adversely affect safety and mission performance. Attainable center of gravity positions, such as indicated above, need to be considered for inclusion and coverage in 5.5.2.14.

For the swing wing bomber, no tolerance was applied to the most forward and most aft center of gravity positions resulting from practical loading conditions and considering fuel transfer rates and wing sweep operational rates. Since the aircraft had an automatic fuel management control system, errors or changes in predicted c.g. locations were accounted for by adjustment of the fuel management control system.

B.5.2.7 SPEEDS

The following speeds and any attainable lesser speeds are applicable for ground use of the air vehicle considering both required and expected to be encountered critical combinations of configurations, gross weights, centers of gravity, thrust or power and shall be used in the design of the airframe.

REQUIREMENT RATIONALE

Speeds are one of the more visible operational needs. They influence the structural capability required in the airframe in many ways, including external local pressures and temperatures. Not only is this requirement needed, but close attention must be paid to its development and application.

REQUIREMENT GUIDANCE

The speeds defined in the subparagraphs are to be based on the operational capability and margins of safety of flight required of the air vehicle. These speeds may be definitions, ratios of other speeds, functions of altitude, or combinations thereof. It may be desirable to present the airspeed requirements in a figure of equivalent airspeeds, calibrated air speeds, Mach number, or a combination of these airspeeds versus altitude. Airspeeds and ground speeds should be in knots and identified as to the system's correct units of indicated (IAS), calibrated (CAS), or true (TAS) with the exception of sink speed and gust speeds which are in feet per second. For modification programs, use applicable technical order speeds with changes as required by the new usage. Airframe development and operating costs increase, often substantially, with increased maximum equivalent speed.

REQUIREMENT LESSONS LEARNED

With the onset of new powerful engines, it appears that the speed criteria must be thoroughly evaluated.

Trade studies need to be conducted to determine the most applicable and effective speeds and their usage.

B.5.2.7.1 TAKEOFF, APPROACH, AND LANDING SPEEDS, V_{LF}

The takeoff, approach, and landing limit speeds shall be the maximum authorized speeds associated with the operation of the landing gear and other devices for and during takeoff and landing operations. These speeds shall be high enough to provide the crew ample time to operate and control the devices with only nominal attitude and trim changes of the air vehicle flight and propulsion control systems. These speeds are _____.

REQUIREMENT RATIONALE

These speed requirements are necessary to assure adequate operational capability exists for the air vehicle to satisfactorily operate out of and into service airports and bases.

REQUIREMENT GUIDANCE

The landing, approach, and takeoff limits speeds should be sufficient to allow operation of the air vehicle safely within these phases and to safely transition into and out of these phases. Some air vehicles may require only one speed for all of these phases, whereas, others may require several. An appropriate limit speed may need to be established for the operable speed range required of airframe components, for example, landing gear, slats, and flaps. These speeds must be relevant to the operations and operating crew efforts necessary to safely fly the air vehicle. Consideration must be given to such factors as the time required to extend or retract/close the high lift devices and landing gear when establishing V_{LF} . Safe transition between phases entails, in part, maintaining adequate margins above the 1.0g stall speeds and minimum control speeds. Consideration should also be given to maintaining sufficient margin above normal operating speeds to allow for pilot inaction. The importance of allowing for pilot inaction is largely a function of the acceleration and deceleration capability of the aircraft as the normal operating speed varies. The effect of altitudes higher than the maximum ground altitude at 5.5.2.8 should be considered to assure flight in these configurations will be adequate for operations to train flight crews.

REQUIREMENT LESSONS LEARNED

A swing wing bomber landing, approach, and take off speeds for the landing gear and high lift devices were chosen to be compatible with expected operational capabilities and procedures. Speed varied as a function of flap extension and was based on maintaining a constant flap loading from 30 to 100 percent flap deflection. Maximum speed was derived using maximum airplane acceleration after a take off at 1.1 times stall speed, followed by a 6-second delay

until initiation of flap retraction and subsequent 20-second retraction time.

B.5.2.7.2 LIFT-OFF LIMIT SPEEDS, V_{LO}

The lift-off limit speeds shall be the maximum authorized and necessary ground speeds for the takeoff operations and are _____.

REQUIREMENT RATIONALE

When the airframe is in the takeoff configuration, this speed requirement is of particular importance in defining the maximum ground speed for establishing landing gear wheel and other aircraft characteristics.

REQUIREMENT GUIDANCE

This speed is the maximum ground speed with any landing gear tire in contact with the ground during takeoff, including those takeoffs at maximum ground altitude in a hot atmosphere for any required mission using normal techniques for rotation and holding of pitch attitude.

REQUIREMENT LESSONS LEARNED

None.

B.5.2.7.3 TOUCH-DOWN LIMIT SPEEDS, V_{TD}

The touch-down limit speeds shall be the maximum authorized and necessary ground contact speeds for the landing operations and are _____.

REQUIREMENT RATIONALE

The touch-down limit speed greatly influences the landing gear loads resulting from landing impact, particularly the spin-up and spring-back loads. The impact loads also are transmitted to the airframe and can result in significant dynamic loads, particularly affecting those items mounted on the extremities of the airframe, for example, external stores, control surfaces, etc.

REQUIREMENT GUIDANCE

This speed is the maximum ground speed with the landing gear tire in contact with the ground during landing, including those landings at maximum ground altitude in a hot atmosphere. This also applies for a one go-round abort immediately after lift-off of any required mission, using normal techniques for holding of final approach pitch attitude and no pilot induced flare.

REQUIREMENT LESSONS LEARNED

None.

B.5.2.7.4 TAXI LIMIT SPEEDS, VT

The taxi limit speeds shall be the maximum authorized and necessary ground speeds for ground operations on taxiways and ramps and are _____.

REQUIREMENT RATIONALE

The airframe can experience significant ground induced dynamic loads which are a function of taxi speed. This speed requirement must be stated clearly so as to not compromise the structure in the flight crew cannot discern this speed limit and may inadvertently overload the structure. Further, if the speed is arbitrarily set too high, the airframe will have extra weight which will be carried throughout its life.

REQUIREMENT GUIDANCE

Large and heavy air vehicles may require two taxi limit speeds, one for ramps and one for taxiways. However, the two speeds must be identifiable and discernable to the operating crew so they can operate safely within these speeds. The taxi limit speeds must be compatible with the intended operational usage of the air vehicle and the ability of the operating crew to recognize the taxi limit speeds and keep the air vehicle ground speeds below them on ramps and taxiways. Ramp speed may be expressed in terms of a man walking at tip of wing (4-8 knots) and taxiing on ramps (30-40 knots). Operations using high speed taxi turn-off will require much higher taxi speeds to be established.

REQUIREMENT LESSONS LEARNED

The residual thrust at idle power setting for a high thrust to weight fighter resulted in taxi speeds up to 60 knots to avoid excess brake wear and maintenance. This required the canopy to be closed, since the canopy open speed did not cover this operating concept.

B.5.2.7.5 LANDING STALLING SPEEDS, V_{SL}

The landing stalling speeds shall be the minimum level flight speeds in the landing Configuration with zero thrust.

REQUIREMENT RATIONALE

This speed requirement is needed to establish the minimum level flight speed in the landing configuration and to define the left side of the operational flight envelope (speed versus altitude).

REQUIREMENT GUIDANCE

The stalling speeds shall be sufficient to allow operation of the air vehicle safely within the landing phases and to safely transition into and out of the landing phases. Some air vehicles may require only one speed for all of these phases, whereas, others may require several. These speeds must be relevant to the

operations and operating crew efforts necessary to safely fly the air vehicle. Safe transition between phases entails, in part, maintaining adequate margins for control.

REQUIREMENT LESSONS LEARNED

None.

B.5.2.7.6 SHIPBOARD RECOVERY SPEED, V_{TDC} (____)

This shall be the maximum deck touch-down speed for determining recovery bulletin limits based on the carrier landing design gross weight, critical c.g. position and store loadings authorized for bring-back. This value used to determine structural landing criteria shall be based on design performance requirements and tropical day temperature.

REQUIREMENT RATIONALE

The mean shipboard recovery speed influences the determination of engaging speed and sink rate.

REQUIREMENT GUIDANCE

This speed is based on the defined on-speed angle of attack which meets the performance requirements for carrier operations times a factor of 1.05. The on-speed angle of attack and corresponding approach speed (VPA versus weight) will become a part of the USNATOPS (U. S. Naval Air Training and Operating Procedures Standardization) and the $V_{TD} = 1.05$ VPA will be listed in the ship-board recovery bulletin for the purpose of wind over deck determination.

REQUIREMENT LESSONS LEARNED

The analytical determination of approach speed and its shorebased validation during flight test has been shown to be statistically lower than the value measured at the ship during normal operations, thus the correction factor of 1.05 is used to reflect the observed touch down speed.

B.5.2.7.7 SHIPBOARD ENGAGING SPEED, V_E (____)

For structural airframe design this shall be equal to the "shipboard recovery speed" less the average wind over deck plus a 3.1 sigma ($P_0 = .001$) on engaging speed derived from aircraft survey data of similar class aircraft.

B.5.2.7.8 SHIPBOARD LAUNCH END SPEED, V_C (____)

This shall be the minimum launch end speed required not to exceed _____ feet of sink over the bow (summation of ship speed, natural winds, and catapult end speed).

REQUIREMENT RATIONALE

This parameter sets the lower limit for catapult tow force.

REQUIREMENT GUIDANCE

The operational value of catapult end speed is equal to the minimum value plus 15 knots.

REQUIREMENT LESSONS LEARNED

None.

B.5.2.7.9 MAXIMUM BRAKE SPEED, V_{HD} (____)

This shall be the maximum allowable speed at which the arresting hook may be lowered during carrier operations and is _____.

REQUIREMENT RATIONALE

This speed will determine the arresting hook extend system design load requirements.

REQUIREMENT GUIDANCE

During carrier operations, the arresting hook extend loads are based in the airspeed while the aircraft is transitioning through the break at 400 knots or greater.

REQUIREMENT LESSONS LEARNED

Landing gear extend and retract design speeds are based on speeds in the high lift take-off and landing configuration and are too low of a value for carrier operation where the aircraft is transitioning through the break in clean or up-away configuration. In the break, the pilot is required to extend the hook and perform a tight turn simultaneously while in the clean configuration. Also if a bolter occurs, the pilot does not want to raise the hook but to keep it in the trail position as he goes around.

B.5.2.7.10 OTHER SPEEDS

Other speeds applicable to specified uses are _____.

REQUIREMENT RATIONALE

Not all required speeds can be identified in the general specification, therefore other speed requirements are necessary to allow for identifying speeds related to other useful aircraft configurations.

REQUIREMENT GUIDANCE

List and define other speeds as necessary and applicable to the air vehicle and its intended usage.

REQUIREMENT LESSONS LEARNED

With a petal door design, a large transport has a 200 knots calibrated airspeed (KCAS) airdrop configuration limit speed. However, there is a 180 KCAS airdrop limit speed due to the differential pressure created on the petal doors during the extraction of the cargo.

There have been several instances of accidents caused by the crew deploying high lift devices at speed above the extended use speed of the device, so care should be exercised in establishing the extended usage speeds of devices, their speed limitations and including the limits in applicable documents.

One air-to-air fighter has leading and trailing edge maneuvering flaps that can be used during combat. Such maneuvering flap speed, which are a function of leading and trailing edge flap angles, can be defined here. Single engine out speeds, if applicable, may be listed here. Cargo aircraft that perform airdrop missions may have airdrop configuration limit speeds for personnel and cargo airdrop.

B.5.2.8 MAXIMUM GROUND ALTITUDES

The maximum ground altitudes shall be the maximum altitudes authorized and necessary for ground operations.

REQUIREMENT RATIONALE

Altitude requirements are needed because density and temperature effects associated with altitude variations also effect the loads, etc. the structure is subjected to during its usage and hence the structural integrity of the airframe is effected.

REQUIREMENT GUIDANCE

For modification programs, the appropriate altitudes from applicable technical orders with changes necessary to be compatible with the air vehicle as modified and its new usage are applicable. For other programs, altitudes consistent with the intended usage of the air vehicle are applicable. The maximum ground altitude includes the highest ground elevation at which the air vehicle must be capable of operating regarding ground handling, takeoffs, and landings.

REQUIREMENT LESSONS LEARNED

None.

B.5.2.9 LOAD FACTORS

The following load factors shall be the maximum and minimum load factors authorized for use and shall be used in the design of the airframe.

B.5.2.9.1 TAKE-OFF, APPROACH, AND LANDING LOAD FACTORS

The take-off, approach, and landing load maximum and minimum load factors are _____.

B.5.2.9.2 OTHER LOAD FACTORS

Other load factors applicable to specified uses are: _____

REQUIREMENT RATIONALE

Definition of take-off, approach, and landing load factors required for operational use of the airframe is probably one requirement of most significance to setting the structural capability of the airframe. This requirement is needed and must be carefully addressed throughout the program to assure that full operational maneuver capability of the airframe is achieved.

REQUIREMENT GUIDANCE

For modification programs, use the appropriate load factors from applicable technical orders with changes as necessary to be compatible with the modified air vehicle and its new usage. For other programs, define or select load factors consistent with the intended usage of the air vehicle.

Landing, approach, and takeoff load factors should be compatible with air vehicle high lift configurations and the maneuvers required to safely operate the air vehicle during these flight phases.

For other load factors, identify and present other load factors as necessary to quantify the full operational maneuver capability required of the air vehicle. In general, load factor selection is a major concern, not only to those who are responsible for determination of adequate strength levels, but for those who must adapt these aircraft to continually varying operational requirements.

REQUIREMENT LESSONS LEARNED

None.

B.5.2.10 LAND BASED AND SHIP BASED AIRCRAFT GROUND LOADING PARAMETERS

The airframe shall have sufficient structural integrity for the air vehicle to take-off, catapult, land, arrest, and operate on the ground or ship under the appropriate conditions of ground loading conditions 5.5.4.2 and the parameters defined here-in, in attainable combinations, considering the required and expected combinations of the applicable parameters of

5.5.2 and 5.5.4. Lesser values of the following parameters are applicable in determining attainable combinations.

REQUIREMENT RATIONALE

Ground loading parameters need to be established realistically for the air vehicle to assure that adequate structural integrity exists in the airframe for all operational usage.

REQUIREMENT GUIDANCE

Ground loads depend on the weight of the aircraft, the landing and taxi gear arrangements, and how the aircraft will be maneuvered on the ground. This section specifies the external conditions which constitute forcing functions to the air vehicle and the maximum sink rates at ground contact in landing which specifies the energy to be absorbed due to the aircraft kinetic energy at landing.

REQUIREMENT LESSONS LEARNED

None.

B.5.2.10.1 LANDING SINK SPEEDS

The maximum landing touchdown vertical sink speeds of the air vehicle center of mass to be used in the design of the airframe and landing gear shall not be less than:

- a. Landplane landing design gross weight: _____.
- b. Ship based landing design gross weight (____) _____.
- c. Maximum land based landing weight: _____.

REQUIREMENT RATIONALE

The landing sink speed requirement is needed to assure that adequate energy absorption capability exists in the landing gear shock absorbers and arresting hook damper (to preclude hook bounce), and that the rest of the airframe is able to withstand the dynamic loads resulting from the landing impact.

REQUIREMENT GUIDANCE

Choose the limit sink speed compatible with the air vehicle's intended usage and the repeated load sources sink speeds of 5.5.2.14.2. The sink speeds of 5.5.2.14.2 are based on cumulative occurrences at the lower or mid-band value. Thus, the landplane landing weight sink speed should be associated upper-band value. The maximum landing weight sink speed should be 60% of the landplane landing weight sink speed value. However, it should be no less than that sink speed resulting from the air vehicle landing at its maximum landing weight and associated maximum

landing touchdown velocity without flare reducing the sink speed from a two degree glide slope approach.

For navy aircraft, the design mean sink rate is a function of the ship Frensol Lens setting, the approach speed of the aircraft, size and characteristics of the ship, and the sea state conditions in which operations are allowed. Based on carrier surveys the mean sink speed is equal to 0.128 times the mean engaging speed (in knots); and the standard deviation of sink rate is equal to 0.015 times engaging speed plus 1.667 feet/second. Sink rate is one of the eight multivariate parameters in which the maximum/minimum values equal the mean plus or minus 3.1 standard deviations.

REQUIREMENT LESSONS LEARNED

None.

B.5.2.10.2 CROSSWIND LANDINGS

The crosswinds at take-off and landing shall be those components of surface winds perpendicular to the runway centerline or ship landing reference centerline. The landing gear loads resulting from crosswind operations shall be _____.

REQUIREMENT RATIONALE

Crosswind landings cannot be avoided throughout the life of the air vehicle. Therefore, this requirement is needed to assure adequate strength exists in the airframe for either field or shipboard operations.

REQUIREMENT GUIDANCE

Most airports are laid-out with the runways in line with the prevailing wind. However, it is not uncommon to have winds of reasonable magnitudes blowing from any direction. Crosswind and drift landings can result in main gear side loads up to 80% of the vertical reaction for the inboard acting load and 60% of the vertical reaction load for the outboard acting load. The vertical reaction is generally considered to be 50% of the maximum vertical reaction load from two point and level symmetrical landings. The side loads and vertical reaction (with zero drag load) should act simultaneously at the ground with these loads being resisted by the aircraft inertia. Alternatively, a dynamic analysis of shipboard and field landings for 90° crosswinds of 30 knots may be accomplished for typical landing techniques (e.g. crabbed, tail-down top rudder).

REQUIREMENT LESSONS LEARNED

None.

B.5.2.10.3 LAND BASED LANDING ROLL, YAW, PITCH ATTITUDES AND SINK SPEED

The landing touchdown roll, yaw, pitch attitude, and sink speed combinations shall be based on a joint

probability within an ellipsoid with axes or roll, yaw, and pitch. The extremes on these axes are:

- Roll angle. Plus _____ and minus _____.
- Yaw angle. Plus _____ and minus _____.
- Pitch angle. Mean plus _____ and minus _____
- Sink speed. Mean plus _____ and minus _____

REQUIREMENT RATIONALE

This requirement is needed to assure that adequate structural integrity exists in the airframe for all types of landings of which the air vehicle may be subjected.

REQUIREMENT GUIDANCE

The roll angles (plus and minus) should be the same and no less than that roll angle needed to maintain the longitudinal axis of the air vehicle in line with the runway centerline when landing in a maximum crosswind without ground effect, flare, or pilot alleviation prior to touchdown. The yaw angle (plus and minus) should be equal and no less than that yaw angle needed to maintain a flight path in line with the runway centerline when landing (wings level) in a maximum crosswind without ground effect, flare, or pilot alleviation prior to touchdown. The pitch angles (plus and minus), normally will not be equal. The positive angle should be the maximum angle attainable considering landing parameters, aerodynamics, tail bumper contact (or contact of other parts of the airframe), etc. The negative angle should be the minimum angle attainable considering landing parameters, aerodynamics, etc. Sink speeds associated with the above landing attitudes shall be combined to produce the landing conditions. For tricycle landing gear air vehicles, the nose landing gear first landings should be considered only for training aircraft.

REQUIREMENT LESSONS LEARNED

None.

B.5.2.10.4 TAXI DISCRETE BUMPS, DIPS, AND OBSTRUCTIONS

The bumps and dips shall be of the _____ wave lengths, amplitudes, and shape.

- Maximum ground weight, slow speeds up to: _____
- Maximum ground weight, speeds at and above: _____

REQUIREMENT RATIONALE

Requirements for discrete runway roughness parameters are needed to assure that adequate structural integrity exists in the airframe to resist the

dynamic loads induced during taxi over all operational ground surfaces.

REQUIREMENT GUIDANCE

The slow speed requirement must cover all surfaces, including parking areas, ramps, and taxiways, as well as the runway. The values in Figure 1 should be used, choosing those curves applicable to the type surface to be operated on. The higher speed requirement of Figure 2 needs cover only runways. The aircraft transition over bumps and dips should be such that the angle between the path of the aircraft and the lateral axis of the contour will be all angles up to 45 degrees. The values on the second figure above should be used, choosing those curves applicable to the type of surface to be operated on. Displaced runway/taxiway concrete slabs, hangar doorway rails, bomb damaged repaired runway profiles, etc. may also be included.

REQUIREMENT LESSONS LEARNED

None.

B.5.2.10.5 JACKING WIND LOADING CONDITIONS

The maximum combination of wind loading and air vehicle load factor conditions that shall be allowed during the jacking of the air vehicle are _____.

REQUIREMENT RATIONALE

This requirement defines the maximum wind loading conditions that will be assumed to exist in determining the total forces and loads acting on the air vehicle during jacking.

REQUIREMENT GUIDANCE

The maximum wind loading conditions can be determined from weather records taken at military and civilian airfields. Specify the magnitude and direction of the winds relative to the longitudinal axis of the air vehicle.

REQUIREMENT LESSONS LEARNED

None.

B.5.2.10.6 CATAPULT TAKEOFF (____)

- a. Maximum catapult design gross weight _____.
- b. Maximum catapult weight _____.
- c. Primary catapult mission weight _____.
- d. Maximum NX (rigid c.g.) _____.
- e. Maximum horizontal tow force _____.

f. Repeatable release holdback bar load _____.

REQUIREMENT RATIONALE

This requirement defines the analysis requirement for the catapult run, dynamic loads determination used for airframe strength design, and for determining the shock environment of mass items.

REQUIREMENT GUIDANCE

The catapulting loads, for all weights ranging from the primary mission to the maximum catapult weight as limited by the maximum N_x and maximum tow force, throughout the catapult run, and the required initial spotting shall be determined for all specified catapults and catapult forces. The engine thrust should be all values from zero to maximum. The effects of pretension loads, holdback release, and weight variations shall be included.

REQUIREMENT LESSONS LEARNED

The results of holdback release and end of shuttle run cause large dynamic airframe response accelerations and inertia loads which effect equipment design, fuel slosh (fuel pressures), and external store responses. The catapults which determine maximum tow force may not be the catapult which causes maximum dynamic response, thus all combinations of CVS setting, launch weight, and catapult must be included in the analysis.

B.5.2.11 LIMIT LOADS

The limit loads, to be used in the design of elements of the airframe subject to deterministic design criteria, shall be the maximum and most critical combination of loads which can result from authorized ground use of the air vehicle, including maintenance activity, the system failures of 5.5.2.22 from which recovery is expected, a lifetime of usage of 5.5.2.14, and all loads whose frequency of occurrence is greater than or equal to _____ per flight. All loads resulting from the requirements of this specification are limit loads unless otherwise specified.

REQUIREMENT RATIONALE

This requirement defines the load capability that the airframe must possess to achieve adequate structural safety and economic operation. Where such loads are the result of randomly occurring loads, the minimum frequency of occurrence of these loads must be defined. This insures the inclusion of loads which are of sufficient magnitude to size elements of the airframe and whose frequency of occurrence warrants their inclusion.

REQUIREMENT GUIDANCE

Limit loads reflect the operational requirements. These loads establish the structural envelope which defines the capability of the airframe to resist loads

experienced during flight within the flight manual and handbook limits and the loads experienced during and following the system failures of 5.5.2.19 from which recovery is expected.

The determination of the limit loads includes flight anywhere within the design flight envelope. This selection of limit loads should address all critical combinations of inertia, aerodynamic and mechanical forces, heat flux, and the thermal strains resulting from the resulting temperature gradients, variations in payload, external configurations, types of missions, and fuel and its distributions. Conservative predictive and test methods should be used to determine these loads. When determining the loads, expected variations in the ability of the pilot or the flight control system to maintain flight within the established limits should be addressed. This is especially important when the performance capability of the air vehicle significantly exceeds the flight manual and handbook limits.

The selection of the critical limit loads needs to take into account the time dependency of the occurrence of the loads. For some aircraft, such as modern fighters, the maximum tail loads may occur at different times during the maneuver and not necessarily during the sustained portion of the maneuver. For airframe components subjected to significant heat flux, the critical design condition does not necessarily coincide with the occurrence of the maximum heat flux.

The selection of the minimum frequency of occurrence of loads, to be included in the determination of the limit loads, can be done by assessing frequency data for similar types of aircraft performing similar missions. This data can then be used in determining the rates at which loads are experienced which cause detrimental structural deformation for structure built using conventional structural design criteria. It is generally only necessary to include loads whose frequency of occurrence is greater than or equal to 1×10^{-7} per flight.

REQUIREMENT LESSONS LEARNED

None.

B.5.2.12 ULTIMATE LOADS

Ultimate loads not derived directly from ultimate load requirements of this specification shall be obtained by multiplying the limit loads by appropriate factors of uncertainty. These ultimate loads shall be used in the design of elements of the airframe subject to a deterministic design criteria. These factors of uncertainty and the circumstances where they are to be used are _____.

REQUIREMENT RATIONALE

This requirement establishes the ultimate load capability that the airframe must possess to provide adequate structural integrity. The factors of

uncertainty and the conditions and circumstances where these factors are used are defined so that the calculation of ultimate loads can be made. Historical service experience has shown that an acceptable level of risk of loss of aircraft due to structural failure can be attained if limit loads are multiplied by a factor of uncertainty (formerly known as a factor of safety) of 1.5.

REQUIREMENT GUIDANCE

The selection of the factor of uncertainty, formerly called the factor of safety, should be made by assessing the factors that have been used on similar air vehicles performing similar missions. The value for manned aircraft has been 1.5. The value for unmanned aircraft has been 1.25, except that a factor of 1.5 has been used when a failure of the structure could result in injury to personnel or damage to or loss of the carriage and launch equipment. The 1.5 factor has been successfully used on metallic airframes using "A" and "B" material allowables, well understood analysis methods validated through appropriate testing, demonstrated fabrication methods, and correct maintenance and inspection procedures.

The selected value of the factor of uncertainty should be increased to account for above normal uncertainty in the design, analysis, and fabrication methods, when the inspection methods have reduced accuracy or are limited by new materials and new fabrication methods, and where the usage of the air vehicle is significantly different. Similar considerations need to be made in the selection of the factor for unmanned aircraft. The use of reduced factors of uncertainty needs to be carefully defined and justified. In this case, consideration of the impact of the use of reduced factors on the safety, maintenance, performance, and structural life needs to be addressed. Such reductions should only be undertaken when a substantial positive benefit to the air vehicle is shown.

Where thermal loads are significant, factors of uncertainty to apply to the external or internal thermal loads should be specified. The selection of these factors should consider the following:

- a. The nature of the thermal load – is it an externally generated load or is it internally generated as the result of the operation of the vehicle equipment and systems?
- b. The ability to accurately measure the magnitude of the thermal loads and the structural response in real time during flight and, if necessary, the ability to predict the future structural response based on the thermal load history that the air vehicle has experienced.
- c. The ability to make real time changes in the flight conditions or the operation of vehicle systems to keep the thermal loads within acceptable limits.

- d. The accuracy of the predictive methods used to determine the thermal loads used in the design of the airframe.
- e. The accuracy of the predictive methods used to determine the structural response of the airframe to the input thermal loads.
- f. The criticality of the failure of the thermally loaded structure, especially failure due to thermal loads.
- g. The ability to accurately simulate the thermal loads with, if necessary, mechanical loads during the development and qualification testing.

REQUIREMENT LESSONS LEARNED

See AFFDL-TR-78-8 for historical and other information relating to this requirement.

B.5.2.12.1 SHIPBOARD LANDING DESIGN LOADS

Design loads are those for which compliance with the deformation criteria in 5.5.2.13 is required.

REQUIREMENT RATIONALE

Landing loads for shipboard aircraft resulting from the Navy's multivariate distribution of impact conditions shall meet the deformation criteria of 5.5.2.13.

REQUIREMENT GUIDANCE

Design loads reflect the strength needed and operability required for shipboard aircraft airframe design.

REQUIREMENT LESSONS LEARNED

None.

B.5.2.13 DEFORMATIONS

Temperature, load, and other induced structural deformations/deflections resulting from any authorized use and maintenance of the air vehicle shall not:

- a. Inhibit or degrade the mechanical operation of the air vehicle or cause bindings or interferences in the control system or between the control surfaces and adjacent structures.
- b. Affect the aerodynamic characteristics of the air vehicle to the extent that performance guarantees or flying qualities requirements cannot be met.
- c. Result in detrimental deformation, delamination, detrimental buckling, or exceedance of the yield point of any part, component, or assembly which would result in subsequent maintenance actions.

- d. Require repair or replacement of any part, component, or assembly.
- e. Reduce clearances between movable parts of the control system and adjacent structures or equipment to values less than the minimum permitted for safe flight.
- f. Result in significant changes to the distribution of external or internal loads without due consideration thereof.

REQUIREMENT RATIONALE

Since deformations can influence the performance as well as the structural capability of the air vehicle and airframe, it is necessary to have a requirement identifying those impacts which cannot be tolerated in service.

REQUIREMENT GUIDANCE

Deformations which can modify or degrade the operating capability of the airframe are to be avoided as part of this requirement. Such deformations include those of lifting surfaces which cause a control surface to jam and those which result in maintenance actions of structural repair, fuel leak sealings, etc.

REQUIREMENT LESSONS LEARNED

None.

B.5.2.14 SERVICE LIFE AND USAGE

The following parameters are applicable and reflect required operational and maintenance capability for the air vehicle structures service life and usage conditions.

REQUIREMENT RATIONALE

This information forms the basis of the design loads/stress spectra and the durability and damage tolerance program. It must represent as accurately as possible both the required functions and the service usage of the system.

REQUIREMENT GUIDANCE

Complete the blanks by entering the service life values provided by basic program directives or by requirements allocation analyses of the basic program directives and historical data from previous systems.

REQUIREMENT LESSONS LEARNED

Premature assessment of service life results in early inspection and modification of a system. When the modification is performed too early, a portion of the useful service life is unused or wasted. After modification, the remaining service life will be adjusted.

Service life specified in the contract may not reflect the actual service life of a system. Manufacture, design tolerances, and usage change may vary the service life significantly. A very large transport was originally projected to have a 30,000 hour service life but ended up with a wing that was good for 8,000 hours. No initial requirement existed to include damage tolerance considerations.

Aircraft designed for high altitude operation required life extension structural modifications when their mission was changed to include high speed, low altitude penetration.

Mission flight plans for strategic aircraft include low level terrain following tracks of specified length. It was found more useful to define the terrain following segment in terms of distance rather than duration, especially in cases where the flight speed was not clearly established. Terrain following tracks should be obtained from the using command. An average track length was found to be approximately 440 NM without reentry. Reentry for a repeat of a race track segment would add on the average 170 NM.

B.5.2.14.1 USER IDENTIFIED REQUIREMENTS

The number of flights, flight hours, shipboard and field operations, landings, mission data, etc. shall be:

- a. _____ Service life (Flight hours). In service use, ninety percent of all aircraft shall project to meet or exceed this value for durability and all aircraft shall meet this value with respect to safety.
- b. For time dependent design functions, a life of _____ years.
- c. _____ of _____ Ground-air ground cycles (flights)
- d. _____ of _____ Field taxi runs
- e. _____ of _____ Field takeoffs
- f. _____ of _____ Catapult launches
- g. Landings.
 - (1) _____ of _____ Field
 - (2) _____ of _____ FCLP (Field Carrier Landing Practice)
 - (3) _____ of _____ Carrier arrested.
 - (4) _____ of _____ Carrier touch and go
- h. (____) mission profiles as specified in _____.
- i. (____) mission mix as specified in _____.

- j. Other service life and usage as specified in _____.

REQUIREMENT RATIONALE

This requirement is necessary to ensure that quantitative and qualitative performance, operations, and support parameters and characteristics are developed in response to and in support of an approved Mission Need Statement (MNS). These user defined requirements (operational requirements) provide a basis for identifying the detail structural design requirements established to ensure system performance objectives are achieved and validated.

REQUIREMENT GUIDANCE

The approval of the MNS and the issuance of the Program Management Directive (PMD) mark the beginning of the user defined requirements activity. Such requirements may address operational and support concepts, deployment and employment of the proposed system, missions, mission constraints, operational environments, and effectiveness and system reliability requirements. Those requirements that result in functional requirements for structural performance should be specified in this section. Reference the document which provides the following information or fill the blank with the planned number of flights, flight hours, landings, mission data, etc. that the typical airframe is expected to experience in one service life.

REQUIREMENT LESSONS LEARNED

The requirements specified in this section must reflect applicable mission and operations parameters that promote integrated design approach, considering economics, supportability, producibility, and optimum system commonality.

Minimum requirements must clearly be stated preferably in the context of threshold values. Structural design trades conducted in support of identifying preferred concepts can use threshold values to conduct trades for identification of operationally significant performance above threshold values.

Requirements should establish operational performance criteria and threshold values that are consistent with current capabilities to verify the resulting functional performance through test and/or analysis.

B.5.2.14.2 REPRESENTATIVE BASING CONCEPT

Occurrences and duration's of taxi, turns, pivoting, braking, fuel, and payload loading and unloading, engine trim runs, towing, and other ground/carrier operations shall be shown in _____.

REQUIREMENT RATIONALE

See 5.5.2.14 Requirement Rationale.

REQUIREMENT GUIDANCE

Define airport or base layout(s) representative of projected service operations. Include remote or substandard airfields, if appropriate.

REQUIREMENT LESSONS LEARNED

A percentage of strategic aircraft in service are rotated on a ground alert mission for a fixed number of days. These ground alerts include recurrent ground movements involving engine starts, taxiing, turns, and runway accelerations to fairly high speeds. A ground alert movement profile should be defined. Determination of the magnitudes of ground turning load occurrences is most readily obtained from historical data. The approach and data of ASD-TR-79-5037 has been applied successfully on a strategic aircraft.

B.5.2.14.3 REPEATED LOADS SOURCES

All sources of repeated loads shall be considered and included in the development of the service loads spectra and shall not detract from the airframe service life. The following operational and maintenance conditions shall be included as sources of repeated loads:

- a. Suppression systems. Systems which enhance ride qualities (____)
 - (1) Active oscillation control
- b. Vibration. The vibration loads spectra and associated duration shall reflect the operational usage of the aircraft as required in 5.5.6.
- c. Landings. The a landing loads spectra shall reflect operational parameters and conditions applicable to landings from 5.5.2 and 5.5.4.2 respectively. The sink speed spectra are _____
- d. Other ground loads. The taxi, braking, brake release, pivoting, turning, towing, and Miscellaneous ground loads spectra shall include vertical, lateral, and longitudinal loads and accelerations resulting from ground/carrier operations of 5.5.2.14. These spectra shall include:
 - (1) Hard and medium braking occurrences per full-stop landings of _____.
 - (2) Pivoting occurrences of _____.

- (3) Taxiway, ramp, takeoff, and landing roll-out vertical loads spectra resulting from operation on surfaces with roughness of _____.

- e. Repeated operation of moveable structures. Impact operational, and residual loads occurring from the normal operation of movable structures shall be included in applicable loads spectra.
- f. Heat flux (____) The repeated heat flux time histories are _____.
- g. Other loads (____).

REQUIREMENT RATIONALE

All sources of repeated loads affecting the durability and damage tolerance of the airframe must be considered to ensure that the required service life of the system is not degraded. Development of a comprehensive database of load sources, exceedances, and other parameters, based on data recorded from actual usage experience, will ensure the greatest possible accuracy in the representation of the design usage and function of the system.

REQUIREMENT GUIDANCE

- a. Provide load factor spectra representative of projected service ground operation based on user requirements and the latest historical data. Final loads spectra should include all variables that impact the landing gear backup structure so that they reflect the projected average usage within the design utilization distribution and also usage such that 90 percent of the fleet will be expected to meet the service life. Baseline exceedance data representative of average fleet usage and exceedance adjustments to account for changes in projected service operations are provided to generate exceedance data used in the damage tolerance analysis given in 5.5.2.14.7. The statistical dispersions provided are used to generate exceedance data used in the durability analysis and test spectra in 5.5.2.14.6 for which 90 percent of the fleet is expected to experience during the operational service life. Repeated loads sources are documented in ASC-TR-xxxx by aircraft type, mission type, and mission segment. See the discussion in 5.5.4.
- b. Provide cumulative occurrences of sink speed per 1000 landings, by type of landing, typical or projected service operation. ASC-TRR-xxxx provides representative data for U. S. Air Force and Navy operations. Final data should include the most representative data available. Careful consideration is to be given to STOL operations. If practical, bi-variant tables should be used to present roll versus pitch, etc., probability of

occurrence requirements. See ASC-TR-xxxx for taxi vertical load factors at the center of mass of the air vehicle.

- c. Completion of the other ground loads paragraphs will provide the basis for the ground taxi spectra for one service life.
- (1) Enter the number of hard and medium braking occurrences per full stop landing along with the associated braking effects. Guidance for braking occurrences is provided in ASC-TRR-xxxx. A typical entry would be hard-braking with maximum braking effects five times per landing. Include anti-skid effects, if applicable.
 - (2) Enter the number of pivoting occurrences and the corresponding torque load. Guidance for pivoting occurrences is provided in ASC-TR-xxxx. A typical entry would be one per ten landings with self-limit torque load.
 - (3) Define the roughness characteristics of the airfield(s) from which the airplane is to operate and the number of taxi operations to be conducted on each airfield. Roughness characteristics should be stated as power spectral density roughness levels. Representative roughness levels are presented in ASC-TR-xxxx.
- d. The operation of doors, landing gear, and other devices should be included in service life usage parameters.
- e. If the aircraft is required to carry and employ stores, insert APP. If not, insert N/A. Store carriage and employment loads shall be determined for representative store configurations and be included in all applicable loads spectra. Representative store configurations, both like loadings and mixed loadings, should consider both critical design and anticipated future store configurations.
- f. List all other repeated loads sources which could have an impact on the airframe service life and usage. Appropriate loads spectra should be developed for each of these repeated load sources.

Representative data for various aircraft types are continually accumulated and are documented in ASC-TR-xxxx. Access to and assistance in selection of suitable data will be provided by the Structures Branch (ASC/ENFS), Aeronautical Systems Center, Wright-Patterson AFB, OH 45433-7101

REQUIREMENT LESSONS LEARNED

The combination of thermal loads and aeroacoustic loadings caused fatigue failures in primary structure very early in the life of a large bomber aircraft. The

failures occurred when hot surface flow caused skins to distort sufficiently to introduce high mean stresses in skins. The skins then failed in vibratory fatigue.

The service life of transports can be shortened significantly by constant hard landings and using rougher than average airfields.

For a multi-role fighter, actual store configurations employed in the field differed significantly from the baseline configurations used in loads spectra development. The difference in configurations combined with the fact that only inertia loads were used for stores may have had a significant impact on service life.

B.5.2.14.4 OTHER REQUIREMENTS

Other operational and maintenance requirements affecting the airframe service life or usage are _____.

REQUIREMENT RATIONALE

See 5.5.2.14 Requirement Rationale.

REQUIREMENT GUIDANCE

Define requirements or functions which affect airframe service life or usage not otherwise included in 5.5.2.14. Examples are functional check flights, ground maintenance checks, jacking, and towing.

REQUIREMENT LESSONS LEARNED

Service load recorders which are not maintained or logistically supported result in a loss of data which affects the actual service life prediction based on actual usage.

B.5.2.14.5 AIRFRAME STRUCTURE INSPECTION

By design, the airframe structure shall not require inspection during the service life specified in 5.5.2.14.

REQUIREMENT RATIONALE

In order to assure optimal operational cost and safety, the airframe must have adequate durability and damage tolerance capability by design such that when subjected to the expected service loads and environmental spectra there shall not be any inspections required within the service life.

REQUIREMENT GUIDANCE

To meet this requirement, the airframe structure should be designed to ensure that cracking or delamination does not occur within two lifetimes of usage and environments specified in 5.5.2.14.6. In addition, the airframe safety of flight structure should maintain residual strength capabilities within two lifetimes of usage and environments specified in 5.5.2.14.7.

REQUIREMENT LESSONS LEARNED

None.

B.5.2.14.6 DESIGN DURABILITY SERVICE LOADS/SPECTRUM

This spectrum shall represent the service life and usage defined in 5.5.2.14.1 through 5.5.2.14.4, adjusted for historical data, potential weight growth, and future aircraft performance at least to initial operational capability (IOC), to reflect severe utilization within the design utilization distribution and such that 90 percent of the fleet will be expected to meet the service life. A flight-by-flight analysis spectrum shall be developed for design durability analysis and a flight-by-flight test spectrum shall be developed for verification tests to verify the structural requirements of 5.5.11.

REQUIREMENT RATIONALE

The purpose of this requirement is to develop a design durability spectrum to size aircraft structure early in the airplane development. Since the design usage is always different from the majority of the fleet actual usage, the design spectrum should be as close as practical to the most severe usage expected in the fleet to ensure that the majority of the fleet will meet the required service life. A structure designed to the most severe usage of a single aircraft is not considered practical and will compromise the performance of the total aircraft system. Therefore, one way to achieve optimum design is to develop a design durability spectrum which represents at least 90% of the expected fleet usage during the operational service life.

REQUIREMENT GUIDANCE

Historical service life data dictates the need to develop a design durability service loads spectrum which represents more than the average aircraft usage of the fleet. Past programs indicate that an expectation of 90 percent of the fleet meeting the service life requirement is both reasonable and acceptable. The design durability service loads spectrum shall be developed for the design service life and usage requirements of 5.5.2.14.1 and the representative basing concept of 5.5.2.14.2. The design durability service loads should represent loads expected to occur in 90% of the fleet operation envelope and should not necessarily be the loads as established for static design criteria. The process of developing a design durability service loads spectrum begins with the selection of all significant repeated loads sources specified in 5.5.2.14.3 and the selection of chemical, thermal, and climatic environments specified in 5.5.2.15 and ends once these individual loads spectra are assembled on a flight by flight basis to form the design service loads sequence. For information, repeated loads sources are documented in ASC-TR-xxxx by aircraft type, missions, and mission segments. Baseline exceedance data representative of the average fleet usage, statistical dispersions, and exceedance adjustments to

account for changes in projected service life operations are also provided in this document. The statistical dispersions and exceedance adjustments can be a basis to generate exceedance data which 90% of the fleet is expected to experience during the operational service life. Ground loads spectra and all significant loads spectra are developed by the use of exceedance data and repeated loads criteria provided in ASC-TR-xxxx plus that developed by the contractor and government for shipboard operations. The flight by flight spectrum is a realistic stress spectrum based on the random ordering of required missions and associated load occurrences, with the exception that shipboard development cycles shall be in realistic blocks. Load occurrences less than once per mission segment or once per flight shall be rationally distributed (randomized or ordered, as appropriate) among appropriate segments and flights.

The external discrete flight loads within the spectrum can be developed by various methods. Two representative methods are multiple mission/multiple segment and single weight, and multiple points in the sky. Mission analysis required the appropriate distribution of aircraft weight, center of gravity, altitude, speed, configuration, maneuver usage, and other significant operational parameters within each mission segment. Point in the sky analysis is based on a single reference weight (multiple configurations and center of gravities) along with setting a damage reference level based on a single point in the sky for each major airframe component, and then developing a single spectrum of multiple points in the sky such that no single components' damage is less than 80% of its reference level. The reference level is determined for each component based on that component's most critical point in the sky.

Full compliance with this requirement is achieved by development of design analysis and test spectrum as discussed below:

- a. Analysis Spectrum. The design durability service loads spectrum may require modifications such as truncation, clipping, and other appropriate techniques in order to achieve a practical/optimal durability analysis. Truncation of the design spectrum is normally required to facilitate the burden of analyzing extremely large numbers of stress cycles which produce negligible damage on aircraft components. High and low stresses in the design spectrum may require clipping of all stress levels above 90% limit load in order to reduce the impact of crack retardation or beneficial residuals for metallic structure. Because composites are very sensitive to high load application and to preclude the development of unconservative analysis spectra, the practice of high load truncation should be avoided. For airframe structures combining metallic and composite structure, the effects of high load truncation should be thoroughly evaluated. The analysis spectrum is generated as a direct result of these spectrum modifications. Particular care should be exercised during the development of this

spectrum since it directly influences the damage which each major component will experience during its service life. In order to assure that each major component is exercised as close as practical to its full service life, a durability analysis spectrum developed by mission analysis methods should have 100% of the equivalent damage of the untruncated spectrum, but some locations could have as little as 95%. A durability analysis spectrum developed by the multiple points in the sky analysis method should result in single component's damage being less than 80% of its reference level.

- b. **Test Spectrum.** Development of the durability test spectrum shall be based on the analysis spectrum. Truncation, elimination, or substitution of stress cycles in the test spectrum may be required to reduce excessive test time and cost for metallic structure. Truncation for composite and hybrid structure (metallic/composite mix) should be evaluated to determine impacts. Durability analysis and development tests will be required to define the effect of the differences in time to reach detrimental crack sizes or establish crack initiation by use of the analysis spectrum and proposed test spectrum. The results of these analyses and tests shall be used to establish the final test spectrum and to interpret the test results. Particular care should be exercised during the development of the final test spectrum since its is used to demonstrate the airframe service life requirements specified 5.5.2.14, identify critical structural areas not previously identified by analyses or development tests, and establish special inspection and modification requirements for the service airframe. In order to assure that the test spectrum satisfies these requirements, a test spectrum goal is to achieve 100% of equivalent damage for the entire airframe but because of practicality, some areas may not achieve this level. Where damage levels will not meet the 100% goal, justification should be provided. To provide assistance in evaluating and investigating fracture surfaces, the test spectrum should include distinguishing indicators such as "Marker Cycles" at specified percentages of the test spectrum. A number between 5% and 10% of full life test spectrum has been used in past programs. The "Marker Cycles" could be rearranged sequence of flights, regroupment of cycles, or substituted cycles into the test spectrum. The "Marker Cycles" should be verified by element tests to provide readable fracture surfaces with negligible impact on fatigue damage and test time.

REQUIREMENT LESSONS LEARNED

Aircraft often experience different uses from those for which they were designed. An example is a multi-role fighter, which is used approximately eight times more severely than its design intended. The current usage of another air superiority fighter is approximately four times more severe than its designed plan. The

tracking program has revealed that this is mainly attributable to weight increases and operation at Mach numbers higher than originally expected. Early operational service data for an attack aircraft showed that usage was approximately three times more severe than originally intended. This was partly due to an increase in normal load factor spectrum, and partly due to fuel loading in excess of design. The development of a flight by flight spectrum which represents the usage which the majority of the fleet is expected to experience during the operational service life is extremely difficult to achieve. However, this problem can be minimized by careful selection of the most current historical usage data for similar type aircraft and by modifying this usage data to account for changes in projected service operations based on user requirements. A non-readable fracture surface can make it difficult to determine what portion of life was crack initiation and what portion was crack growth. In a full scale fatigue test of a fighter aircraft, a completely random flight sequence of recorded service usage data was employed as the spectrum. The results were mostly non-readable fractures even for tension dominated locations which made the analytical correlation very difficult.

5.5.2.14.7 DESIGN DAMAGE TOLERANCE SERVICE LOADS/SPECTRUM

This spectrum shall represent the service life and usage defined in 5.5.2.14.1 through 5.5.2.14.4, adjusted for historical data, potential weight growth and future aircraft performance at least to initial operational capability (IOC), to reflect baseline utilization within the design utilization distribution and such that the average aircraft usage of the fleet will be expected to meet the service life. A flight-by-flight analysis spectrum shall be developed for design damage tolerance analysis and a flight-by-flight test spectrum shall be developed for verification tests to verify the structural requirements of 5.5.8.

REQUIREMENT RATIONALE

The purpose of this requirement is to develop a design damage tolerance spectrum to size aircraft structure early in the airplane development. A proper balance between performance and safety is achieved by designing in the aircraft safety of flight structure to meet the damage tolerance requirements with a spectrum that is representative of the average aircraft usage which the fleet is expected to experience during the operational service life.

REQUIREMENT GUIDANCE

Based on past experience, the development of the design damage tolerance service loads spectrum should be established from the average aircraft usage of the fleet. The design damage tolerance service loads spectrum shall be developed for the design service life and usage requirements of 5.5.2.14.1 and the representative basing concept of 5.5.2.14.2. The design damage tolerance service loads should represent loads expected to occur in the average fleet

operation flight envelope and should not necessarily be the loads as established for static design criteria. The process of developing a design damage tolerance service loads spectrum begins with the selection of all significant repeated loads sources specified in 5.5.2.14.3 and the selection of chemical, thermal, and climatic environments specified in 5.5.2.15 and ends once these individual loads spectra are assembled on a flight by flight basis to form the design service loads sequence. The repeated loads sources are documented in ASC-TR-xxxx by aircraft type, missions, and mission segments. Baseline exceedance data representative of average fleet usage and exceedance adjustments to account for changes in projected service operations are also provided in the document. Ground loads spectra and all significant loads spectra are developed by use of the exceedance data and repeated loads criteria provided in ASC-TR-xxxx. The flight by flight spectrum is a realistic stress spectrum based on the random ordering or required missions and associated load occurrences. Load occurrences less than once per mission segment or once per flight shall be rationally distributed (randomized or ordered, as appropriate) among appropriate segments and flights. An appropriate distribution of aircraft weight, center of gravity, altitude, speed, configuration, and other significant operational parameters shall be made within each mission segment. Full compliance with this requirement is achieved by development of a separate design analysis and test spectrum as discussed below:

- a. Analysis Spectrum. The design damage tolerance service loads spectrum may require modifications such as truncation, clipping, and other appropriate techniques in order to achieve a practical damage tolerance analysis. Truncation of the design spectrum is normally required to facilitate the burden of analyzing extremely large numbers of stress cycles which produce negligible damage on aircraft components. High and low stresses in the design spectrum may require clipping of all stress levels above 90% limit load in order to reduce the impact of crack retardation. The analysis spectrum is generated as a direct result of these spectrum modifications. Particular care should be exercised during the development of this spectrum since it directly influences the damage which each major component will experience during its service life. A developed damage tolerance spectrum should have more than 95% of equivalent damage of the untruncated spectrum.
- b. Test Spectrum. Development of the damage tolerance test spectrum shall be based on the analysis spectrum. Truncation, elimination, or substitution of stress cycles in the test spectrum may be required to reduce excessive test time and cost. Damage tolerance analysis and development tests will be required to define the effect of the differences in time to reach detrimental crack sizes by use of the analysis spectrum and proposed test spectrum. The results of these analyses and tests shall be used to establish the

final test spectrum and to interpret the test results. Particular care should be exercised during the development of the final test spectrum since it is used to demonstrate the airframe service life requirements specified 5.5.2.14, identify critical structural areas not previously identified by analyses or development tests, and establish special inspection and modification requirements for the service airframe. In order to assure that the test spectrum satisfies these requirements, a damage tolerance test spectrum goal is to achieve 100% of equivalent damage for the entire airframe but because of practicality, some areas may not achieve this level. Where damage levels will not meet the 100% goal, justification should be provided. To provide assistance in evaluating and investigating fracture surfaces, the test spectrum should include distinguishing indicators such as "Marker Cycles" at specified percentages of the test spectrum. A number between 5% and 10% of full life test spectrum has been used in past programs. The "Marker Cycles" could be rearranged sequence of flights, regroupment of cycles, or substituted cycles into the test spectrum. The "Marker Cycles" should be verified by element tests to provide readable fracture surfaces with negligible impact on fatigue damage and test time.

REQUIREMENT LESSONS LEARNED

None.

B.5.2.15 CHEMICAL, THERMAL, AND CLIMATIC ENVIRONMENTS

The landing gear shall be designed to operate in the environments defined below:

- a. Ground environments _____.
- b. Shipboard environments: Sulfur and nitrogen oxide containing gasses from ship stacks and aircraft exhaust combined with 3.5 percent sodium chloride sea spray to form highly acidic moisture films of pH 2.4 – 4.0. Relative humidity of 70 percent to 100 percent conditions exist simultaneously with sand and dust particle concentrations ranging from 1.32×10^{-4} to 4.0×10^{-6} lbs/ft³.
- c. Air environments _____.
- d. Man-made environments _____.
- e. Usage environments _____.
- f. Maintenance environments _____.

REQUIREMENT RATIONALE

These requirements are needed to cover those operational environments to which the airframe will be exposed to assure that adequate structural integrity

exists from the viewpoints of corrosion, thermal/mechanical stress interactions, etc.

REQUIREMENT GUIDANCE

Applicable ground, shipboard, and air environments may be selected from MIL-STD-210, MIL-STD-810, and AFCRL-TR-74-0052. As applicable, heavy rain (8 inches/hour minimum), snow, and icing conditions may be encountered. Consider using FAA requirements for icing condition, FAR, Part 25, Airworthiness Standards, Transport Category Airplanes, Appendix C. In terms of the above references, list the applicable paragraph and table number, title, and any discriminating information, for example, percent risk.

Identify those man-made environments the air vehicle will be reasonably expected to encounter. For example, airborne chemical oxides and residues from power plants, vehicles, etc. may be significant man-made environments. Also, for example, mud, dirt, and other contaminants inside the cargo area resulting from loading, carriage, and unloading of the cargo, including spills of chemicals, may be significant.

The heating incidental to operation of power plants and other heat sources from within the aircraft must be considered. Include steady state and transient excursions of the airframe into and out of regimes of aerodynamic heating consistent with the operational intent. The airframe needs to include provisions for handling the cumulative effects of the temperature/load history for its planned service life. Pre- and post-flight operations such as ground run-up and extended taxiing with the tail to wind need to be considered.

REQUIREMENT LESSONS LEARNED

None.

B.5.2.16 MATERIALS AND PROCESSES

Materials and processes shall be in accordance with the following requirements so that the airframe meets the operational and support requirements.

- a. Relevant producibility, maintainability, supportability, repairability, and availability experience with the same, or similar, materials and processes shall be a governing factor for suitability of the airframe design. Environmentally conditioned tests must be performed at the appropriate development test level to meet relevant design conditions.
- b. Material systems and materials processes selected for design shall be stable, remain fixed, and minimize unique maintenance and repair practices in accordance with the specified operational and support concepts.
- c. Material systems and materials processes (including radioactive materials and processes) shall be environmentally compliant, compliant

with best occupational safety, and health practices, and minimize hazardous waste generation.

REQUIREMENT RATIONALE

Proper material selection is necessary to assure adequate structural properties, such as strength, stiffness, fatigue, crack growth rates, fracture toughness, corrosion susceptibility, and material system and processes stability for the imposed environment such that operational performance, safety, reliability, and maintainability can be achieved. To avoid shutdown and fines in both manufacture and operation, it is necessary to ensure materials and processes selected are compliant with environmental regulations/laws.

REQUIREMENT GUIDANCE

Guidance from Military Handbooks. Throughout the following sections MIL-HDBK-5, MIL-HDBK-17, and MIL-HDBK-23 are referenced extensively as sources of material allowable data and design application guidance. These documents contain standardized data and procedures for characterizing material systems and analyzing their performance for given applications and product forms and should be used as a baseline for addressing materials and processes characterization, selection and application, and should be deviated from only with appropriate supporting engineering justification.

Guidance from Military Specifications and Design Documents. The guidance contained in MIL-STD-1568, MIL-STD-1587, and SD-24 should serve as baseline data for addressing materials/processes and corrosion requirements and should be deviated from only with appropriate supporting engineering justification. MIL-STD-1568 and MIL-STD-1587 provide extensive guidance/lessons learned for corrosion prevention and control, and materials and processes performance data and documentation requirements. MIL-STD-1587 and SD-24 provide information relating to materials and processes selection in the design process, material systems performance, and application dependent processes and documentation requirements.

Material Systems and Material Processes Selection. The requirements for strength, damage tolerance, durability, vibrations, sonic fatigue, and weapons effects including battle damage must be defined. One option for establishing material allowables is addressed in the Air Structural Integrity Program; however, these allowables must be established including environmental effects. Materials and processes should be selected with consideration to minimize unique maintenance or repair practices beyond existing organization, immediate, or depot (as applicable) capability. The selection of specific material systems should be based on comparison between material properties of all candidate materials and the operational requirements for each particular application. The spectrum of operational requirements

that should be considered include: Load paths and magnitudes, operating temperatures and environments, including the presence of corrosive and abrasive elements, and water.

Materials should be selected on the basis of suitability and availability, and should include consideration of the additional restrictions created during a national emergency. The use of strategic and critical materials (see definition in MIL-STD-295) should be minimized. Nonstrategic, noncritical materials should be selected when performance, interchangeability, reliability, maintainability, or safety will not be adversely affected, or production significantly altered. Those selected should not include environmentally hazardous materials such as chlorofluorocarbons, asbestos containing materials, paint coating containing lead, or primer/topcoat paints exceeding volatile organic compound limits.

The contractor should consider the requirements of the Clean Air Act, Clean Water Act, Toxic Substance Control Act, Resource Conservation and Recovery Act, Superfund Amendments and Reauthorization Act, Emergency Planning and Community Right-to-Know Act, and other service related guidance. The selection of subcontractors should be governed by their ability to comply with the requirements herein.

Manufacturing and in-service damage. Composite structures as well as metal structures must be designed to minimize the economic burden or repairing damage from low energy impacts such as tool drops, etc. To accomplish this goal, the structure is to be divided into two types of regions. The first type is one where there is a relatively high likelihood of damage from maintenance or other sources. The second type of region is one where there is a relatively low probability of the structure being damaged in service. The specific requirements for these two areas are given in the table I. There are two other threats to the structure that may cause an economic burden or adversely impact safety. These threats are hail damage to the aircraft when parked and runway debris damage to the aircraft from ground operations. The hailstone size for which the structure must be hardened was chosen to include most of the potentially damaging objects found in ground operations. The velocity of these objects is dependent on the weapon system. The details of the hail and runway debris requirements are shown in the table II. The loading spectrum and environmental conditioning for the testing associated with table I and table II requirements will be the same as that described for the durability tests.

Additional damage considerations. In addition to the threats described above, the safety of flight structure must be designed to meet other damage threats. These threats are those associated with manufacturing and in-service damage from normal usage and battle damage. The non-battle damage sources are described in table III for manufacturing initial flaws and in-service damage. The design development tests to demonstrate that the structure can tolerate these

defects for its design life without in-service inspections should utilize the upper bound spectrum loading and the environmental conditioning developed for the durability tests. These two lifetime tests must show with high confidence that the flawed structure meets the residual strength requirements of table IV. These residual strength requirements are the same for the metallic structures.

Special considerations for composites.

For composites, particular emphasis should be placed on the issue of battle damage from weapons since the containment of this damage may well dictate the design configuration. Materials and processes employed in structure must also be selected based on a consideration for reparability for in-service damage. Further, the design usage and missions must be adequately defined such that the potentially damaging high load cases are properly represented.

- a. Temperature and moisture. The temperatures should be derived from the projected operational usage of the aircraft and the moisture conditions ranging from dry to the end of lifetime condition expected from a basing scenario that is representative of the worst expected moisture exposure. The allowable for a given flight condition should be based on the temperature appropriate for that flight condition combined with the most critical of the range of possible moisture conditions. The factor of uncertainty to be used in the application of the allowables derived above is 1.5. Since the strength of a composite structure is inherently dependent on the lay up of the laminate, geometry and type of loading, the "B" basis allowable must include these factors. This "B" basis allowable divided by the mean strength allowed when interpreting the results of single complex component tests.
- b. Low cycle fatigue in composites. Government research programs have demonstrated that aerospace composite structures are relatively insensitive to low cycle fatigue loading for the low stress cycles, but much more damaged by the high stress cycles. Unfortunately, the data base from which the high stress cycles for a new aircraft are derived is somewhat meager. Consequently, care must be used in defining the design usage.
- c. Battle damage. For many composite structures, the damage tolerance requirements will determine the allowable strain. However, the battle damage requirements are likely to influence the composite structure arrangement. For example, the need to contain battle damage to prevent catastrophic loss of the aircraft may well dictate the use of fastener systems and/or softening strips. The battle damage threat must be examined in the initial phase of the design. A fall out capability for battle damage based on configurations that meet all other requirements may not be adequate.

- d. Extreme loading of composites. Since the composites may be critical for the severe loading cases, care must be exercised to assure that these high level load occurrences are properly taken into account in the force management tracking program.
- e. Residual strength. To obtain the desired high confidence that the structure meets the residual strength requirement in the composite components, it may be necessary to show that the growth of the initial flaws is insignificant. Similar to durability testing, there should be a program to assess the sensitivity to changes in the baseline design usage spectrum.
- f. Modification programs. For modification programs, reference the requirements of the original development program if they are still technically valid and cost effective. Otherwise leave 5.5.2.12 unchanged.

In a fighter airplane, many delaminations occurred between the aluminum skin and aluminum honeycomb in a high temperature and high humidity environment. A recommended improved adhesive was implemented in the form of a corrosion inhibiting primer, a superior adhesive, and a change to phosphoric acid etching. These improved materials with the requirement for hermetical sealing and for leak checking critical bonded structures plus improvements in the bond shop environment dramatically improved the structure. After temperature base was established by flight tests, a theoretical damage tolerance assessment program was initiated. This analysis defined such items as type of crack, limit stress, and critical crack length for each component in question.

Cadmium interaction with titanium. Cadmium plate fasteners have been assembled in direct contact with titanium alloy (Ti-6Al-4V) hardware in an all metal weapon system airframe. Cadmium is a widely recognized contaminant of titanium and is generally known to cause embrittlement cracking of titanium. Titanium clips were inspected in two air vehicles to determine if a problem did actually exist. One of the clips, located in a very high temperature area did produce a crack. An extensive investigation to evaluate the effect of Cad/Ti interfaces in actual airframe hardware has been conducted. This survey found:

- a. That even though cadmium plated fasteners were being used in conjunction with titanium, no service failures were reported.
- b. Additional laboratory tests suggested there might be a problem. The latest literature puts emphasis on laboratory test results involving high tensile stress in the titanium and intimate contact at the Cad/Ti interface at high temperature. It was apparent that there were conflicts between theoretical results, laboratory results, and actual experience. The literature survey presents a story of laboratory test results with a high percentage

of failure of cadmium plated titanium fasteners under ideal conditions, to no failures in instances where some of the variables are less than ideal.

After the temperature base was established by flight tests, a theoretical damage tolerance assessment program was initiated. This analysis defined such items as type of crack, limit stress, and critical crack length for each component in question.

Several contractor/military survey teams were assembled to physically examine titanium components in contact with cadmium, especially those exposed to temperatures above 450⁰F on a high time aircraft. A stereoscopic microscope and a fiber optic rod borescope were used in conjunction with fluorescent penetrant to help enhance the capability to locate any cracks around fastener holes. Several components were exchanged and the original part examined by various metallurgical techniques such as the scanning electron microscope and X-ray image scans. No cadmium related cracks were found. Therefore, cadmium/titanium contact on this series of aircraft under service environment experienced does not constitute an operational problem.

A realistic laboratory test was devised. Specimens which represented the various Cad/Ti hardware combinations were assembled and exposed for time, temperature, and stress levels of the operational aircraft. The fabrication and assembly were performed by standard manufacturing procedures, except maximum torque values were used, and the installation was made dry (without the use of primer). The results indicated that cracking of titanium components will not occur from solid cadmium embrittlement when exposed to the following conditions:

- a. Maximum permissible torque.
- b. Surface contact between cadmium and base titanium caused by failure to apply epoxy sealant to holes prior to fastener installation.
- c. Temperature of 500⁰F for times equivalent to 8000 hours of service.
- d. Over temperature conditions of 600⁰F for one hour after completion of exposure of 500⁰F.
- e. Various modes of contact between cadmium and titanium including: thread to thread, shank to hole, and flat surface to flat surface.

Several additional high fit stress (82% of limit) tests were performed at 500⁰F and 300⁰F. Cracking occurred in all the titanium holes of the specimens tested at 500⁰F, but the low temperature specimens did not crack. In actual service all of the significant factors; high stress, high temperature, and no diffusion barrier, such as epoxy primer are generally not present and, therefore, cracking does not develop.

Silver plating. Silver embrittlement can pose the same threat as cadmium embrittlement, as was observed in a cowling of a light air/ground fighter.

A helicopter maintenance instruction manual requires conditional use of a petroleum base corrosion preventative compound for engine corrosion control. Current environmental regulations, however pose new problems associated with the use of petroleum base corrosion preventative compound; emission of the volatile organic compounds, a nonexistent permit to operate the corrosion control cart applying corrosion preventative compound, and no provisions to avoid the removed compound from washing into the storm drains located in or near aircraft parking areas. The long term solution is to apply blade coating to preclude corrosion that eliminates the requirement to use petroleum base corrosion preventative compound.

B.5.2.16.1 MATERIALS

The materials used in the landing gear shall be commensurate with the operational and support requirements for the landing gear. Whenever materials are proposed for which only a limited amount of data is available, the acquisition activity shall be provided with sufficient background data so that a determination of the suitability of the material can be made. The allowable structural properties shall include all applicable statistical variability and environmental effects, such as exposure to climatic conditions of moisture and temperature; exposure to corrosive and corrosion causing environments; airborne or spilled chemical warfare agents; and maintenance induced environments commensurate with the usage of the landing gear.

Specific material requirements are:

- a. Average values of crack growth data (da/dN) shall be used in the crack growth analysis if the variation of crack growth data is a typical distribution. Reference 5.5.10.4.4 for a nontypical distribution.
- b. Minimum values of fracture toughness shall be used for residual strength analysis.
- c. "A" basis design allowables shall be used in the design of all critical parts (see definitions section, definitions _____ through _____). "A" basis design allowables shall also be used in the design of structure not tested to ultimate load in full scale landing gear testing. "B" basis design allowables may be used for all other structure which include: _____
- d. "S" basis design allowables are acceptable for design when "A" or "B" basis allowables are not available, provided they are specified in a governing industry/government document that contains quality assurance provisions at the heat, lot, and batch level in the as-received material condition. Appropriate test coupons shall accompany the material in the as-received

condition and shall be subject to testing for verification of minimum design properties after final processing.

e. _____.

REQUIREMENT RATIONALE

Since different levels of criteria exist for various parts of an airframe, the selection and proportion of metallic and nonmetallic materials must be commensurate with their intended usage. Loading and environmental conditions may influence the selection of a particular material over others. Regardless of material selection, it is appropriate that allowables with the highest probability of meeting minimum values be used in the design of both composite and metallic structural components employed in single load path, non-redundant, and safety of flight critical structure.

It is necessary to select and configure nonmetallic materials that conform to applicable specifications, military standards, and handbooks in order to ensure a more reliable and cost-effective structure.

Nonmetallic materials selection, conforming to approved documentation sources that are called out within drawings and the structural description report, ensure a more reliable strength structure. In order to calculate correct margins of safety, valid material property allowables must be referenced to approved sources within the strength analysis report.

REQUIREMENT GUIDANCE

Material Systems Data. MIL-HDBK-5 provides uniform data for metallic materials/components and minimizes the necessity of referring to numerous materials handbooks and bulletins to obtain the allowable stresses and other related properties of materials and structural elements. MIL-HDBK-17 provides data on polymeric composite material systems in a three volume document addressing guidelines for characterization, statistically based mechanical property data, and use of statistical data in design applications. MIL-HDBK-23 provides guidelines and data for design of structural sandwich composites.

The additional guidance on material systems contained in MIL-STD-1568, MIL-STD 1587, and AFSC DH 1-2 should serve as the baseline approach for addressing materials systems requirements and should be deviated from only with appropriate supporting engineering justification. These documents provide extensive guidance/lessons learned for materials and materials processes selection, application, and support throughout the life cycle of the airframe.

Metallic material properties. Properties of materials for design purposes should be obtained from MIL-HDBK-5 or developed, substantiated, and analyzed using statistical analysis criteria and procedures consistent with those presented in MIL-HDBK-5. MIL-HDBK-5 statistical techniques are employed for maintaining uniformity in the presentation of "A"

basis allowables, whereby 99% of the population of values is expected to equal or exceed the "A" basis mechanical property allowables, with a confidence of 95%. In the presentation of "B" basis allowables, 90% of the population of values is expected to equal or exceed the "B" basis mechanical property allowables with a confidence of 95%. MIL-HDBK-5 represents effect-of-temperature curves on the mechanical properties of metallic properties as well as curves on creep, thermal elongation, and temperature fatigue. Any variance from MIL-HDBK-5 methods for determining reliable mechanical and physical properties should be fully substantiated and documented. Where it is necessary to develop data for materials, the test materials and processes should be those intended for use in production aircraft. The generation and analysis of test data for new material should follow the guideline presented in Chapter 9 of MIL-HDBK-5.

Selection of Steels. Selection of steels should be as follows:

- a. Aircraft quality, vacuum-melted steel should be used for parts which are heat treated to an ultimate tensile strength of 200,000 psi and above.
- b. The maximum ultimate tensile strength of production parts should not be greater than 20,000 psi above the established allowable minimum requirement.
- c. Preference should be given, in selection of carbon and low alloy steels, to compositions having the least hardenability which will provide through-hardening of the part concerned.
- d. Compositions should be selected such that heat treatment to the required strength and service temperatures should preclude tempered martensite embrittlement and temper embrittlement.
- e. Steels should be selected having ductile-brittle fracture transition temperatures as determined by impact test below the minimum operating temperature.
- f. Steels whose mechanical properties are developed by cold deformation should have recovery temperature of at least 50°F above the expected operating temperature range.
- g. Critical parts should be designed and processed so as to result in no decarburization in excess of 0.003 in. in highly stressed areas. Elsewhere, decarburization should be avoided, and where unavoidable, should be compensated by appropriate reductions in design fatigue strength. Unless otherwise specified, design should preclude use of as-forged surfaces. Carburization and partial decarburization of fully hardened steel parts should be restricted such that the difference in hardness from the surface to the nominal

subsurface hardness should not exceed two (2) Rockwell C (HRC).

- h. The mechanical drilling of holes in martensitic steels after hardening to strength levels of 180,000 psi and above should be avoided. When such drilling is unavoidable, the procedure used should be fully substantiated and documented in the appropriate process specification. When required for close tolerance holes or removal of decarburization, holes may be reamed after final heat treatment. Reaming should be followed by retempering at a temperature not more than 50°F below the specified tempering temperature. Reamed holes require a non-embrittling temper etch inspection.
- i. Grinding of martensitic steels and chromium plated martensitic steels hardened to 200,000 psi and above should be performed in accordance with MIL-STD-866.
- j. Maximum use of materials with high fracture toughness is required. Ferrous materials with fracture toughness of less than 100 ksi-in^{1/2} in the longitudinal direction, and 95 ksi-in^{1/2} in the transverse direction should not be used in fracture critical traceable fracture critical, or maintenance critical applications.
- k. H-11, D6-AC, 4340M, and 300M steels should not be used.

Corrosion-Resistant Steels. The following limitations should be observed in the selection and application of corrosion-resistant steels:

- a. Unstabilized austenitic steels should not be fusion welded.
- b. Precipitation hardening semi-austenitic grades should not be used in applications which require extended exposure to temperatures in the 750°F through 900°F range.
- c. 431 and 19-9DL steel should not be used.
- d. Precipitation hardening stainless steels should be aged at temperatures not less than 1025°F. Castings may be aged at 935°F plus or minus 15°F, and springs in the CH900 condition may be used.
- e. Corrosion-Resistant Maraging Steels (ALMAR 362, CUSTOM 455, CUSTOM 450) should be aged at temperatures not less than 1000°F.
- f. The 400 Series martensitic steels should not be used in the 150,000 to 180,000 psi strength range.
- g. Free machining stainless steel should be avoided for all critical Aluminum Alloys. Whenever the design requires the selection of aluminum for structural applications, maximum use should be made of alloys and heat treatments which

minimize susceptibility to pitting, exfoliation, and stress corrosion. Recommended alloys and tempers for exfoliation and stress corrosion resistance are given:

EXFOLIATION RESISTANCE

<u>Alloy</u>	<u>Temper</u>
2014	Artificially Aged
2024	Artificially Aged
2124	Artificially Aged
2219	Artificially Aged
7049	T76XX, T73XX
7050	T76XX, T74XX
7075	T76XX, T74XX
7150	T77XX
7175	T76XX, T74XX

STRESS CORROSION RESISTANCE

<u>Alloy</u>	<u>Temper</u>
2024	Artificially Aged
2124	Artificially Aged
2219	Artificially Aged
7050	T73XX
7050	T74XX
7075	T73XX
7175	T73XX
7175	T74XX
7475	T73XX

In the event these alloys and tempers, or other approved alloys are not used, the susceptibility to stress corrosion cracking of the selected alloy should be established for each application in accordance with the American Society for Testing and Materials (ASTM), test methods ASTM G44 and ASTM G47.

Clad Aluminum Alloys. Suitably clad or inherently corrosion-resistant alloy should be used in exterior skin which (1) is 0.125 in. or less in thickness, (2) forms a leading edge, exhaust trail area of any source, or wheel well area, (3) is spot or seam welded, or (4) is the face sheet in bonded sandwich construction. To preclude partial aging in heat treatable alloys, the bonded sheet should be in the artificially aged

condition prior to bonding. The references above to exterior surfaces and skin mean the external surface only, and do not preclude use of material clad only on one side, or the removal of cladding from internal surfaces. Clad, high strength aluminum alloys should not be fusion welded.

Aluminum Alloy Selection Limitations. The use of 2020, 7079, and 7170 is not advisable without engineering justification and procuring activity approval. The use of 2000 series T3 and T4 temper alloys greater than 0.125 in. thickness and 7075-T6 alloys greater than 0.080 in. thickness is not advisable without engineering justification and procuring activity approval.

Titanium and Titanium Alloys. Titanium alloy extrusions should be procured in accordance with the requirements of MIL-T-81556. All titanium bar and forging stock should be procured in accordance with the requirements of MIL-T-9047 or MIL-F-83142 as appropriate and supplemented by such contractor documents as necessary to insure the metallurgical and structural properties required to meet the reliability and durability requirements of the system.

Titanium Sheet and Plate. Titanium sheet and plate stock should be procured to meet the requirements of MIL-T-9046, as supplemented by contractor specifications, drawing notes, or other approved documents which reflect quality, properties, and processing to provide material suitable for its intended use.

Titanium Fretting. Application of titanium should be designed to avoid fretting and the associated reduction in fatigue life. Components should be designed to fretting allowables. Analyses should be conducted for all fretting conditions and should be augmented when necessary by testing to insure that fatigue life requirements are met. In lieu of repeat testing, the results of previous element or component tests that studied fretting may be used to establish design factors for similar applications where fretting may occur.

Titanium Alloy Prohibition. The use of titanium alloy 8Al-1Mo-1V in other than the beta heat treated condition is not recommended without engineering justification and procuring activity approval.

Surface Considerations for Titanium Alloys. All surfaces of titanium parts should be free of alpha case and, if necessary, should be machined or chemically milled to eliminate all contaminated zones or flaws formed during processing. Titanium fasteners or components should not be cadmium or silver plated.

Magnesium Alloys. These alloys are not suitable for salt water environments and should not be used without engineering justification and procuring activity approval.

Beryllium and Beryllium Base Alloys. Beryllium and beryllium based alloys are classified as hazardous material systems and should not be used without the approval of the procuring activity. Beryllium copper alloys containing less than 2% beryllium by weight have generally not been considered hazardous.

Beryllium Copper Alloys. For high bearing load applications, critical wear applications, and wear applications where good structural load capability is required, the use of a beryllium copper alloy is recommended. Alloy UNS C17200 or UNS C17300 or equivalent is required. Wrought beryllium copper should be acquired to ASTM B196, ASTM B197, or ASTM B194. Beryllium copper castings should be acquired to AMS 4890, and classified (class and grade) per MIL-STD-2175.

Bronze Bearing Alloys. For moderate and light duty bearing loads, wrought UNS C63000 aluminum-nickel bronze per ASTM B150 and ASTM B169 is the preferred alloy. Aluminum bronze (alloys UNS C95200-C95800) and manganese bronze (alloys UNS C86100-C86800) castings are acceptable and, where used, should be classified (class and grade per MIL-STD-2175, and acquired per QQ-C-390. The use of bronze alloys other than those discussed above should be avoided.

Nickel and Cobalt Base (Superalloy) Alloys. The use of nickel and cobalt base superalloys is acceptable. For light gage welded ducting, Inconel 625 (UNS N06625) per AMS 5581, AMS 5599, or equivalent is required. Nickel and cobalt base superalloy casting classification, grade, and inspection standard, with justification including effects of defects analysis, should be fully substantiated and documented.

Material Product Forms.

- a. **Extrusions.** Extrusion should be produced in accordance with QQ-A-200 for aluminum, MIL-S-46059 for steel, and MIL-T-81556 for titanium. Titanium extrusions to be used in applications requiring little or no subsequent machining should be ordered with a class C finish (descaled, free of alpha case).
- b. **Forgings.** All structural forgings should comply with the following requirements. Forgings should be produced in accordance with MIL-F-7190 for steel, MIL-A-22771 for aluminum, and MIL-F-83142 or MIL-T-9047 as appropriate for titanium. The ultrasonic requirements for titanium should be fully substantiated and documented. The forging dimensional design must consider forging allowances such as parting line with regard to final machining such that short transverse grains (end grains) are minimized at the surface of the part. After each forging technique (including degree of reduction) is established, the first production forging should be sectioned and etched to show the grain flow pattern and to determine mechanical properties at critical design points. Sectioning should be repeated after any major change in the forging technique. Orientation of predominant design stresses in a direction parallel to the grain flow should be maximized. The pattern should be essentially free from re-entrant or sharply folded flow lines. All such

information should be retained and documented by the contractor.

- (1) **Residual Stresses in Forgings.** Procedures used to fabricate structural forgings for fatigue critical applications should minimize residual tensile stresses. Procedures for heat treatment, straightening and machining should be utilized which ensure minimum residual tensile stresses.
- c. **Castings including those cold/hot isostatically pressed. (C/HIP).** Castings should be classified and inspected in accordance with MIL-STD-2175. Aluminum castings should confirm to the requirements of MIL-A-21180. AMS 5355 should be used for 17-4 pH castings. The use of castings or C/HIPed parts for primary or critical applications requires successful completion of a developmental and qualification program. Avionics equipment castings should be in accordance with MIL-STD-5400.
- d. **Plate.** The use of aluminum alloy plate starting stock equal to or greater than four inches in thickness should be avoided without engineering justification and procuring activity approval.

Composite material properties. Properties for composite materials should be obtained from MIL-HDBK-17 (if available) or developed, substantiated, and analyzed using statistical analysis criteria and procedures consistent with those presented in the appendix to Volume II of MIL-HDBK-17. Additional guidance for design and application of composite material systems are described in MIL-P-9400, MIL-T-29586, and the composites subparagraphs of MIL-STD-1587. These properties should account for those characteristics of fibrous composites which are associated with the required operating environments (including representative moisture conditions), the directionality of the fibers, and the construction variables. The properties should include, but not be limited to, tension, compression, shear fatigue, and the associated elastic constants.

Selection of composite materials. The selection of the materials to be used for structural applications should take into account all factors which affect required strength, rigidity, and structural reliability. Such factors should include, but are not limited to, chemical characterization of the resin matrix of the composite pre-preg, impact damage, delaminations from manufacturing, scratched, electromagnetic environmental effects, bird strikes, hail damage, manufacturing processes; static, repeated, transient, vibratory, and shock loads; and specific effects of operating environment associated with reduced and elevated temperatures, (including effects of various operating chemicals on composites) repeated exposure to climatic, erosive, and scuffing conditions, the use of protective finishes, the effects of stress concentrations, and the effects of fatigue loads on composite endurance limit and ultimate strength. The actual

values of properties used for structural design should include such effects. Field and depot repair procedures should be established for accepted applications of fibrous composite aircraft structures. Such procedures should be documented for subsequent incorporation in pertinent structural repair manuals. Composite material selection should allow a minimum 50°F wet glass transition temperature margin above the service design temperature as measured by dynamic mechanical analysis.

Environmental exposure and conditioning. The temperature exposure range of the composite materials should include the full range of temperatures anticipated during the life of the aircraft including -65°F and aerodynamic heating based on MIL-STD-210 and local heat source effects. The design moisture content should be expressed as a percentage of weight gained due to moisture absorption. The design moisture content should be achieved by subjecting the test specimens to temperatures equal to or less than the maximum operating temperature experienced on the aircraft for a given material system and as percent relative humidity simulating the worst case moisture gain environment until either: (a) a specified percent of weight gain is achieved, (b) equilibrium is reached, or (c) 75 days are needed.

Lamina. For purposes of developing the lamina properties of the fibrous composites, specimens from a minimum of three batches (which includes three resin batches in combination with three fiber lots) of material should be tested to arrive at minimum mechanical properties above which at least 90% of the population values is expected to fall with a confidence of 95%.

Laminates. Composite laminate properties which are established from single ply properties through analytical techniques should be substantiated by the performance of a sufficient number of laminate tests to permit the statistical evaluation of the laminate. This analysis should produce design values for minimum mechanical properties above which at least 90% of the population values are expected to fall with a confidence of 95%. The test data should be correlated with the design values obtained by the analytical techniques and appropriate corrections should be made to the structural design margins-of-safety. When a fibrous composite of specified constituent composition and construction in all respects representative of the material to be used in a new application, has been used previously in sufficient quantities to establish adequacy of its properties, such properties may be used for structural design in the new application. The design allowable for a given environmental condition should be established by testing a reduced number of specimens for combined temperature-moisture environmental conditions. However, the equivalence of the established properties to those for the material intended for the new application should be substantiated by the appropriate tests.

Organic materials. The following restrictions should apply to the selection of elastomers, plastics, and other

organic materials used in the fabrication of aircraft structures and components:

- a. All organic materials should have resistance to degradation and aging (including resistance to hydrolysis, ozonolysis, and other degradative chemical processes attendant upon atmospheric exposure), and minimum flammability consistent with performance requirements for the intended use.
- b. Organic materials used in contact with other types of materials, metals, and/or other organics should be separated by suitable barrier materials, should not induce corrosion or stress corrosion, and should be otherwise entirely compatible. Decomposition and other products, including volatile and leachable constituents, released by organic materials under normal operating conditions should not be injurious or otherwise objectionable with respect to materials or components or to personnel with which they may be reasonably expected to come in contact.
- c. Cellular plastics, foams, and wood should not be used for skin stabilization in structural components, other than in all-plastic sandwich components as specified herein. Use of foam as sandwich core material should be fully substantiated and documented.
- d. Natural leather should not be used.
- e. Elastomeric encapsulating compounds used should conform to MIL-S-8516, MIL-S-23586, MIL-M-24041, MIL-A-46146, or MIL-I-81550. Use of hydrolytically unstable encapsulation materials is not advisable without engineering justification and procuring activity approval. Use of polyester polyurethanes requires substantiation of hydrolytic stability.
- f. Adhesives used in the fabrication of aircraft structure, including metal faced and metal core sandwich, should be fully substantiated and documented.
- g. Integral fuel tank sealing compounds should conform to MIL-S-8784, MIL-S-8802, MIL-S-29574, and MIL-S-83430.
- h. Materials that are in direct contact with fuels should be resistant to fuel-related deterioration and capable of preventing leakage of the fuel.
- i. All elastomeric components should possess adequate resistance to aging, operational environmental conditions, and fluid exposure for the intended system use.

Transparent materials. Transparent materials used in the fabrication of cockpit canopies, cabin enclosures, windshields, windows, and ports should be limited within the following restrictions:

- a. Acrylic plastic should be of the stretched type, conforming to MIL-P-25690. Stretched acrylic plastic should not be used where it will be exposed to temperatures above 250°F.

- b. Laminated glass should conform to MIL-G-25871 and bullet resistant glass should conform to MIL-G-5485.
- c. The use of polycarbonate should be fully substantiated and documented.

Composite design considerations.

- a. Plastics and glass fiber reinforced plastics conventionally conform to the requirements contained in MIL-HDBK-17. Design data and properties may be obtained from MIL-HDBK-17, developed in accordance with the methods prescribed in MIL-HDBK-17, or obtained from other sources subject to the approval by the acquisition activity. The requirements in MIL-STD-1587 covering composites and adhesive bonding are applicable. Base use of glass fiber reinforced plastic upon weight saving, strength maintainability, adequacy of manufacturing methods, and temperature-strength relationship. MIL-P-9400 should be considered in the fabrication of fiber reinforced plastics, using resins which conform to MIL-R-7575, MIL-R-9299, or MIL-R-9300.
- b. Advanced composites materials usually conform to the specifications contained in contractor-prepared documentation acceptable to the acquisition activity. The guidance for composites and adhesive bonding in MIL-STD-1587 should be considered
- c. All applicable environmental effects should be accounted for in establishing allowables for structural components. Temperatures should be derived from the projected operational usage of the aircraft and moisture conditions should range from dry to the end of lifetime condition expected from a basing scenario that is representative. The allowable for a given flight condition should be based on the temperature appropriate for that flight condition combined with the most critical of the range of possible moisture conditions. The factor of uncertainty to be used in the application of the allowables derived above is 1.5. Since the strength of a composite structure is inherently dependent on, for example, the lay-up of the laminate, geometry, and type of loading, the allowable must include these factors.
- d. Structural sandwich composites design data and properties should satisfy the requirements of applicable sources subject to the approval of the acquisition activity. The guidance on adhesive bonding and sandwich assemblies contained in MIL-STD-1587 as well as those within DN 7B1-11 of AFSC DH 1-2 should be considered. Limit load residual strength of bonded structural components (assuming 100% failure of the bond line) is a baseline performance requirement.
- e. Drawings, as well as a structural description report and the strength analyses report, can adequately list approved nonmetallic materials specifications. Allowable military specification or military handbook tabulated property values

may be directly referenced in the strength analyses report. Property values from sources other than MIL-HDBK-17, military specifications, or contractor-generated values, previously approved by the acquisition activity, are typically presented in a manner similar to the presentation in MIL-HDBK-5. However, properties which are unique for fibrous composites, due to their special characteristics associated with directionality of fiber and construction variables, are included. A sufficient number of specimens are tested to arrive at "B" minimum mechanical-property values which at least 90% of the population of values is expected to fail with a confidence of 95%. Fibrous construction representative of successful previous usage may be used for structural design in the new application, provided its material properties are established by appropriate test substantiation.

- f. Fibrous composite property values, from sources other than MIL-HDBK-17 or contractor generated values previously approved by the acquisition activity, should address the following:
 - (1) Mechanical properties. Mechanical properties for use as structural design allowables should be furnished for fibrous composites. Such properties should be compatible with the applicable analysis procedures, conditions, and configurations. Typically, the following mechanical properties include:
 - (a) Tensile ultimate strength-longitudinal (0°) and transverse (90°) including attendant elongation.
 - (b) Tensile yield strength-longitudinal and transverse.
 - (c) Compressive ultimate strength-longitudinal and transverse including attendant deformation.
 - (d) Compressive yield strength-longitudinal and transverse.
 - (e) Interlaminar tension
 - (f) Shear ultimate strength-membrane and interlaminar.
 - (g) Core shear strength.
 - (h) Flexural strength.
 - (i) Bearing ultimate strength.
 - (j) Bearing yield strength.
 - (k) Modulus of elasticity.
 - (l) Poisson's ration.
 - (m) Density.

- (2) Typical properties. Physical properties and certain other properties of the fibrous composite materials intended for use in the design and construction of aircraft should be developed as typical (average) values. For such properties, information on data scatter should be prepared based on applicable test values. Typically such properties include the following:
- (a) Full range tensile stress-strain curves with tabulated modulus data.
 - (b) Full range compressive stress-strain and tangent modulus curves.
 - (c) Shear stress-strain and tangent modulus curves.
 - (d) Flexural stress-strain curves.
 - (e) Fatigue data-tension and tension/compression stress-life curves.
 - (f) Reduced and elevated temperature effects-temperature range from -65°F to a maximum of +160°F or to the maximum elevated temperature to be encountered by the vehicle under acquisition, whichever is greater.
 - (g) Directional variation of mechanical properties include 360° polar plots as appropriate.
 - (h) Pullout strength of material with mechanical fasteners (or without fasteners for cocured/cobonded structure).
 - (i) Variation of mechanical properties with laminate thickness and with test specimen width.
 - (j) Creep rupture curves.
 - (k) Effects of fatigue loads on mechanical properties.
 - (l) Notch sensitivity.
 - (m) Climatic effects, including property reduction due to moisture.
 - (n) Effects of cyclic rate of load on fatigue strength.
 - (o) Fire resistance.
 - (p) Material repairability.
 - (q) Thermal coefficients.
- (3) Special definition of properties. As appropriate, the mechanical and physical properties developed should be specially defined to accommodate unique failure characteristics of fibrous composites. Such definitions include, but are not limited to, yield strength in terms of ultimate stress or secondary modulus; bearing strength associated with hole elongation and shear tear-out criteria; compression strength associated with failure criteria such as crazing or other matrix properties degradation when such degradation is sufficient to result in incipient fatigue failure. Wet properties are established when they differ from dry properties. Material systems which lose strength during the airframe's expected life due to moisture and temperature excursions are to be accounted for in reducing and establishing the "B" allowable strength level.
- (4) Substantiation of composite strength. For substantiation of the structural integrity of composites, the following should be established:
- (a) Expected absorption rate and saturation level of moisture in the composite matrix.
 - (b) Resultant strength/modulus and fatigue life degradation associated with this moisture content and expected temperature extremes.
 - (c) Design allowables reflecting the most extreme applicable conditions.
 - (d) A statistical description of composite failure parameters achieved by pooling observations from replicated sample sizes of 5 or more to establish batch-to-batch and within-a-batch variability.
 - (e) Validity of fatigue/environment interaction effects from coupon tests by tests of representative subcomponent structure.
 - (f) The reduction in residual strength capability as a result of exposure to fatigue loads with thermal and humidity environment (wear-out) for bolted and bonded joints and complex laminate configuration.
- (5) Thermal effects. The reduced structural properties due to temperature and other environmental effects must be considered in order to attain structural integrity of the airframe. For example, elevated temperatures not only influences the choice of materials but the sizing of structural members as well since thermal stresses are induced by thermal expansion restraint of the fasteners.

REQUIREMENT LESSONS LEARNED

With the advent of composite materials, generic properties for a particular resin/fiber material cannot be used as representative within and between disciplines for all structural components. For example, a strength critical wing skin may have different stiffnesses than an aeroelastic critical wing skin made of the same composite material but with different lamina orientations. The material properties used in the final design must be consistent within and

between disciplines for the same component from a materials processing and applications viewpoint. Check the material properties development requirements for the different disciplines (strength, aeroelasticity, durability and damage tolerance) for consistency and congruency within the applicable discipline and between all structures disciplines. This requirement is also applicable to other materials, including metallic materials.

During an evaluation of the effects of various fluids on composite materials, graphite/polyimide coupons in tin cans containing a combination of jet fuel and salt water solution were seen to suffer degradation induced by galvanic corrosion. Testing has shown that the experiment in question was unrealistically severe. However, a unique effect associated with -imide resins in the presence of corrosion by-products was discovered.

The potential for galvanic metal corrosion resulting from contact with graphite reinforced epoxies has long been recognized, and design practices have been established to work around this potential. Sufficient experience is in place such that no design knockdowns are required when working with such materials (MIL-STD-1586: Materials and Processes for Corrosion Prevention and a Control in Aerospace Weapons Systems; MIL-F-7179: Finishes and Coatings, General Specification for Protection of Aircraft and Aircraft Parts).

An industry working group was convened to evaluate the unique -imide phenomenon and develop a recommended position. USAF Wright Laboratory Materials Directorate and Naval Air Warfare Center personnel participated. The results of their findings were presented at a workshop hosted by USAF Wright Laboratory Materials Directorate in 1991.

Findings: The unique findings of this working group was that galvanic corrosion by-products can degrade -imide resins. Testing was performed with various polyimide, fluid, and metal combinations. -Imide resin degradation was found to occur only when: aggressive metal corrosion occurs where there is a mechanism for concentrating hydroxyl ions and where the -OH concentrations are directly in contact with the polyimide resin surface. Standard corrosion control procedures were found to be effective in protecting against this phenomenon, and engineering solutions were demonstrated through control of design and material selections.

Service experience with polyimide aircraft structures has shown no such reported corrosion problems.

Refer to MIL-STD-1568, MIL-STD-1587, SD-24, MIL-HDBK-5, AFSC DH 1-2, and AFSC DH 1-7 for additional lessons learned and precautionary information.

B.5.2.16.2 PROCESSES

The processes used to prepare and form the materials for use in the landing gear as well as joining methods shall be commensurate with the material application. Further, the processes and joining methods shall not

contribute to unacceptable degradation of the properties of the materials when the landing gear is exposed to operational usage and support environments.

Specific material processing requirements are:

- a. _____.
- b. _____.

REQUIREMENT RATIONALE

This requirement is needed to define material processes and joining methods to ensure adequacy of the airframe in meeting structural integrity requirements.

REQUIREMENT GUIDANCE

The guidance contained in MIL-STD-1568 and MIL-STD-1587 should serve as the baseline approach for addressing materials/processes and corrosion requirements and should be deviated from only with appropriate supporting engineering justification. MIL-STD-1568 and MIL-STD-1587 provide extensive guidance/lessons learned for materials processes selection and application.

Metallics processing.

Heat treatment. Heat treatment of aluminum alloys should be in accordance with the material specification and MIL-H-6088. Titanium should be heat treated in accordance with the material specification and MIL-H-81200. Steels should be heat treated in accordance with the material specification and MIL-H-6875. All reasonable precautions should be taken to minimize distortion during heat treatment. Steel parts which require straightening after hardening to 180,000 psi or below may be cold straightened provided a stress relieving heat treatment is subsequently applied. Except for the 14Co-10Ni family of alloys, straightening of parts hardened to tensile strengths above 180,000 psi ultimate tensile strength should be accomplished at temperatures within the range from the tempering temperature to 50°F below the tempering temperature. The 14Co-10Ni family of alloys may be straightened at room temperature in the as quenched condition (after austenitizing and prior to aging). Parts should be nondestructively inspected for cracks after straightening.

Quench rate sensitivity. Parts produced of materials which (a) require quenching from elevated temperature to obtain required strength and, (b) have corrosion or stress corrosion resistance sensitivity as a function of quench rate should be heat treated in a form as near final size as practicable. Wrought aluminum alloys that meet strength and other requirements and have been mechanically stress relieved by stretching or compressing (TXX51 or TXX52 heat treatments) may be machined directly to the final configuration.

Welding. Welded joints may be utilized in designs where shear stresses are predominant and tensile stresses are a minimum. Weldments involving steels which transform on air cooling to microstructure other than martensite should be normalized or otherwise processed to equivalent hardness in the weld zone. Weldments in parts subject to fatigue conditions should be fully heat treated after welding, unless otherwise specified. Precautionary measures including preheat, interpass temperature control, and postheating should be applied when welding air hardenable steels. Primary structural weldments should be stress relieved after all welding is completed. During welding operations heated metal should be protected from detrimental contaminants. Spot welding of skins and heat shields should be avoided unless approved corrosion control procedures subsequently are applied.

Weld bead removal. To avoid the possibility of stress corrosion or fatigue damage, all weld bead reinforcement of fatigue and fracture critical parts should be accessible for machining after fabrication, and should be fully machined. The weld bead reinforcement on the interior diameter of tubular structures should be fully machined if accessible. Conformance with welding specifications MIL-W-6858 (Resistance Welding), MIL-W-6873 (Flash Welding), and MIL-STD-2219 (Fusion Welding for Aerospace Applications) is required as applicable. Qualification of welding operators should be in accordance with MIL-STD-1595. Weld quality should conform to ASTM E-390, as applicable.

Brazing. Brazing should be in accordance with MIL-B-7883. Subsequent fusion welding operations or other operations which involve high temperature in the area of brazed joints should not be depended upon for any calculated strength in tension. When used, brazed joints should be designed for shear loadings. Allowable shear strengths should conform to those in MIL-HDBK-5. Titanium should not be brazed.

Soldering. Soldering materials and processes should be as specified in MIL-STD-2000. Soldering should not be used as a sole means for securing any part of the airframe or controls. MIL-T-83399 should be complied with for testing for removal of residual flux or by-products after soldering. The contractor should establish a soldering schedule for each joint to be soldered and a flux neutralizing and removal schedule. **Surface finish.** The following surface roughness requirements for parts installed in aircraft should apply:

- a. The surface roughness of chemically or electro-chemically milled parts should not be in excess of 200 microinches as defined in ANSI B46.1-1978.
- b. The surface roughness of forgings, castings, and machined surfaces not otherwise designated should not be in excess of 250 microinches.

Castings are classified to establish the inspection and test procedures and requirements consistent with the importance and criticality of the part, design stress

level of the part, its margin of safety, and the required level of integrity of the part.

Reference the applicable military specifications and documents and provide the indicated requirements in the appropriate blanks. If a subparagraph is not applicable, leave it out and re-letter the following subparagraphs. For castings, MIL-STD-2175 is applicable for classifying and inspecting. For aluminum castings, MIL-A-21180 must be complied with, in structural applications. For magnesium castings, MIL-M-46062 or other casting specifications in MIL-HDBK-5 may be applicable. For steel and CRES castings, AMS 5343 or other casting specifications in MIL-HDBK-5 may be applicable to structural applications. The margins of safety, considering "S" property values, are conventionally not less than 0.33 unless a lower value can be substantiated empirically. For premium grade aluminum castings of the A357-T6 alloy, the following margins of safety on yield and ultimate strength are applicable for the radiographic inspection quality grades as defined in MIL-A-21180. For grades "A" and "B", the margin of safety shall not be less than 0.0. For grades "C" and "D" the margins of safety shall not be less than 0.33 and 1.0, respectively. Flaws shall be assumed to exist in the repaired area and any heat affected zone in the parent material and of a size and shape determined empirically. However, the flaw sizes shall not be less than those required by 5.6.6.11.1.1. Other casting requirements may need to be defined and those in AFSC DH 1-7 are applicable.

Forgings have had to conform to MIL-F-7190 for steel, to MIL-A-22771 and QQ-A-367 for aluminum, and to MIL-F-83142 for titanium. These requirements have been proven necessary to assure structural integrity of the airframe.

Metallic parts, especially forgings, exhibit the greatest strength along the grain direction, which is imparted as the metal is worked between the stages of ingot and finished form.

Reference the applicable military specifications and documents and provide the indicated requirements in the appropriate blanks. If a subparagraph is not applicable, leave it out and re-letter the following subparagraphs. For steel forgings, MIL-F-7190 is applicable. For aluminum forgings, MIL-A-22771 or QQ-A-367 is applicable. For titanium forgings, MIL-F-83142 is applicable. Other forging requirements may need to be defined and those within MIL-STD-1568, MIL-STD-1587, and AFSC DH 1-7 are applicable.

For rolled, extruded, or forged material forms, MIL-HDBK-5 tabulates allowable stresses for the longitudinal (L), long transverse (LT), and short transverse (ST) grain directions. Forgings should be formed from such stock and dimensions that work accomplished on the finished shape results in approximately uniform grain size throughout. Employ forging techniques that produce an internal grain flow pattern, so that the direction of flow in highly stressed areas is essentially parallel to the principal stresses. Ensure that the forging grain flow pattern is essentially

free from reentrant and sharply folded flow lines. Ensure that the angle of grain direction at the surface does not exceed 90 degrees.

Composites processing. Composite processing should pay strict attention to process control to ensure the full development of engineering properties. Materials allowables development must accurately represent actual manufacturing conditions including lay-up, cutting, drilling, machining, and curing. Statistical Process Control (SPC) should ensure process optimization and control through in-process monitoring and recording. An SPC Plan for composites should be established. The SPC Plan should take into account all process variables which influence the final composite product including receiving inspection, handling, environmental controls, dimensional controls, processing, curing, machining, etc.

Shot peening. Metallic parts that require fatigue life enhancement in areas away from fastener holes or corrosion resistance should be shot peened. For non-critical parts, the requirements of AMS 2430L are considered adequate. For critical parts, including 5.5.1.3.2, fatigue/fracture critical parts; 5.5.1.3.3, maintenance critical parts; and 5.1.3.4, mission critical parts; the requirements of AMS 2432A should be used.

REQUIREMENT LESSONS LEARNED

It has been mandatory to conform to MIL-STD-2175 for classifying and inspecting castings, in order to reduce the possibility of parts failure. The single failure of a Class 1A casting could not only cause significant danger to operating personnel, but could result in loss of the air vehicle. It has also been mandatory to conform to MIL-A-21180 for aluminum, to MIL-M-46062 for magnesium, and to MIL-S-46052 for low alloy steel in the use of high strength casting applications. These specifications are necessary for prescribing the composition, inspection, mechanical properties, and quality assurance requirements of high strength castings produced by any method. It is necessary to limit the margin of safety to 0.33, in order to account for the lower strength of production castings, which may be as low as 75% of MIL-HDBK-5 tabulated values. It is the policy of some contractors to mandate a margin of safety even greater than 0.33.

Experience has shown that special considerations are required in the design and strength analysis of forgings. In general, small quantities of hand forgings, made by blacksmithing bars or billets with flat dies, are less expensive than die forgings, but hand forgings also have lower allowable stress levels. Because of the time required to manufacture dies for die forged parts, it may be necessary to use substitute parts on the earlier production aircraft. These substitute parts may be machined from bar stock or hand forgings. The strength analyst should be aware of the fact that substitute parts have different material properties than die forgings. The design of die forgings dictates the direction of grain flow and the designer strives to make certain that the inherent

forging characteristics are used to the best advantage. Reduced mechanical properties usually exist in the vicinity of the parting plane.

Aluminum die forgings are frequently subject to unhealed porosity in the areas of the parting plane. Steel parts are also subject to reduced tensile allowable stresses across the parting plane. Since these characteristics significantly affect the mechanical properties of the finished part, they should be considered in the design, the sizing, and the strength analysis of the forged part.

Experience has shown that most fatigue cracking problems originate on the outer surface of parts. Shot peening has been found to produce compressive stresses in this region and delay the occurrence of this type of cracking. The compressive stresses on the outer surface also have reduced the maintenance burden from corrosion and wear. Parts that are designed with the intent to employ the fatigue benefits of shot peening in meeting the required structural life must use the computer controlled processes of AMS 2432A.

B.5.2.17 FINISHES

The landing gear and its components shall be finished in compliance with the following requirements.

- a. Environmental Protection. _____.
Specific organic and inorganic surface treatments and coatings used for corrosion prevention and control must be identified and established.
- a. Visibility. _____.
- b. Identification. _____.
- c. Aerodynamically smooth exterior surfaces. _____.
- d. Other. _____.

REQUIREMENT RATIONALE

Structural and other parts of the airframe need to be protected from adverse environments, including man-made as well as natural to enhance their useful life and to reduce maintenance down-time and costs. Visibility and identification finishes used on the airframe must also be addressed to assure that they do not adversely affect the airframe. Environmental regulations/laws must be addressed to ensure the finishes used on the airframe are in compliance with applicable environmental protection regulations.

REQUIREMENT GUIDANCE

Identify and reference appropriate finish requirements for preservation (including corrosion prevention and control), visibility, and identification, and insert N/A for those areas which are not applicable. The

guidance contained in MIL-STD-1568, MIL-S-5002, and MIL-F-7179 should serve as the baseline approach for identification and application finishes and should be deviated from only with appropriate supporting engineering justification. For modification programs reference the requirements of the original development program if they are still technically valid and cost effective. Otherwise, identify and reference applicable portions of MIL-STD-1568, MIL-S-5002, MIL-F-7179, MIL-M-25047. The selection and application of all organic and inorganic surface treatments and coatings should comply with air quality requirements. Exterior surfaces should be aerodynamically smooth. Organic coatings (other than fire insulating paints) should not be used for temperature control in inaccessible areas.

REQUIREMENT LESSONS LEARNED

Primers, topcoatings, specialty coatings, cleaner, corrosion preventative compounds, etc. have been reformulated to comply with lower volatile organic compounds (VOC) content requirements (environmental regulations).

B.5.2.18 NON-STRUCTURAL COATINGS, FILMS, AND LAYERS

Coatings (organic and inorganic), films, and layers applied or attached to the interior or exterior of the landing gear or subsystem components shall not degrade the structural integrity of the landing gear below the minimum required by this specification. The coatings, films, and layers shall be sufficiently durable to withstand all flight, ground, and maintenance environments and usage without requiring maintenance during _____.

REQUIREMENT RATIONALE

Although coatings, films, and layers may be non-structural, their application and attachment to subsystems of the air vehicle including the structure can impact the structural integrity of the airframe. This requirement is needed to assure that the design, manufacture, inspection, use, and maintenance (including repair) of coatings, films, and layers is a fully integrated effort and will not degrade the structural integrity of the airframe.

REQUIREMENT GUIDANCE

The intent of using a coating, film, or layer is to derive a system benefit economically and without penalizing the overall performance of the air vehicle. Trade-off studies should be performed to determine if changes in other systems are viable alternatives. Note the distinction between adhesive bonding and other unidentified attachment methods. Adhesive bonding has been the most attractive attachment method for minimum cost, minimum weight, and good durability. But, adhesive bonds, especially to metallic surfaces, are critically dependent on cleanliness of the surface before bonding. A subtle contamination can reduce the bonded strength to almost zero. There is no

known method that will reliably detect this condition. One method of positive bond control is overall proof load testing. Another is local loading by a suction cup or a secondary bonded pad. Contamination typically affects an entire bonded surface rather than a local area, and as such testing of a tag end from each bonded panel may be sufficient. The flight environment will include temperatures, air loads, structural strains and deflections, vibrations, bird impacts, rain, hail, salt air, etc. The ground environment will include humidity, temperature, impact from runway debris, salt spray, fuel and other system fluids, rain, hail, dust, etc. The maintenance environment will include impact damage from dropped tools and line replaceable units, abrasion, and cleaning fluids. In general, both the number of hours of exposure and the number of cycles of application of each parameter may influence the durability behavior of the coating, film or layer, and the means of attachment. The time period inserted in the blank depends upon the requirements of each system, but two airframe service lifetimes of 5.5.2.14 is recommended. The guidance contained in MIL-STD-1568, MIL-S-5002, and MIL-F-7179 should serve as the baseline approach for identification and application finishes and should be deviated from only with appropriate supporting engineering justification.

REQUIREMENT LESSONS LEARNED

Regarding the need for field repairs, experience has shown that damage does occur and repairs (mostly minor) are needed and are cost effective.

B.5.2.19 SYSTEM FAILURES

All loads resulting from or following the single or multiple system failures defined below whose frequency of occurrence is greater than or equal to the rate specified in 5.5.2.11 shall be limit loads. Subsequent to a detectable failure, the landing gear shall with the flight limits of 5.5.2.5, 5.5.2.7.10, and 5.5.2.9.5. Loads resulting from a single component failure shall be designed for as limit load, regardless or probability of occurrence.

- a. Tire failures (____).
- b. Mechanical failures. (____)
- c. Hydraulic failures. (____)
- d. Flight control system failures. (____)
- e. Other failures. (____)

REQUIREMENT RATIONALE

The ability of the airframe to successfully withstand the system failures of 5.5.2.19 is needed to ensure that the safety of the crew and recovery of the air vehicle is ensured.

REQUIREMENT GUIDANCE

This requirement relates to those failures which can be expected during normal operations and includes such things as engine failures, tire failure, hydraulic system failures, autopilot malfunctions, and other failures which have a high likelihood of occurring during the lifetime of any air vehicle. One would not expect to lose the air vehicle because of the occurrence of a likely failure of a component of the air vehicle. All such potential and likely failures are to be identified in this requirement.

The consideration that needs to be taken into account is the designing limit loads that occur during or subsequent to the occurrence of a system failure. Such loads may be considered to be random loads. The cutoff frequency of occurrence that would be used to determine whether or not the loads resulting from a possible failure would be included in the limit loads is the same as the cutoff frequency selected for the loads of 5.5.2.11. Historical data for similar aircraft performing similar missions can be used to determine the rates at which possible failures occur which result in detrimental deformation.

Historical data indicates that any tire should be expected to fail during any phase of taxi, takeoff, flight, or landing and this should be taken into account in the design of the airframe and landing gear. If the probability of the frequency of multiple tire failures occurring during the same flight is greater than or equal to the rate specified in 5.5.2.11, the worst case combination of multiple tire failures should be taken into account in the design of the airframe and landing gear. In determining failure rates, all phases of taxi, takeoff, flight, and landing should be considered. If necessary, one set of failure rates for conventional and prepared surfaces and another set for austere, unprepared surfaces should be used. Define the applicable tire failures in the blank. If tires are not used on the air vehicle, insert N/A (not applicable) in the blank.

Any likely type of propulsion system failure including the airframe parts of the propulsion system that can have an adverse effect on the structural integrity of the airframe, including extinguishable fires, should be considered. Abrupt engine failure conditions, including unstarts, seizures, and the failure of active cooling systems, should be considered at all speeds. Pilot action to mitigate the impact of the failure should be started no earlier than two seconds after the detection of the failure. Define the applicable propulsion system failures in the blank.

Historical data indicate that the likely cause of failure is from bird strikes, hail, or pressurization. The back-up and other structure exposed after the failure of the radome should not deform detrimentally or fail. Define the applicable radome failures in the blank.

The expanded use of composites (dielectrics in particular) may have unique structural integrity implications as in the use of radar absorbing structure of various kinds for stealthy aircraft configurations. The emphasis here will probably be on secondary

structures (LEs, TEs, fairings, windows, etc.) as well as the internal nacelle duct walls which may be more critical to flight safety. There is also some indication that dielectrics may be useful as radar attenuators in the outer layers of composite skins for wing and empennage surfaces. Conflicting requirements may have a tendency to arise from the matrix of structural integrity, electromagnetic compatibility, lightning protection, and radar attenuation needs. If the structural strength of a component is compromised for stealth or other reasons, the likelihood of a failure increases. Any such failure comes under the above requirement and must be accounted for, particularly the strength of the back-up structure must be adequate to take any loads induced by the failure.

Historical data indicate that mechanical systems such as cargo ramps, cargo doors, latching mechanisms, speed brake support structure, slats, flaps, slat/flap tracks, and drive mechanisms fail more frequently than 1×10^{-7} times per flight. Such failures should not degrade, damage, or cause to fail any other components of the flight control, fuel, hydraulic, secondary power or other flight critical systems such that safe, continued, and controlled flight is not possible.

Hydraulic failures must not be allowed to induce failures in the airframe. Areas of concern include those where a hydraulic failure could cause hard over of a control surface, full brake pressure to be applied to the wheel brakes, or air vehicle configuration changes at airspeeds outside of established envelopes. Define the applicable hydraulic failures in the blank.

The single and multiple failures of the flight control system allowed prior to complete loss of control of the air vehicle should be defined so that the loads acting on the airframe during the failure, as a result of the failure, and following the reconfiguration of the control system to maintain control of the air vehicle can be determined. Define the applicable flight control system failures in the blank.

Flight control systems are becoming quite complex; however, they all function based on some pilot or crew member command resulting in some control surface response inducing an anticipated air vehicle response. Any single element failure of the flight control system which prevents the pilot's command from resulting in a reasonable air vehicle response is a candidate for causing a potential airframe problem.

List all other failures that can have an impact upon the structural integrity of the airframe. Special consideration should be given to new or unique systems. Examples of such systems are pneumatic systems and structural active cooling systems.

REQUIREMENT LESSONS LEARNED

Heavy air/ground fighter: Aircraft blew both main tires upon landing. Touchdown was approximately 1100 feet down runway. Upon touchdown, smoke was observed from behind both main gears. One thousand feet down runway from touchdown, sparks from both main gears followed by flames. At

approximately 3000 feet from touchdown, aircraft veered to left side of runway. Aircraft departed runway 3500 feet from touchdown, with a counter-clockwise spin and came to a stop with right main gear buried in the mud. Left main and nose gear were still on the runway. The WSO exited from the rear cockpit via emergency ground egress. Pilot shut down both engines and exited aircraft normally.

Trainer/transport: Tire blowouts and loss of directional control have contributed to 66 aircraft accidents and incidents since 1971. Incorporation of an anti-skid modification was subject to numerous delays which were caused by quality control and design problems, long lead times for delivery of components, and a strike.

Very large transport: During second takeoff attempt, local runway supervisor notified pilot that he appeared to have blown a tire. Takeoff was aborted and stopping roll became extremely rough. Aircraft was stopped; crew and passengers deplaned on runway. Damaged parts included: six tires, two rims, and minor structural damage in wheel well.

Delta wing fighter: The mission was briefed and flown as a student intercept training mission. During the Weapons Systems Evaluator Missile (WSEM) pass the pneumatic pressure light illuminated, therefore, the planned formation landing was not flown. On or immediately after touchdown, the left main tire blew. The aircraft departed the left side of the runway. Shortly before the aircraft came to a stop in the soft earth, the nose gear collapsed and the aircraft fell on its nose.

Prototype fighter aircraft: Part of the landing gear strut mechanism on this aircraft extended in a downward and forward direction from the wheel axle. With a normally-inflated tire no problems existed; however, with a deflated tire or after loss of a tire, the clearance of the mechanism above the runway was less than three inches and it extended beyond the wheel rim. As a result, the mechanism rode under and snagged the barrier arrestment cable. The resulting loads collapsed the gear rearward. The aircraft went off the runway and sustained major damage.

Heavy air/ground fighter: Engine explosion in flight. While flying a low level route, 17 minutes after takeoff, the crew heard a loud explosion and felt the aircraft vibrate. The left engine fire light came on and the No. 1 engine was shutdown. The left fire light remained illuminated for the rest of the flight. A chase aircraft (from another wing) observed a large hole in the fuselage in the vicinity of the left engine turbine section. The aircrew performed a controlled jettison of external fuel tanks in the jettison area. A single engine landing and normal egress were accomplished.

A very large transport aircraft was lost because hydraulic lines were routed in such a way that failure of the pressure door caused loss of control to an extent that return to base was not possible.

Supersonic trainer: Flaps were full down prior to initiating final turn for a full stop landing. Once rolled

out on final, the aircrew heard a pop and noted that it took excessive aileron to keep wings level. The left flap was full up and the right full down. The IP initiated a go-round and retracted the flaps. An uneventful no flap, full stop landing was accomplished. Investigation revealed the left flap operating rod end broke, allowing the flap to retract. Rod end failed at 929 hours and is a 1200 hour time change item.

Supersonic trainer: This split flaps mishap is similar to the one reported where the left flap lower rod end broke and caused the left flap to retract. The student made a no flap landing without further incident. Rod end failed at 646 hours.

Air supremacy fighter: During an inspection on an aircraft two wing attach bolts which retain the wing to fuselage attach pins in proper position were found to be missing from the wing attach pins. This was the result of improperly installed washers on the bolts which retain the wing attach pins.

Swing wing fighter: The overheat sensing elements in the lower crossover area between the engine bay and the wheel well did not respond until an overheat condition reached 575°F. Approximately five aircraft had hot air leaks that were not detected, but did get hot enough to burst the frangible disc on the fire extinguishing bottle resulting in loss of the extinguishing agent.

Swing wing fighter: During post flight inspection, a section of the left aft spike tip assembly was found lying in the engine intake. The spike aft tip attaching eye bolt had broken and the tip assembly had slipped off and gone into the engine. Engine damage was confined to the first stage fan section. No engine damage resulted from the second reported failure. The exhibit eye bolts failed from an overload condition. It is suspected that the overload was the result of overtorqued latch assemblies. Casting shrinkage cracks were noted at the break area. Six eye bolt samples with existing shrinkage cracks were destructively tested and they exceeded design specification requirements with only one exception. Existing shrinkage cracks were determined to not seriously weaken the eye bolt. ECOs were incorporated into drawings to increase the eye radius and reduce the heat treat hardness to eliminate the shrinkage cracks.

Large transport: Problem noted on functional check flight from Robins AFB when pilot experienced difficulty in holding the wings level. A scan of the wings revealed that the right aileron was up even though the pilot was holding a significant opposite aileron input. Inspection of the aileron system after landing showed that the aileron fairing had contacted the access door cover assembly and jammed in the up position.

Air superiority fighter: High angle of attack maneuvers caused high vibration levels in the stabilator actuators at a resonant frequency causing failure of the input lever. Failure of the input lever resulted in a hard over command and loss of control of the aircraft. The aircraft crashed. The solution

involved improving the structural integrity of the actuator and incorporating a centering spring in the control valves to prevent hard over commands to the control surfaces.

Historical data indicate the transparencies fail or are severely damaged more frequently than 1×10^{-7} times per flight. Such failures are often caused by foreign object damage. The modes of failure and the resulting redistribution of loads, both internal and external, need to be determined. Define the applicable transparency failures in the blank.

Transport: From 1965 to July 1981, there were 60 reported Air Force instances of life raft deployments. In addition to the cost of lost equipment and the risk from falling objects, the possibility of losing an aircraft and crew exists. In several instances, aircrews experienced severe control difficulties. The most recent attempt to eliminate inadvertent life raft deployments was the acquisition and installation of a new valve. We have experienced an increase in inadvertent deployments since installing the new valve and have gone back to the old valve and careful evacuation of the life rafts.

B.5.2.20 LIGHTNING STRIKES AND ELECTROSTATIC DISCHARGE

The following electricity phenomena occurring separately shall not degrade, damage, or cause critical components of the landing gear to fail and shall not cause injury to support personnel servicing or maintaining the landing gear.

B.5.2.20.1 LIGHTNING PROTECTION. (____)

The landing gear shall be capable of withstanding _____.

REQUIREMENT RATIONALE

Operational use of any air vehicle will require it to fly into atmospheric conditions conducive to its being subjected to lightning strikes. Strikes occur often at substantial distances from obvious thunder storm cells. This requirement is needed to protect the air vehicle structure from significant lightning damage and to preclude loss of an air vehicle.

There are concerns relating to the expanded use of composites which have generally been of secondary importance in predominantly metal aircraft. These concerns arise from the lower conductivity of graphite/epoxy materials and the non-conductivity of other materials. The structural response to lightning differs from that of metals. The use of composite structural materials as an electrical ground plane and as a shield for the attenuation of electromagnetic fields requires special joining techniques, surface treatments, coatings, edge treatments, etc. Sparking hazards are potentially more prevalent in fuel tanks constructed of the less conductive materials. Design practices need to be developed to provide composite material

airframes with the electrical properties necessary to assure vehicle safety. Fuel tanks built of composite structures can be designed to be spark free to the direct strike lightning environment.

REQUIREMENT GUIDANCE

Complete the blank with the applicable lightning environment that the airframe will be exposed to. Generally, this blank is filled in with "the lightning environments defined in requirements derived from MIL-STD-1795." MIL-STD-1795 is a MIL PRIME standard that defines the external lightning environment that the air vehicle structure needs to be able to withstand. The airframe must withstand lightning strikes without jeopardizing the crew, degrading the structural integrity of the airframe, or requiring unscheduled maintenance time to repair damage or replace parts. MIL-STD-1795 contains a requirement for a lightning protection program to assure that all aspects of providing lightning protection for an air vehicle are considered. MIL-STD-1795 is virtually identical to the lightning requirements imposed by the FAA on commercial aircraft and is in the process of being adopted by NATO countries.

REQUIREMENT LESSONS LEARNED

Tanker/transport: A lightning strike to the aircraft caused an explosion in a reserve fuel tank and loss of twenty-four feet of the outboard wing. Four other wing tip explosions during a three-year period were caused by lightning strikes and ignition of fuel vapors in the wing tip cavity on this same type aircraft. Modification to the wing tip assembly was required to eliminate the potential of an arc occurring during a lightning strike.

Fighter: The airplane was carrying an empty external fuel tank and was struck by lightning which resulted in an explosion of the external tank. This explosion resulted in fragments severing the hydraulic lines and resulted in loss of the aircraft. Design changes to the fuel tank were required to eliminate arcing. This was a case where the aircraft was designed to the lightning requirements but overlooked on the fuel tank.

Bomber: The aircraft, on a training mission, approached a steadily lowering ceiling with associated rain showers and elected to discontinue terrain following and climb to IFR conditions. About 30 seconds after entering the clouds, the crew saw a bright flash and felt a jolt and heard a loud bang. The weather radar was showing no weather returns. One side of the vertical stabilizer lost a 6-foot section and the other side had a 3-foot by 3-foot section.

Swing wing fighter: A flight of three aircraft showed no weather on their radars, however, all three aircraft were struck by lightning. There was a momentary interruption of flight instruments, then all systems returned to normal. Shortly afterward, the flight broke up for separate approaches and one aircraft was hit by lightning again, this time losing all instruments except

standby. One engine also experienced an overheat indication.

B.5.2.20.2 ELECTROSTATIC CHARGE CONTROL. (____)

The landing gear shall be capable of adequately controlling and dissipating the buildup of electrostatic charges for _____.

REQUIREMENT RATIONALE

As aircraft fly, they encounter dust, rain, snow, ice, etc, which results in an electrostatic charge buildup on the structure due to the phenomenon called precipitation static charging. Means must be used to safely discharge this buildup so that it does not cause interference to avionics systems or constitute a shock hazard to personnel. During maintenance, contact with the structure can create an electrostatic charge buildup, particularly on non-conductive surfaces. This can constitute a safety hazard to personnel or fuel.

REQUIREMENT GUIDANCE

This paragraph is generally applicable to all structural systems. Generally, the blank is completed with "internal and external portions of the air vehicle, in particular those components exposed to air flow or personnel contact." Any component of the structure can accumulate an electrostatic charge and adequate means must be provided to dissipate the charge from the aircraft at a low level so as not to cause electromagnetic interference to avionics, shock hazard to personnel, puncture of materials, etc. Also, retained charge after landing may pose a shock hazard to ground personnel. All components need to be electrically bonded to provide a continuous electrical path to dissipate the electrostatic charge. Non-conductive components of the structure will require special attention. They do not provide an inherent means for the electrostatic charge to dissipate; therefore, some technique will need to be provided to dissipate the charge as it accumulates. MIL-E-6051 provides some additional requirements on precipitation static discharging and the use of conductive coatings for external air vehicle structure. In general, all internal and external sections of the air vehicle structure will require some type of conductive coating. For most applications 10E6 to 10E9 ohms per square is required to dissipate the charge buildup. The shock hazard to personnel starts to be felt at about 3000 volts. As a rule, the charge on airframe components should not be allowed to exceed 2500 volts.

REQUIREMENT LESSONS LEARNED

This requirement is important to all aircraft structures with special emphasis required for non-conductive structural components. On all aircraft means must be provided to dissipate the normal precipitation static charge buildup accumulated during flight. This is

normally done by the installation of precipitation static dischargers on trailing edges. Non-conductive sections must be provided with conductive coatings.

An aircraft had a small section of the external structure made of fiberglass. Post flight inspections required personnel to get in close proximity to this non-conductive structural component. On several occasions, personnel received significant electrical discharges which caused them to fall off ladders and receive injury. Corrective action was easily accomplished by applying a conductive paint to the fiberglass area and providing an electrical bond to the rest of the aircraft structure. Generally, 10^6 to 10^9 ohms per square is adequate to dissipate an electrostatic charge.

In another incident a maintenance person working inside a bomb bay next to non-conductive panels, generated a charge on himself by contact with the panel and created an electrical arc as he was opening a fuel tank access panel.

Fighter: The aircraft was experiencing severe degradation of the UHF receiver when flying in or near clouds. Investigation revealed that the aircraft was not equipped with precipitation static dischargers and the normal precipitation static buildup and subsequent uncontrolled discharge was causing electromagnetic interference to the radio. Installing precipitation static dischargers on the aircraft solved the problem.

B.5.2.21 FOREIGN OBJECT DAMAGE (FOD) (____)

The landing gear shall be designed to withstand the FOD environments listed below. These FOD environments shall not result in the loss of the air vehicle or shall not incapacitate the pilot or crew with a frequency equal to or greater than _____ per flight. These FOD environments shall not cause unacceptable damage to the airframe with a frequency equal to or greater than _____ per flight.

B.5.2.21.1 RUNWAY, TAXIWAY, AND RAMP DEBRIS FOD (____)

The airframe shall be design to withstand the impact of _____ FOD during any phase of taxi, takeoff, and landing without loss of the air vehicle or the incapacitation of the pilot or crew. The airframe shall be designed to withstand the impact of _____ FOD during any phase of taxi, takeoff, and landing with no unacceptable damage. Unacceptable damage is _____.

B.5.2.21.2 OTHER FOD (____)

_____.

**REQUIREMENT RATIONALE
(5.5.2.21 THROUGH 5.5.2.21.2)**

Foreign object impingement is difficult if not impossible to prevent, therefore, a requirement is needed from an airframe viewpoint to deal with the problem as it exists and to establish appropriate structural degradation limits.

**REQUIREMENT GUIDANCE
(5.5.2.21 THROUGH 5.5.2.21.2)**

Provide appropriate foreign object damage requirements and structural degradation limits. Structural degradation limits should be stated in terms of man-hours required to repair or replace damaged components and that no impact will cause injury to personnel, with or without attendant structural damage. The runway debris requirement should be made applicable only if the air vehicle configuration, structure, type of runway and surface conditions warrant it. A requirement may exist for operating on wet surfaces or surfaces of loose gravel where structure behind the tires could be impinged upon by water or stones causing damage, including finish erosion, dents, cracks, voids and delaminations. The structural degradation limits for runway debris must be compatible with the requirements. Include other sources, for example, airframe fasteners shed during mission or maintenance tools left in critical airframe bays or areas and define the acceptable airframe degradation permitted for each encounter.

The maximum acceptable frequency of loss of the air vehicle or the incapacitation of the crew due to FOD impact is 1×10^{-7} per flight. The number selected should be consistent with the rate defined in 5.5.2.11. The maximum acceptable frequency of occurrence of FOD impacts which would cause unacceptable damage to the air vehicle is generally 1×10^{-5} per flight for air vehicles built with metallic structures. This specification of a frequency of occurrence is directly related to the type of damage defined in the subparagraphs. The selection of both frequencies is normally based on peace-time usage. However, the frequency distribution for FOD damage may change during actual war usage. Such changes need to be addressed to ensure that FOD damage during war does not cause unacceptable reductions in the war fighting capabilities.

The specification in the subparagraphs of the type or size of FOD should be based on the expected peace-time usage. As with the selection of the frequencies discussed above, the type and size of FOD may change during actual war usage. Such changes need to be addressed to ensure that FOD damage during war does not cause unacceptable reductions in the war fighting capabilities.

The specification in the subparagraphs of the type or level of damage which is unacceptable is intended to distinguish between damage which does not have any significant mission impact and whose burden of repair

is acceptable and damage which significantly impacts mission capabilities or has a high economic burden for repair. Some types of structural elements may be able to tolerate some damage with no significant reductions in performance or in mission capabilities. Other types of structural elements may not be able to tolerate any detectable damage. The selection of the type and level of unacceptable damage should address such considerations as the cost of repairing FOD damage, the length of time to institute the repair, the facilities required to make the repair, the degradation of the structural life due to unrepaired damage, and the reduction of mission capabilities due to unrepaired FOD damage.

**REQUIREMENT LESSONS LEARNED
(5.5.2.21 THROUGH 5.5.2.21.2)**

Impact damage susceptibility: There are certain areas of an aircraft that are subject to high intensity impacts and a high frequency of occurrences. The components in these areas must be designed to withstand the impacts that the component will see during its service life. Thin-skinned components (which are either advanced composite or aluminum) and honeycomb components (which are covered by thin skins of advanced composite or aluminum) are susceptible to impact damage when placed into service. The impact damage to these structures is causing significant maintenance requirements. Honeycomb consists of a thin-skinned outer layer covering a honeycomb structured interior. The outer skin can consist of metal or advanced composite material. Damage to honeycomb parts occurs from skin punctures as well as core crushing. In a majority of instances, impacts to honeycomb structure cause a separation between the skin and the core, thus the skin is not supported. Metal skins are less susceptible to punctures because of their capability to plastically deform, but they are nevertheless susceptible. An impact to a metal skin will cause a dent, misshape the metal, and possibly crush the core material. Advanced composite skins consist of fibers, usually boron or graphite, embedded into an epoxy or polyamide resin. The structural rigidity of the composite skin is based on the direction of the fibers by providing strength in the direction in which they are lying. Because of the properties of advanced composite material, plastic deformation will not occur in a composite skin as it does in a metal. A comparable impact to a composite skin will most probably break the fibers and puncture the skin. Thin-skinned components that are not attached to honeycomb are also susceptible to impact damage in the same manner as described for honeycomb skins.

Transport: Severe wind and hail damage to two aircraft at Chicago O'Hare Airport.

Ground attack: Foreign objects (general) - Foreign objects can either be hard or soft, metallic or non-metallic, large or small, externally or internally hazardous, and either introduced or self-generated in the aircraft. With specific regard to flight control systems, MIL-F-9490 (see Fouling prevention) states that all elements of the flight control system shall be

designed and suitably protected to resist jamming by foreign objects. In principle, the best approach to solving foreign object intrusion problems is to prevent foreign objects from being generated. However, this is idealistic, and every designer of equipment or systems should assume that foreign objects will exist and should design the equipment or system to be invulnerable to foreign object intrusion. For flight systems which are exposed to combat threats, foreign objects may be in the form of fragments (as a result of a bullet/missile hit) and equipment or systems should be designed with this in mind as a survivability enhancement. The aircraft was designed to survive extensive in-flight battle damage, but the flight control system in particular was found to have a number of close clearances vulnerable to foreign object jamming and the Special Review Team has recommended changes to improve that situation. The recommended changes are being documented in the Review Team final report currently in preparation.

Ground attack: Foreign object sources - There are probably many thousands of possible sources of foreign objects in any aircraft if one considers that every fastener, rivet, pin, nut, and bolt can be a foreign object when it is not in its proper place. Two of the most probable reasons for such an object not to be in its place are: (1) failure of the object to be retained because of a breakage or malfunction; and (2) human error - improper installation or oversight. Of these two probabilities, human error is by far the most likely reason. The data base on foreign object incidents/accidents almost always identifies that the suspect object was an unattached fastener or other part which was not broken, and frequently shows the foreign object to be a tool or some other item needed for assembly, maintenance, or repair which had been left in the aircraft. In a ground attack program, the statistics show an average of only one piece of foreign object matter being found in every five aircraft undergoing Air Force Initial Receiving Inspection and this is an excellent record. However, after the aircraft has been in field operations and maintenance for a few years, there are records showing that several pieces of foreign object matter exist in every aircraft inspected. As a consequence, for several of the aircraft which crashed for unknown reasons and when the pilot was also fatally injured, the accident investigating boards invariably list a flight control system jam (implying a foreign object jam) as one of the possible primary causes.

The ground attack aircraft design features a ballistic foam, often referred to as void filler foam, which is in a block form and fitted into the cavities of the fuselage and wing root just external to the fuel tanks. This ballistic foam is intended to improve the survivability of the aircraft against fires/explosion caused by a bullet/missile fragment puncturing a fuel tank. The foam has been noted to be one of the primary sources of soft foreign objects and one fatal crash is suspected to have been caused by a loose piece of the foam migrating between the aileron bellcrank and an adjacent bulkhead. Although unconfirmed, the possibility exists that soft foreign objects such as loose

foam can restrict motion of the flight control system until the soft object is dislodged, crushed, or cut-through. Changes are being implemented to improve the adhesion of the foam, to shape the foam blocks to minimize breakage, to protect the exposed surfaces/corners with a durable coating/mesh, and to improve instructions in the maintenance manuals on how to avoid damage to foam when performing maintenance in the region.

Ground attack: Migration paths - Once a foreign object is generated within an aircraft, maneuvering of the aircraft, vibration, and landing jolts will cause the foreign object to move around. In most aircraft, the bulkheads and frames will have openings to allow wire bundles or cables to pass through and may have cut-outs for weight reduction purposes. Every opening must be regarded as a migration path for a foreign object to take, and the probability must be assessed with many factors considered (i.e., the size/shape of the opening and the relative size/shape of the foreign object, the location of the opening, the maneuvering accelerations and orientations which can be commanded by the pilot, the presence of equipment items which may act as baffles, etc.). Further, as the foreign object migrates along probable paths, one must assess whether there are any critical components (e.g., a flight control system bellcrank) which can be adversely affected by the foreign object. To this writer's knowledge, there are no situations where a foreign object has ever improved the operation of a system, therefore, only two assessments are possible - the foreign object will either be detrimental or have no effect.

Prior to recent improvements, the ground attack aircraft was found to be designed with a highly probable and hazardous migration path. In tracing the cause for one in-flight flight control system jam followed by an emergency it was found that a Tridail fastener used as an access panel support rod pin had fallen into a forward avionics compartment, bounced through a bulkhead opening, fell into the U-shaped fuselage longeron, traveled the length (about 10 feet) of the longeron, and lodged in the lower part of the aileron bellcrank causing a temporary jam. Improvements being made include the blocking of the last bulkhead openings above the fuselage trough, placing a barrier in and above the trough to block migration of loose foam and hard foreign objects from upstream into the bellcrank region, and a design for more positive retention of the access panel support rod end pin.

Ground attack: Clearances - The flight control system specification, MIL-F-9490, reflects the allowable clearances within the flight control system to insure that no probable combinations of temperature effects, air, loads, structural deflections, vibrations, build-up of manufacturing tolerances, or wear can cause binding or jamming of any portion of the control system. The minimum allowable clearances vary from 1/8 inch to 1/2 inch depending on the region/function (see MIL-F-9490 paragraph on System separation, protection, and clearance) and reflect the lessons learned from problems experienced in earlier flight

vehicles. At the start of the production program, waivers to these clearances were requested by the contractor and granted by the Government; in retrospect, this reduction in clearances was probably an economically correct decision but may have overlooked the increase in probability for having flight control system jams due to foreign object intrusion. The Special Review Team has identified areas where small clearances cause a high potential for jam due to foreign object intrusion and changes are being made to install covers over some of these small clearance areas or to add barriers in the potential migration paths into the region of the small clearance.

Ground attack: Manufacturing/assembly - During the manufacture and assembly of every aircraft, there exists a very high potential for foreign objects to be introduced into the aircraft. This is due to many different people working with many different tools and having to install many fasteners and other small parts in the aircraft. The Air Force Regulation 66-33 covering foreign object prevention is normally incorporated in every aircraft acquisition contract and manufacturers add to the regulation their special documents governing how their Manufacturing, Assembly and Quality Assurance Departments will implement their Foreign Object Prevention Program. In addition, the DPRO (resident Government plant representative) will assign Quality Assurance inspectors to assure that the foreign object prevention program is being implemented as planned. The crucial ingredient in any foreign object prevention program is the people who perform the manufacturing, the assembly, and the inspections - and how well they have developed their attitude and discipline towards producing a foreign object free product.

The Special Review Team reviewed the program and operations at both divisions (where the manufacturing and partial assembly is done and where the final assembly and testing is done prior to delivery to the Air Force). In summary, a good program for foreign object prevention was found and needed only a renewal of emphasis plus some minor changes to assure consistency between the two divisions. Management elected to shift the responsibility for their Foreign Object Prevention Program from their Quality Assurance Department to their Manufacturing/Assembly Department. This was based on the logic that it is better to have the activity that is most probably the generator of foreign objects (i.e., manufacturing and assembly) be responsible for keeping the foreign objects out than to rely on the quality assurance inspectors to find and remove the foreign objects. QA will still perform their inspections and the AFPRO QA will still inspect and sign off on each compartment as it is closed during final assembly.

Ground attack: Maintenance/modification - Once an aircraft has been delivered to the Air Force, it is exposed to numerous maintenance actions and to occasional modification actions. This presents the opportunity for foreign objects to be generated in the aircraft principally because it involves many people, many tools and many loose fasteners and other parts.

In fact, the opportunity is increased because maintenance is often required to be performed in a more exposed environment and under poorer lighting conditions than exists on a typical manufacturing/assembly line. Another factor is that the experience of blue suit maintenance personnel is generally much less than that of the manufacturer's work force and it is common that the maintenance manuals are not written as clearly as they might be. Although this is not a unique problem, the Special Review Team has found that the maintenance manuals are generated by engineers and reviewed by more experienced Air Force senior NCOs with very little involvement by the lower grade maintenance people who have to ultimately interpret and apply the instructions.

The number of foreign objects being found in ground attack aircraft is in a decreasing trend but the Special Review Team maintains a concern that there are a lot of aircraft flying with foreign objects in them. The Maintenance Working Group has caused improvements to be made in the maintenance manuals and also has caused a buddy system of maintenance to be done at bases whenever a foreign object sensitive area is opened up for maintenance and repair. These improvements, coupled with the addition of the changes described earlier (barriers, covers, better adhesion, etc.), should greatly reduce the generation of foreign object and the system vulnerability to them. However, it is again emphasized that the effectiveness of a good foreign object prevention program is very dependent on the attitude and discipline of the people performing the maintenance. Carelessness breeds foreign objects.

Ground attack: Protective measures - Because humans always have the potential to make a mistake, because an aircraft such as this one has some areas/systems which are vulnerable to foreign object intrusion, and because a flight control jam can be catastrophic if it occurs during a maneuver near the ground, protective measures must be taken to assure that the system does not suffer a jam for any reason. Small clearances are conducive to jams (e.g., a Tridair fastener head diameter is 1/2 inch and the aileron bellcrank clearance in the fuselage trough is between 1/4 and 3/8 inch); relying on humans to not generate foreign objects is insufficient protection. A cover can be added over the region where a small clearance exists but care must be exercised that the cover itself or the means by which it is attached does not become a source of foreign objects. Care should also be exercised that the cover be complete because if an opening in the cover is large enough to allow foreign objects to enter the region, the cover may perform just opposite to its intent (i.e., it will keep the foreign object in rather than keeping it out) and increase the probability for a jam. The Special Review Team has recommended that the aileron bellcrank with the small clearance be covered, but if that is impractical, then some form of a sweep be added at the bottom of the bellcrank to deflect foreign objects approaching the region.

B.5.2.22 PRODUCIBILITY

Producibility must be designed into the landing gear structure from the beginning and must be a design influence throughout the design process.

REQUIREMENT RATIONALE

None.

REQUIREMENT GUIDANCE

None.

REQUIREMENT LESSONS LEARNED

None.

B.5.2.23 MAINTAINABILITY

Maintainability must be designed into the landing gear from the beginning and must be a design influence throughout the design process. The maintainability shall be consistent with the user's planned operational use, maintenance concepts, and force management program. High or moderate maintenance items must be accessible and/or replaceable to facilitate maintenance.

REQUIREMENT RATIONALE

None.

REQUIREMENT GUIDANCE

None.

REQUIREMENT LESSONS LEARNED

None.

B.5.2.24 SUPPORTABILITY

Supportability must be designed into the landing gear structure from the beginning and must be a design influence throughout the design process. Supportability shall be consistent with the user's present and projected maintenance concepts, maintenance facilities, and force management programs. Projected EPA requirements must be considered.

REQUIREMENT RATIONALE

None.

REQUIREMENT GUIDANCE

None.

REQUIREMENT LESSONS LEARNED

None.

B.5.2.25 REPAIRABILITY

Repair ability must be designed into the landing gear structure from the beginning and must be a design influence throughout the design process. Repairability is required to support production, maintain the fleet, and maximize operational readiness by repairing battle damage. High or moderate maintenance items and items subject to wear must be repairable.

REQUIREMENT RATIONALE

None.

REQUIREMENT GUIDANCE

None.

REQUIREMENT LESSONS LEARNED

None.

B.5.2.26 REPLACEABILITY / INTERCHANGEABILITY

Appropriate levels of replaceability and/or interchangeability must be designed into the landing gear structure to meet the requirements of operational readiness, maintenance, supportability, logistic concepts, repairability, and producibility. Major structural items which are interchangeable are _____.

REQUIREMENT RATIONALE

None.

REQUIREMENT GUIDANCE

None.

REQUIREMENT LESSONS LEARNED

None.

B.5.2.27 COST EFFECTIVE DESIGN

Cost effective design concepts and practices must be used from the beginning of the landing gear design and must be a design influence throughout the design process. Balancing acquisition cost, life cycle cost, performance, and schedule is an integral part of a integrated product development concept. An integrated design approach which strives for a producible cost effective design is critical to achieving the optimal balance of design, life cycle cost, schedule, and performance. A stable design with stable processes is required for accurate cost assessments.

REQUIREMENT RATIONALE

None.

REQUIREMENT GUIDANCE

None.

REQUIREMENT LESSONS LEARNED

None.

B.5.3 SPECIFIC DESIGN AND CONSTRUCTION PARAMETERS

The following specific features, conditions, and parameters, marked applicable, reflect required operational and maintenance capability of the landing gear. These items have a service life, maintainability, or inspection requirement different than the parent airframe as identified in 5.5.2.14. Historical maintainability experience with the same, or similar, design and construction shall be governing factor for suitability of the landing gear design.

REQUIREMENT RATIONALE

If the structural integrity of the airframe is not adequate to safely react with loads induced during a required maneuver, the airframe is clearly deficient. However, if a little used item like a tail bumper does not adequately protect the aft end of the airframe during tail down landings, it may not be identified as being deficient until many airframes have been built and a considerable number of service hours have been accumulated. Therefore, these specific hardware requirements are needed to assure that requirements for selected components are established, particularly those components and requirements not covered by the overall airframe requirement.

REQUIREMENT GUIDANCE

This requirement addresses those cases of criteria where the individual components and subsystems are directly involved with the operational and maintenance needs of the user. The criteria is unique to particular components and subsystems and as such the inherent relationship between the hardware and the desired performance needs to be maintained.

REQUIREMENT LESSONS LEARNED

Modification management - AFLC/AFALD, (1981). Aircraft modification is a double-edged sword. It offers the Air Force a means to improve aircraft safety, maintainability, and mission accomplishment, and can add significant new capabilities. At the same time, poor planning can aggravate minor deficiencies and can even lead to the introduction of new deficiencies. For the modification process to work efficiently, communication must occur between the designer, user, and supporter of the equipment. Those responsible for a modification need to determine (1) the original design intent, (2) weight/space/power and other limitations of the aircraft, and (3) impact of the modification on system supportability. Undesirable side effects are likely to result from a modification when those proposing the change have not considered

the original design intent. This type of oversight occurred on one aircraft when a switch was modified for the sake of standardization. The pilot's overhead control panel in this aircraft cockpit contains four fuel and start switches (one for each engine) and one switch for applying continuous ignition to all engines. As a human factors feature, the original design engineer had chosen a different shape for the handle of the continuous ignition switch. This precaution was intended to let the pilot know by touch that he had indeed selected the correct switch when he placed the continuous ignition switch to the off position following level-off. By inadvertently selecting one of the fuel and start switches, the pilot shuts down an engine. Such a mistake creates an obvious flight hazard and it means an almost certain unplanned descent to achieve air start parameters. Mistakes of this kind were uncommon until a modification was accepted to use only one type of switch and eliminate the other from the inventory. When an incident occurred (an engine was shut down inadvertently at level-off), the safety risk was deemed serious enough to warrant a quick fix. A second modification was needed to undo the damage caused by the first. Even when a modification is well-conceived, failure to consider the demands of the modification upon the existing systems, in terms of weight, space, power, air conditioning, computer capacity, etc., can result in a system deficiency, inoperable equipment, or a safety hazard. A modification to install a flight history recorder in one Air Force aircraft required power beyond the capacity of the existing inverter. While this inverter was adequate for the original configuration of the aircraft, growth of power requirements had already reached maximum inverter capacity. The flight history recorder was installed, but it could not be operated due to lack of power. Finally, modifications can impair supportability and access to other equipment. Although this problem cannot always be avoided, the supportability problems are sometimes so extreme that they outweigh any benefits from the modification. On one aircraft, a modification eliminates access to the drain valve for the auxiliary fuel tank. Access to this valve is needed to facilitate defueling. The consequences of the modification induced inaccessibility is that whenever an auxiliary tank has to be defueled, it is necessary to drain the fuel through a pogo valve. This method takes many hours and requires that a maintenance technician hold the valve open throughout the defueling. Many other instances exist of a modification creating supportability problems in aircraft. These examples are not indicative of the many beneficial aspects of the Air Force Modification Program.

B.5.3.1 DOORS AND PANELS (___)

The structural integrity of doors and panels, including seals shall be sufficient for their intended use, including that resulting from the air vehicle usage of 5.5.2.14. The use of any door/panel shall not be inhibited by interference with other parts of the air vehicle or require special positioning of the air vehicle or any part thereof during normal use. For ground maintenance, all doors/panels shall be fully usable

with the landing gear struts in any position. The door/panel cut-out support structure shall meet the in-flight residual strength requirements of 5.5.12.2.

REQUIREMENT RATIONALE

Access into airframe compartments, both large and small, has long been a necessity. However, the consequences are not readily apparent regarding the placement and motions of doors and panels during use under all attainable operational and maintenance conditions. This requirement is needed to promote the consideration, evaluation, and avoidance of such ramifications regarding airframe doors, including structural panels when applicable.

REQUIREMENT GUIDANCE

As needed, the requirement can be expanded to include structural panels and their associated operational requirements.

REQUIREMENT LESSONS LEARNED

Swing wing fighter bomber: This series of aircraft incorporate large access panels and doors (over 20 sq. ft.). When the aircraft came out of production, the engine bay access doors could be opened and closed by hand with minimal effort. These doors are opened daily for inspection and maintenance purposes. Repeated opening/closing actions have worn the alignment pins and locking mechanism. This, coupled with small structural deformation as the aircraft ages, has caused extreme difficulty in maintaining gap tolerances and aerodynamic smoothness requirements. Alignment pins and locking mechanisms are inspected, repaired, and adjusted during isochronal (ISO) inspections to the extent possible.

Transport: The cargo doors are sealed using a combination of methods, including a rubber flap which is sealed by the pressure placed on it and a pliable bead or strip of sealing material at the point of contact between the door edge and aircraft structure. This bead must be of uniform thickness and remain pliable to be an effective seal. The current seal material hardens with age and requires constant maintenance to retain pressurization. The rubber flap also tends to harden with age and lose its sealing ability.

Very large transport: The crew entry door/ladder is being overstressed during use. When several crew members or maintenance personnel climb up the ladder with their suit cases or tool boxes, excessive stress is applied to the mounting point at the fuselage, since the ladder is not supported at the other end. A recent modification has been initiated to provide an extension to the ladder by adding two rods with small wheels that will extend from the ladder to the ground. This will minimize the cantilever stresses in the door mount. In addition, the hydraulic system used to activate the crew entry door is highly complex requiring many man-hours to rig and adjust.

Transport: Trooper door tracks are a part of the basic structure and require about 125 man-hours to replace. Field units recommend tracks not be made a part of the aircraft basic structure. Further investigation reveals the door tracks have approximately 15 years of life. Door reliability prior to onset of wearout is very good. A weight penalty and additional inspections would most likely be required if tracks were not part of basic structure. Therefore, it appears the current design of the tracks is the best trade-off. A possible improvement of the door system would be quickly replaceable rollers with sacrificial wear properties to further extend the life of the tracks.

B.5.3.1.3 ACCESS DOORS AND COMPONENTS (____)

Access doors and components with one or more quick-opening latches or fasteners shall not fail, open, vibrate, flap, or flutter in flight with _____. This requirement also applies to structural doors and panels. The most critical combinations of latches or fasteners are to be designed for left unsecure conditions.

REQUIREMENT RATIONALE

This requirement is intended to keep access doors from opening in-flight and becoming damaged from being torn free from the airframe and becoming FOD.

REQUIREMENT GUIDANCE

Small as well as large external access doors need to be inherently stable when subjected to attainable air flows with one or more retaining devices fully nonfunctioning. Doors with one or two latches need to have the hinge located so that the air flow will tend to keep the door closed. The second blank is to be filled with the number of latches or fasteners per door or panel that can be left unsecured. Recommend filling in the blank with the cube root (rounded off) of the total number of latches or fasteners per door or panel.

REQUIREMENT LESSONS LEARNED

None.

B.5.3.2 TAIL BUMPER. (____)

A tail bumper shall be provided.

- a. Type: _____.
- b. Capability: _____.

REQUIREMENT RATIONALE

This requirement is aimed at protecting the empennage from damage during ground usage when the brakes are applied while the air vehicle is rolling backwards or the air vehicle is over-rotated on take-off or landing, or during shipboard towing operations for all allowable sea state conditions.

REQUIREMENT GUIDANCE

Define the type and capability required. The type of tail bumper may be active (energy absorbing) or passive, retractable or fixed, and with or without provisions for a replacement shoe. The capability of the tail bumper may be minimum, used only to discern if it contacted the ground during take-offs and landings. The capability may be intermediate, with sufficient energy absorption to withstand ground tip backs at specified rearward velocities and ground slopes and to withstand ground contacts during take-offs and landings but change the pitch altitude only slightly. The capability may be full, with sufficient energy absorption to withstand contact with the ground during any take-off and landing and change the pitch altitude sufficiently to prevent damage to the airframe or other air vehicle system. For a modification program, the need and applicability of this requirement will be known. However, for a new program, full empennage protection should be required and if the developer can show that a lesser tail bumper requirement is adequate for his particular airframe, a reduction can be considered at that time.

REQUIREMENT LESSONS LEARNED

None.

B.5.3.3 TAIL HOOK (___)

A tail hook shall be provided.

- a. Type of hook and shoe: _____
- b. Type of engagements: _____
- c. Arrestment system and cable: _____
- d. Surface in front of arrestment cable:

- e. Capability: _____

REQUIREMENT RATIONALE

A tail hook is desirable for those air vehicles whose weights and ground speeds are within the capabilities of ground based arresting systems because it can contribute to minimizing damage due to emergency landings, including landing of combat damaged air vehicles, or if needed, to operating off of very short runways. A tailhook is a requirement for carrier operations.

REQUIREMENT GUIDANCE

Define the remaining requirements. See 5.5.2.14 for general service life usage requirements regarding number of arrestments, etc. The type of hook and shoe may be emergency (non-retractable from the cockpit) with or without a replaceable shoe or it may be operational (retractable from the cockpit) with a replaceable shoe. The type of engagements may be take-off abort, landing, but in-flight cable pick-up,

landing impact/roll-out cable pick-up or any combination thereof. The arrestment system and cable needs to be defined as to energy absorbing capability and cable size and height above runway through use of figures or applicable technical document references. The surface in front of arrestment cable is to be defined regarding any roughness which could cause the hook to bounce over the cable. The capability of the tail hook assembly is to be defined in terms of successfully withstanding engagements up to the capacity of the arrestment system and cable as limited by the operational parameters of the air vehicle for the condition, for example gross weight, center of gravity, speed, and pitch and yaw attitudes. Define the number of feet away from the centerline of the runway, out to which barrier engagements are expected to be made.

REQUIREMENT LESSONS LEARNED

Swing wing fighter bomber: The major wear on the tail hook assembly occurs in the shoe. The shoe is an integral part of the tail hook assembly, and the whole assembly must be removed when the shoe is worn. This causes expensive part replacement. Other USAF and Navy aircraft have tail hooks with replaceable shoes.

Air Supremacy Fighter: Tactical Air Force Using Commands and especially the Alaskan Air Command, are requesting frequent use of the arresting hook for training and icy runway landings, for engine run-up operations and for simulated damaged runway exercises. Air Force organizations, using two other aircraft in tactical operations, have developed operational landing tactics requiring continual use of the arresting hooks. These arresting hooks are stressed for continuous use. Reasonable engineering analyses indicate that the subject tail hook should be limited to emergency use only. To modify the aircraft to perform routine arrested landings is feasible but requires extensive redesign, analyses, and tests.

Air supremacy fighter: The aircraft was returning to its home station when a utility circuit "A" hydraulic failure light illuminated. Aircraft was diverted to an alternate base for recovery because of weather. Aircraft failed to engage barrier for unknown reason and departed end of runway.

B.5.3.4 DESIGN PROVISIONS FOR SHIP-BASED SUITABILITY (___)

B.5.3.4.1 LANDING GEAR SHIP-BASED SUITABILITY REQUIREMENTS (___)

For aircraft with nose wheel type gear arrangements, the landing gear geometry shall be in accordance with Navy Drawing 607770. Landing gears of ship-based aircraft shall include provisions to prevent damage due to repeated sudden extension of the landing gear as the wheels pass over the deck edge subsequent to catapulting, bolter, or touch and go. Also, the landing gear shall not contain features such as sharp projections or edges that could cause failure of the

arrestment barricade. Landing gear wells shall be designed to allow a 3.5 percent increase in the tire size due to over inflation. To preclude striking catapult shuttles and PLAT camera covers, the centers of nose wheel axles shall clear the deck by at least 6.5 inches when the tires are flat. Tires shall be selected such that neither the nose or main landing gear tires are not fully deflected during catapult. If the nose landing gear has a stored-energy type strut, the energy stored in the shock absorber shall be sufficient to provide rotation of the aircraft to flight altitude at the end of the deck run in the event that one or both nose gear tires have failed during the catapult. The wheel brake hydraulic system shall be capable of providing adequate braking for deck handling without engine operation or external power packages, and be able to perform at least 10 applications of the normal brake before a hand pump or other means must be utilized to repressurize the brake system. A pressure indicator shall be provided in the pilot's cockpit. A parking brake shall be provided as well. A "park-on" cockpit warning system or an automatic park brake release system shall be provided to preclude "brakes-on" during catapulting.

REQUIREMENT RATIONALE

The requirement of 5.5.3.4.1, has proven necessary to permit safe ship-board aircraft operation. Landing gear geometry requirements are necessary to prevent aircraft roll over during ship rolls or tip back during arrested landing pull back. Barricade arrestment is necessary during failure of aircraft arresting hook or landing gear.

REQUIREMENT GUIDANCE

The aircraft design shall meet all the criteria of 5.5.3.4.1.

REQUIREMENT LESSONS LEARNED

None.

B.5.3.4.2 REPEATABLE RELEASE HOLDBACK BAR ()

The holdback bar shall restrain the aircraft against aircraft engine thrust, catapulting tensioning force, and ship motion. The holdback bar shall be of the repeatable release type and shall be designed in accordance with MIL-B-85110. The configuration of the lower portion (deck end) of the holdback bar shall conform to the requirements of NAEC Drawing 607770. The design load for the holdback bar is _____.

REQUIREMENT RATIONALE

This requirement defines the holdback load level design for shipboard operations.

REQUIREMENT GUIDANCE

For the release element, the minimum release load R (in pounds) for the repeatable release device is:

$$R = 1.35(\text{Thrust} + 5500 + 0.2 \text{ Max Catapult Weight})/\text{Cos}(\text{angle between holdback axis and deck at release})$$

where the allowable tolerance is +5% and -0% of R.

The design release load for the airframe design H (in pounds) at the nose gear holdback fitting is:

$$H = 0.06R + 1.65(\text{Thrust} + 5500 + 0.2 \text{ Max Catapult Weight})/\text{Cos}(\text{angle between holdback axis and deck at release})$$

where thrust (lbs.) is the maximum thrust with thrust augmentation devices operating, if the aircraft is so equipped, including surge effects from ignition at sea level on a 20° day (lbs). The initial horizontal component of the tensioning force applied by the catapult shuttle is 5500 pounds and is reacted by the holdback assembly.

For "Buffing", the holdback bar engages the slider of the catapult deck hardware at all critical angles resulting from the spotting requirements of MIL-L-22589. During the buffer stroke, a tension load equal to the load 'H' shall be applied to the aircraft holdback fitting.

For release, the aircraft shall be in all attitudes resulting from the release operation. The deflection of tires and shock struts shall correspond to the forces acting. The load in the launch bar shall be that required for equilibrium. The side loads shall be those resulting from the maximum possible misalignment of the launch system in combination with spotting conditions of MIL-L-22589.

REQUIREMENT LESSONS LEARNED

The design load level of the holdback is crucial to carrier operations. Too low of a release load level and during engine run-up with heavy sea state conditions, the aircraft will release prematurely; too high of a level and at light weight, high wind over deck values with low CSV setting, release may not occur, or significant head-bob will be experienced by the pilot causing disorientation during launch.

B.5.3.4.3 OTHER DESIGN AND CONSTRUCTION PARAMETERS. ()

REQUIREMENT RATIONALE

This requirement is needed to provide flexibility and coverage of additional design and construction requirements that may arise or exist at the time the Type I specification is being prepared.

REQUIREMENT GUIDANCE

Identify and define other design and construction parameter requirements as applicable. Such requirements will generally stem from specific lessons learned for particular types of structural components or assemblies and are applicable only to selected air vehicles.

REQUIREMENT LESSONS LEARNED

Accessibility

Double access panels. An offset design of double access panels on reentry vehicles, combined with limited space between the panels has resulted in excessive man-hours to remove/reinstall the attaching fasteners of the inner panel. Several man-hours are expended to remove/reinstall the inner door to the arm and disarm equipment just to perform simple saving procedures. The limited working space is the primary reason for the difficulties the maintenance technician has when removing/reinstalling the fasteners of the inner door. However, the selection of an attaching fastener with the hi-torque access design compounded the problem. In order to remove/reinstall a hi-torque fastener, the hi-torque adapter tool must be fully inserted into the access or it will disengage, rout-out the access, and destroy the fastener.

Swing wing fighter/ground attack: The damage of a single nutplate or gang channel nut element that is used on access panels or mating assemblies, all too often results in excessive disassembly just to gain access for replacement. On one aircraft to repair a missing or damaged nutplate on any of four access panels, an adjoining permanently installed skin has to be removed and replaced. Even though it takes just a few minutes to replace the nutplate, several hours are required to remove and replace the skin. On the engine used on the other aircraft, in order to replace one of the 84 gang channel nut elements that is used to mate the turbine compressor to the combustion case, the complete turbine section and engine mount ring must be removed. With the mount ring removed the engine support stand cannot be used to support the engine. Therefore, the engine has to be rotated to the vertical position for removal of the combustion case. The complete operation usually requires two days.

Transport: The procedure for removing and replacing one windshield panel entails removing five instruments to gain access to the individual windshield nuts and bolts. The problem has been reviewed by the system manager. No fix action is currently contemplated, because changing windshield panels is a low maintenance man-hour item. Accessibility to the windshield should be a designed-in feature of future instrument panels. A large transport instrument panel, for example, has a center section that disconnects quickly and slides out easily for access to the rear of the panel.

Transport: Due to the design of some moveable antennas on avionics system, such as APN-147 Doppler and APN-59 radar, it is frequently necessary

to perform visual inspection. Without a visual inspection capability, it becomes necessary to remove the antenna cover or radome, which causes unnecessary wear on the hardware and excessive man-hours. For those antenna which require visual inspection, design a means to gain visual access without having to remove antenna covers, such as the window used to insure that the C-130 landing gear is locked.

Transport/swing wing fighter: Several problems associated with the wiring locations and electrical cables were identified by maintenance activities. On the transport, wiring located under the cargo compartment flooring requires that large flooring sections be removed to gain access. This may also require removal of the cargo rails to get to the flooring sections for removal. Since wiring runs under many sections of flooring, a short or opening in a wire may require the removal of several sections to gain access for troubleshooting and repair. The units also indicated that wire bundle cables with electrical connectors should have sufficient slack to permit easy connection to the component. On the swing wing fighter this problem is prevalent on the TFR rack located in the nose section and the horizontal situation indicator, airspeed mach indicator, and the altitude vertical velocity indicator, which are located in the cockpit. Because the cables are short and accessibility is limited, a person has to reach around behind the units and make a blind connection which is particularly frustrating. Another problem area with wiring is that some wire bundles are, of necessity, routed through structural members of the aircraft or through other access holes. The connectors attached to the bundle end, in some instances, are larger than the access clearance for the wiring. If the cable must be removed for any reason, such as to gain sufficient slack to repair a broken wire in the bundle, this means the connector must be removed so the wiring can be withdrawn. Removal and replacement of the electrical connectors is a time consuming and tedious process. In addition, every time the wires are cut and the connector replaced, the cable is shortened.

Swing wing fighter bomber: A panel is installed with screws and nuts (no nut plates) and is difficult to remove. This panel requires frequent removal for hydraulic access, fuel leaks, and throttle cable changes. The panel is installed with screws and nuts. An adjacent panel must be removed to remove and install the other panel. The panel is also removed for 400-hour phase inspection. Many maintenance man-hours are expended in removing/installing the panel.

Swing wing fighter bomber: The aircraft uses hi-torque screws to fasten the hydraulic system access door. Removal of the fasteners for the purpose of servicing or testing the hydraulic system is time consuming and difficult. In many cases, a machinist is required to remove failed fasteners. The panel is hinged and quick disconnect hydraulic couplings are used. Only the fastener is not designed for ease of maintenance. This panel is on the right side of the fuselage in the main wheel well area. Access panels

(except stress panels) or those located where loose parts can be drawn into an engine should be designed with quick release fasteners to provide ease of maintenance and aid in reducing aircraft downtime.

Swing wing fighter bomber: The overspeed warning system on the engine has had many false alarms and failures. Major cause for the failures is the wiring. Secondary cause is sheared tach generator shaft. The tach generator used to monitor the revolutions per minute (RPM) of the N1 compressor is mounted on the nose cone of the engine. The wiring is run through the guide vane and must be cut if the tach is replaced or the guide vane removed. The wires are spliced together when the tach is hooked up. The spliced wires create problems by shorting, opening, and poor continuity. This problem is aggravated by the fact that the inlet guide vane is presently experiencing a high failure rate and must be removed for repair. This causes repeated cuts and splices of the tach generator wiring. Installation and removal of components/parts should be able to be done without cutting wires.

Swing wing fighter bomber: The alternate landing gear extension system is serviced through a charging valve located in the MLG wheel well. This valve (which is common to other emergency pneumatically activated systems) is normally easy to reach; however, when the aircraft is fully loaded, the valve becomes inaccessible. The airframe sits so low that the right MLG strut will not allow enough clearance to hook up the service hose. If any of the emergency systems linked to the common valve requires servicing, the only way to gain access is to pump up the struts to full extension and then readjust the struts after servicing. If this valve were located a few inches forward of its present location, the interference problem would not exist.

Swing wing fighter bomber: The forward equipment cooling duct has become brittle with age, and is experiencing a high failure rate because of cracks and breakage. Repairs of the duct on site are usually unsuccessful. Replacement is difficult because of inaccessibility. Replacement of the ducting requires removal of all avionics equipment and equipment racks on the right hand side and some on the left side. Replacement of the duct requires 36 to 48 man-hours. Vibration and temperature fluctuations increase the failure rate of the brittle cooling duct. The system manager has an agreement with depot maintenance to inspect cooling ducts whenever the forward equipment bay is opened for work during programmed depot maintenance. If the defect in a cooling duct is obvious, then repair is initiated. Aging has caused the polyurethane-type material in the forward equipment cooling ducts, located in a highly inaccessible area, to become brittle and crack. Many man-hours are required for replacement.

Transport: Rubber flap type drain valves are installed in the lower fuselage to allow draining of moisture accumulated from natural condensation, leaks, and spillage. This draining is an important part of the corrosion prevention program. When these drains become blocked with debris, standing moisture results.

Debris enters the interior of the aircraft moisture drain area through the valve and the floor panels in the cargo compartment. Gaining access to clear or replace these rubber flap drains is very time-consuming. The technical order specifies normal cleaning or replacement of drain valves during programmed depot maintenance. However, failure to gain access and clean or replace drain valves at more frequent intervals results in major corrosion repair/replacement.

Attack fighter: The design of the avionics and other component bays on the aircraft is a very desirable feature. Most of the items which require frequent maintenance are located in bays that can be easily reached by a mechanic standing on the ground. This feature enhances safety, makes for ease of work, and reduces the amount of support equipment required for this weapons system.

Transport: The throttle control incorporates a system of mechanical cables from the throttle quadrant to the engines. The cables are routed through a series of three 90-degree turns. The small diameter pulleys used at these turn points apparently contribute to fraying and other cable failure problems that are being experienced. Although the system manager is considering a modification to increase the size of the throttle cable pulleys, the more serious problem involves inaccessibility, because the cables are routed under the flight deck and through other hard to get at places, visual inspection of some critical segments of the cables is impossible. Moreover, braided cable is used on the throttle control. This type of cable is difficult to inspect adequately because points of weakness may be hidden from view. These weaknesses which have been known to cause throttle control failures have been corrected by new cables and larger pulleys. Another problem involves the use of cables for remote actuation of switches and valves which have critical adjustments in position, such as the hydraulic ground test selector valve and the flap position indicator. Proper adjustment and tensioning of these cables is difficult and time-consuming.

Transport: The bolts which mount the engine to the aircraft are very hard to torque since the bolts are located between two of the main engine supporting arms. An extension of approximately 6 inches or more is required to reach and torque the bolts. Since high torque is required with an extension, sometimes the socket slips off the bolt resulting in damage to the engine or individual doing the work. Structural or supporting bolts, which require high torque need to be accessible for torquing without the aid of extensions.

Air superiority fighter: Removal of the cockpit canopy is necessary when the ejection seat is removed from the aircraft for inspection and modification of ejection components (lines, initiators, chutes, etc.) or for replacement of avionics components behind the seat. The task of removing the canopy is time-consuming and requires special support equipment slings and special handling precautions to prevent scratching or abrasion of the optical surface. The canopy removal and reinstallation requires eight man-hours and three clock hours. A delta wing fighter does

not require removal of the canopy in order to remove the seat.

Swing wing fighter: The aircraft has 17 access panels that use form-in-place seals. To replace the form-in-place seal, maintenance personnel must first remove the old sealant by solvents and hand scraping. The surface where the seal is to be applied is cleaned and primed and the primer is allowed to cure. The fastener holes are then covered with plastic or washers and the sealant is applied. The access cover or door is positioned over the sealant with fasteners at least every fourth hole and the sealant is left to cure. After curing, the cover/door is removed, cleaned and reinstalled using all the specified fasteners. The scope of the task can be appreciated, considering that two access covers have 174 fasteners each. A review of data for a six month period indicates that 1363 man-hours were expended on these two covers as opposed to only 662 man-hours for two other access covers which do not have form-in-place seals. Easily replaceable, expendable seals cut from sheet stock or seals fabricated from molded rubber as composition material are more desirable.

Ground attack: Servicing of the LOX system on the aircraft is required before each flight. The LOX converter is located behind an access panel which, due to the proximity of the nose landing gear hinge points, was designed as a stress panel. This panel, with 21 fasteners, must be opened and resecured for servicing of the LOX system. This procedure requires over 20 minutes. Air National Guard units have modified this access panel with a small, quick-open, servicing door. Their servicing time is now three minutes. The average airplane flies three sorties per day; which means a savings of almost one hour servicing time per day per airplane flown.

Bomber: The track antenna azimuth drive motor cable connector was placed behind the right side brace on the gun turret, beneath the track transmitter installation. Removal of the search antenna requires disconnecting this and other connectors. To disconnect the connector the maintenance technician must either remove the track transmitter to gain access or reach up from beneath with a long screwdriver, using the tip to loosen the connector. When wiring repairs are required on the connector (which is frequent because of the age of the equipment, compounded by high vibration which occurs during gun firing), the track transmitter must be removed. Removal and replacement takes several hours to accomplish because the upper right machine gun must also be partly removed to get the track transmitter out. Upon reinstallation the connector must be safety wired. Had the connector been located directly behind the antenna, as the elevation drive motor connector was, access would not have been a problem.

Subsonic trainer: Engine removal and replacement is one of the most difficult and time-consuming tasks on the aircraft. The difficulty results primarily because the aircraft is low to the ground and designed with embedded engines that can only be removed from the underside of the nacelle. In order to remove the

engine, the aircraft has to be jacked. This necessitates towing the aircraft to a hangar to avoid the possibility of wind blowing it off the jacks. The engine has to be removed frequently for other maintenance actions. The tailpipe, which is frequently removed for repair of cracks, cannot be removed unless the engine is removed first. The same is true of the fuel control, which is highly susceptible to leaks and requires frequent adjustment.

Subsonic trainer: Seat removal is not as complicated as for many other aircraft, but it is still a process that requires a significant amount of time. When an ejection seat is removed, it is usually to facilitate maintenance on other items rather than to repair the seat itself. Some of the principal actions requiring seat removal include adjustment of flight control sticks, throttle controls, and linkage; rigging of elevator control cable and canopy actuator declutch cable; and adjustment of flap detent. Although seat removal takes only 1.5 hours, it is a frequently required action and represents a significant cost over the life of the system. Cables and other items requiring that the seats be taken out cannot always be rerouted, but some means of adjustment with the seats installed is desirable.

Subsonic trainer: The design of the passing and taxi lights has caused a serious accessibility problem. A light check is required just before takeoff, and if either the taxi or passing bulb fails to function, replacement takes over 30 minutes and delays the flight. Since the aircraft sits close to the ground, the nose strut is not sufficiently exposed for the two lights to be positioned on it (as they are in many other aircraft). Instead, the passing and taxi lights are located behind the nose cap and are protected by clear windows. These windows are attached by screws and nuts (rather than by screws and nutplates) and as a result are extremely difficult to remove and install. The only practical way to get at the lights is by removal of the nose cap (fastened to the airframe by 24 screws) and the pitot tube; although even with this means of access, the job requires several maintenance personnel and over half an hour.

Subsonic trainer: The nose gear steering valve, located atop the strut, often must be removed because it is prone to hydraulic fluid leaks. When the valve malfunctions or needs adjustment, the entire nose gear assembly must be replaced. This requirement ties up a number of maintenance personnel for several hours.

Subsonic trainer: The four brake control units on the aircraft are located in the cockpit, attached to the rudder pedal supports. Frequent access is required to check the sight gauges and to service the fluid reservoirs. Unfortunately, because of the location of the control units, the sight gauges are extremely difficult to read. However, the filler-bleeder plug is on the back of each control unit and, consequently, accessibility is poor and maintenance is time-consuming. A supersonic trainer is designed with external brake servicing and, as a result, routing brake maintenance can be performed much more efficiently.

Subsonic trainer: Aircraft static grounding receptacles are usually considered not to be replaced devices, even

though maintenance experience has proven otherwise. Consequently, design and location often lead to inaccessible receptacles. On this aircraft, a receptacle is mounted inside the outboard leading edge of each wing and the leading edge must be taken off before a damaged ground can be removed and replaced. If the grounding receptacle was located differently (e.g., next to an access panel), such extensive removal would not be necessary. In many other USAF aircraft, replacement of grounding receptacles necessitates removal of fuel tanks or other structural assemblies. This inaccessibility increases man-hour requirements and in some cases manpower limitations may prevent defective grounds from being replaced at all.

Subsonic trainer: The aircraft has a forward retracting nose landing gear design which is susceptible to collapse if towed without proper support. A peculiar piece of support equipment, often referred to as a stiff knee, was developed to prevent collapse during towing. It is awkward to install because the maintenance specialist has to lie on the ground to position the stiff knee and insert safety pins. A few failures have occurred because of improper installation, but the primary objection to the procedure is the requirement for such a peculiar brace when other aircraft drag braces can be secured with a ground safety pin.

Subsonic trainer: Approximately 16-20 man-hours are required to remove the upper attachment bolt of the speed brake actuator. In order to remove and replace the upper speed brake attachment bolt you first have to remove both ejection seats and the actuator cover that is located between the right position rudder pedals. Since the rudder pedals are under the instrument panel, there is very little working space and the removal of the actuator cover attaching screws is a very time-consuming process. A modification to the access cover that included the cutting of access holes on each side of the attachment bolt has reduced some of the removal time, but it still requires excessive man-hours for the removal of one bolt.

Bomber: Space constraints and interference with equipment on the interior of the aircraft increases the amount of time required to change the pitot tube, angle of attack transducer, and temperature transmitter. The angle of attack transducer requires four to eight man-hours for removal. A fiberglass panel must be removed and the mechanic on the inside of the aircraft must blindly reach through control cables and air ducts to gain access to the transducer. In the period from October 1978 through March 1979 a total of 62 transducers failed on two models of the aircraft. To gain access to the pitot tube on the right side of the aircraft requires removal and replacement of a BNS junction box. This task requires five hours from the bomb-nav specialists and one hour from the instrument shop. The temperature transmitter is an external sensing bulb and the transducer is at station 340. Access is below the floor panels and the BNS remote unit modules power supply rack. During the October 1978 through March 1979 period on one model there were 11 failures which required 110 unscheduled maintenance man-hours. Another mode

has an external access panel which facilitates the removal/replacement process. Desire the use of sensing devices that do not require internal access for removal; have an external access panel that would enable the technician to readily gain access to them; or are placed where internal access is not a problem.

Heavy air/ground fighter: Much of the maintenance cost on ejection seats is attributed to requirements for scheduled maintenance on seat mounted components that cannot be inspected without seat removal. Seat removal and replacement averages approximately one and one-half hours. It is virtually impossible to time change or inspect some seat mounted components, such as the catapult or the rocket motor, without first removing the seat. Many seat mounted components could probably be designed so they could be inspected without removing the seat. Adequate access is needed to permit removal and replacement of seat components without removing the seat.

Radomes: Operational data generally shows a large expenditure of man-hours charged to maintenance on fighter aircraft radomes. In the majority of instances, these man-hours are reported as "No-Defect" maintenance and are generated by the need to gain access to functional components, such as radar and antenna LRUs, installed behind the radome. The cost exceeds \$2.00 per aircraft flying hour in logistics support cost. The opening or removal of some radomes can require several maintenance personnel to handle its bulk and weight. High surface winds, inadequate hold-open devices and complex hinge designs add to the service complexity and frequently require peculiar age such as jury struts. The area behind the radome must be weather proof and too often the seals are not capable of long life or easy replacement in this frequent access area. The action of opening and closing the radomes should be a one-man task. Desire the number of fasteners/locking devices be held to a minimum. Desire a hinge configuration that would support the opened radome in gusting wind conditions. Desire weather seals that can be easily removed and have a reasonable service life. Where practical, desire the number of functional components requiring access through the radome be held to a minimum.

Main instrument panel: Accessibility to equipment forward of the main instrument panel is usually restrictive. Examination of field data indicates that removal of one such panel to facilitate maintenance can take over six hours. Simplification of instrument panel removal or outside access doors will significantly reduce the logistics support cost and reduce maintenance time.

Very large transport: There is a small, quick-access door on the engine cowling door for servicing the engine oil tank. However, a similar door was not provided for CSD oil level inspection. A single maintenance person should be able to open an engine cowling door for quick easy access. If this is not practical, then provisions should be made to provide quick-access panels on the cowling door for

components that require frequent access for inspections or servicing.

Very large transport: During depot maintenance many cracks are found in bulkhead fitting frame flanges at the chine web and outer chine attachments. Large 35 to 48 foot floor panels must be unfastened, jacked-up, and removed before the bulkhead fittings can be removed for repair of the chine web and the outer chine attachments. In addition, the cargo floor must be resealed after repairing and reinstalling the fitting to prevent fluids and debris from falling into the under floor area. Removal and reinstallation of the cargo floor panels can sometimes consume as much as 600 man-hours. If the large one-piece bulkhead fittings could be manufactured in sections, the section above the cargo floor and the section below the cargo floor could be removed independently and without removing floor panels, repairs would cost less and maintenance would be much easier.

Very large transport: Maintenance personnel have been hampered in their efforts to perform the required repairs on components located inside the engine pylon due to the limited accessibility provided. Engine shop personnel have a hard time trying to reach and replace the engine anti-icing valve located at the lower forward section of the pylon. This valve has failed 193 times in a six-month time period with 1858 unscheduled man-hours expended. In addition, other shop personnel are frequently required to enter the pylon area to perform maintenance tasks on cables, wiring, tubing, and hydraulic fittings. There are no side access panels. The only panel large enough to provide accessibility to the inside of the pylon is the top access panel; however, the pylon is about four to five feet deep to the bottom components. A tall thin person has to go in head first to reach the components, cables, wiring, and tubing and is limited to how long he can work hanging upside down.

Very large transport: Inspection of landing gear in flight is accomplished by use of two small windows for the main landing gears and a fiber optics viewer for the nose landing gear. Usually, the landing gears are inspected in flight to determine proper down lock, for the condition of the gears, and for inspection after damage or fire has occurred. The fiber optic viewer installed for the NLG is not effective, is limited to viewing a single component, and provides very poor visual quality. This is because of the inherent characteristics of the fiber optics. They become opaque when moisture enters the assembly as well as from wear and aging. A window near the NLG is desired instead of the fiber optic viewer.

Very large transport: A port hole or exterior fuselage access panel large enough for personnel access is needed for cleaning and inspection of corrosion, water, and hydraulic fluid. Because of the lack of these design features, it will continue to be a problem in the bilge area. Mechanics must crawl approximately 25 feet to reach the problem area. The crawl space is very small with several obstacles, ribs, formers, etc. obstructing the path. The problem is compounded in one area by urinal waste. As in other

aircraft design features, urinal placement and removal of waste does not appear to have been a priority design item. Inherent corrosion problems have resulted. Although performance considerations and placement of aircraft components may necessitate unique locations, priority consideration should be given to latrine locations and easy access for cleaning and treating to avoid detrimental corrosion impacts.

Very large transport: Hydraulic lines routed under the forward cargo floor to provide hydraulic pressure to the NLG actuators sometimes develop leaks and must be repaired. In addition, access to this area is required periodically to inspect the hydraulic lines and other items. Access is by removal of large floor panels. Ease of access is inadequate. Removal of the large floor panels is time consuming and physically difficult because of the size and weight of the panels. It is desirable to have adequately stressed access panels provided directly in the floor to gain access to the hydraulic lines and other underfloor areas.

Ground attack: The mounting bolts for the wing outer panel have to be torqued periodically. The torquing of these wing bolts to 900 in-lbs requires the removal of a small access panel (12" x 18") located in the top of the main landing gear pod. The mechanic must be very small and must crawl up into the landing gear pod, make a 90 degree bend of the body, and squeeze down a four foot passage before torquing the bolts. This procedure is required every 50 flying hours.

Transport: The Doppler radar antenna cover is a stress panel because the compartment is pressurized. The compartment also contains the receiver-transmitter and other Doppler system components which require frequent access. In order to make these units more accessible, the antenna cover is attached with fasteners designed for quarter turn removal and installation. A threaded socket is incorporated in these fasteners which is designed so that a greater force than that afforded by the spring tension applied by a normal quarter turn fastener can be generated. In practice, although the fastener can be disengaged with a quarter turn, the threaded socket must be backed out so that the quarter turn may be reengaged. Many times the socket has corroded so that it is difficult to backout. In addition, backing the socket out too far or trying to engage the quarter turn by impact breaks the socket so that it must be replaced. Many man-hours are consumed in replacing these fasteners. Stress panels must, by their very nature, have high strength, multiple load path attachment to the structure which makes quick access difficult. Equipment requiring frequent access should not be placed behind stress panels. It is highly desirable to make such equipment accessible from inside the aircraft or place it behind quick access panels.

Transport: Modifications made to the aircraft especially by other than the original manufacturer have degraded or eliminated access to other equipment. The inventors have had additional equipment installed in front of them; the gaseous oxygen bottles installed in demodging certain special mission aircraft were placed in front of electrical

terminal boards, and a wing mod completely eliminated the individual tanks refueling access for the auxiliary fuel tanks which were used for defueling also. Desire modifications consider the impact on maintainability of other systems existing in the aircraft.

Air supremacy fighter: Provisions were not provided for appropriate in-flight stowage of ground safety locks, pins, and missile covers. The practice is for the ground crew to remove the pins before taxiing out and retain them on the ground until the aircraft returns. However, the aircraft does not always land at the base of departure, and there is a risk that adequate pins will not be available at the destination. Stowage in the cockpit during flight is not practical because of the danger of handing up the items while directly in front of the engine intake with engines running. In addition, there is no adequately secure place in the cockpit for stowage. Ideally, the pins and covers should be stowed after engine start in a compartment safely accessible from the ground. One ECP to solve the problem was rejected because of the nearly \$800,000 production and retrofit cost. Based on a field suggestion, a solution to the problem is expected which will provide a restrained compartmented stowage bag in an existing ground accessible compartment in the underside of the fuselage. With no structural change required, this solution is expected to be cost effective.

Cargo handling

Transport: An early model cargo winch used on some models of the aircraft is frequently damaged because the cable crosses over itself or the hook is wound onto the reel. The problem occurs when the cable is being retrieved without a load and usually results in damage to the housing, the cable, or both. The winch used on a large transport and some models of the transport has cable guides and limit switches. This winch has been very reliable and does not have any of the problems associated with the other type of winch which does not have cable guides and limit switches.

Transport: Excessive man-hours are spent cleaning the cargo compartment. The cargo rail system has several deep crevices and cavities which catch a great deal of debris. It is not practical to hose out the rails because the drains are inadequate and equipment in the bilge area could be damaged by backed-up water. A large transport has a similar but superior rail system. The rails are hinged on the outboard side and can be flush-stowed against the fuselage when not in use. The system requires minimal cleaning and does not have the debris problem associated with the other transport system.

Castings

Welded versus unwelded castings. Castings were received which had a potential strength reduction. The most serious deficiencies were due to unauthorized and undocumented welding, suspected incorrect weld material, welding techniques without established quality parameters, and suspected incorrect heat treatment. An analysis was made of the

application of every casting and the safety implications of the failure of any given casting. The worst case strength reduction was determined and the uncertainty factor was calculated for each casting. Nine casting classifications were developed based on the expected results of a failure and each casting was identified with its appropriate classification. A sampling plan for each classification was developed and testing was accomplished to gather data on the condition of the deficient castings. Engineering recommendations were devised which detailed action to be taken on each casting or group of castings already installed on aircraft. The recommendations were: to continue flight operations without urgent inspection of some castings, remove and replace some castings; and perform special inspection of other castings. Several lessons were learned from this experience. One was that for critical items care must be exercised in the source selection process. The second was that receiving inspection, especially on critical items, must be thorough. A third was that an in-depth study that brings together the expertise and cooperation of all functional areas may be used to salvage expensive critical items since a thorough analysis of failure modes and safety margins may reveal latitudes not otherwise apparent.

Chafing of cables, tubing, and wires

Swing wing fighter bomber: An avionics cable is damaged (i.e., wires cut or wire coating shaved off, etc.) when the tail hook system is operated. The problem results because the cable and tail hook actuation rod are extremely close together and no protection is afforded the cable by a shield or cable jacket from a bolt used in the actuation assembly. Field personnel must cut out approximately two feet of cable and splice in a new piece using male and female connectors. One airplane has been fitted with aluminum tubing to protect the cable and has experienced no damage. Cables, wire bundles, and other similar materials must not be routed through areas where damage from moving parts is possible or else they must be protected (by metal conduit, tubing, etc.).

Wiring/tubing interaction: Electrical cables and steel lines carrying hydraulic fluid and gas should not be routed in close proximity. Chafing of the insulation on electrical wires may lead to arcing, subsequently causing a fire. When electrical cable clamps are mounted to the same, or adjacent, post as fluid line clamps, the close proximity can cause a fire. If cable chafing occurs, electrical arcing erodes the steel lines to the degree that internal pressure blows a hole in the line. Subsequent arcing ignites the fluid escaping from the line.

Heavy air/ground fighter: As a result of a notable increase in engine/engine bay fire/chafing occurrences in 1976, a conference was convened to determine what corrective measures were required. Recommendations covered a broad spectrum including extensive revision of applicable publications. These improvements also include reclamping the affected fluid lines and wire bundles in the engine bays to reduce chafing potential.

Rerouting or repositioning of some components may be necessary to obtain adequate clearance at specific locations.

Swing wing fighter: During basic post flight inspection, a fuel tube was found leaking from a small hole. The hole was caused from the tube chafing against a hydraulic tube. Local inspection of 49 aircraft revealed eight additional chafed tubes.

Very large transport: An in-flight fire in a pylon was caused by chafed electrical wire sparks rupturing a hydraulic line and igniting hydraulic spray. Engineering study recommends rerouting wiring and fluid systems to reduce possibility of same type of failure recurring.

Air supremacy fighter: Inboard and centerline pylons problem of the preload post pin rubbing against wire bundle assembly and air pressure regulator tube assembly causing damage to both assemblies.

Large transport: Inspection TCTO was issued specifying inspection of specific thrust reverser lines. During inspection, oil residue was noted in area of other thrust reverser lines. Further inspection found lines on one engine had worn through. Inspection of four other engines found bad chafing on the same lines on each engine. Additional clamps solved the problem.

Clearance, alignment, and wear

Transport: Lack of sufficient clearance on the landing gear results in frequent interference and requires extensive man-hours to correct. While the main landing gear system is reliable, the close clearances frequently result in the main landing gear strut rubbing either the shelf bracket that serves as a gear down support and location guide, or the gear on the gear microswitch. Serious out-of-adjustment or failure conditions can result in stopping the gear travel, but the majority of problems stem from a slight rubbing contact between the components mentioned. Correction of these rub conditions usually requires minor adjustments to the shoe assemblies that locate the gear in the track assembly. This requires significant maintenance man-hours to jack the aircraft for retraction and adjustment of the gear. The adjustment may solve the majority of these problems. This problem has been solved by a change to afford sufficient clearance to allow for tolerance build-up due to uneven wear of attaching components.

Swing wing fighter bomber: Fire access doors on the aircraft have a high wearout rate and are not available as spares. Fire access doors in four panels are spring loaded and flutter in flight. This flutter causes quick wearout of hinges and doors. Hinges are frequently repaired in the sheet metal shop. The doors themselves are not provisioned. When a door is damaged beyond repair, the entire panel must be replaced.

Wear of fastener holes: Frequent removal of fiberglass panels results in severe wear to the fastener

holes. Fiberglass panels are used for aircraft weight reduction. Fiberglass is lightweight, structurally sound and is used in many non-load carrying areas. However, constant opening and closing of fiberglass panels elongates the fastener holes.

Swing wing fighter bomber: The cables and connectors to and from pivot pylons are subject to frequent damage during pylon mate/de-mate operations. The insulation is subject to wear because of in-flight pylon vibration. The pivot pylons mount both conventional and non-conventional ordnance. Two types of station program units (SPUs) are in each pylon to program the two types of weapons release: A conventional SPU and an aircraft monitor and control (AIAC) SPU. The pivot pylons require frequent change to tank pylons because of mission requirements. Several problems are associated with the pivot pylons. Cables and plugs connecting the pylon to the aircraft are frequently damaged during the mate/de-mate operation because they get hung up. Also, they are located in a hard to reach position and connecting them causes pin and cable damage. Another cause of cable damage is pylon vibration during flight. This results in the insulation being worn off the wires. Finally, SPUs located in the pylons were reported to be damaged because of frequent pylon change.

Swing wing fighter: The two upper shear pins for the aft engine door frame are difficult to align for insertion of the quick release locking pin. The aft engine door frame is attached to the main bulkhead with four shear pins. The upper shear pins are secured by a ball lock quick release pin which passes through both shear pins. With the engine installed, there is limited access to the holes through which the quick release pin must be installed. If an index mark (such as etched line) were installed on the head side of the shear pin, installation of the locking device would be made much simpler. Alignment or index marks on the visible side of components are needed to facilitate alignment of locking devices.

Very large transport: On the aircraft, some components do not fit as required. Mating parts, with misaligned holes, were apparently forced into place, inducing cracks. A significant number of cracks have appeared in the fuselage contour box beam assembly. Cracks have been found on ten airplanes at one fueling station and on seven airplanes at another. Repair times are 75 man-hours for cracks at the first station and 150 man-hours for cracks at the other. Total man-hours required have reached 1800. In addition, gaps between parts were not corrected with shims to prevent preloading, bending, and stress in those cases. The problem was primarily a tooling problem which affected early aircraft.

Complex and secondary structural components

Swing wing fighter bomber: There are several secondary structural components that do not have a critical function but do require frequent repairs or

replacement. The following areas were noted by the using commands as examples of this on-going problem. First, the auxiliary flap system has minor functional benefits. However, this system has numerous interference problems as well as a complex rigging procedure that is usually inadequate. Because of these difficulties, TAC has reportedly deactivated the system; SAC frequently flies its aircraft without auxiliary flaps. In addition, a PRAM study was conducted by Sacramento ALC. The resulting recommendation was that the system be deleted. Second, the attaching former on the forward wing root teardrop fairing requires frequent replacement because of the thin material design. The problem is compounded by the fact that each former has to be match-drilled to fit each aircraft. (Some of the features of the airplane, e.g., auxiliary flaps and rotating glove, were added primarily to achieve U.S. Navy required carrier operation capability. As such, little could be done in the area of performance/structural complexity tradeoffs. The User, as well as the contractor, must weigh performance requirements/gains against development costs and anticipated maintenance.)

Swing wing fighter bomber: The aircraft initially used translating (movable) vanes (one 12-inch vane for each flap at the trailing edge of the wings). The translating vanes were required because of performance goals and the narrow profile of the wings. As a result, the vanes interfere with normal flap movement when the flaps are retracted. A PRAM project was authorized to develop a permanent engineering fix to this problem along with other auxiliary flight control improvements which will simplify flap/slat rigging procedures. An engineering fix has been developed. The change will permanently attach the vane assemblies to the flaps and will significantly reduce maintenance on the flap/vane system. (Emphasis on performance requirements without limits or guidance regarding the means of achieving the performance have resulted in what appears to be unnecessarily complex systems that give only marginal performance gains for high maintenance upkeep costs.) Ground attack: The entire throttle quadrant has to be removed whenever a switch on the throttle handle fails. This requirement to remove the quadrant causes excessive man-hours to be expended in removal, repair, replacement, and functional check of all components on the throttle quadrant. The throttle quadrant contains the following switches: speed brake switch, missile reject/uncage switch, right and left ignition button, communications "MIC" button, master exterior lights switch-missile video polarity, missile seeker head slew/track control, flap lever, throttle friction control, APU start switch, engine fuel flow norm, engine operator override, and L/G warn silence. There are about 33 maintenance actions involved in the removal, repair, replacement, and checkout of the throttle quadrant. The majority of the man-hours expended are in the throttle rigging, engine trim, and functional check/adjustment of the various switches on the throttle quadrant.

Subsonic trainer: The basic sheet metal airframe is easily maintained with minimal depot level support. The semi-monocoque design is frequently referred to as a sheet metal airplane by maintenance personnel. Although the airframe has some forgings and castings, it does not have exotic materials or components such as titanium, composites, honeycomb and chemmilled skins. Instead, the structure is primarily formed sheet metal parts and extruded angles, hence the name sheet metal airplane. This type of construction is highly desirable, from a maintenance point of view, because the majority of the structural rework can be accomplished by field level maintenance (FLM) personnel. Using typical repairs in the structural repair manual (SRM), the FLM personnel can locally manufacture the repair parts and replace structural damaged parts without expensive depot level support.

Very large transport: The crosswind takeoff and landing capability is achieved by rotating the main landing gear to allow the pilot to point the aircraft into the wind. The rotation mechanism is a complex system of actuators, sensors, hydraulic plumbing and electrical wiring. This system is the most frequent cause of gear malfunction. Comparably sized commercial aircraft do not have this feature. The attendant actuators, sensors, wiring, etc. are complicated and drive up maintenance costs. The aircraft can safely operate with a 35-knot crosswind without the crosswind capability.

Corrosion

General: It is reasonably obvious that maintenance costs increase when corrosion occurs and that ease of access to the corroded areas also affects maintenance costs. Providing access for maintenance is one of the many considerations that are traded against other requirements, such as performance and structural integrity, during design efforts. To insure corrosion prevention considerations are included in the initial design, current systems require a corrosion prevention plan in accordance with MIL-STD-1568. This plan describes the approach to preventing corrosion and includes the establishment of a corrosion prevention team. This team has the responsibility to review preliminary drawings to insure corrosion protection techniques are adequate. This team also reviews the Corrosion Peculiar Technical Order (see MIL-M-38795) which identifies corrosion prone areas and defines maintenance actions. In addition, AFR 400-44 requires establishment of a Corrosion Prevention Advisory Board (CPAB) on all new major weapon systems.

Transport: Overboard draining of aircraft comfort stations allows waste to coat aircraft surfaces resulting in severe corrosion. The overboard draining of comfort stations, urinals, and relief tubes causes severe corrosion. To comply with existing corrosion prevention and remedial directives, excessive maintenance man-hours are expended in the constant actions necessary to prevent and deter this type of

corrosion. Avoid overboard draining of comfort stations, urinals, and relief tubes. Some aircraft have incorporated chemical toilets with holding tanks to avoid this situation.

Crew entrance steps and ladders

Swing wing fighter bomber: High failure of crew entrance step pegs is caused by spline damage to the pegs and by solenoid failure. The crew entrance step pegs, which are also used to secure the entrance ladder, are unnecessarily complex. They are splined and run in and out of the step housing with a windowshade-type spring return mechanism. The pegs are spring-loaded to the extend position; they are held in the closed position by a retaining pin that is solenoid-operated from the pilot's compartment. The step pegs can be manually released from the outside by turning the manual release screws. The solenoids are disabled on many aircraft because of a high failure rate. The close tolerance of the step peg splines and the step housing results in pegs jamming when damaged by the ladder or foot.

Ground attack: The internal boarding ladder is difficult and unsafe to use. Structural failures of the telescoping sections and the rungs have occurred. In addition, the ladder has been jettisoned accidentally. It consists of a telescoping square tubular aluminum apparatus with rungs extending from the left and right sides. The pilot can deploy the ladder by energizing the rotor solenoid that opens the door panel. A ladder ejection spring pushes the ladder outward, allowing it to swing out and telescope to its fully deployed position. The ladder protrudes at an obtuse angle from the vertical axis of the aircraft. This angle imposes a bending load throughout the ladder sections and it has caused splitting of the lower tubular section and breaking of the rungs. The ladder is held open by a magnet which is not sufficient to prevent damage from ground winds which cause the door to flop. A failure of the step casting has occurred. Other problems include accidental jettison of the ladder and the absence of positive indication of ladder deployment. Some of the foregoing deficiencies have been corrected; the lower tubular section and the rungs have been strengthened. The pin ball locks that permit the jettison of the ladder during a scramble have been replaced with a solid bolt and nut.

Air supremacy fighter: The steps are telescoping, spring actuated, and mechanical locked devices. Repeated extensions (high bottoming out loads) have caused cracks and structural failures. The latching mechanism is not adequate since several inflight extensions have occurred. In two cases the steps failed and parts separated from the airplane fortunately missing the engine inlet.

Drain holes

Ground attack: The bottom cap assembly on the rudder fails from internal pressures caused by ram pressure on drain holes. The rudder on the vertical stabilizer contains a bottom cap assembly which is made of fiberglass. This cap assembly is hollow and has a drain hole at the bottom. During high speed

operation, air is forced into the cap assembly via the drain hole causing the cap assembly to act as a baffle. When this happens, the trailing edge of the cap assembly tends to split open in order to relieve the pressure which has built up inside.

Very large transport: Four drain lines are installed in each pylon. However, the existing drains incorporate finger screens which can trap foreign matter and unless carefully inspected, become plugged. To alleviate this possibility, an ECP has been approved to replace the finger screens with ones that are flush with the pylon lower surface and accessible for inspection and cleaning.

Engine/pylon removal/replacement

Ground attack: A positive feature of the aircraft is the engine/pylon design. The engine and pylon are designed to be handled as a unit which is attached to the airframe by three mounts and seven quick disconnects. Thus, all the tubing, hoses, fittings, and connections between the engine and pylon can be done in the engine shop and the entire engine/pylon assembly can be installed on the aircraft as a unit. The engine-to-pylon attachment is still a difficult and time consuming task, but it is much easier to perform in the shelter of the engine shop than out on the flight line. As a result of this design, an engine change can be done in as short a time as four hours.

Equipment location and retention

Liquid oxygen converter, life support systems: On several aircraft, the liquid oxygen converter is the highest logistic support cost item of the life support system. On some of the larger aircraft, the converter is located remote from the crew compartment at the far aft section of the fuselage in an area susceptible to high vibration. Excessively long distribution lines are not insulated from surroundings and result in increased generation of gaseous oxygen through agitation and heating. This situation causes increase in amount of venting through relief valves. Foreign materials, including moisture particles freezing in the lines and forming small ice crystals, enter the oxygen system during converter connection and also contribute to excessive venting until melted or blown loose. Maintenance actions consists of inspecting, servicing, and testing without any repair being performed. This is attributed to the excessive venting and the loss of oxygen being improperly diagnosed as leaks.

Supersonic trainer: As the result of a major accident, a need was recognized to modify survival kits so that they are retained in the seat bucket under negative g conditions. An ejection seat crew/kit retention strap (Crotch Strap) mod was developed.

External lighting (formation)

Swing wing fighter: The aircraft require lighting improvement for join-up and formation flying. An airplane was modified with four lighting fixtures to determine the best lighting arrangements: (1) electroluminescent strip lights; (2) improved formation lights; (3) wingtip/glove light circuits; and

(4) flood lights, OT&E was conducted. Lighting fixes (1) through (3) above constitutes total requirements. Three separate modifications will be processed to provide these lighting improvements.

Flight control (actuators, primary and secondary systems, surfaces, etc.)

Swing wing fighter bomber: The electrical backup system which operates the flap/slat extend/retract mechanism under emergency conditions does not include limit sensors. This permits actuation beyond normal limits with resultant structural damage. The normal hydraulic flap/slat actuation system has limit sensors which shut-off pressure to the hydraulic motors at the extremes of travel. The lack of sensors in the secondary system is conducive to damage to the electric motor and the flex drive shafts. The applicable technical order (T.O.) and the corresponding checklist include numerous warning and caution notes to alert maintenance personnel to use extreme caution when operating the system in the emergency mode. This attempt to preclude damage through warning notes would not be required if the aircraft were equipped with switches which would disengage the electric motor at the extremes of travel.

Swing wing fighter bomber: The flap asymmetry sensor is mounted on the number 4 flap segment of each wing. The sensor prevents flaps 1 through 4 from moving out of synchronization. Number 5 flap, however, has no asymmetry sensing device; consequently, hang-ups at the number 5 flap cannot be detected. Field activities have indicated that no in-flight control problems have been reported to date; however, post-flight inspections have revealed structural damage and flap separation at the number 5 flap. The reason the asymmetry sensor is located at the number 4 flap instead of the number 5 flap is that all swing wing fighter aircraft produced prior to the swing wing fighter bomber had only four flaps. When the swing wing fighter bomber was designed with an extra 2 1/2 feet of wing and a number 5 flap, the asymmetry device was left at the number 4 flap.

Large transport: Field reports have identified the following problems: Ailerons sticking in the up and down positions and inability to center, unwanted movements, and lagging and overshooting of manual and automatic input commands. These conditions are caused by inability of the ailerons to overcome input linkage friction and control valve operating forces at cold temperature in the presence of contaminated hydraulic fluid, which also tends to compress the input override bungee.

Fuel filter retaining strap

Tanker/transport: A flight mishap was caused by the cap of the main fuel filter separating from the filter body assembly. This was a repeat of a similar mishap in 1959. A retaining strap and cable assembly was installed over the cap and body assembly to prevent this from occurring. Since that time no cap separations have occurred; however, testing of the retaining strap and cables has revealed that if the filter

retaining rod breaks below the filter cap, the retaining strap will slide off the fuel filter cap and 10 PSI internal fuel pressure will cause the cap to separate from the filter body assembly. Field level installation of an improved retaining strap and cable assembly on main fuel filters is being done (1981).

Fuel vents

Air superiority fighter: The fuel vent on the aircraft is flush with the bottom of the left wing. When the aircraft is on the ground, changes in ambient temperatures can cause fuel to expand and be vented from the fuel vent. Surface adhesion causes the fuel to cover the entire bottom of the wing. The area covered by the dripping is larger than any drip pan and creates a fire hazard.

Heavy air/ground fighter: A mishap investigation board identified a problem in the aft fuselage fuel vent line system. There were four more mishaps involving aft fuselage fires and damage to the aft section of the aircraft. A test program was performed as the last phase of an evaluation to insure the improvements would solve the existing problems. The test program was completed and a modification was made to enlarge the bulkhead holes through which the vent line passes, relocate the pencil drain in the vent system and install brackets to stiffen the vent line.

Ground refueling

Subsonic trainer: Over-the-wing refueling is a high man-hour consumer and has contributed to fuel system contamination problems. Two people are required for refueling because both wing tanks must be filled simultaneously to preclude damage caused by fuel imbalance. Single point refueling requires only one person and can use higher flow rates, resulting in significant manpower savings. The over-the-wing filler ports are a source of fuel contamination. Paint and metal chips are knocked into the tanks by the filler nozzles and cap retainer lanyards and nozzle basket ports are frequently broken off or dropped into the tanks. The rate of fuel tank contamination occurrences on this subsonic trainer is 10 times that of a supersonic trainer. Review and include as applicable the Standardization Agreement 3212ASP on diameters for gravity filling orifices.

Hoist/cable guides

Hoists: One of the most difficult line replaceable units (LRU) to handle in the avionics intermediate shop (AIS) is the radar antenna. Because of the weight (approximately 80 pounds) and the bulkiness of an antenna, many times damage is caused just in transporting and mounting the unit into the fixture. In one of the AIS, the hoist/cable required constant tension to prevent the cable from slipping off the reels. When this occurred the antenna would have to be manually lifted off the fixture, the cable reinstalled on the reel, and then remounted onto the fixture. The need for cable retention guards and guides applies to airborne hoists as well.

Impact bags, parachutes, and pressure bottle installations

Swing wing fighter bomber: The escape capsule impact bag, the stabilizer brake chute, and the recovery chute are time change items requiring periodic replacement. All three items are compressed and sealed in their shipping containers. Once the containers are opened, the items immediately start to swell. The impact bag in particular will swell to the point that it must be compressed into position with a jack stand if it is not installed in the aircraft within thirty minutes. Installation of all three items takes three days.

Swing wing fighter: Fuel was discovered leaking from the nose wheel well. Investigation revealed the left hand pressure source bottle for the impact attenuation bag had exploded causing extensive aircraft damage. The F-1 fuel tank bulkhead had been punctured, the left hand seat structure attaching points had broken and forced the seat forward, and the adjacent outside aircraft skin was bulged outward. Burst tested six pressure source bottles. All exceeded virgin burst requirements. Burst testing of 15 damaged bottles removed in accordance with TCTO. Problem still under investigation.

Interchangeability

Swing wing fighter bomber: The teardrop panels, like many other panels, come from supply as undrilled blanks. Since the aircraft structure normally warps during its life cycle, predrilled panels usually will not fit. The blank panels are drilled in place to fit the existing structure. For this reason, panels from one aircraft will seldom fit any other aircraft. In the case of the teardrop panels, the panels attach to a heavy forging which is not subject to warping. Predrilled panels would have been practical in this case.

Very large transport: Landing gear and brake failures have occurred as the result of cross-connected hydraulic lines. One of the landing gear retracted, both the normal and emergency systems failed to lower the gear. The normal system was inoperative because of a broken linkage between the unlock actuator and the over-center mechanism that locks the gear in the retracted position. A separate emergency lock/unlock actuator is included in this design but the hydraulic lines to it were reversed. Hence, when the emergency gear-down system was activated, pressure was applied to drive the mechanism firmly into the locked (up) position. One would expect such a condition to be discovered by required checkout procedures following any maintenance on the system. Although such checks were performed, the gear functioned normally during the tests in spite of the cross-connected hydraulic lines. In flight, however, the timing of the door opening and loads on the system were changed. As a result, the gear remained in the up position. A similar incident occurred involving the brake system. During maintenance, hydraulic lines were inadvertently crossed on both main landing gear bogies. Later, maximum braking was applied upon landing from a functional check flight. The anti-skid system sensed a nonskid condition on the "A" pair of

wheels on each bogie and increased the braking pressure. Because of the reversed lines, this pressure increase was directed to the "B" pair of wheels. The system sensed the impending skid of the "B" wheels and relaxed the pressure in the "B" lines which were misconnected to the "A" wheels. The end result was no braking on the "A" wheels and four blown tires on the firmly locked "B" wheels. Thus, the misrigged system caused the condition it was intended to prevent.

Transport: Two jacks are required to change a flat tire. The first jack is needed to lift the strut high enough for a 35 ton jack to be inserted. The second jack will then raise the aircraft so that the tire can be replaced.

Very large transport: Non-permanently installed jack pads increase maintenance man-hours, require 780 record maintenance, and result in the loss of jack pads and attaching parts. Jack pads were not originally installed as a permanent part of the airframe, subsequently, the pads were permanently installed after a test proved that jack pads exposed to the airstream did not result in an appreciable increase of fuel used due to drag. This action reduced 780 equipment record keeping time. Maintenance man-hours required to install and remove the jack pads whenever the aircraft was jacked were eliminated. In addition, jack pad and attaching part losses were also eliminated.

Landing gear position change

Air supremacy fighter: The original location of the MLG was changed to enhance the location of center-of-gravity relative to the MLG and the crosswind landing characteristics of the aircraft. The change incorporated an extended drag link to effect this enhancement rather than a redesign of the MLG. The change, when incorporated, caused geometric misalignment of the MLG wheels resulting in excessive MLG tire wear and maintenance support cost.

Landing gear position locks and servicing

Swing wing fighter: Slight (5-7 percent) overinflation of the gear struts will prevent the main gear from locking in the retract position. The landing gear strut servicing procedure uses air pressure in conjunction with strut extension for proper inflation of the shock struts. The strut extension is measured in one-eighth inch increments and the air pressure is held to plus or minus twenty-five pounds per square inch. The gage used for this procedure has a range of 0-4000 pounds and the dial face is marked in 100 pounds increments which makes accurate air servicing very difficult and almost impossible to meet the plus or minus 25 pound requirement.

Subsonic trainer: The main landing gear cannot be lowered by either the hydraulic system or the emergency air system unless the main gear door uplock mechanism can be released. The conventional tricycle landing gear retracts and extends by power from the aircraft hydraulic system. The inboard main gear doors are actuated hydraulically and are operated

by a sequencing valve in the landing gear system. This valve synchronizes opening and closing of the doors with extension and retraction of the main gear. The inboard main gear doors engage the uplock hooks. The nose-wheel doors are actuated open and closed by mechanical linkages which are connected to the nose gear. The landing gear emergency extension system consists of an emergency gear T-handle and an emergency air bottle containing 2000 +250 psi of air. Activation of the emergency system directs air to the actuators to open the main gear doors and to lower the landing gear when a failure occurs in the hydraulic system. If mechanical failure occurs which prevents operation of the main gear door actuator or the door uplock release mechanism, the main gear cannot be extended. Consideration should be given to a manual uplock release, free-fall emergency landing gear extension system, as one alternative for aircraft such as a light trainer.

Attack fighter: The MLG uplock system has experienced problems due to difficulties in maintaining proper rigging. This condition results in failure of the uplock structure and subsequent failure of the gear to extend. Cause of the problem is abnormally large loads being transferred into structure not designed to withstand such loading. Three gear up landings and numerous maintenance actions have resulted from this condition. A TCTO to replace MLG restrictor with a design allowing for slower gear retraction and resulting smaller loads has been issued.

Evacuation transport: During free fall testing of the NLG, it was discovered that down and locked may be indicated prior to the gear downlock mechanism being overcenter (safe).

Lost antennas

Transport/large transport: Aircraft antennas are bolted to the outer fuselage skin. The loss of an antenna becomes significant when cabin pressure is lost through the hole created by the loss of the antenna. For example, an airplane was cruising at 39,000 feet when a rapid loss of cabin pressure was detected. The pressure was lost through the hole left when an antenna came off in flight. Aircraft antennas are subject to ground damage, vibration, shock, and internal/external pressures while in flight. The cabin pressure tends to force the antenna away from the aircraft and results in advertent depressurizations when the entire antenna is lost. Cabin pressure forces should tend to hold the antenna in place rather than force it loose. External removal and replacement should also be a consideration.

Moisture intrusion

Subsonic trainer: Rain, melting snow, and other forms of moisture seep into the avionics compartment of the aircraft during foul weather causing premature avionics failures. This problem is further complicated because of the design of compartment covers, which raise up and allow water to run off into the compartment. The moisture problem is attributed mainly to the design of these covers and associated rubber seals.

Swing wing fighter: The canopy seals on the cockpit canopy are depressurized when the power is off, as it is when the aircraft is parked. Originally, when these seals were depressurized rain leaked through, causing corrosion and damage to electronic components, such as short circuits. Subsequently, a round tubular shield was placed around the cockpit periphery outside of the original seal. This blocked any moisture from penetrating, even when the pressure seals are depressurized.

Ground attack: Thin panels used on avionics bays do not prevent water intrusion. When sealant is applied to the panels, the panels deform and eventually fail with fasteners pulling through the panels. One factor in the design was to have thin, lightweight, flush panels on all bays. Thin panels do not prevent water intrusion very well and are very susceptible to deformation. The deformation problem is increased when seals are added to prevent water intrusion. Space for the seals could have been allowed and still kept the panels light in weight, thin, and flush.

Overload (NZW) warning

Overload warning system: Although the aircraft mounted accelerometers give accurate "g" load readings, they do not consider weight or altitude for a true depiction of aircraft load conditions. The acceleration limits of one fighter are 5.1 g at 53,300 pounds and 7.3 g at 37,400 pounds. The aircraft has the lowest tolerance to excessive "g" loads occurring in the area of 20,000 feet pulling 7.5 g at 40,000 feet and less than 37,000 pounds would indicate the same on the accelerometer counter at 7.5 g at 20,000 feet at a weight of 53,000+ pounds. Although instrument indications would be identical for each, the latter would be more critical, affecting the fatigue life of the airframe. Consideration should be given to developing and installing an overload warning system in future high performance air combat fighters.

Paratroop seats

Transport: The paratroop seats are designed in segments to facilitate handling. Segments are connected by 16 inch nylon zippers to form a bench. The zippers frequently fail under the loads applied during normal use and handling. Replacement zippers are available, but replacement requires removal of two seat segments. Many times the whole seat unit is replaced because of zipper failure. In either case significant man-hours are required.

Redundant routing of cables, lines, and wires

Very large transport: Failure of the T-tail flight controls was caused when the aircraft pressure door broke loose in flight and severed the hydraulic lines, electrical wires, and cables to the hydraulic power packs that operated the flight controls. Because primary and secondary hydraulic lines were routed together along with electrical circuits for trim control, failure of the control cables was compounded by loss of any control of the primary and secondary flight surfaces in the empennage. This problem has been minimized by rerouting and separating the redundant flight control system hydraulic lines, electrical wires,

and cables. Rerouting has minimized the potential for redundant system loss.

Swing-wing bomber: The aircraft was flying a designated low level, high speed leg of a simulated bombing training mission. A bird penetrated the aircraft structure through the inboard side of engine three's boundary control gutter wall. Critical hydraulic lines, fuel lines, and numerous electrical lines, cables, and junction boxes were grouped together in this bird impact penetration vulnerable area. The requirement to separate critical lines, such as hydraulic, fuel, and electrical is to be made applicable to all airframes, particularly those that are to be used at low level for extended periods of time. This requirement to eliminate the grouping of critical lines and subsystems that do not have separated redundant counterparts is to be made applicable regardless of the size of bird required in 3.2.24, Foreign Object Damage (FOD).

Refueling overpressure

Tanker/transport: Two aircraft are barred from aerial refueling with the aircraft due to unsafe conditions. Some aircraft are restricted to only partial refueling with the aircraft due to unsafe/hazardous results if the receiver aircraft obtains full tanks during refueling (i.e., receiver aircraft fuel tanks will rupture due to tanker fuel pressure).

Aircraft that are designed to receive fuel during inflight refueling operation must have provisions to preclude overpressurization when the fuel tanks reach the full condition.

The refueling system on tanker aircraft must include pressure regulation to preclude unacceptable pressure surges in the event of failure of pressure relief systems on receiver aircraft.

Transport: Number one fuel tank over pressurized causing internal and external structural damage.

Review and include as applicable the Standardization Agreement 3681PHE on criteria for pressure fueling of aircraft.

Reliability

Swing wing fighter bomber: The tail light is a high failure item. Many times, two or more bulb replacements are required after flight. The tail light assembly is isolated to absorb approximately ten g's of vibration. Vibrations as high as 50 g can occur in the tail section. Vibrations of this magnitude can snap a bulb filament. The use of adequate vibration isolation and the use of non-filament high reliability type light bulbs for all light assemblies should be considered.

Swing wing fighter bomber: The anti-collision lights are retracted when they are not in use. The retraction mechanism causes many failures and significantly lower reliability in comparison with fixed lights. The drag benefits of having the lights retracted appear to be minuscule. During normal operations the lights are always extended and on. It appears that the performance benefits of the retractable lights are more than offset by the increased cost and lower reliability

of these units compared to fixed lights. Streamlined, fixed, anti-collision lights instead of retractable lights should be considered.

Very large transport: Fittings in the hydraulic return lines in areas of high flexing (wings and pylons) are failing due to flange separation in the self-aligning part of the tube to fitting interface. They were designed to allow angular misalignment caused from wing and pylon flexing and linear expansion/contraction from pressure surges and thermal effects. A fitting consists of a nut, stainless steel locks or snap ring, O-ring, and two half moon sleeves made of stainless steel or aluminum (depending on where in the hydraulic return system they are used--the stainless steel sleeves are used in areas of higher vibration). The function of the half moon sleeves is to fit over and around the flanges of the two connecting tubes to permit the tubing to slip during flexing. Some of the problems with the fitting can be attributed to the fitting design; others to the thin walled tubing that is used with them. Examples of reported failures are: cracked half moon sleeves (aluminum), broken tube flanges, cracked nuts, holes in tubes caused by rubbing the half moon sleeves, and holes at tube anchor points in high flexure areas. Some aircraft have not experienced this problem. A large transport uses standard AN fittings in the high flex areas with thicker walled tubing. On a tanker/transport, the straight swivel slip coupling is used at strategic locations to absorb the expansions and movement of the hydraulic lines. An air/ground fighter used flexible line segments and rigid fittings.

Repair of lightweight tubing

Ground attack/air superiority fighter/electronics: These aircraft use high strength 21-6-9 instead of the widely used 304 1/8 tubing as a weight savings. The weight savings on the fighter was 18 pounds and 108 pounds on the electronics aircraft. The major difference between the tubing is 21-6-9 has thinner wall structure but is stronger. The 304 1/8 stainless steel tubing was used on earlier aircraft prior to introduction of 21-6-9 and is presently available in the field. By using the 21-6-9 tubing, new tooling and special mandrels were required since the tooling for the 304 1/8 tubing was too soft for bending 21-6-9 tubing. To alleviate procuring additional tooling for bending 21-6-9 tubing, AFLC has authorized the use of 304 1/8 stainless steel as the repair item for failed 21-6-9 stainless steel tubing. Authorization for repair of 21-6-9 tubing with 304 1/8 should be included in each technical order and document applicable to performing tube replacement.

Taxi damage

Large transport: During taxi for takeoff, the aircraft made a right turn onto the taxiway. During the turn the aircraft right wing tip contacted a building inflicting damage to approximately 18 to 24 inches of the right wing tip. Fuel from the number four main fuel tank spilled. The engines were shut down and the crew evacuated the airplane.

Toxic materials

Heavy air/ground fighter: An aircraft was lost when its cockpit filled with smoke and the crew ejected. The smoke, which prevented all outside vision and totally obscured the instruments, was generated by the polyvinyl chloride (PVC) lining of a cockpit insulation blanket. A failed bleed air line clamp allowed high temperature air to impinge on the outside wall of the cockpit. The blanket which was in contact with the inside cockpit wall began to smolder and gave off the dense smoke. In an attempt to clear the cockpit sufficiently to fly the aircraft, the crew jettisoned the rear canopy. The increased air flow in the cockpit, however, fanned the smoldering blanket into a small fire and increased the density of the smoke. All visual references were lost and the crew ejected. PVC is a highly versatile material which has definite cost advantages. However, the hazards associated with this material must not be overlooked. Although not highly flammable, it will give off toxic fumes, dense smoke, and burn when sufficiently heated. Its use in occupied areas of an aircraft, and especially the cockpit, should be seriously questioned. Alternate materials with better high temperature characteristics are available and, although pound-per-pound costs may be higher, may provide the optimal solution. In this mishap, it was the smoke that cost us the aircraft, not the fire. Elimination of the material which generated the smoke is the only completely satisfactory answer. Solutions which center on potential ignition sources exist. The materials used in aircraft interiors are to comply with the PVC restrictions of MIL-STD-1587.

Upper torso crash restraint

Evacuation transport: The present forward and aft attendance seats do not provide upper torso restraint to protect medical crew members from crash impact.

Observation: An aircraft on a tactical range mission crashed during maneuvers. The aircraft was observed to fly past the target, initiate a pull-up and aggressive right turn greater than 90 degrees to target. Pilot made an abrupt pull-out in an estimated 30 degree nose low delivery. The aircraft struck the ground short of the target. The accident board investigation has been completed. A recommendation for a feasibility study to determine how to reinforce the seat base and shoulder harness attach points to increase crash survivability was established by engineering.

Walking on structural components

Very large fan jet engine cowling: The inlet cowling is constructed in large segments made of light-weight aluminum. These segments are easily damaged when maintenance is performed on or around them. The fan section has an inside diameter of approximately seven feet. This large opening allows maintenance personnel to stand inside the cowling and work on the fan assembly. Damage to the cowlings results from tools being dropped on them and people walking on them. Another problem associated with the large inlet cowling is due to its design and size. To provide access to components under the cowling, large sections must be removed. The sections are riveted

together and the rivets must be drilled out to separate the sections. These removals contribute to the wear and tear on the inlet cowling. Maintenance data shows that in a 6-month period, 335 failures were reported and 13,779 maintenance man-hours expended. The majority of the failures were attributed to cracks. Cowlings should be adequately constructed to withstand maintenance actions imposed on and around them. Segment size should be reduced to facilitate easy removals. This applies to similarly exposed airframe components as well.

B.5.4 STRUCTURAL LOADING CONDITIONS

The airframe operational and maintenance capability shall be in accordance with the following structural loading conditions in conjunction with the detailed structural design of 5.5.1 and the general parameters of 5.5.2.

REQUIREMENT RATIONALE

The purpose of this requirement is to insure that the critical loading conditions and associated loading distributions are established in accordance with the specified structural design criteria.

REQUIREMENT GUIDANCE

During flight operations, and maintenance the airframe will be subjected to forces such as aerodynamic, inertia, thrust, and mechanical. The determination of these forces is required to establish the external and internal loads which in general are influenced by structural flexibility and which the airframe must sustain during its expected usage. Within the ground rules of the specified structural design criteria, it is necessary to define the structural loading conditions and load distributions which are required to generate design loads. The loading conditions shall be categorized as flight loading and ground loading conditions. For the purposes of this document flight loading conditions are considered only insofar as they impact landing gear and airframe backup structure.

REQUIREMENT LESSONS LEARNED

Particular care should be exercised in defining the structural loading conditions and load distributions which are used to design the airframe since these items directly influence the performance and structural reliability of the airframe.

B.5.4.1 FLIGHT LOADING CONDITIONS

Flight loading conditions are essentially realistic conditions based on airframe response to pilot induced or autonomous maneuvers, loss of control maneuvers, and turbulence. These realistic conditions shall consider both required and expected to be encountered critical combinations of configurations, gross weights, centers of gravity, thrust or power, altitudes, speeds, and type of atmosphere and shall be used in the design

of the airframe. Flight loading conditions shall reflect symmetric and asymmetric flight operations and are established for both primary and secondary structural components by careful selection of flight parameters likely to produce critical applied loads. Symmetric and asymmetric flight operations shall include symmetric and unsymmetric fuel and payload loadings and adverse trim conditions. The following conditions reflect required flight operations capability of the airframe.

REQUIREMENT RATIONALE

The purpose of this requirement is to insure that all applicable flight loading conditions are established in accordance with the detailed structural criteria of 5.1.1.

REQUIREMENT GUIDANCE

Flight loading conditions include those resulting from maneuvering the aircraft, atmospheric turbulence or failure of an aircraft part or equipment. In case of system failure, the aircraft must have the capability to withstand the resulting maneuvers, plus the corrective action taken by the pilot treated as limit loads. The flight loading conditions should be carefully established since these conditions are used to determine the service loads and maximum loads which the airframe must sustain during its expected usage. Service loads shall be established for the repeated loads sources specified in 5.5.2.14.3. The maximum loads should be distributed to conservatively approximate or closely represent actual loading conditions. Redistribution of these loads must be accounted for if significant distribution changes can occur under structural loading. Airload distributions should be determined by use of acceptable analytic methods or by appropriate wind tunnel test measurements. In general, flight loading conditions should be realistic conditions based on airframe response to control system induced maneuvers and turbulence.

REQUIREMENT LESSONS LEARNED

The flight loading conditions should be established by careful selection of flight parameters likely to produce maximum applied loads. The design speed envelope and V-n diagrams represent the starting point for computation of most critical flight loading conditions. Wing, fuselage, horizontal tail, and vertical tail design load conditions are selected on the basis of maximum shears, bending moments and torsions at panel point locations. Maximum wing shears and bending moments are generally established by combining minimum wing weight with maximum positive and negative airloads. Maximum wing torsions are likely to occur from large deflections of control surfaces such as ailerons or flaps. Stores located near the wing tip or large protuberances on the fuselage are likely to have the greatest effect on wing loads. Maximum fuselage vertical shears and bending moments are usually established by neglecting vertical airloads. Maximum fuselage lateral shears and bending

moments are usually established by determining maximum lateral airloads. Maximum aft fuselage torsions are likely to occur from rolling maneuvers which produce large differential tail loads. Maximum horizontal tail loads are generally established by determining conditions which require maximum balancing tail loads. Maximum horizontal tail torsions are likely to occur from large deflections of control surfaces such as elevators. Rolling maneuvers with heavy wing mounted stores usually produce large tail loads. Maximum vertical tail loads are likely to occur from rolling and yawing maneuvers which produce large sideslip angles. Maximum vertical tail torsions may occur from maneuvers involving large rudder deflections. Flight loading conditions for primary and secondary structural component were previously specified in MIL-A-008861.

B.5.4.1.4 BRAKING WHEELS IN AIR (___)

REQUIREMENT RATIONALE

The purpose of this requirement is to define the structural requirements for landing gear systems equipped with brakes. Application of braking torque can produce high load levels on the support and back-up structure.

REQUIREMENT GUIDANCE

For braking wheels in air, define the braking requirements in terms of required parameters 5.5.2 and 5.5.3, and rational combinations thereof. For example, the airplane shall be airborne in the takeoff configuration with the landing gear in any position between fully extended and fully retracted. All wheels equipped with brakes shall be brought to rest by application of braking torque. The airspeed and wheel peripheral speed shall be 1.3 times the stalling speed in the takeoff configuration. The maximum static braking torque shall be applied from zero to the maximum static value in 0.2 seconds.

REQUIREMENT LESSONS LEARNED

None.

B.5.4.1.5 EXTENSION AND RETRACTION OF LANDING GEAR (___)

REQUIREMENT RATIONALE

The purpose of this requirement is to define structural requirements for extension and retraction of landing gear systems. Extension and retraction of landing gears can produce high load levels on the support and back-up structure.

REQUIREMENT GUIDANCE

For extension and retraction of landing gear, define the landing gear extension and retraction requirements in terms of required parameters 5.5.2 and 5.5.3, and rational combinations thereof. For example, the following loadings shall act separately and

simultaneously with the landing gear in each critical position between fully extended and fully retracted:

- a. Aerodynamic loads up to the limit speed specified for the takeoff and landing configuration.
- b. Inertia loads corresponding to the maximum and minimum symmetrical limit load factors specified for flight in the takeoff and landing configurations.
- c. Inertia loads resulting from accelerations of those parts of the landing gear that move relative to the airplane during extension or retraction. The accelerations shall be those resulting from use of maximum available power of the extension and retraction system.

Gyroscopic loads resulting from wheels rotating at peripheral speed equal to 1.3 times the stalling speed in the takeoff configuration and retracting or extending at the maximum rates attainable.

REQUIREMENT LESSONS LEARNED

None.

B.5.4.2 GROUND LOADING CONDITIONS

Ground loading conditions are generally not truly realistic conditions, but situations which should result in design loads. These conditions shall consider both required and expected to be encountered critical combinations of configurations, gross weights, centers of gravity, landing gear/tire servicing, external environments, thrust or power, and speeds shall be used in the design of the airframe. Ground operations shall include symmetric and unsymmetric fuel and payload loadings and adverse trim conditions. The following conditions reflect required ground operations and maintenance capability of the air vehicle. Forcing functions and time histories for shipboard carrier catapult and arresting gear are provided in MIL-STD-2066. Barricade deceleration is as shown in NAEC-MISC06900. The structural integrity of the airframe shall be adequate for the air vehicle to perform as required.

REQUIREMENT RATIONALE

The purpose of this requirement is to insure that all applicable ground loading conditions are established in accordance with the detailed structural criteria of 5.5.1.1.

REQUIREMENT GUIDANCE

Ground loading conditions are defined by establishing conditions which reflect ground and maintenance operations. These conditions include landing, ground operations, and ground handling or maintenance. Ground operations consists of taxiing, turning, pivoting, braking, and takeoff. Ground handling consists of towing, jacking, and hoisting. Limit loads for the landing operations are obtained by

investigating various aircraft attitudes at ground contact in conjunction with the air vehicle flying at the specified landing and sinking speeds. A typical set of landing conditions for an aircraft with tricycle gear is as follows:

- a. Level landing, three point
- b. Level landing, two point
- c. Tail down landing
- d. One wheel landing
- e. Drift landing

Gear reactions and aircraft accelerations are determined for each condition. The loads on the landing gear are externally applied forces and are placed in equilibrium by translational and rotational inertia forces of the air vehicle. In addition to the static loads on the landing gear, loads associated with accelerating the wheel assembly up to the landing speed must be considered. These spin-up loads are difficult to determine rationally and equally difficult to measure in tower drop test. ANC-2 provides semi-empirical equations for calculating the spin-up loads (drag loads) and vertical loads at the time of peak spin-up loads.

The elasticity of the landing gear assembly is to be considered in determining the forward acting loads. It is assumed that following the wheel spin-up, when the sliding friction has reduced to zero, the energy stored in the gear as a result of rearward deformation causes the wheel mass to spring forward resulting in a sizable forward inertia load. This forward acting dynamic springback load is considered to occur about the time the vertical load reaches its maximum. ANC-2 provides a method of analysis for springback loads along with the spin-up load analysis mentioned previously.

Generally, the spin-up and springback loads can be assumed as high frequency loadings, to which the total aircraft mass does not respond. However, some components of the air vehicle can respond, for example external stores, engines on wing-pylons, etc.

The landing gear loads associated with ground operations are also defined in ANC-2. For a tricycle gear these conditions are as follows:

- a. Braked roll - three wheels
- b. Braked roll - two wheels
- c. Unsymmetrical braking
- d. Reverse braking
- e. Turning
- f. Pivoting

In all braked roll conditions, the air vehicle should be in a horizontal attitude. The friction coefficient of the braked wheels is 0.8. For the turning condition, the air vehicle is considered in a three point attitude while executing a turn. The ratio of side load to vertical load is considered to be the same on each gear. The lateral

load factor is 0.5 or that lesser value which causes overturning. For the pivoting condition, the brakes are locked on one wheel unit and the air vehicle is pivoted about that unit. A coefficient of friction of 0.8 is assumed in the analysis.

Runway roughness for ground operations will be stated in terms of power spectral density levels or discrete bumps and dips.

REQUIREMENT LESSONS LEARNED

The ground loading conditions should be carefully established since these conditions are used to determine the service loads and ground loads which the airframe must sustain during its expected usage. In general, ground loading conditions are not truly realistic conditions but are situations that should result in loads which equal or exceed those expected from realistic conditions. Ground loading conditions such as landing and ground handling were previously specified in MIL-A-008862. Catapult and arrestment condition requirements were defined by MIL-A-008863. Requirements for crash and ditching conditions, control system conditions, refueling conditions, and other miscellaneous conditions were defined by MIL-A-008865.

B.5.4.2.1 TAXI

- a. Dynamic taxi conditions _____.
- b. 2.0g TAXI (____) Taxi conditions at all critical combinations of _____.

REQUIREMENT RATIONALE

The purpose of this requirement is to establish structural requirements for straight ahead taxi without braking. Straight taxi typically produces maximum vertical loads on the landing gear and may produce significant loadings on other primary structure.

REQUIREMENT GUIDANCE

Define the taxi requirements in terms of required parameters 5.5.2 and 5.5.3, and rational combinations thereof. Dynamic taxi conditions should be based on operational requirements such as taxiway, runway, and tire conditions. Taxi loads shall be established at appropriate speeds in accordance with 5.5.2.7. For example, low speed taxi on taxiways and ramps of paved and semiprepared airfields at speeds up to the taxi limit speed, V_T and high speed taxi on runways of paved and semiprepared airfields at speeds up to the lift-off limit speed, V_{LO} . The appropriate effects of weight, cg position, mass distribution, and landing gear characteristics will be included. RTD-TDR-63-4139 Vol. I and ASD-TDR-62-555 Vol. I provide criteria and analysis techniques for establishing alighting gear dynamic loads. Further guidance on dynamic taxi loads is presented in 5.5.4.2.7. Alternately, with approval of the procuring agency, a 2.0g taxi analysis may be substituted. If applicable, define the extent of applicability. For example, taxi

conditions at all critical combinations of aircraft weight, c.g., and mass distributions shall be included in the analyses. The sum of the vertical loads acting at the ground shall be $2.0W$ where W is the weight of the aircraft. The total load of $2.0W$ shall be reacted at each mass item. For nose gear design, $3.0W$ shall be used instead of $2.0W$. No wing lift shall be considered for the 2.0g taxi condition. To account for taxi asymmetry and servicing, loads should be distributed equally (50/50) and alternately 60/40.

REQUIREMENT LESSONS LEARNED

None.

B.5.4.2.2 TURNS

- a. Turns on ramps at speeds up to _____
- b. Turns on taxiways at speeds up to _____
- c. Runway turn-offs at speeds up to _____

REQUIREMENT RATIONALE

The purpose of this requirement is to provide structural requirements for unbraked steady turns.

REQUIREMENT GUIDANCE

Define the turn requirements in terms of required parameters of 5.5.2 and 5.5.3, and rational combinations thereof. Turning design loads should be based on operational requirements such as taxiway, runway, and tire conditions. Turning requirements shall be established at appropriate speeds of 5.5.2.7, but nose gear steering angle and associated turn speed need not exceed those required for a lateral load factor of 0.5g at the aircraft center of gravity. For example, turns on ramps at speeds up to the taxi limit speed, V_T on paved and semiprepared surfaces. Turns on taxiways at speeds up to the taxi limit speeds, V_T on paved and semiprepared surfaces. Runway turn-offs at speeds up to the taxi limit speed, V_T , on paved and semiprepared surfaces. The effects of weight, cg position, mass distribution, and landing gear characteristics shall be accounted for.

REQUIREMENT LESSONS LEARNED

A technique for establishing lateral load factors during ground turning is presented in ASD-TR-79-5037.

B.5.4.2.3 PIVOTS

- a. The pivot points are _____
- b. The power or thrust levels shall be _____

REQUIREMENT RATIONALE

The purpose of this requirement is to establish maximum torsional load on the main landing gear.

REQUIREMENT GUIDANCE

For each applicable subparagraph define the pivoting requirements in terms of the required parameters of 5.5.2 and 5.5.3, and rational combination thereof. For example, the pivot points are about one main landing gear wheel with brakes locked, or in the case of multiple wheel gear units, about the centroid of contact area of all wheels in the gear units. The power and thrust levels should be based on a rational analysis to determine power required to perform the maneuver. The coefficient of friction between the tires and ground shall be 0.8 and the vertical load factor at the c.g. shall be 1.0. Some aircraft configurations, such as a very large transport, preclude true pivot turns, in which cases a minimum radius turn should be defined in 5.5.4.2.2 instead of pivoting.

REQUIREMENT LESSONS LEARNED

Use a 0.8 coefficient of friction has proven to yield satisfactory loads.

B.5.4.2.4 BRAKING

- a. Braking during taxi on _____
- b. Braking during turns on _____
- c. Pivoting (___) Braking during pivoting of _____
- d. Braking after an aborted takeoff on _____
- e. Braking after landing on _____

REQUIREMENT RATIONALE

The purpose of this requirement is to establish structural requirements for ground handling involving the use of braking.

REQUIREMENT GUIDANCE

Define the braking requirements in terms of required parameters of 5.5.2 and 5.5.3, and rational combination thereof. Braking design loads should be based on operational requirements such as taxiway, runway, and tire conditions. Braking requirements shall be established at appropriate speeds of 5.5.2.7. For example, taxiing and turning on paved and semiprepared surfaces, at speeds up to the taxi limit speed, V_T . For pivoting, define the extent of applicability. Braking after an aborted takeoff on paved and semiprepared airfields shall be at speeds up to the liftoff limit speed, V_{LO} . Braking after landing on paved and semiprepared airfields shall be at speeds up to the touch-down limit speed, V_{TD} . The static

ground conditions of MIL-A-8862 and MIL-A-8863, which include two-point braking, reverse braking, unsymmetric braking, and three-point braking, are to be considered.

REQUIREMENT LESSONS LEARNED

None.

B.5.4.2.5 TAKEOFFS

- a. Hard surface runways. (___) Takeoffs from _____
- b. Semi-prepared runways. (___) Takeoffs from _____
- c. Unprepared surfaces. (___) Takeoffs from _____
- d. Takeoff brake release of _____
- e. Catapult launch. (___) _____
- f. Catapult assist ramps. (___) _____
- g. Assisted takeoff. (___) _____
- h. Ski-jump. (___) _____
- i. Other takeoff conditions. (___) _____

REQUIREMENT RATIONALE

The purpose of this requirement is to establish structural requirements for takeoff operations on specified surfaces.

REQUIREMENT GUIDANCE

Define the takeoff requirements in terms of required parameters of 5.5.2 and 5.5.3, and rational combination thereof. Takeoff structural requirements shall be based on operational requirements, such as runway conditions. Takeoff conditions shall be at speeds up to those of 5.5.2.7. For hard surface runways, semi-prepared runways, and unprepared surfaces, define the extent of applicability. For example, takeoffs on semi-prepared runways shall be at speeds up to the lift-off limit speed, V_{LO} . For launch and assisted takeoff, define the extent of applicability. For example, catapult launch shall be at speeds up to the maximum specified launch speed. Further guidance on catapult launch loads is presented in 5.5.4.2.7. For aircraft required to takeoff from ships with either catapult assist ramps or ski-jump, structural requirements and entry speed limitations shall be established.

REQUIREMENT LESSONS LEARNED

None.

B.5.4.2.6 LANDING

- a. Hard surface runways. (___) Landings on _____
- b. Semi-prepared runways. (___) _____
- c. Unprepared surfaces. (___) Landings on _____
- d. Arrestment (___) _____
- e. Decelerating devices. (___) _____
- f. Other landing conditions (___) _____

REQUIREMENT RATIONALE

The purpose of this requirement is to establish structural requirements for landing operations on specified surfaces.

REQUIREMENT GUIDANCE

Define the landing requirements in terms of required parameters of 5.5.2 and 5.5.3, and rational combinations thereof. Landing structural requirements should be based on operational requirements such as runway and tire conditions. Landings shall be at and up to appropriate speeds of 5.5.2.7. For hard surface runways and unprepared surfaces, define the extent of applicability. For example, landings on unprepared surfaces shall be at speeds up to the touch-down limit speed, V_{TD} . Further guidance on landing impact loads is presented in 5.5.4.2.7. For arrestment and decelerating devices, define the extent of applicability. For example, arrestment landings shall be made at speeds up to the maximum specified arrestment speed. Further guidance on arrestment loads is presented in 5.5.4.2.7. NACA TN 3541, NASA TN D-527, AFFDL-TR-68-96, and AFFDL-TR-71-155 provide further insight in establishing landing criteria.

REQUIREMENT LESSONS LEARNED

None.

B.5.4.2.7 DYNAMIC RESPONSE DURING GROUND/SHIP-BASED OPERATIONS (___)

The dynamic response of the air vehicle resulting from ground operations and transient or sudden application of loads shall be included in the determination of design loads. In addition, the air vehicle shall be free from any static or dynamic instabilities.

- a. Dynamic response conditions _____.

- b. Shimmy. During all ground operations (taxi, takeoff, and landing) all landing gears as installed in the air vehicle shall be free from shimmy, divergence, and other related gear instabilities for all attainable combinations of configurations, ground operation speeds, loadings, and tire pressures. This requirement shall apply for both normal and failure operations. For the nose gear, the steering system shall be considered ON and also failed or OFF. The design of the landing gear systems as installed shall meet the damping requirement of _____.

REQUIREMENT RATIONALE

The purpose of this requirement is to establish the maximum loads resulting from dynamic response of the air vehicle during ground/carrier operations and to ensure that the air vehicle response is stable throughout these operations. The stability requirement is intended to more clearly focus on shimmy and other landing gear dynamic response problems.

REQUIREMENT GUIDANCE

Define the dynamic response conditions of the air vehicle in terms of required parameters of 5.5.2 and 5.5.3, and rational combinations thereof. These loading conditions include arresting loads, catapult loads, dynamic taxi loads, and landing impact loads. The arresting loading conditions shall be determined based on the type of ground arrestment system specified by the procuring activity. The magnitude, directions, and distribution of external and internal loads shall be all loads which occur throughout the arresting operation. The determination of these loads shall take into account the time histories of the arresting forces and the resultant response of the airplane structure, with appropriate consideration of the characteristics of tire, shock absorbing, and damping devices.

The catapult loading conditions shall be determined based on the type of catapult launching equipment specified by the procuring activity. The magnitude, directions, and distribution of external and internal loads shall be all loads which occur throughout the catapult operation. The determination of the loads shall take into account the motion of the airplane during the catapult run and shall include the effects of launches at 1.2 times the maximum gross weight to assure that overweight launches with increased winds are feasible.

The dynamic taxi loads shall be determined by a dynamic taxi analysis using both a continuous runway profile and discrete step and (1-cosine) bump and dip inputs. This analysis must account for pitch, translation, and roll rigid body modes and all significant flexible modes. The gear's complete nonlinear air spring and hydraulic damping of the oleo and tire must be included. Aerodynamic lift and engine thrust shall be included and all combinations of gross weight, fuel weight, taxi speed and c.g. consistent with planned usage shall be considered.

Runway profile elevations used in the continuous analysis shall have power spectral densities (PSD) which equal or exceed the spectra for paved, semiprepared, and unprepared airfields which are presented in figures 12 through 14. The terrain roughness contours used to define airfield surfaces for the discrete input shall consist of step inputs and single and double (1-cosine) shaped bumps and depressions. The step inputs shall be up to 1 inch for paved, 2 inches for semiprepared, and 4 inches for unprepared surfaces. The maximum amplitudes for the bump and depression inputs shall be those of the applicable surfaces for slow and high speed taxi as presented in figures 4 and 5. The aircraft shall approach the contours at all critical angles from 0° to 90° to the crestline of the contours.

The landing impact loads shall be determined by a rational dynamic landing analysis which takes into account the characteristics of the aircraft landing gear and realistically models air vehicle response during landing impact. The magnitude, directions, and distribution of external and internal loads shall be all loads which occur during landing impact. If the landing gear is located on the wing, dynamic loads imposed on a wing during landing impacts may result in more critical wing down loads and wing-mounted store loads.

The damping requirement specified in 3.2.1.4 of AFGS-87139A is necessary to establish an acceptable level of dynamic stability. The primary concern is the damping of steered landing gear to prevent shimmy. The system shimmy stability requirements shall be determined by a nonlinear dynamic analysis which properly accounts for torsional freeplay, Coulomb friction, wheel unbalance, and the capability to assess the effect of a velocity squared damper. The structural model should include effective masses and inertias, structural damping, structural stiffnesses, and gyroscopic effects of the rotating wheel assembly. The tire shimmy model should be either the Von Schlippe Dietrich or the Moreland model. Excitation of the shimmy analysis model shall include impulse, cyclic, and initial displacements of the landing gear. Ground tests to support development of the landing gear analysis model includes ground vibration tests (GVT), structural stiffness parameter tests, tire parameter tests, and dynamometer tests.

REQUIREMENT LESSONS LEARNED

Recurrent landing gear shimmy problems have occurred during the development of many aircraft systems. These problems have caused significant impacts on program cost and schedule as well as overall aircraft integrity and performance. Because of these problems, the need to focus on a structured approach to prevention of landing gear shimmy is required. The structured approach should consist of a total quality systems approach which integrates the landing gear design into the overall aircraft design, utilizes a standardized analytical approach in defining landing gear shimmy characteristics, and requires both dynamometer testing early in the landing gear

development phase and aircraft ground operations tests.

The need for a requirement which consists of an integrated design approach is clearly demonstrated by an inadequate main landing gear design process used on a large cargo aircraft. The process consisted of providing the landing gear developer with fixed design loads and spatial constraints with no requirement for dynamic stability. The design process did not allow feedback to assess the adequacy of the design. This process proved to be inadequate because of many main landing gear shimmy incidences which occurred later in the aircraft test program.

Historically, shimmy analyses have not followed a well defined standardized approach in determining landing gear shimmy characteristics. A number of these analyses have not properly considered items such as nonlinear effects, structural damping, structural stiffnesses, freeplay, and the capability to assess the effect of a velocity squared damper. Landing gear tests have shown that a large number of parameters such as tire and structural stiffness, tire and structural damping, and tire shimmy properties vary in a nonlinear manner as a function of strut stroke position. Experience has shown that landing gear structural damping can vary anywhere from 1 to 10% of the critical viscous damping. The amount of damping during any given taxi run is not constant and can vary between these two percentages. Stability predictions made for a prototype fighter were based on an assumption of a constant 7% critical viscous damping. This assumption resulted in erroneous analytical predictions which overestimated the shimmy stability of the landing gear. The analysis agreed with experimental data when an assumption of 1% damping was used. It is generally recommended that a 1% assumption will expose any potential sensitivity that the landing gear might have toward shimmying.

Finite element analyses used to predict landing gear structural stiffness parameters have not always proven to be reliable. Further, these analyses have consistently predicted the structure to be stiffer than what it really is. Use of these stiffer values in the shimmy analysis will generally lead to overconfidence in landing gear stability. This problem has been observed on a large cargo aircraft, a prototype trainer, and a low observable air superiority fighter.

Landing gear torsional freeplay can significantly affect analytical stability predictions and should always be considered in the development of shimmy analyses. Experience indicates that a reasonable range of freeplay on a new landing gear is from an absolute minimum of .5 and is generally not larger than 2 degrees. Some landing gears are extremely sensitive to increasing torsional freeplay while some do not seem to be affected by it. For example, the nose gear of an air superiority fighter was extremely sensitive to small torsional freeplay variations. On the other hand, the nose gear of a prototype trainer was totally insensitive to the freeplay range cited above. Therefore, a freeplay sweep in the shimmy analysis to

determine landing gear dynamic response sensitivity over the design speed range of the gear is recommended.

Velocity squared shimmy dampers have shown themselves to be useful on marginally stable landing gears in spite of added weight and tire wear penalties. Therefore, a standardized shimmy analysis should include consideration of this option to demonstrate that adequate damping is achieved if a velocity squared shimmy damper is used.

While shimmy analysis with analytically derived input data may be useful in identifying major problems of the gear early in the design stage, this approach does not provide a sufficient level of accuracy in the prediction of physical stability characteristics. For this reason, testing of an actual gear is needed to establish further confidence in the analysis. This testing includes ground vibration test (GVT), structural stiffness parameter tests, tire parameter tests, and dynamometer tests.

The GVT is conducted to measure landing gear mode shapes, frequencies, and modal damping for the fore and aft, lateral, and torsional modes of the main and auxiliary landing gears. During these tests, the wheels shall be free from the ground. The test results shall be used to verify all dynamic response analyses. Where applicable, results of the GVT shall be used in resolving and preventing transient vibration problems due to brake chatter, gear walking, antiskid control, wheel unbalance resonances, and shimmy.

Structural stiffness tests are conducted to determine the accuracy of the original stiffness values obtained from the finite element analysis. A common approach used in making these measurements is to input forces to the gear and measure the resulting deflections. A frequent oversight consists of ignoring the stiffness contribution of the fuselage backup structure. If appropriate fuselage backup structure is unavailable during these tests, then a compliant structure which simulates the flexibility of the fuselage structure shall be inserted as an interface between the landing gear and the test support structure. Because of difficulties associated with predicting structural flexibilities, sensitivity studies which consider a range of flexibilities should be conducted to determine the effects of flexibility variations on the stability of the landing gear design. Design of the compliant structure should be based on results of the sensitivity studies and subject to the approval of the procuring agency.

Tire parameter tests are conducted to determine the specific parameters associated with the selection of either the Von Schlippe Dietrich or the Moreland tire model over the range of loading conditions and tire pressures which the tire will experience in actual operations. The specific parameters associated with the Von Schlippe Dietrich tire model are provided in NACA TR-1299. The Moreland tire model parameters are provided in "The Story of Shimmy" by William J. Moreland.

Dynamometer tests are conducted to determine the overall dynamic stability of the landing gear and to

identify potential design changes earlier in the development phase to help minimize cost and schedule impacts. These tests are recommended to support risk management, enhance experimental repeatability, and measurement reliability in a controlled laboratory environment. However, some caution must be used in setting up a dynamometer test. The landing gear cannot simply be rigidly mounted to a platform above the dynamometer. Instead, compliant structure must be inserted between the platform and the landing gear to properly simulate the fuselage backup structural flexibility. Experience indicates that the stiffness values obtained from both a rigidly mounted gear and actual aircraft are nonlinear and vary with stroke position. Also the rigidly mounted gear values will be in error by as much as 300% when compared to the values obtained on the actual aircraft. The dynamometer test conditions should include runs with and without excitation forces applied either at the farthest axle from the primary landing gear post or at the primary landing gear post. The location selected should produce the greatest excitation to the gear structure. The forcing mechanism used in the dynamometer tests should be capable of applying either a single or cyclic impulse to the gear with sufficient force to insure that breakout from the torsional friction binding occurs. For cyclic impulses, care should be taken in the design of the mechanism to insure that it recoils faster than the gear does to prevent interference with the natural motion of the gear. Experience indicates that the dynamometer test matrix should include ten knot speed increments, at least four strut stroke positions, and at least three tire pressures to prevent overlooking a critical shimmy speed, to account for nonlinear effects, and to assure that aircraft weight configurations are adequately represented by these tire pressures.

B.5.4.2.8 SKI EQUIPPED AIR VEHICLES ()

- a. Frozen skis _____.
- b. Ski load distribution conditions
_____.

REQUIREMENT RATIONALE

The purpose of this requirement is to establish structural requirements for ski equipped aircraft operating on snow, ice, and mud.

REQUIREMENT GUIDANCE

If the subparagraphs are applicable, define the requirements in terms of required parameters of 5.5.2 and 5.5.3, and rational combination thereof. Ski structural requirements shall be based on operational requirements such as taxiway and runway, surface conditions and environmental conditions. Ski requirements should reflect appropriate speeds of 5.5.2.7. For example, ski equipped air vehicles shall operate in snow, in mud, and on ice. During the takeoff and landing run, the airplane shall be in the

three-point attitude. The vertical load factor at the gear shall be 1.0 at the maximum ground weight with a linear variation of load factor to 1.2 at the normal landing weight. The coefficient of friction shall be 0.40. Pitching moment shall be balanced by rotational inertia. For frozen skis, the air vehicle shall be in the three-point attitude with each ski alternately assumed fixed. The loads and torques shall be those resulting from application of maximum engine power or thrust available at -60°F to the engine(s) on the side opposite from the fixed ski. The loads shall be reacted by the main gear ski and nose gear ski and alternately, by the main gear ski alone. The nose-gear ski shall resist full steering torque. Ski load distribution conditions shall be established in accordance with the following:

- a. Vertical and side loads resulting from takeoff and landing run shall be distributed as shown on figure 15. Side loads shall be applied on either ski where applicable.
- b. Treadwise loads shall be distributed alternately to the inboard and outboard side of the ski, except that for rolled attitude landings, the distribution shall be 3 to 1.

Drag load shall be distributed uniformly along the base of the ski. Side load and drag need not be combined.

REQUIREMENT LESSONS LEARNED

The criteria suggested above have been used previously and have proven adequate for operations on normal snow surfaces. The criteria have proven inadequate for operations on rough hard packed snow containing blocks of ice and for loose, deep snow containing sastrugi ridges of greater than 12 inches. The criteria are adequate for heavy gross weight operations on smooth, well maintained skiways, where a smooth skiway is defined as one which has been graded a surface free of hardened snowdrifts, ice blocks, pressure ridges, mounds of snow, and sastrugi ridges and which has changes in elevation not exceeding four inches in twenty feet.

B.5.4.2.9 MAINTENANCE

- a. Towing (____) _____.
- b. Jacking (____) _____.
- c. Hoisting (____) _____.

REQUIREMENT RATIONALE

The purpose of this requirement is to establish structural requirements for specified maintenance conditions.

REQUIREMENT GUIDANCE

Define the maintenance requirements in terms of required parameters of 5.5.2 and 5.5.3, and rational

combination thereof. Maintenance requirements should be based on operational requirements such as towing, jacking, and hoisting. For example, towing, jacking, and hoisting loads shall be established in accordance with the following:

- a. Towing. The air vehicle shall be in a three-point attitude. The resultant of the vertical reactions at the wheels shall be equal to the weight of the aircraft and shall pass through the cg. The towing loads shall act parallel to the ground. The side component of the tow load at the main gear shall be reacted by a side force at the static ground line at the wheel to which the load is applied. Additional loads necessary for equilibrium shall be applied. Review and include as applicable the Standardization Agreement 3278ASP on towing attachments on aircraft.
- b. Jacking. The vertical load shall act singly and in combination with the horizontal load acting in any direction. The horizontal loads at the jack joints shall be so reacted by inertial forces that there will be no change in the vertical loads at the jack joints. The maximum landing gear jacking weight is normally the maximum ground weight since it is desired not to offload fuel and payload when a tire change is required. The maximum airframe jacking weight is usually defined as the maximum ramp weight minus the crew and passengers and is used to define the jacking point loads and related structure. Review and include as applicable the Standardization Agreement 3098ASP on aircraft jacking.
- c. Hoisting. When the aircraft is in the level attitude, the vertical component shall be $2.0 W_H$. The maximum airframe hoisting weight, W_H , is usually defined as the maximum ramp weight minus crew and passengers, and is used to design the hoisting point loads and related structures. This is to allow for a more timely removal of an aircraft disabled on a runway.

REQUIREMENT LESSONS LEARNED

None.

B.5.4.2.10 GROUND WINDS

- a. Ground operations _____.
- b. Maintenance _____.
- c. Parked, unattended _____.
- d. Tied-down _____.
- e. Jet blast (____) _____.

REQUIREMENT RATIONALE

The purpose of this requirement is to establish structural requirements for ground and shipboard winds for ground/shipboard operations as well as operational maintenance in normal and adverse weather conditions.

REQUIREMENT GUIDANCE

Define ground and ship wind requirements in terms of required parameters of 5.5.2 and 5.5.3, and rational combination thereof. Wind structural requirements shall be based on operational requirements such as prelaunch and recovery requirements, operational maintenance, and adverse weather operations. During normal operations, the airplane shall be subjected to horizontal tail winds and crosswinds. For example, ground wind on longitudinal, lateral, and directional control surfaces shall be a 70 knot horizontal tail wind (including a 25 percent gust). With the air vehicle on the ground at zero ground speed and all engines delivering thrust or power required for takeoff, the air vehicle shall encounter a horizontal wind (including a 25 percent gust) at 70 knots in all directions within +/- 45 degree from dead ahead. During maintenance, the airplane shall be subjected to ground winds from any horizontal direction. For example, external doors and radomes shall be subjected to winds, while in their open and any intermediate positions, of 50 knots (including a 25 percent gust) from any horizontal direction. The doors and radome actuating mechanisms shall be able to operate during 35 knot steady wind in any horizontal direction combined with a vertical load factor of 1.0 +/-0.5g and a horizontal load factor (in the most critical direction) of +/-0.5g. When parked and unattended, the airplane shall be subjected to ground winds from any horizontal direction of 50 knots (including a 25 percent gust). When tied-down, the airplane shall be secured in the static attitude and with control surfaces locked and battens in place and shall be subjected to a 70 knot wind (including a 25 percent gust) from any horizontal direction. For jet blast, define the extent of applicability. Jet blast requirements shall reflect for operational requirements such as close proximity to other operating jet aircraft.

During shipboard operations, control surface and folded surface loads will result from a combination of inertial loads resulting from ship motion and air loads resulting from the combination of wind over deck (natural winds plus ship speed) as well as superposition of engine exhaust of adjacent aircraft (catapult launch near JBD). Tables I and II of MIL-T-81259A provides combinations of inertia load factors and wind speeds for various ships and weather conditions.

REQUIREMENT LESSONS LEARNED

During maintenance, large aircraft may be positioned inside a building with the fuselage aft body and empennage protruding. The resultant jack/landing gear reactions will differ from those which occur when the entire aircraft is exposed to the ground winds. In particular, the aerodynamic yawing moment is typically higher for the condition where only the empennage and fuselage aft body are exposed to the ground winds rather than the entire airplane. During taxi in carrier deck, engine exhaust has caused static failure or high temperatures to be experienced on adjacent aircraft.

B.5.4.2.11 OTHER GROUND LOADING CONDITIONS ()

REQUIREMENT RATIONALE

The purpose of this requirement is to establish structural requirements for other ground loading conditions such as hail damage, arrested landing, and repaired bomb damaged runways.

REQUIREMENT GUIDANCE

For other ground loading conditions, define the requirement in terms of required parameters of 5.5.2 and 5.5.3 and rational combinations thereof. Other ground loading conditions shall include consideration of system failures 5.5.2.19.

REQUIREMENT LESSONS LEARNED

None.

B.5.4.3 VIBRATION

Vibration loadings shall be combined with the ground loads of 5.5.4.1 and 5.5.4.2. Vibration loads shall be required by 5.5.5 and 5.5.6.

REQUIREMENT RATIONALE

In general, vibroacoustic and flight loads can be handled separately. However, there are cases when the two loadings in combination will cause failures or operational problems.

REQUIREMENT GUIDANCE

Review the flight and vibroacoustic loadings and determine those areas of the airframe or those combinations of flight or ground conditions where loadings may combine in such a way as to cause failures or operational problems. In these cases, develop design requirements which preclude failure or operational problems due to these combinations of loadings.

REQUIREMENT LESSONS LEARNED

The combination of thermal loads and aeroacoustic loads caused fatigue failures in primary structure very early in the life of a large bomber aircraft. The failures occurred when hot surface flow caused skin to distort sufficiently to introduce high mean stresses in skins. The skins then failed in vibratory fatigue.

Many failures have occurred in propeller aircraft fuselage sidewall structure due to the combination of pressure loads and oscillatory pressure fields associated with propeller blade passage.

B.5.4.4 AEROACOUSTIC DURABILITY

The landing gear structure shall operate in the aeroacoustic environments which are commensurate with the required parameters of 5.5.2 and 5.5.3, and rational combinations thereof without failure as described herein. Aeroacoustic load sources include:_____.

REQUIREMENT RATIONALE

This paragraph provides the possible sources of aeroacoustic loads which can cause structural damage and adversely effecting the structural integrity of the airframe.

REQUIREMENT GUIDANCE

Identify the aeroacoustic loads sources associated with the air vehicle and its usage. Some sources of aeroacoustic loads to which the airframe may be exposed are listed below.

- a. Propulsion system noise; for example jet or rocket noise, fan and compressor noise, thrust reverser noise, and propeller noise. Consider increases in noise levels on the airframe caused by the use of ground noise suppressers.
- b. Power lift systems; for example, externally blown flaps and jet flaps.
- c. Boundary layer pressure fluctuations arising from high dynamic pressure and transonic flight conditions and separated flows due to protuberances or discontinuity in external surfaces.
- d. Cavity noise; for example, open weapon bays and compartments open to external flow.
- e. Blast pressures due to armament usage; for example, gunfire and rocket firing. Aeroacoustic loads in ram air ducts, inlets, air conditioning ducts, plenums, and fans.
- f. Aeroacoustic loads caused by auxiliary power units, motors, and pumps.
- g. Jet exhaust turbulence noise experienced when the air vehicle is in launch position on shipboard

catapult with the jet blast deflector (JBD) raised, and when the air vehicle is behind the raised JBD in position for the next launch. Time of exposure for these conditions are as follows.

- (1) Thirty seconds of maximum power when in launch position on shipboard catapult.
- (2) Thirty seconds behind raised JBD when in position for next launch.

Jet engine exhaust and temperature.

REQUIREMENT LESSONS LEARNED

Neglecting the contribution of a potentially damaging source can result in redesign or intolerable maintenance problems. Though propulsion system noise is usually obvious, other sources have often been overlooked. Separated flow is often the dominant source in modern high performance aircraft. Levels can be as high as propulsion system noise and more time may be accumulated with in flight separated flow conditions than at takeoff. For example, structural damage has occurred behind speed brakes and separated flow from the chin pods or fairings.

Separated flows can also be encountered on the outboard wing surfaces during high dynamic pressure and high angle of attack maneuvers. Fan noise has produced cracks in the intake ducts and in inlet guide vanes.

Bomber aircraft have encountered significant problems due to large open weapon bay oscillating pressure levels. In some cases, the disturbance extended to the complete aircraft and ride quality was affected. In addition, weapon bay pressure levels can be of sufficient magnitude to damage the structure of the weapon bay, weapon bay doors, and weapons. Narrow band resonant amplification of pressure levels subjecting structure and equipment to pressure amplitude as much as 10 times the background level has been encountered in small cavities. Cavity resonance suppression (via spoilers, etc.) should be considered to avoid weapons bay and internal noise, vibration, and aeroacoustic fatigue.

B.5.4.4.1 STRUCTURE

The landing gear structure shall withstand the aeroacoustic loads and the vibrations induced by aeroacoustic loads for the service life and usage of 5.5.2.14 without cracking or functional impairment. For design, an uncertainty factor of _____ shall be applied on the predicted aeroacoustic sound pressure levels. For the design fatigue life, a factor of _____ shall be applied on the exposure time derived from the service life and usage of 5.5.2.14.

REQUIREMENT RATIONALE

Safety considerations require that primary load bearing structures be fatigue resistant for the desired service life. Maintenance considerations also dictate that components possess a full service life. The

objective of WADC-TM-58-4 was to control aeroacoustic fatigue to prevent a maintenance burden, determine how and when to inspect and repair, and prevent safety of flight failures. In MIL-A-8870(ASG), the concept of preventing any aeroacoustic failures was introduced. The succeeding specifications, MIL-A-8870B(AS), MIL-A-8870C(AS) and MIL-A-8893, were aimed at prohibiting fatigue failures during the airframe service life or the life for replaceable parts.

Uncertainty factors are necessary in the application of aeroacoustic loads and durations. This is because current and near term state-of-the-art aeroacoustic and vibratory fatigue analysis, prediction, and measurement technology are not adequate to provide sufficient operational life unless factors are applied.

REQUIREMENT GUIDANCE

Fill the first blank with +3.5 dB unless a smaller factor can be fully substantiated based on proven improvements in state-of-the-art technology, exceptionally well defined environments, or exceptionally complete test data. Fill the second blank with 2.0 unless fatigue design data (S-N curves) represent documented lower bound (-3.0 sigma) material properties.

REQUIREMENT LESSONS LEARNED

The most common types of aeroacoustic failures are encountered in skin panels and support structure including stiffeners and rivets. During the full scale test of a large bomber aircraft, a total of approximately 700 failures occurred in 10 hours of maximum engine power.

Experience over many years and many programs has consistently shown that capabilities to measure, analyze, and reproduce aeroacoustic loads and to analyze vibratory fatigue are not adequate without factors of uncertainty. In addition, forecasted improvements in the state-of-the-art will only slowly decrease this uncertainty.

B.5.5 VIBRATION

The landing gear shall operate in the vibration environments which are commensurate with the required parameters of 5.5.2, 5.5.3, and 5.5.4 and rational combinations thereof. Environmental effects such as temperature and humidity shall be included where applicable. Where required, vibration control measures such as damping or isolation shall be incorporated in the landing gear. There shall be no fatigue cracking or excessive vibration of the airframe structure or components. Excessive vibrations are those structural displacements which result in components of the air vehicle systems not being fully functional. The structure and components shall withstand, without fatigue cracking, the vibrations resulting from all vibration sources for the service life

and usage of 5.5.2.14. Vibration sources include:

REQUIREMENT RATIONALE

Determination of sources which must be considered to prevent vibration problems in flight and ground use is needed as a basis of a successful vibration program. A list of generic sources is included below. Other sources should be included as necessary.

Safety and maintenance considerations require that structures and components demonstrate freedom from fatigue cracking for the service life. MIL-A-8870(ASG), MIL-A-8870B(AS), and MIL-A-8870C(AS) prohibited failures due to vibration and required fail-safe features if failures did occur. MIL-A-8892 required freedom from failures during the service life or the life for replaceable parts.

REQUIREMENT GUIDANCE

Identify the vibratory sources associated with the air vehicle and its usage. Some sources of vibration to which the airframe may be exposed are listed below.

- a. Forces and moments transmitted to the aircraft structure mechanically or aerodynamically from the propulsion systems, secondary power sources, propellers, jet effluxes and aerodynamic wakes, downwashes and vortices (including those from protuberances, speed brakes, wings, flaps, etc.) and cavity resonances. Forces from gun recoil or gun blast.
- b. Buffeting forces.
- c. Unbalances, both residual and inherent, of rotating components such as propellers, and rotating components of engines.
- d. Forces from store and cargo carriage and ejection.
- e. Forces due to operation from airfields and ships.

REQUIREMENT LESSONS LEARNED

Numerous service problems have resulted because important vibration sources were not considered.

Modification design must account for the effect of changes on the turbulent flow field of the aircraft. Failure to do so can result in structural failures or restriction of the aircraft flight envelope. Several aircraft have experienced difficulty with equipment mounted on the vertical tail, such as lights and electronic equipment, because of underestimation of the vibration environment.

On an air superiority fighter, a blade antenna mounted behind the canopy exhibited fatigue failures due to high dynamic loads associated with turbulent flow at high angles of attack. Flight testing of a strengthened blade produced a yield failure of the supporting (backup) structure. Relocation of the antenna to a

location not subjected to turbulent airflow resolved the problem.

On an electronic countermeasures aircraft, flight testing showed that blade antennas located downstream from centerline stores were subjected to severe turbulent flow in sideslip maneuvers. Damping material was incorporated into the design of a new antenna to minimize antenna dynamic response loads.

The design of blade antennas and associated mounting structures must account for potentially high dynamic loads, because in-flight separation of an antenna from the aircraft poses risks of downstream damage to the aircraft, injury to ground personnel, and operational deficiencies.

An increase in engine power and a change in propellers was effected without checking empennage response. This resulted in secondary failures in the empennage structure and investigation revealed that primary structure had experienced damage as well. The empennage, it was found, was responding to the propeller slipstream. Solution of the problem consisted of detuning the empennage natural frequencies from the range of propeller excitation frequencies.

Experience with doors and access panels demonstrates that careful attention should be given to the effects of buffeting and movement in flight.

B.5.6 STRENGTH

The landing gear shall be adequate to provide the operational and maintenance capability required commensurate with the general parameters of 5.5.2 and 5.5.3 without detrimental deformations of 5.5.2.13 at 115 percent limit or specified loads and without structural failure at ultimate loads. The landing gear strength shall be adequate to meet the requirements of 5.5.1.2.

REQUIREMENT RATIONALE

Adequate airframe strength must be provided not only for safety of flight, for landings and for maintenance functions, but also to permit full operational capability of the air vehicle to perform its required missions. An understrength airframe impairs the mission potential of the air vehicle, since it must be restricted during its operations.

REQUIREMENT GUIDANCE

The structure shall have sufficient strength so that it can carry limit loads without detrimental deformations which would interfere with its safe operational and maintenance capabilities. The structure must be able to react ultimate loads without rupture or collapsing failure.

REQUIREMENT LESSONS LEARNED

None.

B.5.6.1 MATERIAL PROPERTIES

Strength related material property requirements are contained in 5.5.2.16.1.

REQUIREMENT RATIONALE

This requirement references the basic material properties requirement which are in one place and cover all of the structures disciplines requirements.

REQUIREMENT GUIDANCE

Check to see that all strength related material properties requirements are included in 5.5.2.16.1.

REQUIREMENT LESSONS LEARNED

None.

B.5.6.2 MATERIAL PROCESSES

Strength related material processing requirements are contained in 5.5.2.16.2.

REQUIREMENT RATIONALE

This requirement references the basic material processes requirements which are in one place and cover all of the structures disciplines requirements.

REQUIREMENT GUIDANCE

Check to see that all the strength related material process requirements are included in 5.5.2.16.2.

REQUIREMENT LESSONS LEARNED

None.

B.5.6.3 INTERNAL LOADS

Internal loads of structural members within the landing gear shall react to the external loads generated by the air vehicle during operation and maintenance functions. Load paths shall be configured and controlled to be as direct as practical through the proper locating of primary structural members, selecting materials, and sizing members. The effects of panel buckling, material yield, and fastener tolerances on the internal load distributions shall be considered.

REQUIREMENT RATIONALE

Efficiencies in configuring load paths, in sizing of members, and in selecting materials, are contingent upon having available the associated internal loads values. Also, the internal loads on structural members must be known prior to writing strength analyses and calculating margins of safety. Direct load paths

provide highly reliable structures, while indirect load paths result in complex reactions, inefficient load paths, and heavier structural weights.

REQUIREMENT GUIDANCE

Internal loads on all structural members are typically determined for critical loading conditions. Detailed internal loads are identified as limit or design ultimate loads. For landing gears and other beam-column members, ultimate internal loads are calculated by multiplying the factor of safety times limit internal loads, which necessarily include secondary moment effects resulting from the strut's limit load bending deflections. Recommended load paths and design guides are described in Chapter 2 of AFSC DH 2-1. Internal loads may be determined using classical methods such as those described in "Analysis and Design of Flight Vehicle Structures", "Airplane Structure", and "Aircraft Structures", or using computer finite element computer programs.

REQUIREMENT LESSONS LEARNED

None.

B.5.6.4 STRESSES AND STRAINS

Stresses and strains in the landing gear backup structural members shall be controlled through proper sizing, detail design, and material selections to satisfactorily react to all limit and ultimate loads. In laminated composites, the stresses and ply orientation are to be compatible and residual stresses of manufacturing are to be accounted for, particularly if the stacking sequence is not symmetrical.

REQUIREMENT RATIONALE

It is necessary to control airframe stresses and strains in order to satisfactorily accomplish material selection and part sizing. Stresses and strains must be known prior to determining margins of safety. In addition, stresses and strains must be known for salvage evaluation of any production damaged parts, strength evaluation of engineering change proposals, airframe structural modifications, and evaluation of in-service, structural damage and making of repairs as required.

REQUIREMENT GUIDANCE

Stresses and strains on an airframe's component members for critical loads that encompass the maximum loading conditions need to be determined. The structure must have the ability to support critical loads. Load paths of adequate strength need to be established.

REQUIREMENT LESSONS LEARNED

None.

B.5.6.4.1 FITTING FACTOR

For each fitting and attachment whose strengths are not proven by limit and ultimate load tests in which actual stress conditions are simulated in the fitting and surrounding structure, the design stress values shall be increased in magnitude by multiplying these loads or stress values by a fitting factor. This fitting factor and the conditions for its use are as follows:

_____.

REQUIREMENT RATIONALE

It is necessary to use a fitting factor, since many uncertainties exist in regard to stress distributions within fittings. Manufacturing tolerances are such that bolts within a pattern rarely fit the holes perfectly and small variations in dimensions may affect stress distributions. Failures are more likely to occur at fittings connected to members than in the members themselves because of local stress concentrations at the connections, slight eccentricities of the attachments, or more severe vibration conditions.

REQUIREMENT GUIDANCE

A fitting factor equal to 1.15 is applicable not only for the fitting and attachment but for all bolted and welded joints and for the structure immediately adjacent to the joints. Some contractors use a factor as high as 1.5 for tension joints. However, it is not necessary to use the fitting factor for continuous lines of rivets installed at sheet-metal joints. The fitting factor in the strength analysis can be multiplied by either the load or stress, whichever is convenient. Fitting lug thicknesses and edge distance must be sufficient to account for the most adverse tolerances and allow for future repairs such as reaming, inserting a bushing, or replacement of an existing bushing with an oversize bushing. The guidelines in DN 4B1 of AFSC DH 1-1 are applicable to fittings. The fitting design must also account for angular misalignment.

REQUIREMENT LESSONS LEARNED

Major structural elements on aircraft periodically require repair for attachment of pylons, landing gear components, loading ramps, underfloor fittings, etc. Many existing fittings in current aircraft do not have sufficient, remaining lug material to permit rebushing repair with oversize bushings after reaming the score-damaged lug holes. Since, in many cases, the repair cannot be accomplished without degrading the capability of the fitting below the initial system design requirement, costly and time-consuming replacement is required.

B.5.6.4.2 BEARING FACTOR

When a bolted joint with clearance (free fit) is subjected to relative rotation under limit load or shock and vibration loads, the design stress values shall be increased in magnitude by multiplying a bearing load factor times the stress values. This bearing factor and the conditions for its use are as follows: _____.

REQUIREMENT RATIONALE

Bolts loaded by shock or vibration, such as in landing gears, tend to hammer back and forth in bolt holes. This hammering may enlarge the bolt holes enough to produce failure of the part if the bearing stresses are high.

REQUIREMENT GUIDANCE

A bearing factor of 2.0 or more is applicable; however, when there is no motion between bushing and lug, the bearing factor is one. The bearing factor must be multiplied by the safety factor of 1.5 but need not be multiplied by the 1.15 fitting factor. In lieu of bearing factors, allowable bearing properties which have acceptable reduced values to account for bearing factors may be used. The design guidelines for bushings may be found in Chapter 6 of AFSC DH 2-1.

REQUIREMENT LESSONS LEARNED

None.

B.5.6.4.3 CASTINGS

Castings shall be classified and inspected, and all castings shall conform to applicable process requirements. A casting factor of _____ shall be used. The factors, tests, and inspections of this section must be applied in addition to those necessary to establish foundry quality control. The use of castings or C/HiPed parts for primary or critical applications or castings with a casting factor of less than 1.33 shall require successful completion of a developmental and qualification program approved by the procuring activity.

REQUIREMENT RATIONALE

None.

REQUIREMENT GUIDANCE

None.

REQUIREMENT LESSONS LEARNED

None.

B.5.6.4.4 HIGH VARIABILITY STRUCTURE

Due to the nature of some structural designs or materials, high variability may be encountered around the nominal design. Such design features must have a minimum level of structural integrity at the acceptable extremes of dimensions, tolerances, material properties, processing windows, processing controls, end or edge fixities, eccentricities, fastener flexibility, fit up stresses, environments, manufacturing processes, etc. For the critical combinations of these acceptable extremes, the structure must have no detrimental deformation of the maximum once per

lifetime load of 5.5.2.14.6 and no structural failure at 125 percent of design limit load and meet the requirements of 5.5.7.1. This requirement is in addition to the requirements of 5.5.10. Examples of such structure are stability critical compression structure, stability critical panels, some composites, resin transfer molded composite parts, castings with low castings factors, manufacturing critical parts, etc.

REQUIREMENT RATIONALE

Historically, the analytical baseline criteria is nominal dimensions, nominal blue print eccentricities, and statistically reduced material allowables. However, a minimal level of structural strength is required for all structural members which meet the acceptable extreme range of blue print dimensions, processing windows, material property specifications, and manufacturing tolerances. This is required for safety of flight structure since these parts could easily exist on the aircraft since they are per blueprint and per process specifications.

REQUIREMENT GUIDANCE

This should not normally be a design consideration for most conventional designs and materials since the normal variation in material properties, fabrication, processes, and manufacturing allow the design to meet this requirement. Therefore, the primary focus of this requirement should be to identify those critical dimensions or processes that need extra control or tighter tolerances. This requirement also provides assurance that new materials, processes, or design concepts are sufficiently mature to provide a stable baseline.

REQUIREMENT LESSONS LEARNED

Many low cost production initiatives involve opening up the process windows, tolerances, or specification. Designs that are qualified using nominal dimensions and statistical materials allowables could have safety of flight parts that are significantly understrength while fully complying with all blueprints, processes, and specifications.

A state of the art fighter is using HIP ped castings with thin walls and a casting factor of 1.00 in safety of flight applications. The nominal thickness of these thin walls was 0.08, but the actual range of casting wall thicknesses came out from 0.05 to 0.12. The casting vendor wanted the thickness tolerances opened up to allow this wide variations. Since this variation in wall thickness would allow up to a 38% understrength condition to exist, the contractor agreed to design to minimum thickness x 1.10 while opening up the thickness tolerance to increase casting yield.

The strength of some critical structure such as stability critical panels varies with the square of the thickness. If the minimum thickness is not controlled either by callout or tighter tolerance, a significant understrength condition could exist while still being "per blueprint."

B.5.6.5 STATIC STRENGTH

Sufficient static strength shall be provided in the landing gear and backup structure for reacting to all loading conditions loads without degrading the structural performance capability of the gear or backup structure. Sufficient strength shall be provided for operations, maintenance functions, and any tests that simulate load conditions, such that:

- a. Detrimental deformations, including delaminations, shall not occur at or below 115 percent of limit loads, or during tests required in 6.6.10.5.3 and the deformation requirements of 5.5.2.13 apply.
- b. Rupture or collapsing failures shall not occur at or below ultimate loads.
- c. All structure shall be designed to nominal dimensional of 110 percent of minimum values, whichever is less.
- d. Bonded structure shall be capable of sustaining the residual strength loads of 5.5.12.2 without a safety of flight failure with a complete bond line failure or disbond.

REQUIREMENT RATIONALE

The mission potentials of the air vehicle must not be compromised by lack of airframe static strength. Excessive deflections may not only produce deleterious aerodynamic or aeroelastic effects, but may cause binding interferences between hinge connected and adjacent structures as well. Exterior surface buckles, especially those that are permanent, may produce undesirable aerodynamic characteristics.

REQUIREMENT GUIDANCE

Ultimate stresses are not to be exceeded at ultimate loads. Calculated deflections and surface buckling deformations need to be coordinated through responsible aerodynamic and aeroelastic disciplines for evaluating possible performance penalties.

For composites, the allowable for a given flight condition shall be based on the temperature appropriate for that flight condition combined with the most critical of the range of possible moisture conditions. The factor of uncertainty to be used in the application of the allowables derived above is 1.5. Since the strength of a composite structure is inherently dependent on the lay up of the laminate, geometry, and type of loading, the "B" basis allowable must include these factors. However, the cost of a test program involving the number of complex components necessary to determine the "B" basis allowable could be prohibitive. An acceptable approach is to determine the "B" basis allowable from coupon data representative of the lay up and loading.

REQUIREMENT LESSONS LEARNED

Case histories of static testing programs have been assembled for a number of Air Force aircraft. The static test programs surveyed are typical of all past programs. All production aircraft were static tested in a timely manner, using very low numbered airframes. Some delays were experienced when major structural failures occurred, but these do not reflect on the timeliness of the overall programs. For the aircraft surveyed from 1950-1970, the only aircraft not experiencing major failures were direct outgrowths of earlier models which had gone through complete static test programs; the other tested aircraft are known to have suffered major test failures.

Comparison of Air Force and FAA structural test requirements is often made. Despite the fact that commercial transports are flown conservatively, are designed to low nominal stress levels, and there are no complete ultimate load test requirements by the FAA, an increasing number of manufacturers are conducting ultimate load tests. It should be noted that the size and expense of these airframes has not deterred the manufacturers from recognizing the benefits of such tests. The primary goal has been for the purpose of determining growth potential.

Historically, increased mission requirements have been levied on most military aircraft after entering service. This usually means increased fuel or armament with associated weight increase. At the same time, it is desired to minimize structural capability degradation. It is, therefore, of prime importance to know the growth potential in the structure or, precisely, what limitations may have to be imposed. A proof test program cannot determine growth potential. This can only be accomplished by complete, ultimate load tests, including judiciously-selected, failing load tests.

Efforts have usually been made to discover structural deficiencies by static tests at the earliest possible time, in order to minimize the impact of retrofit changes. Most major, static test failures have necessitated subsequent engineering changes. These changes were usually incorporated within early, follow-on production aircraft with minimal retrofit effort required. However, when major structural redesign efforts have been initiated in programs, concurrent with production adjustments, static tests have had to be rescheduled. Consequently, decisions have had to be made on retrofitting previously produced aircraft with whatever changes the test showed to be necessary.

Almost without exception, past static test programs have revealed a variety of structural deficiencies or related problem areas. Table V is taken from "Structural Testing for Aircraft Development" to show failure trend data and reinforce the basic requirement for conducting static tests at the earliest possible time in the production or preproduction cycle.

Additional information and data from "Analysis of the Premature Structural Failures in Static Tested Aircraft" are the results of a study of static tests

performed at WPAFB from 1940 to 1976. See tables VI through XI. The early tests (1940-1948) represent 115 airplanes, and the later tests (1950-1976) represent 22 airplanes. Many different types of airframes were tested in the 1940s as follows: fighter-32, trainer-22, glider-20, bomber-14, cargo-12, attack-8, liaison-4, observation-2, and one helicopter. Because of the war demand for metals, considerable use of wood/plywood in many airplanes resulted. After the war, from 1950 and on, the use of wood/plywood was phased out completely as far as primary structures were concerned. A review of the data indicates that the type of airplane and material used do not bias or disproportionately influence the distribution of failures. The following is a discussion of the test results from the viewpoint of airplane first failure and major component first failure. Other parts of this handbook have reviewed the test results from the viewpoint of distribution of structural failures, considering only those components which failed, including all retests of those components.

The data presented in figure 26 is from four groupings of the test results. Two of the groups are for first failures of a major component of each airplane. The next two groups are for first failures of each of the five major components of an airplane, that is, fuselage, wing, horizontal tail, vertical tail, and landing gear.

- a. 1940-1948, Airplane first failure. The data represents a wide range of airplanes from liaison to bomber and the two predominant materials, wood and aluminum. Because of the type of loading used (lead shot or sand filled bags), it was not always possible to state the exact percent of ultimate load at which the component failed. Hence, the failure occurred between the last load the structure held and the next load level which it could not hold. This leads to the discontinuous box type of curve. The data shows that 25-30 percent of the airplanes had a first failure below limit load and 10-16 percent of them had a first failure below 80 percent of limit load. These failures below limit load indicate that many of the airplanes would have experienced operational problems if they had not been static tested.
- b. 1950-1976, Airplane first failures. The distribution of failures is remarkably similar to that of the 1940s. However, one can draw some conclusions which may be more intuitive than actual. For example, it appears that there are fewer failures below 60 percent of ultimate, supporting the notion that more is known technically so fewer errors have been made. But, on the other end, 90 to 100 percent of ultimate load, it appears we learned too much (took too many of the conservatisms out of the analyses) and didn't quite have all of the structure needed to carry ultimate load.
- c. 1940-1948 and 1950-1976, Major component first failures. Obviously the second failure of an airplane must occur at a higher percentage of ultimate load than the first failure. Hence, these curves will lie above their respective airplane

first failure curves. It appears that the major component first failure curves are quite similar to the airplane first failure curves, even at the high end, supporting the removal of conservatism trend.

As data becomes available from programs wherein the airplane is designed to durability and damage tolerance requirements, it will be interesting to see if the curves and trends change. Further, as more and more structures are made of composites, it will be equally interesting to see what happens. It appears that both of the above aspects will tend to decrease the number of static test failures, at least those associated with the classical tension, shear, torsion and bending failures. It is not apparent that the structural instability (buckling, etc.) problems have been completely solved. Nor have the secondary and flight control system structural problems been solved. Some of these problems will probably always be with us and, just around the corner, waiting for someone to decide not to run a proof test of the first article or not to perform a static test of a major component, particularly those that are stability critical.

B.5.6.6 DYNAMIC STRENGTH

Sufficient static strength and energy absorption capability shall be provided in the landing gear backup structure to react to all dynamic design landing conditions and reserve energy requirements. For land-based aircraft, the maximum sink speed is _____ and the reserve energy condition is _____. For ship-based aircraft, the design requirements are _____.

REQUIREMENT RATIONALE

Adequate airframe strength and energy absorption must be provided to meet the operational requirements and provide safety of flight. The results of these analyses and tests are required to conduct verification flight tests and carrier suitability testing.

REQUIREMENT GUIDANCE

The structure and aircraft systems shall have sufficient strength and energy absorption capability so that it can carry limit and design loads without detrimental deformations which would interfere with continued operation. The structure must be able to react ultimate loads without rupture or collapsing failure.

REQUIREMENT LESSONS LEARNED

None.

B.5.6.7 MODIFICATIONS

Modifications to an existing air vehicle affecting the external or internal loads on the landing gear structure, as well as new or revised equipment installations, shall have adequate structural capability for the intended usage. This requirement also applies to unmodified structures whose loads have been increased because of the modification.

REQUIREMENT RATIONALE

Airframe modifications must necessarily incorporate sufficient structural capability to preclude the levying of excessive restrictions on air vehicle operations. The weight penalty induced by maintaining the 0.25 margin of safety limitation is quite small for the advantages gained in structural integrity.

REQUIREMENT GUIDANCE

Modified primary structure and new or retrofitted equipment installations are strength designed with structural configurations to accommodate all applicable external loads and environmental conditions. Modified structure adjacent to cut, primary members (fuselage frames, longerons, wing spars, ribs, etc.) are designed to accommodate the change in load paths by using adequate material sizing techniques. Exterior surface additions and internal equipment installations are strength designed to accommodate applicable aerodynamic, pressurization, and inertia loads, including the effects of emergency landing crash load factors.

When strength proof tests of each modified air vehicle are not performed, it is recommended that analytical margins of safety not less than 0.25 be maintained, in order to provide an equivalent factor of uncertainty capability equal to 1.875. The modified airframe may then have the strength capability to be released to 100 percent limit load levels, based on the 80 percent, analytical strength capability. Each structural modification is normally classified as being major or minor as described by AFSCR 80-33, which covers Class II Modifications.

Unmodified structure which has been static tested to ultimate without failure may be qualified by analysis if the internal loads distribution or magnitude approximate the demonstrated static strength.

REQUIREMENT LESSONS LEARNED

None.

B.5.6.8 MAJOR REPAIRS, REWORK, REFURBISHMENT, AND REMANUFACTURE

The landing gear and backup structure of an existing air vehicle shall have adequate structural integrity and capability for the intended usage following major repairs, extensive reworks, extensive refurbishment, or remanufacture.

REQUIREMENT RATIONALE

None.

REQUIREMENT GUIDANCE

None.

REQUIREMENT LESSONS LEARNED

None.

B.5.7 DURABILITY

The durability capability of the landing gear and backup structure shall be adequate to resist fatigue cracking, corrosion, thermal degradation, delamination, and wear during operation and maintenance such that the operational and maintenance capability of the landing gear and backup structure is not degraded and the service life, usage, and other provisions of 5.5.2.14 are not adversely affected. These requirements apply to metallic and nonmetallic structures, including composites, with appropriate distinctions and variations as indicated. Durability material properties shall be consistent and congruent with those properties of the same material, in the same component, used by the other structures disciplines. See 5.5.2.16.1.

REQUIREMENT RATIONALE

When subjected to design service loads and environment an airframe must have adequate durability throughout its service life to preclude adverse safety, economic, operational, maintenance, repair, or modification cost impacts.

REQUIREMENT GUIDANCE

The requirements of this paragraph and subsequent subparagraphs apply to all primary and secondary structures and to all structural material systems except as noted. The contractor needs to perform the analytical and test work necessary to demonstrate compliance with the durability requirements herein, in accordance with the life and usage provisions of 5.5.2.14.6. The objective is to demonstrate airframe resistance to cracking or other structural/material degradation which results in excessive, untimely, or costly actions in service (e.g. maintenance, inspections, repairs, modifications, etc.), in functional problems (e.g. fuel leakage, loss of control effectiveness, loss of cabin pressure, mechanical interference, etc.), or in adverse impacts to operations. Full realization of the objective results in a structure which requires no specific actions (e.g. inspections, modifications, etc.), as demonstrated by design and development, to achieve its full service life, as defined by 5.5.2.14.6, and thereby supports/optimizes projected airframe force inventory levels at least cost and impact to operations/readiness. Finalize the aircraft durability requirements only after careful consideration of:

- a. Unique performance capabilities the air vehicle may have which differ from past air vehicles, and which in part, may nullify the existing data base
- b. Potential changes in usage (for example, mission, tactics, or mission mix)
- c. Potential service life extensions

- d. Projected weight to at least Initial Operating Capability (IOC) based on historical data regarding weight growth during development
- e. Any other change which may impact the scenario in which the air vehicle may operate
- f. Combined impact of natural environmental exposure and service usage on the residual strength capabilities of the structural material. In cases where structural material systems are utilized which do not exhibit a classical metallic structure deterioration mechanism, i.e., fatigue crack initiation and propagation, the concept of durability life still applies. The relevant factors which could cause the deterioration of a particular structural material system must be used to define the point at which the onset or level of deterioration is unacceptable.

REQUIREMENT LESSONS LEARNED

The durability and corrosion resistance of the structure is the final measure of success in service. Durability must be designed into the structure to maximize the life of the airframe and ensure its safe and economical operation. When adequate durability is not attained, adverse cost, operational and safety impacts may result. For example, a very large transport and a ground attack aircraft lacked sufficient durability margin which necessitated complete redesigns of the wing structure of the aircraft.

For background on composites, see Composite Structures/Materials Certification Background under Requirement Lessons Learned for 5.5.2.16.

B.5.7.1 FATIGUE CRACKING/DELAMINATION DAMAGE

For one lifetime when the landing gear and backup structure is subjected to the environment and service usage specified in 5.5.2.14 except where it is desired to meet the special life provisions of 5.5.7.5, the landing gear and backup structure shall be free of cracking, delaminations, disbonds, deformations, or defects which:

- a. Require repair, replacement, inspection to maintain structural integrity, or undue inspection burden for ship based aircraft.
- b. Cause interference with the mechanical operation of the aircraft.
- c. Affect the aircraft aerodynamic characteristics.
- d. Cause functional impairment
- e. Result in sustained growth of cracks/delaminations resulting from steady-state level flight or ground handling conditions.
- f. Result in water intrusion

- g. Result in visible damage from a single _____ foot-pound (ft-lb) impact.

REQUIREMENT RATIONALE

When subjected to design service loads and environment, an airframe must resist fatigue cracking/delamination damage and other structural anomalies (e.g. disbonds, deformations, defects, etc.) throughout its service life to preclude adverse safety, economic, operational, maintenance cost impacts.

REQUIREMENT GUIDANCE

See 5.5.7 Requirement Guidance.

To satisfy durability requirements and account for data scatter, structural anomalies should not occur within two lifetimes of usage and environments specified in section 5.5.2.14. While the full scale durability test results are the primary indicators of compliance, the durability analysis supports key elements in the development of durable structure by establishing stress levels, aiding in definition of structural details and reducing risk relative to testing.

Composite structures, as well as metal structures, must be designed to minimize the economic burden of inspecting or repairing damage from low energy impacts such as tool drops, etc. Specifically for organic matrix composites, service induced damage should be considered (e.g., low velocity impact damage, maintenance and handling damage, etc.) and the potential effect on repair, maintenance, and function must be developed. It should be demonstrated that damage not readily visible on the surface will not result in subsequent degradation of the part, impair function, or require maintenance actions. Visible damage is defined as damage that is visible to the unaided eye from a distance of 5 feet (dent depths of 0.10 inch). The intent is to ensure that costly maintenance will not be incurred due to service exposure. The structure and potential service and maintenance environment should be reviewed to develop typical damage sources. To accomplish this goal, the structure is to be divided into two types of regions. The first type is one where there is a relatively high likelihood of damage from maintenance or other sources. The second type of region is one where there is a relatively low probability of the structure being damaged in service. The specific requirements for these two areas are given in table I. There are two other threats to the structure that may cause an economic burden. These threats are hail damage to the aircraft when parked and runway debris damage to the aircraft from ground operations. The hailstone size for which the structure must be hardened was chosen such that this size or smaller were representative of 90 percent of the hailstorms. The runway debris size was also chosen to include most of the potentially damaging objects found in ground operations. The velocity of these objects is dependent on the weapon system. The details of the hail and runway debris requirements are shown in table II.

The structure should be designed such that the above sources will not incur damage of sufficient magnitude to require inspection or repair throughout two times of design service life usage at the critical environmental condition. The loading spectrum and environmental conditioning for the testing associated with the table I and table II requirements will be the same as that described for the durability tests.

REQUIREMENT LESSONS LEARNED

None.

B.5.7.2 CORROSION PREVENTION AND CONTROL

The landing gear and backup structure shall operate in corrosion producing environments and conditions of 5.5.2.16. Corrosion (including pitting, stress corrosion cracking, crevice, galvanic, filiform, and exfoliation) which effects the operational readiness of the airframe through initiation of flaws which are unacceptable from a durability, damage tolerance, and residual strength viewpoint shall not occur during the service life and usage of 5.5.2.14. Corrosion prevention systems shall remain effective during the service life and usage of 5.5.2.14 in the environments and under the conditions of 5.5.2.15 for the periods indicated below. Specific corrosion prevention and control measures, procedures, and processes must be identified and established commensurate with the operational and maintenance capability required of the airframe. Finishes shall also comply and be compatible with the requirements of 5.5.2.17. The following additional requirements apply:

- a. Structure which is difficult to inspect, repair, or replace, or places an undue economic burden on the user, must comply with the requirements of 5.5.2.14 for the service life of the landing gear.
- b. Other structure for the period of _____.

REQUIREMENT RATIONALE

Corrosion prevention systems must be effective for minimum periods of service usage to minimize the life cycle costs associated with corrosion damage inspection and repair. A systematic and disciplined approach for addressing corrosion prevention and control must be established early in the development life cycle.

REQUIREMENT GUIDANCE

Define the periods of usage which other structure must withstand without incurring corrosion damage. A period of time less than the airframe service life may be specified, such as a percentage of the service life requirements of 5.5.2.14 or a period of time equivalent to regularly scheduled airframe inspections, field maintenance activities, or programmed depot maintenance intervals.

MIL-STD-1568 should serve as a baseline approach to addressing corrosion control and prevention and should be deviated from only with appropriate supporting engineering justification.

The protection of the aircraft and its component parts from corrosion should be in accordance with MIL-F-7179 and NAVMAT-P-4855-2. The corrosion protection requirements and concepts should be applied during system definition, design, development, and production. Emphasis should be placed on correcting historically corrosion prone areas (e.g., bushed flight control surface hinges/structural attachments) during system definition, design, development, and production. The design of the airframe, systems, and the subsystems should preclude the intrusion and retention of fluids. Sharp corners and recesses should be avoided so that moisture and solid matter cannot accumulate to initiate localized attack. Adequate ventilation should be provided in all areas to prevent moisture retention and buildup. Cleaning, surface treatment, and inorganic coatings for metallic materials should be in accordance with MIL-S-5002. Sulfur dioxide salt spray/fog testing should be conducted in accordance with ASTM G85.A4 and for a minimum period of 500 hours. Fasteners should be wet installed with sealant or non water-borne primer.

Use of dissimilar metals (as defined by MIL-STD-889) in contact should be limited to applications where similar metals cannot be used due to peculiar design requirements. When it is necessary to use dissimilar metals in contact, the metals should be adequately protected against galvanic corrosion as per MIL-STD-889. Metals such as aluminum alloys that are prone to galvanic attack in contact with graphite composites should also be protected as per MIL-STD-889 with either coatings and sealants and/or barrier materials such as occurred fiberglass or scrim cloth, whichever is appropriate. Aluminum fasteners, stainless steel fasteners, and cadmium plated fasteners should not be used in contact with graphite composites. Items electrically bonded or used for electromagnetic interference hardening should be sealed to prevent moisture intrusion. Frequently removed items or items that are not practical to seal should be of similar materials. Emphasis should be placed on using fasteners versus bare metal to metal contact to achieve bonding. During the structural design and material/process selection, consideration should be given to various design alternatives which preclude the traditional galvanic corrosion problems created by dissimilar metal bushings (e.g., beryllium copper, aluminum bronze) installed in aluminum structure. Consideration should be given to the avoidance of using removable graphite composite doors/panels fastened to aluminum alloy substructure, particularly on upper surfaces where moisture/salt spray can potentially migrate through the fastener holes and cause corrosion of the aluminum substructure.

All designs should include provisions for the prevention of water, condensation, and other unwanted fluid accumulation and entrapment. Actual aircraft

configuration and attitude should be considered in addition to component design. All metal sections should preferably be open sections to permit drainage, inspection, cleaning, and refinishing of section surfaces. Closed sections, where used, should include provisions for drain holes to allow free drainage of accumulated fluids which can enter by various methods. Drain holes should be located to effect maximum drainage of unwanted fluids. All drainage should be through meniscus free drain holes. Unless otherwise specified, struts and welded tube structures should provide for airtight closure by welding, anti-corrosion treatment, and subsequent positive sealing. This is particularly applicable to steel struts and tube structures which should be welded easily. Mere convenience of fabrication is insufficient reason for not sealing steel tubes. Tubes or struts that cannot be closed readily by welding, should be left open in a manner to provide for free drainage, ventilation, inspection, and refinish. End fittings used with open tubing should not form pockets which may collect moisture. Cork seals, dams, and metal end plugs machined to fit, should not be used.

All crevices in exterior locations and faying surfaces with edges leading to an exterior surface should be filled or sealed with MIL-S-81733 sealant.

REQUIREMENT LESSONS LEARNED

Corrosion costs are extremely high. This problem can be primarily attributed to poor material choices during the development stages and faulty design and manufacturing processes. An example of a poor material choice is the corrosion prone 7075-T6 used in some aircraft, which has resulted in maintenance problems. Stress corrosion cracking and galvanic corrosion are two severe problems which often stem from manufacturing processes and they may not show up until late into the service life of the system.

In the future, aircraft will be forced to fly more hours than initially expected. In addition, funds available for corrosion maintenance will be reduced. These factors give added significance to the corrosion problem.

Methods of corrosion control shown to be effective include proper materials selection (specifically the use of age stabilized aluminum alloys to preclude exfoliation corrosion and stress corrosion cracking), manufacturing processes to preclude built-in stresses during fabrication and assembly operations and those which inhibit rust, use of high quality corrosion protection systems selected on the basis of the anticipated environments, and the frequent use of corrosion inspection techniques. A ground attack, an air supremacy fighter, an air superiority fighter, and some transports which have been overseen by corrosion boards, have had significant decreases in required corrosion maintenance compared to other systems not overseen by corrosion boards.

MIL-STD-1568 provides corrosion prevention and control guidance on materials and processes selection criteria, material systems and processes performance data, standard design practices, repair/maintenance

practices and considerations. Corrosion prevention and control must be addressed early in the development process to insure that optimum materials and protection systems are incorporated and that all disciplines involved in airframe design development production and maintenance are addressed.

Several cases of corrosion damage occurring on in-service aircraft where fasteners were not wet installed with sealant or primer at the manufacturer. The corrosion was initiated by water and salt contamination intrusion around panel retaining fasteners. The lack of wet installation with sealant or primer has resulted in corrosion damage.

Aircraft with beryllium copper or aluminum bronze bushings installed in aluminum structure has resulted in galvanic corrosion.

Several magnesium components have been replaced with aluminum components due to the high scrap rates caused by corrosion.

B.5.7.3 THERMAL PROTECTION ASSURANCE

Thermal protection systems shall remain effective during the service life and usage of 5.5.2.14 in the environments and under the conditions of 5.5.2.15 for the periods indicated below. Finishes shall also comply and be compatible with the requirements of 5.5.2.17 and 5.5.7.2.

- a. Structure which is difficult to inspect, repair, or replace for the service life of the landing gear system.
- b. Other structure for the period of _____.

REQUIREMENT RATIONALE

Thermal protection systems must be designed to be effective for minimum periods of service usage to prevent excessive maintenance and repair costs over the life of the air vehicle.

REQUIREMENT GUIDANCE

Define the time periods of usage which other structures must withstand without incurring damage. A lifetime less than the airframe service life may be specified, such as a percentage of the service life requirements of 5.5.2.14 or a period equivalent to that for regularly scheduled airframe inspections or replacement of parts.

REQUIREMENT LESSONS LEARNED

None.

B.5.7.4 WEAR AND EROSION

The function of structural components, elements, and major bearing surfaces shall not be degraded by wear under the service life and usage of 5.5.2.14 for the periods indicated below. Bearings shall also comply

and be compatible with the requirements of 5.5.3.13 and 5.5.7.2.

- a. Structural surfaces which move for _____.
- b. Structural and maintenance access panels and other removable parts for _____.
- c. Gear doors for _____.
- d. Other structure for _____.

REQUIREMENT RATIONALE

Structural components which are subjected to wear under normal operating conditions must be designed to withstand this environment for minimum periods of usage.

REQUIREMENT GUIDANCE

Define the time periods of usage which functional structures must withstand without incurring wear damage. A lifetime less than the airframe service life may be specified, such as a percentage of the service life requirement of 5.5.2.14 or a period equivalent to that for regularly scheduled airframe inspections or replacement of parts.

The design and manufacture of aircraft should include practices to minimize damage by wear and erosion. Wear and erosion prevention practices should be followed on applicable surfaces of metals, polymers, elastomers, ceramics, glasses, carbon fabrics, fibers, and combinations or composites of these materials. Provision should be made to eliminate or minimize combinations of erosive, corrosive, and thermal effects on structure near heater and engine bleed air, engine exhaust, rocket and missile exhaust, and in the wake of such exhaust gases. In no case should there be direct flame impingement from missiles and rockets on aircraft surfaces unless such surfaces are suitably protected by a coating or device.

Wear. Wear prevention practices should be applied to all load bearing and load transfer interfaces. These areas include fastened, riveted, bolted, and keyed joints; bearings, races, gears, and splines; contact surface of access doors and panels, hinges and latches; contact point of cables, ropes, and wires as well as contact areas between metallic and polymeric strands; interference fits; friction clamps, contact points of springs; sliding racks and pulley surfaces; and other surfaces subject to wear damage. Materials, surface properties, system friction and wear characteristics, liquid and solid lubrication systems, surface treatments and coating, contact geometry, load, relative motion, and service environment should be fully substantiated and documented.

Erosion. Erosion prevention practices should be applied to all surface areas including leading edges, radomes, housings, and other protrusions as well as to

surfaces exposed to particle impingement during take-offs and landings.

Lubrication. Provisions should be made for lubrication of all parts subject to wear. Flight control system servocylinder attachment bearings should not require lubrication during the life of the aircraft except for the leading edge flap transmission. The selection of lubricants (oil, greases, solid film coatings, anti-seize compounds, heat transfer fluids, coolants, and hydraulic fluids) should be in accordance with MIL-HDBK-275 as specified in MIL-STD-838. The fire resistant synthetic hydrocarbon hydraulic fluid, MIL-H-83282, should be used as the aircraft hydraulic fluid. The number of different lubricants required should be kept to a minimum by using multipurpose lubricants such as the wide temperature general purpose grease, MIL-G-81322 whenever possible, without compromising aircraft performance and reliability. All lubrication fittings should be readily accessible. Components in highly loaded/dynamic and potentially corrosive applications (e.g., landing gear, arresting gear) should make maximum use of lubrication fittings, vice other forms of lubricant. Parts subject to immersion in sea water should be designed so as to exclude sea water from bearings.

REQUIREMENT LESSONS LEARNED

Accessibility to areas that may be subject to wear should be a primary development consideration because wear is difficult to predict and may only be identified after extended periods of actual service usage. In Desert Storm, fixed wing and helicopter rotorblade leading edge polyurethane and brush on coatings do not provide adequate protection from sand erosion. More durable erosion resistant coatings should be developed without compromising performance characteristics. In addition, the fine sand caused severe crazing of aircraft canopies during storage and fleet use. High sunlight/heat was damaging components in the cockpit interior.

High failure rates of helicopter tail rotor counterweight arm bearings were experienced due to the fine sand intrusions. In the past, helicopter main landing gear skids were not designed for hard landings in the sand.

B.5.7.5 SPECIAL LIFE REQUIREMENT STRUCTURE

The following structural components shall comply with 5.5.7.1 and 5.5.7.2 for the periods indicated:

- a. Limited life structure _____.
- b. Extra life structure _____.

REQUIREMENT RATIONALE

Any structural component whose performance can be degraded under the expected operational usage must be able to withstand the expected environment for minimum periods of usage.

REQUIREMENT GUIDANCE

It may be cost effective and result in a more efficient airframe structure if some components are repaired or replaced periodically. Define the time periods of usage which these structural components must withstand without incurring degraded operation. A lifetime less than the airframe life may be specified, such as a percentage of the design life requirements of 5.5.2.14 or a period equivalent to that for regularly scheduled airframe inspections or replacement of parts. The provisions of 5.5.7.4 should be considered when selecting components as special life requirement structures. Special consideration should be given to easily accessible non-safety of flight structure.

REQUIREMENT LESSONS LEARNED

In the design of high strength structure, the use of fracture mechanics technique cannot provide adequate solution to predict structural lives. Other methods, such as strain life analysis, require a scatter factor of four to maintain the acceptable reliability.

B.5.7.6 NONDESTRUCTIVE TESTING AND INSPECTION (NDT/I)

NDT/I shall be utilized during the design, development, production, and deployment phases of the program to assure that the system is produced and maintained with sufficient structural integrity to meet performance requirements. Other requirements apply as appropriate:

REQUIREMENT RATIONALE

NDT/I is the only method available to screen materials and structures for harmful defects.

REQUIREMENT GUIDANCE

NDT/I has the potential for assuring that materials and newly manufactured structures meet design quality levels. Additionally, it is useful for evaluating the structural integrity of in-service hardware when conditions warrant (i.e. change in usage or suspected damage). NDT/I requires engineering analysis to identify the appropriate technology for use and qualified personnel for application. NDT/I is most effective when detailed structural analysis has identified structurally critical locations, load paths, and quality criteria necessary for meeting performance and life requirements.

Approved NDT/I methods. MIL-I-6870 identifies the process control documents for a variety of NDT/I methods. Other methods exist that are not controlled with a DOD process standard or specification and may also be used. Selection of the NDT/I methods and development of procedures for use are engineering functions and require understanding of the following factors:

- a. Nature of the defects to be detected. This includes size, shape, location, orientation, and any other properties which will affect detectability with the methods to be used.
- b. NDT/I reliability. For noncritical structure, adequate reliability is assured when the NDT/I is performed by qualified personnel following procedures approved by the appropriate authority. For critical structure, that is structure subject to fracture control considerations, adequate reliability may require more than adherence to approved procedures by qualified personnel. MIL-STD-1823 (draft - to be published) provides guidance on the demonstration of NDT/I reliability when more than normal reliability is required.

Contractor NDT/I process documents. Both government and industry process standards and specification are general in nature and do not contain sufficient detail to address applications to specific hardware in specific facilities. Consequently, contractor process documents must be available which describe how the general requirements of the government and industry documents are implemented in the contractor's facility for the system under procurement.

Acceptance criteria (new manufacture). Historically, acceptance criteria for products such as castings and composites, and processes such as welding, have been extremely conservative. They were developed initially as workmanship criteria, i.e. how well can a part be reasonably made, rather than performance criteria, i.e. how well must a part be made to meet a specific performance requirement. They were adopted after the workmanship criteria were found to result in satisfactory performance in qualification testing. Using excessively conservative criteria can result in significant schedule delays as well as costs. Often the added expense and time required to test (qualification) a product that possesses less than good workmanship features can result in significant cost and time savings in production. These criteria selected must be substantiated by performance tests and, additionally, demonstrated that the selected NDT/I and/or testing methods will be effective.

Test articles. Specimen, component, and full scale tests are used to establish material properties and demonstrate that the design meets system performance requirements. A side benefit of such tests is that they can indicate where the "weak structural links" exist if judicious use of NDT/I is used to monitor the test articles either during or after the testing, or both. Knowledge of the "weak links" can be invaluable when in-service usage exceeds the design usage.

Inspectability, manufacturability, and design. One consideration that is sometimes overlooked by the design function is manufacturability. Weldments and critical composite structures can be particularly susceptible. The non-manufacturability of the design becomes apparent when the hardware is submitted for inspection. NDT/I engineering must be able to interface with the design and manufacturing functions

to prevent non-manufacturable design from serious consideration.

Composites. Structures containing composites present different quality problems than metallic structures. Generally, the size of discrete defects that are considered harmful in composites will be larger than those for metallic structures. However, composites can contain a distributed defect, porosity, not considered significant in metallic structures. Composite porosity can be significant in thick laminate and may be an indicator of "non-manufacturability". As with other NDT/I procedures, capable NDT/I engineering is required to assure adequacy when composite porosity is a defect of concern.

REQUIREMENT LESSONS LEARNED

A fighter aircraft, designed for 4000 flying hours, crashed in less than 200 flying hours. The crash was caused by a large manufacturing defect in the wing structure. NDT/I analysis revealed that the NDT/I procedures were incapable of detecting this particular flaw as well as potentially equally dangerous flaws in the majority of the primary structure of the aircraft. This was a direct result of a breakdown of the NDT/I function during design, testing, and production of the system. Specifically, the NDT/I procedures used were never demonstrated to be effective in detecting flaws in many critical locations and orientations.

B.5.8 DAMAGE TOLERANCE

The damage tolerance capability of the landing gear and backup structure shall be adequate for the service life and usage of 5.5.2.14. Safety of flight and other selected structural components of the airframe shall be capable of maintaining adequate residual strength in the presence of material, manufacturing, and processing defects and damage induced during normal usage and maintenance until the damage is detected through periodic scheduled inspections. All safety of flight structure shall be categorized into one of two categories, either slow crack growth fail-safe. Single load path structure without crack arrest features shall be designated as slow crack growth structure. Structures utilizing multiple load paths and crack arrest features shall be designated as slow crack growth or fail-safe if sufficient performance and life cycle cost advantages are identified to offset the burdens of the appropriate inspectability levels of 5.5.8.2.2 and 5.5.8.2.3. These requirements apply to metallic and nonmetallic structures, including composites, with appropriate distinctions and variations as indicated. Damage tolerance material properties shall be consistent and congruent with those properties of the same material, in the same component, used by the other structure's disciplines. See 5.5.2.16.1. Damage tolerance requirements shall also be applied to the following special structural components:

- a. Gear doors and mechanisms (5.5.3.1, 5.5.3.2, and 5.5.3.3).

- b. Other _____.

REQUIREMENT RATIONALE

U. S. Air Force experience has demonstrated that designing and qualifying a structure for durability is necessary, but not sufficient, to insure the safety of flight of an air vehicle structure. Damage tolerance and verification requirements, as originally defined in MIL-STD-1530 and MIL-A-83444, were established to define minimum damage tolerance capabilities for all safety of flight structure.

REQUIREMENT GUIDANCE

These damage tolerance requirements apply to all safety of flight structure including previously qualified structure that is subjected to different operational usage or structural modification. The requirements of this paragraph and subparagraphs apply to all structural material systems except as noted. Other mission essential structural components are to be included under the damage tolerance requirements if the failure of the component resulting from material, manufacturing, and processing defects or in-service damage would severely impact operational capability. The types of structure that should be considered are weapon and engine pylons, avionics pods, external fuel tanks, landing gear structure, and control surfaces. The inclusion of such components should be a specific program decision.

Multiple load path, fail-safe structure is the preferred structural concept. A durable fail-safe structure provides maximum protection from external damage sources, such as combat or FOD; in addition it provides certain distinct advantages if the requirement for life extension arises.

REQUIREMENT LESSONS LEARNED

Prior to the incorporation of damage tolerance requirements by the Air Force, safety of flight was considered to be adequately assured by strength factors of uncertainty and by scatter factors on fatigue life. As performance requirements increased and technology advanced, the use of higher strength materials at higher stress levels became more prevalent. These high performance structures while approaching the ideal zero margin of safety goal, also resulted in structures that had a zero margin for error in material properties, manufacturing procedures, and inspection capability. A classic example of this situation is the case of the wing pivot fitting on a swing wing fighter. Here the use of a high strength, low toughness steel, resulted in a design that was sensitive to small defects and necessitated an expensive in-service proof test program to maintain safety of flight of the fleet. An air superiority fighter was the first operational aircraft to be designed to the damage tolerance policy established in MIL-A-83444. This application has indicated that, with proper material selection and attention to design detail, the damage tolerance policy can be applied with minimum

weight impact. This policy is now routinely applied at all major airframe companies.

For background on composites, see Composite Structures/Materials Certification Background under Requirement Lessons Learned for 5.5.6.1.

B.5.8.1 FLOW SIZES

The landing gear and backup structure shall have adequate residual strength in the presence of flaws for specified periods of service usage. These flaws shall be assumed to exist initially in the structure as a result of the manufacturing process, normal usage, and maintenance, and after an in-service inspection. The specific flow size requirements are detailed in _____.

REQUIREMENT RATIONALE

The establishment of realistic initial flow size assumptions is necessary to insure that the airframe will have adequate residual strength capability throughout its service life.

REQUIREMENT GUIDANCE

METALLIC STRUCTURES

Tables XII, XIII, and XIV should be referenced in the blank and included in the specification. Additional guidance follows.

Initial flow assumptions. Initial flaws are assumed to exist as a result of material and structure manufacturing and processing operations. Small imperfections equivalent to an .005 inch radius corner flow resulting from these operations are assumed to exist in each hole of each element in the structure and provide the basis for the requirements in paragraphs d, e, and f, below. If the contractor has developed initial quality data on fastener holes (e.g., by fractographic studies, which provides a sound basis for determining equivalent initial flow sizes), these data may be considered and serve as a basis for negotiating a size different than the specified .005 inch radius corner flow. In addition, it is assumed that initial flaws of the size specified in paragraphs a and b can exist in any separate element of the structure. Each element of the structure should be surveyed to determine the most critical location for the assumed initial flaws considering such features as edges, fillets, holes, and other potentially high stressed areas. Only one initial flow in the most critical hole and one initial flow at a location other than a hole need be assumed to exist in any structural element. Interaction between these assumed initial flaws need not be considered. For multiple and adjacent elements; the initial flaws need not be situated at the same location (e.g., chordwise plan in wing structures, except for structural elements where fabrication and assembly operations are conducted such that flaws in two or more elements can exist at the same location). The most common example of such an operation is the assembly drilling of attachment holes. Except as noted in paragraphs d, e, and f, below, more than one source of common

initial cracks need not be assumed along the crack growth path. Initial flow sizes are specified in terms of specific flow shapes, such as through the thickness or corner flaws at holes and semi-elliptical surface flaws or through the thickness flaws at locations other than holes.

Specified initial flow sizes presume the inspection of 100 percent of all fracture critical regions of all structural components as required by the fracture control provisions of 5.5.8.1. This inspection should include as a minimum a close visual inspection of all holes and cutouts, and conventional ultrasonic, penetrant or magnetic particle inspection of the fracture critical regions. Where the use of automatic hole preparation and fastener installation equipment preclude close visual and dimensional inspection of 100 percent of the holes in the fracture critical regions of the structure, a plan to qualify and monitor hole preparation and fastener installation should be prepared and implemented by the contractor. Where special nondestructive inspection procedures have demonstrated a detection capability better than indicated by the flow sizes specified in a, below, and the resulting smaller assumed flow sizes are used in the design of the structure, these special inspection procedures must be used in the aircraft manufacturing quality control. In all situations indicated below, if development test data indicates that more severe flow shapes than assumed are probable, worst case assumptions should prevail.

Smaller initial flow sizes than those specified may be assumed subsequent to a demonstration, described in 5.6.8.1. Smaller initial flow sizes may also be assumed if proof test inspection is used. In this case, the minimum assumed initial flow size shall be the calculated critical size at the proof test stress level and temperature using acquisition activity approved upper bound of the material fracture toughness data.

a. Slow crack growth structure

At holes and cutouts, the assumed initial flow is a .05 inch through the thickness flaw at one side of the hole when the material thickness is equal to or less than .05 inch. For material thicknesses greater than .05 inch, the assumed initial flow is a .05 inch radius corner flow at one side of the hole.

At locations other than holes, the assumed initial flow is through the thickness flaw of .25 inch length when the material thickness is equal to or less than .125 inch. For material thicknesses greater than .125 inch, the assumed initial flow is a semicircular surface flow with a length (2c) equal to .25 inch and a depth (a) equal to .125 inch. Other possible surface flow shapes with the same initial stress intensity factor (K) can be considered as appropriate; for example, corner flaws at edges of structural elements and longer and shallower surface flaws in plates which are subjected to high bending stresses. For welded structure, flaws should be assumed in both the weld and the heat affected zone in the parent material. For embedded defects, the initial flow size assumption should be based on an assessment of the capability of the NDI procedure.

b. Fail safe structure (primary element)

At holes and cutouts the assumed initial flaw is a .05 inch through the thickness flaw at one side of the hole when the material thickness is equal to or less than .05 inch. For material thicknesses greater than .05 inch, the assumed initial flaw is a .05 inch radius corner flaw at one side of the hole.

At locations other than holes, the assumed initial flaw is a through the thickness flaw .25 inch in length when the material thickness is equal to or less than .125 inch. For material thicknesses greater than .125 inch, the assumed initial flaw is a semicircular surface flaw with a length (2c) equal to .25 inch and a depth (a) equal to .125 inch. Other possible surface flaw shapes with the same initial stress intensity factor (K) shall be considered as appropriate. For embedded defects, the initial flaw size assumption should be based on an assessment of the capability of the NDI procedure.

c. Fail safe multi-load path (adjacent structure)

The damage assumed to exist in the adjacent load path at the location of primary failure in fail safe multiple load path structure at the time of failure of a primary load path should be as follows:

- (1) Multiple load path dependent structure. The same as specified in paragraph b, above, plus the amount of growth (+ Δa) which occurs prior to primary load path failure.
- (2) Multiple load path independent structure. The same as paragraph e.(2) plus the amount of growth (+ Δa) which occurs prior to primary load path failure.

d. Fail safe crack arrest structure (adjacent structure)

For structure classified as fail safe crack arrest, the primary damage assumed to exist in the structure following arrest of a rapidly propagating crack depends upon the particular geometry. In conventional skin stringer (or frame) construction, this should be assumed as two panels (bays) of cracked skin plus the broken central stringer (or frame). Where tear straps are provided between stringers (or frames), this damage should be assumed as cracked skin between tear straps plus the broken central stringer (or frame). For other configurations, assume equivalent damage as mutually agreed upon by the contractor and the acquisition activity. The damage assumed to exist in the structure adjacent to the primary damage should be as specified in e.(2) or e.(3), below.

e. Continuing damage

Cyclic growth behavior of assumed initial flaws may be influenced by the particular geometry and arrangement of elements of the structure being qualified. The following assumptions of continuing crack growth should be considered for those cases where the primary crack terminates due to structural discontinuities or element failure.

- (1) When the primary damage and growth originates in a fastener hole and terminates prior to member or element failure, continuing damage should be an .005 inch radius corner flaw plus the amount of growth (Δa) which occurs prior to primary element failure emanating from the diametrically opposite side of the fastener hole at which the initial flaw was assumed to exist.
- (2) When the primary damage terminates due to a member or element failure, the continuing damage should be an .005 inch radius corner flaw in the most critical location of the remaining element or remaining structure or a surface flaw having $2c = .02$ inch and $a = .01$ inch, where, a is measured in the direction of crack growth plus the amount of growth (Δa) which occurs prior to element failure.
- (3) When the crack growth from the assumed initial flaw enters into and terminates at a fastener hole, continuing damage should be an .005 inch radius corner flaw + Δa emanating from the diametrically opposite side of the fastener hole at which the primary damage initiated or terminated, whichever is more critical.

f. In-service inspection flaw assumptions

The smallest damage which is presumed to exist in the structure after completion of a depot or base level inspection should be as follows unless specific NDI procedures have been developed and the detection capability quantified.

- (1) Where NDI techniques such as penetrant, magnetic particle, eddy current, or ultrasonics are applied without component or fastener removal, the minimum assumed flaw size at holes and cutouts should be a through the thickness crack emanating from one side of the hole having a 0.25 inch uncovered length when the material thickness is equal to or less than 0.25 inch. For material thicknesses greater than 0.25 inch, the assumed initial flaw should be a quarter-circular corner crack emanating from one side of the hole having a 0.25 inch uncovered length. The minimum assumed flaw size at locations other than holes should be a through the thickness crack of length 0.50 inch when the material thickness is equal to or less than 0.25 inch. For material thicknesses greater than 0.25 inch, the assumed initial flaw should be a semicircular surface flaw with length (2c) equal to 0.50 inch and depth (a) equal to 0.25 inch. Other possible surface flaw shapes with the same initial stress intensity factor (K) can be considered as appropriate such as corner flaws at edges of structural members and longer and shallower surface flaws in plates which are subjected to high bending stresses. While X-ray inspection may be used to supplement one or more of the other NDI techniques, it by itself, cannot be

considered capable of reliably detecting tight subcritical cracks.

- (2) If the component is to be removed from the aircraft and completely inspected with an NDI technique, the minimum assumed damage is that detectable flaw that the NDI technique can demonstrate with an 90 percent probability and a 95 percent confidence level.
- (3) Where accessibility allows close visual inspection (using visual aid as necessary), an opening through the thickness crack having at least two inches of uncovered length should be the minimum assumed damage size.
- (4) Where accessibility, paint, sealant, or other factors preclude close visual inspection or the use of NDI techniques such as described in (2) above, slow crack growth structure should be considered to be noninspectable and fail safe structure should be considered to be inspectable only for major damage such as a load path failure or arrested unstable crack growth.

g. Fastener policy for damage tolerance

To maximize safety of flight and to minimize the impact of potential manufacturing errors, it should be a goal to achieve compliance with the damage tolerance requirements of this specification without considering the beneficial effects of specific joint design and assembly procedures such as interference fasteners, cold expanded holes, or joint clamp-up. In general, this goal should be considered as a policy but exceptions can be considered on an individual basis. The limits of the beneficial effects to be used in design should be no greater than the benefit derived by assuming a .005 inch radius corner flaw at one side of an as-manufactured, non-expanded hole containing a neat fit fastener in a non-clamped-up joint. A situation that might be considered an exception would be one involving a localized area of the structure involving a small number of fasteners. In any exception, the burden of proof of compliance by analysis, inspection, and test is the responsibility of the contractor.

SPECIAL COMPONENTS

In lieu of more specific data, the flaw size assumptions listed herein are applicable. Generally, individual components can be inspected to a higher level than a large general area and smaller initial flaw size assumptions might be developed.

COMPOSITE STRUCTURES

The composite structure must also be designed to be easily repairable for expected in-service damage. Further, the design usage must be carefully identified. The design missions must be adequately defined such that the potentially damaging high load cases are properly represented.

In addition to the threats described above, the safety of flight structure must be designed to meet other damage threats. These threats are those associated with manufacturing and in-service damage from adverse

usage and battle damage. The initial flaw/damage assumptions are described in table XV for manufacturing initial flaws and in-service damage. The 100 ft-lb of energy required to cause a dent 0.10 inch deep may be reduced if the structure is not exposed to the external impact or maintenance damage threats and the part is thoroughly inspected before closing up. To qualify the structure under this reduced impact energy criteria, the proposed impact energy of _____ shall be approved by the procuring agency and the damage resulting from the impact which will grow to critical sizes in two lifetimes of spectrum loadings shall be detectable by industry standards or special demonstrated NDI techniques. The design development tests to demonstrate that the structure can tolerate these defects for its design life without in-service inspections shall utilize the unclipped upper bound spectrum loading and the environmental conditioning developed for the durability tests. These two lifetime tests must show with high confidence that the flawed structure meets the residual strength requirements in table XVI. These residual strength requirements are the same for the metallic structures except the P_{XX} is not limited to 1.2 times the maximum load in one lifetime. To obtain the desired high confidence in the composite components it is necessary to show that either the growth of the initial flaws arrests and is insignificant, or the damage/flaw will not grow to critical size in two design lifetimes by analysis and the analysis methods could be verified by component testing. As for the durability tests there shall be a program to assess the sensitivity to changes in the baseline design usage spectrum.

OTHER MATERIAL SYSTEMS

While the specifics of the above guidance apply to metallic and composite structures, any structural material system and design approach must comply with the intent of the requirement. Initial flaw size assumptions should be established after an assessment of the design, manufacturing procedures, and inspection method capabilities. Specifically, for organic matrix composites, flaws which are induced in service (foreign object damage, handling damage, etc.) must be considered when the structure is categorized, the degree of inspectability is defined, and the initial flaw size assumptions are established. The size of damage of concern from these low energy impact sources is that size which would not be readily detectable in a routine visual inspection. The impact energy level to be assumed in design for each area of the structure should be that level which produces barely perceptible front face damage in the structure. Because the amount of energy necessary to achieve this level of damage is usually a function of the thickness of the structure, an upper bound energy level cutoff should be established for various zones on the structure dependent on the possible sources of damage. In general, it will be necessary for the contractor to conduct this initial flaw size assessment as part of the contract when the design, manufacturing methods, and inspection techniques are sufficiently defined.

REQUIREMENT LESSONS LEARNED

Two different approaches have been employed in the past to establish initial flaw size assumptions for use in design. In a fighter development, MIL-A-83444 flaw sizes were used in general with exceptions taken at specific locations with NDI demonstrated values. In a bomber development, an extensive NDI capability assessment was performed and smaller than spec size initial flaws were assumed. While both approaches were successful, they both have their advantages and disadvantages, and the technique to be employed should be evaluated on a system by system basis.

B.5.8.2 RESIDUAL STRENGTH AND DAMAGE GROWTH LIMITS

The minimum required residual strength is specified in terms of the internal member load which the airframe must be able to sustain with damage present for the specified period of unrepaired service usage. The magnitude of this load shall be based on the overall degree of inspectability of the structure and is intended to represent the maximum load the internal member might encounter during a specified inspection interval or during a life time for noninspectable structure. This load (P_{XX}) is defined as a function of the specific degree of inspectability in _____.

- a. Airframe loading spectrum. The airframe loading spectrum shall reflect required missions wherein the mission mix and the loads in each mission segment represent service usage. The required residual strength in terms of a maximum load must be greater than the maximum load expected during a given interval between inspections.
- b. Fail-safe structure. For fail-safe structure, a minimum load (P_{YY}) shall be sustained by the remaining structure at the instant of load path failure of the primary member. This load, defined in 5.5.8.2, shall be sustained by the secondary member at any time during the inspection interval defined in 5.5.8.2. The magnitude of this load shall be the product of a dynamic load factor and the internal member load at design limit load whichever is greater. The dynamic factor shall be _____.
- c. Safety of flight structure. All safety of flight structure shall maintain the required residual strength in the presence of damage for a specific period or unrepaired service usage as a function of design concept and degree of inspectability. Periods of unrepaired service usage shall be as defined below.

- (1) Periods of unrepaired service usage are shown in _____.

REQUIREMENT RATIONALE

Residual strength requirements must be established to insure the safety of flight of the structure at every point in time during its service life.

To account for the fact that any individual aircraft may encounter loads considerably in excess of the average during its life, the required residual strength must be equal to or larger than the maximum load expected during a given interval between inspections.

In order to insure the safety of flight of the structure, it must be able to sustain the planned service usage for a period that is longer than required to account for variability in material properties, manufacturing quality, and inspection reliability.

Fail-safe structure must be designed to withstand a specified period of service usage after a primary load path failure. This period of usage depends on the type and frequency of the inspections for the particular structure.

In order to insure that the structure's residual strength is not degraded, with the presence of cracking or a failed member, the structure must withstand a period of service usage longer than the planned inspection interval.

REQUIREMENT GUIDANCE

This requirement applies to all safety of flight structure including doors, and door and ramp mechanisms (see 5.5.3.1) if applicable. Table XVI is to be referenced in the blank and included in the specification.

In order to achieve the goal that the required residual strength must be equal to or larger than the maximum load expected during a given interval between inspections, the inspection interval is magnified. For example, the P_{XX} load for ground evident damage is the maximum load that could be expected once in 100 flights (see Table XVI).

For metallic structure, the minimum acceptable period of unrepaired service usage for slow crack growth structure is two service usage lifetimes i.e., the time for a flaw to propagate to failure from some initial damage must be in excess of two service usage lifetimes. For non-metallic structure, the minimum acceptable period of unrepaired service usage is also two service usage lifetimes. To achieve this requirement, the following criteria should be satisfied for non-metallic structure:

- a. Manufacturing induced flaws: No growth or positive crack arrestment in two service usage lifetimes from the flaw sizes established in 5.5.8.1.
- b. Service induced damage: No growth to failure in two service usage lifetimes from the flaw sizes established in 5.5.8.1.

REQUIREMENT LESSONS LEARNED

The selection of a value for P_{XX} has varying degrees of significance depending on the crack growth rate characteristics of the material, the structural design details, the potential usage variations, and the actual degree of inspectability. All cases which result in P_{XX} being less than design limit load should be carefully evaluated on an individual basis to insure that no undue risk is being incorporated.

- a. Airframe loading spectrum. The airframe loading spectrum shall reflect required missions wherein the mission mix and the loads in each mission segment represent service usage. The required residual strength in terms of a maximum load must be greater than the maximum load expected during a given interval between inspections.
- b. Fail-safe structure. For Fail-safe structure, a minimum load (P_{YY}) shall be sustained by the remaining structure at the instant of load path failure of the primary member. This load, defined in 5.5.8.2, shall be sustained by the secondary member at any time during the inspection interval defined in 5.5.8.2. The magnitude of this load shall be the product of a dynamic factor and the load defined in 5.5.8.2 or the product of a dynamic factor and the internal member load at design limit load whichever is greater. The dynamic factor shall be _____.
- c. Safety of flight structure. All safety of flight structure shall maintain the required residual strength in the presence of damage for a specific period of unrepaired service usage as a function of design concept and degree of inspectability. Periods of unrepaired service usage shall be specified below. For pressurized portions of the structure, the minimum required residual strength shall be based on a factor times the most negative and the most positive pressure differential attainable with normal cabin pressure system operation including expected external aerodynamic pressures and the effects of adverse tolerances combined with the appropriate required residual strength flight and landing loads.
 - (1) Periods of unrepaired service usage are shown in _____.
 - (2) The pressure differential factor is _____.

Because of variations in material properties, manufacturing processes, and usage, a margin on the inspection interval is required to minimize risk. Inspection should be conducted at one-half of the calculated minimum period of safe unrepaired service usage (i.e., the safety limit) for situations where structural disassembly is required for a number of reasons:

- a. Inspection reliability is improved because two inspections are performed at or prior to the safety limit.
- b. Some flexibility can be allowed when the inspection intervals from various locations in the structure are combined into a practical maintenance plan.
- c. The possibility of damaging the structure during disassembly is kept to a minimum.

B.5.8.2.1 SLOW CRACK GROWTH STRUCTURE

The initial damage as defined in 5.5.8.1, which can be presumed to exist in the structure as manufactured, shall not grow to a critical size and cause failure of the structure due to the application of the maximum internal member load in two lifetimes of the service life and usage of 5.5.2.14 as modified by 5.5.8.2.

REQUIREMENT RATIONALE

In order to insure the safety of flight of the structure, it must be able to sustain the planned service usage for a period that is longer than required to account for variability in material properties, manufacturing quality, and inspection reliability.

REQUIREMENT GUIDANCE

For metallic structure, the minimum acceptable period of unrepaired service usage for slow crack growth structure is two service usage lifetimes, i.e., the time for a flaw to propagate to failure from some initial damage must be in excess of two service usage lifetimes. For non-metallic structure, the minimum acceptable period of unrepaired service usage is also two service usage lifetimes. To achieve this requirement, the following criteria should be satisfied for non-metallic structure:

- a. Manufacturing induced flaws: No growth or positive crack arrestment in two service usage lifetimes from the flaw sizes established in 5.5.8.1.
- b. Service induced damage: No growth to failure in two service usage lifetimes from the flaw sizes established in 5.5.8.1.

REQUIREMENT LESSONS LEARNED

None.

B.5.8.2.2 FAIL-SAFE MULTIPLE LOAD PATH STRUCTURE

The degrees of inspectability for fail-safe multiple load path structure are in-flight evident, ground evident, walk-around, special visual, and depot/base level inspectable. The frequency of inspection for each of these inspectability levels shall be as below.

- a. Initial inspection interval. The initial inspection interval and residual strength requirements are a

function of the degree of inspectability of the primary element and shall be as shown in _____.

- b. Subsequent inspection intervals. The subsequent inspection intervals and residual strength requirements are also based on the degree of inspectability of the primary element and shall be as shown in _____.

REQUIREMENT RATIONALE

Fail-safe structure must be designed to withstand a specified period of service usage after a primary load path failure. This period of usage depends on the type and frequency of the inspections for the particular structure.

REQUIREMENT GUIDANCE

Specific guidance for various levels of inspectability is contained in the subsequent subparagraph. The definition of the correct level of inspectability for each structural element is extremely important and it must take into consideration such factors as accessibility, the influence of paint or other coatings, and the loading on the structure when the inspection is performed. Doors and door and ramp mechanisms should be qualified under this category (see 5.5.3.1) when applicable.

REQUIREMENT LESSONS LEARNED

There are currently no aircraft in the U. S. Air Force inventory which have been designed and qualified as fail-safe multiple load path structure under Air Force criteria. However, selected components of three aircraft are being managed as fail-safe structure as a result of durability and damage tolerance assessments.

B.5.8.2.3 FAIL-SAFE CRACK ARREST STRUCTURE

The degrees of inspectability applicable to fail-safe crack arrest structure are the same as for fail-safe multiple load path structures defined in 5.5.8.2.2.

- a. Initial inspection interval. The initial inspection interval and residual strength requirements are dependent on the particular geometry and the degree of inspectability and shall be as shown in _____.
- b. Subsequent inspection intervals. The subsequent intervals and residual strength requirements are also based on the degree of inspectability of the primary damage and shall be as shown in _____.

REQUIREMENT RATIONALE

Fail-safe crack arrest structure must be able to withstand a specified period of service usage after a primary load path failure. This period of usage

depends on the type and frequency of the inspections for the particular structure.

REQUIREMENT GUIDANCE

Specific guidance for the various levels of inspectability is contained in subsequent subparagraphs.

Reference table XVII in the blank and include the table in the specification. The type and extent of the primary damage is a function of the particular geometry and is defined in 5.5.8.1 under initial flaw sizes for fail-safe crack arrest structures. Residual strength requirements are as indicated in 5.5.8.2.

The initial inspection interval should not be greater than one half of the time to primary damage (see below) plus one half of the remaining time to failure of the adjacent structure from the flaw size specified in 5.5.8.1 for adjacent structure at the time of primary damage in fail-safe crack arrest structure. The time to primary damage is determined by assuming an initial flow (the same flow size as is specified in 5.5.8.1 for the primary element in fail-safe structure) in the critical element in the primary damage area. The individual flaws in other elements of the primary damage area with the sizes specified in 5.5.8.1 for fail-safe multiple load path adjacent structure are allowed to propagate to element failure until all elements of the primary damage area have failed. Load redistribution effects as each element fails must be taken into account in the growth of the flaws in the remaining elements.

Reference table XVIII in the blank and include the table in the specification.

REQUIREMENT LESSONS LEARNED

There are currently no aircraft in the U. S. Air Force inventory which have been qualified as fail-safe crack arrest structure under U. S. Air Force criteria.

B.5.9 DURABILITY AND DAMAGE TOLERANCE CONTROL

A durability and damage tolerance control process shall be developed and maintained to ensure that maintenance and fatigue/fracture critical parts meet the requirements of 5.5.7 and 5.5.8.

REQUIREMENT RATIONALE

The process shall identify and define all of the tasks necessary to ensure compliance with the durability and damage tolerance requirement.

REQUIREMENT GUIDANCE

The disciplines of fracture mechanics, fatigue, materials selection and processes, environmental protection, corrosion prevention and control, design, manufacturing, quality control, and nondestructive inspection are involved in damage tolerance and

durability control. The MIL-STD-1568 or equivalent documents should be used as a guide in the development of corrosion prevention and control process.

The durability and damage tolerance control process should include as a minimum the following tasks:

- a. A disciplined procedure for durability design should be implemented to minimize the possibility of incorporating adverse residual stresses, local design details, materials, processing, and fabrication practices into the problems (i.e., to find these problems which otherwise have historically been found during durability testing or early in service usage).
- b. Basic data (i.e., initial quality distribution, fatigue allowables, K_{IC} , K_C , K_{ISCC} , da/dn , etc.) utilized in the initial trade studies and the final design and analyses should be obtained from existing sources or developed as part of the contract.
- c. A criteria for identifying and tracing maintenance critical parts should be established by the contractor and should require approval by the procuring agency. It is envisioned that maintenance critical parts will be expensive, non-economical-to-replace parts. A maintenance critical parts list should be established by the contractor and should be kept current as the design of the airframe progresses.
- d. A criteria for identifying and tracing fatigue/fracture critical parts should be established by the contractor and should require approval by the procuring agency. It is envisioned that fatigue/fracture critical parts will be expensive or safety of flight structural parts. A fatigue/fracture critical parts list should be established by the contractor and should be kept current as the design of the airframe progresses.
- e. Design drawings for the maintenance critical parts and fatigue/fracture critical parts should identify critical locations, special processing (e.g., shot peenings), and inspection requirements.
- f. Material procurement and manufacturing process specifications should be developed and updated as necessary to ensure that initial quality and fracture toughness properties of the critical parts exceed the design value.
- g. Experimental determination sufficient to estimate initial quality by microscopic or fractographic examination should be required for those structural areas where cracks occur during full scale durability testing. The findings should be used in the full scale test data interpretation and evaluation task as specified in 5.6.6.11 and, as appropriate, in the development of the force structural maintenance plan as specified in 5.6.6.14.

- h. Durability analyses, damage tolerance analyses, development testing, and full scale testing should be performed in accordance with this specification.
- i. Complete nondestructive inspection requirements, process control requirements, and quality control requirements for maintenance, fatigue/fracture critical parts should be established by the contractor and should require approval by the procuring agency. MIL-I-6870 should be used as a guide in the development of Nondestructive Inspection procedures. This task should include the proposed plan for certifying and monitoring subcontractor, vendor, and supplier controls.
- j. The durability and damage tolerance control process should include any special nondestructive inspection demonstration programs conducted in accordance with the requirements of this specification.
- k. Traceability requirements should be defined and imposed by the contractor on those fatigue and fracture critical parts that receive prime contractor or subcontractor in-house processing and fabrication operations which could degrade the design material properties.
- l. For all fracture critical parts that are designed for a degree of inspectability other than in-service non-inspectable, the contractor should define the necessary inspection procedures for field use for each appropriate degree of inspectability as specified in the specification.

The durability and damage tolerance control process is similar to what is normally accomplished in most companies during system development and manufacturing. It does, however, represent a significantly more rigorous application of controls and a directed interdisciplinary effort among the company's functional organizations. To accomplish this task, a Durability and Damage Tolerance Control Board or Team should be established to oversee the control process. The control process should establish the criteria for critical part selection and the control of the critical parts. The selection of critical parts starts as system design requirements are translated into a design and analyses are accomplished. Trade studies are performed to determine the most cost effective, lowest weight design. After a design is finalized, durability, fatigue/fracture critical parts are chosen, according to a set of predetermined criteria. Additional design trade studies may result in parts being added to or deleted from the critical parts list. Critical parts can also be selected by engineering judgment. These parts, although not critical according to predetermined criteria, may be deemed critical because of economic consequences of failure (e.g., expensive to repair or replace), or by the aircraft not being mission capable, etc. Those parts that do not make the list are subject to normal controls.

REQUIREMENT LESSONS LEARNED

Without proper durability and damage tolerance control process, the structural integrity cannot be maintained and the cost/weight within the performance requirements cannot be achieved. The control process should be coordinated with all the disciplines and the parts selected for control should be passed through detailed critical parts selection process. The same control process should be implemented in the supply vendors.

B.5.10 SENSITIVITY ANALYSIS

In service landing gear and backup structural life and life cycle cost shall not be significantly degraded by small variations in weight, maneuverability, usage, and _____.

REQUIREMENT RATIONALE

In-service airframe structural life can be significantly degraded by small variations in design parameters such as weight, maneuverability, etc. A sensitivity analysis is performed to evaluate the effects of variations of these design parameters on airframe structural life and its impact on life cycle cost.

REQUIREMENT GUIDANCE

The sensitivity analysis task encompasses those efforts required to apply the existing theoretical, experimental, applied research, and operational experience to specific criteria for materials selection and structural design for the airplane. The objective is to ensure that the appropriate criteria and planned usage are applied to an airplane design so that the specific operational requirements will be met. This task begins as early as possible in the conceptual phase and is finalized in subsequent phases of the airplane life cycle. The analysis should document the impact of variations of design parameters such as: a 10% increase in mission weight, a 5% increase in spectrum severity, etc on structural service life, testing requirements, and operational life cycle cost.

REQUIREMENT LESSONS LEARNED

Sensitivity analysis can provide valuable information for the Program Office to make program decisions. The results will provide the justification of the selection of robust design vs. marginal design and the consequence of the design selection.

B.5.11 FORCE MANAGEMENT

Force management will be applied to the landing gear and backup structure during operational use and maintenance of the air vehicle. A data acquisition system is required that collects, stores, and processes

data which can be used to support the force management systems/ program.

REQUIREMENT RATIONALE

Developing an airframe with adequate strength, rigidity, durability, and damage tolerance and maintaining these qualities depends on knowledge of individual operational usage. The Force Management program utilizes flight and landing usage data collected from the operation aircraft to determine cumulative fatigue damage, estimate fatigue life remaining, update structural maintenance and modification schedules, and provide design criteria for future aircraft modifications and replacement aircraft acquisition programs. Actual aircraft usage has historically varied substantially from development missions and mixes. Airborne flight data recorders (FDR) are needed to record individual aircraft usage and substantiate changes in operational mission usage. Airborne flight data recorders and the force management program are necessary to maximize the service life available based on each aircraft's individual usage, minimize impacts to operational readiness and structurally related maintenance costs and ensure acceptable levels of structural flight safety throughout the service life of the aircraft. Airborne flight data recorders are essential to ensure the successful life management of fleet airframe resources. Early involvement will help ensure a workable program.

REQUIREMENT GUIDANCE

Force management consists of collecting, storing, processing, and disseminating operational usage data throughout an aircraft's service life. The development of a force management system/program requires integration of airborne hardware and software, ground support hardware and software, and a fatigue life analysis or a crack growth analyses methodology and software with the aircraft structural development program. The contractor is normally responsible for development of the force management system/program, but it is to be developed jointly by the contractor and the procuring activity. A parallel engine management program should be integrated with the force management program to the extent compatible with the engine monitoring requirements. Additional information with respect to the airborne data acquisition system, ground/data handling and data processing can be found in AFFDL-TR-78-183, AFWAL-TR-81-3079, and ASD-TR-82-5012.

REQUIREMENT LESSONS LEARNED

None.

B.5.11.1 DATA ACQUISITION SYSTEM PROVISIONS

The data acquisition system shall be capable of recording operational usage data and shall be compatible with the airframe and all air vehicle systems when installed and used. The system shall

interface with air vehicle systems and record the required data within required accuracies.

- a. The data acquisition system shall meet the requirements of _____.
- b. The data acquisition system shall be installed in _____.
- c. Ground/Data Handling _____.

REQUIREMENT RATIONALE

In order to monitor aircraft operational usage and flight/landing parameters, record structurally significant loading events, and derive loads environment and stress spectra (L/ESS), an airborne flight data recorder (FDR) is required.

Aircraft must be instrumented with data acquisition system equipment to obtain individual aircraft operational usage and loading data.

As a system, the airborne data acquisition hardware is virtually useless unless recorded data can be successfully downloaded and transferred to the procuring activities central processing facility and subsequently processed to generate fatigue or crack growth life values for individual aircraft. The contractor must give proper consideration and significant thought to design/interface/integration details with the ground based support equipment to be used by the procuring activity to download/transfer recorded data or to the design/interface/integration of the software/hardware to be used to convert this recorded data into fatigue damage or crack growth life values.

REQUIREMENT GUIDANCE

This blank should be filled by reference to plans and specifications for FDR hardware, new or to-be-developed, and the documentation needed to integrate new or existing FDR equipment into fleet aircraft. In addition, the contractor should also reference specifications and other documentation to describe how the FDR hardware and the data it records interfaces with the ground support equipment, maintenance concepts, and data processing facilities of the procuring activity.

The FDR should continuously monitor appropriate flight parameters and strains, and record significant damaging loading events necessary to determine the nominal strain history at each fatigue critical location. The following system capabilities should be considered when designing/selecting the airborne data acquisition system:

- a. The system should measure, record, and store vertical accelerations, airspeed, altitude, fuel weight, total gross weight, real event time, and other aircraft parameters necessary to reconstruct that aircraft's usage history on a flight-by-flight basis.

- b. The system should be able to accept in-coming signals from other aircraft systems which measure appropriate flight parameters, but should measure the parameter independently if it is not otherwise available. For instance, if pressure altitude readings are required but are not available from another aircraft system, the FDR hardware should include the capability to measure this parameter independently.
- c. The system should be capable of sampling the various aircraft parameter input signals at a rate, determined through analysis, such that the peak values of each signal can be recorded. All system sensors should have a range of measurement sufficient to cover the aircraft's complete flight envelope.
- d. The system should be capable of identifying the real-time sequence, vice relative time sequence, of all recorded data using either an internal real-time clock or any other real-time clock signal from other aircraft systems.
- e. The system should have a memory of sufficient size to store all of the FDR recorded aircraft parameters and usage events such that transfer of the data from the airborne FDR hardware will not need to occur more frequently than once per month.
- f. The system should have a self-diagnostic capability and a method of indicating system failures or malfunctions which would require a maintenance action.
- g. The system should store recorded data in non-volatile memory such that there are no system power requirements to maintain previously recorded usage data in the FDR memory while that aircraft is not flying.
- h. The FDR should have the capability to measure direct strain readings for use in calculating fatigue damage, crack growth, or verifying structural response to changes in aircraft configuration, flight control systems, missions, or weights. Strain sensors should also be capable of recording unanticipated structural responses.
- i. Strain sensor locations should be chosen in uniform or low-gradient strain fields which remain elastic under all load conditions up to 115% of limit load. Locations should also be chosen considering the accessibility of an area for routine sensor inspection and replacement, and should be protected from the normal service environment. Strain sensors should have a back-up sensor at all chosen sensor locations. The FDR system should indicate in the recorded data which strain sensor, primary or back-up, is operating at each sensor location. Each strain sensor location, primary and back-up, should have a reference output level defined by a full-scale test and verified by a flight demonstration program. The sensor should be mounted on a structural component or member such that the slope of the strain to load relationship for each

sensor can be calibrated on the ground using simple testing procedures or in-flight using a reliable calibration flight maneuver.

- j. The FDR system should be automated as much as possible with consideration given to multifunction capability, i.e., the same recording system could serve the structural recording and engine monitoring functions. Programmable, microprocessor computers with solid state memory should be given particular consideration. Historically, microprocessor based systems require less maintenance and data reformatting than the previously used magnetic tape or mechanical recorders.

The use of flight logs and other data gathering techniques may be applicable and should be included in the requirements as necessary.

All fleet aircraft must be instrumented with data acquisition system equipment to obtain individual aircraft operational usage and loading data. The flight loads test aircraft must be instrumented to allow correlation of the loads and stresses derived from the airborne recorded parameters to those recorded during flight tests. Analysis methods and computer programs must be developed to record the initial and later phase of operational environment. In addition, all other flight test aircraft must be instrumented so that structural damage accumulated during air vehicle test and demonstration can be accounted for. The data acquisition system selected to accomplish the loads/environment spectra survey (L/ESS) task should be capable to capture at least 50% of the flight operational data before downloading.

This blank should be filled by reference to plans and specifications for ground support equipment to be used to download and transfer usage data recorded by the airborne data acquisition system. In addition, the contractor should also reference specifications and other documentation (including structural analysis methods and reports, ground test reports, and flight test reports) to describe how the data recorded is converted from engineering units to local strain history and subsequently calculated cumulative fatigue damage or crack growth at each critical structural location.

The contractor should provide the functional description of aircraft ground support equipment required to download the data recorded by the airborne acquisition system, diagnose airborne acquisition system maintenance requirements and reconfigure airborne acquisition systems, as appropriate. The contractor should provide the functional description of any pre-processing requirements of the ground support equipment including procedures for merging flight log data (e.g. logbook hours, number/type of landings, mission use codes, etc.) with the recorded aircraft flight usage data. The contractor should describe step-by-step procedures to download usage data, diagnose airborne system health and reconfigure, as applicable, the airborne system for a specific aircraft installation.

The contractor should provide reference plans and documentation for the data processing procedures and analysis methods necessary to (1) determine the amount of missing or invalid aircraft usage data and replace/substitute for data gaps, (2) convert recorded aircraft usage data to local strains/stresses at each critical location, (3) perform a "rain flow count" of the resulting variations of local stress/strain, and (4) compute and accumulate the fatigue damage or crack growth caused by each stress/strain cycle extracted by the rain flow. The fatigue analysis methods should be based on a local strain approach. For structures subject to random loadings, and where localized plasticity occurs at the critical location, the method selected should account for sequence effects and their impact on changing local residual stresses and the final damage computed. The analysis method should be correlated to the full scale and/or component fatigue/damage tolerance test such that lives calculated at critical locations correspond to test results/experience.

REQUIREMENT LESSONS LEARNED

Some current FDR systems record or transfer usage data on magnetic tape. This requires extensive ground processing of data such as reformatting, transcribing, and data compression before useful engineering data can be analyzed. Also, this system is subject to extensive delays in equipment maintenance because of the delays in processing data tapes. Other FDR programs using programmable, solid state microprocessors have eliminated the inherent problems with tape drive mechanisms. These microprocessor based systems have been used to perform multiple functions/duties (i.e. record structural usage, engine health/usage, and avionics performance data with data compression).

Strain sensors, although providing direct measurement and retention of an aircraft's local strain history, do require periodic maintenance as a result of sensor failures, mechanical damage, or environmental degradation. Strain sensors are also sensitive to location/alignment and there are also times where a "single sensor solution" for the structurally critical area is not always practical. The use of aircraft flight parameters and advanced regression analysis tools, such as neural networks, can yield local strain history results with the same accuracy as direct strain measurements. There are at least two significant advantages to the multiparameter recorder vice strain sensor recorder: (1) generally improved data recovery since several channels of the multiple parameter data would have to be lost before data reconstruction becomes unreliable; however, if the strain data is lost, most information needed to determine the local area strain history is lost and (2) if the critical structural areas change or if new tracking locations are added through service experience, all previously recorded/stored flight usage data can be reused to assess damage in these local areas; however, the strain data recorded/stored for discrete locations is generally valid only for the areas local to the strain sensor.

The sooner operational/maintenance personnel can determine airborne recorder faults/failures, suitable repairs can be completed and a minimal amount of aircraft usage data will be lost due to a non-functioning recorder; therefore, comprehensive system and sensor self-initiated tests have proven invaluable.

The airborne data acquisition system must be specified in the original production contract for the aircraft system. If considered as a post-production retrofit effort, the resulting engineering change proposal could significantly increase the installation costs to account for engineering, integration, and logistics impacts. In addition, because post-production retrofit of airborne data acquisition hardware is viewed as an impact to cost, weight, and delivery schedule of the new aircraft without directly enhancing the performance or operational capability of the air vehicle, gaining program management approval for these engineering changes has been marginally successful.

Data transfer using readily available, compact and reliable electronic media (such as 3 1/2" diskettes) have improved data recovery rates. In addition, the data stored in this medium can be copied to a local workstation for use by an analyst and, using other contractor or government developed software, convert the raw FDR data into engineering units, derive key information from the downloaded data (maximum N_z or 'g', total recorded flight time, etc.) and estimate damage or crack growth accumulated for the incremental flight data recorded. As aircraft life management continues to grow in importance, tools and routine procedures will be required which provide aircraft custodians the ability to review recorded data and perform service life analyses at the aircraft base of operations. Developing these tools as part of the overall force management program will provide the most accurate and streamlined processes for fleet operations to use.

For several Navy fighter and attack aircraft programs, supplemental flight hour, mission, and landing usage data must be gathered and merged with the data recorded by the FDR during the downloading process. Current data acquisition systems record only relative time vice real time, making the effort of matching aircraft flight log information with the recorded usage data time consuming or sometimes impossible. Recent experience with recording the real time of the loading events has greatly improved the ease and accuracy of merging this supplemental data, which is also date/time cataloged.

For many Air Force and Navy aircraft, updating the methodology for life tracking has occurred at least once in the aircraft's lifetime. Regenerating individual aircraft spectra for rebaselining an aircraft's cumulative damage using new tracking algorithms is both time-consuming and expensive. The capability to generate and store the actual sequence of nominal strains for each aircraft for each tracking location on a monthly basis would minimize recalculation efforts.

B.5.12 PRODUCTION FACILITIES, CAPABILITIES, AND PROCESSES

The manufacturing system shall have the facilities, capabilities, processes, and process controls to provide products of consistent quality that meet performance requirements. Key production processes shall have the stability, capability, and process controls to maintain key product characteristics within design tolerances and allowables.

REQUIREMENT RATIONALE

To minimize production risk, to maintain design tolerances during the manufacturing process, and to control product cost and quality in production, it is essential to identify, quantify, qualify, and control key production processes. This requirement is intended to ensure the contractor applies the same discipline and effort to the qualifications of the production processes as previously done for performance of primary mission equipment. By identifying and qualifying key production processes up front, production will be smoother and subsequent process improvement efforts can be directed to control cost and quality.

REQUIREMENT GUIDANCE

None.

REQUIREMENT LESSONS LEARNED

History is replete with development programs which have experienced severe problems in production. Under past practices, development was primarily oriented to the demonstration of product performance with little attention to the ability to consistently and predictably produce the required product characteristics in a cost effective manner. In many cases, the product designs were completed and then turned over to manufacturing who attempted to optimize the production implementation within existing plant capabilities. Little or no effort had been made during development to address producibility as part of the design process. In addition, process control is not a norm within the current aerospace industry. In many cases, therefore, process capability is not known, let alone matched to product requirements. Mismatches between design limits and process capabilities are discovered too late - in real time under the pressure of delivery schedules. Resulting design or process changes are generally sub-optimal.

B.5.13 ENGINEERING DATA REQUIREMENTS

Engineering data for all studies, analyses, and testing generated in accordance with the performance and verification requirements for loads, strength, rigidity, vibroacoustics, corrosion prevention and control, materials and processes selection, application and characterization, durability and damage tolerance, force management, and all other requirements of this specification (as identified) shall be documented. All data bases used to establish, assess, and support

inspections, maintenance activities, repairs, modification tasks, and replacement actions for the life of the landing gear system and backup structure shall be documented. Engineering data shall be consistent with and supportive of all milestones identified in the verification matrix activities identified in 5.6.

REQUIREMENT RATIONALE

Engineering data must be documented, preserved, and available for use in establishing design requirements, assessing compliance with performance, and verification of requirements, and to manage, support, and maintain the aircraft throughout its life.

REQUIREMENT GUIDANCE

The effectiveness of any military force depends in part on the operational readiness of weapon systems. One major item of an aircraft system affecting its operational readiness is the condition of the airframe structure. To establish the adequacy of the design to meet operational and support requirements, the capability of the airframe structure must be established, characterized, and documented. Establishing these characteristics and thereby implementing a successful Aircraft Structural Integrity Program requires the production, compilation, and documentation of engineering data used in assessing compliance with structural performance requirements.

Such engineering data is necessary to:

- a. Establish, evaluate, and substantiate the overall structural integrity (strength, rigidity, damage tolerance and durability, producibility, and supportability) of the airframe structure.
- b. Acquire, evaluate, and utilize operational usage data to provide a continual assessment of the in-service integrity of individual aircraft.
- c. Provide a basis for determining and implementing tasks associated with logistics and force planning requirements (maintenance, inspections, supplies, rotation of aircraft, deployment, retirement, and future force structure.)
- d. Provide a basis for continuous improvement of structural criteria, design methods, evaluation, and substantiation of future aircraft.

The process of identifying, using, and preserving engineering data for use in establishing, evaluating, and substantiating compliance with performance and verification requirements for the airframe structure is well defined in the five tasks outlined in MIL-HDBK-1530. These five tasks should be considered in developing the specific engineering data requirements for the airframe.

REQUIREMENT LESSONS LEARNED

None.

B.6 VERIFICATION

The verification methodologies and the incremental process for completing the verification shall be identified in this section. The incremental verification shall be consistent with the expectations for design maturity expected at key decision points in the program. Table ____ provides a cross-reference between the requirements and the associated method and timing of the verification. This table is used to identify and verify that all requirements have an associated verification and expected level of verification for the key decision points.

VERIFICATION RATIONALE

None.

VERIFICATION GUIDANCE

A Structural Verification Matrix should be tailored to the specific program key decision points and proposed incremental verification.

VERIFICATION LESSONS LEARNED

None.

B.6.1 DETAILED STRUCTURAL DESIGN REQUIREMENTS

The adequacy of the detailed structural design contained in this specification shall be verified by the review of the documentation provided to substantiate the adequacy of the requirements. The landing gear and backup structure shall be shown capable of achieving these requirements by applicable inspections, demonstrations, analyses, and tests. All verifications shall be the responsibility of the contractor; the Government reserves the right to witness or conduct any verification.

VERIFICATION RATIONALE

The ability of the specified structural design requirements to adequately meet the operational and maintenance needs must be demonstrated to ensure that these needs will be met. This verification is achieved by reviewing the documentation that substantiates the selection of each specific design requirement to ensure that the requirement meets the program needs, reflects successful past experience, and has been updated to reflect new design approaches, new materials, etc.

VERIFICATION GUIDANCE

The statement of the requirement alone is generally not sufficient to substantiate its adequacy. This substantiation is accomplished by the accompanying information which shows the adequacy of the

requirement through comparisons with existing designs, through the results of design trade studies and analyses, and through the results of developmental tests.

VERIFICATION LESSONS LEARNED

Durability and damage tolerance assessment programs have been accomplished on operational aircraft that were designed prior to 1970. In many cases documentation of analyses and tests performed during design and development were either not available or inadequate for the durability and damage tolerance assessment. In these cases the analyses and tests were repeated or expanded at considerable cost.

The importance of adequate documentation of design and verification analyses and tests cannot be over emphasized

B.6.1.2 DETERMINISTIC DESIGN CRITERIA

The detailed structural design criteria shall reflect all of the requirements of this specification and those derived from operational, maintenance, engineering, and test needs. This criteria shall be verified by the review of the documentation provided to substantiate the adequacy of the criteria.

VERIFICATION RATIONALE

The ability of the structural design criteria to enable the airframe to meet the structural design requirements must be verified. This verification is achieved by reviewing the documentation that substantiates the selection of each specific design criterion to ensure that the design requirements are being met, that the criterion reflects past experience and lessons learned, and that the criterion has been modified to address circumstances outside the historical data base.

VERIFICATION GUIDANCE

The substantiation of the applicability of the structural design criteria to the particular aircraft being designed is accomplished by documenting that each criterion is supported by applicable past experience, appropriate analyses and trade studies, or design development tests. As each criterion is being selected, the overall structural design philosophy embodied by the criterion as well as the specific numeric values contained in the criterion must be reviewed to determine if it will meet the applicable structural design requirements. Special attention should be given to the selection of criteria which will be used in circumstances outside the historical data base. These circumstances include new design approaches, new materials, new fabrication methods, unusual aircraft configurations, unusual usage, and new aircraft maintenance methods.

VERIFICATION LESSONS LEARNED

None.

B.6.1.3 PROBABILITY OF DETRIMENTAL DEFORMATION AND STRUCTURAL FAILURE (___)

The combined load-strength probability analyses shall be verified by the review of the documentation of the analyses and the review of supporting tests.

VERIFICATION RATIONALE

The airframe must be demonstrated to have an acceptable risk of failure when historically based design approaches, fabrication methods, air vehicle usage, etc., are not used. This verification is achieved by reviewing the documentation of the probability analyses and the supporting test results.

VERIFICATION GUIDANCE

The ability of the airframe to maintain an acceptable risk of structural failure when historically proven methods are not used can be demonstrated through the conduct of appropriate probability analyses and supporting tests. The documentation of these analyses and tests is the primary means of verifying the adequacy of the design of the airframe.

If combined load-strength probability analyses are not used, insert N/A (not applicable) in the first blank.

VERIFICATION LESSONS LEARNED

None.

B.6.1.4 STRUCTURAL INTEGRITY

The requirements of 5.5.1.3 shall be met by analysis, inspection, demonstration and test.

B.6.1.4.1 PARTS CLASSIFICATION

The requirements of 5.5.1.3.1 shall be met by analysis, documentation, inspection.

B.6.1.4.2 FATIGUE/FRACTURE CRITICAL PARTS

The requirements of 5.5.1.3.2 shall be met by analysis, documentation, inspection, and test.

B.6.1.4.3 MAINTENANCE CRITICAL PARTS

The requirements of 5.5.1.3.3 shall be met by analysis, documentation, and inspection.

B.6.1.4.4 MISSION CRITICAL PARTS

The requirements of 5.5.1.3.4 shall be met by examination, analysis, documentation, and inspection.

B.6.1.4.5 FATIGUE/FRACTURE CRITICAL TRACEABLE PARTS

The requirement of 5.5.1.3.5 shall be met by analysis, documentation, and inspection.

**VERIFICATION RATIONALE
(5.6.1.3 through 5.6.1.3.5)**

None.

**VERIFICATION GUIDANCE
(5.6.1.3 through 5.6.1.3.5)**

None.

**VERIFICATION LESSONS LEARNED
(5.6.1.3 through 5.6.1.3.5)**

None.

B.6.2 GENERAL PARAMETERS

Analyses, tests, and inspections shall be in compliance with the following subparagraphs to show that the landing gear and backup structure meets the operational and maintenance capabilities required in 5.5.2.

VERIFICATION RATIONALE

These verification tasks are needed to show that the airframe does in fact perform as required and possesses sufficient structural integrity to perform as required, as often as required.

VERIFICATION GUIDANCE

Many of the general parameter requirements can be verified by those inspections, analyses, and tests needed to verify that the discipline requirements have been met. Integrated verification tasks that can verify several requirements at once are to be encouraged.

VERIFICATION LESSONS LEARNED

None.

B.6.2.1 AIRFRAME CONFIGURATIONS

Contractor selected and acquisition agency approved configurations shall be verified during tests.

VERIFICATION RATIONALE

Verification that all required configurations can be achieved is needed to confirm that the air vehicle will be able to perform as intended.

VERIFICATION GUIDANCE

Most configurations can be verified by inspection, for example, external store configurations. Some configurations may need to be verified by test measurements, for example, flap deflections or wing sweep positions on sweep wing airplanes.

VERIFICATION LESSONS LEARNED

None.

B.6.2.2 EQUIPMENT(____)

The analyses, tests, and inspections required by this specification shall be sufficient to show that the airframe adequately supports and reacts to all of the loads and motions of the equipment defined in 5.5.2.2.

VERIFICATION RATIONALE

Verification of the airframe ability to react all loads and motion is necessary to ensure that the operational mission needs can be achieved by the air vehicle.

VERIFICATION GUIDANCE

Verification will be by load and strength analyses supported by ground and flight test.

VERIFICATION LESSONS LEARNED

None.

B.6.2.3 PAYLOADS (____)

The analyses, tests, and inspections required by this specification shall be sufficient to show that the airframe has the ability to support and react to all of the loads and motions of the payload defined in 5.5.2.3.

VERIFICATION RATIONALE

Verification of the airframe's payload carrying capability is needed to assure that the operational mission needs can be achieved by the air vehicle.

VERIFICATION GUIDANCE

The capability of the airframe to carry the required payload must be determined and verified. Load and strength analyses are supported by ground and flight tests to ensure that the airframe has the required capability.

VERIFICATION LESSONS LEARNED

None.

B.6.2.4 WEIGHT DISTRIBUTIONS

Weight distributions shall be verified by analyses. The following weight distributions shall also be verified by test: _____.

VERIFICATION RATIONALE

Verification of the weight distributions is needed to assure that errors do not invalidate flight or ground performance established for the vehicle, for example, external loads, which rely on the weight distributions of the air vehicle being established and actually known.

VERIFICATION GUIDANCE

Weight distributions can be established using analytical techniques. These numbers can normally be used with confidence. Weightings, ground vibration tests, and tests run to determine moments of inertia can be used to verify weight distributions. Insert in the blank those weight distributions to be verified by test.

VERIFICATION LESSONS LEARNED

None.

B.6.2.5 WEIGHTS

The weight shall be assessed throughout the development program and validated by actual weighing.

VERIFICATION RATIONALE

Verification of the analytical weight values by weighing is needed to confirm that this parameter (weight) is as expected because it so greatly influences the structural capability of the airframe.

VERIFICATION GUIDANCE

Verification shall be a continuing task through all phases of the program (estimated, calculated, and actual). Pieces and parts shall be verified by calculation as drawings are released and actual weighing when parts are available. Each aircraft will be weighed in a completely assembled and dry condition in accordance with MIL-W-25140. Corrections and analysis will be performed to verify each of the weights in this paragraph and the specifications. "Manufacturing Variation" shall be investigated to ascertain the cause and to control the aircraft mass properties.

VERIFICATION LESSONS LEARNED

None.

B.6.2.6 THE CENTER OF GRAVITY

The center of gravity position of the weights in 5.5.2.5 shall be verified by actual weighing of an empty aircraft, fuel calibration, and analysis.

VERIFICATION RATIONALE

Determination of the applicable center of gravities analytically is needed to establish the aircraft's characteristics, including flight characteristics, performance, etc., as well as the airframe structural characteristics. However, these analytical values of center of gravities may or may not represent the actual hardware. Actual weightings of selected weight configurations are needed to verify the center of gravity values or to indicate where discrepancies exist so that the analytical results can be corrected to agree with actual measurements.

VERIFICATION GUIDANCE

Identify and list those weights of 5.5.2.5 and the applicable center of gravities of weight distributions of 5.5.2.4 which are to be verified by actual weightings. The weights and weight distributions selected for verification of center of gravity positions should be included among those required in 5.6.2.5 so as to be cost effective.

VERIFICATION LESSONS LEARNED

Limiting actual weighing of aircraft to the empty weight configuration has proven satisfactory on a large number of transport aircraft. Actual weightings and inertia measurements of external stores and internal payloads to be used in development flight test is recommended as these test stores and payloads have proven in the past to be unrepresentative of operationally configured stores and payloads.

B.6.2.6.1 LATERAL CENTER OF GRAVITY POSITION

The lateral center of gravity position of the weights in 5.5.2.5 shall be verified by actual weighing of an empty aircraft, fuel calibration, and analysis.

VERIFICATION RATIONALE

None.

VERIFICATION GUIDANCE

None.

VERIFICATION LESSONS LEARNED

None.

B.6.2.7 SPEEDS

The speeds of 5.5.2.7 shall be shown to be attainable by the air vehicle by analyses and tests. The following speeds shall be shown to be attainable by the air vehicle by the indicated analyses/tests:
_____.

VERIFICATION RATIONALE

Not all speeds are critical and may be verified by an appropriate analysis, however, the speeds most significant to the structural integrity of airframe, particularly the high speeds, need to be verified by test.

VERIFICATION GUIDANCE

Identify and list those speeds of 5.5.2.7 which are to be verified by analyses, those to be verified by tests, and those to be verified by both analyses and tests.

VERIFICATION LESSONS LEARNED

None.

B.6.2.8 ALTITUDES

The altitudes of 5.5.2.8 shall be demonstrated to be attainable by the air vehicle by analyses and tests. The following altitudes shall be shown to be attainable by the air vehicle by the indicated analyses/tests:
_____.

VERIFICATION RATIONALE

While maneuvering flight may not be attainable at all desired altitudes by the flight test vehicles, engine changes may be incorporated in the future that will make it possible.

VERIFICATION GUIDANCE

Identify and list those altitudes of 5.5.2.8 which are to be verified by analyses, those to be verified by tests, and those to be verified by both analyses and tests.

VERIFICATION LESSONS LEARNED

None.

B.6.2.9 FLIGHT LOADS FACTORS

The flight load factors of 5.5.2.9 shall be demonstrated to be attainable by the air vehicle by analyses and tests.

VERIFICATION RATIONALE

This requirement verifies that the operational maneuver capability of the airframe exists. The performance and structural integrity of the airframe

must be verified and shown capable of performing the maneuvers to the required load factors.

VERIFICATION GUIDANCE

The load factors 5.5.2.9 are to be demonstrated to be attainable by analyses and tests.

VERIFICATION LESSONS LEARNED

None.

B.6.2.10 LAND-BASED AND SHIP-BASED AIRCRAFT GROUND LOADING PARAMETERS

The air vehicle shall be shown capable of takeoff, landing, and operating under the conditions and parameters of 5.5.2.10 and 5.5.4.2 by analyses and tests.

VERIFICATION RATIONALE

Verification that the airframe can achieve the required ground loading parameter of 5.5.2.10 is needed to assure that the air vehicle can satisfactorily operate on the ground.

VERIFICATION GUIDANCE

The ground loading parameters of 5.5.2.10 reflect required operational capability of the air vehicle. The capability of the airframe will be developed by other technical disciplines such as loads, strength, durability and damage tolerance, handling qualities, performance, etc. Most of the verification of these parameters can be achieved by coupling their verification with applicable verification requirements specified for other technical disciplines.

VERIFICATION LESSONS LEARNED

None.

B.6.2.11 LIMIT LOADS

The limit loads shall be verified by inspection of strength analyses and tests.

VERIFICATION RATIONALE

Limit loads are loads to be expected in service. These loads must be verified to assure that the airframe usefulness is not degraded and limited during operational use of the air vehicle.

VERIFICATION GUIDANCE

Each limit load or combination of limit loads is to be verified. These loads are to be verified analytically early in the program to provide as much confidence as practical that the verification testing will not uncover problems.

VERIFICATION LESSONS LEARNED

None.

B.6.2.12 ULTIMATE LOADS

The ultimate loads shall be verified by inspection of strength analyses and tests.

VERIFICATION RATIONALE

Verification of the ultimate loads is needed to assure that the static tests which are performed on the airframe, in fact verify the correct ultimate strength capability required of the airframe.

VERIFICATION GUIDANCE

Ultimate loads reflect the strength needed in the airframe.

VERIFICATION LESSONS LEARNED

None.

B.6.2.13 DEFORMATIONS

That the air vehicle meets the deformation requirements of 5.5.2.13 shall be verified by analyses and tests.

VERIFICATION RATIONALE

Verification that the deformation requirements are met is most important from an operational viewpoint, since binding, jamming, buckling, and other deformation induced degradation of operational capability is aggravated by wear and other aging factors which affect structural deformations.

VERIFICATION GUIDANCE

Deformation requirements can be verified by analyses and tests, however, in very complex structures, emphasis should be placed on verifying these requirements by testing.

VERIFICATION LESSONS LEARNED

None.

B.6.2.14 SERVICE LIFE AND USAGE

The airframe structures service life and usage capability required by 5.5.2.14 shall be verified by analyses and tests. The requirement of 5.5.2.14.5 shall be verified by analysis.

VERIFICATION RATIONALE

Each airframe structure responds to its service life and usage in a unique way which must be identified and verified. If not verified, potentially severe service problems can arise, unperceived by the user, which impact the operational readiness of the air vehicle.

VERIFICATION GUIDANCE

The information, data, and parameter values established in response to 5.5.2.14 requirements are applicable to all of the disciplines and must be validated by all functional areas such as airframe, engine, subsystem, logistics, etc.

VERIFICATION LESSONS LEARNED

None.

B.6.2.15 CHEMICAL, THERMAL, AND CLIMATIC ENVIRONMENTS

Analyses and tests shall verify that the complete airframe can operate in the environment of 5.5.2.15.

VERIFICATION RATIONALE

Verification that the airframe can withstand the operational environment requirements is needed to assure that the air vehicle has the required operational capability.

VERIFICATION GUIDANCE

Verification that the air vehicle can operate satisfactorily in the required environments is a formidable task if one tries to perform all of the verification tests in real world environments. Most verification testing of this type is done under controlled laboratory conditions and the results extended to the real world operational conditions. MIL-STD-810 can be used as a source of guidance for environmental testing.

Accelerated laboratory tests can be a valuable tool for screening materials for use in a corrosive environment. However, for the results of such tests to have any validity, there must be evidence that a correlation exists with results in the actual environment of interest. The only way to obtain such correlation is by conducting exposure tests in the natural environment. Before attempting to simulate the natural environment, that environment should be characterized as to pH, ions present, temperature, and so forth. A monitor to assess corrosivity, or at least determine times of wetness and dryness, would be useful. When an environment keeps changing as it does on an aircraft carrier, depending on its theater of operation and the time of year, the test should be designed to simulate the most severe condition. It is therefore important to be aware that such variations exist. The cyclic sodium chloride-sulphur dioxide test in accordance with ASTM G85.A4.

VERIFICATION LESSONS LEARNED

Based on "Developing an Accelerated Test: Problems and Pitfalls," (Laboratory Corrosion Tests and Standards, ASTM STP 866, ASTM, Philadelphia, 1985, pp 14 - 23) the cyclic sodium chloride-sulphur dioxide test in accordance with ASTM G85.A4 gave the best correlation with the carrier environment.

B.6.2.16 MATERIALS AND PROCESSES

Inspections, analyses, and tests shall verify that the materials and processes selected are in compliance with the requirements of 5.5.2.16. The following requirements also apply:

- a. Materials and processes development and characterization and the selection process must be documented. Second source materials (when established as a program requirement) must be qualified and demonstrated through testing to have equivalent performance and fabrication characteristics as the selected baseline material.
- b. Materials and processes characteristics for critical parts (see definitions in 6.1.23) shall Comply with the requirements of the parts control processes as specified in 5.5.9.
- c. Environmental compliance with all applicable environmental statutes and laws for all materials systems and processes selected must be verified. This shall include life cycle management of hazardous materials.

VERIFICATION RATIONALE

Verification that the materials and processes requirements of 5.5.2.16 are met is needed to assure that the operational capability of the air vehicle is adequate and sufficient for all required missions and service usage.

VERIFICATION GUIDANCE

Adequacy of materials and processes can best be verified by a combination of analyses, inspection and ground tests. Applicable sections of MIL-STD-1568 and MIL-STD-1587 provide guidance for addressing materials/processes and corrosion verification requirements and should be deviated from only with appropriate supporting engineering justification. Specific additional guidance is provided as follows:

Design development testing. Materials and processes considered for application in the weapon system should be subjected to rigorous evaluation in a well defined and documented design development test program. The principle objectives of such testing are to establish material system performance in the defined operational environments; identify, characterize, and optimize associated stable processes; verify methods used in the evaluation of materials, and establish design. Design properties (in the appropriate chemical, thermal, and climatic environments) must be

established during development testing to support transition and application of the material systems and processes into the weapon system.

Building block process. Design development test programs for the characterization of materials and processes typically employ a building block approach consisting of a sequence of coupon, element, and subcomponent tests. Properly implemented, building block tests provide a process for acquiring test data to establish that the material systems and processes will meet the life cycle performance requirements of the weapon system. The following definitions for the building block test specimens are provided:

Coupons are test specimens of a specific product form and condition subjected to appropriate mechanical and environmental testing in sufficient quantities and in accordance with accepted test methods to establish statistically reliable data on performance. As is often the case, material and product form processes are not fully defined for the material system under evaluation during early coupon testing; ultimately however, final properties established through coupon testing accurately represent manufacturing conditions experienced in a production environment.

Elements are test specimens representative of singular and significant design details of the structural concept under consideration. Elements are subjected to more complex combinations of mechanical loading (as might be experienced in detail parts) in the appropriate environments. Element tests provide additional empirical data on the material system as it may be affected by geometric, product form, and mechanical loading combination affects otherwise not explored in simple coupon testing.

Subcomponent testing encompasses the last significant block of testing (prior to component and full-scale testing) providing useful material system performance data. Material property data is very difficult to extract in testing at the component and full-scale level because of the interaction of complex loads, geometries, and test methods that are not easily or precisely discernible in post-test analysis. Typical subcomponent test articles might include a combination of two or more elements subjected to representative mechanical and environmental loading. Subcomponent test results provide insight into overall structural integrity, inspection requirements and limitations, manufacturing concepts, and maintenance and repair issues.

Anomalies in the performance of the material system and associated processes that appear during the above building block process must be evaluated and addressed by a combination of repeated testing (at the appropriate coupon, element, and/or subcomponent levels) and analysis prior to pursuing the transition of the material system and/or process into the structural design under consideration. Properly implemented, the design development test program will yield the necessary data to establish that material system and associated processes meet generally accepted criteria for transition into a structural design. These criteria

include: stabilized material and/or material processes, demonstrated producibility, fully characterized mechanical properties and design allowables, predictability of structural performance and supportability. Refer to a paper entitled "Structural Technology Transition to New Aircraft", Dr. John W. Lincoln, ASC/ENFS, as well as other documents identified in Section 20 of this handbook for additional guidance.

Second source for materials and processes. When industrial base or program requirements dictate a second source for a material system or process, second source equivalency should be established based on demonstrated and documented capability for process compliance and control. Material system and/or process equivalency should also be determined through appropriate mechanical, chemical, environmental, and nondestructive testing/inspection.

- a. Hazardous Materials Management Program Plan. The contractor should plan, develop, implement, monitor, and maintain an effective Hazardous Materials Management Program in accordance with National Aerospace Standard 411. The purpose of this program is to eliminate or reduce (where elimination is not feasible) hazardous and environmentally unacceptable materials. The primary emphasis shall be on eliminating or reducing those hazardous materials and processes that are used or generated during the operation and support of the aircraft. The secondary emphasis shall be on eliminating or reducing those hazardous materials and processes that must ultimately be disposed of when the aircraft has reached the end of its life cycle. The documentation should address how the contractor's Hazardous Materials Management Program will reduce the environmental impact of the systems operations, maintenance, repair, demilitarization, and disposal requirements during systems definition, design, engineering development, production, and deployment phases, which are consistent with the design life of the system. Information that should be considered for inclusion in a description of a pollution prevention process includes:
 - b. Identify methods and procedures for meeting pollution prevention requirements.
 - c. The methodology for identification of hazardous materials, processes, and waste; including justification for use/substitution and associated cost/benefit analysis.
 - d. Identify the process for ensuring that all vendors, suppliers, and subcontractors provide all necessary information to meet Hazardous Materials Management Program requirements.
 - e. Identification of the methodologies for above to be executed including the role of a joint contractor/government Environmental Process Action Team.

Hazardous Materials Management Program Progress. Progress in the prime contractor's hazardous materials

management process should be tracked through periodic reporting (reference NAS 411 for guidance). The following information should be provided:

- a. Overview of the process, participants, objectives, and accomplishments.
- b. Pollution prevention initiatives and status/performance against pre-established criteria.
- c. Assessment of new/proposed regulatory initiatives (if applicable).
- d. A hazardous materials, processes, and waste list with justification for use.
- e. Vendors, suppliers, and subcontractor progress/issues.
- f. Identification of regulatory permits required by the government for the operation and support of the aircraft at the government location.
- g. Trade-off study results/progress.

Demilitarization and Disposal Plan. The contractor should prepare a Demilitarization and Disposal Plan in accordance with DODINST 5000.2, DOD 4160.21-M-1 (Defense Demilitarization Manual), and NAVAIRINST 4500.11 (Policy and Procedures for Aircraft, Aircraft Engines, and Related Aeronautical Items Reclamation and Disposal Program).

VERIFICATION LESSONS LEARNED

None.

B.6.2.16.1 MATERIALS

The materials used in the landing gear and backup structure and their properties shall be validated by inspections, analyses, and tests to verify that they are in compliance with the requirements of 5.5.2.16.1. Standardized test methods used to establish metallic and composite material systems properties shall be used when available. When such standardized methods are not available, a program shall be undertaken to explore and develop standardized test methods. All test methods used in establishing material system performance shall be documented and submitted for the procuring activity review.

VERIFICATION RATIONALE

The early characterization and selection of materials helps keep the weight and cost of the airframe down while meeting operational and maintenance performance requirements.

VERIFICATION GUIDANCE

Materials Systems Testing Data. MIL-HDBK-5 provides uniform data for metallic materials/components and minimizes the necessity of referring to numerous materials handbooks and bulletins to obtain the allowable stresses and other related properties of materials and structural elements.

MIL-HDBK-17 provides data on polymeric composite material systems in a three volume document addressing guidelines for characterization and statistically based mechanical property data.

Materials development and evaluation. Documentation of techniques to be used for process optimization, monitoring, and control should be provided. In addition to process capability, materials should also be quantitatively assessed for risk based on the following criteria: production experience, production capacity, maturity of design allowables, inspectability, availability of sources, and suitability of alternate candidates.

Material substantiating data and analysis. Testing and analysis should be planned and documented to ensure that new or modified materials and processes are characterized in a statistically significant manner relative to the design application, as well as to demonstrate compliance with the requirements herein. The scheduling of characterization testing and analysis should also be documented and specifically related, consistent with a building block approach, to critical path milestones such as first article and test article(s) fabrication, as well as subsequent component qualification test(s).

Material substantiating data and analysis. Documentation of the results of material/process characterization testing and analysis should be provided.

Critical parts first article test. Documentation of the results of first article tests durability and damage tolerant critical parts should be provided. Documentation should include detailed contractor/subcontractor process operation sheets representative of first article manufacture. Differences between processing of the first article and subsequent qualification test article(s) (as fully representative of production) should be specifically identified and substantiated through additional analysis and/or test, and the results provided.

The materials to be used in each of the structural components need to be identified as early in the program as practical. Proper selections of material properties may be verified within the strength analyses, which typically call out the allowables and references.

VERIFICATION LESSONS LEARNED

None.

B.6.2.16.2 PROCESSES

The processes and joining methods applied to the materials used in the landing gear and backup structure shall be validated by inspections, analyses, and tests to verify that they are in compliance with the requirements of 5.5.2.16.2.

VERIFICATION RATIONALE

The verification of structural material processes and joining methods is needed to ensure that structural integrity is attained and maintained in the airframe components.

VERIFICATION GUIDANCE

The verification of the adequacy of structural processes can be accomplished by checking applicable specifications, conducting appropriate inspections, reviewing applicable analyses, and checking the results of tests.

Casting drawings, as well as the structural description report and the strength analysis reports, shall adequately call out the casting specifications. It is conventional to inspect all castings in accordance with MIL-STD-2175. It is also conventional to strength test to destruction the least acceptable castings. These tests also typically verify that the calculated margins of safety, using "S" property values of MIL-HDBK-5, are not less than specified in 3.2.19.2.e.

Forging drawings, as well as a structural description report and the strength analysis reports, can adequately call out the forging specifications. The quality inspection and test guidelines contained within MIL-STD-1587 and AFSC DH 1-7 should be adhered to.

The verification of desired grain directions can be achieved by inspection of drawing notes and parts for compliance with the requirements of 5.5.2.16.2. Drawings, where applicable, shall indicate and note grain directions. After the forging technique (including degree of working) is established, section and etch the first production forgings to show the grain flow structure.

Composite process verification. Composite manufacturing development and production requires sufficient process verification testing to ensure that engineering design values are maintained. Primary, significant secondary, or process critical composite laminates should undergo destructive test and evaluation to validate critical characteristics such as degree of cure, presence of microcracks, fiber waviness, interlaminar shear strength, porosity, etc. Primary or significant secondary structure should have selected composite process verification elements representative of the critical aircraft structure fabricated from the same material, cured under the same cure cycle parameters, and when possible, on the same tool and as part of the part they represent. Where the size and configuration of the process verification element permits, a structural test coupon simulating the critical failure mode of the structure should be conducted. Otherwise, mechanical verification tests best suited to verify the process should be conducted. Additionally, primary or significant secondary composite part should have at least one representative glass transition (T_g) temperature measurement to verify the degree of cure in the worst case location. Process verification test

results should be confirmed with predicted results or results generated from destructive test and evaluation of critical composite structure. The composite structures process verification tests should be provided. A composite process verification plan should be provided.

First part process verification. All primary, significant secondary or process critical composite laminates should undergo destructive test and evaluation. Tests should include nondestructive inspection, dimensional measurements, photomicrographic test analysis of process sensitive areas, glass transition temperature measurement of potential areas of under and over cure, and mechanical tests of local specimens to ensure that resin and fiber/resin dominant design properties are developed during cure. These tests should validate the composite laminating and curing process, as well as, ensure that producibility and process verification is accounted for in design. Composite first part process verification should incorporate the following criteria:

- a. Selection of destructive test articles: One each of the primary composite parts should be destructively tested. Each part should be of the same configuration as EMD/production parts and be produced using the same tooling and procedures. If significant design modifications, tooling changes or changes in fabrication processes/procedures are made, additional articles should be destructively tested to verify the change for each part affected. The following exceptions apply:

- (1) If it can be demonstrated that the left and right hand parts are mirror images (identical details, layups, tooling, and fabrication procedures), then either a left or right hand article will satisfy the requirements for both parts.
- (2) Discrepant parts may be used if part discrepancies are considered to be sufficiently minor as to not interfere with the evaluation. Parts with large areas of delaminations, porosity or other defects indicating a major process anomaly should not be used.

- b. Scheduling of destructive tests: Although it is preferred that destructive testing be conducted on the first part fabricated, any one of the first five parts may be selected for destructive testing with the following restrictions:

- (1) No more than five of each type of part may be produced prior to completion of destructive testing and evaluation.
- (2) No assembly of composite primary structural elements may be performed prior to the completion of the destructive test and evaluation of those parts, unless the structure can be easily disassembled.

The plan should describe those efforts to verify manufacturing and assembly processes as well as tooling concepts.

Statistical Process Control (SPC) for Composites. Composite processing should pay strict attention to process control to ensure the full development of engineering properties. Materials allowables development must accurately model actual manufacturing conditions including layup, cutting, drilling, machining, and curing. SPC should ensure process optimization and control through in-process monitoring and recording. SPC should take into account all process variables which influence the final composite product including receiving inspection, handling, environmental controls, dimensional controls, processing, machining, etc. The plan to establish SPC for composites should be developed and provided.

Fluid Resistance/Durability of Composites. A detailed fluid resistance/durability test program should be conducted and documented to include a description of fluid resistance and weathering characteristics for exposure conditions and measurement of mechanical and physical properties and diffusion characteristics.

Shot peening. Parts that are designed with the intent to employ the fatigue benefits of shot peening must validate the reliability of this process through AMS 2432A. In addition to the development of internal procedures, this specification required continuous, built-in classification systems on shot peening machinery to remove broken particles in the process, specific Almen intensity verification locations to be shown on the drawing, computer monitoring of shot flow, movement of part and movement of peening shot stream. Each of these parameters must be continuously monitored by computer with automatic shutdown should any of the prescribed fall out of tolerance.

VERIFICATION LESSONS LEARNED

None.

B.6.2.17 FINISHES

Analyses and tests shall verify that the landing gear and backup structure finishes are in compliance with the requirements of 5.5.2.17.

VERIFICATION RATIONALE

Verification that the finishes meet the requirements of 5.5.2.17 needs to be accomplished to assure that the operational capability of the air vehicle is adequate and not degraded because of finish breakdowns and failures.

VERIFICATION GUIDANCE

Finishes can be verified as meeting the requirements of 5.5.2.17 by laboratory, ground, and flight testing. Compatibility of the finishes with the material underneath may be accomplished by empirical analysis and inspections derived from previous experience with the finish and material underneath. A

finish specification should be prepared using MIL-F-7179 and MIL-S-5002 as a source of guidance.

VERIFICATION LESSONS LEARNED

None.

B.6.2.18 NON-STRUCTURAL COATINGS, FILMS, AND LAYERS

Analyses and tests shall verify that the landing gear system and backup structure non-structural coatings are in compliance with the requirements of 5.5.2.18. Inspection and repair methods for the coatings, films, and layers shall be provided. Further, methods of nondestructive inspection shall be provided for inspecting the structure behind or beneath the coatings, films, and layers for cracks, failures, damage, corrosion, and other structural integrity anomalies. In particular, if the inspections of 5.6.11.1.2.2.d and 5.6.12.1 are applicable to the structure behind or beneath the coatings, films, and layers, the coatings, films, and layers shall not preclude or impede the performance of the durability and damage tolerance inspections. If the coatings, films or layers are attached by adhesive bonding, a positive bond control system shall be used to minimize the probability of occurrence of a very-low- strength bond and adequate In-process controls during fabrication and final non- destructive inspection techniques shall be established to minimize the probability of bond failure.

VERIFICATION RATIONALE

Verification that the non-structural coatings and films meet the requirements of 5.5.2.18 is needed to assure that the required operational capability of the air vehicle is not degraded during its service life.

VERIFICATION GUIDANCE

The demonstration that the coating does not degrade structural integrity should show that the coating will not cause stress corrosion cracking or accelerated corrosion of structural members.

If no degradation of engine performance is acceptable, the demonstration should address the probability that fragments of the coating may enter the engine and the performance of the engine with such ingested fragments. The demonstration of durability of the coating should begin with chemical stability of the coating material (and its attaching adhesive if applicable) and compatibility with liquid chemicals associated with USAF aircraft.

Resistance to degradation over the temperature and humidity ranges expected on the aircraft should be addressed next.

Ability to withstand the mechanical environment is the final demonstration, including impact, abrasion, vibration, air loads, and structural deformations.

Materials and processes for repairing should demonstrate the same capabilities.

The demonstration of integrity of adhesive bonds will usually consist of process control records and nondestructive inspection for delaminations. In exceptional cases where separation of the coating must be absolutely precluded for every installed coating, the verification should include a proof load test of some kind. Low test loads can be developed by vacuum cups or pressure sensitive adhesive tape. More elaborate procedures would be needed to prove high bond strength of an installed coating.

VERIFICATION LESSONS LEARNED

None.

B.6.2.19 SYSTEM FAILURES

Analyses and tests shall verify that the landing gear and backup structure complies with the failure requirements of 5.5.2.19.

VERIFICATION RATIONALE

Verification of the adequacy of the airframe to withstand successfully system failures of 5.5.2.19 is needed to assure that adequate structural integrity exists in the airframe, particularly for expected failures, so that safety of the crew and recovery of the air vehicle is optimized.

VERIFICATION GUIDANCE

Verify as many system failures by analysis and laboratory tests as practical to reduce the risk of damage to the air vehicle and crew. Some system failures may occur during other ground and flight tests and can be used as applicable verification if adequate and sufficient information is also available to document the occurrence and hence the validation.

VERIFICATION LESSONS LEARNED

None.

B.6.2.20 LIGHTNING STRIKES AND ELECTROSTATIC DISCHARGE

Analyses and tests shall verify that the landing gear and backup structure complies with the lightning strike requirements of 5.5.2.20.

- a. Lightning protection (____) Analyses and tests shall verify that the landing gear and backup structure complies with the lightning protection requirements of 5.5.2.20.1.
- b. Electrostatic charge control (____) Analyses and tests shall verify that the landing gear and backup structure complies with the electrostatic charge control requirements of 5.5.2.20.2.

VERIFICATION RATIONALE

Verification is needed of the capability of the airframe and its components to withstand lightning strikes without jeopardizing the air vehicle's performance of its mission or requiring unscheduled maintenance time to repair damage.

Verification is needed to demonstrate that any precipitation static or electrostatic charge buildup on the structural components of the air vehicle is safely dissipated.

VERIFICATION GUIDANCE

The analysis and tests must be adequate for the type of structure, metallic, composite, or a combination and reflect state of the art techniques of adequate confidence in the design. Full scale testing may be required to prove certain components (and hence the airframe) meet the requirements of 5.5.2.20. MIL-STD-1795 contains details on what type of requirement demonstration is considered adequate. MIL-STD-1757 contains lightning test techniques that may be used in verifying the design of the structural components. These requirements replace the previous lightning requirements specified in MIL-B-5087.

The analyses and tests must be adequate for the type of structural material being used. In most cases verification that the surface resistivity is within approved design limits will be adequate demonstration that this requirement has been met. In other cases, laboratory and flight tests may be needed.

VERIFICATION LESSONS LEARNED

Lightning testing may not be required if previous test data is available and applicable. For example, 0.080 inch of painted aluminum structure has been shown by test to be sufficient to prevent puncture by lightning. However, testing may be necessary to show that the component material thickness equals or exceeds the required thickness. Comparable data for composite structures is not available. Most new composite structural materials and joints require testing. Testing is also required if different manufacturing techniques are used such as different types of fasteners on structural joints.

Some amount of testing is usually required. For instance, the fasteners used in joints have a significant impact on the capability of the joints to conduct the lightning currents. Different companies use different fasteners and installation techniques, therefore, previous test data from one contractor may not be directly applicable to the design of another contractor.

For all structural components this verification must be done during structural component buildup to verify that all components are adequately bonded electrically to each other. After manufacturing is completed, access to some components may not be easily obtained to verify the requirement has been met.

Designers and structural engineers must maintain an awareness of this electrostatic charge control requirement. For example, a structural component was changed from aluminum to fiberglass and experienced electrostatic charge build up in flight, resulting in electrical shock to ground personnel. This material change was made without consideration of the potential for electrostatic charge build up and without an awareness of the impact on the user that resulted in a very expensive modification.

B.6.2.21 FOREIGN OBJECT DAMAGE (FOD) ()

Analyses shall be used to verify that the landing gear and backup structure complies with the foreign object damage requirements of 5.5.2.21. Testing shall be required as appropriate.

VERIFICATION RATIONALE

Verification of the adequacy of the airframe to withstand foreign object impingement is necessary to assure that the air vehicle performance will not be degraded or that unacceptable unscheduled maintenance down-time does not arise when impacts with foreign objects do occur.

VERIFICATION GUIDANCE

None.

VERIFICATION LESSONS LEARNED

None.

B.6.2.22 PRODUCIBILITY

It must be demonstrated that manufacturing is an integral part of the design process. Producibility demonstrations are required for new or unproven design, construction, or manufacturing concepts to minimize the production risk. Maintainability should be a factor in structural design trade studies.

VERIFICATION RATIONALE

None.

VERIFICATION GUIDANCE

None.

VERIFICATION LESSONS LEARNED

None.

B.6.2.23 MAINTAINABILITY

It must be demonstrated that maintainability is an integral part of the design process. Maintainability demonstrations are required for new or unproven

designs, construction, or material systems to minimize the maintenance risk. Maintainability should be a factor in structural design trade studies.

VERIFICATION RATIONALE

None.

VERIFICATION GUIDANCE

None.

VERIFICATION LESSONS LEARNED

None.

B.6.2.24 SUPPORTABILITY

It must be demonstrated that supportability is an integral part of the design process. Supportability demonstrations are required for new or unproven designs, construction, or material systems to minimize the supportability risk. Supportability should be a factor in structural design trade studies.

VERIFICATION RATIONALE

None.

VERIFICATION GUIDANCE

None.

VERIFICATION LESSONS LEARNED

None.

B.6.2.25 REPAIRABILITY

It must be demonstrated that repairability is an integral part of the design process. Structural repair manuals are required by the user to maintain and support the landing gear and backup structure. Repairability demonstrations are required for new or unproven designs, construction, or material systems to minimize the support risk. Items subject to wear must be able to accommodate refurbishment or repairs such as oversize bushings or fasteners. Repairability should be a factor in structural design trade studies.

VERIFICATION RATIONALE

None.

VERIFICATION GUIDANCE

None.

VERIFICATION LESSONS LEARNED

None.

B.6.2.26 REPLACEABILITY/INTERCHANGEABILITY

Interfaces must be identified and controlled on replaceable and/or interchangeable parts. Interchangeable parts must be documented and interchangeability verified by demonstration. The impact on replaceability/interchangeability must be evaluated as a factor in structural design trade studies.

VERIFICATION RATIONALE

None.

VERIFICATION GUIDANCE

None.

VERIFICATION LESSONS LEARNED

None.

B.6.2.27 COST EFFECTIVE DESIGN

The landing gear and backup structure should be designed to cost using allocated cost requirements from higher level specifications. Design trade studies should be made against these allocated costs or a reallocation of costs considering acquisition cost and life cycle cost. A stable design and process is required to minimize the cost assessment risk.

VERIFICATION RATIONALE

None.

VERIFICATION GUIDANCE

None.

VERIFICATION LESSONS LEARNED

None.

B.6.3 SPECIFIC DESIGN AND CONSTRUCTION PARAMETERS

Inspections, analyses, and tests as noted below shall verify that the landing gear and backup structure complies with the design and construction requirements of 5.5.3.

VERIFICATION RATIONALE

These verification tasks are needed to show that the selected hardware components do in fact perform as required and possess sufficient structural integrity to perform as required as often as required.

VERIFICATION GUIDANCE

Deciding which requirements are to be verified by analyses and which ones are to be verified by tests or

both must be accomplished with care. Showing by test that the airframe can satisfactorily withstand the occurrences of all potential and likely failures from which recovery is expected could be very expensive, hence the verification would probably be primarily by analyses. Similarly, not verifying the capability of the arresting hook by test could also be very expensive and testing probably would be the primary means of verification. Each verification task needs to be determined and established on the merits of the requirements.

VERIFICATION LESSONS LEARNED

None.

B.6.3.1 DOORS AND PANELS (___)

Preliminary and final drawings shall contain sufficient detail to show that all doors are fully useable for all applicable operational and maintenance conditions in compliance with the requirements of 5.5.3.1. Tests shall show compliance with the clearance requirements of 5.5.3.1. Damage tolerance analyses and tests shall verify that the damage tolerance requirements of 5.5.3.1 are met.

VERIFICATION RATIONALE

Verification that all doors and panels perform as required by 5.5.3.1 is needed to show that the air vehicle can perform its operational missions and maintenance objectives as intended.

VERIFICATION GUIDANCE

None.

VERIFICATION LESSONS LEARNED

None.

B.6.3.1.3 ACCESS DOORS AND COMPONENTS (___)

Analyses and tests shall verify that access doors and components meet the requirements of 5.5.3.1.1.

VERIFICATION RATIONALE

Verification that all access doors and components perform as required by 5.5.3.1.1 is needed to ensure that the air vehicle can safely perform its operational missions as intended.

VERIFICATION GUIDANCE

None.

VERIFICATION LESSONS LEARNED

None.

B.6.3.2 TAIL BUMPER (___)

Analyses and tests shall verify that the tail bumper has the capability to perform as required by 5.5.3.2.

VERIFICATION RATIONALE

Verification that the tail bumper performs as required by 5.5.3.2 is needed to show that the air vehicle will not be damaged by conditions of 5.5.3.2 capability, up to which the tail bumper must be able to satisfactorily perform.

VERIFICATION GUIDANCE

None.

VERIFICATION LESSONS LEARNED

During normal carrier operations, aircraft with aft c.g. tip back angles of less than 20° have exhibited unacceptable ship compatibility.

B.6.3.3 TAIL HOOK (___)

Dynamic analyses shall show that the tail hook will function as required by 5.5.3.3. Tests shall verify that the tail hook will engage the arrestment cable, perform as required, and meet the requirements of 5.5.3.3.

VERIFICATION RATIONALE

Verification that the tail hook can arrest the air vehicle satisfactorily per the requirements of 5.5.3.3 is needed to minimize the potential of damage to the air vehicle during emergency landings and short field landings where the use of an available arresting barrier is desired by the user.

VERIFICATION GUIDANCE

For carrier based aircraft, the arresting hook verification test requirements are per paragraph 5.5.20, Carrier suitability demonstration tests, and table 6 of MIL-D-8708B plus the requirements of BIS (Board of Inspection and Survey).

VERIFICATION LESSONS LEARNED

None.

B.6.3.4 DESIGN PROVISIONS FOR SHIP-BASED SUITABILITY (___)

B.6.3.4.1 LANDING GEAR SHIP-BASED SUITABILITY REQUIREMENTS (___)

Barricade requirements shall be demonstrated by test. Otherwise requirements shall be verified through the design review process early in the engineering development process.

VERIFICATION RATIONALE

Retrofit of the above requirements would be very costly and schedule disruptive. The design requirements in 5.5.3.4.1 must be addressed during early aircraft configuration studies.

VERIFICATION GUIDANCE

Testing shall be in accordance with MIL-D-8708.

VERIFICATION LESSONS LEARNED

None.

**B.6.3.4.2 REPEATABLE RELEASE
HOLDBACK BAR (___)**

Analyses and tests shall verify that the repeatable release holdback bar has the capability to perform as required by 5.5.3.4.2.

VERIFICATION RATIONALE

Because of safety of flight, this component of the aircraft system will be both laboratory ground tested and verified by numerous carrier suitability compliance tests. In addition, a statistical test will be performed on each release bar to verify its minimum release compliance level.

VERIFICATION GUIDANCE

Carrier suitability tests shall be performed in accordance with MIL-D-8708B.

VERIFICATION LESSONS LEARNED

None.

**B.6.3.4.3 OTHER DESIGN AND
CONSTRUCTION PARAMETERS
(___)**

Analyses, inspections, and tests shall verify that the requirements of 5.5.3.4.3 are met.

VERIFICATION RATIONALE

Verification of other design and construction parameter requirements is needed to assure that these added requirements are met and that the operational use of the air vehicle is not degraded or maintenance requirements increased.

VERIFICATION GUIDANCE

Other specific design and construction parameters, conditions, and situations must be identified and listed in the same way and sequence as in 5.5.3.4.3. Required analyses and tests are to be defined for each specific design and construction requirement.

VERIFICATION LESSONS LEARNED

See Requirement Lessons Learned under 5.5.3.4.3 which is applicable to both 5.5.3.4.3 and 5.6.3.4.

**B.6.4 STRUCTURAL LOADING
CONDITIONS**

The loading conditions and criteria of 5.5.4 shall be detailed and included in the detailed structural criteria of 5.5.1.1. Analyses and tests shall verify that the landing gear and backup structure can operate in the flight and ground environment associated with the operational use as required by 5.5.4.

a. Analyses.

- (1) Flight loads analyses _____.
- (2) Ground loads analyses _____.
- (3) Other analyses (___) _____.

b. Flight and ground tests.

- (1) Ground loads measurements (___) _____.
- (2) Temperature measurements (___)
- (3) Other measurement tests (___) _____.

VERIFICATION RATIONALE

This verification task is required to assure that the structural loading conditions and criteria of 5.5.4 are appropriately determined and formally established. A comprehensive loads program which consists of analyses and tests is required to identify potential critical aircraft components which will be sensitive to particular forms of operational loading environment, and to verify the accuracy of the analytical prediction techniques. Validation of the prediction techniques will enhance their utility in application to other service environments for loads determinations. Extensive instrumentation/testing of aircraft also reveals previously unknown physical phenomena and assists in its understanding, thereby leading to the development of improved loads prediction techniques.

VERIFICATION GUIDANCE

The establishment of detailed loading conditions will assure a high level of structural reliability without undue conservatism which has the inevitable consequence of excessive structural weight and degraded performance. Detailed loading conditions included in the detailed structural criteria of 5.5.1.1 and 5.6.1.1 will permit approval control over the design early in the design cycle and form the basis for the determination of design loads. The analyses shall be of sufficient scope to establish the service loads and maximum loads which the aircraft will experience during operations specified under 5.5.4. The blanks

for flight loads and ground loads analyses shall be completed by specifying the applicable flight loading conditions of 5.5.4.1 and ground loading conditions of 5.5.4.2. For aerodynamic heating and other analyses, define the applicable loading conditions. The wind tunnel tests shall be performed over a wide enough range to insure coverage of the design operating environment specified in 5.5.2 and 5.5.4. For force model, pressure model, aeroelastic model, and other model tests, define the proposed test configurations and conditions. Flight and ground tests shall be extensive enough to substantiate the design loads analyses and to demonstrate aircraft structural integrity for the critical loading conditions. For flight loads, ground loads, temperature, and other measurement tests, define the proposed test configurations, conditions, instrumentation, and calibration procedures. AFFDL-TR-76-23, Volumes I-VII; AFWAL-TR-80-3036, Volumes I-III; FTD-MT-64-269; AGARD Report 113; AGARD-AG-160, Volume 7; NACA TN 1178; NACA TN 1140 and ASD-TR-80-5038 provide some insight in applying the loads analyses and verification requirements.

VERIFICATION LESSONS LEARNED

A comprehensive flight and ground test program which detailed the requirements for aircraft structural integrity flight and ground evaluation and demonstration was previously specified in MIL-A-8871A. The overall value of strict adherence to these requirements has been demonstrated on numerous test programs. On more than one occasion, new critical loading conditions were identified early in the program as a result of this comprehensive approach. These critical loading conditions were then included in subsequent full scale static test programs.

Several aircraft have required extensive redesign of major components to assure compliance with the structural design requirements. Wing tip mounted missiles were lost from an air superiority fighter on two occasions when jet wakes were encountered. The causes were identified as high wing tip accelerations in combination with substandard cast fittings used to attach the launchers to the wing tips. The horizontal tail carry-through structure of a bomber failed during low level operations. Failure was attributed to asymmetric loads exceeding the strength established by the arbitrary 150-50 distribution of the then current specification.

Calibrated strain gage systems and pressure transducer systems have been used successfully to measure flight loads. However, data processing to determine net loads from aerodynamic pressure measurements have been very expensive and time consuming. Because of data processing requirements, this approach to load measurement is not very amenable to inflight real time monitoring. If the use of aerodynamic pressure measurements is the preferred or required method, the addition of some calibrated strain gages to provide real time monitoring of major component total loads has been found useful. Additional details comparing flight load measurements obtained from calibrated strain

gages and pressure transducers are provided in ASD-TR-80-5038.

The load carrying capability of landing gear for the taxi mode of operation has generally been determined by the 2.0g or 3.0g specified load criteria depending on whether the main gear or nose gear design is being considered. Drop testing of the landing gear strut verifies the energy absorption capability of the strut and provides for the validation of its load/deflection or airsprung curve. It has then been assumed that the strut, for purposes of analysis and operation, will behave in accordance with the manufacturers plotted airsprung curve if the strut has been serviced in accordance with the manufacturers instructions. Recent flight test programs with transport aircraft performing taxi and braking tests on low bump amplitude AM-2 metal repair mats has demonstrated conclusively that documented drop test strut data cannot be relied upon to accurately predict landing gear taxi loads and strut deflections. These tests demonstrated that cycling of the struts due to surface roughness resulted in degraded strut damping performance, and in some instances resulted in bottoming of the struts thereby providing the potential for tire, strut, or airframe damage in spite of the fact that pre-test and post-test examination showed the struts to be properly serviced. Strut performance degradation was attributable to air/oil mixing in the landing gear struts. This same test program revealed unexpectedly high lateral and fore and aft accelerations of an outboard engine pylon, attributable to excitation provided by wing bending and anti-skid cycling respectively. The identification of previously unknown critical conditions was the result of a comprehensive loads program utilizing thoroughly instrumented aircraft.

B.6.4.1 FLIGHT LOADING CONDITIONS

Analyses and tests shall be of sufficient scope to determine and verify the loads resulting from and commensurate with the flight loading conditions of 5.5.4.1.

VERIFICATION RATIONALE

This verification task is required to assure that the flight loading conditions are appropriately determined and formally established to assure that the airframe has adequate structural integrity for its required service usage.

VERIFICATION GUIDANCE

Aircraft flight loads and dynamic response analyses and tests shall be conducted to determine the adequacy of the design loads analyses and verify the structural integrity of the aircraft. The flight and dynamic response tests shall be sufficient in scope to assure that all critical design loads are established. These tests shall consist of measuring static and dynamic loads on an instrumented and calibrated test aircraft for flight loading conditions such as those associated with pilot induced maneuvers, loss of control maneuvers, release

or ejection of stores, aerial delivery of cargo, and turbulence.

VERIFICATION LESSONS LEARNED

None.

B.6.4.2 GROUND LOADING CONDITIONS

Analyses and tests shall be of sufficient scope to determine and verify the loads resulting from and commensurate with the ground loading conditions of 5.5.4.2. Dynamic analyses and tests are also required to verify that the landing gear and backup structure is free from dynamic instabilities which could impact ground/ship based operations.

VERIFICATION RATIONALE

This verification task is required so that the ground loading conditions are appropriately determined and formally established to assure that the airframe has adequate structural integrity for its required service usage. It is also required to verify that the air vehicle is free from dynamic instability problems which could cause significant impacts on program cost and schedule as well as overall aircraft integrity and performance.

VERIFICATION GUIDANCE

Aircraft ground and dynamic response analyses and tests which reflect ground/ship based operations must be conducted to determine the adequacy of the design loads analyses and verify the structural integrity of the aircraft. The ground and dynamic response tests should be sufficient in scope to assure that all critical design loads are established. These tests will consist of measuring loads and dynamic responses on an instrumented and calibrated test aircraft during ground operations such as taxi, takeoff, landing, and towing.

Prior to the tests, the dynamic stability of the test aircraft shall be verified to insure that the air vehicle is free from shimmy, divergence, and other related gear instabilities for all attainable combinations of configurations, speeds, loadings, and tire pressures. Verification shall consist of taxiing the test aircraft over various bump configurations. These bumps should be angled with respect to the forward direction of the aircraft to maximize the likelihood of breakout from torsional binding friction. Instrumentation on the landing gear will be required to measure the amount of torque supplied to the gear during bump encounter. The bump configurations are defined by bump spacings and bump heights. Bump spacings are determined by dividing the aircraft's constant forward speed by the frequency obtained from the shimmy analysis. Bump heights are determined analytically by the amount of torque required to assure breakout from torsional binding friction of the landing gear. Maximum bump heights used should not exceed the landing gear and backup structural design capability. The results of the dynamic stability test are required to update the shimmy analysis which will be used for

verification of all nontested aircraft configurations. Further guidance on aircraft ground tests can be found in the Verification Guidance of 4.4. General guidance on shimmy testing is presented in WADC TR-56-197.

VERIFICATION LESSONS LEARNED

Dynamic taxi analyses have been performed for continuous runway profiles, discrete bumps, and 1-cosine bumps and dips of wavelengths tuned to produce maximum aircraft loads. These analyses have resulted in limit loads throughout the airframe and are considered very necessary to the early establishment of confidence in the structural integrity of the airframe. The dynamic taxi analyses should be used to investigate the effects of realistic bomb damage repaired airfield surface profiles in which the structural integrity of the airframe air vehicle is expected to operate in a hostile environment. Dynamic taxi analyses must account for pitch, translation, and roll rigid body modes and all significant flexible modes. The gear's complete nonlinear air spring and hydraulic damping of the oleo and tire must be included. Aerodynamic lift and engine thrust shall be included and all combinations of gross weight, fuel weight, taxi speed, and c.g. consistent with planned usage shall be considered.

When using the power spectral density method of evaluating aircraft response, the assumptions of a stationary, Gaussian random process and a linear system are seldom justified. Nevertheless, the method is useful in estimating repeated loads effects since it yields the average or root mean square value of the response. For a better estimation of peak loads and to better account for the non-linearities of a landing gear system, air vehicle taxi model may be excited by a runway unevenness profile generated from the specified runway roughness PSD. Many profiles can be generated which exhibit the roughness characteristics of the specified roughness PSD, resulting in some variation in peak load conditions. It is, therefore, necessary to study the results of several profiles to be confident that a reasonable estimate of expected peak load is obtained.

Dynamic taxi analyses performed for a strategic aircraft over continuous runway profiles and 1-cosine bumps and dips predicted loads less than those predicted for the 2.0 g static taxi condition.

Quasi-static analyses, using empirical values for vertical and lateral load factors, have proven to yield suitable limit load levels on a number of transport aircraft, including those operating from semiprepared fields. Rational dynamic analyses have generally resulted in loads which were lower in magnitude on most components and hence may be unnecessary for unbraked turns.

A quasi-static analysis or pivoting is considered entirely satisfactory since the very low rates of aircraft rotation do not introduce significant dynamic effects.

Braking loads on past transport aircraft have been based on quasi-static analyses using empirical factors defined in previous specification or elsewhere. The

resulting loads have proven adequate for these aircraft. More recent efforts such as the CX proposal have used rational dynamic analyses and have generally yielded loads equal to or less than those derived by the previous methodology. However, recent aircraft taxi test programs have shown that the landing gear struts are likely to bottom if the aircraft is operated on bomb damage repaired or unprepared rough surfaces. The degradation in strut capability is due to air/oil mixing for those struts where air and oil are in contact with each other. Because of this condition, it was determined that braking was a critical operating condition due to degraded strut performance and the increased loads imposed on the nose gear during braking. A rationale dynamic analysis should account for the occurrence of strut bottoming.

The frequency defined by the bump spacing used in a dynamic stability test should be established by shimmy sensitivity studies which will determine the frequency most likely to excite the landing gear. During dynamic stability testing of a large cargo aircraft, the bump spacing was fixed throughout the test. Since the excitation frequency of the landing gear is established by the aircraft forward velocity and the spacing between adjacent bumps, use of a fixed bump spacing did not generate the established excitation frequency. However, during subsequent flight testing conducted later in the program, recurrent shimmy problems occurred on all main landing gears. Therefore, the results of the dynamic stability test did not satisfy the shimmy verification requirement. Failure to identify these shimmy problems early in the program resulted in the elimination of more desirable design alternatives. These recurrent problems were simply resolved by use of velocity squared shimmy dampers.

During dynamic response testing, should breakout from torsional binding friction not occur within the range of allowable bump heights, one method which may facilitate landing gear frictional breakout is to use a less frictional lubricant on critical landing gear components. This method of facilitating breakout was accidentally encountered on a large cargo aircraft which recently underwent a new weight off wheels greasing procedure on the main landing gears. However, it should be noted that this approach is suggested only for test purposes. If change in landing gear greasing lubricants are likely to occur as a normal servicing procedure, a sensitivity study should be conducted to assess the impact on landing gear stability.

B.6.4.3 VIBRATION

Vibration loadings shall be combined with flight and ground loads in accomplishing 5.6.4, 5.6.4.1, and 5.6.4.2. Vibration loads shall be as required by 5.6.5 and 5.6.6.

VERIFICATION RATIONALE

In most instances, structural, aeroacoustic, and vibration loadings are effectively evaluated separately.

However in a few cases these loadings interact such as to require design and verification analyses and tests to include them simultaneously.

VERIFICATION GUIDANCE

Evaluate the need for simultaneous application of structural, aeroacoustic, and vibration loadings.

VERIFICATION LESSONS LEARNED

A large bomber aircraft developed cracks in a structural deck due to the simultaneous application of flight loads, thermal loads, and aeroacoustic loads. Very extensive combined loading analyses combined with laboratory tests were conducted to develop a design change to eliminate the problem. The problem was exacerbated by the extreme difficulty in measuring and reproducing the complete environment. The design change was a costly retrofit of large sections of major structure. If the original design had been properly based on the combined environments the problem could have been avoided with very little weight, or cost impact and no schedule impact.

B.6.4.4 AEROACOUSTIC DURABILITY

Analyses and tests shall verify that the landing gear and backup structure can operate in the aeroacoustic environment associated with operational use as required by 5.5.4.4.

VERIFICATION RATIONALE

The sources and criteria form the basis of the aeroacoustic durability of the airframe.

VERIFICATION GUIDANCE

Check predicted durations, spatial distributions, and frequency distributions of the aeroacoustic loads from each applicable source identified in 5.5.4.4. Update parameters when changed usage or configuration modifications cause them to change. Replace predictions with measured data when it becomes available.

VERIFICATION LESSONS LEARNED

Few air vehicle programs end with the initial configuration. Subsequent modifications or additions of structure or equipment require the application of the best available criteria for aeroacoustic durability. Up-to-date criteria forestalls costly retrofit changes.

B.6.4.4.1 STRUCTURE

Analyses and tests shall verify that the structure meets the requirements of 5.5.4.4.1.

B.6.4.4.1.1 ANALYSES

Near field aeroacoustic loads shall be predicted for the landing gear and backup structure for the service life and usage of 5.5.2.14 and the sources listed in 5.5.4.4. Model tests are required where reliable predictions of the environment cannot be made. Analytical predictions of the fatigue life shall be made for all structure exposed to aeroacoustic loads.

VERIFICATION RATIONALE

Determining the magnitude of the various aeroacoustic sources allows placing priorities and discovering which sources are insignificant and which need to be emphasized. Wind tunnel or jet models are sometimes necessary to define acoustic levels in cases where prediction methods are inadequate. Accurate fatigue life predictions are needed to design a durable lightweight structure without weight penalties from conservative design compromises, and provide a basis to determine which components are candidates for acoustic testing.

VERIFICATION GUIDANCE

The environment due to all applicable sources should be analyzed and predicted. Wind tunnel model tests may be useful in defining aeroacoustic loads resulting from cavities, separated airflow due to protuberances, etc. Jet models may be used to predict acoustic loads from propulsion systems. The accuracy of the aeroacoustic loading is of great importance to fatigue life estimation as well as internal noise and vibration environment. The external environment provides the basis for internal noise predictions.

If the measurements of 5.6.4.4.1.2.2 and 5.6.4.4.1.2.3 indicate that predicted levels are too low, it will be necessary to revise these analyses using the measured data.

VERIFICATION LESSONS LEARNED

Experience with bomber aircraft weapon bays has shown that wind tunnel testing is very useful, particularly in regard to studying means of suppressing acoustic disturbances.

Acoustic levels measured or predicted without the presence of the aircraft, must be increased to account for surface effects. For normal incidence impingement, this increment would be 6 decibels (dB) to account for the presence of structure. During ground operations ground reflections must also be accounted for.

Failures in secondary structure have been found to be the most common type of structural failure, e.g., skin panels, skin supports, stiffeners, rivets, etc. Primary structures, designed for large magnitude loading, seldom suffer aeroacoustic fatigue failures.

Spikes (or pure tones) should be evaluated separately. Spikes in spectra with low overall sound pressure levels have caused sonic fatigue failures.

B.6.4.4.1.2 TESTS**B.6.4.4.1.2.1 FATIGUE TESTS**

Aeroacoustic fatigue tests shall be performed utilizing the uncertainty factors on sound pressure level and duration specified in 5.5.4.4.1. Other simulated environments (such as temperature and pressure differential) combined with the sonic environment shall be imposed when applicable.

B.6.4.4.1.2.1.1 COMPONENT TESTS

Aeroacoustic fatigue tests of structural components are required to verify the aeroacoustic fatigue analyses of components including those structures where fatigue life cannot be adequately predicted, such as new materials or structures of unusual configuration.

VERIFICATION RATIONALE

Component tests are necessary to demonstrate that the structure does meet life requirements in the aeroacoustic environment. In many cases, theoretical analyses are not sufficiently accurate to risk proceeding directly to production without testing. It is estimated that the accuracy of prediction techniques is no better than three to five decibels.

VERIFICATION GUIDANCE

Tests should be performed on fatigue critical structural components and candidate structural designs where basic data such as S-N curves, fatigue data, or experience with the structural configuration do not exist.

VERIFICATION LESSONS LEARNED

Experience has shown that analyses alone are not sufficiently accurate to provide fatigue resistant structure. Structural deficiencies discovered by testing can be economically corrected early in the program.

B.6.4.4.1.2.1.2 FULL-SCALE TESTS (____)

Tests of the landing gear and backup structure are required to verify the aeroacoustic durability for the environments based on the flight and ground surveys of 5.6.4.4.1.2.2.

VERIFICATION RATIONALE

Full scale tests have been shown to be useful for the following reasons:

- a. The acoustical field is reproduced for the takeoff condition and all critical effects are accounted for realistically. In many cases this aeroacoustic field is the most critical and should be full scale tested.

- b. Structure and equipment are tested simultaneously as a dynamic system.

Repair and maintenance schedules can be more realistically estimated.

VERIFICATION GUIDANCE

The test article should be a complete airframe or a full-scale portion of the airframe. Final determination shall be based on the extent and magnitude of the predicted or measured aeroacoustic loads impact on the structure. If aeroacoustic levels are shown by analysis to be sufficiently low such that no fatigue damage will be expected in the service life, no testing should be required. If relatively minor areas of the aircraft are affected by aeroacoustic fatigue, component test may be sufficient. Examples of specimen candidates are structure near the jet engine exhaust or behind protuberances in high speed flow. Test durations are to be defined based on expected service life exposures. The highest engine noise environment is normally encountered during ground engine use and takeoff. For this condition, the test duration may be determined from:

$$T_D = 0.4 T_t + T_s$$

T_t is the total takeoff time experienced by the airplane during a service life. T_s is the total time experienced at static maximum engine thrust during a service life. Takeoff time is the time of application of maximum thrust before takeoff roll until liftoff from runway. For other conditions, e.g., areas behind speed brakes, or high aeroacoustic levels caused by high speed flight, actual times should be used for the tests when practical. Increased test levels, when justified, may be used to shorten test times.

VERIFICATION LESSONS LEARNED

None.

B.6.4.4.1.2.2 GROUND AND FLIGHT AEROACOUSTIC MEASUREMENTS

Aeroacoustic loads and dynamic response measurements are required for all areas of the landing gear and backup structure designated fatigue critical by analyses of 5.6.4.4.1.1 at pertinent operational conditions based on the mission profiles of 5.5.2.14.

VERIFICATION RATIONALE

Since the prediction of noise environments is not sufficiently accurate, measured values must be obtained to revise the environmental estimates and fatigue life predictions. These data also serve as the definition of the environment for the component and full-scale tests of 5.6.4.4.1.2.1.

VERIFICATION GUIDANCE

Measurements of sound pressure levels are needed during flight and ground conditions which produce significant aeroacoustic loads based on the analyses of 5.6.4.4.1.1. Sufficient instrumentation is required to measure the loads on the structures which are shown by analysis to be fatigue critical. Internal noise measurements should also be made at this time.

VERIFICATION LESSONS LEARNED

Even the best prediction methods are not sufficiently accurate to dispense with measured data. Overestimating the noise environment leads to unnecessary weight and cost; underestimating results in premature failures and maintenance problems.

B.6.4.4.1.2.3 JET BLAST DEFLECTOR (JBD) ACOUSTIC AND THERMAL MEASUREMENTS

Tests of carrier based airframes are required to measure the airplane acoustic and thermal environment forward and aft of the JBD. The test site shall be free of snow and water. Wind velocity shall not exceed 15 knots, ambient temperature shall not exceed 80°F, and relative humidity shall be between 40 and 80 percent. Measurements shall be accomplished at each of the following test positions and engine power settings.

- a. Forward of JBD. The test airplane shall be positioned forward of the JBD in three positions simulating the most critical battery positions which would exist aboard carriers. These positions shall be between 58 feet and 68 feet as measured from catapult station zero to the JBD hinge line. At each of the three positions, all engines of the test airplane shall be stabilized at intermediate thrust for not less than the time required to attain equilibrium structural temperatures, followed by stabilization at maximum thrust for not less than 30 seconds.
- b. Aft of JBD. The test airplane shall be positioned aft of the JBD with a second airplane in front of the JBD. The second airplane shall be selected from carrier qualified aircraft in the inventory such that the airplane/JBD combination shall impart on the test airplane the most critical environment. The test airplane shall be centered immediately behind the JBD with the test airplane centerline perpendicular to the JBD hinge line and separately with the test airplane centerline at a 45 degree angle to the JBD hinge line. For each test airplane position, all second airplane engines shall be stabilized at intermediate thrust for not less than 60 seconds, followed by stabilization at maximum thrust for not less than 30 seconds. All test airplane engines shall operate at idle power during each measurement.

VERIFICATION RATIONALE

Carrier based aircraft will experience these vibroacoustic and thermal environments prior to and during catapult.

VERIFICATION GUIDANCE

This requirement is applicable for carrier based aircraft.

VERIFICATION LESSONS LEARNED

A high performance afterburning fighter in catapult position, produced the highest thermal and acoustic environments on forward portions of aircraft aft of the JBD.

B.6.5 VIBRATION

Analyses and tests shall verify that the landing gear and backup structure can operate in the vibration environments of operational use as required by 5.5.5.

B.6.5.1 ANALYSES

Vibration levels shall be predicted for the landing gear and backup structure based on the sources of 5.5.5 and the service life and usage of 5.5.2.14.

VERIFICATION RATIONALE

Estimates of vibration environments are needed to support structural design and test requirements, as the basis for requirements in equipment procurements, and to determine the necessity for and means of vibration control measures. This need was recognized in MIL-A-8870(ASG), MIL-A-8892, and MIL-STD-1530.

VERIFICATION GUIDANCE

Perform analyses to predict vibration levels for the airframe using existing data bases. These analyses should be performed early in the development process and revised as measured vibration and acoustic data are obtained.

VERIFICATION LESSONS LEARNED

It is necessary in most procurements that subcontractors be on contract before environmental measurements are available in order to meet delivery schedules. Structural response predictions are frequently inadequate due to uncertainties in the critical parameters and inaccuracies in the analytical models used in the prediction process. Inadequate or inaccurate vibration predictions result in both under and over design, retest, and retrofit.

In a bomber aircraft program, extensive redesign of equipment mounting structure was needed to reduce the vibration levels to the equipment. The equipment had been designed and built to meet an environment

that was much less severe than was actually experienced.

B.6.5.2 TESTS

B.6.5.2.1 DEVELOPMENT TESTS

Development tests are required for structures which cannot be adequately analysed.

VERIFICATION RATIONALE

Component tests are needed to verify analytical fatigue life predictions and demonstrate that the components will meet service usage requirements in the vibration environment. In many cases, analyses are not sufficiently accurate to risk proceeding directly to production without some testing. This requirement is contained in MIL-A-8870(ASG), MIL-A-8892, MIL-A-8870B(AS), and MIL-A-8870C(AS).

VERIFICATION GUIDANCE

Tests should be performed on safety-of-flight structural components and candidate structures where basic data such as S-N curves, fatigue data, or experience with the structural configurations do not exist.

VERIFICATION LESSONS LEARNED

Experience has shown that analyses alone are not sufficiently accurate to verify fatigue resistant structure.

B.6.5.2.2 GROUND VIBRATION TESTS

Ground vibration tests of a complete airframe in accordance with 5.6.5.2.5 shall include determination of natural frequencies, mode shapes, and damping of vibration of the airframe components supportive of the requirements of 5.5.4.4 and 5.5.5.

VERIFICATION RATIONALE

This test effort provides the vibration modal characteristics of the airframe and its components. The requirement was derived from MIL-A-8870(ASG), MIL-A-008870A(USAF), MIL-A-8892, MIL-A-8870B(AS), and MIL-A-8870C(AS).

VERIFICATION GUIDANCE

Measurements need to be obtained as early as possible to allow making any needed changes and keep retrofits to a minimum. These tests are to be coordinated with the ground vibration tests.

Propulsion system. Mode shapes and frequencies of power plant (engine and gearbox) installations should be obtained when (1) these components are supported

by resilient mountings (vibrations or shock isolators), (2) unit flexible modes are low enough in frequency to couple with airframe flexible modes, or (3) separate units are coupled by shafting (turbine driving a propeller gearbox, engine driving a propeller through an extended shaft, power takeoff shaft driving a separate machine or gearbox, etc). Natural frequencies and mode shapes of the sprung mass of each unit should be obtained for the six fundamental rigid body modes of motion (three translational and three rotational modes). These data should also be acquired for the coupled system as well as for each unit. Where multiple units are mounted in significantly different locations (inboard and outboard on a wing, wing and aft fuselage, etc.), acquire the data for each location.

Identify other components for which frequency and mode data measurements are needed such as weapon bay doors, wheel well doors, etc.

VERIFICATION LESSONS LEARNED

One of the resonances of the weapon bay doors of a large aircraft coincided with a cavity resonance, causing large amplitude motions of the doors when the weapon bay was opened in flight. A vibration test of these doors was not done and, hence, the problem not detected until flight tests.

During ground vibration test of a large transport aircraft, it was discovered that the first horizontal tail pitch mode, an internal resonance in a pitch stability augmentation system component, and a resonance of the shelf on which the component was mounted were all at the same frequency. The result was that once the tail pitch mode was excited the vibration was self sustaining. This would probably have resulted in violent and dangerous oscillations in flight. The problem was eliminated prior to first flight by detuning the shelf and component resonances.

B.6.5.2.3 GROUND AND FLIGHT VIBRATION MEASUREMENTS

Ground and flight vibration measurements shall be conducted to verify and correct predicted vibration levels, and demonstrate that there are no excessive vibrations. Measurements shall be made at a sufficient number of locations to define the vibration characteristics of the airframe and for flight and ground operating conditions in accordance with the service life and usage of 5.5.2.14.

VERIFICATION RATIONALE

Ground and flight vibration tests are used to obtain the response characteristics of the aircraft to forced vibrations and impulses. Test results either verify or are used to correct analytical predictions of the vibration environment, serve as the basis to verify the analytical and test vibratory fatigue lives, and also as

the basis of equipment environmental requirements. The need for or effectiveness of vibration control measures will also be determined. This requirement was a part of MIL-A-8870(ASG), MIL-A-8892, MIL-A-8870B(AS), and MIL-A-8870C(AS).

VERIFICATION GUIDANCE

Measurements are needed during flight and ground conditions to define vibrations of the airframe. Sufficient instrumentation is required to define the responses of the structure and equipment. The measurement programs are to be coordinated with similar efforts of 5.6.4.4.

Ground and flight vibration tests should include ground engine runup to maximum thrust, taxi, takeoff, climb, level flight with at least five speed increments at two altitudes, approach glide, and landing. The flight altitudes and speeds should be selected to include normal cruise conditions, maximum permissible transonic flight dynamic pressure, maximum dynamic pressure at maximum Mach number, and maximum dynamic pressure as applicable to each of the following listed flight operations, conditions, and maneuvers.

- a. Operating afterburners with and without any takeoff assist units.
- b. Varying wing sweep angles through the permissible range.
- c. During VTOL and transition conditions of V/STOL airplanes.
- d. During gunfire.
- e. While opening and with open weapon bays.
- f. Flight near stalling speeds.
- g. Deflecting speed brakes.
- h. Lowering landing gears and operating high-lift devices, flaps, etc., during the approach glide and landing.
- i. During rapid ground accelerations or decelerations, e.g., catapult takeoffs, arrested landings, deploying drag chutes, and operating thrust reversers.
- j. During ejection of stores or cargo at maximum permissible load factor and critical store combinations.
- k. During maneuvers at intermediate and maximum permissible symmetrical and unsymmetrical load factors.
- l. At flight conditions consistent with the mission profiles of 5.5.2.14 where buffet is predicted.

A sufficient number of transducers should be utilized to define adequately the vibration characteristics of the airplane. Transducers should be so mounted that the transducer and mounting bracket or block will not significantly alter the response characteristics of the item under consideration. Normally, the airplane will be divided into zones (e.g., nose, center, and aft

fuselage; outer and inner wing; empennage; landing gear cavity; engine compartments; and nacelles and pylons). Measurements should be made at several locations in each zone. Emphasis should be placed on locations where high amplitudes of vibration are expected or where failures could be critical with respect to flight safety. Measurements should include, but not be limited to, the following locations:

- a. Electronic and mechanical equipment areas.
- b. Areas where a failure or malfunction might result in loss of or significant damage to the air vehicle.
- c. Fuselage sidewall in the region of propellers.
- d. Passenger and cargo compartments.
- e. Mounts, bearing supports and gear boxes at engines, transmissions, rotating mechanical equipment, and drive shafts.
- f. Cavities.
- g. Gun locations. Equipment and structure located within a minimum radius of 6 feet of the gun mountings and muzzles should be instrumented. Wherever possible, vibration transducers should be internally mounted in surrounding equipment (particularly shock mounted equipment). Equipment mounting point vibration should be recorded.
- h. Inlets.
- i. On external stores and structures near ejectable stores.
- j. Crew and passenger seats (longitudinal, lateral, and vertical).
- k. Rudder pedal (longitudinal).
- l. Rudder heel troughs (vertical).
- m. Handle at terminal of primary flight control system (longitudinal and lateral).
- n. Navigator's table and other work tables (longitudinal, vertical, and lateral).
- o. Primary longitudinal structural members in fuselage (vertical and lateral at the approximate position of crew seat attachment points).

VERIFICATION LESSON LEARNED

Analyses are not complete or accurate enough to provide the information to define vibration responses to the degree necessary. Experience has shown that many problems arise in flight that were not suspected or adequately scoped previously.

Some programs profited from instrumented missiles devoted solely to measuring vibration, loads, temperatures, and aeroacoustic loads.

B.6.5.2.4 LABORATORY TESTS

- a. Component ground vibration tests. (____)
- b. Component stiffness tests (____)
- c. Damper qualification tests (____)

VERIFICATION RATIONALE

- a. These tests are required as necessary, to validate the analyses of 5.6.5.1. All major components of the landing gear and backup structure should be included as mounted on the ground vibration test article. Ground vibration tests of critical components can often be used to check criteria compliance at a stage in the program sufficiently early to permit corrective action without seriously jeopardizing the overall program schedule.
- b. These tests are required, as necessary, to validate the analyses of 5.6.5.1. All major components of the landing gear and backup structure should be included. Component stiffness tests verify that the required stiffness is maintained throughout the envelope of design loads.
- c. These tests are required to ensure the integrity of the damper installation and effectiveness in the frequency range of the modes for which damping is required.

VERIFICATION GUIDANCE

Component Ground Vibration Tests. If these tests are required, define or list the tests required in the blank.

Vibration modal characteristics, i.e., resonant frequencies, mode shapes, and structural damping should be measured, if practical on key components prior to vehicle assembly. Often these tests can be combined with other tests, e.g., the control simulator test or the structural loads tests. Control surface damper compliance tests require a special set-up and must be carefully conducted under laboratory conditions.

Component Stiffness Tests. Define or list the test required in the blank. Candidate components for test include external store pylon, engine pylons, control surfaces, and other flutter critical components.

Judgment is required in selecting those components requiring a stiffness test. Tests should be carried out to 1.2 times limit load. Nonlinearities in deflection with respect to load, as may be caused by buckling, are characteristics to measure. Based upon results, some aeroelastic stability analyses may need to be repeated.

It is often convenient to conduct the stiffness test in parallel with the structural proof tests. Care should be taken that the loading conditions include significant torsion as well as bending.

Damper Qualification Tests. These tests are required if dampers are used to prevent aeroelastic instabilities

and if the damper is a part of a new air vehicle design or a new application.

If dampers are used, experimental verification tests should be performed on the damper and supporting structure to ensure that components will not fail under static or repeated loads, that the dampers will not lose their effectiveness under airplane service conditions including operation at high temperatures, and that proper maintenance and inspection under service conditions can be readily accomplished. In addition, free-play measurements should be performed to substantiate that the free play is within the prescribed limits.

VERIFICATION LESSONS LEARNED

None.

B.6.5.2.5 AIR VEHICLE GROUND TESTS

Ground tests shall be performed to obtain data to validate, and revise if required, the dynamic mathematical models which are used in structural dynamic analyses. Complete air vehicle ground vibration modal tests shall be performed of the first Engineering/Manufacturing Development (EMD) aircraft prior to its first flight and on the EMD aircraft to be used for flight flutter tests (if the first EMD aircraft is not used for this testing) prior to its first flight. These tests shall be repeated on the last EMD aircraft (____).

VERIFICATION RATIONALE

These tests are required to obtain frequencies, mode shapes, and structural damping on the assembled air vehicle to validate the analysis of 5.6.5.1.

Results from a ground vibration test provide the first opportunity to verify by test the structural dynamic mathematical model of the complete airplane as used in dynamic landing analyses. In some cases the results may be the sole source of information for determining the normal modes of vibration as required for the above cited analyses.

It is the exception rather than the rule that the computed modes agree completely with the test modes. Thus the test results provide a basis for correcting the stiffness and mass distribution data such that analyses only are needed for determining the modes of other or subsequent configurations.

VERIFICATION GUIDANCE

These tests are required if the air vehicle is a new air vehicle or if changes occur which affect the structural dynamic characteristics of an existing air vehicle.

The objective of the ground vibration test is to measure the structural modes of vibration. The test is accomplished by exciting the structure with a vibratory force and measuring the response. Excitation may be sinusoidal, using several shakers, or

random using a single point input, or random using multipoint, uncorrelated inputs. Sinusoidal has the advantage of permitting on-line examination of the modes, easy linearity evaluation of each mode, and minimum reliance upon complex data reduction computing programs. Random testing has the advantage of reducing test time in that the complete set of measurements need not be repeated for each mode and reliance is placed upon the data reduction method in obtaining orthogonal modes rather than on the skill of the vibration test engineer. Random testing may not provide adequate data for all cases, for example nonlinear systems.

In obtaining free-free modes, careful consideration of the vehicle supporting system is required. A support such that rigid body frequencies are less than one-third the frequency of the lowest vehicle structural mode is usually accepted as justifying the use of measured modes as free-free modes. However, if this is not practicable, then the dynamic mathematical model shall be formulated to represent the air vehicle on its test support system for correlation analyses.

Test configurations should include the no-fuel configuration and other fuel configurations deemed to be flutter critical or dynamically significant by analyses. Fuel may be simulated by a suitable liquid.

On variable geometry aircraft, tests shall be performed for appropriate positions to cover the important range of geometric variation.

For air vehicles carrying external stores, judgment and analyses should be used to select a sufficient number of store configurations for ground vibration testing to cover the probable range of frequencies that will be encountered.

The air vehicle configurations tested should be equipped with all items having appreciable mass, such as engines and other subsystems, tip tanks, external stores, guns and similar items.

In addition to the test on the complete air vehicle, vibration modal tests should also be performed on components attached to the air vehicle. These components include such items as control surfaces, tabs, flaps, landing gear, landing gear doors, weapon bay doors, turboprop propeller plane, and other auxiliary components attached to the vehicle.

The dynamic mathematical model representation of the air vehicle structure should be verified by correlating the modal analyses with ground vibration tests.

VERIFICATION LESSONS LEARNED

In conducting the ground vibration test, care must be taken in orienting the sensitive axis of the pickup. Corrections are required when the sensitive pickup axis is not normal to the reference plane. This correction is especially needed when there is cross axis motion as may occur on the horizontal stabilizer of T-tail arrangement.

As pure planar motion is seldom excited at all points on the structure, quadrature acceleration response should be used for modal definition. Angular motions of lifting surface tips are most important and because of the reduced chord are often the most difficult to measure accurately.

AIAA Paper No. 78-505 documents a representative case of a complete airplane ground vibration test using transient testing techniques. AFWAL-TR-80-3056 documents a research effort evaluating various ground vibration test techniques.

B.6.6 STRENGTH

Inspections, analyses, and tests shall be performed which encompass all critical airframe loading conditions to verify that:

- a. Detrimental airframe structural deformations including delaminations do not occur at or below 115 percent of design limit load.
- b. Rupture or collapsing failures of the airframe structure do not occur at or below ultimate Loads.

VERIFICATION RATIONALE

Inspections, analytical strength calculations, and tests are needed to show that the airframe structure can withstand the loads expected in service usage. In most cases ultimate load tests and associated test data can only be attained through ground tests under laboratory conditions.

VERIFICATION GUIDANCE

In addition to the analytical strength calculations, it has been conventional to conduct strength proof tests to determine if detrimental deformations will occur in the airframe. Static tests are typically employed to verify that the airframe will sustain ultimate loads without failure.

As for metal structures, the strength analyses for composites are inexorably linked to the design development tests. For support of these analyses it is recommended that the design development testing consist of "building blocks" ranging from coupons to elements, to subcomponents and finally components.

VERIFICATION LESSONS LEARNED

None.

B.6.6.1 MATERIAL PROPERTIES

Strength related material property verification requirements are contained in 5.6.2.16.1.

VERIFICATION RATIONALE

This requirement references the basic material properties verification requirements which are in one

place and cover all of the structures disciplines verifications.

VERIFICATION GUIDANCE

Check to see that all strength related material properties requirements are included in 5.6.2.16.1.

VERIFICATION LESSONS LEARNED

None.

B.6.6.2 MATERIAL PROCESSES

Strength related material processing verification requirements are contained in 5.6.2.16.2.

VERIFICATION RATIONALE

This requirement references the basic material processes verification requirements which are in one place and cover all of the structures disciplines verifications.

VERIFICATION GUIDANCE

Check to see that all strength related material processes verification requirements are included in 5.6.2.16.2.

VERIFICATION LESSONS LEARNED

None.

B.6.6.3 INTERNAL LOADS

Validity of the internal loads and configurations of efficient load paths required in 5.5.6.3 shall be verified by inspections, analyses, and tests.

VERIFICATION RATIONALE

Internal loads must be verified to assure structural integrity of the airframe.

VERIFICATION GUIDANCE

The validity of internal loads are conventionally verified by applicable laboratory tests of 5.6.6.5 and subparagraphs, thereof. The efficiency of load path configurations may initially be determined by reviewing assembly drawings, installation drawings, and the structural description report; however, laboratory tests provide final verification.

VERIFICATION LESSONS LEARNED

None.

B.6.6.4 STRESSES AND STRAINS

Validity of stresses and strains in airframe structural members complying with the requirements of 5.5.6.4 shall be verified by inspections, analyses, and tests.

VERIFICATION RATIONALE

Stresses and strains and stress and strain distributions must be verified to assure that adequate structural integrity exists in the airframe for the intended service usage.

VERIFICATION GUIDANCE

The validity of stress and strain calculations must be verified.

- a. Validation information includes descriptions of the structural components, the type of construction, arrangement, material, location of load carrying members, and other pertinent data.
- b. Also needed for particular components are maximum shears, bending moments, torques and, where appropriate, thermal gradients. Tables of minimum margins of safety are needed.
- c. Stresses and strains are normally determined on the basis of ultimate loads, and sometimes stresses and strains are determined based on limit loads which are more critical for material yield strength. Margins of safety need to be established. Margins of safety calculated by computer methods may not adequately account for joint attachment strength, combined loadings, local discontinuities, beam-column effects, crippling, panel buckling, etc. and separate hand-analyses may be needed.
- d. Measurements of stress and strain distributions on major components obtained from static tests need to be correlated with analytical distributions.

Thermal stresses and strains are typically determined for structures that experience significant heating or cooling whenever expansion or contraction is limited by external or internal constraints. Thermal stresses and strains are combined with concurrent stresses produced by other load sources in a conservative manner.

VERIFICATION LESSONS LEARNED

None.

B.6.6.4.1 FITTING FACTOR

Fitting factors shall be shown to be in compliance with the requirements of 5.5.6.4.1 by analyses.

VERIFICATION RATIONALE

The verification of the fitting factors used shall be accomplished.

VERIFICATION GUIDANCE

Whenever component or complete airframe static tests to limit and ultimate loads are not planned, the

strength analyses report typically incorporates fitting factors for fittings and applicable joints.

VERIFICATION LESSONS LEARNED

As stated in AFSC DH 1-2, ". . . fittings are known to have a relatively high failure rate, the amount of weight added by this [1.15] factor is small for the increase obtained in structural integrity."

B.6.6.4.2 BEARING FACTOR

Bearing factors shall be shown to satisfy the requirements of 5.5.6.4.2 by analyses.

VERIFICATION RATIONALE

The verification of the bearing factors used shall be accomplished.

VERIFICATION GUIDANCE

The use of bearing factors or acceptable reduced bearing allowables is typically shown in the strength analyses report.

VERIFICATION LESSONS LEARNED

None.

B.6.6.4.3 CASTINGS

All castings shall be shown to satisfy the casting factor requirements of 5.5.6.4.3 by analysis. Non-critical castings with a casting factor of 1.33 or greater require no special testing in excess of the requirements of 5.5.6.5.2. Critical castings, castings used in primary structure, or castings with a casting factor less than 1.33 must meet the following requirements:

- a. Receive 100 percent inspection by visual and magnetic particle or penetrant or approved equivalent non-destructive inspection methods.
- b. Three sample castings from different lots must be static tested and shown to meet the deformation requirements of 5.6.6a at a load of 1.15 times the limit load, and meet the ultimate strength requirements of 5.6.6.b at a load of the casting factor times the ultimate load. After successful completion of these tests, a casting factor of greater than 1.00 need not be demonstrated during the full scale static test.
- c. The castings must be procured to a specification that guarantees the mechanic properties of the material in the casting and provides for demonstration of these properties by test coupons cut from cut-up castings on a sampling basis and from test tabs on each casting.

- d. Meeting the analytical requirements of 5.5.6.4.4 without a casting factor.
- e. Meet the service life requirements of 5.5.2.14 for both crack initiation and crack growth for flaws representative of the casting and manufacturing process.

VERIFICATION RATIONALE

None.

VERIFICATION GUIDANCE

None.

VERIFICATION LESSONS LEARNED

None.

B.6.6.4.4 HIGH VARIABILITY STRUCTURE

High variability structure shall be shown to satisfy the requirements of 5.5.6.4.4 by analyses. These analyses should be conducted using at least the following considerations in the critical combinations of these acceptable extremes:

- a. Minimum thickness or area.
- b. Critical dimensions such as longest column length.
- c. "A" allowables for all properties including E or lowest guaranteed properties or lowest incoming inspections limits, whichever are the most critical.
- d. Critical allowable tolerance buildup, eccentricities, or fit up stresses.
- e. Properties that result from the edges or corners of the processing windows or processing controls.
- f. Minimum edge or end fixities unless large scale test results are available for the same Configuration, then the minimum test derived edge or end fixities may be used.
- g. Critical range of fastener flexibility.
- h. Other _____.

VERIFICATION RATIONALE

The verification of this requirement shall be accomplished by analyses considering at least the identified considerations as well as any other critical items.

VERIFICATION GUIDANCE

The primary output of this requirement should be the identification and control of critical dimensions and processes that need extra control. Minimal additional analyses should be required if this requirement is properly implemented.

VERIFICATION LESSONS LEARNED

None.

B.6.6.5 STATIC STRENGTH

Laboratory load tests of instrumented landing gear and backup structure shall verify that the structure static strength requirements of 5.5.6.5 are met. This instrumentation is required to validate and update the structural strength analyses. The applied test loads, including ultimate loads, shall reflect those loads resulting from operational and maintenance loading conditions.

VERIFICATION RATIONALE

Verification of airframe static strength can only be accurately and safely accomplished by static tests. The analytical determination of airframe external loads, internal loads, and resulting stresses is limited by the methodologies available, by the assumptions used and, also, by the idealizations that are usually required. To date there is no proof that these analytical limitations have been minimized to the point whereby complete static testing of military aircraft can be eliminated. Better strength analysis techniques have not improved test results to a degree significant enough to downgrade static test requirements. The objectives of any static test program are to:

- a. Ensure that the basic design is structurally adequate for the required ultimate loads.
- b. Determine the degree of compliance with prescribed structural criteria.
- c. Determine the amount of growth potential in the air vehicle structure (conversely--to determine potential weight-cutting areas based on precise data).
- d. Alleviate and prevent future structural maintenance problems.

Extrapolating strength proof test measurements of structure critical in compressive instability is not likely to be reliable. Only by including a complete ultimate load static test program, can the full potential of the aircraft be realized.

VERIFICATION GUIDANCE

The static test program consists of a series of laboratory tests conducted on an instrumented airframe that simulate the loads resulting from critical flight, landing, and ground handling conditions. Thermal environmental effects are simulated along

with the load applications on airframe where operational environments impose significant thermal effects.

VERIFICATION LESSONS LEARNED

See 5.5.6.5 Lessons Learned.

B.6.6.5.1 DEVELOPMENT TESTS

The contractor shall conduct development tests as defined herein. These tests are for the purpose of establishing design concepts, providing design information, establishing design allowables, and providing early design validation. These tests are critical in reducing and managing the design risk such that the program goes into full scale static test with a reasonable chance of success.

VERIFICATION RATIONALE

Development tests are necessary for obtaining early substantiation of newer, metallic or nonmetallic materials allowables, which will be used in the strength analyses for verifying design sizing. Development tests are also necessary for obtaining early strength validations of unique design configurations. These tests aid a manufacturer in determining if specific structural features, material systems, manufacturing techniques, etc., adequately meet the static strength, durability, and damage tolerance requirements for the airframe.

VERIFICATION GUIDANCE

Examples of design development tests are tests of coupons, small elements, splices and joints, panels of basic sections, and those with cutouts or discontinuities, fittings, and operating mechanisms. These tests should be followed by tests of long lead time critical components such as wing carry-throughs, horizontal tail spindles, wing pivots, etc. The development tests must be orderly and timely in order to correct deficiencies prior to production and, particularly, to incorporate as many changes as necessary in the full scale test program.

The strength for composites are linked to the development tests. In support of these analyses it is recommended that the development testing consist of "building blocks" ranging from coupons to elements, to subcomponents, and finally components. These building block tests must include room temperature dry laminates. Also, if the effects of the environment are significant, then environmentally conditioned tests must be performed at each level in the building block process. The test articles are to be strain gaged adequately to obtain data on potentially critical locations and for correlation with the full scale static test, and in addition, the test program is to be formed so that environmentally induced failure modes (if any) are discovered. The design development tests are

complete when the failure modes have been identified, the critical failure modes in the component tests are judged to be not significantly affected by the nonrepresentative portion of the test structure and the structural sizing is judged to be adequate to meet the design requirements. For static test components, this judgment is based on adjusting the failure loads to the B basis environmentally conditioned allowable.

VERIFICATION LESSONS LEARNED

Lack of timely and comprehensive development test programs for some aircraft has caused very late discovery of significant strength and durability problems. This has led to extremely costly retrofit programs.

B.6.6.5.1.3 DESIGN DEVELOPMENT TESTS

Where data does not exist or is incomplete, these tests are to establish design concepts and to provide design information and early design validation. Design development tests shall include but not be limited to:

- a. Element Test (Coupons/Elements). These tests are typically run with sufficient sample Size to determine a statistical compensated allowable.
 - (1) Material selection properties including structural design allowables.
 - (2) Environmental effects including temperature, moisture, fuel immersion, chemicals, etc.
 - (3) Fastener systems, fastener allowables, and bonding evaluation.
 - (4) Process evaluation including all corners of the allowable processing window.
- b. Structural Configuration Development Tests (Subcomponents/Components). These tests are typically run with a smaller sample size and as such the results are used to validate the analytical procedures and establish design allowables. Actual material properties and dimensions should be used when determining correction factors, and the lower range of test results used for design allowables compatible with the statistical requirements of 5.5.2.16.1.
 - (1) Splices and joints.
 - (2) Panels (basic section).
 - (3) Panels with cutouts.
 - (4) Fittings.
 - (5) Critical structural areas which are difficult to analyze due to complexity of design.

- (6) Manufacturing methods evaluation including all acceptable variations such as gaps, pulldown, shimming, etc.
 - (7) Composite failure modes and strain levels.
 - (8) Environmental effects on composite failure modes and failure strain levels.
- c. Large Component Development Tests. These tests are to allow early verification of the static strength capability and producibility of final or near final structural designs of critical areas. The actual number and types of tests will depend upon considerations involving structural risk, schedule, and cost. The large component tests should be of large assemblies or full scale components landing gear support, complex composites, large structural castings, or any unique design features with design unknowns in:
- (1) Splices and joints
 - (2) Fittings
 - (3) Panels
 - (4) Stability critical end or edge effects
 - (5) Out of plane effects in composites
 - (6) Post buckled structure
 - (7) Environmental effects on composite failure modes and failure strain levels
- d. Design Development Testing Approach for Composites. A building block approach to design development testing is essential for composite structural concepts, because of the mechanical properties variability exhibited by composite materials, the inherent sensitivity of composite structure to out of plane loads, their multiplicity of potential failure modes, and the significant environmental effects on failure mode and allowable. Special attention to development testing is required if the composite parts ultimate strength is to be certified with a room temperature/lab air static test. Sufficient development testing must be done with an appropriately sized component to validate the failure mode and failure strain levels for the critical design cases with critical temperature and end of life moisture.

VERIFICATION RATIONALE

None.

VERIFICATION GUIDANCE

None.

VERIFICATION LESSONS LEARNED

None.

B.6.6.5.2 STATIC TESTS – COMPLETE AIRFRAME

Static tests, which include tests to design ultimate load, shall be performed on the complete, full scale airframe to verify the ultimate strength capability of the landing gear and backup structure. This requirement shall be considered complied with, if specifically approved by the acquisition activity, on the airframe or components thereof, for which it can be shown that:

- a. The airframe and its loadings are essentially the same as that of a previous airframe Which was verified by full scale tests; or
- b. The strength margins, particularly for stability critical structures, have been demonstrated by major component tests; or
- c. The components have been designed to the factors of uncertainty of _____, as verified by strength analysis and data, and the design allowables for critical features (such as stability critical structure, complex or new design concepts, etc.) have been demonstrated by large component tests. This method does not constitute completion of an ultimate static test in meeting the requirements of 5.6.6.5.3, 5.6.6.5.4, 5.6.6.5.5, 5.6.6.5.7, and 5.6.6.5.8.

VERIFICATION RATIONALE

Static tests up to and including ultimate loads are necessary for verifying the structural strength of the airframe. The airframe's factor of uncertainty is verified by successfully completing the ultimate load tests. Satisfactory demonstration of the ultimate strength capability is needed before releasing the air vehicle to operate up to 100 percent limit loads. Complete airframe, or equivalent, static tests are the only way that the strength of the structure can be demonstrated in areas of complex interactions between major components. The use of a 1.875 factor of uncertainty in blank c., above, is equivalent to maintaining a minimum margin of safety of 0.25 when a factor of uncertainty equal to 1.50 is used. This allows airplane operation to 100 percent of design limit load, while retaining the same level of safety as the conventional, 80 percent limit load flight restriction, however this level of safety is not considered acceptable for a fleet of aircraft, but may be acceptable for a small number of flight test vehicles.

VERIFICATION GUIDANCE

Prior to starting the static tests, structural modifications, required as a result of any failures that occur during design development tests, need to be incorporated into the test article. Ultimate load test

conditions are selected for substantiating the strength envelope for each component of the airframe. The internal loads and stresses are commonly used to determine the most critical load conditions. It is recommended that the blank in 5.6.6.5.2.c., above, be completed by inserting a minimum value of 1.875. A larger factor of safety might be justified whenever unconventional aircraft components exist, when unusual dynamic loading might occur, or where manufacturing critical parts are being tested.

Full scale testing is an essential element of ASIP. The full scale static test is essential for the verification of the composite structure. This test is, of course, also essential for the verification of the metallic structure. This test to ultimate may be performed without environmental conditioning only if the design development tests demonstrate that a critical failure mode is not introduced by the environmental conditioning. To provide assurance that the component static tests are representative of the component tests, these articles must be extensively strain gaged. A test of the structure to failure is a program option. If the failure mode criterion cannot be met, then the static test article must be environmentally conditioned.

For metals and nonmetals, the "B" basis allowable divided by the mean strength of the coupons used for the "B" basis allowable calculation is the fraction of the strength allowed when interpreting the results of single complex component tests unless the specific mean strength of the failure location can be determined.

VERIFICATION LESSONS LEARNED

During testing up to ultimate loads, it is found that static tested airplanes experience substantial failure occurrence rates. Designing to a 1.875 factor of uncertainty in conjunction with a proof test was successfully applied to two prototype fighter airplanes.

B.6.6.5.2.1 STATIC TESTING OF COMPOSITES

To establish the test demonstrated strength level, and account for the degradation of material properties due to combined temperature and moisture effects, in order of preference, one of the following methods shall be applied to the testing of composites:

- a. Environmentally precondition the test article for the worst case combination of temperature-moisture condition and test under these conditions to 150 percent design limit load.
- b. Test the composite article at room temperature with lab air to a load level in excess of ultimate to demonstrate the environmental knock down factors for temperature and moisture. The strains measured at 150 percent design limit load in the critical location of the composite structure must be less than the failure strains in the environmentally conditioned and room

temperature/lab air. Development testing must also validate the statistically compensated knock down factor. It is recognized for hybrid structure (metallic and composite) that failure may occur prior to achieving the environmentally compensated load level. If the environmental knock down is greater than 10 percent, this approach requires the approval of the procuring agency.

VERIFICATION RATIONALE

The test article configuration must be as structurally identical to the operational article as practical, in order that close simulations of operational loads and resulting stresses may be attained during the static tests.

VERIFICATION GUIDANCE

Insert in the blank an identification of the test article such as an early FSD airframe or a Research Development Test and Evaluation (RDT&E) airframe or major components of the airframe that may be used to satisfy the static test verification requirements.

Test articles are fabricated to be structurally identical to the structure of the flight articles, except that:

- a. Items such as fixed equipment non-structural fairings and useful loads and their support structures may be omitted from the test structure, provided the omission of these parts does not significantly affect the load, stress or thermal distributions and the structural characteristics of the parts of the structure to be tested, and provided the omitted parts are qualified by separate tests.
- b. Substitute parts may be used, provided they produce the effects of the parts for which they are substituted and provided the structural integrity of the parts for which substitutions are made are demonstrated in a manner that is satisfactory.
- c. Power plants and accessories are replaced by design-and-fabricated test fixtures that properly transmit the power plant loads to the engine mounts, vibration isolators, or both, as applicable. The means for applying the loads to these fixtures (such as loading rods through the fuselage or engine nacelle structure) are determined. All structural modifications necessary to accommodate the loading devices should be designed in such a manner so as to ensure that the structural characteristics of the modified structure will be equivalent to those of the actual structure.
- d. Paint or other finishes that do not affect the structural performance may be omitted from the test structures. When the structural test includes simulation of chemical or thermal environment, the test articles include the associated environmental protection systems under the durability requirements of 5.5.7.

- e. A number of buttock lines, water lines, fuselage stations, and wing stations are usually marked on the test structure. These should be clearly identified and should be of sufficient number to facilitate determining all desired reference points on the airframe.
- f. To the extent required for adequate load simulation during test, mechanical portions of the flight control system and power actuators for the control systems are made operable. Special provisions are made for external power attachments to the actuating mechanisms to permit externally controlled operations. It is therefore permissible to omit any unnecessary portions of the normal internal power systems. Other actuators for landing gear doors, armament bay doors, etc., are made externally operable as required for tests. Air actuated systems may be replaced by hydraulic systems to simplify testing procedures. The external actuation capability is also recommended for tests conducted by the contractor, if test operations can be simplified or costs reduced.

Structural parts and mechanisms which are subject to special qualification requirements outside the scope of this specification are qualified to the extent possible prior to incorporation in the test article. For example, Class I castings must conform to MIL-C-6021.

VERIFICATION LESSONS LEARNED

None.

B.6.6.5.2.2 COMPLETE AIRFRAME VERSUS SEPARATE COMPONENTS

With the approval of the acquisition activity, static tests may be performed on the complete airframe or on separate components (such as landing gear, etc).

VERIFICATION RATIONALE

Testing of separate, major components may be required, since the complete airframe may be too large to fit within available test facilities. Even though total costs may be higher by performing tests on separate, major components, advantages may be gained through early, design development testing to enhance schedules.

VERIFICATION GUIDANCE

When tests of components or separate assemblies are conducted, the test article is mounted in supporting and loading fixtures which accurately simulate the load and deflection interactions with the adjacent structure not being tested. Whenever these actual interactions cannot be attained, it is then customary to provide sufficient transitional test structure with strength and stiffness representative of the full scale airframe.

VERIFICATION LESSONS LEARNED

None.

B.6.6.5.2.3 TEST LOADINGS

The test loads shall be applied using a system capable of providing accurate load control to all points simultaneously and shall contain emergency modes which can detect load errors and prevent excessive loads. In each test condition, parts of the structure critical for the pertinent loading shall be loaded with the best available loads.

VERIFICATION RATIONALE

It may be necessary, initially, to use analytically derived loads to set up the test loading system.

VERIFICATION GUIDANCE

Testing may be initiated using analytically derived loads and wind tunnel data. Loads measured in the flight and ground loads survey program are used to correct the test loads and distributions at the earliest possible time, when the measured loads are significantly different from analytical loads. The distribution of test loads customarily represent the actual, measured distribution as closely as possible.

VERIFICATION LESSONS LEARNED

None.

B.6.6.5.2.4 SIMPLIFICATION AND COMBINATION OF LOADING

Simplifying loading conditions and combining the loading conditions shall be considered during the tests, provided the method and magnitude or resultant loadings do not induce unrepresentative, permanent deformations or failures. Loads resulting from pressurization shall be considered and, if critical, shall be simulated in combination with the applicable flight and ground loads during the appropriate component or full scale test.

VERIFICATION RATIONALE

Simplification and combination of loading during tests conserve time and reduce cost.

VERIFICATION GUIDANCE

Loading conditions may be simplified during tests by modifying the distribution of loads applied to regions of a structure that will not be subjected to critical loads during the loading condition being simulated or that are identical in construction to other regions of the structure that are subjected to critical loads during the same or another test condition. Simultaneously applying more than one loading condition to different portions of the structure is evaluated to ensure that the

interaction of the separate loadings does not affect the critical design loading on any portion of the structure.

VERIFICATION LESSONS LEARNED

None.

B.6.6.5.3 FUNCTIONAL PROOF TESTS PRIOR TO FIRST FLIGHT

Prior to the first flight of the first flight article, proof tests shall be conducted to demonstrate the functioning of flight-critical structural systems, mechanisms, and components whose correct operation is necessary for safe flight. These tests shall demonstrate that the deformation requirements of 5.5.2.13 have been met. The functional proof tests that will be conducted, the articles on which they will be conducted, and the load level to which the systems, mechanisms, and components will be loaded are: _____.

Where these tests are not performed on every flight air vehicle, the substantiation that the planned test program is adequate to demonstrate the flight safety of all air vehicles is documented in _____.

VERIFICATION RATIONALE

The purpose of these functional proof tests is to demonstrate that flight-critical structural systems, mechanisms, and components function satisfactorily when subjected to the applicable maximum operating and overshoot loads, or any lesser load.

VERIFICATION GUIDANCE

The demonstration of the correct functioning of flight-critical structural systems, mechanisms, and components is required prior to their first flight use. This correct functioning is demonstrated through structural tests of the actual flight air vehicles or approved representative test articles. In all cases where the demonstration testing is not done on all flight air vehicles, the applicability of the limited testing to all flight air vehicles must be demonstrated.

One of the primary reasons for conducting these tests is to demonstrate that the deformation requirements of 5.5.2.13 are met so as to preclude loss of control of the air vehicle through bindings or interferences between movable components and adjacent structures or due to excessive deflections of the movable components. To ensure that these requirements are met, the tests should include the introduction of load, thermal, or other induced deformations into the critical components as well as into the adjacent structural members to which it is attached and any other structural members whose deflections may introduce binding, interference, or chaffing. Consideration should also be given to other subsystems, such as electrical or hydraulic, whose installation may cause interference when the overall airframe deforms under load.

The first blank is completed by listing the flight-critical systems, mechanisms, and components which

will be tested, by defining which flight air vehicles or test articles will be used to conduct each test and by defining what load levels, expressed as a percentage of limit loads, to which the tests will be performed.

All structural and load carrying systems, mechanisms, and components of the air vehicle should be reviewed to determine which are flight-critical. Typical examples of flight critical systems, mechanisms, and components are: control surfaces; movable surfaces; control and movable surface drive mechanisms; control cables; rods and pulleys; control sticks and rudder pedals; and pressure control systems. In advanced air vehicles such systems as active and passive thermal control systems may also be flight-critical.

Primary structural members, such as the wings and the fuselage, are not normally included in the list of functionally flight-critical components. The requirement to test these components to demonstrate adequate strength is addressed in 4.10.5.4. It is necessary, however, to include such members when a new or unique function of the component is flight-critical. For example, an aeroelastically tailored forward-swept wing has a flight-critical stiffness function that should be demonstrated prior to flight. If a strength proof test of the wing, in which the actual stiffnesses would be measured, was not performed, then a separate functional proof test to measure the actual stiffnesses would be necessary. Also, as discussed above, it may be necessary to load primary structural members in the functional proof test to demonstrate compliance with the deformation requirements.

The normal requirement is to perform the functional proof tests on all flight air vehicles since they are intended to ensure that the article-to-article variations that occur during fabrication do not cause loss of control or loss of the vehicle. It may be possible to conduct representative tests on a single flight air vehicle, a static test article, or a large component test article and show through analyses and measurements of tolerances that the test results are applicable to the other flight air vehicles. Special attention to the proposed test methods is needed to ensure that a test of a single air vehicle can be shown to be representative of all flight air vehicles. If all flight air vehicles will not be tested, the document which substantiates the adequacy of the proposed alternative test methods is identified in the second blank.

The load level to which the functional proof test is normally performed is 100 percent of the limit loads. A value above 100 percent may be necessary where the functional test is to be representative of other flight air vehicles. A value below 100 percent is not recommended.

It is important to distinguish between the requirements for a functional proof test and a strength proof test for control surfaces, drive mechanisms, etc. The limit loads on such components may occur within the flight envelope and usually cannot be effectively restricted by establishing vehicle maneuver limitations. The functional proof test is intended to demonstrate proper

functioning of these components up to and at their maximum loads, regardless of where they occur in the flight envelope. However, the functional proof tests per the requirements of this paragraph are not alone sufficient to clear these components for use up to limit loads. The strength proof test requirements of 5.6.6.5.4 must still be met if flight restrictions on the use of control surfaces, drive mechanisms, etc. are not to be required.

In determining the functional proof loads to be tested, the loads occurring during upsets and the recovery from upsets and the loads occurring due to the system failures of 5.5.2.19 should be addressed. In some cases, it may not be feasible to establish flight restrictions on such loads as is done in establishing maneuver and speed restrictions. If this is the case, then the corresponding limit loads should be used.

In air vehicles which include electronic flight control systems which regulate the position and/or load of the control surfaces or other moveable surfaces, the correct functioning of these control systems may need to be demonstrated during the functional proof tests if acceptable alternative tests are not performed

B.6.6.5.4 STRENGTH PROOF TESTS

Strength proof tests shall be successfully performed on every airframe or parts thereof to be operated before ultimate load static tests are successfully performed or if static tests are not performed. These proof tests shall demonstrate that the deformation requirements of 5.5.2.13 have been met at all load levels up to the maximum loads expected to be encountered during flight for flight anywhere within the released flight envelope including the effects of system failures of 5.5.2.19. These proof tests shall also validate the accuracy of the strength predictive methods through comparisons of measured critical internal loads, strains, stresses, temperatures, and deflections with predicted values. Re-proof tests shall be conducted when flight tests data indicates that actual loads or load distributions are more severe than those used in the previous proof tests. In cases where these tests are not fully representative of the actual flight environment, where the scope of the planned proof tests is not complete, or where all air vehicles normally tested will not be tested, the substantiation of the adequacy of the planned proof tests is documented in _____.

- a. Strength proof test load levels shall be equal to _____ percent of limit mechanical loads or the maximum mechanical loads to be encountered flight, each multiplied by a factor of _____, whichever is less to account for overshoot, and _____ percent of limit thermal loads or the maximum thermal loads to be encountered in flight, each multiplied by a factor of _____, whichever is less to account for overshoot. The proof load distributions shall be equal to or more severe that the predicted load distributions.

VERIFICATION RATIONALE

The purpose of these proof tests is to demonstrate the capability of each airframe that will be released to fly beyond the initial restricted flight envelope to withstand the maximum mechanical and thermal loads expected to be encountered in flight and the maximum pressurization loads without failure or detrimental structural deformation.

VERIFICATION GUIDANCE

Air vehicles are normally only released to fly beyond the interim strength flight release limits of 5.6.6.7 after the successful completion of the ultimate load static tests. In cases where such ultimate load static tests will not be performed or where these tests will not be performed until after the air vehicle has flown, it is necessary to establish an approach for permitting air vehicles to fly to the full loads envelope, per 5.6.6.7, so that flight testing of the air vehicle can be accomplished.

The normally accepted approach is to accomplish strength proof load static tests on each air vehicle that will be released for flight above the initial strength flight release limits. Through this testing, the quality of each airframe is demonstrated to be sufficient to resist the maximum loads expected to be encountered during flight within the expanded flight envelope, including the loads encountered during the system failures of 5.5.2.19, without structural failure or detrimental structural deformation. This demonstration of quality is achieved through the application of loads equal to or greater than the maximum loads expected to be encountered in the expanded flight envelope. These loads are applied to all major structural components using representative load distributions with representative environmental conditions. An unrestricted strength flight envelope can only be achieved through the successful completion of strength proof tests for all designing limit loads on all primary structure and flight-critical secondary structure.

The value inserted into the first blank in subparagraph a is normally equal to 115 percent. Strength proof tests are normally accomplished to a load level above 100 percent of the maximum loads expected to be encountered during flight to provide a demonstrated margin for stability critical structure, to account for inaccuracies in the proof test, and to account for expected variations in the accuracy of the predictive methods. A value greater than 115 percent should be used where uncertainties in predictive methods, load measurement methods, or static test methods are greater than normal. A value less than 115 percent is not recommended.

The value inserted into the second blank in subparagraph a should be greater than 100 percent to provide a strength margin for uncertainties in thermal load prediction and measurement methods and thermal test methods. If thermal loads are not significant for the design of the airframe or if thermal loads will not

be included in the strength proof testing, insert N/A in this blank.

The value inserted in the first blank in subparagraph b is typically 100. This value should be increased in cases where the maximum pressure differentials are difficult to control especially where the potential for rapid internal pressure change exists. The value inserted in the second blank is typically 1.00. Again, this value should be increased where additional uncertainty exists in the ability to control the maximum pressure differential levels.

Special attention should be given to the determination of the strength proof test requirements for control systems: control surfaces, drive mechanisms, control sticks, cables, rods, pulleys, etc. In many cases, the maximum loads on these components do not occur at the edges of the design flight maneuver envelope. In such cases, meeting the requirements of 5.6.6.7 by establishing flight restrictions to limit these component loads may be difficult to achieve without unreasonably restricting the air vehicle. Such restrictions may also be difficult to implement when limits on control system loads during the recovery from upsets or following the system failures of 5.5.2.19 are to be determined. Strength proof testing of the control systems may be desirable to prevent having to unreasonably restrict the use of these systems.

Similar special attention should be given to the determination of the strength proof test requirements for structural components which are significantly affected by thermal loads. If it is impractical to develop interim strength flight limits per 5.6.6.7, due to complexities of the actual combinations of flight conditions, length of exposure, use of influencing subsystems, etc. which determine the actual thermal loads, conducting a thermal strength proof test would be necessary prior to flights where thermal loads are significant. However, such thermal tests, when combined with mechanical loads or where thermal load distributions are widely varying, may be difficult to implement on actual flight air vehicles. It may be easier to conduct ultimate thermal static tests on large components instead of proof tests on flight air vehicles.

VERIFICATION LESSONS LEARNED

None.

B.6.6.5.5 POST PROOF TEST INSPECTIONS AND ANALYSES

Post proof test inspections, including nondestructive inspection (NDI), shall be conducted to determine if detrimental deformation has occurred in any structural part that would prohibit its usage on the airframe in compliance with the requirements of 5.5.2.14. Extensive examination of instrumentation data shall be

accomplished to determine whether extrapolated, ultimate internal stresses are above predicted values to the extent that airframe structural flight restrictions or modifications are required.

VERIFICATION RATIONALE

Results of the proof tested article must necessarily be inspected and analyzed to ensure safe operational usage of the airframe. A visual examination may not detect test induced damages, while extensive examinations of the airframe and instrumentation data may indicate the necessity of incorporating structural modifications or applying flight restrictions.

VERIFICATION GUIDANCE

Stresses, reduced from instrumentation data recordings, and deflection measurements are correlated with applied test load values. Examinations of the reduced data and tested structure are made to determine if detrimental deformations have occurred. Proof test stresses are extrapolated to ultimate levels and compared with predicted stress analyses values. Structural modifications may be required for reproof testing of larger, flight measured loads.

VERIFICATION LESSONS LEARNED

None.

B.6.6.5.6 FAILING LOAD TESTS (___)

When ultimate load tests are completed, failing load tests shall be conducted to fail the test article by increasing the test loads of the most severe test loading condition.

VERIFICATION RATIONALE

Failing load tests may reflect unneeded overstrength; however, these destruction tests do determine the actual strength of the airframe for substantiating special capabilities such as growth potential or emergency operations. Failure load tests demonstrate the weakest link in the structure, for which inspections or special considerations may be required during service. Sufficient overstrength may be demonstrated overall, or by beefing up the weak points such that growth for increased range or payload may be possible.

VERIFICATION GUIDANCE

If the airframe is to be tested to destruction, this paragraph is applicable. The failing load tests are not conducted until completion of the flight loads survey, so that the static test article will remain intact for conducting of any additional tests necessary. More than one failing load test may be required to attain maximum strength data. In particular, empennage failing load tests would probably be conducted separately. The major failing load condition should be the one that is most critical, overall, for the wings and

fuselage. A careful post failure inspection and analysis should be utilized to determine the initial failure sites and failure modes. Failing load tests are normally specified in the contract unless other uses of the article are specified in the contract.

VERIFICATION LESSONS LEARNED

There has, almost invariably, never been a U. S. Air Force aircraft which has not had some growth requirements imposed or desired, regardless of any words to the contrary within the initial contract. Demonstrated static overstrength has often led to satisfying increased performance demands without extensive redesign and retrofit programs. Significant overstrength, however, is not necessarily an indicator of satisfactory durability design and caution must be exercised in this respect.

B.6.6.6 DYNAMIC STRENGTH

Prior to release for flight verification testing, component or total airframe laboratory testing shall be conducted to demonstrate energy absorption compliance and to validate design loads analysis. For land-based aircraft with maximum limit sink rates less than or equal to 10 feet per second (fps), system functions may be demonstrated by component landing gear jig drops which demonstrate both design conditions and the required reserve energy conditions. For shipboard aircraft, drop tests of the complete airframe shall be conducted.

VERIFICATION RATIONALE

This requirement establishes certification of landing gear load stroke characteristics during dynamic events and validates the energy absorption requirements. In addition, for shipboard aircraft this requirement also provides certification of the shock environment of installed mass items (avionics equipment, hydraulic systems, engines, stores, etc. as well as providing confidence that no interference of adjacent structure/components occur, i.e. deflection.

VERIFICATION GUIDANCE

Navy drop tests. Tests shall be performed on a structurally complete strength test structure and shall include wheel spin-up sufficient to simulate critical effects of wheel contact velocities within the range of contact velocities included in land-based and carrier-based landing design requirements. The wheel radii employed in the determination of wheel speeds shall be the static rolling radii of the tires. For carrier-based airplanes, the landing design gross weight shall be the carrier-landing design gross weight. For noncarrier-based airplanes, the landing design gross weight shall be landplane landing design gross weight. Maximum tire pressures, strut fluid volume, and strut air pressure employed in drop tests shall exceed neither those practicable for service use nor those actually recommended in the erection and maintenance instructions as appropriate for land-based operation, carrier operation, or simulated carrier landings. Wing

lift forces shall be applied. The cockpit shall be instrumented to measure accelerations which would be experienced by the crew to assure that excessive accelerations are not experienced. Coefficients of friction developed in drop tests shall be representative of those occurring in landings on paved runways and carrier decks. Drop tests to maximum design sinking speeds shall be performed at the gross weights and weight distributions specified and also with alternate combinations of internal and external loads for which provisions are required in flight articles, that may be structurally critical by virtue of transient effects or otherwise. For these specified and alternate combinations of loads, the mass, center of gravity position, and method of support of internal and external equipment and stores of appreciable mass, as well as the dynamic motions of fuel or other fluid pressure effects that are structurally significant, shall be accurately simulated. Residual stresses shall be measured at critical landing gear locations both before and after testing to design sink speeds.

Landing gear servicing tests. Tire inflation pressures, strut fluid volume, strut air pressure, and extreme values of other factors that can be varied to thereby influence shock absorption and rebound characteristics shall be such as to attain the most favorable and alternately the least favorable shock absorption and rebound characteristics consistent with specified design requirements. Each of the tests shall be performed twice in the symmetrical attitudes which have been shown by prior drop tests to be critical for the main and, alternately, critical for the nose gear. During these tests, it shall be demonstrated, in successive drops not more than 5 minutes apart, that the shock strut fully recovers its shock absorption abilities. Upon completion of the symmetrical drops, tires shall be deflated, fluid shall be removed, and other changes and adjustments possible in normal operations shall be made. The landing gear shall then be readjusted and serviced by normal, planned fleet maintenance procedures. It shall be demonstrated that each dry deflated strut can be serviced and be ready for full shock absorption in not more than 30 minutes. These tests may be done during landing gear jig drop tests. Data shall be submitted.

VERIFICATION LESSONS LEARNED

None.

B.6.6.7 INITIAL AND INTERIM STRENGTH FLIGHT RELEASES

- a. Prior to the initial flight release, the airframe shall be satisfactorily strength analyzed for reacting all predicted limit and ultimate loads and this analysis shall be approved by the procuring activity. Also, prior to the initial flight release, the functional proof test requirements of 5.6.6.5.3 and 5.6.6.5.4 shall be successfully met if the ultimate static strength tests have not been performed.

- a. Prior to flight beyond the initial strength flight release, the accuracy of the loads predictive methods shall be validated by using an instrumented and calibrated flight test air vehicle to measure actual loads and load distributions during flight within the initial strength flight release envelope. Also, prior to flight beyond the initial strength flight release, the strength proof test requirements of 5.6.6.5.4 shall be successfully met if the ultimate static strength tests have not been performed. Extrapolations of the measured data beyond the initial flight limits shall be used to establish the expected conservatism of the predictive methods for flight up to limit loads. This procedure of loads measurement and data extrapolation shall be used to validate the conservatism of the strength analysis and strength proof tests for each incremental increase in the strength flight release envelope up to limit loads or the strength envelope cleared through the strength proof testing of 5.6.6.5.4, whichever is less.

VERIFICATION RATIONALE

This requirement establishes the verifications of adequate structural strength required to approve the initial and interim flight releases.

VERIFICATION GUIDANCE

The completed reports on the analytical determination of external loads, internal loads, and strength analyses are made available to the acquisition activity for review sufficiently in advance of the initial flight date.

VERIFICATION LESSONS LEARNED

None.

B.6.6.8 FINAL STRENGTH FLIGHT RELEASE

For final strength flight release of the flight test article and service inventory air vehicles, the requirements of (5.5.6.7) shall be complied with by tests.

VERIFICATION RATIONALE

Early, initial static tests utilize analytically derived loads that are of limited accuracy, and which must be verified by a flight loads survey. Therefore, flight measured loads to encompass the 100 percent limit load level must be determined early so that the results can be accounted for in final static testing. For example, if the flight loads survey reveals that actual measured loads are in excess of the analytical loads, redesign with supporting analysis and additional static testing are often necessary, since the alternative of flight restrictions is not only undesirable but frequently intolerable.

VERIFICATION GUIDANCE

The structural flight test aircraft, only, is first released for testing up to 100 percent limit load level after satisfactory completion of the 80 percent structural flight test program and ultimate load static tests. The final strength flight release of the flight test article normally requires acquisition activity approval, following receipt of satisfactory, 80 percent phase, flight test results and satisfactory ultimate load static test results.

Service inventory aircraft are released with operating limitations up to the 100 percent limit load level after satisfactorily completing the flight loads survey with the flight test aircraft. Acquisition activity approval of the final strength flight release of service inventory aircraft is usually contingent upon receipt of satisfactory, 100 percent phase, flight test results, final static test results, and the strength summary and operating restrictions reports.

Final certification of the strength envelope to 100 percent limit load levels for both flight test and service inventory aircraft is contingent upon successful completion of appropriate flight testing and ultimate load static tests. The latter includes extensive examination of static test article instrumentation to ensure that test measured values are within, or well correlated to, predicted values as adjusted by verified external loads (similar to the comparisons of 5.6.6.4 and 5.6.6.5). Structural analyses shall be validated and updated for all testing such that the predictive methods ensure adequate strength levels and understanding of the structural behavior.

VERIFICATION LESSONS LEARNED

None.

B.6.6.9 MODIFICATIONS

To verify that the airframe with modifications has adequate structural capability for the planned usage, the analyses and tests of 5.6.6.5, 5.6.6.6, 5.6.6.7, and 5.6.6.8 shall be performed.

VERIFICATION RATIONALE

Applicable analyses and tests are necessary for verifying safety in the modified air vehicle's operations. Some airframes may be purposely modified for limited operational capability but if previously qualified airframes are to maintain comparable strength when the modification is completed, analyses and tests are necessary to verify that the original strength has not been compromised.

VERIFICATION GUIDANCE

Verifying the modified airframe's structural integrity is customarily accomplished by performing strength analyses or revisions to previous analyses to support installation drawings; performing proof pressurization tests on pressurized compartments, when the pressure vessel has been penetrated as a result of the

modification; and performing limit load, strength demonstration proof tests on significantly modified, primary structures.

VERIFICATION LESSONS LEARNED

None.

B.6.6.10 MAJOR REPAIRS, REWORKS, REFURBISHMENT, REMANUFACTURE

The major repairs, extensive reworks, extensive refurbishment, or remanufacture of an existing landing gear and/or backup structure shall be documented and the structure verified by analysis, inspections, and tests. The contractor shall review, update, and reestablish the technical database on each landing gear/backup structure as required to verify the landing gear/backup structure structural integrity and to support the intended usage and capability. Testing is required to reestablish the technical database as analysis alone is insufficient to reestablish this technical database. Proof testing of each landing gear/backup structure may be the option of choice.

VERIFICATION RATIONALE

None.

VERIFICATION GUIDANCE

None.

VERIFICATION LESSONS LEARNED

None.

B.6.6.11 DURABILITY

The durability requirements of 5.5.7 shall be detailed and included in the detailed structural criteria of 5.5.1.

VERIFICATION RATIONALE

A comprehensive analyses and test effort, and documentation thereof, is necessary to verify demonstration compliance with durability requirements.

VERIFICATION GUIDANCE

The specific tasks required to verify that the requirements of 5.5.7 are satisfied are contained in the individual sections that follow.

VERIFICATION LESSONS LEARNED

In addition to basic airframe components, there are two major durability problem areas which should receive special consideration in the development of the detailed structural criteria for durability besides the specific stated requirements. These areas concern accessibility and system interfaces. A large percentage of the complaints from field service personnel revolve around accessibility problems

associated with correcting wear and corrosion durability problems. The goal of providing maximum accessibility to all structural components and systems should be emphasized. Problems with system and structural interfaces such as fuel or hydraulic lines and brackets have resulted primarily from a lack of attention during development. It should be emphasized in the detailed structural criteria that these interfaces should be considered a part of, not added onto, the structure.

The impact of increases in the aircraft's Basic Flight Design Gross Weight (BFDGW) on the ability of the airframe to achieve the durability requirements should be considered when proposed aircraft modifications increase the BFDGW. The increased BFDGW resulting from changes such as design improvements, new avionics, and new engines may significantly decrease airframe durability unless structural modifications are incorporated. Durability analyses should be updated to reflect BFDGW changes so that areas requiring modification can be identified and the required changes incorporated and evaluated.

B.6.6.11.1 FATIGUE CRACKING / DELAMINATION DAMAGE

The durability analyses and tests shall be of sufficient scope to demonstrate that the landing gear/backup structure meets the requirements of 5.5.7.

VERIFICATION RATIONALE

A comprehensive test and analysis effort is required to develop a durable structure.

VERIFICATION GUIDANCE

The specific tasks required to demonstrate compliance with the requirements of 5.5.7.1 are defined in the following subparagraphs. The verification of the economic life of the airframe requires an extensive evaluation and interpretation of the results of development analyses and tests, full-scale tests, and post test analyses. Because of analytical limitations and testing complexity, an individual analysis or test requirement cannot be formulated such that supporting information from the other development requirements is not needed. Further, the economic life of the airframe cannot be determined without a full scale durability test.

VERIFICATION LESSON LEARNED

As indicated in the guidance above, the verification of the economic life of the structure cannot be done by analysis or test alone. It is important that a well balanced effort be conducted addressing analysis, development testing, and particularly the full-scale testing.

B.6.6.11.1.5 ANALYSES

The analytical requirements of 5.5.7.1 can be met by either one of the following methods but The analysis method or methods selected shall be compatible with the user's life management concept. Beneficial effects of life enhancement processes must be approved by the procuring activity. The general service life requirement is specified in 5.5.2.14 whereas the special life requirement is specified in 5.5.7.5.

- a. Fatigue analysis with a scatter factor of _____ applied shall support two design service lives of testing without crack initiation. Specific scatter factors shall be applied such that crack initiation shall not occur in _____ analytical lives for ship-based and land-based aircraft, and corresponding back-up structure, high strength structure, and other special structures.
- b. Crack growth analysis from a typical manufacturing initial quality flaw shall not grow to functional impairment in two times design service life.
- c. While these analytical methods are considered equivalent to determine the design product configuration, sizing, and robustness, special situations can occur for certain material/spectrum combinations where the fatigue, crack growth, and fracture toughness characteristics are not balanced. In these special situations, the analytical method and/or flaw sizes must be approved by the procuring agency.

VERIFICATION RATIONALE

A verified durability analysis methodology is required to establish design stress levels, aid in definition of structural details and reduce risk for the full scale test phase, interpret test results, and provide a means to assess the impact of usage variations on the life of the structure.

VERIFICATION GUIDANCE

A durability analysis methodology must be established to show compliance with the requirements of 5.5.7.1 and 5.5.10. The analysis methods must correlate with the development and full-scale test results and be directly compatible with the applicable user life management concept. The recommended approach is based upon combined fracture mechanics and fatigue crack initiation analyses; although one analysis will be considered primary and the other secondary depending upon the nature of the respective user tracking program (i.e. crack growth or safe-life method). Both types of analyses should be employed from a design stress screening standpoint and both analyses should predict that no specific actions (e.g. inspections, modifications, etc.) are required in two times design service life durability testing. In situations where the two analyses produce inconsistent results, a mutually

agreed upon approach should be selected on a case by case basis.

The durability fracture mechanics based analysis should demonstrate that an assumed initial flaw in typical quality structure would not propagate to a size which would cause functional impairment in two lifetimes of the design analysis spectrum (5.5.2.14.6), and that, additionally, it is unlikely that, by means of crack initiation analysis, fatigue cracks will initiate in the same period of time.

The durability crack initiation based analysis should support the premise that no fatigue cracks will initiate in two times design service life test and that, additionally, but secondarily, it is unlikely that, by means of durability fracture mechanics analysis, an assumed initial flaw will propagate to a size which will cause functional impairment in two lifetimes of the design analysis spectrum (5.5.2.14.6). Based upon past experience, factors between 2.67 (crack initiation coupon data) and 4.00 (whole life coupon data) have been applied in the fatigue analysis to support no crack initiation in two test lifetimes. Due to the difference in analysis methods, the contractor should prove, demonstrate, and provide supporting data bases to verify that their methodologies can accurately predict structural component lives.

For landing gear, landing gear back-up structure, high strength structure, and special structure, the specified analytical factor on design life shall be between 2.0 and 4.0 as a function of spectrum severity, consequence of failure, material damage tolerance characteristics, weight, cost trades, etc, subject to the approval of the procuring activity. For example, the single point failure mode and catastrophic consequences of failure during the catapult evolution of ship-based operations mandates additional safety margin in both the nose landing gear and the corresponding airframe back-up structures. To ensure structural integrity, an analytical factor of 4 and a spectrum including catapults, landing, and related ground events has been applied. Carrier based aircraft main landing gear and back-up structure, however, have previously implemented a two lifetime requirement as function of the spectrum severity and less catastrophic implications of failure. Land-based aircraft landing gear structure have previously implemented a four lifetime requirement as a result of spectrum severity and material damage tolerance considerations.

The following definitions apply:

- a. Assumed initial flaw size: For initial design, an .01 inch radius corner flaw at stress risers and an .01 inch deep by .03 inch long surface flaw at other locations are to be assumed. Alternate flaw shapes and sizes can be utilized where appropriately based on an equivalent stress intensity or an equivalent initial flaw size approach. These assumptions can be verified or modified or both based on the testing of 5.6.6.11.1.2.

- b. The beneficial effects of interference fasteners, cold expanded holes, shot peening, or other specific joint design and assembly procedures may be used in achieving the durability analysis requirements. For durability fracture mechanics analysis, the limits of the beneficial effects to be used in design should be no greater than the benefit derived by assuming a .005 inch radius corner flaw at one side of an as manufactured, non-expanded hole containing a neat fit fastener in a non-clamped-up joint. For durability fatigue crack initiation analysis, the design stress levels must be compatible with one lifetime without, and three lifetimes with, beneficial effects.
- c. Crack size that would cause functional impairment:
- (1) In pressurized areas of area containing fuel, this crack size is the size which would provide a direct flow path for the fuel to escape or prevent the maintenance of the required pressure.
 - (2) For stiffness structure or structure that is subjected to compressive loading, this crack size would be that which could produce local instabilities or cause undesirable structural deflections.
 - (3) In other areas that are readily accessible, this crack size would be the edge distance (ligament) from the fastener hole.
 - (4) In areas where the presence of a crack would cause load and stress redistribution within adjacent structure, the largest permissible crack size would be that which would reduce the service life or safety limit of the affected structure below the requirements of 5.5.2.14.
 - (5) For non-safety of flight structure, this crack size would be the critical crack size for the structural component. (Structural components such as wheels, pylons, bomb racks, etc., may fall into this category.)

In cases where the crack growth analysis approach may not be applicable or verifiable, such as in the case of non-metallic structure and high strength steel landing gear structure, fatigue analysis method shall be used providing that sufficient development test data is generated to demonstrate compliance with the requirements.

VERIFICATION LESSONS LEARNED

Two basic types of durability analyses techniques have been employed at various times on aircraft in the inventory. Both classical fatigue analysis with a scatter factor and crack growth durability analysis have been widely employed with adequate amount of test data from the actual structure to establish the analysis parameters.

B.6.6.11.1.6 TESTS

The following tests shall be performed to show that the landing gear/backup structure meets the requirements of 5.5.7.1.

VERIFICATION RATIONALE

Comprehensive durability tests are required to verify the service life of the airframe. Both development and full-scale testing are required to get an early indication and validation, respectively, of the service life of the structure.

VERIFICATION GUIDANCE

Specific guidance for the required testing is contained in 5.6.6.11.1.2.1 and 5.6.6.11.1.2.2. (Also see Guidance for 5.6.6.11.1.)

VERIFICATION LESSONS LEARNED

None.

B.6.6.11.1.6.1 DEVELOPMENT TESTS

Development tests shall be conducted to provide data for establishing design concepts, providing early analysis procedure validation, selecting materials, determining spectrum effects, and validating critical component durability. Using existing data to meet this requirement shall be justified. Development tests shall include but not be limited to:

- a. Element test. These tests are typically run with sufficient sample size to determine a statistical compensated allowable.
 - (1) Material selection properties including structural design allowables.
 - (2) Environmental effects including temperature, moisture, fuel immersion, chemicals, etc.
 - (3) Fastener systems, fastener allowables, and bonding evaluation.
 - (4) Process evaluation including all corners of the allowable processing window.
- b. Structural configuration development tests. These tests are typically run with a smaller sample size, and as such, the results are used to validate the analytical procedures and establish design allowables. Actual material properties and dimensions should be used when determining correction factors, and the lower range of test results used for design allowables.
 - (1) Splices and joints
 - (2) Panels (basic section)
 - (3) Panels and cutouts

- (4) Fittings
 - (5) Critical structural areas which are difficult to analyze due to complexity of design.
 - (6) Manufacturing methods evaluation including all acceptable variations such as gaps, pulldowns, shimming, etc.
 - (7) Composite failure modes and strain levels
 - (8) Environmental effects on composite failure modes and failure strain levels.
- c. Large component development tests. These tests are to allow early verification of the durability capability and producibility of final or near final structural designs of critical areas. The actual number and types of tests will depend upon considerations involving structural risk, schedule, and cost. The large component tests should be of large assemblies or full scale components such as landing gear support, complex composites, large structural castings, or any unique design features with design unknowns in:
- (1) Splices and joints
 - (2) Fittings
 - (3) Panels
 - (4) Stability critical end or edge fixates
 - (5) Out of plane effects in composites
 - (6) Post buckled structure
 - (7) Environmental effects on composite failure modes and failure strain levels
- d. Design development testing approach for composites. A building block approach to design development testing is essential for composite structural concepts, because of the mechanical properties variability exhibited by composite materials, the inherent sensitivity of composite structure to out of plane loads, their multiplicity of potential failure modes, and the significant environmental effects on failure modes and allowables. Sufficient development testing must be done with an appropriately sized component to validate the failure mode and failure strain levels for the critical design cases with critical temperature and end of life moisture.

VERIFICATION RATIONALE

Sufficient development test data must be available to substantiate the criteria and assumptions used in the durability analysis, including an evaluation of the sensitivity of the analysis to these assumptions.

VERIFICATION GUIDANCE

Design development tests should progress from basic material property tests through a series of test specimens with increasing levels of geometry and loading complexity. These tests are intended to provide more information than just indicating whether a given structural detail will likely meet the minimum requirements. In order to verify an analytical failure prediction, both the predicted time to failure and the predicted failure mode must be verified. This implies that at least some of the development tests, with a sufficient level of loading and geometry complexity to accurately simulate the full scale structure, must be tested to failure. The same applies to testing to determine stress level, spectrum, and environmental sensitivities and the failure modes.

The scope of the testing is directly dependent upon the available data base for the materials and structural details of interest.

Other areas that should be considered in the development testing are environmental effects and the influence of manufacturing tolerances. Additional guidance can be found in 5.6.6.5.1.

For composite structures, the effect of repeated low level impacts on the durability of the structure should be investigated. Hail impact, tool droppage, or the damage caused by walking on the structure may not be apparent but the repeated impact over a given area may affect the durability of the structure. The structure should be zoned according to the likely types of damage that can be incurred and the sensitivity of the durability of the area to these damage sources should be assessed in the development test program. The magnitude and frequency of the impacts to be evaluated should be based on the consideration of the air vehicle over its service life. Additional guidance can be found in 5.5.7.1. If the durability of an area proves to be sensitive to a repeated damage source, consideration should be given to simulating the damage on the full scale test article to verify the effects of the damage.

The durability analyses for composites are linked to the development tests. In support of these analyses, it is recommended that the development testing consist of "building blocks" ranging from coupons to elements, subcomponents, and finally components. These building block tests must include room temperature dry laminates. Also, if the effects of the environment are significant, then environmentally conditioned tests must be performed at each level in the building block process. The test articles are to be strain gaged adequately to obtain data on potentially critical locations and for correlation with the full scale static test, and in addition, the test program is to be performed so that environmentally induced failure modes (if any) are discovered. The design development tests are complete when the failures modes have been identified, the critical failure modes in the component tests are judged to be not significantly affected by the nonrepresentative portion of the test structure and the structural sizing is judged

to be adequate to meet the design requirements. It is evident from the approach described above that separate tests may be required for the metallic, and mixed metallic and composite structural parts.

For durability test of composite components, the success criteria is somewhat more complicated by the relatively large scatter in fatigue test results and the potential of fatigue damage from large spectrum loads. It has been demonstrated, however, that the durability performance of composites is generally excellent when the structure is adequate to meet its strength requirements. Therefore, the thrust of the durability test must be to locate detrimental stress concentration areas that were not found in the static tests. An approach to achieve this goal is to test the durability components to two lifetimes with a spectrum whose severity accommodates these concerns. When the effects are judged to be significant, durability tests for design development shall be moisture conditioned.

VERIFICATION LESSONS LEARNED

In past programs durability development testing of coupons, small elements, structural design concepts, and critical components included test lives in excess of the number required in the full-scale durability test (i.e., in excess of four lifetimes for a swing wing bomber and air supremacy fighter and two lifetimes for an air superiority fighter). Tests were designed to insure that meaningful data on cracking and failure modes could be obtained. There has been a recent tendency to cut short the test lives for durability development tests to two lifetimes followed by deliberate preflawing and continuing as damage tolerance tests. In many cases, limiting the durability test can restrict the amount of development data obtained from the test. In most cases, the location of cracking and extent of cracking is of more value than the data obtained from deliberately placed flaws. Some specimens have failed to produce any cracking in two lifetimes and no growth of deliberately placed flaws in one lifetime. Such tests have failed to meet their objectives. For this reason, test planning should include clear test objectives with the goal to test until natural cracking occurs.

B.6.6.11.1.6.2 DURABILITY TESTS

A complete airframe or approved alternatives shall be durability tested to show that the landing gear/backup structure meets the required service life specified in 5.5.2.14. Critical structural areas, not previously identified by analyses or development tests, shall be identified. Any special inspection and modification requirements for the service airframe shall be derived from these tests.

a. Test article. The test airframe shall be structurally identical to the operational airframe. Any differences, including material or manufacturing process changes will be assessed for durability impact. Significant differences will require separate tests of a production article or

selected component to show that the requirements of 5.5.7 are met for the operational airframe.

- b. Test schedule.
 - (1) The airframe durability test shall be performed such that one lifetime of durability testing plus an inspection of critical structural areas in accordance with 5.6.6.11.1.2.2.e shall be completed in time to support _____.
 - (2) Two lifetimes of durability testing plus an inspection of critical structural areas in Accordance with 5.6.6.11.1.2.2.e shall be completed in time to support _____.
- c. Test evaluation. All test anomalies which occur within the duration specified in 5.6.6.11.1.2.2.f, to include areas which have initiated cracking or delimitation as determined by post test teardown inspection, shall be evaluated for production and retrofit modifications, particularly with respect to those anomalies which would impose undue inspection burden for carrier based aircraft. Test anomaly analyses must be correlated to test results, and the adjusted analyses must show that the test anomalies meet the durability requirements of 5.5.7 and the damage tolerance requirements of 5.5.8 (if applicable). Modifications shall also be shown to satisfy durability and damage tolerance requirements either by test or analysis at the discretion of the acquisition activity.
- d. Test spectrum. The test spectrum shall be derived from and be consistent with 5.5.2.14.6 and 5.7.7. Truncation, elimination, or substitution of load cycles is allowed subject to approval by the acquisition activity.
- e. Inspections. Inspections shall be performed as an integral part of the durability tests and at the completion of testing. These inspections shall consist of design inspections, special-inspections, and post-test complete teardown inspection after test completion.
- f. Duration. A minimum of two lifetimes of durability testing except as noted below is required to certify the airframe structure. A third lifetime testing shall be performed to support damage tolerance requirements, repair/modification changes, usage changes, and life extension potential.
 - (1) Ship-based aircraft nose landing gear and backup structure shall have _____ lifetimes of durability testing.
 - (2) Ship-based aircraft main landing gear and backup structure shall have _____ Lifetimes of durability testing.

- (3) Land-based aircraft nose landing gear and main landing gear shall have _____ lifetimes of durability testing.
- (4) High strength parts analyzed by fatigue analysis shall have _____ lifetimes of durability testing.
- (5) Others: _____.

VERIFICATION RATIONALE

The timely completion of full-scale durability testing is essential to determine if the service life requirements are satisfied and that any required structural modifications can be identified and incorporated in the structure prior to significant production milestones.

VERIFICATION GUIDANCE

Specific guidance for the individual requirements concerning the full-scale testing are contained in the following subparagraphs. See 5.6.6.5.2 and subparagraphs for additional full-scale test guidance.

VERIFICATION LESSONS LEARNED

None.

VERIFICATION RATIONALE (Paragraph 5.6.6.11.1.2.2a)

In order to demonstrate that service life requirements are satisfied for the production configuration, it is necessary to test an airframe which is identical to the final production design.

VERIFICATION GUIDANCE (Paragraph 5.6.6.11.1.2.2.a)

The timing of the durability test, as indicated in 5.6.6.11.1.2.2.b, usually necessitates the fabrication of the test airframe prior to the final production drawing release. To minimize differences between the test airframe and the production airframe structure, careful attention must be paid to coordinating the timing of the development tests, production drawing releases, and test article fabrication. Differences which are deemed significant must be demonstrated to be in compliance with the requirements of this specification by analysis and test as approved by the procuring agency.

VERIFICATION LESSONS LEARNED (Paragraph 5.6.6.11.1.2.2.a)

Generally, components such as landing gear, some empennage structure, or pylons can be successfully tested as components. It is usually necessary, and most cost effective, to test the wing and fuselage as an assembly to insure that the effects of interface loadings are accounted for properly.

VERIFICATION RATIONALE (Paragraph 5.6.6.11.1.2.2.b)

It is necessary to mesh durability testing with major production milestones to minimize the impact of major redesign and retrofit efforts necessitated by the discovery of structural deficiencies during the test.

VERIFICATION GUIDANCE (Paragraph 5.6.6.11.1.2.2.b)

- (1) One lifetime of testing plus the indicated inspections should be completed prior to a production go-ahead decision.
- (2) The second lifetime of testing plus the indicated inspections should be completed prior to the delivery of the first production aircraft.

VERIFICATION LESSONS LEARNED (Paragraph 5.6.6.11.1.2.2.b)

A fighter development program has demonstrated that these test timing requirements can be accommodated in a reasonable development effort and the advantages to the government of this test before buy approach are clearly evident.

VERIFICATION RATIONALE (Paragraph 5.6.6.11.1.2.2.c)

Full scale durability test results form the basis of actions required to achieve full airframe service life. These actions may take the form of production/retrofit modifications or in-service inspections.

VERIFICATION GUIDANCE (Paragraph 5.6.6.11.1.2.2.c)

If the durability analysis is confirmed by the full scale test, no structural anomalies will occur and, therefore, no specific actions (e.g. inspections, modifications) to achieve full service life are required. However, structural anomalies identified during the two lifetime test, or determined to have initiated during that period as part of the subsequent teardown inspection, must be evaluated with respect to safety, operational and economic impacts. All findings which raise concern for safety, functional impairment or inspection difficulty/implementation, particularly for carrier based aircraft, are the responsibility of the manufacturer and require modification or repair in order that fleet airframes achieve full service with minimum impact to operations, cost, and planned inventory. All other findings should be documented and evaluated with regard to disposition (i.e. no action, inspection, modification) with implementation subject to the discretion of the procuring agency.

When findings occur during test, it is clear that the durability analysis must be corrected such that the analytical prediction will correlate to the test finding. The corrected analysis must show compliance with the durability requirements of 5.5.7 and the damage

tolerance requirements of 5.5.8, if applicable. If modifications are required, they too must meet durability and damage tolerance requirements by test or analysis at the discretion of the procuring activity.

VERIFICATION LESSONS LEARNED
(Paragraph 5.6.6.11.1.2.2.c)

None.

VERIFICATION RATIONALE
(Paragraph 5.6.6.11.1.2.2.d)

The purpose of the durability test is to substantiate the service life of the airframe structure. In order to identify critical areas and protect against planned inventory shortfalls or operational disruptions which can be caused by weight and usage variations, the test loading and environment must reflect the requirements 5.5.2.14.6.

VERIFICATION GUIDANCE
(Paragraph 5.6.6.11.1.2.2.d)

The test spectrum should be derived from the requirements defined in 5.5.2.14.6. The results of the development tests required in 5.6.6.11.1.2.1 should provide additional guidance. The level of chemical and thermal environmental simulation necessary during the test should be defined during development testing. High and low load truncation levels should be evaluated based on the effects on durability (and damage tolerance) limits and substantiated by developmental testing. Proof testing or residual strength testing prior to the completion of two lifetimes of durability testing should be avoided unless the air vehicle will be proof tested in service.

VERIFICATION LESSONS LEARNED
(Paragraph 5.6.6.11.1.2.2.d)

The problem of developing a full-scale test spectrum, and the associated analysis spectrum, has existed on every aircraft development program. The use of average parameters, such as gross weight, altitude, airspeed, etc., within a given segment of the flight envelope to determine external loading generally leads to a benign spectrum which does not adequately interrogate the structure. A maximum amount of attention should be focused on spectrum development to obtain the most realistic spectrum possible consistent with the requirements of 5.5.2.14.

VERIFICATION RATIONALE
(Paragraph 5.6.6.11.1.2.2.e)

Thorough in-test and post-test inspections are required to completely evaluate whether the durability requirements of 5.5.7 have been satisfied. These inspections are an essential part of the assessment to establish the service life, and supporting actions, for the structure. In addition, other valuable information

is derived, such as the identification of accessibility problems, unanticipated cracking, and the location of small cracks which can be used in the damage tolerance testing or analysis. A thorough teardown inspection immediately after test completion will assure that information regarding the need for production redesign and/or service retrofit is obtained early in the production program to minimize the number of aircraft affected.

VERIFICATION GUIDANCE
(Paragraph 5.6.6.11.1.2.2.e)

Durability test inspections need to be established which identify what, how, and when inspections are to be performed. The frequency of inspection should increase as the test progresses. Inspections shall be conducted after one lifetime of testing. This inspection, as a minimum, shall include all areas defined as critical and should include partial disassembly and fastener removal as necessary to accurately assess the condition of the structure. The inspection after two lifetimes of testing shall be as thorough as possible taking into consideration possible continued testing. The final inspection on the test article shall include sufficient disassembly and detailed inspection to identify any unanticipated durability problem areas in the structure. If the teardown inspection is to follow completion of damage tolerance tests or third lifetime durability tests, the test procedure shall specify the procedures which will be used to "mark" the end of two lifetime durability testing. Teardown inspection procedure shall be developed. Items such as removing of skins, door panels, selective fasteners, all the primary structure, etc. shall be included.

VERIFICATION LESSONS LEARNED
(Paragraph 5.6.6.11.1.2.2.e)

A full scale test was completed on a fighter aircraft and only limited non-destructive inspections were conducted on critical areas. The test article was stored for potential future testing if the usage spectrum was more severe than design. Several years later, service aircraft experienced cracking in the wing spars resulting in a maintenance burden for the USAF. The test article in storage was examined and found to contain similar cracks as the service aircraft. If the test article had been thoroughly inspected, a relatively inexpensive production redesign could have avoided substantial maintenance costs.

f. Duration. A minimum of two lifetimes of durability testing except as noted below is required to certify the airframe structure. A third lifetime testing shall be performed to support damage tolerance requirements, repair/modification changes, usage changes, and life extension potential.

- (1) Ship based aircraft nose landing gear and backup structure shall have ____ lifetimes of durability testing.

- (2) Ship-based aircraft main landing gear and backup structure shall have _____ lifetimes of durability testing.
- (3) Land based aircraft nose and main landing gear shall have _____ lifetimes of durability testing.
- (4) High strength parts analyzed by fatigue analysis shall have _____ lifetimes of durability testing.

Others: _____.

VERIFICATION RATIONALE
(Paragraph 5.6.6.11.1.2.2.f)

It is necessary to plan, budget, and test beyond the required service life to provide a margin against normal variations in manufacturing, material, properties, loads, and usage characteristics.

VERIFICATION GUIDANCE
(Paragraph 5.6.6.11.1.2.2.f)

A minimum of two lifetimes of full scale durability testing must be conducted to identify the hot spots and damage tolerance critical locations. However, three lifetimes of the test program shall be planned, budgeted, and included in the proposal. The third lifetime of testing shall be evaluated on the following options:

- a. Continued durability combined with damage tolerance testing.
- b. Continued durability testing for the purpose of life extension and/or modification verifications.
- c. Residual strength testing to failure.
- d. Damage tolerance testing, fail-safe testing, and battle damage tolerance testing.
- e. Usage spectrum sensitivity testing.

At the conclusion of the full scale durability testing, the final teardown inspection shall be conducted.

To compensate for the complexity of the different aircraft systems such as bomber, fighter, and trainer, the test duration requirements may vary from system to system. For landing gear, landing gear back-up structure, high strength structure, and special structure, the specified test factor on design life shall be between 2.0 and 4.0 as a function of spectrum severity, consequence of failure, material damage tolerance characteristics, weight/cost trades, etc, subject to the approval of the procuring activity. For example, the single point failure mode and catastrophic consequences of failure during the catapult evolution of ship based operations mandates additional safety margin in both the nose landing gear and the corresponding airframe back-up structure have a four lifetime durability testing requirement to a spectrum which includes catapults, landing and related ground events. Carrier-based aircraft main landing gear and back-up structure, however, have previously

implemented a two lifetime requirement as a function of the spectrum severity and less catastrophic implications of failure. Land-based aircraft landing gears have previously implemented a four lifetime requirement as a result of spectrum severity, material damage tolerance, or analysis considerations. A test duration of less than four lifetimes may be programmed if test spectrum is more severe than design spectrum. (Reference Lincoln, "Assessment of Structural Reliability from Durability Testing", ICAF Conference 1993.) Gear tests may be conducted either on fixtures or the full scale test article, and may also be the same gear used for the drop test program, with credit accounted for the number and severity of drop test landing events.

VERIFICATION LESSONS LEARNED
(Paragraph 5.6.6.11.1.2.2.f)

The use of the durability test article for the continued durability combined with damage tolerance verification testing has proven to be the best option for continued testing. Besides the obvious cost advantages, additional durability information is obtained and naturally developed cracks can provide significant information to aid in the damage tolerance evaluation. A large aircraft full scale durability test program was planned to have two lifetimes of durability testing followed by one lifetime of damage tolerance testing on the same test article. The contractor did not submit a third lifetime testing proposal in the original proposal. However, the third lifetime of full scale durability testing was recommended late and tremendous time and effort had to be spent to accomplish the required task. If a third lifetime of testing was planned and budgeted in the original proposal, the implementation would have been much easier and cost effective.

B.6.6.11.2 CORROSION PREVENTION AND CONTROL

Corrosion prevention and control measures including the following elements shall be established and implemented in accordance with the following to verify that the requirements of 5.5.7.2 are met.

- a. The criteria for the selection of corrosion resistant materials and their subsequent treatments shall be defined. The specific corrosion control and prevention measures shall be defined and established as an integral part of airframe structures design, manufacture, test, and usage, and support activities.
- b. Organic and inorganic coatings for all airframe structural components and parts, and their associated selection criteria shall be defined.
- c. Procedures for requiring drawings to be reviewed by and signed off by materials and processes personnel shall be defined.
- d. Finishes for the landing gear and backup structure shall be defined. General guidelines

shall be included for selection of finishes in addition to identifying finishes for specific parts, such that the intended finish for any structural area is identified.

- e. The organizational structure, personnel, and procedures for accomplishing these tasks shall be defined and established.

VERIFICATION RATIONALE

Corrosion prevention measures are required to minimize the impact of corrosion problems on the durability and maintenance costs over the expected lifetime of the aircraft.

VERIFICATION GUIDANCE

The entire process (organizational structure, approach, techniques, and plans) should be established and implemented beginning with concept definition activities. The criteria for the selection of corrosion resistant materials and their subsequent treatments, such as shot peening, shall be defined. The guidance contained in MIL-STD-1568 should serve as the baseline approach for addressing materials/processes and corrosion requirements and should be deviated from only with appropriate supporting engineering justification. The development and maintenance of a corrosion prevention and control plan, finish specifications, and system peculiar corrosion control technical order in accordance with the guidance provided in MIL-STD-1568 should be considered. To ensure that the approach to corrosion prevention and control is well coordinated and addresses all phases of the acquisition, a Corrosion Prevention Advisory Board (CPAB) should be established in accordance with the guidance outlined in MIL-STD-1568.

VERIFICATION LESSONS LEARNED

Corrosion Assistance Teams on various aircraft programs have been successful in eliminating corrosion problems in later production aircraft. The corrosion problems were eliminated by changes in design and manufacturing practices. In addition, the correction was incorporated in the in-service aircraft.

B.6.6.11.3 THERMAL PROTECTION ASSURANCE

The following tests and analyses shall be performed to verify that the thermal protection systems of the airframe meet the requirements of 5.5.7.3:

VERIFICATION RATIONALE

It is necessary to validate the durability of thermal protection systems to prevent the occurrence of costly maintenance problems.

VERIFICATION GUIDANCE

For each area of the structure where there is a durability requirement established in section 5.5.7.3, analyses and tests need to be defined to insure that the requirements of 5.5.7.3 are satisfied. The duration of the required tests should be defined to provide adequate life margins considering the cost of the protection system and associated maintenance costs.

VERIFICATION LESSONS LEARNED

None.

B.6.6.11.4 WEAR AND EROSION

The following tests and evaluation shall be performed to show that the landing gear/backup structure meets the requirements of 5.5.7.4: _____.

VERIFICATION RATIONALE

In order to insure that minimum durability requirements are satisfied by components subject to wear in service usage, test verification is required.

VERIFICATION GUIDANCE

The specific test and test duration for each requirement identified in section 5.5.7.4 should be defined. The test durations established should provide adequate margins to cover normally expected variations in manufacturing tolerance and in intended usage.

VERIFICATION LESSONS LEARNED

Testing to evaluate wear should be structured such that acceptable and unacceptable limits on the amount of wear damage for a given component can be defined and the appropriate information incorporated into the maintenance technical instructions.

B.6.6.11.5 SPECIAL LIFE REQUIREMENTS

The following analyses and tests shall be performed to show that the landing gear/backup structure meets the requirements of 5.5.7.5: _____.

VERIFICATION RATIONALE

The durability of any structural component whose function may be degraded in service usage needs to be substantiated by analyses and tests.

VERIFICATION GUIDANCE

Specify the type and duration of the analyses and testing necessary to validate the durability requirements of 5.5.7.5. Also see Verification guidance (5.5.7.5).

VERIFICATION LESSONS LEARNED

To account for scatter factor used in the analysis and to maintain the acceptable structural reliability, high strength structures have been tested for four lifetimes of the average spectrum.

B.6.6.11.6 NONDESTRUCTIVE TESTING AND INSPECTION (NDT/I)

The NDT/I engineering and application efforts during design, testing, and production shall be documented.

VERIFICATION RATIONALE

Documentation is required to provide an audit trail so that the adequacy, thoroughness, and completeness of NDT/I engineering and application efforts can be determined by the contractor's system program management as well as the customer.

VERIFICATION GUIDANCE

MIL-I-6870 describes the detail necessary for the system NDT/I plan which provides the necessary documentation for the engineering efforts. The individual process control documents, either government, industry, or company, describe the detail required for documentation of the application efforts, including records.

NDT/I Manuals. Delivery of the first system into service must be accompanied with manuals that detail when, how often, and how the system is to be inspected for service induced damage. The manuals should include NDT/I methods and their applications as appropriate. As an example, structure subject to impact damage such as leading edges and leading gear should be addressed in the manual. The primary inspection method should be visual for evidence of damage. Determination of the actual presence and/or extent of damage should then be accomplished with the appropriate NDT/I procedures as described in the manuals. As the system ages, the manuals shall be upgraded to contain procedures for the detection of damage found to be appropriate for that system.

NDT/I Advisory Board. An NDT/I Advisory Board containing government and contractor personnel with the appropriate technical skills can provide a very effective way of bringing corporate government knowledge to the contractor for use in the system design, testing, and production functions. They can also provide excellent means for tracking the progress of NDT/I engineering efforts on the program by both contractor and government program management personnel.

VERIFICATION LESSONS LEARNED

None.

B.6.6.12 DAMAGE TOLERANCE

Analysis and test shall be performed to verify that the landing gear/backup structure meets the damage tolerance requirements of 5.5.8 through 5.5.8.2.3. Beneficial effects of life enhancement processes must be approved by the procuring activity. The damage tolerance requirements shall be detailed and included in the structural criteria of 5.5.1.1.

VERIFICATION RATIONALE

In order to maximize the probability of success in satisfying the detailed damage tolerance requirements, damage tolerance analyses and tests must be performed in all phases of the development of the airframe and not addressed after-the-fact. The detailed damage tolerance requirements and the associated verification requirements should be documented in the structural criteria for the airframe.

VERIFICATION GUIDANCE

The specific tasks required to verify that the requirements of 5.5.7.6 are met are contained in the sections that follow.

VERIFICATION LESSONS LEARNED

As demonstrated by both a fighter and a bomber development program, the key to achieving a damage tolerant structure is the selection of proper materials and paying attention to structural details. Because materials and detail structural concepts are selected very early in the development phase, damage tolerance requirements must be addressed as basic structural criteria.

B.6.6.12.1 FLAW SIZES

Production inspections shall be performed on 100 percent of all fracture critical regions of all landing gear/backup structure and related structural components. These inspections shall include, as a minimum, close visual inspections of all holes and cutouts and conventional ultrasonic, penetrant, or magnetic particle inspection of the remainder of the fracture critical region. When automatic hole preparation equipment is used, acquisition activity approved demonstration to quality and statistically monitor hole preparation and fastener installation may be established and implemented to satisfy this requirement.

a. Special nondestructive inspections.

- (1) Where initial flaw assumptions for safety of flight structures are less than those of 5.5.8.1, a nondestructive inspection demonstration shall be performed. This demonstration shall verify that all flaws equal to or greater than the assumed flaw size will be detected with a statistical confidence of _____.

- (2) The demonstration shall be conducted on each selected inspection procedure using production conditions, equipment, and personnel. The defective hardware used in the demonstration shall contain actual flaws and cracks which simulate the case of tight fabrication flaws. Subsequent to successful completion of the demonstration, specifications on these inspection techniques shall become the manufacturing inspection requirements and may not be changed without requalification and acquisition activity approval.
- b. Inspection proof tests. Component, assembly, or complete airframe inspection proof tests of every landing gear/backup structure shall be performed whenever the special nondestructive inspections of 5.6.6.12.1 cannot be validated and initial flaw assumptions for damage tolerant structures are less than those of 5.5.8.1. The purpose of this testing shall be to define maximum possible initial flaw sizes or other damage in slow crack growth structure.
- c. In-service inspections. Demonstration test articles shall be inspected to show that any required in-service inspection can be conducted on the airframe. The landing gear/backup structure shall be inspected in accordance with the designed inspectability levels of 5.5.8 during the course of the testing of 5.6.6.11.1.2.2 and 5.6.6.12.2.b.

VERIFICATION RATIONALE

The key element in assuring that the production airframes will satisfy damage tolerance criteria is to insure that the quality of the structure meets established minimum acceptance levels. This can only be accomplished by subjecting each critical structural location to a thorough inspection during fabrication.

VERIFICATION GUIDANCE

All fracture critical regions need to be identified. The required inspections need to comply with the requirements of MIL-I-6870. The types of inspections to be performed must be consistent with the initial flaw size assumptions established for the particular area of interest. A formal procedure should also be established to document and provide disposition criteria for anomalies found during the inspections.

VERIFICATION LESSONS LEARNED

None.

VERIFICATION RATIONALE (Paragraph 5.6.6.12.5.a)

A demonstration is required to validate the reliability of special inspection techniques.

VERIFICATION GUIDANCE (Paragraph 5.6.6.12.5.a)

A flaw size smaller than the design flaw size must have a probability of detection of 90 percent. This capability must be verified with a 95 percent confidence level by conducting a statistically valid demonstration. This special inspection provision in the specification should not be employed to cover basic structural deficiencies in new structures. It is recommended that thorough consideration be given to the following factors before a structural component is permitted to be qualified and certified using special inspection techniques:

- a. As a minimum, the component should satisfy all requirements in the specification with the smaller initial flaw size assumption.
- b. The component should be depot or base level inspectable in case the need for in-service inspection should arise from a change in usage or operational environment.

A life cycle cost advantage to the Air Force should be demonstrated.

VERIFICATION LESSONS LEARNED (Paragraph 5.6.6.12.5.a)

Special nondestructive inspection demonstrations have been successfully completed, for example, in a bomber design, dye penetrant inspections were qualified to smaller flaw sizes.

VERIFICATION RATIONALE (Paragraph 5.6.6.12.5.b)

Proof-testing can be a highly reliable inspection technique that can be used where standard inspection methods cannot be employed, provided that the full impact of the test on the structure can be assessed.

VERIFICATION GUIDANCE (Paragraph 5.6.6.12.5.b)

A decision to employ proof-testing must take the following factors into consideration:

- a. The loading that is applied must accurately simulate the peak stresses and stress distributions in the area being evaluated.
- b. The effects of the proof-test loading on other areas of the structure must be thoroughly evaluated.

Local plasticity effects must be taken into account in determining the maximum possible initial flaw size after test and in determining subsequent flaw growth.

VERIFICATION LESSONS LEARNED (Paragraph 5.6.6.12.5.b)

Production type proof-testing has been successfully employed on a swing wing fighter wing pivot fitting, a bomber wing, and a fighter horizontal tail. Proof-

testing of a fighter's speed brake was less than successful because the proof-test loading did not accurately load the portion of the structure which eventually experienced problems in service.

VERIFICATION RATIONALE
(Paragraph 5.6.6.12.5.c)

Demonstration of the inspection techniques and procedures on actual hardware is required to validate the proposed procedures.

VERIFICATION GUIDANCE
(Paragraph 5.6.6.12.5.c)

Inspections of the full scale test articles should be performed using the techniques and procedures planned for in-service use. Flight test articles can also be employed.

VERIFICATION LESSONS LEARNED
(Paragraph 5.6.6.12.5.c)

Numerous cases in the past have occurred where inspections were called out for areas that were difficult to inspect because of accessibility limitations or other considerations that were overlooked. Demonstration of the inspection procedures on the full-scale test airframe usually identifies these problems, but interferences from other factors, such as equipment and plumbing not usually installed on the test airframe, should be taken into account.

B.6.6.12.2 RESIDUAL STRENGTH REQUIREMENTS

Analyses and tests shall be conducted to verify that the landing gear/backup structure meets the damage tolerance requirements of 5.5.8.

- a. Analyses. Damage tolerance analyses consisting of crack growth and residual strength analyses shall be performed. The analyses shall assume the presence of flaws placed in the most unfavorable location and orientation with respect to the applied stresses and material properties. The crack growth analyses shall predict the growth behavior of these flaws in the chemical, thermal, and sustained and cyclic stress environments to which that portion of the component shall be subjected in service. The flaw sizes to be used in the analysis are those defined in 5.5.8.1. The analyses shall demonstrate that cracks growing from the flaw sizes of 5.5.8.1 will not result in sustained crack growth under the maximum steady flight and ground loads of the usage of 5.5.2.14 as modified by 5.5.7.5.a.
- b. Tests, development (___) and full scale (___) damage tolerance tests are required to demonstrate that the landing gear/backup structure meets the requirements of 5.5.8. The material properties derived from development tests shall be consistent and congruent with those properties of the same material, in the same

component, used by other structures disciplines. See 5.5.2.16.1.

VERIFICATION RATIONALE

A comprehensive analysis and test effort is required to validate the damage tolerance capability of the airframe.

VERIFICATION GUIDANCE

The verification that the requirements of 5.5.8.1 have been satisfied requires an extensive evaluation and interpretation of design analysis, development testing, full-scale testing, and post test analysis results. Because of analysis limitations and testing complexity, an individual analysis or test requirement cannot be accurately evaluated without supporting information from the other requirements. Specific guidance concerning the required analyses and testing is contained in the following subparagraphs. Where analytical capability is invalidated or does not exist, the development testing must be expanded to compensate for this deficiency.

VERIFICATION LESSONS LEARNED

Both a fighter and a transport wing design have been validated by conducting analysis and test verification of the damage tolerance requirements. Lessons learned from these efforts are contained in the following subparagraphs.

VERIFICATION RATIONALE
(Paragraph 5.6.6.12.2.a)

The development of a validated analysis methodology for each fracture critical component of the structure is of primary importance. The ability to predict the crack growth behavior of a flaw in any component over the entire range of expected crack sizes and shapes, possible usage variations, and operating environments is critical to the management of fleet airframe resources throughout the service life of the air vehicle.

VERIFICATION GUIDANCE
(Paragraph 5.6.6.12.2.a)

Crack growth and residual strength analyses should be conducted for each critical location of each fracture critical component to demonstrate compliance with the requirements under the indicated assumptions. The validity of the analytical methods should be demonstrated by correlation with the testing indicated in paragraph b. below. The analysis methods should be updated, corrected, or modified as necessary as test results become available to obtain the best predictive capability possible.

The test data and analysis should be thoroughly studied to identify any trends in the correlation with

regard to such factors as initial flaw size, shape, structural geometry, or environment which may isolate analysis deficiencies. An analysis method should not be considered acceptable based on the fact that it has been demonstrated to be overly conservative in all test correlations. This can have serious repercussions if under some future usage variation the method predicts an unrealistically short life.

As for metal structures, the damage tolerance analyses for composites are inexorably linked to the design development tests. For support of these analyses it is recommended that the design development testing consist of "building blocks" ranging from coupons to elements, to subcomponents, and finally to components.

**VERIFICATION LESSONS LEARNED
(Paragraph 5.6.6.12.2.a)**

None.

**VERIFICATION RATIONALE
(Paragraph 5.6.6.12.2.b)**

Extensive development and full-scale damage tolerance tests are required to verify the analytical predictions and to support force management of the air vehicles.

**VERIFICATION GUIDANCE
(Paragraph 5.6.6.12.2.b)**

Indicate the testing that is applicable. Test requirements should be defined according to the following guidance:

Damage tolerance development tests: Development testing should be conducted to provide data for the following areas:

- a. Material properties
- b. Analytical procedure verification of crack growth rates and residual strength
- c. Stress level effects
- d. Spectrum effects
- e. Early validation of the damage tolerance critical components

In addition, data should be generated to validate the methods to be used in introducing artificial damage (sharp fatigue cracks) in the full-scale test airframe. If early testing indicates that the design spectrum does not adequately mark the fracture surfaces for use in fractographic analysis, a scheme to artificially mark the fracture surfaces at periodic intervals should be developed. Development testing should consist of a progression from basic material property tests through a series of test specimens with increasing levels of geometry and loading complexity. These tests are intended to provide more information than just indicating whether a given structural detail will likely meet the minimum structural requirements. In order to verify an analytical failure prediction, both the

predicted time to failure and the predicted failure mode must be verified. This implies that at least some of the development tests, with a sufficient level of loading and geometry complexity which accurately simulate the full scale structure, must be tested to failure. The same applies to testing to determine stress level, spectrum, and environmental sensitivities. Both the time to failure and the failure modes must be verified.

The damage tolerance analyses for composites are linked to the development tests. In support of these analyses it is recommended that the development testing consist of "building blocks" ranging from coupons to elements, to subcomponents, and finally to components. These building block tests must include room temperature dry laminates. Also, if the effects of the environment are significant, then environmentally conditioned tests must be performed at each level in the building block process. The test articles are to be strain gaged adequately to obtain data on potentially critical locations and for correlation with the full scale static test, and in addition, the test program is to be performed so that environmentally induced failure modes (if any) are discovered. The design development tests are complete when the failure modes have been identified, the critical failure modes in the component tests are judged to be not significantly affected by the non-representative portion of the test structure and the structural sizing is judged to be adequate to meet the design requirements. For static test components, this judgment is based on adjusting the failure loads to the "B" basis environmentally conditioned allowable.

Damage tolerance tests: A complete airframe or approved alternatives should be damage tolerance tested to demonstrate compliance with the requirements. See 5.6.6.5. 2.1 through 5.6.6.5.2.4 for additional guidance for full-scale testing.

- a. Test article. The test airframe or components should be as structurally identical to the operational airframe as production practicalities will permit. Any differences, including material or manufacturing process changes, should be assessed for impact. The assessment should include additional component testing if the changes are significant. The test articles should include artificially induced damage by the techniques developed in development testing. The sharp fatigue cracks introduced should be of the appropriate size and shape consistent with the initial flaw size assumptions for the component. It is recommended that the full-scale durability test article be employed for this testing at the completion of the required durability testing (see 5.6.6.11.1.2.2). This approach has several advantages. First, any naturally developed fatigue cracks will be present, eliminating the need to artificially induce damage. Second, additional durability information is developed. Third, a cost savings can be realized by not having to fabricate a second test article. The amount of artificial damage that is introduced into the test article is a

function of the number of identified fracture critical locations, the number of naturally developed cracks if the durability article is used, and practical limitations caused by the particular structure. Extensive tear-down of a structure to introduce damage at an isolated location is usually not warranted unless the analysis and development testing indicate that proper internal member loading can only be simulated in the full-scale article.

b. Test requirements

- (1) The airframe or component damage tolerance tests should be performed in accordance with the guidance provided below.
- (2) If the crack growth rates demonstrated during the full-scale testing are different than expected from analysis or development testing, additional analysis and testing should be conducted to substantiate the full-scale test results.

c. Test spectrum.

- (1) A flight-by-flight test spectrum should be derived from the service loads and chemical and thermal environment spectra of 5.5.2. The effects of chemical and thermal environmental spectra should be thoroughly evaluated during the development testing, and these spectra should be included in the full-scale testing only if the development testing results indicate that it is necessary.
- (2) High and low load truncation, elimination, or substitution of load cycles should be substantiated by development testing.

d. Inspections. Major inspections should be performed as an integral part of the damage tolerance testing. Proposed in-service inspection techniques will be evaluated during the tests. Surface crack length measurements should be recorded during the tests. Evaluate surface crack length. The end-of-test inspection should include a structural teardown, a removal of cracked areas, and fractographic analysis of all significant fracture surfaces.

e. Duration. The duration of the tests should be sufficient to verify crack growth rate predictions. The test may need to run for one lifetime, but sufficient information might be derived in a shorter period.

f. Composite structures. Full scale testing is an essential element of ASIP. There is normally a full scale durability and damage tolerance test in the development of a weapon system, however, these tests are generally for the verification of the metal structure. In those cases where the metallic structure durability and damage tolerance tests capability can be confidently established in the design development tests, the full scale durability and damage tolerance tests may not be required. For example, a structure that is primarily composite, but contains a

limited number of metallic joints, may fall into this category. Normally, the durability and damage tolerance capability of the composite structure can be verified by the design development tests.

VERIFICATION LESSONS LEARNED (Paragraph 5.6.6.12.2.b)

None.

B.6.6.13 DURABILITY AND DAMAGE TOLERANCE CONTROL

The durability and damage tolerance control process shall be properly documented and implemented to ensure that maintenance and fatigue/fracture critical parts meet the requirements 5.5.7 and 5.5.8.

VERIFICATION RATIONALE

The process identifies the management approach to ensure the contractor's coordinated interdisciplinary functions to design and produce a fatigue resistant and damage tolerant aircraft.

VERIFICATION GUIDANCE

Durability and damage tolerance process control needs to be established to identify the maintenance, fatigue/fracture critical parts selection, and critical parts control. The control of critical parts is administered by the Durability and Damage Tolerance Control Board. The board is comprised of a broad range of people that represent different functional areas within the company - engineering, manufacturing, quality assurance, etc. The board is responsible for establishing and overseeing the administration of the specific controls that will be applied to the critical parts.

VERIFICATION LESSONS LEARNED

Durability and Damage Tolerance Controls have been developed and used successfully on recent development programs. Contractors have found durability and damage tolerance control to be a sound and reasonable approach to ensuring structural integrity. The number of critical parts selected should be adequate without overloading the manufacturing process.

B.6.6.14 SENSITIVITY ANALYSES

Verification of 5.5.10 shall be accomplished by sensitivity analyses to evaluate the proposed structure's optimum design and to identify the performance, and cost impacts of more robust design options. The analysis shall include variation of parameters such as projected weight growth after IOC, performance and utilization severity in the selection of detailed structural configurations.

VERIFICATION RATIONALE

A verified sensitivity analysis methodology is required to ensure the results of the sensitivity analysis can be used to assess variations of design options.

VERIFICATION GUIDANCE

The airframe structural life can be significantly degraded by small variations in design parameters such as weight, maneuverability, mission usage, etc. The analysis methods to be used must have been verified and used in the similar programs before.

VERIFICATION LESSONS LEARNED

A complete sensitivity analysis will yield important information for the Program Office to make Program Management decisions with the option to select structural robust design vs marginal design on the basis of system life cycle cost.

B.6.6.15 FORCE MANAGEMENT

Verification of 5.5.11 and subparagraphs shall be accomplished by analyses and tests to ascertain that all the requirements are met.

- a. **Analyses.** Analyses which support the force management and maintenance concepts of the procuring activity are required to verify, for each fatigue critical location, that the individual aircraft tracking (IAT) methodology is updated and well correlated to full scale durability, damage tolerance, and flight load test results.
- b. **Tests.** Demonstration tests shall be performed to verify that the data acquisition system records and processes all required aircraft systems and flight parameters necessary for the IAT methodology.

VERIFICATION RATIONALE

A comprehensive test and analyses effort is required to develop and validate the operation of the aircraft data acquisition system and the individual aircraft tracking methodology selected.

VERIFICATION GUIDANCE

An analysis methodology must be established to show compliance with the requirements of 5.5.11. The analysis methods must be calibrated to full scale durability, damage tolerance, and flight test results such that 100% of fatigue life expended or durability crack growth analysis calculated by the IAT methodology corresponds to one-half of the test demonstrated durability service life. The methodology should be verified by performing analysis with the IAT algorithm using the full scale durability and damage tolerance spectra of 5.5.7 and 5.5.8, respectively. These analyses shall be performed for each critical location being tracked, including:

- a. For existing aircraft models, locations known to experience fatigue damage in service.
- b. Locations experiencing fatigue damage during component or full scale durability and damage tolerance testing.
- c. Locations having the lowest margins of safety based on durability and damage tolerance analysis using the appropriate design spectra where the margin of safety is defined as:

$$\text{Margin of Safety (MS)} = [(\text{Analytically Predicted Life})/(\text{Design Life})] - 1$$

Testing shall also be performed to evaluate, for all flight and structural parameters, the accuracy of the data measured and recorded by the data acquisition system against corresponding measurements from the tests of 5.6.6.5, 5.6.6.7, 5.6.6.11.1.2.2, and 5.6.6.12.2, as applicable.

In addition, the contractor shall test and demonstrate all aspects and capabilities of the force management data processing program. This should be accomplished using data from the FDR collected during tests of 5.6.6.7 and other demonstration flight testing, to demonstrate the ability to download data from the airborne acquisition system, transfer the data to the appropriate transfer media, merge the recorded data with the applicable supplemental logbook information, identify missing/invalid data, convert the recorded data into fatigue damage values, generate and store nominal strain spectra for the aircraft, and produce monthly incremental information/data files for each aircraft, including bureau/tail number, custodian, total flight hours, total landings (field and ship-based, as applicable), cumulative N_z exceedances, incremental/total fatigue damage or crack growth accrual values, and other pertinent information required to track service life of aircraft in consonance with the force management and maintenance concepts of the procuring activity.

VERIFICATION LESSONS LEARNED

None.

B.6.6.16 PRODUCTION FACILITIES, CAPABILITIES, AND PROCESSES

These requirements shall be incrementally verified by examination, inspections, analyses, demonstration, and/or test. The incremental verification shall be consistent with the expectations for design maturity expected at key decision points in the program.

VERIFICATION RATIONALE

Incremental verification is employed to mitigate the risk associated with production, to ensure the ability to maintain design tolerances during the manufacturing process, and to confirm that the contractor has a process to control production cost and quality in production.

Verification at the aircraft structures level verifies that the contractor has established a disciplined approach with a process development strategy that (1) includes pre-planned process improvement and evolutionary strategies, (2) provides for the identification and risk abatement of high risk production identification and control of key processes, (4) ensures consistency between process performance, product performance, can cost, (5) defines quality assurance requirements consistent with product performance and cost requirements, (6) flows these requirements to the subtier contractors, and (7) is consistent with the approach at the weapon system level.

Key product characteristics are those measurable design details that have the greatest influence on the product meeting its requirements (form, fit, function, cost, service life, etc.) and are documented in a manner processes within the program's overall risk management process, (3) includes the determined by the contractor on the drawings and supporting Technical Data Packages in the "Build-To" and "Support" Packages. Key production processes follow logically from the identification of key product characteristics and the selection of production processes. Key production processes are those processes associated with controlling those key product characteristics. The identification of the key process requirement is accomplished through the system engineering process and design trade studies to establish a cost effective design.

In general, production cost risk can be controlled by demonstrating the key process requirements which include the establishment of design limits and process capabilities. Process capability is typically defined in terms of the statistical probability of non-conformance, such as defects per million or Cp, which is the ratio of design limits to the process variation. Once process capability requirements are established and the capability of the key processes verified, the process controls are established for use during production.

The identification of key product characteristics and key processes, and the establishment of process capability and process control requirements occur at the aircraft structure and subtier levels. Tasks essential to accomplishing this are (1) identification of high risk production processes with appropriated risk abatement activities, (2) identification and documentation of key product characteristics, (3) identification of key production processes and their key process characteristics, (4) establishing the process requirements, which include both the design limits and the process capability, (5) determination of the actual process capability, (6) establishing the process control requirements, and (7) flow down of these requirements to the suppliers whose products will have an effect on the system's attainment of performance requirements. Therefore, verification at the aircraft structure level confirms compliance with requirements at the aircraft structure level, that appropriate requirements are flowed down to the subtier level, and that essential tasks have been

accomplished at the appropriate aircraft structure/subtier level.

VERIFICATION GUIDANCE

The following incremental verifications should be accomplished early in a program such as prior to the System Functional Review (SFR). Examine and analyze documentation to verify that the contractor has a process documented and in place that (1) establishes a process technology development strategy including pre-planned process improvement and evolutionary strategies, (2) identifies, as part of the overall program risk management process, high risk production processes and risk abatement activities, (3) provides for the early identification of key product characteristics, key processes, and their key characteristics, (4) assesses key process technology performance, availability, and suitability, (5) establishes process capability requirements (Cpk), (6) verifies actual process capabilities, (7) establishes and implements process controls with minimal inspections, (8) flows down requirements to all subtier levels, and (9) is consistent with the overall weapon system level requirements and approach. This verifies the contractor's readiness for the next phase or engineering effort by ensuring that the contractor has a working process in place to identify, develop, and control key manufacturing processes.

Early identification of critical manufacturing process technology performance, availability, and suitability, with the implementation of an appropriate strategy, reduces production risks by allowing the manufacturing processes to be developed and matured prior to full-scale production.

The following incremental verifications should be accomplished prior to 20% drawing releases or Preliminary Design Review (PDR). Examine and analyze documentation and design trade study reports to confirm the following have been accomplished at the appropriate aircraft structure/subtier levels: (1) manufacturing feasibility assessment, (2) identification of key product characteristics and the documentation of those characteristics on drawings including appropriate geometric tolerancing and datum control, (3) identification of key processes, (4) establishment of process capability requirements, which include both the design limits and process capabilities (Cpk, defects per million, etc.), (5) evaluation of key process capabilities, (6) flow down of key process requirements, and (7) assessment of risk abatement status on high risk production processes and appropriate action taken is needed. This verification ensures that an appropriate manufacturing process has been developed and the preliminary design to address manufacturing processes has been confirmed to be complete, correct, and adequate.

Usually, the fidelity of the design at PDR is such that all key product characteristics and key production processes are not yet identified. However, based on historical data and the existing level of design, an initial identification and assessment of key production processes can be accomplished and initial capability

requirements should be established. In addition, sufficient information exists to assess the progress of risk abatement activities for high risk production processes.

The following incremental verifications should be accomplished prior to 80% drawing release or Critical Design Review (CDR). Examine and analyze documentation and design trade study reports to confirm the following have been accomplished at the appropriate aircraft structure/subtier levels (1) more refined effort of the verification done at PDR to reflect expected design maturity at CDR, (2) completion of preliminary specifications for key processes, (3) completion of preliminary process control plans, (4) documentation of rationale to support the detailed design (product/special tooling/special test equipment/support equipment) including key product characteristic's design limit sensitivity to off nominal production (details to include the results of key suppliers' efforts), (5) documentation of rationale to support selection of production processes, including comparison of required process capabilities to documented capabilities and selection of process control criteria with the associated process control plan for achieving required product quality, and (6) definition of verification requirement for key processes including facility capabilities. This verification ensures that manufacturing process development and the detail design to address manufacturing processes has occurred and has been confirmed to be complete, correct, and adequate.

Usually the fidelity of the design at CDR is such that all key product characteristics and key production processes are identified, capability requirements established, process capabilities verified, and preliminary process control plans completed. In addition, sufficient information exists to assess the progress of risk abatement activities including the demonstration of process capability for high risk production processes.

The following incremental verifications should be accomplished prior to System Verification Review (SVR). Examine and analyze documentation and design trade study reports to confirm the following have been accomplished at the appropriate aircraft structure/subtier levels (1) identification of all key product characteristics and the documentation of those characteristics on drawings including appropriate geometric tolerancing and datum control, (2) establishment of process capability requirements, which include both the design limits and process capabilities, (3) verification of key process capabilities complete including validated process control plans, (4) completion of final process control plans, (5) proof of final manufacturing feasibility including facility capability, (6) completion of final specifications for all key production processes, and (7) completion of contractor build-to documentation. This verification requirement ensures that manufacturing process development, detail design to address manufacturing processes, and contractor build-to documentation has occurred and has been confirmed to be complete,

correct, adequate and stable, and ensures the system is ready for the production phase.

The fidelity and stability of the design at SVR is such that all key product characteristics and key production processes are identified, capability requirements established, process capabilities verified, process control plans completed, and contractor build-to package completed. Risk abatement activities should have lowered key production process risk to an acceptable level for start of production.

The following incremental verifications should be accomplished prior to Physical Configuration Audit (PCA). Examine documentation to confirm that the adequacy and completeness of the build-to documentation was verified at the aircraft structure and subtier level. This verification requirement is to determine the completeness, correctness, and adequacy of the final build-to documentation.

VERIFICATION LESSONS LEARNED

None.

B.6.6.17 ENGINEERING DATA REQUIREMENTS VERIFICATION

Data requirements content and format for studies, analyses, and test requirements shall be selected from the DOD Authorized Data List and shall be reflected in the contractor data requirements list attached to the request for proposal, invitation for bids, and the contract as appropriate. Documentation and submittal of data and on-site review requirements shall be in accordance with and supportive of the activities identified in 5.6.0. and shall be subject to approval of the procuring activity. The documentation of the data shall also be compatible with generation and support of technical orders and maintenance plans, and allow the using command a database to support and manage the aircraft throughout its life.

VERIFICATION RATIONALE

Documentation of engineering data in a uniform and timely manner is necessary to ensure that requirements are met. It is essential that the data be compatible with generation and support of technical orders, and allow the using command a database to support and manage the aircraft throughout its life.

VERIFICATION GUIDANCE

When this specification is used in an acquisition which incorporated a DD Form 1423, Contract Data Requirements List (CDRL), the data requirements identified below shall be developed as specified by an approved Data Item Description (DD Form 1664) and delivered in accordance with the approved CDRL incorporated into the contract. When the provisions of DAR 7-104.9(n)(2) are invoked and the DD Form 1423 is not used, the data specified below shall be delivered by the contractor in accordance with the contract or purchase order requirements. Deliverable

data required by this specification is cited in the following paragraphs. Each data requirement has been assigned a recommended submittal category.

- a. Category I. Information and data assigned to this category is generated by the contractor in response to the contract requirements, but is retained by the contractor in contractor format. This category is applicable and may result in deliverable data if the CDRL, DD Form 1423, incorporates a Data Item Description line item for DI-A-3027 Data Accession List/Internal Data, or if the contract contains an equivalent data requirement.
- b. Category II. Information and data assigned to this category is generated and submitted by the contractor in response to the contract requirements and the applicable line items of the CDRL, DD Form 1423. These items are not to be submitted for approval, i.e. the Block 8 of the DD Form 1423 should contain a "D", "N", or are blank. See DI-A-23434 for definition of codes.
- c. Category III. Information and data assigned to this category is generated and submitted by the contractor in response to the contract requirements and the applicable line items of the CDRL, DD Form 1423. These items are to be submitted for approval, i.e. the Block 8 of the DD Form 1423 should contain an "A", "AD", or "AN". Approval clarification instructions for an "A", "AD", or "AN" in Block 8 must be included in Block 16.. See DI-A-23434 for definition of codes and approval clarification instructions.

VERIFICATION LESSONS LEARNED

None.

B.7 DEFINITIONS

The following definitions are applicable to this specification to enhance its understanding and application.

B.7.1 ACOUSTIC ENVIRONMENT.

The acoustic environment is the pattern of sound pressure levels within specified boundaries.

B.7.2 AERIAL DELIVERY.

The air shipment of cargo or personnel to a point in which the cargo is delivered by airdropping or landing of the air vehicle.

B.7.3 AEROACOUSTIC FATIGUE.

Aeroacoustic fatigue is the material fracture caused by the rapid reversal of stresses in the structure which in turn is caused by the fluctuating pressures associated with the aeroacoustic load produced by flight vehicles.

B.7.4 AEROACOUSTIC LOAD.

The aeroacoustic load is the acoustic-noise, turbulent, or separated boundary layer pressure fluctuations, or oscillating shock pressures acting on the surface of the structure.

B.7.5 AIRCRAFT.

As used herein, that subset of machines designed to travel through the air, supported principally by aerodynamic forces acting on wings, and power driven.

B.7.6 AIRFRAME.

The structure of the air vehicle including fuselage, wing, empennage, landing gear, mechanical/structural elements of the control systems, control surfaces, radomes, antennas, engine mounts, nacelles, pylons, structural operating mechanisms, structural provisions for equipment, payload, cargo, personnel, and other components specified in 1.2.3.

B.7.7 AIR TRANSPORT.

Delivery of personnel or cargo from point to point in which cargo is delivered by landing of the air vehicle.

B.7.8 AIR VEHICLE.

That particular aircraft, including all airborne systems, suspension equipment, and subsystems designed to perform a designated mission or missions.

B.7.9 AUXILIARY SYSTEMS.

An auxiliary system is any mechanism or structure other than the airframe, power plant, or armament which performs a function at some time during the operation of the aircraft for a period exceeding two minutes, for example, heating and ventilation; pressurization, defrost and defog; inverters; pumps; auxiliary power unit (APU); etc..

B.7.10 CONTAINER DELIVERY SYSTEM (CDS).

A method of airdropping containers either in single or double row in which an aft restraint is removed and the containers exit the aircraft by gravity.

B.7.11 DAMAGE TOLERANCE.

The ability of the airframe to resist failure due to the presence of flaws, cracks, or other damage for a specified period of unrepaired usage.

B.7.12 DAMPING COEFFICIENT (g).

Damping coefficient, g, is expressed by the equation $g = \frac{\ln(A_i/A_j)}{\pi N}$, where $N = (j - i)$, A_i is the amplitude of the i th cycle, and A_j is the amplitude of the j th cycle.

B.7.13 DEGREE OF INSPECTABILITY.

The degree of inspectability of safety of flight structure shall be established in accordance with the following definitions.

B.7.13.1 DEPOT OR BASE LEVEL INSPECTABLE.

Structure is depot or base level inspectable if the nature and extent of damage will be detected utilizing one or more selected nondestructive inspection procedures. The inspection procedures may include NDI techniques such as penetrant, X-ray, ultrasonic, etc.. Accessibility considerations may include removal of those components designed for removal.

B.7.13.2 IN-FLIGHT EVIDENT INSPECTABLE.

Structure is in-flight evident inspectable if the nature and extent of damage occurring in flight will result

directly in characteristics which make the flight crew immediately and unmistakably aware that significant damage has occurred and that the mission should not be continued.

B.7.13.3 IN-SERVICE NON-INSPECTABLE STRUCTURE.

Structure is in-service non-inspectable if either damage size or accessibility preclude detection during one or more of the above inspections.

B.7.13.4 GROUND EVIDENT INSPECTABLE.

Structure is ground evident inspectable if the nature and extent of damage will be readily and unmistakably obvious to ground personnel without specifically inspecting the structure for damage.

B.7.13.5 SPECIAL VISUAL INSPECTABLE.

Structure is special visual inspectable if the nature and extent of damage is unlikely to be overlooked by personnel conducting a detailed visual inspection of the aircraft for the purpose of finding damaged structure. The procedures may include removal of access panels and doors, and may permit simple visual aids such as mirrors and magnifying glasses. Removal of paint, sealant, etc. and use of NDI techniques such as penetrant, X-ray, etc., are not part of a special visual inspection.

B.7.13.6 WALKAROUND INSPECTABLE.

Structure is walkaround inspectable if the nature and extent of damage is unlikely to be overlooked by personnel conducting a visual inspection of the structure. This inspection normally shall be a visual look at the exterior of the structure from ground level without removal of access panels or doors without special inspection aids.

B.7.14 DISCIPLINE.

A technical area, for example, aeroelasticity, loads, durability, strength, etc..

B.7.15 DIVERGENCE.

Divergence is a static aeroelastic instability of a lifting surface that occurs when the structural restoring moment of the surface is exceeded by the aerodynamic torsional moment.

B.7.16 DURABILITY.

The ability of the airframe to resist cracking (including stress corrosion and hydrogen induced cracking), corrosion, thermal degradation, delamination, wear, and the effects of foreign object damage for a specified period of time.

B.7.17 DURABILITY SERVICE LIFE.

That operational life indicated by the results of the durability tests and as available with the incorporation of approved and committed production or retrofit changes and supporting application of the force structural maintenance plan. In general, production or retrofit changes will be incorporated to correct local design and manufacturing deficiencies disclosed by test. It will be assumed that the life of the test article has been attained with the occurrence of widespread damage which is uneconomical to repair and, if not repaired, could cause functional problems affecting operational readiness. This can generally be

characterized by a rapid increase in the number of damage locations or repair costs as a function of cyclic test time.

B.7.18 FACTOR OF UNCERTAINTY.

The ratio of the load that would cause failure of a member or structure, to the load that is imposed upon it in service. For design purposes, it is the value by which limit loads are multiplied to derive ultimate loads. The factor of uncertainty has in the past been referred to as the factor of safety.

B.7.19 FAIL-SAFE CRACK ARREST STRUCTURE.

Crack arrest fail-safe structure is structure designed and fabricated such that unstable rapid propagation will be stopped within a continuous area of the structure prior to complete failure. Safety is assured through slow crack growth of the remaining structure and detection of the damage at subsequent inspections. Strength of the remaining undamaged structure will not be degraded below a specified level for the specified period of unrepaired service usage.

B.7.20 CRITICAL PARTS.

A critical part is defined as one, the single failure of which during any operating condition could cause loss of the aircraft or one of its major components, loss of control, unintentional release of or inability to release any armament store, failure of weapon installation components, or which may cause significant injury to occupants of the aircraft or result in major economic impact on the aircraft, or a significant increase in vulnerability, or a failure to meet critical mission requirements.

B.7.20.1 FATIGUE/FRACTURE CRITICAL PARTS.

Fatigue/fracture critical parts are primary structural components that are designed by durability and/or damage tolerance requirements, the single failure of which could lead to the loss of the aircraft, aircrew, or inadvertent stores release (pylons, racks, launchers, etc.). These parts generally call for special fatigue/fracture toughness controls, quality control procedures, NDT/I practices, and analytical requirements.

B.7.20.2 FATIGUE/FRACTURE CRITICAL TRACEABLE PARTS.

Fatigue/fracture critical traceable parts are fatigue/fracture critical parts, the single failure of which could lead to immediate loss of the aircraft, aircrew, or inadvertent stores release (pylons, racks, launchers, etc.). These parts generally call for the fatigue/fracture critical parts requirements as well as, serialization and traceability from starting stock to tail number and reverse.

B.7.20.3 MAINTENANCE CRITICAL PARTS.

Maintenance critical parts are structural components that are designed by durability requirements. The failure of the part may result in functional impairment of, or major economic impact on an aircraft or subsystem performance. The failure of the part requires costly maintenance and/or part repair or replacement, which if not performed would

significantly degrade performance or operational readiness. Failure of these parts will not cause a safety of flight condition. In addition to general analytical requirements, these parts generally call for special quality control procedures and NDT/I practices.

B.7.20.4 MISSION CRITICAL PARTS.

Mission critical parts are airframe components (including secondary structure, fairings, coatings, films, etc.) whose inflight damage or failure would result in a failure to meet critical mission requirements or a significant increase in vulnerability. These parts generally call for special design criteria, special quality control procedures, and NDT/I practices.

B.7.21 FREQUENCY OF INSPECTION.

Frequency of inspection is defined in terms of the interval between the conduct of a particular type of inspection.

B.7.22 HARDNESS.

A measure of the ability of a system to withstand exposure to one or more of the effects of either nuclear or nonnuclear weapons including those weapons of a chemical and biological nature. The effective hardness for a specific effect can be expressed either quantitatively or qualitatively.

B.7.23 INITIAL QUALITY.

A measure of the condition of the airframe at the completion of the manufacturing and assembly process relative to flaws, defects, or other discrepancies in the basic materials or introduced during manufacture of the airframe.

B.7.24 LOAD FACTOR.

The multiplying factor by which the inertial weights of the aircraft are multiplied and subsequently combined vectorally with gravitational forces to obtain a system of external applied forces equivalent to the dynamic force system acting on the aircraft during flight and ground usage.

B.7.25 MARGIN OF SAFETY.

The ratio of the excess allowable stress to the calculated or applied stress. The margin of safety (M.S.) is calculated as follows:

$$M.S. = \frac{F - kf}{kf} = \frac{F}{kf} - 1$$

Where F is the allowable stress, f is the calculated or applied stress, and k is any special factor such as fitting factor or bearing factor.

B.7.26 MINIMUM ASSUMED INITIAL DAMAGE SIZE.

The minimum assumed initial damage size is the smallest crack-like defect which shall be used as a starting point for analyzing residual strength and crack growth characteristics of the structure.

B.7.27 MINIMUM ASSUMED IN-SERVICE DAMAGE SIZE.

The minimum assumed in-service damage size is the smallest damage which shall be assumed to exist in

the structure after completion of an in-service inspection.

B.7.28 MINIMUM PERIOD OF UNREPAIRED SERVICE USAGE.

Minimum period of unrepaired service usage is that period of time during which the appropriate level of damage (assumed initial or in-service) is presumed to remain unrepaired and allowed to grow within the structure.

B.7.29 MULTIPLE LOAD PATH - FAIL-SAFE STRUCTURE.

Multiple load path fail-safe structure is designed and fabricated in segments (with each segment consisting of one or more individual elements) whose function it is to contain localized damage and thus prevent complete loss of the structure. Safety is assured through slow crack growth in the remaining structure prior to the subsequent inspection. The strength and safety will not be degraded below a specified level for a specified period of unrepaired service usage.

B.7.29.1 MULTIPLE LOAD PATH - DEPENDENT STRUCTURE.

Multiple load path structure is classified as dependent if a common source of cracking exists in adjacent load paths at one location due to the nature of the assembly or manufacturing procedures. An example of multiple load path-dependent structure is planked tension skin where individual members are spliced in the spanwise direction by common fasteners with common drilling and assembly operations.

B.7.29.2 MULTIPLE LOAD PATH - INDEPENDENT STRUCTURE.

Multiple load path structure is classified as independent, if by design, it is unlikely that a common source of cracking exists in more than a single load path at one location due to the nature of assembly or manufacturing procedures.

B.7.30 OPERATIONAL NEEDS.

Those user requirements and capabilities needed to effectively perform the designated mission or missions.

B.7.31 PALLET.

A flat structure used to support cargo for air transport. Normally referred to as a #463L Pallet."

B.7.32 PERSONNEL EAR PROTECTION.

Personnel ear protection consists of standard issue helmet, earplugs, or earmuffs.

B.7.33 PURE TONE OR NARROW BAND.

If the sound pressure level of any one-third octave band exceeds the level in the adjacent one-third octave bands by 5 dB or more, that band and associated octave band shall be considered to contain pure tone or narrow band components.

B.7.34 REPORTED SOUND PRESSURE LEVEL.

The peak sound pressure level to be reported is the arithmetic average of the measured minimum and maximum levels provided the difference between the average and maximum is 3 dB or less. If this

difference is greater than 3 dB, the level to be reported shall be obtained by subtracting 3 dB from the maximum level. The peak sound pressure level means impulsive noise (bursts) as defined in American National Standard ANSI S1.13-1971 (R1976) "Methods for the Measurement of Sound Pressure Levels."

B.7.35 SAFETY OF FLIGHT STRUCTURE.

That structure whose failure would cause direct loss of the air vehicle or whose failure, if it remained undetected, would result in loss of the air vehicle.

B.7.36 SLOW CRACK GROWTH STRUCTURE.

Slow crack growth structure consists of those design concepts where flaws or defects are not allowed to attain the critical size required for unstable rapid crack propagation. Safety is assured through slow crack growth for specified periods of usage depending upon the degree of inspectability. The strength of slow crack growth structure with subcritical damage present shall not be degraded below a specified limit for the period of unrepaired service usage.

B.7.37 SOUND PRESSURE LEVELS.

The sound pressure level, in decibels, of a sound is 20 times the logarithm to the base 10 of the ratio of the pressure of this sound to the reference pressure. All sound pressure levels given in decibels in this specification are based on a pressure of $0.0002 \text{ dynes/cm}^2$ (2×10^{-5} newtons per square meter).

B.7.38 SPECIAL MISSION AIRCRAFT.

Special mission aircraft include Anti-Submarine Warfare (ASW), Aircraft Early Warning (AEW), Airborne Command and Control, Electronic Countermeasures (ECM), Presidential/VIP Transports, etc..

B.7.39 SPEEDS.

Speeds will be in knots based upon the international nautical mile.

B.7.39.1 CALIBRATED AIRSPEED (CAS).

The calibrated airspeed is the indicated airspeed corrected for installation and instrument errors. (As a result of the sea level adiabatic compressible flow correction to the air speed instrument dial, CAS is equal to the true airspeed (TAS) in standard atmosphere at sea level.)

B.7.39.2 EQUIVALENT AIRSPEED (EAS).

The equivalent airspeed is the indicated air speed corrected for position error, instrument error, and for adiabatic compressible flow for the particular altitude. (EAS equals CAS at sea level in standard atmosphere.)

B.7.39.3 INDICATED AIRSPEED (IAS).

The indicated airspeed is the reading of the airspeed indicator uncorrected for installation and installation errors, but includes the sea level standard adiabatic compressible flow correction.

B.7.39.4 TRUE AIRSPEED (TAS).

The true airspeed is the speed at which the airplane moves relative to the air mass surrounding it. TAS

equals EAS times the square root of the sea level to altitude density ratio.

B.7.40 STORE.

Any device intended for internal or external carriage and mounted on aircraft suspension and release equipment, whether or not the item is intended to be separated in flight from the aircraft. Stores include missiles, rockets, bombs, nuclear weapons, mines, torpedoes, pyrotechnic devices, detachable fuel and spray tanks, dispensers, pods (refueling, thrust augmentation, gun electronic-counter measures, etc.), targets, cargo drop containers, and drones.

B.7.40.1 EMPLOYMENT.

The use of a store for the purpose and in the manner for which it was designed, such as releasing a bomb, launching a missile, firing a gun, or dispensing submunitions.

B.7.40.2 SUSPENSION EQUIPMENT.

All airborne devices used for carriage, suspension, employment, and jettison of stores, such as racks, adapters, launchers and pylons.

B.7.41 STRUCTURE.

Any airframe metallic or non-metallic component, element or part reacting, carrying or transmitting forces or motions required for stiffness and mechanical stability.

B.7.42 STRUCTURAL INTEGRITY.

The structure strength, rigidity, damage tolerance, durability and functioning of structural parts of the airframe as affecting the safe use and cost-of-ownership of the air vehicle.

B.7.43 STRUCTURAL OPERATING MECHANISMS.

Those operating, articulating, and control mechanisms which transmit forces and motions during actuation and movement of structural surfaces and elements.

B.7.44 SURVIVABILITY.

The capability of a system to avoid and withstand a man-made hostile environment without suffering an abortive impairment of its ability to accomplish its designated mission.

B.7.45 VULNERABILITY.

The characteristics of a system which cause it to suffer a definite degradation in capability to perform the designated mission as a result of having been subjected to a certain level of effects in an unnatural (man-made) hostile environment.

B.7.46 KEY PROCESS CHARACTERISTICS.

Key process characteristics are broken into two categories, input or control characteristics, and output characteristics. Output characteristics are those process output parameters which control the associated key product characteristics. The variation in these output characteristics characterize the process, and is the primary focus of customer process control requirements. Input characteristics are those process input parameters which control the key output characteristics of the process. Input characteristics should be of primary interest to the manufacturer, and

are generally the most amenable to application of statistical process control or other variability reduction techniques.

B.7.47 KEY PRODUCT CHARACTERISTICS.

Those measurable design details that have the greatest influence on the product meeting its requirements (form, fit, function, cost, or service life).

B.7.48 KEY PRODUCTION PROCESS.

Those production processes which control key product characteristics. This may be a fabrication process, assembly process, test process, or an inspection process.

B.7.49 PROCESS CAPABILITY INDEX (C_p).

The ratio of the design tolerance to the process variability.

$$C_p = \frac{\text{design tolerance}}{\text{process spread}} = \frac{\text{upper spec limit} - \text{lower spec limit}}{\text{process spread (6}\sigma\text{)}} = \frac{\text{upper spec limit} - \text{lower spec limit}}{6 \text{ sigma}}$$

B.7.50 PRODUCTION.

To manufacture, fabricate, assemble, and test products according to an organized plan and with division of labor.

B.7.51 PRODUCTION CONTROL.

Systematic planning, coordinating, and directing of all manufacturing activities and influences to insure having goods made on time, of adequate quality, and at reasonable cost.

B.7.52 PRODUCTION PROCESS.

The basic methods required to manufacture, fabricate, assemble, and test hardware, including sub-assemblies, assemblies, components, subsystems, and systems, the associated process control technologies, and the quality assurance requirements implementation.

B.7.53 A-BASIS ALLOWABLE

At least 99 percent of the population of values is expected to equal or exceed the A-basis mechanical property allowable, with a confidence of 95 percent.

B.7.54 B-BASIS ALLOWABLE

At least 90 percent of the population of values is expected to equal or exceed the B-basis mechanical property allowable, with a 95 percent confidence.

ACRONYMS

A

ACO	Administrative Contracting Officer
ADS	Air delivery system
AEW	Aircraft early warning
AGL	Above ground level
AIAC	Aircraft monitor and control
AIS	Avionics intermediate shop
ANG	Air National Guard
APU	Auxiliary power unit
ARI	Aileron rudder interconnect
ASE	Aeroservoelastic
ASW	Anti-submarine warfare

B

BLW	Basic landing weight
BNS	Bomb navigation system

C

CAS	Calibrated airspeed
CDRL	Contract Data Requirements List
CDS	Container delivery system
cg	Center of gravity
CPAB	Corrosion Prevention Advisory Board
C _p	Process capability index
C _{pk}	Process performance index
CS	Constant speed drive
CSV	Constant selector valve

D

da/dn	Crack growth rate
DAL	Data accession list
DAR	Defense Acquisition Regulation
dB	Decibel
DD	Data documentation
DF	Dynamic factor
DLL	Design limit load
DoD	Department of Defense
DoDISS	Department of Defense Index of Specifications and Standards

E

EAS	Equivalent air speed
ECM	Electronic countermeasures
ECP	Engineering change proposals
ECS	Environmental control system
EMD	Engineering and Manufacturing Development
EMI	Electromagnetic interference
EMP	Electromagnetic pulse
EPA	Environmental Protection Agency

F

f	Applied stress
F	Allowable stress
FCAS	Flight control augmentation system

F/CGMS	Fuel/center of gravity management system	PMD	Program Management Directive
FCLP	Field carrier landing practice	PSD	Power spectral density
FLM	Field level maintenance	PSI	Pounds per square inch
FOD	Foreign object damage	PVC	Polyvinylchloride
fps	Feet per second	P _{XX}	Internal member load
FSD	Full scale development	P _{YY}	Internal member load for fail-safe structure
	G		Q
g	Acceleration = 32.2 ft/sec ²	q	Maximum permissible dynamic pressure
g	Damping coefficient	QA	Quality assurance
	I		R
IAS	Indicated airspeed	R	Reliability
IAT	Individual Aircraft Tracking	RCS	Ride control system
IFR	Instrument flight rule	RDT&E	Research development test and evaluation
IOC	Initial operation capability	RFP	Request for proposal
IP	Instrument pilot	RH	Right hand
ISO	Isochronal	RPM	Revolutions per minute
	J		S
JBD	Jet blast deflector		
	K	SCN	Specification change notice
		SON	Statement of need
k	Special factor	SOW	Statement of work
KIAS	Knots indicated airspeed	SPC	Statistical process control
KTAS	True air speed in knots	SPO	System Program Office
	L	SPU(s)	Station program unit(s)
L	Longitudinal	SRM	Structural repair manual
LAPES	Low altitude parachute extraction system	SS	System safety
lbs	Pounds	ST	Short transverse
LH	Left hand		T
LOX	Liquid oxygen	TAS	True air speed
LRU(s)	Line replaceable unit(s)	TASTCTO	Time Compliance Technical Order
LT	Long transverse	TER	Triple ejection racks
	M	TFR	Terrain following radar
		TO	Technical Order
			V
M	Mach		
M	Maintainability	V _A	Maneuver speed
MER	Multiple ejection racks	V _C	Launch end speed
M _L	Maximum Mach	V _D	Dive speed
MLG	Main landing gear	V _e	Equivalent air speed
MS	Margin of safety	V _E	Engaging speed
	N	V _G	Gust limit speed
NAEC	Naval Aeronautical Engineering Center	V _H	Maximum level flight speed
NDT/I	Nondestructive testing/inspection	V _{HD}	Maximum speed hook extended
NLG	Nose landing gear	VIP	Very Important Person (Presidential Vehicles)
NM	Nautical miles		
	P		
PA	Product assurance	V _L	Limit speed
PCO	Procuring Contracting Officer	V _{LF}	Limit speed take-off and landing
PLAT	Pilot landing aided television		

V_{LO}	Lift-off speed		W
V_{S1}	Maneuver stall speed	WSEM	Weapons systems evaluator missile
V_{SF}	Maximum speed for system failure	WSO	Weapons system officer
V_{SL}	Landing stall speed	WOD	Wind over deck
V_T	Taxi speed		Y
V_{TD}	Touch down speed	Y_d	Limit gust velocity
V_{TDC}	Shipboard recovery speed		
V_V	Landing sink rate		

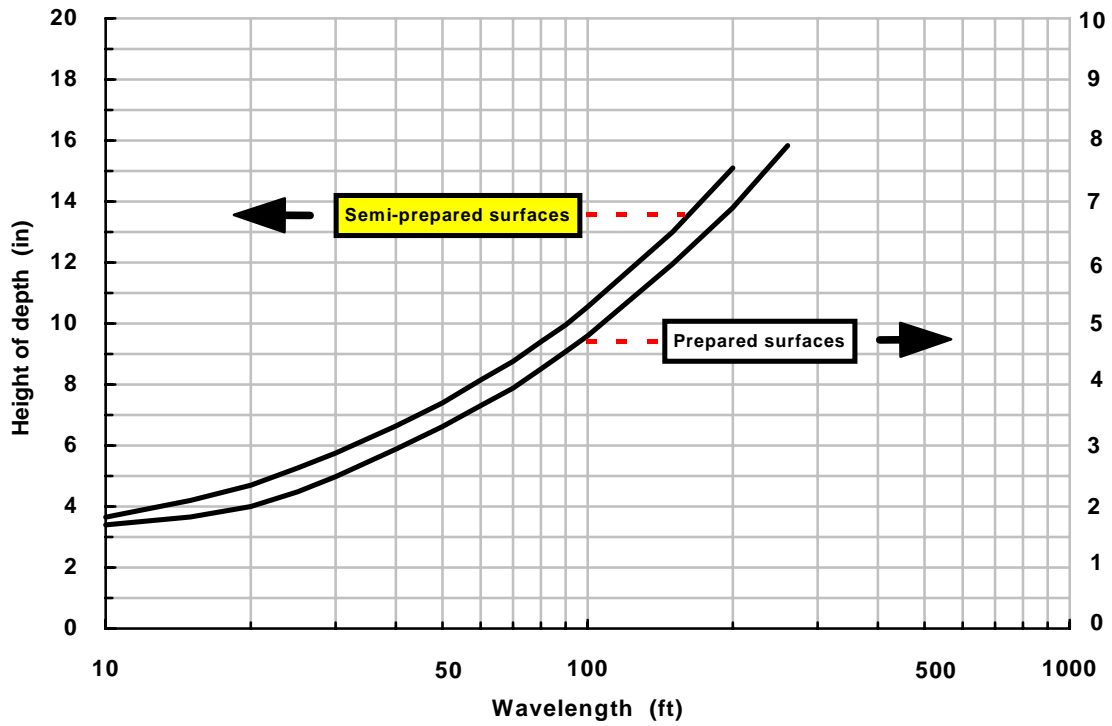

FIGURE 1. Discrete $(1-\cos)$ bumps and $(\cos -1)$ dips for slow speeds up to 50 knots -- single and double excitations.

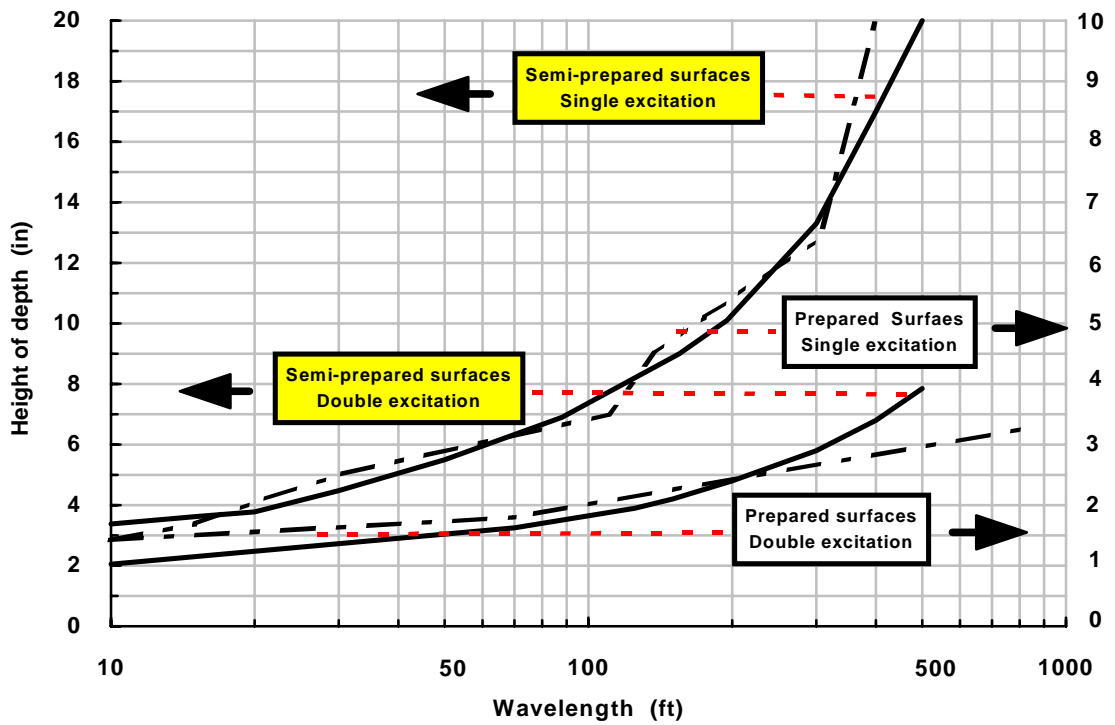

FIGURE 2. Discrete $(1-\cos)$ bumps and $(\cos -1)$ dips for high speeds above 50 knots -- single and double excitations.

TABLE I Low Energy Impact (Tool Impact)

Zone	Damage Source	Damage Level	Requirements in addition to Paragraph 3.11.1
1 High Probability of Impact	<ul style="list-style-type: none"> * 0.5 in. dia. solid impactor * low velocity * normal to surface 	Impact energy smaller of 6 ft-lbs or visible damage (0.1 in. deep) with min. of 4 ft-lbs.	<ul style="list-style-type: none"> * no functional impairment or structural repair required for two design lifetimes and no water intrusion * no visible damage from a single 4 ft-lb impact
2 Low Probability of Impact	Same as Zone 1	Impact energy smaller of 6 ft-lbs or visible damage (0.1 in. deep)	* no functional impairment after two design lifetimes and no water intrusion after field repair if damage is visible

TABLE II. Low Energy Impact (Hail and Runway Debris)

Zone	Damage Source	Damage Level	Requirements in addition to Paragraph 3.11.1
All vertical and upward facing horizontal surfaces	Hail: <ul style="list-style-type: none"> * 0.8 in. dia. * sp. Gr. = 0.9 * 90 ft/sec * normal to horizontal surfaces * 45 deg. angle to vertical surfaces 	Uniform density 0.8 in. on center	<ul style="list-style-type: none"> * no functional impairment or structural repair required for two design lifetimes * no visible damage
Structure in path of debris	Runway debris: <ul style="list-style-type: none"> * 0.5 in. dia. * sp. Gr. = 3.0 * velocity appropriate to system 	N/A	* no functional impairment after two design lifetimes and no water intrusion after field repair if damage is visible

TABLE III. Initial Flaw/Damage Assumptions.

Flaw/Damage Type	Flaw/Damage Size
Scratches	Surface scratch 4.0" long and 0.02" deep
Delamination	Interply delamination equivalent to a 2.0" diameter circle with dimensions most critical to its location
Impact Damage	Damage from a 1.0" diameter hemispherical impactor with 100 ft-lbs of kinetic energy or with that kinetic energy required to cause a dent 0.10" deep, whichever is less.

TABLE IV. Residual Strength Load.

$P_{XX}^{(1)}$	Degree of Inspectability	Typical Inspection Interval	Magnification Factor, $M^{(3)}$
P_{FE}	In-Flight Evident	One Flight ⁽²⁾	100
P_{GE}	Ground Evident	One Day (Two Flights) ⁽²⁾	100
P_{WV}	Walk-Around Visual	Ten Flights ⁽²⁾	100
P_{SV}	Special Visual	One Year	50
P_{DM}	Depot or Base Level	1/4 Lifetime	20
P_{LT}	Non-Inspectable	One Lifetime	20

(1) P_{XX} = Maximum average internal member load (without clipping) that will occur once in M times the inspection interval. Where P_{DM} or P_{LT} is determined to be less than the design limit load, the design limit load should be the required residual strength load level. P_{XX} need not be greater than 1.2 times the maximum load in one lifetime, if P_{XX} is greater than the design limit load.

(2) Most damaging design mission.

(3) See 5.5.8.2.a.

TABLE V. Failure occurrences vs. load at failure.

Percent of Ultimate Load	Number of Failures	Cumulative Number of Failures	Cumulative Percent of Failures
45	1	1	2
50	1	2	5
55		2	5
60		2	5
65	2	4	9
70	1	5	12
75	1	6	14
80	5	11	26
85	5	16	37
90	10	26	60
94	9	35	81
98	6	41	95
100	2	43	100

Failures in 8 different test programs. Considered only major structure.

419 Total tests involved

43 Failures (10%) occurred

376 Tests (90%) to ultimate load without failure

TABLE VI. WPAFB static tests first failure of major components, 1940 through 1948.

Percent Ultimate Load	Number of Failures		Cumulative Number of Failures		Cumulative Percent of Failures	
	Low	High	Low	High	Low	High
35	1	1	1	1	.2	.2
40	13	6	14	7	3.2	1.6
42	1	1	15	8	3.5	1.9
50	5	3	20	11	4.6	2.6
51	1	1	21	12	4.9	2.8
53	2	2	23	14	5.3	3.2
55	5	4	28	18	6.5	4.2
58.5	1	1	29	19	6.7	4.4
60	13	14	42	33	9.7	7.7
62	1	1	43	34	10.0	7.9
65	2	2	45	36	10.4	8.4
67	3	3	48	39	11.1	9.0
68	1	1	49	40	11.4	9.3
70	11	11	60	51	13.9	11.8
75	4	4	64	55	14.8	12.8
77	2	2	66	57	15.3	13.2
78	1	1	67	58	15.6	13.5
80	30	37	97	95	22.5	22.0
85	4	3	101	98	23.4	22.7
87	1	1	102	99	23.7	23.0
90	27	26	133	129	30.9	29.9
93	1	1	134	130	31.1	30.2
95	15	14	149	144	34.6	33.4
96	1	1	150	145	34.8	33.6
98	7	7	157	152	36.4	35.3
100	274(1)	279(1)	431	431	100.0	100.0

NOTE: First failure in major components, i.e. landing gear, fuselage, wing, horizontal tail and vertical tail.
(1). No failure.

TABLE VII. WPAFB static test first failure of airplane, 1940 through 1948.

Percent Ultimate Load	Number of Failures		Cumulative Number of Failures		Cumulative Percent of Failures	
	Low	High	Low	High	Low	High
35	1	1	1	1	.9	.9
40	12	6	13	7	11.3	6.1
45	1	1	14	8	12.2	7.0
50	4	3	18	11	15.7	10.0
55	8	7	26	18	22.6	15.7
58.5	1	1	27	19	23.5	16.7
60	4	7	31	26	26.9	22.6
65	3	3	34	29	29.6	25.2
70	8	8	42	37	36.5	32.2
75	3	3	45	40	39.1	34.8
80	14	18	59	58	51.3	50.4
85	2	1	61	59	53.0	51.3
90	11	12	72	71	62.6	61.7
95	9	8	81	79	70.4	68.7
<100	7	7	88	86	76.5	74.8
100	27 ⁽¹⁾	29 ⁽¹⁾	115	115	100.0	100.0

NOTE: Landing gear, fuselage, wing, horizontal tail, and vertical tail test results used.

(1). No failure.

TABLE VIII. WPAFB static tests first failure of major components, 1950 through 1976.

Percent Ultimate Load	Number of Failures		Cumulative Number of Failures		Cumulative Percent of Failures	
	Low	High	Low	High	Low	High
40	3	1	3	1	2.9	1.0
45	1	0	4	1	3.9	1.0
50	0	1	4	2	3.9	1.9
53	1	1	5	3	4.9	2.9
60	3	4	8	7	7.8	6.8
65	1	1	9	8	8.7	7.8
67	1	1	10	9	9.7	8.7
70	4	1	14	10	13.6	9.7
75	0	3	14	13	13.6	12.6
76	1	1	15	14	14.6	13.6
80	9	6	24	20	23.3	19.4
85	2	3	26	23	25.2	22.3
88	1	1	27	24	26.2	23.3
90	6	9	33	33	32.0	32.0
91	1	1	34	34	33.0	33.0
94	1	1	35	35	34.0	34.0
95	4	3	39	38	37.9	36.9
97	1	1	40	39	38.8	37.9
100	63(1)	64(1)	103	103	100.0	100.0

NOTE: First failure in major components, i.e. landing gear, fuselage, wing, horizontal tail and vertical tail.
(1). No failure.

TABLE IX. WPAFB static test first failure of airplane, 1950 through 1976.

Percent Ultimate Load	Number of Failures		Cumulative Number of Failures		Cumulative Percent of Failures	
	Low	High	Low	High	Low	High
40	2	1	2	1	9.1	4.5
60	3	4	5	5	22.7	22.7
65	1	0	6	5	27.3	22.7
67	1	1	7	6	31.8	27.3
70	2	1	9	7	40.9	31.8
75	0	2	9	9	40.9	40.9
76	1	1	10	10	45.5	45.5
80	4	1	14	11	63.6	50.0
85	0	1	14	12	63.6	54.5
90	3	5	17	17	77.3	77.3
95	2	2	19	19	86.4	86.4
<100	-	-	19	19	86.4	86.4
100	3(1)	3(1)	22	22	100.0	100.0

NOTE: Landing gear, fuselage, wing, horizontal tail, and vertical tail test results used.
(1). No failure.

TABLE X. WPAFB static tests first failure of control system structural components.

Percent Ultimate Load	Number of Failures		Cumulative Number of Failures		Cumulative Percent of Failures	
	Low	High	Low	High	Low	High
20	1	1	1	1	6.7	6.7
40	1	0	2	1	13.3	6.7
47	1	1	3	2	20.0	13.3
50	1	2	4	4	26.7	26.7
60	3	2	7	6	46.7	40.0
67	1	2	8	8	53.3	53.3
100	7(1)	7(1)	15	15	100.0	100.0

NOTE: Number is percent of Design Ultimate Load (DUL).
(1). No failure.

TABLE XI. WPAFB static tests first failure of secondary structure (other).

Percent Ultimate Load	Number of Failures		Cumulative Number of Failures		Cumulative Percent of Failures	
	Low	High	Low	High	Low	High
30	1	1	1	1	4.8	4.8
50	2	2	3	3	14.3	14.3
60	4	4	7	7	33.3	33.3
67	2	2	9	9	42.9	42.9
70	1	1	10	10	47.6	47.6
80	3	3	13	13	61.9	61.9
85	1	0	14	13	66.7	61.9
90	1	2	15	15	71.4	71.4
95	1	1	16	16	76.2	76.2
100	5(1)	5(1)	21	21	100.0	100.0

TABLE XII. Initial flaw assumptions

Category	Critical Detail	Initial Flaw Assumption (1) (2)
<u>Metallic Structure</u>		
Slow Crack Growth and Fail Safe Primary Element	Hole, Cutouts, etc. Other Welds Embedded Defects	For thickness $\leq .05$ ", .05" long through thickness flaw For thickness $\geq .05$ ", .05" radius corner flaw For thickness $\leq .125$ ", .25" long through thickness flaw For thickness $> .125$ ", .125" deep x .25" long surface flaw TBD TBD
<u>Metallic Structure</u>		
Fail-safe Adjacent Structure	Holes, cutouts, etc.	For thickness $\leq .05$ ", .05" long through thickness flaw + \square a For thickness $> .05$ ", .05" radius corner flaw + \square a
Multiple Load Path Dependent	Other	For thickness $\leq .125$ ", .25" long through thickness flaw + \square a For thickness $> .125$ ", .125" deep x .25" long surface flaw + \square a
Multiple Load Path Independent and Crack Arrest	Holes, cutouts, etc. Other	.005" radius corner flaw + \square a .01" deep x .02" long surface flaw + \square a
<u>Other Material Systems</u> (3)	TBD	TBD

(1) Flaw oriented in most critical direction.

(2) \square a is the incremental growth of the indicated flaw prior to primary element failure.

(3) Including organic and metal matrix composites.

TABLE XIII. Continuing damage assumption for situation where initial flaw growth terminate prior to catastrophic failure ⁽¹⁾

Initial Flaw or Primary Damage Termination Site	Continuing Damage Site	Continuing Damage Assumption ⁽²⁾ ⁽³⁾
Fastener hole, Cutout, etc.	Diametrically opposite side of hole where damage terminated	.005" radius corner flaw + \square a
Other	Diametrically opposite side of hole where damage initiated	.005" radius corner flaw + \square a
Complete element or member failure	Critical location in adjacent structure	.005" radius corner flaw + \square a or .01" deep x .02" long surface flaw ⁽⁴⁾ + \square a

(1) Applicable to metallic structures only, requirements for other material systems are TBD.

(2) Flaw oriented in most critical direction.

(3) \square a is the incremental growth of the indicated flaw prior to initial damage termination.

(4) Other flaw shapes and sizes can be assumed based on an equivalent stress intensity.

TABLE XIV. In-service inspection initial flaw assumptions.

Accessibility	Inspection Method	Initial Flaw Assumption ⁽¹⁾ ⁽²⁾
Off-Aircraft or On-Aircraft with Fastener Removal	Same as initial	Same as initial
On-Aircraft without Fastener removal but Accessible	Penetrant, Mag Particle, Ultrasonic, Eddy Current	For thickness \square .25", .25" long through thickness flaw at holes ⁽¹⁾ For thickness \square .25", .50" long through thickness flaw at other location ⁽¹⁾ For thickness \square .25", .25" radius corner crack at holes ⁽³⁾ For thickness \square .25", .25" deep x .50" long surface flaw at other locations ⁽¹⁾ For thickness .25", 2.0" through thickness flaw ⁽³⁾
On-Aircraft with restricted Accessibility	Visual	For slow crack growth structure, non-inspectable For fail-safe structure, primary load path failed

(1) May be superceded by special inspection capability demonstration.

(2) Applicable to metallic structures, only, requirements for other material systems are TBD.

(3) Flaw size indicated is uncovered crack length.

TABLE XV. Initial Flaw/Damage Assumptions.

Flaw/Damage Type	Flaw/Damage Size
Scratches	Surface scratch 4.0" long and 0.02" deep
Delamination	Interply delamination equivalent to a 2.0" diameter circle with dimensions most critical to its location
Impact Damage	Damage from a 1.0" diameter hemispherical impactor with 100 ft-lbs of kinetic energy or with that kinetic energy required to cause a dent 0.10" deep, whichever is less.

TABLE XVI. Residual Strength Load.

$P_{XX}^{(1)}$	Degree of Inspectability	Typical Inspection Interval	Magnification Factor, $M^{(3)}$
P_{FE}	In-Flight Evident	One Flight ⁽²⁾	100
P_{GE}	Ground Evident	One Day (Two Flights) ⁽²⁾	100
P_{WV}	Walk-Around Visual	Ten Flights ⁽²⁾	100
P_{SV}	Special Visual	One Year	50
P_{DM}	Depot or Base Level	1/4 Lifetime	20
P_{LT}	Non-Inspectable	One Lifetime	20

(1) P_{XX} = Maximum average internal member load (without clipping) that will occur once in M times the inspection interval. Where P_{DM} or P_{LT} is determined to be less than the design limit load, the design limit load should be the required residual strength load level. P_{XX} need not be greater than 1.2 times the maximum load in one lifetime, if P_{XX} is greater than the design limit load.

(2) Most damaging design mission.

(3) See 3.12.2.a.

This page has been deliberately left blank



Page intentionnellement blanche

REPORT DOCUMENTATION PAGE

1. Recipient's Reference	2. Originator's References RTO-TR-045 AC/323(AVT-024)TP/30	3. Further Reference ISBN 92-837-1077-0	4. Security Classification of Document UNCLASSIFIED/ UNLIMITED
5. Originator Research and Technology Organisation North Atlantic Treaty Organisation BP 25, 7 rue Ancelle, F-92201 Neuilly-sur-Seine Cedex, France			
6. Title Design Loads for Future Aircraft			
7. Presented at/sponsored by the RTO Applied Vehicle Technology Panel (AVT) TG 024.			
8. Author(s)/Editor(s) Multiple			9. Date February 2002
10. Author's/Editor's Address Multiple			11. Pages 300
12. Distribution Statement There are no restrictions on the distribution of this document. Information about the availability of this and other RTO unclassified publications is given on the back cover.			
13. Keywords/Descriptors			
Aerodynamic loads Aircraft design Airframes Aviation safety Composite structures Design loads Dynamic loads Failure analysis Fatigue (materials) Flight control Flight loads		Flight manoeuvres Gust loads Load monitoring systems NATO agreements Procedures RTO Task Group Specifications Structural analysis Structural weight Turbulence	
14. Abstract			
<p>This RTO Task Group reviewed the requirements which regular flight and manoeuvring will put as design loads on the structure of future NATO aircraft, addressing also safety aspects, structural weight, elastic effects and influence of the control system. Treated are: load critical flight manoeuvres as well as external loads such as induced by turbulence. Existing specifications are reviewed and procedures for establishing design loads are presented. Metal and composite structures are treated, and the analysis pertains to main structures as well as critical subassemblies. Under operational aspects the monitoring of loads and of structural fatigue are treated and some actual failure cases are analysed. The request for NATO agreements on relevant design criteria is mentioned.</p>			

This page has been deliberately left blank



Page intentionnellement blanche



RESEARCH AND TECHNOLOGY ORGANISATION

BP 25 • 7 RUE ANCELLE

F-92201 NEUILLY-SUR-SEINE CEDEX • FRANCE

Télécopie 0(1)55.61.22.99 • E-mail mailbox@rta.nato.int

DIFFUSION DES PUBLICATIONS

RTO NON CLASSIFIEES

L'Organisation pour la recherche et la technologie de l'OTAN (RTO), détient un stock limité de certaines de ses publications récentes, ainsi que de celles de l'ancien AGARD (Groupe consultatif pour la recherche et les réalisations aérospatiales de l'OTAN). Celles-ci pourront éventuellement être obtenues sous forme de copie papier. Pour de plus amples renseignements concernant l'achat de ces ouvrages, adressez-vous par lettre ou par télécopie à l'adresse indiquée ci-dessus. Veuillez ne pas téléphoner.

Des exemplaires supplémentaires peuvent parfois être obtenus auprès des centres nationaux de distribution indiqués ci-dessous. Si vous souhaitez recevoir toutes les publications de la RTO, ou simplement celles qui concernent certains Panels, vous pouvez demander d'être inclus sur la liste d'envoi de l'un de ces centres.

Les publications de la RTO et de l'AGARD sont en vente auprès des agences de vente indiquées ci-dessous, sous forme de photocopie ou de microfiche. Certains originaux peuvent également être obtenus auprès de CASI.

CENTRES DE DIFFUSION NATIONAUX

ALLEMAGNE

Streitkräfteamt / Abteilung III
Fachinformationszentrum der
Bundeswehr, (FIZBw)
Friedrich-Ebert-Allee 34
D-53113 Bonn

BELGIQUE

Coordinateur RTO - VSL/RTO
Etat-Major de la Force Aérienne
Quartier Reine Elisabeth
Rue d'Evère, B-1140 Bruxelles

CANADA

Services d'information scientifique
pour la défense (SISD)
R et D pour la défense Canada
Ministère de la Défense nationale
Ottawa, Ontario K1A 0K2

DANEMARK

Danish Defence Research Establishment
Ryvangs Allé 1, P.O. Box 2715
DK-2100 Copenhagen Ø

ESPAGNE

INTA (RTO/AGARD Publications)
Carretera de Torrejón a Ajalvir, Pk.4
28850 Torrejón de Ardoz - Madrid

ETATS-UNIS

NASA Center for AeroSpace
Information (CASI)
Parkway Center
7121 Standard Drive
Hanover, MD 21076-1320

FRANCE

O.N.E.R.A. (ISP)
29, Avenue de la Division Leclerc
BP 72, 92322 Châtillon Cedex

GRECE (Correspondant)

Hellenic Ministry of National
Defence
Defence Industry Research &
Technology General Directorate
Technological R&D Directorate
D.Soutsou 40, GR-11521, Athens

HONGRIE

Department for Scientific
Analysis
Institute of Military Technology
Ministry of Defence
H-1525 Budapest P O Box 26

ISLANDE

Director of Aviation
c/o Flugrad
Reykjavik

ITALIE

Centro di Documentazione
Tecnico-Scientifica della Difesa
Via XX Settembre 123a
00187 Roma

LUXEMBOURG

Voir Belgique

NORVEGE

Norwegian Defence Research
Establishment
Attn: Biblioteket
P.O. Box 25, NO-2007 Kjeller

PAYS-BAS

NDRCC
DGM/DWOO
P.O. Box 20701
2500 ES Den Haag

POLOGNE

Chief of International Cooperation
Division
Research & Development Department
218 Niepodleglosci Av.
00-911 Warsaw

PORTUGAL

Estado Maior da Força Aérea
SDFA - Centro de Documentação
Alfragide
P-2720 Amadora

REPUBLIQUE TCHEQUE

DIC Czech Republic-NATO RTO
VTÚL a PVO Praha
Mladoboleslavská ul.
Praha 9, 197 06, Česká republika

ROYAUME-UNI

Dstl Knowledge Services
Kentigern House, Room 2246
65 Brown Street
Glasgow G2 8EX

TURQUIE

Millî Savunma Başkanlığı (MSB)
ARGE Dairesi Başkanlığı (MSB)
06650 Bakanlıklar - Ankara

AGENCES DE VENTE

NASA Center for AeroSpace

Information (CASI)
Parkway Center
7121 Standard Drive
Hanover, MD 21076-1320
Etats-Unis

The British Library Document

Supply Centre
Boston Spa, Wetherby
West Yorkshire LS23 7BQ
Royaume-Uni

Canada Institute for Scientific and

Technical Information (CISTI)
National Research Council
Acquisitions
Montreal Road, Building M-55
Ottawa K1A 0S2, Canada

Les demandes de documents RTO ou AGARD doivent comporter la dénomination "RTO" ou "AGARD" selon le cas, suivie du numéro de série (par exemple AGARD-AG-315). Des informations analogues, telles que le titre et la date de publication sont souhaitables. Des références bibliographiques complètes ainsi que des résumés des publications RTO et AGARD figurent dans les journaux suivants:

Scientific and Technical Aerospace Reports (STAR)

STAR peut être consulté en ligne au localisateur de ressources uniformes (URL) suivant:
<http://www.sti.nasa.gov/Pubs/star/Star.html>
STAR est édité par CASI dans le cadre du programme NASA d'information scientifique et technique (STI)
STI Program Office, MS 157A
NASA Langley Research Center
Hampton, Virginia 23681-0001
Etats-Unis

Government Reports Announcements & Index (GRA&I)

publié par le National Technical Information Service
Springfield
Virginia 2216
Etats-Unis
(accessible également en mode interactif dans la base de données bibliographiques en ligne du NTIS, et sur CD-ROM)



Imprimé par St-Joseph Ottawa/Hull
(Membre de la Corporation St-Joseph)

45, boul. Sacré-Cœur, Hull (Québec), Canada J8X 1C6



RESEARCH AND TECHNOLOGY ORGANISATION

BP 25 • 7 RUE ANCELLE

F-92201 NEUILLY-SUR-SEINE CEDEX • FRANCE

Telefax 0(1)55.61.22.99 • E-mail mailbox@rta.nato.int

DISTRIBUTION OF UNCLASSIFIED

RTO PUBLICATIONS

NATO's Research and Technology Organisation (RTO) holds limited quantities of some of its recent publications and those of the former AGARD (Advisory Group for Aerospace Research & Development of NATO), and these may be available for purchase in hard copy form. For more information, write or send a telefax to the address given above. **Please do not telephone.**

Further copies are sometimes available from the National Distribution Centres listed below. If you wish to receive all RTO publications, or just those relating to one or more specific RTO Panels, they may be willing to include you (or your organisation) in their distribution.

RTO and AGARD publications may be purchased from the Sales Agencies listed below, in photocopy or microfiche form. Original copies of some publications may be available from CASI.

NATIONAL DISTRIBUTION CENTRES

BELGIUM

Coordinateur RTO - VSL/RTO
Etat-Major de la Force Aérienne
Quartier Reine Elisabeth
Rue d'Evère, B-1140 Bruxelles

CANADA

Defence Scientific Information
Services (DSIS)
Defence R&D Canada
Department of National Defence
Ottawa, Ontario K1A 0K2

CZECH REPUBLIC

DIC Czech Republic-NATO RTO
VTÚL a PVO Praha
Mladoboleslavská ul.
Praha 9, 197 06, Česká republika

DENMARK

Danish Defence Research
Establishment
Ryvangs Allé 1, P.O. Box 2715
DK-2100 Copenhagen Ø

FRANCE

O.N.E.R.A. (ISP)
29 Avenue de la Division Leclerc
BP 72, 92322 Châtillon Cedex

GERMANY

Streitkräfteamt / Abteilung III
Fachinformationszentrum der
Bundeswehr, (FIZBw)
Friedrich-Ebert-Allee 34
D-53113 Bonn

GREECE (Point of Contact)

Hellenic Ministry of National
Defence
Defence Industry Research &
Technology General Directorate
Technological R&D Directorate
D.Soutsou 40, GR-11521, Athens

HUNGARY

Department for Scientific
Analysis
Institute of Military Technology
Ministry of Defence
H-1525 Budapest P O Box 26

ICELAND

Director of Aviation
c/o Flugrad
Reykjavik

ITALY

Centro di Documentazione
Tecnico-Scientifica della Difesa
Via XX Settembre 123a
00187 Roma

LUXEMBOURG

See Belgium

NETHERLANDS

NDRCC
DGM/DWO0
P.O. Box 20701
2500 ES Den Haag

NORWAY

Norwegian Defence Research
Establishment
Attn: Biblioteket
P.O. Box 25, NO-2007 Kjeller

POLAND

Chief of International Cooperation
Division
Research & Development
Department
218 Niepodleglosci Av.
00-911 Warsaw

PORTUGAL

Estado Maior da Força Aérea
SDFA - Centro de Documentação
Alfragide
P-2720 Amadora

SPAIN

INTA (RTO/AGARD Publications)
Carretera de Torrejón a Ajalvir, Pk.4
28850 Torrejón de Ardoz - Madrid

TURKEY

Millî Savunma Başkanlığı (MSB)
ARGE Dairesi Başkanlığı (MSB)
06650 Bakanlıklar - Ankara

UNITED KINGDOM

Dstl Knowledge Services
Kentigern House, Room 2246
65 Brown Street
Glasgow G2 8EX

UNITED STATES

NASA Center for AeroSpace
Information (CASI)
Parkway Center
7121 Standard Drive
Hanover, MD 21076-1320

SALES AGENCIES

NASA Center for AeroSpace
Information (CASI)

Parkway Center
7121 Standard Drive
Hanover, MD 21076-1320
United States

The British Library Document
Supply Centre

Boston Spa, Wetherby
West Yorkshire LS23 7BQ
United Kingdom

Canada Institute for Scientific and
Technical Information (CISTI)

National Research Council
Acquisitions
Montreal Road, Building M-55
Ottawa K1A 0S2, Canada

Requests for RTO or AGARD documents should include the word 'RTO' or 'AGARD', as appropriate, followed by the serial number (for example AGARD-AG-315). Collateral information such as title and publication date is desirable. Full bibliographical references and abstracts of RTO and AGARD publications are given in the following journals:

Scientific and Technical Aerospace Reports (STAR)

STAR is available on-line at the following uniform resource locator:

<http://www.sti.nasa.gov/Pubs/star/Star.html>

STAR is published by CASI for the NASA Scientific and Technical Information (STI) Program
STI Program Office, MS 157A
NASA Langley Research Center
Hampton, Virginia 23681-0001
United States

Government Reports Announcements & Index (GRA&I)

published by the National Technical Information Service
Springfield
Virginia 22161
United States
(also available online in the NTIS Bibliographic Database or on CD-ROM)



Printed by St. Joseph Ottawa/Hull
(A St. Joseph Corporation Company)
45 Sacré-Cœur Blvd., Hull (Québec), Canada J8X 1C6