



**UNITED STATES AIR FORCE  
RESEARCH LABORATORY**

---

**Measurements of Sonic Booms Due to  
ACM Training in the Elgin MOA  
Subsection of the Nellis Range  
Complex**

**Kenneth D. Frampton  
Michael J. Lucas  
Kenneth J. Plotkin**

**WYLE RESEARCH  
WYLE LABORATORIES  
2001 Jefferson Davis Highway  
Arlington VA 22202**

**Kevin Elmer**

**DOUGLAS AIRCRAFT COMPANY  
3855 Lakewood Blvd  
Long Beach CA 90846-0001**

**April 1993**

**Interim Report for the Period January 1987 to April 1993**

**20020318 104**

*Approved for public release; distribution is unlimited.*

**Human Effectiveness Directorate  
Crew System Interface Division  
2610 Seventh Street  
Wright-Patterson AFB OH 45433-7901**

## NOTICES

When US Government drawings, specifications, or other data are used for any purpose other than a definitely related Government procurement operation, the Government thereby incurs no responsibility nor any obligation whatsoever, and the fact that the Government may have formulated, furnished, or in any way supplied the said drawings, specifications, or other data, is not to be regarded by implication or otherwise, as in any manner licensing the holder or any other person or corporation, or conveying any rights or permission to manufacture, use, or sell any patented invention that may in any way be related thereto.

Please do not request copies of this report from the Air Force Research Laboratory. Additional copies may be purchased from:

National Technical Information Service  
5285 Port Royal Road  
Springfield, Virginia 22161

Federal Government agencies and their contractors registered with the Defense Technical Information Center should direct requests for copies of this report to:

Defense Technical Information Center  
8725 John J. Kingman Road, Suite 0944  
Ft. Belvoir, Virginia 22060-6218

### DISCLAIMER

This Technical Report is published as received and has not been edited by the Air Force Research Laboratory, Human Effectiveness Directorate.

### TECHNICAL REVIEW AND APPROVAL

AFRL-HE-WP-TR-2002-0012

This report has been reviewed by the Office of Public Affairs (PA) and is releasable to the National Technical Information Service (NTIS). At NTIS, it will be available to the general public.

This technical report has been reviewed and is approved for publication.

**FOR THE COMMANDER**



MARIS M. VIKMANIS  
Chief, Crew System Interface Division  
Air Force Research Laboratory

**REPORT DOCUMENTATION PAGE**

Form Approved  
OMB No. 0704-0188

Public reporting burden for this collection of information is estimated to average 1 hour per response, including the time for reviewing instructions, searching existing data sources, gathering and maintaining the data needed, and completing and reviewing the collection of information. Send comments regarding this burden estimate or any other aspect of this collection of information, including suggestions for reducing this burden, to Washington Headquarters Services, Directorate for Information Operations and Reports, 1215 Jefferson Davis Highway, Suite 1204, Arlington, VA 22202-4302, and to the Office of Management and Budget, Paperwork Reduction Project (0704-0188), Washington, DC 20503.

1. AGENCY USE ONLY (Leave blank)	2. REPORT DATE April 1993	3. REPORT TYPE AND DATES COVERED Interim - January 1987 to April 1993
----------------------------------	------------------------------	--

4. TITLE AND SUBTITLE Measurements of Sonic Booms Due to ACM Training in the Elgin MOA Subsection of the Nellis Range Complex	5. FUNDING NUMBERS C - NAS1-19060 PE - 62202F PR - 7757 TA - 7757C1 WU - 7757C101
--	--

6. AUTHOR(S) Kenneth D. Frampton, Michael J. Lucas, Kenneth J. Plotkin (Wyle) Kevin Elmer (Douglas Aircraft Company)	
--	--

7. PERFORMING ORGANIZATION NAME(S) AND ADDRESS(ES) Wyle Research Wyle Laboratories 2001 Jefferson Davis Highway Arlington VA 22202 Douglas Aircraft Company 3855 Lakewood Blvd Long Beach CA 90846-0001	8. PERFORMING ORGANIZATION REPORT NUMBER WR-93-5
--	---

9. SPONSORING/MONITORING AGENCY NAME(S) AND ADDRESS(ES) Air Force Research Laboratory, Human Effectiveness Directorate Crew System Interface Division Aural Displays and Bioacoustics Branch Air Force Materiel Command Wright-Patterson AFB OH 45433-7901	10. SPONSORING/MONITORING AGENCY REPORT NUMBER AFRL-HE-WP-TR-2002-0012
---	---

11. SUPPLEMENTARY NOTES

12a. DISTRIBUTION AVAILABILITY STATEMENT Approved for public release; distribution is unlimited.	12b. DISTRIBUTION CODE
---	------------------------

13. ABSTRACT (Maximum 200 words)

The Elgin MOA is a subsection of the Nellis Range Complex located in southern Nevada. This airspace is regularly used for air combat maneuver (ACM) training which involves occasional supersonic flight. A sonic boom measurement program was conducted during the period from 25 March through 30 September 1992. The primary purpose of the measurement program was to obtain data suitable for the assessment of the sonic boom noise environment within the Elgin MOA. A secondary purpose of the program was to further refine current sonic boom noise environment prediction models.

The sonic boom monitoring program described in this report was similar to the WSMR project in that monitors were distributed throughout the Elgin MOA over a six-month period. However, as in the R-2301E monitoring program, all of the monitors were BEARs. Data were also collected from all Air Combat Maneuver Instrumentation (ACMI) equipped flights in the Elgin MOA over the measurement period.

This report contains a description of the Elgin MOA and the corresponding ACM operations in Section 2. The test plan including monitoring locations, operations data, and ACMI data are described in Section 3. Execution of the measurement program is described in Section 4, and the analysis of the collected data is described in Section 5. Finally, an updated model of the Lcdn contours associated with sonic booms resulting from ACM operations is presented in Section 6.

14. SUBJECT TERMS Sonic Booms, Air Combat Maneuvering, Aircraft	15. NUMBER OF PAGES 115
17. SECURITY CLASSIFICATION OF REPORT UNCLASSIFIED	16. PRICE CODE

17. SECURITY CLASSIFICATION OF REPORT UNCLASSIFIED	18. SECURITY CLASSIFICATION OF THIS PAGE UNCLASSIFIED	19. SECURITY CLASSIFICATION OF ABSTRACT UNCLASSIFIED	20. LIMITATION OF ABSTRACT UL
---	--	---	----------------------------------

This page intentionally left blank.

## TABLE OF CONTENTS

	<u>Page</u>
1.0 INTRODUCTION . . . . .	1
2.0 ACM TRAINING AND THE ELGIN MOA . . . . .	3
2.1 ACM Training . . . . .	3
2.2 The Elgin MOA . . . . .	5
2.3 ACM Operations and Scheduling . . . . .	7
2.3.1 Operations . . . . .	7
2.3.2 Scheduling . . . . .	7
3.0 TEST PLAN . . . . .	13
3.1 Sonic Boom Monitoring Equipment . . . . .	13
3.1.1 Characteristics of Sonic Booms . . . . .	13
3.1.2 Sonic Boom Metrics . . . . .	15
3.1.3 BEAR Monitor System . . . . .	17
3.2 Monitoring Locations . . . . .	20
3.2.1 ACMI Data Analysis . . . . .	20
3.2.2 Ideal Site Selection by D-Optimality . . . . .	22
3.3 Operations Data and ACMI Analysis . . . . .	25
3.3.1 Operations Data . . . . .	25
3.3.2 ACMI Data Analysis . . . . .	25
4.0 MONITORING PROGRAM EXECUTION . . . . .	29
4.1 Monitor Deployment and Operation . . . . .	29
4.1.1 Installation . . . . .	29
4.1.2 Operation . . . . .	31
4.1.3 Monitor Removal . . . . .	32
4.2 Processing of Sonic Boom Data . . . . .	32
4.3 Collection of Operations Data . . . . .	36
4.4 Processing of Operations Data . . . . .	37
4.5 Collection and Processing Atmospheric Profiles . . . . .	37

TABLE OF CONTENTS (Continued)

		<u>Page</u>
5.0	ANALYSIS . . . . .	40
5.1	Operations . . . . .	40
5.2	The Measured Sonic Boom Environment . . . . .	40
5.3	ACMI Analysis . . . . .	52
5.3.1	ACMI Statistics . . . . .	52
5.3.2	Boom-Map3 Analysis . . . . .	59
6.0	MODELING $L_{Cdn}$ IN ACM AIRSPACES . . . . .	62
6.1	Historical $L_{Cdn}$ Modeling Techniques . . . . .	62
6.2	Modeling $L_{Cdn}$ in the Elgin MOA . . . . .	62
6.3	Refinement of the ACM Airspace Sonic Boom $L_{Cdn}$ Model . . . . .	64
6.3.1	$L_{Cdn}$ Ellipse Scaling Factor . . . . .	64
6.3.2	Ellipse Axis Orientation . . . . .	65
6.3.3	The Standard Deviations of the $L_{Cdn}$ Model . . . . .	67
6.3.4	ACM Sonic Boom $L_{Cdn}$ Model Summary . . . . .	68
7.0	CONCLUSIONS . . . . .	70
	REFERENCES . . . . .	R1
	APPENDIX A: Overpressure Distributions, Recorded Sonic Booms . . . . .	A1

**LIST OF FIGURES**

<u>Fig. No.</u>		
1	The Nellis Range Complex . . . . .	6
2	The Elgin MOA . . . . .	8
3	Flight Tracks for a Typical ACM Training Mission . . . . .	9
4	ACMI Data Sheet . . . . .	11
5	Sonic Boom Waveform Generation . . . . .	14
6	Types of Boom Signatures in a Focal Region . . . . .	16
7	Boom Event Analyzer Recorder (BEAR) . . . . .	18

LIST OF FIGURES (Continued)

<u>Fig. No.</u>		<u>Page</u>
8	Supersonic Flight Tracks From 30 ACMI Mission Tapes . . . . .	21
9	Boom Hits From 30 ACMI Mission Tapes . . . . .	23
10	Gaussian Distribution of Boom Hits for 30 ACMI Mission Tapes . . . . .	24
11	Elgin MOA Monitor Site Locations . . . . .	27
12	BEAR Installation . . . . .	30
13	Example BEAR Record . . . . .	33
14	Example BEAR Record . . . . .	34
15	Overpressure Cumulative Probability Distribution . . . . .	45
16	Overpressure Cumulative Probability Distribution . . . . .	46
17	Peak Level Cumulative Probability Distribution . . . . .	47
18	C-Weighted Sound Exposure Level Cumulative Probability Distribution . . . . .	48
19	A-Weighted Sound Exposure Level Cumulative Probability Distribution . . . . .	49
20	Perceived Loudness Cumulative Probability Distribution . . . . .	50
21	Elgin MOA $L_{Cdn}$ Contours Based on Measured Data . . . . .	51
22	Mach Number Distribution for 14 F-18 Supersonic Sorties . . . . .	53
23	Mach Number Distribution for 140 F-16 Supersonic Sorties . . . . .	54
24	Mach Number Distribution for 219 F-15 Supersonic Sorties . . . . .	55
25	Altitude Distribution for 14 F-18 Supersonic Sorties . . . . .	56
26	Altitude Distribution for 140 F-16 Supersonic Sorties . . . . .	57
27	Altitude Distribution for 219 F-15 Supersonic Sorties . . . . .	58
28	Elgin MOA $L_{Cdn}$ Contours as Predicted by Boom-Map3 . . . . .	60
29	Elgin MOA Scaled $L_{Cdn}$ Contours Without Anomalous Low-Altitude Carpet Boom . . . . .	61
30	Elliptical $L_{Cdn}$ Contours Based on Measured Data . . . . .	63
31	Available Airspace Ellipse for the Elgin MOA . . . . .	69

**LIST OF TABLES**

<u>Table No.</u>		<u>Page</u>
1	Nellis Range Group Schedule Excerpt . . . . .	10
2	Elgin MOA Monitor Site Locations Relative to ACMI Center . . . . .	26
3	Example BEARLOUD Output File . . . . .	35
4	Excerpt From Mission/Boom Data Base . . . . .	38
5	Operations in the Elgin MOA . . . . .	39
6	ACM Activity in Elgin MOA, 1 April 1992 Through 30 September 1992 . . . . .	41
7	Elgin Range Individual Site Statistics . . . . .	43
8	Booms Greater Than 5 psf . . . . .	44
9	Supersonic Operations for ACMI Sorties . . . . .	52



## 1.0 INTRODUCTION

The Elgin MOA is a subsection of the Nellis Range Complex located in southern Nevada. This airspace is regularly used for air combat maneuver (ACM) training which involves occasional supersonic flight. A sonic boom measurement program was conducted during the period from 25 March through 30 September 1992. The primary purpose of the measurement program was to obtain data suitable for the assessment of the sonic boom noise environment within the Elgin MOA. A secondary purpose of the program was to further refine current sonic boom noise environment prediction models.

Two similar sonic boom monitoring programs have been executed in the past. The first sonic boom monitoring program took place at the White Sands Missile Range in 1988.<sup>1</sup> That program employed 17 Sonic Boom Monitoring 1 systems (SBM-1),<sup>2</sup> which record sonic boom overpressure and C-weighted Sound Exposure Level (CSEL),<sup>3</sup> and 21 Boom Event Analyzer Recorders (BEARs)<sup>4</sup> which record complete sonic boom signatures. These monitors were placed throughout the Lava/Mesa airspace and operated for a period of six months. During the monitoring period, tracking data from an Air Combat Maneuver Instrumentation (ACMI) system<sup>5</sup> were collected and analyzed. Results from that monitoring program led to the development of an elliptical model for the  $L_{Cdn}$  contours associated with ACM activity and the resulting sonic booms.

A second sonic boom monitoring program took place in R-2301E, a section of the Barry Goldwater Range in southern Arizona from 28 January through 26 April 1991.<sup>6</sup> That program attempted to exploit the elliptical nature of  $L_{Cdn}$  contours by arranging a minimum complement of 12 BEARs in a cross pattern corresponding to the expected major and minor axes of the ellipse. Results from that monitoring program did produced contours which were generally elliptical along the major axis but increased linearly along the minor axis. These non-conclusive results were attributed to the limited number of available monitors and the relatively short measurement period. Analysis of the ACMI data obtained for the measurement period did produce  $L_{Cdn}$  contours which were elliptical in shape.

The sonic boom monitoring program described in this report was similar to the WSMR project in that monitors were distributed throughout the Elgin MOA over a six-month period. However, as in the R-2301E monitoring program, all of the monitors were BEARs. Data were also collected from all Air Combat Maneuver Instrumentation (ACMI) equipped flights in the Elgin MOA over the measurement period.

This report contains a description of the Elgin MOA and the corresponding ACM operations in Section 2. The test plan including monitoring locations, operations data, and ACMI data are described in Section 3. Execution of the measurement program is described in Section 4, and the analysis of the collected data is described in Section 5. Finally, an updated model for the  $L_{Cdn}$  contours associated with sonic booms resulting from ACM operations is presented in Section 6.

## **2.0 ACM TRAINING AND THE ELGIN MOA**

### **2.1 ACM Training**

ACM training is an activity designed to provide fighter pilots with proficiency in air-to-air combat against other fighters. There is a variety of mission types involved, depending on the level and type of training. Basic Fighter Maneuver (BFM) missions consist of pilots learning the types of maneuvers involved in ACM. A BFM mission will generally consist of a flight of two to four aircraft, working together. Air Combat Training (ACT) missions consist of realistic exercises where two flights of aircraft (two to four aircraft in each) take aggressor/defender roles. Engagements include simulated weapon release and scoring kills. Dissimilar Air Combat Training (DACT) involves the aggressor/defender roles being taken by different aircraft types and/or different tactics. The ultimate goal is for pilots to become proficient at flying against the aircraft and tactics employed by their opponents, and to train under realistic circumstances. ACT and DACT missions are typically two versus two to four versus four. Major exercises can include more fighter aircraft, and also support aircraft such as Airborne Warning And Control System (AWACS). There are also a number of other basic categories of ACM in addition to BFM, ACT, and DACT, but these three exemplify the genre.

A typical ACM mission consists of entering the airspace, conducting several engagements, then leaving the airspace. Upon entering the airspace, pilots first perform g-familiarization maneuvers as a warmup. The aggressors and defenders then proceed to setup points about 30 to 50 miles apart. This is the distance at which combat aircraft generally begin to use their internal electronic systems to detect and track opponents. The setup points themselves tend to be based on prominent visual references which are regularly used in a given airspace. Once at the setup points, the two flights will head toward an engagement. Depending on the nature of the mission, the nature of this start can vary. For BFM, it can be by mutual agreement. For ACT or DACT, the aggressor flight might begin and the defenders initiate an intercept when they detect the aggressors. For many scenarios, a forward controller (perhaps an AWACS or a ground controller simulating AWACS) may provide attack or intercept vectors. Once the aircraft leave the setup points, they may proceed directly or circuitously toward an engagement point. Depending on tactics, they may remain together or divide into smaller

groups. The actual engagement point(s) evolve, depending on the tactics employed by each side.

When aircraft are 10 to 20 miles apart, each pilot will have formed his plan. Since maneuver capability is a major element to survival, each aircraft will generally accelerate to an airspeed representing the best maneuver capability of that aircraft. This typically corresponds to some indicated airspeed, so that the true airspeed will vary with altitude. If an aircraft is at a high enough altitude, it will be supersonic. Acceleration to a desired airspeed is often referred to as "energy addition".

When aircraft are close to each other, the engagement itself (dogfight or "furball") begins. This generally takes place in a region between the setup points. It is characterized by tight maneuvers as each pilot tries to maneuver an opponent into his weapon envelope. Speeds are nearly always subsonic, with the maneuver capability of the aircraft a major (but not sole) consideration. Speeds can become supersonic if momentary tactics require it. This generally occurs in a dive as one aircraft chases another or builds up speed preparatory to a maneuver. Given the nature of air combat, one cannot predict what will happen or where it will happen during a given engagement.

The furball phase will end with one side or the other declared to be the winner, or with a disengagement by one or more of the aircraft. A disengagement can consist of leaving the furball at high (often supersonic) speed when at a tactical disadvantage. In actual combat, this would often be followed by maneuvering to a better position, then reengaging. In training situations, the engagement is usually ended, aircraft return to the setup points, and another engagement is begun. An engagement can also be terminated if a potential safety hazard arises or if airspace boundaries are about to be exceeded.

The training value of ACM is greatly enhanced by the use of an Air Combat Maneuver Instrumentation (ACMI) system.<sup>5</sup> This system consists of a set of ground tracking stations and a transponder pod attached to each aircraft. Each pod contains its own internal navigation system and pitot tube. Every 100 to 200 milliseconds each pod is interrogated by a ground station. It telemeters the aircraft coordinates, velocity, g-load, angular rates, air speed, Mach number, etc. These data are recorded and are used to generate a real-time video display in a

small theater, where training officers and other pilots can observe the mission as it takes place. A Range Training Officer (RTO) monitors the mission and can select various views of the mission on the display. The RTO serves as referee in scoring kills, monitors safety or airspace constraints, and can act as a simulated advance controller. After a mission, the recording may be played back so that pilots can analyze their performance. The primary recording medium for ACMI is analog magnetic tape. A digital version of each mission is also prepared.

The value of an ACMI system for the current project is that it provides tracking data of actual missions. These data, while designed for video simulation (as opposed to flight test tracking) purposes, are precise enough for calculation of sonic booms from supersonic segments of ACM missions. They also provide a quantitative record of how the airspace is utilized on a given mission. These data are available on standard nine-track digital tape.

## **2.2 The Elgin MOA**

The Elgin MOA is a subsection of the Nellis Range Complex located just north of Las Vegas, Nevada. Figure 1 depicts the Nellis Range Complex with the Elgin MOA shaded. Figure 2 shows the Elgin MOA boundaries (including the Elgin North and Elgin South subdivisions) along with the partial boundaries of the Caliente MOA located to the north. The symbols to the north and south of the Elgin MOA indicate the towns of Caliente and Moapa, respectively. The cross in the center of the Elgin MOA indicates the ACMI coordinate center.

The primary users of the Elgin MOA are F-15s and F-16s from Nellis AFB. Many different mission scenarios are practiced in the Elgin MOA. The most common mission types include basic fighter maneuvers (BFM), air combat tactics (ACT), surface-to-air tactics (SAT), and air combat maneuvers (ACM). Other mission types include dissimilar air combat tactics (DACT), tactical intercept (TI), weapons delivery (WPN), and electronic combat tactics (ECT).

The terrain under the Elgin MOA consists of mountains, particularly in the northern part of the MOA, and high desert valleys. Most of the land is the property of the U.S. government and falls under the jurisdiction of the Bureau of Land Management (BLM). Much of the land is used for cattle grazing by local ranchers. There are very few inhabitants under the Elgin MOA. Some are located

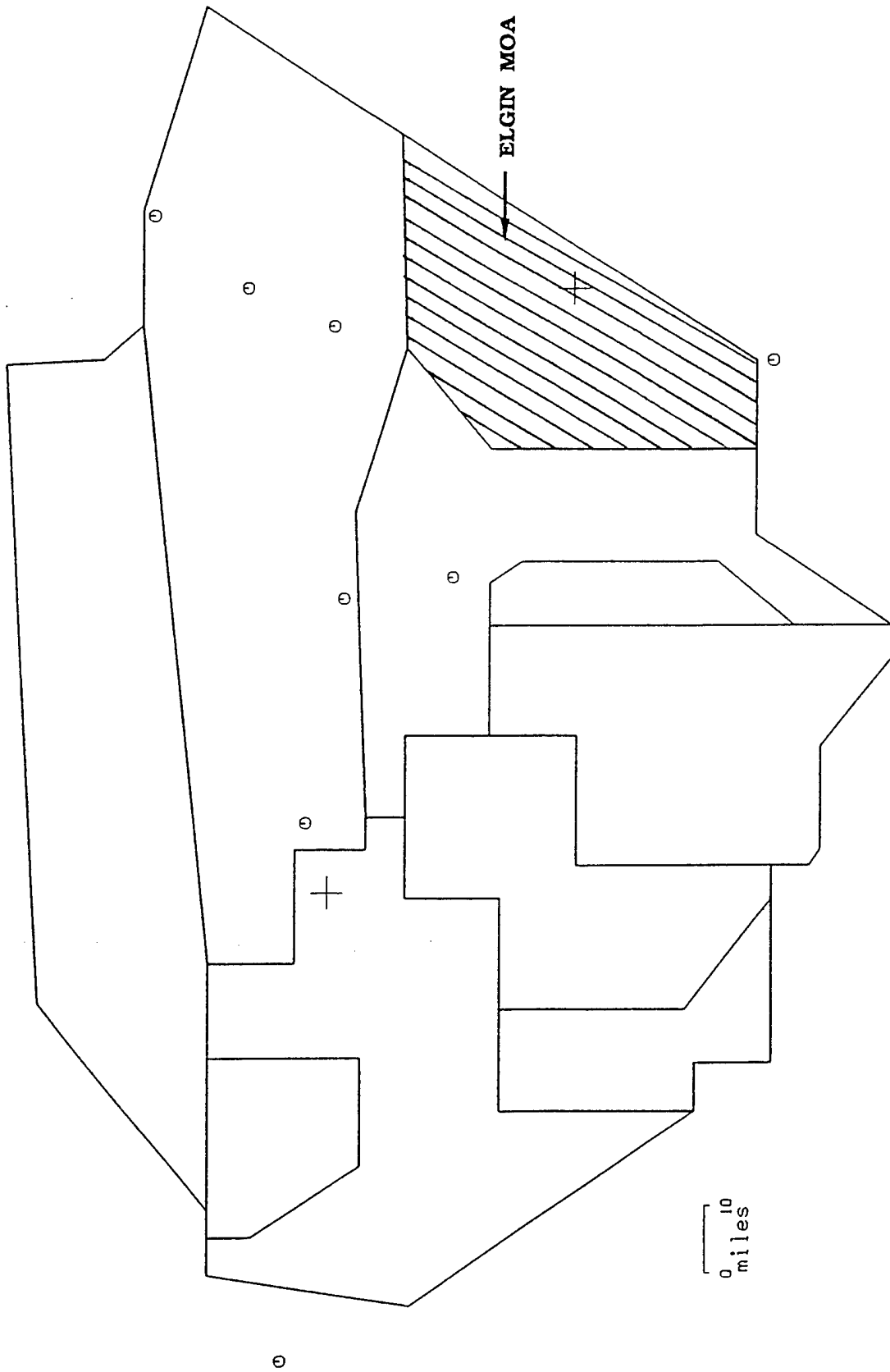

Figure 1. The Nellis Range Complex.

in the town of Elgin in the northern part of the MOA. The town of Caliente (indicated in Figure 2) is located just north of the Elgin MOA boundary and experiences some sonic boom from operations which spill over into the Caliente MOA. The town of Moapa is located just to the south of the Elgin MOA boundary, as indicated in Figure 2. There are also some isolated ranches located along the Union Pacific Railroad service road which runs north to south through the middle of the MOA.

## **2.3 ACM Operations and Scheduling**

### **2.3.1 Operations**

Most ACM activity in this airspace involves two-versus-two or four-versus-four. The setup points are a group of water tanks at Leith Station in the north-central region of the MOA and the "farms", a group of irrigated fields in the south central part of the MOA. Figure 3 shows flight tracks from a typical mission. Dashed lines represent subsonic flight, and solid lines represent supersonic flight segments. Note the flight tracks over the southern setup point, and the somewhat random track pattern roughly centered within the airspace.

ACM operations are always above 5,000 feet above ground level (AGL). ACM operations in the Elgin MOA occasionally venture out of the range boundaries into the Caliente MOA to the north. Operations rarely exceed the boundaries to the east, west, or south with the exception of range entry and exit.

### **2.3.2 Scheduling**

All activity in the Elgin MOA is scheduled through the Nellis AFB Range Group. The data base provided by the Range Group contained "as-flown" information organized chronologically. Included in the data base is the date, time block reserved for each mission, unit to which the scheduled missions belonged, range subdivision being used, mission type, number and type of aircraft, mission call sign, and other information. An excerpt from the data base is shown in Table 1.

Schedules of ACMI missions are maintained by the ACMI operator. Figure 4 shows a typical ACMI schedule sheet. A mission number, constructed from the

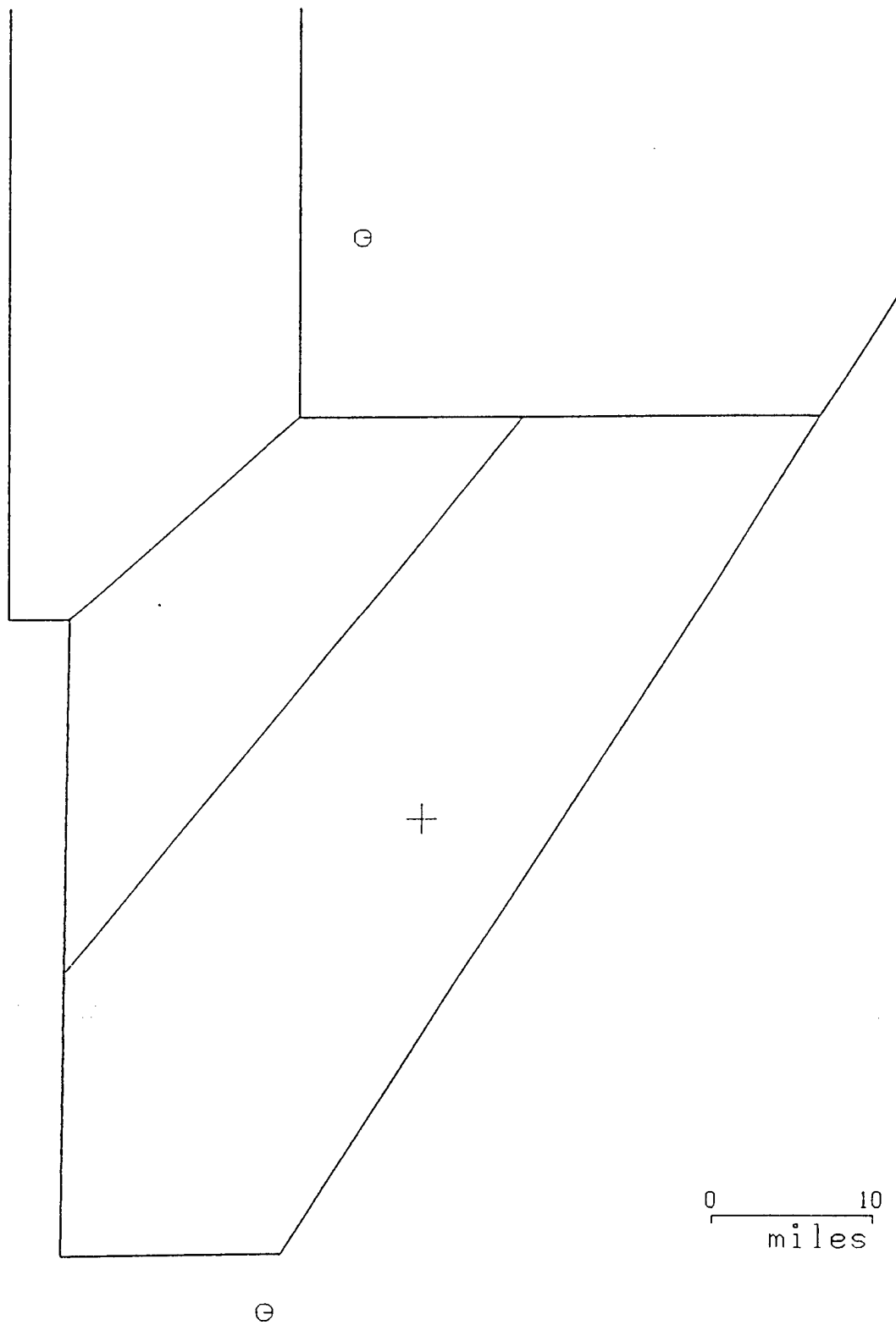

Figure 2. The Elgin MOA.



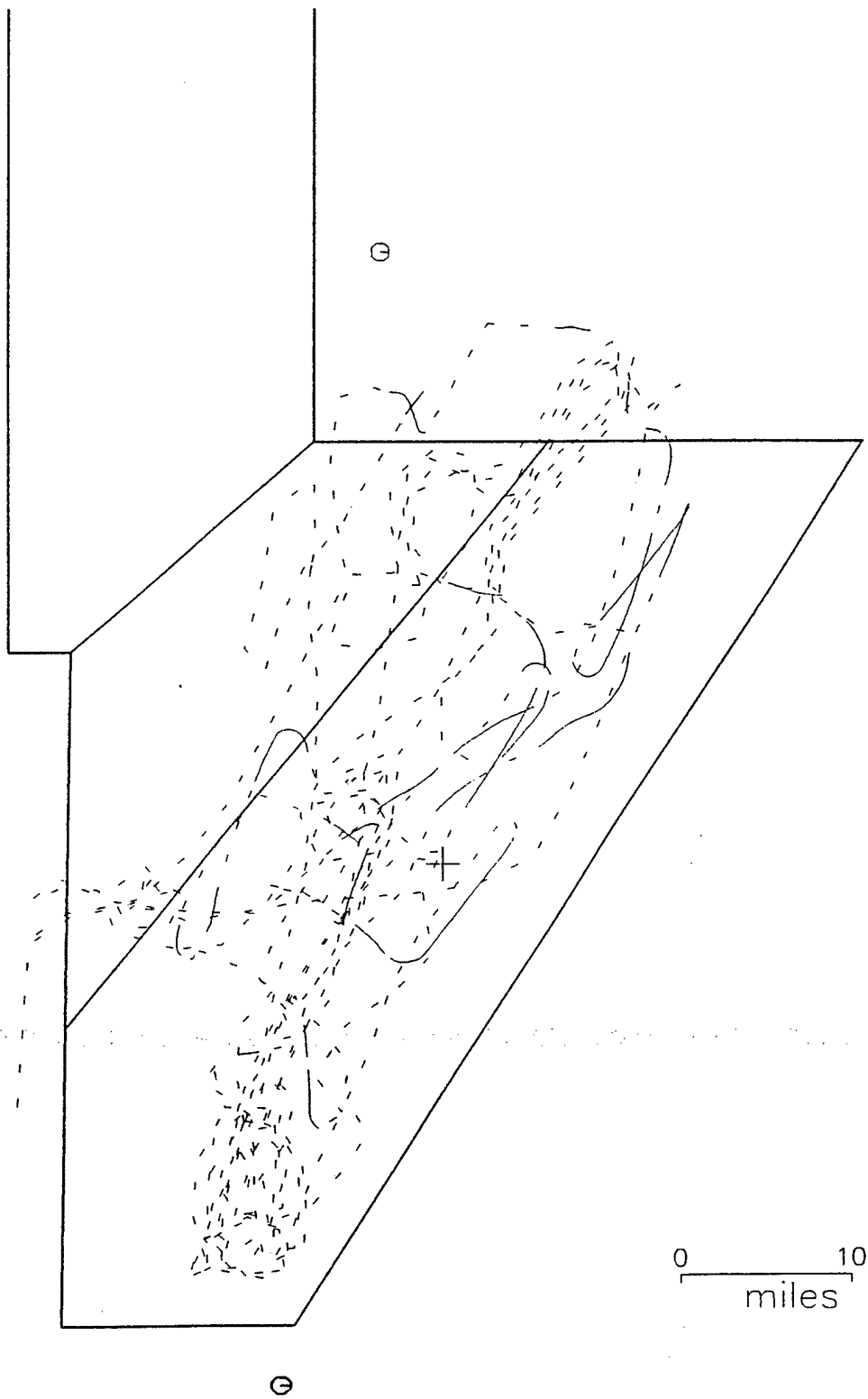

Figure 3. Flight Tracks for a Typical ACM Training Mission.

Table 1

Nellis Range Group Schedule Excerpt

0092040107000745FWS	2TTA57ELGTI	FX02F15	RAMBO 01	0270CHAFF/F
0092040107000745FWS	2TTA57ELG	X02F15	CONAN 01	0272
0092040107000745VFA-151	2TTA57ELG	X02F18	VCSL 11	
0092040107000745VFA-25	2TTA57ELG	X04F18	VCSL 01	
0092040107450845422	2TTA57ELG06	FX02F15E	BAT 01	4340NONE
0092040108450930422	2TTA57ELGACT	FX04F16	VIPER 01	CHAFF/F
0092040108450930422	2TTA57ELG	X08F-15	VCSL	
0092040109301030AT	2TTA57ELGSAC	FX02F16	MIG 01	4301CHAFF/F
0092040109301030AT	2TTA57ELG	X02F16	IVAN 01	4311
0092040110301200FWS	2TTA57ELG	X02F16	COBRA 01	0254MK82 (I
0092040110301200FWS	2TTA57ELG	X02F16	WOLF 01	0260
0092040110301200FWS	2TTA57ELG	X02F16	SHARK 01	
0092040110301200FWS	2TTA57ELGSAT-3	FX02F16	SNAKE 01	CHAFF/F
0092040110301200FWS	2TTA57ELG	X02F16	SNAKE 11	
0092040110301200FWS	2TTA57ELG	X02F16	SPIE 01	
0092040112151315FWS	2TTA57ELGTI	FX02F15	RAMBO 01	0270CHAFF/F
0092040112151315FWS	2TTA57ELG	X02F15	CONAN 01	0272
0092040112151315VFA-151	2TTA57ELG	X02F18	VCSL 11	
0092040112151315VFA-25	2TTA57ELG	X04F18	VCSL 01	
0092040113151400422	7TWA53ELG05	FX02F15C	RINGO 01	4330NONE
0092040113161400AT	2TTA57ELGSAC	FX02F16	MIG 01	4301CHAFF/F
0092040113161400AT	2TTA57ELG	X02F16	IVAN 01	4311
0092040114001500422	2TTA57ELG06	FX02F15E	BAT 01	4340NONE

**ACMI MISSION DATA**

FLIGHT NUMBER <i>2210-BFM-133A</i>							DATE <i>28.6/92</i>	RANGE TIME <i>1330-1415</i>		
RTO				MODE <i>6A</i>	PK <i>90</i>	AUTO REBIRTH <i>10 SEC.</i>	START TIME <i>134938</i>	STOP TIME <i>140027</i>		
A/C	SQDN	A/C TYPE/ POD LOC.	A/C CONF.	POD S/N	POD ID	TAIL NO.	CALL SIGN	PILOT NAME	WEAPONS TYPE/#!/TYPE/#	PERF. CODE
<i>1</i>	<i>FWS</i>	<i>F15/20</i>		<i>440</i>		<i>044</i>	<i>Rambo 01</i>			<i>0</i>
<i>2</i>	<i>"</i>	<i>"/20</i>		<i>875</i>		<i>043</i>	<i>Rambo 02</i>			<i>0</i>
<i>3</i>	<i>"</i>	<i>"/20</i>		<i>416</i>		<i>044</i>	<i>Coran 02</i>			<i>0</i>
<i>4</i>	<i>"</i>	<i>"/20</i>		<i>592</i>		<i>165</i>	<i>Coran 01</i>			<i>0</i>
5										
6										
7										
8										
9										
10										
11										
12										
FREQUENCIES			259.4	357.1			268.2	243.0		

RTO REMARKS

DDS OPERATOR USE ONLY

ACTION	YES		NO		YES		NO		YES		NO	
	YES	NO	YES	NO	YES	NO	YES	NO	YES	NO		
PODS LOADED - Au PRIMARY AIRCRAFT	<input checked="" type="checkbox"/>											
DATA CALLED IN ON TIME	<input checked="" type="checkbox"/>											
ACMI FREQUENCIES USED	<input checked="" type="checkbox"/>											
RTO PRESENT	<input checked="" type="checkbox"/>											
MISSION DEBRIEFED			<input checked="" type="checkbox"/>									

AUTO REBIRTH TIMER FOR ALL A/C: 1-60 SEC. 0 - NO R.B.

<p><b>MODE 6 OPTIONS</b></p> <p>6A = 1 SHOT ANYWHERE KILL</p> <p>6B = 1 SHOT BEHIND 3/9 LINE KILL</p> <p>6C = 2 SHOTS ANYWHERE KILL</p> <p>6D = 2 SHOTS BEHIND 3/9 LINE KILL</p>	<p><b>A/C CONFIGURATION</b></p> <p>A = BORESIGHT AIM 7 &amp; 9</p> <p>B = B.S. 7, OFF B.S. 9</p> <p>C = OFF B.S. 7, B.S. 9</p> <p>D = OFF B.S. 7 &amp; 9</p> <p>E = SERIAL DATA F-16</p>	<p>F = A-10 AIM 9 CONTROL</p> <p>I = F/A-18 INTERNAL AIS</p> <p>M = MSIP F-15</p> <p>N = S-2 LOGIC F-16</p>
--	--	---

**PERFORMANCE CODES**

0 = GOOD TRACKING	3 = AIR DATA PROBLEMS
1 = POOR TRACKING - NON EFFECTIVE	4 = GOOD TRACKING WITH SIM PROBLEMS
2 = INTERMITTENT TRACKING	5 = NO RESPONSE

Figure 4. ACMI Data Sheet.

Julian date and an index representing half-hour time blocks, is assigned to each mission, and appears in the upper left corner. This allows identification of the scheduled time of any mission. The aircraft involved and the pod on/off times are also noted on the ACMI sheet.

Correlation between ACMI schedules and range schedules for ACMI missions was found to be very good. Using these two resources, the pertinent activity in the Elgin MOA was well established for the period of this study.

### 3.0 TEST PLAN

The monitoring project consisted of collecting two types of data: sonic boom data as measured on the ground under the Elgin MOA and information on ACM operations flown during the monitoring period. Collection of the sonic boom data required installation and servicing of many monitoring devices distributed throughout the area. The monitors are discussed in Section 3.1, while the locations of these monitors are discussed in Section 3.2. ACM operations information was gathered from two sources including ACMI data and scheduling information from the Range Group. Each of these topics are covered in Section 3.3.

#### 3.1 Sonic Boom Monitoring Equipment

##### 3.1.1 Characteristics of Sonic Booms

Figure 5 is a sketch of a sonic boom generated by an aircraft in supersonic level flight. Near the aircraft, there is a complex shock wave pattern associated with aerodynamic loads. Far away from the aircraft, this pattern distorts and coalesces into the "N-wave" shape shown. There is an initial shock wave, followed by a linear expansion, then a tail shock almost equal in strength to the bow shock. This type of signature occurs for fighter aircraft at 5,000 feet AGL and above. For fighter aircraft between 5,000 feet and 40,000 feet AGL, the shock strength (peak overpressure) is in the range 1 to 10 pounds per square foot (psf) (lower at higher altitudes) and the duration between shocks is in the range 100 to 200 milliseconds (longer at higher altitudes). The shock waves themselves are not instantaneous jumps, but are ramps with rise times in the range of 1 to 10 milliseconds.

The sonic boom sketched in Figure 5 occurs directly under the flight path. To the side of the flight track, the boom is generally similar but with lower amplitude. Due to refraction by wind and temperature gradients in the atmosphere, there is a lateral cutoff distance beyond which there is no boom. It is common to refer to the area impacted by boom, between the cutoff distances and extending for the length of the flight track, as a sonic boom "carpet", and the associated N-wave as a "carpet boom". Measurements of carpet booms generally agree with the ideal N-wave sketched in Figure 5, but atmospheric turbulence can cause significant fine-scale distortion. Instrumentation must be capable of recording N-waves when they depart from nominal.

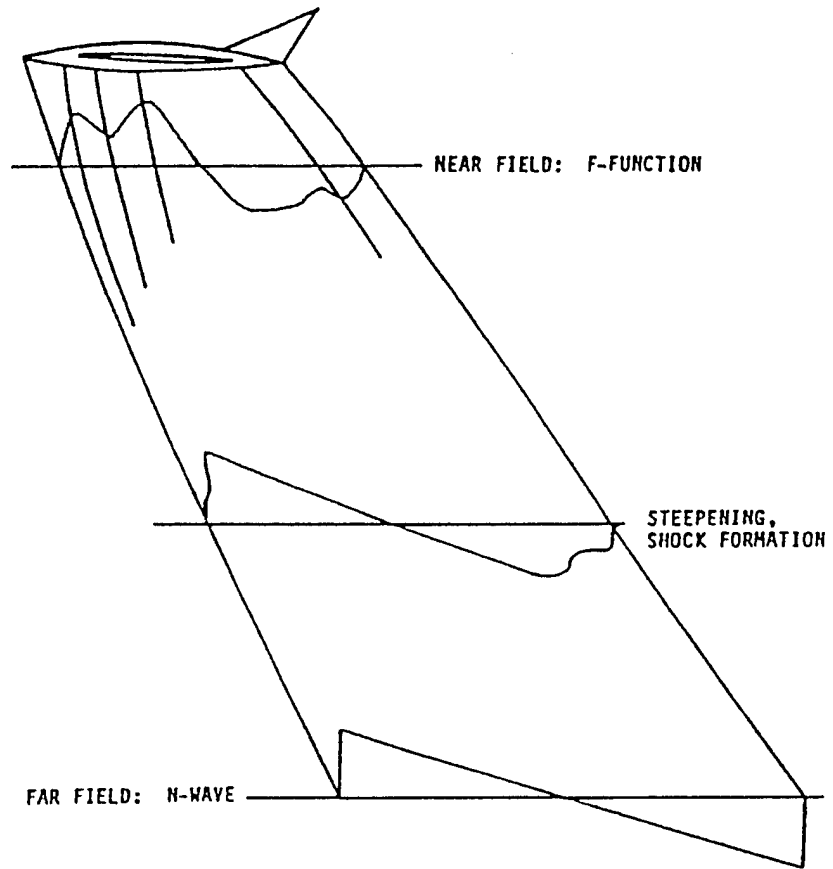

Figure 5. Sonic Boom Waveform Generation.

Aircraft engaged in ACM rarely sustain supersonic speeds for more than a few tens of seconds, and even more rarely do this in steady level flight. ACM supersonic events tend to include acceleration, deceleration, and turns. Maneuvers can enhance the boom by focusing (nominally during acceleration or toward the inside of turns) or defocusing (deceleration, outside of turns). Acceleration to supersonic speeds generally causes a focus. When focusing occurs, there is a narrow focal zone where the boom is an enhanced focus boom with a distorted "U-wave" shape. The shock peaks are typically enhanced by a factor of two to three.<sup>7</sup> Downtrack of the focus boom, there is a transition to carpet boom. In this transition, there is a carpet-like N-wave and a decaying U-wave. Sometimes, the N-wave in this region is referred to as being "pre-focus" and the U-wave as "post-focus". Uptrack of the focus boom, there is a decaying "evanescent" wave which has a rounded shape. Figure 6 shows these three types of focal zone sonic boom. There can be substantial variations in detail in particular cases, there can be overlap of different types, and there can be turbulent distortion. Even in non-ideal cases, however, an understanding of the basic sonic boom waveforms (i.e., those shown in Figures 5 and 6) may be used to identify sonic boom records.

### 3.1.2 Sonic Boom Metrics

It is desirable to have a description of a given sonic boom which is simpler than presenting the complete pressure-time signature. An N-wave sonic boom is described completely by the peak overpressure and the duration. The overpressure is the dominant parameter affecting environmental impact, so that most sonic boom data are reported in terms of overpressures. The peak overpressure  $P_{pk}$ , in psf, can be converted into a decibel level, re 20  $\mu$ Pa, by the relation:

$$L_{pk} = 127.6 + 20 \log_{10} P_{pk} / 1 \text{ psf} \quad (1)$$

The peak level can be measured by standard impulse sound level meters and readily converted to  $P_{pk}$ . This quantity is directly applicable to existing studies of N-wave sonic boom impact, but does not relate directly to studies involving other impulsive noise.

It has been found<sup>8</sup> that the environmental impact of a variety of impulsive sounds, including sonic boom, correlates well with the C-weighted sound exposure level (CSEL). CSEL is obtained by filtering the waveform via a standard

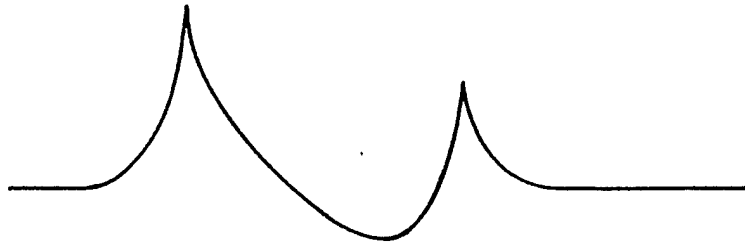

a. Maximum Focus U-Wave.

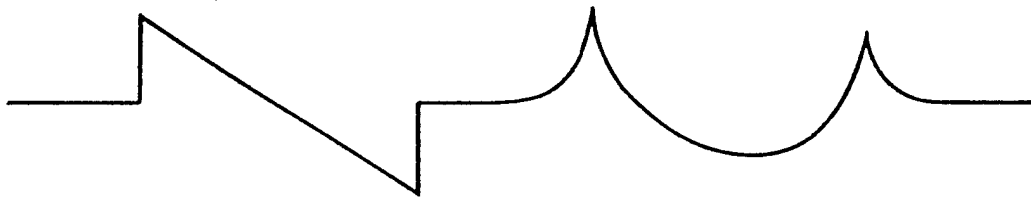

b. Transitional N-U Combination.

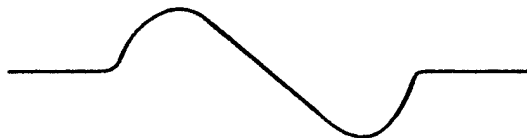

c. Evanescent Wave.

Figure 6. Types of Boom Signatures in a Focal Region.



C-weighting filter,<sup>9</sup> which attenuates energy below 25 Hz and above 10,000 Hz (the nominal audio frequency range), then computing the total energy and presenting this as a sound level. For N-wave sonic booms,  $L_{pk} - CSEL = 26$  dB to within  $\pm 2$  dB.<sup>10</sup> For U-wave focal zone booms,  $L_{pk} - CSEL$  is larger, while for rounded booms (lateral cutoff, evanescent focal zone) it is smaller. CSEL can be computed from a complete waveform, and can also be directly measured by an integrating sound level meter. With individual booms characterized by CSEL, the cumulative impact of sonic booms over long periods is characterized by the C-weighted day-night equivalent level ( $L_{Cdn}$ ).  $L_{Cdn}$  is obtained by summing the energy associated with CSEL for each event in a given period of some number of days, dividing by the length of the period, and presenting this average energy rate as a sound level. Events occurring at night (2200-0700) are penalized by adding 10 dB to the CSEL. Interpretive criteria for land-use compatibility is based on the relationship to annoyance presented in Reference 8.

### 3.1.3 BEAR Monitor System

The BEAR (Boom Event Analyzer Recorder) was developed by the Air Force for automatic recording of sonic boom signatures.<sup>4</sup> It is a digital microprocessor-controlled recording system. This system has a frequency response of 0.5 Hz to 2500 Hz, and records complete sonic boom waveforms. It incorporates pattern recognition algorithms so that it will record only those events which have the characteristics of a sonic boom.

There are two models of BEAR. The original design, referred to as "old" BEAR, stores data in removable RAM modules. The "new" BEAR design uses fixed data storage, and data are accessed via an RS-232 communication port.

Figure 7 is a sketch of an old BEAR system. The microphone (PCB 106B50) employed with the BEAR unit is mounted inside a hemispherical, foam inner windscreen, with its diaphragm one-half diameter above and facing a steel baseplate on the ground. A conical outer windscreen, constructed of wire mesh and covered with nylon fabric, is placed over this. Sound detected by the BEAR is digitized at a rate of 8,000 samples per second and enters a recirculating buffer memory with two-second duration. When the signal exceeds a programmed threshold (generally set to 105 dB, 0.075 psf), the system examines the waveform to assess if

BOOM EVENT ANALYZER RECORDER (BEAR)

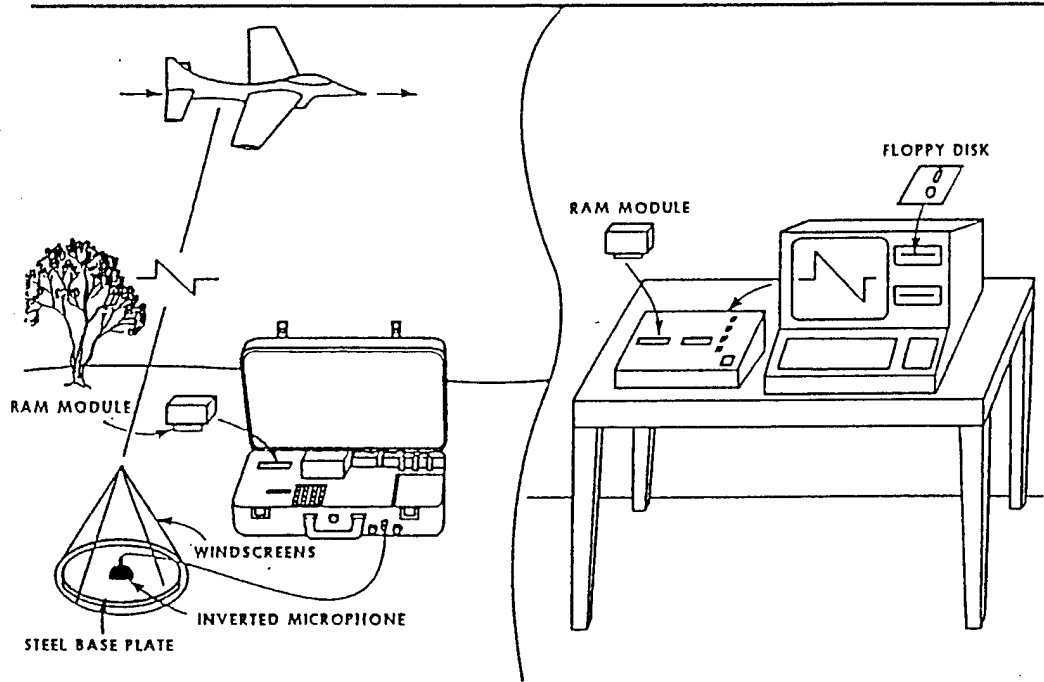

Figure 7. Boom Event Analyzer Recorder (BEAR).

it is a candidate sonic boom. Parameters examined include the rise time of the initial signal, time to reach the maximum, and the duration of the first positive phase of the signal. If the event satisfies the programmed criteria, the event (from the signal start until it falls below a lower "off" threshold) is recorded in non-volatile random access memory (RAM). Record length varies, corresponding to the actual duration of the boom plus some time before and after it. The system has 512 kB of RAM, capable of storing a total of about 40 seconds of data. This is adequate for over 100 sonic booms of 200 msec duration each.

The old BEAR data RAM is contained in removable modules. When the BEAR is serviced in the field, the modules are removed and replaced with fresh ones. Data from the RAMs are transferred to a personal computer, where they are stored on disk and may then be analyzed. This transfer takes place in two steps. First, the RAMs are inserted into a Data Retrieval Unit (DRU), which is connected to a computer via an RS-232 link. Data transfer is controlled by the program COMM. This results in a master file which is an image of the RAM contents. Second, the master file is operated on by program PROCESS. This program divides the master file into individual records. Each record is written as a separate file. The name of each file is constructed from the site number, the date, and the time to the nearest minute. The recorded waveforms are plotted for examination. The discrimination criteria in the BEAR are somewhat liberal so that, while excluding most non-boom events, there will be some records which are not booms. These are easily identified and rejected by visually examining them and comparing them with the types of waveforms discussed in Section 3.1.1.

Functionality of the new BEAR is similar, except that BEAR RAM is fixed and stored data are collected by transfer, via an RS-232 connection, to a computer. This is accomplished in the field with a portable computer and program PCBEAR. Data are transferred directly as processed individual files. The serial port also allows data download via modem, should a telephone link be available at the measurement site.

Each BEAR was located in an environmentally sealed box and equipped with a solar panel. The box was secured to the ground with a screw-in anchor. The solar panels served to recharge the battery. Further details of BEAR installation are discussed later in Section 4.1.1.

## 3.2 Monitoring Locations

A total of 41 BEARs were available for this measurement program. Thirty five of these BEARs were fielded in and around the Elgin MOA while one BEAR was placed in each of the towns Rachel, Hico, and Caliente. Since some of the ACM operations in the Elgin MOA spilled over into the Caliente MOA, the data collected with the BEAR located in Caliente were considered in this study. The towns of Rachel and Hico were too far removed from these operations to be considered. The booms recorded in these towns were associated with missions in other sections of the Nellis Range Complex.

A significant amount of boom activity was noted, after three months of monitoring were completed, along the eastern edge of the airspace. One of the monitors located near the center of the Elgin MOA was moved at this time in order to better cover this region. This brought the total number of measurement sites covering the 2,400-square-mile Elgin MOA to 37.

The process of selecting specific site locations for the available sonic boom monitors was similar to that used for the WSMR sonic boom study.<sup>1</sup> Prior to the field measurement program, data from 30 ACMI missions flown in the Elgin MOA were analyzed. This information was used to estimate the distribution of boom impact throughout the Elgin MOA, from which a D-optimal grid<sup>11</sup> was designed. The available ACMI data and its analysis are described in Section 3.2.1. The use of D-optimality and the design of an ideal monitor placement grid are discussed in Section 3.2.2 along with the adaptation for practical considerations.

### 3.2.1 ACMI Data Analysis

Prior to the start of the field measurements, ACMI tapes from 30 training missions in the Elgin MOA were obtained. These 30 missions included 116 sorties, of which 80 involved supersonic flight. The information on the tapes was read onto a PC and converted into ACMI library files. Software was prepared which would read an ACMI library and compute the number of booms, using ray-tracing algorithms equivalent to those in Boom-Map3.<sup>12</sup>

Figure 8 shows the supersonic tracks from this library. These tracks are plotted as they would have been by Boom-Map3. Notice that the general grouping

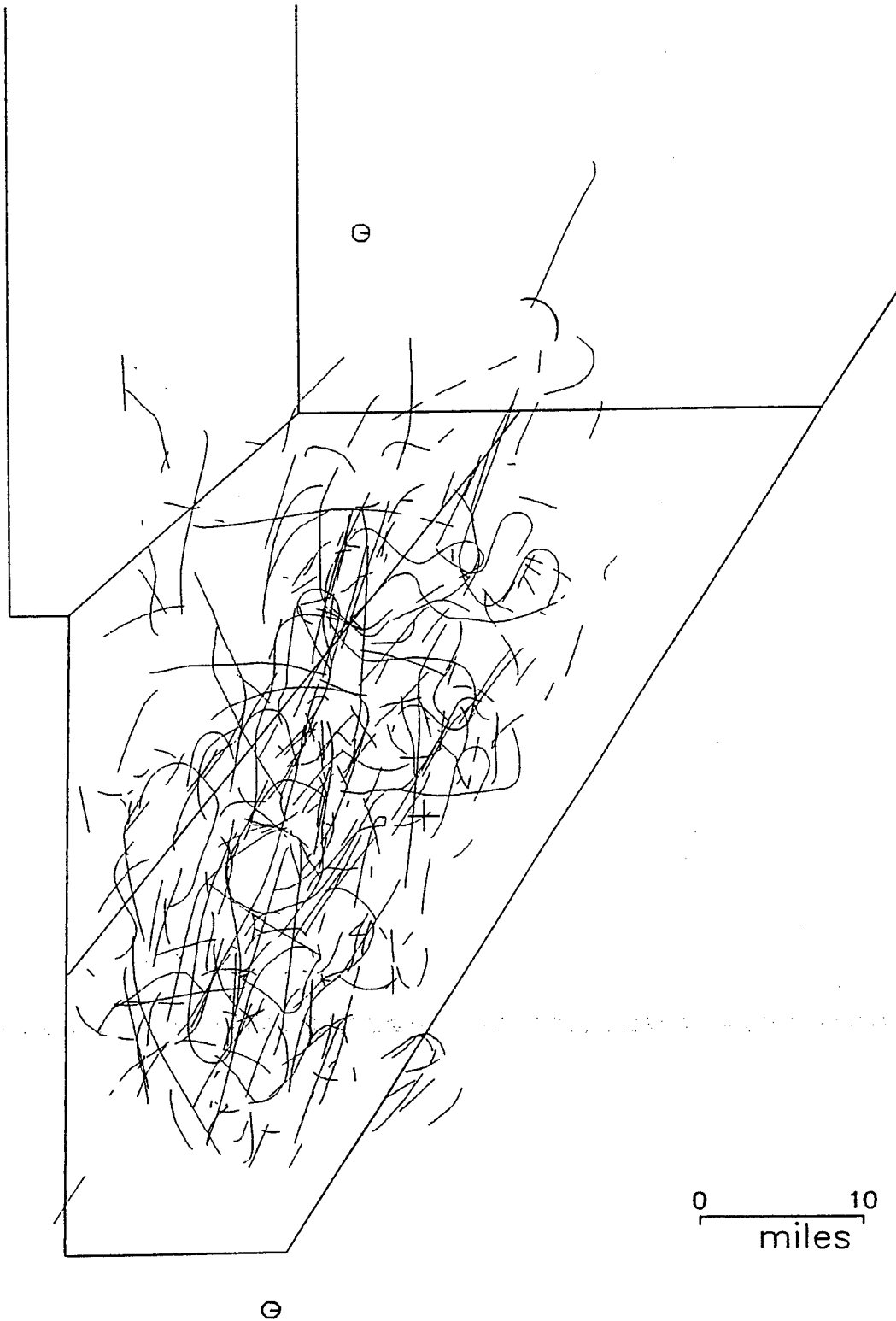

Figure 8. Supersonic Flight Tracks From 30 ACMI Mission Tapes.

of these tracks illustrate the elliptical airspace utilization which is expected from ACM activity.<sup>1,13</sup>

Figure 9 shows computed numbers of booms. This set of contours was developed by dividing the area into a matrix grid of square-mile cells and counting how many boom events impinged each cell. A boom event was considered to be the ground footprint associated with a single excursion above Mach one. For each such supersonic excursion, the envelope of the footprint was computed and a boom "hit" count was incremented for each cell within the footprint. Definition of a boom footprint did not include impingement of post-focus U-waves, since those would occur at locations covered by primary focus or carpet boom from the same event. No consideration was given to boom amplitude. Contours were generated from the final count matrix via a commercial contouring software package. The contours shown are actual counts for the 116 sorties, and have not been normalized. Dividing by 116 would, however, yield booms per sortie.

Figure 9 represents contours fitted directly to the numerical boom count results. Since calculating the ideal site locations with D-optimality requires a functional representation of the measurement distribution the data was fitted, in a least-square-error sense, to a two-dimensional Gaussian distribution. This function is represented in Figure 10. The standard deviations of the distribution along the major and minor axes are 14.3 and 10.7 miles, respectively, and the entire ellipse is rotated clockwise by 25 degrees relative to true north.

The elliptical nature of the sonic boom impingement obtained from this analysis is consistent with results from the original Oceana model<sup>13</sup> and subsequent sonic boom modeling programs.<sup>1,6</sup> It is very convenient that the distribution of sonic booms in such a complex environment as ACM is accurately described by a Gaussian distribution. The well-understood parameters of this distribution make modeling the sonic boom environment relatively easy.

### 3.2.2 Ideal Site Selection by D-Optimality

To determine the ideal locations for the sonic boom monitors, the previously discussed Gaussian boom hit distribution was used with D-optimality calculations. This calculation selects the statistically best points to place the

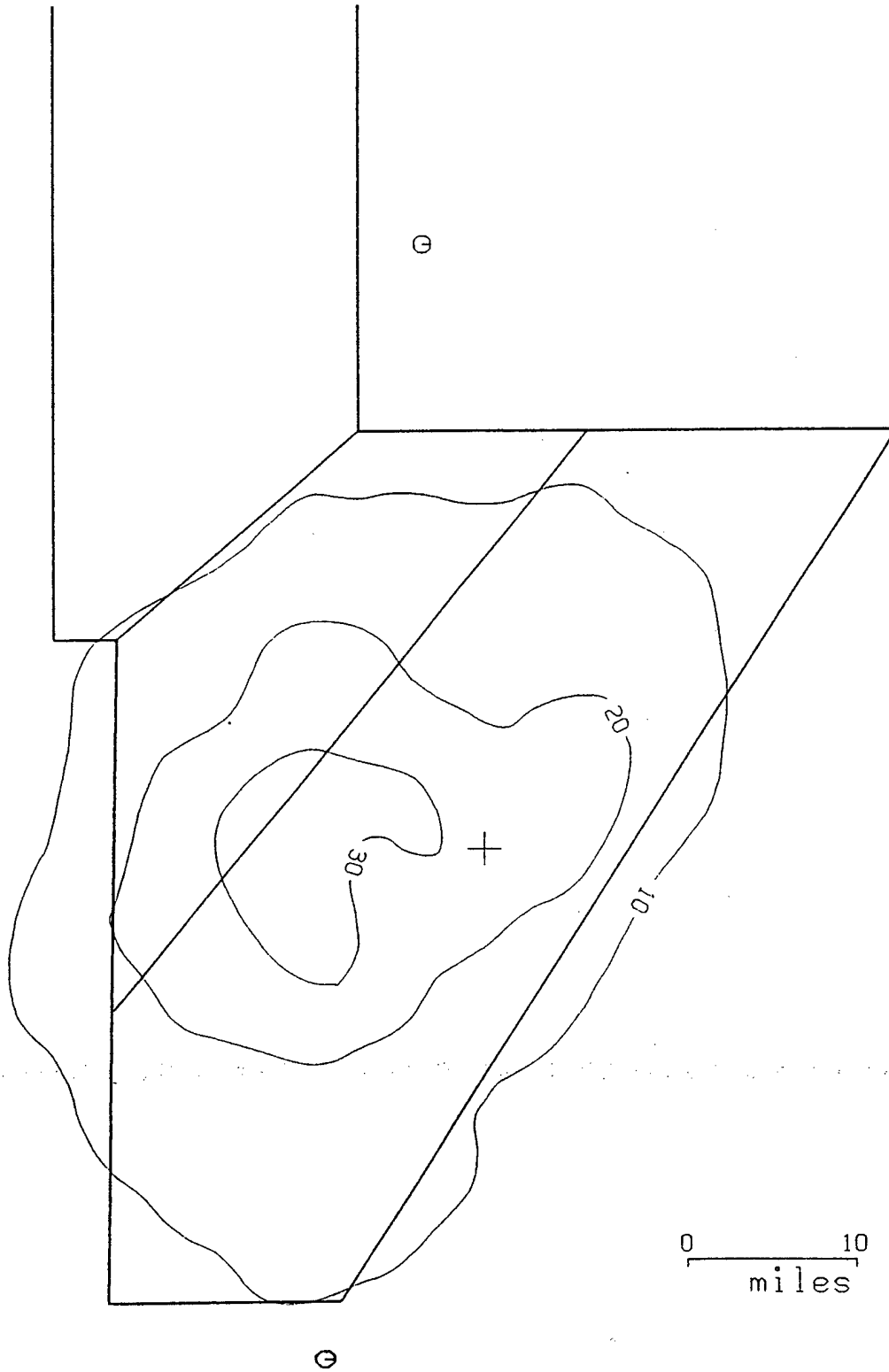

Figure 9. Boom Hits From 30 ACMI Mission Tapes.

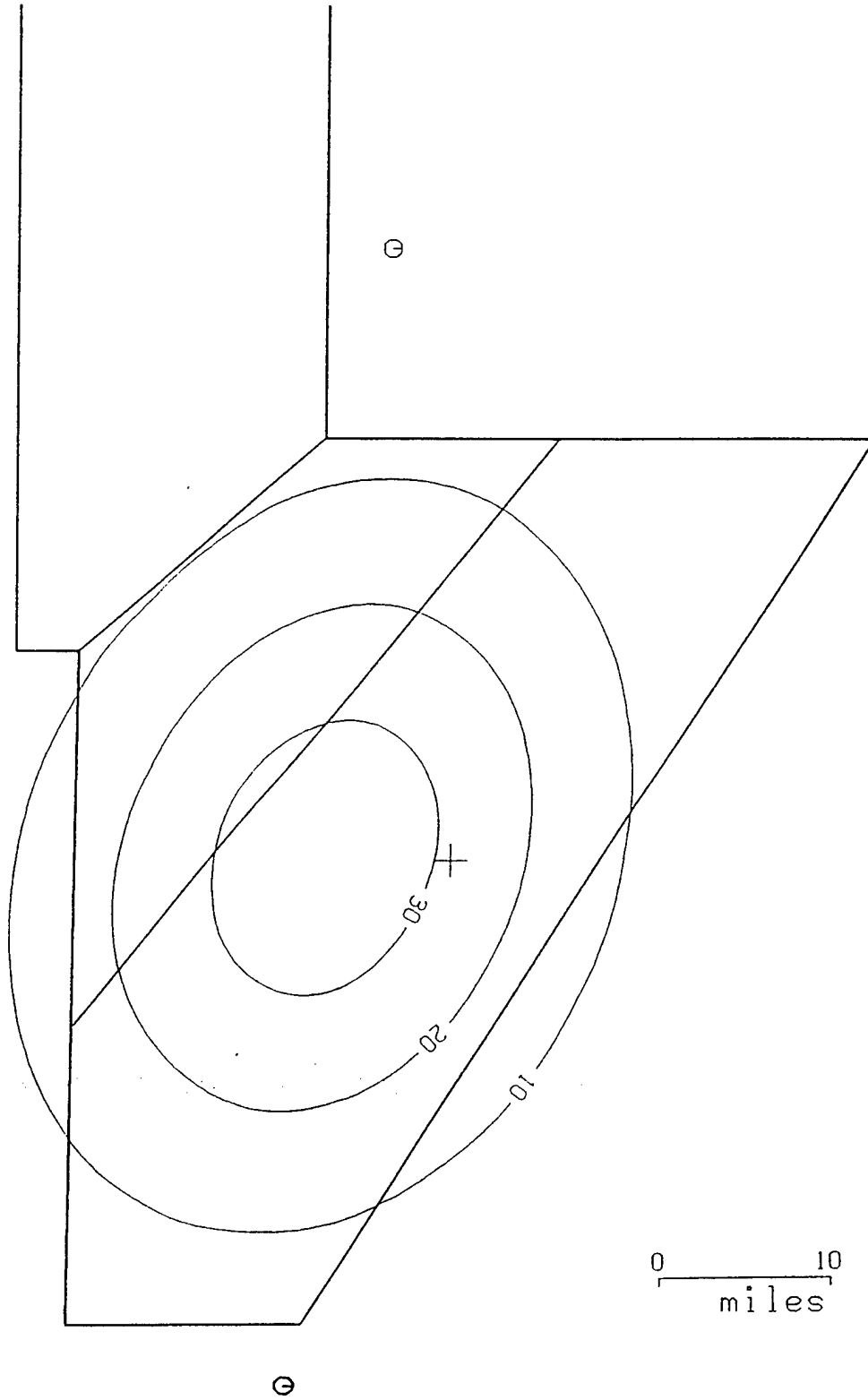

Figure 10. Gaussian Distribution of Boom Hits for 30 ACMI Mission Tapes.



boom monitors in order to characterize the expected Gaussian distribution. A detailed description of D-optimality as applied to this task can be found in References 1 and 11.

Once the optimum set of monitor locations was obtained, they had to be adjusted for practical considerations. The primary constraint on monitor locations was the need to be able to access them by road. The set of ideal monitor locations were located on USGS maps of the area. These locations were then adjusted to be close to available roads. This process dictated the locations of 35 of the 37 boom monitoring sites. Of the two remaining sites, site 37 was located in the town of Caliente, NV, just north of the Elgin MOA boundary. Site 36 came as a result of relocating site 28 halfway through the monitoring program. It was noted that the area just east of the Elgin MOA boundary was receiving some sonic boom activity and was lacking good monitor coverage. For this reason, site 28, which was among a group of relatively closely spaced monitors near the center of the MOA, was relocated to a convenient access location east of the boundary.

The specific locations of each of the monitors relative to the ACMI coordinate center (37° 6' 30" W, 114° 26' 42" N) are listed in Table 2 and shown relative to the Elgin MOA boundaries in Figure 11.

### **3.3 Operations Data and ACMI Analysis**

#### **3.3.1 Operations Data**

Arrangements were made with the Nellis Range Group to obtain as-flown schedule information for the entire Nellis Range Complex, including the Elgin MOA, for the period of the measurement program. ACMI data and schedule sheets were supplied by Loral Aerospace, Inc., who are responsible for ACMI data maintenance at Nellis AFB.

#### **3.3.2 ACMI Data Analysis**

The Air Force developed a series of computer programs which access ACMI tracking data for sonic boom analysis, falling under the general name of Boom-Map. The original software,<sup>14,15</sup> hosted on a CDC 170 computer at AFESC, Tyndall AFB, consisted of three programs. The first, EXTRACT, reads ACMI tapes

Table 2

Elgin MOA Monitor Site Locations  
 Relative to ACMI Center, 37° 06.5"N, 114° 26.7"W

Site	X (mile)	Y (mile)	Site	X (mile)	Y (mile)
1	-23.3	-22.4	20	-18.5	-1.4
2	-15.6	+23.2	21	-14.3	+2.9
3	-6.8	+25.3	22	-6.0	+3.9
4	+4.1	+25.3	23	+4.2	+2.7
5	+14.4	+24.2	24	+6.6	-3.7
6	-9.0	+17.5	25	-2.2	-0.2
7	-4.3	+15.8	26	-6.6	-4.0
8	+9.7	+19.6	27	-11.1	-10.9
9	-21.8	+13.5	28	-11.4	-14.2
10	-11.5	+11.1	29	-11.3	-20.5
11	+3.6	+10.7	30	-29.3	-15.9
12	+15.9	+10.0	31	-28.5	-21.3
13	-28.7	+11.9	32	-18.1	-23.6
14	-21.4	+9.3	33	-13.8	-26.4
15	-10.9	+7.9	34	-7.7	-15.2
16	-3.9	+7.8	35	-2.0	-22.5
17	+12.0	+4.7	36	20.5	5.5
18	-29.9	-9.1	37	-4.0	35.5
19	-21.8	-4.6			

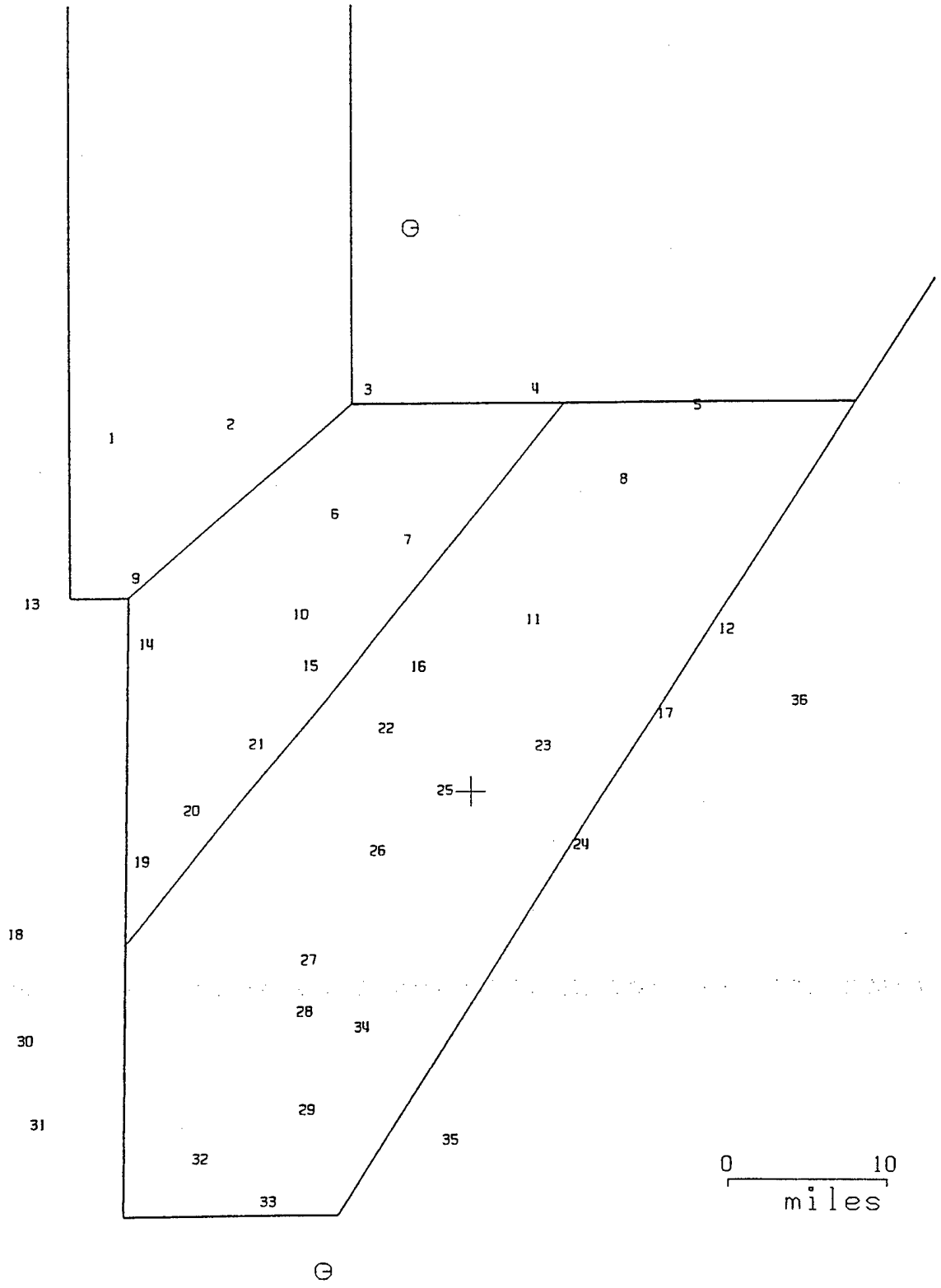

Figure 11. Elgin MOA Monitor Site Locations.

and generates a library of tracking data for the supersonic segments of ACMI missions. The second program, MOAOPS, generates statistical reports of these data. The third program, Boom-Map itself, reads the supersonic library and calculates the resultant sonic boom footprints. The boom footprints are combined to give  $L_{Cdn}$  contours for all operations in a given library. More recently, the EXTRACT program has been ported to a PC and software was developed for use on a PC which performed the same task as MOAOPS.

The Boom-Map program was further developed under the WSMR and Luke AFB sonic boom monitoring programs. Most notable was the development of Boom-Map3. Boom-Map3 is a totally new computer program written for the MS DOS/PC environment. It performs the same analysis as Boom-Map2 but employs a much faster ray tracing algorithm. Boom-Map3 is additionally capable of accommodating arbitrary atmospheric profiles. It has been found<sup>6</sup> that it is necessary to use the correct local atmospheric model.

Development of Boom-Map3 continued through this project. All ACMI data obtained for the monitoring period was analyzed to predict  $L_{Cdn}$  contours for the measurement period. Atmospheric profile data were obtained for each day of the measurement period from radiosonde balloon launches performed daily at Mercury, NV, on the southern edge of the Nellis Range Complex. The availability of "real-time" atmospheric data greatly improved the accuracy of the Boom-Map3 predictions.

## **4.0 MONITORING PROGRAM EXECUTION**

Field operations were based in Las Vegas, Nevada. Geo-Marine, Inc., provided a field crew chief and Wyle Laboratories provided three additional field crew members. Two 4-wheel-drive vehicles were leased for use by the field crew. Additional Wyle Laboratories personnel participated in the installation.

### **4.1 Monitor Deployment and Operation**

#### **4.1.1 Installation**

All sites were installed during the period 19 March through 2 April 1991 with the exception of site 37 in Caliente, NV, installed on 9 April. Site 36 was installed on 9 July and was actually the relocation of site 28.

Each monitor was installed in a location which could be reached via an existing road or jeep trail. Sites were selected in flat areas, away from any hills or other significant reflecting surfaces. The acoustical acceptability of each site was determined by Wyle Laboratories. Attempts were made to hide the monitors behind local terrain features or vegetation. It was necessary to locate monitors so that the solar panels would receive full sun. The solar panels were directed south, and elevated at an angle recommended by the manufacturer for this latitude. The microphones were placed 10 feet from the BEAR unit, so as to avoid acoustical interference by the BEAR security case. The microphone cables were protected by a length of PVC pipe. Once in place, the BEAR was calibrated and started in accordance with standard operating procedures.<sup>16</sup> Figure 12 shows a typical BEAR installation.

Almost all sites were located on public land managed by the Bureau of Land Management (BLM). BLM gave environmental approval for each site, and also issued a special use permit for repeated access to the area. A handful of sites were located on private property, for which permission was obtained from each landowner.

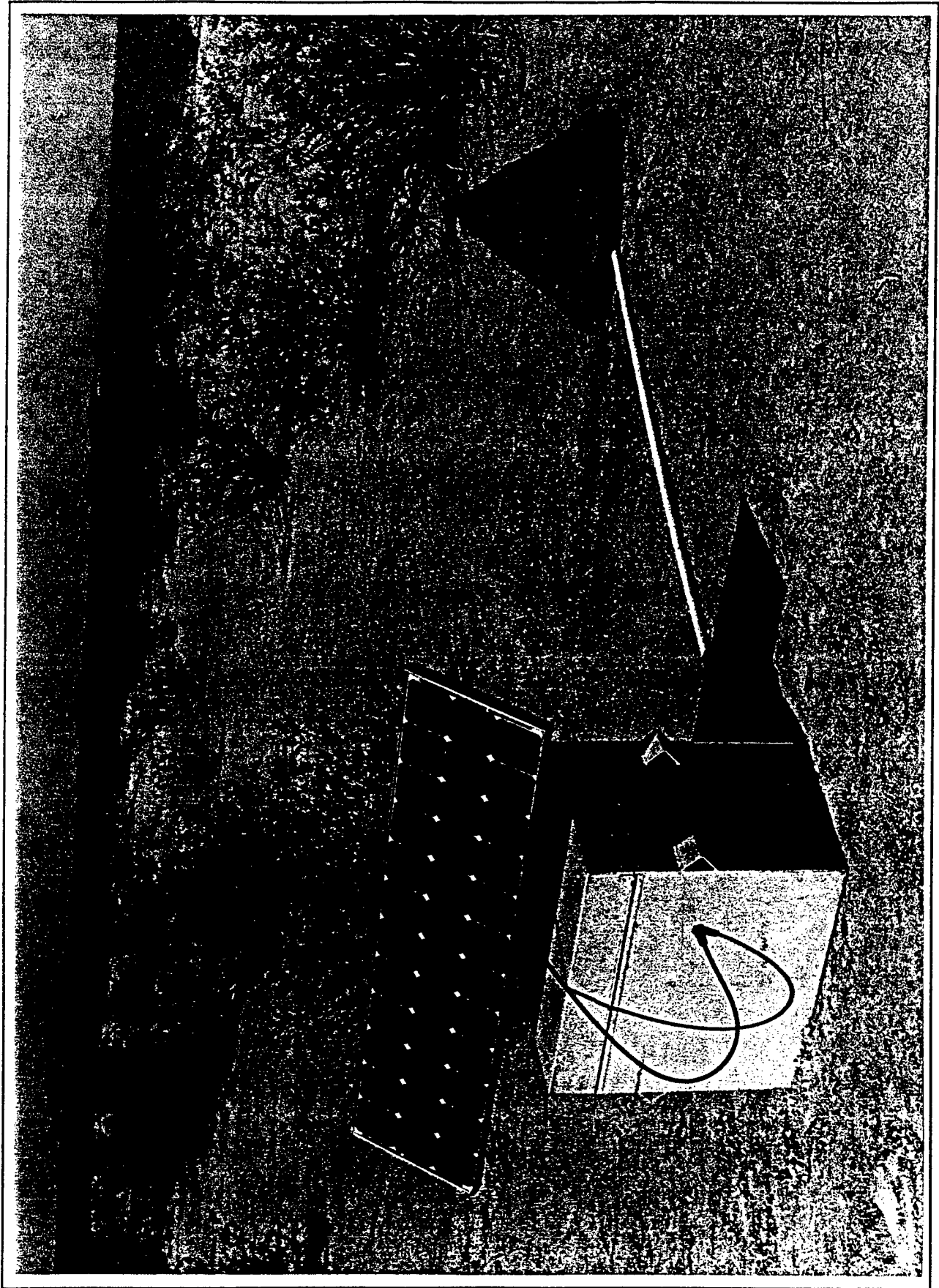

Figure 12. BEAR Installation.

#### 4.1.2 Operation

Servicing followed the procedures as employed at WSMR, using the BEAR procedures in Reference 16 with some routine modification for the new BEARs. Each BEAR was visited at least once per week. Each service visit consisted of the following steps:

- Inspect the monitor for physical condition and signs of animal or human tampering. No significant animal damage occurred, although one site was moved when it was discovered that its location was occasionally used as a river.
- Note the number of records indicated on the front panel, check BEAR system time relative to a reference timepiece, and measure the battery voltage.
- Remove the RAMs on old BEAR units. New BEAR units were connected to a laptop computer via serial cable through which data files were downloaded and system parameters were reset.
- Correct any problems noted in the inspection. Sufficient spare parts (microphones, cables, batteries, and a spare BEAR) were carried so that virtually any problem could be corrected.
- For old BEARs, install new RAMs, reset the clock and operating parameters. Calibrate both old and new BEARs using a B&K Type 4220 pistonphone.
- Start the BEAR and secure the site.

During operation of these monitors, most problems were similar in nature to those encountered at WSMR and R-2301E. Those were either RAM filling with extraneous non-boom events and occasional instrument malfunctions. Malfunctions were rarer than at WSMR and R-2301E, due to additional reliability development of BEARs by the Air Force, based on field experience to date.

The overall up-time, averaged across all sites, was about 83 percent. This was comparable to the 87 percent up-time achieved at WSMR.

#### 4.1.3 Monitor Removal

The final day of monitoring was 30 September 1992. During the scheduled service visits over the next few days, all BEARs were removed.

#### 4.2 **Processing of Sonic Boom Data**

Following each day's servicing, old BEAR RAM modules were downloaded at the Las Vegas field office. Retaining backup copies in Las Vegas, data were shipped to Douglas Aircraft Company for preliminary screening and printing of the boom records. Data were organized and correlated with monitor operating times from the field logs. Obvious bad BEAR records were removed from the data at this time and the remaining data was shipped to Wyle's Arlington office. This data consisted of the BEAR event files on floppy disk, printed representations of each of the data files, and copies of the field data logs. Data logs were reviewed to establish time periods when each monitor was actively collecting data.

All recorded pressure signatures were examined. Some of the data files were edited in order to remove spurious "spikes" in the data due to radio frequency interference. Consecutive files which had been split by quirks in BEAR logic were spliced together. All of the BEAR data files which were clearly not sonic boom events were discarded.

Figures 13 and 14 are examples of two BEAR recordings of sonic booms. Each plot shows the pressure signature, i.e., pressure (psf) as a function of time. Annotation on the plot shows the site number, the time and date, the file name, and other supporting information. The sonic boom shown in Figure 13 is a good example of an N-wave. Figure 14 is an example of an N-wave followed by a U-wave as would be expected in a post-focus region. Both signatures exhibit atmospheric turbulence distortion.

The pressure signatures as shown in Figures 13 and 14 directly provide the peak pressure and duration, as well as the type of boom (N-wave, U-wave, etc.). As discussed in Section 3.1.2, environmental analysis requires other metrics, in particular the peak level and the C-weighted sound exposure level (CSEL). The analysis software<sup>17</sup> includes the computer program BBALL. This program computes noise metrics for groups of BEAR signature files, and generates a tabulated



File w200823A.715 08:23:39.23 July 15 1992  
Pmax= .81 Pmin = -.56 7050 points Site 20 S/N 4016

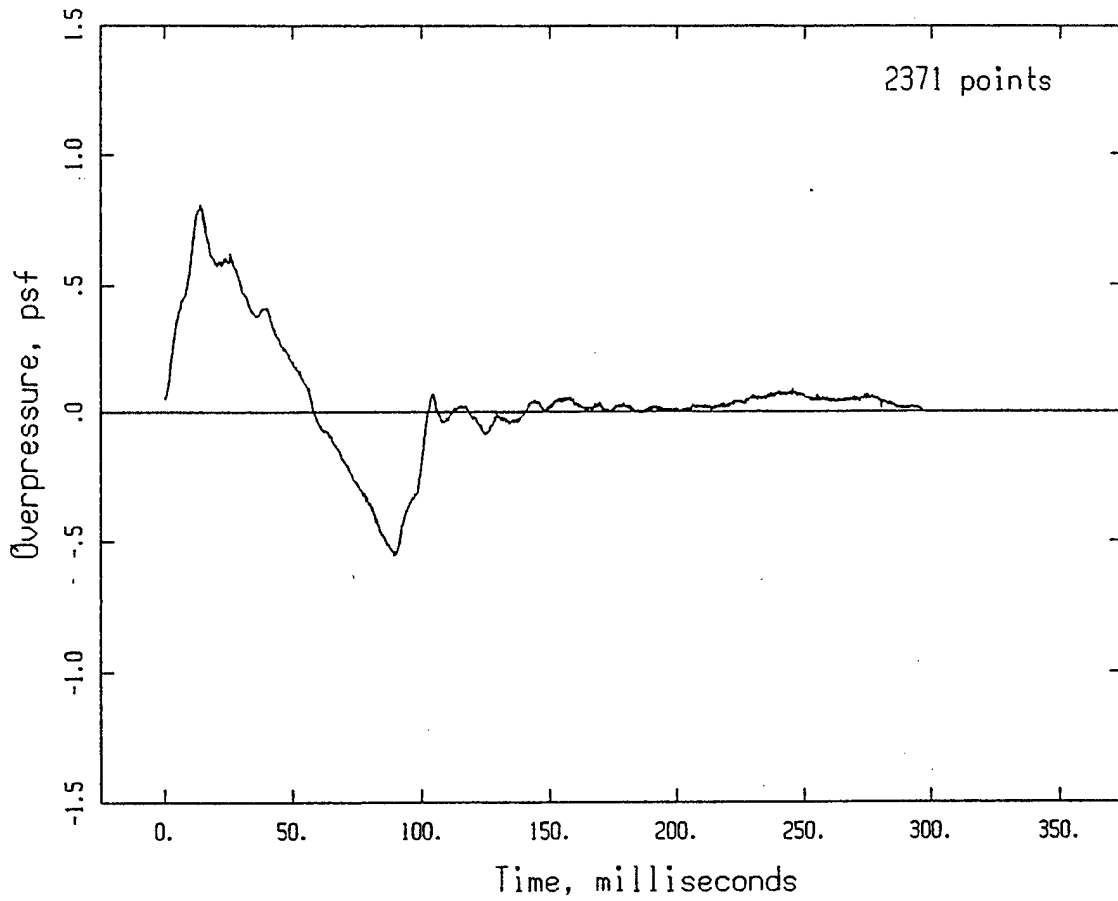

Figure 13. Example BEAR Record.

File w231809A.827 18:09:15.00 August 27 1992  
Pmax= 1.61 Pmin = -1.11 16124 points Site 23 S/N 1004

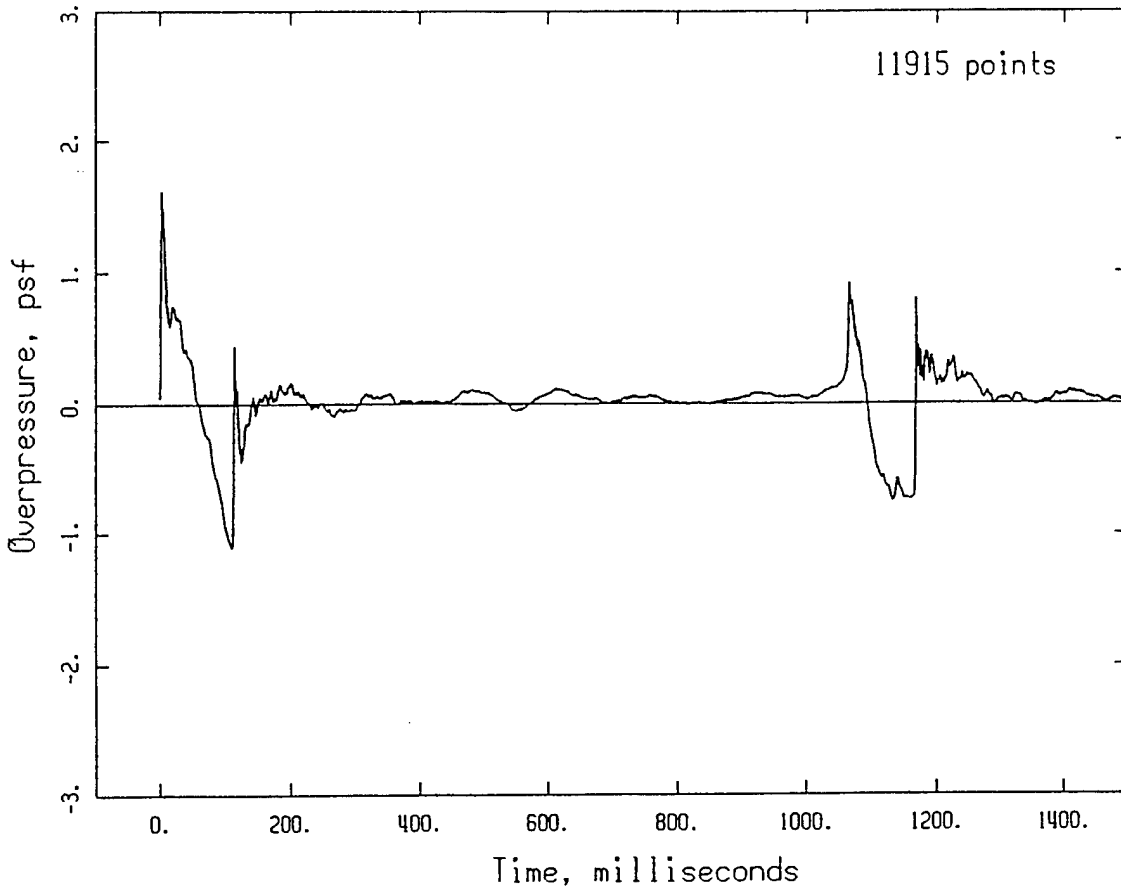

Figure 14. Example BEAR Record.

Table 3  
Example BEARLOUD Output File

BEAR LOUDNESS METRICS									
FILE NAME	POINTS	Pmax (PSF)	Pmin (PSF)	Lpk (dB)	ESEL (dB)	ASEL (dB)	CSEL (dB)	PLDB (dB)	WARNING CODE
-----									
B031225A.100	4161	.252	-.201	115.6	103.3	74.7	88.7	85.6	
B031101B.430	1594	.214	-.127	114.2	100.2	70.9	86.4	82.4	
B031239A.430	11650	.638	-.399	123.7	111.7	80.0	100.7	94.2	B
B031339A.501	4458	.272	-.153	116.3	103.4	74.5	89.0	84.5	
B030654A.505	15944	1.045	-1.577	128.0	119.6	84.2	101.0	97.4	E
B030655A.505	3056	.829	-.587	126.0	110.4	78.8	101.6	94.2	
B030719A.508	6701	.755	-.859	125.2	113.8	82.4	100.7	96.6	E
B030730A.508	5266	1.500	-1.086	131.1	115.2	89.8	107.9	104.7	
B031509A.813	12841	.277	-.361	116.5	107.5	79.7	93.7	90.8	B E
B030725A.821	15856	1.561	-1.332	131.5	119.9	85.9	108.1	102.1	
B030736A.821	15951	1.442	-2.004	130.8	121.8	93.6	110.6	108.1	B E
B030820A.904	7968	.359	-.206	118.7	105.2	77.4	89.8	87.9	
B031324A.909	6618	.242	-.203	115.3	103.8	76.8	89.0	87.0	
B031317A.910	16077	1.587	-1.599	131.6	122.5	88.2	108.2	103.6	E
B032025A.F26	15811	1.325	-1.086	130.0	117.9	84.2	104.9	100.2	
B031857A.F27	15752	.275	-.259	116.4	105.7	81.2	92.1	91.9	

WARNING MESSAGE CODES	
-----	
A	: "Ppk">=10 : CHECK FOR SPIKE !
B	: Lpk - CSEL <= 23 : NO N-WAVE ?
C	: Lpk - CSEL >= 29 : U WAVE ?
D	: NPTS > 16384 : SPECT TRUNCATED
E	: "PHIN" > PMAX !

summary. An example of a BBALL output file is shown in Table 3. The first column lists the names of the files processed. The next column lists the number of data points in the data file. This is followed by two columns containing the maximum and minimum pressure in pounds per square foot, a column of the  $L_{peak}$ , four columns containing the unweighted SEL, ASEL, CSEL, and PLDB, in dB. The last column contains various warning codes which flag data files for possible problems. These problems include spikes in the data file (due to RF noise), files which may not contain sonic boom data ( $L_{pk} - CSEL \leq 23$  dB), files which contain only a U-wave ( $L_{pk} - CSEL > 29$  dB) (the accompanying N-wave may be in a separate data file), and files which exhibit a greater negative peak pressure than positive peak pressure ( $|P_{min}| > P_{max}$ ).

A BEARLOUD file was prepared for each site.  $L_{Cdn}$  at each site (the primary environmental metric) could then be calculated by combination of CSELs, as described in Section 3.1.2. Analyses of both single-event metrics (peak pressure or CSEL) and the cumulative metric ( $L_{Cdn}$ ) are presented in Section 5.

### 4.3 Collection of Operations Data

While sonic boom data were being recorded in the airspace, all available related operations data were collected from Nellis AFB. The following operations data items were obtained:

1. Range Group schedule data, as discussed in Section 3.3.1, were collected at the end of the measurement program.
2. ACMI schedules, as discussed in Section 2.3.2, were shipped periodically with ACMI tapes.
3. ACMI data tapes. The digital tapes for each mission are normally returned to the available supply after a mission has been analyzed. They were instead placed in a container which could hold ten tapes. When the container was filled, it was sent to Wyle's Arlington, VA office.

Upon reaching Wyle, the ACMI tapes were immediately processed by EXTRACT, then returned. A supply of 100 blank tapes was provided. This

ensured that Loral Aerospace's normal supply of tapes would not be depleted by those in transit. A total of 508 tapes were received which contained 320 training events.

#### **4.4 Processing of Operations Data**

The primary objective of collecting operations data was to develop a time-line of activity in the Elgin MOA, then correlate each measured sonic boom with a specific training event. This would identify those booms associated with ACM training. The numbers of associated sorties, mission types, etc., would also be known, allowing statistical projection of current results to other airspaces.

The foundation for a time-line of activity were the Range Group schedule and the ACMI summaries. All the missions in the Elgin MOA were entered in chronological order into a computerized data base. Only known ACM (Air Combat Maneuver) missions scheduled for the Elgin MOA were considered in creating this time-line.

Table 4 is an excerpt from this data base. Scheduled missions were cross-checked against the ACMI summaries to complete the information for each mission. Whenever inconsistencies were encountered, the ACMI as-flown summaries were assumed to be correct. For missions with ACMI data, the pod "on" and "off" times were noted. Any occurrences of sonic booms were also noted.

The total operations occurring during the monitoring period are summarized in Table 5. ACMI data were obtained for 20 percent of ACM sorties.

#### **4.5 Collection and Processing Atmospheric Profiles**

It has been found in past studies<sup>6</sup> that boom prediction by Boom-Map3 is very sensitive to the atmospheric profile used. For this reason, data was collected from the National Oceanic and Atmospheric Administration (NOAA) on atmospheric profiles. NOAA launches radiosonde balloons twice daily at 3 p.m. and 3 a.m. which collected temperature, pressure, wind, and other information from their Mercury, NV site. This site is located on the southern edge of the Nellis Range Complex.

Table 4

Excerpt From Mission/Boom Data Base

Date	Mission Type	# AC	AC Type	Call Name	Schedule		ACMI Pod	Time		Measured Booms			SEL	EVENT #
					Start	Stop		Start	Stop	Site	Time	Peak		
033092	T1	02	F15	RAMBO 01	0730	0815				10	808	.165	84.0	015
033092		02	F15	CONAN 01	0730	0815				26	833	1.050	103.7	016
033092		02	F18	VCSL 01	0730	0815				10	837	.270	86.5	017
033092		04	F18	VCSL 01	0730	0815				23	837	.905	101.8	017
033092		04	F16	MIG 01	0815	0900	X	0808	0902	24	838	.915	99.4	017
033092	06	02	F15C	RINGO 01	0815	0900	X	0808	0902	16	849	.643	99.1	018
033092		02	F16	VENOM 01	1115	1200								
033092	06	04	F16	VIPER 01	1115	1200								
033092	INCT	01	F16	TBIRD 07	1200	1230								
033092		00		REST	1220	2359				27	1237	.959	124.1	019
033092		00		REST	1220	2359								
033092		02	F16	MIG 01	1230	1315								
033092		02	F15	RINGO 01	1230	1315								
033092		02	F15	BURNER	1230	1315								
033092		02	F16	IVAN	1230	1315								
033092		02	F15C	COWBOY	1230	1315								
033092		02	F15	RINGO02	1230	1315								
033092		02	F15	CONAN 01	1315	1400								
033092	T1	02	F15	RAMBO 01	1315	1400								
033092		02	F18	VCSL 01	1315	1400								
033092		04	F18	VCSL 01	1315	1400								
033092		00		TBIRD 08	1445	1615								
033092		02	F15	RAMBO 01	1615	1700								
033092		02	F18	VCSL	1615	1700								
033092	SAT	24	F117	VCSL 11	1730	2300								

Table 5

Operations in the Elgin MOA

<b>Aircraft Type</b>	<b>ACM Sorties</b>	<b>ACMI Sorties</b>
F-111	33	0
F-18	509	66
F-16	3,101	447
F-15	2,333	690
F-14	18	0
F-5	2	2
F-4	2	0
Other	227	0
<b>TOTAL</b>	<b>6,225</b>	<b>1,213</b>

Data from these balloon launches was obtain from NOAA for each day of the monitoring period. This provided actual atmospheric data from which atmospheric profiles could be constructed for use with Boom-Map3.

## **5.0 ANALYSIS**

Data analysis consisted of three main tasks. These included a summary of total ACM operations which are presented in Section 5.1, statistical summaries of booms measured at each site, and empirical  $L_{Cdn}$  contours which are discussed in Section 5.2. The data analysis also included an analysis of ACMI data which consisted of Boom-Map3  $L_{Cdn}$  predictions. This topic is discussed in Section 5.3.

### **5.1 Operations**

During the monitoring period, schedule data documenting Air Force operations in the Elgin MOA were collected. Table 6 summarizes the ACM activity obtained from this data base. Included are distributions by aircraft mix. In Table 5, a sortie is a single aircraft and a mission is a flight of aircraft operating together under one call sign. A training event consists of one or more missions operating in an airspace at the same time. The predominant aircraft utilizing the Elgin MOA for ACM operations were F-15s and F-16s. There were a total of 6,225 ACM sorties, grouped in 1,080 training events during the six-month monitoring period. Of the 1,080 ACM training events, ACMI data were obtained for 320.

### **5.2 The Measured Sonic Boom Environment**

A total of 1,337 sonic booms were recorded by the BEAR monitors. Since a single boom event may be recorded by more than one monitor, multiple boom recordings which were part of one boom event were grouped together. These booms were grouped such that the time between recorded booms was consistent with sound propagation speed, aircraft speed, and site spacing. Recorded booms which were not consistent with these parameters were counted as separate events. Counting booms in this manner yielded a total of 609 individual boom events.

Of the 609 boom events, 584 correlated with scheduled ACM activity. The source of the remaining booms is apparently from mission types which are not classified as ACM or, perhaps, unscheduled ACM missions. The 584 ACM boom



Table 6

ACM Activity in Elgin MOA  
1 April 1992 Through 30 September 1992

Aircraft Involved	No. of Training Events	No. of Sorties by Aircraft							
		F-111	F-18	F-16	F-15	F-14	F-5	F-4	Others
F-111	4	21	--	--	--	--	--	--	--
F-18	7	--	23	--	--	--	--	--	--
F-16	291	--	--	1,585	--	--	--	--	--
F-15	327	--	--	--	940	--	--	--	--
F-14	3	--	--	--	--	10	--	--	--
F-5	0	--	--	--	--	--	0	--	--
F-4	1	--	--	--	--	--	--	2	--
Others	24	--	--	--	--	--	--	--	57
F-111/F-16	3	12	--	6	--	--	--	--	--
F-18/F-16	9	--	44	38	--	--	--	--	--
F-18/F-15	58	--	282	--	222	--	--	--	--
F-16/F-15	270	--	--	1,095	964	--	--	--	--
F-16/Other	30	--	--	215	--	--	--	--	96
F-15/F-14	1	--	--	--	4	4	--	--	--
F-15/Other	4	--	--	--	12	--	--	--	10
F-18/F-16/F-15	18	--	80	56	66	--	--	--	--
F-18/F-15/Other	7	--	42	--	28	--	--	--	14
F-16/F-15/F-14	1	--	--	2	2	1	--	--	--
F-16/F-15/Other	12	--	--	62	55	--	--	--	32
All Others	10	0	38	42	40	3	2	0	18
<b>TOTAL</b>		<b>33</b>	<b>509</b>	<b>3,101</b>	<b>2,333</b>	<b>18</b>	<b>2</b>	<b>2</b>	<b>227</b>

events represented 0.09 boom per sortie, which is close to the 0.11 boom per sortie obtained at WSMR. Of the 584 ACM boom events, 210 were associated with ACMI missions.

Table 7 lists summary site-by-site recorded boom statistics including the following: site number, the number of monitor operating days, the total booms recorded, the number of acoustical day and night booms, the maximum and average boom overpressure, the number of booms greater than 5 psf overpressure, the maximum and energy average of the peak level, the maximum and energy average of the CSEL, and the total  $L_{Cdn}$ . Site locations can be seen in Figure 11 and are listed in Table 2. Recall that site 37 is located in the town of Caliente, NV.

As noted previously, a total of 1,337 booms were recorded, of which 62 occurred during acoustical night (between 2200 and 0700). A total of 18 booms were recorded which had peak overpressures greater than 5 psf. These booms are summarized in Table 8. The overall average boom overpressure was 0.93 psf. This is slightly larger than the 0.69 psf and 0.67 psf average boom overpressure measured at R-2301E<sup>6</sup> and WSMR,<sup>1</sup> respectively.

The cumulative distribution of all recorded booms, i.e., the percentage of booms which exceeded various overpressures, is shown in Figures 15 and 16. Peak overpressure is shown on a linear scale in Figure 15 and a logarithmic scale in Figure 16. The central portion of Figure 16 is a straight line, which corresponds to (on this log probability plot) a log normal distribution, which is commonly found for sonic booms. Similar plots for individual sites are provided in Appendix A.

Figures 17 through 20 show  $L_{pk}$ , C-weighted SEL, ASEL, and Perceived Loudness (PLdB) distributions for all measured booms. ASEL and PLdB are shown because of recent interest in these metrics for assessing human response to sonic booms.<sup>18</sup>

Contours of  $L_{Cdn}$  as measured at each site are shown in Figure 21. Notice how the empirical contours form a generally elliptical shape. This coincides well with the previously developed concept of elliptical contours for the description of  $L_{Cdn}$  under ACM airspace.<sup>1,6,13</sup>

Table 7

## Elgin Range Individual Site Statistics

Site No.	Operating Days	No. of Booms			Overpressure, psf			L <sub>pk</sub> , dB		CSEL, dB		L <sub>Cdn</sub> , dB
		Total	Day	Night	Max.	Avg.	No. >5 psf	Max.	Eng. Avg.	Max.	Eng. Avg.	
1	166	17	15	2	2.25	0.75	0	135	127	110	103	44
2	159	19	18	1	2.02	0.67	0	134	126	109	101	43
3	141	16	14	2	1.59	0.79	0	132	127	112	106	47
4	149	67	67	0	8.62	0.85	1	146	131	120	105	52
5	174	27	27	0	7.42	1.06	1	145	133	120	107	50
6	183	27	24	3	2.95	0.75	0	137	128	113	105	48
7	119	33	31	2	7.01	1.37	1	145	134	124	112	57
8	161	44	43	1	3.31	0.83	0	138	128	112	102	47
9	131	19	18	1	2.20	0.82	0	134	128	119	107	49
10	181	70	61	9	7.33	1.05	1	145	131	122	108	55
11	148	78	77	1	5.37	1.05	2	142	131	118	106	54
12	180	29	29	0	1.43	0.49	0	131	123	104	97	40
13	157	21	20	1	3.86	0.77	0	139	129	123	110	52
14	130	21	21	0	1.57	0.61	0	132	125	105	97	40
15	161	106	98	8	8.76	0.98	2	146	132	121	106	54
16	177	56	51	5	6.43	1.04	1	144	131	119	108	53
17	153	27	24	3	11.03	1.05	1	149	135	124	110	53
18	118	8	8	0	1.91	0.66	0	133	126	108	100	39
19	166	31	30	1	2.98	0.80	0	137	128	114	103	47
20	187	59	55	4	4.12	0.83	0	140	129	114	104	49
21	172	68	64	4	4.16	0.97	0	141	130	116	106	52
22	92	63	60	3	5.34	1.02	1	142	131	118	107	56
23	150	60	56	4	4.01	0.82	0	140	129	117	106	53
24	191	42	40	2	2.03	0.64	0	134	125	113	101	45
25	107	59	59	0	19.36	1.75	3	153	138	129	113	61
26	157	60	59	1	6.26	1.16	2	144	132	121	108	55
27	113	29	28	1	7.55	1.01	1	145	132	124	112	56
28	94	14	14	0	7.87	1.46	1	146	135	122	111	54
29	159	43	43	0	3.40	0.74	0	138	128	114	103	48
30	148	4	4	0	0.80	0.38	0	126	121	98	93	28
31	0	--	--	--	---	---	--	--	--	--	--	--
32	178	12	12	-	1.54	0.44	0	131	123	103	96	35
33	177	23	22	1	2.53	0.49	0	136	125	111	101	43
34	170	41	40	1	3.70	0.97	0	139	130	115	107	51
35	124	13	13	0	0.80	0.44	0	126	122	101	96	37
36	90	3	3	0	0.69	0.41	0	124	121	97	93	29
37	171	22	21	1	2.34	0.60	0	135	126	109	99	41
TOTAL	--	1,337	1,275	62	19.36	0.93	18	153	131	129	107	--

Table 8

Booms Greater Than 5 psf

Site No.	Date	Time	Maximum Overpressure, psf	L <sub>pk</sub> , dB	CSEL, dB
28	7 Apr 92	1055	7.87	145.5	121.8
25	8 Apr 92	1347	19.37	153.3	129.2
26	8 Apr 92	0815	5.71	142.7	120.6
26	8 Apr 92	1110	6.26	143.5	119.5
25	29 Apr 92	1244	8.30	146.0	119.6
25	29 Apr 92	1244	6.00	143.2	116.4
16	1 May 92	1338	6.43	143.8	119.2
22	14 May 92	0912	5.34	142.1	114.6
10	20 May 92	1424	7.33	144.9	118.3
15	20 May 92	1424	7.91	145.6	115.3
27	26 May 92	1807	7.55	145.2	120.4
4	23 Jun 92	1316	8.62	146.3	120.2
5	25 Jun 92	1346	7.42	145.0	120.0
17	25 Jun 92	1741	11.03	148.5	123.8
11	25 Aug 92	1321	5.37	142.2	118.4
7	10 Sep 92	1315	7.02	144.5	119.0
15	18 Sep 92	1740	8.76	146.4	121.4
11	24 Sep 92	1311	5.19	141.9	115.7

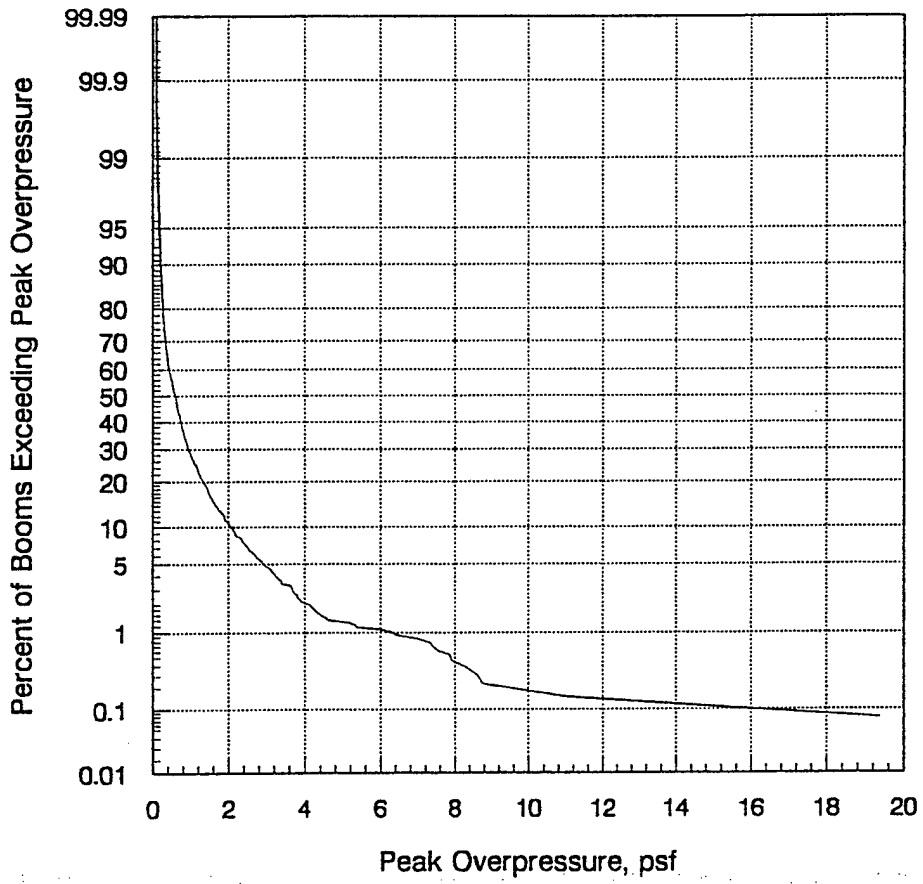

Figure 15. Overpressure Cumulative Probability Distribution.

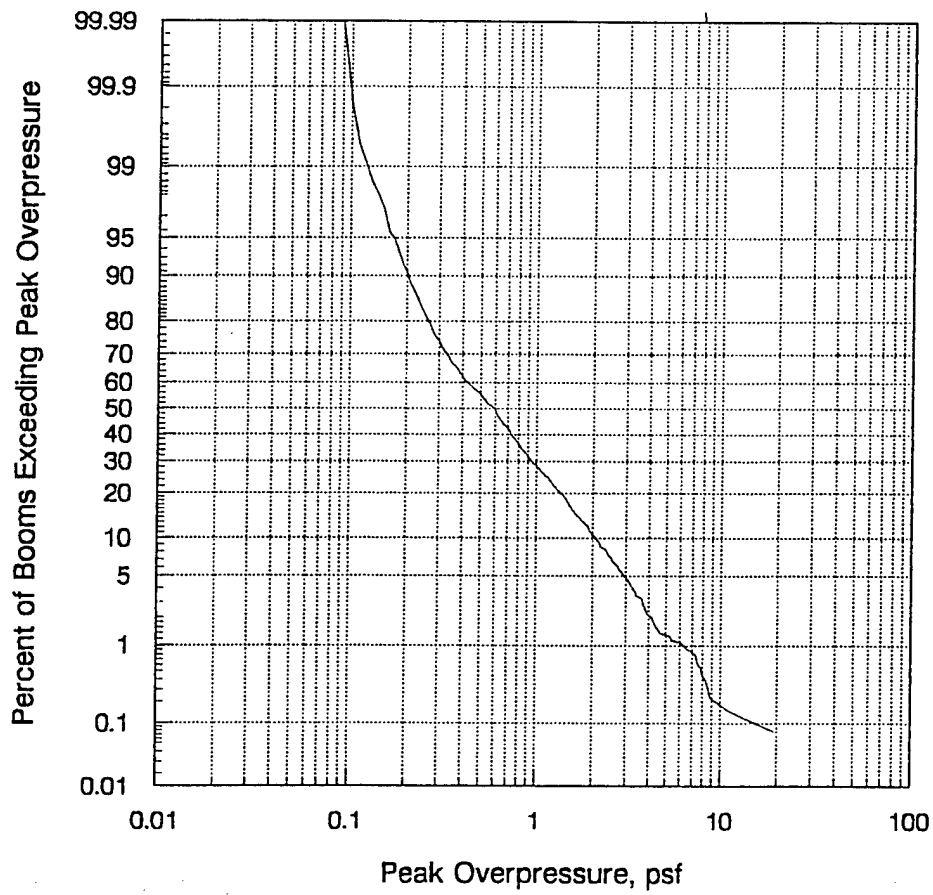

Figure 16. Overpressure Cumulative Probability Distribution.

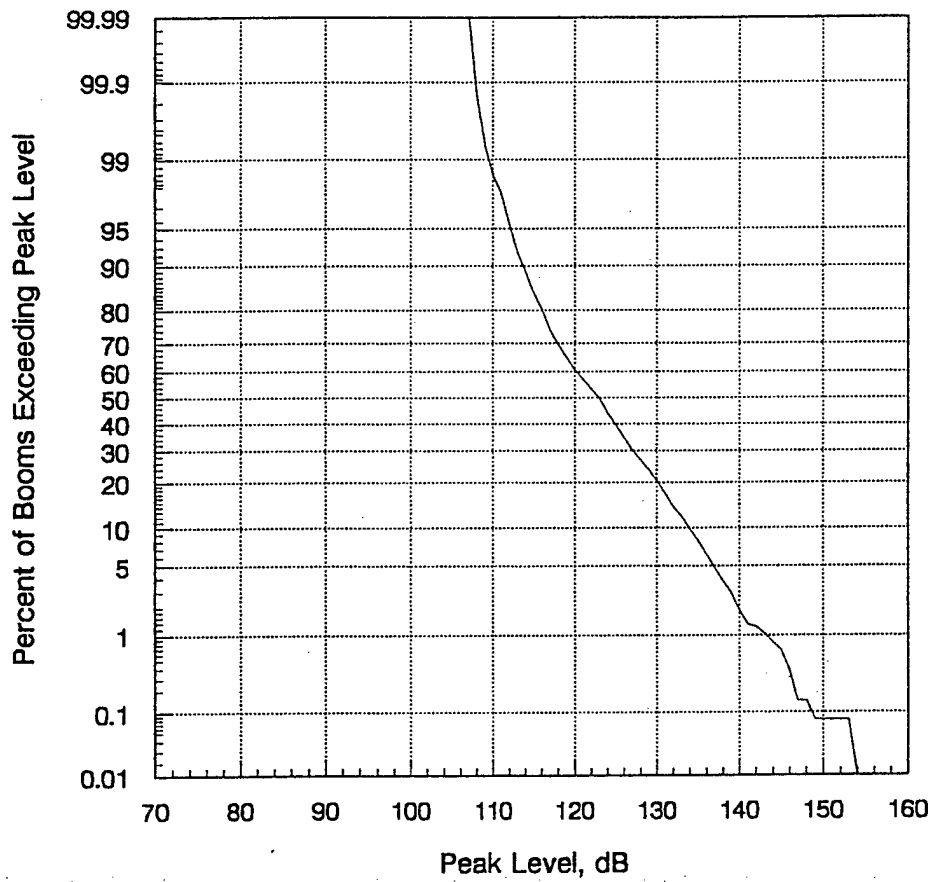

Figure 17. Peak Level Cumulative Probability Distribution.

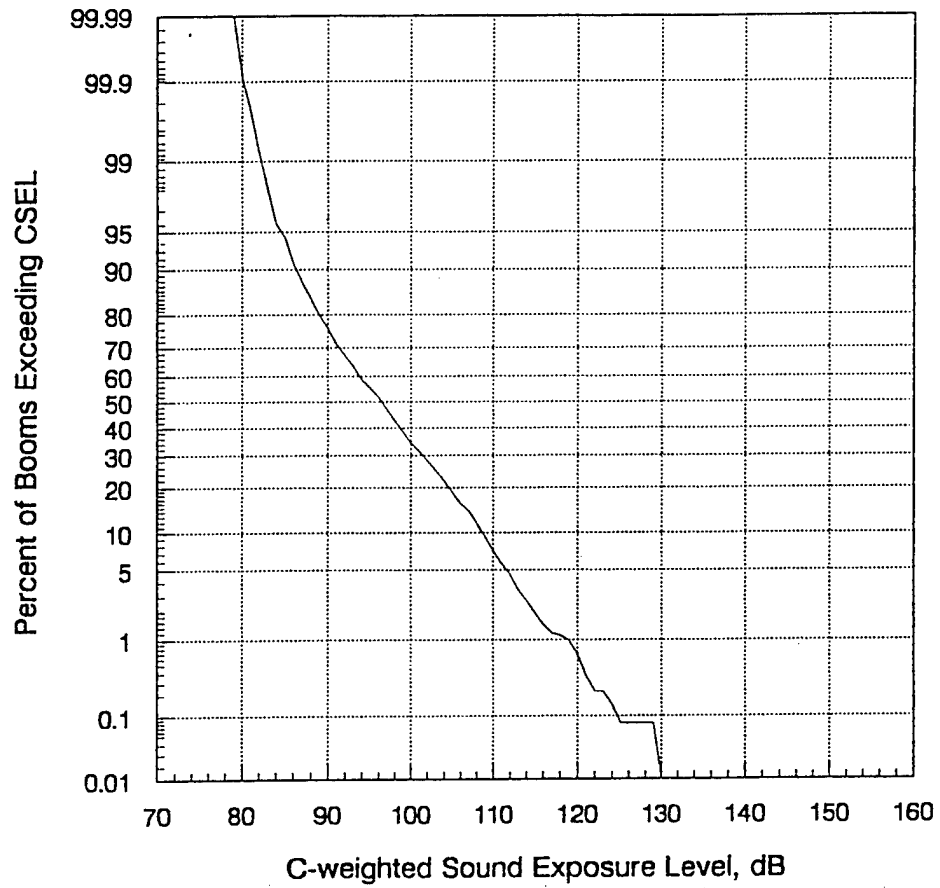

Figure 18. C-Weighted Sound Exposure Level Cumulative Probability Distribution.



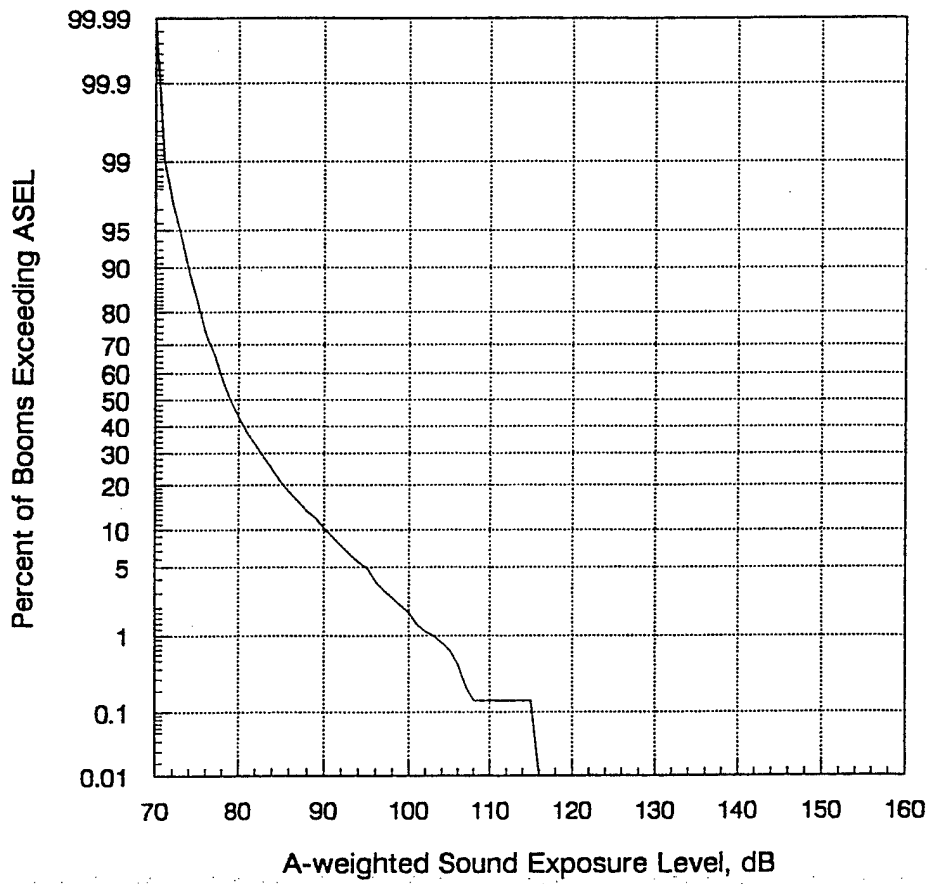

Figure 19. A-Weighted Sound Exposure Level Cumulative Probability Distribution.

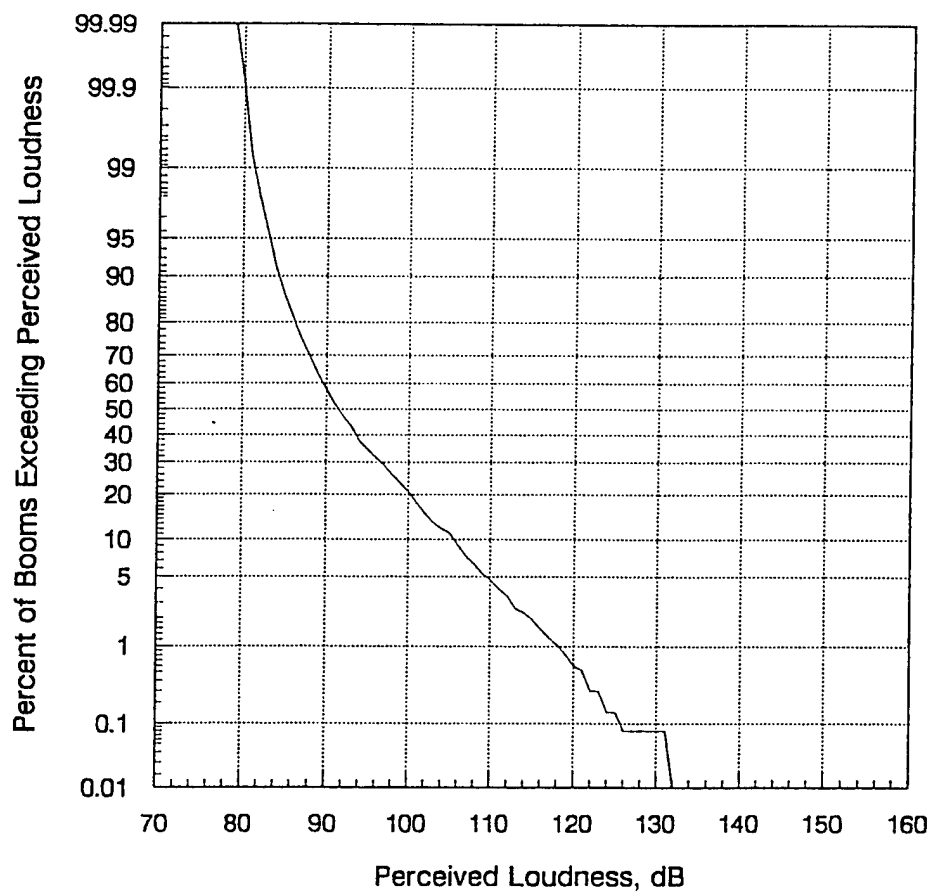

Figure 20. Perceived Loudness Cumulative Probability Distribution.

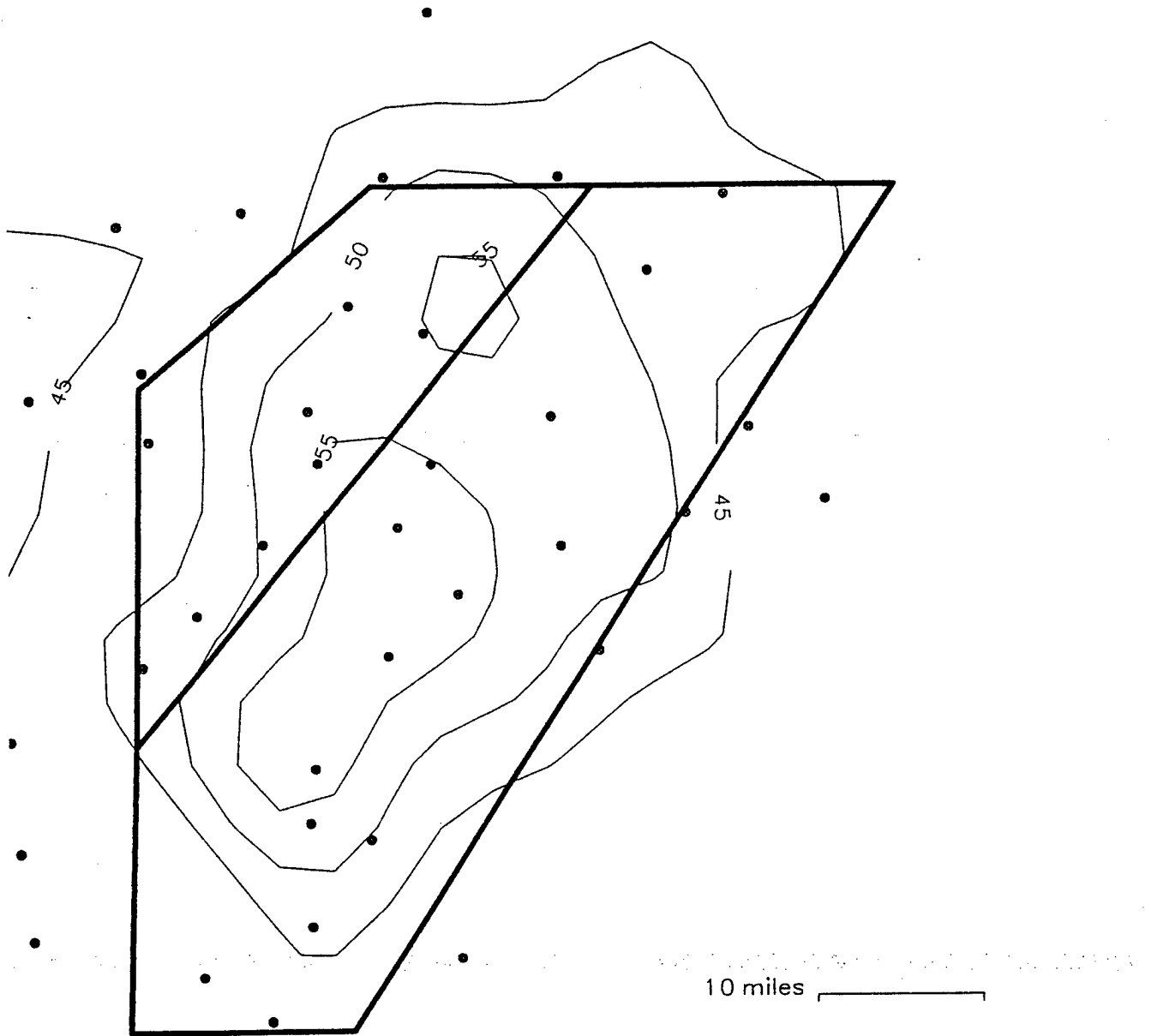

Figure 21. Elgin MOA  $L_{cdm}$  Contours Based on Measured Data.

### 5.3 ACMI Analysis

ACMI tapes were processed for 320 training events containing 1,203 sorties. This represented 20 percent of ACM sorties flown. Two types of analysis were performed on ACMI data including statistical summaries of altitudes and Mach numbers for supersonic flight time and sonic boom predictions with Boom-Map3.

#### 5.3.1 ACMI Statistics

Aggregate statistics of supersonic operation are presented in Table 9. The analysis of F-5 ACMI operations have been omitted since their total of two ACMI sorties comprised less than 1 percent of the total. This table shows (for each aircraft type) the total number of sorties for which ACMI data were collected, and the number of sorties which involved supersonic flight. Also shown is the average time above Mach 1 for each supersonic sortie. Overall, supersonic time is about 6 percent of total (all ACMI sortie) range time. This compares well with the 7.5 percent supersonic time found at WSMR, and the 5 percent supersonic time found at R-2301E.

Table 9  
Supersonic Operations  
for ACMI Sorties

<b>Aircraft Type</b>	<b>ACM Sorties</b>	<b>Supersonic Sorties</b>	<b>Supersonic Time Per Supersonic Sortie (sec)</b>
F-18	66	14	59
F-16	447	140	80
F-15	690	219	137

Operational distributions are presented in Figures 22 through 27. Figures 22 through 24 show the percentage of supersonic time spent at various Mach numbers, while Figures 25 through 27 show percentage of supersonic time spent at different altitudes. Each caption shows the total range time for all supersonic sorties and the total supersonic time. The distributions for F-15s and F-16s are similar to those obtained at WSMR<sup>1</sup> and R-2301E.<sup>6</sup>

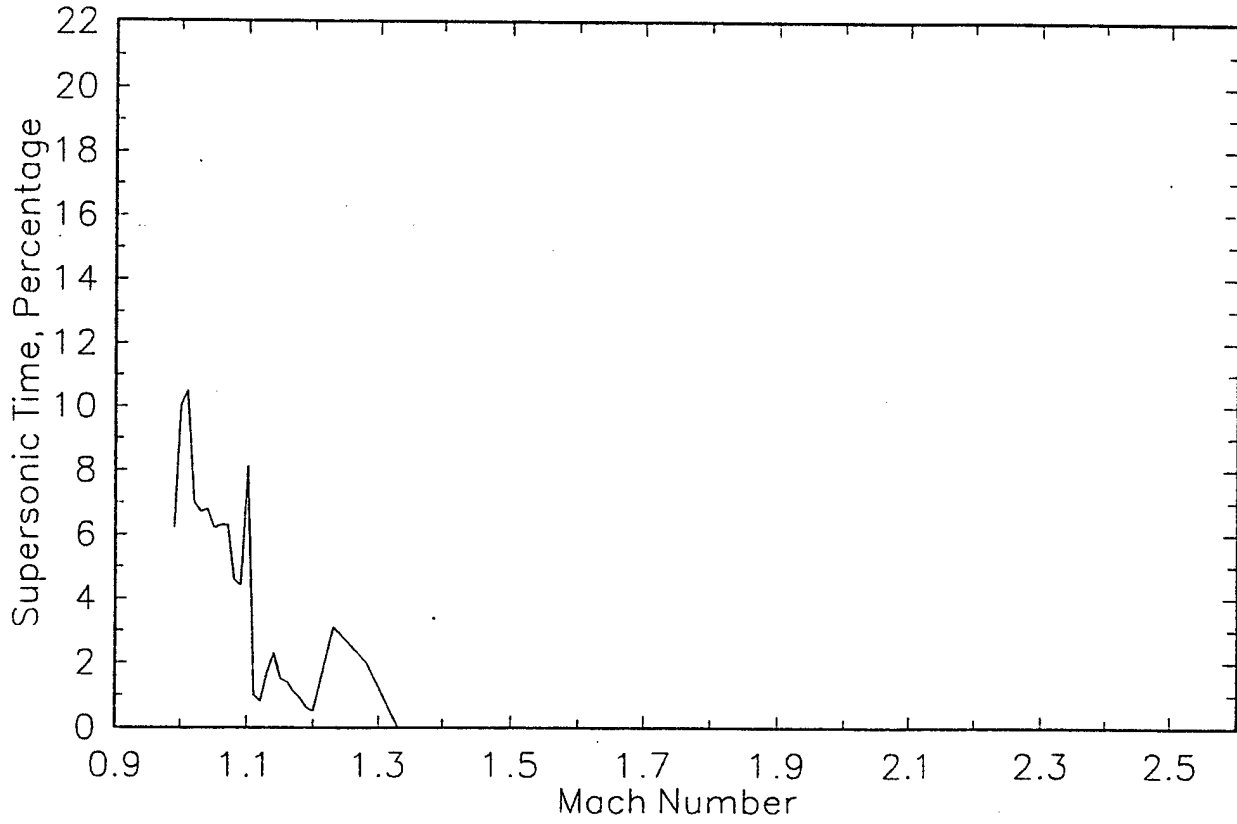

**Figure 22. Mach Number Distribution for 14 F-18 Supersonic Sorties.**  
 Total Supersonic Time = 38 minutes.  
 Total Time on Range = 1,320 minutes.

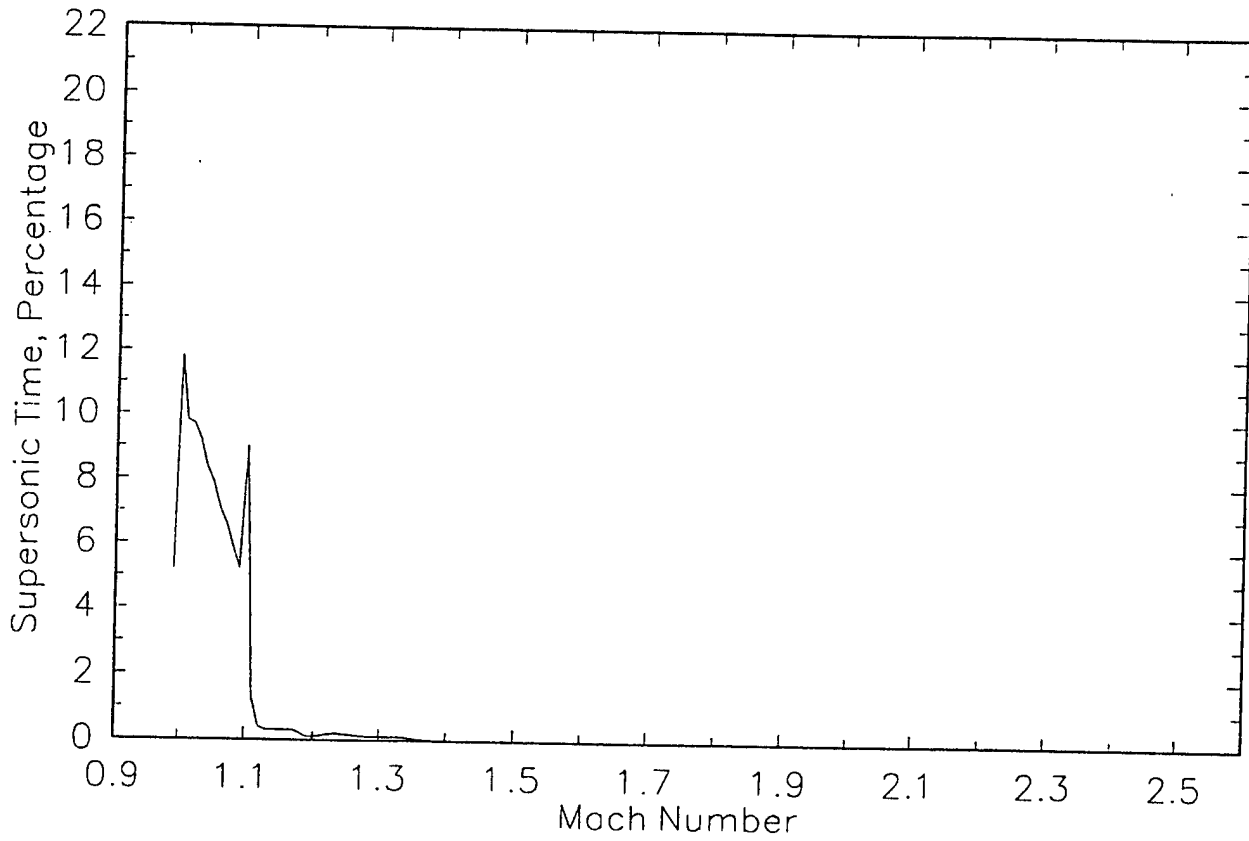

Figure 23. Mach Number Distribution for 140 F-16 Supersonic Sorties.  
Total Supersonic Time = 579 minutes.  
Total Range Time = 13,342 minutes.

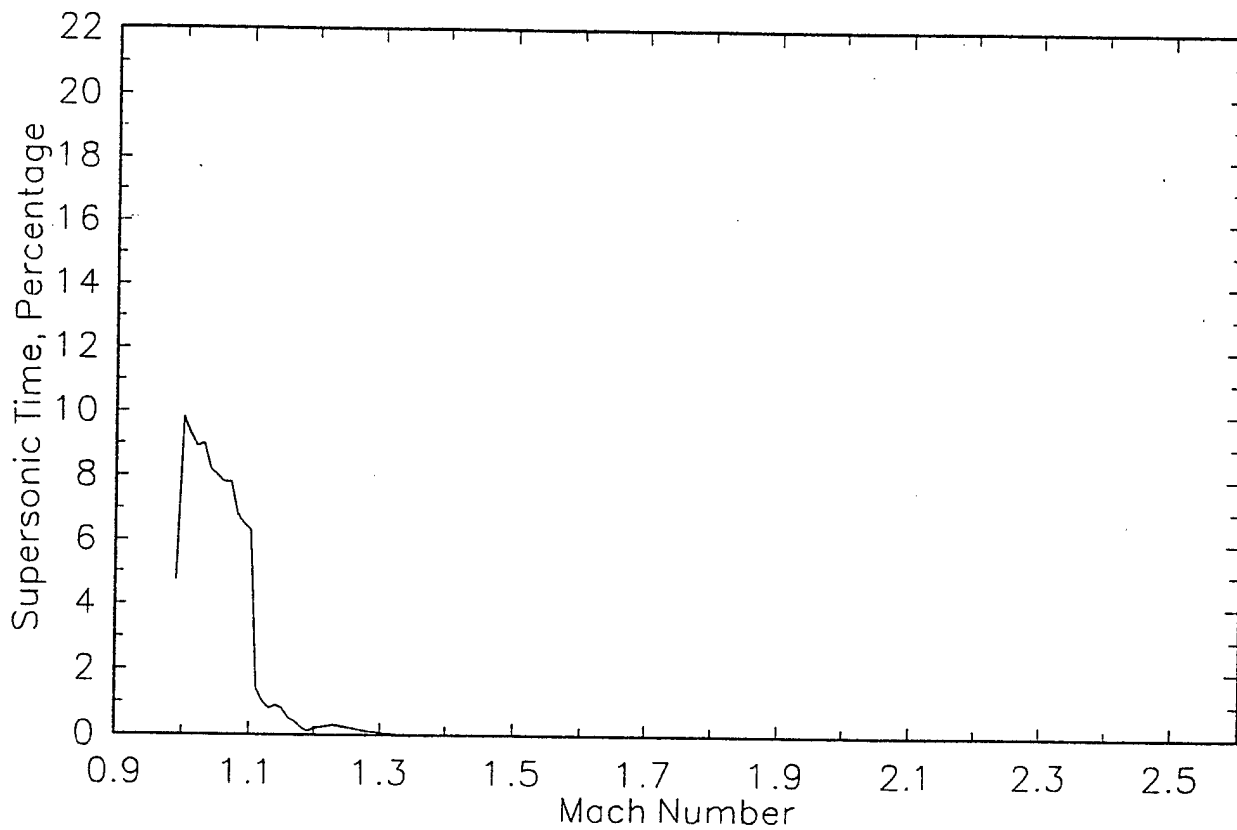

Figure 24. Mach Number Distribution for 219 F-15 Supersonic Sorties.  
Total Supersonic Time = 1,196 minutes.  
Total Time on Range = 15,726 minutes.

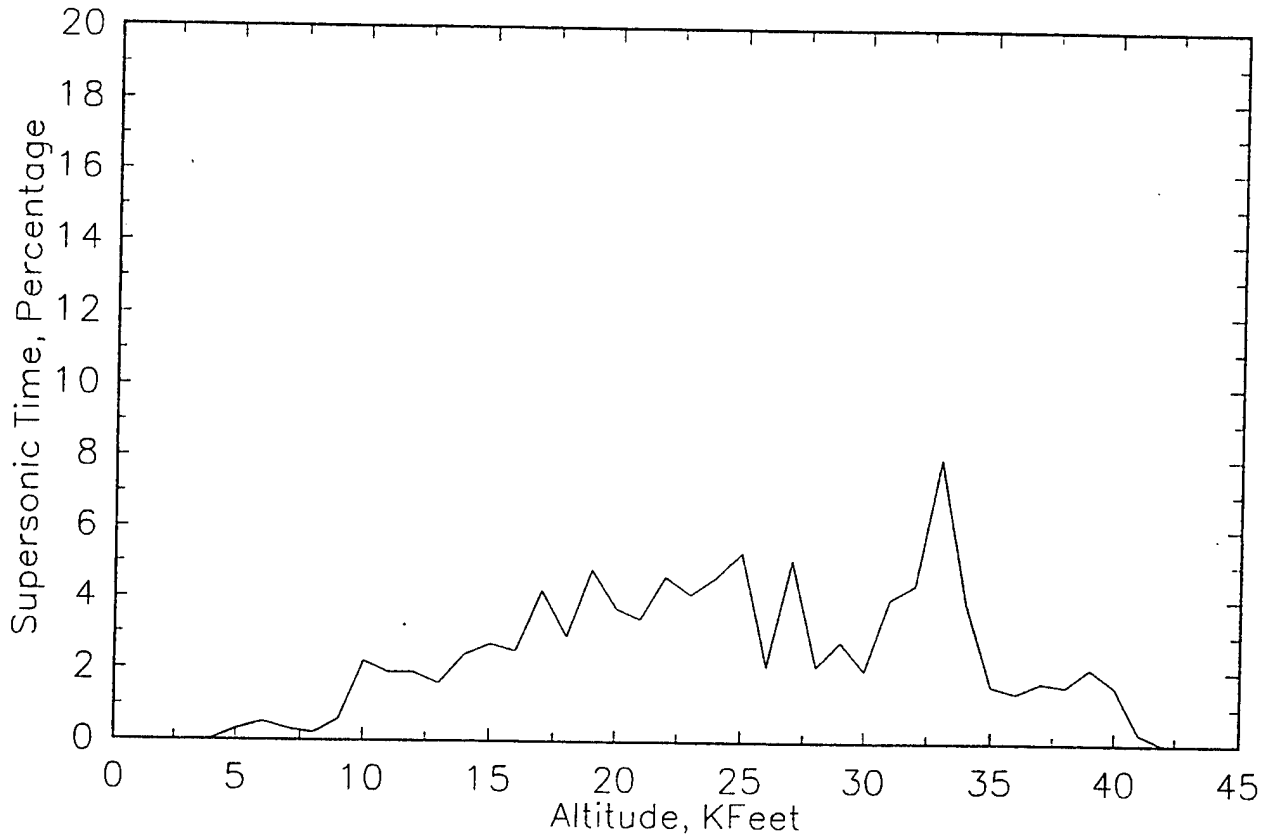

Figure 25. Altitude Distribution for 14 F-18 Supersonic Sorties.  
 Total Supersonic Time = 38 minutes.  
 Total Time on Range = 1,320 minutes.



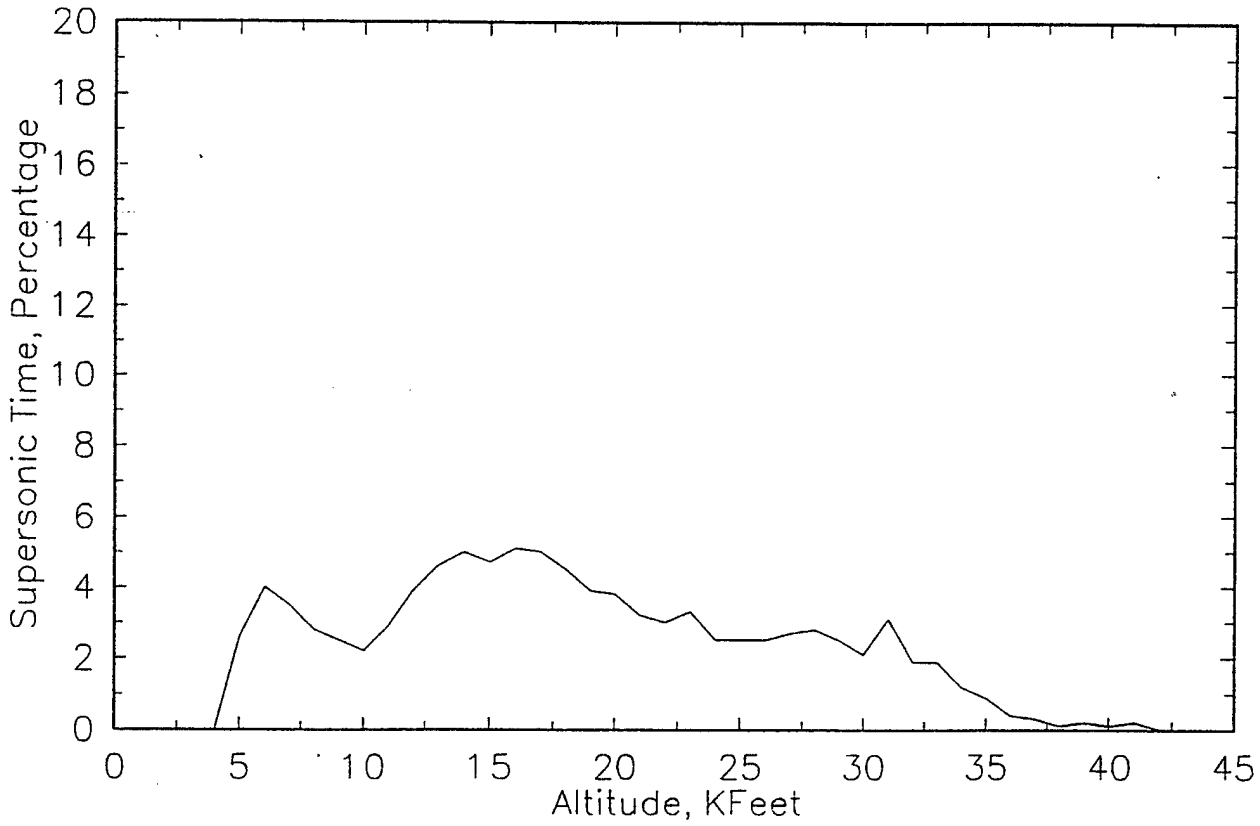

Figure 26. Altitude Distribution for 140 F-16 Supersonic Sorties.  
 Total Supersonic Time = 579 minutes.  
 Total Time on Range = 13,342 minutes.

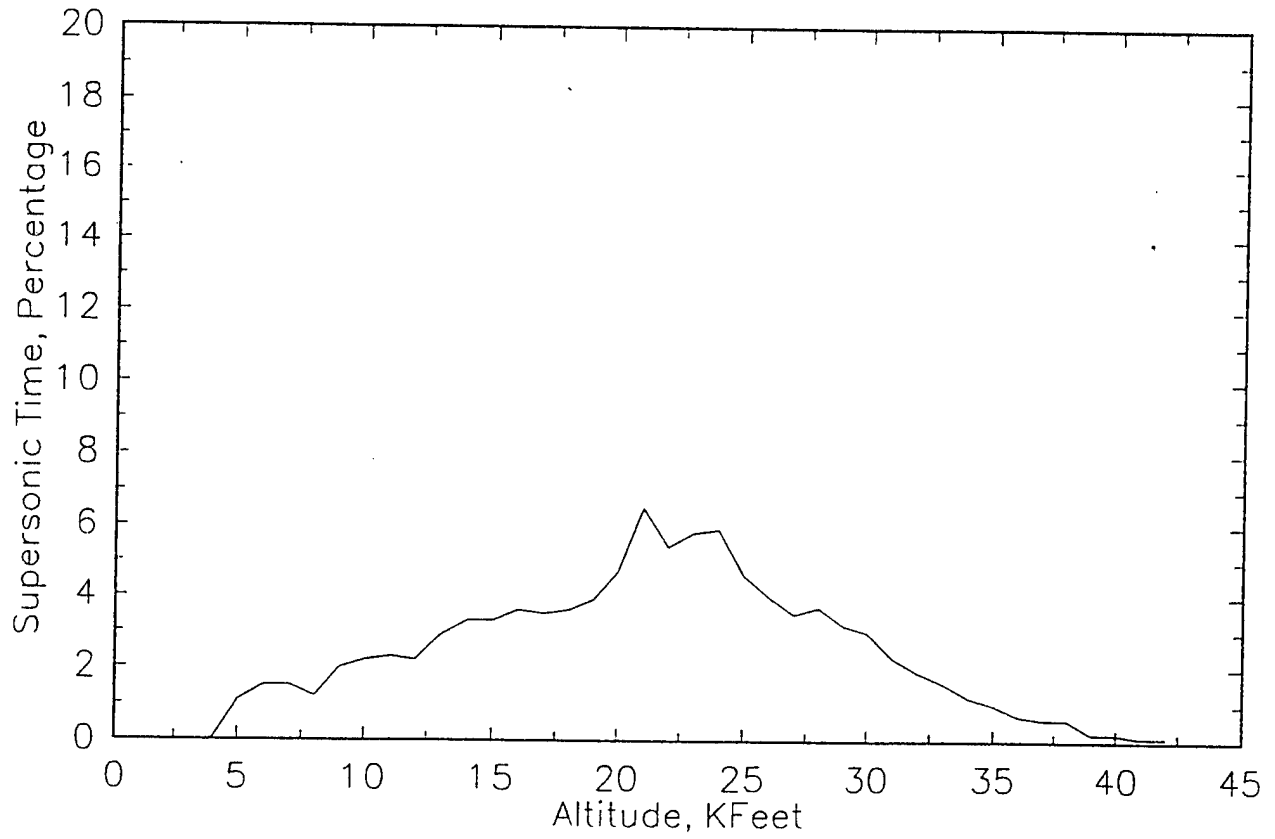

Figure 27. Altitude Distribution for 219 F-15 Supersonic Sorties.  
Total Supersonic Time = 1,196 minutes.  
Total Time on Range = 15,726 minutes.

### 5.3.2 Boom-Map3 Analysis

As described in Section 3.3.2, Boom-Map3 is a model which computes the sonic boom resulting from each supersonic event, using ACMI tracking data and full ray-tracing sonic boom theory. This model is a research tool used for understanding detailed mechanisms involved in ACM sonic booms. Versions are available which compute single-event psf contours for individual missions or sorties, and which compute  $L_{Cdn}$  contours for a library of ACMI data.

Figure 28 shows calculated  $L_{Cdn}$  contours for all ACMI missions using the average atmospheric profile for the entire measurement period. These levels have been scaled to account for all ACM sorties flown. The 55 dB contour which starts at the ACMI origin and streaks out over the northern Elgin MOA boundary was caused by a single sortie. This single supersonic track was flown at about 6,000 feet AGL and at a Mach number between 1.07 and 1.12. Because of the low altitude, the sonic boom footprint was narrow and fell between several monitors but was not detected on any.

Figure 29 shows the  $L_{Cdn}$  contours without this single sortie. Notice how, without this anomalous sortie, there is excellent agreement between the predicted  $L_{Cdn}$  contours and the measured contours shown in Figure 21.

This boom, while not being included in the Boom-Map3 contours, was a real event, comparable to the 20 psf boom measured at Site 25 on 8 April. There is a question as to the meaning of including such rare events in  $L_{Cdn}$  contours.  $L_{Cdn}$  is an average level, quantifying the cumulative impact of a number of booms over an extended period. We feel that it is appropriate to omit statistically rare anomalous booms from this average. It is important, however, to recognize their existence (as we have done in Table 8 for measured booms) and account for the impact of these occasional worst-case events.

As mentioned previously, Boom-Map3 predictions are sensitive to the atmospheric profile. In this project, actual atmospheric profiles, obtained from NOAA, provided an accurate atmospheric model from which to predict sonic booms. Previous sonic boom studies have suffered from a lack of appropriate atmospheric data. The accuracy with which Boom-Map3 was able to predict the  $L_{Cdn}$  contours for the measurement period is largely attributed to the availability of this local atmospheric information.

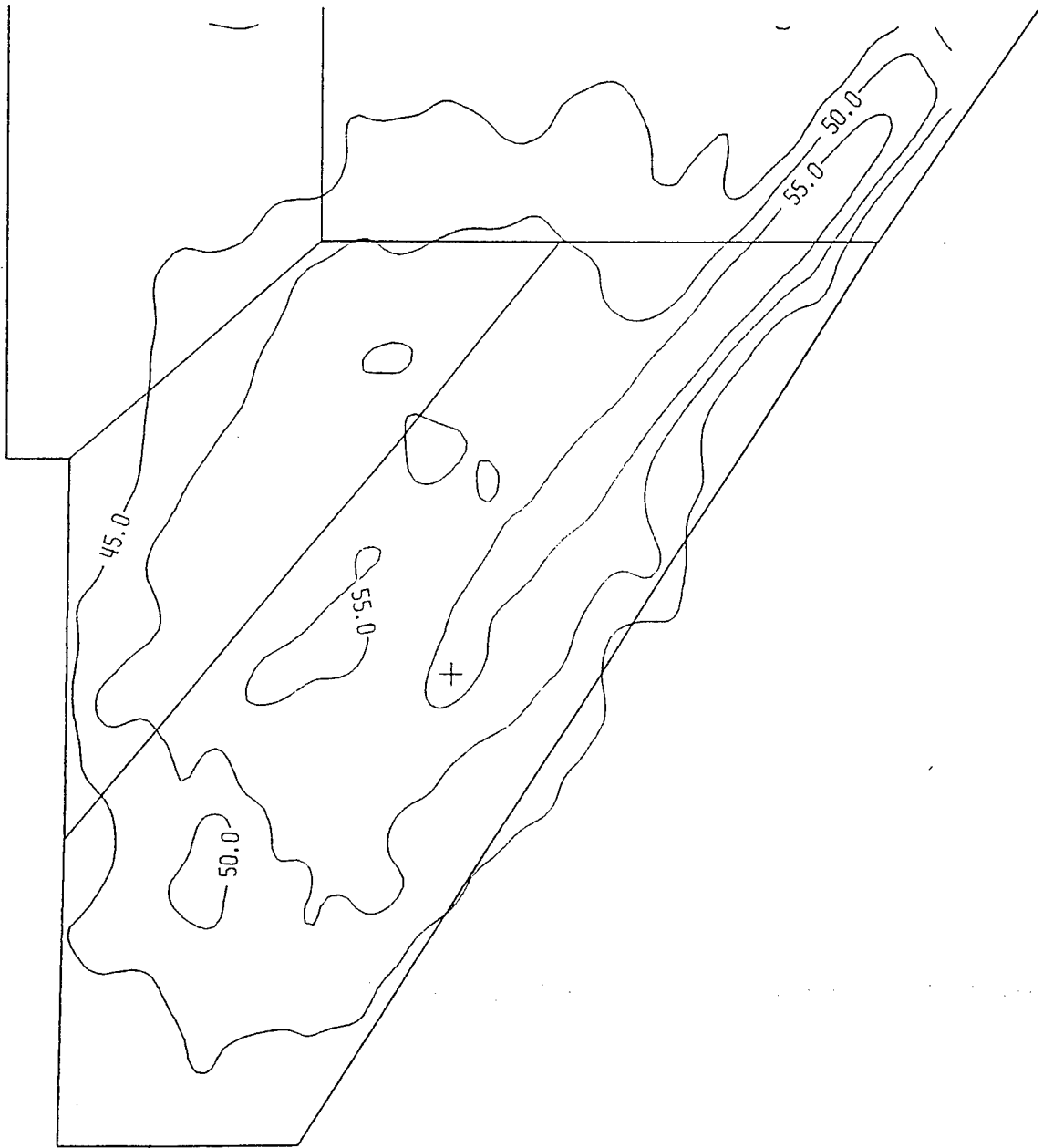

Figure 28. Elgin MOA  $L_{Cdn}$  Contours as Predicted by Boom-Map3.  
Levels have been scaled to reflect time and operations.

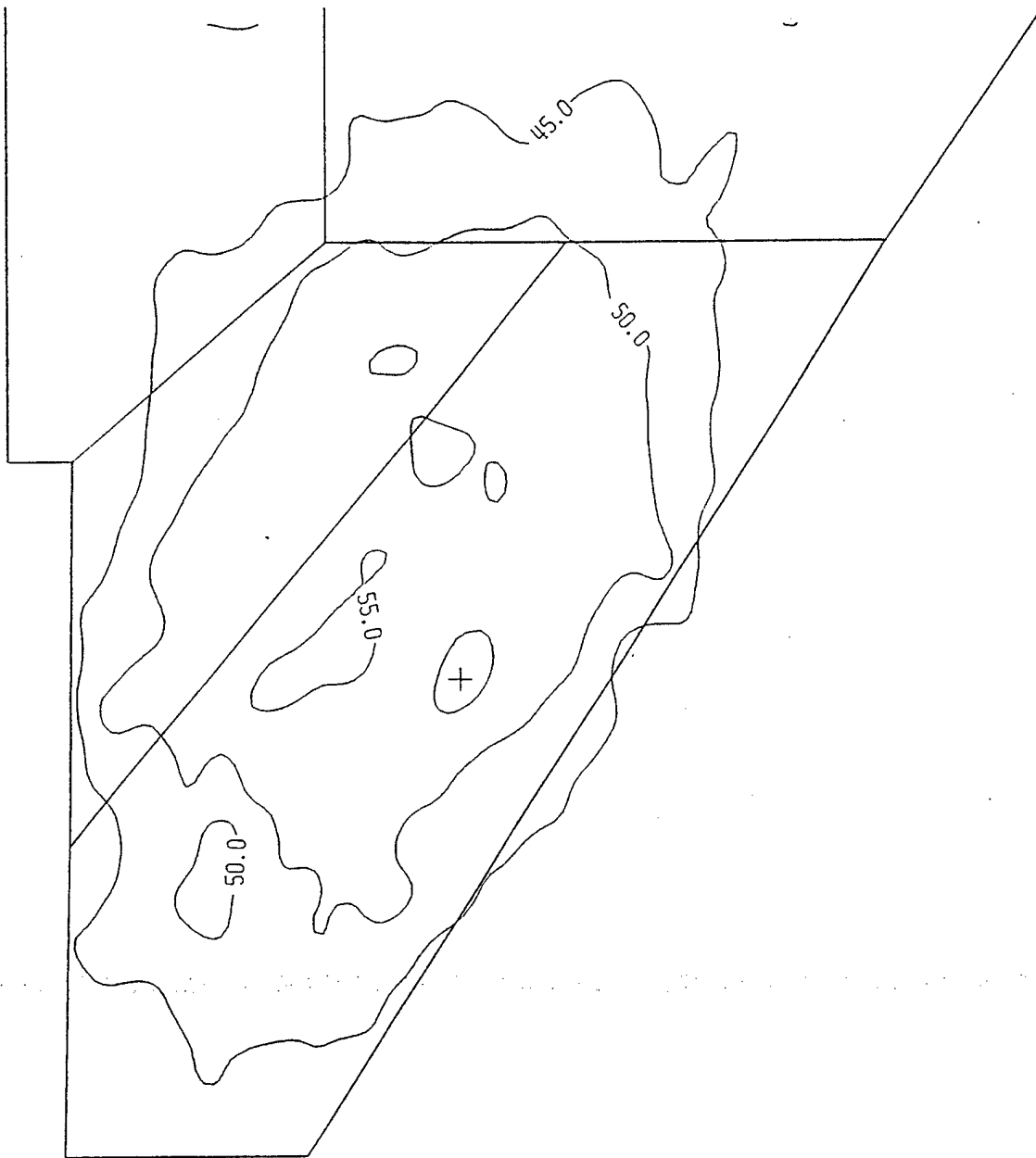

Figure 29. Elgin MOA Scaled  $L_{Cdn}$  Contours Without Anomalous Low-Altitude Carpet Boom.

## 6.0 MODELING $L_{Cdn}$ IN ACM AIRSPACES

### 6.1 Historical $L_{Cdn}$ Modeling Techniques

Each of the previous sonic boom studies<sup>1,6,13</sup> has attempted to further develop practical modeling of  $L_{Cdn}$  in ACM airspaces. One of the goals of this project was to enhance and/or modify the currently accepted model as developed in the WSMR study.<sup>1</sup> This model defines the  $L_{Cdn}$  level as follows:

$$L_{Cdn} = L_o + 10 \log_{10} N + 10 \log_{10} e^{-\frac{1}{2} \left[ \left( \frac{x}{\sigma_x} \right)^2 + \left( \frac{y}{\sigma_y} \right)^2 \right]} \quad (2)$$

where  $N$  is the number of sorties per month,  $L_o$  is an amplitude constant, and  $\sigma_x$  and  $\sigma_y$  are the standard deviations along the minor and major axes. This equation essentially defines the distribution of the average sound energy as Gaussian, which, when transformed by the base 10 logarithm, defines elliptical average sound level contours.

The parameters of this equation, namely  $L_o$ ,  $\sigma_x$ , and  $\sigma_y$ , were determined, from a least-squares curve fit to the data measured at WSMR,<sup>1</sup> to be 25 dB, 11.1 miles, and 18.9 miles, respectively. This form of the model fit the data collected at WSMR much better than the previously developed Oceana model.<sup>13</sup> Since that time the model developed from the WSMR project has been used to estimate sonic boom noise levels in other ACM airspaces.

The measurement program performed at R-2301E was targeted at exploiting the elliptical nature of the  $L_{Cdn}$  contours. Those data supported the value of  $L_o$ , but were too sparse and irregular to apply to  $\sigma_x$  and  $\sigma_y$ .

### 6.2 Modeling $L_{Cdn}$ in the Elgin MOA

This sonic boom monitoring program offers good supportive evidence for the elliptical model of  $L_{Cdn}$  contours. Simple examination of both the measured and predicted  $L_{Cdn}$  contours supports the validity of the model. Performing a least-squares fit to Equation (2), the measurement data yields 25 dB, 7.9 miles, and 10.8 miles for  $L_o$ ,  $\sigma_x$ , and  $\sigma_y$ , respectively. Contours of this least-squares fit ellipse are shown in Figure 30. These contours agree very well with both the measured and predicted data.

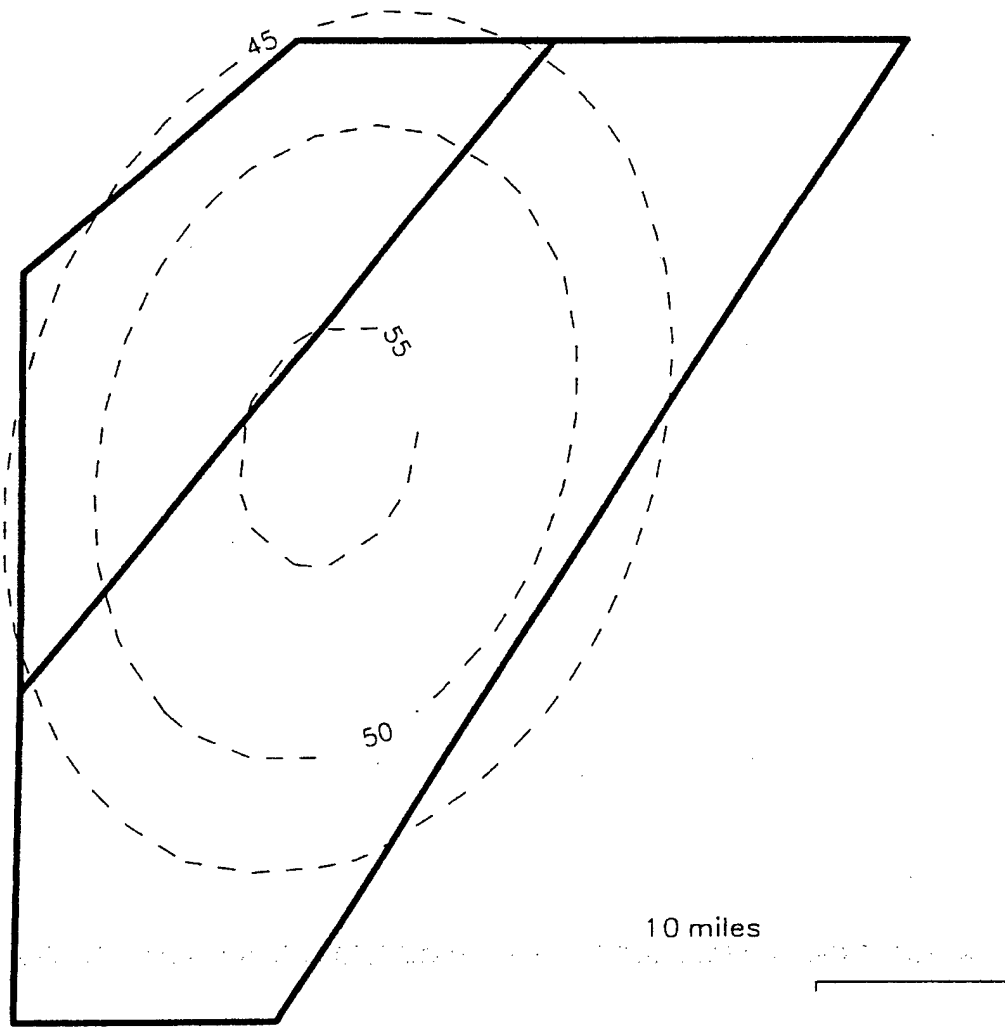

Figure 30. Elliptical  $L_{cdn}$  Contours Based on Measured Data.

### 6.3 Refinement of the ACM Airspace Sonic Boom $L_{Cdn}$ Model

The results from this sonic boom monitoring program have provided an information source with which to refine the model for  $L_{Cdn}$  within ACM airspaces. It has already been demonstrated that the elliptical  $L_{Cdn}$  contour, first postulated for the Oceana model<sup>13</sup> and further refined in the WSMR study,<sup>1</sup> is the most appropriate model. Results from the study conducted in R-2301E,<sup>6</sup> although not as convincing as this study, are also supportive of this model.

Each parameter of the  $L_{Cdn}$  model will be discussed in the following sections. First is the ellipse center amplitude scaling parameter,  $L_o$ , which is discussed in Section 6.3.1. This is followed by a discussion of contour ellipse orientation in Section 6.3.2. Finally, the standard deviations are covered in Section 6.3.3. The complete, refined  $L_{Cdn}$  model is then summarized in Section 6.3.4.

#### 6.3.1 $L_{Cdn}$ Ellipse Scaling Factor

The first parameter in the  $L_{Cdn}$  model is the overall scaling factor,  $L_o$ . This parameter, along with the operations term  $10 \log_{10}(N)$ , establishes scaling of  $L_{Cdn}$  at the center of the ellipse to the appropriate level. The sum of these two terms will be the maximum  $L_{Cdn}$  for the ACM arena in question.

Intuitively, the  $L_{Cdn}$  at the center of the ellipse will be a function of many parameters. The most obvious of these is the number of operations conducted in the airspace. If the number of operations is doubled, one would expect that the number of booms to hit the ground would double. For this reason, the term governing the  $L_{Cdn}$  as a function of the number of operations was treated separately from the other parameters influencing the ellipse. This separate treatment of the number of operations is expressed as  $10 \log_{10}(N)$  in the model, where  $N$  is the number of monthly sorties.

Other factors which would influence the  $L_{Cdn}$  at the center of the ellipse are the number of booms produced by a sortie, the amplitude of these booms, and the size of the boom footprint. Each of these parameters are themselves functions of the altitude at which the aircraft are operating, the Mach number of the aircraft during supersonic flight, and the types of maneuvers the aircraft are involved in during supersonic flight.



At first it may seem plausible to construct some "average" values for these parameters which would permit the theoretical calculation of a viable scaling factor ( $L_0$ ). However, due to the complex and variable nature of ACM operations, calculating averages is somewhat dubious. It has been demonstrated that the variability among ACM operations is quite large, resulting difficult to predict sonic boom footprints. Unpredictability is an inherent aspect of ACM operations. Predictable pilots do not last long in air-to-air combat. Also, many obvious parameters (e.g., dive angle, Mach number) have a decidedly non-linear effect on boom footprints, so that average values can be misleading.

However, the scaling factor ( $L_0$ ) can be, and has been, determined empirically. At WSMR, the first full-scale sonic boom monitoring project, the scaling factor, based on a least-squares fit of the measured data to the elliptical model, was found to be 25 dB.\* The same value for the scaling factor was obtained from the R-2301E project and again for this project in the Elgin MOA. The similarity between these three projects is not coincidental. Comparison of the distributions of altitude and Mach number between the three projects shows them to be very similar. This implies that the nature of ACM operations is very much the same at each of the three locations. It is reasonable to expect that this is true of all ACM airspaces utilized by the U.S. Air Force.

This evidence suggests that a value of 25 dB for the  $L_0$  parameter is appropriate.

### 6.3.2 Ellipse Axis Orientation

The orientation of the ellipse, as defined in the model, is such that the major ellipse axis is coincident with the y-ordinate and the minor axis is coincident with the x-ordinate. However, it is important to position the origin of the x,y axis system and correctly. The location and orientation of the axis is a function of the set-up points utilized by the ACM participants.

---

\*  $L_0$  by itself represents the long-term average  $L_{Cdn}$  for an average of one sortie per month

Set-up points, as discussed previously, are generally prominent land features at opposite ends of the available airspace which pilots can use as visual references. Generally, attackers and defenders will loiter over opposite set-up points until the engagement begins, at which time the opposing teams will move toward each other and initiate the engagement between the two set-up points.

From this description of typical exercises within an ACM airspace, it is reasonable to expect that the resulting sonic boom  $L_{Cdn}$  ellipse will be centered midway along a line connecting the two set-up points. It is also reasonable that the major axis of the ellipse will coincide with this line. This concept was supported by results from the WSMR study and again for the Elgin MOA program.

An additional parameter was introduced into the  $L_{Cdn}$  model which allowed the ellipse to mathematically orient itself according to the best statistical fit of the measured data. This form of the model was applied to the data measured at WSMR and the Elgin MOA. The major axis of the ellipse, based on the WSMR data, was rotated clockwise by 20 degrees from true north. This agrees well with the angle of the line connecting the set-up points, which is 19 degrees. Similar analysis of the Elgin MOA data yielded an ellipse axis rotation of 21 degrees as compared to the set-up point line angle of 23 degrees. This evidence supports the idea that the ellipse major axis corresponds to the line connecting the set-up points.

Similar to the ellipse orientation, the model ellipse center was allowed to take on the value which produced the least mean square error. The ellipse center, as calculated based on the Elgin MOA measured data, was found to be about 6 miles from the center point of the line connecting the set-up points. Similarly, the ellipse based on the WSMR measured data was within 5 miles of the center point. These ellipse centers are not close enough to support the set-up line center as the model ellipse center.

A difficulty with using set-up points for locating the ellipse is that what we have considered to be set-up points are actually the visual references used by pilots for orientation during set-up. The actual airborne set-up points are loitering areas within sight of these. Another factor in the location is the terrain

under the main engagement area. There is a preference for this to be over a valley, for the sake of more vertical space. This can lead to asymmetry with regard to set-up points.

Overall, while set-up points are a good reference for ellipse orientation, they may not provide precise enough information for ellipse location. Examination of ACMI data at additional airspaces may be required to establish a useful relation. Another potential guide for ellipse location is the airspace boundary, which places real constraints on maneuver area.

### 6.3.3 The Standard Deviations of the $L_{cdn}$ Model

The final parameters for the elliptical sonic boom noise environment model are the standard deviations ( $\sigma_x$ ,  $\sigma_y$ ). These parameters describe how the level decreases away from the ellipse center. It is logical to assume that the values of these standard deviations would be a function of the dimensions of the airspace available for the ACM operations. The larger the airspace is the more spread out the operations will be, which would lead to larger standard deviations.

At WSMR the standard deviations were found to be 11.1 miles and 18.9 miles along the minor and major axes, respectively. At R-2301E the major axis standard deviation was found to be 11.1 miles. Data along the minor axis did not permit the calculation of a meaningful standard deviation. For the Elgin MOA, the standard deviations were found to be 7.9 miles and 10.8 miles along the minor and major axes, respectively. Direct comparison of these values yields no discernible pattern.

However, considering the previously mentioned concept that the standard deviations are a function of the available airspace, a distinct pattern does emerge. Notice in Figure 8 that most of the supersonic tracks fall within an imaginary ellipse which fills the Elgin MOA. Operations avoid the remote corners of the airspace. This tendency was also observed at WSMR and R-2301E. These relatively "tight" corners of the airspace are avoided by the pilots since their maneuvering room is limited and they run the risk of exceeding the airspace boundaries.

If the  $L_{Cdn}$  model standard deviations for each of the three studied airspaces are compared to the dimensions of the available airspace, a predictable pattern is obtained. At WSMR, the ratio of both standard deviations to the respective dimensions of the available airspace is 0.29. For R-2301E, a similar dimension comparison (in the major axis direction only) yields a ratio of 0.25. For the Elgin MOA the ratios are 0.25 and 0.26 along the major and minor axes, respectively. This is fairly good reproduction of the ratio from one study to another.

This method requires defining the available airspace in order to obtain the standard deviations. Given the variable and irregular shapes defining airspace boundaries, the concept of available airspace can be vague. A tentative definition of available airspace is to inscribe an ellipse within the boundaries, oriented with the set-up points. An example of the inscribed ellipse for the Elgin MOA is shown in Figure 31. The standard deviations will be 27 percent (the average ratio from WSMR, R-2301E, and Elgin MOA) of the width and height of this ellipse. Note that this ellipse is centered somewhat north of the center of the airspace, forced there because of the narrowing of the southern portion. This location is consistent with the data, so that an inscribed ellipse may also provide a definition of the location.

#### 6.3.4 ACM Sonic Boom $L_{Cdn}$ Model Summary

To summarize, the refined model for the  $L_{Cdn}$  associated with sonic booms under an ACM operations is as follows:

$$L_{Cdn} = L_o + 10 \log_{10} (N) + 10 \log_{10} \left\{ \exp \left[ -\frac{1}{2} \left( \frac{x^2}{\sigma_x^2} + \frac{y^2}{\sigma_y^2} \right) \right] \right\} \quad (3)$$

where  $L_o = 25$  dB

$N =$  number of monthly operations.

$x, y =$  coordinates corresponding to the ellipse major/minor axis.  $y$ -axis is coincident with a line connecting the set-up areas. Coordinate origin is located midway between the set-up points.

$\sigma_x, \sigma_y = 0.27$  times the corresponding available airspace dimension.

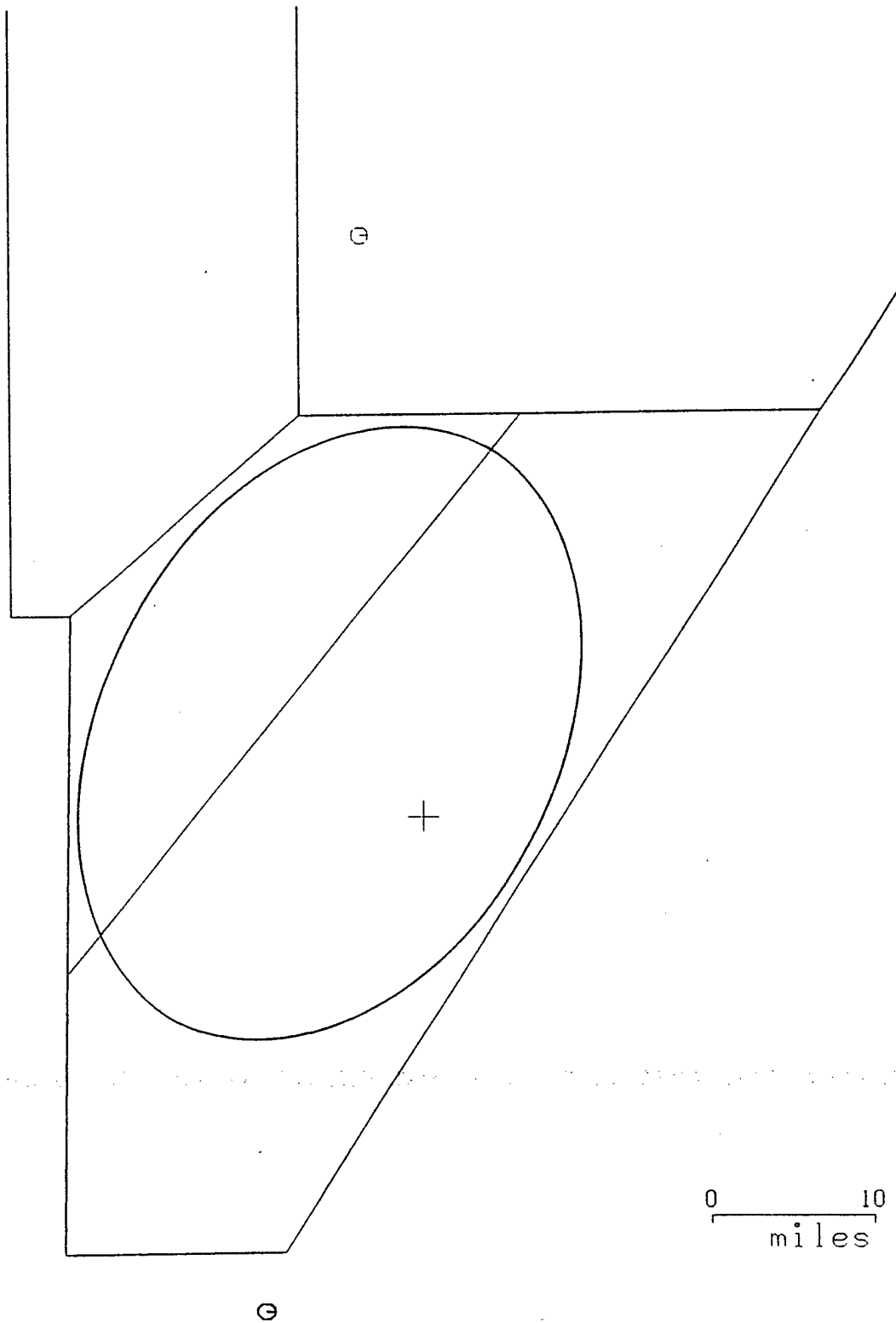

Figure 31. Available Airspace Ellipse for the Elgin MOA.

## 7.0 CONCLUSIONS

A measurement program has been conducted of the sonic boom environment in the Elgin MOA subsection of the Nellis Range Complex. Thirty-six sonic boom monitors were optimally arranged throughout the area for a period of six months.

The sonic boom environment measured in the Elgin MOA is consistent with those measured at WSMR<sup>1</sup> and R-2301E.<sup>6</sup> In addition, combined results of the three sonic boom monitoring programs has resulted in an improved model for the  $L_{cdn}$  contours associated with ACM operations. This model is as follows:

$$L_{cdn} = L_o + 10 \log_{10} (N) + 10 \log_{10} \left\{ \exp \left[ -\frac{1}{2} \left( \frac{x^2}{\sigma_x^2} + \frac{y^2}{\sigma_y^2} \right) \right] \right\} \quad (4)$$

where:  $L_o = 25$  dB

$N$  = number of monthly operations.

$x, y$  = coordinates corresponding to the ellipse major/minor axis. The  $y$ -axis is coincident with a line connecting the set-up areas. Coordinate origin is located midway between the set-up points.

$\sigma_x, \sigma_y$  = 0.27 times the corresponding available airspace dimension.

Another benefit of this program was the demonstrated accuracy of the sonic boom prediction computer program Boom-Map3. Through the utilization of ACMI tracking data and accurate atmospheric profiles, Boom-Map3 was capable of accurately predicting the sonic boom noise environment.

## REFERENCES

1. Plotkin, K.J., Desai, V.R., Moulton, C.L., Lucas, M.J., and Brown, R., "Measurements of Sonic Booms Due to ACM Training at White Sands Missile Range", Wyle Research Report WR 89-18, September 1989. Also, "Sonic Boom Environment Under an ACM Training Arena", *J. Aircraft*, November-December 1992.
2. "Instrumentation for the Measurement of Sonic Booms", Wyle Research Report WR 85-31, March 1986.
3. "Assessment of Community Response to High-Energy Impulsive Sounds", National Research Council, Committee on Hearing, Bioacoustics, and Biomechanics, 1981.
4. Lee, R., Mazurek, D., and Palmer, B., "Boom Event Analyzer Recorder (BEAR) Operators Manual", AAMRL/BBE, WPAFB, OH, September 1987.
5. St. Clair, M., and Rostamizadeh, A., "Data Reduction User Guide for Mission Standard Data Reduction Programs", Cubic Corporation, San Diego, CA, December 1981.
6. Plotkin, K.J., Frampton, K.D., Lucas, M.J., and Desai, V.R., "Measurements of Sonic Booms Due to ACM Training in R-2301E of the Barry Goldwater Air Force Range", Wyle Research Report WR 92-4, March 1992.
7. Plotkin, K.J., "Sonic Boom Focal Zones From Tactical Air Maneuvers", *J. Aircraft*, 30 (1), January-February 1993
8. "Assessment of Community Response to High-Energy Impulsive Sounds", National Research Council, Committee on Hearing, Bioacoustics, and Biomechanics, 1981.
9. Appendix C, ANSI S1.4 (1983), American National Standard for Sound Level Meters.
10. Galloway, W.J., "Studies to Improve Environmental Assessments of Sonic Booms Produced During Air Combat Maneuvering", AFAMRL-TR-93-078, October 1983.
11. Lucas, M.J., "Selecting Optimum Sonic Boom Monitoring Sites in a Special-Use Airspace", to be presented at Noise-Con 93, Williamsburg, VA.
12. Desai, V.R., and Plotkin, K.J., "Boom-Map3 Computer Program for Sonic Boom Analysis", Wyle Research Report WR 92-5, April 1992.
13. Galloway, W.J., "Development of C-Weighted Day-Night Average Sound Level Contours for F-15 Air Combat Maneuvering Areas", BBN Report 4430, August 1980.
14. Wilby, E., Horonjeff, R., and Bishop, D., "User's Guide to MOAOPS and Boom-Map Computer Programs for Sonic Boom Research", HSD-TR-87-004, May 1987.

## REFERENCES (Continued)

15. Bishop, D.E., Haber, J.M., and Wilby, E.G., "BOOMAP2 Computer Program for Sonic Boom Research: Technical Report", BBN Report 6487, November 1987.
17. Desai, V.R., Lucas, M.J., and Moulton, C.L., "Software Developed to Support Sonic Boom Measurements at White Sands Missile Range", Wyle Research Technical Note TN 89-15, December 1989.
16. Brown, R., and Moulton, C., "Data Accumulation and Field Servicing Procedures for the White Sands Missile Range Sonic Boom Study", Wyle Research Technical Note TN 89-15, December 1989.
18. Leatherwood, J.D., and Sullivan, B.M., "Subjective Loudness Response to Simulated Sonic Booms", High-Speed Research: Sonic Boom, NASA Conference Publication 3172, February 1992.



**APPENDIX A**  
**Overpressure Distribution,**  
**Recorded Sonic Booms**

SITE 01 : 17 Booms recorded over 166 days

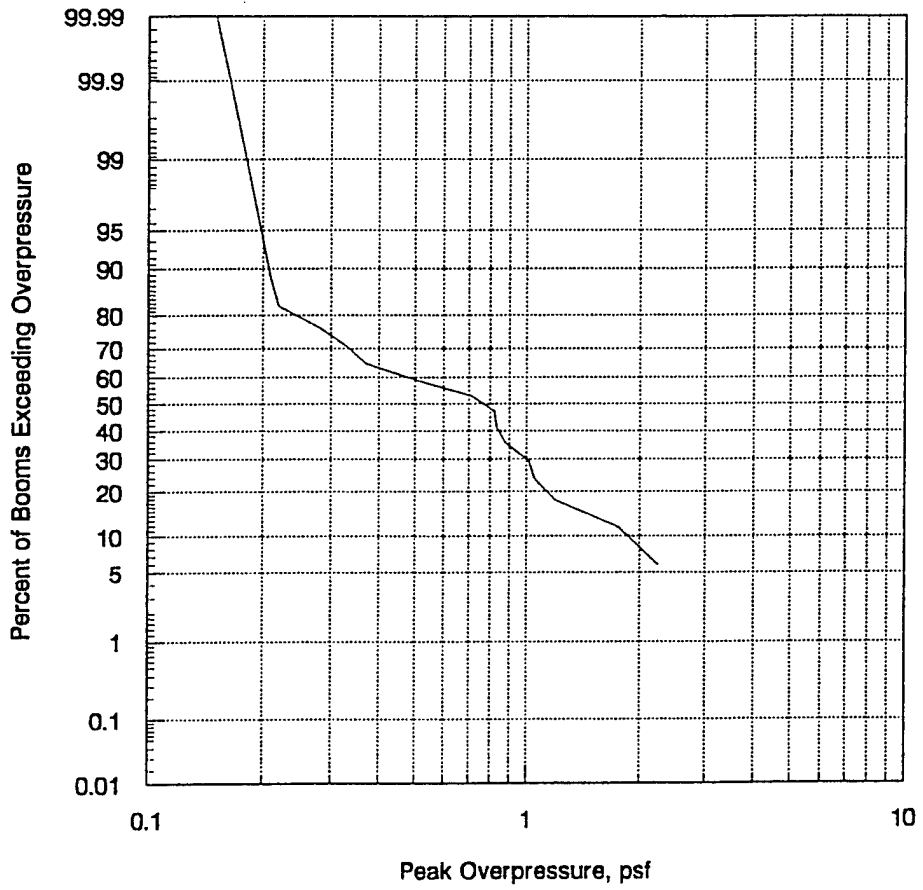

Figure A1. Site 1 Overpressure Distribution.

SITE 02 : 19 Booms recorded over 159 days

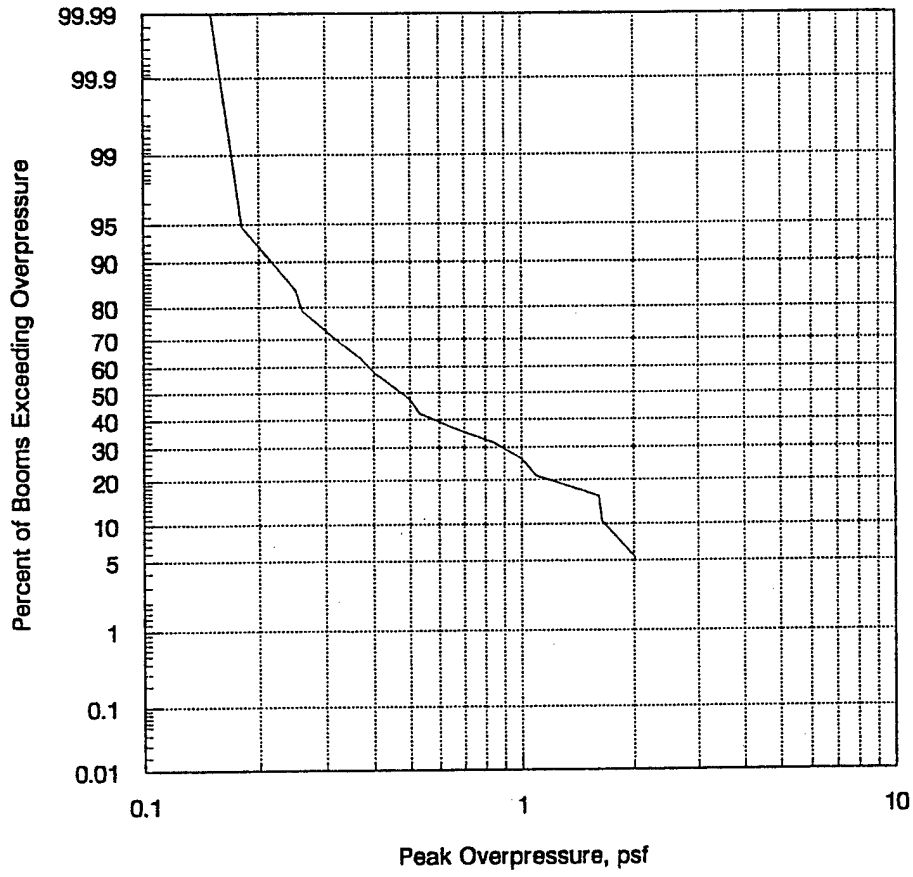

Figure A2. Site 2 Overpressure Distribution.

SITE 03 : 16 Booms recorded over 141 days

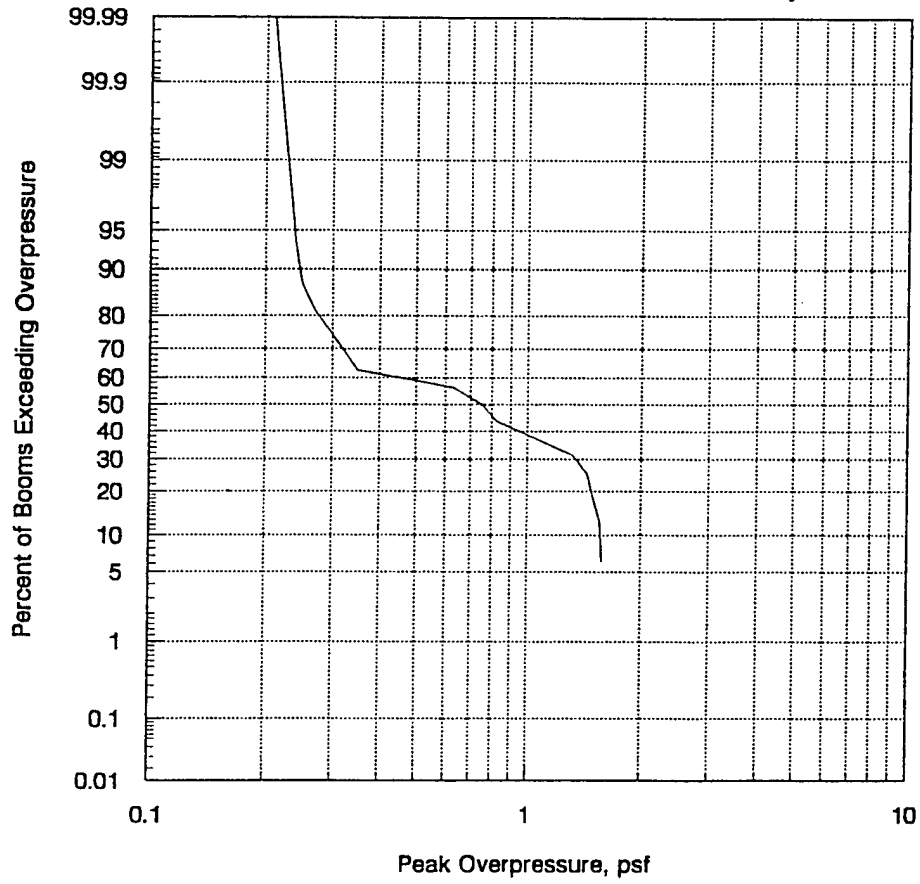

Figure A3. Site 3 Overpressure Distribution.

SITE 04 : 67 Booms recorded over 149 days

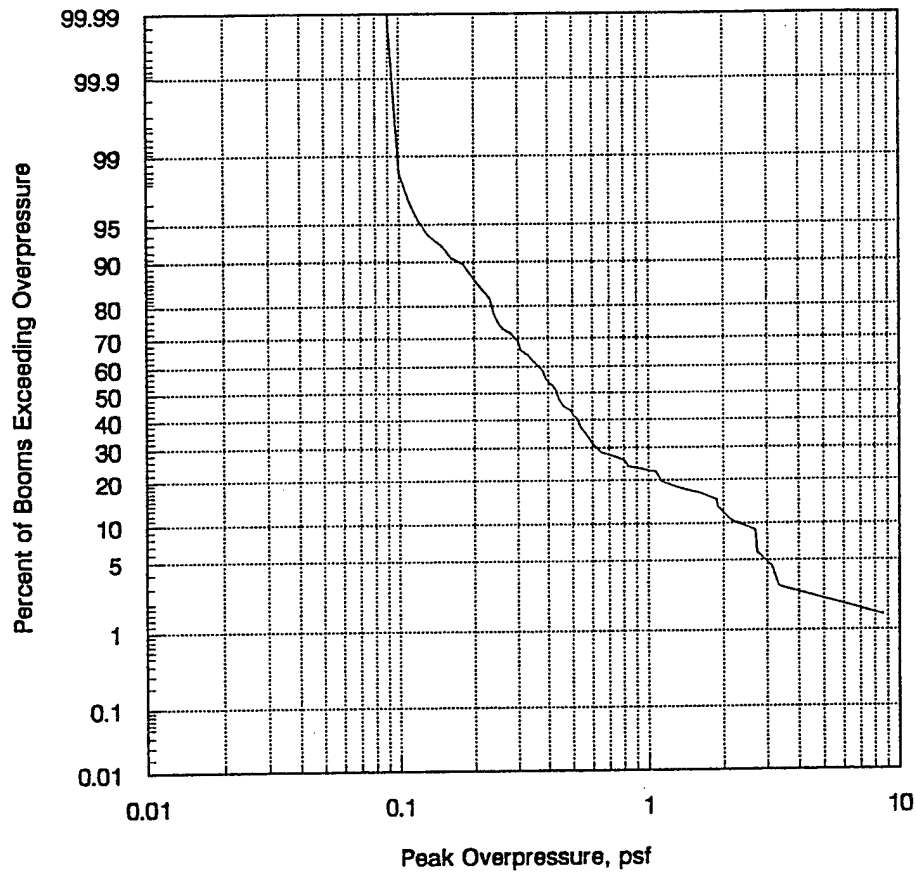

Figure A4. Site 4 Overpressure Distribution.

SITE 05 : 27 Booms recorded over 174 days

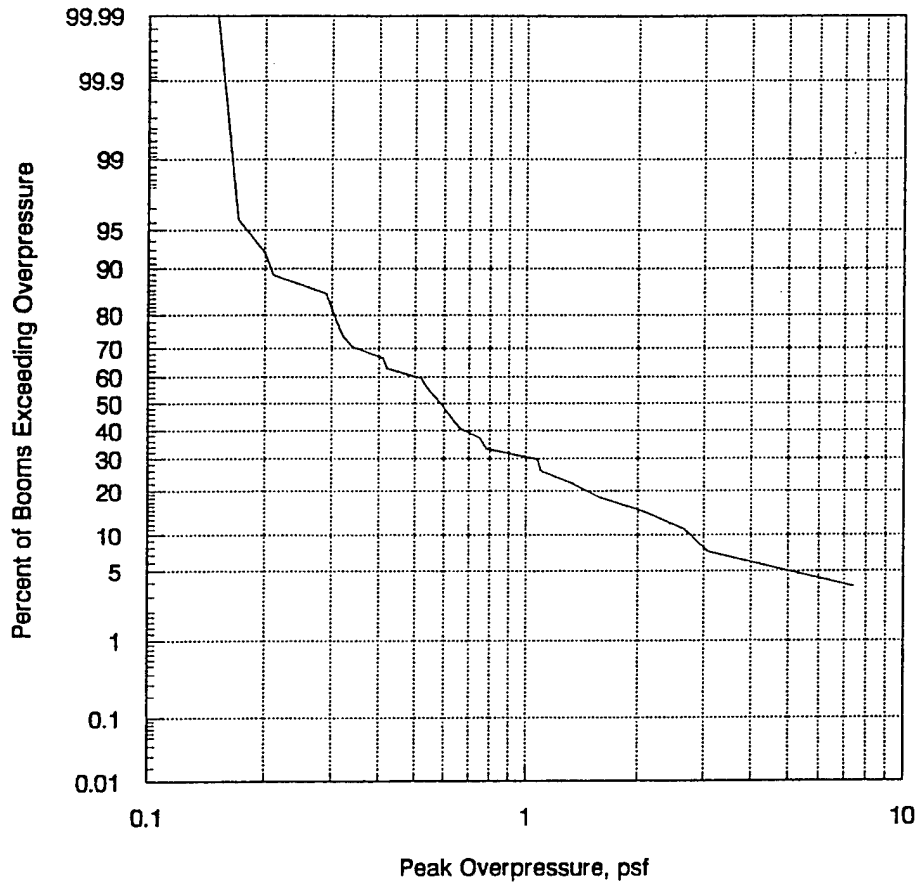

Figure A5. Site 5 Overpressure Distribution.

SITE 06 : 27 Booms recorded over 183 days

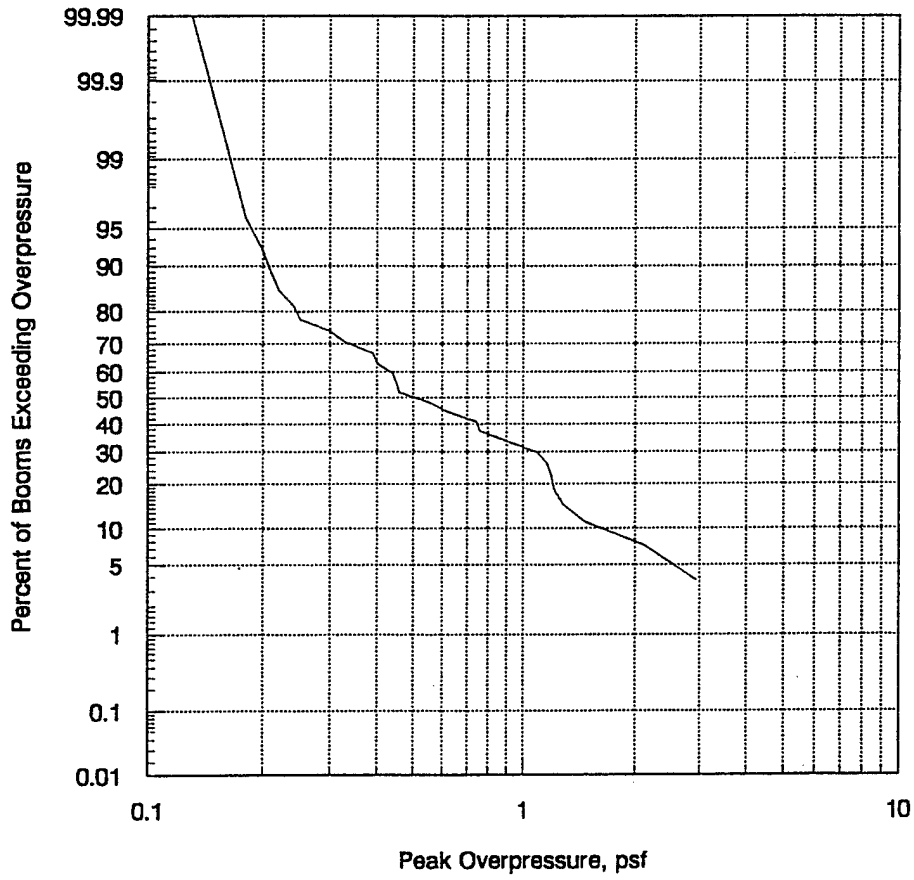

Figure A6. Site 6 Overpressure Distribution.

SITE 07 : 33 booms recorded over 119 days

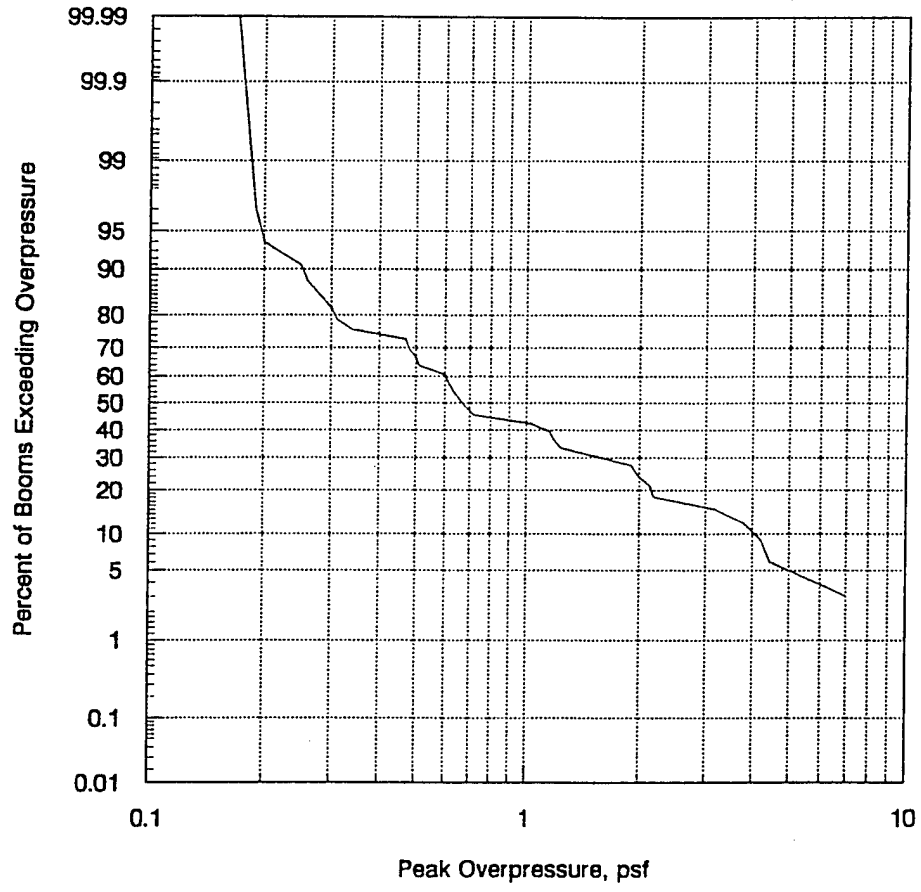

Figure A7. Site 7 Overpressure Distribution.



SITE 08 : 44 booms recorded over 161 days

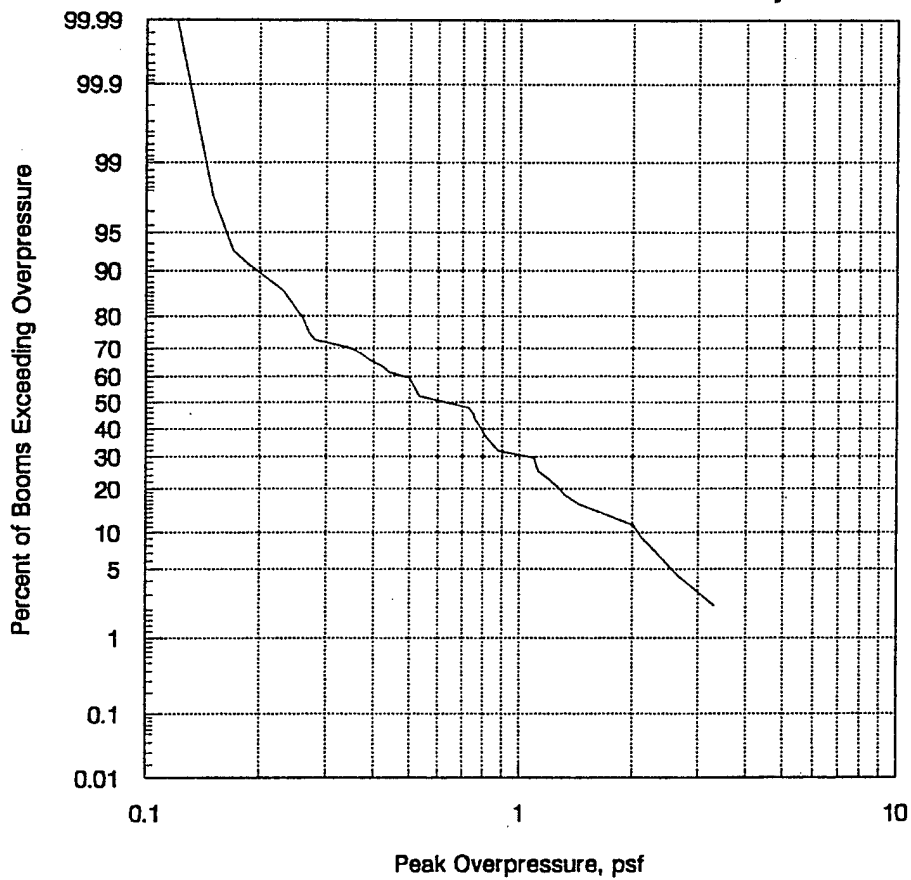

Figure A8. Site 8 Overpressure Distribution.

SITE 09 : 19 booms recorded over 131 days

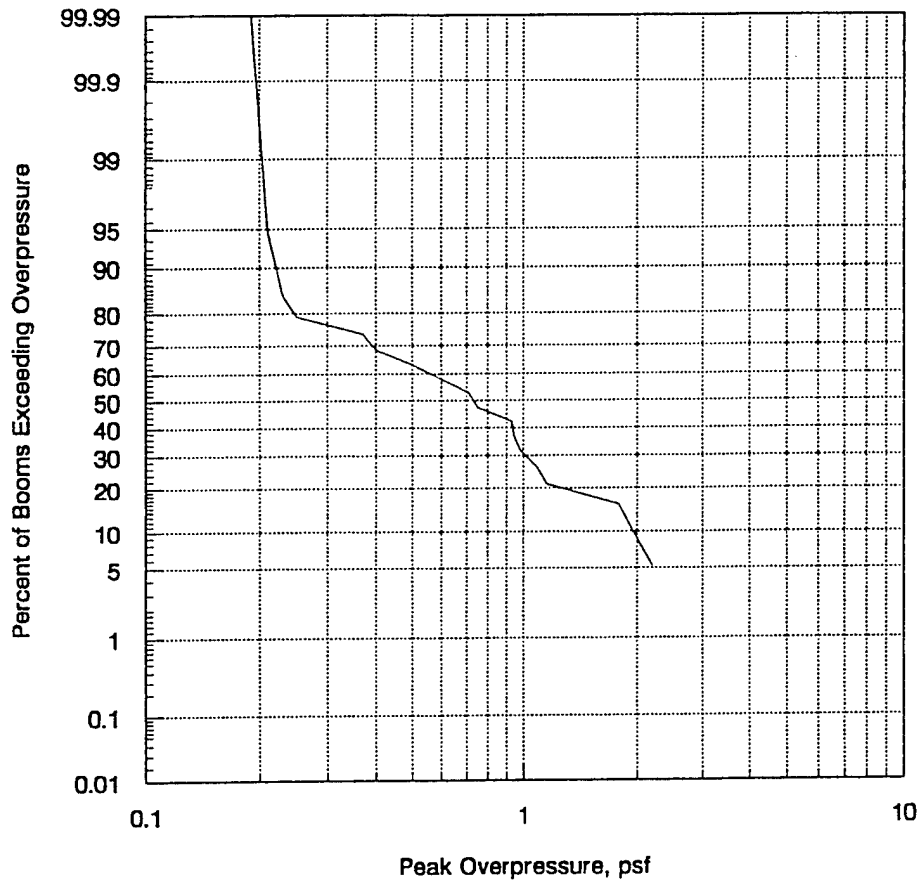

Figure A9. Site 9 Overpressure Distribution.

SITE 10 : 70 booms recorded over 181 days

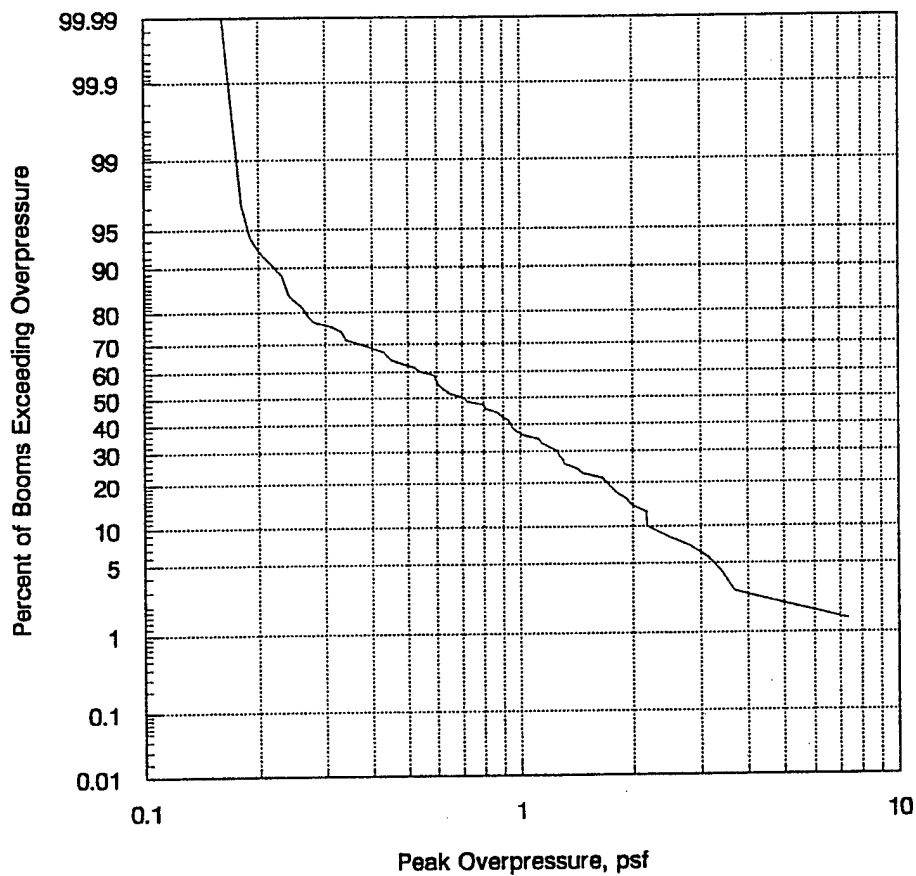

Figure A10. Site 10 Overpressure Distribution.

SITE 11 : 78 booms recorded over 148 days

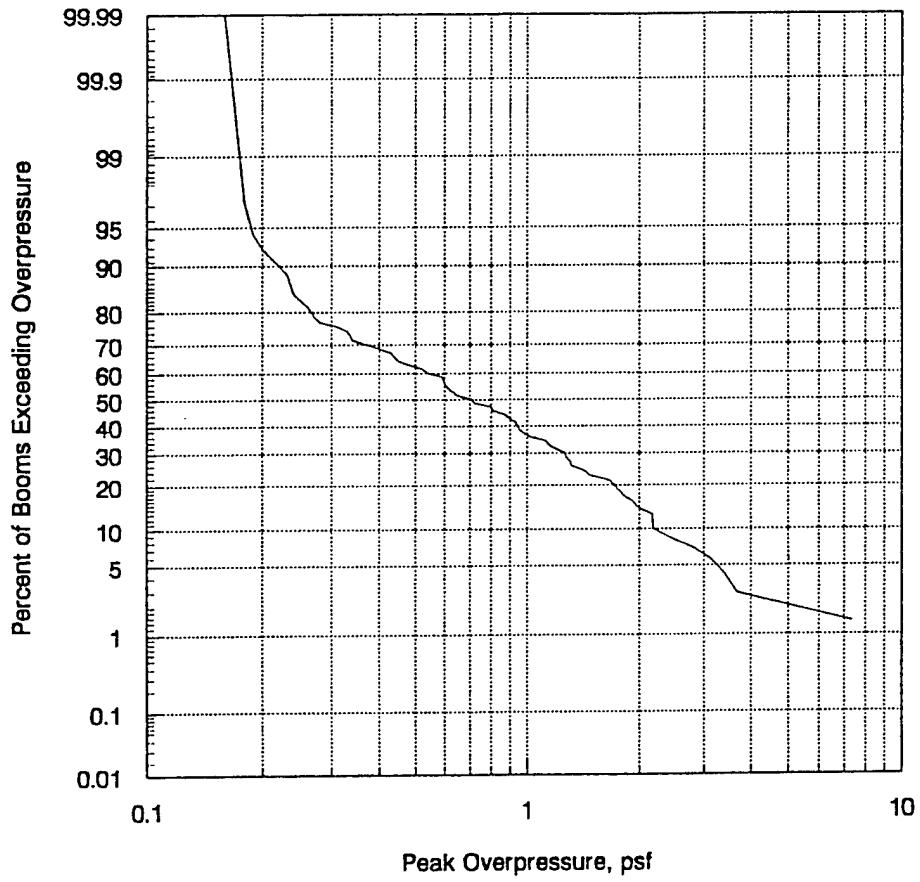

Figure A11. Site 11 Overpressure Distribution.

SITE 12 : 29 booms recorded over 180 days

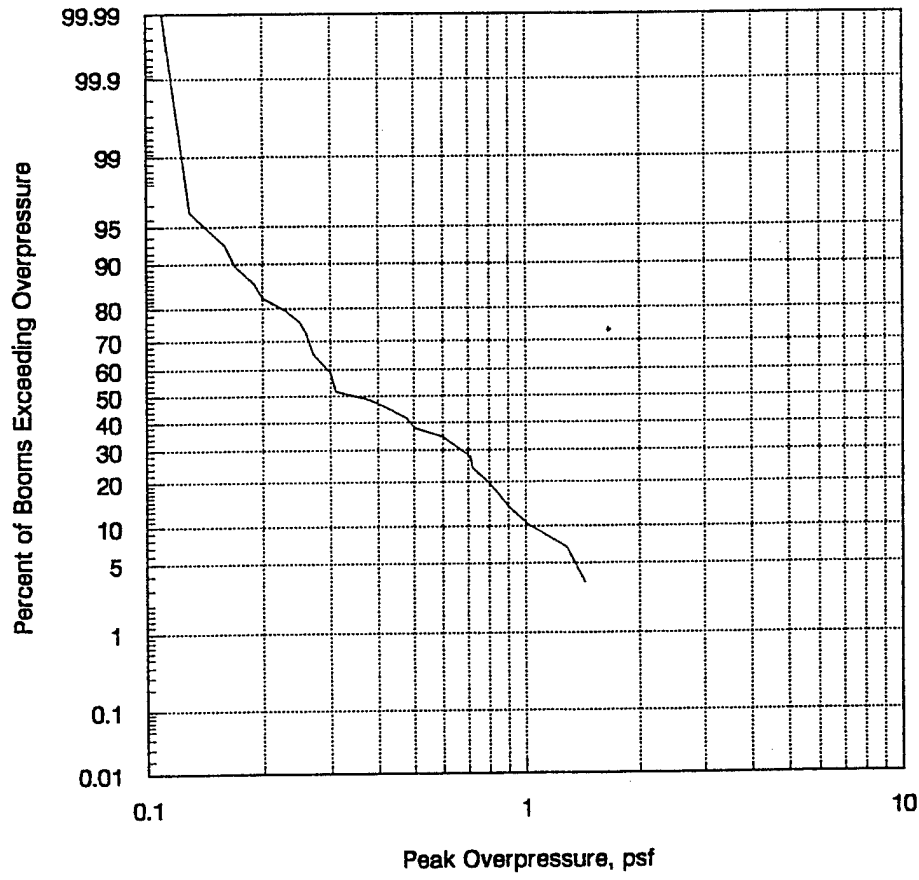

Figure A12. Site 12 Overpressure Distribution.

SITE 13 : 21 booms recorded over 157 days

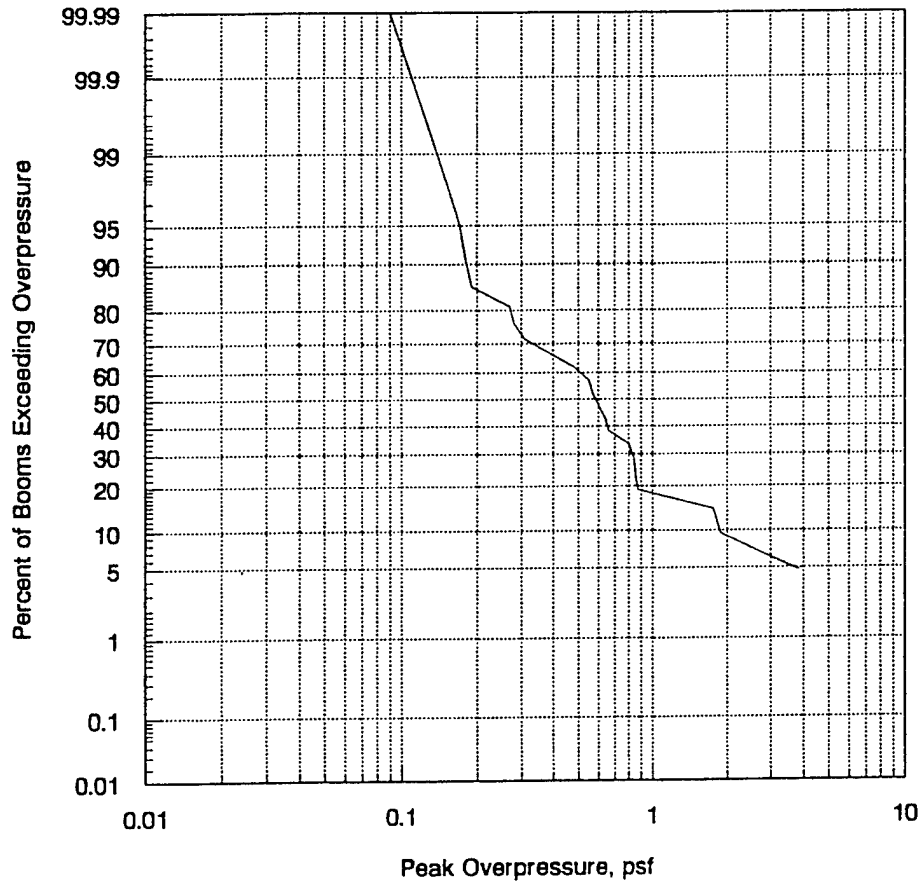

Figure A13. Site 13 Overpressure Distribution.

### SITE 14 : 21 booms recorded over 130 days

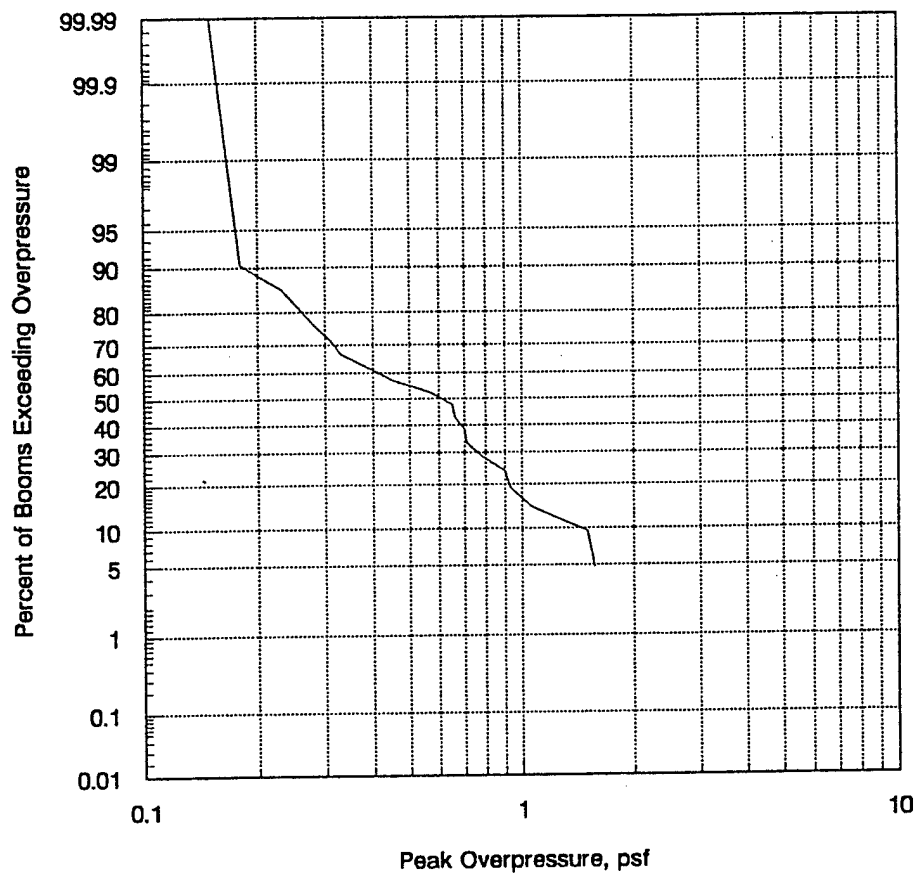

Figure A14. Site 14 Overpressure Distribution.

SITE 15 : 106 booms recorded over 161 days

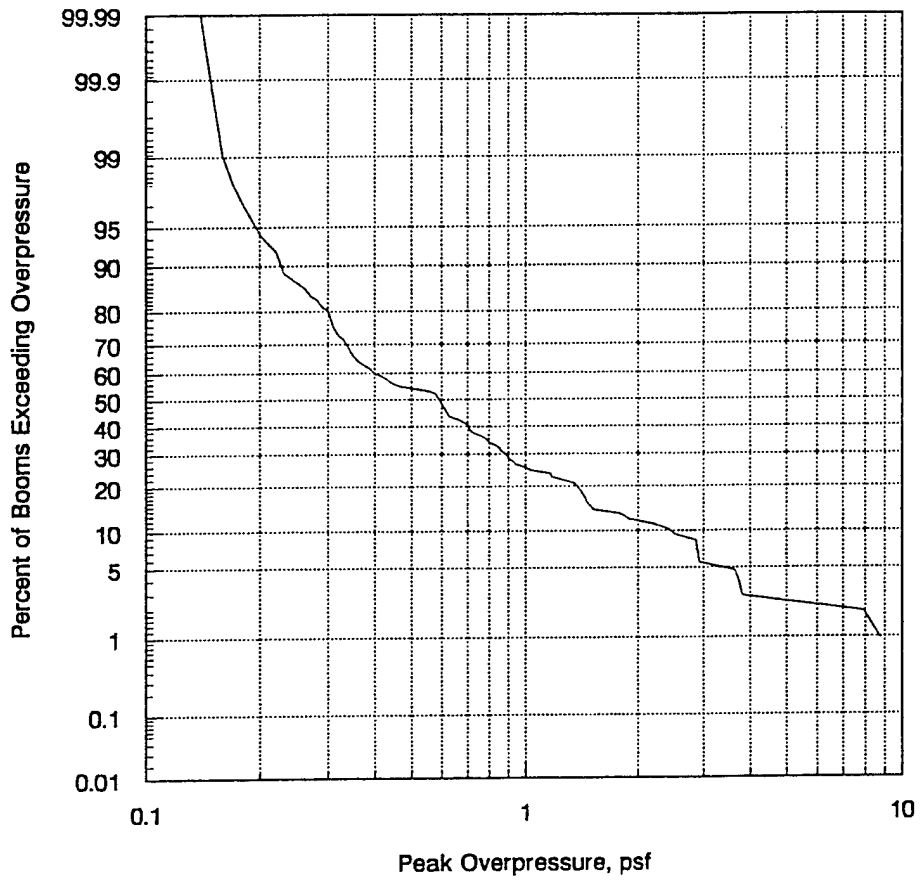

Figure A15. Site 15 Overpressure Distribution.



SITE 16 : 56 booms recorded over 177 days

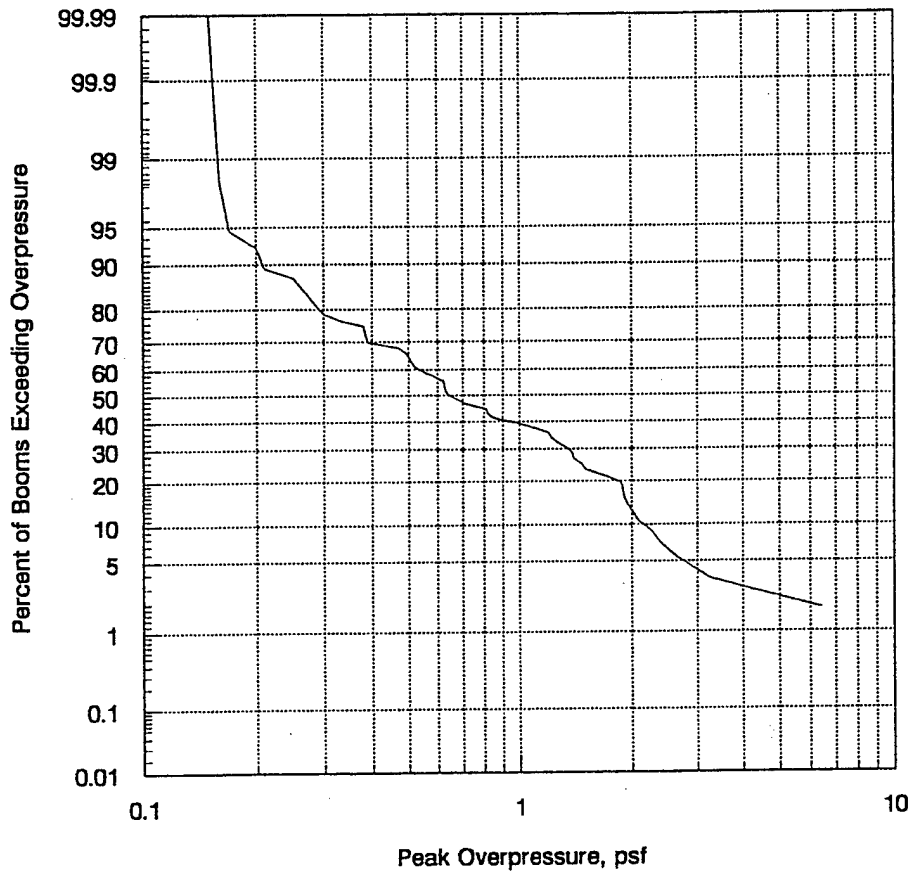

Figure A16. Site 16 Overpressure Distribution.

SITE 17 : 27 booms recorded over 153 days

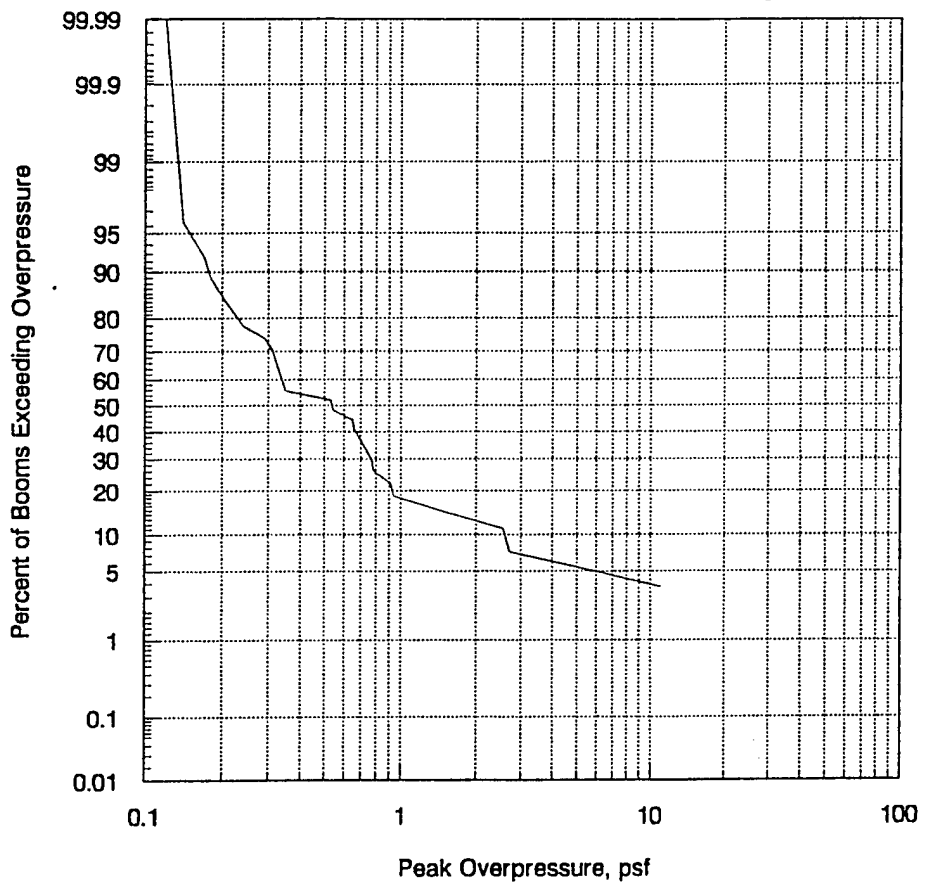

Figure A17. Site 17 Overpressure Distribution.

SITE 18 : 8 booms recorded over 118 days

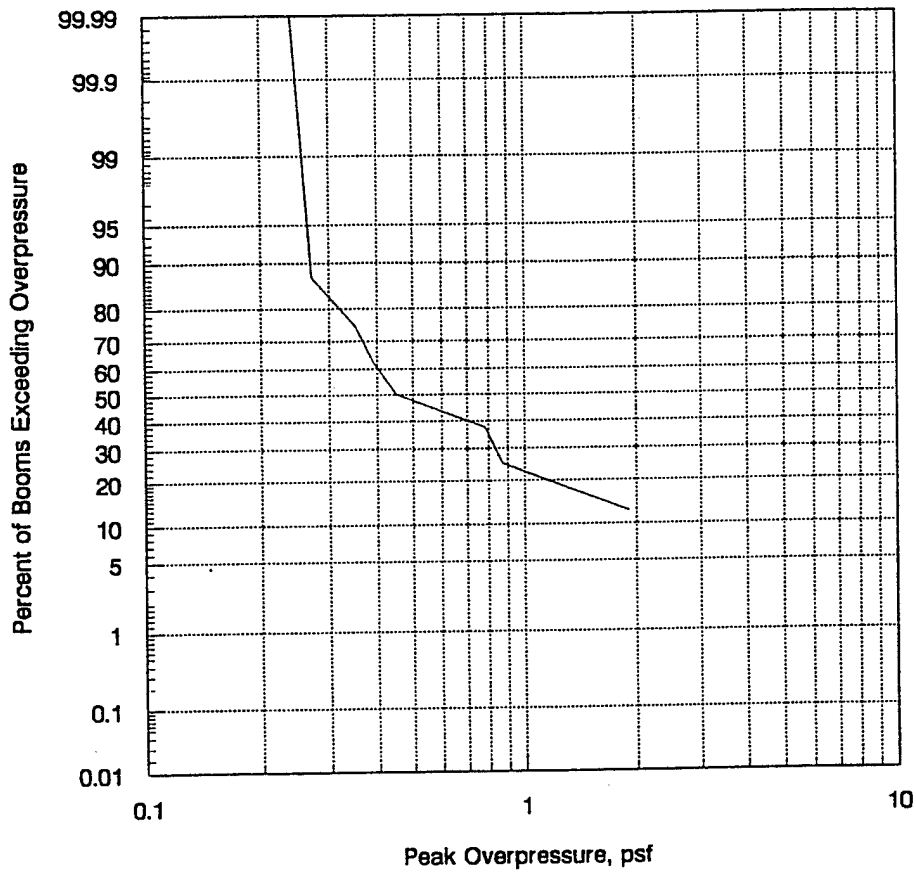

Figure A18. Site 18 Overpressure Distribution.

SITE 19 : 31 booms recorded over 166 days

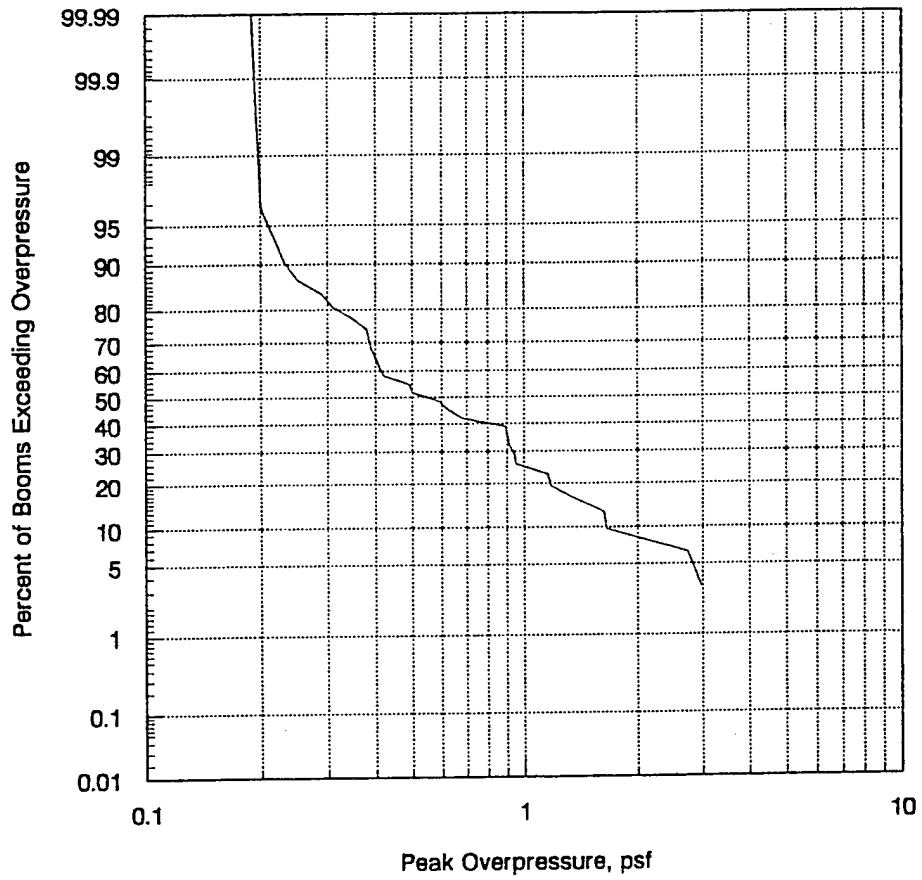

Figure A19. Site 19 Overpressure Distribution.

SITE 20 : 63 booms recorded over 187 days

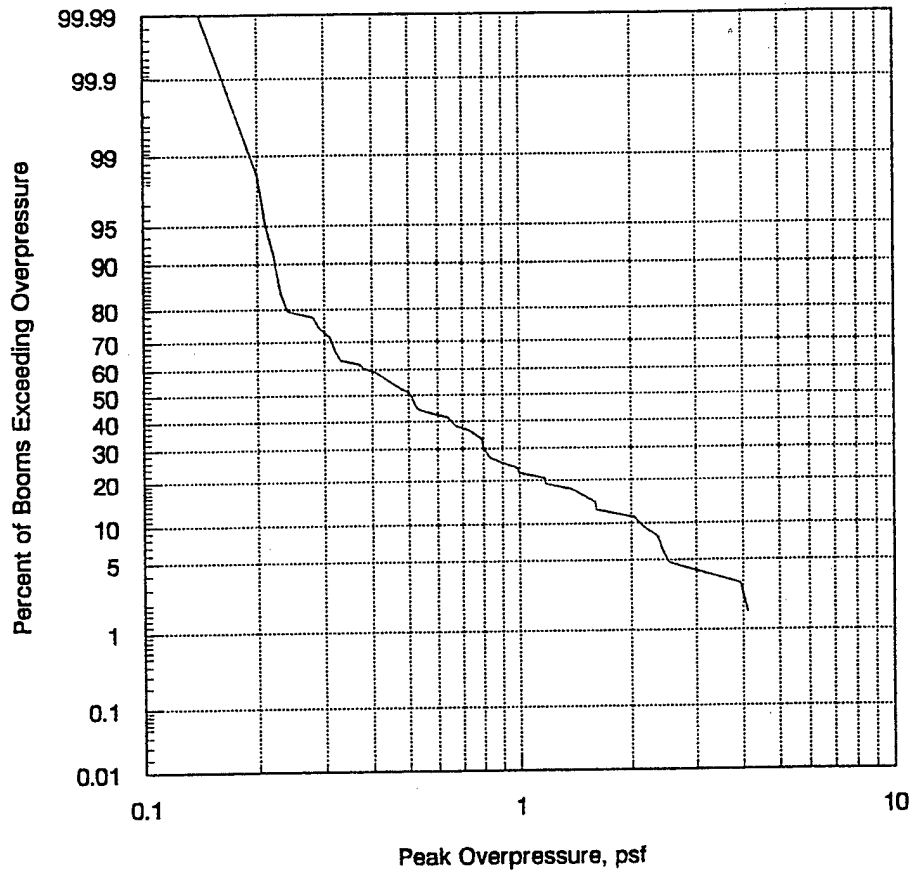

Figure A20. Site 20 Overpressure Distribution.

SITE 21 : 68 booms recorded over 172 days

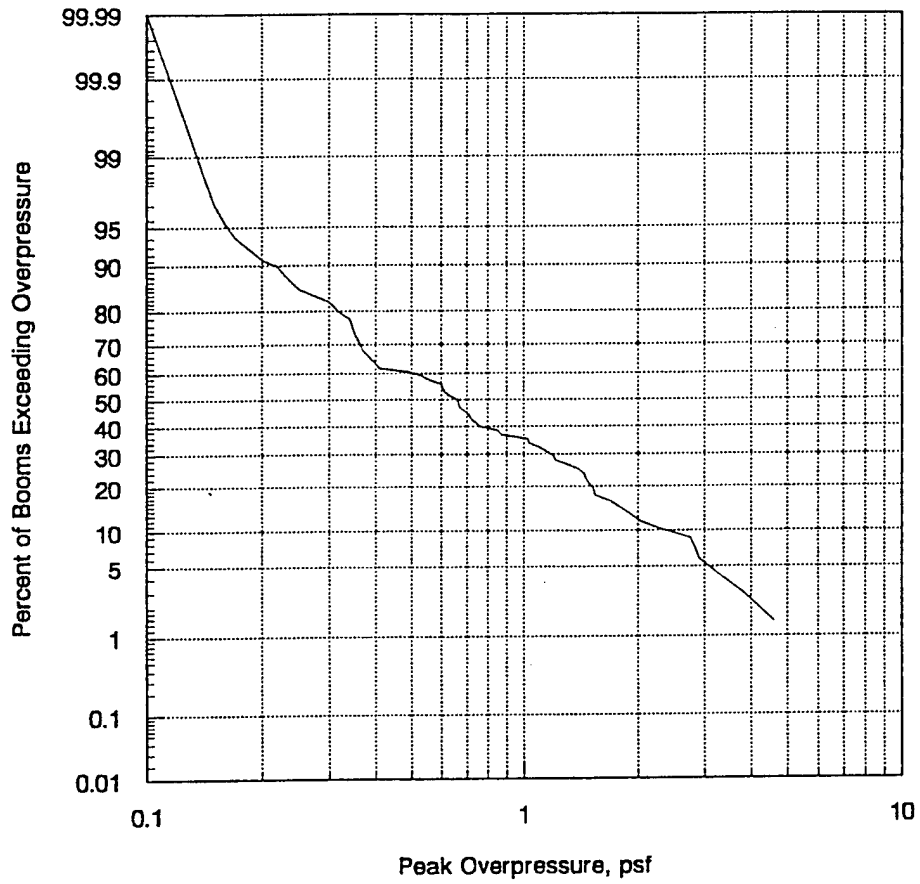

Figure A21. Site 21 Overpressure Distribution.

SITE 22 : 65 booms recorded over 92 days

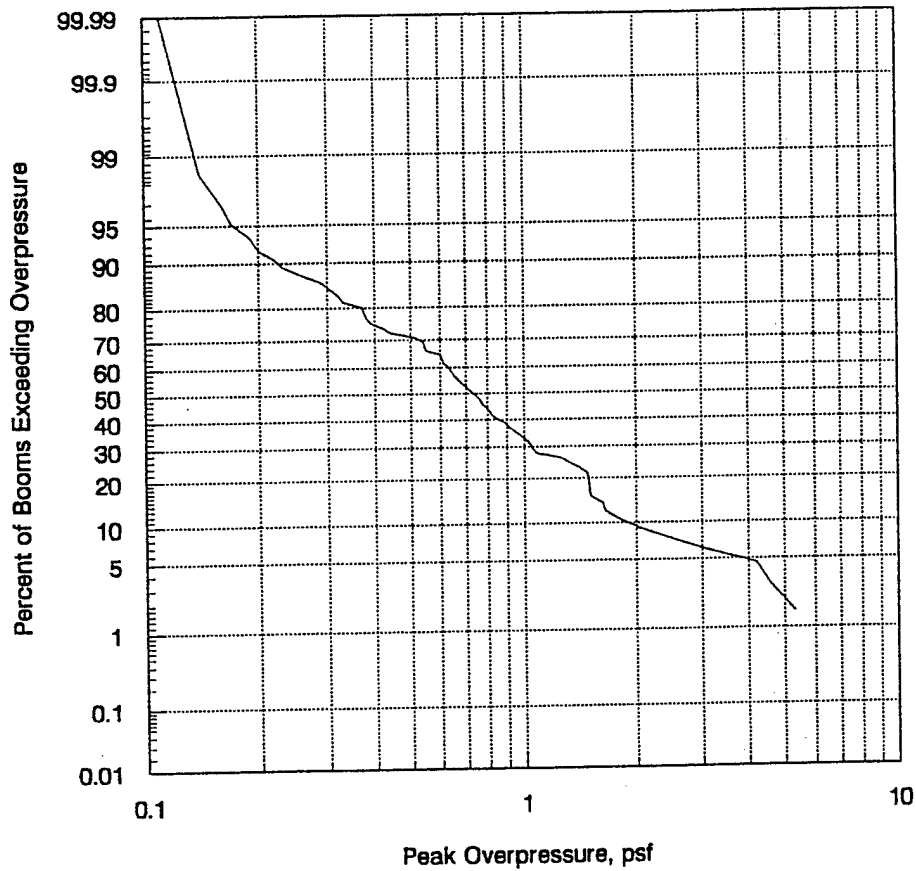

Figure A22. Site 22 Overpressure Distribution.

SITE 23 : 60 booms recorded over 150 days

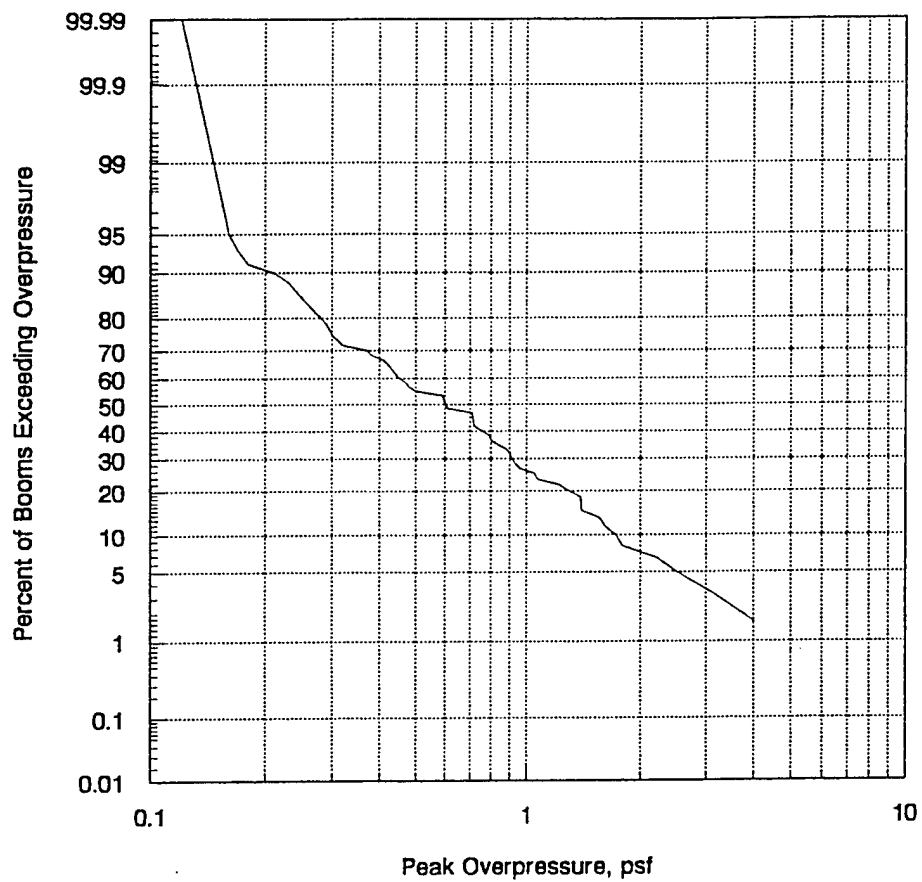

Figure A23. Site 23 Overpressure Distribution.



SITE 24 : 42 booms recorded over 191 days

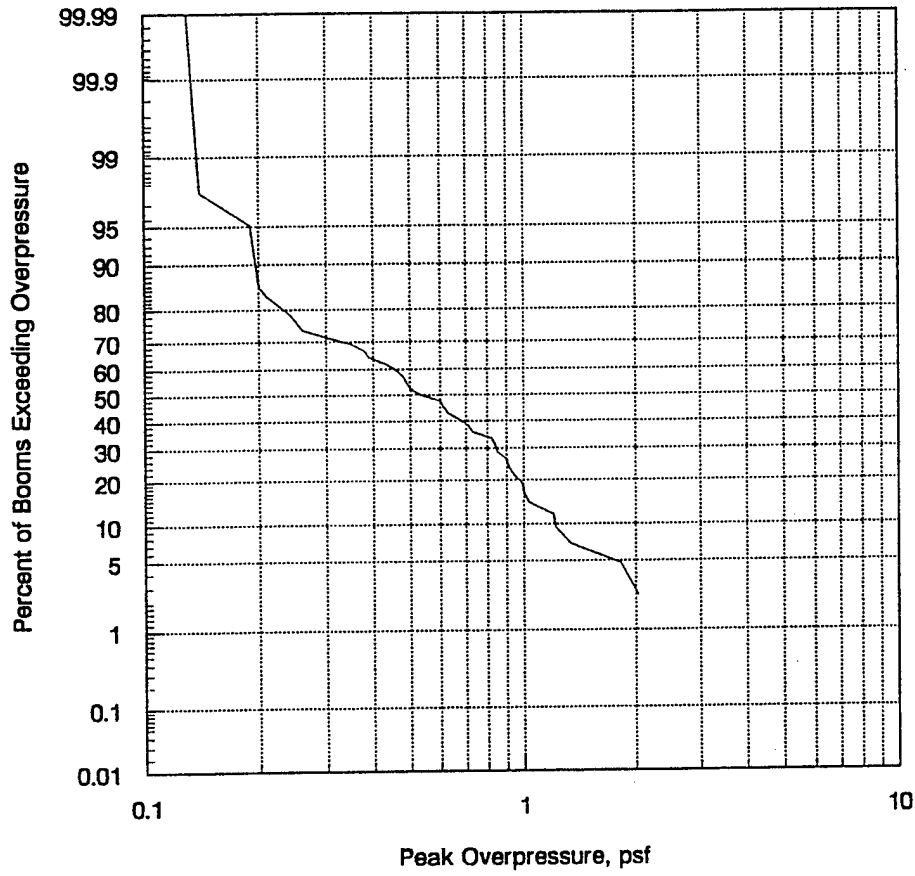

Figure A24. Site 24 Overpressure Distribution.

SITE 25 : 59 booms recorded over 107 days

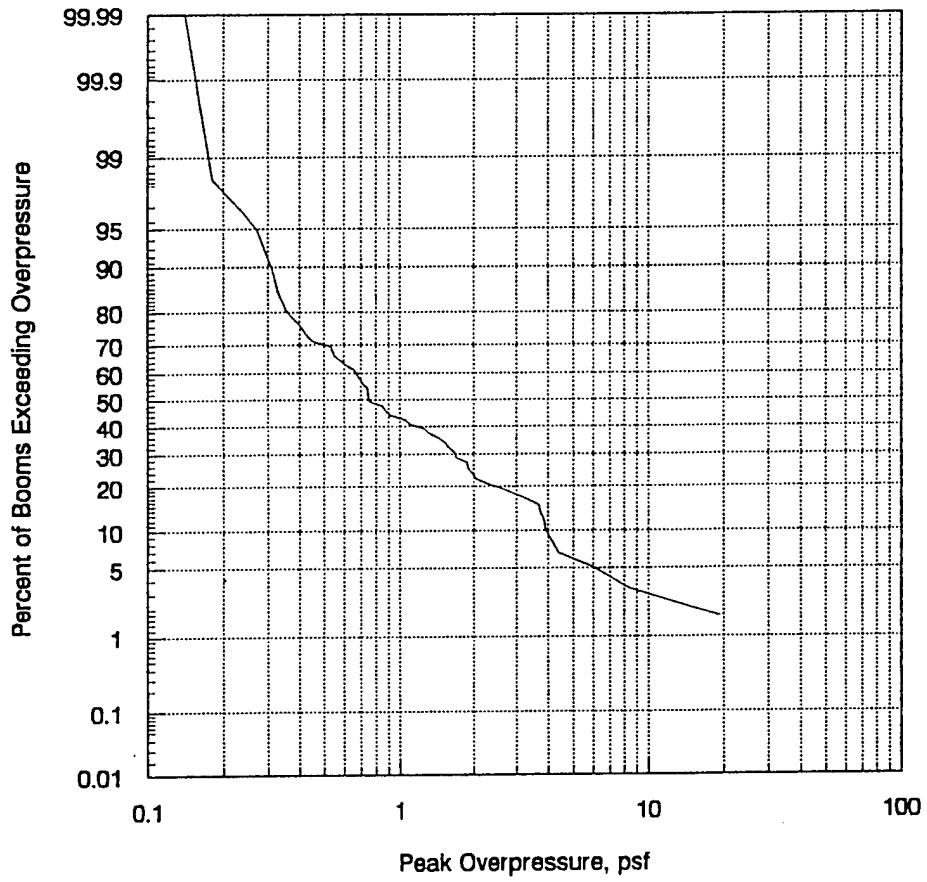

Figure A25. Site 25 Overpressure Distribution.

SITE 26 : 60 booms recorded over 157 days

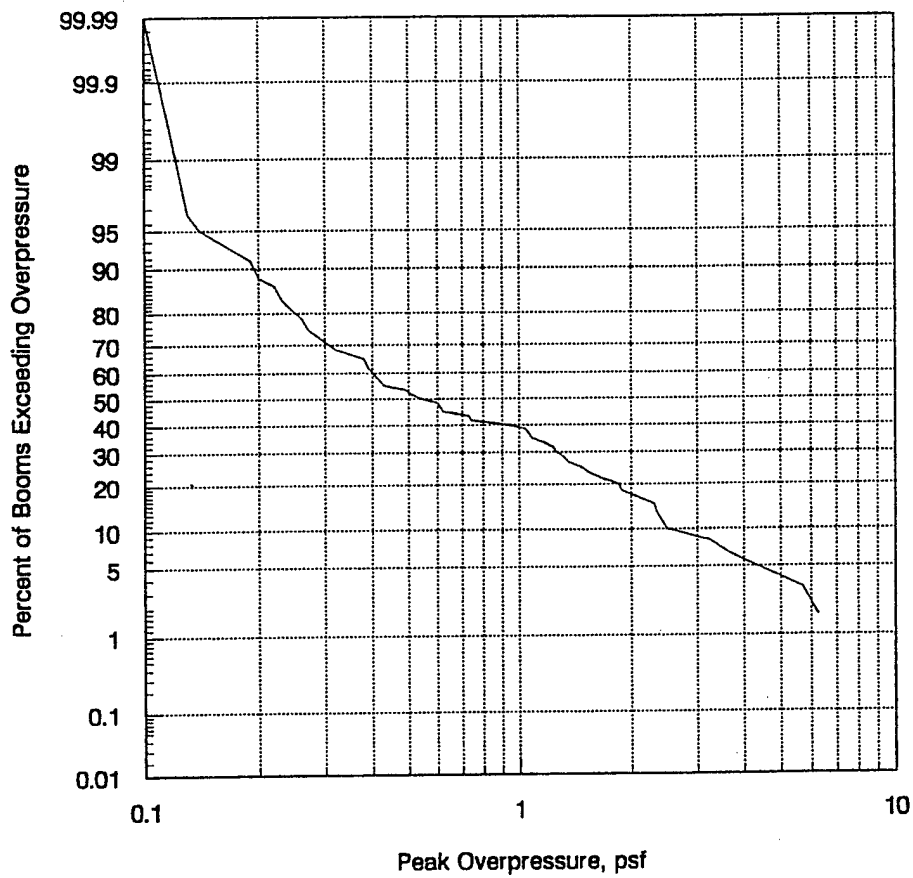

Figure A26. Site 26 Overpressure Distribution.

SITE 27 : 29 booms recorded over 113 days

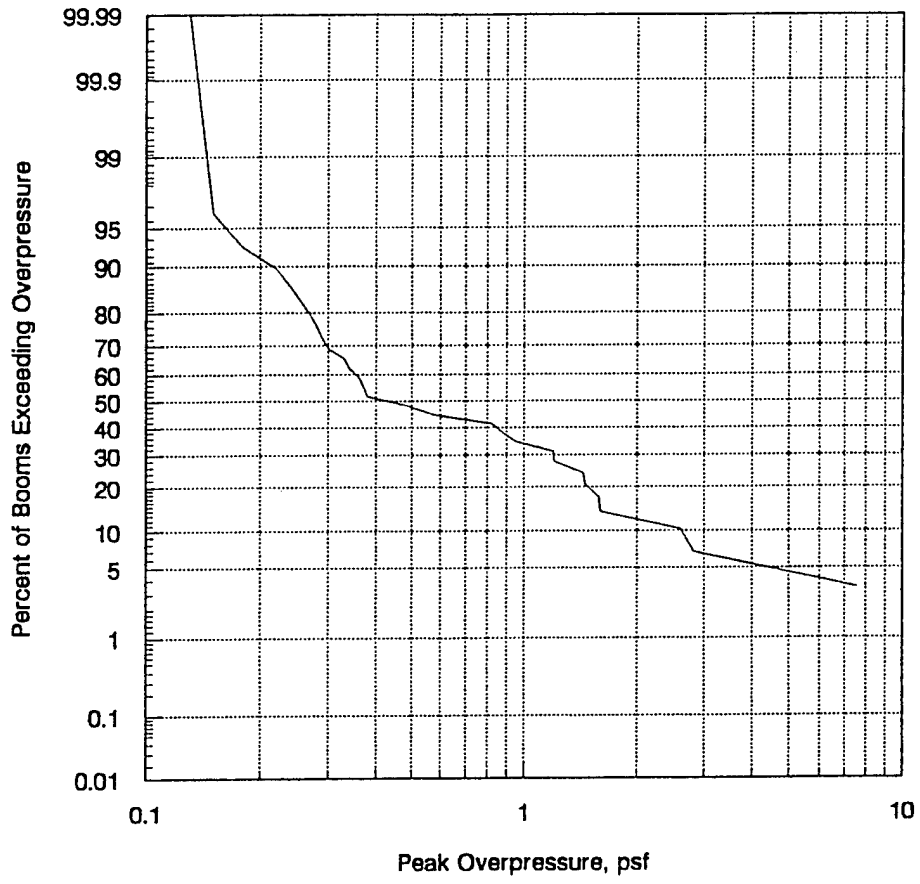

Figure A27. Site 27 Overpressure Distribution.

### SITE 28 : 14 booms recorded over 94 days

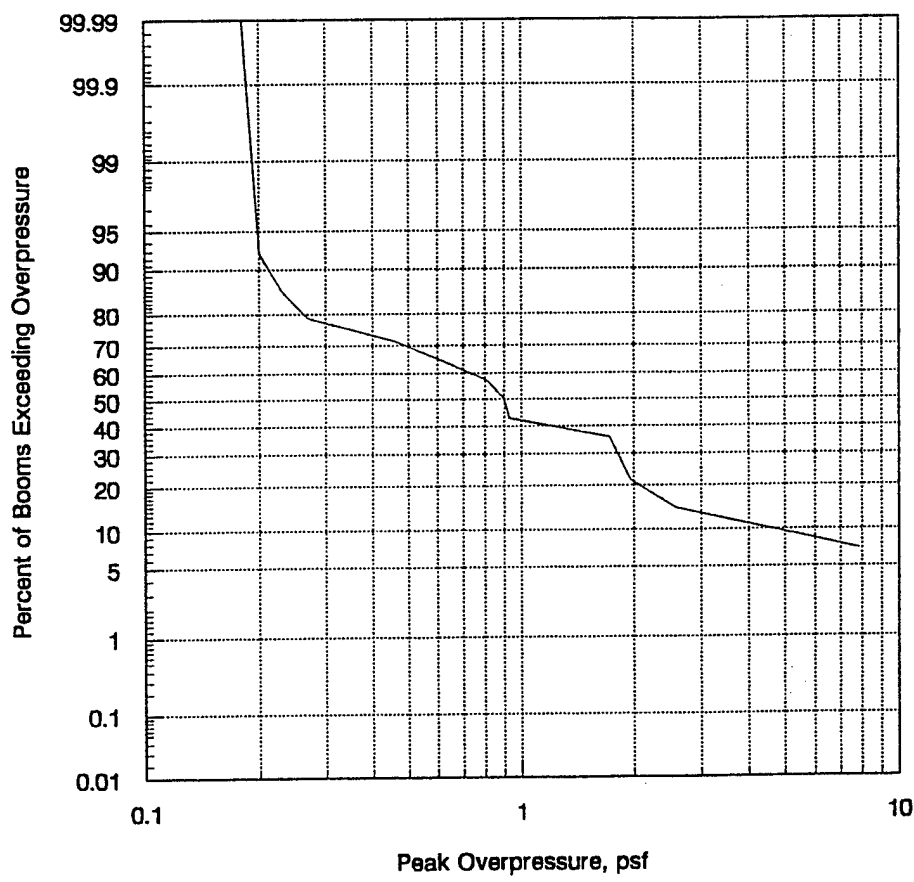

Figure A28. Site 28 Overpressure Distribution.

SITE 29 : 43 booms recorded over 159 days

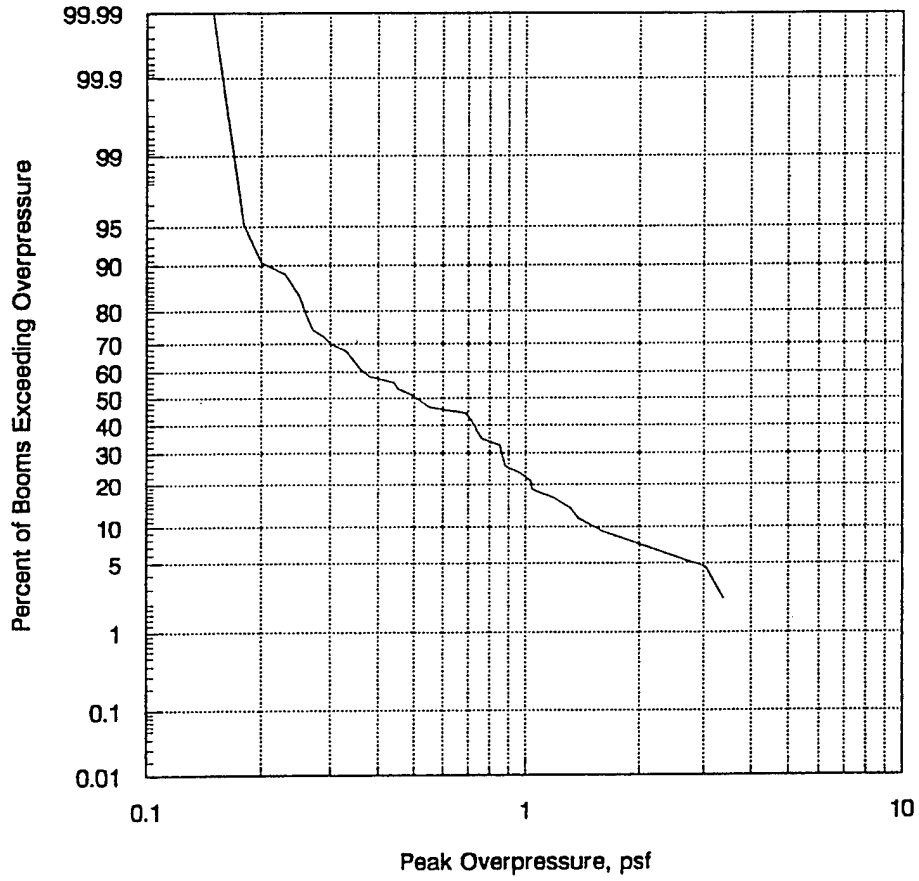

Figure A29. Site 29 Overpressure Distribution.

SITE 30 : 4 booms recorded over 148 days

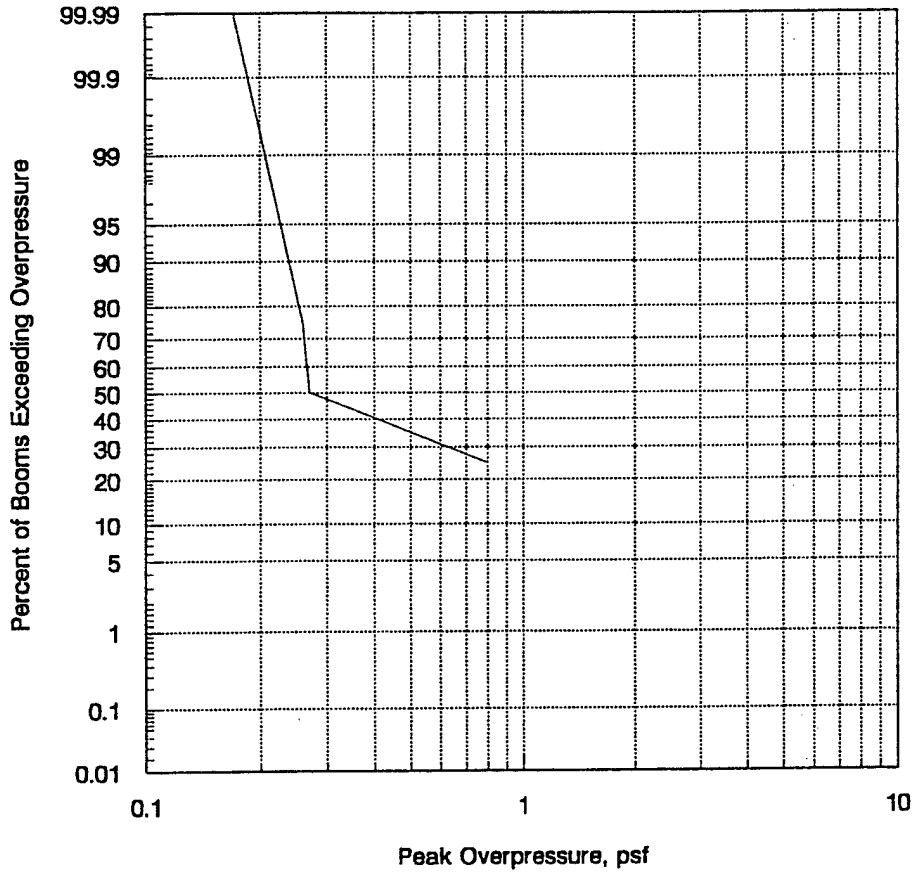

Figure A30. Site 30 Overpressure Distribution.

SITE 32 : 12 booms recorded over 178 days

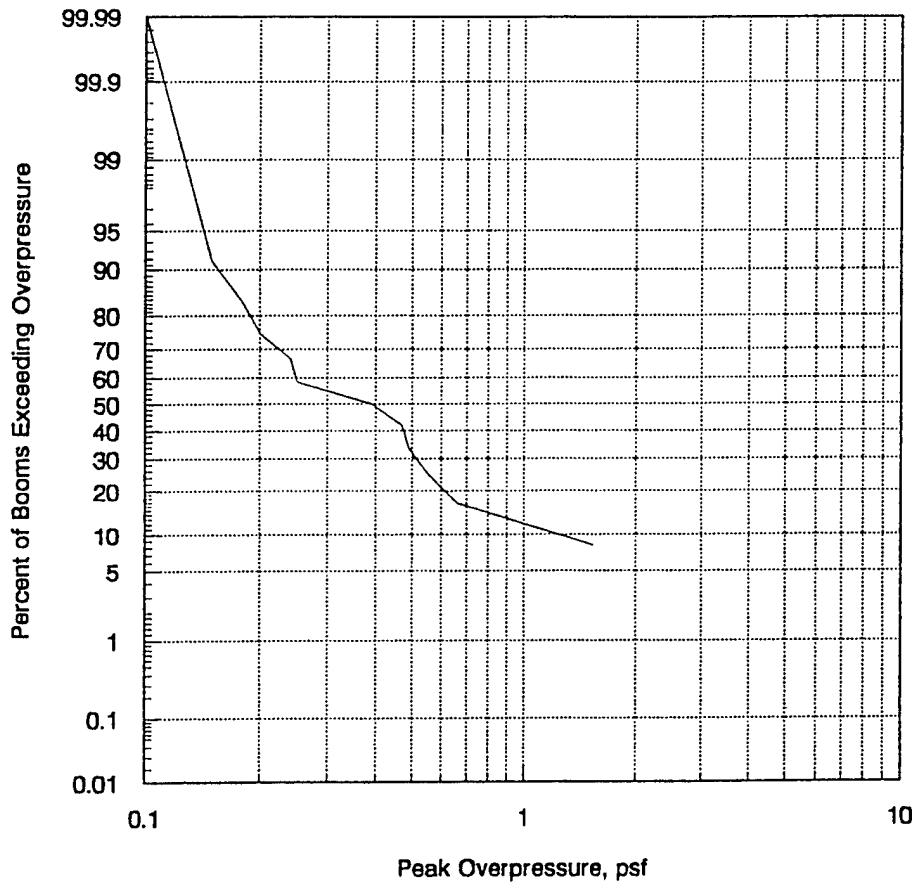

Figure A31. Site 32 Overpressure Distribution.



SITE 33 : 23 booms recorded over 177 days

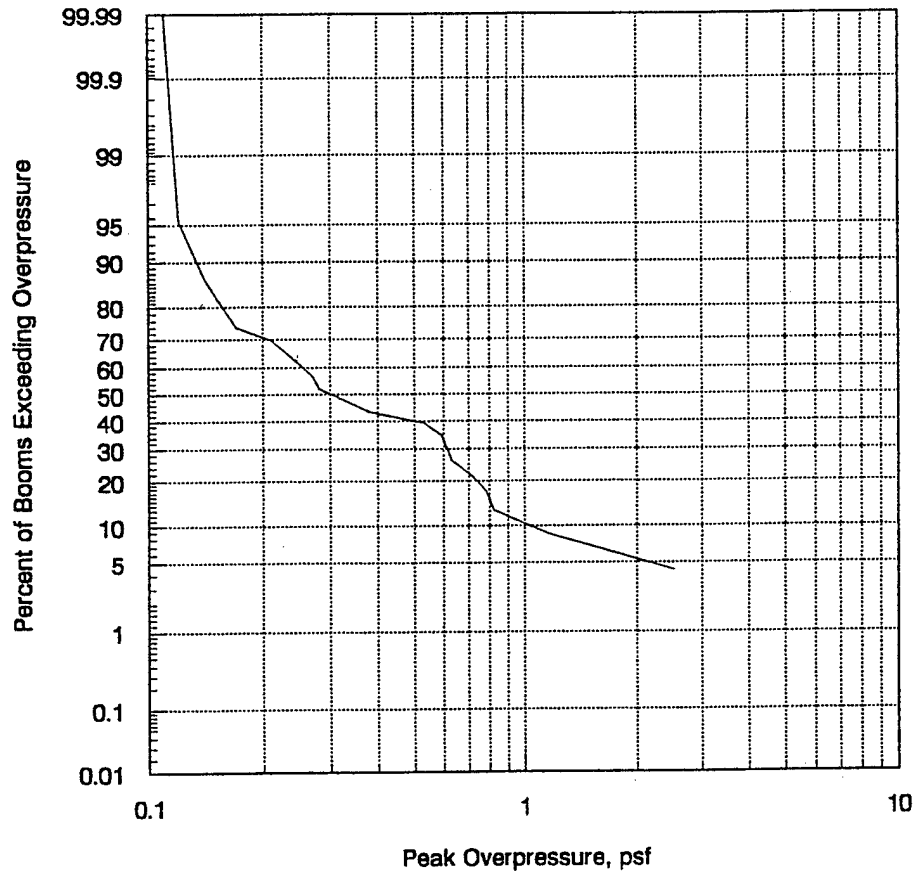

Figure A32. Site 33 Overpressure Distribution.

SITE 34 : 41 booms recorded over 170 days

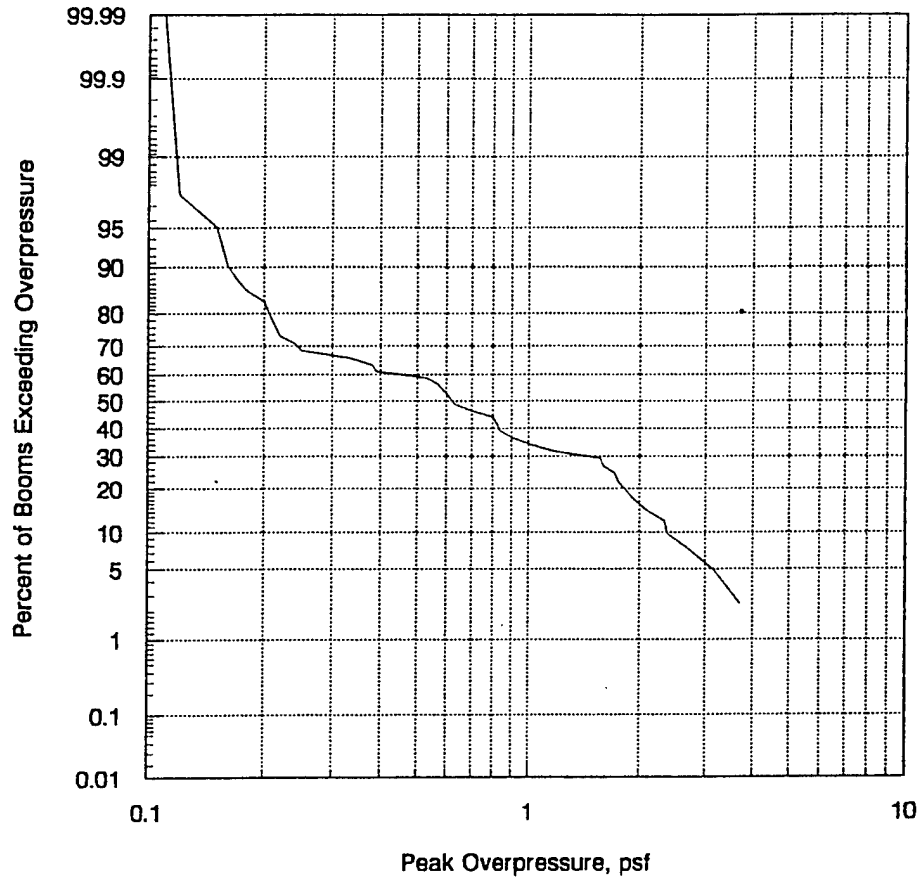

Figure A33. Site 34 Overpressure Distribution.

SITE 35 : 13 booms recorded over 124 days

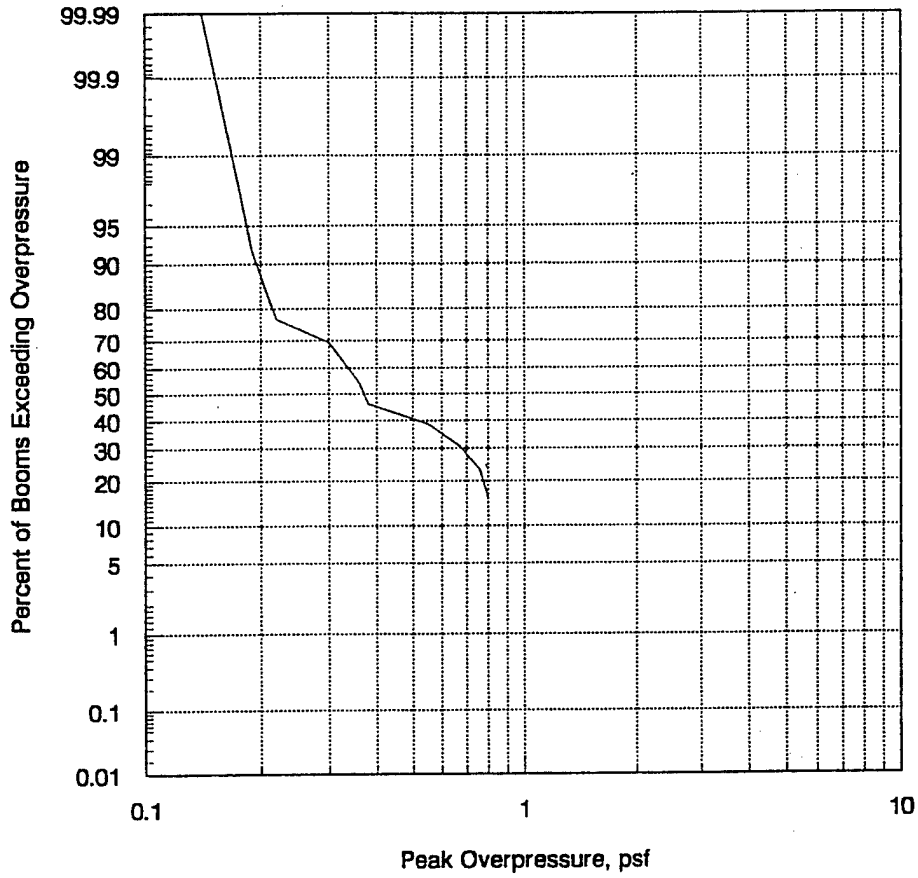

Figure A34. Site 35 Overpressure Distribution.

SITE 36 : 3 booms recorded over 90 days

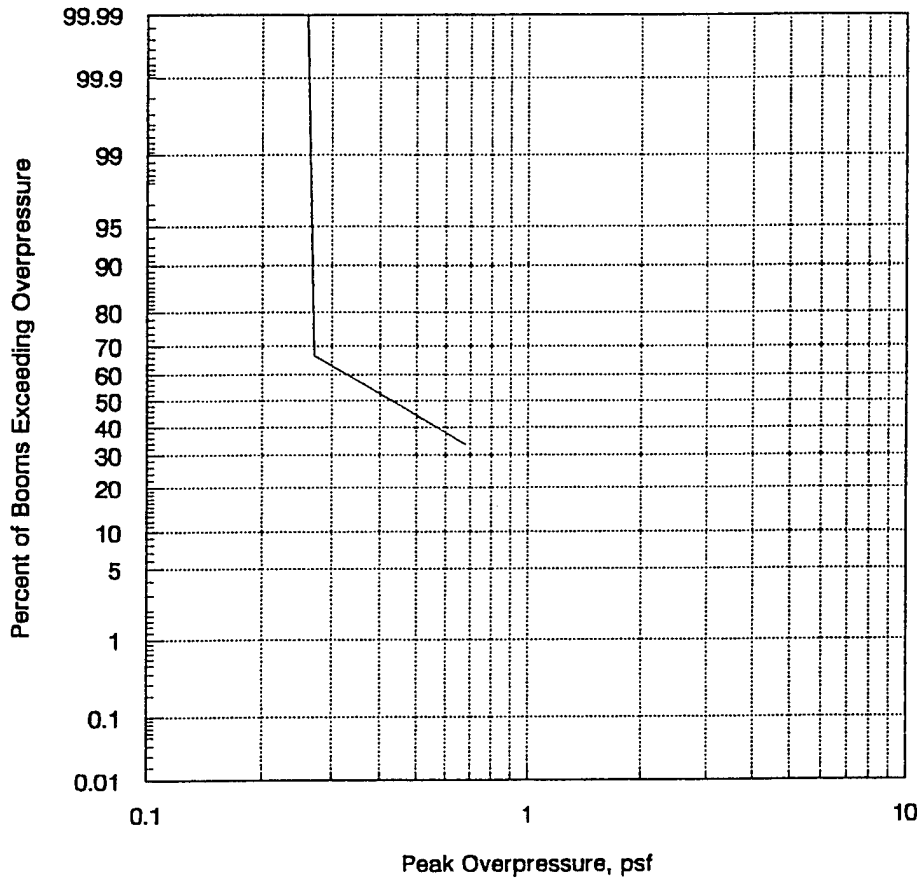

Figure A35. Site 36 Overpressure Distribution.

SITE 92 : 22 booms recorded over 171 days

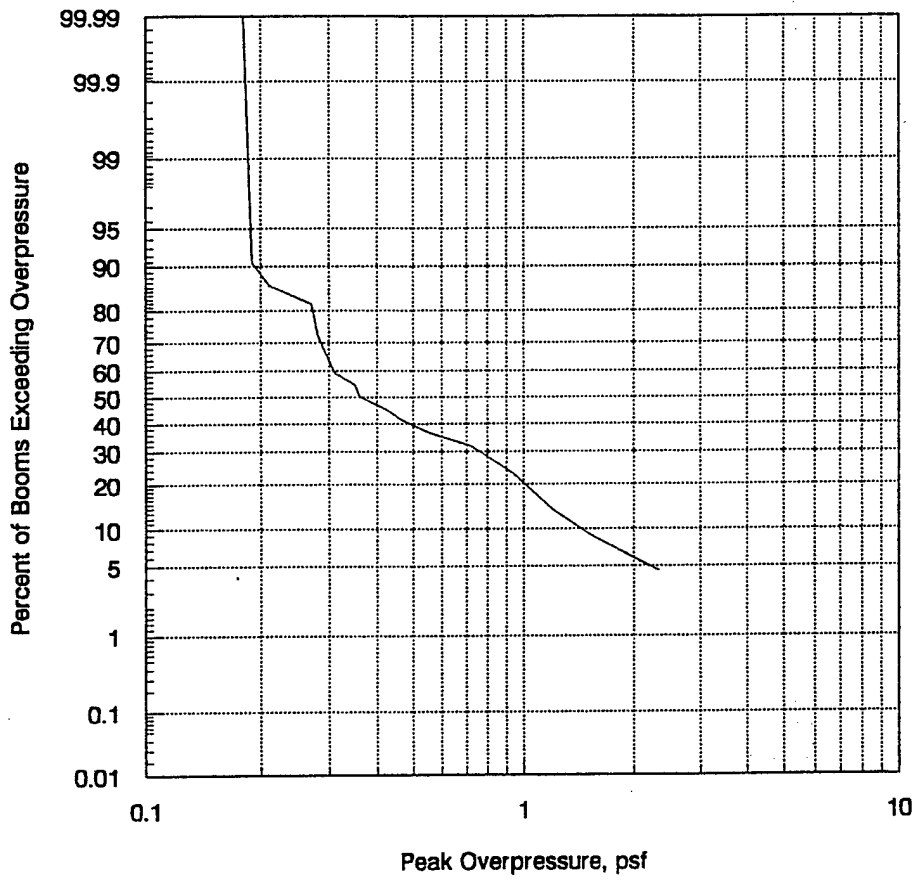

Figure A36. Site 92 Overpressure Distribution.