

AD

TECHNICAL REPORT ARCCB-TR-01020

**CANNON COATING EROSION
MODELING ACHIEVEMENTS**

**S. SOPOK
S. DUNN
P. O'HARA**

**D. COATS
G. PFLEGL
C. RICKARD**

OCTOBER 2001



**US ARMY ARMAMENT RESEARCH,
DEVELOPMENT AND ENGINEERING CENTER
CLOSE COMBAT ARMAMENTS CENTER
BENÉT LABORATORIES
WATERVLIET, N.Y. 12189-4050**



APPROVED FOR PUBLIC RELEASE; DISTRIBUTION UNLIMITED

20011106 100

DISCLAIMER

The **findings** in this report are not to be construed as an official Department of the Army **position** unless so designated by other authorized documents.

The **use** of trade name(s) and/or manufacturer(s) does not constitute an official endorsement or approval.

DESTRUCTION NOTICE

For **classified** documents, follow the procedures in DoD 5200.22-M, Industrial Security Manual, Section II-19, or DoD 5200.1-R, Information Security Program Regulation, Chapter IX.

For **unclassified, limited** documents, destroy by any method that will prevent disclosure of contents or reconstruction of the document.

For **unclassified, unlimited** documents, destroy when the report is no longer needed. Do not return it to the originator.

REPORT DOCUMENTATION PAGE

Form Approved
OMB No. 0704-0188

Public reporting burden for this collection of information is estimated to average 1 hour per response, including the time for reviewing instructions, searching existing data sources, gathering and maintaining the data needed, and completing and reviewing the collection of information. Send comments regarding this burden estimate or any other aspect of this collection of information, including suggestions for reducing this burden, to Washington Headquarters Services, Directorate for Information Operations and Reports, 1215 Jefferson Davis Highway, Suite 1204, Arlington, VA 22202-4302, and to the Office of Management and Budget, Paperwork Reduction Project (0704-0188), Washington, DC 20503.

1. AGENCY USE ONLY (Leave blank)		2. REPORT DATE October 2001	3. REPORT TYPE AND DATES COVERED Final	
4. TITLE AND SUBTITLE CANNON COATING EROSION MODELING ACHIEVEMENTS			5. FUNDING NUMBERS AMCMS No. 6226.24.H180.0 PRON No. 4A1B1FYK1ABJ	
6. AUTHOR(S) S. Sopok, S. Dunn*, P. O'Hara, D. Coats*, G. Pflagl, and C. Rickard * Software and Engineering Associates, Inc., Carson City, NV				
7. PERFORMING ORGANIZATION NAME(S) AND ADDRESS(ES) U.S. Army ARDEC Benet Laboratories, AMSTA-AR-CCB-O Watervliet, NY 12189-4050			8. PERFORMING ORGANIZATION REPORT NUMBER ARCCB-TR-01020	
9. SPONSORING / MONITORING AGENCY NAME(S) AND ADDRESS(ES) U.S. Army ARDEC Close Combat Armaments Center Picatinny Arsenal, NJ 07806-5000			10. SPONSORING / MONITORING AGENCY REPORT NUMBER	
11. SUPPLEMENTARY NOTES Presented at the 10 th U.S. Army Gun Dynamics Symposium, Austin, TX, 23-26 April 2001. Published in proceedings of the symposium.				
12a. DISTRIBUTION / AVAILABILITY STATEMENT Approved for public release; distribution unlimited.			12b. DISTRIBUTION CODE	
13. ABSTRACT (Maximum 200 words) Our repeatedly verified erosion theories are derived from many years of conducting the Army's mission of characterizing a broad spectrum of fired and eroded cannons. Based on these characterizations, we chronicle the establishment, development, achievement, and advancement of the first practical cannon and cannon coating/ablative erosion models for large and medium caliber gun systems. The U.S. Army Research Laboratory's subsequent confirmation and adoption of our cannon and cannon coating/ablative erosion theories and models is also chronicled. This new method, in conjunction with limited-scale firings, has greatly increased the Army's technical capability and provides a reliable and cost effective means of comprehensively studying the erosion of coated cannon bores that previously required costly full-scale firings. Our comprehensive cannon erosion theories, models, and predictions have been widely embraced by Army and Navy program managers, saving them millions of dollars, and having a far-reaching impact on gun system design, optimization, and testing. Initially we discuss our early erosion theories and limited erosion models. Then we continue in chronological order with a discussion of our first practical cannon erosion model with an advanced artillery gun system example. Next, we discuss the extension of this initial model to our first practical cannon coating/ablative erosion model with an advanced medium caliber gun system example. We then discuss the adaptation of our cannon coating/ablative erosion model to advanced tank gun systems. Finally, we conclude with a description of our recent erosion modeling efforts. The following is a description of the methodology that has been established, developed, and applied to address the current Army problem of cannon bore erosion on advanced gun systems.				
14. SUBJECT TERMS Gun System Erosion Modeling, Cannon Coating Erosion Modeling, Cannon Erosion Measuring Techniques, Medium and Large Caliber Gun Systems			15. NUMBER OF PAGES 21	
			16. PRICE CODE	
17. SECURITY CLASSIFICATION OF REPORT UNCLASSIFIED	18. SECURITY CLASSIFICATION OF THIS PAGE UNCLASSIFIED	19. SECURITY CLASSIFICATION OF ABSTRACT UNCLASSIFIED	20. LIMITATION OF ABSTRACT III	

TABLE OF CONTENTS

	<u>Page</u>
EARLY EROSION THEORIES AND LIMITED MODELS	1
FIRST PRACTICAL CANNON EROSION MODEL	3
FIRST PRACTICAL CANNON COATING/ABLATIVE EROSION MODELS.....	7
FIRST PRACTICAL TANK CANNON COATING/ABLATIVE EROSION MODELS.....	11
RECENT EROSION MODELING EFFORTS AND CONCLUSIONS.....	14
REFERENCES.....	16

LIST OF ILLUSTRATIONS

1. Flow chart of cannon coating erosion model	4
2. Typical gas/wall oxidation rate	6
3. Typical magnifying borescope data	8
4. Typical exposed substrate interface temperature	8
5. M242 erosion for Cycle A scenario at 6 inches from RFT	9
6. Nonablative M256/M829E3 erosion at 60 inches from RFT.....	13
7. Ablative M256/M829E3 erosion at 60 inches from RFT	13

EARLY EROSION THEORIES AND LIMITED MODELS

During the 1980s, we gained significant experience examining and characterizing eroded cannons to determine their erosion mechanisms that set the stage for developing our current cannon and cannon coating erosion models. In 1990, we acquired the XKTC interior ballistics (ref 1) and BLAKE thermochemistry (ref 2) gun codes from U.S. Army Research Laboratory (ARL), which provided the initial building blocks necessary to develop our cannon/cannon coating erosion models based on our cannon erosion theories. We also acquired the CET thermochemistry (ref 3), IBHVG2 interior ballistics (ref 4), and CHEMKIN chemical kinetics (ref 5) codes that year which further enhanced our capabilities.

In 1991, we were given two opportunities on crisis teams to determine erosive/ablative mechanisms and model these mechanisms with our limited thermal-thermochemical modeling capabilities. Over a three-year period, these crisis teams investigated unexpected severe cannon erosion in the experimental chromium plated 155-mm AFAS Regenerative Liquid Propellant Gun, nitrided steel 25-mm M242/M919, and chromium plated 25-mm M242/M919 gun systems. The respective baseline 155-mm AFAS (solid propellant bag and Unicharge) and 25-mm M242/M791 gun systems had normal erosion. We examined and characterized associated eroded cannons to determine their erosion and ablative mechanisms. The results of these microscopic, metallurgical, and chemical examinations/characterizations allowed us to formulate erosion theories that are widely accepted today. Using our limited erosion modeling capabilities, we conducted interior ballistic and thermochemical calculations to predict erosion for these gun systems (refs 6,7).

Etched and unetched cross-sectional samples of these baseline and experimental eroded cannons were microscopically and metallurgically characterized, both as new and after firing. The chromium plated cannons had significant mechanical wear of the chromium plate, heat checking, chromium plate cracking/pitting, and gun steel gas wash in the exposed pits at and near the bore origin. These unfired chromium plated cannons had a very fine radial crack network at all positions due to manufacturing. This crack network extended to the interface upon firing. Its radial crack density stayed essentially constant to cannon condemnation, but these cracks widened due to combustion gas heating from firing. The nitrided cannons had significant gun steel mechanical wear, gun steel heat cracking, and gun steel gas wash for the first six inches of bore travel.

We chemically and metallurgically examined unetched cross-sectional samples and residues of these fired cannons by the following techniques:

- Elemental (SEM/EDS, DRES, ICP, WDXFS)
- Molecular (Auger, ESCA)
- Thermal (TGA-FTIR, DSC-FTIR, TMA)

Turbulent combustion gas induced thermal-chemical-metallurgical degradation of the chromium plate/exposed gun steel. In turn, their degradation thresholds and their molecular decomposition products were determined.

With sufficient turbulent heating, the main contributors to the degradation of gun steel in chromium plated cannons are:

- Combustion gas-induced thermal heating (transformations, stresses, heat-check cracking)
- Diffusional-thermochemical damage (interstitials, reactions, reaction product melting)
- Pure mechanical effects

Gun steel gas/wall reaction products form a brittle scale that easily spalls and also melts at a lower temperature than gun steel metal.

We found that all degraded bore surface, radial crack/pit wall and interfacial wall locations of the fired chromium plate exposed to combustion gases universally had subsurface grain growth/recrystallization, a thin passivated semi-metallic oxide surface layer, and a nonmetallic surface residue that included iron oxide, iron sulfide, and other minor combustion products. The chromium plate is fairly inert to reactions.

We also found that all degraded bore surface, crack/pit wall, and interfacial wall locations of the fired gun steel exposed (directly or exposed through the chromium plate) to combustion gases universally had a subsurface heat-affected zone of untempered martensite, a near-surface carburized white layer, and a surface thin flaking semi-metallic oxide scale layer of the same iron oxide, iron sulfide, and other minor combustion products. Its nonmetallic surface residue also had these same chemical combustion products. Interfacial gun steel exposed to combustion gases is preferentially degraded due to its higher energy state compared to adjacent gun steel.

Carburization of gun steel (and chromium) involves the diffusion of carbon into its matrix at peak gun temperatures and pressures, thus forming a solid solution. As the system returns to room temperature, the matrix cannot physically retain the free carbon and precipitates it as iron carbide (Fe_3C). This rapid cooling causes thermal contractions between the surface austenite and the carburized subsurface tempered martensite that produces stress cracks called heat checking. Carburization degrades the gun steel by significantly lowering its melting point and inducing cracks.

Oxidation of gun steel (and chromium) involves the diffusion of oxygen and sulfur into the metal surface at peak gun temperatures and pressures, forming a distinct brittle oxide scale layer that is susceptible to cracking. This oxidation occurs despite the reducing solid propellant combustion environment. As the system returns to room temperature, this metal oxide scale layer retains the same high-temperature chemical structure. Oxidation degrades the gun steel by significantly lowering its melting point.

Rifled large caliber artillery and medium caliber cannons have a much lower erosion condemnation depth and tolerate erosion less than smoothbore large caliber tank cannons. Degradation of their bore surfaces, radial crack/pit walls, and interfacial walls was worse in the peak-eroded locations of these fired cannons. In these peak-eroded areas, chromium crack tip extension into the gun steel is slowed/blunted by erosion of the gun steel crack tips, and this

blunting is less prevalent in lesser-eroded areas. The sulfur compound erosion products are universally from black powder igniters and flash suppressants. The other minor combustion products typically include condensed phase products of additives, fillers, ablatives, and soot.

Our many and varied characterizations of fired cannons directly confirm our theories that high-temperature combustion gas products that include oxygen, carbon, and sulfur are chemically reacting with/degrading the gun steel at exposed bore surfaces, crack/pit walls, and if coated, then the interfacial walls by way of cracks/pits.

We theorize that the coating cracks are initially very narrow, allowing modest amounts of combustion gases to reach/degrade the gun steel interface by high-pressure filling. As the coating is repeatedly heated by subsequent firings, we theorize that it progressively shrinks/contracts leading to progressive crack widening. This allows significant combustion gases to reach/degrade the gun steel interface, and thereby accelerate platelet spallation and pitting. Different coating materials vary in the degree of shrinkage/contraction, distributions of crack/pit frequencies, and distributions of crack/pit widths. Linking up of this interfacial gun steel degradation at coating crack tips leads to abrupt spallation and formation of pits. Mechanical interaction between the projectile and loosened platelets assists in this pit formation. Without the coating as protection, the gun steel in these pits readily gas washes and erodes to condemnation by the same degradation mechanisms that degraded its interface. This accelerates the loss of adjacent coating platelets, thus forming larger pits.

Coating shrinkage is due to nonmetallic out-gassing/repacking from heating and yielding at the coating crack walls. Low-contractile chromium plate has less shrinkage/contraction, producing a lower crack/pit density and narrower crack widths compared to high-contractile chromium plate. These two chromium-coating types are nonequilibrium materials that tend to evolve back to equilibrium when heated or fired.

FIRST PRACTICAL CANNON EROSION MODEL

Although our customers were pleased with our previous accomplishments, we realized that we needed a more comprehensive cannon erosion modeling capability. In 1991, we searched the military, national, and international literature for a year hoping to find a more comprehensive cannon erosion code. There was an unsuccessful cannon erosion code called TBLIMP by Aerotherm from 1984 that was funded by U.S. Navy-Indian Head (ref 8). Upon further investigation, we found that poor quality BLIMP rocket calculations nearly bankrupted Aerotherm in the 1970s and 1980s. TBLIMP was based on BLIMP, and we determined that this model could not do coated cannon bores and its melt-wipe progressive ablation model lacked the thermochemical component necessary to do uncoated cannon bores.

By 1992, we had convinced ourselves that what we sought for cannons did not exist. We set our sights in a different direction looking for viable analogous rocket erosion codes. We interviewed people associated with a half dozen of the most promising potential rocket erosion code sources. It quickly became clear that only one source had the analogous rocket erosion code that we sought. By mid-1992, we realized that our co-authors at Software and Engineering

Associates, Inc. (SEA), Carson City, NV, had what we were seeking. After more than a half-year of discussions, we teamed with them to develop their rocket erosion codes (refs 9,10) into a cannon erosion code. SEA's standardized rocket codes were the necessary missing models that we needed. These codes are used throughout the industry for rocket nozzle and nose-tip erosion.

It took until March 1995 to develop our progressively ablating/eroding cannon thermal-chemical-mechanical erosion code (ref 11). Our initial modeling effort featured the previously examined/characterized baseline 155-mm AFAS Unicharge solid propellant gun system as an example (ref 6). Our updated erosion theories, models, and predictions are guided and calibrated by substantial gun system firing data and laboratory analysis of fired specimens. These data are derived from firing tests, laboratory tests, and nondestructive/destructive cannon characterizations.

Our erosion model compared different round types for the same bore material or different bore materials for the same round type. This complex computer analysis is based on rigorous scientific thermochemical erosion considerations that have been validated in the reentry nose-tip and rocket nozzle community over the last forty years. It consists of five main modules. The first two modules include the gun community's XKTC interior ballistics code (ref 1) and their nonideal gas BLAKE thermochemical equilibrium code (ref 2). The last three modules, significantly modified for gun systems, include three rocket community codes. These are the mass addition boundary layer MABL code (ref 9), gas/wall thermochemical CET code (ref 3), and the wall material ablation conduction erosion MACE code (ref 10). Our analysis provided wall temperature, ablation, and erosion profiles for each material as a function of time, axial position, and rounds/round types fired. Experimental data showed that thermomechanical effects alone did not fully explain the extent of erosion in cannon tubes, thus implying a thermochemical effect.

Figure 1 shows a flow chart of our cannon coating erosion model. The various codes, their inputs, and their outputs have respective boxes with solid borders, fine-dashed borders, and coarse-dashed borders.

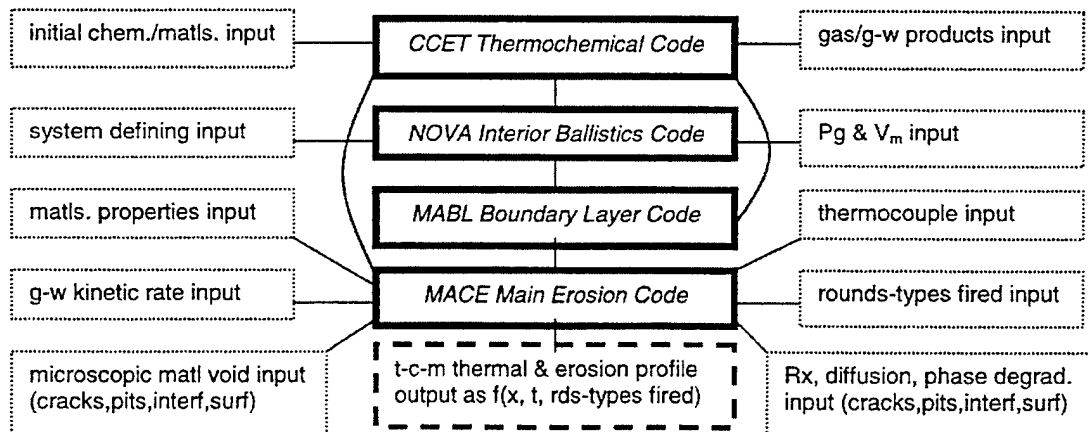

Figure 1. Flow chart of cannon coating erosion model.

Although our erosion model could only show calculations for noncracked coatings and gun steel, it was still a remarkable landmark achievement. We predicted a low rate of fire erosion results for the 155-mm AFAS Unicharge gun system with noncracked chromium and bare gun steel. The exposed bare gun steel took about 8000 rounds to achieve erosion condemnation, while the noncracked chromium plate essentially did not erode at all by 8000 rounds. Both results agreed well with firing data. In both cases, the peak-eroded position was at the bore origin. It is important to note here and for the rest of the report that distributions exist around these cannon erosion predictions.

Our cannon erosion modeling efforts have the most value to our customers when they are used in conjunction with a new gun system propellant, projectile, and/or cannon with limited firings. Field and laboratory examinations of these cannons with limited firings help calibrate our models. These calibrated erosion models can then be used to predict what has not been measured yet and what is not measurable. When we have very few measured inputs, we make many assumptions, and produce less reliable predictions. When we have many measured inputs, we make few assumptions, and produce good predictions.

The thermochemical equilibrium products are confirmed by:

- Experimental thermal gas/wall Arrhenius testing
- Experimental combustion gas analysis for metal products (gas chromatography, mass spectrometry, x-ray diffraction)
- Experimental surface/subsurface bore analysis for metal products (Auger, ESCA, WDXFS)
- Previous experimental data for combustion product species

A key point is that gun steel's oxide products melt and ablate well below those of gun steel, thus cooling the surface and somewhat inhibiting the melting of gun steel. Chemical equilibrium is a practical approximation for cannon erosion modeling, since high-pressures and temperatures generate lots of collisions, activation energy achievement, and fast reaction rates.

Due to the lack of gas/wall kinetic reaction rate data, we invented, developed, and/or applied various kinetic rate characterization techniques (TGA-FTIR, DSC-FTIR, and others) to study the reactions of combustion gases with bore materials. These included gas/wall degradation thresholds and reaction rates as a function of temperature, pressure, and time. Reaction rate is a weak function of pressure. Low pressure flow of propellant gases is compensated by the extreme sensitivity of these instruments. These Arrhenius gas/wall techniques determine degradation thresholds of bore coating and substrate materials for their transformation, carburization, oxidation-scale, other reactions, oxide melting, and metal melting thresholds. Figure 2 shows typical normalized gas/wall coating and substrate steel oxidation rate data as a function of wall temperature for an advanced tank gun system.

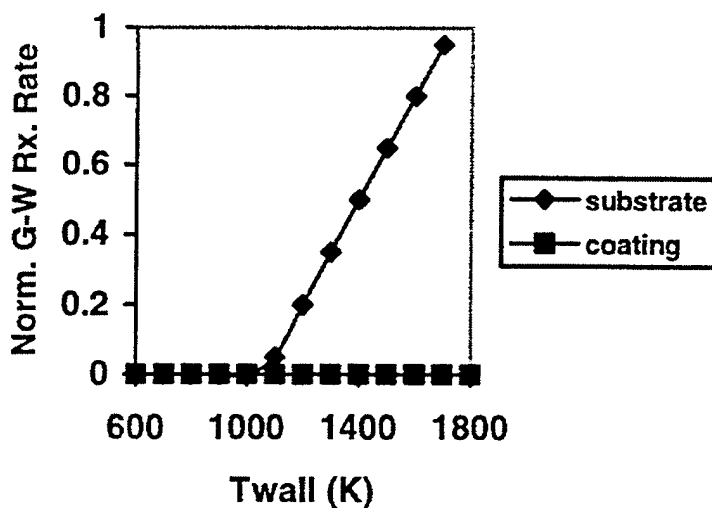

Figure 2. Typical gas/wall oxidation rate.

Previously, ARL provided us with copies of their BLAKE and XKTC codes. In turn, on multiple occasions in 1995, we provided ARL with presentations and descriptions of our cannon erosion theories, mechanisms, and models. In March 1995, we first presented our cannon erosion theories, mechanisms, and models to Keller, Montgomery, and Conroy of ARL at a small ARDEC-ARL gun erosion workshop (ref 11). In June 1995, we again presented and Army-wide published this same information at the annual ARDEC-ARL Gun Propulsion Review Meeting (ref 12) that included Keller, Conroy, and many other ARL modeling personnel. In July 1995, we further presented and internationally published a description of our practical cannon erosion theories, mechanisms, and models at an AIAA Joint Propulsion Conference (ref 13). Prior to our July 1995 AIAA presentation and paper, no other organization within or outside the U.S. Army had a practical gun erosion model or code. This is supported by ARL's lack of an erosion model or code in their March and June 1995 presentations and papers (refs 14,15). From 1995 to 2001, our references in this report describe capabilities and results of our erosion modeling and measuring efforts, but the referenced papers do not tell how to make these models and devices.

In October 1995 at the JANNAF Combustion Meeting, Conroy et al. (ref 16) presented a paper on ARL's gun tube erosion model. It appears that our cannon erosion theories, mechanisms, and models were subsequently confirmed and adopted by them by modifying analogous codes available at ARL. They used XKTC and IBHVG2 codes for core flow, the Blake and CET codes for thermochemistry, and the XBR-2D code for convective/conductive heat transfer, surface binary diffusion, surface reactions, melt-wipe ablation, and multi-round gun tube erosion.

From the M256/M829A1 gun system example in their initial erosion modeling paper, it appears that ARL was not fully able to implement our cannon erosion model in about a dozen key areas. Variable values instead of constant values are required for the density-specific heat-conductivity material inputs. Chromium plate protection must be included despite its cracking and eventual spalling. The exposed gun steel substrate must be eroded by a full gas/wall thermochemical model, instead of a lesser melt-wipe model. ARL's erosion model needs to

include combustion gas/exposed gun steel reactions at threshold temperature onsets, reaction product melting at higher-threshold temperature onsets, and exposed gun steel melting at still higher-threshold temperature onsets. The model needs to include a turbulent reacting boundary layer with mass addition and gas/wall kinetic rate functions to supplement gas/wall chemical equilibrium. In addition, their model must allow reaction energy to provide all the energy for future reactions and melting. Their erosion model is film coefficient driven for energy when it should be enthalpy driven and highly dependent on all species and reactions chosen. They need an exposed gun steel ablation and erosion gas/wall products model. This model should include the reacting/melting of the gas/wall iron oxidation products (particularly FeO and FeS) and of the gas/wall iron carburization products (particularly Fe₃C).

In December 1995 and June 1996, we further presented and published these same practical cannon erosion theories, mechanisms, and models (refs 17,18).

FIRST PRACTICAL CANNON COATING/ABLATIVE EROSION MODELS

Although our customers were further pleased with our accomplishments, we realized that we needed a more comprehensive cannon erosion modeling capability that better addressed our erosion theories and mechanisms for chromium plated gun steel. It took us until May 1996 to develop our cannon coating erosion model. In May 1996, we presented and published results of our nonablative and ablative cannon coating erosion models (ref 19) using the previously examined/characterized 25-mm M242 gun system as an example (ref 7). Although we applied our models to the M242 chromium plated cannon, we did not publish a description of these models until 1999 after gaining significant confidence. Our modeling efforts provide a means for evaluating the erosive nature of candidate charges, protective nature of candidate cannon bore coatings, and protective nature of ablatives.

Destructive micrographic examination/characterization techniques historically gave only one important snapshot of erosion as a function of axial position at the end of a cannon's life. As a result of this deficiency, in 1996 we invented, developed, and applied a nondestructive magnifying borescope characterization technique to monitor the cannon bore substrate exposure and erosion as a function of axial position and rounds/round types fired. Figure 3 shows typical substrate exposure data from a magnifying borescope as a function of axial position at various stages of an advanced tank gun system's life. Our monitoring of substrate exposure and erosion through a cannon's life is because of the lack of a thermal-mechanical crack/pit model. Substrate exposure is based on crack/pit frequency, coating shrinkage/contraction, and crack/pit widths. Our magnifying borescope technique was chronologically used on the following programs:

- PM-Bradley M242/M919 (ARDEC-Benet Laboratories, 1996)
- PM-TMAS M256/ M829E3 (TECOM-APG, 1997)
- PM Crusader XM297/ MACS (TECOM-Yuma, 2001)

Even in the absence of erosion modeling, periodic magnifying borescope monitoring throughout a cannon's life says volumes about its erosion progression.

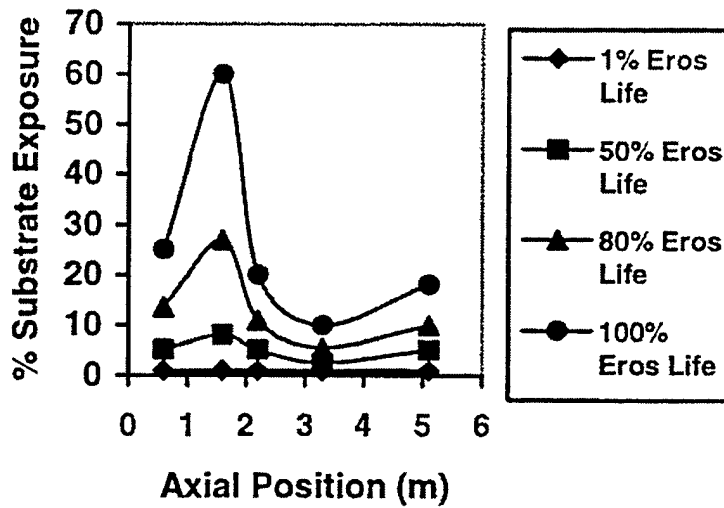

Figure 3. Typical magnifying borescope data.

We have further discovered that magnifying borescope subsurface exposure measurements allow us to calculate conductive and convective exposed gun steel interface temperatures at the base of coating crack/pits as a function of axial position and rounds/round types fired. Figure 4 shows typical exposed substrate interface temperatures as a function of coating crack/pit width for selected advanced tank gun system axial positions. Based on these exposed gun steel interface temperatures, we thermally, metallurgically, and thermochemically use the model to degrade the exposed gun steel substrate interface through the coating cracks/pits, producing coating platelet spallation and subsequent exposed gun steel gas wash-to-condemnation.

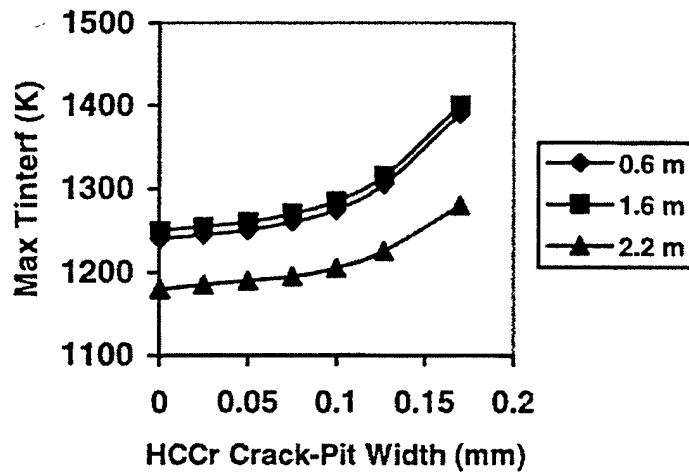

Figure 4. Typical exposed substrate interface temperature.

Benet Laboratories also employs a complementary evaluation technique called the LOTIS system. Typical LOTIS system resolution is about 0.0100-inch (typically ranges from 0.0070 to 0.0150-inch), but it cannot measure typical crack/pit widths, crack/pit frequencies, or pit initiation that ranges from 0.0001 to 0.0010-inch. Even though it fails to measure crack/pit initiation/development, the LOTIS system is a valuable tool that can measure erosion depths of much smaller pits than the standard Benet Laboratories erosion gage.

The M242 cannon coating modeling efforts predicted erosion for exposed bare gun steel, nitrided gun steel, and most importantly, chromium plated gun steel, which was a remarkable achievement. Figure 5 shows typical rounds-to-erosion condemnation for various round type/bore type configurations associated with the M242/M919 Program using the Cycle A firing scenario at the 6-inch from rear face of the tube (RFT) peak-eroded position. The round type/wall material combinations shown are:

- M919 (HES9053)/nitrided gun steel
- M919 (HES9053)/0.002-inch chromium plated gun steel
- M791/nitrided gun steel
- M919 (type-classified)/0.002-inch chromium plated gun steel

It took about 400, 800, 4000, and 5000 rounds to achieve erosion condemnation for these four respective round type/wall material combinations, which agreed well with firing data.

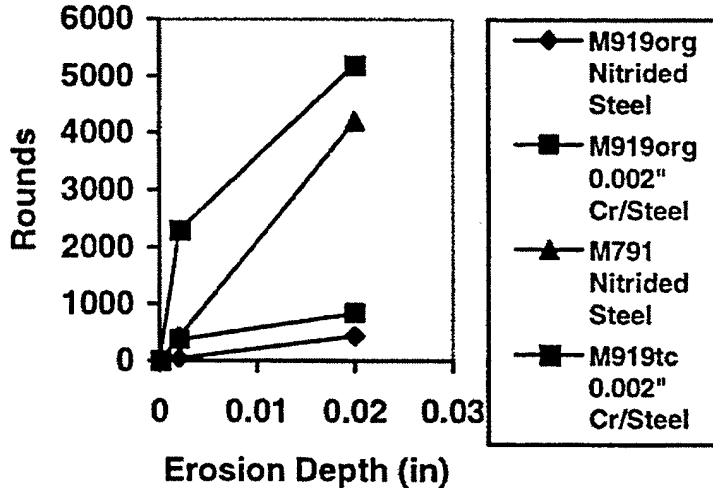

Figure 5. M242 erosion for Cycle A scenario at 6 inches from RFT.

Based on the next presentations and papers on ARL's gun tube erosion model from May 1996 through July 1996 (refs 20-23), it appears that our cannon coating erosion theories, mechanisms, and models were subsequently confirmed and adopted by them. The latter two papers additionally modify analogous codes available at ARL. They used enhanced XKTC and IBHVG2 codes for core flow, enhanced Blake and CET codes for thermochemistry, and the enhanced XBR-2D code for convective/conductive heat transfer, surface binary diffusion,

surface reactions, melt-wipe ablation, and multi-round gun tube erosion. They supplemented these calculations by adding Janke's ETC extension to the IBHVG2 code called the IBBLAKE code (ref 24) and by adding a pyrolysis model so the reaction products could be solids, liquids, and gases.

From the M829A1 and M829E3 tank round examples in the last four papers, it appears that they were still not fully able to implement our cannon/cannon coating erosion models in the same key areas mentioned above with the following exceptions. They adopted a variant of our gas/solid phase conceptual diagram. The exposed gun steel substrate still needs to be eroded by a gas/wall thermochemical model instead of their lesser melt-wipe (stated as ~99%) and pyrolysis (stated as ~1%) model. They added a lesser iron oxide gas/wall product (incorrectly Fe_3O_4 instead of FeO) model, but failed to include an iron carbide gas/wall product (Fe_3C) model.

During the period October 1996 through July 1997, we presented and published further results of our nonablative and ablative cannon coating erosion models (refs 25,26) using the same previously examined/characterized 25-mm M242 gun system examples (ref 7). We assisted in the type classification of the M919 round by modeling its erosion life for the various configurations compared to the baseline configuration. Our M919 erosion modeling efforts made it possible to reject many configurations without firing tests, thus resulting in significant Army savings. The final type classified configuration increased erosion life by an order-of-magnitude over the initial experimental M919 (HES9053) round and equaled the baseline M791 round. This final configuration included an HES9053/HC33 propellant mix, an ablative, and chromium plating.

In July 1996, we presented and published our erosion-related theories and mechanisms on environmental-assisted cracking of cannon bore materials (ref 27). The RegenerativeLiquid Propellant Gun environmental-assisted cracking modeling effort contributed to the demise of this gun system, resulting in significant Army savings. In October 1996, we presented and published two more erosion modeling-related papers. The first (ref 28) included transformation of the NASA-Lewis ideal gas CET thermochemical equilibrium code (ref 3) into the robust-compressible CCET code by combining it with BLAKE and TIGER (ref 2). The second (ref 29) included the Navy 5-Inch-54/EX99 gun system analysis versus its Navy 5-Inch-54/NACO gun system baseline. The Navy 5-Inch-54/EX99 gun system erosion modeling effort made it possible to reject numerous design configurations without firing tests, also resulting in significant Navy savings.

FIRST PRACTICAL TANK CANNON COATING/ABLATIVE EROSION MODELS

In 1996, our M256 cannon erosion characterizations, theories, and modeling efforts for various M829E3 propellants detailed how their associated M256 cannons failed dramatically and prematurely. These erosion-related efforts became the cornerstone justification and then guideline for the TACOM-ARDEC Wear and Erosion Program, which focuses on refractory metal sputtered coatings. This guidance played a significant role in determining refractory metal sputtered coating types and properties, which resulted in significant Army savings. Our effort on every important artillery, tank, and medium caliber gun system since 1992 contributed to this guidance.

Although customers continued to be pleased with our accomplishments, we realized that we needed a cannon coating erosion model for large caliber, chromium plated smoothbore tank gun systems. It took us until the spring of 1997 to develop this enhanced cannon coating erosion model, which calculated large caliber, chromium plated smoothbore tank cannon erosion in a manner similar to that used for rifled medium caliber, chromium plated cannons.

From April 1997 through November 2000, we presented and published several cannon coating erosion modeling and erosion effective full charge (EFC) factor predictions (refs 30-39). These predictions were for a variety of rounds (M865, M829, M829A1, M829A2, various HEAT, and various M829E3-type rounds) used in the chromium plated M256 tank cannon. The erosion EFC factors allow the Army to better manage their M256 tank cannon inventory, resulting in significant Army savings. Developing erosion mechanism theories for newly examined and characterized 120-mm M256 gun systems that have fired these rounds supported the predictions. These nondestructive and destructive thermal, metallurgical, and chemical examinations/characterizations were based on techniques used for previous artillery and medium caliber gun systems (refs 6,7). We used our nonablative and ablative cannon coating models for predicting erosion of the M256 round types. In 1999, after gaining significant confidence, we published a description of these models. The ablative-like components of this analysis include the initial bore-protecting 1600°K combustible case gases and the further bore-protecting paste ablative. They each protect the start of the bore from extreme heating and each move the peak heating position farther down bore, where the heating is less extreme. We also determined that the muzzle wear was purely mechanical erosion.

Our M256 cannon coating erosion modeling efforts for chromium plated gun steel in smoothbore tank cannons was a further landmark achievement and included the evaluation of hot, ambient, and cold round-conditioning temperatures. Our erosion predictions for the M256/M829A2 gun system included about 350 (120°F round-conditioning temperature), 500 (70°F), and 775 (-25°F) rounds to achieve erosion condemnation at the 85-inch from RFT peak-eroded position. Our erosion predictions for the M256/M829 gun system included about 500 (120°F round-conditioning temperature), 750 (70°F), and 1200 (-25°F) rounds to achieve erosion condemnation at the 95-inch from RFT peak-eroded position. The M829A2 and M829 erosion predictions agreed well with firing data for this 0.005-inch chromium plated M256 cannon.

We assisted in the optimization of various experimental M82E3 rounds used in the M256 cannon including propellant, case, and ablative configurations. Our M829E3 erosion modeling efforts made it possible to reject many design configurations without firing tests, resulting in significant Army savings. We determined that M829E3 cannon erosion was much more severe than its M829A2 counterpart, that M829E3 peak erosion moved up-bore a half meter more than its M829A2 counterpart, and that HEAT rounds in combination with M829E3 rounds moved the M829E3 peak-eroded position farther up-bore to the origin. Additionally, we predicted the effects of an ablative on erosion. This was supported by paste decomposition and paste viscosity degradation measurements as a function of increasing temperature. We described our model for determining the exposed substrate interface temperature for a given crack/pit width using conductive and convective elements. We determined degradation thresholds of materials for transformation, oxidation, reactions, carburization, oxide melting, and material melting. We also used diffusion-controlled transformation codes for multi-component gun steel transformation calculations. Finally, we observed that tank, artillery, and medium caliber cannon erosion positionally correlates with maximum interface degradation and maximum substrate exposure, but not necessarily with maximum crack/pit depth or maximum transformation depth.

Figure 6 shows typical predicted rounds-to-erosion condemnation for various round-conditioning temperatures associated with the nonablative M256/M829E3 gun system at the 60-inch from RFT peak-eroded position. Our erosion predictions indicated that it took about 130 (120°F round-conditioning temperature), 210 (70°F), 190 (-25°F), and 170 (equal distribution of round-conditioning temperatures) M829E3 rounds to achieve erosion condemnation. We also predicted erosion results for the M256 cannon firing a nonablative mixture of M829E3 and HEAT rounds. Our erosion predictions indicated that it took about 120 (120°F round-conditioning temperature), 200 (70°F), 180 (-25°F), and 160 (equal distribution of round-conditioning temperatures) M829E3 rounds to achieve erosion condemnation at the 25-inch from RFT peak-eroded position. Similarly, Figure 7 shows typical predicted rounds-to-erosion condemnation for various round-conditioning temperatures associated with the ablative M256/M829E3 gun system at the 60-inch from RFT peak-eroded position. Our erosion predictions indicated that it took about 240 (120°F round-conditioning temperature), 390 (70°F), 350 (-25°F), and 315 (equal distribution of round-conditioning temperatures) M829E3 rounds to achieve erosion condemnation. All of these erosion predictions agreed well with firing data.

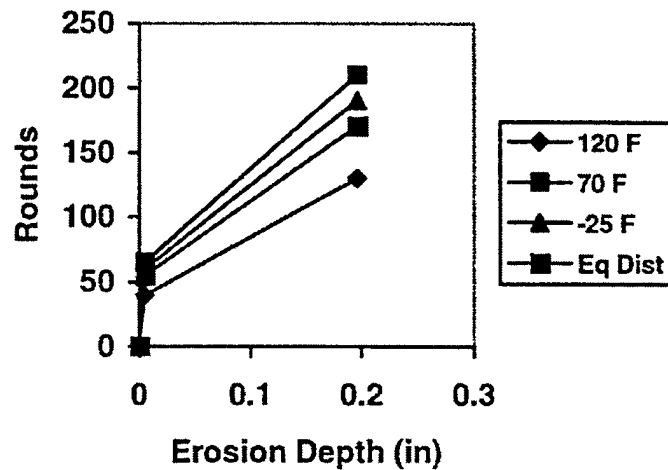

Figure 6. Nonablative M256/M829E3 erosion at 60 inches from RFT.

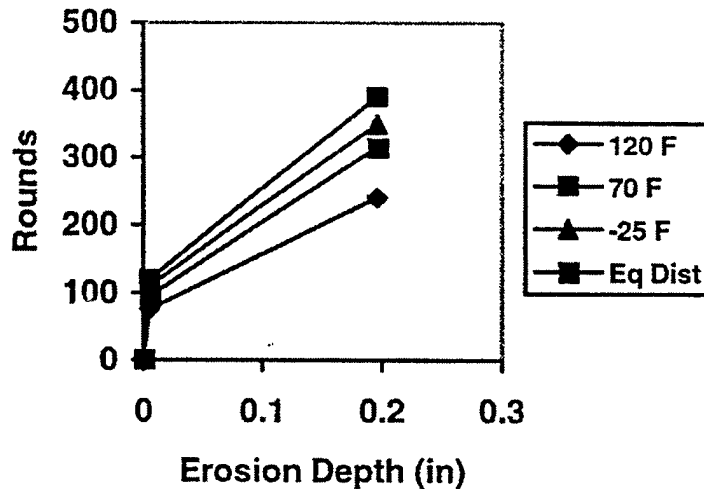

Figure 7. Ablative M256/M829E3 erosion at 60 inches from RFT.

Based on work by Cote (refs 40,41) and Cote and Rickard (refs 42,43) in 1999 and 2000, it appears that our cannon/cannon coating theories and mechanisms (thermal, metallurgical, thermochemical, and mechanical) mentioned earlier were completely confirmed. Dr. Cote and his associate did a remarkable and comprehensive investigation of tank cannon, artillery cannon, and medium caliber cannon erosion mechanisms. They confirmed our theories and mechanisms of cannon erosion, including theories detailing thermal, metallurgical, and thermochemical damage to the exposed chromium plated gun steel at surface layers, crack/pit wall layers, and interfacial wall layers.

Cote and Rickard used similar characterization techniques (microscopy, SEM-EDS, and atomic electron microprobe analysis) to find what they called "heat-affected zones, gray layers, and white layers" (our heat-affected zones, wall layers, and white layers), which formed with sufficient heating and consisted of the same iron oxides, sulfides, and carbide compounds. They also found, as we did earlier, that the initiation of chemical attack of the exposed gun steel substrate interface begins at the tips of the narrow chromium cracks by combustion gas/gun steel wall oxidation reactions. These reactions form semi-metallic layers on the exposed gun steel walls consisting of iron oxide and iron sulfide. They also confirmed our findings that as the coating progressively shrinks/contracts, the radial cracks progressively widen, and accelerate the linking up of substrate interfacial damage at crack tips. This leads to coating platelet spalling/pitting and subsequent substrate gas wash of these pits.

Between October 1997 and November 2000, Conroy et al. (refs 44-48) presented several papers on ARL's gun tube erosion model. It appears that our cannon coating erosion theories, mechanisms, and models were further confirmed and adopted by them by additionally modifying analogous codes available at ARL. They further enhanced their XKTC, IBHVG2, IBBLAKE, BLAKE, CET, and XBR-2D codes.

Conroy et al. (refs 44-48) used the M829A1, M829A2, M829E3, M791, 616W, Navy 5-Inch-62/NACO, Navy 5-Inch-62/M30A1, and Navy 5-Inch-62/EX99 round examples in their last five papers. However, they were still not fully able to implement our cannon/cannon coating erosion models in the same key areas mentioned above, with the following exceptions. They adopted a variant of our gas/solid phase conceptual diagram. They also added variable temperature-dependent material input values for density, specific heat, and conductivity. They added a surface roughness model to address chromium plated gun steel pitting, but still ignored lesser subsurface exposure such as progressive radial crack widening of the chromium plate. They improved their pyrolysis model to include a higher percentage of ablation-related gas/wall chemical reaction products. This now makes it a more balanced melt-wipe and pyrolysis model. Conroy et al. then included a subsurface-interfacial multi-component diffusion and reaction model, now realizing that gun steel degradation is important at the chromium crack tips and exposed gun steel interfaces. They further updated a lesser iron oxide gas/wall product model (incorrectly Fe_3O_4 instead of FeO) and correctly included an iron carbide gas/wall product model (Fe_3C). They need to calculate the effect on erosion of the Navy 5-Inch-62/EX99 and Army M829E3 gun system ablatives that were deposited on the bore surface of these cannons. They added a finite rate thermochemistry model, which we also have but do not use due to the lack of available input data.

RECENT EROSION MODELING EFFORTS AND CONCLUSIONS

In 1999, we developed a robust time-dependent gun tube boundary layer (GTBL) code (ref 49) to complement and eventually replace our current steady-state gun tube mass addition boundary layer (MABL) code (ref 9). In that same year, when conventional interior ballistic models failed us, we successfully began using the GTBL code for future combat system rarefaction wave gun (RAVEN) systems. In these RAVEN systems, high-velocity combustion gases exit both a breech venting nozzle for recoil reduction, as well as the conventional muzzle

venting after projectile exit (refs 50-53). From 1999 to 2000, we conducted an extensive erosion modeling effort for the U.S. Navy Advanced Gun System (AGS); the results are proprietary, and are only published in very limited distribution. These RAVEN and AGS modeling efforts made it possible to reject design configurations without firing tests, resulting in significant savings for the respective programs.

In the last ten years, the Army and Navy's quest for increased performance has resulted in significant cannon erosion on their advanced gun systems. We have assisted or are currently assisting in the design, optimization, testing, characterization, and/or type classification of the advanced: M242/M919, M256/M829A2, M256/M829E3, Navy 5-Inch/EX99, Navy AGS, XM297/MACS, and FCS-RAVEN gun systems. Applications of this method have led to:

- Identification of erosive gun system design configurations prior to testing or with limited testing
- Optimization of gun system design configurations to minimize erosion and increase life
- Comparison of competing gun system design configurations
- Guidance/justification of coating and charge design programs
- Prediction of round type specific erosion EFC factors for inventory management
- Prediction of what otherwise has not been or cannot be measured in gun systems

REFERENCES

1. Gough, P., "The XNOVAKTC Code," Paul Gough Associates, Portsmouth, NH, U.S. Army BRL-CR-627, February 1990.
2. Freedman, E., "BLAKE - A Thermodynamic Code Based on Tiger: User's Guide and Manual," U.S. Army BRL-TR-02411, Aberdeen, MD, 1982.
3. Gordon, S., and McBride, B., "Computer Program for Calculation of Complex Chemical Equilibrium Compositions, Rocket Performance, Incident and Reflected Shocks, and Chapman-Jouguet Detonations (CET)," NASA Lewis SP-273, Cleveland, OH, 1971.
4. Anderson, R., and Fickie, K., "IBHVG2 - A User's Guide," U.S. Army BRL-TR-2829, Aberdeen, MD, 1987.
5. "CHEMKIN User's Guide Code," U.S. DOE-SNL Manual, Sandia, NM, 1990 and 1997.
6. Thornton, P., Senick, J., Underwood, J., Sopok, S., and Cox, J., "LP Gun No. 2 Materials/Failure Analysis," U.S. Army ARDEC Special Publication SP92-1, Watervliet, NY, 1992.
7. Capsimalis, G., Cox, J., O'Hara, P., Witherell, M., Sopok, S., Underwood, J., Pflagl, G., and Cote, P., "M242/ M919 Multi-Disciplinary Analyses," U.S. Army ARDEC Special Publication SP92-2, Watervliet, NY, 1992.
8. Evans, M., "User's Guide for Transient Boundary Layer Integral Matrix Procedure TBLIMP," Aerotherm UM-74-55, Prepared for U.S. Navy Indian Head, Mountain View, CA, October 1984.
9. Levine, J., "Transpiration and Film Cooling Boundary Layer Computer Program (MABL) - Numerical Solution of the Turbulent Boundary Layer Equations with Equilibrium Chemistry," NASA Marshall N72-19312, Huntsville, AL, June 1971.
10. Dunn, S., "Materials Ablation Conduction Erosion Program (MACE)," Software and Engineering Associates, Inc., Carson City, NV, June 1989.
11. Sopok, S., "First Gun Erosion Modeling Code," *Proceedings of ARDEC/ARL Gun Erosion Workshop*, Stanhope, NJ, March 1995.
12. Sopok, S., "First Gun Erosion Modeling Code", *Proceedings of 8th ARDEC/ARL Gun Propulsion Review Meeting*, Pocono Manor, PA, June 1995.

13. Dunn, S., Sopok, S., Coats, D., O'Hara, P., Nickerson, G., and Pflagl, G., "Unified Computer Model for Predicting Thermochemical Erosion in Gun Barrels," *Proceedings 31st AIAA Joint Propulsion Conference*, San Diego, CA, July 1995; Also: Sopok, S., Dunn, S., Coats, D., O'Hara, P., and Pflagl, G., "Unified Computer Model for Predicting Thermochemical Erosion in Gun Barrels," *Journal of Propulsion and Power*, Vol. 15, No. 4, July 1999.
14. Keller, G., and Conroy, P., "Gun Tube Erosion," *Proceedings of ARDEC/ARL Gun Erosion Workshop*, Stanhope, NJ, March 1995.
15. Keller, G., and Conroy, P., "Gun Tube Erosion," *Proceedings of 8th ARDEC/ARL Gun Propulsion Review Meeting*, Pocono Manor, PA, June 1995.
16. Conroy, P., Weinacht, P., and Nusca, M., "ARL Tube Erosion Code," *Proceedings of 32nd JANNAF Combustion Meeting*, Huntsville, AL, October 1995.
17. Sopok, S., Dunn, S., O'Hara, P., Coats, D., and Pflagl, G., "First Computer Model for Predicting Thermochemical Erosion in Gun Barrels," *Proceedings of JANNAF Propulsion Meeting*, Tampa, FL, December 1995.
18. Sopok, S., Dunn, S., O'Hara, P., Coats, D., and Pflagl, G., "First Computer Code for Predicting Thermochemical Erosion in Gun Barrels," *Proceedings of 20th Army Science Conference*, Norfolk, VA, June 1996.
19. Sopok, S., O'Hara, P., Pflagl, G., Dunn, S., and Coats, D., "Thermochemical Erosion Modeling of M242 Gun Systems," *Proceedings of 8th U.S. Army Symposium on Gun Dynamics*, Newport, RI, May 1996.
20. Keller, G., and Conroy, P., "ARL White Paper on Gun Barrel Erosion," U.S. Army ARL Report, Aberdeen, MD, May 1996.
21. Conroy, P., Weinacht, P., and Nusca, M., "Surface Chemistry Effects on High Performance Tank Ammunition," *Proceedings of 8th U.S. Army Symposium on Gun Dynamics*, Newport, RI, May 1996.
22. Conroy, P., Weinacht, P., and Nusca, M., "Direct Fire Gun Tube Erosion Calculations," *Proceedings of 20th Army Science Conference*, Norfolk, VA, June 1996.
23. P. Weinacht, P. Conroy, "A Numerical Method for Predicting Thermal Erosion in Gun Tubes," U.S. Army ARL-TR-1156, Aberdeen, MD, July 1996.
24. Janke, P., Dyvik, J., and Marksberry, C., "Electrothermo-Chemical Propellant Extension to IBHVG2 Interior Ballistic Simulation: Model Development and Validation," *Proceedings of 31st JANNAF Combustion Meeting*, Monterey, CA, October 1994.

25. Sopok, S., O'Hara, P., Pflegl, G., Dunn, S., and Coats, D., "Thermochemical Erosion Modeling of the Original M242/M919 Gun System," *Proceedings of 33rd JANNAF Combustion Meeting*, Monterey, CA, October 1996.
26. Sopok, S., O'Hara, P., Pflegl, G., Dunn, S., and Coats, D., "Thermochemical Erosion Modeling of the 25-mm M242/M791 Gun System," *Proceedings of 33rd AIAA Joint Propulsion Conference*, Seattle, WA, July 1997.
27. Sopok, S., and O'Hara, P., "Chemical Factors Associated with Environmental-Assisted Cracking of Generic Gun Systems - RLPGs, Tanks, and Howitzers," *Proceedings of 32nd AIAA Joint Propulsion Conference*, Lake Buena Vista, FL, July 1996.
28. Coats, D., Dunn, S., Sopok, S., O'Hara, P., and Pflegl, G., "A New Chemical Equilibrium Code with Compressibility Effects," *Proceedings of 33rd JANNAF Combustion Meeting*, Monterey, CA, October 1996.
29. Dunn, S., Coats, D., Sopok, S., O'Hara, P., and Pflegl, G., "Thermochemical Erosion in the Navy 5-Inch 54 Caliber Gun," *Proceedings of 33rd JANNAF Combustion Meeting*, Monterey, CA, October 1996; Also U.S. Navy Indian Head CR 99-71, Indian Head, MD, 1999.
30. Sopok, S., O'Hara, P., Vottis, P., Pflegl, G., Rickard, C., and Loomis, R., "Erosion Modeling of the 120-mm M256/M829A2 Gun System," *Proceedings of 32nd ADPA Gun and Ammunition Meeting*, San Diego, CA, April 1997.
31. Sopok, S., and O'Hara, P., "Modeling of Erosive Combustion Products Affecting the 120-mm M256/M829A2 Gun System," *Proceedings of 34th JANNAF Combustion Meeting*, West Palm Beach, FL, October 1997.
32. Sopok, S., Vottis, P., O'Hara, P., Pflegl, G., and Rickard, C., "Comprehensive Erosion Model for the 120-mm M256/M829A2 Gun System," *Proceedings of 29th CH/GE/NL/US 120-mm Joint Configuration Board Meeting*, Hampton, VA, April 1998.
33. Sopok, S., Vottis, P., O'Hara, P., Pflegl, G., and Rickard, C., "Shot-by-Shot Erosion Modeling of Retired 120-mm M256 Tube #1988," *Proceedings of 34th AIAA Joint Propulsion Conference*, Cleveland, OH, July 1998.
34. Sopok, S., Vottis, P., O'Hara, P., Pflegl, G., and Rickard, C., "Comprehensive Erosion Model for the 120-mm M256/M829 Gun System," *Proceedings of JANNAF Propulsion Meeting*, Cleveland, OH, July 1998.
35. Sopok, S., Vottis, P., Pflegl, G., and Rickard, C., "Erosion Modeling of Fielded 120-mm M256/M829A2 Gun Systems," *Proceedings of CH/FR/GE/NL/US High Performance Tank and Artillery Gun Erosion Conference*, Bundesamt fur Wehrtechnik und Beschaffung, Koblenz, Germany, October 1998.

36. Sopok, S., and Billington, R., "Erosion EFC Factors for Kinetic Energy Rounds Used in the 120-mm M256 Tank Cannon," *Proceedings of 35th AIAA Joint Propulsion Conference*, Los Angeles, CA, June 1999.
37. Sopok, S., Loomis, R., Pflegl, G., and Rickard, C., "Preliminary Erosion Analysis for the Experimental M829E3 Kinetic Energy Round," *Proceedings of 36th JANNAF Combustion Meeting*, Cocoa Beach, FL, October 1999.
38. Sopok S., "Cannon Coating Erosion Model with Updated M829E3 Example," *Proceedings of 36th AIAA Joint Propulsion Conference*, Huntsville, AL, June 2000.
39. Sopok, S., and Fleszar, M., "Ablative Erosion Model for the M256/M829E3 Gun System," *Proceedings of 37th JANNAF Combustion Meeting*, Monterey, CA, November 2000.
40. Cote, P., "Fools Gold, Soot, Wurtzite and Talc in the Degradation of Gun Bore Surfaces," Presented at Benet Laboratories Technology Seminar, Watervliet, NY, April 1999.
41. Cote, P., "Initiation of Chrome Loss on Gun Bore Surfaces," Presented at Benet Laboratories Technology Seminar, Watervliet, NY, September 1999.
42. Cote, P., and Rickard, C., "Gas-Metal Reaction Products in the Erosion of Chromium Plated Gun Bores," *Wear*, Vol. 241, Issue No. 1, June 2000, pp. 17-35.
43. Cote, P., and Rickard, C., "Gray Layers and the Erosion of Chromium Plated Gun Bore Surfaces," U.S. Army ARDEC Technical Report ARCCB-TR 99016, Benet Laboratories, Watervliet, NY, September 1999.
44. Conroy, P., Weinacht, P., and Nusca, M., "A Parametric Erosion Investigation," *Proceedings of 34th JANNAF Combustion Meeting*, West Palm Beach, FL, October 1997; Also U.S. Army ARL-TR-1954, Aberdeen, MD, June 1999.
45. Conroy, P., Weinacht, P., Nusca, M., and Rice, K., "Extended Range 5" Navy Gun, Theoretical Thermal and Erosion Investigations," *Proceedings of 24th TTCP WPN/TP4 Meeting*, Indian Head, MD, April 1999.
46. Conroy, P., Weinacht, P., and Nusca, M., "An Investigation of the Erosion Physics/Mechanisms of Current Army Systems (Point Studies)," U.S. Army ARL-TR-2054, Aberdeen, MD, September 1999.
47. Conroy, P., Weinacht, P., and Nusca, M., "Gun Tube Coatings in Distress," *Proceedings of 36th JANNAF Combustion Meeting*, Cocoa Beach, FL, October 1999.

48. Conroy, P., Nusca, M., Chabalowski, C., and Anderson W., "Gun Tube Erosion Macroscopic Surface Kinetics (Initial Study)," *Proceedings of 37th JANNAF Combustion Meeting*, Monterey, CA, November 2000.
49. Dunn, S., Coats, D., and Sopok, S., "Gun Tube Boundary Layer Code (GTBL)," Software and Engineering Associates, Inc., Carson City, NV, 1999.
50. Kathe, E., and Dillon, R., "RArefaction waVE guN (RAVEN)," *Proceedings of 35th NDIA Guns and Ammunition Symposium*, Williamsburg, VA, May 2000.
51. Kathe, E., Dillon, R., Sopok, S., Witherell, M., Dunn, S., and Coats, D., "Rarefaction Wave Gun Propulsion," *Proceedings of 37th JANNAF Combustion Meeting*, Monterey, CA, November 2000.
52. Kathe, E., Dillon, R., Sopok, S., Witherell, M., Dunn, S., and Coats, D., "Rarefaction Wave Gun Propulsion," *Proceedings of 22nd Army Science Conference*, Baltimore, MD, December 2000.
53. Kathe, E., and Dillon, R., "Sonic Rarefaction Wave Low Recoil Gun," *Proceedings of 39th AIAA Aerospace Sciences Meeting*, Reno, NV, January 2001.

TECHNICAL REPORT INTERNAL DISTRIBUTION LIST

	<u>NO. OF COPIES</u>
TECHNICAL LIBRARY ATTN: AMSTA-AR-CCB-O	5
TECHNICAL PUBLICATIONS & EDITING SECTION ATTN: AMSTA-AR-CCB-O	3
OPERATIONS DIRECTORATE ATTN: SIOWV-ODP-P	1
DIRECTOR, PROCUREMENT & CONTRACTING DIRECTORATE ATTN: SIOWV-PP	1
DIRECTOR, PRODUCT ASSURANCE & TEST DIRECTORATE ATTN: SIOWV-QA	1

NOTE: PLEASE NOTIFY DIRECTOR, BENÉT LABORATORIES, ATTN: AMSTA-AR-CCB-O OF ADDRESS CHANGES.

TECHNICAL REPORT EXTERNAL DISTRIBUTION LIST

	<u>NO. OF COPIES</u>		<u>NO. OF COPIES</u>
DEFENSE TECHNICAL INFO CENTER ATTN: DTIC-OCA (ACQUISITIONS) 8725 JOHN J. KINGMAN ROAD STE 0944 FT. BELVOIR, VA 22060-6218	2	COMMANDER ROCK ISLAND ARSENAL ATTN: SIORI-SEM-L ROCK ISLAND, IL 61299-5001	1
COMMANDER U.S. ARMY ARDEC ATTN: AMSTA-AR-WEE, BLDG. 3022 AMSTA-AR-AET-O, BLDG. 183 AMSTA-AR-FSA, BLDG. 61 AMSTA-AR-FSX AMSTA-AR-FSA-M, BLDG. 61 SO AMSTA-AR-WEL-TL, BLDG. 59 PICATINNY ARSENAL, NJ 07806-5000	1 1 1 1 1 2	COMMANDER U.S. ARMY TANK-AUTMV R&D COMMAND ATTN: AMSTA-DDL (TECH LIBRARY) WARREN, MI 48397-5000 COMMANDER U.S. MILITARY ACADEMY ATTN: DEPT OF CIVIL & MECH ENGR WEST POINT, NY 10966-1792	1
DIRECTOR U.S. ARMY RESEARCH LABORATORY ATTN: AMSRL-DD-T, BLDG. 305 ABERDEEN PROVING GROUND, MD 21005-5066	1	U.S. ARMY AVIATION AND MISSILE COM REDSTONE SCIENTIFIC INFO CENTER ATTN: AMSAM-RD-OB-R (DOCUMENTS) REDSTONE ARSENAL, AL 35898-5000	2
DIRECTOR U.S. ARMY RESEARCH LABORATORY ATTN: AMSRL-WM-MB (DR. B. BURNS) ABERDEEN PROVING GROUND, MD 21005-5066	1	COMMANDER U.S. ARMY FOREIGN SCI & TECH CENTER ATTN: DRXST-SD 220 7TH STREET, N.E. CHARLOTTESVILLE, VA 22901	1
COMMANDER U.S. ARMY RESEARCH OFFICE ATTN: TECHNICAL LIBRARIAN P.O. BOX 12211 4300 S. MIAMI BOULEVARD RESEARCH TRIANGLE PARK, NC 27709-2211	1		

NOTE: PLEASE NOTIFY COMMANDER, ARMAMENT RESEARCH, DEVELOPMENT, AND ENGINEERING CENTER,
BENÉT LABORATORIES, CCAC, U.S. ARMY TANK-AUTOMOTIVE AND ARMAMENTS COMMAND,
AMSTA-AR-CCB-O, WATERVLIET, NY 12189-4050 OF ADDRESS CHANGES.
