

КИНО 2001

Минск, Беларусь

ICONO 2001

Minsk, Belarus

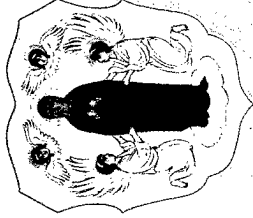
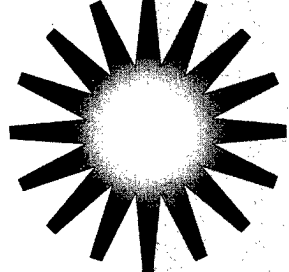

TECHNICAL DIGEST

ПОДВИГ

**Minsk
Belarus**

June 26 - JULY 1, 2001

XVII International Conference on Coherent and Nonlinear Optics



REPORT DOCUMENTATION PAGE

Form Approved OMB No. 0704-0188

Public reporting burden for this collection of information is estimated to average 1 hour per response, including the time for reviewing instructions, searching existing data sources, gathering and maintaining the data needed, and completing and reviewing the collection of information. Send comments regarding this burden estimate or any other aspect of this collection of information, including suggestions for reducing this burden to Washington Headquarters Services, Directorate for Information Operations and Reports, 1215 Jefferson Davis Highway, Suite 1204, Arlington, VA 22202-4302, and to the Office of Management and Budget, Paperwork Reduction Project (0704-0188), Washington, DC 20503.

1. AGENCY USE ONLY (Leave blank)		2. REPORT DATE 2001	3. REPORT TYPE AND DATES COVERED Conference Proceedings	
4. TITLE AND SUBTITLE ICONO 2001 -- XVII International Conference on Coherent and Nonlinear Optics: Technical Digest (Part 2)			5. FUNDING NUMBERS F61775-01-WF015	
6. AUTHOR(S) Conference Committee				
7. PERFORMING ORGANIZATION NAME(S) AND ADDRESS(ES) Moscow State University Vorob'evy Gory, Khokhlova str. 1 Moscow 119899 Russia			8. Performing Organization Report Number N/A	
9. SPONSORING/MONITORING AGENCY NAME(S) AND ADDRESS(ES) EOARD PSC 802 Box 14 FPO 09499-0200			10. SPONSORING/MONITORING AGENCY REPORT NUMBER CSP 01-5015	
11. SUPPLEMENTARY NOTES Proceedings are contained in two volumes. ICONO 2001 -- XVII International Conference on Coherent and Nonlinear Optics: Advance Program (Part 2)				
12a. DISTRIBUTION/AVAILABILITY STATEMENT Approved for public release; distribution is unlimited.			12b. DISTRIBUTION CODE A	
ABSTRACT (Maximum 200 words) The Final Proceedings for XVII International Conference on Coherent and Nonlinear Optics (ICONO 2001), 28 June – 1 July 2001. This is a multi-disciplinary conference. Topics of discussion include fundamental aspects of laser-matter interaction, ultrafast phenomena, quantum and atomic optics, nonlinear optical phenomena, novel trends in nonlinear laser spectroscopy and optical diagnostics, physics of nanostructures, high-precision measurements in optics, laser in chemistry, biophysics and biomedicine, optical information processing and storage, strong laser fields and high field physics, nonlinear dynamics of optical physics.				
14. SUBJECT TERMS EOARD, Russia, Non-linear optics, Laser physics			15. NUMBER OF PAGES Part 2 – 353 pages Part 1 – 107 pages	
			16. PRICE CODE	
17. SECURITY CLASSIFICATION OF REPORT UNCLASSIFIED	18. SECURITY CLASSIFICATION OF THIS PAGE UNCLASSIFIED	19. SECURITY CLASSIFICATION OF ABSTRACT UNCLASSIFIED	20. LIMITATION OF ABSTRACT UL	

ICONO 2001

XVII International Conference on Coherent and Nonlinear Optics

Belarus Cultural Center
Minsk, Belarus, June 26–July 1, 2001
Technical Exhibit, June 28–30, 2001

20010926 144

AQ FOI-12-2610

ORGANIZED BY

National Academy of Sciences of Belarus (NASB)
Scientific Council on Optics and Laser Physics of the Russian Academy of Sciences (RAS)
 B. I. Stepanov Institute of Physics, NASB
Institute of Molecular and Atomic Physics, NASB
 M. V. Lomonosov Moscow State University
 Institute of Laser Physics, RAS
 General Physics Institute, RAS
 P. N. Lebedev Physical Institute, RAS
Russian Center of Laser Physics, St. Petersburg State University

IN COOPERATION WITH AND SPONSORED BY

Belarusian Republic Foundation for Fundamental Research (BRFFR)
State Committee for Science and Technology of the Republic of Belarus
Department of Physics, Mathematics, and Informatics, NASB
 Belarusian Physical Society
Ministry of Industry, Science, and Technologies of Russian Federation
 Russian Foundation for Basic Research (RFBR)
 Ministry of Education of Russian Federation
 United Physical Society of Russian Federation (UPSRF)
 International Science and Technology Center (ISTC)
SPIE – The International Society for Optical Engineering
 SPIE Russian Chapter (SPIE/Rus)
International Union of Pure and Applied Physics (IUPAP)
 Optical Society of America (OSA)
European Office of Aerospace Research and Development (EOARD)

Tuesday, June 26

TuA Opening Remarks. Plenary Lectures I

TuB R. V. Khokhlov Memorial Session

Tuesday/3

TuA2
(Plenary lecture)

FEMTOSECOND COHERENT RAMAN SPECTROSCOPY

W. KIEFER, T. CHEN, M. HEID, A. MATERNY, J. POPP,
S. SCHLÜCKER, U. SCHMITT, T. SIEBERT, A. VIERHEILIG

Institut für Physikalische Chemie, Universität Würzburg, Am Hubland,
D-97074 Würzburg, Germany

Femtosecond coherent Raman spectroscopy is a technique that utilizes the broad spectral bandwidths associated with femtosecond laser pulses in order to prepare and monitor coherent states of the sample in its electronic ground state by involving coherent anti-Stokes Raman Scattering (CARS) processes. The time evolution of wavepackets or beatings between different modes prepared by such methods allow the direct measurement of vibrational frequencies and their temporal behaviour on a femto-pico-second time scale. Long time delay scans and successive Fourier transformation allow high spectral resolution. Applications discussed here will focus on several works performed recently in our laboratories.

First, we report on fs time-resolved dynamics of the vibrational motions and energy flow in polydiacetylene. Femtosecond CARS is invoked to prepare and to probe the ground-state vibrational mode beatings. The probing is made in time (fs) and wavenumber (cm^{-1}) simultaneously using a "single-shot" optical multichannel analyzer. The spectrally resolved anti-Stokes signal was recorded as a function of the delay time between the time coincident pump and Stokes pulses preparing the mode beatings and the second pump laser pulse. From these three-dimensional data (delay time, CARS wavenumber, CARS intensity) we were able to elucidate the time scales and phases of the coherently excited ground state dynamics.

Second, the fs-CARS technique was used to study the dephasing dynamics in hydrogen bonded (pyridine/water) complexes. By detecting the spectrally resolved CARS signal, a mapping of the vibrational coherence dynamics of ring modes at about 990 and 1030 cm^{-1} was achieved. The quantum beatings among different modes of the hydrogen-bonded network are clearly exhibited employing Fourier transform methods to the time domain signal. The oscillatory patterns in the CARS transients are adequately explained when contributions from several modes are accounted for. The pure vibrational dephasing times for these modes were obtained with high precision.

Finally, we report on femtosecond time-resolved CARS measurements on magnesium octaethylporphine dissolved in dichloro-methane. In order to suppress the non-Raman resonant background special polarization geometries of the fs pulses and the coherently scattered CARS signal were employed. Fast beating patterns in the 100 to 200 fs range were observed between several porphyrin normal modes. Similar results were also obtained in tetraphenylporphyrin and in the free-base octaethyl-porphyrin. Again, the pure dephasing times for the macrocycle modes were obtained with high accuracy.

CONTROL OF NUCLEAR PROCESSES IN HOT FEMTOSECOND LASER PLASMA:

TOWARDS STIMULATED GAMMA EMISSION

A.V. Andreev, V.M. Gordienko, A.B. Savel'ev

Physics Department, M.V. Lomonosov Moscow State University

Vorobievsky Gory, Moscow 119899 Russia

Phone: (095)939-3092, Fax (095)939-3113, E-mail: andreev@sr1.phys.msu.su

The hot dense plasma created by femtosecond laser pulse at solid surface is a bright source of energetic electrons, photons, neutrons and highly ionized ions. The energy of the emitted photons and plasma electrons is a few keV at laser intensity 10^{16} W/cm² to a few MeV at 10^{19} W/cm². Therefore the wide range of isomeric levels of stable and unstable nuclei can be excited in plasma. There are a few specific features of laser plasma as a source of nucleus excitation. The most important among them are the short time of excitation $\sim 10^{-12}$ s and possibility to control the degree of ionization of excited ion. It opens up the new opportunities in developing of novel schemes for nuclear spectroscopy, isotope separation and population inversion creation at nucleus levels.

Here we discuss the results of the experimental research on gamma decay of 6.238 keV Ta-181 isomeric level with lifetime of 6 ncs excited in laser plasma produced by 200 fs, 600 nm and 1 ps, 1053 nm laser pulses at intensity $2 \cdot 10^{16}$ W/cm², and results of theoretical research on developing of population inversion schemes based on the use of internal electronic conversion of excited nuclei.

LOCALIZED OPTICAL WAVES IN QUADRATIC MEDIA

A. P. SUKHORUKOV

Nonlinear Waves Laboratory, Faculty of Physics,
M.V. Lomonosov Moscow State University, Moscow, 119899, Russia

The review of works on research of spatio-temporal localization of optical waves in media with quadratic nonlinearity is presented. Such processes occur due to parametrical self-action at which the waves change refraction indexes each other instead of an energy exchange. The dispersion of parametrically coupled waves can be controlled by changing linear phase mismatch. At large mismatch the cascading quadratic nonlinearity takes place similar on cubic one. Change of phases on π leads to replacement of focusing media on defocusing.

In focusing media, spatial and temporal parametrically coupled (quadratic) soliton trapping can be occur. Properties and stability of such solitons, and also methods of beam direction switching as a result of interaction are discussed. The internal structure of two- and three-coloured solitons is discussed at the synchronism of I and II type. For example, they have the non-uniform wave front in quadratic media with GVM. For sub-wavelength solitons the nonlinear diffraction weakening quadratic nonlinearity is developed.

Generating dissipative structures in bistable quadratic cavities with various qualities, detunings from a resonance and seeded beams is examined as well. The near-field and round-trip models are compared. The periodically non-uniform media such as gratings and photonic crystals give new resources for quadratic soliton trapping. In QPM crystals from 2 up to 6 ordinary and extraordinary waves can be trapped.

Of great interest is parametric interplay of optical vortices. In quadratic media vortices can be transferred from one frequency on others, multiply and disappear, move in cross section, divide a beam into parts etc.

Thus, quadratic solitons represent a new class of the localised structures and may be used in all-optical schemes of light beam control, switching, multiplication, information storage and processing.

Wednesday, June 27

WA	Physics of Nanostructures I	WO	Fundamental Aspects of Laser-Matter Interaction I
WB	High-Precision Measurements in Optics I	WR	Symposium on Entangled States IV
WC	Symposium on Entangled States I	WS	Lasers in Chemistry, Biophysics, and Biomedicine IV
WD	Lasers in Chemistry, Biophysics, and Biomedicine I	WT	Fundamental Aspects of Laser-Matter Interaction II
WE	ISTC Workshop I	WV	High-Precision Measurements in Optics (Posters)
WG	High-Precision Measurements in Optics II	WX	ISTC Workshop (Posters)
WH	Symposium on Entangled States II	WY	Fundamental Aspects of Laser-Matter Interaction (Posters)
WI	Lasers in Chemistry, Biophysics, and Biomedicine II		
WJ	ISTC Workshop II		
WL	High-Precision Measurements in Optics III		
WM	Symposium on Entangled States III		
WN	Lasers in Chemistry, Biophysics, and Biomedicine III		

Photonic Crystal Fibres and Films

P.S.L.J. Russell

*Optoelectronics Group, Department of Physics, University of Bath, Bath BA2 7AY, UK
Tel +44 1225 826946, Fax +44 1225 826110, p.s.j.russell@bath.ac.uk*

Nature has been microstructuring materials for millions of years, and the optical results are all around us. Butterfly wings, beetle carapaces, peacock feathers and natural opals all divide sunlight into its constituent colours, to often visually stunning effect [1]. A creature that has recently excited wide-spread interest is the sea-mouse (marine worm, genus *Aphrodita*) [2]. Its hairs are spectacularly iridescent, caused by a remarkable hexagonal close-packed photonic crystal microstructure running along their length.

Photonic crystal fibre (PCF) is similar in form – a thin thread of silica glass, of almost unlimited length, with a parallel array of microscopic air holes running along it [3]. Indeed, although being around for only 10 years, PCF is an example of a photonic crystal structure which is already being used in a variety of different applications. Guiding cores are created by filling in or enlarging individual air holes, and several new guidance mechanisms have been demonstrated, including photonic bandgap confinement in a hollow core [4] and an endlessly single-mode “sieve” waveguide [5]. Many nonlinear optical applications are emerging, including efficient supercontinuum generation [6,7] gas-Raman amplifiers and cold atom guides.

Thin films of high index dielectric, perforated with an array of holes (looking rather like salami slices of photonic crystal fibre), can act as efficient vertical cavity resonators and highly dispersive components for telecommunications [8,9,10]. These structures are technologically much more challenging to realise, since the degree of out-of-plane leakage must be controlled with precision. A two-dimensional optical circuit must be capable of confining light efficiently to the plane, whereas vertically emitting structures (such as couplers and lasers) must allow controlled leakage out of the plane. These requirements present a formidable design challenge, one that can only be met by rigorous theoretical techniques and numerical modelling.

The major remaining challenge is how to design practical photonic crystal components which efficiently confine, process, direct and deliver optical signals.

1. M. Hutley and M. Large: *Special Issue on Optical Design in Nature J. of Optics A 2 (R15-R50) 2000*
2. A.R. Parker et al., “Aphrodite’s iridescence,” *Nature* 409 (36-37) 2001
3. J.C. Knight, T.A. Birks and P.S.L.J. Russell, “Holey silica fibers,” in *Optics of Nanostructured Materials* (Editors V.A. Markel and T.F. George), pp 39-71, (John Wiley & Sons, New York, 2001)
4. R. F. Cregan, B.J. Mangano, J.C. Knight, T.A. Birks, P.S.L.J. Russell, P.J. Roberts and D.C. Allan, “Single-mode photonic band gap guidance of light in air,” *Science* 285 (1537-1539) 1999
5. T.A. Birks et al., “Endlessly single-mode photonic crystal fibre,” *Opt. Lett.* 22 (961-963) 1997
6. J.K. Ranka, R.S. Windeler and A.J. Stenzel, “Visible continuum generation in air-silica microstructure optical fibers with anomalous dispersion at 800 nm,” *Opt. Lett.* 25 (25-27) 2000
7. J.C. Knight, J. Arraga, T.A. Birks, A. Ortigas-Blanch, W.J. Wadsworth and P.S.L.J. Russell, “Anomalous dispersion in photonic crystal fibres,” *IEEE Photonics Technology Letters*, 12 (807-809) 2000
8. E. Silvestre et al., “Design of thin-film photonic crystal waveguides,” *Appl. Phys. Lett.* 77 (942-944) 2000
9. J.M. Pottage, E. Silvestre and P.S.L.J. Russell, “Vertical-cavity surface-emitting resonances in photonic crystal films,” *J. Opt. Soc. Am. A* 15 (442-447) 2001
10. H. Kosaka, et al., “Photonic crystals for micro lightwave circuits using wavelength-dependent angular beam steering,” *Appl. Phys. Lett.* 74 (1370-1372) 1999

A.B. Fedotov,¹ M.V. Alifimov,² A.A. Ivanov,² S.N. Bageyev,³ V.S. Pivtsov,³ A.P. Tarasevitch,⁴ D. von der Linde,⁴ A.A. Podshivalov,⁴ L.A. Golovan,⁴ P.K. Kashkarov,⁴ V.I. Bologlavov,⁵ B.A. Kirillov,⁴ S.A. Magnitskii,¹ A.V. Tarasishin,¹ D. Chorvat,⁶ D. Chorvat Jr.,⁶ A.N. Naumov,¹ D.A. Sidorov-Biryukov,¹ L.A. Mel'nikov,¹ N.B. Skibina,² and A.M. Zheltikov¹

¹ Physics Faculty, M.V. Lomonosov Moscow State University, Moscow, Russia
² Center of Photochemistry, Russian Academy of Sciences, Moscow, Russia
³ Institute of Laser Physics, Siberian Branch, Russian Academy of Sciences
⁴ Institut für Laser- und Plasmaphysik, Universität Essen, Essen, Germany
⁵ Inst. Technology and Processing of Glass Structures, Russian Acad. Sci., Saratov, Russia
⁶ International Laser Center, Bratislava, Slovak Republic
⁷ Saratov State University, Saratov, Russia

Creation of holey fibers, i.e., fibers with a cladding having a form of a two-dimensional (often periodic) array of closely packed glass capillaries drawn at a high temperature, is one of the most significant achievements of optical technologies within the last five years. Since the very first papers reporting the fabrication of holey fibers back in 1996 [1], much attention has been focused on the investigation of remarkable properties of such fibers [2]. The range of applications of these fibers is now permanently expanding, resulting in a fast growth in the number of research groups using holey fibers in their studies.

This paper summarizes the results of our studies devoted to the investigation of the structure and optical properties of holey fibers with the lattice constant of the PBG cladding ranging from 0.4 to 32 μ m. Propagation of Ti: sapphire and Cr: forsterite laser pulses (Fig. 1) through such fibers is studied. Efficient spectral broadening of ultrashort laser pulses is demonstrated (Fig. 2) and the ways to control the dispersion properties of holey fibers are explored. Metrological applications of holey fibers are discussed.

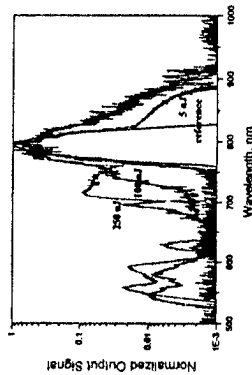
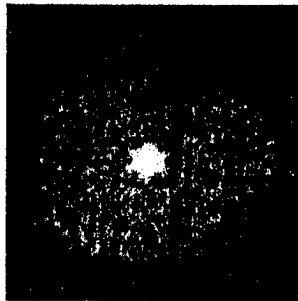

Fig. 1. Waveguiding the second harmonic of a Cr: forsterite laser through a holey fiber.

Fig. 2. Spectral broadening of Ti: sapphire laser pulses in a 1.5- μ m pitch holey fiber

This study was supported in part by the President of Russian Federation Grant no. 00-15-99304, the Russian Foundation for Basic Research (project no. 00-02-17567), the Volkswagen Foundation (project I/76 869), and the “Fundamental Metrology” Federal Program.

1. Knight J.C., Birks T.A., Russell P.S.L.J., and Atkin D.M., *Opt. Lett.* 21, 1547 (1996).
2. Birks T.A., Knight J.C., and Russell P.S.L.J., *Opt. Lett.* 22, 961 (1997); Broderick N.G.R., Monro T.M., Bennett P.J., and Richardson D.J., *Opt. Lett.* 24, 1395 (1999); Cregan R.F., Mangano B.J., Knight J.C., Birks T.A., Russell P.S.L.J., Roberts P.J., Allan D.C. *Science* 285 1537 (1999); Fedotov, A.B., Zheltikov, A.M., Mel'nikov, L.A., Tarasevich, A.P., and von der Linde, D., *JETP Letters* 71, 281 (2000); Ranka, J.K., Windeler, R.S., and Stenzel, A.J., *Opt. Lett.* 25, 25 (2000); Alifimov, M.V., Zheltikov, A.M., Ivanov, A.A., Bologlavov, V.I., Kirillov, B.A., Magnitskii, S.A., Tarasishin, A.V., Fedotov, A.B., Mel'nikov, L.A., Skibina, N.B., *JETP Lett.* 71, 714 (2000).

Resonant Enhancement of Optical Nonlinearities in Photonic Band Structures

Joseph W. Haus
Electro-Optics Program, University of Dayton
 Dayton, OH 45469-0245

This talk considers several problems related to the unusual properties of periodic dielectric materials. In two and three-dimensional systems the band symmetry and resonance effects are examined. We use higher dimensional periodic systems to study uncoupled modes, i.e. modes that do not couple to the outside plane waves because of symmetry, and the occurrence of flat bands. A dye-doped two-dimensional nanochannel glass system, designed by Kuon Inoue's group in Hokkaido University, exemplifies an application of these concepts. Time domain terahertz radiation experiments for two- and three-dimensional samples are used to illustrate the optical properties and correlate them with computations.

We also study the linear dispersive properties of one-dimensional, finite photonic band gap structures with deep gratings and use the effective refractive index to derive coupled mode equations for nonlinear quadratic interactions for structures of finite length. The resulting equations reveal the essential roles played by the density of modes and effective phase matching conditions necessary for the strong enhancement of the nonlinear response. Our predictions find confirmation in an experimental demonstration of significant enhancement of second harmonic generation near the photonic band edge. Then, a re-evaluation of the notions of group and energy velocities in finite photonic band gap structures leads us to conclude that the two phenomena are related. This result can be used to better understand a wide range of phenomena including the question of superluminal tunneling times. Finally, we combine numerical methods and the effective index approach to show that it is possible to obtain highly efficient, phase-matched nonlinear of second- and third-harmonic generation processes.

Photonic crystal fibres with elliptical pores.

D. Mogilevisev

Quantum Optics Lab, Institute of Physics, National Academy of Sciences of Belarus,
 F. Skarina ave. 68, Minsk 220072, Belarus

J. Broeng and Stig E. Barkou

Center for Communications, Optics and Materials (COM),

Technical University of Denmark, Building 349, DK-2800 Lyngby, Denmark

In this work we suggest and discuss a photonic crystal fibre with the elliptical lattice of cladding holes in a bulk silica and smaller elliptical hole as a defect which serves as a core of such fibre. Due to the elliptical shape of holes, the polarisation degeneracy of fundamental cladding modes is lifted, and appearing birefringence could be very large. Large birefringence preserves also for fundamental modes of the fibres made by removing one of the holes or replacing it with the smaller hole. Parameters of the fibre (hole shape, size and orientation) can be chosen in such a way that it

can guide only fundamental modes for all frequencies. In the figure presented below modal indices are plotted for fibres with cladding of hexagonal lattice of elliptical holes. In this figure effective V -values for fundamental and second-order modes of the fiber with the small hole defect and hexagonal lattice of holes for the cladding (solid lines). Dash-dotted lines represent V -values for the fundamental mode of the cladding. The ratio of largest half-axis to the period of lattice

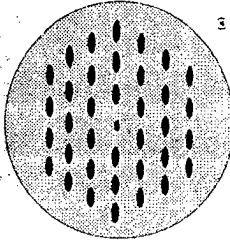

for the cladding hole is 0.3652, for the defect hole is 0.1826, the axis ratio is 0.3. For such parameters, normalised frequency equal to 8.7 ($\Lambda\omega/c$) and $\Lambda=1 \mu\text{m}$ (period of the lattice) the

estimated beat length between the fundamental

modes is approximately 91.1 μm . Such small beat

length indicates that proposed design of the fiber

with the lattice of elliptical holes for the cladding

and smaller elliptical hole for the high-index core

defect could be very useful for creating silica-air

polarization-preserving fibers. In the work an

optimal design of such fibers is also analyzed, in

particular, an achievement of a minimal beat

length for the given frequency.

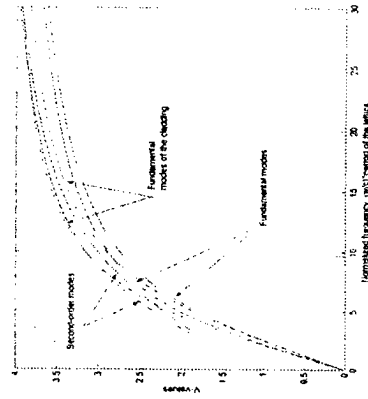

400 HZ TWO-PHOTON RAMSEY FRINGES IN THE 30 THZ SPECTRAL RANGE

A. Shelkovich^{1,2}, Ch. Grain¹, C.T. Nguyen¹, R.J. Butcher^{1,3}, A. Amy-Klein¹,
and Ch. Chardonnet¹

¹ Laboratoire de Physique des Lasers, UMR 7538 C.N.R.S. Université Paris 13, 99, av. J.-B. Clément, 93430 Villetaneuse, France, tel 00 33 1 49 40 33 92, fax 00 33 1 49 40 32 00, E-mail : amy@lpl.univ-paris13.fr

² P.N.Lebedev Physical Institute, Leninsky Prospect, 53, Moscow, 117924, Russia.

³ The Cavendish Laboratory, Madingley Road, Cambridge CB3 0HE, UK.

In the 30 THz spectral region, a secondary frequency standard is provided by the CO₂ laser locked onto a saturated absorption resonance of OsO₄ in an external cell. The reference line width is about 20 kHz, limited by the transit time through the laser beam, and the reproducibility and accuracy are of the order of 10⁻¹³ for the strongest lines [1]. To enhance this performance, we have developed a new experiment based on a supersonic beam of SF₆: some Doppler-free two-photon Ramsey fringes are recorded using two zones of interaction composed of standing waves [2]. The resolution is then determined by the distance between the two zones.

With an interzone distance of 50 cm, we recorded some fringes with a periodicity of 400 Hz and a signal-to-noise ratio (S/N) of 20 in a bandwidth of 1 Hz. With an He-seeded beam with 20 % of SF₆, the S/N is increased to 140 and the periodicity is 700 Hz. Due to the very high resolution, the projection for accuracy and long-term stability is in the 10⁻¹⁵ range. Then, this Ramsey system is very promising for a novel frequency standard in the infrared region.

[1] V. Bernard *et al.*, IEEE J. of Quant. Electron. **QE-33**, 1282 (1997); O. Acéf, IEEE Trans. Instrum. Meas. **46**, 162 (1997).

[2] A. Amy-Klein *et al.*, Phys. Rev. A **63**, 013404 (2000).

FREQUENCY STABILIZATION OF HE-NE LASER OVER 100 HZ METHANE RESONANCES

S.N.Bagayev, A.K.Dmitriyev, A.A.Lugovoy, V.M.Semibalamut
Institute of Laser Physics SB RAS
Prospect Lavrentyev 13/3, Novosibirsk 630090, Russia

Summary

Up to now the significant progress is achieved in obtaining of the narrow optical resonances, that can be used for creation of the frequency standards.

We have investigated the He-Ne/CH₄ frequency standard at 3.39 μm. The recoil doublet components on the 6-7 transition F₂^{(2)P}(7)_{v3} methane line have been used as a reference.

Two similar He-Ne lasers with intracavity telescopic light beam expanders were used in our experiments. The length and diameter of the absorbing cells were 8,5 m and 0.5 m, respectively. The absorbing gas was protected by Permalloy jacket that decreased the magnitude of the Earth magnetic field inside the methane cells approximately by a factor of 10 [1].

Uncontrolled variations in such factors as temperature, light beam cross-section, laser power, frequency modulation, and magnetic field do not limit the reproducibility of 10⁻¹⁵. The main problem is determined by the shifts due to the methane pressure in the absorbing cell. These shifts are connected with the second-order Doppler effect and mutual influence of the neighbouring wings of the recoil doublet components. At the same time, it has been found that the position of the high-frequency component at pressure of 30-90 μTorr shifts in the frequency range of about ± 3 Hz. In this case the frequency reproducibility is at the level of ± 2 Hz there in our experiments.

The experimental results are in agreement with the calculations that take into account the influence of the quadratic Doppler effect, the recoil effect, the second-order saturation, and modulation.

Our investigations have shown that the frequency reproducibility of the standard based on the laser created is of the order of 10⁻¹⁴.

References

[1] S.N.Bagayev, V.P.Chebotayev, A.K.Dmitriyev, A.E.Ohm, Yu.V.Nekrasov, B.N.Skvortsov, "Second-order Doppler-free spectroscopy", in *Appl. Phys.*, B52, pp.63-66 (1991).

Femtosecond optical clock

S.N. Bagayev¹, A.M. Zheltikov², V.I. Beloglazov³, A.K. Dmitriyev¹,
A.S. Dychakov¹, V.F. Zakhar'yash¹, V.M. Klementyev¹, D.B. Kolker¹,
S.A. Kuznetsov¹, Yu.A. Matyugin¹, M.V. Okhapkin¹, V.S. Pivtsov¹,
M.N. Skvortsov¹, S.V. Chepurov¹

¹ Institute of Laser Physics, Siberian Branch, Russian Academy of Sciences

² Physics Faculty, M.V. Lomonosov Moscow State University, Moscow, Russia

³ Inst. Technology and Processing of Glass Structures, Russian Acad. Sci.,
Saratov, Russia

The creation of a femtosecond optical clock with the use of the He-Ne/CH₄ laser frequency standard, a femtosecond Ti:S laser, and a photonic fiber is reported. The principle of operation of the scheme is as follows. The radiation spectrum of the femtosecond Ti:S laser is broadened with the help of a photonic fiber to 100 THz. The difference frequency of the corresponding frequency components of the obtained radiation is phase-locked to the frequency of the He-Ne/CH₄ laser. The characteristics of the laser frequency standard are transferred, in a cascade, from the optical region into the radio range. The power of these components is, however, too small for nonlinear transformation. Therefore, in the experiment the frequency of diode lasers whose radiation is transformed into the radiation with difference frequency is phase-locked to these components. The diode lasers play the role of "amplifiers" of the power of the components. The results of investigations of the transmission system of frequency characteristics from the optical region into the radio range are presented. The prospects for using this scheme and its modifications are discussed.

This study was supported in part by the Russian Foundation for Basic Research (project No. 00-02-17475) and the "Fundamental Metrology" Federal Program.

Wednesday/9

WCI
(Invited)

Hypereentanglement in Parametric Down-Conversion

A. V. Sergienko, M. Atature, G. Di Giuseppe, M. D. Shaw, B. E. A. Saleh, and M. C. Teich

Quantum Imaging Laboratory, Department of Physics and Department of Electrical and Computer Engineering, Boston University, 8 Saint Mary's Street, Boston, MA 02215, USA

Summary

Entanglement is, undoubtedly, one of the most fascinating features of quantum mechanics. Spontaneous parametric down-conversion (SPDC) a nonlinear optical phenomenon, has been one of the most widely used sources of entangled quantum states. In this process, pairs of photons are generated in a state that can be entangled in frequency, momentum, and polarization when a laser beam illuminates a nonlinear optical crystal. The experimental arrangement for producing entangled photon pairs is simple both in conception and in execution.

Ironically, a significant number of experimental efforts designed to verify the nonseparability of entangled states, the hallmark of entanglement, are carried out in the context of models that fail to access the overall relevant Hilbert space, but rather are restricted to only a single kind of entanglement, such as polarization entanglement (Polarization). Inconsistencies in the analysis of down-conversion quantum-interference experiments can emerge under such circumstances, as highlighted by the failure of the conventional theory of ultrafast parametric down-conversion to characterize quantum-interference experiments.

In this paper we present a complete quantum-mechanical analysis of entangled-photon state generation via SPDC, considering simultaneous entanglement (hypereentanglement) in momentum, frequency, and polarization at the generation, propagation, and detection stages. As an important example of the application of this approach, we use it to describe new, and previously obtained, results of SPDC experiments with a femtosecond pump. Our analysis confirms that the inconsistencies between existing theoretical models and the observed data in femtosecond down-conversion experiments can indeed be attributed to a failure of considering the full Hilbert space spanned by the simultaneously entangled quantum variables. Femtosecond SPDC models have heretofore considered only a single wavevector, which does not incorporate the previously demonstrated angular spread of the down-converted light. The approach presented here is suitable for Type-I, as well as Type-II, spontaneous parametric down-conversion.

Our study leads to a deeper physical understanding of hypereentangled photon states and, concomitantly, provides a route for engineering these states for specific applications, including quantum information processing.

WC2
(Invited)

QUANTUM ENTANGLEMENT, TELEPORTATION AND LITHOGRAPHY

Yanhua Shih
Department of Physics, University of Maryland, Baltimore County,
Baltimore, MD 21250, U.S.A.

One of the most surprising consequences of quantum mechanics is the entanglement of two or more distance particles. Even though we still have question in regard to fundamental issues of the entangled quantum systems, quantum entanglement has started to play important roles in quantum information and quantum computation. Quantum teleportation and quantum lithography are two of the recent hot topics.

The idea of quantum teleportation is to utilize the nonlocal correlations between an Einstein-Podolsky-Rosen pair of particles to prepare a quantum system in some state, which is the exact replica of an arbitrary unknown state of a distant individual system.

We have recently demonstrated a quantum teleportation scheme in which the complete set orthogonal Bell states are distinguished in the Bell state measurement process. Teleportation of a quantum state can thus occur with certainty in principle. This is because the Bell state measurement is based on nonlinear interactions which are necessary and non-trivial physical processes for quantum teleportation.

The basic elements of the experiment consists of four essential parts: (a) an arbitrary input quantum state, (b) the EPR pair, (c) Alice (who performs the Bell state measurement of the input state and her EPR particle), and (d) Bob (who carries out unitary operations on his EPR particle). Four Sum Frequency Generation (SFG) (or "upconversion") nonlinear crystals are used for "measuring" and "distinguishing" the complete set of Bell states. The input photon and Alice's share of the EPR photon-pair may interact either in the two type-I SFG or in the two type-II SFG to generate a higher frequency photon. The polarization projection measurements on this "up-converted" photon, by four independent photon counting detectors, correspond to the four Bell states. To obtain the exact replica of the input state, Bob needs simply to perform a corresponding unitary transformation after learning from Alice which of her four detectors is triggered. The experimental results have demonstrated and confirmed the working principle of our quantum teleportation scheme.

Classical optical lithography technology is facing its limit due to the diffraction effect of light. However, this classical limit can be surpassed, surprisingly, by utilizing the quantum nature of entangled multi-photon states. In an idealized experimental situation, the minimum width of the entangled N-photon diffraction pattern can be N times narrower than the width of a classical diffraction pattern.

We wish to report a proof-of-principle quantum lithography experiment. By using entangled photon pairs in Young's two-slit experiment, we found that under certain experimental conditions, the two-photon interference-diffraction pattern has spatial interference modulation period smaller and diffraction pattern width narrower, by a factor of two, than in the classical case. This result has "beaten" the classical diffraction limit by a factor of two. However, it has to be emphasized that this effect is a pure quantum two-photon phenomenon but not a violation of the uncertainty principle.

PREPARATION AND MEASUREMENT

A.V.Burlakov, M.V.Chekchova O.A.Karabutova, and S.P.Kulik

Department of Physics, Moscow State University

119899 Moscow, Russia

Tel: 7(095)939-4372, Fax: 7(095)939-1104, E-mail: postmast@qopt.ilt.msu.su

Spontaneous parametric down conversion (SPDC) is one of the most convenient and efficient methods to generate two-photon light or biphotons. There are only two types of biphotons existing in nature, called type-I and type-II biphotons. Type-I biphotons are pairs of correlated photons with the same polarization while type-II biphotons are orthogonally polarized pairs of correlated photons. The polarization basis is determined, basically, by orientation of the nonlinear crystal. In the general case, a pair of collinear frequency-degenerate correlated photons has the state vector [1]

$$|\Psi\rangle = \alpha|2,0\rangle + \beta|1,1\rangle + \gamma|0,2\rangle, \quad (1)$$

where α, β, γ are complex normalized amplitudes, and $|m, n\rangle, m+n=2$ denotes m H-polarized photons and n V-polarized photons in natural basis. The first and the third terms describe type-I biphotons, and the second one describes type-II biphotons. A simple question arises. Is it possible to create other states of biphoton field differing from natural ones? The answer is positive and we consider such types of the states. The present work is devoted to the experimental proof of this statement.

The experiment consists of two parts: The first one is preparation of different biphoton states from type-I biphotons. Type-I SPDC radiation is generated from two LiIO₃ crystals located in both arms of a Mach-Zehnder interferometer. We prepared and tested the states $\Psi_\phi = \frac{1}{\sqrt{2}}(|2,0\rangle + e^{i\phi}|0,2\rangle)$, with $\phi = \pi$ (which leads to $\Psi_\pi = |1_{45^\circ}, 1_{-45^\circ}\rangle$), $\phi = 0$ ($\Psi_0 = |1_{\text{right}}, 1_{\text{left}}\rangle$) and also states corresponding to an arbitrary phase shift λ^2 . The second part consists in a measurement of synthesized states using both the first-order correlation function technique and the anticorrelation effect [2,3]. We prove that artificially created type-II states of biphoton field are characterized by rather narrow anticorrelation gap. In conclusion, we discuss a possibility to prepare and measure other biphoton states, synthesized artificially.

References

1. A.V.Burlakov, M.V.Chekchova, O.A.Karabutova, D.N.Klyshko, and S.P.Kulik, Phys. Rev. A **60**, R4209 (1999).
2. M.H.Rubin, D.N. Klyshko, Y.H.Shih, and A.V.Sergienko, Phys. Rev. A **50**, 5122 (1994).
3. C.K.Hong, Z.Y.Ou, and L.Mandel, Phys. Rev. Lett. **59**, 2044 (1987).

QUANTUM HOLOGRAPHIC TELEPORTATION: PHYSICAL LIMITS AND FIDELITY

A.Gatti¹, I.V.Sokolov², M.I.Kolobov³ and L.A.Lugiato⁴

^{1,4} INFN, Dipartimento di Scienze CC FF MM, Università dell'Insubria, Via Valleggio 11, 22100, Como, Italy

e-mail: ¹alesandra.gatti@mi.infn.it, ⁴lugiato@fis.unico.it

² Physics Institute, St. Petersburg University, Ul. U'lyanovskaya 1, 198904 Petrodvorets, St. Petersburg, Russia

e-mail: sokolov@is2968.spb.edu

³Laboratoire PhLAM, Université de Lille 1, Cité Scientifique Bat P5, F-59655 Villeneuve d'Ascq Cedex France

e-mail: mikhaik.kolobov@phlam.univ-lille1.fr

Quantum holographic teleportation, proposed for the first time in [1], allows for transportation of quantum state of a distributed in space-time field from one place to another using classical information exchange. Quantum holographic teleportation is an extension of the continuous-variable teleportation schemes [2,3] to spatially-multimode light fields and can be considered as quantum analog of conventional holography. The essential part of the holographic teleportation scheme, shown below, is a pair of broadband spatially-multimode entangled Einstein-Podolsky-Rosen (EPR) beams E_1 and E_2 . The interest in this phenomenon is stimulated by the

potential importance of the parallel methods of quantum information exchange and processing. We consider in detail the characteristic space-time scales (i.e. the "resolving power") of holographic teleportation and the optimization of these scales. The quality of teleportation of quantum state is usually quantified by the fidelity parameter. We find the fidelity of teleportation of essentially multimode light field, distributed in space-time. The role of the space-time scales and of the number of the teleported field degrees of freedom is examined.

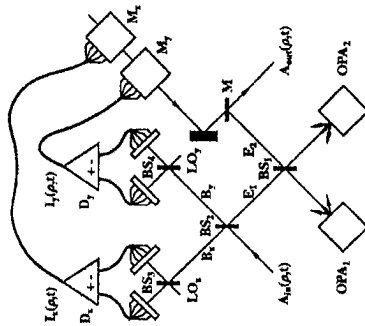

- [1] I. V. Sokolov, M. I. Kolobov, A. Gatti, and L. A. Lugiato, L'ANL arXiv: quant-ph/0007026; submitted to Phys.Rev.Lett.
- [2] L. Vaidman, Phys. Rev. A **49**, 1473 (1994); S. L. Braunstein and H. J. Kimble, Phys. Rev. Lett. **80**, 869 (1998).
- [3] A. Furusawa, J. L. Sorensen, S. L. Braunstein, C. A. Fuchs, H. J. Kimble, and E. S. Polzik, Science, **282**, 706 (1998).

Single molecule detection in life scienceT. Yanagida^{1,2}¹ *Single Molecule Process Project. ICORP, JST
2-4-14 Senba-Higashi, Mino, Osaka 562-0035, Japan*² *Department of Physiology and Biosignaling,
Osaka University Graduate School of Medicine
2-2 Yamadaoka, Suita, Osaka 565-0871, Japan*

Biomolecules assemble to form molecular machines such as molecular motors, cell signal processors, DNA transcription processors and protein synthesizers to fulfill their functions. Their collaboration allows the activity of biological systems. The reactions and behaviors of molecular machines must be flexible in order to respond to their surroundings. This flexibility is essential for biological organisms. The underlying mechanism of molecular machines is not as simple as one would predict from analogy to man-made machines. Since molecular machines are only nanometers in size and has a flexible structure, it is very prone to thermal agitation. Molecular machines operate under a strong influence of thermal noise, with a high efficiency of energy conversion. This is in sharp contrast to man-made machines that operate precisely and rapidly at energies much higher than thermal noise. The aim of our research is to approach the essential engineering principle of the adaptive biological systems by uncovering the unique operations of molecular machines. For this aim, we have developed several new technologies for single molecule imaging and manipulation of biomolecules. These new techniques allow the dynamic properties of individual molecules in molecular machines, which were previously hidden in averaged ensemble measurements, to be unveiled. I will survey the applications of single molecule detection (SMD) techniques to several biological molecular machines and briefly discuss the unique mechanism of motion underlying molecular motors, the system on which SMD has been most successfully used.

Infra-red Fibre Lasers and Tissue InteractionsTerence A King
University of ManchesterLaser Photonics Group, Department of Physics & Astronomy
University of Manchester, Manchester M13 9PL, UK
Tel: 44-161-275-4181 Fax: 44-161-275-5509
Email: terry.king@man.ac.uk

Biological tissues exhibit strong interaction with radiation in the near infra-red near 2µm and 3µm, primarily due to the high absorption coefficients of water and biomolecules such as hydroxyapatite. Weaker absorption bands, eg at 1.4µm, from OH vibrational harmonics also occur. This wavelength region has been accessed by pulsed solid state crystal lasers operating on holmium, thulium and erbium dopants and producing pulse energies up to a few Joules at repetition rates up to about 50 Hz. More recently fibre lasers operating on Yb, Tm, Ho or Er dopants in silica or fluoride glass hosts have been demonstrated to provide useful characteristics for biomedical application. The use of a double-clad fibre geometry enables efficient coupling of high power pumping, which is able to be coupled efficiently into the doped small diameter core, to give output of good beam quality.

The operation and performance of continuous wave and pulsed fibre lasers for medical application will be described using a variety of dopants and fibre glass hosts including Tm-silica, Er:Pr-ZBLAN and Yb:Er-silica. The nature of the laser radiation-tissue interaction will be illustrated and the phases of continuous wave heating and ablation of soft tissues will be related to absorption and laser irradiation conditions.

**THERMO-OPTICAL NONLINEAR EFFECTS INDUCED BY RADIATION OF
IR-LASERS IN BIOLOGICAL TISSUES**

Omel'chenko A.I., Bagratashvili V.N., Sobol E.N., Sviridov A.P., Tsykina S.I.

Institute of Laser and Information Technology of Russian Academy of Sciences

Pionerskaya str. 2, Troitsk, Moscow reg. 142092, Russia

Tel./Fax: +7(095)334-03-42, E-mail: omel@omega.laser.ru

Gapontsev V.P., Minaev V.P., Samartzev I.E.

IRE-POLUS Group

Vvedenskogo Sq.1, Fryazino, Moscow reg. 141120, Russia

Tel. +7(095)526-9083, Fax: +7(096)565-9687, E-mail: gap@ms.ire.rssi.ru

Makmutova G.Sh.

Medical Center of Department of President of Russian Federation

129090, Grokholsky crstr. 31

Tel: +007(095)280-7301, Fax: +007(095)232-6409

This paper is aimed at the investigation of optical properties of some connective tissues, such as hyaline cartilage and the tissues of head and neck facial system heated with mid IR fiber lasers. Heating of hyaline cartilage with 0.97 μm and 1.56 μm fiber lasers and degradation of its optical properties was studied. Laser induced self-transparency (for 1.56 μm laser) and self-darkening (for 0.97 μm laser) caused by heating and transfer of water through cartilage, and, also, by transformation of cartilage matrix was revealed. These effects must be taken into account when estimating the depth of tissue heating. Dynamics of light scattering in cartilage heated by laser radiation was investigated. This allows to optimize the conditions of laser reshaping of cartilage.

Other presented results deal with application of laser reshaping of connective tissue in facial plastic surgery. It is shown that subcutaneous tissues can be contracted due to short time heating by the 1.56 μm fiber laser. The new perspectives of laser application to connective tissue reshaping in reconstructive and aesthetic surgery are discussed.

**PHOTODYNAMIC LASER THERAPY IN THE TRANSPARENCY REGION OF
BIOTISSUES USING TRICARBOCYANINE DYES AS PHOTOSENSITIZERS**

E.S. Voropay¹, M.P. Samitsov², A.P. Lugovsky², E.A. Zhavrid³, Yu.P. Istomin³

E.N. Alexandrova³ and V.N. Chalov³

¹Belarusian State University, 4 F. Skaryna Av., 220050 Minsk, Belarus,

tel./fax 220 73 20, e-mail: Voropay@phys.unibel.by

²Research Institute for Applied Physical Problems, 7 Kurchatov St., 220064 Minsk

³Research Institute of Oncology and Medical Radiology, p.o. Lesnoi 24

In the investigations into the spectral properties of dyes in organic solvents, water, nutrient media and cell cultures at various concentrations it has been found that the tumor cells contain monomers of dye molecules, associates are not appreciable and the solvation shell of dyes is composed of biological molecules [1]. Pharmacokinetics was studied in cell structures and tissues of animals. It was demonstrated that on introduction of dyes in a nontoxic dose of 0.5 mg/ml their concentration in tumor cell is rather high varying for different preparations from 10^{11} to $2.1 \cdot 10^9$ mol per million cells. Investigations of phototoxicity were performed for two stocks of HeLa tumor cells and choroid HM melanoma. Irradiation of the preparation-containing cell monolayer in the region of photosensitizer absorption resulted in damage of tumor cells for the majority of the compounds. The greatest phototoxicity was exhibited by dyes with end indolimine groups and substitutes. The established selectivity of tumor accumulation in tumor tissues was rather high. The accumulation factor lies within 1.2 to 2.5. In the process the photosensitizer concentration in the tissues is reduced. The phototoxicity studies were performed with using semiconductor lasers ($\lambda = 740$ and 807 nm) and xenon lamp. Isolation of the required spectral region was effected by a system of light filters. In the experiments on animals it was found that certain of the studied compounds are characterized by a high photoactivity causing the total damage of tissues in tumor nodes to a depth of 15-20 mm.

1. Voropay E.S., Samitsov M.P., Kaplevsky K.N., Chalov V.N., Lugovsky A.P. Spectral and Luminescence Characteristics of Symmetric Tricarboyanine Dye (TICS) in Solvents. // Proc.of BSU, Issue I: Phys., Math. and Inform., 2000, № 26, p. 28-30.

Processing of bone and cartilage tissue with pulsed CO₂ lasers:

an in vitro investigation.

M. M. Ivanenko¹, S. Afzal¹, T. Mitra¹, P. Hering^{1,2}

¹ CAESAR (center of advanced european studies and research), Friedenspl. 16, D-53111 Bonn
phone +49 228 9656-257, fax +49 228 9656-112, ivanenko@caesar.de

² Institute of Laser Medicine, Duesseldorf University, P.O. Box 101007, D-40001 Duesseldorf
phone +49 211 8112761, fax +49 211 811374, hering@uni-duesseldorf.de

Effective and "clean" ablation of a stiff mineral-collagen bone matrix is possible with an Er:YAG laser (2.94 μm) and short pulses of a CO₂ laser (9.6 and 10.6 μm). The wavelengths of both laser systems are very strongly absorbed by the tissue. A very fast evaporation of the internal tissue liquid causes mechanical disintegration of a thin absorption layer at relatively low temperature. Our experimental investigation put the accent on the influence of the CO₂ laser wavelength and pulse duration on the ablation efficiency and on the extend of the collateral thermal damage. Results demonstrate that ablation characteristics correlate with tissue absorption spectra. The wavelength of 9.6 μm provides at least two times faster ablation of cortical tissue as compared to 10.6 μm . This could be partially compensated by the higher available laser energy at 10.6 μm , but only at the expense of extended thermal damage. Comparative measurements with TEA ($\tau_{1/2} = 45$ ns), Q-switched (250 ns) and "long"-pulsed (100 μs) CO₂ lasers show an increase of the ablation threshold, optimal energy density and specific ablation energy with laser pulse duration. These results are in agreement with models considering a competition of the ablation process and heat dispersion in the tissue. A technique to control the laser cut shape and depth will be reported, as well as results for cartilage tissue, which can be easily ablated with short CO₂ laser pulses with very minor collateral thermal damage. The results, including histological tissue examinations, prove that an optimised CO₂ laser systems with sub- μs pulse duration can be used in medicine for processing different types of hard tissue and cartilage. It will be especially attractive to integrate such a laser in a computer assisted surgical system.

ISTC Projects in the Field of Coherent and Nonlinear Optics

Yuri I. Malakhov, ISTC, Moscow

Luganskaya ulitsa, 9, P.O. Box 25, 115516 Moscow,
Russian Federation

The International Science and Technology Center (ISTC) was established as an intergovernmental organization working for nonproliferation of weapons of mass destruction and related expertise. The ISTC has received more than 200 laser-related proposals. These proposals cover a large number of areas of science and applications, including the fundamental theoretical and experimental study in the field of super strong electric and magnetic fields generation in solid state plasma, created by powerful short pulse laser radiation interaction with matter, studies of non-linear optical processes at broadband laser radiation phase conjugation using stimulated Brillouin scattering, laser spectroscopy of polyatomic molecules, and use of lasers for application in industrial technological areas and in biomedicine.

The results some of these projects are presented. Areas of the selected projects include the development of new solid-state materials for stimulated Raman scattering (SRS), the development of a stimulated Brillouin scattering mirror (SBS-mirror) with raster of diffraction Fresnel lenses for its use in a commercial pulse-periodic solid-state laser, creation of a pilot device for destroying specific hazardous forms of pathogenic microorganisms in fluid media, including midair and water, by powerful short pulse irradiation with power density of about 10^6 W/cm^2 and broad optical spectrum, including ultraviolet (UV) and infrared (IR) ranges, the development of a new method for pumping gas lasers by powerful runaway electron beams (REB), and creation, on this basis, efficient sources of coherent ultraviolet (UV) and vacuum ultraviolet (VUV) radiation with ecologically safe gases used as the active medium, the development and creation of a powerful source of coherent radiation with a small divergence on the basis of phase-locked in an external resonator laser diode array mounted on a heat exchanger with liquid cooling. This device is the new perspective type of semiconductor lasers possessing the following advantages: excellence of radiation (low divergence - less than 10^{-4} rads, high intensity - up to 50 W, uniformity of a light beam), high efficiency (up to 70-80 %), compactness, simplicity and reliability of a construction. Currently, more than 60 Russian institutions and about 10 non-Russian, CIS institutions are involved in these projects.

THE EXPERIENCE OF ISTC ACTIVITY IN BELARUS AND BELARUSIAN PROJECTS IN FIELD OF LASERS AND OPTICS

A. Klepatsky

International Science and Technology Center, Belarus Branch Office,
220109, Minsk, Sosny, Republic of Belarus, Tel./Fax: +(375 17) 2467361,

e-mail: abk-istic@sosny.bas-net.by

The International Science and Technology Center (ISTC) was established by international agreement in November 1992 as a nonproliferation program to provide peaceful research opportunities to weapons scientists and engineers in Commonwealth of Independent States (CIS) countries.

Since beginning operation in March 1994, the ISTC has funded more than 1250 peaceful scientific projects with a value exceeding \$335 million employing over 30,000 scientists and engineers at more than 400 institutes in the CIS. These projects cover a broad range of science and technology areas, including lasers and optics.

In the report the ISTC Programs including Science Project Program, Partner Program, Seminar Program, Project Development Grant Program, Technology Database Program and others are presented and described. Project funding by technology area, by stage of development, by CIS States etc. are demonstrated and discussed. The rules and experience of proposal preparation and project implementation are presented also.

The experience of ISTC activity in Belarus and Belarusian projects implementation are presented and discussed. The project distribution by technology stages, by participating institutes, by foreign collaborators and institutions, by duration and costs etc. are analyzed. The main emphasis is made on projects in field of lasers and optics. The ISTC opportunities for international cooperation in the field are described and discussed.

NONLINEAR OPTICAL CONVERSION OF RADIATION FROM TI:SAPPHIRE
LASERS: NEW AVAILABILITIES FOR CREATION OF ALL-SOLID-STATE
HIGH-ENERGY LASER SYSTEMS CONTINUOUSLY TUNABLE FROM
188.5 TO 1400 NM.

V.A. Orlovich¹, P.A. Apanasevich¹, A.S. Grabchikov, A.V. Kachinski²,

V.D. Kopachevski², A.A. Buj², H.J. Eichler³, W. Kiefer⁴, P.-Y. Turpin⁵

¹ B.I. Stepanov Institute of Physics, National Academy of Sciences of Belarus,

70 F. Skaryna Ave., 220072 Minsk, Belarus

² JV Solar TH Ltd., 15/2 Akademicheskaya Str., 220072 Minsk, Belarus

³ Technische Universität Berlin, Str. Des 17 Juni 135, D-10623, Berlin, Germany

⁴ Universität Würzburg, Am Hubland, D-97074, Würzburg, Germany

⁵ Université P. Et M. Curie (Paris VI), Tour 22-12, 3^{eme} etage, Case Courrier 138,

4 place Jussieu 75252 Paris, Cedex 05, France

Laser radiation sources, wavelength-tunable in the deep UV, UV, VIS and near IR spectral regions, are being widely applied in microelectronics, medicine, environmental protection and other applications.

The availabilities for creation of an all-solid-state pulsed laser system tunable between 188.5 and 1400 nm have been studied in the present work. The system is based on a Ti:Sapphire laser (100 mJ, 8 ns) and nonlinear optical converters. Conversion of the laser radiation to a shorter wave-spectrum region by generating the second, third and fourth harmonic radiation in BBO crystals has been investigated. Radiation tunable from 340 to 480, 230 to 320 and 188.5 to 240 nm with a conversion efficiency of more than 40%, 15% and 12%, respectively, has been generated. SRS-generation in barium nitrate crystals pumped with the tunable radiation from the Ti:Sapphire laser has been studied for the first time. Four Stokes components with an efficiency of up to 60% with wavelength tuning between 920 and 1400 nm have been produced. The radiation of four Stokes components was converted to the second harmonic. As a result, the radiation tunable in the range 420 - 690 nm has been obtained.

The research was partially supported by the International Science and Technology Center under project B-266-99.

GROUND AND EXCITED STATE DIPOLE MOMENTS OF NEW FLAVONOLS TO PROBE THE EFFECT OF GRADIENT LASER FIELDS IN BIO-MEMBRANES

W. Baumann¹ and N. A. Nemkovich²

¹Institute of Physical Chemistry, University of Mainz, Jakob Welder-Weg 11, 55099 Mainz, Germany, FAX: +49 6131 392 2980; email: wbaumann@mail.uni-mainz.de
²B.I.Stepanov Institute of Physics, National Academy of Sciences of Belarus, F. Skaryna Ave.68, Minsk220072, Belarus

The ISTC project # B-479, designed by Prof. Dr. A. N. Rubinov on the biophysical application of gradient laser fields, uses new flavonol fluorescent probes to study the influence on biological objects. Since structural information is derived from

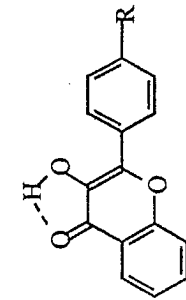

the wavenumber shift, the degree of anisotropy and the decay time of the probe fluorescence, those basic molecular properties of the flavonols determining the interaction with the membrane sites must be precisely known. These are the ground and the excited state dipole moments μ_g and μ_e . They are determined by electro optical absorption measurements (EOAM) described e.g. in [1]. The figure shows the basic structure of the flavonol probes and the table displays preliminary values and statistical errors on the dipole moments μ_g and μ_e of the investigated compounds determined in 1,4-dioxane. Further details with respect to the angles between dipole moments and regarding the direction of the transition moment will be presented.

R	Name	$\mu_g/10^{-30}\text{Cm}$	$\mu_e/10^{-30}\text{Cm}$
-N(CH ₃) ₂	FME	15.5 ± 0.2	58 ± 1.2
-N(CH ₂ CH ₃) ₂	PET	16.3 ± 0.2	59 ± 5
-N(15-azacrown-5)	FCR	17 ± 0.6	60 ± 3
-OCH ₃	FOM	9.3 ± 0.6	27 ± 4
*	FME3ME	18.9 ± 0.1	70.2 ± 1

* Like FME but -OCH₃ instead of -OH; no hydrogen bonding!

Using these dipole moment values the interaction energy between the probe compound and its environment can be estimated [2] and information on the polarity of the interaction site thus is available.

- [1] W. Baumann et al., Chem. Phys. Lett. **224**, 517 - 524 (1994)
 [2] N.A. Nemkovich et al., J. Fluoresc. **7**, 363 - 370 (1997)

SPATIAL-TEMPORAL DYNAMICS OF THE CONCENTRATIONAL RESPONSE OF POLARIZING PARTICLES EXPOSED TO THE ACTION OF A GRADIENT FORCE IN A HIGH-POWER LARES RADIATION FIELD

A.N.Rubinov, A.A.Afanas'ev, S.I.Voitovich, Yu.A.Kurochkin, S.Yu.Mikhnevich
 I.Ye.Yermalayev

Institute of Physics, National Academy of Sciences,
 F.Scorina av. 70, Minsk, 220072, Belarus.

Polarizing particles found in the field of a high-power laser radiation with a spatially inhomogeneous intensity are acted upon by a gradient force whose direction is determined by the sign of its polarizability α_0 . Depending on the sign of the quantity α_0 , the particles acted upon by the gradient force are drawn into the region of the acting radiation maxima, or they are forced out of it. The evolution of the concentration of particles under the action of the gradient force can manifest itself in different processes of interaction of laser radiation with molecular systems, among which pumping of dynamics distributed feedback lasers, propagation of a speckle-inhomogeneous laser radiation in a biological media, kinetic spectroscopy of complex molecules, etc.

In the present work, a theoretical investigation of the action of a nonresonance spatially modulated laser radiation on a solution of polarizing particles has been performed. Under the action of the gradient force the initially homogeneous concentration of polarizing particles redistributes, which leads to the formation of spatial structures dependent on the form of modulating intensity. An analytical solution of the linearized one-dimensional Smolukhovskii equation with zero boundary conditions has been obtained in the approximation of a relatively small change in the concentration of particles. This solution was used as the base for investigation of the kinetics of the formation of spatial concentrational structures of particles, which are induced by a gradient force. The process of relaxation of the concentrational response was investigated with the use of the known solution of a diffusion equation. Two cases of spatial modulation of the acting intensity were considered: 1) a harmonic modulation arising as a result of interference of Gauss beam and 2) a modulation characteristic of a zero-order beam.

It is shown that under a high-power nonresonance spatially-modulated radiation, in a solution a concentrational response is induced as a result of the action of the force field of the gradient force. During the action of the laser radiation rectangular in shape, the amplitude of the concentrational response increases linearly with time, and the relaxation process is characterizes by a markedly nonlinear time dependence.

FOUR-WAVE MIXING IN ONE-DIMENSIONAL PHOTONIC CRYSTALS:
INHOMOGENEOUS WAVE EXCITATION.

A.V.Andreev⁽¹⁾, A.V.Balakin, ⁽¹⁾ Д.Быше⁽²⁾, A.B.Kozlov⁽¹⁾, P.Masselim⁽²⁾,
I.A.Ozheredov⁽¹⁾, I.R.Prudnikov⁽¹⁾ and A.P.Shkurinov⁽¹⁾

⁽¹⁾ Department of Physics and International Laser Center, M.V.Lomonosov Moscow

State University, Moscow 119899 Russia

⁽²⁾ Laboratoire de PhysicoChimie de l'Atmosphère, Université du Littoral

145 avenue Maurice Schumann,
59140, Dunkerque, France

Nonlinear optical phenomena in the media with periodic modulation of linear and nonlinear susceptibility have attached considerable attention of optical scientists. In this report we described and experimentally studied the effect of "inhomogeneous" wave excitation in one-dimensional Photonic Crystal (PC) prepared in the form of one-dimensional ZnS/SrF₂ periodical multilayer structure.

In our experiments we measured the intensity of coherent signal on the $\omega_3=2\omega_1+\omega_2$ frequency as a function of the angle of incidence. In order to observe the waveguiding effect on and ω_3 frequency we performed the experiments with different ω_1 and ω_2 wavelengths We used also noncollinear wave interaction to optimize the efficiency of Four wave mixing process in PC. We experimentally observed the waveguiding mode excitation on the ω_3 frequency that opens new possibilities for the wave profile monitoring in PC. It could be also used for the sufficient increasing of nonlinear conversion efficiency in technology and the thin layers diagnostics.

GIANT MICROCAVITY ENHANCEMENT OF QUADRATIC NONLINEAR
RESPONSE OF POROUS SILICON PHOTONIC CRYSTALS

T.V. Dolgova¹, M.G. Martemyanov¹, A.A. Fedyanin¹, and O.A. Aksitipetrov¹

D. Schulmacher², G. Marowsky², V.A. Yakovlev³, G. Mattei⁴

¹Department of Physics, Moscow State University, 119899 Moscow, Russia

²Laser-Laboratorium Goettingen, Hans-Adolf-Krebs-Weg 1, D-37077 Goettingen, Germany

³Institute of Spectroscopy, Russian Academy of Sciences, 142092 Troitsk, Moscow reg., Russia

⁴Istituto di Metodologie Avanzate Inorganiche, CNR, Area della Ricerca di Roma, C.P. 10, 00016, Italy

The presence of photonic band gap makes the photonic crystals (PC) are of great importance both for applications and fundamental research. Varying the parameters of PC mirrors allows to manage the localization of the light in the microcavity (MC) active layer. By the solid-state analogy the MC mode plays the same role as levels of interface traps or defects inside electron band gap in semiconductor. In this paper we report the fabrication of the specially designed porous silicon MC with the cavity mode located inside the photonic band gap and the experimental observation of the enhancement of the second-harmonic (SH) response in the vicinity of the MC mode using a tunable nanosecond parametric generator/amplifier laser system.

Fig. 1, shows the spectrum of the SH intensity (top panel) and linear reflection (bottom panel) for porous silicon MC in s-in,p-out polarization combination for 45 degrees angle of incidence. In the vicinity of the microcavity (at 780 nm) the SH intensity is more than 150 times enhanced. Inset in Fig.1 shows spatial distribution of the amplitude of the fundamental radiation calculated by matrix method. The fundamental radiation is strongly localized in the vicinity of the MC active layer leading to the enhancement of the nonlinear response.

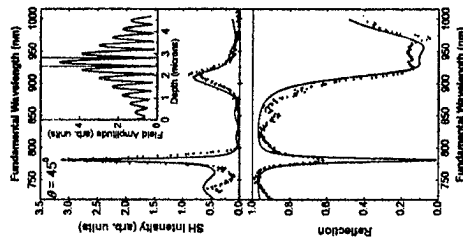

Fig.1. Top panel: SH intensity spectrum measured in porous silicon microcavity in s-in, p-out geometry. Bottom panel: the spectrum of linear reflection of s-polarized fundamental radiation. The inset: the calculated spatial distribution of the amplitude of the fundamental field inside the microcavity. Lines indicate the boundaries of the microcavity active layer.

PHOTONS AND ELECTRONS IN MESOSCOPIC STRUCTURES

S. V. Gaponenko

Institute of Molecular and Atomic Physics

National Academy of Sciences, Minsk, 220072 Belarus

In mesoscopic structures, i. e. inhomogeneous media with topological peculiarities on a length scale of the order of photon and electron wavelengths properties of electromagnetic waves, of electrons and field-matter interaction are significantly modified because of spatial confinement of photons and electrons. In many instances, electrons and photons behave similar if potential relief with respect to electrons is considered by analogy with local dielectric function with respect to electromagnetic waves and if the relevant length scale is considered (nanometer scale in case of electrons and submicron scale in case of photons). This is the case when electron spin effects and many-body interactions within electron subsystem can be neglected. In the present contribution, an overview of properties and processes is presented of electronic and photonic mesostructures and a transfer of concepts from optics to solid state physics and back is discussed. These are conventional and resonance tunnelling, band gap formation in crystals and superlattices, weak and strong localization, fractal spectra of quasiperiodic structures, concept of effective mass and others. Current status of photonic crystal research and development is discussed. In the context of a relation between spatial regularities and spectral properties, optical fractal structures are discussed and the problem of development of structures with pre-determined optical transmission spectrum is considered.

Because of the different length scales where confinement of electrons and photons occurs, a possibility of distinct simultaneous modification of electron and photon density of states exists resulting in novel materials and devices with controllable optical features. Specific experimental realizations of such structures including quantum dots in microcavities and quantum dots in photonic crystals are reviewed.

COHERENT LONG-LIVED ELECTRON-NUCLEAR VIBRATIONS IN WF4
ORDERED POLYACETYLENE NANOPARTICLES (Invited)

D.Yu. Paraschuk

Physics Department, Moscow State University, Moscow 119899, Russia

V.M. Kobryanski

Institute of Chemical Physics, RAS, Moscow 117977, Russia

We found a very unusual behaviour of Raman response in trans-nanopolyacetylene [1]. Nanopolyacetylene is a highly ordered form of polyacetylene [(CH)_x] in which (CH)_x nanoparticles are dispersed in a polyvinylbutyral matrix. For C=C and C-C bond length vibrations of nano-(CH)_x we observed: extremely high Raman cross-section in the transparency range (near IR region), high ratio of the anti-Stokes intensities to the Stokes ones in the transparency range, the Raman excitation spectrum does not show correlation with the electronic absorption spectrum.

We present a qualitative model of coherent weakly damped electron-nuclear vibrations which involve joint motion of both π -conjugated electrons and nuclei. This motion is associated with a collective mode of coupled oscillators which corresponds to $k=0$ optical phonon in an ideal trans-(CH)_x chain. In a real trans-(CH)_x chain the frequencies of the partial oscillators are slightly different, however synchronisation of these oscillators is possible owing to their nonlinear coupling via conjugated π electrons. Thus, the bond length vibrations, for example C=C, occur in-phase along a trans-(CH)_x conjugated chain. This effect resembles the mode-locking effect in lasers. The amplitudes of nuclear displacements are added in many cells of the trans-polyacetylene chain that gives an extremely high Raman signal. The coherent electron-lattice vibrations have a very long lifetime that leads to a high anti-Stokes signal in the transparency range of nanopolyacetylene. The possibility of the phase transition by cooling in a state with persistent electron-nuclear vibrations without scattering is discussed.

I. D. Yu. Paraschuk, V.M.Kobryanski, JETP Lett. 73, 171 (2001).

PRESENT STATUS OF HIGH PERFORMANCE METHANE BASED TRANSPORTABLE OPTICAL FREQUENCY STANDARDS

M. Gubin, A. Shelkovnikov, A. Kireev, E. Kovalchuk, D. Krylova, E. Petrukhin,
V. Polubojarov, M. Petrovskiy, D. Tyurikov

P. N. Lebedev Physical Institute, Leninsky pr. 53, Moscow 117924, Russia

New generation of compact, transportable He-Ne ($\lambda=3,39 \mu\text{m}$) and solid state (RbCl:Li, $\lambda=3,2-3,3 \mu\text{m}$) lasers stabilised over super narrow resonances of saturation dispersion promises to reach the level 10^{-14} - 10^{-15} in frequency repeatability/reproducibility. Simultaneously their relative stability may exceed up to 2 orders the parameters of H-maser at averaging times (10^2 - 10^4) s.

The initial goal of these devices is the transferring of mid-IR frequency calibrated with respect to a Cs primary standard to any laboratory interested in such reference for precise spectroscopy and metrology of optical frequencies. During several years the absolute frequency calibrations with different models of He-Ne/CH₄ lasers at the phase coherent radio frequency chains of PTB (Braunschweig, Germany) and LPTF (Paris, France) are carried out and the transportable lasers are used as secondary references in a number of precise measurements. At present due to fantastic progress with "fermo second comb bridges" able to link the microwave and optical ranges the role of such devices should be reconsidered and the new applications have appeared. In combination with compact "fs-comb chains" methane based standards allow:

- to transfer their excellent short and middle term stability (10^{-14} - 10^{-15} per second) to the desired range of spectrum. In particularly they can play a role of narrow spectrum interrogative oscillators for future super accurate (10^{-16} - 10^{-18}) frequency standards based on laser cooled atoms/ions;
- to serve as intermediate calibrators of proper operation of the fs-comb chains itself.

The talk considers investigations of frequency stability, repeatability/ reproducibility with a set of transportable He-Ne/CH₄ OFS carried out by direct comparison with H-maser and primary Cs frequency standard. The physical and technological ways for radical improvement the performance of the methane based OFS, including narrowing the reference linewidth down to 1 kHz (up to recoil doublet resolution) will be discussed.

ENTANGLEMENT OF MACROSCOPIC ATOMIC SAMPLES, TOWARDS TELEPORTATION OF ATOMS

B. Julsgaard and E. S. Polzik.

Institute of Physics and Astronomy, University of Aarhus
8000, Denmark

Entanglement is a key ingredient in quantum information processing. With entanglement of atoms and/or entanglement of light in hand, a variety of quantum communication protocols is possible [1]. It is most surprisingly that to entangle macroscopic samples of atoms and to perform atomic teleportation [2] only light in a coherent state is necessary.

In our attempt to realize such an entanglement we use two paraffin coated vapor cells with Cesium close to room temperature. The coherence time of the spins of our cesium vapor in paraffin coated glass cells is up to 30ms and can in principle be even longer. This sets the scale for the entanglement life time.

The atomic variables to be entangled are the transverse spin components of two oriented Cs samples in $F=4$, $6S_{1/2}$ ground state. Orientation is achieved by optical pumping. The creation of entanglement itself takes advantage of a basic principle in quantum mechanics; when an observable is measured, the wave function will collapse into an eigenstate of the measured observable.

For an oriented spin J_x , two transverse spin components are non-commuting, $[J_x, J_y] = J_z$, and cannot be measured simultaneously. On the other hand, for two oppositely oriented spins of equal magnitude $J_{x1} = -J_{x2}$ the sums of transverse spins can be measured simultaneously, and if this is done with sufficient accuracy, the samples must collapse into an Einstein-Podolsky-Rosen (EPR) entangled state $J_{y1} = J_{y2}$, $J_{z1} = J_{z2}$.

The measurement which creates the entanglement is performed via Faraday effect. The transverse spin components are measured by detecting the polarization rotation of a probe beam of light tuned about 1 GHz off D_2 transition. Note, that Doppler broadening is of little importance at such a detuning. This is the reason why the experiments can be carried out in a room temperature vapor.

The first pulse of the probe light creates the EPR state and the second pulse sent after a delay of about 1 ms verifies that the state has been created and has survived during the delay period. The progress and latest results on the degree of observed entanglement will be reported.

Note, that the number of atoms in each sample is of the order 10^{10} , thus the spin components can be regarded as continuous variables. With the entanglement described above, it is possible to perform teleportation of continuous atomic variables in a manner very similar to the technique used in [3] for teleportation of continuous variables of light. Other quantum information processing routines, such as quantum memory for light can also be implemented [1].

[1] A. Kuzmich and E. S. Polzik, Phys. Rev. Lett., vol. 85 (2000) p. 5639

[2] Lu-Ming Duan, J. I. Cirac, P. Zoller, E. S. Polzik, Phys. Rev. Lett., vol. 85 (2000) p. 5643

[3] A. Furusawa, J. L. Sørensen, S. L. Braunstein, C. A. Fuchs, H. J. Kimble and E. S. Polzik, Science, vol 282 (1998) p. 706

Entangling Macroscopic Oscillators

Vittorio Giovannetti, Stefano Mancini, and Paolo Tombesi

*Dipartimento di Matematica e Fisica, Università di Camerino
I-62032 Camerino, Italy*

It is since the original formulation of Quantum Mechanics that efforts to unambiguously distinguish the classical from the quantum world have persisted. The Bohr-Einstein debate about the interpretation of the quantum theory rose questions that still are controversial, although evidences there are supporting the Bohr point of view.

However, a clear-cut answer to the questions posed by the formulation of the theory is still far to be achieved. In this context, we think an important point is to asses whether one of the peculiarities of the quantum world, i.e. the entanglement, could be applicable to macroscopic bodies and, moreover, measurable.

It is indeed usually believed that, being a superposition of states, the entanglement between macroscopic objects is not measurable because of the fast diagonalization of the system's density matrix due to the coupling with the environment.

It will be proposed an experiment, which could be realized with present technologies, to show that, by exploiting the radiation pressure force, it is possible to entangle massive oscillators, at least as long as one can consider oscillators with a mass of 10 mg sufficiently macroscopic.

The entanglement in open systems is not easily measurable, to this goal, and because in an Einstein-Podolsky-Rosen (EPR) paradox the entanglement is the essential ingredient, by showing that an EPR-like relationship holds for massive macroscopic oscillators, one can be sure of its presence.

Quiet Atoms

Klaus Mølmer

Institute of Physics and Astronomy, University of Aarhus
DK 8000, Århus C., Denmark
molmer@ifa.au.dk

Squeezed states of light, an example of so-called 'non-classical' states of light, may outperform classical fields in high precision experiments, because measurements on these states are less noisy than measurements on classical fields, and even on the vacuum. Atomic squeezing is defined in a way similar to squeezing of light, and squeezed atoms are thus 'more quiet' than for example a state where all atoms are in the ground state. Because atoms with two states can be represented by the algebra of spin $1/2$ particles, we refer to such states as spin squeezed states.

The achievements and practical potential of squeezed states of light and spin squeezed states of atoms differ for two reasons:

1. With non-linear optical processes in suitable materials, moderately squeezed light has been produced, and several non-classical properties have been demonstrated. Due to quite strong interactions between atoms and between atoms and light, and due to the long storage and interaction times for atoms, the degree of correlations and squeezing obtainable in atomic systems exceeds the same effects in light by orders of magnitude.
2. Classical technology has so far left enough space for improvement at a lower cost than required to install non-classical light, so that a real practical high precision application of squeezed light remains to be seen. This is to be contrasted with the fact, that there is a real potential for application of squeezed atoms since already current atom interferometers and atomic clocks operate at a limit of precision which can only be improved by imposing quantum correlations between the atoms.

In the talk we will review the definition and expected practical use of squeezed atomic states. We will address a series of competing proposals for atomic squeezing from the past one or two years, and we will point out that measurements of the squeezed macroscopic atomic properties quantify the amount of entanglement between atoms.

Wednesday/21

WG1
(Invited)

THE DESIGN OF A COMPACT OPTICAL FREQUENCY SYNTHESIZER

Th. Udem, R. Holzwarth, M. Zimmermann, and T.W. Hänsch

Max-Planck-Institut für Quantenoptik, Hans-Kopfermann-Str.1, 85748 Garching, Germany
Phone: +89-32905-257 fax: +89-32905-200 email: thomas.udem@mpg.mpg.de

J.C. Knight, W.J. Wadsworth, and P.S.L.J. Russell
Optoelectronics Group, Department of Physics, University of Bath, Claverton Down, Bath,
BA2 7AY, UK

Ever since it became possible to directly measure optical frequencies in the early 70s [1], large and delicate harmonic frequency chains where necessary for this task. Because of this tremendous effort, only a few of these chains have been realized worldwide [2,3,4,5]. A harmonic frequency chain, that is designed to measure only one particular optical frequency, starts from a well known reference frequency either in the radio frequency or in the optical region. With a chain of frequency multiplication (and possibly sum- and difference frequency generation) the target frequency is phase coherently linked to the reference frequency. This approach makes it necessary to traverse the whole electromagnetic spectrum between the reference and the target frequency with different oscillators, detectors and nonlinear devices.

The use of a femtosecond mode locked laser as an active frequency comb generator immediately enabled the measurement of large optical frequency differences by referencing the mode spacing (=pulse repetition frequency) and counting a large number of modes. When applied to different harmonics of the same laser, its absolute frequency is effectively mapped onto an optical frequency difference [6]. In its simplest form the frequency difference between the laser (f) and its second harmonic ($2f$) is measured [7,8,9]. An octave spanning frequency comb is conveniently realized with a Ti:Sapphire laser and photonic crystal fiber [9,10]. After the comb is locked every mode in the resulting optical frequency synthesizer is calibrated with the same accuracy as the radio frequency reference that is used to control the mode spacing and a radio frequency offset that results from the difference of the phase velocity and the group velocity inside the laser cavity. Such a synthesizer can consist of a single laser only and is nevertheless capable of measuring almost any optical frequency without modification.

We have thoroughly tested and applied these optical synthesizers to measure various optical transitions of fundamental and practical interest.

- [1] K.M. Evenson *et al.*, Appl. Phys. Lett. **22**, 192 (1973).
- [2] Th.Udem *et al.*, Phys. Rev. Lett. **79**, 2646 (1997).
- [3] H.Schnatz *et al.*, Phys. Rev. Lett. **76**, 18, (1996).
- [4] C.Schwob *et al.*, Phys. Rev. Lett. **82**, 4960 (1999).
- [5] J.E. Bernard *et al.*, PRL **82**, 3238 (1999).
- [6] Th.Udem *et al.*, Phys. Rev. Lett. **82**, 3568 (1999).
- [7] S.A. Diddams *et al.*, Phys. Rev. Lett. **84**, 5102 (2000).
- [8] R. Holzwarth *et al.*, Phys. Rev. Lett. **85**, 2264 (2000).
- [9] J.C. Knight *et al.*, Opt. Lett. **21**, 1547 (1996).
- [10] J.K. Ranka *et al.*, Opt. Lett. **25**, 25 (2000).

WG2
(Invited)

Frequency standard based on Nd:YAG/ I_2 laser system

A.Yu.Nevsky, P.V.Pokasov, M.N.Skvortsov, S.N.Bagayev,
Institute of Laser Physics,
Siberian Branch of the Russian Academy of Sciences
630090, Russia, Novosibirsk, Prosp. Ac.Lavrentyev, 13/
H.Schnatz, F.Riehl,

Phys.-Tech. Bundesanstalt, Germany.

J.von Zanthier, E.Peik, H.Walther, R.Holzwarth, J.Reichert, Th.Udem, T.W.Hänsch,
Max-Planck-Inst. für Quantenoptik, Germany.

Two-wavelength optical frequency standard based on compact diode-pumped Nd:YAG laser with intracavity frequency doubling was developed. The tuning range of 400 GHz was obtained at wavelength 532 nm. To obtain long-term frequency stability the second harmonic signal lasing frequency was locked the saturated absorption resonance in $^{127}I_2$. The range of Nd:YAG frequency stability of about $\Delta\nu/\nu=5 \times 10^{-14}$ at 200-400sec was achieved. Influence of physical factors at frequency stability and reproducibility was investigated. The absolute frequency of Nd:YAG/ I_2 system with employment of He-Ne/ CH_4 optical standard and scheme of optical frequency syntheses was developed. A frequency comparison two independent I_2 - stabilized laser systems, one set up at Institute of Laser Physics, Novosibirsk, Russia, the other at the Physikalisch - Technische Bundesanstalt, Braunschweig, Germany, were investigated.

Laser spectroscopy applied to environmental and medical research

Sune Svanberg

Department of Physics, Lund Institute of Technology

P.O. Box 118, S-221 00 Lund, Sweden

Email: sune.svanberg@fvsk.lth.se

Laser spectroscopy provides many possibilities for real-world applications. Powerful techniques have been developed for chemical analysis, combustion diagnostics, environmental monitoring and biomedical diagnostics. The present paper focuses on the two latter aspects, and numerous examples from the research performed at the Lund Institute of Technology are given. Atmospheric monitoring includes the laser radar, the diode laser spectroscopy and the gas correlation imaging methods, while laser-induced fluorescence (LIF) is applied to hydrophobic pollution measurements, vegetation status assessment and building facade monitoring. LIF also provides new possibilities for early cancer detection employing the native tissue autofluorescence and specific fluorescence from tumour seeking agents. Point-monitoring and imaging systems have been constructed. The latter substances also enable photodynamic therapy of tumours. Pulsed tissue transillumination allows the suppression from scattered light blurring, providing new possibilities for optical mammography. Narrow-band diode-laser spectroscopy combined with diffuse light transport through scattering media enable novel gas monitoring, also allowing pressure and diffusion assessment. Finally, laser-produced X-rays may provide means for reducing the dose of ionizing radiation needed for diagnostic imaging employing methods similar to those for the optical case. Selected references are given.

1. S. Svanberg, *Atomic and Molecular Spectroscopy - Basic Aspects and Practical Applications*, 3rd Edition (Springer, Heidelberg, Berlin, New York 2001)
2. C. Foakis, and S. Svanberg, *Applications of Laser Spectroscopy*, Europhysics News 29, 151 (1998)
3. P. Weibring, H. Edner, S. Svanberg, G. Cecchi, L. Panzani, R. Ferraro and T. Calabiano, *Monitoring of Volcanic Sulphur Dioxide Emissions*, Appl. Phys. B67, 419 (1998)
4. S. Svanberg, *Fluorescence Lidar Monitoring of Vegetation Status*, Phys. Scripta T58, 79 (1995)
5. U. Gustafsson, G. Somesfalean, J. Alnis and S. Svanberg, *Frequency Modulation Spectroscopy with Blue Diode Lasers*, Appl. Optics 39, 3774 (2000)
6. J. Alnis, U. Gustafsson, G. Somesfalean and S. Svanberg, *Sum-frequency Generation with a Blue Diode Laser for Mercury Spectroscopy at 254 nm*, Appl. Phys. Lett. 76, 1234 (2000)
7. U. Gustafsson, J. Sandsten, and S. Svanberg, *Simultaneous Detection of Methane, Oxygen and Water Vapour Utilizing Near-Infrared Diode Lasers in Conjunction with DFG*, Appl. Phys. B 71, 853 (2000)
8. M. Sjöholm, G. Somesfalean, J. Alnis, S. Andersson-Engels, and S. Svanberg, *Analysis of Gas Dispersed in Scattering Solids and Liquids*, Opt. Lett. 26, 16 (2001)
9. J. Sandsten, P. Weibring, H. Edner and S. Svanberg, *Real-time Gas-Correlation Imaging Employing Thermal Background Radiation*, Optics Express 6, 92 (2000) <http://www.opticsexpress.org>
10. S. Svanberg, *New Developments in Laser Medicine*, Phys. Scripta T72, 69 (1997)
11. U. Gustafsson, S. Pålsson, and S. Svanberg, *Compact Fiber-optic Fluoresensor using a Continuous-wave Violet Diode Laser*, Rev. Sci. Instr. 71, 3004 (2000)
12. I. Wang, N. Bendsoe, C. af Klimateberg, A.M.N. Ejegder, S. Andersson-Engels, S. Svanberg and K. Svanberg, *Photodynamic Therapy versus Cryosurgery of Basal Cell Carcinomas*; Results of a Phase III Clinical Trial, *British J. Dermatology*, in press
13. M. Stenberg, M. Soto Thompson, Th. Johansson, S. Pålsson, C. af Klimateberg, S. Andersson-Engels, S. Svanberg and K. Svanberg, *Interstitial Photodynamic Therapy - Diagnostic Measurements and Treatment of Rat Malignant Experimental Tumours*, SPIE 4161 (2000)
14. S. Svanberg, *High Power Lasers and their Applications*, Adv. Quant. Chem. 30, 209 (1998)
15. M. Grätz, A. Pifferi, C.-G. Wahlström, and S. Svanberg, *Time-gated Imaging in Radiology: Theoretical and Experimental Studies*, IEEE ISTQE 2, 1041 (1996)
16. M. Grätz, L. Kiernan, K. Herrlin, C.-G. Wahlström, and S. Svanberg, *Time-gated X-ray Tomography*, Appl. Phys. Lett. 73, 2899 (1998)

FAST RELAXATION PROCESSES IN IMMUNOACTIVE HETEROSTEROID MOLECULES

A. A. Akhrem^a, N. A. Borisevich^b, A. L. Mikhalechuk^a, and G. B. Tolstorozhev^b

^aInstitute of Bioorganic Chemistry, National Academy of Sciences of Belarus, Kuprevich Ave. 5/2, 220141 Minsk, Belarus

^bInstitute of Molecular & Atomic Physics, National Academy of Sciences of Belarus, F. Skaryna Ave. 70, 220072 Minsk, Belarus

Our investigations in this field of biochemistry of heterosteroids have shown that 8-azasteroid molecules represent a new class of low-molecular and non-antigenic agents to modulate immune functions of man and animals [1].

Laser spectroscopy research on fast relaxation processes and structural changes in 8-azasteroids is urgent, first, to establish an electronic structure of this specific class molecules, second, to reveal interrelations between spectroscopic parameters of molecules and their physiologic action, like immune-regulation, upon a living organism [2,3].

The orbital nature of n,π^* and π,π^* electronic states of 8-azasteroid molecules is established by quantum-chemical calculation methods. The probabilities of relaxation processes in excited states of molecules over femtosecond and picosecond time ranges are determined [4].

The picosecond kinetics of transient absorption under long and short wavelength excitation differs essentially. This is consistent with theoretical predictions for a different orbital n,π^* and π,π^* nature of excited electronic states.

The dynamic model of fast intramolecular charge transfer in the framework of "mesomeric tautomerism" for sp^3-sp^2 rehybridization in 8-azasteroids is proposed as an original cause of the spectroscopic effects seen for molecules.

Spectroscopic testing of the structural-dynamic state of membrane proteins of lymphoid cells in solutions added with 8-azasteroids is performed.

1. A.A. Akhrem, B.B. Kuzmitsky, F.A. Lakhvich, V.A. Khripach, Yu.L. Zhuravkov. In: "Chemistry and Biology of Immunoregulators", (Rus) Riga (1985) 265-278
2. A.A. Akhrem, N.A. Borisevich, O.V. Gulyakevich, L.A. Mikhalechuk, S.A. Tikhomirov, G.B. Tolstorozhev. In: "Spectroscopy of Biological Molecules", Kluwer Acad. Publ. (1999) 133-134
3. A.A. Akhrem, N.A. Borisevich, O.V. Gulyakevich, L.A. Mikhalechuk, T.F. Raichenok, S.A. Tikhomirov, G.B. Tolstorozhev. *J. Fluorescence*, v. 9 (1999) 357-361
4. A. Ya. Arukhob, N.A. Borisevich, O.V. Gulyakevich, L.A. Mikhalechuk, T.F. Raichenok, G.V. Mayer, G.B. Tolstorozhev. *J. Appl. Spectr.*, (Rus) v. 69 (2001) 5-10

SUBPICONSECOND PHOTOPHYSICS OF Cu(II) PORPHYRINS: EXCITED STATE
QUENCHING BY AN AXIAL LIGAND ASSOCIATION

Vladimir S. Chirvony¹, Michel Negretie², Pierre-Yves Turpin³

¹ *Institute of Molecular and Atomic Physics, National Academy of Sciences of Belarus*

F. Skaryna Ave. 70, Minsk 220072, Belarus

² *INSERM U451, ENSTA Centre de l'Yvette, Chemin de la Huniere*

91761 Palaiseau Cedex, France

³ *Universite Pierre et Marie Curie, LPBC (CNRS ESA 7033), Box 138*

4 place Jussieu, 75252 Paris Cedex 05, France.

Photophysics of Cu(II) porphyrins (CuPs) is rather complex due to a presence of the low-lying excited state of an intramolecular charge-transfer (CT) origin. But this photophysics is, however, much more simple than that of Fe porphyrins which serve as cofactors in numerous heme proteins. This allows one to consider the CuPs as a good model of the heme. Besides, CuPs may participate in biologically important reactions of an axial ligand exchange

Dynamics of photoinduced axial ligand association to the cationic Cu(II) porphyrin Cu(II)TMPyP4 in water is studied by the method of femtosecond transient absorption spectroscopy. It is shown that the reaction of water association to the excited Cu(II)TMPyP4 follows monoexponential kinetics (time constant 1.0 ± 0.2 ps) resulting in a formation of five-coordinate CuP in excited electronic (d,d) state (so called exciplex), efficiency of the exciplex formation being ~ 0.85 , lifetime 7.0 ± 0.5 ps. A minor part of excited CuP molecules ($\sim 15\%$) does not participate in the exciplex formation and is quenched to the ground state with time constant 25 ± 2 ps. It is suggested that only vibrationally hot CuP molecules associate water as an axial ligand, the remaining part of excited CuP molecules is quenched without water association, through the low-lying CT state, position of the CT state being modulated by encounters with polar water molecules.

PATHWAYS AND MECHANISMS OF RELAXATION PROCESSES
IN SELF-ASSEMBLED PORPHYRIN TRIADS IN SOLUTIONS AND FILMS

E.I. Zenkevich¹, A.M. Shulga¹, D.S. Kilit², C. von Borczyskowski²

¹ *Institute of Molecular and Atomic Physics, Natl. Acad. Sci. of Belarus,*

F. Skaryna Avenue 70, 220072 Minsk, Belarus.

² *University of Technology Chemnitz, Reichenhainer Str. 70, 09107 Chemnitz, Germany*

The elucidation of the structural and electronic properties of natural light-gathering arrays and reaction centres provide a foundation for the design of artificial nanoscale models with the effective photoinduced electron transfer (PET) and energy migration (EM) as well as synthetic photovoltaic devices for molecular electronics.

In this respect, the competition between PET and EM processes in a real time scale has been studied for self-assembled triads of various geometry (one type is seen in Fig.) based on Zn-octaethylporphyrin chemical dimer (energy and electron donor, D) and dipyrityl substituted extra-ligands (porphyrins, chlorin, tetrahydrophyrin) as the acceptors, A, in liquid solutions and polymeric (PMMA) films at 350-77 K. On the basis

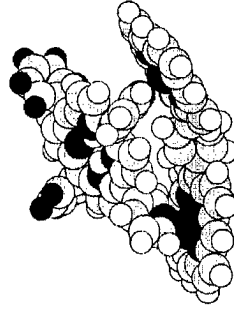

of time correlated single photon counting technique (system response $\Delta t_{1/2} = 75$ ps) with a global analysis fit and pump-probe spectroscopy ($\Delta t_{1/2} = 280$ fs) it has been found that D fluorescence quenching with time constant ranging from 1.7 ps to 10 ps is due to competing

EM and ET processes from the dimer to A's. Interestingly, in toluene at 293 K the extra-ligand fluorescence decay time shortening in ns time scale is observed being hard dependent on the triad geometry. This quenching becomes stronger upon the solvent polarity increase and the temperature lowering (278 K \rightarrow 221 K). The experimental data are analyzed using the reduced density matrix formalism in the frame of Haken-Strobl-Reineker method. This approach includes EM and ET processes as well as the dephasing of coherence between the excited electronic states of the triad. The possible reasons and mechanisms of the non-radiative deactivation of D and A locally excited S₁-states in the triads are discussed taking into account a close lying charge-separated state.

Yb:KYW MICROCHIP LASER

A. N. Kuzmin, V. A. Orlovich,

Institute of Physics, National Academy of Sciences of Belarus, F. Skaryna Ave. 68,

220072 Minsk, Belarus

e-mail: kuzmin@dragon.bas-net.by

A. A. Demidovich,

Institute of Molecular and Atomic Physics, National Academy of Sciences of Belarus,

F. Skaryna Ave. 70, 220072 Minsk, Belarus

M. B. Danailov,

Laboratory for Lasers and Optical Fibres, SS14, km. 163.5, Sincrotrone-Trieste, Italy

A. Bednarkiewicz, W. Strek,

Institute for Low Temperature and Structure Research, Polish Academy of Sciences, 50-950 Wrocław 2, PO Box 937, Poland

H. J. Eichler,

TU Berlin -Optisches Institut, Str. d. 17. Juni 135, D-10623 Berlin, Germany

A. N. Titov

Vavilov State Optical Institute, Byrzhnevaya line 12, 199034 St.-Petersburg, Russia

Ytterbium doped potassium yttrium tungstate (KY(WO₄)₂:Yb³⁺ or Yb:KYW) is known as an efficient laser medium for miniature diode pumped solid-state lasers, including Raman lasers with self-frequency conversion. In this communication we present the results on investigation of Yb:KYW diode pumped microchip laser CW operation to our knowledge for the first time.

The microchip laser was made of a 1 mm thickness Yb:KYW crystal cut along the b axis and HR/AR coated in the wavelength range 1010-1160 nm on the pump/output facet, respectively. The crystal was mounted with the AR coated surface in close proximity to the flat output coupler

Maximum slope efficiency of about 23% and best efficiency relative to incident pump power of 10% were achieved with an output coupler with 10% transmission.

OPTICALLY PUMPED TRANSVERSE LASERS BASED ON ZnMgSSe/ZnSe AND InGaN/GaN HETEROSTRUCTURES

E. V. Lutsenko, V. Z. Zubiatevich, V. N. Pavlovskii, I. P. Marko, A. L. Gurskii,

G. P. Yablonskii

Stepanov Institute of Physics, National Academy of Sciences, F. Skaryna Ave. 68,

220072 Minsk, Belarus

H. Kalisch

Institut für Theoretische Elektrotechnik, RWTH Aachen, Kopernikusstr. 16,

D-52074 Aachen, Germany

O. Schön, H. Protzmann, M. Lünenbürger, B. Schimeller, M. Heuken

AIXTRON AG, Kackerstr. 15-17, D-52072 Aachen, Germany

ZnMgSSe/ZnSe and InGaN/GaN heterostructures are very promising for the fabrication of light emitting devices from the near UV up to the green spectral region. The ZnSe- and GaN-based multiple quantum well (MQW) heterostructures with different compositions and active, barrier, cladding and waveguiding layer numbers and thicknesses were grown in AIXTRON MOVPE reactors on GaAs and Al₂O₃ substrates.

Laser action was achieved in all types of ZnSe QWs in the spectral range from 440 nm up to 490 nm in a temperature interval of 78 - 620 K. The laser pulse energy at T=300 K was 20 - 30 nJ and the minimum laser threshold was 20 kW/cm² for N₂ laser radiation. The far field pattern consisted of an oval spot with a divergence of $(\theta/2)_H = 14^\circ$ in the sample plane and $(\theta/2)_V = 26^\circ$ in the perpendicular plane. The ZnSe MQW lasers degraded at T>450 K due to sulfur diffusion from the barrier layers.

Optically pumped lasing without any degradation up to T=580 K over the wavelength range of 370 - 470 nm in the GaN-based MQWs and layers was achieved. The energy and power per pulse of the laser were 80 nJ and 10 W, correspondingly, for one facet at T=300 K. The energy quantum of the laser emission was lower than the mobility edge of the MQWs lasing in the green spectral region. The PL and PLE spectrum structures suggest that In-rich quantum dots inside the InGaN active QWs are involved in the recombination mechanism.

METHODS AND DEVICES FOR OPTICAL DIGITAL PROCESSING,
TRANSFER AND SWITCHING OF LIGHT SIGNALS ON THE BASIS
OF OPTICAL BISTABILITY AND ANISOTROPY IN CRYSTALS

AND A2B6, A3B5 SEMICONDUCTOR COMPOUNDS

A.M. Goncharenko, G. V. Sinitsyn, S.P. Apanasevich, N.A. Khilo, V.L. Malevich,
A.S. Yasukevich, M.A. Khodasevich, A. V. Lyakhovich, I.A. Utkin, A. V. Kazberuk,
N.A. Saskevich, N. V. Strizhenok, M. V. Rogovaya

Division for Optical Problems in Information Technologies, NAS of Belarus
Kuprevich str, 1, build. 2, 220141, Minsk, Republic of Belarus

The project is aimed at development and creation of new element base for optical digital information processing systems.

In the course of project's realization the following main results have been obtained:

- * the methods of forming light fields of the desired spatial structure (including Bessel and other non-gaussian beams) for optical information processing systems are developed;
- * fundamental physical and quantum-mechanical restrictions on throughput and capacity of bosonic and fermionic information channels are estimated;
- * transverse effects in optical bistability, that provide a basis for developing the concept of digital information processing in optics are studied both theoretically and experimentally with the help of thin-film interference structures;
- * new methods for designing optical information systems such as "transverse lock-and-clock" and "planar — free space" architectures are developed;
- * a number of strong and fast mechanisms of optical nonlinearity in semiconductor compounds A3B5 is revealed and studied;
- * 2D and 3D nonlinear optical elements and circuits for logical processing and switching of digital light signals on the basis of optical bistability are designed, created and experimentally investigated.

This work has been supported by the ISTC (grant B-129).

LASER HYDROACOUSTIC PROBE OF WIDE MEDICAL APPLICATION

Zhel'tov G.L., Pozniak N.I., Rozhdestvin V.N.*, Rubanov A.S., Spiridonov I.N.*

B.I. Stepanov Institute of Physics National Academy of Sciences
Scorfina Ave. 70, 220072, Minsk, Belarus.

* N.E. Bauman Moscow State Technical University

Research Institute of Radioelectronics and Laser Technology
2-nd Baumanskaya 5, 107005, Moscow, Russia.

The project's purpose is to create a new laser device, which provide effective conversion of laser energy to energy of acoustic (shock) waves in biological tissues. The device is intended for wide use in different branches of medicine.

Response of any liquid or quasi-liquid media to irradiation by short (from unities up to tens ns) includes forming of acoustic or shock waves. Amplitude, shape and frequency of the waves depend both on irradiation conditions (wavelength, power, exposure time, frequency of modulation, duration of individual spikes and so on), and, to a great extend, on physical (density, sound velocity, spectral absorption coefficient and others) parameters of medium. Eigenfrequency of tissues vibrations in the response has order of MHz. If falling laser radiation constitutes a train of short spikes, the acoustic signal can be amplified (in-phase pumping) or damped (out-of-phase pumping). These phenomena are expected to be used for early diagnostic of any pathological new growths (cataract, cancer tumors, cerebral growth and many others), which properties differs from surrounding media, and, if laser power is sufficiently high, for selective disruptive action.

The Project includes creation of unique high power quasi — CW diode pumped solid state laser with pulse modulation of radiation. Frequency of modulation has to be lain within the limits from fractions to units of MHz.

Deep theoretical and experimental investigations is planned to find the optimal conditions of effective conversion of laser energy to acoustic vibration of media, and to determine the best parameters of radiation for concrete medical applications: diagnostic, different kinds of surgery, ophthalmology, cosmetology, high resolution acoustic tomography and others.

The device and some new medical applications of lasers have to be tested in clinics and patented.

THEORETICAL AND EXPERIMENTAL RESULTS OF INVESTIGATION ON ATOMIC AND NUCLEAR PROCESSES IN LASER PRODUCED PLASMAS

Vadim S. Belyaev and Anatoly P. Matafonov

Central Research Institute of Machine Building of Russian Aviation Space Agency
4, Pionerskaya Str., Korolev, Moscow Region, 141070, Russia
Phone: (7) 095-5134693 Fax: (7) 095-1871588 E-mail: matafonov@mtu-net.ru

The theory of self-activated atomic and nuclear conversion in laser produced plasma is developed. Plasma produced by action of high intensity (more than 10^{16} W/cm²) ultrashort pulse (less than 10^{-12} sec) laser radiation on a solid target is considered. In case of the laser-produced plasmas one has to do with stabilities (of atoms and nuclei), as well as with unstabilities, i.e. collective processes at all stages of laser-produced plasma development. The collective processes play the decisive role in the laser-produced plasmas. This is the reason for representation of plasma of the sort as a quantum object. The mechanism of superstrong magnetic fields energy transformation into the energy of atomic and nuclear systems excitation in a laser-produced plasma are studying.

In frame of reasonable simplification the model of intensive ultra short pulse radiation interaction with matter has been build with regard to the effect of the produced plasmas with atoms. In the processes of model development a fundamentally new fusion concept was put forward and substantiated, namely, the photo-field fusion. Plasma anomalous diffusion in a magnetic field is demonstrated to be of quantum nature as a tunnel transition of an oscillator potential barrier having periodic structure of energy levels. The anomalous diffusion coefficient is determined. It is shown that this coefficient governs the cyclotron emission, dynamic pinch and field (tunnel) ionization of atoms. The periodic structure of electron rotation energy levels in a magnetic field is shown to produce an "antireflection" effect analogous to the well-known phenomenon in optics and similar to the process of electron transit through a solid periodic structure.

Modification of the analytical and numerical models of phenomena and processes, connected with super strong fields interaction with and passing through the matter was carried out taking into account of laser radiation prepulse existing. The nuclear-physical research methods which are promising for laser produced plasma processes control were developed and created with using of x-ray spectrometers, all-wave neutron detector, two scintillation detectors based on organic stilbene crystal (C₁₄H₁₂) and scintillation γ -spectrometer based on inorganic NaI(Tl) crystal.

The paper presents results of updating the laser system to gain the required parameters predetermined by the project goals ($J \sim 10^{17} \pm 10^{18}$ W/cm², $t < 10^{-12}$ sec) with use of new technique developed by us for measuring ultrashort-pulse radiation parameters based on the chirped pulse spectral interferometry method.

The paper also presents results of the experimental investigation on x-ray, gamma-radiation and neutron generation in laser produced plasma.

The present work was supported by International Science and Technology Center under Project number 856.

ULTRAFAST ELECTRON DYNAMICS IN METAL NANOPARTICLES

Frank Träger

Fachbereich Physik, Universität Kassel,

Heinrich-Platt-Str. 40, D-34132 Kassel, Germany

Surface plasmon excitation in metal nanoparticles has found great interest in the past, since this collective oscillation of the conduction electrons can be stimulated with light and since its resonance frequency can be tuned over a wide spectral range by varying the size and shape of the particles, by changing the dielectric surrounding and choosing different metals. At present, however, no systematic investigation of the ultrafast decay time T_2 and the decay mechanisms of this excitation are available. Main reason is that nanoparticles usually have broad size and shape distributions which introduce inhomogeneous line broadening and prevent the determination of T_2 by optical absorption spectroscopy as well as time-resolved experiments using femtosecond laser pulses.

This paper presents an overview of recent experiments by a novel technique [1] to determine the homogeneous linewidths of surface plasmon resonances of nanoparticles in the presence of *inhomogeneous broadening* and thus measure T_2 . The method is based on persistent spectral hole burning in the absorption profiles of supported metal clusters by nanosecond laser pulses. In order to demonstrate the potential of the new method, we have applied it to oblate Ag clusters on quartz substrates under ultrahigh vacuum conditions. Size and shape dependent dephasing times ranging from 2.5 to 10 fs have been extracted from the experimental results and a theoretical model of hole burning. The values reflect the reduced dimensions of the nanoparticles, and we conclude that additional damping mechanisms, in particular surface scattering, come into play, if the electrons are confined in aggregates with dimensions below about 5 nm. The results are also essential to optimize the local field enhancement in the vicinity of the particles for purposes like surface enhanced Raman scattering or high-sensitivity fluorescence detection.

[1] F. Stietz, J. Bosbach, T. Wenzel, T. Vartanyan, A. Goldmann, F. Träger, Phys. Rev.

Let. **84**, 5644 (2000)

Light-induced structural transformations
and optical nonlinearity
in gallium nano-films and self-assembled nanoparticles

*K.MacDonald, [†]V.Fedotov, [‡]G.Stevens, [§]S.Pochon, [¶]V.I.Emel'yanov,
^{||}W. Brocklesby and ^{|||}N.I.Zheludev

[†]Department of Physics and Astronomy, University of Southampton, SO17 1BJ, UK
[‡]Department of Physics, Moscow State University, Moscow 119899, Russia

We report observation of an optical nonlinearity in gallium nano-particles resulting from a light-induced structural transformation in the metal which is known for its incredible polymorphism. A freshly cleaved single-mode optical fiber was put into a vacuum chamber and cooled to 100 K. The end of the fiber was exposed to a beam of mirror made of just a few picograms of material. The gallium forms nano-particles by self-organization. These particles are relatively uniform in size, with a diameter typically between 80 and 200 nm, which depends on the thickness of the gallium film from which they formed.

The mirror shows dramatic and unusual nonlinear characteristics that depend strongly on temperature. These were studied *in situ* using a pump-probe arrangement based on diode lasers - a cw probe laser ($\lambda_{\text{probe}} = 1.3 \mu\text{m}$) and a pulsed pump laser ($\lambda_{\text{pump}} = 1.55 \mu\text{m}$). Irradiation with pump pulses lasting between 100ns and 1.2 μs with peak powers up to 20 mW, changes the mirror's reflectivity by up to 5% in a reversible and highly reproducible fashion. The induced reflectivity change is greatest at the nano-particles' melting temperature and disappears above it. When the optical stimulation is withdrawn the reflectivity recovers to its original level with a temperature-dependent relaxation time which critically increases from about 200ns to more than 6 μs at the melting temperature. A clear hysteresis is seen in both the magnitude of the effect and its relaxation time when the sample temperature is scanned from -170°C to +40°C and back. The nonlinear characteristics of the nano-particles are compared to those of a gallium film during the deposition process, i.e. before particle self-assembly has taken place. They show a strong dependence of the relaxation time on the layer's thickness up to several nanometers.

We believe that our observations are consistent with a light-induced structural transformation in the gallium nano-particles leading to a strong change in the optical properties of the film. We discuss thermal and non-thermal mechanisms of light-induced transformation in nano-particles which occurs between the crystalline alpha- and beta-phases of gallium and liquid gallium.

PLASMONIC MESO- AND NANO-STRUCTURES:
NEW AVENUES FOR PHOTONICS, LASER PHYSICS AND SPECTROSCOPY

Vladimir M. Shalaev
New Mexico State University, U.S.A.

Department of Physics, MSC 3D, New Mexico State University, Las Cruces, NM 88003,
U.S.A.; tel: (505) 646-1932, fax: (505) 646-1934, email: vshalaev@nmsu.edu

Fundamentals of electromagnetic and optical properties of micro- and nano-structured metal-dielectric composites, both ordered and disordered, are reviewed. We analyze how symmetries of different plasmonic materials influence their optical properties [1,2]. By employing unique properties of metal nanostructures, we show a possibility of the fabricating of low-loss plasmonic crystals with a large and scaleable photonic band gaps. We also show that in periodic metal mesostructures, the "effective" electron mass can be significantly enhanced resulting in extremely low-frequency plasmons. The periodicity makes possible sneaking light through sub-wavelength hole arrays leading to extraordinary optical transmission. By combining periodic and percolation nanocomposites one can design left-handed "metamaterials" with a negative refractive index, which have unique optical properties and can act, for example, as the perfect lens. Finally, the scale-invariant fractal symmetry of disordered nanocomposites results in Anderson localization of light by nanometer-sized plasmonic resonators, where the local field exceeds the applied field by many orders of magnitude and optical nonlinearities are dramatically enhanced [1,2]. The electromagnetic modes focused within nm-sized "hot spots," acting like nano-antennas, make possible a number of novel applications, such as low-threshold microlasers, super-dense optical recording, attosecond pulse generation, Raman and nonlinear spectroscopy of single molecules and quantum dots, enhanced photochemistry and photobiology.

REFERENCES:

1. Vladimir M. Shalaev, *Nonlinear Optics of Random Media: Fractal Composites and Metal-Dielectric Films* (Springer, Berlin Heidelberg 2000).
2. Andrey K. Sarychev and Vladimir M. Shalaev, Electromagnetic field fluctuations and optical nonlinearities in metal-dielectric composites, *Physics Reports* 335, 275 (2000).

NEW METHOD TO STUDY STRUCTURAL PARAMETERS OF MESOSCOPIC
SYSTEMS: OPTICAL FLUCTUATION MICROSCOPY

A. M. Bonch-Bruевич, V. V. Khromov, N. B. Leonov, S. G. Przhibel'skii,
T. A. Vartanyan
State Optical Institute, St. Petersburg 199034, Russian Federation
E-mail: tigran@jamnet.spb.su

We propose a new optical technique for characterization of mesoscopic systems. In this technique, fluctuations of the scattered light intensity are registered when the sharply focused laser beam of diffraction divergence is scanned throughout the system under examination.

To be specific, let us consider the nano-sized metal island films on a transparent dielectric support. In this case, which was studied theoretically as well as experimentally, mean values and fluctuations of transmitted and reflected intensities were measured together with the correlation function of both. These data were further evaluated by means of the specially developed theory that relates the measured optical parameters with the number density, mean volume, and size distribution of metal clusters present on the surface. The statistical part of the theory assumes Poisson distribution of metal particles in the focal spot. The theory includes also electrodynamic part that treats the passage of electromagnetic waves through an array of supported metal particles, taking into account the light reflected on the boundary of the support.

This technique was successfully employed to study evaporation kinetics of small sodium clusters deposited on the amorphous quartz substrate. Evaporation was stimulated by either resistive heating of the substrate or by the illumination of metal particles with resonant radiation. Under the action of light, the size distribution function is shown to evolve quite differently as compared to the case of substrate heating, whereas the mean values evolve similarly in both cases. This observation provide a clear evidence of the size-selective mechanism of the photoinduced evaporation and opens up the possibility to manipulate the size distribution function, in particular, to narrow it, via resonant illumination.

General features and other applications of fluctuation microscopy are discussed.

DISCRETE SPECTRUM OF ANTI-STOKES EMISSION FROM METAL
PARTICLE-ADSORBATE COMPLEXES IN MICROCAVITY

V. P. Drachev*, W. Kim, V. A. Podolskiy, V. P. Safonov**, V. M. Shalaev and R. L. Armstrong

Department of Physics, New Mexico State University, Las Cruces, NM 88003
Institute of Semiconductor Physics, Novosibirsk, Russia

*Institute of Automation and Electrometry, Novosibirsk, Russia

Since the discovery of surface-enhanced Raman scattering, the optical properties of metal-molecule complexes have generated considerable interest [1, 2]. Molecules adsorbed onto nanoscale roughened metal surfaces or nanostructured metal colloids produce a millionfold increase in the intensity of Raman scattering, enhanced absorption, fluorescence, and hyper-Raman scattering. Lasing at low intensity has also been reported from a dye-Ag colloid solution placed in a cylindrical microcavity [3].

This report presents the discovery of greatly enhanced, broad-range, multiphoton excited emission from Ag aggregate-adsorbate complexes seeded into a cylindrical microcavity. The emission spectrum contains discrete peaks spanning the wavelength range from the 632 nm HeNe laser exciting wavelength down to 200 nm; the intensity of this emission is comparable to that of the Stokes Raman emissions at longer wavelengths (above 632 nm), even at the low exciting light intensity (20 W/cm^2) used in our experiments. This observation became possible due to using of a fractal-microcavity composite, where coupling the localized plasmon modes in fractal aggregates with microcavity resonances is provided. The colloids in our experiments have an average radius $R_0 \sim 11 - 12 \text{ nm}$ while the aggregates, comprising $N = (R_c/R_0)^D \sim 10^5$ monomers, have radii $R_c \sim 1 \mu\text{m}$, where D is the fractal dimension. Sodium citrate molecules are adsorbed on the silver particles in concentrations of $5 \times 10^{-4} \text{ M}$. Composites are formed when aggregates are seeded into a dielectric microcavity, consisting of a hollow quartz tube of outer diameter 1 mm, inner diameter 0.7 mm.

Although some peaks have wavelengths in near-coincidence with second- and third-order hyper-Raman scattering from citrate molecules enhanced in the fractal-microcavity composite, one cannot attribute the observed spectra to hyper-Raman emission from pure molecular transitions. Observed emission in the anti-Stokes region is supposed to be a result of two- and three-photon excitation of metal states followed by radiative decay, via surface states coupled to the molecular transitions, into unoccupied discrete states of the metal nanoparticles.

References

- [1] *Surface Enhanced Raman Scattering* eds. R.K. Chang & T.E. Furtak (Plenum Press, New York, 1982)
- [2] M. Moskovits, *Rev. Mod. Phys.* **57**, 783 (1985)

Miniaturized Laser Magnetometers and Atomic Clocks

R. Wynands, C. Affolderbach, L. Hollberg¹, J. Kitching¹, S. Knappe, M. Stähler*Institute for Applied Physics, Bonn University, D-53115 Bonn, Germany*¹ *National Institute of Standards and Technology, Boulder, CO 80303, USA**Tel +49-228-732483, Fax +49-228-739474, E-mail: wynands@iap.uni-bonn.de*

We have experimentally investigated the potential of narrow coherent population trapping (CPT) resonances [1] for precision applications like magnetometry [2, 3] or atomic frequency standards [4], using the *D* lines in thermal Cs or Rb vapor. The magnetometer works by monitoring the position of the Zeeman-shifted outermost resonance component. The central Zeeman component is well suited for frequency standard applications because its position is shifted by magnetic fields only in second order. We derive the laser fields from a special diode laser (a VCSEL) by direct modulation of the injection current [5]. PicoTesla sensitivity for a magnetometer and 10^{-12} relative instability for a finger-sized clock have been achieved in this way.

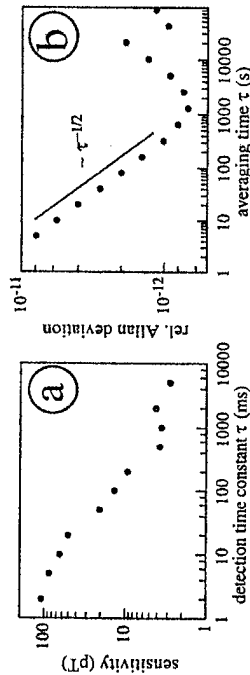

Figure 1: (a) Magnetometric sensitivity of the Cs dark resonance magnetometer. (b) Allan standard deviation of a Cs dark resonance clock.

- [1] E. Arimondo, *Progress in Optics* **35** 257 (1996).
- [2] A. Nagel *et al.*, *Europhys. Lett.* **44** 31 (1998).
- [3] M. Stähler *et al.*, submitted for publication.
- [4] J. Kitching *et al.*, *IEEE Trans. Instrum. Meas.* **49**, 1313 (2000).
- [5] C. Affolderbach *et al.*, *Appl. Phys. B* **70** 407 (2000).

Nonlinear Hartman Sensor

A. K. Poteomkin, N. F. Andreev and A. N. Mal'shakov

*Institute of Applied Physics Russian Academy of Sciences
46, Ulianov St. Nizhny Novgorod 603600 Russia
Phone (8312) 384545, Fax (8312) 363792, E-mail ptkm@appl.sci-nnov.ru*

Over the recent years the quality requirements for optic elements have significantly increased. For example, for the NIF project the accuracy of deviation from flatness over element aperture must be no worse than $\lambda/600$. Extreme ultraviolet applications require even higher accuracy ($\lambda/2000$). In view of this the problem of measuring such small wavefront distortions becomes most acute. The accuracy of commercial interferometers in the visible range is no more than $\lambda/50$.

In the present works [1-3] we propose a method for measurements of wavefront distortions which is based on detection of the deviation angle of a laser beam as a function of cross-section of the tested element (similar to one channel of the *Hartmann sensor - HS*). The diffraction in a linear medium makes it impossible to measure a deviation angle much lower than the diffraction limit. The corresponding accuracy is approximately equal to the interferometer accuracy.

Beam propagation in a medium with cubic nonlinearity leads to self-focusing that partially suppresses the diffraction, thus allowing increasing the measurement accuracy. A device based on this principle may be called the *Nonlinear Hartmann Sensor (NHS)*. This idea was realized experimentally. A 170 ps Gaussian beam 1 mm in radius from a neodymium glass laser was incident on a spatial filter comprising two diaphragms with a diameter of 0.6 and 0.8 mm and separated from each other at 70 cm. The filter forced the emergent beam to assume its spatial distribution and direction. Once the beam propagated along 1 m in free space it was focused on the output window of a cell 40-cm long with benzene by use of a lens adjacent to the input window of the cell. The cross-section of the beam leaving the cell in the plane of the output window was projected with tenfold magnification on a CCD camera and then was digitized with a frame grabber.

At self-focusing threshold a self-focusing spot $a_{min} = 5 \mu\text{m}$ in radius was observed in the cross-section. The beam radius in the linear case was $a = 250 \mu\text{m}$. I. E. the accuracy of the nonlinear variant of the scanning Hartmann Sensor was improved by the factor of $a/a_{min} > 50$ in comparison with the linear Hartmann Sensor. Another factor that limits the NHS's measurement accuracy of wavefront distortions is the vibration of the experimental setup. To decrease the negative effect of vibration, all optical elements of the experimental setup were mounted on a single optical table measuring 3×1 m. The table was supplied with vibration-isolating legs (STANDA company). To understand the effect of vibration of the optical table on the NHS accuracy, we conducted experiments on measurements of statistical parameters of the scatter of the coordinate of the self-focusing point. A histogram of the measurements was almost normal. A typical value of the mean-square deviation of the coordinate values measured at 50 laser shots in the horizontal and vertical directions was different and corresponded to the deviation angle $\text{Stdev}(x) \approx 3.5 \mu\text{rad}$ and $\text{Stdev}(y) \approx 4.8 \mu\text{rad}$, respectively.

It is corresponds to experimental accuracy of defining the coordinates of the self-focusing spot and hence the direction of radiation incident on the cell was no worse than 0.25 % of the diffraction limit of beam divergence. And corresponds to the distance on the beam radius less than 1/3000 of a wavelength.

New Optical Correlation Techniques for Rough Surfaces Characterizing

Oleg V. Angelsky and Peter P. Maksimyak

Correlation Optics Dept, Chernivtsi National University,
2 Kotsyubynsky St., Chernivtsy 58012, Ukraine.
Tel/Fax (03722) 44730, E-mail:oleg@optical.chemnovisya.ua

Summary

It is known that Power Spectral Density Function, PSDF, describing inhomogeneity distribution among different spatial frequencies is considered as preferable and the most comprehensive of them. But conventional profilometric techniques for reconstruction of PSDF are rather labor- and time-consuming and is implemented using expensive measuring equipment.

The gist of the proposed approach is as follows. One can estimate an autocorrelation function (ACF) of a surface instead of its PSDF directly. For that, (a) within the framework of a model of infinitely extended random phase screen (that presumes phase variance of the boundary object field to be much less than unity, correlation length of surface inhomogeneity to be much exceeding λ , and registration to be carried out within the area where all spatial frequencies of a surface roughness contribute to the resulting field), one can use unambiguous interrelations between the statistical parameters of a surface and radiation scattered by it; (b) on this reason, one can measure a field's transverse coherence function instead of a surface itself. By elementary computations, one can recalculate the experimental data to find the object boundary field's ACF, and then reconstruct the desired PSDF from it (by applying Wiener-Khinchine theorem).

Let us emphasize the advantages of such an approach.

1. Rough surface system characterization is contactless (non-destructive) in this case.
2. The excellent feasibilities for fast and high-accuracy measurement of field's transverse ACF (as well as the field's structure function) are provided by interference/polarization techniques, some of which have been developed.
3. Actually, optical correlation measurement of some of the higher-order statistical moments of the field parameters performed side-by-side with measuring of an ACF through the same techniques enables to reconstruct PSDF with the accuracy appropriate for most of practical needs.
4. In any specific case, one can either estimate from a PSDF conventional statistical parameters of the object (rms deviation of a profile from the base line, correlation length of inhomogeneity, if sufficient, or parameterize PSDF in terms of the fractal model).

In the report we will consider as example a new optical correlation measuring device for estimation of PSDF of slightly rough surfaces embodying the following merits of optical systems: contactlessness, fast-acting operation $\sim 1-3$ sec due to all-optical averaging of the measured data, high sensitivity ($\sim 10^{-4}$) estimated by both the height parameter of inhomogeneities and correlation length of them.

Our device is based on polarization interferometer consisting of the tandem of two identical calcite wedges forming a plane-parallel plate, which are placed between the crossed linear polarizers. For that, the optical axes of the wedges make the angle 45° with the axes of maximal transmittance of each polarizer. The distance between two wedges determines transversal shift of the interfering beams. Thus, one can determine the field's transversal coherence function by the measuring of visibility of an interference pattern for various transversal shifts. The proposed design permits to avoid relative longitudinal shift among the mixed components that provides essential increasing of measurement accuracy.

The proposed measuring device will be applicable into industrial environment being: protected against vibrations, adapted to roughness characterization at surfaces of various macroforms (plane, spherical, cylindrical, parabolic), portable, with outrigger measuring head, much cheaper in comparison with commonly used equipment.

We will also consider interrelations between the conventional statistical description and the fractal model in the problem of diagnostics of slightly rough interfaces.

RESONANT SURFACE POLARITONS OF NEAR-FIELD TIP

S.A. Alexeev, M.N. Libenson, D.S. Smirnov

Saint-Petersburg State Institute of Fine Mechanics and Optics (Technical University)

14, Sablinskaya str., St. Petersburg, 197101, Russia

tel/fax +7 (812) 233-3406, e-mail <basilisk@green.ifmo.ru>

In order to localize an electromagnetic field within a subwavelength area near-field devices typically exploit tapered fiber waveguides or probes that have an output aperture of much smaller size as compared to the light wavelength in vacuum. Development of new principles for near-field probe design has been crucial for near field technology progress for the last ten years. Employing surface polaritons gives new opportunity for near-field probe development [1, 2]. Basing on the approach suggested in [1], the present paper investigates polariton modes in three-layered waveguide.

The propagation parameters and their relation with the medium properties were investigated for surface polaritons excited in coated cylindrical waveguide. It has been shown that the near field of cylindrical surface polariton (CSP) can be theoretically localized to arbitrarily small space. The conditions for total localization of the near field of the TM_0 -mode were determined by numerical simulation for three-layered waveguide with a metal core. The result of this analysis can be used for development of more effective probes for IR near-field devices.

1. Gurevich V.S., Libenson M.N.. Surface polaritons propagation along micropipette. //Ultramicroscopy. 1995. V. 57. P. 277-281.

2. J. Takahara, S. Yamagishi, H. Taki, A. Morimoto, T. Kobayashi. Guiding of one-dimensional optical beam with nanometer diameter //Optics Letters. 1997. V. 22. N.

7. P. 475-477

SUPERRESOLVING PROCESSING OF THE COMPLEX RESPONSE OF DIFFERENTIAL INTERFEROMETER WITH SAMPLING EXPANSIONS

D.V.Baranov, A.A.Yegorov, E.M.Zolotov

General Physics Institute, Vavilov str.38, Moscow, 119991 Russia

Tel.: (095) 135-0210, Fax: (095) 135-0270, e-mail: zolotov@kapella.gpi.ru

The image formation in optical system is defined as a rule by diffraction restriction. The exceeding of the diffraction limit is based on specific processing of the system image. The main method to accomplish the superresolution is the analytical extension of the response spectrum outside the optical system aperture [1]. In this paper we propose the superresolving processing of the complex response of differential heterodyne interferometer based on expansion of the interferometer response and optical profile function in terms of basic sampling functions. This method of the solution of the inverse problem has not been used previously for this kind of interferometer. It allows to simplify the linearization of the differential response and to reduce the linear integral equation to the system of the linear equations [2]. The sampling expansion permits to omit the Fourier transform and to enhance accuracy of profile restoration. The analytical extrapolation is achieved owing to oversampling in object plane. In this case the optical profile is described in the form:

$$f(x) = \sum_m f_m S(x - x_m, M).$$

Here $f_m = f(x_m)$ are the samplings of the optical profile, $S(x, M) = \text{sinc}(\pi Mx/\delta)$ is the sampling function, $x_m = m\delta/M$, δ is the diffraction limit, M is the superresolution coefficient. The coefficient M is preset to optimum value provided a maximum resolution. This value is limited by the accuracy of initial data and system noise. The restored optical profile of the rectangular groove in computer simulation for various values of the superresolution coefficient is shown in Fig.1. Further resolution enhancement is due to the modification of signal processing and taking account of noise statistics.

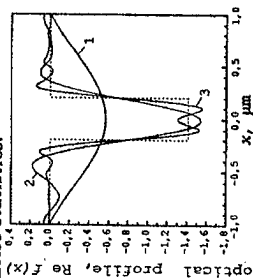

Fig.1. Restored optical profile (real part.) of the rectangular groove in computer simulation for various values of the superresolution coefficient: $M = 1.0$ (1), 4.0 (2), 9.5 (3). The original profile is shown by dashed line.

[1] Goodman J.W., *Introduction to Fourier Optics* (New York: McGraw-Hill), 1968.
 [2] Baranov D.V., Egorov A.A., Zolotov E.M., Svidzinskii K.K., *Optics and Spectroscopy*, **83**, 483 (1997).

Quantum solitons – correlations and entanglement

Gerd Leuchs, Natalia Korolkova, and Christine Silberhorn

Zentrum fuer Moderne Optik, Universitaet Erlangen-Nuernberg, Staudstr. 7/B2, D-91058 Erlangen
leuchs@physik.uni-erlangen.de

During their propagation in optical fibres quantum solitons develop quantum correlations between amplitude and phase as well as spectral amplitude correlations, both based on the Chi-3 non-linearity of the material [1]. These correlations can be transformed into reduced amplitude noise through spectral filtering of one pulse or through the interference of two pulses experiencing different non-linear phase shifts. Combining two such amplitude noise reduced pulses at a beam splitter leads to quantum entangled pulses [2]. The pulses are macroscopic containing 10^6 photons at a wavelength of 1500 nm and a pulse width of 130 fs. The measures of entanglement are discussed and the experimental determination of the entanglement, i.e. of the correlations in amplitude and phase, is presented using linear optical elements and direct detection [3].

Immediate applications of this source of entangled light pulses are quantum interferometry, i.e. interferometry below the shot noise limit, quantum dense coding, i.e. a doubling of the channel capacity, and polarisation squeezing. Other applications are polarisation entanglement, quantum teleportation, and entanglement swapping. Further quantum functions may be generated by combining non-linear interactions inside individual channels with linear optical function elements involving several different channels.

References:

- [1] S. Spälter, N. Korolkova, F. König, A. Sizmann, G. Leuchs, „Observation of multimode quantum correlations in fiber optical solitons“, *Phys. Rev. Lett.* 81, 786-789 (1998); and N. Korolkova, R. Loudon, G. Gardavsky, M. W. Hamilton, G. Leuchs, "Time evolution of a quantum soliton in Kerr medium", *J. Mod. Opt.*, in print 2001
- [2] G. Leuchs, T.C. Ralph, C. Silberhorn, N. Korolkova, "Scheme for the generation of entangled solitons for quantum communication", *J. Mod. Optics* 46, 1927-1939 (1999)
- [3] Ch. Silberhorn, P.K. Lam, O. Weiß, F. König, N. Korolkova, G. Leuchs, "Generation of Continuous Variable Einstein-Podolsky-Rosen Entanglement via Kerr Nonlinearity in an Optical Fibre", *Phys. Rev. Lett.* 86, 4267-4270 (2001)

TWO-PHOTON COHERENT CONTROL OF ATOMIC COLLISIONS
WITH NON-CLASSICAL LIGHT

M.D. Havey

Physics Department, Old Dominion University, Norfolk, Virginia 23529

D.V. Kupriyanov, A.V. Slavgorodskii, and I.M. Sokolov
Department of Theoretical Physics, State-Technical University, 195251,
St.-Petersburg

Significant developments in studies of non-classical properties of light have now promised realization of practical applications in quantum information, quantum cryptography, quantum computing and quantum teleportation. In this presentation we would like to point out that in traditional and practically important spectroscopic studies based on the optical control of the elementary photochemical processes such as half collisions (photodissociation) or fractional collisions (two- or many-photon optical collisions) there is also good outlook for the implementation of the quantum properties of light, such as squeezing or entanglement. The general idea and basic principles for coherent control of atomic collisions and reactive processes using a parametric light source with entangled polarization have recently been proposed in Havey, *et al.* [*Phys. Rev. Lett.* 84 3823 (2000)].

We show that, for the case of two-photon excitation when the photon pair exists in a cooperative quantum state with entangled polarization, the dynamics of a fractional collision significantly differs from the corresponding "classical" prediction. In particular, there is a strong interference of photon "quantum" correlations with correlations arising from internal collisional dynamics. We illustrate the essential effects qualitatively in a quasistatic recoil limit approximation of the atomic collision as well as by full numerical simulations of the process. A particular example is made in the Mg - rare-gas atom system of fractional collisions governed by radiation from a type-II phase-matched optical parametric oscillator operating in a subthreshold regime.

In particular, we describe a new method of coherent optical control of internal dynamics of atomic collisions by means of two correlated light beams having entangled polarizations. We show that if excitation of a colliding pair of atoms is by two photons having entangled polarizations, it is possible to redirect the output fragments of the collision into certain channels with a selected type of internal transition symmetry. The transition symmetry is defined in a body-fixed coordinate frame that has random and originally unknown orientation in space.

Anticorrelation effect in femtosecond-pulse pumped type-II SPDC

V. Berardi, M.V. Chekhova, Y.H. Kim, and Y.H. Shih

Department of Physics, University of Maryland, Baltimore county,
1000 Hilltop Circle, Baltimore, MD 21250, USA

Tel: 1(410)455-1932, Fax: 1(410)455-1072, E-mail: chekhova@umbc.edu

Abstract: Anticorrelation effect is observed for type-II spontaneous parametric down-conversion generated from femtosecond-pulse pump in a relatively thick BBO crystal. In agreement with the theory, shallow flat symmetric anticorrelation 'dip' is observed.

Spontaneous parametric down-conversion (SPDC) with femtosecond-pulsed pump has several peculiar features. In particular, as shown in [1], the anticorrelation effect for type-II SPDC should manifest low visibility for short pump pulses or/and thick crystals. The condition for high visibility is $T_p \gg DL$, where T_p is the pump pulse duration, L the crystal thickness and D is the inverse group velocity difference for signal (extraordinary) and idler (ordinary) photons. The explanation is clear if we take into account that short pump pulses act as a 'clock' for the SPDC process [1]: having registered a pair of photons, one knows for sure in which place of the crystal it was born. The anticorrelation 'dip' predicted by the theory is thus *flat, shallow, and symmetric*, with width given by DL and depth depending on the ratio T_p/DL . The visibility can be increased by using either a thin crystal or narrow-band spectral filters in front of the detectors.

Our experimental results obtained for 1 and 2 mm thick BBO crystal, 100 fs pump pulses (T_p/DL is about 0.3) and broadband (70 nm) filter, which does not cut the SPDC spectrum, confirm these theoretical predictions. According to the theory, the visibility is increased if narrow-band (10 nm) filters are inserted in front of the detectors.

Our results differ from the recent results obtained in [2], which showed a 'dip' with clearly asymmetric shape. Comparing our experimental setup with the one used in [2], we see an important difference in the way how the SPDC is filtered from the residual pump after the crystal: while we use a dichroic mirror reflecting the pump but transmitting the SPDC, the authors of [2] used a prism. Our natural assumption is that the asymmetry is introduced by the prism, which causes a 'chirp' in signal and idler SPDC pulses. To check this assumption, we repeated the experiment using a prism instead of a dichroic mirror. The results definitely revealed an asymmetry. Finally, we 'symmetrized' the setup by adding a second prism with the base opposite to the first one. The obtained experimental data again showed a symmetric 'dip'.

A theoretical consideration of the observed effects is now in progress [3].

References

1. T.E. Keller and M.H. Rubin, Phys. A 56, 1534 (1997); W.P. Grice and I.A. Walmsley, Phys. Rev. A 56, 1627 (1997).
2. M. Atature, A.V. Sergienko, B.M. Jost, B.E.A. Saleh, and M.C. Teich, Phys. Rev. Lett. 83, 1323 (2000).
3. M.H. Rubin, to be published.

QUANTUM INFORMATION PROCESSING WITH TRAPPED IONS

F. Schmidt-Kaler, H. Rohde, S. Gulde, A. Mundi,
P. Barton, D. Leibfried, J. Eschner, and R. Blatt,

Institut für Experimentalphysik, Universität Innsbruck, A-6020 Innsbruck, Austria,
Tel: +43 512 507 6350, Fax: +43 512 507 2952,
Ferdinand.Schmidt-Kaler@uibk.ac.at

Single ions in Paul traps are investigated for quantum information processing. Superpositions of the $S_{1/2}$ and $D_{5/2}$ states are used to implement a qubit. Single $^{40}\text{Ca}^+$ ions are either held in a spherical Paul trap or alternatively, in a linear Paul trap. The ions are optically cooled and fluorescence light at 397 nm on the $S_{1/2} - P_{1/2}$ transition is monitored for a state measurement by the "electron shelving" technique. The $S_{1/2} - D_{5/2}$ quadrupole transition at 729 nm is excited for sideband cooling and for quantum state preparation. Individual ions in a linear string are addressed by a tightly focused 729 nm laser beam [1]. In the spherical Paul trap (4.5 MHz trap frequency) a single Ca^+ ion has been cooled to the ground state of vibration with up to 99.9% probability [2]. Cooling is achieved in all three dimensions simultaneously as well as ground state cooling of two ions. In the latter case, all modes were cooled resulting in a ground state population of more than 95% [3].

Starting from a Fock state $|n=0\rangle$, coherent quantum state manipulation on the $S_{1/2} - D_{5/2}$ transition is achieved. More than 30 Rabi oscillations within 1.4 ms are observed on the blue motional sideband of this transition indicating the preserved coherence. A similar number of Rabi oscillations is obtained after preparation of the ion in the $|n=1\rangle$ Fock state. The data show that decoherence is negligible on the time scale of a few oscillations, i.e. during the time required for a quantum gate operation [2,4]. The measured 1 ms decoherence time is attributed to residual laser and magnetic field fluctuations. Heating of the motional degrees of freedom has been measured directly and appears at a rate of 1 phonon per 190 ms (70 ms) at the secular frequencies ω_{axial} (ω_{radial}).

A novel type of ground state laser cooling [5] of a single trapped ion is achieved using a technique which tailors the absorption profile for the cooling laser by exploiting electromagnetically induced transparency in the Zeeman structure of the $S_{1/2} - P_{1/2}$ dipole transition. This new method is robust, easy to implement and proves particularly useful for cooling several motional degrees of freedom simultaneously, which is of great practical importance for the implementation of quantum logic schemes with trapped ions [6].

- [1] H.C. Nägerl, et al., Phys. Rev. A 60, 145 (1999)
- [2] Ch. Roos et al., Phys. Rev. Lett., 83, 4713 (1999)
- [3] F. Schmidt-Kaler et al., Journal of Modern Optics 47, 2573 (2000), see also H. Rohde et al., quant-ph/0009031
- [4] A. Steane et al., Phys. Rev. A 62, 042305 (2000)
- [5] G. Morigi, J. Eschner, C. H. Keitel, Phys. Rev. Lett. 85, 4458 (2000)
- [6] C. F. Roos et al., Phys. Rev. Lett., 85, 5547 (2000)

Applications of Entangled State Interference

Gunnar Björk, Jonas Söderholm, Alexei Trifonov¹,
Pavel Usachev¹, and Luis L. Sánchez Soto²

Department of Microelectronics and Information Technology
Royal Institute of Technology (KTH), Electrum 229, SE-164 40 Kista, Sweden

¹Ioffe Physical Technical Institute

26 Polytekhnicheskaya, 194021 St. Petersburg, Russia

²Departamento de Óptica, Facultad de Ciencias Físicas
Universidad Complutense, E-28040 Madrid, Spain

In many areas of physics, and in particular in optics, interference phenomena are important and lead to a wealth of applications. On the quantum level, interference is a consequence of indistinguishability. In classical physics indistinguishability manifests itself as coherence between temporal and spatial modes. However, quantum particles have many more degrees of freedom than classical modes. Therefore, quantum particles can interfere in ways classical modes cannot. We shall present a few recent experimental demonstrations of this fact, showing how quantum mechanics allows us to surpass the measurement sensitivity in interferometry, polarimetry and imaging. To give a specific example, we shall show that there exist more than two circular polarization states of light. Using only two photons it is possible to generate left-hand and right-hand polarized light. It is also possible to generate light that is rotationally invariant (i.e. circularly polarized) but that is neither left-handed or right-handed. In fact, it lacks chirality! We have named this polarization state "neutrally" polarized light, which should not be confused with unpolarized light (that is a statistical mixture of the three states). Using other entangled polarization states we shall show that with two photons, it is possible to distinguish three "linear" polarization states separated by rotations of 60 degrees. With N photons, it is in principle possible to distinguish rotation angles as small as $\pi/(N+1)$ with certainty. Turning to image writing, standard diffraction theory predicts that the smallest features one can write have a linear dimension of about half the wavelength used. We shall show that this limit is by no means fundamental, using specific entangled $2N$ photon states, it is in principle possible to write features with a linear dimension of $\lambda/2(N+1)$ with almost perfect contrast. However, to be able to profit from this possibility the "film" used in the process must have a dominant $2N$ -photon absorption cross section.

Biomedical imaging using ultrahigh resolution optical coherence tomography

J. G. Fujimoto, I. Hartl, W. Drexler, C. Chudoba, T. Ko, X.D. Li, P. Hsiung, U. Morgner, and F. Kaerter

Department of Electrical Engineering and Computer Science and Research Laboratory of Electronics
Massachusetts Institute of Technology, Cambridge, MA 02139
phone 617 253 8528, fax 617 253 9611

Optical coherence tomography (OCT) is an emerging technique for micron-scale cross-sectional imaging of biological tissue. OCT is analogous to ultrasound imaging except that it uses low coherence light instead of sound waves [1]. High sensitivity detection of reflected or backscattering light is performed using low coherence interferometry. The axial resolution of OCT is limited by the bandwidth of the light source, usually a superluminescence diode, to typically 10-15µm. This is approximately one order of magnitude better than any other conventional technique. However many research and clinical applications require higher image resolutions.

Recent advances in femtosecond Kerr lens mode locking of solid state-lasers have yielded powerful low-coherence light sources for OCT [2]. An in vivo ultrahigh resolution OCT system has been developed using a state of the art femtosecond Kerr-lens mode-locked Ti:sapphire laser as low coherence light source [3]. This laser emits sub two optical cycles pulses, the shortest ever generated directly from a laser oscillator, corresponding to bandwidths of over 350 nm centered at 800 nm by using specially designed double chirped mirrors with high reflectivity bandwidth and controlled dispersion response. By carefully matching dispersion, minimizing chromatic aberrations, and optimizing optics, fibers, electronics and data acquisition, a fiber optic OCT system has been developed, being able to support 260 nm and therefore enabling in vivo imaging with axial resolutions of 1 µm in biological tissues. The broad bandwidths available from femtosecond lasers also permit spectroscopically resolved imaging. Spectroscopic information may be obtained by digitizing the interference signal and applying digital Fourier or wavelet transform techniques [4].

The ability of ultrahigh resolution OCT system to perform in vivo and in situ optical biopsy with unprecedented axial resolution approaching that of conventional histopathology is a quantum leap in performance over current OCT systems. This technology could have an impact for early diagnosis and monitoring of many diseases, including retinal disease, the detection of early neoplastic changes for cancer diagnosis, and surgical guidance. Furthermore, ultrahigh resolution OCT system operates in a spectral region which is especially important, because it overlaps absorption features of several tissue chromophores, e.g. melanin, oxy- and deoxyhemoglobin and may enable the functional imaging of hemoglobin oxygen saturation. Spectroscopic OCT can enhance image contrast by "spectroscopic staining" analogous to histological staining. Furthermore, it could provide additional information on tissue pathology and may enable micron scale, cross sectional, functional imaging of tissue. This presentation will discuss recent technological advances as well as potential clinical applications.

References

- [1] D. Huang, E. Swanson, C.P. Lin, C.J.S. Schuman, W.G. Stinson, W. Chang, M.R. Hee, T. Flotte, K. Gregory, C.A. Puliafito, J.G. Fujimoto. "Optical coherence tomography," *Science*, 254, 1178-1181 (1991).
- [2] U. Morgner, F.X. Kärtner, S.H. Cho, Y. Chen, H.A. Haus, J.G. Fujimoto, E.P. Ippen, V. Scheuer, G. Angelow, T. Tschudi, "Sub-two-cycle pulses from a Kerr-lens mode-locked Ti:sapphire laser," *Opt. Lett.* 24, 411-13 (1999).
- [3] W. Drexler, U. Morgner, F.X. Kärtner, C. Piris, S.A. Boppart, X.D. Li, E.P. Ippen, J.G. Fujimoto, "In vivo ultrahigh resolution optical coherence tomography," *Opt. Lett.* 24, 1221-1223 (1999).
- [4] U. Morgner, W. Drexler, F. X. Kaerter, X. D. Li, C. Piris, E. P. Ippen, and J. G. Fujimoto, "Spectroscopic optical coherence tomography," *Opt. Lett.* 25, 111-113 (2000).

FAST VISUALIZATION OF INTERNAL STRUCTURE OF MULTIPLE-SCATTERING OBJECTS BY DIFFUSION OPTICAL TOMOGRAPHY

V.V. Shuvalov, I.V. Shutov, E.V. Tre'akov

M.V. Lomonosov Moscow State University, Vorob'evy Gory, Moscow 119899, Russia
Phone: 7(095)9395035, Fax: 7(095)9393113, E-Mail: vsh@vsh.phys.msu.su

We present our results in diffusion optical tomography [1-3] with visualization of small (size ≥ 5 mm) highly-absorbing and highly-scattering insertions ("phantoms") inside extensive (size ≤ 150 mm) weakly-absorbing and highly-scattering (absorption and scattering constants 0.005-0.015 and 1.4 mm⁻¹) model objects. CW diode lasers (wavelengths 770 ÷ 820 nm) with output power ≤ 15 mW and a small-sized fat-in-water emulsion with an absorber, simulating optical characteristics of a tissue, have been used in our experiments. An output radiation has been detected by a high-sensitive photon counting system. A 2D matrix, composed of 32x32 projections, has been used to reconstruct phantoms' images, hidden by multiple scattering. For a minimal signal to noise ratio $s/h = 1$, the maximal time of one-projection measurement ~ 0.3 sec has been reached [2]. A special modification of a fast (time ≤ 3 min) statistical reconstruction algorithm has been developed [3].

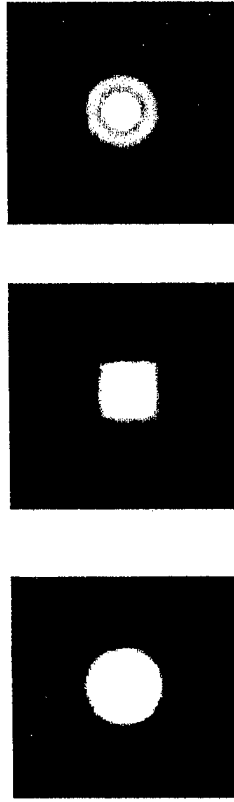

Zoomed reconstructed images of highly-absorbing phantoms with round (left) and square (middle) cross-sections. A halo around an image of highly-scattering round phantom (right)

- 1. D.A. Chursin et al. *Quantum Electronics* 29, 921 (1999).
- 2. E.V. Malikov et al. *Quantum Electronics* 30, 78 (2000).
- 3. D.A. Chursin et al. *Laser Physics*, April, 2001.

Laser Optoacoustic Imaging of Breast Cancer in vivo

A.A.Karabutov, S. V. Solomatin, E. V. Savateeva, V. G. Andreev, Z. Gatalica, H. Singh, R. D. Fleming, A. A. Oraevsky,
BMEC, UTMB, 301 University Blvd., MS 0456, Galveston, TX 77555, USA

The second generation of the laser optoacoustic imaging system (LOIS) for breast cancer detection and localization with 32-element PVDF transducer array was developed and tested in vivo. The resonance ultrasound frequency of the PVDF film allowed 100-Bum axial in-depth resolution. Cylindrical shape of the transducer array provided an improved lateral resolution of 0.5 mm. Multichannel low noise charge preamplifiers, wide band amplifiers and 12 bit ADC converters were designed in collaboration with LaserSonic Technologies Inc. The system was optimized for contrast and sensitivity. Data acquisition, signal conditioning and image processing were significantly improved and optimized resulting in reduced image frame rate of 5 seconds employing 700 MHz Aphlon processor. The computer code for digital signal processing employed band-pass Gaussian filtering and denoising. An automatic recognition of the opto-acoustic signal detected from the irradiated surface was implemented in order to visualize the breast surface and improve the accuracy of tumor localization. Radial back-projection algorithm adopting Radon transform was used for image reconstruction. The system performance was evaluated initially in breast tissue-like phantoms with embedded blood vessels. Clinical studies in breast cancer patients scheduled for surgical mastectomy were performed and compared with x-ray radiography, ultrasound and pathology reports.

Optoacoustic measurement of optical properties of turbid media

A.A.Karabutov*, N.B.Podymova, I.M.Pelivanov, P.S.Grashin, and A.A.Oraevsky*

International Laser Center of Moscow State University, Moscow, 119899 Russia

*University of Texas Medical Branch at Galveston, 77555 Texas, USA

Time-resolved laser optoacoustic method was developed for noninvasive measurement of the spatial distribution of light intensity in uniformly absorbing and scattering turbid media and to determine the optical properties of such media - light absorption and reduced scattering coefficients (μ_a and μ_s , correspondingly). The investigated turbid media were aqueous suspensions of titanium oxide (TiO₂) particles and milk with 3.5% fat. The method is based on detection with a high temporal resolution of laser-induced acoustic transients in a medium under study.

The temporal course of the front $p(\tau < 0)$ of these transients - optoacoustic (OA) signals - resembles the light intensity distribution vs. the depth in a turbid medium. This makes it possible to determine the effective light attenuation coefficient μ_{eff} by fitting an exponential function to the front of OA signal (see Fig.). The time-resolved measurements of the absolute

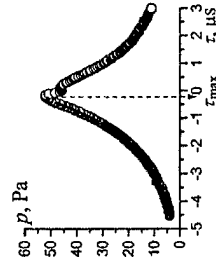

pressure of acoustic transients, induced in the light diffusion zone, yield both μ_a and μ_s values for turbid media with known efficiency of thermo-optical excitation (Gruneisen parameter). For the turbid media with unknown value of Gruneisen parameter (such as biological tissues) it was proposed to use the experimentally obtained dependence of the depth z_{max} of maximum light intensity location in a turbid medium on the μ_a and μ_s . The value of z_{max} was determined with the measured value of location of OA signal maximum on the temporal scale, τ_{max} (see Fig.), and with value of ultrasound velocity, V_0 : $z_{max} = -V_0 \tau_{max}$. Thus the possibility to determine the optical properties of turbid media with the dependence of z_{max} vs. the ratio of μ_a / μ_s and without the measurement of absolute pressure of OA signal was demonstrated.

POLARIZATION VISUALIZING AND BIOFRACTALS CORRELOMETRY.

O.V. Angelsky[a], A.G. Ushenko[a], D.N. Burkovets[a], Y.A. Ushenko[a]

V.P. Pishak[b], O.V. Pishak[b]

[a]Chernivtsi National University, 2 Kotsyubinsky St., Chernivtsi 58012 UKRAINE

tel./fax. (380-3722) 44730; e-mail: oleg@optical.chernovtsy.ua

[b]Bukovinian State Medical Academy, 1 Theatre sq., Chernivtsi 58000 UKRAINE

The phase-polarized method of visualization of optical-anisotropy inhomogeneities of bioissues is proposed. It is based on the multifractal modeling of bioissue properties. The algorithm of receiving topograms of orientation of fractal domains of visualized architectonic net of a bioissue is elaborated and approbed experimentally.

The intensive development of systems of biomedical laser diagnostics of bioissue structure (optical tomography and mammography) stimulates the elaboration of new methods of receiving and processing of coherent images obtained. The widget problem is the bioissue inhomogeneity visualization (tumors, hemorrhages, tissue liming, collagen architectonic nets of connective and bone tissue, etc.) and the analysis of their microstructure. It is well known that the majority of such biological objects appeared to be optical-anisotropy and multifractal by their structure.

After doing research one can conclude that: * the polarized analysis of coherent images of bioissues makes it possible to visualize their multifractal, optical-anisotropy structures with the high contrast level; * phase-polarized correction of obtaining laser bundle provides the possibility of obtaining further information of orientation structure (architectonics) of Bioissue multifractal net; * the data obtained can be useful in creating systems of polarized-correlative tomography and mammography.

SOME WAYS TO OPTIMIZE OPTICAL IMAGING OF TUMOR-LIKE

INCLUSIONS IN BIOLOGICAL TISSUES

Vladimir V. Barun and Alphiya Ya. Khairullina

Institute of Physics, National Academy of Sciences of Belarus

68 Skaryna Pr., Minsk 220072, Republic of Belarus

We simulate optical imaging of a local inhomogeneity in a dense light-scattering medium as applied to optical tomography problems. Our purpose is the comparison of different viewing schemes operating by reflected or transmitted light under illumination with wide or narrow laser beams with the aim to enhance image contrast and, thus, to provide improved and more reliable detection of the inclusion. Another purpose is to search a working spectral range, where the contrast magnitude will be maximal. This is just that is meant as the optimization of optical images here. Scattering and absorption properties of the inclusion and medium were taken as those corresponding to tumor-like and surrounding normal tissues. The foundation for the investigations is the diffusion approximation of the radiative transfer theory enabling one to get the analytical solution to the imaging problem by "sewing" the respective solutions at the interface of the inclusion and adjacent tissue [1]. Figure compares maximal negative contrast

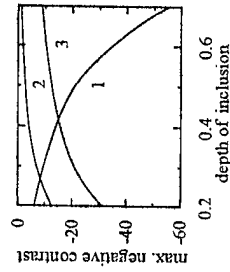

magnitudes (in %) as a function of the inclusion depth for several imaging schemes operating by transmission (curve 1) and reflection (2 and 3) under illumination by wide (1 and 2) and narrow (3) light beams. For curve 3, the inclusion is viewed at the "optimal" separation between the source and receiver providing the maximal contrast [2]. The depth is calculated in fractions of the total thickness of the tissue layer,

i.e. depth 0.5 corresponds to the center of the layer. One can compare the opportunities provided by each scheme. The paper will discuss also the spectral effects of optical tissue properties corresponding to the usage of different working wavelengths.

1. Feng S. et al.//Appl. Opt. 1995. V.34. No.19. P.3826-3737.
2. Dolin L.S.//Izv. Vuzov. Radiophysics. 1997. V.40. No.10. P.1191-1209.

Nonlinear Probing of Acoustic, Thermal and Convective Molecular Motion

Prof. Richard B. Miles
PRINCETON UNIVERSITY
Dept. Mechanical & Aerospace Engineering
Room D-414 Engineering Quad., Olden St.
Princeton, NJ 08544 USA

PH: 609-258-5131 FAX: 609-258-1139 EMAIL: miles@princeton.edu

For many years, coherent anti-Stokes Raman scattering (CARS), degenerate four-wave mixing (DFWM), stimulated Raman scattering (SRS), and other nonlinear techniques have been used as diagnostic tools for gas phase environments. These techniques are based on strong resonant enhancement that is associated with vibrational/rotational or electronic transitions. More recently, however, various new approaches are being developed that rely on measurements of molecular motion, including collective transport, as well as thermal and acoustic modes. For example, the RELIEF approach uses stimulated Raman scattering to vibrationally excite oxygen molecules along a line, and then images the displacement of that line after a short time period by laser-induced fluorescence. This process generates a quantitative measure of the flow velocity profile and can be used for the measurement of turbulence parameters, as well as flow convection. Acoustic wave velocities in a gas are measured by laser-induced thermal anemometry (LITA), which is accomplished by forming a pulsed interference pattern with crossed laser beams and observing, in real time, the propagation of acoustic waves emanating from that location. This has been shown to be a very important tool for getting localized, single-pulse measurements of static temperature for atmospheric pressure gases. At lower pressures where acoustic waves are less observable, coherent Rayleigh scattering is used to map-out the Boltzmann velocity distribution of the atoms or molecules. In this case, an interference pattern is again generated and coupling is through ponderomotive forces. Since rotational and vibrational states are not involved, this approach is useful for measurements of temperature in atomic gases, and may be extended to measurements in plasmas.

SELF-CONSISTENT EQUATIONS FOR AN ATOM INTERACTION WITH ELECTROMAGNETIC FIELD

A.V.Andreev

Physics Department, M.V.Lomonosov Moscow State University,
Moscow 119899 Russia

The self-consistent set of equations for vector and scalar potentials of electromagnetic field $\vec{A}(\vec{r}, t)$, $\varphi(\vec{r}, t)$ and electron current and charge density $\vec{j}(\vec{r}, t)$, $\rho(\vec{r}, t)$ has been obtained. An analyses of the influence of electron part of intra-atomic potential on the linear and nonlinear atomic response has been carried out on the basis of obtained equations. It is shown that the steady-state distribution of the electron charge and current density is determined by the simultaneous solution of the atomic and field equations. The account of the electron part of the intra-atomic potential changes drastically the spectrum of fluctuations of steady-state density distribution and results in the appearance of the gap $\omega = \sqrt{\omega_p^2 + \hbar^2 k^4 / 4m^2}$. Some reconstruction of the steady-state density distribution can occur only at $\omega > \omega_p$. It is this feature that explains the stability of the steady-state distribution and it is similar to the stability of the superfluid or superconducting states. The presence of the gap in the spectrum of density fluctuations can be measured experimentally. Such kind of measurements for the hydrogen atom could answer the question whether we should take into account the electron part of the intra-atomic potential. The account of self-consistent field results also in the change of the polarization and angular dependency of the nonlinear atomic response and enables to explain the coherency of the different harmonics in the spectrum of nonlinear atomic response.

Reference

1. A.V.Andreev, JETP Lett., **72**, 238 (2000)

Nonlinear Optical Processes in Rydberg Atoms Systems

Edward A. Manykin

Nonlinear Optics Department, RRC "Kurchatov Institute"
Address: Kurchatov sq. 1, Moscow 123182, RUSSIA.

Fax: 7 (095) 196 59 73 Phone: 7 (095) 196 91 07 E-mail: edmany@issph.kiae.ru

The interaction between Rydberg systems {Rydberg atoms (RA) gas or Rydberg matter (RM)} and coherent light in various frequency bands is considered. It is shown why Rydberg systems possess a greater polarizabilities and, accordingly, linear and nonlinear susceptibilities and strong sensitive to high-l (circular) Rydberg states in RA and RM. Quantum theory of physical and chemical properties of RA and RM [1] are related with recent obtained results on the optical spectroscopy [2]. The experimental data and theoretical description of Raman processes, wave mixing effects in gas of RA, and their clusters of RM with quantum interference are analyzed. Problem of blueshifts and stimulated electronic laser Raman processes, as well as four wave mixing in RM [3] are discussed. Strong influence of amplitudes of laser fields and quantum interference of atomic transitions on nonlinear optical processes in RA and RM reveals itself in all above-mentioned effects [4].

- [1] E.A. Manykin, M.I. Ojovan, P.P. Poluektov,
Chem. Phys. Reports, **18**(7), 1353, (2000)
- [2] R. Svensson, and L. Holmlid, Phys. Rev. Lett., **83**, 1739, (1999)
- [3] L. Holmlid, Phys. Rev. A, **63**, 013817-1, (2000)
- [4] E.A. Manykin, Laser Physics, **11**, 60, (2001)

Hanle Effect in Rydberg Atoms of Sodium

Igor Ryabtsev and Denis Tretyakov

*Institute of Semiconductor Physics
pr. Lavrentyeva 13, 630090 Novosibirsk, Russia*

The Hanle effect in low-excited atoms appears in the magnetic field as depolarization of resonant fluorescence at spontaneous transitions from the excited degenerate states. Usually Hanle signals have Lorentzian or dispersive shapes with a width determined by the relaxation rate of the excited state.

For the microwave transitions between the highly excited Rydberg states an interference of degenerate sublevels in the magnetic field appears in a different way. Since the spontaneous relaxation of Rydberg states is almost absent, envelope of the Hanle signal is determined by the spectral width of the microwave emission, and quantum beats are also observable.

We have studied experimentally the Hanle effect in Rydberg atoms of sodium. An interference signal of the $37P_{3/2}-37S_{1/2}$ microwave transition at 70.166 GHz was recorded in the variable magnetic field. At the durations of the microwave pulse less than 1 μ s, the interference oscillations of the probability were observed at the linear σ -polarization of exciting laser emission (Fig.1). An envelope of the oscillations corresponded to the spectral width of the pulse. At π -polarization the oscillations were absent, and the signal had anomalous asymmetrical shape which is not described by theory (Fig.2). The detailed analysis and results will be presented.

This work was supported by the Russian Foundation for Basic Research, Grants Nos. 99-02-17131, 00-02-17924, and 00-02-17993.

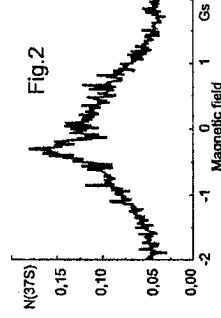
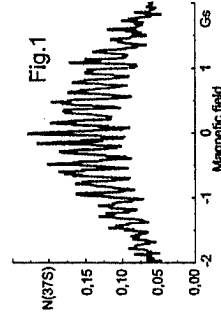

Photorefractivity in Novel Nanostructured Inorganic: Organic Hybrid Media

Paras N. Prasad
 Institute for Lasers, Photonics and Biophotonics
 Phone: 716-645-6800 ext. 2099
 Fax: 716-645-6945

Photorefractivity is a truly multifunctional property combining the electronic function of photocharge generation and transport to create an internal space charge field with the electrooptic function of refractive index change by an electric field. Inorganic semiconductors are very efficient in producing highly mobile photocarriers. Organic systems exhibit large electro-optic coefficients. Therefore, a hybrid structure can utilize the benefits of these two different classes of materials.

At our Institute for Lasers, Photonics and Biophotonics we are using nanoscale design and processing to make Inorganic: Organic nanocomposites with enhanced photorefractive performance and tailored to operate at any desirable wavelength. We are studying the physics of interfacial charge transfer and carrier dynamics at nanoscale.

An example of our photorefractive hybrid nanocomposite is a hole transporting organic polymer containing an electrooptic chromophore in which a specific inorganic quantum dot is produced in situ. Since the band gap of the quantum dot can be varied over a broad range by the choice of the material and the size of quantum confinement, the spectral range of photorefractive operation can be judiciously selected. We have used this approach to demonstrate photorefractivity at the communication wavelength of 1.30 microns.

NOVEL APPROACHES TO MEASURE THE SURFACE PLASMON DEPHASING TIME: THEORETICAL FOUNDATIONS AND RECENT EXPERIMENTAL RESULTS

T. A. Vartanyan
 State Optical Institute, St. Petersburg 199034, Russian Federation
 E-mail: tigran@jamnet.spb.su

Localized surface plasmons in nanostructured metal films play an important role in a number of laser-induced surface processes. The intensity and the width of the corresponding resonances are determined by the dephasing time of the plasmon. To get information on the dephasing times, the linear spectroscopy methods are of limited use because of their inability to discriminate between the homogeneous and inhomogeneous line broadening. Consequently, the linear extinction spectra provide only the lower limit of the surface plasmon dephasing time. Nonlinear techniques, such as autocorrelation measurements of second and third harmonic generation employing bandwidth-limited femtosecond pulses and performed with an interferometric accuracy, were intended to give a direct access to the dephasing time of the plasmon excitation. Nevertheless, it was shown that these particular nonlinear techniques suffer from the inhomogeneous broadening to almost the same extent as the linear extinction measurements.

We review the results of three recent successful attempts to overcome the problem of inhomogeneous broadening and to get unambiguous results for the surface plasmon dephasing times. First, an array of almost identical metal particles with dimensions in the range of 100 nm was prepared via electron lithography methods, so that the inhomogeneous broadening was diminished. In another approach based on the scanning near-field optical microscopy, only one particle at a time was studied. Finally, the persistent spectral hole burning technique was applied for the first time to an ensemble of metal particles grown on a dielectric support under usual nucleation conditions in ultra high vacuum. The mean particle diameter was in the range of 10 nm, while the size and shape distributions were rather broad. Intense laser irradiation was employed to reshape and evaporate a small part of the whole ensemble, so that a narrow dip in the resonance frequency distribution was produced and then measured.

OPTICAL AND ELECTRONIC PROPERTIES OF SILICON NANOCRYSTAL ASSEMBLIES

P. K. Kashkarov and V. Yu. Timoshenko

Moscow State M. V. Lomonosov University, Physics Department, 119899 Moscow, Russia

Crystalline Si has indirect band gap and highly isotropic cubic lattice structure what limits its optical applications. Porous Si produced by its electrochemical etching consists of Si nanocrystals (SNs) which properties are drastically modified by quantum and dielectric confinements. The quantum confinement in a SN leads to an increase of its band gap and to an enhancement of the probability of excitonic radiative recombination. The dielectric confinement in SNs arises from difference of dielectric constants of a SN and surrounding medium what results in unusual electronic and optical properties of SNs assemblies.

We propose a quantitative model of recombination processes in a SNs assembly as interconnected Si quantum wires, where the existence of dynamically related subsystems of excitons and free charge carriers is assumed. The filling of space among the Si wires by dielectric medium results in the decrease of binding energy of excitons and thus their concentration and at the same time in the increase of free carrier concentration. Our calculations of concentrations of free carriers and excitons as well as the concentration kinetics after pulsed laser excitation are coherent with the experiments on time-resolved photoluminescence and time-resolved IR absorption by free carriers in porous Si filled by different dielectrics.

Multilayer structures of SNs show photonic band gap tunable with the period of structure, sizes of SNs and their dielectric surroundings. Experiments demonstrate possibility to reach quasi-phase matching for second-harmonic generation in SNs multilayers.

The SNs assembly produced by anisotropic electrochemical etching of c-Si exhibits strong in-plane birefringence which depends on the sizes of SNs, spacing between them and dielectric properties of their surrounding media. Second harmonic generation experiments have revealed phase matching conditions for wave interaction in the layers of SNs. Furthermore, they can serve as a phase-matching matrix for optically nonlinear substance incorporated in their pores. This finding expands significantly the choice of nonlinear optical media since their anomalous dispersion is not strictly required for phase matching conditions.

This work was supported by CRDF project RP2-2275 and project "Semiconductor Nanostructures" of Ministry of Industry, Science and Technologies of Russia.

NONLINEAR-OPTICAL STUDY OF LOCAL AND NONLOCAL RESPONSES OF NANOSTRUCTURED SILVER COMPOSITES

V.P. Drachev, S.V. Perminov, E.N. Khalullin

Institute of Semiconductor Physics SB RAS, pr. Lavrent'eva 13, Novosibirsk, 630090, Russia

S.G. Rautian, V.P. Safonov

Institute of Automation and Electrometry SB RAS, pr. Koptyuga 1, Novosibirsk, 630090, Russia

Large enhancement of optical responses, selective photomodification and other fascinated effects have been observed in aggregated nanocomposites of noble metals [1, 2]. The present concepts [2] connect high optical nonlinearities of the aggregated nanocomposites with a large local electric field enhancement, that takes place due to a strong dipole-dipole interaction between the nanoparticles. In this report, we show that, besides the factor of the local field enhancement, the size of the aggregate is very important for some polarization-sensitive effects.

Our paper contains a phenomenological analysis given for the general case with both local and nonlocal frequency-dispersive nonlinearity, and non-collinear propagation of pump and probe waves. It is shown that the cubic polarization of isotropic medium is given by the four constants: χ_1 , χ_2 , describing the local response, and ρ_1 , ρ_2 of the nonlocal one. The values of these constants are experimentally determined via investigation of the inverse Faraday effect, optical Kerr-effect, ellipse self-rotation, and nonlinear optical activity [3] for the silver colloid solutions with a various aggregation degree.

The nonlocal susceptibility was observed to rise by two orders of magnitude with increasing the aggregation degree. At the same time, the local constants have found only 3-times growth. The difference in the enhancement factors revealed for local and nonlocal responses can be understood in the following way. The local nonlinear response is mostly determined by the local field amplification which is slowly grows with increase of the aggregate from a pair of particles to a fractal cluster build by hundreds of particles. For nonlocal nonlinear-optical effects, important is the size of the area occupied by a resonant plasmon mode, relatively to the wavelength, and, consequently, the dimension of the aggregates in colloid solution. This is in accordance with the calculations of the linear extinction for the right-hand- and left-hand-polarized radiation. The difference in extinction coefficients is showed to significantly increase with the aggregate enlargement.

References

- [1] A.V. Butenko et al, *Z. Phys. D*, **17**, 283-289 (1990).
- [2] V.M. Shalaev, *Phys. Reports*, **272**, No. 2-3, 61-137 (1996).
- [3] V.P. Drachev et al, *JETP Lett.*, **68**, No. 8, 651-656 (1998).

NONLINEAR OPTICAL PROPERTIES OF PHOSPHATE GLASSES DOPED WITH

PbSe QUANTUM DOTS

Malyarevich A.M., Savitski V.G., Posnov N.N., Yumashev K.V.

International Laser Center, bldg. 17, #65 F. Skaryna Ave., 220027 Minsk, Belarus, Fax: +375 17 2326286, malyar@ilc.unibel.by

Lipovskii A.A.

St.-Petersburg State Technical University, Polytechnicheskaja, 29, St.-Petersburg, 195251 Russia

Nonlinear optical properties of the low-dimensional semiconductor structures (so-called quantum dots - QD) attract considerable interest due to their possible applications for various non-linear devices. In this talk we report on differential absorption spectra and absorption saturation measurements of PbSe QD-doped phosphate glasses with pico- and nanosecond laser technique. The PbSe QD-doped glasses studied exhibit first exciton peaks at 0.87, 1.47, 1.54 and 1.67 μm in dependence on the average QD radius (2, 2.3, 2.5 and 3.5 nm respectively).

For 2-nm QDs, the induced absorption in the range from 0.48 up to 1 μm with an instrumentally limited rise time of ~ 20 ps was observed. The signal demonstrated two-component decay: the fast one with time constant less than the pump pulse duration, and the slow one with time constant longer than 500 ps.

Absorption saturation of the samples with the average QDs radii of 2.3, 2.5 and 3.5 nm was studied at the laser wavelength of 1.54 μm , tuned at high- and low-energy wings of the exciton band of the samples as well as the maximum of the band. The absorption bleaching was observed. The experimental transmission data were analyzed within the frame of the fast-relaxing absorber model. The saturation intensities and the ratios of the excited state absorption to the ground state absorption cross sections were estimated.

Samples with the average QDs radii of 2.3, 2.5 and 3.5 nm were successfully used for the first time as the passive Q-switchers for 1.54 μm Er-glass laser.

Complementarity and simultaneous measurement of discrete-valued observables

Alexei Trifonov^{1,2}, Gunnar Björk¹, and Jonas Söderholm¹

¹*Department of Microelectronics and Information Technology
Royal Institute of Technology (KTH), Electrum 229, SE-164 40 Kista, Sweden*

²*Ioffe Physical Technical Institute, 26 Polytekhnicheskaja, 194021 St. Petersburg, Russia*

Complementarity is the central issue of quantum theory and means the intrinsic indeterminism of the theory associated with the preparation and/or detection of a quantum state. There are numbers of different approaches to describe complementarity, but what is most essential is that doing the *sharp* measurement of any kind of the one of the conjugate observables one is losing completely the information about the other observable (observables) in agreement with the von Neuman postulate. Here we come to a conclusion that the true simultaneous measurements (yielding partial information about the two or more non-commuting observables from the same copy in an ensemble) must be *unsharp*. This statement is a clear sequence of the no-cloning theorem. Doing unsharp measurements (for example POVM) one faces with certain problems, one of which is a correct-true-mean problem. This was pointed out and discussed by Arthurs and Kelly in their seminal paper on uncertainty relation. They have shown that the uncertainty product of any *true* simultaneous measurement of canonical observables is at least four times larger than those predicted by the Robertson-Schrödinger uncertainty relation and that in order to minimize the uncertainty product one must have an *a priori* knowledge about the state.

Recently the interest was focused on the observables with a discrete spectrum, the simplest example of which is a qubit state. Such state can be an eigenstate of a spin $\frac{1}{2}$ operator, one-photon Stocks operator etc. The implementation of the qubit states is quantum computing, which most practical and feasible reading is quantum cryptography.

We shall present a generalization of Arthurs and Kelly treatment for operators with a discrete spectrum, shall analyze the problem of correct-true-mean of the discrete-valued observables, as well as the minimum-uncertainty-product measurements and their connection to intelligent states. Finally, we shall supplement the theoretical treatment with experimental finding, which are based on partial-entangled-state preparations and measurements via manipulations of a biphoton state.

QUANTUM TOMOGRAPHY OF THE POLARIZATION STATE OF LIGHT

Masalov A.V.

Lebedev Physical Institute, Leninsky prosp. 53, 117924 Moscow, Russia

The quasiprobability distribution (reduced density matrix, or polarization Wigner function) in the three-dimensional space of Stokes observables, introduced in [1], is considered as a power tool for quantitative description of polarization state of light in quantum optics. Variety of states of unpolarized light can be distinguished with the help of this distribution, and new classes of polarization states can be introduced, such as light with hidden polarization [2], polarization-squeezed light, etc. We present an experimental realisation of polarization state tomography (retrieval of polarization Wigner function) of light emitted by optical parametric oscillator. This radiation consists of two orthogonally-polarized parametric waves (II-type phase-matching) with a strong photon correlation and exhibits the property of hidden polarization. Data on noise of Stokes observables has been used to retrieve the polarization Wigner function of parametric light. The resulting uncertainty body (surface of $1/e$ level) appeared to be an ellipsoid 20%-squeezed in one direction.

Advantages of noise manipulation and measurement in the case of precision polarization devices are discussed.

1. V.P.Karassiov. *Bulletin of the Lebedev Physics Institute (Kratkie soobsheniya po fizike)*, N9 (1999).
2. V.P.Karassiov, A.V.Masalov. *Optics and Spectroscopy*, 74, N5 (1993).

Hemoglobin as Nonlinear Cooperative System: Biophysical and Biochemical Problems of Oxygenation and Laser Time-Resolved Spectroscopy.

B.M. Dzhagarov

Institute of Molecular and Atomic Physics, National Academy of Sciences of Belarus, F. Skaryna Ave., 70, 220072, Minsk, Belarus, telephone +375-17-284-16-20,

bmd@imaph.bas-net.by

Proteins are the simplest biological systems in which nonlinear cooperative phenomena can be studied in considerable detail. They have a complex conformational energy landscape with numerous energy minima separated by energy barriers. Because of this landscape proteins are nonlinear systems. Cooperativity is another feature for sufficient for proteins' functions.

A paradigm example of cooperativity in biochemistry and biophysics is the cooperative binding of molecular oxygen by hemoglobin (Hb). The quaternary structure of Hb imparts a cooperative effect between four subunits, which regulates oxygen transport. If one heme in any subunit loses oxygen, the adjacent heme is more likely to do the same, and vice versa. In this manner, Hb forms a synergistic feedback loop in which the molecule responds dynamically and nonlinearly to changes in O_2 pressure.

A paper is presented of our current understanding of the mechanism and dynamics of oxygen rebinding following photodissociation of oxyhemoglobin with short laser pulses. The main topics of our contribution devoted to the time-resolved studies of hemoglobin are following:

- (i) Photophysics: excited electronic states, electronic and vibrational relaxation processes
- (ii) Photochemistry: oxygen photodissociation, quantum yield and a dissociative electronic state.
- (iii) Oxygen rebinding: a motion in protein matrix and solvent, efficiency and dynamics of different geminate stages, escape from protein to solvent and return.

NEW IN BIOMECHANICS OF BLOOD CIRCULATION AND POSSIBILITIES OF PRECISION LASER MEASUREMENTS

S.N. Bagayev, V.N.Zakharov, V.A. Orlov

Institute of Laser Physics, Siberian Branch, Russian Academy of Sciences

Experimental investigations by the authors at the system level allowed them to establish the existence of the rotational-translational blood motion in the heart auricles and ventricles, in the major arteries and veins with the different direction of blood rotation in the system and lung blood circulation circles. It turned out that such motion of biological media also exists in other transport canals, because the cardiovascular, alimentary, urinary-excretory, and other systems have common morphological and functional properties. The universal character of the phenomenon has made it possible to decode the general physical mechanism of helical motion of biological media by using the morphological and functional relations between the transport systems of an organism. Active interaction of the walls of transport canals with the medium due to the twisting wave generated by spirally packed muscle elements is a basis of this mechanism. It turned out that the energy of rotational motion in the initial sections of the arterial blood vessels is approximately by a factor of 2 higher than the translational energy. It has been shown that this is rational in the living transport system, and is realized as a property of the twisted flow of a living medium in canals with a cone-shaped narrowing. This property manifests itself in the existence of an additional pull caused by the rotational component in the helical blood motion. Its functional role is to overcome the distributed resistance determined by viscous friction in the vessels. The resistance of all small sections of a blood vessel, from the periphery to the heart, accumulates and becomes large. Its characteristic is the arterial diastolic pressure being measured. The diastolic pressure itself in a blood vessel has a directed gradient, which can be expressed mathematically as follows:

$$\frac{dP_d}{dZ} = \rho \frac{W^2}{2} \frac{1}{S} \frac{dS}{dZ},$$

where W is the blood rotation velocity, ρ is its density, and S is the cross-section of the canal. The relation between the dynamic and kinematic characteristics of the blood flow is as follows: $\frac{P_s - P_d}{P_d} = \frac{U^2}{W^2}$, where P_s and P_d are the systolic and diastolic

pressures, and U and W are the translational and rotational velocities of blood motion, respectively. The main function of diastolic pressure is to provide uniform flow in capillaries. Systolic pressure compensates for the constant blood outflow through capillaries into the veins. Systolic pressure contains information about the total kinetic energy of blood motion consisting of the rotational and translational components, and diastolic pressure contains information about the energy density in the rotational component of blood motion.

It is known that the transport function of the cardiovascular system of humans and animals is realized in the microvascular vessels in the form of transcapillary exchange. The microcirculation should clearly be investigated with the use of noninvasive physical methods. Phase-sensitive laser light scattering spectroscopy is such a method. This method is developed by the authors of this paper, in particular, to study microhemocirculation.

APPLICATION OF GRADIENT LASER FIELDS IN BIOLOGY AND MEDICINE (PHYSICAL PRINCIPLES AND PROSPECTS)

A.N. Rubinov, A.A. Afanas'ev

B.I. Stepanov Institute of Physics, National Academy of Sciences of Belarus

F. Skariny prospect 68, 220072, Minsk, Belarus

Tel.: 375 (017) 284-26-29, Fax: 375 (017) 284-16-46

E-mail: rubinov@ifanbel.bas-net.by

We are trying to show that, contrary to popular beliefs, the effect of the highly coherent laser radiation on biological structures and on the living organism as a whole can differ radically from that of incoherent radiation with the same intensity, duration, and wavelength. As is well known, upon illumination of an arbitrary body by laser radiation, a speckle structure of the light field is created on its surface (or in its volume) due to the interference of scattered components with each other and with the incident light flux. This structure is characterized by a sharp small-scale spatial modulation of the radiation intensity, i.e. by strong spatial gradients of the light field. On another hand it is known that a micro-object placed into a gradient light field is affected by gradient forces which, as a rule, pull the object into the region of light field maximum. Electromagnetic gradient forces are widely used for controlling atomic beams and for manipulating micro-objects in laser tweezers. At the same time, another problem – the influence of gradient light fields on functioning biological systems, and in general, human organism – remains unexplored.

Basically the gradient forces can cause two effects: 1) change of the local concentration of certain biological components of a micrometer-scale (enzymes, erythrocytes, leukocytes, etc.) and 2) stimulation of conformational changes in various biological structures both within the cell and on the supracellular level. As a result, this can lead to changes in the character of the cell metabolism, and possibly to changes of its genetic structure.

Apart from the speckle effect the gradient laser field may be created artificially by using interference between laser beams. It allows to obtain one-, two-, or three-dimensional modulation of radiation intensity with the controllable spatial period across the biological object. We discuss the possible consequences of such irradiation on the separate biological systems and a living organism as a whole.

Visualization of intracellular Ca^{2+} dynamic with Third Harmonic Generation microscopy

L. Canioni, S. Rivet, L. Sarger, and R. Barille

Centre de Physique Moléculaire et ondes Hertziennes /CNRS UMR 5798

351, Crs de la libération, 33405 Talence Cedex, France

E-mail: barille@cpmoh.u-bordeaux.fr

Pierre Vacher

Laboratoire de Physiologie et Physiopathologie de la Signalisation Cellulaire

146, rue Léo Saignat, 33076 Bordeaux Cedex

Pierre Voisin

Laboratoire de résonance magnétique des systèmes biologiques /CNRS UMR 5536

146, rue Léo Saignat, 33076 Bordeaux Cedex

We present for the first time measurements with Laser scanning third harmonic generation microscopy of biological dynamic events and especially Ca^{2+} dynamic flow in glial cells which is a special importance in cellular biology.

For the biological experiments, we have used a human astrocytome cell line. Intracellular calcium increase was obtained using thapsigargin, a cell permeable inhibitor of the endoplasmic reticulum calcium-ATPases. The effect of 10 μ M thapsigargin has been analyzed as a function of time. The thapsigargin acts directly on the intracellular calcium concentration.

The experimental set-up uses a synchronously pumped OPO which provides 130 fs pulses at wavelength of 1.5 μ m. For the experiment several images of the unperturbed sample have been acquired as reference in order to insure the repeatability of the technique. After injection, images have been recorded and analyzed to track the evolution of the product at the cellular level. A cross section along the imaged cell before and after the product injection evidences the various dynamics of the phenomena. The THG intensity increases just after the product injection and decreases to a level roughly to the reference level, at the end of the biochemical process. This has been compared with similar measurements with conventional microfluorimetric techniques and leads to similar thapsigargin response kinetics. We have shown that intracellular flow and especially changes due to calcium movements could be seen using THG microscopy without labeling. Functional imaging is demonstrated with this technique of microscopy.

RAMAN BACKGROUND DECAY

IN AQUEOUS SOLUTIONS OF PLANT TOXINS AND HUMAN BLOOD SERUM

N.N. Brandt¹, N.B. Brandt¹, A.Yu. Chikishev¹, M.G. Gangardt², N.F. Karyakina²¹*International Laser Center and Physics Department, Moscow State University, 119899 Moscow, Russia*²*Russian Academy of the Advanced Medical Studies, 2 BARRICADNAYA, Moscow, 123836 Russia*

It is well known that the spectra of inelastic light scattering of the majority of bioorganic compounds in the Stokes range consist of narrow vibrational bands and wide fluorescence background [see, for example, 1]. The presence of the background can considerably influence the Raman bands frequencies. Upon the irradiation of the sample the intensity of the background decreases. The time dependence of the corresponding signal can be approximated by one or several exponentials. The photobleaching can be explained by photodestruction or photochemical transformations of fluorophores contributing to the fluorescence signal at the given wavelength. These fluorophores can be represented in the sample by impurities as well as by the sample molecules themselves. The decrease of the fluorescence signal can be caused also by aggregation of the molecules resulting from interaction of the radiation with the sample.

In this work we carried out the studies of the kinetics of the decay of the fluorescence background of human blood serum from healthy persons and patients suffering from oncological diseases, and of three proteins: ricin, ricin agglutinin, and ricin B subunit. We compare two different excitations: cw and pulsed at the wavelengths 532 and 488 nm, respectively. It was also found that the decay kinetics depend on emission wavelength. To approximate the kinetics we used the simplest model and determined the characteristic decay times. We have shown that one can also use for approximation two exponents. The kinetics of all the same sample were featured by good reproducibility. We found that fluorescence spectra of the samples depend on molecular weight of the molecules. Based on the data obtained from the kinetics of photobleaching we discuss the possibilities of the early cancer diagnostics.

1. Overman S.A., Thomas G.J., Jr. Novel vibrational assignments for proteins from Raman spectra of viruses. // *J. Raman Spectroscopy*, v.29, pp.23-29, 1998.

ENZYMATIC AND NONENZYMATIC PHOTOINDUCED PROCESSES IN MEMBRANES OF LASERRADIATED CELLS

O.A. Tiphlova

Institute of Laser and Information technologies RAS, Troitsk, Russia

Spectral data suggest cytochromes membranelocated enzymes of electrontransport chains as primary photoreceptors both in prokaryotic and mammalian cells. Local overheating of chromophores facilitates the diffusion of electron carries along the membrane securing extra membrane gradient production that leads to modification of cell surface prerequisites to division as well as to exogenous DNA uptake - the key step of laser gene therapy. Low-power visible or near IR laser radiation can induce photocompetence and be easily delivered to appropriate cells by endoscope or through blood vessels via optical fibers during gene therapy trials. Critical parameter to be calculated prior to application of laser in gene therapy is exact time of irradiation. "Time of irradiation - effect" curves for continuous wave radiation usually have bell-shaped form. There exists wavelengthindependent time of threshold (t) with value determined by intensity of light and cell type. At times near 5t maximum is observed. Phase of decline takes period equal to 5 to 7t. Complex shape of curves implies superposition of two or more processes induced in cell by laser radiation. Therefore we investigate action of pulse radiation of semiconductor diode with wavelength 950nm, fixed average power - 1.2x103W/m2 on the simplest system - bacteria *Escherichia coli*. A set of "time of irradiation - effect" curves for radiation with only one parameter - pulse duration varied between 0.1 and 420ms - has been obtained. The bacteria have been irradiated during 30 - 600s in buffer. Viable cell account have been performed by standard procedure after postirradiation incubation in LB medium during an hour. Three types of curves have been obtained with $\tau=30s$. When pulse duration is near 1ms the curves is bell-shaped similar to the curves for continuous wave light. When pulse duration is less than 1ms the curves show dose-dependent inhibition at 180 - 600s. At pulse duration more than 30ms the curve has phase of saturation at times more than 120s. Let us assume that the last one with constant of photoinduction, $K=50s$ reflects photoenhancement of cell membrane diffusion under conditions of complete restoration of fraction of reduced cytochromes in a time between two pulses. The assumption is valid as effective collisions between electron carriers happen every 5-20ms. Then bell-shaped curve is the difference between saturation curve and curve reflecting accumulation of oxidized enzymes with $K=100s$. At high repetition rates nonenzymatic exponential moderation of membrane fluidity probably by singlet oxygen photogenerated by laser radiation and having half life time in biological membranes 0.002ms exists. Thus, the advantage of pulsed laser at low repetition rates is equal efficacy over a wide range of times of irradiation avoiding undesirable processes and selecting suitable laser sources for possible application in laser gene therapy.

COLLECTIVE LIBRATIONS IN THE LH2 ANTENNA SYSTEMS
AND MODULATED BROADENING OF B800 AND B850
ABSORPTION SPECTRA

V. S. Pavlovich

*Institute of Molecular and Atomic Physics, National Academy of Sciences of Belarus
70 F. Scaryna Prospect, Minsk, 220072, Belarus*

The collective librations of polar fragments and polar elements in the LH2 antenna complex and the protein environment of the photosynthetic purple bacteria are described as a motion of the *histons*, new quasi-particles, introduced in [1]. Assuming that the exciton-phonon coupling is fairly weak, we study the effect of the dynamic disorder on the B800 and B850 absorption spectra as a result of the *exciton-histon interactions*. Taking into account that the histons modulate the frequency of exciton transitions, the mean-square thermal fluctuation of the frequency and the half-width of B800 and B850 absorption spectra have been defined as a function of the difference in permanent dipole moment between excited and ground states. Theory is used for interpretation of the experimental data [2] on thermal broadening of the B800 and B850 for LH2 of *Rb. sphaeroides* and *Rps. acidophila* (10050) in the glycerol-water solvent at 4.2-270 K. In the calculations it is suggested that the effects of static disorder (due to structural heterogeneity) are unchanged under these temperature conditions. Obtained equation for the full half-width provides an excellent fit to the *Rb. sphaeroides* and *Rps. acidophila* B800 data at 4.2-270 K [2] with an average histon frequency of 63 and 50 cm^{-1} , respectively.

The reasons of large distinction of the zero-phonon hole half-widths at the laser burn wavelengths near the B800 and B850 maxima are also discussed.

[1] V. S. Pavlovich, *J. Fluoresc.*, **7** (1997) 321.

[2] H.-M. Wu, M. Ratssep, R. Jankowiak, R. J. Cogdell, and G. J. Small, *J. Phys. Chem. B*, **101** (1997) 7641.

(Invited)

NOVEL WAYS OF CREATION OF INVERSION POPULATION
DUE TO COLLISIONS AND SPECIFIC POLARIZATIONS OF RADIATION

A.M. Shalagin

Institute of Automation and Electrometry, Siberian Branch RAS,
Pr. Ak. Koptuyga 1, Novosibirsk 630090, Russia

As was shown in [1,2], frequent collisions between gas particles can create a specific phenomenon consisting in population inversion in transitions to the ground atomic state. Under the conditions [1,2] there appeared an inversion in the transition $P_{1/2} - S_{1/2}$ of alkali atoms resonantly irradiated in $P_{3/2} - S_{1/2}$ transition. It turns out that when using specially polarized radiation, the collisions can inversely populate levels in the transition with frequency greater than that one of pumping radiation. As a result there appears generation in the regime of frequency up-conversion.

Frequent collisions can give rise to population inversion in the simplest continuously irradiated two-level system. Note that previously there was a conviction that under such condition the radiation is able only to equalize the level populations. For manifestation of the new effect one needs to have great positive frequency detuning, sufficiently high radiation intensity and frequent collisions. The collisions cause relaxation to Boltzmann distribution in the system of dressed atomic levels, which leads to inversion and, as a consequence, to generation with the transition frequency. We have observed experimentally both of these effects. There are discussed also applications of such effects for generation of short-wave-length radiation.

This work was supported by the Russian Foundation for Basic Research.

1. B.A. Glushko, M.E. Movsesyan, T.O. Ovakimyan, *Optika i Spektroskopiya (USSR)* **52**, 762 (1982).
2. S.N. Atutov, A.I. Plekhanov, A.M. Shalagin, *Optika i Spektroskopiya (USSR)* **56**, 134 (1984).

LASER-INDUCED COLLECTIVE INTERACTIONS UNDER PROPAGATION OF
POLYCHROMATIC RADIATION PULSE THROUGH RESONANT OPTICALLY
DENSE EXTENDED MEDIUM WITHOUT POPULATION INVERSION

S. N. Bagayev

Institute of Laser Physics, SB RAS, Lavrentyeva 13/3, 630090 Novosibirsk, Russia

V. S. Egorov, I. B. Mekhov, P. V. Moroshkin, A. N. Fedorov, I. A. Chekhonin

St. Petersburg State University, Department of Optics,

Ulianovskaya 1, 198904 Petrodvorets, St. Petersburg, Russia

E. M. Davliatchine, E. Kindel

Institute of Low-Temperature Plasma Physics,

Friedrich-Ludwig-Jahn-Strasse 19, 17489 Greifswald, Germany

The investigation of interaction between short pulses of polychromatic radiation and an optically dense resonant medium has been carried out under the conditions of the strong coupling between the electromagnetic field and the inversionless matter. Experimental measurements of transmission and amplification (in the probe-pump beam configuration) spectra correspond to the plasma of positive column in Ne glow discharge and pulse discharge in the Hg-Ar mixture. The collective behaviour of the atomic system in the resonant field was caused by the sufficient density (about 10^{12} cm^{-3}) of the atoms in the lower state of the optical transitions under consideration: $\lambda = 588.2 \text{ nm}$ for Ne; $\lambda = 546.1 \text{ nm}$ for Hg.

The nonlinear spectral transmission coefficient of the medium appears to be less than unity, its spectral width is much greater than that of the resonance and is equal to the width of the input probe-beam spectrum at the relatively small intensities of the electromagnetic field. In the presence of the pump field, the coherent cooperative interaction leads to the amplification of the probe at the spectral side-bands.

The experimental data obtained have been treated in the terms of the laser-induced cooperative interaction between field and matter accompanied by the non-stationary coherent Raman-like scattering due to collective self-splitting of the medium energy levels and the excitation of the cooperative parametric resonance.

SHORT PULSES GENERATION DUE TO COHERENT POPULATION TRAPPING

Roman Kolesov and Olga Kocharovskaya

Institute of Applied Physics of Russian Academy of Science,

603600, Nizhny Novgorod, Ulyanov str., 46, Russia

and Physics Department, Texas A&M University,

College Station, TX 77843-4242, USA

E-mail: roman@xena.tamu.edu

Recently, a way of generating broadband coherent spectra using molecular coherence excited in a Raman type process (see Fig. 1) has been proposed by Harris and Sokolov in Refs. 1-2. The generated spectrum allows compression in a normally dispersive medium, so that a sequence of very short pulses of radiation with high repetition rate (tens THz) can be created. In works [1-2] the case of narrow optical lines as compared to the vibrational frequency was analyzed. Thus, the population difference at

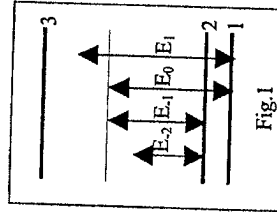

Raman transition is required in order to excite molecular coherence. We consider the opposite case of broad optical line as compared to the frequency of Raman transition which is rather typical for paramagnetic impurities in solids. Taking into account the relaxation processes involving the excited state 3 (see Fig. 1) we show that there exists another mechanism of generating the low frequency coherence between the two lower levels 1 and 2. This is the same mechanism as is responsible for the coherent population trapping. It allows efficient generation of broadband optical spectra even in the case of equal populations of levels 1 and 2, e.g. when these are hyperfine sublevels which are typically equally populated at temperatures down to liquid helium and below. The advantage of this technique is a possibility of generating dense coherent optical continua and compressing the generated spectrum into the sequence of short optical pulses with rather low repetition rate (1GHz).

- Harris S.E., Sokolov A. V., Phys. Rev. Lett., **81**, 2894 (1998)
- Sokolov A. V. et al., Phys. Rev. Lett., **85**, 562 (2000)

COHERENT TRANSIENTS IN MOLECULAR GASES

N.N. Rubtsova

Institute of Semiconductor Physics, Siberian Branch RAS, acad.

Lavrentyev ave., 13, Novosibirsk, 630090, Russia, Telephone (+007 3832) 332769, Fax (+007 3832) 332771, E-mail rubtsova@isp.nsc.ru

Coherent transient phenomena are usually generated by the abrupt changes of parameters either of the electromagnetic field or of the matter. Comparative analysis of these two approaches, made on the base of experimental research in molecular gases SF₆, ¹⁵NH₃, HFCO and ¹³CH₃F, excited by the radiation of CW CO₂ and ¹³CO₂ lasers, is presented.

The first group of experiments on photon echo and its modifications, made by electro-optically formed pulses of resonant exciting radiation, has shown the advantages of such approach for intense infrared molecular transitions. The coherent responses are sufficiently powerful to be applied in high resolution spectroscopy, including the creation of spectral markers [1], and in the studies of molecular collisions [2], [3]. But this technique is not effective in free polarization decay formation.

Another approach was used for free polarization decay and photon echo generation in polar gas ¹³CH₃F by Stark switching of molecular levels irradiated by CW CO₂ laser. Unlike conventional technique [4], coherent transients were detected as heterodyne signals in the weak component of radiation, polarized at right angle to the polarization of exciting radiation. Free polarization decay has shown the pronounced frequency shift because of dynamic Stark effect in the CW radiation field. This specific feature of coherent transients, created by Stark switching, limits the high resolution spectroscopy by the low intensity range of exciting radiation. From other viewpoint, this technique gives unique possibility to investigate coherent transients generated at the dressed molecular levels.

So, the choice of the method of generation leads to specific properties of coherent response and hence determines the specificity of its application in scientific research.

- L.S.Vasilenko, N.N.Rubtsova, Laser Physics, **7**, pp. 1021-1031 (1997)
- L.S.Vasilenko, N.N.Rubtsova, Laser Physics, **7**, pp. 903-919 (1997)
- N.N.Rubtsova, L.S.Vasilenko, E.B.Khvorostov, ZhETF, **116**, pp. 47-56 (1999)
- R.G.Brewer, R.L.Shoemaker, Phys. Rev. Lett., **27**, pp. 631-634 (1971)

Atom in a Resonant Elliptically Polarized Field: the Exact Stationary Solution

A. V. Taichenachev, A. M. Tumaikin, V. I. Yudin
 Novosibirsk State University, 2 Pirogova, Novosibirsk 630090, Russia
 G. Nienhuis
 University of Leiden, P.O.Box 9504, 2300 RA Leiden, The Netherlands

In the present paper we give a complete set of exact analytical expressions for the steady state of atoms in an elliptically polarized field. The results are presented in a unified and invariant form, and the radiative relaxation is included in the description. The nature of the steady state strongly depends on the value of total angular momentum of the excited state (F_e) and of the ground state (F_g). This leads to four classes of transitions.

- a) Transitions $F_g = F_e \rightarrow F_e = F_e - 1$. In this case atoms are optically pumped into two dark states, where they do not couple to the light field (CPT effect). These dark states are linear superpositions of the Zeeman substates of the ground level.
- b) Transitions $F_g = F_e \rightarrow F_e = F_e$ with F_e integer. In this case a single dark state exists, and CPT takes place. Therefore, the steady state does not depend on the initial conditions, the intensity or the detuning.

c) Transitions $F_g = F_e \rightarrow F_e = F_e$ with F_e half-integer. For this class no dark state exists, and CPT does not occur. The only exception is the case of a circularly polarized field, where a single dark state does occur. The steady state is uniquely defined and it has the remarkable property that the excited-state submatrix of the density matrix is fully isotropic.

d) Transitions $F_g = F_e \rightarrow F_e = F_e + 1$. For this class of transitions the steady-state solution is unique. There is no dark state. The excited-state submatrix is always anisotropic. Only in the cases c) and d) does a steady-state excitation exist. In both cases, the anisotropy of the excited state and of the optical coherence matrix depends only on the polarization of the driving field. The intensity and the detuning enter only as an overall multiplicative factor. Moreover, in both cases we find that the submatrices both for the excited and the ground state are even functions of the detuning. We apply these solution to solve a number of problems of nonlinear spectroscopy and laser cooling.

This work is partly supported by RFBR and by grant of Russian Ministry of Education.

NOVEL FARADAY MIRROR FOR HIGH AVERAGE POWER APPLICATION

Efim Khazanov, Alexey Anastasyev, Nikolay Andreev, Oleg Palashov.
 Institute of Applied Physics, 46 Uljanov st., N.Novgorod, 603600 Russia

Because of the recent increase in the average laser power the study of the thermal effects caused by the absorption of radiation in Faraday elements becomes ever more topical. Faraday mirror (FM) (dashed-line rectangle in Fig.1) is used for compensation of birefringence in active element (AE). If the Faraday element induces, owing to the thermally induced effects, the polarization distortions, the compensation of birefringence in AE will be only partial. In this paper we suggest and investigate a novel FM. The idea of the new FM consists in replacing a 45° Faraday element by two elements (30° and 15°) and placing a 90° reciprocal rotator between them (Fig.1b). The inaccuracy of birefringence compensation in the AE is characterized by the contrast ratio γ , a ratio of the depolarized power to the total power. It depends on power of heat release in AE P_a and normalized laser power p . At high P_a , γ does not depend on P_a . Fig.2 displays the theoretical dependences γ on p at high P_a . Experiments were made with 50W CW Nd:YLF laser. The results have a good agreement with the theory.

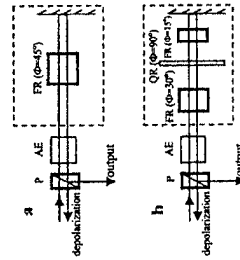

Fig.1. Compensation of birefringence in AE with a traditional (a) and new (b) FM. P – polarizer, FR – Faraday element, QR – reciprocal rotator (Φ – an angle of polarization rotation).

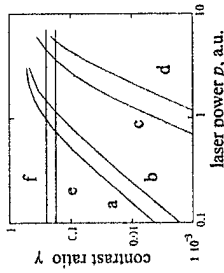

Fig.2. Dependences $\gamma(p)$ for the traditional (TGG – (a), glass – (b)) and new (TGG – (c), glass – (d)) FM, and for the design with $\lambda/4$ plate [1] (e) and with no compensation (f).

The contrast ratio with the new FM (Fig.1b) is considerably less than in the traditional design (Fig.1a). New FM can compensate for thermally induced birefringence in AE with an accuracy of 1% at average power of laser radiation of 1kW.

[1]. W.A.Clarkson, D.C.Hanna, N.S.Felgate, Opt. Lett. 24, 820-822 (1999).

"Prospects of VUV and X-ray laser on the effect of charge-transfer of laser-produced ions."

Institute of Laser Physics, Novosibirsk, Russia
Bagayev S.N., Ponomarenko A.G., Shaikhislamov I.F.

In the Department of Laser Plasmas of the Institute of Laser Physics, Novosibirsk, Russia, investigations are carried out in the field of charge-transfer pumping of ions on neutrals for lasing in the EUV spectral region. In already performed experiments with laser-produced plasmas and laser-ablated gas [1] promising results have been obtained. On the basis of the obtained results a gain experiment has been proposed [2]. It was suggested to use lithium-like OVI ions with lasing on the 4-3 transition at 520 Å, and charge transfer is to be realized by the interaction of laser-produced flow of OVII ions with a neutral gas cloud in the already tested experimental scheme.

In this work the results of the two important preliminary investigations concerning the proposed lasing experiment are reported. The first one consists of the numerical simulation of the problem. A numerical code has been developed that takes into account charge-transfer and Coulomb interaction of particles. It is specifically appropriate for the intermediate range of free-path lengths comparable to the typical gradient-scale of plasma. The main question that the simulation was able to answer is the rate of electron heating which is crucial for the whole concept of charge-transfer lasing. The second issue concerns the atomic specifics of the chosen charge-transfer interaction. It is known from other works that the distribution of the population of charge-transferred electrons over the sublevels 4s,4p,4d,4f is very sensitive to this velocity. This fact, being important for the proposed lasing scheme, motivated a separate project to study the specifics of excitation of OVI ion in the charge-transfer interaction OVI +H in the range of velocities 100-300 km s⁻¹ by means of direct observation of the main spectroscopic lines of OVI ion in the EUV range.

This work has been financially supported by Russian Fund of Basic Research (grant 99-02-17040) and National Fund of Fundamental Metrology.

[1] Ponomarenko A G et al, 1998 *J. Phys. D: Appl. Phys.* **31** 2117

[2] Zakharov Yu P, Ponomarenko AG, Shaikhislamov IF 1999 *Proceedings of 6-th Int. Conf. on X-ray Lasers (Kyoto, Japan) 1-5 Sep. 1998* (UK Institute of Physics Conference Series) **159** 339

Ablation of metals by ultrashort laser pulses.

Irina N. Zvestovskaya, Yuri V. Afanasiev,
Nikolai N. Demchenko and Vladimir A. Isakov

P.N. Lebedev Physical Institute, Russian Academy of Sciences, Leninsky Pr. 53,
Moscow 117924, Russia,

Metal ablation under the action of ultrashort laser pulses is studied numerically and analytically within a wide range of laser fluences (J) and pulse durations (ps). The physical model used in the computer code is based on the two-temperature hydrodynamic equations, and takes into account the ponderomotive forces, the electron and ion heat conduction, and ion viscosity. The model involves a description of the phase transition "condensed matter-vapor." For this purpose the phase equilibrium curve in the plane (J) is constructed, where and are the ion pressure and temperature, respectively.

In case of long laser pulses, the evaporation occurs in a hydrodynamics regime. In this regime the ablation front propagates faster than the heat conduction wave, and this makes the heat conduction ineffective as an energy transport mechanism. The laser radiation is absorbed in the subcritical region, and drives directly the ablation wave. The ablation in hydrodynamic regime has a stationary character, and its duration is determined by the duration of the laser pulse.

In case of short laser pulses the thermal regime of ablation is realized at low fluences, and is transformed into the regime of ablation by a shock wave with an increasing fluence. This happens when the pressure in the material heated during the thermal ablation stage becomes high enough to generate a strong shock wave (, where is the pulse duration and is the typical time of hydrodynamic rarefaction of the heated material). The energy stored in the shock wave is released in the ablation process. The front of the shock wave coincides with the front of the ablation wave, and the velocities of these waves are equal to each other. In the thermal regime the ablation ceases at the moment . The ablation in the shock wave regime continues for some time (as long as the pressure at the shock wave front remains higher than a certain critical value). Later the shock wave becomes weak, and the shock wave front from the phase transition boundary (which is now motionless) occurs.

Analytical model for thermal and shock-wave ablation regime description are proposed.

Holographic interferometry of a conducting surface using surface-plasmons

A.K. Nikitin, A.P. Loginov, N.I. Golovtsov

Peoples' Friendship University of Russia
Ordzhonikidze str., 3, Moscow, 117419 Russia

Photon excitation of surface-plasmons (SPs) is accompanied by substantial enhancement of the incident wave field. That is why SPs are widely employed for study of super thin layers and reconstruction of holograms [1, 2]. When used in holography SPs considerably increase the diffraction efficiency and thus improve contrast and quality of the image. So far scientists effectively employed SPs in holography, but no one used holography in SP-microscopy of a conducting surface [3]. Meanwhile this combination of the methods promises many benefits.

We have investigated the possibility of performing holography of a plane conducting surface under the conditions of SP-resonance occurring on the surface. It was found that SP-holography could be especially profitable when snudding slight modifications of the surface's transition layer on comparatively large areas. Moreover as phase of the reflected light is much more sensitive to SPs excitation efficiency (depending on the state of the surface) as compared with the light's amplitude a special attention was focused on combining phase SP-microscopy and holographic interferometry (HI). The project should not take a lot of efforts as it could be done on the setup used for performing SP-microscopy while replacing the screen with a holographic photo plate. Registration of holograms on different stages of the controlled process enables us to compare interferograms using such standard HI techniques as the method of real time and the method of a double exposition. Thus we can combine high sensitivity of SPs and full time resolution of wave front distortions inherent to HI.

References

1. Surface polaritons. Electromagnetic waves on media's surfaces and interfaces. Ed. by V.M. Agranovich and D.L.Mills // M.: Nauka, 1985. – 525 p.
2. Maruo S., Nakamura O., Kawata S. Evanescent-wave holography by use of surface-plasmon resonance // Applied Optics 36 (11), 2343-2347 (1997).
3. Nikitin A.K., Tishchenko A.A. Surface electromagnetic waves phase microscopy // Pisma v GTF (Letters to the Journal of Technical Physics) 17(11), 76-79 (1991).

Interferometry Based on Autodyne Detection in Semiconductor Laser
D.A. Usanov, A.V. Skripal, M.Yu. Kalinkin

Saratov State University, Russia, 410026, Saratov, Moskovskaya, 155
Tel.: 8452-514563. Fax: 8452-240446. E-mail: usanovda@info.sgu.ru

A tremendous interest in the autodyne detecting effect in semiconductor lasers is explained by the possibility of combination of generator and detector functions in one device. For objects to be investigated with small reflection coefficient which is within limits of 1% the generator and detector functions are realized practically independently. When the feedback level rise the autodyne signal form begins to be different from the form of the interference signal formed with the same motion of the reflector in the interference system separated from the light source. At the same time the essential influence on the autodyne signal form is ascribed stationary phase and motion character of external reflector.

The motion form determination by the autodyne signal can be solved at two stages. On the first stage the detected signal form, which conforms to the signal form of homodyne interference system separated from the light source, are reconstructed by the autodyne signal [1]. On the second stage, when the mechanical movement form are reconstructed, it allows to use the known methods for the form determination either of sinus movements or of nonharmonic periodical movements [2] by the interferograms for the homodyne system protected from the reflector beam.

The use of the semiconductor laser autodyne for measuring goals has given the possibility to elaborate new technologies of fast-changing processes control. One of such technologies is the returning of the complicated vibrations of an object, while their amplitude not exceeds several microns.

We have used the semiconductor laser autodyne for the form reconstruction of heart beating of fresh water crawfish – daphnia [3] as the same for the diagnostics of the microsaccadic eye movements, known as eye tremor, whose amplitude does not exceed several microns.

1. D.A.Usanov, A.V.Skripal, M.Yu. Kalinkin, Form determination of complicated movements of object by the signal of autodyne detection of semiconductor laser, Technical Physics. Vol. 70, No. 2, 2000, P.125-129.
2. D.A.Usanov, A.V.Skripal, V.A/Vagarin, M.R.Vasiliev, Optical homodyne methods of measurements, Foreign radioelectronics. No. 6, 1995, P.43-48.
3. D.A.Usanov, A.I.V.Skripal, A.Yu.Vagarin etc., Laser autodyne interferometry of the dynamic parameters of biological specimens, Technical Physics Letters. Vol. 24, No. 3, 1998, P.183-185.

Igor Gurov^{*)}, Petr Hlubina^{**)} and Vladimir Chugunov^{*)}

^{*)}Institute of Fine Mechanics and Optics (Technical University)
14, Sablinskaya st., Saint-Petersburg, 197101 Russia

^{**)}Institute of Physics, Silesian University at Opava
14, Beznucovo nám., Opava, CZ-746 01 Czech Republic

Spectral interferometry is based on the channelled spectrum observation at the output of low-coherent interferometer with a subsequent spectrometer. The problem of the spectral data analysis is that the spectral fringe intensity distribution contains the non-uniform background and essentially varied envelope that can be systematic errors sources in the conventional spectral analysis. It is important to verify the accuracy of the fringe phase recovery by using an alternative data analysis method based on the phase-locked loop (PLL) technique that is widely used in electronics. Basically, PLL method is described by differential equations that is another approach with respect to the Fourier transform.

It was proposed recently [1] to use the PLL method for conventional interferogram analysis iteratively. At each iterative step the data obtained from a previous processing step are used as new initial conditions. We have developed the optimal filtering and iterative procedures applied to spectral fringes with wide-varied parameters. The high accuracy and stability of the PLL method were verified experimentally in the optical scheme of the uncompensated Michelson interferometer [2] excited by a low-coherence source when the optical path difference between both beams exceeds the source coherence length. The nonlinearity of the unwrapped fringe phase caused by the beamsplitter dispersion was estimated with a good coincidence of the theoretical and experimental results.

References

- I. M. Servin, R. Rodrigues-Vera and D. Malacara, "Noisy fringe pattern demodulation by an iterative phase locked loop", *Opt. Laser Eng.*, vol. 23, pp.355-365 (1995).
- P. Hlubina, "Fourier transform analysis of the spectral modulations obtained at the output of the uncompensated Michelson," *Opto-Electr. Rev.*, vol. 5, No. 2, pp. 117-122 (1997).

Theory of Doppler-free Spectroscopy with λ -Thick Vapor Cells

A.N. Naumov,¹ A.A. Podshivaylov,¹ K.N. Drabovich,¹
R.B. Miles,² and A.M. Zheltikov¹

¹ International Laser Center, Faculty of Physics, Moscow State Univ., Russia
² Dept. Mechanical and Aerospace Eng., Princeton Univ., Princeton, NJ, USA

Doppler broadening of spectral lines is a key issue in many areas of high-resolution spectroscopy, optical frequency metrology, and optical frequency standards. There are several standard ways to alleviate problems related to Doppler broadening widely used in ultrahigh-resolution spectroscopic measurements. The use of nonlinear-optical processes in counterpropagating beams, hole burning, measurements on slow, cold, and trapped particles, laser spectroscopy of forbidden transitions, and spectroscopy of Ramsey fringes are among the most widespread methods of high-resolution spectroscopy [1]. A simple approach to sub-Doppler measurements with a room-temperature gas has been recently proposed by Briaudeau *et al.* [2], who observed sub-Doppler features in transmission spectra of a low-pressure vapor filling a commercially available thin glass cell with a thickness of 10 – 100 μm , thus extending the pillbox-cavity approach to microwave spectroscopy, proposed and experimentally implemented by Romer and Dicke back in 1955 [3], to the optical range.

In this paper, we will examine the extension of the approach proposed by Briaudeau *et al.* [2] to anisotropic vapor cells with one of the sizes reduced to a characteristic scale of optical wavelength (Fig. 1a). Cells of this type and even one- and two-dimensional arrays of such cells (often arranged in periodic structures, called photonic band-gap structures, see Fig. 1b) can be fabricated by means of modern technologies. Our analysis shows that the width of a resonant spectral line observed in transmission spectra measured in the direction perpendicular to the larger dimension of the cell tends to its natural width as one of the sizes of the vapor cell approaches the wavelength of the spectral line.

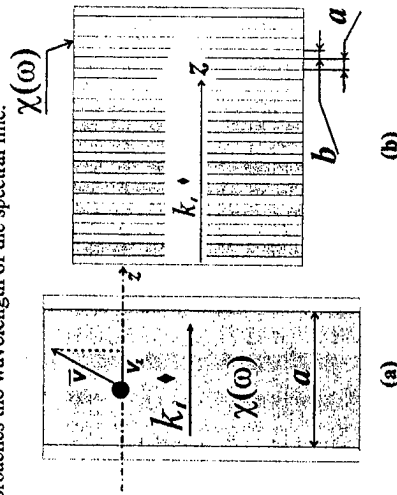

Fig. 1. An ultrathin vapor cell (a) and an array of such vapor cells arranged in a periodic one-dimensional (photonic band-gap) structure (b): a is the thickness of the cell; b is the thickness of cell walls; k and ω are the wave number and the frequency of incident light, respectively; $\chi(\omega)$ is the linear susceptibility of the resonant gas filling the cell; v is its projection on the z -axis, which is chosen along the direction corresponding to the minimum size of the cell.

This work is supported by the Civilian Research and Development Foundation (Award RP2-22666).

- V.P. Chebotayev, V.S. Letokhov, *Nonlinear Laser Spectroscopy* (Berlin: Springer, 1977).
- S. Briaudeau, D. Bloch, and M. Ducloy, *Europhys. Lett.*, **35**, 337 (1996); S. Briaudeau, S. Saltiel, G. Nienhuis, D. Bloch, and M. Ducloy, *Phys. Rev. A*, **57**, R3169 (1998).
- R.H. Romer and R.H. Dicke, *Phys. Rev.* **99**, 532 (1955).

SHOT-NOISE LIMIT SENSITIVITY IN CW PUMP-PROBE SPECTROSCOPY OF CONJUGATED POLYMERS

V.A. Rutilova-Zavgorodniy, O.Yu. Nedopekin, S.G. Elizarov and D.Yu. Paraschuk
Physics Department, Moscow State University, Moscow 119899, Russia

Lasers are irreplaceable light sources for spectroscopy, however, as a rule, they have a noticeable level of power fluctuations or technical noise. Even though various stabilization schemes for various lasers are known in some cases other types of light sources as incandescent lamps (IL) and light emitting diodes (LED) can compete with lasers. In cw pump-probe spectroscopy of conjugated polymers we have met with a measurement problem of probe power modulations as small as $\delta P/P < 10^{-5}$ using lock-in detection in the frequency range 0.1–1 kHz. As the spectral resolution ~ 1 nm is quite acceptable for us, we have tried three types of light sources in the probe channel: lasers, LEDs and ILs. In this work we compare these light sources for highly sensitive cw pump-probe spectroscopy of organic materials. Moreover, we have improved the sensitivity by a few orders of magnitude in three ways.

First, we have applied near-IR LEDs as probe sources instead of using low spectral luminance ILs. The LEDs yield satisfactory spectral resolution and spatial characteristics. Furthermore, we have found that the LEDs have no technical noise when powered from batteries (just as in the case of ILs) and $\delta P/P$ can reach values as small as 10^{-7} . We have proven this type of source in photoinduced absorption spectroscopy of nanopolyacetylene.

Second, we have used a semiconductor diode laser with negative optical feedback in order to suppress the technical noise. The measured $\delta P/P$ values reach 10^{-7} . We have applied this stabilized laser working at 750 nm to probe dipole-forbidden A_g states of nanopolyacetylene in its transparency range by a photothermal method.

Finally, we have applied a light noise compensation scheme using a differential photodetector. By using this method we achieved the shot-noise limit for IR diode lasers and a He-Ne laser ($\delta P/P \sim 10^{-7}$). We have applied this photodetection system to study the Faraday effect in nanopolyacetylene.

Narrow Resonances of the Saturated Absorption and Dispersion

T.V. Radina

*Institute of Physics, St.-Petersburg State University
1, Ulyanovskaya st., Petrodvoretz, 198904, St.-Petersburg, Russia
ph.: +7 (812) 311-27-36, fax: +7 (812) 428-72-40, e-mail: radina@paloma.spbu.ru*

We have discussed here a new approach to a genesis of resonances of waves intensities which one are accompanied by the index of refraction resonances at their passage in nonlinear gas medium. The "radiation + matter" system under consideration joins in itself both the properties of quantum object (at the level of formation of polarization) and classical (at a level of propagation of light waves). Until now the reason for the intensity and phase resonances was explained from the point of view of changing of the shape of the polarization medium. We consider that in half classical system alongside with the quantum mechanism there exists also the classical mechanism of a genesis of resonances. Two (or several) oscillating systems have resonances in points of maximum conjunction between them rather than at the expense of resonant change of the medium absorption coefficient. For this reason the widths of these can be very small.

This contention is correlated well with theoretical study and many experimental data.

Results are presented of theoretical studies into the resonances of the saturated absorption and saturated dispersion in an external absorption cell. The theory has been worked out by means of combining methods of mathematical theory of diffraction and quantum mechanical method for computing the polarization of active media. This made it possible for the first time to find a self-consistent spatial solution of the density matrix equation for the two-level system and the Helmholtz equation for electromagnetic field and to solve the problem of propagation of two counterpropagating monochromatic waves through an absorption nonlinear medium taking into consideration the transverse transit-time effect.

The Function of Diffraction in Intracavity Spectroscopy and Metrology Problems

T.V. Radina, A.F. Stankevitch

Institute of Physics, St.-Petersburg State University

1, Ulyanovskaya st., Petrodvoretz, 198904, St.-Petersburg, Russia

ph.: +7 (812) 311-27-36, fax: +7 (812) 428-72-40, e-mail: radina@paloma.spbu.ru

In an actual laser, restriction of the oscillation on the lowest-order Gaussian mode necessitates to use of a suitable limiting aperture. In addition, the radial distribution of the saturated gain forms an extended amplitude-phase corrector, the optical power and the stopping down properties of which are proportional to the transverse inhomogeneity parameters. An allowance for the multiplicative effect of the active medium and of the aperture explains the asymmetric nature of the frequency shift and losses and hence also of the intensity and Lamb dip relative to the central transition frequency. The sing of the asymmetry is determined by ratio of the inhomogeneity (linear and nonlinear) parameters to an aperture size.

The problem of eigen modes of an optical cavity containing a transversely nonuniform active medium and an aperture is solved by the standard method of asymptotic expansion. The refractive index of the nonlinear active medium $n = n_z(z) + n_x(z)x^2 + n_y(z)y^2$ is determined from quantum-mechanical calculations with consideration of the transversal transit-time effect, induced by thermal vibration of the excited atoms. The matrix for the transformation of a Gaussian beam on passage through a longitudinally and transversely inhomogeneous medium was obtained for the first time. The calculation is made of the frequency-depend change in the main cavity characteristics (g-parameter, eigen-frequencies, losses) - parameter of a cavity. The transverse distribution of the field in counterpropagating waves are determined.

The analytical expressions for the frequency-dependent diffraction losses, intensity and frequency shift are derived in the terms of the cavity and medium parameters taking into consideration the induced spatial nonuniformity of the nonlinear active medium. The good agreement of the experimental data with the theory provides a verification of the study.

Calculations of Second-Harmonic Near-Field Images

S. Bozhevolnyi

*Institute of Physics, Aalborg University, Pontoppidenstraede 103,
DK-9220 Aalborg Ost, Denmark. E-mail: sergey@physics.aau.dk*

V. Lozovski

*Institute of Semiconductor Physics, National Academy of Sciences of Ukraine,
pr.Nauki 45, 03028, Kyiv-28, Ukraine. E-mail: lozovski@imol.semicond.kiev.ua;
Fax/Phone: +380 (44) 265-5530*

The macroscopic self-consistent approach that allows one to describe image formation rigorously in second-harmonic (SH) scanning near-field optical microscopy is developed for nonlinear objects situated at the surface of nonlinear substrate. This approach is the development of the self-consistent scheme proposed by authors earlier [1]. The SH field is determined by taking into account both the linear and nonlinear contributions in the currents generated by the self-consistent fields at the fundamental frequency (FF) and SH. The self-consistent problem for both frequencies is solved exactly with the approach to the determination of the Green dyadic of the system. General expressions for the FF and SH fields are obtained in terms of effective local susceptibility of the object-substrate system. Image formation in the Gauss beam-illumination SH near-field microscopy is considered within the framework of the approach developed. In this kind of near-field microscopy the illumination of system is realized by the Gauss beam in which the field amplitude is proportional to $\exp[-|\vec{r} - \vec{r}_p|^2 / \sigma_0^2]$ (\vec{r}_p is the two-dimensional coordinate of the center of beam, σ_0 is its characteristic radius). This beam is scanned along the plane of the substrate surface. Near-field optical FF and SH images are calculated for different polarization configurations and parameters of rectangular nano-object located at substrate. The different cases of the system nonlinearities are considered. Namely, i- nonlinear object situated at the surface of linear substrate; ii- linear object situated at the surface of nonlinear substrate; iii- nonlinear object situated at nonlinear substrate. The calculations were made for the case of $\sigma_0 = 0.5\lambda$, where λ is the wavelength of probing FF field. The effect of SH signal from the domain occupied by the linear object situated at the nonlinear substrate is obtained.

[1] Sergey I. Bozhevolnyi and Valeri Z. Lozovski, Phys.Rev.B 61, 11139-11150 (2000)

RESTORATION OF THE AUTOCORRELATION FUNCTION OF A STATISTIC SURFACE ROUGHNESS ON THE LIGHT SCATTERING IN A PLANAR OPTICAL WAVEGUIDE IN THE PRESENCE OF THE ADDITIVE STOCHASTIC NOISE

A. A. Yegorov
 People's Friendship University of Russia,
 3, Ordjonikidze str., Moscow, 117923 RUSSIA
 Tel.: 007 (095) 3940414
 E-mail: yegorov@kapella.gpi.ru

The problem of the TE-mode scattering in an integrated planar optical waveguide with 3D small statistic irregularities is described. The possibility to restore the autocorrelation function of the substrate (quartz) surface roughness from the far zone 2D scattering diagram in the presence of the additive stochastic noise is demonstrated.

On the left figure the normalized restored experimental (curve 6) and theoretical Gauss autocorrelation functions (curve 2-5) with correlation interval $r = 0.05, 0.10, 0.15$ and $0.20 \mu\text{m}$ are presented. In a similar way on the right figure the same restored experimental (curve 7) and theoretical Gauss autocorrelation functions (curve 2-6) with correlation interval $r = 0.15, 0.20, 0.25, 0.30$ and $0.35 \mu\text{m}$ are presented. Curve 1 is the plot of theoretical Gauss autocorrelation function with correlation interval $r = 0.15 \mu\text{m}$. The rms error of deviation of the experimental autocorrelation function from the theoretical one with $r = 0.20 \mu\text{m}$ for the same level of the noise ($\text{SNR} \geq 10$) is not greater than 20%.

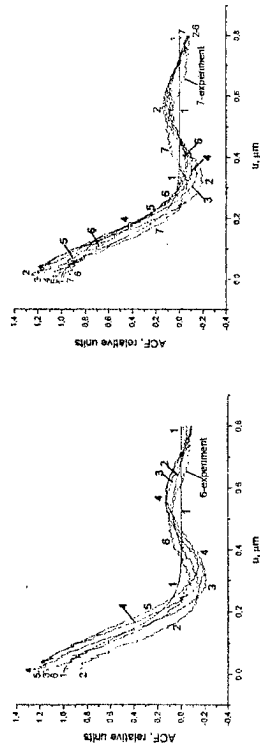

Real time waveguide acoustooptical optic radiation spectrum analyzer.

Prof. Alexander G. Sobolev, Dr. Evgene N. Epikhine, Dr. Nikolay V. Masalsky, Dr. Vladimir A. Volkov.
 Dept of Optoelectronics of Institute for Microprocessors, Russian Academy of Sciences, mailing address: Nahimovsky Pr 36, block 1, Moscow, 117997, Russia.
 Phone: (007)-095-332-4980, fax: (007)-095-332-4862,
 E-mail: volkov@mail.invs.ru.

The problems of design and manufacture of the waveguide acoustooptical optic radiation spectrum analyzer are discussed. Elaboration of device construction, computer simulation, manufacture of the device sample and its characteristics investigation have been done during the work. Schematically the device consists of three block: input optical block, waveguide acoustooptical block and photo receiver block.

The waveguide chip was manufactured on the surface of the Y-cut lithium niobate substrate. An optical beam from the optic fiber is input into the planar waveguide and is collimated with planar aplanatic lens system. Then it is diffracted on a surface acoustic wave that is generated with the inter-digital transducer. The input RF-signal is a measure standard. The RF-signal frequency is fixed constantly. The each component of an optical beam is diffracted on the define angle corresponding own optical frequency under Bragg condition. This resulting optical field is focused with planar aplanatic lens system on photodetector array and is registered in a real time scale. The WAOSA experimental sample has the following experimental parameters: RF-signal frequency - 396 MHz, analyzer optical radiation range from 750 nm to 1060 nm, wavelength resolution of two optical signals - 3 nm, measuring accuracy of optical signal - 0.01 nm, low level of measured optical signal - 10 μW, outline dimensions 150x90x40 mm.

The theoretical researches show that aplanatic modified Fresnel lenses application allow to increase the wavelength resolution at list up to 1.5 nm.

THERMAL WAVE PHASE AND AMPLITUDE MEASUREMENTS OF THIN METAL FILMS THICKNESS

Reznikov Andrei V., Laser-Compact Co. Ltd.

Vvedensky st., 3, Moscow 117342, Russia

phone: (095)-720-54-52, fax: (095)-720-54-50, e-mail: ik@lcompact.msk.ru

Measurement of thin metal films thickness is an actual problem of electronics. When a sample undergoes by periodically heating of a laser, temperature of its surface is depended on film thickness and thermal parameters of film and subsurface. Thin film thickness measurement problem may be divided into two ones. The first – measurements on all area with microns accuracy along surface (mapping) of complex samples, and the second – average control measurements along surface samples.

One of noncontact method of is based on temperature dependence of reflectance detected with probe laser beam reflected from heated area of sample.

It is shown that relatively low modulation frequency of heating laser beam (tens kilohertz instead of some megahertz) for average control thin submicron thickness metal films is available in despite of thermal wave length is more longer than thickness of this films. This frequency reducing leads to simplification both of detecting and processing devices and heating laser modulation.

In this report phase and amplitude techniques for relatively low modulation frequency of heating laser beam will be compared.

FORMING OF THE LONG HOLOGRAPHIC LATTICES WITH A USING OF FREQUENCYSHIFT OF THE LIGHT BUNDLES, WHICH INTERFERES

Pilipovich V.A., Yarmolitski V.F., Polyakov V.I., Konojko A.I.

Institute of Electronics, National Academy of Sciences of Belarus,

22 Logoisly Trakt, Minsk 220090, Belarus

Tel. +375 17 265 34 38, Fax +375 17 265 23 41, E-mail: kanojka@imel.bas-net.by

Summary

One of the effective way of the development of high – frequency diffraction grids is the method, considered in this work, of its formation by use light fluxes polarization-frequency transformation of which are realized by electrooptics aids. Essence of the method consists of creation of the dynamic interference picture on continuously moving registering material at the speed of the displacement of planes of loops which is equal to the velocity of the material motion. As a result the diffractive lattice is recorded along the whole length of the registering material. The spatial frequency of diffractive lattice is defined by the wavelength of used laser and by the angle of convergence of light bundles which interferes.

The frequency and amplitude transformations of light bundles during the process of the record of diffractive lattices are realized by means of the wideaperture highstable electrooptical modulators, that allows the to organize a stable dynamic relationship between moving interference picture and registering material.

Described method allows to develop a technology of the high-frequency (1000 line/mm and more) long diffractive lattices which are used, for example, in precise sensors of linear displacements.

The autocontrol by the contrast of interference picture is an important particularity of the considered variant of the registration of diffractive lattices. As a results, the offered tech and the optical scheme developed on its basis allow permit to create large-format diffraction filters having optical properties multigradedly, smoothly or by assigned law.

**DETERMINATION OF PARAMETERS OF NANOLAYERS
BY THE MODIFIED KRETCHMAN'S SCHEME**

V.A. Karpenko, A.A. Romanenko

Institute of Applied Optics of National Academy of Sciences of Belarus

11 Byalynitskogo-Biruli Street, Mogilev 212793

Republic of Belarus

Tel./Fax +375(222) 264649

E-mail: ipo@physics.belpak.mogilev.by

In studying optical properties of molecular layers adsorbed onto the surface of a solid, problems of increasing the measuring device sensitivity and correct solutions of inverse problems of reconstruction of optical parameters of these devices are still actual. The construction of Kretchman [1] is the most sensitive to among the prism devices for excitation of guided waves. However, it is difficult to solve the inverse problem of unique reconstruction of ϵ and d for this device because the only one plasmon mode can be excited in it.

In this paper it is shown that the modification of Kretchman's scheme through deposition of a thin dielectric film onto the metal one allows the device's sensitivity to the adsorbed layers to be essentially increased as well as the solution of the inverse problem to be obtained because in this case the dielectric film is a wave guide which can guide modes of TE and TM polarizations. Measurands are the mode propagation constants h for two polarizations and their increments Δh stipulated by the presence of the adsorbed layer onto the dielectric film. The analytical solution of the inverse problem of reconstruction of ϵ and d through measured h and Δh is obtained with the help of the perturbation theory known for planar wave guides. The problem of a choice of the waveguide parameters which ensure high sensitivity and minimization of errors of ϵ and d determination is studied. The device sensitivity to the adsorbed layers is shown to be growing monotonically with an increase in the waveguide permittivity ϵ_w . It is established that for any fixed ϵ_w there are ranges of values of the wave guide thickness where errors of reconstruction of ϵ and d are minimal. For these ranges at $\epsilon_w = (1.65)^2$ and the error of determination of mode propagation constants $\text{Re}(\delta h/k_0^{-1}) = \pm 5 \cdot 10^{-5}$ [2], where k_0 is the free space wave number, reconstruction of ϵ and d (~ 1 nm) can be made with an error which is less than 2% and 5%, respectively.

[1] *Ulman A.* Ultrathin organic films. Now York, 1991.

[2] *Romanenko A. A., Sotsky A. B.* // Zh. Tekhn. Fiz. 1998. V. 68. № 4. P. 88-95.

RAMAN SCATTERING CROSS SECTION IN TRANS-NANOPOLYACETYLENE

A.G. Smekhova, I.V. Golovnin, D.Yu. Paraschuk,

Physics Department, Moscow State University, Moscow 119899, Russia

V.M. Kobryanski

Semenov Institute of Chemical Physics, RAS, Moscow 117977, Russia

Nanopolyacetylene, nano-(CH)_x, demonstrates a very high spontaneous Raman response in the transparency range that rather indicates the case of «resonant» Raman scattering [1]. In this work we evaluate the spontaneous Raman scattering (SRS) cross section for bond length vibrations (C=C and C-C) of trans-nano-(CH)_x by comparison with one of the strongest Raman active material, LiNbO₃ crystal.

Nano-(CH)_x is a π-conjugated material in which ≤ 30 nm (CH)_x nanoparticles are dispersed in a polyvinylbutyral matrix with a content of ~1%. Each nanoparticle has a globular shape and comprises of ordered π-conjugated chains. Nonoriented 5-μm thick films of *trans-cis* blend of nano-(CH)_x at 300 K were studied. We used films of nano-(CH)_x with optical density ~1.6 on a glass substrate. An 1-mm thick plate of LiNbO₃ oriented along the optical axis was used as reference material. We measured Raman spectra of trans-nano-(CH)_x for lines ν_{C-C} = 1081 cm⁻¹, ν_{C-C} = 1471 cm⁻¹ and LiNbO₃ for line ν = 832 cm⁻¹ at the excitation wavelength 514 nm in the forward scattering geometry. The measured relative integral SRS intensities for ν_{C-C} and ν_{C-C} lines of nano-(CH)_x and LiNbO₃ are similar that corresponds to

$$\left(\frac{\partial \sigma}{\partial \Omega} \right)_{(CH)_x} / \left(\frac{\partial \sigma}{\partial \Omega} \right)_{LiNbO_3} \sim 10^5. \text{ Thus, the SRS cross section magnitude for trans-} \\ (CH)_x \text{ nanoparticles is evaluated as } \left(\frac{\partial \sigma}{\partial \Omega} \right)_{(CH)_x} \approx 4 \cdot 10^{-2} \text{ cm}^{-1} \text{sr}^{-1}. \text{ As shown in [1]}$$

the similar SRS magnitude is expected for the transparency range of nano-(CH)_x. The nature of high Raman activity in nano-(CH)_x is discussed.

I. D. Yu. Paraschuk, V.M.Kobryanski, JETP Lett. **73**, 171 (2001).

Influence of oxidation on process of particle emission from silicon surface at solid-phase laser destruction.

A.F. Banishev, V.S. Golubev, A.Yu. Kremnev

ILPIT RAN— Institute on Laser and Information Technologies,
Russian Academy of Sciences. 140700 Shatura, Moscow Region, Russia
Fax: (096-45) 2-25-32, E-mail: banishev@laser.nictl.msk.su

SUMMARY

The destruction of surface of opaque solids with powerful laser radiation before its melting can be due to generation of high ($n=10^5$ m) concentration of point defect (vacancies, interstitial sites) in the thin surface layer of material (10^{19} - 10^{20} cm⁻³) [1,2]. High thermal stresses and considerable concentration of defect may initiate formation of microcracks, which, in its turn, may be accompanied by emission of particles from material surface.

Previously, the authors observed the emission of glowing particles from monocrytalline Si surface under the action of submicrosecond laser pulses in the air (irradiation intensity did not exceed the threshold value for Si melting) [3]. The results of the work were not uniquely interpreted: the mechanism of emission and a substantial time delay (~5-15 μs) of individual emission spikes relative to back front of surface thermal glow signal remained vague.

This paper will present the results of further investigations of the observed emission. The studies were performed in vacuum in order to reveal a possibility of oxidation influence on the process of particle emission. The early stage of monocrytalline Si surface destruction with laser has been studied by conditions of emission occurrence and its parameters.

1. B.L. Volodin, V.I. Emel'yanov, Yu.G. Shlykov, Kvantovaya Elektronika, Vol. 20, N 1, p. 57, 1993.
2. V.I. Boiko, B.S. Lukyanchuk, E.P. Tsarev, "Laser generation of non-equilibrium defects in the solid", Proc. IOFAN, Vol. 30, p. 6, 1991.
3. A.F. Banishev, V.S. Golubev, A.Yu. Kremnev, "Damage to the surface of silicon in the solid phase by the action of Nd:YAG laser pulses", Kvantovaya Elektronika, Vol. 28, N 10, p. 917, 1998.

Theory of laser-induced surface periodic Temperature-Deformational structures formation in solids

Eriomin K.I.

Physics Faculty & International Laser Centre, M.V. Lomonosov Moscow State University, Vorobyevy gory, Moscow, 119899 Russia, phone (095) 190-0410, fax (095) 939-3113, e-mail: kostia_eriomin@mtu-net.ru

The general theory of laser-induced selforganization of non-coherent surface spatially periodic (micrometer scale) temperature-deformational structures in solids is developed[1].

The mechanism of temperature structures formation consists in the following. The strong laser pulse of millisecond duration heats subsurface layer which we consider as a thin "film" bonded to the underlying "substrate". Thickness of this "film" is determined by heat diffusion depth $h \approx \sqrt{\chi T_p}$. We consider the heated film. The Thermal-Deformational(TD) instability can develop in this film in the following way. A spatial fluctuation of thermal phonon distribution create deformation(strain) fields in the elastic continuum due to elastic anharmonism of crystal. This deformation field (film bending) in its turn acts on phonons changing their spatial distribution and enhancing initial fluctuation. Due to this positive feedback the initial state of uniform temperature field within the film becomes unstable at some critical temperature and transition to a state with spatially periodic temperature distribution and periodic strain coupled with surface corrugation occurs.

Based on this theory the geometries, periods, and times of formation of structures are determined in dependence on laser intensity and pulse duration t_p , laser-induced temperature and crystalline symmetry of the surface.

The theory predicts general scaling law for the characteristic period of temperature field. The theory developed was applied for description of a number of experimental observations of formation of surface periodic damage, scaled with the law $h \approx \sqrt{\chi T_p}$. In particular the theory results are shown to be in good agreement with experimental data on formation of d -30nm surface crystallographically oriented damage gratings in Si, formed under irradiation of millisecond laser pulses.

References

1. V.I.Emelyanov, K.I.Eriomin, Kvant.Elektron.T.30,N2,2001.

Formation of Si nanocrystals in a-Si films using excimer laser.

V.A.Volodin, M.D.Efremov, V.V.Bolotov*, A.V.Kretinin**, A.S.Kochubei, A.K.Gutakovskii, L.I.Fedina.

Institute of Semiconductor Physics SB RAS, 630090, pr. ak.Lavrent'eva 13, Novosibirsk, Russia, E-mail: volodin@isp.nsc.ru,

*Institute of Sensor Microelectronic SB RAS, 644055, Pr. Mira 55a, Omsk, Russia,

**Novosibirsk State University, 630090, Pirogova Street 2, Novosibirsk,Russia.

SUMMARY

Using Raman spectroscopy and HREM techniques, the Si nanocrystals were observed in a-Si:H films after nanosecond pulse excimer laser impacts. The dependence of the average size and concentration of nanocrystals on energy density and numbers of the laser impacts was studied. Anisotropy of Raman scattering intensity in different polarization geometries was experimentally observed. This can be interpreted as result of preferred (110) orientation and correlation of in-plane orientation of the nanocrystals. Appearance of the preferred (110) orientation of nanocrystals was observed also using HREM technique. Moreover, it was observed that the significant part of the nanocrystals were self-oriented in plane with angle disorientation less than 7°. From symmetry selection rules, assuming that γ is the content of (110) oriented nanocrystals, and ρ is portion of them with the mutual planar orientation, one can obtain expressions for Raman intensities in various polarisation geometries:

$$I_{XX} \sim \gamma \cdot (\rho \cdot (\sin^4(\varphi) + 4\sin^2(\varphi)\cos^2(\varphi)) + 7/8(1-\rho)) + (1-\gamma)$$

$$I_{YY} \sim \gamma \cdot (\rho \cdot (\cos^4(\varphi) + 4\sin^2(\varphi)\cos^2(\varphi)) + 7/8(1-\rho)) + (1-\gamma)$$

$$I_{XY} \sim \gamma \cdot (\rho \cdot (\sin^2(\varphi)\cos^2(\varphi) + (\cos^2(\varphi) - \sin^2(\varphi))^2) + 5/8(1-\rho)) + 3/4(1-\gamma)$$

were φ - angle between (001) crystal direction of the mutually oriented nanocrystals and the direction of initial light polarization - X', direction Y' is perpendicular to X'. The Raman spectra of films with nanocrystals formed by pulse laser treatments with different energy density were registered in three different polarization geometries at the different position of angle φ . Then the Raman intensities of "nanocrystal" peaks were calculated and ratios of the intensities in Y'Y' and X'Y' geometries were obtained. These ratios versus angle φ are presented in fig. 1.

The Russian Fund of Basic Research has supported this work Grant No 00-02-17946.

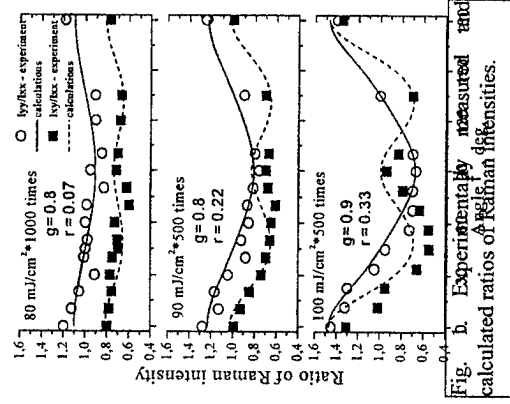

Fig. D. Experimentally measured and calculated ratios of Raman intensities.

OPTICAL SIZE RESONANCES IN ATOMIC NANOSTRUCTURES

O.N.Gadomsky, T.T.Idistullov

Ulyanovsk State University, 432700, L.Tolstoy Str., 42, Ulyanovsk, Russia

Yu.Yu.Voronov

Ulyanovsk Branch of Institute of Radio Engineering and Electronics of RAS,

432011, Goncharov Str., 48, Ulyanovsk, Russia

SUMMARY

The possibility of existence of optical size resonances in nano-structural atomic systems is demonstrated. The properties of size resonances are strongly determined by interatomic distance and polarization of external optical radiation. The properties of linear and nonlinear size resonances are examined in the case of two-atom nano-structural object. The linear optical size resonances are considered on the basis of closed system of equations for dipole oscillators and nonlocal field equations in view of dipole-dipole interaction of atoms in the field of optical radiation. The stationary solution of these equations shows that two isotropic atoms with definite eigenfrequencies form the anisotropic system with two or four size resonances depending on the fact whether the atoms are equal or not. In addition, nano-structural object with two different atoms has two linear size resonances with positive dispersion and two resonances with negative one. The frequencies of size resonances considerably differ from the eigenfrequencies of isolated atoms of nano-structural object. It is demonstrated that, upon varying the incidence angle of external wave, it is possible to excite different size resonances. The properties of nonlinear optical size resonances are also investigated theoretically and with numerical experimentation on the basis of modified Bloch equations for intense radiation and nonlocal field equations. The dispersion relations of nonlinear resonances are obtained and inversion of atoms of nano-object is investigated for different polarizations of external optical wave.

Effect of Coulomb charging energy on electron oscillations in a coupled-quantum-dot structure

P.I. Khadzhi, V.I. Gratyshchak

Dniester State University, 25 October str., 128, Tiraspol, Moldova, 3300,

tel: (10-373-33)-3-44-87, 3-2504, fax: (10-373-33)-3-25-04, e-mail: idsu@irasel.md

Institute of Applied Physics, Academy of Sciences, Academy str., 5, Kishinev,

Moldova, 2028

One of the fundamental problems of quantum mechanics is the time evolution of a nonstationary wave packet.

We have investigated the effects of the Coulomb charging energy on the electron tunneling in a symmetric coupled-quantum-dot structure by use of two coupled equations for the time-dependent electron amplitudes derived from the Schrodinger equation. The semiconductor quantum dot has very small capacitance and it can lead to the non-negligible Coulomb charging energy in addition to the quantum confined energy. If the Coulomb charging energy does not exceed a certain threshold value, the electron wave packet, which was initially localized in one of the dots, is completely transferred to the other dot and oscillates back and forth between the two dots. If the Coulomb charging energy exceeds the threshold, the transfer of the electron wave packet becomes abruptly incomplete and is reduced to less than one-half due to the Coulomb blockade of the resonant electron tunneling. The transfer period of the wave packet is increased very much at the threshold. We have obtained exact analytical solutions of the system of nonlinear coupled equations for the occupation probabilities of the electron in each dot and have studied the bifurcation diagram. We found that the Coulomb charging energy strongly modifies the electron oscillation between the dots and influences the time evolution of the electron occupation probabilities.

TWO-QUANTUM RELAXATION OF IMPURITY IN PHOTONIC CRYSTAL

A.M.Basharov

Moscow Engineering Physics Institute

Moscow 115409, Kashirskoye sh31, Russia. E-mail: bash@online.ru

In my report I want to point attention to the some new channels of energy level relaxation of impurity embedded in dielectric medium with photonic band gaps (PBG) in external coherent wave. These channels determine new optical effects such as electric-induced transparency and hole burning. Also, they influence the dynamic of localized photon mode near the impurity. These new channels are essential in photonic crystal with both full band gap and when there is no full PBG.

The first channel is based on the energy transfer as in the case of radiative atomic collision. The interaction between impurity and PBG-crystal atom can accompanied by the emission of the quantum $\hbar\omega$, $\approx E_b - E_a - (E_c^C - E_a^C)$ where $E_b \rightarrow E_a$ is electric-dipole optical transition in impurity and $E_c^C \rightarrow E_a^C$ is two-photon transition in PBG-crystal atom. The excited energy level E_b of impurity lies inside the PBG.

The other new relaxation channels are essential in the field of resonant or non-resonant coherent wave. These channels are based on the two-photon relaxation processes with participation of quantum from this coherent wave. Allowance for these two-photon relaxation processes in nonresonant coherent field leads to an additional relaxation of excited level inside the PBG as well as relaxation of atomic coherence. In other situations the two-photon relaxation processes in coherent field can serve as effective pumping of level inside the PBG that leads to the induced transparency of coherent excited transition. The constants of the two-photon relaxation and pumping are proportional to the field intensity but in usual medium without the PBG's they are less than the constant of the ordinary spontaneous emission. The two-photon relaxation becomes effective in PBG materials when the ordinary spontaneous emission of impurity atom is suppressed. There are various situations where the two-photon relaxation should be taking into account.

LASER DIAGNOSTICS OF INHOMOGENEOUS NANOMETER-SCALE FILMS BY DIFFERENTIAL REFLECTIVITY AND ELLIPSOMETRY

P. V. Adamson

Institute of Physics, University of Tartu, 51014 Tartu, Estonia

Fax: 372 7 383033, E-mail: pcep@fi.tartu.ee

The fast development of nanotechnology in recent years has acutely raised the question of optical diagnostics of nanometer-scale films. The purpose of this paper is to show how one can use the differential reflection methods to determine the parameters of inhomogeneous nanoscale dielectric films on transparent or absorbing substrates.

From an analytical standpoint the nanofilms have an important advantage: the thickness d is much less than a laser wavelength λ . The simple expressions for the relative changes in the reflectance at two states of polarizations (s and p), as well as the changes in the ellipsometric angles caused by N-layer system of inhomogeneous nanometric layers, are derived by the perturbation method. It is determined that in the case of transparent substrate, the contribution of each nanometric inhomogeneous layer to the amplitude and energy reflection coefficients is characterized by four(two) independent integral parameters for p(s)-polarization, but for absorbing substrate the number of corresponding integral parameters is two times smaller. The dependence of the differential reflectivity on the angle of incidence was analyzed, e. g., in the case of p-polarization, the reflection of light incident at the Brewster angle is found to be independent, with an accuracy to the second-order in d/λ , of the way in which inhomogeneous nanometric layers are arranged.

The obtained new formulas make possible a simple solution of the inverse problem. A number of novel potentialities are shown for unambiguous determination of the thickness and refractive index of nanofilms. It is established that from the standpoint of optical diagnostics of nanoscale dielectric films on transparent substrates good advantage can be made of differential reflectivity measurements by p-polarized light at the Brewster angle, on absorbing substrates of combining differential reflectivity and ellipsometry. For transparent systems we have discovered for the first time a differential p-polarized photoreflectance method whose sensitivity is in principle the same as that of ellipsometry.

"CONFIGURATIONAL RESONANCES" PHENOMENA IN OPTICAL
SCATTERING SPECTROSCOPY OF NANOOBJECTS

S.G. Moiseev

Dept. of Physics, Military Communications University, Ulyanovsk Branch

19, Tukhachevsky Str., Ulyanovsk 432013, Russia

In optical scattering spectroscopy, the case, where a nano-sized object is represented by two or three dipole atoms (polarizable components), is studied using a microscopic approach. The atoms are considered to be linear Lorenz oscillators interacting only by the electromagnetic field. It is shown that in the presence of strong near-field interaction the polarizing characteristics of atoms are modified, and the total optical response of the nanoobject depends on various system parameters such as the number of atoms, the interatomic distances, the atomic polarizabilities and the geometry of the object. For example, this results in the suppression of the total polarizability, while the external wave is in exact atomic resonance. Generally, the scattered light intensity detected in the far-field zone is related not only to the configuration of nanoobject but also both the frequency and the direction of polarization of external linearly polarized wave. The frequency dependence of the scattered intensity can contain more than one resonance peak. It is demonstrated that the shift of the resonance peak mainly depends on the configuration of the nanoobject and can significantly exceed the natural linewidths. In special case, where the direction of polarization of the external wave is parallel to a symmetry axis of object, the only group of resonances is present. Similar situation is observed in the case when vector of polarization is perpendicular to a plane (or axis) containing all atoms of the nanoobject. For several simple configurations of nanoobject the self-consistent electromagnetic problem is solved analytically and resonance conditions are presented in an explicit form. Possible applications of obtained results in the near-field optical microscopy and the optical diagnostics of nanoobjects are discussed.

STRONG FARADAY EFFECT IN TRANS-NANOPOLYACETYLENE WU10

A.K. Vereshchagin, V.A. Rulova-Zavgorodniy, D.Yu. Paraschuk,
Physics Department, Moscow State University, Moscow 119899, Russia

V.M. Kobryanski

Semenov Institute of Chemical Physics, RAS, Moscow 117977, Russia

It is known that π -conjugated systems show enhanced diamagnetic properties owing to delocalized π electrons observed, for example, in graphite and carbon nanotubes. In this paper we report on strong magneto-optic activity (Faraday effect) of nanopolyacetylene, nano-(CH)_x. Nanopolyacetylene is a π conjugated material in which <30 nm polyacetylene nanoparticles are dispersed in a polyvinylbutyral matrix, PVB, with a content ~1%. Each nanoparticle has a globular shape and comprises of highly ordered π -conjugated chains. Because of the enhanced π -electron delocalization we expect strong intrachain electronic currents in the presence of magnetic field.

The Faraday polarization rotation induced by a magnetic field with an amplitude ~150 Oe and frequency ≈ 70 Hz was measured using a highly sensitive polarimetric method combined with a lock-in technique. The Verdet constant, V , was measured in free-standing 5-25 μm thick films of nano-(CH)_x at room temperature. The measurements were done at two wavelengths, one corresponds to the trans-nano-(CH)_x absorption band (633 nm) and the other to its transparency range (810 nm). For both wavelengths we obtained similar magnitudes of V that indicates the absence of correlation between the absorption coefficient and the V constant of nano-(CH)_x, at least for these two wavelengths. We found that V for nano-(CH)_x is 3-4 times higher than V for PVB. The latter was obtained in the range 250-350 min/Tl cm that is in good agreement with known values for organic materials. Bearing in mind the low content of (CH)_x in PVB we conclude that the (CH)_x nanoparticles give a two orders higher magneto-optic response than that of saturated polymeric materials. The nature of the high magneto-optic response of nano-(CH)_x is discussed.

PHOTOTHERMAL PROBING OF A_g STATES OF NANOPOLYACETYLENE IN THE TRANSPARENCY RANGE

N.V. Chigarev, V.A. Ruliova-Zavgorodny, D.Yu. Paraschuk, Physics Department, Moscow State University, Moscow 119899, Russia
V.M. Kobryanski

Institute of Chemical Physics RAS, Moscow 117977, Russia

NANO:TUBES; ELECTRONICS; OPTICS

B.A.Akanev [^], B.A. Baitimbetova, [^] M.A. Bijsenbaev*, Z.A.Mansurov*

[^] Physical department, ph. 8 (3272) 910 004, e-mail: akanev@physics.kz

*-chemical department, ph. 8 (3272) 924 346, Fax:8 (3272) 696 196, e-mail: mansurov01@yahoo.com

Since discovery of a fullerene C60 (1985) and other varieties: C80, C120, and as inserted fullerenes [1]: C60 inside C240 and triplex: C80; C240; C560 the carbon nanotubes with metal or semiconductor fullerenes inside carbon nanotubes were explored. For example, are obtained [2] by a unary wall carbon nanotubes with charged buckyballs from gadolinium fullerenes lined up inside the nanotubes at about 1 nm intervals a unary series in so-called one-dimensional crystals. Deriving single-layer nanotubes with cross stacking of huge molecules of different substances by the sizes about a nanometer (quantum points) from semiconductors, dielectrics, metals is of interest.



Fig.1



Fig.2



Fig.3

We obtain, alongside with usual nanotubes (fig. 1), by the sizes packed carbon nanotubes with cross stacking of carbon (fig. 2,3).

Reference

Nanopolyacetylene (nano-(CH)_x) shows a very unusual behavior of spontaneous Raman response in the transparency range that looks like resonant Raman scattering [1]. One of the possible explanations of this behavior involves activation of dipole-forbidden states of A_g symmetry in Raman scattering. In this work we try to probe A_g states of trans-nano-(CH)_x films by a photothermal method.

Nonoriented 5-10µm thick films of *trans-cis* blend of nano-(CH)_x at 300 K were studied. We introduce an original photothermal pump-probe method based on a high thermochromic effect in trans-nano-(CH)_x to obtain the spectrum of low absorption in its transparency range. An infra-red pump beam (monochromatized radiation of a Xe-lamp or a Nd:YAG laser at 1064nm) chopped at ~100Hz was slightly absorbed by a free-standing nano-(CH)_x film and slightly heated it. Using a probe beam with the wavelength in the spectral region of the absorption edge of trans-nano-(CH)_x (~750nm), we measured a photothermal signal proportional to the thermochromic shift of the absorption edge. A typical value of the film transmission modulation was ~10⁻⁴, which corresponds to a temperature modulation of ~0.02K. The absorption coefficient of trans-nano-(CH)_x film was evaluated as ~0.1cm⁻¹ at 1064nm. It is at least four order less than the absorption coefficient corresponding to the main dipole-allowed transition $|1A_g\rangle \rightarrow |1B_g\rangle$. The spectrum of low absorption in trans-nano-(CH)_x was obtained.

We assume that small absorption of nano-(CH)_x below the absorption wedge is associated with dipole-forbidden A_g states. These states are invisible in linear absorption but play an important role in the nonlinear-optical response and relaxation processes in π -conjugated polymers.

I. D.Yu. Paraschuk, V.M.Kobryanski, JETP Lett. 73, 171 (2001).

Gain Effects in 1-D Photonic Band-Gap Structure

Leonid A. Melnikov, Olga N. Kozina,

Saratov State University, Saratov 410026, Astrakhanskaya 83, Russia.

e-mail: lam@ns.ssu.ru phone: 7 845 2 - 515195 fax: 7 845 2 - 240446

Igor S. Nefedov, Sergei V. Romanov

Saratov Division of the Institute of Radio-Engineering and Electronics of Russian Academy of Science, Zelyonaya 38, Saratov 410019, Russia, phone 78452-511179

We considered the 1-D air-glass periodic multilayered structure with active glass layers. Different number of periods were used (up to 50). Nonlinear problem of light transmission through the structure was solved using 2x2 transfer matrix method and iteration scheme. The model of active medium corresponds to Nd^{3+} doped glass, including gain saturation. The spectral dependencies of the transmission on pump level and on the intensity of incident wave are presented.

The high linear gain was used to show the effect (see fig.). The large enhancement of the transmission at wavelength near 1.04 μm occurs mainly due to decrease of the velocity of energy transfer or, other word, the increase of the effective length of light propagation in the structure similarly to ordinary laser system. Another important

reason is gain enhancement due to optimal space configuration of the field when the field maxima of standing wave are coinciding with the active layers.

Using standard procedure [1] we have obtained the laser threshold expression for the PBG material.

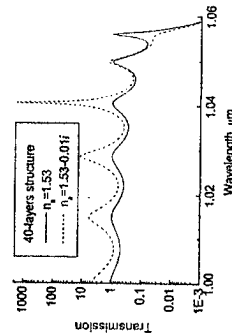

I. M. Sargent, III, M. Scully, W. E. Lamb. Laser Physics, 1974.

LOW-FREQUENCY RAMAN SPECTROSCOPY OF POLYMER NANOCCLUSERS WITH FRACTAL DIMENSION

A. M. Saletsky, A. V. Chervyakov

Moscow M.V. Lomonosov University, Department of Physics, Moscow, 119899 Russia tel: 7(095)939-3558; fax: 7(095)939-1489; e-mail: saletsky@gen566a.phys.msu.su

The study of photophysical and photochemical processes in molecular ensembles of complex organic compounds is an urgent problem of optics and spectroscopy because of their importance for natural systems and increasing applications in practice. The efficiency and selectivity of photoprocesses strongly depend on degree of a molecular system structures.

We present results of study of the low-frequency Raman spectra of polyacrylic acid solutions in water for different concentrations and different polyion chain lengths for analysis of their structure. The results of our experimental study showed the difference of polyelectrolyte solutions from an ideal homogeneous molecular systems, which is attributed to the presence of fractal structures in the systems under study. The fractal dimension of a molecular systems γ is a nonmonotone function of concentration and the minimum fractal dimension ($\gamma=1.7$) of polyacrylic acid solutions, determined for different chain lengths, is observed for $c \sim 10^{-4}$ mol/l. The fractal dimension of the polymer systems increases with increasing chain length. The greatest change in γ (for different lengths of polymer chains) is observed for low and high polyacrylic acid concentrations.

We have estimated the size of fractal regions for the macromolecular systems under study from the low-frequency Raman spectra. The fractal region in the domain of concentrations and polymer chain lengths under study ranges in size from 3.6 to 4.5 nm. The fractal regions increase in size with increasing polyacrylic acid concentrations. The polymer chain length had an effect on the fractal region size only at low polyacrylic acid concentrations. At high concentrations, the fractal region size was almost independent of the chain length.

BINARY COHERENT INTERACTIONS IN PLANAR PARTIALLY ORDERED METAL-DIELECTRIC NANOSTRUCTURES.

Dynich R.A.¹, Ponyavina A.N.², Khairullina A. Ja.³, Kachan S.M.²

¹ Belarusian State University of Informatics and Radioelectronics
P. Brovka 6, Minsk 220600, Belarus

² Institute of Molecular and Atomic Physics, National Academy of Sciences of Belarus
F. Skaryna Ave. 70, Minsk 220072, Belarus

³ Institute of Physics, National Academy of Sciences of Belarus
F. Skaryna Ave. 72, Minsk 220072, Belarus

The methods of laser diagnostics are a perspective tool for the effective research of electronic states and size effects in metalline nanostructures, especially in the plasmon resonance spectral region. In this report, polarization and coherent effects on light extinction and angular distribution for planar metallic nanostructures are considered in the interference approximation [1] with taking into account of binary interactions. It means that we use effective single scattering indicatrix and extinction

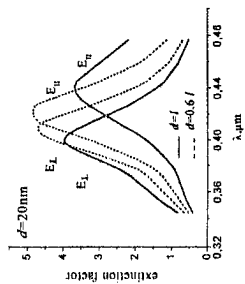

factors defined for a two-particle system with an interparticle distance of l , that is determined by a particle concentration. In the case of aspherical particles these effective values are calculated by the use of the volume integral equation formulation [2]. Size-dependent permittivity of metallic nanoparticles are determined on the base of the LEMFP model [1], which we have also modified for two spheres in a contact.

In the case of oriented chain-like particle clusters, binary coherent interactions lead to the plasmon resonance frequency dependence on a polarization state, which appears more evidently as interparticle distances decrease. In the figure one can see this effect for nanosphere silver clusters. It may be used to find the orientation of nanoparticle chains in metallic planar nanostructures.

References

1. Khairullina A.J., et.al., *Opt.Spektrosk.* **38** 677 (2000)
2. Vereshchagin V.G., Dynich R.A., Ponyavina A.N., *J.Appl.Spekt.* **66** 60 (1999)

OPTICAL ANISOTROPY OF NANOSTRUCTURED SILICON FILMS STUDIED BY FTIR SPECTROSCOPY

L.P. Kuznetsova, A.I. Efimova, L.A. Golovan, V.Yu. Timoshenko, P.K. Kashkarov
Moscow State M. V. Lomonosov University, Physics Department, 119899 Moscow
Russia

Electrochemically nanostructured silicon is a promising material for nonlinear optics. Its large birefringence [1] allow us to reach the phase matching conditions for nonlinear optical wave interaction. Such structures can be used as a phase-matching matrix for nonlinear media incorporated into their pores. Therefore it is very important to determine the birefringence values of this material in wide spectral range.

Nanostructured Si films were prepared from (110) oriented, boron doped Si substrates with typical resistivity of 0.001 – 4 Ω -cm. The electrochemical etching was done in ethanoic hydrofluoric solution. The porosities of the layers were in range from 50 to 70%. FTIR spectra measured for non-polarized light show clear evidence of the birefringence in the films (fig.1). The reflectance spectrum exhibits interference fringes modulated by beats. The mean period of the interference gives average refractive index of the film to be about 1.7. The beats arise from the existence of two principal in-plane directions with different refractive indices (the birefringence). Their difference n_x-n_y are calculated from the beats period (fig.2) and agrees with our calculations based on the effective media approximation for anisotropically spaced Si nanocrystals.

This work was supported by CRDF project RP2-2275 and project "Semiconductor Nanostructures" of Ministry of Industry, Science and Technologies of Russia.

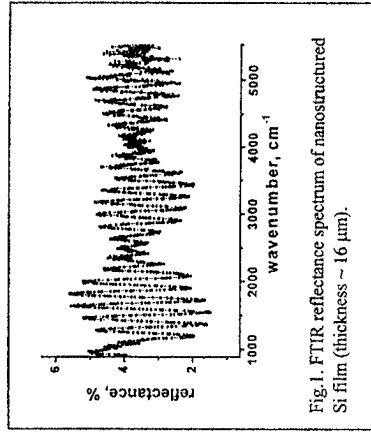

Fig.1. FTIR reflectance spectrum of nanostructured Si film (thickness – 16 μ m).

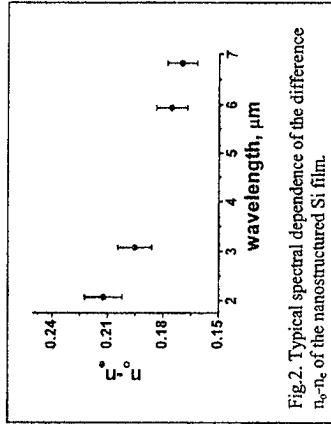

Fig.2. Typical spectral dependence of the difference n_x-n_y of the nanostructured Si film.

I. D. Kovalev, G. Polisski, J. Diener, H. Heckler, N. Kunzner, V. Yu. Timoshenko,
F. Koch, *Appl. Phys. Lett.* **78**, 916 (2001).

PHASE MATCHING SECOND-HARMONIC GENERATION
IN ANISOTROPIC POROUS SILICON

L.A. Golovan, V.Yu. Timoshenko, A.B. Fedotov, D.A. Sidorov-Biryukov, P.K.

Kashkarov, and A.M. Zheltikov

Moscow State University, Faculty of Physics and International Laser Center, 119899

Moscow, Russia

D. Kovalev, N. Künzer, G. Polisski, J. Dienes, and F. Koch

Technische Universität München, Physik-Department E16, D-85747 Garching.

Germany

Formation of pores in semiconductor is a very promising way of production of an anisotropic medium. To achieve in-plane uniaxial dielectric anisotropy we used the electrochemical etching of (110) Si wafers. The conditions of phase matching of the second-harmonic generation (SHG) were studied.

The obtained PS films are birefringent ($n_e - n_o$ reaches 0.23). The experimental set-up for SHG consists of a Nd:YAG master oscillator with passive mode locking and amplification cascades (35 ps, 4 mJ).

The phase matching in this PS film in air is impossible. Filling pores with a dielectric medium (e.g. glycerol) reduces optical anisotropy and allows us to phase match SHG.

The sample rotation and pore filling control the anisotropy of PS, and, as a result, SHG (see figure). The maximal signal in glycerol-filled PS is found for incidence at 31° that is close to the calculated phase-matching angle. The obtained results can be easily explained by anisotropy properties of the used PS film.

Thus, birefringence of PS allows us to achieve phase matching that makes this material very promising for various nonlinear-optical applications. This work was supported by CRDF project RP2-2275 and RFBR project 00-02-17567.

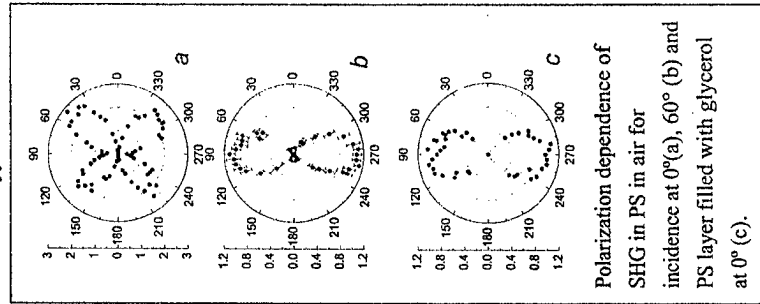

Polarization dependence of SHG in PS in air for incidence at 0°(a), 60° (b) and PS layer filled with glycerol at 0° (c).

Multicomponent one-dimensional photonic band-gap structures: dispersion relations and extended phase-matching abilities

A.N. Naumov,¹ J.W. Haus,² M. Bertolotti,³ C. Sibilia,³ and A.M. Zheltikov¹

¹ Int. Laser Center, Faculty of Physics, Moscow State University, Moscow 119899, Russia

² University of Dayton, Dayton, OH, 45469-0245 USA

³ Università di Roma "La Sapienza", Dip. di Energetica, Via A. Scarpa 14, 00161 Roma, Italy

Periodic multilayers are extensively used in many areas of optics and laser physics [1]. The presence of a photonic band gap (PBG) in dispersion relations and reflection spectra is a key feature of such structures, opening the way for creating highly reflective mirrors, optical filters, compact delay lines, and optical switches, as well as for compressing light pulses and phase-matching nonlinear-optical interactions (see, e.g., [2] for an up-to-date review).

In this paper, we introduce a concept of multicomponent 1D PBG structures. Structures of this type are obtained by periodically translating a unit cell that consists of many different dielectric layers with different refractive indices (Fig. 1). We study dispersion relations for such structures and demonstrate that, in many cases, these structures provide additional degrees of freedom in dispersion control relative to conventional binary 1D PBG structures. In particular, in the case of a ternary 1D PBG structure, i.e., a periodic multilayer obtained by translating a three-layer unit cell consisting of materials with refractive indices n_1 , n_2 , and n_3 and thicknesses a , b , and l by a reciprocal-lattice vector, the dispersion relation can be represented in the following canonical form (see also [3]):

$$\sin^2 \frac{Kd}{2} = \delta_0 \sin^2 \frac{\omega \bar{\pi}}{2c} d + \delta_1 \sin^2 \frac{\omega \gamma_1}{2c} d + \delta_2 \sin^2 \frac{\omega \gamma_2}{2c} d + \delta_3 \sin^2 \frac{\omega \gamma_3}{2c} d \quad (1)$$

where K is the Bloch wave number, ω is the frequency, c is the speed of light, $d = a + b + l$ is the lattice constant,

$$\bar{\pi} = (n_1 a + n_2 b + n_3 l) / d, \quad \gamma_1 = (n_1 a - n_2 b + n_3 l) / d,$$

$$\gamma_2 = (n_1 a + n_2 b - n_3 l) / d, \quad \delta_0 = 1/4(1 + \Delta_1 + \Delta_2 + \Delta_3),$$

$$\delta_1 = 1/4(1 + \Delta_1 - \Delta_2 - \Delta_3), \quad \delta_2 = 1/4(1 - \Delta_1 + \Delta_2 - \Delta_3),$$

$$\delta_3 = 1/4(1 - \Delta_1 - \Delta_2 + \Delta_3), \quad \Delta_1 = \frac{1}{2} \frac{n_2 + n_3}{n_1}, \quad \Delta_2 = \frac{1}{2} \frac{n_1 + n_3}{n_2},$$

$$\Delta_3 = \frac{1}{2} \frac{n_1 + n_2}{n_3}$$

and

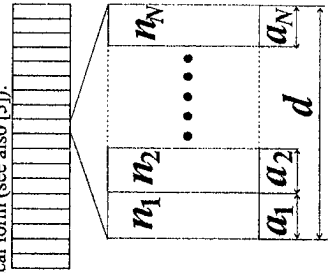

Fig. 1. Generic scheme of a multicomponent 1D PBG structure

Expression (1) is reminiscent of the dispersion relation for a conventional (binary) 1D PBG structure (e.g. see [1]), but, since now three layers are involved in the formation of the band gap, much broader opportunities of dispersion control are provided.

Extending our analysis to the case of multicomponent 1D PBG structures and exploring their dispersion relations and phase-matching abilities, we shall demonstrate that the properties of such structures suggest new ways to achieve phase and group-velocity matching in nonlinear-optical interactions of short light pulses and can be also employed to produce ultrashort pulses by phase-matching equidistant spectral components produced, e.g., through high-order harmonic generation.

This work is supported by the Civilian Research and Development Foundation (Award RP2-2275).

1. A. Yariv and P. Yeh, *Optical Waves in Crystals*, New York: Wiley, 1984.
2. *Nanoscale Linear and Nonlinear Optics*, Proc. Erice Summer School, M. Bertolotti, C. Bowden, C. Sibilia, et al., Eds., AIP, 2001
3. A.N. Naumov, A.M. Zheltikov, *Laser Physics*, **11**, no. 5 (2001).

INTERFEROMETRIC SECOND-HARMONIC SPECTROSCOPY OF POROUS SILICON PHOTONIC CRYSTALS

T.V. Dolgova¹, M.G. Martemyanov¹, A.A. Fedyanin¹, and O.A. Aktsipetrov¹

D. Schuhmacher², G. Marowsky², V.A. Yakovlev³, G. Mattei⁴

¹Department of Physics, Moscow State University, 119899 Moscow, Russia
²Laser-Laboratorium Goettingen, Hans-Adolf-Krebs-Weg 1, D-37077 Goettingen, Germany
³Institute of Spectroscopy, Russian Academy of Sciences, 142092 Troitsk, Moscow reg., Russia
⁴Istituto di Metodologie Avanzate Inorganiche, CNR, Area della Ricerca di Roma, C.P. 10, 00016, Italy

Photonic crystals (PC) and microcavities (MC) are in the focus of the basic interest of both fundamental and applied research. Nonlinear-optical methods are very attractive being sensitive to inner properties of PC in comparison with linear spectroscopies. In this paper the combined second-harmonic (SH) intensity and phase spectroscopy is proposed as a direct probe of localization of the light inside porous silicon PC and MC.

For the SHG spectroscopy the polarized output of a tunable nanosecond parametric generator/amplifier laser system is used as a fundamental radiation. The phase of the SH radiation reflected from porous silicon MC and PC is measured using the SH interferometry technique.

Fig. 1 shows the spectra of the SH intensity s-in, p-out polarizations combination (top panel), linear reflection (bottom panel) and phase of the p-polarized SH field (middle panel) for porous silicon MC in for 60 degrees of angle of incidence. The enhancement of the SH intensity at the edges of photonic band gap and the large changes of the SH phase inside the photonic band gap are seen. This enhancement is associated with the homogeneous increase of the fundamental field in the PC-mirrors of MC.

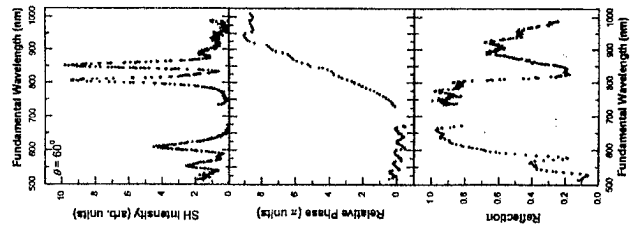

Fig. 1. Top panel: SH intensity spectrum measured in porous silicon microcavity in s-in, p-out geometry. Middle panel: the spectrum of the phase of the p-polarized SH wave. Bottom panel: the spectrum of linear reflection of s-polarized fundamental radiation.

PHOTOLUMINESCENCE OF SILICON NANOCRYSTALS IN WEAK CONFINEMENT REGIME

M. G. Lisachenko, V. Yu. Timoshenko, V. A. Bazyleenko, E. A. Konstantinova, and P. K. Kashkarov

Moscow State M. V. Lomonosov University, Physics Department, 119899 Moscow Russia

It is well known that photoluminescence (PL) intensity I_{PL} of the near-band-edge emission in semiconductors is proportional to I_{exc}^k , where I_{exc} is the excitation intensity and k is a coefficient varied from 1 to 2 for exciton-like transition. The value of k does not exceed 1 for the visible PL of porous Si with small (1-3 nm diameter) nanocrystals.

We investigate mesoporous Si with typical size of Si nanocrystals larger than 5 nm. The PL spectrum of the samples is observed just on 20? 50 meV above the PL band of c-Si (fig. 1) what points out weak quantum confinement regime for Si nanocrystals. The experimental dependence $I_{PL}(I_{exc})$ shows superlinear ($k=2$) and linear dependences for mesoporous Si and c-Si, respectively (fig. 2). A kinetic model of excitonic recombination in Si nanocrystals may explain the experimental dependence of $I_{PL}(I_{exc})$ for mesoporous Si. We note that the effect of optical amplification due to inversion of population of excitonic states in Si nanocrystals should influence their PL properties under intensive laser excitation. This effect can lead to the nonlinear dependence of I_{PL} on laser pumping observed in our experiment.

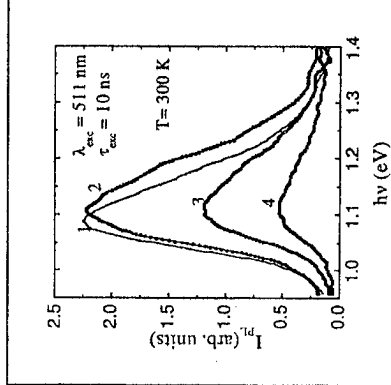

Fig.1. Typical PL spectra of c-Si (1) and mesoporous Si (274) at different excitation intensities: 220 kW/cm² (2), 130 kW/cm² (3), 83 kW/cm² (4).

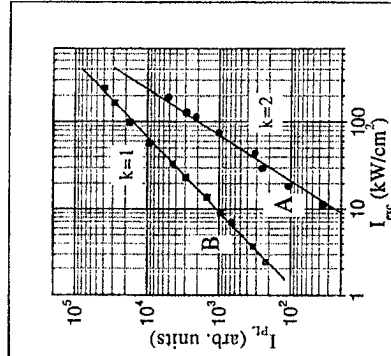

Fig.2. The intensity of PL of mesoporous Si (A) and c-Si (B) vs. peak intensity of pulsed laser excitation.

SEMICONDUCTOR NANOSTRUCTURES FOR QUANTUM WIRE LASERS

D. Plesier, A. A. Ivanov, A. S. Bakin, H.-H. Wehmann, A. Schlachetzki

Institut für Halbleitertechnik

Hans-Sommer-Straße 66, D-38106 Braunschweig, Germany

Tel.: ++49 (0)531 391 3774, Fax.: ++49 (0)531 391 5844, e-mail: iht@tu-bs.de

We fabricated quantum wires (QWR) in the material system InGaAs/InP by metal-organic vapor-phase epitaxy. We used V-groove patterned substrates employing standard photolithography. The geometrical properties were studied by atomic-force microscopy, the optical properties by photoluminescence. By comparing the measured optical transition-energies with the expected ones from solving Schrödinger's equation, we found nearly lattice-matched quantum wires [1].

We used this quantum wire as the active region in a laser. The properties of the QWR laser were very promising (e. g. threshold current of about 38 mA) [2]. However, a second laser line, which we observed in the electroluminescence spectra, is assigned to the waveguiding InGaAsP. Additionally, due to technological reasons, two InP buffer layers were inserted, which impede the current injection into the QWR. An improvement of the structure is possible by reducing the thicknesses of these energy barriers in order to enable carrier tunneling. The upper InP buffer layer may be omitted completely by increasing the growth temperature from 600 °C to 640 °C. However, this entails different growth conditions for lattice matched QWRs. We include these improvements into a new concept of a single QWR laser with an index/gain guiding structure, which will be discussed in this contribution.

References:

- [1] T. Schrimpf et al., *J. Appl. Phys.*, **86**, 5207-5214 (1999)
- [2] D. Plesier et al.: *IEEE J. Select. Top. Quantum Electron.*, **6**, 522-527 (2000)

A photonic band-gap planar hollow waveguide

A.B. Fedotov,¹ A.N. Naumov,¹ J.W. Haus,² R.B. Miles,³ D.A. Sidorov-Biryukov,¹ N.V. Chigarev,¹ and A.M. Zheltikov¹
¹ Int. Laser Center, Physics Faculty, M.V. Lomonosov Moscow State University, Russia
² University of Dayton, Dayton, OH, USA
³ Dept. Mechanical and Aerospace Eng., Princeton University, Princeton, NJ, USA

Recently, much work has been done to understand the ways photonic band-gap (PBG) structures [1] can be used to improve the efficiency of nonlinear-optical interactions, to control short light pulses, and to create narrow-band filters. A parallel trend in the development of ultrafast nonlinear-optics involved the use of hollow fibers for the generation of very short light pulses and frequency up-conversion [2]. The main idea of our study is to integrate a hollow waveguide and a PBG structure into a compact optical component. Guided by this idea, we created an optical element consisting of a diffraction grating and a mirror (or another diffraction grating). We were able to easily tune the photonic band gap in transmission spectra of such structures (Fig. 1) by changing the separation between the grating and the mirror. Physically, it is very instructive to think of the photonic band gap arising in dispersion and transmission of such a structure as a region where backward and forward waves are strongly coupled to each other due to a Bragg resonance. The condition of such a resonance away from the waveguide cut-off region can be represented as $2k + \frac{u_r^2 + u_b^2}{2ka^2} = lG$, where $k = 2\pi/\lambda$, λ is the radiation wavelength, a is equal to half the distance between the grating and the mirror, u_r and u_b are the eigenvalues of strongly coupled forward and backward waveguide modes, $G = 2\pi/\Lambda$ is the reciprocal grating vector, Λ is the grating period, and l is an integer. It can be easily seen from this Bragg condition that the photonic band gap should be blue-shifted with a decrease in the separation between the grating and the mirror. This is exactly what we observed in our transmission measurements.

Since the created optical component combines dispersion properties of a hollow waveguide, a PBG structure, and a gap filling the gap between the grating and the mirror, it opens up many new possibilities for creating filters with tunable passbands and stopbands, phase-matching nonlinear optical interactions, improving the sensitivity of nonlinear-optical methods of gas-phase analysis, and developing new types of distributed-feedback systems. Such a structure can be viewed as a planar corrugated hollow waveguide, where the waveguide dispersion is supplemented with the dispersion of a PBG structure. This hybrid optical element considerably expands the possibilities of hollow waveguides for the generation of ultrashort pulses and nonlinear-optical frequency conversion.

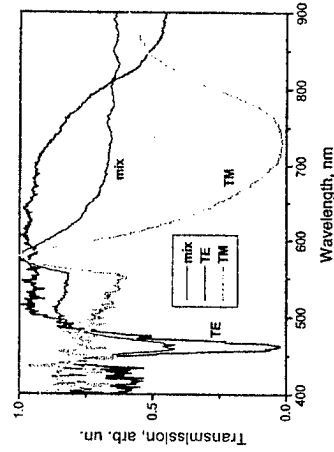

Fig. 1. Transmission spectrum of a PBG air-filled planar corrugated hollow waveguide consisting of a 1200-lines/mm grating and a mirror separated by a 22-µm air gap.

This work is supported by the CRDF (Awards RP2-2266 and RP2-2275).

- 1. *Nanoscale Linear and Nonlinear Optics*, M. Bertolotti, C. Bowden, C. Sibilia, et al., Eds., AIP, 2001.
- 2. M. Nisoli et al., *Opt. Lett.*, **22**, 522 (1997); A. Rundquist et al. *Science* **5368**, 1412 (1998).

Size Effects on Optical Properties of $\text{Lu}_2\text{O}_3:\text{Eu}^{3+}$ NanocrystallitesW. Stręk^a, E. Zych^b, D. Hreniak^b, J. Hanuza^a, and R. Acevedo^c^a Institute for Low Temperature and Structure Research

Polish Academy of Sciences, Wrocław, Poland

^b Faculty of Chemistry, University of Wrocław, Poland^c Departamento de Química Básica, Facultad de Ciencias Físicas y Matemáticas, Universidad de Chile, Casilla 2777, Santiago-Chile

Nanostructured materials attract a lot of interest in recent years. Such materials consist of particles, whose dimensions fall below 100 nm. In the case of luminophors such small sizes of the particles make the materials properties different from their classical, micron-sized counterparts. This happens since, among others, the wavelength of the excitation/emission light is longer than the average size of crystallites. When the crystallites become even smaller, being about 10 nm or less in diameter, physical quantum effects (for example quantum confinement) may play so significant role that the luminescent properties of such phosphors make them truly new luminescent materials.

In this communicate we will report on luminescent properties of nanocrystalline Eu-doped Lu_2O_3 prepared via combustion synthesis. Samples with Eu-concentration varying between 0-13% with respect to Lu were prepared combusting $\text{Lu}(\text{NO}_3)_3$ with urea, $(\text{NH}_2)_2\text{CO}$, or glycine, $\text{NH}_2\text{CH}_2\text{COOH}$ in a furnace preheated to 650 °C. Depending on the fuel used the products were characterized by different size of the crystallites. Using urea the formed phosphor was built of particles whose dimensions were about 11 nm. Glycine as the fuel led to product with crystallites of about 27-30 nm.

We have measured IR, Raman and emission spectra for both types of materials. In all the measurements we have observed a significant influence of the crystallites size on the measured properties. Hence, excitation and emission spectra exhibit a significant change in the line width. For the small crystallites the spectral width of the lines (FWHM) is much bigger than it is for the larger crystallites. Such behavior may indicate a varying strength of electron-phonon coupling with the changes of nanoparticle sizes. Furthermore, the decay kinetics measured under 308 nm excimer laser excitation showed the strong size dependence of rise time and the Eu-content.

EXCITATION OF WAVEGUIDE MODES IN ONE-DIMENSIONAL PHOTONIC CRYSTAL

A.V.Andreev, A.B.Kozlov

Physics Department, M.V.Lomonosov Moscow State University
Vorobyevy Gory, Moscow 119899 Russia

Here we show that the wave at four-wave mixing frequency $\omega_3 = \omega_1 + \omega_2 - \omega_3$ can be generated inside the one-dimensional photonic crystal in waveguide regime. It is open up the new opportunities for control of the nonlinear process efficiency in photonic crystals. It is well known that the boundary conditions at the interfaces of one-dimensional multilayer structure require the continuity of the tangential projections of wave vectors of incident and generated inside the structure waves. Therefore under proper choice of the incidence angles for pumping waves at frequencies ω_1 and ω_2 the tangential projection of the wave vector of four wave mixing wave generated in side the structure can be made longer than the length of wave vector in vacuum $k_3 = \omega_3/c$. In this case the four-wave mixing wave becomes inhomogeneous in vacuum and propagates along the structure. The amplitude of this wave depends significantly on the tangential projection of its wave vector and it is increased drastically when the condition of the waveguide mode excitation is met.

We have calculated the structure of the waveguide modes in one-dimensional photonic crystal consisting of seven ZnS/SiO_2 bilayers. It is shown that the intensity of S-polarized mode is strongly modulated across the structure and intensity is significantly higher in low-refractive index material. The intensity of P-polarized mode is more uniformly distributed across the structure. The efficiency of waveguide mode excitation as a function of incidence angles for S-, P- and cross-polarized pumping waves has been calculated. It is shown that the amplitude of four-wave mixing wave increases a few order of magnitudes under resonant waveguide mode excitation conditions.

The results presented here show the significant increase in the efficiency of the nonlinear transformations in photonic crystals under waveguide regime of the generated wave propagation. Along with the control of the efficiency of nonlinear processes in photonic crystals this regime can be used for the development of surface sensitive spectroscopy schemes.

NONLINEAR REFRACTION IN THE GaAs QUANTUM WELLS

V. K. Kononenko and V. I. Tsvirko
*Stepanov Institute of Physics, NASB
 Fr. Scorina Pr., 70, 220072 Minsk, Belarus*

Previously, exciton effects in the index of refraction of multiple quantum wells (QW) and superlattices [1] and main peculiarities of nonlinear refraction in QWs have been described [2]. In this work, influence of spectral broadening and light polarization effects on the change in the index of refraction of the QW heterostructures at the excitation is analyzed. Calculations based on the Kramers-Krönig relation are carried out for the GaAs-AlGaAs laser system and connection between the nonlinear refraction coefficient, nonlinearity parameter of absorption [3], and susceptibility is established.

It is shown that the spectral broadening (Lorentzian or Gaussian) due to carrier relaxation results in effective smoothing the resonance nonlinear refraction peaks at the initial transitions between the subbands (Fig. 1). Nonlinear dispersion properties of the QWs for the TE and TM modes differ. For the TE polarization, the change in the index of refraction at the excitation of the heterostructure will be stronger at the transitions through heavy hole levels and for the TM mode it will be more manifested at the transitions involving light holes. The change in the index of refraction Δn with increasing the radiation density U in the active region of the QW heterostructure follows practically a degree function with the power of 1/2. It is in contrast to bulk semiconductors when Δn is proportional to $U^{1/3}$ [4].

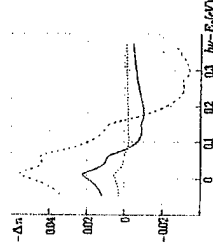

Fig. 1. Spectrum $\Delta n(\nu)$ for the TM mode at different $\nu U = 0.7$ (dotted curve), 15 (solid curve), and 312 kW/cm² (dashed curve). ν is the light velocity, QW width $d = 20$ nm, broadening parameter $\Gamma_{cv} = 10$ meV, excitation quantum energy $\hbar\nu_{exc} = 1.68$ eV, energy band gap $E_g = 1.42$ eV.

1. K.B. Kahen and J.P. Leburton. Appl. Phys. Lett. 1986. Vol.49, No.12. P.734-736.
2. V.K. Kononenko. Laser Technique and Optoelectronics. 1993. No.3-4. P.75-79.
3. V.K. Kononenko. Phys. stat. sol. (b). 1988. Vol.150, No.2. P.695-698.
4. B. Jensen and A. Torabi. J. Appl. Phys. 1983. Vol.54, No.10. P.5945-5949.

OPTICAL PROPERTIES OF FRACTAL CANTOR-LIKE MULTILAYER NANOSTRUCTURES

K. S. SANDOMIRSKI AND S. V. GAPONENKO,
*Institute of Molecular and Atomic Physics, National Academy of Sciences
 220072 Minsk, Belarus*

S. V. ZHUKOVSKY AND A. V. LAVRINENKO,
*Physics Department, Belarusian State University
 220080 Minsk, Belarus*

Multilayer dielectric structures have been a subject of thorough investigation in recent years due to their distinctive optical properties and wide applications in various devices, from ordinary dielectric mirrors and high-Q optical cavities to spontaneous emission control and omnidirectional reflectors. Nowadays, the focus of research is shifting towards a new, distinct class of media which are non-periodic but deterministic.

Cantor-like structures are fractal non-periodic multilayers generated according to an algorithm similar to that of Cantor set construction. Any Cantor multilayer is characterized by two fundamental parameters, the generator $G=3, 5, 7 \dots$ and the number of generations $N=1, 2, 3 \dots$. Cantor multilayer consists of G^N layers. Both for calculations and for measurements, layer thicknesses were chosen to form a quarter-wave stack, i.e. $d_1 = \frac{\lambda_0}{4n_1}$ and $d_2 = \frac{\lambda_0}{4n_2}$, and the total thickness of the stack was $D = 2^N \cdot d_1 + (G^N - 2^N) d_2$.

Transmission spectra of the Cantor multilayered structures possess the following features. Firstly, the number of transmission resonances (peaks) increases as G^N and equals the total number of layers. Secondly, the spectra exhibit apparent scalability, i.e. a transmission spectrum for a given N value contains spectra of all previous generations in 'compressed' state. The compression factor is equal to G . This points to a strong connection between geometrical and spectral properties of Cantor multilayer structure. Thirdly, as N increases, not only new peaks appear, but also existing ones tend to split into doublets. The number of peaks in the multiplet equals $\frac{G+1}{2}$.

SPECTRAL-ANGULAR AND THRESHOLD CHARACTERISTICS OF
ULTRAVIOLET-BLUE In(Al)GaN/GaN/Al₂O₃ HETEROSTRUCTURE LASERS

G. P. Yablonskii, E. V. Lutsenko, V. Z. Zubialevich, V. N. Pavlovskii, I. P. Marko,

A. L. Gurskii,

Stepanov Institute of Physics, National Academy of Sciences, F. Skaryna Ave. 68,

220072 Minsk, Belarus

O. Schön, H. Protzmam, M. Lünenbürger, B. Schineller, M. Heuken

AIXTRON AG, Kackerstr. 15-17, D-52072 Aachen, Germany

GaN based compounds and quantum well heterostructures are very promising for fabrication of the green-UV light emitting diodes and lasers.

The undoped GaN epitaxial layers, InGaN/GaN multiple quantum well (MQW) heterostructures and AlGaIn/GaN single quantum well (SQW) heterostructures were grown on c-plane sapphire substrate by MOVPE in AIXTRON reactors. The laser spectra and thresholds as well as the photoluminescence (PL) and stimulated emission spectra were investigated in a wide temperature interval (T=77-600 K) as a function of excitation intensity ($I_{exc} = 10^2 - 3 \times 10^6$ W/cm²) of the nitrogen laser radiation, temperature, active layer thickness and In or Al content. Laser action was achieved for these QWs and epitaxial layers in a spectral range from 376.5 nm up to 469.5 nm up to T = 400 - 580 K. The spatial distribution of the laser emission as a rule consisted of two spots localized at positive and negative angles of 30-50°. The laser spectra structure for the MQWs with lower value of the optical confinement factor depended on the registration angle evidencing on the leaky modes. The spectra and the far field patterns depended also on the I_{exc} which was attributed to an alteration of the active layer refractive index due to the electron-hole plasma effects. The spatial distribution of the laser light conditioned by transverse and leaky modes is calculated and compared to the experimental results. The influence of the layer thickness and structure design, the In concentration, the optical confinement factor and the spontaneous emission efficiency on the temperature behaviour of the laser thresholds of the different GaN epitaxial layers and GaN based QW heterostructures are studied and discussed.

SECOND HARMONIC GENERATION
IN PHOTONIC BAND GAP STRUCTURES WITH GaAs

R.G.Zaporozhchenko, S.Ya.Kilin

Stepanov Institute of Physics National Academy of Sciences 68 F. Scaryna ave.,
Minsk, 220072, Belarus Phone: (375)017-284-10-23, E-mail: rzap@dragon.bas-net.by

The interest to periodic dielectric structures created by dielectric layers, each about a quarter wavelength thick with interchanging high and low refraction index, called in their analogy with semiconductors band gap a photonic band gap (PBG) structures, is connected to their potential to revolutionise photonics. In the present work of the conversion efficiency and temporal evolution of second harmonic (SH) generation for 100-fs pulses in a simple 1-D periodical structure is analysed. The structures were a slabs of 4-20 interchanged quarter-wave layers of crystal GaAs and dielectric layers two different kinds: AlAs and fused quartz ($N_{cr}=2 \div 20$ periods). The ratio of the indexes of refraction (n_2/n_1) for pump ($\lambda_p=1.06\mu\text{m}$) and SH waves are 1.21 for GaAs and AlAs and 2.38 for GaAs and quartz. The electromagnetic field inside the slab is a sum of forth and back propagating pump and doubled frequency waves. The theoretical consideration was based on the second-order temporal differential equations for pump and SH waves amplitudes. Simulations of propagating in nonlinear medium employed the method of characteristics. The second-order derivative was treated by means of fast Fourier transform. We studied time- and energy characteristics of transmitted and reflected pump and second-harmonic radiation in different PBG- s as functions of periods N_{cr} , group synchronism and pump intensity. The linear transmitted and reflected spectrum and the electromagnetic density of modes also have been calculated for these PBG-s. It was shown that the conversion efficiency for reflected SH wave of a PBG with $n_2/n_1=1.21$ exceeds about in forty time the same value of PBG with $n_2/n_1=2.38$, PBG with AlAs is SH -reflected sample. For the second type of PBG the transmit- and reflected SH have the same amplitudes. The ratio 'SH pulses duration to transmitted pump pulse duration' is $1/\sqrt{2}$. The maximum of total conversion efficiency is reached for 10- period slab in the both cases. The estimation of SH energy density at $N_{cr}=10$ for the same length of a nonlinear crystal, but without a dielectric, gives the ratio which is about in 500 times less.

Electroabsorption of an ensemble of close-packed CdSe quantum dots

L.I. Gurinovich

*Institute of Molecular and Atomic Physics, National Academy of Sciences,
F. Skaryna Ave. 70, Minsk 220072, Belarus*

M.V. Artemyev

*Institute for Physico-Chemical Problems, Belarussian State University,
Leningradskaya Str. 14, Minsk 220080 Belarus*

At present, the optical properties of II-VI semiconductor nanocrystals are intensively studied. However, only a few studies exist which deal with collective phenomena in ensembles of interacting ultrasmall quantum dots.

In this contribution, we investigate the electric field effect on absorption spectra of thin films of close-packed CdSe nanocrystals 1.8 nm in size at various external biases. For spectroscopic studies the samples are prepared on glass plate covered with transparent conductive SnO₂:Sb layer-electrode, and Al mirror electrode is formed by vacuum evaporation atop the film 100 nm thickness of close-packed CdSe nanocrystals.

The application of strong ($\sim 10^6$ V·cm⁻¹) external electrical fields to an ensemble of *isolated* nanocrystals results in the quantum-confined Stark effect. The optical transitions are broadened and shifted to the red due to field-induced ionization of excitons.

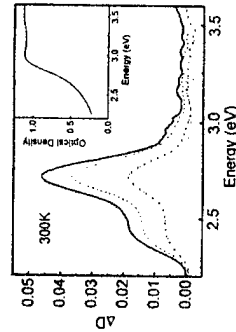

The change in optical density of thin films of *close-packed* CdSe nanocrystals at different bias (from top to bottom: 10, ..., 4 V) presents on the Figure. In the insert is shown the optical absorption of same films at room temperature.

For the positive Stark signal and no red shift with increasing electric field observed here, we suggest an increase of absorption because of stronger localization of the electron-hole pair states, i.e. a reverse effect compared to the delocalization effect due to the spatial overlap of the wavefunction in the close-packed structure. Even when taking into account the more complex behavior of electric field effects (appearance of former forbidden transitions and Franz-Keldysh effect of the delocalized *eh*-pairs) the observed changes fit well our qualitative picture.

WEAK PHOTONIC CRYSTALS FOR SOFT X-RAYS

E.P. Petrov¹ and D.A. Ksenzov²

¹*B.I.Stepanov Institute of Physics, National Academy of Sciences of Belarus,*

F.Skaryna Ave. 68, Minsk 220072, Belarus

²*Institute of Molecular and Atomic Physics, National Academy of Sciences of Belarus,*

F.Skaryna Ave. 70, Minsk 220072, Belarus

Photonic crystals attract considerable attention both as interesting physical objects providing a deeper insight into light-matter interactions and due to promising applications. Presently, self-assembling and self-organization-based techniques are considered as most efficient methods for developing photonic band gap structures for frequency ranges from the near-IR to near-UV. We show that using the self-organization-based approach one can, in principle, develop photonic band gap structures for wavelengths as short as ~ 1 nm and less.

Implantation of crystalline samples of some metals with noble gas ions is known to lead, under certain conditions, to formation of a 3D superlattice of gas bubbles with the typical diameter of the lattice constant within the range of ~ 4 to 7 nm, the bubble diameter being smaller by a factor of about 2 to 3.5 [1]. For the first time, we treat these structures as weak photonic crystals for the soft x-ray range and investigate optical properties of a helium bubble lattice in molybdenum. Computations by the electromagnetic transfer matrix method [2] show that bcc superlattices of He bubbles in Mo with the lattice constant of 5.0 nm and bubble diameters of 2.4 and 3.0 nm should exhibit selective reflection of soft x-rays at wavelengths close to 10 nm. The reflectivity peaks have relative widths of less than 1% and peak values in the range of 2-15%, depending on the bubble size and helium concentration in bubbles and in the metal host, which compares well with reflectivities of multilayer Bragg mirrors developed for the same spectral range.

[1] P.B. Johnson and D.J. Mazey, *J. Nucl. Mater.* **218** (1995) 273.

[2] P.M. Bell, J.B. Pendry, L.M. Moreno, and A.J. Ward, *Comp. Phys. Commun.* **85** (1995) 306.

FORMATION AND DEPOSITION OF NANOSTRUCTURED POWDERS BY DOUBLE PULSE LASER ABLATION TECHNIQUE

Ageev V.A., Burakov V.S., Bokhonov A.F., Kovalevskiy V.N., Nedel'ko M.I.,
Rozantzev V.A., Tarasenko N.V.

Institute of Molecular and Atomic Physics National Academy of Sciences of Belarus,
70 Scaryna Ave., 220072 Minsk, Belarus

Since the unique properties of nanoparticles are strongly size and shape dependent a fabrication of monodisperse nanoparticles, i.e. particles of almost equal size is highly desirable. In this paper a possibility of fabrication of metallic nanopowders with a narrow size distribution based on double pulse laser ablation is described. According to our idea a role of the second laser pulse is in a selective excitation and ionization of atomic species in the time-space interval of their highest density and as a result the initiation of condensation process through the creation of ionic centers.

Experiments were made by using a double pulse Nd:YAG (1064nm, 10ns) laser or two beams from Nd:YAG and excimer XeCl (308nm, 10ns) lasers with an appropriate delay between pulses. The laser beams were focused on the surface of the Al samples placed in the air or helium atmosphere to provide a power density at the target of $10^8 - 10^9$ W/cm². Spectroscopic characterization of the ablated plume was performed by the time resolved emission and laser-induced fluorescence spectroscopy. The emission spectra (300-700nm) were recorded at different locations upstream of the target and at different delays from the ablation events. The major species including AlI, AlII, Al₂, and AlO within the plume were identified. The correlation between the emission characteristics of ablated plume and properties of deposited powders will be discussed.

The fabricated powders were studied by the transmission electron microscopy method in the regimes of "plain view" and "cross-section". The results of measurements confirmed the possibility of fabrication of metal and metal oxide nanosized powders with amorphous structure. The mean diameter of fabricated particles was in the range of 2.5-50 nm. The results obtained may serve as a basis for more quantitative model of the nanoparticles formation in the laser ablation plume.

Nonlinear optical properties of copper selenide nanoparticles in sol-gel glasses

P.V. Prokoshin, K.V. Yumashev, S.A. Zolotovskaya, N.N. Posnov
International Laser Center, 220027 Minsk, Belarus, Fax/tel/ +375-12-2326286
prokosh@ilc.unibel.by

V.S. Gurin

Physico-Chemical Research Institute, 220080 Minsk, Belarus

V.B. Prokopenko, A.A. Alexeenko

Advanced Materials Research Laboratory, Gomel State University,
246699 Gomel, Belarus

Copper chalcogenides nanoparticles (NP's) are of great interest since the presence of transition metal (Cu) opens many pathways to change this optical properties due to its multivalence, variable stoichiometry, and appearance of intense charge-transfer transitions [1]. In this talk, we report on nonlinear optical properties of sol-gel glasses containing copper selenide (Cu_xSe) nanoparticles. Transient differential absorption spectra of the NP's have been studied with picosecond pump-probe

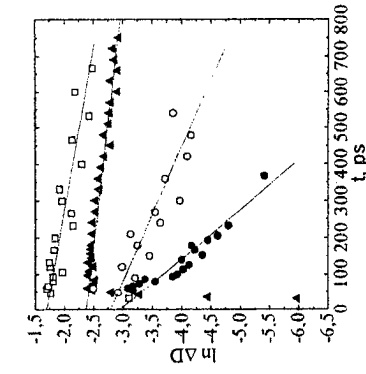

Fig 1 Bleaching decay for various stoichiometry x of Cu_xSe

technique. Oxidation of the Cu_xSe NP's results in the appearance of the additional absorption band peaked at 1.0-2.2 μ m, which can be transiently bleached under laser excitation. The bleaching recovery time was found to depend on coefficient of stoichiometry x and vary from 130 ps to 1.4 ns. Intensity-dependent transmission of the oxidized Cu_xSe NP's in sol-gel glasses has been measured at different laser wavelengths of 1.08, 1.3, 1.5, and 2.1 μ m. The absorption saturation intensities at

these wavelengths are estimated.

[1] K. V. Yumashev, P. V. Prokoshin etc. JOSA B. 17, #4, 572-579, 2000.

CHEMICAL MODIFICATION OF SURFACE AND OPTICAL PROPERTIES OF
COMPOSITE SEMICONDUCTOR NANOPARTICLES (CdSe)/ZnS

N.D. Strelak¹, M.V. Artyemyev², A.A. Maskevich¹, S.A. Maskevich¹ and I.R. Nabiev³

¹Y. Kupala Grodno State University, Grodno, 230023, Belarus

tel: +375-152-44-31-87, fax: +375-172-10-85-99, e-mail: strelak@grsu.grodno.by

²Institute for Physico-Chemical Problems of Belorussian State University, Minsk,

220080, Belarus

³Reims University, Champagne-Ardenne, 51100 Reims, France

Semiconductor nanocrystals with CdSe core (3-5 nm size) capped with ZnS shell (ca 0.6 nm size), received by inorganic synthesis, possess high ($\eta > 50\%$) photoluminescence quantum yield with narrow emission band ($\Delta\lambda_{1/2} = 30$ nm), its position (450-600 nm) depends on CdSe-core diameter. The modification of crystallites surface, covering them by polar groups allow to make them soluble in water and conjugate with biomolecules aimed at subsequent utilization as highly stable fluorescent labels [1,2].

Upon water solubilization the photoluminescence quantum yield is changed due to dependence of the oscillator strength of a radiative transition on electron-hole wave function [3], which is sensitive to boundary conditions at the surface of nanocrystal, degree of covering, localization of surface charge.

The radial distribution of charge carriers wave functions for chemically modified (CdSe)/ZnS crystallites are calculated by numerical methods on a basis of «particle-in-a-box» model regarding the near surface band distortion.

Calculated data are compared with measured quantum yield η of modified crystallites. Possible ways for η increase in water soluble nanocrystals are discussed.

[1] Chan W.C., Nie S. *Science*, 1998, 25, 2016-2018.

[2] Bruchez M., Moronne M., Gin P., Weiss S. & Alivisatos A.P. *Science*, 1998, 281, 2013-2016.

[3] Brus L.E. *J. Chem. Phys.* 1984, 80, 4403-4409.

INTRACAVITY FABRICATION OF NANOSTRUCTURES ON BULK MATERIALS

V. Osipov, V. Valyavko

Stepanov Institute of Physics, 220072, F.Scaryna Ave. 68, Minsk, Belarus

Presently laser micro-machining of bulk materials in industry follows the traditional route, focusing laser radiation in a small spot while scanning over the surface to be processed using a complicated computer-controlled mechano-optical system [1]. The minimal size of the laser spot is strictly limited by the diffraction effect. For some applications, this problem may be solved using a new laser method of intracavity processing, which allows the fabrication of a complete sub-micron structure on a solid state surface during a single pulse of radiation [2]. It was demonstrated that the application of this method resulted in the formation of 0.3 μm periodic structures on the 80 nm Al film with a single pulse (about 100 ns) of 10.6- μm laser radiation. In this work the analytical and experimental investigations describing the intracavity processing of different solid-state materials (Al, Cr, Ge, Si) are presented. New designs of the laser cavity were explored to facilitate the fabrication of structures composed of a system of equidistant parallel sub-micron-sized grooves and periodic micro-dots on massive samples of metals and semiconductors, as well as micro-holes in thin metallic films. This method is highly attractive from the perspective of fabrication of microelectronic devices, superfine filters or diffractive optical elements. The next logical step in minimization of the period and microstructures size was to apply laser radiation with shorter wavelength. For this reason the application of a pulsed Nd:YAG laser was investigated experimentally, creating micro-grooves and micro-hollows with 10x smaller periods (up to 0.7 μm). There are analysed possible ways of increasing the processing area on the base of the formation of a super-Gaussian (flat-top) laser beam intensity distribution in the vicinity of the solid state (metal or semiconductor) sample to be processed.

References:

1. V.V.Kononenko, V.I.Konov etc., *Quantum Electronics*, 26 (1), 9-10,1999.

2. V.Osipov, V.Valyavko, in *Interferometry in Speckle Light - Theory and Applications*, Springer-Verlag, Berlin, 2000, pp.557-562.

OPTICAL PROPERTIES OF ULTRA-DISPERSE DIAMONDS IN AQUEOUS
SUSPENSIONS

A. V. Gubarevich, A. Ya. Khairullina, T. M. Gubarevich*, V. A. Lapina

B. I. Stepanov Institute of Physics, National Academy of Sciences,

Minsk, 220072 Belarus

*SPA "Sinta", Minsk 220082 Belarus

Ultra-disperse diamonds (UDD) are the new type of nanostructures with diamond crystal lattice and average grain size about 4-6 nm.

Absorption and scattering spectra of the aqueous suspensions of the UDD of various kinds were measured by single-light-scattering methods at the range of 210 to 600 nm. The objects of study were the UDD samples with different surface properties: negative charge ($\zeta = -35$ mV) and positive charge ($\zeta = +15$ mV) of particle surface.

The imaginary and real parts of the complex refractive index of two UDD modifications were calculated by using known relations. The absorption spectrum and imaginary part are shown to have a maximum at the range $\lambda = 500$ nm for the both modifications. The position of the luminescence maximum is also estimated. The maximum are near 215 nm and 400 nm to coincide practically with the data for natural diamond [1]. The imaginary part of the complex refractive index locates near values of $(0.3 - 1.3) \cdot 10^{-3}$ to be different from the data for UDD film [2], where apparently estimations of this quantity have contained some contribution of scattered radiation. The real part of the complex refractive index is higher that of Ref. [2]. The comparison between aqueous suspensions of UDD and diamond of static synthesis with grain $1/0 \mu$ was carried out.

The sizes of UDD aggregates in aqueous suspensions are expediently to determine by the dynamic spectroscopy method.

1. Kompan M.E. et al./Phys. Solid State. 1997. V.39. No.12. P.2156-2158.
2. Aleksenskii A.E. et al./Lett.Zh. Techn.Phys. 1997. V.23. No.22. P.39-44.

CHAOTIC ABSORPTION OF COHERENT LASER LIGHT BY AN ANHARMONIC MOLECULE

S.V.Prants and M.Yu.Uleysky
 V.I.I'ichev Pacific Oceanological Institute of the Russian Academy of Sciences, 43
 Baltiiskaya St., 690041 Vladivostok, Russia
 ph: 4232 313081, fax: 4232-312573, e-mail: prants@mail.ru

A model for multiple photon excitation of molecular vibrational modes by an infrared laser field is developed. The closed semiclassical Heisenberg equations of motion for a periodically driven anharmonic oscillator with a few degrees of freedom are derived. The equations for a free nonlinear oscillator with two degrees of freedom are shown to be integrable with solutions in terms of Jacobian elliptic functions resulting on a strictly regular intermode exchange of energy. When illuminating the molecule by a periodic infrared laser field, the absorption strongly depends on the values of the molecular and laser parameters. We have found numerically that the molecule may absorb chaotically in a diffusive manner up to 5 - 10 photons (fig. 2). The other interesting effect is suppression of chaos by increasing energy of the laser light. It is evident from the topographical λ -map (fig. 1), which shows the dependence of the strength of chaos (the maximal Lyapunov exponent λ) on the molecular nonlinearity parameter q and on the laser Rabi frequency Ω . A mechanism of the onset of Hamiltonian chaos in our system is studied with an arsenal of methods of the modern dynamical system's theory.

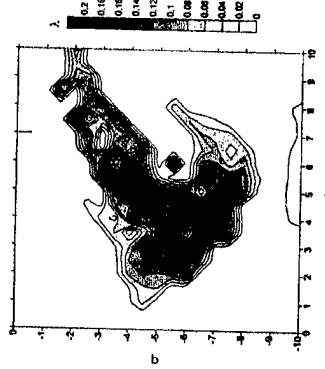

Figure 1: Topographical map of chaos.

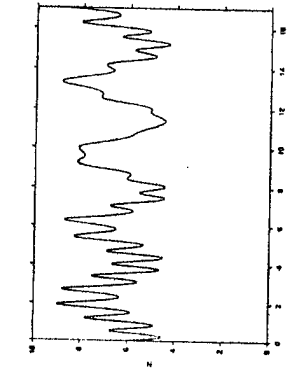

Figure 2: Chaotic absorption of laser photons.

New nonlinear optical effect: Self-reflection phenomenon due to exciton-biexciton-light interaction in semiconductors

P.I.Khozhi, K.D.Lyakhomskaya, L.Yu.Nadkin, D.A.Markov
 Dnister State University, 25 October str., 128, Tiraspol, Moldova, 3300,
 tel: (10-373-33)-3-44-87, 3-2504, fax: (10-373-33)-3-25-04, e-mail: tdsu@tirastel.md
 Institute of Applied Physics, Academy of Sciences, Academy str., 5, Kishinev,
 Moldova, 2028

The propagation of a laser beam through a nonlinear medium can strongly depend on its intensity, which gives rise to nonlinear optical effects, in particular, to the self-reflection phenomenon. By the self-reflection phenomenon we shall further mean the effect of an appearance of backward propagating wave in an optically homogeneous nonlinear semi-infinite medium on the spatially inhomogeneous distribution of the medium refractive index, induced by the field of the forward propagating wave. If the spatial transition between the regions of a low and high absorption is sufficiently sharp, the change in the nonlinear refractive index across the transition region gives rise to the self-reflected wave. This effect can take place in the system of excitons and biexcitons in semiconductors. We carried out the theoretical investigation of the self-reflection of the laser radiation in a semi-infinite semiconductor, in which the photons of the same pulse excite the excitons from the ground state of the crystal and simultaneously convert them into biexcitons due to the process of optical exciton-biexciton conversion. We suppose that the plane electromagnetic wave incidents normally on the flat interface vacuum-crystal. The main task is the determination of the spatial distribution of the field, refractive index, absorption coefficient and the reflectivity of the interface.

We have obtained the expression for the complex dielectric function, which depends on the frequency detuning and on the intensity of the propagating wave. By the solution of the nonlinear wave equation beyond the slowly varying envelopes approximation we have obtained the steady-state spatial distribution of the intensity of propagating light, the points of the abrupt change of the nonlinear refractive index and the field profiles inside the crystal, where the strong reflection of light occurred. This wave gives the additional contribution to the usual Fresnel reflection from the boundary.

Influence of strong laser radiation on the photoelectric properties and charge transfer of ZnP_2 and CdP_2

S. I. Beril, I. G. Stamov, S. Yu. Duboshchevskii, V. V. Panasenko

Dniester State University, 25 October str., 128, Tiraspol, Moldova, 3300,
tel: (10-373-33)-3-44-87, 3-2504, fax: (10-373-33)-3-25-04 e-mail: isb@iirastel.md

We have obtained that the current in the thin layers of $\beta-ZnP_2$ in the case of hole conductivity in the system ITO- ZnP_2 -ITO are limited by the space - charge of free carriers and by the charge of traps. The influence of the illumination by the laser radiation in the region of fundamental absorption and of temperature is very substantial. For the control of electric field strength on the contacts we have used the very sensitive exciton reflectivity spectra depending on the electric field and surface state. In the case of negative polarity of the impressed voltage to the illuminated electrode the exciton reflectivity control exhibits the Stark shift and broadening up to the effects of the contour rotation. The illumination of the contact causes the strong reformation of the contour of the exciton reflectivity. The effect of the laser radiation (He-Ne-laser; 0,1 W/cm^2 , $\lambda=632,8$ nm; Ar^+ - laser, $5W/cm^2$, $\lambda=488$ nm) reduces the electric field strength on the electrode up to zero value. In the case of positive polarity of the illuminated surface we did not observe any changes in the exciton reflectivity spectra.

The modeling of the space-charge-limited current for the high resistive semiconductor with traps for the free carriers in the condition of the illumination assisted monopolar injection shows that in the case of different recombination mechanisms the electric field distribution changes very small for the wide range of the intensity of the incident radiation.

The investigation of the current dependencies on the temperature of the Schottky-barriers on the CdP_2 and $\alpha-ZnP_2$ shows the strong temperature influence and the very small influence of the illumination by the laser radiation on the tunnel charge transfer in the limit of break-down, which is due to the thermofield ionization of the impurity centers.

COHERENT TRANSIENTS GENERATED AT MOLECULAR LEVELS, DRESSED BY ELECTROMAGNETIC FIELD

N.N. Rubtsova, T.P. Konstantinova
Institute of Semiconductor Physics, Siberian Branch RAS,
acad. Lavrentyev ave., 13, Novosibirsk, 630090, Russia,
Telephone (+007 3832) 332769, Fax (+007 3832) 332771,
E-mail rubtsova@isp.nsc.ru

Free polarization decay and photon echo were studied experimentally in polar gas $^{13}CH_3F$ at the transition $R(4,3)$ of vibrational mode $0 \rightarrow 1 \frac{1}{2}$ by Stark switching of molecular levels under irradiation by CW CO_2 laser at $9P(32)$ line. Coherent responses of the gas were detected as heterodyne signals in the weak component of radiation, polarized at right angle to the polarization of the principal part of exciting radiation, in contrast to usual technique, based just on the detection of high intensity radiation [1].

Depending on its intensity, the CW radiation prepares molecular transition either in the form of overlapping optical transitions, corresponding to possible values of magnetic quantum number M , or in the form of the set of non-equidistant components of non-equal intensities, corresponding to partial reduction of molecular levels degeneracy over M by the dynamic Stark effect [2]. Application of long (5 mcs) pulse to the Stark electrodes inside the gas cell allows to detect the free polarization decay signal. The sign of the signal corresponds to the increase of absorption in the limit of low intensity (not over $0.01 W/cm^2$) saturating radiation. Exciting intensity growth till the level of $6.0 W/cm^2$ implies decrease of the signal amplitude, till the change of its sign, while the frequency of the free polarization decay signal reveals remarkable frequency shift. Such behaviour is attributed to the combined action of the dynamic Stark effect of CW radiation field and the levels splitting by the Stark voltage. The free polarization decay rate versus the gas pressure, till the optical density of 0.3, is under consideration.

Two shorter (of about 0.1 and 0.2 mcs) Stark pulses, applied to the gas, generate the photon echo signals by using the same technique. The variations of photon echo parameters as the function of exciting radiation intensity will be also reported.

1. R.G.Brewer, R.L.Shoemaker, Phys. Rev. Lett., 27, pp. 631-634 (1971)
2. K.A.Nasyrov, A.M.Shalagin, ZhETF, 83, pp. 1685-1697 (1982)

NONLINEAR MECHANISMS OF UV LASER RADIATION ABSORPTION IN CaF_2

Sergeev P.B.

P.N.Lebedev Physical Institute, Division of Quantum Radiophysics,
Leninsky Prospekt, 53, Moscow, 117924, Russia.

Internal two-photon ionization of crystals by intensive laser radiation (LR) creates in them a recombination flow. A complex of new electronic states is appeared in a crystal, the part from which can effectively absorb in one-quantum processes. If the duration of a laser pulse exceeds formation times of such absorbers (~ 100 ps), at moderate intensities is established quasistationary process of interaction of LR with a crystal. Thus the effective nonlinear absorption for nanosecond pulses can in tens times exceed classical two-photon absorption.

The ways of the description of such processes for the widest gap materials as alkaline earth fluorides crystals and UV LR were considered in [1]. There on an example of MgF_2 and the KrF-laser radiation are considered features of behavior of crystals for a case, when LR gets in an absorption band of the F-centers. In the given work the second variant in details is analyzed, when LR gets in photodissociation band of the H-centers. As well as earlier the reaction of crystals to influence of LR is estimated on the basis of numerical modeling of electronic excitation relaxation processes. The behavior of free electrons, holes, self-trapped holes, self-trapped excitons, two pairs of Frenkel's defects are taken into account. The model was debugged on the base of experimental results on influence of excimer KrF- and ArF-laser radiation (248 and 193 nm) and also of ionising radiation upon various samples of CaF_2 .

In the work is shown, that the photodissociation of "molecular" V_K - and H-centers in one photon processes leads occasionally to their scattering on a pair of holes. They rapidly give two new absorbed V_K -centers. For certain conditions the considered mechanism of defects formation may become the basic. The classical two-photon ionization provides here initial defects, bringing in common balance of the absorbed energy only insignificant part.

REFERENCES

1. Kurbasov S.V., Sergeev P.B. Quantum Electronics. **30**, p.703 (2000).

INSTABILITY OF LIGHT-DRIVEN CONVECTIVE MOTIONS

R. S. Akopyan, R. B. Alaverdyan, Yu. S. Chilingaryan, H. Ye. Seferyan
Department of Physics, Yerevan State University, A. Manoogian st. 1, Yerevan, Armenia, 375025.
Phone: (3741) 553810, Fax: (3741) 151087. E-mail: rhakob@www.physdep.r.am

We report experimental and theoretical results on the convective motions and surface hydrodynamic waves caused by the absorption of light radiation correspondingly with stationary and travelling spatially periodic (with period Λ) intensity structures. We consider a horizontal layer of liquid or liquid crystal (LC) and assume that a fringe optical pattern is incident on it, which leads to periodic distribution of heat sources in the bulk due to the absorption. Such a distribution of heat production leads to the onset of convective motions. We consider theoretically the stability of ordered convective structures by the fixed cell thickness with respect to the light intensity and the period of intensity distribution. The quantitative aspects of the stability are determined by two dimensionless parameters: Rayleigh number R (proportional to the average light intensity) and the ratio L/Λ (L - the cell thickness). We carried out numerical studies of appropriate equations for perturbed quantities and found the stable regions on the phase diagram ($R \times (L/\Lambda)$). A horizontal cell of isotropic liquid or NLC SCB was used at the experiment. The layer of liquid was open to air at its upper surface and illuminated by a fringe optical pattern. The absorption of light led to the onset of ordered, roller structures with a period coincided nearly with $\Lambda/2$ and with an establishment time $\tau \approx 150 \div 200$ sec. The observation showed that there is an optimal cell thickness for the onset of roller structures coincided with $L = \Lambda/2$. In case of thin cells ($L < 0.75 \text{ mm}$) the convection was driven by thermocapillary mechanism, and in case of thick cells by the gravitational. At a fixed intensity the convective structures became unstable in case of very small and very large values of the parameter L/Λ . Carrying out the appropriate measurements we found the stable regions of convective motions and surface hydrodynamic waves on the phase plane.

The use of laser beams will allow us to create various initial perturbations in liquids and to control the dynamic behavior of convective structures.

The work was supported by the grant INTAS 97-1672.

STOCHASTIC MAGNETIC FIELD INDUCED FREEDERIKSZ TRANSITION IN NLC

L.S. Aslanyan, V. B. Pakhalov, J.Ch. Grigoryan
 Physics depart., Yerevan State University, A. Manoogyan, Yerevan Armenia, 375025.
 e-mail: laslan@www.physdep.r.am

Many papers are devoted to research noise induced phase transitions in simple systems. The analysis of such systems is convenient, because on the one hand it is possible to carry out both approximate analytical and numerical solution, and on the other hand it is possible to realize simple experiments. One of the most practical in this aspect are nematic liquid crystals (NLC). The dynamic behaviour of NLC molecules in external static and high-frequency magnetic fields are investigated rather in detail. In [1] we showed, that interesting peculiarities at the Freederiksz transition can arise also in case of application of oscillating magnetic field, when the temporary scales of the change of the field are comparable with own temporary scales of relaxation movements of NLC molecules. The present paper is devoted to the research of dynamic behaviour of NLC molecules in an external stochastic magnetic field. We consider the case of pure T-deformation, as in this case there are no hydrodynamic motions. We carried out the numerical modeling of the equation of motion of the NLC director. As an example in fig.1 the dependence of the dynamics of the NLC director reorientation angle is presented when the root-mean-square deviation of the stochastic field excess twice the H_c^2 . As it is shown in fig.1 in spite of the chaotic change of the magnetic field, the reorientation of the director appears, i.e. it is possible the

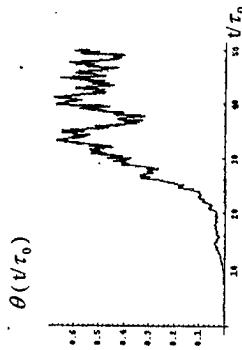

occurrence of Freederiksz transition in a stochastic magnetic field. We also carried out quantitative research of the dependence of the temporary characteristics of Freederiksz transition on the correlation characteristics of the stochastic field. We also discuss the analogy of the predicted phenomenon with completely unpolarized light driven Freederiksz transition, considered in [2].

REFERENCES

1. L. S. Aslanyan, V. B. Pakhalov. *Lasers* 2000. USA.
2. L. Marrucci, P. Maddalena, et al. *Phys. Rev. E* 1998, v. 57, No. 3, p.3033.

MODIFICATION OF THE MOSSBAUER SPECTRA BY MEANS OF POLARIZATION-SELECTIVE OPTICAL PUMPING

Roman Kolesov and Elena Kuznetsova
 Institute of Applied Physics of Russian Academy of Science,
 603600, Nizhny Novgorod, Ulyanov str., 46, Russia
 and Physics Department, Texas A&M University,
 College Station, TX 77843-4242, USA
 E-mail: roman@xena.tamu.edu

A new branch of Mossbauer spectroscopy, Laser-Mossbauer spectroscopy, has been initiated recently in Ref.1. It allows one to modify Mossbauer spectra by means of optical coherent or incoherent driving and to study hyperfine structures of the excited electronic states of ions in solids. On the other hand, great interest is attracted towards polarizing the nuclei. Several experiments demonstrating nuclear polarization both in gases and in solids at level of several per cent have been performed [2,3].

In this work we propose the way of achieving almost 100% nuclear polarization in paramagnetic impurities introduced in solids. This way of polarizing nuclei makes use of the fact that some of the hyperfine sublevels of the ground-state optical level are not involved into the interaction with circularly polarized light. The "atomic-like" polarization-selective selection rules in solids are shown by explicit calculation done for octahedrally coordinated $^{231}\text{Pa}^{4+}$ ions for both parity allowed and forbidden transitions of this ion. Nuclear polarization can be studied by the Mossbauer spectroscopy. It is predicted that some resonances in the Mossbauer spectrum of protactinium-231 should vanish under the action of the optical pumping. The advantage of this method is its high efficiency even when the optical linewidth covers the hyperfine structure.

1. O.Kocharovskaya et al., *Phys. Rev. Lett.*, **82**, 3593 (1999)
2. T.G.Walker and W.Happer, *Rev. Mod. Phys.*, **69**, 629 (1997)
3. C. Wei and N.B.Manson, *J.Opt.B: Quantum Semiclass. Opt.*, **1**, 464 (1999)

LASER - INDUCED TRANSPARENCY IN THE LIGHT - DIFFUSING MEDIA

V.L. Komolov, S. G. Przhibel'skii, V.N. Smirnov
Vavilov State Optical Institute, 12 Birzhevaya Line, St. Petersburg, 199034, Russia

The possible manifestations of a new class of the optical phenomena predicted by the authors - laser-induced homogenization (LIH) of the light - diffusing media has been studied and the description of an abrupt decrease of the light diffusion in condensed media under the intensive light action is presented. Some key features of LIH mechanisms for the different types of the media have been studied, including possible mechanisms of the avalanche-like changes of medium state.

We present the results of detailed analysis for the thermal model of LIH, describing the "induced transparency wave" arising upon melting of a solid, when the abrupt drop of the light scattering occurs due to homogenization of optical properties of the medium.

The analysis of the LIH is carried out for the one-dimensional light propagation in the semi-infinite light-diffusing medium. We use the extinction coefficient approximation assuming the light intensity to be attenuated according to the Bouguer law. In the framework of the model the scattering is considered to disappear in the melted phase.

The analysis of the absorption changes has been carried out for two possible situations: (I) when the absorption in the solid and liquid phases is the same (if it is caused, e.g., by an impurity whose properties are the same for the two aggregate states) and (II) when the absorption in the melt vanishes (as, for example, in polycrystals whose absorption results from processes on the grain boundaries). For the above cases, we have analyzed the motion of the melting isotherm, which is the front of the laser-induced homogenization, and have found dependence of the LIH front velocity on the light intensity, parameters of the medium, and boundary conditions.

We analyzed the conditions when the LIH front movement behavior is strongly defined by the feedback between the temperature and optical parameters of the medium. We discussed also the possibility of the avalanche-like evolution of the LIH in converging light beams where an additional acceleration of the LIH front is caused by an increase in the light intensity as the melting isotherm is moving towards the focal point. On the other hand, it may be shown, that under certain boundary conditions LIH front stops. For this case, we estimated the depth of penetration of the LIH front into the medium versus the light intensity and the light-scattering properties of the medium.

The work has been supported by the Russian Foundation for Basic Research (project 00-02-16830).

PHOTOREFRACTION SCATTERING IN LiNbO_3 CRYSTALS WITH DIFFERENT ALLOYING ADDITIVES

Yu. M. Karpets, V. A. Maksimenko

Far Eastern State Transport University, 47 Seryshev st., Khabarovsk, Russia,
680021

Tel.: (421-2) 359-114, E-Mail: fizika@festu.khv.ru

Lithium niobate is a perspective material for recording of the polarization-phase holograms in the optical systems of information processing and storage. In this work, the direct and back photorefraction scattering in LiNbO_3 crystals with iron and rhodium as alloying additives have been studied. Figures 1a and 1b show the pictures of direct scattering in $\text{LiNbO}_3:\text{Fe}$ and $\text{LiNbO}_3:\text{Rh}$. Unlike $\text{LiNbO}_3:\text{Fe}$, a picture for scattering in $\text{LiNbO}_3:\text{Rh}$ has a complex structure. The arcs in Figure 1b suggest a selective nature of a direct scattering in $\text{LiNbO}_3:\text{Rh}$. In Figures 1c and 1d, the pictures of direct and back scattering for $\text{LiNbO}_3:\text{Rh}$ and $\text{LiNbO}_3:\text{Fe}$ are presented. In the case of back scattering for both crystals, the arcs of selective scattering are observed. The angle sizes of these arcs are approximately 16 degrees. However, if for $\text{LiNbO}_3:\text{Fe}$ these arcs appear on the background of non-selective scattering in ≈ 30 minutes after irradiation beginning and have immediately the above size then a back scattering in $\text{LiNbO}_3:\text{Rh}$ is presented by only area of selective scattering. These arcs increase in size synchronously with the picture of direct scattering and approach maximum values in 10-12 minutes of beginning of crystal irradiation. The results obtained assume that an alloying additive in LiNbO_3 affects not only the quantitative characteristics but also a nature of the photorefraction scattering.

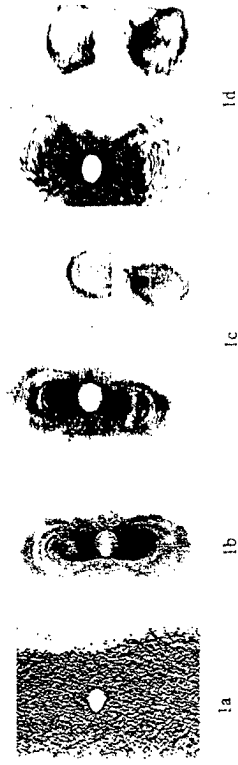

Coherent exchange between the forward and backward waves in induced superradiance

A. A. Bogdanov and A. I. Zaitsev

Herzen Russian State Pedagogical University, Moika 48, St. Petersburg, 191186, Russia,
e-mail: tiphys@herzen.spb.su

Induced superradiance is characterized by the regimes of possible predominance of the transmitted or reflected waves within narrow ranges of sample lengths around the lengths equal to even numbers of quarters of a wavelength and the regime of equality of these waves for other sample lengths. The occurrence of a certain regime is associated with a periodic dominance of the forward or backward waves at the linear stage of the process, determined by the nonstationary reflection and amplification of these waves in a medium. The decay of the oscillatory kinetics is controlled by the deviation of the sample length from the nearest even number of half-wavelengths. The relation of the transmitted and reflected waves in the main pulse of superradiance is determined by the degree of this decay in the formation of the main SR pulse (in the transition to the nonlinear stage).

The logarithmic dependence on the area of the triggering pulse displays a periodic alternation of the predominance of transmitted and reflected waves for system lengths close to even numbers of quarters of a wavelength. In the remaining range of sample lengths, the wave pulses are equal to each other. This is due to the fact that a variation in the area of the external pulse changes the delay time of the SR pulse. Thus, we can scan oscillations of the fraction of the forward wave.

A considerable increase in the sample length, when the ISR delay time becomes less than a quarter of the period of coherent exchange, may transfer superradiance to the regime of total predominance of the transmitted wave.

INVESTIGATION OF STARK SHIFT AND SHOCK WAVES PARAMETERS RELATIONSHIPS IN LASER PLASMAS GENERATED ON THE SURFACES OF SOLID TARGETS

O.A. Bukin, A.A. Il'm, S.S. Golik, V.I. Tsarev
Optic Spectroscopy Lab, Far Eastern State University,
Sukhanova 8, Vladivostok, 690600 Russia
e-mail: lasspec@jift.phys.dvgu.ru

Recently it was shown that simultaneous use of spectral line Stark shift and broadening values permitted diagnostics of laser plasmas produced on the surfaces of solid targets at various pressure of ambient gas [1]. It was registered that Stark shift maximal values was the result of shock waves influence in laser plasma.

The experimental investigation of the continuous spectra radiance dynamics in the different zones of the laser plume is presented in this work. The continuous spectra radiance temporal dependence has two maximums. The second maximum is explained by shock wave effect on the laser plasma [2]. The position of the second maximum coincide with the position of the maximum spectral line Stark shift in the limit of the experimental errors.

The radiation of Nd:YAG laser with 1,06 μm wavelength are used in our experiments. Both Q-switched pulses and complex pulses (Q-switched spikes above free oscillation background) up to 1 J energy per pulse were employed. Special diaphragm installed before plasma plume allowed us to select investigated area into the laser plasma. The curve of the continuous spectra radiance was registered with 10 ns temporal resolution. The target was placed into the special chamber. The ambient gas pressure around the target was changed from 10^2 Torr to $3 \cdot 10^3$ Torr.

References:

1. Bukin O.A., Bazarov I.V., Bodin N.S. et al. Influence of the pressure of a gaseous atmosphere on the characteristics of the emission spectra of a laser plasma generated on surfaces of solid targets. Quantum Electronics. 28. (8). 1998. p. 685-688.
2. Sukhov L.T. Lazerniy Spektral'nyy Analiz (Laser Spectral Analysis). Novosibirsk. Nauka. 1990.

VIBRATIONALLY INDUCED TRANSPARENCY
IN OPTICALLY DENSE RESONANCE MEDIUM

Y.V.Radeonychev, M.D.Tokman, A.G.Litvak,
Institute of Applied Physics Russian Academy of Science,
46 Ulyanov str., 603600 Nizhny Novgorod, Russia
Olga Kocharovskaya
Institute of Applied Physics Russian Academy of Science
and Texas A&M University, Department of Physics,
College Station, TX 77843

We propose a novel method of suppression of resonant absorption of monochromatic radiation due to mechanical supersonic vibration of a medium sample along the propagation of electromagnetic wave. Our analysis is based on the model of two-level quantum system interacting with probe multi-frequency laser radiation within RWA. It is shown that mechanical harmonic oscillations of atoms at the frequency exceeding the transition width lead to essential alteration of the absorption law for the field. If the frequency interval between field components is multiple to the frequency of atomic vibration then for any initial energy distribution among the spectral components and any amplitude of vibration the field tends to steady-state regime of propagation (normal wave) characterized by absence of resonant loss. In particular, resonant propagation of monochromatic field through the vibrating medium leads not only to bleaching of the resonant transition but also to appearance of a set of equidistant spectral components. Intensity of the non-absorbed resonant wave and structure of appearing Stokes and anti-Stokes satellites depends on amplitude of atomic vibrations. Mechanism of the effects is parametric interaction between mechanical and electromagnetic oscillations. Our numerical estimations show efficiency of the proposed method of bleaching of resonance media.

HYPER-RAMAN SCATTERING BY 2LO-PHONONS IN A CdS CRYSTAL

L.E.Semenova and K.A.Prokhorov
General Physics Institute of Russian Academy of Sciences
Vavilov 38, Moscow, 117942, Russia

The multiphonon resonant Raman scattering of light was observed in a CdS crystal [1]. The lines corresponding to the scattering by longitudinal optical (LO) phonons of even order were dominant in the process. A qualitative explanation of the difference in the intensities of the multiphonon lines in the Raman spectra has been offered by using a theoretical model assuming the Wannier excitons as the intermediate states [1]. According to this theory the odd order lines are to dominate in the hyper-Raman spectra. However, at conditions of the two-photon resonance with the lowest excitonic states a sharp enhancement of the line corresponding to the hyper-Raman scattering (HRS) by 2LO-phonons was observed in the CdS crystal, whereas the 3LO line was not detected [2]. We assume that the appearance of the intense 2LO line can be accounted for by the HRS mechanism which includes the two-photon transition to the s-excitonic state and is analogous to mechanism of the Raman scattering by 2LO-phonons. Taking into account the results which were obtained in studies Raman scattering by 2LO-phonons in the CdS crystal [3], we have estimated the cross sections of the HRS by 2LO- (σ_{2LO}) and 1LO-phonons (σ_{1LO}). Fig.1 illustrates the cross sections σ_{2LO} and σ_{1LO} as a function of the parameter $\eta = (E_g - 2\hbar\omega_L)/R$, where E_g and R are the energy gap and the Rydberg constant. As seen from the Fig.1, the cross sections of the HRS by 2LO- and 1LO-phonons are comparable, when the two-photon resonance with the 1S exciton level takes place.

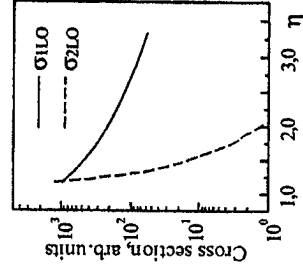

Fig.1.

1. A.A.Klochikhin, S.A.Permogorov, and A.N.Reznitskii, *Sov. Phys. JETP*, **44**, 1176 (1976).
2. V.A.Maslov, K.K.Ondriash, Yu.N.Polivanov et al., *Laser Physics*, **6**, 132 (1996).
3. L.E.Semenova and K.A.Prokhorov, *Zh. Eksp.Teor. Fiz.*, **119**, (2001) (in print).

MULTIPLE SCATTERING OF POWERFUL LASER RADIATION

S.E. Skipetrov

Department of Physics, Moscow State University, 119899 Moscow, Russia

M.A. Kazaryan

Lebedev Physical Institute, Russian Academy of Sciences, 117924 Moscow, Russia

Coherent multiple scattering of light in random media is an old problem, having important fundamental and applied aspects. A large variety of scattering media can be viewed as a random arrangement of discrete scattering centers (scatterers), whose motion is pre-defined by the particular experimental conditions. However, the second part of such a picture breaks down as the intensity of the wave incident upon the random medium increases [1]. For powerful laser radiation, not only the scattering of light by the scatterers, but also the effect of light on the scatterer motion should be taken into account in an adequate theoretical model. Indeed, the scattering (either single or multiple) consists in a partial exchange of mechanical momenta between the wave and the scatterer. As long as the intensity of light is low, the change of the scatterer's momentum upon the scattering event can be neglected. In contrast, for high intensities the scatterer can be accelerated to considerable velocities [2], and this should be taken into account when calculating the characteristic of scattered light.

We consider the scattering of a powerful cw laser beam in a suspension of dielectric spheres. Careful application of Mie theory allows us to calculate the force acting on a scatterer as the incident wave is scattered in the medium. Such forces in combination with hydrodynamic interaction between the scatterers cause their collective motion, leading to the intensity-dependent, self-induced decorrelation of the scattered radiation. This issue may be very important for future experiments, since it suggests that the velocity of laser-accelerated scatterers can be estimated by measuring the time autocorrelation function (or, equivalently, the power spectrum) of multiple-scattered radiation.

1. S.E. Skipetrov *et al.*, JETP Lett. 67, 635 (1998).
2. S.E. Skipetrov, *et al.*, Quantum Electronics 28, 434 (1998).

Polarizability difference at the transition as a characteristic of Raman-active properties of a molecule.

S.Yu.Nikitin

M.V.Lomonosov Moscow State University, Physics Department, Chair of general physics and wave processes, 119899 Moscow, Russia. Tel. (095)939-19-34, Fax (095)939-31-13, E-mail Nikitin@sr.phys.msu.su

The derivative of molecule electron polarizability on the nuclei coordinate α' plays an important role in the theory of stimulated Raman scattering (SRS) of light on molecular vibrations [1]. Here we present a simple way to estimate this value. The basic formula is

$$\alpha'q_{12} = \Delta\alpha,$$

where q_{12} is matrix element of vibration coordinate, $\Delta\alpha$ is the molecule polarizability difference at the states, forming Raman-active transition. In the harmonic oscillator approximation $q_{12} = \sqrt{\hbar/2M\omega_0}$, where M is reduced mass of the oscillator, ω_0 is frequency of the Raman-active vibrations, \hbar is the Planck constant.

The spontaneous Raman scattering cross-section is expressed through the polarizability difference in the following way:

$$\frac{d\sigma}{d\Omega} = (\Delta\alpha)^2(\omega_s/c)^4.$$

The stimulated Raman gain constant is

$$g = \frac{16\pi^3 N T_2 (\Delta\alpha)^2 \nu_s}{c\hbar \tau_p \tau_s}.$$

Here $\nu_s = \omega_s/2\pi c$ is frequency of the Stokes component of the SRS, T_2 is dephasing time for molecular vibrations, N is number of molecules per unit volume, τ_p and τ_s are refractive indices at the frequencies of the pumping wave and the Stokes component respectively, c is the velocity of light.

We have performed estimates for vibrational transition of the hydrogen molecule. The estimates show that our model predicts correct values of the spontaneous Raman scattering cross-section and of the stimulated Raman gain constant at least as to the order of magnitude.

References

1. Akhmanov S.A., Nikitin S.Yu. Physical optics. Clarendon Press, Oxford, 1997.

INFLUENCE OF COLLECTIVE EMITTING TO THE THRESHOLD OF LASER
GENERATION OF THE CONCENTRATED DYE SOLUTIONS

Verhovskii E.B., Ermolaeva G.M., Klochkov V.P., Shilov V.B.
Vavilov State Optical Institute, All-Russia Scientific Center
12, Birzhevaya Liniya, St.-Petersburg, 190034 Russia

Significant reduction of the lasing threshold P_{th} of the superconcentrated ($\sim 10^{19} \text{ cm}^{-3}$) solutions of Rhodamine dyes with increasing of the vibronic energy is found experimentally at the excitation of molecules by laser radiation under the transversal pumping. We suppose that it is coupled with the decreasing of a competition between the development of lasing and collective emission [1,2]. Two bands with a half-width $\sim 200\text{-}300 \text{ cm}^{-1}$ are observed in the emission spectrum of superconcentrated ethanol solutions of Rhodamine 6G and B. One band corresponds to the usual superfluorescence, the second one belongs to the collective emission from the vibronic levels populated at pumping. The ratio of their intensities depends on the dye concentration and the pumping power. The collective emission of Rhodamine dyes is radiated in the femtosecond time domain. This time is determined by the dephasing rate of excited complex molecules ($\sim 10^{13} \text{ s}$). The dephasing rate grows with increasing of absorbed photon energy. The lasing threshold of Rhodamine 6G ($C = 4 \times 10^{18} \text{ cm}^{-3}$) reduced more than 20 times with the changing of pumping wavelength from 532 to 347 nm. The obtained results show the dominant influence of the collective processes on the threshold conditions of generation of the superconcentrated solutions at laser pumping, rather than the concentration quenching [3].

1. V.P. Klochkov, E.B. Verhovskii, *Opt. Spektrosk.*, 88, p.692 (2000).
2. G.M. Ermolaeva et al., *Opt. Spektrosk.*, 89, p.143 (2000).
3. B.I. Stepanov, A.N. Rubinov, *Usp. Fis. Nauk* 95, p.45 (1968).

Influence of near-by level on the superradiance kinetics of a superthin film .

Local – field regime

A.I.Zaitsev, I.V.Ryzhov

Herzen State Pedagogical University of Russia, Moika 48,
191186 Saint-Petersburg, Russia, thphys@herzen.spb.ru

We analyse the collective spontaneous emission (superradiance) from a partially excited superthin film comprised of three – level atoms with a Λ – configuration of operating transitions. In contrast to superradiance without inversion, no initial low-doublet coherence is supposed. The thickness of the system is assumed to be smaller than the emission wavelength so that the local – field correction to the acting field appears to be of importance and affects significantly the three – level radiance. Due to this correction, there exists a Raman transition in own superradiant field between the doublet sublevels, resulting in a partial exchange of their populations.

Local – field (and low-doublet splitting) have a different influence on the superradiance of superthin layer comprised of three – level atoms with an initially empty low or higher sublevel of the doublet. In the first case the superradiant kinetics is gradually changed from collective to independent transitions regime. In the second case the new regime of superradiance – the local field regime – is formed. In this regime the pulse delay time depends on the local field and low-doublet splitting parameters, and the Raman transition leave behind the pulse development.

LASER MEASUREMENTS OF COLLISION-INDUCED DISTORTIONS OF MOLECULAR POLARIZABILITY IN GASEOUS FLUORIDES

A.P. Burtsev, I.M. Kislyakov, Yu.M. Ladvischenko, Yu.M. Sveshnikov

Department of Molecular Spectroscopy, Institute of Physics, Saint-Petersburg State University, Ul'yanovskaya 1, St. Petersburg-Petrodvorets, 198904, Russia. E-mail: burtsev@mol.sp.phys.spbu.ru

This paper deals with the effect of collisions on the molecular polarizability. It is believed that such data are of considerable importance from the points of view of the theory of laser radiation-matter interaction, and practical applications as well. Gaseous fluorides are suitable for studies of refractivity (polarizability) virial effects, as they have very strong absorption in mid-IR region, and the vibrational contribution forms the main (up to 98%) part of the molecular polarizability in the vicinity of the fundamental absorption band. Extremely strong density-caused distortions of the profiles of ν_3 -band of $^{12}\text{SF}_6$, $^{34}\text{SF}_6$, CF_4 were observed [1] that's why the pronounced density dependence of the polarizability may be expected. The nonlinear dependence of refractive index of SF_6 on density was obtained by a two-frequency interferometric method [2] using original measuring procedure. A part of our experimental data is presented in figure a. The calculated spectral behaviour of the second refractivity virial coefficient B_R for SF_6 pure (figure b, 1) is compared with $5 \cdot B_R$ for the SF_6 -Xe mixture (figure b, 2) taken from [3]. The obvious discrepancy demonstrates the resonance character of the polarizability distortion in pure gas. The results shown (curve 1) are in a good quantitative agreement with the experimental data on Br.

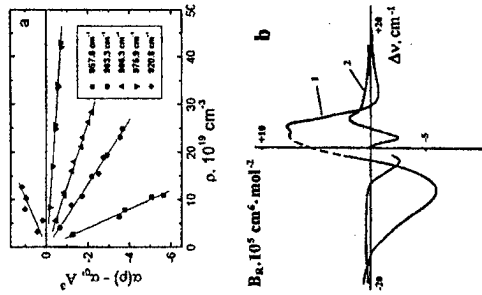

1. A.P. Burtsev, I.M. Kislyakov, T.D. Kolomiitsova, Proceedings of SPIE, V. 4063, p. 224-228, 2000.
2. M.O. Bulanin, A.P. Burtsev, P.Yu. Tretyakov, Opt. Spectrosc., V.69, p. 1285, 1990.
3. M.O. Bulanin, A.P. Burtsev, Yu.M. Ladvischenko, K. Kerl, Mol. Phys., V. 97, N. 12, p. 1233-1242, 1999.

Optically Induced Polarization Rotation and Spontaneous Coherence Transfer in Two-color Laser Spectroscopy of ^{87}Rb

V. M. Entin*, I. I. Ryabtsev, A. E. Boguslavskiy and Yu. V. Brzhasovskiy

Institute of Semiconductor Physics, Russian Academy of Sciences,

pr. Laurentieva 13, 630090, Novosibirsk, Russia, E-mail: ventin@isp.nsc.ru

Spontaneous emission transfer of coherence induced by a strong polarized light in a three-level scheme of open optical transitions [1] can create isotropic or anisotropic distribution of populations of the magnetic sublevels of the final state. This effect can be tested experimentally by an absence or presence of optical rotation of the weak probe wave resonant to another transition from the final state.

We have made the experiments using diode laser polarization spectroscopy of two absorption lines of ^{87}Rb . The strong pump beam ($\leq 0.2 \text{ W/cm}^2$) tuned to the D_1 line was passed through a Rb cell at a small angle to the weak ($\approx 25 \mu\text{W/cm}^2$) counterpropagating probe beam tuned to the D_2 absorption line. The polarization of the probe was set to be 45° to the polarization of the pump, and the rotation was measured using a Glan-Thompson polarizer and two photodiodes.

When the pump beam was tuned to the $5S_{1/2}(F=2) \rightarrow 5P_{1/2}(F=1)$ transition and the probe beam was scanned around the D_2 line absorption spectrum (transitions $5S_{1/2}(F=1) \rightarrow 5P_{3/2}(F=0, 1, 2)$), the observed optical rotation was several times smaller than the rotation in the case of pump beam tuned to the $|2\rangle \rightarrow |2\rangle$ transition and probe beam scanned across $|2\rangle \rightarrow |1, 2, 3\rangle$ transitions. This result was in a good agreement with the theoretical predictions of [1] and thus confirms the spontaneous coherence transfer effect in atoms. The records of the polarization signals will be presented and discussed.

Authors thank A.M. Tumaikin, A.V. Taichenachev, and V.I. Yudin for the basic ideas and fruitful discussions. This work was supported by the RFBR, Grant Nos. 00-02-17924, 99-02-17131, and 00-02-17993.

[1] A.V. Taichenachev, A.M. Tumaikin, V.I. Yudin, and G. Nienhuis, Abstracts of ICAP'2000, Florence, Italy, June 4-9, 2000, p.418.

DAMAGE THRESHOLD OF NONLINEAR CRYSTALS AT 9.55 μm

Yu.M. Andreev¹, V.V. Badikov², V.G. Voevodin³, L.G. Geiko¹, P.P. Geiko¹,
M.V. Ivashchenko⁴, A.I. Karapuzikov⁴, I.V. Sherstov⁴

¹ Institute for Optical Monitoring SB RAS, Russia, Tomsk, andreev@iom.tsc.ru

² Krasnodar State University, Russia, Krasnodar, ntlab@kubsu.ru

³ Siberian Physics-Technical Institute, Russia, Tomsk, voevodin@ic.tsu.ru

⁴ Institute of Laser Physics SB RAS, Russia, Novosibirsk, ir@laser.nsc.ru

Damage thresholds (I_d) of numerous of known, and for the first time AgGaGeS₄ and Cd_{0.35}Hg_{0.65}Ga₂S₄ crystals are determined at identical experimental conditions with parameter stable TEA CO₂ laser operating at 9.55 μm. AlI, but GaSe and CdSe crystals, has orientation for CO₂ laser SHG. Active CO₂:N₂:H₂ mixture was used in high passively stabilized laser with intensive pre-ionization system to generate 0.5J pulses with 3% variations in amplitude (averaged in fine structure), 30±2 ns leading pulse and 12±3% content of ~270 ns "tail" in total pulse energy. Pulse-shape control was carried out with Ge "photon-drag" detector (τ~1ns) and digital oscilloscopes C9-27 (Δf=50MHz, 100MS/s) and TDS-210 (Δf=60MGz, 1GS/s). Damage thresholds were determined by one operator visual detection. Damage intensities of known crystals differ not significantly. GaSe doping is not completed and is resulted in low damage intensity. High damage intensity I_d of new AgGaGeS₄, HgGa₂S₄ (orange and yellow phases) and new mixed Cd_{0.35}Hg_{0.65}Ga₂S₄ crystals can make them preferable in TEA CO₂ and so may be erbium and even holmium laser SHG if account as follows. Phase-matching angles are close to optimum 90° in these negative crystals, they are characterized by smaller optical extinction coefficient and have as high as about 20 pm/V second order nonlinear susceptibility.

Crystal	I_d , MW/cm ²
CdGeAs ₂	242±24
ZnGeP ₂	209±13
AgGaGeS ₄	382±17
AgGaSe ₃	196±9
CdSe	138±10
HgGa ₂ S ₄ (oran.)	607±36
HgGa ₂ S ₄ (yell.)	652±39
GaSe	171±17
GaSe:In (0.5%)	86±5
Cd ₄ Hg _(1-x) Ga ₂ S ₄	670±78
Ag ₃ As ₃	275±33
AgGaS ₂	182±9

The Photon Echo generated in thin-film cavity structures

V.A. Goryachev, S.M. Zakharov

Institute for Microprocessors of the Russian Academy of Sciences,
Block 1, Nakhimovski prospekt, 36, Moscow, GSP-7, 117997, Russia

E.A. Manykin

Nonlinear Optics Department, Russian Research Center "Kurchatov Institute",
Kurchatov Sq. 1, Moscow, 123182, Russia

The theory of interaction of coherent light pulses with thin-film planar Fabry-Perot resonator structures (RS) containing two-level resonant atoms has been developed [1,2]. Computer simulations of dynamic processes indicate that the following effects can be observed in thin microcavities: self-induced transparency, population inversion in the ensemble of atoms at frequencies close to the atomic resonance, generation of a multiple Photon Echoes (PE) with an excess delay close to the photon lifetime in the cavity [3].

Coherent interaction for USP of light with RS displays temporal features in many ways similar to those seen in infinite bulk media. As a result, the temporal response can repeat in direct (stimulated PE) or in mirror-reversed time directions (ordinary two-pulsed PE) the temporal form of one of the exciting light pulses, or can be described by a correlation or convolution function of paired combination of the amplitudes of the exciting pulses. The multiple photon-echoes phenomena in exciting by UPS with "small-areas" in a view of standing waves don't arise in resonator structures. Again, resonator structures may be more efficient in comparison with the bulk media. It is important in the case of holographic systems to form and transform two-dimensional images.

1. Zakharov S.M., JETP, 1995, **81**(3), 452-458.
2. Goryachev V.A., Zakharov S.M., JETP, 1998, **87**(5), 855-863.
3. Goryachev V.A., Zakharov S.M., Manykin E.A., Izv. RAN, Ser. Fiz., 1999, **63**(4), 683-690.

THE MODEL OF IONIZATION OF CONDENSED MEDIUM IN THE FIELD OF INTENSIVE FEMTOSECOND PULSES

Alexander A. Korolev, Saint-Petersburg State Mechanics and Optics
 Sviatoslav A. Stumpf, Saint-Petersburg State Mechanics and Optics
 SPBSIFMO, 14 Sablinskaya st., Saint-Petersburg, Russia, 197101

Since 1980s in notable number of experiments a generation of spectral supercontinuum initiated by high-intensive femtosecond laser pulses have been noticed in different media. Theoretical investigations of this phenomenon require a dynamical model of interaction of laser radiation and medium that correctly describes a dispersion of linear and non-linear medium polarization response in a wide spectral range. In the field of femtosecond pulses with intensity 10^{15} W/cm² significantly increases a role of ionization medium non-linearity.

In this paper we obtain a new wave equation, which includes the description of dispersion and plasma-caused non-linearity and describes effects of propagation of femtosecond pulses with intensity values up to a level of dielectric destruction in transparent condensed media. In case of prevalence of ionization effects this model can be reduced to one given by the theory of multi-photon and tunnel ionization by L. V. Keldysh. It is shown that these non-linearity mechanisms limit self-focusing effectiveness. Obtained model is suitable for medium-radiation interaction effects description in a wide range of field intensity, light frequency, media parameters (i.e., solid body) and so on. Matter equations for the model obtained by methods of quantum mechanic, have been re-formulated in terms of macroscopic medium parameters. Finally they have been taken to a view of system of regular differential equations of second order. The obtained system could be pseudo-classically interpreted as a combination of parametrically associated inharmonic oscillators. We have also built approximations that are based on a concretization of some parameters values. They make possible a significant simplification of a model for practical application.

1. Brodeur A., Chin S.L. Ultrafast white-light continuum generation and self-focusing in transparent condensed media. -- *J.Opt.Soc.Am.B*, 1999, v.16, N 4, p. 637-650.

SIMULATION OF THE PHOTON MEASUREMENT DENSITY FUNCTION FOR A MULTI-LAYERED HIGHLY SCATTERING MEDIUM

I.V. Meglinski
 School of Mechanical Engineering, Cranfield University, Cranfield, MK43 0AL, UK
 S.J. Matcher
 School of Physics, University of Exeter, Exeter, EX4 4QL, UK

We consider the problem of the Photon Measurement Density Function simulation by using the Monte Carlo technique, for the specific cases that the medium contains plane and wavy interfaces between media of different refractive indices [1]. Such interfaces alter the photon density distribution by causing partial reflection and refraction of the photon. One standard method [2] of dealing with this situation is to generate a random number whenever a photon encounters an interface and compare this to the appropriate Fresnel reflection coefficient. Hence a photon definitely only reflects or refracts at the interface. Whilst rigorously correct, this technique has the disadvantage that the whole photon trajectory up to this point is used only for one of the outcomes, whereas both outcomes could be computed simultaneously, more efficient use of the generated photon histories could be made. One way of achieving such "variance reduction" is to allow the trajectory to split into it a reflected and a transmitted part and complete the their subsequent histories simultaneously. Unfortunately this scheme rapidly becomes computationally expansive as multiple reflections will cause the number of such trajectories to grow exponentially. We propose a simple scheme which can, to a good approximation, include the effects of a photon being partially reflected and refracted, without this computational complexity overhead.

[1] I.V.Meglinski, S.J.Matcher, *Medical & Biological Engineering & Computing*, 39, (2001).

[2] L. Wang, S.L. Jacques, L. Zheng, *Computer Methods and Programs in Biomedicine*, 47, (1995).

Laser - Induced Orientation and Population Dynamics in the Antiprotonic Helium

Maria V. Ryabinina, Leonid A. Melnikov

Saratov State University, Saratov 410026, Astrakhanskaya 83, Russia.

e-mail: mvr@vtt.net, phone: 7 - 845 - 2 - 515 - 195, fax: 7 - 845 - 2 - 240 - 446

The metastable antiprotonic helium [1] $\bar{p}He^+$ is a unique object in atomic physics since it provides conditions for new fundamental experiments with antimatter. The results of the numerical modeling of the optical laser-induced transition dynamics is performed taking into account the Zeeman structure of the levels with large angular momentum quantum numbers. For the description of the population and orientation dynamics the equations for the probability amplitudes of separate Zeeman sublevels A_a and B_b of the transition ($n_a=35, l_a=33 \leftrightarrow n_b=34, l_b=32$) were used:

$$\frac{d}{dt} A_a = -\gamma_a A_a + \frac{i}{\hbar} \sum_{q=-l_a, l_a-1}^{l_a} (-1)^q \rho_{b, a+q} B_b \delta(b-a+q) \exp(i\Omega t) E_{-q}(t)$$

$$\frac{d}{dt} B_b = -\gamma_b B_b + \frac{i}{\hbar} \sum_{q=-l_b, l_b-1}^{l_b} (-1)^q \rho_{a, b+q} A_a \delta(a-b+q) \exp(i\Omega t) E_{-q}^*(t)$$

where $a = -33, \dots, 33$; $b = -32, \dots, 32$ are the magnetic quantum number, γ is the relaxation rate of the levels, Ω is Zeeman splitting, $E_{\pm q}$ are spherical components of the field. The orientation of the final states follows automatically from the calculation. Different laser polarizations, pulse width and amplitudes are considered. Hyperfine and super-hyperfine structure of the energy levels can be taken into account in a similar way. It is shown that the optimum pulse amplitude exists leading to maximum number of the atoms in lower state. The orientation of final states is shown to depend on the electric field vector orientation and its polarization. It can be used for the control of these states. The numerical simulation shows that the use of the linear polarization of the laser pulse leads to more pronounced changes of the population of the final state. The transition line shape dependence on laser power is calculated.

This work was supported partially by CRDF grant REC006.

[1] S.N.Nakamura, R.S.Hayano, et.al. Phys. Rev. A, 49 (1994) 4457.

THE PECULIARITIES OF THE SUB-PICOSECOND PULSE INTERACTION WITH BULK DIELECTRIC SAMPLES

T. Smirnova, O. Fedotova, B. Rethfeld*, O. Khasanov, K. Sokolowski-Tinten*, and D. von der Linde*

Institute of Solid State and Semiconductor Physics, NAS Belarus, 17, P. Brovka str., Minsk 220072 Belarus, Phone: +375 172841117,

E-mail: khasanov@ifftp.bas-net.by

*Institute for Laser and Plasma Physics, Universität GH Essen, Universitätsstr.5, Essen 45117 Germany Phone: +49 201 1832656, E-mail: brf@physik.uni-essen.de

We investigate theoretically and numerically the processes occurring when intense femtosecond laser pulses are focused into the bulk of dielectric materials. Experimentally it was found [1] that for femtosecond laser irradiation no indication of plasma formation or catastrophic self-focusing could be seen in the bulk. We compare the results of numerical modeling with experiments. In particular, possible reasons for the absence of laser-induced breakdown in bulk media, as observed in [1] are discussed and the necessity of solving the self-consistent problem for the evolution of both the pulse field and the material parameters is shown. The change of the refraction index leads to self-focusing in the medium, due to normal (Kerr) dispersion. However, if ionization processes contribute, plasma induced defocusing needs to be included. The numerical analysis was based on (2+1) D nonlinear Schrödinger equation taking into account the group velocity dispersion, diffraction, and the polarization change due to non-linear refractive index change, multiphoton absorption and electron plasma formation. We integrate this equation for the conditions similar to those of the experiment [1]. The integration technique was based on the finite-difference method.

[1] D. von der Linde and H. Schuler, *J. Opt. Soc. Am. B*, 13, P.216-222 (1996)

OPTICAL TRANSIENTS IN DENSE RESONANT MEDIA

A.A.Afanasyev^a, R.A.Vlasov^a, O.K.Khasanov^b, T.V.Smirnova^b and D.V.Gorbach^c

^aInstitute of Physics, National Academy of Sciences, 70 F. Skaryna Ave., Minsk 220072, Belarus, Tel: (375 172)840 958; Fax: (375 172)840 888; e-mail: lvp@dragon.bas-net.by

^bInstitute of Physics of Solids and Semiconductors, Academy of Sci., 17 P.Brovka str., Minsk 220072, Belarus, Tel: (375 172)841 117; Fax: (375 172)840 888; e-mail: khasanov@iftp.bas-net.by

^cBelorussian State University, 4 F. Skaryna Ave., Minsk 220050, Belarus

It is well known that in a dense resonant medium near dipole-dipole interaction (NDD) can result in such effects as intrinsic optical bistability and cooperative up-conversion [1]. Here we show that such an interaction has a significant effect on formation of spontaneous responses.

The analytical and numerical solution of the modified Maxwell-Bloch equation system was used to investigate the influence of local field on free polarization decay and photon echo generation by short and long pulses. In the process of the photon echo generation by short pulses when their durations are much less than the both irreversible relaxation times, T_2 and T_1 , there may be observed the echo-signals under standard phase matching conditions and additional ones. These responses are to propagate in the directions ($mk_2 - mk_1$), $n, m = 1, 2, \dots$, but with smaller intensity and different observation times. Conditions are discussed which are necessary for the free polarization decay and the excitation of all photon echo signals. While driving the dense resonant media by a sequence of two long pulses, echo-like signals are generated in the direction of the second pulse. However, they have no phase information about the first pulse and, in fact, are the free polarization decay signals of complicated form.

The up-conversion influence on the photon echo generation is considered. It is shown that the up-conversion process can enhance the echo-signal.

[1] M. P. Hehrlen, H. U. Gudel et al. *J. Chem. Phys.* **104**, 1232 (1996).

LASER FREQUENCY UP-CONVERSION INDUCED BY COLLISION AND POLARIZATION EFFECTS

R.V.Markov, A.I.Plekhanov, and A.M.Shalagin

Institute of Automation and Electrometry, Siberian Branch RAS, Pr. Ak. Koptyuga 1, Novosibirsk 630090, Russia

In recent years a growing interest has been drawn to new schemes of laser action in gases. Especially attractive is an opportunity to achieve population inversion with respect to the ground state. It is the situation that allows one to obtain lasing with a most shortest wavelength.

In our experiment conversion of a monochromatic radiation frequency to a shorter wavelength range was observed in a sodium vapor in mixture with helium as a buffer gas. Driving radiation was tuned to the resonance with sodium D_1 line and had a particular time-polarization arrangement. The radiation pulse consisted of low intensity prepulse with circular polarization and high intensity main pulse with orthogonal circular polarization. Duration of the prepulse is long in comparison with radiative relaxation time while duration of the main pulse is short. Action of the prepulse results in total population being optically pumped into a magnetic sublevel $m = -1/2$ of the ground state $3S_{1/2}$ while another sublevel $m = 1/2$ becomes empty (optical orientation phenomena). Next applied high intensity main pulse equalizes populations of $3S_{1/2}$ $m = -1/2$ sublevel and $3P_{1/2}$ $m = 1/2$ sublevel. Frequent collisions of the sodium atoms with buffer gas particles efficiently mix populations of magnetic sublevels of $3P_{1/2}$ and $3P_{3/2}$. Taking into account that collisions with non-magnetic buffer gas particles do not mix essentially ground state sublevel populations, one obtain population inversion between $3P_{3/2}$ $m = 3/2$ and $3S_{1/2}$ $m = 1/2$ sublevels that corresponds to the sodium D_2 line frequency. Using the physical basis pointed out above for multi-photon excitation, one can achieve population inversion between ground state and highly excited state that leads to up-conversion with a more essential frequency shift.

THE STORAGE EFFECT IN LINE BURNING AT THE INFRARED REFLECTION SPECTRA OF
NATURAL SILICATES INDUCED BY PULSED CO₂ LASER RADIATION

Anel F. Mukhamedgalieva,

Moscow State Mining University, Leninsky prospect 6, Moscow 117935, Russia,

Fax: +7(095)2376488, E-mail: BAM@ULTRA.IMET.AC.RU

Anatolii M. Bondar*

Institute of Metallurgy and Materials Science, Russian Academy of Sciences,

Leninsky prospect 49, Moscow 117911, Russia,

Fax: +7(095)1358680, E-mail: BAM@ULTRA.IMET.AC.RU

It has been established that by action of infrared pulsed CO₂ laser radiation (pulse time of 200 ns, pulse energy of 2 J) on nepheline KNa₃[AlSiO₄]₄ and rodonite CaMn₄[Si₃O₁₃] a stable burning of wide line with the line width of 50 cm⁻¹ and narrow line with the line width of 5 cm⁻¹ in infrared reflection spectra just at the frequency of laser action is appeared. This line burning at the different frequency of laser action has been observed. It has been found also, that this line burning is accompanied by burning of line at region of 520 cm⁻¹ related with low frequency vibration mode. The accumulative properties of line burning have been established. It has been found, that the line burning degree increase with the increase of a number of laser pulses which fall at the samples.

The X-ray emission analysis of irradiated samples has shown, that this burning in IR reflection spectra of samples is accompanied with the selective sublimation of silicon oxides from irradiated surface.

All these dates give the possibility to conclude, that the burning of narrow line connects with the selective breaking of the strong covalent Si-O bonds at the frequency of laser action and the burning of wide line connects with the selective sublimation of Si_mO_n complexes from irradiated surface. The burning of the narrow line with line width of 5 cm⁻¹ represents the burning of homogeneously widened line of Si-O vibrations at the surface of silicates.

ON INFLUENCE OF LOCAL INHOMOGENEITY OF REFRACTIVE INDEX
ON LASER DAMAGE

Vitali E. Gruzdev, Mikhail N. Libenson
State Research Centre "S.I. Vavilov State Optical Institute"
12 Birzhevaya Liniya, St. Petersburg, 199034, Russia

Developing of field instability in transparent microinclusions is the nonlinear effect to be considered in this paper. It is shown that transparent microinclusion can initiate local field increase accompanied by positive feedback resulting in further field increasing near the inclusion. The process is connected with formation of resonant field mode in the inclusion resulting from laser-induced variations of refractive index. Those variations result in increasing of inclusion quality factor in the way similar to the case of field bistability. The key point is sharp step of electric field amplitude in dependence of field amplitude inside the inclusion on electric field amplitude of incident radiation. That points at sharp threshold of instability. The process develops till negative feedback through laser-induced variations of refraction or absorption becomes strong enough to stop field increase and stabilize it at certain level. If the electric-field strength exceeds damage threshold during nonlinear evolution in the inclusion then developing of field instability results in damage of micro-inclusion before electric field reaches the upper level. In that case threshold of laser-induced damage is determined by the threshold of nonlinear process of instability developing. We estimate threshold of field instability to be about 10⁶ V/cm for inclusions of simple geometry (sphere) and consider parametric dependence of the threshold on radiation and material parameters. Approximate estimation of instability threshold is compared with exact solution for the case of plane dielectric layer. It is shown that inclusions with certain parameters can be the most dangerous from the viewpoint of laser damage.

EXCITATION IN THE RUBBER OF THE SOLITONIC-TYPE WAVE OF CHANGE OF REFLECTION AND CONDUCTION.

E.M.Kudriavtsev, S.D.Zotov,
Optical Department, Lebedev Physical Institute of RAS,
117924 Moscow, Leningrad Pr. 53, RUSSIA

Is proved experimentally that in samples from elastic soft polymers such as rubber the IR-laser pulse excites some components of solitonic-type Wave of change of reflection and conduction (WCRC). The arrival of a WCRC results in local temperature decreasing of different rubber samples. The velocity measurement at T_{room} for two different thickness samples of vacuum rubber have given agreeable results- (0,25-0,33 cm/s). They correspond to 19^{th} WCRC component (0,28 cm/s) if to start with tabulated values of a longitudinal speed of sound v_l in rubber and retrieved by us before a ratio between v_l and WCRC components velocities. In crude, not polymerized rubber WCRC also was excited (measured velocity was 0,15 cm/s).

The excitation of WCRC components took place at cooling of vacuum rubber up to ~230 K, and the general nature of record variations has not changed in comparison with records at T_{room} . Measured at 230 K velocity of WCRC components on 35 % is lower measured at T_{room} .

As well as in previous study with plexiglas, in the given work the effect of "saturation" of a new (not irradiated) sample by WCRC components - solitons - was seen. It is visible, that "contrast" of a solitons manifestation is reduced with increase of number of exciting pulses affecting a sample. It confirms availability of such solitonic properties for WCRC as low energy losses at reflections from sample walls.

Presented experimental results also speak about inapplicability of the dislocations recombination mechanism as the universal causes resulting in to WCRC formation, at least, in a concrete case of stuffs such as rubber.

The work was executed at RFBR financial support, project 00-02-17249- (a).

LASER INDUCED RESONANT MULTIPHOTON AND COLLISIONAL IONIZATIONS OF Rb ATOMS.

Bakhranov S.A., Kokkharov A.M., Parpiev O.R., Vaganov E.V.
NPO "Academprigor" AS RU, Akademgorodok, Tashkent 143, Uzbekistan.Tel:
(3712)1628031, E-mail: bahramov@uzsci.net

The main ionization channels of a resonant excited alkali atoms are- multiphoton ionization (low atomic densities and short laser pulses), collisional ionization involving atom-atom collisions and different laser assisted and laser modified processes (for example, associative and laser induced Penning ionizations at long-pulsed or cw laser excitation and high atomic densities).

In our experiments the beam from ruby-pumped dye-laser ($I(2,5 \text{ MW/cm}^2, \tau=0,2 \text{ cm}^{-1}, (25 \text{ ns, linear polarization})$ was passed through a cell with Rb vapor. There is no buffer gas in the cell. A dye-laser was tuned to the rubidium D_1 or D_2 lines at 780 nm and 794,7 nm.

We are registered the absolute ion yield dependence as a function of laser intensity $N_{ion}(I^n)$ for the $5S-5P_{1/2,3/2}$ transitions at different values of vapor density. The Rb vapor density was changed between $10^{10}, 10^{14} \text{ cm}^{-3}$. For $2,5 \text{ MW/cm}^2$ ($I(10 \text{ kW/cm}^2$, we obtained $N_{ion}(I^2)$ (vapor density below than $3(10^{11} \text{ cm}^{-3})$, $N_{ion}(I^{1,8})$ (vapor density $=1,2(10^{12} \text{ cm}^{-3})$ and $N_{ion}(I^{1,6})$ (vapor density $=3(10^{12} \text{ cm}^{-3})$. Subsequent increase of vapor density led to the lesser dependence of N_{ion} on laser intensity I . This experimental fact show that under high vapor density conditions there are mutual competitions of multiphoton and collisional ionizations.

For the analysis of experimental results we used following equation for electron density

$$\frac{dN_e}{dt} = ({}^{(2)}N_{SP} F^2 + (1/2)(\nu N_{SP}^2 F + (1/2)(\lambda \nu N_{SP}^2) \quad (1)$$

where $({}^{(2)}$ is the two photon ionization cross section from $5P$ level in $\text{cm}^4 \text{ s}$, λ is the laser induced Penning ionization cross section for $\text{Rb}(5P)$ atom in $\text{cm}^4 \text{ s}$, λ is associative ionization cross section for $\text{Rb}(5P)$ atom in cm^4 , N_{SP} is concentration of $\text{Rb}(5P)$ atoms in cm^{-3} , F is photon flux in $\text{photon/cm}^2 \text{ s}$ and ν is average relative velocity of atoms in cm/s .

The graphics of the eq.1 were fitted to the experimental results. The best fit gave the values $({}^{(2)}(2,7(10^{-39} \text{ cm}^4 \text{ s}$, $\lambda(5,4(10^{-16} \text{ cm}^2$, $\lambda(4,5(10^{-39} \text{ cm}^4 \text{ s}$ for the $\text{Rb}(5P_{3/2})$ atoms and $\lambda(1,4(10^{-17} \text{ cm}^2$, $\lambda(6,0(10^{-41} \text{ cm}^4 \text{ s}$ for the $\text{Rb}(5P_{1/2})$ atoms.

THE VIOLATION OF PARITY SELECTION RULE IN ATOMIC TRANSITIONS FROM RESONANTLY MIXED STATES

V.V.Suran, I.I.Bondar

Physical Department, Uzhgorod National University, Voloshin str.54, 88000 Uzhgorod, Ukraine

The experimental investigations of effect of resonant mixing of states of three-level system and multiphoton transitions from them under the influence of one and two laser fields were performed. The Ba atoms were investigated. Resonant mixing of ground ($6s^2\ ^1S_0$), first resonant ($6s6p\ ^1P_1^0$) and metastable ($6s5d\ ^3D_2$) states was studied. The radiation of two tunable lasers: dye laser (DL) and laser on color centres (LCC) was used. The frequency of DL was fixed at $\omega_2=18060\text{ cm}^{-1}$ corresponding to one-photon transition $6s^2\ ^1S_0 \rightarrow 6s6p\ ^1P_1^0$. The frequency of radiation of LCC (ω_1) was varied in vicinity of frequency $\omega_{\text{mm}}=8845\text{ cm}^{-1}$ relevant to one-photon transition $6s5d\ ^3D_2 \rightarrow 6s6p\ ^1P_1^0$. The field strengths of DL and LCC were equal to $E=6\text{--}10^4\text{ V/cm}$ and $E=2\text{--}10^6\text{ V/cm}$, correspondingly. The polarization of both radiations was linear with parallel orientation of light vectors.

Under the influence of two laser radiation on Ba atoms the resonant mixing of the states of three-level systems occurs. Resulting this the populations of these three states depend on the value of matrix elements of mentioned one-photon transitions. The estimations show that the population of mentioned above three states must be of the same order of magnitude.

Under the simultaneous action of two laser fields on the beam of Ba atoms except population of all three states the one- and multiphoton transitions from these states can be realized. The investigation of such transitions was performed by the method of measurement of the Ba^+ ions yield, formed in result of ionization of Ba atoms in two laser fields. The result of these measurements shows that in the Ba^+ yield side by side with transitions allowed by selection rules for dipole approach the forbidden transitions are manifested. It must be noted that the amplitudes of maxima caused by forbidden transition are the same as the amplitudes of maxima caused by allowed transitions.

EXPERIMENTAL INVESTIGATIONS OF NONRESONANT MIXING OF ATOMIC STATES BY STRONG LASER RADIATION

I.I.Bondar, V.V.Suran

Physical Department of Uzhgorod National University,
Voloshin str.54, 88000 Uzhgorod, Ukraine

The investigation of perturbation of Ba atoms under circumstances when shift of energy levels is comparable with difference between energies of levels was performed. In particular, the perturbation of $6s5d\ ^3D_1$ and $6s5d\ ^3D_2$ states by radiation of laser on colour centres (CCL) with frequency $\omega_1=8700\text{ cm}^{-1}$ was investigated. Perturbation of these levels by such radiation was strong as the frequency of this radiation is close to frequencies ω_{mm} corresponding to transitions from mentioned above states to $6s6p\ ^1P_1^0$ ($\omega_{\text{mm}}=8845\text{ cm}^{-1}$ for transition from $6s5d\ ^3D_2$ state and $\omega_{\text{mm}}=9027\text{ cm}^{-1}$ for transition from $6s5d\ ^3D_1$ state).

The estimations show that under the increase of laser field strength $6s5d\ ^3D_2$ state must shift more rapidly than $6s5d\ ^3D_1$ and, at some values of ϵ the variation of energy of $6s5d\ ^3D_2$ state will equal to the difference between energies of $6s5d\ ^3D_2$ and $6s5d\ ^3D_1$ states. In result the mixing of these states could set in. For testing of the energies of these levels we used the excitation and subsequent ionization from them. We used the radiation of dye laser (DL) with frequency $\omega_2=17735\text{ cm}^{-1}$ for excitation. During simultaneous action of this radiation and CCL radiation the Raman processes of excitation could be realized.

We have measured the yield of Ba^+ ions as function of frequency of CCL radiation. The field strength of CCL radiation was $5\cdot 10^6\text{ V/cm}$. In this function three maxima take place. The analysis shows that one of these maxima is caused by excitation of unperturbed $6s5d\ ^3D_1$ state. Other two maxima are caused by excitation of mixed in result of strong perturbation of $6s5d\ ^3D_1$ and $6s5d\ ^3D_2$ states. Positions of these maxima on frequency scale are very close and essentially differ from one corresponding to excitation of unperturbed $6s5d\ ^3D_1$ and $6s5d\ ^3D_2$ states. The amplitudes of these two maxima are approximately equal to each other. This finding indicates that the $6s5d\ ^3D_1$ and $6s5d\ ^3D_2$ states are mixed in the case under consideration.

EXPERIMENTAL INVESTIGATIONS OF NONRESONANT MIXING OF ATOMIC STATES BY STRONG LASER RADIATION

I.I.Bondar, V.V.Suran

Physical Department, Uzhgorod National University,
Voloshin str.54, 88000 Uzhgorod, Ukraine
Tel.(+38 03122) 361-87, Fax.(+38 03122) 323-39

Stimulated IR emission by optical pumping of Cs vapour.

N.V. Znamenskii, E.A. Manykin, E.A. Petrenko, M.G. Sitnikov
 RRC "Kurchatov Institute", 123182, Russia, Moscow, Kurchatov sq. 1
 phone: 7-(095)-196-92-81, fax: 7-(095)-196-59-73
 e-mail: zanjia@jissph.kiac.ru

G.G. Grigorian

Institute for Physical Research, 378410, Armenia, Ashtarak-2.

As it well known, generation of high efficiency IR radiation may occur by optical pumping of alkaline-metal vapours.[1,2] In this paper it has been first demonstrated the possibility to obtain the generation at transitions $6^2P_{1/2} - 5^2D_{3/2}$ ($\lambda=3.49 \mu\text{m}$) and $6^2P_{3/2} - 5^2D_{3/2}$ ($\lambda=3.01 \mu\text{m}$) of Cs atom when pumping frequency ω_L of exciting laser was tuning in the range $17020\text{cm}^{-1} - 19200\text{cm}^{-1}$ and $20150\text{cm}^{-1} - 21390\text{cm}^{-1}$.

The dependences of generation intensity on vapour concentration, frequency and pump power have been studied. It has been established that under the condition ω_L coincides with the frequencies of the transitions between the levels $6^2P_{1/2,3/2}$ and upper states, an essential growth in the efficiency of the generation is observed. In exact resonance, excitation threshold did not exceed 30 kW/cm^2 , and quantum efficiency achieved 10%.

Under the same conditions, in addition to generation at atomic transitions $6^2P_{1/2,3/2} - 5^2D_{3/2,5/2}$, generation due to population of higher lying nS ($n=10-21$) and mD ($m=8-23$) levels in the range of other bandwidths is observed.

It has been shown that population inversion between $6^2P_{1/2,3/2}$ and $5^2D_{3/2,5/2}$ levels, inducing generation, is determined by photodissociation of dimeric Cs_2 .

The results obtained can be applied to development of highly efficient compact converters of visible laser radiation to IR range, and also to spectroscopy of high excited S and D states in atoms of alkaline metals.

Literature:

1. N.V. Znamenskii, E.A. Manykin, D.V. Marchenko, E.A. Petrenko, M.G. Sitnikov, G.G. Grigorian Quant. Elctron. V24 №3 p.893-894, 1997.
2. M.G. Sitnikov, N.V. Znamenskii, E.A. Manykin, E.A. Petrenko, G.G. Grigorian Quant. Elctron. V30 №3 p.221-224, 2000.

PROPAGATION OF A COHERENT ELECTROMAGNETIC WAVE IN A MEDIUM WITH CYLINDRICAL PORES

N.L. Cherkas

Belarusian State University of Informatics and Radioelectronics,

p.Brovki, 6, Minsk, 220027, Belarus

Phone: (0172) 2398928, E-mail: cherkas@inp.minsk.by

Under certain conditions the electrochemical anodization of metals leads to the formation of the oxide layer with parallel cylindrical pores on the surface of metal. The optical properties of the porous layer are described by the effective refractive index which could be found from the dispersion equations. The dispersion equations for the effective refractive index for a medium with parallel non-overlapping cylindrical scatterers and for a medium with chaotic distribution of pores (the pores are located randomly and can be overlapped) were deduced in the works [1,2]. In figure it is shown

the dependence of the real and imaginary parts of the effective refractive index of the porous medium with different degrees of pores placement ordering on the normalised frequency, the filling parameter equals to 0,2, the refractive index of material equals 1,65. The wave is assumed to be propagating in direction parallel to the axes of cylindrical pores. The curve (1) corresponds to the pores, placed in non-overlapping circles with radius $R_p=1,72R$, (2) - non-overlapping chaotic pores, (3) - chaotic placement of pores with possible overlapping.

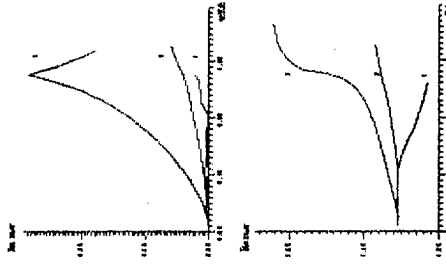

For the calculations the curves 1,2 it were used the dispersion equations from [1], and for the curve 3 it was used the results from [2]. If the ordering becomes more chaotic, the imaginary part of the effective refractive index caused by the scattering of the coherent wave becomes larger. It is maximal for the random and possibly overlapping placement of pores. The real part of the refractive index is also dependent from ordering.

1. Cherkas N.L., Opt. and Spectr., 1996, Vol. 81, № 6, p.906-912 (1990-996 in Russian).
2. Cherkas N.L., Differentialnyye uravneniya, 1999, Vol.35, № 8, p.1111-1113.

Malikov R.F., Hismatullin R.K., Zinatullin M.M.
Bashkir state pedagogical university,
450000, Ufa, str. October revolutions 3A,
E-mail: gen_phys@bspu.ru

Abstract

Maxwell-Bloch equations for modeling of the process of the superradiance were used.

$$\frac{\partial A^z}{\partial t} = \frac{1}{L} G(\Delta) R^z(\Delta) d\Delta,$$

$$\frac{\partial R^z}{\partial t} = (-g_2 \pm i\Delta \tau_R) R^z + A^z (\rho_{22} - \rho_{11}),$$

$$\frac{\partial \rho_{22}}{\partial t} = g_{33} \rho_{33} + A^- R^+ + A^+ R^-,$$

$$\frac{\partial \rho_{11}}{\partial t} = -g_{11} \rho_{11} - (A^- R^+ + A^+ R^-),$$

$$\frac{\partial \rho_{00}}{\partial t} = g_{11} \rho_{11} - \Lambda \rho_{00}, \quad \frac{\partial \rho_{33}}{\partial t} = -g_{33} \rho_{33} + \Lambda \rho_{00},$$

here A^z , R^z - slowly-changing field amplitudes and polarizations, ρ_{00} , ρ_{11} , ρ_{22} , ρ_{33} , - populations of levels, Λ - pump, $g_{33} = \gamma_{33} \Omega$ - a parameter, describing the electron transition from the level 3 to the metastable level 2, $g_{11} = \gamma_{11} \Omega$ - describing the electron transition the first level to the level one, g_2 - a transverse relaxation.

The dynamics of superradiance pulse as a function of the value of the pump is shown on the fig.1. Self-oscillation mode takes place in the active environments with the weak relaxation population of the lower laser level. When the parameter (g_{11}) is increased the transition from the self-oscillation mode to the nutation mode of superradiance is observed.

The dynamics coherent amplification of the ultrashort light pulses, which depend on the pump value, has been investigated. The effect of relaxation on the dynamics of superradiance and coherent amplification under incoherent pump has been studied.

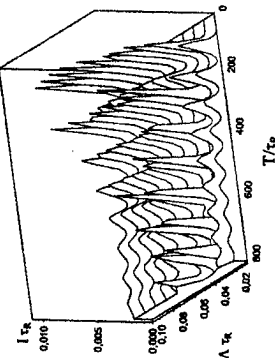

Fig.1. The dynamics of the intensity of the superradiance as a function of the pump value. $L = 5 \text{ cr}_k$, $\gamma_{33} = 0.3 \text{ cr}_k^{-1}$, $\gamma_{11} = 0.008 \text{ cr}_k^{-1}$, $\text{Re}(R^z_0) = 0.001$, $g_2 = 0.0$

Laser induced mechanoluminescence of thin metallic film surface.
A.F. Banishev, V.Ya. Panchenko, A.V. Shishkov

PLIT RAN - Institute on Laser and Information Technologies,
Russian Academy of Sciences, 140700 Shatura, Moscow Region, Russia
Fax: (096-45) 2-25-32, E-mail: banishev@laser.nictl.msk.su

SUMMARY

Diagnostics of defects in opaque solids presents considerable difficulties. The diagnostic techniques used to date (X-ray diffraction methods, tunnel microscopy, etc.) have low time resolution and involve problems in studying motion and interaction of defects. One of suitable methods allowing defect interaction to be studied in real time is built upon the use of mechano-emission phenomena. It has been known that the defects (vacancies, dislocations, impurities) contained initially in the material become mobile under high thermoelastic stresses. Interaction between defects and rising of them on the surface may be accompanied by weak glow (triboluminescence or mechanoluminescence) or by emission of particles (triboemission), electrons, ions, atoms, etc. These phenomena can be used in diagnostics of processes of defects emergence, motion and accumulation, being causes for material surface destruction. In this connection, the necessity arises of detailed investigation of these processes.

The aim of this work is to study mechanoluminescence (ML) of metallic films that was excited by thermal stresses induced by laser pulses. A pulsed YAG:Nd laser ($E \sim 3.5 \text{ J}$, $\tau \sim 1.4 \text{ ms}$) was used in investigations. Laser radiation was focused to a spot of 3 to 5 mm diameter. ML signal was picked off the back (relative to laser radiation) side of the sample. All the experiments were made in vacuum chamber in order to eliminate a possible influence of thermo-chemical processes on the surface, related to atmosphere. The pressure in vacuum chamber was $P \sim 10^{-2} \text{ Torr}$. Mechanoluminescence of metallic films (Al, Ti, Mo, Cu) was studied, their thickness being 1.5 to 2 μm .

It is reported in the literature that ML of metals is due to annihilation of mobile dislocations or to their rising on the surface under mechanical or thermal stresses. Though for thin (1.5-2 μm) fine-grain metallic films the presence of mobile dislocations in the volume is unlikely. So, the ML observed by the authors is probably not related to dislocations, but is of different nature. ML may be possibly caused by rearrangement of energetic states of surface atoms (or atomic groups) or inter-grain bonds as a result of thermal deformation.

GENERATION OF CASCADE STOKES AND ANTISTOKES COMPONENTS
BY STIMULATED RAMAN SCATTERING IN GASES

A.V. Andreev, A.A. Valeev

Physics Department, Moscow State University, Vorob'evy Gory, Moscow 119899 Russia
Phone: +7-095-939-30-92, e-mail: valeev@cha.ru

Here we discuss the results of theoretical study and computer simulations on cascade Stokes and anti-Stokes component generation by stimulated Raman scattering in molecular and atomic gases. The specific features of spatio-temporal dynamics of generation are discussed.

It is shown that the generation of high-order Raman components in strong synchronism conditions became possible only if we take into account the dispersion of the nonlinear susceptibility. In a steady-state case the analytical expression for integral intensity of Stokes and anti-Stokes components as a function of Raman-active medium length has been obtained. An analysis of the obtained equations shows that the generation of high-order Stokes and anti-Stokes components in strong synchronism conditions occurs only at population inversion between the Raman active medium levels. On the other hand the results of computer calculations shows that outside the synchronism conditions the generation of cascade Stokes and anti-Stokes components became effective even in steady-state case.

It is shown that the set of equations for integral intensity of Stokes and anti-Stokes components and intercorrelation function has analytic solution in a form of soliton. Dynamics of propagation of self-similar pulses has been investigated numerically. This enables us to describe the dependency of the generated spectrum characteristics as a function of the pumping pulse parameters.

The analytic solution of the above-mentioned equations has been obtained in a transient case for plane-wave and first order dispersion approximations. The profile of the integral field including the whole Stokes, anti-Stokes and pumping components has a form of the phase-modulated pulse. The possibility of synchronization of the different spectral components and pulse compression in the dispersive medium is discussed. The minimal values of the compressed pulse temporal width are estimated.

THE INFORMATION APPROACH TO LIGHT-INDUCED DRIFT

O. A. Chichigina

M. V. Lomonosov Moscow State University, 119899 Moscow, Russia
E-Mail: chichigina@squeeze.phys.msu.su

The light-induced drift was predicted in [1] and has now been well studied [2]. The crux of the effect is that there appears a directed macroscopic flux of absorbing particles, which interact with a traveling light wave and undergo collisions with buffer-gas particles. Most experiments on light-induced drift have been performed with alkali-metal vapors in an inert-gas atmosphere. It is shown that the entropy decrease in the system of atoms is much smaller than the entropy increase in the system of photons. The total entropy increases, and the process is irreversible. However, the atoms can be studied separately. The ideal-gas model is quite applicable to the mixture. The interaction cross section (which changes when a photon is absorbed) does not appear in the equations describing the behavior of the thermodynamic parameters. Hence it can be assumed that this ideal gas is not subject to external perturbations and that the system is thermodynamically isolated. The entropy and internal energy of such a system do not change. But the light-induced drift itself testifies that the entropy decreases, since part of the internal energy is converted into ordered motion, as a result of which the temperature decreases. This contradiction can be resolved by keeping in mind that the light adds to the system information about the direction of motion of the particles. Light appears to mark the atoms moving in a prescribed direction. Then the entropy decrease in the system does not exceed the amount of information entering the system.

In [3] a generalized formulation of the second law of thermodynamics is proposed for an equilibrium process in isolated system $dH = dI$, where I is the information. The term dI is added in connection with the discussion of the influence of the so-called Maxwell's demon. An important result is that agreement with the experimental data [3] is achieved neglecting many seemingly important factors, for example, neglecting the change in the scattering cross section of an atom on absorption of a photon or neglecting the real, complicated structure of the energy levels of atom. This is because the drift velocity is expressed in terms of the thermodynamic parameters and therefore cannot depend on many "model refining" parameters, just as it does not depend on the positions and velocities of each particle.

1. F. Kh. Gel'mukhanov and A. M. Shalagin, JETP Lett. **29**, 711 (1979).
2. P. H. G. C. Werij and J. P. Woerdman, Phys. Rep. **169**, 145 (1988).
3. R. L. Stratonovich, *Information Theory* (Sovetskoe radio, Moscow, 1975).

HARTY-FOCK SEMICONDUCTOR BLOCH EQUATIONS
AND CHARGE DENSITY CORRELATIONS

A. Klyukonov

Dep. of Physics, State University of Moldova, 60 Mateevici, Kishinau 2009, Moldova

N. Loiko

Institute of Physics, NAS, 70 Skaryna Ave., Minsk 220072, Belarus

Projection operator, equations of motion methods or Green's function formalism are successfully used to describe optical properties of semiconductors. But physical mechanisms and results obtained by these different methods are various drastically. Especially it concerns coherently driven plasmons in highly excited semiconductors. Our aim is to draw together these different approaches and derive equations of motion which allow to include multiquantum optical processes into the consideration. Using fluctuation-dissipation theorem to calculate four operator expectation values like density-density correlators $\langle \rho_1 \rho_2 \rangle$ with account of coherent memory effects, we have obtained the general equations. For polarization they are:

$$[i\hbar \frac{d}{dt} - e_k(t) - h_k(t)]P_k(t) = [f_k^+(t) + f_k^-(t) - i]K_k(t) + \frac{i}{\pi} \int_0^t dt_1 \sum_{\kappa} v_{\kappa} \int d\omega \text{Im} \left\{ \frac{\epsilon_{\kappa}}{\epsilon(\kappa, \omega)} \right\} e^{-i\omega(t-t_1)} [C_{\kappa}(t) - C_{\kappa, \kappa}(t_1)],$$

$$C_{\kappa}(t) = [\varphi_{k, k-\kappa}^{\#}(t) + \varphi_{k, k-\kappa}^{\#}(t)]P_{k-\kappa}(t), \varphi_{k, k-\kappa}^{\#}(t) = [n_{\kappa} + 1 - f_{\kappa}^+(t)]G_{k, k-\kappa}^{\#}(t - t_1).$$

$$G_{k, k-\kappa}^{\#}(t - t_1)$$

is the Green function of the equations of motion. The rest notations are standard. Interactions with mixed plasmon-phonons modes and excitonic effects are taken into account. Comparison with different others theoretical approaches are made. Numerical calculations of gain spectra and spontaneous radiation produced by interband multiplasmon recombination of electron-hole pairs are carried out in dependence on the temperature and plasma concentration. It is shown that the intensity maximum of spontaneous radiation shifted to the region of the first LO-phonon satellite with increasing of concentration in accordance with experiments.

The authors thank Prof. S. Koch for fruitful discussions.

STATISTICAL PROPERTIES OF QUASINEERGY SPECTRUM FOR A SYSTEM
OF COUPLED QUANTUM STATES IN A QUASIMONOCROMATIC FIELD

V. S. Starovoitov, V. V. Churakov

B.I.Stepanov Institute of Physics, NBAS, Scorina ave. 68, 220072 Minsk, Belarus.

The dynamical thermalization effect due to state-state interaction for quantum many-state systems to be exposed to external field (including laser one) is of a special interest for various areas of modern physics. In the work we study statistical properties of the quasienergy spectrum for a generic two-level system (the states $|0\rangle$ and $|1\rangle$), the upper state $|1\rangle$ of that is coupled with a band of states $\{|n\rangle\}$ in the presence of a quasimonochromatic field. We apply a Random Matrix Theory approach (the zero-order energies for the band states and the state-state interaction strength are random numbers) and determine the shape and the inverse participation ratio of the Fourier transform C_{ω} for the correlation $C_t = \text{Re} \{ \langle \varphi(t) | 0 \rangle \}$. The lowest state $|0\rangle$ is an initial state of evolution. The halfwidth γ for the C_{ω} contour gives the coherence decay rate. The state-state interaction is specified in terms of the halfwidth $\gamma_0 = L/(2\rho)$ of Lorentzian-shaped spread over eigenenergies for the state $|1\rangle$ in the absence of field (L is the ergodic localization length, ρ is the mean density of zero-order states).

The disorder averaged shape of C_{ω} is well described by the contour obtained for a two-level system with irreversible losses (TLIL) exposed to a monochromatic field. Similar to TLIL the system shows an aperiodic (the Rabi frequency $\Omega < \gamma_0$) or oscillating ($\Omega > \gamma_0$) temporal behavior for C_t . At a strong field ($\Omega > \gamma_0$) the quantity γ equals $\gamma_0/2$ (dynamical localization, $L > 1$) or $\gamma_0/2^{1/2}$ (perturbative localization, $L < 1$). In a weak field ($2\Omega < \gamma_0$) the rate γ exhibits a quadratic dependence on Ω ($\gamma \approx \Omega^2/(4\gamma_0)$) if $L > 1$ and $1/\rho < \Omega < \gamma_0$). With increasing L the Ω -dependence for γ approaches asymptotically a curve given by the TLIL model to be characterized by continuous quasienergy spectrum with $L \rightarrow \infty$. The quadratic Ω -dependence of γ can be explained as a manifestation of 'classic'-like behavior for the mesoscopic system. The linear Ω -dependence for γ ($\gamma < \Omega$ at $\Omega < 1/\rho$ or $L < 1$) is associated with the quantum nature of the considered system.

COHERENT STATES FOR THE SELF-CONSISTENT PROBLEM ON
DIRAC PARTICLE IN A STRONG MAGNETIC FIELD

H. Grushevskaya and G. Krylov
Department of Physics, Belarusian State University
4 Fr. Skaryny av., Minsk, Belarus

Nonlinear quasi-Hamiltonian systems describe the systems behaviour in an external field. One of such a system, having important applications is Dirac problem for the electron in the vicinity of ionization threshold in strong oscillating magnetic field. The reorientation of electron's orbital as a possible reason of photodissociation will not lead to the complex defragmentation as the vibrational and rotational relaxation times are much longer than the excited state's life time. In such processes one have to probably on quasi-steady states. The purpose of a given work is to demonstrate that such quasi-steady states can be represented in the form of an expansion on coherent states of Dirac electron moving in self-consistent atomic potential, and to construct asymptotic solutions describing highly excited atomic states in the vicinity of ionization threshold in a strong self-consistent oscillating magnetic field.

With this goal we consider the second order Dirac equation describing the electron wavefunction ψ in a self-consistent vector-potential of an atom in a strong external axially symmetric magnetic field. We demonstrate that self-consistent atomic vector-potential \vec{A} functionally depends on bilinear form $\langle \psi, \psi \rangle$.

The solution of the problem considered via subsequent approximation method. In the case of dynamical symmetry we construct the an explicit expression for the nonlinear term N , proportional to \vec{A} . This allows to give the following explanation of the behaviour of the highly excited states of atoms in a strong oscillating magnetic fields. Zeeman splitting is a reason of diamagnetic response, the last in its turn change the character of Zeeman splitting up to the stability break. As a result the behaviour of an atom near ionization threshold in a strong magnetic field can be explain through the influence of diamagnetic effects on Zeeman splitting.

As a result the infinite chain of coupled equations has been constructed where every equation is the known problem on fermion's pair creation in an external uniform oscillating magnetic field. The solution of this system known as a coherent states $|\alpha(t)\rangle$ of a quantum system with dynamical symmetry described by the rotation groups $SO(3)$ or $SO(4)$. It is proved that self-consistent coherent states $|\alpha(\psi)(t)\rangle$ are the functional of a bilinear form $\langle \psi, \psi \rangle$ and asymptotic method for construction of the coefficients $\alpha[\psi](t)$ is proposed for the levels near the ionization threshold based on standard jet technique.

For evolutionary equations with jets' interaction we demonstrate that there is a codimension-two bifurcation leading to the period doubling bifurcation scenario to deterministic chaos.

Slow laser-induced deformation-thermal and defect-deformational solitons in thin solid films.

V.I.Emelyanov, A.V. Rogacheva

Physics Faculty of Moscow State University, 119899 Moscow, Russia
e-mail: emel@em.msk.ru

We propose the mechanism and develop the theory of slow (velocity of order of several cm/sec, or less) solitons of a new type: deformation-thermal (DT) and defect-deformational (DD) solitons, propagating steadily in a solid with constant strain gradient. The velocity of such solitons is proportional to this strain gradient. The DT and DD solitons are described by similar modified Cortevge-de-Vries (CdV) equations, excited by action of laser radiation on surface of strongly absorbing solid films and propagating from the surface into the bulk of material. DT solitons are piles up of thermal phonons captured in self-consistent deformation well. The steady state propagation of DT solitons occurs due to mutual cancellation of thermal diffusion and deformation-induced thermal fluxes. Similar DD-solitons are piles up of point defects captured in the self-consistent deformation well. It is shown that the conditions of DT and DD solitons propagation are automatically arise under the action of laser radiation on the surface of strongly absorbing solid films. The laser-generated defects (vacancies) leads to the bending deformation of the film accompanied by appearance of constant positive deformation gradient along the normal to the surface. The propagation of DT and DD solitons along this gradient leads to nondiffusional long-range transfer of heat and matter (defects) from the laser excited solid into the bulk of the film. The shape, size and velocity of DT and DD-solitons are obtained from the solution of the modified CdV equation. Recent experiments demonstrating long range heat and matter transfer in solid films and plates are discussed from the view-point of the developed theory.

THE EFFECT OF ION FORMATION AND EMISSION FROM LIQUID WATER UNDER IR LASER VIBRATIONAL EXCITATION OF H₂O

A.A. Chistyakov, D.V. Klotchkov, G.E. Kotkovskii, A.S. Nalobin, E.S. Tanamina

Moscow State Engineering Physics Institute (Technical University)

115409, Moscow, Kashirskoe str., 31, tel.: 3229103, e-mail: klotch@mail.ru

We use Ion Mobility Spectrometry (IMS) method for ion registration, that permit us to investigate the processes of ion formation and emission, taking place at ambient conditions under the action of laser radiation on liquid water and water solutions.

We investigate the effect of ion emission from double-distilled water under intensive IR resonant pulse laser radiation. As the laser source we use optical parametric oscillator (OPO) tunable in wavelength range of $\lambda=2,6-3,7 \mu\text{m}$. This wavelength range corresponds to OH-stretch vibrations of water molecules. It was discovered that IR laser excitation of water leads to ion emission from water. This effect was observed in range of $q=5-20 \text{ MW/cm}^2$ of laser radiation intensities. Corresponding ion mobility spectra demonstrate that main contribution in ion spectra is assigned with ion's mobilities $\mu=0,7$ and $\mu=0,33 \text{ [cm}^2/(\text{V}\cdot\text{s})]$. Thus we conclude that observed ions are not water or water clusters ions ($\mu=1,8-3$), contra mobilities less than $\mu=1$ correspond to large molecules, with molecular weight more than 500. The dependencies of ion mobility spectra on the radiation wavelength and radiation intensity were recorded. It was detected that there is the optimum intensity for any radiation wavelength at the maximum ion emission. Furthermore, our experiments show that ion spectral distribution depends on the laser radiation intensity. Laser radiation wavelength tuning demonstrates that in the case of hydrogen-bonded water molecules excitation (low frequency range of inhomogeneously broadened absorption band of water) the effect of ion emission happens much greater than in the case of non-bonded water molecules, whereas linear absorption magnitudes being equal.

Our experiments carried out with water and de-ionized water demonstrate that observed ions are not ions, present in water, but form under the resonant laser radiation as a result of charge transfer from water molecules to impurity molecules.

NONLINEAR SUSCEPTIBILITIES OF AIIIBV SEMICONDUCTORS IN FAR INFRARED AND MICROWAVE RANGE

Moisseenko E.V., Shepelev A.V.

A.N. Kosygin Moscow State Textile University

Development of nonlinear optics in long-wave range, stimulated by creation of corresponding sources of intensive radiation, causes necessity of calculation of non-linear susceptibilities and search for substances with high non-linearity. In the long-wave range optical properties of semiconductors are mostly defined by free carriers, i.e. semiconductor plasma. Significant optical non-linearity of the plasma allows to expect high values of nonlinear susceptibilities of semiconductors in long-wave range.

In our work an approach to definition of nonlinear susceptibilities of semi-conductors in long-wave range is developed and susceptibilities of a set of AIIIBV semiconductors are calculated. The method is based on the account of dependence of pulse relaxation time τ and carriers energy on the external field. In assumption of quasi-thermalization, temperature of carriers T_e depends on external field E that allows to present dielectric permeability ϵ as $\epsilon = \epsilon(\tau(T_e(E)))$ and to expand it to series on degrees of the field. Finding of an explicit form of dependence of $\epsilon(E)$ requires an account of a set of carriers relaxation processes. Basic of them for AIIIBV semi-conductors are scattering on ionized impurities, on acoustic and polar optical phonons.

Calculations of nonlinear susceptibility χ_3 for GaAs, InP, InSb, GaP, InAs were done, which found out high values of χ_3 . Figures show dependencies of χ_3 on frequency ω , temperature T , and carriers concentration N .

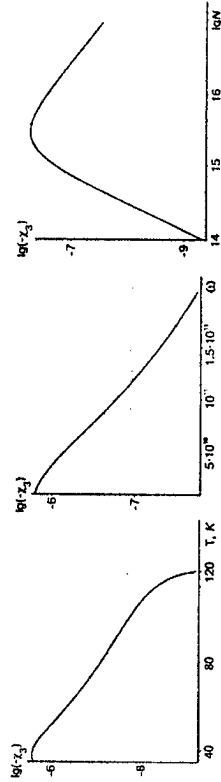

OPTICAL SUPERRADIANCE AND REVERSED FREE-INDUCTION DECAY
IN VAN VLECK PARAMAGNET

V. V. Samartsev, A. A. Kalachev and V. A. Zaitkov

Kazan Physicotechnical Institute, Sibirskii trakt 10/7, Kazan, 420029 Russia

Phone: (8432)763681

e-mail: samartsev@kfti.knc.ru

This paper reports on the first experimental observation of phase-conjugate free photon induction decay in a $\text{LaF}_3:\text{Pr}^{3+}$ crystal. In fact, we deal with a four-wave mixing regime when observing this phenomenon, since a pulse of a standing wave can be considered as a superposition of two counterpropagating pulses of a running wave. The fact that a $\text{LaF}_3:\text{Pr}^{3+}$ crystal is employed as a resonant medium is very important for practice, since this crystal holds much promise as a data carrier for optical processors. A demonstration of multiple reading of PCPID signals using one of the signals forming the standing wave as a reading pulse would be very important for the implementation of optical data-storage devices and optical phase processors. This regime will be also analyzed in this paper.



An oscilloscope trace of the phase-conjugate photon induction decay signal from a $\text{LaF}_3:\text{Pr}^{3+}$ crystal (right) excited with three 10-ns pulses.

Varying parameters (the duration and the power) of the pump pulses and the intervals between these pulses and choosing appropriate parameters (the optical density) of the resonant medium, one can examine the kinetics of the signal reflecting the alternation of the regimes of four-wave mixing, phase-conjugate photon induction decay, phase-conjugate photon echo, and optical superradiance.

HIGH POWER LASER DIODE ARRAYS ON DIAMOND HEAT SINKS

Batay L.E., Kuzmin A.N., Nikeenko N.K., Paraschuk V.V., Ryabtsev G.I.

Stepanov Inst. of Physics, F. Skaryna Ave. 70, 220072 Minsk, Belarus

Fax: +375-17/2840-879, e-mail: ryabtsev@dragon.bas-net.by

Latest achievements in the field of the heterostructure epitaxy growth create the necessary prerequisites for fabrication of single laser diode chips or laser diode arrays with output power up to tens or even hundreds watts in a continuous wave operation regime. Obtaining high output power values for that light emitters deals directly with a solution of the problem of heat spreading from an active layer of a laser diode heterostructure. Modern types of heat sinks on the base of diamond substrates and heat micropipes with a thermal conductivity as high as 2.5-5 times greater than that for copper provide an effective spread of the thermal energy. This leads to decreasing the operation temperature of the active layer and enhancing the laser diode emitter life time.

We demonstrate the possibility of decreasing of laser diode array thermal resistance and an increase in an output radiation power by applying the diamond heat sink substrates on the base of «Almazot» - type synthetic material.

Conditions for optimal heat exchange between the powerful laser diode array heterostructure and diamond-type heat sink have been determined using a computer modeling approach. Technology of metallization of the «Almazot» heat sink with utilization of high adhesive Ti-Ni coating layers has been developed. It has been shown that despite of some decrease in the thermal conductivity value after the metallization procedure, the «Almazot» - type synthetic materials metallized by the ion-beam evaporation method surpass essentially the copper heat sinks in the thermal properties.

Spectral and power-current characteristics of the laser diode arrays assembled on «Almazot» - type heat sinks are displayed.

The work presented was made under partial financial support from the ISTC project # B-082-97.

CRYSTAL GROWTH FOR IR-RANGE LASERS.

V.N. Matrossov, T.A. Matrosova, E.V. Pestryacov, V.V. Petrov.

Belarusian State Polytechnical Academy

Partizansky Ave. 77, Minsk, 220107, Belarus

Phone/Fax: (375 17) 245 53 11 ; E-mail: ph2028@belsinet.net

Works of alexandrite ($\text{BeAl}_2\text{O}_4:\text{Cr}^{3+}$) and berillium hexaluminate ($\text{BeAl}_6\text{O}_{10}:\text{Cr}^{3+}$) high optical quality crystal growing are planned to be accomplished under the Project ISTC # B-263.

Alexandrite lasers found broad application in medicine: photodynamic cancer therapy, blood purification during AIDS treatment, skin and hypodermic tissue therapy, hair epilation. Besides, the company "Light Age" produced first tunable alexandrite lasers with diode pumping as well as laser with double frequency effect, operating at 720nm to 190nm. However, there are some obstacles which prevent their wide introduction to practice. These are beam break-down (low beam strength of crystals), absorption nonuniformity of pumping energy along the crystal length, low optical quality. All above-mentioned problems are closely related to crystal growth process and can be diverted with the development of appropriate technology for their obtaining. Particularly this is the leading aim of the Project.

Berillium hexaluminate is a new crystal. We were the first who obtained it. Its tunable range in comparison with alexandrite removed to IR-range. Crystal can be effectively pumped both by diodes ($\lambda = 650\text{-}670\text{ nm}$) and by lamps.

It's leaked out that maximal therapeutic effectiveness is reached thanks to laser radiation affect of the following wavelength : 0,8-0,95 mkm ; 0,63-0,69 mkm; 0,45-0,59 mkm; 0,25-0,3 mkm. $\text{BeAl}_6\text{O}_{10}:\text{Cr}^{3+}$ laser with frequency doubling get into these regions, so it will be very prospective for medical application.

Moreover, spectra-generation characteristics of these crystals allow to use them in the same resonator. This hybrid laser will help to obtain tunable generation from 700nm to 1000nm and broaden ability of the practical use significantly.

Both crystals are grown by Czochralski technique from iridium crucibles in neutral atmosphere.

The paper carefully considers the reasons of above-listed defects forming in crystals and gives methods how to get rid of them.

The final result of work process under the Project ISTC # B-263 is the development of obtaining technology for high quality above-mentioned crystals with optical losses at maximum generation wavelength less or equal to $0,002\text{ cm}^{-1}$.

DEVELOPMENT OF THE COMPACT IR GAS LASERS

Orlov L. N., Gaiko O.L., Necrashevich J.L., Nevdiakh V.V., Churakov V.V., Gorobetz V.A., Petuchov V.O., Yasinskii V.M., Gudelev V.G., Zhurik Ju.P.

Institute of Physics, National Academy of Sciences of Belarus; 70 F.Skaryna ave., 220072 Minsk
Phone: (017)284 0432; e-mail: orlov@dragon.bas-net.by

There were investigated and developed several new designs of compact IR gas lasers for different applications:

1. It has been investigated the properties of a RF discharge plasma in various conditions and tubes configuration; it was shown that the spatial structure of a discharge essentially depends on frequency of RF field, but the width of the sheath is almost independent on it; it sufficiently differs from the theoretical predictions. As well it was offered a new resonator configuration for slab-lasers, which is formed by two extended high-reflective mirrors, inclined one to the other at the small angle and exterior semitransparent output mirror. On this base it were manufactured 2 new variants of the RF pumped slab CO₂ lasers with the CW output power up to 5 and 35 W and developed a high power gas-flow CO₂ lasers with transversal middle-frequency pumping.

2. The CW CO₂ (CO) laser with automatic tuning over great quantity of lasing lines and stabilized output have been created. The laser could be switched from CO₂ to CO by replacing the discharge tube. As well the system for the second harmonic generation of such laser radiation in new nonlinear crystals AgGaSe₂ and ZnGeP₂ has been developed. The opportunity of independent work of each block and joint work of the whole laser system with PC control is supplied. The laser is completed by the interface and software.

3. A lot of two-frequent IR gas lasers were investigated both theoretically and experimentally: helium - neon lasers with $\lambda = 1.52$ and 3.39 microns, the experimental models of linear CO₂ laser with Faraday cell in the resonator and ring CO₂ laser with the four-mirror nonplanar resonator are. It was proved the opportunity of realization of stable two-frequency regime of oscillation of orthogonal polarized modes both in absence of a magnetic field, and in the orthogonal transversal magnetic fields. It is experimentally shown that in the CO₂ laser the interaction of waves with circular orthogonal polarizations is much weaker, than with linear orthogonal polarizations.

DYNAMICS OF A LASER WITH NONLINEAR INTERNAL REFLECTION IN A RESONATOR

A.N. Rubinov, I.M. Korda

B.I. Stepanov Institute of Physics, National Academy of Sciences of Belarus

F. Skaryny prospect 68, 220072, Minsk, Belarus

Tel.: 375 (017) 284-26-29, Fax: 375 (017) 284-16-46

E-mail: rubinov@ifanbel.bas-net.by

The ISTC project B-479 is devoted to the investigation of the gradient laser fields influence on biological objects. There are different ways how to produce high gradients of laser intensity. One of them is connected with use of the internal reflection from the border of some transparent dielectric and liquid. Of a special interest is a case of a strongly absorbing liquid. Due to the absorption of the refracted beam in a liquid the temperature of the last is gradually increasing until it reaches the value corresponding to the critical angle of the total internal reflection at the border. Thus the nonlinear mirror may be created on this phenomenon. On the other hand the strong gradients of laser field, temperature and pressure may be created near the border using this phenomenon.

We have considered the dynamics of a laser with nonlinearly reflecting mirror inside a resonator based on the nonlinear internal reflection. The model has been developed which takes into account all main factors of importance: the absorption of the refracted laser light in a liquid near the border, the heat conduction at the boundary of liquid and a dielectric, the pressure dynamics in the heated zone, the compression of refracted light with the change of temperature and finally the change of the reflection at the border and it's influence on the dynamics of a laser as a whole. Possibility of cooling the liquid zone by using materials with high thermal conductivity such as sapphire is considered.

Results of experimental measurements of laser dynamics, obtained for the Nd:glass laser illustrate the main dependencies observed at computer calculations.

The work is supported by ISTC Project B-479

TWO-COLOR AUTOMATED GAS LASER FOR IR LIDAR
TUNED OVER BROAD SPECTRAL RANGE

I. M. Bertel¹*, V. V. Churakov, V. O. Petukhov,

Institute of Physics of NASB, Scaryna Ave. 68, Minsk 220072, Belarus

**State Medical Institute, Grodno, Belarus*

Tel/Fax 375-017 2841111, e-mail: churakov@dragon.bas-net.by

The IR range is attractive for atmosphere monitoring as there are distinctive absorption bands of practically all known molecules and enough wide transparency windows of atmosphere. The literature analysis and experience of the Project participants show that there are important problems preventing progress in this field.

1. The limited number of detected gases for every IR laser due to finite number of accessible oscillation lines.
2. Technical complications of differential measurements under condition of "frozen" atmosphere (generally accepted time is about 10 μ s) on two oscillation lines ("on line" and "off line") having different absorption for the detected gas.
3. The absence of full automation of lidar measurements that results in additional errors and increased requirements to staff qualification. This Project is directed to solve these problems.

It is suggested to use the same active medium and the same laser output mirror for pulses with different wavelengths. The using of relatively orthogonal polarizations for separation of two different wavelengths and new optical element (window-mirror) allow to organize two independent cavities. Each oscillation channel has electronic-mechanical tuning unit with computer control for oscillation frequency tuning. Smoothly controlled losses in both channels provide delay between oscillation pulses from 0 to 10 μ s. Owing to special laser construction the working particles of active medium can be molecular (CO_2 , CO, N_2O) and noble (Xe, Kr, Ar, Ne) gases and their mixtures that provides many oscillation lines in the range of 1 – 12 μ m.

The two-color laser will be tested in lidar measurements basing on the specially developed methods.

ELABORATION OF PHYSICAL FOUNDATIONS AND TECHNOLOGIES TO
MAKE LOW-VOLTAGE LIGHT MODULATORS BY POLYMER DISPERSED
LIQUID CRYSTAL MONOLAYERS WITH INTERFERENCE ENHANCEMENT OF
CONTRAST RATIO

V. A. Loiko, A. V. Konkolovich

Institute of Physics of the National Academy of Sciences of Belarus

F. Scaryna ave. 68, Minsk, 220072, Belarus

V. Ya. Zyryanov, A. V. Shabanov, V. V. Presnyakov

Institute of Physics of the Russian Academy of Sciences, Siberian Branch

Akademgorodok, Krasnoyarsk, 660036, Russia

Modern liquid crystal (LC) materials are widely used in optoelectronics. They allow one to create compact devices for recording systems, information processing and display systems with low voltage control by integral circuits.

The experience in using LC optoelectronic devices with the traditional scheme of crossed polarizers has revealed a number of disadvantages: a high sensitivity to external effects, low light fastness and mechanical strength, lack of flexibility. In recent years composite LC materials – polymer dispersed liquid crystal (PDLC) films and devices on their base that are free from the above disadvantages started to be developed.

The urgent problem of the PDLC films is the problem of contrast enhancement. The conventional approaches (based on the increasing of film thickness) that are being used today deal with high values of control voltage provided by integral circuits. To get contrast ratio more than 20:1 the driving voltage has to be 30V and more. But modern integrated circuits have a driving voltage value less than 15V. That is why it's important to find methods for contrast ratio enhancement simultaneously with reduction of the driving voltage. For monolayer PDLC films the low driving voltage will be provided by small film thickness and high contrast will be provided by the interference effect for coherent (direct) component of transmitted light.

THE DEVELOPMENT OF OPTICAL METHODS AND DEVICES FOR DIAGNOSTICS OF GASEOUS FUEL COMBUSTION PRODUCTS

Project manager N. K. Tolochko, project submanager K. I. Arshinov

Institute of Technical Acoustics, NAS of Belarus

210717, 13 Ludnikova str., Vitebsk, Belarus

Other Participating Institutions

B. I. Stepanov Institute of Physics, NAS of Belarus, Minsk

A. V. Luikov Heat & Mass Transfer Institute, NAS of Belarus, Minsk

The essential part of modern developments in industrial technologies relate to the new methods of burning oriented onto the environmental protection and the fuel resources saving. In particular, the quantity of harmful emissions can be decreased by substitution of the stoichiometric compositions with extremely lean fuel mixtures. The modern methods of investigating the turbulent combustion are based mainly on the experimental, mathematical and numeral simulation of the process. For the checking of applicability of new models of combustion the experimental data about the temperature, speed of burning and concentration of combustion products are necessary. For the fuel burning study, in principle, it is possible to use the gas-analyzers of combustion products. However, the samples' extraction is rather hard and inert what prevents from wide use of gas-analyzer for regulation and optimization of burning processes. The ideal mean for burning process control is optical monitoring. Among the optical methods the special attention attracts the method of multi-frequency laser diagnostics. The advantages of this method are not realized because of absent of the correct solution of system of non-linear equations describing the spectral distribution of absorption. In this project it is suggested to use the method of multi-frequency laser diagnostics for investigating the gaseous products of fuel combustion containing CO_2 . In this case there can be more effective realized the main advantage of the given method, namely the possibility of the simultaneous determination of the temperature and the carbon dioxide concentration from the measured absorption coefficients spectra. Thus, the method of multi-frequency laser diagnostics can be a base for creation of new devices controlling both the energetic efficiency and the ecology of fuel combustion.

GROWTH AND PROPERTIES OF ACTIVATED BERYLLIUM HEXALUMINATE CRYSTALS.

V.N. Matrossov, T.A. Matrosova, E.V. Pestryacov, V.V. Petrov.
Belarusian State Polytechnical Academy
Partizansky Ave. 77, Minsk, 220107, Belarus

Phone/Fax: (375 17) 245 53 11 ; E-mail: pb202@ibelsontel.net

Extensive investigations of spectral luminescence properties of crystalline matrices activated by transition element ions have place for creation on their basis new effective tunable lasers. As an example of such mediums we can mention beryllium hexaluminate activated by chromium - $BeAl_6O_{10} : Cr^{3+}$.

The present paper is devoted to synthesis, growth and some properties of this compound.

Oxides BeO and Al_2O_3 taken in the stoichiometric ratio were used to synthesis process. They were heated to $1200^\circ C$ and left to ripen from 12 to 72. First portions of $BeAl_6O_{10}$ began to form when exposure time reached 24 hours. The complete reaction of compound forming proceeds at $1000^\circ C$ and exposure duration of two weeks.

The crystals were grown by the Czochralski method from iridium crucibles 60mm in diameter using induction heating devices. Growth rate was $1-1,5mm/hour$, rotation rate varied from 40 to 60 rev/min. Cr_2O_3 concentration in the mixture was 0,1-0,15 wt. %.

Generation characteristics analysis accomplished for the 0,5 cm-length crystal pumped coherently by the second harmonic of YAG-Nd³⁺ laser with acoustic-optical Q-switching. Tunable radiation of 0,79 - 0,92 mkm region was obtained with the help of Lio filter.

Generation of 0,78 - 0,92 mkm range was also got using lamp pumping of $\varnothing 0,4 \times 2,5$ cm elements in a line resonator with a dispersion prism. Tunable range can be extended.

The Table below shows some properties of $BeAl_6O_{10} : Cr^{3+}$ and $BeAl_2O_4 : Cr^{3+}$.

Table

Crystal	Mohs' hardness	Heat conduction, W/mkm	Density, g/cm ³	Heat capacity, J/kg K	Young's modulus, 10 ⁹ N/m ²	Poisson modulus	Fluorescence range, mkm	Fluorescence peak, mkm	Lifetime, mks	Transition cross-section, 10 ²⁰ cm ²	Lasing maximum, mkm
$BeAl_6O_{10}$	8	12,5	3,7	0,8	381	0,24	0,7-1,1	0,77	13,5	6,0	0,83
$BeAl_2O_4$	7,5	23	3,74	0,83	469	0,3	0,7-0,82	0,71	260	0,7	0,75

Therefore, the new compound, which can operate effectively in tunable lasers with lamp and diode pumping, was obtained. The work was supported by ISTC Project # B-263 (PDG).

NEW CONCEPT FOR THE COMPACT SSDPL DEVELOPMENT

Orlov L. N.

Institute of Physics, National Academy of Sciences of Belarus; 70 F. Skaryna ave., 220072 Minsk
Phone: (017)284 0432; e-mail: orlov@dragon.bas-net.by

It is well known that solid-state lasers with semiconductor diode pumping (SSDPL), possessing high efficiency, low threshold of generation in comparison with semiconductor lasers, but considerably exceeding the last on parameters of a laser radiation. As a rule the basic problems in development of such laser are connected with using of traditional optical schemes to the system with a new method of pumping.

In the present work it is offered the qualitatively new approach to create the active elements and resonators for compact SSDPL with the help of new steady multipass resonators formed by reflections from inclined lateral sides of crystal. It leads to create a lot new variants of pumping geometry and more homogeneous excitation of the whole volume of active media without any thermal induced stresses in it and without using of collimators or diroic laser mirrors. As a rule such lasers are more compact, they could work in a single-mode regime and have much higher quality of the output beams. Some features of this main idea were proved in our preliminary calculations and measurements.

Within the framework of the present project we assume to investigate a lot of new compact designs of SSDPL, suitable for working both in a continuous, pulse or Q-mode conditions; to compare and optimize various schemes of the longitudinal, transversal or side pumping for these designs, which increase their reliability and reduce the cost of the lasers; to explore several new materials for IR SSDPL (according to our preliminary estimations the greatest improvement with our schemes could be obtained with the active media with the strong but narrow absorption bands and relatively low gain); to create several experimental samples of SSDPL (such as microchip Tm:YAL SSDPL with the cw output power up to 2 W and a slope efficiency up to 40 % and Ho:YAG SSDPL with the output power up to 1 W).

Such compact IR SSDPL will have high efficiency, good stability and beam quality; their light has a low divergence and is relatively safe. So they are good for lots of applications, especially for medicine and instrument engineering.

RELAXATION PROCESSES AT IR MULTIPLE-PHOTON EXCITATION OF POLYATOMIC TRIPLET MOLECULES

G.A. Zaleskaya, D.L. Yakovlev, E.G. Sambor, D.V. Prikhodchenko

Institute of Molecular and Atomic Physics, National Academy of Sciences of Belarus,
70, Skaryna Ave., 220072 Minsk, Belarus
e-mail: zaleskaya@imaph.bas-net.by

Over many years great care was taken to study the sensitivity of a triplet decay time to vibrational energy excess E_{vib} in different media. In the present study delayed fluorescence (DF) induced by direct infrared (IR) multiple-photon excitation of triplet molecules of benzophenone ($C_{10}H_{10}O$) and fluorenone ($C_{13}H_8O$) by CO_2 laser radiation was used to study the E_{vib} dependence of relaxation rates for all nonradiative processes in the triplet state T_1 : intersystem crossing from state T_1 to ground electronic state S_0 , reversible intersystem crossing between excited singlet state S_1 and triplet state T_1 , as well as competitive intermolecular vibrational relaxation. An advantage of this method was the possibility to regulate change vibrational energy of triplet molecules over a wide range up to 20000 cm^{-1} .

Vibration-translation (V-T) relaxation was found to be responsible for the pressure dependence of DF decay rates. At vibrational energies corresponding to vibrational quasicontinuum, the efficiency of V-T energy transfer changes not much with an E_{vib} growth, and their values proved to be close to typical ones for the discrete vibrational level region of the state S_0 .

The energetic dependence of electronic energy relaxation rates under isolated molecule and vibrational equilibrium condition was obtained within the wide vibrational energy range ($3000\text{--}20000\text{ cm}^{-1}$). This results were adopted to predict the sensitivity of triplet molecule decay rates to intrinsic molecule parameters and ambient medium properties at different temperature.

CONTROL OF CHEMICAL REACTIONS AND LASING
AT SELECTIVE EXCITATION OF SUBSTANCE
IN MESO CAVITIES AND AEROSOLS

L.G.Astafieva, L.A.Kotomtseva, G.P.Lednyeva, G.K.Paramonov, V.A.Savva

Institute of Physics of the National Academy of Sciences of Belarus
Scorina prospect 68, Minsk, 220072, Belarus
Tel.: 375 172 840431

Fax: 375 172 840879

E-mail: savva@dragon.bas-net.by

It is offered to use peculiar features of behaviour of substance in meso cavities and aerosols to develop the modern "know-how" of new materials satisfied the condition for energy and material economy and to build up micro lasers.

The production of materials is based on the control of chemical reactions by selective excitation of atoms or molecules in the target states in the field of powerful radiation in aerosols. Due to high quality morphological resonances and the cavity quantum electrodynamical effect, density of radiation grows strongly inside aerosol, that allows us to lower a level of necessary power of incident radiation. The areas of formation and dynamics of various configurations of spatial field structures of modes in particles of aerosols for several kinds of symmetry are defined under action of ultrashort pulses. The recommendations for practical realization of technology with the use of the sprayed jets are developed.

To advance information technologies in microarea it is supposed to develop the theory of oscillation of radiation to micro lasers. The optimization of the output characteristics of the solid-state chip lasers and aerosol micro lasers will be carried out due to new knowledge of multistability of laser steady states, hysteresis effects, instabilities and nonlinear dynamics with controlled polarization, frequency and intensity of radiation.

LASER SPECTROSCOPY OF POLARIZED FLUORESCENCE OF JET COOLED
INDOLE

V. A. Povedailo, V. A. Tolkaichev

Institute of Molecular and Atomic Physics, National Academy of Sciences of
Belarus, 70, Skaryna Ave., 220072 Minsk, Belarus

e-mail: poved@imaph.bas-net.by

When excited by a sufficiently monochromatic light, whose coherence time essentially exceeds a period of molecular rotation, a molecule is excited by mechanism, which implies resonance interaction between exciting light and rotating transition dipole. Under these conditions, the excitation probability depends on rotation parameters. Such parameters both for simple and complex molecules essentially change along rotational contour of a band (line) of a dipole transition. Studies of mean energy of complex molecules absorbing in different parts of a rotational contour of IR bands have shown that this energy sharply grows from the band center to its wings, achieving a magnitude that exceeds mean energy of a ground state by several kT. Recently, it has been illustrated by the example of vibration vapour-benzoquinone line that a mean value of a rotational moment of absorbing molecules also increases in passing from the center of a rotational contour to its wings. Now several papers are known where measurement have been made of the dependence of a fluorescence polarization degree on an excitation wavelength within a rotational contour of an excitation line. The heteroanalogs of benzole: pyrimidine, pyrasine and 1,3,5-triazine were investigated. In all cases a very essential change in polarization along a contour with a steady difference of polarization in 3 main subbands was seen. The character of such a dependence for different -type asymmetric tops with different intramolecular orientation of dipole transitions is of undoubted interest. We have considered the characteristic regular changes in fluorescence polarization of indole and some of its complexes excited in a Q-branch. It is shown that so excited fluorescence is very sensitive to a molecular structure and comparison is made with theoretical prediction about orientation of fluorescent transition dipole moment of indole.

DYNAMICS OF INTERMOLECULAR HYDROGEN BOND FORMATION FOR
8-AZASTEROID BIOMOLECULES

O.V. Buganov^b, V.A. Ksenzov^b, A.L. Mikhalechuk^a, S.A. Tikhomirov^b,
G.B. Tolstorozhev^b

^a Institute of Bioorganic Chemistry, National Academy of Sciences of Belarus, Kuprevich Ave. 5/2, 220141 Minsk, Belarus

^b Institute of Molecular & Atomic Physics, National Academy of Sciences of Belarus, F. Skaryna Ave. 70, 220072 Minsk, Belarus

Studies of photophysical and photochemical properties of 8-azasteroids are important to elucidate an electronic structure of these compounds and to reveal possible correlations between their spectroscopic parameters and physiological immunotropic action upon the cells of living organisms. The fluorescence properties of 8-azasteroid solutions have recently been investigated [1].

The results on the specific features and kinetics of transient absorption spectra of 8-azasteroids in a picosecond time domain in aprotic and protic solvents are presented. The objects for spectroscopic investigations were 2,3-dimethoxy-8-azagone-1,3,5(10),13-tetraene-12,17-dione (1) and their analogs.

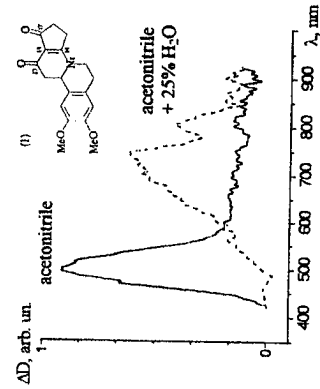

Fig. 1. Transient absorption spectra: $\Delta t = 10$ ps

Fast $S_1 - S_0$ internal conversion and dynamics of intermolecular hydrogen bond formation have been analyzed.

[1]. A.A. Akhrem, N.A. Borisevich, O.V. Gulyakevich, L.A. Mikhalechuk, T.F. Raichenok, S.A. Tikhomirov, G.B. Tolstorozhev, J. Fluorescence. 1999. V. 9. P. 357-361

FEMTOSECOND ROTATIONAL DYNAMICS OF FREE POLYATOMIC
MOLECULES IN A GAS PHASE

A.P. Blokhin^a, M.F. Gelin^a, E.V. Khoroshilov^b, I.V. Kryukov^b, A.V. Sharkov^b,
S.A. Tikhomirov^a

^a Institute of Molecular & Atomic Physics, National Academy of Sciences of Belarus, F. Skaryna Ave. 70, 220072 Minsk, Belarus

^b P.N. Lebedev Physics Institute, Russian Academy of Sciences, Moscow, Russia

Decay kinetics of optically induced anisotropy due to free molecular rotation in a gas phase differs essentially from exponential kinetics for condensed media. Initial decay is manifest on a time scale comparable with a period of free molecule rotation (~ 1 ps) [1]. The conservation law of space-fixed angular momentum in collisionless conditions gives a time-independent asymptotic value of anisotropy. Femtosecond time-resolved polarization spectroscopy is able to get full information about ultrafast molecular rotation.

The experimental results on molecule rotation dynamics for perylene in a gas phase are presented. Two different techniques are used. The first technique is a femtosecond fluorescence kinetic measuring system based on fluorescence up-conversion. The second harmonic of femtosecond Ti:sapphire laser (400 nm, 100 fs) excites a perylene vapor sample, and fundamental pulses serve as gate ones. A highly sensitive photon counting system is used to register a sum frequency signal. The second is femtosecond transient absorption pump-probe measurements.

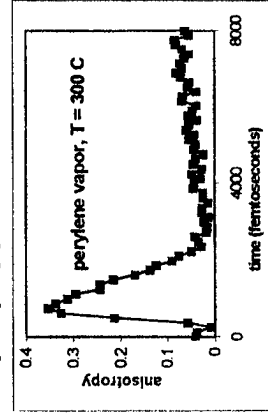

An example of induced anisotropy kinetics for the perylene vapors measured under collisionless conditions is plotted in Fig. 1. Kinetics shows fast non-exponential decay to a zero value within several picoseconds and is then followed by stationary nonzero anisotropy.

Photoinduced anisotropy is calculated in terms of second-rank orientational correlation functions (OCF) for an ensemble of asymmetric top molecules. The behavior of free molecules OCF looks like that of highly damped oscillations within a few thermally average rotational periods and agrees with the experimental curves.

I. N.A. Borisevich, E.V. Khoroshilov, I.V. Kryukov, A.V. Sharkov, A.P. Blokhin, G.B. Tolstorozhev, Chem. Phys. Lett. 1992, V191, No.3,4, P.225-231.

MESOSCOPIC LIGHT EMITTERS, SWITCHES, AND TRANSFORMERS

S. V. Gaponenko, A. N. Ponyavina, G. E. Malashkevich
Institute of Molecular and Atomic Physics

National Academy of Sciences, Minsk, 220072 Belarus

In mesoscopic structures, i. e. inhomogeneous media with topological peculiarities on a length scale of the order of photon and electron wavelengths properties of electromagnetic waves, of electrons and field-matter interaction are significantly modified because of spatial confinement of photons and electrons. This permits to control the energy spectrum, propagation of light, and the probability of spontaneous emission of light by excited atoms, molecules, nanocrystals, and other quantum systems.

The objective of the ISTC project B-276 is the use of mesoscopic optical phenomena for the development of novel efficient light emitters, switches, and transformers. In more detail, mesoscopic effects will be purposefully used to develop experimental grade samples of:

- visible light emitting plates with enhanced efficiency by means of controlled directionality via photonic band gap formation in periodic porous materials,
- spectral transformers for silicon solar cells and photodetectors based on luminescence enhancement in the presence of metal colloids and spectrum control via electron confinement effects,
- photostable fluorescent materials for the visible based on soluble semiconductor nanocrystals,

- wide-band optical switches based on strong nonlinearities due to electron confinement in semiconductor-doped glasses and photon confinement at the interface of two different media.

The project will be performed in collaboration with the Corning Centre European de Recherche (France), FIAT Research Centre (Italy), EVOTEC BioSystems AG (Germany), and the University of Dortmund (Germany).

LIDAR ANALYTICAL MODELLING TO INCLUDE MULTIPLE SCATTERING AND POLARISATION AND A STUDY OF THE RETRIEVAL CAPABILITIES OF OCEAN LIDAR

E. P. Zege, I. L. Katsev, A. S. Prikhach

Institute of Physics NANB, Ave. F. Skarina 68, 220072, Minsk, Belarus

Fax: (375-17) 2841997; E-mail: eleonor@zege.bas-net.by

Lidar sounding is a remote sensing method, which is capable of fast, accurate and inexpensive characterisation of wide areas of ocean. Information on world wide ocean optical properties is badly needed for ecological monitoring of the ocean and for performance predictions and deployment decisions for current and near term electro-optic sensor systems.

One of the main problems in ocean lidar sounding is that the lidar return profiles do not provide reliable quantitative estimates of the seawater optical properties. The lack of an adequate theory of a lidar return, which includes multiple scattering, polarisation, effects of the atmosphere and the air-water interface, and regards to noise of different origin, is one of the main obstacles preventing lidar sounding from giving such parameters. Such a theory will develop the real potential of lidar methods and allow the optimisation of ocean lidar systems.

The goal of this project is to fill the above gaps. New theory, which regards to all above-mentioned features, will form the basis to study the lidar return dependence on the inherent optical properties of ocean water. This theory will directly relate the lidar returns to the vertical profiles of the inherent optical properties of the ocean water. This theory will also allow the optimisation of different lidar systems and the development of adequate retrieval techniques.

The main result of this project will be an analytical model of the lidar return from ocean in an airborne system with regard to the multiple scattering, polarisation, atmosphere and surface effects, noise of different origin (shot noise and noise due to the windy air-ocean interface). This model will be a real tool for lidar designers and other users to estimate the information content of the lidar signal and develop various retrieval techniques, to optimise the design of the ocean lidar before creating hardware, to optimise the working mode for the existent lidar.

ROTATION DIFFUSION OF DYE MOLECULES IN WATER-ELECTROLYTE SOLUTIONS

B. Bushuk, A. Rubinov, Yu. Kalvinkovskaya, S. Bushuk

B.I. Stepanov Institute of Physics of the National Academy of Sciences of Belarus, Skaryny Ave. 70, Minsk, Belarus. E-mail: bushuk@ifanbel.bas-net.by

The dynamics of polar molecules solvation is interesting from many perspectives such as the study of coupling of solvent motion and chemical reaction rates. Considerable efforts has been devoted to understanding the solvation dynamics of probe molecules in neat solvents. The solvation of dye molecules in water-salt solvents has attracted much less attention. However, this media is of great interest because many biological reactions take place namely in such environment.

In the present work we have investigated the microstructure of 6-aminophenolone solvate shell in the set of protic and aprotic solvents, water, buffer media including water with various concentrations of several salts by steady-state and picosecond polarization spectroscopy methods. It was found that 6-aminophenolone forms intermolecular H-bond with protic alcoholic molecules and such interaction causes the increase of reduced rotation diffusion time of the dye with respect to the value registered in aprotic and nonpolar solvents. Rotation diffusion time of dye molecules in neat water corresponds well to the value determined in such solvents. This result gives evidence of the absence of intermolecular specific interaction between dye molecule and water clusters. On the other hand rotation diffusion time of 6-aminophenolone in the buffer media essentially decreases and its values depend on the charge and size of doped ions. It should be noted that macroviscosity of binary water-salt solvents increases upon salt addition. The set of experimental results allows to conclude that microstructure of dye molecule solvate shell in buffer solution is determined by ion-water interaction which in the case of large size monovalent ions causes the increase of water molecules exchange rate between inner and outer coordination spheres of dye solvate shell.

OPTICAL FORMATION OF SPATIAL GRATINGS WITH A LINEARLY CHIRPED PERIOD

T.Stk.Efendiev, V.M.Katarkevich, A.N.Rubinov

B.I.Stepanov Institute of Physics, National Academy of Sciences of Belarus
Skaryny prospect 68, 220072, Minsk, Belarus
Tel.: 375 (017) 284-23-49, Fax: 375 (017) 284-16-46
E-mail: efendiev@ifanbel.bas-net.by

It is well known that if a polarizable particle is placed into a spatially-modulated laser field it is affected by gradient forces. As a result depending on the sign of the polarizability a particle is pulled up or pushed out from the region of light field maximum. The influence of gradient laser field on the particles of the same size should depend on the period of the field spatial modulation.

In the ISTC Project B-479 the problem of influencing the interfering laser fields on physical and biological objects will be studied. As a rule for spatial grating formation in any medium two crossed laser beams are used. The medium is placed into the interference field of these beams. At given wavelength of recording radiation the period of created structure is identical on whole length.

We have realized an optical scheme providing formation of spatial gratings with a linearly chirped period. In such scheme an interference field is created by collimated and converging by cylindrical lens recording beams. As a result spatial structure with a linearly chirped period is formed in investigated medium. Single-mode radiation of He-Cd-laser ($\lambda = 441.6$ nm) was used for gratings formation.

About twice change of the structure period (from 0.8 to 1.5 μm) along its length ($L \approx 1$ cm) was achieved. Thus gradient field with magnitude decreasing with the increase of period is produced along the structure length. Probing simultaneously the different sites of created structure it is possible to obtain information on the influence of gradient fields of different intensities on microparticles. Calculated dependencies of the grating period variation on the converging angle of beams and the focus length of cylindrical lens are presented in the report.

Thursday, June 28

ThA	Plenary Lectures II	ThO	Quantum and Atomic Optics
ThB	Physics of Nanostructures V	(Posters)	
ThC	Nonlinear Optical Phenomena I	ThP	Optical Information Processing, Transmission, and Storage (Posters)
ThD	Lasers in Chemistry, Biophysics, and Biomedicine V		
ThE	Quantum and Atomic Optics I		
ThG	Fundamental Aspects of Laser-Matter Interaction III		
ThH	Nonlinear Optical Phenomena II		
ThI	Lasers in Chemistry, Biophysics, and Biomedicine IV		
ThJ	Quantum and Atomic Optics II		
ThK	Fundamental Aspects of Laser-Matter Interaction IV		
ThM	Nonlinear Optical Phenomena (Posters)		
ThN	Lasers in Chemistry, Biophysics, and Biomedicine (Posters)		

ThA1
(Plenary lecture)

Optical Frequency Standards – the Clocks of the Future

L. Hollberg, C.W. Oates, E.A. Curtis*, S.A. Diddams, Th. Udem†,
J.C. Bergquist, R.E. Drullinger, W.M. Itano, D.J. Wineland

National Institute of Standards and Technology, 325 Broadway, Boulder, CO 80305

Highly stabilized lasers probe and lock to narrow optical transitions in a single trapped mercury ion as well as a sample of laser-cooled calcium atoms. We have measured the absolute frequency of both the Hg⁺ and Ca optical standards relative to the cesium primary frequency standard, NIST F-1, a laser-cooled atomic fountain. The measured frequencies are: $\nu(\text{Hg}^+) = 1,064,721,609,899,143(10)$ Hz and $\nu(\text{Ca}^+) = 455,986,240,494,158(26)$ Hz. Given fractionally, the uncertainties are $\Delta\nu(\text{Hg}^+)/\nu(\text{Hg}^+) = 9.4 \times 10^{-15}$ and $\Delta\nu(\text{Ca}^+)/\nu(\text{Ca}^+) = 5.7 \times 10^{-14}$. The uncertainty in the Hg⁺ measurement (± 10 Hz) is a conservative estimate based on theory since we have not done a full evaluation of systematic effects. This still represents the highest accuracy optical frequency measurement to date. The Ca measurement is the best reported accuracy for Ca, and is in excellent agreement with previous measurements made by the PTB laboratory. These systems already provide frequency standards with exceptional stability, and accuracy evaluations will be done in the near future.

Optical transitions provide numerous advantages for the development of frequency standards with higher accuracy and stability than traditional standards based on microwave transitions. The fundamental, conceptual and technological developments that have allowed this move toward optical clocks are: the frequency stabilization of lasers to high-finesse mechanically-stable reference cavities, laser cooling and trapping of ions and neutral atoms, and the development of a practical method for high accuracy optical frequency measurements and synthesis using fs mode-locked lasers.

* On leave from Max-Planck Institut für Quantenoptik, Hans-Kopfermann Str.1, 85748 Garching, Ger. many.

† Also with the Department of Physics, University of Colorado, Boulder, CO 80309.

OPTICAL TOMOGRAPHY OF BIOTISSUES: OLD PROBLEMS AND NEW DEVELOPMENTS

A.M.Sergeev

Institute of Applied Physics of the Russian Academy of Sciences,
Nizhny Novgorod, 603600 Russia

This talk is an attempt to follow the development of lidar sensing techniques in turbid media from underwater laser vision towards optical tomography of biotissues. It will be demonstrated how, based on understanding general principles of light propagation in scattering media, new bioimaging modalities have been implemented and are making their way to clinical applications.

The development of lidars for sensing turbid media provided an effective means for underwater vision based on lasers operating in the blue-green part of the spectrum. The basic idea was to enhance sensing distances using coherent properties (i.e. a higher directionality) of laser light, an optimal choice of the distance between a source and a detector, and the use of the time-of-flight detecting technique for selecting scatterers situated at different distances. The laser pulse method has since found widespread application in tomographic problems of oceanography, in particular to observe the stratification of optical characteristics of water and to construct images of internal waves in the ocean. The early progress in underwater lidars has given impetus to the development of a nearly universal theory of instrumental vision in turbid media that can be applied to a wide variety of seemingly distinct optical systems.

Although detecting submarines in the ocean and tumors in the body appear to be distinct challenges from an optical perspective, they are actually quite similar within the framework of this theory. In particular, it turned out that a nanosecond ocean lidar is directly scalable to a femtosecond biotissue imager providing the same distance resolution in the units of the photon free path. That is why with the advent of femtosecond lasers it became quite seductive to apply the lidar technique to bioimaging area for micron-scale, few-millimeter-depth tissue tomography. The optical coherence tomography is a bioimaging modality based on infrared probing light with 10-100 fs coherence duration and interferometric of signal extraction. Being developed in 90-ies, it is already used in clinics for early diagnostics of pathologies and intraoperational control in ophthalmology, gynecology, urology, laryngology, etc.

While this method is able to provide high resolution superficial images, it is also possible to image much deeper, to few centimeters, albeit with a significant loss in resolution, using diffuse component of the probing light. Employing CW near infrared laser sources and several approaches for contrast enhancement (such as choosing optimal baseline between the source and detector) inhomogeneities in living tissues can be imaged at depths more than 10 transport photon scattering paths with about 1 cm resolution. CW tomography has been successfully applied in practice to detect absorbing inhomogeneities in tissue, such as tumors in the human breast and cerebral hematomas in neonatal patients.

Objects in biotissue may be located more effectively with the help of diffuse light fields which are modulated in intensity by a sinusoidal RF microwave signal, so called **photon density waves** (PDW). Advantages of this technique over pure CW tomography include higher resolution, which can be explained by preservation of the PDW directionality in the depth of the tissue, and the possibility for discrimination of absorbing and scattering objects based on results of measurements of amplitude and phase of the PDW. Based on this techniques, frequency-domain light mammography apparatus have been constructed and employed clinically, and are capable of

detecting tumors greater than 1 cm in size as well as determining their optical coefficients, an important diagnostic for evaluating hemoglobin concentration and hemoglobin saturation in tumor.

Methods in which the complementary properties of sound and light are combined to image absorbing objects in biotissue are making first steps to biomedical applications. One of the most advanced developments in this regard is the method of **pulsed opto-acoustic tomography**. It employs nanosecond laser radiation to tag objects hidden in a turbid medium and sound waves to read out information. The specific contrast mechanism is the selective absorption of diffuse laser light (e.g. on blood hemoglobin), in which energy is deposited in highly absorbing tissue regions on time scales much faster than thermal time scales. Acoustic pulses are then generated due to the pulsed optoacoustic effect within the tissue, transporting information to surface, where it is read out by acoustic detectors, as in conventional ultrasonography. Of particular interest are the capabilities of this method to diagnose breast cancer, where in recent experiments tumors at the depth of few cm were imaged with a contrast at the level of 300%.

As opposed to opto-acoustic sensing, **acousto-optical tomography** of biotissue uses focused sound waves to tag trajectories of photons passing through a given area of the medium to detect information these photons bear. A distinctive feature of signal detection in acousto-optics is that, although a highly scattered light component is used for reception, information is extracted from its coherent characteristics, namely from the properties of the speckle pattern. Using this technique successful acquisition of 3D images of absorbing objects was demonstrated hidden in *ex vivo* samples of biotissue up to 3.5 cm in thickness with resolution as good as 2 mm. This progress gives a potential to this method to become in the future a complementary diagnostic modality to the standard echography.

Nonlinear Optical Spectroscopy of Confined Excitons
in Semiconductor Nanocrystals

Tadashi Itoh and Keiichi Edamatsu

Department of Physical Science, Graduate School of Engineering Science
Osaka University, Toyonaka, Osaka 560-8531, Japan

Quantum size effects on confined excitons have been extensively studied on nanocrystals (or in other words, quantum dots) of many kinds of semiconductors with exciton radii generally comparable to or even larger than the nanocrystal size, where the exciton internal motion between electron and hole is much modified in strong confinement regime. On the other hand, the quantum confinement of the lowest 1S exciton state in CuCl nanocrystals is an exceptional case and classified to weak confinement regime because of the very small exciton Bohr radius of 0.7nm. Here, the effect of exciton confinement appears essentially on the exciton translational motion with less influence on the exciton internal motion.

Since the measurements of one-photon absorption and luminescence excitation spectra are strongly influenced by inhomogeneous broadening of the exciton bands due to the wide distribution of the nanocrystal size, it is difficult to investigate the exciton excited states with higher principle quantum numbers. For these excited states the exciton radii in the bulk crystal are expected to be much larger than that of the 1S state and become comparable or even larger than the nanocrystal size, resulting in possible breakdown of the weak confinement regime.

In the present paper, we demonstrate that two-photon excitation and two-step IR transient absorption methods are useful for the investigation of exciton excited states of CuCl nanocrystals embedded in NaCl single crystalline matrix. Under the two-photon excitation spectroscopy, those exciton states with P-type symmetry are optically allowed together with a polarization-dependent forbidden transition to the 1S state.[1] There appears a pronounced absorption edge ascribed to the 2P exciton state. With the decrease of the nanocrystal size, the photon energy of this edge increases much more than that of the 1S exciton energy. Since the weak 1S exciton absorption spectra clearly show the polarization dependence with respect to the NaCl crystal axes, the CuCl nanocrystals are considered to be epitaxially grown inside the NaCl matrix.

Under the strong, selective ns-pulsed excitation around the 1S exciton absorption band, two-step transient absorption appears in the mid-infrared region of 2-8 μ m.[2] The transient absorption consists of fast and slow components. The decay time of the fast component with ns time response is comparable to the lifetime of the 1S exciton and the excitation spectrum of this component exactly coincides with the 1S exciton absorption spectrum. Therefore, we reasonably consider that the fast component is the transient absorption from the 1S exciton states to the 2P excited state. The transient absorption peak shifts toward the higher energy side with the decrease of the nanocrystal size. This fact indicates the breakdown of the weak confinement regime for the 2P state.

We compare these experimental results with the theoretical expectation obtained by Uozumi and Kayanuma [3] and discuss about the coexistence of the weak and strong confinement regimes among different exciton states in CuCl nanocrystals.[4]

[1] K. Edamatsu, K. Hisakawa and T. Itoh, *Phys. Rev. B* **59** (1999) 15868.[2] K. Yamanaka, K. Edamatsu and T. Itoh, *J. Lumin.* **76&77** (1998) 256.[3] T. Uozumi, Y. Kayanuma, K. Yamanaka, K. Edamatsu and T. Itoh, *Phys. Rev. B* **59** (1999) 9826.[4] T. Itoh, K. Yamanaka, K. Edamatsu, T. Uozumi and Y. Kayanuma, *Intern. J. Modern Phys. B*, in press.

SECOND-HARMONIC NEAR-FIELD MICROSCOPY OF NANOSTRUCTURES

Sergey I. Bozhevolnyi

Institute of Physics, Aalborg University

Pontoppidanstræde 103, DK-9220 Aalborg Øst, Denmark

SUMMARY

Second-harmonic (SH) scanning near-field optical microscopy (SNOM), in which radiation from an uncoated sharp fiber tip upon penetration into a sample gives rise to SH radiation detected in transmission geometry, is considered [1]. SH-SNOM is a unique tool that enables one to map local second-harmonic susceptibilities, i.e., to locally probe material symmetry properties, on the nanometer scale. However, the underlying physical mechanisms involved in nonlinear near-field optical phenomena and, consequently, in image formation in SH-SNOM are very intricate and far from being understood. In this presentation, recent [1,2] and current [3] experiments on wavelength- and polarization-resolved SH-SNOM of ferroelectric domain walls, Langmuir-Blodgett films, and semiconductor quantum dots are reviewed emphasizing new physical effects occurring due to specific properties of nanostructured optical fields. In particular, modifications of selection rules for SH generation, with near-field interactions being involved, are considered. A self-consistent microscopic approach that allows one to model the SH-SNOM and establish the relationship between the SH-images of nanostructured nonlinear materials and local second-order susceptibilities [4] is also outlined. Finally, on the basis of the results obtained, important issues unresolved so far are identified and perspective directions for future investigations are discussed.

References

1. S. I. Bozhevolnyi, B. Vohnsen, and K. Pedersen, *Opt. Commun.* **150**, 49 (1998).2. S. I. Bozhevolnyi and T. Geisler, *J. Opt. Soc. Am. A* **15**, 2156 (1998).

3. B. Vohnsen and S. I. Bozhevolnyi, to be published.

4. S. I. Bozhevolnyi and V. Z. Lozovski *Phys. Rev. B* **61**, 11139 (2000).

Nonlinear Optics and Nonlinear Magneto-Optics in Magnetic Nanoparticles

O.A. Aktsipetrov

Department of Physics, Moscow State University, Moscow, 119899 Russia
e-mail: aktsip@shg.phys.msu.ru URL: <http://shg.phys.msu.ru>

In this paper, we survey the fundamental and application aspects of the quadratic nonlinear optical effects in magnetic nanoparticles. The special attention is paid to the observation of (i) the giant nonlinear magneto-optical Kerr effect (GNM) in magnetic nanogranular films exhibiting giant magnetoresistance effect (GMR) and (ii) the magnetization induced hyper-Rayleigh scattering (MHR) in the random two-dimensional arrays of magnetic nanoparticles fabricated by Self-Assembly techniques.

Nonlinear optics of metal and semiconductor nanoparticles traces back to min-1980's as the size effects in second harmonic generation (SHG) from the Ag and CdSe nanocrystals were studied [1]. Since 1988's experimental observation of magnetization induced second harmonic generation (MSHG) in thin magnetic films [2], nonlinear magneto-optics of magnetic nanomaterials has been intensively studying in a variety of systems. Recently, magnetization induced effects were observed in nonlinear-optical response of magnetic granular films containing nanoparticles of magnetic materials [3]. The observation of MSHG in the nanomaterials exhibiting the GMR effect brings up a fundamental question of a correlation between the features in the mechanisms of these phenomena. The recent simultaneous studies of the GNM and GMR effects in the magnetic nanostructures as the $\text{Co}_x\text{Cu}_{1-x}$, $\text{Co}_x\text{Ag}_{1-x}$ and $(\text{Co}_x\text{Fe}_{0.5})_x(\text{Al}_2\text{O}_3)_{1-x}$ granular films reveal an amazing correlation between the nonlinear magneto-optical properties and the GMR coefficient [4]. Apart from the basic significance of this observation, an aforementioned correlation shows the perspectives of the application of GNM as the method of the nonlinear optical readout [5] from the memories based on these promising GMR nanomaterials.

Magnetic and nonlinear optical properties of ordered and random arrays of nanoparticles are of high interest as the new hybrid effects might come in light in these structures. As an analog of coherent specular SHG discussed above, hyper-Rayleigh scattering (incoherent diffuse SHG) is observed in the random arrays of nanoparticles. The extension of the latter approach to the random systems of magnetic nanoparticles brings about the observation of magnetization induced hyper-Rayleigh scattering. This effect was observed, for the first time, in layer-by-layer self-assembly (SA) films containing yttrium-iron garnet (YIG) nanoparticles [6]. The mechanism of magneto-induced hyper-Rayleigh scattering in SA films containing YIG nanoparticles is discussed.

References

- [1] O.A. Aktsipetrov et al. JETP Lett. **41**, 615 (1985).
- [2] O.A. Aktsipetrov et al. Sov. J. Quantum Electron. **20**, 259 (1990).
- [3] T.V. Murzina et al. Appl. Phys. Lett. **73**, 3769 (1998).
- [4] T.V. Murzina et al. Surf. Sci. (2001) to be appeared.
- [5] O.A. Aktsipetrov et al. Jpn. J. Appl. Phys. **37**, 122 (1998).
- [6] T.V. Murzina et al. Appl. Phys. Lett.(2001) submitted.

Nonlinear Magneto-optic Quantum Micro-cavities

R. Frey⁽¹⁾, R. André⁽²⁾ & C. Flytzanis⁽³⁾

- (1) Laboratoire Charles Fabry de l'Institut d'Optique, Institut d'Optique & CNRS, B.P. 147, 91403 Orsay cedex, France
- (2) Laboratoire de Spectrométrie Physique, Université J. Fourier Grenoble I & CNRS, B.P. 87, 38102 Saint Martin d'Hères cedex, France.
- (3) Laboratoire de Physique de la Matière Condensée, Ecole Normale Supérieure & CNRS, 24 rue Lhomond, 75231 Paris cedex 05, France

The study of exciton-polariton modes received a renewed attention in the recent years with the use of quantum micro-cavities where the material (exciton) and electromagnetic (photon) components can be independently and artificially modified through appropriate matching of micro-cavities and quantum well characteristics [1,2]. The exciton-polariton are very sensitive to light induced changes and this allows in particular to assess the nonlinear regime, its dynamics and the effective exciton-cavity coupling.

We have performed a theoretical and experimental study [3,4] of the nonlinear behavior of a magneto-optic quantum cavity in the strong coupling regime and were able to delineate the main photo-induced mechanisms that are effective there.

In our experiments the micro-cavity consisted of a single quantum well CdMnTe and the measurements were performed at 5K and with applied magnetic field intensity of 0.2T. A well controlled and characterized tunable coherent source delivering 10ps duration pulses was used. Reflectivity and Faraday rotation spectra were recorded in the linear regime and for moderate laser fluences (typically up to 1-3 $\mu\text{J}/\text{cm}^2$).

The modifications of the Faraday spectra were relatively mild in the case of large exciton and cavity frequency detuning (untuned micro-cavity). On the other hand the impact of the light intensity changes were striking when operating at zero detuning (equal exciton and cavity frequencies, tuned cavity). Actually the micro-cavity could be switched from the tuned to the untuned state by increasing the laser intensity by mere 1-3 $\mu\text{J}/\text{cm}^2$.

The measurements and the observed behavior were also accounted for in terms of a model incorporating the Rabi and Zeeman splittings of the exciton transition of the quantum well inside the micro-cavity and also introducing the light modification of the material (exciton) component due to the large generated exciton densities. Several extensions and cavity configurations were considered.

- (1) C. Weissbuch, M. Nishioka, A. Ishikawa & Y. Arakawa, Phys. Rev. Lett. **69**, 3314 (1992)
- (2) M.S. Skolnick, T.A. Fisher & D.M. Whittaker, Semic. Sci. Techn. **13**, 645 (1998)
- (3) M. Haddad, R. André, R. Frey & C. Flytzanis, Sol. St. Comm. **111**, 61 (1999)
- (4) R. Frey, M. Clusel, A. Radu, R. Andre & C. Flytzanis to be published.

Nonlinear propagation of femtosecond pulses
in the atmosphere

B. Prade, A. Mysyrowicz
LOA, ENSTA, Ecole Polytechnique, Palaiseau, 91761 France
33169 31 99 89 prade@enstai.ensta.fr

Intense ultrashort laser pulses propagating through the atmosphere undergo important changes in their spatial and spectral characteristics. They self-organise in the form of narrow filaments with high peak intensity which persist over exceptionally long distances. This spectacular effect can be explained in terms of a dynamic competition between self-focusing and multi-photon ionisation. This presentation will review the state of the art concerning this phenomenon. In a short introduction we first recall the physical effects coming into play. The optical Kerr effect acts as a focusing lens leading to a catastrophic collapse of the beam, if the incident power exceeds a critical value P_c . This collapse is limited for multi-photon bound-free electronic transitions. The on-axis intensity is sufficient for multi-photon bound-free electronic transitions. The created plasma reduces the local refractive index and thus acts as a diverging lens. We describe the theory for the unusual form of propagation, which results from a dynamic balance between these two effects. A semi-analytical solution gives an intuitive picture of the features, which can be expected. However, this variational approach must be complemented by more detailed numerical simulation which integrates other processes such as group velocity dispersion, retarded Kerr effect, space-time focusing and self-steepening. Numerical results from several existing codes will be presented both for incident laser power close to the critical power and well above P_c .

In a second part, we describe experiments on filamentation, on self-guiding of IR and UV femtosecond laser pulses. Narrow filaments are observed over distances exceeding several tens of meters. The peak intensity in the filament is measured via the generation of high-order odd harmonics in noble gases. The presence of a plasma column from multi-photon ionisation of air is detected from electric conductivity measurements. The filament diameter and the plasma lifetime can be measured by time-resolved optical diffractometry. Other expected features, such as time compression of the pulse and spectral broadening of the laser in the filament will be compared to numerical predictions.

Finally, we describe applications. The white continuum generated by the filament can be used for multi-spectral identification of air pollutants. It can be also used to guide and trigger reproducible electric high voltage discharges in air.

WIDEBAND CONICAL EMISSION IN THE PROPAGATION OF POWERFUL
FEMTOSECOND LASER PULSES IN AIR

I. S. Golubtsov, V. P. Kandidov, O. G. Kosareva
International Laser Center MSU.

119899, Russia, Moscow, Vorobjevy Gory, MSU, Department of Physics.

In the nineties it was found that propagation of powerful femtosecond laser pulses in air is accompanied by generation of wideband conical emission [1-3].

We have developed the model that explains the origin of the conical emission on the basis of nonlinear self-phase modulation of powerful laser radiation tightly concentrated in space and time. The cubic nonlinearity of air causes self-focusing and the growth of the pulse intensity up to 10^{13} - 10^{14} W/cm². At this value the intensity growth is limited by nonlinear refraction in the plasma produced due to ionization of air in strong laser field. The ionization rate is calculated according to the PPT model with corrected value of the effective charge of the ionized molecule of oxygen.

Self-focusing leads to pulse self-steepening which results in narrow (10-20 fs) temporal peaks. At this time scale the delayed response of cubic nonlinearity should be taken into account. We have also considered material dispersion of higher orders, since the latter can be important in the course of strong temporal contraction of laser radiation. The changes in the refractive index due to the joint effect of Kerr and plasma nonlinearity lead to strong broadening of pulse frequency spectrum and angular divergence. The simulated angular dependence of the conical emission angle on wavelength is in good agreement with the experimental data [4]. The higher is temporal and spatial localization of light field the stronger is the self-phase modulation and the conical emission.

References:

1. Braun A. et al. // Optics Letters, 1995, V.20, P.73.
2. Nibbering E. T. J. et al. // Optics Letters, 1996, V.21, P.62.
3. Brodeur A. et al. // Optics Letters, 1997, V.22, P.304.
4. Kosareva O. G. et al. // Opt. Lett. 1997. V. 22. P. 1332.

Supercontinuum and harmonic generation in optical fiber pumped by high power CW fiber laser

Ken-ichi Ueda, M. Prabhu, J. Xu

Institute for Laser Science, University of Electro-Communications
1-5-1 Chofugaoka, Chofu, Tokyo 182-8585 Japan
Tel +81-424-43-5700 E-mail: ueda@its.ucc.ac.jp

Summary

Broadband pumping source for the Raman fiber amplifier in 1.55 micron range is critically important for the wavelength division multiplication (WDM) technique for massive internet communication. The requirement for terabit communication is more than 100 nm to 200 nm. Furthermore, the spectral density is very high in the most advanced optical communication, for example, the frequency utility is 0.4 to 0.8. It means the pumping source should be almost continuum over 100 nm. We developed the high power supercontinuum source by a fiber Raman laser. The high power Yb-doped fiber laser was used as a pumping source.

The second topic is the fiber laser pumped fiber laser. The Tm-Ho doped fiber laser generated 2 micron output and the second harmonic generation in the green cooperated with blue and red emission by upconversion process. In this paper we report these nonlinear phenomena in the fiber lasers operating in cw mode.

[Super continuum generation in fiber]

The experimental setup is simple as shown in Fig. 1. We used the Yb-doped fiber laser with 8.4 W output in a single mode. A phosphosilicate fiber has a large Stokes shift of 1300 cm^{-1} due to the P-O double bond structure. So, two step Raman generates the Raman output of 2.7 μm at 1484 nm in cooperation with low loss fiber Bragg grating, which is the pumping wavelength of 1.55 micron communication band¹⁾. When we arranged the additional fiber with FBG as shown in Fig-2, we could measure the supercontinuum over 100 nm with more than 1 W²⁾. This power is available to the effective pumping of fiber Raman amplifier for optical communication. The mechanism of super continuum generation is not clear at this moment. The temperature dependence carried out in the cryogenic temperature showed that this continuum is not attributed to the stimulated Brillouin scattering.

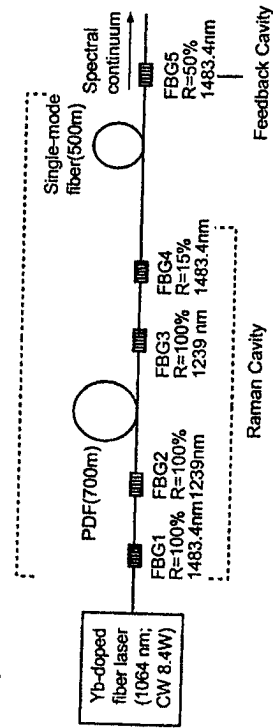

Fig. 1 Experimental setup of super continuum generation from fiber lasers.

RFL Spectrum
L=700m & R₂=15%
No Cavity

Spectral continuum from BRFL
- with additional Cavity
- No FBG5 & FBG6

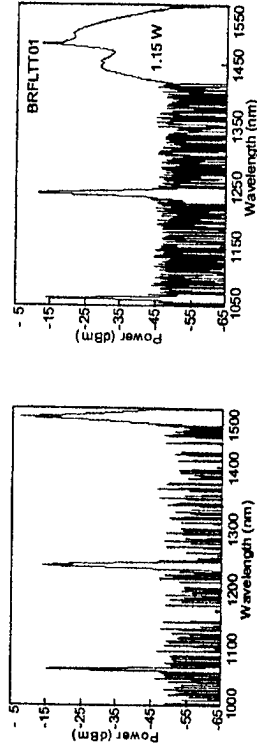

Fig. 2 Spectra of Raman oscillation and super continuum in fiber lasers.

2) Second harmonic generation in fiber.

Fiber laser pumped fiber lasers have a great potential because they give us the opportunity to realize the very high intensity pumping with almost 100 % coupling efficiency. This is a big advantage for the pumping of Tm, Ho lasers for longer than 2 micron lasers. These lasers are powerful for the medical and LIDER applications. We carried out the experiment of Tm-Ho codoped fiber laser by using the tunable Raman fiber laser pumping. The Tm-Ho fiber is 2 cm long. The spectroscopic studies in visible range gave the spectra shown in Fig.3. The blue and red emissions are identified to the upconversion emission of Ho ions. The green emission has the second harmonics of pumping Raman beam. We discuss the characteristics of this nonlinear phenomena in optical fibers in cw mode.

References

- 1) N.S. Kim, M. Prabhu, C. Li, J. Song and K. Ueda, *Jpn. J. Appl. Phys.*, vol.39, 6264-6267 (2000).
- 2) M. Prabhu, N. S. Kim, K. Ueda, *Jpn. J. Appl. Phys.*, vol.39, L291-L293 (2000).

Filamentation of powerful femtosecond laser pulses in the atmospheric air

K.Yu.Andrianov, V.P.Kandidov, O.G.Kosareva, M.P.Tamarov
International Laser Center, Physics Department, Moscow State University, 119899, Moscow,
Russia

S.L.Chin, A.Talebpour
Center for Optics, Photonics and Laser, Department of Physics, Laval University, Quebec,
G1K 7P4, Canada.

Long light filaments are produced when powerful femtosecond laser pulses with peak power $5 \cdot 10^3 - 2 \cdot 10^2$ W propagate through air [1,2,3,4]. Filamentation process is unregular. The evidence for this fact are random displacements of the filament center from shot to shot in the plane perpendicular to the propagation direction [3]. In the pulses with terawatt peak power a bunch of filaments is created. The number of filaments in the bunch changes randomly from one laser shot to another [4]. One of the reasons for stochastic behaviour of filaments is random fluctuations of refractive index in air.

In this paper we present the results on numerical and experimental study of statistical characteristics of random displacements of filaments. Random displacements are registered in the plane perpendicular to the direction of femtosecond pulse propagation. Experimentally obtained ensemble of filament center displacements demonstrates that the field of random fluctuations stimulating these displacements is isotropic.

By analyzing the experimental data we have developed the model of powerful femtosecond laser pulse filamentation in the Kolmogorov atmospheric turbulence. According to this model refractive index fluctuations in air are responsible for nucleation and wandering of filaments. In atmospheric air the filament is a succession of moving foci in randomly inhomogeneous medium. Using the developed model we have performed the Monte-Carlo simulations of filamentation in the turbulent atmosphere.

Statistical processing of experimental and numerical data shows that filament center displacements in the transverse plane obey the Rayleigh distribution law. Parameters of Rayleigh distribution obtained for numerical and experimental data are close to each other.

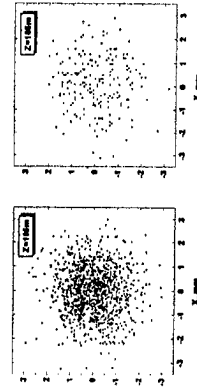

Filament center positions registered from shot to shot in the plane perpendicular to the propagation direction z . The distance from laser system output is $z=105$ m. Experimental data are on the left plot and simulated displacements are on the right plot.

1. Braun A, Korn G, Liu X, Du D, Squier J, Morou G *Opt. Lett.* **20**, 73, (1995)
2. Nibbering E T J, et al., *Opt. Lett.* **21**, 62, (1996)
3. Brodeur A, et al., *Opt. Lett.* **22**, 304, (1997)
6. Fontaine B.L., et al., *Physics of Plasmas* **6**, 1815 (1999)

Femtochemistry with 20 fs Pulses: Letting Vibronic Wavepackets Teach us about the Reaction Mechanism

Eberhard Riedle

LS für BioMolekulare Optik, Ludwig-Maximilians-Universität München
Oettingenstr. 67, D-80538 München, Germany

In a chemical reaction bonds are broken and/or formed leading to a new distribution of the electrons within the molecule. Nearly simultaneously there is a large scale change from the nuclear geometry of the educt to that of the product. For an ultrafast photoinduced reaction the conservation of atomic momentum leads to ringing of the product molecule. This ringing can be observed experimentally as coherent wavepacket motion. With sufficient temporal resolution oscillatory contributions are observed in addition to the exponential components of a pump-probe signal.

In our experiments UV pump pulses and widely tunable visible probe pulses of about 20 fs duration each are derived from noncollinearly phase matched optical parametric amplifiers [1]. The typical crosscorrelation of 35 fs is shorter than the period of low frequency skeletal modes in prototype organic molecules. In the figure the transient absorption change at 502 nm probe wavelength is shown for 350 nm excitation of 2-(2'-hydroxyphenyl)benzothiazole (HBT) [2]. The frequencies of the dominant vibrational motions can be seen from the Fourier transform of the time trace. Comparison with calculated and known vibrational frequencies allows the unique identification of the molecular distortion during the ultrafast excited state proton transfer. All four observed motions correlate with a significant contraction of the H-chelate ring within HBT and we can therefore conclude that this distortion plays a major role in the photoinduced reaction.

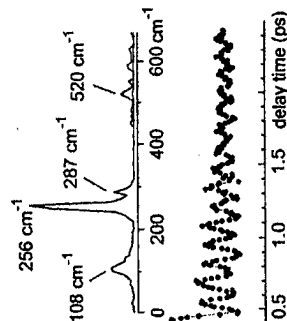

[1] E. Riedle, M. Beutler, S. Lochbrunner, J. Piel, S. Schenkl, S. Spörlein, and W. Zinth, *Appl. Phys. B* **71**, 457 (2000)

[2] S. Lochbrunner, A. J. Wurzer, and E. Riedle, *J. Chem. Phys.* **112**, 10699 (2000)

COHERENT CONTROL OF ELEMENTARY CHEMICAL REACTIONS BY MEANS OF FEMTOSECOND LIGHT PULSES.

O. M. Sarkisov

N.N. Semenov Institute of Chemical Physics, Moscow, Russia

Principally new possibilities of the chemical reactions control will be discussed. These possibilities are provided by the recently introduced to chemistry new instrument – light pulses with the duration in the femtosecond time scale.

Femtosecond light pulses possess several specific features: ultra-short duration, high degree of coherence and high intensity. The first two features provide the opportunity to form coherent non-stationary quantum states (wave packets) of the molecules. The mentioned features of the femtosecond light pulses allow to suggest several new approaches to the elementary chemical reaction control. One of the most promising is variation of the phase properties of the formed molecular wave packet by means of the amplitude-phase modulation of the pump femtosecond pulse. It has already been applied to some systems. The principle idea of this approach is based on the fact that intramolecular dynamics at short times depends significantly upon the phase characteristics of the initially formed molecular vibrational wave packet. Therefore varying phase characteristics of the exciting light pulse may lead to changes of the different reaction products outcome.

Such coherent reaction control can be realized if the reaction time is shorter than the phase relaxation time. Characteristic phase relaxation times in the molecular systems are of the order of 100-1000 fs. This means that the chemical transformation of interest is to take place at even shorter times.

Our results on multi-photon photo-dissociation of ammonia and on two-proton photo-transfers in [2,2'-bipyridyl]-3,3'-diol will be discussed.

The examples presented prove the possibility to use phase characteristics of the pump femtosecond pulse to get the reaction control both in the gas and liquid phase. Theoretical model providing interpretation of the coherent control of the two-channel chemical transformation of the three-atomic molecule is now under study.

SELECTIVE IR MULTIPLE-PHOTON + UV MULTIPHOTON (Invited)
FRAGMENTATION AND IONIZATION OF POLYATOMIC MOLECULES

V.N. Lokhman, A.A. Makarov, D.D. Ogurok, E.A. Ryabov
Institute of Spectroscopy, Russian Academy of Sciences,
142190 Troitsk, Moscow region, Russia

A novel technique of nonlinear IR+UV laser photolysis of polyatomic molecules is presented. It is based on IR multiple-photon dissociation (MPD) of parent molecules and subsequent fragmentation and ionization of produced radicals in the process of UV multiphoton ionization (MPI). This approach is shown to combine the high selectivity of IR MPD and the high level of fragmentation available for UV MPI. The results of IR MPD + UV MPI of CF_2HCl and SF_6 molecules are presented.

The formation of CF^+ ions was found as a result of multiphoton IR+UV photolysis of CF_2HCl for λ_{UV} 244 nm. It was shown that these ions are formed by UV MP fragmentation and ionization of CF_2 radicals resulted from IR MPD of CF_2HCl . The found effect was used to study the unimolecular decay of CF_2HCl in molecular beam conditions. The kinetics of this process as well as the translational energies of CF_2 radicals were measured.

Multiphoton IR+UV photolysis of SF_6 molecules was found to result in formation of S^+ and SF^+ ions for λ 243 nm. The modeling of the IR MPD process in combination with the detailed studies of the spatial and temporal evolution of S^+ and SF^+ signal provided to evaluate the mechanism of these ions formation. A part of them are resulted from UV MP fragmentation and ionization of SF_5 radicals produced by IR MPD of SF_6 . Besides of this channel the highly vibrationally excited SF_6 molecules were found to take part in the formation of the above ions, too. The relative contribution of these two channels is estimated. The gas-dynamic cooling of the parent molecules was shown to result in the considerable increase of the isotopic selectivity of IR MPD of $^{13}\text{CF}_2\text{HCl}$ and $^{34}\text{SF}_6$. The possible applications of the proposed nonlinear IR+UV photolysis are discussed.

Chemical reactions of HCl^+ ions - from understanding to control

M. Michel^{a)}, M.V. Korolov^{a,b)}, M. Malow^{a)}, K. Brembs^{a)}, K.-M. Weitzel^{a)}

a) Institut für Chemie - Physikalische und Theoretische Chemie,
Freie Universität Berlin, Takustr. 3, 14195 Berlin, Germany

b) B.I. Stepanov Institute of Physics, National Academy of Sciences of Belarus,
Scarina ave.70, 220602 Minsk, Republic of Belarus

The study of state-selected molecular ions is of crucial importance for the understanding of unimolecular and bimolecular reactions of both fundamental and technical interest. In the first part of this work we investigated the formation of state-selected HCl^+ ions in a double resonance experiment, where the first laser forms the ions in the vibronic ground state $^2\Pi_{3/2}(v=0, N)$ via a 2+1 REMPI process and the second laser induces photodissociation. From a comparison of experimental and calculated photodissociation spectra (Fig. 1) we derived the rotational state distribution of HCl^+ ions formed in the $^2\Pi_{3/2}(v=0, N)$ state (Fig. 2).

In the 2nd part we investigated the ion-molecule reaction of state-selected HCl^+ ions with CO. Here, very efficient proton transfer leads to the formation of HCO^+ with a rate constant close to the Langevin limit (Fig. 3). The ultimate goal of this work is to control chemical reactions by means of specific rotational states of the HCl^+ ion.

References:

M. Michel, M.V. Korolov, M. Malow, K. Brembs, K.-M. Weitzel, PCCP, accepted.

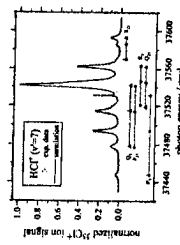

Fig. 1

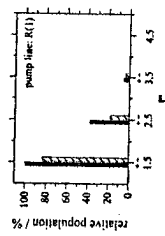

Fig. 2

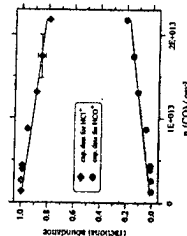

Fig. 3

ISOTOPICALLY SELECTIVE IR MULTIPHOTON DISSOCIATION OF
MOLECULES IN A PULSED GAS DYNAMIC FLOW INTERACTING
WITH SOLID SURFACE

G. N. Makarov^{a,*}, S.A. Mochalov^a, A. N. Petin^b

^a Institute of Spectroscopy, Russian Academy of Sciences, 142190, Troitzk,

Moscow region, Russian Federation

Tel.: +7 (095) 334-0232, FAX: 7 (095) 334-0886

e-mail: g.makarov@isan.troitsk.ru

^b Troitzk Institute of Innovation and Thermomuclear Research, 142190, Troitzk,

Moscow region, Russian Federation

A summary

When a pulsed gas dynamically cooled supersonic molecular flow interacts with solid surface a pressure shock is formed in front of it, non-equilibrium conditions in which may be inverse to those in the incident (unperturbed) flow ($T_{1,ir} \leq T_{1,ret} \leq T_{1,vb}$ in the incident flow and $T_{2,ir} \geq T_{2,ret} \geq T_{2,vb}$ in the pressure shock; $T_{1,ir}$, $T_{1,ret}$ and $T_{1,vb}$ are the translational, the rotational and the vibrational temperatures of molecules accordingly).

Isotopically selective IR multiphoton dissociation of molecules (SF_6 and CF_3I) (i) in the non-equilibrium conditions of the pressure shock, (ii) in the flow incident on the surface, and (iii) in an unperturbed flow was investigated. The parameters of the molecular flow and the conditions of formation of the pressure shock were studied. The time-of-flight (TOF) spectra of molecules in the flow interacting with surface were obtained. The dissociation yields of SF_6 and CF_3I versus the excitation laser energy and frequency in the flow interacting with surface were investigated. The SF_4 and C_2F_6 products yield and the selectivity of molecular dissociation were measured. It is shown, that the efficiency of isotopically selective dissociation of molecules in the pulsed gas dynamic flow can be essentially increased at the expense of formation of a pressure shock in the front of the surface. The concentration and temperature of SF_6 in the pressure shock are estimated and the obtained results are discussed.

Recent advances in dielectric cavity QED

Daniel Bloch and Martial Ducloy
Laboratoire de Physique des Lasers
Institut Galilée, Université Paris Nord
F-93430 Villetaneuse

The optical properties of atoms are strongly modified when they are confined near dielectric surfaces, or inside dielectric media. They are submitted to highly inhomogeneous surface potentials, their energy levels are shifted, their transition probabilities are altered, and forbidden transitions can get surface-allowed. Recent developments in this field concern (i) the influence of dielectric dispersion [1] (e.g. related to absorption bands), or dielectric cavity resonances (like Mie resonances of dielectric microspheres or microcylinders[2,3]), which can lead to resonantly-enhanced, giant atom-dielectric attraction or repulsion, with the prediction of possible atom trapping, (ii) as well as atom symmetry break due to the anisotropy of the surface near field. All these phenomena have implications in cavity QED and optical processes in microcavities and microlasers.

1. The existence of a long-range, resonant, van der Waals (vW) repulsion exerted by a sapphire surface on excited ($6D_{3/2}$) Cs atoms has been experimentally demonstrated - thanks to an energy coincidence between a de-excitation channel of the $6D_{3/2}$ Cs level and a surface polariton resonance of sapphire at $12.2 \mu m$ [4]. We will discuss the dielectric window dependence of vW interactions, as well as the critical role played by the orientation of the sapphire birefringence axis in this singular behaviour (due to frequency shift of the surface polariton [5]), and will present experimental observations by reflection spectroscopy [4], or absorption spectroscopy of submicrometer gas cells.

2. The symmetry break of atomic wavefunctions reflects itself in the anisotropy of the atom-surface vW interaction Hamiltonian, and induces a degeneracy lifting of the Zeeman multiplet, along with the appearance of optical transitions forbidden in free-space [6]. We will review the main properties of the off-diagonal component of the surface vW interaction, as well as the observation of surface-induced level mixing and population transfer between metastable states ($^3P_0 - ^3P_2$) of rare gases, in a beam-surface diffraction experiment, or atom beam transmission through nanostructures. [7]. The modification of the vW interaction due to alterations in the surface near-field symmetry will also be discussed in relation with either the birefringence of the crystalline surface [5] or change in the interface geometry (surface form factor). Adequate change of the surface geometry (e.g. from planar interface, to spherical or cylindrical geometries) may alter the symmetry break and then selectively enhance forbidden lines (like quadrupole transitions) with respect to electric dipole transitions [3].

[1] M. Fichet, F. Schuller, D. Bloch and M. Ducloy, Phys. Rev. A51, 1553 (1995).

[2] V. Klimov *et al.*, J. Mod. Opt. 43, 2251 (1996); 44, 1081 (1997); Phys. Rev. A56, 2308 (1997)

[3] V. V. Klimov and M. Ducloy, Phys. Rev. A62, 043818 (2000)

[4] H. Failache *et al.*, Phys. Rev. Lett. 83, 5467 (1999)

[5] M. P. Gorza *et al.*, Eur. Phys. J. D 14 (2001) in press

[6] M. Ducloy, in "Nanoscale Science and Technology" (Kluwer, the Netherlands, 1998) p. 235

[7] M. Boustimi *et al.*, Phys. Rev. Lett. 86, 2766 (2001); M. Boustimi, Thesis, Paris XIII (2000)

ATOM OPTICS AND HIGH-RESOLUTION SPECTROSCOPY OF COOLED
MG BEAMS.

S.N. Bagayev, V.I. Baraulya, A.E. Bonert, A.N. Goncharov, M.R. Seydaliyev
Institute of Laser Physics, SD RAS, Novosibirsk, Russian Federation

13/3, Lavrentyev prosp., 630090, Novosibirsk
tel: 7(383)2-33-21-27, fax: 7(383)2-33-20-67, e-mail: gonchar@laser.nsc.ru

The level schemes of light alkali earth elements, such as Mg and Ca, are promising for frequency standards and atom interferometry experiments [1]. We performed atom interferometry experiments with a Mg beam in the four-beam Bordé geometry. Zero-order interference fringes corresponding to the recoil doublet were detected with the resolution of ~ 10 KHz. The laser system at 457 nm based on a CW ring Ti:Sa laser and SHG in nonlinear crystals [2] was used in these experiments. For the laser cooling of Mg beam, we developed a laser system at 285 nm based on a CW ring dye laser and SHG in the enhanced cavity with a BBO crystal. We proposed and realized the Zeeman laser cooling scheme with a transverse magnetic field. The velocity analyzer based on Zeeman effect was developed to study the velocity distribution of Mg beam. With this analyzer, it is possible to study the beam velocity distribution without an additional tunable laser system. The deflection of Mg beam was used to extract a cooled beam from the cooling magnet. With the laser beam crossing atomic beam almost perpendicularly, the deflection angle of cooled Mg atoms was $\sim 5^\circ$. Mg atomic beam with the mean velocity of ~ 200 m/s and the width of velocity distribution of ~ 50 m/s (FWHM) was produced. This Mg beam with the flux of $\sim 10^{11}$ atoms/s was used in experiments on atom interferometry and high-resolution spectroscopy with resolution better than 1 KHz.

REFERENCES

1. «Atom Interferometry», edited by P.R. Berman, Academic Press, San Diego, pp.293-362, (1997).
2. S.N. Bagayev *et al*, A radiation source at 457 nm for high-resolution spectroscopy of Mg atom, to be published in Russian J. QE.

Coherent storage of photon states and quantum information processing in atomic ensembles

Mikhail D. Lukin

ITAMP, Harvard-Smithsonian Center for Astrophysics,
60 Garden street, Cambridge, MA 02138 USA
tel 1-617-496-7611, fax 1-617-496-7668

We describe a technique that allows to transfer quantum correlations from traveling-wave light fields to collective atomic states and vice versa with nearly ideal efficiency. This is achieved by adiabatically reducing the group velocity of light to zero, thereby "trapping" the photons in the medium [1].

The specific mechanism is based on dark-state polaritons [2] associated with light propagation in electromagnetically induced transparency (EIT). The properties of the polaritons such as the group velocity are determined by the mixing angle between light and matter components and can be controlled by an external coherent field as the pulse propagates. In particular, light pulses can be decelerated and "trapped" in which case their shape and quantum state are mapped onto atoms. Once the transfer is completed, the atomic ensemble "stores" quantum information in collective spin states. The stored quantum states can be transferred back to light by reversing the storage procedure.

We discuss the basic properties of such a coherent quantum memory device as well as the experimental progress towards implementation of these ideas. In particular, we report an experiment in which a light pulse is effectively decelerated and trapped in a vapor of Rb atoms, stored for a controlled period of time, and then released on demand [3].

Finally we outline several approaches for coherent processing of quantum information stored in collective atomic excitations.

- [1] M.-D.-Lukin, S.-F.-Yelin, and M.-Fleischhauer, Phys.-Rev.-Lett. 84, 4232 (2000).
- [2] M.-Fleischhauer and M.-D.-Lukin, Phys.-Rev.-Lett. 84, 5094 (2000).
- [3] D.-Phillips, A.-Fleischhauer, A.-Mair, R.-Wahlworth, M.-D.-Lukin, Phys.Rev.Lett., 86, 783 (2001)

Exploring the role of the relative phase in atom-field interactions

L. L. Sánchez-Soto, A. B. Klimov¹, J. Delgado, and E. C. Yustas
Departamento de Óptica, Facultad de Ciencias Físicas, Universidad Complutense, 28040 Madrid, Spain

¹*Departamento de Física, Universidad de Guadalajara, Revolución 1500, 44420 Guadalajara, Jalisco, México*

The problem of the interaction of an atomic system with a radiation field is a keystone of quantum optics. Needless to say, it is impossible to obtain exact solutions to this problem and some approximations must be used.

The two-level atom is, perhaps, the most common hypothesis. Such an object is an important tool because it allows us to replace the whole atomic system by an effective two-level system that accounts for all the relevant details of the interaction. The Dicke model, describing the interaction of A identical two-level atoms with a single-mode field in a perfect cavity, is perhaps the archetype of this situation.

In the semiclassical version of this Dicke model, correlations are safely ignored and the field is interpreted to be a purely classical electric field. Such an approximation reduces the problem to the exclusive knowledge of the atomic dynamics, which is studied in terms of the inversion and the components of the atomic dipole in-phase and in-quadrature with the field (i.e., the Bloch vector). In its fully quantized version, although one must take care also of the evolution of the field amplitudes, the atomic dynamics is still explained in terms of inversion and dipole quadratures. However, the natural way of understanding the resonant behavior is in terms of the relative phase between the field and the atomic dipole.

While the quantum quadratures are well known, the operator for this relative phase has resisted a quantum description. At this respect, we think that, in spite of its maturity and success, the Dicke model is apparently incomplete since it lacks a satisfactory description in terms of this relative phase, indispensable to compare with the classical world. The main goal of this communication is precisely the general description of that variable.

For the Dicke model, a polar decomposition of the amplitudes seems to be involved, mainly because, unlike for the case of two harmonic oscillators, the Hamiltonian cannot be cast in terms of $su(2)$ operators, but rather in terms of some polynomial deformation of $su(2)$. These nonlinear algebras have been examined recently in different physical contexts and, by exploiting these results, it is possible to perform such a decomposition in an elegant way, obtaining a Hermitian operator representing the relative phase we wish to examine.

LASER-INDUCED NONSEQUENTIAL MULTIPLE IONIZATION OF ATOMS: A PREMIUM FOR COOPERATION

W. Becker
 Max-Born-Institut
 Max-Born-Str. 2a, 12489 Berlin, Germany

Under most circumstances, laser-induced multiple ionization proceeds sequentially, that is, electrons are removed one at a time. Experiments have shown, however, that sometimes a nonsequential mechanism is more efficient by many orders of magnitude [1]. Ever since, the nature of the underlying physical mechanism has been debated. It is of particular interest, since up to now this is the only case in intense-laser atom physics where the electron-electron correlation becomes important and can be studied. Recent experiments have been able to measure the momentum of the multiply charged ion [2,3] and, most recently, complete kinematical information has become available [4]. This allows one for the first time to rule out some mechanisms that have been discussed, such as a shake-off. The talk will review the experimental data and discuss a simple approximation method [5] to the many-electron S matrix that is able to explore the consequences of a given scenario for the interaction mechanism.

1. B. Walker et al., *Phys. Rev. Lett.* **73**, 1227 (1994).
2. Th. Weber et al., *Phys. Rev. Lett.* **84**, 443 (2000).
3. R. Moshhammer et al., *Phys. Rev. Lett.* **84**, 447 (2000).
4. Th. Weber et al., *Nature* **405**, 658 (2000).
5. R. Kopold et al., *Phys. Rev. Lett.* **85**, 3781 (2000).

ABOUT THE ROLE OF THE EXCITED ATOMIC STATES OF A GAS IN THE
NONLINEARITY OF THE PHOTOIONIZED PLASMAS.

V.P.SILIN.

LEBEDEV PHYSICAL INSTITUTE

Russia, 117926, Moscow, GSP-1, Leninskii prospekt 53

Fax: 095-938-22-51

e-mail: silin@sci.lebedev.ru

The paper [1] dealt the properties of the third harmonic generation in the air before the gas ionization and after the recombination of the ionized air. The experimental data were discussed in this paper on the base of Ansatz of the extremely strong enhancement of the harmonic generation in the case of the gas of the excited states of atoms and molecules of air. The theoretical basis of this Ansatz is connected with the theoretical results of papers [2,3,4], which describe the enhancement of the optical nonlinearity of the excited atomic states. Other basis of this Ansatz is connected with the theoretical results on the enhancement of the optical nonlinearity of the photoionized plasmas when the reason of harmonics generation is the coherent Bremsstrahlung effect [5]. The results of paper [5] were obtained for the case of the photoionization of gas with the atoms in excited states. The theoretical approach of paper [5] was constructed in the asymptotic case of the $h_{i,j,h}$ order harmonic generation [6].

Now we should like to discuss once more the nonlinear properties of the photoionized plasma, which is produced from the gas of excited atoms. Instead of the high order harmonic nonlinearities of the papers [5,6] we obtain the analytic description as for the nonlinear inverse Bremsstrahlung absorption of the pump radiation as for the coherent Bremsstrahlung radiation of the third harmonic.

We discuss the case of the barrier suppression ionization for our description of plasmas which are created after photoionization of a gas with the atoms with excited electron states. Our theory predicts the laws of the quantitative enhancement of the intensity of nonlinear phenomena as functions of the principal quantum number n of the electronic states of the excited atoms. The enhancement of the inverse Bremsstrahlung absorption is directly proportional to the fifth power of the principal quantum number. The enhancement of the maximum effectiveness of the third harmonic generation is directly proportional to the tenth power of the principal number of the excited states of the atomic electrons.

So we have predicted very strong enhancement of the nonlinearity of the photoionized plasma which is produced of the pre-excited gas.

1. A.B.Fedotov, A.N.Naumov, V.P.Silin, S.A.Uryupin, A.M.Zhelitikov, A.P.Tarasevitch, D.von der Linde, Phys. Letters, A271,407(2000)
2. S.M.Gladkov, N.I.Koroteev, M.V.Rychev, O.Shtensel, JETP Lett.43,287(1986)
3. S.M.Gladkov, A.M.Zhelitikov, N.I.Koroteev, Bull. Acad. Sci. USSR, Phys. Ser. 52 (2) 7 (1988)
4. G.A.Askaryan, JETP Lett. 4,270 (1966)
5. V.P.Silin, Zh Exp Teor Fiz,v.117(5) 926 (2000); JETP, 90, (5) 805 (2000)
6. V.P.Silin, Quantum Electronics,29(10)887(1999)

Laser-produced metastable ultracold plasma

Yakovlenko S.I., Tkachev A.N.

General Physics Institute, RAS, Russia

Dynamical Lamb effect versus dynamical Casimir effect

Yu.E. Lozovik, N.B. Narozhny, A.M. Fedotov
 Moscow State Engineering Physics Institute, Moscow, Russia
 Institute of Spectroscopy, 142090 Moscow reg., Troitsk, Russia

An atom interacting with a quantized electromagnetic field in a cavity with variable parameters is considered. Variation of the cavity parameters results in non-stationary dynamics of the field which leads, in turn, to excitation of the atom, even if photons were initially absent in the cavity. We distinguish three mechanisms of such excitation: excitation due to absorption of real photons created by the dynamical Casimir effect, excitation due to absorption of virtual photons during the transient process, and excitation due to non-adiabatic parametric modulation of the atomic Lamb shift. The last mechanism has no relation to the dynamical Casimir effect and thus should be considered as a new vacuum QED effect. Normally all these three mechanisms give contribution to the amplitude of the atom excitation and are accompanied by creation of photons. Therefore presence of the atom in the cavity alters the average number of created photons in comparison with the case of an empty non-stationary cavity. Our consideration is based mainly on a simple model of a two-level atom interacting with a single mode of quantized electromagnetic field. However, our results are qualitatively valid for more realistic models.

SPHERICALLY SYMMETRIC STRUCTURAL RESONANCES OF LASER RADIATION IN NONLINEAR MEDIA

Vladimir V. Kabanov
Institute of Physics, National Academy of Sciences of Belarus
F. Skarina Ave. 68, Minsk 220072, Belarus

Great interest is being recently shown in spherical fields, which is connected with considerable investigations of the nonlinear interaction of the laser radiation with spherical microparticles. An overview of the results on this problem is given and the perspectives of their applications are discussed in the report. The possibility of the realization of a spherically symmetric vortex of the electromagnetic field in a homogeneous isotropic medium are analyzed. The existence of this vortex is determined by the radial-gradient distribution of the nonlinear refractive index, which acts as the spherical microcavity induced in the nonlinear medium. This structure — the structural resonance has quite discrete values of the energy and the orbital angular momentum. Mechanisms and conditions of self-organization of the spherically symmetric structural resonance are discussed on a basis of the nonlinear-optical and quantum-mechanical approaches. Physical aspects of manifestation of the spherically symmetric structural resonance are considered.

It was shown that the structural resonance could be obtained at the interaction of the vector spherical harmonic with the nonlinear medium having a negative linear permittivity. As a result the nonlinear refractive index becomes the valid value in a small volume near the centre. Within this volume a set of nondamped vector spherical harmonics are formed the spherical symmetric structure of the electromagnetic field of a soliton type. The combined angular momentum of the structural resonance is equal to zero. While each vector spherical harmonic within the structure has by itself the angular momentum differing from zero. The associated centrifugal potential counteracts the collapsing exclusion of the electromagnetic field from the nonlinear medium and provides the stability of the structural resonance. Different aspects of the stability of the spherically symmetric structural resonance in the nonlinear medium are discussed.

Photons confined in 3D-microcavities doped with quantum dots

U. Woggon, M.V. Artemyev, B. Mueller, W. Langbein

Fachbereich Physik, Universität Dortmund, Otto-Hahn-Strasse 4, D-44221 Dortmund,

phone: ++49-231-755 3767, fax: ++49-231-755 3674

We present the concept of a complete three-dimensionally confined photonic dot (PD) doped with CdSe quantum dots (QDs). In such a QDs@PD structure we realize the combination of two main concepts of modern solid state physics – the merging of 3D-electronic confinement of quantum dots with 3D- photonic confinement in a spherical microcavity. The coupling of a single CdSe nanocrystal to a single cavity mode is achieved, the concept of nanocrystal-quantum dot laser emitting at room temperature in the visible is discussed and the control of spontaneous emission of quantum dots in photonic dots is studied. The samples have been prepared using hollow polymer microspheres doped with CdSe QDs or very small glass spheres covered with a thin polymeric shell containing QDs. With $R < 5 \mu\text{m}$, the small size of the PD ensures a large mode spacing of a few tens of meV, comparable or even larger than the emission linewidth $\hbar\Delta\omega_{\text{QP}}$ of a single CdSe QD. For the cavity mode widths $\hbar\Delta\omega_{\text{cav}}$, values between 250 μeV and 1.5 meV were observed yielding maximum Q-factors measured at room temperature. Using imaging spectroscopy at the diffraction limit, the emission spectra are analyzed and intensity and polarisation are mapped across a single microsphere. Polarisation-selective detection schemes allow a spatial addressing of nanocrystals at the surface of the cavity exploiting the lifting of degeneracy of TM and TE-modes in a spherical cavity. The experimentally obtained polarisation-dependent mode images confirm the calculated mode assignment. At low temperatures and homogeneous linewidths of single quantum dots as narrow as the photonic dot modes, we observe an enhancement in the spontaneous emission rate, i.e. the Purcell effect is found for quantum dots inside a photonic dot. Enhancement factors of the spontaneous emission rate in the 3D-cavity compared to emission in free space varying between 2 and 6 have been obtained.

Problems of nonlinear optics of extremely short light pulses

Sergei A. Kozlov
St. Petersburg State Institute of Fine Mechanics and Optics (Technical University), 14
Sablinskaya, St. Petersburg, 197101, Russia
E-mails: kozlov@phd.ifmo.ru

The necessity of a development of a qualitatively new approach to a propagation theory of few-optical cycle pulses [1] is based. Derivation principles of nonlinear evolutionary equations for the electrical field of a femtosecond pulse in a waveguide medium (a hollow waveguide filled with gases or liquids; a silica fiber, an air-silica microstructure fiber) with various-nature nonlinearities are formulated [2]. The equations incorporating material and waveguide linear dispersion over a significant region of the medium transparency band as well as electron and electron-vibration nonlinearities are presented. A number of femtosecond phenomena such as the generation of a spectral supercontinuum and its compressibility in the time domain to one field cycle, the formation of an ultrashort soliton or a shock wave of a pulse profile are studied using the equations. Self-reflection conditions of an ultrashort pulse in a waveguide are determined. It is shown that the spectral approach is more productive than the field-based one to analyze the self-focusing of ultrashort pulses in medium bulk [3]. The equations for paraxial and nonparaxial dynamics of space and time spectra in transparent nonlinear media are derived. A "light bubble" formation is studied. It is shown that the natural cause of the limitation of a self-focusing collapse is a backward self-reflection.

References

- G. Steinmeyer, D. H. Sutter, L. Gallmann, N. Matuschek, U. Keller, "Frontiers in Ultrashort Pulse Generation: Pushing the Limits in Linear and Nonlinear Optics," *Science* **286**, 1507-1512 (1999).
- V.G. Bespalov, S.A. Kozlov and Yu.A. Shipolyanskiy, "Method for analyzing the propagation dynamics of femtosecond pulses with a continuum spectrum in transparent optical media," *J. Opt. Technol.* **67** (4), 303-308 (2000).
- S. A. Iz'yurov and S. A. Kozlov, "Dynamics of the Spatial Spectrum of a Self-Focusing Optical Wave in a Nonlinear Medium," *JETP Letters* **71** (11), 453-456 (2000).

Nonparaxial spatial optical solitons
in transparent nonlinear media

N.N.Rosanov
Research Institute for Laser Physics, Birzhevaaya liniya 12, 199034 St.Petersburg, Russia,
Tel. 812-3281093, Fax. 812-3285891, E-mail: rosanov@ilph.spb.su

A review of theory of spatial transversely two-dimensional conservative optical solitons with transverse size w comparable with the light wavelength is given. For weakly nonparaxial solitons with the size exceeding the wavelength, a sequential perturbation theory is developed taking into account nonparaxial corrections to the paraxial equation [1]. In the case of the Kerr nonlinearity, the theory predicts existence and stability of solitons with power P exceeding the critical power of self-focusing P_{cr} . Radiation polarization is elliptical (close to linear one) and changes over the beam transverse section. Transient to a stationary soliton has an oscillatory nature; "internal mode" of soliton perturbations was found with anomalously weak damping.

In the strongly nonparaxial case, extremely narrow Ω were found – the "optical needles" [2]. For the Kerr nonlinearity, the soliton half-width w is determined by its power. The electric field includes a noticeable longitudinal component; the soliton polarization is again elliptical changing over transverse section. Numerical simulations with a saturable nonlinearity confirm stability of "optical needles" and possibility of their formation from initially wide laser beams [3].

A theory was developed of weakly nonparaxial transversely two-dimensional optical solitons in anisotropic media with the quadratic nonlinearity. Polarization state of the solitons is also elliptical and changing over the beam transverse section [4].

Possibilities of experimental verification of the theory and potential applications are discussed.

1. N.N.Rosanov, N.V.Vysotsina, A.G.Vladimirov. *JETP* **118** (2000) 1307.
2. V.E.Semenov, N.N.Rosanov, N.V.Vysotsina. *JETP* **116** (1999) 243.
3. N.N.Rosanov, V.E.Semenov, N.V.Vysotsina (in press).
4. N.N.Rosanov, S.V.Fedorov (in press).

SHORT PULSE GENERATION BY ONE-STEP SBS

R.Buzelis, A.Dement'ev, E. Kosenko, E.Murauskas

Institute of Physics, Savanoriu 231, LT-2028 Vilnius, Lithuania
 Tel.: (370 2) 641990, Fax: (370 2) 321975, e-mail: aldement@ktl.mii.lt

The main regularities of laser pulse compression by backward SBS and SRS are known quite well. The possibility to simulate numerically the spatio-temporal structure of Stokes pulses [1] allows to optimize the SBS-compression process. The use of truncated pulses (~0.6 ns) of the passively Q-switched Nd:YAG laser allowed to obtain Stokes pulses with duration of ~75 ps [2]. In this paper, we present a detailed numerical and experimental analysis of the evolution of the spatio-temporal structure of Stokes pulses during a transient SBS process. For experimental investigation, Nd:YAG-laser

pulses with duration of ~2 ns were used. It is shown that for the tightly focused Gaussian pump beam the whole divergence of the Stokes beam can increase or decrease considerably (as compared to the pump beam) after passing backwards through the focusing spherical lens depending on the ratio of geometrical and diffraction divergence in the incident pump beam.

Compressed Stokes pulses usually have a complex spatio-temporal structure (Fig. 1). The peripheral part of the pulse contains a long tail (dashed curve). But for the central part of the Stokes beam (extracted by an aperture), short pulses were observed (solid curve). For pump pulses with energy of about ten times above the SBS threshold, the Stokes pulses with duration of ~80 ps were obtained in heavy fluorocarbon C_6F_{12} . This simple method of short pulse generation might be interesting for different applications, such as satellite ranging, short electrical pulse generation, etc.

1. V.Girdauskas, A.S.Dement'ev et al., Lithuanian Phys. J., 37, 269 (1997).
2. R.Buzelis, A.Dement'ev, and E.Murauskas, Lithuanian Phys. J., 39, 253 (1999).

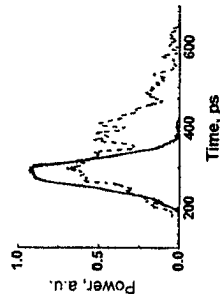

Fig.1. Temporal shapes of Stokes pulses

THE CNOIDAL WAVE CONCEPT IN SOME PROBLEMS OF NONLINEAR OPTICS

Victor Aleshkevich and Yaroslav Kartashov

Physics Department, M.V.Lomonosov Moscow State University, 119899 Moscow Russia
 Victor Vysloukh

CICAp, U.A.E.M., Cuernavaca, Mor., Mexico, C.P. 62210

We report review and generalization of quite recent theoretical, numerical and preliminary experimental results concerning the application of the cnoidal wave concept [1] in such problems of nonlinear optics as a spatial [2,3] and temporal [4,5] self-action, bandwidth limited amplification of pulse trains in optical fiber amplifiers [6], and Raman frequency conversion [7]. The cnoidal waves concept is especially attractive because it enables one to analyze propagation dynamics of pulse trains (or periodic laser beam arrays) starting from extremely high repetition rates up to solitary waves from the unified point of view. The practical importance of the cnoidal waves is related, first of all, with their stability with respect to the small input profile perturbations and collisions. It makes cnoidal waves potentially useful in fiber ultra high bit rate optical communication networks and photorefractive media based devices for light-by-light control.

References

1. V. Vysloukh, V. Petnikova, V. Shuvalov. Multicomponent photorefractive cnoidal waves: stability, localization, and soliton asymptotics. Phys. Rev. E, 60, 1009 (1999).
2. V. Aleshkevich, V. Vysloukh, Y. Kartashov. Self-bending of cnoidal waves in photorefractive medium with drift and diffusion nonlinearity. Optics Communications, 174, 277 (2000).
3. V. Aleshkevich, Y. Kartashov, V. Vysloukh. Propagation of the cnoidal waves in the medium with saturable nonlinear response. Accepted by Quantum Electronics, December (2000).
4. V. Aleshkevich, V. Vysloukh, Y. Kartashov. Cnoidal waves compression by means of multisoliton effect. Optics Communications, 185, 305 (2000).
5. V. Aleshkevich, Y. Kartashov, V. Vysloukh. Self-frequency shift of the cnoidal waves in the medium with delayed nonlinear response. Accepted by JOSA B, November (2000).
6. V. Aleshkevich, Y. Kartashov, V. Vysloukh. On the possibility of suppression of the self-frequency shift of the cnoidal waves in the medium with delayed nonlinear response by bandwidth-limited amplification. Accepted by Optics Communications, December (2000).
7. V. Aleshkevich, Y. Kartashov, V. Vysloukh. Raman conversion of the cnoidal waves. Accepted by Quantum Electronics, December (2000).

APPROACHES TO COHERENCE DESTRUCTION OF SHORT LASER PULSES

E. V. Ivakin, A. I. Kizak, N. V. Karelin, A. M. Lazaruk (late), A. S. Rubanov

B. I. Stepanov Institute of Physics, National Academy of Sciences,

Minsk, 220072 Belarus

A problem of coherence transformation of light pulses has appeared due to recent technological improvement in high-efficiency low-cost solid-state lasers with frequency conversion. Development of methods for controllable high-speed coherence destruction enables one to broaden the range of applications of such lasers. The most important example is the deep-ultraviolet projective photo-lithography, where monochromatic radiation with low degree of spatial coherence is required for speckle-noise reduction.

In the present paper we analyse, both theoretically and experimentally, two schemes of coherence transformation of short laser pulses: self phase-modulation and time-delay line. These methods enables one to form images with low level of coherent noise within one pulse.

In the process of phase self-modulation of light pulse the degree of coherence is controlled by power density of incident light, pulse duration and by relaxation properties of nonlinear medium. Experimentally, four times decrease of speckle-noise for 4th harmonics of YAG:Nd³⁺ laser has been obtained in CCl₄ with thermal nonlinearity. Optical time-delay line can be constructed by a set of optical fibers with a step change of length or by a Fabri-Perot interferometer. It is shown, that the degree of coherence transformation to be determined by the number of beams in delay line, distribution of mutual beams' energy, damping factor and delay time. Under weak damping and delay time much more than time of phase correlations the final contrast of speckled picture K can be expressed by empirical formula $K = 1/\sqrt{N_0 + N_p}$, where N_0 is a number of modes in laser light and N_p is a number of beams in delay line.

At the end of the paper we give theoretical analysis of some other methods of coherence destruction: nonlinear modulation on saturable absorber, electro-optical analogue of moving phase diffuser and nonlinear reflection from liquid mercury surface.

Simulation of Ultra-short Soliton-like Pulse Generation in Lossy Nonlinear Dispersive Optical Fibers Using the Beam Propagation Method

A. H. Tehranchi*, and N. Granpayeh**

Department of Electrical Engineering, K. N. Toosi University of Technology, Tehran, Iran 16314, P. O. Box 16315-1355.

Tel: (009821)8600075-9 Fax: (009821)8849348

e-mails: * Tehranchi_amir@hotmail.com ** granpayeh@eed.kntu.ac.ir

Summary

Induced modulational instability is referred to the process in which the input wave is externally modulated and coupled into the nonlinear dispersive media to induce the instability at the prescribed modulation frequency and leads to break up of CW or quasi-CW signal into a train of ultra-short pulses during its propagation.

In this paper, we show the evolution of generation of an ultra-short pulse from a quasi-CW weak-modulated signal by induced modulational instability in lossy nonlinear dispersive optical fibers, in time and frequency domains by means of dimensionless numerical simulations, using the beam propagation method (BPM), and also obtain pulse widths, compression ratios and optimum lengths at the output of the fiber for achieving shortest (sub)pico-second pulses with maximum peak intensities in the normalized form, which are applicable for different parameters of various optical fibers.



Dimensionless evolution of a quasi-CW weak-modulated optical pulse envelope into a short pulse is shown, in time domain (left) and frequency domain (right), along its propagation in a lossy nonlinear dispersive optical fiber.

Reference: K. Tai, A. Hasegawa, and A. Tomita, Phys. Rev. Lett., 56, 135, 1986.

SOLVATE SHELL MICROSTRUCTURE OF DYE MOLECULES IN WATER-ORGANIC BINARY SOLVENTS REVEALED BY POLARIZATION PICOSECOND LASER SPECTROSCOPY

B. Bushuk, A. Rubinov, Yu. Katvinkovskaya, S. Bushuk

B.I. Stepanov Institute of Physics of the National Academy of Sciences of Belarus, Skaryny Ave. 70, Minsk, Belarus. E-mail: bushuk@ifanbel.bas-net.by

Thermodynamic, X-ray, NMR- and IR-spectroscopy methods are known to give only averaged information concerning intermolecular interactions. Direct data on polyatomic molecules solvate shell microstructure formation and its fluctuations in binary water-organic solvents are almost absent. In such objects the probe microenvironment often consists of water and biostructure fragments (heteroatoms O, N; -OH group; amino groups; carbonyl oxygen). These fragments is quite well modeled by organic co-solvent in binary mixture. In order to perform such investigations we have studied Rhodamine 6G solvate shell microstructure in water-organic (methanol, acetonitrile, dioxane) binary solvents by means of steady-state and picosecond polarization spectroscopy. It was established that in the case of water-methanol solvent the microstructure of solvate shell consists of two spheres. The first coordination sphere contains mainly methanol molecules due to selective solvation of the doped center. The formation of the outer structure can be explained as follows. Hydrophilic group of methanol molecules (-OH) can form two intermolecular H-bonds through its hydrogen with electron donor and through its oxygen with electron acceptor. So, for the solvate shell composition in question methanol molecules situated outside the first coordination sphere can simultaneously form H-bond with water cluster and with methanol molecule of the nearest environment of the doped center. To develop further the mechanism of solvent-solvate interactions Rhodamine 6G rotational diffusion time in water-acetonitrile solution was studied. In this case, as was deduced from experimental results, there is no strong intermolecular H-bonds between inner and outer parts of the solvate shell. This experiment proves the mechanism of solvate shell build up for water-methanol mixture by means of intermolecular H-bond formation between inner and outer parts of the solvate shell.

Controlling Single Neutral Atoms

Dietler Meschede, Stefan Kuhr, Wolfgang Alt,
Dominik Schrader, Martin Müller, Victor Gomer

*Institut für Angewandte Physik, Universität Bonn
Wegelerstr. 8, 53115 Bonn, Germany
Tel.: (+49) 228 / 73-3477, Fax: -3474, meschede@iap.uni-bonn.de*

In order to achieve full quantum control atomic particles have to be localized and prepared in a pure quantum state. The most advanced experiments can be found in the field of ion traps. Electromagnetic fields are used to manipulate stored atomic particles but cause also disturbances by stray fields. Due to their weaker coupling to the environment, neutral particles may offer advantages in applications of quantum devices. Efficient quantum manipulation may be accomplished by the exchange of optical photons e.g. in a high finesse cavity. This is in principle possible with the current cavity QED technology, but in recent experiments [1, 2] atoms enter a cavity in a random way not allowing to have a certain small number of atoms on demand. In the present work we demonstrate a transportation device for single atoms which offers a novel kind of cold atom source free of the indeterminism intrinsic to conventional sources.

In our experiment the primary source for single cold atoms is a special magneto-optical trap, where strong field gradients provide good initial localization of the atoms [3]. Efficient fluorescence detection allows to determine the exact number of trapped atoms in real time. They are then transferred into a standing wave dipole trap consisting of two counterpropagating Nd:YAG laser beams where we achieve transfer efficiencies of 100% [4]. Consequently atoms can be exchanged arbitrarily between the two traps. In preliminary studies population relaxation times for the hyperfine ground states of order seconds have been measured. The detunings of the two Nd:YAG laser beams are controlled independently by means of two acousto-optic modulators (AOM) allowing the interference pattern to travel if the AOM frequencies are detuned. Trapped atoms now follow the motion of the potential wells of this "single atom conveyor belt". By applying suitable frequency ramps they are accelerated and brought to halt at preselected points along the standing wave.

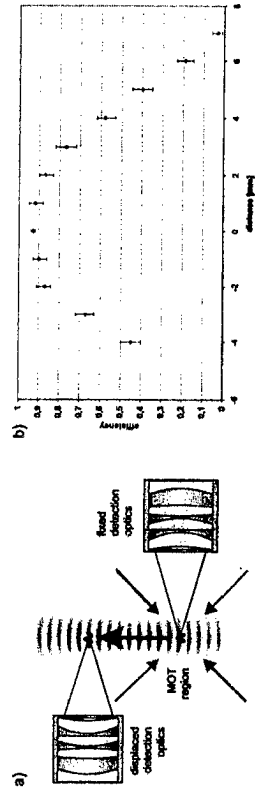

Fig. 1. a) The "conveyor belt" transfers trapped atoms to a desired spot along its axis. The displaced detection optics then collects fluorescence light of these atoms being illuminated by a resonant probe laser. b) Transportation efficiency as a function of the displacement. Each data point results from ~100 shots performed with one atom each.

After transport atoms are detected by an optical system similar to the one used for the atoms in the MOT (see fig. 1). To prove the reliability of our device we have measured the transportation efficiency as a function of the displacement.

In all our experiments the exact number of atoms involved is known. The setup could serve as a unique deterministic source of cold atoms for promising future experiments in the field of quantum information processing.

References

- C.J. Hood, T.W. Lynn, A.C. Doherty, A.S. Parkins, H.J. Kimble, "The Atom-Cavity Microscope: Single Atoms Bound in Orbit by Single Photons", *Science* **287**, 1447 (2000)
- P.W.H. Pinkse, T. Fischer, P. Maunz and G. Rempe, "Trapping an atom with single photons", *Nature* **404**, 365 (2000);
- D. Haubrich, H. Schradwinkel, F. Strauch, B. Ueberholz, R. Wynands and D. Meschede, "Observation of individual neutral atoms in magnetic and magneto-optical traps", *Europhys. Lett.* **34**, p. 663 (1996)
- D. Frese, B. Ueberholz, S. Kuhr, W. Alt, D. Schrader, V. Gomer und D. Meschede, "Single Atoms in an Optical Dipole Trap: Towards a Deterministic Source of Cold Atoms", *Phys. Rev. Lett.* **85**(18), 3777 (2000)

LASER-INDUCED PHOTOCHEMICAL GAS-PHASE REACTIONS OF
VIBRATIONALLY EXCITED TRIPLET MOLECULES

G.A. Zalesskaya, D.L. Yakovlev, E.G. Sambor

Institute of Molecular and Atomic Physics, National Academy of Sciences of Belarus,
70, Skaryna Ave., 220072 Minsk, Belarus
e-mail: zaleskavava@imaph.bas-net.by

Mechanisms and rates of laser-induced gas-phase photochemical reactions of complex carbonyl aromatic compounds (acetophenone, benzophenone, anthraquinone) vibrationally excited by CO₂ or N₂ laser radiation in a triplet state T₁ were investigated as these molecule were able to participate in important photochemical reactions such as hydrogen atom, electron or proton transfer. Up to now a few studies have been devoted to photoinduced reactions of polyatomic molecules in a gas-phase where an additional contribution from surrounding solvent molecules does not exist and photochemical behaviour of interacting molecules depends only on their individual properties. In the present study, competing photoinduced processes such as energy transfer (vibrational and electronic), unimolecular decomposition, and chemical reactions with various compounds (hydrogen and electron donors) were considered over a wide range of vibrational energies and at different heating temperatures. Analysis of laser-induced time-resolved delayed emissions as well as transient absorption was used to evaluate the reaction rates and to identify the reaction products.

Conclusions were made that initial vibrational excitation did not influence on the rates of gas-phase photochemical reactions. In a vibrational quasicontinuum, the vibration-vibration relaxation was the most effective process among bimolecular ones. The photochemical reaction occurred after relaxation to vibrational equilibrium. It was found that the main features of gas-phase photochemical reactions were determined not only by reacting molecules properties (ionization and redox potentials, triplet level positions, electronic interactions, etc.) but also by dynamics of gas-phase motion, in particular by the important role of steric effects and the lack of solvation.

STUDY OF ULTRAFAST CHEMICAL DYNAMICS
BY INTENSE LASER FIELD DISSOCIATIVE IONIZATION

S.A. Trushin***, W. Fuss*, K.-L. Kompa*, W. E. Schmid*

*Max-Planck-Institut für Quantenoptik, D-85741 Garching, Germany,
Tel.:49-89-32905-237, Fax: :49-89-32905-237, e-mail: set@mpq.mpg.de

**Institute of Physics, Belarus Academy of Sciences, Minsk, Belarus

At laser intensities near the threshold for barrier-suppression ionization all molecules are efficiently ionized. Ionization is usually followed by extensive fragmentation of the parent ion. Using this kind of nonresonant (800 nm) ionization as a probe in a pump-probe experiment (pumping at 267 or 200 nm) for studying chemical dynamics offers several advantages: (1) There are no dark states. In particular all excited states are detected. (2) Different locations on the potential energy surface give rise to different fragmentation patterns. (3) The many signals (parent and fragment ions) yield many (sometimes 5 or more) time constants with high redundancy, typically much more than e.g. transient absorption. (4) The many signals can also improve the effective time resolution to better than 10 fs. Whereas previous measurements typically only investigated the disappearance of the initially prepared state or appearance of the product, we can monitor all the pathway of the molecule along the potential energy surfaces from the Franck-Condon region down to the product ground state. Examples will be shown from 3 classes of reactions: (1) pericyclic reactions such as cyclohexadiene ring opening, where even the driving forces could be deduced, (2) reactions (sigmatropic, cis-trans and formation of carbenes) of simple olefins, where multiple branchings (conical intersections) and dynamic effects (memory of momentum) were found, (3) photochemistry of metal carbonyls, which in contrast to the previous belief is not a simple direct dissociation, but involves several intermediate surfaces and is guided by slopes and conical intersections; coherent oscillations observed indicate that the molecules are far from statistical energy distribution, in spite of the many states which are available.

INTERPLAY BETWEEN MICRO- AND MACRO-SCOPIC FRICTION DURING
EXCITED STATE ISOMERIZATION OF 1,1'-DIETHYL-2,2'-CYANINE IODIDE IN
N-ALCOHOL SOLUTIONS.

Arkady Yartsev, Alexander Tamovsky, and Villy Sundström
Department of Chemical Physics, Lund University
P.O.Box 124, S-22100, Lund, Sweden

By means of time-resolved pump-probe spectroscopy we have studied the photo-induced dynamics of 1,1'-diethyl-2,2'-cyanine iodide (1122C) in n-alcohol solutions.

The barrierless character of isomerization has been confirmed by the following observations. Stimulated emission (SE) exhibits a large spectral shift from ~570 nm to more than 1000 nm. This SE spectral evolution reflects the dynamics of all-downhill motion of the excited state population followed by formation of a quasi-equilibrated distribution at the bottom of the excited state potential. Neither solvation processes nor IVR can cause this spectral shift. We also observe the characteristic barrierless kinetics of ground state absorption recovery with a pronounced induction period. This delayed ground state absorption recovery is – as expected for barrierless dynamics – very similar to the rise time observed for the near-infrared SE, which corresponds to molecular conformations in the vicinity of the bottom of the excited state potential. Depopulation of the entire excited state has been measured as the decay of the excited state absorption (ESA) (recorded at ~400 nm where neither SE nor ground state bleach contribute to the signal) and the decay of the red-most SE, which are very similar.

Because of stochastic character of the 1122C torsion motion at the bottom of excited state, the same close to linear dependence on solvent shear viscosity (η) was found for the decay of the ESA and the red-most SE as well as for ground state recovery. In contrast, strongly non-linear dependence on η has been observed for dynamics of the short-lived SE signals, which corresponds to highly non-equilibrated positions on the steep part of the reaction co-ordinate potential surface. Since, in the overdamped regime, torsional motion of a bulky molecular group is determined by solvent local friction, we conclude that for 1122C in n-alcohols the relation between solvent friction and viscosity depends on the speed of population motion, or in other words, on the steepness of the excited state potential.

Collisionally Assisted Highly Selective Laser Isotope Separation

Oleg V. Boyarkin and Thomas R. Rizzo

Ecole Polytechnique Fédérale de Lausanne
LCPM, DC, EPFL, Lausanne, CH-1015, Switzerland
tel: +41 21 693 3038, fax: +41 21 693 4111, e-mail: Oleg.Boyarkin@epfl.ch

Over the last several years we have developed a combination of selective infrared multiphoton dissociation (IR MPD) with LIF detection of the dissociation products to a detection techniques for overtone spectroscopy of jet-cooled polyatomic molecules. It is based on specific properties of IR MPD and allows extremely high selective and efficient dissociation of vibrationally excited polyatomic molecules in the presence of a large excess of vibrationally ground state ones^{1,2}.

High selectivity of IRMPD in dissociating vibrationally excited molecules prompted us to apply it to highly selective Molecular Laser Isotope Separation (MLIS). Two lasers are used in our new approach. The first laser preexcites with high selectivity molecules of a desirable isotopic species to a low vibrational overtone level of a light atom stretch vibration. Following this, a CO₂ laser pulse selectively dissociates only the preexcited molecules, composed mostly of one isotopomer. The isotopically enriched dissociation fragments are chemically converted to molecules different from their parent. A novel aspect of our approach is the use of vibrational overtone pre-excitation as a first step in the dissociation phase of separation. This can be done by a narrow bandwidth tunable laser with extremely high isotopic selectivity, even in the case of a relatively small isotopic shift. Moreover, overtone pre-excitation promotes molecules directly to quasicontinuum of vibrational states, greatly facilitating the subsequent infrared multiphoton dissociation (IRMPD). This scheme has been applied to MLIS of carbon-13 on CF₃H molecule. It turns out, that already intrinsically high selectivity of this scheme at some circumstance can be significantly increased by collisional vibrational energy deactivation of preexcited ¹³CF₃H molecules. This allows single stage enrichment of C₂F₄ dissociation product to 99% of ¹³C.

1. Boyarkin, O. V. and T. R. Rizzo *J. Chem. Phys.* **105**: 6285 (1996).
2. Boyarkin, O. V., T. R. Rizzo, et al. *J. Chem. Phys.* **110**: 11346 (1999).

Laser Distillation of a Racemic Isotropic Mixture of Chiral Molecules

Boris A. Grishanin, Victor N. Zadkov, Stanislav S. Bychkov

International Laser Center and Faculty of Physics
M. V. Lomonosov Moscow State University, Moscow 119899, Russia

Preferential synthesis with light from a racemic (which shows no optical rotation) mixture of enantiomers is of great importance in chemistry, pharmacy, and medicine. Experimentally, there have been no successful realizations of laser synthesis of a racemic solution by now. Theoretically, two different approaches have been discussed so far. One of them is based on preferential selection of left- or right-handed enantiomers from a racemic mixture of chiral molecules with no change in the nuclear configurations of molecules. Another approach is based on *photoinduced synthesis* of left-handed enantiomers from right-handed ones using methods of coherent control. Such synthesis, called *laser distillation* of a racemic mixture, was first proposed by Brumer and Shapiro [1]. Unfortunately, as we demonstrated in [2], this idea does not work properly for an isotropic racemic solution due to the averaging over the rotational degrees of freedom of chiral molecules and therefore further modification of Brumer and Shapiro's idea is required.

To elucidate key peculiarities of using coherent control for manipulating molecular chiral states, we start with the study of hydrogen peroxide (H_2O_2) molecule and its isotopomer (HOOD), the simplest chiral molecules. This molecule has a characteristic double-well potential minima of which correspond to the left- and right-handed enantiomers and are mirror-symmetrically spaced. As a result, eigenstates of the torsional Hamiltonian are split due to the tunneling through the potential barrier separating two wells. For H_2O_2 and HOOD molecules this tunneling splitting is equal to 11.4 cm^{-1} and 5.5 cm^{-1} for the torsional ground states, respectively, so that the left-right conversion time is a fraction of picosecond or a few picoseconds and therefore the molecule shows rapid oscillations between left- and right-handed enantiomers. In a vapor situation is complicated due to the averaging over ensemble.

Using modified method of laser distillation from a racemic solution, we analyze feasibility of laser distillation from a racemic vapor of hydrogen peroxide molecules. Our theoretical analysis of laser distillation scenario shows that two different types of photoinduced chirality in hydrogen peroxide vapor can be realized for different parameters of laser excitation: *stable* and *dynamic* chirality. If the left-right conversion time is much longer than the pulse duration, we have the case of stable chirality. In the opposite case we have the dynamic chirality. We show also that Raman excitation of the split ground torsional levels in H_2O_2 or HOOD induces the dynamic chirality, which means that there is an induced gyrotropy with the frequency of the tunneling splitting in H_2O_2 or HOOD vapor. One can scatter then at this inhomogeneity a probe pulse and, as a result, NOA-CARS signal will be generated. An experiment to study NOA-CARS signal in H_2O_2 or HOOD vapor that serves as an indicator of photoinduced chirality is proposed and estimations for the real experimental situations are presented.

References

1. M. Shapiro, E. Frishman, and P. Brumer, *Phys. Rev. Lett.* **84**, 1669 (2000).
2. S. S. Bychkov, B. A. Grishanin, and V. N. Zadkov, *JETPH* (2001) (in print).

SURFACE SECOND HARMONIC GENERATION FROM CHIRAL LIQUIDS ENCHASSED BY SURFACE ELECTROMAGNETIC WAVE EXCITATION

M.M.Nazarov, and A.P.Shkurinov

Department of Physics and International Laser Center, Moscow State University, Moscow
119899 Russia

Last years it is demonstrated that the second order nonlinear optical process, such as Second Harmonic Generation (SHG) and Sum Frequency Generation (SFG) can be successfully applied for studies of chiral media [1]. For the phenomenological description of the phenomena, the symmetry of the media is important. In the isotropic centrosymmetrical media the even order nonlinear optical process are forbidden in the dipolar approximation [2]. The SHG and SFG are possible on the surface of chiral liquid where the symmetry is broken [3] and in the bulk due to the presence of "nonlocal", magneto-dipolar and quadrupolar contributions into the nonlinear optical signal.

In the homogenous isotropic media with the lack of microscopic inversion center, such as the ciral liquids, the nonlinear optical process based on the even order dipolar nonlinearities become possible [2].

In this presentation we are discussing the methods of nonlinear optical diagnostics of chiral media based on the Surface Second Harmonic generation [4]. We present the description of the results of experimental and theoretical studies in this field [5]. The particular interest will be paid to the discussion of tendencies and prospects of practical applications of nonlinear optical methods for studies of molecules of biological origin.

References

1. A.P.Shkurinov, A.V.Dubrovskii, and N.I.Koroteev, *Phys. Rev. Lett.* **70** (1993) 1085.
2. N.I.Koroteev, *JETP* **79** (1994) 681.
3. A.Angeluts, A.V.Balakin, D.Boucher, I.G.Ill'ina, N.I.Koroteev, P.Masselin, O.V.Mikhalev, A.V.Pakulev, E.Fertein, and A.P.Shkurinov *Optics and Spectroscopy* vol. 87, No. 1, p.151-156, 1999.
4. A.V.Balakin, A.A.Goncharov, N.I.Koroteev, M.M.Nazarov, A.P.Shkurinov, D.Boucher, P.Masselin. *Nonlinear Optics*, Vol 23, pp. 331-346 (2000).
- 5 Yu.E.Lofovik, S.P. Merkulova, M.M. Nazarov, A.P. Shkurinov, *Physics Letters*, A 276 pp.127-132 (2000).

LASER COOLING AND TRAPPING OF RADIOACTIVE ATOMS

L. Moi¹, S.N.Atutov^{2,3}, V.Biancalana¹, A. Burchianti¹, R.Calabrese², L. Corradi⁴,
A. Dainelli⁴, V.Guidi², B.Mai², C.Marinelli¹, E. Mariotti¹, G. Stancari¹,
L. Tomassetti², S. Veronesi¹

¹Dipartimento di Fisica dell'Università, INFN, Unità di Siena, I-53100 Siena, Italy

²Dipartimento di Fisica dell'Università, INFN, Sezione di Ferrara, I-44100 Ferrara, Italy

³Permanent address: Institute of Automation and Electrometry, Novosibirsk 90, Russia

⁴Laboratori Nazionali di Legnaro, Legnaro, Italy.

Laser cooling and trapping of radioactive atoms represent the new frontier in atomic physics. A cold sample of trapped atoms is in fact the ideal tool to make high resolution spectroscopy and to study with very high accuracy fundamental problems, like for example atomic parity non conservation and nuclear decay processes. Magneto-optical traps (MOT) are very good, robust and versatile devices. The atoms can be trapped from a vapor confined in a cell and the geometry gives a large freedom to the analyzing apparatus. This kind of experiments demands, in the case of radioactive atoms, new solutions with respect to the standard approach in order to circumvent two major problems: the low atom production rates and the short atomic lifetimes. We are setting up at the Legnaro National Laboratories a ²¹⁰Fr magneto-optical trap. The Francium atoms are produced by bombardment of a gold target with an high energy oxygen ion beam. Francium ions are extracted from the gold, neutralized and collected in a vapor cell where are trapped by the lasers. The loading rate of neutral atoms into the cell is expected to be very low and, for this reason, the collection efficiency of the MOT has to be improved. We are following two different but complimentary directions. An important improvement can be introduced with the utilization of particular broad-band laser sources to perform white-light laser trapping. This last in fact can provide at the same time high cooling rate and large velocity capture range. A second step is to use special organic coatings having the property to adsorb the atoms and to release them when shined with light. This effect is known as LIAD (light induced atom desorption). The preliminary tests made with Rb and Na MOT will be presented.

Evaporative cooling in optical traps

R. Grimm, M. Hammes, D. Rychtarik, T. Weber, J. Herbig, H.-C. Nägerl

Institute for Experimental Physics, Innsbruck University, Austria

M. Mudrich, S. Kraft, K. Singer, A. Mosk, M. Weidemüller

Max-Planck-Institute for Nuclear Physics, Heidelberg, Germany

phone: ++43 512 507 6300, e-mail: rudolf.grimm@uibk.ac.at

Optical dipole traps operating with laser light very far from resonance [1] can provide conservative trapping potentials with interesting new features for evaporation experiments. We explore the prospects of evaporative cooling in various trapping schemes:

In a gravito-optical surface trap a dense gas of 10^7 cesium atoms is prepared by evanescent-wave Sisyphus cooling with a temperature of $10\mu\text{K}$ and a peak number density approaching 10^{12} cm^{-3} [2]. By increasing the detuning of the evanescent wave and reducing the trapping potentials we implement evaporative cooling. Preliminary experiments, in which we have already obtained temperatures around 300 nK and phase-space densities approaching 10^{-3} , indicate that a degenerate 2D surface gas may be reached in this way.

In a quasi-electrostatic trap realized with a CO_2 -laser photon scattering is practically absent so that extremely long storage times can be achieved and elastic and inelastic interactions of pure ground-state atoms can be studied [3]. Using a crossed-beam CO_2 -laser trap we explore the possibility to produce a BEC of Cs in the lowest ground-state sublevel, which is stable against two-body decay. As the trap is very shallow, a magnetic gradient of 31 G/cm is used to counterbalance gravity for atoms in the substate of interest. In another experiment we study inelastic and elastic collisions of binary mixtures of Li and Cs in a 100-W CO_2 -laser trap. Recent measurements show a surprising new effect, which we call "sympathetic evaporation": A "cold" cesium gas ($T_{\text{Cs}} \approx 20\mu\text{K}$) cools down in the presence of a much "hotter" lithium gas ($T_{\text{Li}} \approx 200\mu\text{K}$). The explanation is an evaporation of Li atoms out of the trap caused by elastic collisions with Cs.

[1] R. Grimm, M. Weidemüller, and Yu.B. Ovchinnikov, *Adv. At. Mol. Opt. Phys.* **42**, 95 (2000).

[2] M. Hammes *et al.*, *J. Mod. Opt.* **47**, 2755 (2000).

[3] H. Engler *et al.*, *Phys. Rev. A* **62**, 031402(R) (2000).

It is well known that polarization gradients play a crucial role in sub-Doppler laser cooling of neutral atoms. However, theoretical analysis of the problem was restricted, as a rule, by field configuration formed by light waves with the "simple" polarizations, i.e. linear or circular. Using such waves, one can form 1D field either with an ellipticity gradient (lin.lin configuration) or with a gradient of orientation (σ_+ - σ_- configuration). The two basic mechanisms of sub-Doppler laser cooling have been firstly described for these simple configurations [1]. Nevertheless elliptically polarized light waves can lead to new interesting kinetic effects [2].

In this work we analyze the atomic kinetics in the most general 1D field configuration which is formed by counterpropagating elliptically polarized light waves. For atoms with optical transitions $jg=1/2 \rightarrow jg=1/2$, $jg=1/2 \rightarrow jg=3/2$, $jg=1 \rightarrow jg=2$ (jg, j_e are total angular momentum for ground and excited states) we get expression for potential force, friction and diffusion coefficients, which govern kinetics of slow atoms in the quasiclassical limit. It was shown that the ellipticity of waves allow us (similar to the field detuning and intensity) to control not only efficiency of cooling, but even the direction of kinetic process (heating or cooling). The potential force F , the friction coefficient ξ and the induced part of diffusion coefficients D_{ind} can be expanded on gradients of light field parameters: intensity (I), phase (ϕ), ellipticity (ε) and angle of polarization ellipse orientation (φ). The friction coefficient contains terms odd in the detuning (that is well known) as well as the new terms with the even dependence on detuning. It is important that the sum of these anomalous terms does not vanish in average over the spatial period only for fields which are formed by elliptically polarized light waves. The diffusion coefficient also contains anomalous terms with odd dependence on the detuning. The most striking manifestation of the anomalous friction consists in the possibility of laser cooling at zero detuning in $\varepsilon - \theta - \bar{\varepsilon}$ configuration. In this case the direction of kinetic process is controlled by the ellipticity and by the angle θ between polarization ellipses of laser waves forming a field. Anomalous parts of friction and diffusion influence on kinetics even in the case of nonzero detuning. In this case, depending on the ellipticity and orientation, one may get heating instead of cooling and vice versa. The obtained results may be of interest for optimization of laser cooling and trapping.

This work was supported by Grant of Russian Ministry of Education.

1 J.Jalilbarad and C.Cohen-Tannoudji, *J.Opt.Soc. Am. B* **6**, 2023 (1989).

2 O.N. Prudnikov, A.V. Taichenachev, A.M. Tumaikin and V.I. Yudin, *JETP Lett.* **70**, 434 (1999).

GENERALIZED COHERENT STATES AND QUANTUM INFORMATION

S. Ya. Kilin

B. I. Stepanov Institute of Physics, National Academy of Science,
F. Skarina Ave., 70, Minsk, 220072, Belarus

Coherent state techniques have been among the useful tools of modern physics for many years. Originally proposed by Schrödinger in 1926, their properties were really first investigated by Glauber in the context of quantum optics. Subsequent works have developed the concept to generalized coherent states (GCS) associated with various algebras. Contrary to the coherent state having the properties similar to those of the classical radiation field, GCS may exhibit some nonclassical properties. An examples of GCS may be quoted the eigenstates of square of annihilation operator \hat{a} - even and odd CS, the eigenstates of nonlinear annihilation operator $\hat{A} = \hat{a} \exp(i\phi \hat{a}^\dagger \hat{a})$, or of more general nonlinear operator $\hat{A}_F = \hat{a} F(\hat{a}^\dagger \hat{a})$. We will show here that the GCS can be the useful objects for quantum information.

To explore one of the main resources of quantum information - an entanglement - one should to discriminate the states of bi- or multipartite system. Instead of two known parameters for the discrimination, polarization or direction of squeezing, one can apply for CS phase as discrimination parameter. The coding of field qubit states as even and odd CS is crucial for a proposed method for restoration of entanglement after the decoherence process by means of local operations with one copy of mixed non-separable state and classical communication channel. Surprisingly, the entanglement within considered bipartite (two modes) optical system can persist for a much longer time than does the coherence [1]. This quantum coding method allows also to propose universal quantum gates transforming the incoming states with the help of nonlinear cross-Kerr interactions. It is shown that the coding of 2D images by GCS is optimal and an estimation of ability of this method is presented. The physical methods of GCS generation are discussed and a new method of generation of special type $(F(\hat{a}^\dagger \hat{a}) = \sqrt{1 + \nu / \hat{a}^\dagger \hat{a}})$ of the so-called Mittag-Leffler CS [2] by a single atom laser is proposed.

[1] S. Ya. Kilin, M.G.Raymer, *Phys. Rev. Lett.*, (2001) submitted.

[2] S. Ya. Kilin, *Phys. Rev. Lett.*, (2001) submitted.

NONLINEAR OPTICAL SPECTROSCOPY AS A NOVEL TOOL
FOR STUDYING MAGNETIC PHENOMENA IN SOLIDS

R. V. Pisarev

Ioffe Physical Technical Institute, 194021 St. Petersburg, Russia

Magnetic materials are indispensable in the modern electronic technology and their properties are easily shaped and controlled to make magnetic memory systems, heads, field sensors, transformers and many other devices. The development of novel devices requires new materials, as well as new methods for their characterisation. Recently, nonlinear optical methods, and in particular second harmonic generation (SHG), have been applied for the studies of magnetic thin films, surfaces, interfaces, and bulk magnetic materials, see e.g. [1]. In principal, several nonlinear optical methods can be used for studying magnetic materials. However, in this talk we will show that SHG as the lowest order nonlinear process can already be used as an efficient tool and may serve as an important supplement to other diagnostic methods.

The application of SHG to the magnetic materials is based on the relation between the induced nonlinear polarization $P_i(2\omega)$, the electric field components $E_j(\omega)$ and $E_k(\omega)$ of the fundamental light, and the magnetic parameter $M_i(0)$

$$P_i(2\omega) = \epsilon_0 \chi_{ijk} E_j(\omega) E_k(\omega) + \epsilon_0 \chi_{ijh} E_j(\omega) E_k(\omega) M_h(0).$$

The magnetic parameter $M_i(0)$ is either a magnetic-field induced magnetization or a ferromagnetic or antiferromagnetic order parameter. The symmetry analysis of this equation shows that in the electric-dipole approximation the magnetic term is allowed in non-centrosymmetric media or in centrosymmetric media with non-centrosymmetric magnetic structure. Thus, two or more sources of nonlinear polarization may coexist and interfere in magnetic materials that leads to several novel nonlinear optical phenomena.

Experimental spectroscopic SHG data will be presented and analysed for the rare-earth magnetites RMnO_3 , Cr_2O_3 , thin films of magnetic garnets (on the basis of YIG), magnetoelectronic hybrid structures MnAs/Si, and other magnetic materials. We will show how crystallographic and magnetic contributions to SHG can be unambiguously distinguished and what are consequences of their interference.

[1] *Nonlinear Optics in Metals*, edited by K. H. Bennemann (Oxford, 1998)

LIGHT BEAM SCATTERING UNDER TRANSMISSION THROUGH
DIELECTRIC PLATE WITH LARGE-SCALE ROUGH SURFACE

Seminogov V.N., Semchishen V.A., Panchenko V.Ya.

Institute on laser and information technologies Russian academy of sciences
Pionerskaya street 2, Troitsk, Moscow region, 142092, Russia.

Phone. (095)1424673; Fax: (095)33340201; E-mail: svn@laser.ru

Analytical vector theory of light beam scattering refracted by the dielectric plate with large-scale rough surface ($l_c \gg \lambda$, where l_c is correlation length, λ is wavelength) is developed. The problem was solved by Kirchhoff's method and Stratton-Chu's integral equations in the case of arbitrary intensity profile of incident on a medium boundary beam. General expressions for distribution of average irradiance (analog of Beckmann's formula for light reflection at rough surface with ideal conductivity) are derived, taking into account effect of full internal reflection. These expressions are true, in contrast to results of phase screen theory, not only in Fraunhofer's zone, but also in Fresnel's zone, not only for sloping ($\sigma \ll 1$, σ is r.m.s. of roughness slope), but for steep ($\sigma \geq 1$) roughness. Cases of strong ($h \gg \lambda$) and weak ($h \ll \lambda$, where h is r.m.s. of surface topography height) phase fluctuations are investigated. The limitations of applicability of derived formulae are defined.

Effect of homogenization of small-scale, in comparison with beam radius, spatial inhomogeneous of intensity distribution in the incident beam cross section, when the beam transmits through the rough surface of dielectric plate is investigated theoretically and experimentally. Effect of transformation of arbitrary intensity profile of an incident beam into Gaussian profile with circular symmetry is studied and class of rough surfaces realizing such transformations is defined. The scope for use rough plates in ophthalmology for laser vision correction has been demonstrated.

Supported by the RFBR, grant N 01-02-17774

Investigation of optical nonlinearities in n-GaAs based on multi-valley distributed hot electrons

J. Stiens¹, V. Kotov², G. Shkerdin², G. Borghs³, R. Vounckx¹

¹Vrije Universiteit Brussel, Lab for Micro-and Optoelectronics,

Electronics Department, Pleinlaan 2, B-1050 Brussels, Belgium.

²Institute of Radio Engineering and Electronics of RAS,

Vvedensky Square 1, 141195 Fryazino (Moscow reg.), Russia

³IMEC, MCP-Division, Kapeldreef 75, B-3001 Heverlee, Belgium.

Only recently a rigid quantum-mechanical modeling of free-electron induced optical nonlinearities in highly doped n-GaAs has been elaborated [1]. The total theory takes into account non-parabolicity, hot phonons, effective mass modulation due to Γ -L intervalley transfers, scattering due to equivalent intervalley transfers inside the ellipsoidal L-valleys, nonlinear screening, etc. It was shown that this hot free electron nonlinearity is strongest near the plasma resonance and significantly depends on the deformation potential field A_{LL} describing transitions of L-valley electrons between equivalent L-minima. For the experiments a very sensitive multi-layer leaky waveguide structure for TM polarized waves was designed and grown by MBE. Measurements were performed with 100ns duration CO₂ laser pulses. For a doping concentration n_0 of $7.6 \times 10^{18} \text{ cm}^{-3}$ a nonlinear refractive index value $n_2 = (1.0 \pm 0.12) \times 10^{-6} \text{ cm}^2 \text{ W}^{-1}$ at $\lambda = 10.6 \mu\text{m}$ was obtained, which was based on an experimentally derived $A_{LL} = (1.0 \pm 0.2) \times 10^9 \text{ eV cm}^{-1}$. With intensities of only several MW cm^{-2} more than 50% of the electrons could be transferred to the L-valleys, leading to impressive absorption increases of more than 50%. With respect to bulk samples the nonlinearity could be more than 20 times increased. In combination with an estimated relaxation time of 6-7ps, this nonlinearity exceeds most other results at room temperature for $\lambda = 10.6 \mu\text{m}$.

[1] G. Shkerdin, J. Stiens, R. Vounckx, A Multi-Valley Model for Hot Free-Electron Nonlinearities at 10.6 μm in Highly Doped n-GaAs, Eur. Phys. J-Appl. Phys. 12(3), pp.169-180 (2000).

PROPAGATION HANLE EFFECT
OF QUADRUPOLE POLARITONS IN Cu_2O

S. A. Moshkalenko¹, M. A. Liberman²

¹ Institute of Applied Physics of the Academy of Sciences of Republic Moldova, Academy str. 5, Kishinev MD 2028, Moldova. tel.+3732738084, e-mail<exciton@phys.asm.md>

² Condensed Matter Theory Group, Department of Physics, Uppsala University, Box 530, S-751 21, Uppsala, Sweden. e-mail<Michael.Liberman@fysik.uu.se>

Time-integrated quantum beats of two polariton wave packets with the same group velocities belonging to two different Zeeman components of the quadrupole-active ortho-exciton Γ_3^+ level in Cu_2O crystal were studied theoretically. The wave packets which interfere in Voigt geometry and give rise to the Propagation Hanle effect are characterized by the frequencies and wave vectors of the carrier waves as well as by the widths and group velocities of the wave packets. The new dependence on the magnetic field strength of the time integrated intensity of the light at the rear side of the sample is a function depending on the splitting Ω between the frequencies of the carrier waves as well as on the phase angle Θ proportional to the difference of their wave vectors. The both values depend directly or indirectly on the magnetic field strength H_0 . Ω serves as the argument of one quasisresonant function and of one dispersion-type curve, whereas Θ is the argument of two trigonometric functions. They become periodic functions on H_0 with the period ΔH_0 inverse proportional to the sample thickness d . Just this periodic dependence side by side with the quasisresonant one distinguishes the propagation Hanle effect from the earlier considered variant. To our knowledge such dependence is discussed for the first time. The resultant dependence on H_0 of the time-integrated light intensity arises due to the competition between quasisresonant and periodic functions and essentially depend on d . In the case of small d the quasisresonant dependence prevails, whereas at greater thickness the periodic dependence can be observed. The experimental results published by S.Kono and N.Nagasawa, Solid State Commun.110,159 (1999) can be explained taking into account the effective propagation way. The interference of two monochromatic waves with the same frequency but with opposite circular polarizations in Faraday geometry gives rise to a resultant linearly polarized wave, the azimuth of which depends on the coordinate of the propagation way.

Microscopic description of laser induced phase transitions in carbon

Martin E. Garcia, Harald O. Jeschke and K. H. Bennemann

Institut für Theoretische Physik der Freien Universität Berlin, Arnimallee 14, 14195 Berlin, Germany,

Abstract

We present a theoretical study of ultrafast phase transitions induced by femtosecond laser pulses of arbitrary form and duration. We discuss different examples of laser induced nonequilibrium structural changes in carbon.

Summary

The laser induced structural changes are described by performing molecular dynamics simulations on time dependent potential energy surfaces derived from a microscopic electronic Hamiltonian. Electron thermalization and diffusion effects are explicitly taken into account.

Applying this method to diamond bulk and diamond films we show that for a wide range of pulse durations and intensities below the ablation threshold a nonequilibrium graphitization takes place (see Figure). This ultrafast transition (~ 100fs) is driven by the suppression of the diamond minimum in the potential energy surface of the laser excited system.

The theory is also applied to study the laser ablation of graphite. We show that graphite has the unique property of exhibiting two distinct laser induced structural instabilities. For high absorbed energies (> 4.0 eV/atom) we find nonequilibrium melting followed by fast evaporation. For low intensities above the damage threshold (> 2.4 eV/atom) ablation occurs via removal of intact graphite sheets.

Further applications of our theory to C₆₀-crystals, C₅₀ clusters and carbon nanotubes are discussed.

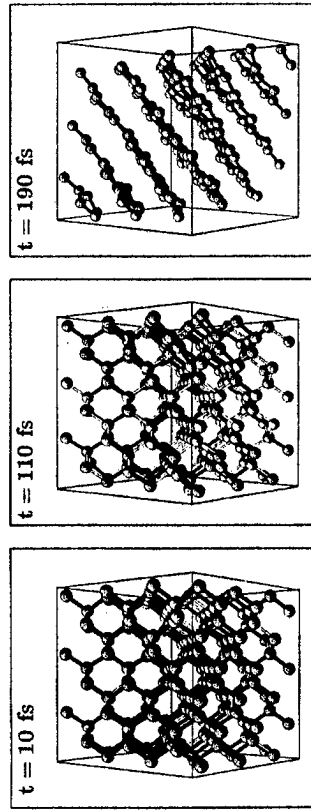

Snapshots describing the response of diamond (100) bulk to an excitation with a laser pulse of duration. $\tau = 20$ fs. The absorbed energy is $E_{obs} = 1.1$ eV/atom.

ECHO-SPECTROSCOPY OF TWO LEVEL SYSTEMS OF MULTI-WELL ADIABATIC POTENTIAL OF Pr³⁺ ACTIVATOR CENTERS IN Y₂SiO₅ CRYSTALS

Yu.V. Malyukin, R.S. Borysov, P.N. Zhmurin, A.N. Lebedenko, B.V. Grinyov
Institute for Single Crystals, National Academy of Sciences of Ukraine, 60 Lenin Ave., 61001 Kharkov, Ukraine, malyukin@isc.kharkov.com

G.G. Grigoryan, N.Y. Znamsky, E.A. Manykin, Yu.Y. Orlov,
E.A. Petrenko, T.G. Yukina

RRC "Kurchatov Institute", 123182 Moscow, Russia

Based on the detail research and analysis of temperature dependent slumps of the signal intensity of a photon echo (PE) at the ¹D₂ ↔ ³H₄ resonance optical transition of Pr³⁺ doped ions in a Y₂SiO₅ crystal, we have shown up a strong discrepancy between the slumps obtained in the experiment and ones predicted by theory. As a rule, at helium temperatures the intensity of PE signal is described by the ratio:

$$I_{echo} = I_0 \cdot \exp(-2 \cdot \gamma(T)) \quad (1)$$

$$\gamma_{ph}(T) = \alpha \cdot \exp\left(\frac{\gamma}{k}\right) \quad (2)$$

The homogenous linewidth of the resonance optical transition γ in the relation (1) is governed by phonon scattering processes and the constant of spontaneous transitions. For crystals, phonon contribution to the homogenous width is governed by the relation (2). For Pr³⁺ ions γ is the width on half maximum of ³H₄(0) Stark component, α is the energy gap between ³H₄(0) and ³H₄(1) Stark components.

Taking into account only phonon contribution (2) to homogenous width, we can not describe the slump of PE signal intensity observed in the experiment. Especially strong discrepancy takes place in the 1.5-7 K temperature range. Used optical holeburning [1], it was shown that the doped ions have several nonequivalent positions within the cation sites. Assumed that in the low temperature range Pr³⁺ undergoes thermally stimulated tunnel transitions between nonequivalent positions within the cation site, we can write down an additional contribution to homogenous width of an optical transition:

$$\gamma_{TIS}(T) = \lambda \cdot sh^{-1}\left(\frac{\gamma}{k}\right) \quad (3)$$

where λ is the parameter depending on electron-phonon interaction, γ is the energy gap between nonequivalent states of the doped ions. The relationship (3) allows us to describe adequately the slump of PE intensity observed. Having approximated the experimental data obtained, we determined the following values of the parameters: $\alpha = 1,04 \cdot 10^{10}$ and $\lambda = 1,1 \cdot 10^5$ ($\approx 0,25$ cm⁻¹).

I. K. Holliday, M. Croci, E. Vanthey and U. P. Wild, Phys. Rev. B47, 14741 (1993).

Summary

MICROWAVE MAGNETIC ENVELOPE SOLITONS - PARALLELS AND
CONTRASTS TO OPTICAL SOLITONS

Carl E. Patton

Department of Physics, Colorado State University

Fort Collins, CO 80523 USA

Solitons in optical fibers are of both fundamental and technological interest from the perspective of basic nonlinear optics and for applications in communications. There is a growing interest in magnetic analogues to these processes. An extensive program of research at Colorado State University on microwave magnetic envelope (MME) solitons in thin yttrium iron garnet (YIG) films has revealed important new physics for these fundamental nonlinear localized magnetic excitations in ferrite films. At the fundamental level, work has been accomplished in the following areas: (1) The use of phase as well as the usual amplitude profiles for soliton identification. (2) The use of soliton threshold power data to quantify soliton order experimentally. (3) The use of soliton pulse energy measurements and energy decay to understand the special decay properties for MME solitons. (4) The discovery of a power dependent velocity characteristic for MME solitons. (5) The successful modeling of MME soliton properties through the standard nonlinear Schrödinger equation. (6) The successful modeling of MME soliton properties through the nonlinear Schrödinger equation. (7) The generation and detection of MME dark solitons. This talk will review progress in areas (1) - (7), with an emphasis on the basic intuitive properties of microwave magnetic envelope solitons and microwave soliton measurements which demonstrate these properties.

Work supported in part by the National Science Foundation (USA), Grant DMR-9801649 and the U. S. Army Research Office, Grant DAAG55-98-1-0430.

Third optical harmonic generation in media with positive dispersion near three photon resonance

I.A.Kulagin and T.Uzmanov

NPO «Akademprigor», Akademgorodok, Tashkent, 700143, Uzbekistan

Optical harmonic generation in gaseous media is widely used for reception of coherent radiation in vacuum and extreme ultraviolet spectral ranges. The similar sources of short-wave radiation find use for the decision of various spectroscopic and technical tasks. The interest to harmonic generation in gaseous media is caused also by possibility of ultra short laser pulse control. The efficient optical harmonic generation is traditionally supposed not to take place in media with positive dispersion under the most frequently used condition of tight focusing at the centre of the medium. The harmonic generation absence is provoked by phase shift caused by focusing. However, the change of frequency conversion conditions in these regions should result in possibility of efficient harmonic generation. In the conditions of two-photon resonance the possibility of such changes caused by ac Shtark shift and saturation of the resonant part of susceptibility was indicated in [1]. The analysis of the changes of laser and harmonic fields has shown, that in non-resonant conditions the spatial non-uniform changes of phase conditions caused by Kerr nonlinearities also should result in possibility of efficient harmonic generation in media with positive dispersion [2-3].

In our work the analysis of third harmonic generation (THG) near three-photon resonance is carried out taking into account the redistribution of generated field as a result of self-action influence. It is shown, that in three-photon resonant medium with positive dispersion under tight focusing the influence of ac Shtark shift results in fourth-order power dependence of third harmonic efficiency on fundamental intensity and medium density. The influence of susceptibility saturation is capable to result in the eighth degree of similar fundamental intensity dependence. The inseparability of ac Shtark shift, resonant Kerr nonlinearity and fifth order nonlinearity responsible for third harmonic generation is indicated.

The comparison with known experimental data for THG in xenon at wavelength 117,055 nm near three photon resonance [4] is carried out. In [4] the possibility of THG was explained on the base of simple six-photon mechanism, but there is large disagreement with absolute values of third harmonic signal at various medium densities. Our results much better agree with experimental data and show that, in this case the ac Shtark shift and resonant absorption of the harmonic radiation are the basic mechanisms which determine the frequency conversion process.

References:

1. V.I.Anikin, V.D.Gora, K.N.Draboovich et al. *Sov.J. Quantum Electron.* **3**, 330 (1976)
2. I.A.Kulagin, T.Uzmanov. *Quantum Electron.* **28**, 1121 (1998)
3. V.S.Buylikin. *Quantum Electron.* **28**, 541 (1998)
4. J.Kuzner, H.Zacharias. *Appl.Phys.* **B 66**, 571 (1998)

ON PHOTOVOLTAIC CURRENT AND 2 ω -GENERATION PHASE SYNCHRONISM SHIFT AT PHOTOREFRACTION IN KD*P

Anikeev B.V., Kutsenko S.A., Bakharev D.Yu., Samoylenko T.V.

Volgograd State University

2-ya Prodolnaya St., 30, Volgograd, 400062, RUSSIA

Tel.: (8442) 43-35-08, E-mail: khramov@phys.volsu.ru

The accounted by us in dislocation model a room-temperature photorefractive effect [1] due to failure of dislocations to new fastening points. It gives to initiation of electrical polarized areas in light heating zones in KD*P crystal. In this investigation pulse currents generated in the crystal at its pulsing irradiation have been detected.

The dislocation model of a photorefraction in this crystal has been discussed. The electrometric device for measuring rather small pulse currents (up to 10^{-12} A) has been designed. Their measurings are carried out, and the comparison of obtained results with similar measurings on an optical polarization method [1] have been carried out. The results coincidence of electrophysical measurings of effect parameters with results of optical polarization measurings has been found. The some decreasing of real relaxation time of photorefractive effect noted by us at the room temperature.

In accordance with dislocation photorefractive model the experiments under the direct proof of an electrical nature of this photorefraction type at the room temperatures have been realized. The measurings of the synchronism angles shift at a second harmonic generation of Q-switched YAG:Nd³⁺ laser in KD*P crystal have been carried out. In this case the photorefractive state was excited by the YAP:Nd³⁺ laser in free-run regime. The comparisons of this results with similar synchronism angle displacements through applied external electric field ± 5000 V to the crystal are carried out.

The investigation was supported by Ministry of education of Russian Federation (grant № 98-31 on fundamental researches in instrument-making industry).

[1] Anikeev B.V., Gurkin O.A., Belonenko M.B. In *Solid State Lasers and New Laser Material, Proc. of SPIE. 1859*, 1991, p.324.

'PURE' BACKWARD SRS

ON THE TRANSITION IN VIBRATIONALLY EXCITED HYDROGEN MOLECULES

G.M. Mikheev, T.N. Mogileva

Institute of Applied Mechanics, Ural Branch of Russian Academy of Sciences

ul. M.Gor'kogo 222, 426000, Izhevsk, Russia

Tel: (3412)216611; fax: (3412)431713; e-mail: mikheev@udmnet.ru

It is known that SRS is an effective means for altering the populations. This makes it possible to observe the stimulated scattering on excited vibrational and rotational states. For example, the SRS on the $Q_{01}(1)$ transition in the hydrogen molecules amplifies the Stokes scattering component at the frequency $\nu_s^{01} = \nu_p - \nu\{Q_{01}(1)\}$, where ν_p is the frequency of the exciting (pump) Raman laser and $\nu\{Q_{01}(1)\}$ is the frequency of the Raman-active $Q_{01}(1)$ transition. This makes it possible to populate efficiently the vibrational state with $\nu = 1, j = 1$. When the population of this quantum state is sufficiently high, SRS on the $Q_{12}(1)$ transition becomes possible. The second Stokes scattering component then appears and it is shifted to the blue part of the spectrum. The frequency of this component is $\nu_s^{12} = \nu_p - \nu\{Q_{12}(1)\}$, where $\nu\{Q_{12}(1)\}$ is the frequency of the $Q_{12}(1)$ transition.

The feasibility of observing 'pure' backward SRS on the $Q_{12}(1)$ transition in the hydrogen molecules have been shown qualitatively in this paper.

In experiments we used Nd³⁺:YAG laser with electro-optical Q-switching. The parameters of the pump laser radiation at the $\nu_p = 532$ nm wavelength were as follows: the pulse duration at half-amplitude 7 ns, the energy per pulse varying from zero to 30 mJ, the radiation line width varying from one laser shot to the next between the limits 0.8-1.2 cm⁻¹, the beam diameter 2 mm, and the divergence close to the diffraction limit. The SRS was excited in a cell containing compressed hydrogen and 20 cm long. The pump radiation was focused at the cell center by the lens with the focal length of 13.8 cm. Under this conditions and in the absence of feedback the backward scattering on the $Q_{12}(1)$ transition was accompanied by complete suppression of the forward (concurrent) scattering for wide range gas pressure in Raman cell.

LASER BEAM PROPAGATION THROUGH A CONDENSATION TRAIL BEHIND AIRCRAFT

A.N. Kucherov

Central Aerohydrodynamic Institute n.a. prof. N.E. Zhukovsky (TsAGI), Department of Fundamental Research; 140180 Zhukovsky, Moscow region, Russia; Phone: (095)5564807, Fax: (095)9110019; E-mail: ank@dept.aerocentr.msk.su

Summary

A clearing channel in the water aerosol of a contrail behind a large civil airbus is part of the research ecological problem of harmful exhaust from aircraft engines. The problem is described by a nonlinear system of aero-optic equations. The solution of optical equation [1] is calculated by using a rigorous numerical algorithm of Fourier sets and Fast Fourier Transform [2]. The contrail is described with a solution for averaged values (temperature, velocity, vapor and condensed water concentrations) [3] and an asymptotic solution for distributed parameters [4], including aerosol particle radii, near the initial section of the contrail. Khrgian - Mazin distribution law is supposed for particle sizes in a polydispersive water aerosol. The coefficient of laser beam extinction is calculated by using the Mie theory. The standard summer and winter atmosphere was considered. Comparison is made for optical parameters of contrails behind different aircraft (IL-86, IL-96, B-747-400, etc.) at the initial time interval after contrail formation.

The work was supported by Russian Foundation for Basic Research.

REFERENCES

1. Vinogradova M.V., Rudenko O.V., Sukhorukov A.P. Theory of Waves. Moscow: Nauka, 1979.
2. Fleck J.A., Morris J.R., Feit M.D. Time-dependent propagation of high energy laser beam through the atmosphere. /Applied Physics. 1976, v. 10, p. 129-160.
3. Kucherov A.N. Criterion of contrail formation behind accelerating body. /Physics Doklady, 2001, v. 377, N 3.
4. Kucherov A.N. Clearing of contrails behind accelerating bodies. /Proceedings of SOQUE, International Conference on "LASERS' 2000" (4-8 December, 2000, Albuquerque, New Mexico, USA).

Generation of fifth harmonic in xenon using Bessel-Gauss laser beams.

V. E. Peet and R. V. Tsubin

Institute of Physics, University of Tartu, Riia 142, Tartu 51014, Estonia

e-mail: pomah@ut.ee

Bessel-Gauss beams represent a special type of light beams that approximate ideal diffraction-free Bessel beams in real experiments. Bessel-Gauss beam can be obtained when a Gaussian laser beam is transformed into an annular one with the aid of ring-shaped amplitude masks. Being focused, the annular beam forms in the focal region an amplitude profile, which is close to the desired Bessel-Gauss one.

We studied the generation of a tunable resonance-enhanced fifth harmonics (FH) in xenon with the use of both Gaussian and Bessel-Gauss beams. Generated FH photons were monitored through multiphoton ionization of the target gas due to absorption of the FH photons and subsequent ionization of excited xenon atoms by laser photons. The arranged experiments and numerical simulations have shown that the transformation of a Gaussian beam into a Bessel-Gauss one leads to a red shift of the FH tuning curve toward the atomic resonance. This shift is similar to the red shift of the third-harmonic excitation profiles known from earlier experiments [1,2] and it seems to be the general feature of the low-order harmonic generation with Bessel-Gauss beams. Due to this shift, the maximum of the resonance-enhanced FH for Gauss and Bessel-Gauss beams is realized at different wavelength. In its maximum, the FH output for the Gaussian beams exceeded by several times the maximum FH output for the Bessel-Gauss beam of the same pulse energy. However, at the red wings of the FH profiles the FH output for the Bessel-Gauss beam was nearly the same or even exceeded slightly the FH output for the reference Gaussian beam. This circumstance may be useful for generation of low-order harmonics in experiments with a fixed excitation wavelength.

1. V. E. Peet and R. V. Tsubin, Phys. Rev. A **56**, 1613 (1997).

2. V. E. Peet and R. V. Tsubin, Physica Scripta **T75**, 295 (1998).

DYNAMICS OF OPTICAL VORTICES NUCLEATION AND NONLINEAR OPTICAL CATASTROPHE FROM A SMOOTH BEAM IN KERR-LIKE MEDIA

MEDIA

A. M. Deykoon^a, M. S. Soskin^b, G. A. Swartzlander^a

^aDepartment of Physics, Worcester Polytechnic Institute, Worcester, Massachusetts,

01609 - 2280, USA

^bInstitute of Physics, NAS of Ukraine,

Prospect Nauki 46, Kiev, 03650, UKRAINE

Fax: +(38044) 365 15 89, e-mail: marats@vortex.kiev.ua

Self-action of smooth laser beams in Kerr-like media is one of well known nonlinear effects. We have shown that a collimated elongated (aspect ratio 2:1) Gaussian beam of Argon laser ($\lambda = 514 \text{ nm}$) focussed into the middle of vertically aligned nonlinear cell of variable length D , with $D_{\text{max}} = 250 \text{ mm}$. The cell was filled by a slightly absorbing liquid. The dynamics of self-action, linear and nonlinear diffraction by increasing of beam intensity was investigated and two-step nonlinear dynamics was observed. At lower power we did observed one, two and three sets of quadruples along the perimeter owing to nonlinear lensing¹, for $P = 26 \text{ mW}$, $P = 34 \text{ mW}$, and $P = 42 \text{ mW}$.

The nonlinear optical cusp diffraction catastrophe was observed at input power more then 100 mW and is characterized by a two-step. First, the beam energy exhibits nonlinear refraction in the vicinity of focal plane and forms annual ellipse with increase the area in focal region nearly 600 times. Second, the beam undergoes quasi-linear propagation beyond this region, resulting in the formation of an astroid, i.e. a curve that satisfies $(x/x_0)^{2/3} + (y/y_0)^{2/3} = 1$. The vortex quadruple nucleates in the two cusp of astroid along its short axis y .

We suggest that this instability can be managed in applications involving high-power lasers by control of the aspect ratio of the beam to counter this elongation.

1. L.V. Kreminskaya, M. S. Soskin, and A. I. Khizhnyak, Opt. Commun. **145**, 337 (1997).

NONLINEAR UNIDIRECTIONAL COUPLER IN THE PHOTOREFRACTIVE MEDIUM WITH PURELY DIFFUSION NONLINEARITY

Victor Aleshkevich and Yaroslav Kartashov

Physics Department, M.V.Lomonosov Moscow State University, 119899 Moscow Russia

Victor Vysloukh

CIICAp, U.A.E.M., Cuernavaca, Mor., Mexico, C.P. 62210

We report the specific features of switching of optical radiation between the channels of the nonlinear unidirectional coupler consisting of two parallel waveguiding structures putted in close proximity in photorefractive medium with purely diffusion nonlinearity. The propagation of optical radiation is described by the nonlinear Schrödinger equation for the complex field amplitude q

$$i \frac{\partial q}{\partial \xi} = -\frac{1}{2} \frac{\partial^2 q}{\partial \eta^2} - \frac{q}{1+S|q|^2} \frac{\partial |q|^2}{\partial \eta} - pU$$

where p is the guiding parameter, $U(\eta) = \exp(-(\eta-\eta_0)^2) + \exp(-(\eta+\eta_0)^2)$ describes the refractive index distribution in the cross-section of two Gaussian waveguides separated by distance $2\eta_0$, parameter S describes the strength of diffusion effects, ξ and η are the normalised longitudinal and transverse coordinates. The input conditions correspond to the exact profile of the mode of the single nonlinear photorefractive Gaussian waveguide in the absence of second waveguide. The presence of the second waveguide results in the periodic energy exchange between two neighbouring waveguides in the process of propagation. It is shown that the transmission properties of photorefractive coupler is completely different from the properties of the coupler embedded in Kerr material. Thus the maximal part of the input mode energy that can be transmitted into the second guide monotonically decreases with increase of input mode energy i.e. no critical threshold value of mode energy exists (see figure below that shows the relative values of energies concentrated in the waveguides at the distance corresponding to the maximal energy transfer as a functions of input mode energy).

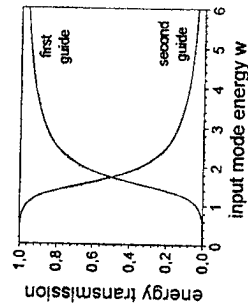

SELF-COMPRESSION OF THE CNOIDAL WAVES IN OPTICAL FIBERS

Victor Aleshkevich and Yaroslav Kartashov

Physics Department, M.V.Lomonosov Moscow State University, 119899 Moscow Russia

Victor Vysloukh

CIICAp, U.A.E.M., Cuernavaca, Mor., Mexico, C.P. 62210

We report the specific features of self-compression of the periodical cnoidal waves

$$q_m(\eta, \xi) = k \operatorname{cn}(\eta, k) \exp[i\xi(k^2 - 0.5)]$$

$$q_{2m}(\eta, \xi) = \operatorname{dn}(\eta, k) \exp[i\xi(1 - 0.5k^2)]$$

in optical fibres with Kerr-type nonlinearity in the anomalous dispersion regime (η and ξ are the dimensionless running time and propagation coordinate, correspondingly). Cnoidal waves can serve as a model of trains of the optical pulses in fibres. In the limit of strong localisation $k \rightarrow 1$ cnoidal waves transform into bright optical solitons. We consider the evolution of the N -order cnoidal waves with the input profiles $N\operatorname{Kcn}(\eta, k)$ and $N\operatorname{dn}(\eta, k)$ with integer $N > 1$. It is shown that N -order cnoidal waves periodically restore their initial profiles in the process of propagation. This indicates on the possibility of an exact analytical solution (periodical in both time and longitudinal direction) of the nonlinear Schrödinger equation that can be found using Darboux transformations or equivalent technique for initial conditions in the form of $N\operatorname{Kcn}(\eta, k)$ and $N\operatorname{dn}(\eta, k)$ functions. Transforming the infinite-dimensional system of coupled equations for the harmonics of the cnoidal waves into two-dimensional Hamiltonian system in finite number harmonic approximation we calculate the degree of compression of the cnoidal waves as a function of localisation parameter k and obtain that the compression degree monotonically increases for cn -wave and decreases for dn -wave with growth of k (see figures below).

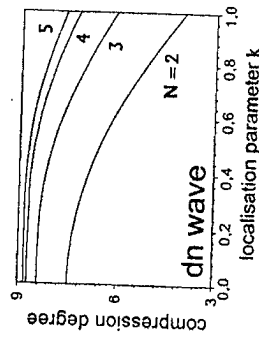
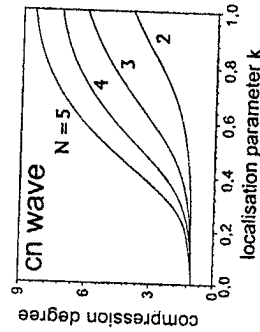

FRACTIONAL FREQUENCY CONVERSION IN NONLINEAR PERIODIC MEDIA

Vladimir V. Konotop

Centro de Física da Matéria Condensada, Universidade de Lisboa, Complexo Interdisciplinar, Av. Prof. Gama Pinto, 2, Lisbon, P-1649-003 Portugal.

Vladimir Kuzmiak

Institute of Radio Engineering and Electronics, Czech Academy of Sciences, Chaberska 57, 182 51 Prague 8, Czech Republic

We consider a periodic multilayered structure consisting of two different components and fabricated from the materials possessing $\chi^{(2)}$ nonlinearity and assume that the filling fraction and the dielectric permittivities of the two types of layers are chosen in such a way that $\omega(3q + Q_1) = 3\omega(q)$ and $\omega(2q + Q_2) = 2\omega(q)$ where Q_j ($j = 1, 2$) are vectors of the reciprocal lattice, are satisfied. Such a system allows two resonant conditions for the second and third harmonic generation fulfilled simultaneously. An example is given by the one-dimensional periodic structure consisting of the alternating slabs of $Al_{0.1}Ga_{0.9}As$ and $InSb$.

The wave evolution is described in terms of the envelope function approach where we take into account three resonant waves which leads to coupled mode differential equations for the field amplitudes. One of the solutions of the so obtained equations, which is of a special importance, is that of possessing the second harmonic having a constant amplitude and the first and third harmonics having zero amplitude. We analyze its stability. On this basis we show that the use of double resonances allows one to obtain difference frequency generation. A particular example is $\omega \rightarrow (\frac{2}{3})\omega$.

Parabolic approximation for a given scaling results in a dynamical system characterized by Hamiltonian H . The non-zero Hamiltonian corresponds to the permanent energy exchange among the modes, while $H = 0$ corresponds to the case when the energy can be concentrated in one or two higher harmonics. One can distinguish the following types of the dynamics: (a) the total energy is transferred from the first and third harmonic into the second one, (b) a periodic exchange between the modes occurs and (c) exponentially growing solution, which represents instability within the parabolic approximation. The qualitative picture based on the analysis of the motion of the effective particle in the potential which indicates different types regimes is very well reflected by the results obtained from the numerical simulation carried out to solve dynamical equations.

The evolution equations governing three-wave processes in the presence of double resonances allow a solitary wave solution in a form of coupled two bright solitons and a dark soliton.

Periodic structures can provide us with a large diversity of other matching conditions. In particular one can obtain double resonances as follows: $\omega(4q + Q_1) = 2\omega(2q)$, $\omega(2q + Q_2) = 2\omega(q)$.

EFFICIENT NONLINEAR REFLECTION OF UV-LASER RADIATION IN FREONS CF₃BR, CF₃CL AND MIXTURES WITH DIFFERENT GASES.

A.P. Burtsev, V.V. Bertsev, V.N. Bocharov

Department of Molecular Spectroscopy, Institute of Physics, Saint-Petersburg State University, Ulyanovskaya 1, St. Petersburg, Petrodvorets, 198904, Russia.

E-mail: burtsev@molsp.phys.spbu.ru

Efficient (energy reflectivity up to 40 %) nonlinear reflection of XeCl-laser radiation was observed in CF₃Br ($\rho_{\text{thres}} \approx 7 \text{ Amagat}$) and CF₃Cl ($\rho_{\text{thres}} \approx 15 \text{ Amagat}$) in pump intensity range $10^{10} - 10^{11} \text{ wt cm}^{-2}$. Pronounced enhancement of the effect was established when buffer gases Xe, Kr, O₂, CF₄ and SF₆ were admixed, whereas no effect was found, when He was added. To study spectral selectivity of reflection, pump radiation in /204-500/nm region was produced by SRS-conversion of broadband (effective coherence length $\approx 0.3 \text{ cm}$) XeCl excimer laser output in compressed H₂ ($P = 30-80 \text{ atm}$). Spectral components chosen were focused into a high-pressure stainless steel opto-acoustic cell with crossed BaF₂ windows to monitor IR-UV spectral absorption of possible stable photoproducts and to record secondary emission in UV-VIS regions from the caustic zone. The most extensive studies of the nonlinear reflection at $\lambda_{\text{pump}} = 308 \text{ nm}$ have been done. The dependences of reflection on pump conditions with low-intensity cut-off were obtained. Under fixed pump conditions ($I_{\text{pump}} \approx 10^{11} \text{ wt cm}^{-2}$) the nonlinear dependences, including the threshold region, of the reflected pulse energy, photoacoustic signals and secondary emission on the density and composition of the sample were studied. Analysis of the data obtained for various admixtures and mixture compositions in the threshold and quasi-linear on density regions unambiguously suggested the cooperative (binary) mechanism of the effect. Sharp frequency selectivity (absence of reflection for $\lambda > 308 \text{ nm}$) was observed in freons and mixtures, unlike pure compressed Xe, where distinct reflection was detected in 245-413 nm region; the stimulated Brillouin scattering nature of effect in Xe was established in [1]. Possible explanation of the influence of admixtures on observed effects will be presented.

1. M.A. O'Key and M.R. Osborne, *Opt. Commun.*, 1992, vol. 89, p. 269.

Efficient Parametric Oscillation in the Presence of Magnetic Field.

Praveen Aghamkar, Shiwani, Sunayana Nepal and Suta.
 Dept. of Applied Physics, Guru Jambheshwar University,
 Hisar, Haryana, INDIA-125001.

The optical parametric oscillator (OPO) has been widely recognised as a most convenient source for providing tuneable coherent radiation through out the electromagnetic spectrum [1]. In the present study we propose a method of generating coherent radiation in the far-infrared regime by a parametric oscillation of phonon modes in n-InSb in the presence of a magnetic field. The equation of motion of a polaron mode is obtained as

$$[\partial^2/\partial t^2 + \omega_{\text{OPO}} + 2T\partial/\partial t]S_{e\text{-ph}} = [q/M_e - e/m_e]E_{e\text{-ph}} \quad \text{---(1)}$$

[2], we obtain threshold as $I_{\text{th}} = [\eta_{\text{e0}} c^2 / 8R_{\text{e}}(\beta_1, \beta_2)] [1/L^2 \{ \cosh^{-1}(Q^2) - 4\alpha^2 - 1 \}]$ where $Q = [\exp(-\alpha_1 L/2) R_{\text{e}}(\beta_2) E_0(0)/E_{\text{e}}(0)]$ and $\beta^2 (= \omega \chi^2 / \eta c)$ is the coupling coefficient. χ^2 is the second-order susceptibility of the crystal at finite magnetic field and obtained as $\chi^2 = \kappa \omega_p^2 (e/m_e \epsilon_0) \delta_2 / \omega_0 A_1^2 A_2^2 [Nq^2/M_e - \eta_0 q e/M_e + \eta_0 e^2/m_e]$.

In Fig. 1 a remarkable reduction in the value of threshold intensity may be obtained at 10 Tesla and hence one may achieve large conversion efficiency of the parametric oscillator. To conclude, it may be stated that the above analytical investigation establishes the usefulness of the parametric oscillations in moderately doped n-InSb crystal at the polaron frequency in developing the new infrared laser sources.

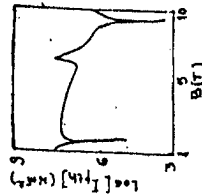

Fig. 1

References: 1. J. L. Oudar, 'Nonlinear optics: Material and Devices' ed C. Flyzauis and J.L. Oudar (n Berlin: Spinger Verlag) PP. 104-114.

2. P. Aghamkar and P.K.Sen, Nonlinear Optics, 8 (1994) 97.

Experimental Study of Second-Harmonic Generation by a Laser Pulse with Varying Direction of Polarization in a Type-II Synchronism Doubling Crystal

Juan Jose Soto Bernal, Alexander V. Kir'yanov, Victor Pinto Robledo
 Centro de Investigaciones en Optica A.C., Apartado Postal 948, Leon 37000, MEXICO

Nowadays, a crystal Cr⁴⁺:YAG is widely exploited as a saturable absorber (SA) for Q-switched solid-state lasers. It has turned out that the direction of polarization of the generated giant pulse (GP) depends on the angular orientation of the Cr⁴⁺:YAG SA inside the cavity [1]. Such pulses can be used as a pump for Type-II second-harmonic generation (SHG) when one may need a harmonic-pulse shortening and / or a possibility to transform its shape. These features caused by a time variation of the direction of the GP, polarization have been theoretically predicted [2]. The aim of the present study is to give an experimental verification of the model [2].

It is first shown experimentally that extremely diverse scenarios of the polarization azimuth of intracavity radiation are realized depending on the laser parameters (linear and nonlinear anisotropy of the cavity, cavity length, focusing of the intracavity radiation in active medium and SA, etc.). The process of conversion of the radiation with nonlinearly changing state of polarization to SH is then experimentally analyzed at propagation throughout a doubling KTP crystal cut for Type-II synchronism. It is found, in particular, that the output SH pulse shape is very sensitive to whether the state of polarization of the fundamental incidence changes or not. Considerable decrease in the duration of the SH pulse is experimentally observed for the case, when state of polarization of the fundamental rotates comparing with the case of its absence. The experimental data are in excellent agreement with the theoretical prediction [2]. Finally, it is demonstrated experimentally that SH crystals may be effectively used for control of the state of polarization of nanosecond pulses, since this method gives not only an absolute value of the nonlinear rotation, but its direction as well. The last observations are clearly shown in Fig. 1, 2.

Fig.1. Dependences of SH peak intensity vs KTP crystal orientation. Curves 1,2 correspond to fixed and nonlinearly rotated (~35 deg.) azimuth of polarization of the GP incidence.

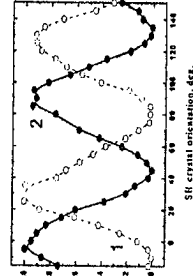

Fig.2. Dependences of SH pulse width vs KTP crystal orientation. Curves 1,2 correspond to fixed and nonlinearly rotated (~35 deg.) azimuth of polarization of the GP incidence.

[1] N.N.Ilichev, A.V.Kir'yanov, et al. Quantum Electron., 28 (1998) 17.
 [2] A.V.Kir'yanov, V.Aboites. Laser Physics, 10 (2000) 845.

SEPARATE CONVERSION OF THE POLARIZATION STATE
OF POLARIZED LIGHT SPECTRAL COMPONENTS

V.V. Chirkov, N.D. Kundikova, L.F. Rogacheva

*Joint Laboratory of Nonlinear Optics, Institute of Electrophysics
of Urals Branch of RAS and South Urals State University
Lenin Av. 76, Chelyabinsk, 454080, Russia*

In studies of some nonlinear optics effects, for example in the experimental investigations of the process of second harmonic generation in glasses [1], it is necessary to transform the state of polarization of laser light harmonics independently. As was shown in the papers [2, 3], complex adjustable polarization systems allow to control the state of polarization of monochromatic laser radiation in a required way. In these works two-component and three-component systems, operated as adjustable phase retarders $\lambda/4$ and $\lambda/2$, respectively, are considered. We developed the theory of complex adjustable polarization systems [2, 3] on the basis of Jones matrix calculus and found that new possibilities for the control of the state of polarization results from the addition of the system components. We demonstrated that it is possible to use the system of four wave plates for independent transformation of the polarization state of two spectral components at a time.

To test the validity of the theory we worked out the polarization systems with particular characteristics, which must be the phase retarder $\lambda/2$ at a wavelength λ_1 and exhibit an adjustable phase retardance at another wavelength λ_2 . The experiment was carried out with polarization transformation for $\lambda_1 = 632.8$ nm (helium-neon laser) and $\lambda_2 = 488.0$ nm (argon ion laser). The polarization system consisted of four identical mica plates. From the results obtained it appears that the investigated system really have the theoretically predicted polarization properties, and consequently it can change the light polarization property.

Thus it is shown that the complex retardation system can be used for simultaneous transformation of polarization state of laser harmonics.

This work was partly supported by grant of the state programme "Integratsiya" N A0067.

1. A.I. Valeev, V.M. Churikov, Pisma v JTP. 23, 46 (1997).
2. I.V. Goltser, M.Ya. Darshat, N.D. Kundikova, B.Ya. Zel'dovich, Opt. Commun. 97, 291 (1993).
3. M.Ya. Darshat, I.V. Goltser, N.D. Kundikova, B.Ya. Zel'dovich, Appl. Opt. 34, 3658 (1995).

PARAMETRIC WAVE COUPLING IN THE SCHEME OF A DOUBLE PHASE
CONJUGATION

M.V. Bolshakov, N.D. Kundikova, Yu.V. Miklyaev, M.V. Zubrik

*Joint Laboratory of Nonlinear Optics, Institute of Electrophysics of Urals Branch of
RAS and South Urals State University
Lenin Av. 76, Chelyabinsk, 454080, Russia*

The purpose of this study is to investigate experimentally the interaction of gratings arising at illumination a photorefractive crystal by three mutually non-coherent waves, one of which propagates towards two other waves.

It is possible to explain a principle of a phase conjugation in the double phase conjugation scheme as follows. If two waves pass through photorefractive crystal, so that one wave propagates towards other, there is amplification of light, scattered on inhomogeneities of a crystal (fanning), due to gratings recording for each of waves. These waves can be mutually non-coherent, since there is an interaction not between waves, but between gratings, recorded by them. However if the interacting waves are plane, the condition of simultaneous diffraction of both waves on one grating will be fulfill not only for mutually phase conjugated waves, but also for other waves, which wave vectors will form a cone. As a result there is a conical diffraction [1].

At interaction of three mutually non-coherent waves, one of which is propagated towards to two by other, the grating will be recorded, for which the value of positive feedback is higher, than for all remaining. Thus, it is possible to provide such conditions, under which the value of positive feedback will be sufficient for a record only of this grating, i.e. the suppression of conical diffraction is possible.

The three-wave interaction of non-coherent waves was investigated experimentally in photorefractive crystal $\text{Bi}_{12}\text{TiO}_{20}$. The external alternative meander-shape field was applied to a crystal. Three HeNe-lasers were used as sources of optical radiation.

As a result, the suppression of conical diffraction and extracting of a mutual grating recorded by all three waves was experimentally observed.

This work was partly supported by grant of the State program "Integratsiya" # A0067

1. M.D. Ewbank, P. Yeh and J. Feinberg, *Opt. Comm.*, 59 p.423-426 (1986).

LOW-THRESHOLD INSTABILITY OF SPECKLES IN NONLINEAR DISORDERED MEDIA

S.E. Skipetrov

Department of Physics, Moscow State University, 119899 Moscow, Russia

It is well known that waves propagating in nonlinear media may become unstable (in time and in space) for sufficiently strong nonlinearities. The phenomenon of wave instability has been also studied in *weakly disordered* nonlinear media (e.g., atmosphere), where weak spatial fluctuations of the linear dielectric constant tend to modify the instability threshold.

We consider the opposite case of strongly disordered but *weakly nonlinear* media, where scattering of waves is essentially multiple [1, 2], while the Anderson localization is not achieved yet. The instability threshold appears to be extensive in this case due to the long-range spatial correlations of scattered intensity fluctuations, well known for waves in disordered media. Assuming the cubic nonlinearity, we find that the threshold value of $\chi^{(3)}/l$ scales as $l/V^{1/2}$, where V is the volume of the medium. This result has been obtained by analyzing the conditions of validity of the perturbation theory for the time autocorrelation function of scattered wave field [2], as well as it follows from a more sophisticated self-consistent analysis [1, 2]. The instability of multiple-scattered waves should manifest itself in spontaneous fluctuations of the speckle pattern. Inverse proportionality of the threshold value of $\chi^{(3)}/l$ to $V^{1/2}$ suggests that the instability threshold can be made arbitrary small by simply increasing the size of the sample. When the size of the sample compares to the macroscopic absorption length, the latter starts to determine the effective volume of the sample. Thus the role of dissipation appears to be crucial for stability of waves in extended disordered media in the presence of nonlinearity.

1. S.E. Skipetrov and R. Maynard, Phys. Rev. Lett. 85, 736 (2000).
2. S.E. Skipetrov, to appear in Phys. Rev. E (2001); see also cond-mat/0101059.

SUPERCONTINUUM GENERATION BY FREQUENCY TUNABLE PUMP IN DISPERSION SHIFTED FIBERS

V. Archireev¹, A. Korolev¹, D. Nolan², V. Soloviev¹

¹ Corning Ltd., St.-Petersburg 199034, RUSSIA

² Corning Inc., Corning, New York, 14831, USA

Supercontinuum generation in optical fibers is a subject of intensive investigations due to potential interests in optical coherence tomography, optical metrology [1] and pulse compression. It is a complex interplay of a number of nonlinear processes passing simultaneously and their contributions depend significantly on detuning of input wavelength from position of zero dispersion [2]. Nevertheless small attention is paid to sharpness of pump frequency dependence of such a generation in vicinity of zero dispersion.

In the experiments we used tunable parametric oscillator PG-501VIR pumped by second harmonic of Quantel YAG-900 laser. Resulting single pulses of 30 ps duration were inserted into the fiber. Power level inside the fiber did not exceed 10^{-8} J. Different samples of dispersion shifted fibers have been studied.

It is shown that shape of output spectra changes dramatically by tuning of the pump through zero dispersion point. Fig.(a-c) refers to fiber of 20 m long with zero dispersion at 1374 nm. In the region of normal dispersion ordinary Raman shifted component appears (a), tuning to zero dispersion demonstrates noticeable asymmetric broadening (b) and in region of anomalous dispersion unidirectional broadening to long wavelength side up to 2100 nm is observed (c).

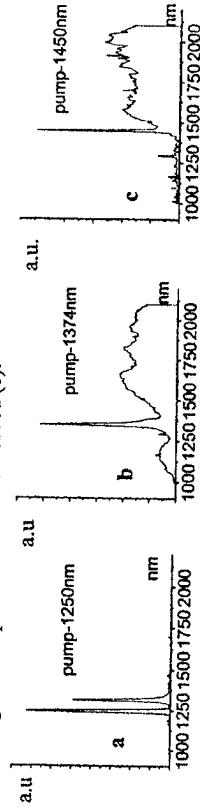

I.D.J.Jones, et al. Science, 288, 635, 2000

Z.G.P. Agrawal, Nonlinear Fiber Optics /Academic, 1995

Optical soliton in a dielectric medium due to rotational torque on the dipoles of the medium

V. Veerakumar and M. Daniel

Centre for Nonlinear Dynamics, Department of Physics, Bharathidasan University, Tiruchirappalli 620 024, India.

Summary

Recent studies on the propagation of optical soliton in dielectric fiber medium have become very important due to its technological advantages like lossless propagation and application to all optical logic gates. These studies are based on the fact that the dielectric fiber medium exhibits the nonlinear effect called Kerr effect when it is exposed to high intense optical source like laser. This nonlinear effect is able to balance the dispersion of the propagating wave and hence the optical pulses travel in the form of localized solitons which can travel without losing the energy for a long distance.

We now propose a simple and novel way of generating optical soliton in a dielectric fiber medium even without the help of Kerr effect. This is achieved by considering the rotational effect of the dipoles of the medium due to the interaction with the external electric field (\mathbf{E}) component of the propagating EMW which is governed by the torque equation $\frac{\partial \mathbf{P}}{\partial t} = \mathbf{P} \wedge \mathbf{E}$ where \mathbf{P} is the polarisation of the medium. The dynamics of the electric field component of the EMW in a dielectric medium is governed by the wave equation derived from Maxwell's equation given by $\frac{\partial^2 \mathbf{E}}{\partial t^2} = c^2 [\nabla^2 \mathbf{E} - \nabla(\nabla \cdot \mathbf{E})] - \frac{1}{c} \frac{\partial^2 \mathbf{P}}{\partial t^2}$, where c is the velocity of the wave in the dielectric medium. On solving the coupled torque and the Maxwell equation using a reductive perturbation method we find that the electric field component of the propagating EMW is described by the completely integrable derivative Nonlinear Schrödinger (DNLS) equation that, possess N-soliton solutions. The analysis shows that the electric field component of the EMW is modulated in the form of soliton through a simple effect in the dielectric medium. This shows the possibility of lossless propagation of EMW in a dielectric medium even in the absence of Kerr effect.

PROPAGATION OF LASER BEAMS IN PHOTONIC CRYSTALS WITH CUBIC NONLINEARITY

Kurilkina S.N., Zzykov A.L.

Gomel State University

246699, Gomel, Belarus, ul. Sovetskaya, 104.

E-mail: gzzykov@gsu.unibel.by Fax: (0232)576557

Last years photonic crystals (PC) are widely investigated in the connection with great practical perspectives, including control by spontaneous radiation, creation of semiconductive lasers with vertical resonator and Bragg mirrors, nonlinear optical diodes. Possibilities of control by group and phase velocities of light beams and impulses are very important for use of photonic crystals as nonlinear optical transformer of frequency. But, as a rule, investigations of laser radiation propagation in PC were limited by the case of structures formed by isotropic media. In the present report it has been considered the peculiarities of transformation of beams in nonlinear photonic crystals formed by anisotropic media.

It has been investigated the influence of cubic optical nonlinearity and dispersion of group velocity on laser beam divergence. It has been established the correlation between focusing properties of photonic crystals and parameters of incident laser beam, anisotropy of linear dielectric permittabilities and cubic nonlinearities of PC components. It has been shown that anisotropy of linear dielectric coefficients of PC components may essentially strengthen the focusing. It has been grounded the opportunity of nondiffractive beam propagation and it has been founded conditions of this phenomenon.

It has been obtained that low- frequency electric field, affecting on group velocity dispersion, may lead to strengthening the laser beam focusing. It has been shown the possibility of use of the photonic crystals with cubic nonlinearity for creation of binary focusing- defocusing optical elements controlled by electric field. For given elements it has been estimated the divergence of incident laser beam for which dispersion of higher orders isn't essential.

ULTRABROADENING OF SPATIAL SPECTRUM OF A SELF-FOCUSING LIGHT BEAM

A.E. Kurasov, O.B. Bogumirsky, S.A. Izyurov, S.A. Kozlov

Alexander Kurasov
Kamennooostrovskiy pr. 34-57 Saint-Petersburg 197101, Russia
Tel: +7 (812) 234-6649
E-mail: kurri@mail.ru

The self-focusing of optical beams in media with positive nonlinearity of refractive index is a classical phenomenon of nonlinear optics now. The theory of paraxial radiation self-focusing is based on an analysis of the solutions of nonlinear Schrödinger equation, describing evolution of slowly varying field amplitude. However, to formulate the theory of nonparaxial deep self-focusing of radiation is still actual problem.

In this work a spectral method for an analysis of the nonparaxial self-focusing of monochromatic radiation in an isotropic medium with cubic nonlinearity is developed. It is shown that the dynamics of spectrum $G(k_x, z)$ of self-focusing two-dimensional light beam is described by equation:

$$\frac{\partial G}{\partial z} - i\sqrt{k^2 - k_x^2} = i \frac{\chi}{4\pi^2} \frac{G^*(\alpha - k_x) G(\alpha - \beta) G(\beta) d\alpha d\beta}{\sqrt{k^2 - k_x^2} - \sqrt{k^2 - (k_x - \alpha)^2} + \sqrt{k^2 - (\alpha - \beta)^2} + \sqrt{k^2 - \beta^2}}$$

where z is the propagation direction, k is the wave number, χ is the nonlinear coefficient. Derived new spectrum equation exactly describes the diffraction of a unidirectional wave, including the situation where its ultrabroadened spatial spectrum involves components with spatial frequencies k_x exceeding the wave number k .

A snapshot of the self-focusing beam field obtained by inverse transformation of the calculated spectrum dynamics is illustrated on figure:

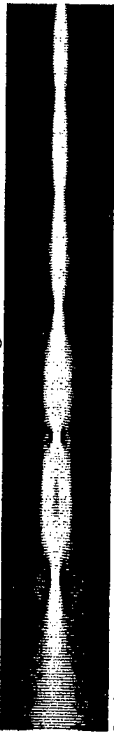

In the focuses with cross section on the order of a wavelength the spatial spectrum acquires high-frequency components that are responsible for the radiation self-reflection. Backward self-reflection phenomenon is analyzed in details.

Self-phase modulation of short light pulses in a gas-filled hollow fiber: searching for an optimum

A.N. Naumov, O.A. Kolevatova, A.M. Zheftikov
Physics Faculty, International Laser Center, M.V. Lomonosov Moscow State University, Moscow 119899, Russia

G. Cerullo, M. Nisoli, S. De Silvestri
Istituto Nazionale di Fisica della Materia, Dipartimento di Fisica del Politecnico, Piazza L. Da Vinci 32, Milan 20133, Italy

The use of hollow fibers for increasing the length of nonlinear-optical interactions of femtosecond laser pulses has resulted recently in a considerable progress in pulse compression [1, 2] and high-order harmonic generation [3]. Efficient self-phase modulation (SPM) of femtosecond pulses in gas-filled hollow fibers has been shown to allow the generation of sub-5-fs pulses [2]. This approach extends the opportunities of up-to-date femtosecond laser systems, permitting 6-7-fs pulses to be routinely produced and allowing an unprecedented time resolution to be achieved in pump-probe measurements and ultrafast spectroscopy [4].

pulse-compression systems. This paper focuses on the physical factors limiting the fiber length in this case. Analytical expressions for the amplitude and the phase of a laser pulse undergoing self-phase modulation in leaky modes of a hollow fiber will be presented. These expressions are then used to examine the effects arising in the SPM of a short laser pulse in a hollow fiber due to waveguide losses and to develop some general recipes for choosing parameters of hollow fibers for SPM pulse compression. The magnitude of optical losses due to the leakage of radiation out of a hollow fiber can be reduced by increasing the inner radius of the fiber a (Fig. 1). However, radiation energy lost through the excitation of higher order waveguide modes also increases under these conditions (Fig. 1), requiring a careful optimization of hollow-fiber parameters for the maximum efficiency of pulse compression. Such an optimization will be the central issue of this paper.

This study is supported by the President of Russian Federation Grant no. 00-15-99304, CRDF (Award RP2-2266), and the Volkswagen Foundation (project I/76 869).

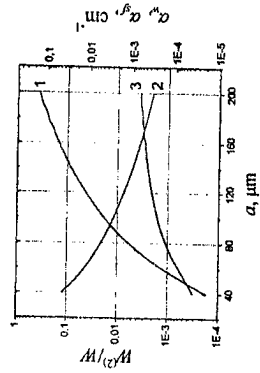

Fig. 1. Average energy of waveguide mode $EH_{12} W^2$ normalized to total energy W (1) and the coefficients α_w and α_d of optical losses due to the leakage of radiation out of a hollow fiber (2) and due to the excitation of higher order waveguide modes (3) as functions of the inner radius a of a hollow fiber filled with 1 atm of argon for radiation with a wavelength of 800 nm and an intensity of 10^{14} W/cm 2 .

While phase-mismatch problems usually restrict high-order harmonic-generation experiments to rather short hollow fibers [3, 4], SPM is a frequency-degenerate nonlinear-optical processes, which is insensitive to phase matching. This circumstance allows much longer hollow fibers to be used in hollow-fiber

1. M. Nisoli, S. De Silvestri, and O. Svelto, Appl. Phys. Lett. **68**, 2793 (1996).
2. M. Nisoli, S. De Silvestri, O. Svelto, R. Szpöcs, K. Ferencz, Ch. Spielmann, S. Sartania, and F. Krausz, Opt. Lett. **22**, 522 (1997).
3. C.G. Durfee III, S. Backus, M. M. Murnane, and H. C. Kapteyn, Opt. Lett. **22**, 1565 (1997); A. Rundquist et al. Science **5368**, 1412 (1998).
4. G. Cerullo, M. Nisoli, S. Stagira, S. De Silvestri, and O. Svelto, Proceedings of the Second Italian Russian Symposium on Ultrafast Optical Physics, (Intellect Center, Moscow, 2000), p. 141.

The paraxial self-focusing of few-cycle light pulses in transparent media

M.A. Bakhtin, A.N. Berkovsky, S.A. Kozlov, Yu.A. Shpolyanskiy
 St. Petersburg State Institute for Fine Mechanics and Optics (Technical University)
 14 Sablinskaya st., St. Petersburg, 197101, Russia
 E-mail: berkov@green.ifmo.ru

Recent advances of ultrafast laser technology have resulted in generation of pulses containing only a few cycles of a light field. In the paper the paraxial self-focusing of such extremely short pulses in a transparent isotropic nonlinear medium is theoretically investigated. The features of the spatial-temporal and spectral evolution of different-intensity ultrashort pulses are studied. The effect of the self-focusing on the spectrum supercontinuum formation and development is evaluated.

The results are based on analysis of a new $(2+1)$ dimensional wave equation, describing nonlinear evolution of an ultrashort pulse electrical field in a bulk or waveguiding medium.

The linear part of the wave equation (first equation in the set) provides the approximation accuracy up to 10^{-3} for the dispersion of linear refraction index within the medium transparency band.

The nonlinearity model describes the combined effect of all cubical nonlinear processes including phase self- and cross-modulation, phase self-shift, stimulated Raman scattering and four-wave parametric processes, not separating them.

Numerical simulations of the paraxial self-focusing of few-cycle pulses with input spectrum in a normal group-delay-dispersion region of fused silica are presented. Two different self-focusing pathways are found. There is a range of input peak intensity that beam waist arises during propagation of a few-cycle pulse through fused silica bulk. A light formation with emptinesses, "light bubble" can be formed at higher intensities. It is shown that spectrum supercontinuum generation is more significant in a medium bulk than in a fiber of the same material.

STEADY-STATE SPATIAL SCREENING PHOTOREFRACTIVE SOLITONS WITH APPLIED EXTERNAL ALTERNATIVE ELECTRIC FIELD

V.V. Anikeyev, N.D. Kundikova, A.A. Postnikov
 Joint Laboratory of Nonlinear Optics, Institute of Electrophysics of Urals Branch of
 RAS and South Urals State University
 Lenin Av. 76, Chelyabinsk, 454080, Russia

Spatial solitons in photorefractive media have been the object of intensive interest last ten years [1,2]. Spatial solitons was observed with external direct electric field [3]. Theoretical simulation and theoretical observation of steady-state screening solitons with external alternative field was the main goal of this work. The results of modeling of laser beam propagation in photorefractive crystal present distribution of electric space charge and beam intensity. It has been shown that background illumination should be comparable with light intensity for observation of screening solitons. We directed laser beam with power 2 mW on crystal $\text{Ba}_2\text{NaNb}_3\text{O}_{15}$ so that beam waist was situated before front face. The crystal was oriented with its c axis in the horizontal plane and perpendicular to the direction of the laser beam propagation. The polarization of light was chosen to be along the c axis. Synchronization between external field and optical beam has been achieved by means of acousto-optical modulator. With the presence of external electric field the diameter of laser spot at the exit face began decrease in the direction of external field E we have observed the beam propagation throughout crystal without diffraction and under $E = 6,7$ kV/cm. If the magnitude was smaller self-focusing effect was insufficient to compensate diffraction, otherwise the self-focusing effect overcame diffraction.

This work was supported by grant # 97-52-104 of Competition Center of Basic Natural Science

1. M. Segev, G.C. Valley, B. Crosignani, P. Di Porto, A. Yariv, Phys. Rev. Lett, Vol. 73, No. 24, 3211, 1994.
2. M. Segev, G.C. Valley, S.R. Singh, M.I. Carvalho, D.N. Christodoulides, Optics Letters, Vol. 20, No. 17, 1764, 1995.
3. G.C. Ducee, J.L. Shultz, G.J. Salamo, M. Segev, A. Yariv, B. Crosignani, P. Porto, E.J. Sharp, R.R. Neurgaonkar, Phys.Rev.Lett., 71, 533 (1993).

GEOMETRIC LIMITS TO PHASE MATCHING IN SELF-DIFFRACTION EXPERIMENTS

José Viana Gomes, António José Guedes Pereira, Michael Belsley
Departamento de Física, Universidade do Minho, 4710-057 Braga

In this communication we present a detailed study regarding the limitations that geometry imposes on the degree of phase matching attainable in a self-diffraction experiment. In a typical self-diffraction experiment two incident pump beams are superposed within an active medium creating a modulation in its complex refractive index. This modulation can, in turn, diffract the incident beams into several spatial orders. In this geometry, the finite angle α between the incident beams, leads to a small phase mismatch $\Delta k = \alpha^2 k$ for the beam diffracted in third order. We have constructed a "home-made" wedge cell in order to explore the dependence of the signal on the thickness of the active sample. Surprisingly we find that to generate a strong signal the active medium thickness must be much smaller than the length of the region of superposition of the two incident pump beams. This restriction can be understood in terms of the geometrical limitations imposed by transversal dimension of the two pumps. The non-linear interaction of these two beams creates a set of coherent dipoles distributed throughout the medium. The lines of constant phase of the induced dipoles are separated by a distance $(1 - \alpha^2)\lambda$, only slightly less than λ , due to the geometric phase mismatch.

Generally, for a unidimensional problem the signal varies with thickness d like $\sin(\Delta k d)^2$ [1]. In this case tilting the sample by a small amount would vary slightly the optical thickness and one could, in principle, always adjust the sample so that a maximum signal is obtained. However, for pump beams of a finite transverse dimension, the lines of constant phase will have different lengths, decreasing the further a given line is from the sample center. Thus the vector sum of the polarization generated by each half of the sample takes the form of a spiral as the sample becomes thicker (reminiscent of Cornu Spirals in diffraction theory [2]). The overall complex polarization generated by the sample therefore displays rapid oscillations as the spirals evolve with an overall envelope that is described by a complex error function.

References

- [1]- "The Principles of Nonlinear Optics", Y.R. Shen, Wiley, New York (1984).
 [2]- "Principles of Optics", M. Born and E. Wolf, Pergamon Press, Oxford (1975).

PHOTOREFRACTIVE GRATING AND FOUR-WAVE MIXING
 IN DOPED CADMIUM TELLURIDE CRYSTALS

I.N.Agishev¹, A.L.Tolstik¹, O.K.Khasanov², V.N.Yakimovich²

¹Belarusian State University, 4 F. Skaryna Av., 220050, Minsk, Belarus

²Institute of Solid State and Semiconductor Physics,

Belarus National Academy of Sciences, 220072, Minsk, Belarus

Cadmium telluride is known as one of the most promising materials for recording of photorefractive gratings in the near IR. The interest to nonlinear optical elements based on cadmium telluride stems from the possibility of their integration into the fiber-optic communication lines and usage for power limitation of IR radiation aimed at protection of sensors against active electronic suppression.

In the present work the spectroscopic and nonlinear optical properties of photorefractive semiconductor materials based on cadmium telluride (CdTe) doped by vanadium, titanium or ferrum were investigated. It was demonstrated that vanadium introduction results in extra absorption bands in the range 0.9 to 1.6 μm . Doping with titanium leads to a marked maximum at a wavelength of 1.1 μm at a halfwidth of 100 nm, while the introduction of ferrum causes increased absorption over a wide range of the wavelengths: 0.9 - 2.5 μm . Nonlinear optical properties of doped CdTe were studied on the basis of four-wave mixing geometry at the wavelength of 1.06 μm and pulse width of 10 ns. Maximum diffraction efficiency was revealed for the convergence angle of light beams $\sim 8^\circ$ associated with the grating period of 7 μm . It was shown that introduction of vanadium, titanium or ferrum allows enhancement of the photorefractive characteristics and improvement of the dynamic grating diffraction efficiency by a factor of 3 - 4 compared to pure monocrySTALLINE CdTe. Recording of dynamic gratings in the absence of an external electrical field in all doped CdTe crystals was realized with the diffraction efficiency up to 2 % and recording pulse energy of about 1 mJ. It was demonstrated that the dynamic grating lifetime is practically independent of the dopant and amounts to ~ 200 ns.

NUMERICAL SIMULATION OF PARAMETRIC GAP SOLITON TRAPPING IN BRAGG GRATINGS

E. G. Pavlova, A. P. Sukhorukov, I. G. Zakharova

Department of Physics, Lomonosov State University, 119899 Moscow, Russia
 lena@nls.phys.msu.su

Gap solitons in quadratic Bragg gratings are of great interest due to elaboration of optical memory devices [1-2]. The interaction of counterpropagating waves at fundamental frequency (FF) and second harmonic (SH) in such a grating is investigated numerically in the frame of the following equations for envelopes:

$$i \pm \frac{\partial u_1^\pm}{\partial z} + v_1 \frac{\partial u_1^\pm}{\partial t} + \delta_1 u_1^\pm + \kappa_1 u_1^\mp + (u_1^\pm)^* u_2^\pm = 0,$$

$$i \pm \frac{\partial u_2^\pm}{\partial z} + v_2 \frac{\partial u_2^\pm}{\partial t} + \delta_2 u_2^\pm + \kappa_2 u_2^\mp + (u_1^\pm)^2 / 2 = 0.$$

We investigated soliton trapping in one- and double- Bragg resonant in finite gratings with input FF Gaussian pulse. shows soliton reflection at the grating boundary. The input pulse parameter sets were found which make it possible to observe soliton reflection at the grating boundary (Fig.1) or decay into grating (Fig.2).

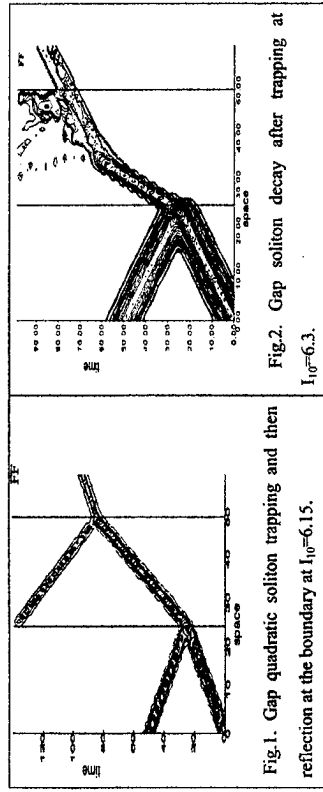

Fig.1. Gap quadratic soliton trapping and then reflection at the boundary at $I_{10}=6.15$.

Fig.2. Gap soliton decay after trapping at $I_{10}=6.3$.

This research was supported by the RFBR (99-02-16181), Federal Program "Leading Scientific Schools" (00-15-96561) and UR-BR(992251) grants.

1. Conti C., Assanto G., Trillo S., Phys. Rev. E. 1999. V. 59. P. 2467.
2. Conti C., Assanto G., Trillo S., Opt. Lett., 1998. V. 23, P. 334.

CHARACTERIZATION OF THERMO-OPTIC NONLINEARITIES IN NEUTRAL DENSITY FILTERS USING THE Z-SCAN TECHNIQUE

A. Karalevich and M. Belsley

Departamento de Fisica, Universidade do Minho, 4710-057 Braga, Portugal

Thermo-optic nonlinearities excited using continuous laser radiation are dominated by the balance between local excitation and the diffusion of heat within the sample. Diffusion, however is an inherently a non-local effect and is not properly taken into account in the standard analysis of Z-scan data [1]. In this communication we explore the influence that the non-local heat diffusion can have on Z-scan curves. For our thermo-optic nonlinear medium we have chosen to use a set of Schott neutral density filters, with well-known physical characteristics. Most importantly their absorption coefficients stay constant over a large range of incident beam power densities and it is a simple matter to vary the optical density or optical path length of the nonlinear medium.

Using filters with an optical density between 0,2 and 2,0 and a few 100 mW of incident radiation form and Argon ion laser it is possible to produce thermal heating that results in a surprisingly high on-axis thermally induced optical phase of several pi radians. In contrast to typical Z-scan transmission curves, we obtain curves that quickly become asymmetric with a separation between the transmission peak that increases slightly as the incident power is increased.

We have developed a simple quadratic model for the induced thermal gradient within the filters that qualitatively reproduces the above features. The existence of a slight thermal birefringence within the samples gives us an independent test of the model. We believe that to obtain full quantitative agreement boundary effects at the entrance and exit surfaces of the filters as well as beam propagation effects within the filter are important.

References:

- [1] M. Sheik_Bahae, A.A. Said and E.W. Van Stryland, Opt. Lett 14, 955 (1989).

THE USE OF NONUNIFORM PHASE PLATES FOR COMPENSATION OF THERMALLY INDUCED BIREFRINGENCE IN FARADAY ISOLATOR

Efim Khazanov, Anatoly Poteomkin, Evgeny Katin, Nikolay Andreev, Oleg Palashov, Institute of Applied Physics, 46 Uljanov st., N.Novgorod, 603600 Russia

David H. Reitze

Department of Physics, University of Florida, Gainesville, Florida, 32601

One of the factors that hampers the development and application of powerful single-mode solid-state lasers is the birefringence in Faraday isolators (FI) caused by absorption of the laser radiation. Various techniques have been employed to compensate for the birefringence. However, none are completely free of disadvantages. In this presentation we suggest a novel technique for compensating depolarization in FI.

The technique consists in construction of a phase plate with the same transverse distributions of eigenpolarizations and phase difference (though with an opposite sign) as in the FI. In this case (Fig. 1), having passed subsequently through the depolarizing element and the plate, the radiation keeps its initial polarization undistorted. A heated Faraday element has elliptical eigenpolarizations. A quartz crystal (optical axis is parallel to the z axis) placed inside a telescope has the same distributions of eigenpolarizations and of phase difference. If the directions of rotation of polarization in the quartz and in the FI are opposite, the phase incursions will be subtracted, compensating for the birefringence.

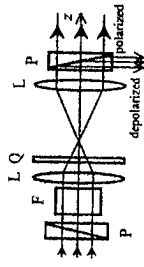

Fig.1. Experimental setup. P - polarizer, L - lens, Q - 45° quartz rotator, FR - 45° Faraday rotator

In the experiment we used a commercial TGG-based Faraday rotator. We measured the isolation ratio as a function on laser power (Fig.2). Optimal power corresponds to the equality of phase incursions in the sample and in the quartz plate. By varying the geometry and/or the length of the crystal in the sample one can achieve optimal compensation at any power. Isolation ratio was maximally reduced by a factor of 8.

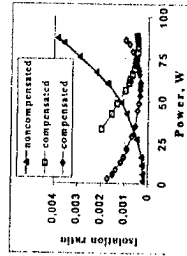

Fig.2. Dependences of depolarization ratio on laser power. For the last case two compensated curves represent different focussing geometries.

NONLINEAR PROPAGATION OF GAUSSIAN BEAMS IN MICRO-EMULSIONS

M. Belsley and A. Karalevich

Departamento de Física, Universidade do Minho, 4710-057 Braga Portugal

Water-in-oil micro-emulsions are stable suspensions of surfactant coated water droplets dispersed in an oil-like organic solvent. An incident optical beam with a strong power gradient can alter the local concentration of the water droplets via an electrostrictive force. Due to a large refractive index contrast between the water droplets and the oil continuum, strong self-focusing can be induced in these materials at modest incident powers [1]. We have carried out a series of Z-scan measurements in an attempt to fully characterize these induced nonlinearities.

We have carried out our investigations in the three component system of water, sodium di-2-ethylhexylsulfosuccinate (AOT) and iso-octane. Neutron scattering measurements [2] have established an empirical relationship between the ratio of water to AOT and the average water droplets size. We find that the induced nonlinearity varies significantly with the water droplet size, changing sign close to the optical matching point.

The analysis of our data brings in to play several subtle aspects of the Z-scan method as applied to nonlinear optical solutions. The concentration gradients induced by the electro-strictive force are counterbalanced by particle diffusion. We find that it necessary to generalize the usual formalism for the analysis of the Z-scan transmission curves to account for this "nonlocal" contribution due to diffusion. Furthermore, at sufficiently high incident powers, the local water droplet concentrations can be dramatically altered, giving rise to a sudden phase transition to a highly scattering state (critical opalescence) [3]. Once formed, this optically induced phase, requires very little optical power to survive, leading to a bistable optical transmission curve.

References:

[1] E. Freysz, E. Laffon and A. Ducasse, Optics Letters 16, 1644 (1991).
 [2] C. Robinson, et al. Chem Faraday Trans. 80, 13 (1984).
 [3] A. Ponton, et al., Europhysics Letters, 17, 27-32 (1992).

SELF-ACTION OF LIGHT BEAM IN A PHOTOREFRACTIVE CRYSTAL UNDER
AN EXTERNAL AC ELECTRIC FIELD

S. M. Shandarov¹, M. N. Frolova¹, M. V. Borodin¹, and N. I. Najestkina²

¹State University of Control Systems and Radioelectronics,

40 Lenin Avenue, Tomsk 634050, Russia

²Department of Physics, University of Joensuu, P.O. Box 111, Joensuu FIN-80101,

Finland

Recently a possibility to existence of a spatial soliton in photorefractive crystal $Ba_2NaNb_2O_{15}$ by modulation of light intensity synchronously with external alternating electric field was experimentally demonstrated.¹ In this report we analyze the propagation of light beam which contains the periodical modulation in time, through photorefractive crystal subjected to the square-wave electric field.

We derive the general nonlinear equation for the time-averaged distribution of the space-charge field for this case. It was shown that the space-charge field has two parts. First of them is related to the gradient type of photorefractive nonlinearity. The second part is the screening field, that can provide a steady-state self-trapping of the optical beam.

We have determined the existence conditions of the soliton regime for the propagation of the light under paraxial assumptions from wave equation. Soliton is formed when the contribution of gradient type of nonlinearity is negligible. If the contribution of gradient type of nonlinearity is increasing, this conditions breaks, and the beam defects. It was shown that the relative contributions for two components of the space-charge field can be changed by regulating of the electric field magnitude and modulation depth of the light intensity. An influence of "dark" irradiance and a shape of a beam on its self-bending has been also investigated.

1. V.V. Anikeev, M.V. Bolshakov, N.D. Kundikova et al., Proc. Int. Conf. "Fundamental Problems of the Optics", St.-Petersburg, October 17-19, 2000, p.130.

TRANSIENT QUASI-PHASE MATCHING SRS GENERATION.

N. S. Makarov¹, V. G. Bespalov²

¹State Institute of Fine Mechanics and Optics, ²S. I. Vavilov State Optical Institute
Suzdalsky av. 5-1-225, Saint-Petersburg, 194355, Russia

Phone: +7(812) 515-07-27

Fax: +7(812) 328-13-35

E-mail: mak_nick@newmail.ru, mak_nick@diablo2.com

For efficient second harmonic generation the conditions of quasi-phase matching in media with periodically changed parameters of the second order nonlinearity along longitudinal coordinate was proposed and realized [1,2]. In the present paper we analyzed the increasing of anti-Stokes SRS generation efficiency in conditions of quasi-phase matching in media with periodically changing of parameters of the third order (Raman) nonlinearity $\chi^{(3)}$.

For three waves SRS approximation (pump, Stokes and anti-Stokes components) in steady-state regime and for four waves SRS approximation (pump, Stokes, anti-Stokes components and phonon wave) in transient regime the systems of the equations for complex amplitudes of interacting waves were numerically solved. In the systems the waves mismatching and Raman gain were the functions of coordinate for nonlinear and linear layers ($\chi^{(3)}=0$). The thickness of layers was optimized for effective energy conversion from pump and Stokes waves to the anti-Stokes component and correspondingly the conditions of quasi-phase matching was fulfilled.

The numerical analysis of the system has shown that the conversion efficiency into the anti-Stokes component in special layered gaseous Raman media (for example hydrogen, deuterium, methane with glass or crystal plates) reached ~35 %, and the intensity of anti-Stokes component is compared to the intensity of output Stokes component. In conclusion, the layered nonlinear SRS media with quasi-phase matching conditions were favored the increasing of conversion efficiency into the anti-Stokes component.

1. J. A. Armstrong, N. Blombergen, J. Ducuing, P. S. Pershan, Phys. Rev. 127, p. 1918 (1962)

2. E. J. Lim, M. M. Fejer, R. L. Byer, W. J. Kozlowsky, Electron. Lett. 25, 731 (1989)

ON NONLINEAR EFFECT OF SELF-INDUCED VARIATION OF POLARIZATION OF TIGHTLY FOCUSED LASER BEAMS

Vitali E. Gruzdev, Mikhail N. Libenson

State Research Centre "S.I. Vavilov State Optical Institute"
12 Birzhevaya Liniya, St Petersburg, 190034, Russia

Results of theoretical analysis of laser-induced variations of light polarization of tightly focused high-power laser beam are presented.

The analysis is based on asymptotical expansion of solution to general nonlinear wave equation including gradient nonlinear terms. Bearing in mind contributions of higher order in the expansion describing gradient interactions, we show initial polarization to change sufficiently in the vicinity of focal spot. This effect is illustrated by detailed calculations of space distribution of polarization-ellipse parameters induced by laser radiation for the case of low-order Gaussian beams of initial linear polarization in transparent isotropic media. It is shown that linear polarization is conserved only along certain axes in transversal plane and cross-shaped structures are clearly observed for beams of certain symmetry. To generalize obtained results, we consider a beam with arbitrary transverse field distribution. Qualitative analysis shows deep connection between described depolarization effect and symmetry of transverse space distribution of electric field of the beam. There are compared contributions to depolarization effects resulting from linear diffraction and nonlinear propagation.

Obtained results allow to consider observed dependence of laser-induced damage threshold on light polarization [1] as well as absence of polarization dependence of damage threshold for femtosecond tightly focused laser radiation [2].

1. M.J. Soileau, W.E. Williams, N. Mansour, E.W. VanStryland, *Opt. Engineering*, v. **28** (10), p. 1133 (1989)
2. C.B. Schaffer, E.N. Gleser, N. Nishimura, and E. Mazur, in Proc. of SPIE, v. **3269**, p. 36 (1998)

QUADRATIC SOLITON TRAPPING IN LOSSY CAVITIES

O. A. EGOROV, A. P. SUKHORUKOV, I. G. ZAKHAROVA

Physics Faculty, Lomonosov Moscow State University, 119899 Moscow, Russia

Quadratic optical cavity solitons were investigated basically within the framework of the mean-field theory [1,2]. We have considered the dynamics of dissipative soliton trapping on the basis of round-trip model which is described by the following equations:

$$\frac{1}{t_1} \frac{\partial A_1^+}{\partial t} \pm \frac{\partial A_1^+}{\partial z} + iD_1 \Delta_{\perp} A_1^+ = -i\gamma(A_1^+)^* A_1^+, \quad \frac{1}{t_2} \frac{\partial A_2^+}{\partial t} \pm \frac{\partial A_2^+}{\partial z} + iD_2 \Delta_{\perp} A_2^+ = -i\gamma A_1^+,$$

with the boundary conditions on two mirrors $A_j^+(0) = |R_j(0)| A_j^+(0) \exp[i\Phi_j(0)] + E_j$, $A_j^+(L) = |R_j(L)| A_j^+(L) \exp[i\Phi_j(L)]$, where Φ_j is the phase mismatch. We determined numerically the multistability domain of driven field and detuning where stable soliton trapping occurs (Fig. 1).

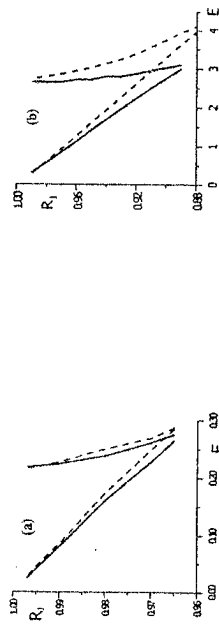

Fig. 1. The multistability domain on a plane of parameters (E, R), where E is the driving field amplitude and R is the mirror reflectance. Detuning is equal to $\phi_1 = 0.1$ rad (a) and $\phi_1 = 0.3$ rad (b). The solid lines correspond to the round-trip model, while the dashed line to mean-field one.

if resonance detuning is increased, multistability range extends and soliton intensity grows. The results of the mean-field theory are valid for the reflectance more than 0.92 and to the phase mismatch less than 0.3.

This research was supported by the RFBR (99-02-16181), Federal Program "Leading Scientific Schools" (00-15-96561) and UR-BR(99-2251) grants.

1. D. V. Skryabin, *Phys. Rev. E* **60**, 3505 (1999).
2. C. Eirich, U. Peschel, F. Lederer, *Phys. Rev. Lett.* **79**, 2454 (1997).

SUB-WAVELENGTH QUADRATIC SPATIAL SOLITONS

A.V. Pimenov and A.P. Sukhorukov
 Physics Faculty, Lomonosov Moscow State University, 119899 Moscow, Russia
 Phone: 07(095)9393317, Fax: 07(095)9328820, E-mail: alex@mls.phys.msu.ru, ap@mls.phys.msu.ru

We investigated properties of ultra-narrow quadratic spatial solitons finding exact solutions of Maxwell's equations [1, 2] in the form $E_j = E_j(y) \exp(-ik_j z)$ with phase matching of total wavevectors $k_2 = 2k_1$. The following equations for soliton profiles were obtained:

$$\frac{d^2 u}{dy^2} - u + \frac{uv}{1+bv} = 0, \quad \frac{d^2 v}{dy^2} - av + \frac{u^2}{2(1+bv)^2} = 0 \quad (1)$$

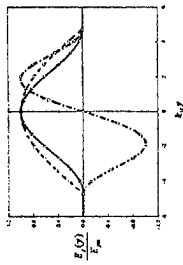

Fig. 1. The envelopes of electrical field components of extremely narrow soliton. Analytically calculated profiles are shown with symbols \circ, \square, Δ .

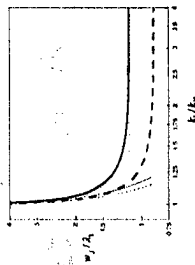

Fig. 2. Soliton width vs on total FW wavenumber. Paraxial theory (thin lines on the left) and asymptotic solutions (thin lines on the right) are presented.

- [1] A.D. Boardman, K. Marinov, D.I. Pushkarov, and A. Shivarova, Phys. Rev. E, **62**, 2871-2877 (2000).
- [2] A.V. Pimenov, A.P. Sukhorukov, Bull. RAS, Phys. **64**, 2349-2354 (2000).

SUM-FREQUENCY GENERATION IN PHOTONIC BANDGAP STRUCTURE UNDER CONDITION OF NONCOLLINEAR WAVE INTERACTION

V. A. Bushuev, B. I. Mantsyzov, E. V. Petrov
 Physics Department, M. V. Lomonosov Moscow State University,
 Moscow, 119899, Russia

It has been shown recently [1], that a sum-frequency signal, generated in one-dimensional photonic bandgap (PBG) structure with a high contrast of the refractive index modulation, may be increased more than by one order of magnitude. This happens because of an increase of the electromagnetic field density at the fundamental frequencies near the photonic band gap edge, or non-phase-matching enhancement, and quasi-phase-matching (QPM) [2] enhancement. However, in the experiment with a real structure [1], at the collinear geometry of wave interaction, the QPM conditions near the photonic band gap edge are fulfilled approximately. Here we study the enhancement of sum-frequency generation in PBG structure under condition of noncollinear geometry of wave interaction. Using the propagation matrix method, the optimal angle between two incident fundamental waves is calculated to realize exact QPM and non-phase-matching enhancement conditions near the photonic band gap edge simultaneously. In this case, the intensity of generated reflected or transmitted sum-frequency signals may be increased in a few times compared with a case of collinear wave interaction. We show also that at specific angles of incidence the values of effective refractive indexes of two fundamental and sum-frequency waves are equal near photonic band gap edge. This gives rise to enhancement of nonlinear signal due to dispersive phase matching and non-phase-matching enhancement.

- 1. A. V. Balakin, V. A. Bushuev, B. I. Mantsyzov, I. A. Ozheredov, E. V. Petrov, A. P. Shkurinov, P. Masselin, and G. Mouret, Phys. Rev. E **63**, N3 (2001)
- 2. M. M. Fejer, G. A. Magel, D. H. Jundt, and R. L. Byer, IEEE J. Quantum Electron. **28**, 2631 (1992).

SELF-ACTION OF BESSEL BEAM IN BENZENE

R.Gadonas, V.Jarutis, V.Smilgevičius, A.Stabinis, V.Vaičiaitis

Department of Quantum Electronics, Vilnius University, Sauletekio ave. 9, building 3, 2040 Vilnius, Lithuania

The self-action of Bessel beam was firstly investigated in plasma [1] and the longitudinal modulation of propagating beam intensity was observed. In stimulated Raman scattering with ultrashort pulses axicon focusing has advantages over lens focusing because the pump beam undergoes 2-3 orders of magnitude less self-phase-modulation and is much less distorted [2].

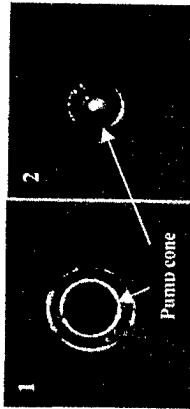

Fig.1.

In our report we present the experimental results of an investigation of a self-action of Bessel beam ($\lambda=532$ nm, pulse duration 20 ps) propagating in benzene. The typical far-field intensity distributions of Bessel beam after benzene cell are presented in Figs.1 and 2. Fig.2 was obtained in the case when intensity of the pump cone was attenuated by two orders of magnitude. The appearance of the central spot (axial beam) in the far-field intensity distribution (Fig.2) is the result of the distortion of the central peak of Bessel beam in a focusing medium ($n_2 > 0$). The additional ring seen in the Fig.1 is caused by parametric amplification ($\omega = \omega_1 + \omega_2$) of axial beam by Bessel pump beam. Thus, self-action of Bessel beam leads to considerable modifications of its angular spectrum.

The computer simulation of the self-action of Bessel beam in the medium with cubic nonlinearity was provided by the numerical solution of nonlinear Schrödinger equation. The obtained results are in good agreement with experimental data.

1. N.E.Andreev et al, Sov.Phys.JETP 73, 969 (1991).
2. I.Golub, Opt.Lett. 20, 1847 (1995).

ON THE SELF-CHANNELLING OF LIGHT BEAMS IN SEMICONDUCTOR COMPOUNDS

Uladzimir V. Zubryski

B. I. Sisyapanau Institute of Physics, Belarus National Academy of Sciences, F. Skaryna Ave. 68, Minsk 220072, Belarus

The self-action [1] of the intrinsic radiation has been come into use to explain the filamentation of light fluxes in semiconductor lasers [2], including streamer ones [3].

To examine the possibility of the combined action of the self-focusing and self-defocusing near band gap edge E_g in II-VI semiconductors the self-trapping of light beams [1, 4] is analysed versus the power, light frequency, and crystallographic orientation in GaAs, ZnSe, and CdS in this paper. Having the use of the set of known nonlinear refractivities, the critical powers P and diameters D of the light channels are numerically determined, spectral regions of the phenomenon existence are pointed, and a comparison of the data obtained and reported for different laser systems is made.

It is shown that the existence range of the self-channelling of cylindrical beams in the cubic GaAs and ZnSe houses at $\Delta E = h\nu - E_g > 0$, as the carrier density N_{eh} increases its low energy edge shifts to the higher energy range (Fig. a). The derived relationship between the parameters of the light channels in the samples (Fig. b) is similar to that in dielectric media; that is the effect of $n_2(N_{eh})$ on the light self-trapping in the semiconductors is analogous to the combined action of nonlinear refractivities n_2 and n_4 in dielectrics.

Good correlation between numerical estimations and experiments — e. g.,

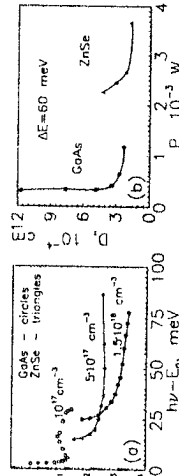

$D = 1.5 \cdot 10^{-3}$ cm and the light flux density Φ of $1.3 \cdot 10^4$ W/cm² at $N_{eh} = 1.5 \cdot 10^{18}$ cm⁻³ relative to the experimental data (Ref. [28] in Ref. [2]) $D \approx 10^{-3}$ cm, $\Phi \approx 10^4$ W/cm² at $N_{eh} \approx 10^{18}$ cm⁻³ — confirms validity of the used approach. It can be employed to model simply the self-trapping anisotropy of light beams in the semiconductor compounds envisaged as well as examines the anomalous distinctions between the measured values of nonlinear optical susceptibilities in CdS crystals.

1. S. A. Akhmanov, A. P. Sukhorukov, R. V. Khokhlov. *Zurn. Eksper. Teoret. Fiz.*, **50**, 1537 (1966); *Uspekhi Fizich. Nauk*, **93**, 19 (1967).
2. P. G. Eliseev, A. P. Bogatov. *Trudy FIAN*, **166**, 15 (1986).
3. V. V. Parashchuk, V. P. Gribkovskii, K. I. Rusakov. *Liet. Fiz. Zurn.*, **37**, 343 (1997).
4. R. Y. Chiao, E. Garmire, C. H. Townes. *Phys. Rev. Lett.*, **13**, 479 (1964); **16**, 347 (1966).

STABILIZATION OF OPTICAL SOLITON TRAIN DYNAMICS
IN CUBIC INERTIAL MEDIA

E.V. Doktorov, R.A. Vlasov

B.I. Stepanov Institute of Physics, National Academy of Sciences of Belarus,
68 F. Skaryna Ave., 220072 Minsk, Belarus,

N.P. Matsuka, V.M. Volkov

Institute of Mathematics, National Academy of Sciences,
11 Surganov St., 220072 Minsk, Belarus

Bit rates of soliton-based communication systems depend on the ability to pack solitons into as short of a space as possible. If solitons are too close to each other, mutual interaction between them can cause corruption of the information signal. For certain values of soliton parameters [1], solitons can propagate rather close together, still maintaining the signal integrity. This conclusion was however inferred for an idealized situation, when a number of important additional effects, e.g., the intrapulse Raman scattering (IRS) was neglected.

IRS acts destructively on the dynamics of a single soliton [2]. We show that the same takes place for a soliton train as well: initially equal-velocity, slightly overlapping solitons acquire different additives to velocity and move apart from each other.

To prevent the IRS-induced soliton train decay, we use a model of two-component material nonlinearity proposed earlier for a single soliton [3, 4]. We assume that there occur the fast and slow relaxation processes in a medium with short and large relaxation times, the pulse duration falling between them. We predict analytically a relationship between the characteristic times which provides partial compensation of the soliton train decay. Numerical simulations for 3-soliton train well agree with the prediction.

[1] V.S.Gerdjikov et al. Phys. Rev. Lett. **77**, 3943 (1996); Phys. Rev. E **55**, 6039 (1997).

[2] D.J.Kaup, B.A.Malomed. JOSA B **12**, 1656 (1995).

[3] E.V.Doktorov, R.A.Vlasov. Europhys. Lett. **26**, 487 (1994).

[4] A.A.Afanas'ev, E.Doktorov, R.A.Vlasov, V.M.Volkov. Opt. Comm. **153**, 83 (1998).

NONLINEAR ABSORPTION AT 266 nm IN BBO CRYSTAL
AND ITS INFLUENCE ON FREQUENCY CONVERSION

N.Kondratyuk, A.Shagov

SC "Solar LS", 77, Partizansky av., Minsk, 220107, Belarus

Phone: (375 17) 245-52-21, Fax: (375 17) 246-48-33, E-mail: solarls@infonet.by

At present, optical parametric oscillation in BBO crystal pumped by fourth harmonic of Nd:YAG laser (266nm) makes it possible to obtain continuously tunable radiation from the UV (300nm) to middle IR range (2340nm) [1]. The efficiency ranged up to 15% near the peak of the tunability curve at the pump intensity $\sim 46 \text{ MW/cm}^2$ was obtained. The nonlinear frequency conversion efficiency in BBO is limited by its nonlinear absorption in the UV region of the spectrum.

In this work the nonlinear absorption and influence it on frequency conversion was investigated. It was experimentally established that:

- the maximal nonlinear losses for pump radiation were equal $\sim 22\%$ at pump intensity 60 MW/cm^2 in 14 mm BBO crystal when the signal and idler waves were absent,
- the nonlinear losses for pump radiation was reduced when the idler wave at 1426 nm was injected into BBO crystal where this wave was amplified and signal wave at 327 nm was generated.

The parametric amplifier on BBO crystal in a range 300-400 nm was developed and its efficiency is higher than efficiency of the parametrical oscillator. In BBO OPA output energies up to 10 mj at 327 nm were achieved from a 35 mj of pump energy when the injected idler energy at 1426 nm was equal 6 mj. The BBO OPA total efficiency up to 30% was obtained in the range 300...400 nm.

1. N.Kondratyuk, A.Shagov *et al.*, Quantum Electronics **30** 253 (2000)

SECOND HARMONIC GENERATION WITH ELLIPTICAL BESSEL BEAMS

V.N. Belyi, N.A. Khilo, E.S. Petrova, A.G. Maschenko, V.E. Leparski

B.I. Stepanov Institute of Physics of National Academy of Sciences of Belarus, F. Skaryna Ave. 68, 220072 Minsk, Belarus, e-mail: nkhilo@optoinform.bas-net.by

Until the present time the theoretical investigations of nonlinear frequency conversion of high-power Bessel fields were based only on the concept of circular Bessel light beams (BLBs). However, the real BLBs in anisotropic media are elliptical beams, that is their plane-wave components lie on the surface of an elliptical cone. In this report, for the first time, a systematic study of SHG by elliptical BLBs is carried out. An exact solution of Maxwell equations for elliptical BLBs is derived. The Bessel functions involved in these solutions depend on the transverse coordinates x and y as

$$J_m \left(q \sqrt{x^2 + \alpha y^2} \right) \exp(ik_z z + im\varphi), \quad \text{where } \alpha = 1 - (\epsilon_o - \epsilon_e)/\epsilon_e, \quad \cos(\varphi) = x / \sqrt{x^2 + \alpha y^2},$$

$q = \sqrt{k_o^2 \epsilon_o / \alpha - k_z^2}$. For example, ellipticity α for LiNbO₃ crystal is 0.915, and for BBO – 0.84. The influence of the ellipticity on the type-I SHG ($oo-e$) was analyzed. It is shown that the ellipticity of the frequency-doubled BLB leads to a decrease in the overlap integral due to the transversal mismatch of the interacting waves. The magnitude of the mismatch is determined by the ratio of the difference of the ellipse axes to the distance between the adjacent maxima. This ratio must be less than 1, which limits the maximum number M of BLB rings. Therefore $M=22$ for LiNbO₃, and $M=11$ for BBO crystal. To avoid an unwanted decrease of the overlap integral, it is necessary to limit the number of rings in used BLBs. For $oo-e$ phase matching, the influence of the beam ellipticity decreases at the transition from the collinear interaction to vectorial one and increases when the conicity angle grows. In this case, it is necessary to take into account the azimuthally-inhomogeneous correction for nonlinear polarization, which is proportional to $q \sin(\varphi)$. The calculations are compared with our experiment on noncritical type-I temperature-tunable SHG in LiNbO₃. It has been found that in relatively thick crystal the effect of self-tuning to vector phase-matching takes place. In this case, the conversion efficiency for all vector interactions is virtually the same.

ORIENTATION OF AZO-DYE MOLECULES AND OPTICAL NONLINEARITY IN AZO-DYE-DOPED POLYMER WAVEGUIDES

A. V. Tomov, A. V. Khomchenko, E. P. Kalutskaya

Institute of Applied Optics of National Academy of Sciences of Belarus
B.-Biruly St. 11, 212793 Mogilev, Belarus

The nonlinear optical waveguides on the basis of thin films and layers doped by azo-dyes are widely studied because of potential use of the *trans-cis* isomerization effect for optical signal processing.

In the report orientation of molecules of the methyl red azo-dye (MR) in optical waveguides made in polycarbonate by the chemical diffusion from a solution [1] is considered. The waveguides have been studied by waveguide and IR-spectroscopy methods and it has been shown that a fabrication process results in an ordering of a spatial position of molecules of the polymer. It gives rise to the preferred orientation of macromolecules in a plane of the sample and an increase in optical anisotropy of the waveguide layer. Besides, the IR-spectroscopy testifies the chemical interaction between the polymeric matrix and MR. The results of application of the waveguide spectroscopy method [2] and the spatial Fourier-spectroscopy of guiding modes [3] show that in these waveguides absorption for TM-polarization of the probing light (633 nm) considerably exceeds that for TE-polarization.

Accounting for the results of comparison of nonlinear optical properties of azo-dye-doped waveguides made in polycarbonate and PMMA at various polarizations and previously obtained data about sensitivity of *trans-cis* isomers of MR to the probing light [3], the deduction about the preferred orientation of dipoles of dye molecules in the a direction which is perpendicular to the waveguide surface is made. The orientation rate is evaluated and the possible mechanisms of orientation of dye molecules are considered.

1. A.V. Tomov //Tech. Phys. Lett. 1995. V.21. № 10. P. 25-26
2. A.V. Khomchenko, D.N.Kosjuchenko. //Probl. of Appl. Opt. Mogilev. 2000-P. 149
3. A.B. Sotsky, A.V. Khomchenko, L.I. Sotskaya //Techn. Phys. Lett. V.20, №8, P.667
4. A.V. Tomov, A.I. Voitenkov //Opt. Com. 2000. V.174. P. 133-137

BESSEL LIGHT BEAM SELF-DIFFRACTION IN HEAVILY DOPED n-InP UNDER CONDITIONS OF HIGH OPTICAL NONLINEARITY

A.A.Ryzhevich
 Institute of Physics, National Academy of Sciences of Belarus
 68 F. Skaryna Ave., Minsk, 220072, Belarus; Phone 375 017 2841616

E-mail: tol@dragon.bas-net.by

I.A.Utkin

Division for Optical Problems in Information Technologies,
 National Academy of Sciences of Belarus, 1/2 Kuprevicha str., Minsk, 220141, Belarus,
 Phone 375 017 2637735, E-mail: iutkin@optoinform.bas-net.by

Bessel light beam (BLB) is axially symmetrical interference pattern with period depending on its conicity angle. BLBs are very suitable for investigations of nonlinear optical effects caused by non-uniform modulation of optical properties of the nonlinear medium, such as self-diffraction effect. In this paper the results of theoretical and experimental investigations of BLB self-diffraction in heavily doped n-InP under conditions of high nonlinearity are presented.

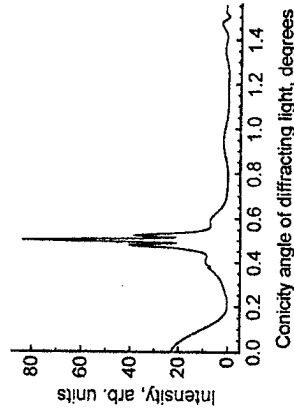

Fig. 1. Angular intensity distribution of diffracting light for the input BLB having the conicity angle of 0.5 degree.

Both external and internal diffraction maxima with respect to the input BLB far-field ring was registered for the first time. Location and values of maxima of the angular intensity distribution (Fig. 1) are explained and calculated for different parameters of the input BLB and for properties of the nonlinear media.

TRANSVERSE EFFECTS IN PARAMETRIC INTERACTION OF SUPER-GAUSSIAN PUMP BEAM AND GENERATED BESSEL BEAMS

T.A. King¹, W. Hogerworst², V.N. Belyi³, N.S. Kazak³, N.A. Khilo³,
 N.V. Kondratyuk³, A.A. Shagov³

¹Laser photonics, Department of Physics and Astronomy, University of Manchester, M13 9PL, Manchester, UK, e-mail: terry.king@man.ac.uk; ²Laser Centre, Department of Physics and Astronomy, Free University, De Boelelaan 1081,1081 HV, Amsterdam, NL, e-mail: wh@nat.vu.nl; ³B.I. Stepanov Institute of Physics of National Academy of Sciences of Belarus, F.Skaryna Ave. 68, 220072 Minsk, Belarus, e-mail: nkhuilo@optoinform.bas-net.by

We report the transverse effects in parametric conversion process due to interaction of super-Gaussian pump beam with the generated signal and idler Bessel beams. The parametric generation of Bessel beams was obtained using type I BBO 355 nm-pumped optical parametric oscillator (OPO) with Bessel mode structure cavity resonating at an idler. Along with the Bessel type cavity for the idler wave in OPO an additional plane-parallel cavity for signal wave has been formed.

It is found out that the signal wave is a diffraction-limited axial beam and a set of Bessel beams with different cone angles. The total conversion efficiency of 30% was obtained at low sensitivity to misalignment of the cavity mirrors.

We experimentally registered the transverse effect of spatial energy redistribution from large-area pump and idler beams to the narrow axial signal beam. This effect exists undoubtedly as only about 1% of the total power of pump beam was overlapped with the axial signal beam while the efficiency of conversion into the axial beam was about 16% of total conversion efficiency. The developed theoretical model explains the obtained experimental results. This model represents the generated signal field as a superposition of Bessel modes of a cylindrical waveguide formed by the pump beam. In particular, the axial signal beam is a linear superposition of the several lowest-order modes of this waveguide. The combination of constructive and destructive interference of these modes results in the spatial energy redistribution. As a result, the energy of signal wave is transferred efficiently from the beam periphery to its center.

SECOND HARMONIC GENERATION BY QUADRI-BEAM

N.S.Kazak, A.N.Khilo, E.G.Katranji, A.A.Ryzhevich

Institute of Physics, National Academy of Sciences of Belarus

68 F.Skaryna Ave., 220072, Minsk, Belarus; Phone 375 017 2841616

E-mail: to@dragon.bas-net.by

Quadribeams belong to a class of gradient light beams which form in result of interference of two or more light beams. Quadribeams forms due to interference of four plane waves travelling at the same angle with the longitudinal coordinate axis whose wave vectors are symmetric with respect to this axis. The calculated intensity distribution in the interference area is shown in Fig.1a for this case of multi-beam field. In our experiment, the quadribeam was produced (Fig.1b) by means of a pyramid having four faces with the angle 2 deg. at the pyramid base. It is also possible to use two orthogonally crossed biprisms as the refractive element. In this paper the longitudinal and transverse distributions of the second harmonic field of the quadribeam depending on the position of nonlinear KTP crystal relative to the refractive element are investigated theoretically and experimentally. Changing the crystal position one can obtain the second harmonic field comprising 9 (Fig. 2a), 8 (Fig. 2b), or 4 (Fig. 2c) light beams having the divergence close to the diffraction limit.

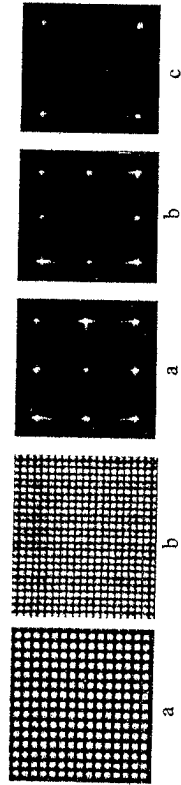

Fig. 1. Quadribeam:

(a) calculated, (b) experimental.

Fig. 2. Second harmonic of the quadribeam. The distance between refracting element and nonlinear crystal is (a) 3.2cm (b) 4.5cm (c) 4.9cm.

Both quadribeams and their second harmonic field can be used for controlling the nano- and micro-particles (e.g. the organic cell or its components) and in systems for optical information transferring and processing.

RAMAN AMPLIFICATION IN BARIUM NITRATE STUDIED WITH FOCUSED LASER BEAMS

A. I. Vodechits, V. P. Kozich, D. A. Ivanov, and V. A. Orlovich

B. I. Stepanov Institute of Physics, National Academy of Sciences of Belarus

Fr. Scaryna Ave. 68, Minsk 220072, Belarus

Solid-state Raman shifters and lasers are rather effective devices for frequency shifting the laser radiation [1]. To optimize their characteristics one should know the nonlinear optical properties of Raman-active crystals used.

In this study we applied two-beam Z-scan technique for measuring absolute magnitude of Raman amplification coefficient in such a promising Raman crystal as barium nitrate, Ba(NO₃)₂. The second harmonic (SH) radiation of nanosecond Nd:YAG laser with the spectral width of about 0.5 cm⁻¹ was used as a pump beam. The first Stokes component radiation of stimulated Raman scattering in 6 cm long Ba(NO₃)₂-based Raman shifter excited with the SH served as a probing and amplified beam. The two beams were focused in the investigated Ba(NO₃)₂ crystals of 4-7 mm thickness and Raman amplification profiles were measured as typical Z-scans for the Stokes energy after the sample. It is known that in exact Raman resonance, as in our case, the real part of Raman nonlinearity is equal to zero and only imaginary part can manifest itself. Therefore the measured Z-scan curves give an information about the imaginary part of Raman nonlinearity, from which one can obtain Raman amplification coefficient.

Raman amplification was studied for the different power regimes (with and without amplification depletion) and focusing conditions. The measured profiles are rather well fitted with theoretically calculated ones giving Raman amplification coefficients. The results also show that there is a difference in distribution of Raman amplification over the cross section of the Stokes beam for convergent and divergent focused pump beams of the same intensity.

[1] P.G. Zverev, T.T. Basiev, and A.M. Prokhorov, Opt. Mat., 11, 335, (1999).

THERMAL LENSING IN BARIUM NITRATE DUE TO STIMULATED RAMAN SCATTERING OF NANOSECOND LASER PULSES

V. P. Kozich, A. I. Vodchits, P. A. Apanasevich, and V.A. Orlovich

B. I. Stepanov Institute of Physics, National Academy of Sciences of Belarus
Fr. Scaryna Ave. 68, Minsk 220072, Belarus

Recently a number of promising crystals were investigated as materials for Raman shifters and lasers [1]. In this report the results of studying new peculiarities in nonlinear optical properties of barium nitrate crystal, $\text{Ba}(\text{NO}_3)_2$ excited with nanosecond laser pulses are presented.

We applied single-beam [2] and two-color time-resolved [3] Z-scan technique to investigate the nonlinear refractive index in barium nitrate. $\text{Ba}(\text{NO}_3)_2$ crystals of 4-7 mm thickness were excited with the focused second harmonic radiation of nanosecond Nd:YAG laser. In the case of two-color Z-scan, the focused cw radiation from He:Ne-laser was used as a probing beam. This kind of Z-scan technique permitted us to observe a contribution to nonlinear index from slow nonlinearities.

For the first time to our knowledge, we observed and measured a contribution to the nonlinear refraction index in barium nitrate due to defocusing thermal nonlinearity. This nonlinearity is originated from the dissipation of energy of the SRS-excited A_g vibrational mode at a frequency of 1047.3 cm^{-1} to the heat. The nonlinear index change of about -3.4×10^{-6} was measured at SRS-efficiency of 25-30 %. Our results also show for the first time that a destructive interference between the thermal and focusing electrostrictive nonlinearities can occur in barium nitrate. This effect causes a considerable compensation of the two contributions.

[1] P.G. Zverev, T.T. Basiev, and A.M. Prokhorov, *Opt. Mat.*, **11**, 335, (1999).

[2] M. Sheik-Bahae, A.A. Said et al., *IEEE J. Quantum. Electron.*, **QE-26**, 760, (1990).

[3] J. Castillo, V.P. Kozich, and A. Marciano O. *Opt. Lett.*, **19**, 171, (1993).

TO THE THEORY OF LIGHT BULLETS

A. M. Goncharenko, I. L. Garanovich

Division for Optical Problems in Information Technologies,
National Academy of Sciences of Belarus,
Kuprevich St. 1 / 2, 220141 Minsk, Belarus

3+1-dimension optical spatial-temporal solitons called light bullets can be formed in nonlinear media under the influence of the powerful ultrashort laser pulses. There is no analytical description for such solitons. Dynamics of their formation and their properties are determined by numerical solution of suitable nonlinear equations. When numerically simulating light bullets properties we consider that Kerr local nonlinearity is just the most suitable one for the description of the almost instant interaction of the light bullet with the media. Other nonlinearities have finite time of the response and can not determine peculiarities of squeezed in space and time light bullets. It is known that in Kerr nonlinear media only 1-dimension solitons are stable. Nevertheless soliton squeezing process takes finite time. Collapse time estimation shows that because light bullet is the ultrashort pulse there is just no enough time for the soliton collapse to occur. It is well-known that spatial solitons have bell-like shape. Proceeding from this fact we have tried to use Gaussin's functions when analysing light bullets properties. It is shown that in general case light bullet exists in the form of the pulse oscillating in space and time.

1. Silberberg Y., 1990, *Opt. Lett.* **15**, 1282

2. E. Wolf, *Progress in optics XXXV*. Transverse patterns in wide-aperture nonlinear optical systems. By N. Rosanov, 1996

3. A. W. Snyder, D. J. Mitchell and Y. Chen, 1994, *Opt. Lett.* **19**, 524

4. A. W. Snyder, S. J. Hewlett and D. J. Mitchell, 1994, *Phys. Rev. Lett.* **72**, 1012

5. A. W. Snyder, D. J. Mitchell, 1997, *Science*, **276**, 1538-1541

MONTE-CARLO SIMULATION OF THz-PULSE AND SECOND-HARMONIC GENERATION FROM SEMICONDUCTOR SURFACE

V.L. Malévich

Division for Optical Problems in Information Technologies, NAS of Belarus
Kuprevich Str., 1, bl. 2, 220141 Minsk, Republic of Belarus

The dynamics of intensively studied electric field induced second-harmonic (SH) generation and THz-pulse radiation from semiconductor surface excited by an ultrashort laser pulse is fundamentally governed by photocarrier-induced depletion field screening caused by charge-separation effect. The spatio-temporal evolution of the surface depletion electric field and photocarrier dynamics at n-GaAs surface excited by a subpicosecond laser pulse have been investigated on the basis of ensemble Monte-Carlo simulation of electrons transport in the time-varying inhomogeneous depletion field found self-consistently from the Poisson equation. The real three-valley conduction band structure (Γ -X-L) and electron scattering by acoustic, polar optical and intervalley phonons were taken into account. The numerical simulation shows that at not too high excitation photon energy ($\hbar\omega \leq 1.7$ eV) with increasing the photoexcitation level the temporal decay of the surface electric field varies from monotonic to oscillatory that can be explained as changing screening regime from hydrodynamics to collisionless. The frequency of oscillations approaches the plasma frequency calculated at photoexcitation electrons density and at Γ -valley electron effective mass. As a consequence of this the waveform of THz-pulse emitted by the transient photocurrent is accordingly bipolar or oscillatory. At higher photon energy the photoexcited electrons have sufficiently large average energy to populate L- and X-valleys where the electron effective masses are large, and as a result the coherent oscillation is realised under higher photoexcitation level. The dynamics of the probe-generated SH in the depletion layer previously photoexcited by the pump laser pulse is also analysed. It was found that with increasing the pump intensity the probe-generated SH-signal dependencies on pump-probe time delay varied from monotonic to oscillatory.

EXPERIMENTAL AND THEORETICAL INVESTIGATION OF ENERGY CHARACTERISTICS OF TRANSIENT SRS IN COMPRESSED HYDROGEN AT 2.5 ps PUMPING

A.G. Shvedko, S.G. Kruglik, V.A. Orlovich, P.A. Apanasevich
B.I. Stepanov Institute of Physics, Academy of Sciences of Belarus
F. Skaryna Avenue 70, Minsk 220072, Belarus

It is well known that SRS in the compressed gases is widely used for wavelength conversion [1,2]. Nowadays the steady-state SRS has been rather good understood from both theoretical and experimental points of view. SRS method becomes complicated and difficult to treat when the pump pulse has a picosecond or subpicosecond duration, because in this case transient regime of SRS is realized. Although theories of transient SRS have been reported, so far there have been a few experimental works, which deal with the details about energy of SRS pulses generated by picosecond pump pulses. In our report picosecond SRS in compressed hydrogen is characterized both experimentally and theoretically in terms of pulse energy in the range of gas pressure 10-60 atm to use it as a light source for different applications. SRS was pumped by the second harmonic (400 nm) of a Ti:sapphire oscillator-regenerative amplifier laser system with pulse energy up to 200 μ J, duration 2.5 ps and repetition rate of 1 kHz. Energy conversion to the first and second Stokes SRS components was more than 13 % and 10 % respectively. We numerically simulated the energy characteristics of the picosecond SRS on the basis of the set of wave equations describing transient interaction between pump, first Stokes, second Stokes and first anti-Stokes component waves in the framework of plane-wave approximation and obtained good correspondence with experiment.

1. A. De Martino, R. Frey, F. Pradere, J. Ducuing, *Infrared Phys.* 19 (1979) 247.
2. T.R. Loree, R.C. Sze, D.L. Barker, P.B. Scott, *IEEE J. Quantum Electron.* QE-15 (1979) 337-342.

RAMAN CONVERSION OF SUB-NANOSECOND LASER PULSES IN A BARIUM NITRATE CRYSTAL

A.S.Grabtchikov, A.G.Shvedko, R.V.Chulkov, V.A.Lisimetskii,
P.A.Apanasevich, V.A.Orlovich

B.I.Stepanov Institute of Physics, NASB, F. Scaryna ave. 68, Minsk, 20072, Belarus,
Tel/Fax - 375-17-2-84-16-65, asg@dragon.bas-net.by

Application of a resonator for stimulated Raman scattering gives such advantages as the high conversion efficiency and the low divergence of the output Stokes beam. This approach works very well for pulses of tens nanoseconds when the long resonator length (tens of centimeters) is relatively small compared to the laser pulse length providing a sufficient number of passes. For sub-nanosecond pulses synchronous pumping by pulse train is ordinary used in resonator of the similar length.

In this report we propose approach based on the short length resonator for Raman conversion of the single sub-nanosecond pulse. In these conditions the length of laser pulse is larger than the resonator length. To maintain the acceptable level of the threshold pump intensity we used a solid-state Raman medium with the high value of Raman gain coefficient such as barium nitrate. For comparison we analyzed two different experimental schemes: single pass (i) and short length Raman laser (ii). For the single pass configuration (the 7 cm crystal length) we obtained the conversion efficiencies to the first and second Stokes components up to 30% and 20%, respectively. The spatial profile of the strongly divergent Stokes beam was highly inhomogeneous in this case. Usage of the short length Raman laser (with the 4 mm crystal length) essentially improves the spatial characteristics of the Stokes beam. The Stokes beam divergence about 0.3 mrad and the smooth spatial beam profile were obtained with a Fresnel number of 1. The corresponding conversion efficiency in the first Stokes radiation was up to 24%.

GROUP REPRESENTATIVE OF LINEAR AND NONLINEAR WAVE PROCESSES IN CRYSTALS

A. G. Khatkevich¹, L. A. Khatkevich²

¹Institute of Physics, National Academy of Sciences of Belarus, F. Skaryna Ave.68,
220072, Minsk, Belarus, e-mail: khag@dragon.bas-net.by;

²Belarusian State University, F. Skaryna Ave 4, 220050, Minsk, Belarus

We have established that after introduction instead of permeabilities their square roots the wave equations system are factorized and first and second pear of Maxwell equations are symmetrized. As a result, the wave equations system is reduced to relations of orthogonality or in the general case to unitarity for the matrixes (tensors) of corresponding Maxwell equations pears. Because of these relations it is possible to be restricted by consideration of one tensor linearly dependent on a direction. This tensor is orthogonal (or unitary) and planary, and with vanishing trace. It directly determines both a velocity tensor and an index tensor which are mutually inverse and similar to an angular momentum tensor.

We have shown that components of the velocity tensor directly determine the ray (group) velocities of isonormal waves in the crystals. As a result, the expression for the ray velocity vectors is very simple and the ray vectors are linearly dependent on the direction of a wave normal. The phase velocities (and refraction indexes) and the polarization vectors are determined as normal component of the ray velocity vectors and a square root of the orthogonal tensor, respectively. Using these expressions for the velocity vectors and the group properties of the orthogonal or, in the general case, unitary tensors the processes of frequency conversion of optical radiation in nonlinear crystals have been considered. For the first time, the simple expressions for phase-matching cones in biaxial crystals have been obtained and the conditions for the effective nonlinear-frequency conversion have been defined.

GAUSSIAN BEAM SELF-FOCUSING IN DYNAMIC POLYMER MEDIUM WITH PHOTOINDUCED DIFFUSION

Yu. V. Gritsai, U. V. Mahilny
 Physical Optics Department, Belarusian State University
 F. Scoriny av., 4, Minsk, 220050, Belarus

Light beam self-focusing in nonlinear media is a classical effect of nonlinear optics and can be used for light intensity control. Usually the phenomenon is based on nonlinear polarizability or saturation of short-living electron-excited states. This determines a necessity of high pumping intensity. The restriction can be overcome by using resonant nonlinear materials with optical parameters transformation due to photoactive absorbing centers conversion into metastable states (long-living electron-excited states or photoisomers).

In the present work Gaussian beams propagation in anthracene containing polymeric layers is investigated. As it was established by holographic researches [1] dispersive nonlinearity of the third order in this media arises due to reversible photodimerization of anthracene derivatives and photoinduced diffusion of neutral added molecules. For numerical simulation of Gaussian beams propagation the method of "layer by layer" calculation of light wave electric field [2] was modified. The models proposed in [1] were generalized for the case of arbitrary light field distribution with numerical account of photoneutral molecules diffusion and were used to calculate complex transmittance of the layer.

An opportunity of beam self-focusing under the maximum intensity not exceeding $100 \text{ mW}\cdot\text{cm}^{-2}$ is established. It is shown, that the self-focusing in the medium is possible at presence of photoinduced diffusion only, which leads to refractive index increase under the intensity increasing. An optimization of self-focusing conditions is carried out and it is shown that the greatest effect is reached when a waist of the beam is localized near to back border of the layer. This makes possible to reach two-fold reduction of waist radius.

1. Mogil'nyi V. V., Gritsai Yu. V. // Opt. & spectr. (Rus), **83**, 832 (1997)
2. Q. Wang Song, X.-M. Wang, R.R. Birge et al. // Proceed. SPIE, **3402**, 511 (1998)

FOUR-WAVE MIXING IN V-TYPE ATOMS IN A NONRESONANT LIGHT FIELD

L. Gaida, V. Kartazaev, V. Savchik
 Grodno State University, Ozeshko 22, Grodno, 230023, Belarus.
kartazaev@grsu.unibel.by

Intense laser light of frequency ω_L modifies the atomic energy structure by the ac Stark effect [1]. In this report we present the results of angular and spectral nature of the FWM emission spectra of sodium atoms driven by the laser tuned near the dispersion-free point. Sodium atoms are considered as the V-type energy level system. We have performed our experiment with sodium vapour as non-linear medium and have eliminated self-trapping of laser beam.

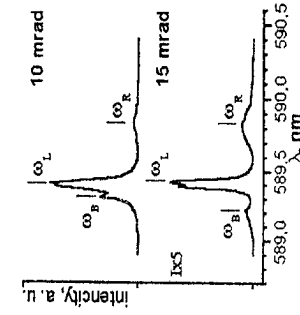

In Fig. we present emission spectra behind the oven for various angles when ω_L is far from resonance and near the dispersion-free point ($\omega_L=589.41 \text{ nm}$). Two strong components ω_R and ω_B shifted to red and blue sides were detected. We have also detected two blue and red shifted weak peaks at ω_{B1} and ω_{R1} frequencies, which are situated at higher detunings from ω_L . With increasing

the angle the blue shifted peak ω_B displaces to high frequencies in the direction to D_2 line. The frequency of red shifted peak ω_R also changes with increasing the angle and displaces to D_1 sodium line. When the intensity of the pump laser is decreased the FWM spectra is modified. The essential feature of this spectra is that the peak at the frequency ω_R at high angles is the dominant feature. In order to describe the nature of the FWM spectrum we have calculated the energy level structure of sodium atom driven by a strong laser field. We used the time-dependent perturbation theory and consider sodium atom as a V-type three-level system. For ω_L lying near the dispersion free point there are six quasienergy levels. The wavelengths of the peaks correspond to the wavelength of the transitions between quasienergy levels.

1. R. W. Boyd et al, Phys. Rev. A, **24** (1981), 411

REVIVALS IN ELECTRONIC-VIBRATIONAL DYNAMICS
OF DIATOMIC MOLECULESS.A. Moiseev¹⁾, M.I. Noskov¹⁾¹⁾Zavoisky Kazan Physical Technical Institute of Russian Academy of Sciences
Sibirsky trakt, 10/7, Kazan 420029, RussiaR.M. Aminova²⁾²⁾Kazan State University, Kremlyovskay 18, Kazan, 420008, Russia

Use of the revival effect in dynamics of molecules interacting with the light arouses interest as offering a new possible technique for high resolution spectroscopy [1]. In the present work we theoretically study the possibility of realization of revivals in diatomic molecules of Na₂-type at various interaction parameters and temperatures up to ~ 1000 K. Quantum dynamics of Na₂ is studied on the basis of a rigorous approach to the calculation of the nonquidistant spectrum of the electronic-vibrational transitions with the number the vibrational sublevels at each electronic term being not less than 9. To obtain the values of the parameters of the optical transitions we used high-accuracy quantum chemistry methods to calculate potential energy curves of the first and the second terms of the molecule Na₂, which then were used to calculate the frequencies and dipole moments of electronic-vibrational transitions. At that we applied a new approach [2], allowing to find the dipole moments of transitions analytically. At the final stage temporal behavior of the total probability of excitation of the molecule to the second electronic term was calculated using numeric methods and the stability of the revival picture against variations of the molecular parameters (relative position of the potential energy curves, their dissociation energy and slope of the potential wells) was investigated as a function of the temperature of the molecules and mean number of photons in the mode of the field. The obtained results allowed to establish that the value of the pedestal of the revival picture is considerably affected by a change of the slope of the potential wells while relative shift of the potential wells has little effect on the behavior of the revivals. We also established conditions at which increase in temperature has a strong impact on the revivals.

The work was supported by RFBR and CRDF grants.

1. M. Nakano, K. Yamaguchi Chem. Phys. Lett., **324**, 289 (2000).2. M. Carvajal, J.M. Arias, J. Gomez-Comacho Phys. Rev. A, **59**, 3462 (1999).

LASER INDUCED POLARIZATION ROTATION EFFECT IN SOLUTIONS OF THE GLYCINI

Bakhramov S.A., Kokhkharov A.M., Farpiev O.R., Vaganov E.V.

NPO "Academprigor" AS RU, Akademgorodok, Tashkent 700, Uzbekistan. Tel:
(3712)1628031, E-mail: bahramov@uzsci.net

Application of nonlinear optical techniques in biology is very attractive from two points of view: 1) application of various nonlinear optical methods for investigation of structural and functional features of biomolecules [1]; 2) realization of multiphoton excitation and stimulation of effective photoinduced biochemical reactions [2].

It is well known that solutions of natural amino-acids (except Glycini) have natural optical activity and rotate a plane of polarization of passing light beam. Solutions of these amino-acids [3] under strong laser field have also nonlinear optical activity. Moreover, the efficiency of nonlinear rotation can be comparable with efficiency of natural rotation.

The present paper is devoted to experimental investigation of laser induced polarization rotation (LIPR) effect in initial non-chiral solutions of Glycini. We are investigated the following dependencies of LIPR effect:

- 1) Variation of the LIPR angle as a function of laser beam intensity at (≈ 530 nm. - ((/)). The parameter (ρ) is nonlinearly depends on I ;
- 2) The LIPR angle vs laser beam ellipticity - ((/)). (ρ is zero under linearly polarized beam and saturates in case of circularly polarized beam;
- 3) The LIPR angle vs laser wavelength - ((/)). (≈ 320 (1060 nm. Approaching of the (ρ) to the 280 nm leads to resonant increasing of the LIPR angle (ρ). Here, (≈ 280 nm is ((transition of chromophore COOH group of the Glycini molecules.
- 4) Variation of the LIPR angle as a function of the solution protonism - ((pH)) at (≈ 530 nm. The value of LIPR angle is increases under the transfer from alkaline to neutral form and from neutral to acidic form of molecules of the Glycini.

A mechanism of the LIPR effect in initial homogenous non-chiral solution and its application for investigation of structural and functional features of biomolecules was discussed.

1. Korotcev N.I. JETP. V.106, 1260 (1994)

2. Hovhannisyann V.A., Avanesian L.A. ICONO-98, 106 (1998).

3. Bakhramov S.A., Kokhkharov A.M. SPIE, V.3485, 359 (1998).

SOME APPLICATIONS OF THE SIGNAL VELOCITY FOR THE TOMOGRAPHY, IN PARTICULAR LASER PHOTOACOUSTIC TOMOGRAPHY

¹Aboutrab A. Aliverdiev, ²Magomed G. Karimov, ¹Anise A. Amirova,
³Gussein M. Hatilulayev

¹*Institute of Physics, DSC Russian Academy of the Science*
367003, Russia, Makhachkala, 94 Yarasgogo Street

²*Daghestan State University,*

367000, Russia, Makhachkala, 43a Gadzhieva,

E-mail: lowtemp@datacom.ru,

URL: <http://www.chat.ru/~aliverdiev> <http://www.dgu.ru/~aliverdiev>

The problem of non-blasting diagnostics prolongs to be a one of the most urgent problems of science. Therefore a lot of new approaches to this question, in particular, bound with attraction of a space of velocities (impulses) and time, were offered last years. There were raised the spectrotomography, the chronotomography, the time-of-fly and coherent tomography of scattering media, the stochastic emission correlation tomography, the photoacoustic tomography, etc, which very distinguished from tradition tomographic methods.

Now we bring a brief result to our previous examinations in a direction of the application of a registered signal velocity for a time-resolved reconstruction. Also we give some new results for the photoacoustic tomography. Early [1] we've that the application of registered signal velocity gives a key opportunity to transfer a reconstructive problem to a spatial-time plane, stating it on a joint of a chronotomography and spectrotomography. We have designated key difficulties, bound with strongly restricted number of angular projections having a place in actual physical examinations, and have considered series of mathematical approaches (including based on Hartley transformation), allowing to overcome them. In this context we considered, the method of a photoacoustic (opto-acoustic) tomography. Earlier [2] we carried out the analytical analysis of the account of absorption of initiating laser radiation. Now we've developed this problem with the account of a composite two-component distributed absorption constant, and obtained the law of this account. Some results of numerical simulations are presented.

References

- [1] Aliverdiev A.A. Application of the velocity spectrum to a spatiotemporal study of high-speed processes 1997 *Technical Physics*, 42, No. 9, p.1102-1103.
- [2] Karimov M.G., Aliverdiev A.A. Modeling 2D opto-acoustic researches studies of excited media. 1999 *Radiophysics and Quantum Electronics*, 42, No. 1, p. 72-75

CONCENTRATIONAL QUENCHING OF PHOTOINDUCED BACTERIAL ACTIVITY PROCESSES OF THE TRIPLET EXCITED STATES AND MECHANISMS WHEN DEACTIVATION

E. Ph. Stranadko ¹, A. E. Obukhov ²

¹-State Research Center for Laser Medicine, Ministry of Public Health of Russia, Moscow, 121165, Russia, Studentcheskaya st. 40. E-mail: getinic@cityline.ru.

²-Russian Peoples' Friendship University, ul. Ordzhonikidze 3, Moscow, 117302 Russia. E-mail: aobukhov@sci.pfu.edu.ru

A series of experimental studies on letal photosensitization of microorganisms most often met in suppurative wounds (Staphylococcus aureus, Staphylococcus epidermidis, Proteus mirabilis, Escherichia coli, Pseudomonas aeruginosa). Sulphonated aluminum phthalocyanine in concentrations of 20,50, and 100 mg/ml was used as a photosensitizer for pre-irradiation incubation. Straight correlation between concentration of photosensitizer and bactericidal action of PDT was observed at the same energy density ($24 J/cm^2$). At higher Photosense concentration of 100 mg/ml significant (5-125 fold) decrease of bactericidal effect (Staphylococcus epidermidis, Staphylococcus aureus, Escherichia coli) or its absence took place (Pseudomonas aeruginosa, Proteus mirabilis) in comparison to lower concentrations (20 and 50 mg/ml).

The foundation theory of the intercombination conversion presumes that the fluorescence $S_1^*(\pi\pi^*, \sigma\pi^*, n\pi^*)$ state interacts effectively with either $T_1(n\pi^*)$ state or with the near-lying $T_i(\sigma\pi^*, \pi\pi^*)$ states. In the case of laser pumping of organic and nonorganic molecules – Formaldegede, Phorpirine, et al, and effective population of the high-lying S_n^* and T_n states the processes interconversion ($k_{ST} > 10^{12} s^{-1}$) and of the electron-vibrational photoionization and the subsequent photodestruction are virtually inevitable. The reason lies in the fact that the processes of reabsorption of the excited energy are of two-photon nature; generally, the photoprocesses are multiphoton and are followed by recombination of the changed particales (electrons and molecular ions) in the active medium.

Reference: E. Ph. Stranadko ¹, A. E. Obukhov ², U. M. Koraboyev. *Concentration quenching of photochemical bactericidal activity and triplet mechanism of deactivation of excitation* / Book of Abstracts 9 th Annual International Laser Physics Workshop (LPHYS'2000). Bordeaux. France. 17 – 21 July 2000. P. - 58.

THE LUMINESCENCE AND DECOMPOSITION MECHANISM OF
TRIETHYLSILANE MOLECULES BY PULSED CO₂ LASER

G.P. Zhitneva

Karpov Institute of Physical Chemistry, ul. Vorontsovo pole 10, Moscow, 103064

e-mail: zhitneva@cc.nifhi.ac.ru

Yu.N. Zhitnev

Lomonosov Moscow State University, Vorob'evy Gory, MSU, Chimfak,
Moscow, 119899, phone (095)9394168; e-mail: zhitnev@kge.msu.ru

A.P. Mosyakin, V.V. Dobryakov

Russian People's Friendship University, ul. Miklucho-Maklaya 6, Moscow, 117198

IR-multiphoton excitation (IR MPE) of triethylsilane (TES) molecules was performed with a TEA CO₂ laser which was tuned to the frequency of 985 or 944 cm⁻¹. The laser pulse was focused by a 16 cm. focal length BaF₂ lens. The duration of the laser pulse - 100 ns, the pressure of TES - 5-40 Pa, the laser pulse energy - 0.03-0.12J.

The main reaction channels under collisionless decomposition were the C-Si and C-C bonds fission reactions



following the spontaneous fragmentation of C₂H₅ and (C₂H₅)₂Si(H)CH₂ radicals.

At the high laser fluences ($\geq 70 \text{ J cm}^{-2}$) and the laser frequency of 985 cm⁻¹ dissociation of TES was accompanied by the laser-induced fragmentation of the primary dissociation products (C₂H₅)₂SiH. At the same conditions were observed both the luminescence in the range 300-800 nm and the formation of the solid phase. The luminescence at 300 - 400 nm can be assigned to the electronically excited (C₂H₅)₂SiH radicals but the one in the range 500 - 800 nm - to silylenes. The analysis of the results led to the conclusion that the electronically excited silylenes produced in the fragmentation (C₂H₅)₂SiH. The possible causes of the electronic excitation of silylenes were discussed.

DYNAMICS OF MOLECULAR EXCHANGE-RESONANCE PHOTOPROCESSES
ON THE SURFACE OF CHEMICALLY MODIFIED SILICA

V.V. Bryuhanov

Kaliningrad state technical university: 236000, Kaliningrad, Soviety sky prospect 1.

The results of the research on triplet-triplet (T-T) energy transfer and triplet-triplet homo- and hetero annihilation (TTA) of the molecule of erytrosin (E) and antracen (An), which were sorbed on the surface of the chemically modified ((CH₂)₃-N⁺(CH₃)₃Cl) porous silica (CMS) of C-80 are presented: $\text{[}-(\text{CH}_2)_3-\text{N}^+(\text{CH}_3)_3\text{Cl]}$. The erytrosin molecules are sorbed on the surface by the chlorine-dye anion exchange. The erytrosin molecules were the donors (D) of the triplet energy for the acceptor molecules (A). The dye molecules were excited by using second harmonic of the Nd:YAG laser. The pulse energy was 50 mJ at the pulsewidth of 10 ns. Sorbents were researched at the pressure of 10⁻⁴ Torr. The photoexcitation resulted in resonance exchange interactions of the triplet molecule with the singlet one: $T_D + S_A \rightarrow S_D + T_A$ (1); $T_A + T_A \rightarrow {}^1S_A + S_A$ (2); $T_A + T_D \rightarrow {}^1S_D + S_A$ (3). This interaction was accompanied by the delayed fluorescence (DF) of homo-TTA (2-¹S_A) and hetero-TTA (3-¹S_D) of antracen and erytrosin and phosphorescence (PH) erytrosin molecules. The constant rates (K_{T-T} = 10⁶; K^A_{TTA} ~ 10⁸; K^{DA}_{TTA} ~ 3x10⁶ mol⁻¹nm²c⁻¹) were calculated from the measured phosphorescence and delayed fluorescence damping. The concentration of donor molecule on the surface was 2x10⁻³ mol/nm². The acceptor molecule concentration was 4x10⁻³ mol/nm². The constant of homo-TTA determines the diffusion-controlled interactions on the surface of CMS. The constant of T-T energy transfer (and hetero-TTA) is less than diffusion one because of stereo factor, which is 0.02 for contact interaction of hetero molecules. The temperature influence was researched too. It was shown that the observed effects confirm the existence of diffusion processes in pseudoliquid layer of modifier on the surface of CMS.

THE SELECTIVE DESTRUCTION OF VIRAL PARTICLES CAPSIDES BY POWERFUL LASER RADIATION.

A.A. Rudenko¹, N.B. Matsko^{1,2}, D.I. Chekhov¹, A.A. Manykin² and A.G. Leonov¹

¹ Moscow Institute of Physics and Technology,

Institutsky Per., 9, Dolgoprudny, Moscow Region, 141700, Russia

² The D.I. Ivanovsky Institute of Virology, Russian Academy of Medical Sciences, ul. Gamaleya 16; Moscow, 123098, Russia

The internal DNA organization in different viruses is one of the fundamental biological problem. Biological methods usually used for the destruction of protein capsides of viral particles result in significant disorganization of the structure of packed DNA. In this work to study the structural DNA organization we applied a method of the selective destruction of viral particles' capsides by powerful laser radiation. We used a bacteriophage PhiKZ as a biological model because due to its specific internal structure it is a convenient object to study the DNA packing. The specially selected dye, which absorbs the light on the laser frequency, was added to the water suspension of viral particles. The solution obtained was irradiated by strong laser pulse. We used the second harmonic of YAG:Nd³⁺ laser (wavelength 532 nm, pulse duration 18 ns, pulse energy 30 mJ, frequency 10 Hz). The electron microscopy investigations have shown that best results were obtained when Yanus Green or Methylene Blue dye was used. We succeeded in destroying the phage capsid without morphologic changes in the internal structure of the phage head. We believe the most likely mechanism of destruction to be the following. The dye molecules adsorbed onto virus capsides form centers of absorption of laser radiation. The energy absorbed transforms into heat, resulting in strong brief local heating. In such a way, the protein molecules of capsid connected to dye molecules denature, whereas the internal structure of the virus head does not heat up significantly. As the interaction duration is short, the temperature of the suspension changes negligibly (3-4 °C), while the temperature of local heating near the dye molecules can reach 100 °C. Besides this, another mechanism of the relaxation of the energy of absorbed photons also seems to be possible. The energy absorbed transforms into vibration degrees of freedom of dye molecules and then, by intermolecular conversion, transmits to capsid molecules resulting in a partial break of bonds between the subunits of capsid proteins (so-called adsorption mechanism).

MICROSPECTRAL INVESTIGATION OF HAIR OF ONE GIRL OVER 6 YEARS BY LASER EMISSION ANALYSIS

T.N. Sokolova (RPF "Pribor-T", 77, Politekhnicheskaya str., 410054, Saratov, Russia; Tel. +7(8452) 372-975; e-mail: pribor-t@mail.ru)

E.L. Surmenko (Saratov State University, 83, Astrakhanskaya str., 410026, Saratov, Russia; Tel. +7(8452) 51-46-93; e-mail: SurmenkoEL@info.sgu.ru)

V.V. Tuchin (Saratov State University, 83, Astrakhanskaya str., 410026, Saratov, Russia; Tel. +7(8452) 51-46-93; e-mail: vvt@sgu.ssu.ru; net.ru)

Interest in the trace element analysis of hair has increased since discoveries have shown relationships between trace elements in hair and certain demographic variables. Attempts to apply this method to diagnostic practice failed [1], because the use of hair analysis for medical diagnosis is limited. Nevertheless, results of spectral hair analysis can be considered as a good addition to basic diagnostic practice [2,3]. Besides, spectral analysis can be regularly used to assess analytical variability of patient's hair.

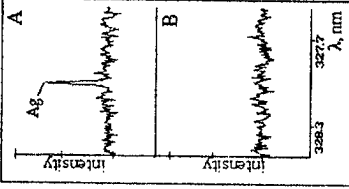

Concretely laser emission analysis identifies patients over several years reliably enough. In a Fig. the plot of spectra of two patients is shown. The analytical line of silver in spectra of patient A's hair is constantly repeated whenever analysis is carried out; at the same time silver is always absent in spectra of patient B's hair.

Multiple chemical elements were measured in the hair of a girl - cerebral paralysis patient to determine time and nutrition trends. Besides, laser emission analysis is convenient because the preliminary preparation of a sample is not necessary. Investigating the samples of girl's hair we needed only to anchor hair on the coordinate table.

References:

1. Barrett S. Commercial hair analysis: Science or scam? JAMA 254:1041-1045, 1985.
2. Christopherson D., Shuler T, Klevay L. Multiple trace elements in hair of one man over two decades. www.nal.usda.gov/ttic/tektran/data/00000796/0000079632.html
3. Trace Mineral Systems. Alternative Medicine Digest, Aug/Sept 1998, p 99.

PHOTOCHEMISTRY OF PYRYLIUM COMPOUNDS: EXCITATION-INDUCED REARRANGEMENT OF A MOLECULE-SOLVENT COMPLEX

E. N. Kaliteevskaya, V. P. Krutyakova, T. K. Razumova

S. I. Vavilov State Optical Institute, 12 Birzhevaya Line, St. Petersburg, 190034, Russia

A. D. Roshal

Scientific-Research Institute of Chemistry, Khar'kov National University, 4 Svoboda Square, 310098, Khar'kov, Ukraine

The photochemical rearrangement of a solvated complex of pyrylium compounds is studied in solvents of various polarity and nucleophilicity. The absorption spectra, absorption cross-sections, and relaxation kinetic of transient rearranged complexes are measured by laser kinetic spectroscopy. The population of the stable and transient complexes in ground and excited state (S0 and S1) is studied within 215-295 K. The relaxation rate of the transients and the energies of rearrangement activation are determined. The increase in the solvent polarity and nucleophilicity results in the short-wave shift of the transient absorption. In the process, the fluorescence spectrum of liquid solutions shifts toward longer wavelengths, which is not the case for solid and frozen solutions. Within the fluorescence spectrum the decay time and polarization degree vary. The AM1 quantum-chemical method is used to calculate the ground-and excited-state energies for stable and transient complexes in various solvents and the rearrangement barriers. The existence of two stable non-planar isomers (cis and trans) with close photophysical parameters is concluded. The different optical transitions are localized on the different molecular moieties. The excitation results in intramolecular charge transfer, which in liquid solutions is accompanied by partial flattening of molecule and by solvate rearrangement. Two transient complexes (cis and trans) in excited state are formed determining liquid solution fluorescence. The S0→S1 bands of the transients are shifted by 1500-2000 cm⁻¹ toward lower frequencies, with the transition cross-sections being increased by 2-3 times with respect to stable molecule. The S0 state relaxation rates of the transients are higher by 2-6 times compared to the S1 state. The photochemical rearrangement enhances efficiency and extends tunability of laser active media.

The work is supported by the Russian Foundation for Basic Research (project 00-02-81024 Bel2000_a).

Laser detoxication of sharp poisonings with carbon monoxide

Provorov A.S., Salmin V.V., Stavickay E.Y., Egorova A.B.

660041 Svobodny st, bld.79, Krasnoyarsk, Russia, Krasnoyarsk State University

(3912)44-54-69, e-mail salmin@lan.krasu.ru

Ligand photolysis and analysis of heme proteins kinetics in aqueous solution are intensively studied so far. Spectroscopic characteristics provide the suitable tool for the assessment of conformational and functional properties of some vitally important hemoproteids like hemoglobin, cytochromes etc. Nevertheless, the reliable models are expected to be applied in the theoretical and clinical medicine are not created yet.

A series of model experiments has been carried out. Those experiments have provided the fact of laser -induced photodissociation of HbCO using Nd-YAG-laser with wavelength 533 nm. We have analyzed the carbon monoxide rebinding at different degrees of photolysis. Photodynamics was monitored for horse and human carbon (deoxy)hemoglobin being solved in the phosphate buffered saline solution (pH 7.4) and absorption spectra were measured at 534 nm (for HbCO) and 555 nm (for DoxHb) are known to be the peaks of absorption for these form of heme proteins. Spontaneous reassociation of ligand to hemoprotein has been observed during the inter-impulse period. The data obtained show that Nd-YAG-laser-induced photodissociation is believed to be the reversible process with the dose-dependent characteristics . Only HbCO, but not DoxHb exhibited the kinetics associated with laser-induced structural conformations and ligand rebinding in the interimpulse period. The reversibility of above-mentioned reaction was thought to be limited by the availability of competitive ligand in the solution.

The preliminary results allow us to propose the application of non-reversible laser-induced HbCO photodissociation in the capacity of the new physical method to treat the acute carbon monoxide poisoning.

UV-INDUCED SIGNAL TRANSDUCTION IN EPIDERMAL CELLS:
FROM SURFACE RECEPTORS TO PROTEIN KINASE C.

THE MATHEMATICAL MODEL.

Mikhail M. STOLNITZ, Senior Researcher of Department of Optics,
Anna Yu. PESHKOVA, Post-graduate Student of Department of Optics,
Saratov State University, 155 Astrakhanskaya, Saratov, 410026 Russia.

Irradiation of cells with ultraviolet light (UVA, B and C) induces variety of biochemical reactions cascades [1]. In epidermal cells, especially melanocytes, the protein kinase C (PKC)-dependent signaling pathway plays important role, because tyrosinase, the key enzyme of melanogenesis, is activated by PKC-mediated phosphorylation [2].

In the paper the mathematical model of UV-induced PKC activation is presented. The following processes are taken into account: phosphorylation of growth factor receptors due to inhibition of tyrosine phosphatases; activation of membrane phospholipases C, D and A₂; phospholipids turnover stimulation, diacylglycerol (DAG), inositol trisphosphate (InsP₃) and arachidonic acid production; Ca²⁺ releasing from endoplasmic reticulum; activation of PKC isozymes; PKC-mediated phosphorylation of phospholipase D and inhibition of receptor-mediated activation of phospholipase C. Thus, one can tractate PKC-dependent signaling pathway as a nonlinear dynamic system with positive and negative feedbacks.

On the base of developed model some complex dynamic responses of cells on UV-irradiation [3] are analyzed.

1. K. Bender, C. Blattner, A. Knebel, M. Iordanov, P. Herrlich and H.J. Rahmsdorf, J. Photochem. and Photobiol. B, V. 37, pp. 1-17, 1997.
2. H. Park, J. M. Perez, R. Laursen, M. Hara, and B.A. Gilchrist, J. Biol. Chem., V. 274, pp. 16470-16478, 1999.
3. C.J. Carsberg, J. Ohanian and P.S. Friedmann, Biochem. J., V. 305, pp. 471-477, 1995.

THE PROPAGATION OF SHORT LASER PULSE IN WATER

Stanislav S. Narivonchik, Saint Petersburg State Institute of Fine Mechanics and Optics (Technical University) (Advisor: Victor G. Bespalov, Russian Research Center "S. I. Vavilov State Optical Institute");

194374 Saint Petersburg, Primorsky pr. 145-2-118.

Tel.: +7 (812) 345-19-94, e-mail: nar_stas@green.ifmo.ru

There has been considerable interest in the problems of optical imaging in turbid, strongly scattering media, such as biological tissues, sea water etc. To detect objects (tumors in tissues, solid objects or plankton in water, turbulence in air or water) the analysis of scattering short signal ($t \sim 10$ ps) can be used.

In this paper we report about the influence of medium parameters (density of scattering particles, cross section, scattering volume, inhomogeneity) and detector position and parameters (solid angle of detection, sensitivity, temporal resolution) on temporal profile of the reflected pulse (FWHM duration, duration of front and back fronts) and its intensity (reflecting factor).

Virtual experiments were carried out with the MONTE-CARLO method [1], including the following steps: (1) short laser pulse consisting of N photons ($N \sim 10^6$) are emitted from the circular hole to the scattering medium; (2) at a random time, from the random position (with the known probability density function) a photon is started; (3) it propagates for a random distance and is absorbed by the particle or is scattered to the random direction (according to scatter diagram); (4) the photons goes until it is absorbed or leaves the scattering medium of length L and volume V ; (5) caught by detector photons are counted, so that the scattered signal is obtained. The temporal profile of signal, obtained in the virtual experiments (Fig.1), was in good agreement with the experimental one and this confirms the correctness of this model. The dependencies of the fore-part and back-part of the signal front, maximum position of the reflected signal and the reflection coefficient from the scattering particle density and cross section were obtained. These dependencies show that the back-part of the signal is greatly decreased while the density is increased, compared to the fore-part of the signal. The maximum position is changed too. These results can be used to analyze the scattering particle density and cross section in the turbid materials.

I. L. Cipelletti, Phys. Rev E55, p.7733 (1997).

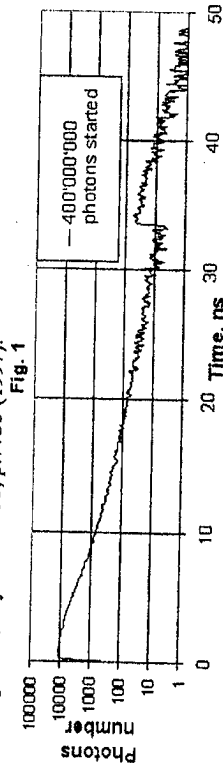

Fig. 1

LASER PHOTOMODIFICATION OF NUCLEIN ACIDS BY XHANTENE DYES

S.N. Letuta, Yu.D. Lantukh, S.N. Pashkevitch, H.N. Nikiyan

Orenburg State University
460352, Russia, Orenburg, pr. Pobedy, 13. E-mail: letuta@ic.osu.ru

Various ways of photomodification of nuclein acids by laser radiation of a visible range are considered in the work. The molecules of xhantene dyes participate in all cases of modification. Dye acts as mediator between laser radiation and macromolecule.

Rodhamine 6G (cation), erythrosin and eosin (anions) xhantene dyes acted as the molecules - intermediaries. The sources of excitation were YAG:Nd³⁺ - laser (second harmonic, $\lambda_1=532$ nm) and dye laser ($\lambda_2=550-650$ nm). The first laser was used for excitation of dye molecules in an electronic $S_0 \rightarrow S_1$ absorption band or, at a rather large radiation density, for $S_0 \rightarrow S_1 \rightarrow S_n$ excitation as a result of absorption by a dye molecule two photons of $\lambda_1=532$ nm light. The pulse of the second laser came on a sample either simultaneously with the first, or delayed in time. At simultaneous excitation of dye molecules by light with λ_1 and λ_2 high S_n states are selectively populated. The delay of the second pulse in time results to selectively population of high triplet T_m states of the molecules - intermediaries. In this case the wavelength λ_1 uses to populate S_1 states, and wavelength λ_2 uses to populate T_m states of dye molecules.

One of the mechanisms of photomodification is the process, sensitized by chromophore, being in a complex with macromolecule. When rodhamine 6G (concentration $2 \cdot 10^{-5}$ M) added into the DNA solution (concentration in nucleotides 10^{-4} M) the dye is bounded with an external side of a polymer chain by means of an electrostatic interaction and is present in the system mainly in a monomer form. If the excitation of the system by light with $\lambda_1=532$ nm at power density $P=20-50$ MW/cm² is performed, the S_n state of dye (~ 37500 cm⁻¹) is reached. This level is isoenergetic to S_1 DNA level and by means of singlet-singlet energy transfer the macromolecule is modified down to generation of polymer chain breaks. At increasing of dye concentration a cooperative character of binding process of dye with macromolecule becomes apparent. It is resulted in an effective formation of rodhamine 6G associates. The dye properties are varied, namely, the quantum yield to triplet state is increased. In this case the excitation by two photons with delay between pulses leads to formation of triplet state of acceptors.

The dye anions are not bound by macromolecules, but the cutting of a double helix takes place too. This effect is a result of realization of two independent processes - an oxidizing action of singlet oxygen and nonradiative singlet-singlet energy transfer from high excited states of dye molecules to macromolecules.

NEOPLASM DIAGNOSTICS BASED ON
FLUORESCENCE OF POLYMETHINE DYESVoropay E.S., Samtsov M.P.,² Zhavrid E.A.³ and Chalov V.N.³¹Belarusian State University, 4 F. Skaryna Av., 220050 Minsk, Belarus,
tel/fax 220 73 20, e-mail: Voropay@phys.unibel.by²Research Institute for Applied Physical Problems, 7 Kurchatov St., 220064 Minsk³Research Institute of Oncology and Medical Radiology, p.o. Lesnoi 24

Fluorescence of polymethine dyes in various organs of experimental animals was excited by emission of the semiconductor laser. It has been found that polymethine dye exhibiting absorption and fluorescence in the transparency region of biological tissues may be detected to a depth of 1.5 cm from the animal body surface [1,2]. The intensity of fluorescence registered from the body surface of an animal on introduction of the dye with a dose of $1 \div 2$ mg/kg is directly proportional to its concentration in tumor nodes and muscles. A higher contrast degree (up to a factor of 3.6) was exhibited by the dye in tumors compared to the neighboring muscle tissues. The dye is practically completely removed from the tumor as well as normal muscle tissues in a period of 7 days after the introduction. Surface scanning of homogeneous tumor nodes, having no spontaneous necrosis, revealed the fluorescence intensity variation no greater than 7%. It has been demonstrated that the difference of the dye content in tumor nodes near the surface and inside the tumor was never in excess of 7%. In the region of spontaneous tumor necrosis the dye content was one-third - one-fifth as high as in other parts of the tumor.

1. Voropay E.S., Samtsov M.P., Kaplevsky K.N., Chalov V.N., Lugovsky A.P. Spectral and Luminescence Characteristics of Symmetric Tricarboyanine Dye (TICS) in Solvents. // Proc. of BSU, Issue I: Phys., Math. and Inform., 2000, № 26, p. 28-30.

2. Voropay E.S., Samtsov M.P., Lugovsky A.P., Chalov V.N., Zhavrid E.A., Istomin Yu.P., Alexandrova E.N., Korobtsova G.I., Zhuravkin I.N., Nemkovich E.L. Investigation of Antitumorogenic Efficiency of Photodynamic Treatment Using Tricarboyanine Dyes // In: Actual Problems of Oncology and Medical Radiology. -

Minsk, Research Institute of Oncology and Medical Radiology, 1998. - p. 409-418.

Laser-thermal transformation in collagenous tissues

N.Yu. Ignat'eva, V.V. Lunin, A.F. Majorova, S.N. Mudretsova, T.E. Grohovska
 Chemistry Department, M.V. Lomonosov Moscow State University, 119899 Moscow,
 Russian Federation.

Fax: +7 095 9328846; E-mail: nvul@kcc.msu.ru

V.N. Bagratashvili, E.N. Sobol, A.P. Sviridov, G.Sh. Makhmutova

Institute of Laser and Information Technology, Russian Academy of Sciences, 142092
 Troick, Moscow Region, Russian Federation.

Fax: +7 095 3420342 E-mail: sviridov@omega.laser.ru

Laser heating of cartilage and tendon can induce the change in its shape without dramatic destruction of tissue structure [1,2]. This work is aimed at studying heat effects under laser-treatment of collagenous tissues.

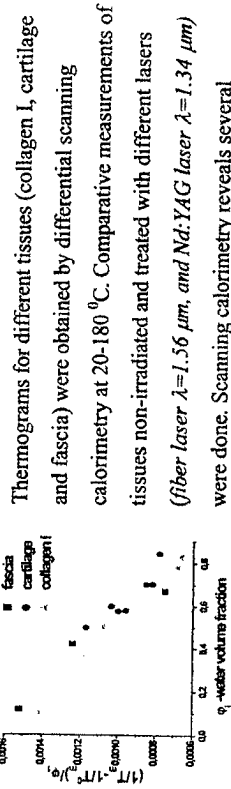

Thermograms for different tissues (collagen I, cartilage and fascia) were obtained by differential scanning calorimetry at 20-180 °C. Comparative measurements of tissues non-irradiated and treated with different lasers (fiber laser $\lambda=1.56 \mu\text{m}$, and Nd:YAG laser $\lambda=1.34 \mu\text{m}$) were done. Scanning calorimetry reveals several thermal induced processes. The temperature of the first transitions T_m agrees with collagen melting temperature but depends on water contents ϕ_1 (fig). The heat effect of transitions in fascia tissue is 34 J/g dry matter and corresponds to ΔH of collagen denaturation. ΔH of the first transition in cartilage is about 7.5 J/g dry matter. We assume that the first feature can be connected with total (fascia) or partial (cartilage) denaturation of collagen. The following features on thermograms are related to deep destruction of tissue matrix. The value of ΔH of the first transition was shown to diminish with increasing of laser irradiation dose and can be used, as criteria of tissue modification. Micro calorimetric data were supported by our FTIR spectroscopic measurements.

1. E. Helidonis, E. Sobol, G. Kavvalos, V. Bagratashvili, et al., *American Journal of Otolaryngology*, 1993,14, 410.

2. Hayashi K., Peters D.M., Thabit G, et al., *Clin. Ortop.*, 2000,v.370, 236-249.

New approach for absorption spectrums and dispersion of erythrocytes and polarization of medium.

A.M.Radin

Lab of Dynamic Processes in Optical Systems
 St.-Petersburg University for low-temperature technologies,
 Tel: 3112736, E-mail: amradin@mail.ru, radina@palona.spbu.ru

The modes in three-dimensional ring optical resonators inclusive selective elements, and also absorptive or strengthening fields of media are constructed. In such resonators members four-by-four ABCD of full circumvention of a resonator (the matrices of a monodromy) appear complex. The steady-state conditions for such resonators are studied, which one have qualitatively diverse kind, than for resonators without losses and gain. The main outcomes:

1. Any properties of a matrix of a monodromy for one selected cross-section do not guarantee steadiness of a resonator as a whole (at presence of amplification of a field): beam, concentrated in one cross-section, can cease to be by those in the other cross-section.
2. The fact of two-sided and unilateral steadiness of resonators is established. The unilateral steadiness corresponds to a mode of support by a resonator of a unidirectional laser oscillation.
3. In case of unilateral steadiness the existence of several undamental modes applicable to one propagation direction is possible.
4. The modes of a natural oscillation being continuum sets of gaussian modes (spatial degeneration of infinite ratio) are possible.
5. There is not a connection of steadiness of a resonator with eigenvalues of a matrix of a monodromy. The steadiness of a resonator is determined by its eigenvectors.
6. The eigenvalues of the operator depicting transformation of a field at circumvention of a resonator, lie, generally, not on a circumference, and on a spiral. In this case among them certainly is not present conterminous. The sets of eigenfunctions of such operators for head seas (in case of two-sided steadiness are biorthogonal in sense of real scalar product. The functions of each of such sets real are orthogonal with complex is powerful, not dependent from numbers of a mode.
7. The theory is applied for the computer prognosis of absorption spectrums and dispersion of erythrocytes intracavity by a method.
8. The new approach for estimation of a polarizability of mediums is offered.

MONTE-CARLO SIMULATION OF MULTI-LAYERED BIOLOGICAL TISSUE NON-INVASIVE RESEARCH

E.P. Savchenko (Saratov State University, 83, Astrakhanskaya str., 410026, Saratov, Russia; Tel. +7(8452) 51-78-68; E-mail: SavchenkoEP@info.sgu.ru)
 V.V. Tuchin (Saratov State University, 83, Astrakhanskaya str., 410026, Saratov, Russia; Tel. +7(8452) 51-46-93; E-mail: tuchin@ns.ssu.runnet.ru)

In the Monte-Carlo method the light fluence rate distribution is estimated by simulating the paths of a large number of light quanta (photons). This Monte-Carlo method is a method to estimate the exact solution to the equation of transfer. The random paths of a large number of photons are simulated, while sampling from various probability distributions: the phase-space distribution of the source, the phase-space distribution of the source, the absorption and scattering distribution, and the distribution of the scattering angle.

For skin model we used the reflection optical scheme (see Fig.):

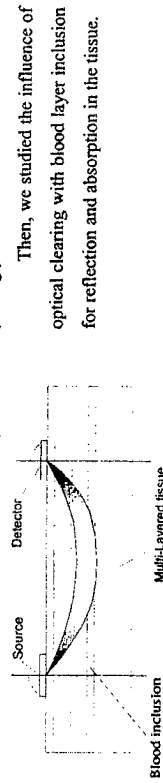

We included optical cleared inclusions at the depth from 0 to 0,3 mm (μ_a was decreased with coefficient 0,01) with different geometry. Then we compared results with experimental dates.

References

1. V.V. Tuchin "Lasers and fiber optics in biomedical researches", Saratov State University, 1998.
2. M. Keijzer "Light Transport for medical laser treatments", Technische Universiteit Delft, 1993.

ARE THE SUBGLOBULAR OSCILLATIONS OF PROTEIN MOLECULES IN WATER OVERDAMPED?

Netrebko A.V.¹, Netrebko N.V.², Romanovsky Yu.M.², and Chikishev A.Yu.³

Lomonosov Moscow State University, ¹Institute of Mechanics, ²Physics Department, and ³International Laser Center, Vorob'evy gory, Moscow, 119899 Russia
 tel: (095)9392612, fax: (095)9393113, e-mail: romanov@yurmr.phys.

The efficiency of enzymes (molecular machines) strongly depends on the Q-factor of the selected degrees of freedom in these molecules [1]. The quasi-harmonic subglobular oscillations of α -chymotrypsin (linear dimension, 40 Å, mass, $4 \cdot 10^{-24}$ g) presumably determine the catalytic rate of this molecule, representing molecular scissors cutting peptide bonds in polypeptides. Raman spectra of chymotrypsin crystals exhibit maxima that may correspond to the subglobular oscillations with the frequencies of about 10^{12} Hz. Such vibrational bands are also typical of the other subglobular proteins (e.g., lysozyme, pepsine, etc.) [2]. Enzyme molecules work *in vivo* in water environment at room temperature. Raman spectroscopy of aqueous solutions of proteins failed to detect the low-frequency bands observed in the crystal samples. According to the hydrodynamics of the viscous liquid the Q-factor of such oscillations is less than 2. Since the thickness of the boundary layer is about the size of a water molecule [3] and the amplitude of the oscillations is about 0.1 Å, water can be hardly considered as a continuous medium.

We used molecular dynamics to estimate the Q-factor by simulating subglobular oscillations in a 2D(3D) volume containing 120–400 water molecules. The interactions of water molecules ("disks" or "spheres") with each other and with the subglobules were described by the Lennard-Jones potential. The computations yield the Q-factors of 5 and 10 for the 2D and 3D models, respectively. The allowance for the water quasi-crystals containing tens of water molecules leads to a several-fold increase in the Q-factor. For the C-C stretching vibration in a $\text{CH}_3\text{-CH}_3$ molecule, $Q \sim 100$ which is in agreement with the results of simulation [4], in which the models of the water molecules and their interactions are closer to reality. If the condition of the Fermi resonance is met, the 2D system exhibits energy redistribution between the degrees of freedom. The results obtained stimulate the further experimental studies of the low-frequency vibrations ($20\text{--}30 \text{ cm}^{-1}$) in aqueous solutions of globular proteins.

References

1. Molecular Dynamics of Enzymes, Yu. Romanovsky and W. Ebeling, Eds., Moscow: Moscow State University, 2000.
2. Painter P.C., Mosher L.E. and Rhoads C., Biopolymers, 1982, v. 21, pp. 1469-1472.
3. Landau L.D. and Lifshitz E.M., Hydrodynamics, Moscow: Nauka, 1986.
4. Shaitan K.V. and Saraikin S.S., Biofizika, 2000, v. 45, pp. 407-413.

BACKGROUND SUBTRACTION METHOD FOR RAMAN SPECTRA

Mihaileuk, I.K., Razjivin, A.P.

A.N. Belozersky Institute of Physico-Chemical Biology, Moscow State University,
Moscow 119899, Russian Federation

The subtraction of background from experimental spectra is a one of current problems for Raman spectroscopy. The original method based on scale differences of legitimate and background signal is proposed. An algorithm is following: for each point i of the input array curve there is a circle which satisfy next requirements 1) X -coordinate of the circle center is equal to X_i , 2) the input array curve and the circle have at least one common point, 3) Y -coordinates of all other circle points are smaller than Y -coordinates of corresponding points of input curve (the circle is placed under the input curve). At first step the input array is written to an output array. Then for each point of input array curve the circle is plotted and differences between Y -coordinates of the input curve and Y -coordinates of corresponding (with the same X -coordinates) points of the upper arc of the curve are calculated. The obtained differences are compared point by point with Y -values of the input array and the minimal one is written back to the output array. Intuitively this algorithm may be visualized as a process of "rolling motion" of the circle along downside of the input array curve. The rolling circle "erases" a background with small curvature under the input curve but this circle can't fall down to narrow peaks of the legitimate signal.

The partial support of RFBR grant No. 00-04-48308 is acknowledged.

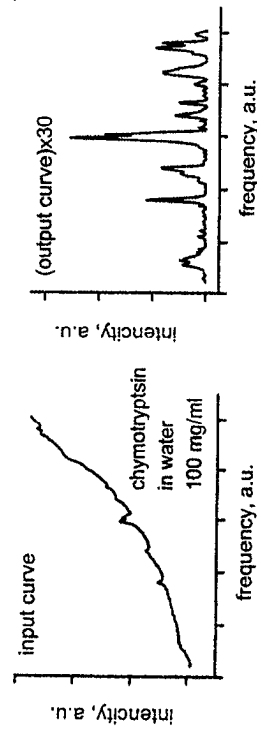

UNUSUAL MECHANISM OF MEDIA POLARITY INFLUENCE ON THE FLUORESCENCE LIFETIME OF NONPLANAR PORPHYRINS

Igor V. Sazanovich, Vladimir S. Chirvony, Victor A. Galievsky
Institute of Molecular and Atomic Physics NAS of Belarus

F. Skaryna Ave., 70, 220072, Minsk, Belarus

A series of three free-base nonplanar porphyrins with graded degree of saddle macrocycle distortion was studied by steady-state absorption and steady-state&kinetic emission spectroscopies. Besides, semiempirical quantum-chemical calculations were performed. The new data obtained, such as twice larger absorption-emission shift and twice shorter fluorescence lifetime in polar solvent acetonitrile comparing with nonpolar n-hexane, manifest a presence of large static dipole moment for saddle-distorted nonplanar porphyrins. According to the performed semiempirical calculations the dipole moment is expected to be directed orthogonally to the mean porphyrin plane for symmetrically-substituted porphyrin. Important thing is the compounds studied do not contain any electron-donating or electron-accepting substituents. Owing to this, the compounds do not have any low-lying charge transfer (CT) states which might shorten the fluorescence lifetimes due to the CT state stabilization in more polar solvents. Instead of this, the proposed new mechanism is in the following. An interaction of the porphyrin dipole moment with polar media should result in additional nonplanar conformational distortions of the relatively flexible porphyrin macrocycle because this increases the porphyrin orthogonal dipole moment and is energetically favourable. Such increasing of macrocycle nonplanarity facilitates crossing of activation barriers towards quenching funnels on S_1 potential energy surface and, hence, leads to enhanced radiationless deactivation of S_1 excited state, in accordance with the mechanism published recently [1]. The new found interplay of photophysical properties of nonplanar porphyrins and local polar microenvironment is important for understanding tetrapyrrole's functioning in natural and model systems.

[1] Chirvony, V.S., van Hoek, A. et al. *J. Phys. Chem. B*, 2000, 104, p.9909.

Determination of molecular parameters of humic substances using the complex laser spectroscopy method.

V.V. Fadeev, I.V. Boychuk, T.A. Dolenko, K.V. Anikin.

Quantum Electronic Division, Physical Department, Moscow State University, Moscow, 119899, Russia.

Aquatic humic substances (AHS), founded in any natural water, contains major budget of the oceanic organic carbon. This organic complex has a number of interesting spectral characteristics: unstructured and extensive band, small difference of form and positions of bands for AHS of different origin and of different weight fractions. Number of fluorofors in AHS and nature of their fluorescence are not known until.

In our work the attempt of description of AHS by the two-fluorofors model was made. In this case we obtained a five-parametrical inverse problem of fluorimetry. Sought parameters are the following: fluorescence lifetimes of both fluorofors τ_1 and τ_2 , their absorption cross-sections σ_1 , and σ_2 , and the ratio of partial fluorescent contributions of components Φ_{01}/Φ_{02} . As it was shown in [1], number of inverse problem sought parameters of nonlinear fluorimetry has not to exceed three for spectral bands of typical AHS. So, in this work, the complex method, including the method of spectroscopy with variable strobing (the parameters τ_1 , τ_2 and Φ_{01}/Φ_{02} were determined by means of this method) was used. The parameters σ_1 and σ_2 were determined by means of the method of saturation spectroscopy.

In both stages of this inverse problem the technique of artificial neural networks (ANN) was used. Measure of discrepancy of indicated parameters for different types and for different weight fractions of AHS was investigated.

1. Fadeev V.V., Dolenko T.A., Filippova E.M., Chubarov V.V. Saturation spectroscopy as a method for determining the photophysical parameters of complicated organic compounds. Optics Communications, 1999, v. 166, pp. 25-33.

DETERMINATION OF THE PHOTOSYNTHESISING ORGANISMS
PHOTOPHYSICAL PARAMETERS BY THE METHOD OF NON-LINEAR
FLUORIMETRY

Fadeev V.V., Maslov D.V., Litvinov P.N., Burikov S.A.

Quantum Electronics Division, Physical Department, Moscow State University, Moscow, 119899, Russia

There is set of discussed questions in the study of primary processes of the photosynthesis. Solution of these problems stimulates development of new methods for determination of the photosynthetic unit photophysical parameters *in-vivo*. In the report possibilities of non-linear fluorimetry method in this problem are investigated. The first step required is creation of small-parametrical model of the photosynthesising organisms (PSO) fluorescence response formation. The corresponding inverse problem can be solved for such model.

In the report the three-parametrical model of the PSO fluorescence formation under pulse laser excitation is proposed. Parameters of this model are the following: the excitation cross-section of chlorophyll-a molecules σ^* (it takes into account both direct absorption of exciting emission by these molecules and energy transfer on them from accessory pigments), excited states lifetime of chlorophyll-a molecules τ^* (which describes the rate of them linear deactivation, τ^* is a sum of the rates of intramolecular energy transitions and energy transfer on reaction centres); constant of the singlet-singlet annihilation rate γ . The approximate expressions for parameters σ^* and τ^* which connect them with the parameters of initial multi-parametrical model were obtained. The dependencies of the parameters σ^* and τ^* on parameters of multi-parametrical model and photon flux density of exciting emission F were investigated. The conditions when σ^* and τ^* don't depend on F were determined.

Preliminary results of experimental verification of the proposed method are presented.

PECULIARITIES OF DYNAMICS OF MOLECULAR MULTILEVEL SYSTEMS
IN A POWERFUL LASER FIELD: ANALYTICAL SOLUTIONS

V.A. Savva, V.I. Zelenkov, O.V. Khilus

Institute of Physics, National Academy of Sciences of Belarus
68 Scaryna ave. 220072 Minsk Belarus. savva@dragon.bas-net.by

Two methods to obtain exact analytical solutions of the equations describing coherent dynamics of multilevel systems in a powerful laser field are submitted. They are: (1) a method based on integral transform with the use of orthogonal polynomials of continuous or discrete variable and (2) a method based on distribution functions of level populations and phases of probability amplitudes. Both methods result in the solutions describing dynamics of various multilevel systems. On the basis of the solutions the dynamics of various systems following from properties of systems and conditions of excitation are investigated. The excitation occurs owing to radiative transitions between the neighboring levels in conditions when relaxation processes can be neglected.

Level population inverting in a system consisting of finite number of levels can be realized. The examples of restriction of amount of populated levels are given at presence of the detuning of radiation frequency from frequencies of transitions in a system as well as when one of transitions is much weaker or much more strong than the other ones. The restriction of excitation in non-resonant conditions can be removed if the dipole moments of consecutive transitions increase quickly enough.

The examples are given when the distribution function of populations of levels realized at resonant excitation holds its shape in conditions of non-resonant excitation by radiation with constant amplitude along with in a field of a laser pulse. The parameter of this distribution changes its time dependence only.

The quantum multilevel systems under consideration with the exact analytical solutions describing their dynamics represent various models of excitation process of molecules and atoms in powerful laser field.

NEW APPLICATIONS OF POWER EXCIMER LASERS

K. Znosko, A. Volodenkov, A. Anufrik, D. Ritcshik

Yanka Kupala State University of Grodno
22, Ozheshko Street, Grodno, 230023, Belarus

E-mail: znosko@grsu.grodno.by

Excimer lasers using halogens of inert gases are known to be power sources of coherent radiation and they are beyond the competition in the generation efficiency in comparison with other UV-lasers. Now they are not only a subject for a study but also they are broadly used in research experiments, new technologies, optical remote control, bio-medical researches. The reasons why the excimer lasers are of interest in many fields are the following: 1) an absorption factor for UV spectrum is much greater than that for Nd and CO₂-lasers usually used in technologic processes; 2) the quantum energy of the excimer lasers is greater than 6 eV and it allows to affect directly on chemical bonds and to initiate necessary chemical reactions (quantum energy of visible and IR-lasers is not enough for it); 3) smaller wavelength of excimer lasers comparing with that for IR-lasers allows to increase by several powers the level of spatial localization what is important in nano-technologies.

The excimer lasers developed in this work were used for technologic needs. Their radiation was used for improving surface micro-hardness of alloys made on the basis of Fe, Al and Cu, changing of the surface structure, enhancing its corrosion steadiness. The XeCl-laser radiation was used to improve the adhesion between metal coatings and polymer surface. The XeCl-lasers were used for the lidar remote control of the Earth Ozone layer. The distribution of Ozone for heights of 20-100 km has been studied. The excimer lasers were used for bio-medical studies. In particular, an effect of coherent UV-radiation on nervous system, protein and organic systems was studied. Their radiation was used to stimulate protein and ferment activity. The excimer laser radiation was used also for pumping tunable narrow-band dye lasers. The efficiency of this pumping may achieve value about 50 %.

PHOTO-STIMULATED HYDRODYNAMIC PHENOMENA IN BIOSTRUCTURES AND THEIR MEDICAL APPLICATIONS

Zhetkov G.I., Vitkin E.I., Rubanov A.S.

B.I. Stepanov Institute of Physics, National Academy of Sciences Scorina Ave. 70, 220072, Minsk, Belarus.

Response of any liquid or quasi-liquid media to irradiation by short (from tenths up to tens ns) includes forming of acoustic or shock waves. Amplitude, shape and frequency the waves depends not only on irradiation conditions, but also from physical (density, sound velocity, spectral absorption coefficient and others) parameters of medium. This phenomenon is proposed to be used for early diagnostic of any pathological new growths (cataract, cancer tumors, cerebral growth and many others) which properties differs from surrounding media, such as for selective disruptive action, if laser power is sufficiently high. New developed mathematical approach has been used for calculation of hydrodynamic response (dynamics of fields of temperature, pressure, local velocities) of multi-layer quasi-liquid structures onto action of laser pulses with different temporal, power and spatial parameters. Above mentioned selective phenomena for medical applications have been illustrated.

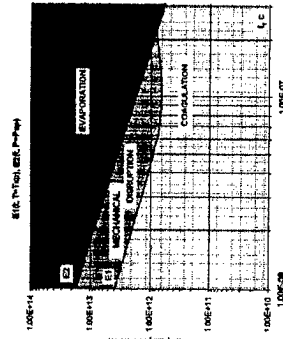

In more details these effects surveyed for using in laser surgery. As object of action the man's skin was chosen. The conditions have been observed in which different types of laser-stimulated disruption of tissues (thermo-coagulation, mechanical fracture at the expense of a cavitation, explosive evaporation) can

take place. Above picture shows some results for the case of laser with wavelength of 530 nm, t – pulse duration. Obviously the type of laser scalpel action may be controlled correspondingly to features of pathology and individual tasks of a surgeon. On this background a new types of laser surgeon instruments can be created.

RED-EDGE EXCITATION EFFECT IN INTRAMOLECULAR PROTON TRANSFER IN FLAVONOLS

J.V. Kruchenok¹, N.A. Nembkovich¹, A.N. Sobchuk¹, E.P. Petrov¹, A.N. Rubinov¹, V.G. Pivovarenko², and W. Baumann³

¹B.I. Stepanov Institute of Physics, National Academy of Sciences of Belarus, F. Skaryna Ave. 68, Minsk 220072, Belarus, Fax: +375 17 2841646, E-mail: julia@ifanbel.bas-net.by
²Department of Chemistry, National Taras Shevchenko University, Volodymyrska 64, Kiev 252033, Ukraine

³Institute of Physical Chemistry, University of Mainz, Jakob Welder-Weg 11, 55099 Mainz, Germany

3-hydroxyflavone (FET) and 4'-(15-azacrown-5) (FCR) derivatives of microparameters of biological structures. Our steady-state measurements prove the existence of spectral heterogeneity of flavonols in binary solvents and erythrocyte membranes. The effect manifests itself in the dependence of the efficiency of excited-state intramolecular proton transfer (ESIPT) in flavonols on the excitation frequency, which can be explained by the change in the rate of forward and reverse ESIPT and the interplay between charge and proton transfer.

The electrooptical absorption method was used to measure dipole moments of the normal form of FET. The electric dipole moments in the ground (μ_g) and excited Franck-Condon (μ_c) states have the values of 22.7×10^{-30} Cm and 53.3×10^{-30} Cm, respectively. Upon optical excitation, the electric dipole moment increases by 34×10^{-30} Cm, and the angle between μ_g and μ_c is 25° . The results of the electrooptical and spectroscopic measurements allow to describe more precisely the process of charge and proton transfer in 4'-amino-3-hydroxyflavones. Charge transfer and proton transfer occur alternately. The main stage of the forward electron charge transfer takes place upon excitation of the normal form (N^*) and partly after ESIPT. In the phototautomer (T), only partial reverse charge transfer happens after photon emission. The second, more efficient stage of reverse electron charge transfer occurs after radiationless conversion of the phototautomer into the normal form.

Our time-resolved laser spectrofluorimetry measurements show that fluorescence lifetimes of the normal form and phototautomer of FET and FCR vary from about 1 ns to about 5 ns depending on the medium.

KINETIC DESCRIPTION OF DIOXYGEN BINDING TO HUMAN
HEMOGLOBIN ON THE 1-100 NS TIME SCALE

I.V. Sazanovich,^a V.A. Galievsky,^a J. Karpiuk,^b E.P. Petrov,^c J. Waluk,^b
and B.M. Dzhangarov^a

^a*Institute of Molecular and Atomic Physics, National Academy of Sciences of Belarus,*

F. Skaryna Ave., 70, 220072, Minsk, Belarus

^b*Institute of Physical Chemistry, Polish Academy of Sciences, Warsaw, Poland*
^c*B.I.Stepanov Institute of Physics, NAS Belarus, Minsk, Belarus*

Photoexcitation of oxyhemoglobin HbO₂ leads to a very rapid rupture of the heme iron-oxygen (Fe-O₂) bond. However, not all photodissociated oxygen molecules can escape from the protein into the solvent. Certain fraction of O₂ rebinds from within the protein matrix. This reaction is known as geminate recombination (GR) and provides important information on the protein function and ligand motion in the protein interior. At an ambient temperature, GR of O₂ occurs on both nanosecond and picosecond time scales. Long GR stages cover several tens of nanoseconds. However, up to now, the exact kinetics of these stages has not been determined. In this paper, we present the results of nanosecond optical spectroscopy studies of GR on the 1-100 ns time scale. Analysis of our transient absorption data has shown that the following fitting functions provide equally satisfactory description of our experimental data:

$$\Delta A^{(2\text{exp})}(t) = 0.16 + 0.64 \exp(-t/(1.2 \text{ ns})) + 0.20 \exp(-t/(16 \text{ ns}))$$

$$\Delta A^{(3\text{exp})}(t) = 0.165 + 0.44 \exp(-t/(0.9 \text{ ns})) + 0.20 \exp(-t/(6 \text{ ns})) + 0.185 \exp(-t/(40 \text{ ns}))$$

$$\Delta A^{(\text{stretch})}(t) = 0.15 + 0.85 \exp(-t/(3.5 \text{ ns}))^{0.36}$$

Here $\Delta A(t)$ is the absorbance change corresponding to the normalized number of desoxy Hb molecules. Constant terms in all functions determine a nonzero baseline belonging to a slowly recovering bimolecular nongeminate recombination. Although the signal-to-noise ratio of the data does not allow to make an unambiguous differentiation between these three models, two main conclusions can be deduced from our data: (i) the kinetics of O₂ recombination to Hb cannot be described as a single-exponential process, (ii) the predominant part of GR takes place on the initial stage of this process.

ABOUT THE MECHANISM OF ULTRAFAST RELAXATION
OF EXCITED ELECTRONIC STATES OF CIS-ISOMERS
OF THE ETHYLENE-BRIDGED PORPHYRIN DIMERS

Svetlana I. Shishporenok, Vladimir S. Chirvony

Institute of Molecular and Atomic Physics, National Academy of Sciences of Belarus

F. Skaryna Ave. 70, Minsk 220072, Belarus

Recently, we have determined a key role of an olefinic linker in formation of unusual spectral and photophysical properties of *trans*-isomer of the ethylene-bridged octaethylporphyrin dimers [1,2]. In the present work a comparative systematic study is carried out for another isomeric form of the ethylene-bridged octaethylporphyrin dimers, namely for the following *cis*-isomers: *cis*-(H₂OEP-H₂OEP) (1) and *cis*-(ZnOEP-ZnOEP) (2) homodimers and *cis*-(ZnOEP-H₂OEP) (3) heterodimer. Analysis of the experimental data obtained in course of our steady-state spectral research shows that, in contrast to the *trans*-isomers [1,2], *cis*-isomers of 1-3 exhibit absorption and fluorescence spectra generally similar to the spectra of the corresponding monomers composing the *cis*-isomeric dimers. The only essential difference is a structureless character and broadening of the absorption and fluorescence spectra. This effect is explained to be a result of inhomogeneous broadening originating from an enhanced sensitivity of the spectra to the relative position of the porphyrinic macrocycles being in excitonic interaction.

Very short lifetimes of an excited S₁-state (a few ps against a few ns for the corresponding monomers) found for both *trans*- and *cis*-isomers, as well as strong viscosity dependence of their fluorescence intensities are explained by conformational rearrangements in the double-bond bridge region. These excited-state rearrangements lead to deactivation funnels on an energy surface of the S₁(π,π^*) state. The funnels are suggested to be conical intersections between the ground and excited electronic states.

1. Chachiviliis, M.; Chirvony, V.S.; Shulga, A.M.; Kallerbring, B.; Larsson, S.;

Sundstrom, V. *J. Phys. Chem.* 1996, 100, 13857-13866; *ibid.* 13867-13873.

2. Chirvony, V.S.; Pershukovich, P.P.; Galievsky, V.A.; Shulga, A.M.

Opt. Spectroscopy 1997, 82, 717-722.

EXTRA-LIGATION AND SCREENING EFFECTS UPON INTERACTION OF PHOTOINDUCED EXCITED STATES OF MULTIPORPHYRIN ARRAYS WITH MOLECULAR OXYGEN IN SOLUTIONS

E.I. Zenkevich¹, E.I. Sagun¹, V.N. Knyukshto¹, A.M. Shulga¹, C. von Borczyskowski²

¹*Institute of Molecular and Atomic Physics, Natl. Acad. Sci. of Belarus,*

F. Skaryna Avenue 70, 220072 Minsk, Belarus

²*University of Technology Chemnitz, Reichenhainer Str. 70, 09107 Chemnitz, Germany*

At the moment, it is well-known that in natural protein complexes metalloporphyrins are co-ordinated to additional ligands of various nature. Such co-ordination plays the essential role in the formation of structurally organised complexes as well as might affect the excited states properties, rate constants and the efficiency of primary photoinduced processes (energy and charge transfer, quenching by molecular oxygen).

Here, we report the results (based on laser nanosecond fluorescent and pump-probe kinetic methods) showing how the extra-ligation, spacer properties and porphyrin macrocycle screening may influence on the conformational dynamics and photophysical properties of multiporphyrin arrays (chemical dimers, self-assembled triads and pentads, see Fig.) as well as on their interaction with molecular oxygen in solutions at 293 K.

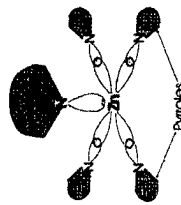

Extra-ligation

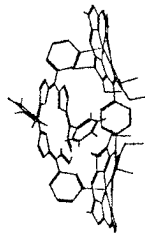

Porphyrin triad

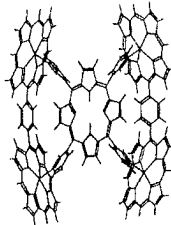

Porphyrin pentad

The extra-ligation of the dimers by pyridine leads to T_1 -states quenching (decrease of phosphorescence lifetimes and quantum yields by ~ 1.5 - 2.5 times at 77 K). At 293 K the T_1 -state quenching by O_2 for Zn-dimer-pyridine complexes depends on the nature and flexibility of the spacer between macrocycles. In triads and pentads the dimeric subunit plays the role of screen weakening O_2 interaction with the second subunit (pyridyl substituted porphyrin). As a result, the T_1 -state quenching by O_2 in triads and pentads is decreased by 50-70% with respect to that for the corresponding individual monomers.

FORMATION OF REACTIVE NITRIC OXIDE DERIVATIVES UNDER ACTION OF UV AND VISIBLE LIGHT ON S-NITROSOCOMPOUNDS IN THE PRESENCE OF PHOTOSENSITIZERS

Ivan Stepuro, Raisa Adamchuk

Institute of Biochemistry, Tarashkevich Blvd. 50, Grodno 230017, Belarus,

tel. (152) 337933, e-mail: ianstepuro@grsu.unibel.by

Vitaly Stepuro

Y. Kupala State University, Ozheshko 22, Grodno 230023, Belarus,

tel. (152) 444297, e-mail: stepuro@grsu.unibel.by

It was shown that under the action of UV or visible light in anaerobic conditions S-nitrosocompounds (S-nitrosoglutathione, S-nitrosocysteine, and S-nitrosothiols) were degraded to release NO and produce disulfides.

The NO concentration was determined spectrophotometrically by the amount of HbNO produced from deoxyhemoglobin or using the method of pyrene fluorescence quenching. The quenching of fluorescence method was also used to determine the distribution of NO between aqueous and hydrophobic media.

In the presence of oxygen NO_x reaction products (N_2O_3 , NO_2) were formed in addition to NO, which nitrosylated thiol sulphhydryl groups and proteins.

We showed that visible light irradiation of aqueous solutions containing dyes (photosensitizers) and S-nitrosothiols gave rise to peroxynitrite, a potential oxidizer.

We suggest that tumor cell irradiation in the presence of photosensitizers and S-nitrosothiols will result in effective sensitization and enhanced cell death.

PHOTOINDUCED ELECTRON TRANSFER IN SELF-ORGANIZED TRIAD SYSTEM CONSISTING OF POSITIVE CHARGED PORPHYRIN-ANTRAQUINONE DYAD AND NEGATIVE CHARGED CHLORIN MOLECULE

Yolkovichi D.L., Nichiporovich I.N., Tikhomirov S.A., Shulga A.M., Solovyov K.N.

Institute of Molecular & Atomic Physics, National Academy of Sciences of Belarus, F. Skaryna Ave. 70, 220072 Minsk, Belarus

Porphyrim and chlorins with oppositely charged peripheral substituents form dimers which can serve as model systems for the study of photoinduced energy and charge transfer processes. Based on such type investigations with 5-phenyl, 10, 15, 20-tris (3-N-methylpyridinium)porphyrin triiodide + tetrasulfophenylchlorin (Ph-TriMetPyr I₃ +TSPC) heterodimer our researches have been extended on more complicated triad system consisting of 5-antraquinonyl, 10, 15, 20-tris(3-N-methylpyridinium) porphyrin triiodide (AQ-TriMetPyr I₃) +TSPC.

The rate of photoinduced electron transfer (PET) from excited S₁ state of porphyrin part of AQ-TriMetPyr dyad to antraquinone one varies from value $<10^7$ s⁻¹ in pyridine to $6 \cdot 10^{10}$ s⁻¹ in water buffer solution. For the triad and heterodimer the transient absorption spectra measured immediately after excitation are practically the same as the spectrum of the chlorin component with typical bleaching band at 640-660nm. This fact indicates that in both systems after excitation ultrafast energy transfer to chlorin components takes place. Indeed, estimates in accordance with Forster theory give the rate constant for energy transfer about $1.3 \cdot 10^{13}$ s⁻¹.

Fast optical decay with the rate of $k_{pet} = (7.3 \pm 0.8) \cdot 10^{10}$ s⁻¹ for the triad and $k_{pet} = (5 \pm 1) \cdot 10^9$ s⁻¹ for the heterodimer reflects the processes of PET from S₁ state of the chlorin component to porphyrin one. The slower decay component of $(6 \pm 2) \cdot 10^9$ s⁻¹ for the triad was detected at wavelengths 730- 800 nm where cation radicals of porphyrins show a broad absorption. This process does not result in change of optical density in the spectral range of chlorin bleaching band showing that detected process is not the recombination to the ground state of the triad chlorin component. It may be conclude that after chlorin-porphyrin step of an PET the process proceeds toward antraquinone and reverse electron transfer process is much slower. The situation is quite different for the heterodimer where the slow component in the decay process is about $(4.8 \pm 0.7) \cdot 10^9$ s⁻¹ and reflects recombination to the chlorin ground state.

TIME-RESOLVED AND STEADY-STATE FLUORESCENCE OF β -NO₂-SUBSTITUTED PORPHYRINS

Andrei Yu. Panarin¹, Igor V. Sazanovich¹, Arie van Hoek², Svetlana I. Shishporenok¹, Vladimir S. Chirvony¹

¹ Institute of Molecular and Atomic Physics, National Academy of Sciences of Belarus F. Skaryna Ave. 70, Minsk 220072, Belarus

² Laboratory of Molecular Physics, Department of Biomolecular Sciences, Agricultural University, Dreijenlaan 3, 6703 HA Wageningen, The Netherlands

A series of mono- and di- β -NO₂-substituted free base tetraphenylporphyrins (NO₂-H₂TPPs) is studied by the methods of steady-state and time-resolved fluorescence spectroscopy. Owing to the electron-withdrawing nature of the nitro group the porphyrin becomes polar that manifests itself in large and solvent-polarity dependent Stokes shift of the fluorescence spectrum and solvent-polarity dependent deactivation of the fluorescence state. Experiments at 77 K enabled to show that the NO₂-H₂TPPs under study exist in solution as an equilibrium mixture of two nonequivalent NH tautomers. Spectral and photophysical characteristics of individual tautomers are studied at these conditions.

Besides, dynamics of the fluorescence spectrum Stokes shift is studied by the method of time-correlated photon counting. The time constant of this shift is found to be as short as 10 ps and less depending on solvent. On the basis of semiempiric quantum chemical calculations [1] and data on the related β -Br- and β -CN-TPPs we suggest that the photoinduced rotation of the nitro group to the geometry coplanar with the porphyrin macrocycle rather than usual reorientation of solvent molecules is responsible for the observed Stokes shift dynamics.

1. V.S. Chirvony, A. van Hoek, T.J. Schaafsma, P.P. Pershukevich, I.V. Filatov, I.V.

Avilov, S.I. Shishporenok, S.N. Terekhov, V.L. Malinovskii. *J.Phys.Chem.B* 1998, 102, 9714-9724.

THE INTERACTIONS OF INTERCALATORS WITH CALF THYMUS DNA: PHOTOCHEMICAL AND PULSE RADIOLYSIS STUDIES

Marian Wolszczak^a, and Cezary Peszynski-Drewns^a

^aInstitute of Applied Radiation Chemistry, Technical University of Lodz, Wroblewskiego 15, 93-590 Lodz, Poland

+4842 6313159 / +4842 6840043; marianwo@mitr.p.lodz.pl

^bCenter of Excellence, Application of Laser Techniques and Biomaterials in Medicine, Wolczanska 215, 93-005 Lodz, Poland,

+4842 6313648 / +4842 6816139; cdtl@ck-sg.p.lodz.pl

Due to the important role that DNA plays in living organisms, much effort has been aimed to the design of novel DNA-targeted drugs as potential antitumor agents. Our method of approach to this problem is to synthesize trifunctional molecule consisting of two classical intercalators linked by polyamine chain showing itself site-specific interactions in the grooves of DNA. Several bis-anthracene moieties, joined at the 9-position by polyamine linker of varying length, rigidity and numbers of N⁺ cationic groups have been synthesized for the first time. The photophysical properties (absorption spectra, fluorescence spectra, excited state lifetimes, fluorescence anisotropy etc.) of bis-anthracenes have been studied in homogenous solutions and in the presence of the calf thymus DNA. The obtained results were compared to data acquired for classical intercalators, namely ethidium bromide, quinacrine and proflavine. Addition of DNA to the buffer solution of bis-anthryl probe results in dramatic decrease in the probe absorbance connected with red shift of the absorption spectrum. Absorption titration experiments were used to determine the binding constant of the probe with DNA. Scatchard plot constructed from this titration gave binding constants in the range $2 \cdot 10^4 - 8 \cdot 10^5 \text{ dm}^3 \text{ mol}^{-1}$. Binding of the bis-anthracenes to DNA helix induces quenching of the probe fluorescence very efficiently. Fluorescence sensitization by DNA bases already reported in the literature for the mono-anthryl intercalators was also established for our bisintercalators. The excimer laser photolysis of the bis-anthracenes in nitrogen saturated buffer and DNA-buffer solutions, allowed us to characterize the transient T-T absorption of the chromophore. Using pulse radiolysis technique we recorded absorption spectra of reduced and oxidized forms of bis-anthracenes in aqueous solutions.

AXIAL COORDINATION OF Ni-PORPHYRINS IN SOLUTION STUDIED BY RESONANCE RAMAN SPECTROSCOPY

V.V. Ermolenkov, S.G. Kruglik, V.A. Orlovich, P.-Y. Turpin

¹B.I. Stepanov Institute of Physics, National Academy of Sciences of Belarus, 70 F. Skaryna Ave., 220072 Minsk, Belarus

²Université Pierre et Marie Curie Paris VI, Paris, France

In the present work axial ligation of meso-substituted Ni-tetraarylporphyrins by environmental coordinating solvent molecules was investigated. We focused our attention on axial coordination of water-soluble Ni(TMpy-P4) with water and non-water-soluble NiTPP with piperidine.

In a phosphate water buffer solution of Ni(TMpy-P4), where both 4- and 6-coordinate species exist in equilibrium in the ground electronic state [1], the excitation of either 4-coordinate species at 397 nm or 6-coordinate one at 441.6 nm resulted in appearance of transient Raman lines originated from the excited (d,d) state of 4-coordinate form. Analysis of transient Raman spectra recorded at "intermediate" wavelength 423 nm allowed to conclude that axial photoligation of 4-coordinate ground state Ni(TMpy-P4) occurred at high excitation power. Besides, RR spectra recorded with the excitation of 6-coordinate ground state species Ni(TMpy-P4)(L)₂ (L - axial ligand) clearly showed that some part of initially complexed porphyrin molecules lost water ligands in the excited state.

For 6-coordinate NiTPP(L)₂ in benzene/piperidine mixture similar axial ligand photorelease process was detected with high power excitation at 441.6 nm. By varying the piperidine concentration we studied the stationary process of NiTPP ligation with piperidine. The nature of various NiTPP ligated species was discussed on the basis of the results obtained.

I. R.F. Pasternack, E.G. Spiro, M.J. Teach, Inorg. Nucl. Chem. **36** (1974) 599.

RICIN, RICIN AGGLUTININ, AND RICIN BINDING SUBUNIT STRUCTURAL
COMPARISON BY RAMAN SPECTROSCOPY

N.N. Brandt¹, A. Yu. Chikishev¹, A.I. Sotnikov¹, Yu.A. Savochnikina², I.I. Agapov²,
A.G. Tonevitsky³

¹International Laser Center and Physics Department, Moscow State University,

119899 Moscow, Russia

²State Scientific Centre "GNIgenetika", 1st Dorozhiny pr.1, 113545 Moscow, Russia

³Institute for Transplantation and Artificial Organs, Shchukinskaya st. 1, Moscow,
Russia

Raman spectroscopy is an effective tool in studying the structure of toxins. The plant toxins ricin and ricin agglutinin can be classified as ribosome-inactivating proteins of type II. Raman spectra of proteins exhibit several conformation sensitive bands. This work aims at studying the structural properties of the toxins ricin, ricin agglutinin and ricin binding subunit in solution and comparison of the Raman and X-ray structural data. The analysis of the conformation sensitive bands in the Raman spectra of ricin and ricin agglutinin yields nearly identical structure of these two proteins which agrees well with the fact that these proteins are highly homologous. Assume that an isolated binding subunit of ricin is structurally similar to this subunit as a part of the protein molecule. The changes in tyrosine and tryptophan markers may follow then from the fact that some of these amino acids appear to be exposed into the solvent upon isolation of the B subunit. The comparison of the ricin and ricin binding subunit Raman spectra allows us to suggest a trans-gauche-trans conformation for the disulfide bond connecting active and binding subunits of ricin. The comparison of the Raman and X-ray data regarding the secondary structure and conformations of the disulfide bonds points to the difference of the conformations of the proteins in crystal state and aqueous solution.

Multiple light scattering by suspensions of aggregating erythrocytes
in geometrical optics approximation

V. V. Lopatin, A. V. Priezhev

Physics Department and International Laser Center
M.V. Lomonosov Moscow State University, Moscow, 199899, Russia

The most adequate and simple approximations that predict the light scattering by biological suspensions and permit significant simplifications in calculations are the RGD [1], WKB [2] and anomalous diffraction [1] approximations. However, the direct application of these methods is limited by single light scattering and results in significant errors in calculations of backscattered field for particles, which sizes considerably exceed the wavelength of incident light, in particular, the erythrocytes. Also these methods do not provide for the calculations of light scattering indicatrices for the particles of arbitrary shapes and structures, but only for very narrow class of objects. In cases, when we deal with particles of complex and irregular shape e.g. erythrocytes and their aggregates in whole blood, and with multiple scattering, e.g. in thick layers of blood, it is necessary to seek the new approaches for the description of light scattering and absorption processes.

Based on relations of geometrical optics we designed a computer code allowing to perform calculations of single light scattering by large particles of arbitrary shape and structure. The spaces between the particles during the aggregation and the nonsphericity of single erythrocytes were taken into account. We used the indicatrices, obtained with the help of these calculations, to develop the method of calculation of multiple light scattering by suspensions of large nonspherical particles. As an example of application of this method we calculated light scattering by the models of erythrocyte aggregates in whole blood, which shapes change during the aggregation process under the experimental conditions. We obtained the indicatrix of light scattering by models of deformed erythrocytes in shear flow. Theoretical description of the phenomenon of light scattering asymmetry, observed in the experiment, is given by the investigation of the shapes of light scattering indicatrices, and the time dependence of backscattered intensity is obtained. We also investigated the dependence of a degree of polarization of scattered light on the inclination angle of a particle in a shear flow and on its index of asphericity.

1. H. C. Van de Hulst, Light scattering by small particles, Wiley, New York, 1957.
2. N.A. Shepelevitch, V.N. Lopatin, V.P. Maltsev and V.V. Lopatin, Structure formation of the light scattering indicatrice from a homogeneous sphere in Wentzel-Kramers-Brillouin approximation. // J. Opt. A: Pure Appl. Opt. 1, pp. 448-453, 1999.
3. S.G. Khatsevich, V.V. Lopatin and A.V. Priezhev, Asymmetry of light scattering from Couette flow of RBC suspensions: application for biomonitoring of blood samples // Proc. SPIE, V. 3567, pp. 213-232, 1998.

UV LASER-INDUCED FLUORESCENCE OF SEX HORMONES

Fedorov V.I., Cherkasova O.P., Meshalkin Yu.P., Samoilova E.S.

Institute of Laser Physics, prospekt Lavrentyeva 13/3, Novosibirsk, 630090, Russia,
Phone: +7-(3832)-33-24-92, FAX: +7-(3832)-33-20-67, e-mail: fed@laser.nsc.ru

Estragens (estradiol, estrone and estriol) are the only sex hormones whose native fluorescence is induced by a lamp source up to detection level, but native contents of estrogens in biosamples are lower than sensitivity limit of modern fluorescence detectors. Because sex hormones are prominent regulators of all physiological functions, estimation of their levels in biological fluids and tissues plays an essential part in diagnostics, however modern clinical methods of estimation of these hormones are insufficiently selective. Selective methods of hormone analysis using high performance liquid chromatography are insufficiently sensitive.

On basis of fluorescence very sensitive methods of substance detection can be elaborated. The experimental complex for laser-induced fluorescence of various substances has been created. This complex includes a quasi-continuous Nd:Yag laser ($\tau \approx 150$ ns, $f = 3$ kHz), a monochromator, a photomultiplier, a specific counting system based on a pulse collecting peak detector, and an analog-to-digital converter which transfers the data to a computer. The 4-th harmonic of this laser ($\lambda = 266$ nm) was used as a source of radiation excitation ($P = 50$ mW, measured by actinometry).

It was demonstrated for the first time that representatives of all classes of sex hormones (androgens, estrogens, and progestins) are capable of fluorescence. The fluorescence intensity of estradiol and estriol was similar and maximum between all of sex hormones. The relative quantum yields of laser-induced fluorescence of sex hormones were measured. Tryptophan was used as standard. Quantum yield varies from $1.16 \cdot 10^{-2}$ (estradiol) to $2.87 \cdot 10^{-6}$ (testosterone). The spectra of laser-induced fluorescence of sex hormones were obtained. Fluorescence maximum of the most of hormones varies from 302 (testosterone) to 311 (estrone) nm. Fluorescence maxima of progesterone and androstendione are 360 and 415 nm, respectively. The full width at half maximum varies from 15 to 32 nm. These results serve as a basis for the creating of a method of a simultaneous analysis of steroid hormones based on laser-induced fluorescence.

This research supported by the Russian Foundation of Basic Researchs. Grant N 00-02-17486.

Characteristics of bright squeezed light produced in a below-threshold optical

parametric oscillator (OPO)

E.G. Lariiontsev and I.I. Zolotoverkh

Nuclear Physics Institute, Moscow State University

Moscow 119899, Russia

E-mail: eg@nsf.phys.msu.ru

By running the OPO as an amplifier with an input seed wave, one can generate squeezed states with a nonzero coherent amplitude, the so-called bright squeezed states [1,2]. We perform the theoretical analysis of steady-state solutions and quantum noises in a below-threshold OPO operating as an amplifier with an input seed wave. Both the amplitude-squeezed and phase-squeezed states of the output field are considered. Unlike the preceding studies of noise reduction in the amplitude fluctuations of bright squeezed light [1], we take into account the nonlinear losses due to up-conversion of the subharmonic wave (SW) in the OPO's cavity and quantum fluctuations of the pump field. We analyze an effect of nonlinear losses of the SW wave on the steady-state solution and on the threshold of the OPO. The up-conversion affects the SW intensity and increases the threshold of parametric generation. We study the quantum noise behaviour of the OPO and show that, due to the nonlinear losses and quantum fluctuations of the pump field, noise reduction in the amplitude fluctuations of bright squeezed light becomes less than vacuum squeezing (squeezing for the vacuum state generated in the absence of the seed wave). We show that squeezing in the amplitude-squeezed state and in the phase-squeezed state is different. For the amplitude-squeezed state, squeezing strongly degrades with increasing the output intensity. On the contrary, one can obtain good squeezing for phase-squeezed beams of high output intensity.

1. Lam P. K., Ralph T. C., Buchler B. C., McClelland D. E., Bachor H. - A. and Gao J. 1999 *J. Opt. B Quantum Semiclass. Opt.* 1, 469

2. Schneider K., Lang M., Mlynek J and Schiller S. 1998 *Optics Express* 2, 59

RANDOM WALKING OF AN ATOM
IN A STANDING-WAVE FIELD
AND INTERACTION OF NONLINEAR RESONANCES

S.V.Prants and V.Yu.Sirotkin.
V.I.Ill'ichev Pacific Oceanological Institute
of the Russian Academy of Sciences,
Baltiyskaya St., 43, Vladivostok 690041, Russia

In the strong-coupling regime, we study dynamics of a two-level atom in a single-mode ideal Fabry-Perot cavity whose coherent standing-wave field couples its translational and electronic degrees of freedom. The model describes the well-known effect of oscillator-like and ballistic-like motion of the atom in the field and a new phenomenon of random walking inside a cavity. It should be stressed that the atom can move randomly in the process of *coherent energy exchange* between the atomic and the field degrees of freedom in the absence of any random fluctuations due to spontaneous emission or other factors breaking the coherence. The mechanism of the atomic random walking is found to be heteroclinic, and its properties are investigated in the rotating-wave and semiclassical approximations.

Working at the crossroad of cavity QED, atom optics, and classical chaos we find the interaction of nonlinear resonances in the fundamental atom-field system which may cause local instability of the center-of-mass motion in a one-dimensional spatially periodic potential and even random walking. These points are confirmed numerically by calculating chaotic trajectories (fig. 1a), Poincaré sections (fig. 1b), maximal Lyapunov exponents, heteroclinic structures and other fingerprints of classical chaos. The next step is to relate the quantum evolution of this system to the underlying classical dynamics and to answer the question: How does classical chaos manifest itself in the quantum dynamics of the atom?

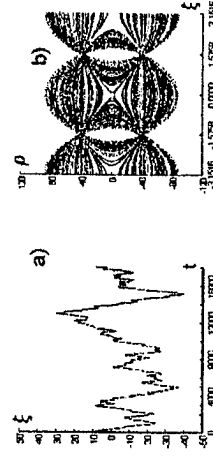

Figure 1: a) a typical chaotic trajectory of the atom, b) Poincaré section

ECHO-SPECTROSCOPY OF SQUEEZED VACUUM

A.M.Basharov, V.D.Popov
Moscow Engineering Physics Institute
Moscow 115409, Kashirskoye sh31, Russia. E-mail: bash@online.ru

The photon echo produced in gaseous medium by two resonant ultrashort light pulses is treated theoretically in the case of additional medium irradiation by nonresonant electromagnetic waves. We consider a weak squeezed wave as one of the nonresonant waves and a strong coherent wave as another. This choice allows us consider no Stark shifts in the field of squeezed wave. We derive master equation for the case of broadband squeezed field using the method of stochastic quantum equation. Then we analyze the relaxation of excited atom in such nonresonant fields. This relaxation is not exponential and it depends on the detuning between nonresonant waves, coherent field amplitude E_c, and on parameters of squeezed wave. We show how on can obtain experimentally the parameters of squeezed wave by investigating the relaxation of photon echoes on varying the time delay tau_12 between excited resonant pulses. The simplest expression of the echo intensity

I_e = I_0 exp{-4gamma^{(0)}tau_12 - 4gamma_{ho} |E_c|^2 [N_s + 1/2 - M_s cos(2(phi_d - phi_s))] } Tr_{12}

corresponds to the coincidence of the carrier frequencies nu and Omega_s of nonresonant waves, where phi_d - phi_s is a phase shift between nonresonant waves. The squeezed field is characterized by

<b_{omega_s} b_{omega_s}^*> = (N_s + 1)delta(omega_s - omega_s'), <b_{omega_s}^* b_{omega_s}> = N_s delta(omega_s - omega_s')
<b_{omega_s} b_{omega_s}> = M_s e^{-2i(alpha_s + phi_s)} delta(2Omega_s - omega_s - omega_s'), <b_{omega_s}^* b_{omega_s}^*> = M_s e^{2i(alpha_s + phi_s)} delta(2Omega_s - omega_s - omega_s')

where b_{omega_s} and b_{omega_s}^* are the annihilation and creation operators of quantum hbar*omega_s and the brackets denote the averaging over the initial states of squeezed field.

The photon echo in nonresonant squeezed field seems to be more simple than the one produced by resonant coherent and squeezed waves and allows to perform detailed analysis of squeezed field.

OPTICAL PATTERNS SUSTAINED BY QUANTUM NOISE

Roberta Zambriani^1, Stephen M. Barnett^2, Maxi San Miguel^1 and Pere Colet^1

^1 Instituto Mediterraneo de Estudios Avanzados, IMEDEA (CSIC-UIB),

Campus Universitat Illes Balears, E-07071 Palma de Mallorca, Spain.

^2 Department of Physics and Applied Physics, University of Strathclyde,

107 Rottenrow, Glasgow G4 0NG, Scotland, United Kingdom

Noise-sustained patterns have been predicted in several optical systems including cavities filled with Kerr media and Optical Parametric Oscillators [1]. In OPO's, due to birefringence, walk-off between pump and signal appears. This walk-off is responsible for the existence of convective regime, in which a transverse pattern arises as a macroscopic manifestation of amplified and spatially structured quantum noise. These noise-sustained structures are interesting candidates for the study of quantum correlations at a macroscopic level. However, standard methods to calculate quantum fluctuations are not helpful in this situation. Linearization schemes, usually invoked to use a positive-definite Wigner distribution, can not be applied since the reference state is unstable and fluctuations are amplified. P-positive representation is also not useful because of trajectories which diverge from the reference unstable state.

We propose to study quantum correlations in the convective regime of a degenerate type-I OPO using two approximation methods. A first proposal consists in a time dependent parametric approximation, in which the intracavity pump field is taken as a classical stochastic field A_0. In this way we have a quadratic Hamiltonian describing the quantum dynamics of the down-converted field. In the Wigner representation we obtain a stochastic equation for the c-number associated with the signal field, which is coupled to the equation defining the dynamics of A_0.

A second method consists in the use of the Q representation: due to non-linearity diffusion is not always positive, but in the range of parameters of the convective regime we find that fluctuations of the stable pump, for which positiveness of diffusion is not fulfilled, have a negligible probability to occur. So we consider Langevin equations in which these trajectories are disregarded.

Results obtained with both approximations are in good agreement. They reveal the importance of non-linearities in the fluctuations of the signal in the convective regime. The probability distributions are not Gaussian: in the figure we show the Wigner distribution function associated with the superposition of signal modes alpha_1(k) + alpha_1(-k).

We investigate the non-classical properties of radiation. We find that amplified fluctuations which occur in the convective regime destroy the effects of squeezing or sub-poissonian statistics, that are present without walk-off.

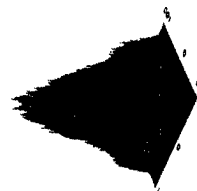

[1] M. Santagustina, P. Colet, M. San Miguel, and D.Walgraef, Phys. Rev. Lett. 79, 3633 (1997); Phys. Rev. E 58, 3843 (1998).

ATOM MOTION IN HELICAL DOUGHNUT BEAMS

M.E. J. Friese, J.A. Andersen, Z. Ficek and H. Rubinsztein-Dunlop

Department of physics, The University of Queensland, Brisbane Qld, 4072 Australia.

Laguerre-Gaussian (LG) beams of non-zero order have lately attracted interest in atom trapping and cooling research due to their unusual phase and intensity variation. These beams carry orbital angular momentum (OAM) proportional to l' , which can exert torque if the light is absorbed by matter². It is predicted that under some conditions the atoms will move in spiral trajectories about the optical axis of a LG beam³. Semi-classical theory predicts that an atom interacting with a plane EM wave propagating in the z direction is subjected, in the saturation limit, to a light pressure force proportional to the wave vector k_z . Any wavefront tilted with respect to the propagation direction might be expected to have associated with it a wave vector k_ϕ and an associated force in the ϕ direction.

Our experiments are aimed at observation of the reaction of cold atoms to the spiralling wavefronts of vortex beams by positioning the atoms in counter-propagating LG beams. The doughnut beam is produced using a diode laser beam and a computer-generated hologram⁴. By controlling the handedness of the helicity of two vortex beams in a counter-propagating arrangement, we can obtain either zero average OAM ($\langle L \rangle = 0$) or double OAM ($\langle L \rangle = 2\hbar$). We tune the LG beam 70 MHz to the red of the rubidium $F=3 \rightarrow F'=4$ transition, where atoms are weakly trapped in the LG beams due to dipole forces, yet we are still close enough to the transition to observe Doppler cooling/heating. If atoms absorb momentum in the ϕ direction, we expect to observe cooling for the $\langle L \rangle = 0$ case, and heating for the $\langle L \rangle = 2\hbar$ case. Our experiments show substantial heating when the LG beams' helicities act on the atoms in the same ϕ direction ($\langle L \rangle = 2\hbar$). For the zero average OAM case, we observe no heating and slight cooling. This effect can be attributed to transfer of OAM from light to the cold atoms.

¹ M. Padgett, L. Allen, *Contemporary Physics* 41: 275 (2000).

² He, M.E.J. Friese, N.R. Heckenberg, H. Rubinsztein-Dunlop, *Phys. Rev. Lett.* 75: 826 (1995)

³ M. Babiker and S. Al-Awfi, *Opt. Commun.* 168 145 (1999)

⁴ N.R. Heckenberg, R. McDuff, C.P. Smith, H. Rubinsztein-unlop and M.K. Wegener, *Opt. Quantum Elec.* 24 S951 (1992)

The Dipole Force Rectification in a Light Field Formed by Elliptically Polarized Waves

O.N.Prudnikov, A.V. Taichenachev, A.M.Tumaikin, V.I.Yudin

Novosibirsk State University, Novosibirsk 630090, Russia

In this paper we show that the rectification effect appears in monochromatic field even at zero magnetic field, when atoms with the degenerate ground state interacts with laser field formed by elliptically polarized waves. More specifically, we consider an 1D field configuration consisting of two counterpropagating plane waves with the same amplitude and ellipticity ε ($|\tan \varepsilon|$ is equal to the polarization axis ratio, and $\sin(2\varepsilon) > 0$ for the right circulation). The major semiaxes of ellipses make an angle θ . For this $\varepsilon - \theta - \varepsilon$ configuration the σ_{\pm} circular components are standing waves spatially shifted on the phase angle θ : $I_{\pm}(z) = |E_{\pm}(z)|^2 \propto \cos^2(kz \pm \theta/2)(1 \pm \sin(2\varepsilon))$. The difference between intensity of the σ_{\pm} components controlled by the ellipticity parameter ε is necessary for the rectification at equal detunings (monochromatic field and zero magnetic field).

The rectification mechanism here is similar to that considered previously in Refs. [1,2]. It is based on spatially inhomogeneous optical pumping and it requires the simultaneous presence of gradients of the intensity and the ellipticity.

When both the detuning and the Rabi frequency is much greater than the natural width γ , the averaged over spatial period force is proportional to the Rabi frequency $\langle F \rangle = \eta \hbar k \Omega$. The optimal magnitude of the field parameters and the maximal "rectification coefficient" η are calculated for various optical transitions. This work is partly supported by RFBR (projects 01-02-17744 and 01-02-17036) and by grant of Russian Ministry of Education.

1. J. Javanainen, *Phys. Rev. Lett.* 64, 519-522 (1990).

2. A. I. Sidorov, R. Grimm, V. S. Letokhov, *J. Phys. B* 24, 3733-3740 (1991).

Novosibirsk State University, Novosibirsk 630090, Russia

Considering transformations of generalized optical Bloch equations for atomic density matrix $\hat{\sigma}$ under the inversion of coordinate frame, we find a specific symmetry, which was not explicitly discussed previously. For the steady-state density matrix of atoms in a monochromatic laser field of arbitrary configuration $\mathbf{E}(\mathbf{r})$ it can be written as

$$\hat{\sigma}(\mathbf{r}, \mathbf{v}, \delta, \gamma, \mathbf{E}(\mathbf{r})) = \hat{\sigma}(\mathbf{r}, -\mathbf{v}, -\delta, -\gamma, \mathbf{E}(\mathbf{r})), \quad (1)$$

where δ is the detuning, γ is the spontaneous decay rate, the transformed density matrix $\hat{\sigma}_{\mu_e \mu_b}^{(ab)} = P_e P_b \hat{\sigma}_{\mu_e \mu_b}^{(ab)}$, P_e and P_b are the parity of levels, and μ denotes the Zeeman sublevels. As an application we consider consequences of the symmetry (1) for the resonant radiation pressure force. Combinations of the symmetry (1) with the time-reversal symmetry and the symmetry with respect to spatial reflections and rotations allows us to formulate relationships limiting a possible dependence of the light force on the atomic velocity \mathbf{v} and the field parameters. It is shown that four symmetric classes of 1D light field configurations can be distinguished with respect to these relations. Among them two classes are formed by counterpropagating elliptically polarized waves of equal intensity. The polarization ellipses have the same shape, but they oriented along different axes. When the instant electric field vector rotates for both waves in the same or opposite directions, we have co- or counter-rotating classes, respectively. For both classes the symmetry relations substantially differ from usual ones. For example, in the counter-rotating case they read

$$\langle F \rangle(\mathbf{v}, \delta, \gamma) = \langle F \rangle(\mathbf{v}, -\delta, -\gamma); \quad \langle F \rangle(\mathbf{v}, \delta, \gamma) = -\langle F \rangle(-\mathbf{v}, \delta, \gamma),$$

where angle brackets denote spatial averaging. Thus, the friction force can acquire the even dependence on the detuning.

This work is supported by grant of Russian Ministry of Education.

CONTROLLING KAPITZA-DIRAC EFFECT WITH INTERFERENCE

A.M. Ishkhanyan

Engineering Center, Armenian National Academy of Sciences, Asharak-2, 378410 Armenia
 Tel: (374-3) 236373 Fax: (374-1) 151251 E-mail: artur@ec.sci.am

Most of the theory of atomic scattering by standing waves has so far focused on the dynamics of initially pure coherent states or incoherent mixtures rather than coherent superposition states [1]. However, the recently developed theory of anomalous scattering of atoms in the strong field of counterpropagating light pulses has established that the character of the diffraction by a standing wave dramatically depends on the particular form of the initial wave packet of the atom. For instance, it was shown that the diffraction pattern may be strongly asymmetric and oscillatory (depending on the detuning of the field frequency). The demonstration of these peculiarities beg the question as to how strongly one may control the diffraction pattern by means of the initial state preparation. The key component of the anomalous scattering is the secondary quantum-mechanical interference that is induced by an initial splitting of the atomic wave packet in the momentum space prior to the scattering. Physical situations requiring consideration of such initial conditions involving several initial momentum peaks arise, for instance, in the scattering problems when the atoms have already experienced a preliminary action of another wave. The first interaction, in general, splits the initial wave packet into several diffraction peaks separated in the momentum space by multiples of the photon momentum. During the second scattering, the peaks of this wave packet then decay and give rise to separate sets of peaks that interfere.

In the anomalous scattering theory, the interference is assumed to be between ground state atoms and excited atoms whose momenta differ by one (odd) photon momentum. This corresponds to the initial conditions when different translation states correspond to different internal states. However, one may imagine a number of physical situations where the same internal state involves a set of different translation states. The very usual scattering by a standing wave is an example of such situation.

In the present paper, we consider general initial conditions when different maxima of the atomic momentum density may correspond to the same internal state. First we outline the qualitative model of the asymmetric scattering for both resonant and adiabatic limits. Then we consider the diffraction of an effective two-state system in the field of a standing wave provided the initial state of the atom involves more than one translation states belonging to the same, ground or excited, internal state whose momenta differ by even number of photon momenta. We show that this type of the splitting prior to the standing wave interaction leads to an essential narrowing of the interference fringes of the diffraction pattern. We analyze specific initial splitting types leading to the narrowing of higher orders. We show that sufficiently high order narrowing can be achieved using binomial wave packets that are well approximated by familiar Gaussian wave packets [2]. Further, we introduce an exact solvable model of the three-state problem and show that the wave-packet splitting in this system using stimulated Raman adiabatic passage leads to the narrowing of high non-integer order [3]. Since these effects help to overcome the broad spreading of the atomic beam over a large number of diffraction orders (the diffraction decay of the atomic wave packet) occurring during the standard standing wave scattering, we hope that they will be useful for development of new schemes of atom interferometry using coherent standing-wave diffraction. For instance, we propose and analyze an atomic beam splitting technique (with controllable splitting angle determined by the interaction time with the standing wave) using preparation of atoms by STIRAP. Further, we show that the narrowing can be combined with the asymmetric scattering causing a deflection of the atomic beam as a whole. We demonstrate that it is possible to construct a superposition of considered specific initial states resulting in a final probability distribution with arbitrary given envelope.

References:

- [1] A.P. Kazantsev, G.I. Surdutovich, and V.P. Yakovlev, Mechanical Action of Light on Atoms, World Scientific, Singapore (1990); V.G. Minogin and V.S. Letokhov, Pressure of Laser Radiation on Atoms, Nauka, Moscow (1986).
- [2] A.M. Ishkhanyan, Phys. Rev. A 61, 063609 (2000).
- [3] A.M. Ishkhanyan, Phys. Rev. A 61, 063611(2000).

PERTURBATION OF NON-GROUND STATIONARY STATES IN ATOMIC BOSE-EINSTEIN CONDENSATE

V.V.Serov, V.L.Derbov,
 Department of Physics, Saratov State University, 83, Astrakhanskaya st., Saratov,
 410026, Russia; e-mail: derbov@sgu.ssu.runnet.ru
 S.I.Vinitzky, V.I.Yukalov
 Laboratory of Theoretical Physics, Joint Institute for Nuclear Research, Dubna,
 Moscow Region, 141980, Russia

We report the new properties of Bose-Einstein condensate of atoms in a harmonic trap. In the mean-field and s-scattering approximations it is described by the Gross-Pitaevskii (GP) equation $i\frac{\partial\Psi}{\partial t} = \hat{H}_0\Psi + g|\Psi|^2\Psi$. The stationary states Ψ_i of this system satisfy the

stationary GP equation $\mu_i\Psi_i = \hat{H}_0\Psi_i + g|\Psi_i|^2\Psi_i$, where μ_i is the corresponding chemical potential. For a weakly perturbed stationary state $\Psi(t) = e^{-i\mu_i t}(\Psi_i + u e^{-i\omega t} + v^* e^{i\omega t})$, corresponding to the small oscillations of the order parameter around the stationary-state value, the linearized GP equation is reduced to the coupled equations

$$\begin{aligned} (\hat{H}_0 - \mu_i + 2g|\Psi_i|^2)u + g|\Psi_i|^2 v &= \omega u; \\ (\hat{H}_0 - \mu_i + 2g|\Psi_i|^2)v + g|\Psi_i|^2 u &= -\omega v. \end{aligned}$$

The properties of the ground state and the corresponding set of eigenstates (u, v) are well known, namely, u and v possess the same number of nodes and v is of the order of g . We investigated the set (u, v) for non-ground stationary states that were not studied before. These states are shown to possess new and unexpected features, namely, the pair coupling of modes having different number of nodes. The energies of the states found are shown to lie both higher and lower than that of the unperturbed state. These states were analyzed by means of the first-order perturbation theory at small g and by means of numerical modeling at large g . An example of such state in a cylindrical trap with

$$\hat{H}_0 = -\frac{1}{2\rho} \frac{\partial}{\partial\rho} \rho \frac{\partial}{\partial\rho} - \frac{1}{2\rho^2} \frac{\partial^2}{\partial\phi^2} + \frac{\omega_{p,exp}^2}{2}$$

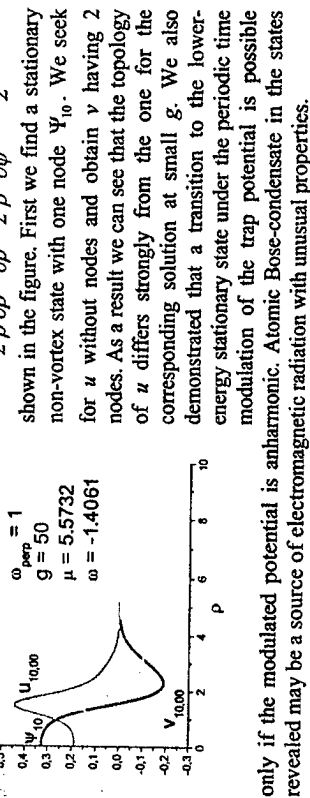

only if the modulated potential is anharmonic. Atomic Bose-condensate in the states revealed may be a source of electromagnetic radiation with unusual properties.

Bose-Einstein Condensation in Low-Dimensional Structures in A Non-Dissipative Optical Lattice.

A.V. Taichenachev, A.M. Tumaikin and V.I.Yudin
 Novosibirsk State University, Novosibirsk 630090, Russia

In this paper we propose schemes for the formation of low-dimensional optical lattices, where resolved sideband Raman cooling [1] allows one to freeze out the vibrational degrees of freedom. Then we consider manifestations of the Bose statistics of atoms in such non-dissipative lattices. It is shown that in the tight binding regime, when tunneling for lower vibrational levels is negligible, low-dimensional structures are formed. Each of them consists of particles moving near the bottom of a single potential well. These structures are thermodynamical and mechanically independent systems. On the base of thermodynamical consideration in the framework of the ideal Bose-gas model we show that BEC in such structures appear at temperatures and densities that typical for current laser cooling experiments. The phase of condensate in localization domains is changed randomly from one domain to another. Thus, if the whole lattice volume is considered, the above described process should be considered as the quasicondensation.

For example, if we consider an 1D lattice, then cold atoms are localized in parallel planes, which are thermodynamically independent 2D system. Let in one concrete plane we have N atoms. Then, using the corresponding formula form [2], we obtain for the transition temperature T_c in

additional isotropic harmonical potential the following estimate: $N = 1.65 \left(\frac{k_B T_c}{\hbar f} \right)^2$, where f is the oscillation frequency in this potential. Taking $n \sim 10^{11} - 10^{12} \text{ cm}^{-3}$ in the cubic volume $L^3 \sim 10^3 \text{ cm}^3$ and the lattice period $a = 10^4 \text{ cm}$, we obtain $N \sim 10^5 - 10^6$. For magnetic traps the typical frequency

$f \sim 2\pi \cdot 10^3 \text{ c}^{-1}$. For these numbers $T_c \sim 10^5 \text{ K}$, that two orders higher than the critical temperature in magnetic traps [3].

1. S. Hanman, et al, Phys. Rev. Lett. **80**, 4149 (1998).
2. V. Bagnato and D. Kleppner, Phys. Rev. A **44**, 7439 (1991).
3. M. Anderson et al, Science **269**, 198 (1995); K. B. Davis et al., Phys. Rev. Lett. **75**, 1687 (1995).

A Multiparticle Quantum Channel for Teleportation and Dense Coding

V.N. Gorbachev, A.I.Zhiliba*, A.I. Trubilko

Department of Physics, University of Sankt-Petersburg, vn@VG9025.spb.edu
Department of Physics, Tver State University, p000962@tversu.ru,*
tan@ut3024.spb.edu

Now a large number of quantum communications are based on the teleportation and dense coding protocols, proposed by Bennett et al [1]. Several optical experiments have demonstrated its reality [2] and a lot of schemes have been suggested for which the main resource is the Einstein-Podolsky-Rosen pair, called also the EPR channel.

If the EPR channel is used, there is a one-to-one correspondence between all dense coding and teleportation schemes as it has been found by Werner [3] for tight schemes. A scheme is tight, if the Bell-state measurement, a collection of unitary operators and a von-Neuman projection observable is included along with 4 distinguishable classical signals in the qubit case. It results in the important fact, if one can teleport a quantum state, then no additional resource is needed for dense coding and vice versa.

In this work we consider a multiparticle quantum channel, modeled by a N -particle entangled state, say N -cat state. When $N/2$ the features of the channel become complicated and both the teleportation and the dense coding schemes are not tight. If $N=3$, it reduces to the Greenberger-Horne-Zeilinger (GHZ) channel represented by the GHZ triplet. It has been established that any quantum state can't be teleported perfectly using the GHZ channel, however the task can be accomplished for a two-particle entangled state to be transmitted, if the non Bell-state measurement of three particles is performed cited. Indeed the N quantum particle channel allows not only transmitting information but distributing it, that is cloning or telecloning. For $N=3$ telecloning has been discussed in ref. [5].

The set of questions we study is the following. First, what is the dense coding schemes for the multiparticle quantum channel and how much is an enhancement of the classical capacity of the channel? What are main resources for dense coding and teleportation and is there any correspondence between both schemes, if $N/2$? Considering the N -particle quantum, we find the protocols for dense coding and teleportation for discrete variables in the qubit case. For dense coding the enhancement of the classical capacity is found to be $N/N-1$. If $N/2$ there is no one-to-one correspondence between dense coding and teleportation schemes. When together with the main resource two additional operation like entangling and disentangling are permitted one finds a set of the modified schemes. The main modifications can be reduced to preparing of quantum channel and observable. If before measuring some of particles are disentangled it allows the non Bell-state measurement to look more simple, but the cost of the modification is some additional transformations.

NOISE-FREE QUANTUM NONDEMOLITION MEASUREMENTS OF OPTICAL SOLITONS

D.A. Ivanov

Russian Center of Laser Physics, St. Petersburg State University,
 1 Ulianovskaya street, Petrodvoretz, St. Petersburg, 198904, Russia

V.V. Kozlov

Abteilung für Quantenphysik, Universität Ulm, Ulm D-89081, Germany

SUMMARY

Quantum Nondemolition (QND) way [1] of measuring photon number and/or momentum (carrier frequency) of optical solitons is promising concept for future ultrafast technologies [2]. By measuring phase or position of a (meter) soliton one can gain information about photon number and momentum of the other (signal) soliton. By colliding the signal and the meter solitons in an optical fiber, the QND measurement of the signal photon number has been realized experimentally, [3]. However, there are obstacles on the way of extracting information about the signal by measuring the meter soliton. The problem is that after propagating through a nonlinear fiber, the meter picks up an undesirable phase noise as a result of self-phase modulation. Here, we present a recipe for arranging a homodyne setup for noise-free measurements of the meter soliton. For subtracting the self-phase modulation noise, one should not detect the phase directly, but rather measure a specific quadrature of the incoming light. This can be achieved by choosing an appropriate form of the Local Oscillator shape. Our proposal allows us to measure a signal soliton in any unknown quantum state. It is the main advantage of the proposed strategy when compared to the previous proposals [4].

[1] V.B. Braginsky and F.Ya. Khalili, Quantum measurement, Cambridge University Press, 1992.

[2] H.A. Haus, K. Watanabe, and Y. Yamamoto, *J. Opt. Soc. Am. B* 6, 1138 (1989).

[3] S.R. Friberg, S. Machida, and Y. Yamamoto, *Phys. Rev. Lett.* 69, 3165 (1992);

S.R. Friberg, T. Mukai, and S. Machida, *Phys. Rev. Lett.* 84, 59 (2000).

[4] P.D. Drummond, J. Breslin, R.M. Shelby, *Phys. Rev. Lett.* 73, 2837(1994).

THEORETICAL STUDY OF ATOMS DYNAMICS IN OPTICAL DIPOLE TRAP

D. N. Yanyshev, B. A. Grishanin, and V. N. Zadkov

Physics Faculty and International Laser Center, M.V.Lomonosov Moscow State University

Phone: 7-095-9395173; FAX: 7-095-9393113; E-mail: yanyshev@comsint1.phys.msu.su

Summary

Cold collisions between atoms in an optical dipole trap are thought to be one of the key mechanisms for atomic losses from the trap. As it has been recently shown experimentally [1] this mechanism could result to a tendency for atoms escape in pairs. At the same time, another fundamental mechanism, long-distant resonant dipole-dipole interactions (long-distance RDDI), also results in correlations between interacting atoms and therefore to the same tendency for atoms escape in pairs. In this paper, we discuss this second mechanism.

In our model, we consider dynamics of atoms in a red-detuned optical dipole trap [2]. To clarify a role of long-distance RDDI correlations we shine the atoms additionally by a probe (weak) resonant laser field. This additional field enhances significantly interactions between atoms via jointly emitted photons and reveals in increasing of correlations of stochastic radiation forces acting on atoms. For simulation of atomic dynamics we use quasiclassical approximation for the emission radiation force.

In computer simulation, we analyze the atomic dynamics in the trap and the corresponding atomic losses by varying the frequency detuning of the probe laser field and its intensity.

References

1. B. Ueberholz, S. Kuhr, D. Frese, D. Meschede, and V. Gomer, "Counting Cold Collisions", *Lant e-print quant-ph/9910120 v2* 8 Dec 1999.
2. R. Grimm, M. Weidemuller, Y. B. Ovchinnikov, "Optical dipole traps for neutral atoms", *Adv. Atom. Mol. and Opt. Phys.* **42**, 95 (2000).

CONDITIONED ATOMIC STATE AND QUANTUM INTERFERENCE IN RESONANCE FLUORESCENCE WITH SPECTRAL RESOLUTION

V. N. Shatokhin and S. Ya. Kilin

B. I. Stepanov Institute of Physics of NAS of Belarus, Fr. Skaryna Ave. 70, 220072

Minsk, Belarus

Determination of the conditioned atomic state following a detection of a spectrally filtered photon in resonance fluorescence (RF) represents an important issue of the quantum measurement theory. It is so because the atomic state is measured by means of monitoring scattered photons whose emission times are indefinite in the case of a narrowband detection, due to the energy-time uncertainty relation.

Recently, we have proposed [1] to use the joint correlation function of the filtered and unfiltered photons to obtain the general expression for the conditioned state. Detection of both passed through and reflected from the interference (Fabry-Perot) filter photons has been described in terms of the generalized quantum measurement theory [2]. Here we have derived expressions for the measurement operators corresponding to a detection of passed and reflected photons which completely characterize properties of the conditioned atomic state. We discuss these properties which have been studied in the limit of well-separated spectral lines of RF spectrum. In this limit, photons emitted by the atom arise from spontaneous transitions between the dressed atomic states. Tuning the filter to a particular region of the RF spectrum allows one to detect photons arisen mainly from one given transition, or to detect photons which might have resulted from either of the transitions. The latter case is common for a manifestation of quantum interference. In measuring the passing photons, quantum interference manifests itself in the atomic inversion for the filter tuned in between the central line and any of the sidebands. As for the reflected photons, quantum interference between the dressed states plays a role when the filter is tuned to separate peaks. We show how to observe the properties of the conditioned state.

[1] V. N. Shatokhin and S. Ya. Kilin, *Opt. Commun.* **174**, 157 (2000).

[2] V. N. Shatokhin and S. Ya. Kilin, *Phys. Rev. A* **63**, 023803 (2001); *Opt. Spectrosc.* (in press)

NONCLASSICAL STATES OF ONE-ATOM LASER

T.B.Karlovich and S.Ya.Kilin,

*B.I.Stepanov Institute of Physics, National Academy of Science, F.Skaryna Ave. 68,
220072 Minsk, Belarus.*

Tel.: 375 17 2841061, fax: 375 17 2840879, e-mail: karlov@dragon.bas-net.by

The model of one-atom laser is considered on the basis of Jaynes-Cummings model including incoherent pump, damping of cavity mode and spontaneous emission of two-level atom to noncavity modes. We obtain the analytical solutions for the P-distribution function of intracavity field and for the atom-field density matrix in the case of strong atom-field interaction. Under the condition $g \gg A, R_{12}, R_{21}$, where g is coupling constant, $A/2$ is cavity mode damping, R_{12} is spontaneous emission rate, R_{21} is intensity of the incoherent pump, the P-function is bounded by the range $|\alpha|^2 \in [0, 2R_{21}/A]$. This peculiarity of the P-distribution is connected with the nonclassical effects such as generation without inversion [1], subpoissonian statistics of light [2] and entanglement between the atomic and field states [3].

We obtain, that in the lasing regime the generation without inversion takes place at the range $A \leq R_{12} \leq 3A$.

We calculate the Fano-factor for the system both numerically and analytically and found that the subpoissonian statistics of light occurs when the spontaneous emission rate less than the cavity mode damping. The maximum of squeezing is achieved under the condition $R_{21} = A$.

It is shown, that the model of one-atom laser can be reduced to the model of the interacting two-level atom and deformed oscillator with two eigenstates. This allows us to calculate the entanglement between atomic and field states as the entanglement for a pair of spin-1/2 particles [3] in the case of small intensity of the incoherent pump.

[1] O.A.Kocharovskaya, Ya.I.Khanin, Pisma JETP, 1988, V.48, P.581.

[2] A.V.Kozlovskii, A.N.Oraevskii, JETP, 1999, V.115, P.1210.

[3] W.K.Wooters, Phys.Rev.Lett., 1998, V.80, P.2245.

QUANTUM COMPUTING WITH NONCLASSICAL POLARIZATION
STATES OF LIGHT

A.Yu.Leksin, A.V.Prokhorov, A.P.Alodjants, S.M.Arakeljan

Department of Physics and Applied Mathematics,

Vladimir State University, Gorky str., 87 Vladimir, 600000, Russia

Tel.: +7(0922) 279947, 233334

e-mail: laser@vpti.vladimir.su

SUMMARY

In our paper we propose the formation of entangled polarization state superposition ("Schrödinger cat like state") in optical nonlinear interferometers. Indeed we consider two cases for which these interferometers contains special optical fiber systems and cooled atomic gases (Bose-Einstein condensate). Quantum interference of such a states leads to principal new physical effects and nonclassical behaviour of the distribution functions for Hermitian quadratures of light, number of photons and/or of the Wigner quasi-distribution functions. The macroscopic entangled quantum states of light can be used in the high spatial resolution devices for the first time. We discuss the fundamental problem of realization of quantum computations and quantum logical gates using continuous variables of atomic and optical systems. In the work we have shown how the quantum logical XOR-operation and data swapping procedure can be realized in spatially inhomogeneous physical systems that are described by the special type quantum optical Hamiltonian. In this case we take into account several principal linear and nonlinear processes, which can take place in such systems – two-core and four-core optical fibers, nonlinear lattices, liquid and photonic crystals. We have shown that the processes of cross-interaction between optical modes plays the key role, while the self-interaction and phase cross-modulation leads only to the phase shifts in the result states at the output of logical elements and can be practically suppressed.

Dark state resonances in Sm vapour in the presence of velocity changing collisions

A.V. Akimov,¹ N.N. Kolachevsky,¹ V.N. Sorokin,¹ N.A. Kiselev,¹ and S.I. Kanorsky^{1,2}

¹ P.N. Lebedev Physics Institute, Russian Academy of Sciences

Leningrad prosp. 53, Moscow 117924, Russia

² Max-Planck Institute fuer Quantenoptik

Hans-Kopfermann str.-1, Garching, Germany

Recent experiments [1] revealed the important role played by the buffer gas in the formation of a dark state resonance in an atomic system. The collisions with buffer gas significantly change spectra of dark state resonances. The decrease of the time-of-flight broadening allowed to observe extremely narrow resonances in Cs vapor [2]. The effect of buffer gas strongly depends on the atomic system involved. The splitting of hyperfine ground-state components used as lower levels of a Λ -system in alkali atom is practically insensitive to the collisions and the coherence of these levels is practically not disturbed during the collision. In rare-earth atoms the characteristic splitting of the fine-structure ground state components have considerably larger splitting (10-100 THz), so one can expect much larger Q-factor of dark resonances in the rare-earth atoms. These levels are shielded by the outer closed $6s^2$ shell [3], and it was shown [4] that the total relaxation cross-section of the fine-structure components is smaller than the hard-sphere cross section. The method of bichromatic velocity selective optical pumping (VSOP) gives an excellent opportunity to measure simultaneously the cross-sections of velocity changing collisions (VCC) and the profile of dark resonance. In this contribution we represent the experimental results of VSOP in ^{154}Sm atom.

A Samarium atom with a precisely known level structure [5] was taken for our experiments. In Sm the first metastable level $4f^6 6s^2(7F_1)$ is separated from the ground state $4f^6 6s^2(7F_0)$ by 8.79 THz. We chose these two levels as the lower levels of Λ -system while the upper level was $4f^6(7F) 6s6p(^3P^o_1)$ $^3F^o_1$. Two diode lasers (672 nm, 686 nm) were tuned to the corresponding transitions in ^{154}Sm . The velocity selective optical pumping and coherent population trapping effects were studied in co-propagating beams configuration with the lasers locked to the stable interferometer. The VCC cross section for samarium atom was determined. Hard sphere collisions model gave an appropriate results in frames of our experiment configuration apart from commonly used Keilson-Storer model.

Acknowledgments. The work is supported by Volkswagen Stiftung I/73 647 and the Program of the Russian Ministry of Science "Physics of quantum and wave processes".

References

- [1] E. Arimondo, *Coherent population trapping in laser spectroscopy*, Progress in Optics, edited by E. Wolf (Elsevier, Amsterdam), 35, 257 (1996).
- [2] R. Wynands, A. Nagel, Appl. Phys. B, 68, 1 (1999).
- [3] E. B. Aleksandrov, V. N. Kofyev, V. N. Kulyasov, and K. P. Vasilevski, Opt. Spektrosk. 54, 3 (1983) [Opt. Spectrosc. 54, 1 (1983)].
- [4] E. Buhr et al *Phys.Rev.A* 34(3) 34 (1986).
- [5] N. N. Kolachevsky et al., Sov. J. Quant. Electron. 31(1), 61, 2000.

COOPERATIVE RAMAN-TYPE TRANSITIONS IN THE SYSTEM OF TWO FOUR-LEVEL ATOMS: ENTANGLEMENT IN THE SPIN SUBSYSTEM OF TWO SPATIALLY RESOLVED ATOMIC ENSEMBLES

D. V. Kupriyanov, A. V. Slavgorodskii, and I. M. Sokolov
*Department of Theoretical Physics, State-Technical University, 195251,
 St.-Petersburg*

In the paper we have considered the optical coupling of two four level atoms via the cooperative Raman scattering of the correlated photons of the non-degenerate spontaneous parametric radiation. The Raman scattering of twin photons incident on the atoms is additionally stimulated by coherent classical radiation in such a way, that it is slightly off-resonant for each atom considered independently but resonant for joint system. There have been discussed the special excitation conditions when the amplitude of the cooperative stimulated Raman scattering from quantum to classical modes becomes greater than the normal transition rates associated with independent Raman scattering. In certain conditions the weak entanglement between the Zeeman sublevels in the ground states of these atoms can appear. The small admixture of entanglement in the system of two atoms leads to the strong entanglement between transverse macroscopic spin fluctuations of two spatially resolved atomic ensembles coupled by such quantum light. The proposed mechanism of entanglement is relevant to the ground state spin subsystem of two distant macroscopic and optically thin atomic ensembles. Such an entangled state can be stored for long time and used as a basic EPR system in different applications pursuing the goal to spread the quantum information schemes on atomic subsystems.

BISTABILITY OF ACOUSTOOPTIC INTERACTION IN GYROTROPIC CRYSTALS WITH ELECTROINDUCED ANISOTROPY

Kurikina S.N., Shuba M.V.
 Gomel State University, ul. Sovetskaya, 104; 246699 Gomel, Belarus
 E-mail: Shuba@gsm.unibel.by, Fax: (0232)57-65-57

Last years effects of optical bistability in different nonlinear systems are investigated intensively. This is caused by possibility of their utilization for creation of bistable optical elements. It has been theoretically studied the bistable regimes of acoustooptic interaction in high-symmetrical crystals in the presence of optoelectronic feedback. Many crystals, using by this and having high acoustooptic and electrooptic effectiveness, are gyrotropic. But this is ignored by theoretical consideration of effects of bistability.

In the present report we proposed the scheme permitting to realize the bistable mode of acoustooptic coupling in different ways: by changing the wave detuning (the detuning bistability); by changing intensity of the incident electromagnetic radiation (optical bistability); by changing ultrasonic wave power (electrical bistability). Configuration for realization of bistable regimes consists of acoustoelectrooptic crystal, where acoustooptical interaction takes place, and the feedback leading to existence of nonlinearity and including beam splitter for diffracted light with energy reflection coefficient $R \approx 1$, fast-response high-sensitive photodetector, operational amplifier whose output voltage is applied to metallic electrodes and produces in the crystals the electric field strength. We estimated that the speed of switching is achieved to $10^{-8} - 10^{-9}$ sec. It has been obtained that existence of gyrotropy leads to essential change of conditions for bistable mode realization: two, rather than one, regions of values of the parameter (all other conditions being the same) appear within which the bistability mode is achieved. As the incident light intensity increases, the ranges of bistability narrows and shifts. In this case, smaller sound power is needed to realize transition to the upper branch.

The relationships and the results of computer simulation with feedback, obtained in this paper, can be useful in design, development and optimization of parameters of the high-speed multi-purpose bistable elements.

THE INFLUENCE OF A LONGITUDINAL MAGNETIC FIELD ON THE BEHAVIOR OF THE SPECKLE-PATTERN OF THE LIGHT, TRANSMITTED THROUGH OPTICAL FIBER

V.V. Anikeyev, M.V. Bolshakov, N.D. Kundikova, A.I. Valeyev, V.S. Zinatulin.

Joint Laboratory of Nonlinear Optics, Institute of Electrophysics of Urals Branch of RAS and South Urals State University
Lenin Av. 76, Chelyabinsk, 454080, Russia

It is well known, that a magnetic field H applied to the transparent medium influences velocity of the right and left circular polarized light. As a result, Faraday effect can be observed.. It was shown that longitudinal magnetic field can lead to some kind of speckle-pattern rotation of the light transmitted through optical fiber with step-like refractive index profile. According to [1] the angle φ of speckle-pattern rotation is $\varphi \sim VHL$. Here V is the Verdet constant, H is module of magnetic field and L is the length of a fiber. That rotation was experimentally observed [2]. Here we present the results of the investigation of this effect in detail, namely, dependence of speckle-pattern angle rotation on the magnetic field magnitude.

The beam of He-Ne laser with a wavelength $\lambda = 0.63 \mu\text{m}$ was transmitted through a few mode optical fiber with step-like refractive index profile. The standard telecommunication fiber with a core from a germanium-silicate glass was used. The fiber was placed at the axis of a coil with a magnetic field. Speckle patterns were recorded by means of CCD-matrix. Special software for determination of the speckle pattern angle rotation was developed. The dependence of speckle pattern angle rotation on the strength of applied magnetic field is shown at the picture. There is good coincidence with theoretical estimation..

This work performed under support of ISTC, grant #1026.

[1] N.B. Baranova, B. Ya. Zel'dovich. *JETP Lett.* **59**, 681 (1994).

[2] M. Ya. Darsht, I.V. Zhirgalova, B. Ya. Zel'dovich, N.D. Kundikova. *JETP Lett.* **59**, 763 (1994)

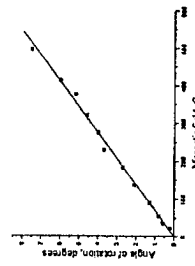

OPTICAL LOGIC ELEMENTS ON THE BASE OF FIBRE BRAGG REFLECTORS

Pilipovich V.A., Esman A.K., Goncharenko I.A., Kuleshov V.K.

Institute of Electronics, National Academy of Sciences of Belarus.
22 Logoisky Trakt, Minsk 220090, Belarus
Tel. +375 17 2839121, Fax +375 17 2652541, E-mail: lomoi@inel.bas-net.by

Summary

In the report the basic parameters (signal-to-noise ratio, switching energy, operation time) of a complex fibre Fabry-Perrot resonator are estimated. Such a resonator is formed by the length of amplifying erbium/ytterbium doped fibre and combination of three reflectors. Two reflectors are Bragg gratings written in the fibre core, the third one is an end mirror. Transmission properties of such complex fibre resonator depend on the level of pump power.

In depend on the schedule this device can perform three input logic operation "AND" or logic operation "NO", i.e. produce the complete set of logical functions. These logic elements operates on switching between modes of the complex resonator. For this the optical pump signals are supplied on one or two inputs of the device and the signal radiation on the wavelength from the erbium amplification spectra is supplied on the third input. The frequency properties of the logic elements are determined by the time of the light travel in complex resonator. With the total length of the resonator in 6.6 cm the operation time is about 300 ps.

If we use the fibre erbium amplifier with the amplification curve slope 11 dB/mW, the calculated switching energy is equal to $0,15 \cdot 10^{-12}$ J for pump inputs and is substantially less for information signal input. For this the average optical power losses on radiation and dissipation of the logic element in closed conditions are ≤ 1 mW and the one in open conditions are $\ll 1$ mW.

Considered optical logic elements can be used for preliminary information processing in fibre interconnections between chips or blocks of computing systems.

ACCELERATION OF ARITHMETIC OPERATION PERFORMING BY THE USE OF SPECTRAL COMPRESSION

Pilipovich V.A., Esman A.K., Posedko V.S., Kuleshov V.K., Goncharenko I.A.
*Institute of Electronics, National Academy of Sciences of Belarus,
 22 Logoisky Trakt, Minsk 220090, Belarus*
Tel. +375 17 2839121, Fax +375 17 2652541, E-mail: lomoi@inel.bas-net.by

Summary

We present the architecture of parallel optoelectronics adder that permits simultaneous performing various arithmetic operations under optical data arrays and is not limited by a digit capacity.

The algorithmic and schematic approaches for parallel perform of logic and arithmetic operations with optical digital data arrays is considered. The spectral compression correspondingly optical inputs for various operands x_i and y_i , propagating in fibre or spatial channels is used for acceleration of operation performing. Functional scheme of one digit of optoelectronics adder is presented. This scheme is designed on the base of various thin-film photoresistors with maximal spectral sensitivity on the wavelengths $\lambda_1 = 660$ nm and $\lambda_2 = 565$ nm and LEDs emitting on the same wavelengths. We developed the functional scheme of optoelectronics adder on the element base mentioned above with optronic bistable pairs: photodetector-emitter which are all-galvanic isolated correspondingly input/output. The truth table of functioning of optoelectronics adder is presented. Algorithmic acceleration of adder operating is achieved by the use of thinning coding in binary sign-bit computation system. For the one cycle of adder functioning the n simplest arithmetic operations under the $2n$ -digit operands can be performed.

The use of broadband elements (photodetector-semiconductor laser) makes it possible in the frame of proposed structural approach to organize the processing of matrix arrays of optical data in a wide frequency region.

MAXIMUM ACHIEVABLE EFFICIENCIES FOR PULSE POSITION MODULATION IN OPTICAL COMMUNICATION SYSTEMS

Khodasevich M.A., Simitsyn G.V., Yasukevich A.S.
 Division for Optical Problems in Information Technologies, NAS of Belarus
 Kuprevich str., 1, bl.2, 220141, Minsk, Republic of Belarus

Various kinds of pulse position modulation are used usually in optical systems that need the high power efficiency of the information transmission. Three of them — ordinary pulse position modulation (PPM), multi-pulse one (MPPM) and overlapping pulse one (OPPM) are wide-spread. In the present work the limiting characteristics of communication systems with such kinds of modulation are considered within the framework of the number-state model for narrow-band bosonic communication channel [1].

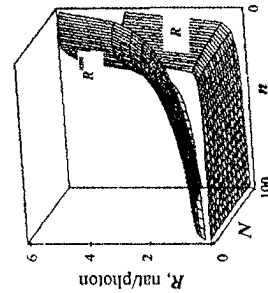

It is shown, that the limiting efficiency in optical systems with ordinary PPM is determined by the ratio of the number of photons in the signal slot to the number of slots in the signal block. The comparison of the efficiencies of PPM and MPPM shows, that the limiting power efficiency of MPPM without additional coding and with optimum amount of signal pulses in the signal block exceeds that of PPM when the length of the block is greater than one half of photon number in a single pulse. The comparison of maximum achievable efficiencies of the considered methods is carried out too.

There is no doubt that OPPM is the most favorable one for communication channels. Furthermore it is shown that the application of additional encoding to OPPM allows to achieve the highest power efficiency of information transmission in optical communication systems (see Figure).

I. Lebedev D.S., Levitin L.B. *Inf. Control.*, 9, 1 (1966).

OPTIMIZATION OF LOW-NOISING HOLOGRAM CHARACTERISTICS IN PHOTOREFRACTIVE PIEZOCRYSTALS

V.V. Shepelevich, A.A. Firsov
 Mozyr State Pedagogical Institute, Laboratory of Coherent Optics & Holography,
 Mozyr, 247760, Belarus

For improvement of the contrast and the ratio signal/noise of the photorefractive image it is suggested in [1] to use that fact, that at two-wave interaction a signal beam leaving a crystal, contains a component with polarization, orthogonal to the polarization of a signal beam passing the crystal in absence of a holographic grating. This effect of cross-polarization coupling give opportunity to decrease the power of a pumping beam with the help of a polarizer, while the part of a signal wave polarized orthogonally passes through the polarizer freely.

At the orientation of a holographic grating $\vec{K} \parallel [001]$ in a cubic crystal the piezoelectric effect is not shown, and at $\vec{K} \perp [001]$ it is shown very weakly. However, as is known (see, for example, [2]), at other orientations of vector \vec{K} the piezoelectric effect in these crystals plays an essential role and can considerably change the polarization and power characteristics of the holograms.

In the present the work influence of the piezoelectric effect on dependence of an amplification coefficient at cross-polarization coupling on orientation of a holographic grating vector and initial conditions of polarization of light beams in a cubic photorefractive piezocrystal is investigated for the first time. It is shown, that by a suitable choice of initial conditions of polarization of interacting light waves and orientations of a crystal the amplification coefficient can be essentially increased due to the piezoelectric effect. The maximal value of a square of the amplification coefficient is reached at the orientation angle $\theta \approx 320^\circ$ (Fig.1) and the polarization angle of a signal wave $\psi_0 \approx 8^\circ$.

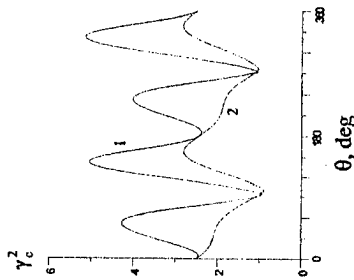

Fig.1. Dependence of a square amplification coefficient on the orientation angle. Thickness of the BSO crystal is 10 mm, Bragg angle is 12° , the initial ratio of the light beams $I_{s0}/I_{p0} = 1/100$. 1 - with the piezoelectric effect, 2 - without the piezoelectric effect.

1. F. Vachss, T.Y. Chang, J. Opt. Soc. Am. B6 (1989) 1683-1692.
2. A.E. Mandel, S.M. Shandarov, V.V. Shepelevich, Sov. Tech. Phys. Lett.14 (1988) 932-933.

LASER BEAM MODULATION BY SURFACE DROPLETS OF LIQUID CRYSTAL

V.A. Loiko, A.V. Konkolovich

Institute of Physics of the National Academy of Sciences of Belarus
 F.Scaryna ave. 68, Minsk, 220072, Belarus

V.Ya. Zyryanov, A.N. Serebrennikov, A.V. Shabanov, V.V. Presnyakov
 Institute of Physics of the Russian Academy of Sciences, Siberian Branch
 Akademgorodok, Krasnoyarsk, 660036, Russia

The polymer dispersed liquid crystal (PDLC) films, in which liquid crystal (LC) droplets are distributed in the binding polymer, are promising materials for different electrooptical applications: information processing and storage, communication, etc.

The main problems for PDLC films are the enhancement of contrast and the decreasing of driving voltage. The traditional way to get high contrast is to use the thick PDLC films. The high contrast of these films is achieved owing to the strong multiple scattering of light. This way brings into a high value of driving voltage. Last years particular consideration has been given to the new type of PDLC materials, in which LC droplets are arranged in polymer in one layer (monolayer). It opens a new possibility to decrease in the driving voltage and increase in the contrast ratio if interference quenching effect for coherent component of transmitted light is realized.

The detailed theoretical consideration of the interference quenching effect in PDLC monolayer at illumination of linearly polarized plane wave is carried out. To realize this effect it is necessary to meet rigid requirements for the PDLC film characteristics (size, concentration, polydispersity and orientation of the LC droplets, director configuration within the droplet, refractive indexes of LC and polymer). This problem can be solved by use of PDLC monolayer on the base of nematic LC, when the electrooptical response of the film depends on the changing in the director configuration inside the droplet under electric field.

In this work the theoretical investigation and experimental verification of the interference quenching effect in the surface nematic droplets of liquid crystal is carried out.

OPTICAL RECORDING OF STATIONARY SPATIAL GRATINGS IN A JELLY-LIKE DYE-DOPED GELATIN

T.Sh.Efendiev, V.M.Katarkevich, A.N.Rubinov

B.I.Stepanov Institute of Physics, National Academy of Sciences of Belarus
F. Skaryny prospect 68, 220072, Minsk, Belarus

Tel.: 375 (017) 284-23-49, Fax: 375 (017) 284-16-46

E-mail: efendiev@ifanbel.bas-net.by

Results of experiments on optical recording stationary spatial gratings in a jelly-like dye-doped gelatin are presented. The main advantage of such medium in comparison with the well-known and commonly used dichromated gelatin is the absence of any chemical processing of the material. Due to the high spatial resolution a set of gratings with different periods may be written in the same site of the jelly sample. It makes possible to create in a very simple way a steady-state distributed feedback (DFB) dye laser, operating at single or at several frequencies simultaneously.

To obtain stable and efficient operation of DFB laser based on the permanent gratings, recorded in a jelly-like dye-doped gelatin, the dependence of its output characteristics on the experimental conditions of the gratings recording was investigated. The second harmonic radiation of YAG:Nd laser with pulse duration of 14 ns, ~2 mJ energy and up to 50 Hz repetition rate was employed both for gratings recording and for DFB laser excitation.

It was established experimentally that the most preferable for the use in DFB laser is the jelly dye solution containing ~10% of gelatin with dye absorption coefficient of 40-60 cm⁻¹ at recording (pumping) wavelength. It was also found that at grating recording there exists an optimal irradiation dose of the jelly sample providing the highest DFB laser efficiency. The DFB laser on a jelly-like rhodamine 6G-doped gelatin with optimally recorded grating emits narrow-band ($\Delta\lambda \approx 0.01-0.03$ nm) radiation exhibiting up to 7-8% efficiency at ~0.1 mJ output energy. Possibilities of the further improvement of the DFB laser parameters are discussed.

This work was carried out in the frame of the ISTC project № B-479.

PLANAR DEVICES FOR SWITCHING OPTICAL SIGNALS WITH THE USE OF TRANSVERSE EFFECTS IN OPTICAL BISTABILITY

A.M.Goncharenko, G.V.Sinityn, S.P.Apanasevich, A.V.Lyakhnovich, A.A.Dokutovich

Division for Optical Problems in Information Technologies, NAS of Belarus
Kuprevich str, 1, build. 2, 220141, Minsk, Republic of Belarus

Methods and devices for optically controlled addressing of digital information data flows in the plane of optical bistable 2D array are presented. The methods are based on "transverse lock-and-clock" architecture and the simplest basic element of planar switch of optical information signals is shift register. New approach to controlled translation of information in the plane of bistable device is proposed which consists in using these basic shift register chains for constructing complex tree-like structures. Node in the tree structure connects several chains which share one joint bistable pixel. A 3-chain node can operate as multiplexing/demultiplexing unit 1×2 or 2×1 and as bi-directional splitter or coupling device for shifted data. While being split data signal suffers no decrease of its magnitude due to inherent peculiarity of shift technique in the plain of bistable layer. Specific operation mode of the node can be defined by modulation of control or holding beams. Besides tree-like structures it is possible also to build ring circuits, regular networks, etc. Limitation on packing density of shifter chains that is imposed by crosstalk from control channel is discussed.

In the framework of the concept 2D multidigit arrays of switches can be developed that operate in parallel on wide data words. Design of serial-to-parallel and parallel-to-serial converters is also proposed. It is worth noting that each pixel in the array can perform logic or arithmetic operations over bits stored.

"Transverse lock-and-clock" architecture is developed further to cover also the third dimension. Two or more planes of 2D arrays of bistable pixels can be coupled by free-space or waveguide interconnections. Optically controlled data transfer in 3D structures could result in another type of multiplexing devices. Combining transverse data shift in the plane of different matrices with the proper interface algorithm of data exchange between matrices it is possible to direct any input channel to any output one.

Schematic design of 3D devices, in particular $M \times N$ multiplexer, is discussed.

This work has been supported by the ISTC (grant B-129).

DYNAMICS OF SWITCHING WAVES AND REALIZATION OF SHIFT REGISTER IN OPTICALLY BISTABLE GaAs/GaAlAs INTERFEROMETER

G.V.Sinityn, S.P.Apanasevich, A.V.Lyakhovich, A.S.Yasukevich,
M.A.Khodasevich, Yu.A.Varaksa, A.A.Dokutovich

Division for Optical Problems in Information Technologies, NAS of Belarus
Kuprevich str, 1, build. 2, 220141, Minsk, Republic of Belarus

Switching waves that accompany optical hysteresis at interaction of spatially non-uniform light fields with distributed nonlinear media [1] have been investigated earlier mainly in interference structures based on A_2B_6 semiconductor compounds [2].

Here the dynamics is investigated in detail of rise and propagation of switching waves in all-epitaxial GaAs/GaAlAs Fabry-Perot interferometers (reported for the first time in [3]) with electron mechanism of nonlinearity.

Requirements for parameters of light beams are determined that are necessary to achieve bistable switching in such interferometers. Peculiarities of build-up of switching waves at different intensities of input light beam are analyzed as well as shape of wave front at different propagation stages and its dependence on excitation conditions. Methods of controlling speed and direction of switching wave propagation are discussed.

A number of Boolean algebra operations are demonstrated with the use of logical devices based on all-epitaxial GaAs/GaAlAs Fabry-Perot interferometers. Typical optical apertures of bistable pixels used were about 7–20 μm .

A possibility of transverse interconnections between neighbor pixels is demonstrated and planar shift registries of optical signals are experimentally realized. The rate of information transmission between neighbor pixels is determined basically by speed of switching wave propagation which is equal approximately to 1 $\mu\text{m}/\text{ns}$.

Operation parameters of such shift registers as well as characteristics of serial and parallel devices for input/output of digital optical data are reported.

This work is supported by the ISTC (grant B-129).

1. N. N. Rosanov, Optical bistability and hysteresis in distributed nonlinear systems, Phys. Math. Lit. Publish. Company, Rus. Acad. Sci., Moscow, 1997 (in Russian).
2. S.P.Apanasevich, A.V.Lyakhovich. *Phys. Stat. Solidi (b)*, 150, c.507–512 (1988)
3. G.V.Sinityn, F.V.Karpushko, A.M.Goncharenko, et al. Technical Digest, International Topical Meeting "Optical Computing'96", Sendai, Japan, p.214, (1996).

METHODS OF HOLOGRAPHIC PROTECTION AND IDENTIFICATION

Leonid V. Tanin, Petr V. Moiseenko, Valentin V. Manikalo, Sergey A. Ryzhechkin, Valery K. Erokhovets²

¹Joint venture "Holography industry"
Per.Kalinina, 12, Minsk 220012, Belarus

²Institute of Engineering Cybernetics, National Academy of Sciences of Belarus

Tel.: + 375 17 2842172, Fax: + 375 17 2842175,
E-mail: Erokh@ncwman.bas-net.by

Today holographic protection of documents, securities, food and industrial product packaging is considered to be one of the methods complicated to counterfeit. The recording density of the identifying information in holographic process surpasses greatly all the other methods of data keeping. That is why it is practically impossible to counterfeit the exact holographic images. A good feature about holographic protection is complexity. One hologram can include different degrees of protection, each of them is ment for the definite identification level: starting from the visual (at the level of the goods' consumer) up to the expert level with the use of special devices.

The classification of holographic marks according to the degree of protection is given, and identification methods and means of holographic recordings are analyzed in the report:

- Plane image hologram, recorded on the holographic table.
- 2D-3D hologram, recorded on the holographic table, having a front plan on the surface and a back plan on a given distance.
- Image hologram, recorded on the holographic printer.
- Plane image hologram, recorded on the holographic printer and having microtext.
- 2D-3D hologram with hide image. The hide image can be decoded with the use of special equipment.
- 2D-3D hologram with several hide images, wich are localized in different surfaces, wich can be decoded with the use of special device.
- 2D-3D hologram with hide image, recorded in a dot or in the part of the visible image.
- Hologram, recorded on the holographic printer according to the dot matrix technology with three-dimensional image.
- Hologram of synthesized voluminous image, recorded on the holographic table by synthesis of flat images.
- Hologram of synthesized voluminous image, which includes special viewing sides.
- Hologram, consisting of plane image, to the dot matrix technology, and voluminous image, recorded on the holographic table with the hide image.
- Hologram, recorded on the holographic printer according to the dot matrix technology with three-dimensional image, with hide image in the dot, recorded on the holographic table.

OPTIMIZING THE PERFORMANCE OF ERBIUM DOPED FIBER AMPLIFIER

ANUBHUTI SHRIVASTAVA (KHARE)

Lecturer (Deptt. of Electronics)

GEC BHOPAL, INDIA

Correspondence Address: 357, Rachna Nagar Bhopal. (M.P), 462023

INTRODUCTION: In EDFA the resonant enhanced optical nonlinearities and dispersion caused by erbium ions (Er^{3+}) in a glass matrix are currently attracting considerable interest as they influence the performance of erbium doped fiber amplifiers. This paper reports on the quantitative examination of noise.

OPTICAL CHARACTERIZATION OF NOISE FIGURE OF EDFA: The noise figure (NF) of EDFA including reflection from an optical component is determined by the equation given below

$$NF = NF_0 + 4R_1(R_2 G_s + R_{EDFA}) \frac{\Delta\nu}{(\Gamma^2 + \Delta\nu^2)^2 E} \quad (1)$$

Where $R_{1,2}$ is the reflectivity of the EDFA ends, G_{fb} is the forward and backward gain of EDF, R_{EDFA} is the Rayleigh scattering of EDF, P_{in} is the input signal power, $\Delta\nu$ is the line width of the signal light source, E is a photon energy and f is the frequency. NF_0 is ASE noise and the second term of the right side of the equation is the reflection noise.

OPTIMIZATION OF NOISE FIGURE WITH RESPECT TO PUMP POWER: To optimize the noise figure of erbium doped fiber amplifier experiment was conducted on a kit shown in Figure-1. Using the equation 1 of noise figure we can calculate the noise figure of the EDFA for different values of forward gain G_f corresponding to different pump power. The graphs of gain of EDFA with respect to input pump power and Noise figure of EDFA with respect to input pump power are plotted in Figure-2 and Figure-3 respectively.

This it is clear from the observations that pump-power should be less than 3.05 milliwatt for optimum gain and noise figure.

OPTIMIZATION OF NF WITH RESPECT TO REFLECTIVITY: NF determined by equation 1 with R_1 as a parameter is plotted in Figure-4. According to Figure-4 if reflection from optical components which corresponds to R_1 , is -60 dB or less, the increase of noise caused by reflection from optical components is 0.1dB or less.

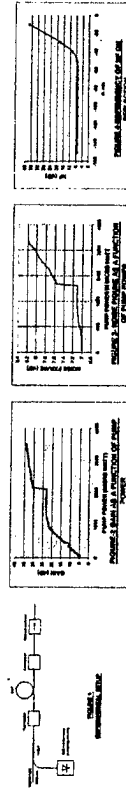

RESULT AND CONCLUSION: The result of the experiment conducted shows that for the EDFA used in the experiment has optimum noise figure of 8dB or less for optimum gain if the pump power is less than 3.05mW. Moreover the reflection from optical component should be -60dB or less so that noise caused by reflection from optical component is 0.1dB or less.

REFERENCES

Shigeru Shikii, Akira Sasaki, Mikiya Suzuki and Toru ITO, Optical Amplifier Module, 1997-98 Oki Electric Industry Co. Ltd, Special issue on electronic components, Number-158, volume 63, April 1997.
 Carsten Thirstrup, Yuan Shi and Bera Palsdotir, Pump-Induced Refractive Index Modulation and Dispersion in Er^{3+} - Doped Fibers, Journal of Lightwave Technology, Vol-14, No-5, May 1996.

Temporal interference of periodical pulse train in optical fibers

V.P.Minkovich¹, A.N.Starodumov¹, V.I.Borisov², V.I.Lebedev², S.N.Perechko²

¹ Centro de Investigaciones en Optica, A.C., Loma del Bosque N 115, Col. Lomas del Campestre, 37150 Leon, Gto., Mexico

² Mogilev State University, 212030 Mogilev, Belarus

Summary

Pulse-to-pulse interaction in optical fibers with dispersion is one of the limiting factors in high-bit-rate optical transmission system. A lot of attention has been paid to nonlinear interactions of the two solitons or ultrashort pulses [1-3]. In this work we report on collective effects for the train of optical pulses when a reconstruction of the periodical pulse train occurs at some distance in dispersive medium. The reproduction of the initial temporal distribution can be treated as a temporal analog of the spatial Talbot effect. Dispersion broadening of the individual pulses results in pulse overlapping, providing an interference of the neighboring pulses. For an infinite train of coherent laser pulses, the initial pulse distribution will be reproduced periodically along a fiber. We have obtained an analytical solution for propagation of the finite pulse train in dispersive media. The theoretical results have been proved experimentally. We have compared dispersion effects for a continuous train of pulses with those for a group of two and seven optical pulses at distance of 300 m and 1200 m in a multimode optical fiber. The groups of two and of seven pulses lost their temporal shape converting in one broad pulse at the distance of 300 m, while continuous train of pulse preserved its temporal structure at the distance of 1200 m.

References

1. J.P.Gordon, Opt. Lett. 8 (1983) 596-598.
 2. G. Berto, F.Neddham, S.Wabnitz, Opt. Lett. 25 (2000) 144-146.
 3. P.V.Mamyshev, N.A.Mamysheva, Opt. Lett. 24 (1999) 1454-1456.

STABILIZATION OF DISSIPATIVE SOLITON SEQUENCES IN FIBERS BY SELF-PHASE-MODULATION FEEDBACK

A.K. Komarov, K.P. Komarov

*Institute of Automation and Electrometry, Siberian Branch of RAS,
Pr. Acad. Kopyug 1, 630090, Novosibirsk, Russia*

The propagation and the evolution of dissipative solitons in fibers with gain and saturable absorption are investigated. It is shown that the combined action of a nonlinear refractive index resulting in frequency chirp of pulses and a frequency dispersion of gain induces the negative feedback. As a result, the sequence of dissipative solitons is stabilized: the weak pulses are suppressed, the powerful pulses with different amplitudes are equalized (the suppression of weak pulses is due to the saturable absorption).

It is shown that the investigated system is multistable. The number of pulses in the stable sequence depends on initial conditions of transient process. This multistability has the similar origin that in the case of passive mode-locked lasers [1,2].

The theoretical analysis and the numerical simulation have been performed with an use of the Ginzburg-Landau equation. The analyzed equation accounts for the frequency dispersion of both gain and refractive index of intracavity elements, the nonlinear losses, and the nonlinear refractive index. The nonlinearity of losses is assumed to decrease with the increase of radiation intensity (as in the case of nonlinear diffraction losses in passive mode-locked lasers with Kerr-lens or saturable nonlinear losses in dye). The saturation of the gain is ignored.

The condition of stability of multiple soliton sequences and the parameters of transient process are defined. The number of stable multiple pulse states has been determined by characteristics of fiber line.

The application of discovered multistability and stabilization of pulse sequence to optical communications and information processing is discussed.

[1] A.K. Komarov and K.P. Komarov, *Phys. Rev. E* **62**, R7607 (2000).

[2] A.K. Komarov and K.P. Komarov, *Opt. Commun.* **183**, 265 (2000).

Cascade acousto-optic diffraction for communication systems

V. Kotov¹, J. Stiens², G. Shkerdin¹, R. Vounckx²

¹Institute of Radio Engineering and Electronics of RAS,
Vvedensky Square 1, 141195 Fryazino (Moscow reg.), Russia

²Vrije Universiteit Brussel, Lab for Micro-and Optoelectronics,
Electronics Department, Pleinlaan 2, B-1050 Brussels, Belgium.

A new variant of the cascade acousto-optic (AO) diffraction based on the Bragg polarization splitting effect in the anisotropic crystals is developed. Cascade AO diffraction consists of the multiple, successive interaction of an optical beam with the same acoustic wave and makes it possible, in principle, to get many outgoing beams with different frequencies or to shift the frequency of a single optical beam by a value exceeding the acoustic frequency by more than an order of magnitude. The proposed variant is simpler in comparison with the developed before cascade AO diffraction realized in gyrotropic media, new variant does not demand the transformation of the light polarization after reflection of beam from the mirrors. The experimental AO cell is performed from LiNbO₃ mono crystal with dimensions 8x8x10 mm along [100], [010] and [001] axes, respectively. The optical beam generated by He-Ne laser (0.63 μm) diffracts on the shear acoustic wave propagated along [010] axis and direction of the displacement parallel to [100]. Three acts of the cascade diffraction were obtained.

In the report we discuss the significant increasing of the number of the acts of diffraction, the applications for the wavelength-division-multiplexing (WDM) and the optical image compressing, the advantages and perspectives for the optical communication systems.

QUANTUM COOPERATIVE CLUSTER – A NEW BASIC ELEMENT FOR OPTICAL PARALLEL COMPUTERS

S. N. Bagayev
 Institute of Laser Physics, SB RAS, Lavrentyeva 13/3, 630090 Novosibirsk, Russia
 V. S. Egorov, V.I.Dmitriev, I.A. Chekhonin, M.A. Chekhonin
 St. Petersburg State University, Uljanovskaya 1, 198904 St. Petersburg, Russia

In this report, methods for development of the new basic elements of optical computers – quantum cooperative clusters (QCC) – are proposed. These devices are microscopic cooperative lasers with N-wave coherent optical pump, in which effects of the parametric excitation of the cooperative radiation in a dense ensemble of inversionless resonant atoms in an optical microcavity are used [1].

QCC can be represented as a 2D dot computer generated hologram, synthesised in such a way, that the superposition of N pump waves coincides in phase with the eigenmode of the microcavity and has the supercritical coupling with the atomic ensemble [1]: $E(t)\exp(i\Phi_0) = \sum_{i=1}^N f(k_x, k_y) \exp(i\Phi_{i0})$, where $\Phi_0 = k_x x + \Phi_q$ are the pump-wave phases, $q = 0 \dots N$, $f(k_x, k_y)$ is the complex 2D Fourier transform of the cluster.

The methods of cluster structure calculation and experimental setup were developed for the cluster recording in the form of the dot microholograms ($100 \times 100 \mu\text{m}^2$) using the technique of parallel vaporisation of ≈ 6000 microholes ($d \approx 0.7 \mu\text{m}$) in a thick Cr film by pulse radiation of a Cu-vapour laser. Calculation methods were generalised for the case of the multilayer computer generated holograms (3DStudioMAX models); the records of such holograms on a $36 \times 36 \text{ mm}^2$ sample ($N=31$) were demonstrated.

1. S.N. Bagayev, V.S. Egorov, P.V. Moroshkin, A.N. Fedorov, and I.A. Chekhonin, "Amplification and generation in two-level optically dense resonant media without population inversion on the basis of the cooperative effects under light – matter interaction", Opt. Spectr. v. 86, 6, pp. 912 – 917 (1999).

DYNAMIC AND STATIONARY HOLOGRAPHIC RECORDING IN RIGID SOLUTIONS OF ORGANIC DYES

Yu. D Lantukh, S. N Letuta, E. K. Alidjanov, S. N Pashkevitch
 Institute of Micro- and Nanotechnologies of Orenburg State University,
 Pobedy 13, Orenburg, 460352, RUSSIA. E-mail: lantukh@ic.osu.ru

Dynamic holographic recording in solid solutions of organic dyes is a well known phenomenon, which may be useful in some optical and technical applications. In many occasions the mechanism of the recording is the triplet photochromism [1]. Essential merit of this effect is a possibility to receive versatile information about photophysical properties of the substances [2].

In the present paper we investigate two different holographic record modes realized in dye-polymer media by pulse laser beams. Both methods – dynamic and stationary – are applicable to the same sample and are reversible. Stationary relief-phase holograms stored in dye-polymer media [3] are noted for high diffraction efficiencies.

Methylene blue, eosine and some other dyes were introduced in polymer matrices and used as the base of recording media. Holographic gratings were written by Q-switched solid-state (YAG-Nd³⁺, ruby) laser.

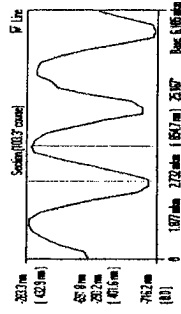
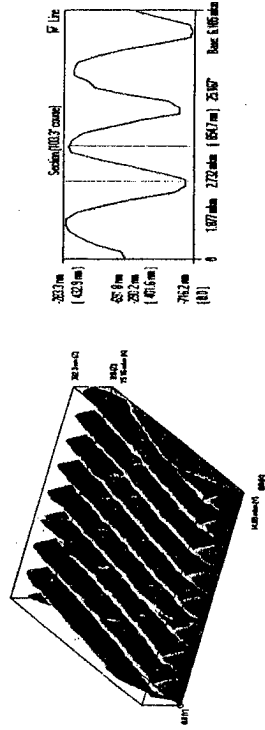

Scanning probe microscope (SMM-2000T Zelenograd KPD-company) was used to investigate the relief-phase holographic grating.

STM images of photomodified polymer film with methylene blue (figure) show the presence of periodic microrelief with a period of 1.7 μm and height of 400 nm. Period of the phase grating is in agree with a two-beam holographic structure.

The dependence of microrelief structure on the type of polymer matrix and dye, laser power density, as well as the possibility of erasing the hologram was investigated.

1. G.A .Ketsle, Yu.D. Lantukh, et al., Optics and Spectroscopy (USSR) 1989, Vol.67(4), pp. 580-581.
2. Lantukh Yu.D., Levshin L.V., 15-th International Conference on Coherent and Nonlinear Optics, 1995, St-Petersburg, Russia, Technical Digest, Vol.2, p.85.
3. E. K. Alidjanov, Yu. D Lantukh et al., Third International Conference "Electronic Processes in Organic Materials" (ICEPOM-3) 2000, Kharkiv, Ukraine, Technical Digest pp. 96-97.

Experimental study of light-induced birefringence in an azo-containing polymer film

K.S. Nesterouk, I.P. Nikolaev, A.N. Simonov, and A.V. Larichev
 Physics Department of M.V.Lomonosov Moscow State University
 Vorob'evy Gory, 119899 Moscow, Russia. E-mail: nksbox@usa.net

Photosensitive polymers are considered to be attractive non-linear media for optical storage and processing systems. A theoretical model describing dynamic light-induced processes in azo-containing side-chain polymers has been recently presented

[1]. The model takes into account two types of intramolecular processes induced by polarized laser radiation: changes in the concentrations of the *trans*- and *cis*-isomers of azo-dyes and "hole burning" in the angular distribution of the *trans*-isomers. These processes are closely coupled and take place simultaneously, resulting in light-induced birefringence of the irradiated polymer sample.

To check the validity of the theory, several experiments were carried out. Second harmonic radiation of a diode-pumped CW Nd:YAG laser ($\lambda=532\text{nm}$, $P_{\text{max}}=100\text{mW}$) was used to induce birefringence in an azo-containing polymer film placed in a temperature-stabilized optical cell. The refractive index changes were measured with a Mach-Zehnder interferometer. A space-

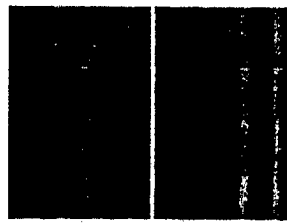

Fig.1. Dynamics of interference fringe shift. On and off ticks mark the interval during which the recording beam was on. The polarization directions of the recording and reading beams are: a) parallel, b) orthogonal.

time plot representing temporal changes in a typical interferogram is shown in Fig. 1.

The values of Δn for orthogonally polarized reading beams appeared to have opposite signs and $\sim 4:1$ ratio of magnitudes, which agrees with the theory. It was also found that the optimal temperature range for dynamic recording in the azo-containing polymer is $65\pm 75^\circ\text{C}$.

1. A.N. Simonov and A.V. Larichev, *Quantum Electronics*, 28 (1999) 87.

Computer Simulation of the Wavefront Correction System with Local Curvature Sensing

V.O. Miifitsin, S.A. Shlenov
 M.V. Lomonosov Moscow State University
 A.V. Kudryashov
 Institute on Laser and Information Technologies RAN

Deformable mirrors such as membrane or bimorph mirrors have been widely used as correctors for low-order or large-scale wavefront distortion in adaptive optical systems [1]. These distortions take place in the processes of imaging and laser beam propagation through turbulent atmosphere [2]. The local wavefront tilts are usually measured for compensation of atmospherically distorted wavefronts through the local wavefront curvature sensor has some advantages [3, 4].

The problem of optimization of the adaptive optical system using local curvature sensor with a lenslet and CCD-camera as a detector is discussed in the paper. Computer simulations of the sensor including closed-loop operation are based on ray-tracing method. We consider as a result comparative analysis of wavefront reconstruction for different algorithm of data processing from the curvature sensor. The limits for accurate wavefront reconstruction were analyzed.

In Fig. 1 we present as an example the results obtained for correction of wavefront aberrations with circular symmetry. The curvature sensor with lenslet of five ring-shaped patterns was simulated. The values of local wavefront curvature and their approximation are shown in Fig. 2.

The results of atmospherically distorted wavefront corrections will be also presented.

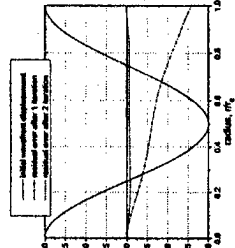

Fig. 1. Wavefront displacement after 1 and 2 steps of correction.

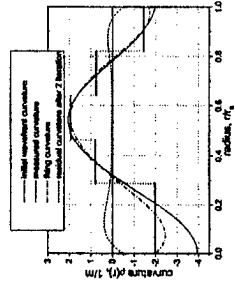

Fig. 2. Local wavefront curvature. Horizontal segments conform to sensor patterns.

REFERENCES

1. V.P. Kandidov, S.S. Chesnokov, S.A. Shlenov, *Optica atmosfery i okeana*, 11, No. 4, p. 401 (1998).
2. A.V. Kudryashov, V.I. Shmalhausen, *Opt. Engineering*, 35, No. 13, p. 3064 (1996).
3. F. Roddier, *Appl. Optics*, 27, No. 7, 1223 (1988).
4. N. Roddier, F. Roddier, *SPIE Active Telescope Systems*, 1114, 92 (1989).

Nd : YAG LASER WITH INDEPENDENT CHANNELS FOR ILLUMINATION AND HEAT-DEVELOPED OF HOLOGRAPHIC RECORDING ON PHOTOTHERMOPLASTIC MATERIALS

Kovalev A.A., Zhdanovich S.N.

*Institute of Electronics, National Academy of Sciences of Belarus,
22 Logoisky Tract, Minsk 220090, Belarus
Tel. +375 17 265 19 00, Fax + 375 17 265 25 41 E-mail: polam@inel.bas-net.by.*

Two-Channel Nd : YAG laser with intracavity polarization decoupling of channels is designed to be used in devices for the recording and development of holograms on photothermoplastic materials. It is reasonable to design such systems, in which the exposure and thermal treatment functions will be integrated in a single laser. The device ensures the obtainment of nanosecond radiation pulses (~30 ns, 0.01J) of the second harmonic for exposure of photothermoplastic media and millisecond (~4 ms, 0.5J) IR radiation pulses at the fundamental frequency for proximate development of relief-phase holograms on photothermoplastic materials.

This system was arranged so that the single pulse for the exposure channel was generated on the *p*-component of the radiation and a radiation pulse in the free-running oscillation mode was used for development at the *s*-component. This scheme was chosen taking into account the properties of the two-frequency polarizer of the decoupling unit having the high reflectivity ($R \sim 0.99$) of the *s*-component and selective properties for the transmitted *p*-component.

This system uses a radiation frequency doubler with the *00-e* type of conversion, which ensures the orthogonal polarization of the second-harmonic radiation, together with the two-frequency polariser thus ensuring the intracavity polarization decoupling of the *p*- and *s*-components of the radiation with λ_1 and spatial separation of radiations with λ_1 and λ_2 .

Friday, June 29

FA	Seminar on Nonlinear Materials I	FO	Nonlinear Dynamics of Optical Systems III
FB	Nonlinear Optical Phenomena III	FP	Seminar on Nonlinear Materials (Posters)
FC	Ultrafast Phenomena I	FQ	Strong Laser Fields and High Field Physics (Posters)
FD	Quantum and Atomic Optics III	FR	Ultrafast Phenomena (Posters)
FE	Nonlinear Dynamics of Optical Systems I	FS	Novel Trends in Nonlinear Laser Spectroscopy and Optical Diagnostics (Posters)
FF	Seminar on Nonlinear Materials II	FT	Nonlinear Dynamics of Optical Systems (Posters)
FG	Nonlinear Optical Phenomena IV		
FH	Ultrafast Phenomena II		
FI	Quantum and Atomic Optics IV		
FJ	Nonlinear Dynamics of Optical Systems II		
FK	Seminar on Nonlinear Materials III		
FL	Nonlinear Optical Phenomena V		
FM	Ultrafast Phenomena III		
FN	Quantum and Atomic Optics V		

Effects of frequency self-conversion in $\chi^{(2)}$ and $\chi^{(3)}$ activated laser nonlinear crystals,

V.G.Dmitriev, R&DI "Polus", Russia, A.A.Kaminsky, *Inst. of Crystallography, Russia.*

NEW MATERIALS FOR NON-LINEAR OPTICS

O.L. Antipov,^a R.E. Benfield,^b B.A. Bushuk,^c G.A. Domrachev,^d W.E. Douglas,^e R.G. Jones,^b L.G. Klapshina,^d A.S. Kuzhelev,^d A.N. Rubinov,^e and V.V. Semenov^d
^a *Institute of Applied Physics, Russian Academy of Sciences, Uljanov Street 46, Nizhny Novgorod, 603600, Russia.* ^b *School of Physical Sciences, University of Kent, Canterbury CT2 7NR, GB.* ^c *Laboratory of Laser Dyes, B.I. Stepanov Institute of Physics, National Academy of Sciences of Belarus, Skoriny Avenue 70, Minsk, 220072, Bietorussia.* ^d *G. A. Razuvaev Institute of Metallo-organic Chemistry, Russian Academy of Sciences, Tropinin Street 49, GSP-445, Nizhny Novgorod, 603600, Russia.* ^e *CNRS UMR 5637, Université Montpellier II, Place E. Bataillon, 34095 Montpellier cedex 5, France; e-mail, douglas@univ-montp2.fr*

A variety of novel materials has been synthesized and studied. a) Poly[(arylene)(ethynylene)silylene]s (PAES) containing hypercoordinate silicon atom as well as donor and acceptor groups. Sol-gel films incorporating 5-14 mass% polymer show $|\text{Re}\chi^{(3)}| = 3\text{-}9 \times 10^{-11}$ esu. b) A complementary series of poly[(arylene)silylene] statistical copolymers without acetylene groups synthesized by Wurtz-type condensation. c) Films of metal-containing polyacrylonitrile materials synthesized by the polycyanoethylation reaction between acrylonitrile and Ar_2M where $\text{M} = \text{Cr}$ (CrPAN) or V. CrPAN in air shows $\chi^{(3)} = -2.5 \times 10^{-10}$ esu, CrPAN in a polyethyacyanacrylate matrix -1.7×10^{-10} esu, and the charge transfer complex CrPAN/TCNE (10mole%) in a polyethyacyanacrylate matrix -1.2×10^{-10} esu. d) Polyvinylcarbazole-based compositions with PAES as novel optical chromophores for photorefractive studies. Experiments on nonlinear lens formation and four-wave mixing showed the formation of a refractive index pattern with a relaxation time dependent on beam intensity. Two-beam coupling gain and a $\pi/2$ -phase shift of the grating from the interference field have been demonstrated, thus confirming the non-local photorefractive origin of the refractive index changes. Financial support from INTAS (Brussels) [Open Call no. 97-1785] is gratefully acknowledged.

NONLINEAR OPTICAL CRYSTALS FOR LASER FREQUENCY CONVERSION:

PRESENT STATE AND DEVELOPMENT OUTLOOKS

L.I. Isaenko, A.P. Yelisseyev

Design & Technological Institute of Monocrystals SB RAS, 43 Russkaya str., 630058
Novosibirsk Russia; Phone/Fax 7(3832)333843, E-mail: elise@mail.nsk.ru

For forty years, passed from the day of first publication on nonlinear optics, conversion of laser radiation frequency in crystals with quadratic nonlinear susceptibility transformed from a purely laboratory effect into the powerful technique, widely used in modern quantum electronics and laser physics in interests of various fields of science and industry as electronic industry, medicine, ecological monitoring, analytical techniques etc..

In the present report the known nonlinear optical (NLO) crystals which cover a spectral region of available coherent radiation from 0.17 μm (LB4) to 18 μm (GaSe, AgGaSe₂) are reviewed and their main parameters, growth techniques and a present state of technology as well as application features are given. For optimum usage of certain NLO crystal more than 10 parameters are to be taken into account. An intense search for new, more effective, NLO crystals, based on modern understanding of "composition-structure-property" correlation and sometimes on computer simulation of expected parameters is in progress.

One of important features which determines both growth and outlooks of NLO crystals is their pyroelectric properties, presence of domain structure and opportunity to affect a direction of spontaneous polarisation vector. The most well studied crystals are those related to lithium niobate and KTP families where periodic structure and quasi-phase-matching regime can be realized which in turn allows to extent considerably the spectral range of produced coherent radiation and increase an efficiency of nonlinear conversion process.

Directions of the NLO crystals search and the opportunity of expansion of element base for quantum electronics are discussed.

PRINCIPLES OF SEARCH FOR NEW SELF-FREQUENCY DOUBLING LASER CRYSTALS

B.I. Kidyarov¹, E.V. Pestryakov²

¹Institute of Semiconductor Physics SB RAS, Novosibirsk, 630090, Russia

²Institute of Laser Physics SB RAS, Novosibirsk, 630090, Russia

The simple method to generate the second harmonic of laser radiation is the use a self-frequency doubling (SFD) laser crystals with both nonlinear optical and laser properties. But most nonlinear optical crystals have no suitable sites in host crystals for doping them with rare earth or transition metals laser ions, which have f- or d- configuration of electronic shells, accordingly.

In this report the principles of search for new efficient SFD laser crystal have been discussed on the basis phenomenological model of acentric oxide crystals [1]. It is shown that the chemical bond lengths of acentric crystals and the dimensions of impurity laser ions are the most informative criterions for search of new SFD laser materials. In figure on plane of chemical bond lengths shown the ellipse of "acentricity" of niobate crystalline compounds, i.e. the region of the existence the acentric oxide niobate crystals (mark as stars). In this case, a oxide niobate crystals having the high nonlinear optical susceptibility are arranged inside of ellipse of "acentricity" on some

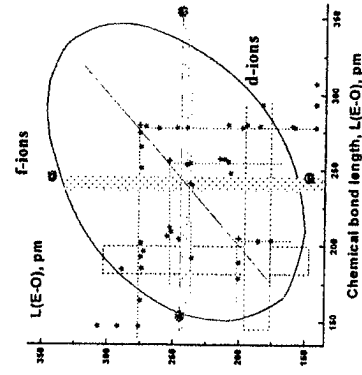

Raman fiber lasers and amplifiers.

I. A. Bufetov

Fiber Optics Research Center at the General Physics Institute of the Russian Academy of Sciences,

38 Vavilov Street, 119991, Moscow, Russia

tel: 7 (095) 135-0256, fax: 7 (095) 135-8139, E-mail: iabuf@fo.gpi.ac.ru

The stimulated Raman scattering in fibers allows the realization of efficient single-mode cw fiber lasers with the output power of the order of several watts and of fiber optical amplifiers for communication systems with the gain efficiency of $\sim 30\text{dB/W}^1$. And of particular interest is the ability of these devices to operate at any predetermined wavelength in the transparency window of optical fibers. For the silica fibers this corresponds to the wavelengths $\sim (1-1.7)\mu\text{m}$. Moreover, Raman lasers represents excellent pump units for the Raman amplifiers.

The Raman lasers can be based on germanium- or phosphorus-doped fibers. Phosphosilicate fibers have two strong Raman gain bandwidths shifted from a pump radiation frequency by 490 and 1330cm^{-1} . This permits to obtain practically any wavelength in the spectral region of 1.1-1.7 μm with a less number of Raman conversion cascades.²

To estimate the potential efficiency of Raman lasers and amplifiers, based on different types of fibers, the values of fiber Raman gain coefficients of a numbers of fibers were measured³, the simple analytic model of cw multicasade Raman laser was developed⁴. The recent results on the development of effective phosphosilicate fiber-based Raman lasers with the generation wavelength of 1.24, 1.41 and 1.48 μm and Ge-doped fiber amplifiers operating at the wavelength 1.3 and 1.5 μm will be presented.

- ¹ S.Grubb, T.Erdogan, V.Mizrahi, T.Strasser, et al. "1.3 μm cascaded Raman amplifier in germanosilicate fibers", Proc. Top. Meet. Opt. Amplifiers Appl. Breckenridge, PD 3-1, p. 187, 1994.
- ² E.M.Dianov, I.A.Bufetov, M.M.Bubnov, M.V.Grekov, S.A.Vasiliev, O.I.Medvedkov. "Three-cascaded 1407nm Raman laser based on phosphorus-doped silica fiber", *Optics Lett.*, vol. 25, pp. 402-404, 2000.
- ³ I.A.Bufetov, M.M.Bubnov, V.B.Neustruev, V.M.Mashinsky, A.V.Shubin, M.V.Grekov, A.N.Guryanov, V.F.Khopin, E.M.Dianov, A.M.Prokhorov. "Raman gain properties of optical fibers with a high Ge-doped silica core and standard optical fibers." *Laser Physics*, vol.11, No.1, pp.130-133 (2001).
- ⁴ I.A.Bufetov, E.M.Dianov. "A simple analytical model of a cw multicasade Raman laser." *Optimum electronics*, vol.30(10), pp.873-877 (2000).

SECOND HARMONIC GENERATION BY REFLECTION OF
AN ELLIPTICALLY POLARIZED LASER BEAM FROM A CHIRAL LIQUID
UNDER THE DIFFERENT INCIDENCE ANGLES

P. M. Bogdanovich, V. A. Makarov*

Physics Department and International Laser Center

M. V. Lomonosov Moscow State University

Vorobiev Gory, Moscow 119899, Russia

*Fax: (095) 939-3113, Phone: (095) 939-1225, * E-mail: makarov@wavlab.ilc.msu.su*

The second harmonic generation from the surface of an isotropic gyrotropic medium under the oblique incidence of elliptically polarized Gaussian beam is theoretically investigated (earlier, the detailed study was carried out [1] only in case of the normal incidence of a linearly polarized fundamental beam). The inhomogeneity of the near-surface region and the nonlocality of the nonlinear optical response of the chiral medium are taken into account by adopting modified boundary conditions for an electromagnetic field. Formulas are obtained for expressing the intensity, the degree of ellipticity, and the angle of rotation of the main axis of the polarization ellipse, in the different points of the cross-section of light beam at the doubled-frequency in the far-field diffraction zone.

The noncollinear interactions of the different spatial Fourier components of the electric field in the second harmonic generation process under study play a determining role in formation of the light beam at the doubled-frequency with strongly nonuniform distribution of polarization and very complex (non-Gaussian) intensity distribution over its cross-section. It appears most clearly for the normal incidence of an elliptically polarized Gaussian beam (second harmonic generation is forbidden for the normal incidence considered in the plane wave approximation), and when the angle of incidence is approximately equal to the critical angle of the total internal reflection (the maximum efficiency of the second harmonic generation is attained in this geometry). Our investigation shows that the veritable spectroscopic information about the material tensors which describe the quadratic optical response of the surface and the spatial dispersion of the medium nonlinearity can not be obtained from the experimental data with the theory based on the plane wave approximation.

1. Volkov S. N., Koroteev N. I., Makarov V. A. *Opt. Spectr.*, 1998, 85, p. 286.

FREQUENCY CONVERSION OF BESSEL LIGHT BEAMS IN NONLINEAR CRYSTALS

V.N. Belyi, N.S. Kazak, N.A. Khilo

B.I. Stepanov Institute of Physics of National Academy of Sciences of Belarus,
F. Skaryna Ave. 68, 220072 Minsk, Belarus, e-mail: nkhilo@optoinform.bas-net.by

Properties of frequency conversion of Bessel light beams (BLBs) in nonlinear crystals are studied theoretically and experimentally. New possibilities and prospects of the developments of methods for nonlinear optical frequency conversion using BLBs are discussed. Both second harmonic generation (SHG) and sum-frequency conversion as well as parametric generation are studied under the conditions of critical and noncritical phase matching. The longitudinal and transverse phase matching is analyzed in detail. The key parameter of nonlinear frequency conversion with BLB, azimuthal width of phase matching, is introduced, and its value is calculated for collinear and π -vectorial interactions. The regime of azimuthally matched interaction is selected, which is realized when the azimuthal phase matching width is small. A correlation of the azimuthal BLB components caused by this interaction is predicted. It is shown that a nonlinear polarization formed by azimuthally correlated BLBs is proportional to the Bessel function but not to the quadratic combination of Bessel functions as in the case of uncorrelated beams. As a consequence, the azimuthally correlated BLBs are characterized by a significant increase in the overlap integral and a resistance to nonlinear destruction of their spatial structure.

Properties of parametric frequency conversion in a cavity with Bessel mode structure pumped by a super-Gaussian light beam were investigated theoretically and experimentally. In experiment we observed a diffraction-limited axial signal beam which formed as a result of spatial energy redistribution from large-area pump and idler beams to the narrow axial signal beam. It is shown that the advantage of BLBs is the possibility of wavelength-tunable parametric and sum-frequency generation. The type II SHG by Bessel beams with optical vortices has been studied. Results of investigation of the processes of Bessel light vortices doubling, transfer of vortices to the second harmonic radiation, and annihilation of optical vortices with opposite sign are presented.

SECOND HARMONIC GENERATION OF HOLLOW BESSEL BEAMS

V. Jirutis, A. Matijošius, A. Piskarskas, V. Smilgevičius, A. Stabinis

Department of Quantum Electronics, Vilnius University, Sauletekio ave. 9, building 3,
2040 Vilnius, Lithuania

The hollow Bessel beam is a vortex and the nonlinear optical interactions may provide an efficient way for vortex transformation. The second harmonic (SH) and sum-frequency generation of waves with Laguerre-Gaussian vortices was studied in [1,2].

In this paper, the results of the comprehensive investigation of angular distribution of SH radiation generated by Bessel J_1 , J_2 , J_3 beams in KTP crystal are presented. Theoretically calculated (a) and experimentally (b) registered intensity

distribution of the SH radiation of J_1 beam in the far field are presented in Fig. An angular spectrum of Bessel vortices SH significantly differs from the fundamental harmonic (FH)

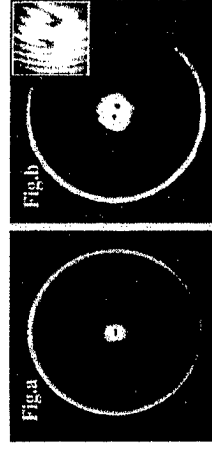

spectrum. The FH angular spectrum is the ring with radius β_0 , where β_0 is transverse wavevector. The SH spectrum consists of two parts, namely, the central spot and the outer ring with radius $2\beta_0$. If the background (I_0 beam) is absent the central spot is doubly charged vortex. In contrary, when the background is present in the central spot the doubly charged vortex decay into two singly charged vortices is observed. This confirm two fork type bands seen in the interference pattern between SH field and Gaussian beam (corner of Fig.b). Good agreement of the experimental results with the theoretical predictions was obtained.

1. V. Basistiy, V. Yu. Bazhenov, M.S. Soskin, M.V. Vasetsov, Opt. Commun. **103**, 422 (1993).
2. A. Beržanskis, A. Matijošius, A. Piskarskas, V. Smilgevičius, A. Stabinis, Opt. Commun. **150**, 372 (1998).

EFFICIENT INTRACAVITY SECOND HARMONIC GENERATION OF CO₂ LASERS WITH NONLINEAR AgGaSe₂ CRYSTALS

V. O. Petukhoy, V. A. Gorobets, S. Ya. Tochitsky, V. V. Churakov

V. N. Jakimovich*, V. I. Konstantinovich*

Institute of Physics of NASB, Scaryna Ave. 68, Minsk 220072, Belarus

**Institute of Solid State and Semiconductor Physics of NASB,*

Tel/Fax 375-017 2841111, e-mail: gopetoch@dragon.bas-net.by

Intracavity nonlinear frequency conversion is a powerful tool allowing increasing efficiency. However, even the state-of-the-art mid-IR nonlinear crystals do not provide sufficiently low absorption necessary for intracavity schemes. We report results of studies aimed, first, on growing AgGaSe₂ samples of high-optical quality and, second, exploring novel efficient schemes for intracavity second harmonic generation (SHG) using these crystals. A two-stage method of annealing, allowing to accelerate essentially the process of annealing and improve the crystal's quality has been developed. Laser absorption spectroscopy with high spatial resolution was used to characterize optical and nonlinear properties of IR crystals on each stage of technological process. By optimization the growth process, AgGaSe₂ single crystals of high optical quality were obtained. Optical and nonlinear parameters of samples produced using this technology are comparable with the best samples grown by the world leader in this field – Cleveland Crystals Inc., USA, and some of AgGaSe₂ crystals demonstrate an advantage in the absorption coefficient ($\leq 0.008 \text{ cm}^{-1}$). Several optical schemes for intracavity SHG were proposed and realized experimentally in both TEA and cw CO₂ lasers. Record values of harmonic light in an absolute scale were reached. For cw laser radiation, up to 100 mW of 5- μm power was obtained opening this class of lasers for many practical applications. For pulsed regime using a nonlinear output coupler made of AgGaSe₂ was studied. For a common TEA CO₂ laser the harmonic output energy of $\sim 60 \text{ mJ}$ (the energy conversion efficiency $\sim 15\%$ and peak power efficiency $> 60\%$) was demonstrated.

ENHANCEMENT OF SUM-FREQUENCY GENERATION NEAR THE PHOTONIC BAND GAP EDGE UNDER THE QUASI-PHASE-MATCHING CONDITIONS

A. V. Balakin, V. A. Bushuev, B. I. Mantysyzov, I. A. Ozheredov, A. P. Shkurinov,

Physics Department and ILC, Moscow State University, Moscow, 119899, Russia

P. Masselin, and G. Mouret

Universite du Littoral, 145 avenue Maurice Schumann, 59140, Dunkerque, France

The possibility of increasing the intensity of second harmonic (SH) signal in photonic band gap (PBG) structure because of increasing of electromagnetic field density at the fundamental frequencies near the PBG edges, or non-phase-matching enhancement, and at the same time the satisfaction of the conditions of dispersive phase matching was theoretically shown recently [1]. Here we demonstrate theoretically and experimentally the possibility of optimization of the efficiency of sum-frequency (SF) and SH generation processes due to the action of both grating assisted phase matching, or quasi-phase matching (QPM) [2], and non-phase-matching enhancement simultaneously. The theoretical description is carried out on the basis of the recurrence relations that allow one to get the exact and complete solution of this problem for nonlinear multilayer structure of finite length [3]. It is shown that due to the non-phase-matching enhancement, the intensities of SF and SH signals under condition of QPM interaction may be increased more than in one order of magnitude. In the case of the SH generation process, in addition to the exact fulfillment of QPM condition, the phase matching, caused by the dispersive properties of the PBG structure, may also give a contribution to the intensity of the signal. This happens because at the specific angles of incidence the edges of linear reflection curves at the fundamental and the SH frequencies are crossed. We show and discuss the experimental results on SF and SH generation in a ZnS/SrF₂ multilayer structure. In the experiments we have obtained a non-phase-matching enhancement of both the SF signal near the QPM condition and the SH signal under QPM interaction near dispersive phase-matching condition. The experimental data demonstrate good agreement with the theoretical predictions.

1. M. Centini, C. Sibilia, M. Scalora, *et al*, Phys. Rev. E **60**, 4891 (1999).
2. M. M. Fejer, G. A. Magel, *et al*, IEEE J. Quantum Electron. **28**, 2631 (1992).
3. A. V. Balakin, V. A. Bushuev, B. I. Mantysyzov, *et al*, Phys. Rev. E **63**, N3 (2001)

E. Wintner

Institut für Photonik
 Technische Universität Wien
 Gusshausstrasse 27, A-1040 Wien
 Austria

Tel.: +43(1)58801-38712, Fax: +43(1)58801-38799
 Email: emslawintner@tuwien.ac.at

Ultra-short pulse solid-state lasers nowadays face many challenging new applications. If shortest pulse durations in the 10-fs regime are required, broad-band transition metal-doped laser crystals are the media of choice. Despite the outstanding results of few-cycle pulses yielded by Ti:sapphire oscillators allowing even to stabilize the carrier-envelope phase shift for the first time, diode-pumping is highly attractive for the sake of compactness, transportability and last, but not least cost. Cr³⁺:LiSAF, as an example, has proven to meet these requirements yielding diode-pumped 12-fs pulses and demonstrated its capability for ultra-high precision measurements of optical frequencies based on the precise mode-spacing of the fiber-broadened spectra. Optical coherence tomography (OCT) performed with Ti:sapphire or Cr:forsterite femtosecond laser pulses yielded unprecedented spatial resolution in the µm-regime demonstrating the possibility of in-vivo sub-cellular investigations. Cr²⁺:ZnSe emitting between 2.1 and 2.9 µm offering very favourable laser specifications for the generation of shortest pulses sometimes is called the "Ti:sapphire of the infrared". Very promising diode-pumped and mode-locked results have been recently achieved. Its application for OCT will eventually allow much deeper penetration depth and comparable resolution like Ti:sapphire. Other attractive applications of ultra-short pulses require moderate pulse durations in the ps or sub-ps regime together with high average power. Rare earth-doped laser media have proven highest diode-pumped cw output powers associated with high effectivity and beam quality. Yb:YAG offers sufficient bandwidth to support pulses in the 100-fs regime and effectivity above 50 % when being pumped by the cheapest high-power laser diodes to date (InGaAs). Recently, the thin disk laser concept which proved to be among the best for highest cw output powers was successfully applied to the generation of ultra-short pulses of 730 fs duration at more than 18 W of output power opening a new promising approach to applications like materials processing of anorganic or biological materials.

Reference: E. Sorokin, I.T. Sorokina, E. Wintner, Appl. Phys. B 72, 3-14 (2001)

Femtosecond Interactions and Optical Gain in Semiconductor Quantum Dots

Victor I. Klimov

Chemistry Division, Los Alamos National Laboratory, Los Alamos, NM 87545, USA

Semiconductor quantum dots (QDs) promise the lowest lasing threshold for semiconductor media. Additionally, QDs in the strong confinement regime have an emission wavelength that is a pronounced function of size, adding the advantage of continuous spectral tunability simply by changing the dot radius. Lasing has previously been demonstrated for epitaxially grown III-V QDs. Large lateral dimensions and difficulties in size control limit their spectral tunability using quantum confinement effects. An alternative approach to fabricating QDs is through chemical synthesis which can produce semiconductor nanoparticles (colloidal QDs) with radii from 1 to 6 nm and with size dispersions as small as 5%. Such dots show strong quantum confinement and permit size-controlled spectral tunability over an energy range as wide as 1 eV.

The combination of tunable electronic energies and chemical flexibility make colloidal QDs ideal building blocks for the bottom-up assembly of optical device structures, including optical amplifiers and lasers. However, despite more than a decade of effort, lasing in small-size colloidal nanoparticles has not been realized. To determine what hinders lasing action we performed extensive dynamical studies of radiative and nonradiative processes in colloidal QDs. In particular, we demonstrate that nonradiative carrier losses in QDs are dominated not by surface trapping, as was thought initially, but by intrinsic Auger recombination [1]. Auger recombination is a nonradiative multiparticle effect that turns on as soon as two or more electron-hole (e-h) pairs per dot are excited. Since lasing also requires at least two e-h pairs per dot, the Auger effects are intrinsically unavoidable if the condition for lasing is satisfied. In colloidal nanoparticles, the Auger decay occurs with sub-ns time constants. In particular, in CdSe QDs the two-pair Auger life time changes from approximately 400 to 6 ps with reducing the QD radius from 4.1 to 1.2 nm [1]. However, despite very short time constants, Auger recombination does not inherently prevent lasing. Lasing can still be realized if the development of stimulated emission occurs faster than the Auger decay. The rate of the stimulated emission buildup is proportional to the dot concentration in the sample. We show that by close packing dots into solid state films (QD solids) it is possible to obtain dot concentrations that are sufficiently high for the optical gain to successfully compete with the Auger decay. Using these solids we demonstrate stimulated emission at wavelengths broadly tunable with the dot size [2]. Furthermore, we investigate the use of colloidal QDs for realizing lasing in different cavity configurations.

1. V. I. Klimov, A. A. Mikhailovsky, D. W. McBranch, C. A. Leatherdale, and M. G. Bawendi, *Science* **287**, 1011 (2000).
2. V. I. Klimov, A. A. Mikhailovsky, S. Xu, A. Malko, J. A. Holingsworth, C. A. Leatherdale, H.-J. Eisler, and M. G. Bawendi, *Science* **290**, 314 (2000)

Towards optimal generation and delivery of 1 fs pulses in dispersive media

Misha Ivanov

*Femtosecond Program, Steacie Institute for Molecular Sciences,
NRC of Canada, 100 Sussex Drive, Ottawa, Ontario K1A 0R6, Canada*

We discuss pump-probe scheme of generating and delivering single pulses as short as 1 fs onto the target, through known dispersive elements in the optical setup.

Since short pulses have very broad spectrum, dispersion of the elements in an optical setup may have a dramatic (or even devastating) effect.

There are two possible solutions to this problem. First is to generate ultrashort pulse in the vicinity of the target, thus avoiding propagation through the dispersive elements. So far, the only known realization of this scheme would be to use ultra-high harmonics produced by intense few-cycle infrared pulse incident on atomic gas. The drawback of using ultra-high harmonics is their extremely low energy.

Second solution is to use dispersion to one's advantage, generating a pulse tailored to known dispersive elements. The problem can be treated as an optimization problem, where the input pulses and the nonlinear medium have to be tailored to achieve optimal compression of the single pulse at the target.

We propose to use rotational coherence excited by intense shaped pump pulses to realize required preparation of the nonlinear medium for optimal compression of the probe pulse. We discuss the guidelines for choosing appropriate medium and pump pulse and illustrate our method using the example of rotationally excited nitrogen gas in a hollow core fibre, which allows us to obtain 1-2 fs pulses behind 1 mm thick CaF₂ glass.

Ultrafast THz generation from InAs surface using toroidal permanent magnet

V. G. Bespalov, V. Krylov, D. I. Staselko

*Holography Laboratory, S.I. Yavilov State Optical Institute, 199034 St. Petersburg, Russia
bespalov@ca.admiral.ru*

SUMMARY

Terahertz (THz) radiation from different semiconductor surfaces excited by a femtosecond laser has been investigated during last 10 years. These kind of THz sources were used for application to FIR imaging and time-resolved spectroscopy.

In this paper we report the investigation of THz generation from InAs surface pumped by a femtosecond optical pulses with different magnetic fields.

Ti:sapphire laser delivered 100-fs pulses at 780 nm with 150 mW average power. The excitation pulses irradiated the (100) surface of the nondoped bulk InAs (10x10x0.1 mm²) at an incidence angle of 45° with respect to the surface normal. The conduction type of InAs was n with the carrier density $\sim 3 \cdot 10^{16}$ cm⁻³. The laser beam was focused to 500 μm diameter by 1-m lens. The InAs sample was placed into the different kind of magnet systems based on Nd-B-Fe permanent toroidal magnets. The THz radiation was generated in the reflection direction and THz average power measured by photoacoustic detector. A pair of off-axis flat and parabolic mirrors focused the THz radiation onto the photoacoustic detector operated at the room temperature. The pump pulses were chopped at 10 Hz and the signal was lock-in detected after being amplified by a current amplifier. The minimum of measured THz power was less than 1 nW. For 1.0 T magnetic field was used the single toroidal permanent magnet with the outer/inner diameters 72/12 mm and the thickness of 10 mm.

The THz-radiation power exhibits almost quadratic dependence on the excitation power, and saturation of the radiation power was observed when excitation power exceeded 150 mW. The maximum efficiency of THz generation was reached with maximum pump power and magnetic field strength and was about 10⁻⁴ relatively input optical power.

EFFICIENT ULTRASHORT LIGHT PULSES CONVERSION
IN GHz-THz PULSES IN ZnTe, GaAs, DAST CRYSTALS

A.S.Nikoghosyan, E.M.Laziev, R.M. Martirosyan, A.A. Hakhoumian

Department of Radiophysics, Yerevan State University,

Alex Manoogian 1, Yerevan, 375025 Armenia,

Fax: +(3742) 151-087, E-mail: mika@ysu.am, Laziev@uniph.xerph.am

ausen@irmlc.am

We have demonstrated an efficient ultrashort pulse generation in the LiNbO_3 and LiTaO_3 crystals by a new phase matching method [1]. Choosing the crystal filling degree of a rectangular waveguide provides phase matching of nonlinear polarization wave and difference frequency radiation (DFR). In this case the crystal acts both as a nonlinear frequency converter and a millimeter wave phase velocity moderator. This technique allows to remove restriction on the choice of the nonlinear material; so, the material may possess small birefringence or do not have it at all – such are, for example, the cubic symmetry crystals, as well as possess a high nonlinear coefficient d_{14} of the order of 100 pm/V or more.

Here we present the preliminary results of collinear phase matching study of nonlinear polarization wave with difference frequency of the millimetre and submillimeter (GHz-THz) range at optical rectification in GaAs, ZnTe, DAST crystals. The interest toward DAST is based on its large second-order nonlinearity: $d_{11}=1010\pm100$ pm/V at 1318 nm and $d_{11}=313$ pm/V at 213 μm .

It is shown that radiation can be efficiently generated in the crystal GaAs in wavelength range of 40.35-0.38 mm; in DAST- in the range of 23-0.18 mm, and in ZnTe - in the range of 70,7-0,85 mm. The difference frequency pulse generation in the above-mentioned GHz-THz range by the mode-locked Nd: glass laser is provided for the studied crystals.

1. E.M.Laziev, A.S.Nikogossian, in Mode-Locked Lasers and Ultrafast Phenomena, Proc.SPIE, v.1842, pp. 113-118, 1992.

CAVITY ASSISTED QUASIPARTICLE DAMPING IN A BEC

S.A. Gardiner

Institut für Physik, Universität Potsdam, D-14469 Potsdam, Germany, and

Institut für Theoretische Physik, Universität Hannover, D-30167 Hannover, Germany

K.M. Gheri and P. Zoller

Institut für Theoretische Physik, Universität Innsbruck, A-6020 Innsbruck, Austria

It is a constant goal within the field of atomic Bose Einstein condensation (BEC) to achieve colder temperatures, and to control excitations where the eventuate. To this ultimate end we consider an atomic BEC held inside a lossy optical cavity and interacting with laser fields. The BEC atoms are considered to have two levels, which couple to the laser-cavity superposition field. Assuming a sufficiently large detuning, the excited internal atomic state can be adiabatically eliminated, and it can be subsequently deduced that the light field provides a term which acts like a driving field for the cavity mode. It thereby implements a mechanism to transfer energy to the cavity, which in turn will shed this energy to the environment by means of cavity damping [1].

Using a Bogoliubov-like analysis [2] we show how specific linearized excitations of the BEC can be targeted and damped away, deducing an insightful and very simple damping equation, and comparing it with the results of numerical simulations. In the case of a finite temperature BEC, where there is a range of populated quasiparticle excitations, these can be individually targeted, resulting in cooling of the BEC. Thus, through astute choice of parameters, specific excitations can be rapidly damped, and this damping procedure can in principle be applied to produce extremely cold condensates.

- [1] P. Horak, G. Hechenblaikner, K.M. Gheri, H. Stecher, and H. Ritsch, Phys. Rev. Lett. 79, 4974 (1997); G. Hechenblaikner, M. Gangl, P. Horak, and H. Ritsch, Phys. Rev. A 58, 3030 (1998); V. Vuletić and S. Chu, Phys. Rev. Lett. 84, 3787 (2000).
- [2] N.N. Bogoliubov, J. Phys. (USSR) 11, 23 (1947); C.W. Gardiner, Phys. Rev. A 56, 1414 (1997); Y. Castin and R. Dum, Phys. Rev. A 57, 3008 (1998).

NONCLASSICAL STATES, SWITCHING AND MACROSCOPIC DYNAMICS FOR MULTICOMPONENT BOSE SYSTEMS

A.P. Alodjants, S.M. Arakelian

Department of Physics and Applied Mathematics,

Vladimir State University, Gorky str., 87 Vladimir, 600000, Russia

Phone.: +7(0922) 279947, 233334

e-mail: laser@vpti.vladimir.su

SUMMARY

In our paper we discuss the behaviour of two-component Bose-gases. In quantum optics we consider the formation of beams in spatially inhomogeneous systems like special graded optical fibers and waveguides with photon trapping. For the first time we discuss the nonclassical interference of coupled bosonic systems. For quantum states of the modes we consider spin (polarization) squeezing, i.e. suppression of fluctuations of $SU(2)$ observables for two-level bosonic system including the effects of switching as well. In the limit of large particle numbers we also analyze the dynamics of interacted two-mode optical system under the adiabatic approximation that include the spatial distribution of optical field. For that we use coupled Gross-Pitaevskii (or nonlinear Schrödinger) equations for macroscopical mean bosonic fields (wave functions) under the Hartree approximation. The macroscopical properties of the beams in this case can be found from the dynamics and stability analysis of collective "photonic motion" using variational methods with Gaussian ansatz for the condensate wave function. The effect of spatial distribution reduces to appearance of some static (spatial) additional shift for the widths of beams. In this case new nonlinear phenomena – switching of interacting beams parameters (population imbalance, phase difference, widths of the beams) between different regions appears. For atomic systems we propose two Bose-Einstein condensates (BEC) placed in harmonic magnetic traps coupled by external laser field. In our paper we also discuss the possibilities of implementation of considered effects for quantum information and computation using continuous variables.

DYNAMICS OF BOSE-EINSTEIN CONDENSATE WITH NONLOCAL INTERACTIONS NEAR COLLAPSE.

Vladimir V. Konotop

Centro de Física da Matéria Condensada, Universidade de Lisboa, Complexo Interdisciplinar, Av. Prof. Gama Pinto, 2, Lisbon, P-1649-003 Portugal.

Víctor M. Pérez-García and Juan J. García-Ripoll

Departamento de Matemáticas, Escuela Técnica Superior de Ingenieros Industriales, Universidad de Castilla-La Mancha, 13071 Ciudad Real, Spain.

When a system of weakly interacting bosons with two body interactions is cooled down below the Bose-Einstein transition temperature it may be well described by the so called Gross-Pitaevskii equation for the order parameter of the superfluid Ψ

$$i\hbar \frac{\partial \Psi}{\partial t} = -\frac{\hbar^2}{2m} \nabla^2 \Psi + V(\mathbf{r})\Psi + \Psi \int K(\mathbf{r} - \mathbf{r}') |\Psi(\mathbf{r}')|^2 d\mathbf{r}', \quad (1)$$

where $K(\mathbf{r} - \mathbf{r}')$ is the function which possesses the information on the mutual interaction between the bosons and other notations are conventional.

Dynamics of a large condensate with negative scattering length in the case $K(\mathbf{r}) \sim \delta(\mathbf{r})$ displays collapse, which is prevented by long range interactions. We address to the question about the dynamics of the nonlocal interacting condensate "near the collapse".

We complement qualitative arguments justifying that a nonlocal potential of a rather general type prevents collapse by time dependent variational analysis, numerical simulations and the analysis of the strongly nonlocal limit.

Our conclusions are as follows: (i) There exists a limit on the minimum width of the wavepacket, predicted to be of the order of the interaction range by the gaussian ansatz approach, and (ii) Oscillations on the wave packet substitute the collapse. In order to test these results and the other predictions related to the dynamics of the condensate which we have obtained during our approximate variational analysis we have integrated numerically Eq. (1). Numerical analysis (exploring different kernels and initial shapes of the condensate) shows remarkable agreement with predictions and even those made on the basis of variational approach.

One can also show [1] that the collapse is already stopped by higher dispersion (neglecting from expansion of the integral term in (1) in the Taylor series). Outline of the respective results will be presented.

References

- [1] J. J. García-Ripoll, V. V. Konotop, B. Malomed, V. M. Pérez-García, Phys. Rev. E (2001) (to appear)

SUPERELASTIC SCATTERING OF EXCITED ATOMS ON A SOLID SURFACE: EFFICIENT TRANSFER OF THE PHOTON ENERGY INTO ATOMIC MOTION

A. M. Bonch-Bruевич, V. V. Khromov, S. G. Przhibel'skii, V. N. Smirnov, T. A. Vartanyan

State Optical Institute, St. Petersburg 199034, Russian Federation
E-mail: tigran@jamnet.spb.su

Laser control of atomic particle motion requires an effective coupling of the photon energy to translational degrees of freedom of atoms. We report on the first observation of highly efficient transformation of the photon energy into kinetic energy of atoms in the course of superelastic scattering on a solid surface. Our experimental study of the quenching process of the electronic excitation of Cs atoms on a variety of solid surfaces such as glass, sapphire, and quartz has shown that the mean kinetic energy of the atoms departing from the surface amounts to 0.5 eV, about one third of the photon energy used for the resonant excitation of the atoms in front of the surface. This value is about ten times larger as compared to the mean kinetic energy acquired by atoms in the course of an allied process of laser-induced photodesorption, accomplished with the photons of the same energy. The major discrepancy is accounted for by the difference in the initial states of both processes. Photodesorption is due to absorption of light by adsorbed species. After the quenching of electronic excitation, energy of the incident photon is spread evenly among the adsorbed atom and all its surface partners entering the tightly bound adsorption complex. Contrary to that, quenching of the electronic excitation of incident atoms takes place at a distance from the surface, simultaneously with the excitation of surface vibrations. Since the surface attraction accelerates excited atoms towards the surface, incident atoms acquire considerable kinetic energy. Due to Frank-Condon principle, this part of the photon energy is out of the redistribution process and preserved by the scattered atom after an elastic collision with the repulsive part of the surface potential.

Superelastic scattering of excited atoms on the surface of transparent dielectric material is appeared to be one of the most effective ways to transfer the photon energy into kinetic energy of atomic motion.

QUANTUM TRAJECTORY DYNAMICS OF MACROSCOPIC MEDIUM AT THE EMISSION OF SINGLE PHOTON ECHOES

S.A.Moiseev,* S.Kröll** N. Ohlsson**

* Zavoisky Physical-Technical Institute, Kazan, Russia
** Lund Institute of Technology, Lund, Sweden

The Hahn echo effect is used to study a large number of fundamental properties of quantum dynamics in the multi particle systems having various nature. Recently Hahn echo was detected in the experiments with single quantum objects, such as electron [1], and in the flows of single muons [2] and neutrons [3]. These experiments provide a crucial progress for the development of the higher resolution spectroscopy methods. In this work we propose that Hahn echo on a single photon could also give unique information about the interactions of the photons with a macroscopic quantum media.

We develop a theory of single photon echo using quantum measurement approach to the description of field irradiated by the macroscopic medium at the interaction of the medium with two resonant photons and then by a short laser pulse according to the scheme of single photon echo. Solving the Lindblad-type equations we found analytical solutions for the emission probability of single photons for various possible quantum trajectories which correspond to the different quantum excitations of the medium. The main result obtained is that the spatial-temporal properties of different quantum trajectories unusually differ wherein basic differences are connected with properties of single photon echo. We stress, that ordinary photon echo is possible for quantum trajectories with one irradiated photon, but for two photon trajectories the ordinary photon echo is impossible. Any of two photons are emitted randomly, but time and direction of their emission are correlated like in photon echo, so we call it a hidden two photon echo. It is important, that the physical nature of the hidden echo is connected with wave function reduction of macroscopic medium at the optical detection.

1. J.Wrachtrup, C.von Borczyskowsky, J.Bernard, R.Brown, M.Orrit Chem.Phys.Lett. **245**, 262 (1995).
2. S.R.Kreizman et.al. Phys.Rev.Lett. **61**, 2890 (1988); S.A.Moiseev et.al. Phys.Rev.B. **61**, 5891 (2000); N.M.Suleumanov et. al. Physica B. **289-290**, 676 (2000).
3. M.Th.Rekveidt, Nucl.Instr. and Meth. Res.B. **114**, 366 (1996).

Multiple-photon exchange in atom optics: intensity- and density-dependent effects

K. V. Krutitsky, K.-P. Marzlin and J. Audretsch

Fakultät für Physik, Universität Konstanz, Fach M 674, Konstanz 78457, Germany

We present the rigorous microscopic quantum-field theory of the interaction of ultracold Bose gases with the electromagnetic field of vacuum and laser photons. The main attention has been paid to the consistent consideration of dynamical dipole-dipole interactions in intense photon fields.

Making use of the multipolar formulation of QED and electric dipole approximation we have derived the general system of Maxwell-Bloch equations for atomic creation and annihilation operators and the propagation equation for the laser field. It describes the processes of the modification of the properties of the external off-resonant laser radiation in a medium due to dipole-dipole interactions and the influence of this modification on the center-of-mass motion of the ultracold atoms as a single dynamical process. The system can be employed for the analysis of nonlinear phenomena in atom optics at high densities of the atomic system and high intensities of the laser radiation.

We have developed a general procedure of the elimination of the excited state. The annihilation and creation operators of the excited state are represented in the form of a series expansion in powers of the inverse detuning of the frequency of the laser wave from the frequency of the atomic transition, which corresponds to multiple-photon-exchange processes of different orders between the atoms. Neglecting the frequency conversion of the laser radiation in a medium, we have derived a compact analytical expression, which relates annihilation and creation operators of the excited state to the corresponding operators of the ground state.

Optical properties of ultracold Bose gases are investigated and formulae for the intensity-dependent refractive index are derived. The refractive index is shown to be an important parameter in atom optical processes, because it defines the momentum transfer from the laser beam to the atomic beam. We discuss different possibilities of manipulation the propagation of the ultracold atomic beams with the aid of intense laser radiation.

K. V. K. would like to thank Alexander-von-Humboldt Stiftung for financial support.

ZEEMAN "DARK" AND "BRIGHT" STATES IN CESIUM

(Invited)

BY SINGLE MODE EXCITATION

E. Mariotti^a, C. Andreeva^b, V. Biancalana^a, A. Burchianti^a, S. Cartaleva^b, Y. Dancheva^b, C. Marinelli^a, K. A. NasYROV^c, L. Moi^a

^aDipartimento di Fisica, Università di Siena,
Via Banchi di Sotto 55, 53100 Siena, Italy

^bInstitute of Electronics, Bulgarian Academy of Sciences,
Boul. Tsarigradsko Shosse 72, Sofia 1784, Bulgaria

^cInstitute of Automation and Electrometry
Novosibirsk, Russia

The coupling of two ground states to a common excited state by means of two coherent laser radiations leads to coherent effects in the excitation process. When the frequency difference of the two coupling laser fields equals the frequency separation among the two ground levels, the atoms are prepared in a non-absorbing state, observed experimentally as a high-contrast and narrow-width dip in the fluorescence.

A significant simplification of the experimental technique has been achieved when involving as ground states the magnetic sublevels of a single ground-state hyperfine (hf) level. A single hf transition is excited by a single frequency laser field. The atomic fluorescence is observed as a function of a small magnetic field scanned around zero value.

In this communication we present systematic investigation of the coherent effects at the Zeeman sublevels of hf states at the D_2 line of Cs. Cs vapour in a vacuum cell or in a cell with buffer gas (Ar) was irradiated by a single-frequency diode laser beam. The laser frequency was stabilized to the maximum of the fluorescence line under consideration or scanned over the spectrum of the D_2 line. Linearly or circularly polarized laser beam was used. The magnetic field (about 1 Gauss) parallel or perpendicular to the laser beam was scanned around zero value. The fluorescence perpendicular to the laser beam was registered as a function of the applied magnetic field.

In the case of Cs in a vacuum cell, for linearly polarized laser beam, subnatural-width (less than 10 kHz FWHM) dips in the fluorescence have been observed for hf transitions with degeneracy of the ground level F_g equal to or higher than the degeneracy of the excited level F_e ($F_g \geq F_e$). For transitions with $F_g < F_e$, subnatural-width peaks in the fluorescence have been observed.

If the polarization of the laser beam is changed from linear to circular, the sign of the narrow resonances is reversed. The contrast and width of the narrow resonances is measured in dependence on laser power density. A discussion will be presented about the physical processes responsible for the subnatural-width peaks and dips in the fluorescence.

In the case of Cs cell with 5 Torr of buffer gas, no narrow resonances have been observed at linear polarization. However, when the laser beam polarization is changed to circular, only single-sign narrow resonances are observed throughout all hf transitions of the D_2 line. Theoretical investigation is in progress about the reason behind this phenomenon.

The observed extremely narrow peaks and dips in the fluorescence, their sensitivity to atomic collisions and to very weak magnetic fields are interesting for high resolution spectroscopy and for precise magnetic field measurements.

NONLINEAR OPTICAL PROPERTIES OF FULLERENE-CONTAINING MEDIA
AND LASER OPTICS

I. M. Belousova, O. B. Danilov, A. A. Mak
Research Institute for Laser Physics
12, Birzhevaya line, St. Petersburg, Russia

We present the results of the work on study of nonlinear-optical properties of fullerene-containing media and carbon nanostructures.

The results on application of the fullerene-containing media and nanostructures for fast-rate optical limiters of laser radiation are obtained in the wavelength range from 0.3 to 1.3 μm with switching time down to 1.5 ps. We have studied peculiarities of dynamic hologram recording in the fullerene-containing media. It is shown that nonlinear-optical fullerene-containing media can be used for refinement of spatial parameters of laser radiation in the near zone.

We present the results of theoretical and experimental studies on obtaining of singlet oxygen on the base of photochemical reactions with fullerenes and carbon nanostructures for oxygen-iodine laser. It is shown that the fullerene-oxygen-iodine laser due to absence of Stockes losses can transform the energy of optical radiation, including the solar one, into the laser beam with efficiency of more than 50%.

DEVELOPMENT OF FEMTOSECOND LASER SYSTEMS
BASED ON Cr AND Ti DOPED BERYLLIUM ALUMINATE CRYSTALS

E. V. Pestryakov¹, A. I. Aimpiev², V. N. Matrosov³

¹Institute of Laser Physics SB RAS, Novosibirsk, 630090, Russia

²Technological Institute of Monocrystals SB RAS, Novosibirsk, 630058, Russia

³Belarusian State Polytechnical Academy, Minsk, 220107, Belarus

The results of the studies of the growth the beryllium containing crystals in system - p-BeO-m-Al₂O₃-n-SiO₂, investigations of their physical properties and spectral and laser characteristics of impurity titanium and chromium ions and basic properties of doped crystals needed for femtosecond laser systems have been presented.

The spectroscopic properties of trivalent chromium and titanium ions in BeAl₂O₄, BeAl₆O₁₀, Be₃Al₂Si₆O₁₈ and BeLaAl₁₁O₁₉ crystals were studied. The absorption, fluorescence, excitation spectra and thermal dependencies of lifetimes and lasing parameters of broadband vibronic transitions of doped ions were investigated. Laser action was achieved on BeAl₆O₁₀:Cr crystal in spectral range 780-950 nm and on BeAl₂O₄:Ti crystal with gain band in range 700-1000 nm. Generation of ultrashort pulses was realized in Kerr-lens locking regime on BeAl₂O₄:Ti crystal. With intracavity GVD compensation laser produced the bandwidth limited ultrashort pulses with duration 30-50 fs. Nearly the analogous results were achieved on BeAl₆O₁₀:Cr crystal.

Figure of merit of active media for Kerr-lens femtosecond laser were developed and applied to Cr and Ti doped crystals. The comparison of beryllium containing active media with well-know laser materials, such as Al₂O₃:Ti and Mg₂SiO₄:Cr, was performed. For Kerr-lens femtosecond lasing, BeAl₂O₄:Ti and BeAl₆O₁₀:Cr have figure of merit of the same order of magnitude that those of Al₂O₃:Ti crystal. But the laser action on chromium doped crystals is possible under diode pumping at 650-670 nm. It is shown that the beryllium aluminate crystals - BeAl₂O₄:Ti and BeAl₆O₁₀:Cr are perspective active media for generation and amplification femtosecond pulses.

This work was performed in part under the support of the RFBR grant 01-02-16845 and of Siberian Branch of RAS grant IG2000-49 and IG2000-8.

SECOND HARMONIC GENERATION OF Cr-FORSTERITE FEMTOSECOND
LASER RADIATION IN PARTIALLY DEUTERATED DCDA CRYSTALS

V.M.Gordienko, S.S.Grechin, A.A.Podshivlov, V.I.Pryalkin

International Laser Center, Moscow State University, Moscow, 119899 Russia

Telephone: (095)9391630. Fax: (095)9393113. E-mail: vip@lbo.phys.msu.su

A.A.Ivanov

Center of Photochemistry, Russian Academy of Sciences, ul. Novatorov 7a, Moscow,

117421 Russia

Telephone: (095)9350209. Fax: (095)9351763.

Nonlinear frequency conversion of femtosecond pulses under a zero-group-velocity mismatch conditions is very attractive, because high efficiency conversion may be realized without significant temporal distortion of output pulse [1]. Calculations show that there is only one wavelength of pump radiation for the group velocity matching second harmonic generation in uniaxial nonlinear crystals. These wavelengths for isomorphous CDA-DCDA crystals are 1210 nm and 1310 nm respectively [2]. It is evidently that this wavelength should coincide with Cr:forsterite laser wavelength in a partially deuterated CDA crystal.

Several DCDA crystals with different deuteration degree were grown to choose the properly level of deuteration. Nonlinear elements for second harmonic generation of femtosecond Cr:forsterite laser radiation were produced. We studied temporal and spectral parameters of second harmonic (oo-e interaction) pulse. The radiation of self-started passive mode-locked SESAM-mirror Cr:forsterite laser (pulse duration is 80 fs) was focused into nonlinear crystal. Spectra of SH output were measured by OMA (spectral resolution 0.1 nm), pulse duration derived from second-order autocorrelation function measurements with resolution 5 fs. No temporal spreading of second harmonic pulse took place when DCDA crystals (17%-32% level of deuteration) with length up to 16 mm were used.

1. A.S.Akhmanov, A.S.Chirkin, V.A.Vyslouch. Optics of femtosecond laser pulses. (M., Nauka, 1988).

2. A.A.Lukashev, A.S.Magnitski, V.I.Pryalkin. Izv. RAN 59, 123 (1995).

SECOND HARMONIC GENERATION OF FEMTOSECOND LASER RADIATION
IN CESIUM TRIBORATE CRYSTALS

V.A.D'yakov, S.S.Grechin, V.I.Pryalkin

International Laser Center, Moscow State University, Moscow, 119899 Russia

Telephone: (095)9391630. Fax: (095)9393113. E-mail: vip@lbo.phys.msu.su

Cesium triborate crystal (CsB_3O_5 , CBO) was grown and characterized in the middle of 90th. There are two dispersion relations for CBO refractive indices [1,2]. These relations are the base for calculations of phase and group velocity matching directions for second harmonic generation. It should be mentioned, that calculation of phase matching angles for second harmonic generation according [1] and [2] gives different results. For example, the angle for second harmonic generation of YAG:Nd laser radiation according the dispersion relation from [1] is 67.5 arc degree, according [2] is 58.2 arc degree, and experimental value is 62 arc degree. The difference becomes smaller in the visible range of spectra. Calculation of a group velocity matching wavelength for second harmonic generation in CBO crystal gives the wavelength in the blue [1] and in the near infrared [2] region of spectrum.

To make more precise phase matching angles and group velocity matching wavelength in CBO crystal, we had grown some cesium triborate crystals with dimensions up to 5 cubic centimeters. Crystals were grown by seeded growth from a melt and samples with high optical quality were cut for nonlinear optical experiments. An optical parametric oscillator based on KTiOPO_4 crystal was used to measure the second harmonic generation phase matching angles and spectral bandwidth. Measurements show, that SHG spectral bandwidth has upper bound in the range of pump wavelength about 1100-1350 nm. So dispersion relation for CBO refractive indices from [2] is more acceptable than one from [1]. Also, the experimental results show, that CBO crystal may be used for second harmonic generation of femtosecond Cr:forsterite laser radiation.

1. Y.Wu, T.Sasaki, S.Nakai, et. al. Appl. Phys. Lett., 62, 2614 (1993).

2. K.Kato. IEEE JQE, 31, 169 (1995).

STIMULATED RAMAN SCATTERING IN NEW BaWO₄ CRYSTAL

P. G. Zverev, T. T. Basiev

Laser Materials and Technology Research Center of General Physics Institute
Vavilov str., 38, Moscow 117942 Russia

Stimulated Raman Scattering (SRS) in solid state materials is a new extensively growing area in laser physics. SRS allows to change laser radiation frequency with the certain energy shift that is determined by the crystal structure of Raman material. Recently spontaneous Raman spectroscopy of various crystalline materials was investigated [1]. This allowed us to propose new BaWO₄ crystal for SRS. Its A_g mode (925 cm⁻¹) has high peak and integral Raman scattering cross section with linewidth 1.6 cm⁻¹.

The steady state Raman gain in BaWO₄ crystal measured under pumping with 12 ns pump pulses (λ=532 nm) was found to be 36 cm/GW that was close to record value observed in barium nitrate crystal [2]. The highest conversion efficiency to the 1st and 2nd Stokes components reached 20% and 10%, correspondingly.

High steady state Raman gain and good thermo-mechanical properties of BaWO₄ crystal allowed to use it for SRS of second harmonic of quasi-cw Nd³⁺:YLiF₄ pump laser with 400 ns pulse duration and 1 kHz repetition rate. Usage of additional Raman cavity allowed to reach 130 mW average output power in the 1st Stokes oscillation (λ=554 nm) with 7.8 W pump power with slope efficiency as high as 15%. Optimization of cavity mirrors provided 2nd Stokes radiation (λ=583 nm) with 21 mW power for 2.5 W pumping.

Short A_g mode relaxation time of 6.6 ps resulted in efficient SRS of picosecond pulses in BaWO₄ crystal. The scattering of 28 ps pump pulses provided 30% and 15% conversion efficiency to the first and second Stokes components that proved the unique feature of new barium tungstate Raman medium.

1. T. T. Basiev, A. A. Sobol, P. G. Zverev, V. V. Osiko, and R. C. Powell, *Applied Optics*, **38** (1999) 594-598.
2. P. G. Zverev, T. T. Basiev, A. A. Sobol, V. V. Skorniyakov, L. I. Ivleva, N. M. Polozkov, V. V. Osiko, *Quantum Electronics*, **30**, (2000) 55-59.

NEW CLASS OF NONLINEAR OPTICAL CRYSTALS AMONG ARGININE SALTS

Petrosyan A.M.^{a)}, Feigelson R.S.^{b)}, Van Stryland E.W.^{c)}, Sukiasyan R.P.^{a)}, Karapetyan H.A.^{d)}
^{a)} Yerevan State University, Alex Manoogian 1, Yerevan, 375049, Armenia, ^{b)} Center for Material Research, Stanford University, 105 McCullough Building, Stanford, CA 94305-4045, USA, ^{c)} CREOL, University of Central Florida, Orlando, FL, USA, ^{d)} Molecular Structure Research Center, NAS of Armenia.

The design of crystals, which combine the positive features of inorganic and organic crystals, is the proposed direction of a search for new nonlinear optical materials. One such direction is the development of salts of protonated amino acids, in particular arginine. The discovery of promising nonlinear optical properties of L-Arg.H₃PO₄.H₂O (LAP) stimulated a further search for crystals of this family [1]. When trying to synthesize arginine monoarsenate, unexpectedly diarsenate L-Arg.2H₃AsO₄ was formed [1]. As we discovered later, the crystal of L-Arg.2HI had been synthesized earlier (see private communication of O.Seely in [2]). These facts show the possibility of the formation of arginine salts with composition 1.2. However, this did not attract proper attention at that time. Meanwhile, as we determined [3], there is an entire class of such crystals. In the present work we report on obtaining 11 salts of L-arginine from which 4 are LAP-analogs with composition 1.1 (L-Arg. HCOOH, L-Arg.HClO₄, L-Arg.HBrO₃, L-Arg.(COOH)₂) and 7 crystals of a new class of arginine salts with composition 1.2 (L-Arg.2HIO₃, L-Arg.2HNO₃, L-Arg.2H₃PO₄, L-Arg.2HF, L-Arg. 2HCl.H₂O, L-Arg.2HBr.H₂O and L-Arg.2(COOH)₂). The crystal and molecular structures of all these crystals have been determined and characterized by spectral and thermal analysis methods and SHG. The possibility of growing single crystals of all these salts and the detection of strong phase-matched SHG signals of the Nd:YAG laser in most of them shows that crystals of this class are promising for further study and applications in nonlinear optics.

- [1] Monaco S.B., et al., *J. Crystal Growth*, **85**, 252 (1987).
- [2] Lakshminarayana A. V., et al. In: *Conformation of Biopolymers*. Ed. by G.N. Ramachandran. London, Acad. Press, vol. 1, p.61 (1967).
- [3] Petrosyan A.M., et al., *J. Crystal Growth*, **213**, 103 (2000).

Modulational Instability in Quadratically Nonlinear Media: Role of Dimensionality and Measurement of the Gain Coefficients

George I. Stegeman, Roland Schiek, Hui Fang and Roman Malendevich
School of Optics and CREOL, University of Central and Florida
4000 Central Florida Blvd., Orlando FL 32816-2700, USA

Plane waves are unstable eigenmodes of self-focusing media. At high intensities, beams with large transverse dimensions and superimposed noise perturbations break up into periodic patterns of intensity maxima. This occurs with every nonlinearity which produces beam narrowing, including second harmonic generation. In this paper are reported the first experiments on generating MI in media with $\chi^{(2)} = 0$, in LiNbO_3 slab waveguides and in bulk KTP and KNbO_3 crystals. This allowed us to investigate the effects of dimensionality (waveguide versus bulk) on MI, and by seeding the perturbations with specific periodicities, to measure the gain coefficients.

The waveguide experiments were performed in Ti:indiffused LiNbO_3 waveguides with birefringent phase-matching at 1300nm. When a noisy fundamental beam was inputted, it was observed to break up into individual maxima whose periodicity decreased with increasing power. This was in good agreement with theoretical predictions when the pulsed nature of the beams was taken into account. In additional experiments, the input beam was modulated periodically in space and the experimental conditions were set so that the modulation was amplified, but not into saturation. As a result, the gain coefficient was measured as a function of intensity, periodicity and phase-mismatch, all in excellent agreement with theory.

MI was also measured in bulk KTP with an elliptical beam with a large aspect ratio. In contrast to the waveguide case, the maxima at the output was essentially a periodic array of spatial solitons, because the large aspect ratio allowed excess energy to be radiated away along the short ellipse axis.

This research was supported by an ARO MURI.

LIGHT PROPAGATION IN DENSE RESONANT MEDIA: INTRINSIC OPTICAL BYSTABILITY, SOLITONS AND TRANSIENTS

A.A.Afanas'ev^a, V.I.Reshetnyak^a, R.A. Vlasov^a, V.M.Volkov^a
O.K.Khasanov^b, O.M.Fedotova^b, D.V. Gorbach^b, and T.V.Smirnova^b
^aInstitute of Physics, NASB, 68 F.Scaryna Ave., ^bInstitute of Physics of Solids and Semiconductors, NASB, 17 P.Brovki Str.; 220072 Minsk, Belarus

This report is concerned with some new results of our studies of the stationary and nonstationary interaction of laser radiation with dense resonant media. At this the local-field effects associated with the near dipole-dipole (NDD) interaction are taken into consideration.

As to the stationary interaction, we consider the joint action of the dynamic Stark effect and up-conversion on the intrinsic optical bistability (IOB) in a dense ensemble of quiresonant atoms modeled by the generalized two-level systems. Such a combination is shown to be advantage in facilitating of IOB emergence. This implies: (a) the possible reduction of the necessary NDD interaction constant, (b) the decrease in the intensity threshold, (c) the possibility of increasing sample temperatures.

The nonstationary interaction consideration includes the soliton formation and transients. There are two soliton regimes: "coherent" with the pulse width being much less than the both relaxation times and "incoherent" when the pulse width falls between them. The latter is of most interest because the very soliton existence is ensured by the NDD interaction that allows the dephasing process to be suppressed. Its realization is hindered by the rather large necessary NDD interaction constant. This difficulty is resolved by introducing the group velocity dispersion or by making use of the tilted pulse technique, taking account of the diffraction (in principle, the dispersion and diffraction can be combined). Characteristic properties of spontaneous responses such as echo signals and free polarization decay are analyzed. For example, echo responses can arise even in the absence of the inhomogeneous broadening, unlike the usual echo formation. The transients can markedly be influenced by the up-conversion.

FUNDAMENTAL ASPECTS OF SINGULAR OPTICS

(OPTICAL VORTICES)

M. S. Soskin, M. V. Vasnetsov,
Institute of Physics, NAS of Ukraine,
Prospect Nauki 46, Kiev, 03650, UKRAINE

Singular optics is a new branch of modern optics and photonics. It subject is a wide class of phenomena associated with phase singularities in wave fields, which appear in the points where field amplitude equals exactly zero and phase is undetermined^{1,2}. Three types of optical singularities are known:

- ray singularities, or caustics, considered by catastrophe optics³.
 - singular optics of scalar fields, or linearly polarized light⁴. Phase singularities of scalar fields possess the form of helicoidal optical vortices (OVs), or screw wave-front dislocations, and edge wave-front dislocations. Being the structure of classical wave fields OVs are characterized by new quantified parameters: the integer topological charge and the orbital angular momentum mh per photon for arbitrary frequency. It was shown recently that OV exist even as the mode of quantum noise and play the fundamental role in the structure of single photon⁴.
 - polarization singularities of vector light fields⁵.
- All linear and nonlinear effects and phenomena with laser singular beams possess essential peculiarities like dark solitons, "vortex street" in SHG⁷, birth of phase singularities during propagation of ultra-short pulse in nonlinear media, what influence on its form⁸, etc.

1. J.F. Nye, M.V. Berry, Proc. Roy. Soc. London, A **336**, 165 (1974).
2. M. Soskin, and M. Vasnetsov, Photonic Science News **4**, issue 4, 21 (1999).
3. M.V. Berry, and C. Upstill, Progress in Optics, **XVIII**, 257 (1980).
4. P. Di Trapani, A Berzanskis, S. Mirandi, S. Sapone, and W. Chinaglia, Phys. Rev. Lett., **81**, 5133 (1998).
5. J.F. Nye, Natural Focusing and Fine Structure of Light Caustics and Wave Dislocations (Bristol, Institute of Physics Publishing, 1999).
6. Yu. S. Kivshar, and B. Luther-Davies, Phys. Rep. **298**, 81 (1998).
7. G. Molina-Terriza, L. Torner, and D. Petrov, Opt. Lett. **24**, 13 (1999).
8. H.S. Eisenberg and Y. Silberberg, Phys. Rev. Lett., **83**, 540 (1999).

Intrinsic Optical Bistability in Composite Materials

K.C.Rustagi and S.Mukhopadhyay
Laser Programme, Centre for Advanced Technology, Indore 459 013, India

I. SUMMARY

Using an effective medium theory we evaluate the nonlinear optical response of composite media. We first show that the nonlinear optical response of a spherical metal nanoparticle near its plasmon resonance depends sensitively on the phase of the nonlinear susceptibility. For purely imaginary nonlinear coefficient bistability can occur only for $Im(\chi^{(2)}) < 0$, corresponding to an intensity dependent gain. This explains why such a bistability has not been observed experimentally in metal-insulator composites since most of the proposed mechanisms predict a predominantly imaginary $\chi^{(3)}$.

We next show that an effective medium theory provides a good description of the intersubband plasmon resonance observed recently in the InAs/AlSb multiple quantum well system[1]. In the effective medium theory the effective dielectric function $\bar{\epsilon}$ for a simple barrier (width $(1 - \alpha)d$) and well (width αd) layered structure is given by

$$1/\bar{\epsilon} = \alpha/\epsilon_W + (1 - \alpha)/\epsilon_B \quad (1)$$

where ϵ_W and ϵ_B denote $(\epsilon_W)_{zz}$ and $(\epsilon_B)_{zz}$, respectively, z -axis being the normal to the plane of the layers. The intersubband plasmon corresponds to the condition, $1/\bar{\epsilon} \rightarrow 0$, or

$$\epsilon_W(\omega) \equiv -\alpha\epsilon_B(\omega)/(1 - \alpha). \quad (2)$$

In semiconductor quantum wells with moderately high doping this condition can be obtained just above the frequencies for intersubband transitions. Eq.(2) is similar to the condition for surface plasmon resonance in various geometries. For example, for a spherical nanoparticle, the resonance frequency is given by $\epsilon + 2 = 0$ where ϵ is the relative dielectric function of the sphere. There are important differences, though. In all surface plasmons, the field is enhanced only in interfacial region e.g. near the sphere for the nanosphere and near the interface for the semi-infinite interface. For the MQW an intersubband plasmon (ISBP) corresponds to an enhancement of field amplitudes in the well regions as well as in the barrier regions although with opposite signs. To check this theory on a specific system we consider InAs/AlSb MQWs investigated recently by Warburton et. al.[1] The theory gives good agreement for the linear spectra and predicts a shift of the plasmon peaks with barrier width. Extending the theory to the nonlinear regime, it is predicted that this system will show intrinsic optical bistability near the plasmon resonance.

I.R. J. Warburton et al Phys. Rev. Lett. **80**, 2185 (1998).

BRIGHT SPATIAL SOLITONS OF A STABLE WIDTH IN A RANGE OF
NONLINEARITY IN STRONTIUM BARIUM NIOBATE CRYSTAL

V.Shandarov

State University of Control Systems and Radioelectronics
40 Lenin Ave., Tomsk, 634050, Russia

D.Kip, M.Wesner

Osnabrueck University, 49069 Osnabrueck, Germany

Different kinds of photorefractive spatial solitons were the subject of intense investigations in the last years. However, there are still many points within this field that require more detail inspections. The one of important among them is the sensitivity of the soliton states to the variation of light beam parameters at the nonlinear medium input with respect to such parameters strictly required by the soliton existence curve.

The main aim of this work was the experimental investigation both of the one - dimensional bright screening spatial solitons in a strontium barium niobate crystal and of a range of conditions that allows the convergence of a light beam to the soliton.

Experiments were performed at wavelength of an Ar - ion laser ($\lambda = 514$ nm). The laser beam was splitted into two separate orthogonally polarized beams. The first was used as the recording beam to form the one - dimensional bright spatial soliton. The beam size at the crystal input face along the c - axis changed from 9 to 20 μm and it was extraordinarily polarized. The second ordinary beam provided the background light within a crystal necessary for the correct soliton regime. The electric voltage applied to the crystal was varied in experiments from 0 V up to 5 KV. The images of a light beam at an input and output faces of a crystal were inspected by a CCD camera. In experiments we studied the dependences of the light beam width at the crystal output face both on the electric field and the recording beam intensity ratio to the background intensity (I/I_{bg}) for different input beam widths. The one of main experimental results is the stable soliton width in the range of electric voltage from 1,8 KV to 5 KV for $I/I_{bg} < 0,5$ and the input beam width of 12 - 14 μm . This effect cannot be explained by the ideal soliton existence curves. Its possible origins will be discussed in the report.

(Keynote)
FHI

Ultrafast Hydrated-Electron Dynamics

Maxim S. Pshenichnikov, Andrius Baltuska, Douwe A. Wiersma
Department of Chemistry, Materials Science Centre
University of Groningen
Nijenborgh 4, 9747 AG Groningen, The Netherlands
e-mail: m.s.pshenichnikov@chem.rug.nl

The hydrated electron is an excess electron trapped in a pre-existing potential-well formed by surrounding water molecules. The energy levels of the hydrated electron are those of a particle in a heavily perturbed spherical box. Excess electrons in condensed-phase media play a crucial role in the dynamics of important chemical processes. Among these are solution photochemistry, non-radiative electronic transitions, and charge transfer reactions. Hydrated electrons are particularly interesting because they can be viewed as a probe for extracting information about solvation processes in water, which play an outstanding role in nature. Another motivation for a detailed study of the hydrated electron stems from the unique possibility to directly confront the results of mixed classical-quantum mechanical molecular dynamics simulations with the experimental results. This allows verification of the basic *a priori* assumptions put into the computer modelling.

We performed pump-probe and photon echo experiments on the hydrated electron with an unprecedented sub-5-fs time resolution, resolving the long-standing issue of homogeneous vs. inhomogeneous broadening in the optical absorption spectrum of the excess electron in water. We have shown that the spectrum is homogeneously broadened with a dephasing time of 1.7-1.6 fs. With this value, the absorption spectrum of the hydrated electron can be successfully modelled provided the conventionally used rotating wave approximation is abandoned. For the modelling of the experimental observations, we derived the complete expressions for the non-linear signal, valid even in the single optical cycle regime.

Frequency-resolved pump-probe experiments have shown that the amplitude of the stimulated emission rapidly decreases within the first 100 fs. The frequency of the energy gap, where the population of the excited state crosses back to the ground state, is ~ 9500 cm^{-1} . Therefore, a large amount of energy deposited on the hydrated electron is rapidly absorbed by the water molecules with the characteristic transfer time of ~ 50 fs. This decay time is dominated by the librations of water molecules as follows from a substantial isotope effect. The following relaxation occurs in the hot-ground stage at a ps time scale. During this stage the water molecules in the first solvation shell deploy the accumulated excess energy into a collective-type translational motion, most probably via the existing hydrogen-bond network. Finally, by ~ 6 ps.

Our results pose a serious challenge for mixed classical-quantum mechanical MD simulations, which predict different dynamics and therefore seem to have missed essential elements of the electron-water interaction potential.

Coherence, Relaxation and Reaction of Solution-Phase Molecules

Studied by Femtosecond Nonlinear Spectroscopy

Tahpei Tahara

Institute for Molecular Science, Myodaiji, Okazaki 444-8585, JAPAN

Tel: +81-564-55-7391, Fax: +81-564-54-2254, E-mail: tahara@ims.ac.jp

With recent remarkable improvements of ultrashort-pulse lasers, we are now able to generate an optical pulse shorter than a few tens of femtoseconds. Owing to its ultrashort duration and broad frequency bandwidth, the ultrashort pulse can excite a molecule 'impulsively' into a coherent superposition of a number of vibrational eigenstates. This vibrationally-coherent state evolves in time, which is so-called a wavepacket motion. The observation and control of the wavepacket motion have been receiving recent attention in spectroscopy using ultrashort optical pulses. In femtosecond pump-probe measurements, the wavepacket motion (or vibrational coherence) in the system often gives rise to oscillatory features in the pump-induced absorption signals. These features are theoretically treated as the third-order nonlinear optical processes that involve interactions with both the pump and probe electric fields.

We report the recent results of our femtosecond pump-probe experiments on several fundamental molecules, which were undertaken using a non-collinear OPA system giving sub-10 fs pulses. The vibrational coherence in the S_1 state of *trans*-stilbene is discussed in relation to the data of the frequency-domain vibrational spectroscopy. The wavepacket motion and reaction dynamics of the photodissociation of diphenylcyclopropanone are also discussed.

KINETICS OF STRIPES AND PSEUDOGAP IN HIGH TEMPERATURE SUPERCONDUCTORS

V.M. Petnikova, V.V. Shuvalov, A.V. Voronov

M.V.Lomonosov Moscow State University, Vorob'evy Gory, Moscow 119899, Russia
Phone: 7(095)9395035, Fax: 7(095)9393113, E-Mail: vsh@vsh.phys.msu.su

We present a new semi-classical phenomenological model of magneto-dipole interaction of charge carriers ("holes") in CuO_2 planes of cuprate high-temperature superconductors (HTSCs). In terms of the developed model, we show that decrease of HTSC sample temperature to the range $T < T^*$ (here $T^* \sim 1.6 \div 1.7 T_c$ is the specific critical temperature, T_c is the temperature of superconductive phase transition) leads to instability of holes' spatially uniform distribution. This results in a specific structural phase transition with formation of holes' spatially non-uniform periodical distributions (so-called "stripes" [1]) and in appearance of a specific energy gap ("pseudogap" [2]) in the sample energy spectrum. We analyze steady-state properties of the stripes as well of the energy pseudogap and show that ultra-fast heating of cooled HTSC sample to the temperature range $T^* < T < 1.4 \div 1.5 T^*$ leads to specific long-living metastable states of stripes. On this basis, we interpret our recent experimental results [3], obtained by non-steady-state coherent four-photon picosecond spectroscopy of high-quality optimally-doped Y-Ba-Cu-O films after (time delay $\sim 0.5 \div 1$ ns) preliminary excitation by an additional picosecond pumping (pulse duration ~ 20 ps) with energy density up to 10^{-3} J/cm². These experimental results fully contradicts to the data of numerous direct measurements of conductivity of HTSC films [4], which have shown that superconducting state should be practically instantly destroyed by a laser pulse with such excitation level.

4. J.M. Trancquada, et al. Nature 375, 561 (1995).
5. H. Ding, et al. xxx.lanl.gov/abs/cond-mat/9712100.
6. V.A. Lobastov, et al. Physica C 221, 311 (1994).
7. N. Bluzer. Phys. Rev. B44, 10222 (1991).

ULTRAFAST INTERFACIAL ELECTRON TRANSFER IN DYE-SENSITIZED TiO₂ FILMS.

Arkady Yartsev, Gabor Benkő, and Villy Sundström
 Department of Chemical Physics, Lund University
 P.O.Box 124, S-22100, Lund, Sweden

We have observed electron injection from two photoexcited dyes, Fluorescein 27 and Ru(4,4'-dicarboxy-2,2'-bipyridine)₂(NCS)₂, into the TiO₂ conduction band in the visible and near IR spectral regions recording both differential spectra from 400 to 1050 nm and kinetics at appropriate characteristic wavelengths. Spectra were measured with 5 nm spectral resolution by a conventional differential spectrometer with 150 fs response function (FWHM). Spectrally integrated characteristic kinetics were recorded by means of a novel non-collinear parametric amplification laser system with ~30 fs pulses tuneable from 450 to 1200 nm. With both approaches differential absorption signals as weak as 10⁻⁵ OD could be accurately measured. Care has been taken to control the artefact signals from the sample front window and solvent and to minimize their amplitude. Appropriate sample handling and low excitation intensity allowed us to obtain easily reproducible dynamics of the photoinduced spectral changes.

In both samples electron injection with very broad distribution of rates from sub-100 fs to tens of ps was observed. Injection before and after thermalization was found. Intersystem crossing was observed to compete with "hot" electron injection in the case of Ru(4,4'-dicarboxy-2,2'-bipyridine)₂(NCS)₂. Clear modification of the electronic structure of the Fluorescein 27 under adsorption on TiO₂ surface was observed. Fast and relatively efficient recombination of the conduction band electrons with the photo-oxidized dye molecule was observed only for Fluorescein 27.

Ultrafast charge carriers generation in C60 films, excited by femtosecond pulses at different wavelengths.

S.V. Chekalin Institute of Spectroscopy RAS, 142190 Troitsk, Russia
 phone (7-095)3340237, FAX (7-095)3340886, e-mail: chekalin@isan.troitsk.ru
 A.P. Yartsev, V.Sundstroem Lund University Chemical Center, S-221 00 Lund, Sweden

We investigated relaxation in C60 films of 140-200 nm thickness on quartz substrates, excited by 100-120 fs laser pulses (repetition rate 5 kHz), probing by weak pulses of femtosecond supercontinuum in the broadband spectral range of 400 –1100 nm Data were compared on excitation in fundamental bands of C60 (wavelengths 367 and 345 nm), and in forbidden HOMO-LUMO band (645 nm). In the former case the influence of oxygen has been investigated. In all cases only some percents of C60 molecules were excited.

The experiments revealed that the basic features in difference spectra are the same for different excitation wavelengths. The second important result is quite different behavior of characteristic bands in difference spectra. We note this wide intersecting bands as 500nm (450-530nm), 600nm (500-750nm) and 900nm (700-1100nm) bands. Decay kinetics of all these bands have quite different temporal behavior and dependence on the excitation intensity, wavelength and oxygen content.

These observations evidences that .during the excitation a multicomponent system arises with different decays for each component. As for the nature of these components we can conclude that some of the observed spectral features belong to charges produced by excitation. It follows from the observation that difference spectrum in the spectral region 400 – 520 nm, arising just under excitation, strongly resembles electroabsorption (EA) spectrum of C60 film. EA features point to fast appearance of local electric fields in the sample during the excitation pulse. These features can be seen in difference spectra up to maximal delay times (550 ps) and are far and away connected with production of electric charges by the pulse.

According to our experimental findings charge carriers are generated very quickly (during excitation time) in all cases. The primary excitations, which arise with pulsewidth –limited rise time are excited molecules (band 600nm), holes (band 900nm) and electrons (no absorption). Anions (band 500nm) arises more slowly (nonexponential rise with characteristic risetimes from 10⁻¹³ s to 10⁻¹¹ s) due to effective capture of electrons by C60 molecules in the ground state (electron affinity 2.65 eV).

This work is supported by the Swedish Institute.

QUANTUM COMPUTER WITH ODD AND EVEN COHERENT STATES OF LIGHT

D.B.Horoshko and S.Ya.Kilin

*Stepanov Institute of Physics, Belarus National Academy of Sciences
F.Skarilya Ave. 68, Minsk 220072 Belarus*

We propose a new model of quantum computer, where the role of qubit is played by

a single-mode optical field, specially prepared in odd or even coherent state:
 $|\alpha_{\pm}\rangle = (\alpha \pm |-\alpha\rangle) / \sqrt{2}$. The basic states of the qubit can be encoded in two ways: (i) via discrimination by parity $|0\rangle = |\alpha_+\rangle, |1\rangle = |\alpha_-\rangle$, or (ii) by phase: $|0\rangle = |\alpha\rangle, |1\rangle = |-\alpha\rangle$.

The gates are represented by nonlinear media implementing multi-wave cross-phase modulation. The C-NOT and Toffoli gates are shown on the Fig. 1 and Fig. 2 respectively. \hat{n} is the photon number operator. The controlling qubits are encoded via first way, while the controlled one - via second way. The re-encoding can be realised by a transformation similar to C-NOT gate with the use of an ancillary field.

We show how a fully reversible quantum adder can be built by combining these gates and re-encoders. We also show how the recently found algorithm of entanglement restoration for odd and even coherent states [1] can be applied for quantum error-correction.

[1] S.Ya.Kilin and M.G.Raymer, Phys. Rev. Lett. (2001) (submit.)

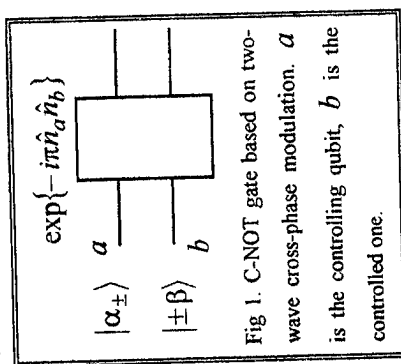

Fig 1. C-NOT gate based on two-wave cross-phase modulation. *a* is the controlling qubit, *b* is the controlled one.

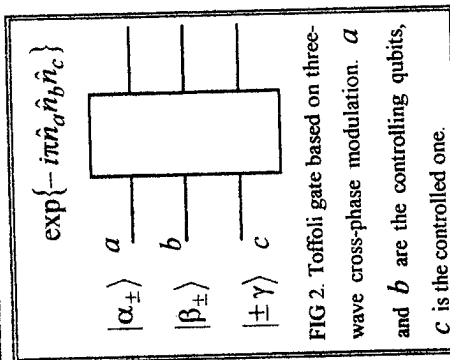

FIG 2. Toffoli gate based on three-wave cross-phase modulation. *a* and *b* are the controlling qubits, *c* is the controlled one.

Nonclassical light generation at consecutive and simultaneous QPM wave interactions

A.S. Chirkin
M.V. Lomonosov Moscow State University, 119899 Moscow, Russia

The so-called quasi-phase-matched (QPM) light wave interactions are realized in periodically poled nonlinear crystals, for instance LiNbO₃ crystal. Besides conventional three frequency wave interactions, in the case of QPM interactions two three frequency wave processes can be implemented as consecutive ones [1] or simultaneous ones. Consecutive interactions of waves with multiple frequencies ω , 2ω , and 3ω give rise to particular interest as in this situation the process of parametric amplification of the wave with frequency 3ω at the 2ω pumping frequency can be realized (low frequency parametric amplification).

Recently we established that in the periodically poled LiNbO₃ crystal the QPM wave interactions can also be used to implement simultaneously two three frequency wave processes which have the same pumping frequency (two parametric down-conversion processes).

In this paper we present the results of quantum analysis of light generated by the consecutive and simultaneous QPM interactions. At the consecutive interactions the process of the low frequency parametric amplification is considered in the cases of co-directional and contra-directional waves interactions. We study forming quadrature-squeezed light at the frequencies ω and 3ω (pumping frequency is equal to 2ω), statistics photons and correlation and entangled properties between photons with the frequencies ω and 3ω .

In the case of two simultaneous QPM three frequency processes the main attention is paid to analysis of forming the entangled states at the collinear geometry of interactions. It is shown that such interactions can be employed for generation of the entangled states with different frequencies.

1. Chirkin A.S., Volkov V.V., Laptev G.D., and Morozov E.Yu.(review) Quantum Electronics, 30, 847 (2000).

Quantum properties of the two-mode Kerr states

Ryszard Tanaś
*Nonlinear Optics Division, Institute of Physics, Adam Mickiewicz University, 61-614
 Poznań, Poland*

Quantum description of elliptically polarized light propagating in a nonlinear Kerr medium requires two modes of the electromagnetic field to be accounted for properly. The two modes of the field are coupled via the nonlinear medium and this coupling can significantly change the state of the field. It is interesting to study quantum evolution of the individual modes and their quantum correlations. It is known that nonlinear interaction of the Kerr type leads to a number of nonclassical effects such as squeezing or creation of Schrödinger cats even in the one-mode (anharmonic oscillator) case. The same effects, with some modifications, can also be observed in the two-mode case. But the dynamics in the two-mode case is much richer and leads to some new quantum effects such as sub-Poissonian photon statistics of the linearly polarized light or the quantum depolarization effect, when the initially completely polarized light becomes partially polarized due to the quantum noise that is always present. The striking effect of the quantum nature of the field is, for example, the fact that the linearly polarized light, unlike classical field, becomes partially polarized when propagating in the isotropic medium.

The two-mode field can be conveniently described in terms of the quantum Stokes parameters. The Stokes parameters which are the expectation values of the Stokes operators carry information on the degree of polarization of the field, but the Stokes operators are quantum observables that themselves exhibit quantum fluctuations. Classically, the Stokes parameters are related to the phase difference between the two modes of the field. In quantum description it is by no means a trivial task to infer the phase properties from the Stokes parameters. Quantum phase description requires special attention and appropriate quantum treatment. There are several approaches that are used to describe phase properties of optical fields. Finally, quantum effects are rather sensitive to dissipation present in the system which degrades quickly the quantum effects. All these issues will be addressed in my talk.

Type-II Biphotons with Spectral Properties of Type-I Biphotons

A.V. Burlakov, M.V. Chekhova, O.A. Karabutova, S.P. Kulik and G.O. Rytikov.

*Department of Physics, Moscow State University
 119899 Moscow, Russia
 Tel: 7(095)939-4372, Fax: 7(095)939-1104, E-mail: postmast@qopt.ilt.msu.su*

Abstract: Anticorrelation effect is observed for type-II biphotons synthesized from type-I collinear spontaneous parametric down-conversion (SPDC) radiation. Combination of polarization properties of type-II with the spectrum of type-I SPDC suggests a convenient technique for precise group delay measurement.

Spontaneous parametric down-conversion (SPDC) is observed in two different versions. In type-I SPDC, pairs of correlated photons (biphotons) with the same polarization are generated. In type-II SPDC, polarizations of photons in each pair are orthogonal. Recently, it has been demonstrated experimentally that using the effect of two-photon interference, two beams of collinear type-I biphotons can be losslessly transformed into a beam of collinear type-II biphotons [1]. This transformation involves only linear optical elements and hence should preserve the original spectrum of SPDC.

In the present work we study the artificially synthesized type-II biphoton state by observing the anticorrelation effect for this state [2]. Collinear frequency-degenerate type-I SPDC is excited in two spatially separated domains of LiIO_3 crystal placed into a Mach-Zehnder interferometer and pumped by He-Cd laser with wavelength 325 nm. Then, type-II biphotons are synthesized from type-I biphotons. The delay between signal and idler photons is introduced, as usually for type-II SPDC, by means of a birefringent material, which ensures high stability of measurement. The width of the anticorrelation 'dip' is determined by the inverse width of type-I SPDC spectrum, which is essentially wider than the spectrum of type-II SPDC. For 15 mm LiIO_3 crystal, FWHM of 30 fs is observed. The 'dip' shape is compared with the shape of the first-order correlation function, $g^{(1)}(t)$, of type-I SPDC radiation, measured using the same setup. According to the theory, the 'dip' shape repeats the shape of $g^{(1)}(t)$ but its width is twice narrower.

The state synthesized in our experiment can be used for accurate measurement of group delays between orthogonally polarized photons. High stability is ensured by using polarization interferometer for introducing signal-idler delays; at the same time, the spectral properties of type-I SPDC lead to a very narrow anticorrelation 'dip'. Estimation for 2 mm BBO crystal gives the 'dip' width of about 5 fs. In addition, the interferometric technique used for the preparation of type-II state in the general case will give a state of two correlated photons with orthogonal elliptical polarizations. Hence, the anticorrelation effect also provides a way to measure group delays between photons with orthogonal elliptical polarizations.

References

1. A.V. Burlakov, M.V. Chekhova, O.A. Karabutova, D.N. Klyshko, and S.P. Kulik, *Phys. Rev. A* **60**, R4209 (1999).
2. C.K. Hong, Z. Y. Ou, and L. Mandel, *Phys. Rev. Lett.* **59**, 2044 (1987).

EFFECTS OF INSTANTANEOUS PHASE AND STARK SHIFT ON TWO-PHOTON PROCESS

M. M. Ashraf
 Pakistan Institute of Lasers and Optics
 P.O. Box 505 Rawalpindi, PAKISTAN
 Fax: 0092-51-9280239; E-mail: ashrafmian@hotmail.com

ABSTRACT

The effects of instantaneous phase shift experienced by the N th atom on other ($N-1$) atoms (all obeying two-photon transitions) inside a high-Q cavity, are presented. The effects of Stark shift on the probability amplitudes are also investigated. Our results show that for the two-atom case, by selecting phase, its timing and Stark parameter b_1 judiciously the photon-pair can be trapped and released periodically. A photon-pair after phase shift exhibits a mirror image of an atom-pair before phase shift. Under certain physical conditions the atoms seem to be localized by clamping the photon-pair. The photon emission probability like transition probability is linear with b_1 . For larger N atoms, the atoms are partially trapped periodically. The atomic trapped-time increases and the photon emission probability decreases with N .

SELF-ORGANIZATION OF NONLINEAR DYNAMIC CAVITY IN A HIGH-AVERAGE-POWER LASER OSCILLATOR

O.L. Antipov, A.P. Zinoviev, D.V. Chausov, A.V. Afanas'ev
 Institute of Applied Physics of the Russian Academy of Science
 46 Ulijanov St., Nizhnii Novgorod, 603600 Russia

Holographic gratings induced in a nonlinear active medium by generating optical beams themselves can complete the cavity of a laser oscillator. An important advantage of these new-class lasers is the self-adaptive property of their cavity provided by a nonlinear dynamic mirror, which is a self-pumped phase-conjugate mirror [1]. In this report we present new results of the theoretical and experimental investigation of the processes of spatio-temporal self-organization in lasers with cavity completed by holographic gratings. We also show that such lasers are capable of generating high average power optical beams with near-diffraction limited quality.

Numerical calculations of partial-derivative equations allowed us to determine the threshold and temporal behavior of the generated mode in different schemes of the self-starting laser. The calculation of the mode competition shows good discrimination properties of the nonlinear dynamic cavity.

The schemes of the self-starting laser, which differed by the geometry of wave intersection inside the laser crystal and by the period of population gratings, were studied experimentally. It was found that the self-starting conditions for lasers with dynamic cavity formed by large-scale transmitting grating and by small-scale reflecting grating are greatly different due to the difference in their spatio-temporal selectivity. The large-scale transmitting grating with weak spatio-temporal selectivity can initially be induced by waves of amplified spontaneous emission within the full luminescence line, whereas the small-scale reflecting grating with strong spatio-temporal selectivity can be induced only by few spontaneous components.

The generation of a good-quality beam with an average power up to 250...300 W was achieved experimentally. These experiments confirm good adaptability of the laser oscillator with dynamic cavity formed by the nonlinear gratings.

[1] O.L. Antipov, et al, "250W-Average-Power Nd:YAG Laser with Self-Adaptive Cavity Completed by Dynamic Refractive-Index Gratings", IEEE J. of Quantum Electronics V. 37, N. 5 (May 2001).

Vector and Scalar Spatial Solitons in Inhomogeneous Planar Magneto-optic Waveguides

A D Boardman and M Xie
Joule Physics Laboratory, School of Sciences, University of Salford
Salford, M5 4WT, UK

Magneto-optic material and thin film technology is already in an advanced state because of the very strong interest in magneto-optic recording media. This is implemented through a wide variety of materials and structures.

The paper will present the latest results on both scalar and vector spatial optical solitons in asymmetric magneto-optic waveguides, in which a fascinating array of vector Manakov-type TE-TM interactions will be displayed. Interfaces are important elements for the modulation of beams so it will be shown that a wide range of tuning possibilities exist, all of which depend upon the magneto-optic properties.

It will be shown that any complex form of waveguide structure that combines nonlinear element with magneto-optic and discontinuities in the form of interfaces and edges have an elegant description in terms of a global nonlinear Schrödinger-form of equation. TM results will be shown to contain generic features that facilitate the analysis of the much more complex TE-TM interactions.

A combination of linear magneto-optics and intrinsic optical nonlinearity will be used to model asymmetric nonlinear waveguide systems that permit soliton control and a possible new range of devices. The asymmetry makes it possible to use a transverse magnetic format in which the linear TM waves are nonreciprocal and the linear TE waves are reciprocal. The nonlinearity will couple them and produce a fascinating combination of forced gyrotropy and cross-phase modulation. Applications are proposed both for reasonably fast optical and also for routing purposes that are less demanding upon speed.

The paper discusses both scalar and vector solitons and will emphasise the multi-soliton approach. Magneto-optics is attractive for planar technology photonics if some degree of integration can be achieved. This will be addressed briefly with some suggestions being put forward for experimental realisation through surface matching and coupled waveguide approaches. The objective is an all-optics 'chip-level' format that will participate in, and control all-optical processing operations of the future. Once solitons are created, controlling their dynamics becomes an important issue and magneto-optics is put forward as a very attractive option.

The global equation will deal with waveguide complexity in quite a straightforward way and the new idea is to use an inhomogeneous magneto-optic presence created by deploying electrode structures or waveguide discontinuities. Even the simplest design gives an impressive degree of control over the soliton dynamics. Interesting examples will be given involving buried focusing structures.

Oscillating and rotating states for laser solitons

S.V.Fedorov, N.N.Rosano, A.N.Shatsev,
Institute for Laser Physics, Birzhevaya line 12, 199034 St.Petersburg, Russia,
N.A.Veretenov, A.G.Vladimirov,
St.Petersburg State University, Physics Faculty, 1 Uljanovskaya st, 198904 St.Petersburg, Russia.

The conditions and scenario for stability loss of laser solitons in 2D wide-aperture cavity with inertialless media are analyzed. The instability of radially symmetrical solitons with respect to asymmetrical perturbations with amplitude proportional to azimuthal dependency $\cos 2\varphi$ was found. Developing of these perturbations leads to an oscillating metastable state with zero momentum in accordance with the analogy between light intensity and mass density. Asymmetrical oscillations for 2D laser soliton are unstable relatively to perturbations with nonzero momentum of pulse. Growth of these perturbations with small rate leads to choosing of rotational direction as result of spontaneous symmetry breaking. Soliton excitation is of the hard type for linear gain large enough. Numerical simulations confirm the existence of bistability between two stable, radially symmetrical and rotating asymmetrical states of solitons. The instability of a rotating soliton is connected with radially symmetrical perturbations, which leads to a new type of stable laser soliton with periodic oscillations and rotation. For the case of 1D solitons in laser with finite relaxation rates of media, the region of stability of oscillating solitons is found. An example is presented of multiple consequent period doubling of symmetrical oscillations. This doubling can be connected with chaotic behavior arising in framework of one-particle interpretation of soliton. Asymmetrical oscillations of soliton with strong and slow modulation for amplitude of pulsations are demonstrated. Development of asymmetrical perturbations is, as well as in 2D case, a symmetry breaking process. As the result, we have soliton moving with a large speed in one of two directions, and emitting a finite number of similar structures (so called "the gun"). Possibilities of laser solitons applications in information processing are discussed.

TWIN BEAM GENERATION IN SPATIALLY COUPLED NG:YVO₄ MICROCHIP LASERS

C. Serrat, M. C. Torrent, J. García-Ojalvo, and R. Vilaseca

Departament de Física i Enginyeria Nuclear,

Universitat Politècnica de Catalunya,

Colom 1, E-08222 Terrassa, Spain

Light sources with low intensity noise are of interest for applications requiring high sensitivity such as high precision interferometry and spectroscopy, and optical communications. It is also of a great interest the generation of light beams having an intensity noise below the standard quantum limit (SQL) [1]. A possible way to approach such states is the generation of twin laser beams, i.e., two beams having correlated intensity fluctuations [2].

We have investigated the phase and intensity fluctuations in two spatially coupled microchip lasers, by using a classical Langevin-type rate equations description. In analogy with phenomena observed in unstable coupled lasers [3], we find synchronization in the quantum-noise-driven dynamics of the two output fields when they are suitably coupled. This phenomenon provides a new easy method for the generation of twin laser beams. The synchronization effect is robust against frequency detuning and persists for pump powers well above threshold. We observe suppression of the dominant relaxation oscillations peak in the noise spectrum of the intensity difference between the generated beams. It will also be certainly interesting to investigate the possibilities of noise reduction below the SQL from the twin beams studied here.

[1] Y. Yamamoto et al., *Phys. Rev. A* **34**, 4025 (1986).

[2] A. Z. Khoury, *Phys. Rev. A* **60**, 1610 (1999); A. Heidmann et al., *Phys. Rev. Lett.*

59, 2555 (1987).

[3] R. Roy et al., *Phys. Rev. Lett.* **72**, 2009 (1994); K. S. Thornburg et al., *Phys. Rev. E*

55, 3865 (1997).

Transient Transverse and Polarization Mode Selection in Vertical-Cavity Surface-Emitting Lasers

Josep Mulet^a, Salvador Balle^a, Claudio R. Mirasso^b and Maxi San Miguel^a

^aInstituto Mediterraneo de Estudios Avanzados, CSIC-UIB, E-07071 Palma de Mallorca, Spain
tel: +34 971 173229, fax: +34 971 173126, email: maxis@imada.uib.es

^bDepartament de Física, Universitat de les Illes Balears, E-07071 Palma de Mallorca, Spain

We implement a mesoscopic model of semiconductor dynamics for vertical-cavity surface-emitting lasers (VCSELs) which incorporates polarization properties and a quantum well electronic susceptibility. It has been shown [1] that this model is able to explain two independent mechanisms, observed experimentally, for polarization switching (PS) in the fundamental transverse mode (FTM), namely "thermally induced" and "non-thermal" PS. In this paper we focus our attention on the selection processes and turn-on delay for the switch-on of different transverse modes in VCSELs. We consider different excitation conditions and active-region diameters, addressing the experimental situation considered in [2].

We study the transient response of gain-guided VCSELs taking into account the transverse dependence of the injection current, field diffraction, carrier diffusion and thermal lensing (TL). The electrical excitation consists in a 1 ns current pulse with rise and fall times of 50 ps. The current is switched from below (0.85 μA) to well above threshold (4 μA). TL is approximated by a parabolic variation of the refractive index. As example of our results, the separated time-evolution of each transverse mode is shown in Fig (a) for a VCSEL with an active-region diameter of 12.5 μm . The laser switches-on in the FTM after a turn-on time, followed by a delayed onset for the appearance of higher-order transverse modes. When the maximum value of the injection current is close to the threshold value, the turn-on delay of higher-order transverse modes is larger and a smaller number of excited modes appear. The average optical spectrum for both polarizations over the transient time under excitation conditions of Fig. (a) is shown in Fig. (b). We observe a broad FTM and some higher-order modes at higher frequencies with a typical frequency separation of ~ 100 GHz. Both polarizations are active during the transient response displaying similar dynamics. Their optical spectra (\hat{x} -solid and \hat{y} -dashed lines) show a birefringence splitting of (~ 10 GHz). The near field images correspond to the time-averaged power distribution of each transverse mode reconstructed by a filtering technique. These results are in good agreement with experimental findings [2].

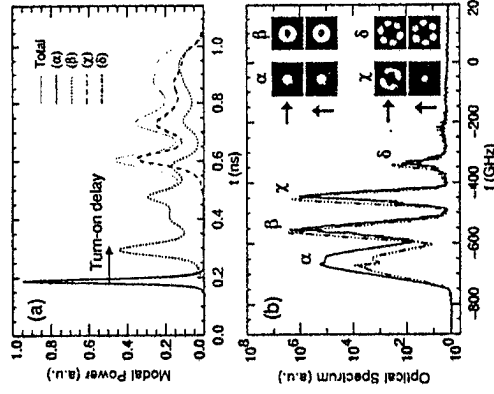

More generally, we conclude that the model used here provides an accurate description of VCSEL dynamics within a relatively simple mesoscopic framework.

1. S. Balle, E. Tolkachova, M. San Miguel, J.R. Tredice, J. Martín Regalado, and A. Gahl. *Opt. Lett.* **24**, 1121 (1999).

2. O. Bucarcusa, J.L.A. Chilla, J.J. Rocca, P. Brusenbach, and J. Martín-Regalado. *IEEE Journal of Quantum Electron.* **35**, 608 (1999).

STRONG OPTICAL NONLINEARITIES OF ABSORBING NEMATIC LIQUID
CRYSTALS

M.I.Barnik¹⁾, V.F.Kitava²⁾ and A.S.Zolot'ko³⁾

¹⁾A.V.Shubnikov Institute of Crystallography, Leninsky pr. 59, Moscow, 117333, Russia

²⁾P.N.Lebedev Physical Institute, Leninsky pr. 53, Moscow, 117333, Russia

Transparent nematic liquid crystals (NLC) are well known to exhibit a "giant" orientation optical nonlinearity, which is due to the direct light field action on the induced dipoles and allows one to observe many nonlinear phenomena at fairly low level of light intensity [1, 2].

Even stronger (by 1-2 orders of magnitude) orientation nonlinearities reveal themselves in NLCs doped with small admixtures of absorbing molecules. Here, the light-induced refractive index, as opposed to the case of transparent NLCs, can be, depending on the type of dopant, not only positive (positive nonlinearity) but also negative (negative nonlinearity) [3]. Yet another feature of absorbing NLCs is the sign-inversion nonlinearity, typical of the conformationally active dopants. This nonlinearity is characterized by changing the sign with the light propagation direction [4, 5].

The review of the current state of the experimental and theoretical studies of the orientational nonlinearity of absorbing NLCs and related light-wave-propagation phenomena are presented. The mechanism of collective reorientation of molecules, arisen from the variation in the noncentral potential of intermolecular interaction, is considered [6].

1. N.V.Tabiryan, A.V.Sukhov, and B.Ya.Zel'dovich, *Mol.Cryst.Liq.Cryst.*, 136, 1 (1986).
2. V.F.Kitava and A.S.Zolot'ko, *Laser Res. USSR*, 10, no.4, 275 (1989).
3. I. Janossy and T. Kosa, *Opt. Lett.*, 17, 1183 (1992).
4. M.I.Barnik, A.S.Zolot'ko, V.G.Rumyantsev, and D.B.Terskov, *Gyrsallogr. Rep.*, 40, 691 (1995).
5. V.F.Kitava, A.S.Zolot'ko, and M.I.Barnik, *Mol. Materials*, 12, 271 (2000).
6. A.S.Zolot'ko, *JETP Lett.*, 68, 437 (1998).

TEMPERATURE NON-CRITICAL INTERACTIONS IN BIAxIAL
OPTICAL CRYSTALS

V.G.Dmitriev

RDI "POLYUS", ul. Vvedenskogo 3, Moscow, 117342 Russia
Telephone: (095)3339166. E-mail: vgdmitr@orc.ru

S.G.Grechin

SRI RL, Dauman MSTU, ul. 2-ya Baumanskaya 5, Moscow, 107005 Russia
Telephone: (095)7314312. E-mail: gera@mx.bmstu.ru

V.A.D'yakov, V.I.Pryalkin

International Laser Center, Moscow State University, Moscow, 119899 Russia
Telephone: (095)9391630. Fax: (095)9393113. E-mail: vip@lbo.phys.msu.ru

The results of theoretical and experimental investigations of temperature-noncritical birefringence and nonlinear frequency conversion (second and third harmonic generation) in biaxial optical crystals are presented. It was shown that the temperature-noncritical birefringence there is in all biaxial optical crystals. The conditions of realization of noncritical interactions were determined for frequency conversion processes.

The influence of temperature-induced strains of the crystal on temperature dependencies of birefringence and temperature bandwidth of nonlinear processes is studied. Strain-induced changes are expressed by the rotation of the crystal faces and lead to the rotation of the crystal-optical coordinate system to the direction of propagation of the radiation. The angle of rotation depends on the anisotropy of crystal's linear expansion and the angle of cut of the crystal. It may reach one arc degree. The thermal-induced processes may be compensated by properly selection of fastening of the crystal.

An experimental investigation of the temperature-noncritical birefringence was carried out for a KTP and an LBO crystals. The temperature-noncritical nonlinear frequency conversion was realized in a KTP (second harmonic generation) and in an LBO (third harmonic generation).

A novel family of semiorganic NLO materials based on glycine

M. Narayan Bhat, M. Shashidar M, S.M. Dharmaprakash
Dept of Physics Mangalore University, Mangalagangothri, Karnataka state

We are reporting the design of a new class of semiorganic materials in which a highly polarisable organic molecules glycine which is incapable of generating second harmonic frequency is converted into a high efficient second harmonic crystal by inclusion of another inorganic salt. New semiorganic materials were prepared by mixing glycine with inorganic salts of various metals. In all the experiments glycine was taken as a host and various metal salts were taken as guests. The metal salt was added to an aqueous solution of glycine and allowed to crystallize by slow evaporation of the aqueous solution at room temperature. The formation of the new materials was confirmed by Powder X-ray powder diffraction pattern and Energy dispersive Xray analysis (EDX). The transmission spectra was taken to determine the transparency range of the new crystal and IR spectra was taken to determine the nature of bonds. Quantitative measurements of the conversion efficiencies of the crystals were determined using the powder technique developed by Kurtz and Pery. Of the 35 new materials screened for SHG 11 showed a reater than that of KDP. There is every reason to anticipate that these represent only a small fraction of the total number of SHG active materials in this class. We have discussed the probable reason for the conversion of centrosymmetric structure into noncentrosymmetric structure due o the inclusion of inorganic salt

Optical Nonlinearities of Thin Mesoporous Titanium Dioxide Films

V. Gayvoronovsky, M. Brodyn, O. Loginenko

*Institute of Physics NASU, pr. Nauki, 46, Kiev, 03650, Ukraine,
vlad@iop.kiev.ua, tel. +380-44-2650814, fax +380-44-2651589*

Th. Dittrich, V. Duzhko

Technical University of Munich, Physical Dept. E16, 85747 Garching, Germany

V. Timoshenko

Moscow State University, Physical Dept., Vorobyevy gory, Moscow, 117899, Russia

Porous TiO₂ films are widely used in solar cell, optical coatings, sensing and photocatalytic applications. We have studied optical and electron properties of the 1 μm sintered layers (porosity ~ 50%) on quartz substrate with optical transmission spectroscopy, refractive index dispersion and photovoltage measurements. It was shown contribution of an intrinsic defect absorption in visible range with multiple reflections and light scattering phenomena account. Urbach tails are 2-3 times broader in comparison with bulk, spread defect distribution (~ 900 meV) have been observed in the gap.

Nonlinear optical response have been studied with Z-scan technique at 1.06 μm and 532 nm (pulse width 30 ps FWHM). With photon energy $\Delta < \hbar\nu = 1.17 \text{ eV} < \frac{1}{2}E_g$ (Δ -depth of defect level, E_g - band gap) reversible absorption saturation has been observed in the beam waist. When $\hbar\nu = 2.33 \text{ eV} > \frac{1}{2}E_g$ the complicate Z-scan trace with oscillating peculiarity before the waist and accumulating absorption saturation in the waist region has been observed at high laser fluencies. The detailed measurements beyond the waist have shown pronounced absorption saturation which is accompanying with positive nonlinear refraction variation. Typical saturation intensities I_s are about 100 MW/cm² for as prepared and 200 MW/cm² vacuum treated samples and depend on defect (oxygen vacancies) concentration due to the sample preparation. At higher laser beam intensities $I > 2I_s$ the nonlinear refraction changes the sign. The further increasing of the input intensity produces the typical response of the photoexcited free carriers into refraction. Such complicate behavior of the samples absorption and refractive properties can be explained with the competition of the valence band-defect level-conduction band transitions and their saturation and direct two-photon assisted transitions and photochemical oxygen vacancies generation at higher intensities.

Modification of the non-linear Optical, dielectric and structural properties of p-Nitroaniline and 2-Methyl-4-nitroaniline crystals through re-crystallization under a strong dc electric field

E. de Matos Gomes, E. Nogueira, S. Lanceros-Mendez

Departamento de Física, Universidade do Minho, 4710-057 Braga, Portugal

M. Margarida R. Costa

*Departamento de Física, Faculdade de Ciências e Tecnologia,
Universidade de Coimbra, 3000 Coimbra, Portugal*

A. Criado

Departamento de Física de la Materia Condensada,

Universidad de Sevilla, Apartado 1065, 41080 Sevilla, Spain

We report a novel way of modifying the non-linear properties of organic crystals formed by acceptor-donor groups separated by π -electron bonds, by re-crystallization under an intense dc electric field.

Structural alterations in the normally centrosymmetric organic compound p-nitroaniline have been induced through re-crystallization under an intense dc electric field of $9.8 \times 10^4 \text{ V/m}$ as evidenced by the generation of an optical second harmonic signal. In addition, the electric field grown crystals displays a significantly lower dielectric permittivity at low frequencies as well as slight modifications in its thermal behavior.

The method has also been used in the re-crystallization of 2-methyl-4-nitroaniline (MNA-E), in which the second harmonic generation power was increased by a factor of two.

The authors will present and discuss in detail the observed physical properties modifications found.

SOLITARY WAVES WITH DIFFERENT PHASE BEHAVIOR AT STIMULATED RAMAN SCATTERING IN REGIMES OF GENERATION AND AMPLIFICATION

A.S. Grabtchikov, P.A. Apanasevich, V.A. Orlovich
B.I. Stepanov Institute of Physics, NASB, F. Scaryna Ave. 68, Minsk, 220072, Belarus
Phone: (375-172) 841-071, Fax: (375-172) 841-665, e-mail: asg@dragon.bas-net.by

Solitary waves at stimulated Raman scattering (SRS) in hydrogen are observed as intensity spikes in the depleted pump pulse. Their behavior can be described by the system of Raman equations, for transient interaction of pump, Stokes waves and polarization. These solitary waves were considered as a one type of solitary objects. Meanwhile still in early theoretical works about an existence of Raman solitons the similarity between Raman equations and sine-Gordon equation was discussed. It is known that sine-Gordon equation has three solitary solutions: soliton, anti-soliton and breather.

In this report we present our experimental and theoretical results on the phase-amplitude behavior and conditions for observation of three types of solitary waves at SRS. The first type is a solitary wave, which has the field phase coinciding with the pump field phase, the second type is an anti-solitary wave that has the field phase opposite to the pump field phase and the third type is a breather with an oscillating phase. Such solitary waves can be generated both spontaneously from quantum noise at Raman generation and deterministically at Raman amplification of specially prepared input fields. The single-pass Raman interaction for a spontaneous generation of solitary waves from quantum noise is used in the experiment with an interferometric observation of the solitary phase. These results are supported by the data of numerical calculations. A Raman amplification scheme was employed for the deterministic generation of different type solitary waves. In this case an initiation of different solitary waves is realized by an electro-optical modulation of input pulses in the Raman amplifier. Solitary waves are produced with a modulated Stokes input pulse. Generations of the anti-solitary and breather waves are shown at seeding the Raman amplifier with a modulated pump pulse. A possibility for generation of a solitary wave train at Raman amplification is demonstrated experimentally. The coexistence of different types of solitary waves, such as kink and bell-shaped, in the Raman process is discussed.

EFFECT OF DISCRETENESS OF LASER ACTION AND CONDENSED MEDIUM RESPONSE ON THE NONLINEAR AND PHOTOPHYSICAL PHENOMENA

M.N. Libenson

S.I. Vavilov State Optical Institute, 12, Birzhevaya Line, St. Petersburg, 190034, Russia
 e-mail: <libenson@beam.ifmo.ru>

It is considered an influence of the discreteness of condensed medium and laser action on laser-induced nonlinear optical and photophysical processes.

When analyzing optical response of the dielectric or semiconductor to penetrating radiation, taking into account the medium discreteness results in correction for classic consideration, that is known as the Ewald-Oseen theorem. This correction is essential only nearby the surface and depends on to the lattice type and lattice constant as well as on electromagnetic interaction between secondary radiation sources which are associated with discretely located atoms. At the first time, they are responsible for rapidly dying down (with a distance from the surface) near field of medium optical response, on correspondable frequency of light. In accordance with the approach developed in [1] the simple examples are analyzed in the paper in order to evaluate the peculiarities of the near field of such kind for optical frequency range. It is certified that manifestation of such kind discreteness of optical response is important for the analysis of nonlinear optical processes in the near-field optical systems, in low-dimensional quanta structures, and also under interaction of super short laser pulses with medium, when only number of the atomic layers is entrained in the optical response.

A role of "the lattice discreteness" in the metals is strongly smoothing by free electrons. However a discreteness in metals becomes apparent in a quite another sense – in superposition of absorption jump on the surface (as result of anomalous skin-effect) and continuously distributed volumetric absorption. It is shown the influence of this peculiarity on thresholds and increments of fast instabilities, connected with temperature dependence of metal absorption.

It is explained a quite difference of results of laser influence on the surface for continuous and pulse-periodical (discontinuous) scanning laser radiation. It becomes apparent of principle impossibility to reach asymptotically a stationary state for discontinuous irradiation of material if laser-induced optical and photo-physical processes are connected by strong feedback. There are presented the experimental data that confirm above mentioned point of view.

I. Gedomsky O.N., Krutitsky K.V. JETP, 1994, 106, N 4, p. 936-955.

Quasi-Phase-Matched Three-Frequency Wave Interactions in Active-Nonlinear Periodically Poled Lithium Niobate

Georgy D. Laptev

International Laser Center, M.V.Lomonosov Moscow State University, Moscow,
119899 Russia, phone: (095) 9392228, fax: (095) 9393113,
e-mail: Laptev@qopm.phys.msu.su

The combination of quasi-phase-matching (QPM) technique and selective excitation of active-nonlinear crystal allows us to realize the self-frequency conversion processes that can involve the laser and pump radiation [1,2]. QPM is an alternative technique for compensation of the phase velocity dispersion in frequency conversion application and any interaction within the transparency range of the material can be noncritically phase matched at a specific temperature, interactions for which birefringent phase matching is impossible [3]. The so called active-nonlinear crystals (Nd:YCaO(BO₃)₃, Nd:GdCa₄O(BO₃)₃, Nd:Ba₂NaNd₅O₁₅ and Nd:LiNbO₃) act like lasers in which the active medium (host material) serves itself furthermore as a nonlinear medium. The technique of laser diode pumping (selective excitation) of active-nonlinear crystals allows to use not only laser radiation in self-frequency conversion, but also pump radiation.

We represent the results of study of the following QPM processes: self-frequency doubling and halving, self-parametric amplification at low frequency pumping, and frequency mixing using pump wave in the active-nonlinear periodically poled Nd:Mg:LiNbO₃ crystal located in double resonant cavity. We develop the theory of intracavity three-frequency QPM wave interactions in Nd:Mg:LiNbO₃, describe the active-nonlinear periodically poled Czochralski-grown Nd:Mg:LiNbO₃ crystal which applied in the experiments, and also discuss the experimental results of self-frequency converting.

1. N.V. Kravtsov, G.D. Laptev, E.Yu. Morozov, I.I. Naumova, V.V. Firsov // *Quantum Electronics*, 29, 933–934 (1999).
2. G.D. Laptev, A.A. Novikov, A.S. Chirkin, V.V. Firsov, N.V. Kravtsov // *Proc. SPIE*, 4268, (2001).
3. A.S. Chirkin, V.V. Volkov, G.D. Laptev, E.Yu. Morozov // *Quantum Electronics*, 30, 847–858 (2000).

PERIODICALLY POLED LITHIUM NIOBATE OPTICAL PARAMETRIC OSCILLATOR PUMPED BY A DIODE-PUMPED, Q-SWITCHED Nd:YAG LASER

O. Balachninaite, R. Grigonis, V. Sirutkaitis

Laser Research Center, Vilnius University, Sauletkio al.10, 2040 Vilnius, Lithuania
Phone: 370-2-769447, fax: 370-2-775623, email: Valdas.Sirutkaitis@l.vu.lt

R.C. Eckardt

Cleveland Crystals, Inc., 676 Alpha Drive, Highland Heights, OH 44143-2156, USA

An optical parametric oscillator (OPO) based on a multi-grating periodically poled LiNbO₃ (PPLN) crystal was pumped by a Q-switched laser. The PPLN sample was fabricated by electric-field poling in a 0.5-mm-thick, 26-mm-long wafer. The crystal was mounted in an oven held at an elevated temperature of 105°C to minimize photorefractive distortion. The diode-pumped Nd:YAG laser pumped the OPO at 1064 nm with 13-ns-FWHM pulses. The OPO was singly resonant with the signal wave resonated, and the pump beam was optimally matched to the 140- μ m signal waist. The input mirror of the 40-mm-long linear cavity had a 60-mm radius of curvature, reflectivities R>99% at the signal wavelength and R<15% at the idler wavelength, and transmission T>97% for pump wavelength. The optimization was performed by using flat output mirrors with different reflectivities at the signal wavelength (see Figure). Double passing the pump with an output coupler reflective at the pump wavelength lowered threshold but did not improve efficiency. Translating the crystal across the cavity allowed pump-beam interaction with the different grating regions (periods from 25.5 to 31.5 μ m in 0.25- μ m steps) and provided wavelength tuning in the range 1.37-5.3

μ m. The highest total conversion efficiency observed exceeded 52% at the center of the tuning range.

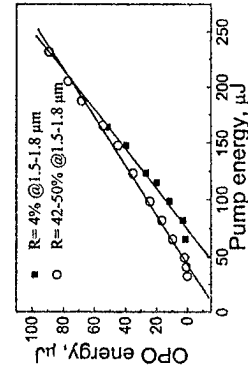

Fig. 1. OPO output (signal pulse at 1.55 μ m) energy as a function of pump energy. Use of two different mirrors show the dependence on output coupling.

RED OPO BASED ON THE PERIODICALLY POLED KTP

V. Pasiskevicius, J. A. Tellefsen, F. Laurell, H. Karlsson

Department of Physics, Royal Institute of Technology, Stockholm, Sweden

R. Butkus, V. Smilgevicius, A. Fiskarskas

Department of Quantum Electronics, Vilnius University, Lithuania

Laser radiation in the red spectral region is important in such fields as laser display, biology and medicine. Many applications in these fields, especially in laser display and medicine require high-energy and, preferentially, tunable red laser radiation.

In this work we investigate performance of PPKTP in the visible optical parametric oscillator (OPO) pumped at 532 nm and generating tunable radiation in the red spectral region. In the shot cavity OPO configuration with 8 mm long PPKTP crystal (domain inversion period of 12.77 μm) the efficiency of 50% at 20 $^{\circ}\text{C}$ was achieved. OPO tuning range 642-652 nm was provided by changing crystal temperature from 15 till 170 $^{\circ}\text{C}$. Figure shows OPO signal generation efficiency versus pump pulse energy for crystal temperature ~

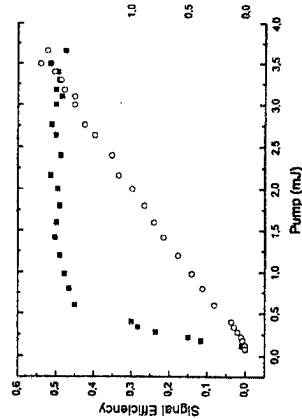

20 $^{\circ}\text{C}$ ($\lambda=650\text{nm}$). At the temperature of 160 $^{\circ}\text{C}$, the signal generation efficiency reached 61% and OPO produced 2.2 mJ of red light. This is caused by lower concentration of absorbing centers in the PPKTP crystal at higher temperature. Optical parametric generator operation investigated with the same crystal has yield 1.8 mJ pulses with 23% efficiency at room temperature.

The properties of fast-axial turbulent flow of laser mixture with light-induced heat releasing.

M.G.Galuskin, V.S.Golubev, V.Ya.Panchenko, Yu.N.Zavalov, V.D.Dubrov, S.A.Buyarov, R.V.Grishayev

Institute on Laser and Information Technologies of

Russia Academy of Sciences

Svyatoozerskaya 1, Shatura, Moscow region, 140700, Russia

E-mail:panch@laser.nictl.msk.su

SUMMARY

Energy and spatial characteristics of radiation of high-power CO_2 laser with fast-axial flow (FAF) are the functions of properties of turbulence of laser mixture flow. In this case the inertial and viscosity turbulence should be affected by unequilibrated energy flow of laser mixture with nonlinearity due to effect of light-induced heat releasing. So we studied the properties of turbulence in condition of fast-axial flow of amplified gas mixture.

The fluctuations of phase incursion of probe laser beam in turbulent flow of active medium of cw CO_2 laser with fast axial flow were determined using method of shear interferometry. The dependence of coefficient of mutual correlation of phase incursion on intensity of high power laser beam was found. This light-induced effect was theoretically considered early [1] for dc discharge and in [2] for radio-frequency discharge.

Besides this the coefficient of turbulent diffusion was determined by method of intra-resonator four-waves mixture using nonlinear grid of active-medium gain.

As result the parameters of turbulent nonequilibrium flow were found. They influence on optical quality of laser medium and on efficiency of discharge input through homogeneity and stability of discharge.

1. V.S. Golubev, M.G. Galushkin, A.M. Zabelin, V.Ya. Panchenko, Light-induced small-scale optical inhomogeneities in the active medium of cw CO_2 laser, Bulletin of Russian Academy of Sciences, Physics, Vol. 56, N 8, pp. 1268-1272, 1992.

2. M.G.Galuskin, V.S.Golubev, V.Ya.Panchenko, Yu.N.Zavalov The Light-Induced Enhancement of Optical Inhomogeneities in Active Medium of High-Power FAF RF CO_2 Laser. In Proceed. of International Conf. LASER 2000, Albuquerque, NM, USA (to be published)

Ultrashort x-ray sources: Theory and experimental aspects

Thomas Brabec

*Institut fuer Photonik, Technische Universitaet Wien
Gusshausstrasse 27/387, A-1040 Wien, Austria*

Recent technological advances in ultrafast optics have permitted the realization of ultrashort, high-intensity laser sources that are unique with respect to pulse duration and peak intensity. The shortest light wave packets to date have duration of 5 fs and peak intensities up to 10^{16} W/cm². At somewhat longer pulse durations (20 fs) peak intensities exceeding 10^{21} W/cm² can be realized. As a result, matter can be exposed to strong laser fields in unprecedented time intervals. One important consequence is the possibility to realize new ultrashort radiation sources in a broad spectral range extending from the THz to the x-ray regime. The following processes will be considered:

- 1) A promising process for the generation of coherent xuv and x-ray radiation is high harmonic generation (HHG). A particular exciting feature of HHG is the possibility to generate as-pulses. Methods of measurement and application of as-pulses will be discussed.
- 2) Unfortunately, the efficiency of HHG is too low for many applications, so alternative routes for ultrashort x-ray sources are needed. Free electron lasers (FEL) can generate huge x-ray energies, however the duration of the pulses is around 300 fs, which is too long for the resolution of fast dynamic processes, such as electron correlation effects, in matter. We will propose methods for shortening FEL x-ray pulses down to the sub-10 fs regime.
- 3) Another interesting concept for x-ray generation is the generation of ultrashort electron pulses and the subsequent generation of x-ray pulses. Our 3-dimensional PIC (particle in cell) simulations show that the use of sub-30 fs relativistic laser pulses is particularly efficient for electron acceleration in underdense plasmas. The calculations reveal the possibility of generating electron pulses with unprecedented parameters (energy of up to 50 MeV, sub-10 fs electron pulse duration). This would present a promising source for the generation of high-energy, sub-10 fs x-ray pulses.

4) Finally, the PIC calculations of issue 3) show that relativistic sub-30 fs laser pulses in underdense plasmas can also generate THz pulses with relativistic intensities exceeding 10^{17} W/cm². These intensities are by orders of magnitude larger than intensities realized in current THz generation processes. Such a source would open the possibility of nonlinear optics in the THz regime and would make novel spectroscopic techniques for the investigation of molecules and solids feasible.

ULTRAFAST DYNAMICS OF InAs/GaAs QUANTUM DOT LASERS

C. Lingg, J. Zimmermann, G. von Plessen, J. Feldmann,

S. T. Cundiff*, M. Arzberger[†], G. Böhm[†], and G. Abstreiter[‡]

Physics Department, University of Munich, Germany;

*JILA, University of Colorado, USA; [†]WSI, TU Munich, Germany

In this work the effects of the inhomogeneously broadened gain spectrum of quantum dots (QDs) on the dynamics of QD lasers is investigated using ultrafast time-resolved spectroscopy.

In a first experiment, the room temperature lasing dynamics of an optically pumped gain-switched edge-emitting InAs/GaAs QD laser is measured. The Fabry-Perot laser ($L = 1.6$ mm) with cleaved uncoated facets is nonresonantly pumped with 100 fs optical pulses in a stripe focus. Fig. 1 shows the emission dynamics of the laser below and above laser threshold. The curve below threshold shows the almost mono-exponential decay of the amplified spontaneous emission. Above threshold we observe an intense 60 ps long gain-switched output pulse and a clear modulation (period: 37 ps) in the signal. This ultrafast intensity modulation is the mode beating of longitudinal modes in the resonator (beat period: $T_{\text{beat}} = 2nL/c = 37.3$ ps). This mode beating proves the coherence of the laser light and shows that simultaneous lasing on many wavelengths is possible without QDs of two adjacent longitudinal modes electrically interacting with each other.

In a second experiment, an electrically pumped edge-emitting QD laser is perturbed by injecting a spectrally nonresonant fs-pulse from an optical parametric oscillator (OPO) into the waveguide. A time-resolved emission curve is shown in Fig. 2, where several effects on various timescales are observed. The OPO pulse causes relaxation oscillations and is reflected back and forth in the cavity burning a spatial hole into the gain. The refilling of this spatial hole is observed within several picoseconds. After the OPO pulse disappears, the effect of the hole burning survives for a long time and remains visible as a train of dark pulses.

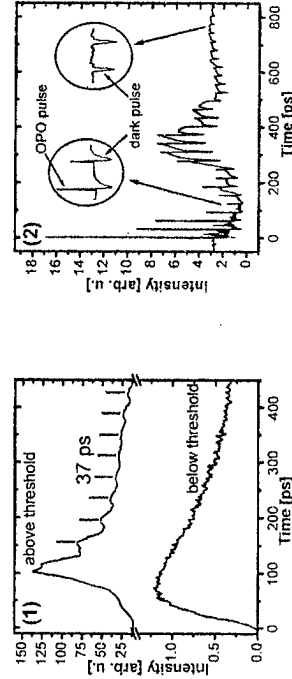

Cr²⁺:ZnSe LASER CRYSTAL FOR FEMTOSECOND PULSE GENERATION

V. G. Shcherbitsky and N. V. Kuleshov

International Laser Center, Belarus St. Politechnical Academy, Scorina Av. 65, Minsk 220027, Belarus.

V. I. Levechenko and V. N. Yakimovich

Institute of Solid State and Semiconductor Physics, NASB, P. Brovki st. 17, Minsk 220072, Belarus

M. Mond, A. Diening, E. Heumann, H. Kretschmann, S. Kück, and G. Huber
Institut für Laser-Physik, Universität Hamburg, Jungiusstr. 9a, D-20355 Hamburg,
Germany

Cr²⁺:ZnSe laser crystals were shown to exhibit high laser efficiency and broad tunability in the spectral range between 2 and 3 μm [1]. In combination with a high thermal conductivity they are promising laser materials for high power and broadly tunable mid-IR femtosecond lasers. Here we report on a crystal growth and laser performance of Cr²⁺:ZnSe single crystals under continuous wave and Q-switched Tm:YAG-laser pumping, as well as direct diode laser pumping.

Cr-doped ZnSe single crystals were prepared by a two stage diffusion doping method. Laser experiments with Cr:ZnSe crystals under 4.1 W Tm:YAG-laser pumping at 2013 nm were performed and an output power as high as 1400 mW near 2500 nm and slope efficiency of 73% were demonstrated. A total tuning range from 2134 nm up to 3040 nm was measured for the Cr:ZnSe laser pumped by Q-switched Tm:YAG laser.

The laser threshold of 75 mW with respect to absorbed pump power and the highest output power of 15.4 mW at a slope efficiency of 14.2% were demonstrated with Cr:ZnSe laser with direct diode-laser pumping at 1.54 μm .

[1] R. H. Page et al., IEEE J. of Quantum Electronics **33**, 609 (1997)

SPECTRAL CHARACTERISTICS OF ULTRASHORT PULSES IN KERR-LENS MODE-LOCKED LASERS

V.L. Kalashnikov¹, E. Sorokin², I.T. Sorokina²

¹International Laser Center, 65 F. Skorina Ave., 220027 Minsk, Belarus

²Institut für Photonik, TU Wien, Gausshaus str. 27/387, A-1040 Vienna, Austria

A rapid progress in Kerr-lens mode locking (KLM) technique allows to reach 14 and 12-fs pulse durations in Cr:LiSGaF and Cr:LiSAF lasers, respectively [1, 2]. These active media are attractive due to possibilities of sub-20 fs pulse generation directly from the diode-pumped laser. At the same time, the lasers demonstrate a significant Stokes shift of the pulse spectrum at such short pulse widths [1, 3]. A number of explanations for the ultrashort pulse spectrum shift in mode-locked lasers have been suggested, however there is not the clear understanding of the nature of such shift at this moment. In this work we performed a numerical analysis of the spectral characteristics of ultrashort pulses on the basis of a relatively simple model of KLM. The main advantages of our model is taking into consideration of the high-order dispersion (up to eight order that is necessary for modeling of the chirped mirrors characteristics), exact profiles of the loss and gain bands, frequency dependent reabsorption in the active medium, gain saturation and stimulated Raman scattering in active medium. The two main factors causing the ultrashort pulse self-frequency shift have been established: the nonlinear shift of the net-gain band due to the gain saturation in the presence of reabsorption in the active medium (up to 30 nm) and Raman self-scattering in active crystal (over 50 nm). The contribution of the high-order dispersion, gain-band asymmetry and spectral characteristics of output coupler are much smaller than that of the stimulated Raman scattering, which is the main cause of spectral red-shift in KLM laser. The shift values obtained from the numerical simulations are in good agreement with experimental data.

[1] I.T. Sorokina, E. Sorokin et al., *Opt. Lett.* **22**, 1716 (1997).

[2] S. Uemura, K. Torizuka, *Opt. Lett.* **24**, 780 (1997).

[3] I.T. Sorokina, E. Sorokin et al., *Appl. Phys. B* **65**, 245 (1997).

Comparative analysis of second harmonic generation in large aperture crystals with multi-terawatt femtosecond Ti:Sa chirped-pulse amplification laser

I.A. Begishev, M.P. Kalashnikov, V. Karpov, H. Schönengel, P.V. Nickles
*Max-Born-Institut für Nichtlineare Optik und Kurzzeitspektroskopie, Max-Born-Strasse, 2a, D-12489,
 Berlin, Germany*

I.A. Kulagin, U.K. Sapaev, T. Usmanov
NPO "Akademprilbor", Akademgorodok, 700143, Tashkent, Uzbekistan

Efficient harmonic generation of femtosecond multi-terawatt laser radiation is an extremely important task, especially for laser-matter interaction experiments. Despite that FWHM pulse duration of modern high power Ti:Sa laser systems [1-4] has a typical value of 20-50 fs, the architecture of the chirped pulse amplification lasers allows appearance of a substantial picosecond prepulse with an intensity sufficient for plasma creation. The sources of the prepulse are the amplified spontaneous emission and reshaping of the pulse after recompression. The harmonic generation partly suppresses the pedestal. An important aspect of the harmonic generation with the femtosecond multi-terawatt lasers comes from the fact that the spectrum of fundamental pulse is rather broad and the intensities reaches extreme values. These features demand the use of thin and large aperture nonlinear crystals.

The experiments were done using the MBI multi-terawatt Ti:Sa laser system [3]. Laser pulses of 50 fs duration and up to 600 mJ energy were used. The incident laser intensity varied with the polarization-based attenuator which allowed to vary the output intensity in the range of 1-1/30 without changing in the pulse duration and divergence. The near-field distribution of the laser radiation direct after the recompression had slightly elliptical shape with the size of 50x60 mm² and peak intensity of $1 \sim 10^{12}$ W/cm². The incident beam divergence was about 2 times diffraction limited one. The fundamental pulse spectrum width was about 25 nm and peaked at 790 nm.

The second harmonic generation for type I in 1 and 2 mm KDP crystals has been studied. The conversion efficiency of ~40% was achieved. The substantial modulation of the second harmonic spectrum was observed. The experimental data are in a good agreement with theoretical analysis provided on the base of strong interaction approximation and numerical calculations taking into account influence of fundamental and harmonic group velocity dispersion, self-actions, and incident phase modulation. From our experimental data the Kerr nonlinearity values of KDP crystals were determined. Limiting influences of self-actions and fundamental phase modulation were demonstrated. It was shown, that initial phase modulation of fundamental radiation can partially compensate for the influence of self-actions leading to increase of the conversion efficiency.

1. C.P.J. Barty, T. Guo, C. Le Blanc et al. *Optics Letters*, **21**, 668 (1996)
2. J.P. Chambaret, C. Le Blanc, A. Antonetti et al. *Optics Letters*, **21**, 1921 (1996)
3. M.P. Kalashnikov, P.V. Nickles, G. Kulcsar et al. In: *Inertial Fusion Sciences and Applications 99*, p.691, ELSEVIER 1999.
4. K. Yamakawa, M. Aoyama, S. Matsuoka et al. *Optics Letters*, **23**, 1468 (1998)

TRACING THE FREQUENCY OF A SINGLE FS LIGHT PULSE BY SHG AND SELF-DIFFRACTION AUTOCORRELATORS

V. Kabelka

Institute of Physics, Savanoriu 231, LT-2628, Vilnius, Lithuania
 phone/fax (3702) 427437; E-mail: vidausk@ktl.mii.lt

A.V. Masalov

Lebedev Physical Institute, Leninsky prosp. 53, 117924, Moscow, Russia
 phone: (095) 1326760; fax: (095) 1352408; E-mail: masalov@mail.liebedev.ru

Summary

Our previous analysis has shown that nonlinear autocorrelators based on second-harmonic generation and self-diffraction, in addition to pulse duration measurements can provide measurement of the instantaneous frequency of a pulse as well [1-4]. The device for measuring the instantaneous frequency of a pulse was named FREQUENCY TRACER. This device consists of a conventional second-harmonic (SH) or self-diffraction (SD) nonlinear autocorrelator and the special optical set, which resolves the wavefront curvature of the signal beam, generated in the autocorrelator. The main features of such device are: FT can visualize the instantaneous frequency versus time in a two-dimensional image without using any spectral apparatus, and determination of fs pulse phase distortion does not require iterative mathematical algorithm.

In this contribution we describe the detailed analysis and comparison of SHG and SD Frequency Tracers characteristics. SHG FT is more sensitive and requires lower energy of fs pulse as compared with SD FT. Due to the symmetry of SHG autocorrelator the SHG FT is able to trace only even (quadratic, fourth and etc.) orders of the phase distortions of fs pulses. Contrary to SHG FT, the SD FT is able to reproduce the whole dependence (odd and even orders) of the phase distortion of fs pulse. The computer simulations for SHG and SD FT two-dimensional images of fs pulses with various phase distortions (transform-limited, linear chirped, cubic distortion, fourth-order and etc.) are given.

1. V. Kabelka, A.V. Masalov. *Opt. Commun.* **100**, 482 (1993).
2. V. Kabelka, A.V. Masalov. *Opt. Lett.* **20**, 1301 (1995).
3. V. Kabelka, A.V. Masalov. *Opt. Commun.* **121**, 141 (1995).
4. V. Kabelka, A.V. Masalov, S. Nikitin, H. Milchberg. *Opt. Commun.* **156**, 43 (1998).

ATOMIC COHERENCE EFFECTS: SOLIDS VERSUS GASES

Olga Kocharovskaya^{1,2}¹Institute of Applied Physics Russian Academy of Science,
46 Ulyanov str., Nizhny Novgorod, 603600, Russia²Texas A&M University, Department of Physics,
College Station, TX 77843, USA
E-mail: kochar@atlantic.tamu.edu

Atomic coherence phenomena: electromagnetically induced transparency (EIT), slow group velocity (SDV), lasing without inversion (LWI) and enhancement of refraction index, have formed novel fast developing field of research in quantum optics for the last decade.

The interest is due to broad range of potential applications including low intensity nonlinear optics, quantum information processing, high sensitivity magnetometry, mastering of the frequency ranges difficult to access (VUV, x-ray, gamma-ray and far-infrared, etc.).

We overview some novel results in this field, concerning coherent control of Mossbauer spectra of nuclei, stopping of the pulse of light using spatial dispersion of the hot atoms in a cell, inversionless lasing at fast decaying (for example, x-ray or interband far-infrared) transitions due to self-generated driving field at the inverted slow decaying transition, etc.

We emphasize the advantages of solid over gaseous materials for applications of these effects.

- 1) Olga Kocharovskaya, Yuri Rostovtsev, and Marlan O. Scully, *Phys.Rev.Lett.*, v. 86, p. 628 (2001)
- 2) Olga Kocharovskaya, Roman Kolesov, and Yuri Rostovtsev, *Phys.Rev.Lett.*, v. 82, p. 3593 (1999)

Scalable quantum computing with quantum optical systems

T. Calarco*, D. Jaksch, J.I. Cirac, and P. Zoller

Institute for Theoretical Physics, University of Innsbruck

Technikerstrasse 25, A-6020 Innsbruck, Austria

phone: +43 512 507 6217, fax: +43 512 507 2919, e-mail: Tommaso.Calarco@uibk.ac.at

Quantum optical techniques allow accurate control of the coherent evolution of quantum systems, and are therefore promising candidates for the implementation of quantum logic. Quantum computing requires (i) storage of the quantum information in a set of two-level systems (qubits), (ii) the processing of this information using quantum gates, and (iii) reading out the results. So far only few systems have been proposed for the realization of quantum computer models. Examples include trapped ions, cavity QED and neutral trapped atoms, NMR and solid state systems using nuclear spins, quantum dots and Josephson junctions. Here we present in detail two recent schemes, which combine the outstanding features of quantum optical proposals, in particular quantum control and long decoherence times, with the technological capabilities of engineering micro-structures implying scalability, a feature usually associated with the solid state proposals and required by actual computations, including error correction procedures to keep decoherence under control.

A dynamical implementation of a quantum gate with quantum optical systems requires an external field which produces time-dependent conservative trap potentials. To obtain conditional dynamics, either the trapping forces should be state-dependent, or the interaction term, or both. We can choose to work either with cold neutral atoms, interacting via collisions described by a state-dependent contact potential, or with ions, interacting via the electrostatic force, which does not depend on the internal state, but can give rise to interesting conditional dynamics, if combined with state-independent trapping forces.

The general concept underlying all our schemes is as follows. Initially, the two particles are in the ground state of the trapping potentials and the centres of the two potential wells are sufficiently far apart so that the particles' wavefunctions do not overlap. Then the form of the potential wells is changed such that the wave functions of the two atoms are displaced in a different way according to their internal state; the particles interact with each other, and eventually the potential is restored to the original situation. Different regimes are possible for the time dependence of the potential, leading to specific schemes for entanglement manipulation, suitable for different physical implementations. In particular, the limits of slow (adiabatic) and fast (sudden) potential changes are both interesting and will be analysed here in conjunction with possible experimental realizations. We calculate the fidelity for the gate operation under realistic conditions, and study how it depends on the temperature of the motion of each particle (very weakly, in the case of ions).

*Also at: ECT, European Centre for Theoretical Studies in Nuclear Physics and Related Areas, Strada delle Tabarelle 286, 38050 Villazzano (TN), Italy.

EFFECTS OF INHOMOGENEOUS LINE BROADENING ON ELECTROMAGNETICALLY
INDUCED TRANSPARENCY (EIT) AND
SLOW GROUP VELOCITY

Elena Kuznetsova^{1,2}, Olga Kocharovskaya^{1,2}, and Marlan O.Scully^{2,3}

¹Institute of Applied Physics Russian Academy of Science,

46 Ulyanov str., Nizhny Novgorod, 603600, Russia

²Physics Department, Texas A&M University,

College Station, TX 77843-4242, USA

³Max-Planck-Institut für Quantenoptik, D-85748 Garching, Germany

E-mail: ekuznetsova@rainbow.physics.tamu.edu

Electromagnetically Induced Transparency (EIT) and Slow Group Velocity (SGV) have attracted a lot of interest during the last five years due to their important applications for the low intensity nonlinear optics and quantum information processing.

In view of these applications it is essentially important to know the dependence of EIT linewidth on the intensity of the coherent driving field. In the case of homogeneous line broadening of the optical transition this is well-known that both EIT linewidth and SGV accompanying EIT are proportional to the intensity. However, most of the experiments on EIT and SGV, both in gases and solids, deal with the case of inhomogeneously broadened transitions. We show that inhomogeneous broadening can drastically modify the dependence described above leading to some counter intuitive effects such as EIT line narrowing and reduction of the group velocity due to inhomogeneous broadening [1,2].

1. A.Javan et al., Phys. Rev. A, submitted
2. O.Kocharovskaya et al., Phys. Rev. Lett., **86**, 628 (2001)

Coherent Information: A Key to Information Analysis of Quantum Systems

Boris A. Grishanin and Victor N. Zadkov

International Laser Center and Department of Physics,
M. V. Lomonosov Moscow State University, 119899 Moscow, Russia

Fax: +7(095)939-31-13, E-mail: grishan@comsim1.phys.msu.su

An enormous progress made over last decade in experiments on manipulation with quantum information stored in quantum systems like atoms and ions interacting with electromagnetic fields leads to a necessity of theoretical analysis of this specific kind of information—quantum information—that drastically differs from classical information and for which previously developed Shannon's theory of information does not work correctly. As a result, a number of recent efforts have been made to propose a new measure and concept of quantum information of which the most interesting and productive is the *coherent information* [1, 2]. This quantity introduced first for analysis of an abstract quantum channel goes to zero in case when no coherent superpositions of the transmitted states are preserved and therefore distinguishes between classical and quantum information exchange. Applying the coherent information concept to real quantum systems of interest for experimentalists requires, however, additional nontrivial efforts in both the corresponding mathematical description of real quantum channels in quantum systems under consideration and appropriate calculation technique, which combines symbolic and matrix superoperator representations [3, 4].

Here, we discuss a number of quantum channels, which are important in physics of quantum information, namely, a single two-time channel—the simplest physical implementation of an abstract quantum information channel, a channel between two-time states of the parts of a bipartite system, a channel between two subspaces of states of a single system, and a one-time channel.

Calculation results for the coherent information analysis of a number of simple quantum systems, which can be described in terms of mentioned above quantum channels are presented, as well. Among them are (i) information decay in a two-level atom under action of external resonant field, (ii) transmission of information from an open subsystem to another one of the same atom, (iii) information exchange between two coupled two-level atoms, (iv) information transfer from a two-level atom on to another one and (v) to the vacuum photon field via spontaneous emission, as well as (vi) from a stable Λ -system to the two photons emitted under appropriate laser excitation.

Presented here results allow us to conclude that the concept of *coherent information* can serve as an appropriate tool for characterization of quantum information stored in quantum systems relevant to the modern experiments with quantum information.

References

1. B. Schumacher and M. A. Nielsen, Phys. Rev. A **54**, 2629 (1996).
2. S. Lloyd, Phys. Rev. A **55**, 1613 (1997).
3. B. A. Grishanin and V. N. Zadkov, Phys. Rev. A **62**, 032303 (2000).
4. B. A. Grishanin and V. N. Zadkov, Laser Physics **10**, No. 6, 1280 (2000).

POLARIZED PATTERNS IN A BROAD-AREA VCSEL

N. Loiko, I. Babushkin

*Institute of Physics, National Academy of Sciences of Belarus,
70 Skaryna Ave., Minsk 220072, Belarus*

Due to remarkable improvements in VCSELs performance in recent years they can be scaled to broad-area devices. At a considerably large aperture their transverse modes can be practically independent from wave guiding effect created by lateral boundary conditions and are determined by nonlinearities in an active media. Thus, transition from a Hermite mode to an extended nonlinear pattern was observed in circular VCSELs with increasing its diameter up to 54 μm [1]. Striped and square patterns were found in the near field of VCSELs with a square active area of size ranging between 15 and 25 μm [2]. These structures were strongly dependent on the laser field polarization.

Theoretical explanation of patterns in a broad-area laser is based on the gain dispersion mechanism of transverse Fourier mode selection [3]. We have showed that the dependence of the reflection from distributed Bragg reflectors (DBR) used in VCSELs on an incidence angle of a tilted wave influences the mode selection process [4]. Here, this influence is studied in depth and more details. DBR brakes the rotational symmetry in the transverse plane and introduces differences in the polarization anisotropy of different tilted waves. Regularities resulted from interplay between material and DBR anisotropies are elucidated. Control of polarized patterns by applying of an axial magnetic field is studied. Deformations of extended patterns under influence of boundary conditions are analyzed.

References

1. T. Ackemann, et al., *J. Opt. B: Quantum Semiclass. Opt.*, **2** (2000) 406.
2. S. P. Hegarty, et al., *Phys.Rev. Lett.*, **82** (1999) 1434.
3. P. K. Jakobsen, et al., *Phys. Rev. A*, **45** (1992) 8129.
4. N.A. Loiko, I.V. Babushkin, *Kvantovaya elektronika (Moscow)*, **31**, No2, 2001.

Excitability in Semiconductor Laser Systems

S. Barland, P. Couillet, M. Giudici, and J. R. Tredicce

*Institut Non Lineaire de Nice (INLN), UMR CNRS 66180 Universite de Nice-Sophia
Antipolis, 1361 Route des Lucioles 06560, Valbonne, France*

S. Balle

*Instituto Mediterraneo de Estudios Avanzados (IMEDEA)**CSIC- Universidad de las Islas Baleares,**Palma de Mallorca, 07015, Spain*

We review the concept of excitability in terms of available theoretical models. We show that excitability is a common phenomena in Optics , and we propose different experimental schemes to proof the existence of excitable behavior and how to use them as test benches for general properties of excitable systems. In particular we show experimental results obtained in semiconductor lasers : laser with double cavity, laser with optical feedback, laser with injected signal and broad area semiconductor amplifiers. In all those cases we present experimental confirmation of excitability. In a double cavity laser we show both experimentally and theoretically which are the necessary conditions and the parameter values for which the behavior can be classified as excitable. We analyzes the particular properties of the pulse response , and we use phase space portraits to investigate the different fixed points playing a role in the dynamics of the system.

Using a laser with optical feedback we present experimental evidence of coherent resonance and we analyze its physical meaning and origin.

Furthermore we use broad area amplifiers to show that thermal effects may induce excitable behavior and oscillations. We analyze the properties of the system under perturbations ; we show the existence of a well define threshold for excitable pulses to appear and how such threshold depends on parameter values. We study the shape of the excitable pulses and we identify the bifurcation leading to periodic oscillations. Finally we demonstrate that the general behavior of the system can be well described in terms of the well-known FitzHugh-Namuno equations.

Finally we present a perspective for future studies on excitable waves in Optics, and we show that optical systems may present very peculiar properties (in particular related to the possibility of changing their control parameter values) which make them the ideal test bench for theoretical models of nonlinear dynamics.

SPATIAL AND TEMPORAL STRUCTURES OF LIGHT FIELDS IN NONLINEAR INTERFEROMETER

O.G. Romanov, A.S. Rubanov, A.L. Tolstik
Department of Laser Physics and Spectroscopy, Belarusian State University
4, Fr. Skaryna av., 220050 Minsk, Belarus

Nonlinear interferometer is a typical optical system exhibiting various effects of self-organization due to nonlinearity of interaction between laser radiation and intracavity material, and also due to different types of feedback available. Coherent intracavity interaction of two light beams permits realization of an additional type of the distributed feedback on scattering from the dynamic gratings written in the medium.

In the work consideration is given to the schemes of interaction between two counterpropagating waves in a ring resonator, and between four waves when two beams are symmetrically and obliquely incident on the Fabry-Perot. The stationary solutions characterizing the modes of symmetrical and asymmetrical optical bistability have been derived theoretically. Linear stability analysis of interferometer transmission stationary states has made it possible to classify bifurcations characteristic for this system. Nonstationary energy exchange between the light beams is determining the possibility of realizing various dynamic operating modes of the interferometer at constant input intensity: asymmetrical self-pulsing (self-oscillations near the asymmetrical states of the interferometer transmission), switchable self-pulsing (mode of alternate transmission of two light beams) and chaotic intensity oscillations between the states of minimum and maximum interferometer transmission.

The peculiarities of the light beam spatial structure formation have been analyzed with regard to a diffraction mechanism of transversal interaction depending on the interaction geometry and nonlinearity type. It has been demonstrated that the process of energy exchange between the beams in the interferometer due to the symmetry breaking instability is responsible for the complex spatial and temporal structure formation of a light beam (coupled and localized states, asymmetrical transversal profiles and self-oscillations).

INTENSITY NOISE IN SEMICONDUCTOR LASERS COUPLED TO FIBER BRAGG GRATING

P. Besnard
*ENSSAT, Laboratoire d'Optronique (UMR 6082),
6 rue de Kerampont, 22305 Lannion, France*
A. Naumenko and N. Loiko
Institute of Physics, NAS, 70 Skaryna Ave., Minsk 220072, Belarus
G. Ughetto and J.C. Bertreux
Acatel Optronics Route de Villejust 91625 NOZAY Cedex France.

The usefulness of a semiconductor laser usually depends on its spectral width and intensity stability. One technique for improving laser design is by its coupling with a filtered external optical feedback. Its stabilization effect can be enforced in the case of strong feedback. Such device was considered in reference [1] when the frequency selectivity was achieved by the feedback from a fiber Bragg grating. Noise and modulation characteristics were investigated analytically in the small signal regime using a Volterra functional series expansion method.

In this communication, we present for what we think the first time numerical simulations of such coupled system. A first method using fast Fourier transform is discussed and a more elegant method using Green function approach is presented. The stationary solutions for such systems are calculated. Comparison with analytical solutions obtained for the mode with the highest gain is given. Their stability is elucidated. The dependence of the relative intensity noise of a diode coupled to the fiber Bragg grating on different parameters (the reflectivity of the coupled facet, the reflectivity of the Bragg grating and so on) is discussed. Numerical simulations show good agreement with experimental measurements. This work is intended to design low noise pump source with a fixed wavelength for optical amplifiers.

[1] M.Premaratne, et al, IEEE J. of Select. Topic in Quantum Electronics, 3, 289 (1997).

Polarization Transverse Pattern Dynamics in Lasers: Investigation of the Patterns Produced Using the Stereographic Projection of the Poincare Sphere on the Complex Plane and Their Singular Points

Irina V. Veshneva, Leonid A. Melnikov,

Saratov State University, Physics Department, Astrakhanskaya 83, Saratov 410026, Russia, phone 8-845-2-51-51-95, fax 8-845-2-24-04-46

Andrei I. Konukhov

Saratov Division of the Institute of Radio-Engineering and Electronics of Russian Academy of Science, Zelyonaya 38, Saratov 410019, Russia, phone 8-845-2-51-11-79

We consider Zeeman laser with image rotating ring cavity with large Fresnel number [1]. For each slowly varying complex amplitudes the paraxial wave equation was solved (in terms of Laguerre-Gauss modes in free-space part of the cavity, and grid representation of the field in active medium). The density matrix equation for the spherical tensors were solved algebraically. Round-trip variations of the total field describes the laser dynamics. We consider high-gain active media, and large number (>200) of the transverse modes. To describe spatio-temporal dynamics we have used the Karhunen-Loewe procedure: calculation of the eigenvectors and eigenvalues of the normalized correlation matrix 2×2 , obtained via the time-averaging of the product of the values of field components at two different points in the transverse plane [2]. The zeroes and poles of complex function

$$w(z) = \frac{X(x,y) + iY(x,y)}{1 - Z(x,y)},$$

where X, Y, Z are the normalized Stokes parameters of the field,

x, y are the transverse coordinates represent the vortex structure of the field. In Fig. the contour plot of $Re[\log(w)]$ and density plot of the $Im[\log(w)]$ are shown demonstrating vector defect of the 3-d order. The given mapping is easy to use in experiments.

1. Melnikov L.A, Konukhov A.I, Ryabinina M.V 1998 Quant.& Sem.Optics **10**, 1672.
2. Veshneva I.V, Konukhov A.I, et.al 2001 Quant.& Semiclassical Optics (submitted)

Nonlinear - optical properties of colloidal metals

A. I. Ryznyansky^{1a}, R. A. Ganeev², M. K. Kodirov¹, T. Usmanov²

¹ Samarkand State University, Samarkand 703004, Uzbekistan

² NPO Akadempribor, Academy of Sciences of Uzbekistan, Tashkent 700143, Uzbekistan

^a e-mail: demis@uni.uzsci.net

Summary

We measured nonlinear refractive indices, nonlinear optical susceptibilities and nonlinear absorption of such solutions on the wavelength of picosecond/nanosecond Nd:YAG laser radiation and its second harmonic ($\lambda = 1,064$ nm and 532 nm, $\tau = 35$ ps and 27 ns).

We have investigated the correlation between nonlinear optical characteristics of colloidal silver measured under the action of picosecond and nanosecond pulses and its aggregation rate calculated on the basis of spectroscopic analysis of colloidal solution. An analysis of temporal characteristics of nanosecond radiation passed through the colloidal solution placed at different positions of Z-scan scheme have shown thermal nature of self-defocusing in this medium. Kerr mechanism of self-defocusing has been considered for analysis of colloidal silver in the field of picosecond pulses. Characteristic peculiarity of these investigations is a sign change of n_2 with the growth of aggregation rate both for nanosecond and picosecond pulses. Nonlinear susceptibilities, responsible for Kerr-induced and thermal-induced self-defocusing were calculated to be $(2.4 \pm 1.2) \cdot 10^{14}$ esu and $(7 \pm 3.5) \cdot 10^{11}$ esu respectively.

Third harmonic generation of picosecond Nd:YAG laser radiation was investigated in colloidal metals. Third harmonic conversion efficiencies of Nd:YAG laser radiation were found to be $7 \cdot 10^{-7}$ and $3 \cdot 10^{-7}$ for colloidal platinum and copper respectively. Nonlinear susceptibilities $\chi^{(3)}(-3\omega; \omega, \omega, \omega)$ of colloidal platinum and copper were measured to be $(1.5 \pm 0.75) \cdot 10^{14}$ esu and $(1 \pm 0.5) \cdot 10^{14}$ esu respectively.

Nonlinear susceptibilities of fullerenes

A. I. Ryasnyansky^{1a}, R. A. Gancev², M. K. Kodirov¹, I. A. Kulagin²,
T. Usmanov²

¹ Samarkand State University, Samarkand 703004, Uzbekistan

² NPO Akademprihor, Academy of Sciences of Uzbekistan,
Tashkent 700143, Uzbekistan

^a e-mail: denis@uni.uzsci.net

Summary

Nonlinear optical characteristics of fullerenes are under active investigation for the last time due to their attractive properties as optical limiting elements, media for frequency conversion of laser radiation etc.

We report on investigations of nonlinear-optical refractive indices (n_2), Kerr-induced susceptibilities ($\chi^{(3)}(-\omega; \omega, -\omega, \omega)$) and nonlinear absorption (β) measurements at, as well as $\chi^{(3)}(-3\omega; \omega, \omega, \omega)$ susceptibilities of fullerenes. Calculated experimental results on n_2 , $\chi^{(3)}(-\omega; \omega, -\omega, \omega)$ and β of investigated materials are presented in the table.

For THG experiments picosecond radiation of Nd:YAG laser has been applied. As investigation samples, fullerene-doped polyimide films were used. The third order nonlinear susceptibilities of fullerene-doped films with different C_{70} concentrations were investigated for the first time by THG method. Nonlinear susceptibility $\chi^{(3)}(-3\omega; \omega, \omega, \omega)$ of fullerene-doped film was found to be $(9 \pm 4.5) \cdot 10^{-13}$ esu (for 0.5% C_{70} in polyimide 6B films). An influence of the nonlinear refraction of fullerene-doped films on phase-matching conditions of THG was responsible for deviation from the cubic $I_{3\omega}$ (I_{ω}) dependence. THG conversion efficiencies of Nd:YAG laser radiation were found to be $6 \cdot 10^{-6}$ and 10^{-6} for 0.5% C_{70} - doped and 0.2% C_{70} - doped polyimide films respectively. In 0.5% C_{70} -doped polyimide film the maximal predicted efficiency of THG at weak focusing has been achieved.

Media	λ , nm	n_2 , esu	$\chi^{(3)}$, esu	β , cm W ⁻¹
Polyimide layer with 0.5 wt. % C_{70}	1064	$-1.4 \cdot 10^{-9}$	$2.2 \cdot 10^{-10}$	
C_{70} solution in toluene (1 wt. %)	1064	$-5 \cdot 10^{-13}$	$8 \cdot 10^{-14}$	
C_{60} solution in toluene (0.5 wt. %)	1064	$-1.3 \cdot 10^{-12}$	$2 \cdot 10^{-13}$	$1.5 \cdot 10^{-10}$
C_{70} solution in toluene (1 wt. %)	532	$-6.7 \cdot 10^{-13}$	$8.1 \cdot 10^{-14}$	$4.48 \cdot 10^{-11}$
C_{60} solution in toluene (0.5 wt. %)	532	$-1.06 \cdot 10^{-12}$	$1.3 \cdot 10^{-14}$	$2.15 \cdot 10^{-10}$

PHOTOREFRACTIVE AND PHOTOVOLTAIC CONTRIBUTIONS TO FORMING
OPTICAL DISTORTIONS IN LiNbO₃.

Grishachev V.V.

Physics Dept., MSU, Vorob'evy gory, Moscow, 119899, Russia.

The optical distortions are formed in photorefractive crystals, such as LiNbO₃, through local recharge photorefractive centers (photorefractive effect, PRE) and with transposition of photoelectrons (photovoltaic effect, PVE). Both effects are determined by asymmetry of electron photoexcitation processes in electromagnetic wave, external and internal fields as well as processes of forming electric fields. The effects have common nature, but the kinetics of forming optical distortions at them is various. In lack of exterior electric fields PVE lead to modification of crystal index refraction δn according to exponential dependence from light energy W past through crystal: $\delta n = a(1 - \exp(-W/W_0))$. And for PRE δn has linear dependence from W : $\delta n = (W/W_0)$. Here a , W_0 , W_0 - optical process parameters. The logging of $\delta n(t)$, t - exposure time, allows to separate PR and PV contributions. The second harmonic generation (SHG) in nonlinear crystals depends on a phase mismatch between radiations pumping and SH so, that conversation coefficient $\eta = I_{2\omega} \cdot \{[\sin(\pi(L/\lambda_{2\omega})\Delta n)]/\Delta n\}^2$. Here I_{ω} , $I_{2\omega}$ of pumping intensity and SH, $\lambda_{\omega} = 1.064 \mu\text{m}$ - wavelength of pumping, $\Delta n = |n_{\omega} - n_{2\omega}|$ - difference of index refractions of pumping and SH. Exploring kinetics of transformation in the second harmonic for various types of interaction in crystal it is possible to allocate modifications of index refraction on one of frequencies ω (δn_{ω}) or 2ω ($\delta n_{2\omega}$).

The experimental research of SHG kinetics in pure crystal LiNbO₃ is carried out by the offered procedure. The research became simpler as the basic modifications of index refraction happens in LiNbO₃ for extraordinary ray (e), therefore at interactions $oo \rightarrow e$ and $ee \rightarrow o$ (here o - ordinary ray) have $\delta(\Delta n) = \delta n_{2\omega}$ or δn_{ω} . The reference associations $\eta(t)$ allow stating about dominance PR contribution for the phase mismatched SHG and PV contribution for the phase matched SHG.

THE ORIGIN OF NEAR ULTRAVIOLET ABSORPTION OF NONLINEAR BBO CRYSTALS

V.D.Antsygin¹, O.Yu.Dashevsky¹, V.P.Solntsev², R.I.Mashkovtsev², E.G.Tsvetkov²

¹Institute of Automation & Electrometry SB of RAS, 630090 Novosibirsk, Russia

²Institute of Mineralogy & Petrography SB of RAS, 630090 Novosibirsk, Russia

E-mail: antsygin@iae.nsk.su

For clearing up of the origin of impurities and own defects having allowed energy states in a forbidden region the optical absorption, photoluminescence (PL), thermoluminescence, thermostimulated currents and also spectrums of an electronic paramagnetic resonance (EPR) of α - and β -BaB₂O₄ (BBO) crystals have been investigated. Bulk single crystals have been grown by TSSG method in Czochralski variant, using a stoichiometric melt or Na₂O, NaF and PbO as the solvents.

It is established that in the crystals grown with Na₂O or NaF as the solvents the absorption bands at 300K are not found. However, when temperature is decreased to 77K, the weak absorption bands with $\lambda_1 \approx 200$, $\lambda_2 \approx 235$, and $\lambda_3 \approx 280$ nm and the electron traps with $E_a = 0.61, 0.67, 0.75, 0.91$ eV appear. At the same time in α - and β -BBO crystals grown from a stoichiometric melt the intensive absorption band 225-255 nm ($\lambda_{\max} = 238$ nm, $\kappa = 0.3 \text{ cm}^{-1}$), more weak bands ($\kappa < 0.05 \text{ cm}^{-1}$, $\lambda_{\max} = 207, 253$, and 290 nm) and the traps with $E_a = 0.62, 0.71, 0.87$ eV at 300K are observed. In β -BBO crystals grown with PbO at 300K the absorption bands at 207 and 238 nm have intensities on two order more than in crystals grown from a stoichiometric melt (the traps with $E_a = 0.62, 0.66, 0.74$ eV, correspondingly). The exposure of β -BBO(PbO) crystals by γ - or X-rays at 77K results in decrease of the absorption band 238 nm and in appearance of EPR spectrums from ions Pb^{3+} in a positions Ba^{2+} . Consequently, the additional near ultraviolet absorption bands are caused by the transitions from the anionic group to the cations Pb, Na substituting for Ba. The PL band is the intrinsic emission of the crystals arise from exciton-type excitations localized near impurities and defects (vacancies).

Experimental estimation of the uniform internal electric field and photoconductivity inside the Ba_{0.77}Ca_{0.23}TiO₃ crystal (BCT)

V. Matusевич*, A. Kiessling, R. Kowarschik
Friedrich Schiller University Jena, Institute of Applied Optics
Max-Wien-Platz 1, 07743 Jena, Germany
Tel.: +49 (0)3641 947659

Fax: +49 (0)3641 947652
*E-mail: p7maw1@nds.fz.uni-jena.de

Ba_{0.77}Ca_{0.23}TiO₃ (BCT) - crystals have interesting photorefractive and electrooptic properties as was recently demonstrated by several papers [1-4]. Analysing these results and our own experiments we come to the conclusion that there is an uniform internal electric field inside the crystal. Our suggestion is supported by the fact that BCT crystals are poled under an external uniform electric field that shifts atoms in the crystallographic structure (fig. 1).

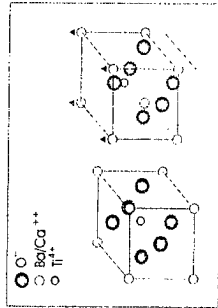

Fig. 1. Unpoled and poled states of the BCT crystal

In order to estimate the value of the suggested internal electric field inside the crystal we have developed an experimental method based on two- and four-wave mixings, whereas we are using a BCT-crystal that has been grown by Ch. Kuper and co-workers from the University of Osnabrueck.

Mathematical calculations and experimental setup will be presented in the poster.

1. Kuper Ch, Pankrath R, Hesse H 1997 Appl. Phys. A 65 301-5
2. Kuper Ch, Buse K, van Stevedaal U, Weber M, Leidlo T, Hesse H, Kraetzig E 1998 Ferroelectrics 208 213-23
3. Matusевич V, Kiessling A, Kowarschik R 2000 Appl. Phys. B 71 533-8
4. Bernhardt S, Delay Ph, Hesse H, Rytz D and Roosen G 1999 OSA TOPS 27 132-39

FEATURES OF NONLINEAR CONVERSION OF THERMAL RADIATION
IN A CRYSTAL LITHIUM FORMATE

N.A.Deinekina, I.A.Korosteleva

Far-Eastern State Transport University, 47 Seryshev st., Khabarovsk, Russia, 680021
Tel.: (421-2) 359-114, E-Mail: Korostelev@Drkngl.kht.ru

The perspective materials for nonlinear optics from the point of view of realization of more various directions of synchronous interactions are biaxial crystals. They have high components of a nonlinear susceptibility, many of them are easy to grow, cut and nonhygroscopic etc. Besides a series of them allow to realize simultaneously some types of nonlinear interactions of light waves.

The authors of work carry out theoretical and experimental researches of nonlinear conversion of thermal radiation in biaxial crystals of a nm2 class. One of perspective materials for such conversion is lithium formate.

The basic differences are found out during conversion of wide infrared spectrum of frequencies in lithium formate crystals in comparison with other crystals consisting available of a limiting corner of synchronism in crystallophysic of a xy plane and rotation of curves collinear of synchronism in space near to a strip of absorption 1,1...1,3 μm (at change of a plane of supervision in the field of corners of synchronism $\phi_s = 60^\circ$ the anomaly is observed: at same of pump ($\lambda_1=1,1 \mu\text{m}$) for lengths of waves conversed of radiation λ_2 , getting in a strip of absorption ($> 1,4 \mu\text{m}$), occur sharp changes of a corner of synchronism).

The originality of a crystal lithium formate, noticed by results of account proved to be corroborate experimentally. It was revealed, that length of a wave 975 nm was an original rotary point. For $\lambda < 975 \text{ nm}$ the interaction of II type realizes in a xy plane, and for $\lambda > 975 \text{ nm}$ in a xz plane. The transition carries out through an X axis from a xy plane in a xz plane. It is convenient that it is possible to realize on one cut of a nonlinear crystal conversion of a wide spectrum at the expense of angular turn of a crystal. This phenomenon is possible for using as a basis for creation nonlinear spectrometer of an essentially new design.

Nonlinear optical properties of fullerene-doped π -conjugate organic materials based on polyimide and COANP structures

N.V. Kamanina, V.N. Sizov, and D.I. Stasel'ko
Vavilov State Optical Institute, 12 Birzhevaya Line, St.Petersburg 199034, Russia

At present time a list of photosensitive materials is sufficiently long. Among them, fullerene-doped π -conjugate organic systems based on polyimide (PI6B) and 2-cyclooctylamino-5-nitropyridine (COANP) occupy a special place due to their large optical nonlinearities.

The 2-3 μm thick structures were doped with fullerene C_{70} . The fullerene concentration was varied from 0.15 wt.% to 0.5 wt.%. Spectroscopic measurements were carried out using a Perkin-Elmer Lambda 9 instrument in the wavelength range 200-3000 nm. A second harmonic (532 nm) of a pulsed Nd laser was applied to investigate the holographic recording and optical limiting effect.

It was established, when fullerenes were introduced in the organic matrix, the diffraction efficiency increased drastically. The sensitization resulted in a larger increase in the optical absorption at the laser wavelength of 532 nm for the fullerene-doped PI6B and COANP structures, in a conformation transformation of organic chain and in a laser-induced photorefractive effect in them. Using dynamic hologram technique, the drastic change of refractive index Δn_i was observed and the nonlinear coefficients n_2 and $\chi^{(3)}$ were estimated. The results are presented in the Table 1.

Table 1. Materials nonlinear coefficients

Materials	$n_2, \text{cm}^2 \text{W}^{-1}$	$\chi^{(3)}, \text{cm}^3 \text{erg}^{-1}$	T, K	Method
CS ₂	$3 \cdot 10^{-14}$	10^{-12}	300	[1]
Quartz	$3 \cdot 10^{-16}$	10^{-14}	300	
C ₆₀ film		$8.7 \cdot 10^{-11}$		THG [2]
C ₇₀ film		$2.6 \cdot 10^{-11}$		THG [2]
PI + C ₇₀	$0.78 \cdot 10^{-10}$	$2.64 \cdot 10^{-9}$		Estimated
Si	10^{-10}	10^{-8}	300	[1]

It should be mentioned that the large values of Δn_i influence the optical limiting effect in the structures investigated. It has been established that the fullerene-doped systems could be applied for optical limiting at the incident laser energy density of more than 3.54 J cm^{-2} . The reverse saturable absorption mechanism, the two-photon absorption, the Förster mechanism, reinforcement of the donor-acceptor interaction due to the charge transfer complex formation, as well as an enhancement in the laser induced refractive index should be included to consider the optical limiting peculiarities in the fullerene-doped structures based on polyimide and COANP.

[1] S.A. Akhmanov, S.Yu. Nikitin. *Physical Optics*, Moscow University, Moscow, 1998 [in Russian].

[2] F.Kaizar, et al., *Proceed. SPIE 2284*, pp.58-68, 1994.

OBSERVATION OF OPTICAL NONLINEARITY SIZE ENHANCEMENT
IN ONE-DIMENSIONAL MOLECULAR AGGREGATES

R. V. Markov, A. I. Plekhanov

Institute of Automation and Electrometry, Siberian Branch RAS,

Pr. Ak. Koptuyga 1, Novosibirsk 630090, Russia

V. V. Shelkovnikov

Novosibirsk Institute of Organic Chemistry, Siberian Branch RAS

Pr. Ak. Lavrentjeva 6, Novosibirsk 630090, Russia

Optical and nonlinear optical properties of low-dimensional Frenkel exciton systems, such as molecular aggregates, polymers and semiconductor microcrystals are interesting examples of collective phenomena. Examples are absorption line shift, exciton superradiance, exchange narrowing, and size enhancement of nonlinear optical properties. This work presents experimentally observed dependence of nonlinear optical susceptibility of one-dimensional molecular aggregates on delocalization length of the exciton along the aggregate.

Molecular aggregates of pseudoisocyanine with various width of a distinctive absorption line were obtained in thin ($l=15\text{nm}$) films on glass substrates. These films possess a giant optical nonlinearity of third order and high photochemical stability at room conditions. Exciton delocalization length was derived from absorption line width that is attributed to a mixing of lowest exciton band states. Energy difference between the states in turn depends on delocalization length. Nonlinear optical susceptibility of third order $\chi^{(3)}$ within resonance absorption band was measured by Z-scan technique. Experimental results show a scaling dependence of the nonlinear optical susceptibility on the exciton delocalization length $\chi^{(3)} \propto N_{del}^{\delta}$, where $\delta = 2.1 \pm 0.5$. This result coincides with a theoretical prediction for size enhancement phenomena $\chi^{(3)} \propto N^2$.

NONLINEAR OPTICAL STUDY
OF BARIUM HEXAFERRITE SINGLE CRYSTALS

A. A. Rzhovsky, V. V. Petrov, R. V. Pisarev

Loffe Physical Technical Institute, 194021 St. Petersburg, Russia

A. Kirilyuk, Th. Rasing

Research Institute for Materials, 6525 ED Nijmegen, The Netherlands

Barium hexaferrites are promising high-density magneto-optical recording media due to their suitable magnetic properties and good mechanical and chemical stability [1]. The surface structural and magnetic properties of these materials can be different from the bulk and the new phenomena at the surface can arise. So far surface properties of these materials and their modification under substitution by paramagnetic or diamagnetic ions have been scarcely studied. Moreover, the optical behaviour of the cations imbedded in the hexagonal ferrite lattice is far from being fully understood [2].

Recently it was shown [3] that the SHG is a very sensitive and versatile method for probing the surface and interfaces of materials. In this talk we report on the study of the $\text{BaFe}_{12-x}(\text{Al}, \text{Sc})_x\text{O}_{19}$ and $\text{Ba}_2\text{Zn}_2\text{Fe}_{19}\text{O}_{22}$ barium hexaferrite crystals by the SHG method. The azimuthal dependence of the SHG signals were measured in the reflection geometry at $\lambda=0.8\ \mu\text{m}$ by using a femtosecond Ti:sapphire laser for four different input-output combinations of the linearly polarized light. We found that the azimuthal dependence of SHG in both types of crystals is similar and anisotropic. They can be fitted by a $\cos^2(3\theta)$ or $\sin^2(3\theta)$ functions. Since the SHG is sensitive to the point crystal group of the material, we claim that in reality the surface symmetry of the Ba-(Al, Sc) hexaferrite is lower than its assumed point group $6/\text{mmm}$. The magnetic contribution to the SHG signal was also studied and analyzed.

[1]. *Handbook of Physical Quantities*, ed. by I. S. Grigoriev and E. Z. Meilikhov. (CRC Press, Boca Raton, 1997).

[2]. Z. Šimša, R. Gerber, T. Reid, R. Tesař, R. Atkinson, and P. Papakonstantinou. *J. Phys. Chem. Solids*, **59**, 111 (1998).

[3]. *Nonlinear Optics in Metals*, ed. by K. H. Benneman (Clarendon Press, 1998).

SPECTROSCOPIC INVESTIGATIONS OF CHROMIUM DOPED KTIPO, SINGLE CRYSTAL

E.V.Pestryakov, V.V.Petrov, A.G.Volkov

Institute of Laser Physics SB RAS, Novosibirsk, 630090, Russia

V.A.Maslov

General Physics Institute RAS, Moscow, 117942, Russia

In recent years the self-frequency doubling (SFD) laser crystals received much attention because of its multifunctional properties. They may combine the laser emission arising from the impurity active ions and self second harmonic generation (SHG) associated with the nonlinear optical properties of the matrix of crystals. Only few crystals doped with Nd ion demonstrate the effective SFD laser emission, but there are no SFD laser crystals doped with Cr and other transition metal ions, which have lasing activity in vibronic broadband [1].

In this work we investigated the possibility of lasing on vibronic transitions of typical d-ion Cr^{3+} , incorporated into a well-known nonlinear crystal - KTIPO_4 (KTP).

KTP crystals doped with chromium ions were grown by Czochralski method. The grown crystals had a perfect structure. It's discovered that chromium ions substitute the fourvalent Ti with charge compensation and occupy the octahedral sites with local symmetry C_1 . The absorption and emission properties of Cr^{3+} ions are investigated. The magnitude of emission cross-section in maximum of vibronic transition ${}^4T_2 - {}^4A_2$ of Cr^{3+} ion at 833 nm is $\sigma(\lambda) \sim 10^{-20} \text{ cm}^2$. The excited state (4T_2) lifetimes are determined at room and liquid nitrogen temperatures: $\tau_{77} = 90 \mu\text{sec}$ и $\tau_{300} = 3.5 \mu\text{sec}$. It's shown that in KTP crystal Cr^{3+} ions are placed in positions with a weak crystal field: $Dq = 1507 \text{ cm}^{-1}$, $B = 652 \text{ cm}^{-1}$, $C = 2800 \text{ cm}^{-1}$. The main peculiarities of fluorescence spectra according to configuration diagrams model and the perspective of lasing in the near IR range from 700 to 1000 nm are considered.

This work was performed in part under the support of the RFBR grant 01-02-16845 and of Siberian Branch of RAS grant IG2000-49.

I. D. Jaque, J. Campany, J. Sanz Garcia et al. // Optical materials, v.13, p.147-157, 1999.

PHOTOREFRACTIVE RESPONSE OF A CUBIC GYROTROPIC CRYSTAL WITH APPLIED SQUARE-WAVE ELECTRIC FIELD ON THE INTERFERENCE GRATING WITH LARGE CONTRAST

R. V. Litvinov

Department of Electronic Devices, State University of Control Systems and

Radioelectronics, 40 Lenin Avenue, Tomsk 634050, Russia

Analysis of steady-state photorefractive response is carried out for symmetric incidence on a crystal of two plane light wave with equal intensity. The light waves diffracted in the second orders are taken into account. Nonlinear equation for time-averaging space-charge field¹ and coupling wave equations obtained from nonlinear wave equation² are used at modeling of propagation of light wave through BTO crystal under external field 10 kV/cm with typical photorefractive parameters. Interference structure limited by crystal thickness and value of fundamental grating spacing Λ is shown on Fig. 1,a for $\Lambda = 15 \text{ mkm}$ on Fig. 1,b for $\Lambda = 42,1 \text{ mkm}$ at diagonal electrooptic configuration. Nonlinear interaction of photorefractive and interference gratings forms the local components of space charge field, including zeroth spatial harmonics.

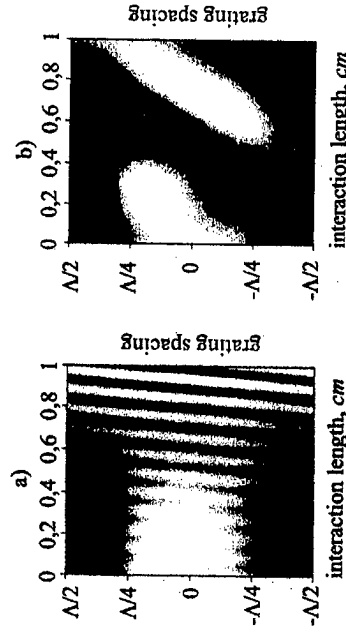

Fig. 1

1. S. M. Shandarov, N. I. Nazhestkina, O. V. Kobozev, A. A. Kamshilin. Appl. Phys. B 68, 1007-1012 (1999).

2. R. V. Litvinov, A. N. Werenickin, S. M. Shandarov. J. Opt. Soc. Am. B. 18, 21-31 (2001).

KDP domain structure properties near the phase transition point

A.A.Zhukov, P.A.Prudkovskii

Chair of Quantum Electronics, Physics Dept., Moscow State University

phone (095)9394372 fax (095)9391104

e-mail postmast@qopt.phys.msu.su

Sometimes the modern theories of the phase transition can not be applied for theoretical study of the domain structures in the ferroelectric crystals because of its inhomogeneity. Therefore some experimental results cannot be explained by means of usual theory of the domain structures. As examples of such results we can refer to the observation of the incommensurate phase [1], fractal domain structures [2] and block configuration of the domain structure in the KDP crystals.

At the present work we have constructed one-dimensional mathematical model for describing of the transition from paraelectric phase to the domain in the ferroelectric phase. The main feature of this model is the additional long-range term for the depolarization field in the Hamiltonian. This term leads to the appearance of the minimum of the Hamiltonian in the Fourier-space at $k \neq 0$, that means incommensurate phase existing possibility. Further investigation of the domain structure formation can be made both in the continuous limit by means of the independent-mode approximation and in the discrete Ising-like model with the aid of the mean field method.

This work was supported in part by RFBR, grant #99-02-16418, in the framework of the integration program "Fundamental Optics and Spectroscopy".

[1] Yu.M.Vysochansky, V.Yu.Slivka, Sov.Phys.Usp., **162**, 139 (1992)

[2] T.Ozaki, T.Kitamura, J.Ohgami, E.Nakamura, Ferroelectrics, **157**, 87 (1994)

[3] A.V.Belinsky, G.Kh.Kitaeva, S.P.Kulik, A.N.Penin, Ferroelectrics, **170**, 171 (1995)

ABSORPTANCE MEASUREMENT OF NONLINEAR CRYSTALS BY CALORIMETRIC METHOD

O. Balachninaite, M. Barkauskas, R. Grigonis, M. Maciulevicius, A. Melnikaitis, V. Sirutkaitis

Laser Research Center, Vilnius University, Sauletekio al.10, 2040 Vilnius, Lithuania
Phone: 370-2-769447, fax: 370-2-336006, e-mail: Ona.Balachninaite@ff.vu.lt

The optical absorbance of nonlinear crystals constrains their utility for harmonic generation or electro-optic switching in high-average power lasers. We report the measurements of absorbance of some crystals at 1064 nm performed according to the ISO11551 standard by pulse calorimetric method. In these procedures, the absorbance is determined calorimetrically as the ratio of energy absorbed by the crystal to the total energy impinging upon the crystal.

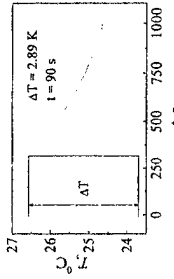

The typical recorded curve of the crystal temperature changes due to irradiation is presented in Figure. Pulsed diode-pumped Q-switched TEM₀₀ mode YAG:Nd laser with 1 kHz repetition rate and average

power in linearly polarized beam up to 8 W was used. The temperature was measured by thermistor and recorded versus time through AD converter by PC. The sensitivity of the measurements was ~0.001 K. The duration of irradiation was selected in range 30 - 180 s.

Crystal	α_n , %/cm	α_n , %/cm
KDP ($\Theta=77$ $\varphi=45$)	3.48 ± 0.30	0.72 ± 0.03
DKDP ($\Theta=0$ $\varphi=0$)	0.20- 0.83	0.20- 0.80
KTP ($\Theta=90$ $\varphi=23.5$)	0.056 ± 0.05	0.044 ± 0.04
LiInS ₂ ($\Theta=28$ $\varphi=90$)	4.00 ± 0.20	3.80 ± 0.20

For the temperature difference estimation extrapolation backward to the temperature at half irradiation time was performed. The summary of the results (absorbance for 1cm length crystal) for few investigated crystals at perpendicular polarizations is presented in Table. Also possibilities of the absorbance measurements in the wide spectral range with radiation of optical parametric oscillators will be discussed.

PHOTOREFRACTION IN NOVEL POLYMER COMPOSITIONS

I.V. Yurasova, O.L. Antipov

Institute of Applied Physics of the Russian Academy of Science, 46 Uljanov St., Nizhny Novgorod, 603600 Russia, Tel.: +7(8312) 384547; Fax: +7(8312) 363792; e-mail: antipov@appl.sci-nnov.ru

W.E. Douglas

Laboratoire de Chimie Moléculaire et Organisation du Solide, CNRS UMR 5637, Université Montpellier II, 34095 Montpellier cedex 5, France Tel.: +33(0)467143853, Fax: +33(0)467143852; e-mail: douglas@univ-montp2.fr

*L.G. Klapshina, V.V. Semenov, G.A. Domrachev, T.I. Lopatina
Institute of Metallo-organic Chemistry, Russian Academy of Sciences, Tropinin Street
49, GSP-445, Nizhny Novgorod, 603600 Russia; e-mail: klapsha@imoc.sinn.ru*

To date photorefractive polymeric materials have been intensively investigated due to a variety of potentially important applications, including high-density optical data storage, image-processing techniques, phase conjugation, etc.^{1,2} We present the results of optical investigations of the extraordinarily large photorefractive effect in a novel type of polymer nanocomposites, containing poly(9-vinylcarbazole) as a charge transport agent, fullerenes C₇₀ and C₆₀ as a charge generator, plasticizers N-ethylcarbazole and phenyltrimethoxysilane, and various nonlinear optical chromophores based on new conjugated silicon-ethynylene polymers poly(aryleneethynylenesilylene)s or organometallic polymers (bis(arene)chromium-containing polyacrylonitrile and others). The proportions of the components were also varied. The polymer layer with thickness ranging from 100 μm to 200 μm was confined by electro-conducting glass walls. The magnitude of the change in refractive index, its origin and temporal behavior were studied by a variety of nonlinear optical techniques: z-scan, two-wave mixing, and four-wave mixing. Electro-optical and spectroscopic properties of the materials in the visible, IR and UV regions were also studied.

References.

1. «*Photorefractive effects and materials*», Edited by David D. Nolte, (Kluwer Academic Publishers, Boston / Dordrecht / London, 1995).
2. I.V. Yurasova, A.S. Kuzhelev, O.L. Antipov et al. «*Dynamic photorefraction in a novel type of polymer nanocomposites*», in CLEO-Europe 2000 Proceedings, p. 191.

Er³⁺ to glass matrix energy transfer in Ga-Ge-S:Er³⁺ system.

T.Yu. Ivanova, A.A. Man'shina, A.V. Kurochkin, Yu.S. Tver'yanovich,
Russian Center of Laser Physics, St. Petersburg State University,
198504, St. Petersburg, Petrodvorets, Ulianovskaya 1.

Over several years chalcogenide glasses are remained the subject of investigation as promising material for realizing of high efficiency optical devices. An active interest in chalcogenide glasses is caused by their attractive properties as a matrix for doping with rare-earth ions (RE). Moreover chalcogenide glasses possess semiconductor properties. Therefore an idea of combination semiconductor properties of chalcogenide systems and luminescence properties of rare-earth ions seems to be very promising.

At the present work spectroscopic characteristics of Er³⁺ in Ga₂S₃-GeS₂-Er₂S₃ glassy system are investigated by use of Judd-Ofelt theory. The transition probabilities calculation and lifetime measurements for ⁴S_{3/2} level of Er³⁺ showed that nonradiative energy transfer between Er³⁺ and glass matrix is possible. It should be note that the energy gap between ⁴S_{3/2} and ⁴I_{15/2} levels (18300 cm⁻¹) is near to the optical gap energy of the Ga-Ge-S:Er glass matrix (about 20000 cm⁻¹). Therefore the ⁴S_{3/2} level of Er³⁺ may relax through the nonradiative energy transfer from Er³⁺ ions to the glass matrix. The verification of our assumption was the enhancement of the nonradiative relaxation rate of ⁴S_{3/2} level with approaching to the resonance between the energy of ⁴S_{3/2} level of Er³⁺ ion and the optical gap energy of the glass matrix.

An idea of the practical use of this nonradiative energy transfer is suggested. Since the levels of Er³⁺ ion may be excited by the absorption of two or three infrared quanta the realization of spectral selective infrared emission detector is possible. Its operating principle is a consecutive absorption of infrared quanta by rare-earth ions followed by nonradiative energy transfer to the chalcogenide matrix, which can be registered as a photocurrent.

INFRARED OPTICAL AND MAGNETOOPTICAL SPECTRA OF (CoFeZr)SiO FILMS WITH TUNNEL MAGNETORESISTANCE

I. Bykov*, A. Bogoroditsky**, E. Gan'shina**, A. Granovsky**, V. Guschin**, A. Kozlov***, Yu. Kalinin**, O. Stogney**, A. Yurasov**

*Vernadsky Institute of Geochemistry and Analytical Chemistry of RAS, Moscow
** Moscow State University, 119899 Moscow, Russia (7-095)939 3379,
guschin@genphys.phys.msu.ru

*** Astrakhan University, 414004, Astrakhan, Russia

The tunnel-type magnetoresistance observed in granular metal-dielectric structures is a phenomenon which has attracted considerable attention both because of its potential application as well as its intriguing origin. The linear on magnetization magneto-optical Kerr effect (MOKE) has been used with considerable success to investigate these materials. This time we have greater investigation possibilities due to existence of a substantial nonlinear MOKE in nanocrystalline magnetic structure in IR range [1,2].

The amorphous metal-dielectric granular films $(\text{Co}_{0.9}\text{Fe}_{0.1}\text{Zr})_x(\text{SiO}_2)_{100-x}$, with $1.3 < x < 1.9$ and $x = 36, 45, 54, 57$ (with thickness $\sim 4 \mu\text{m}$ and the size of metallic granules of 3-5 nm) were obtained by evaporation. The composition of the films was close to percolation threshold and the films exhibited large tunnel-type giant (GMR) magnetoresistance of 5% magnitude (the sample with $x = 45$). The optical and static magneto-optical measurements in the frequency range 500-6000 cm^{-1} were performed with the IR Fourier spectrometer RU9800 with magnetic field amplitude $H_{\text{max}} = 2700 \text{ Oe}$ at room temperature.

It was found that the reflectivity index $R(\nu)$ is by several times less than the one of the metals that enter into composition of granules and practically it does not depend on frequency in the 1800 - 6000 cm^{-1} range. In the 500 - 1800 cm^{-1} range there was found a decrease of reflectivity magnitude for all the samples. In the films possessing maximum GMR, i.e. for $x = 35$ and 45, $R(\nu)$ also exhibits an oscillatory character connected with interference of radiation. For the transverse magnetization geometry in the films with GMR magnitude over 2% there were found quadratic in magnetization changes of the reflectivity index. Meanwhile the MOKE investigations showed that the magnitude of the transversal Kerr effect (TKE), which is linear in magnetization, does not exceed the experimental errors in the whole frequency range. For the samples exhibiting the greatest magnitudes of GMR the MRE reaches the magnitude of 0.3% and exceeds by more than an order of magnitude the linear TKE measured in the visible light range [3]. Since the reflectivity index and the absorption factor both depend on the conductivity of the material, which is magnetic field dependent in the materials with GMR, the observed magnetic field dependence of the $R(\nu; H)$ spectra, i.e. the MRE, is a manifestation of tunnel magnetoresistance effects.

1. J.C. Jacquet, T. Valet MRS Symposium Proceeding, 1995, **384**, 477
2. I. Bykov, E. Gan'shina, A. Granovsky, V. Guschin PSS, 2000, **42**, 487
3. A.A. Bogoroditsky, E.A. Gan'shina, V.S. Guschin *et al.* Proc. Int. Worksh. XXVII New Magn. Mater. in Microelectron.) Moscow, 2000, 308

LIGHT-INDUCED DIRECTOR REORIENTATION IN NEMATIC LIQUID CRYSTAL UNDER FEMTOSECOND PULSES

A.A. Goncharov¹⁾, V.F. Kitaeva²⁾, I.A. Ozheredov¹⁾, A.P. Shkurinov¹⁾ and A.S. Zolot'ko²⁾

¹⁾Department of Physics and International Laser Center, M.V. Lomonosov Moscow State University, Moscow, 119899, Russia

²⁾P.N. Lebedev Physical Institute, Leninsky pr.53, Moscow, 117333, Russia

It is well known that the director of a nematic liquid crystal (NLC) can be reoriented not only under continuous, but also under pulse radiation. The interaction of single intense nano- and picosecond pulses with NLC was shown to be of rather complex nature conditioned by coupling of orientation, flow, density and temperature.

We extended the range of pulse duration to femtoseconds and directly compared the orientation response to succession of femtosecond pulses and to continuous radiation.

In experiment, the succession of femtosecond pulses (length 100 fs, repetition rate 100 MHz, energy flux $S_p \leq 10^9 \text{ W/cm}^2$) with a wavelength centered at 780 nm or continuous beam ($P < 40 \text{ mW}$) were focused by lens ($f = 6 \text{ cm}$) into 100- μm -thick homeotropic NLC ZhKM-1282.

At oblique ($\alpha=30^\circ$) incidence of pulses on NLC the increase of the beam divergence and formation of aberration pattern were observed. The dynamics of pattern formation, its suppression by external electric field, and the sign of self-action (self-focusing) indicated to orientational mechanism of nonlinearity. The values of the optical responses to the femtosecond and the continuous radiation, (see Fig. 1) exhibit no essential difference. This bears witness to the absence of notable effect of the flow and photoelastic stresses on the light-induced director reorientation.

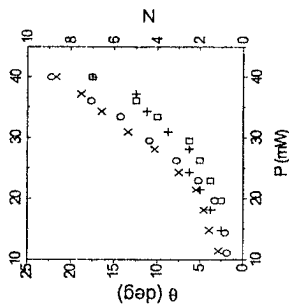

Fig. 1. Beam divergence θ (X, O) and number of aberration rings N (+, \square) vs. beam power P. X, + - pulses; O, \square - continuous mode.

Intracavity Quasi-Phase-Matched Self-Frequency Conversions in Periodically Poled Nd:Mg:LiNbO₃

Georgy D. Laptev

International Laser Center, M.V.Lomonosov Moscow State University, Moscow, 119899, Russia, phone: (095) 9392228, fax: (095) 9393113, e-mail: Laptev@qopm.phys.msu.su

Alexey A. Novikov

Physics Department, M.V.Lomonosov Moscow State University, Moscow, 119899, Russia, 119899, phone: (095) 9391630, fax: (095) 9393113, e-mail: novikov@qopm.phys.msu.su

Inessa I. Naumova

Physics Department, M.V.Lomonosov Moscow State University, Moscow, 119899, Russia, 119899, phone: (095) 9391630, fax: (095) 9393113

The laser oscillation of active ions with nonlinear optical properties of the host material in combination with quasi-phase matching (QPM) as an alternative technique for compensation of the phase velocity dispersion and laser diode pumping technique offers an opportunity for production self-frequency converting miniature laser devices.

In this paper we give thorough description of our theoretical investigations of the intracavity QPM self-frequency conversion of light waves in active-nonlinear periodically poled Nd:Mg:LiNbO₃ crystal located in double resonant cavity. Although there are a large number of highly nonlinear crystals, only a few of them have been successfully doped with active ions using existing crystal growing technique. The results of study of periodically poled Czochralski-grown Nd:Mg:LiNbO₃ by chemical etching and X-ray microanalysis is presented in the paper. Continuous-wave QPM second harmonic generation at 0.542 μm by self-doubling the fundamental laser radiation at 1.084 μm has been demonstrated in periodically poled Nd:Mg:LiNbO₃ end pumping by diode laser at 0.810 μm [1].

1. G.D. Laptev, A.A. Novikov, A.S. Chirkin, V.V. Firsov, N.V. Kravtsov // *Proc. SPIE*, 4268, (2001).

PHOTODYNAMICS OF OPTICAL LIMITING OF POWER LASER RADIATION

I. M. Belousova, V. P. Belousov, O. B. Danilov,

V. V. Danilov, A. I. Sidorov, I. L. Yachnev

Research Institute for Laser Physics

12, Birzhevaya line, St. Petersburg, Russia

Results of researches on design of optical limiters of laser radiation, based on different physical principles and functioning in the wide spectral range from 0.3 to 12 μm , are presented. We studied limiting of fullerene-containing media in the spectral range of 0.3...1.315 μm on C₆₀, C₇₀, and C₇₆₋₈₄. Analysis of photodynamics of limiting on the fullerene-containing media showed a significant contribution to the limiting from reverse saturable absorption and photoinduced scattering. Fullerene-containing solutions gives the optical limiting of 10³ at laser pulse duration of 10⁻⁸-10⁻⁹ s. Peculiarities of the limiting mechanism in the fullerene-containing media at laser pulse duration lower than 1 ns are shown experimentally and theoretically.

We suggested and studied the principle of low-threshold limiting (at the level of 10⁻⁶ J/cm²) on the base of Kerr nonlinearity in absorbing liquid-crystal admixtures chiral and nematochiral structures at diffraction suppression of absorption by reflection.

In the mid-IR range, laser radiation reduction is based on phase transitions semiconductor-metal in vanadium dioxide. In multilayer interference systems with vanadium dioxide film, we obtained radiation attenuation of 10³ at pulse duration of 1-50 μs .

We experimentally obtained and theoretically proved the limiting at superhigh energy density in the IR range at multiphoton absorption in the strong field in gas molecular media. The effect of the optical limiting of laser radiation at $\lambda=10.6$ μm has been obtained with sulfur hexafluoride SF₆. In the pressure range of 0.3-1 atm., energy density up to 45 J/cm², and radiation pulse duration of 25 μs , we obtained laser radiation attenuation of 10³-10⁴.

LOW INTENSITY OPTICAL NONLINEARITY IN THIN FILMS BELOW THE BAND EDGE

A. V. Khomchenko

Institute of Applied Optics NAS of Belarus,

11 Belyitskogo-Biruli St., 212793, Moglev, Belarus,

The optical nonlinearity in the semiconductor and dielectric thin-films and multilayer structures is studied at a wavelength of 630 nm in a range of light intensities below 0.1 W/cm^2 by waveguide methods. The applications of the guiding mode spatial Fourier-spectroscopy method for determination of linear (the refraction index n and the absorption coefficient k) and of nonlinear optical parameters (n_2 and k_2) of thin films are presented. The measured magnitudes of the nonlinear optical constants were equal $10^{-3} \text{ cm}^2/\text{W}$. It's shown a possibility of controlling light in the self-effect case. Variations of an integrated reflection coefficient as function of the incident light beam power I_{in} at excitation of a guiding mode in As_2S_3 thin film presented in Fig. The analysis of our

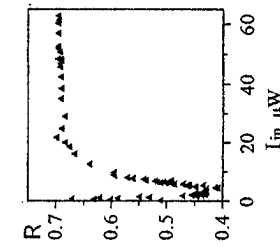

experimental results obtained by methods of the guiding mode spatial Fourier-spectroscopy, of waveguide spectroscopy and of photomodulation spectroscopy shows that the photoinduced change in optical properties of the thin films is a result of some photoelectronic effects. Its origin is speculated as a modification of surface states in the band gap. Common tendencies in relationships between intensity of light and optical properties of multilayer structures, polycrystalline films and semiconductor-doped glass films are detected. It is shown that a state of interfaces defines a character of optical nonlinearity for the semiconductor low-dimension structures, the crystallite sizes determine the nonlinear optical constants for the polycrystalline films. Thus, the nonlinear changes in the optical properties of these structures can be a result as photostimulated migration of non-equilibrium carriers out of the film volume to the interface, of subsequent capture of electrons in localized states in the band gap as well as the processes of carrier recombination. From our point of view these processes define the non-monotonic behavior of the intensity dependence of the thin-film optical properties.

PHOTOPHYSICAL AND SECOND-ORDER NONLINEAR PROPERTIES OF PUSH-PULL FLUORINATED 4-(DICYANOMETHYLENE)-PYRANES

S.L. Bondarev, V.N. Knyuksho, S.A. Tikhomirov, I.I. Kalosha
Institute of Molecular and Atomic Physics, 220072, Minsk, Belarus

V.I. Tyvorskii, D.N. Bobrov, N.M. Nevar, O.G. Kulinkovich
Belarus State University, 220050, Minsk, Belarus

I. Ledoux

Département d'Électronique Quantique et Moléculaire, France Télécom, 196 avenue
Henri Ravera, BP 107, 92225 Bagneux cedex, France

Substituted 4-(dicyanomethylene)-pyranes are well known not only as efficient laser dyes [1], but also for their large optical nonlinearities [2]. Such materials, capable of manipulating laser harmonics, are of potential importance in diverse technologies such as optical computing, telecommunications and information storage [3].

The present report gives the steady-state and time-resolved spectroscopic studies with second-order polarizability measurements of some 4-(dicyanomethylene)-pyranes:

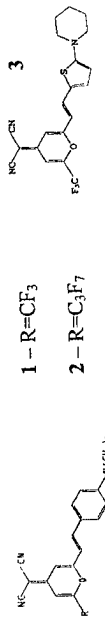

in organic solvents at 293 K. The ground-state absorption and fluorescence spectra show bathochromic shifts on going from **1** to **3** with decrease of fluorescence quantum yields. The solvatochromism and strong fluorescence quenching of studied pyranes (especially for **3**) in polar solvents determined by the large intramolecular charge transfer have been also revealed. The transient picosecond and fluorescence polarization investigations have allowed to establish the electronic structure and oscillator model for compounds. Nonlinear molecular measurements using an electric-field-induced second-harmonic-generation of **3** in chloroform have given high value of $\mu_g\beta=2300 \cdot 10^{48}$ esu by laser excitation at $1.9 \mu\text{m}$ (μ_g - ground-state dipole moment and β - second-order polarizability). An influence of structural and environment characteristics on the photophysical and nonlinear properties of investigated compounds have been discussed.

1. Marason E.G. Opt. Commun. 1981.V.37. P. 56

2. Moylan C.R., Ermer S., Lovejoy S.M. et al. J.Am.Chem.Soc. 1996. V.118. P. 12950

3. Burland D.M., Miller R.D., Walsh C.A. Chem. Rev. 1994. V. 94. P. 31

NONLINEAR ABSORPTION PROPERTIES OF NEW COBALT-DOPED TRANSPARENT GLASS CERAMICS

A. M. Malyarevich, I. A. Denisov, K. V. Yumashev

International Laser Center, #65 F. Skaryna Ave., bldg. 17, 220027 Minsk, Belarus

O. S. Dymshits, A. A. Zhilin

S. I. Vavilov State Optical Institute, 197131, St-Petersburg, Russia

New materials for nonlinear optical devices are under intensive study during last years. In the row of them transparent glass ceramics is of significant interest due to its near-zero thermal expansion coefficient and high thermal stability. This talk presents study of nonlinear absorption properties of magnesium-aluminum transparent glass ceramics (Co:MAS) prepared at different temperatures and doped with various concentrations of Co^{2+} ions.

The absorption spectra of Co:MAS are characteristic for tetrahedrally coordinated Co^{2+} . The absorption saturation was studied for the Co:MAS samples prepared under different conditions (i.e. CoO concentrations, temperatures and durations of second stage heat treatment) at the wavelength of 1.54 μm as well as the difference spectra of stimulated emission and excited state absorption under picosecond excitation were derived and analyzed. In the difference absorption spectra of Co:MAS, stimulated emission around 650 nm and excited state absorption in the range of 450-630 nm and around 740 nm were observed. Both the stimulated emission and the excited state absorption were tentatively assigned to the transitions of tetrahedral Co^{2+} ions. The ground state absorption cross sections of the different Co:MAS samples were estimated from the absorption saturation measurements at 1.54 μm to be $(3+4) \times 10^{-19} \text{ cm}^2$. The level of unsaturable losses is proportional to the Co concentration in the raw material and independent on the temperature and duration of heat treatment. This absorption probably due to presence of some amount of Co ions in octahedral co-ordination and other impurities. Influence of the synthesis conditions on the nonlinear absorption properties and possible applications of the Co^{2+} -doped magnesium-aluminum glass ceramics will be discussed.

OPTICAL PROPERTIES OF LiInS_2 NONLINEAR CRYSTAL

Andreev Yu.M.¹, Geiko L.G.¹, Geiko P.P.¹, Grechin S.G.²

¹Institute of Optical Monitoring SB RAS, Russia, 634055 Tomsk, Academicheskyy p., 10/3

²SRI RL, Bauman MSTU, Russia, 107005 Moscow, 2-nd Baumanskaya str., 5

Results of investigation for linear and non-linear optical properties, and damage threshold for biaxial LiInS_2 crystal are represented. Transmission band on the 0,1 level is equal 0,4 - 12,5 μm , and on the 0,5 level is equal 0,5 - 11 μm . Inside the band of transmission 1,0-8,0 μm the absorption coefficient is equal $\alpha \approx 0,1 - 0,25 \text{ cm}^{-1}$, on the CO_2 laser wavelengths 9,2 - 10,8 μm : from 1,1 to 2,3 cm^{-1} . Sellmeier equation's coefficients for spectral band 0,45-11,5 μm are followings:

$$n^2 = A + B / (\lambda^2 - C) - D\lambda^2$$

	Y	X	Z
A	4,418222	4,559534	4,59206
B	0,1254461	0,1403701	0,1410887
C	0,0657432	0,069233	0,069287
D	0,0028850	0,0028731	0,0030589

The coefficients of non-linear susceptibility are: $d_{31} = 6,2$; $d_{32} = 5,4$ и $d_{33} = 9,8 \text{ pm/V}$. Damage threshold of crystal is equal 120-130 MW/cm^2 for 36 ns monopulse on 9,55 μm wavelength.

The phase-matching conditions computation results for different problems of frequency conversion (angular and spectral tuning curves) are represented.

It is shown the possibility of group-velocity phase matching realization in wide spectral band for sum- and difference-frequency generation. The figure shows the spectral dependencies for group-velocity phase matching, that take place in phase-matching direction for following waves: sfs (1), sfs (2), $f-fs$ (3) and $f-fs$ (4) for sfs -type (1, 4) and $f-fs$ -type (2, 3) of interactions. These properties give possibilities for creation of a frequency converters for femtosecond Erbium 3 μm lasers.

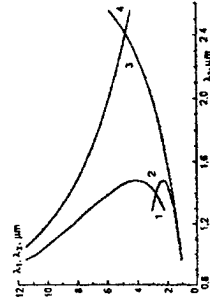

Spectroscopy and Population Dynamics of Monoclinic Crystals KY(WO₄)₂:1÷15% Tm Pumped by a Free-Running Nd:YAG Laser

S.N.Bagayev¹, S.M.Vatnik¹, A.P.Majorov¹, A.A.Pavluk²

¹Institute of Laser Physics SB RAS, Novosibirsk 630090, Russia

²Institute of Inorganic Chemistry SB RAS, Novosibirsk 630090, Russia

Thulium and thulium-holmium-doped crystals are currently used in all-solid-state 2-μm laser sources. The laser operation of monoclinic crystals KY(WO₄)₂:1.5%Tm under CW 0.5W@800nm pump has been demonstrated recently the spectroscopy and In this work we present the results on population dynamics and laser operation for a set of potassium-yttrium (or ytterbium) tungsten oxides doped with Tm concentration from 1% to 15%.

Fig.1 shows absorption coefficients of a 1.2mm thick KYW:10%Tm crystal for the light polarized along N_g (maximal absorption) and N_a (minimal absorption) indicatrix axes and the arrow indicates the pump wavelength.

Fig.2 shows the spectral intensity of fluorescence for the ³F₄→³H₆ transition (dashed curve) as well as the laser output of 1.2mm KYW:15%Tm (thick solid curve) and 2.5mm KYW:7%Tm (solid curve) under pump of 1064nm Nd:YAG laser (10ml@300μs), pump waist is 230μm.

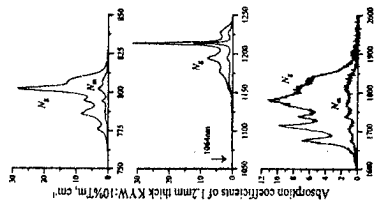

Fig.1

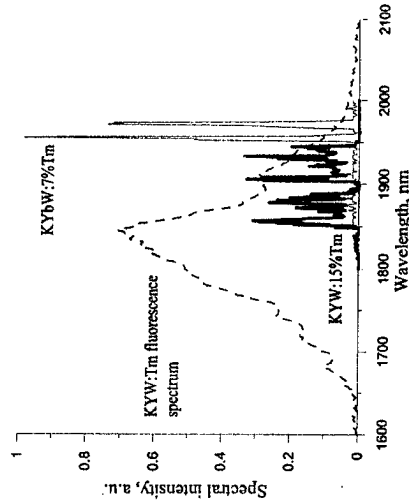

Fig.2

The blue emission corresponding to ¹G₄→³H₆ transition was observed for all crystals under study, with the most bright emission being detected for the KYW:3%Tm samples. The concentration dependence of cross-relaxation efficiency and dynamics of ESA absorption as well as lifetimes of ³H₄ and ¹G₄ manifolds are discussed also.

EXCITED STATE ABSORPTION AND POPULATION OF HIGHER-LYING LEVELS OF Nd³⁺ IONS UNDER DIODE AND LASER PUMPING OF Nd:YAG CRYSTALS

O.L. Antipov, O.N. Eremykin, V.A. Vorob'ev

Institute of Applied Physics of the Russian Academy of Science

46 Ulijanov St., Nizhniy Novgorod, 603600 Russia, e-mail: antipov@appl.sci-nnov.ru

O.S. Morozov, A.P. Savikin

Nizhniy Novgorod State University, 23 Gagarin St., Nizhniy Novgorod, 603000 Russia

A Nd:YAG crystal is widely used as an active medium for high-average-power diode-pumped lasers because of its strong absorption at a 808-nm pump band, four-level nature, high emission cross-section at 1064 nm, and good thermo-mechanical properties. However, strong aberrations induced inside the laser crystal under intensive diode pumping due to ground-state and excited-state absorptions limit the potential of the Nd:YAG lasers.¹ An important role in the refractive-index changes of the Nd:YAG crystal is played by higher-lying levels of its 4f electron shell, of which the most long-living is the ²F₂ level.²

In this report we present the result of excitation of the ²F₂ level in Nd:YAG crystals under diode and laser pumping. The luminescence bands at 396 nm and 405 nm indicated the transition from the ²F₂ level. The effectiveness of the level population by the ground-state and excited-state absorption induced by a 30W cw-diode-array pumping and additional laser beams at 580 nm (from a dye laser), 532 nm, and 266 nm (second and fourth harmonics of a Nd:YAG oscillator) was investigated.

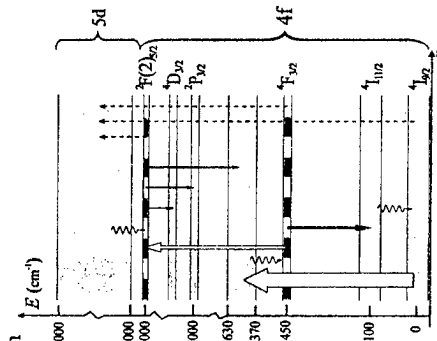

Fig. Energy levels of Nd³⁺ ion in a Nd:YAG crystal.

References

1. M. Pollnau, W.A. Clarkson, D.C. Hanna, in Technical Digest of CLEO'98 (Optical Society of America, Washington DC, 1998) v. 6, p. 100.
2. O.L. Antipov, A.S. Kuzhelev, D.V. Chaousov, and A.P. Zinov'ev, *J. Opt. Soc. Am. B* **16**, 1072-1079 (1999).

LONG-LIVED NONLINEAR REFRACTION OF DIAMONDS WITH DIFFERENT
IMPURITIES CONTENT INDUCED BY UV RADIATION

V.V. Filippov, S.P. Firsov, E.V. Ivakin, N.M. Lapchuk*, and A.V. Sukhodolov

B. I. Stepanov Institute of Physics, National Academy of Science, F. Skarina Ave., 70,
220072 Minsk, Belarus. e-mail: ivakin@dragon.bas-net.by

* Belarusian State University, F. Skarina Ave., 4, 220072 Minsk, Belarus

Nitrogen is the most common chemical impurity in both synthetic and natural diamonds. Different types of N-related defects lead to additional optical absorption in UV and IR regions as well as to a weak luminescence in specific spectral bands. In this report we consider another optical effect in defects-containing diamond crystals. It consists in the refractive index changes induced by UV laser radiation. Monocrystalline diamond samples with different concentration of A, B1, C and B2 defects were investigated by the method of transient gratings. Q-switched YAG:Nd (wavelength of output 266 nm) and He-Ne lasers have been used as pump and readout sources.

Crystals with paramagnetic (C-centers) and non-paramagnetic (B2) defects have been shown to give rise to a long-lived nonlinear refraction excitation of lifetime 100 ms and 0,5 ms respectively in addition to thermal response. Paramagnetic diamond crystals with C-defects exhibit a well defined temperature dependence of lifetime. It is four orders of magnitude decreased as the temperature varies from 20 to 120°C. Natural diamonds with high concentration of B2 defects display a rather moderate decrease of grating lifetime under the same experimental conditions. We did not reveal a simple correlation between the amplitude of the refractive index change Δn and A and B1 defects presence, as well as the concentration of C and B2 defects. At the same time direct correlation was observed between the value of Δn and the heat conductivity of diamond crystals.

In natural diamond crystals with low defects concentration no any other gratings but fast thermal and free carrier (wavelength of excitation 213 nm) gratings are observed.

STABILIZATION OF THE THREE-DIMENSIONAL QUANTUM SYSTEM
WITH A SHORT-RANGE POTENTIAL

A.M.Popov, O.V.Tikhonova and E.A.Volkova

The strong-field stabilization is one of the most interesting and counter-intuitive phenomena. One of the main known mechanisms of stabilization is the Kramers-Henneberger (KH) stabilization [1], that is interpreted in terms of the KH eigenstates using the transformation to the Kramers coordinate frame [2]. For the 1D model system KH eigenstates are found to be more appropriate to describe the ionization of the system in the high-frequency limit and the stabilization observed in this case is caused by the increase of resistance of the KH states against ionization [3]. However, in [4] the strong-field dynamics of a 3D model system with the delta-potential was investigated analytically and the rate of ionization was obtained in dependence on laser intensity and the ionization rate was found to be a growing function of intensity besides the channel closing regions.

In this paper the ionization of the 3D model system with a short-range potential by a linearly polarized laser field is studied by the direct numerical integration of the non-stationary Schroedinger equation in a wide range of laser pulse parameters. The intensity-dependence of the ionization probability is found and the stabilization regime is established. Moreover, the energy spectra of photoelectrons are obtained. In a high intensity region a new structure of the photoelectron spectrum is found to appear that should be attributed to the ionization from the KH states. Thus, the KH stabilization is proved to occur for the 3D model system in the strong-field limit.

References.

1. Gavrilin, M., 1992 *Atoms in Intense Laser Field* (New York: Academic), p.435
2. Kramers, H., A., 1956 *Collected Scientific Papers* (Amsterdam: North-Holland), p.262
3. Popov, A., M., Tikhonova, O., V. and Volkova, E., A., 1999, *J.Phys.B*, 32, 3331
4. Manakov, N., L., Frolov, M., B., Borca, B. and Starace, A., F., 2000, *Pisma v ZhETF*, 72,

Strong increasing the efficiency of high-order harmonic generation using counter-propagating laser pulses

I.P. Prokopovich, A.A. Khrtutchinsky, D.Yu. Churmakov, J. Peatross*, A.A. Apolonsky[†]
Institute of Nuclear Problems, BSU, 11 Bobruiskaya Str., Minsk 220050, Belarus.
E-mail: prok@np.minsk.by, Phone: (+375 17) 226 42 25, Fax: 226 51 24
^{*}*Dept. of Physics and Astronomy, Brigham Young University, Provo, UT, USA*
[†]*Photonics Institute, Vienna University of Technology, Vienna, Austria*

The counter-propagating pulses (CPP)-based quasi phase matching at high-order harmonic generation (HHG) was studied for the simplest phenomenological model¹. For the first time, we report the results of numerical investigations the nonlinear dynamics of laser pulses and HHG, including CPP with the same peak intensity, as exact solutions of self-consistent equations, namely Maxwell's equations for laser fields and equations for two different models of gaseous media, as ensembles of (I) Duffing oscillators^{2,3} for atoms as well as (II) two-level systems relating to fine structure of ground state of their ions⁴. We show that both models (I) and (II) give similar qualitatively results when CPP were used: (A) the increase of a number of harmonics, (B) the increase of intensities of higher harmonics in plateau (i.e. the harmonics of more higher order) by several orders of magnitudes, and (C) the decrease of intensities of lower harmonics. But quantitatively the efficiency of HHG is much more always in the case (II) when compared to (I). An explanation for this fact is given by us. We used in (I) and (II) the parameters of the anharmonicity and the polarizability respectively, in rare gases that was obtained from experimental estimations for the intensity $I_0 = 10^{14} \text{ W/cm}^2$. We present the amplitude spectra of 20-fs pulse passed the gaseous media in (I) and (II) cases without using 160-fs CPP and with using one.

We have demonstrated that the use of counter-propagating pulses leads to an increase in the generating efficiency of the highest harmonics at least by more than four orders of magnitude of their intensities as well as allows to reach higher photon energies. And the single pulse with more initial intensity (even though four times as large as) can not give such effect.

In addition, we have calculated the effect of the plasma on coherent lengths for this HHG. These coherence lengths, for the harmonics in the cutoff region, are in the neighbourhood of the propagation distance, where the highest increased efficiency of HHG we had for the 20-fs pulse.

This research was supported in part by INTAS, Projects No. 97-1058 and No. 97-02018, and by Belarus Basic Research Foundation (Grant No. F98-319).

- [1] J.Peatross, S.Voronov, I.Prokopovich, Opt. Express **1**, 108 (1997).
- [2] J.Peatross and D.D.Meyerhofer, Phys. Rev. A **52**, 3976 (1995).
- [3] Ph. Balcou, A. L'Huillier, and D.Escaude, Phys. Rev. A **53**, 3456 (1996).
- [4] I.P.Prokopovich and A.A.Khrtutchinsky, Laser Phys. **6**, 41 (1996); A.A.Khrtutchinsky and I.P.Prokopovich, Opt. Quant. Electron. **29**, 515 (1997).

The processes occurring in a crystal of aluminum (Al, a FCC lattice) after absorption have been simulated by superficial metal layers of powerful laser radiation pulse energy. The following parameters of laser radiation are given. A pulse width is 10^{-13} s, diameter of a spot is $20 \cdot 10^{-6}$ m, pulse energy is $3.3 \cdot 10^{-4}$ J, length of a wave is 10^{-6} m, peak intensity in a pulse is 10^{15} W/cm². The factor of an Al surface reflection is equal to 0.85 and no its change during a pulse is taken into account. Nor energy losses from the surface as a result of reirradiation and convection are taken into account. The calculation has been performed using a molecular dynamics method with a time step allowing us to receive not less than 50 points at passing by the atom a distance, equal to interatomic.

For the first time the direct energy transformation of laser radiation beam into mechanical energy of atomic movement of irradiated bulk of a crystal is shown to be possible. This is due to changing the interaction potentials. Such a change is caused by screening change between the ions and indirect interaction owing to instant temperature change of electron conductivity after laser pulse radiation influence. The atoms, moving to the new energetically favourable places, get an energy sufficient for damage of bindings with the neighbours.

Thus, the direct confirmation of the nonthermal damage mechanism has been received. The damage of the irradiated part of a crystal for the time when the energy from an electronic subsystem has no time to be transferred into an ionic subsystem has been illustrated. The part of atoms of the irradiated region as clusters of the form like a plate leaves a surface of the crystal, and the other part penetrates into the crystal.

Besides there a plane shock wave appears. It can be distributed to the very large distances in comparison with the projecting runs.

The practical aspects of this effect are discussed.

Valery V.Besogonov, Vladimir G.Chudinov
 Institute of Applied Mechanics, Ural Branch of Russian Academy of Sciences
 222, Gorki St., 426000, Izhevsk, Russia
 Tel: (3412)216611; fax: (3412)431713; e-mail: mikheev@udmnet.ru

TUNNEL ABOVE-THRESHOLD IONIZATION OF MULTICHARGE IONS:
PHOTOELECTRON RELATIVISTIC DISTRIBUTIONS
AND EFFECT OF GRADIENT STABILIZATION

R. V. Kulyagin, V. D. Taranukhin

Physics Department, Lomonosov Moscow State University,
Vorob'evy Gory, Moscow 119899 Russia

Current progress in laser physics resulted in the development of superstrong field coherent sources with peak intensities $I_0 \sim 10^{18} - 10^{21}$ W/cm² that made possible an experimental investigation of relativistic effects for the electrons produced during the multiphoton atom (ion) ionization. In the present paper the spatial distributions of above-threshold photoelectrons produced during the tunnel ionization of multicharge ions by laser radiation of relativistic intensity are theoretically investigated. It is shown that an essential modification of these distributions should be due to simultaneous manifestation of relativistic effects and Coulomb interaction of photoelectron with its parent ion. For short laser pulse, the distribution becomes composed of two peaks. Positions of these peaks depend on the radiation intensity and ellipticity, and also, on the charge of the parent ion. The last dependence can be used for the control of ionization process of multielectron atoms.

A new mechanism has been found that increases the multicharge ion stability in regard to ionization by superintense ultrashort pump pulse. The gradient forces on the trailing edge of the pulse can compensate the relativistic drift of photoelectron. And due to Coulomb attraction, it is possible to the photoelectron be captured back to the closed orbit after the pump pulse is over (Fig.).

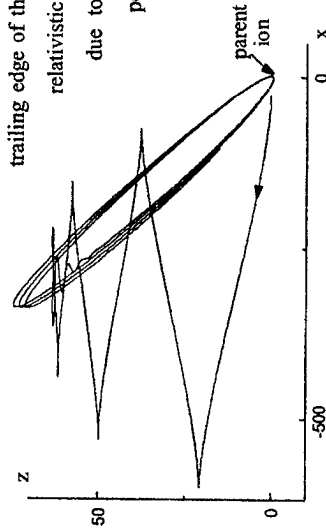

NEW APPROACH TO LASER ELECTRON ACCELERATION

A. Bahari, I. V. Ivanov, I. A. Kudinov, V. D. Taranukhin
Physics Department, Lomonosov Moscow State University,
Vorob'evy Gory, Moscow 119899 Russia

In laser beams of intensity $I \square 10^{18} - 10^{19}$ W/cm², electron quiver velocity is comparable with a speed of light c , so it becomes fundamentally important to take relativistic effects into account. Also, it is essential that superstrong fields are usually attained with strong focusing of radiation. In addition to oscillation, electron drifts in such fields due to the field spatial and temporal inhomogeneities. This drift is described by a ponderomotive force F . Our calculations show that, in general case, F is not a gradient force. Despite that it can be described (as for weak fields) by one scalar function - effective mass of electron in the field m^* . In co-moving reference frame:

$$F = -(\nabla + \dot{y}\Phi_x(\beta) \partial/\partial y + \dot{x}\Phi_x(\beta) \partial/\partial x) m^* + \Delta T,$$

where $\beta = U_p^*/m^*$, U_p^* is a ponderomotive potential with electron mass $m = m^*$. For linearly polarized field, functions $\Phi_{x,y}(\beta)$ are shown in Fig. For circularly polarized field, $\Phi_{x,y} = 0$. Term ΔT is essential only when velocity of electron oscillation center $V_0 \sim c$.

Thus, for linearly polarized laser, the force F in addition to gradient part $-\nabla m^*/\partial x$ and a vortex part with components along the laser wavevector $(-\partial m^*/\partial y)$ and along the laser polarization $(-\partial m^*/\partial x)$. The difference in this force for linearly and circularly polarized laser fields enables us to develop (analytically and with numerical simulation) a basically new technique of charge acceleration with using laser beam of combined polarization [1]. We considered the increase of electron kinetic energy $\Delta \epsilon$ after electron single crossing such a beam and determined that the maximum energy increase $\Delta \epsilon/m = 7/15$. To get higher $\Delta \epsilon$ multicrossing acceleration schemes should be arranged.

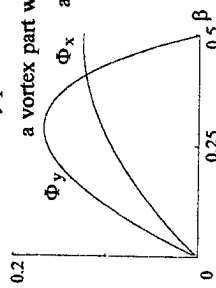

1. V. D. Taranukhin, JETP, 90, 447 (2000).

RESONANCE EXCITATION OF LANGMUIR WAVES IN THE COURSE OF TUNNEL IONIZATION OF GAS BY SHORT LASER PULSE

V.B. Gildenburg and N.V. Vvedenski

Institute of Applied Physics, RAS, 603600, 46 Ul'yanov st., Nizhny Novgorod, Russia

The resonance generation of Langmuir waves during transition of plasma density through the critical value can play a large role in the dynamics of the microwave and optical discharges [1, 2]. We present here the results of computer simulation of this process in the laser-produced gas breakdown within the framework of the 2D boundary problem. The approach used allows the description of small-scale plasma-field structures created by a short laser pulse incident on the flat boundary of the ionizable medium. The structures of this kind and their related Langmuir fields of high intensity are excited as a result of development in the discharge of the so-called plasma-resonance ionization instability resulting in, at the nonlinear stage, a transversal modulation of the electromagnetic wave and wave-created plasma. The method of the solution of a problem was based on the distinctions between large (electromagnetic) and small (Langmuir) spatial scales. The small-scale (transversal) structure was studied on the basis of 1D phenomenological model which takes into account the spatial and time dispersion and Landau damping in time-varying plasma. The large-scale (longitudinal) structure was described by the wave equation containing an effective permittivity defined by the solution of the equation for the small-scale (transversal - periodic) field.

The results obtained shows that the development of the ionization instability and generation of intensive Langmuir waves affect drastically the dynamics of the field and plasma during a gas breakdown, making possible, in particular, the creation of extended enough layers of the dense (overcritical) plasma without appreciable energy losses in the transmitted pulses.

The work was supported by RFBR (Grant No 99-02-16238).

1. Gildenburg V.B. and Vvedenski N.V., *Physics of Plasmas*, v. 8, No. 5, 2001.
2. Bystrov A.M. and Gildenburg V.B., *Plasma Physics Reports*, v. 27, No. 1, p. 71, 2001.

ON THE ANGULAR DISTRIBUTIONS OF THE FRAGMENTS OF COULOMB EXPLOSION OF DIATOMIC MOLECULES IN THE STRONG FIELD.

V. V. Gridchin, A. M. Popov, O. V. Smirnova

Moscow State University, Moscow, 119899, Russia

The multielectron dissociative ionization (MEDI) of molecules in intense laser field is now extensively studied both experimentally [1] and theoretically [2,3]. To simplify the picture of MEDI in theoretical description the variety of events involved in this process can be reduced to the electron removal and Coulomb explosion of the transient molecular ions. We consider the dissociation of molecule HD in the strong laser field of linear polarization and focus on the second stage of the MEDI - Coulomb explosion of the nuclear subsystem of HD, studying it in the framework of the classical mechanics. The picture of angular distributions of the fragments of Coulomb explosion is shown to be dissimilar in different regions of the field parameters. In particular, two sufficiently different regimes of the nuclear dynamics are established. The dynamics in Coulomb field ($\theta_{out} = \theta_0$, θ_{out} - the angle between the polarization of the field and the direction of moving of the fragments of Coulomb explosion, θ_0 - the initial angle between the axis of the molecule and polarization of the field) and the dynamics in the field of an effective potential "nucleus + field" ($\theta_{out} = \pi/2$). The effective potential includes both the force of Coulomb repulsion of the nuclei and the force of the laser field, averaged over the period. This potential can be derived on the basis of the Kramers-Henneberger (KH) method [4]. We also discuss the ranges of applicability of the KH - approximation [5] for this problem, defining the region of field parameters where the motion of the fragments in the direction perpendicular to the polarization of the field can be observed for the arbitrary θ_0 .

1. Ph. Hering and C. Cornaggia, *Phys. Rev. A* **59**, 2836 (1999).
2. T. Zuo, S. Chelcowski, A.D. Bandrauk, *Phys. Rev. A* **55**, 622 (1997).
3. T. Seideman, M. Yu. Ivanov, P.V. Corkum, *Phys.Rev.Lett.* **75**, 2819 (1995).
4. N.B. Delone, V. P. Krainov, *Usp. Fiz. Nauk* **165**, 1295 (1995)
5. O.V. Smirnova, *Zh. Eksp. Teor. Fiz.* **117**, 702 (2000)

Fusion Neutrons Production in D-enriched Modified Solid Targets Using Moderate Intensity Femtosecond Pulses

Golishnikov D.M, Gordienko V.M., Savel'ev A.B., Sevastianov V.D., Volkov R.V.

Moscow State University, International Laser Centre and Physics Faculty,

Vorob'evy gory, 119899, Moscow, Russia

Phone: +7-095-9395318; e-mail: golishnikov@femto.phys.msu.su

In this paper we report on our recent progress in neutrons production from thermonuclear reaction $d(d,n)^3\text{He}$, taking place in femtosecond plasma created on the surface of modified solid-state target at moderate intensity of 10^{16} W/cm² [1].

Titanium targets were enriched with atoms of D up to the concentration 10^{22} cm⁻³ in the layer with the depth at least 5 μm . To transfer the kinetic energy of the plasma expansion into the energy of collisions of D ions we implemented multi shots method. The first laser pulse (200fs, 0,3mJ) created a crater, while the subsequent pulses (the same parameters) induced the ablation of walls of the crater and the collisions of plasma jets streaming towards the centre of the crater [2]. The ³He-filled corona counter, placed inside the polyethylene moderator was served as a detector of 2,45 MeV neutrons. The efficiency of detection was determined to be $4 \cdot 10^{-4}$. The detector was coupled with oscilloscope and the neutron signal was sought over 5 ms after the laser shot. The number of detected neutrons was $2 \cdot 10^{-3}$ per shot (total of 2000 shots) for the Ti target, while the probability of background signal was $5 \cdot 10^{-4}$. Taking into the account the detection efficiency, the number of fusion events in plasma volume was 5 per shot.

Further experimental progress toward efficient point-like table-top ultrashort neutron source design is also discussed (including usage of $d(t,n)^4\text{He}$ reaction).

This work was supported by RFBR (Grant No. 99-02-18343).

1. R.V.Volkov, D.M.Golishnikov, V.M.Gordienko et al // JETP Lett., 2000, vol.72, N.8, pp.401-404
2. R.V.Volkov, V.M.Gordienko, A.B. Savel'ev et al // Quantum Electronics, 2001, vol.31, N.3.

X-rays and Hot Particles Generation in Laser-Induced Plasma Created on the Surface of Solid Laser-Modified Targets

Volkov R.V., Chutko O.V., Dzhidzhoev M.S., Golishnikov D.M., Gordienko V.M., Mikhchev P.M., and Savel'ev A.B.

Moscow State University, International Laser Centre and Physics Faculty, Vorob'evy gory, 119899, Moscow, Russia
volkov@femto8.lic.msu.su

Recent experiments showed that the irradiation of solid targets with modified surface by femtosecond superintense laser pulse allows to obtain the parameters of plasma (such as soft and hard X-ray and SH yield, temperature of hot electrons and fast ions) which are achievable only at higher intensities in the case of commonly used solid flat target. In this paper we report on farther investigation of interaction of femtosecond laser radiation with laser-modified targets at moderate intensities.

The plasma was created by 200 fs laser pulse with intensity up to $2 \cdot 10^{16}$ W/cm², p-polarized, at the angle of incidence 45° . As the targets were used a lot of flat targets, porous silicon, and laser-modified targets. Laser modification was obtained by creation of crater on the surface of flat target by superintense laser pulse [1].

The experiments showed that for porous silicon and laser-modified silicon and Ge targets temperature of hot electrons grows faster with intensity than for flat targets and reaches about 8 keV at $2 \cdot 10^{16}$ W/cm² (~ 5 keV for flat target). At the same time there was not noticeable difference in temperature between laser-modified and flat targets in the case of metallic targets (Ti, Pd, Fe, W). We attribute this behavior to differ in structure and thermal properties of the targets.

Measurements of ionic current were conducted for porous, laser-modified and flat Si targets for several angles of TOF spectrometer location with respect to the target normal. It was shown that in case of laser-modified targets the expansion of fast component was essentially isotropical. Velocity of fast ions reached $3 \cdot 10^8$ cm/s, corresponding to the temperature of hot Si ions exceeding 100keV.

The work was supported by RFBR (Grants No. 99-02-18343, 00-02-17302).

1. R.V.Volkov, et al., Quantum Electronics, 2001, vol.31, no.3.

Internal electronic conversion decay of low-energy nuclear levels excited in hot dense femtosecond laser plasma

Chutko O.V., Gordienko V.M., Lachko I.M., Mikheev P.M., Rusanov A.A., Savel'ev A.B.

Moscow State University, International Laser Center and Physics Department, Vorob'evy gory, 119899, Moscow, Russia

Phone: +7-095-9395318; e-mail: chutko@mail.sitek.ru

In our previous experiments we showed that even in case of non-relativistic laser intensities $\sim 10^{16} - 10^{17}$ W/cm² it is possible to stimulate the process of excitation of low-energy nuclear levels in laser plasma [1]. The measurements of the quantity of excited nuclei were performed by separate detection of each γ -quantum corresponding to γ -decay of excited nuclear level.

In this paper we consider other ways of excited nuclei detection, which are connected to the other channel of the decay – internal electronic conversion having much higher probability than γ -decay. For example in the case of natural Ge sample including 7% of ⁷⁶Ge (5/2⁺, 13.275 keV, 4.3 μ s, $\sigma=1200$) we expect to excite ~ 1000 nuclei per laser shot (0.5 mJ, 200 fs, 616 nm) so only one of them will emit γ -quantum while others will emerge electrons and characteristic X-rays which can be easily detected. The probability of internal electronic conversion strongly depends upon the atomic charge state and in case of strongly ionized atoms this process can be partly or completely forbidden. Thus the measurement of conversion electrons and characteristic X-rays provides one with the invaluable information about internal electronic conversion in strongly ionized atoms. Besides one can expect increase in the number of γ -decays and in the life-time of the nuclear level. We showed by numerical modeling that in the case of ²⁰⁰Hg (1.561 keV, 1-10 ns, $\alpha \sim 10^4$) the formation of shock waves in the residual gas in the chamber decreases the velocity of the flying plasma and increases its temperature. So we can expect that charge state in the flying plasma will be frozen during several life-times of the level which allows us to detect more γ -quanta.

This work was supported by RFBR (Grant No. 00-02-17302)

[1] Andreev A.V., Volkov R.V., Gordienko V.M., et. al., JETP, 2000, v. 118(6), p. 1343-1357.

LOCAL FIELD AMPLIFICATION IN FEMTOSECOND LASER PLASMA FORMED ON A MODIFIED SURFACE OF THE TARGET.

Mikheev P.M., Gordienko V.M., Savelev A.B.

Faculty of Physics, International Laser Center, M.V.Lomonosov Moscow State University, 119899, Moscow, Leningradskiy gory, mikheev@femto.lic.msu.su

There are large class of problems, bound with superthermal laser plasma of solid-state density (high harmonics generation, non-coherent X-radiation, low-lying nuclear levels excitation etc.), created by radiation of commercially available femtosecond laser systems permitting to obtain on a targets surface the intensity of the order 10^{16} W/cm². Thus a problem of efficiency increasing of laser pulse energy absorption by plasma is very important. One of the solution of this problem is the excitation of surface electromagnetic waves on boundary vacuum - plasma created on a modified surface of the target by a laser radiation with intensity of $10^{15} - 10^{16}$ W/cm².

We showed, that the effective increase of a local field amplitude in plasma is possible when plasma electron temperature higher 500 eV and ionisation degree of a matter lower 10. The excitation of a surface electromagnetic wave in plasma on a surface of nanostructured target results in essential increase of efficiency of all non-linear processes. Hence on silicon or aluminium gratings and in carbon foam it is possible to obtain 3-5 times local field amplitude amplification, that will cause 3-4 fold increase of plasma electronic temperature up to 1.5-20 keV.

Usage of nanostructured targets will increase of efficiency of a high order harmonic generation and non-coherent soft X-ray radiation.

The work is supported by grants of Russian Foundation for Basic Research №99-02-18343 and program "Fundamental metrology".

Off-axial Phase-matched High-order Harmonic Generation in Extended Medium under Self-guiding of Laser Beam.

V. T. Platonenko, V. V. Strelkov,

Physics Department, M.V. Lomonosov Moscow State University, Vorob'evy gory, 119899 Moscow, Russia. e-mail: plati@garm.phys.msu.su; strelkov@garm.phys.msu.su

G. Ferrante

*Department of Physics and Related Technologies, University of Palermo
Viale delle Scienze, 90128, Palermo, Italy. e-mail: ferrante@unipa.it*

We present results of analytical and numerical calculations of the angular spectrum and the power of high-order harmonics generated with a limited laser beam in an extended medium. It is shown that the spectrum of harmonics generated in a thick target dramatically differs from that of the single-atom response. In particular, in this spectrum there are two plateaus due to off-axially phase-matched generation of some harmonics (phase-matching condition holds only for a part of the harmonic angular spectrum). The origin that makes the off-axially phase-matched generation effective is the amplitude modulation of the high-frequency single-atom response in the laser beam cross section that increases the divergence of the harmonic beam. In gaussian beams the off-axially phase-matched generation in extended medium (i.e. under target thickness close to the confocal length) is effective under any value of geometrical dispersion (i.e. under arbitrary hard focusing). Our treatment explains features of the high harmonic spectra obtained experimentally¹ using extended targets as well as high conversion efficiencies achieved in these experiments.

It is shown that under self-guiding of a laser beam in a noble gas off-axially phase-matched high harmonic generation is possible if there some easily ionizable gas is added to the main generating gas. In calculations of high-order harmonic generation mixtures conversion efficiency as high as about $10^{-3} - 10^{-2}$ for 33-rd harmonic of Titanium-Sapphire laser and about 10^{-4} for 121-st one is obtained.

[1] Tamaki Y., Itatani J., Nagata Y., et al., *Phys. Rev. Lett.*, **82**, 1422 (1999).

Nuclear Excitation by X-ray Emission and Hot Electrons of Femtosecond Laser Plasma

A. V. Andreev, R. A. Chalykh

*Physics Department, Moscow State University, Vorob'evy Gory, Moscow 119899 Russia
Phone: +7(095)939-30-92, e-mail: chalykh@mail.ru*

Irradiation of the solid target by the laser pulse with duration about 100 fs and intensity about 10^{16} W/cm² on a surface of this target will produce plasma with energy of electrons about 1 keV [1]. In such plasma the excitation of low-lying nuclear levels with energy in few keV is possible.

The efficiency of nuclear excitation is determined primarily by hot electron component when the temperature of electrons is lower than energy of a nuclear level. The analysis of process of excitation of nuclei has been performed on the basis of density matrix equation accounting the doppler broadening of a nuclear level. The following channels of excitation have been taken into account: excitation of nuclei by a X-radiation of plasma, inelastic scattering of electrons on nuclei, inverse internal electronic conversion.

The characteristics of hot electronic component were calculated on the basis of a Boltzman kinetic equation in an approach of an anomalous skin-effect. If we choose as a small parameter the ratio of depth of a skin layer to a free length of an electron then we can neglect a non-uniformity of a distribution function of electrons on depth of a skin layer and obtain the approximated solution of an Boltzman equation inside a skin layer. Using this solution it is possible to receive boundary conditions for a distribution function of electrons in all remaining volume of plasma, where the laser field is absent. The dependence of the characteristics of hot electronic components on laser pulse parameters and efficiency of nuclear excitation in laser plasma are obtained. These results are compared with experimental data [1].

Reference:

I. Andreev A.V., Volkov R.V., Gordienko V.M., Mikhchev P.M., Savel'ev A.B., Tkalya E.V., Chutko O.V., Shashkov O.A. Excitation of nuclei of Ta¹⁸¹ in high-temperature femtosecond laser plasma. //ZETF Letters, 1999, vol. 69, p. 343-348.

ABOUT THE RADIATION AT $n\omega_p$ FROM OVERDENSE PLASMA LAYERS

O.P. Polyakov, P.A. Polyakov.

Lomonosov State University. Physics Faculty.

Vorobjovy Gory, Moscow 119899, Russia.

In [1] by the numerical analysis was obtained the emission from overdense plasma layers at second and third harmonic of the plasma frequency ω_p , when irradiated by intense ultra-short laser pulses. Authors are interpreted this effect as arising in the such plasma three - four wave processes of conversional of two (three) plasmons into a photon. In the present work are obtained other generation mechanism of higher plasma harmonics in plasma layer due to strong nonlinearity in dynamic of electrons flows in the plasma-vacuum bound. Computer simulation of the plasma electrons flows dynamic due to interaction of the sinusoidal electric field and the instantaneous impulse are carried out. The computation of the time law of the electric field intensity in different points near the plasma layer bound - as inside as outside the substance are realized. The power spectra of the appropriate time evolution are received. As result it was obtained strong non-linear plasma oscillations near the bound of the plasma layer. The power spectra of those oscillations contain many peaks in the area of higher plasma frequency $n\omega_p$. Particularly by computer simulation of 50000 particle-in-cell dynamics in the vibration spectrum of electric field near the plasma layer bound are obtained seven plasma harmonics with higher intensity than the chaotic vibration spectrum. The analytical theory those non-linear oscillation was developed. This theory well correspond with results of computer simulation.

[1] R. Lichters, J. Meyer-ter-Wehn, A. Pukhov. Superstrong Field in Plasma: First International Conference. 1997. P.41.

ULTRA-FAST COOLING OF ELECTRONIC SUBSYSTEM IN ULTRA-THIN METAL FILMS

V.M. Petnikova, K.V. Rudenko, V.V. Shuvalov

M.V.Lomonosov Moscow State University, Vorob'evy Gory, Moscow 119899, Russia

Phone: 7(095)9395035, Fax: 7(095)9393113, E-Mail: vsh@vsh.phys.msu.su

A problem of ultra-fast cooling of electronic subsystem in ultra-thin metal films after such films' preliminary excitation by an ultra-short laser pulse is discussed. We show that electronic subsystem's cooling rate is strongly dependent on the film thickness L . This conclusion follows from non-elastic electronic collisions with the film surface and is true when $L \ll \lambda$, where λ is the free path length. On the basis of our consideration, we interpret our recent experimental results, obtained in ultra-thin (thickness $\sim 5 \pm 25$ nm) continuous Ni, Cu and Au films by some different transient four-photon picosecond (pulse duration ~ 20 ps) spectroscopic techniques [1-3]. In our analysis, we take into account a real electronic structure of the investigated films, this structure quantum-size renormalization and spin splitting, as well as, main inter- and intra-band relaxation processes, saturation and selection rules. We show that such spectroscopic techniques as biharmonic pumping (BP) and degenerate four-photon spectroscopy (DFPS) differ from each other in respect of observed spin kinetics because of quite different spatial redistribution of free carriers between different magnetic domains ("spin mixing") in the ferromagnetic films. While 20 ps is quite enough for full destruction of the such film's domain structure under spatially uniform excitation (BP), DFPS is not the case. Under spatially non-uniform excitation (DFPS), an interference pattern of pumping components "burns" out spatial distribution of magnetic momentum and forms quite new domain structure in the film, which corresponds to the intensity distribution. The inter-band polarization relaxation time as 200 ± 250 fs is determined.

1. V.M. Petnikova, et al. Laser Physics 9, 441 (1999).
2. V.M. Petnikova, et al. Physics of Vibrations 7, 33 (1999).
3. L.P. Kuznetsova, et al. J. of Raman Spectroscopy 31, 755 (2000).

ULTRA-FAST COOLING OF ELECTRONIC SUBSYSTEM IN ULTRA-THIN
METAL FILMS

V.M. Petnikova, K.V. Rudenko, V.V. Shuvaiov

M.V. Lomonosov Moscow State University, Vorob'evy Gory, Moscow 119899, Russia
Phone: 7(095)9395035, Fax: 7(095)9393113, E-Mail: vsh@vsh.phys.msu.su

A problem of ultra-fast cooling of electronic subsystem in ultra-thin metal films after such films' preliminary excitation by an ultra-short laser pulse is discussed. We show that electronic subsystem's cooling rate is strongly dependent on the film thickness L . This conclusion follows from non-elastic electronic collisions with the film surface and is true when $L \ll \lambda$ where λ is the free path length. On the basis of our consideration, we interpret our recent experimental results, obtained in ultra-thin (thickness $\sim 5\text{-}25$ nm) continuous Ni, Cu and Au films by some different transient four-photon picosecond (pulse duration ~ 20 ps) spectroscopic techniques [1-3]. In our analysis, we take into account a real electronic structure of the investigated films, this structure quantum-size renormalization and spin splitting, as well as, main inter- and intra-band relaxation processes, saturation and selection rules. We show that such spectroscopic techniques as biharmonic pumping (BP) and degenerate four-photon spectroscopy (DFPS) differ from each other in respect of observed spin kinetics because of quite different spatial redistribution of free carriers between different magnetic domains ("spin mixing") in the ferromagnetic films. While 20 ps is quite enough for full destruction of the such film's domain structure under spatially uniform excitation (BP), DFPS is not the case. Under spatially non-uniform excitation (DFPS), an interference pattern of pumping components "burns" out spatial distribution of magnetic momentum and forms quite new domain structure in the film, which corresponds to the intensity distribution. The inter-band polarization relaxation time as $200\text{-}250$ fs is determined.

1. V.M. Petnikova, et al. *Laser Physics* **9**, 441 (1999).
2. V.M. Petnikova, et al. *Physics of Vibrations* **7**, 33 (1999).
3. L.P. Kuznetsova, et al. *J. of Raman Spectroscopy* **31**, 755 (2000).

EVOLUTION OF ULTRA-SHORT AND EXTREMELY SHORT
ELECTROMAGNETIC PULSES IN QUADRATIC-CUBIC NONLINEAR MEDIUM

Andrey I. Maimistov

Department of Solid State Physics, Moscow Engineering Physics Institute,
Moscow, 115409, Russia, maimistov@pico.mephi.ru

Extremely short nonlinear pulses (ESPs) of the electromagnetic field, which consist of few optical cycles, or even of half a cycle, have recently attracted considerable attention. The existing models that can be used for the description of ESPs fall into two classes, resonant and nonresonant ones. The nonresonant medium is frequently modeled in terms of anharmonic oscillators. If the nonlinear contribution into the medium's polarization is small, the unidirectional wave propagation may be assumed. This approximation allows us to reduce the wave equation to the first-order one without any assumption about the shape of the waves.

An objective of the present work is to study the unidirectional propagation and interactions of linearly polarized extremely short pulses in a nonlinear dispersive medium modeled by an anharmonic oscillator combining quadratic and cubic nonlinearities.

Two families of exact analytical solutions (with a positive or negative polarity) are found for the moving solitary pulses. Direct simulations demonstrate that the pulses are very robust against weak perturbations, and collide nearly elastically, irrespective of their relative polarity. However, the model is not integrable, as the collisions may produce small changes in the velocity of the pulses and radiation. Collision of two pulses with different polarity results in oscillating waves generation. One of these waves is located between resulting EUPs. The interaction of the two steady state pulses with equal velocities leads to the two different pulses, which become widely separated, if initial distance between them is equal approximately to one half-widths of a steady-state pulse. Else, these ESPs ran to great distance as solitary ones with parallel courses.

ULTRASHORT LIGHT PULSE SCATTERING
BY 3-D INTERFERENCE FRINGE STRUCTURE

M. A. Cervantes

Universidad de Sonora, Centro de Investigación en Física, C.P. 83190, Hermosillo,
Sonora, Mexico, mcervan@cajeme.cifus.uson.mx

A.M.Smolovich

Scientific and Technological Center of Unique Instrumentation, Russian Academy of
Sciences, 117342 Moscow, Butlerova 15, Russia, mshaxkep@cityline.ru

A family of maximum intensity contour surfaces resulting from the interference of counter-propagating ultrashort laser pulses, recorded in a volume medium, is considered. Such structure contains only a few fringes. There are two possible regimes of interaction of radiation with the structure: diffraction and geometrical-optical reflection [1,2]. In the latter case, the effect of achromatic wavefront reconstruction is possible and in fact it was experimentally observed [3-5]. Here, the reconstructing ultrashort pulse scattering by the interference structure is theoretically investigated. The first Born approximation is used, thus, each point of the interference structure is assumed to produce a secondary scattered spherical wavelet whose amplitude is supposed to be proportional to the exposure at this point. The reconstructed wave amplitude at a given time at the observation point is obtained as a result of integration of the wavelets, scattered by the fringe structure which come to the observation point at this time. The integration area is the part of the fringe structure between two ellipsoid surfaces, which correspond to the leading and back tails of the pulse. The recording medium is supposed to be parallel-plane. Such an approach proves to be very helpful, because it allows to describe the light pulses formed as a result of diffraction by the fringe structure and also as a result of geometrical-optical reflection from the maximum intensity contour surfaces of the fringe structure. The temporal characteristics of both types of pulses are investigated.

1. I.N. Sisakyan and A.M. Smolovich, Computer Optics/ International Center for Scientific and Technical Information, Moscow, 1990, issue 7, 56 (in Russian).
2. I.N. Sysakyan, A.M. Smolovich. Sov. Tech. Phys. Lett., V.17, No. 1, 16 (1991).
3. D.A. Dement'ev, A.L. Ivanov, O.B. Serov, A.G. Stepanov, S.V. Chekalin, and A.M. Smolovich, JETP Lett., V.65, No.5, 402 (1997).
4. D.A. Dement'ev, A.L. Ivanov, Yu. A. Matveets, O.B. Serov, A.G. Stepanov, S.V. Chekalin, A.M. Smolovich, Optics commun., V.150, No.1-6, 38 (1998).
5. S.V. Chekalin, D.A. Dement'ev, A.L. Ivanov, Yu. A. Matveets, O.B. Serov, A.M. Smolovich, and A.G. Stepanov, Proceedings of SPIE, V. 3733, pp. 452-458 (1999).

ULTRASHORT MODE LOCKED LASERS WITH ADDITIONAL RAMAN

ACTIVE ELEMENTS

V.I.Trunov, A.V.Kirpichnikov, E.V.Pestryakov, V.V.Petrov

Institute of Laser Physics, SB RAS, Novosibirsk, 630090, Russia

A.K.Komarov, K.P.Komarov

Institute of Automation and Electrometry, SB RAS, Novosibirsk, 630090, Russia

Recently in our work [1] the generation of ultrashort pulses in the laser with a composite active medium has been considered. This type of laser has a complex spectral gain contour with local minimum. Its depth for fixed set of laser parameters determines the value of maximum separation between the individual gain band and as a result the minimum duration that defined by inverse with of combine gain contour.

In the present work the numerical simulation of ultrashort pulse generation in the laser with a composite active medium and additional Raman active element in a laser cavity has been done. It was created that for some laser parameters the optimization of a Raman gain and a frequency shift values was resulted in additional shortening of pulse duration. At the same time for other laser parameters the Raman active medium can be a reason of the limitation of the minimum achievable width of optical pulses, as for LiSAF:Cr³⁺ lasers [2]. The developed numerical simulation technique opens the possibilities to analyze of Raman active medium influence in the laser with arbitrary form of the spectral gain contour on the conditions of starting and sustaining of mode locked mode. Simulation of the dynamic femtosecond pulse generation in the investigated laser was performed taking into consideration the effects of phase modulation and frequency dispersion of intracavity elements. The stability range of single pulse mode was analysed and the conditions of a multipulse mode of generation were revealed. It has been shown that Raman active medium can result in smoothing of spectral gain contour and accordingly it was reduced the requirements on self-start conditions for a mode locked regime.

This work was supported by the RFBR (grant N99-02-17117)

1. E.V.Pestryakov, et. al., Laser Physics, 8, 612 (1998).
2. H.A.Haus, I.Sorokina, E.Sorokin, J.Opt.Soc.Am., B15, 223 (1998).

COHERENT FEMTOSECOND PHOTOCHEMISTRY OF RADIATION DEFECTS, AND STUDY OF THEIR MIGRATION IN CRYSTALLINE MEDIA

E.F.Martynovich

Institute of Laser Physics of SB RAS, Irkutsk Division

P/o Box 4246, Irkutsk, 664033, Russia, phone +7(3952)511438, fax +7(3952)512160

e-mail: mart@home.isu.ru

The objective of this work was the study of spatial selectivity of photochemical transformation of photosensitive quantum systems, and the development of methods of study of migration of radiation defects and charge carriers in crystals. We investigated two ways of coherent couples of femtosecond laser pulses action upon photosensitive quantum systems in crystals. The scheme of outrunning components of the pulse couple, and the counter-directed components scheme. Experiments and calculations were carried out for crystals with natural and induced anisotropy. The crystals were irradiated with fast neutrons (sapphire, Al_2O_3), accelerated electrons (MgF_2) and gamma-rays (LiF) to create photosensitive quantum systems (color centers) of necessary symmetry. Under linear excitation, in the outrunning pulses scheme, the spatial selectivity is of the order of $Y=c\tau_e/\Delta n$, where c - speed of light in vacuum, τ_e - time of coherence, equal to pulse duration for spectrally limited pulses, Δn - birefringence factor [1]. In the counter-directed pulses scheme [2], axial selectivity, as spatial definition for coherent optical tomography [3] is of the order of $Y=c\tau_e$. On the other hand, due to nonlinear sharpening at photochemical color center transformation, the width of the axial spatial concentration profile may be $Y \ll \lambda/2$, where λ - wavelength. Methods of study of migration of radiation defects, as well as charge carriers, is based on registering and analyzing of the temporal relaxation of the sharp spatial profile, induced by femtosecond light pulses beforehand.

1. E.F.Martynovich, Proc. of the 1-st Int. Congress on Radiation Physics, High Current Electronics, and Modification of Materials. G.A.Mesyats, Chair. Vol. 1, D.Vaisburd, Ed., Tomsk, 2000, pp. 179-184.
2. E.F.Martynovich, Proc. of the Third Int. Symp. MPLP'2000. Novosibirsk, Eds: S.N. Bagaev, V.I. Denisov (to be published).
3. J.G.Fudjimoto, W.Drexler, U.Morgner, F.Kartner, E.Ippen. OPN, № 1, 2000, pp. 24-31.

Evolution of few-cycle light pulses in two- and three-level media: finite-difference time domain simulations

A. V. Tarasishin, S. A. Magnitskii, and A.M. Zheltikov

Physics Department, International Laser Center, M.V. Lomonosov Moscow State University, Vorob'yevy gory, Moscow, 119899 Russia

An impressive progress achieved recently in the generation of ultrashort light pulses with a duration corresponding to a few cycles of the optical field [1] allowed unique measurements with an unprecedentedly high resolution to be performed and stimulated many applications. The methods of theoretical analysis of the generation and propagation of ultrashort light pulses have to meet the challenges of the rapidly progressing experimental technique. In particular, many useful physical results obtained within the framework of slowly varying envelope approximation have to be tested very carefully with the use of numerical methods. As a part of this program, in this paper, we employ the finite-difference time-domain (FDTD) technique [2] to examine the evolution of the amplitude, duration, waveform, and phase of ultrashort light pulses propagating in a medium of two-level atoms or molecules (Fig. 1). The results of these simulations are compared with predictions of the McCall-Hahn area theorem [3] and with previous FDTD simulations performed for two-level media [4]. This comparison shows that the predictions of the area theorem for the amplitude and the phase of short pulses generally agree reasonably well with the results of numerical simulations for pulses longer than two field cycles. Our numerical analysis reveals several new physical features in the formation of 2π solitons produced as a result of decay of single-cycle pulses propagating in a two-level medium. In particular, the resulting pulses are shown to have different amplitudes, durations, and group velocities, allowing the formation of subfemtosecond pulses and slowing down of the light in two-level media.

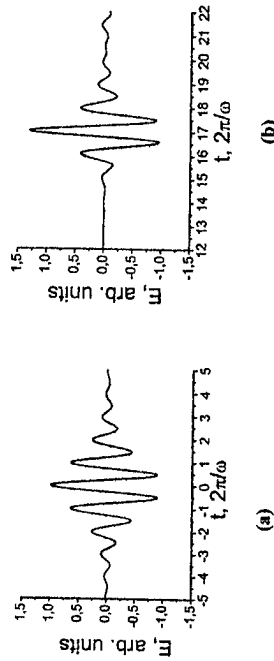

Fig. 1. Evolution of a 2.9π ultrashort pulse to a 2π pulse in a two-level medium: (a) the input pulse, (b) a pulse at a distance of 8λ from the entrance boundary of the medium

This study was supported by the President of Russian Federation Grant no. 00-15-99304, the Russian Foundation for Basic Research (project no. 00-02-17567), and the Volkswagen Foundation.

1. M. Nisoli, S. De Silvestri, O. Svelto, et al., *Opt. Lett.* **22** (1997) 522; A. Baltuska, Z. Wei, M.S. Pshenichnikov, and D.A. Wiersma, *Opt. Lett.* **22** (1997) 102.
2. A. Taflov, *Computational Electrodynamics: The Finite-Difference Time-Domain Method* (Artech House, Norwood, MA, 1995).
3. S. L. McCall and E. L. Hahn, *Phys. Rev. Lett.* **18** (1967) 908; S. L. McCall and E. L. Hahn, *Phys. Rev.* **183** (1969) 457.
4. R. W. Ziolkowski, J.M. Arnold, and D.M. Coggny, *Phys. Rev. A* **52** (1995) 3082; S. Hughes, *Phys. Rev.* **42** (2000) 055401.

INVESTIGATION OF RELAXATION TIMES OF POLYMETHINE DYES
ABSORBING IN 750-850 NM SPECTRAL RANGE

R.Grignis, V.Sirutkaitis

Laser Research Center, Vilnius University, Sauletekio al. 10, 2040 Vilnius, Lithuania
Phone: 370-2-769447, fax: 370-2-366006, e-mail: Rimantas.Grignis@ff.vu.lt

N.A.Derevyanko, A.A.Ishchenko

Institute of Organic Chemistry of National Academy of Sciences of Ukraine
5 Murmanskaya Str., Kyiv-94, 02094, Ukraine

The relaxation time (τ) of the first excited state of cationic symmetric polymethine dyes absorbing in spectral region 750-850 nm have been determined by a direct method of the excited-probe. Picosecond pulses (~ 1.5 ps) tunable in the investigated spectral range were generated by OPO synchronously pumped by train of neodymium glass laser with passive mode-locking and active feedback. Exciting and probing pulses were formed by split of main pulse. The relaxation times of dyes were determined in solvents of different polarities.

The influence of the structure of end heterocyclic groups (isomerism, annelation, nature of heteroatom and substituent), the length of polymethine chain and cyclization chromophore on value of τ are discussed. The role of the photoisomerization, internal conversion and intersystem crossing in deactivation of the excited state of dyes was considered. It is shown that lowest values of τ have polymethines containing heteroresidue, of benz[c,d] indolium, α -pyrylium and its analogues. Experimental relaxation times of these dyes have been compared with results of quantum-chemical calculations. It has been established that the main role in deactivation of the excited state of polymethines based of mentioned above heteroresidue play the vibronic interactions. The influence of the solvent nature, including deuterium -containing solvent, on the value of τ will be discussed also. The perspective polymethine dyes for passive mode-locking of lasers on $\text{LiGaAlF}_6\text{Cr}^{3+}$, $\text{KZnF}_3\text{Cr}^{3+}$, $\text{LiSrAlF}_6\text{Cr}^{3+}$ crystals were found on the basis of the analysis of relaxation times.

PICOSECOND PULSE CHARACTERIZATION USING FIBER
NONLINEARITIES

Rama Chari, Vijay Shukla and S.M.Oak

Laser Physics Division, Centre for Advanced Technology, Indore 452013, India

An ultra-short pulse propagating in a low-loss, single mode fiber undergoes changes in its shape and spectrum due to the self-phase modulation and dispersion in the fiber. The propagation is described by the Nonlinear Schrödinger's equation (NLSE) [1]. We show by numerical solutions of the NLSE how the chirp and shape of the input pulse affect the features in the fiber-broadened spectra and how this effect can be used to estimate the input pulse parameters. Experimental results are also presented. This technique is single-shot and requires very low energies so is ideal for on-line monitoring of shot-to-shot fluctuations in low rep-rate lasers. Beam pointing stability of the lasers can also be monitored by this method due to extreme sensitivity of the generated power spectra to the laser pulse power coupled into the fiber.

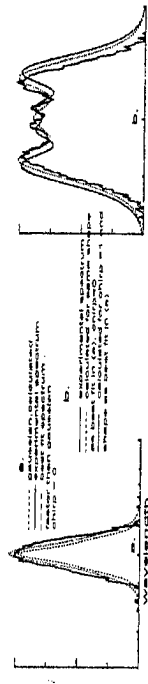

Fig. 1. Experimental and calculated spectra of a cw mode-locked (7 ps) Nd:YVO₄ beam after propagation through a 100m long single-mode fiber.

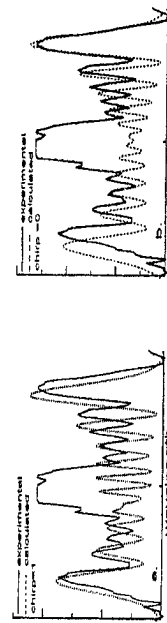

Fig 2. Experimental and calculated spectra of a single-shot 36 ps Nd: YAG laser. The input pulse shape assumed for the calculations is faster than Gaussian.

REFERENCES:

1. W.J.Tomlinson, R.H.Stolen and C.V.Shank, JOSA B 1(12), p139 (1984).

Generation of high-intense individual attosecond pulses

I.P.Prokopovich, J.Peatross*

Institute of Nuclear Problems, BSU, 11 Bobruiskaya Str., 220050 Minsk, Belarus

E-mail: prok@inp.minsk.by, Phone: (+375 17) 226 42 25, Fax: 226 51 24

* Dept. of Physics and Astronomy, Brigham Young University, Provo, UT, USA

Recently the schemes based on the self-induced transparency (SIT) in the stimulated Raman self-scattering (SRSS)¹ to generate 0.284- and 0.233-fs pulses from initial of 4.6- and 7-fs pulses respectively under electronic SRSS at the fine structure ionized rare gas were proposed.² We present computer simulations for the generation and amplification of intense individual attosecond pulses through electronic SRSS in ionized rare gases, utilizing the range of initial laser pulse durations from 2.5 fs to 10 fs. We have investigated SRSS of laser pulses specifically for the cases where the initial pulse contains one, three, and four optical cycles (within the Full-Width-at-Half-Maximum (FWHM) of the intensity profile). In all cases, the attosecond pulses result in amplitudes that are significantly greater than the amplitude of the initial pulse. We find that the efficiency of self-compression and "self-amplification" depends sensitively on the initial duration of the laser pulse, or rather the number of optical cycles initially present in the laser pulse (phase effect). The result is also sensitive to the optical path length of the medium wherein saturation of the self-amplification can occur. We demonstrate that the production of attosecond pulses when the initial pulse contains either three or four optical cycles (FWHM) can be considerably enhanced by adjusting the intensity to make the initial pulse as a 4 π -pulse rather than a 2 π -pulse of SIT at SRSS. In this case, the 4 π -pulse splits into two 2 π -pulses and one of these evolves into a very sharp and intense peak at the others expense. The splitting of the 4 π -pulse into two propagating 2 π -pulses takes place as in a single-quantum, double-quantum and ordinary Raman transition SIT, but in contrast with these situations the 2 π -pulses under SIT at SRSS are nonstationary in both shape and spectrum, however, the total laser pulse energy is conserved. In this case, the trailing edge of the laser pulse is enriched with high-frequency components into which the energy from the front of the pulse is transferred, and the pulse field is dramatically compressed. No methods proposed to date can generate attosecond pulses (high harmonic generation, multiple SRS et al.³) with like efficiency and peak intensity that we demonstrate.

This work was partially supported by INTAS (Project No 97-02018). I.P.P. thanks the Deutsche Forschungsgemeinschaft for a grant as well as acknowledges a partial support from the Belarus Basic Research Foundation (Grant No F98-319).

[1] E.M.Belenov, A.V.Nazarkin, I.P.Prokopovich, JETP Lett. 55, 218 (1992); E.M.Belenov, P.G.Kryukov, A.V.Nazarkin, I.P.Prokopovich, JETP 78, 15 (1994). A.V.Nazarkin et al. Phys. Rev. A58, R61 (1998).

[2] I.P.Prokopovich, A.A.Khrushchinskii, Laser Phys. 7, 305 (1997); I.P.Prokopovich, J.Peatross, Laser Phys. 9, 588 (1999).

SUBPICOSECOND ABLATION ("COULOMB EXPLOSION") OF METALS AND SEMICONDUCTORS HEATED BY INTENSE 100-FS LASER PULSE

S.I.Kudryashov, V.I.Emel'yanov

International Laser Center, Moscow State University, 119899 Moscow, Russia

e-mail: sergeikudryashov@chat.ru, emel@em.msk.ru

The ultrafast (subpicosecond) ablation ("Coulomb explosion") of metallic films (Al, Cu) and the self-induced metallic liquid surface layers (films) in bulk semiconductors (Si, GaAs) [1] heated by a 100-fs pumping laser pulse was studied with a temporal resolution by various optical techniques. Optical constants n° and k° of the films were determined using time-resolved ellipsometric (self-reflectivity) measurements of R_s° and R_p° within the pump pulse ($\omega=1.56$ eV) duration for the pumping fluence values F up to 1.5 J/cm². In the specific range of $F \leq 1$ J/cm² for all these materials there are universal plateaus of R_s° and R_p° . These plateaus correspond to the "resistively saturated" state of these films when its k° value is nearly constant over the range of F but the n° value increases linearly vs. F , eventually exceeding k° . The resulting anomalies in corresponding ϵ_1° and ϵ_2° dependencies on F (the increase of the former till positive values and the plateau for the latter) are concerned with a formation of a surface positively charged layer as well as a thin (about 1 nm) subsurface negatively charged layer in the rest of the skin layer where a drastic rise in an electron density (up to 10^{23} - 10^{25} cm⁻³) and a temperature (till 10 eV) occurs. This electron density redistribution in the skin layer is assumed to be driven by an electron pressure gradient directed toward the surface and appearing due to a temperature dependence of Fermi energy in the metallic films heated non-uniformly by the pump pulse to 1-10 eV/atom. The hydrodynamic expansion of the double electrical layer was observed on a subpicosecond time scale using the time-resolved optical microscopy. This time scale is consistent with a characteristic time for propagation of an ionic rarefaction sound wave ($C_s \sim 10^4$ m/s) on the skin depth of 10 nm. The craters are considerably shallower on the spots corresponding to this specific range of F because of the ultrafast removal of material which prevents energy transport from the skin layer by an electron thermal conduction. "Coulomb explosion" was proposed as a possible ablation mechanism for metals and metallic melts of semiconductors over the specific fluence range.

[1] S.I.Kudryashov, V.I.Emel'yanov, Pis'ma v ZhETF 73, 263 (2001).

Stable Regenerative Laser Amplifier on Colored $\mu\mu$ -Layer in LiF Crystal with Nanosecond Flash Lamp Pumping

V.I.Baryshnikov, T.A.Kolesnikova

Applied Physics Institute of Irkutsk State University,
20 Gagarin Blvd, Irkutsk, 664003, Russia
Fax: 7-395-2-332140, E-mail: vib@api.isu.runnet.ru

Ultrashort laser pulses (< 1 ps) was formed on regime regenerative amplification in LiF crystalline layer (10 μm) with superhigh concentration F_2 color centers-CC (coef. abs. of 2000 cm^{-1} for F_2 band around of 450 nm) at pumping by nanosecond flashes of powerful Xe-lamp (5 mJ, 400-500 nm, 20 ns, 25 Hz).

Colored 10 μm -layer in crystals LiF was induced at special regime by powerful nanosecond (5 ns) electron beams (10-50 keV; 1-3 kA/cm²). At that absorption of a parasitic defects in the range of F_2 -luminescence (630-780 nm) is less than of 0,1 cm⁻¹. F_2 CCs in LiF are stable at action of powerful 20 ns- flashes of xenon lamp. However in this crystal F_2 CCs were destroyed effective with pumping by pulses of Dye C440 (440 nm) laser. At that intensity of 20 ns- flashes of Xe-lamp and Dye C440 nm laser pulses was selected equal (0,25 MW/cm²). But in this case the spectral intensity of 20 ns- flash of Xe-lamp is 2,5 kW/mm cm², but Dye C440 laser pulse - 25 MW/mm cm². Therefore probability of two-photon and two- step processes in ionization of F_2 CC in LiF tends to neglectly low magnitude at pumping by powerful 20 ns- flashes of Xe-lamp [1-2].

Pump (powerful 20 ns- flashes of Xe-lamp) and probe (AlGaInP-laser, 685 nm) experiments was made on these F_2 :LiF laser medium. High and stable coefficient amplification (about of 500 cm⁻¹, single pass) of laser beam at 685 nm at puls duration of 15 ns was achieved with energy Xe- ns- flashes of 2,0 mJ. Coefficient amplification has a linear dependence if energy of pumping ns-flashes of Xe-lamp is less than of 2,5 mJ. Ultrashort laser pulses (< 1 ps) at 685 nm was formed on regime regenerative amplification with ns-flash-lamp pumping at energy $> 3,0$ mJ. Thus crystalline laser medium on the base of $\mu\mu$ - layer with super high concentration F_2 color centers in LiF has the perspective for development of pico- and femtosecond laser systems. Wide spectrum (640-750 nm) of the laser emission on F_2 :LiF crystals allows to hope on the using of F_2 :LiF $\mu\mu$ -layer in the laser Ti:Sapphire complexes for effective of a gain and formation of the femtosecond pulses at duration < 5 fs.

[1]. Baryshnikov V.I., Kolesnikova T.A. Interaction of powerful nanosecond optical flashes and laser pulses with color centers in fluoride lithium. Optics and Spectroscopy(Russia), 1994, V.77, N.1. P.57-60.

[2]. Baryshnikov V.I., Kolesnikova T.A. Ionizing mechanisms of F_2 centers in laser LiF crystals. Optics and Spectroscopy (Russia). 2000, V.89, N.1. P.62-67.

From two-beam surface plasmon interaction to femtosecond surface optics and spectroscopy.

Nazarov M.M, Shkurinov A.P.

Department of Physics and International Laser Center, M.V.Lomonosov Moscow State University, Moscow, 119899, Russia

Lozovik Yu.E.

Institute of Spectroscopy, 142092 Moscow region, Troitsk, Russia.

Summary

In optics and spectroscopy, many effects are hard to observe, because of a weak response, or because of a small amount of substance. To register weak response one needs a more localised and a stronger electromagnetic field. But on the other hand the average field must not be too strong, otherwise a sample under study will be damaged. To achieve this we concentrate optical field energy in space and in time.

New surface-sensitive method of time-resolved studies is proposed. Frequency mixing is demonstrated in degenerate three-wave mixing with two noncollinear beams of femtosecond laser pulses on a metal grating. The observed enhancement of the nonlinear optical response is concerned with the synchronised excitation of two surface plasmon-polaritons (SPP) waves, their nonlinear interaction and photon generation with the sum (second harmonic) frequency. The dependence of this process *versus* the temporal delay between two laser pulses and the mutual spatial overlapping of the beams on the grating surface are studied. Nonlinear optical signal amplitude enhanced by the interacting SPPs reflects the spatial and temporal behaviour of these SPPs, which can be observed using suggested technique. The direct measurements of the SPP temporal properties are presented. The possibility to work with different plasmon directions (and accordingly frequencies) and the possibility to enhance a weak signal are demonstrated. As an example, we measured the SPP lifetime on the surface of the gold grating, which proved to be 80 fs. Experiments of this type opens a possibility of development of femtosecond surface plasmon optics.

THERMAL MAPPING IN A DRY LOW NO_x EMISSION METHANE/AIR BURNER WITH N₂ CARS SPECTROSCOPY

M. Marrocco*, M. D'Apice**, R. Cipriani, S. Giammartini

Centro Ricerche ENEA Casaccia

Energy Department - Combustion Technology Section

Via Anguillarese 301, S.M. di Galeria - Roma (Italy)

Phone: 0039-06-30484685, Fax 0039-06-30484811

*E-mail: michele.marrocco@casaccia.enea.it

**E-mail: massimo.dapice@casaccia.enea.it

SUMMARY: Coherent Anti-Stokes Raman Spectroscopy (CARS) on molecular nitrogen is a well established non-linear spectroscopy technique for measuring temperatures needed for evaluation of pollutants, like NO_x, produced in hydrocarbon/air flames at atmospheric pressure. In this context, the present work reports temperature measurements on a GENERAL ELECTRIC Dry Low NO_x Emission premixed combustor (mod. DLE for gas turbine LM 1600, 2500 and 6000), by using broadband CARS in the planar BOX-CARS configuration. Temperature evaluations were obtained comparing experimental spectra with theoretical nitrogen spectra at atmospheric pressure through a neural network based analysis s/w, especially designed for real-time acquisition and elaboration.

The CARS system (CLS 400 by Quanta System, Milan, Italy) was made of two beams produced from a 350 mJ second harmonic of a Nd:Yag laser combined with a 30 mJ broadband dye-laser emission of Rhodamine 610. The data have been collected with a Jobin-Yvon monochromator (mod. HR 640, 3000 grooves/mm) equipped with a gated OMA (EG&G 1420).

Measurements were taken in order to detect temperature distributions along the horizontal central axis of the burner combustion chamber and along some vertical crosscuts for different horizontal distances from the burner head. The measurements demonstrate very high temperatures only in proximity of the pilot flames of the combustor head (around 2000 K for operating conditions with an air excess $\lambda=1.77$ at atmospheric pressure) while the central volume of the burner chamber remains rather cold (1000-1200 K). Temperatures around 1600 K are reached only at the exit port of the burner.

The data obtained in this work are now being used to test numerical simulations of kinetic and chemical models employed in FLUENT code.

Spectroscopy of Coherent Dark Resonances in Samarium

J. V. Vladimirova, B. A. Grishanin, and V. N. Zadkov
International Laser Center and Department of Physics

M. V. Lomonosov Moscow State University, 119899 Moscow, Russia

N. N. Koliachevsky, A. V. Akimov, N. A. Kiselev, S. I. Kanorsky

P.N. Lebedev Physics Institute, Russian Academy of Sciences
Leninski prosp. 53, Moscow 117924, Russia

Coherent Population Trapping phenomenon (CPT) is currently widely used in different applications such as magnetometry, metrology, and others. Direct coherent coupling of dipole-allowed optical transitions in Λ -system formed of Sm atom hyperfine structure levels with the rf transition between ground levels (cf. Cesium standard frequency [1]) results in ultra-narrow, high-finesse resonances in the optical range, which can be used for new frequency standards. By now, most CPT-studies were carried out on the components of hyperfine structure of the ground state of alkali atoms [2, 3]. At the same time, it is known that energy levels of fine structure of rare-Earth atoms are deeply shielded and therefore they have much bigger energy splitting of the ground sublevels by contrast with alkali atoms (10-100 THz). Thus, the frequency of the CPT-resonance is shifted to higher frequencies, up to the optical range.

Theory of CPT-phenomenon is well understood in the frame of three-level model [2], however it significantly complicates for the case of multilevel systems and analytical calculations in most cases are impossible. Enriched energetic structure of multilevel atoms results also in essential modification of resonance dependencies on the radiation parameters. In this work, we present a theoretical model of CPT in multilevel Sm atom and compare theoretical calculations with experimental spectroscopic data taken for Sm [4].

Theoretical model used in our calculations describes a degenerated Λ -system in Sm atom formed of the transitions

$$4f^6 6s^2 ({}^7F_0) \rightarrow 4f^6 ({}^7F) 6sp ({}^3P^o) {}^9F_1^o \rightarrow 4f^6 6s^2 ({}^7F_1)$$

and includes also a fourth level $4f^6 6s^2 ({}^7F_2)$, which complements the model making it an open system. This four-level model is the simplest one that shows good agreement with experimental data. An open character of the system reduces the contrast of the resonance curves in the CPT-spectra, but does not influence the width of the CPT resonance. Numerical modeling of CPT resonances in Sm atom was carried out for the case of applied longitudinal and transverse magnetic fields in 7- and 12-level models, as well.

References

- [1] R. Holtzwarth, Th. Udem, and T.W. Haensch, Phys. Rev. Lett. **85**(11), 2264 (2000).
- [2] E. Arimondo, *Coherent population trapping in laser spectroscopy*, Progress in Optics, edited by E. Wolf (Elsevier, Amsterdam), **35**, 257 (1996).
- [3] R. Wynands, A. Nagel, Appl. Phys. B, **68**, 1 (1999).
- [4] N. N. Koliachevsky et al., Sov. J. Quant. Electron. **31**(1), 61, 2000.

INFLUENCE OF PHOTOINDUCED ELECTRONIC PROCESSES ON SECOND HARMONIC GENERATION AT REFLECTION FROM A SILICON SURFACE:

TRANSVERSAL DEMBER'S EFFECT

Baranova I.M., Evtukhov K.N., Muravyev A.N.

Bryansk State Academy of Engineering and Technology
Russia, 241037, Bryansk, Stanke Dimitrov Av., 3

The generation of a second harmonic, reflected from a surface of the semiconductor, is determined by a number of parameters, including distribution of an electrical field in near-surface area. In this paper the problem of a influence of photoinduced electronic processes on parameters of this distribution, and thus on generation of a reflected second harmonic is reviewed.

The model of electronic processes caused by absorption in the semiconductor of a pulse pump radiation, describing combination of such phenomena, as photogeneration of nonequilibrium carriers, their recombination (in volume and on surface), time-space transformation of a near-surface space charge region owing to diffusion and drift of carriers is offered. It is taken into account, that in cross section the beam is limited (Gaussian and rectangular distributions of intensity are reviewed). On the basis of this model analytically, and also with use of numerical methods the electronic processes called in silicon by an infinite pulse train are investigated. The nanosecond pulse train with the repetition frequency of some hertz from the YAG:Nd³⁺ laser (weak absorption) and the femtosecond pulse train from a Ti-sapphire laser with a tuned wavelength and with the repetition frequency of some megahertz (more strong absorption) are considered.

It is shown that these processes influence generation of a reflected second harmonic in the main by two ways:

- by means of fast narrowing of the near-surface space charge region;
- by means of transversal Dember's effect.

The Dember's effect is conditioned by boundedness of beam in a transverse direction and consists in originating of a radial field both potential difference between lighted and unlighted parts of a volume of the semiconductor.

The conducted researches allow to explain some outcomes of experiments on generation of a reflected second harmonic.

NONLINE OPTICAL DIAGNOSTICS OF HYDROGEN EMISSION PROCESS FROM DIELECTRIC OIL

G.M. Mikheev, Georgi M. Mikheev*, A.N. Knilikov*, S.F. Nikitin*

Institute of Applied Mechanics, Ural Branch of Russian Academy of Sciences
ul. M.Gor'kogo 222, 426000, Izhevsk, Russia

Tel: (3412)216611; fax: (3412)431713; e-mail: mikheev@udmnet.ru

*Joint-stock company "Chuvashenergo", 40, Pr. Lenina, 428000, Cheboksari, Russia

Tel.: (8352)221321; fax: (8352)202221

It is known that in high-voltage industrial transformer's oil different gases (H₂, CH₄, C₂H₂, C₂H₄) may appear under the actions of heating, electrical discharge and strong ultrasonic. Therefore the study of hydrogen emission from dielectric oil is important to elaborate the method of continuous diagnostics of powerful high-voltage industrial transformer. By the method of Coherent anti-Stokes Raman scattering (CARS) we have investigated hydrogen emission from transformer oil under the different actions such as electrical discharge and ultrasonic. It is known, that the CARS method requires two coherent laser beams with the frequency difference between them scanned near the frequency of Raman transition of the investigated substance. In our experiments biharmonic laser pumping we have got by the method of stimulated Raman scattering and all measurements were then carried out with just one laser operation in a pulse-periodic regime.

We investigated the dependence of the appearing hydrogen volume V_{H_2} in transformer oil on the energy W of electrical discharge of voltage 1.5 kV. It has been found experimentally the following relation: $V_{H_2} = kW^{1/2}$, where k – some proportional coefficient. We investigated the kinetics of hydrogen emission processes from the transformer oil under focused low power (4 mW; 220 mW/cm²) and 1.76 MHz frequency of ultrasonic in vacuum and in air under normal pressure. It has been shown that both in vacuum and in air low power ultrasonic doesn't result in transformer oil distraction but essentially speed up the emission process of dissolved gas from the liquid. These investigations allowed us to find hydrogen diffusion coefficient in the transformer oil equal about to 10^{-3} cm²/s.

Autler-Townes splitting of biexcitons in CuCl

P.I. Khaizhi, A.V. Coronai, D.V. Tkachenko

Dnister State University, 25 October str., 128, Tiraspol, Moldova, MD 3300,
tel: (10-373-33)-3-44-87, 3-25-04, fax: (10-373-33)-3-25-04, e-mail: tdsu@tirastel.md

Institute of Applied Physics, Academy of Sciences, Academy str., 5 Kishinev,
Moldova, 2028

We present the theory of optical properties of semiconductor for the case of strong resonant pumping in the region of M-band of luminescence due to the optical exciton-biexciton conversion and two-photon probe of the biexciton state. We assume that the pump beam is tuned to the transition between exciton and biexciton states. In this case two excited states are mixed to create dressed states. The coherent coupling causes the modification of eigenenergies of exciton polariton states due to the polariton renormalization effect. The formation of dressed states can be proved as the splitting of the biexciton resonance in the two-photon absorption spectra. The splitting in the exciton-biexciton system is proportional to the Rabi frequency $\Omega = \mu E_0$, where μ is the dipole transition matrix element between exciton and biexciton states and E_0 is the internal electric field vector of the pump beam. Because of the large Bohr radius of biexcitons, the dipole moment μ is large and therefore the splitting becomes very large.

We have obtained the expressions for the real and imaginary parts of the susceptibility, which depend on the intensity of the pump beam and the corresponding transition self-frequencies. The imaginary part of the susceptibility exhibits two spectrally resolved peaks of the absorption band of the weak probe radiation at high level of the pump excitation. The theoretical results are in a good agreement with the clear experimental evidences of the Autler-Townes splitting of biexcitons in CuCl [1].

1. R. Shimano, M. Kuwata-Gonokami, Phys.Rev. Lett., 72, № 4, 530-533, 1994.

NONLINEAR FLUOROMETRY OF BIS-CYANINE DYES SOLUTIONS

K. G. Blinova, A. A. Ivantsov, A. A. Ishchenko, S. V. Patsayeva,
A. V. Pekhota, B. D. Ryzhikov, V. I. Yuzhakov
M. V. Lomonosov Moscow State University, Faculty of Physics
Vorobievsky gory, Moscow, 119899 Russia
tel. (095) 939-3690, fax (095) 939-1489, blinova@genphys.phys.msu.su

Nonlinear fluorometry (or spectroscopy of saturated fluorescence) of complex organic compounds is based on their solution bleaching under laser pulse irradiation, which appears as a nonlinear dependence of detected fluorescence signal versus excitation intensity. A method of nonlinear fluorometry is applicable to determination of such spectral characteristics as fluorescence lifetime τ , absorption cross-section σ at the excitation wavelength and quantum yield of intersystem crossing η_{ic} .

For spectra excitation the copper vapor laser emitting at 511 nm with pulse duration of 15 ns was used. Different values of the intensity of laser source were obtained with calibrated neutral density filters in the path of the exciting laser beam. Maximal flux density of the excitation radiation was $5 \cdot 10^{25}$ photons / (cm² s).

The properties of monomeric thiocarbocyanin (parent cyanine dye) and four bis-cyanines with two covalently linked chromophores in ethanol solutions were studied. The angle between polarization axes of two chromophores of bis-cyanine dyes (1-4) were 95, 128, 147 and 180° correspondingly.

Resonance interaction of chromophores provides a splitting of the singlet excited state for bis-cyanines. The excitation splitting energy ΔE is characterized by the distance between short-wave and long-wave emission maxima in the absorption spectra. It is obtained that while ΔE is rising both quantum yield of intersystem crossing η_{ic} and Stokes shift ΔS in bis-cyanin solutions are increasing.

Dye	σ_{511} , 10^{16} , cm ⁻²	λ_{max}^{ab} , nm	λ_{max}^f , nm	ΔS , cm ⁻¹	ΔE , cm ⁻¹	τ , ns	η_{ic}
1	2,41	509; 626	643	4094	3672	1,1	0,03
2	1,45	516; 596	612	3040	2601	0,6	< 0,01
3	0,56	510; 629	650	4223	3710	1,3	0,08
4	0,17	508; 639	658	4487	4036	1,2	0,27

Parent cyanine dye forms J-aggregates in aqueous solution in presence of inorganic salt. Dependence of fluorescence saturation factor on excitation intensity is found to be essentially nonlinear. That fact is accounted for bimolecular processes of excited state deactivation.

Power laser excitation causes 250-300 cm⁻¹ blue shift of fluorescence band of bis-cyanine dyes embedded in polyvinyl alcohol matrix due to appearance of inhomogeneous spectral broadening.

Spectroscopy of the excited singlet states of molecular oxygen

R.J. Knize, M.P. Murdough
 Laser and Optics Research Center, US Air Force Academy, CO 80840, phone:
 (719)333-4165, fax: (719)333-3182, email: randy.knize@usafa.af.mil
 B.V. Zhdanov, D.K. Neumann
 Directed Energy Solutions, 14125 Candlewood Ct., Colorado Springs, CO 80921,
 phone: (719)481-9802, fax: (719)481-8515, email: dneumann@codenet.net

The collisional deactivation of the lowest singlet states of molecular oxygen $O_2(b^1\Sigma_g^-)$ and $O_2(a^1\Delta_g)$ is of great interest for many applications (e.g. as energy donors in gas phase transfer kinetics and oxygen based lasers). An interesting feature of these collisions that has been postulated is that the $(b^1\Sigma_g^-)$ state is quenched exclusively to the $(a^1\Delta_g)$ state and not to the ground state ($X^3\Sigma_g^-$). Direct measurement of the fraction of $O_2(b^1\Sigma_g^-)$ species quenched to the $(a^1\Delta_g)$ state is not very easy task because of very long lifetime of the $(a^1\Delta_g)$ state (more than 60 minutes) and a long wavelength of the fluorescence emission (1268 nm) from this state to the ground state. In this work we present the first direct measurement of the $O_2(a^1\Delta_g)$ deactivation rate, direct measurement of the $O_2(b^1\Sigma_g^-)$ deactivation rate and measurement of the fraction of $O_2(b^1\Sigma_g^-)$ species quenched to the $(a^1\Delta_g)$ state.

We used direct laser excitation of molecular oxygen in the band $b^1\Sigma_g^-(v=0) - X^3\Sigma_g^-(v=0)$. A fluorescence emission corresponding to the $b^1\Sigma_g^-(v=0) \rightarrow X^3\Sigma_g^-(v=1)$ transition (865 nm) and a fluorescence emission corresponding to the $a^1\Delta_g(v=0) \rightarrow X^3\Sigma_g^-(v=0)$ transition (1268 nm) were observed at oxygen pressure varied in the range 2 - 1000 torr.

A numerical fitting routine to the emission decay curves showed that a single exponential function fits very well the data in the whole oxygen pressure range. The corresponding Stern-Volmer plots of decay rate versus oxygen density are presented.

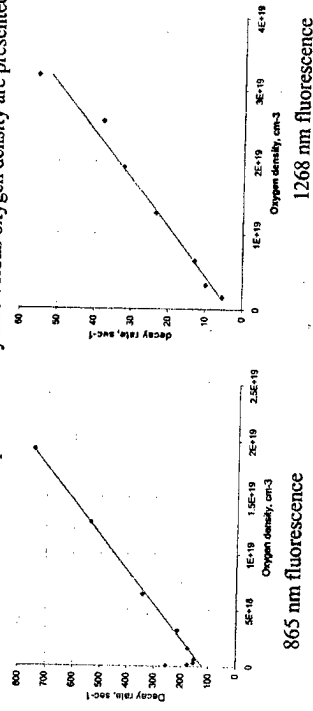

A linear fit through the data points (excluding the 2-20 Torr pressure data which is affected by diffusion) yields the following values for quenching rate by $O_2(X^3\Sigma_g^-)$: $b^1k = 3.26(8) \cdot 10^{-17} \text{ cm}^3 \text{ s}^{-1}$ and $a^1k = 1.52(9) \cdot 10^{-18} \text{ cm}^3 \text{ s}^{-1}$. The preliminary measurements show that most of the $O_2(b^1\Sigma_g^-)$ species are quenched to the $(a^1\Delta_g)$ state.

DIFFUSING-WAVE SPECTROSCOPY OF NONERGODIC MEDIA

S.E. Skipetrov

Department of Physics, Moscow State University, 119899 Moscow, Russia

F. Scheffold, S. Romer, and P. Schurtenberger

Institute of Physics, University of Fribourg, 1700 Fribourg, Switzerland

Diffusing-wave spectroscopy (DWS) is an extension of the dynamic light scattering (DLS) technique to turbid, multiple-scattering media. DWS allows useful information about the medium to be derived from the measured time autocorrelation function of multiple-scattered intensity. While DWS is widely applied to study various ergodic media (e.g., colloids, where particles move freely), its application to nonergodic, solid-like media (e.g., gels, emulsions, and foams, where the particle motion is restricted) is complicated by the necessity of additional efforts (such as translation or rotation of the sample in course of the measurement procedure) to ensure the proper ensemble averaging of the light-scattering signal.

We introduce a novel, elegant method of achieving the proper ensemble averaging for light scattered by a nonergodic turbid medium. The idea is to put an additional, ergodic light-scattering cell just after the cell containing the nonergodic medium under study, and to force the light scattered by the first cell to pass through the second one. Theoretical analysis shows that the resulting light-scattering system is ergodic as a whole, and that a proper adjustment of parameters of the two-cell setup reduce the intensity autocorrelation function of transmitted light to a product of autocorrelation functions corresponding to individual cells taken alone [1, 2]. Our DWS experiments performed with colloidal gels as model nonergodic media confirm the validity of the above conclusions, and show that the proposed method opens possibility for efficient DWS study of nonergodic media [2, 3].

1. S.E. Skipetrov and R. Maynard, Phys. Lett. A 217, 181 (1996).
2. F. Scheffold, S.E. Skipetrov, S. Romer, and P. Schurtenberger, Phys. Rev. E., submitted (2001).
3. S. Romer, F. Scheffold, and P. Schurtenberger, Phys. Rev. Lett. 85, 4980 (2000).

MULTIPEAK STRUCTURES IN THE PROBE-FIELD SPECTRUM OF 4-LEVEL SYSTEM

Yu.I. Belousov, D.A. Shapiro
 Institute of Automation & Electrometry
 Siberian Branch,
 Russian Academy of Sciences
 k 630090, Russia

The multi-peak structure was predicted in the probe-field spectrum or in the conversion efficiency of resonant FWM for 4-level systems with two strong fields interacting resonantly with the opposite or adjacent transitions. The peaks are narrow, their width is insensitive both to power and Doppler broadening [1].

In the 4-level system with two strong fields at the opposite transitions the quantity of peaks in spectrum was up to eight [2]. It is twice as much as for the motionless molecules. The peaks are located at so called "turning points", the extreme points of the difference between energies of the dressed states in the frequency-velocity plane. The substantial enhancement in the nonlinear susceptibility is predicted when two or three peaks merge into one.

In experiment [3], in contrast to theory where six peaks were predicted, the number of peaks was up to four. Relaxation constants of the upper levels were of the same order as the Rabi frequencies. So the resonances are smoothed and only 4 peaks instead of six were observed. Nevertheless, fast relaxation could not explain the experimental contrast of peaks. The degeneration of the molecular levels is shown to be insignificant in experiment with parallel linear polarisation. The absorption of pump field in the medium is found to be the main mechanism of the broadening. The Rabi splitting by strong field decreases along the cell. Then the inhomogeneity blurs the multi-peak structure, then the contrast decreases. The result of numerical calculation agrees qualitatively with experiment for wide set of parameters.

1. Babin S.A., Podivilov E.V., Shapiro D.A., Hinze U., Tiemann E., Wellegehausen B. *Phys. Rev. A*, **59** (2) 1355 (1999).
2. Yu.I. Belousov, E.V. Podivilov, M.G. Stepanov, D.A. Shapiro. *Zh. Eksp. Teor. Fiz.*, **118** (2) 328 (2000).
3. S.A. Babin, S.I. Kablukov, U. Hinze, E. Tiemann, B. Wellegehausen. *Opt. Lett.*, **63**, 12701 (2001).

NONLINEAR PUMP-PROBE VECTORIAL SPECTROSCOPY WITH ARBITRARY POLARIZED LIGHT

Gancheryonok I.I.*, Lavrinenko A.V.* Dreier T.**

*Belarusian State University, F. Skaryny Av. 4, Minsk 220001, Belarus

**Physikalisch Chemisches Institut, Universitat Heidelberg, Heidelberg 69120, Germany

Among a number of unsolved or "quasi-solved" problems in polarization optics and spectroscopy (however, under the use of totally non-polarized radiation or non-collinear geometry of laser beams interaction, it is more logically to speak about vectorial optics and spectroscopy rather than polarization ones) particular place occupies the problem dealing with inclusion into consideration of "real world" effects, e.g. depolarization (or polarization incoherence) of laser radiation [1,2,3]. Another point of interest is correct description of non-collinearity of interacting laser beams. In the present paper we develop the theory of nonlinear vectorial spectroscopy with arbitrary polarized light based on a tensor of a light beam formalism introduced by Fedorov F.I. [1]. In our theoretical analysis we consider a very general case within the traditional $\chi^{(3)}$ -scheme, when an initially isotropic (polarization inhomogeneous) medium is subjected to irradiation of two non-parallel laser beams, one of which (or both pump and probe) can be partially elliptically polarized.

Starting from the formal procedure of covariant description of light-induced anisotropy(LIA) we have found that in the general case of the partially elliptically polarized pumping a medium with LIA can simulate the properties of a biaxial anisotropic crystal with a special type gyrotropy. Using Fedorov's classification of crystals analogy we called it intrinsic gyrotropy. We were able also to find an analytical expression for the signal detected in the optically heterodyned polarization interferometry technique as we believe for the first time. The general expression has been adapted for the traditional experimental configurations. We have demonstrated the usefulness of the above dependence for the spectroscopic purposes. On the other hand, some predictions concerning new "magic angles" in non-collinear vectorial spectroscopy(both the transmissive and reflective variants) have been made. We have generalized the concept of normal waves in nonlinear vectorial too, taking into account realistic geometrical factors and polarization incoherence. Moreover, our theoretical findings allow one to perform corresponding optimization procedures in respect to vectorial configuration of the experimental setup.

1. Gancheryonok I.I. *Jpn. J. Appl. Phys.* **31**(1992)3862.
2. Svirko Y.P., Zheludev N.I. *Phys. Rev. A* **50**(1994)709.

3. Svirko Yu.P., Zheludev N.I. *Polarization of Light in Nonlinear Optics.* — Chichester: John Wiley & Sons, 1998. — 231p.

THE NARROWING OF MODULATION TRANSFER RESONANCES
IN DOPPLER BROADENED MEDIUM IN THE STRONG
LIGHT FIELDS

S.A.Pulkin, S.V.Uvarova

D.I.Mendeleyev Institute for Metrology (VNIIM), 198005 Moskovskii pr. 19, St.-
Petersburg, Russia, phone 251-86-38, fax 113-01-14, e-mail spulkin@mail.ru

T.H. Yoon

Korea Research Institute of Standards and Science (KRISS), P.O.Box 102, Yusong, Taejeon
305-600, Korea, e-mail thyoon@kriiss.re.kr

The theoretical interpretation of the phenomenon of narrowing of modulation transfer spectroscopy resonances obtained in the experiment carried out by T.H.Yoon has been made. The 2-level Doppler broadened medium is placed in the modulated strong pump field and strong counterpropagating probe field. In the system of moving atoms with the velocity v this configuration of the fields is equivalent to the case of four fields. When the condition $kv = \omega \pm g$ is satisfied, the super-narrow resonances $1/1, 2/2$ in the polarization spectrum arise (where k -wave vector, v - velocity of given group of atoms, ω - modulation frequency, 1 and g - integers). Because of multiwave mixing parametrical processes these components of the polarization create the new waves in the probe wave direction that interfere with the probe wave. The beat signal is proportional to the interference member and is registered by the synchro-detector, only the signal with the beat frequency $\omega \pm$ is decreased with the shape determined by the parameters of atoms and fields. For some of these parameters the width of the modulation transfer resonances can be smaller than the homogeneous line width. In the experiment the homogeneous line width of one of the superfine components of the iodine line is equal to 1 MHz and the width of the usual signal for the weak probe field is equal to the same value. When the intensity of the probe field increases the narrow signal on the transition frequency arises with the width about 60 KHz and with the homogeneous width on the detunings $\omega \pm, 2\omega \pm$. The numerical calculations in the density matrix formalism in the rotating wave approximation confirm these experimental results.

1. L.F.Vitushkin, S.V.Lazaryuk, S.A.Pulkin, L.Robertsson, G.I.Toptygina, IEEE Transactions on Instrumentation and measurement, 1995, v.44, N 2, pp. 177-180
2. T.H.Yoon, S.A.Pulkin, J.R.Park, M.S.Chung, H.-W.Lee, Phys.Rev.A, 1999, v.60, N1, pp.605-613

LIGHT SCATTERING BY EXTRAORDINARY POLARITONS IN KDP AND
ADP CRYSTALS

T.V.Laptinskaya, A.N.Penin

Physical faculty, Moscow State University,
119899, Moscow, Russia. Phone: 7(095)9394372,
E-mail: postmast@opt.phys.msu.su.

We studied the anisotropy of the deformation potential and dipole moment of the KDP and ADP crystals lattice vibrations by the method of the near-forward Raman scattering by extraordinarily polarized (anisotropic) polaritons (RSP).

Extraordinary polaritons in these crystals are the result of coupling of the macroscopic electromagnetic wave with dipole active phonons of $B_2(z)$, $E_1(x)$, $E_2(y)$ types. Scattering spectra were observed for the wide interval of frequencies when the laser wavevector (wavelength 488nm) was oriented under different angles φ on the optical axis of the crystal (Z axis). We chose such an orientation when the plane of scattering was parallel to Z axis, the laser wave was polarized ordinary, and the signal and polariton waves were polarized extraordinary. In this case, two components of quadratic susceptibilities need be taken into account. The angle φ varied from 60° to 90° for the best observation of certain vibrations with frequencies from 900 to 3500 cm^{-1} . For the different φ , phonons of different dipole moment orientation are manifested in the scattering into one or another side from laser wave vector direction. The method of computer simulation of spectrum using oscillator functions for the first-, second-, and third-order susceptibilities¹ was applied to determine the contributions of individual vibrations into different-order susceptibilities components.

1. T.V.Laptinskaya, A.N.Penin, JETP, v.91, n.5, 957 (2000)

DETECTION OF ULTRALOW CONCENTRATION OF ORGANIC COMPOUND IN AIR

A.A.Chistyakov, D.V.Klotchikov, G.E.Kotkovskii, V.S.Motchkin¹, A.S.Nalobin,
V.S.Pershenkov, E.S.Tananina.

The Moscow State Engineering Physics Institute (Technical University);
115409, Moscow, Kashirskoe str., 31, tel.: 3239103, e-mail: klotchik@mail.ru

¹Scientific Institute of Microelectronic Equipment "Progress"

125183, Moscow, Cherepanovych str., 54, tel.: 1530311

In the present work the laser resonance-enhanced multiphoton ionization (REMPI) of molecules followed by ion detection by specially developed ion mobility spectrometer was used. The sensitivity of spectrometer was 1000 ions per laser pulse with resolution 40. The products of a photo-ionization of aromatic molecules benzene, toluene, parinitrotoluene (PNT), dinitrotoluene (DNT), trinitrotoluene (TNT).

The fourth ($\lambda=266$ nm) and the third harmonics ($\lambda=354$ nm) of pulse YAG:Nd³⁺ laser as well as the second harmonics of the dye laser ($\lambda=280-290$ nm) were used for ion formation. The laser intensities are less than 10^6 W/cm² (pulse energy is 60 μ J).

The high efficiency of TNT molecules photo-ionization (some tens percents) is due to their excitation to the second singlet state $\pi\pi^*$ ($\lambda=230-290$ nm) with the subsequent superrapid intersystem crossing to the triplet. This allows to reach the sensitivity of TNT detection at the level of some ppt (not less 5 ppt) for the wavelength $\lambda=266$ nm. Analyses of mobility spectra of positive ions shows that main TNT ionization products are TNT⁺, (TNT-NO)⁺, toluene⁺ with correlation between them depending on the laser intensity. The formation of negative ions is one order less effective. In a negative ion spectra mode the ions (TNT-NO₂⁻), toluene⁻ are observed.

The ionization of TNT molecules by $\lambda=354$ nm is quite less effective due to weakness of the intersystem crossing from the first singlet (corresponding to the 354 nm) to the triplet state. The IMS spectra are also changed radically demonstrating a single peak.

Cavity Ring-Down Trace Gas Detector Based on a CW Quantum Cascade Laser

A.L.Malinovsky*, A.A.Kosterev*, and F.K.Tittel*

*Rice University, ECE Dept., MS 366, 6100 Main Str., Houston, TX 77251-1892, USA
tel.: (713) 348-5418, fax.: (713) 348-5686, e-mail: akoster@rice.edu

* Institute of Spectroscopy RAS, 142190, Troitsk, Moscow reg., Russia
tel.: (095) 334-0231, fax: (095) 334-0886, e-mail: almalino@isan.troitsk.ru

C.Gmachl, F.Capasso, D.L.Sivco, J.N.Baillargeon, A.L.Hutchinson, and A.Y.Cho
Bell Labs., Lucent Technologies, 600 Mountain Avenue, Murray Hill, NJ 07974, USA

The measurement of an absorption-dependent optical cavity decay constant is a novel modification of conventional absorption spectroscopy in a multipass cell that is based on the recent availability of ultra low loss dielectric mirrors. This approach known as Cavity Ring-Down Spectroscopy (CRDS) has a number of features that make it an attractive tool for various applications requiring ultra sensitive detection of trace gases. Until recently, one of the main obstacles for expanding this technique to molecular fingerprint region in the mid-IR, was the lack of powerful tunable coherent light sources. The situation has changed with the availability quantum-cascade distributed-feedback (QC-DFB) lasers that emit intense narrow band radiation in the 3.4 to 19 μ m spectral range.

In this contribution we present a CW QC-DFB laser based gas sensor to perform CRDS detection of NO via its fundamental absorption at 5.2 μ m. In our work we use a cryogenically cooled CW QC-DFB laser which can be tuned by varying laser current over a range from 1920.8 to 1922.9 cm⁻¹. A pair of lines at 1921.599 and 1921.601 cm⁻¹ is used for NO detection. The QC laser output power is ~20 mW and its linewidth is $\Delta\nu \approx 3$ MHz. The high-Q optical cavity is formed by two concave mirrors with an effective reflectivity $R \approx 0.99965$ spaced at 37 cm. One of them is mounted on a PZT. Dithering of the mirror position results in scanning of the cavity resonances through more than four free spectral ranges. As soon as the detector signal reaches a certain level indicating a build-up of the intracavity radiation as a result of the QC laser frequency coincidence with the cavity mode, the laser current is rapidly reduced to a sub-threshold value. The radiation leaking out the cell is focused onto a HgCdTe detector. The signal from the detector is acquired using a fast A/D board capable of up to a 50 MS/s conversion rate. The cavity ring-down time is determined by fitting the acquired data with an exponential function.

In our setup the decay rate for the empty cell was found to be $\tau_0 = 3.48$ μ s and the relative standard deviation of a single-measurement ring-down time $\sigma/\tau_0 = 2.24 \cdot 10^{-3}$. This yields a potential single-point sensitivity of $\alpha = 2.2 \cdot 10^{-8}$ cm⁻¹ that enables NO to be detected at the ~15 ppb level. Two last figures can be further improved by averaging of acquired data. To date we have detected NO diluted in nitrogen at the 50 ppb level as well as CO₂ ($\nu = 1921.641$ cm⁻¹) in atmospheric air. With the commercial availability of QC-DFB laser throughout the mid infrared spectral region other trace gases, such as CH₄, CO₂, NH₃ and H₂O can be detected with the CRDS technique demonstrated in this work.

STRONG-FIELD THEORY OF POLARIZATION SENSITIVE SPECTROSCOPY

I.I. Gancheryonok¹, O.G. Romanov¹, A.L. Tolstik¹, T. Dreier²

Department of Laser Physics and Spectroscopy, Belarusian State University
4, Fr. Skaryna av., 220050 Minsk, Belarus

²Physikalisch-Chemisches Institut, Universität Heidelberg, 69120 Heidelberg, Germany

One of the main drawbacks of nonlinear polarization sensitive spectroscopy as a tool for applied research (including combustion diagnostics) is the lack of appropriate theory describing the experimentally observed dependencies under the regime of saturation, when the weak-field theory does not work properly. Authors of existing theoretical treatments as well as experimental works use the standard polarization-geometry conditions, which are not obviously optimal in intensity-dependent experiments (see, e.g., [1], where the pump field is polarized at an angle 45° with respect to the polarization plane of the probe beam, however, such an angle provides the maximum magnitudes of the effects detected under condition of weak excitation [2]).

In this paper we present the theory both of nonlinear polarization spectroscopy (NPS) with crossed analyzer as well nonlinear spectroscopic ellipsometry (NSE), when the probe polarization state alterations are studied. We introduce an arbitrary angle between linear polarization of the interacting waves. A nonlinear initially isotropic media has been modeled by different N -level energy-relaxation schemes. In some cases we were able to deduce analytical expressions describing intensity dependent effects in NPS and NSE. Polarization azimuth tuning of the probe beam in respect the linearly polarized pumping provides the effective method to optimize the magnitude of the registered effects; (3) we have also clarified the influence of geometry of interacting waves (counter- or co-propagating geometry) on saturation behavior of the NPS-signal and NSE-parameters.

This paper has been supported in part by the INTAS-Belarus Grant 97-270.

1. Beenken W., May V // JOSA. 14(1997)2804.
2. Gancheryonok I.I., Kanematsu Y., Kushida T // J. Phys. Soc. Jpn. 62(1993)1964.

PHOTON ECHO FREQUENCY IN DOPED POLYMERS

O.K. Khasanov, O.M. Fedotova, T.V. Smirnova

Institute of Solid State and Semiconductors Physics NASB, 17 P. Brovka

str., Minsk 220072, Belarus, Phone: +375 -172 841117, Fax: +375 - 172 840888

E-mail: khasanov@ifftp.bas-net.by

The process of the photon echo generation by two non-collinear laser pulses in polymer doped with organic dye molecules is investigated theoretically. Such a medium is characterized by a large value of the inhomogeneous broadening, what permits to change the angle β between the excitation pulses in a quite large range. According to phase matching conditions, changing the angle β results in the blue shift of echo signal frequency with respect to pump pulses [1]. However, the frequency of observable response is due to diffraction origin of echo phenomenon and, simultaneously, is defined by the concentration of active centers, which radiate at given part of the inhomogeneously broadened spectral line. The spectral shift of the photon echo frequency depends on the inhomogeneous broadening Γ_{inh} , the thickness of the polymer film L , and the pulse duration τ_p . If the width of the principal diffraction maximum of the response $\Delta\Omega$ connected with the sample thickness, is comparable with Γ_{inh} , and the angle β is in some limited range of values: $\beta_{min} < \beta < \beta_{max}$, then a red shift of the echo frequency may take place. Thus, as the angle β increases, the echo frequency spectral switching takes place between the blue and red part of the inhomogeneously broadened line. The origin of the red shift and the conditions of spectral switching are discussed. When $\Gamma_{inh} = 6 \cdot 10^{13} \text{ s}^{-1}$, the red shift was shown to be observed for the polymer film of $L < 300 \text{ }\mu\text{m}$.

[1] A. A. Kalachev, et al. // Laser Phys. V.6, N 5, p.942-945 (1996)

Rozhdestvensky's Hooks and Two-Photon Interference

D.Y. Korystov, S.P. Kulik, A.N. Penin

Department of Physics, Moscow State University
119899 Moscow, Russia

Tel: 7(095)939-4372, Fax: 7(095)939-1104, E-mail: postmast@qopt.ilc.msu.su

Abstract: Interference of biphoton radiation emitted from two spatially separated nonlinear crystals is considered. The scheme of nonlinear Mach-Zehnder interferometer was realized. It was shown that frequency-angular spectra of SPDC contain information about the optical properties of the medium located between the crystals and have a common features with well-known Rozhdestvensky's method.

The interference of spontaneous radiation emitted from two macroscopic regions is considered. Interferometer is based on two nonlinear crystals, excited in series by a common laser pump. The crystals are separated by a layer with unknown dispersion law. It was shown that frequency-angular intensity distribution of scattered light formed in far zone carries information about dispersion properties of the substance placed between two nonlinear crystals. Specific feature of this effect is that phase of resulting intensity distribution depends on phase shift of all three fields that are involved in the interaction process (pump, signal and idler with frequencies $\omega_p, \omega_s, \omega_i$).

There are two ways for this effect application. First one allows to manipulate the structure of biphoton fields, the second one gives possibility to study dispersion of gases, liquids and solids in wide spectral range like by well-known spectroscopy of scattering by polaritons. However such interferometry does not require that intermediate substance has quadratic susceptibility. The two-photon interference effect is of special interest in case of intermediate media has a strong dispersion in IR (resonance in frequency range of idler wave). The typical frequency-angular distribution at the exit of such nonlinear interferometer consists on alternating maxima and minima; angular distance between neighbor orders at given frequency depends on refractive indexes of intermediate substance both in visible and IR. Fig.1a demonstrates the experimental results when two LINBO₃ crystals doped with Mg(thickness is 440 μ) were use as nonlinear crystals and paraffin oil was used as an intermediate substance (thickness is 50 μ). One can see that in the vicinity of resonance the behavior of the spectrum is analogous to Rozhdestvensky's "hooks", which are observed near to anomalous dispersion regions. From our spectra we reconstructed the dispersion law for the paraffin (Fig.1b).

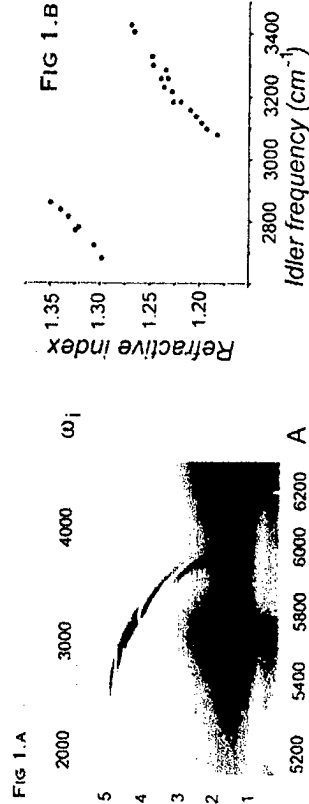
A UV TUNABLE DIODE LASER SOURCE BASED ON AN EXTERNAL
RESONANT CAVITY FOR OH ABSORPTION DETECTION

G. Hancock, J. S. Gibb, V. L. Kasyutich*, G.A.D. Ritchie

Physical and Theoretical Chemistry Laboratory, Oxford University, South Parks
Road, Oxford OX1 3QZ, UK

*Institute of Molecular and Atomic Physics, 70 Av. F. Scarina, Minsk, Belarus

A solid-state tunable light source operating at 309-320nm has been developed based on a cooled diode laser, frequency doubled in an external bow-tie cavity. The 3mW single mode AlGaInP multi quantum diode laser initially operating at 638nm at room temperature is mounted on a four-stage Peltier element fixed to a copper sink and inserted into a vacuum case. The temperature of the laser diode could be controlled in the range 170 - 323 K with stability ± 1 mK. This allowed operation in the region 619.6 - 640 nm with scanning range 10-15 GHz. The laser beam passes through a Faraday isolator, a prism pair and a half-wavelength plate prior to entering a bow-tie cavity. The cavity consists of two concave mirrors with 50mm radius of curvature and two plane mirrors. The input coupler has 94% reflectivity, and all other cavity mirrors have reflectivity greater than 99.9%. The separation between the concave mirrors is 104mm, the round-trip length of the cavity is 784mm, and the angle of incidence at the mirrors is 0.08 rad. An 8mm type I phase-matched 39.1° cut plane-faced BBO crystal is placed at the short arm waist of the cavity. The cavity has a finesse of 30-40 with an enhancement factor of 25-35. The laser beam is actively locked to the cavity using a fringe locking technique with 40-45% coupling efficiency. Using this system we have generated ultraviolet radiation at 309.8-320 nm with $\sim 0.1 \mu$ W power. By scanning the length of the cavity using a piezoelectric transducer on one of the mirrors, the scanning range of UV is 20-30 GHz with linewidth ~ 15 MHz. The UV radiation is in the correct region for the study of the OH radical, which is a species of crucial importance in both atmospheric and combustion chemistry. We are developing a system for the measurement of trace amounts of the radical, using diode lasers and cavity techniques such as continuous-wave Cavity Ring-Down Spectroscopy (CRDS) and Integrated Cavity Output Spectroscopy (ICOS).

MANIFESTATION OF INHOMOGENEOUS SPECTRAL BROADENING OBSERVED BY TECHNIQUE OF FLUORESCENCE SATURATION

Patsayeva S., Blinova K., Yuzhakov V.,

Physics Department, Moscow State University, Moscow 119899 Russia,
(7-095) 939 3690, Fax (7-095) 939 1489, svetlana@ltdar.phys.msu.ru

Vartanov V.

Institute of Ecology, Tallinn Pedagogical University, Kohtu 6,
Tallinn, E-10116, Estonia, (372) 644 5676, Fax (372) 645 2742, viktor@zlo.ee

Nonlinear fluorescence spectroscopy considers the cases of spectra excitation by powerful laser sources when resulting fluorescence intensity is not proportional to excitation power. The deviation from linearity, or «the effect of fluorescence saturation», is typically noticeable at conditions of excitation photon flux higher than 10^{24} s⁻¹cm⁻², which can be easily achieved with industrial laser sources. We present the theoretical consideration and experimental results of fluorescence saturation under intensive pulsed laser excitation.

The theory of fluorescence saturation under quasi-stationary and non-stationary conditions is described for organic complexes with interacting chromophores. Under conditions of fluorescence saturation inhomogeneous broadening of emission band could appear as distortion of spectral bands as well as gradual shift of peak position along with increase of excitation intensity.

The experimental results on fluorescence saturation for dye molecules (bys-cianine and acridine dyes) in solutions and polymer films, some organic luminophores of natural origin (dissolved organic matter and its components in water, mineral oils) are described. The spectra were excited using YAG-laser operating at 266, 355 or 532 nm and Cu-laser operating at 511 nm. All investigated samples demonstrated the effect of fluorescence saturation. Nonlinear fluorescence response under pulsed laser excitation was studied, and experimental results were compared with model predictions.

The manifestation of inhomogeneous spectral broadening was observed for some of the samples: «blue shift» of maximum position for acridine orange ($\lambda_{exc} = 355$ nm) and bis-cyanine dyes ($\lambda_{exc} = 511$ nm) in polymer films; for crude mineral oils ($\lambda_{exc} = 266$ and 355 nm); «red shift» of maximum position for humic acid in water ($\lambda_{exc} = 355$ nm) along with rising of exciting laser power. Distortion of spectral shape for mineral oils was received with both excitation wavelengths, while gradual shift of maximum position for humic compounds in water appeared only with excitation at 355 nm.

Three-dimensional microimaging of inhomogeneities in transparent media using third-harmonic generation and four-wave mixing

D.A. Akimov, S.O. Konorov, D. A. Sidorov-Biryukov, A. N. Naumov,
A. B. Fedotov, and A. M. Zheltikov

International Laser Center, Faculty of Physics, Moscow State University,
Vorob'evy gory, Moscow 119899, Russia

Third-harmonic generation has been recently demonstrated to be an efficient method for the microscopy and microimaging of biological objects [1, 2]. The main idea of this approach is that a nonzero signal of third harmonic arises when a fundamental beam is focused on the boundary between media with different refractive indices, suggesting a high-resolution method for imaging inhomogeneities in the spatial distribution of the refractive index.

In this paper, we demonstrate that THG and, more generally, four-wave mixing (FWM) processes allow not only interfaces between media with different refractive indices to be visualized, but also inhomogeneities in the spatial distribution of absorption and nonlinear susceptibility to be imaged. The results of our experiments show that THG and FWM permit a three-dimensional microscopy of laser-produced plasma to be implemented, providing an opportunity to visualize the plasma boundary and image plasma inhomogeneities. FWM microscopy was also employed to visualize inhomogeneities in transparent solutions. Biomedical applications of FWM microimaging will be also discussed.

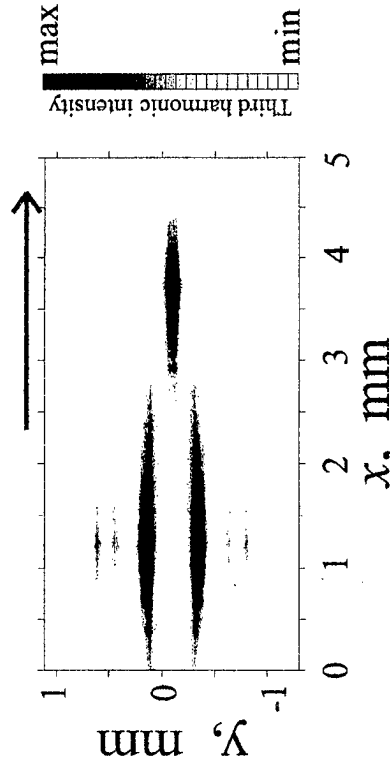

Fig. 1. THG image of a laser-produced plasma.

This study was supported in part by the President of Russian Federation Grant no. 00-15-99304, the Russian Foundation for Basic Research project no. 00-02-17567, the Volkswagen Foundation (project 1/76 869), and the "Fundamental Metrology" and "Fundamental Spectroscopy" Federal Programs.

I. Barad Y., Eizenberg H., Horowitz M., Silberberg Y. *Appl. Phys. Lett.*, **70**, 922 (1997);
Yelin D. and Silberberg Y. *Opt. Express*, **5**, 169 (1999).

2. Squier J., Muller M., Brakenhoff G.J., and Wilson K.R. *Opt. Express*, **3**, 315 (1998).

CO₂ Q-BRANCHES ANALYSES BY MEANS OF TIME-DOMAIN MEASUREMENTS

V.B. Morozov, A.N. Olenin, and V.G. Tunkin

International Laser Center, M.V. Lomonosov Moscow State University
119899 Moscow, Russia
tel.: (095)9391934, fax: (095)9393113; e-mail: olenin@picar1.phys.msu.su

Time-domain CARS investigations of CO₂ 1265 and 1285 cm⁻¹ Q-branches in pressure range of 0.025-20 atm are reported. We have observed quite complicated picture of beats between different components of Q-branches (Fig. 1). Beats picture was transformed with increasing pressure. Pulse responses, measured at 0.025 atm, were

compared with theoretically calculated ones. The aim of the theoretical calculations was to restore amplitude distribution of Q-branch components taking into account their frequencies, known from IR spectroscopy [1]. All possible products of components amplitudes and differences of components frequencies determine beats picture. The following procedure of successive approximations was used to find amplitude distribution. Small modifications were introduced into amplitude distribution to minimize step by step an error between calculated pulse response and experimental one.

Computed in this way amplitude distribution for 1285 cm⁻¹ band is close to the ordinary Q-branch amplitude distribution (Fig. 1). However in the case of 1265 cm⁻¹ band, consisting of two Q-sub-branches with ro-vibrational components corresponding to odd- and even-J rotational states, amplitude distribution is more complicated.

References

1. Laurence R. Rothman, Appl.Opt. 25,1795 (1986)

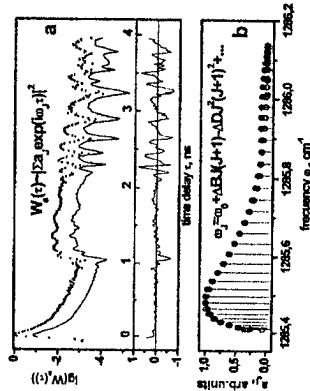

Fig. 1. a). Pulse response of CO₂ 1285 cm⁻¹ transition at 0.025 atm (points: experiment, solid line: theory). b). Corresponding components amplitude distribution (circles: ordinary Q-branch amplitude distribution, points: calculated distribution).

SINGLE-MODE OSCILLATIONS IN DFB-LASER BASED ON CHOLESTERIC LIQUID CRYSTAL AS A METHOD OF OPTICAL DIAGNOSTICS OF LIQUID CRYSTALS

Gryshchenko S.V. and Ichishim I.P.

Institute of Physics of National Academy of Sciences
46, prospect Nauky, Kyiv, 03650, Ukraine

Tunable distributed feedback (DFB) laser based on dye-doped cholesteric liquid crystals (CLC) a long time ago was realized [1]. Recently this ultra-compact and rugged laser, which maybe realized in the form of screens of arbitrary square, to be of interest for making of the colour laser projection screens of higher brightness [2]. As is known [3], helical periodical structure of CLC provide greater spectral selectivity of the DFB-laser in comparison with linear periodical structure [3] and lasing spectra of this laser to represent triplet take place from the Bragg wavelength and two longitudinal modes with index $N=\pm 1$. In the sufficient qualitative samples of active elements of planar texture the oscillations of the longitudinal modes of the DFB-laser with index greater than $N=\pm 1$ in the broad range of the excitation intensity not appear. Therefore the width of spectra oscillations of the DFB-laser of this type define quantity by distance between of the longitudinal modes.

We investigated the possibility of narrowing of the lasing spectra of the DFB-laser based on CLC under change of relative position of maxima of selective reflection (SR) CLC and fluorescence of doping dye. Three different mixture based on cholesterol oleate, cholesterol pelargonate and cholesterol chloride was used. Their SR maxima dispose accordingly on short-wave (mixture I) and long-wave (mixture II) side of the fluorescence band of doping dye and coincide with its maximum (mixture II).

It was shown that in the DFB-laser based on mixture I and II in the bulk of range of possible excitation intensity (≈ 20 MW) in the lasing spectra triplet unity nm wide for thickness of the CLC layer 40-50 μm was registered. In the DFB-laser based on mixture II single-mode oscillations with line wide 0,1-0,15 nm depending on excitation intensity was registered. In this case oscillations on modes with index $N=\pm 1$ in the bulk of range of excitation intensity was default. The condition of the realization single-mode oscillations depending on temperature was studied and it was shown enough strong criticality in relative position the SR and fluorescence bands at its realization.

The possibility of polarization characteristics of this DFB-laser and their coupling with peculiarities of polarization characteristics of this DFB-laser and quality of active layer of the planar texture are discussed. The machinery broadening in the single-mode regime oscillations at great excitation intensity also are discussed.

1. Ichishim I.P., Tikhonov E.A. et al. JETP Lett. 1980, v.32, p.24.
2. V.I.Kopp, B.Fan, H.K.M.Vithana and A.Z. Genack. Opt.Lett. 1998, v.23, p.1707.
3. Ichishim I.P. Tikhonov E.A. and Shpak M.T. Ukrainian Phys.J. 1988, v.33, p.10.

Nonlinear fluorimetry of organic fluorofors admixtures.

I.V. Boychuk, T.A. Dolenko, V.V. Fadeev.

Quantum Electronics Division, Department of Physics, Moscow State University,
Moscow, 119899, Russia.

In [1] the possibility of simultaneous determination of three photophysical parameters of one-fluorofor system (the one-component solutions of dyes) within the framework of the nonlinear fluorimetry method (saturation fluorimetry) is shown. Application of this method to fluorofors admixtures was not considered earlier. In the same time actuality of this problem is great. At the same time many natural organic complexes, study of which is very actual, are multi-fluorofors systems.

In this work to research two-fluorofors system 4-6 parametrical inverse problem was considered. It was shown [1], that in connection with particularities of fluorescence saturation curves of complex organic compounds, number of parameters of inverse problem has not to exceed three. So, partial determination of the sought parameters when others are known is investigated.

In this work computer modelling was carried out for solution of two problems: (1) determination of the absorption cross-sections σ_1 , σ_2 when lifetimes of fluorofors τ_1 , τ_2 are known; (2) determination of the parameters τ_1 , τ_2 when the parameters σ_1 , σ_2 are known. The method of artificial neural networks (ANN) was used.

The method is approved on two-component solutions of dyes, and it has shown the possibility of determination of these parameters accurate to units %.

1. Fadeev V.V., Dolenko T.A., Filippova E.M., Chubarov V.V. Saturation spectroscopy as a method for determining the photophysical parameters of complicated organic compounds. Optics Communications, 1999, v. 166, pp. 25-33.

COHERENT AND OPTICAL METHODS OF THE DIAGNOSTICS OF PERIODIC STRUCTURES WITH THE INCREASING OF THE SENSITIVITY OF MEASUREMENTS

A.M. Lyalikov, M.Yu. Serenko

Yanka Kupala Grodno State University
Ozheshko, 22, Grodno, 230023, Belarus

ignat@grsu.grodno.by.

There exist objects with pronounced periodic structure of surface. This structure may be both transparent and reflecting type. The class of these objects consists of diffraction hologram elements, biological tissues, surfaces of objects with various texture, for example, solids after laser irradiation processing etc.

In this work the new optical methods of the visualization of both various defects of structures and surface shape of this class of objects are considered. These methods are based on visualization of phase distortions of coherent wave diffracted by a structure or its photographic image. As a principle of this methods are taken the principles of optical image processing such as spatial filtering and interference pattern formation. The latter visualizes the defects of studied structure or the surface shape. The increasing of the sensitivity of measurements is achieved in the using of high order diffracted waves and also in the rewriting photographic images of studied objects. The questions of adjusting of reference interference fringes and correcting aberrations are considered. The results of experimental tests of the methods in the investigating of various one-component and multi-component structures of transparent type are presented [1-3].

1. Lyalikov A.M., Opt. Spectrosc., 1999, vol. 86, no. 3, p. 489.
2. Lyalikov A.M. and Serenko M.Yu., Journal of Technical Physics (S. Petersburg), 1999, vol. 69, no. 10, p. 126.
3. Lyalikov A.M. and Serenko M.Yu., Optics Journal (S. Petersburg), 2000, vol. 67, p. 111.

THE HIGH SENSITIVITY TO IMPURITY OF LASING OF MICRODROPLETS

A.V.Korzhev, L.G.Astafieva, L.A.Kotomiseva, G.P.Lednyeva

Institute of Physics of the National Academy of Sciences of Belarus

Scotina prospect 68, Minsk, 220072, Belarus

Tel.: 375 172 841808

Fax: 375 172 840879

E-mail: ledneva@dragon.bas-net.by

Lasing and other nonlinear-optical effects in droplets or dielectric microspheres are realized due to the very high quality factor of electromagnetic whispering gallery modes or morphology dependent resonances. The extremely low threshold of the nonlinear phenomena in microdroplets can be attributed to interacting waves simultaneously resonant with the high-quality droplet mode and to the presence of significant cavity quantum electrodynamics enhancement of nonlinear gain. High sensitivity of modal radiation to absorbing impurities is found reliable method for detection micro impurities in an aerosol micro droplet. Results of consideration for bimodal laser regime in microparticle under the action of the second harmonic of a Nd-doped power glass laser as a pumping source for mixture of active substance and a saturable absorber as micro impurity in a spherical micro particle are proposed.

The conventional semiclassical theory of nonstationary stimulated processes is modified to description of lasing of spherical particle on conditions that the polarization follows the electric field. The components of the radiated electromagnetic fields are expressed in conventional way through the Debye potentials. Interaction between two modes and effects of spatial short wave grating of populations of about half of the length of the light wave due to self-action of one mode during it is counter propagation inside cavity and of the long wave grating of populations at the difference of the lengths of waves of modes as result of interaction of two modes in microdroplet and their role in laser action are considered. Conditions which permit us to get two orders more high sensitivity to impurities due to effect of cavity quantum electrodynamics in the presence of detuning between the resonant modal frequency, the resonant frequency of the gain line and the resonant frequency of absorption line of impurity are determined. Dependences of a bimodal steady state on the spatial overlapping of the modes and unsaturated gain are obtained in Fig.1.

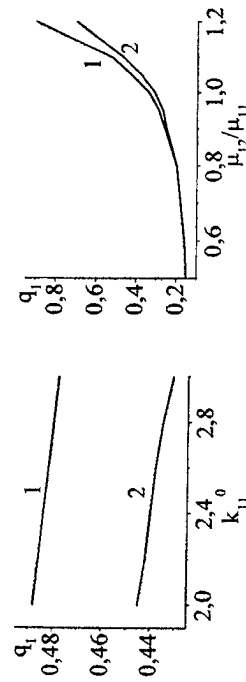

Fig.1. The intensity coefficient q_1 of the first mode on the gain k_{11}^0 (at left) and coupling coefficient μ_{12}/μ_{11} (at right) at the absence of a saturable absorption $k_1=0$ (1) and for $k_1=0.0001$ (2).

NEW ASPECTS OF POLARIZATION OF AN AMPLIFIED RADIATION AND INDUCED CAUSY-CRYSTALLINITY OF DYE SOLUTIONS

V.A.Chernyavsky, L.G.Pikuik, A.F.Grib

Institute of Molecular and Atomic Physics, National Academy of Sciences of Belarus.

220072 Minsk, Belarus. E-mail: illum@imaph.bas-net.by

It is known, that molecular system excited by polarized radiation acquires the optical properties of single-axis crystal.

In the present work the spectral regularities of the behavior Δn (the difference of refractive indexes of ordinary and extraordinary waves $\Delta n = n_o - n_e$) of various solutions of organic compounds are investigated at the excitation in visible and ultraviolet ranges of absorption spectrum. For the solution of rhodamine 6G in glycerol it is shown, that at excitation in visible range of absorption spectrum ($\lambda_{ex} = 532$ nm) the spectral dependence Δn is negative in the band of fluorescence and positive in visible band of the absorption. At excitation in ultraviolet range of absorption spectrum ($\lambda_{ex} = 354$ nm) the spectral dependence Δn is positive in the band of fluorescence and is negative in visible band of the absorption. Specified spectral dependencies Δn are symbolically mirror symmetric concerning the abscissa axis. The similar regularity was found out for other investigated object - 3,6-tetramethyldiaminophthalimid in glycerol.

In the work the first time found spectral regularities of behavior Δn are discussed. These discussions are based on the oscillator model of a molecule, which widely and fruitfully is used for description of polarized fluorescence. The spectral regularities of the polarized fluorescence are defined by the orthogonality of oscillators of the long-wave band of absorption and fluorescence and oscillators of the short-wave band of absorption. The found out spectral regularities of behavior Δn are considered and described on the basis of interaction of probing radiation with molecular oscillators of various electronic bands.

Nonstationary coherent light scattering in supercritical CO₂

V.N.Bagrashvili*, V.B.Morozov, A.N.Olenin, V.K.Popov*, V.G.Tunkin,
D.V.Yakovlev

International Laser Center, M.V. Lomonosov Moscow State University
119899 Moscow, Russia

Time-domain CARS observations of supercritical CO₂ 1388 cm⁻¹ Q-branch have been fulfilled. Supercritical fluid (SCF) is an unequal object for chemical and molecular dynamics study. Density of SCF can be continuously varied from values characteristic of a gas to those characteristic of a liquid. If the temperature is above critical value T_c this broad density range is accessible without a gap in physical characteristics associated with first-order phase changes such as vaporization and condensation. In this case the behavior of gases compressed to densities close to their critical densities ρ_c is so far from ideal that supercritical fluids have been a source of continuing scientific interest. Long correlation length of density variations around the critical pressure at temperature near above the critical point results in notable features in behavior of thermodynamic constants of matter and its physicochemical properties such as extremely effective capacity to dilute solids, high miscibility with gas, high diffusibility, low viscosity anomalous scattering of light etc [1,2,3].

Experimental observation of coherent light scattering of carbon dioxide near the critical point both in subcritical, and in supercritical condition, will allow to study dynamics of formation and decay of the induced molecular coherency and to make conclusions about features of molecular interactions in this conditions.

Our first experiments were fulfilled with carbon dioxide charging high-pressure gas cell with temperature stabilization within 0.1 K. Dephasing kinetics of of 1388 cm⁻¹ Q-branch (upper Fermi doublet $\nu_1 + 2\nu_2$) has been measured at critical temperature at pressures near above and below critical value.

References

1. J.A.Darr, M.Poliakoff, 99(2), 495-541 (1999)
2. X.Ma and D.L.Tomasco, *Ind. Eng. Chem. Res.*, 36(5), 1586-1597 (1997)
3. R.S.Urdahl, D.J.Myers, K.D.Rector, P.H.Davis, B.J.Cheryil, and M.D.Fayer, *J. Chem. Phys.*, 107(10), 3747-3757 (1997)

SPECTRAL EFFICIENCY OF GENERATION NEW COUMARIN DYES

V. Tarkovsky, S. Anufrik

Yanka Kupala State University of Grodno, 230023, Grodno,
22, Ozhesfko Street, Tarkovsky grsu. unibel. by

At realization of researches generation characteristics of some known dyes coumarin, rhodamine and oxazine, and also again synthesized coumarin connections from spectral structure of radiation pumped at excitation by pulses of microsecond duration abnormal dependence of efficiency of generation, and also spectral characteristics on length of a wave $\lambda_{\text{накачки}}$ was found out. It is expressed that efficiency Generation in process of change of length of a wave of stimulating radiation in the beginning grows, then near to a maximum of a strip of absorption falls, with the subsequent growth on a long-wave slope. Spectra of generation thus find out the appropriate displacement, and, the long-wave border of them does not vary. At increase of length of a wave pumped there is an expansion of a generated strip in area of short lengths of waves on 10-12 nm. and in the field of a failure two-way generation is observed. The same two-way generation is observed and in case of some bichromophom connections. In spectra of efficiency of generation such bichromophom there are two characteristic failures.

The analysis of the literary data on spectral characteristics of absorption in the channel excited singlet levels for ethanol solutions of some coumarins, rhodamines and oxazines dyes allows to conclude, that the given effect is connected to absorption in the channel excited singlet levels. It proves to be true also a spectral course of factor Einstein for absorption in the channel excited singlet levels $B_{S_1} \rightarrow S_n$ (ν). Comparison of a spectral course of losses in the channel excited singlet levels with dependence efficiency. To generation rhodamine 6G from length of a wave of excitation explains received abnormal its dependence on spectral structure pumped at excitation by pulses of microsecond duration. It is shown, as for other classes of connections abnormal dependence of efficiency of generation on length of a wave pumped can be explained by presence of spectral losses in the channel excited singlet levels.

DATA PROCESSING AND ESTIMATION OF MEASUREMENTS ERRORS IN INTRACAVITY LASER SPECTROSCOPY

V.S. Burakov, A.V. Isaevich, P.Ya. Misakov,

Institute of Molecular and Atomic Physics of National Academy of Sciences of Belarus,

F. Skaryna Ave. 70, 220072 Minsk, Belarus, Tel.: +375 17 2842763,

Fax: +375 17 2840030, E-mail: misakov@imaph.bas-net.by

V.V. Apanasovich, V.M. Lutkovski, P.V. Nazarov

Belarus State University,

F. Skaryna Ave. 4, 220050, Minsk, Belarus,

Tel.: 2789345, E-mail: lutkovski@rfe.bsu.umibel.by

Methods of absorption spectra processing in intracavity laser spectroscopy (CLS) are investigated for the case of very low concentration of cesium in water solutions. Common procedures in such cases require fitting or filtering of the laser generation broadband spectrum, search for the investigated atomic or molecular absorption lines, calculation the examined substance concentration in quantitative analysis and determination its wavelength in quality analysis.

In this study various methods of absorption spectra processing in the case of atomic cesium line $\lambda = 455,531$ nm in the intracavity laser spectrometer are examined. A graphite electric thermal atomizer was used for the probe atomization. It was shown that errors distribution is gaussian (may be approximated by the normal law) if the relative depth of gap and relative gap area are used as the concentration sensitive measure (estimate). The artificial neural network algorithms were tried as a tool to reduce the apparatus error. In the trace concentration definition the mean-square error was decreased to a value less than 9.5 %.

STOCHASTIC RESONANCE IN LIGHT EMITTING DIODES

V.B. Pakhatov, L.S. Aslanyan, V.L. Eibakyan

Physics depart. Yerevan State University, A. Manoogyan 1, Yerevan, Armenia,
375025. e-mail: laslan@www.physdep.r.am

As it is well known, the stochastic resonance (SR) leads to improvement of many characteristics of the information signal (the signal-to-noise ratio (SNR)), amplification, coherency et al.) in case of the variation of the level of simultaneously acting noise [1].

In this paper we studied SR in a nondynamical threshold system [2], such as, for example, the light emitting semiconductor diodes. In modern research experiments, as well as in computer technology the system laser diode or light emitting nonlasing diode (LED) plus photodiode or photomultiplier is widely used.

We registered SR, which arise when the sum of regular and noisy component of the modulating voltage crosses some threshold level of radiation. At the absence of noise the amplitude of a regular signal is insufficient for the achievement of a radiation threshold. Via adding noise it is possible to overcome randomly the threshold. In case of crossing the threshold by the noisy pulse, a light pulse is radiated. On the output of the photoreceiver a random sequence of noisy pulses, modulated on frequency by a regular signal is registered. The other words, modulation of a threshold by the regular signal occurs. Power spectral density of the photocurrent contains the basic frequency and its harmonics.

The measurements are carried out by the application of various laser diodes and LED-s as a source of radiation. The radiation was detected by the photodiode or photomultiplier.

The input signal was the sum of signals from the standard signal generator and from the noise generator. The output signal was registered via the spectrum analyzer. SNR for optimum values of the noise increased approximately 10 times.

In our experiment the SNR on the second harmonic proved to be 3-4 times less than the SNR on the basic frequency. The approximate theoretical analyses gives the value of an order less. We registered also the increase of the noise in case of the increase of the signal amplitude. The growth of the noise in some LED-s has "resonant" character.

REFERENCES

1. L. Gamaitoni et al. Rev.Mod.Phys. 1998, v. 70, p.223.
2. F. Moss et al. Int.J.Bif. Chaos 1994, v.4, p.1383.

SYNCHRONIZATION EFFECTS IN A DUAL-WAVELENGTH CO₂ LASERB. F. Kuntsevich¹, A. N. Pisarchik^{1,2}

¹B. I. Stepanov Institute of Physics, NBAS, Skoryna ave. 68, 220072, Minsk, Belarus
²Centro de Investigaciones en Optica, A.C., Loma del Bosque 115,
 Col. Lomas del Campestre, 37150 Leon, Gto., Mexico.

During recent years, an interest in studying the synchronization phenomena in various coupled systems for such areas as chemistry, physics, biology and economics has increased significantly. We study theoretically synchronization effects for a dual-wavelength CO₂ laser. We consider a single-mode lasing in the centers of *P*22 and *P*16 lines of the 00⁰1-10⁰ transition. The coupling between the lasing lines is realized through rotational relaxation. In the first channel (master) the losses are modulated as the follows: $k_1 = k_{10} + k_{11}[1 + \sin(2\pi\nu t)]$, where k_{11} and ν are the modulation amplitude and frequency and k_{10} is a constant loss. The losses in the second channel (slave) are fixed, $k_2 = k_{20}$. The active medium CO₂:N₂:He=1:1:8 is under the pressure of 15 Torr. At the low frequencies ($\nu < 10$ kHz) the pulses in the channels are lased in antiphase (antiphase dynamics) and their shape is close to the rectangular one. Varying k_{11} it is possible to control the ratio between the pulse durations in the wide dynamical range. The pulse amplitudes meet to the stationary generation level. At a high ν the transition to inphase dynamics is observed. The pulse amplitudes can be of one order of magnitude higher and more than the stationary generation level. For the certain parameters a regime of the obvious nonlinear oscillation, which is inherent for system with two degrees of freedom, is realized. Then for each channel the amplitude-frequency characteristics of the response exhibit two low-frequency resonant 1*T*-spikes ($T = 1/\nu$) and at higher frequencies 2*T*-spikes corresponding to the doubled oscillation period. In order to realize more complex generation regimes (period doubling and chaos), a rather small increase in k_{20} is necessary. Generally, the complete (inphase), antiphase, phase, lag, and combined inphase-antiphase types of synchronization between the master and slave channels were observed.

The dual-wavelength CO₂ laser is specified by four steady states. The dependence of steady state stability on parameters of the system is investigated.

POLARIZATION DYNAMICS IN A MICROLASER WITH A SATURABLE ABSORBER

Kotomtseva L.A., Rusov S.G.

B.I. Stepanov Institute of Physics National Academy of Sciences of Belarus, 68,

F. Skoryna prospect, Minsk 220072, Belarus

E-mail: kotomts@dragon.bas-net.by

Different types of crystals are widely used as active and passive elements in a laser with a saturable absorber (LSA) and polarization effects are observed experimentally. That is why we propose models for theoretical consideration of LSA with an isotropic active medium and absorber with anisotropy and for anisotropy of the definite symmetry type in active medium and isotropic absorber for prediction potential possibilities of multi valued states and nonlinear dynamics in such LSA. Perspectives of their application in optical information systems are discussed.

Steady states for two sets of linearly polarized orthogonal modes are considered for each of two models. It appears that several values of nonzero intensity for the linearly polarized mode can coexist for some parameters of LSA. We find that intensity of linearly polarized mode in dependence on the value of an angle of turn of element with anisotropy has two or four maximums (minimums) for complete angle of rotation in dependence on the parameters. Conditions for multistability of these steady states are described and detailed consideration of their instability is proposed. Nonlinear dynamics of each of linearly polarized modes is considered for the case when polarizer is present in the cavity.

Polarization dynamics of LSA for the general case of simultaneous presence of both polarization components in the cavity is revealed in detail as in dependence on the angle of turn of element with anisotropy so on the decay rate of a saturable absorber and other parameters of LSA. Specific features of intensity, frequency and polarization properties behavior in time are demonstrated.

VECTRIAL MODEL OF NONLINEAR RESONATOR

I.I. Gancherenok¹, O.G. Romanov¹, A.L. Tolstik¹, B. Fleck², L. Wenke²

¹Department of Physics, Belarusian State University,

4, F. Skaryna ave., 220050 Minsk, Belarus,

²Institute of Applied Optics, Friedrich Schiller University

Frobelstieg 1, D-07743, Jena, Germany

Last years much attention has been paid to complex dynamics in nonlinear interferometers under excitation by single or poly-beam laser radiation. The use of multilevel resonant medium as an intracavity material seems to be perspective for realization of high-speed self-oscillations of the light beam intensity. The reason for arising of self-oscillations is a competition of light induced changes in the refractive index and (or) the absorption coefficient caused by the transitions between different energy levels of complex molecules. An anisotropic element, placed into the nonlinear interferometer, provides an additional phase shift between orthogonal polarization modes. Thus, different conditions of the feedback lead to the different transmission functions of the interferometer for the polarization modes.

The present work gives a theoretical analysis of the conditions for realization of the spatial-temporal structures of orthogonal polarization modes in the anisotropic Fabry-Perot interferometer with a multilevel resonant medium. The use of a passive anisotropic element (phase plate) contributing to the phase difference between polarization modes makes it possible to realize complex spatial and temporal self-oscillations of radiation polarization at the output of interferometer upon constant intensity at the interferometer input. Changing the parameters of nonlinear element or polarization of the input radiation one can control azimuth and ellipticity of the output, generate beams with the specified distribution of polarization characteristics of the cross-sectional profile. The considered scheme of the molecular energy states may be used for the description of interactions between radiation and dye solutions, activated crystals, vapours of organic compounds and also allows one to take into consideration the realistic light-induced anisotropy effects under polarized excitation.

NONLINEAR DYNAMICAL PHENOMENA IN A FOUR-FREQUENCY RING GAS CLASS-A LASER WITH ELLIPTICALLY POLARIZED EIGENSTATES

L.P. Svirina

Institute of Physics Academy of Sciences of Belarus

Skaryna Avenue 68, Minsk 220072, Belarus

Theoretical modeling of a four-frequency ring gas class-A laser in the presence of a linear coupling due to backscattering which involves not only polarization, but also phase characteristics of emitted waves can be used to elucidate the laws of formation of nonlinear dynamics in multimode vector-field lasers with more complicated active media. On the basis of the Jones matrix formalism assuming that a reflecting element is placed inside the cavity and the boundary conditions for electromagnetic field on this element are undertaken, a model has been developed of a single-mode (four-frequency) ring gas laser with arbitrary anisotropy of the cavity [1]. In the case of linearly polarized laser eigenstates all experimentally observed regimes [2] have been revealed.

In the present work the influence of the ellipticity of emitted waves on the dynamical behavior of such a laser is investigated. The diagram of attractors was calculated on the plane of the amplitude of the backscattering coefficient and frequency detuning. A series of polarization-phase dynamical effects has been found: antiphase spontaneous pulsations of intensities of four running elliptically polarized waves, continuous change of instantaneous phase difference between counterrunning waves on π at transition from negative to positive tunings and reversal of maxima and minima values of nonstationary intensity while mean value of the phase difference remains unaltered, as well as jumps of mean phase difference on 2π at nonzero tunings. Analogous phase behavior at nonstationary operation has been revealed in class-B scalar-field CO₂ laser [3].

1. L.P. Svirina, Quantum and Semiclassical Optics, JEOS, part B, 10 (1998) 213.
2. V.M. Yasinskii, Proc. SPIE, 2792 (1995) 166.
3. C.L. Pando, G.A. Luna Acosta, Opt. Commun, 114(1995) 509.

ASYMMETRIC TRANSMISSION OF ONE-DIMENSIONAL BANDGAP STRUCTURES WITH DEFECT; OPTICAL DIODE

Andrey G. Smirnov
Institute of Physics of NASB,
70 F. Scaryna Ave., 220072, Minsk, Belarus,
E-mail: andr@dragon.bas-net.by

New model of ultracompact optical diode operating at self-induced transparency^{1,2} soliton regime is presented. Soliton formation consists of two stages, when, firstly, powerful light pulse burns itself out from the stop band and, secondly, it moves in transparency regime under influencing of group velocity dispersion of the grating and nonlinear self-phase modulation³. On the basis of numerical simulation it is proved that nonlinear PBG structure with a defect layer exhibits an anisotropic transmission properties, i.e. operates as optical diode. The insertion of a defect with proper optical thickness matched to a radiation wavelength allows to localize light energy within the defect area and increase the amplitude of electric field (Fig.1a). Thereby the excitation of solitons occurs at lower intensity of light pulse. In the case of asymmetric positioning of a defect bandgap structure exhibits strong left-to-right/right-to-left anisotropy for certain interval of light intensity (Fig.1 b,c).

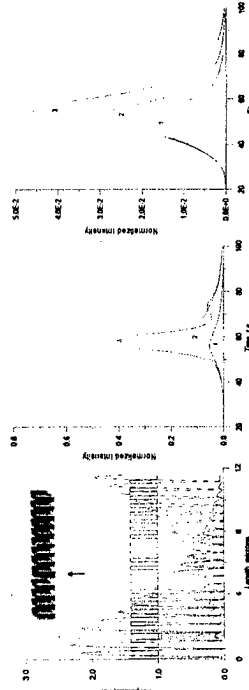

Fig 1. Amplitude spatial distribution in PBG structure (a) and transmitted pulse envelopes for different input intensities; pulse comes either to the right (b) or to the left (c).

1. Aceves A.B., Wabnitz S. // *Physics Letters A* - Vol. 141, p.37 (1989).
2. Conti C., Assanto G. // *Opt. Lett.* - Vol. 22, p.1350 (1997).
3. Koroteev N.I., Magnitskii S.A., e.a. // *Opt. Commun.* - Vol. 159, p. 191 (1999).

SPONTANEOUS SWITCHING BETWEEN SPLAY STATES IN ANTI-PHASE DYNAMICS OF A MULTIMODE LASER

E.V.Grigoireva
Department of physics, Belarus State University, 4 Skoryna av., 220050 Minsk,
BELARUS, agrig@nsys.by

We analyze dynamics of N longitudinal modes in a solid-state laser with intracavity second harmonic generation. The system is known to produce antiphase oscillations which may be unstable through the quasiperiodic bifurcation leading finally to chaotic itinerancy [1,2]. Far away threshold, i.e. for relatively high pumping rate and cross-saturation, chaotic switching is observed between splay states when all modes oscillate with the same waveform but each mode has its phase shifted by $2\pi N$ from the previous mode. These splay states are interrupted by intervals where modes oscillate still out of phase but with different waveforms and periods.

We derive asymptotically Poincare maps and follow for bifurcations of periodic solutions. Conditions of a global stability of antiphase oscillations are analytically proved. For $N \geq 3$ the maps predict the phase space to be divided into the basins in which different kind of periodic solutions can exist. The corresponding fixed points appear to be unstable due to the tangent bifurcation. As far as any phase trajectory reaches one of the separating surfaces the switching occurs to another attractor. In this way the discrete maps determine alternation (or itinerancy) between ruins of former periodic attractors. The obtained scenario of instability is similar but not equivalent to the "attractor crowding" in circuits containing N coupled Josephson junctions [3]. The last one implies noise-induced switching between basins of $(N - 1)$ coexisting splay states while our approach elucidates dynamical nature of switching between antiphase solutions of different types.

1. K. Wiesenfeld, P.Hadley. *Phys.Rev.Lett.* 62 (1989) 1335
2. A.G.Vladimirov, E.A.Victorov, P.Mandel. *Phys.Rev.E* 60 (1999) 1616
3. K. Wiesenfeld, C.Brackikowski, G.James, R.Roy. *Phys.Rev.Lett.* 65 (1990) 1749.

ASYMMETRICAL SOLITONS UPON INTRACAVITY FOUR-WAVE MIXING

O.G. Romanov, A.S. Rubanov, A.L. Tolstik

Department of Laser Physics and Spectroscopy, Belarusian State University
4, Fr. Skaryna av., 220050 Minsk, Belarus

Localized transversal structures in nonlinear interferometers are presently popular subjects of investigation considering their much promising applicability in pure optical elements for the conversion of laser beams.

In this work the scheme of intracavity four-wave mixing has been considered. The stability of the light beam transversal structure has been studied in conditions of symmetry breaking bifurcation development. It has been demonstrated that in case of overlapping regions, where the modes of symmetrical and asymmetrical optical bistability are realized, one should expect the presence of soliton modes with symmetry breaking of the transversal structure of light beams and (or) their integral intensity. To illustrate a localized structure, Fig. 1a presents coupled states of two solitons, which are mirror symmetric relative to the axis $x = 0$, derived by numerical modeling of a system of wave equations and conforming to a symmetrical solution. When a control optical pulse approaches one of the beams, the structure of asymmetrical coupled solitons is shifted in the transversal direction of the modulated light beam (Fig. 1b, c).

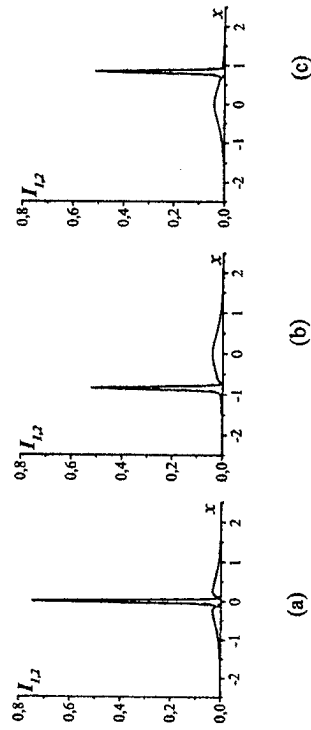

Fig. 1 Coupled states of asymmetrical solitons

SHORT PULSE LSB:Nd³⁺ MICROCHIP LASER

Danailov M.,

ISTP Laser Lab., 34100 Trieste, Italy. Fax: +39-40/2240-443

e-mail: danailov@istp.trieste.it

Demidovich A.A.

Inst. of Molec. & Atom. Physics, F. Skaryna Ave. 70, 220072 Minsk, Belarus

Fax: +375-17/2393-064, e-mail: demidovich@imaph.bas-net.by

Kuzmin A.N., Batay L.E.

Stepanov Inst. of Physics, F. Skaryna Ave. 70, 220072 Minsk, Belarus

Fax: +375-17/2840-879, e-mail: kuzmin@dragon.bas-net.by, batay@dragon.bas-net.by

Passive Q-switched microchip lasers are very attractive as simple and compact sources of high peak power subnanosecond pulse emission. In our paper we present the results on investigation of the relatively new laser medium LSB:Nd which is perspective for applications in diode pumped solid state lasers. The growth technology of this crystal allows to obtain active elements with low optical losses (less than $0,003 \text{ cm}^{-1}$) and Nd^{3+} concentration up to 30% [1]. This crystal is known as very efficient medium for CW microchip lasers with high slope efficiency (~60%) [2], and the intracavity frequency doubled LSB:Nd / KTP microchip laser is one of the most efficient laser in this class of devices [3]. We have investigated in detail the output characteristics of Nd:LSB/Cr:YAG microchip laser depending on the active element, passive Q-switch and cavity parameters under laser diode pumping with the power less than 1 W. Pulse duration about 500 ps and peak power about 5 kW have been achieved.

1. B. Chai, K. Petermann, G. Huber, CLEO/Europe'96 Technical Digest, 1996, Hamburg, CTuG3, p.76.
2. J.-P. Meyn and G. Huber, Opt. Lett., 19, 1436-1438, (1994)
3. V.G. Ostroumov, F.Heine, S. Kueck, G. Huber, Appl.Phys. B 64, 301-305, (1997).

REGIME OF GENERATION OF CLASS-B LASER
WITH NONLINEAR BRAGG REFLECTOR

E.G.Tolkacheva, A.A.Afanas'ev

Institute of Physics, Academy of Science of Belarus
70, F.Skaryna ave., 220072, Minsk, Belarus
email: leng@dragon.bas-net.by

In the report, we present results of numerical simulation of quasi-stationary generation regime of laser with nonlinear Bragg reflector (NBR) as a one of resonator mirrors. NBR is a layer of a Kerr nonlinearity medium with the refractive index periodically modulated along the propagation direction. Besides the ability for the filtration of certain frequency radiation, the NBR possess an interesting behavior such as the optical bistability, pulse compression, formation of solitons, self-pulsation of radiation etc. In [1] a stationary generation theory of laser with NBR as a one of resonator mirrors have been developed and it was shown that the laser radiation can exhibit the multistable dependence on a pump rate value.

The influence of the Bragg reflector nonlinearity on the nature of B-class laser radiation is illustrated in Fig., where the laser output intensity I_{out} is plotted versus the normalized pump rate $H(t)=H$, at $t \geq 0$. To compare, we plot also the curves $I_{out}(H)$ corresponding to the cases of an ordinary mirror and a linear Bragg reflector ($n_2=0$) instead of the NBR. The reflectivity of the ordinary mirror and linear Bragg reflector coincides with the reflectivity of NBR at $n_2 \rightarrow 0$. In Fig., for each H , one value of the output intensity I_{out} corresponds to the regular damped oscillations and two values - to the regular undamped oscillations correspondingly. It is shown that the temporal dynamic of generation of class-B laser with NBR substantially depends on the magnitude and sign of the Bragg detuning and is basically defined by the bistable dependence of the NBR reflectivity versus the input radiation intensity due to the space-temporal shifting of the NBR forbidden band.

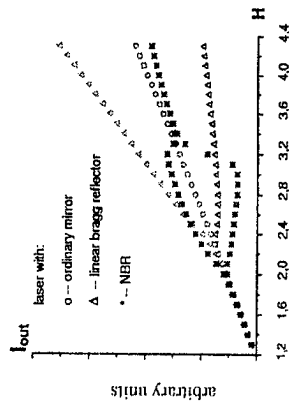

Fig. Output laser radiation intensity versus normalized pump rate.

1. A.A.Afanas'ev, E.G.Tolkacheva, IEEE J. of QE, v.32, p.1740,1996.

TRANSIENT EFFECTS AT DIPOLE-DIPOLE INTERACTIONS IN DENSE

MEDIUM

A.A.Afanas'ev (Ph NASB, Minsk 220072, Belarus), M.V. Voitkova (IMAPh NASB,

Minsk 220072, Belarus), voitkova@imaph.bas-net.by

Dipole-dipole interaction (local field effect), having place in dense resonant medium, is a reason of internal optical bistability (IOP). IOB effect is exhibited in the Z-shape form of dependence of level population difference of resonant atoms from radiation intensity. In work on the basis of modified Bloch equations the transient effects were investigated in a field of the rectangular and sine waveform impulse in dense resonant atoms medium. It is shown, that the increase of intensity above certain value results to sharp reduction of population difference $n(t)$. Thus $n(t)$ during time of several value T_1 (longitudinal relaxation time), approaches to steady state determined by the stationary decision of the modified equations. For a impulse of the sine waveform the hysteresis character of dependence $n(t)$ from intensity I takes place, which is observed at performance of threshold value conditions for a constant of dipole-dipole interaction $b > 4$ and under condition that frequency of radiation is inside of an interval formed by resonant frequency ω_0 and frequency adjusted for a local field. Special case for dense resonant medium is a ratio $T_2 \ll T_1$ (the longitudinal and cross relaxation time) allows to divide dynamics for n (slow process) and dynamics for P (fast process), and to reduce system to one differential equation for $n(t)$, which can be solved analytically. As a special case ap-conversion processes were taken into account. This process raises a level of intensity necessary for occurrence of IOB effect. In a case of "instant" inclusion of intensity of radiation the influence of processes of ap-conversion is reduced to increase the time of "switching" of system from a low excitation branch on high excitation branch. Thus, it was shown, that the population difference n during time about several times of longitudinal relaxation for a impulse of the rectangular form reaches stationary value at any value of managing parameters. In case of a adiabatic slow impulse and the value of constant dipole-dipole interaction $b > 4$ in the certain area frequency detuning in ensemble of atoms of large density arises effect IOB - hysteresis character of dependence $n(t)$.

POLARIZATION MULTISTABILITY AND SYMMETRY BREAKING IN LASERS: THE EFFECT OF THE POPULATION DYNAMICS.

Yu. V. Loiko, A. M. Kul'minskii, and A. P. Voitovich

Institute of Molecular and Atomic Physics, National Academy of Sciences of Belarus
Skarina Avenue 70, 220072 Minsk, Belarus

If the electric field polarization is not fixed entirely, there are additional (vector) degrees of freedom in lasers, which lead to a new problem of polarization symmetries and their breaking. We call symmetric (asymmetric) state if under the transformations of polarization symmetry group (PSG) it is translated into itself (complementary state).

Vector lasers of class-B // can exhibit complicated dynamics including periodic and chaotic. The PSG of such lasers consists of 4 elements if the cavity is amplitude anisotropic in the Cartesian basis. This implies that in such lasers, unlike class-A // lasers, up to 4 asymmetric periodic states (PSa) with different polarization can appear. Indeed, we have found that in a certain domain of the control parameters there is multistability among 4 PSa states. Changing the control parameters across the boundary of this domain each of the PSa states can be excited equally likely, that manifests perfect polarization symmetry breaking phenomenon. Presence of the phase anisotropy in the Cartesian basis reduces the order of the PSG by a factor of two. For this case the 4 PSa states can be arranged into two pairs. Under the PSG transformations a state of each pair is translated only into the complementary state of the same pair. Stability domains of the states of each pair are overlapped giving multistability among the 4 PSa states. We report on two hysteresis loops with switching between the states of different pairs. Varying the control parameters the switching remains unpredictable in the sense which of the two states in a pair will be excited. This is the case of imperfect polarization symmetry breaking.

Thus, reducing the laser symmetry leads to more predictable behavior of the laser emission. These phenomena can be used for improvement of such class-B lasers, as for instance, commercially available vertical cavity surface emitting and Nd-YAG lasers.

//, C.O. Weiss and R. Vilaseca, *Dynamics of Lasers*, VCH, Weinheim, 1991. P.14.

MODAL THEORY AND OUTPUT PATTERNS OF STOKES RADIATION IN SRS - GENERATION AT PUMP WITH BESSEL LIGHT BEAMS

V.N.Belyi, N.A.Khilo, B.B.Sevruk, V.A.Orlovich, A.S.Grabitnikov, R.V.Chulkov

B.I. Stepanov Institute of Physics of National Academy of Sciences of Belarus,
F. Skaryna Ave. 68, 220072 Minsk, Belarus, e-mail: nkhilo@optoinform.bas-net.by

The stimulated Raman scattering (SRS) theory for pump Bessel beams based on the concept of Bessel modes has been developed. The essence of the theory is the representation of the Stokes radiation field as a superposition of partial Bessel beams. These beams are the modes of a cylindrical waveguide with radius R_B formed by a pump Bessel beam. It is found out that the transverse phase-matching conditions select from all possible SRS channels two groups of the Stokes radiation modes located in the vicinity of the maxima of the overlapping integral. The calculated spatial-angle structure of Stokes radiation for SRS in hydrogen is in a good agreement with the obtained experimental results. The expression $P_{th} = 25/(G\chi_R)$ for the threshold power of SRS conversion to a Bessel Stokes beam has been derived. The threshold power is inversely proportional to the value $G = gZ_d$ which is equal to the product of the overlap integral g and the Bessel beam diffraction length $Z_d = R_B k/q_p$. For Raman gain coefficient in hydrogen $\chi_R = 2.5 \text{ cm/GW}$ and the calculated $G = 0.9 \cdot 10^4 \text{ cm}^{-1}$, this formula yields $P_{th} = 10.9 \cdot 10^5 \text{ W}$, which is close to the experimental value of $11 \cdot 10^5 \text{ W}$. It is shown that in the case of large number of rings in the pump beam ($N > 100$) Stokes radiation is a Gaussian-like axial beam. Otherwise, if the pump beam contains only few rings ($N < 5$), Stokes radiation is the conical beam. The transverse spatial structure of a diffraction-limited axial Stokes beam has been studied in detail. The intensity distribution $I_s(\rho)$ of Stokes radiation at the output face of the active medium is found to possess an interference structure with a strongly pronounced central maximum and few weak additional maxima. Thus, upon generation of the axial Stokes beam by partial Bessel beams, the interference spatial redistribution of the Stokes radiation intensity takes place. In particular, mainly destructive interference is realized in the periphery zone, with the constructive interference taking place at the beam center.

SELF-OSCILLATION REGIMES IN THE RING CO₂ LASER
WITH NON-PLANAR RESONATOR

V.M. YASINSKII

Institute of physics of the National Academy of Sciences of Belarus,
68, F. Skaryna Ave., Minsk, 220072, Belarus
Tel: 284-14-20, Fax: 284-08-79, E-mail: yasin@dragon.bas-net.by

A ring laser with a non-planar resonator allows one to investigate the dynamics of oscillation of four waves with elliptic polarizations.

The original scheme of a non-planar resonator was experimentally implemented, which allowed us use an isotropic gas-discharge tube scaled on the one hand by clarified window and on the other hand by an opaque spherical mirror ($R=1,2$ m). The resonator represented a strongly prolate scalene rhomb broken along the short diagonal so that the corner between planes was ~ 5 degrees, and the vertex angle of the more prolate triangle was $\sim 0,5$ degree. At the vertex of the more prolate triangle the spherical mirror of the gas-discharge tube was placed. Thus, the counterpropagating waves spreading inside the gas-discharge tube with an inner diameter of the discharge channel of 8 mm, impinged on the interior mirror at an angle of $\sim 0,25$ degrees. At the remaining vertexes of the rhomb the flat mirrors were placed. One of these mirrors was attached to a piezoelement. The perimeter of the resonator was 194 sm. The frequency split of the unidirectional waves with orthogonal elliptic polarizations was $\sim 4,3$ MHz.

It was established, that, depending on the parameters of the backscattering, in the radiation there occur two counterpropagating waves with coincident frequencies or all the four waves. In the case of a four-frequency operation a self-oscillation of the intensities of all four waves takes place, as a rule. It is caused by the nonlinear interaction of waves and their coupling due to the backscattering. The similar regime of self-oscillations of intensities was earlier observed in a single-isotope He-Ne ring laser working in a four-frequency operation on waves with circular polarizations [1].

1. Yasinskii V.M. Kvantovaya Elektron. (Moscow) **23**(12) 1086-1090 (1996) (Quantum Electronics **26**(12) 1056-1060 (1996))

SPATIO-TEMPORAL DYNAMICS OF TAPERED SEMICONDUCTOR
DFB LASER INCORPORATING A CURVED-GRATING

V.M. Volkov¹, J.Sarma², S.I. Turovets³ and F.Causa²

¹Institute of Mathematics, National Academy of Sciences of Belarus,
11 Surganov St. 220072 Minsk, Belarus

²Department of Electronic and Electrical Engineering University of Bath,
Bath BA2 7AY, UK

³Siros Technologies Inc. 101 Daggest Drive, San Jose, CA 95134, USA

Tapered geometry semiconductor lasers attract attention as coherent optical sources which achieve high output power in the single mode and single frequency regime. One of the recognised methods for controlling the spatio-temporal output characteristics is to utilize curved gratings, [1], in the DBR or DFB configurations. It is clear that the spatio-temporal optical-field dynamics in such a DFB structure will be non-trivial because of the refractive index dependence on the carrier density. In this paper a basic model of a tapered semiconductor DFB laser incorporating non-uniform curved gratings, [1], is considered. The device is analysed on the basis of the following set of equations for the (optical) electric fields of the forward and backward travelling waves, E_{\pm} , and the carrier density, N :

$$\pm \frac{1}{r} \frac{\partial}{\partial r} (r E_{\pm}) + \frac{\partial^2 E_{\pm}}{\partial \varphi^2} = i \tau^2 \frac{\partial^2 E_{\pm}}{\partial \varphi^2} + i \kappa(r) E_{\mp} \exp\{\pm i \Delta(\tau)r\} + g[(N-1) - i \alpha N] E_{\pm}, \quad (1)$$

$$\frac{\partial N}{\partial t} = \frac{D_N}{r^2} \frac{\partial^2 N}{\partial \varphi^2} - \frac{N}{\tau} + I(\varphi) - p(N-1)(|E_{+}|^2 + |E_{-}|^2). \quad (2)$$

Equations (1) and (2) are written for the dimensionless variables in polar coordinates, τ, φ , ($R_0 < r < R_1$, $-\varphi_0 < \varphi < \varphi_0$), since that is the most suitable co-ordinate system for describing a linearly tapered geometry structure.

Numerical experiments show that with $\kappa(r) = \text{const}$ and $\Delta = \text{const}$, a two-frequency regime is typical for the system of equations, (1),(2), near lasing threshold since this model does not take into account gain dispersion. When $\kappa(r)$ has minimal (close to zero) values in the middle of the gain section ($\kappa(r \simeq R_0) = \kappa(r \simeq R_1) > \kappa(r \simeq (R_1 + R_0)/2)$), single-mode, single frequency regimes dominate for a wide range of values for the parameters, up to several times the lasing threshold. As a rule, temporal instability of the single frequency regime is accompanied by lateral instability. It should be noted that when $R_1 > R_0$ the output power at the wide end ($r = R_1$) is less than that at the narrow end ($r = R_0$). For some values of the parameters the system of equations, (1),(2) exhibits bistability of the single-frequency regimes; further, there is the possibility of temporal switching under pulse or continuous optical injection with switching times in the range τ .

[1] G.S.Sokolovskii, E.U.Rafailov, D.J.L.Birkin, W.Sibbett. "High power Laser structures incorporating novel curved-grating". Optical and Quantum Electronics **31**, 215(1999).

THEORY OF PLANE WAVE DIFFRACTION IN FABRY-PEROT INTERFEROMETERS WITH BUILT-IN THIN AND THICK GRATINGS

A.V.Kazberuk, G.V.SinitSyn

Division for Optical Problems in Information Technologies, NAS of Belarus
Kuprevitch str., 1, build 2, 220141, Minsk, Republic of Belarus

Nonlinear and bistable Fabry-Perot interferometers gain extra opportunities of light flows control while forming of a phase diffraction grating in an intermediate layer of interferometers. For a light information signal, directed on a grating, superimposed against each other angular conditions of maximums of diffraction and interference can result in an essential asymmetry and a redistribution of the intensity of diffracted beams.

In the report the theoretical model of a diffraction of plane waves on an extended Fabry-Perot interferometer with a built-in phase sinusoidal diffraction grating is proposed. The theory is constructed on the basis of Maxwell equations in approach of non-absorptive mediums. The wave equation for the modulated intermediate layer is sought in the form of the Mathieu differential equation with the subsequent searching of eigenvalues and eigenvectors and numerical solution of a formed boundary problem. This model enables to calculate distribution of transmitted and reflected light fields for modulated interference system of arbitrary thickness without resorting to essential restricting assumptions.

The examples of calculation of distribution of light fields of the interferometers are given while taking into account all the possible orders of diffraction in transmission and reflection. The requirements at which waves of the high orders can considerably predominate above waves of lower orders are found. The possibility to redirect the essential part of power of an information signal from one order of diffraction to another by only changing the intensity of beams, forming a grating, is exhibited.

This work is supported by the International Science and Technology Center (grant B-129).

Dynamics and Stability of Long-Wavelength Quantum-Well Lasers with Phase-Conjugate Feedback

S.V. Voitkov and V.P.Gribkovskii

Institute of Physics, NASB, pr. F.Skorina 68, Minsk, Belarus, tel.:+375-17 2 840435

Investigation of dynamics and stability of long-wavelength quantum-well (QW) lasers with carrier transport effects subjected to a phase-conjugate (PC) mirror has been developed. Unremovable in QW lasers carrier transport affects significantly both cw and dynamic laser performance. Laser stability has been studied by the analysis of the laser rate equations describing optical field behavior and carrier transport including diffusion is separate confinement heterostructures and both capture and escape in QWs. In Fig.1 the stability-instability boundary of a laser with PC feedback is presented. In Fig.1a the curve 1 corresponds to the physically grounded description of carrier capture, escape, and diffusion, whereas the curve 2 corresponds to the case when carrier escape and diffusion are neglected. In Fig.1b the stability regions of a laser near and above the threshold are shown.

In conclusion, carrier transport in long-wavelength QW lasers with a phase-conjugate feedback narrows drastically the stability region in ≈ 1.5 to ≈ 2.5 times and increases the unstable-output oscillation frequency in ≈ 2 to ≈ 3 times.

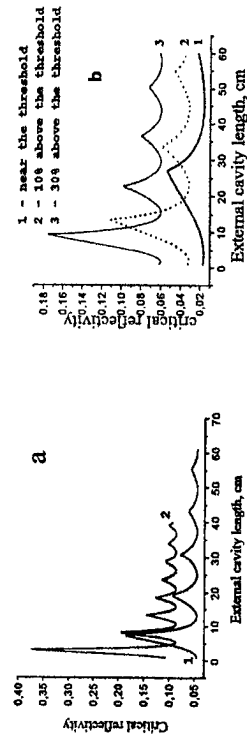

Fig.1 Critical reflectivity at the stability boundary vs the external cavity length

The work was supported by Belorussian Foundation for Basic Research, gr. F98-318

TRANSVERSE MODE DISCRIMINATION FROM A NON-APERTURED FABRY-PÉROT INTERFEROMETER

K. Aït Ameur

Centre Interdisciplinaire de Recherche Ions Lasers
ISMRA, 6 Bd. Maréchal Juin, F14050 Caen, FRANCE.

E-mail : aitameur@spalp255.ismra.fr

The coupling of an external cavity to a laser induces effects that are generally modeled in the framework of plane waves. This is probably correct for describing the resulting longitudinal mode selection, loss level variations and some temporal dynamics. However, the understanding of transverse effects due to the feedback needs an analysis that takes into account the beam nature of the problem. We consider, using a power ratio, the reflectivities R_{00} and R_{01} of a Fabry-Pérot Interferometer (FPI) when the incident beam is a TEM_{00} or a TEM_{01} beam having incoherent multi-frequency components which number is N in a Free Spectral Range $c/2d$ of the FPI. The latter, with equal mirror reflectivities $R=0.3$, has a length $d=4mm$. The input beam is characterized by the Rayleigh distance $Z_R = \pi W_0^2 / \lambda$, where W_0 is the beam-waist radius. The graphs in figure 1 show that the FPI acts like an apertured mirror since R_{00} can be greater than R_{01} , depending on the value of Z_R / d . For different values of N , figure 2 shows the behavior of the discrimination ratio R_{00} / R_{01} which is different from the single-frequency case [1,2].

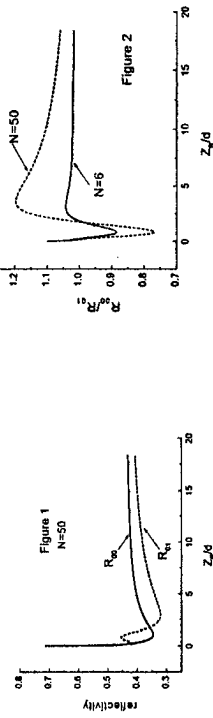

[1] K. Aït Ameur, *Reflection and transmission of the first two Laguerre-Gauss modes incident on a Fabry-Pérot interferometer*, J. Modern Opt., 43,99-104,(1996).

[2] K. Aït Ameur, *Transverse properties of a Michelson mirror*, Appl. Opt., 36,1860-1866, (1997).

CIRCULAR AND ELLIPTIC BEAM SHAPING USING SIMPLE DIFFRACTIVE OPTICS

M.Fromager and K. Aït Ameur

CIRIL/ISMRA, 6 Bd Maréchal Juin, F14050 Caen, France

E-mail : aitameur@spalp255.ismra.fr

Most of lasers have a fundamental mode that is Gaussian in shape. Although many applications benefit from such a profile, many other applications need a different shape. In this paper we describe the conversion of a Gaussian beam into another profile using a simple diffraction optics known as π -circular phase aperture that introduces a π phaseshift in its central portion of radius b . Figure 1 shows that the far-field pattern is made up of a doughnut profile having a central depression whose depth can be continuously adjusted by varying parameter $\Delta = b/W$, where W is the incident beam width. This property may be useful for optical trapping of small particles which are caged by a central dip or for cooling and trapping of atoms. Another property of the π -plate is shown in figure 2 where θ_{out} (θ_m) is the angular divergence of the diffracted field (incident Gaussian beam). This property is used to transform an elliptic beam, as emitted by a laser diode, into a circular beam thanks a π -phase slit, oriented along the minor axis that is assumed to be vertical, which spreads out more in the horizontal direction than in the vertical direction.

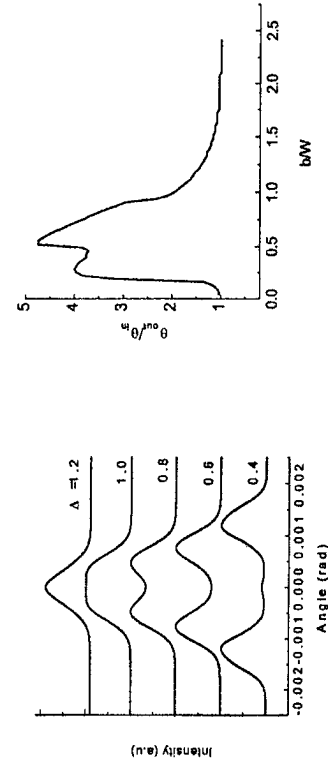

Figure 1

Figure 2

SELF-Q-SWITCHING BEHAVIOUR OF A Cr^{3+} :LiSAF LASER

M. Fromager and K. Ait Ameur
 CIRIL/ISMRA, 6 Bd Maréchal Juin, F14050 Caen, France
 E-mail : aitameur@spalp255.ismra.fr

We consider the behaviour of a Cr^{3+} :LiSAF laser pumped by a flash with an output made up of one spike only. We demonstrate that a mechanism of intensity-dependent losses can be created by the combination of a hard aperture and a nonlinear time-dependent lensing effect originating from the direct coupling of the average lattice strains to the excited ions. Indeed, Cr^{3+} ions slightly change their coupling to the crystal field with changes in energy state and produce a variation in the refractive index which is found proportional to the inverted population [1]. It results a lensing effect which is time-dependent. It results that the geometrical characteristics of the laser beam also change and consequently the loss level becomes a function of time when a limiting aperture is present in the laser [2]. The overall results is a loss avalanche as in the case of a saturable absorber. Figure 1 and 2 shows the characteristics of the output pulse with (solid line) and without (dotted line) the nonlinear lensing effect. One can conclude that more the aperture is closed more the laser is well Q-switched. The results of our modeling are in agreement with experimental observations.

Figure 1

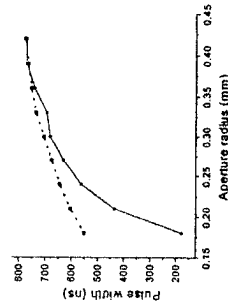
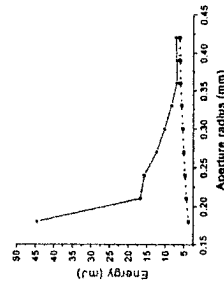

Figure 2



[1] K. Ait Ameur, T. Kerdja and D. Louhibi, *J. Phys. D*, **15**, 1667-1672, (1982).
 [2] K. Ait Ameur, *Appl. Opt.*, **36**, 7809-7817, (1997).

Usage of fractional Talbot effect for multi-core fiber laser phase locking

Dmitry V. Vysotsky, Anatolii P. Napartovich,
 Troitsk Institute for Innovation and Fusion Researches (TRINITI), Troitsk, Moscow region, 142190, Russia, tel.: 7+095+ 334-04-50,
 Marc Wraque, Peter Glas

Max-Born-Institut für Nichtlineare Optik und Ultrakurzzeitpektroskopie, Max-Born Strasse 2a, D-12489, Berlin, Germany

Periodical field distribution is reproducing after propagation through the Talbot distances $Z_T = 2\lambda^2/\Lambda$, Λ is the field distribution period, λ is the radiation wavelength. Earlier it was obtained numerically that the field distribution reproduces with multiplying N times after propagation through N -th part of half of Talbot distances. We obtain analytically field distributions for distances $Z_T/4j$, $Z_T/2(2j+1)$, jZ_T ($j=1,2,\dots$), if the delta-function infinite lattice: $\delta(x - m\Lambda)$ is considered as the initial condition. The field distribution multiplies 4 times after propagation through $Z_T/8$ two images on the period shifted on $\pi/4$ from third image. The fourth image being used to feed back, strong intermodal discrimination and radiation axis brightness of laser array can be achieved. Multi core fiber laser, which we used, contains 18 doped monomode fibers confined within a common multimode pump core. Placing 18-sector mirror at a distance $Z_T/8$ from multi core fiber laser outlet high quality output radiation was obtained.

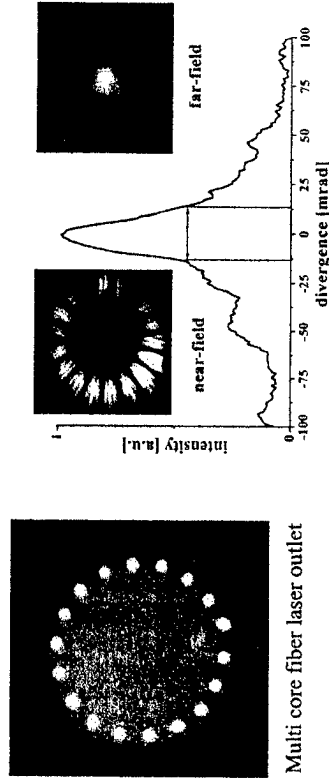

Multi core fiber laser outlet

DYNAMIC NONLINEAR ANALYSIS OF STOCHASTIC INTERFERENCE FIELDS

Igor Gurov and Alexey Zakharov

Institute of Fine Mechanics and Optics (Technical University)
14, Sablinskaya st., Saint-Petersburg, 197101 Russia

In modern interferometry technique the Fourier transform method with analytical signal recovery and phase shifting methodology are widely used. In both approaches whole determinate data series is required before phase calculation. Such methods are not applicable directly for stochastic interference fields analysis and not convenient for real-time measurement.

We propose to use recurrence interferometric data processing procedure. If it is known the interference field model one can predict the signal value from a previous step of data samples to a next step. The difference of predicted and measured signal values is used for dynamic signal parameters correction. Such a procedure is stable with application to determinate interferometric data. The observation noise influence can destroy the results stability. Following the recently proposed and investigated methodology [1] we have used the dynamic stochastic data analysis by the recurrence nonlinear Kalman filter for 2-D fringe frequency and phase recovery.

We have investigated the permissible range of initial conditions error with correspondence to variable fringe parameters. Then we verified the noise-immunity of nonlinear 2-D stochastic frequency and phase Kalman filtering with a variable noise level by computer simulations. The dependencies of the frequency and phase estimates stability and accuracy on *a priori* information about stochastic field model and initial conditions were found. Developed recurrence processing procedure was practically used for real 2-D stochastic interferogram analysis. Accuracy and noise-immunity of recurrence data processing was verified.

References

1. I. Gurov, D. Sheyniovich, "Interferometric data analysis based on Markov non-linear filtering methodology", *J. Opt. Soc. Amer. A*, vol.17, No.1, pp.21-27 (2000).

TRANSVERSE QUASI-PERIODIC STRUCTURE OF OPTICAL FIELDS IN A WIDE-APERTURE LASER WITH FREQUENCY DETUNING

A. A. Kurguzkin, N. E. Molevich, A. P. Zaikin*

Samara State Aerospace University, 443086, Samara, Moscow str., 34

* Samara branch of P. N. Lebedev Physical Institute,
443011, Samara, Novo-Sadovaja st. 221

It is shown in [1] that stability characteristics of the trivial (nonlasing) state of wide area laser system strongly depends on the sign of the frequency detuning Δ . In this paper we present the results of analytical and numerical investigations of detuning wide aperture laser stability beyond the laser threshold. The basic equations governing the dynamical behavior of the laser, under the slowly varying envelope and paraxial approximations, were the Maxwell-Bloch equations.

1. It is shown that at $\Delta < 0$ the instability of homogeneous stationary lasing state is possible to plane-wave state due to Andronov-Hopf bifurcation. We was found the expressions for bifurcation values of speed, the wave length, frequency and linear wave increment. We showed also the loss of autowave solution regularity by period doubling at decrease of the wave speed.

2. It is investigated directly (without automodel approach) the process of the forming of spatiotemporal structure of optical field $E(x, z, t)$ in a Fabry-Perot cavity with an inertial active medium. It is obtained that at negative Δ the homogeneous laser field takes turns with increase $|\Delta|$ to periodic traveling intensity transverse profile (fig. 1, 2). Its wave characteristics are in a good correspondence with characteristics obtained by automodel analysis. The further increase of $|\Delta|$ leads to irregular spatiotemporal structure of optical fields. The steady-state transverse optical field structure is found in a strong dependence on factor G , which is proportional to the linear increment and square root from Fresnel number.

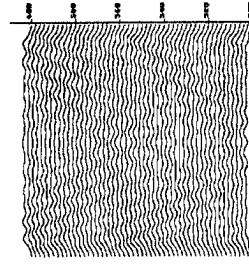

$\Delta = -0.6$
fig. 1

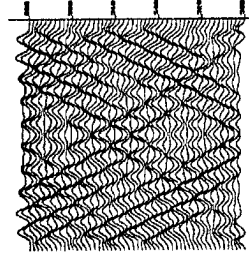

$\Delta = -0.7$
fig. 2

- [1] P. K. Jacobsen, J. V. Moloney, A. C. Newell et al. Space-time dynamics of wide-gain-section laser//Phys.Rev. A. 1992 V.45 P.8129.

Chaos and synchronization of the counterpropagating waves in a solid-state ring laser with periodic pump modulation

S.N. Chekina, N.V. Kravtsov, E.G. Lariontsev, A.A. Makarov, S.S. Sidorov
Nuclear Physics Institute, Moscow State University
Vorobjevy gory, Moscow, 119899, Russia
E-mail: lar@npi2.phys.msu.ru

L.A. Kotomtseva, N.A. Loiko, A.V. Naumenko, S.G. Rusov
Institute of Physics, NASB, Belarus
Skaryna ave. 70, Minsk, 220072, Belarus.
kotomts@dragon.bas-net.by

The problems of synchronization of chaotic oscillations in counterpropagating waves generated in a solid-state ring laser (SSRL) were considered earlier in [1-3]. In this report, dynamics of a SSRL with periodic pump modulation is studied theoretically and experimentally. We present a detailed study of the role of a phase nonreciprocity of the laser cavity under conditions of a periodic pulsed modulation of counterpropagating waves and of dynamic chaos. By changing a phase nonreciprocity, we observe two groups of the periodic and chaotic lasing regimes of a bidirectional SSRL: the regimes of phase synchronization of the counterpropagating waves and the beat regimes. For both groups of lasing regimes, we investigate the behavior of intensities, phases and spectra of the counterpropagating waves. We show that, for the periodic and chaotic regimes of phase synchronization, the counterpropagating waves have equal mean optical frequencies. For the beat regimes, we study the dependence of the mean beat frequency on the phase nonreciprocity of the cavity.

1. Klimenko D. N., Kravtsov N. V., Lariontsev E. G., Firsov V. V. 1997 *Quantum Electronics* 27, 631
2. Klimenko D. N., Lariontsev E. G. 1998 *Quantum Electronics* 28, 358
3. Lariontsev E. G. 1998 *Optics Express* 2, 198

NONLINEAR DYNAMICS OF SINGULAR WAVE FIELD
AT LASER BEAM PROPAGATION THROUGH
OPTICAL INHOMOGENEITIES

V.P. Akseonov, I.V. Izmailov, B.N. Poizner, O.V. Tikhomirova
Institute of Atmospheric Optics, Russia, 634055, Tomsk, 1 Akademicheskii Ave.
(3832) 258954 / (3822) 259086, avp@iao.ru; tov@iao.ru
Tomsk State University, Russia, 634050, Tomsk, 36 Lenina Ave.
(3832) 415722 / (3822) 415 585, pznr@elefot.tsu.ru; izmi@elefot.tsu.ru

The evolution of Gaussian optical beam distorted by optical inhomogeneities is studied within the framework of a numerical model using the methods of nonlinear dynamics and topology. Investigation of the intensity and phase distributions as well as the phase gradient (Fig. 1) and Umov-Pointing vector in the laser beam cross-section allowed the regularities of birth and development of the wave front dislocations (optical vortices) to be revealed.

The evolutionary processes are accompanied by bifurcations in the corresponding phase space. The birth of vortices happens through the bifurcation "a pair of the steady and unsteady knot - a pair of unsteady focuses". An influence of the singular points of a type "knot" is manifested as (de)focusing of energy streamlines in the beam cross section near the singular points of a type "(un)steady knot". It means that local focusing of light energy is a forerunner of optical vortex birth: some streamlines in the beam having an originally smooth wavefront are focused in the vicinities of the points of a type "steady knot". Further the rise of the conjugate singular points of a type "unsteady focus" (the birth of two pairs of optical vortices) results in that the streamlines have the form of spirals untwisted around these points in its neighborhoods (Fig. 2). When propagating of the beam all singular points, excepting the central point of a type "unsteady knot", go to the beam periphery.

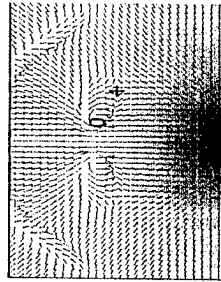

Fig. 1



Fig. 2

It is shown that all modifications in the singular point complete set, including the points of types "saddle", "focus", and "knot", obey the theorem on the algebraic number of singular points.

Obtained results open the possibility to develop new techniques for correction of distortion in the adaptive optics systems.

TIME-DELAYED NONLINEAR OPTICAL SYSTEMS:
TEMPORAL INSTABILITY AND COOPERATIVE CHAOTIC DYNAMICS

S.S. Chesnokov, A.A.Rybak, V.I.Stadnichuk

Department of Physics, M.V. Lomonosov Moscow State University,
Vorob'evy Gory, 119899 Moscow, Russia

chesnok@msu.jic.msu.su, rybak@msu.jic.msu.su

The discussed mathematical model is based on the LCLV (liquid crystal light valve) system with external time-delayed feedback that can be implemented by the use of some rewritable holographic device. We started with the model of diffusely coupled chaotic oscillators and demonstrated the transverse spatial symmetry breaking in the system and appearance of spatiotemporal chaotic states. Taking into the consideration the diffraction in the feedback loop and proceeding with statistical analysis we studied the cooperative influence of local temporal instability and diffractive coupling on the chaotic system dynamics in the wide range of control parameters. The studies of statistical properties of these regimes were carried out both in instantaneous response approximation and by taking into account the relaxation in the system. We found two main regimes with different types of averaged spatial spectra: monotonically decreasing as a function of spatial frequency and circle-type one. We have shown that these types of spectra correspond to different relative influence of both mentioned phenomena into system dynamics. We also obtained a map of these two regimes in the diffraction-diffraction plane. The appearance of isotropic monotonically decreasing spectra causes us to anticipate that time-delayed optical systems can be used for an artificial optical turbulence generation.

1. F. T. Arecchi, S. Boccaletti, S. Ducci, E. Pampaloni, P. L. Ramazza & S. Residori
Journal of Nonlinear Optical Physics and Materials **9**, 183 (2000)
2. S.S.Chesnokov and A.A.Rybak, *Laser Physics* **10**, 1061 (2000).

ON POSSIBILITY OF SELF INJECTION REALIZATION
IN STRML-LASER WITH CHIRPED USP

Anikeev B. V., Khranov V.N., Zatrudina R.Sh., Rudov V.V., Dronov S.A.

Volgograd State University

2-ya Prodolnaya St., 30, Volgograd, 400062, RUSSIA

Tel.: (8442) 43-35-08, E-mail: khranov@phys.volsu.ru

The ultrashort pulses (USP) of STRML-lasers (with short-term resonant modulation of losses) differ by high energy. The possibilities of their intracavity or extracavity shortening are discussed below. In the first case it is possible to make it directly in the laser, realizing a self injection principle. For USP compressing outside of a laser cavity it is necessary, as is known, to realize a chirp in amplified pulses.

The possibility of realization of the self injection regime in the STRML-lasers has been shown by numerical experiments. The physical experiment is described and the reality of realization in the STRML-laser of such regime of generation is shown. In this case the passive intracavity modulator on the optical characteristics agreed beforehand with the spontaneous noise power in the beginning of a linear generation stage. And the possibility of realization of the self injection in the STRML-laser was confirmed by experiment. For the STRML-laser the monoblock electrooptical double modulator has been designed and investigated.

By the analysis the natural chirp in USP of the STRML-laser was detected. It has confirmed also by numerical calculations using model [1] and by experiments on compressing of the USP of STRML-laser using a diffraction grating. This quality is interlinked to working of the STRML-laser with multiple overflows by pump of a generation threshold and with USP energies about energy of gain saturation in active medium.

The investigation was carried out at financial support of Ministry of education of Russian Federation (grant № E00-3-424).

- [1] Khranov V.N., Zatrudina R.Sh., Anikeev B.V. *Quantum Electronics*, **23** (7), pp.626-629 (1993).

SUPPRESSION OF CHAOS
IN A LASER DIODE WITH THE EXTERNAL OPTICAL FEEDBACK.

V.V. Jakutkin, S.P. Kotova

P.N. Lebedev Physical Institute of Russian Academy of Science, Samara Branch,
221 Novo-Sadovaja St., 443011 Samara, Russia.

The non-selective external optical feedback can considerably aggravate characteristics of the laser diode. Even a small part of light, which returns in the laser, can lead to the chaotic generation evolving. This will be apparent from the increase of the intensity noise and the broadening of the emission line, a so-called "coherence collapse" [1]. A conventional way of fight with the non-selective external optical feedback is the increase of the output mirror reflection or using optical isolators. For this purpose the methods of chaos control [2, 3] can also be applied. In this paper the suppression of chaotic generation by the small perturbation in the laser current is researched. The control signal looks like $P(t) = P(t - \tau)$ [4], where τ is the roundtrip time of light. The experimental data of the intensity noise and the spectrum of the longitudinal laser modes for the free generation (a, b); - chaotic generation (c, d); - suppression of chaos (e, f) is presented.

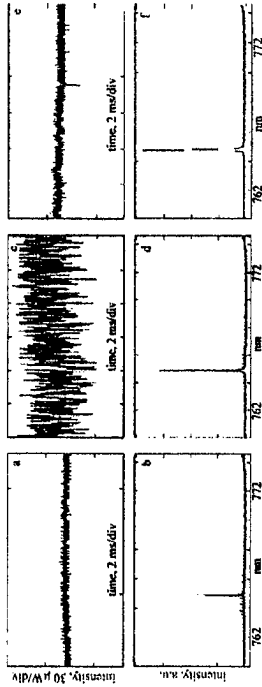

1. H.Li, J.Ye, J.G.McInerney, *IEEE J. of Quantum Electron* 29 (1993) 2421.
2. F.T.Arecchi, S.Boccaletti, M.Ciofini, R.Meucci, C.Grebogi, *Int. J. of Bifurcation and Chaos* 8 (1998) 1643.
3. A.V.Naumenko, N.A.Loiko, S.I.Turovets, P.S.Spencer, K.A.Shore, *Int. J. of Bifurcation and Chaos* 8 (1998) 1791.
4. K.Pyragas, *Phys. Lett. A* 170 (1992) 421.

BROADBAND SEMICONDUCTOR SATURABLE ABSORBER
DISPERSION CONTROLLED MIRRORS FOR MID-IR LASERS

N.D.Goldina, V.I.Trunov, E.V.Pestryakov,

Institute of Laser Physics SB RAS, Novosibirsk, 630090, Russia

At present time were realized an efficient laser generation in the mid-IR (2-3 μm) in Cr²⁺ doped crystals. This laser crystals have ultrabroad spectral gain band (up 1000nm) and are perspective for ultrashort pulse generation. Self-starting Kerr lens mode-locking threshold is increased with the growth of laser wavelength and using of ultrafast saturable absorbers is needed for femtosecond regime in the mid-IR lasers. Semiconductor HgCdTe quantum well structures with femtosecond relaxation times are the most suitable in this case.

In this report we present design of novel integrated structure- semiconductor broadband saturable absorber dispersion controlled mirror (SESADCM), that is created possibilities of independent simultaneously saturated absorption and dispersion control in the femtosecond mid-IR lasers. The novel design of SESADCM based on the multilayer structure like the Gires-Tournois (G-T) interferometer. High reflector consists of the metal mirror with low losses in this spectral range. Top section consists a few layers forming the linear group dependence of group delay vs. wavelength function by using of G-T interferometer resonance effects. The thin HgCdTe quantum well layer with nonlinear absorption can be put into a transparent semiconductor layer near the antinode of the standing-wave electric field. SESADCM maintains spectral broadband high reflection, gives the possibilities to realize a considerable values of group delay dispersion and to optimize relation between second and third order dispersion parameters for extremely short optical pulse generation. This structure has low number of the nonequal thickness layers that is created the high reproducibility way of such type structure experimental realization. SESADCM design for Cr:ZnSe laser is analyzed in detail.

This work was performed in part under the support of the RFBR grants N99-02-17117 and N99-02-39135.

Effect of inhomogeneities on features of solitons in passive driven nonlinear interferometers

G.A. Chizhova,

St.Petersburg Institute for Fine Mechanics and Optics, 14, Sablinskaya ul., 197101 St.Petersburg, Russia.

N.N. Rosanov,

Research Institute for Laser Physics, 12, Birzhevaya liniya, 199034 St.Petersburg, Russia

Dissipative optical solitons (DOSs) in wide-aperture passive nonlinear interferometers driven by a coherent external radiation were predicted theoretically (1988) and found experimentally recently (2000) in semiconductor microcavities. These localized structures have interesting features promising for applications to optical information processing [1]. In the present report we present an analytical study of effect of inhomogeneities of characteristics of holding radiation and the scheme on main features of DOSs.

We consider transversely one-dimensional scheme of driven interferometers with threshold nonlinearity [1]. This model, in the mean-field approximation, allows studying effects of inhomogeneities of different types. For a stationary single DOS, we present and analyze an exact general solution of a master equation for electric field in presence of arbitrary inhomogeneities of holding radiation intensity and phase and cavity losses and optical path length. Distortions of DOS characteristics are found for cases of small- and large-scale perturbations, as compared with the DOS width.

For smooth (large-scale) perturbations, inhomogeneities do not distort essentially DOS characteristics, but induce mainly its motion as a whole with the velocity proportional to gradients of the inhomogeneities, equations of motion of DOS centre being of type of "Aristotelian mechanics" [1]. For threshold type of optical nonlinearity, coefficients in these equations are found analytically. Analysis of resulting equations of motion reveals new possibilities to control position and motion of DOSs important for information processing.

I. N.N. Rosanov. *Optical bistability and hysteresis in distributed nonlinear systems*. Moscow, Nauka, 1997.

AN ADAPTIVE LOOP RESONATOR WITH AUXILIARY MIRROR.

V.B.Tsvetkov, D.A.Nikolaev, G.A.Bufetova, I.A.Shecherbakov,

General Physics Institute, 117942, Vavilov str.,38, Moscow, Russia.

Fax:(7-095)135-11-24, E-mail:tsvetkov@sk.gpi.ru

An adaptive loop resonator is a conventional resonator where an additional phase-conjugate resonator is switched on as lasing builds up. This additional resonator involves a highly efficient phase-conjugate scheme with parametric feedback, which is referred to as the loop scheme.

In our case, an adaptive loop resonator was proposed and experimentally implemented with the use of degenerate four-wave mixing (FWM) in different garnet crystals doped with Cr^{4+} ions. The scheme of the experiment is similar to the scheme employed earlier for the investigation of parameters of classical FWM. The specific features of our experiments can be summarized in the following way. We did not use an optical isolator, which would allow the reverse effect of phase conjugation on the parameters of lasing to be excluded. Our approach was quite the opposite: the reflection coefficient of an auxiliary mirror was small and comparable with the reflectivity of dynamic holographic gratings, which enhanced the influence of the phase-conjugation FWM process on the parameters of lasing.

A Nd :YAlO₃ crystal was employed as an active medium with Cr^{4+} :GSGG crystal with an initial transmission equal to 48% simultaneously serving as an FWM-active nonlinear medium and a passive Q switch. The measurements were performed for the reflection coefficient of the output coupler being in the range $2 \div 18$ %. This output coupler served as auxiliary mirror for the loop resonator when the FWM is switched on. The repetition rate of pump pulses was equal to 5 Hz.

In dependence on the reflection coefficient of the auxiliary mirror the increase of the output energy was observed in 3 – 7 times.

The changes in divergence of the output emission are also observed and discussed.

This research was performed as a part of SFP-974143 and RFBS-00-15-96715.

LASER STABILIZATION BY COMBINATION OF POSITIVE
AND NEGATIVE DELAYED FEEDBACK LOOPS

M. V. Gorbunkov, Yu. V. Shabalin

P. N. Lebedev Physical Institute, RAS, Leninsky pr. 53, Moscow, Russia.

Tel. (095)132-6472, e-mail: gorbunk@lebedev.ru

Single loop negative feedback stabilization mechanism is well known in laser applications [1]. Sufficient drawback is a fundamental instability at high active-media gain due to non-linear dynamics of negative delayed feedback controlled lasers. With pump growing pulsations appear in laser output and finally laser turns to chaotic operation. Stable operation was believed to be in the range $(1 \pm 3)G_0$, where G_0 is a gain corresponding to a lasing threshold [2].

In this paper we report new two- loops feedback stabilization system allowing steady operation of both continuous and pulse lasers in wide range of active media gain and resonator Q. One feedback loop should be negative with a delay less than a round-trip time T_r , another should be positive with a delay greater than a T_r . According to our considerations, this dramatically changes the system dynamics. Following equation describes laser field energy x_{n+1} in the resonator at $(n+1)$ -th pass:

$$x_{n+1} = r \left(1 - \alpha \sum_{m=0}^n x_{n-m} \cdot \gamma_1^m + \sum_{m=0}^n x_{n-m-1} \cdot \gamma_2^m \right) x_n, \text{ where } r \text{ is overall round-trip gain in}$$

the resonator (including all losses), α is a negative to positive feedback loops responsivities ratio, and $\gamma_{1,2}$ are damping coefficients. Stability analysis shows the increase of possible G value up to more than $10G_0$ provided $2 < \alpha < 10$.

In self mode-locking regime at appropriate delays and response times in both feedbacks positive feedback loop causes not only greater stability but also shorter pulse due to sharper loss modulation.

The work was partially supported by RFFBR grants No. 00-02-17060 and 00-02-16419 and "Integration" Federal Program (project AO133).

[1] H. Stutz et al. Journal of Applied Physics, vol. 36, no. 5, 1965, p. 1510.

[2] Bayanov I. M. et al. Quantum Electronics, vol. 16, No. 8, 1989, p.1545.

LOCALIZED STRUCTURES AND CIRCULAR DOMAIN WALLS IN
A VECTORIAL KERR CAVITY

Damià Gomila¹, Pere Colet¹, Gian-Luca Oppo², Graeme Harkness², and
Maxi San Miguel¹

¹Instituto Mediterráneo de Estudios Avanzados, IMEDEA (CSIC-UIB),
Campus Universitat Illes Balears, E-07071 Palma de Mallorca, Spain.

Phone: +34 971 172537, fax: +34 971 173248, e-mail: gomila@imedea.uib.es

²Department of Physics and Applied Physics, University of Strathclyde,
107 Rottenrow, Glasgow G4 0NG, Scotland, UK.

Spatially localized structures (LS) in nonlinear optical cavities, including Kerr resonators, optical parametric oscillators, saturable media and second harmonic generation, have attracted a large amount of attention in the last years. Here we show the existence of a novel kind of stable localized structures, circular domain walls (CDW) in a vectorial self-defocusing Kerr cavity [1, 2]:

$$\partial_t E_{\pm} = -(1 - i\theta)E_{\pm} + \epsilon \nabla^2 E_{\pm} + E_0 - \frac{1}{4}(|E_{\pm}|^2 + \beta|E_{\mp}|^2)E_{\pm},$$

The dynamics of formation of such localized structures is closely linked to the problem of the growth of spatial domains of different phases. We show that an initial circular domain of one homogeneous solution embedded in the other follows a growth law of the form $\dot{R}(t) \propto -1/R + R_0/R^2$, where R_0 is the radius of the stable LS. We also show the existence of two kinds of LS for different system parameters, namely dark ring cavity solitons for which R_0 is small and CDW for which R_0 is large. In the first case the term R_0/R^2 is a minor correction and we recover the growth law $\dot{R}(t) \approx -1/R$ [3].

In the regime of existence of the CDW, the term R_0/R^2 becomes dominant so that $\dot{R}(t) \approx 1/R^2$, which implies a power law $R(t) \propto t^{1/3}$.

[1] J.B. Geddes et al, Opt. Comm. 111, 623 (1994).

[2] M. Hoyuelos et al, PRE 58, 2292 (1998).

[3] R. Gallego, M. San Miguel and R. Toral, Phys. Rev. E 61, 2241 (2000).

HEXAGONAL PATTERN CORRELATIONS IN A KERR CAVITY

Damià Gomila and Pere Colet

Instituto Mediterráneo de Estudios Avanzados, IMEDEA (CSIC-UIB),

Campus Universitat Illes Balears, E-07071 Palma de Mallorca, Spain.

Tel: +34 971 172597, fax: +34 971 173426, e-mail: gomila@imedea.uib.es

Transverse optical patterns are capable of allowing noteworthy aspects linked to quantum fluctuations. These issues have been mainly studied in stripes patterns, which present only two modes in the far-field. Here we address the study of the fluctuations and correlations in an hexagonal pattern in a ring cavity filled with a self-focusing Kerr medium [1]: $\partial_t E = -(1+i\theta)E + ia\nabla^2 E + E_0 + i2|E|^2 E + \xi(\vec{x}, t)$, where $\xi(\vec{x}, t)$ a Gaussian white complex noise.

The homogeneous steady-state bifurcates sub-critically to an hexagonal pattern which is stationary for low pumps and presents highly focused peaks. We show that the pattern fluctuations can be understood in terms of the neutral modes of the pattern and modes with small damping. These modes are obtained from a stability analysis of the hexagonal pattern.

We find strong correlations between the intensity fluctuations of the modes of the pattern, not only among the fundamental harmonics but also with the higher order ones. For the fundamental harmonics the correlation is large for the modes forming an angle $\theta = \frac{2\pi}{3}$ and small for $\theta = \frac{\pi}{3}$. We show how this is related to momentum conservation [2]. We also find strong anti-correlations between the intensity fluctuations of the modes of the pattern and the homogeneous mode which are related to energy conservation. We obtain semi-analytical expressions for the correlation function which are in full agreement with the numerical simulations.

[1] J.B. Geddes et al, *Opt. Comm.* **111**, 623 (1994).

[2] G. Grynberg and L.A. Lugiato, *Optics Communications* **101** (1993) 69-73.

FROM HEXAGONS TO OPTICAL TURBULENCE

Damià Gomila and Pere Colet

Instituto Mediterráneo de Estudios Avanzados, IMEDEA (CSIC-UIB),

Campus Universitat Illes Balears, E-07071 Palma de Mallorca, Spain. Tel: +34

971 173382, Fax: +34 971 173248, e-mail: gomila@imedea.uib.es

The transition from regular static patterns to spatio-temporal chaotic regimes is not yet well understood. We address this problem in a ring cavity filled with a nonlinear self-focusing Kerr medium pumped by an external field [1]:

$$\partial_t E = i\nabla^2 E - [1 + i(\theta - 2|E|^2)]E + E_0.$$

At low pumps there are sub-critical static hexagons. Increasing the pump, the intensity of the peaks of the hexagonal pattern grow. A stability analysis shows that the static hexagons undergo a Hopf bifurcation. The pattern does not oscillate uniformly, instead it splits in three hexagonal sub-lattices with a wavelength $\lambda_H = \sqrt{3}\lambda_0$, where λ_0 is the wavelength of the original pattern. Two sub-nets oscillate with the same frequency and amplitude but dephased by $1/2$ of the period and the third sub-net oscillates with double frequency and smaller amplitude, showing an anti-phase behavior.

A Floquet analysis shows that increasing the pump the periodically oscillating hexagons undergo another Hopf bifurcation which introduces a new temporal frequency. This second frequency is incommensurate with the first one so the temporal evolution of the system becomes quasi-periodic. Spatially, each of the previous sub-lattice splits in three sub-lattices with a wavelength $\lambda_{2H} = \sqrt{3}\lambda_H = 3\lambda_0$.

Increasing even more the pump the oscillations become temporally chaotic while the spatial hexagonal structures is basically preserved. Finally for larger values of the pump the spatial order is lost entering in a regime of spatio-temporal turbulence where peaks, formed at random position, suddenly grow and decay.

[1] L.A. Lugiato, R. Lefever, *Phys. Rev. Lett.* **58**, 2209 (1987).

POLARIZATION COUPLING AND TRANSVERSE EFFECTS IN TYPE-II OPTICAL PARAMETRIC OSCILLATOR

G. Izis, M. San Miguel ^[1], M. Santagiustina

Instituto Mediterráneo de Estudios Avanzados, IMEDEA ^[2] (CSIC-UIB)

Universitat de les Illes Balears, E-07071 Palma de Mallorca, Spain.

We address the question of vectorial properties of transverse pattern formation and Bloch domains walls in type-II optical parametric oscillator when a direct polarization coupling between the down converted fields (DCF) signal and idler is taken into account. First we consider a birefringent and/or dichroic intracavity mirror which provides a polarization coupling and leads to the formation of Bloch phase domain walls for positive DCF's detunings [3]. In the walls the field amplitude does not vanish while the phase rotates when going from one domain to the neighboring one. The domains present defects at points along the wall, where sections of the wall of different chirality join (Fig.1). Two dynamical regimes are found: in a first one the vector field approaches a final homogeneous state, while in a second one walls are continuously generated and annihilated. In the first case flat Bloch walls do not move and in the second one walls of different chirality move spontaneously with opposite velocities. Secondly we consider a type-II OPO with an intracavity quarter wave-plate (QWP) which also provides a polarization coupling [4]. For negative DCF's detunings transverse intensity patterns are predicted and numerically observed. These structures arise spontaneously and exhibit a transient competition between two concentric rings of unstable modes in the far field (Fig.2). For long times a stripe intensity pattern with an arbitrary orientation associated with the inner ring is selected in the near field (Fig.3).

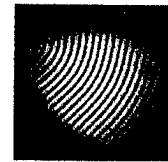

FIG. 1. Real part of the signal field. Black and white segments in the walls correspond to opposite sense of rotation of the phase (chirality)

FIG. 2. Typical far field intensity pattern for the signal during the transient behavior as it results from numerical simulations.

FIG. 3. Near field: Stripe intensity pattern for the signal during the transient behavior as it results from numerical simulations.

[1] maxi@imedea.uib.es

[2] <http://www.imedeauib.es/PhysDept>

[3] G. Izis, M. San Miguel, M. Santagiustina, *Opt. Lett.* **25**, 1454 (2000).

[4] C. Fabre, E. Manson, N. Wong; *Opt. Comm.* **170**, 299 (1999).

MODE CHARACTERISTICS OF OXIDE-CONFINED VCSELS

Pavel S. Ivanov, Igor A. Sukhoivanov

Kharkov State Technical University of Radio Electronics, Lenin av. 14, 61166

Kharkov, Ukraine, e-mail: P.Ivanov@icee.org

Simulation of Vertical-Cavity Surface-Emitting Lasers (VCSELS) is especially difficult because of the small cavity. The optical beam is not distributed in the general part of radial plane and it is strongly limited by the oxide layers. The photon distribution in the same plane is inhomogeneous and it results in the non-uniform distribution of the carriers. By the way, non-uniformity carriers can be formed due focusing properties of the oxide-implanted layer. We use the model [1] including steady-state distributions of cavity modes for taking into account all factors mentioned.

Figure 1 shows computed radial optical power distribution dependence on pumping current. It shows domination of LP11 mode power at high pumping rate. This cavity mode determines the output power of laser device (Fig. 2 – Power versus current characteristics). But the same mode has smaller modulation bandwidth in comparison with LP01 cavity mode (Fig. 3 – Modulation characteristics calculated at 4mA).

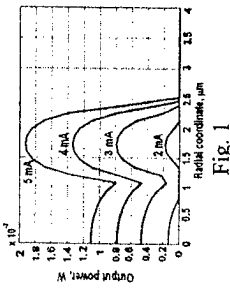

Fig. 1

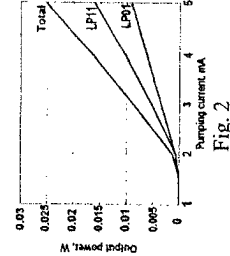

Fig. 2

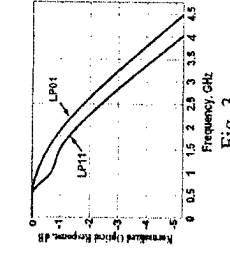

Fig. 3

Presented results correspond to real VCSEL and they demonstrate the possibility of the laser operating parameters optimisations. The optimisation is carried out from the viewpoints of minimal threshold current and maximal output power and the results will be discussed during the presentation.

Reference

- I. Ivanov P.S., Sukhoivanov I.A. Diffusion dynamic model for study of the non-uniform carrier distribution effects in VCSEL, CLEO/Europe'2000 Conference, 10-15 September 2000, Nice, France.

DYNAMICAL BEHAVIOR OF TWO COUPLED SEMICONDUCTOR LASERS

E. Tolkacheva¹, J. Tredicce²

¹Institute of Physics Academy of Sciences of Belarus, Minsk, Belarus
²Institut NonLinéaire de Nice, Nice, France
 email: lena@dragon.bas-net.by

Here we present the model describing the dynamical behavior of two semiconductor lasers coupled in Fabry-Perot configuration (see Fig.). We started from Maxwell-Bloch equation writing down for the both semiconductor lasers independently. The field E inside the two active media as a superposition of two counterpropagating waves with complex slowly varying amplitudes having different optical frequency ω :

$$E(z,t) = [E^+(z,t)e^{iKz} + E^-(z,t)e^{-iKz}]e^{-i\omega t}, \quad (1)$$

where $K = \omega/c$. We present the polarization P and the population inversion N as spatial harmonics serial expansions: $P = \beta \sum_{m=-\infty}^{\infty} p^m e^{imz} e^{-i\omega t}$, $N = \beta \sum_{m=-\infty}^{\infty} n^m e^{imz}$.

Using approximations mentioned above we can obtain the following equations for dynamical evolution of the field, polarization and population inversion:

$$\pm \frac{\partial E^\pm}{\partial z} + \frac{1}{c} \frac{\partial E^\pm}{\partial t} = -p^\pm \pm \frac{\partial p^\pm}{\partial t} = -\frac{1}{T_1} \left[(1+i\Omega) p^\pm - (E^+ n^{m-1} + E^- n^{m+1}) \right], \quad (2)$$

$$\frac{\partial n^m}{\partial t} = -\frac{1}{T_1} \left\{ (1+I) n^m - (1-I) \delta_{m0} N_0 + \frac{1}{2} [E^+ p^{m+1} + (E^-)^* p^{m-1} + E^+ (p^{-m+1})^* + E^- (p^{-m-1})] \right\},$$

where $\Omega = \omega_1 - \omega_2$ is the atomic frequency, T_1 and T_2 are the longitudinal and transverse relaxation times, I is the normalized pump rate value, I is the pump rate value. Considering different I for different lasers, one can introduce the laser frequency difference $\Delta\omega = \omega_1 - \omega_2$ which come from the device self heating.

Boundary conditions for equations (2) according with Fig. are:

$$\begin{aligned} E^+(0,t) &= E^-(0,t) \\ E^-(L_1,t) &= R_1 E^+(L_1,t) + \xi_1 E^-(L_2,t - \tau) \\ E^+(L_2,t) &= R_2 E^-(L_2,t) e^{-i\Delta\omega L_2 / c} + \xi_2 E^+(L_1,t - \tau) \end{aligned} \quad (3)$$

$$E^-(L,t) = E^+(L,t),$$

where $\tau = (L_2 - L_1)/c$ is the delay time, R_1 and R_2 are the reflectivity of the laser 1 and 2 correspondingly, n is the number of active modes, ξ_1 and ξ_2 are coupling coefficients.

We perform a numerical simulation of system of equation (2) together with boundary conditions (3) and studied a dynamics of coupled lasers for different regimes: the regime at resonance ($\Delta\omega=0$), close to the resonance (small $\Delta\omega \sim 1$ GHz) and far from resonance (big $\Delta\omega > 10$ GHz).

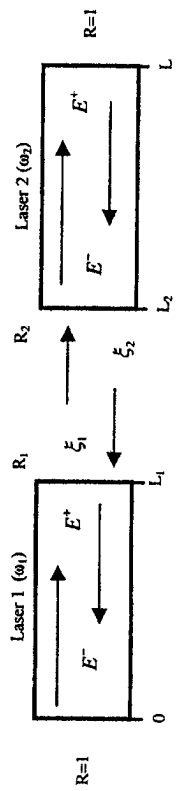

Saturday, June 30

SA	Novel Trends in Nonlinear Laser Spectroscopy and Optical Diagnostics I	SK	Novel Trends in Nonlinear Laser Spectroscopy
SB	Strong Laser Fields and High Field Physics I		and Optical Diagnostics III
SC	Ultrafast Phenomena IV	SL	Strong Laser Fields and High Field Physics III
SD	Nonlinear Dynamics of Optical Systems V		Session PDL I
SE	Optical Information Processing, Transmission, and Storage I	SN	Optical Information Processing, Transmission, and Storage II
SF	Novel Trends in Nonlinear Laser Spectroscopy and Optical Diagnostics II	SO	Novel Trends in Nonlinear Laser Spectroscopy and Optical Diagnostics IV
SG	Strong Laser Fields and High Field Physics II	SP	Strong Laser Fields and High Field Physics IV
SH	Ultrafast Phenomena V	SQ	Session PDL II
SI	Nonlinear Dynamics of Optical Systems VI	SS	Optical Information Processing, Transmission, and Storage II
SJ	Optical Information Processing, Transmission, and Storage I	ST	Optical Information Processing, Transmission, and Storage IV

RESONANT NONLINEAR MAGNETO-OPTICAL EFFECTS IN ATOMIC VAPOURS AND BEAMS

A. Weis

Département de Physique, Université de Fribourg
1700 Fribourg, Switzerland

Atomic spin coherences, i.e. coherent superpositions of Zeeman (or hyperfine) sublevels in the atomic ground state can be produced and manipulated by the combination of optical pumping by polarized resonance radiation and oscillating as well as static magnetic fields. These coherences are extremely fragile objects and require special experimental care in order to achieve their efficient production and to assure a long lifetime. Due to their extreme sensitivity to external perturbations atomic spin coherences can be used as highly sensitive probes for the investigation of controlled perturbations.

In this lecture I will review the basic experimental techniques involving spin coherent atomic samples and discuss a few practical applications realized in our lab. The first application deals with the detection of small magnetic fields in the sub-pT range. In particular we tune the operating parameters of optically pumped magnetometers in order to achieve the sensitivity, bandwidth and spatial resolution necessary for detecting the magnetic field generated by the human heart. The second experiment uses a spatial imaging technique (optically detected magnetic resonance tomography) that allows the time resolved measurement of spin density distributions in the gas phase. As an application we have measured the diffusion coefficient of Cs in Ne gas via the time-resolved mapping of the evolution of a known initial density distribution. Nonlinear magneto-optical effects in atomic beams (Faraday-Ramsey spectroscopy) and their use to study Stark effects (topological phases, tensor polarizabilities) will be discussed next. Last but not least I will report on the present status of our experiments investigating (foreign) atomic defect structures in He crystals and their use to study symmetries and dynamics of local field in quantum crystals. Second and third order perturbation theory based on symmetry arguments allows the quantitative interpretation of spectral changes (in the r.f., microwave and optical domain) induced by the b.c.c.-h.c.p. phase transition of the matrix in terms of a single asymmetry parameter.

CARS SPECTROSCOPY IN LOCAL NONPERTURBING DIAGNOSTICS OF GASEOUS PARAMETERS

V.V. Smirnov

General Physics Institute of Russian Academy of Sciences
Vavilov str.38, 119991 Moscow, Russia

Achievement of the last years in the field of quantum electronics and nonlinear optics have allowed to create a number of new methods of spectroscopy of scattered light, based on physical principles coherent nonlinear optical phenomena and using as sources of excitation lasers with tunable frequency of radiation.

In the report the possibilities one of these methods namely Coherent Anti-Stokes Raman Scattering (CARS) are illustrated on examples of a number of solved fundamental problems, connected to spectral researches of structure of energy levels, peculiarities of line broadening of ro-vibrational transitions, caused by collisional dynamics of molecules, and also processes of transfer of intramolecular energy.

On the basis of these researches a direction of use of these methods and equipment in practical problems of local nonperturbing diagnostics of gas parameters such, as chemical composition, density, velocity, distribution of energy between internal degrees of freedom, and temperature were created.

In the report an extensive experimental material on measurement of functions of distribution of population density of vibrational and rotational states of molecules in conditions of their nonequilibrium excitation in the discharges, on research of processes of nonequilibrium cooling of molecules in supersonic flows is resulted, including flows with condensation, on thermometry in chambers of hydrogen-oxygen combustion engines, allowing to generate the impression about opportunities of nonlinear optical methods in the practical tasks of gas analysis.

The precision of two-wavelength (2λ -CARS) and dual-broadband (DBB-CARS) spectroscopy for single shot temperature measurements in hydrogen-oxygen combustions, in dependence on spectral characteristics of the pump laser, linewidth of probe Raman transition is analyzed and possibilities of its enhancement are discussed.

Time-resolved polarization-sensitive measurements of the electric field in a sliding discharge by means of dc-field-induced coherent Raman scattering

S. N. Tskhai,¹ D. A. Akimov,² S. V. Mitko,¹ V. N. Ochkin,¹ A. Yu. Serdyuchenko,¹
D. A. Sidorov-Biryukov,² D. V. Sinyaev,² and A. M. Zhelezikov²

¹ P. N. Lebedev Physical Institute, Russian Academy of Sciences, Moscow 117924, Russia
² Physics Department, M. V. Lomonosov Moscow State University, Moscow 119899, Russia

The development of reliable and sensitive methods for remote noninvasive electric-field measurements is a key issue for the investigation of discharge propagation. Coherent four-photon spectroscopy [1], which has long proved to be a convenient and efficient method for a diagnostics of excited and ionized gases [2], seems to open the ways to solve the problem of electric-field measurements in discharges [3, 4].

In this paper, we will demonstrate that the polarization technique of coherent Raman scattering (CRS) allows a local noninvasive measurement of a dc electric field in discharges produced in molecular gases. We will present the results of experimental investigation of the IR signal generated through coherent Raman scattering involving the $Q(1)$ transition ($\nu = 0, J = 1 \rightarrow \nu = 1, J = 1$) of a hydrogen molecule in the presence of the quasi-static electric field of the sliding discharge propagating along a ferrite surface in a hydrogen atmosphere (Fig. 1). This type of surface discharge is induced on a conductive surface by a high voltage applied to a pair of electrodes and moves along the surface in a gap between the electrodes. The properties of such discharges are similar to the properties of discharges sliding over dielectric surfaces, but characteristic discharge voltages in the case of conductive surfaces are noticeably lower, which makes this type of discharge advantageous for many applications. Polarization time-resolved measurements performed on the coherent Raman signal will be employed to determine the parameters of the electric field around the sliding discharge leader.

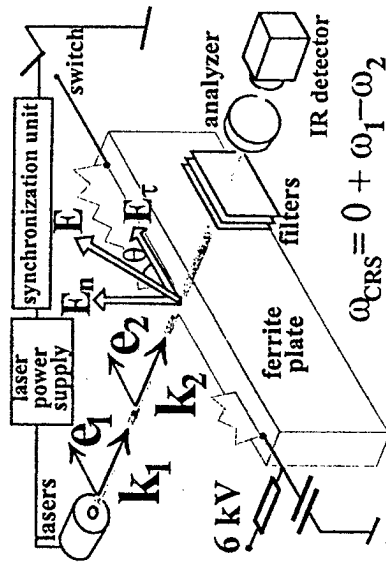

Fig. 1. Diagram of the experimental setup for polarization measurements of the quasi-static electric field in a sliding discharge produced on a ferrite surface.

This work was partially supported by the President of Russian Federation Grant no. 00-15-99304 and the "Integration" federal program (project no. A0133).

1. S.A. Akhmanov, N.I. Koroteev, *Methods of Nonlinear Optics in Spectroscopy of Light Scattering*. Nauka: Moscow, 1981 (in Russian).
2. A.M. Zhelezikov, N.I. Koroteev, *Phys. Uspekhi* 1999; 42: 321.
3. O.A. Eysin, E.B. Kupryanova, V.N. Ochkin, S.Yu. Savinov, S.N. Tskhay, *Quantum Electron.* 1995; 25: 278.
4. D.A. Akimov, A.M. Zhelezikov, N.I. Koroteev, A.N. Naumov, V.N. Ochkin, A.Yu. Serdyuchenko, D.A. Sidorov-Biryukov, S.N. Tskhai, A.B. Fedotov, *JETP Lett.* 1999; 70: 375.

Degenerate Four Wave Mixing and Polarization Spectroscopy in NO₂

L. De Dominicis, R. Fantoni, M. Giorgi

Applied Physics Division, ENEA C.R. Frascati
Via E. Fermi 45, 00044 Frascati (Rome) Italy

Degenerate Four Wave Mixing (DFWM) is a non-linear coherent spectroscopic technique based on light scattering from resonant laser induced grating in a medium. The high resolution DFWM spectrum of the Douglas-Huber band of NO₂, around 455nm, has been recorded in a static optical cell. In particular, the formation of a thermal grating and its contribution to the DFWM signal has been studied by adding different amount of air used as buffer gas. As fig.1 shows, the intensity of the Q(15) line initially decreases due to the pressure induced relaxation in the population grating and the successively increases due to the collisionally assisted onset of thermal grating. The experimental data have also been simulated using the time-dependent density matrix equations for a two level system [1].

The Douglas-Huber band spectrum has also been studied with Polarization Spectroscopy technique in different experimental configurations in order to resolve NO₂ composite spectral features.

Finally the NO₂ PS spectrum has been recorded on a small laboratory Bunsen burner generating a flame at atmospheric pressure.

References

1. R. Fantoni, L. De Dominicis, M. Giorgi, R.B. Williams: *Chem. Phys. Lett.* 259, 342 (1996)

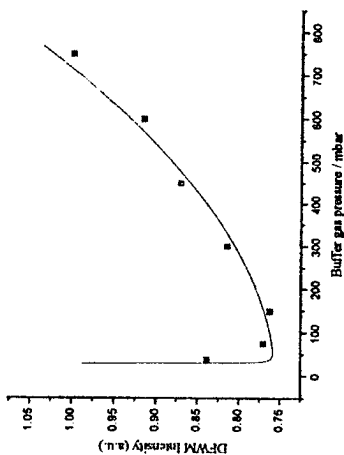

Fig. 1 Q(15) line DFWM intensity vs. buffer gas pressure. NO₂ pressure is fixed at 4 mbar

UVX/IR Multiphoton Ionization

P. Agostini
CEA DSM/DRECAM/SPAM
CE Saclay 91191 Gif Sur Yvette France

Focusing an intense femtosecond laser pulse in a rare gas atomic jet generates odd harmonics of the fundamental frequency up to very high orders. High harmonic generation is a source of UVX coherent radiation delivering femtosecond pulse and has become a routine tool in many laboratories. High harmonics (HH) are by nature synchronized with the fundamental pulse. This latter property combined to their high brightness, coherence and directivity make HH ideal for pump probe experiments or, more simply, multicolor-multiphoton transitions requiring a spatio-temporal overlap of the two fields. The present talk is about recent studies of multiphoton ionization of rare gas atoms by a superposition of HH and IR pulses and applications to the metrology of femto and attosecond XUV pulses.

From a fundamental point of view, such transitions are of the Above-Threshold Ionization (ATI) type when the HH UVX photons has an energy larger than the ionization potential of the atom, which is the usual situation. The atom is photoionized by absorbing a single HH photon but it may absorb or emit one or several IR photons: the kinetic energy of the photoelectron is then changed by one or several quanta of the fundamental radiation. These ATI transitions are therefore easily monitored by electron spectrometry.

Two-color, IR/UVX ATI transitions have several interesting and unique properties partly due to the fact that the transition matrix element is complex. Circular dichroism for instance, is not observed in photoionization of a system with spherical symmetry like an atom (although it may be observed in double photoionization). However circular dichroism is predicted in non-chiral systems for two-photon, two-color ATI transitions, due to the complex transition matrix element [1]. We have indeed measured circular dichroism of argon atoms irradiated by the fundamental pulse of a Ti:sapphire laser at 800nm and its harmonics of orders 13-19[2].

The presence of the IR field induces multiphoton transitions but also produces ac-Stark shifts of the atomic levels and in particular leads to an increase of the ionization potential equal to the ponderomotive energy. This induces a corresponding decrease of the electron energy and a broadening of the kinetic energy distribution. In the case of a very short harmonic peak, the broadening is proportional to the derivative of the ionization potential change with respect to time at the center of the harmonic pulse. The method that we called "ponderomotive streaking of the ionization potential" has been applied to measuring 10fs harmonic pulses with a 40 fs IR pulse, without the limitations of the usual cross-correlation method [3]. The lower limit of this method using Ti:sapphire harmonics is about 3fs.

Another property of ATI produced by superposing several consecutive harmonics and the fundamental is that a given final state may in general be reached through several quantum paths: for example, a final state differing by one fundamental photon from the energy of a photoelectron peak caused by a given harmonic may be due to the absorption of n harmonics and one IR photon or the absorption of the next-order harmonic and the emission of one IR photon. It can be shown that the transition

amplitude depends on the phase difference of the two consecutive harmonics. By scanning the relative phase of the IR and harmonic pulses, the harmonic phases can therefore be measured. This is a unique method to determine this phase and in particular to test the possibility of attosecond pulse train generation from HH. Again using ATI in argon we have demonstrated that high harmonics of orders from 11 to 19 are indeed almost phase-locked and, therefore, correspond in the time domain to a train of 270 attosecond pulses [4].

Two-photon, two-color double ionization may be in principle studied too by electron spectrometry and coincidence techniques. Such an experiment is currently in progress at the time of this writing.

- [1] R. Taieb et al. Phys. Rev. A 62, 013402 (2000).
- [2] P.M Paul et al., in preparation.
- [3] E. S. Toma et al., Phys. Rev. A 62,061801(R) (2000).
- [4] P.M. Paul et al., Science (2001) submitted.

RELATIVISTIC BEHAVIOR IN ATOMIC PHOTOIONIZATION

H.R. Reiss

Physics Department, American University, Washington, DC 20016-8058, USA
 Telephone: 1-202-885-2749; Fax: 1-202-885-2723; E-mail: reiss@american.edu

Summary

Within the context of the Strong-Field Approximation (SFA), the ionization of atoms under relativistic conditions can be treated exactly. That is, initial Dirac hydrogenic wave functions and final Dirac Volkov solutions can be incorporated in a fully relativistic analytical framework. Though not yet done for the relativistic case, relativistic analytical Hartree-Fock wave functions to represent any atom, and arbitrary spatial and temporal profiles of focused lasers can be included in the calculations. Since the approximations of the SFA become slight under relativistic conditions, it is then possible to explore a variety of relativistic effects in a three-dimensional analytical theory that is far more complete than numerical approaches. The expected effects of photon momentum appear in angular photoelectron distributions [1]. The SFA approaches exactness in the stabilization domain, where results much refined from earlier investigations are now available. It is shown that stabilization is reinforced by relativistic considerations in circularly polarized light [2], but is decreased in linearly polarized light. These differences can be explained by simple physical models. Results for photoelectron spectra show the predicted peak at the ponderomotive energy in the circular polarization case. For the linear polarization case, relativistic spectra become very different from tunneling spectra in that there is a peak at an elevated energy that can be significantly greater even than the above-barrier threshold energy that occurs at high intensities. Linear polarization spectra are significantly "hardened" by relativistic effects.

[1] H.R. Reiss, J. Am. Opt. Soc. Am. B 7, 574 (1990).

[2] H.R. Reiss, Optics Express 8, 99 (2001).

ATOMIC STABILIZATION IN A STRONG LASER FIELD

A.M. Popov, O.V. Tikhonova and E.A. Volkova

The investigation of the ionization of 3D quantum systems with Coulomb or short-range potential by a linearly polarized laser field is studied by the direct numerical integration of the non-stationary Schrodinger equation in a wide range of laser pulse parameters.

The structure of the energy spectrum of the atom in the presence of the electromagnetic field was analyzed. It was found that in the case of one-photon ionization the atomic potential in the presence of the laser field is modified to the KH potential and the atom exists in the form of the KH atom. In the low intensity limit (the amplitude of the free electron oscillations is less than typical atomic size $a_0 < a_0 n^2$) the difference between the energy of nonperturbed atomic state and corresponding Kramers - Henneberger (KH) state is shown to coincide with the Stark shift of atomic level.

Different mechanisms of the ionization suppression (KH stabilization, Λ - or V-type interference stabilization) are found to take place and to change each other in dependence on laser intensity if the laser intensity exceeds some critical value [1].

In terms of field free atomic states the KH stabilization observed can be interpreted as the result of the interference of the direct one-photon transition to the continuum $|n\rangle \rightarrow |E\rangle$ and the three-photon bound-free transition via the intermediate continuum states $|n\rangle \rightarrow |E'\rangle \rightarrow |E''\rangle \rightarrow |E\rangle$.

Comparative analysis of the stabilization in the systems with Coulomb and short-range potential is presented.

This work was supported by CRDF (grant RP1-2259) and RFBR (grants 00-02-16046, 00-15-96554)

References.

1. Popov A.M., Tikhonova O.V., Volkova E.A, Laser Phys., 10, 188 (2000).

Femtosecond spectroscopy of photochemical reaction from high-exciting electron states and dynamics of coherent intramolecular vibrations of polyatomic molecules.

Yu.A. Matveets, V.O. Kompanets, S.E. Vinogradov,
A.L. Dobryakov and V.S. Letokhov.

Institute of Spectroscopy, 142190 Troitsk, Moscow region, Russia

The investigation of ultrafast photochemical process gained by two- or multiphoton absorption of intense ultrashort UV or visible laser pulse in the ordinary photochemically stable polyatomic molecules begins under time resolution about 20 fs. Presets experiments of excitation of water solution of malein acid by intense ($\sim 10^{11}$ W/cm²) femtosecond UV pulse have been run and the dynamics of photoinduced response have been investigated. First analysis of laser radiation parameters influence on the possibility of settling of electron excitation power and channels of photochemical reactions were carried out.

The coherent vibrations of the Raman-active modes of polyatomic molecules under study are observed in time domain by using femtosecond optical pulses. The case of nonresonant excitation of the coherent vibrations of pure C₂Cl₄ was investigated. Both amplitude and phase spectral dependence of excited vibrations was analyzed.

WEAKLY RELATIVISTIC LASER IONIZATION DYNAMICS

A. Scrinzi and T. Brabec

Photonics Institute, Vienna University of Technology
Gusshausstrasse 27/387, A-1040 Vienna, Austria/EU

e-mail: scrinzi@tuwien.ac.at, phone: +43-1-58801-38733, fax: +43-1-58801-38799

M. Walsor

Institut für Theoretische Quantendynamik, U. of Freiburg
Hermann Herder-Strasse 3, D-79104 Freiburg, Germany

High intensity laser ionization is investigated numerically and analytically. For the analytic results we employ the strong field approximation (SFA) [1,2]. Numerically, the three-dimensional time-dependent Schrödinger equation is rigorously solved by using an expansion for the exact solution similar as in the SFA

$$\Psi(t) = c(t)|0\rangle + \int d^{(3)}k b(\vec{k}, t)|\vec{k}\rangle, \quad \int d^{(3)}k (0|\vec{k}\rangle b(\vec{k}, t) = 0,$$

where $|0\rangle$ and $|\vec{k}\rangle$ are initial bound state and Volkov states, respectively, and $c(t)$ and $b(\vec{k}, t)$ are the corresponding expansion coefficients. The expansion is uniquely defined by the extra linear constraint on b . The equations for the coefficients are solved on a discrete grid in Volkov space including the atomic potential and the magnetic component of the laser field in lowest order of v/c . By explicitly including the initial bound state into the representation, the time evolution in both, the initial bound state and in final free electron states, becomes numerically trivial. Numerical effort then concentrates on the ionization dynamics in the field.

We find that the Coulomb potential plays a crucial role for ionization. When the Coulomb potential is neglected, ionization is severely underestimated and, depending on the field strength, electron spectra bear no similarity with the correct results. Based on these findings, we will give quantified limits for the applicability of the strong field approximation and simple quasi-classical pictures of ionization. Calculations at the Ti:Sapphire wave length of 800 nm and with laser intensities up to 10^{17} W/cm² will be presented. At the highest field strength, the drift motion in laser propagation direction due to the non-dipole character of the laser field was calculated. A detailed comparison between analytical results for the drift and the full numerical result will be presented.

[1] M. Lewenstein et al., Phys. Rev. A **49**, 2117 (1994).

[2] M.W. Walsor, C.H. Keitel, A. Scrinzi, T. Brabec, Phys. Rev. Lett. **85**, 5082 (2000).

NONLINEAR SPECTROSCOPY OF AMORPHOUS QUANTUM STRUCTURES

E. A. Vinogradov

Institute of Spectroscopy, Russian Academy of Sciences

Nonlinear optical spectroscopy (nonlinear absorption/reflection and second-harmonic generation) has recently been successfully applied to study properties of semiconductor low dimensional structures. Studies of nonlinear optical properties of quantum wells (QWs) were performed mainly with crystalline structures based on III-V or II-VI compounds. Much less attention has been paid to amorphous quantum wells and superlattices which can be fabricated from quite different materials - because of their nonperiodical structure - that provide more deep potential wells and stronger confinement. The disorder in amorphous quantum structures is expected to lead to a reduction of the lifetime of the excited carriers and reduces a time response of the nonlinearity in such QWs. Being very sensitive to the electron transition resonances between quantum subbands, nonlinear spectroscopy could be useful for the investigations of quantum effects in amorphous multiple quantum wells. In this talk we discuss linear optical properties and nonlinear absorption/reflection spectra and second-harmonic generation from amorphous semiconductor α -Si/SiO₂ multiple quantum well structures.

The dispersive nonlinearity has been investigated in the multilayered very thin films structure formed by the α -Si/SiO₂ multiple quantum wells. The refractive index changes obtained from intensity dependent reflection spectra depend on the excitation intensity in nonlinear manner and can be described by the model of saturating nonlinearity for lower pump intensity (<6 MW/cm²). The spectral dependencies of the nonlinear index reveal a resonant behavior associated with the electronic states of the quantum subbands as well as due to resonant transfer of excited electrons into the barrier layers. Carrier lifetime of about 1ps have been estimated restricting the switching time of the nonlinearity.

Determination of Localization of Carriers in Disordered Semiconductors by Femtosecond Spectroscopy

Yu.E. Lozovik¹

A.L. Dobryakov¹, S.A. Kovalenko², S.P. Merkulova¹, S. Volkov¹, N.P. Eristing²

¹Institute of Spectroscopy, Russian Academy of Sciences,

142190, Troitsk, Moscow region, Russia

²Institut Humboldt Universität,

D-10117 Berlin, Germany

A new method for determination of the mobility edge in the disorder materials by femtosecond pump-supercontinuum probe spectroscopy is presented. The method is based on the determination of the spectral dependence of a stretched exponential relaxation in a wide spectral range of probing, $\hbar\omega_{\text{probe}} = 1.6 - 3.2$ eV. It is shown that the relaxation parameters for porous silicon have essential spectral dependence. The spectral dependence of stretched exponential index $\beta(\omega)$ give unique information about existence of the mobility edge in disorder materials, and thus may be used as effective tool in manifestation of the transition from localized to delocalized relaxation regime on the femtosecond time scale.

Optimal control of the current through a double quantum dot

Ilija Grigorenko, Oliver Speer and Martin E. Garcia,

*Institut für Theoretische Physik der Freien Universität Berlin,
Arnimallee 14, 14195 Berlin, Germany,*

The time dependent charge transfer between quantum dots induced by an ultrashort electric field is theoretically analyzed. For a double quantum dot coupled to metallic reservoirs and configured as an electron pump we show that the electron tunneling processes are analogous to those occurring in collisions between ions and atoms. As a consequence, the total current exhibits Stückelberg-like oscillations as a function of the duration and amplitude of the external field. This effect leads to a remarkable enhancement of the nonlinear response.

By using a genetic algorithm we performed a global search to optimize the shape of the ultrafast external field in order to maximize the current. The optimal shape induces an interesting electron dynamics within the double quantum dot and achieves a strong amplification of the current with respect to Gaussian shaped pulses.

FEMTOSECOND CARS THERMOMETRY

T. Lang and M. Motzkus

*Max-Planck-Institut für Quantenoptik,
Hans Kopfermann Strasse 1, D - 85748 Garching, Germany
Fax: +49 89 32905 200, E-mail: mcm@mpq.mpg.de*

Summary

Coherent anti-Stokes Raman scattering (CARS) is a widely used detection technique for the measurement of temperatures and local concentrations in combustion processes. This technique is usually performed in the frequency domain. In this paper we show that also time resolved CARS can be used for precise measurements of temperatures [1] as well as for the determination of line shifts caused by collisions [2], which play an important role in combustion research. We also present a single shot time domain technique, where a linearly chirped probe pulse induces a time-frequency mapping instead of a time-space mapping [3]. A theoretical analysis yields regions of linear and nonlinear mapping. In the linear regime we apply this technique in a high repetitive single shot thermometry experiment.

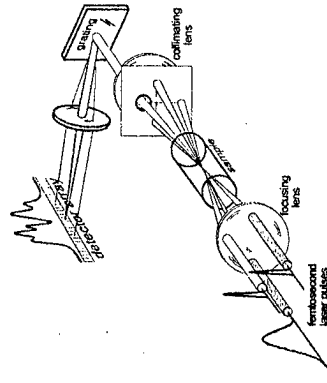

Fig. 1: Experimental scheme of the single shot fs-CARS setup.

- [1] T. Lang, K.-L. Kompa, and M. Motzkus, Chem. Phys. Lett. **310** (1999), 65-72
- [2] T. Lang and M. Motzkus, J. Raman Spectrosc. **31** (2000), 65-70
- [3] A.M. Zheltikov and A.N. Naumov, Laser Physics **10** (2000) 887

PATTERN PRECURSORS IN A LIQUID CRYSTAL WITH OPTICAL FEEDBACK

Pierre GLORIEUX, Eric LOUVERGNEAUX and Christophe SZWAJ

Laboratoire de Physique des Lasers, Atomes et Moléculaires, Université des Sciences et Technologies de Lille,
59655 Villeneuve d'Ascq Cedex (France)

Pattern formation in the near threshold region has been investigated in a simple optical pattern forming system. Our system consists in a liquid crystal (LC) layer irradiated by a continuous wave laser and subjected to feedback from a plane mirror¹. Thermally induced fluctuations of molecular orientation inside the LC layer induce noise which affects pattern formation². We show experimentally and numerically that, due to the presence of noise, there exists in addition to the standard behaviors observed well below and above threshold, a transition region where noisy pattern precursors reveal the underlying order.

To exhibit clearly these qualitatively different regimes, we use a phase space representation in which these patterns have different degrees of localization. Well below threshold, the patterns are diffuse and exhibit no regularity. They are associated with points widely and randomly scattered around the zero order point. On the other hand, when threshold is largely exceeded, these points gather in a small region around the point corresponding to a perfectly ordered pattern. The intermediate noisy precursor region corresponds to localized structures in the phase space. They may be considered as the spatio-temporal analogs of those studied by Wiesenfeld in the case of dynamical systems³. These effects are the classical counterparts of the quantum images appearing below threshold in the quantum theory of optical pattern forming systems⁴.

Our experiments have been carried out in a variety of system geometries and corresponding numerical simulations have been performed on a model of the LC with optical feedback¹ in which stochastic terms have been added to account for thermal noise. They reproduce very well the experimental observations.

References

- [1] G. D'Alessandro and W.J. Firth, *Phys. Rev. A* **46**, 537 (1992).
- [2] I. Rehberg, S. Rasenat, M de la Torre Juanes, W. Schopf, J. Hömer, G. Ahlers and H.R. Brand, *Phys. Rev. Lett.* **67**, 596, (1991); M. Wu, G. Ahlers and D.S. Cannell, *Phys. Rev. Lett.* **75**, 1743 (1995), M. Treiber in "Pattern Formation in Liquid crystals", A. Buka and L. Kramer eds., Springer (Berlin), 1996.
- [3] K. Wiesenfeld, *J. Stat. Phys.* **38**, 1071 (1985).
- [4] A. Gatti, H. Wiedemann, L.A. Lugato, I. Marzoli, G.L. Oppo and S.M. Barnett, *Phys. Rev. A* **56**, 877, (1997); R. Zambini, M. Hoyuelos, A. Gatti, P. Colet, L.A. Lugato and M. San Miguel, *Phys. Rev. A* **62**, 063801 (2000).

Optical pattern formation far beyond threshold: multiple instability balloons, superlattices and effects of wavefront curvature

T. Ackemann, E. Große Westhoff, M. Pesch, D. Rudolph, and W. Lange

Institut für Angewandte Physik, Westfälische Wilhelms-Universität Münster,
Corrensstraße 2/4, 48149 Münster, Germany, Email: t.ackemann@uni-muenster.de

The emergence of complex but periodic structures due to a sequence of secondary bifurcations from hexagons is analyzed. The experimental system is based on a single-mirror feedback scheme using sodium vapor as the nonlinear medium and a quarter-wave plate in the feedback loop [1]. The threshold for the formation of hexagons is low enough to allow investigations up to power levels of ten times above threshold [1].

If the sodium particle density is sufficiently high, secondary bifurcations from hexagons to patterns consisting of twelve fundamental wave vectors occur. Besides quasiperiodic patterns and irregular ones, two types of *superlattice* patterns on a hexagonal, respectively square, grid appear. For even higher input power there are tertiary bifurcations to square and stripe-like patterns which contain many harmonics. Hence, we call them *chessboards* and *walls*. All patterns with twelve wave vectors as well as chessboards and stripes give way to hexagons if the harmonics are cut off by a Fourier filter in the feedback loop. It is expected from a linear stability analysis that these harmonics are nearly resonant with a high order instability balloon.

We confirm this prediction by realizing a direct measurement of the boundaries of the *high order instability balloons* by means of a Fourier filtering technique. Furthermore, the results indicate that chessboards and walls are formed, if the third instability balloon becomes active.

Pattern selection depends critically on the wavefront curvature of the input beam. In a slightly diverging beam a new type of superlattice is formed that is based on a *rhombic grid*.

- [1] A. Aumann *et al.*, *J. Opt. B: Quantum Semiclass. Opt.* **1**, 166 (1999).

SPATIO-TEMPORAL MODULATION INSTABILITY OF OPTICAL RADIATION WITH SHG IN A PLANAR WAVEGUIDE

A. K. Sukhorukova, and A. P. Sukhorukov

Department of Physics, Lomonosov Moscow State University, 119899 Moscow, Russia

Optical beam can be split into many sub-beams or spots because of SHG in bulk crystals and slabs [1]. There are some reasons of modulation instability (MI). Main from them there is noise, input periodical modulation of amplitude and nonlinear aberrations that is a beam distortion itself [2]. In the case of impulse laser beam MI we considered the following equations for the amplitudes a_j of FW and SH with $j=1,2$ respectively.

$$\frac{\partial a_j}{\partial z} + \frac{1}{u_j} \frac{\partial a_j}{\partial t} + iD_{ix} \frac{\partial^2 a_j}{\partial x^2} - iD_{ij} \frac{\partial^2 a_j}{\partial t^2} = -i\kappa a_1^{2(j-1)} a_1^{*(2-j)} a_2^{(2-j)} \exp(i\Delta kz)$$

By means of numerical simulations we have found domains of the MI (Fig. 1) and detected a wide powerful background of output intensity distribution (Fig. 2).

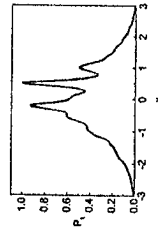
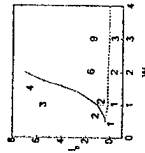

Fig. 1. The MI domains in absence (solid line) and at presence (dashed line) of spatial noise. Numbers $l_{01}=1$ GW cm^{-2} , $L=4.7$ cm, $\Delta k L = -20\pi$, $w=350$ mkm, $T=20$ ps.

This work was supported in part by the RFBR (project no. 99-02-18161), the programs "Leading Scientific Schools" (grant no. 00-15-96561) and "Russian Universities" (grant no. 99-2251).

1. R. A. Fuerst, D. M. Baboiu, B. Lawrence at all, Phys. Rev. Lett. 78, 2756 (1997).
2. A. K. Sukhorukova, and A. P. Sukhorukov, Bull. RAS, Physics. 63, 1906 (1999).

POLARIZATION BAD CAVITY LIMITS IN A VECTOR CLASS-B LASER.

A. M. Kul'minskii, Yu. V. Loiko, and A. P. Voitovich

Institute of Molecular and Atomic Physics, National Academy of Sciences of Belarus
Skarina Avenue 70, 220072 Minsk, Belarus

Development of new lasers with cylindrically symmetric architecture has renewed the interest on the vectorial case in laser physics [1]. Unlike the scalar case, the light polarization state in vector lasers is not fixed entirely by the cavity optics and thus leads to the existence of vectorial degrees of freedom, which might strongly affect the dynamics. In this work we present the results of investigation of the effect of the cavity linear (in the Cartesian basis) anisotropy on the instability thresholds in a class-B vector laser.

Our model has been particularly adapted for gas (He-Ne, He-Xe) lasers with homogeneously broadened $j_2 = 1 \rightarrow j_1 = 0$ transition. However, it is also suitable for modeling of CO₂ gas and solid-state (Nd:YAG) lasers. The model takes into account intersublevel coherence and the fact that dipole and quadrupole tensorial components of the density matrix of the $|j_2 = 1\rangle$ level decay with different rates (γ_j and γ_c , respectively). Basic steady states of such an isotropic-cavity laser are circularly (CP) and linearly (LP) polarized ones. The CP (LP) mode is stable when $\gamma_j > \gamma_c$ ($\gamma_c > \gamma_j$). The CP (LP) state can be destabilized by a Hopf bifurcation when the laser is in the condition of the polarization bad cavity limit (PBCL) $k > \gamma_j / 2$ ($k > \gamma_c / 2$), where k is the cavity decay rate.

These PBCLs coincide with those for an isotropic-cavity class-C laser [2]. We show that the amplitude losses do not modify the PBCL of the LP modes in the class-B laser. In contrast, the cavity phase anisotropy is a critical factor, which can reduce the instability thresholds so the instabilities can occur even when $k < \gamma_c / 2$. Because realistic quasi-isotropic lasers are not free of numerous imperfections, which can cause difference in the phase accumulations for the orthogonal LP modes, this is of importance in practice.

1. The Special Issue of Quant. and Semicl. Opt. on "Polarization Effects in Lasers and Spectroscopy", Ed. by N. B. Abraham and G. M. Stephan, 10, Issue 1 (1998)
2. N. B. Abraham, M. D. Matin, R. S. Gioggia, Phys. Rev. A 53, 3514 (1996).

SELFDIFFRACTION OF THE BEAMS IN LINEAR THREE-MIRRORS CAVITY OF ND-LASER.

D.A.Nikolaev*, V.B.Tsvetkov*, I.A.Shecherbakov*, O.L.Antipov**
 *General Physics Institute, 117942, Vavilov str.,38, Moscow, Russia.
 Fax:(7-095)135-11-24, e-mail: nikolaev@fsk.gpi.ru
 ** Institute of Applied Physics of the Russian Academy of Science
 46 Ulijanov Str., Nizhny Novgorod, 603600 Russia
 Fax: +7(8312) 363792 e-mail: antipov@appl.sci-mnov.ru

The goal of experiments was the investigation of the processes of forming of spacial structure of laser emission due to the intracavity beams interaction in active rod for free-running and Q-switch operation of Nd-laser.

Schematic of the experiment set-up is shown in Fig.1. The resonator is formed by mirrors HR1 and OC. The interference pattern is written in the active rod AR (Nd:YAG Ø6.3x60 mm) by the intracavity beam splitted by the additional mirror M (R=30%) in three nearly equal intensity beams. The angles between the beam axes falling in the plane of figure and the resonator axis are correspondingly -2β , 0 and 2β , where α is the angle of M mirror inclination. While using the semitransparent mirror M2 and objective lens L1 the arbitrary cross-section of the active rod may be projected to the plane of the detecting system VS1 for the detailed study of the parameters of the interference pattern inside the rod. Simultaneously the far-field intensity distribution is studied with the use of lens L2 and detecting system VS2 and near-field pattern by VS3.

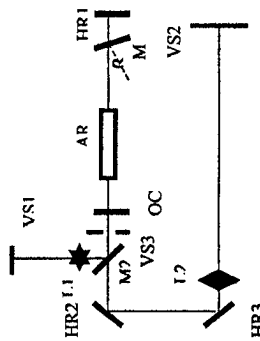

Fig.1.Schematic of the experiment.

We obtained the depth of modulation of the periodic structure formed in active rod and also in near- and far-field zones.

The comparison was made for free-running and Q-switch modes of laser operation. The origin of the effects is discussed.

This research was performed as a part of SRP-974143 and RFBS-00-15-96715.

Excitability, selfpulsations and coexistence in an optically injected diode laser

Sebastian Wicczorek and Daan Lenstra
 Faculty of Sciences, Vrije Universiteit Amsterdam, De Boelelaan 1081,
 1081 HV Amsterdam, The Netherlands.
 sebek@nat.vu.nl, phone:+31-20-444-7860, fax:+31-20-444-7899

Bernd Krauskopf
 Department of Engineering Mathematics, University of Bristol, Bristol BS8 1TR, UK.

Semiconductor lasers with optical injection are modeled by the three-dimensional rate equations for the complex electric field E and population inversion n and are known to produce an enormous wealth of instabilities and complex dynamics for parameter values outside the locking region. Here, we investigate theoretically the dynamical behavior of the injected laser system in the region of parameters where it locks to the input signal and produces a constant power output with the frequency of the injected light. We demonstrate that even in this locking region an injected laser may exhibit a very rich nonlinear behavior.

Most interesting example is excitability, a phenomenon characteristic for systems in which sufficiently large but still small perturbation (could be noise for example) of the steady equilibrium results in producing a large amplitude excursion before setting back to the equilibrium. Our laser system, after it is triggered, produces a high intensity pulse before returning to the continuous wave operation. On top of this, for certain parameters values, the steady laser output may coexist with periodic or even chaotic oscillations! We find out that these highly nonlinear phenomena are brought about and organized by global homoclinic bifurcations (see Fig.1 for an example), which we detect and, using advanced tools from bifurcation theory, compute in the (K, ω) -plane. (K is the strength of the injected light and ω is its detuning from the unperturbed laser frequency.) Moreover, we show how particular phenomena, that is excitability and coexistence of equilibrium with several kinds of dynamics, are connected by codimension-two bifurcations and fit into a consistent picture. We also discuss possible applications in optical switching and optical communication.

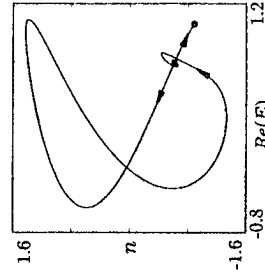

Fig. 1. Shilnikov bifurcation for $\omega = -0.9397$ and $K = 0.46$. Homoclinic orbit connects the stable and unstable manifolds of the gray saddle point, the stable equilibrium is marked with a black dot.

Status Report on Holographic Data Storage

Hans J. Coufal
 IBM Research Division
 Almaden Research Center, K10/D2
 San Jose, CA 95120-6099, USA

Holographic data storage claims the potential of high storage densities, high data rates, fast access time and associative retrieval of the stored information. Storage densities of the order of TB/ccm should be feasible, at least in principle. The page oriented character of holographic data storage with its potential for highly parallel data input and output should allow very high aggregate data rates for this data storage technique and using standard optical techniques the stored data should be rapidly accessible and content addressable.

These claims have been made for many years and would make holographic data storage, if affordable, the prime data storage technique. Despite years of research in this field by a large number of groups around the globe no commercially viable product is on the market today and lab demonstrations have not yet been convincing. Disk drives, on the other hand have been getting better in performance and lower in cost. Is there hope for a viable holographic data storage technology?

The basic physical limitations of this optical storage scheme, most recent progress in components, systems and recording materials are reviewed. The open issues that have to be resolved to make it a viable storage technology are discussed in detail.

TWO-PHOTON OPTICAL DATA STORAGE

Sergey Magnitskii
 International Laser Center
 Physics Dep., KNO, M.V.Lomonosov Moscow University, Moscow 119899, Russia

Three-dimensional (3D) optical memory offers wide opportunity for enlargement of data density. In fact, the transition from two to three dimensions leads to quantitative change of concept of data density. Actually, if a bit "size" is equal to $1\mu^3$, then 1cm^3 of 3D memory contains information about 10^4 times larger than 1cm^2 of 2D memory.

In principle, different 3D optical memory systems can exist. In this report we consider only one concept of 3D memory based on two-photon data writing. Using two-photon nonlinear process one can easily penetrate into material depth (Fig.1) and provide low value of interlayer cross-talk (Fig.2).

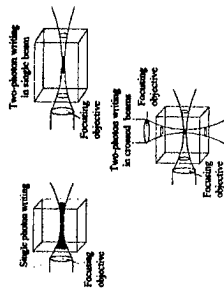

Fig.1

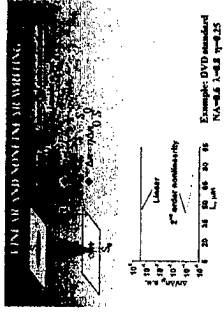

Fig.2

Comparison of methods of parallel and consequent two-photon writing based on literature data and on our experimental results [1] show that the use of femosecond pulses for bit-by-bit sequential recording information into multilayered structures with photoactive layers alternated by non-photoactive inert polymer layers is a promising method to reach the goal of creating optical data storage with enhanced information capacity. However, analysis of large amount of two-photon sensitive materials and compositions shows that typical values of their two-photon cross-section are not enough for market requirements and, therefore, some addition efforts to create materials and compositions with enlarged two-photon cross-sections are needed

The work was financed by "Constellation Group".

[1] N.I.Koroteev, S.A.Magnitskii, *Nonlinear Optics, 2000, Vol.23, pp.149-156*

Second Harmonic Generated Hologram for Superfast Information Processing

Yu.N.Denisyuk*, A.Andreoni**, M.Bondani**, M.Potenza**

*Ioffe Physico-Technical Institute, 26 Polytekhnicheskaya Str., St.Petersburg 194021, Russia; Phone: +7 (812) 2479384, Fax: +7 (812) 2471017, E-mail: denis@bala.ioff.rssi.ru

**Universita de gli studi dell'Insubria, Dipartimento di Scienze Chimiche, Fisiche e Matematiche, Via Valleggio 11, 22100 Como, Italy

A new method of wavefronts' cross-correlation by means of so-called Second Harmonic Generated Hologram (SHG hologram) is considered. According to this method, the interference pattern of an object and reference waves is recorded in a nonlinear light-sensitive material using its second order nonlinearity. The SHG hologram generates a wave that forms the reconstructed image of the object without any time delay at the moment when the interfering wavefronts intersect the light-sensitive material, the frequency of the reconstructed wave being doubled in comparison with the frequency of the recorded waves. An expression that describes the electrical field of the reconstructed wave is deduced. Basing on this expression the methods of the construction of the image generated by the SHG hologram are developed. It is shown that the change of the wavelength of the radiation generated by the SHG hologram leads to the doubling of all the longitudinal sizes of the image, whereas the transversal sizes remain equal to that of the object. It is suggested to use the transforming properties of the SHG hologram for constructing the network of changeable interconnection lines which operates on the principle "light is controlled by light". The scheme of an element of the network of such a type is presented and considered. The experiment on the recording of the SHG hologram was carried out. The SHG hologram was recorded in a BBO 1 crystal with the help of a Nd:YAG pulse laser. The experiment has confirmed the ability of the SHG hologram of forming high quality images of arbitrary objects. The rules of the transformation of the images were also confirmed. The ways of overcoming the effect of doubling the frequency of the light after each act of a signal transformation are considered. The theory has shown that by using the effect of "down-conversion" it is possible either to return the frequency of the signal to its initial value or to sustain the value of the frequency at the constant level.

Optical storage of information via refreshing by inverse seeding in photorefractive Ba_{0.77}Ca_{0.23}TiO₃ crystal (BCT)

V. Matusevich*, A. Kiessing, R. Kowarschik
Friedrich Schiller University Jena, Institute of Applied Optics
Max-Wien-Platz 1, 07743 Jena, Germany
Tel.: + 49 (0)3641 947659
Fax: +49 (0)3641 947652
*E-mail: p7maw@i.onds.rz.uni-jena.de

We present a new experimental setup for optical storage of information via refreshing by inverse seeding (OSIRIS), which gives a sixfold increase of the storage time of holograms in a single Ba_{0.77}Ca_{0.23}TiO₃ crystal (BCT).

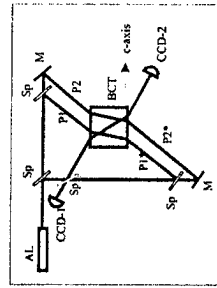

Fig. 1. Setup of OSIRIS: AL Argon laser; Sp beam splitters; M mirrors; CCD-1,2 detectors; BCT crystal; P1, P2 and P1*, P2* pump and phase-conjugated pump waves.

The setup consists of two four-wave mixing processes with common signal waves and phase-conjugated waves (fig. 2).

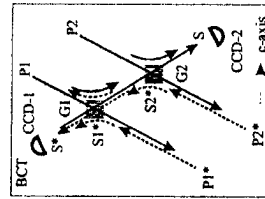

Fig. 2. Interplay of two four-wave mixings: S and S*, S1*, S2* signal and phase-conjugated signal waves; G1, G2 gratings.

The recorded information can be read out during 40 minutes after the signal wave is switched off. Temporal behaviours of the phase-conjugated and amplified signals for OSIRIS as well as for the four-wave mixing experiment are discussed. Solutions of coupled equations in the case of the depleted-pump approximation are obtained in order to simulate the phase-conjugated reflectivity inside the crystal.

HIGHER-ORDER HOLOGRAPHIC ASSOCIATIVE MEMORIES AND IMAGE PROCESSING

Peter V. Polyanskii, Christina V. Fel'de
Dept of Correlation Optics, Chernivtsi National University, 2 Kotsyubinsky Str.
58012 Chernivtsi, Ukraine

Associative properties of a static hologram caused by the nonlinear part of its complex amplitude response are under intensive study now [1-4]. It has been shown early [1,2] that the most effects of holographic recording nonlinearity follow from the quadratic and the cubic components of the power series expansion of a hologram's amplitude response onto exposure degrees. Such nonlinearities lead to the reconstruction of error-corrected associative responses either in the form of the conjugate image of the stored memory or in the form of its self-conjugated replica. In this communication, we for the first time extend previous analysis of nonlinearly recorded holograms taking into account nonlinearities of the orders higher than the cubic one. It is shown that such extension is expedient only in the case when one uses the input signal without a diffuser, and records a hologram in Fraunhofer domain. It is substantiated and demonstrated that in this case associative responses are reconstructed in several spatially separated diffraction orders (in our experiments, up to the fifth one). For that, various operations of the stored memory processing are realized simultaneously in different associative responses, such as contour detection, double contouring, inversion of image contrast etc. These results are interpreted on the base of the Young-Rubinowicz model of diffraction phenomena [5,6] considering a diffraction field as a superposition of the geometrical optics wave and the edge diffraction wave. It is also established that thin structure of associative images is in excellent agreement with the prediction following from the Rubinowicz's representation of the Kirchhoff's diffraction integral [6].

1. Polyanskii P.V. // Journ. Opt. Technol. - 1997. - V.64, μ 4. - P.28-37.
2. Polyanskii P.V. // Opt. and Spectr. - 1999. - V.86, μ 2. - P.333-338.
3. Angelsky O.V., Konovchuk A.V., Polyanskii P.V. // Journ. of Optics A: Pure and Applied Optics. - 1999. - V.1, μ 1. - P.15-24.
4. Bogatiryova G.V., Polyanskii P.V. // Optica Applicata. - 1999. - V.29, μ 4. - P.583-600.
5. Bogatiryova G.V., Polyanskii P.V. // Proc.SPIE. - 1999. - V.3904. - P.240-255.
6. Miyamoto K., Wolf E. // JOSA. - 1962. - V.52, μ 6. - P.615-637.

OPTIMAL COHERENT CONTROL OF THE MOLECULAR FWM RESPONSE

BY ARBITRARILY SHAPED FEMTOSECOND PULSES

M. Motzkus

Max-Planck-Institut für Quantenoptik,
Hans Kopfermann Strasse 1, D - 85748 Garching, Germany
Fax: +49 89 32905 200, E-mail: mcm@mpq.mpg.de

Coherent control of quantum phenomena can be achieved by using phase- and amplitude modulated laser pulses. With a self-learning loop, which combines a femtosecond pulse shaper, an optimization algorithm and an experimental feedback signal, it is possible to automatically steer the interaction between system and electric field. This approach allows control even without any knowledge of the Hamiltonian.[1]

We have successfully implemented this learning loop for the adaptive compression of tunable pulses in a non-collinear OPA to below 20 fs [2] and the coherent control of the nonresonant two-photon excitation in sodium (3s-5s) [3]. New solutions for "bright" and "dark" pulses could be designed for this two-photon resonance without previous knowledge of the resonances.

In a further experiment we combined the self-learning loop with degenerate four-wave-mixing spectroscopy (DFWM) in order to study the influence of phase and amplitude modulated pulses on the molecular FWM response. As a prototype system K_2 has been taken and the vibrational wavepacket motion in the electronic ground and excited state could be controlled with different processes. A theoretical model for such arbitrarily shaped pulse excitations in a FWM process has been developed which proved to be in excellent agreement with the observed FWM signal. In addition, the spectrally resolved DFWM signal works as a molecular FROG, which provides information about the activated molecular vibrations, the DFWM signal itself and the shapes of the pulses used in the excitation sequence.

- [1] H. Rabitz, R. deVivrie-Riedle, M. Motzkus, and K.-L. Kompa, Science **288** (2000) 824
- [2] D. Zaidler, T. Hornung, D. Proch, and M. Motzkus, Appl. Phys. B **70** (2000) S125
- [3] T. Hornung, R. Meier, D. Zaidler, K.-L. Kompa, D. Proch, and M. Motzkus, Appl. Phys. B **71** (2000) 277
- [4] T. Hornung, R. Meier, and M. Motzkus, Chem. Phys. Letters, **326** (5-6) (2000) 445

VIBRATIONAL KINETICS OF ULTRAFAST INTRAMOLECULAR ELECTRON TRANSFER STUDIED BY PICOSECOND RESONANCE RAMAN SPECTROSCOPY

Wolfgang Werncke

Max-Born-Institut, Max-Born-Strasse 2A, D-12489-Berlin, Germany

Applying picosecond time-resolved anti-Stokes Raman spectroscopy we studied vibrational excitation and relaxation initiated by back-electron transfer (b-ET) of betaine-30 from the first excited into the electronic ground state $/1/$. Assignment of vibrational frequencies as well as optimizing molecular geometries have been obtained by ab initio calculations $/2/$. Within the first few picoseconds after photoexcitation we observe a non-instantaneous and mode-specific build-up of the anti-Stokes Raman intensities and consequently pronounced non-thermal vibrational population distributions. The rise times of the strongest vibration with the highest frequency $/1/$ are close to the corresponding back-electron transfer times $\tau_{b-ET} /3/$ in different solvents.

From our investigations it can be concluded, that:

- (i) After b-ET intense high frequency Raman active vibrations are most effective as accepting modes.
- (ii) A low-frequency mode due to a torsional motion between the phenoxide and pyridinium rings plays an important role in promoting the transfer.

(iii) Depending on the solvent, 10 -15 ps after excitation thermal equilibrium between the subgroup of strongly Raman-active modes - but not for the whole molecule - has been established.

References:

1. S. Hogiu, W. Werncke, M. Pfeiffer, J. Dreyer, T. Elsaesser, J. Chem. Phys. **113** (2000) 1587
2. S. Hogiu, J. Dreyer, M. Pfeiffer, K.-W. Brzezinka, W. Werncke; J. Raman Spectrosc. **31** (2000) 797
3. G.C. Walker, E. Akesson, A.E. Johnson, N.E. Levinger, P.F. Barbara; J. Phys. Chem. **6** (1992) 3728

High-resolution spectroscopy of inhomogeneously broadened Raman resonances by time-domain CARS

V.B.Morozov, A.N.Olenin, and V.G.Tunkin

International Laser Center, M.V. Lomonosov Moscow State University
119899 Moscow, Russia

In methods of time-domain spectroscopy, spectrum reconstruction reliability and, in fact, higher equivalent spectral resolution are achieved by increasing delay times of a probe pulse relative to pump ones and by corresponding increasing decay range of measured signal. It will be shown in this paper that delay times as large as 12 ns allows to observe in time-domain CARS different effects connected with transformation by collisions of narrow inhomogeneously broadened molecular Raman resonances.

Time-domain technique is especially effective when narrow resonances with total width $\leq 10^2 - 10^3 \text{ cm}^{-1}$ and with spectral shape profile governed by several physical mechanisms are investigated. Dicke effect manifests itself in transformation with pressure of pulse response from initially Gaussian to exponential and in slowing down of the signal decay. Collisional dephasing results in acceleration of the signal decay. When several spectral components are excited, their beats observed in pulse response are transformed with pressure due to spectral exchange. In some cases, all these effects can be separated in time domain $[1]$.

The features of collisional dephasing dynamics of pure rotational transitions of hydrogen in the Dicke region, in which Doppler and collisional dephasing manifest themselves, was studied experimentally. In the case of $S_0(1)$ transition, for example, the slowest pulse response decay was observed at pressure of 0.25 atm and this decay corresponded to line half width of $(9.2 \pm 0.5) \cdot 10^{-4} \text{ cm}^{-1}$. Excitation and probing different CO_2 ro-vibrational Q-branches revealed different pictures of J-components beats. In the case of 1388 cm^{-1} Q-branch (upper Fermi doublet $\nu_1 + 2\nu_2$), which cannot be resolved in spectrum due to Doppler effect, spectral exchange manifested itself in gradual shift of the beats with pressure to longer delay times. It will be shown that spectral shape can be reconstructed on the base of a rather complicated beats picture.

1. D.S.Kuznetsov, V.B.Morozov, A.N.Olenin, V.G.Tunkin. Chem. Phys., **257**, 117 (2000)

Coherent Four-Wave Mixing in Hollow Waveguides: Expanding the Possibilities of Gas-Phase Analysis

A. N. Naumov,¹ F. Giammanco,² P. Marsili,² A. Ruffini,² A. B. Fedotov,¹ O. A. Kolevatova,¹ D. A. Sidorov-Biryukov,¹ and A. M. Zheltikov¹

¹ Faculty of Physics, International Laser Center,
M.V. Lomonosov Moscow State University, 119899 Moscow, Russia;

² Dipartimento di Fisica e Unità INFN – University of Pisa, 56127 Pisa, Italy

While the progress in using hollow fibers to produce a-few-cycle pulses [1] and to improve the efficiency of high-order harmonic generation [2] is striking, there is not much work being done nowadays on employing hollow fibers to increase the sensitivity of nonlinear spectroscopic schemes of gas-phase analysis, which was historically the initial motivation behind using hollow fibers in nonlinear-optical experiments by Miles *et al.* back in 1977 [3]. In this paper, we explore the possibilities of using four-wave mixing (FWM) enhanced in hollow fibers for improving the sensitivity of gas-phase analysis by studying third-harmonic, difference-frequency, and sum-frequency generation processes. Hollow fibers are shown to expand the possibilities of nonlinear-optical analysis of gases by allowing the generation of third-harmonic and sum-frequency signals, which vanish in the regime of light focusing in a medium with normal dispersion. Phase-matching effects in four-wave mixing in hollow fibers are considered. The experimental dependence of the difference-frequency signal on the pressure of the gas filling the fiber agrees well with the results of calculations (Fig. 1) when the contribution of higher order waveguide modes is taken into consideration, thus indicating the importance of nonlinear-optical processes involving higher order waveguide modes of a hollow fiber [4].

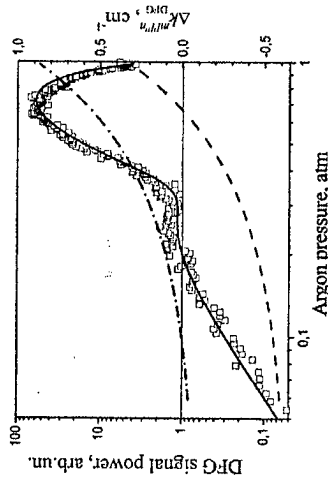

Fig. 1. The power of the difference-frequency signal as a function of the gas pressure (squares represent the experimental data, and the solid line shows the results of calculations) and the phase mismatch $\Delta k_{DFG}^{m,l,n}$ for the difference-frequency generation process involving the $E_{H_{11}}$ hollow-fiber modes of fundamental radiation, second harmonic, and the DFG signal ($m, l, n, m = 1$, the dashed line) and the $E_{H_{12}}$ mode of fundamental radiation, $E_{H_{11}}$ and $E_{H_{13}}$ modes of the second harmonic, and the $E_{H_{12}}$ mode of the DFG signal ($m = 2, l = 1, n = 3, m = 2$, the dash-dotted line) in a 17.4-cm-long hollow fiber with an inner diameter of 100 μm filled with argon.

This study is supported by the President of Russian Federation Grant no. 00-15-99304, CRDF (Award RP2-22866), the Volkswagen Foundation (project 176 869), and the "Integration" Federal Program.

1. M. Nisoli, S. De Silvestri, O. Svelto, *et al.*, *Opt. Lett.* **22**, 522 (1997)
2. C.G. Durfee III, S. Backus, M. M. Murnane, H. C. Kapteyn, *Opt. Lett.* **22**, 1565 (1997)
3. R.B. Miles, G. Lauffer, and G.C. Bjorklund, *Appl. Phys. Lett.* **30**, 417 (1977)
4. A.B. Fedotov, F. Giammanco, A.N. Naumov, P. Marsili, A. Ruffini, D.A. Sidorov-Biryukov, and A.M. Zheltikov, *Appl. Phys. B* (in press).

THREE WAVE BRILLOUIN INTERACTION IN OPTICAL FIBER

Vladimir A. Saetchnikov, Elina A. Chernyavskaya, Tatjana P. Yanukovich,
Bielorusian State University, Kurchatov str., 7, Minsk, Buelarus

Distributed temperature and strain measurements can be realized by using stimulated Brillouin scattering. This effect can be described as a three-wave interaction of pump laser wave, a Stokes wave and an acoustic wave of characteristic Brillouin frequency. This frequency depends on temperature and strain. This effect is used for distributed measurements and realized in Brillouin optical time-domain analysis.

In the method, the continuous wave light of narrow linewidth pump laser is coupled into one end of the sensor fiber and a sinusoidal modulated intensity of a probe laser is coupled to the other end. If the frequency difference between both lasers equals to characteristic Brillouin frequency, the pump light will interact with the modulated probe light in the fiber. By analyzing the transmitted pump intensity at different frequency differences between probe and pump lasers, the temperature and strain distribution along the fiber can be determined.

In this numerical simulation several fiber lengths with different but spatial constant gain coefficients were placed one after another. For each fiber part the fundamental oscillation of the transmitted pump intensity is calculated by the derived analytical expression with respect to individual Brillouin gain coefficients. The DC components of the input pump and Stokes powers of each region are determined by numerical iteration. Only the DC component of the pump power produces Brillouin interaction. Considering the phase shift of the transmitted alternating components of the pump powers of each different located fiber regions, the baseband modulation transfer function is calculated.

By means of inverse Fourier transformation pulse response is calculated. Pulse response is a two-dimensional function of length of fiber and frequency difference between probe and pump lasers. It gains maximum when frequency difference is correspondent to characteristic Brillouin frequency of certain temperature and strain. So, pulse response represent distribution of temperature and strain along optic fiber.

QUANTUM EFFECTS IN ABOVE-THRESHOLD IONIZATION

G. G. Paulus, F. Grasbon, and H. Walther
Max-Planck-Institut für Quantenoptik, 85748 Garching, Germany

Many aspects of the behavior of atoms in strong laser fields can be understood with a simple classical model. An early and important example for the power of this approach is the cutoff-law for the high-harmonic generation plateau. Subsequently, the model was refined and extended to ionization. This, for example, explains the high-energetic plateau-like part of above-threshold ionization (ATI) spectra by rescattering during the ionization process. The corresponding photoelectrons therefore are often dubbed as rescattered electrons, whereas the low-energetic ones are called direct electrons. The success of this simple picture has been so complete that atoms in strong laser fields are believed to behave classically by many.

In this paper we present four experiments each showing a phenomenon which neither can be explained by the simple classical model nor by semi-classical refinements. The first example is related to a seemingly erratic structure of dips in the envelope of ATI spectra which were revealed in theoretical calculations. Experimentally, these dips are washed out by intensity averaging in the laser focus in most cases. However, by using elliptically polarized light, it was possible to observe them. They originate from tunneling electron trajectories which enter the time-dependent electrical field of the laser at different phases within an optical period.

A much stronger effect can be observed in the angular distribution of the photoelectrons if elliptically polarized light is used. Under these circumstances the ATI plateau splits into two. Again it can be proven that this is due to an interference effect, namely interference between electrons that do and that do not rescatter.

By recording ATI spectra as a function of laser intensity, we observed an effect that can even dominate extended regions of the ATI plateau. At laser intensities where the ponderomotive shift of the ionization threshold closes the lowest lying ATI channel, a group of ATI peaks located in the ATI plateau grows quickly and dominates the rest of the plateau by up to an order of magnitude. Our explanation for this phenomenon is based on constructive interference of trajectories that return to the vicinity of the core not only once but several times.

Finally, we compared ATI spectra of N_2 and O_2 with their respective companion atoms Ar and Xe, i.e. atoms with similar ionization thresholds as the molecules. We observed a good agreement between N_2 and Ar but large deviations between O_2 and Xe. According to a theory developed in Faisal's group this is due to the bonding and anti-bonding orbitals of N_2 and O_2 , respectively. The latter leads to destructive interference and thus explains the differences observed.

Recoil-Ion and Electron Momentum Distributions for Single and Double Ionization in Strong Laser Fields

H. GiesSEN, C. Urbasch, and M. Vollmer
Fachbereich Physik, Philipps-Universität Marburg, Renthof 5, 35032 Marburg, Germany

T. Weber, M. Weckenbrock, A. Staudte, and R. Dörner
Institut für Kernphysik, Universität Frankfurt, 60486 Frankfurt, Germany
Phone: (49) 6421-282-2122, Fax: (49) 6421-282-7036, Harald.giesSEN@physik.uni-marburg.de

We use the well established technique of cold target recoil-ion momentum spectroscopy to investigate the momentum distributions of He^+ and He^{2+} in the focus of 800 nm, 220 fs, 1 kHz laser pulses at intensities ranging from $2.9\text{-}6.6 \cdot 10^{14}$ W/cm². These differential ion yields give more insight into the dynamics of the ionization process. For double ionization, two models have been suggested, shake-off on one hand and rescattering on the other hand. Our measured ratios of the He^{2+}/He^+ rate are 0.036%, 0.049% and 0.085% at 2.9, 3.8, and $6.6 \cdot 10^{14}$ W/cm². For single ionization, we find a momentum distribution which is strongly aligned along the electric field vector of the light.

We will present the He^{2+} momenta for three increasing intensities. Furthermore, we will show the ion momenta in the direction of the polarization integrated over the two momentum components perpendicular to the laser polarization. The distributions are rotationally symmetric around the horizontal axis. We find much larger momenta of the He^{2+} ions (5-10 a.u.), showing directly that double ionization does not proceed via sequential single electron processes and hence cannot be described by an independent electron approach, since for a sequential process one expects a momentum distribution of the single electron distribution convolved with itself.

The very broad momentum distribution of the He^{2+} ions implies also that the electrons from double ionization have much higher kinetic energy than those from single ionization. The broad distribution and in particular the minimum at momentum zero at the highest intensity indicate that two electrons having equal energy and being emitted back to back is not a significant contribution to the total cross section. In contrary, we find contributions up to a momentum of $2(4U_p)^{1/2}$, where U_p is the mean quiver energy of a free electron in the photon field. This corresponds to the parallel emission of two electrons with the maximum energy that can be classically acquired in the photon field. Furthermore, the momentum distributions in the direction perpendicular to the light polarization are narrower than expected from the rescattering model, whereas the momenta parallel to the light are higher than expected from this model.

For the Ar target, we succeeded in detecting the momentum of one electron in coincidence to the recoiling Ar^{2+} ion. Using momentum conservation one obtains also the momentum of the second electron. We find that both electrons are emitted preferentially to the same side with similar momentum [2]. This is in striking contrast to all correlated double ionization processes investigated so far for ion, electron and single photon impact.

[1] Th. Weber et al., Phys. Rev. Lett. **84**, 443 (2000)

[2] Th. Weber et al., Nature **405**, 658 (2000).

STRONG-FIELD INTERFERENCE STABILIZATION IN MOLECULES

M.V. Fedorov and M.E. Sukharev

General Physics Institute, Russian Academy of Sciences
38 Vavilov st., Moscow, 117942, Russia

The phenomenon of interference stabilization is known to arise in Rydberg atoms owing to coherent re-population of Rydberg levels in the process of ionization via Raman-type transition between discrete levels close to the initially populated one. Subsequent transitions to the continuum from the re-populated Rydberg levels interfere with each other and decrease the rate of ionization.

In molecules, such an effect has never been found to occur, and in this work we give the first theoretical proof of its existence. In a strong light field, the process of photo-dissociation of a molecule can be accompanied by Raman-type transitions back to ground-electronic-state vibrational levels, which are analogous to Λ -type transitions in Rydberg atoms. The main difference is in much more complicated frequency- and level-number-dependencies of Raman-type two-photon matrix elements in molecules compared to Rydberg atoms. For the molecular ion H_2^+ these matrix elements are calculated directly from the known data about dipole moment and potential curves of the two lowest-energy electronic states. The arising equations for probability amplitudes to find a molecule at ground-state vibrational levels are solved (a) in stationary and (b) in the initial-value-problem formulations. In the stationary formulation, complex quasienergies and quasienergy zones are found. In dependence on light frequency ω and intensity I , regions of stabilization are found, where some quasienergy zones narrow with growing light intensity. In these regions, the time-dependent probability of photo-dissociation and the total probability of photo-dissociation per pulse vs. the light peak intensity are calculated. These results are used to describe in details the dynamics of strong-field photo-dissociation and to estimate the conditions under which the field-induced interference stabilization of a molecule can exist.

ICONO 2001

IMPULSIVE GENERATION OF PHONON POLARITONS:
CHERENKOV EMISSION AT SUBLUMINAL SPEEDSR. Merlin,^{*} T. E. Stevens,^{*} J. K. Wahlstrand,^{*} and J. Kuhl[†]^{*}University of Michigan, Ann Arbor, MI 48109, USA and [†]Max-Planck-Institut FKf, D-70569 Stuttgart, Germany

As shown by Auston and co-workers [1], an ultrafast pulse moving in an electro-optic medium produces Cherenkov radiation (CR) if its group velocity, c_g , is greater than the phase velocity of light at infrared frequencies. The pulse generates a low-frequency polarization as it interacts with itself through a $\chi^{(2)}$ -process and, in so doing, it behaves as an optical analog of a relativistic dipole. For a point particle, the radiation is emitted in a cone with the characteristic Cherenkov angle $\theta_c = \cos^{-1}(c_0/c_g)$, where $c_0 = c/n_0$ and n_0 is the low-frequency index of refraction. Here, we demonstrate new and unexpected features of CR resulting from optical dispersion. We identify conditions for which CR is emitted at subluminal but not at superluminal speeds and verify this prediction in pump-probe experiments on ZnSe. We also present calculations for a point source revealing that an arbitrary cone angle is actually associated with two velocities, one above and one below a certain speed threshold. Finally, we argue that CR due to optical nonlinearities and phase-matched excitation of phonon polaritons by ultrafast pulses are the same physical phenomenon.

Pump-probe measurements were carried out at 10K using an OPA laser system that produces 90 fs pulses in the range 1.8-2.3 eV at 200 kHz. The optical parameters of ZnSe are such that, in the operating range of our laser, the group velocity becomes smaller than the phase velocity of light at zero frequency, c_0 . Differential transmission data reveal oscillations with frequency Ω that disappear if $c_g > c_0$ and for which $d\Omega/dc_g < 0$. This behavior is consistent with CR due to a planar distribution of dipoles [2].

Calculations of the Cherenkov field for a point particle reveal that θ_c is well defined not only at superluminal but also at subluminal speeds. More importantly, our results generally indicate that a given θ_c is connected not with one but with two particle velocities, one below and one above the light threshold at c_0 . We discuss the relevance of these results to high-energy physics experiments.

The diagrams in Fig. 1 address the issues of phase matching, CR and impulsive generation of coherent polaritons. The scheme in (A) relies on a tightly focused beam to produce infrared radiation [1] while the (two-beam) traveling grating method (B) is the approach most commonly used to generate coherent polaritons [3]. What these methods and ours (C) have in common is that the polarization source is solely a function of $t - z/c_g$. Given this dependence, it can be shown that the necessary condition for polariton phase matching is identical to that for the generation of CR [2].

[1] D. H. Auston, K. P. Cheung, J. A. Valdmanis and D. A. Kleinman, Phys. Rev. Lett. 53, 1555 (1984).

[2] T. E. Stevens, J. K. Wahlstrand, J. Kuhl and R. Merlin, Science 291, 627 (2001).

[3] See, e.g., H. J. Bakker, S. Hunsche and H. Kurz, Rev. Mod. Phys. 70, 523 (1998), and references therein.

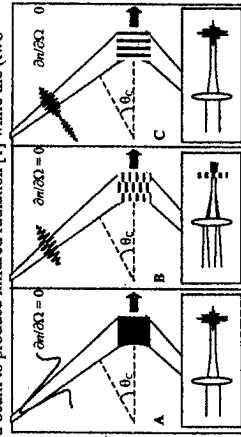

Fig. 1. Three methods used for generating Cherenkov fields. (A) and (B) represent Auston's [1] and the traveling-grating method (two pump beams). Our approach is illustrated in (C). The rectangular patterns are gray-scale plots of the field in the vicinity of the pump pulse; the vertical field vanishes in (A). The checkerboard-like field given by (B) reflects interference between two polaritons of wavelength given by the grating spacing that travel in opposite directions. (A) and (B) require $c_g > c_0$ for phase matching.

MODIFICATION AND ABLATION OF TRANSPARENT DIELECTRICS BY FEMTOSECOND LASER RADIATION

N.M.Bityurin, A.N.Stepanov, A.A.Babin, A.I.Korytin, A.P.Alexandrov, N.A.Babina, A.M.Kiselev, A.I.Kuznetsov, D.I.Kulagin, V.V.Lozhkarev, A.Yu.Malyshchev, S.V.Muraviov, A.M.Sergeev

Institute of Applied Physics, Russian Academy of Sciences
603600, Nizhny Novgorod, Russia

A controllable and reproducible modification of transparent dielectrics within the bulk of material by focused ultra-short laser pulses (USLP) provides the possibility for writing three-dimensional photonic structures. Firstly we consider creation of localized high-contrast structural changes in dielectrics by femtosecond radiation emitted by Ti:Sa-based master oscillator. We present experimental results on modification of polymers especially doped by dye molecules providing two-photon absorption and reducing the breakdown threshold. It is shown that irradiation by the second harmonic (SH) of Ti:Sa laser provides well-defined spots with micrometer diameter in a controllable manner in pure PMMA. Significant decrease in recording time is observed when combined irradiation by SH and fundamental frequency (FF) radiation is performed. We theoretically consider model when combined effect of two-color irradiation (SH+FF) has advantage compared to monochromatic irradiation. The results of experimental investigation of irradiation of halcogenide glass As_2S_3 are presented. We produce modified regions with diameters less than 1 μm . The exposure time necessary to fabricate a microstructure reduces drastically with increase in pulse energy. Minimum exposure time is as small as 0.3 μs . The model based on two-photon absorption of laser radiation and heating of irradiated area up to the melting temperature is developed. When the amplified femtosecond radiation is focused by an axicon lens inside the transparent dielectrics the formation of long channels with modified optical properties and extremely high (up to 10^4) aspect ratio is observed. Harmonic generation in a radiation pattern passed through the sample is discovered. The parameters of harmonics were investigated. Theoretical interpretation of experimental phenomena is presented. We also consider theoretically ablation of highly absorbing dielectrics and especially polymers by a single UV USLP and two successive pulses near ablation threshold.

Transient Deformations of Solid Surfaces Irradiated by Ultrashort Laser Pulses

Vasily V. Temnov^{1,2}, Klaus Sokolowski-Tinten¹, and Dietrich von der Linde¹
1. Institute for Laser and Plasma Physics, University of Essen, 45117, Essen, Germany, phone: 0201 1832456, fax: 0201 1832120, email: temnov@ilp.physik.uni-essen.de
2. Institute of Applied Physics RAS, 603600, Nizhny Novgorod, Russia.

The dynamics of femtosecond laser ablation of absorbing solids near threshold exhibits a material-independent behavior characterized by formation of transient optical interference pattern (Newton fringes) in the ablation region on a nanosecond time-scale [1]. Time- and space-resolved optical interferometry with femtosecond time and micrometer spatial resolution is used to directly detect transient surface deformations with an accuracy of a few nanometers. A Fourier transform method applied to the interferograms (example: Fig.1a, GaAs, $\lambda=800nm$, $\tau_{laser}=100fs$, $\Delta t=1.4ns$) is used to reconstruct the transient phase shift in the ablated area (Fig. 1b). The observed large phase shifts are mostly induced by transient surface deformations. The time dependence of the maximal surface excursion (in nm) in the center of the ablated area for a laser fluence $F=1.45 F_{ab}$ is plotted in Fig.2 and leads to an estimate for the velocity of the ablation front of about 400 m/s, in accordance with [1]. Transient surface deformations observed below the ablation threshold represent the thermal expansion of the laser-heated material. The time dependence of the maximal surface excursion in the center of the irradiated area for a laser fluence $F=0.95 F_{ab}$ plotted in Fig.2 shows the initial material expansion with a maximal velocity of approximately 100 m/s followed by its contraction within a few nanoseconds.



Fig.1a

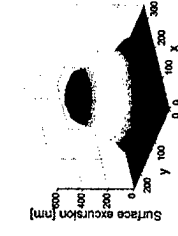

Fig.1b

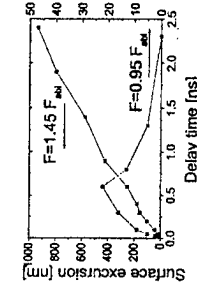

Fig.2

[1] K.Sokolowski-Tinten et. al., Phys.Rev.Lett. 81, 224 (1998)

Laser amplification of resonant and coherent injected fields
down to the femtowatt range

G.M. Stephan

ENSSAT, 6 rue de Kerampont, 22305, Lannion.FRANCE
Tel. 33 2 96466611; FAX 33 2 96370199

The properties of a laser ("slave") injected by another laser ("master") are strongly influenced by the incoming signal and have extensively been studied since the first experiment by Stover in 1966. The situation where the spectrum of the seed light is narrower than that of the injected laser has already been studied (Baev) and a big gain has been expected from the condensation of the laser energy from its broad band into the narrow signal. A distributed feedback semiconductor (DFB) single mode laser typically works in the (optical) 10 mW range and its frequency can lock onto an injected signal as small as 10 nW, if the detuning is small enough. However, in this work we focus on a novel situation in which the injected power is further reduced, especially when its spectrum is narrower than that of the injected laser.

A laser usually acts as a filter and amplifier for spontaneous emission: if an external small signal with a resonant frequency is injected, it should thus be amplified at the same rate as the spontaneous field. In our experiment, light from a tunable, commercially available, semiconductor laser is injected into a distributed feedback (DFB) laser currently used in optical telecommunications. Both lasers are single mode at the same frequency (1.55 μm) and their linewidths are different by 3 orders of magnitude. The injected laser works in the ordinary milliwatt domain with a linewidth which can be set between 1 and 200 MHz following the injection current. The output signal from the injected laser can be sent either onto a fiber Fabry-Perot analyzer or a Mach-Zender, heterodyning device.

Typical spectra of the output of the injected laser are obtained with a Fabry-Perot interferometer. This spectral analysis shows a narrow line on top of a wide spectrum. The line corresponds to the amplification of the incoming signal and the pedestal to the output spectrum of the non-perturbed laser. This method allows us to observe signals as weak as -90 dBm. The heterodyning method leads to a minimum detection level of -117 dBm ($10^{-14.7}$ W). As the coherence time of the field is 12 microsecond, this power corresponds also to 0.2 photon per coherence time (or one photon every 5 coherence time). The minimum detectable signal can also be measured when the laser amplifier is removed: the maximum gain is deduced to be 60 dB. This figure corresponds to the amplification of the spontaneous emission at the central resonance.

We have recently generalized the optical Airy function of the Fabry-Perot interferometer to the laser and theoretically shown that this method allows a simple and precise description of the laser linewidth and intensity for any value of the gain in the frequency domain. The idea here is that the laser feeds itself on the spontaneous emission which is filtered and amplified. In the injected laser, the external signal competes with the spontaneous emission to extract the energy.

At very low levels of injected light, it is necessary to quantize the field. In order to take the linewidth into account, it is also necessary to build photon wave packets, either in the frequency or in the time domains. These packets are characterized by a spectral width Γ and a single photon state $|1\rangle$ can be written as a linear superposition of normalized $|\omega, l\rangle$ states. The Lorentzian lineshape is the probability to have a photon in a given state $|\omega, l\rangle$. It results from the theory as well as from the experiment that the minimum power detectable by a laser is infinitely small: the energy minimum is one photon but the detection time can become as long as the coherence time of the wave packet associated to it. This is in striking contrast with ordinary detectors where one photon can be detected roughly only if the associated wave packet is shorter than the dipole lifetime.

BAND GAP COLLAPSE AND ULTRAFAST "COLD" MELTING
IN GaAs AND Si WITHIN A 100 FS PUMPING LASER PULSE

S.I. Kudryashov, V.I. Emel'yanov

International Laser Center, Moscow State University, 119899 Moscow, Russia
email: sergeikudryashov@chat.ru, emel@em.msk.ru

Bandgap collapse followed by the "cold" melting was found in GaAs and Si under strong excitation of electron-hole plasma by a 100 fs, 800 nm pumping laser pulse [1]. These phenomena occurring within the pump pulse duration were studied using self-reflectivity and pump-probe technique (probe wavelength of 400 nm).

Spacially and temporally deconvoluted dependencies of GaAs(100) and Si(100) self-reflectivity for s and p pump polarizations on laser fluence exhibit two prominent minima followed by a sharp increase in self-reflectivity up to its complete saturation. The reflectivity of the normally incident probe pulse shows the similar behaviour. The optical constants $n(800 \text{ nm})$ and $k(800 \text{ nm})$ as functions of the instantaneous pumping laser fluence were determined for both materials numerically inverting Fresnel equations. The obtained dependencies of n and k allow to associate the occurrence of these two reflectivity minima with well-known E_1 and E_2 absorption bands of GaAs and Si lying in the spectral range of 3-5 eV. The occurrence of this "red" shift of the bands was confirmed using the "sum rule" principle. The "red" shift is concerned with the collapse of GaAs and Si band gap at [111] and [100] directions under strong excitation of electron-hole plasma (densities well above 10^{22} cm^{-3}) and is followed by ultrafast "cold melting" structural transition. The latter occurs at the beginning of the sharp rise of pump self-reflectivity and probe reflectivity as is seen from the coincidence of the calculated $n(800 \text{ nm})$ and $k(800 \text{ nm})$ values with those reported in literature for equilibrium GaAs and Si melts.

[1]. S.I. Kudryashov, V.I. Emel'yanov, Pis'ma v ZhETF 73, 263 (2001).

High power double-clad Yb-doped fiber laser

A.Hideur¹, T.Chartier¹, S.Louis¹, M.Bruneel¹ and F.Sanchez²¹Groupe d'Optique et d'Optronique, CORIA UMR 6614, Université de Rouen
Place Emile Blondel, 76821 Mont-Saint-Aignan Cedex, France²Laboratoire POMA UMR 6136, Université d'Angers
2 Bd. Lavoisier, 49045 Angers Cedex, France

Summary

High power compact solid-state lasers in the 1-1.1 μm spectral range are of great interest for many applications involving optical pumping of either Raman lasers or Pr-doped fiber amplifiers. In this context we have started experiments on high power Yb-doped fiber lasers. In this communication, we present recent experimental results obtained with a double-clad side-pumped Yb-doped fiber laser. The fiber is 10 m long and has a double-clad allowing the use of high power semiconductor lasers as pumping sources by multimode propagation in the inner cladding. The pump is injected using the V-groove technique [1] thus ensuring both a high launching efficiency and free fiber ends. The core diameter allows a single-mode propagation of the laser signal. In absence of an optical feedback, the device is a simple fiber amplifier with an output power saturation up to 1 W. The high power amplifier has been used in various optical configurations. In a simple two-mirror cavity, the laser operates spontaneously in a self-pulsing regime which results from Brillouin backscattering. We have efficiently stabilized the laser with the use of a unidirectional ring cavity [2]. Indeed, the use of an optical isolator allows to suppress Brillouin backscattering. In addition, we have designed and realized an all-fiber tunable Yb-doped double-clad fiber laser in a unidirectional ring cavity [3]. The fiber laser delivers up to 800 mW and is tunable in the spectral range 1.04 μm to 1.10 μm . The laser linewidth is about 0.1 nm. Recent experiments have consisted to realize a self-starting passively mode-locked laser. For that we have used the additive pulse mode-locking (APM) technique [4]. The APM uses nonlinear polarization rotation in a unidirectional ring cavity together with an intracavity polarizer, which converts the rotation into fast saturable absorber action. Pulses with a duration of about 30 ps have been first obtained. The use of a grating pair has allowed to compress the initial pulses. The resulting pulsewidth is about 700 fs and the average power is 0.5 W. The repetition rate of the laser corresponds to the free spectral range of the cavity, about 15 MHz.

[1] D.J.Ripin and L.Goldberg, *Electron. Lett.* **31**, 2204, 1995.[2] A.Hideur, T.Chartier, C.Özku and F.Sanchez, *Opt. Com.* **186**, 311, 2000.[3] A.Hideur, T.Chartier, C.Özku and F.Sanchez, « All-fiber tunable Yb-doped double-clad fiber ring laser », submitted to *Opt. Lett.*[4] H.A.Haus, E.P.Ippen and K.Tamura, *IEEE Jour. Quant. Electron.* **30**, 200, 1994.CW-Pumped Erbium Fiber Laser Passively Q-Switched with $\text{Co}^{2+}:\text{ZnSe}$ Crystal

Alexander V. Kir'yanov, Valery N. Filippov, and Andrei N. Starodumov

Centro de Investigaciones en Optica A.C., Apartado Postal 948, Leon 37000, MEXICO

Q-switched erbium fiber lasers are currently used for purposes of communications, distributed fiber-optical sensing, etc. There exist active and passive methods to enforce a laser to oscillate giant pulses. The passive methods are the most actively studied now. In this work, we report, for the first time to our knowledge, on a novel scheme of an erbium fiber laser passively Q-switched with a use of a $\text{Co}^{2+}:\text{ZnSe}$ crystal under CW pump.

Fig.1. Schematic of laser.

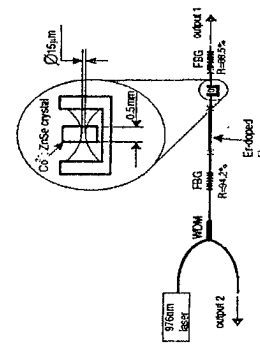

The laser (Fig.1) is formed by a piece (20 m) of optical fiber with moderate concentration of erbium, a sample of $\text{Co}^{2+}:\text{ZnSe}$ crystal (initial transmission - 92%) inserted in a U-bench unit, and two fiber Bragg gratings as output mirrors (with reflectivity of 89 and 94%). The pump is a semiconductor laser ($\lambda=976 \mu\text{m}$). Output characteristics of the laser were studied with a fast Ge photodiode, an oscilloscope, and a powermeter.

Fig.2. Regime of giant pulses (pump power - 48.5 mW).

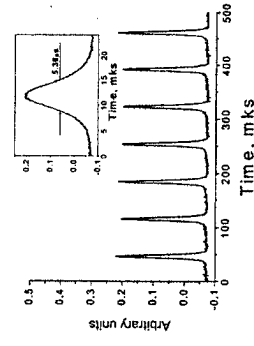
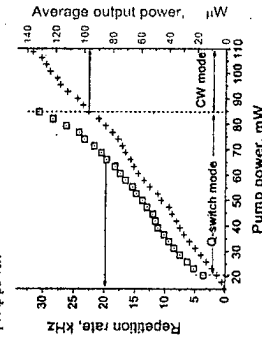

Fig.3. Output power (right) and repetition rate (left) vs pump power.



Laser threshold was measured to be 19 mW at $\lambda=1560 \text{ nm}$. Just above the threshold, with pump power rise up to 21 mW, the laser transitioned to the passive Q-switching mode, when stable giant pulses are generated (Fig.2). Pulse width depends on pump power and is measured from 3 to 15 μs . Rather big duration of the pulses is explained by considerable length of the cavity. Fig.3 shows the dependencies of average output power of the laser and repetition rate of pulses vs pump power. It is seen that both curves are very close to the linear law, being practically parallel in the whole range of input powers. At further rise of pump, starting from $\sim 85 \text{ mW}$, the passive Q-switching mode takes unstable character with a time jitter appearance and, at further increase of pump, is replaced by CW operation. There is no any change in output power at the laser transiting from the passive Q-switching mode to the CW one.

MULTISTABILITY IN LOSS-MODULATED CLASS B LASERS INDUCED BY WEAK PERIODIC PERTURBATIONS

V.N. Chizhevsky

B.I. Stepanov Institute of Physics, National Academy of Sciences of Belarus,

Fr. Skaryna 68, 220072 Minsk, Belarus

In this report a simple method for obtaining multistability is presented which can be achieved in loss-modulated class B lasers displaying the period doubling route to chaos. It is shown here that weak perturbations at the frequencies f_d/N (where f_d is the main driving frequency, $N=3,4,5,8,16,\dots$) can induce up to N coexisting attractors under an appropriate choice of the modulation amplitude as well as the amplitude and the phase of resonant perturbations. An underlying mechanism is so-called imperfect bifurcations which lead to the appearance of multiple attractors by saddle node bifurcations. The experimental and numerical evidences are given on the basis of a CO_2 laser.

Multistability was studied numerically with a help of bifurcation diagrams in the presence of periodic perturbations. Two different cases were considered. At first, the effect of the perturbation at the frequencies $f_d/4$, $f_d/8$ and $f_d/16$ on the period-1 branch were investigated in a wide range of the modulation amplitude. It was found numerically a coexistence of 4, 8 and 16 attractors, respectively. Besides, the phase effects in the obtaining of multistability were studied. It is found scaling laws which relate the onset of saddle-node bifurcations induced with the perturbation phase in the vicinity of the first three original unperturbed period-doubling bifurcations. Secondly, it was studied the effect of periodic perturbations at f_d/N on the NT -subharmonic branches which result from saddle-node bifurcations of the period- N ($N=3,4,\dots$, T is the driving period). It is shown that the periodic perturbations split the original NT -subharmonic branches into N new ones with the same period N .

The experimental results are in good agreement with numerical ones and confirm all main conclusions made from the numerical simulation.

DISPERSION PHASE-MODULATION BISTABILITY OF PASSIVE MODE-LOCKED LASERS

F.M.Mitschke^a, A.K.Komarov^b, K.P.Komarov^b

^a Universität Rostock, Universitätsplatz 3, D-18055, Rostock, Germany

^b Institute of Automation and Electrometry, RAS, 630090, Novosibirsk, Russia

Novel mechanism resulting in generation bistability of passive mode-locked lasers is predicted. It is shown by numerical simulation that after transient evolution either single stationary pulse operation or operation in which the whole laser cavity is filled with the generated radiation can realized depending on the initial conditions. This bistability is connected with the phase-modulation instability of passive mode-locking in circumstances where the spectral gain-loss profile has a complicate form. The complicate profile can be related to a spectral selectivity of parasitic losses or a spectral inhomogeneity of an active medium amplification.

The nonlinear refractive index of intracavity elements and the nonlinear losses are assumed to be proportional to the radiation intensity. The dispersion of both gain and the refractive index are modeled by the parabolic frequency dependence. The additional narrow-band spectral component of gain-loss due to parasitic losses or a spectral gain inhomogeneity is modeled by corresponding Lorentzian.

The condition of realization of the self-start for passive mode-locking on initial conditions and on parameters of laser system is determined. The single stationary pulse mode is realized if considerable part of energy is concentrated in one of initial pulses. In opposite case, the whole resonator is filled with radiation.

We have established that very weak narrow-band parasitic losses can result in the above mentioned bistability (the amount of the selective loss is of order 0.01 part of the gain; its spectral bandwidth is of order 0.01 part of the gain bandwidth). This bistability of laser operation is correlated with experimentally observed bistability in passive mode-locked Ti:sapphire laser with Kerr-lens: specific initial generation conditions are necessary for self-start of passive laser mode-locking. This bistability extends the assortment of possible reasons preventing the passive mode-locking of lasers.

Obtained results are compared with the corresponding experimental results and with other known mechanisms producing an analogous bistability.

RESONANCE REFLECTION FROM AND TRANSMISSION THROUGH A DENSE GLASSY FILM OF ORIENTED J-AGGREGATES

A.A.Bogdanov¹, I.V.Ryzhov¹, A.I.Zaitsev¹, V.A.Malyshv²

¹Herzen Pedagogical University, Moika 48, 191186 Saint-Petersburg, Russia
²National Research Center "Vavilov State Optical Institute", Birzhevaia Liniya 12, 199034 Saint-Petersburg, Russia

We carry out a theoretical analysis of the resonance optical response from a dense glassy film consisting of oriented J-aggregates and model this system as an ensemble of short (as compared to an optical wavelength) linear Frenkel chains of three-level molecules. The two lower molecular states are assumed to form an excitation band, as a result of a sufficiently strong resonant dipole-dipole inter-molecular coupling. The high-lying electronic-vibrational molecular term serves as the intermediate state through which excitons annihilate due to a resonance between one of the electronic-vibrational levels and the two-exciton optical states. The chain length distribution results in fluctuations of all exciton optical parameters (transition frequencies and dipole moments as well as radiative rates). We account only for nearly resonance optical transitions ground state - one-exciton band bottom - two-exciton band bottom as having the dominating oscillator strengths as compared to the other states of the one- and two-exciton manifolds. We mainly interested in the system behavior under the condition of a well developed polariton band gap in the spectrum of system eigenmodes (excitons + field) [1,2].

From our study, the following conclusions can be drawn:

- (i) within a certain range of driving parameters (resonance detuning, polariton splitting, and inhomogeneous width), the system may show a bistable behavior with respect to both the reflection and transmission of the resonant input field;
- (ii) the bistability effect exists until the inhomogeneous width of the transition approaches the polariton splitting;
- (iii) the exciton-exciton annihilation acts as a factor of reducing the inhomogeneous broadening;
- (iv) the system may show self-oscillations and chaotic behavior of both transmittivity and reflectivity on increasing the polariton bang gap.

Estimates of the driving parameters show that films of oriented J-aggregates of polymethine dyes at low temperatures seem to be suitable species for the experimental verification of the behavior found.

[1] V. A. Malyshv and E. Conejero Jarque, *J. Opt. Soc. Am. B* **12**, 1868 (1995); *ibid* **14**, 1167 (1997); *Opt. Exp.* **6**, 227 (2000).

[2] E. Conejero Jarque and V. A. Malyshv, *Opt. Commun.* **142**, 66 (1997).

HOLOGRAPHIC SCREENS FOR 3-DIMENSIONAL IMAGE PROJECTION, ITS CURRENT STATUS AND PERSPECTIVE

Author: Jung-Young Son, Korea Institute of Science and Technology, P.O. Box 131 Cheongryang, Seoul, Korea, Email: siv@kist.re.kr

Summary

Unlike plane images, the first thing to do in displaying 3 Dimensional(3-D) images is to create a mechanism to separate left and right eye images and then to deliver the images to the corresponding eyes. Holographic screen(HS) is one of special optical plates designed to provide the mechanism and same time projecting images[1]. It is an holographic optical element which has the properties of either a spherical mirror or a lens combined with a diffuser. Hence HS is an essentially dispersive element. To make it display full color images, a specially designed recording set-up or method should be used. For the full color transmission type HS, a long narrow diffuser is used as an object in the recording set-up to cover full visible spectral range as shown in Fig.1, and for the reflection type HS, a process of chirping fringe structure is required. The currently available size of the HS are 40inches for transmission type and 20 X 30 . For the case of the transmission type HS, any size can be recorded if recording space and laser power are big enough. It is also possible to have bigger size HS by mosaicking smaller ones. HS has almost unlimited screen resolution and creates very bright viewing zone(s). These make HS be a good 3-D image projection screen. Currently, the possible applications of HS to 3-D game machine and monitors are progressing.

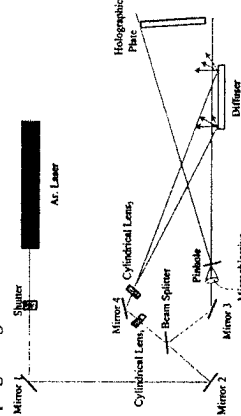

Fig. 1. The Holographic Screen Recording Setup

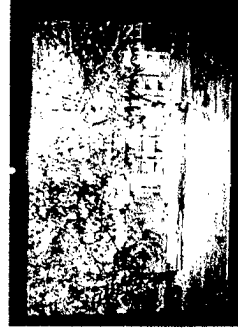

Fig. 2. Image displayed on a 40inch size screen

[1] Jung-Young Son, V. I. Bobrinev, Autostereoscopic Imaging Systems based on Holographic screen, Photonics East, Boston, Nov.5th, 2000

TRANSFER, STORAGE AND MULTIPLEXING OF OPTICAL SIGNALS IN BISTABLE PLANAR SEMICONDUCTOR STRUCTURES

A.M.Goncharenko, G.V.Sinit SYN

Division for Optical Problems in Information Technologies, NAS of Belarus
Kuprevich str. 1, build. 2, 220141, Minsk, Republic of Belarus

Principles of formation and controlled propagation of switching autowaves in optically bistable interference structures are considered. On this basis methods and devices are developed for read-in, storing, read-out, switching and transfer of information light signals in the plane of 2D-arrays of nonlinear optical elements of micron size. A peculiarity of these methods is the possibility to shift data laterally in the array's plane in a direction that is perpendicular to the direction of incident light beams without its interim transformation into electrical signals. This distinctive feature enables developing new architecture concepts of optical information processing systems.

Examples of numerical simulations and experimental realizations of optical digital devices with a wide range of functional applications such as Boolean logic elements, shift registers, multiplexers/demultiplexers, basic planar ring processors, etc. The limiting operation parameters of the above devices are discussed.

The results presented in the report are based on original investigations of the authors and their colleagues at the Division for Optical Problems in Information Technologies, National Academy of Sciences of Belarus.

The work has been supported by the ISTC (grant B-129).

THEORETICAL ASPECTS AND POTENTIAL APPLICATIONS OF CAVITY SOLITONS IN SEMICONDUCTOR MICRORESONATORS

T. Maggipinto^a, M. Brambilla^a, I.M. Perrini^a, G. Tissoni^a and L. Spinelli^b

^aINFM, Dipartimento di Fisica Interateneo, Università e Politecnico di Bari,

via Orabona 4, 70126 Bari, Italy

^bINFM, Dipartimento di Scienze Chimiche, Fisiche e Matematiche, Università dell'Insubria,

via Valleggio 11, 22100 Como, Italy

Cavity Solitons (CS) appear as self-confined light peaks embedded in the transverse profile of a homogeneous coherent field propagating in a nonlinear cavity. They have recently been predicted for GaAs semiconductor microcavities (both MQW and bulk), for which we have developed a microscopic model that describes the field and the carrier dynamics inside the active region [1-2]. CS can be created/erased, in any desired location in the transverse plane, by injecting a suitable addressing pulse, and their position can be controlled by means of gradients in the input field [3]. These features are appealing for applications of CS to optical information processing (OIP).

In this talk we present some recent progress in the theoretical/numerical modelization. We improve our previous model by adding the temperature dynamics. The combination-competition of the slow temperature nonlinearity and the fast carrier nonlinearity, forces the system to peculiar behaviours. In small parameter regions, around the situation of nascent bistability, we observe regenerative oscillations (RO) and the phenomenon of switching point. In this regime we are in presence of a Hopf instability, characterized by a very small oscillation frequency.

Next, as for CS application to OIP, we use a powerful numerical method to deeply investigate CS stability, robustness and controllability [4]. We show how it is possible to relate the CS dynamical properties to their internal eigenmodes, either stable, unstable or neutral. In particular we find regimes where CS are "particle like" so that they can act as individually addressable and reconfigurable optical pixels.

[1] L. Spinelli, *et al.*, Phys. Rev. A **58**, 2542 (1998).

[2] G. Tissoni, *et al.*, J. Opt. Soc. Am. B **16**, 2083 (1999)

[3] G. Tissoni, *et al.*, J. Opt. Soc. Am. B **16**, 2095 (1999).

[4] T. Maggipinto, *et al.*, Phys. Rev. E **62**, 8726 (2000).

COHERENT EFFECTS ON ZEEMAN SUBLEVELS OF BARIUM

INTERCOMBINATION TRANSITION $6^1S_0 - 6^3P_1$

D. Sarkisyan and A. Papoyan

Institute for Physical Research, Asharak-2, Armenia (E-mail <david@ipr.sci.am >)

Methods of Laser Spectroscopy on the forbidden 2^1S-2^3S Transition of Helium

E. V. Baklanov

*Institute of Laser Physics, Siberian Academy of Sciences,
Prospect Lavrentyev, 133, Novosibirsk, 630090, Russia
e-mail: bakl@laser.nsc.ru*

Although the calculation of level energies for a helium atom is a rather complex problem, these energies have been calculated with an accuracy of about 100 kHz [1]. Comparison with the relevant experimental data is of crucial importance for the development of fundamental theory. In this work two methods of laser spectroscopy for the 2^1S-2^3S forbidden transition of helium have been analyzed: linear absorption and stimulated Raman scattering [2].

Linear absorption. The probability of the forbidden magnetic-dipole 2^1S-2^3S transition is $W \approx 6 \cdot 10^{-8} \text{ s}^{-1}$ [3]. We have considered the resonant absorption radiation ($\lambda = 1557 \text{ nm}$) in a gas on this transition. The number of atoms excited to the 2^1S level under the action of a running wave per unit time is $10^5 \text{ cm}^{-3} \text{ s}^{-1}$ (the energy flux density is 1 mW/cm^2).

Stimulated Raman scattering. The pumping field is assumed to be a running wave whose frequency is close to the frequency of the 2^3S-2^3P transition ($\lambda = 1083 \text{ nm}$), while the signal produced through stimulated scattering is represented as a wave whose frequency is close to the frequency of the 2^1S-2^3P transition ($\lambda = 3561 \text{ nm}$). The line width of the scattered wave is 4 MHz . The density of atoms excited to the 2^1S state per unit time is $10^{10} \text{ J} [mW/cm^2]$, where J 's the energy flux density of the scattering wave. These estimates show that the linear gain for the scattered wave is rather high, and the measurement of this quantity should not encounter considerable difficulties.

1. G.W.F. Drake, W.C. Martin. *Can.J.Phys.* **76**, 679 (1998).
2. V.S. Letokhov, V.P. Chebotayev, *Nonlinear Ultra-high-Resolution Laser Spectroscopy*, Moscow, Nauka (in Russian) 1990.
3. E.V. Baklanov, A.V. Denisov, *Laser Physics*, **9**, 559 (1999).

Resonant magneto-optic effects where coherence effects can be observed have proven to be powerful tools in laser spectroscopy, as well as in sensitive magnetometer development [1-2]. Here we report (for the first time) the observation of Nonlinear Faraday effect (NFE) on Ba atomic intercombination line (791.1nm, natural linewidth of 110 kHz). The set-up includes a unique 10 cm-long sealed-off sapphire cell (with the garnet birefringence-free windows) containing Ba vapor heated in the range of $400^\circ\text{C} - 750^\circ\text{C}$ ($N(\text{Ba}) \sim 10^{10} - 10^{14} \text{ cm}^{-3}$). The cell's oven is made of nonmagnetic materials. The cell was placed between the crossed polarizers. To cancel the ambient laboratory magnetic field and apply the magnetic field along the laser propagation direction, the cell was surrounded by a set of 3D Helmholtz coils. Frequency of the cw laser diode was scanned within ^{138}Ba isotope intercombination line which is a simple V-system with $J=0$ to $J'=1$ (Zeeman splitting of 2.1 MHz/G). The dependence of the radiation intensity passed through Crossed-Polarisers (CP) versus external magnetic field is presented in the figure. A characteristic width of 200 mG of this structure (determined by the Zeeman coherence relaxation rate) corresponds to a spectral width of $\sim 100 \text{ kHz}$ in frequency units according to twice the Larmor frequency and is narrower by a factor of more than 10^3 than 600 MHz-Doppler width (also is much narrower than 20 MHz laser linewidth). Efficiency of 10^3 is achieved for pump intensity of 50 mW/cm^2 , $N \sim 5 \times 10^{11} \text{ cm}^{-3}$. I(CP) is observed down to $N(\text{Ba}) \sim 10^8 \text{ cm}^{-3}$ demonstrating that NFE is a powerful tool for weak transition spectroscopy. Under some conditions the frequency profile of I(CP) exhibits a regular sub-Doppler structure.

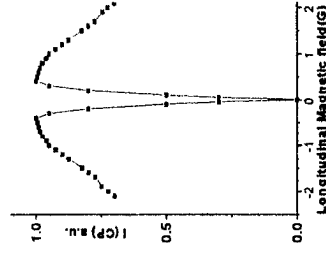

1. D. Budker et al., *PRL*, **v.85**, 2088(2000). *PRL*, **v.83**, 1767(1999).
2. D. Sarkisyan et al. *Adv. Progr. QWd8*, p. 79, (2000), Nice, France, 2000.

SINGLE NITROGEN-VACANCY DEFECT CENTERS IN DIAMOND:
SPECTROSCOPY AND QUANTUM-OPTICAL APPLICATIONS

A. P. Nizovtsev and S. Ya. Kilin

B.I. Stepanov Institute of Physics, National Academy of Science,
F. Skarina Ave., 70, Minsk, 220072, Belarus

Single Molecule Spectroscopy has been applied recently to study the *individual* Nitrogen-Vacancy (NV) defect centers in diamond [1,2] which are of great interest owing to possibilities to use them as a stable room-temperature single-photon emitter [2] or to build quantum computer at ^{13}C nuclear spins neighboring the center [3].

Based on new spectroscopic information retrieved in [1] we have developed the photophysical model of the center which takes into account the triplet-triplet character of the optical transition $^3\text{A} - ^3\text{E}$ (637 nm) of a center and the presence of metastable singlet state ^1A . Possible deshielding of the ^1A state both by phonons (effective at room temperature) and by laser through higher electronic states of the center [1] (the only deshielding mechanism at low temperatures) is also incorporated into the model.

Using the model we were able to fit consistently a variety of experiments on observation of fluorescence-detected magnetic resonance (FDMR) phenomena, which took place when cw/pulsed microwaves affect resonantly the ground-state EPR transition at 2.88 GHz of the laser-excited NV center. Supposing the optical excitation rates from X(Y) and Z spin substates of the ground ^3A state to be different by ~ 6 times while the fluorescence emission rates to X(Y) and Z substates - by ~ 9 times we fit the FDMR lineshapes for single centers [1] as well as their changes due to random static strains within the crystal. Recent observations of antibunching [2] of the fluorescence photons emitted by single NV center are also fitted. Moreover, preliminary calculations show that numerous FDMR transients (nutaton, Hahn echo, stimulated echo, spin-locked echo, adiabatic fast passage etc.) observed previously for the NV ensemble can be described within the model.

[1] A. Gruber et al., *Science*, **276** (1997) 2012; A. Drabenstedt et al., *Phys. Rev. B* **60** (1999) 11503.

[2] C. Kurtzseifer et al., *Phys. Rev. Lett.*, **85** (2000) 290; R. Brouni et al., *Opt. Lett.*, **25** (2000) 294; A. Beveratos et al., *quant-ph/0010044* (2000).

[3] J. Wrachtrup, S. Ya. Kilin, A. P. Nizovtsev, *Phys. Rev. Lett.*, (2000) submitted.

SINGLE MOLECULE SPECTROSCOPY OF MOLECULES ISOLATED
IN SOLID-DEPOSITED MATRICES

A. Starukhin, A. Shulga

Institute of Molecular and Atomic Physics, 220072, F. Scaryna Ave. 68, Minsk,
Belarus

J. Septiol, R. Kolos

Institute of Physical Chemistry, Kasprzaka 44/52, 01-224 Warsaw, Poland

A. Renn, U. P. Wild

Swiss Federal Institute of Technology, ETH-Zentrum, CH-8092 Zurich, Switzerland

Single molecule spectroscopy of compounds at liquid helium temperature has revealed a number of unique information about processes into molecules. Fluorescence microscopy of single molecules under line-narrow excitation is especially suited for investigation of a whole set of molecules in parallel under identical conditions. Matrix isolation technique was successfully adapted to the spectroscopic studies of single molecules embedded in solid matrixes. Under this conditions the concentration of guest molecules and the thickness of a matrix deposited directly on the objective surface can be easily controlled.

As the laser scans, single molecules show up at different spatial positions in the images when the transition frequency is in resonance with the laser frequency. Usually fluorescence microscopy images recorded while scanning the single-mode dye laser frequency over the range of 2 GHz with the step of near 3 MHz.

For terylene molecules in *n*-alkane matrixes deposited directly on the surface of the mirror objective was established that the line-shape well reproduced by a Lorentzian fit with spectral width near 60 MHz.

The fluorescence of single molecules of dibenzanthrene and Mg-tetraporphyrin in xenon and krypton solid state matrixes has been recorded at 2 K. Single molecules of dibenzanthrene in xenon matrix has a Lorentzian profile with spectral width near 80 or 100 MHz. For Mg-tetraporphyrin in xenon matrix very stable single molecules with line-widths around 40 MHz has been observed at 2 K and this value is well agree with lifetime for the first singlet state.

BROAD-BAND ANTI-STOKES EMISSION FROM (DYE
MOLECULES)/(SILVER FRACTAL AGGREGATES)/ MICROCAVITY
COMPOSITES

V.P. Safonov, N.S. Zakovryashin

Institute of Automation and Electrometry SB RAS, Novosibirsk, 630090, Russia

A novel class of composites for optics, microcavities doped with metal fractal aggregates, was studied. It is well known that metal nanostructures provided large enhancement for Raman scattering, luminescence [1], two-photon excited luminescence [2] and for nonlinear scattering processes [3]. The enhancement is due to excitation of high quality optical plasmon modes localized in metal aggregates ($Q_f \sim 10^3$). Seeding the aggregates into a microcavity further increases the optical responses because of excitation of morphology-dependent resonances (MDR's) in the microcavity with high quality factors $Q_m \sim 10^5$. Lasing at extremely low cw pump intensities (below 0.5 mW) have been observed from Rhodamine 6G (R6G) molecules adsorbed on silver colloidal aggregates inside a microcavity [4].

In this paper a broad-band anti-Stokes luminescence from R6G/silver colloid/microcavity composite at Nd:YAG laser pulse excitation ($\lambda_e = 1064$ nm) was studied. Silver fractal aggregates in aqueous or ethanol colloidal solutions consisted of nanoparticles with size ≈ 10 nm. Size of aggregate (~ 1000 nm) was compared with λ_e . Colloid with 10^{-6} M R6G was placed within a cylindrical microcavity (1 mm quartz tube with thin wall). The observed emission spectrum was much wider and stronger than luminescence of R6G molecules in solutions without Ag aggregates. The spectrum consisted of many peaks in the range of 410 nm - 650 nm. Pulse duration of the observed emission increased with the pump intensity (up to 400 ns and more) and considerably exceeded the pump pulse duration (10 ns), dye molecule fluorescence time, and relaxation times in silver particles.

The broad-band long-time luminescence was not observed in Ag/microcavity composite without R6G or in Ag/R6G/microcavity composite at $\lambda_e = 532$ nm excitation.

Our observations may be interpreted as a multiphoton-excited luminescence of dye/(metal particle) complexes in multiplex cavity, formed by nano-resonators (fractal aggregates) and by microresonator. This multiplex cavity provides large ($\propto Q_f Q_m$) enhancement factors for the multiphoton excitation process as well as for spontaneous emission process, including emission starting from long living triplet states of dye molecules.

References

- [1] M. Moskovits, *Rev. Mod. Phys.*, **57**, 783 (1985).
- [2] A.V. Baranov, Ya.E. Bobovich *Optika i Spektrosk.*, **57**, 3 (1984)
- [3] V.M. Shalaev, *Phys. Reports*, **272**, 61 (1996).
- [4] W. Kim, V.P. Safonov, V.M. Shalaev, R.A. Armstrong, *Phys. Rev. Lett.*, **82**, 4811 (1999).

New Opportunities in Solution of Inverse Problems in Laser Spectroscopy
Due to Application of Artificial Neural Networks

T.A. Dolenko, I.V. Boychuk, I.V. Churina, V.V. Fadeev

Quantum Electronics Chair, Physical Dept., Moscow State University

S.A. Dolenko, I.G. Persiantsev

Nuclear Physics Institute, Moscow State University

Moscow, 119899, Russia

Solution of inverse problems is one of the most important attributes of spectroscopy. In a large class of such problems it is possible to find such a volume of *a priori* information that is sufficient to make the problem correct by Tikhonov. One of the necessary conditions for such correctness is stability of the solution. As a rule, the inverse problem with a limited number of determined parameters is theoretically stable, but often it is very difficult to reach the high practical stability using conventional algorithms of solving inverse problems based on variation methods - minimization of the residual functional by varying the determined parameters.

The situation is radically changed if the inverse problem is solved with the help of artificial neural networks (ANN) technique. ANN are a set of computational methods capable of solving a large number of image recognition and analysis problems [1]. These methods are different from variation methods in principle, as they take into account a large number of features in the input data, selecting the most appropriate features to minimize the error of determination of the sought parameters.

The following results reported illustrate the unique opportunities of ANN to successfully solve inverse problems: (1) precise determination of water temperature from Raman spectra, (2) determination of small fluorescent contributions for components of an organic compounds mixture in water from their fluorescence spectra, (3) determination of molecular parameters of organic compounds from fluorescence saturation curves, and (4) time-resolved kinetic spectroscopy performed with long excitation pulse and a detector with low temporal resolution. In particular, in task (2), the minimal detectable relative fluorescent contribution was about 10^3 .

[1] <http://www.emsl.pnl.gov:2080/prof/neuron/neural/neural.homepage.html>

Molecular Above Threshold Ionization (ATI) and Coulomb Explosion (CE) spectra using a Moving Adaptive grid method for numerical solutions of the molecular Time Dependent Schroedinger Equation (TDSE) in intense laser fields

A.D. Bandrauk, S. Chelkowski, I. Kawata, H.Z. Lu
Laboratoire de Chimie Theorique
Universite de Sherbrooke, Que, J1K 2R1, Canada

Advances in current laser technology are providing experimentalists with ultrashort ($t < 10$ fs), intense ($I > 10^{14}$ W/cm²) laser pulses [1] which allow one to study the behavior of atoms [2] and molecules [3] in the highly nonperturbative nonlinear regime of laser-matter interaction. Since the atomic unit of electric field $E_0 = 5 \times 10^9$ V/cm or the equivalent intensity $I_0 = 3.5 \times 10^{16}$ W/cm², the current laser fields or intensities approach the above atomic values so that for molecules dissociative ionization is a dominant process. One must therefore deal theoretically and numerically with bound-continuum and continuum-continuum transitions both in the electronic and nuclear Hilbert spaces. The advent of high speed supercomputers allows one to solve numerically for the appropriate TDSE's yielding exact electronic and nuclear wave functions. In the case of molecules we have previously performed the first non-Born-Oppenheimer simulation of ATI and CE spectra for H₂⁺, the simplest one-electron molecule [4]. Such benchmark calculations have led the way to the concept of Charge Resonance Ionization, CREI [5] and Laser Coulomb Explosion Imaging, LCEI [6].

All our previous calculations were performed in the Er (length) gauge, which necessitated projecting asymptotic wave functions, both electronic and nuclear on appropriate Volkov states, the exact solutions of free particles in the presence of a laser pulse. In the Coulomb (A.p) gauge the laser-matter interaction appears as a convection term which in the spirit of classical fluid dynamics [7] can be removed using a Lagrangean coordinate system. This has now been called the Space-translation method [2] although it was originally used by Pauli & Fierz in QED [8]. We will show that this Lagrangean method can be implemented in highly parallel numerical codes provided one uses an adaptive moving numerical grid to solve the TDSE. These new equations have the advantage that for large electron-nuclear separation as occurs in dissociative ionization [4], the grid moves exactly in phase with the asymptotic electron wave function. Examples of ATI and LCEI for the systems H₂⁺, H₃⁺⁺ and even the 2-electron system H₃⁺ will be presented using this new numerical method. Emphasis will be put on new applications of ATI and CE as imaging tools for time-dependent molecular dynamics.

- [1] T. Brabec, F. Krausz, *Rev Mod Phys* 72, 545 (2000)
- [2] M. Gavrilu, "Atoms in Intense Laser Fields", Academic Press, NY, 1992
- [3] A. D. Bandrauk, "Molecules in Laser Fields", M. Dekker Pub. NY, 1994
- [4] S. Chelkowski, C. Foisy, A. D. Bandrauk, *Phys Rev A* 57, 1156 (1998)
- [5] A. D. Bandrauk, "Physics of Electronic, Atomic Collisions", ed. Y. Itikawa et al, AIP-CP 500, p 102
- [6] S. Chelkowski, P. B. Corkum, A. D. Bandrauk, *Phys Rev Lett* 82, 3416 (1999)
- [7] L. D. Landau, E. M. Lifschitz, "Fluid Mechanics", Pergamon Press, NY, 1987
- [8] W. Pauli, M. Fierz, *Nuovo Cimento*, 15, 167 (1938).

SHAPING MOLECULAR BEAMS WITH LIGHT

Tamar Seideman
Steacie Institute for Molecular Sciences, National Research Council of Canada
Ottawa, Ontario K1A 0R6, Canada
Tel: 1-613-990-0945, Fax: 1-613-947-2838
E-mail address: tamar.seideman@nrc.ca

Atom optics, the application of lasers to spatially manipulate atomic motions, has been one of the most active sub disciplines of atomic physics, with applications ranging from atom holography to atom lithography. Unfortunately, the techniques of atomic manipulation with light cannot be extended to spatially manipulate molecular motions, due to the complex level structure and weak transition dipole elements of molecules. Success in the atomic domain nevertheless suggests that an analogous field of molecular optics could open a rich variety of new opportunities.

Recently it was proposed that general molecules could be focused and guided using a non-resonant, moderately intense laser field. Spatial manipulation in that case is based on the nonlinear interaction of the intense field with the quasi-static polarizability tensor, rather than on near-resonance interactions as in the atomic case. The spatial intensity profile of the strong field produces an effective well for the center of mass motion which accelerates the molecular trajectories toward the high intensity region and brings them to a focus in a predetermined point in space. The method is applicable to all molecules (and atoms), since all molecules are polarizable to some extent, and robust, since the deep well translates into weak sensitivity to velocity distribution and other aberrations. Molecular focusing generalizes to a field of molecular optics, with possible applications in nanoscale surface processing and molecular separation techniques.

An important advantage of atom optics which the molecular optics scheme does not share, is the availability of both attractive and repulsive optical elements, obtained by red- or blue-detuning the laser frequency from resonance. The molecular optics scheme, by contrast, is based on attractive interactions alone. One of our purposes in the present talk is to examine the possibility of extending molecular optics to include repulsive optical elements and illustrate some of their potential applications.

Related to intense-light molecular optics is the problem of molecular alignment in intense laser fields. From the formal view-point, both intense field alignment and photomanipulation of the center-of-mass motion rely on inhomogeneous field effects. Furthermore, both reduce in one limit to fully quantal cycles between two electronic states and in another to the nearly classical interaction of an electric field with a many level system. From a practical view point, the possibility of simultaneously aligning molecules and focusing their translational motion is intriguing, with potential applications in stereodynamics, gas-surface research, surface catalysis and material processing. It is clear, however, that to become useful, simultaneous focusing and alignment should be realized under field-free conditions. A second goal of this presentation is to discuss and examine a means of simultaneously focusing and aligning molecules in a field-free region of space.

Finally, it is to be noted that alignment is a one-dimensional concept; a uniaxial field can only define one direction in space. It will be shown that by means of an elliptically polarized field it is possible to force the three axes of an arbitrary polyatomic molecule to align along given three axes fixed in space.

THE EVOLUTION OF DEUTERIUM CLUSTERS IRRADIATED BY SUPER-INTENSE
ULTRA-SHORT LASER PULSES

V.P. Krainov

Department of theoretical physics, Moscow Institute of Physics and Technology
Institutskii proezd 9, Dolgoprudny 141700, Moscow Region, Russia

Tel. 7-095-911-1191, fax 7-095-408-6869, e-mail: krainov@cyberax.ru

M.B. Smirnov

Institute of Molecular Physics, Russian Research Center "Kurchatov Institute"
Kurchatov Square 1, Moscow 123182, Russia

Tel. 7-095-196-7638, e-mail: smirnov@imp.kiae.ru

Summary

We consider the evolution of deuterium clusters irradiated by super-atomic femtosecond laser pulses using recent experimental data [1]. Quick total inner ionization occurs at the leading edge of the laser pulse. For example, for cluster with the radius 25 Å there are 3370 free electrons and 3370 deuterons. Thus, the cluster presents a neutral plasma ball consisting from the deuterons and free electrons. All free electrons are ejected from the cluster as well as at the leading edge of the laser pulse by laser field. Both inner and outer ionization occur as barrier-suppression ionization [2]. Simultaneously the process of cluster expansion begins, first slowly, then quickly (this is so called Coulomb explosion). The final plasma in laser focus presents a matter with the concentration of electrons and deuterons of order of 10^{19} cm^{-3} . The average kinetic energy of produced deuterons is of order of 1 keV. In this plasma the tunnelling nuclear reaction $d + d \rightarrow {}^3\text{He} + n$ takes place. In experiments [1] authors observed up to 10^4 neutrons per laser pulse. The problem of presence of deuterons with the greater kinetic energy that is required for nuclear reaction is discussed.

[1] J. Zwickback et al, Phys. Rev. Lett. **85**, 3640 (2000).

[2] V.P. Krainov, M.B. Smirnov, Physics – Uspekhi, **170**, 969 (2000) (in Russian).

ELECTRONIC DYNAMICS OF MOLECULAR EXCITATION AND
MULTI-ELECTRON IONIZATION IN ULTRA-SHORT LASER PULSES

A.I. Pegarkov

Physics Faculty, Voronezh State University,
1 University Square, Voronezh 394693, Russia

In strong laser fields the molecular ionization becomes enhanced considerably in comparison with atomic ionization. Recent experiments on two-electron pulse ionization of molecules showed failure of one-electron theoretical models and stressed the many-body nature of multiply ionization [1].

In the presented paper the electronic quantum dynamics of multi-electron molecules in short laser pulses is studied for example of the N_2 molecule in the cases where the laser field is far from ($\lambda = 800 \text{ nm}$) as well as near the resonance ($\lambda = 147 \text{ nm}$) to an electronic transition [2]. In the resonant ultra-short pulses, like resonant harmonic fields [3], the new interesting effects as *giant above-threshold absorption* (Fig.1) and *resonant revival of population* (Fig.2) arise. The one-electron, two-electron, sequential and non-sequential molecular ionization is analyzed in detail in comparison with the experiment [1].

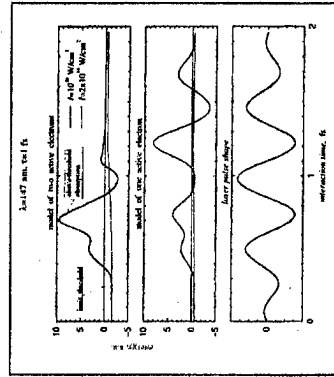

Fig.1

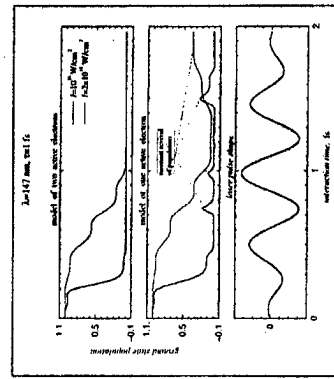

Fig.2

REFERENCES

- [1] C. Cornaggia and Ph. Hering. *Physical Review. Ser. A*. **62**, 023403 (2000).
- [2] A.I. Pegarkov. *Canadian Journal of Physics*, (submitted).
- [3] A.I. Pegarkov. *Physics Reports*. **336**, 255 (2000).

THE ANOMALOUS THERMAL MECHANISM OF THE FILAMENTATION OF THE
HIGH INTENSITY RADIATION IN COLLISIONAL PLASMAS.

V.P.SILIN

Lebedev Physical Institute

Russia, 117926, Moscow, GSP-1, Leninskii Prospekt 53

Telefax: 095-938-22-51

e-mail: silin@sci.lebedev.ru

We have constructed the theory of the filamentation instability of the high intensity radiation in the strongly collisional fully ionized plasmas when the size of filaments is larger than the free path of electrons. The role of the thermal mechanism of the filamentation is dramatically changed in the case of the strong enough radiation field. Usually the thermal mechanism is the reason of the radiation filamentation [1]. Our theory proves that in the case of the strong radiation field the thermal mechanism is the reason of the stabilization of the filamentation instability. This nonlinear property of plasmas is realized in conditions when the quiver velocity of the electron oscillations in the radiation field is larger than the electron thermal velocity. In this conditions the increase of the pump field intensity gives the decrease of the radiation energy absorption because of the inverse Bremsstrahlung heating of plasmas [2]. Last phenomenon is the principal reason of the nonlinear plasma property, which is discussed in our theory. The quantitative description of the thermal mechanism is also changed because of the increase of the electron heat conductivity. Last phenomenon is connected with the suppression of the electron-ion collisions in the radiation field of the high intensity [3]

So our theory permits to see new nonlinear plasma response in the case of the strong pump radiation field.

This work was done under the auspices of the International Science and Technical Center (Project No.1253) and RFBR (Project No.99-02-18075).

1. W.L.Kruer, Comm. Plasma Phys. Contr. Fusion, 9,33 (1985)
2. В.П.Силин, ЖЭТФ,67,313(1964); V.P.Silin, Sov.Phys.JETP, 20,1510(1965)
3. V.P.Silin, JETP,84(2)262(1997)

ANALYSIS OF ASSOCIATIVE RECONSTRUCTION OF INFORMATION
BY THIN HOLOGRAMS WITH SUPERPOSED REGISTRATION

A. S. Rubanov, L. M. Serebryakova

Institute of Physics, National Academy of Sciences of Belarus,
220072, Scoryna Ave. 70, Minsk, Belarus
E-mail: serebr@ifanbel.bas-net.by

Suggested by us earlier^{1,4} method of analysis of matched filtering by thin holograms, which gives the possibility to take into account informational contributions from all the nonlinear components of correlation responses, is generalized to the case of superposed registration with an arbitrary extent of correlation of registered fields with each other and with the reading field^{5,6}, and with its help on the example of lensless Fourier holograms the associative reconstruction and processing of information are considered for several variants of using the nonlinearity in the recording and retrieval processes.

So, with the account of contributions from all the nonlinear inter- and cross-modulation components the quadraticity of registration of an off-axis superposed hologram⁷ leads to an essential, in comparison with a linear hologram, broadening of conditions of retrieval of original waves. Attributed to "phase-conserving" nature of wave-front reversing (phase conjugating - PC) mirror, the processes of "nonlinear matched reading"^{3,4} in thin linear hologram - PC-mirror system lead to the possibility of partial transformation of noise components of fields into informational ones, with the account of which the above system may be in essence considered as a quadratic hologram with PC-modifiable response. Linear referenceless recording of hologram by mutually reversed waves^{2,4} may be used in the creation of adapted nonlinear static PC-mirrors for associative memory systems.

- 1) L. M. Serebryakova, Opt. & Spekt. 78 (6) 984 (1995), 2) A. S. Rubanov, L. M. Serebryakova, Opt. & Spekt. 79 (6) 1009 (1995), 3) L. M. Serebryakova, Opt. & Spekt. 85 (4) 629 (1998), 4) A. S. Rubanov, L. M. Serebryakova, Proc. SPIE, 3733 374 (1999), 5) L. M. Serebryakova, Opt. & Spekt. 89 (5) 849 (2000), 6) A. S. Rubanov, L. M. Serebryakova, Proc. SPIE (in press).

writing of information in optical processor and optical storage devices realizing on the base of nonlinear absorption

Vyacheslav A. Trofimov

Lomonosov Moscow State University, Department of Calculation Mathematics & Cybernetics
Vorbovyovy Gory, Moscow 119899, Russia. E-mail vatro@cs.msu.ru

One of the main problems of optical memory devices and optical processor is an improvement of reliability of data storage. As it is known till present time the most paper dealing with optical switching devices based on nonlinear absorption did not take into account the action of diffraction of laser beam. But on the stage of formation of high absorption domain due to increasing absorption in small transverse domain a laser beam profile has a "tubular - like" profile. Hence a diffraction length decreases and diffraction effect may strongly influence on laser beam interaction with medium. For example, this tubular profile induces a formation of additional stationary or moving domains of high absorption.

It should be noticed that early to explain a formation of motion of high absorption domain various authors taken into account only focused light beam. In this report a regime of formation of moving domain under the action of initial collimated light beam is described.

The other problem that is discussed in the report is an influence of elliptical profile of laser beam on writing of information in continuous nonlinear medium and multi-layers medium. In last case there are two types of layers: nonlinear ones and transparent ones. They follow each for other. As in continuous case and as in multi-layers case self-switching in additional longitudinal sections were obtained. This report shows that many well-known results have to review for real systems of data storage and optical processor.

Functional Optical Fiber Bragg Grating Devices and Their Applications

Sang Bac Lee
Photonics Research Center, Korea Institute of Science and Technology,
P.O. Box 131, Cheongryang, Seoul, 130-650, KOREA
Tel: +82-2-958-5696, Fax: +82-2-958-5789, E-mail: sblee@kist.re.kr

Sang Sam Choi
Korea Photonics Technology Institute
864-6 Wolgye-dong, Gwansan-gu, Gwangju, 506-302, KOREA
Tel: +82-62-973-9630, Fax: +82-62-973-9639, E-mail: sschoi@kpti.re.kr

Fiber Bragg gratings (FBGs) are fabricated by exposing the core of a germanosilicate fiber to an intense UV periodic fringe pattern, thereby producing a periodic index modulation in the fiber core. A light propagating in such a grating experiences a reflection over a narrow wavelength region centered at the so-called Bragg wavelength. Therefore, Bragg gratings can be tailored to act as wavelength-selective optical components such as mirrors, filters, partial reflectors or sensors, and furthermore, is ideal for integrating with fiber-based telecommunication, laser, and sensor systems.

As one of such applications, we have proposed and experimentally demonstrated a novel transmission filter, which consists of a 3-port circulator and a segmented CFBG (chirped fiber Bragg grating) and can select any channel of input WDM signals. The transmission filter, which can control four wavelength channels just by using the specially- designed CFBG, requires a simple structure. This type of filter may be used in WDM telecommunication applications such as wavelength multiplexing, routing and cross-connecting.

We have also demonstrated a novel optical CDMA spectral coding technique using SCFBGs (special chirped fiber Bragg gratings). The SCFBGs-based encoding scheme is advantageous compared to the version employing cascaded fiber Bragg gratings in that the former needs only a single grating structure. The proposed algebraic optical code synthesis algorithm produces codes comparable in size and performance to those previously proposed.

Finally, fiber Bragg grating (FBG) sensors have the important advantage of being able to measure the stress of the monitored structure without affecting its structural strength. In addition, it can sense multiple locations with only one fiber line. Such a FBG sensor system was developed and employed to measure the stress distribution at 8 different locations of Nambae suspension bridge in Korea for health monitoring, which was verified to be quite accurate from other corroborative measurements.

Quasisolitons

V.N.Serkin

General Physics Institute of the RAS, 117942 Moscow, Russia
 Benemerita Universidad Autonoma de Puebla, 72001, Puebla, Mexico

Today optical solitons are regarded as the natural data bits and as important alternative for the next generation of ultrahigh speed optical telecommunication systems. In this report, we show that there exists an effective mathematical algorithm to discover and investigate an infinite number of novel solitary wave solutions for the nonlinear systems described by the nonlinear Schrödinger equation model with varying dispersion, nonlinearity, and gain or absorption. If we compare the model considered with the quantum mechanical Schrödinger equation we recognize that varying coefficients in our model represent the equivalent time-dependent external potentials for the quasiparticle wave function, and therefore, we call the novel soliton solutions obtained as quasisolitons. The novel stable bright and dark "soliton islands" in a "sea of solitary waves" are discovered. It is shown that quasisolitons exist only under certain conditions and the parameter functions describing dispersion, nonlinearity and gain or absorption inhomogeneities cannot be chosen independently. We show that there exists a nonlinear Bloch theorem for temporal and spatial Schrödinger solitons propagating through an inhomogeneous nonlinear and dispersive structures characterized by translational symmetry. Fundamental soliton management regimes are discovered. We develop a systematic analytical approach to find the fundamental set of the different quasisolitons management regimes: soliton dispersion management, soliton energy and intensity control, soliton optimal compression and amplification, combined nonlinear and dispersion management. In the case of soliton dispersion management in optical telecommunication lines the optimal dispersion management function has been obtained. For the soliton amplification and compression problem the optimal gain control function has been discovered. The surprising aspect of our approach is that an analytical solutions are obtained in quadratures. It seems very attractive to use the quasisoliton concept in nonlinear optics and quantum electronics to design novel types of soliton lasers and to optimize different nonlinear optical phenomena. The best soliton laser performance is obtained, when there is a sign-reversal periodic dispersion and/or nonlinearity inside the laser cavity. The finding of a new mathematical algorithm to discover solitary wave solutions in nonlinear dispersive systems with spatial parameter variations is important to the field, and might have significant impact on future research.

References

1. V.N.Serkin and A.Hasegawa, "Soliton management in the nonlinear Schrödinger equation model with varying dispersion, nonlinearity and gain", *Pisma v ZhETF*, vol.72, iss.2, pp.125-129, 2000.
2. V.N.Serkin and A.Hasegawa, "Novel soliton solutions of the nonlinear Schrödinger equation model", *Phys. Rev. Letters*, vol.85, number 21, pp.4502-4505, 2000.

Thermal crosstalk analysis of vertical-cavity surface-emitting laser arrays

S.M. Zakharov,

Institute for Microprocessors of the Russian Academy of Sciences,
 Block 1, Nakhimovskiy prospekt, 36, Moscow, GSP-7, 117997, Russia

E.A. Manykin

Nonlinear Optics Department, Russian Research Center "Kurchatov Institute",
 Kurchatov Sq.1, Moscow, 123182, Russia

Vertical-cavity surface-emitting lasers (VCSELs) are increasing interest for a variety of optoelectronic applications. The potentially simple packaging make VCSELs very attractive for parallel optical interconnection. Thermal characteristics are necessary for a large-scale integrating of lasers in 2D arrays and there must be known to optimize the device structure. Thermal crosstalk between laser elements is important for 2D arrays, because the local temperature affects on light output power and emission wavelength [1-4].

Here we present the different model approaches to the solving of thermal problems in a VCSEL arrays with due account of central or axial type of symmetry and of finite thickness of semiconductor wafer. The basic attention concentrates on the analytical analysis for the thermal field out of the laser area. Thermal reciprocal crosstalk in a VCSEL's operating in the regime of matrix is considered. Thermal resistances for different laser configurations in matrix are estimated.

1. M. Kajita, T. Numai, K. Kurihara et al. *Jpn. J. Appl. Phys.*, 33 (1B), 859-863, 1994.
2. Y. Ohiso, Y. Kohama and T. Kurokawa. *Electron. Lett.*, 30 (18), 1491-1492, 1994.
3. D.L. Huffaker and D.G. Deppe. *IEEE Photon. Technol. Lett.*, 8(7), 858-860, 1996.
4. T. Wipiejewski, D.B. Young, B.J. Thibeault. *IEEE Photon. Technol. Lett.*, 8(7), 858-860, 1996.

Two-wave coupling in azo-containing photosensitive polymers with liquid crystal properties.

M.S. Andreeva, A.N. Simonov, V.I. Shmalhauzen
Lomonosov Moscow State University, Physics Department
Moscow 119899, Vorob'evy Gory, tel.: 9393306
E-mail: andreeva_maria@mail.ru.

Interest in application of photosensitive polymers for optical data processing has been growing rapidly in the past few years. Large nonlinear susceptibilities of the azo-containing polymers enable processing of optical signals with the intensities of the order of 1 mW/cm^2 . High sensitivity of the polymers in combination with their multi-component structure result in a variety of multiwave-mixing effects. Dynamics of the medium response in these processes strongly depends on external conditions.

In this work we present new results of theoretical study of the two-wave coupling in the films of azo-containing polymers with liquid-crystal (LC) properties. An adaptive interferometer using the photosensitive 50- μm thick polymer film as a non-linear medium was designed and created. The interferometer operated at $\lambda = 532\text{ nm}$. The CW intensity of the interacting beams was about 100 mW/cm^2 .

It was demonstrated experimentally that the effective energy flow between the interacting light beams occurs in non-stationary regime and results in high gain (up to 250 cm^{-1}) of the signal beam. Energy interchange is also possible in the steady-state regime when there are regular (periodic) phase disturbances in the interferometer arms. This effect can be used for automatic stabilization of the interferometer operating point with respect to low-frequency phase fluctuations and may find application for metrology. We present results of theoretical investigation of the system behavior in different regimes: transitional regime, phase perturbation in one beam when the angles between the interacting beams and the normal to the surface of the film are equal or different. The influence of the wavefront distortions on the energy coupling was studied theoretically. The possibility of effective control of the two-beam coupling dynamics by variation of the film temperature was demonstrated experimentally. At polymer temperature of $T \approx 87^\circ\text{C}$ the complete compensation of phase disturbance in the interferometer arm occurs in about 500 ms. The influence of beam intensities ratio and their polarizations on the energy coupling efficiency was studied experimentally.

A theoretical model of the two-wave mixing in the polymer film was suggested. The model takes into account the effects of linear light absorption, light-induced saturation in the medium and diffusion of azo dye isomers. The data of carried out experiment are in a good agreement with the theoretical results.

New Developments in Odd-Wave Mixing in Isotropic Chiral Materials

Peer Fischer and Andreas Albrecht*

Department of Chemistry and Chemical Biology,
Cornell University, Ithaca NY, 14853-1301, USA

The electric field-based nonlinear spectroscopy called three wave mixing (3WM) is the lowest order member of the general family of odd-wavemixing oWM processes. Here, two incident fields interact in a nonlinear material and may generate a signal field at new sum and difference frequencies (SFG and DFG). Three-wave mixing is best known through its second harmonic generating (SHG) capability when appropriate crystals are used. In normally isotropic media such signals cannot exist because averaging over randomly oriented chromophores obliges all components of the parity-odd 3WM hyperpolarizability tensor to vanish. However, as has been known for several decades, if chiral centers are present and if they are macroscopically resolved (i.e. not racemic) then the rotationally invariant component of the beta tensor is non-vanishing under special experimental configurations. Both SFG and DFG (but not SHG!) should now be possible. To date only few efforts to detect such novel 3WM have been reported, including a recent study of vibrationally resonant infrared-visible SFG¹. Nonresonant electronic SFG signals are at best exceptionally weak.² Recently we have analyzed the rotationally invariant beta tensor component for all eight Liouville paths in the sum-over-states representation.³ For this special tensor element we have found anti-Hermitian behavior in each of the usual two parts found in any hyperpolarizability tensor - the numerator consisting of transition dipoles and the denominator of (potentially resonant) energy factors. The product of the anti-Hermitian factors accounts for weak or non-existing signals in previous work. It also points the way to an enhancement of many orders-of-magnitude for sum and difference frequency signals. Namely, an experimental arrangement is necessary that offers special two-state resonances. This requirement is in striking contrast to the familiar single-state resonances that enhance even-wave mixing (eWM) events - including conventional one photon absorption. With theory as a guide we have designed new SFG experiments based on optically active carotenoids in which the appropriate two-state resonance is present. One laser is chosen to be resonant with the transition between the ground state and an excited state, A, of the chromophore. The second laser matches the energy gap between the excited state A and a second excited state, B. The computation of the isotropic component of the beta tensor converges over the lowest 80 quantum chemically determined states and confirms the requirement of such a three state scheme. We also hope to present preliminary experimental findings.

* We are grateful for support through a grant from the National Science Foundation CHE-0095056.

1. M. A. Belkin, T. A. Kulakov, K.-H. Ernst, L. Yan, Y. R. Shen; "Sum-frequency vibrational spectroscopy of chiral liquids: A novel technique to probe molecular chirality", *Phys. Rev. Lett.* **85** (2000), 4474-4477.

2. Peer Fischer, Diederik Wiersma, Roberto Righini, Benoit Champagne, and David Buckingham; Three-wave mixing in chiral liquids, *Phys. Rev Lett.* **85**, (2000), 4253-4256.

Novel spectroscopic techniques for microscopic diagnostics of semiconductors,

V. V. Yakovlev, Univ. of Wisconsin, USA.

Detection of material contaminants and material defects on microelectronic-grade silicon wafers is necessary to ensure high-quality material before beginning the value-added processing [1]. Structural properties of thin films and subsurface layers are important for material characterization and phase identification [2]. We report on our recent results on applying different optical techniques for microscopic imaging of semiconductor and ceramic layers.

Imaging of short-range order structure.

The determination of crystal order structure of nanometer-thick films deposited on the surface of materials becomes increasingly important with the development of nanostructures materials, whose properties depend strongly on the thickness and crystal structure of the film. In our particular case of interest we consider thin titania (TiO₂) films deposited on the surface of silicon. By using Raman spectroscopy we demonstrated [3], that the short-range order of such a film can be precisely determined for films as thin as several nanometers. Precise determination of structural components becomes important for evaluation of thin films treated with a pulsed-laser radiation [4]. In our preliminary experiments we irradiate titania films (with a thickness of ~100 nm) with 7-ns pulses centered at 355 nm (3-rd harmonic of Q-switched Nd:YAG laser). We observe a laser-induced transformation of thin films from one phase to another by monitoring the ratio of 2 peaks 398 cm⁻¹ (anatase) and 448 cm⁻¹ (rutile).

Imaging of the crystal structure.

Determination of crystal order structure is important to understand the structure of the interface. One of the most important transitions is "order" to "disorder" transformation. Typically, a nonlinear optical technique - second-harmonic-generation - is used to determine whether the structure is ordered or not. Due to the symmetry of $\chi^{(2)}$ tensor, the intensity of second harmonic will vanish for the layer with inversion symmetry. Thus, by measuring the intensity of generated second harmonic one can distinguish centrosymmetric from a noncentrosymmetric phase [2]. However, this method is difficult to implement for silicon wafers, since Si belongs to $m\bar{3}m$ crystalline class, which is centrosymmetric. To avoid this complication we design a technique based on third-harmonic generation, which is allowed for every material. It can be shown [5], that 3-rd harmonic of circular polarized light is not allowed in disordered system, thus the ratio of 3-rd harmonic intensities, produced by circular polarized and linear polarized beam, can serve as a structural probe of any material.

We use the radiation of femtosecond Cr:forsterite laser (center wavelength ~1250 nm) to generate third harmonic from Si(111) surface [5]. To induce structural changes we use ion implantation and laser radiation. For each point we measure 2 intensities of 3-rd harmonic and normalize them one against each other. The sharp drop of the ratio of 2 intensities ($I_{\text{circular}}(3\omega)/I_{\text{linear}}(3\omega)$) observed for ion-implanted and laser-irradiated areas of Si surface is due to the amorphization of the surface layer.

Imaging of defects and stains.

The process of semiconductor wafer preparation involves the intensive cleaning and polishing of the surface. Typically, water is used to remove the chemicals used for etching. The drying procedure leaves water stains in the microcracks, which are due to the defects on the surface. It is rather difficult to characterize the distribution of these microcracks and estimate the amount of water left on the surface after a typical cleaning and drying procedure. Recently we have invented a new approach [6] that for the first time allows for such quantitative evaluation on both macro- and micro-levels. We add a microscopic quantity of water-soluble dye (Rh6G or Rh B; <0.1 mg per l liter) to a water used for cleaning in a typical process. This dye serves as a fluorescent "stain", which can monitor the distribution of water contaminants on the surface of the silicon wafer. By using confocal fluorescence imaging we are able to achieve sub-micron spatial resolution. High-efficient dyes ensure high signal level and fast acquisition.

Conclusion

Several microscopic optical techniques are used to identify the surface quality of semiconductor and ceramic layers and thin films. The application of these methods to study the effect of laser-induced transformations has been demonstrated as well.

References:

1. S. D. Wolter, M. B. Ferrara, and K. A. Welch, *Solid State Technology* **10**, 85 (1995).
2. G. Lupke, *Surface Science Reports* **35**, 75 (1999).
3. V. V. Yakovlev, G. Scarel, C. R. Aita, and S. Mochizuki, *Appl. Phys. Lett.* **76**, 1107 (2000).
4. J. Magyar, C. Aita, A. Sklyarov, K. Mikhaylichenko, and V. V. Yakovlev, "High-intensity laser processing of thin-films"; *Proceedings of SPIE - Laser Applications in Microelectronics and Optoelectronic Manufacturing* (in press) 2001.
5. V. Yakovlev, V. Sheshelskii, and S. V. Govortov, "Structural imaging using polarized third harmonic microscopy" *Appl. Phys. Lett.* (in press) 2001.
6. V. Yakovlev, K. Mikhaylichenko, M. Ravkin, "Optical instrument for microscopic imaging of defects" - US patent pending, M. Mikhaylichenko, M. Ravkin, V. Yakovlev, "Quality control of silicon wafers using fluorescence imaging technique" US patent pending.

SECOND AND THIRD HARMONIC SPECTROSCOPY OF MAGNETIC GARNET FILMS

V. V. Pavlov, R. V. Pisarev, M. Fiebig¹, and D. Fröhlich¹

¹*Institut für Physik, Universität Dortmund, 44221 Dortmund, Germany*
¹*Instytut Fizyczny, Uniwersytet Wrocławski, 50-204 Wrocław, Poland*

Magnetic garnet films have very large values of linear magneto-optical (MO) effects. Their magnetic and MO parameters can be easily controlled by varying the chemical composition what is very important for magneto-electronic and magneto-optical devices. Surprisingly, it was found that films of garnet ferrites exhibit high intensities in second harmonic generation (SHG) [1], and display a giant linear magnetoelectric effect [2]. Garnet films were well studied in linear optics, but the microscopic origin of the high nonlinear optical response remains unclear.

Thin films of bismuth-substituted garnets (YB)₃(FeGa)₅O₁₂ can have a noncentrosymmetric structure due to nonuniform distortions or due to a selective distribution of ions in the unit cell during the growth process. This symmetry breaking was proven by observations of SHG and the linear magnetoelectric effect [1, 2]. In the electric-dipole approximation SHG and third harmonic generation (THG) can have two contributions, which are crystallographic and magnetic origin, respectively:

$$P_i(2\omega) = \epsilon_0 \chi_{ijk} E_j(\omega) E_k(\omega) + \epsilon_0 \chi_{ijk}^m E_j(\omega) E_k(\omega) M_m(0),$$

$$P_i(3\omega) = -\epsilon_0 \chi_{ijk} E_j(\omega) E_k(\omega) E_l(\omega) + \epsilon_0 \chi_{ijk}^m E_j(\omega) E_k(\omega) E_l(\omega) M_m(0).$$

In the present work, SHG and THG in garnet films have been studied in the spectral range 1.5-4.5 eV using an optical parametric oscillator pumped by a Nd:YAG laser. Garnet films with different composition were epitaxially grown on thin wafers of Gd₃Ga₅O₁₂ garnet (GGG) and substituted GGG having crystallographic orientations (111) and (210). A strong enhancement of SHG response was found in the spectral region of the *d-d* transitions near the band gap (see Figure, left part).

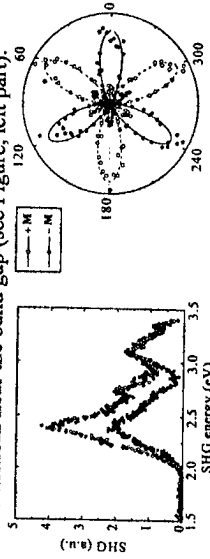

Bismuth substitution for yttrium leads to the appearance of a peak at 2.4 eV in the SHG spectra. Close to this energy, crystallographic and magnetization-induced contributions to SHG have intensities of the same order of magnitude. Using the rotation anisotropy method, an unambiguous separation of the crystallographic and magnetic contributions to SHG was achieved (see Figure, right part). The main contribution to THG was found above the band gap due to charge-transfer transitions, as they are parity allowed for four-photon processes. This contribution was of the crystallographic type, whereas no magnetization-induced contribution to THG has been observed.

[1] R. V. Pisarev, B. B. Krichevskoy, V. N. Gridnev, V. P. Klin, D. Fröhlich, and Ch. Pahlke-Lerch, *J. Phys. C* **5**, 8621 (1993).

[2] B. B. Krichevskoy, V. V. Pavlov, and R. V. Pisarev, *JETP Lett.* **49**, 535 (1989)

N.V. Chigarev and D.Yu. Paraschuk

Physics Department, Moscow State University, Moscow 119899, Russia

Laser picosecond photoacoustics gives a possibility to excite and to measure ultrashort sound pulses in condensed media and allows us to realize an efficient method for characterization of optical and acoustical properties of metals and semiconductors. Recently from the measurements of profiles of sub-nanosecond acoustic pulses in Ge monocrystals we obtained that the mechanism of photoacoustic transformation in Ge is electronic and evaluated the diffusivity of photoexcited electron-hole plasma. In this work we apply our method of hypersound spectroscopy for Si and GaAs monocrystals.

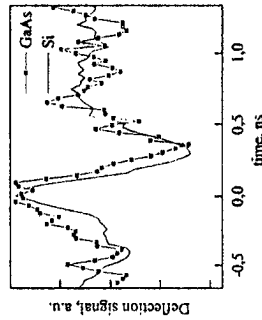

Figure

The profiles of hypersound pulses were measured using a pump-probe photodeflection technique. A picosecond cw-pumped laser (pulse duration is ~ 100 ps, pulse repetition rate is 100 MHz) was used as a source of pump and probe ($\lambda=532$ nm) radiation. The pump and probe were focused on the opposite surfaces of a thin semiconductor plate. The deflection signals in GaAs and Si are shown in Figure. We show that the electron-deformation mechanism of photoacoustic conversion is dominated. The diffusivity of photoexcited electron-hole plasma is evaluated.

This work was supported by INTAS, project #97-31680.

I. N.V. Chigarev, D.Yu. Paraschuk, X.Y. Pan, and V.E. Gusev, Phys. Rev. B **61**, 15837 (2000).

G.Kh.Kitaeva, K.A.Kuznetsov, S.V. Solosin, and A. N.Penin
M.V.Lomonosov Moscow State University, Physics Department,
119899, Moscow, Russia. Phone: 7(095)939 43 72.
Fax: 7(095)939 11 04. E-mail:postmast@qopt.phys.msu.su

Lithium niobate crystals are intensively studied due to their high nonlinear susceptibilities and photorefractive properties. Differently doped crystals have different structural defects, which are quite complicated and, as a sequence, exhibit differing physical properties.

We have studied the four-wave mixing of light by phonon polaritons in $\text{LiNbO}_3:\text{Mg}$ crystals with different content of Mg and in chemically reduced crystal with high concentration of small polarons. Two IR pumping beams, generated by YAG:Nd-laser and tunable LiF:F_2^- -laser, coherently excited the phonon polariton under different values of phase mismatch between polariton and pump wave vectors. The polariton phase mismatch was changed by varying the crystal orientation toward the pumping beams, while the polariton frequency was constant. The third pumping beam (second harmonic of the YAG:Nd-laser) was used as the probe pump. The Stokes component of the probe pump scattering was measured. According to the theory of the four-wave scattering in non-centrosymmetrical media, the origin of the cascaded part of the signal is due to the scattering by the coherent part of nonlinear crystal polarization on polariton frequency. We studied the dependence of the intensity of the cascaded part on the polariton mismatch.

To explain some peculiarities of measured spectra we studied the optical properties of $\text{LiNbO}_3:\text{Mg}$ in the IR region, where the undoped LiNbO_3 was transparent. As a result, several absorption bands were found, being sensitive to the pump illumination and, much more, to the chemical reduction. We assign these bands to the small polaron absorption. The values of polaron shifts and the mean value of the frequency of optical phonons interacting with free electrons in polaron formation were measured. This work was done in frames of the Russian Program "Integration: Fundamental optics and spectroscopy" and was supported by the Russian Foundation of Basic Research (Grants No. 99-02-16418, 00-15-19541).

Four-photon Raman spectroscopy as a method of the ocean remote sounding.

A.F.Bunkin, K.I.Voliak

Wave Research Center, General Physics Institute, Russian Academy of Sciences, 38 Vavilov Street, Moscow, 117942, Russia, abunkin@orc.ru, +7 (095) 1358234

The intensive development of laser remote diagnostics of the atmosphere and ocean has such limitation as a relatively low level of the useful signal. The possible way of overcoming this drawback is to employ four-photon Raman spectroscopy. But in traditional coherent anti-Stokes Raman scattering (CARS) or Raman induced Kerr effect spectroscopy (RIKES), the phase matching conditions dictate the arrangement of laser radiation sources and receivers on different sides of a studied medium. Hence, in order to realize the advantages of CARS or RIKES methods in the remote measurements, at least one of the interacting waves should go back in studied medium, i.e. towards the receiver. As this wave one can utilize the signals of stimulated Brillouin or elastic scattering of one of the pump waves.

The experiments on remote RIKES measurements were carried out in the laboratory and in marine expedition with the help of four-photon spectrometer, which had been a specially designed for field condition applications. The applicability of remote RIKES for measuring the temperature and salinity of seawater at the accuracy 0.1-0.2° C and 5×10^{-3} m/l respectively, as well as oil contamination at the concentration 100 ppb have been shown experimentally. The hydrocarbons spectra had been recorded in the range from 990 to 3100 cm^{-1} and water temperature/salinity measurements were based on temperature/salinity dependence of liquid water stretching vibrations Raman band in the range from 3000 to 4000 cm^{-1} .

One can compare these results and the data of spontaneous Raman scattering remote sensing of the ocean, which had been accumulated in our marine expeditions. It is shown that in spite of experimental hardness of four-photon remote measurements in field conditions this technique could be useful for practical applications.

LASER DIAGNOSTICS OF THE HIGH TEMPERATURE LASER-INDUCED PHENOMENA.

Valerii G. Prokoshchev, Arkadii F. Galkin, Dmitrii V. Abramov,
Sergei D. Parfionov, Sergei M. Arakelian

Department of Physics and Applied Mathematics, Vladimir State University,
Gorki str. 87, Vladimir, Russia

Phone: 7-(0922) 233334, 279437

Fax: 7-(0922) 233334

E-mail: laser@vpti.vladimir.su
arak@vpti.vladimir.su

The various wave processes being excited on a free surface of a melted material under action of intensive laser radiation have a significant interest in laser technology. However direct study of surface waves in conditions of the high intensity laser radiation action is limited by arising of brightly flashing erosive plume just above the area of interaction. To study experimentally the behavior of surface waves and arising structures in the treatment area in a real time the laser monitor on the base of a copper laser has been used. Laser-induced instabilities have been developed by radiation of solid state YAG:Nd-laser. The laser monitor has allowed to observe the wave processes on a surface of melted material through the formed erosive plume due to YAG:Nd-laser action. Laser-induced surface waves were detected for lead and titanium samples and characteristic spatial parameters of the instabilities have been determined by means of the laser monitor computer image recognition program. The wave structures on a surface of melted material arised not during the all time of laser action on the surface. In fact, they becomes weak and are replaced by laminar movement of melted substance from center of interacting zone to its periphery or are replaced by hardly turbulent movement. The mathematical modelling of the surface waves induced by a laser radiation has been carried out under condition of influence of the returned vapour pressure. Mathematical modelling of high temperature laser-induced processes includes determining the distribution of temperature in a rectangular titanium sample under the action of laser radiation are considered. The heat conductivity coefficient depended on the temperature results in nonlinearity of the heat transfer equation. We consider the stationary process of distribution of temperature and take into account the heat exchange within the environment using the boundary conditions. The results of these calculations can be recognized as an initial approach to find an expected zone of titanium's bath of melting. We calculated the distribution of temperature using the developed algorithm being of synthesis of both the Galyorkin - Petrov's method and the method of structural functions of Rvachiyov - Obgatzde (RO - functions). Influence of surface oxide layer on the temperature field distribution has been studied. The results of mathematical modeling are true for laser heating of the small size samples of arbitrary form.

X-RAY DIFFRACTION WITH SUBPICOSECOND TIME RESOLUTION

D. von der Linde, K. Sokolowski-Tinten, Ch. Blome, C. Dietrich, A. Tarasevitch
Institut für Laser- und Plasmaphysik, Universität Essen, D-45117 Essen, Germany

A. Cavalleri, C. W. Siders, J. A. Squier, C. P. J. Barty, K. R. Wilson
Department of Chemistry and Biochemistry

University of California, San Diego, La Jolla, CA 92093-0339, U.S.A.

During the past years femtosecond laser-driven X-ray sources have been developed that provide short bursts of hard X-rays. These ultrashort X-ray pulses now enable many types of X-ray measurements to be performed with subpicosecond time resolution. In particular, time-resolved X-ray diffraction for studying laser-induced lattice dynamics and structural changes is possible. We have studied the X-ray diffraction from photoexcited crystalline films of (111)-Ge heteroepitaxially grown on (111)-Si substrates. The Ge-films are selectively photoexcited and melted by a small fraction of the pulses from a Ti-sapphire laser at 800 nm. The main portion of the laser energy serves to produce a microplasma on a metallic target in order to generate multi-keV x-rays for probing. In the experiment we measure the rocking curves of the Bragg diffraction from (111)-lattice plains of Ge and Si as a function of the delay time between the laser excitation pulses and the x-ray probe pulses. At high laser fluence a distinct decrease of the x-ray diffraction from Ge within a few hundred fs after optical excitation is observed. Recovery of the diffraction takes place on a very much longer time scale, indicating epitaxial recrystallization of the partially molten Ge layer. At lower laser fluences, below the melting threshold, we observe the generation and relaxation of acoustic lattice waves. From the latter data, anharmonic damping rates of acoustic phonons are extracted. The principal conclusions drawn from our work are that: (i) The optically induced solid-to-liquid transition of Ge occurs within a few hundred fs, (ii) an upper limit of the X-ray pulse duration of about 300 fs can be given.

SPECTRUM TRANSFORMATION OF HIGH INTENSITY FEMTOSECOND LASER PULSES IN GAS-FILLED CAPILLARY TUBES

A.A.Babin, D.V. Kartashov, A.M. Kiselev, V.V. Lozhkarev, A.N. Stepanov
Institute of Applied Physics RAS, 46 Ulyanov St, Nizhny Novgorod, Russia

A hollow dielectric capillary tubes provide very effective way for guiding a high intensity femtosecond laser pulses over distances much larger than vacuum diffraction length. Under these conditions we can expect that nonlinear phenomena's of laser-gas interaction will be enhanced significantly. In particular, self-phase modulation of intensive laser pulses in capillary filled by dense gases provides an unique way to achieve a few-optical-cycle duration at microjoule energy level [1]. In this report we present the results of both experimental and theoretical investigations for ionization frequency blue shift and spectrum transformation of high intensity (up to $3 \cdot 10^{15}$ W/cm²) femtosecond laser pulses passed through the gas filled hollow capillary tubes in respect with pulse intensities, capillary length, gas pressure and gas species. A blue shift of a spectrum features comparable with initial spectrum width was observed at Ar and He under pressures as low as few Torr for 20 cm long 100 μ m diameter capillary tubes. An analogous spectrum transformation was previously seen under such femtosecond pulses focusing by a lens in gases at several atmospheric pressures level [2]. The monomode guiding with efficiency of radiation transmission as high as 45% for 20 cm capillary and 55% for 10 cm capillary was achieved for all investigated pressures and intensities range. Numerical simulation for ionization dynamics of high intensity femtosecond laser pulses in gas filled capillary have shown a good qualitative agreement with experiment. It is shown that phase modulation caused by ionization can be compensated in simple compression scheme providing an effective way to achieve a few-optical-cycle pulse duration at millijoule energy level.

[1] M. Nisoli et al. Optics Lett. V.22, N8, p. 522, 1997.

[2] M.C. Downer et al. Phys. Rev. Lett. V.67, N25, p. 3523, 1991

High-order harmonic generation by limited beam. Spatial structure of the atomic response and phase-matching.

Platonenko V.T.

Under HOHG the wave-vector k_{rad} of a HOH of the nonlinear polarization as a rule differs by length from the wave-vector k_{light} of the light wave of the same frequency. The phase-matching condition written as $k_{\text{rad}} = k_{\text{light}}$ ordinary does not hold. It is much easier to provide the inequality $|k_{\text{light}}| \geq |k_{\text{rad}}|$. Then at some angle θ Vavilov-Cherenkov's phase-matching condition

$$|k_{\text{rad}}| = |k_{\text{light}}| \cos \theta \tag{1}$$

occurs fulfilled. It does not guarantee the effective emission of the harmonic. The emission to be effective the polarization have to be modulated strongly enough in the beam cross-section. In other words the polarization distribution in the cross-section have to contain non small spectral component at the spatial frequency $|k_{\text{light}}| \sin \theta$.

Numerical simulation based on the approximated analytical approach [1] shows that typical intensity dependence of a HOH of the atomic response is not monotonous. And so the harmonic can be modulated in the cross-section of the laser beam. Analytical and numerical investigation [2] show that effective phase-matched emission of non-axial component of some HOH in extended medium is possible. Besides the high efficiency the effect produces essential modification of the structure of the harmonic "plateau" as compared to single-atom response.

To prove the conclusion detailed calculation of harmonic amplitudes of atomic response are fulfilled by numerical integrating Shredinger's equation for hydrogen atom under oscillating electrical field of light with the wavelength 1.06μm and with the intensity changed from $4.9 \cdot 10^{13}$ to $2.1 \cdot 10^{14}$ w/cm² [3]. The dependence of any amplitude starting from 5-th and at least to 55-th harmonic on the intensity contains deep modulation. In case of high-order harmonics the depth of the modulation is close to unity.

An analysis of HOHG is carried out based on semi-classical approach to the phenomenon and completed with some new considerations. Relatively simple formulas for amplitudes of HOHs of atomic response are obtained which well accord with the numerical results under tunnel ionization, and satisfactory accord under over-barrier ionization. A HOH contains two terms, corresponding to different electron trajectory. The phases of the terms depend on the intensity of the exciting light in different ways. The interference of the terms produces oscillation in the dependence of HOH amplitude on the intensity. The fields generated by the terms strongly differ from each other by divergence. Far from the source they slightly interfere with each other. Typically the divergence strongly exceeds diffraction one and phase-matched emission at the angles determined by (1) is possible.

1. Lewenstain M, Balcou Ph, Ivanov M, Yu, et al. Phys. Rev. A 48 4709 (1993)
2. V T Platonenko, V V Streilkov, Quantum Electronics 30(3) 236 (2000)
3. V T Platonenko, Quantum Electronics 31(1) 55 (2001)

HIGH-ORDER HARMONIC GENERATION WITH FREQUENCY SELECTION

V.D.Taranukhin

Physics Department, Lomonosov Moscow State University, Vorob'evy Gory, Moscow 119899 Russia

An atom ionization by ultrashort pulse of high-frequency (HF) radiation and following photoelectron evolution in the continuum under the control of strong low-frequency (LF) field is considered. A new method of high-order harmonic generation (HHG) with such two-component pump is proposed and studied. It is suggested that LF radiation, for example the radiation of CO₂ laser, is strong enough ($\sim 5 \times 10^{13}$ W/cm²). However, it must not ionize the atoms by itself. Another pump component should be an ultrashort HF pulse ($\tau \sim 1-3$ fs) which can resonantly ionize the atoms. Such pulses ($\hbar\omega_h \approx 10$ eV) are effectively obtained in the current HHG experiments.

If HF pulses are precisely synchronized in time with the LF radiation, then photoelectrons (released by HF pulse in time t_0) gain the kinetic energy (due to LF field) which essentially depends on the phase $\varphi = \omega t_0$ of LF field. The frequency of harmonic radiation ω_n generated in this case depends on the phase φ too (see Fig. where the case of CO₂ radiation with $\varphi = \pi/10$ (from the crest of LF field) and HF pulse with $\tau = 1$ fs is shown).

The advantage of such HHG scheme is that harmonic generation occurs only in the narrow and selected frequency range $\Delta\omega$ (not in the whole "plateau" region: $0 \div \Omega$, where $\Omega \approx 3.17 U_p$ is a cut-off frequency, U_p is a ponderomotive potential of LF radiation). For the case shown in the Fig., $\Delta\omega \approx 0.05 \Omega$. The selection of the central frequency of harmonic frequency range $\Delta\omega$ can be attained by tuning the amplitude of LF field.

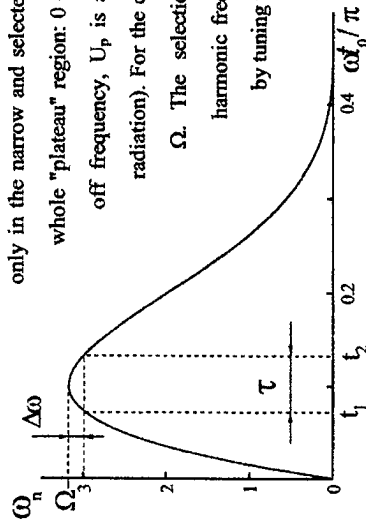

INTERACTIONS OF RELATIVISTICALLY INTENSE LASER PULSES WITH LOW FREQUENCY WAVES IN COLD UNDERDENSE PLASMAS

A.L. Galkin, V.V. Korobkin, and O.B. Shiryayev

Coherent and Nonlinear Optics Department

General Physics Institute of the Russian Academy of Science

Box 117942, Yavilov st. 38, Moscow, Russia

Interactions of relativistically intense linearly polarized laser pulses with cold underdense plasmas are considered in 1D geometry in the framework of a model comprising Maxwell and the relativistic electron fluid dynamics equations (with an inertially frozen ion background) [1]. New asymptotic solutions to the above equations are derived in the $\omega_p/\omega \ll 1$ limit, ω_p and ω being the plasma and laser frequencies. They describe finite size and duration nonmonochromatic laser pulses interacting with waves in the plasma electron component. This interaction is a mechanism of a laser pulse amplitude self-modulation and spectrum modification.

The proposed result generalizes the slow amplitude technique of the nonlinear optics, where localized solutions are obtained by allowing for slow amplitude variations in a plane monochromatic wave. Here the role of the plane wave is played by the solutions to the Akhiezer-Polovin problem [2] corresponding to a nonmonochromatic electromagnetic wave of a relativistic intensity coupled to a plasmon [3]. This makes it possible to investigate the effects related to the excitation of large amplitude waves in the plasma electron fluid by the propagating intense laser pulse.

References

1. A.V. Borovskii, O.B. Shiryayev, Zh. Eksp. Teor. Fiz. **109**, 865 (1996) [Sov. Phys. JETP **83**(3), 475 (1996)]
2. A.I. Akhiezer, R.V. Polovin, Zh. Eksp. Teor. Fiz. **30**, 915 (1956) [Sov. Phys. JETP **3**(5), 696 (1956)]
3. A.V. Borovsky, A.L. Galkin, O.B. Shiryayev, *Kratkie Sobsheniya po Fizike* **5**, 33 (1998) [Bulletin of the Lebedev Physics Institute **5**, 28 (1998)]

NONLINEAR FILTERING OF NOISY INTERFERENCE FRINGES WITH THE 2-D SPATIALLY-DEPENDENT FILTER IMPULSE RESPONSE

Igor Gurov and Mikhail Volkov

*Institute of Fine Mechanics and Optics (Technical University)
14, Sablinskaya st., Saint-Petersburg, 197101 Russia*

Image processing, enhancement and retrieval play an important role in modern information and measurement technologies. An important kind of images is obtained in coherent systems in holography and interferometry in the form of fringe patterns. Because of the physical and technical limitations fringe patterns obtained are often distorted by noise influence and fringe breaks. It is proposed new noise-immune method for fringe pattern enhancement and evaluation. The main idea of distorted noisy fringe pattern enhancement is based on the fringe intensity histogram modification. As known, for an ideal fringe pattern is inherent a two-mode histogram with the peaks corresponded to the extreme values of fringe intensity. On another hand, is known the image enhancement method [1] when globally observed gray-level histogram is modified to the desired one. It was found that the local histogram modification can be performed as nonlinear data-dependent algorithm without the knowledge of the ideal histogram, in other words, without a priori information about the local fringe parameters. The proposed histogram modification method allows to suppress the noise without decreasing the fringe visibility. Automatic data-dependent formation of the filtering area allows to link the local fringe breaks. The proposed method was successfully used in the stress analysis by moiré interferometry [2] and was recently applied for low-contrast noisy hologram evaluation. Experimental results of proposed method application for noisy hologram evaluation show efficiency and noise-immunity of the proposed method.

References

1. R.E. Woods, and R.G. Gonzalez, "Real-time digital image enhancement", *Proc.IEEE* **69**, pp.643-658 (1981).
2. S. De Nicola, P. Ferraro, I. Gurov, R. Koviain and M. Volkov, "Fringe analysis for moiré interferometry by modification of the local intensity histogram and use of a two-dimensional Fourier transform method", *Meas.Sci.Technol.* **11**, pp.1328-1334 (2000).

ALL-OPTICAL SIGNAL PROCESSING FOR THE NEXT-GENERATION
FIBRE TELECOMMUNICATION NETWORKS

Marian Marciniaik, National Institute of Telecommunications,

1 Szachowa Street, 04-894 Warsaw, Poland

The introduction of Erbium-Doped Fibre Amplifiers which replaced electronic regenerators in fibre based transmission links in early 90s resulted in optical transparency of the links [1]. Networks at regional and global scale with transmission speed exceeding one terabit-per-second became a reality [2]. The optically transparent transmission is expected to be of essential advantage in future "IP over Optical" networks [3]. A commercial deployment of wavelength-division multiplexed (WDM) systems with hundreds of transmission channels is foreseen in the near future. WDM offers the orthogonality between wavelength and time, so they can be processed independently and simultaneously [4]. WDM requires sophisticated narrow-band light sources with extreme wavelength stability, as well as a variety of photonic devices for all-optical signal processing. The future technology has to meet new demands especially in the field of optical digital signal processing, including full 3R regeneration. Moreover, a concept of the 4R regeneration has been introduced with the fourth "R" standing for regeneration of the optical signal spectrum [5]. In order to profit fully from optical signal processing it is essential to develop advanced devices with novel materials and concepts as optical nonlinearities or photonic bandgap structures [6].

1. Marciniaik, "Transparency of optical networks: How to manage it?", *International Conference on Transparent Optical Networks ICTON'99*, Kielce, Poland, June 9-11, 1999
2. M. Marciniaik, "The impact of optical transparency on the successful development of all-optical terabit networks", *The 5th World Multi-Conference on Systemics, Cybernetics and Informatics SCI 2001*, Orlando, Florida USA, July 22-25, 2001
3. M. Klinkowski and M. Marciniaik, "Development of IP/WDM Optical Networks", *International Workshop on Laser and Fiber Optic Network Modelling*, Kharkov, Ukraine, May 22-24, 2001
4. R.C. Alfness, "Research challenges in optical networking", *ECOC'98*, Madrid, Spain, Sept. 1998
5. L. Thylen, "Some aspects of photonics and electronics in communications and interconnects", *International Conference on Transparent Optical Networks ICTON'99*, Kielce, Poland, June 9-11, 1999
6. M. Marciniaik, "Solving present and future problems in optical telecommunications with PBGs", *International Summer School of Quantum Electronics*, 29th Course on "Nanoscale Linear and Non-Linear Optics", Erice-Sicily, Italy, July 2-14, 2000

Enhanced Semiconductor Photorefractivity in Presence of a Magnetic Field
Praveen Aghamkar, Sunayana Nepal and Shiwani and Suta.

Dept. of Applied Physics, G.-J. University, Hisar, Haryana, INDIA-125001.

The non-local response of refractive index variation due to photorefraction, concedes photorefractive (PR) crystals as most efficient recyclable photosensitive media for all-optical signal processing [1]. Among various PR-crystals, GaAs is one of the highest sensitive material in the infrared regime for the optical data storage in a short-time scale. In this report, we study effect of a magnetic field on the photorefractivity by illuminating GaAs:Cr with two co-propagating pico-second pulses under Vioget configuration. The photogeneration rate of electron in diffusion dominated regime [2] is obtained as:

$$\frac{\partial N}{\partial t} = (-N/\tau_r) - u \frac{\partial^2 N}{\partial x^2} - \tau_p < t < \tau' \quad (1), \text{ with } (1/\tau_r) = (1/\tau_0 - 1/\tau_R)$$

$$\tau_0 = (\hbar \omega_p / 2\pi \Phi_0 \alpha_L) \text{ and } u = \frac{2k_0 \Gamma(v-\omega)}{m_e [(v-\omega)^2 + \omega_c^2] \{1 - \frac{\omega_c}{\omega} (v-\omega)\}}$$

Using Kukhtarev et. al approach [2] and eq. (1), we obtain the PR-gain and diffraction efficiency from imaginary and real part of the space charge electric field, respectively as $\phi(x,t) = 2\pi m^3 \{E_{sc}(x,t)\} / \lambda \cos \theta$ and $\xi(x,t) = \sin^2 \{ \pi L \Gamma \{ E_{sc}(x,t) \} / 2\lambda \cos \theta$, with $E_{sc}(t) = -ie [N_A / k_g s_0 - (iNe / (1+k_g^2 u \tau_p) k_g s_0) [1 + k_g^2 u \tau_r \exp \{-t / (\tau_r + k_g^2 u)\}]]$, $t > \tau$. In Fig.1 large value of PR-gain co-efficient (24.6 cm⁻¹) is achieved when B=17.0T and t=10⁻⁹ sec. Fig. 2 exhibits efficient recording of the information while Fig. 3 reveals exponential decays of that information at B=17 with fast response time. These findings may open new door for optical information processing and storage with high efficiencies in the very short time scale by using magneto-active semiconductor PR-grating.

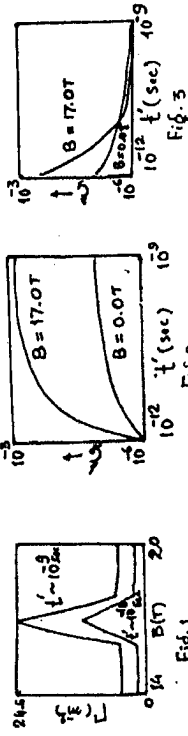

References:

1. P.Yeh, Introduction to Photorefractive Nonlinear Optics (John Wiley, New York, 1993)
2. Kukhtarev et. al, Ferroelectric, 22, 961, 1979.

Sunday, July 1

SuB Strong Laser Fields and High Field Physics V

Short X-ray pulse generation towards time-resolved spectroscopy

Naoshi Uesugi, *Hidetoshi Nakano, *Tadashi Nishikawa and *Katsuya Oguni
Tohoku Institute of Technology
35-1 Yagiya Kasumicho, Taihaku-ku Sendai, 982-8577 Japan

Tel: +81 22 229 1151

Fax: +81 22 228 0447

e-mail: uesugi@titan.tohtech.ac.jp

*NTT Basic Research Laboratories

3-1 Wakamiya, Morinosato Atsugi-shi, Kanagawa 243-0198 Japan

The short X-ray pulses generated from fs laser produced plasma attract a lot of attention to realize time-resolved spectroscopy in X-ray region, recently. The pulse duration of X-ray from fs laser produced plasma is assumed to be determined mainly by the cooling processes of the hot plasma created on the solid target surface. As the most of the incident light is reflected on the solid targets, the X-ray generation yields is limited to be small for flat solid targets. The enhancement of X-ray generation yield depends on the interacting volume of target materials with fs laser pulses. Therefore, it may be essential to apply the fine-structured targets to achieve the efficient short X-ray pulse generation from fs laser produced plasmas. In this paper, we evaluated the soft X-ray generation properties for both flat targets and structured targets such as nanohole-alumina and Au-nanocylinder. The experimental results for flat metal targets have revealed the fundamental properties of soft X-ray such as broadband continuum spectra and short pulse duration of less than 3 ps. By adopting structured targets such as nanohole-alumina and Au-nanocylinder targets, a more than 20-fold enhancement of X-ray generation yield is achieved compared with that for flat targets of the same materials with a slight increase of pulse duration, less than 20 ps.

The time-resolved measurement of the inner-shell absorption change of Si during the irradiation with a high-intensity fs laser pulse is achieved by using a picosecond soft X-ray pulse as a probe pulse in pump-probe experiments. A more than 5% increase in the absorption of Si membrane at near the $L_{II,III}$ edge (around 100eV) was observed. The recovery time of the absorption change was measured to be about 20ps. From these experimental results, this absorption change is assumed to be the bandgap renormalization of Si.

Ultrashort x-ray pulse generation on long-lived atoms and ions in laser fields of subrelativistic intensities

M. Yu. Ryabikin and A. M. Sergeev

Institute of Applied Physics RAS, 46 Uljanov St., 603950 Nizhny Novgorod, Russia

Among the most interesting strong-field phenomena is the atomic stabilization against ionization in a very intense high-frequency laser field. Atomic stabilization, on the one hand, is of interest as a rather counterintuitive effect of decreasing ionization probability with increasing laser intensity. On the other hand, it provides a long-lived highly nonlinear medium that possesses a number of uncommon features. We demonstrate that electron localization during atomic stabilization in a pulsed laser field (dynamic stabilization) is accompanied by high-order harmonic production with unusual time- and polarization dependencies.

We present the results of numerical experiments on 2D models for hydrogen atom and H^- ion. The electron wave-packet behavior and its macroscopic manifestations are explored for arbitrary laser polarizations in a range of laser parameters corresponding to the dynamic stabilization regime.

At dynamic stabilization the oscillating electron wave packet evolves from the initial isotropic distribution to the strongly localized structure. These localized wave packets exhibit sharp features originating from the manifold of dressed states populated due to the fast turn-on of the laser field. These sharp features give rise to the harmonic production as a result of electron collisions with the nucleus. We find that high-order harmonics in this regime are emitted as a long train of attosecond pulses. Sharpening of features during wave packet localization leads to an increase of harmonic peak intensities with time, in spite of ionization. Uncommonly, dynamic stabilization allows rather efficient harmonic production with arbitrary laser polarizations including circular one, in contrast to the normal regime when there is no stabilization. We demonstrate the changes in the scenarios of wave packet evolution and the disappearance of high-order harmonics as the laser intensity enters the value area where the dipole approximation breaks down. The boundaries of "stabilization window" for the systems investigated are found.

The above-stated unusual properties of high-order harmonics prove to be the very characteristic manifestations of the dynamic stabilization and can be used as a tool for probing this special regime of strong-field laser-atom interactions.

Production and applications of secondary sources of intense femtosecond laser systems

Antoine ROUSSE

Laboratoire d'Optique Appliquée
ENSTA, CNRS UMR7639, Ecole Polytechnique,
Chemin de la Hunière, 91761 Palaiseau, France.

phone: +33 1 69 31 99 01

fax: +33 1 69 31 99 96

email: rousse@ensta.fr

The Laboratoire d'Optique Appliquée (LOA) is a European Laser Large Scale Facility and runs laser systems with very high peak powers up to 100 TW (2.5 J, 25 fs, 10 Hz) and high repetition rates (7 mJ, 40 fs, 1 kHz). These systems allow the investigation of new domains of strong field physics such as High Harmonic generation, laser-assisted nuclear physics, production of ultra fast X-rays by non-linear Thomson scattering, generation of x-ray lasers and Neutron production. The significant results recently obtained in these field (1) will be discussed as well as the oncoming experiments scheduled in the Facility.

In particular, the achievements obtained on the X-ray generation part have launched a program on the application of ultrafast X-rays to the analysis of femtosecond atomic motions in condensed matter physics and biochemistry. For many years it has been realized that intense radiation in the X-ray spectral range would give a breakthrough in the studies of rapid dynamics of structural changes. Depending of the spectral range of observation, different properties can be studied. Usually, visible or near-visible radiation provide information on the electronic properties, but atomic motion can be directly monitored *only* through very-short wavelength radiation like x-rays. The electronic changes associated with processes like vibrations in single molecules, liquids or crystal lattices, isomerization and the breaking or formation of chemical bonds, can be monitored by ultrafast optical spectroscopy techniques, but the accompanying ultrafast structural rearrangements can not be directly observed. In the detailed characterization of structure on the atomic level, x-ray diffraction and absorption are unparalleled tools, making feasible the track of reaction intermediates with a full mapping of transient atomic behavior. The results obtained at LOA in this emerging field will be discussed (2-4).

(1) S. Sebban *et al*, accepted in *Phys. Rev. Lett.* (February 2001)(2) C. Rischel, A. Rousse, I. Ueschmann, *et al.*: *Nature* **390**, 490 (1997).(3) A. Rousse, C. Rischel, S. Fourmaux, I. Ueschmann, *et al.*: accepted in *Nature*, (December 2000)(4) A. Rousse, C. Rischel and J.C. Gauthier, *Rev. Mod. Phys.* **73** (1) (2001)

NUCLEAR PROCESSES IN DENSE FEMTOSECOND PLASMA

AT MODERATE INTENSITIES

V.M. Gordienko, P.M. Mikhchev, A.B. Savel'ev, and R.V. Volkov

International Laser Centre & Physics Faculty

M.V.Lomonosov Moscow State University

Vorobyevy gory, Moscow, 119899, Russia

Tel:+7(095)9394719; Fax:+7(095)9393113; e-mail:gord@fermito.phys.msu.su

We overview our recent results on experimental observation of nuclear process in hot dense plasma created by focusing of femtosecond laser pulses with intensity below 10^{17} W/cm² on the target surface. Such an intensity can be easily achieved with the help of relatively cheap commercially available table-top femtosecond lasers. By the contrast to the commonly used relativistic regime of interaction, hot electrons created at moderate intensities possess energy below 10 keV that in most cases not enough to ignite nuclear processes directly. Ions temperature is even two orders of magnitude lower, that again is too small even in the case of thresholdless thermonuclear DD reaction. This implies special means in order to push the nuclear process in such a plasma.

In the first part of the paper we introduce special technique of target properties modification allowing us to increase both hot electron temperature (by a factor of 2) and ion temperature (by a factor of 100). Namely, we use laser-modified targets, there the first femtosecond pulse produces surface microstructuring, and the next, delayed by a few seconds, explodes this structure.

We successfully applied this technique to rise ion temperature in D-enriched Ti target up to 10-20 keV, thus observing 2.5 MeV neutron yield at intensity of as small as 10^{16} W/cm².

We further discuss the possibility to use observed hot electron temperature increase in laser modified Fe and Ge to enhance the efficiency of low energy nuclear level excitation.

This work has been done with financial support from Russian Foundation for Basic Research under grants #99-02-18343 and 00-02-17302.

Fusion neutron studies from $D(d,n)^3\text{He}$ reaction induced by 55fs, 10 Hz Ti:Sa-laser pulses

P.V. Nickles, O. Berndt, M. Kalashnikov, H. Ruhl, W. Sandner,
D. Hilscher*, U. Jahnke*

Max-Born-Institute, Berlin
**Hahn-Meitner-Institute, Berlin*

The interaction of energetic subps laser pulses makes now possible to generate particles, like electrons, bremsstrahlung photons and ions with energies in the range of keV-MeV. If especially a high-intensity subps laser pulse interacts with a deuterated target hot deuterium ions are created which can produce fast neutrons. There is an enhanced interest in this process because of its relevance to the inertial thermonuclear fusion as well as for a wide array of applications including material sciences and radiography. Especially the possibility to generate ps neutron bursts allows to consider in principle ultrafast studies. All these applications need a detailed knowledge about the neutron source like yield, energy and angular distribution of the emission.

We have measured detailed neutron energy spectra for the fusion reaction $D+D \rightarrow \text{He}^3 + n$, irradiating solid $(\text{CD}_3)_n$ -targets by 55 fs pulses with an intensity up to $2 \times 10^{18} \text{ W/cm}^2$ of an 10 Hz Ti:Sa laser. The maximum mean neutron yield was about 10^4 neutrons per pulse respectively 3×10^4 neutrons per Joule laser pulse energy. Neutron energies up to 4 MeV have been recorded indicating that deuterons are accelerated in the plasma up to a kinetic energy of 1 MeV. Dependencies of the neutron generation on electron and Bremsstrahlungs spectra of the plasma are discussed. The neutron spectra observed at different angles allows to make assumptions for the directionality of the deuteron acceleration, which is a special feature of the interaction in a solid target.

The experimental results are compared with detailed simulations of deuteron acceleration under oblique incidence of the laser pulse. The simulations reveal that the deuterons are predominantly accelerated normal to the target surface. Inline calculations of neutron yield from the $D(d,n)$ fusion reaction show double-humped spectra for the detector positions used in the experiment. The results are in good agreement with the experiment.

ON ABSORPTION MECHANISM OF ULTRAHIGH CONTRAST
SUBPICOSECOND LASER PULSES BY METAL TARGETS

L.L.Losev and V.I.Soskov
P.N.Lebedev Physical Institute, Moscow
117924, *Leninsky prospect, 53, Moscow, Russia*
E-mail: losev@x4u.lebedev.ru

The experiments on interaction of 0.8 ps high contrast ratio laser pulses with metal targets are presented. The extremely high contrast ratio of more than 10^{12} is achieved by using unique laser system: Raman master oscillator - Nd:glass laser amplifiers. The plasma electron temperature, target reflectivity and high harmonics generation on target surface were researched at laser intensity up to $5 \times 10^{16} \text{ W/cm}^2$. It was shown that at oblique incident of laser light on target surface the radiation is absorbed in regime of normal skin-effect and the absorption mechanism does not depend on laser polarization. The effect of anomalous dependence of electron temperature on laser polarization was discovered. The electron temperature at s-polarization of laser radiation is 10% higher as at p-polarization.

Key to Authors

- Abramov D.V. — SP7
 Abstreiter G. — FM2
 Acevedo R. — WU23
 Achasov O.V. — WX7
 Ackermann T. — SD2
 Adamchuk R.I. — ThN31
 Adamson P. — WU8
 Afanas'ev A.A. — FG2, FJ1, FT10, FT11, WE8, WS3, WY27
 Afanasiev Y.V. — WT8
 Affolderbach C. — WL1
 Afiat S. — WD5
 Agapov I.I. — ThN36
 Ageev V.A. — WU31
 Aghamkar P. — ST3, ThM11
 Agishev I.N. — ThM24
 Agostini P. — SB1
 Aït Ameur K. — FT18, FT19, FT38
 Akanaev B.A. — WU11
 Akhrem A.A. — W12
 Akimov A.V. — FS2, ThO18
 Akimov D.A. — FS20, SA3
 Akopyan R.S. — WY6
 Aksenov V.P. — FT25
 Aktopetov O.A. — ThB3, WF2, WU19
 Alaverdyan R.B. — WY6
 Albrecht A. — SP1
 Aleshkevich V.A. — ThH4, ThM7, ThM8
 Alexandrov A.P. — SH2
 Alexandrova E.N. — WD4
 Alexeenko A.A. — WU32
 Alexeev S.A. — WL4
 Alfimov M.V. — WA2
 Alidjanov E.K. — ThP18
 Alimpiev A.I. — FF2
 Aliverdiev A.A. — ThN3
 Alodjants A.P. — FD2, ThO17
 Alt W. — ThJ1
 Aminova R.M. — ThN1
 Amirova A.A. — ThN3
 Amy-Klein A. — WB2
 Anastasiyev A. — WT6
 Andersen J.A. — ThO5
 André R. — ThB4
 Andreev A.V. — FQ13, TuB1, WF1, W02, WU24, WY39
 Andreev N.F. — ThM27, WL2, WT6
 Andreev V.G. — WN3
 Andreev Yu.M. — FP23, WY21
 Andreeva C. — FD7
 Andreeva M.S. — SO6
 Andreeva O.V. — FR4
 Andreoni A. — SE3
 Andrianov K.Yu. — ThC4
 Angelsky O.V. — WL3, WN5
 Anikeev B.V. — FT27, ThM2
 Anikeyev V.V. — ThM20, ThP3
 Anikin K.V. — ThN23
 Antipov O.L. — FA2, FJ1, FP14, FP26, SD5
 Antsygin V.D. — FP4
 Anufrik A. — ThN26
 Anufrik S. — FS29
 Apanasevich P.A. — FL1, ThM45, ThM48, WE5
 Apanasevich S.P. — ThP10, ThP11, WJ3
 Apanasovich V.V. — FS30
 Apolonsky A.A. — FQ2
 Arakelian S.M. — FD2, SP7, ThO17
 Archireev V. — ThM16
 Armstrong R.L. — WK5
 Arshinov K.I. — WX7
 Artemyev M.V. — ThG2, WU29, WU33
 Arzberger M. — FM2
 Ashraf M.M. — F15
 Aslanyan L.S. — FT1, WY7
 Astafieva L.G. — FS25, WX11
 Atature M. — WC1
 Atutov S.N. — ThJ2
 Audretsch J. — FD6
 Babin A.A. — SH2, SQ2
 Babina N.A. — SH2
 Babushkin I. — FO1
 Badikov V.V. — WY21
 Bagayev S.N. — FP25, The2, ThP17, WA2, WB1, WB3, WB4, WG2, WS2, WT2, WT7
 Bagratashvili V.N. — FS27, ThN15, WD3
 Bahari A. — FQ5
 Baillagreon J.N. — FS14
 Baitimbetova B.A. — WU11
 Bakharev D.Yu. — ThM2
 Bakhramov S.A. — ThN2, WY32
 Bakhitin M.A. — ThM19
 Bakin A.S. — WU21
 Baklanov E.V. — SK1
 Balachninaite O. — FL4, FP13
 Balakin A.V. — FB6, WF1
 Balle S. — FJ5, FO2
 Baltuska A. — FH1
 Bandrauk A.D. — SL1
 Banishev A.F. — WU2, WY38
 Baranov D.V. — WL5
 Baranova I.M. — FS3
 Barauliya V.I. — ThE2
 Barille R. — WS4
 Barkauskas M. — FP13
 Barkou S.E. — WA4
 Barland S. — FO2
 Barnett S.M. — ThO4
 Barnik M.I. — FK1
 Barton P. — WM4
 Barty C.P. — SQ1
 Barun V.V. — WN6
 Baryshnikov V.I. — FR13
 Basharov A.M. — ThO3, WU7
 Basiev T.T. — FF5
 Batay L.E. — FT9, WX1
 Baumann W. — ThN28, WE7
 Bazylenko V.A. — WU20
 Becker W. — ThF1
 Bednarkiewicz A. — WJ1
 Begishev I.A. — FM5
 Beloglazov V.I. — WA2, WB4
 Belousov V.P. — FP19
 Belousov Yu.I. — FS9
 Belousova I.M. — FF1, FP19
 Belsley M. — ThM23, ThM26, ThM28
 Belyaev V.S. — WJ5
 Belyi V.N. — FB3, FT13, ThM39, ThM42
 Benfield R.E. — FA2
 Benkö G. — FH4
 Bennemann K.H. — ThK5
 Berardi V. — WM3
 Beril S.I. — WY3
 Berkovsky A.N. — ThM19
 Bernal J.J.S. — ThM12
 Berndt O. — SuB5
 Bertel' I.M. — WX5
 Bertolotti M. — WU18
 Bertreux J.C. — FO3
 Bertsev V.V. — ThM10
 Besnard P. — FO3
 Besogonov V.V. — FQ3
 Beshpalov V.G. — FC4, ThM30, ThN12
 Bhat N. — FK3
 Biancalana V. — FD7, ThJ2
 Bijsenbaev M.A. — WU11
 Bityurin N.M. — SH2
 Björk G. — WM5, WR2
 Blatt R. — WM4
 Blinova K.G. — FS19, FS6
 Bloch D. — The1
 Blokhin A.P. — WX14, WX19
 Blome Ch. — SQ1
 Boardman A.D. — FJ2
 Bobrov D.N. — FP21
 Bocharov V.N. — ThM10
 Bogdanov A.A. — S16, WY11
 Bogdanovich P.M. — FB2
 Bogumirsky O.B. — ThM21
 Boguslavskiy A.E. — WY20
 Böhm G. — FM2
 Bohórquez J. — FR3
 Bokhonov A.F. — WU31
 Bolotov V.V. — WU4
 Bolshakov M.V. — ThM14, ThP3
 Bonch-Bruевич A.M. — FD4, WK4
 Bondani M. — SE3
 Bondar A.M. — WY29
 Bondar I.I. — WY33, WY34
 Bondarev S.L. — FP21
 Bonert A.E. — The2
 Borghs G. — ThK3
 Borisevich N.A. — W12, WX19
 Borisov V.I. — ThP14
 Borodin M.V. — ThM29
 Borysov R.S. — ThK6
 Boyarkin O.V. — ThI4
 Boychuk I.V. — FS23, SK6, ThN23
 Bozhevolnyi S.I. — ThB2, WV8
 Brabec T. — FM1, SB4
 Brambilla M. — S13
 Brandt N.B. — W55
 Brandt N.N. — ThN36, W55
 Brembs K. — ThD4
 Brocklesby W. — WK2
 Brodyn M. — FK4
 Broeng J. — WA4
 Brunel M. — SI2
 Bryuhanov V.V. — ThN6
 Brzhasovskiy Yu.V. — WY20
 Bufetov I.A. — FB1
 Bufetova G.A. — FT31

- Buganov O.V. — WX13, WX19
 Buj A.A. — WE5
 Bukin O.A. — WY12
 Bunkin A.F. — SP6
 Burakov V.S. — FS30, WU31
 Burchianti A. — FD7, ThJ2
 Burikov S.A. — ThN24
 Burkovets D.N. — WN5
 Burlakov A.V. — F14, WC3
 Burtsev A.P. — ThM10, WY19
 Bushnev V.A. — FB6, ThM34
 Bushuk B.A. — FA2, ThI7, WX17
 Bushuk S.B. — ThI7, WX17
 Butcher R.J. — WB2
 Butkus R. — FL5
 Buyarov S.A. — FL6
 Buzelis R. — ThH3
 Bychkov S.S. — ThI1
 Bykov I. — FP16
- C**
 Calabrese R. — ThJ2
 Calarco T. — FN2
 Camacho A.S. — FR3
 Canioni L. — WS4
 Capasso F. — FS14
 Carcía-Ojalvo J. — FE3
 Cartaleva S. — FD7
 Causa F. — FT15
 Cavalleri A. — SQ1
 Cerullo G. — ThM22
 Cervantes M.A. — FR5
 Chalov V.N. — ThN14, WD4
 Chalykh R.A. — FQ13
 Chardonnet Ch. — WB2
 Chari R. — FR10
 Chartier T. — S12
 Chauvot D.V. — FJ1
 Chekalin S.V. — FH5, FR4
 Chekhonin I.A. — ThP17, WT2
- Chekhonin M.A. — ThP17
 Chekhov D.I. — ThN7
 Chekhova M.V. — F14, WC3, WM3
 Chekina S.N. — FT24
 Chelkowski S. — SL1
 Chepurov S.V. — WB4
 Cherkas N.L. — WY36
 Cherkasova O.P. — ThN38
 Chernyavskaya E.A. — SF5
 Chernyavsky V.A. — FS26
 Chervyakov A.V. — WU14
 Chesnokov S.S. — FT26
 Chichigina O.A. — WY40
 Chigarev N.V. — SP4, WU12, WU22
 Chikishev A.Yu. — ThN19, ThN36, WS5
 Chilingaryan Yu.S. — WY6
 Chin S.L. — ThC4
 Chirkin A.S. — FI2
 Chirkov V.V. — ThM13
 Chirvony V.S. — ThN21, ThN29, ThN33, W13
 Chistyakov A.A. — FS13, WY45
 Chizhevsky V.N. — S14
 Chizhova G.A. — FT30
 Cho A.Y. — FS14
 Choi S.S. — S03
 Chorvat D. — WA2
 Chorvat D., Jr. — WA2
 Chudinov V.G. — FQ3
 Chudoba C. — WN1
 Chugunov V. — WV3
 Chuikov R.V. — FT13, ThM49
 Churakov V.V. — FB5, WX3, WX5, WY42
 Churina I.V. — SK6
 Churmakov D.Yu. — FQ2
 Chutko O.V. — FQ10, FQ9
 Cipriani R. — FS1
 Crac J.I. — FN2
- Colet P. — FT33, FT34, FT35, ThO4
 Corovai A.V. — FS5
 Corradi L. — ThJ2
 Coufal H.J. — SE1
 Couillet P. — FO2
 Criado A. — FK5
 Cundiff S.T. — FM2
- D**
 D'Arice M. — FS1
 D'yakov V.A. — FF4
 Dainelli A. — ThJ2
 Danailov M.B. — FT9, WJ1
 Dancheva Y. — FD7
 Daniel M. — ThM17
 Danilov O.B. — FF1, FP19
 Danilov V.V. — FP19
 Dashevsky O.Yu. — FP4
 Davliatchine E.M. — WT2
 De Dominicis L. — SA4
 de Matos Gomes E. — FK5
 De Silvestri S. — ThM22
 Deinekina N.A. — FP7
 Delgado J. — ThE4
 Demchenko N.N. — WT8
 Dement'ev A. — ThH3
 Dement'ev D.A. — FR4
 Demidovich A.A. — FT9, WJ1
 Denisov I.A. — FP22
 Denisuk Yu.N. — SE3
 Derbov V.L. — ThO9
 Derevyanko N.A. — FR9
 Deykoon A.M. — ThM6
 Dharmaparakash S.M. — FK3
 Di Giuseppe G. — WC1
 Diener J. — WU17
 Diening A. — FM3
 Dietrich C. — SQ1
 Dittrich Th. — FK4
 Dmitriev A.K. — WB3
- Dmitriev V.G. — FA1, Tub3, FK2
 Dmitriev V.J. — ThP17
 Dmitriyev A.K. — WB4
 Dobryakov A.L. — SC1, SC3
 Dobryakov V.V. — ThN5
 Doktorov E.V. — ThM37
 Dokutovich A.A. — ThP10, ThP11
 Dolenko S.A. — SK6
 Dolenko T.A. — FS23, SK6, ThN23
 Dolgova T.V. — WF2, WU19
 Domrachev G.A. — FA2, FP14
 Dörner R. — SG2
 Douglas W.E. — FA2, FP14
 Drabovich K.N. — WV4
 Drachev V.P. — WK5, WP4
 Dreier T. — FS10, FS15
 Drexler W. — WN1
 Dronov S.A. — FT27
 Duboshevskii S.Yu. — WY3
 Dubovskiy V.L. — WX19
 Dubrov V.D. — FL6
 Ducloy M. — ThE1
 Duzhko V. — FK4
 Dychkov A.S. — WB4
 Dymshits O.S. — FP22
 Dynich R.A. — WU15
 Dzhangarov B.M. — ThN22, WS1
 Dzhidzhoev M.S. — FQ9
- E**
 Eckardt R.C. — FL4
 Edamatsu K. — ThB1
 Efendiev T.Sh. — ThP9, WX18
 Efimova A.I. — WU16
 Efremov M.D. — WU4
 Egorov O.A. — ThM31
 Egorov V.S. — ThP17, WT2
 Egorova A.B. — ThN10
 Eichler H.J. — WE5, WJ1
 Elbakyan E.L. — FT1
- Elizarov S.G. — WV5
 Emelyanov V.I. — FR12, SH4, WK2, WY44
 Entin V.M. — WY20
 Epikhine E.N. — WV10
 Eremykin O.N. — FP26
 Eriomin K.I. — WU3
 Ermolaeva G.M. — WY17
 Ermolenkov V.V. — ThM49, ThN35
 Ernsting N.P. — SC3
 Erokhovets V.K. — ThP12
 Eschner J. — WM4
 Esman A.K. — ThP4, ThP5
 Evtuyukhov K.N. — FS3
- Fadeev V.V. — FS23, SK6, ThN23, ThN24
 Fang H. — FG1
 Fantoni R. — SA4
 Fedina L.I. — WU4
 Fedorov A.N. — WT2
 Fedorov M.V. — SG3
 Fedorov S.V. — FJ3
 Fedorov V.I. — ThN38
 Fedotov A.B. — FS20, SF4, WA2, WU17, WU22
 Fedotov A.M. — ThF4
 Fedotov V. — WK2
 Fedotova O. — FS16, WY26
 Fedotova O.M. — FG2
 Fedyanin A.A. — WF2, WU19
 Feigelson R.S. — FF6
 Fel'de C.V. — SE5
 Feldmann J. — FM2
 Fernández J.J. — FE3
 Ferrante G. — FQ12
 Ficek Z. — ThO5
 Fiebig M. — SP3
 Filippov V.N. — S13

- Filippov V.V. — FP27
 Firsov A.A. — ThP7
 Firsov S.P. — FP27
 Fischer P. — SP1
 Fleck B. — FT4
 Fleming R.D. — WN3
 Flytzanis C. — ThB4
 Font J.L. — FE3
 Frey R. — ThB4
 Friese M.E.J. — ThO5
 Fröhlich D. — SP3
 Frolova M.N. — ThM29
 Fromager M. — FT19, FT38
 Fujimoto J.G. — WN1
 Fuss W. — Th16
Gadomsky O.N. — WU5
 Gadonas R. — ThM35
 Gaida L. — ThM52
 Gaiko O.L. — WX3
 Galievsky V.A. — ThN21, ThN22
 Galkin A.F. — SP7
 Galkin A.L. — SQ5
 Galuskin M.G. — FL6
 Gan'shina E. — FP16
 Gancheryonok I.I. — FS10, FS15, FT4
 Ganeev R.A. — FP1, FP2
 Gangardt M.G. — WS5
 Gaponenko S.V. — WF3, WX15, WU26
 Gaponov V.P. — WD3
 Garanovich I.L. — ThM46
 Garcia M.E. — SC4, ThK5
 García-Ojalvo J. — FJ4
 García-Ripoli J.J. — FD3
 Gardiner S.A. — FD1
 Gatalica Z. — WN3
 Gatti A. — WC4
 Gayvoronsky V. — FK4
 Geiko L.G. — WY21, FP23
 Geiko P.P. — WY21, FP23
- Gelin M.F. — WX14, WX19
 Gheri K.M. — FD1
 Giammanco F. — SF4
 Giammartini S. — FS1
 Gibb J.S. — FS18
 Giessen H. — SG2
 Glidenburg V.B. — FQ6
 Giorgi M. — SA4
 Giovanetti V. — WH2
 Giudici M. — FO2
 Glas P. — FT21
 Glorieux P. — SD1
 Gmachl C. — FS14
 Gnatyshchak V.I. — WU6
 Goldina N.D. — FT29
 Golik S.S. — WY12
 Golishnikov D.M. — FQ8, FQ9
 Golovan L.A. — WA2, WU16, WU17
 Golovnin I.V. — WU1
 Golovtsov N.I. — WW1
 Goltubev V.S. — FL6, WU2
 Goltubtsov I.S. — ThC2
 Gomer V. — ThJ1
 Gomila D. — FT33, FT34, FT35
 Goncharenko A.M. — SJ2, ThM46, ThP10, WJ3
 Goncharenko I.A. — ThP4, ThP5
 Goncharov A.A. — FP17
 Goncharov A.N. — ThE2
 Gorbach D.M. — WY27
 Gorbach D.V. — FG2
 Gorbachev V.N. — ThO12
 Gorbunkov M.V. — FT32
 Gordienko V.M. — FQ10, FQ11, FQ8, FQ9, SubB4, TuB1, FF3
 Gorobets V.A. — FB5, WX3
 Gonyachev V.A. — WY22
 Grabtchikov A.S. — FL1, FT13, ThM49, WE5
- Grain Ch. — WB2
 Granovsky A. — FP16
 Granpayeh N. — ThH6
 Grasbon F. — SG1
 Grashin P.S. — WN4
 Grechin S.G. — FK2, FP23
 Grechin S.S. — FF3, FF4
 Grib A.F. — FS26
 Gribkovskii V.P. — FT17
 Griddchin V.V. — FQ7
 Grigonis R. — FL4, FP13, FR9
 Grigorenko I. — SC4
 Grigorian G.G. — WY35
 Grigorieva E.V. — FT7
 Grigoryan G.G. — ThK6
 Grigoryan J.Ch. — WY7
 Grimm R. — ThJ3
 Grinyov B.V. — ThK6
 Grischchenko S.V. — FS22
 Grishachev V.V. — FP3
 Grishanin B.A. — FN4, FS2, ThI1, ThO14
 Grishayev R.V. — FL6
 Gritsai Yu.V. — ThM51
 Grohovska T.E. — ThN15
 Große Westhoff E. — SD2
 Grushevskaya H. — WY43
 Gruzdev V.E. — ThM32, WY30
 Gubarevich A.V. — WU35
 Gubarevich T.M. — WU35
 Gubin M. — WG3
 Gudelev V.G. — WX3, WX7
 Guidi V. — ThJ2
 Gulde S. — WM4
 Gurin V.S. — WU32
 Gurinovich L.I. — WU29
 Gurov I. — FT22, ST1, WY3
 Gurskii A.L. — WJ2, WU27
 Guschin V. — FP16
- Gutakovskii A.K. — WU4
Hakhournian A.A. — FC5
 Halilulayev G.M. — ThN3
 Hammes M. — ThJ3
 Hancock G. — FS18
 Hänsch T.W. — WG1, WG2
 Hanuza J. — WU23
 Harkness G. — FT33
 Hartl I. — WN1
 Haus J.W. — WA3, WU18, WU22
 Havey M.D. — WM2
 Herbig J. — ThJ3
 Hering P. — WD5
 Heuken M. — WJ2, WU27
 Hideur A. — SJ2
 Hilscher D. — SuB5
 Hismatullin R.K. — WY37
 Hlubina P. — WV3
 Hogenworst W. — ThM42
 Hollberg L. — ThA1, WL1
 Holzwarth R. — WG1, WG2
 Horoshko D.B. — FI1
 Hreniak D. — WU23
 Hsiung P. — WN1
 Huber G. — FM3
 Hutchinson A.L. — FS14
Idiatullof T.T. — WU5
 Ignat'eva N.Yu. — ThN15
 Il'in A.A. — WY12
 Ilchishin I.P. — FS22
 Isaenko L.I. — FA3
 Isaevich A.V. — FS30
 Isakov V.A. — WT8
 Ishchenko A.A. — FR9, FS6
 Ishkhanyan A.M. — ThO8
 Istomin Yu.P. — WD4
 Itoh T. — ThB1
- Ivakin E.V. — FP27, ThH5
 Ivanenko M.M. — WD5
 Ivanov A.A. — WA2, WU21, FF3
 Ivanov D.A. — ThM44, ThO13
 Ivanov I.V. — FQ5
 Ivanov M. — FC3
 Ivanov P.S. — FT37
 Ivanova T.Yu. — FP15
 Ivantsov A.A. — FS6
 Ivashchenko M.V. — WY21
 Izmailov I.V. — FT25
 Izús G. — FT36
 Izyurov S.A. — ThM21
- J**ahnke U. — SuB5
 Jakimovich V.N. — FB5
 Jaksch D. — FN2
 Jarufis V. — FB4, ThM35
 Jeschke H.O. — ThK5
 Jones R.G. — FA2
 Julsgaard B. — WH1
- K**abanov V.V. — ThF5
 Kabelka V. — FM6
 Kachan S.M. — WUJ15
 Kachinski A.V. — WF5
 Kaertner F. — WN1
 Kalachev A.A. — WY47
 Kalashnikov M. — SubB5
 Kalashnikov M.P. — FM5
 Kalashnikov V.L. — FM4
 Kalinin Yu. — FP16
 Kalinkin M.Yu. — WW2
 Kalisch H. — WJ2
 Kaliteevskaya E.N. — ThN9
 Kaliteevskii N.A. — WE6
 Kalosha I.I. — FP21
 Kalutskaya E.P. — ThM40
 Kalvinkovskaya Ju.A. — WX17

Key to Authors

- Kalvinkovskaya Yu. — Th17
 Kamanina N.V. — FP6
 Kaminsky A.A. — FA1
 Kandidov V.P. — ThC2, ThC4
 Kanorsky S.I. — FS2, ThO18
 Karabutov A.A. — WN3, WN4
 Karabutova O.A. — F14, WC3
 Karalevich A. — ThM26, ThM28
 Karapetyan H.A. — FF6
 Karapuzikov A.I. — WY21
 Karelin N.V. — ThH5
 Karimov M.G. — ThN3
 Karlovich T.B. — ThO16
 Karlsson H. — FL5
 Karpenko V.A. — WV13
 Karpets Yu.M. — WY10
 Karpiuk J. — ThN22
 Karpov V. — FM5
 Kartashov Ya.V. — SQ2, ThH4, ThM7, ThM8
 Kartazhev V. — ThM52
 Karyakina N.F. — WS5
 Kashkarov P.K. — WA2, WP3, WU16, WU17, WU20
 Kasyutich V.L. — FS18
 Katarkevich V.M. — ThP9, WX18
 Katin E. — ThM27
 Katranji E.G. — ThM43
 Katshev I.L. — WX16
 Kawata I. — SL1
 Kazak N.S. — FB3, ThM42, ThM43
 Kazanyan M.A. — WY15
 Kazberuk A.V. — FT16, WJ3
 Khadzhi P.I. — FS5, WU6, WY2
 Khairullina A.Ja. — WU15
 Khairullina A.Ya. — WN6, WU35
 Khaliullin E.N. — WP4
 Khasanov O.K. — FG2, FS16, ThM24, WY26, WY27
 Khatkevich A.G. — ThM50
 Khatkevich L.A. — ThM50
 Khazanov E. — ThM27, WT6
 Khilo A.N. — ThM43
 Khilo N.A. — FB3, FT13, ThM39, ThM42, WJ3
 Khilus O.V. — ThN25
 Khodasevich M.A. — ThP11, ThP6, WJ3
 Khormchenko A.V. — FP20, ThM40
 Khoroshilov E.V. — WX14
 Khramov V.N. — FT27
 Khromov V.V. — FD4, WK4
 Khrutchinsky A.A. — FQ2
 Kidyarov B.I. — FA4
 Kiefer W. — TuA2, WE5
 Kiessling A. — FP5, SE4
 Kilin D.S. — W14
 Kilin S.Ya. — FI1, SK3, ThJ5, ThO15, ThO16, WU28
 Kim W. — WK5
 Kim Y.H. — WM3
 Kindel E. — WT2
 King T.A. — ThM42, WD2
 Kip D. — FG5
 Kir'yanov A.V. — SI3, ThM12
 Kireev A. — WG3
 Kirillov B.A. — WA2
 Kirilyuk A. — FP9
 Kirpichnikov A.V. — FR6
 Kiselev A.M. — SH2, SQ2
 Kiselev N.A. — FS2, ThO18
 Kisiyakov I.M. — WY19
 Kitaeva G.Kh. — SP5
 Kitaeva V.F. — FK1, FP17
 Kitching J. — WL1
 Kitsak A.I. — ThH5
 Klapshina L.G. — FA2, FP14
 Klementyev V.M. — WB4
 Klepatsky A.B. — WE2
 Konukhov A.I. — FO5
 Kop'yev P.S. — ThG1
 Kopachevski V.D. — WE5
 Korda I.M. — WX4
 Kornev A.F. — WE6
 Korobkin V.V. — SQ5
 Korolev A.A. — ThM16, WY23
 Korolkov M.V. — ThD4
 Korosteleva I.A. — FP7
 Konystov D.Yu. — FS17
 Konytin A.I. — SH2
 Korzhov A.V. — FS25
 Kosareva O.G. — ThC2, ThC4
 Kosenko E. — ThH3
 Kosterev A.A. — FS14
 Kotkovskii G.E. — FS13, WY45
 Kotomtseva L.A. — FS25, FT24, FT3, WX11
 Kotov V. — ThK3, ThP16
 Kotova S.P. — FT28
 Kovalchuk E. — WG3
 Kovalenko S.A. — SC3
 Kovalev A.A. — ThP21
 Kovalev D. — WU17
 Kovalevskiy V.N. — WU31
 Kowarschik R. — FP5, SE4
 Kozich V.P. — ThM44, ThM45
 Kozina O.N. — WU13
 Kozlov A.B. — FP16, WF1, WU24
 Kozlov S.A. — ThH1, ThM19, ThM21
 Kozlov V.V. — ThO13
 Kraft S. — ThJ3
 Krainov V.P. — SL3
 Krauskopf B. — SD6
 Kravtsov N.V. — FE1, FT24
 Kremnev A.Yu. — WU2
 Kretinin A.V. — WU4
 Kretschmann H. — FM3
 Kröll S. — FD5
 Kruchenok J.V. — ThN28
 Kruglik S.G. — ThM48, ThN35
 Krutitsky K.V. — FD6
 Krutyakova V.P. — ThN9
 Krylov G. — WY43
 Krylov V. — FC4
 Krylova D. — WG3
 Kryukov I.V. — WX14
 Ksenzov D.A. — WU30
 Ksenzov V.A. — WX13
 Kucherov A.N. — ThM4
 Kück S. — FM3
 Kudinov I.A. — FQ5
 Kudriavsev E.M. — WY31
 Kudryashov A.V. — ThP20
 Kudryashov S.I. — FR12, SH4
 Kuhl J. — SH1
 Kühr S. — ThJ1
 Kul'minskii A.M. — FE3, FT12, SD4
 Kulagin D.I. — SH2
 Kulagin I.A. — FM5, FP1, FP2, ThM1
 Kuleshov N.V. — FM3
 Kuleshov V.K. — ThP4, ThP5
 Kulik S.P. — F14, FS17, WC3
 Kulikov A.N. — FS4
 Kulinkovich O.G. — FP21
 Kulyagin R.V. — FQ4
 Kundikova N.D. — ThM13, ThM14, ThM20, ThP3
 Kuntsevich B.F. — FT2
 Künzer N. — WU17
 Kuprenyuk V.I. — WE6
 Kupriyanov D.V. — ThP1, WM2
 Kurasov A.E. — ThM21
 Kurguzkin A.A. — FT23
 Kurikina S.N. — ThM18, ThP2
 Kurochkin A.V. — FP15
 Kurochkin Yu.A. — WE8
 Kutsenko S.A. — ThM2
 Klimov A.B. — ThE4
 Klimov V.I. — FC2
 Klochkov V.P. — WY17
 Klotchkov D.V. — FS13, WY45
 Klyukanov A. — WY41
 Knappe S. — WL1
 Knize R.J. — FS7
 Knyukshito V.N. — FP21, ThN30
 Ko T. — WN1
 Kobryanskii V.M. — WF4, WU1, WU10, WU12
 Koch F. — WU17
 Kocharovskaya O.A. — FN1, FN3, WT3, WY13
 Kochubei S.A. — WU4
 Kodirov M.K. — FP1, FP2
 Kokhkharov A.M. — ThN2, WY32
 Kolachevskiy N.N. — FS2, ThO18
 Kolesnikov T.A. — FR13
 Kolesov R.L. — WT3, WY8
 Kolevatova O.A. — SF4, ThM22
 Kolker D.B. — WB4
 Kolobov M.I. — WC4
 Kolos R. — SK4
 Komarov A.K. — FR6, SI5, ThP15
 Komarov K.P. — FR6, SI5, ThP15
 Komolov V.L. — WY9
 Kompa K.-L. — Th16
 Kompanets O.V. — FR4
 Kompanets V.O. — SC1
 Kondratyuk N.V. — ThM38, ThM42
 Konkolovich A.V. — ThP8, WX6
 Konojko A.I. — WV12
 Kononenko V.K. — WU25
 Konorov S.O. — FS20
 Konotop V.V. — FD3, ThM9
 Konstantinov V.I. — FB5
 Konstantinova E.A. — WU20
 Konstantinova T.P. — WY4

Key to Authors

- Kuzhev A.S. — FA2
 Kuzniak V. — ThM9
 Kuzmin A.N. — FT9, WJ1, WX1
 Kuznetsov A.I. — SH2
 Kuznetsov K.A. — SP5
 Kuznetsov S.A. — WB4
 Kuznetsova E.A. — FN3, WY8
 Kuznetsova L.P. — WU16
- L**abuda S.A. — WX7
 Lachko I.M. — FQ10
 Ladvishchenko Yu.M. — WY19
 Lanceros-Mendez S. — FK5
 Lang T. — SC5
 Langbein W. — ThG2
 Lange W. — SD2
 Lantukh Yu.D. — ThN13, ThP18
 Lapchuk N.M. — FP27
 Lapina V.A. — WU35
 Laptrev G.D. — FL3, FP18
 Laptinskaya T.V. — FS12
 Larichev A.V. — ThP19
 Lariontsev E.G. — FE1, FT24, ThO1
 Laurell F. — FL5
 Lavrinenko A.V. — FS10, WU26
 Lazaruk A.M. — ThH5
 Laziev E.M. — FC5
 Lebedenko A.N. — ThK6
 Lebedev V.I. — ThP14
 Lednyeva G.P. — FS25, WX11
 Ledoux I. — FP21
 Lee S.B. — SO3
 Leibfried D. — WM4
 Leksif A.Yu. — ThO17
 Lenstra D. — FE2, SD6
 Leonov A.G. — ThN7
 Leonov N.B. — WK4
 Leparskii V.E. — ThM39
 Leshchev A.A. — WE6
- Leshenyuk N.S. — WX7
 Letokhov V.S. — SC1
 Letuta S.N. — ThN13, ThP18
 Leuchs G. — WM1
 Levchenko V.I. — FM3
 Li X.D. — WN1
 Liberson M.N. — FL2, ThM32, WL4, WY30
 Liberman M.A. — ThK4
 Lingk C. — FM2
 Lipovskii A.A. — WP5
 Lisachenko M.G. — WU20
 Lisinetskii V.A. — ThM49
 Litvak A.G. — WY13
 Litvinov P.N. — ThN24
 Litvinov R.V. — FP11
 Loginenko O. — FK4
 Loginov A.P. — WV1
 Loiko N.A. — FO1, FO3, FT24, WY41
 Loiko V.A. — ThP8, WX6
 Loiko Yu.V. — FT12, SD4
 Lokhman V.N. — ThD3
 Lopatin V.V. — ThN37
 Lopatina T.I. — FP14
 Losev L.L. — SuB6
 Louis S. — SI2
 Louvergneaux E. — SD1
 Lozhkarev V.V. — SH2, SQ2
 Lozovik Yu.E. — FR14, SC3, ThF4
 Lozovski V. — WV8
 Lu H.Z. — SL1
 Lugjato L.A. — WC4
 Lugovoy A.A. — WB3
 Lugovsky A.P. — WD4
 Lukin M.D. — ThE3
 Lundeen J.S. — WR1
 Lünenbürger M. — WJ2, WU27
 Lunin V.V. — ThN15
 Lutkovski V.M. — FS30
- Lutsenko E.V. — WJ2, WU27
 Lyakhnovich A.V. — ThP10, ThP11, WJ3
 Lyakhomskaya K.D. — WY2
 Lyalikov A.M. — FS24
- M**acDonald K. — WK2
 Maculevicius M. — FP13
 Maggipinto T. — SJ3
 Magnitskii S.A. — FR8, SE2, WA2
 Mahilny U.V. — ThM51
 Mai B. — ThJ2
 Maimistov A.I. — FR2
 Majorov A.P. — FP25
 Majorova A.F. — ThN15
 Mak A.A. — FF1
 Makarov A.A. — FT24, ThD3
 Makarov G.N. — ThD5
 Makarov N.S. — ThM30
 Makarov V.A. — FB2
 Makhmutova G.Sh. — WD3
 Maksimenko V.A. — WY10
 Maksimyak P.P. — WL3
 Mal'shakov A.N. — WL2
 Malakhov Yu.I. — WE1
 Malashkevich G.E. — WX15
 Malendevich R. — FG1
 Malevich V.L. — ThM47, WJ3
 Malikov R.F. — WY37
 Malinovsky A.L. — FS14
 Malow M. — ThD4
 Malyarevich A.M. — FP22, WP5
 Malyshv A.Yu. — SH2
 Malyshv V.A. — SI6
 Malyukin Yu.V. — ThK6
 Man'shina A.A. — FP15
 Mancini S. — WH2
 Manikalo V.V. — ThP12
 Mansurov Z.A. — WU11
 Mantsyov B.I. — FB6, ThM34
- Manykin A.A. — ThN7
 Manykin E.A. — SO5, ThK6, WO3, WY22, WY35
 Marciniak M. — ST2
 Margarida R.Costa — FK5
 Marinelli C. — FD7, ThJ2
 Mariotti E. — FD7, ThJ2
 Marko I.P. — WJ2, WU27
 Markov D.A. — WY2
 Markov R.V. — FP8, WY28
 Marowsky G. — WF2, WU19
 Marrocco M. — FS1
 Marsili P. — SF4
 Martemyanov M.G. — WF2, WU19
 Martirosyan R.M. — FC5
 Martynovich E.F. — FR7
 Marzlin K.-P. — FD6
 Masalov A.V. — FM6, WR3
 Masalsky N.V. — WV10
 Maschenko A.G. — ThM39
 Mashkovtsev R.I. — FP4
 Maskevich A.A. — WU33
 Maskevich S.A. — WU33
 Maslov D.V. — ThN24
 Maslov V.A. — FP10
 Masselin P. — FB6, WF1
 Matafonov A.P. — WJ5
 Matcher S.J. — WY24
 Matjosišius A. — FB4
 Matrosov V.N. — FF2, WX2, WX8
 Matrosova T.A. — WX2, WX8
 Matsko N.B. — ThN7
 Matsuka N.P. — ThM37
 Mattei G. — WF2, WU19
 Matusевич V. — FP5, SE4
 Matveets Yu.A. — FR4, SC1
 Matyugin Yu.A. — WB4
 Meglinski I.V. — WY24
 Mekhov I.B. — WT2
- Mel'nikov L.A. — FO5, WA2, WU13, WY25
 Melnikaitis A. — FP13
 Merkulova S.P. — SC3
 Merlin R. — SH1
 Meschede D. — SC405, ThJ1
 Meshalkin Yu.P. — ThN38
 Michel M. — ThD4
 Mihailuk I.K. — ThN20
 Mikhalechuk A.L. — WJ2, WX13
 Mikheev G.M. — FS4, ThM3
 Mikheev Geor.M. — FS4
 Mikheev P.M. — FQ10, FQ11, FQ9, Sub4
 Mikhnevich S.Yu. — WE8
 Mikhyaev Yu.V. — ThM14
 Miles R.B. — WO1, WU22, WV4
 Militsin V.O. — ThP20
 Minaev V.P. — WD3
 Minkovich V.P. — ThP14
 Mirasso C.R. — FJ5
 Misakov P.Ya. — FS30
 Mitko S.V. — SA3
 Mitra T. — WD5
 Mitschke F.M. — SI5
 Mochalov S.A. — ThD5
 Mochkin V.S. — FS13
 Moelmer K. — WH3
 Mogileva T.N. — ThM3
 Mogilevtsev D. — WA4
 Moi L. — FD7, SC404, ThJ2
 Moiseenko P.V. — ThP12
 Moiseev S.A. — FD5, ThN1
 Moiseev S.G. — WU9
 Moiseenko E.V. — WY46
 Molevich N.E. — FT23
 Mond M. — FM3
 Monyakin A.P. — ThN5
 Morgner U. — WN1

Key to Authors

- Moroshkin P.V. — WT2
 Morozov O.S. — FP26
 Morozov V.B. — FS21, FS27, FS28, SF3
 Mosk A. — ThJ3
 Moskalenko S.A. — ThK4
 Motzkus M. — SC5, SF1
 Moutret G. — FB6, WF1
 Mudretsova S.N. — ThN15
 Mudrich M. — ThJ3
 Mueller B. — ThG2
 Mukhamedgalieva A.F. — WY29
 Mukhopadhyay S. — FG4
 Mulet J. — FJ5
 Müller M. — ThJ1
 Mundt A. — WM4
 Murauskas E. — ThH3
 Muraviov S.V. — SH2
 Muraviov A.N. — FS3
 Murodough M.P. — FS7
 Myaldun A.Z. — WX7
 Mysyrowicz A. — ThC1
- N**
 Nablief I.R. — WU33
 Nadkin L.Yu. — WY2
 Nägerl H.-C. — ThJ3
 Najestkina N.I. — ThM29
 Nakano H. — SuB1
 Nalobin A.S. — FS13, WY45
 Napartovich A.P. — FE4, FT21
 Narfvonchik S.S. — ThN12
 Narozhny N.B. — ThF4
 Nasyrov K.A. — FD7
 Naumenko A.V. — FO3, FT24
 Naumov A.N. — FS20, SF4, ThM22, W42, WU18, WU22, WW4
 Naumova I.I. — FP18
 Nazarov M.M. — FR14, ThI2, WF1
 Nazarov P.V. — FS30
 Necrashevich J.I. — WX3
- Nedel'ko M.I. — WU31
 Nedopekin O.Yu. — WV5
 Nefedov I.S. — WU13
 Negrenie M. — WI3
 Nemkovich N.A. — ThN28, WE7
 Nepal S. — ST3, ThM11
 Nesterouk K.S. — ThP19
 Netrebko A.V. — ThN19
 Netrebko N.V. — ThN19
 Neumann D.K. — FS7
 Neumann E. — FM3
 Nevar N.M. — FP21
 Nevdakh V.V. — WX3, WX7
 Nevsky A.Yu. — WG2
 Nguyen C.T. — WB2
 Nichiporovich I.N. — ThN32
 Nickles P.V. — FM5, SuB5
 Nikeenko N.K. — WX1
 Nikitin A.K. — WV1
 Nikitin S.F. — FS4
 Nikitin S.Yu. — WY16
 Nikiyan H.N. — ThN13
 Nikoghosyan A.S. — FC5
 Nikolaev D.A. — FT31, SD5
 Nikolaev I.P. — ThP19
 Nishikawa T. — SuB1
 Nisoli M. — ThM22
 Nizovtsev A.P. — SK3
 Nolan D. — ThM16
 Noskov M.I. — ThN1
 Nougaira E. — FK5
 Novikov A.A. — FP18
- O**
 Oak S.M. — FR10
 Obukhov A.E. — ThN4
 Ochkin V.N. — SA3
 Oguri K. — SuB1
 Ogurok D.D. — ThD3
 Ohlsson N. — FD5
- Okhapkin M.V. — WB4
 Olenin A.N. — FS21, FS27, FS28, SF3
 Omel'chenko A.I. — WD3
 Oppo G.-L. — FT33
 Oraevsky A.A. — WN3, WN4
 Orlov L.N. — WX3, WX7, WX9
 Orlov V.A. — WS2
 Orlov Yu.V. — ThK6
 Orlovich V.A. — FL1, FT13, ThM44, ThM45, ThM48, ThM49, ThN35, WE5, WJ1
 Osipov V. — WU34
 Ozheredov I.A. — FB6, FP17, WF1
- P**
 Pakhatov V.B. — FT1, WY7
 Palashov O. — ThM27, WT6
 Panarin A.Yu. — ThN33
 Panasenko V.V. — WY3
 Panchenko V.Ya. — FL6, ThK2, WY38
 Papoyan A. — SK2
 Paramonov G.K. — WX11
 Parashchuk D.Yu. — SP4, WF4, WU1, WU10, WU12, WY5
 Parashchuk V.V. — WX1
 Parfionov S.D. — SP7
 Parpiev O.R. — ThN2, WY32
 Pashkevich S.N. — ThN13, ThP18
 Pasiskevicius V. — FL5
 Patsaeva S.V. — FS6
 Patsayeva S.V. — FS19
 Patton C.E. — ThK7
 Paulus G.G. — SG1
 Pavlov V.V. — SP3
 Pavlova E.G. — ThM25
 Pavlovich V.S. — WS7
 Pavlovskii V.N. — WJ2, WU27
 Pavlujk A.A. — FP25
 Peatross J. — FQ2, FR11
 Peet V.E. — ThM5
- Pegarkov A.I. — SL4
 Peik E. — WG2
 Pekhota A.V. — FS6
 Pelivanov I.M. — WN4
 Penin A.N. — FS12, FS17, SP5
 Penyazkov O.G. — WX7
 Pereira A.J. — ThM23
 Perepechko S.N. — ThP14
 Pérez-García V.M. — FD3
 Perminov S.V. — WP4
 Perrini I.M. — SJ3
 Pershenkov V.S. — FS13
 Persiantsev I.G. — SK6
 Pesch M. — SD2
 Peshkova A.Yu. — ThN11
 Pestryakov E.V. — WX2, WX8
 Pestryakov E.V. — FA4, FF2, FP10, FR6, FT29
 Peszynski-Drews C. — ThN34
 Petin A.N. — ThD5
 Petnikova V.M. — FH3, FR1
 Petrenko E.A. — ThK6, WY35
 Petrosyan A.M. — FF6
 Petrov E.P. — ThN22, ThN28, WU30
 Petrov E.V. — ThM34
 Petrov V.V. — FP10, FP9, FR6, WX2, WX8
 Petrova E.S. — ThM39
 Petrovskiy M. — WG3
 Petrukhin E. — WG3
 Petuchov V.O. — WX3
 Petukhov V.O. — FB5, WX5
 Plester D. — WU21
 Plikulik L.G. — FS26
 Pilipovich V.A. — ThP4, ThP5, WV12
 Pimenov A.V. — ThM33
 Pisarchik A.N. — FT2
 Pisarev R.V. — FP9, SP3, ThK1
 Pishak O.V. — WN5
- Pishak V.D. — WN5
 Piskarskas A. — FB4, FL5
 Pivovarenko V.G. — ThN28
 Pivtsov V.S. — WA2, WB4
 Platonenko V.T. — FQ12, SQ3
 Plekhanov A.I. — FP8, WY28
 Plotnichenko V.G. — FP24
 Pochon S. — WK2
 Podolskiy V.A. — WK5
 Podshivalov A.A. — WA2, WV4, FF3
 Podymova N.B. — WN4
 Poizner B.N. — FT25
 Pokasov P.V. — WG2
 Pokrovskii V.P. — WE6
 Polisski G. — WU17
 Poloubojarov V. — WG3
 Polyakov O.P. — FQ14
 Polyakov P.A. — FQ14
 Polyakov V.I. — WV12
 Polyanski P.V. — SE5
 Polzik E.S. — WH1
 Ponomarenko A.G. — WT7
 Poryavina A.N. — WX15, WU15
 Popov A.M. — FQ1, FQ7, SB3
 Popov V.D. — ThO3
 Popov V.K. — FS27
 Posedko V.S. — ThP5
 Posnov N.N. — WP5, WU32
 Postnikov A.A. — ThM20
 Potenza M. — SE3
 Poteomkin A.K. — ThM27, WL2
 Povedailo V.A. — WX12
 Pozniak N.I. — WJ4
 Prabhu M. — ThC3
 Prade B. — ThC1
 Prants S.V. — ThO2, WY1
 Prasad P.N. — SC403, WP1
 Presnyakov V.V. — ThP8, WX6
 Priezhev A.V. — ThN37

- Prikhach A.S. — WX16
 Prikhodchenko D.V. — WX10
 Prokhorov A.V. — ThO17
 Prokhorov K.A. — WY14
 Prokopenko V.B. — WU32
 Prokopovich I.P. — FQ2, FR11
 Prokoshchev V.G. — SP7
 Prokoshin P.V. — WU32
 Protzmann H. — WJ2, WU27
 Provorov A.S. — ThN10
 Prudkovskii P.A. — FP12
 Prudnikov I.R. — WF1
 Prudnikov O.N. — ThJ4, ThO6
 Pryalkin V.I. — FF3, FF4, FK2
 Przhibel'skii S.G. — FD4, WK4, WY9
 Pshennicnikov M.S. — FH1
 Pulkin S.A. — FS11
 Pyrkov Yu.N. — FP24
- R**adeonychev Y.V. — WY13
 Radin A.M. — ThN16
 Radina T.V. — WV6, WV7
 Randoshkin V.V. — FP24
 Rasing Th. — FP9
 Rautian S.G. — WP4
 Razjivin A.P. — ThN20
 Razumova T.K. — ThN9
 Reichert J. — WG2
 Reiss H.R. — SB2
 Reitze D.H. — ThM27
 Renn A. — SK4
 Resch K.J. — WR1
 Reshetnyak V.I. — FG2
 Rethfeld B. — WY26
 Reznikov A.V. — WV11
 Riedle E. — SC401, ThD1
 Ritchie G.A.D. — FS18
 Ritschik D. — ThN26
 Rivet S. — WS4
- Ryzhin M.V. — WY25
 Ryabov E.A. — ThD3
 Ryabtsev G.I. — WX1
 Ryabtsev I.I. — WO4, WY20
 RYasnyanskiy A.I. — FP1, FP2
 Rybak A.A. — FT26
 Rychtarik D. — ThJ3
 Rytikov G.O. — F14
 Ryzhechkin S.A. — ThP12
 Ryzhevich A.A. — ThM41, ThM43
 Ryzhikov B.D. — FS6
 Ryzhov I.V. — S16, WY18
 RZhevskiy A.A. — FP9
- S**aetchnikov V.A. — SF5
 Safonov V.P. — SK5, WK5, WP4
 Sagun E.I. — ThN30
 Saleh B.E.A. — WC1
 Saletsky A.M. — WU14
 Salmin V.V. — ThN10
 Samartsev V.V. — WY47
 Samartzev I.E. — WD3
 Sambor E.G. — Th15, WX10
 Samoilova E.S. — ThN38
 Samoylenko T.V. — ThM2
 Samtsov M.P. — ThN14, WD4
 San Miguel M. — FJ5, FT33, FT36, ThO4
 Sanchez F. — S12
 Sánchez Soto L.L. — ThE4, WM5
 Sandner W. — SuB5
 Sandomirski K.S. — WU26
 Santiagiustina M. — FT36
 Sapaev U.K. — FM5
 Sarger L. — WS4
 Sarkisov O.M. — ThD2
 Sarkisyan D. — SK2
 Sarma J. — FT15
 Saskevich N.A. — WJ3
- Savateeva E.V. — WN3
 Savchenko E.P. — ThN17
 Savchik V. — ThM52
 Savel'ev A.B. — FQ10, FQ8, FQ9, SubB4, TuB1, FQ11
 Savikin A.P. — FP26
 Savitskiy V.G. — WP5
 Savochkina Yu.A. — ThN36
 Savva V.A. — ThN25, WX11
 Sazanovich I.V. — ThN21, ThN22, ThN33
 Sazonova Z.S. — ThO11
 Scheffold F. — FS8
 Schiek R. — FG1
 Schineller B. — WJ2, WU27
 Schlachetzki A. — WU21
 Schmid W.E. — Th16
 Schmidt-Kaler F. — WM4
 Schön O. — WJ2, WU27
 Schönnagel H. — FM5
 Schrader D. — ThJ1
 Schuhmacher D. — WF2, WU19
 Schurtenberger P. — FS8
 Scrinzi A. — SB4
 Scully M.O. — FN3
 Seferyan H.Ye. — WY6
 Seideman T. — S12
 Semchishen V.A. — ThK2
 Semenov V.E. — WE6
 Semenov V.V. — FA2, FP14
 Semenova L.E. — WY14
 Semibalamut V.M. — WB3
 Seminogov V.N. — ThK2
 Sepiol J. — SK4
 Serdyuchenko A.Yu. — SA3
 Serebrenniko A.N. — ThP8
 Serebryakova L.M. — SO1
 Serenko M.Yu. — FS24
 Sergeev A.M. — SH2, SubB2, ThA2
- Sergeev P.B. — WY5
 Sergienko A.V. — WC1
 Serkin V.N. — SO4
 Serov O.B. — FR4
 Serov V.V. — ThO9
 Serrat C. — FE3, FJ4
 Sevastianov V.D. — FQ8
 Sevruk B.B. — FT13
 Seydaliyev M.R. — ThE2
 Shabalin Yu.V. — FT32
 Shabanov A.V. — ThP8, WX6
 Shagov A.A. — ThM38, ThM42
 Shaikhislamov I.F. — WT7
 Shalaev V.M. — WK3, WK5
 Shalagin A.M. — WT1, WY28
 Shandarov S.M. — ThM29
 Shandarov V. — FG5
 Shapiro D.A. — FS9
 Sharkov A.V. — WX14
 Shashidar M.M. — FK3
 Shatokhin V.N. — ThO15
 Shatsev A.N. — FJ3
 Shaw M.D. — WC1
 Shcherbakov I.A. — FT31, SD5
 Shcherbitsky V.G. — FM3
 Shelkovnikov A. — WB2, WG3
 Shelkovnikov V.V. — FP8
 Shepelev A.V. — WY46
 Shepelevich V.V. — ThP7
 Sherstobitov V.E. — WE6
 Sherstov I.V. — WY21
 Shih Y.H. — WC2, WM3
 Shilov V.B. — WY17
 Shiryaev O.B. — SQ5
 Shishkov A.V. — WY38
 Shishporenok S.I. — ThN29, ThN33
 Shiwani — ST3, ThM11
 Shkardin G. — ThK3, ThP16

- Shkurinov A.P. — FB6, FP17, FR14, Th12, WF1
 Shlenov S.A. — ThP20
 Shmalhausen V.I. — SO6
 Shpolyanskiy Yu.A. — ThM19
 Shrivastava A. — ThP13
 Shuba M.V. — ThP2
 Shukla V. — FR10
 Shulga A.M. — SK4, ThN30, ThN32, W14
 Shutov I.V. — WN2
 Shuvalov V.V. — FH3, FR1, WN2
 Shvedko A.G. — ThM48
 Sibilia C. — WU18
 Siders C.W. — SQ1
 Sidorov A.I. — FP19
 Sidorov S.S. — FT24
 Sidorov-Biryukov D.A. — FS20, SA3, WA2, WU17, WU22, SF4
 Silin V.P. — SL5, ThF2
 Simonov A.N. — SO6, ThP19
 Singer K. — ThJ3
 Singh H. — WN3
 Singh R. — ThO11
 Smitsyn G.N. — SJ2
 Smitsyn G.V. — FT16, ThP10, ThP11, ThP6, WJ3
 Sinyayev D.V. — SA3
 Sirotkin V.Yu. — ThO2
 Sirutkaitis V. — FL4, FP13, FR9
 Sitnikov M.G. — WY35
 Sivco D.L. — FS14
 Sizov V.N. — FP6
 Skibina N.B. — WA2
 Skipetrov S.E. — FS8, ThM15, WY15
 Skripal A.V. — WV2
 Skvortsov M.N. — WB4, WG2
 Slagorodskii A.V. — ThP1, WM2
 Smekhova A.G. — WU1
 Smilgevičius V. — FB4, FL5, ThM35
 Smirnov A.G. — FT6
 Smirnov D.S. — WL4
 Smirnov M.B. — SL3
 Smirnov V.N. — FD4, WY9
 Smirnov V.V. — SA2
 Smirnova O.V. — FQ7
 Smirnova T. — FS16, WY26
 Smirnova T.V. — FG2, WY27
 Smolovich A.M. — FR4, FR5
 Sobchuk A.N. — ThN28
 Sobol E.N. — ThN15, WD3
 Sobolenko N.V. — WX7
 Sobolev A.G. — WV10
 Söderholm J. — WM5, WR2
 Sokolov I.M. — ThP1, WM2
 Sokolov I.V. — WC4
 Sokolova T.N. — ThN8
 Sokolowski-Tinten K. — SH3, SQ1, WY26
 Solintsev V.P. — FP4
 Solomatina S.V. — WN3
 Solosin S.V. — SP5
 Soloviev V. — ThM16
 Solovyov K.N. — ThN32
 Son J.-Y. — SJ1
 Sorokin E. — FM4
 Sorokin V.N. — ThO18
 Sorokina I.T. — FM4
 Soskin M.S. — FG3, ThM6
 Soskov V.I. — SuB6
 Sotnikov A.I. — ThN36
 Speer O. — SC4
 Spinelli L. — SJ3
 Spiridonov I.N. — WJ4
 Squier J.A. — SQ1
 Stabinis A. — FB4, ThM35
 Stadnichuk V.I. — FT26
 Stähler M. — WL1
 Starnov I.G. — WY3
 Stancari G. — ThJ2
 Stankevich A.F. — WV7
 Starikov F.A. — WE4
 Starodumov A.N. — SI3, ThP14
 Starovoitov V.S. — WY42
 Starukhin A. — SK4
 Stasel'ko D.I. — FP6, FC4
 Staudte A. — SG2
 Stavitskay E.Y. — ThN10
 Stegeman G.I. — FG1
 Steinberg A.M. — WR1
 Stepanov A.N. — SH2, SQ2
 Stephan G.M. — SI1
 Stepuro I.I. — ThN31
 Stepuro V.I. — ThN31
 Stevens G. — WK2
 Stevens T.E. — SH1
 Stiens J. — ThK3, ThP16
 Stogney O. — FP16
 Stolnitz M.M. — ThN11
 Strek W. — WJ1, WU23
 Strekal N.D. — WU33
 Streikov V.V. — FQ12
 Strizhenok N.V. — WJ3
 Stumpf S.A. — WY23
 Sukharev A.G. — FE4
 Sukharev M.E. — SG3
 Sukhodolov A.V. — FP27
 Sukhoivanov I.A. — FT37
 Sukhorukov A.P. — SD3, ThM25, ThM31, ThM33, TuB2
 Sukhorukova A.K. — SD3
 Sukiasyan R.P. — FF6
 Sundström V. — FH4, FH5, ThI3
 Suran V.V. — WY33, WY34
 Surmenko E.L. — ThN8
 Suta — ST3, ThM11
 Svanberg S. — SC402, WI1
 Sveshnikov Yu.M. — WY19
 Sviridov A.P. — ThN15, WD3
 Svirina L.P. — FT5
 Swartzlander G.A. — ThM6
 Sysoev N.N. — FP24
 Szewaj C. — SD1
 Tahara T. — FH2
 Taichenachev A.V. — ThJ4, ThO10, ThO6, ThO7, WT5
 Talebpour A. — ThC4
 Tamarov M.P. — ThC4
 Tananina E.S. — FS13, WY45
 Tanas R. — FI3
 Tanin L.V. — ThP12
 Taranukhin V.D. — FQ4, FQ5, SQ4
 Tarasenko N.V. — WU31
 Tarasevitch A.P. — SQ1, WA2
 Tarasishin A.V. — FR8, WA2
 Tarkovsky V. — FS29
 Tarnovsky A. — ThI3
 Tehranchi A.H. — ThH6
 Teich M.C. — WC1
 Tellefsen J.A. — FL5
 Temnov V.V. — SH3
 Tikhomirov S.A. — FP21, ThN32, WX13, WX14, WX19
 Tikhomirova O.V. — FT25
 Tikhonova O.V. — FQ1, SB3
 Timoshenko V. — FK4
 Timoshenko V.Yu. — WP3, WU16, WU17, WU20
 Tiphlova O.A. — W56
 Tissoni G. — SJ3
 Titov A.N. — WJ1
 Tittel F.K. — FS14
 Tkachenko D.V. — FS5
 Tkachev A.N. — ThF3
 Tochitsky S.Ya. — FB5
 Tokman M.D. — WY13
 Tolkachev V.A. — WX12
 Tolkacheva E.G. — FT10, FT20
 Tolochko N.K. — WX7
 Tolstik A.L. — FO4, FS15, FT4, FT8, ThM24
 Tolstorozhev G.B. — WI2, WX13, WX19
 Tomassetti L. — ThJ2
 Tombesi P. — WH2
 Tomov A.V. — ThM40
 Tonevitsky A.G. — ThN36
 Torrent M.C. — FE3, FJ4
 Träger F. — WK1
 Tredicce J.R. — FO2, FT20
 Tret'akov E.V. — WN2
 Tretyakov D. — WO4
 Trifonov A. — WM5, WR2
 Trofimov V.A. — SO2
 Trubilko A.I. — ThO12
 Trunov V.I. — FR6, FT29
 Trushin S.A. — ThI6
 Tsarev V.I. — WY12
 Tskhai S.N. — SA3
 Tsubin R.V. — ThM5
 Tsvetkov E.G. — FP4
 Tsvetkov V.B. — FT31, SD5
 Tsvirkov V.I. — WU25
 Tuchin V.V. — ThN17, ThN8
 Turmaikin A.M. — ThJ4, ThO10, ThO6, ThO7, WT5
 Tunkin V.G. — FS21, FS27, FS28, SF3
 Turovets S.I. — FT15
 Turpin P.-Y. — ThN35, WE5, WJ3
 Tver'yanovich Yu.S. — FP15
 Tyurikov D. — WG3
 Tyworski V.I. — FP21
 Tzipina S.I. — WD3
 Udem Th. — WG1, WG2

- Ueda K.-I. — ThC3, WE3
 Uesugi N. — SuB1
 Ughetto G. — FO3
 Uleysky M.Yu. — WY1
 Urbasch G. — SG2
 Usachev P. — WM5
 Usanov D.A. — WV2
 Ushenko A.G. — WN5
 Ushenko Y.A. — WN5
 Usmanov T. — FM5, FP1, FP2, ThM1
 Utkin I.A. — ThM41, WJ3
 Uvarova S.V. — FS11
- V**
 Vacher P. — WS4
 Vaganov E.V. — ThN2, WY32
 Vaïçaitis V. — ThM35
 Valeev A.A. — WY39
 Valeyev A.I. — ThP3
 Valyavko V. — WU34
 van Hoek A. — ThN33
 van Stryland E.W. — FF6
 Varaksa Yu.A. — ThP11
 Varlamov V.G. — FS19
 Vartanyan T.A. — FD4, WK4, WP2
 Vasil'ev M.F. — WE6
 Vasilyeva N.V. — FP24
 Vasnetsov M.V. — FG3
 Vatrik S.M. — FP25
 Veerakumar V. — ThM17
 Vereshchagin A.K. — WU10
 Veretenov N.A. — FJ3
 Verhovskii E.B. — WY17
 Veronesi S. — ThJ2
 Veshneva I.V. — FO5
 Viana Gomes J.C. — ThM23
 Vilaseca R. — FE3, FJ4
 Vinit'sky S.I. — ThO9
 Vinogradov E.A. — SC2
 Vinogradov S.E. — SC1
- Vitkin E.I. — ThN27
 Vladimirov A.G. — FJ3
 Vladimirova J.V. — FS2
 Vlasov R.A. — FG2, ThM37, WY27
 Vodchits A.I. — ThM44, ThM45
 Voevodin V.G. — WY21
 Voisin P. — WS4
 Voitkov S.V. — FT17
 Voitkova M.V. — FT11
 Voitovich A.P. — FT12, SD4, TuA1
 Voitovich S.I. — WE8
 Voliak K.I. — SP6
 Volkov A.G. — FP10
 Volkov M. — ST1
 Volkov R.V. — FQ8, FQ9, SuB4
 Volkov S. — SC3
 Volkov V.A. — WV10
 Volkov V.M. — FG2, FT15, ThM37
 Volkova E.A. — FQ1, SB3
 Volkovich D.I. — ThN32
 Vollmer M. — SG2
 Volodenkov A. — ThN26
 Volodin V.A. — WU4
 von Borczyskowski C. — ThN30, W14
 von der Linde D. — SH3, SQ1, WA2, WY26
 von Plessen G. — FM2
 von Zanthier J. — WG2
 Vorob'ev V.A. — FP26
 Voronov A.V. — FH3
 Voronov Yu.Yu. — WU5
 Voropay E.S. — ThN14, WD4
 Vounckx R. — ThK3, ThP16
 Vvedenskii N.V. — FQ6
 Vysloukh V.A. — ThH4, ThM7, ThM8
 Vysotina N.V. — WE6
 Vysotsky D.V. — FT21
- W**
 Wahlstrand J.K. — SH1
- Walser M. — SB4
 Walther H. — SG1, WG2
 Waluk J. — ThN22
 Weber T. — SG2, ThJ3
 Weckenbrock M. — SG2
 Wehmann H.-H. — WU21
 Weidemüller M. — ThJ3
 Weis A. — SA1
 Weitzel K.-M. — ThD4
 Wenke L. — FT4
 Werncke W. — SF2
 Wesner M. — FG5
 Wieczorek S. — FE2, SD6
 Wiersma D.A. — FH1
 Wild U.P. — SK4
 Wilson K.R. — SQ1
 Wintner E. — FC1
 Woggon U. — ThG2
 Wolszczak M. — ThN34
 Wrage M. — FT21
 Wynands R. — WL1
- X**
 Xie Ming — FJ2
 Xu J. — ThC3
- Y**
 Yablonskii G.P. — SC202, WU27
 Yablonskii G.P. — WJ2
 Yachnev I.I. — FP19
 Yadroitsev I.A. — WX7
 Yakimovich V.N. — FM3, ThM24
 Yakovlenko S.I. — ThF3
 Yakovlev D.L. — ThI5, WX10
 Yakovlev D.V. — FS27
 Yakovlev V.A. — WF2, WU19
 Yakovlev V.V. — SP2
 Yanagida T. — WD1
 Yanukovich T.P. — SF5
 Yanyushev D.N. — ThO14
 Yarmolitski V.F. — WW12
- Yartsev A. — FH4, ThI3
 Yartsev A.P. — FH5
 Yasinskii V.M. — FT14, WX3
 Yasukevich A.S. — ThP11, ThP6, WJ3
 Yegorov A.A. — WL5, WV9
 Yelissev A.P. — FA3
 Yermalayeu I.Ye. — WE8
 Yoon T.H. — FS11
 Yousefi M. — FE2
 Yudin V.I. — ThJ4, ThO10, ThO6, ThO7, WT5
 Yukalov V.I. — ThO9
 Yukina T.G. — ThK6
 Yumashev K.V. — FP22, WP5, WU32
 Yurasov A. — FP16
 Yurasova I.V. — FP14
 Yustas E.S. — ThE4
 Yuzhakov V.I. — FS19
 Yuzhakov V.I. — FS6
- Z**
 Zadkov V.N. — FN4, FS2, SC201, ThI1, ThO14
 Zaikin A.P. — FT23
 Zaitsev A.I. — SI6, WY11, WY18
 Zakharov A. — FT22
 Zakharov S.M. — SO5, WY22
 Zakharov V.N. — WS2
 Zakharova I.G. — ThM25, ThM31
 Zakharyash V.F. — WB4
 Zakovryashin N.S. — SK5
 Zaleskaya G.A. — Thi5, WX10
 Zambrini R. — ThO4
 Zaporozhchenko R.G. — WU28
 Zatrudina R.Sh. — FT27
 Zavalov Yu.N. — FL6
 Zavestovskaya I.N. — WT8
 Zege E.P. — WX16
 Zelenkov V.I. — ThN25
 Zenkevich E.I. — ThN30, WI4
- Zhavrid E.A. — ThN14, WD4
 Zhdanov B.V. — FS7
 Zhdanovich S.N. — ThP21
 Zheltikov A.M. — FR8, FS20, SA3, SC204, SF4, ThM22, WA2, WB4, WU17, WU18, WU22, WV4
 Zheltov G.I. — ThN27, WJ4
 Zheludev N.I. — WK2
 Zhiliba A.I. — ThO12
 Zhilin A.A. — FP22
 Zhitnev Yu.N. — ThN5
 Zhitneva G.P. — ThN5
 Zhmurin P.N. — ThK6
 Zhukov A.A. — FP12
 Zhukovsky S.V. — WU26
 Zhurik Ju.P. — WX3
 Zhurik Yu.P. — WX7
 Zimmermann J. — FM2
 Zimmermann M. — WG1
 Zinatulin V.S. — ThP3
 Zinatulin M.M. — WY37
 Zinoviev A.P. — FJ1
 Znamenskii N.V. — WY35
 Znamensky N.V. — ThK6
 Znosko K. — ThN26
 Zoller P. — FD1, FN2
 Zolot'ko A.S. — FK1, FP17
 Zolotov E.M. — WL5
 Zolotoverkh I.I. — ThO1
 Zolotovskaya S.A. — WU32
 Zotov S.D. — WY31
 Zubialevich V.Z. — WJ2, WU27
 Zubrik M.V. — ThM14
 Zubrytski U.V. — ThM36
 Zulkov V.A. — WY47
 Zverev P.G. — FF5
 Zych E. — WU23
 Zykov A.L. — ThM18
 Zyryanov V.Ya. — ThP8, WX6

XVII International Conference on Coherent and Nonlinear Optics.

Подписано к печати 5.06.2001. Формат 60×90^{1/8}
Тип бумаги - Ким люкс. Печать офсетная
Объем 22.5 усл.л. 35.2 уч.изд.л.
Тираж 720 экз. Заказ 35

Институт физики им. Б.И.Степанова НАНБ
220072, Минск, проспект Ф.Скорины,68
Отпечатано на ризографе Института физики НАНБ
Лицензия ЛП № 20 от 20.08.1997 г.

LASER SYSTEMS AND OPTICAL COMPONENTS

... from 200 nm up to 2200 nm

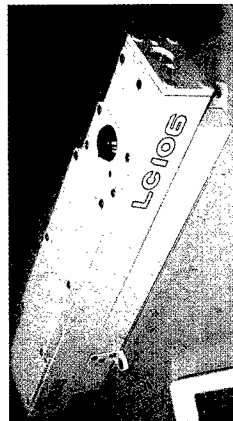

Nd:YAG Lasers for scientific applications

Tunable Lasers



Nonlinear Converters

Medical Laser Systems

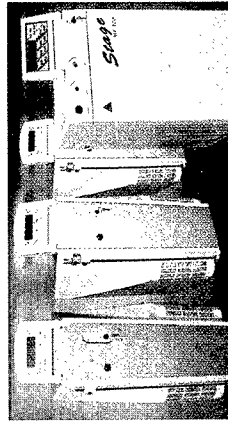

Industrial Laser Systems

High Power Optics and Crystals

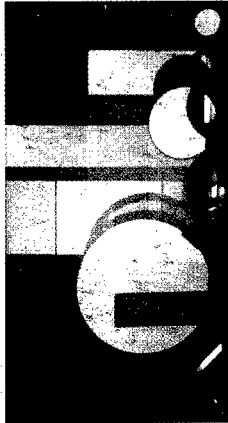
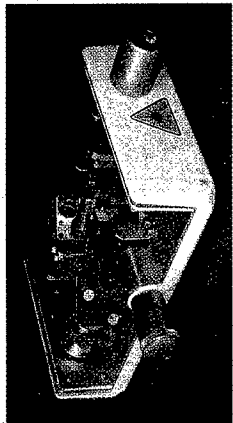

SOLAR Laser Systems, 77 Partisansky ave., Minsk, BELARUS
fax: 375 (17) 2464833; phone: 375 (17) 2854662, 2854661
e-mail: solarls@infonet.by; <http://solarls.infonet.by>