

**AIRPOWER RESEARCH INSTITUTE**

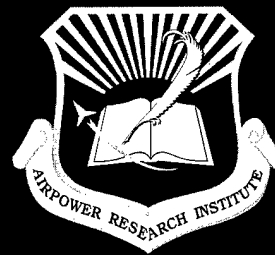

**DISTRIBUTION STATEMENT A**  
Approved for Public Release  
Distribution Unlimited

**Wizardry for Air Campaigns  
Signals Intelligence Support to the Cockpit**

Captain Gilles K. Van Nederveen, USAF

**20011005 052**

Research Paper 2001-03  
August 2001



**College of Aerospace Doctrine,  
Research and Education**

**Air University**



## **Disclaimer**

Opinions, conclusions, and recommendations expressed or implied within are solely those of the author and do not necessarily represent the views of CADRE, Air University, the United States Air Force, the Department of Defense, or any other US Government agency. Clear for public release: distribution unlimited.

## **Airpower Research Institute Papers**

ARI papers are occasional studies written by military defense analysts assigned to the Airpower Research Institute of the College of Aerospace Doctrine, Research and Education at Air University. The purpose of this series is to provide useful ideas and independent analysis of issues of current or potential importance to Air Force commanders and their staffs. This Airpower Research Institute paper and others in the series are also available electronically and at the Air University Research Web Site (<http://research.au.af.mil>) and the *Aerospace Power Chronicles* (<http://www.airpower.au.af.mil>).

## Research Feedback

Air University is working hard to keep its research focused on interests important to the Air Force and to the nation. After you have read the research paper, please give us your frank opinion on the contents. All comments, large and small, complimentary or caustic, will be appreciated.

Director, Airpower Research Institute  
CADRE/AR  
401 Chennault Circle  
Maxwell AFB AL 36112-6428

Title of Paper **Wizardry for Air Campaigns Signals Intelligence Support to the Cockpit**

Author **Captain Gilles Van Nederveen, USAF**

Please use the scale below to answer these important questions,					
1. Fail	2. Poor	3. Fair	4. Good	5. Excellent	
1. Is the subject matter relevant to the Air Force?	1	2	3	4	5
2. How would you rate the readability of this paper?	1	2	3	4	5
3. How useful is this research to you and your organization?	1	2	3	4	5

Or note comments:

Thank you for your assistance.

**FOLD HERE**

---

Address

Place Stamp Here

ADDRESS CORRECTION REQUESTED

Director, Airpower Research Institute  
CADRE/AR  
401 Chennault Circle  
Maxwell AFB AL 36112-6428

---

**FOLD HERE**

## Executive Summary

In order for all applications of airpower -- including counter-air, deep interdiction strike, air landing, and combat search and rescue -- to succeed, they must be informed by comprehensive data on targets. Moreover, it would be helpful if intelligence included the intentions and capabilities of opponents. Getting signals intelligence data to the cockpit and pilots for instantaneous use on the battlefield is the objective. Signals intelligence can provide needed information, but its collection, processing, analysis, and distribution is secretive. Consequently, an operator is slow to get even minimal data. Real-time signals intelligence support to the cockpit is an on-going challenge, but it is not as cosmic or fantasy-based as some believe. Three historical examples illustrate what can be done when operations and intelligence ensure that critical data reach the battlefield in a timely fashion.

For example, during World War II both Eighth and Ninth Air Forces were able to tap into British expertise in the integration of intelligence with air operations. Targets, intercept opportunities, and general battlefield information were collected and passed to airborne fighters, greatly increasing the efficiency of air force operations in Northwest Europe. At one point intercepted enciphered German data were deciphered and passed to USAAF fighters in fifteen minutes -- an extraordinary achievement given the technology of the day. Confronted with linguistic and operational challenges, commanders in Korea forgot their World War II successes with intercepts. This hindered the establishment of a voice intercept and fighter vector capability. After General Earl Partridge used his personal influence, signals intelligence units of the newly formed USAF helped F-86 pilots successfully engage communist MiG pilots during the Korean War.

The Vietnam War had numerous intercept operations, but the factors of timeliness and relevance to an aircrew were not addressed until 1972 when Linebacker operations showed senior air commanders critical gaps in intelligence data utilization. The "Teaball" weapons control center, established in 1972, not only collated diverse intelligence inputs, but had a friendly radar air picture giving commanders and controllers a comprehensive view of North Vietnamese air space. This underpinned U.S. success in obtaining air superiority. This control center facilitated the transmittal of precise and user-friendly data to fighters' cockpits. It serves as a model for the future.

In spite of initiatives and dollars spent there is still a lot to do to improve real-time intelligence support to air operations. Dissemination architecture, doctrine, training, and education require improvements and innovations. Excessive secrecy, a plague in peacetime, has to be removed so that operations can be planned and executed. Lack of understanding can be overcome by exercises, but signals intelligence support is more vital today than fifty years ago. The existing structures and systems still fall short, and the next generation of weapons and aircraft require more, not less, signals intelligence data. Today's weapons systems, which make concepts like precision strike and effects based operations possible, require superior intelligence data in order to be effective.

## Table of Contents

	<i>Page</i>
EXECUTIVE SUMMARY .....	i
LIST OF ILLUSTRATIONS .....	iv
INTRODUCTION .....	1
WORLD WAR II .....	5
KOREA .....	15
VIETNAM .....	23
POST-VIETNAM AND ANALYSIS .....	31
RECOMMENDATIONS .....	35
ACKNOWLEDGEMENTS .....	37

## *List of Illustrations*

	<i>Page</i>
Figure 1. USAAF used a variety of units to collect signals intelligence data to protect bomber formations and to vector fighters towards the Luftwaffe, but particularly the Kingsdown Switch and the 951 <sup>st</sup> SRI (A). (Author's depiction, with graphic design assistance of Mr. Daniel Armstrong).....	7
Figure 2. A diagram of the 3 <sup>rd</sup> Radio Squadron Mobile (German) and its tie-ins with British SIGINT sites 1944-45. (Original from Major Ted Silverstein's papers).....	10
Figure 3. Artist's depiction of one of the mobile vans used by 3 <sup>rd</sup> RSM (G) in Western Europe, a British vehicle with American van body attached. (Author's depiction with graphic design assistance of Mr. Daniel Armstrong) .....	11
Figure 4. Artist's depiction of a typical camouflaged 3 <sup>rd</sup> RSM (G) site in France or Belgium 1944. The antenna was used to intercept German communications. (Author's depiction with graphic design assistance of Mr. Daniel Armstrong) .....	12
Figure 5. Korean peninsula. The map shows the 1954 DMZ line, MiG alley, and the location of Cho-Do island that was critical in detecting MiG operations over North Korea. (Author's depiction with graphic design assistance of Mr. Daniel Armstrong) .....	20
Figure 6. A graphic representation of "Teaball" operations in 1972. The 300-mile line-of-sight UHF link to "Luzon," the KC-135 radio-relay aircraft, ended up being the Achilles heel of "Teaball." (Author's depiction with graphic design assistance of Mr. Daniel Armstrong).....	26
Figure 7. The numerous feeds into "Teaball" provided the near real-time data necessary to defeat the North Vietnamese air force. (Author's depiction with graphic design assistance of Mr. Daniel Armstrong).....	28

## Introduction

Intelligence and surveillance of enemy forces are critical to execution of any military operation.<sup>1</sup> They give indications and warning of enemy intentions and provide up-to-date data on enemy force dispositions. Both are essential to help planners prepare air campaigns and commanders execute air operations. While other forms of intelligence are vital in military operations, only signals intelligence (SIGINT) data can be delivered in a near real-time manner, as other intelligence disciplines require some processing.<sup>2</sup>

This study examines the evolution of near real-time intelligence support to air operations in three wars: Eighth Air Force operations during World War II, support to U.S. aircraft operating in "MiG Alley" over North Korea during the Korean War 1950-1954, and the "Teaball" weapons control center support to U.S. aircraft operating over North Vietnam during Linebacker II in 1972.

Historically, national intelligence efforts were directed towards strategic indicators and warning. This meant that little tactical military data were gathered in peacetime. The military had to rely on its own means, or go without. The intelligence community, as a whole, has typically been poorly prepared for combat operations on short notice. It has required a long lead time to acquire data, personnel, and resources to support combat operations. Both intelligence and reconnaissance were criticized by military leaders in the Korean and Vietnam conflicts for lack of support to combat commanders. Even during Desert Storm it took months to build an intelligence infrastructure in Saudi Arabia to support the theater.

---

<sup>1</sup> General William W. Momeyer, *Airpower in Three Wars* (Washington, D.C. US GPO, 1978) 202-203; 231-233. He stresses how important intelligence is in mission planning and targeting. He also mentions (pp. 154-55) how intelligence was critical in directly supporting air operations over North Vietnam in 1972. Colonel John A. Warden III, *The Air Campaign: Planning for Combat* (Washington, D.C.: National Defense University Press, 1988), (p. 35). Two JCS publications also discuss the importance of good intelligence, JCS Pub. 3-51 *Electronic Warfare in Joint Military Operations*, and JCS Pub. 2-0 *Doctrine for Intelligence Support to Joint Operations*.

<sup>2</sup> This statement while taken from intelligence doctrine publications is not quite current. The U-2 Contingency Airborne Reconnaissance System (CARS) at Beale AFB processes SIGINT and imagery intelligence (IMINT) data (both electro-optical and radar) in near-realtime.



## Overview of real-time intelligence

There are many types of intelligence that can provide effective support to air operations. Most intelligence is essential for mission planning purposes, but only certain sources of intelligence give the near real-time data needed by aircrews during a mission. Intelligence support during combat operations is crucial to overall battlefield success. Signals intelligence (SIGINT) provides immediate threat warning and updates on targets. SIGINT is made up of two components, electronic intelligence (ELINT) and communications intelligence (COMINT). ELINT is information on enemy threats and capabilities of systems such as radars, surface-to-air missile systems, and non-voice data-links. It also provides accurate location information. However, it is susceptible to deception and is limited to line of sight collection. COMINT provides information on enemy intentions and assists in determining the enemy command and control structure. Shortfalls of COMINT are the requirement for linguists and the need of line of sight with a transmitter in the UHF/VHF frequency band.<sup>3</sup> The biggest drawback from an operational standpoint, however, is that intelligence derived from COMINT is highly classified to protect sources, and selective in distribution. A collector of signals intelligence does not want the enemy to even suspect that his communications, by whatever means he conducts them, are being monitored, for fear that other frequencies, new codes, or different forms of communications will be substituted. Thus signals intelligence remains one of the most classified and protected intelligence categories. This concern, however, must be counterbalanced by military necessity, winning and achieving one's political and military goals. Dissemination of these products in historical examples shows that during military operations information must flow to decision-makers in a timely manner in order to be useful and relevant.<sup>4</sup>

Although air operations require a great deal of intelligence data, signals intelligence holds a unique key to successful air operations. SIGINT operations to tactical military commanders include a dynamic update capability during the execution phase of military operations, especially in direct support to combat aircraft. The aircrew needs the most timely intelligence to keep them ahead of the enemy on the battlefield. SIGINT can provide this. After planning a mission, and while en route to their targets, aircrews still require intelligence updates about their targets, routes, and hostile threats. While they already know enemy capabilities and anticipated reactions, updates on actual changes in the enemy's force disposition require that new intelligence be passed to aircrews. This would include threat updates, enemy order of battle changes (e.g., movement of a surface-to-air missile launch site), and observed enemy reactions. These data are only useful if passed in near real-time. Rear area analysts can do little with the data and aircrews can suffer without it.

---

<sup>3</sup> The interception of high frequency bands is not a problem since the signal while losing strength still can be picked up hundreds of miles from the transmitting source. The UHF/VHF bands are used primarily for air to air and air to ground transmissions, their signal strength drops with distance, thus SIGINT collection must be relatively close, no more than 400 miles from site of transmissions in order to intercept these signals.

<sup>4</sup> The description of each type of intelligence comes from JCS Publication 1-02, *DOD Dictionary of Military and Associated Terms* (Washington, D.C., Joint Chiefs of Staff, 1 August 2000).

This intelligence is vital to a number of air force personnel involved in operations and operational support. During air operations, weapons or battle controllers require timely updates from intelligence operations. Today these battle managers<sup>5</sup> are airborne in such platforms as E-3 AWACS, E-8 JSTARS or EC-130 ABCCC, but in previous conflicts these officers worked in ground control intercept (GCI) sites. Personnel at these radar sites guided aircraft to their targets. While weapons controllers<sup>6</sup> at GCI sites positioned fighters to optimally engage the enemy, ABCCC controllers support attack missions with updates on mobile targets. SIGINT provides updates on locations of enemy threats, enemy intentions, and enemy movements. This support to air battle managers is critical during air campaigns.

Air-to-ground platforms need real-time data so that they can find and hit their targets. Mobile targets are the most difficult to find on a battlefield and updated information is required by bombers in order to strike their targets with precision. Air-to-air fighter crews need current data on aircraft and mobile systems which could engage them or the attacking aircraft. SIGINT can help a fighter detect a target beyond its radar horizon and then cue the aircraft to be placed into an optimal position. Identifying aircraft types allows air defenders and escorts to attack higher priority targets and provides information on what types of threats they face. While information can be passed by secure radio, 21<sup>st</sup> century data-link technology is making it possible to display this data in the cockpit of fighter-sized aircraft.

The previous paragraphs describe the ideal, but what does near real-time intelligence in practice look like? We do have historical examples that give us valuable information on the employment of, but especially the problems with, near-real-time SIGINT support. These case studies hammer home a number of lessons that are relevant. While SIGINT has been used by aircrews since 1940, this study looks at American action in World War II, Korea, and Vietnam. To a large degree, the United States has regressed during World War II when there were operational intelligence interfaces at every level of command, meeting the needs of the expeditionary Air Force. In Korea and Vietnam the learning process was steep. Operational intelligence interface during the Vietnam war did not occur until 1972 when the war was winding down! Bureaucratic policies and over centralization, coupled with budgetary pressures and a lack of interest by senior leadership in intelligence, have left gaps that warfighters must struggle to fill during operations and conflicts in the 21<sup>st</sup> century.

---

<sup>5</sup> Battle managers and weapons controllers are job descriptions of officers who manage the air battle from command and control nodes and authorize weapons release.

<sup>6</sup> Their duty title has been changed to air battle managers.

## World War II

The large scale introduction of radio communications and mechanical cipher machines during World War II led to technological innovations in military operations. The dramatically increased use of radio suggests that World War II should be the starting point of this study. At the start of World War II the Germans used a machine-encrypted code system called Enigma. The British broke the code at Bletchley Park and the data gleaned from this coding system was designated Ultra.<sup>7</sup> The British also analyzed low grade ciphers (not machine encrypted) and voice and Morse systems used by the Germans. Since 1940 the RAF's Y service, an RAF signals intelligence organization, intercepted enciphered Luftwaffe communications<sup>8</sup> and clear voice transmissions supplying these data to the Royal Air Force (RAF).<sup>9</sup> The intercepted Y service data gave RAF fighter controllers information to intercept German formations during the Battle of Britain. The U.S. lacked a comparable signals intelligence organization to deal with tactical signals when Japanese forces struck Pearl Harbor.

The U.S. Eighth Air Force in 1942 created a system similar to the British Y service units to decrypt enemy communications. The 124<sup>th</sup> Signal Radio Intelligence (SRI) company, part of Military Intelligence or G-2, was the specialized unit stood up for Eighth Air Force. A long acrimonious debate had raged in Washington D.C. between the intelligence and communications branches as to who would control signals intelligence units. A compromise was achieved providing that military intelligence handled tactical signals and the signals corps handled the strategic ones. In addition air and ground branches of the U.S. Army organized signals intelligence units. The Army Air Forces, requiring the same specialized RAF intelligence, wanted separate units. In 1943 the SRI companies expanded. The RAF also integrated a large number of Americans at its intercept sites, RAF Cheadle and RAF Kingsdown. Eighth Air Force radio intelligence

---

<sup>7</sup> These data were deciphered at Bletchley Park and an American contingent supplied by Signals Intelligence Service operated here after 1942. This information was limited in distribution and Special Security Officers or SSOs handled the Ultra classified intelligence. Although the terms ULTRA and MAGIC are generically used to refer to allied codebreaking efforts during World War II, they actually refer to different systems. The British effort was primarily against the German coded radio traffic generated by the German Enigma machine. The decoded intelligence data were given the codeword ULTRA to assist in special handling and control of this sensitive information. The primary American effort was against Japanese coded radio traffic generated by the Purple machine. This decoded intelligence was given the codeword MAGIC, also for control of the information. The Americans and British shared ULTRA and MAGIC information extensively and assisted each other's efforts to exploit the data to the greatest extent possible.

<sup>8</sup> Enigma encrypted communications were broken by Station X or Bletchley Park and sent to the RAF in a manner that disguised their origin.

<sup>9</sup> Aileen Clayton, *The Enemy is Listening* (New York: Ballantine Books, 1982) is the only first person account of the RAF Y service in World War II.

units assigned to RAF Chicksands intercepted German Engima traffic. These American units were controlled by the Signals Intelligence Service (SIS), a Signal Corps entity.<sup>10</sup>

The Eighth Air Force used Y decrypts to plan and execute its operations over Europe from 1943 to 1945. Planners of daylight bomber missions learned from Luftwaffe intercepts the location of active fighter bases, how and where fighters assembled, how fighters timed their attacks against American bombers, and the endurance and range of fighters.<sup>11</sup> As the Eighth Air Force bombers flew early missions without any long range fighter escort, the planners attempted to select routes avoiding known Luftwaffe fighter bases. Operational planners used diversionary fighter sweeps and deceptive measures to lure fighters away from the main bomber force. Y intelligence revealed the effectiveness of these measures. This in turn allowed Eighth Air Force planners to judge the effectiveness of their route planning in confusing Luftwaffe fighter controllers. Planners used Y intelligence data to develop a system of escort relays that enabled fighters to spend longer periods protecting bombers. Y intelligence also disclosed changes and improvements in the Luftwaffe fighter command and control system. While this was not a direct example of near real-time intelligence, other uses of Y intelligence were.

For example, Eighth Air Force exploited Y intelligence nearly real-time during bombing missions over Western Europe. Activated in 1943, the RAF Kingsdown Switch produced and disseminated near real-time intelligence from voice intercepts to the pilots of Eighth Fighter Command as they flew escort missions and fighter sweeps in Northwest Europe. The RAF Kingsdown Switch was an intelligence analysis center where communications intelligence was collected and analyzed. The secure telephone hookup gave Eighth Air Force access to the intelligence data while missions were in progress. The gathered intelligence was passed directly into the fighter control room, AJAX, at the headquarters of the VIII Fighter Command. AJAX, in turn, passed it to the fighter control centers (FCCs) of three subordinated wings: the 65<sup>th</sup>, 66<sup>th</sup>, and 67<sup>th</sup> Fighter Wings.<sup>12</sup> Specially trained intelligence and operations officers held conference calls and moved aircraft according to intercepted data engaging Luftwaffe fighters and protecting bomber formations.

---

<sup>10</sup> F.H. Hinsley, E.E. Thomas, C.F.G. Ransom, and R.C. Knight, *British Intelligence in the Second World War: Its Influence on Strategy and Operations* (London: Her Majesty's Stationery Officer, 1979), 5 Volumes. George F. Howe, *American Signal Intelligence in Northwest Africa and Western Europe* (Special Research History #391). Dr. Diane T. Putney, "Allied Y Intelligence and the Daylight Air War in Europe" (Washington D.C.: Society of Military Historians, 1996).

<sup>11</sup> Peter Gray Lucas, "Tactical Signals of the German Air Force," in F.H. Hinsley and Alan Stripp, eds, *Codebreakers: The Inside Story of Bletchley Park* (New York: Oxford University Press, 1993), pp. 246-49.

<sup>12</sup> F.H. Hinsley, *British Intelligence in the Second World War*, Volume 3, Part 1, pp. 308-22. The Kingsdown hookup is also described in Dr. Putney's "Allied Y Intelligence and the Daylight Air War in Europe."

Western Europe SIGINT Operations  
Autumn 1943-Spring 1945

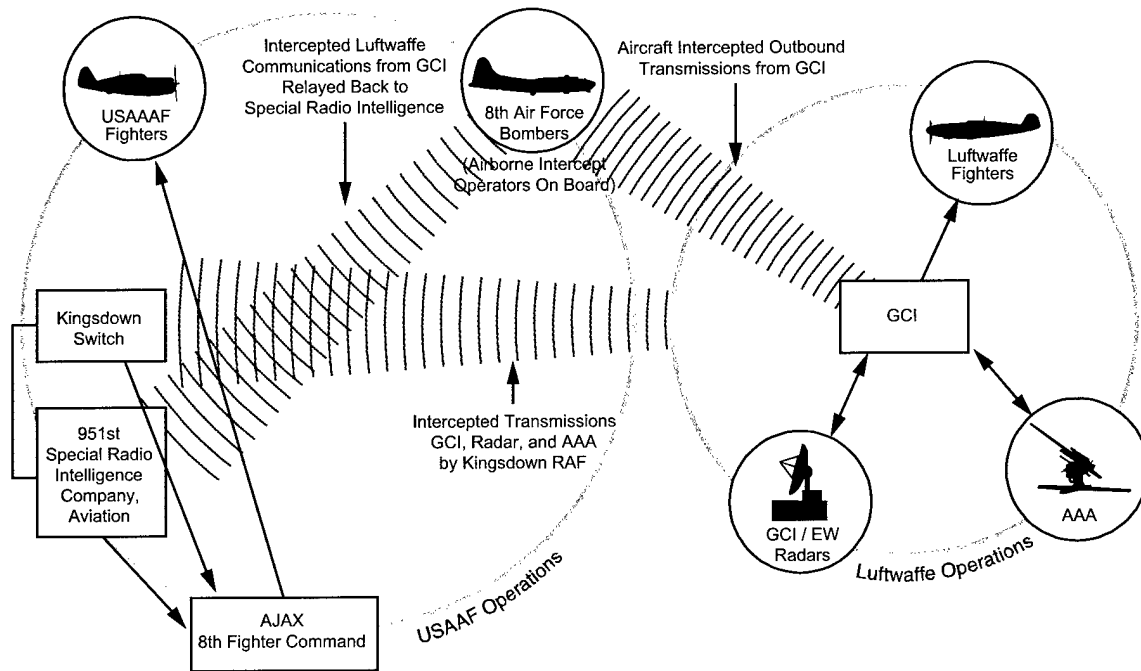

**Figure 1. USAAF used a variety of units to collect signals intelligence data to protect bomber formations and to vector fighters towards the Luftwaffe, but particularly the Kingsdown Switch and the 951<sup>st</sup> SRI (A).** (Author's depiction, with graphic design assistance of Mr. Daniel Armstrong)

Since Eighth Air Force bombers flew outside the range of UK-based tracking radars, US fighter controllers used intercepted Luftwaffe communications from Y intelligence to locate Allied bombers on raids over Germany. As longer ranged fighter escorts entered the USAAF inventory, the RAF Kingsdown Switch increased in value as wing controllers operating exclusively on Y intelligence vectored P-51s and P-38s to Luftwaffe fighter assembly areas. U.S. fighters could then engage Luftwaffe fighters far from Allied bombers, seriously disrupting the Luftwaffe plan and sequence of attack. This helps to explain how the Allies were able to gain and maintain air superiority so necessary for OVERLOAD, the ground invasion of the continent.

By March 1944 the Luftwaffe withdrew its fighters further east to strengthen the inner defenses of the Reich. The Luftwaffe withdrew so far that UK-based Y intelligence collection sites could no longer intercept its communications. But the Y intelligence service did not go completely deaf. It still intercepted data from the large command and control bunkers located throughout Germany, the bunkers that controlled Luftwaffe air movements and anti-aircraft fire over Germany.

When the Allies advanced onto the Italian peninsula, Y intelligence intercepts from North Africa were affected because Italian mountain ranges and the Alps made ground based radio interception from North Africa difficult. To solve the reception

problem beginning in 1943, the Fifteenth Air Force used German-speaking linguists abroad B-24 bomber formations to hand record Luftwaffe communications. Using just paper and pencil, the intercept operators were soon overwhelmed by the number of Luftwaffe communications they intercepted. To improve collection the Air Force installed the first tape recorders in B-24s, allowing the operator to concentrate on gathering signals and evaluating them, rather than having to write intercepts down. Airborne Y intelligence interception continued in the Mediterranean theater until 8 May 1945. In 1944 the Eighth Air Force in northeast Europe adopted these procedures, assigning six operators, two with each of the three bombardment divisions. This small investment in airborne Y operations produced excellent intelligence data. Information relayed back by these operators to RAF Kingsdown Switch was, in turn, relayed to fighters over northwest Europe within 20 minutes after interception. Eighth Air Force used its airborne Y intelligence flights until V-E Day.

As planning for OVERLOAD, the invasion of the European continent, got underway, allied tactical air forces, like their strategic bombing counterparts, wanted to ensure that they would have the means to collect, analyze, and use Y intelligence. Ninth Air Force and its primary components, the IX and XIX Tactical Air Commands (TACs) and the IX Bomber Command, all sought Y intelligence. In March 1944 the Army Air Force reassigned the 951<sup>st</sup> Signal Radio Intelligence Company Aviation, an Eighth Air Force unit collecting Luftwaffe communications for RAF Cheadle, to Ninth Air Force and redesignated it 3<sup>rd</sup> Army Air Forces (AAF) Radio Squadron Mobile (RSM) (German [G]). This unit was self-contained and mobile and was equipped to “provide radio intelligence to the Air Force Commander and to the Theater Commander by means of radio intercept, radio direction finding, traffic analysis, and the evaluation of enemy air radio traffic, telegraph and voice.”<sup>13</sup> In July 1944 the AAF had nine RSMs worldwide to intercept German or Japanese traffic.<sup>14</sup>

Code breaking tools were frequently nothing more than people, paper, pencils, and six to eight radios in a detachment monitoring German radio frequencies. In some cases the operators just kept searching the frequency band until they found something. This work was conducted in a radio trailer. The intercept message would then be sent to a direction finding (D/F) van where triangulation got a fix on the radio transmissions. The message would come to the crypto-analysts van, where teams would break out or decode the message into plain German and then translate it into English. The message was then sent to Ninth Air Force, Supreme Headquarters Allied Expeditionary Force (SHAEF), RAF Cheadle, and the Air Ministry in London. The radio, direction finding, and decrypt vans delivered the decrypted and translated Y intelligence data by telephone landlines and motorcycle messengers to users. This procedure was designed to protect the source of

---

<sup>13</sup> Unit citation in Major “Ted” Silverstein paper’s deposited in AFHRA Maxwell AFB.

<sup>14</sup> General Kenney had to make do with an Australian intercept unit on New Guinea until more Americans were trained. In the Pacific the U.S. Navy employed Radio Intelligence Units (RIU) on ships, especially aircraft carriers. These collected Japanese tactical aircraft communications and provided valuable information allowing carrier-based naval aircraft to intercept and destroy many Japanese aircraft. (“The Employment of Mobile Radio Intelligence Units by Commands Afloat During World War II,” in Ronald H. Spector, *Listening to the Enemy: Key Documents on the Role of Communications Intelligence in the War with Japan* [Wilmington, Delaware: Scholarly Resources, 1988], 76-79).

the intelligence and deny the Germans the opportunity to figure out that the Allies were breaking their message traffic.

Eager for better operational interface with its signals intelligence collectors, the Army Air Force broke larger formations into smaller units to integrate them into every part of the expeditionary force retaking France and Western Europe. The 3<sup>rd</sup> RSM (G) was divided into three detachments to support Ninth Air Force units. Detachment A stayed with Ninth Air Force, Detachment B went to IX TAC and 70<sup>th</sup> Fighter Wing, and Detachment C supported XIX TAC and the 100<sup>th</sup> Fighter Wing. Detachment B landed in France on 8 June 1944, with the rest of the unit arriving shortly thereafter. The unit intercepted its first transmission on 9 June.<sup>15</sup> In short order the detachment set up near Cricqueville which had a perforated steel plank airfield from which 354<sup>th</sup> Fighter Group flew P-51s. Meanwhile, Detachment A produced order of battle reports and situation reports and stayed in close touch with RAF Cheadle to assist in codebreaking. Detachments B and C passed all intelligence they intercepted directly to fighter control centers (FCCs) of the tactical air commands which, in turn, radioed American fighters and bombers. On 6 October 1944 Detachment D was set up to support XXIX TAC with Y intelligence. Concurrently Detachment A moved to support air planners at SHAEF, while Detachment E took over supporting Ninth Air Force.

The Y intelligence provided decrypts that helped destroy Luftwaffe aircraft. For the period 8 June to 26 October 1944, the 3<sup>rd</sup> RSM (G) received credit for a large number of enemy aircraft kills. Detachment A produced intelligence resulting in 73 enemy aircraft destroyed, 3 probably destroyed, and 8 damaged. During the German evacuation from southern France, Detachment A's decrypts revealed that bases near Cognac, Bourges, and Dijon were Luftwaffe evacuation centers and active at certain times. Based on Y intelligence a single fighter sweep against Cognac and Dijon on 25 August 1944 destroyed 33 aircraft on the ground.<sup>16</sup>

---

<sup>15</sup> Arnold Franco, *Code to Victory* (Manhattan, KS: Sunflower University Press, 1998), p. 65. This is the only account written by a member of the 3<sup>rd</sup> RSM(G) and covers the unit from the UK till Arnold Franco's discharge in 1945 from the Army.

<sup>16</sup> Eleven Ju-52 transports, two FW-200 transports, three Ju-88 bombers, one Do-217 Bomber, one Fw-190 fighter and one Me-109 fighter. Major Hyman "Ted" Theodore Silverstein, *Organization and Operation of Tactical Radio Intercept Squadron (German) Assigned to a Tactical Air Force*, undated, in AFHRA under personal papers. These papers offer a remarkable glimpse of what tactical collection of SIGINT was like in 1944/45 in Europe.

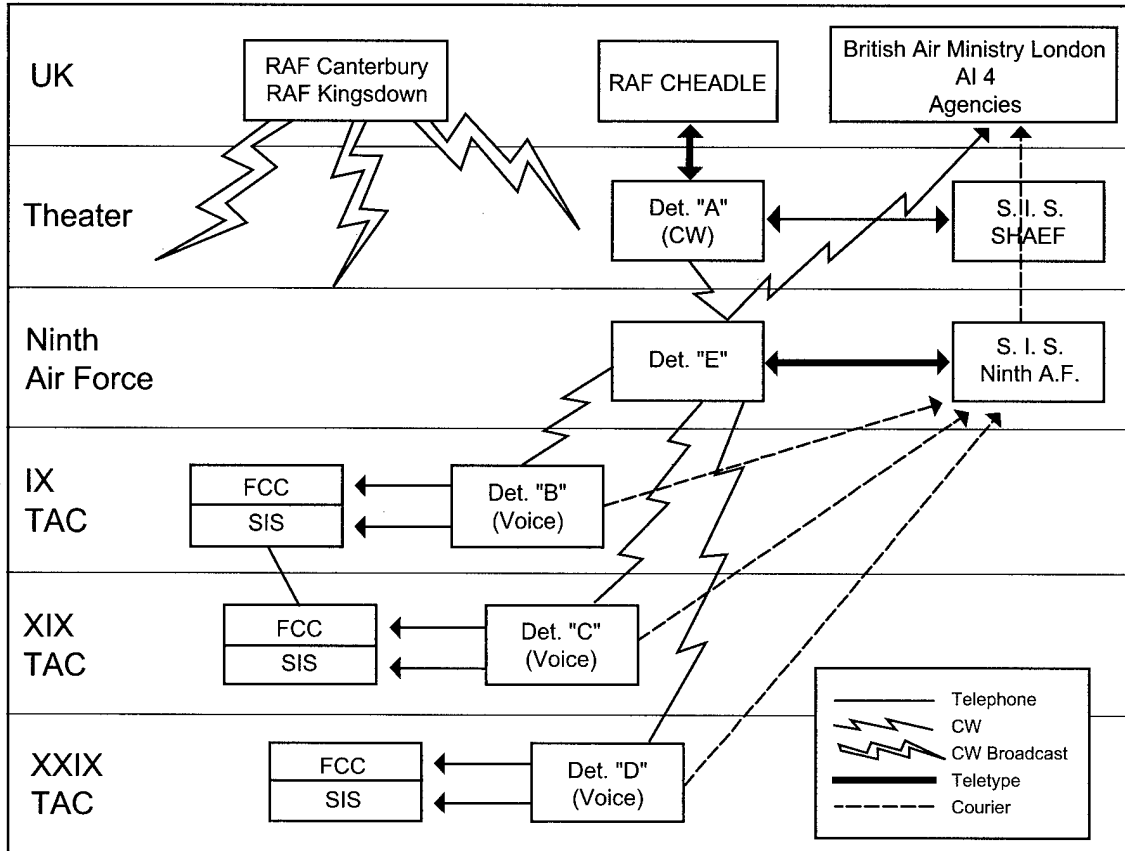

**Figure 2. A diagram of the 3<sup>rd</sup> Radio Squadron Mobile (German) and its tie-ins with British SIGINT sites 1944-45. (Original from Major Ted Silverstein's papers)**

Detachment B, feeding data to the 70<sup>th</sup> Wing, was credited with 199 Luftwaffe aircraft destroyed, 36 probable, and 26 damaged. Y intelligence passed to fighter controllers contributed to Allied fighters attacking Luftwaffe forward landing strips and the radar plotting station near St. Lo. Detachment C was credited with two Luftwaffe aircraft destroyed, as it had no linguists and its XIX TAC fighters attacked more ground than air targets during the Normandy campaign. The ground results were impressive though with 150 tanks and armored vehicles destroyed.



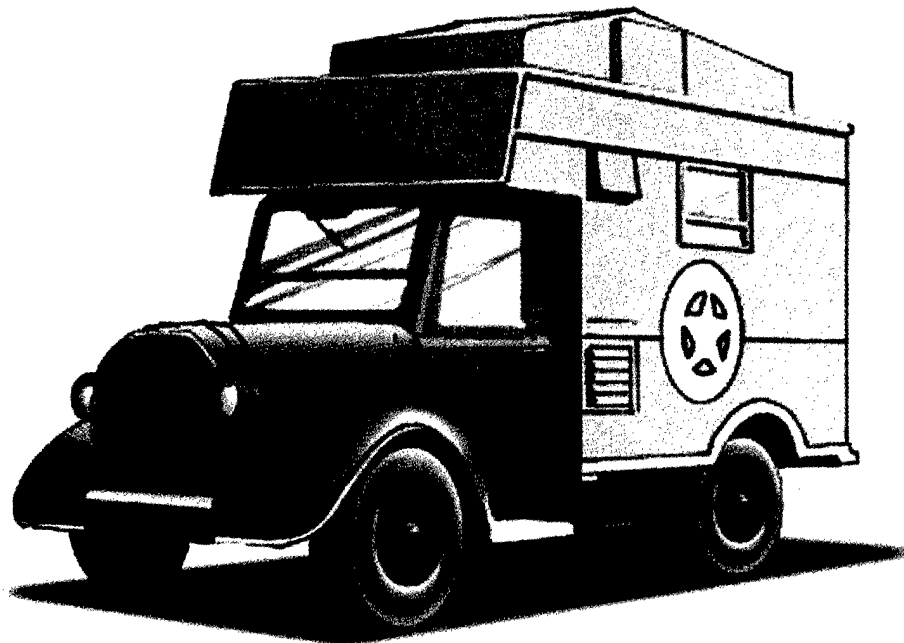

**Figure 3. Artist's depiction of one of the mobile vans used by 3<sup>rd</sup> RSM (G) in Western Europe, a British vehicle with American van body attached.**

(Author's depiction with graphic design assistance of Mr. Daniel Armstrong)

Units of the 3<sup>rd</sup> RSM (G) also supported the microwave early warning (MEW) radar sites of both Eighth and Ninth Air Forces, which provided radar controllers with advanced warning of airborne Luftwaffe aircraft. These radars helped to direct aircraft towards targets and also managed air traffic over newly liberated countries in Western Europe. Y intelligence reports allowed controllers to identify their radar targets as friendly or enemy, ensuring that Luftwaffe and not allied aircraft were targeted. The RSM personnel could, by listening to Luftwaffe frequencies and carefully cataloging call signs, tell what type of aircraft were flying and, by triangulation, could help radar controllers pinpoint enemy aircraft. Each of the TACs in Ninth Air Force had a MEW site which the RSM detachments supported as well. These radar sets allowed USAAF and RAF fighters to be vectored against Luftwaffe aircraft. Ninth Air Force moved these radar sets to the continent of Europe in August 1944, and they relocated with every Allied advance towards Germany. The Eighth Air Force set, the most powerful, was moved from the UK to Holland, codenamed Oakland, in November 1944. This station controlled fighters by directing them to their rendezvous points with bomber formations. Realizing how valuable the Kingsdown Switch was, General Spaatz requested the RAF to relocate part of their Y intelligence service to work with this site in Western Europe. Since the Luftwaffe had pulled further back, and Eighth Air Force radar control was now also located on the continent, General Spaatz was eager to continue Y intelligence support. In the meantime 3<sup>rd</sup> RSM (G)'s detachments B and D fed the MEW site Y intelligence. In

November 1944 the RAF started the move which then was halted due to the Ardennes offensive. In March 1945 the RAF's 364<sup>th</sup> Wireless Unit relocated to Belgium to provide data to the Army Air Force's Oakland site.

Luftwaffe anti-aircraft (flak) messages sent by radio were a useful source of Y intelligence. German anti-aircraft units were told by command and control units when they could fire to avoid hitting Luftwaffe fighters operating against allied bombers. These messages also established safe zones through which Luftwaffe aircraft flew on their missions. These messages could be used by RSM intercept operators to determine what kinds of operations the Luftwaffe was planning or conducting. If bombing strikes cut landlines, the Luftwaffe was forced to use radio links to warn flak units of friendly Luftwaffe aircraft in their vicinity. These radio communications were vital in helping Eighth Air Force steer clear of fighter concentrations and intercept Luftwaffe fighters before they could mass against bomber raids. The RSM also tracked other Luftwaffe movements, including supply flights to the beleaguered garrisons in French ports such as Lorient and Brest, and battlefield interdiction bombing sorties early in the Normandy operation. The resupply sorties were targeted in the hope that a lack of food and ammunition would force the early surrender of these port cities. Intercepts also allowed 3<sup>rd</sup> RSM (G) personnel to warn U.S. AAA of German aircraft approaching Allied frontlines.

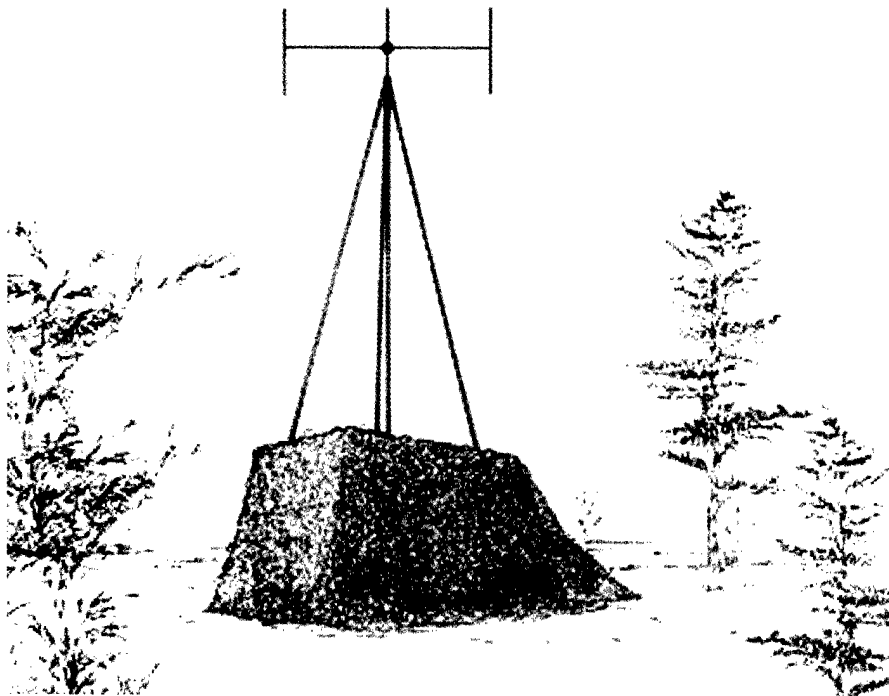

**Figure 4. Artist's depiction of a typical camouflaged 3<sup>rd</sup> RSM (G) site in France or Belgium 1944. The antenna was used to intercept German communications.**

(Author's depiction with graphic design assistance of Mr. Daniel Armstrong)

In 1944, preparations for the Ardennes offensive (the Battle of the Bulge) caused the German High Command to impose strict signal silence. Detachment A of the 3<sup>rd</sup> RSM (G) may be the only allied unit that picked up signals indicating preparations for the German operation. On 16 December 1944, using the Luftwaffe AAA as their source, codebreakers heard that 90 Ju-52 transports and 15 Ju-88 medium bombers were being moved in Germany. The message was cancelled but then repeated on December 17<sup>th</sup>. The aircraft carried Lt. Col. Von Der Heydte's Luftwaffe paratroopers who were to jump behind Allied lines and cause confusion. This fact was unknown to the codebreakers, but based on observed air traffic patterns, the 3<sup>rd</sup> RSM reported some sort of operation was being mounted by the Germans. The message was passed to SHAEF and acknowledged, but no action was taken by higher headquarters since no one really believed the Germans could mount an operation this late in the war. Moreover, Ultra, the German Engima code traffic, revealed nothing. On December 18<sup>th</sup>, finding German parachutes at Detachment B's site in Jalhay, Belgium, the unit under Capt. Silverstein evacuated the site, saving it from the German ground assault. Capt. Silverstein wrote after the war that he believed, based on the reduced volume of intercepts in December 1944, that the Germans were using strict signal security to hide their preparations from the Allies. After-action reporting indicates that while the detachment's signal was intercepted and passed on to higher headquarters, no one acted on it until the German attack began. German signal security was unusually good during the Battle of the Bulge.<sup>17</sup> This gave U.S. SIGINT units little information with which to support Allied aircraft.

Aircrews had to make electronic compromises in their conduct of the air war over Europe. Jamming to protect the bomber formations from radar-guided flak was conducted exclusively by the 36<sup>th</sup> Bomb Squadron (Heavy) with modified B-17s and then B-24s. As it turned out, this airborne jamming also disrupted Luftwaffe communications links, both radio and Morse operated, which in turn degraded the ability of the Y service to intercept valuable communications.<sup>18</sup> Therefore careful coordination with jammers was required to ensure that the 3<sup>rd</sup> RSM (G) could still listen to and gather Y intelligence from relevant forces. This jamming in 1944/45 over Germany illustrates a point that continues to pit operations against intelligence to the present day: When do you jam or destroy a communications node, and when is it better to leave a site operational in order to gather signals intelligence data? This issue is only resolved at the highest level of command and frequently will find a theater commander at odds with his intelligence chief.

Signals intelligence benefited the Allies and evolved throughout the war. The final innovation in signals intelligence in World War II appeared in the Mosquito fighter's airborne radar system that could interrogate the German Identification Friend or Foe (IFF) system on the Me-262 jet fighter that appeared in late 1944. IFF operates in various modes and is a system that monitors the positions of friendly aircraft through a transponder. A radar control facility (either airborne or on the ground) sends out an

---

<sup>17</sup> Franco, 159.

<sup>18</sup> Alfred Price, *Instruments of Darkness: The History of Electronic Warfare* (New York: Charles Scribner's Sons, 1978); Martin Streetly, *Confound and Destroy. 100 Group and the Bomber Support Campaign* (New York: Jane's Publishing, 1978); Stephen Hutton, *Squadron of Deception. The 36<sup>th</sup> Bomb Squadron in World War II* (Atglen, PA: Schiffer Publishing Ltd, 1999).

interrogation signal which is received by the IFF transponder on the aircraft. The transponder automatically responds to the query by sending a coded message that identifies the friendly aircraft. The system on the Mosquito allowed a fast escort fighter to home in on the signal and shoot down Me-262s, considered a major threat to Eighth Air Force bomber formations. Several were shot down in this manner during March and April 1945.

## Korea

At the end of World War II rapid demobilization of ground based signals intelligence squadrons (radio squadrons mobile [RSMs]) left only minimal expertise in these units. In 1947 when the Air Force became a separate service, the existing nine RSM squadrons<sup>19</sup> were divided between the Army and the Air Force. The USAF received three RSMs - one in Europe, one in the U.S., and one in the Far East. The U.S. Army kept six RSMs which were formed into the Army Security Agency (ASA). The Air Force squadrons were formed into the United States Air Force Security Service (USAFSS). Decimated by post-war budget cuts, the USAFSS directed its primary collection effort at the Soviet Union. In 1949 the DOD established the Armed Forces Security Agency (AFSA) which was supposed to manage the cryptological activities of all three services, thus eliminating duplication of effort and streamlining management. None of these plans worked, however, since the new agency lacked the legal authority to manage U.S. SIGINT on a centralized basis. They actually proved to be more of a bureaucratic hindrance during the Korean War.<sup>20</sup> As a result, most collected signals intelligence in Asia was forwarded to the United States for processing and collation. Few members of the Far East Command (FECOM), General MacArthur's headquarters in Tokyo, were allowed to see the finished intelligence products. The Far East Air Force stationed in Japan thus could provide little useful target intelligence on Korea to its aircrews.

The two central missions that preoccupied U.S. intelligence gathering activities involving SIGINT in Asia were the Soviet nuclear threat and observing Communist Chinese threats towards Taiwan. SIGINT also emphasized listening for perceived communist infiltration in occupied Japan, rather than monitoring developments elsewhere in Asia, in places such as Korea or Vietnam.

With the outbreak of the Korean war, intelligence information collected in Asia was still processed through agencies located in the U.S., naturally precluding any timely distribution. Pilots flying in support of U.N. and U.S. operations in Korea had very little useful tactical intelligence. Shortly after the Korean War broke out, two highly critical reports decried U.S. intelligence support to Asia theater commanders.<sup>21</sup> The Joint Chiefs

---

<sup>19</sup> During World War II both the Army and Army Air Forces had used the nine established RSMs for cryptological work.

<sup>20</sup> David Hatch with Robert Louis Benson, *The Korean War: The SIGINT Background*, [www.nsa.gov/korea/papers/sigint\\_background\\_korean\\_war.htm](http://www.nsa.gov/korea/papers/sigint_background_korean_war.htm).

<sup>21</sup> Major General Glenn Barcus, *An Evaluation of the Effectiveness of the USAF in Korea* (Washington, D.C.: Department of the Air Force, 25 June – 31 December 1950) and Robert Stearns, *Korean Evaluation Project. Report on Air Operations* (Washington, D.C.: U.S. Government Printing Office, 16 January 1951). These documents highlight many deficiencies noted on the early conduct of USAF operations in the Korean conflict and focus heavily on lack of intelligence support. See also *Complete Air Staff Comments – Stearn's Report Conclusions* (Washington, D.C.: Department of the Air Force, 20 March 1951) and Robert Futrell "USAF Intelligence in the Korean War" in *The Intelligence Revolution: A Historical Perspective*, edited by

of Staff described COMINT in the Far East in 1950 as "far short of requirements for peacetime and incapable of handling a vastly greater load during wartime."<sup>22</sup>

Manpower shortages, lack of linguists, and dated equipment all meant that the U.S. SIGINT establishment was unprepared for the war that came to the Korean peninsula.<sup>23</sup> Air Force intelligence squadrons assigned to Korea lacked personnel and equipment. The 1<sup>st</sup> RSM based at Johnson AB, Japan, with an additional D/F site at Misawa in northern Japan, provided tactical support at the outbreak of the war. But intelligence gaps forced Fifth Air Force, commanding air operations over Korea, to monitor developments inside Korea using a team of trusted South Koreans. However, this collection effort provided little information useful to tactical or strategic missions.<sup>24</sup> ROK troops were quickly formed into a SIGINT unit managed by American officers. The North Korean invasion of the South initially received little COMINT attention as the United States had larger global strategic concerns. Immediately after the first U.S. soldiers were sent to South Korea, however, most of the COMINT sites in Asia were directed to monitor whether Soviet ground forces were intervening in Korea. After the Inchon landing on 25 September 1950 and the advance towards the Yalu, Stalin decided to intervene in the war. On 1 November 1950 three Soviet fighter aviation divisions with MiG-15s began flying missions. An additional 50,000 troops provided security to the Soviet base complexes in Manchuria. The Soviet air force rotated its fighter units in Manchuria throughout the war. They were the dominant communist force, especially early in the war. Chinese MiGs did not come on line until December 1951 and North Korean MiGs only started operations in January 1952.<sup>25</sup> The first air activity reports were produced in Autumn 1951 by COMINT personnel.

During World War II linguists had been trained on-the-job in both theaters of war. However, since no one had anticipated a conflict in Korea there were no American Korean linguists in the U.S. military. The bulk of the intelligence work involved direction finding, the pinpointing of emitters, and a unique cryptological product -- traffic analysis. Traffic Analysis attempts to ascertain valuable intelligence data without decoding or translating a message. Valuable information can be gleaned by watching who is sending messages to whom. It can reveal the enemy's location, strength, and purpose, even if the enemy's codes and encryption systems are unbroken. Silence is not an option on a modern battlefield where units move rapidly and must be supplied on the move. Air operations always have some emissions -- radio, radar, transponder, or datalink -- that can be exploited, even if encrypted.

---

Lt. Col. Walter Hitchcock (Washington, D.C.: Office of Air Force History, 1991) for more on these shortcomings.

<sup>22</sup> Report to the Secretary of State and the Secretary of Defense, commonly referred to as the "Brownell Committee Report," Special Research History 123, National Archives and Records Administration, Record Group 457, pp. 59-60.

<sup>23</sup> Maj. Gen. Glenn O. Barcus, *USAF Oral History Program Interview* (conducted by Lt. Col. John N. Dick at Solana Beach, California, 10-13 August 1976), pp. 214-17.

<sup>24</sup> David Hatch with Robert Louis Benson, *The Korean War: The SIGINT Background*, [www.nsa.gov/korea/papers/sigint\\_background\\_korean\\_war.htm](http://www.nsa.gov/korea/papers/sigint_background_korean_war.htm).

<sup>25</sup> Ralph Wetterhan, "The Russians of MiG Alley," *ROA Magazine*, August 2000, p. 70.

In order to conduct successful intercept operations in the Korean War, communications intelligence operators needed the enemy to communicate on frequencies, which they could receive. As with air operations conducted in World War II, air planners laid on tactical bombing missions during the Korean war to destroy portions of the North Korean communications infrastructure in order to give COMINT a better chance of accessing useable intelligence. After the successful landing at Inchon the JCS ordered FECOM to destroy all telegraph repeater stations. This would prevent the North Koreans from using land lines that provided secure message traffic. Target intelligence on the North Korean ground communications system revealed there were only seven stations. On 24 September FECOM ordered FEAF to destroy seven telegraph repeater stations, especially those at Pyongyang and Wonson.<sup>26</sup> The FEAF lost three B-26s in strikes at Pyongyang and Wonson due to a heavy concentration of anti-aircraft guns, but the strikes were successful. U.S. SIGINT units gained a dramatic increase in militarily significant radio communications that established the intent of communist air and ground actions. The U.S. did not operate alone in the U.N. command. The Hong Kong-based RAF 376<sup>th</sup> Signals unit intercepted Chinese traffic, and these data were relayed to Korean battlefield commanders and their intelligence staffs in Korea and in Japan.<sup>27</sup>

Following the appearance of Soviet-made MiG-15 jet fighters over the Yalu river, on 13 November 1950 the commander of Fifth Air Force, Maj. Gen. Earl Partridge, dispatched his only SIGINT unit to Sinanju airfield in North Korea to intercept the air to ground communications of the MiG-15s. At about the same time in November 1950, after repeated requests from Fifth Air Force, the 1<sup>st</sup> RSM finally moved a detachment to Korea. The 1<sup>st</sup> RSM component of the USAF Security Service did not belong to Fifth Air Force and thus had to await approval from Washington D.C. before moving. Saved by sheer luck from being captured during the first Chinese attack, the 1<sup>st</sup> RSM set up operations in Seoul. The Chinese attack prompted FECOM to request Chinese linguists, especially those who spoke or understood the Manchurian dialect. Until they arrived, COMINT voice interception operations could not be conducted.<sup>28</sup>

In December 1950, with the arrival of Chinese linguists in Korea, the 1<sup>st</sup> RSM provided useful intelligence. It confirmed that the Chinese People's Liberation Army Air Force (PLAAF) would not interfere with an evacuation operation near Hamhung.<sup>29</sup> The linguists also began flying radio intercept missions behind the frontline in C-47 transport aircraft to increase their field of view and intercept possibilities.<sup>30</sup> The fact that Russian pilots were flying some of the MiG-15s soon created a demand for Russian linguists. After Russian transmissions were picked up in Manchuria and not from Vladivostok an intense effort began to gather the background of these Russian transmissions. It soon

---

<sup>26</sup> Matthew Aid, "US HUMINT and COMINT in the Korean War," from "Approach of War to the Chinese Intervention," in *Intelligence and National Security* (Winter 1999), p. 52.

<sup>27</sup> Desmond Ball, "Over and Out: Signals Intelligence in Hong Kong" in *Intelligence and National Security* (July 1996), p. 62.

<sup>28</sup> History, Far East Air Force, July-December 1950 (Yokota AB, Japan, undated), p. 375.

<sup>29</sup> Most Chinese linguists were stationed on Taiwan to monitor the People's Republic of China. The U.S. military did not have a large cadre of Chinese linguists since China had been an ally from 1945-49 and had relied on Nationalists for linguist work.

<sup>30</sup> Unit 4, 21<sup>st</sup> Troop Carrier Squadron, Taegu South Airfield (K-37) in South Korea.

emerged that Russian pilots, GCI controllers, and airfield tower personnel were talking in their mother tongue.

Able to read Chinese air force (PLAAF) codes, 1<sup>st</sup> RSM intelligence allowed USAF fighters to intercept Chinese MiGs shortly after they crossed the Yalu river. This intelligence information gave U.S. and U.N. fighters an edge since they knew where the communist aircraft would be. U.S. radar ground controllers could provide vectors to intercepting U.S. aircraft allowing them to move behind communist aircraft or at least avoid ambushes. The fact that some ground chatter could be picked up in Manchuria before the MiGs took off, allowed U.S. fighters to avoid long fruitless orbits near MiG Alley. COMINT also permitted the monitoring of North Korean airfields' status and readiness allowing FEAF to bomb them before they achieved operational status.<sup>31</sup> On 19 June 1951, Fifth Air Force was alerted via COMINT that the PLAAF wanted to use Soviet supplied IL-10 bombers to intervene in the ground war. The next day P-51s spotted eight Il-10s, and in an ensuing dogfight the P-51s shot down two Il-10s. When Chinese Yak-9 fighters appeared they were jumped by another flight of P-51s resulting in one Yak-9 shot down.<sup>32</sup> Then Chinese MiG-15s joined the fracas and were, in turn, met by F-86s. The F-86s damaged four MiG-15s but the MiGs got a P-51.<sup>33</sup>

When the ground war bogged down into a stalemate, USAF bombing missions increased. Consequently, during the spring of 1951, the number of B-29 bomber losses mounted. SAC pressed FEAF commanders to provide real-time warning to the bombers. On 6 August 1951, advisory support, as this type of support was now labeled, commenced on the island of Paengyong-Do off the North Korean coast. But it shut down a month later when reception of communications links proved poor. Other success followed, however, when, on 30 November 1951, a force of 31 F-86s was vectored towards a Chinese attack force of 12 Tu-2 bombers, 16 La-9 fighters and 16 MiG-15 jet fighters. The USAF shot down eight Tu-2 bombers, three La-9s and one MiG-15 with only one F-86 damaged.<sup>34</sup> The initial operations-intelligence interface also allowed USAFSS to protect B-26 night-intruder missions from PLAAF night fighters. On 23 April 1952 the 1<sup>st</sup> RSM co-located a detachment with a tactical control site operated by 606<sup>th</sup> Air Control and Warning (AC&W), code-named "Horse-radish," a tactical control site near K-6, an airfield located at Pyong'taek.<sup>35</sup> Also in April 1952, radar control and signals intelligence operations moved to Cho-Do, another island off the west coast of North Korea. COMINT information could thus be passed immediately to controllers who could vector fighters or move bombers away from PLAAF activity.

---

<sup>31</sup> Robert F. Futrell, *The US Air Force in Korea 1950-1953* (Washington DC: Office of Air Force History, 1983), pp. 287-93.

<sup>32</sup> Official USAF History lists only 1 Yak-9 downed, while the 606<sup>th</sup> ACW lists more aircraft downed. This discrepancy probably results from damaged aircraft crashing and data picked up via COMINT.

<sup>33</sup> Futrell, p. 310; Hitchcock, p. 286.

<sup>34</sup> Futrell, p. 415.

<sup>35</sup> *History of the 606<sup>th</sup> Aircraft Control and Warning Squadron*, 1-31 May 1952 (Yokota, Japan: 5AF/FEAF, undated), pp. 6-9.



In late autumn 1951, COMINT analysts had noticed a shift in PLAAF radio communications frequencies from HF to VHF. The shorter range VHF radio links required COMINT sites to be located closer to the Yalu to pickup air-to-ground transmissions.<sup>36</sup> An additional RSM, the 15<sup>th</sup>, was formed to provide expanded SIGINT coverage to USAF units operating from South Korea. At this new site the 15<sup>th</sup> was able to provide support to U.S. fighters over most of the Korean peninsula, including the Yalu river.<sup>37</sup> Getting SIGINT support to the GCI site took a while. Proposed in August 1952, by Capt. Delmar C. Lang of the 1<sup>st</sup> RSM, it took the personal intervention of Maj. Gen. Partridge, Commander Fifth Air Force, in December 1952 to bring about a merger of intelligence and GCI capabilities. Concerned about the lack of low altitude radar coverage over the Yalu river, General Partridge requested that SIGINT enhance the operational air picture for controllers. In response to this request, USAFSS personnel already located on Cho-Do island, as a detachment of the 15<sup>th</sup> Radio Squadron Mobile, started to provide real time intelligence information to the GCI controllers of Detachment 2, 608<sup>th</sup> Aircraft Control and Warning Squadron on the island. This intelligence allowed USAF F-86s to avoid traps or to be vectored to intercept targets.<sup>38</sup> Able to listen to Chinese and Russian MiG-15 radio links, COMINT helped the GCI controllers with their air picture. The result was a dramatic increase in MiG kills. Between October 1952 and July 1953 American fighters shot down 345 MiG-15 fighters for a loss of only 18 F-86s. During the months of May and June 1953 133 MiG-15s were shot down for the loss of only one F-86.<sup>39</sup> Unfortunately there is no statistical data to allow any definitive conclusions as to what degree SIGINT contributed to these numbers, but the fact that ratios changed can only lead to the assumption that SIGINT played a role in shooting down MiGs.

---

<sup>36</sup> Far East Air Force, *FEAF ECM History during the Korean Conflict*, K720.04C AFHRA, Maxwell AFB, pp. 6-14.

<sup>37</sup> "History of the 608<sup>th</sup> Aircraft Control and Warning Squadron, 1-31 May 1952 through 1-31 August 1953" (Yokota, Japan: 5AF/FEAF, undated).

<sup>38</sup> Delmar C. Lang papers in National Archives.

<sup>39</sup> Futrell, pp. 60-110 and 652-6; Histories of the 502<sup>nd</sup> Tactical Control group, 606<sup>th</sup> Aircraft Control and Warning Squadron, and the 608<sup>th</sup> Aircraft Control and Warning Squadron from mid-1952 to mid-1953 provided the MiG kill statistics.

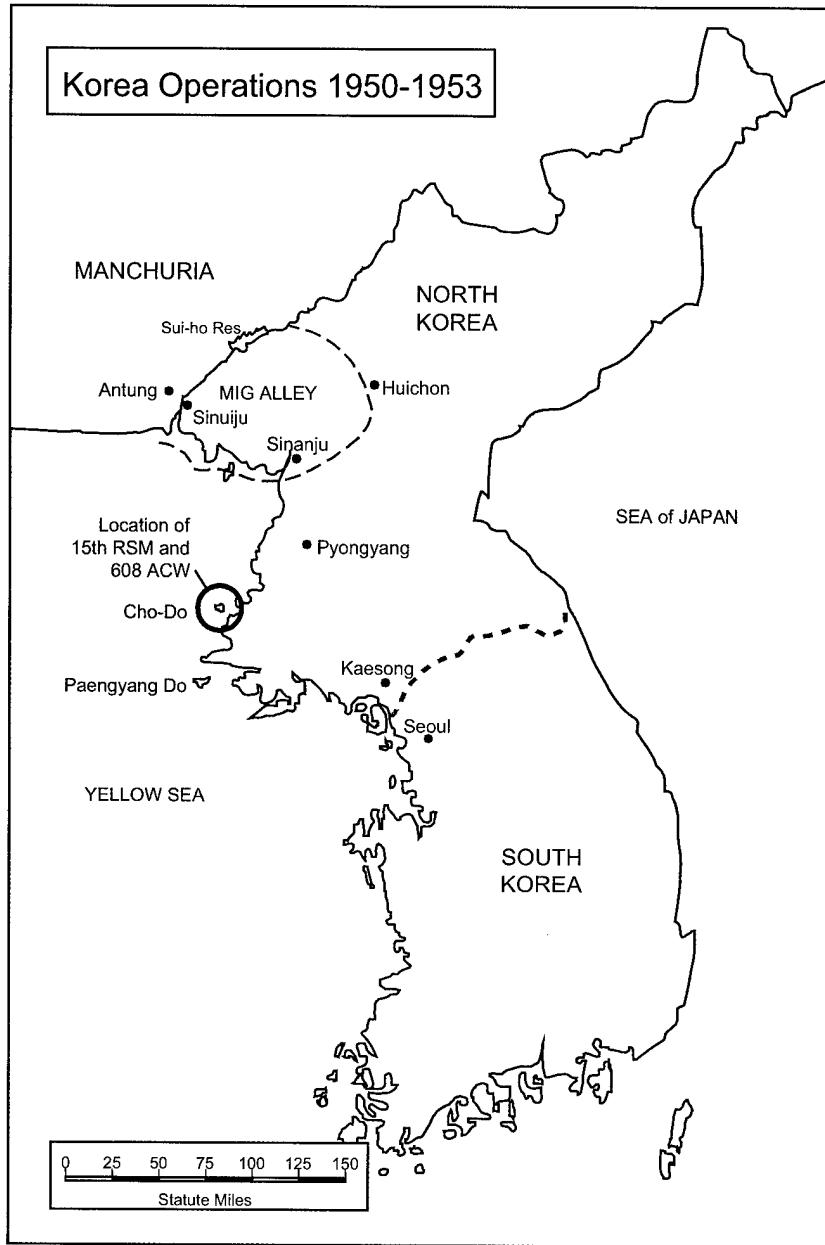

**Figure 5. Korean peninsula. The map shows the 1954 DMZ line, MiG alley, and the location of Cho-Do island that was critical in detecting MiG operations over North Korea.** (Author's depiction with graphic design assistance of Mr. Daniel Armstrong)

The spring of 1953 marked the beginning of airborne COMINT collection over Korea. SAC's RB-29 strategic reconnaissance aircraft had been flying missions around the Soviet Union and China, but rarely flew missions over Korea. As the RB-29 force aged it was replaced by RB-50 aircraft in strategic reconnaissance squadrons. In December 1952, RB-50Gs began to accompany SAC bomber aircraft (B-29 Superfortresses) on bombing missions over North Korea. The purpose was to afford ELINT support to the bomber formation. Electronic intelligence in this case meant protecting the bombers from radars and searchlights that tracked them and guided AAA

fire toward them. Jamming equipment carried by the SAC B-29s could only function if the correct North Korean/Chinese/Soviet frequencies were detected and USAF jamming equipment programmed. The RB-50s also carried a linguist to monitor radios and record any useful information for analysis on the ground, as well as to warn the bomber formation of any immediate threat such as that from communist night fighters. Specially modified RB-50Gs also orbited over the Yellow Sea or flew racetrack patterns collecting COMINT on North Korean and Chinese communications.<sup>40</sup>

The Soviet forces in Manchuria tried to make life hard for USAF pilots in the Korean War. Colonel Walker "Bud" Mahurin, an F-86 pilot with four MiG kills, recalls being scrambled by GCI and not finding any MiGs at the vectored location. Mistrusting the GCI operators, he went to their site and discovered that linguists were listening to Russian transmissions and that scrambles were called based on SIGINT data vice actual radar plots. A Russian interviewed in 2000 explained why the F-86s frequently did not find any MiGs in spite of the intercepted Russian voice transmissions. The Soviets listened to American radio transmissions in South Korea and if the weather was bad over Manchuria would make fake transmissions to lure aircraft into the air where they found no opponents. This type of deception is a hallmark of Russian electronic reconnaissance operations. For national security reasons Colonel Mahurin never revealed this fact to his pilots.<sup>41</sup>

After the Korean War, developing and maintaining this SIGINT capability received little official attention. The SIGINT operations in South Korea were transformed into fixed site operations with a strategic focus. The RSMs were redesignated as security squadrons and their primary focus became the Soviet Union and monitoring strategic communications links for signs of hostility. The airborne collection capability expanded under Strategic Air Command, but it too was focused on the Soviet Union and its most threatening satellites. The hard-won tactical abilities were lost to the Air Force when the focus shifted to other intelligence problems. As with the inter-war period between World

---

<sup>40</sup> "Historical Report," 91st Strategic Reconnaissance Squadron, Medium, Photo, 1 April -30 April 1953 (Kadena, Japan, undated); Far East Air Force, *FEAF ECM History during the Korean Conflict*, K720.04C AFHRA, Maxwell AFB, p. 20.

The U. S. Navy had a Naval Security Group stationed in Japan and sent detachments of linguists on board ships operating off the coasts of Korea. In 1951, for example, the USS *New Jersey* and USS *Essex* had such detachments embarked. This practice dates back to World War II. (Seventh Fleet, *Commander Seventh Fleet Report of Operations, March 28, 1951 - March 3, 1952*, Enclosure 1, Annex E, p. 5, Operational Archives, Naval Historical Center, Washington D.C.

<sup>41</sup> Ralph Wetterhan, "The Russians of MiG Alley" in *ROA Magazine* (August 2000), p. 74.

War II and the Korean War (1945 to 1950), the focus of the period between the Korean War and start of the Vietnam War (1954 to 1965) was on gathering strategic intelligence about the rapidly growing military and nuclear capabilities of the Soviet Union. Thus, the United States was guaranteed to enter another Asian war unprepared for signals intelligence support to tactical air operations.

## Vietnam

When U.S. involvement in the Vietnam War increased in August 1964, there were no intelligence assets in country. As operations in 1966 escalated into "Rolling Thunder" air strikes over North Vietnam, Seventh Air Force required better intelligence support and tactical air control to counter the aggressive North Vietnamese air force. It took four years to build the network. In April 1965 the first three EC-121Ds airborne early warning and control aircraft (AWACS) had arrived at Tan Son Nhut Air Base.<sup>42</sup> They flew orbits over the Gulf of Tonkin preventing North Vietnamese fighters from shooting down U.S. aircraft. Extending the American radar picture into North Vietnam, the EC-121D was equipped with search and height finding radars and an identification friend or foe (IFF) system to plot U.S. aircraft positions. Although they were an improvement over existing ground-based radars, the EC-121Ds had limited capabilities. Their radars broke down frequently, and they had no other data such as communications intercepts to characterize the radar targets. Seventh Air Force was not happy with initial EC-121D operations.<sup>43</sup> However, improvement soon came in the form of EC-121Ks that could interrogate enemy IFF systems and thus establish the position of North Vietnamese fighters.<sup>44</sup> This technical innovation, which had worked so well in the final months of World War II against Luftwaffe Me262 jet fighters, now was used to exploit Vietnamese reliance on IFF transceivers to direct the air battles over Hanoi. A test aircraft was deployed from the U.S. to Vietnam in July 1967 under the codename "Rivet Top." When it proved successful, all EC-121Ds were modified into EC-121Ks. USAF Security Service personnel manned four positions on the EC-121K aircraft to monitor North Vietnamese ground control intercept (GCI) communications, and to employ the IFF interrogation equipment. They provided near-real-time support to USAF and USN aircraft flying over North Vietnam.<sup>45</sup> This information provided by the EC-121Ks reduced the number of North Vietnamese intercepts of U.S. fighter-bombers, allowing more U.S. bombs to hit their targets with fewer losses.<sup>46</sup>

In 1966 work on an automated system of intelligence and a tactical air control system named "Combat Lighting" was started on Monkey Mountain near Da Nang, South Vietnam. It was planned to be a ground-based operations and intelligence fusion center. The EC-121Ks only flew when air strikes were scheduled over North Vietnam and Laos, thus did not provide 24/7 coverage. By 1969, the Southeast Asian "Combat

---

<sup>42</sup> Originally based outside of Saigon, the EC-121s were later moved to Thailand to cut down their transit times to stations in Laos and the Gulf of Tonkin.

<sup>43</sup> "College Eye Special Report," Project CHECO (Hickam AFB, Hawaii: PACAF, 1 November 1968).

<sup>44</sup> QRC-248 in College Eye Special report, pp. 18-19.

<sup>45</sup> "Project Red Baron II: Air to Air Encounters in Southeast Asia, Volume II," Part 1 (Nellis AFB: USAF Tactical Fighter Weapons Center, January 1973), D-3; Stephen Hardy, "Air Force Hits the Intelligence Fastball," *Journal of Electronic Defense* (January 1992), pp. 29-31.

<sup>46</sup> "Project Red Baron II: Air to Air Encounters in Southeast Asia," Volume III, Part 2 (Nellis AFB: USAF Tactical Fighter Weapons Center, March 1973), statistical tables in appendix 3.

Lighting” tactical systems linked USAF, USN, USMC, and USA tactical data systems together, forming a comprehensive air picture over North Vietnam.<sup>47</sup> It provided a real-time exchange of tactical air operations information throughout the theater for the first time. While this system received a variety of inputs from intelligence collectors throughout Southeast Asia, classification problems and dissemination concerns by national intelligence agencies which “owned” the data meant that little information was actually passed to aircrews operating over North Vietnam. The USAF also made use of the radar picket ship code named “Red Crown” in the Gulf of Tonkin. This ship had naval SIGINT, national SIGINT, and an E-2<sup>48</sup> airborne radar feed linked into its Combat Information Center (CIC), giving it a complete picture of the air situation over Hanoi. Because of the curvature of the earth, the ship’s radar could only look up the Red River delta to Hanoi.

U.S. pilots, already frustrated by the small amount of data provided to them, felt betrayed when they learned that some losses over Vietnam could have been prevented if intelligence data had been shared with them. ELINT data which revealed SA-2 launch sites were not passed to pilots until confirmed by an additional source. This policy raised loss rates significantly since SA-2 sites only transmitted when engaging a U.S. aircraft. The problem was one of sources, methods, and security protecting SIGINT. Because the pilots lacked proper security clearance, only a few signals intelligence tidbits could be provided to them. Signals intelligence, even then, was classified at top secret or higher, and access was granted to only a few individuals. Lack of effective analysis and restrictive classification also limited dissemination of data. This problem persisted until 1972 and was a classic example of the “green door syndrome” -- a caustic euphemism for intelligence data kept locked away in a vault in the squadron or wing operations buildings, usually behind a green door.<sup>49</sup>

On 9 May 1972, following a three-year (1968 to 1971) curtailment of air activity over North Vietnam during peace talks, President Nixon ordered renewed bombing of the north. This new bombing campaign came in response to a North Vietnamese invasion of South Vietnam. During the truce the North Vietnamese air force was rebuilt and the North Vietnamese air defense network was greatly expanded. It was considered by many air operations planners to be one of the finest air defense systems in the world. With the resumption of full-scale bombing on 10 May 1972, the U.S. soon suffered shocking losses to these defenses. From 10 May to 31 July 1972, the U.S. aircraft shot down 31 MiGs while losing 21 aircraft to MiGs and an additional 27 tactical aircraft to SAMs and AAA. During June and July, when the North Vietnamese air force was most effective, it shot down 13 U.S. aircraft while losing only 11 MiGs in aerial combat.<sup>50</sup> One factor in

---

<sup>47</sup> “Southeast Asia Tactical Data Systems Interface,” Project CHECO (Hickam AFB: PACAF, 1 January 1975), p. 3. This is an excellent text on how data systems developed and were used throughout the Vietnam War.

<sup>48</sup> The E-2 was a small AWACS aircraft that used a radar to extend the radar horizon of a carrier task force. In the Gulf of Tonkin, the E-2 monitored air strikes in the Red River valley over Hanoi.

<sup>49</sup> Robert Futrell, et al., Aces and Aerial Victories: The United States Air Force in Southeast Asia 1965-1973 (Washington, D.C.: Office of Air Force History, 1976), pp.31-66.

<sup>50</sup> “Linebacker: Overview of the First 120 Days,” Project CHECO (Hickam AFB: PACAF: 27 September 1973), pp. 44-45 and “Red Baron”, Vol III. Part 1, p. 88.

this unacceptable kill:loss ratio was North Vietnamese radar control and the lack of American radar warning.

In response to these losses, Gen. John Vogt, 7<sup>th</sup> Air Force commander, demanded a better system to provide MiG warnings to U.S. aircraft operating outside existing radar coverage. The elements of the tactical air control system discussed earlier had serious radar limitations. They could not provide effective low altitude radar support to strike and escort packages coming from bases in Thailand to targets in North Vietnam. Gen. Vogt sent an eyes-only message to Air Force Chief of Staff Gen. John D. Ryan, describing his analysis of the air war over North Vietnam. He bluntly pointed out that the USAF was losing the air war. The problem boiled down to increasingly proficient North Vietnamese pilots using single high speed passes firing Atoll air-to-air missiles, and inexperienced U.S. pilots rotated into the combat zone every year. Compounding the problem was the unsatisfactory way intelligence information was relayed to pilots using the UHF guard channel.<sup>51</sup>

Gen. Vogt asked for Air Staff help. Gen. Ryan directed AF/IN and the quick reaction group in AF/XOO to take immediate action. He forcefully stated that he wanted action, "not another staff study, not a briefing, not a plan."<sup>52</sup> An Air Staff action group was organized, consisting of Lt. Col. William Kirk, Maj. Ernie Short, and Mr. Delmar Lang. Lang of the NSA had set up the Cho-Do operation during the Korean War as a USAF captain. He had repeatedly offered to do the same in Vietnam, but commanders in Southeast Asia had turned him down. After running into opposition from 7<sup>th</sup> AF/IN opposed to giving aircrews "raw data" directly, the team moved its operation to Nakhon Phanom (NKP) Royal Thai Air Force Base. Here the team assembled control vans and radios that allowed it to monitor North Vietnamese air operations. Intelligence personnel tracked, plotted, and recorded air movements and passed the data on to weapons controllers in communication with the USAF strike packages over North Vietnam. In order to broadcast the intelligence information on UHF radios to pilots over North Vietnam, the team developed a KC-135 radio relay aircraft, call sign "Luzon." The weapons control center site at NKP used the call sign "Teaball."<sup>53</sup> The center also had access to radar data from EC-121Ks, code-named "Disco," orbiting over Laos and the Gulf of Tonkin. This meant that weapons controllers could cue aircraft towards or away from North Vietnamese threats, since the weapons controllers saw both pictures -- the USAF/USN radar returns and North Vietnamese data on their map displays.

---

<sup>51</sup> Maj. Gen. Doyle Larson, "Direct Intelligence Support in Vietnam. Project 'Teaball'," in *American Intelligence Journal* (Spring/Summer 1994) 56-58.

<sup>52</sup> Maj. Gen. Doyle Larson, "Direct Intelligence Support in Vietnam. Project 'Teaball'," in *American Intelligence Journal* (Spring/Summer 1994) 56.

<sup>53</sup> Maj. Gen. Jack Bellamy, "CORONA HARVEST, End of Tour Report" (Assistant Director Air Operations MACV/J-3, COMUSSAG/7<sup>th</sup> Air Force Deputy Chief of Staff Operations, 15 August 1974).

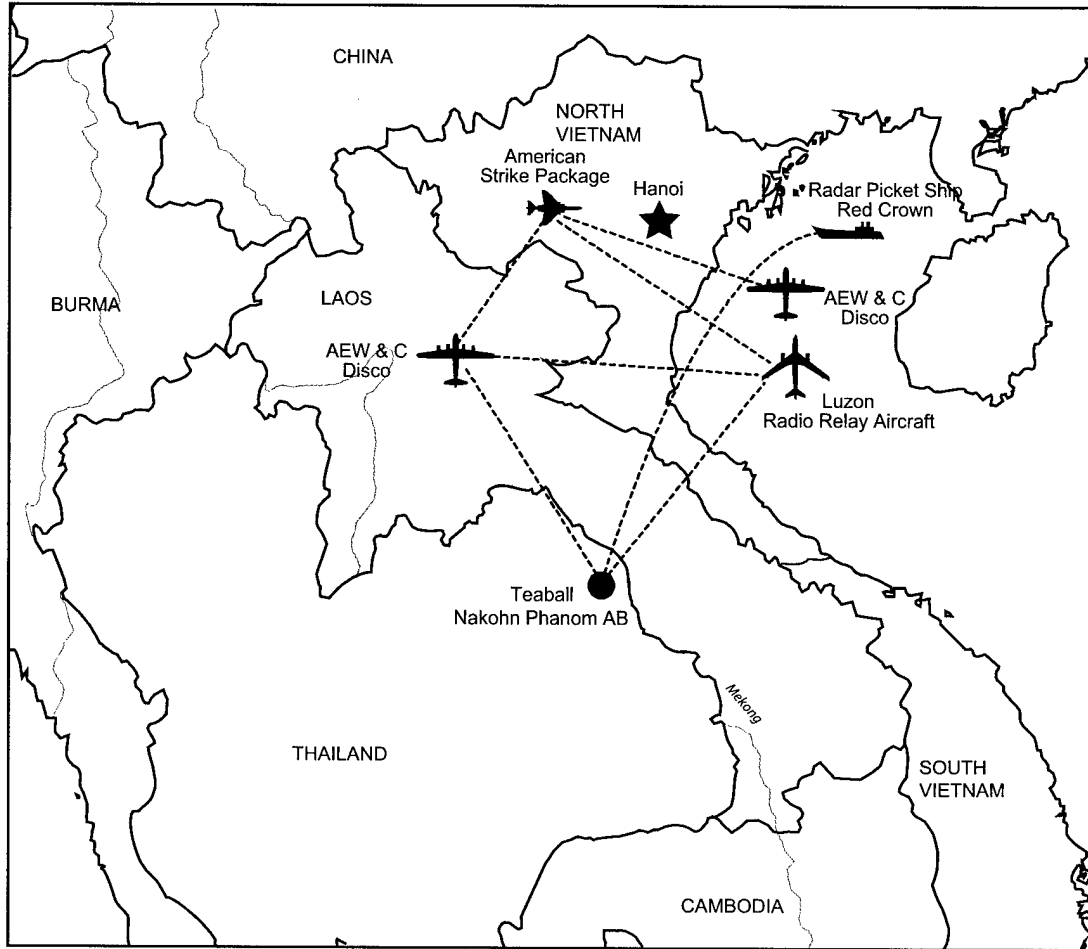

**Figure 6. A graphic representation of “Teaball” operations in 1972. The 300-mile line-of-sight UHF link to “Luzon,” the KC-135 radio-relay aircraft, ended up being the Achilles heel of “Teaball.”** (Author’s depiction with graphic design assistance of Mr. Daniel Armstrong)

To get over the ill feelings pilots still felt towards intelligence and the “green door syndrome,” Lt. Col. Kirk personally briefed every wing in Southeast Asia on the capabilities and workings of “Teaball.” Pilots could not be told that some of the data would come from COMINT, but Lt. Col. Kirk stated that they (the pilots) should “pay attention when I call you on your discrete UHF channel.”<sup>54</sup> He made sure the pilots understood that accurate data would be passed to them and they were to follow it. He did this by stripping the collection data from the COMINT and ELINT and just telling pilots approach vectors and pertinent threats.

On 26 July 1972 “Teaball” commenced operations.<sup>55</sup> ‘Teaball’ daily operations functioned like this: RC-135C/Ms orbited over Laos and the Gulf of Tonkin collecting

<sup>54</sup> Maj. Gen. Doyle Larson, “Direct Intelligence Support in Vietnam. Project “Teaball”,” in *American Intelligence Journal* (Spring/Summer 1994) pp. 56-58.

<sup>55</sup> “History of Linebacker Operations 10 May 1972 – 23 October 1972” (Tan Son Nhut AB: 7<sup>th</sup> Air Force, undated), pp. 51-53.



both COMINT and ELINT. These data were passed, via a USAFSS squadron at NKP, to "Teaball's" operations room. U-2s also orbited over Laos and the Gulf at a very high altitude passing their collected data to "Teaball." In the "Teaball" operations room the SIGINT data were collated with radar data from the EC-121 orbiting over Laos and the Gulf of Tonkin, as well as with ground-based radar data. Using a data-link the U.S. Navy's radar picket ship, "Red Crown," sent its radar picture and U.S. Navy SIGINT data to "Teaball." Together these sources gave "Teaball" access to all data forms being collected real-time over North Vietnam.

Once analyzed, warnings and intentions of the North Vietnamese air force were sent via radio relay KC-135s to U.S. fighters flying over North Vietnam. In addition to "Teaball," "Red Crown," in constant data-link communications with "Teaball," could also send warnings directly to U.S. aircraft flying over North Vietnam. The basis of "Teaball's" success was the highly classified "Iron Horse" system, a computerized system assimilating and displaying collected SIGINT data to a few cleared weapons controllers in the "Teaball" operations room. An NSA system, "Iron Horse," was manned by USAFSS personnel. It improved threat advisories issued by "Teaball."<sup>56</sup> "Teaball" passed the data to U.S. aircrews in the same format used by "Red Crown" and EC-121Ks.<sup>57</sup> This format made operations easier for the pilots who were used to calls being made from a "bull's eye" point in North Vietnam. Bull's eye is an aviation term used to help pilots pinpoint threats or traffic relative to their own positions. The data are passed to the pilot in the form of a compass heading, speed, and vector. During Linebacker II and before, the bull's eye was usually Hanoi. In recent operations bull's eye points have been varied to avoid compromise.

---

<sup>56</sup> "Southeast Asia Tactical Data Systems Interface," Project CHECO (Hickam AFB: PACAF, 1 January 1975), p. 7.

<sup>57</sup> "Red Baron III," Vol. III, Part 1, p. 88.

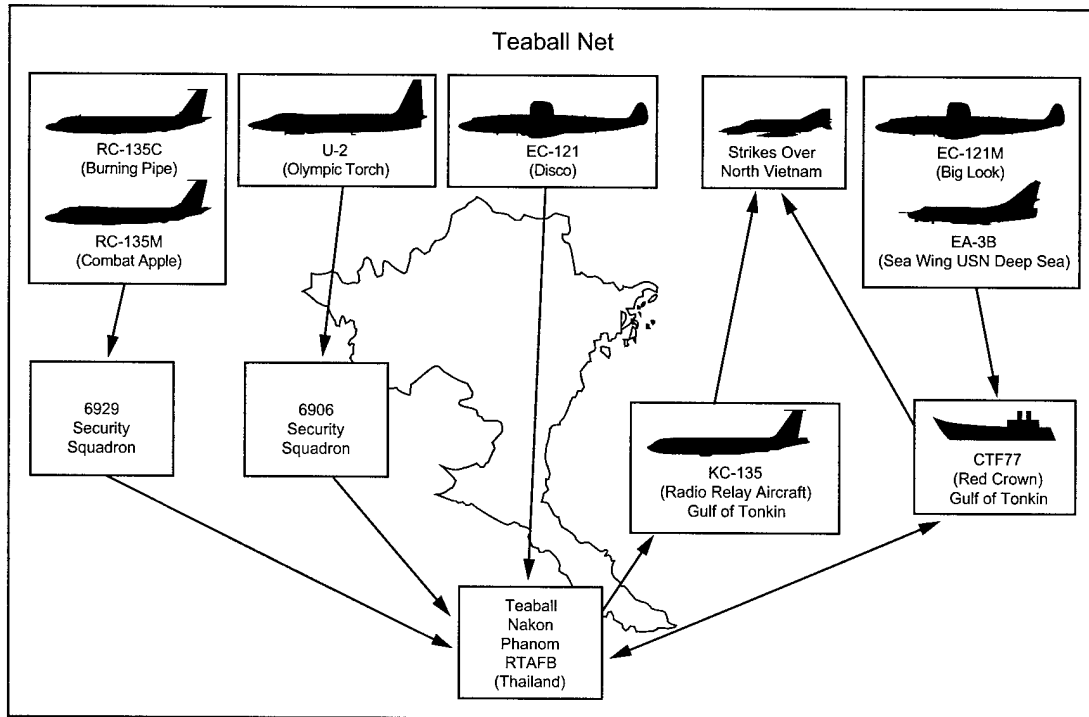

**Figure 7. The numerous feeds into “Teaball” provided the near real-time data necessary to defeat the North Vietnamese air force.** (Author’s depiction with graphic design assistance of Mr. Daniel Armstrong)

“Teaball” provided critical GCI assistance in 16 of the 59 air-to-air engagements during this period. From 29 July until the end of the war, U.S. aircraft shot down 30 MiGs while losing only 10 aircraft in air-to-air engagements. While other factors also contributed, General Vogt commented that “all these improvements did not work before “Teaball” but they all worked after ‘Teaball’.”<sup>58</sup> On 28 August 1972 “Teaball” helped Capt. Steve Richie in an F-4D score a kill on a MiG-21.<sup>59</sup>

Despite successes with “Teaball,” there were some shortfalls with the system. The intelligence information collated at “Teaball” enabled the weapons controllers to provide minute by minute plotting of North Vietnamese air force air activity. But the plots usually ran a few minutes late (usually 2 minutes), due to delays in passing the information from intelligence sources. Although near real-time, even one minute can be too late when aircraft have 1000-knot closing speeds. Aircrew debriefs state that “Teaball” information was most useful in providing the early tip-off of enemy activity but was not useful during engagements. Another problem with “Teaball” was reliance on a KC-135 radio relay aircraft to pass threat warning information; it proved to be the weak link in the network. The radio relay gear on board the KC-135 experienced frequent outages, and “Teaball”

<sup>58</sup> Gen. John W. Vogt Jr., Project CHECO Interview (conducted by Claude Morita, 12 November 1972); also “History of Linebacker Operations, 10 May 1972 – 23 October 1972” (Tan Son Nhut AB, Vietnam: Headquarters 7<sup>th</sup> Air Force, undated), pp. 68-69.

<sup>59</sup> “Red Baron III,” Vol. II, Part 2, pp. 99-102.

communications personnel spent weeks trying to obtain optimal frequencies.<sup>60</sup> The fact that a KC-135 radio relay system did not work is puzzling in light of the fact that SAC used a series of EC-135 variants to maintain a complex multiple node communications and datalink system over the U.S. for nuclear alert. These aircraft utilized some of the same equipment installed on "Luzon" radio relay aircraft.<sup>61</sup> Claims that this radio relay link was being disrupted by U.S. jamming aircraft were never substantiated.<sup>62</sup> An additional limitation was that the intelligence collection aircraft did not operate continuously in support of "Teaball." Even with those limitations, aircrew comments regarding "Teaball" information were generally positive. After the U.S. withdrew from active air operations in Vietnam, U.S. air operations over Cambodia were run from "Teaball" until after the *Mayaguez* rescue and the removal of U.S. forces from Thailand.

"Teaball" possessed another feature that assisted in planning air operations: the ability to replay engagements over North Vietnam. The radar plot data and intelligence data collected were stored on magnetic tape and this feature allowed air commanders to replay entire engagements or an entire day's flying. It also allowed the commander of the 7<sup>th</sup> Air Force to monitor Chinese border violations. But most important for aircrew, it allowed for post-mission analysis. All radar plots and SIGINT data could be displayed, thus permitting American planners to judge the tactics and engagement criteria of their North Vietnamese counterparts. This technical ability, now incorporated in most command and control systems, is vital in designing new and better air tactics against foes. The video replay feature also helped save lives; stored data allowed search and rescue coordinators to pinpoint downed airmen's positions, thus narrowing the search and response times to save shot-down crews.

Drone operations over North Vietnam, code named "Buffalo Hunter," were vital for the imagery and ELINT data they were able to bring back. These unmanned drones could fly over the most heavily defended targets in North Vietnam, saving aircrew and aircraft from such dangerous missions. Launched outside of North Vietnamese air space, the drones were controlled from a mother ship, a DC-130, and recovered in mid-air by CH-3 helicopters. "Teaball," using intercepted North Vietnamese COMINT, was able to prevent the interception of these drones by helping the drone control officer on board the DC-130 mother ship. Since neither "Red Crown" (U.S. Navy ship) nor "Disco" (USAF EC-121K) radars could track the drone as it flew over North Vietnam, "Teaball" command and control capabilities relied on intercepted COMINT for success of these missions.<sup>63</sup>

"Teaball" shows that intelligence support to mission execution was valuable and suggests obvious ways to apply it in the future. SIGINT operations incorporated into EC-

---

<sup>60</sup> "Radio Relay Operations" (376<sup>th</sup> Strategic Wing message 020700Z Oct 72) and "Radio Relay Backup Capability" (Headquarters 7<sup>th</sup> Air Force messages 051045Z Jan 73 and 051136Z Jan 73) detail some of the radio relay problems and the efforts undertaken to solve them.

<sup>61</sup> SAC flew a large number of EC-135s to command and control nuclear forces, but was unwilling to give up any of these aircraft during the Vietnam war, due to their SIOP commitment.

<sup>62</sup> See "Project Red Baron," Vol. III, Part 1.

<sup>63</sup> "Southeast Asia Tactical Data Systems Interface," Project CHECO (Hickam AFB: PACAF, 1 January 1975), p. 40.

121K operations and the weapons center significantly enhanced the ability of the tactical air control system to support the execution of tactical air operations over North Vietnam. However, the fact that "Teaball" was not established until 1972, in spite of earlier offers from the NSA, is difficult to understand, but perhaps can be attributed to the gradual escalation of the Vietnam War. A lack of understanding of intelligence systems and capabilities prevented the establishment of an effective SIGINT support system until U.S. losses over North Vietnam reached a painful threshold. But Vietnam did not end the problem for Air Force operators. Classification of post-Vietnam operational data prevents a candid review of all situations, but tidbits of after-action reports provide evidence that problems continue to exist.

### **A Post Vietnam Sample of the Problem**

Security considerations make it difficult to comment on or provide more than sketchy details on recent SIGINT support. However, one small example illustrates a lack of integration of SIGINT by the military. In 1986 the U.S. launched Operation EL DORADO CANYON against Libya. The USAF portion of the mission involved a nearly eight-hour flight from the United Kingdom to Libya by F-111 strike aircraft. During those eight hours and, in spite of the fact that a RC-135 was on station supporting the carrier task force off the coast of Libya, no updates were provided to the F-111s or EF-111s. Considering the fact that the purpose of the strike was to attack terrorist targets which are small and mobile, and that the strike force would face mobile surface-to-air missile batteries, eight hours is an awfully long time to go without updating your target intelligence.<sup>64</sup>

---

<sup>64</sup> James P. Marshall, "Near-Real-Time Intelligence on the Tactical Battlefield" (Maxwell AFB: AU Press, 1994), p. 42.

## Post-Vietnam and Analysis

The ability to move signals intelligence data to aircraft cockpits has existed since World War II. Without sophisticated electronic dissemination systems, 8<sup>th</sup> Air Force used British and USAAF Y intelligence data to defeat the Luftwaffe in 1944/45. During World War II the Radio Squadron Mobiles could decrypt vital data and pass information on to operational controllers in about 20 minutes. While not real-time by today's standards, these data were still fresh enough to allow the Air Force to prevail over or defeat large Luftwaffe concentrations. More importantly, the data allowed fighter-bombers to strafe valuable targets, thus contributing to the German defeat in France.

After great difficulty in starting SIGINT operations in Korea, the USAF finally did use COMINT to achieve a decisive edge in aerial combat in Korea. By the time the Cho-Do island operation began interception of SIGINT, data could be provided in minutes. This was vital since air combat was now in the jet age and took place in fleeting seconds rather than minutes.

In Vietnam twenty years later, "Teaball" could pass information faster, but aircrews in Project Red Baron reports after the war said what "Teaball" did was provide better warning times. Once combat got close, most pilots relied on "Disco," the EC-121 AWACS, or "Red Crown," the Navy radar picket ship, to assist in the kill. Nevertheless "Teaball" did reduce the appalling losses of previous months in the Vietnam air war. Project Red Baron was an Air Warfare Center study at Nellis AFB that documented all air-to-air encounters over North Vietnam and analyzed the data for tactics and doctrine improvements for the USAF fighter community. Begun during the Vietnam War, it was completed in 1975 and contains the comprehensive data base on air-to-air encounters.

The "green door syndrome," a belief that valuable intelligence should be kept from air force operators and decision makers, continues to haunt the Air Force and sister services. Bureaucratic politics, lack of understanding, and a blindness to the new battlefield -- especially when confronted with a shortened decision cycle -- have kept changes in intelligence data distribution to a minimum. The underlying problems of security clearance -- how much do you tell an operator, and do you compromise intelligence sources by revealing certain data -- have remained with the U.S. military until the present day. Efforts have been undertaken since DESERT STORM to increase the number of people cleared for SIGINT data, and new multi-level access intelligence systems are being developed to allow greater dissemination of the data. But bureaucratic struggles take time and results to date have been mixed.

As the three historical examples show, signals intelligence plays a crucial role in air operations, and technology continues to lead to further innovations in this field. Today intelligence data are passed directly to fighters via a secure data link and displayed in the cockpit on a "heads up" display. This allows the pilot to be kept apprised of his target

while flying his mission. But task saturation -- that is, the workload in single-seat aircraft -- and other technical and bureaucratic problems still need be solved. One solution is to let someone else on the datalink cue the pilot's weapons to the target. This, however, raises other problems such as bandwidth in current datalink technology.

A long-running problem that continues today is the compartmentalization of intelligence gathered on a daily basis, in order to protect the sources and methods of collection. Information must be sanitized, that is, stripped of information that indicates its source and origin, before the intelligence community will give it to the operational user. While a valid caution, this level of secrecy has fostered a feeling within the operational community that the "good stuff" is kept behind the green door.

An additional problem that hurt the Air Force most in Korea is the fact that linguists require a long time to train and that both the Air Force (and the other armed services) and the National Security Agency often do not have trained personnel in the right language when a crisis erupts. The lead time to train a linguist to do basic translation is usually a year to eighteen months. To train someone to do voice intercept with the level of proficiency required for a battlefield takes longer and probably cannot be accomplished while a conflict is ongoing, although the duration of the Vietnam War did allow linguists to be trained. Finding linguists for modern conflicts which are short in duration is a far greater challenge, if not impossible. Building a robust signals intelligence structure is an even greater challenge. Once the communication links are intercepted and translated, specialist personnel are required to fuse the data with other intelligence sources in order to make it useable by aircrews. These personnel must be trained in peace time. Some of these challenges were met by starting a series of Green Flag exercises at Nellis AFB akin to Red Flags, but they usually demonstrated shortcomings and were rarely used as vehicles to fix identified problems.

Precision strike and SIGINT targeting are some of the innovations that make SIGINT a dynamic force multiplier on the battlefield. Near-real-time processing of signals intelligence, particularly for use by weapons capable of striking beyond the range of organic sensors, is a new but effective use of SIGINT. While the shooter's organic sensors, may be incapable of providing sufficient targeting information the more capable intelligence sensors are under the control of different national intelligence organizations and are often not available for use by theater commanders. Targeting must be a combination of operations and intelligence assets working together. Decision cycles have gotten significantly smaller on the modern battlefield, with increased automation of command and control systems. SIGINT as the ears and, to a degree, the eyes of the commander must be responsive to these needs.

Speed in gathering, decrypting, and displaying data is vital for modern command and control systems. Aircrews in the future may fly several missions a day. There will be no time to do extensive target and threat study. The aircrew will have to rely on near-real-time intelligence to update situational awareness en route to the target area. Information on mobile targets must be passed to aircraft en route, and targeting data in turn passed via aircraft computer to stand-off weapons.

The primary reason for the delay in using tactical SIGINT in Korea and Vietnam was the national strategic-level focus of SIGINT collection during peacetime. The United States feared a nuclear surprise attack more than any other threat during the Cold War, thus virtually all intelligence resources were devoted to this issue. After each conflict, Korea and Vietnam, the signals intelligence community returned to examining the strategic threat. Budgetary cuts, and lack of foreknowledge of which third world conflict might require U.S. signals intelligence expertise, kept the U.S. signals intelligence organizations from making far-reaching changes until the end of the Cold War in 1989. Additional strains were a lack of familiarity and training with SIGINT by aircrews and commanders, and security restrictions on releasing SIGINT information. Both of these problems have not entirely disappeared.

It may seem trite, but we keep identifying the same lesson. No matter how good our intelligence product is, it is worthless unless we can get it to the commander in a timely manner and in a useable form. Timeliness of near-real-time intelligence data plays an even greater role on the 21<sup>st</sup> century battlefield. As the decision loops go from being man-centric to machine- or automation-centric, better, faster, quality data is required to allow aircraft and new weapons to attack and successfully destroy enemy targets. Commanders, command and control networks, and aircrews themselves require better, faster data in order to have situational awareness and to survive on the modern battlefield.

## Recommendations

1. Establish a better, more comprehensive training program and incorporate intelligence training, showing limitations and capabilities, in all levels of USAF training.
2. Establish a true multi-level user-friendly intelligence system with common data bases to allow all Air Force operational personnel access to intelligence data. The intelligence community also needs to establish data bases which will merge with Air Force planning systems. Eliminate overlapping and redundant systems.
3. Redraft charters of national-level intelligence agencies to reflect national and strategic commitments, and wartime tactical missions. "Support to military operations" sounds like and frequently means "no-support today GI."
4. Redraft intelligence support plans so that SIGINT plays the key role that it can and should play in military operations, especially for future weapons systems.
5. Play SIGINT wargames in ACSC/AWC level schools and model SIGINT futures in Title 10 wargames.
6. Enhance operators' knowledge of intelligence through a user's book that is unclassified to allow widest distribution. Restrictive manuals tend not to get read or consulted.
7. Improve education and guidance to intelligence personnel on the best way to conduct intelligence operations. Behind the "green door" no longer works.
8. Develop and refine doctrine to allow intelligence personnel and operators to work simultaneously in supporting air operations.
9. Increased collection capabilities require more analytical support, and qualified linguists to meet 21<sup>st</sup> century contingencies.



## *Acknowledgements*

A number of individuals made this study possible. At the Airpower Research Institute, I would like to thank Col. Al Howey, Lt. Col. Eric Ash, Maj. Mark Grandstaff, Dr. Jim Titus, Dr. Lee Dowdy, Dr. Dan Mortensen, and Dr. Ken Werrell. Ms. Cathy Parker and Ms. Tawanda Eaves provided critical support in editing and illustrating the manuscript. Mr. Daniel Armstrong at the Air University Press provided exceptional graphic support. Dr. Dianne Putney from OSD/HO provided me with a copy of her research into World War II SIGINT, and Mrs. Mary Silverstein, wife of Maj. Ted Silverstein, who was the operations officer of the 3<sup>rd</sup> RSM (G) in World War II, graciously provided her husband's papers to make this research possible.

My research was aided by Mr. Milton Steele and Mr. Joe Craver of the Air Force Historical Records Agency. The interlibrary loan staff at Air University Library headed by Ms. Edith Williams was immensely helpful in obtaining countless books and magazines.

Most of all, this study was made possible by the support of my family: Sheila-Llyn, Viktoria, and Alexandra.

## **The Author**

Captain Gilles Van Nederveen is Associate Editor of the *Aerospace Power Journal* at Maxwell AFB. A career intelligence officer, his previous assignments included RC-135, E-8, and EC-130 flying tours. In addition to having served as an airborne intelligence officer, he has also served as a political-military affairs officer, signals and imagery analyst, and test engineer.

*Air University*

**Donald A. Lamontagne, Lieutenant General, USAF, Commander**

*College of Aerospace Doctrine, Research and Education*

**Bobby J. Wilkes, Colonel, USAF, Commander**

*Air Power Research Institute*

**James R. W. Titus, PhD, Dean of Research, Air University**

**Allan W. Howey, Colonel, USAF, Director**