

Vehicle Electronic Architecture

Rakesh Patel

Electronic Architecture Team

Email: patelrak@tacom.army.mil
(810) 574-5188 / DSN 786-5188
Fax (810) 574-5008

U.S. Army Tank-Automotive RD&E Center (TARDEC)
Vetronics Technology Area
(AMSTA-TR-R, Mailstop 264)
Warren, MI 48397-5000

30 May 2001

UNCLASSIFIED

Tank-automotive & Armaments COMmand

Report Documentation Page

Report Date 30May2001	Report Type N/A	Dates Covered (from... to) -
Title and Subtitle Vehicle Electronic Architecture	Contract Number	
	Grant Number	
	Program Element Number	
Author(s) Patel, Rakesh	Project Number	
	Task Number	
	Work Unit Number	
Performing Organization Name(s) and Address(es) U.S. Army Tank-Automotive RD&E Center (TARDEC) Vetronics Technology Area (AMSTA-TR-R, Mailstop 264) Warren, MI 48397-5000	Performing Organization Report Number	
Sponsoring/Monitoring Agency Name(s) and Address(es) NDIA (National Defense Industrial Association) 211 Wilson Blvd, STE. 400 Arlington, VA 22201-3061	Sponsor/Monitor's Acronym(s)	
	Sponsor/Monitor's Report Number(s)	
Distribution/Availability Statement Approved for public release, distribution unlimited		
Supplementary Notes Proceedings from the 2001 Vehicle Technologies Symposium - Intelligent Systems for the Objective Force, 29-31 May 2001 Sponsored by NDIA		
Abstract		
Subject Terms		
Report Classification unclassified	Classification of this page unclassified	
Classification of Abstract unclassified	Limitation of Abstract UU	
Number of Pages 21		



Outline

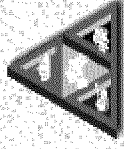

- TARDEC Vetronics Architecture - History
- VTT System Architecture
 - ▶ Data Distribution
 - ▶ Power Management & Distribution
- VTT Hardware Architecture
 - ▶ Crew Vetronics Station
 - ▶ Drive Vetronics Station
 - ▶ Video Distribution
- VTT Software Architecture
 - ▶ Context and Level 1 DFD
 - ▶ GOA Model - Application/System Services Layer
 - ▶ GOA Model - System Services Layer & Below
- Lessons Learned



TARDEC Vetronics Architecture - History

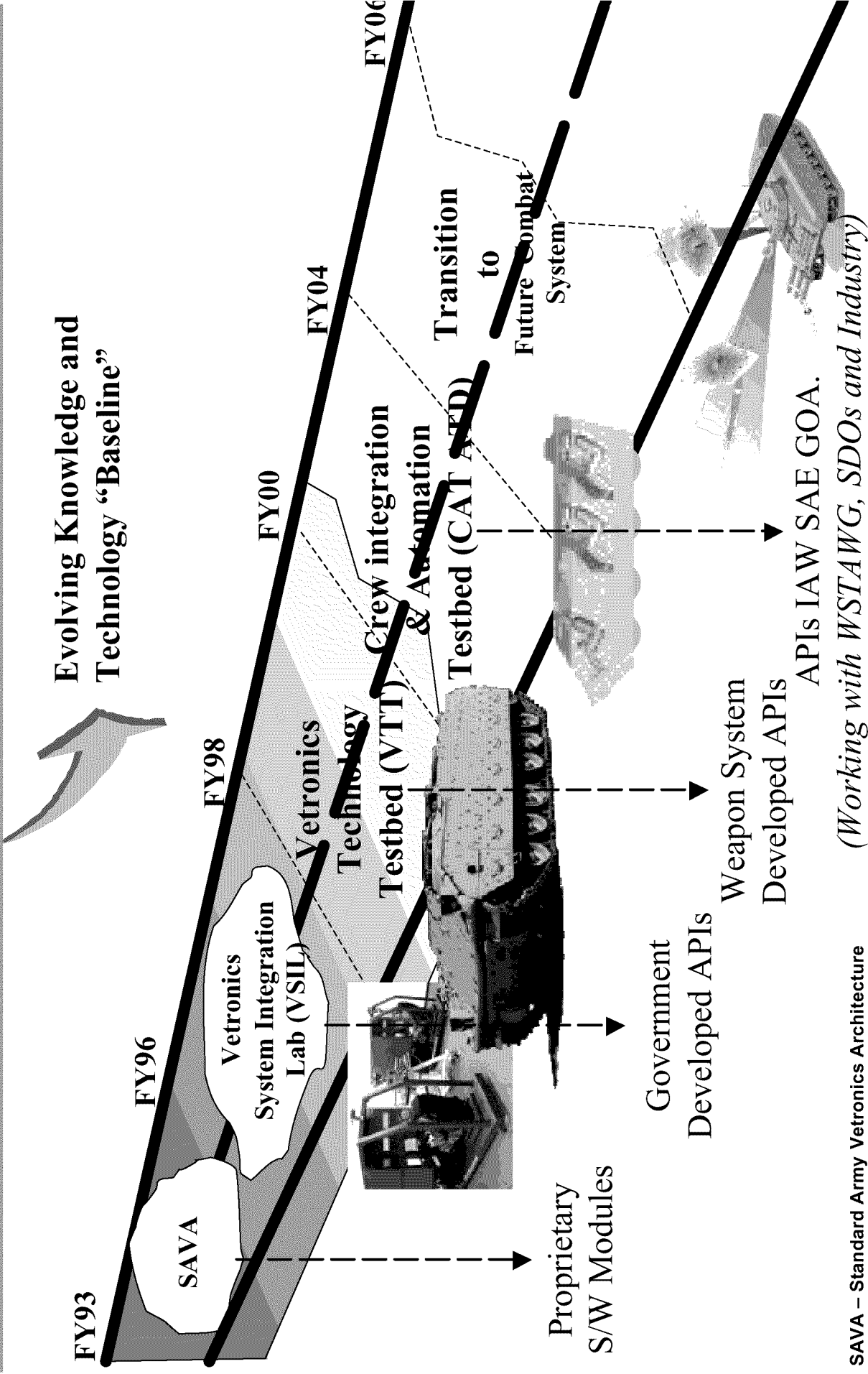
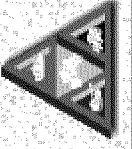

SAVA – Standard Army Vetronics Architecture
 SDO – Standards Development Organization
 WSTAWG – Weapon System Technical Architecture Working Group

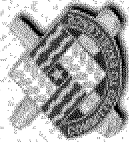

VTT System Architecture Design Process

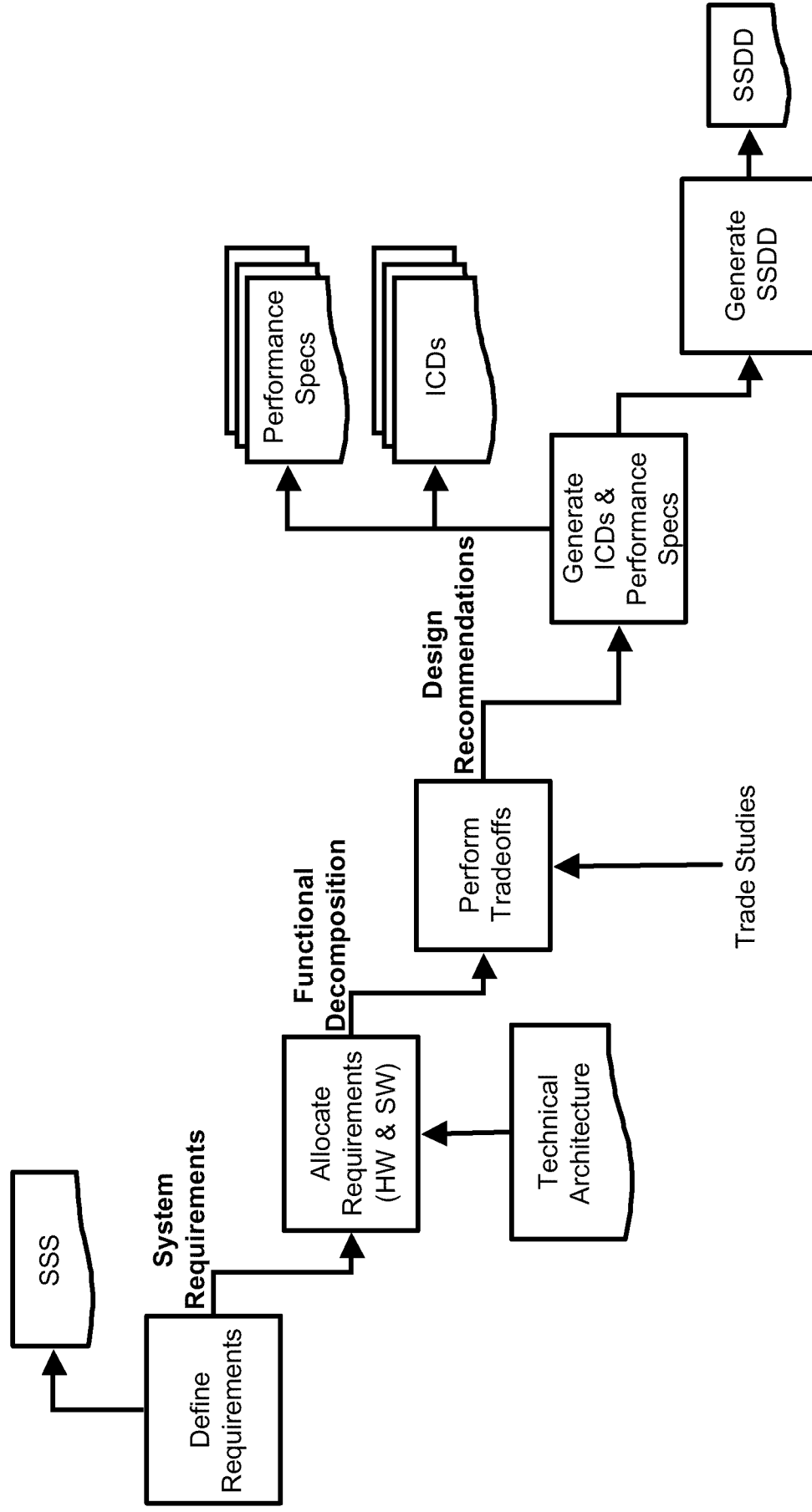
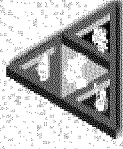



VTT System Architecture

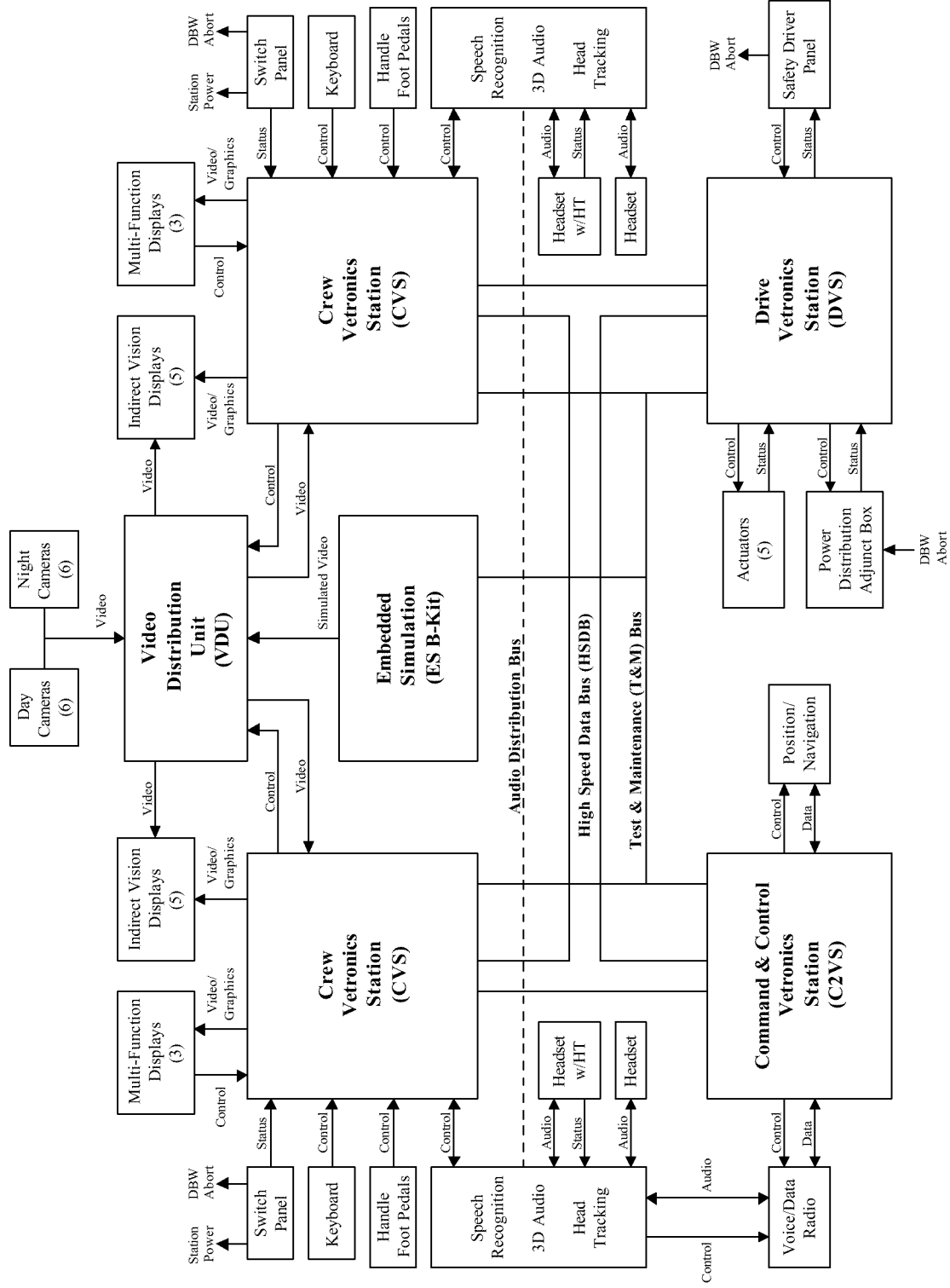
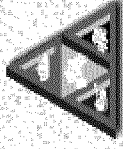



VTT System Architecture Data Distribution Block Diagram

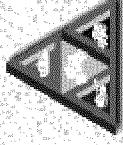

Includes High Speed Data Bus (HSDB) and Test and Maintenance (T&M) Bus.

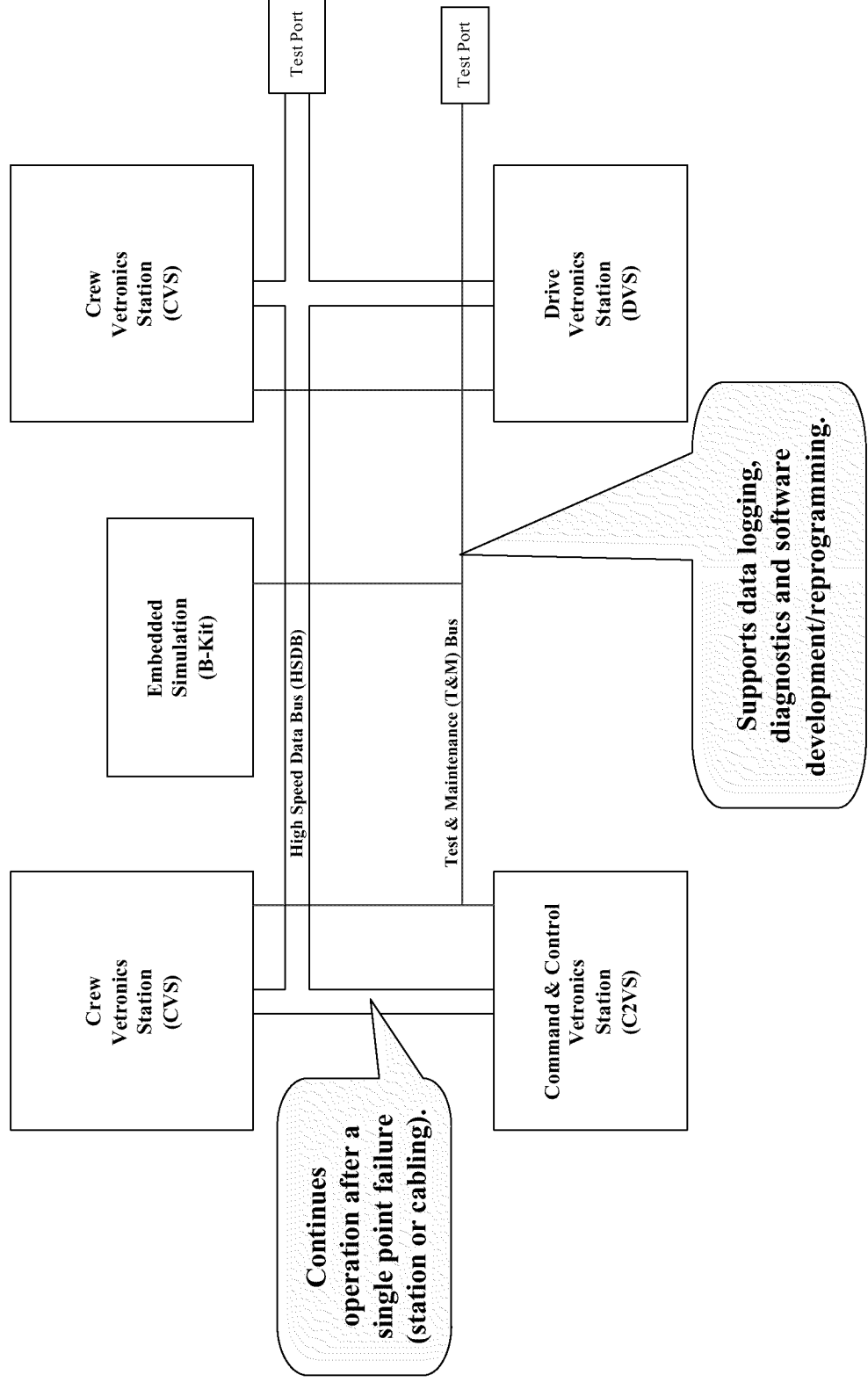



VTT System Architecture Data Distribution Candidates

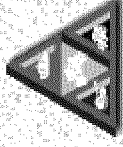

Candidate	Standard	Data Rate	Study/Drop	Justification
Linear Bus				
1553	MIL-STD-1553	1 Mbps	Drop	Too Slow
SAE 1773	SAE AS1773	20 Mbps	Drop	Too Slow
Collision Sensing				
Ethernet	IEEE 802.3	10 Mbps	Drop	Too Slow, Non-Deterministic
Fast Ethernet	IEEE 802.3u	100 Mbps	Drop	Non-Deterministic
Gigabit Ethernet	IEEE 802.3z	1 Gbps	Drop	Still Evolving
Token Bus				
IEEE Token Bus	IEEE 802.4	10 Mbps	Drop	Too Slow
LTPB	SAE AS4074	50/100 Mbps	Drop	Fiber Implementations Only
Token Ring				
IEEE Token Ring	IEEE 802.5	4/16 Mbps	Drop	Too Slow (SAVA)
FDDI	ISO 9314	100 Mbps	Study	Deterministic, Fault Tolerant
HSRB	SAE AS4075	100 Mbps	Drop	No available products
VNet	VSO VITA 21	24 Mbps	Drop	Too Slow, Discontinued
New Technology				
ATM	ATM Forum	155 Mbps	Study	Deterministic
Fibre Channel	ANSI X3	100/800 Mbps	Study	Deterministic, Fault Tolerant

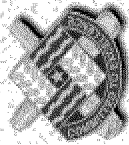

VTT System Architecture Data Distribution

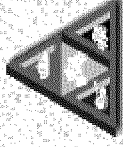

Characteristic	FDDI	ATM	Fibre Chanel
Standardization	ISO 9314-x	ATM Forum	ANSI X3
Topology	Ring	Switched	Looped
Media Access Control	Token Passing	Switched Fabric	Arbitrated Loop
Redundancy Features	Dual Counter-	Redundant switches	Dual Counter -
	Rotating Rings		rotating Loops
	Bypass Switches		Bypass Switches
Data Rate	100 Mbps	155 Mbps	100/800 Mbps
Signal Rate	125 Mbps	155 Mbps	125/1000 Mbps
Data Encoding	4B/5B NRZI	NRZ	8B/10B
Message Overhead	224 bits Max	5 Bytes	288 bits Max
Data Packet Size	1 to 4500 Bytes	48 Bytes	0 to 2112 Bytes
Error Checking	32-bit CRC	32-bit CRC	32-bit CRC
# of Nodes	500 Max	Switch Dependent	Loop, 127 ports
Addressing Modes	Individual	Individual	Individual
	Multicast	Multicast	Multicast
	Broadcast	Broadcast	Broadcast
Supported Media	Fiber/Copper	Fiber/Copper	Fiber/Copper
Price	\$8,550	\$8,000	\$4,500
Availability	24 Weeks	16 weeks	22 weeks (Jan 99)
Notes:	Rejected	Rejected	Selected
	Second Choice	Third Choice	Meets Requirements



VTT System Architecture PM & Distribution Block Diagram

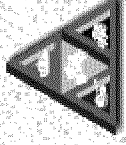

Provides the crew and subsystems the capability to control, monitor and protect electrical loads.

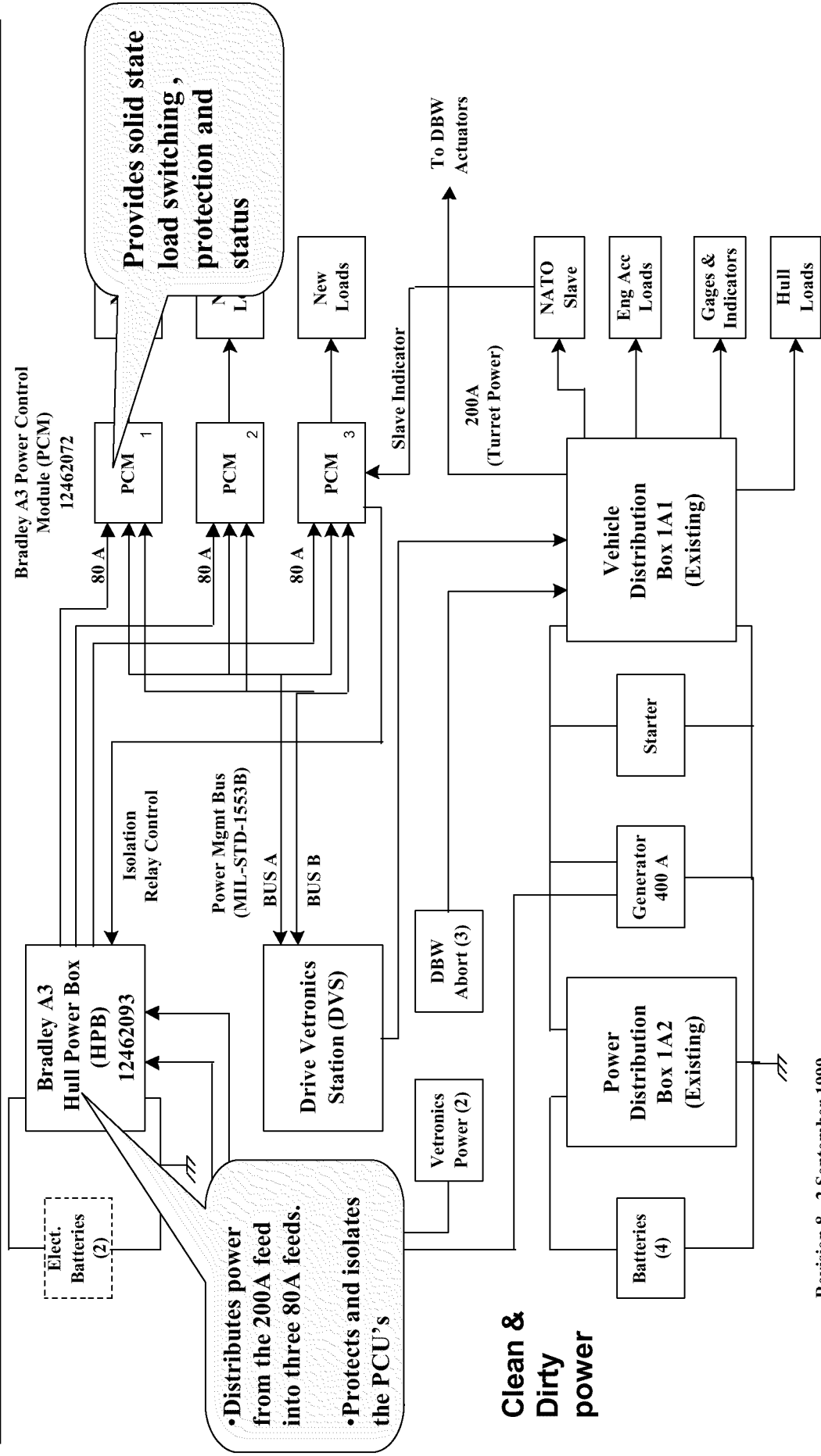

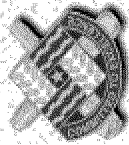

VTT System Architecture Power Control Module

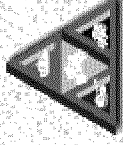

PCM Characteristics	PCM Option #1	PCM Option #2	PCM Option #3
Standardization	Mil-Std-461 & 1275	Mil-Std-461 & 1275	Mil-Std-461 & 1275
Load Control & Status	Yes	Yes	Yes
Overload Protection	Yes	Yes	Yes
Master Power Override	Yes	No	No
Built in Test (BIT)	Yes	Yes	Yes
Switch Control Type	Solid State	Solid State	Solid State
Input Voltage	28 Volts DC	28 Volts DC	28 Volts DC
Input Current	80 Amps	80 Amps	80 Amps
Grounding	Separate Returns	Separate Returns	Separate Returns
Bond	Yes	Yes	Yes
Number of Outputs	10	10	11
Output Load Range	5 to 25A ⁽¹⁾	1 to 25A ⁽²⁾	2 to 25A ⁽²⁾
Serial Interface Type	EIA RS-485 ⁽³⁾	Mil-Std-1553 ⁽¹⁾	Utility Bus / RS-485 ⁽¹⁾
Redundant Serial Bus	Yes	Yes	Yes
Automatic Reset	Yes	No	Yes
Cable Continuity Detection	Yes	Yes	Yes
Unit Cost Est.	\$30K ⁽²⁾	\$10K	\$7,250
Delivery	26 weeks	26 weeks	26 weeks
Notes:			
	Meets All Requirements	Meets All Requirements	⁽¹⁾ Will require UB PMC or IP
	High Cost	⁽¹⁾ Will require 1553 PMC or IP	Proprietary protocol
	⁽¹⁾ (6) 5A, (1) 10A, (3) 25A		
	⁽²⁾ Estimated cost		
	⁽³⁾ One RS232 port	⁽²⁾ (1) 2A, (4) 7A, (2) 15A, (3) 25A	⁽²⁾ (6) 7A, (3) 15A, (1) 25A

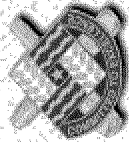

VTT Hardware Architecture Crew Vetronics Station (CVS)

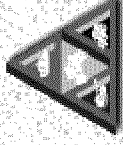

Provides the capability for Soldier machine interface

Communicates to other devices via the High Speed Data Bus (Fibre Channel)

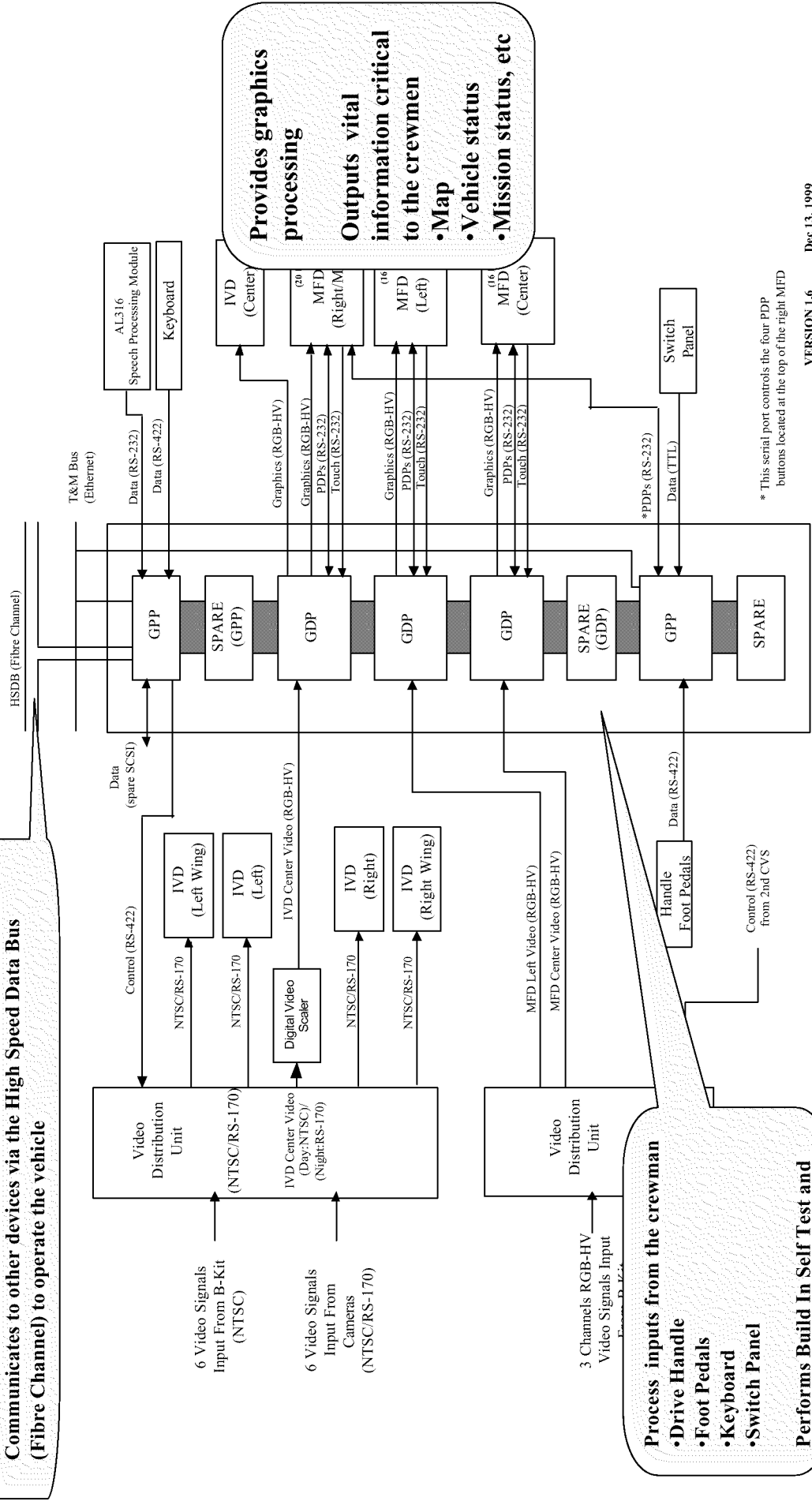

* This serial port controls the four PDP buttons located at the top of the right MFD

VERSION L-6

Dec 13, 1999

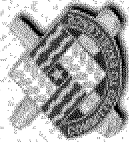

VTT Hardware Architecture CVS GPP

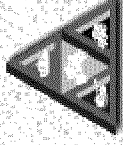

Characteristic	GPP Option #1	GPP Option #2	GPP Option #3
Processor Type	PowerPC G4 @ 366 Mhz	PowerPC 750 @266Mhz,	Pentium II @ 266MHz
Dram Size	256 Mbyte SDRAM,	64 Mbyte DRAM,	128 Mbyte SDRAM
Cache Size / Type	2Mbyte L2 cache,	1 Mbyte L2 cache,	512 Kbyte L2 cache,
Flash Size	48 Mbyte Flash,	16 Mbyte Flash,	1 Mbyte Flash,
Non-Volatile Memory	32 K NOVRAM,	512K EEPROM,	24 Mbyte Disk on Chip
Ethernet Type	10/100 Base T	Fast	10/100 base T
SCSI Type	SCSI-2,	Ultra SCSI,	SCSI-2
Serial Interface	4 serial ports,	4 serial ports,	4 serial ports
I/O Support	12 bit discrete I/O	mouse, keyboard, floppy &, parallel ports,	parallel port, USB, SVGA, IDE
PMC Support	2 PMC sites	2 PMC sites	2 PMC sites
Built in Test (BIT)	Yes	Yes	Yes
Temperature	(-40 to 71 degree C)	(-50 to 85 degree C)	(-40 to 71 degree C)
Shock	40 g, half sine 11 ms	20 g, half sine 11 ms	40 g, half sine 11 ms
Vibration	10 g, 15 to 2KHz	2g, 10 to 500 Hz	10 g, 15 to 2KHz
Unit Cost Est.	\$ 14,000.00	\$ 14,943.00	\$ 10,120.00
Delivery	22 weeks	no commitment	
Notes:	Selected	Rejected	Rejected
	1) meets all requirements	1) Fibre Channel not supported	1) no software legacy
	2) software legacy	2) no discrete port	2) no discrete port
		3) mem expansion PMC site only	

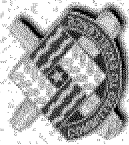

VTT Hardware Architecture

CVS GDP

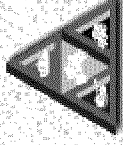

Characteristic	GDP Option #1	GDP Option #2
Processor Type	C-80 processor @40 Mhz	C-80 processor @60Mhz
VRAM Size	8MB	4MB
Video Output	2 RGB	1 RGB
Output Standard	RS-170, RS-343, RS-330	RS-170, RS-343
	VESA up to 1600x1200	1600x1280 @76 Hz
Video Input	RS-170, RGB, PAL	Monochrome, RGB, PAL
	NTSC	NTSC
Video Overlay	Frame grabber, analog	Frame grabber, analog
Serial Interface	2 RS-423	2 RS-423
I/O Support	None	Keyboard & Mouse (PS2)
Built in Test (BIT)	Yes	Yes
Temperature	(-40 to 71 degree C)	(-50 to 85 degree C)
Shock	40 g, half sine 11 ms	20 g, half sine 11 ms
Vibration	10 g, 15 to 2KHz	2g, 10 to 500 Hz
Unit Cost Est.	\$26,860.00	\$26,843.00
Delivery	24 weeks	24 weeks
Notes:	Selected:	Rejected:
	Two independent video channels	one single video channel

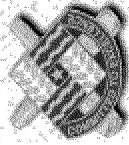

VTT Hardware Architecture CVS Chassis

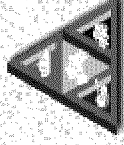

Characteristic	Chassis Option #1	Chassis Option #2	Chassis Option #3
Number of slots	8 slots	7 slots	8 slots
VITA 1 & 1.1 compliant w/5 row P0, P1, & P2	yes	non-standard P0	yes
IEEE 1101.2 form factor	yes	yes	yes
Configurable back-plane to I/O panel interface	yes	yes	yes
Configurable I/O panel	yes	yes	yes
28 VDC Input Power	yes	yes	yes
Power Supply	158.5 watt	225 watt	250 watt
Temperature	(- 40 to 85 degree C)	(-55 to 85 degree C)	(-55 to 75 degreeC)
Humidity	0 to 100%	0 to 95%	0 to 95%
Shock	20g, 11ms, half sine	MIL-STD-810E (516.3)	20g, 11ms
Vibration	0.1g2/Hz, 15 to 2000 Hz	MIL-STD-810E (514)	0.1g2/Hz, 15 to 2000 Hz
Unit Cost Est.	\$26,500	\$29,500	\$39,086
Delivery	24 weeks	26 weeks	26 weeks
Notes:	Selected meet all requirements	Rejected non-standard P0	Rejected price

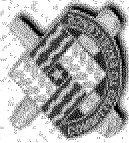

VTT Hardware Architecture Drive Vetronics Station (DVS)

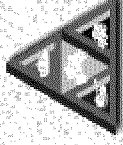

Provides primary interface between the VTT crewstations and the Drive-By-Wire Subsystem

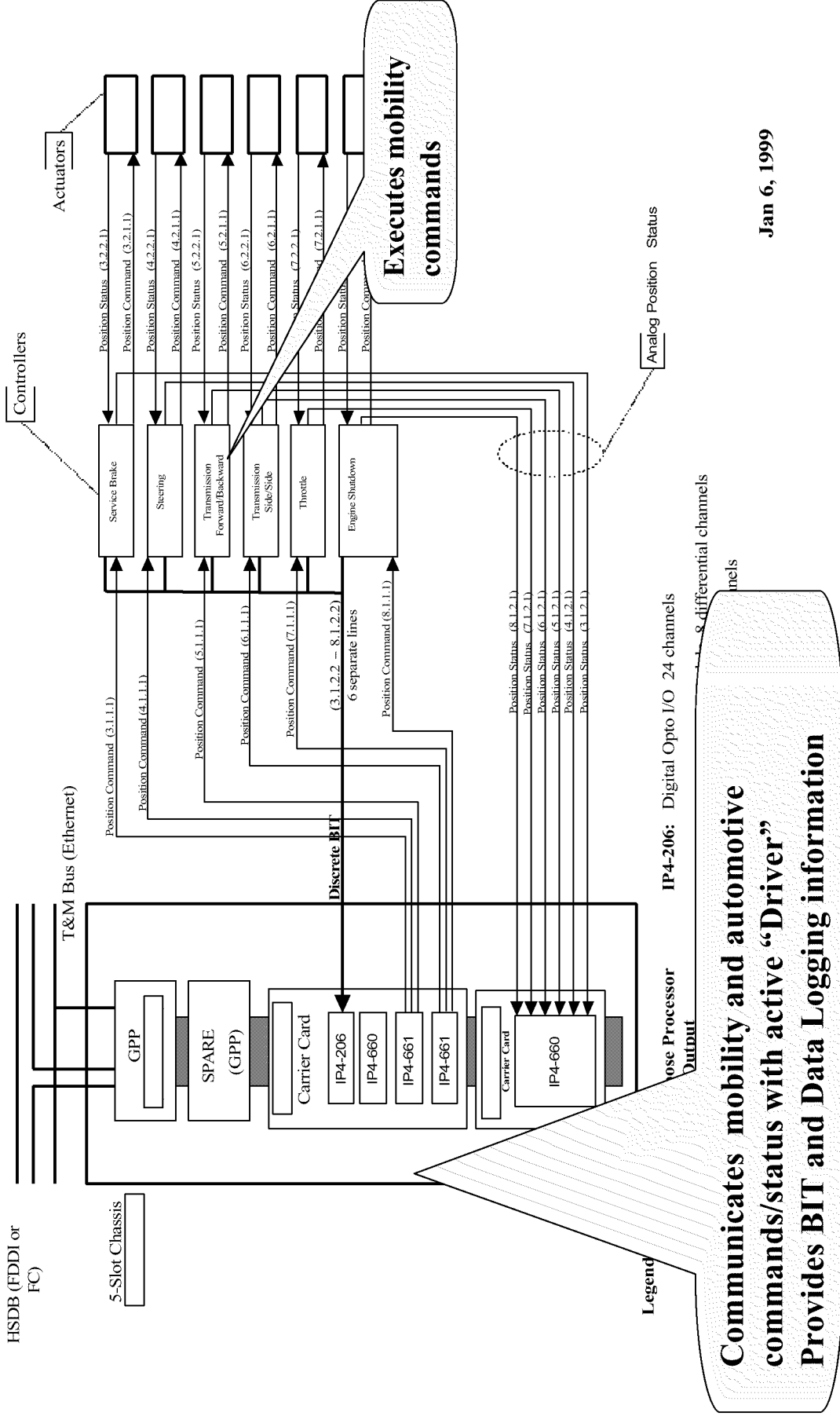

Jan 6, 1999



VTT Hardware Architecture Video Distribution Diagram

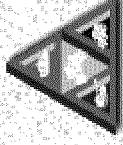

Provides the capability to distribute live and simulated video from cameras, FLIRs, and B-Kit to Crew Station IVDs, and MFDs.

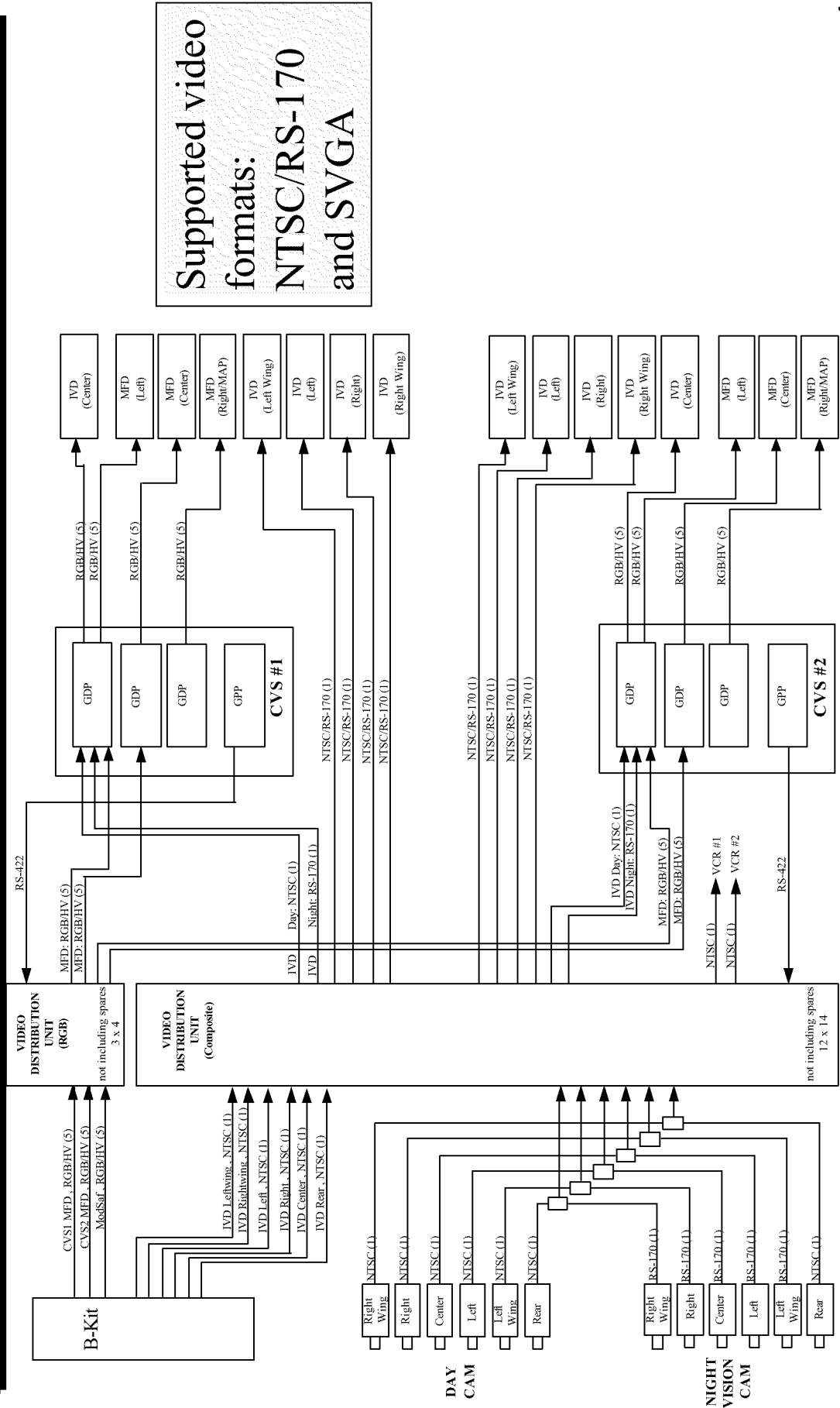

**Supported video formats:
NTSC/RS-170
and SVGA**



VTT Hardware Architecture VDU

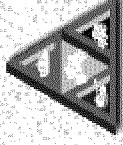

Characteristic	VDU		
	Option #1	Option #2	Option #3
Switch Matrix 24x26 min (18x14 NTSC, 6x12 SVGA)	32x32		
Video formats	NTSC, RS-170, SVGA	2x(16x16 NTSC), 8x16 SVGA NTSC,RS-170,SVGA	23x16 NTSC, 6x12 SVGA NTSC,RS-170, SVGA
Active Switching	yes	yes	no
Switch Element	solid state	solid state	solid state
Bandwidth	DC - 120 MHZ	DC - 125 MHZ	DC - 100 MHZ
75 ohms I/O interface	yes	yes	yes
Control	RS-232, GPIB	RS-232, RS-422, GPIB	RS-232, RS-422
Dimension (HxWxD)	4 each, 3.5"x19"x16"	8.72"x19"x20"	8.73"x19"x17"
Power requirement	120 VAC	120 VAC	120 VAC
Mounting	Rack mount	rack mount	rack mount
Weight	n.a.	n.a.	5 lb
Temperature	0 to 70 degree C	0 to 60 degree C	0 - 60 degree C
Shock	n.a.	n.a.	
Vibration	n.a.	n.a.	
Unit Cost	\$15,360.00	\$10,600.00	\$8,000.00
Engineering Cost	0	0	\$3,750.00
Delivery	8 weeks	8 weeks	
Notes: All data shown are commercial grade, decision is not final on which vendor			



VTT Software Architecture Context and Level 1 DFD

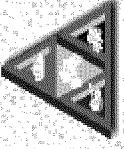

VTT Context Diagram

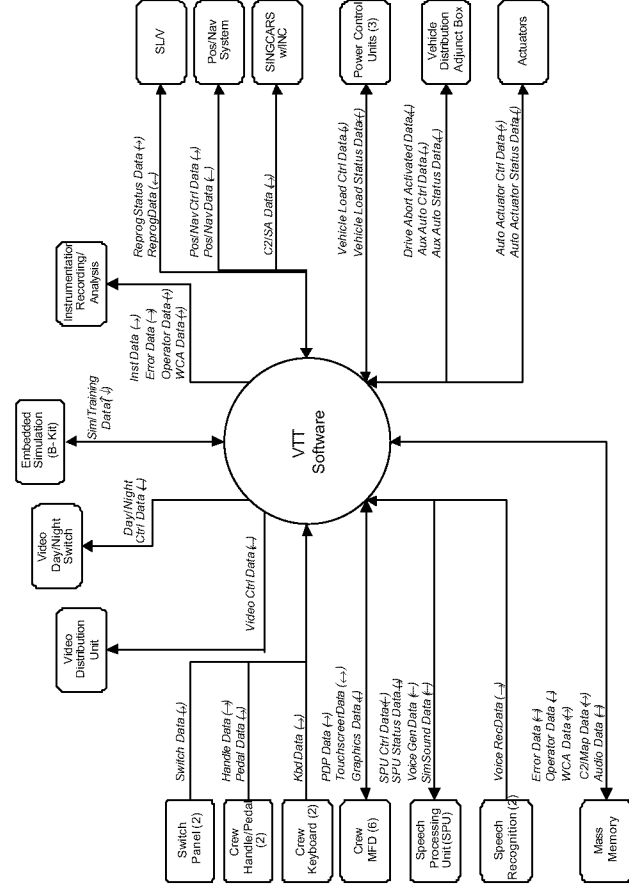

VTT Level 1 DFD

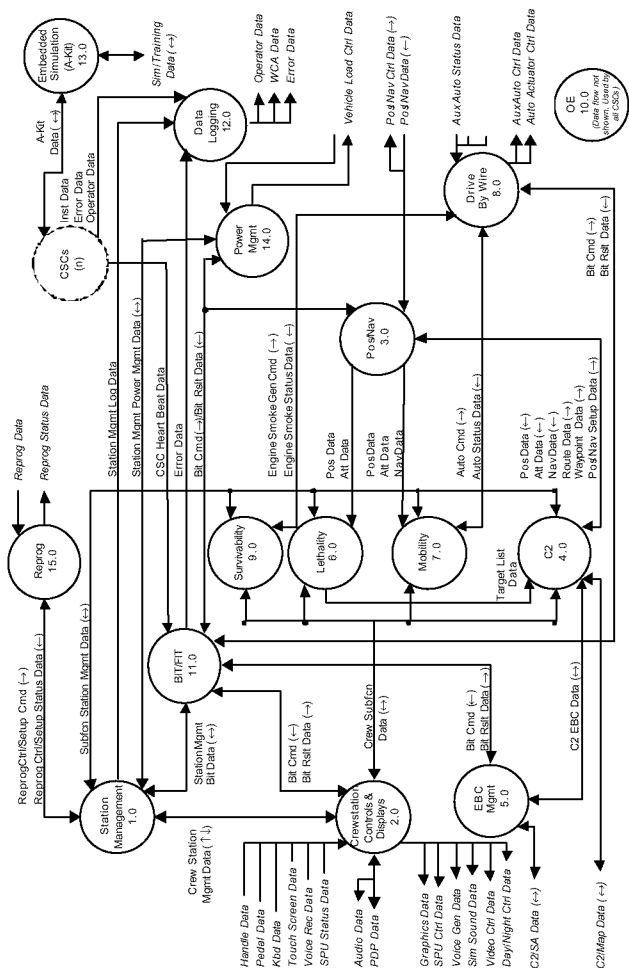



VTT Software Architecture

GOA Model – Application/System Services Layer

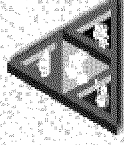

CVS (2)

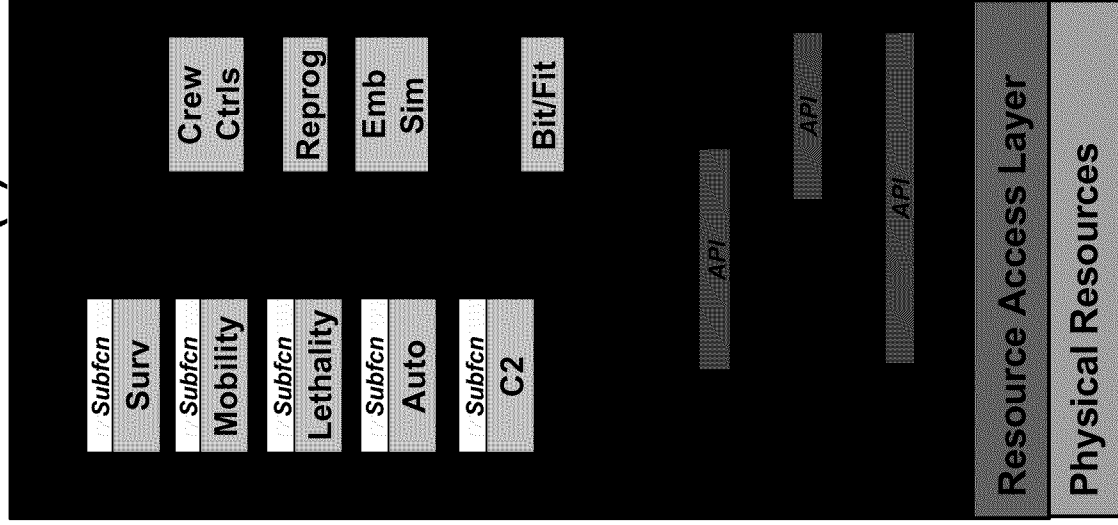

C2VS

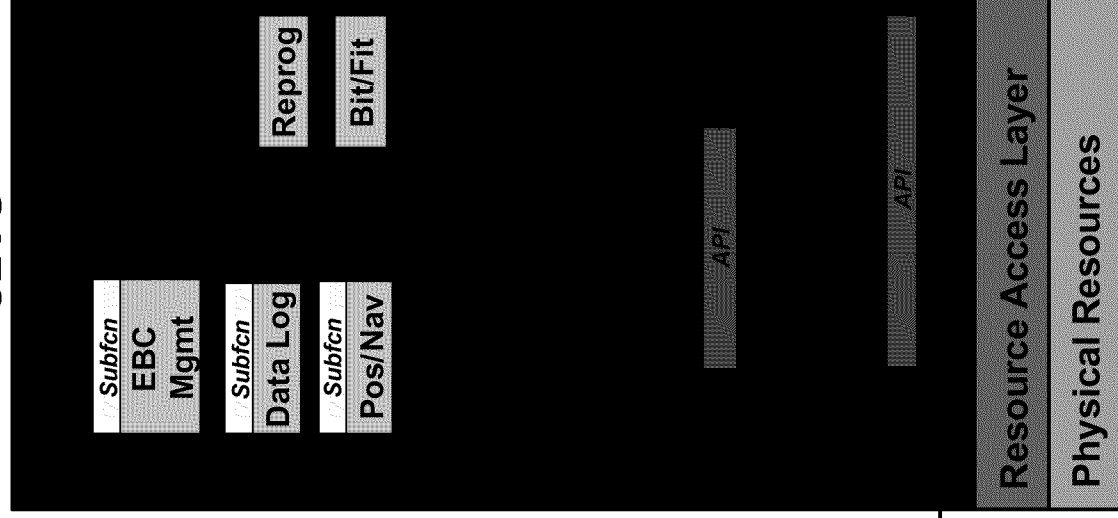

DVS

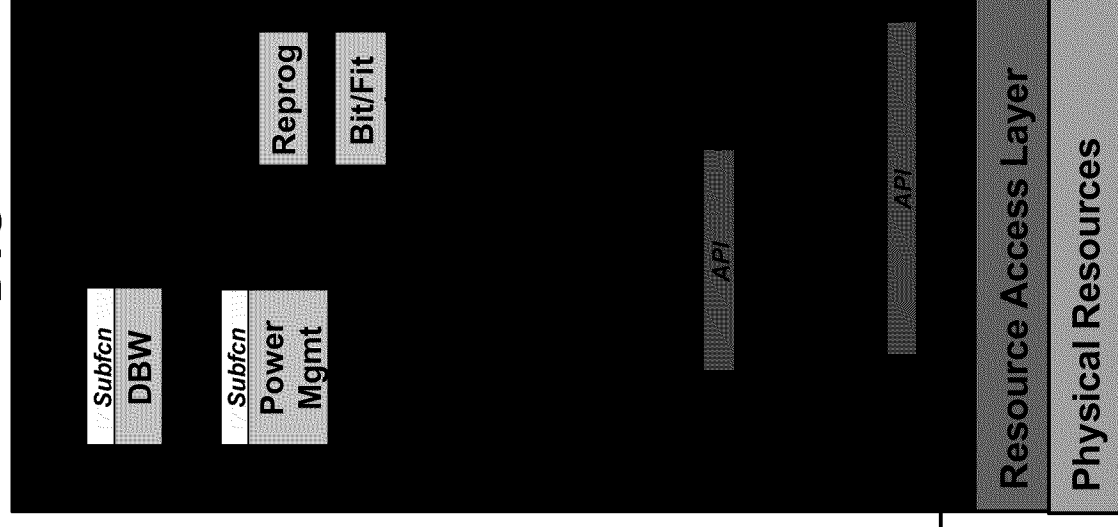



VTT Software Architecture

GOA Model – System Services Layer & Below (CVS)

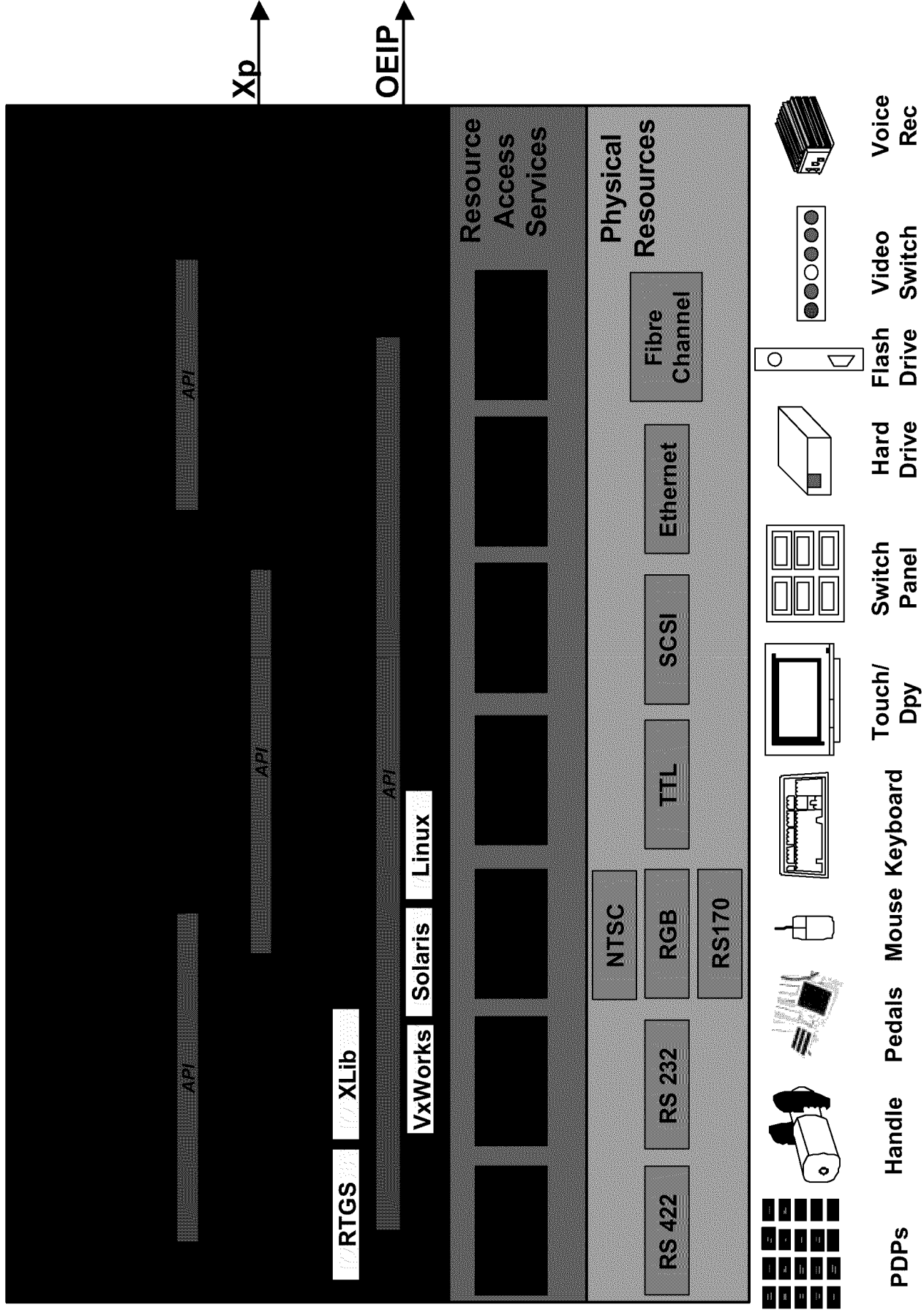
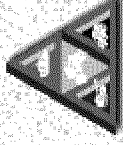

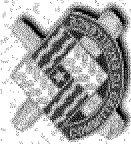

TARDEC Vetronics Architecture - Lessons Learned

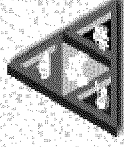

- Architectures will evolve, specify to utilize well established open standards.
- Focus on interfaces, don't mandate implementations/products (especially proprietary).
- Don't be trapped by current hw limitations (provide flexibility where possible).
- Provide traceability from APIs to defined system requirements.
- Define APIs/middleware to isolate dependencies, ease porting, and delay hw buys.
- Define APIs/middleware to be "thin" in order to map to a variety of implementations.
- Define APIs/middleware such that they can be replaced by emerging standards as they mature and are accepted by industry and DoD.
- Design APIs for reuse and interoperability (define physical/logical interfaces).
- Design APIs for testability (carry through conformance/validation requirements).
- Don't lock into specific paradigms (e.g. patterns, languages, methodologies).
- Include industry, academia, and standards bodies to the degree possible when defining new APIs and/or middleware.