



Marine Corps Systems Command



National Defense Industrial Association

Joint Services Small Arms Section

Annual Conference

LtCol Jim Diehl, USMC

Report Documentation Page

Report Date 13Aug2001	Report Type N/A	Dates Covered (from... to) -
Title and Subtitle National Defense Industrial Association Joint Services Small Arms Section Annual Conference	Contract Number	
	Grant Number	
	Program Element Number	
Author(s) Diehl, Jim	Project Number	
	Task Number	
	Work Unit Number	
Performing Organization Name(s) and Address(es) USMC	Performing Organization Report Number	
Sponsoring/Monitoring Agency Name(s) and Address(es) NDIA (National Defense Industrial Association) 211 Wilson Blvd, STE. 400 Arlington, VA 22201-3061	Sponsor/Monitor's Acronym(s)	
	Sponsor/Monitor's Report Number(s)	
Distribution/Availability Statement Approved for public release, distribution unlimited		
Supplementary Notes Proceedings from the 2001 Joint Services Small Arms Symposium, Exhibition & Firing Demonstration 13-16 August 2001 Sponsored by NDIA		
Abstract		
Subject Terms		
Report Classification unclassified	Classification of this page unclassified	
Classification of Abstract unclassified	Limitation of Abstract UU	
Number of Pages 28		



GROUND WEAPONS DIRECTORATE



MISSION

**Plan for and execute the approved plans for all Research,
Development, Acquisition, Fielding, and Life Cycle
Support for assigned equipment and weapon systems**



GROUND WEAPONS DIRECTORATE



<u>Projects</u>	I	II	III	IV & BELOW	TOTAL
ACAT					
USMC	1			51	52
JT/USMC				4	4
<u>JT/OTHER</u>	<u>1</u>	<u>4</u>	<u>10</u>	<u>25</u>	<u>40</u>
TOTAL	1	4	11	80	96

Funding and Personnel

<u>FUNDING</u>	<u>STAFFING</u>
R&D \$41 M/YEAR	28 OFFICERS
PMC \$221 M/YEAR	15 ENLISTED
O&M \$4.0 M/YEAR	<u>48 CIVILIAN</u>
	91 TOTAL



GROUND WEAPONS DIRECTORATE

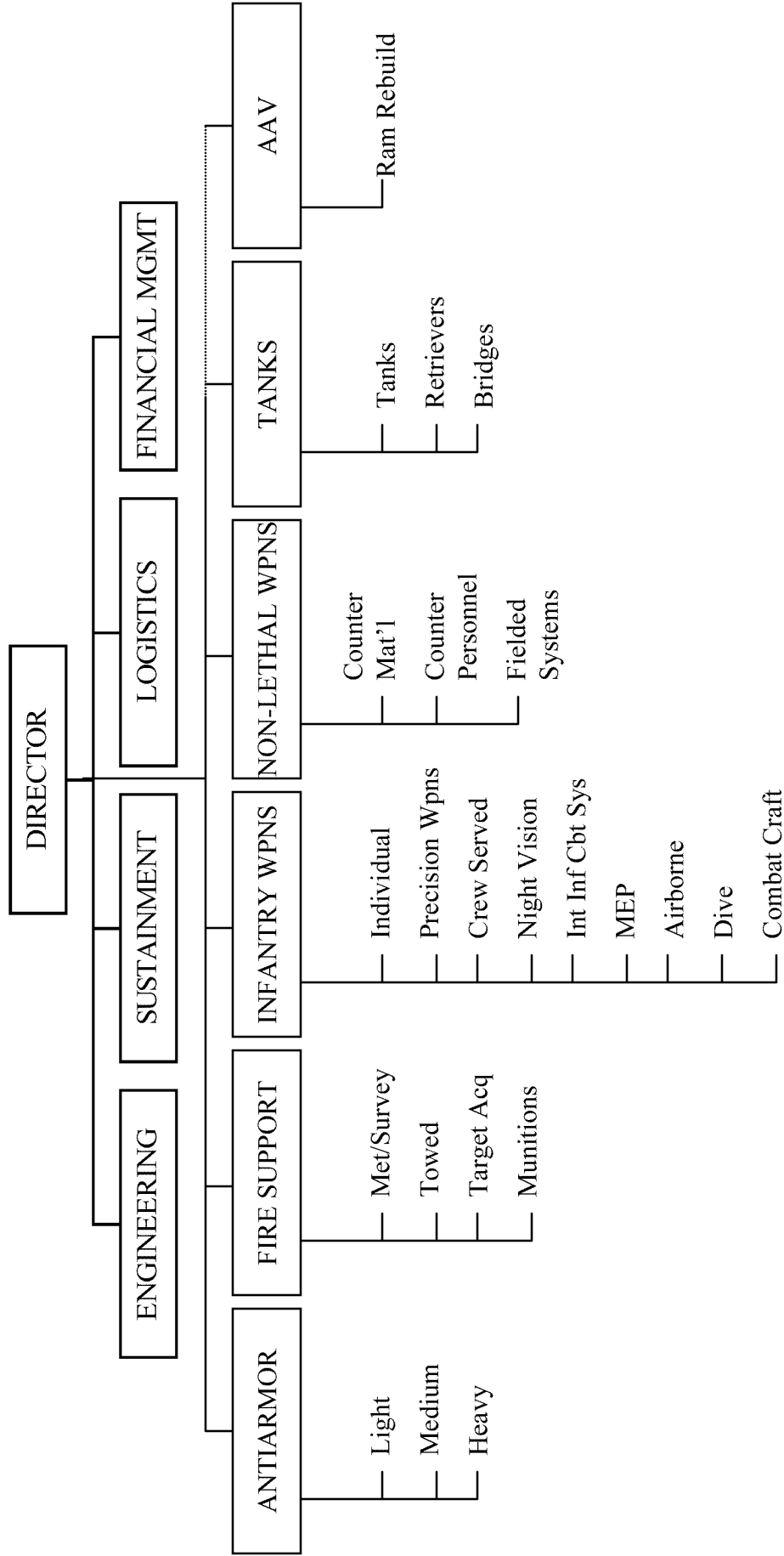
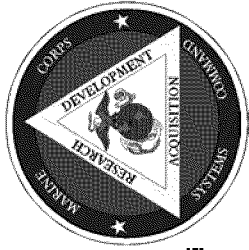



GROUND WEAPONS DIRECTORATE



Overall goals

- **Rebuild readiness**
- **Determine requirements to improve capability and lethality**
 - * Infantry Weapons (SARs, Rifle Combat Optics)
 - * Night Vision
 - * Full Spectrum Battle Equipment/Improved Helo Passenger Air-Breathing Device
 - * Small Craft Propulsion System
- **Areas of industry interest**
 - * Mortars
 - * Modular Weapons System
 - * Parachute Capability and Safety
 - * Improvements: e.g., laser coatings on optics; camouflaged weaponry, light weight paws for bipods and tripods, ceramic lined MG barrels, and air-bursting fuzes for 40mm grenades
- **Reorganization**

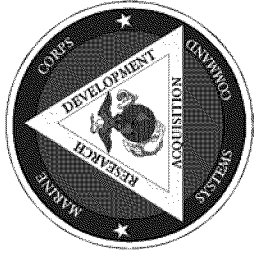

INFANTRY WEAPONS

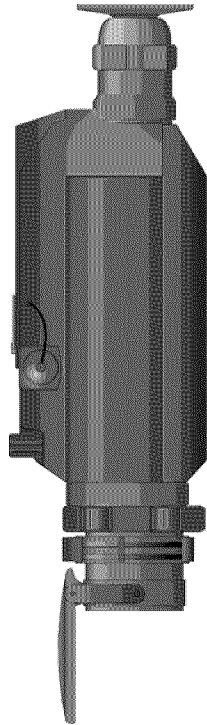
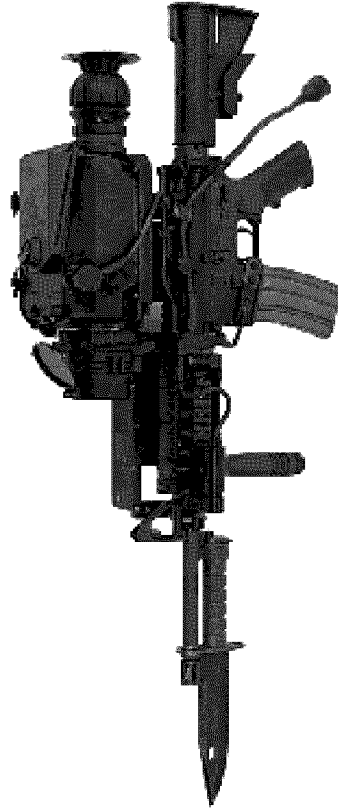
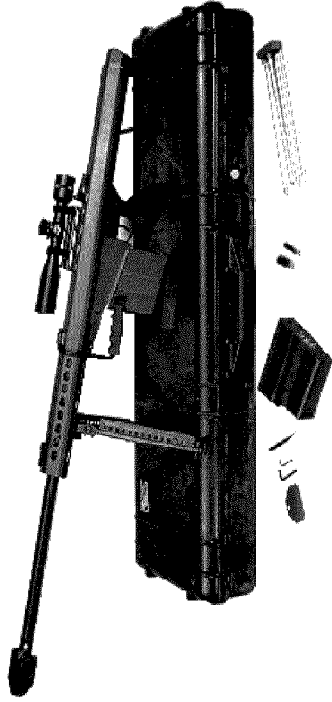



JOINT SERVICE COMBAT SHOTGUN

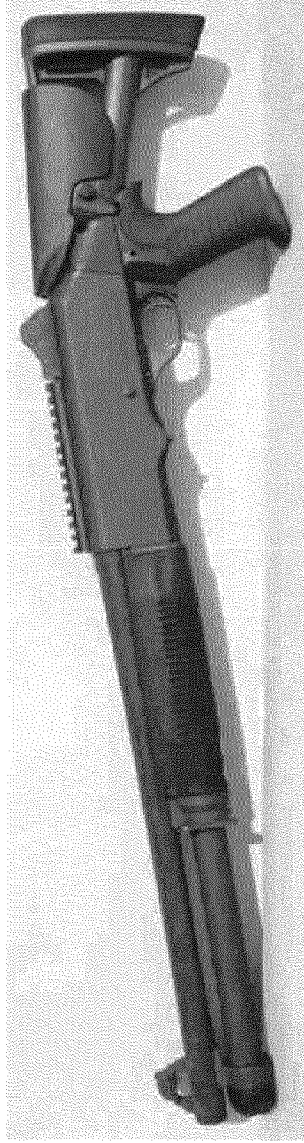

- **Description:** The Joint Service Combat Shotgun will be a 12 gauge, semi-automatic, compact, lightweight weapon. It will be configured with low light level rifle-type sights and a surface which will mount current and developmental day/night sighting scopes.
- **Status:**
 - * MS III: 1st QTR FY00
 - * IOC: 1st QTR FY01
 - * FOC: 4th QTR FY01
- **Point of Contact:** Maj Tafolla (703) 784-2006 ext. 2729

AN/PVS-17 NIGHT VISION SIGHT

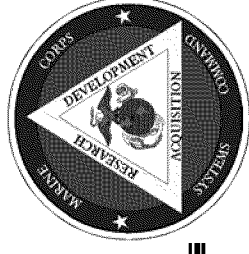

- **Description:** The AN/PVS-17 Night Vision Sight is a replacement for the PVS-4. This sight incorporates the new Gen III image intensification I² tube. It has an mounting attachment to interface with the Mil-std 1913 rail. The system weighs less than 2lbs. The system can configured for either 2.25x or 4.5x magnification.
- **Status:** The program is currently in staffing as an Abbreviated Acquisition Program. Procurement action is anticipated during 4th Qtr FY01. Unfunded Priority List (UPL) for FY02 has been submitted to buy to full AO. FY99/00 funds will buy approximately 3766 units for towards a requirement of 6346 AN/PVS-17.
- **Point of Contact:** Ms Beal, (703) 784-2006, x2706



THERMAL WEAPONS SIGHT (TWS)

AN/PAS-13(V2)

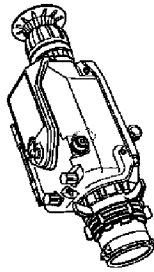

AN/PAS-13(V3)

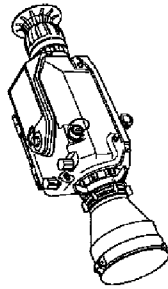

Description

Thermal Weapons Sight (TWS) is a lightweight, low power, high performance, forward looking, infra-red device. TWS will complement existing crew-served night vision sights. It does not rely on visible light for operation, and it is virtually unaffected by weather and obscurants. The TWS operates by discerning the temperature variation between targets and their background. The TWS is completely passive and although designed for target detection and engagement with Marine Corps crew served weapons, can be used for all weather surveillance.

Schedule

IOC 3QFY01
FOC 3QFY06

Prime Contractor:
- Raytheon

FUNDS

\$(M)

RDT&E	TOTAL
PMC	1.007
O&M	90.95
	11.18



SMALL CRAFT PROPULSION SYSTEM (SCPS)

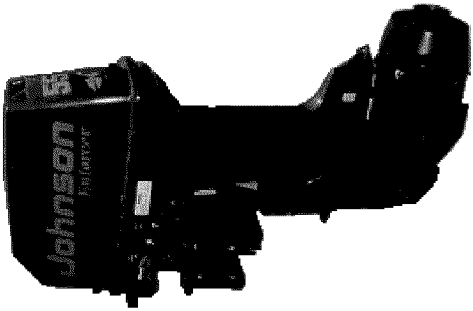

DESCRIPTION

The SCPS, 55hp engine will out perform the current dual engines on the CRRRC. It is fitted with a new pumpjet design that will exceed propeller performance, while still providing the safety of the shrouded pumpjet rotor.

SCHEDULE

OT	3QFY00
MS III	3QFY01
IOC	4QFY01
FOC	4QFY02

FUNDS (\$M)

	TOTAL
RDT&E	1.0M
PMC	3.8M

Prime Contractor:

- Bombardier



NONLETHAL WEAPONS

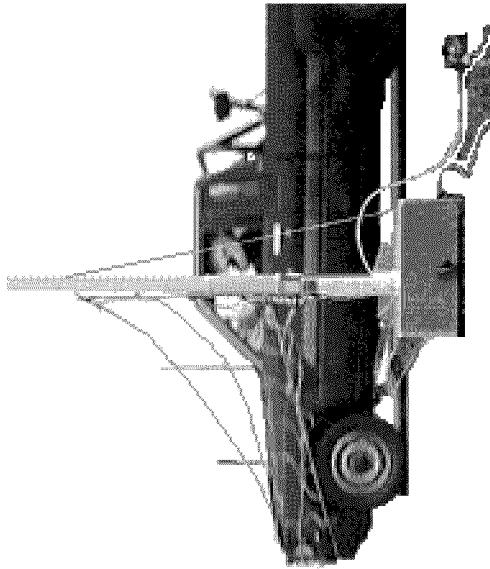
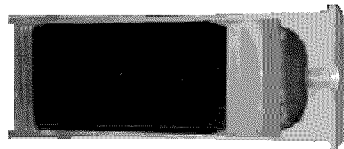
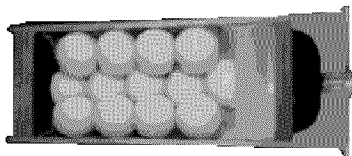
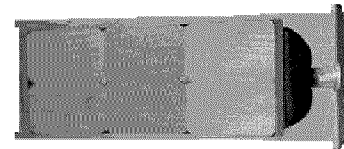
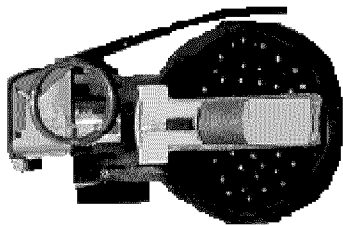
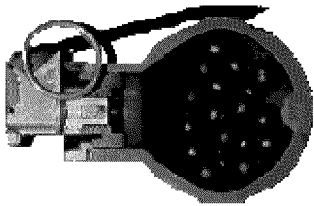
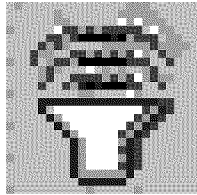
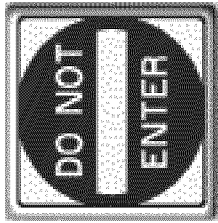
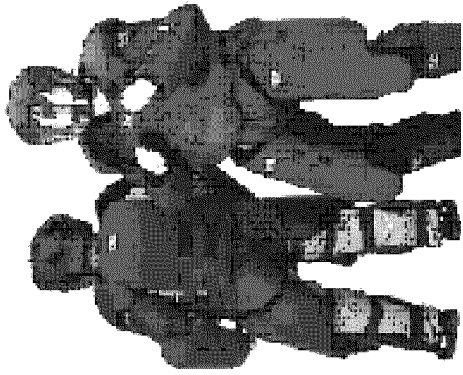
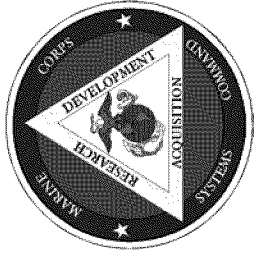



CAPABILITY SETS

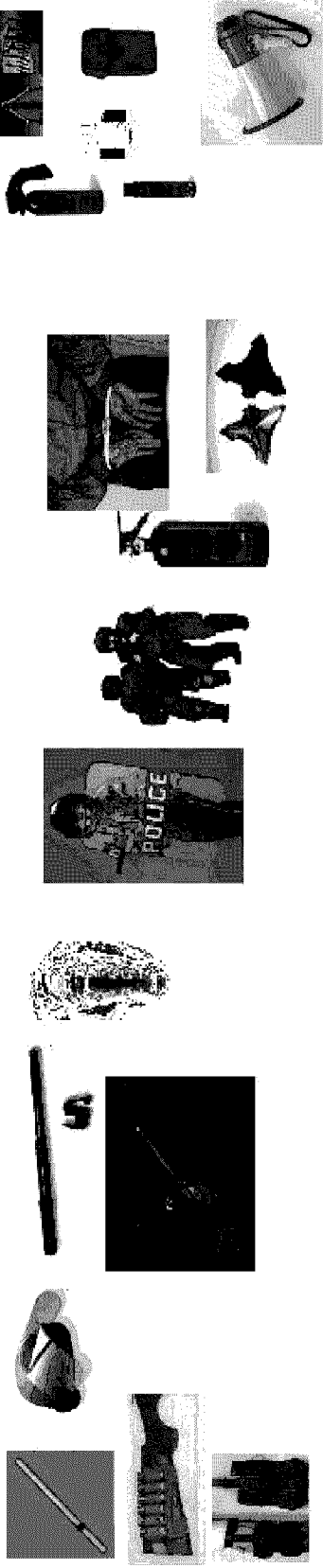

- **Description:** The Capability Sets contains the weapon systems, munitions, and equipment required to satisfy the operational requirement for an enhanced capability to apply non-lethal force. The components are intended to incapacitate personnel or material, while minimizing fatalities or permanent injury to intended targets and collateral damage to property and the environment. *They are not required to have zero probability of producing fatalities or permanent injuries but are designed and employed in a manner that significantly reduces those probabilities over the traditional employment of currently fielded military weapon systems, munitions and equipment.* Although most applicable in Military Operations Other Than War, the components are intended to be useful to Marines across the range of military operations. The sets are intended to augment currently fielded weapon systems and munitions.

- **Status:** Fielded.

- **Point of Contact:** Capt Warren, (703) 784-2006, ext. 2735



PORTABLE VEHICLE ARRESTING BARRIER (PVAB)

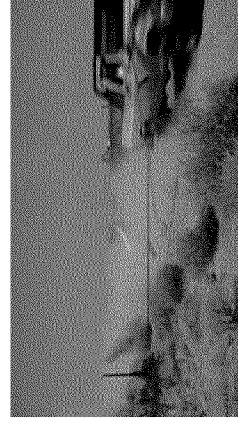
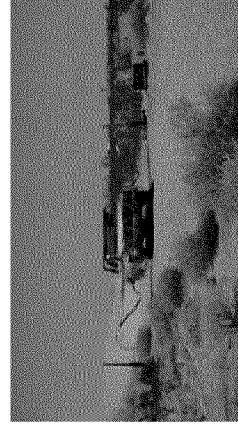

- **Description:** The PVAB is designed to provide a portable means of safely stopping and capturing a suspected vehicle and preventing it from entering an unauthorized area, or attempting to run a control point, with minimal damage to the vehicle and minimal injury to the occupants. It also retains the occupants within the vehicle until released by security personnel. The PVAB consists of the capture net, capture lines, two high-pressure erector assemblies, two 16-inch anchor plates and hardware, the bump, and two brake boxes.
- **Status:**
 - * **FOC:** 4th QTR FY02
- **Point of Contact:** Mr Frank Pratt, (703) 784-2006 ext. 2722

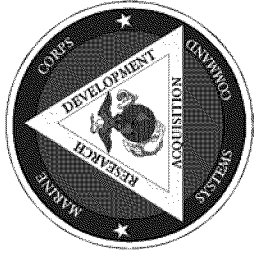

ANTI-ARMOR

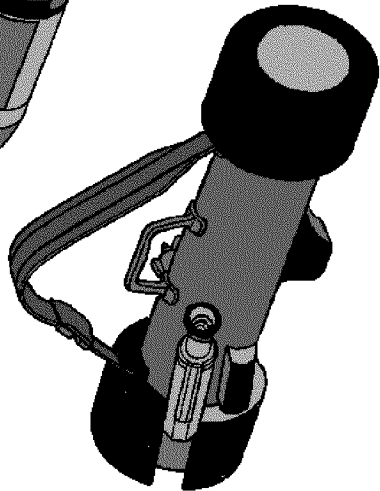
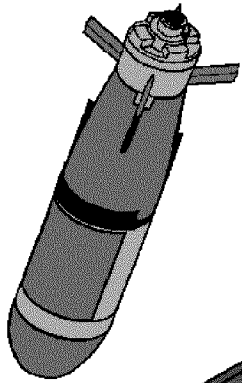
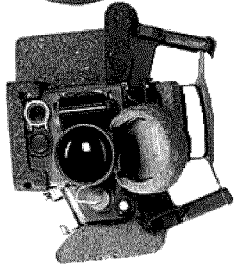
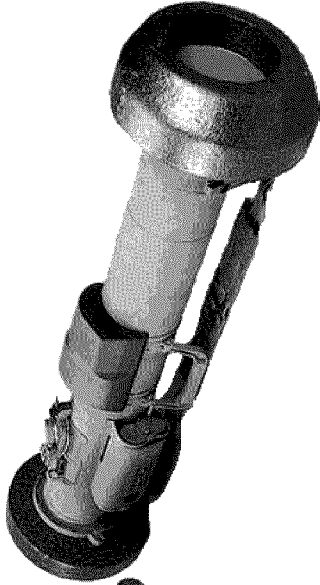



JAVELIN

(MEDIUM ANTI-TANK WEAPON)

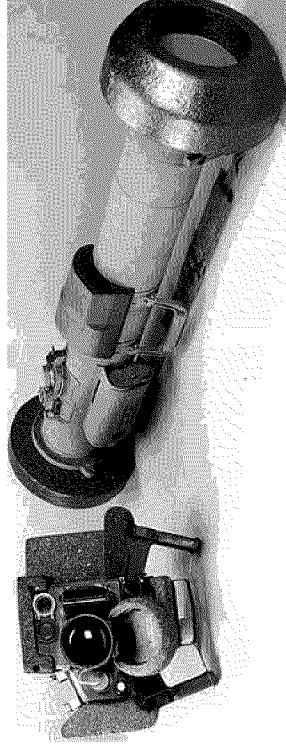

- **Description:** The JAVELIN is a highly maneuverable, man-portable fire-and-forget weapon with an advanced tandem warhead capable of defeating advanced battle tanks, including those with reactive armor. The missile employs a soft launch that reduces the gunner's vulnerability to counter-fire because of its minimum launch signature and its ability to be fired from enclosures and covered positions. The JAVELIN can be employed in either a top attack or direct fire trajectory. The range is 2000+ meters.
- **Status:**
 - * IOC: 1st QTR FY00
 - * FOC: 4th QTR FY03
- **Point of Contact:** Capt Conway (703) 784-2006 ext. 2714



PREDATOR (LIGHT ANTI-TANK WEAPON)

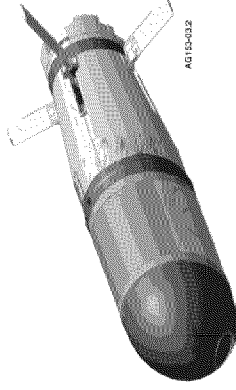
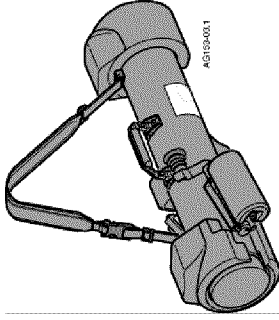

■ **Description:** The Predator (SRAW) is a short range, one-man portable, disposable antitank weapon system. Predator is a fire and forget, soft-launched missile, with a top-attack (fly-over, shoot-down) flight profile. This system satisfies the Marine Corps requirement for a light weight, short range anti-tank weapon which is both highly lethal and sufficiently simple to employ (i.e. issueable as a round of ammunition). This weapon does not require a dedicated gunner and is highly proliferable down to the individual Marine. The range of the PREDATOR is 17-600 meters.

■ **Status:**

- * MS III: 4th QTR FY00
- * FUE: 4th QTR FY02
- * IOC: 2nd QTR FY03
- * FOC: 4th QTR FY08

■ **Point of Contact:** Mr. Mike Woodson (703) 784-2006 ext. 2712



FIRE SUPPORT

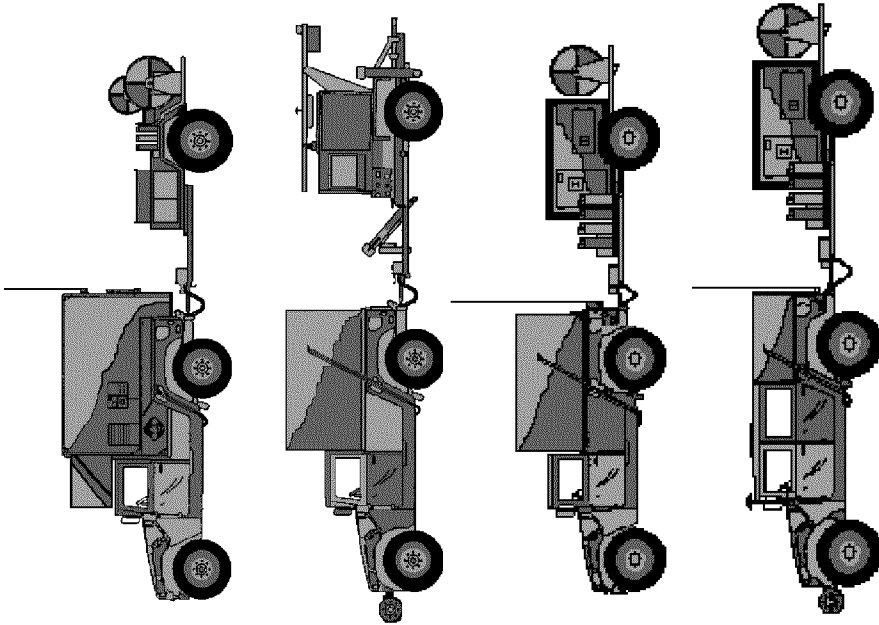
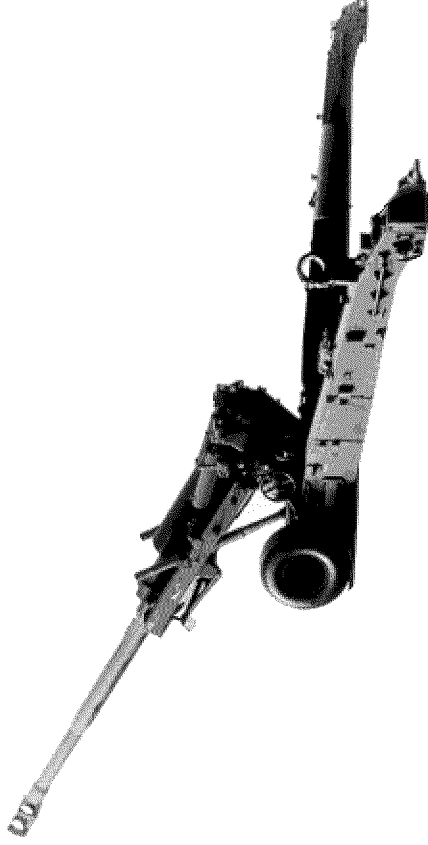
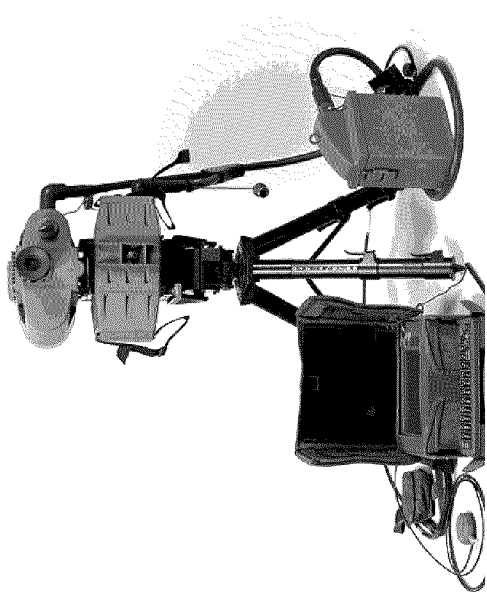



HIGH MOBILITY ARTILLERY ROCKET SYSTEM (HIMARS)

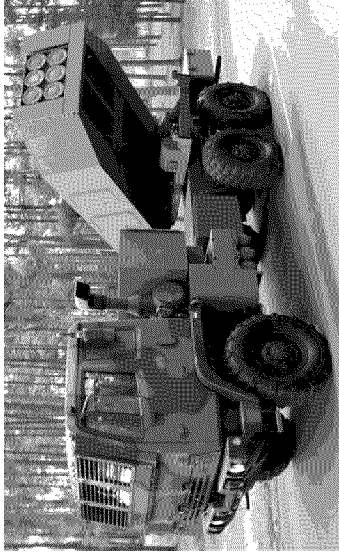
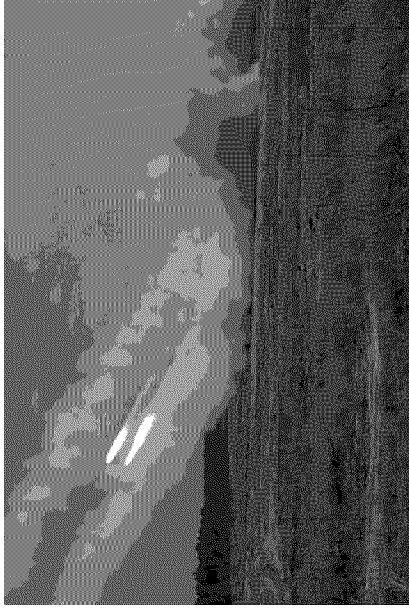

- **Description:** The Expeditionary Indirect Fire General Support Weapon System (EIFGSWS) will be a long range (45km+) weapon system capable of satisfying USMC general support artillery requirements. It will be transportable by air and by amphibious shipping.
- **Status:** The program has received funding for FY01 which has allowed us to acquire of two HIMARS for assessment in Marine Corps operational environments.
- **Point of Contact:** LtCol Jim Dixon (703) 784-2006 x5092



TARGET LOCATION, DESIGNATION HAND-OFF SYSTEM (TLDHS)

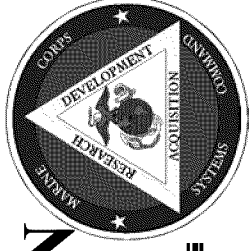

- **Description:** The TLDHS is a man-portable, automated equipment suite that provides FOs, FACs, and Reconnaissance Teams with the ability to accurately acquire, locate, and designate targets, then digitally transmit (hand-off) target data to weapons delivery platforms and agencies.
- **Status:**
 - * IOC: 3d QTR FY03
 - * FOC: 3d QTR FY06
- **Point of Contact:** Maj Garay (703) 784-2006 ext. 5094



AN/TPQ-46A FIREFINDER RADAR

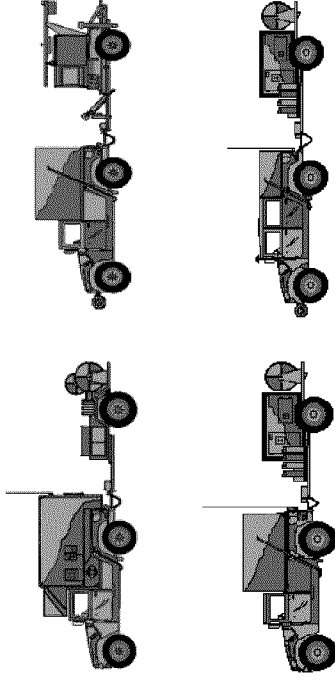

- **Description:** The AN/TPQ-46A is an upgrade to the Q-36 Firefinder Radar. The initial upgrade replaced the two 5-ton Q-36 configurations with the four - HMMWV Q-46. The subsequent Q-46A is a shelter/electronics upgrade that enhances target detection, survivability and interoperability while reducing maintenance and logistics requirements.
- **Status:** Upgrading software.
- **Point of Contact:** Capt Lovelace, (703) 784-2006, ext. 5087

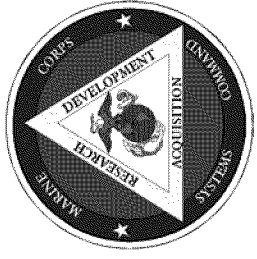

TANKS

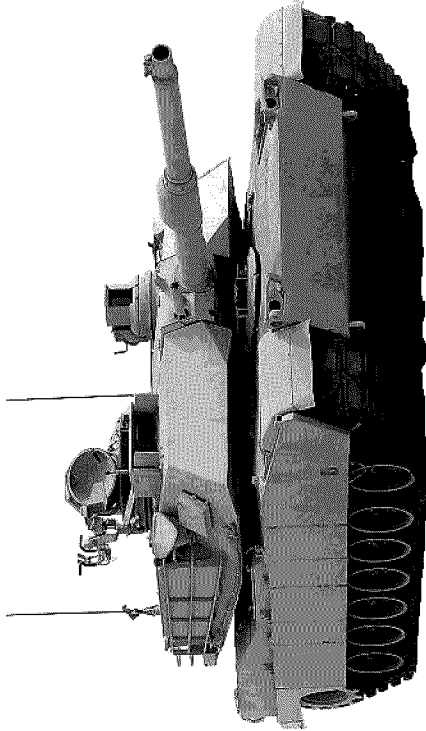
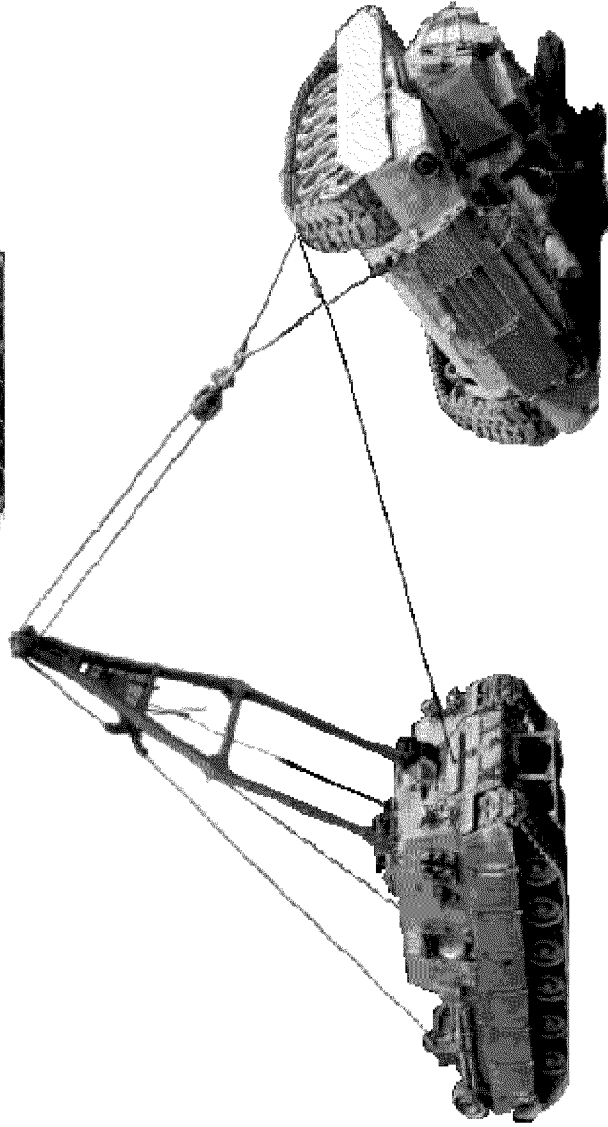
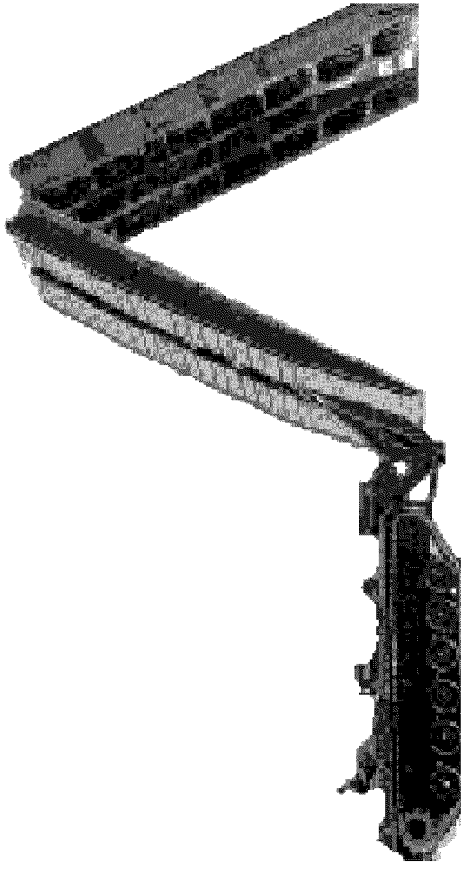



M1A1 TANK FIREPOWER ENHANCEMENT PROGRAM

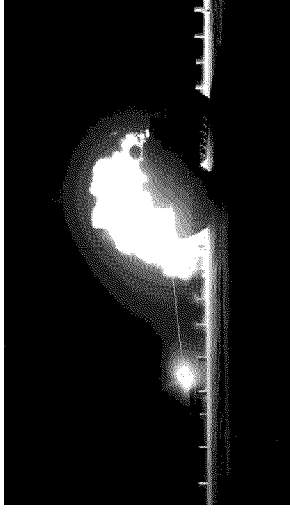

■ **Description:** The M1A1 Firepower Enhancement Program integrates a low-cost 2nd generation thermal sight and far-target location capability into the tank to increase target acquisition and engagement ranges under conditions of reduced visibility, improve situational awareness, and reduce fratricide potential.

■ **Status:**

- *MSII: 3rd QTR FY02
- *MSIII: 4th QTR FY04
- *IOC: 2nd QTR FY06
- *FOC: 4th QTR FY09

■ **Point of Contact:** Maj Bianca, (703) 784-2115/2201



M88A2 HERCULES

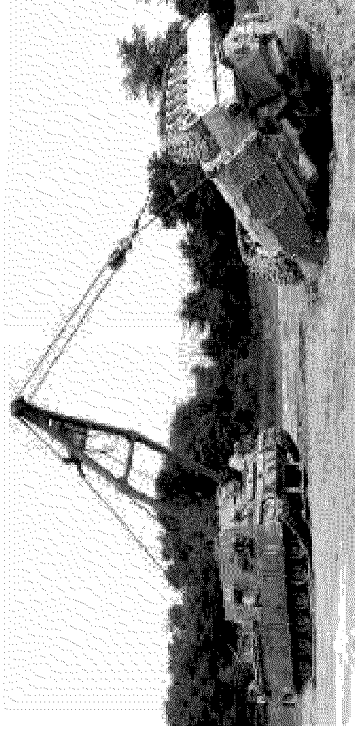

- **Description:** The M88A1 HERCULES is an armored, fully-tracked vehicle. It is used for hoisting, winching, and towing operations for all vehicles up to 70 tons. It is equipped to assist in repairing disabled vehicles under field conditions. The HERCULES will be an upgraded M88A1 whose new configuration will provide for a new engine with increased horsepower and hoisting and winching capabilities, a new and upgraded transmission, upgraded suspension, new final drives, and added armor protection.
- **Status:**
 - * IOC: 3rd QTR FY01
 - * FOC: 3rd QTR FY07
- **Point of Contact:** Capt Estep, (703) 784-5013/3472

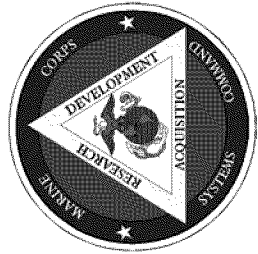

AMPHIBIOUS ASSAULT VEHICLE

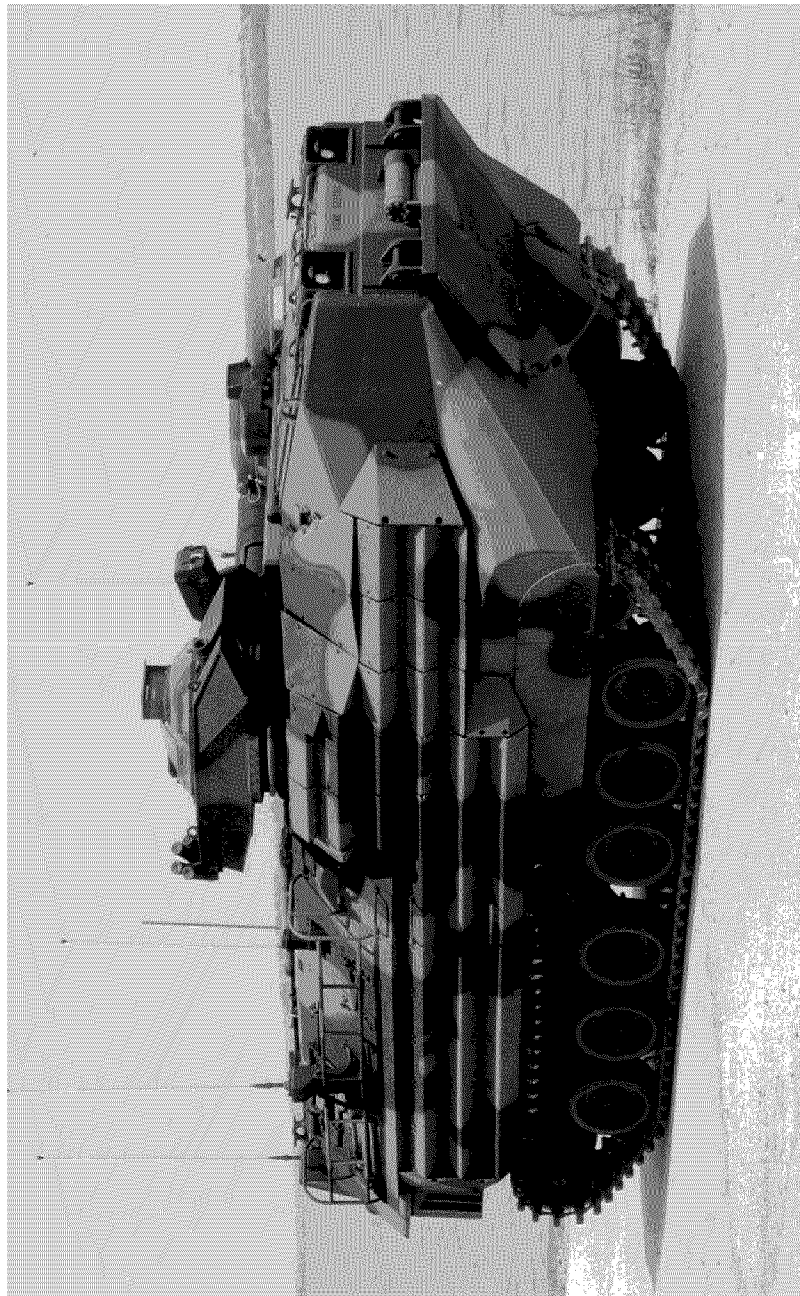



RAM/RS PROGRAM

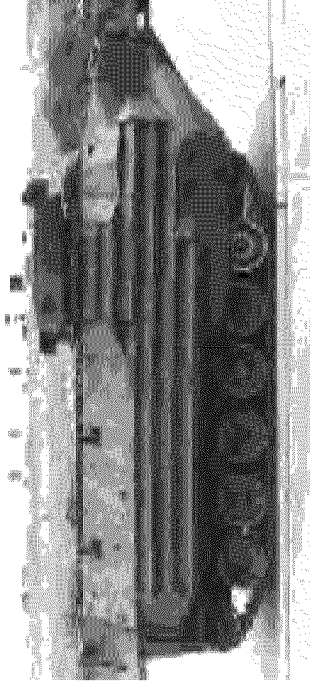

- **Description:** The AAV RAM/RS program (Reliability, Availability, Maintainability/Rebuild to Standard Program) will focus on the engine, suspension, hull, and transmission. This program focused efforts on reducing total ownership costs by identifying the top ten fleet cost factors. Additionally, it analyzed the ever increasing depot level repair costs and provided specific modifications for reducing life cycle costs.
- **Status:**
 - * IOC: 3rd QTR FY99 (achieved)
 - * FOC: 1st QTR FY03
- **Point of Contact:** Mr. Havrin (GS-14) (703) 784-4558



AAV MODIFICATION KITS

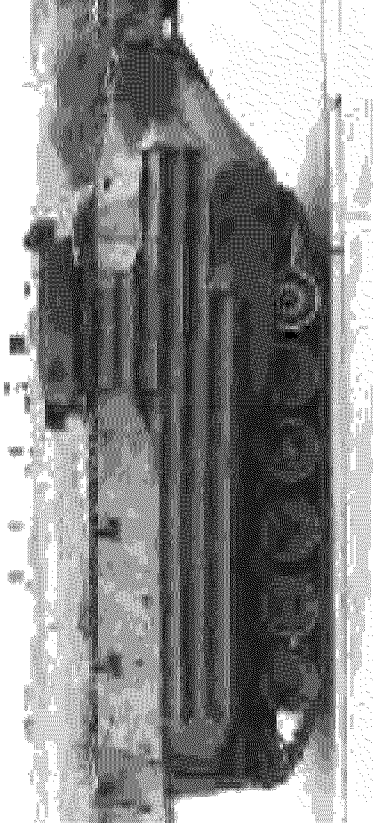

- **Description:** The AAV7A1 Mod Kit Line covers a large group of engineering changes to the vehicle that allow for greater reliability and maintainability. These changes include: navigation system improvements (TACNAV); communication system improvements (PLGR, DACT); material improvements (crew heaters, corrosion prevention, fuel system improvements, alternate vendor verification). Some of these will be fielded in conjunction with the RAM/RS Rebuild schedule.
- **Status:**
 - * IOC: Varies with item
 - * FOC: Varies with item
- **Point of Contact:** Mr. Bunn, (703) 784-1946



Back Up Slides



Marine Corps Systems Command

