

# **FM 34-130**

## **INTELLIGENCE PREPARATION OF THE BATTLEFIELD**

US Army Intelligence Center and Fort Huachuca  
Fort Huachuca, Arizona 85613-6000

**FINAL DRAFT**

**JULY 1993**

## Form SF298 Citation Data

<b>Report Date</b> <i>("DD MON YYYY")</i> 01071993	<b>Report Type</b> N/A	<b>Dates Covered (from... to)</b> <i>("DD MON YYYY")</i>
<b>Title and Subtitle</b> Intelligence Preparation on the Battlefield		<b>Contract or Grant Number</b>
		<b>Program Element Number</b>
<b>Authors</b>		<b>Project Number</b>
		<b>Task Number</b>
		<b>Work Unit Number</b>
<b>Performing Organization Name(s) and Address(es)</b> US Army Intelligence Center and Fort Huachuca Fort Huachuca, Arizona 85613-6000		<b>Performing Organization Number(s)</b>
<b>Sponsoring/Monitoring Agency Name(s) and Address(es)</b>		<b>Monitoring Agency Acronym</b>
		<b>Monitoring Agency Report Number(s)</b>
<b>Distribution/Availability Statement</b> Approved for public release, distribution unlimited		
<b>Supplementary Notes</b>		
<b>Abstract</b>		
<b>Subject Terms</b> "IATAC COLLECTION"		
<b>Document Classification</b> unclassified	<b>Classification of SF298</b> unclassified	
<b>Classification of Abstract</b> unclassified	<b>Limitation of Abstract</b> unlimited	
<b>Number of Pages</b> 348		

<b>REPORT DOCUMENTATION PAGE</b>			<i>Form Approved OMB No. 074-0188</i>	
Public reporting burden for this collection of information is estimated to average 1 hour per response, including the time for reviewing instructions, searching existing data sources, gathering and maintaining the data needed, and completing and reviewing this collection of information. Send comments regarding this burden estimate or any other aspect of this collection of information, including suggestions for reducing this burden to Washington Headquarters Services, Directorate for Information Operations and Reports, 1215 Jefferson Davis Highway, Suite 1204, Arlington, VA 22202-4302, and to the Office of Management and Budget, Paperwork Reduction Project (0704-0188), Washington, DC 20503.				
<b>1. AGENCY USE ONLY (Leave blank)</b>	<b>2. REPORT DATE</b> 7/1/93	<b>3. REPORT TYPE AND DATES COVERED</b> Report		
<b>4. TITLE AND SUBTITLE</b> Intelligence Preparation of the Battlefield			<b>5. FUNDING NUMBERS</b>	
<b>6. AUTHOR(S)</b> US Army Intelligence Center and Fort Huachuca Fort Huachuca, AZ				
<b>7. PERFORMING ORGANIZATION NAME(S) AND ADDRESS(ES)</b> IATAC Information Assurance Technology Analysis Center 3190 Fairview Park Drive Falls Church VA 22042			<b>8. PERFORMING ORGANIZATION REPORT NUMBER</b>	
<b>9. SPONSORING / MONITORING AGENCY NAME(S) AND ADDRESS(ES)</b> Defense Technical Information Center DTIC-IA 8725 John J. Kingman Rd, Suite 944 Ft. Belvoir, VA 22060			<b>10. SPONSORING / MONITORING AGENCY REPORT NUMBER</b>	
<b>11. SUPPLEMENTARY NOTES</b>				
<b>12a. DISTRIBUTION / AVAILABILITY STATEMENT</b>			<b>12b. DISTRIBUTION CODE</b>  A	
<b>13. ABSTRACT (Maximum 200 Words)</b> The purpose of this manual is to describe the fundamentals of Intelligence Preparation of the Battlefield (IPB). It describes IPB, its use in directing the intelligence effort, and its role in driving the staff's planning for contingency or combat operations. It prescribes the procedures followed in performing IPB and illustrates the application of IPB in various situations.				
<b>14. SUBJECT TERMS</b> Information Warfare			<b>15. NUMBER OF PAGES</b>	
			<b>16. PRICE CODE</b>	
<b>17. SECURITY CLASSIFICATION OF REPORT</b> Unclassified	<b>18. SECURITY CLASSIFICATION OF THIS PAGE</b> UNCLASSIFIED	<b>19. SECURITY CLASSIFICATION OF ABSTRACT</b> UNCLASSIFIED	<b>20. LIMITATION OF ABSTRACT</b>  None	

FIELD MANUAL 34-130

Headquarters  
Department of the Army  
Washington, DC,

INTELLIGENCE PREPARATION OF THE BATTLEFIELD (IPB)

Table of Contents

	Page
<b>PREFACE</b> .....	<b>iii</b>
<b>CHAPTER 1. INTRODUCTION</b> .....	<b>1-1</b>
What is <b>IPB</b> ?.....	<b>1- 1</b>
Who Conducts <b>IPB</b> ?.....	<b>1- 5</b>
Doctrine versus TTP.....	<b>1-6</b>
What IPB Accomplishes.....	<b>1- 7</b>
IPB and the Intelligence <b>Estimate</b> .....	<b>1- 7</b>
IPB and the Decision Making Process.....	<b>1- 8</b>
IPB and the Targeting Process.....	<b>1-13</b>
IPB and the Collection Management Process.....	<b>1-14</b>
IPB and the Command and Staff Execution of Battle.....	<b>1-17</b>
How IPB Relates to Everything Else.....	<b>1-17</b>
<b>CHAPTER 2. CONDUCTING INTELLIGENCE PREPARATION OF THE BATTLEFIELD</b> .....	<b>2-1</b>
Define the Battlefield <b>Environment</b> .....	<b>2- 3</b>
Describe the Battlefield's <b>Effects</b> .....	<b>2-12</b>
Evaluate the Threat.....	<b>2-56</b>
Determine Threat Courses of <b>Action</b> .....	<b>2-7 2</b>
Abbreviated <b>IPB</b> .....	<b>2-9 6</b>
<b>CHAPTER 3. APPLICATIONS OF INTELLIGENCE PREPARATION OF THE BATTLEFIELD</b> .....	<b>3-1</b>
Scenario One - Conventional <b>Offense</b> .....	<b>3-1</b>
Scenario Two - Conventional <b>Defense</b> .....	<b>3-4 3</b>
Scenario Three - <b>Counterinsurgency</b> .....	<b>3-55</b>
Scenario Four - Noncombatant <b>Evacuation</b> .....	<b>3-7 7</b>

This publication supersedes FM 34-130, 23 May 1989.

CHAPTER 4. INTELLIGENCE PREPARATION OF THE BATTLEFIELD FOR SPECIAL STAFF **AND SUPPORT UNITS**.....4- 1

- Air Defense .....4-1
- Artillery . . . -.....4- 4
- Aviation ..... ..4- 6
- Counterintelligence & **Counter-Reconnaissance**..4- 9
- Electronic **Warfare**.....4-11
- Engineer**.....4-14
- Intelligence ..... ..4-18
- Nuclear, Biological, and Chemical (NBC).....4-2 1
- Signal**.....4-2<sup>3</sup>
- Special **Operations**.....4-2 5
- Rear Area and Combat Service **Support**.....4-2 7

CHAPTER 5. TACTICAL, OPERATIONAL, AND STRATEGIC INTELLIGENCE PREPARATION OF THE **BATTLEFIELD**.....5-1

- Define the Battlefield **Environment**.....5-1
- Describe the Battlefield's **Effects**.....5-3
- Evaluate the **Threat**.....5-6
- Determine Threat Courses of **Action**.....5-8

CHAPTER 6. INTELLIGENCE PREPARATION OF THE BATTLEFIELD FOR OPERATIONS OTHER THAN **WAR**.....6- 1

- Humanitarian Assistance and Disaster **Relief**...6- 1
- Support to **CounterDrug Operations**.....6- 5
- Peacekeeping **Operations**.....6- 8
- Shows of **Force**.....6-14
- Attacks and Raids ..... ..6-18
- Non-Combatant Evacuation **Operations**.....6-19
- Peace **Enforcement**.....6-2 3
- Support for Insurgencies and **Counterinsurgencies**.....6-25
- Support to Domestic Civil **Authorities**.....6-2 8

APPENDIX A. INTELLIGENCE PREPARATION OF THE BATTLEFIELD,  
WARGAMING, AND INTELLIGENCE SYNCHRONIZATION.....A- 1  
    General Rules ..... A-2  
    Prepare for Wargaming.....A- 3  
    Conduct the Wargame.....A- 4  
    Record the Results of Wargaming.....A- 6  
    Conduct the Targeting Conference.....A- 9  
    Compare Friendly Courses of Action.....A- 9  
    Synchronize Intelligence.....A-10  
    Execute the Battle.....A-12  
    An Example Application.....A-14  
    Summary ..... A-19

APPENDIX B. GUIDELINES FOR INTELLIGENCE PREPARATION OF THE  
**BATTLEFIELD**.....**B-1**  
    Define the Battlefield Environment.....B- 2  
    Describe the Battlefield's Effects.....B- 3  
    Evaluate the **Threat**.....**B-16**  
    Determine Threat Courses of Action.....B-2 6

GLOSSARY .....**Glossary-1**

REFERENCES.....References-1

## Preface

The purpose of this manual is to describe the fundamentals of Intelligence Preparation of the Battlefield (IPB). It describes IPB, its use in directing the intelligence effort, and its role in driving the staff's planning for contingency or combat operations. It prescribes the procedures followed in performing IPB and illustrates the application of IPB in various situations.

This manual is intended to serve as a guide for the use of IPB by units of all types, at all echelons, across the entire spectrum of conflict, and during the conduct of any mission. It does not contain all the data required to conduct IPB, such as specific information on threat doctrine or equipment capabilities. Rather, it is intended as a guide to applying the fundamentals of the IPB process to any situation which a unit might face.

No part of this document should be construed as limiting commanders' freedom of action or committing commanders to a fixed or particular course of action (COA). Nor should it be construed to imply that all IPB products must be prepared by all commands in all situations. Commanders should apply the doctrine and information presented in this manual in any manner appropriate to their particular situation and mission.

This manual is intended for Army commanders and staffs at all echelons. It applies equally to the Active Army (AC), Army Reserve, and Army National Guard (ARNG). It is also intended to be of use to commanders and staffs of joint and combined commands; Marine and Naval forces; units of the Air Force; and the military forces of allied countries.

The proponent of this publication is the United States Army Intelligence Center and Fort Huachuca, Fort Huachuca, Arizona. Send comments and recommendations for improvement on DA Form 2028 (Recommended Changes to Publications and Blank Forms) directly to Commander, US Army Intelligence Center and Fort Huachuca, ATTN: ATZS-TDL-D, Fort Huachuca, AZ 85613-6000.

This manual does not implement any international standardization agreements.

Unless this publication states otherwise, masculine nouns and pronouns do not refer exclusively to men.





A brief overview of each function is presented below. For a more thorough discussion see chapter two.

Define the Battlefield Environment
------------------------------------

In step one of the IPB process the **G2/S2** identifies characteristics of the battlefield which will influence friendly and **threat** operations, establishes the limits of the area of interest, and identifies 'gaps in current intelligence holdings. This focuses the command's initial intelligence collection efforts and the remaining steps of the IPB process.

The **G2/S2** establishes the limits of the area of interest (AI) to focus analytical and intelligence collection efforts on the geographic areas of significance to the command's mission. He bases the **AI's** limits on the amount of time estimated to complete the command's mission and the location and nature of the characteristics of the battlefield which will influence the operation. If the command has not been assigned an area of operations, the **G2/S2** coordinates with the **G3/S3** to develop a joint recommendation on its limits for the commander's approval. Similarly, the **G2/S2** confers with the **G3/S3** on recommendations for the command's battle space during development of friendly courses of action.

To focus the remainder of the IPB process, the **G2/S2** identifies characteristics of the battlefield which require in-depth evaluation of their effects on friendly and threat operations, such as terrain, weather, logistical infrastructure, and demographics. Generally, these are analyzed in **more** detail for areas within **the command's** area of operations and battle space than for other areas in the area of interest.

In addition to focusing the IPB effort, defining the significant characteristics of the battlefield environment aids in identifying gaps in current intelligence holdings and the specific intelligence required to fill them. Similarly, the **G2/S2** identifies gaps in the command's knowledge of the threat and the current threat situation.

Once approved by the commander, the specific intelligence required to fill gaps in the command's knowledge of the battlefield environment and threat situation become the command's initial intelligence requirements.

Describe the Battlefield's Effects
------------------------------------

Step two evaluates the effects of the environment with which both sides must contend. The **G2/S2** identifies the limitations and opportunities the environment offers on the potential operations of friendly and threat forces. Until courses of action are developed in later steps of the IPB process, this evaluation focuses on the general capabilities of each force.

This assessment of the environment always includes an examination of terrain and weather but may also include discussions of the characteristics of geography and infrastructure and their effects on the friendly and threat operations. Characteristics of geography include general characteristics of the terrain and weather as well as such factors as politics, civilian press, local population demographics, etc. An area's infrastructure consists of the facilities, equipment and framework needed for the functioning of **systems**, cities or regions. Products developed in this step might include, but are not limited to,--

- o Population status overlay.
- o Overlays that depict the **military** aspects and effects of terrain.
- o Weather analysis **matrix**.
- o Integrated products such as modified combined obstacle overlays.

Regardless of the subject or means of presentation, the **G2/S2** ensures that these products focus on the effects of the battlefield environment.

Evaluate the Threat:
----------------------

In step three the **G2/S2** and his staff analyze the command's intelligence holdings to determine how the threat normally organizes for combat and conducts operations under similar circumstances. When facing a well-known threat, the **G2/S2** can rely on his historical databases and well developed

threat models. **When** operating against a new or less well-known threat, he may need to develop his intelligence databases and threat models concurrently.

The **G2/S2's** evaluation is portrayed in a threat model that includes doctrinal templates which depict how the threat operates when unconstrained by the effects of the battlefield environment. Although **they** usually emphasize graphic depictions (doctrinal templates), threat models sometimes emphasize matrices or simple narratives.

Determine Threat Courses of Action:
-------------------------------------

Step four integrates the results of the previous steps into a meaningful conclusion. Given what the threat normally prefers to do, and the effects of the specific environment in which he is operating now, what are his likely objectives and the courses of action available to him? In step four the **G2/S2** develops enemy course of action models that depict the threat's available courses of action. He also prepares event templates and matrices that focus intelligence collection on identifying which course of action the threat will execute.

The enemy course of action models developed in step four are the products that the staff will use **to portray** the threat in the decision making and targeting processes. The **G2/S2** cannot produce these models, effectively predicting the threat **COAs**, unless he has--

- o Adequately analyzed the friendly mission throughout the time-duration of the operation; identified the physical limits of the **AO** and **AI**; and identified every characteristic of the battlefield environment that might affect the operation (step 1).
- o Identified the opportunities and constraints the battlefield environment offers to threat and friendly forces (step 2).
- o Thoroughly considered what the threat is capable of and what he prefers to do in like situations if unconstrained by the battlefield environment (step 3).

In short, the enemy course of action models which drive the decision making process are valid only if the **G2/S2** establishes a good foundation during the first three steps of the IPB process.

## Who Conducts IPB ?

Everyone in the US Army conducts **some** form of IPB. For example:

- o A rifleman in an infantry fire team considers the possible actions of the enemy soldier he is about to engage. He also considers how the local terrain and weather affect both himself and his adversary.
- o An armor company commander considers the possible actions of the enemy battalion that he is about to engage. He also considers how terrain affects the enemy's courses of action and the accomplishment of his own mission.

Both of these examples illustrate an informal application of IPB; that is, describe the effects of the battlefield and determine the threat's courses of action. It is the application of battlefield **commonsense**. At this level it requires little formal education beyond realistic field training exercises against a savvy enemy.

As the size of the unit increases, the level of detail required in the IPB effort increases significantly. An **armor** company commander's informal IPB produces little more than an appreciation of what the threat is **most** likely to do during their engagement. A division staff's IPB can produce--

- o Detailed terrain analysis products.
- o Climatic summaries.
- o Detailed studies of the threat, his equipment, and his doctrine.
- o A comprehensive set of **enemy** course of action models depicting a broad range of possible threat **COAs**.

Any unit large enough to have a staff (**S1, S2, S3, and S4**) develops at least some of the formal IPB products described in this manual. The **G2/S2** has staff responsibility for the command's IPB--that IPB which directly supports the decision making process. The **G2/S2**, however, is not the only one who conducts or needs to understand and use IPB.

Every commander and every member of the staff needs to understand and apply IPB during the staff planning process. IPB identifies the facts and assumptions about the battlefield and the threat that allow effective staff planning. IPB forms the basis for defining the courses of action available to the friendly command and drives the wargaming process that selects and refines them.



The doctrinal principles of IPB always call for:

- o evaluating the battlefield's effects on friendly and threat operations;
- o determining the threat's possible courses of action **and** arranging them in order of probability of adoption;
- o identifying assets the threat needs to make **each course** of action successful (high value targets) and where they can be expected to appear on the battlefield (target **areas** of interest); and,
- o identifying the activities, or lack of, and the locations where they will occur that will identify **which** course **of** action the threat has adopted.

**The** decision to use a sketch instead of an overlay to depict **the** battlefield's effects or the threat's available courses of action is a matter of TTP. Such decisions can only be made within the context of a given situation. Similarly, the amount of detail that goes into each step of the IPB process, the techniques for depicting areas of RESTRICTED terrain, and other such decisions are also driven by factors of METT-T and local policies and procedures.

#### What IPB Accomplishes

IPB identifies facts and assumptions about the battlefield environment and the threat. This enables staff planning and the development of friendly **COAs**.

IPB provides the basis for intelligence direction and synchronization that supports the command's chosen course of action.

IPB contributes to complete staff synchronization and the successful completion of several other staff processes, which are described **below**.

#### IPB and the Intelligence Estimate

In order to facilitate staff planning, the **G2/S2** prepares the intelligence estimate before the remainder of the staff complete their own estimates if at all possible. The intelligence estimate forms the **basis** for the facts and assumptions of the decision making process, driving the other staff **estimates** and the remaining steps in the decision making

process. The products of IPB are the basis of the intelligence estimate. In fact, if the **G2/S2** lacks the time required to prepare a written estimate he can usually substitute graphics that depict the results of his IPB evaluations and analysis.

Paraaravh 1 of the intelligence estimate restates the command's mission.

Paragraph 2, the Area of Operations, is derived from step 2 of the IPB process/describe the battlefield's effects. The most important sub-paragraphs of paragraph 2 are the "effects on enemy **COAs**" and "effects on own **COAs**." These sections describe the battlefield's impact on operations.

Paraaravh 3, Enemy Situation, is derived from step 3 of the IPB process, evaluate the threat. This is primarily a discussion of what is known about the threat (facts) and the results of analysis of those facts (assumptions).

Paraaravh 4, Enemy Capabilities, is derived from step 4 of the IPB process, determine threat **COAs**. This is a listing and discussion of the **COAs** available to the threat. These **COAs** should exactly correspond with the enemy course of action models developed in step four of the IPB process.

Paragraph 5, Conclusions, is derived from the evaluations made during the IPB process. Here you summarize the effects of the battlefield **environment** on friendly and enemy courses of action, list the set of probable threat courses of action (in order of probability of adoption), and list the threat's exploitable vulnerabilities.

### ▄▄▄▄▄▄▄▄▄▄▄▄ IPB and the Decision Making Process ▄▄▄▄▄▄▄▄▄▄▄▄

Commanders and staffs use the decisionmaking process to select a course of action and develop an operations plan, operations order, or fragmentary orders that implement it. The results and products of IPB, conveyed in the intelligence estimate, are essential elements of the decision making process. Accordingly, the major IPB effort occurs before and during the first step of the decision making process.

The decision making process is a dynamic and continuous process. The staff continues to estimate the situation as the operation progresses, adapting the command's course of action to unforeseen changes in the situation. The IPB which supports the decision making process must also remain dynamic, constantly integrating new information into the initial set of facts and assumptions.

The relationship of the IPB process to each step in the decision making process is discussed below.

Mission Analysis:

In this step IPB products enable the commander to assess facts about the battlefield and make assumptions about how

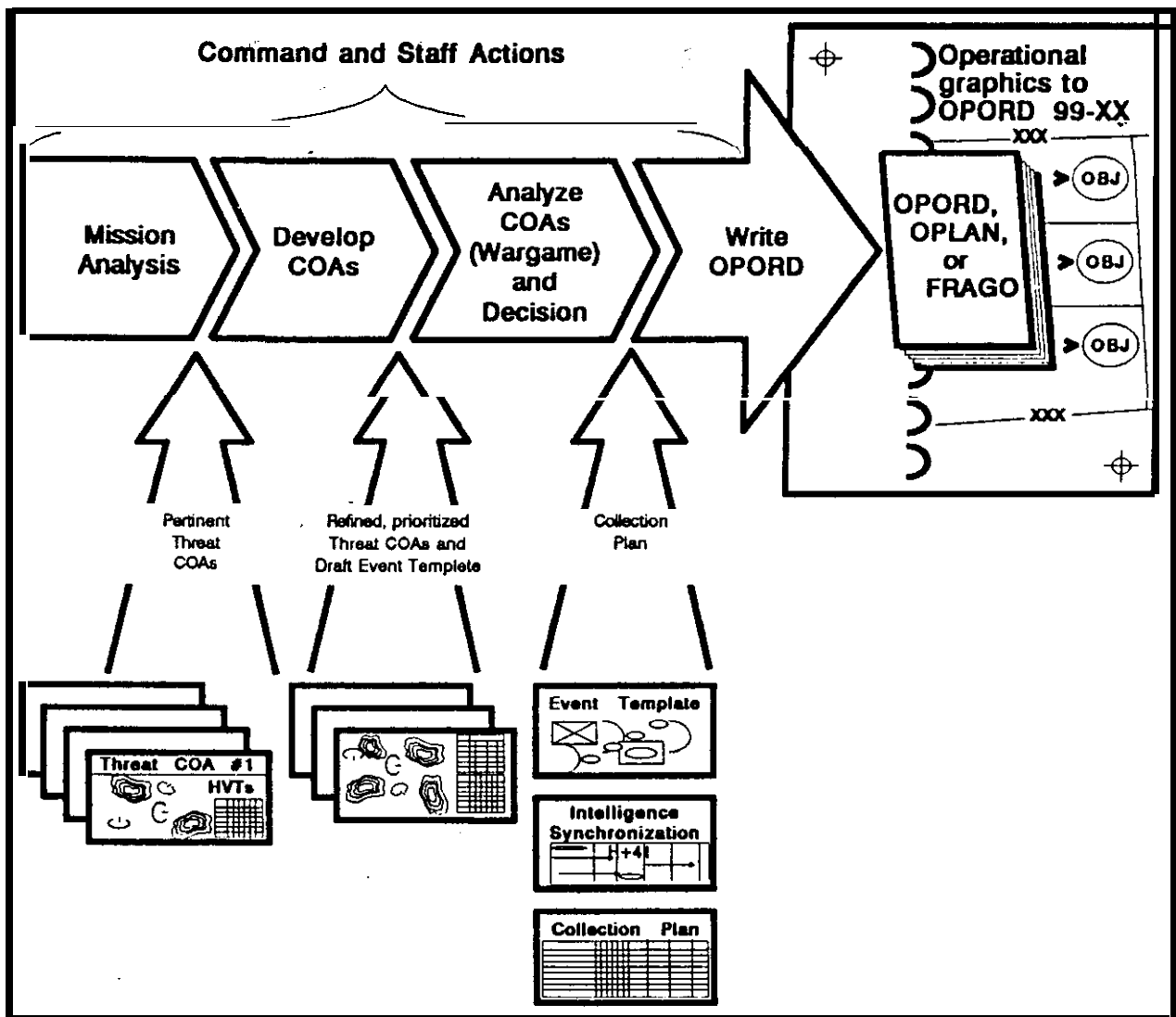

Figure 1-1. The S2 or G2 must support the tactical decision-making process with specific products.



friendly and threat forces will interact on the battlefield.

The description of the battlefield's effects identifies constraints on potential friendly courses of action and may reveal **implied** missions. It also identifies opportunities the battlefield environment presents, such as avenues of approach, engagement areas, zones of entry, etc., which the staff integrates into potential friendly courses of action and their staff estimates.

Enemy capabilities and vulnerabilities identified during evaluation **of the** threat allow the commander and staff to make assumptions about the relative capabilities of the friendly command. Threat evaluation also provides the detailed information on the threat's current dispositions, recent activities, equipment and organizational capabilities the staff need to complete their own staff estimates and planning.

Enemy course of action models developed in step four of the IPB process, assumptions about threat courses of action, provide a basis for the formulation of potential friendly courses of action and complete the intelligence estimate.

The IPB process identifies any critical gaps in the command's knowledge of the battlefield environment or threat situation. As part of his initial planning guidance the commander uses these gaps to as a guide to establish his initial intelligence requirements.

---

Develop Courses of Action:

---

The staff develops friendly **COAs** based on the facts and assumptions identified during IPB and mission analysis. Incorporating the results of IPB into COA development ensures that each friendly COA takes advantage of the opportunities the environment and threat situation offer and is valid in terms of what they will allow.

Analyze and Compare Courses of Action:
--

During the wargaming session the staff **"fights"** the set of threat courses of action, developed in step four of the IPB process, against each **potential** friendly COA. Targeting

conferences follow or accompany the wargaming session to refine selected high value targets (HVTs) from the enemy course of action models into high payoff targets (HPTs) that support the friendly COA. (See Figure 2-1)

Based on the results of wargaming, for each potential friendly course of action the staff--

- o **Construct** a decision support template (DST) and its associated synchronization matrix.
- o Identify supporting intelligence requirements.

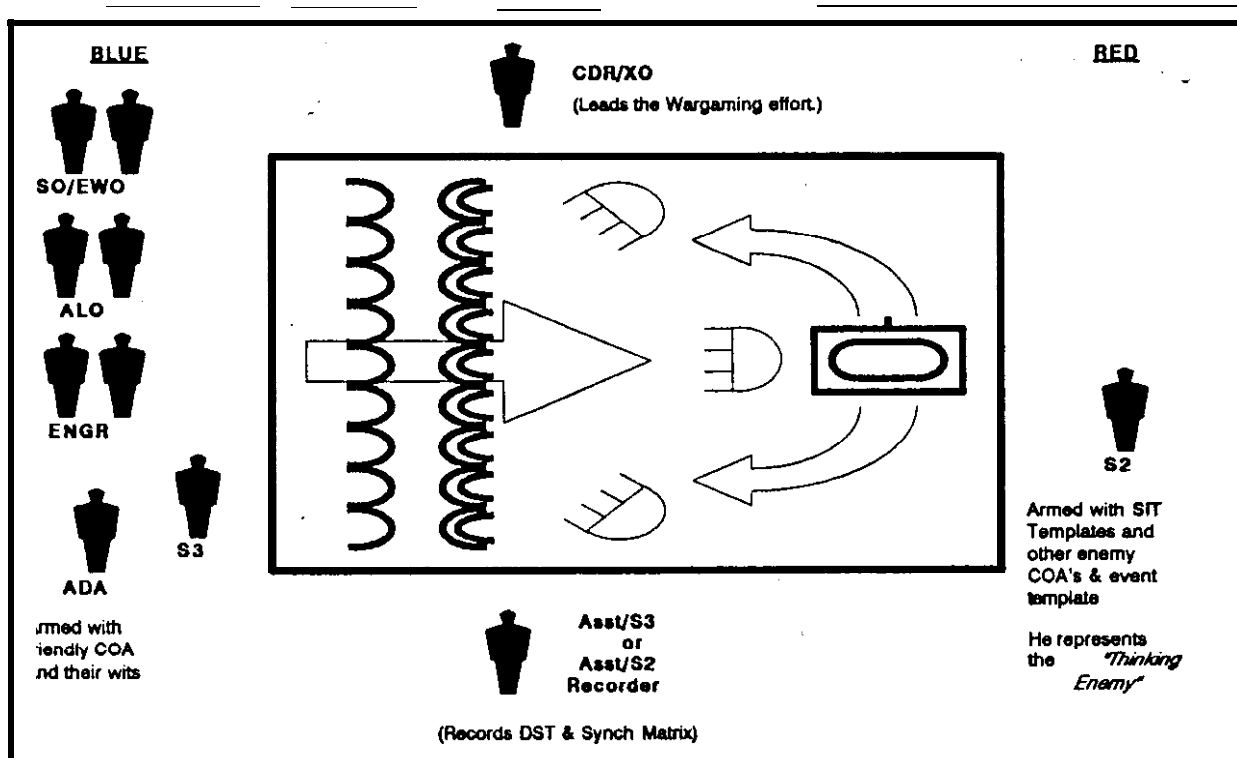

Figure 1-2. wargaming.

- o Refine the enemy course of action models and event **templates and** matrices, focusing on the intelligence required to execute the friendly course of action.
- o Arrange the threat courses of action in order of probability of adoption. There may be a different order of probability for each potential friendly course of action.
- o Identify the most dangerous threat course of action.

- o Refine the friendly course of action, to include identifying the need for branches and sequels.
- o Determine the probability of success of the friendly course of action.

The results of wargaming each potential friendly course of action against the set of enemy course of action models allows the staff to **make** a recommendation on the best friendly course of action. The **G2/S2's** recommendation includes an evaluation of the intelligence system's ability to provide the intelligence needed to, support each course of action.

Appendix A of this manual discusses the relationship between IPB and wargaming in more detail.

**Decision:**

Following staff recommendations, the commander decides upon a COA and issues implementing orders. He also approves the list of intelligence requirements associated with that COA, developed during wargaming, and identifies the most important as PIR. The command's collection manager uses the results of IPB to develop and implement a collection plan that will satisfy these requirements (see below).

**Execution:**

As intelligence confirms or denies planning assumptions on the battlefield environment or the threat's course of action, a continuous IPB process identifies new intelligence requirements. As the battle progresses, IPB is used to continuously evaluate the situation facing the command, driving new iterations of the decision making process and the directing step of the intelligence cycle.

For a complete discussion of the decision making process see FM 101-5, Command and Control for Commanders and Staff.

**IPB and the Targeting Process**

As part of course of action analysis and comparison, or immediately after, the staff generally starts the targeting process with a targeting conference. The targeting process results in targeting guidance that supports the command's course of action. The relationship of the IPB process to each step in the targeting process is discussed below.

CATEGORY	HPTs <sup>1</sup>	WHEN	HOW	RESTRICTIONS
1 (C <sup>3</sup> )	46, 48	I	N and EW	Coordinate attack with EW
2 (FS)	1, 2, 7	A	N	DNE MRL older than 10 minutes
3 (MANUEVER)	25, 28	A	S	Last volley RAAMS/ADAM
4 (ADA)	58	P	S2 or G2	SEAD program 120800A
5 (ENGR)	85	P	N	Counter mobility program O/O
6 (RISTA)	103, 105	P	EW	
7 (RECON)	111, 112	P	N	
8 (NUKE/CHEMICAL)		I	D	Accuracy 0 to 200 meters; TDA required
9 (POL)		A	D	
10 (AMMO)		A	D	
11 (MAINTAINANCE)		P	N	Not HVT nor HPT
12 (LFT)		P	N	Not HVT nor HPT
13 (LOC)		P	N and G3	Not HVT nor HPT - No FASCAM

<sup>1</sup>Numbers refer to target spreadsheets (FM 6-20-10).

<sup>2</sup>This is only a type attack guidance matrix. Actual matrices are developed by the G3 or S3 and the FSE on the basis of the tactical situation.

<b>LEGEND:</b>	
I = Immediate	N = Neutralize
P = Planned	S = Suppress
A = As acquired	D = Destroy

Figure 1-3. IPB supports development of the attack guidance matrix.

**Decide:**

Using the list of high value targets that form part of each enemy course of action model, developed in step four of the IPB process, the staff determine which targets should be acquired and engaged as part of the friendly course of action. The resulting list of high payoff targets generates additional refinement of the event templates and **matrices** during the targeting process as the staff **wargames** the command's selected COA **to** ensure the **HPT** are acquired during execution of the friendly course of action.

**Detect:**

The command's collection manager uses the refined templates and **matrices** to develop SIR and plan intelligence collection to detect and track high payoff targets.

**Deliver:**

IPB structures the analysis that enables the **G2/S2** to advise the commander and fire support officer on the execution of the fire support plan.

For a complete discussion of the targeting process see FM 6-20-10, The Taraetina Process.

▄▄▄▄▄▄▄▄▄▄▄▄ IPB and the Collection Management Process ▄▄▄▄▄▄▄▄▄▄▄▄

Collection management synchronizes the activities of organizations and **systems** to provide intelligence the commander needs to accomplish his course of action and **targeting** efforts. IPB helps the commander identify his intelligence requirements **and** provides the focus and direction needed to satisfy them.

The commander bases his initial intelligence requirements on the critical gaps identified during IPB in the mission analysis step of the decision making process. Refined and updated requirements result from staff wargaming and selection of a particular friendly course of action.

During staff wargaming the **G2/S2** uses the enemy course of action models developed in step **four** of the IPB process to portray the enemy. The remainder of the staff **"fights"** each potential **friendly COA** and note where and when in its execution decisions are required to make the COA successful. They also determine the specific intelligence required to support each decision and record it **onto** the list of proposed intelligence requirements. When the commander selects a particular friendly course of action he also approves and prioritizes the supporting intelligence requirements.

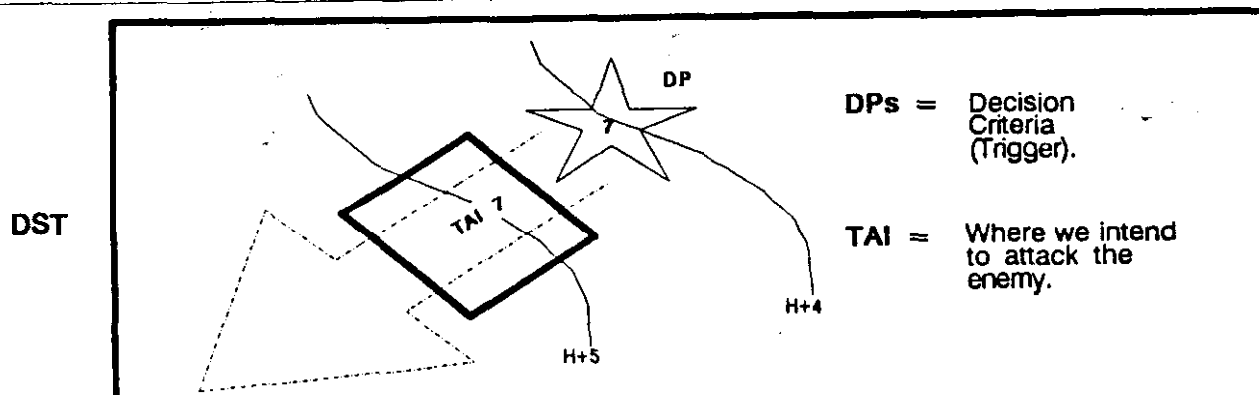

**BOS  
Synch  
Matrix**

	<b>DP</b>		<b>#7</b>	
	Time		H+4	
	Decision Criteria (Enemy Action)		MRR CATK (Tk Co)	
<b>(BOS) FRIENDLY ACTIONS</b>	Intelligence		2-9 CAV. Collects	
	Maneuver		Attack Helos to TAI 7 at H+5	
	Fire Support & EW		H+5 DPICM to TAI 7 Jam MRR c 2	

**Figure 1-4. The DST and BOS Synchronization Matrix.**

IPB supports further development of requirements by identifying the activity which will satisfy each requirement and where and when the activity is expected to occur.' The event template identifies the named areas of interest **where the** activity will occur. The event matrix describes the indicators associated with the activity. Both the event template and event matrix depict the times during which the activity is expected to occur. The details these tools provide are the basis of an effective' intelligence collection plan.

IPB products also contribute to the development of staff synchronization tools such as the decision support template (DST) and battlefield operating system (BOS) synchronization matrix (see Figure 2-3). The collection manager uses these additional tools to **ensure** that the collection plan stays synchronized with the command's operations. The resulting intelligence synchronization matrix depicts the collection strategies which support the command's course of action (see Figure 2-4).

5

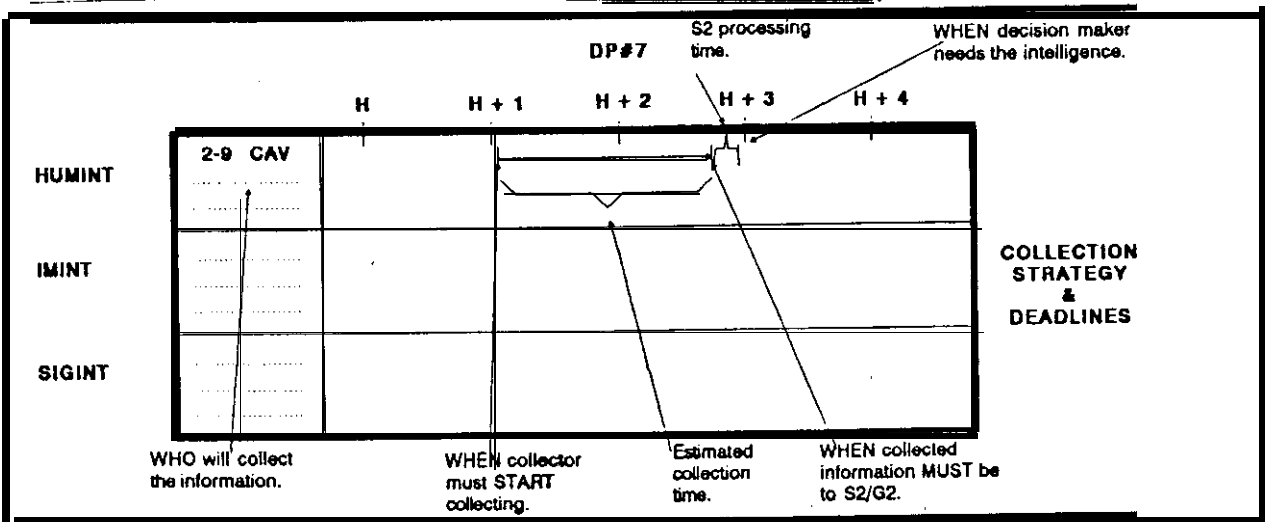

Figure 1-5. The Intelligence Synchronization Matrix.

Intelligence synchronization is much more than simply ensuring that collection systems of various sorts are operating 24 hours a day. The G2/S2 must direct the intelligence system, receive the information it produces, process it and then produce and disseminate intelligence of value to the commander in time to support his decisions. The coordination of this entire cycle is intelligence synchronization.

FM 34-2, Collection Management and Synchronization Planning discusses **intelligence synchronization** and the collection management process in detail.

.....  
 ■■■■■■■■■■ IPB and the Command and Staff, Execution of Battle ■■■■■■■■■■

IPB provides the **G2/S2** the tools he needs to quickly evaluate incoming information and intelligence as it relates to **the command's** synchronization matrix and DST. This supports the commander's decisions during course of action execution and helps him to quickly confirm or deny the assumptions used during course of action development.

During battle, the commander and staff track the DST and the synchronization matrix against incoming reports. As the staff nears each decision point they look to the **G2/S2** for the intelligence that supports that decision.

Sometimes the battle will progress in a direction unanticipated during the initial IPB and wargaming. The **enemy** is following his own plans and **time** lines; those determined during staff wargaming are only estimates. Therefore, staffs should ensure they use IPB, wargaming, and intelligence synchronization as dynamic tools rather than as one-time events. As the operation unfolds and the enemy's intentions become **more** clear reinitiate the IPB and decision making processes as needed.

This requires key members of the staff to "**huddle**" or conduct "**mini-wargaming**." During these sessions, the **G2/S2** reviews and modifies the initial IPB. The battle staff then **wargames** the best friendly response or preemptive action based on the updated set of IPB predictions. New decisions and **COAs** lead to updating and refining the collection plan, intelligence synchronization, and new decision support tools.

■■■■■■■■■ How IPB Relates to Everything Else ■■■■■■■■■■

IPB is an essential element of the intelligence cycle. The products developed during IPB are so critical to this cycle and the staff planning effort that it is a distinct function. There are six intelligence and electronic warfare (IEW) tasks described in FM 34-1, the Army's intelligence principles manual. They are to **develop-**

- o IPB products.
- o Situation development products.
- o Indications and warnings (I&W) products.
- o Target development and target acquisition products.
- o Battle damage assessment (BDA) products.
- o Force protection products.



These IEW functions are accomplished within the intelligence system of systems (ISOS) to operate in this cycle and respond to the commander's intelligence needs. The ISOS is the flexible architecture of procedures, organizations and equipment that collect, process, store and disseminate intelligence. The **G2/S2** uses IPB products to process volumes of information provided by the ISOS and the intelligence **cycle**.

IPB products also enable staffs to exploit the modern technology of the ISOS **by focusing** collection systems that now provide near-real-time information in sufficient accuracy to conduct direct targeting. IPB not only enables a staff to put steel on target, but helps prioritize and maximize the effects of targeting. IPB plays a critical role in the decision-making process. Finally, the commander leads the IPB effort. The entire staff executes the IPB process.

3

The military intelligence (MI) unit commander is not responsible for the supported command's IPB. However, the MI unit commander will use the IPB process to support his own unique planning requirements. Some of these involve employment of the ISOS assets under his control.

<p>CHAPTER 2 CONDUCTING INTELLIGENCE PREPARATION OF THE BATTLEFIELD</p>
---

Intelligence preparation of the battlefield consists of four steps which you perform each time you conduct IPB:

- Define the battlefield environment.
- Describe the battlefield's effects.
- Evaluate the threat.
- Determine threat courses of action.

### How To Conduct IPB

Each step of the IPB process consists of several principal judgment decisions and evaluations which together form the basic "how to" of IPB. These are presented in outline form below:

Define the battlefield environment
------------------------------------

- Identify significant characteristics of the environment.
- Identify the limits of the command's area of operations and battle space.
- Establish the limits of the area of interest.
- Identify the amount of detail required and feasible within the time available for IPB.
- Evaluate existing data bases and identify intelligence **gaps**.
- Collect the material and intelligence required to conduct the remainder of IPB.

Describe the battlefield's effects
------------------------------------

- Analyze the battlefield environment
  - terrain analysis
  - weather analysis
  - analysis of other characteristics of the battlefield
- Describe the battlefield's effects on threat and friendly capabilities and broad courses of action.

Evaluate the threat

- Update or create threat models:
  - Convert threat doctrine or patterns of operation to graphics (doctrinal templates);
  - Describe in words the threat's tactics and options.
  - Identify high value targets.
- Identify threat capabilities.

Determine threat courses of action

- Identify the threat's likely objectives and desired end state.
- Identify the full set of courses of action available to the threat.
- Evaluate and prioritize each course of action.
- Develop each course of action in the amount of detail time allows.
- Identify initial collection requirements.

The principles and steps of the intelligence preparation of the battlefield process remain constant regardless of the type of mission, unit, staff section or echelon conducting IPB. The application of the principles, however, varies with each specific situation. The situation template prepared by an air defense battery, for example, is very different from the one prepared by an electronic warfare section or a counter-intelligence analysis section.

Similarly, a given unit or staff section does not always prepare all IPB products in every situation. Determining which products to prepare and identifying their relative priority depends on the factors of METT-T and command guidance. Chapters three through six give examples of IPB applied in specific situations, illustrating modification of the basic process to particular needs. The remainder of this chapter describes each step of the IPB process in detail.

**Define the Battlefield Environment**

What is it?
-------------

Definition:

Identifying for further analysis specific features of the environment or activities within it, and the physical space.-where they exist, that may influence available courses of action or the commander's decisions.

Two Short Examales:

During planning for a humanitarian assistance operation the J2 identifies the activity of local armed factions as a feature influencing available courses of action and his commander's decisions. The J2 expands the area of interest to encompass the area within the neighboring country where these groups have established safe havens. He examines the data bases and determines that they do not contain the information he needs to estimate the different courses of action each faction might adopt. He identifies for collection information about the areas where they are located and their past operations to complete his data bases. **Realizing** that the information will probably arrive too late to support initial planning, the J2 discusses with the commander reasonable assumptions for use during planning. As the intelligence arrives, he confirms his initial assumptions and incorporates the new information into his ongoing IPB process.

During planning for a mounted attack the **S2** identifies the enemy's divisional attack helicopters as a major threat to accomplishment of the brigade's mission. The **S2** expands the brigade's area of interest to encompass the reported location of the enemy's attack helicopter battalion and the zone where it will probably establish forward operating bases and forward area arming and refueling sites. He reviews his intelligence holdings to determine the types of intelligence he will need about the terrain, weather, and enemy helicopter operations to identify potential helicopter locations and courses of action. He builds an initial R & S plan to provide the intelligence he needs to complete his IPB. As the reports come in, he uses them to update or validate the results of his initial

Define the battlefield environment (**cont**)  
So what? (**cont**)

IPB. If necessary, he reinitiates the IPB process to account for intelligence that denies assumptions made during the IPB and decision making process.

Desired End Effect:

Focus **the IPB** effort on the areas and characteristics of the battlefield which will influence the command's mission. Acquire the intelligence needed to complete the IPB process in the degree of detail required to support the decision making process.

So what?

Success Results in:

Saving time and effort by focusing only on those areas and features which will influence courses of action and command decisions.

Consequences of Failure:

Failure to focus on only the relevant characteristics leads to wasted **time** and effort collecting and evaluating intelligence on features of the battlefield environment that will not influence success of the command's mission.

On the other hand, failure to identify all the relevant characteristics may lead to the command's, surprise and unpreparedness when **some** overlooked feature of the battlefield exerts an influence on success of the command's mission.

How to do it:

- o Identify significant characteristics of the environment.
- o Identify the limits of the command's area of operations and battle space.

Define the battlefield environment (cont)  
How to do it (cont)

- Establish the limits of the area of interest.
- Identify the amount of **detail required** and feasible within the time available for IPB.
- Evaluate existing data bases and **identify** intelligence gaps.,:
- Collect the material and intelligence required to conduct the remainder of IPB.

IDENTIFY SIGNIFICANT **CHARACTERISTICS** OF THE ENVIRONMENT

Characteristics of the battlefield environment that will influence the commander's decisions or affect the courses of action available to your own force or the threat are of **special significance** in the IPB process.

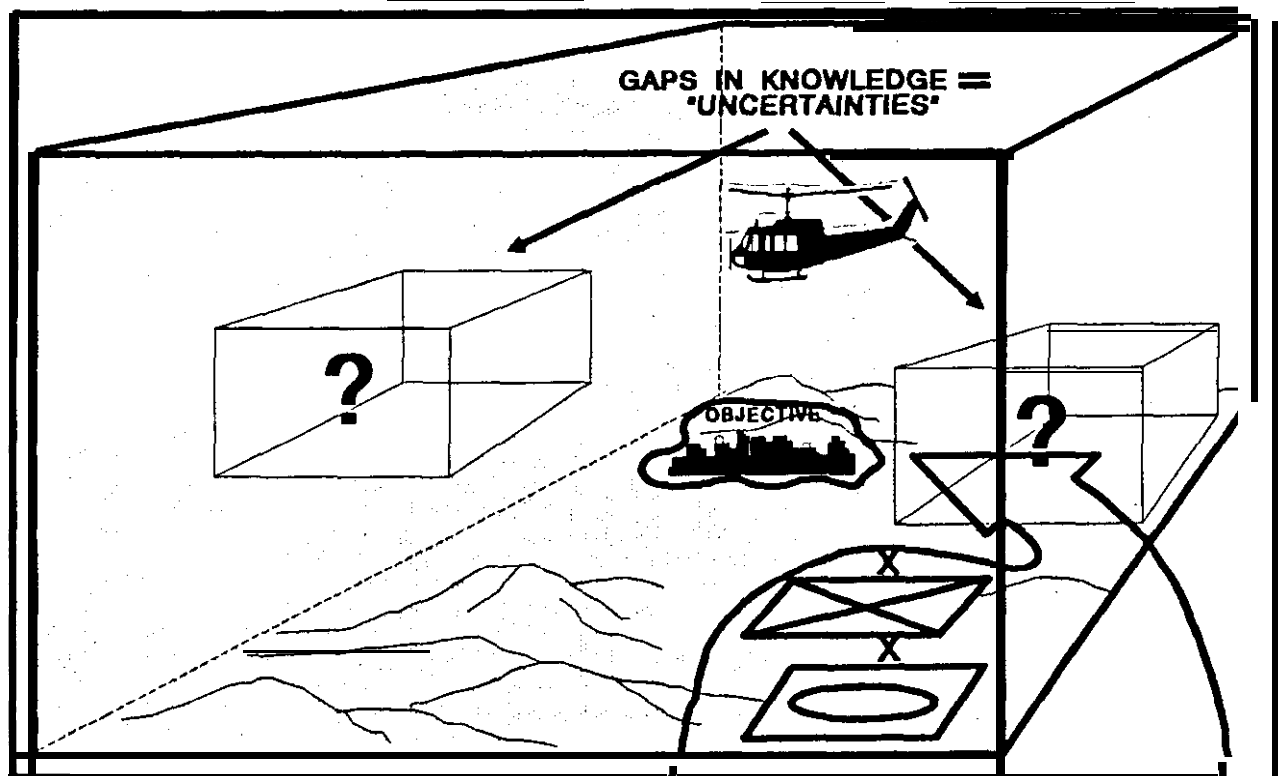

Figure 2-1. The common understanding of the battlefield.

Define the battlefield environment (**cont**)

How to do it (**cont**)

Identify significant characteristics of the environment

During a humanitarian assistance operation, for example, the location and activities of civilian relief organizations might be a significant characteristic of the battlefield. During support to counterdrug operations, significant characteristics might include the production of narcotics or **the trading** of weapons. During war characteristics such as the location and activities of enemy reserves, reinforcements, and long range fire support assets are typical significant characteristics. At some levels of command they might also include characteristics such as economic trade activity between a neutral country and our enemy.

When identifying significant characteristics of the battlefield, consider threat forces and all other aspects of the environment that may have an effect on accomplishment of the unit's mission. Depending on the situation these might include--

- o Geography, terrain, and weather of the area.
- o Population demographics (ethnic groups, religious **groups**, age distribution, income groups, etc.)
- o Political or socio-economic factors, including the role of clans, tribes, gangs, etc.
- o Infrastructures, such as transportation or telecommunications.
- o Rules of engagement or legal restrictions such as International treaties or agreements.
- o Threat forces and their capabilities, in general terms. Consider para-military forces. as well.

Initially, examine each characteristic only in general terms to identify those of significance to the command and its mission.. Further evaluation of the effects of each characteristic takes place during later steps of the IPB process. For example, at this step the evaluation of threat forces is limited to an identification of forces that have the ability to influence the command's mission based on their location, mobility, general capabilities, weapons ranges, etc. During later steps of the IPB process you will actually evaluate each threat force's specific capabilities and probable courses of action.

**Define the battlefield environment (cont)****How to do it (cont)**

Identify significant characteristics of the environment

Identifying the significant characteristics of the battlefield environment helps establish the geographical limits of the area of interest and directs analytical efforts **in** steps two and three of the IPB process. It also helps identify gaps in the common understanding of the battlefield, serving as a guide to the type of intelligence and information required to complete the IPB process.

**IDENTIFY THE LIMITS OF THE COMMAND'S AREA OF OPERATIONS AND BATTLE SPACE**

The area of operations (AO) is the geographical area where the commander is assigned the responsibility and authority to conduct military operations. A thorough knowledge of the characteristics of this area leads to its effective use. Generally, because this is the area where the command will conduct its operations, the evaluation of the battlefield's effects is more thorough and detailed within the **AO** than it is within the area of interest. Identify the limits of the **AO** in order to provide the focus you need. The limits of the area of operations are normally the boundaries specified in the operations order or contingency plan from higher headquarters that define the command's mission.

The limits of the command's battle space are determined by the maximum capabilities of a unit to acquire targets and physically dominate the threat. The command's capabilities in this regard include the target acquisition and long range assets of supporting and higher commands as well as its own organic systems. A command's battle space generally includes all or most of the area of operations as well as areas outside of the AO. The evaluation of the area within the command's battle space may be as detailed as the evaluation of the area of operations if the commander's guidance or intent requires the command to request, conduct, plan, or synchronize operations there. This is true even if the operations are to be conducted by some other command. In other cases the command's battle space may receive the same treatment as its area of interest.



Define the battlefield environment (cont)  
 How to do it (cont)  
 Establish the limits of the area of interest

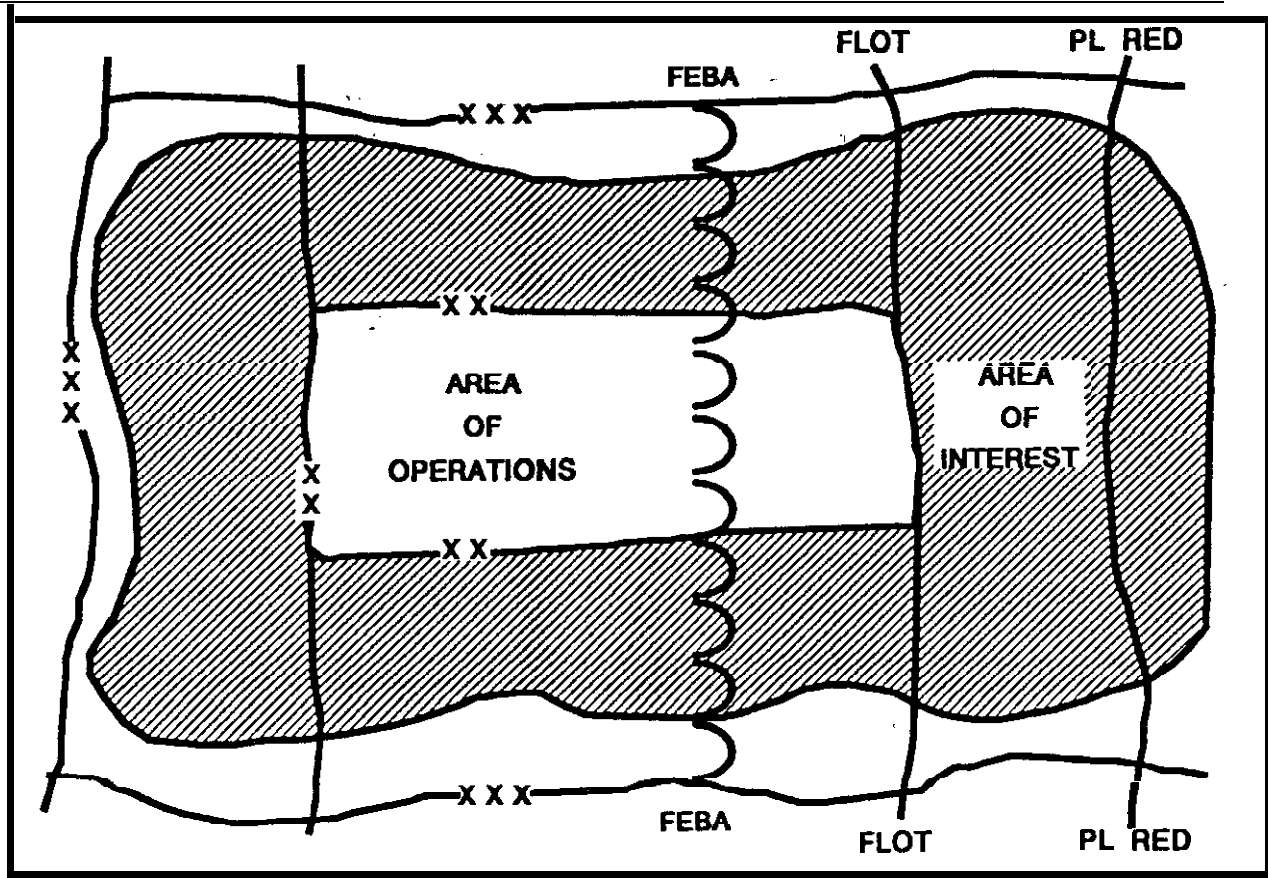

Figure 2-2. Battlefield areas.

ESTABLISH THE LIMITS OF THE AREA OF INTEREST

The area of interest is the geographical area from which information and intelligence are required to permit planning or successful conduct of the command's operation. Because the commander and staff need time to process information and to plan and synchronize operations, the command's area of interest is generally larger than its area of operations and battle space. The limits of the area of interest include each of the characteristics of the battlefield environment you identified as exerting an influence on available courses of action or command decisions.

Define the battlefield environment (**cont**)

How to do it (**cont**)

Establish the limits of the area of interest (**cont**)

Base the limits of the AI on the ability of the threat to project power or move forces into the area of operations. Also consider the geographical locations of other activities or characteristics of **the** environment which might influence courses of action or the commander's **decisions**. Consider also any anticipated future mission or "**be prepared**" and "**on order**" missions identified during mission analysis and determine their effect on the limits of the AI. Finally, consider changes in the command's battle space as **a**result of **maneuver**.

#### Additional Considerations:

You might divide the AI into several components, such as a ground AI, an air AI, or a political AI. Such a division accommodates the types of information relevant in each area of interest as well as their usually different geographical limits. The air AI, for example, is usually much larger than the ground AI. Within this extensive area, however, only activity related to the projection of air power is of interest. Although you might develop and consider the various areas of interest separately, at some point you must consider them as an integrated whole to insure that you present the commander with a complete, integrated description of the battlefield.

For the air AI include a consideration of altitude. When conducting air defense related IPB, the AI should extend upwards to the maximum service ceiling of the threat's aircraft. When conducting aviation related IPB, the AI should extend to the maximum service ceiling of the friendly aircraft or the maximum effective altitude of threat air defense **systems**, whichever is greater.

One of the primary considerations in establishing the limits of the AI is time. Base the time limit not only on the threat's mobility, both ground and air, but also on the amount of time needed to accomplish the friendly mission. For example, if a command estimates that it will take two days to complete an operation, the AI must encompass all forces or activities that could influence accomplishment of the command's mission within two days.

Define the battlefield environment (cont)

How to do it (cont)

Establish the limits of the area of interest (cont)

For missions that are of relatively short duration, such as the evacuation of non-combatants or raids, the AI usually includes only immediate, direct threats to mission accomplishment and may be relatively small. A helicopter raid on a battlefield where we enjoy air superiority might have an **AI that** includes only the air defense systems within range of the engagement area and the air routes to and from. Some long-term missions, such as nation building, will result in an extensive area of interest that considers many political and economic factors as well as the more conventional military factors.

Since the limits of the AI are based on threats to mission accomplishment rather than strictly terrain considerations, they might cross into neutral countries. For example, if political developments in a neutral country might influence the accomplishment of the unit's mission, include that country within the area of interest. Likewise, if the population of a neutral country provides a base of support for forces opposing the command's operations, include it within the AI.

#### IDENTIFY THE AMOUNT OF DETAIL REQUIRED AND FEASIBLE WITHIN THE TIME AVAILABLE

The time available for completion of the IPB process may not permit the luxury of conducting each step in detail. Overcoming time limitations requires a focus on the parts of IPB that are most important to the commander in planning and executing his mission. Identifying the amount of detail required avoids **time** wasted on developing more detail than necessary in each step of the process.

For example,, the situation may not require an analysis of all threat forces within the AI. Perhaps only selected areas within the command's **AO** require detailed analysis due to the assigned mission or other factors of "mission, enemy, troops, terrain and time available." **Some** geographical areas or threat forces within the **AO** may require only a summary type evaluation of their effects or capabilities.

Define the battlefield environment **(cont)**

How to do it **(cont)**

Identify the amount of detail required and feasible within the time available **(cont)**

Identify the amount of detail required on each area of the battlefield or each threat force to support planning by consulting with the commander and the remainder of the staff. Prioritize your efforts to produce the amount of detail required within the available time. Backwards plan the IPB process and determine how much time you can reasonably devote to each step to meet the commander's, time lines. See scenario 3 in chapter 3 for an **example**.

#### EVALUATE EXISTING DATA BASES AND IDENTIFY INTELLIGENCE GAPS

Not all the intelligence and information required to evaluate the effects of each characteristic of the battlefield and each threat force will be in the current data base. Identifying the gaps early allows you to initiate action to collect the intelligence required to fill them.

Identify and prioritize the gaps in the current holdings, using the commander's initial intelligence requirements and intent to set the priorities. You should also identify any gaps which can not be filled within the time allowed for IPB. Discuss with the commander and the remainder of the staff the gaps you do not expect to be filled and formulate reasonable assumptions to fill them.

#### COLLECT THE REQUIRED INTELLIGENCE AND MATERIALS

Initiate collection or requests for intelligence to fill intelligence gaps to the level of detail required to conduct IPB. Include collection against all identified significant characteristics of the battlefield, not just threat forces, in priority order.

Continuously update the IPB products as you receive additional intelligence. Inform the commander if you confirm assumptions made during the initial mission analysis and IPB process. If any assumptions are denied, re-examine the evaluations and decisions on which they were based.

Ideally, intelligence operations enable you to develop the perception of the battlefield and the threat to

Define the battlefield environment (**cont**)  
How to do it (**cont**)  
Collect the required intelligence and materials (**cont**)

completely match the actual situation on the battlefield. In reality intelligence will never eliminate all of the unknown aspects or uncertainties which concern a commander and his staff. Be prepared to fill gaps with reasonable assumptions.

Describe the Battlefield's Effects

What is it?

Definition:

The determination of how the battlefield environment affects both threat and friendly operations.

A Short Example:

"General Eisenhower, after the Pas de Calais area, the best available landing sites are along the coast of Normandy. Our best chances of a favorable combination of moon light, tides, and weather is in late May and early **June.**"

An **S2** tells his commander, "**Sir**, terrain and weather best accommodate offensive operations in the western part of the region. The best avenue of approach **is** number 3, but avenues 1 and 4 are also good. Avenue of approach 2 is unsuitable since it requires use of terrain within the neutral province. The region's best defensive terrain is along PL TOM, but suitable terrain is also available near PL **JONELL** and PL **GARY.**"

Desired End Effect:

Identify how the battlefield environment influences the operations and courses of action of threat and friendly forces.

Describe the Battlefield's Effects (cont) So what?
---

So what?
----------

Success Results in:

- (1) Allowing the commander to quickly choose and exploit the terrain (and associated weather, politics, economics, etc.) that best supports the friendly mission;

or

knowingly pick the second or third best terrain for operations supported by a deception in the first best terrain.

- (2) Identifying the set of threat courses of action available within a given geographic area.

Consequences of Failure:

- (1) The commander will fail to exploit the opportunities that the environment provides.
- (2) The threat will find and exploit opportunities in a manner the command did not anticipate.

How to do it:
---------------

Evaluate and integrate the various factors of the battlefield environment that affect both friendly and threat operations. Begin the evaluation with an analysis of the existing and projected conditions of the battlefield environment then determine their effects on friendly and threat operations and broad courses of action. The specific steps are--

- Analyze the battlefield environment:
  - terrain analysis;
  - weather analysis;
  - analysis of other characteristics of the battlefield.
- Describe the battlefield's effects on threat and friendly capabilities and broad courses of action.

Describe the battlefield's effects ( <b>cont</b> ) How to do it ( <b>cont</b> ) Analyze the battlefield environment
---

#### ANALYZE THE BATTLEFIELD ENVIRONMENT

The degree of detail **in** the analysis will vary depending on the area of the battlefield environment you are evaluating. Generally the evaluation of the area of operations is more detailed than the area of interest. Additionally, the focus will vary throughout each area. For example, rear areas within the area of operations may require a different focus than areas near the main **battle** area.

Also bear in mind that the battlefield is not homogeneous. Certain areas, or sub-sectors, will affect various types of operations to varying degrees. During the evaluation identify areas that favor each type of operation. Include **the** traditional operations (defense, offense, etc.) as well as the operations associated with any METT-T specific factors (counterterrorism, peace enforcement, etc.).

#### TERRAIN ANALYSIS

The best terrain analysis is based on a reconnaissance of the **AO** and **AI**. Identify gaps in knowledge of the terrain which a map analysis cannot satisfy. Use the gaps you identify as a guide for reconnaissance planning. Because of time constraints focus reconnaissance on the areas of most importance to the commander and his mission. For example, when conducting terrain analysis for a signal unit you might focus on identifying locations from which the unit's assets can best support the force commander while also identifying the best locations for the threat's EW assets that might target friendly Signal systems.

Similarly, a counterintelligence analysis section might focus on locations that best support employment of threat intelligence collection systems and locations that best protect friendly elements from their collection activities. See chapter 4 for additional considerations in tailoring terrain analysis.

Describe the battlefield's effects **(cont)**

How to do it **(cont)**

Analyze the battlefield environment **(cont)**

Terrain analysis **(cont)**

The engineer (terrain) detachment that supports divisions, corps, and echelons above corps usually conducts the **major** portion of the terrain analysis, **combining extensive** database information with the **results** of reconnaissance. The engineers work closely with the USAF weather detachment or staff weather officer to ensure that their terrain analysis incorporates the effects of current and projected-weather phenomena.

The engineer (terrain) detachment has access to special terrain data bases compiled by the Defense Mapping Agency, allowing automated support of the terrain analysis process. **TERRABASE**, if available, also offers automated terrain analysis capabilities. While unequalled in conducting pre-hostility and pre-deployment terrain analysis, you should supplement these data bases with reconnaissance of the terrain in question whenever feasible.

If engineer terrain support is unavailable, evaluate **the terrain** through a map analysis supplemented by reconnaissance. The Defense Mapping Agency produces specialized maps, overlays and databases to aid in map based evaluations. Specialized Defense Mapping Agency products address such factors as--

- cross country mobility;
- transportation systems (road and bridge information);
- vegetation type and distribution;
- surface drainage and configuration;
- surface materials (soils);
- ground water;
- obstacles.

Ensure that the terrain analysis includes the effects of weather on the military aspects of the terrain. Consider the existing situation as well as conditions forecasted to occur during mission execution.

Also consider that terrain analysis is a continuing process. Changes in the battlefield environment may



Describe the battlefield's effects **(cont)**

How to do it **(cont)**

Analyze the battlefield environment **(cont)**

Terrain analysis **(cont)**

change the evaluations of its effects that result from terrain analysis. For example,

If built-up areas are reduced to rubble or lines of **communication** are destroyed by battle, you must re-evaluate the mobility characteristics of the area of operations.

Similarly, if weather conditions change you must re-evaluate the terrain's effect on military operations. Terrain analysis must always consider the effects of weather.

Express the results of evaluating the terrain's effects by identifying areas of the battlefield that favor, disfavor, or do not affect each broad course of action. Examples of conclusions about the terrain that help you make evaluations of the terrain's effects are identification of the places best suited for use as--

- o engagement areas,
- o battle positions,
- o infiltration lanes
- o avenues of approach, and
- o specific system or asset locations.

You reach conclusions about the effects of terrain through the following sub-steps.

- (1) Analyze the military aspects of the terrain.
- (2) Evaluate the terrain's effects on military operations.

Each of these sub-steps is discussed below.

- (1) Analyze the military aspects of the terrain.

Terrain analysis consists of an evaluation of the military aspects of the battlefield's terrain to determine its effects on military operations. The military aspects of terrain are:

Describe the battlefield's effects (**cont**)

How to do it (**cont**)

Analyze the battlefield environment (**cont**)

Terrain analysis (**cont**)

Analyze the military aspects of terrain

- o observation and fields of fire,
- o concealment and cover,
- o obstacles,
- o key terrain, and
- o avenues of approach

Consider all of these factors when analyzing terrain, but always focus on the ones of most relevance to the specific situation at hand and the needs of the commander. Evaluate them in any order that best supports your analysis.

Remember that the terrain analysis is not the end product of the IPB process. Rather, it is the means to determine which friendly **COAs** can best exploit the opportunities the terrain provides and how the terrain effects the threat's available courses of action.

#### Observation and Fields of Fire:

Observation is the ability to see the threat either visually or through the use of surveillance **devices**. Factors that limit or deny observation include concealment and cover.

A field of fire is the area that a weapon or group of weapons may effectively cover with fire from a given position. Terrain that offers cover limits fields of fire.

Terrain that offers good observation and fields of fire generally favors defensive courses of action.

The evaluation of observation and fields of fire allows you to:

- o identify potential engagement areas, or "**fire sacks**" and "**kill zones**,"

Describe the battlefield's effects (cont)

How to do it (cont)

Analyze the battlefield environment (cont)

Terrain analysis (cont)

Analyze the military aspects of terrain

Observation and fields of fire (cont)

- o identify defensible terrain and specific **system or** equipment positions, and
- o identify where maneuvering forces are most vulnerable to observation and fires.

Evaluate observation from the perspective of electronic and optical line-of-sight systems as well as unaided visual observation. Consider systems such as weapon sights, laser range finders, radars, radios, and jammers.

While ground based systems usually require horizontal line-of-sight, airborne systems use oblique and vertical line-of-sight. The same is true of air defense systems.

An evaluation of oblique line-of-sight aids in planning ADA system locations, selecting landing and drop zones, planning helicopter forward area arming and refueling position locations, identifying areas vulnerable to aerial intelligence collection systems, and selecting low-level flight routes and aerial battle positions.

Evaluate fields of fire for all flat trajectory and indirect fire weapons the unit owns--

An ideal field of fire for flat trajectory weapons is an open area in which the threat can be seen and on which he has no protection from fire from those weapons, out to the weapon's maximum effective **range**. Although observation is essential to effective control of fire, the best observation does not guarantee the best field of fire; you must also consider the availability of cover.

Dr  
R  
1

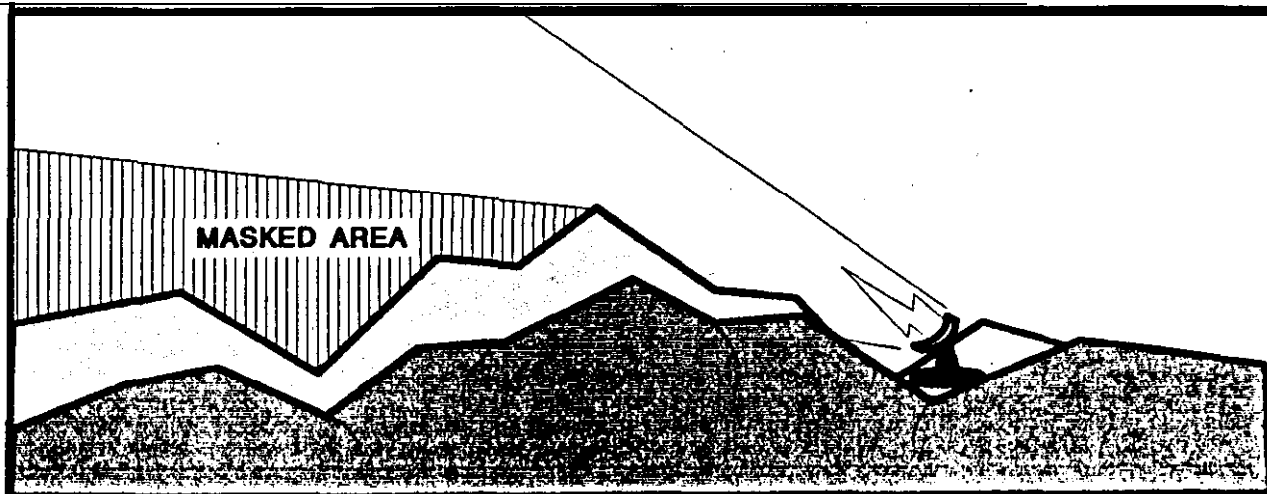

Figure 2-3. Oblique LOS (ground).

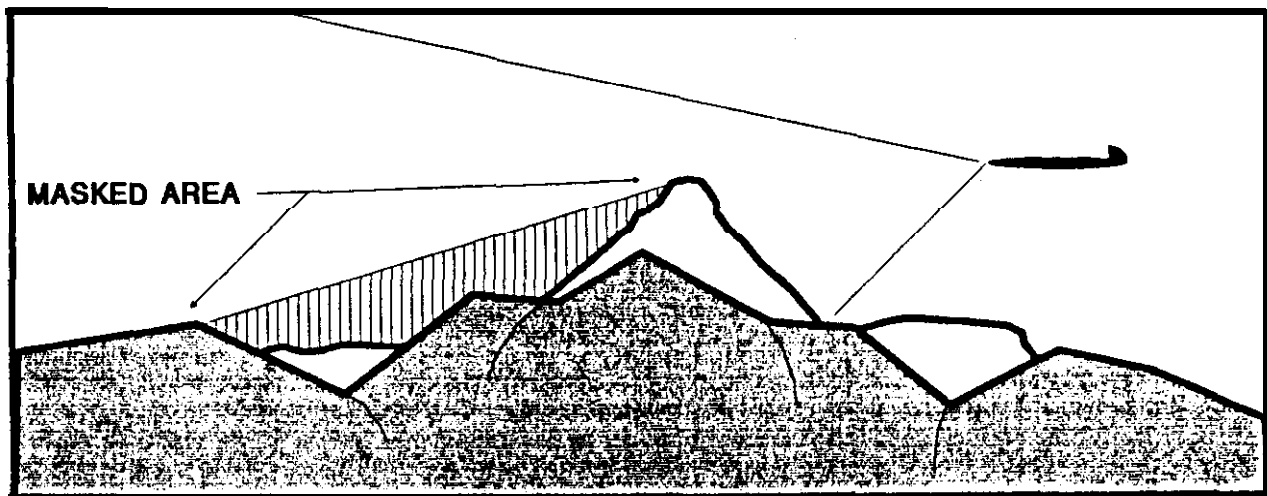

Figure 2-4. Oblique LOS (air).

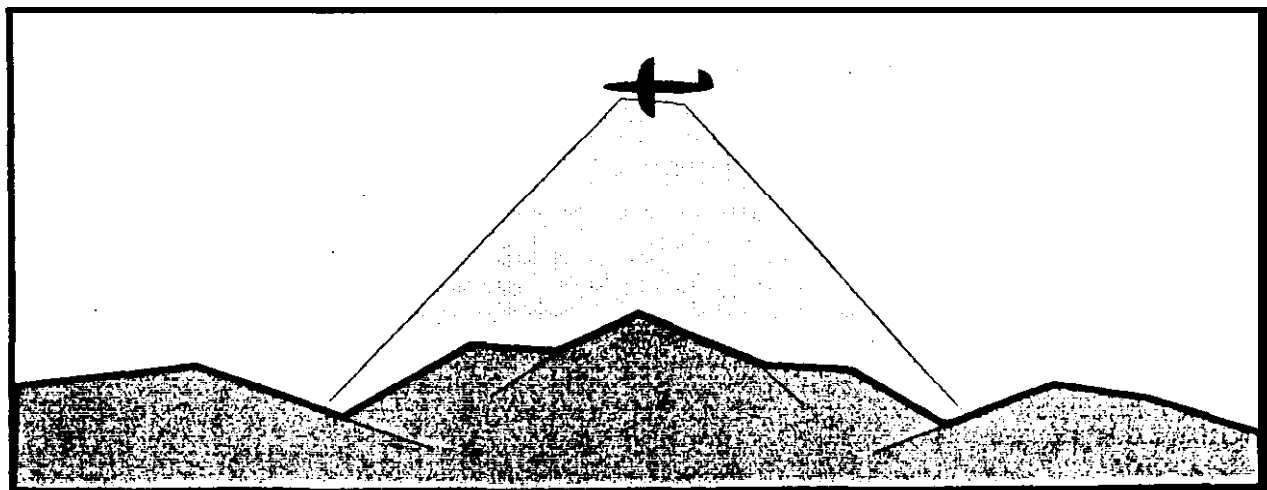

Figure 2-5. Vertical LOS.

Describe the battlefield's effects (cont)

How to do it (cont)

Analyze the battlefield environment (cont)

Terrain analysis (cont)

Analyze the military aspects of terrain

Observation and fields of fire (cont)

For indirect fire weapons consider only the nature of the terrain in the target area and the amount of protection it provides from those weapons.

Combine the analysis of each factor limiting observation and fields of fire into a single product. **This** is usually an overlay with areas of poor observation and fields of fire marked by parallel diagonal lines or cross hatching. It identifies the areas where a unit is vulnerable to observation by intelligence collection systems or engagement by threat forces. Use products such as this to help you identify potential engagement areas and evaluate avenues of approach.

To complete the analysis identify areas that offer positions overwatching areas of vulnerability. This helps you to identify defensible terrain, potential battle positions, and possible locations for intelligence collectors.

If time and resources permit prepare terrain factor overlays to aid in evaluating observation and fields of fire. Consider the following:

- vegetation or building height;
- canopy or roof closure;
- vegetation or building density;
- relief features, including micro-relief features such as defiles (elevation tinting techniques are helpful);

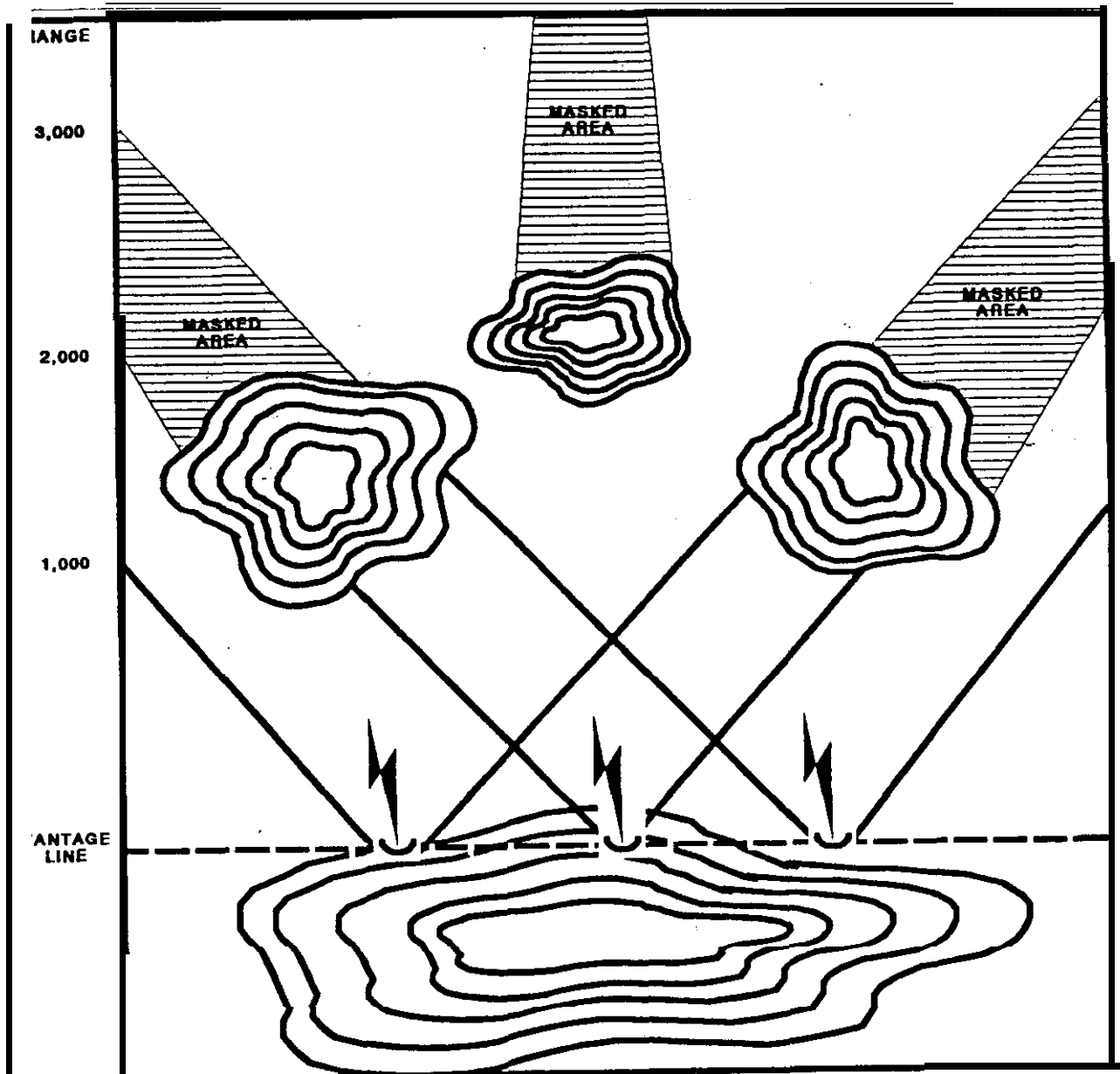

Figure 2-6. Example of a horizontal line-of-sight template.

- friendly and threat target acquisition and sensor capabilities;
- specific lines of sight.

Another technique which aids an evaluation of observation and fields of fire is to conduct or request line-of-sight studies. Some commands, such as signal units, MI units, and **ADA** units, have a great need for line-of-sight analysis.

Describe the battlefield's effects (cont)

How to do it (cont)

Analyze the battlefield environment (cont)

Terrain **analysis** (cont)

Analyze **the** military aspects of terrain observation and fields of fire (cont)

**Line-of-sight** studies aid in site selection for specific systems requiring direct line of sight. Normally, you request or conduct line-of-sight studies after the evaluation of the terrain's effects on observation have identified areas for likely employment of these systems.

Concealment and Cover:

Concealment is protection from observation. It can be provided by areas of woods, underbrush, snowdrifts, tall grass, cultivated vegetation, etc.

Cover is protection from the effects of direct and indirect fires. It can be provided by ditches, caves, river banks, folds in the ground, shell craters, buildings, walls, embankments, etc.

The evaluation of concealment and cover aids in identifying defensible **terrain**, possible approach routes, assembly areas, and deployment and dispersal areas. Evaluate concealment and cover in the same manner as for observation and fields of fire. Combine the analysis of each factor into a single product such as an overlay cross-hatched to depict areas that offer concealment and cover. You can usually use the products developed during the evaluation of observation and fields of fire as a start point. Use the results of the evaluation to:

- o identify and evaluate avenues of approach
- o identify defensible terrain and potential battle positions
- o identify potential **assembly** and dispersal areas.

Describe the battlefield's effects **(cont)**

How to do it **(cont)**

Analyze the battlefield environment **(cont)**

Terrain analysis (Cont)

Analyze the military aspects of terrain

Concealment and cover **(cont)**

Concealment and cover are desirable for both the attack and the defense:

- If an attacking force can move forward under concealment the chances of achieving surprise are greater. If a force can move protected from the threat's fire the attack will be more effective. Concealed and covered approach routes are particularly important to reconnaissance units, dismounted infantry, and insurgent or terrorist forces.
- Defending forces seek to defend in an area which offers both concealment and cover but does not provide covered approaches for the threat.

Rear area units seek deployment areas and movement routes that are concealed from threat intelligence collection systems and provide cover from deep attack systems, including level I, II, and III rear area threats. Cover and concealment are desirable during force movements by any means. Units always seek to maximize:

- the cover and concealment of their own forces, and
- their observation and fields of fire into potential threat positions or threat avenues of approach.

#### Obstacles:

Obstacles are any natural or man-made terrain features that stop, impede, or divert military movement.



Describe the battlefield's effects (cont)

How to do it (cont)

Analyze the battlefield environment (cont)

Terrain analysis (cont)

Analyze the military aspects of terrain

Obstacles (cont)

Some examples of obstacles to ground mobility are buildings, steep slopes; rivers, lakes, forests, deserts, swamps, **jungles**, cities, minefields, trenches, and military wire obstacles,

Obstacles to air mobility include features that exceed the aircraft's service ceiling, restrict nap-of-the-earth flight or that force the aircraft to employ a particular flight profile. Examples are tall (greater than 75 feet) trees, towers, buildings, rapidly rising terrain features, mountains, and smoke or other obscurants.

An evaluation of obstacles leads to the identification of mobility corridors. This in turn helps identify defensible terrain and avenues of approach. To evaluate obstacles:

- o **Identify** pertinent obstacles in the AI,
- o Determine the effect of each obstacle on the mobility of the evaluated force, and
- o Combine the effects of individual obstacles into an integrated product.

If DMA products are unavailable, and time and resources permit, prepare terrain factor overlays to aid in evaluating obstacles. Some of the factors to consider are:

- o Vegetation (tree spacing and trunk diameter);
- o Surface drainage (stream width, depth, velocity, bank slope and height);

Describe the battlefield's effects (**cont**)

How to do it (**cont**)

Analyze the battlefield environment (**cont**)

Terrain analysis (**cont**)

Analyze the military aspects of terrain

Obstacles (**cont**)

- o Surface **materials** (soil types and conditions that affect mobility);
- o Surface configuration (slopes that affect mobility)
- o Obstacles (natural and man made, consider obstacles to flight as well as ground mobility);
- o Transportation systems (bridge classifications and road characteristics such as curve radius, slopes, width, etc.)
- o Effects of actual or projected weather such as heavy precipitation or snow cover.

Combine the several factor overlays into a single product known as **the combined** obstacle overlay. The combined obstacle overlay integrates the evaluations of the various factors into a single product that depicts the battlefield's effects on mobility (see Figure 2-7).

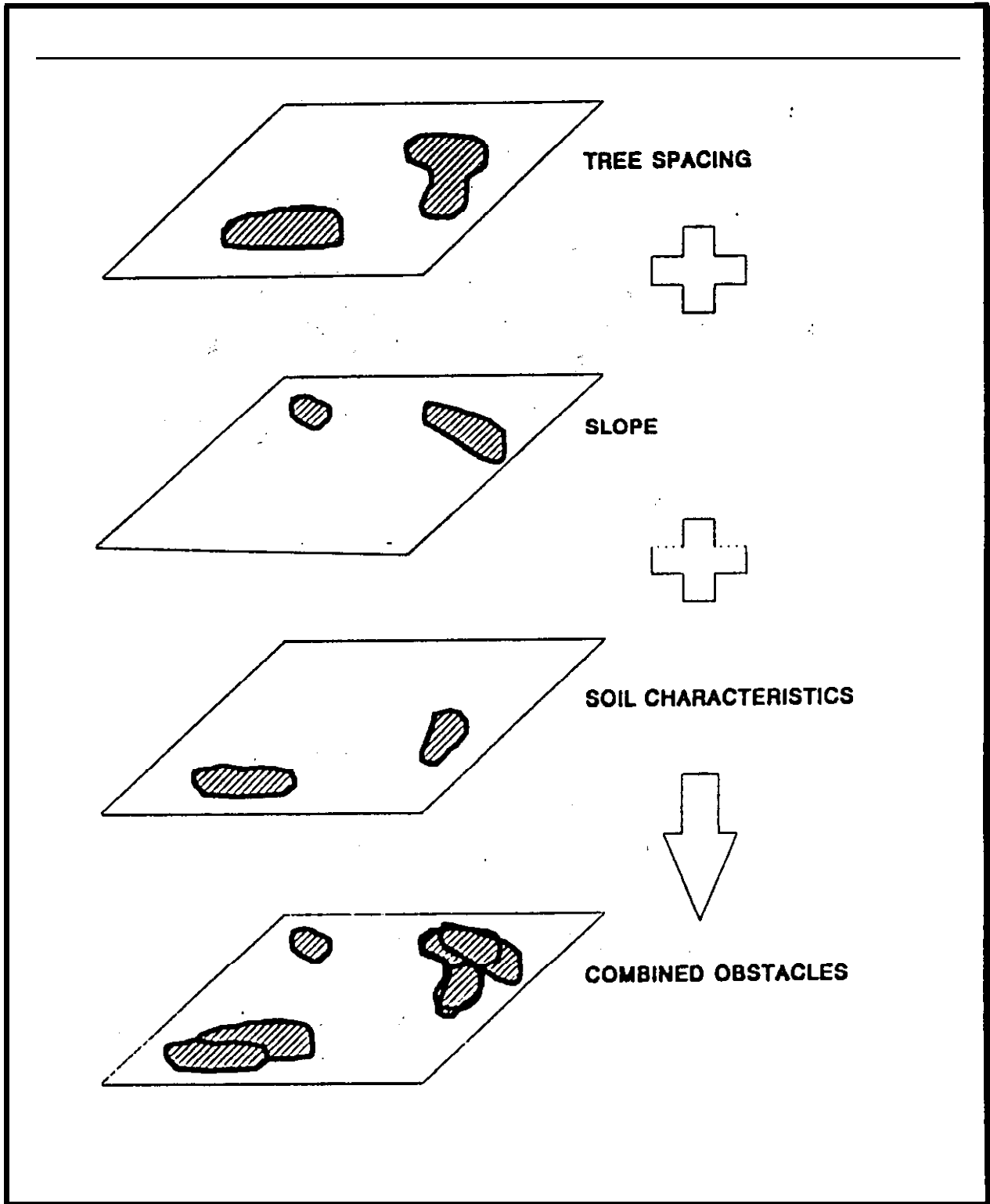

Figure 2-7. Combine all evaluated factors to produce an integrated product.

Describe the battlefield's effects **(cont)**

How to do it **(cont)**

Analyze the battlefield environment **(cont)**

Terrain analysis **(cont)**

Analyze the military aspects of terrain

Obstacles **(cont)**

A **technique** often used to **display** the cumulative evaluation of obstacles is a graphic product that depicts areas of terrain classified as **UNRESTRICTED**, **RESTRICTED**, and **SEVERELY RESTRICTED** in terms of their **effects** on mobility. IPB defines these three classifications as:

- **UNRESTRICTED** indicates terrain free of any restriction to movement. Nothing needs to be done to enhance mobility.

**UNRESTRICTED** terrain for armored or mechanized forces is typically flat to moderately sloping terrain with scattered or widely spaced obstacles such as trees or rocks. **UNRESTRICTED** terrain allows wide maneuver by the forces under consideration and unlimited travel supported by well developed road networks.

- **RESTRICTED** terrain hinders movement to some degree. Little effort is needed to **enhance** mobility but units may have difficulty maintaining preferred speeds, moving in combat formations, or transitioning from one formation to another. **RESTRICTED** terrain slows movement by requiring zig-zagging or frequent detours.

**RESTRICTED** terrain for armored or mechanized forces typically consists of moderate to steep slopes, moderate to densely spaced obstacles such as trees, rocks, or buildings. Swamps or rugged terrain are examples of **RESTRICTED** terrain for dismounted infantry forces. Logistical or rear area movement may be supported by poorly developed road systems.

Describe the battlefield's effects **(cont)**

How to do it **(cont)**

Analyze the battlefield environment **(cont)**

Terrain analysis **(cont)**

Analyze the military aspects of terrain

Obstacles **(cont)**

A common and useful technique is to depict RESTRICTED terrain on overlays and sketches by marking the areas with diagonal lines.

- o SEVERELY RESTRICTED terrain **severely** hinders or slows movement in combat formations unless some effort is made to enhance mobility. This could take the form of committing engineer assets to improving mobility or of deviating from doctrinal tactics, such as moving in columns instead of line formations or at speeds much lower than those preferred.

SEVERELY RESTRICTED terrain for armored and mechanized forces is typically characterized by steep slopes and large or densely spaced obstacles with little or no supporting roads. A common technique is to depict this type of SEVERELY RESTRICTED terrain on overlays and sketches by marking the areas with crosshatched diagonal lines.

Other types of SEVERELY RESTRICTED terrain include minefields, unfordable rivers that exceed vehicle-launched bridge length, and road or railroad embankments, as just a few examples. Depict these types of SEVERELY RESTRICTED terrain using the symbology contained in FM 101-5-1, Operational Terms and Symbols. If standard symbology does not exist, such as in the case of unfordable rivers, depict them using wide solid lines, ad hoc symbology, or crosshatching as appropriate. Ensure that all non-standard symbols are explained in the graphic's legend.

**Describe** the battlefield's effects (cont)

How to do it (cont)

Analyze the battlefield environment (cont)

Terrain analysis (cont)

Analyze the military aspects of terrain

Obstacles (cont)

Terrain mobility classifications are not absolute but reflect the relative effect of terrain on the maneuver of **combat** formations. They are based on the ability of a force to maneuver in combat formations, usually linear, or to transition from one type formation to another, as opposed to simply moving through a piece of terrain.

Identifying an area as SEVERELY RESTRICTED terrain, for example, does not imply that movement through that area is impossible, only that it is impractical. Units moving in column formations along roads generally have little trouble traversing SEVERELY RESTRICTED terrain.

Additional Considerations:

- Obstacles perpendicular to an axis of attack favor the defender by slowing the attacker, forcing him into concentrations while crossing or negotiating obstacles, and holding the attacker for longer periods under the fires of the defender.
- Obstacles parallel to an axis of advance may give the attacker flank protection but they may also interfere with his lateral movement, employment of reserve forces, and coordination between adjacent units.
- **To** be effective the defender must cover obstacles by observation and fire. However, even undefended obstacles **may** canalize an attacker into concentrations which are easier to detect and attack.
- Terrain considered SEVERELY RESTRICTED for one unit **may** pose no obstruction to the mobility of another unit. For example, a

Describe the battlefield's effects (cont)

How to do it (cont)

Analyze the battlefield environment (cont)

Terrain analysis (cont)

Analyze the military aspects of terrain

Obstacles (cont)

dismounted infantry unit could easily negotiate a hilly, forested area that a mounted infantry unit might consider SEVERELY RESTRICTED. Similarly an attack helicopter unit may consider an area containing several tall towers and many high tension wires as SEVERELY RESTRICTED terrain while the same terrain would pose little or no obstacle to high performance aircraft operating at higher altitudes.

- o When evaluating the terrain's effects on more than one type force, such as dismounted infantry and armor, you may have to prepare separate combined obstacle overlays. Each one should focus on the mobility of a particular type force. As an alternative, if the situation or available time require you to accept the clutter, you can mark dismounted infantry infiltration lanes on an overlay that depicts the terrain's effects on the mobility of mounted forces.
- o Consider the cumulative effects of individual obstacles in the final evaluation. For example, by themselves a gentle slope or moderately dense woods may present little obstacle to mounted movement. Taken together, however, the combination **may** be restrictive.
- o Ensure that you account for the weather's effects on factors which affect mobility. For example, heavy **rains** swell **streams** and decrease the load bearing characteristics of most soil types. Some soil types, however, actually improve when wet. See FM 34-81-1 for details and Appendix B of this manual for rules of thumb.

Describe the battlefield's effects (cont)

How to do it (cont)

Analyze the battlefield environment (cont)

Terrain analysis (cont)

Analyze the military aspects of terrain

Obstacles (cont)

- When considering threat courses of action in relation to the terrain's effects on mobility keep the **lessons** of history in mind. There are many examples of a force achieving surprise by negotiating, supposedly "**impassable**" terrain. The classification of terrain into various obstacle types reflects only its relative impact on force mobility. The classifications are not absolute.

#### Key Terrain:

Key terrain is any locality or area the seizure, retention, or control of which affords a marked advantage to either combatant.

An example of key terrain is a bridge over an unfordable river which gives access to the opposite shore without requiring an assault crossing. Another example is a level clearing in rough terrain which is the only accessible landing field for airmobile operations.

Key terrain is often selected for use as battle positions or objectives.

Evaluate key terrain by assessing the impact of its seizure by either force upon the results of battle. Techniques that aid this evaluation are:

- Evaluate the other four aspects of military terrain first and integrate the results into the evaluation of key terrain. For example, if you identify only one valid avenue of approach to the command's objective, then the choke points on that avenue will probably become key terrain (compared to a situation where several avenues of **approach** are available).



Describe the battlefield's effects **(cont)**

How to do it **(cont)**

Analyze the battlefield environment **(cont)**

Terrain analysis **(cont)**

Analyze the military aspects of terrain

Key terrain **(cont)**

- Time permitting, 'conduct "**mini-wargaming**" to visualize possible outcomes of battle. See appendix A for a discussion on how to accomplish this.

A common technique is to depict key terrain on overlays and sketches with a large "**K**" within-a circle or curve that encloses and follows the contours of the designated terrain. On transparent overlays use a color that stands out, such as purple.

In the offense, key terrain features are usually forward of friendly dispositions and are often assigned as objectives. Terrain features in adjacent sectors may be key terrain if their control is necessary for the continuation of the attack or the accomplishment of the mission. If the mission is to destroy threat forces, key terrain may include areas whose seizure helps ensure the required destruction. Terrain which gives the threat effective observation along an axis of friendly advance may be key terrain if the threat must be denied its possession or control.

In the defense, key terrain **is** usually within the area of operations and within or behind the selected defensive area. Some examples of such key terrain are:

- Terrain which gives good observation over avenues of approach to and into the defensive position.
- Terrain which permits the defender to cover an obstacle by fire.

Describe the battlefield's effects (cont)

How to do it (cont)

Analyze the battlefield environment (cont)

Terrain analysis (cont)

Analyze the military aspects of terrain

Key terrain (cont)

- o Important road junctions or communications centers which affect the use of reserves, sustainment, or lines of communications.

Additional Considerations:

- o Key terrain varies with the level of command. For example, to an army or theater commander a large city may afford marked advantages as a communications center. To a division commander the high ground which dominates the city may be key terrain while the city itself may be an obstacle.
- o Terrain which permits or denies maneuver may be key terrain. Tactical use of terrain is often directed at increasing the capability for applying combat power and at the same time forcing the threat into areas which result in reduction of his ability to apply his combat power. Terrain which permits this may also be key terrain.
- o Major obstacles are rarely key terrain features. The high ground dominating a river rather than the river itself is usually the key terrain feature for the tactical commander (since holding the high ground allows full use of the river's obstacle value). An exception is an obstacle such as a built-up area which is assigned as an objective.
- o Key terrain is decisive terrain if it has an extraordinary impact on the mission. Decisive terrain is rare and will not be present in every situation. To designate

Describe the battlefield's effects **(cont)**

How to do it **(cont)**

Analyze the battlefield environment **(cont)**

Terrain analysis **(cont)**

Analyze the military aspects of terrain

Key terrain **(cont)**

terrain as decisive is to recognize that the success of the mission depends on seizing or retaining it. The commander designates decisive terrain to communicate its importance in his concept of operation to his staff and subordinate commanders.

### **Avenues of Approach:**

An avenue of approach is an air or ground route of an attacking force of a given size leading to its objective or to key terrain in its path.

The identification of avenues of approach is important because all **COAs** which involve maneuver depend upon available avenues of approach.

During offensive operations, the evaluation of avenues of approach leads to a recommendation on the best avenues of approach to the command's objective and identification of avenues available to the threat for withdrawal **or** the **movement** of reserves.

During the defense, identify avenues of approach that support the threat's offensive capabilities and avenues that support the movement and commitment of friendly reserves.

To develop avenues of approach use the **results** of evaluating obstacles to--

- Identify mobility corridors;
- Categorize mobility corridors;
- Group mobility corridors to form avenues of approach;

Describe the battlefield's effects (cont)

How to do it (cont)

Analyze the battlefield environment (cont)

Terrain analysis (cont)

Analyze the military aspects of terrain

Avenues of approach (cont)

- o Evaluate avenues of approach;
- o Prioritize avenues of approach.
- o Identify Mobility Corridors:

Mobility corridors are areas where a **force** will be canalized due to terrain constrictions. They allow military forces to capitalize on the principles of **mass** and speed.

Evaluate the combined obstacle overlay to identify mobility corridors wide enough to permit maneuver in tactical formations. If friendly and threat forces require mobility corridors of different widths, perhaps due to organizational or equipment differences, you **may** have to conduct two separate evaluations. Identification of mobility corridors requires **some** knowledge of friendly and threat organizations for combat and preferred tactics. See Appendix B for some rules of thumb on threat forces.

The best mobility corridors use UNRESTRICTED terrain that provides enough space for a force to **move** in its preferred doctrinal formations while avoiding **major** obstacles. Mobility corridors usually follow the direction of roads and trails.

You **may** have to evaluate factors other than obstacles and mobility when identifying mobility corridors. Mobility corridors, like obstacles, are a function of the type and mobility of the force being evaluated. For example, mechanized and armor units generally require large open areas in which to **move**. Dismounted

Describe the battlefield's effects **(cont)**

How to do it **(cont)**

Analyze the battlefield environment **(cont)**

Terrain analysis **(cont)**

Analyze the military aspects of terrain

Avenues of approach **(cont)**

infantry, and most insurgents and terrorists, are less restricted by the presence of obstacles or hindering terrain and prefer areas that provide cover and concealment.

Similarly, the mobility **corridor used** by a jet aircraft with a minimum operating altitude of 1,000 feet is quite different from that considered by a helicopter with a maximum service ceiling of 12,000 feet.

Depict mobility corridors and zones of entry (see below) on overlays and sketches using simple, easily recognized symbols. See Chapter 3 for examples. If using colored graphics, use red when focusing on threat mobility or blue when the attention is on friendly force mobility. Ensure that any nonstandard symbols are explained in the graphic's legend.

o Categorize Mobility Corridors:

Once you have identified mobility corridors, categorize them by the size or type of force they will accommodate. You may prioritize them in order of likely use if warranted. For example, because military units generally require logistical sustainment a mobility corridor through UNRESTRICTED terrain supported by a road network is generally more desirable than one through RESTRICTED terrain or one unsupported by a road network.

Normally, identify mobility corridors for forces two echelons below the friendly command. This varies with each situation. Where the terrain is restrictive, allowing only relatively small mobility corridors, you may need to evaluate mobility corridors several echelons below the friendly command.

Describe the battlefield's effects (cont)  
 How to do it (cont)  
     Analyze the battlefield environment (cont)  
         Terrain analysis (cont)  
             Analyze the military aspects of terrain  
                 Avenues of approach (cont)

**o Group Mobility Corridors to form Avenues of Approach:**

Group mobility corridors together to form avenues of approach. An avenue of approach must provide ease of movement and **enough** width for dispersion of a force large enough to significantly affect the outcome of an operation.

Normally, identify avenues of approach for a force one echelon below the friendly command. Unlike mobility corridors, avenues of approach may include areas of SEVERELY RESTRICTED terrain since they show only the general area through which a force can move.

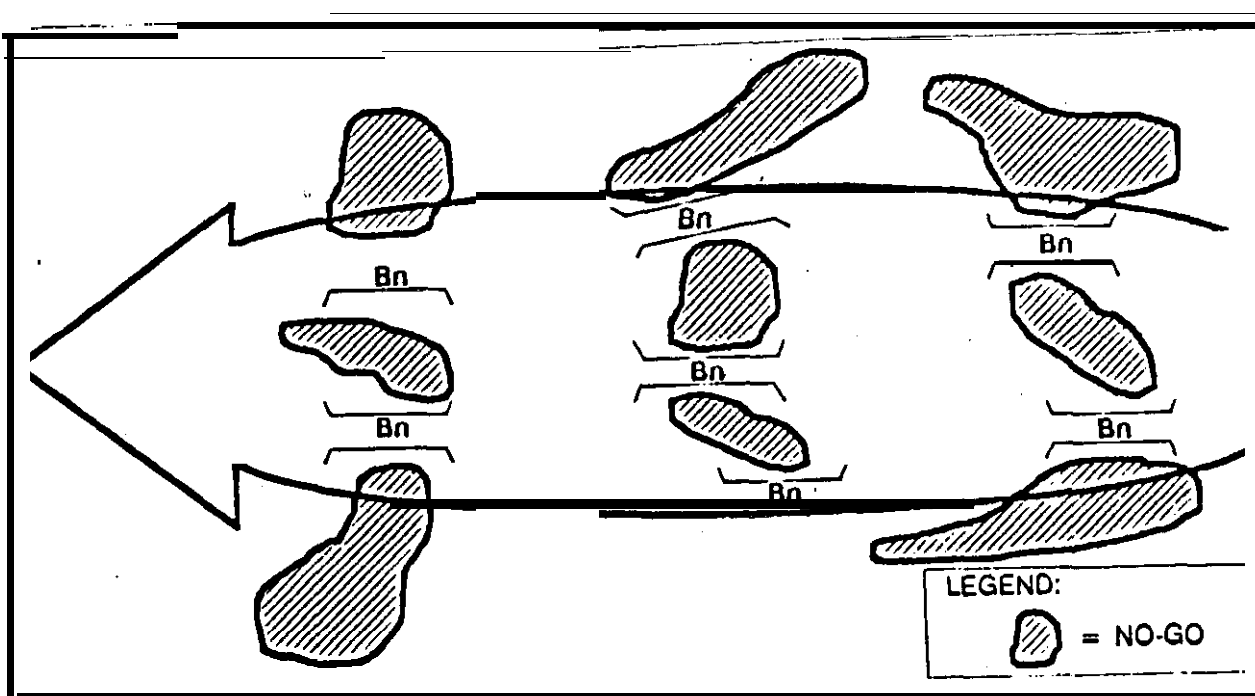

**Figure 2-8. Group mobility corridors to form avenues of approach.**

Describe the battlefield's effects **(cont)**

How to do it **(cont)**

Analyze the battlefield environment **(cont)**

Terrain analysis **(cont)**

Analyze the military aspects of terrain

Avenues of approach **(cont)**

Depict avenues of approach using arrows that encompass the mobility corridors which constitute the avenue. Use the same considerations for color selection that apply to mobility corridors.

o Evaluate Avenues of Approach:

An evaluation of avenues of approach identifies those which best support maneuver capabilities. Most engineer detachments do not have the expertise on threat or friendly tactical doctrine required to conduct this step alone. It should be performed by the **G2/S2** or his analysts, with assistance from the **G3/S3** as required. Evaluate them for suitability in terms of:

- o access to key terrain and adjacent avenues;
- o degree of canalization and ease of movement;
- o use of cover and concealment (force protection from both fires and intelligence collection);
- o use of observation and fields of fire;
- o sustainability (LOC support);
- o directness to the objective.

The results of evaluating mobility corridors and avenues of approach is usually depicted on the combined obstacle overlay. This may vary with the situation.

Describe the battlefield's effects (cont)

How to do it (cont)

Analyze the battlefield environment (cont)

Terrain analysis (cont)

Analyze the military aspects of terrain

Avenues of approach (cont)

o Prioritize Avenues of Approach:

Prioritize the avenues of approach based on how well each supports maneuver.

As always, the final product should focus on the results of the evaluation rather than the factors of the analysis.

Additional Considerations:

- o Do not confuse avenues of approach with direction of attack or axis of advance, which, to achieve surprise, may not follow avenues of approach (see glossary).
- o Mobility corridors and avenues of approach are based on the maneuver requirements of tactical formations. They will not by themselves identify likely infiltration lanes or routes likely to be used by reconnaissance assets. you must consider other factors, such as the availability of concealment and cover, to identify likely infiltration lanes or reconnaissance unit routes.
- o Avenues of approach are based solely on assigned or likely objectives, the effects of the battlefield environment, and force mobility considerations. The ability of an opposing force to interfere with the friendly use of an avenue of approach does not influence the evaluation at this point in the IPB process. Threat actions will be **wargamed** during step four of the IPB process, Determine Threat Courses of Action, and during staff wargaming.



Describe the battlefield's effects (cont)

How to do it (cont)

Analyze the battlefield environment (cont)

Terrain analysis (cont)

Analyze the military aspects of terrain

Avenues of approach (cont)

- When evaluating avenues of approach for units with amphibious, airborne, or airmobile capabilities you must also consider suitable zones of entry, such as airfields, landing zones or beachhead sites. See Appendix B for rules of thumb in identifying zones of entry.
- The type unit under consideration is a major factor in identifying mobility corridors and avenues of approach. In built-up areas, for example, a mechanized unit might prefer areas of wide streets and parks for movement. In the same area, dismounted infantry might prefer an area of closely built structures that allow them to move under cover via holes knocked through walls between buildings. Similarly, helicopters look for areas that allow access to cover and concealment by nap-of-the-earth flight techniques while high performance aircraft generally avoid obstacles and use direct approaches.

This is more than a function of mobility. For example, mechanized and armor units generally require open areas in which to **move**. This certainly enhances mobility but the improved observation of open areas also facilitates command and control over maneuvering sub-elements. Similarly, reconnaissance units generally prefer areas that allow them to conduct their mission without detection, favoring areas that offer concealment even if it requires **some** sacrifice of mobility.

- Air avenues of approach permit the employment of penetrating aerial sensors, attack aircraft and airmobile forces. Air

Describe the battlefield's effects (cont)

How to do it (cont)

Analyze the battlefield environment (cont)

Terrain analysis (cont)

Analyze the military aspects of terrain

Avenues of approach (cont)

**avenues** of approach are generally as direct as possible **in order** to minimize risk to the aircraft and maximize the aircraft's payload.

However, terrain can influence the choice of particular routes. Terrain corridors are usually desirable because they afford **some** defilade protection from ADA systems outside the corridor. Corridors, and other linear terrain features such as roads or rivers, also provide aids to navigation at high speeds. Concealment from ground observation or radar acquisition is also important to low flying aircraft, particularly helicopters. All other things being equal, aircraft will generally use the **most** direct approach to the target area.

In the target area, many attack profiles depend on low level flight. It is here that terrain analysis is **most** useful in identifying aircraft avenues of approach. In addition to the terrain factors considered above, evaluate air avenues of approach by considering obstacles to flight. See Chapter 4 for example considerations.

- (2) Evaluate the terrain's effects on military **operations.**

A common fault is to discuss the military aspects of terrain in great detail without addressing **why** they are important. To avoid this common fault **you must relate** the analysis to the terrain's effects on the broad courses of action available to threat and friendly forces.

Describe the battlefield's effects (**cont**)

How to do it (**cont**)

Analyze the battlefield environment (**cont**)

Terrain analysis (**cont**)

Evaluate the terrain's effects on military operations (**cont**)

Evaluate the terrain's effects on offensive and **defensive** courses of action by identifying the areas along each avenue of approach best suited for use as **potential--**

- 0 engagement areas and ambush sites: using the results of evaluating cover and **concealment** identify areas where maneuvering forces are vulnerable to fires. Consider weapon ranges, missile flight times and the likely speed of maneuvering forces. If your command is attacking these are areas where it will be vulnerable to threat fires. If your command is defending these are potential engagement areas.
- 0 battle positions: identify covered and concealed positions that offer observation and fields of fire into potential engagement areas. If your command is defending they are potential defensive positions. If your command is attacking they provide a start point for determining possible threat courses of action. They might also be used by friendly attacking forces to block enemy counterattacks.
- 0 immediate or intermediate objectives: identify any areas or terrain features that dominate the avenues of approach or assigned objective areas. These will usually correspond to areas already identified as key terrain.

As time permits or the situation requires also identify potential--

- 0 assembly and dispersal areas
- 0 observation posts;
- 0 artillery firing positions;
- 0 air defense system positions

Describe the battlefield's effects (cont)

How to do it (cont)

Analyze the battlefield environment (cont)

Terrain analysis (cont)

Evaluate the terrain's effects on military operations (cont)

- o intelligence and target acquisition system positions;
- o Forward area arming and refueling **positions;**
- o landing or drop zones;
- o infiltration lanes;
- o etc.

See chapter four for additional considerations.

The terrain rarely favors one type of operation throughout the width and breadth of the battlefield. Within a given area certain sub-sectors will affect various operations to varying degrees. Based on the location and nature of potential engagement areas, battle positions, etc., determine which areas of the battlefield favor each broad course of action.

Disseminate the results of terrain analysis in the analysis of the AO, the intelligence estimate, and in graphic products that will aid the staff in the completion of their own estimates and plans. A common and effective technique is the use of a modified combined obstacle overlay (MCOO).

To construct a **MCOO** start with the combined obstacle overlay and consider adding--

- o Cross country mobility classifications. Mark areas of RESTRICTED and SEVERELY RESTRICTED cross country mobility with easily distinguishable symbology.
- o Avenues of approach and mobility corridors. Tailor these to the type force under consideration, basing them on factors other than mobility as required. Categorize them by the size force they accommodate and rank them in priority order if justified. While it is possible to put

Describe the battlefield's effects **(cont)**

How to do it **(cont)**

Analyze the battlefield environment **(cont)**

Terrain analysis **(cont)**

Evaluate the terrain's effects on military operations **(cont)**

both ground and air mobility corridors and avenues of approach on the same overlay, clarity may require separate overlays. Consider both friendly and threat avenues.

- Counter-mobility obstacle systems planned for future emplacement by friendly units or suspected **within enemy positions.**
- Defensible terrain. Evaluate terrain along each avenue of approach to identify potential battle positions or possible defensive sectors for subordinate units.
- Engagement areas. Combine the results of evaluating defensible terrain with the results of evaluating observation and fields of fire to identify potential engagement areas.
- Key terrain. Identify any areas or terrain features which dominate the avenues of approach or objective areas. These will usually correspond to terrain already identified as potential battle positions or **intermediate objectives.**

Distribute terrain analysis products as widely as possible. Make the specific terrain factor overlays available to other units and staff sections for their own planning use. They will refine them to meet their own needs. For example, the counterintelligence analysis section will use the results of evaluating the terrain's effects on observation to aid in evaluating the threat's intelligence collection capabilities.

Describe the battlefield's effects (**cont**)  
How to do it (**cont**)  
Analyze the battlefield environment (**cont**)  
Terrain analysis (**cont**)

For more information on terrain analysis see:

FM 5-33, Terrain Analysis, and  
FM 5-170, Engineer **Reconnaissance**.

For terrain analysis techniques and considerations in various climates and terrain types see:

FM **90-3**, Desert Operations;  
FM 90-5, Jungle Operations;  
FM 90-6, Mountain Operations;  
FM 90-10, Military Operations on Urbanized  
Terrain;  
FM **90-11**, Cold Weather Operations.

#### WEATHER ANALYSIS

Terrain and weather analyses are inseparable. YOU should have already included the weather's effects on terrain during terrain analysis. In this sub-step weather analysis evaluates the weather's direct effects on operations.

If time and resources permit, you can obtain climatology based overlays for planning purposes from the USAF Environmental Technical Applications Center. Once deployed, the supporting USAF Weather Team can prepare similar but less detailed overlays depending on the availability of data.

USAF weather teams at division, corps, and echelons above corps (EAC) work together with engineer teams during much of the analysis process. The weather team analyzes the weather's direct effects and its effects on terrain and integrates climatic, forecast, and current weather data with terrain analysis.

Evaluate the effects of each military aspect of weather. However, just as in terrain analysis, focus on the aspects that have the most bearing on the situation **your** command faces. Begin the evaluation of each aspect with the local climatology, but always fine-tune the evaluation with the most current forecast available.

Describe the battlefield's effects (**cont**)  
 How to do it (**cont**)  
 Analyze the battlefield environment (**cont**)  
 Weather analysis (**cont**)

The sub-steps you use to accomplish weather analysis are--

- (1) **Analyze** the military aspects of weather.
- (2) Evaluate the weather's effects on military operations.

Each of these steps is discussed below.

- (1) Analyze the military aspects of weather.

The military aspects of weather are:

Visibility:

Low visibility is beneficial to offensive and retrograde operations. In the offense, it conceals the concentration of maneuver forces, thus enhancing the possibility of achieving surprise. Low visibility hinders the defense because cohesion and control become difficult to maintain, reconnaissance and surveillance are impeded, and target acquisition is less accurate.

When evaluating visibility, consider the effects of all aspects of the weather. For example, temperature conditions can have either an adverse or beneficial effect on the use of modern thermal sights. Cloud cover can negate the illumination provided by the moon. Precipitation and other obscurants can also have varying effects.

A major factor in evaluating visibility is the amount of available light. Consider the phase of the moon as well as the times associated with--

- o Beginning morning nautical twilight (BMNT-see glossary);

Describe the battlefield's effects (cont)

How to do it (cont)

Analyze the battlefield environment (cont)

Weather analysis (cont)

Analyze the military aspects of weather

Visibility (cont)

- o Sun rise;
- o **Sun** set;
- o End evening nautical twilight (EENT-see glossary);
- o Moon rise; and,
- o Moon set.

Winds:

Winds of sufficient speed can reduce the combat effectiveness of a force downwind as the result of blowing dust, smoke, sand, or precipitation. The upwind force usually has better visibility. NBC operations usually favor the upwind force.

Strong winds and wind turbulence **limit** airborne, air assault, and aviation operations. Evaluation of weather in support of these operations requires information on the wind at the surface as well as at varying altitudes. High winds near the ground increase turbulence and **may** inhibit maneuver. High winds at greater altitudes can improve or reduce fuel consumption.

Wind generated blowing sand, dust, rain or snow can reduce the effectiveness of radars and communication systems. Strong winds can also hamper the efficiency of directional antenna **systems** by inducing antenna wobble.

Precipitation:

Precipitations affects soil trafficability, visibility, and the functioning of many electro-optical systems. Heavy precipitation



Describe the battlefield's effects **(cont)**

How to do it **(cont)**

Analyze. the battlefield environment **(cont)**

Weather analysis **(cont)**

Analyze the military aspects of weather

Precipitation **(cont)**

can reduce the quality of supplies in storage. Heavy **snow cover** can reduce the efficiency of many communication systems as well as degrading, the effects of many munitions and degrading air operations.

#### Cloud Cover:

Cloud cover affects ground operations by limiting illumination and the solar heating of targets. Heavy cloud cover can degrade many target acquisition systems, the use of infrared-guided artillery, and general aviation operations.

Heavy cloud cover often canalizes aircraft within air avenues of approach and during the final approach to the target. Partial cloud cover can cause glare, a condition attacking aircraft might use to conceal their approach to the target. Some types of clouds reduce the effectiveness of radars.

#### Temperature and Humidity:

Extremes of temperature and humidity reduce personnel and equipment capabilities, and may require the use of special personnel shelters or equipment. Air density decreases as temperature and humidity increase, which may necessitate a reduction of aircraft payloads.

Temperature "crossovers," when target and background temperatures are nearly equal, degrade the use of thermal target acquisition **systems**. The length of crossover time is dependent on air temperature as well as cloud cover and other factors.

Describe the battlefield's effects (cont)

How to do it (cont)

Analyze the battlefield environment (cont)

Weather analysis (cont)

Evaluate the weather's effects on military operations

- (2) Evaluate the weather's effects on military operations.

Weather has **both** direct and indirect effects on military operations. Examples of indirect effects are--

- temperature inversions might cause some battle positions to **be** more at risk to the effects of chemical warfare than others due to their altitude.
- local conditions of visibility, such as fog, might make some potential engagement areas more attractive than others.
- Hot, dry weather might force a unit to consider water sources as key terrain.

All of these conditions would significantly affect the selection of defensive positions even though their effects are indirect. An effective technique for evaluating and depicting the weather's indirect effects is to modify the terrain analysis products to depict the effects of weather considerations.

Remember to revise the effects of weather upon terrain analysis as the weather changes from the originally evaluated conditions.

You must also evaluate the weather's direct effects on personnel, equipment, and operations. Begin by establishing the critical values of the military aspects of weather that affect the effectiveness of:

- personnel;
- specific types of equipment; and,
- types of military operations.

Describe the battlefield's effects **(cont)**

How to do it **(cont)**

Analyze the battlefield environment **(cont)**

Weather analysis **(cont)**

Evaluate the weather's effects on military operations **(cont)**

An example would be setting critical values for 'visibility's effects on airborne operations as:

visibility of 1 **km** or less as an unfavorable condition;

- visibility of 1-5 km as a marginal condition.

A forecast of 2 km visibility can then be quickly evaluated as making the conditions for airborne operations marginal.

See Appendix B for other examples and rules of thumb in establishing critical values. An example of critical values arranged into matrix format is shown in chapter three at figure 3-1-13.

Once you have set the critical values, use them as gauges to evaluate the effects of local weather on the operations and courses of action available to both friendly and threat forces.

An example might be an S2 reporting to his commander, "**Sir**, weather practically rules out the use of air assault operations because temperature and humidity have reduced the lift capability of the enemy's helicopters by **70%**."

Weather effects are harder to depict graphically and may have to be portrayed in a matrix. Figure 2-9 is an example of one type of matrix that depicts the results of the evaluation of the weather's effects on military operations. See Chapter 3 for other examples.

MISSION AREA OR USE	FORECAST TIME PERIOD (1992)															
	6 Oct				7 Oct				8 Oct				9 Oct			
	6	12	18	24	6	12	18	24	6	12	18	24	6	12	18	24
Mobility (ground)									Yellow	Yellow	Yellow	Yellow	Yellow	Yellow	Yellow	Yellow
Direct Fire Target Acquisition									Yellow	Yellow	Yellow	Yellow				
Airmobile Operations (Landing Lanes)									Red	Red	Red	Red				
NBC			Yellow	Yellow					Yellow	Yellow	Yellow	Yellow				

**KEY:**  
 FAVORABLE (No shading-Green) UNFAVORABLE ( [Red Box] -Red) MARGINAL ( [Yellow Box] -Yellow)

**Figure 2-9. Determine the weather's effects on military operations.**

Regardless of the means of presentation, ensure you focus on the effects of weather on **military** operations rather than the factors that make up the analysis.

For example, you might express the effects of visibility and precipitation on the mobility of a force in terms of movement rates or the amount of time the force will be exposed in an engagement area. These types of evaluations are more readily usable by the commander than **statements** such as "...**three** inches of rain over the next **24-48** hours..."

For more information:

- o Commands that are not supported by a USAF weather team should refer to **FM34-81-1**, Battlefield Weather Effects, for "how to" information on determining the weather's effects on military operations.
- o Commands that are supported by USAF weather teams should refer also to **FM 34-81/AFM 105-4**.

Describe the battlefield's effects (**cont**)

How to do it (**cont**)

Analyze the battlefield environment (**cont**)

Analysis of other characteristics of the  
battlefield

#### ANALYSIS OF OTHER CHARACTERISTICS OF THE BATTLEFIELD

**"Other Characteristics"** include all aspects of the battlefield environment that affect friendly or threat **COAs** not already incorporated into **the terrain** and weather analysis.

An example might be an S2 reporting to his commander, **"Sir**, religious considerations will make cordon and search operations on Wednesdays extremely difficult to execute - the local population will be praying at the same time we're trying to conduct the search."

In another example, during riot control assistance to civil authorities the influence of gangs or other unofficial political elements becomes very important.

Use the same two step process to determine the effects of other characteristics of the **battlefield--**

- (1). Analyze the other characteristics of the battlefield.
- (2) Evaluate the effects of other characteristics of the battlefield on military operations.

Each of these sub-steps is discussed below.

- (1) Analyze the other characteristics of the battlefield.

**Typical Characteristics**: Because these aspects vary greatly with each circumstance a comprehensive list cannot be provided here. However, depending on the situation, these characteristics might include:

- o Logistics infrastructure, such as--
  - Land use patterns.
  - Sources of potable water.
  - Bulk fuel storage and transport systems.

Describe the battlefield's effects (**cont**)

How to do it (**cont**)

Analyze the battlefield environment (**cont**)

Analysis of other characteristics of the battlefield (**cont**)

- Canals and waterways, with associated control facilities such as locks.
  - Communication **systems**.  
Transportation means and systems, including road and rail networks, transloading facilities, and airfields.
  - Natural resources.  
Industries and technologies.
  - Power production facilities.  
Chemical and nuclear facilities.
  - o Population demographics, such as--  
Living conditions.  
Cultural distinctions.  
Religious beliefs.  
Political grievances.  
Political affiliation.  
Education levels.
  - o Economics.
  - o Politics; local, regional and international (government systems, treaties, agreements, and legal restrictions; includes unofficial systems such as gangs, etc).
- (2) Evaluate the effects of other characteristics of the battlefield on military operations.

As with terrain and weather, the evaluation of the other characteristics of the battlefield is not complete until you express it in terms of their effects on friendly and threat courses of action.

In some situations, the "other **characteristics**" of the battlefield are of **more** concern than terrain and weather. An historical example illustrates this well:

Describe the battlefield's effects **(cont)**

How to do it **(cont)**

Analyze the battlefield environment **(cont)**

Analysis of other characteristics of the  
battlefield **(cont)**

All US Army activities during and preceding Operation JUST CAUSE were bound by the Carter-Torrijos treaty. Certain provisions of this treaty categorized land within the old canal zone into five different categories. The rights and responsibilities of the United States and the Republic of Panama varied widely depending upon the legal designation of the terrain.

During the show of force operations that led to JUST CAUSE the legal status of each piece of land influenced the **COAs** of US forces and Panamanian Defense Forces far more than the tactical significance of the terrain and weather.

To further illustrate this point, the perception of "seizing the moral **highground**" also influenced the actions of both sides in Panama far more than the mere terrain and weather.

These other characteristics of the battlefield are particularly important at the operational and strategic levels, but also play a major role at the tactical level in hostilities short of war. Chapter 5 gives examples of "**other characteristics**" as they might affect operations at different levels of war.

Although you will usually be forced to discuss the **effects** of other characteristics of the battlefield in text products or a matrix always attempt to use graphics. Examples of graphic depictions include an overlay showing areas most vulnerable to insurgent operations, based on demographics; or an overlay identifying high value targets in the logistics infrastructure, in either the threat or friendly rear area.

Describe the battlefield's effects (**cont**)

How to do it (**cont**)

Describe the battlefield's effects on threat and friendly capabilities and broad courses of action

DESCRIBE THE BATTLEFIELD'S EFFECTS ON THREAT AND FRIENDLY CAPABILITIES AND BROAD COURSES OF ACTION

Combine the evaluation of the effects of terrain, weather, and the other characteristics of the battlefield into one integrated product. Do not focus on the factors that lead to your conclusions. Instead, focus on the total environment's **effects** on courses of action available to both friendly-and threat forces.

Some examples of techniques for accomplishing this are:

o Prior to the development of friendly **COAs**:

Provide the evaluated and prioritized set of avenues of approach to the **S3** so he can develop **COAs** by designating an axis of advance, direction of attack, or zone of attack for each subordinate unit (offense).

Provide the sets of defensible terrain along threat avenues of approach to the **S3** so he can develop strongpoints, battle positions, or sectors for each subordinate unit (defense and retrograde).

Identify the periods when weather conditions will optimize the use of friendly sighting and target acquisition systems so the **S3 can make** recommendations on the timing of operations.

o After the development of friendly **COAs** emphasize concluding sentences such as "...of the courses of action available, COA 2 makes second best use of the opportunities the battlefield environment offers for the following reasons..."

You must address the battlefield's effects on threat as well as friendly courses of action. A good technique for accomplishing this is to completely place yourself in the perspective of the threat's **S2** and **S3** who must recommend a set of courses of action to their commander.



Describe the battlefield's effects **(cont)**

How to do it **(cont)**

Describe the battlefield's effects on threat and friendly capabilities and broad courses of action **(cont)**

Ensure that you evaluate the-effects of battlefield environment on threat courses of action considering the specific threat your command is facing. Some examples to consider are--

- Threat vehicles may have -different values than the friendly vehicles you are used to in terms of mobility, optical systems, etc.
- The threat may have an organic capability that undermatches or overmatches your unit. If the threat is attacking without dismounted infantry, don't waste time identifying infiltration lanes. Likewise, a threat unit with exceptional bridging capabilities will be less affected by river obstacles.
- Bear in mind that weather will affect threat equipment differently than U.S. equipment. An AK-47 is more resistant to moisture than an M-16, for example. Likewise, fog will affect U.S. thermal sights less than it will affect vehicles with optical sights only.
- Remember that "**other** characteristics" may sometimes influence threat actions much more than terrain or weather considerations. Remember to account for the cultural bias the threat operates within. They will evaluate the same legal, political, economic, and demographic aspects in a completely different manner than U.S. personnel would.

The bottom line is to evaluate the battlefield completely from the perspective of the threat. Remember to express this evaluation in terms of courses of action, not detailed descriptions of the analytical factors that led to the conclusions.

Focus the commander on concluding statements such as, "Sir, the battlefield environment best supports insurgent attacks on U.S. and host nation forces near Daleytown. The next best place for their operations is **Elkinsville.**" Be prepared to back these conclusions with the detailed analysis prepared in the previous steps.

Describe the battlefield% effects **(cont)**

How to do it **(cont)**

Describe the battlefield's effects on threat and friendly capabilities and broad courses of action **(cont)**

Communicate the final conclusions-from the description of the battlefield environment in written reports such as the analysis of the area of operations **or the** intelligence estimate. Distribute the graphic products developed during the analysis and evaluation as needed to support the remainder of the staff and other commands in their own IPB and planning efforts.

## ■ ■ ■ ■ ■ Evaluate the Threat ■ ■ ■ ■ ■

What is it?

### Definition:

The determination of threat force capabilities and the doctrinal principles, tactics, techniques, and standard operating procedures threat forces prefer to employ.

### A Short Example:

While planning a contingency show of force operation a J2 directs the Joint Intelligence Center to study the decisions on record of the targeted country's dictator. As a result of this research the intelligence center produces a model of how the dictator makes decisions, with special emphasis on his tendencies **during** political crises.

Meanwhile, the S2 of the brigade which will conduct the operation does his own evaluation of the threat. He evaluates his contingency area order of battle files and determines that the two threat brigades within the target area are equipped, organized, and well trained enough to be capable of offensive as well as defensive operations against the friendly brigade. He prepares threat models depicting the threat's normal offensive and defensive, operations in built-up areas (the setting for the show of force operation).

Evaluate the threat (cont) What is it? (cont)
--

Desired End Effect:

Know the enemy. Develop threat models which accurately portray how threat forces normally execute operations and how they have reacted to similar situations in the past. Know what the threat is **capable of** given the current situation.

The 'threat model should include:

- o standard graphic control measures, such as 'boundaries, etc;
- o a description of typical tasks for subordinate units;
- o an evaluation of how well the threat force is trained on the task;
- o employment considerations; and
- o a discussion of typical contingencies, sequels, failure options, and **wildcard** variations.
- o an evaluation of the threat's strengths, weaknesses, and vulnerabilities, including an evaluation of typical **HVTs**;

So What?
----------

Success Results in:

Threat **COAs** developed in the next step of IPB reflect what the threat is and is not capable of and trained to do in similar situations.

Consequences of Failure:

The staff will lack the intelligence needed for planning.

The threat 'will surprise the friendly force with capabilities that the S2 failed to account for.

At the other extreme, the friendly staff may waste time and effort planning against threat capabilities that do not exist.

Evaluate the threat (cont) 1  
 How to do it

How to Do it:

- o **Update or create** threat models.  
 Convert **threat** doctrine or patterns of operation to graphics (doctrinal templates);
  - Describe in words the threat's tactics and options. Identify high value targets.,'
- o Identify threat capabilities.

Each of these steps is discussed below.

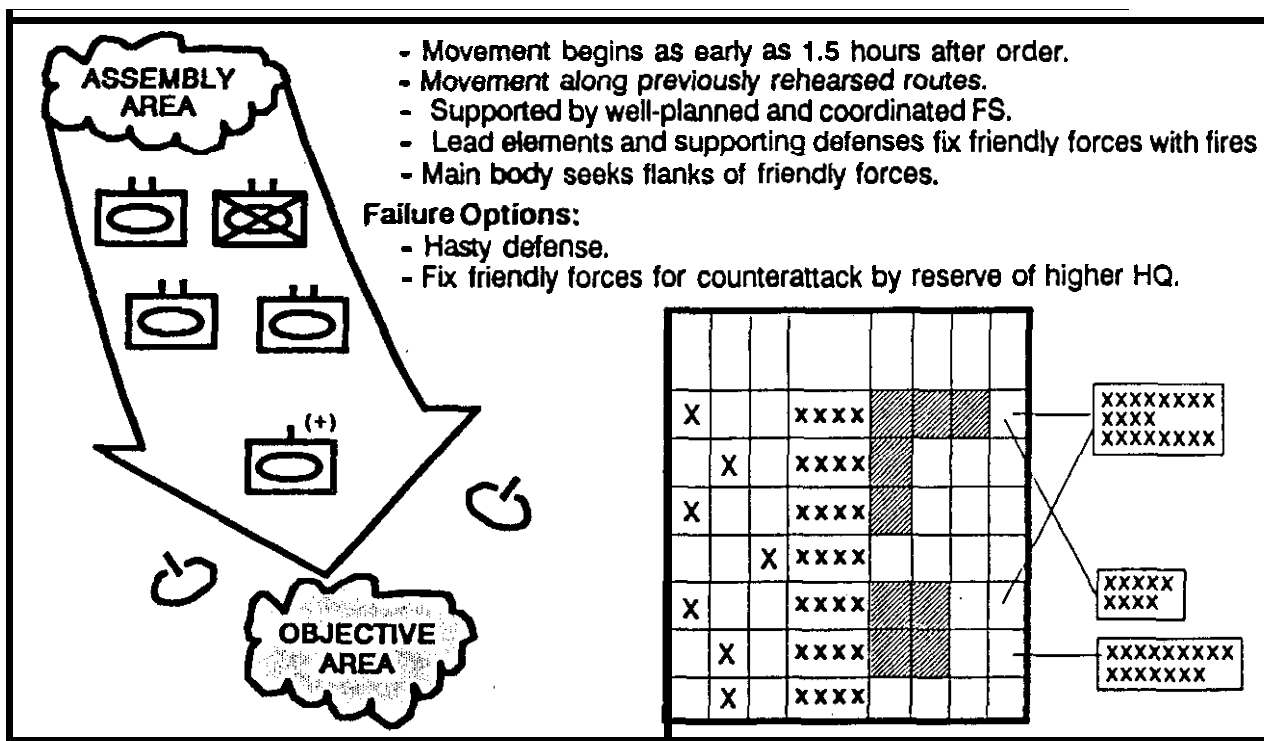

**Figure 2-10. A complete threat model consists of a template, a description of tactics, and identification of HVTs.**

UPDATE OR CREATE THREAT MODELS

Threat models depict how threat **forces** prefer to conduct operations under ideal conditions. They are based on the threat's **normal or "doctrinal"** organization, equipment, doctrine and TTP. Threat models result from a detailed study of the threat force. Ideally, you construct threat

Evaluate the threat (cont)  
 How to do it (cont)  
 Update or create threat models (cont)

models prior to deployment. Even after deployment, however, continue to evaluate the threat and update the threat models as required.

Threat models consist of three parts:

- o doctrinal templates;
- o a description of preferred tactics and options; and,
- o an identification of type high value targets.

An effective technique for recording threat models is to use the target spread sheet format (see Figure Z-10).

Each part of the threat model is discussed in detail below.

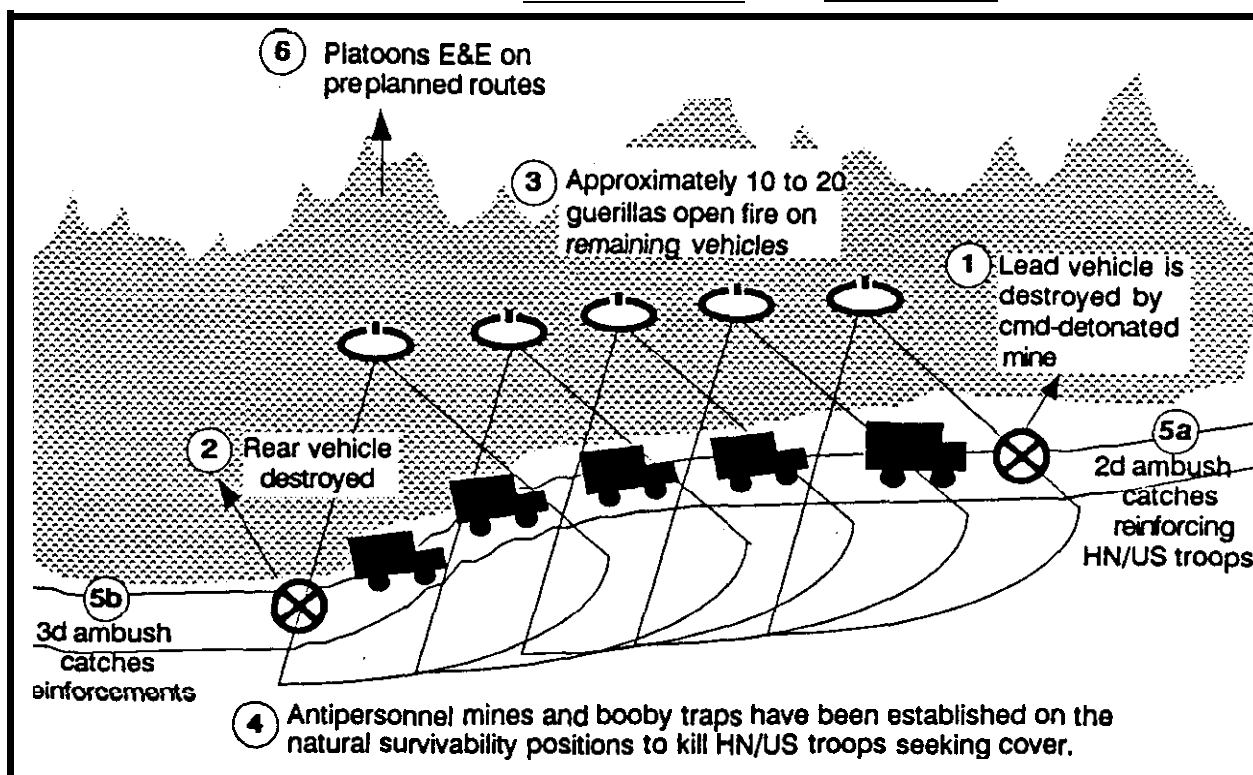

Figure 2-11. Doctrinal templates depict the enemy's normal or preferred tactics.

Evaluate the threat (cont) How to do it <b>(cont)</b> Update or create threat models <b>(cont)</b> Doctrinal templates
---

Doctrinal Templates:

Doctrinal templates illustrate the deployment pattern and disposition preferred by the threat's normal tactics when not constrained by the effects of the battlefield environment. They are usually scaled graphic depictions of threat dispositions for a particular type of standard operation, such as a battalion movement to contact, an insurgent **ambush, or** a terrorist kidnapping. Figure 2-11 shows one such doctrinal template.

Construct doctrinal templates through an analysis of the intelligence data base and an evaluation of the threat's past operations. Determine how the threat normally organizes for combat and how he deploys and employs his units and the various battlefield operating system (BOS) assets. Look for patterns in task organization of forces, timing, distances, relative locations, **groupings, or** use of the **terrain** or weather. Focus on major elements as well as individual high value targets.

Even unconventional operations lend themselves to graphic depiction. For example, an evaluation of the database might indicate that **when robbing** banks the threat always sends four guerrillas inside with at least two remaining outside. The four who move inside the bank usually take up positions at distinct locations within the bank. This type of information can easily be converted into a graphic representation, although not necessarily to a standard map scale.

Doctrinal templates can **also** portray the threat's normal organization for combat, typical supporting elements available from higher commands, frontages, depths, boundaries, engagement areas, objective depths, and other, control measures. Whenever possible, convert these patterns into graphic representations such as overlays or sketches.

Evaluate the threat <b>(cont)</b> How to do it <b>(cont)</b> Update or create threat models <b>(cont)</b> Doctrinal templates <b>(cont)</b>
--

Doctrinal templates are tailored to the needs of the unit or staff section creating them. For example, a division G2 creates a template that differs in scope from that constructed by a battalion **S2**; the template constructed by an electronic warfare section differs drastically from that constructed by an air defense unit. An air defense doctrinal template, for example, would include a description of normal strike package **composition**, altitudes, time spacing between groups of aircraft; etc.

Some doctrinal templates consider the threat unit or force as a whole, while others focus on a single battlefield operating system such as intelligence or fire support.

#### Description of Tactics and Options:

The threat model includes a description of the threat's preferred tactics. It addresses the operations of the major units or elements portrayed on the template and the activities of the different battlefield operating systems. It also contains a listing or description of the options available to the threat should the operation fail (branches), or subsequent operations if it succeeds (sequels).

Even if the threat's preferred tactics can be depicted graphically, the threat model includes a description. This allows the template to become more than a "snapshot in **time**" of the operation being depicted. It aids in mentally wargaming the operation over its duration during the development of threat courses of action and situation templates.

Like the template itself, you develop the description of the threat's tactics and options from an evaluation of his doctrine and past or current operations. Include a description of the branches and sequels normally available to or preferred by the threat should the depicted operation succeed or fail. For example, the threat might prefer to follow successful

Evaluate the threat (cont)

How to do it (cont)

Update or create threat models (cont)

Description of tactics and options (cont)

attacks with pursuit. Should an attack begin to fail his preferred branches might include committing reserves, reinforcement, or shifting the main effort. Should the attack fail, his preferred sequel might be a hasty defense.

If the database reveals any decision criteria that cause the threat to prefer one option over another, include that in the description. This information will aid in wargaming threat and friendly courses of action, targeting, and deception planning.

Techniques:

- o Time event charts describe how the threat normally conducts an operation. For example, while it is difficult to depict a large scale air operation graphically, the time relationship between the various echelons and their normal composition can easily be described in a time event chart, narrative, or matrix format.
- o Marginal notations on the graphic template are an effective technique, especially when the notes are tagged to key events or positions on the template. For example, marginal notes might describe the insurgent's normal reactions to friendly reinforcements during their conduct of an ambush (see Figure 2-11).
- o A BOS synchronization matrix depicts the threat's "SOP" in matrix form. See Chapter 3 for some examples.

**High Value Targets:**

Assets that the threat commander requires for the successful completion of the mission depicted and described on the template are high value targets (HVT).



Evaluate the threat **(cont)**  
 How to do it **(cont)**  
 Update or create threat models **(cont)**  
 High value targets **(cont)**

Identify **HVT** from an evaluation of the database, the doctrinal template, its supporting narrative, and the use of tactical judgement. Develop the initial list of **HVT** by mentally wargaming: and thinking through the operation under consideration.

For example, while mentally wargaming an enemy air attack against friendly targets supported by a well prepared air defense system, it is logical to assume that the enemy will need a substantial air defense suppression package as part of the strike force. In such a case, threat aircraft commonly used in such a role become high value targets.

Identify assets which are key to executing the primary operation. Also identify any assets which are key to satisfying decision criteria or initial adoption of the branches and sequels listed in the description and option statements.

After identifying the set of **HVT**, rank order them with regard to their relative worth to the threat's operation and record them as part of the threat model.

As you identify key assets, group them into one of the 13 categories used to develop target sets. These 13 categories are--

- Command, control and communications;
- Fire support (includes target acquisition assets, ammunition, aircraft, fire direction control, etc.);
- **Maneuver;**
- Air defense (includes radars, processing centers and headquarters);
- Engineer;
- NBC (includes support elements and weapons);
- REC (radio electronic combat or EW assets);
- Bulk fuels (storage and refueling assets);
- Ammunition storage sites and distribution points;
- Maintenance and repair units (includes collection points and mobile repair facilities);

Evaluate the threat (cont)  
 How to do it (cont)  
 Update or create threat models (cont)  
 High value targets (cont)

- o LOC (lines of communication-- roads, bridges, railheads, transloading facilities, airfields, choke points, etc.).

In a pinch, you can annotate the identified HVTs in the margins of the doctrinal template. When fully developed, high value target evaluations take the form of target relative value matrices (see Figure 2-12). Target value matrices give a measure of the relative worth of targets, the rationale behind an attack on each type of target, and the resulting effects on the operation. See FM 6-20-10, The Targeting Process, for a complete discussion.

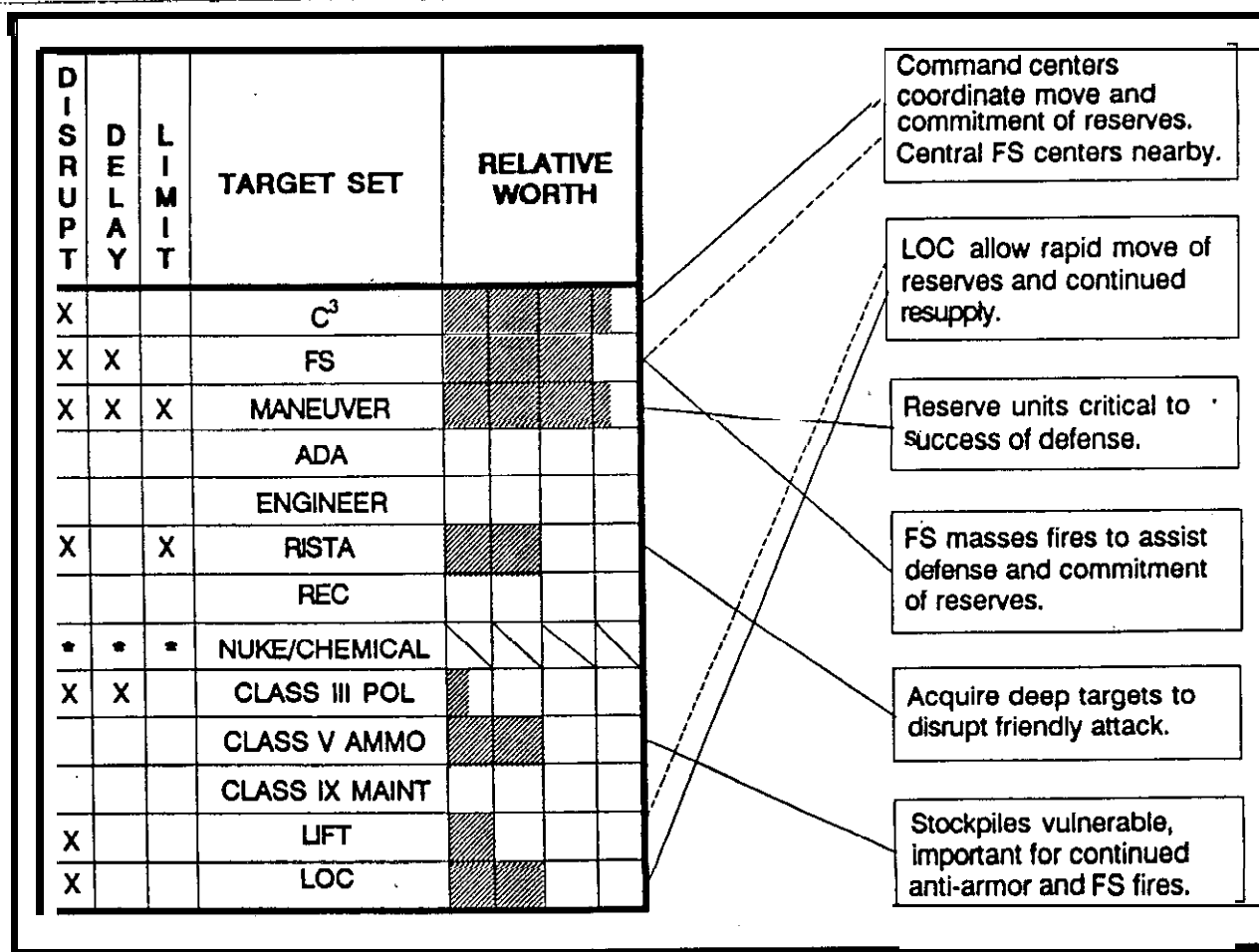

Figure 2-12. A complete threat model identifies HVTs.

## Evaluate the threat (cont)

## How to do it (cont)

## Update or create threat models (cont)

## High value targets (cont)

As always, tailor IPB to your needs by concentrating on potential HVT important to your command or mission area. For example, an ADA unit's evaluation of HVT might concentrate on distinguishing between the relative **HVT** worth of one type of aircraft over another. A counterintelligence analysis section might focus on the relative HVT worth of one type of intelligence collector or 'discipline over another.

Additional Considerations

- You use all of the available intelligence sources to **update and** refine threat models. The most useful are the Order of Battle (OB) files. Order of Battle files contain the details which allow you to reach conclusions about the threat's operations, capabilities and weaknesses. The OS factors that structure the OB files are:
  - Composition;
  - Disposition;
  - Strength;
  - Tactics or modus operandi (including habitual operating areas for unconventional warfare forces, **gangs**, insurgencies, etc.);
  - Training status;
  - Logistics;
  - Effectiveness;
  - Electronic technical data;
  - Miscellaneous data (personalities, pseudonyms, etc.).
  
- Create an order of battle file for each threat unit you are concerned with. Comparing the doctrinal norm with the files on each unit will indicate that most vary from the standard. Types of equipment as well as organization, training status, etc., may differ. As much as possible, the threat models should portray the unit you are evaluating, not just the doctrinal norm.

Evaluate the threat (cont)

How to do it (cont)

Update or create threat models (cont)

- As time permits, continuously update the OB files as you develop intelligence during the processing phase of the intelligence cycle. Do not wait until staff planning begins to **conduct the** analysis. A common technique is to maintain a set of threat models under the "tactics" or "modus operandi" tab of each OB file.
- Consider the various order of battle factors and their relationship when conducting the evaluation and updating the threat models. For example, **how do** direct fire weapon ranges and the threat's preferred size and location of engagement areas and battle positions relate? If he increases his direct fire weapons system range will he move his engagement areas further from his battle positions, or make the engagement areas larger? If he improves the range of his artillery systems will he employ them further to his own rear, or use the extra range to engage deeper targets? If his air defense capability improves will he reduce the number of ADA assets in each unit?
- The OB factors are not independent of each other; they are closely related - consider them as a whole. For example, changes in training status, command personality, strength, or any other of the OB factors may affect the tactics of a unit at a given time.
- The OB factors form a framework for evaluation of any force, not just those that are strictly military. For example, when considering composition during a counterdrug operation you might include an analysis of extended family ties of suspected traffickers. In evaluating an insurgent force, you would include an analysis of the insurgent political structure and its relationship to the military elements.
- Tailor evaluation of the OB factors to your unit needs. For example, an aviation unit's evaluation of composition would focus more heavily on those units that contained air defense assets. Its evaluation of equipment would focus on the vulnerabilities of likely threat targets as well as the technical characteristics of the threat's air defense systems.

## Evaluate the threat (cont)

## How to do it (cont)

## Update or create threat models (cont)

- o Consider not only the threat's physical capability, based on organization and equipment strength, **but also** his normal modus operandi, tactical doctrine, and state of training. This requires an understanding of the art and science of war **as well** as current knowledge of the threat. Ensure that you update the historical data bases with current observations whenever possible. For **example**, in scenario three of chapter three of this manual, the S2 uses three reports of recent insurgent ambushes to create a threat model depicting an insurgent ambush (see Figure 3-3-12).
- o A useful technique in understanding how threat forces conduct operations is to first gain an understanding for how your own force conducts them. Then compare and contrast the threat's normal approach to the same operations. The OB factors form the framework for this evaluation. Another useful framework is the battlefield operating systems (BOS-see glossary).
- o For a full discussion of the analytical techniques used in constructing threat models see **FMs** 34-3, 34-7, 34-40(S) and 34-60.

## IDENTIFY THREAT CAPABILITIES

Threat capabilities are the broad courses of action, and supporting operations, which the threat can take to influence the accomplishment of the friendly mission. They take the form of statements such as--

- o **"The** enemy has the capability to attack with up to 8 divisions supported by 170 daily sorties of fixed wing aircraft."
- o **"The** enemy can establish a prepared defense by 14 May."
- o **"The** enemy has the ability to insert up to 2 battalions of infantry in a single lift operation."
- o **"The** drug smugglers have the capability to detect the radars used at our observation posts."

Evaluate the threat (cont)

How to do it (cont)

Identify threat capabilities (cont)

- o "The threat can conduct up to three separate smuggling operations simultaneously."
- o "The protesters can effectively block traffic at no more than 7 different intersections."

There are generally four tactical courses of action open to military forces in conventional operations:

- o attack;
- o defend;
- o reinforce; and,
- o conduct a retrograde.

Each of these broad courses of action can be divided into a variety of more specific courses of action. For example, an attack may be an envelopment, a penetration, or other variations of an attack. A retrograde movement may be a delaying action, a withdrawal, or a retirement (see glossary).

Other capabilities include support to broad courses of action or specific types of operations. Examples of these types of capabilities are--

- o Use of NBC weapons;
- o Use of supporting air assets;
- o Intelligence collection;
- o Electronic warfare;
- o Engineering operations;
- o Air assault or airborne operations;
- o Amphibious assaults;
- o Riverine operations;
- o Psychological operations;
- o **Deception** operations;
- o etc.

At other levels of war and during operations other than war you will consider other types of operations and broad courses of action. In any case, start with the full set of threat models and consider the threat's ability to conduct each operation based on the current situation.

## Evaluate the threat (cont)

## How to do it (cont)

## Identify threat capabilities (cont)

Most situations will not present the threat with the ideal conditions envisioned by his doctrine and TTP. He will usually be under-strength in terms of personnel or equipment. He may be short of logistical support. He **may** not enjoy air superiority. His troops may be inexperienced or poorly trained. As a result, the threat's actual capabilities usually will not mirror the ideal/capabilities represented by the complete set of threat models. For **example,--**

- 0 The threat's doctrine **may** call for penetration **attacks** whenever possible. Your evaluation of his current strength, however, may indicate that the threat lacks the force ratio he normally considers adequate for a penetration attack.
- 0 A terrorist group's normal tactics may call for the use of car bombs or similar devices to tie down emergency services while they conduct raids in other parts of town. Your evaluation of the threat's current logistics status, however, might indicate **a** critical shortage of explosive materials.

Additional considerations

- 0 Use all available intelligence sources in the evaluation of the threat's current situation. **Focus on the effects** each incident or fact has on threat capabilities rather than simply enumerate details.

Evaluate the threat (cont)

How to do it (cont)

Identify threat capabilities (cont)

- Use the OB files for the particular threat force you are evaluating. Most forces differ from the ideal portrayed in threat doctrine or tables of organization and equipment. They may be equipped or organized **differently**, train for special missions, or have a particular record of combat experiences that give them a **unique** set, of capabilities.
- In addition to identifying actual threat capabilities, the evaluation may identify additional threat strengths or vulnerabilities caused by the current situation. Ensure you incorporate them into the threat models, the intelligence estimate, and the threat courses of action you develop in the next step of the IPB process.
- Consider the threat's ability to operate in darkness or adverse weather. This is more than the technical capability of selected items of threat equipment. For example, the threat's tank fleet may be equipped with the latest in night vision devices but the supporting infantry and other arms may not be.
- Also consider training levels. A force that frequently trains in night combat may have a better capability for such operations than a better equipped force that seldom trains at night. A force that has never trained in large scale troop movements may have a limited capability to conduct large offensive maneuvers.
- Consider the time element when evaluating capabilities. For example, the threat's forces may be currently dispersed to the point where he is not capable of offensive action. Given time, however, he can **mass** his forces. Similarly, the threat's current logistical **stockage** may permit offensive operations for only a limited amount of time before his stockpiles are exhausted.



Evaluate the threat (cont)  
 How to do it (cont)  
 Identify threat capabilities (cont)

- o When time or some **other factor** is a critical element in a threat capability ensure that you state it explicitly. For **example,--**

**"The** enemy has the capability to attack to seize objectives no deeper than 'the line SOCHATON-MESSVILLE due to insufficient fuel reserves. "

**"The** enemy has the capability to attack after **repositioning** major elements of the IV Army. Current dispositions preclude an attack before 9 July."

**"The** insurgents will have the manpower they need to conduct offensive action once the harvest is completed."

Do not limit the threat models and evaluation of capabilities to the strictly military forces of the threat. Student rioters during a **NEO** operation, for example, are a threat to the friendly mission. Evaluate them using all the techniques described in this section.

Like all other parts of the IPB process, tailor the evaluation to your particular needs. A counterintelligence analysis section, for example, focuses on the threat's intelligence collection capabilities, and level I and II threats. Signal units focus on the ability of the threat to disrupt friendly communications.

Disseminate the results of evaluating **the threat** as widely as possible. This allows other staff sections and units to include them in their own IPB process. For example, the doctrinal templates produced by a division will be refined **by** subordinate battalions to include a greater degree of detail. Templates produced by a G2 or **S2** section will be modified by other staff sections, possibly to highlight specific battlefield operating systems in more detail, such as air defense assets.

Evaluate the threat (cont)  
How to do it (cont)  
Identify threat capabilities (cont)

In addition to distributing threat models, disseminate the results of evaluating the threat's capabilities, strengths and vulnerabilities. The traditional means of disseminating the evaluation is the intelligence estimate, but always use the means best suited to the situation. The graphics that make up the threat model might best be delivered by courier. You can also deliver other parts of the evaluation by voice communications or over automated systems.

For a full discussion of the analytical techniques used in evaluating the threat see--

- o FM 34-3, Intelligence Analysis;
- o FM 34-7, IEW Support to Low Intensity Conflict Operations;
- o FM 34-40(S), Electronic Warfare Operations (U);
- o FM 34-60, Counterintelligence.

██████████ Determine Threat Courses of Action ██████████

What is it?

Definition:

The identification and development of likely threat courses of action that will influence accomplishment of the friendly mission.

A Short Example:

A Boer S2 tells his commander, "**Sir**, the enemy platoon leader's likely objective is to retain control of the only crossing point suitable for wheeled traffic over the Silliaasvogel River. He can defend the crossing, known as **Duffer's Drift**, with his 50 soldiers in any one of the following ways:

- (1) **He** can leave it undefended until tomorrow (being inexperienced and thinking that **we will** not arrive until the next day);

---

Determine threat courses of action (cont)  
What is it? (cont)

---

- (2) **"He** can dig his platoon into a small enclosure just on the other side of the drift. A variant of this COA would be for him to establish a trenchline astride the main road;
- (3) **"He** can occupy and fortify the Xraal village that overlooks the drift;
- (4) **"He** can occupy the river bed itself with only a small outpost in the Kraal village. This goes against every canon in British doctrine, however, we must consider this **COA** because it is so dangerous to the accomplishment of our mission.

**"Sir,** I think the platoon leader will adopt one of these **COAs**, in order of probability as I gave them. We need to conduct reconnaissance of the riverbed and the Kraal in order to find out which of these **COAs** he has chosen."

(Note: The Defence of Duffer's Drift, by MG Sir Ernest Swinton, is a classic vignette illustrating the proper use of tactics, IPB, and the practical application of doctrine)

Desired End Effect:

Replicate the set of **COAs** that the threat commander and staff are considering.

Identify all **COAs** that will influence the friendly command's mission.

Identify those areas and activities that when observed will discern which COA the threat commander has chosen.

<b>So What?</b>
-----------------

The staff uses the resulting threat courses of action, along with other facts and assumptions about the battlefield environment, to drive the wargaming process and develop friendly courses of action.

Determine threat courses of action (cont)  
So what? (cont)

Success Results in:

The friendly commander and staff will avoid being surprised with an unanticipated threat action.

You will be able to quickly **narrow the** set of possible threat courses of action to the one he has chosen.

Consequences of Failure:

You **will fail** to identify which of the possible courses- of action **the** threat has chosen, leading to surprise of the friendly command.

How to Do it:

- o Identify the threat's likely objectives and desired end state.
- o Identify the full set of courses of action available to the threat.
- o Evaluate and prioritize each course of action.
- o Develop each course of action in the amount of detail time allows.
- o Identify initial collection requirements

Each of these steps is discussed below.

IDENTIFY THE THREAT'S LIKELY OBJECTIVES AND DESIRED END STATE

Start with the threat command at least one level above your own and identify likely objectives and **the desired** end state. As you identify the likely objectives at each level of command, repeat the process for the next subordinate level, working down to two levels below your own command. Ensure that each level's objective will accomplish the likely objectives and desired end state of its parent commands.

<p>Determine threat courses of action (<b>cont</b>)</p>
---

<p>How to do it (<b>cont</b>)</p>
-----------------------------------

<p>Identify the threat's likely objectives and desired end state</p>
--

Additional considerations

- The situation may require you to start at more than one level above your command, particularly in operations other than war.
- Only in rare cases will you have the intelligence you need to state the threat's objectives and intended end state as facts. You will usually state them **as** assumptions. As with all assumptions, ensure that you discuss them with the commander and the remainder of the staff. Ensure that you identify assumptions as such.
- Especially during operations other than war it is important that you consider more than the conventional objectives of terrain or friendly forces. This is also true at higher levels of command where the threat's political and economic objectives have a direct influence on his courses of action.
- Terrain related objectives (intermediate and final) often focus on key terrain features. Force related objectives usually focus on reserve forces.
- Even during defensive operations the threat will have objectives, such as retain control of a piece of terrain, defeat or delay a friendly force, etc. YOU must also identify likely counterattack objectives such as terrain features or friendly reserve forces.
- It is possible that the threat's intent and objectives may not interfere with the accomplishment of the friendly mission. This is more likely during operations other than war.

IDENTIFY THE FULL SET OF COURSES OF ACTION AVAILABLE TO THE THREAT

To ensure that you consider the full set of courses of action available to the enemy you must at least consider--

- The courses of action the threat's doctrine believes appropriate to the current situation and the likely

Determine threat courses of action (cont)

How to do it (cont)

Identify the full set of courses of action available to the threat (cont)

objectives you have identified. This requires an in depth understanding of **the threat's** decision making process as well as an appreciation for how he perceives the current situation.

- o The threat courses of action which could significantly influence your command's mission, even if the threat's doctrine considers them infeasible or "**sub-optimum**" under current conditions. Consider any indirect or "**wildcard**" courses of action that the threat is capable of executing.
- o The threat courses of action indicated by recent activities and events. To avoid surprise from an unanticipated course of action consider all possible explanations for the threat's activity in terms of possible courses of action.

Consider each sub-set of courses of action independently to avoid forming biases that restrict the analysis and evaluation. Once you have evaluated each sub-set separately, combine them to eliminate redundancy and minor variations. Compare the consolidated list to threat capabilities you identified in step three of the IPB process and eliminate any courses of action which the threat is incapable of executing.

Based on the evaluation of the threat's capabilities (step three of the IPB process) select threat models that will accomplish the threat's likely objectives. Examine how the effects of the battlefield (from step two of the IPB process) influence their application as courses of action (see Figure 2-13). You will usually find that terrain, weather, and other characteristics of the battlefield environment "**offer**" a limited set of **COAs**, encouraging some while discouraging others.

Start with the general courses of action open to the threat, such as deliberate attack, hasty attack, defend, and delay. Further define each general COA as a set of specific courses of action by integrating the threat

<p>Determine threat courses of action <b>(cont)</b></p>
---

<p>How to do it <b>(cont)</b></p>
-----------------------------------

<p>Identify the full set of courses of action available to the threat <b>(cont)</b></p>
---

models from step three of the IPB process with the description of the battlefield's effects from step two. Factors to consider include--

- The threat's intent or desired end state.
- Likely attack or counterattack objectives.
- Effects of the **battlefield environment** on operations and broad courses of action.
- Threat vulnerabilities or shortages in equipment or personnel.
- Current dispositions.
- Location of main and supporting efforts.
- Threat perception of friendly forces.
- Threat efforts to present an ambiguous situation or achieve surprise.

Refine each broad course of action statement into a set of specific courses of action. For example, a general course of action such as "**hasty** attack" might be further defined as a set of specific courses of action such as "**with** main effort in the east....in the west. . .against the adjacent **unit.**"

#### Criteria for Courses of Action

Each threat course of action you identify should meet five criteria: suitability, feasibility, acceptability, uniqueness, and consistency with doctrine.

##### Suitability:

A threat course of action must have the potential for accomplishing the threat's likely objective or desired end state. If the course of action is successfully executed will it accomplish the threat's objectives?

##### Feasibility:

Consider the time and space required to execute the course of action. Are they available?

Determine threat courses of action (cont)

How to do it (cont)

Identify the full set of courses of action available to the threat (cont)

Criteria for courses of action (cont)

Consider the resources required to execute the course of action. Does the threat have the physical means required to make it a success?

Occasionally force ratios or other factors might indicate that the threat lacks the means to accomplish his likely objectives. Before discounting the threat completely, consider all actions he might take to create the conditions needed for success. For example, he might conduct economy of force operations in some sectors in order to generate sufficient combat power for offensive operations in others. His lack of resources might force him to violate his own doctrine in order to accomplish his objective. What seemingly radical measures can he take to create the conditions for success? Avoid surprise.

**Acceptability:**

Consider the amount of risk involved. Will threat forces accept the amount of risk entailed in adopting the course of action? Can they afford the expenditure of resources for an uncertain chance at success? This is obviously a subjective judgment based on knowledge of the threat and his doctrine. In some instances, the threat might undertake otherwise unfavorable courses of action, particularly if they are the only means to accomplishing his objective.

**Uniqueness:**

Each threat course of action must be significantly different from the others. Otherwise, consider it as a variation rather than a distinct course of action. Factors to consider in determining if a course of action is "significantly" different are:

- o Its effect on the friendly mission;
- o Use of reserves or second echelon;



<p>Determine threat courses of <b>action (cont)</b></p>
---

<p>How to do it <b>(cont)</b></p>
-----------------------------------

<p>Identify the full set of courses of action available to the threat <b>(cont)</b></p>
---

<p>Criteria for courses of action <b>(cont)</b></p>
---

- 0 Location of main effort;
- o Scheme of maneuver;
- o Task organization.

This is obviously a subjective judgement based on  
 \* your experience and training.

Consistency with Doctrine:

Each threat course of action must be consistent with the threat's doctrine. Base the evaluation of consistency on the threat's written doctrine and observations of his past application of doctrine, as revealed in the intelligence database. Do not, however, overlook threat efforts to achieve surprise by deviating from known doctrine or using "**wildcard**" courses of action.

Additional Considerations

- 0 Account for the effect of friendly dispositions, or the threat's perception of friendly dispositions, when determining the **COAs** the threat believes are available. A technique for accomplishing this is to conduct "reverse **IPB**." In other words, replicate the process that the threat is employing to discern friendly **COAs**.
- 0 Focus on those courses of action that will affect accomplishment of your command's mission. This obviously includes those threat COA that will interfere with the command's mission. If there are indications that the threat might adopt a COA that favors accomplishment of your command's mission, include it as well. This prepares the commander to take advantage of opportunities that might arise. For example,

Determine threat courses of action (cont)

How to do it (cont)

Identify the full set of courses of action available to the threat (cont)

if the friendly command's mission is to attack to destroy the threat, threat courses of action that would interfere with the friendly mission are: defend, including counterattacks; reinforce; and, withdraw.

If your command's mission is to attack to seize a terrain objective, threat courses of action that could interfere with the mission are: **defend**, including counterattacks; and, reinforce. Threat withdrawal would favor accomplishment of the friendly mission and would also be included in the set of probable courses of action if there were indications the threat might actually withdraw.

- It is possible for the threat to have objectives and choose courses of action which will not interfere with success of your command's mission.
- Identify the full set of courses of action available to the threat. History repeatedly demonstrates that those who predict only one COA are often surprised by the enemy.
- Do not overlook the less likely but still viable courses of action. Do not risk surprise by failing to take the time to consider all feasible courses of action. Identify alternative methods by which the threat can achieve his objective or desired end-state. Consider the following possibilities that might lead to "**wildcard**" courses of action:

Superior understanding of "**other** characteristics of the battlefield" (politics in particular),

- Ignorance of the military arts and sciences,
- Immature decision-making,
- Uncertainty as to friendly disposition or intent,
- Unexpected objectives or desired end-states,
- Desperation,
- Bureaucratic inefficiency, and
- Audacity.

Determine threat courses of action ( <b>cont</b> )
--

How to do it ( <b>cont</b> )
------------------------------

Identify the full set of courses of action available to the threat ( <b>cont</b> )
--

**On** the other hand, avoid developing a "**full**" set of **COAs** by including bogus options.

- For a complete discussion of methods used to construct courses of **action** (friendly or threat) refer to **FM 101-5**, Command and Control for Commanders and Staffs.

#### EVALUATE AND PRIORITIZE EACH COURSE OF ACTION

The resulting set of courses of action depicts the full set of options available to the threat. Remember that the threat **COAs** you identify are assumptions about the threat, not facts. Because of this you cannot predict with complete accuracy which of the **COAs** the threat will employ.

However, the commander and his staff still need to develop a plan that is optimized to one of the courses of action, while still allowing for contingency options if the threat chooses another COA. Therefore, you must evaluate each COA and prioritize it according to how likely you estimate it is that the threat will adopt that option. Establish an initial priority list to allow the staff to plan for friendly courses of action. Once the commander selects a friendly course of action, you may need to reorder the list of threat courses of action. Consider especially any changes in the threat's perception of friendly forces.

To prioritize each course of action:

- Analyze each COA to identify its strengths and weaknesses, centers of gravity, and decisive points.
- Evaluate how well each COA **meets** the criteria of suitability, feasibility, acceptability, and consistency with doctrine (see above).
- Evaluate how well each COA takes advantage of the battlefield environment. How does the battlefield encourage or discourage selection of each COA?

Determine threat courses of action (cont)

How to do it (cont)

Evaluate and prioritize each course of action (cont)

- o Compare each COA to the others and determine if the threat is **more** likely to prefer one over the others. Most forces will choose the COA that offers the greatest advantages while minimizing risk.
- o Consider the possibility that the threat may choose the second or third "**best**" COA while attempting a deception operation portraying acceptance of the "**best**" COA.
- o Analyze the threat's recent activity to determine if there are indications that one COA is already being adopted. Does his current disposition favor one COA over others?

Use judgment to rank the threat's courses of action in their likely order of adoption. Modify the list as needed to account for changes in the current situation. For example, the **initial** priority order of threat courses of action does not account for the friendly course of action, since one has not yet been selected. Friendly dispositions may change as the command moves to adopt its own COA. How will that change the likelihood of each threat COA? Given time, you could develop several different versions of the prioritized list of threat courses of action: a different order for each potential friendly course of action. Alternatively, after the commander has selected the friendly course of action, reprioritize the initial list of threat courses of action to reflect changed friendly dispositions and activities.

DEVELOP EACH COURSE OF ACTION IN THE AMOUNT OF DETAIL TIME  
ALLOWS

Once you have identified the complete set of threat **COAs** develop each course of action into as much detail as the situation requires and time available allows. Base the order in which you develop each COA on its probability of adoption and the commander's guidance. To ensure completeness, each course of action must answer five questions:

- o What - the type of operation, such as attack, defend, etc.

<p>Determine threat courses of action (<b>cont</b>)</p>
---

<p>How to do it (<b>cont</b>)</p>
-----------------------------------

<p>Develop each course of action in the amount of detail time allows (<b>cont</b>)</p>
--

- o When - the time the action will begin. You usually state this in terms of the earliest time that the threat can adopt the course of action under consideration.
- o Where - the sectors, zones, axis of attack, avenues of approach and objectives that make up the course of action.
- o How - the method by which the threat will employ **his** assets, such as dispositions, location of main effort and the scheme of maneuver.
- o Why - the objective or end-state the threat intends to accomplish.

Consider threat forces available to at least one level of command above your own when developing each **course** of action. For example, a battalion S2 would consider the courses of action available to threat regiments and brigades. This helps to ensure that you account for possible reinforcing forces and the higher command's own objectives and intent.

Time permitting, the final product should consist of a comprehensive, detailed set of threat courses of action. Work to a degree of resolution at two levels of command below your own. For example, a brigade S2 would depict the missions and actions of threat battalions and companies in the threat courses of action he develops.

Each developed threat course of action has three parts:

- 0 a situation template,
- 0 a description of the course of action, and
- 0 a listing of high value targets.

Situation Template:

Situation templates are graphic depictions of expected threat dispositions should he adopt a particular course of action. They usually depict the most critical point in the operation as agreed upon by the G2 and G3. However, you might prepare several

Determine threat courses of action (cont)  
 How to do it (cont)  
 Develop each course of action in the amount of detail time allows (cont)  
 Situation template (cont)

templates representing different "snapshots in time" starting with the threat's initial array of forces. These are useful in depicting points where the threat might adopt branches or sequels to the main course of action, places where the threat is especially vulnerable, or other key-points in the battle such as initial contact with friendly forces. You use situation templates to support staff wargaming and develop event templates.

To construct a situation template, begin with the threat model representing the operation under consideration. Overlay the doctrinal template on the products that depict the battlefield environment's effects on operations. Typically, the product of choice is the modified combined obstacle overlay, but this may vary with the situation.

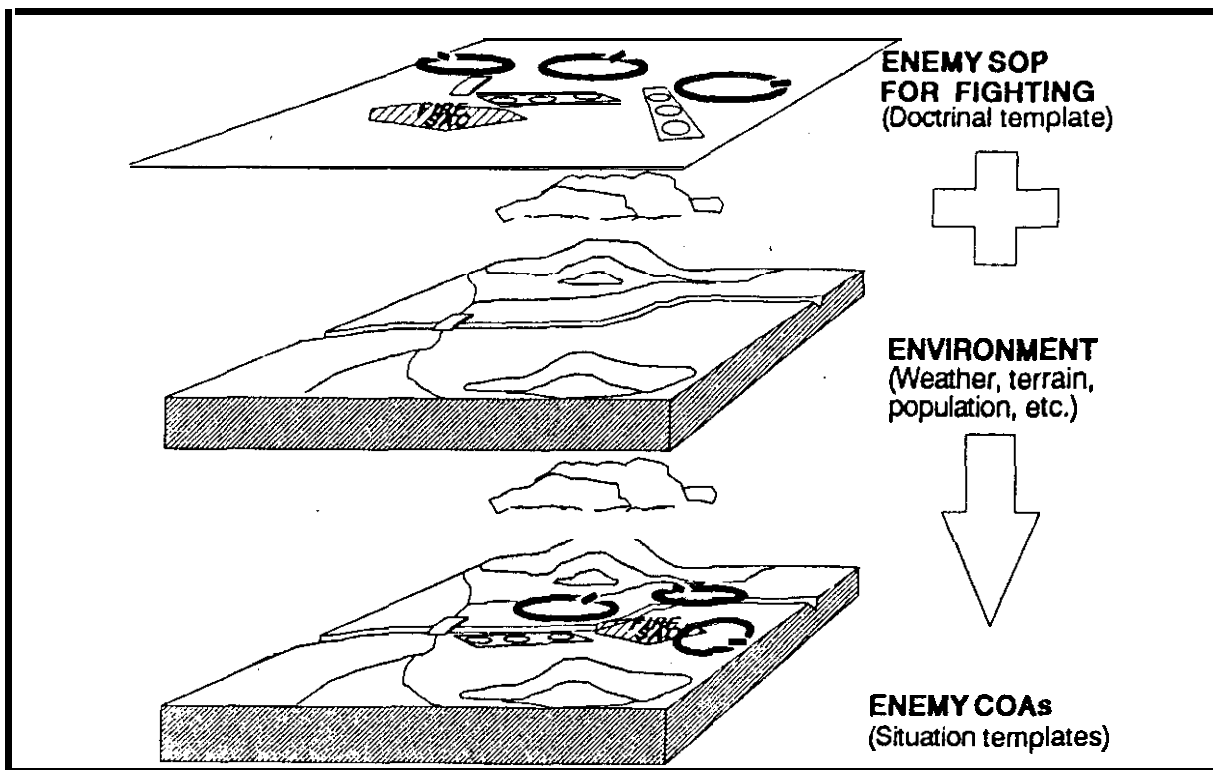

Figure 2-13. Consider the effects of the environment on the enemy's doctrine to develop enemy COAs.

Determine threat courses of action **(cont)**

How to do it **(cont)**

Develop each course of action in the amount of detail time allows **(cont)**

Situation template **(cont)**

Using your judgment and knowledge of the threat's preferred tactics and doctrine as depicted in the threat model, adjust the dispositions portrayed on the doctrinal template to account for the battlefield environment's effects. Obviously, there will be many options available. Attempt to view the situation from the point of view of the threat commander when selecting from among them.

**Check the** situation template to ensure that you have accounted for all of the threat's major assets, and that none have been inadvertently duplicated.

Ensure that the template reflects the main effort identified for this course of action. Compare the depicted dispositions to the threat's known doctrine; check for consistency. Consider the threat's desire to present an ambiguous situation and achieve surprise.

Include as much detail on the situation template as the time and situation warrant. For example, if the threat is defending, identify the likely engagement areas, reinforcing obstacle systems, and counterattack objectives that form part of his defensive course of action.

Next, using the description of preferred tactics that accompanies the doctrinal template as a guide, think through the course of action's scheme of maneuver. Attempt to visualize how the threat will transition from his current positions to those depicted on the template.

Mentally **wargame** the schema of maneuver from the positions depicted on the template through to the course of action's success or failure. Evaluate time and space factors to develop time phase lines **depicting** threat movement. Draw time phase lines on the template to depict the expected progress of attacking forces, the movement of reserves or counterattacking forces, and the movement of forces in the deep and rear battle areas.

Determine threat courses of action (cont)

How to do it (cont)

Develop each course of action in the amount of detail time allows (cont)

Situation template (cont)

Base time-phase lines on the threat's doctrinal rates of movement, with some modification. Evaluate actual movement **rates**, as revealed in the database, with written doctrine. Consider the effects of the battlefield environment on mobility. If contact with friendly forces is expected, mentally **wargame** the effects this will have on the threat's speed as well.

When-placing time phase lines consider only the time it will take to adopt movement formations, time to conduct movement to the selected location, and time for the unit to close after arrival. This assumes

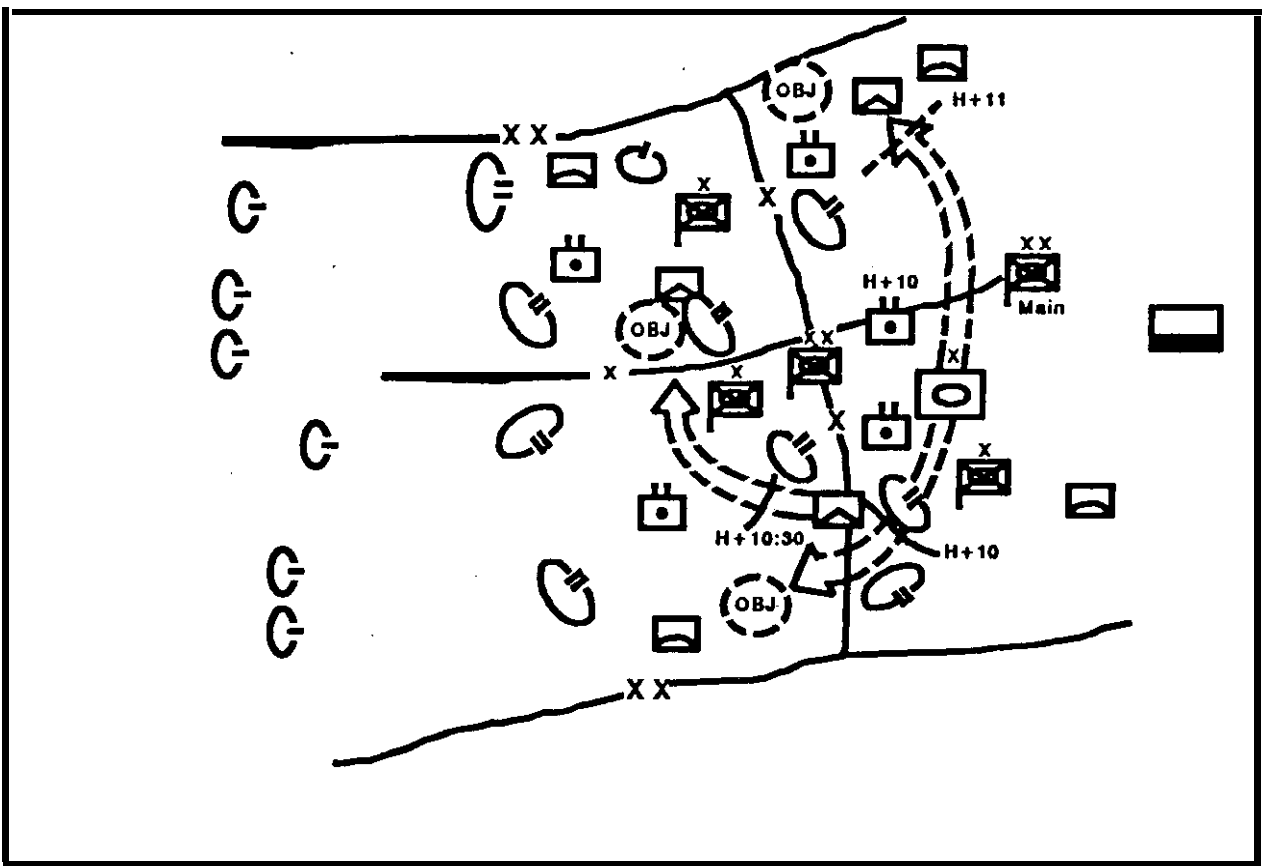

Figure 2-14. Situation templates depict enemy COA.



**Determine threat courses of action (cont)****How to do it (cont)**

Develop each course of action in the amount of detail time allows **(cont)**

Situation template **(cont)**

that time consuming planning, issuance of orders, reconnaissance, and logistical preparations may occur during movement.

During staff wargaming of the situation templates against potential **friendly courses** of action, update time phase lines to consider when threat movement will be triggered or how they might be influenced **by** friendly actions.

Prepare as many graphics as necessary to depict the course of action in enough detail to support staff wargaming and collection planning. For example, a course of action may begin as a movement to contact, transition to a hasty attack, followed by pursuit operations that include a river crossing. Each of these phases may require a separate template.

Tailor the situation templates to your needs by focusing on the factors that are important to the commander or mission area. For example, the situation might focus only on the threat's reconnaissance assets when determining and developing threat courses of action. The situation templates you produce might show only the location and movement routes of these assets, their likely employment areas, and their likely areas of interest. An aviation unit, for example, might develop situation templates that depict details such as specific radar and weapon locations and their range fans or areas of coverage.

At higher echelons the situation templates will **usually focus** on culminating points and installations or activities associated with centers of gravity rather than specific military units.

Some situation templates are better presented in a matrix format. Figure 2-15, for example, illustrates a situation template in matrix form that depicts one threat course of action for an air strike against friendly targets. The time line indicates spacing between the various groups as well as the time each group is expected within each NAI.

insert figure 2-15  
new illustration  
based on B-5 from fm 44-53

Sometimes, situation templates are replaced by other products, such as a key facilities and targets overlay. Use whatever technique best graphically illustrates the threat's courses of action.

Course of Action Description and Ootions:

This is a description of the activities of the forces depicted on the situation template. It can range from a narrative description to a detailed "synchronization matrix" depicting the activities of each unit and battlefield operating system in detail. It should address the earliest time the course of action can be executed, **time** lines and phases associated with the COA, and decisions the threat commander will make during execution of the COA and after. You use the course of action description to support staff wargaming and to develop the event template and supporting indicators.

Start with the description of preferred tactics that accompanies the doctrinal template. As you mentally **wargame** the situation template note when and where you expect the threat to take certain actions or make

Determine threat courses of action **(cont)**

How to do it **(cont)**

Develop each course of action in the amount of detail time allows **(cont)**

Course of action description and options **(cont)**

certain decisions. Record each event into the description of the course of action. Where possible, tie each event or activity to time-phase lines or other specific geographical areas on the situation template. This will help you later when constructing the event template.

As the threat force approaches decision points, record each decision and its time line into the **COA** description. The description you develop forms the basis for the development of threat branches or sequels, should they be necessary to support friendly planning. Also record any decision criteria that are associated with each decision point.

Develop the description of the course of action into as much detail as time and the situation require. Use whatever tools or techniques best satisfy your needs. For example, you might use a time event chart or a simple narrative description. Given enough time, you might develop an elaborate matrix. See Chapter 3 for examples.

Regardless of the form initially chosen, the course of action statement will be refined to greater detail during the staff wargaming of potential friendly courses of action.

#### High Value Targets:

As you prepare and mentally **wargame** the situation template note how and where the threat might employ the high value targets listed on the doctrinal template. The relative worth of each **HVT** target will vary with the specific situation under consideration, perhaps even several times during the COA you are developing.

Using judgment, refine and modify the list of HVT from the doctrinal template to reflect changes in their relative worth over the course of the COA under

Determine threat courses of **action (cont)**

How to do it **(cont)**

Develop each course of action in the amount of detail **time** allows **(cont)**

High value targets **(cont)**

consideration. If the relative worth of an HVT varies by phase of the operation, ensure you make the appropriate notations. Transfer the updated list to the situation template. You will use the list to **support** staff wargaming and the targeting process.

Note on the situation template any areas where high value targets must appear or be employed to make the operation successful. These are potential target areas of interest and engagement areas. Cross reference each potential NAI with the description of the course of action that accompanies the template.

Additional Considerations

- o When considering an attacking threat, less detailed resolution is required. For example, depending on the situation, a friendly defending battalion might need only to work to a level of detail of threat companies. Considering the possible variations in the threat's course of action based on the details of employment of the individual platoons adds a tremendous amount of effort to the process; perhaps more than the results will justify.
- o When considering a defending threat, a greater level of detail might be required. For example, an attacking battalion might concern itself with individual anti-tank or crew served weapons positions. A greater level of detail in resolution is generally required during hostilities short of war as well.
- o After developing each course of action in detail you may need to reprioritize the order of likely adoption. For example, as you develop a particular course of action you may discover that a particular **section** of terrain offers only a limited number of suitable defensive positions or concealed avenues of approach. This may cause a change in the relative priority of courses of action using that section of terrain.

Determine threat courses of action (**cont**)

How to do it (**cont**)

Develop each course of action in the amount of detail time allows (**cont**)

- o The level of command and type of operation has a direct bearing on the level of detail that goes into each situation template. For **example,---**
  - At tactical levels situation templates sometimes depict individual vehicles in threat dispositions. **NAIs** are often "pin-point" locations such as road junctions or small unit battle positions.
  - At operational levels situation templates might focus on large reserve formations, major staging bases and lines of communication. **NAIs** are often large dispersal areas, reserve assembly areas, or logistical support areas.
  - At strategic levels situation templates might focus on the shift of large forces from one theater to another as well as political and economic developments. **NAIs** can sometimes encompass large regions.

#### IDENTIFY INITIAL COLLECTION REQUIREMENTS

After identifying the set of potential threat courses of action the initial challenge is to determine which one he will actually adopt. Initial collection requirements are designed to help you answer the challenge.

The art of identifying initial collection requirements revolves around predicting specific areas and activities, which when observed, will reveal which course of action the threat has chosen. The areas where you expect key events to **occur** are called named areas of interest, or **NAIs**. The activities which reveal the selected course of action are called indicators.

#### The Event Template

The differences between the **NAIs**, indicators, and time-phase lines associated with each course of action

Determine threat courses of action (**cont**)

How to do it (**cont**)

Identify initial collection requirements (**cont**)

Event template (**cont**)

form the basis of the event template (see Figure 2-16). The event template **is a guide** for collection and R&S planning. It depicts where to collect the information that **will** indicate which COA the threat has adopted.

Evaluate each course of action to identify its associated **NAIs**. Mentally **wargame** execution of the course of action and note places where activity must **occur** if that COA is adopted. Pay particular attention to times and places where the threat's high value targets are employed or enter areas where they can be easily acquired and engaged. These areas will evolve into **NAIs** in support of targeting. Also consider places you expect the threat to take certain actions or make certain decisions, such as the adoption of a branch plan or execution of a counterattack.

An NAI can be a specific point, a route, or an area. They can match obvious natural terrain features or arbitrary features, such as time phase lines or engagement areas. Make them large enough to encompass the activity which serves as the indicator of the threat's course of action.

Compare and contrast the **NAIs** and indicators associated with each COA against the others and identify their differences. Concentrate on the differences that will provide the **most** reliable indications of adoption of each unique course of action. Mark the selected **NAIs** on the event template.

The initial event template focuses only on identifying which of the predicted courses of action the threat has adopted. Later, you will update and further refine the event template and its supporting matrix to support friendly decisions identified during staff wargaming.

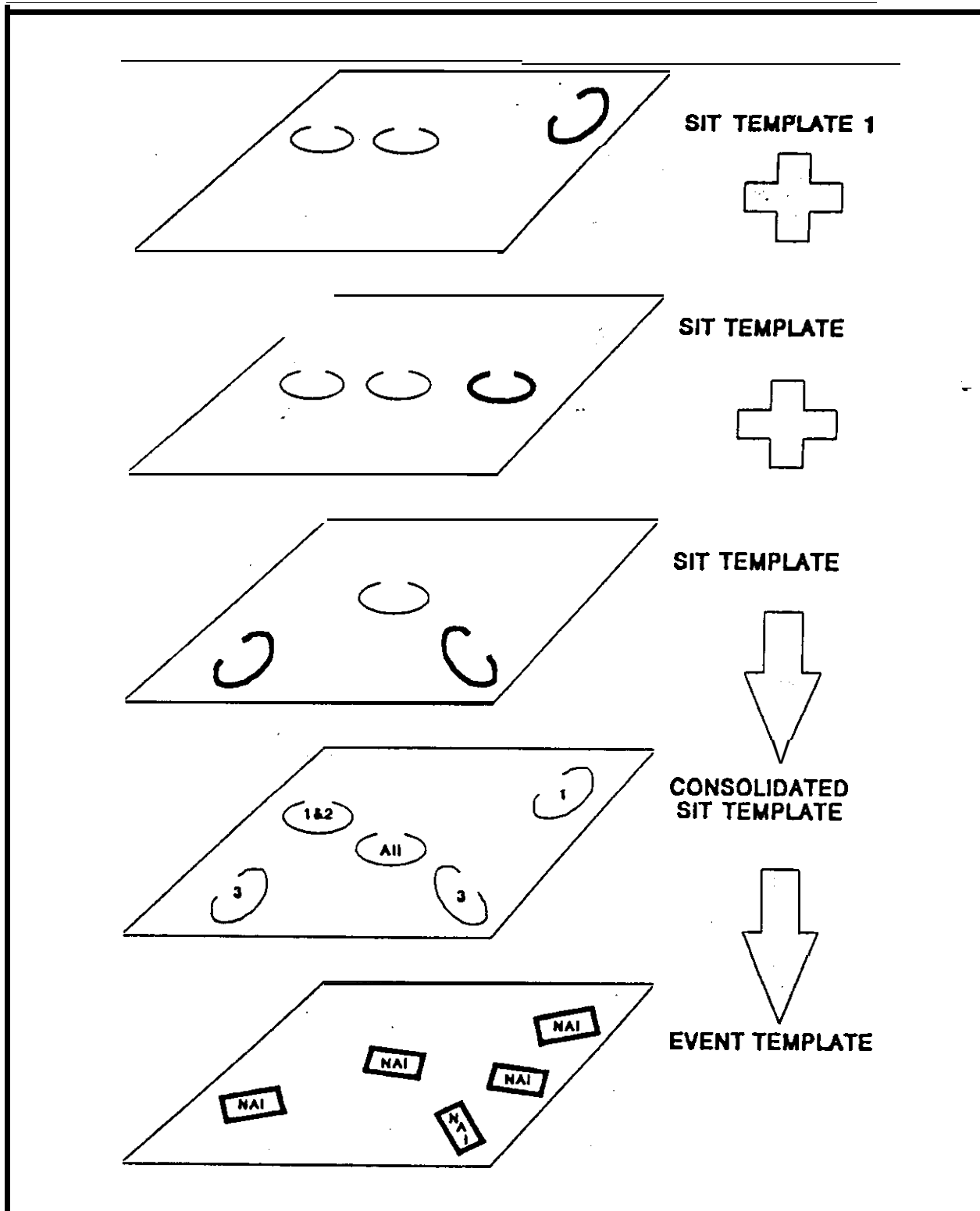

Figure 2-16. Compare enemy COAs to produce the event template.

NAI	INDICATORS THAT WOULD HELP CONFIRM COA 1	INDICATORS THAT WOULD HELP CONFIRM COA 2	INDICATORS THAT WOULD HELP CONFIRM COA 3	INDICATORS THAT WOULD HELP CONFIRM OTHER COAs OF CONCERN
1		Air assault forces		
2		Air assault forces		
3	Air assault forces		Air assault forces	
4		Infiltration of light Inf		
5		Light Inf attack NAI 5		
6		Light Inf attack NAI 6		
7	Light Inf attack NAI 7		Light Inf attack NAI 7	
8	Light Inf attack NAI 8		Light Inf attack NAI 8	
9	■ Poised to attack	■ Poised to attack		TD attacks
10	■ Poised to attack	■ Poised to attack	■ ■ Poised to attack abreast	TD attacks
11			■ Shifts N	
12				1 or 2 Bdes attack W
13				1 or 2 Bdes attack S

Figure 2-17. The event matrix supports the event template.

The Event Matrix

The event matrix supports the event template by providing details on the type of activity expected in each NAI, the times the NAI is expected to be active, and its relationship to other events on the battlefield.- Its primary use is in planning intelligence collection, however, it serves as an aid to situation development as well (see Figure 2-17).

Examine the events associated with each NAI on the event template and restate them in the form of indicators. Enter the indicators into the event matrix along with the times they are likely to occur. Use the time-phase lines from the situation template or the description of the COA to establish the



<p>Determine threat courses of action (<b>cont</b>)</p>
---

<p>How to do it (<b>cont</b>)</p>
-----------------------------------

<p>Identify initial collection requirements (<b>cont</b>)</p>
---

<p>Event matrix (<b>cont</b>)</p>
-----------------------------------

expected times in the event matrix. If there is a "latest-time-information-of-value" time line, based on the expected flow of events, record it into the event matrix as a guide for the collection manager.

Refine the event matrix during staff wargaming and the targeting process.

Additional considerations

- Differences between **courses** of action are usually reflected in different **NAIs** but might also consist of **different** time-phase lines or indicators associated with a particular NAI.
- Consider the effects of threat deception attempts on the reliability of each event as an indicator.
- NAI for counter-air operations are more similar to those used in targeting. Their focus is on locations where threat aircraft are likely to appear when using particular air avenues of approach, likely forward support bases, and forward rearming and refueling points. Generally, ADA units will cover these NAI with their own target acquisition assets.
- During staff wargaming you will help establish a decision support template that incorporates **NAIs** supporting decisions by the commander and the tracking of high payoff targets. The additional NAI are developed from potential **NAIs** identified on the-situation templates and the results of decisions made during wargaming of friendly courses of action.

Threat course of action models drive the wargaming of potential friendly courses of action. They aid in the construction of the command's decision support template and other synchronization tools the staff uses during mission execution. Disseminate the threat course of action models as widely as possible. They are the most



The abbreviated IPB process (cont) Work ahead (cont)
---

Become familiar with the support available to you from the intelligence system of **systems**. Know how to get what you need when you need it. Think through methods to get support before, during, and after deployment.

## FOCUS ON ESSENTIALS

Consider the general factors of METT-T when starting the IPB effort, particularly that of time. Backward plan the IPB effort. Determine how much **time** you can devote to each step of the IPB process. Ensure that **the timeline** allows you to properly support the decision-making process.

Decide which products you will develop and to what degree of detail. Focus on the products **most** important to your mission. Rather than fully developing one threat course of action at the expense of all others, identify the full range of available courses of action. Determine the degree of detail required and then develop all courses of action to that level of detail.

Always work in a priority order established by the commander's intent and needs. If he is particularly pressed for time, he **may** specify which courses of action he wants you to focus on, such as the most likely or the most dangerous. This implies that you first identify all **courses** of action and evaluate them to determine which is the most likely or most dangerous. You abbreviate the IPB process by developing in detail only those he has specified.

## STAY OBJECTIVE ORIENTED

The objective of IPB is to help the commander and his staff put together the **best** possible plan in the time available. This requires models of the range of viable threat courses of action that will influence mission accomplishment. Supporting the finished plan with intelligence requires a good event template and matrix. Everything else is only a means to producing these essentials.

The abbreviated IPB process (cont) The minimum essentials
--

**THE MINIMUM ESSENTIALS**

In a pinch you can get by with just a good set of threat course of action models and a good event template and matrix. To save time and materials, you can combine all threat course of action models templates and the event template on a single map overlay or use cartoons and sketches as a map substitute.

If you have not yet described the battlefield environment's effects, work directly from the map or a sketch of major terrain features. Start by identifying the set of threat courses of action and briefly comparing them to determine which is most likely and which is most dangerous, considering the current situation and your command's mission. Rank the remainder in order of likely adoption.

Begin by developing the most dangerous or most likely threat course of action. In the absence of guidance from the commander you will have to use your own judgment on which to do first. Develop the selected course of action to as much detail as the available time allows before turning to the other.

Next, construct an event template that focuses on identifying which of the two courses of action the threat has adopted. Then turn to developing the remaining courses of action. Work each COA in the priority order you put them in when evaluating their likelihood of adoption.

As each COA is finished to the determined degree of detail, incorporate **NAIs** associated with it into the event template. The initial structuring of the collection requirements can actually wait until after staff wargaming. The most important milestone prior to wargaming is to develop the most likely and most dangerous **COAs**.

If the most likely COA is also the most dangerous COA, develop the second most likely or the second most dangerous COA. NEVER take just one COA into wargaming - this is not an acceptable way to abbreviate the IPB or staff planning processes.

The abbreviated IPB process (cont)  
The minimum essentials (cont)

The single product that results from this approach is a far cry from the full-blown set of products described in the first scenario of chapter three. However, the "one-overlay product," when developed to a quality standard, has repeatedly proven to be effective on the battlefield. This is IPB in its most elementary form, and it proves the strength of the fundamental IPB process.

CHAPTER 3' EXAMPLE APPLICATIONS OF INTELLIGENCE PREPARATION OF THE BATTLEFIELD
--

Basic IPB doctrine can be applied to support planning in any situation. However, the application of doctrine will vary according to the circumstances. **This chapter** shows application of the IPB **process** to four different **METT-T** situations.

Four scenarios are used to illustrate the application of IPB in very different situations.

- Scenario 1 portrays a heavy division attacking an understrength enemy division (Figure 3-1 through Figure 3-1-38).
- Scenario 2 portrays a light or heavy brigade defending against a heavy division (Figure 3-2 through Figure 3-2-9).
- Scenario 3 portrays a light infantry battalion in a counterinsurgency mission (Figure 3-3 through Figure 3-3-18).
- Scenario 4 portrays an evacuation of noncombatants by an infantry brigade (Figure 3-4 through 3-4-12).

Although all four scenarios use the same basic IPB process, **each** one emphasizes different techniques. Combine or discard these various **TTP** to suit the situation with which your command is faced. Innovate as required. Use the doctrine of IPB in Chapter 3 to guide you in applying or creating your own TTP. Use these four scenarios as a source of inspiration; not as the "**school** solution".

■■■■■■■■■■ Scenario One : Division Conventional Offense ■■■■■■■■■■

As the attacking enemy reaches his culminating point, the corps prepares to launch a counteroffensive. The corps will attack with its main effort in the north. Our division will conduct a supporting attack in the south, crossing the Kald River and establishing a hasty defense once it reaches the corps limit of advance (LOA).

The division is composed of one armored brigade, two mechanized infantry brigades, one light infantry brigade, and the normal complement of aviation, artillery, and combat support and combat service support units.

The enemy in the division's sector is one understrength mechanized infantry division. Beyond the limit of advance is the enemy's second echelon, two armored divisions, also understrength. An air assault brigade and surface-to-surface missile units are located in the enemy's depth (Figure 3-1).

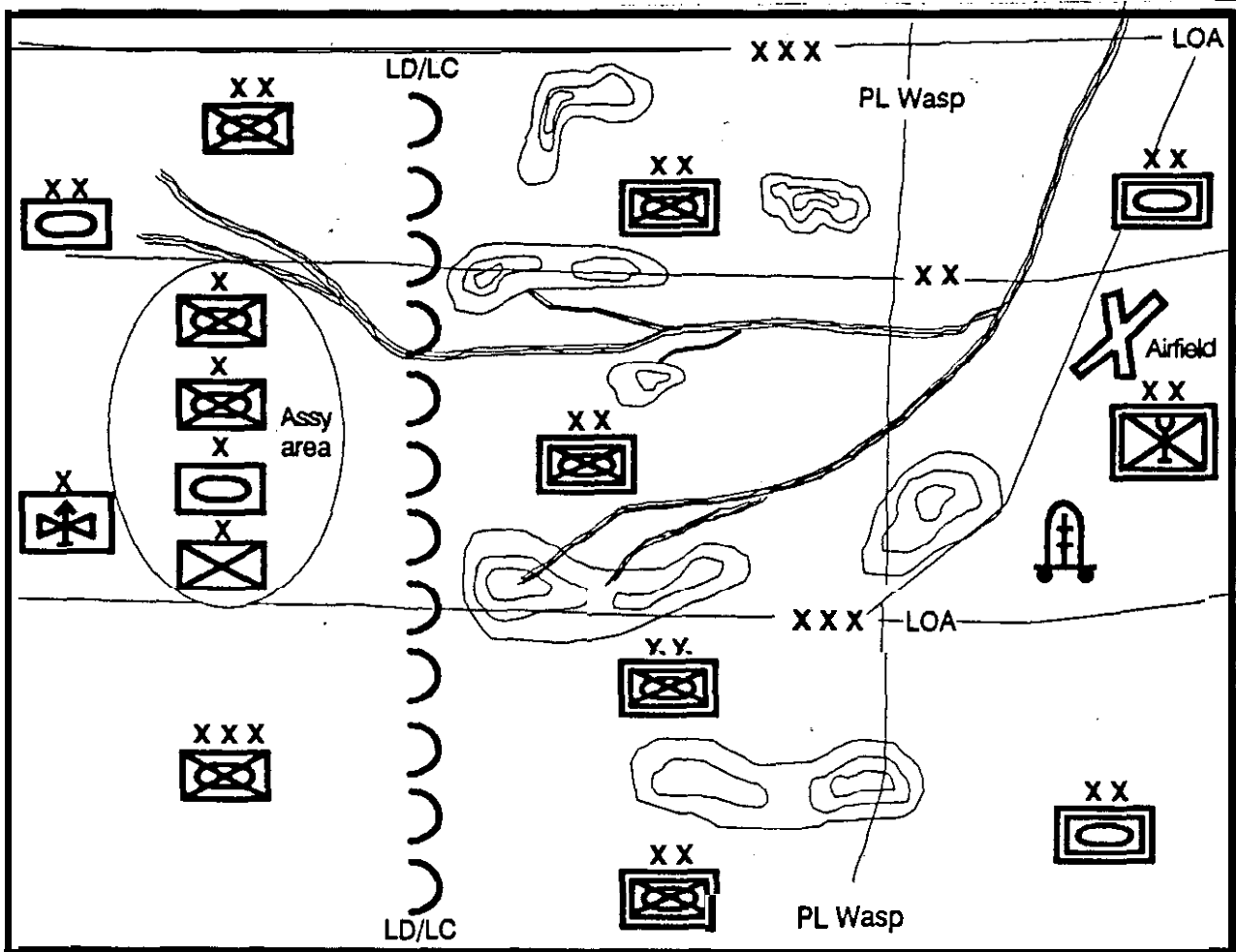

Figure 3-1. Scenario 1, general situation.

DEFINE THE BATTLEFIELD ENVIRONMENT

The operations graphics from corps specify the division's **AO**. It lies within the current boundaries and extends out to the **LOA** (**Figure 3-1-11**).

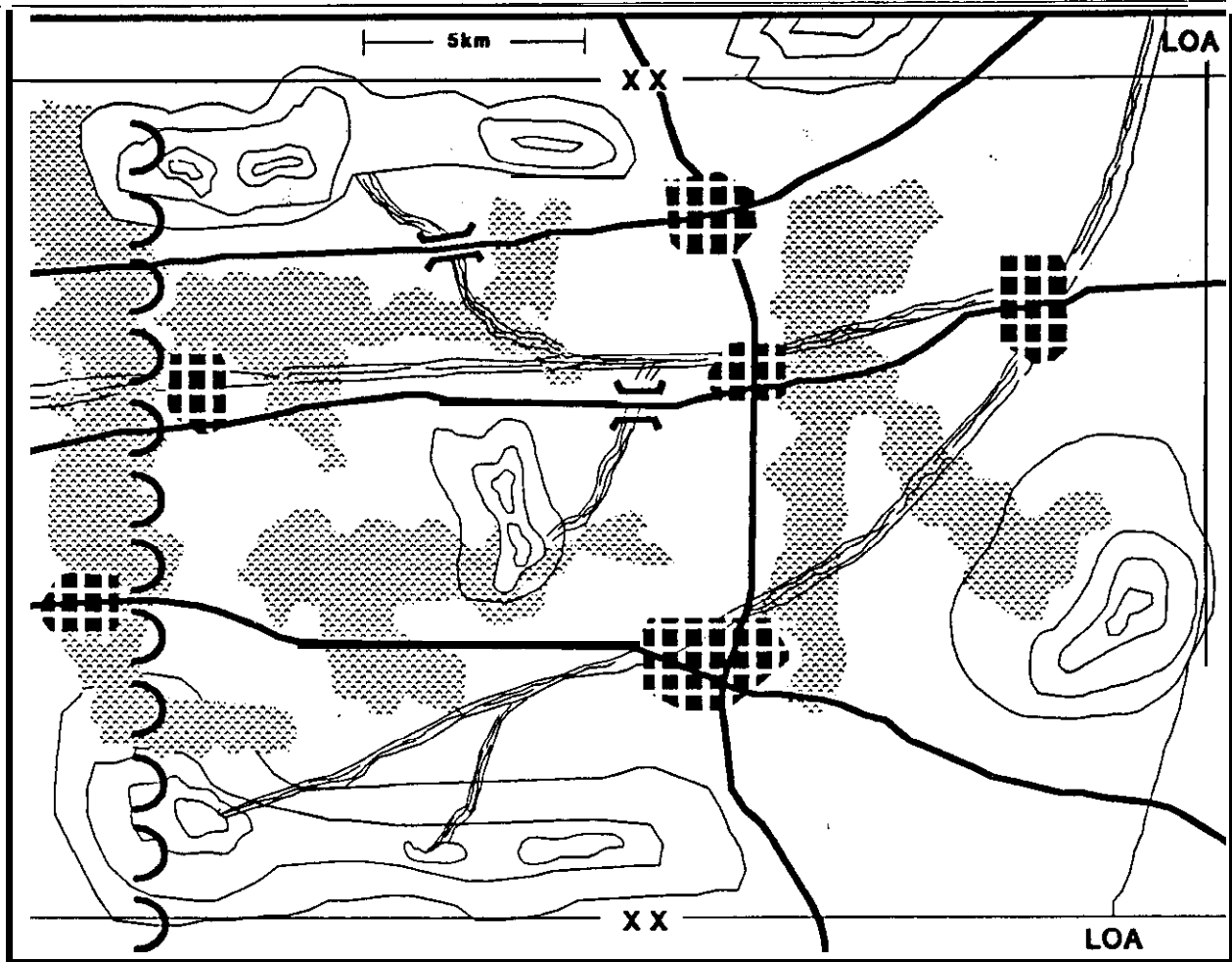

Figure 3-1-1. Operations graphics specify the AO.



We establish the AI to include all 'likely threats to our mission. We know from previous operations in **the** sector now **controlled by** the enemy that the populace's sympathies are mixed. We define the battlefield environment as including the civilians within the sector, and **their political** sympathies, and establish the limits of the AI (Figure 3-1-2).

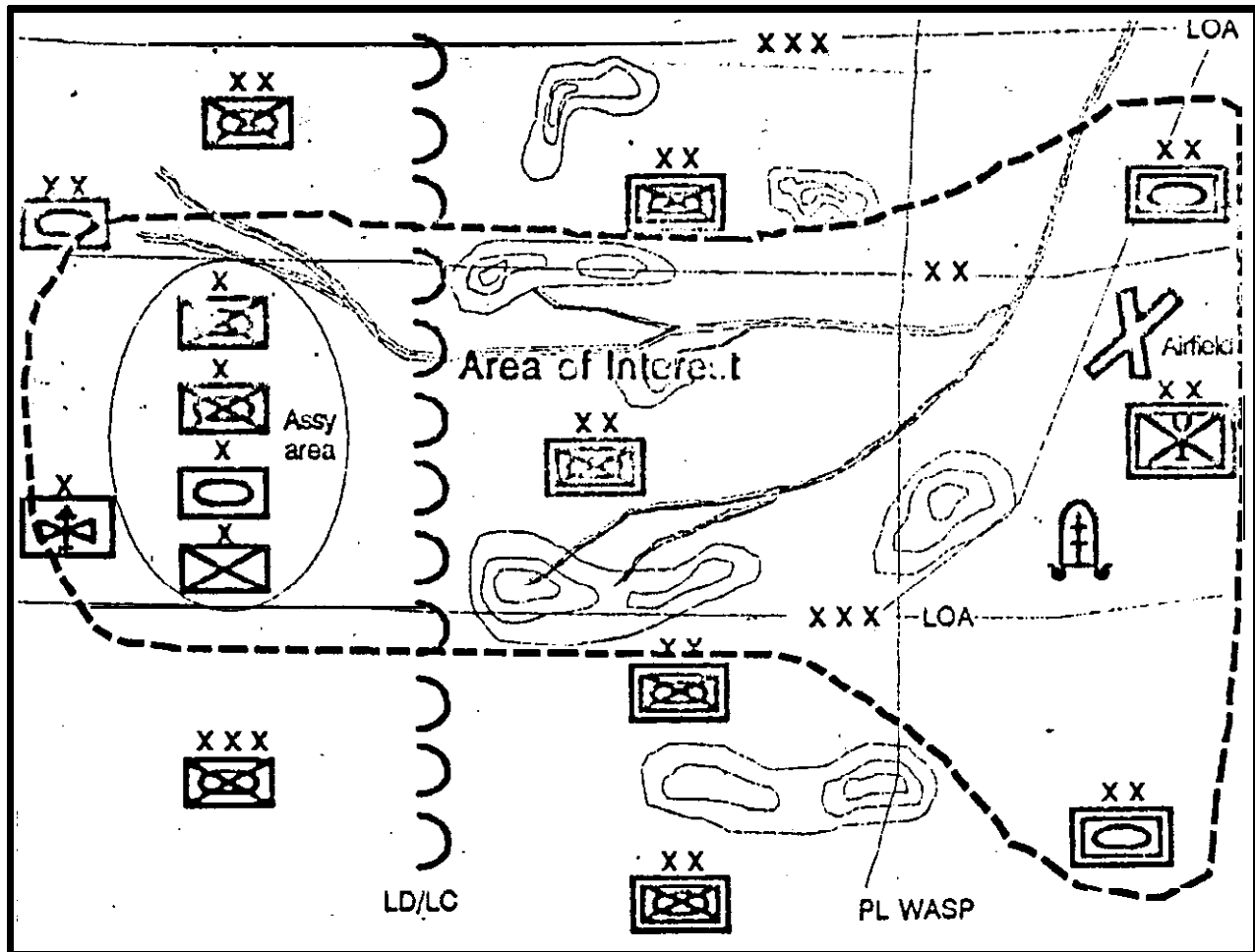

Figure 3-1-2. Expand the AI to include potential threats affecting friendly COAs.

*at  
for  
at*

DESCRIBE THE BATTLEFIELD'S EFFECTS

Since the division contains a mix of heavy and light forces, we must evaluate the effects of the battlefield environment on both types of forces. We start with the environment's effects on the mobility of the heavy forces (Figure 3-1-3).

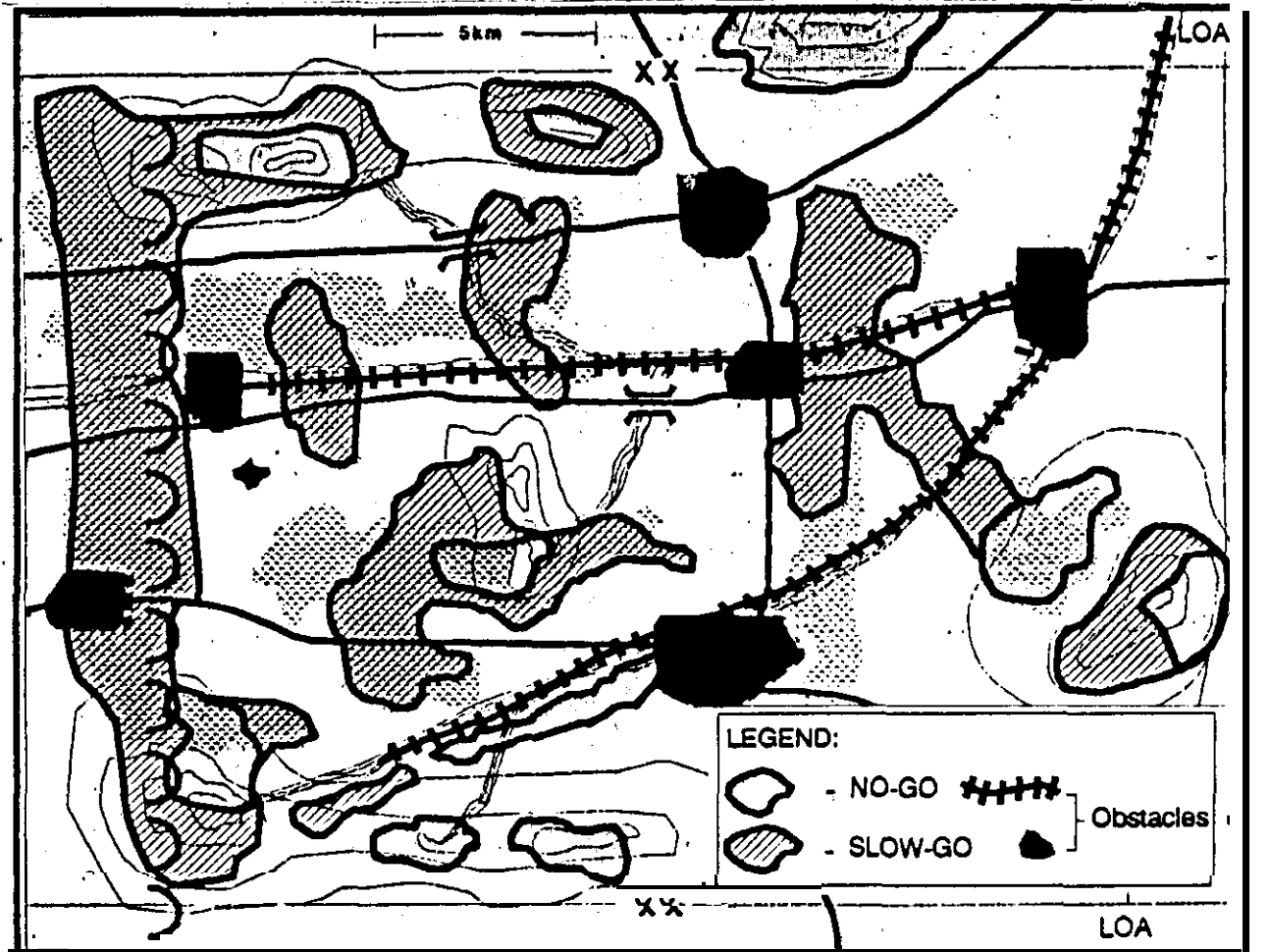

Figure 3-1-3. The combined obstacle overlay depicts effects on mobility.

The engineer (terrain) detachment conducts an analysis of the various terrain factors that constitute obstacles to movement to produce a base graphic depicting the environment's effects on mobility. Because of the availability of logging roads and the lack of dense undergrowth, the woods are passable. Some branches of the river system are fordable and pose no real obstacle to maneuver. The Kald River, however, is a major obstacle that will require the division to conduct river crossing operations if the bridges cannot be taken, intact.

To the engineer detachment's base graphic we add any other characteristics of the battlefield that will affect mobility. In this case, it consists of the apparently unrestricted terrain at (A); which is SEVERELY RESTRICTED due to the presence of a historic and religious landmark, a 10th century abbey, protected by international laws and treaties (see Figure 3-1-3).

Using the combined obstacle overlay as a base, we identify mobility corridors between areas of restrictive terrain and determine the size force they will accommodate. This requires some basic knowledge of friendly unit frontages during the attack. Areas which are not restricted are not marked (Figure 3-1-4).

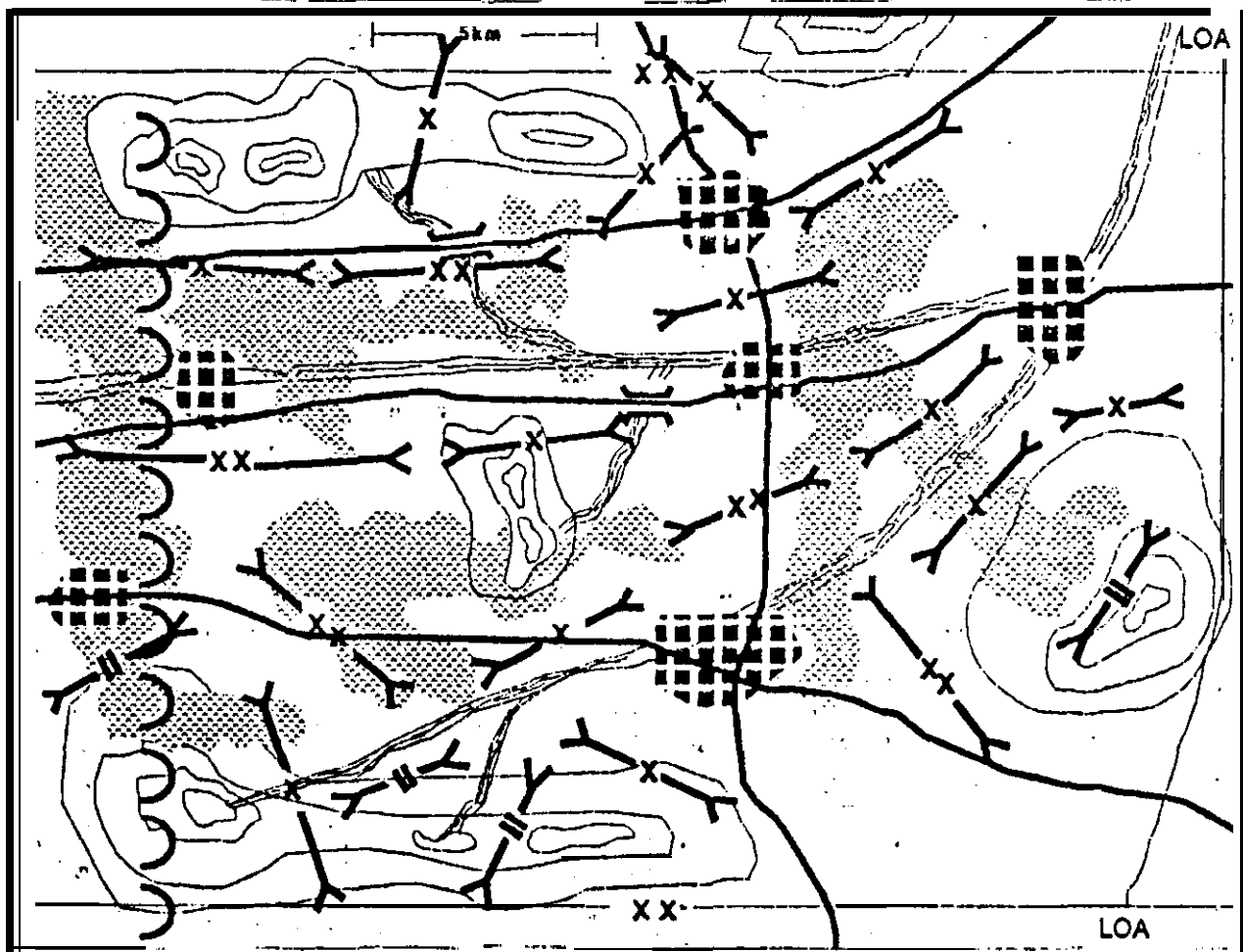
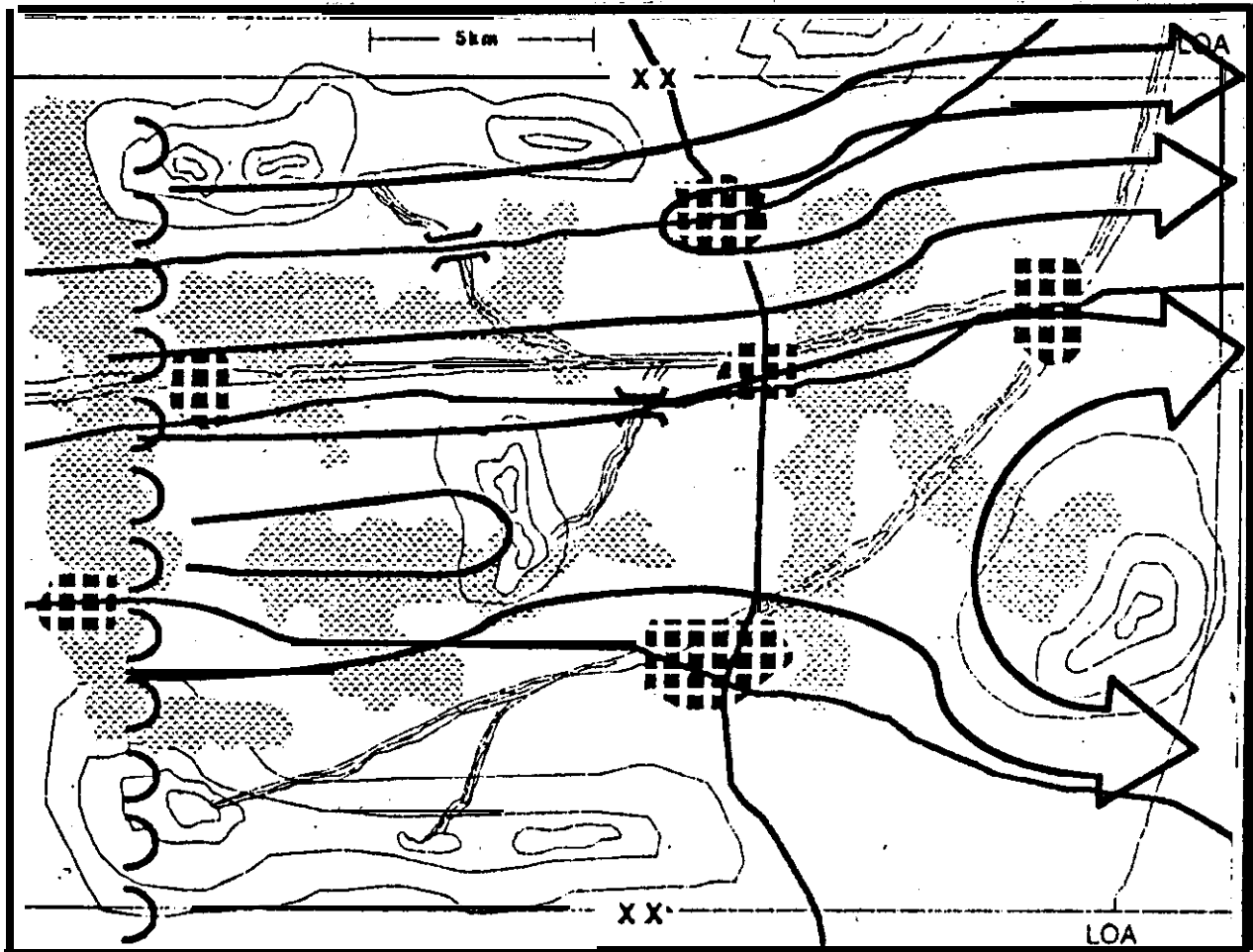

Figure 3-1-4. Mobility corridors supporting enemy maneuver.

We group mobility corridors together to identify heavy force avenues of approach-(Figure 3-1-5).



**Figure 3-1-5. Avenues of approach indicate the general areas through which a force can move.**

Although they have already included the effects of current and expected weather into their analysis, we ask the engineer (terrain) detachment to evaluate the effects of the worst possible weather expected during the operation's duration.

Based on climatic studies provided by the supporting Air Force weather team, the engineers predict that the worst expected weather would restrict mobility corridors along the river valleys due to the effect of rain on the soil types in the area (Figure 3-1-6). By comparing the new **evaluation** with previous ones (see Figure 3-1-3), we note that these weather conditions would cause some water features to go from a fordable to an unfordable condition; requiring a greater need for tactical bridging assets.

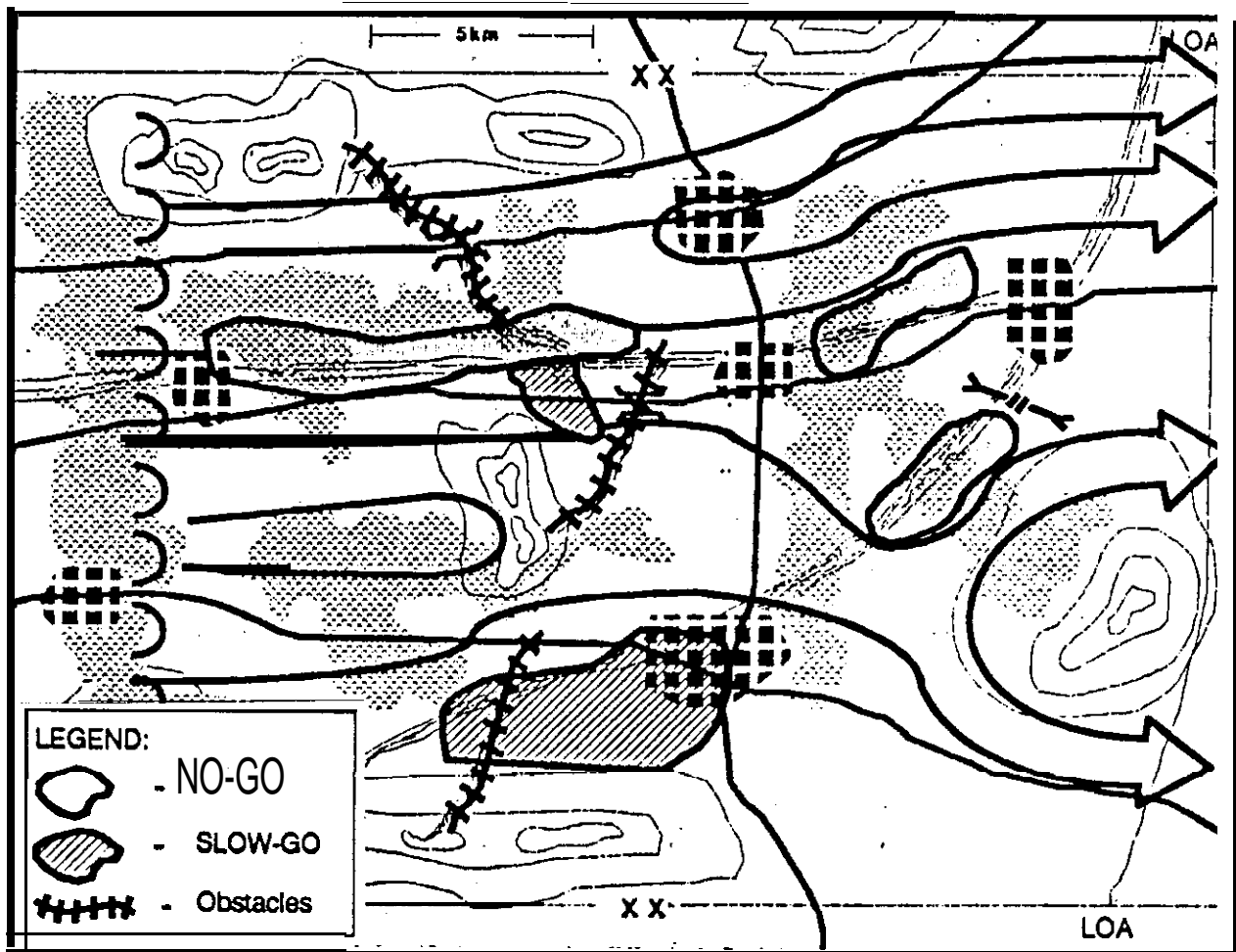
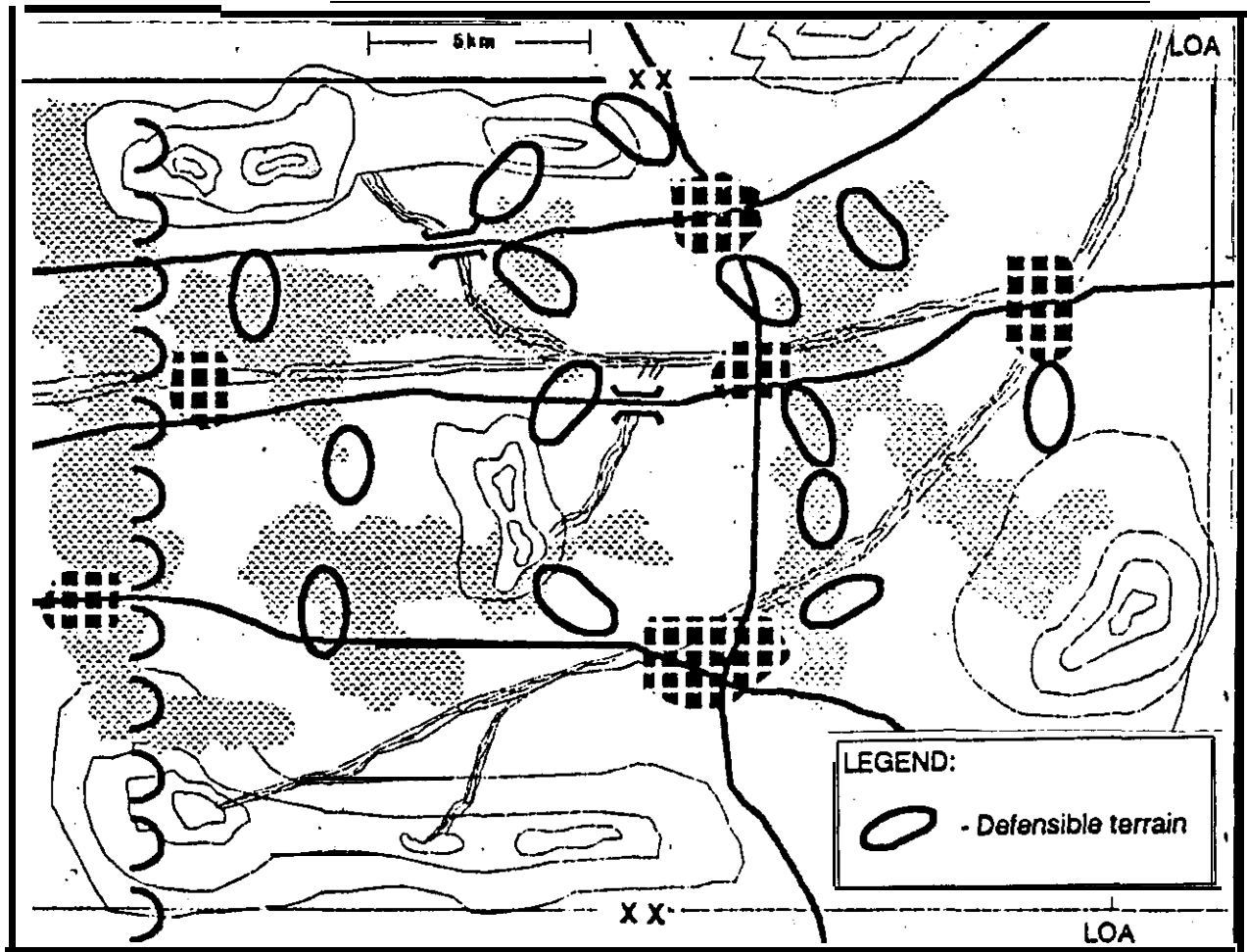

**Figure 3-1-6. Possible effects of weather on mobility.**

More significantly, we note that some mobility corridors become infeasible, causing one avenue of approach to detour around terrain **now** classified as SEVERELY RESTRICTED. The avenue of approach, now less direct than the others, is still viable although less likely to be used.

We reserve the second overlay for use in the event of poor weather during the operation.

We next identify defensible terrain along the avenues of approach (see Figure 3-1-5). We evaluate observation, fields of fire, concealment and cover and obstacles to identify areas that offer **potential** defensive positions against forces using each avenue of approach (Figure-3-1-7).



**Figure 3-1-7. Defensible terrain along avenues of approach.**

Using the defensible terrain as likely objectives for the division's light forces, we evaluate available infiltration lanes. We look for areas that offer concealment and cover to dismounted forces as they approach their likely objectives. Only the streams offer any obstacles to light forces, and these are only minor obstacles except during periods of flooding (Figure 3-1-8).

We include an evaluation of suitable zones of entry. In this case, we identify potential helicopter landing zones that support approaches to the likely objectives.

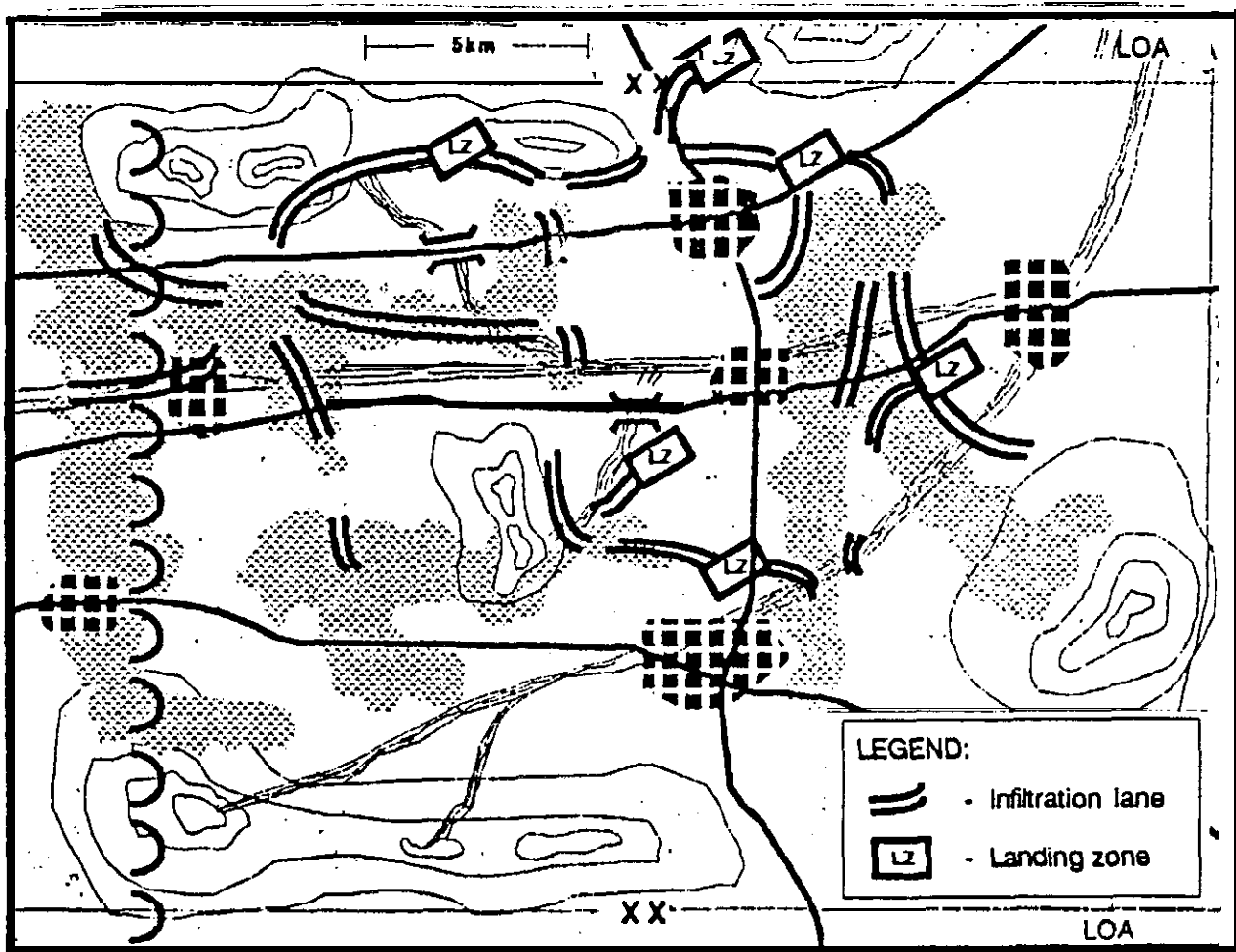

Figure 3-1-8. Approach routes for friendly light infantry.

We identify friendly air avenues of approach to the landing zones and into the enemy's depth for deep battle attacks (Figure 3-1-9).

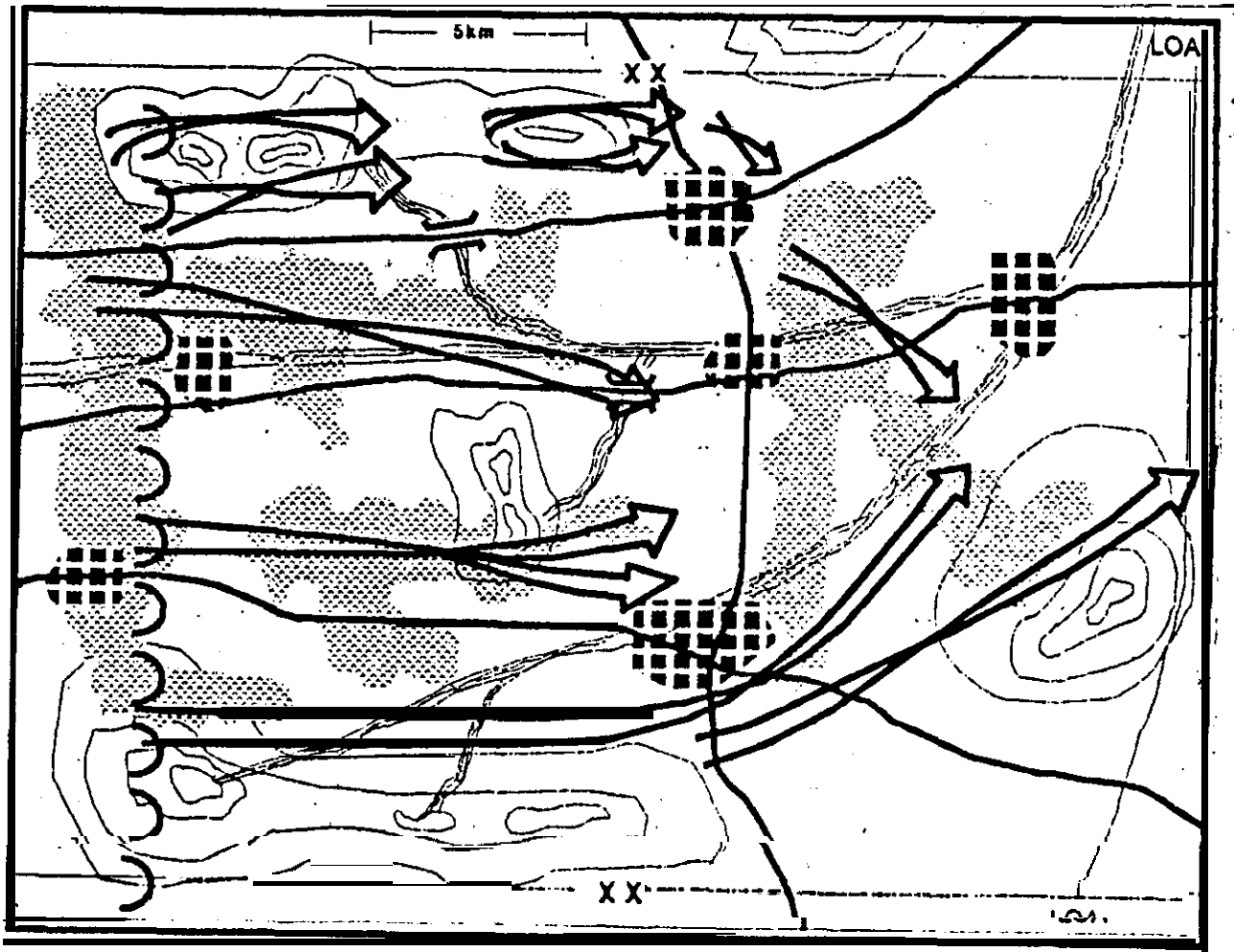

Figure 3-1-9. Friendly air avenues of approach.



Even though we expect the enemy to defend, we must consider his avenues of approach as well. These may support counterattacks or the commitment of additional forces into the sector (Figures 3-1-10 and 3-1-11).

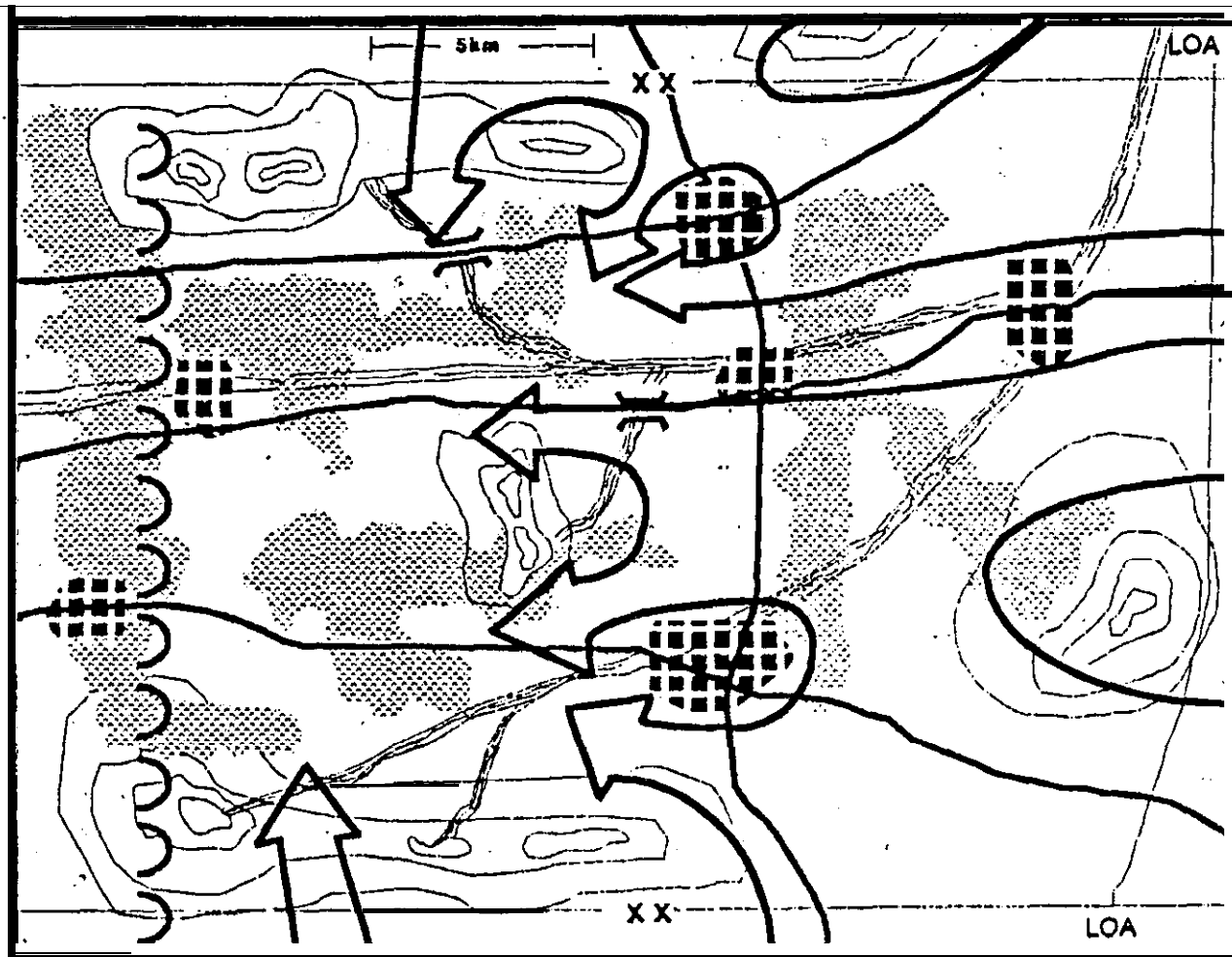

Figure 3-1-10. Avenues of approach available to the enemy.

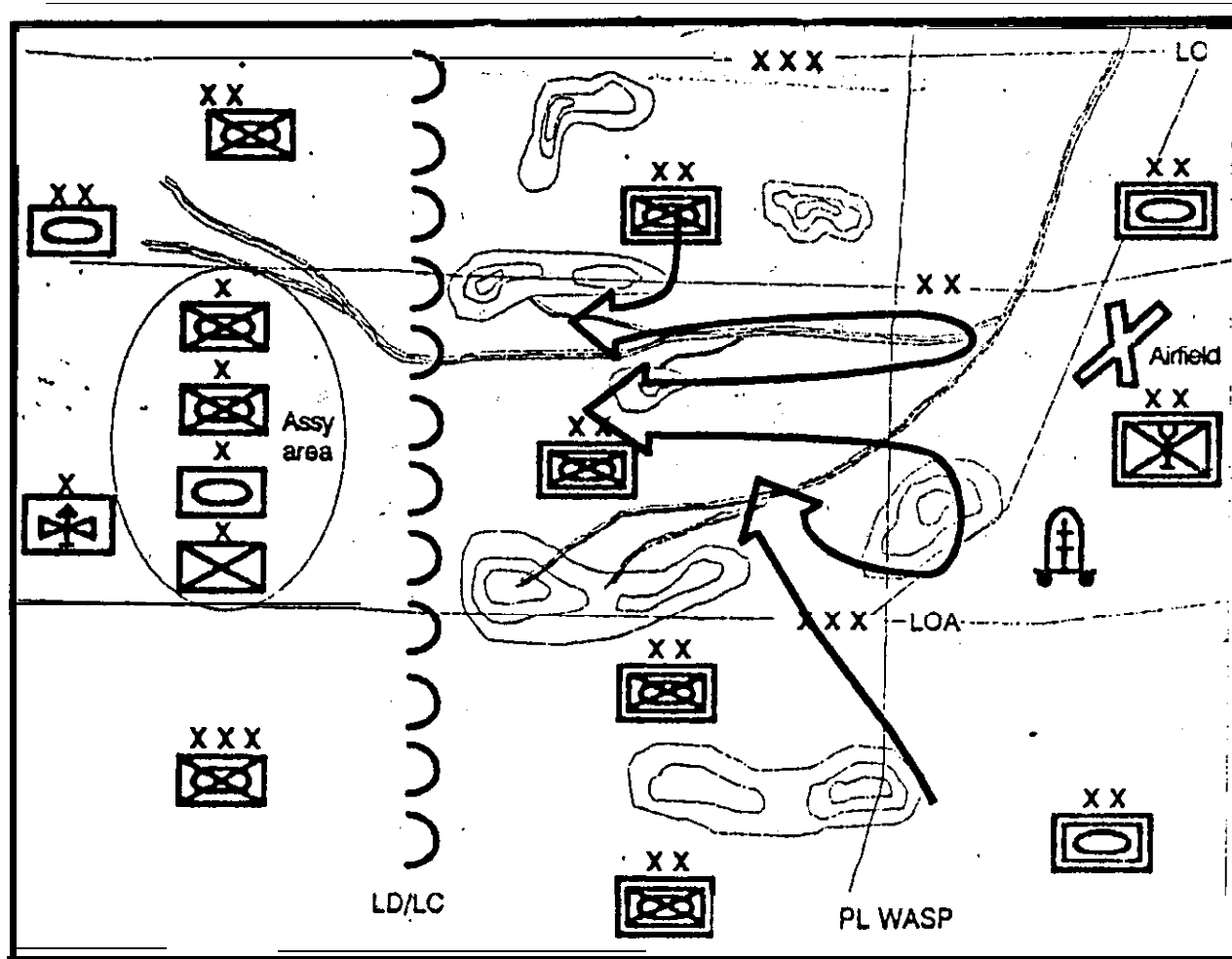

Figure 3-1-11. Avenues of approach for reinforcing and counterattack forces.

We also identify the air avenues of approach available to the enemy. These will support their defensive operations and their own deep **battle** operations in our rear area (Figure 3-1-12).

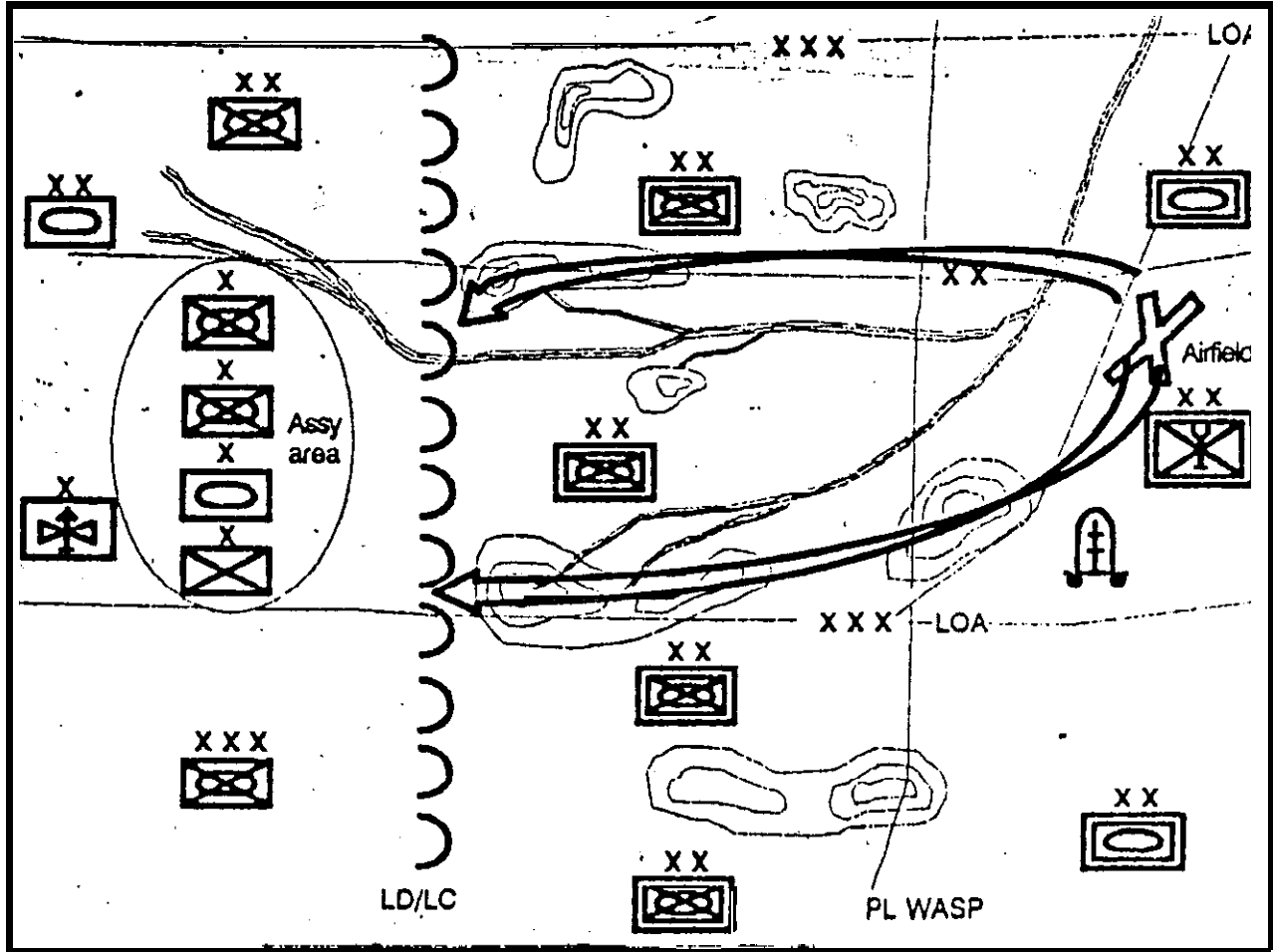

Figure 3-1-12. Enemy air avenues of approach.

We have already included the effects of the expected weather in the terrain analysis. To evaluate the direct effects of weather **on military** operations, we start with identifying critical values relevant to the situation (Figure 3-1-13).

<b>MISSION AREA OR USE</b>	<b>FAVORABLE</b>	<b>MARGINAL</b>	<b>UNFAVORABLE</b>
Mobility (ground)	Vis > 1 mile Rain < 0.1 inch/hr	Vis 0.5 to 1 mile Rain 0.1 to 0.5 inch/hr	Vis < 0.5 mile Rain > 0.5 inch/hr
Direct fire target acquisition	Vis > 2 miles Temp ≥ -10°	Vis 0.5 to 2 miles Temp < -10°	Vis < 0.5 mile
Airmobile (LZ)	CIG/vis ≥ 300 and 1-1/2 miles. No icing or turbulence Surface winds at ≤ 20 knots	CIG/vis ≤ 300 and 1-1/2 miles but ≥ 200 and 1/2 mile Light icing and turbulence Surface wind > 20 knots but < 30 knots	CIG/vis < 200 and 1/2 mile Moderate icing and turbulence Surface wind > 30 knots
Night vision goggles (PVS-5) and starlight scope	Sky clear Moon > one quarter Elevation > 30°	Scattered clouds New moon to one quarter	Overcast clouds or new moon

**Figure 3-1-13. Critical weather values support weather analysis.**

We compare the critical values with the forecasted weather to evaluate its effects on operations. We present the weather's effects **on operations** in a "forecast style" format that allows the commander to easily match the weather's predicted effects on operations (Figure 3-1-14). In this example, he can easily **see** that airmobile operations in the early hours of 8 October will be hampered by weather and that ground mobility will be hampered late that same day. As the staff develops friendly courses of action they consider this information. **For** example, in this case they may plan to make rapid progress before 8 October, and then use the period of poor mobility conditions to conduct reconstitution operations. They can also plan any airmobile operations around the poor weather forecasted for early 8 October.

MISSION AREA OR USE	FORECAST TIME PERIOD (1992)															
	6 Oct				7 Oct				8 Oct				9 Oct			
	6	12	18	24	6	12	18	24	6	12	18	24	6	12	18	24
Mobility (ground)									■	■	■	■	■	■	■	■
Direct Fire Target Acquisition									■	■	■	■				
Airmobile Operations (Landing Lanes)									■							
NBC		■	■						■	■						

**KEY:**  
 FAVORABLE (No shading - Green)    UNFAVORABLE (□ - Red)    MARGINAL (▨ - Yellow)

Figure 3-1-14. Weather effects charts and matrices present the results of weather analysis.

The commander wants to exploit his technical advantage in limited visibility target acquisition. Accordingly, we evaluate predicted light data and the effects of temperature changes and other weather factors to identify periods that will allow us to optimize our target acquisition technology (Figure 3-1-15). The staff incorporates this information into their planning. For example,, they may time the start of the attack to force major engagements to take place just after midnight.

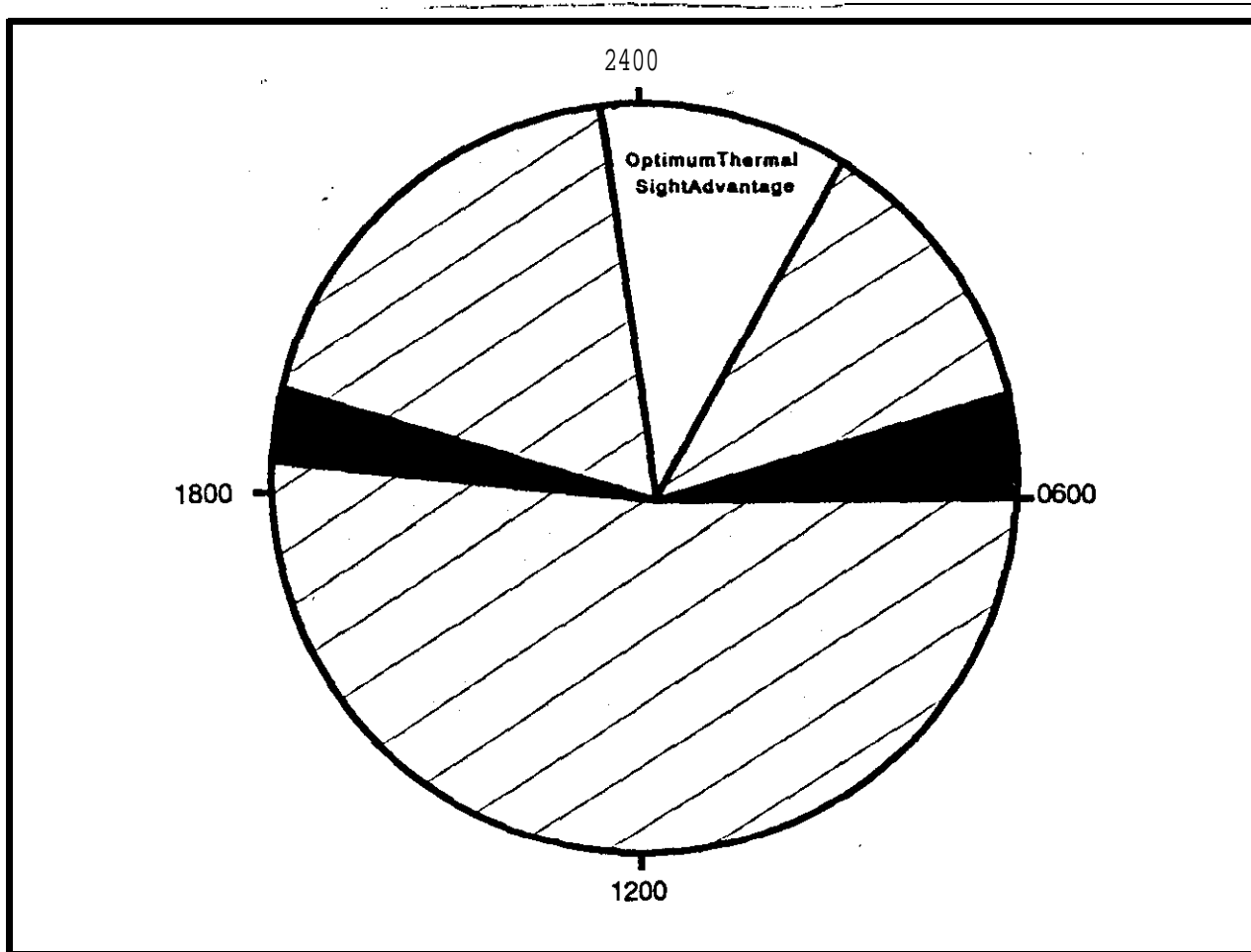

**Figure 3-1-15. Weather effects on target acquisition.  
Focus on specific evaluations as needed.**

Earlier, we identified **the populace's** political sympathies as a characteristic of the environment likely to have a significant effect on operations. Here we identify the general political stance of the major population centers on the battlefield (Figure 3-1-16). From this analysis we can make conclusions about areas where rear area units can expect problems with local civilians. Similarly, it indicates areas where the local population might support friendly operations in the enemy's rear. We can also make deductions about how lines of communication will be **affected** by refugee flows. For example, it is more likely that refugees from pro-friendly areas will move westward, leaving eastbound roads relatively clear. We can also identify the pro-enemy town near the line of contact as a risk to operations security during the division's preparations for attack, allowing the staff to plan accordingly. Conversely, the deception planning staff can easily identify the pro-enemy town as a target for their deception efforts with reasonable assurance that the **enemy has intelligence sources there.**

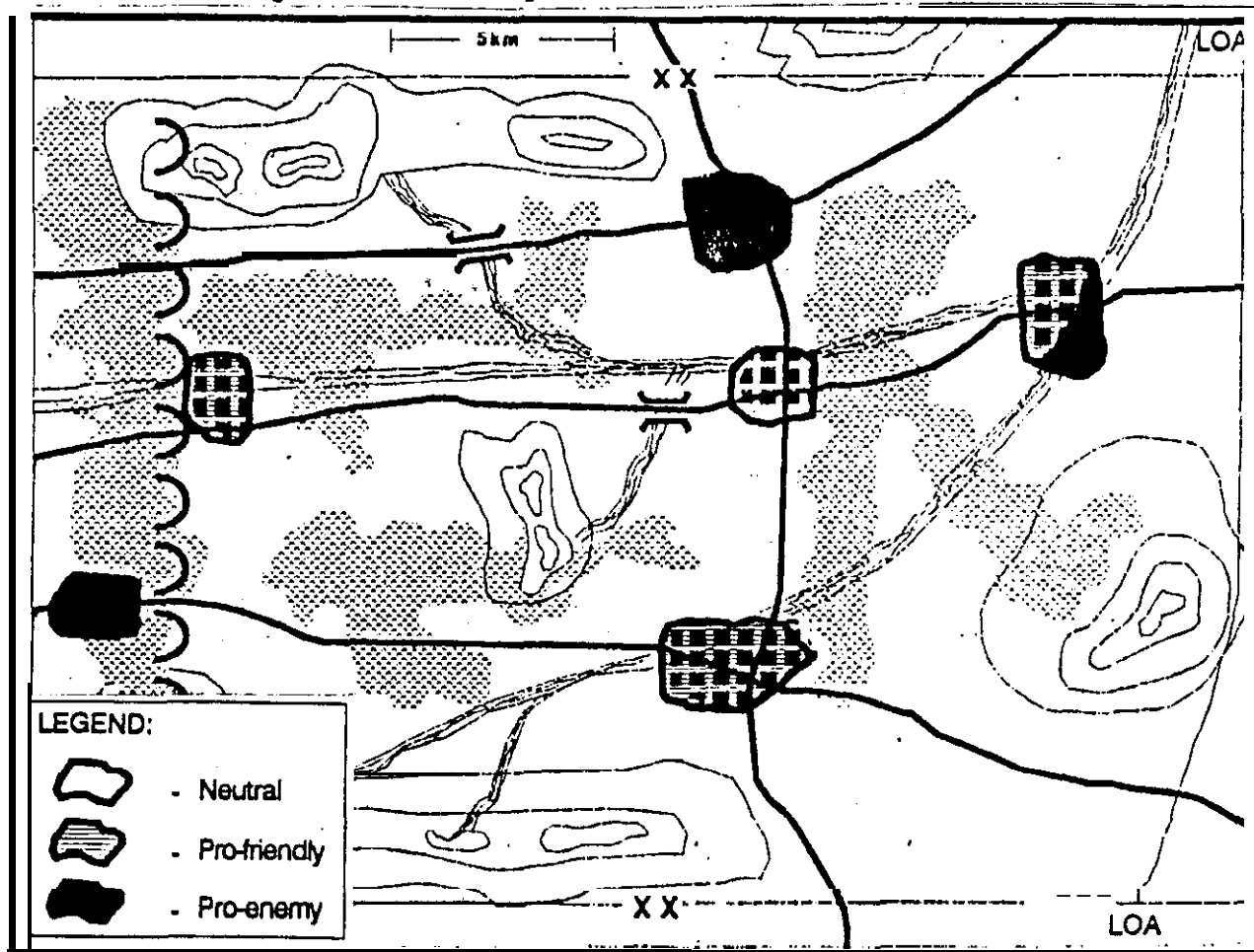
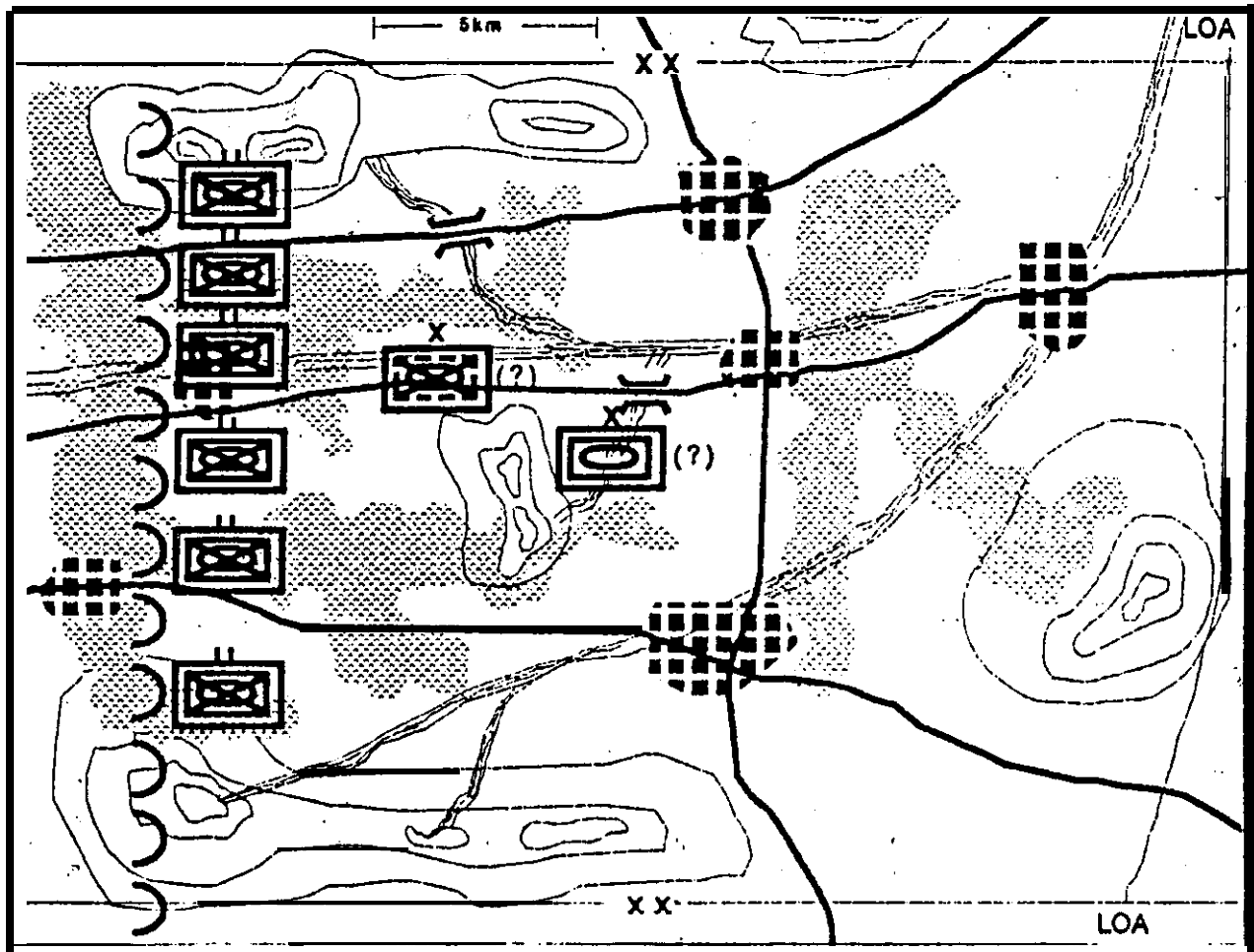

Figure 3-1-16. Population status overlay.

## EVALUATE THE THREAT

We start with the common understanding of the battlefield. We use the **SITMAP** to determine what we know about the enemy's dispositions (Figure 3-1-17). Since the enemy has not completed his shift to a defensive posture, we expect changes in his disposition.



**Figure 3-1-17. The current SITMAP is one tool used in evaluating the enemy's current state.**



To identify the likely changes, we examine the other intelligence holdings to identify how the enemy **usually** defends. We then evaluate his current state to determine his capabilities to execute his normal or preferred defensive tactics. We are **careful to** include available air support and the uncommitted armored divisions and air assault brigade in our **evaluations**.

From the data **base** we extract the threat model that depicts the enemy's **"typical"** defensive operations. We first look at the **typical** defending division to get an **understanding for** the overall defensive framework (Figure 3-1-18). We examine current intelligence reports and determine that the enemy's recent defensive operations are consistent with the model in the data base.

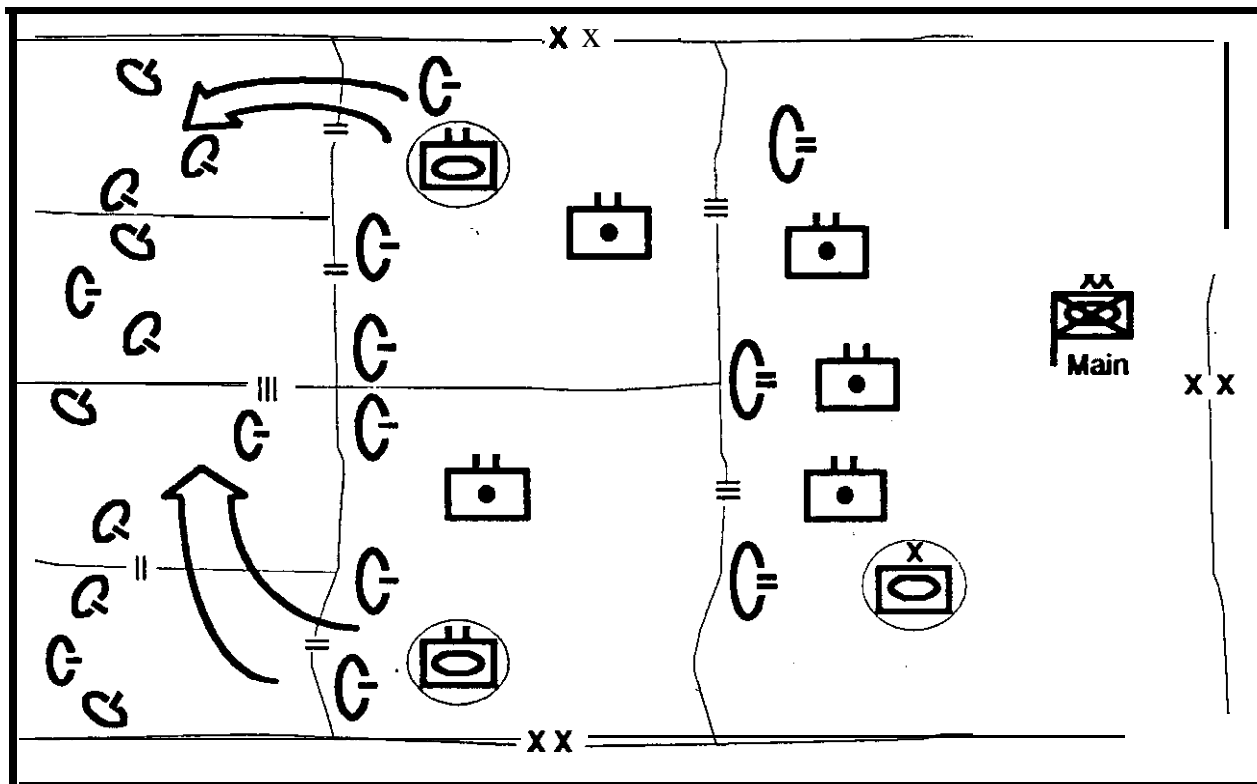

Figure 3-1-18. Doctrinal template for a defending division.

We **next** examine the typical defending brigade to add greater detail to the threat model (Figure 3-1-19). We normally **work** down two levels, depicting the brigade's subordinate battalions, even though the data base threat model depicts dispositions down to company level. We include likely high value targets such as command posts, the tank platoons, and certain air defense and fire support assets.

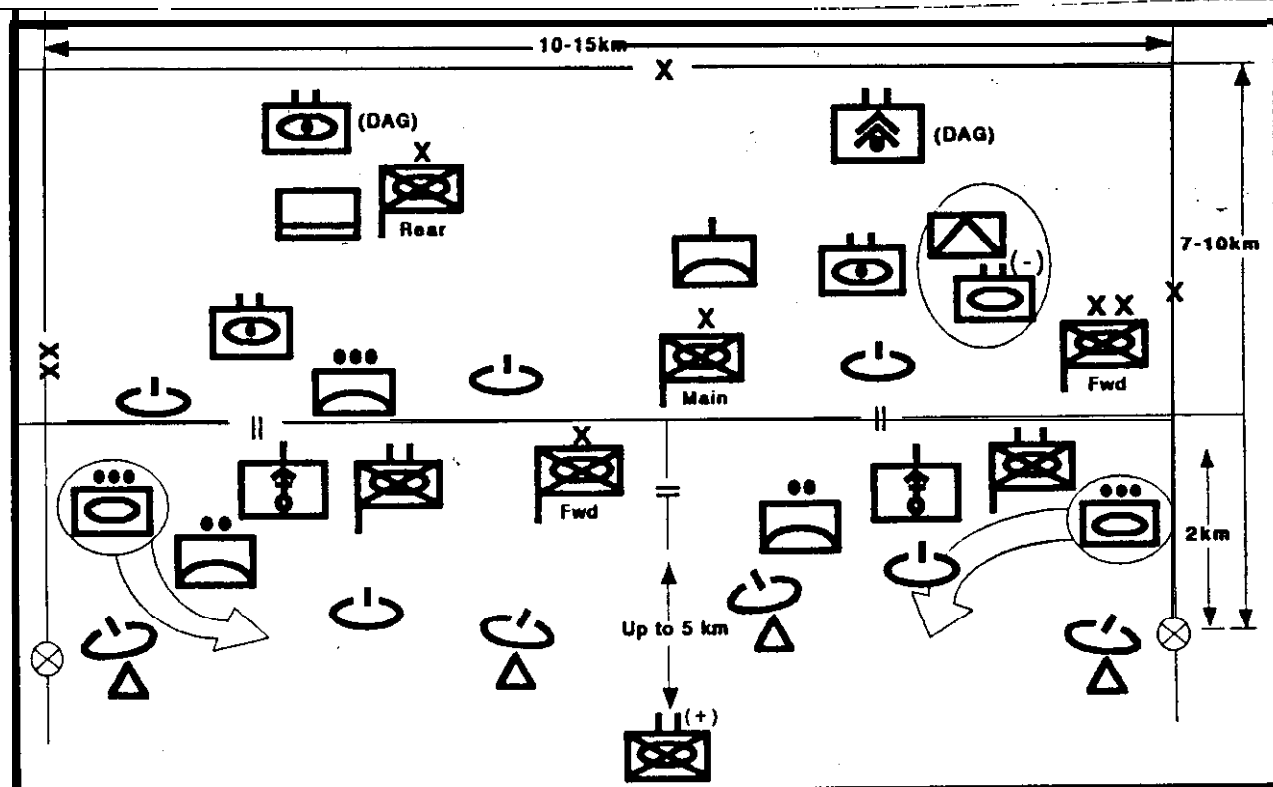

Figure 3-1-19. Doctrinal template for a defending brigade.

The **threat** model already includes a description of the **"normal" tactics** used by the forces depicted on the template. We check all recent reports of enemy defensive operations against the model **and** determine that **it** needs no changes (Figure 3-1-20).

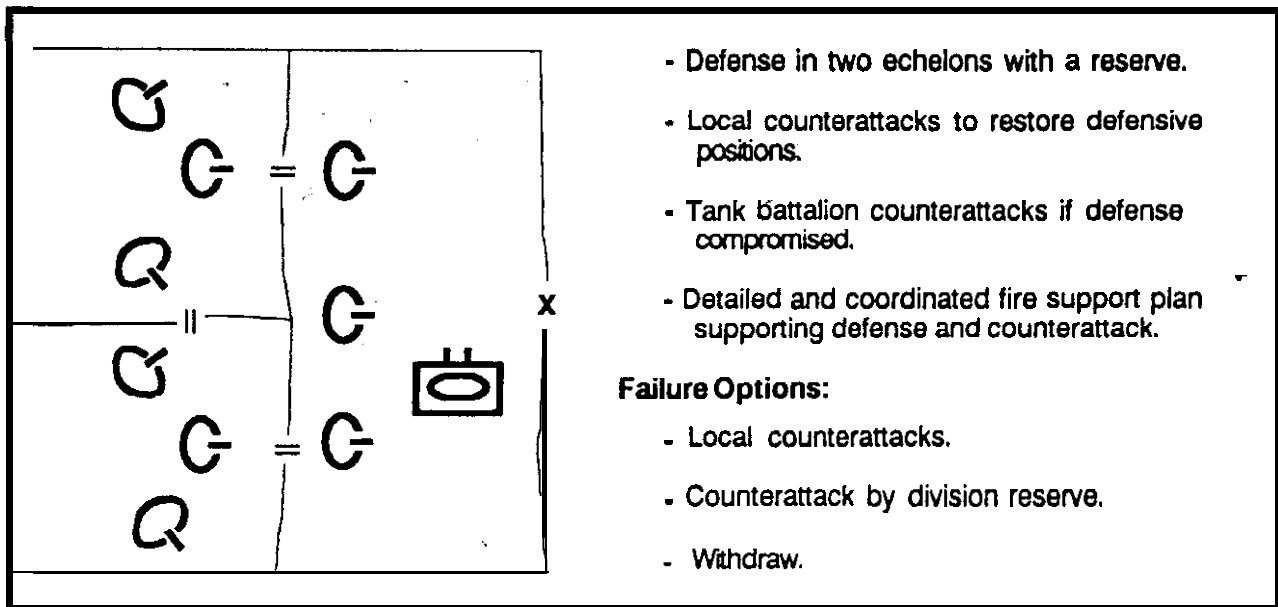

Figure 3-1-20. Use text or a matrix to describe conduct of the COA.

The threat model also contains a list of assets normally critical to the operation, in this case defensive operations. Since it is based on operations in doctrinally "ideal" conditions we identify that we will have to modify the list when we develop enemy courses of action. In this example, we know that the enemy's tactical doctrine is built on the assumption of air superiority. Since he does not currently have air superiority ADA assets will probably increase in relative value. (Figure 3-1-21).

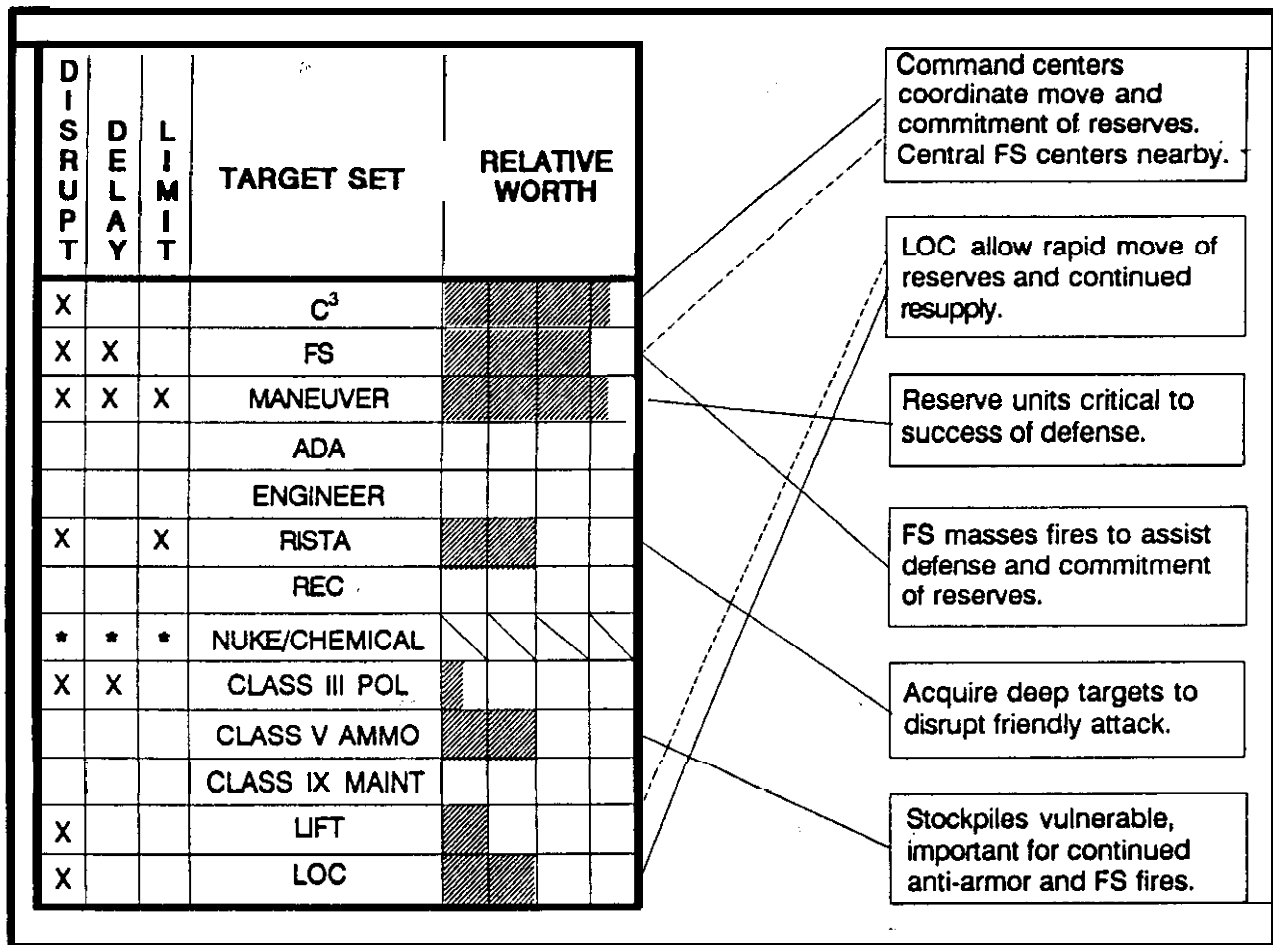
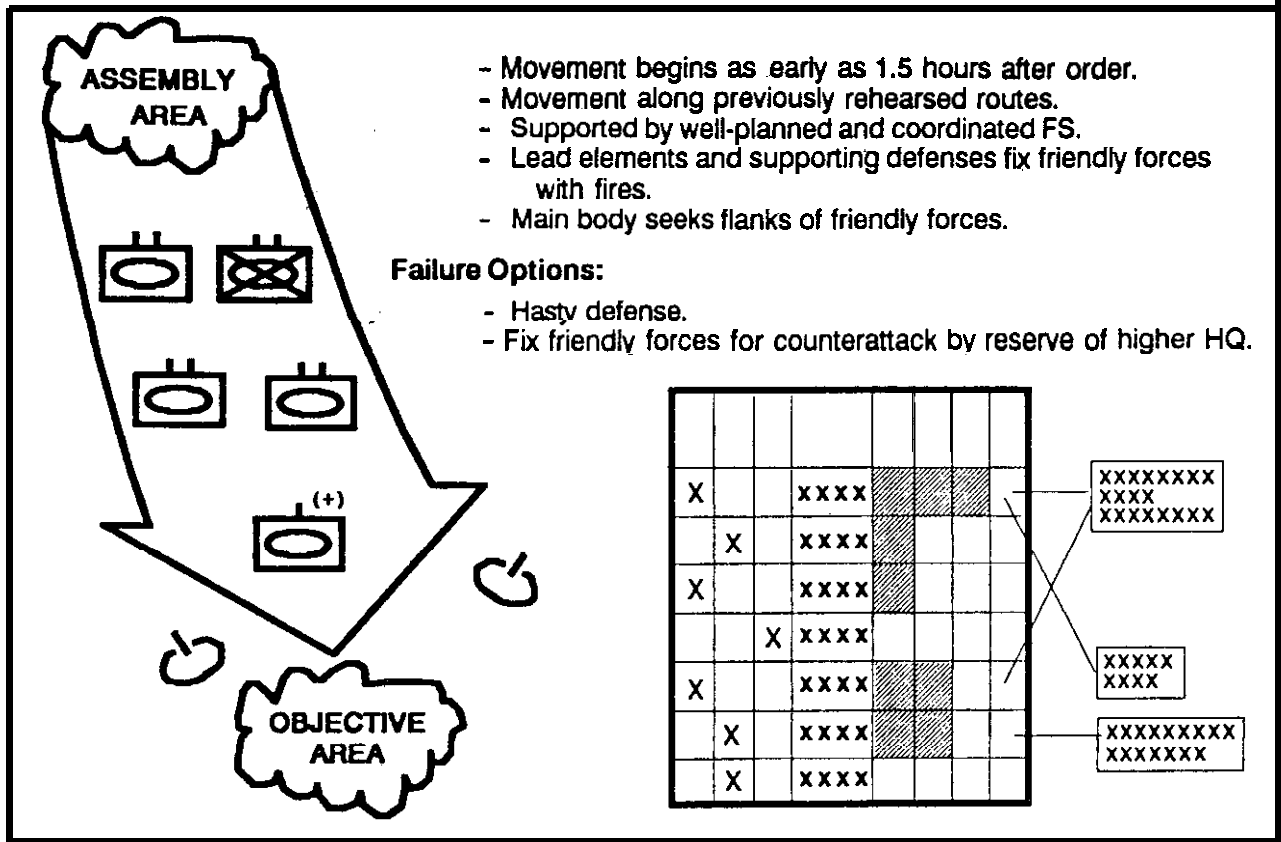

Figure 3-1-21. Relative target values.

Since the threat model indicates defensive operations include counterattack options (see Figure 3-1-20) we **also examine** the threat models for counterattack operations by the enemy division's tank brigade (**Figure 3-1-22**).



**Figure 3-1-22. Enemy counterattack options.**

We must also consider counterattacks by the armored divisions and the operations of the **air** assault brigade., We examine the threat models depicting their operations and make any changes indicated by current intelligence reporting on these types of operations.

DETERMINE THREAT COURSES OF ACTION

We start by comparing the enemy's doctrine **for** defense with the results of describing the battlefield. Using the potential defensive positions we identified earlier (see Figure 3-1-7) we identify three potential defensive lines. Because the western most set **of** defensive positions (positions a, b, and c) can be easily bypassed, a defense there will not accomplish the enemy's likely objective (Figure 3-1-23). Accordingly, we set this course of action aside **as** a low priority. If time permits, we will later develop it as **an** alternative course of action. **For** the present **we concentrate** on **defenses along** a line from position "d" to position "g" and along a line from position "h" to position "l".

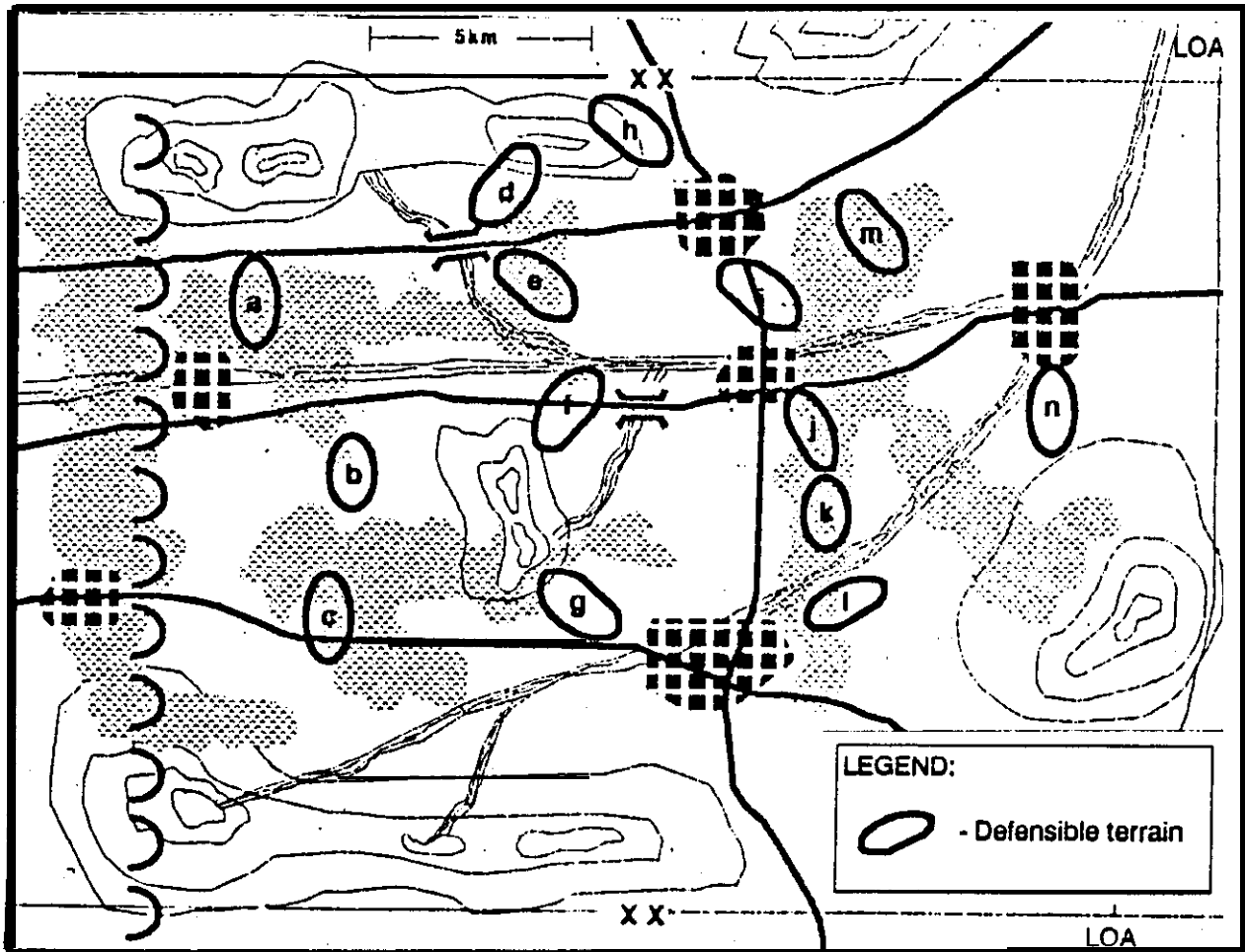

Figure 3-1-23. Terrain supporting defensive COAs.

As enemy course of action (COA) 'one, we place the enemy's covering force in the western most set of positions. We array the main defense in the remaining positions by modifying the doctrinal dispositions depicted in the threat model to account for the effects of the terrain. We also identify likely locations of counterattack objectives and include the **enemy's** counterattack options on the developing situation template (Figure 3-1-24).

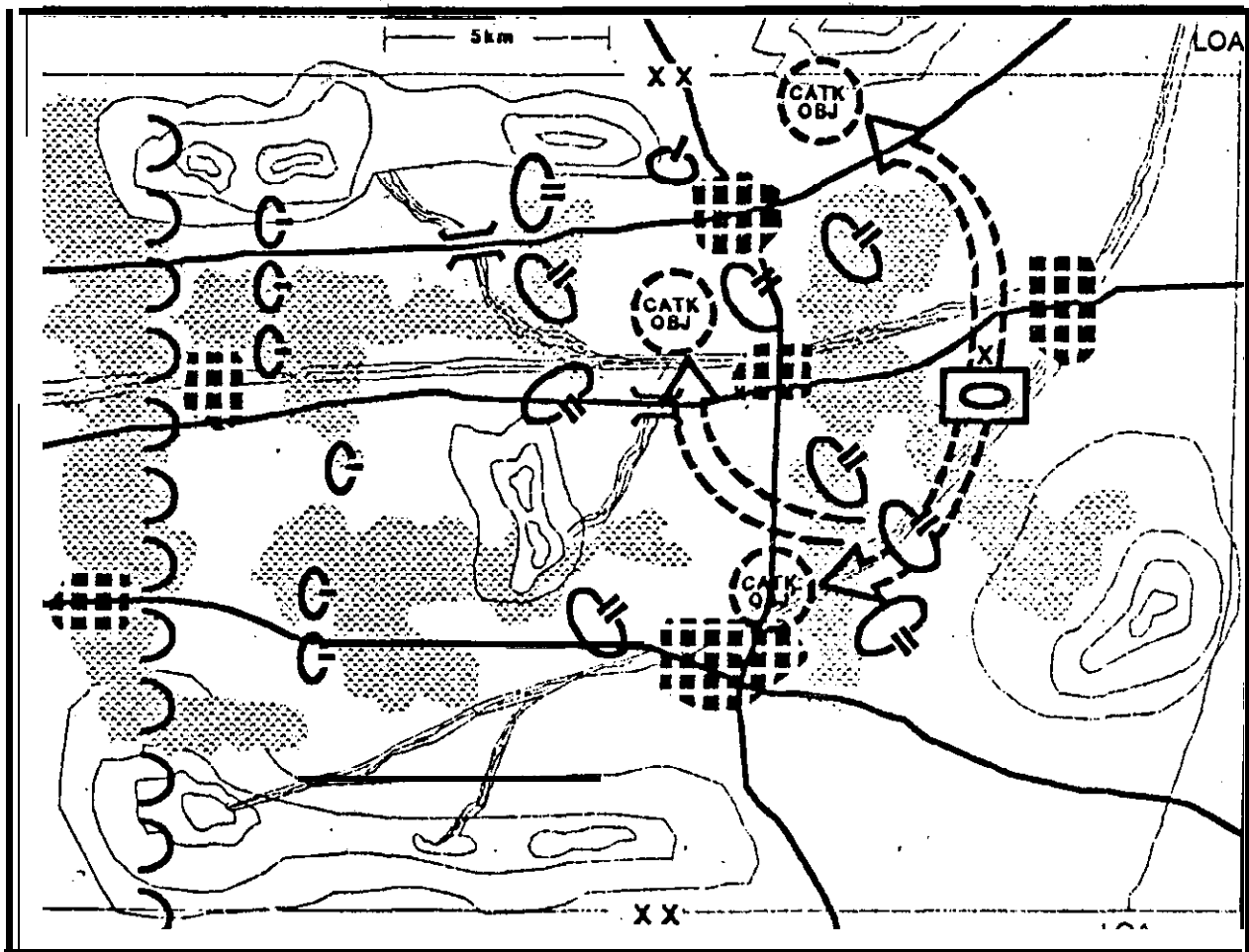

Figure 3-1-24. Enemy COA 1.

We use the same technique to develop COA two. We place the covering force in the center set of defensive terrain (positions d, e, f, and g) and place the main defense in the eastern most set. The defense is weighted more heavily in the north than in the south (Figure 3-1-25).

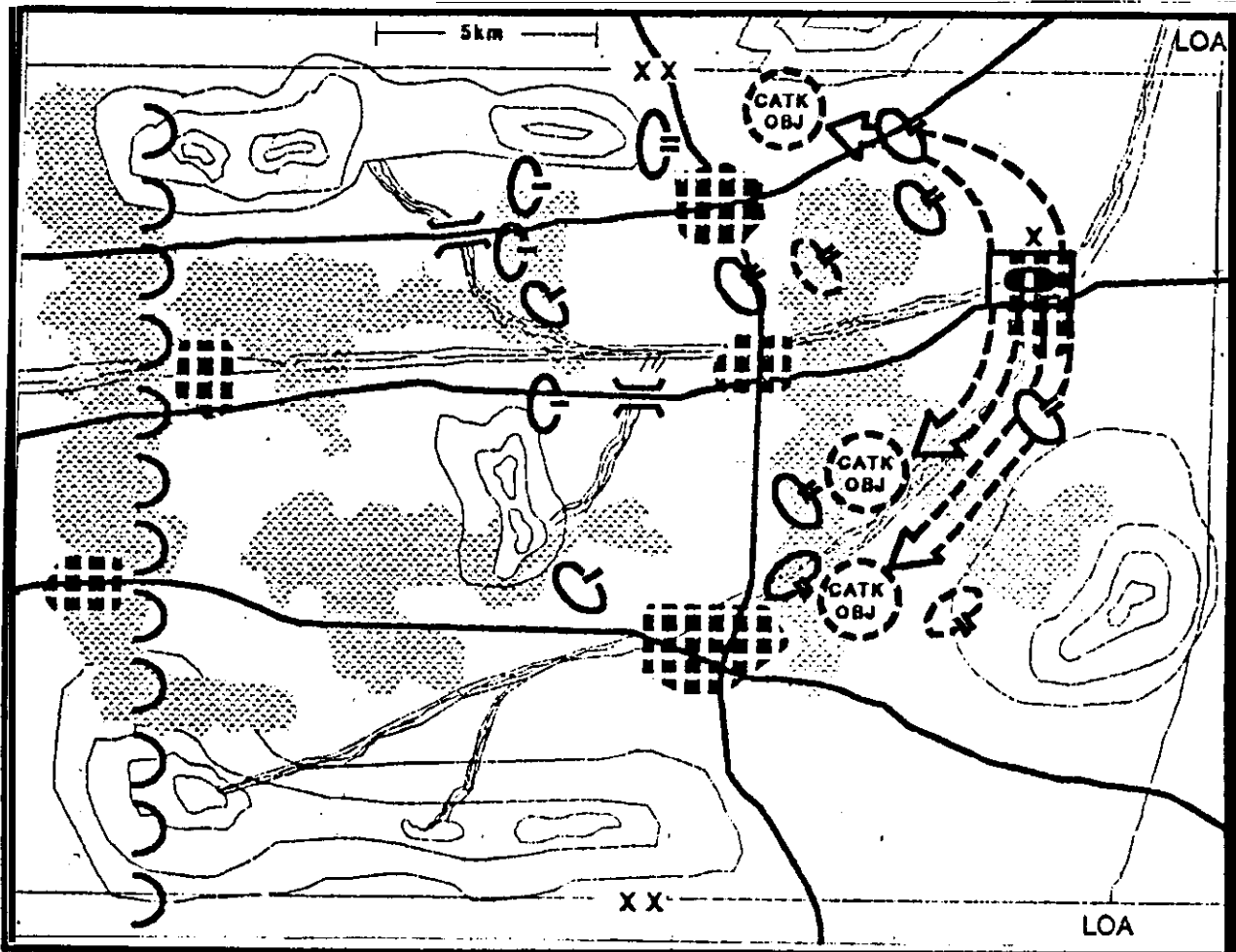

Figure 3-1-25. Enemy COA 2.



Obviously, the enemy has the **option** to weight the south more heavily than the north. We depict this option as **COA 3** (Figure 3-1-26).

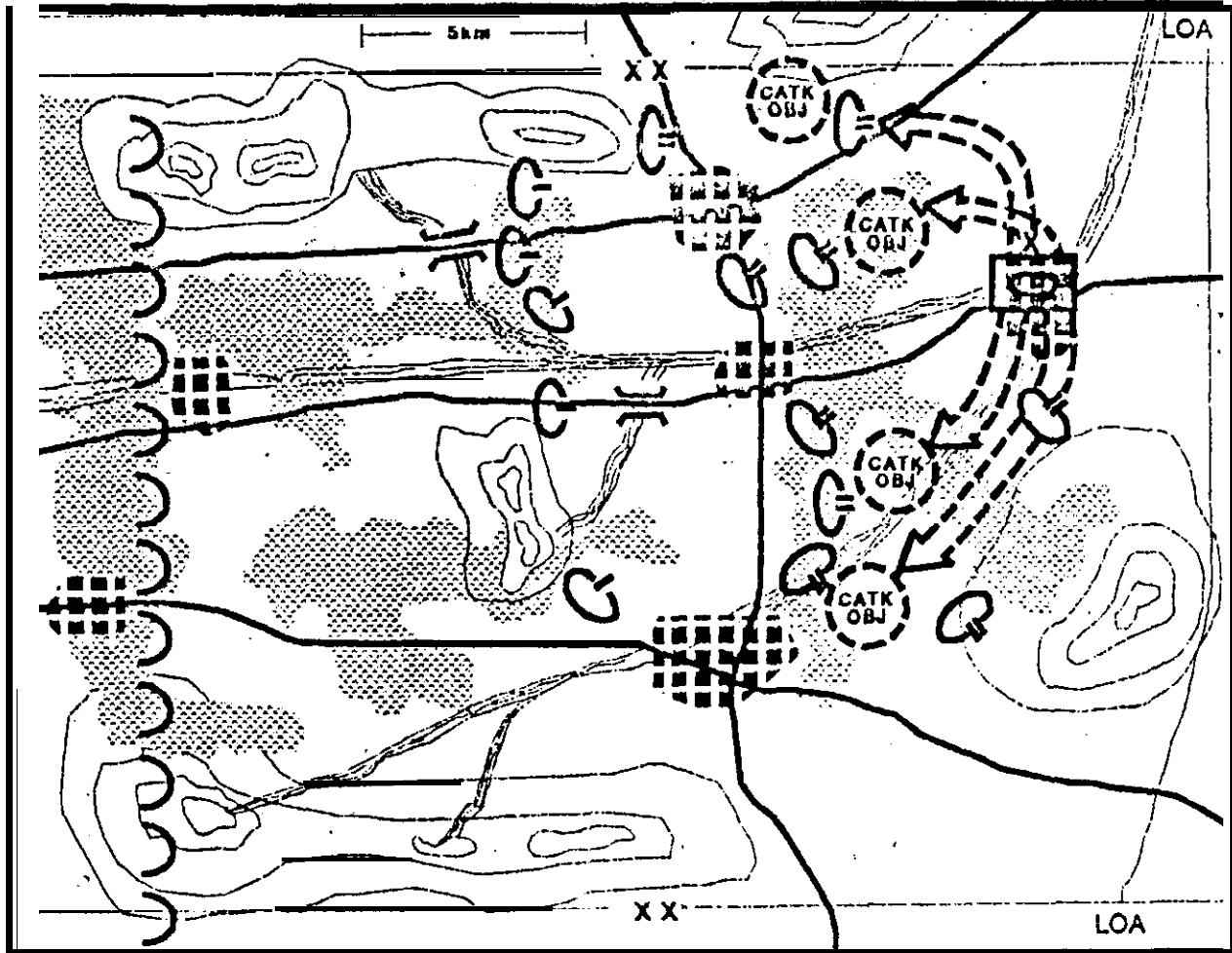

Figure 3-1-26. Enemy COA 3.

The enemy also has the option of withdrawing from his current positions and taking up defensive positions east of the Kald River. However, the description of the battlefield's effects indicated a lack of suitable positions on the east bank of the river and the enemy's TTP discourages the "sacrifice" of terrain in this manner. It is, however, a feasible COA that the enemy could adopt if faced with overwhelming friendly strength. A defense on the east bank of the river; even without suitable positions would force our division to conduct an opposed crossing, **significantly** slowing the attack. Conversely, if friendly forces catch the enemy during his withdrawal over the river they **could** readily destroy any opposition to our attack. Based on these considerations we add enemy withdrawal to positions east of the river as COA 4 and highlight potential crossing sites as target areas of interest and potential engagement areas.

figure 3-1-27  
new figure

We continue to develop each COA by adding more detail. We use doctrinal templates as a guide and modify the portrayed dispositions to take advantage of the available defensive terrain. We also use the doctrinal templates to determine the likely locations of high value targets (HVT). We evaluate the effects of the battlefield on the enemy's mobility and determine likely **movement rates** along each counterattack avenue of approach. We use time-phase lines (TPL) to depict his expected progress along each avenue (Figure 3-1-28). For the present, these reflect only the time it will take to form the unit and conduct movement. Later, during staff wargaming, we will update the **TPLs** to incorporate **consideration** of events that are likely to initiate or influence movement, such as friendly **penetration** of the enemy defense, or enemy reserve contact with **friendly** forces or unexpected obstacle **systems**.

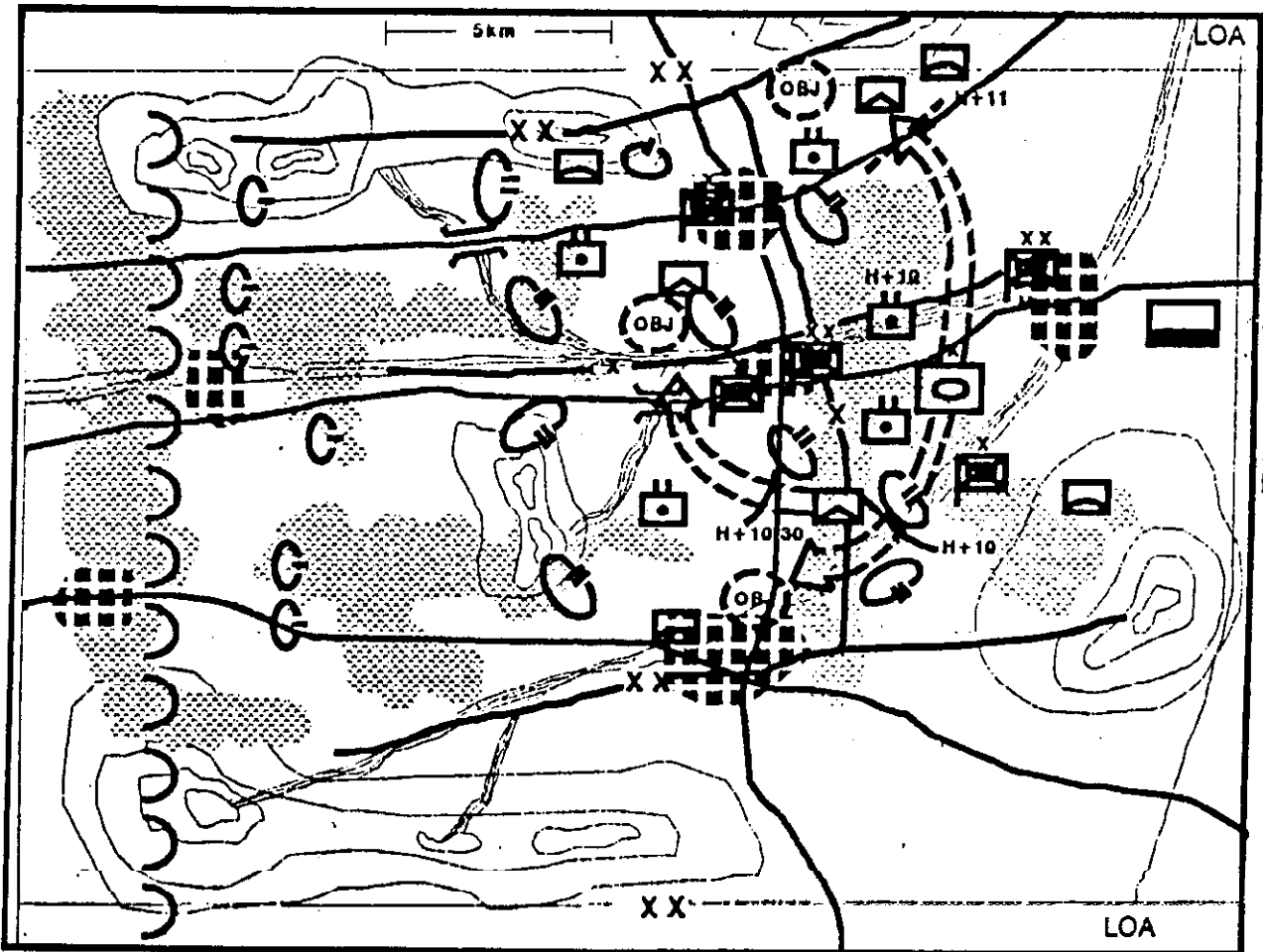

Figure 3-1-28. Develop situation templates to include TPLs and HVTs.

Using the description of tactics from the threat model as a guide, we mentally **wargame** each situation template. This allows us to tailor the description of the tactics associated **with** the **COA** to the specific situation. We focus on activities that are associated with the enemy's adoption of each option open to him or those likely to lead to a friendly decision. In this case, we use a matrix style format (Figure 3-1-29). The matrix addresses each of the enemy's battlefield operating systems in as much detail as necessary to support friendly planning. Like the situation templates, we will update and **refine it** during staff wargaming.

TIME	H-10	H-1	H	H+4	H+7	H+8.5	H+10
friendly action	Begin move to attack position	Prepare fires	Cross	Engage 1st LD Echelon	Defeat 1st Echelon		
DP					1		
Maneuver				Local counter-attacks		Reserves begin move	Reserves pass NAIG
Fs		Counter-battery	Engage HPTs	Defensive fires	Countermobility fires	Support counter-attack	
Intelligence	Locate main effort	Locate arty, ID main effort	Locate reserve, HPTs				
C <sup>2</sup>					Commit reserve to counterattack or block		
Engineers	Continue counter-mobility				Countermobility support to counterattack		

Figure 3-1-29. Each situation template includes a description of the COA.

We also refine the list of high value targets to reflect any changes due to the specific situation at hand. We consider the enemy's current situation, and the effects of friendly forces and the battlefield **environment** on the enemy's course of action. In this case we increase the relative value **of** the enemy's air defense assets to account for friendly air superiority. The enemy needs his ADA assets to protect his reserve forces **from** friendly air attacks before and during the **enemy** counterattack. Otherwise, the counterattack might fail without ever contacting ~~attacking friendly ground forces~~ (**Figure 3-1-30**).

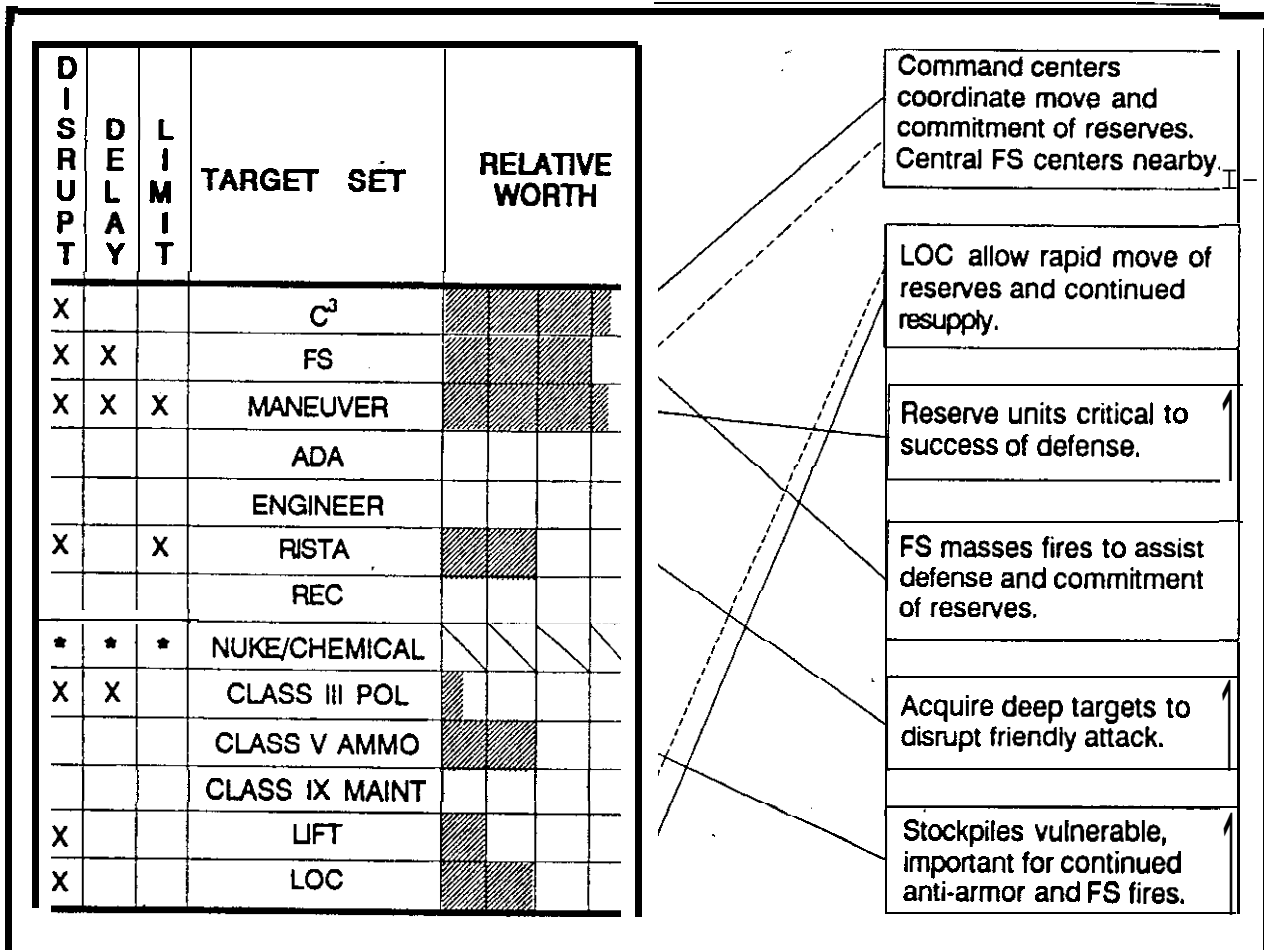

**Figure 3-1-30. Doctrinal HVTs are refined and included in the description of the enemy COA.**

To establish initial collection requirements designed to tell us which COA the enemy will adopt, **we compare** the four situation templates and identify differences among them. The unique locations and events associated with each COA, if detected, serve as reliable indicators of adoption of the COA. The event template focuses on the locations where events unique to each COA are expected to occur. We extract the named areas of interest depicting unique events from each situation template and consolidate them on a single **overlay** (Figure 3-1-31). The resulting event **template** allows us to focus collection planning on confirming the "set" of the enemy's defenses. This, however, is just the **start** of the event template.

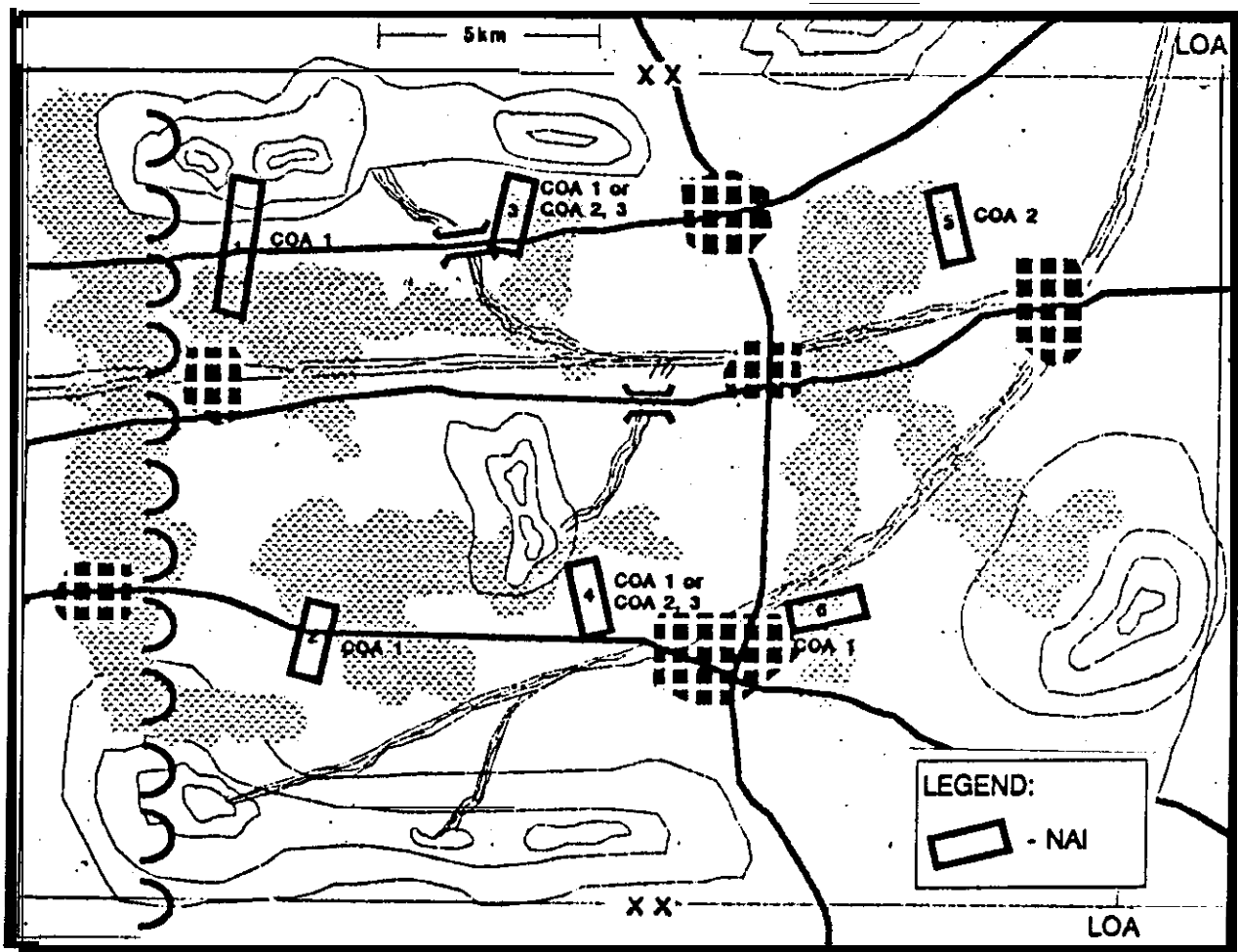

Figure 3-1-31. Base the event template on the set of enemy COAs.

We examine the **situation templates** to identify **NAIs** associated with the various counterattack options of the enemy's armored brigade. We add these **NAIs** onto the event template., along with time lines that reflect the expected arrival time of the counterattacking brigade in each NAI (Figure 3-1-32). Some of the **NAIs** may **be** dropped during staff wargaming, while additional NAI may be added.

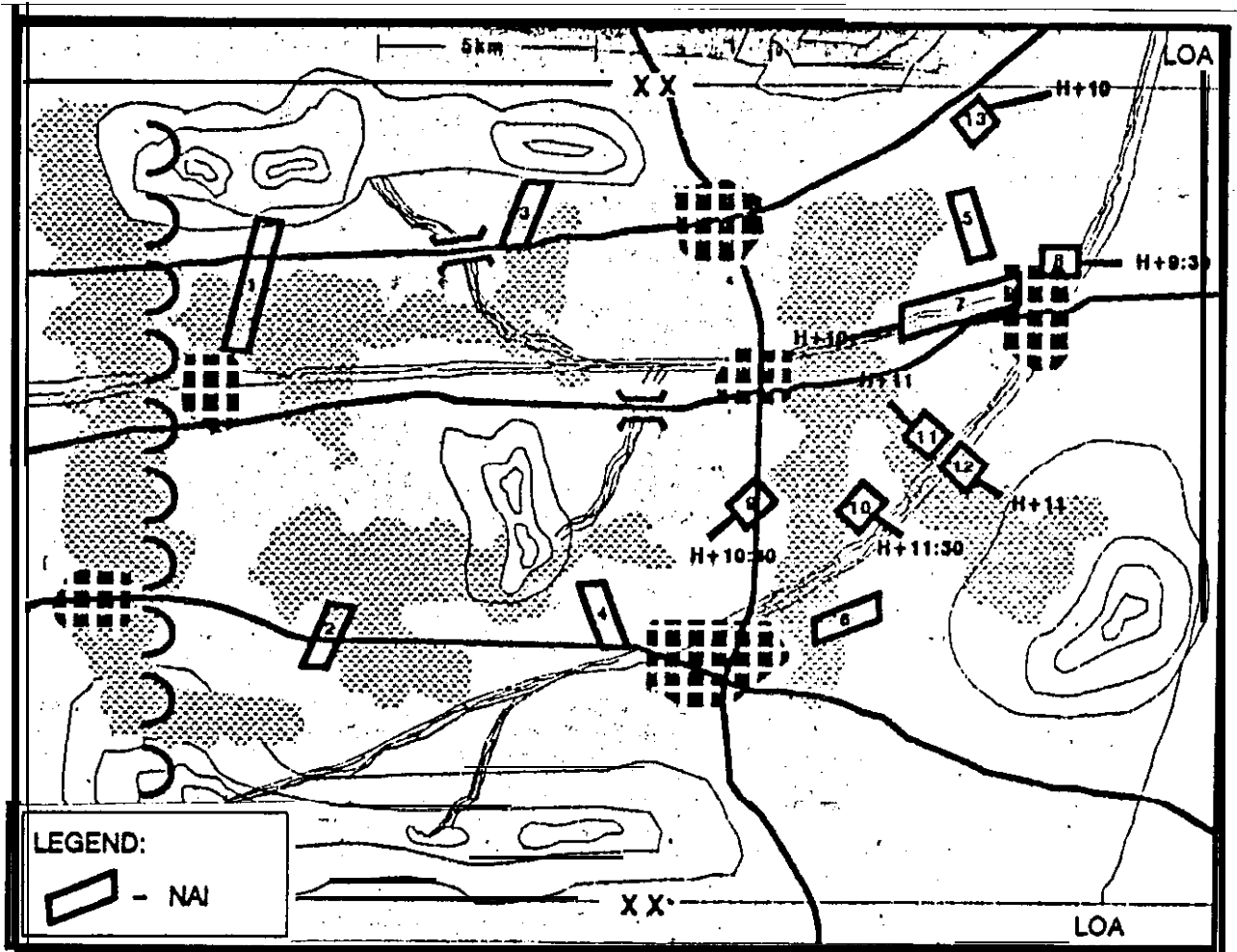

Figure 3-1-32. Refine the event template to include key events in each enemy COA.

We turn next to the **COAs** available to the two armored divisions. After identifying likely counterattack objectives, in priority order, we identify available avenues of approach. We evaluate each COA for **NAIs** that will provide confirmation or denial of its adoption by the enemy. We include these **NAIs** on the event template, along with the **TPLs** associated with the armored divisions' movement (Figure 3-1-33).

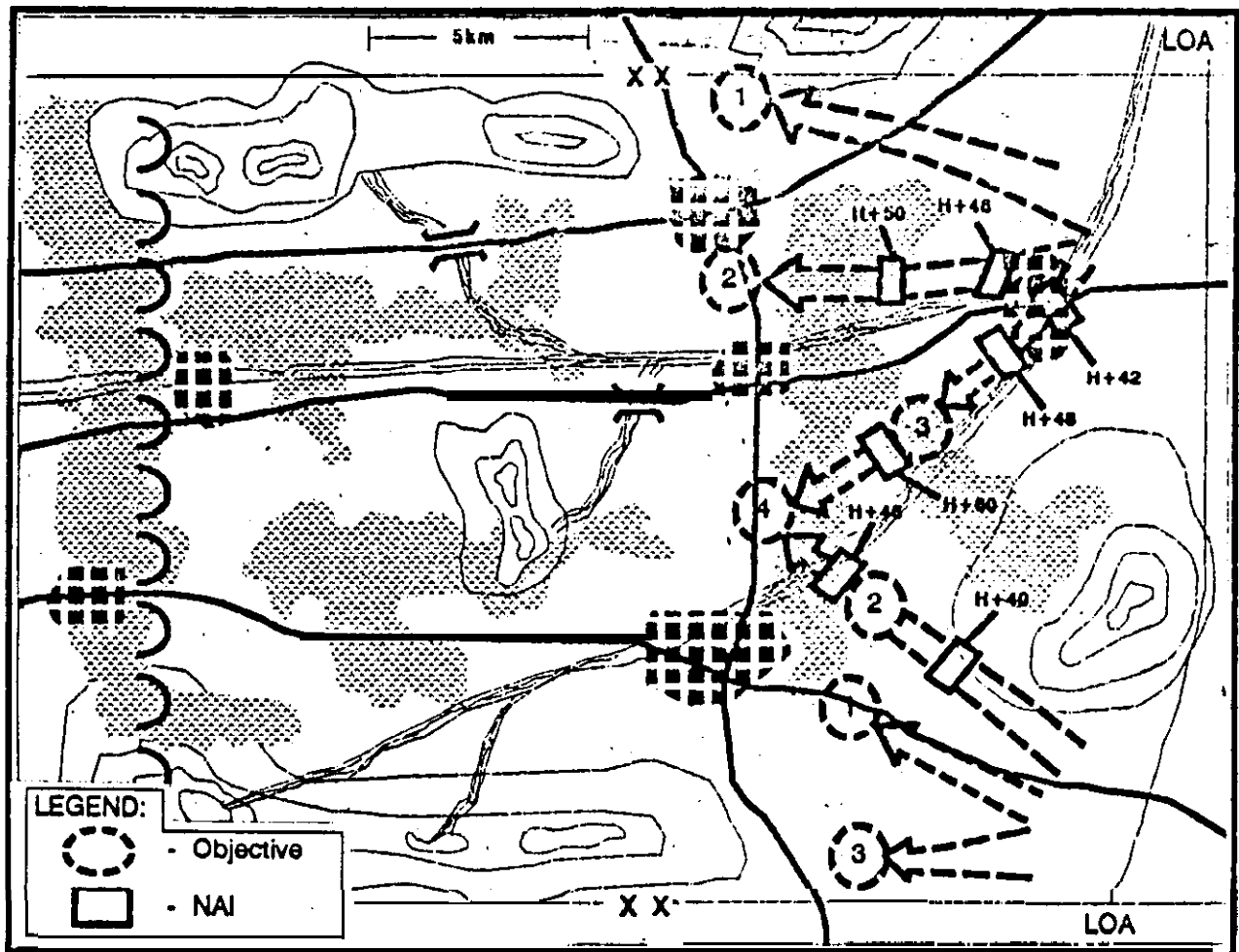

Figure 3-1-33. Consider the COAs of reinforcing or counterattacking forces.



We evaluate the **COA** available to the air assault brigade in the same way. Because of friendly air superiority, enemy air assaults into the friendly rear are unlikely. Accordingly we concentrate on **COAs** that use air assault assets to block friendly penetrations. We identify **NAIs** associated with each COA and transfer them to the event template (**Figure 3-1-34**).

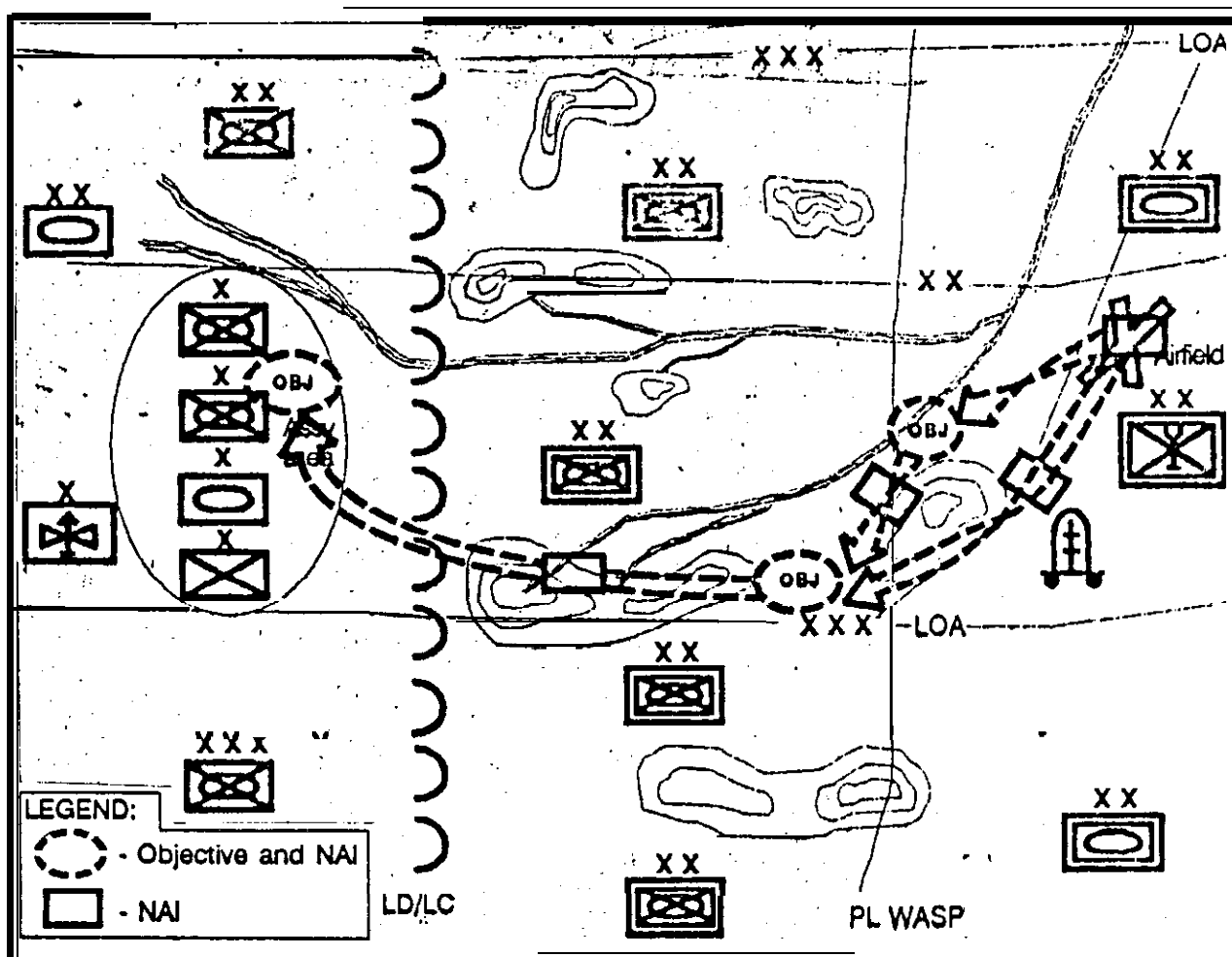

Figure 3-1-34. NAIs associated with the air assault brigade's COAs.

We prepare an event matrix to accompany the event template (Figure 3-1-35). The event matrix adds the indicators associated with each NAI and additional information to aid in collection planning. We will refine and update the event matrix during staff wargaming.

NAI	EVENT	TIME		INDICATES COA
		EARLIEST	LATEST	
1	Covering force			1
2	Covering force			1
3	Covering force			2,3
3	Battalion defense			1
4				

Figure 3-1-35. The event matrix supports the event template.

## DISSEMINATE, USE, AND REFINE IPB PRODUCTS

Completing the event template and event matrix does not end the IPB process. As we receive new information and intelligence, we re-evaluate the IPB products to ensure they are still accurate. If intelligence indicates the need, we reinitiate the IPB process to include information that changes initial assumptions and evaluations..

We disseminate the results of IPB to other staff sections and units to use in their own IPB efforts. **Subordinate** units and other staff sections take the results of our IPB and refine and adapt them **to meet** their own needs. (See Figures 3-1-36 through 3-1-39.)

For example, among other things, the Fire Support Element uses the results of describing the battlefield's effects to identify areas that are not suited to the large-scale deployment of friendly artillery units (Figure 3-1-36). Notice that the Fire Support Element has included areas inhabited by a large number of enemy sympathizers in this category.

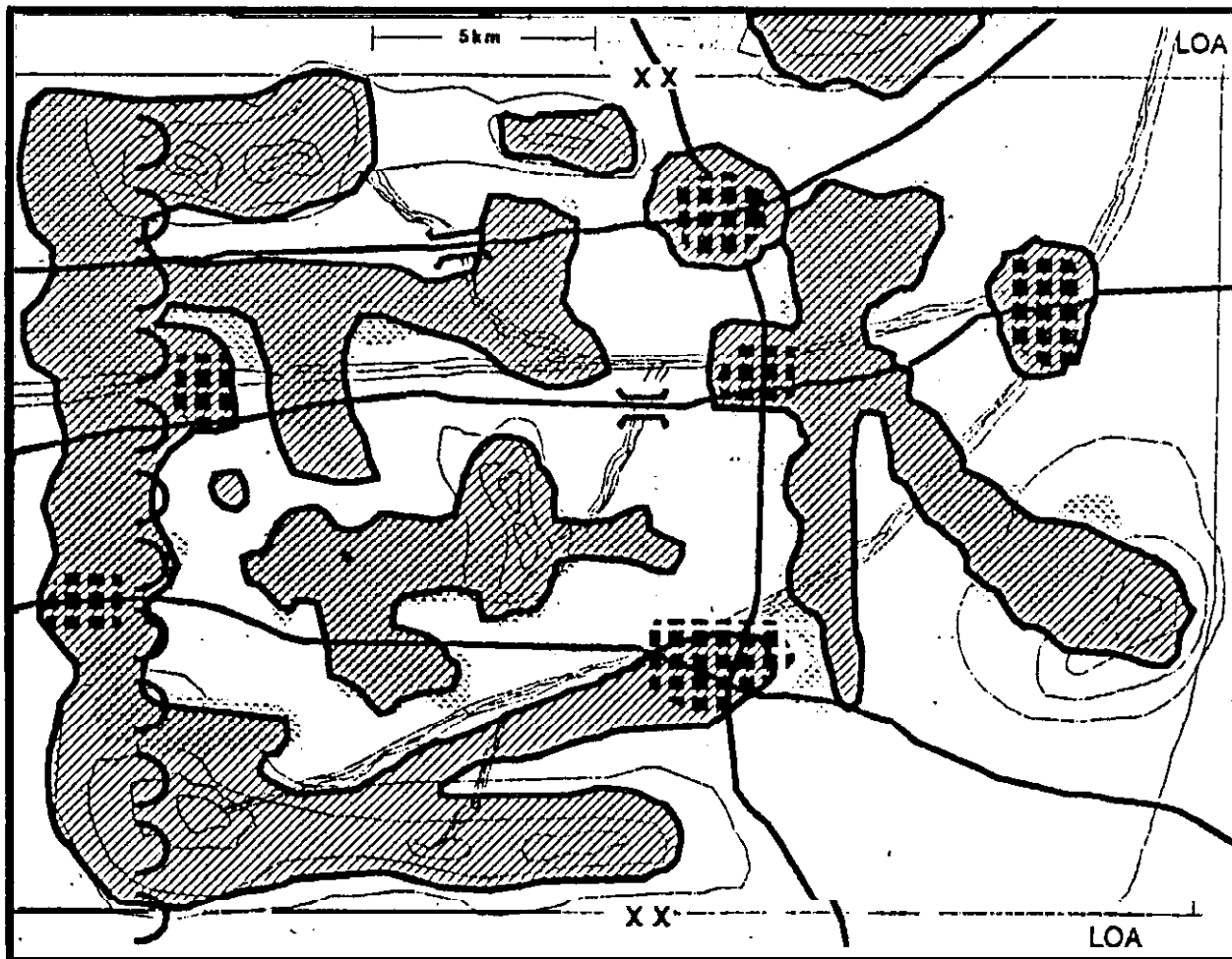

Figure 3-1-36. Potential locations for fire support assets.

The Fire Support Element also uses the results of terrain analysis as a start point for identifying potential locations for friendly and enemy counter-mortar and battery radars or other target acquisition assets. Based on the evaluation of observation and fields of fire, the Fire Support Element may request that the engineer (terrain) detachment conduct line-of-sight studies for selected sites.

The targeting cell uses the set of situation templates as the starting point for their own templates emphasizing **HVTs** (Figure 3-1-37). They further develop **descriptions** of tactics and target relative value matrices that focus on the **HVTs** to support development of high payoff targets during the targeting process.

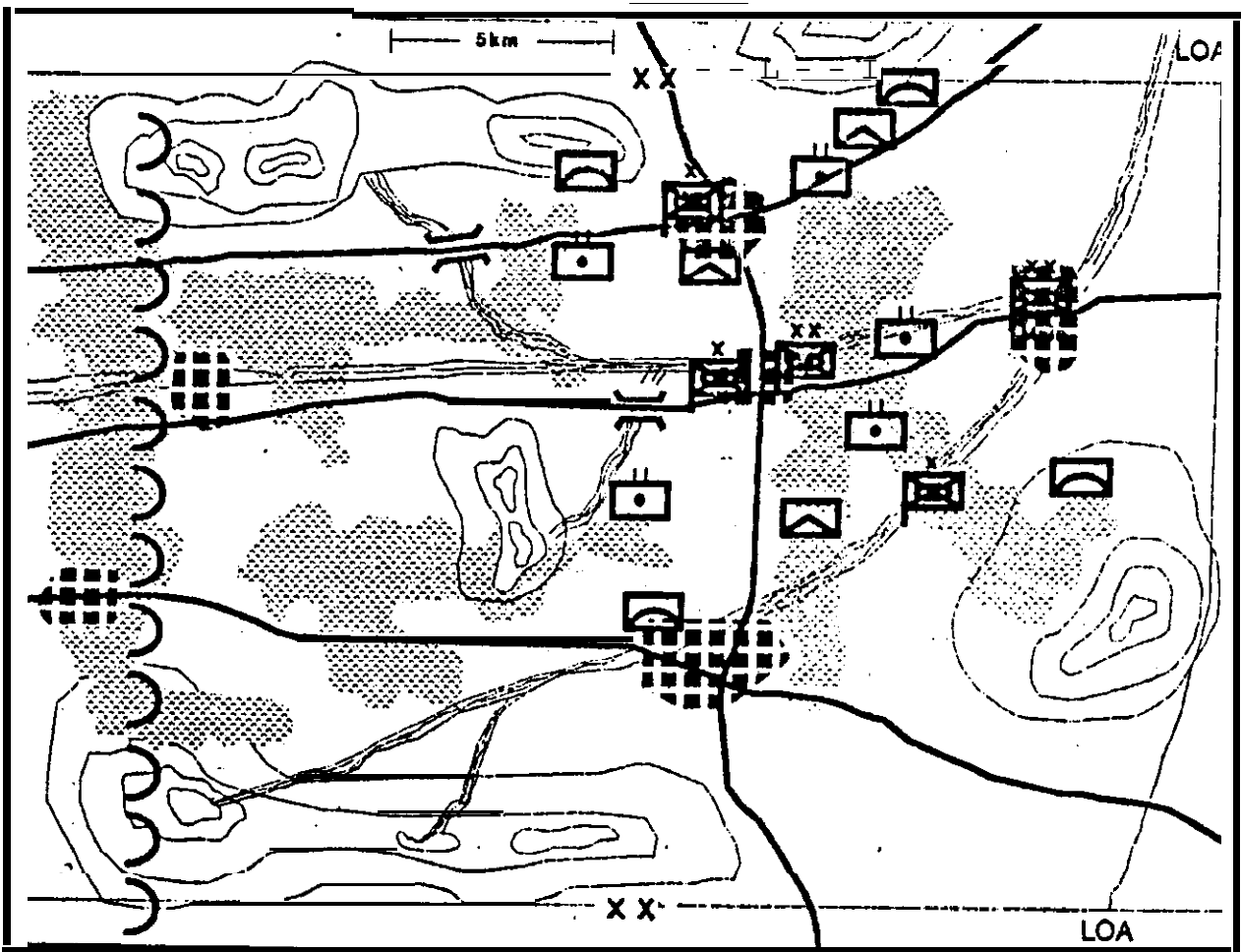

Figure 3-1-37. Templated locations of HVTs.



The Counterintelligence analysis section uses the situation templates as a starting point **for its** own templates that focus on the enemy's electronic attack and collection assets (Figure 3-1-39). In turn, the counterintelligence analysis section passes its IPB products on to the Deception and Targeting Cell for their own use.

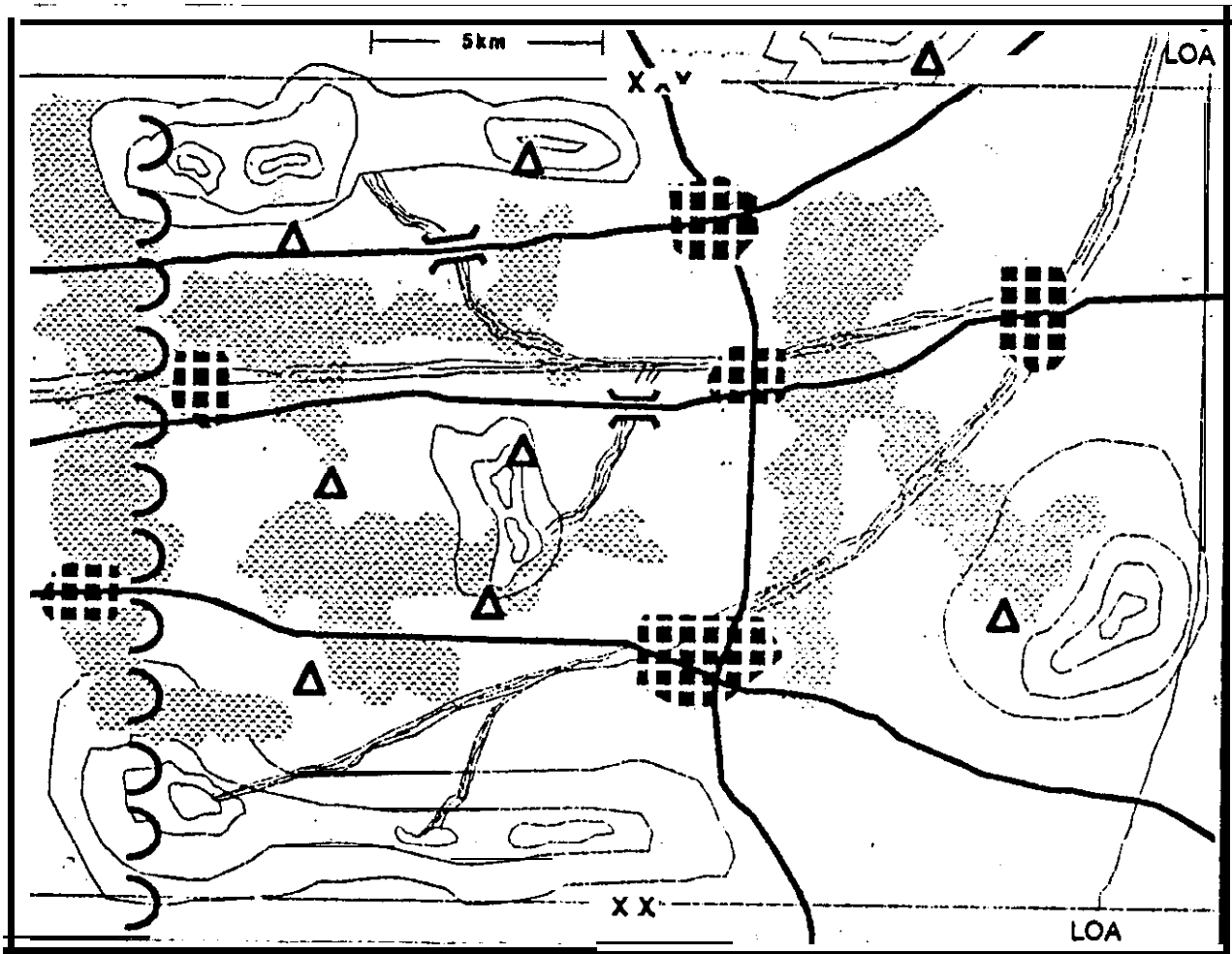

Figure 3-1-39. Templated locations of enemy IEW assets.

FM 34-130

The chemical section uses the threat models and situation templates to develop the NBC threat assessment and to conduct vulnerability analysis. They identify contaminated areas and likely targets for the enemy's use of chemical weapons. As a result, specific **NAIs** are assigned for focused NBC reconnaissance efforts.

The chemical section uses the results of terrain analysis as a starting point for identifying potential friendly decontamination sites (Figure 3-1-40). Terrain and weather analysis products also allow them to evaluate the terrain's effects on **chemical** agent and obscurant clouds.

figure 3-1-40  
new figure  
chemical school input

Scenario Two: Brigade Conventional Defense

After a rapid deployment in support of a threatened ally, our parent division begins to organize its defense. Our brigade is assigned to the center of the division's sector. Due to the relatively close terrain, the brigade has been organized with one armor battalion, one mechanized battalion, and two light infantry battalions.

The threat directly opposite our sector is one mechanized infantry division. Available as the threat corps' reserve is an armored division (Figure 3-2).

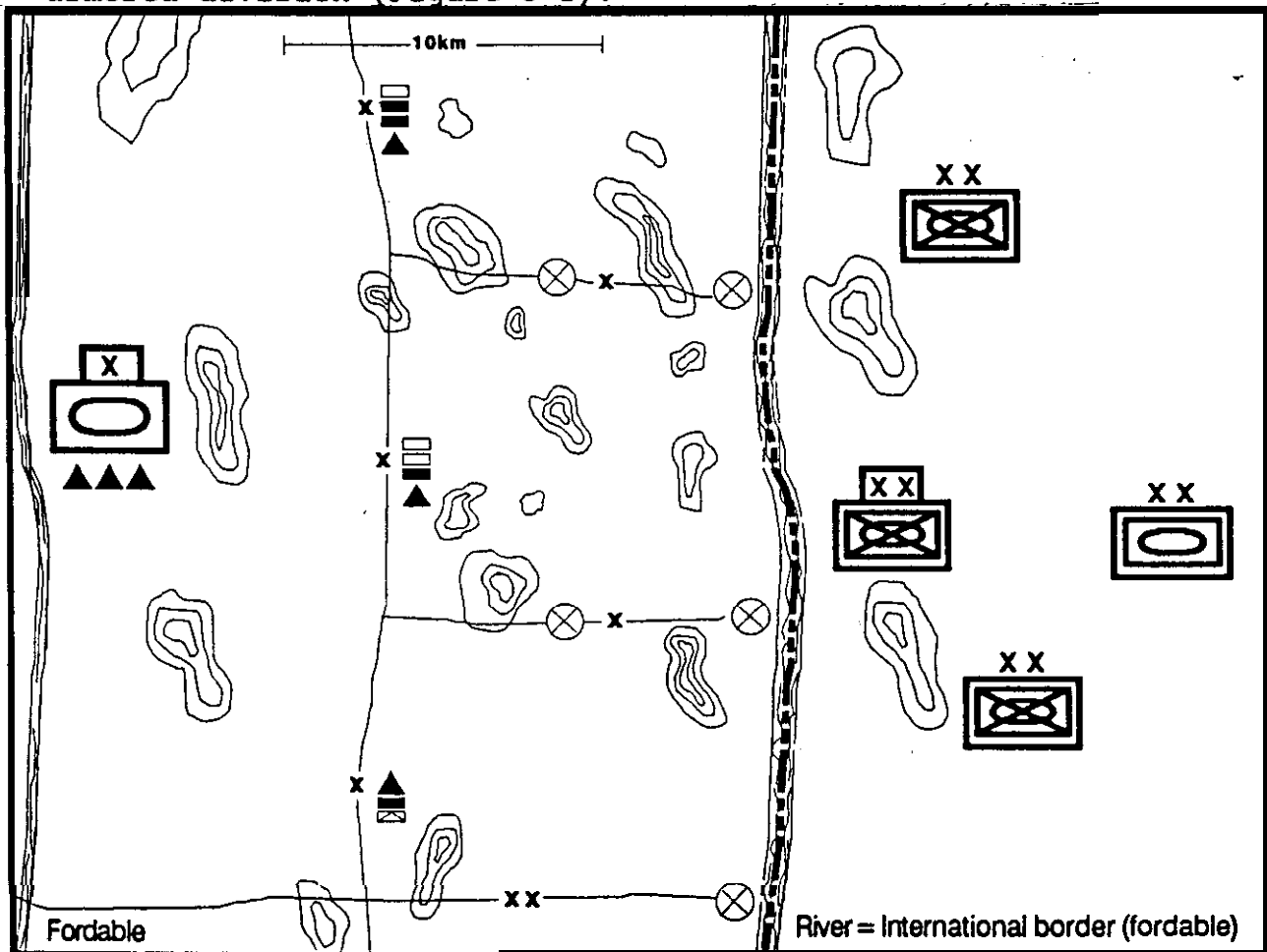

Figure 3-2. Scenario 2, general situation.

Because of the uncertain political situation, with the threat of imminent hostilities, we conduct the IPB process as quickly as prudence allows. This is an example of abbreviated IPB.



**DEFINE THE BATTLEFIELD ENVIRONMENT**

We define our AI to include all probable threats to the brigade's defensive mission. We consider concentration for an attack in our sector as well as the risk of attacks from adjacent sectors (Figure 3-2-1).

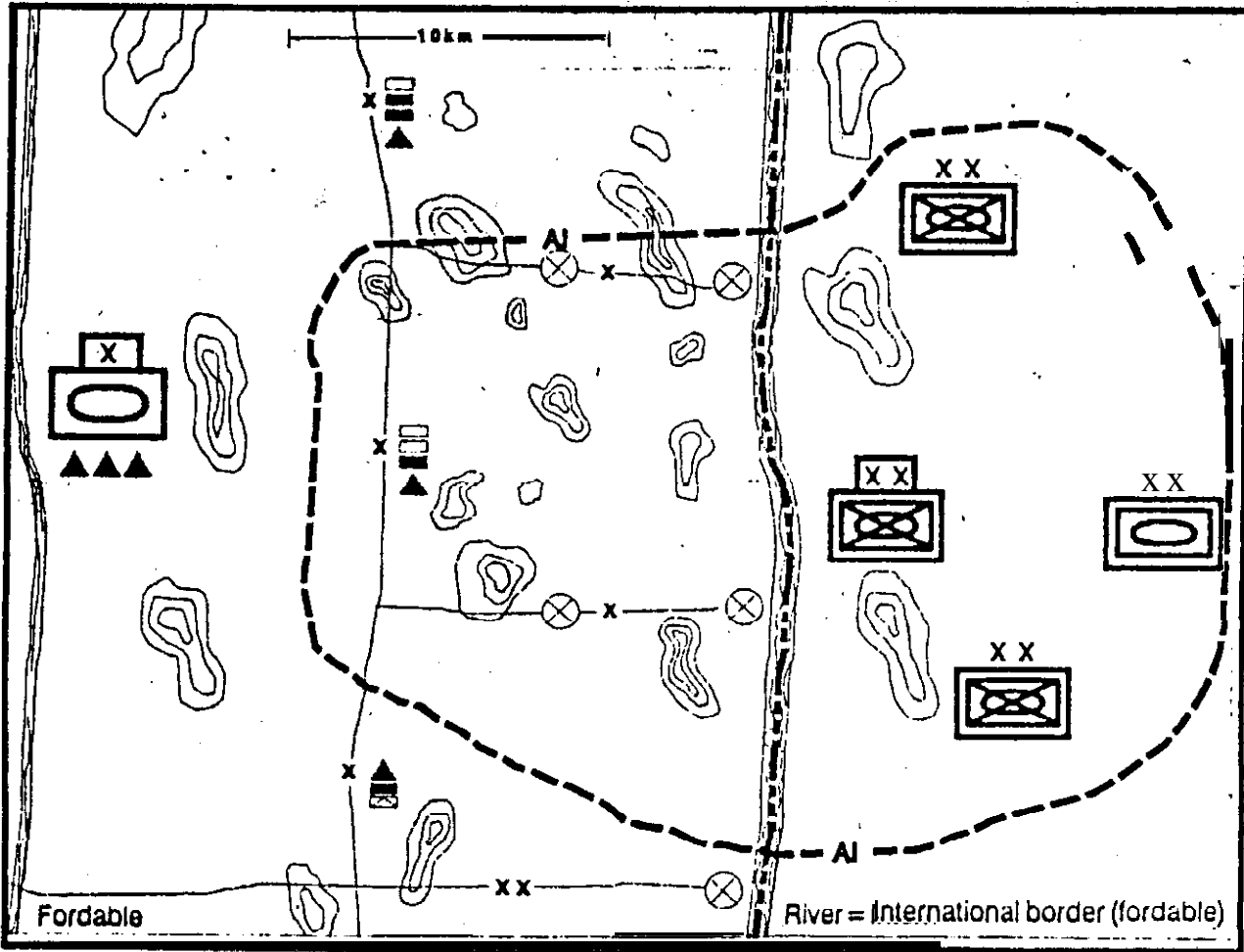

**Figure 3-2-1. Area of interest.**

DESCRIBE THE BATTLEFIELD'S EFFECTS

We examine the map for the various terrain factors that create obstacles to mobility within the AI. Rather than create separate overlays for each factor, we record the end results (mobility corridors and avenues of approach) on a single graphic product (Figure 3-Z-2). To determine avenues of approach, we must first identify likely objectives. To keep the graphic from getting too cluttered, we put air avenues of approach on a separate overlay.

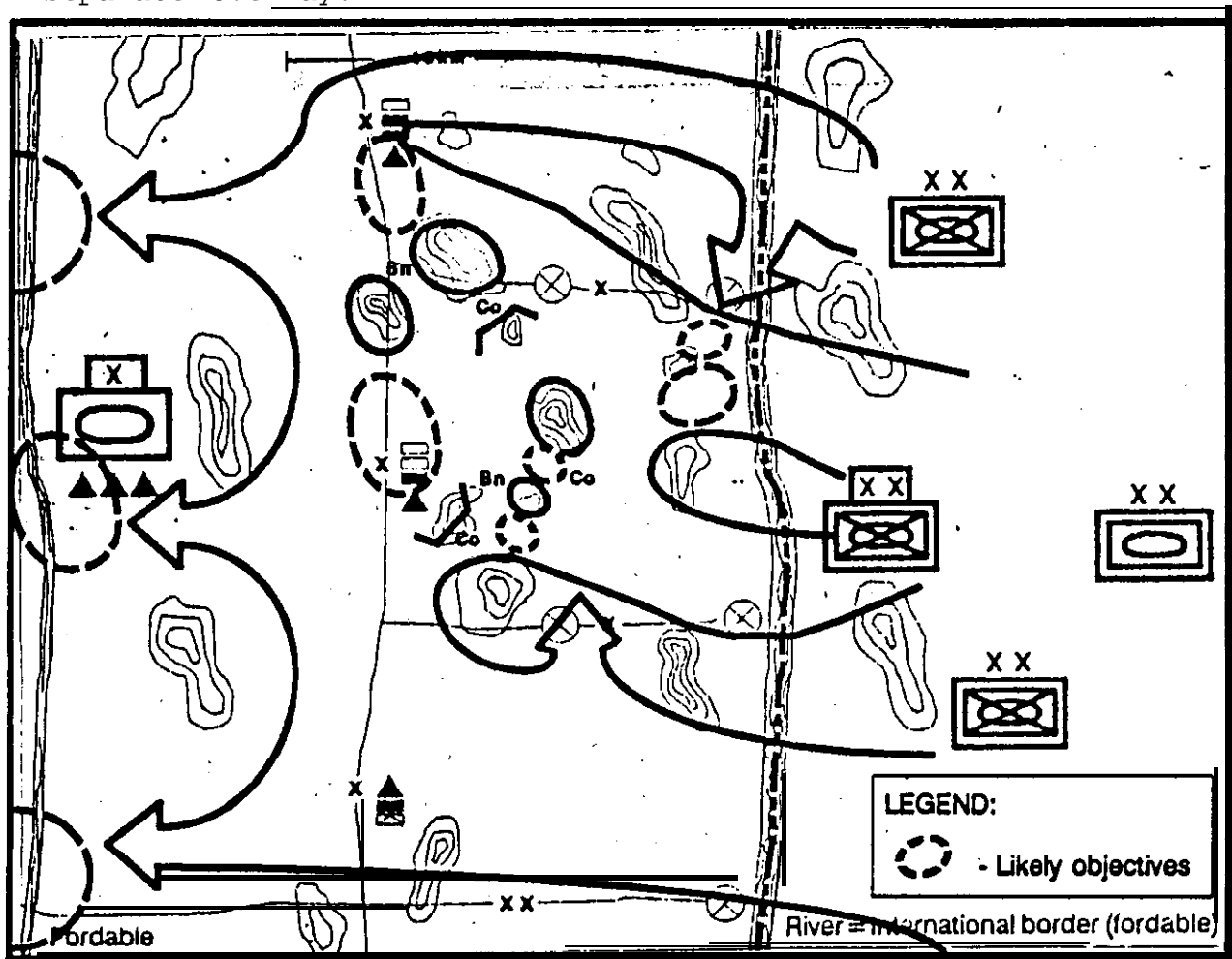

Figure 3-2-2. Mobility corridors and avenues of approach.

There are few obstacles to flight within the AI. Accordingly our evaluation of threat air avenues of approaches focuses on direct routes that offer some protection to **aircraft** (Figure 3-2-3).

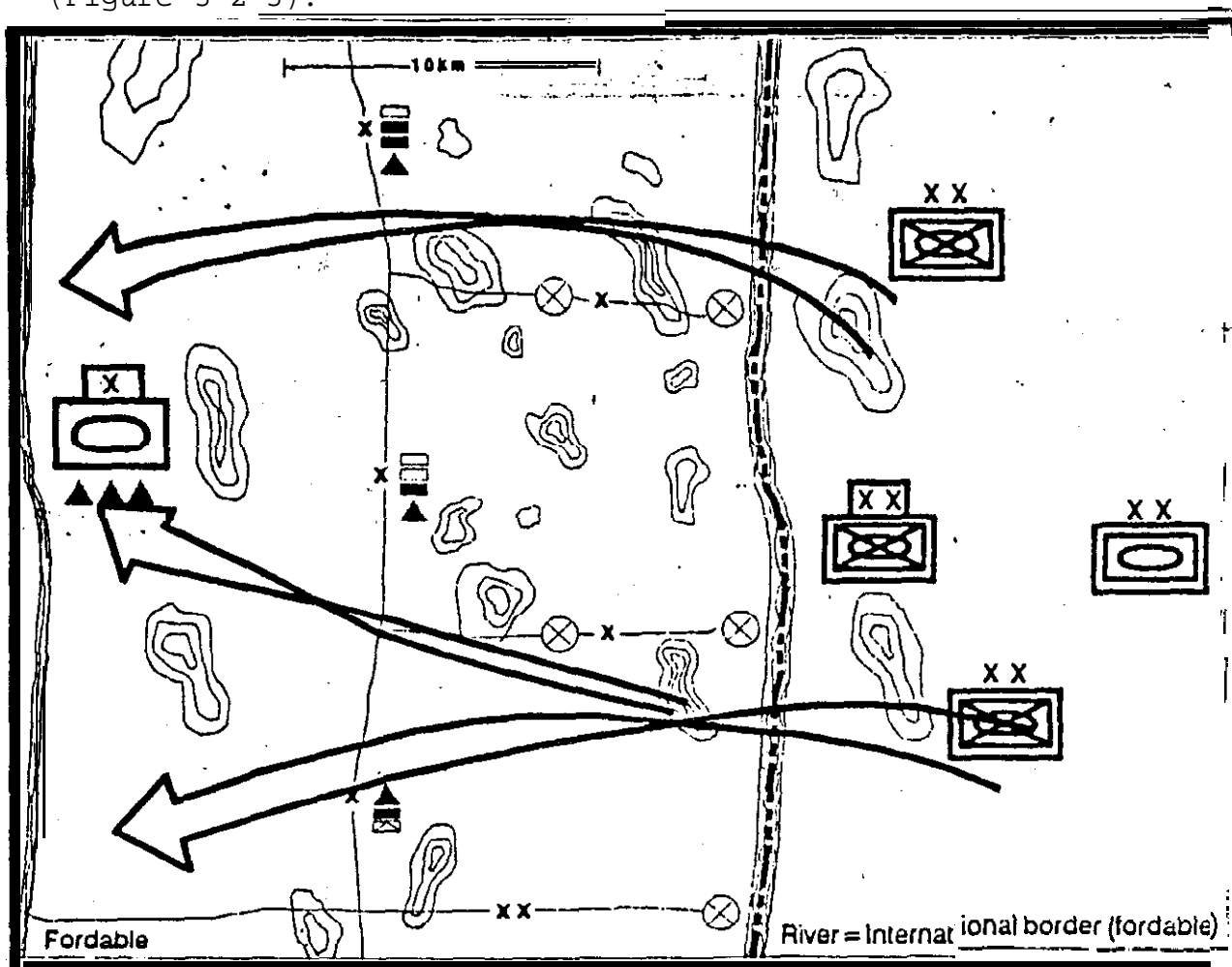

Figure 3-2-3. Air avenues of approach.

We next identify defensible terrain within the brigade's sector. We identify potential defensive positions for both the heavy and light forces within our brigade, oriented on the threat's likely avenues of approach (Figure 3-2-4).

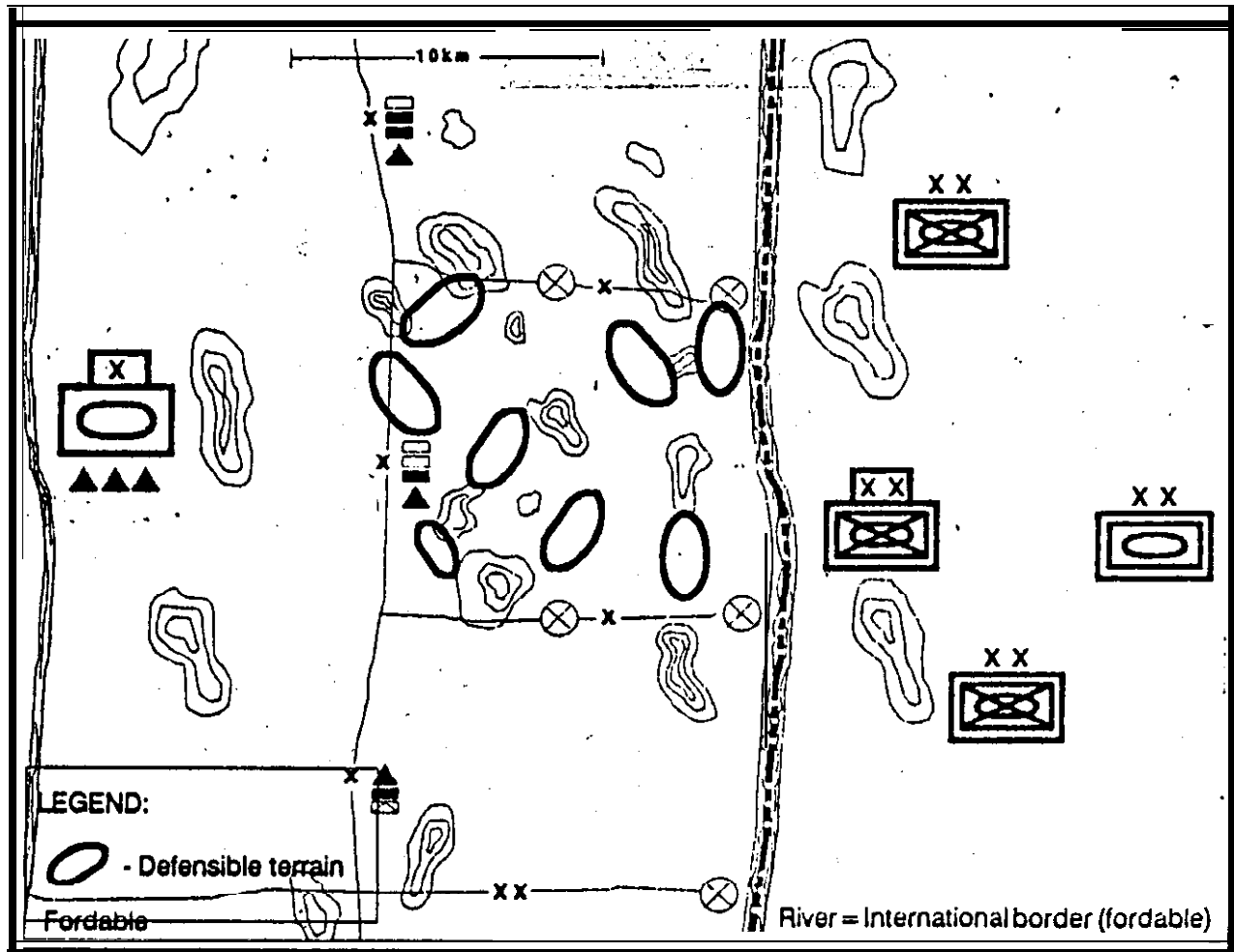
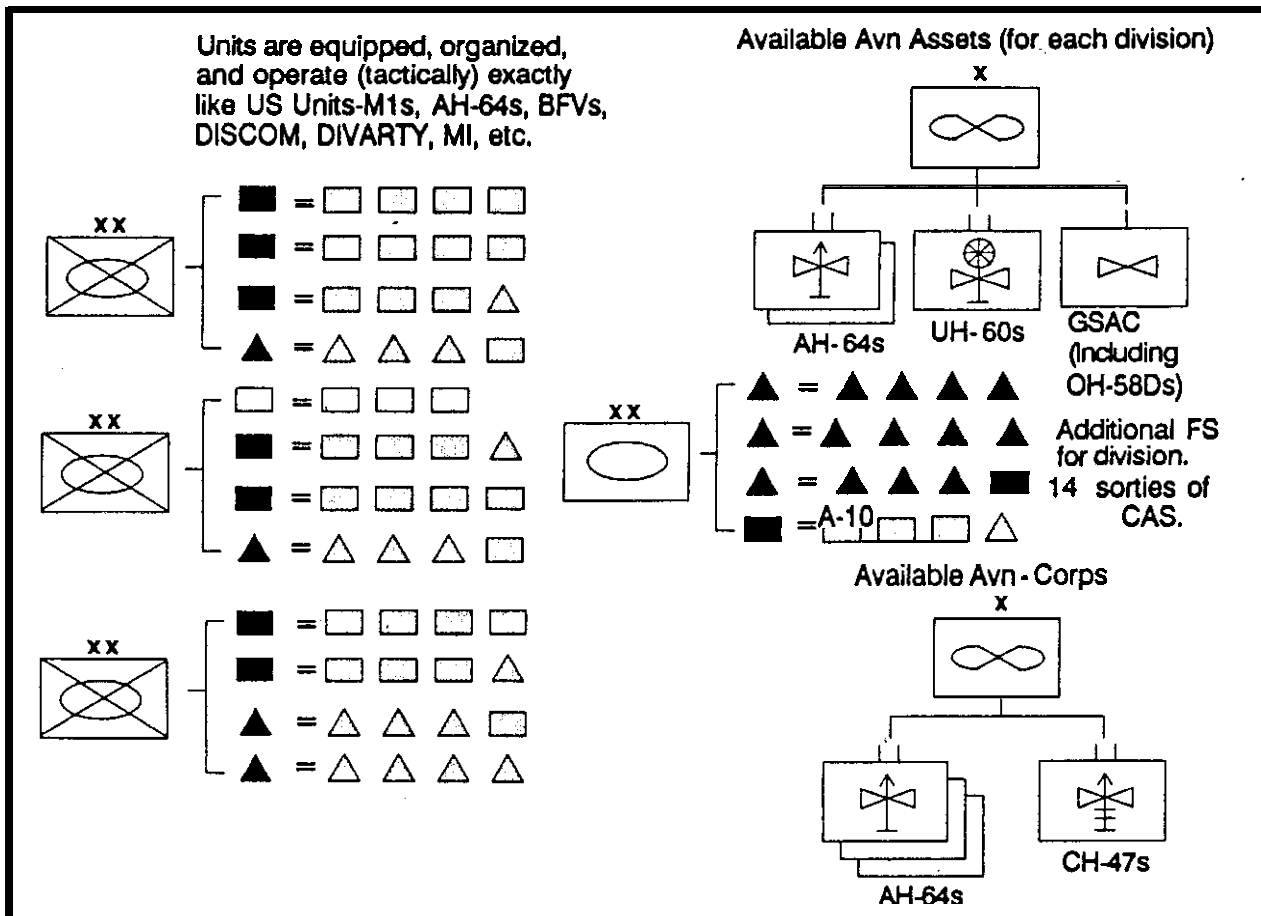

Figure 3-2-4. Defensible terrain.

**EVALUATE THE THREAT**

Our evaluation of the threat model reveals the **threat's** similarity to our own forces in doctrine and organization (Figure 3-2-5). In this **case**, even their equipment is identical. Accordingly, since the entire staff is familiar with US style operations, we save time by using mental doctrinal templates for ground forces instead of creating physical products.



**Figure 3-2-5. Enemy organization.**

We can not count on air superiority during the opening stages of the conflict and therefore must pay special attention to the threat's air support capabilities. Evaluation of the threat model indicates we can expect up to 14 fighter/bomber sorties against targets in the brigade's sector each day. We extract the appropriate doctrinal template from the threat model.

figure 3-2-6  
new figure

FM 34-130

During the fight for air superiority the threat will probably pass deep strike aircraft over the brigade sector en route to deeper targets. The threat model indicates that the threat may attack air defense assets deployed in the brigade sector in order to create the necessary air corridors. Accordingly, we examine the template that depicts threat force large scale air operations.

figure 3-2-7  
new figure.

DETERMINE THREAT COURSES OF ACTION

Overlaying our mental doctrinal templates on the evaluation of the terrain's effects, we create a graphic depiction of the set of threat **COAs**. This serves as our situation template (Figure 3-2-8). For the moment, we put off developing the **COAs** in detail.

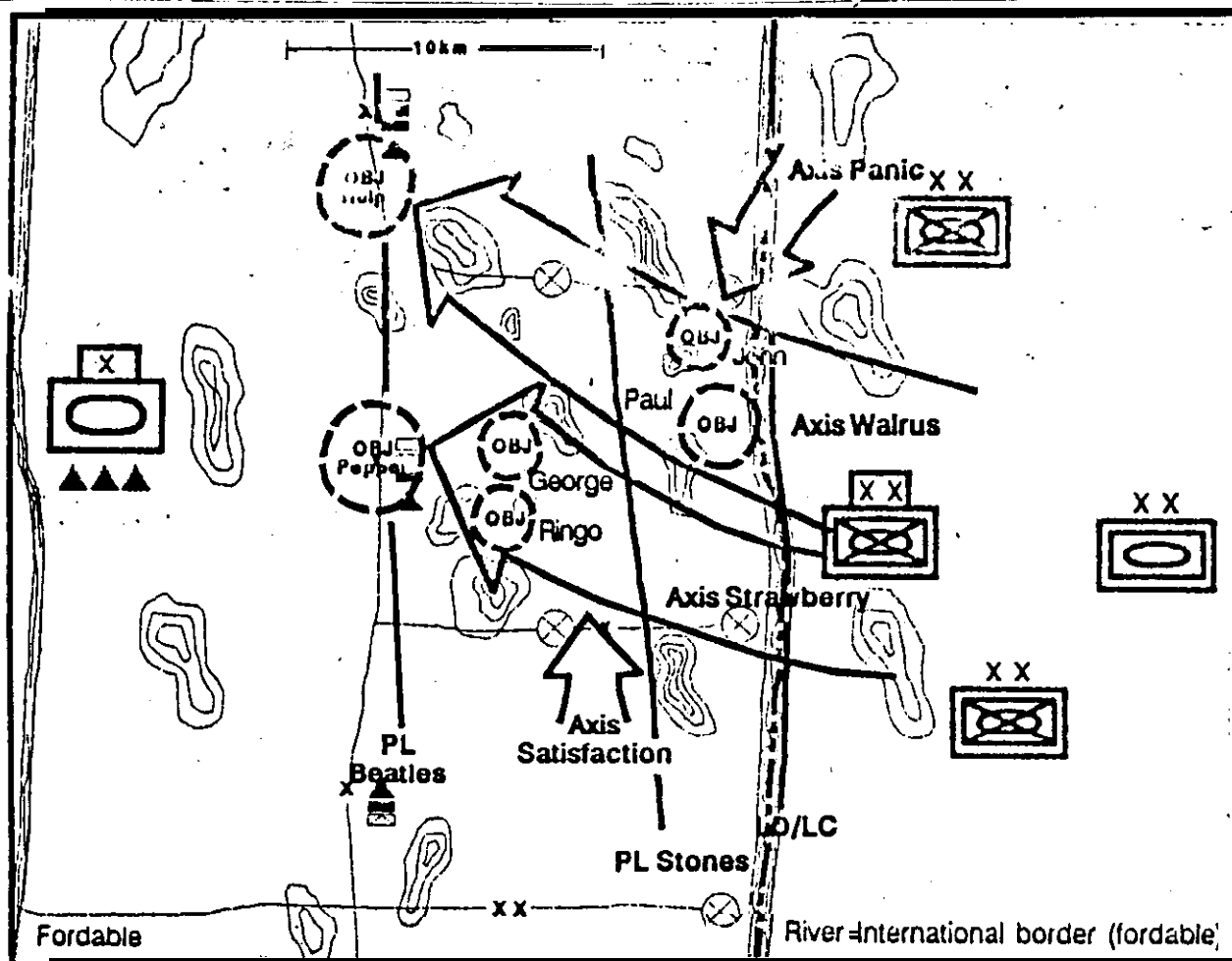

Figure 3-2-8. Enemy COAs.



We create a matrix to describe each COA within the set (Figure 3-2-9). This helps us to **visualize** the conduct of each threat COA during wargaming and aids collection planning.

Note that the matrix reads from right to left in order to match the flow of action on the graphic (see Figure 3-2-8). This is one acceptable technique.

NAI	INDICATORS THAT WOULD HELP CONFIRM COA 1	INDICATORS THAT WOULD HELP CONFIRM COA 2	INDICATORS THAT WOULD HELP CONFIRM COA 3	INDICATORS THAT WOULD HELP CONFIRM OTHER COAs OF CONCERN
1		Air assault forces		
2		Air assault forces		
3	Air assault forces		Air assault forces	
4		Infiltration of light Inf		
5		Light Inf attack NAI 5		
6		Light Inf attack NAI 6		
7	Light Inf attack NAI 7		Light Inf attack NAI 7	
8	Light Inf attack NAI 8		Light Inf attack NAI 8	
9	■ Poised to attack	■ Poised to attack		TD attacks
10	■ Poised to attack	■ Poised to attack	■ ■ Poised to attack abreast	TD attacks
11			■ Shifts N	
12				1 or 2 Bdes attack W
13				1 or 2 Bdes attack S

Figure 3-2-9. Event matrix.

Using the situation template **and** the matrix describing the **COAs**, we prepare an event template. **We** focus on **NAIs** that will confirm or deny adoption of each COA within the set. The nature of the terrain causes some of the **NAIs** to take untraditional shapes (Figure 3-2-10).

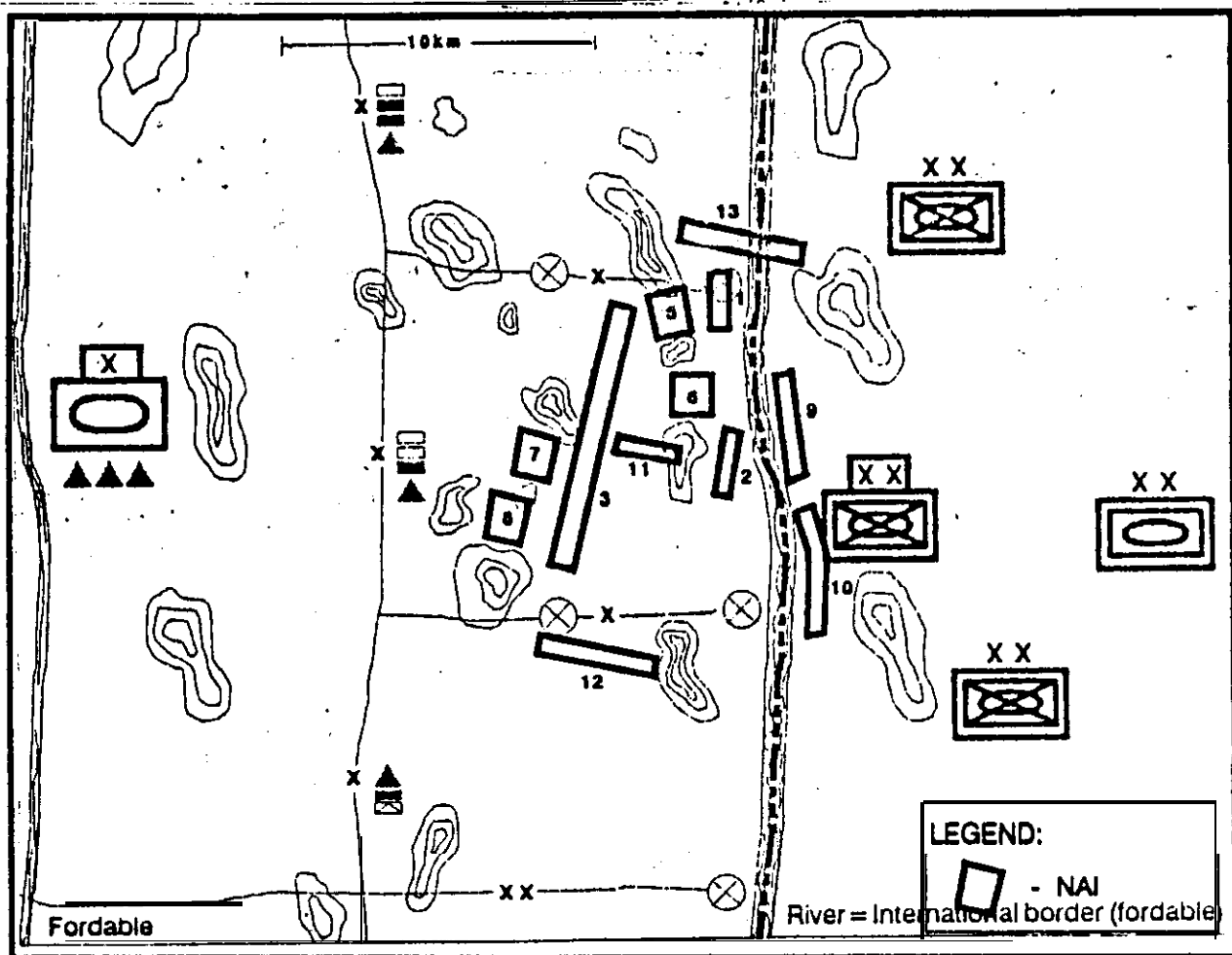

Figure 3-2-10. Event template.

We prepare an event matrix to describe the activities we expect to find in each NAI if the threat adopts its associated COA (Figure 3-2-11).

NAI	INDICATORS THAT WOULD HELP CONFIRM COA 1	INDICATORS THAT WOULD HELP CONFIRM COA 2	INDICATORS THAT WOULD HELP CONFIRM COA 3	INDICATORS THAT WOULD HELP CONFIRM OTHER COAs OF CONCERN
1		Air assault forces		
2		Air assault forces		
3	Air assault forces		Air assault forces	
4		Infiltration of light Inf		
5		Light Inf attack NAI 5		
6		Light Inf attack NAI 6		
7	Light Inf attack NAI 7		Light Inf attack NAI 7	
8	Light Inf attack NAI 8		Light Inf attack NAI 8	
9	■ Poised to attack	■ Poised to attack		TD attacks
10	■ Poised to attack	■ Poised to attack	■ ■ Poised to attack abreast	TD attacks
11			■ Shifts N	
12				1 or 2 Bdes attack W
13				1 or 2 Bdes attack S

Figure 3-2-11. Event matrix.

DISSEMINATE, USE, AND REFINE IPB PRODUCTS

As usual, we disseminate the products of IPB to other staff sections and subordinate units to support their planning efforts.

We use the time remaining before the onset of hostilities to refine and improve our basic IPB products. As needed to support planning, we develop the target relative value matrices and develop detailed situation templates. As we receive new information and intelligence, we refine, update, and

incorporate it into the initial IPB. If incoming intelligence denies assumptions made during planning, we reinitiate the IPB process to identify the impact on current plans. If necessary, we recommend to the commander that he reinitiate the decision making process in order to change or modify the friendly plan.

Scenario Three: Counterinsurgency Operations

The 2d Battalion, 9th Infantry (Light [L]), is conducting **counterinsurgency operations** within the rural country of Forgotonia. The host nation is plagued **by** an insurgency which is sponsored by Metropolania, the country that neighbors Forgotonia to the east.

The advance party for the 2d Battalion, 9th Infantry, has just arrived at the capital city staging base. The staff of **the** 9th Regimental Combat Team has issued an OPORD at the arrival airfield.

The battalion executive officer (**XO**) initiates the command estimate process. The **XO** informs the **S2** that he must present the initial set of IPB products to the battalion staff in 6 hours.

The regimental **S2** and several intelligence experts from the host nation present the battalion S2 section with a **15-minute** overview of the division and regimental level intelligence situations. They also leave several boxes of intelligence reports that may be pertinent to the battalion mission.

The **S2** reflects upon the briefings he has received. He realizes that the regimental **S2** developed good IPB products for the regimental level of focus. However, their level of detail will not support planning at the battalion level of focus. As he sifts through the stack of intelligence reports, he realizes that these files contain raw information in enough detail to support battalion planning, but they must first be analyzed within the context of the battalion's mission.

In order to produce the IPB products necessary to support staff wargaming, which starts in 5-1/2 hours, the **S2** sets the following schedule for the section:

- o 10 Minutes: Define the Battlefield: Determine the types of information that need to be extracted from the intelligence files and define the limits of the battlefield.

FM 34-130

- 2 Hours: Process the stack of intelligence using the filter procedures established in **define** the battlefield.
- 30 Minutes: Describe the Battlefield's Effects: Evaluate the battlefield's effects on military operations. Develop overlays that depict the effects of the battlefield on enemy and friendly **COAs** within the **AO**.
- 30 Minutes: Evaluate **the** Threat: Identify the organization, composition, and tactics of the enemy that the 2d Battalion,, **9th Infantry** (L), **is** likely to face within the AO.
- 1 Hour: Determine Threat **COAs**: **Although** he has studied the "doctrine" of insurgents operating in this region and the tactics of light infantry, the **S2** will "**bounce**" the IPB products against the battalion personnel who best understand the tactics of dismounted infantry; that is, the S3, the C Company commander, the A Company first sergeant (**1SG**), and the scout platoon sergeant (PSG). These "second opinions" help the S2 ensure that he has considered all possibilities. Meanwhile, the remainder of the S2 section will re-process the stack of intelligence reports to find any pertinent information they may have overlooked during the initial processing.
- 20 Minutes: Determine the most effective methods for presenting the IPB products to the battalion staff. Conduct rehearsal briefing.

Using the resulting time schedule, the S2 section jumps into the IPB process.

#### DEFINE THE BATTLEFIELD ENVIRONMENT

As usual, the **AO** is established by higher headquarters. The S2 examines the characteristics of the battlefield and determines that the populace as well as terrain and weather will have a significant effect on friendly and threat force options and operations. He also determines that the complicated rules of engagement included in the brigade's operation order are a significant characteristic of the environment. Not only will they affect friendly options but, once the threat learns of their nature, they are likely to influence threat courses of action as well.

Because the insurgents are getting some assistance from Metropolitan military units (the "**Nuevo** Metropolitan **Ejercito**"-NME), the S2 notes the nearby NME regiment as an additional significant characteristic of the battlefield.

Based on these considerations the S2 recommends the area of interest depicted in Figure 3-3.

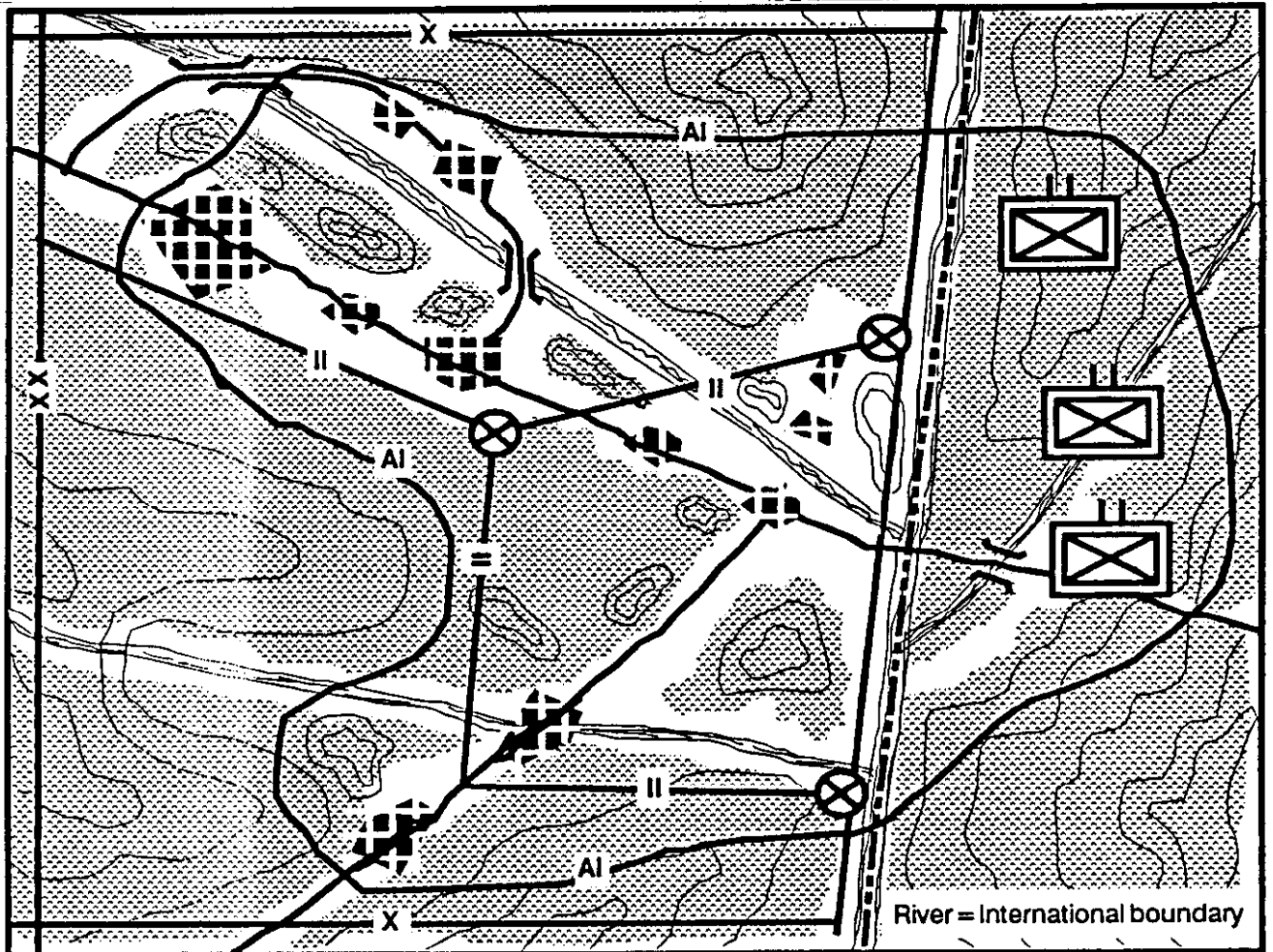

Figure 3-3. AO and AI.

DESCRIBE THE BATTLEFIELD'S EFFECTS

The S2 decides that the population is one of the most important characteristics of the battlefield, likely to have a major influence on both friendly and enemy COAs. Accordingly, he prepares a population status overlay depicting their political sympathies (Figure 3-3-1). He will use it later in determining enemy COAs. Other staff sections will use it while developing potential friendly COAs.

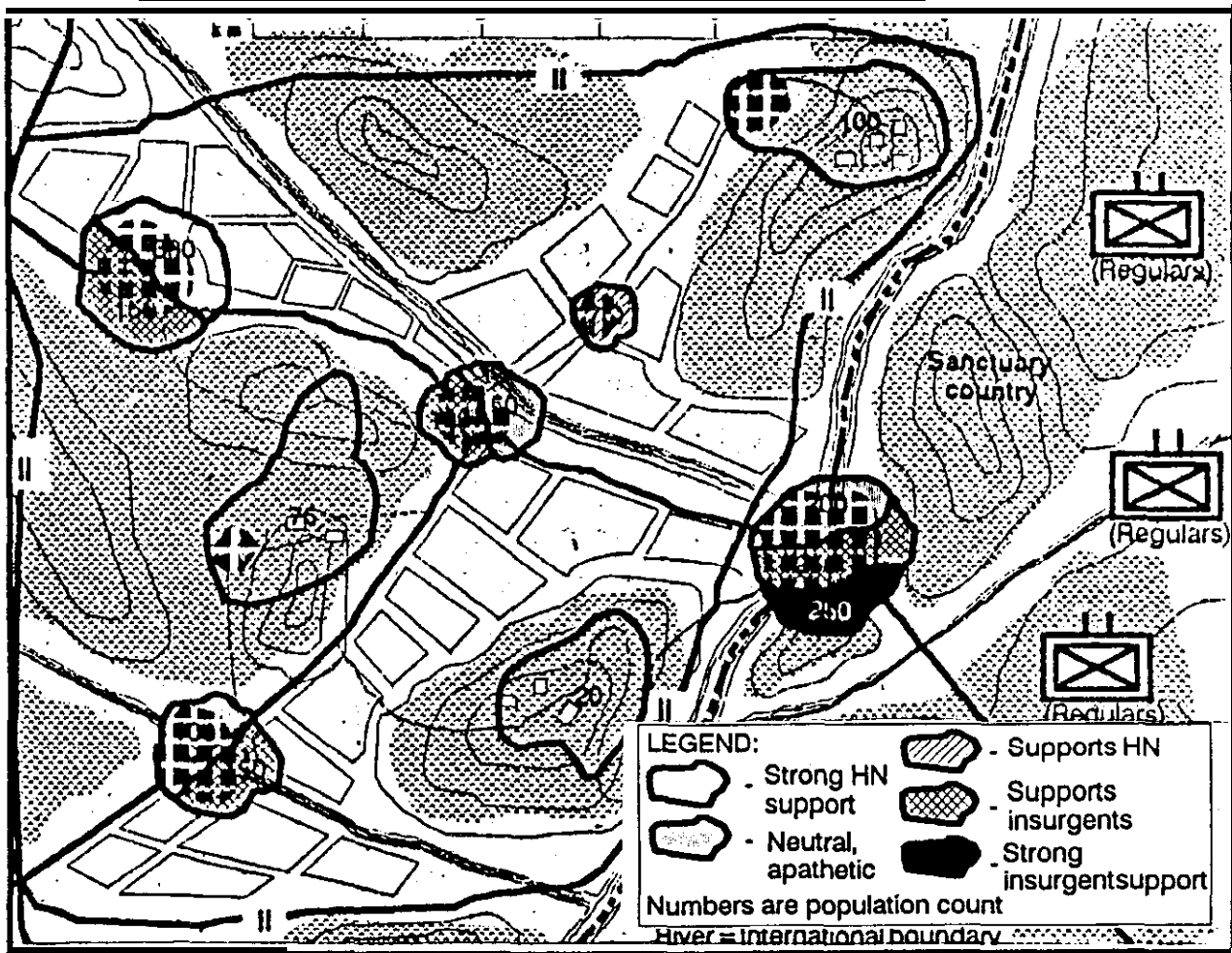

Figure 3-3-1. Population status overlay.

Although unusual, the **S2** decidesto prepare a legal status overlay (Figure 3-3-2) that considers rules of engagement. In this case, the host nation has established an elaborate status of forces agreement which drastically alters the rights and authority of the **2d** Battalion, 9th Infantry (L), as it moves through the AO. This varying sets of restrictions and rules of engagement obviously affect the **COAs** open to the friendly command. Similarly, since the enemy will no doubt learn of these restrictions on the friendly force, they will probably influence enemy **COAs** as well. The **S2** will use this overlay to integrate the effects of friendly rules of engagement on threat **COAs** as he **develops** them.

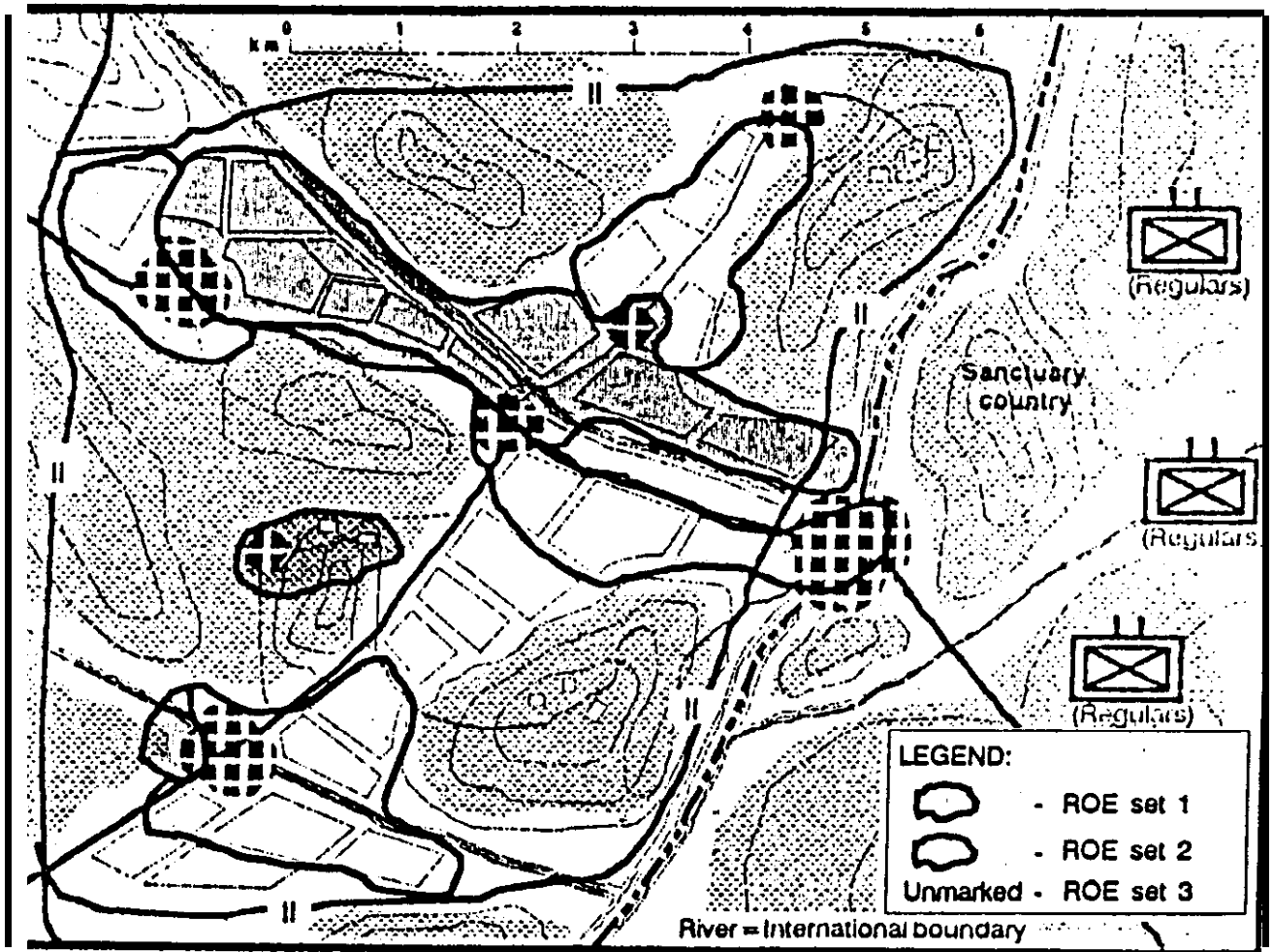

Figure 3-3-2. Legal status overlay.



The **S2 section** then prepared an overlay depicting LOC within the AI. After evaluating the **effects** of the various military aspects of terrain, the **S2 section** identified the areas along each **LOC** that best lend themselves for use as ambush sites (Figure 3-3-5).

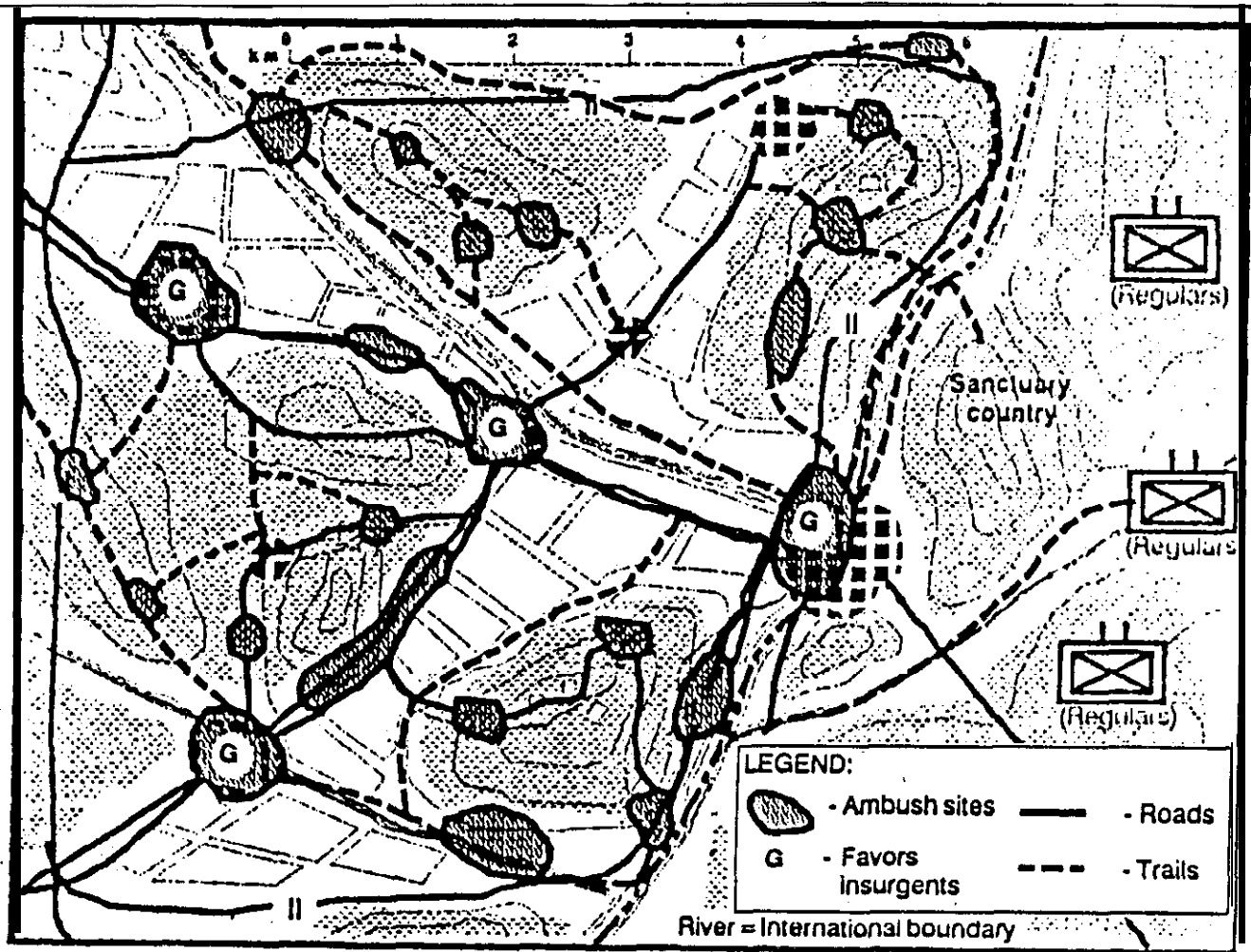

Figure 3-3-5. LOC and likely ambush sites.

EVALUATE THE THREAT

The S2 section begins evaluating the threat **by reviewing** the common understanding of the battlefield. They examine the organizations of the nearby NME infantry regiment as well as that of the insurgents operating within the AO (Figure 3-3-6). Neither the **insurgents** or the Metropolitanians have any **significant air power** canabilities..

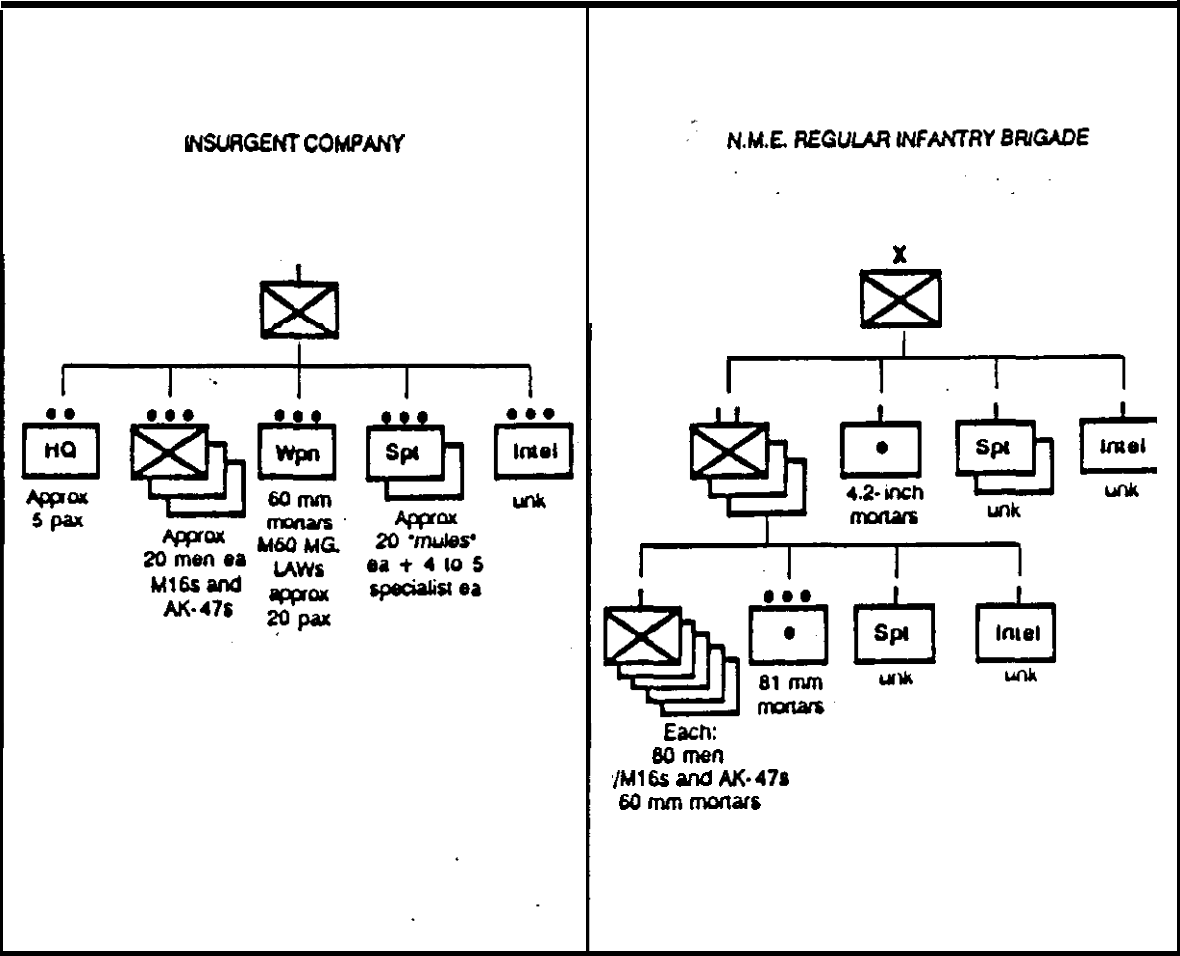

Figure 3-3-6. Enemy organizations.

The S2 section started to plot a **SITMAP** in order to record the mass of available information, but realized that a time event chart described the general intelligence situation in the **AO** more effectively (Figure 3-3-7). Instead of a **SITMAP** they decided to use coordinates registers to track activity within selected areas.

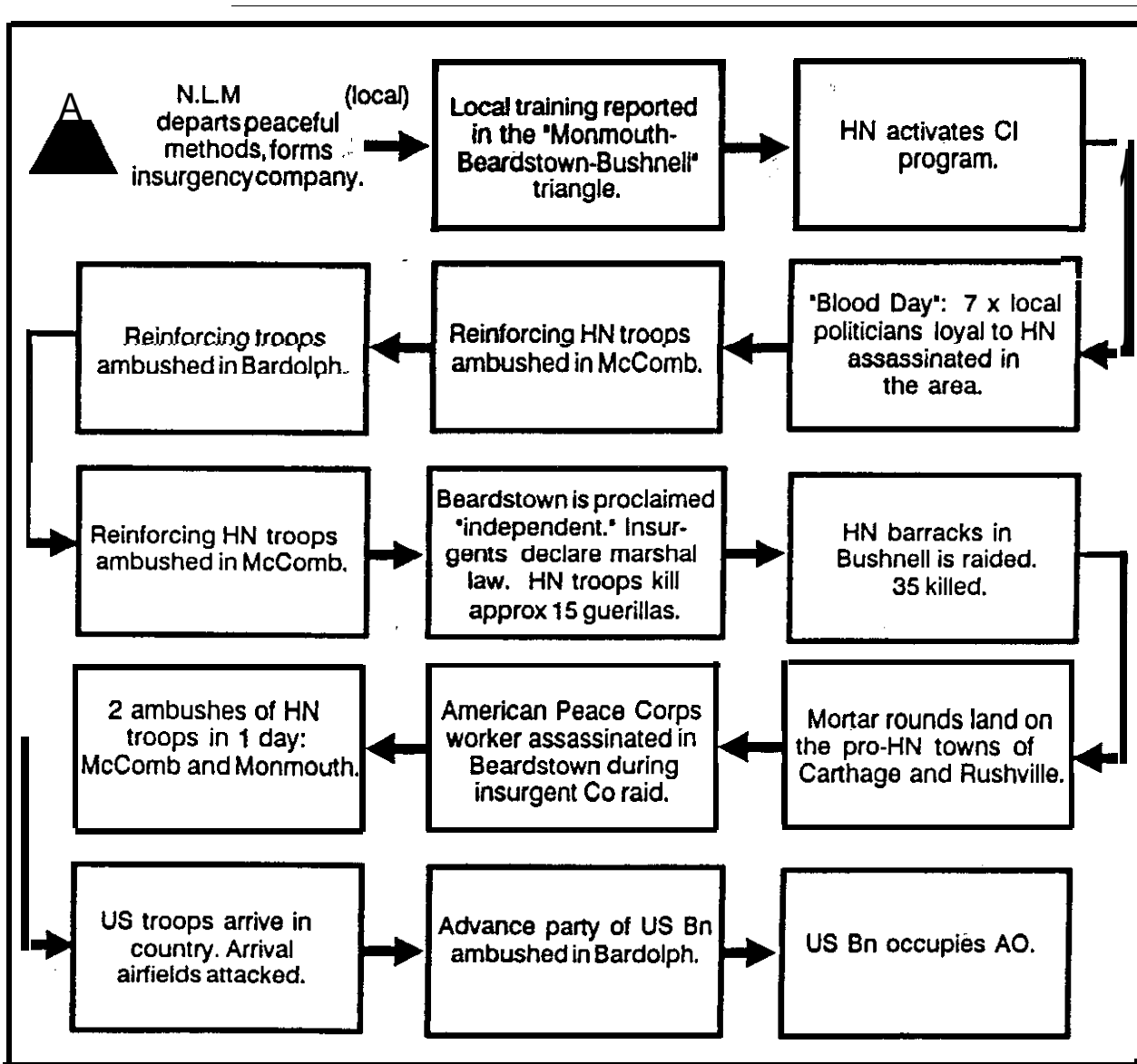

Figure 3-3-7. Time event chart.

While processing the stack of intelligence reports, the S2 section noticed certain recurring 'names. The S2 section established an activities matrix to quickly display which prominent personnel within the AO were related to each organization or type of activity (Figure 3-3-S).

LEGEND: ● - Confirmed ○ - Probable ○ - Possible		Christian Reform Party (good guys)	Society for the preservation of order (right wingers)	Farmer's alliance (unk peasant group)	People's Democratic Society (peaceful moderate)	Insurgent Company	New Liberation Movement (political front for N.M.E.)	N.M.E.	Name of Individual	
Warrant outstanding	Leader in the insurgent co. Possible plt cdr or co cdr.					●	●	●	Johnston, S.D. alias 'The Red'	Bardolph
	Possibly linked to death squad activities.	●	○						Garra, N.A.	
	Mayor, ineffective due to war-torn town.	●							Mulvihill, P.	
	Possible plt leader.	○		●	○	○	○		Daniels, P.	
	Regional governor.	○	○	○	●				Jenkins, T.L.	
Warrant outstanding	Tactical genius, principal trainer of insurgent co.					●	●	○	Cormier, J.	Macomb
				○		○	○	○	Webb, C.	
					○	○	○		Seipel, B.	
	Leader in the insurgent co. Plt leader or XO.			○		○	○	○	Trollinger, L.	Beardstown
	Possible head of intelligence.					○	●	●	Ahearn, E.	
	Probable plt leader.					○	○		Timoney, J.	
						●	●		Thompson, J.	
	Probable hvy wpn plt leader.					●	○	●	Bridgeford, R.	
	Possible liaison between insurgent co and the N.M.E.			○	○	○		○	Halbleib, M.	Bushnel
	'Doctor of Death' leads the SPO.	●	●	□	□				Mueller, H.	
						●	○	○	Martinez, E.	

Figure 3-3-8. Activities matrix.

The intelligence reports also revealed that certain of these individuals associated with others. The section used an association matrix to show the relationships (Figure 3-3-9).

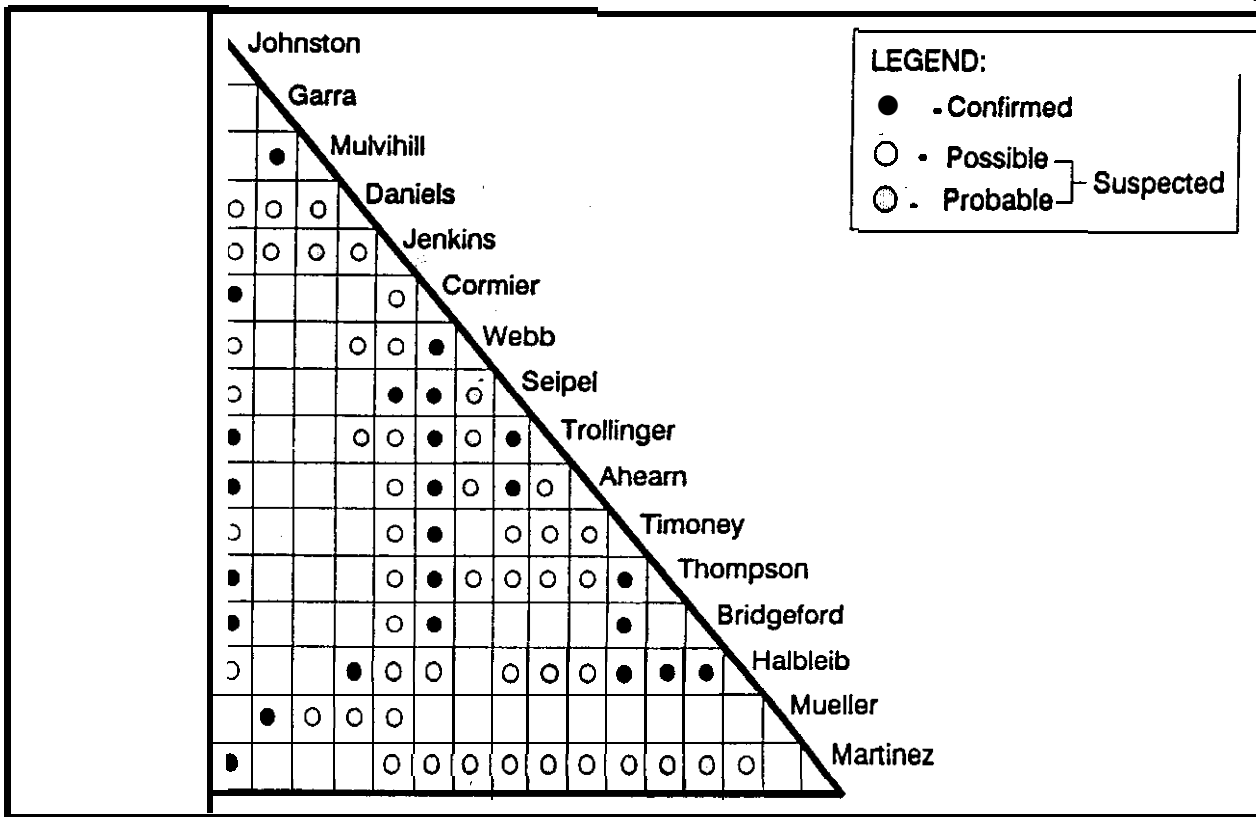

Figure 3-3-9. Association matrix.

Using all of the information shown in the products above, the section then developed a link diagram to show the interrelationship of individuals, organizations, and activities (Figure 3-3-10).

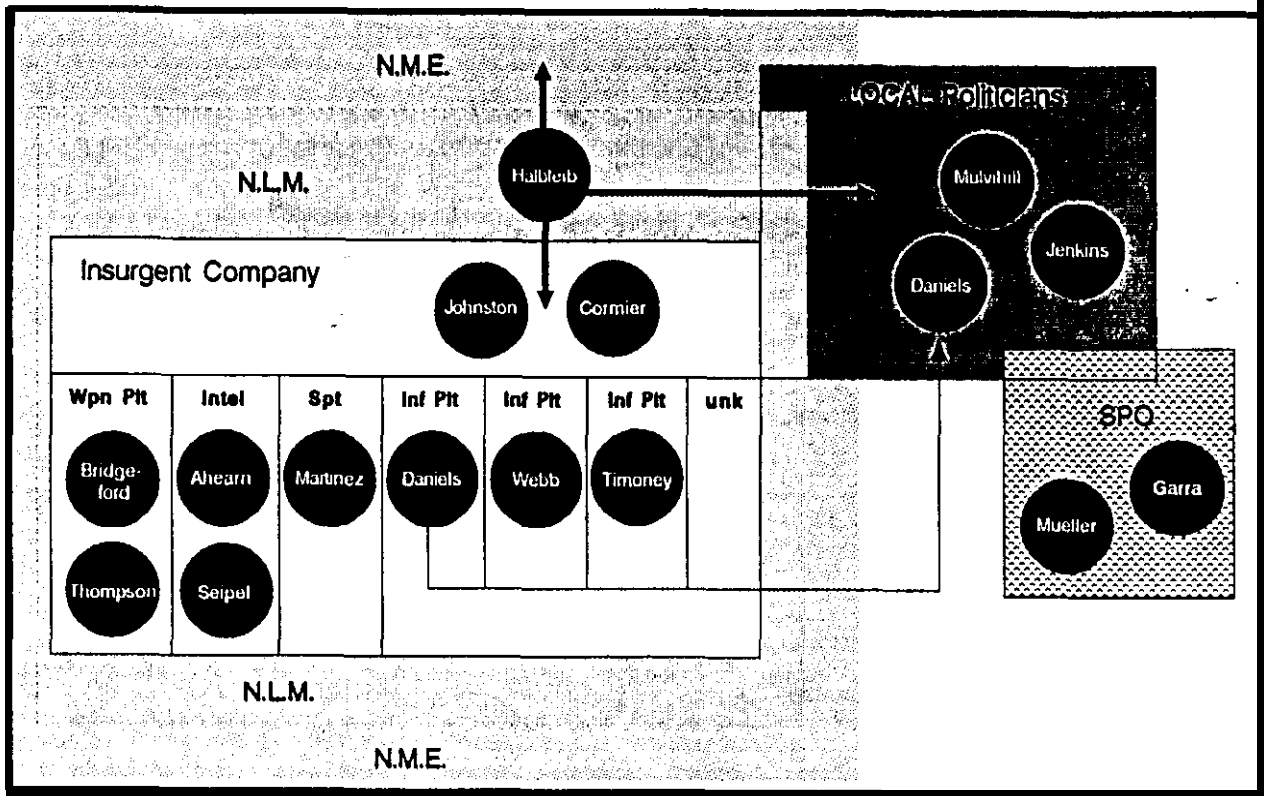

Figure 3-3-10. Link diagram.

To better illustrate the events that have occurred within the AO, the S2 section established a set of coordinates registers. Coordinates registers aid in pattern analysis and help build doctrinal templates from scanty intelligence databases: This coordinates register page shows activities around the town of Macomb, one of the biggest "hot spots" (Figure 3-3-11).

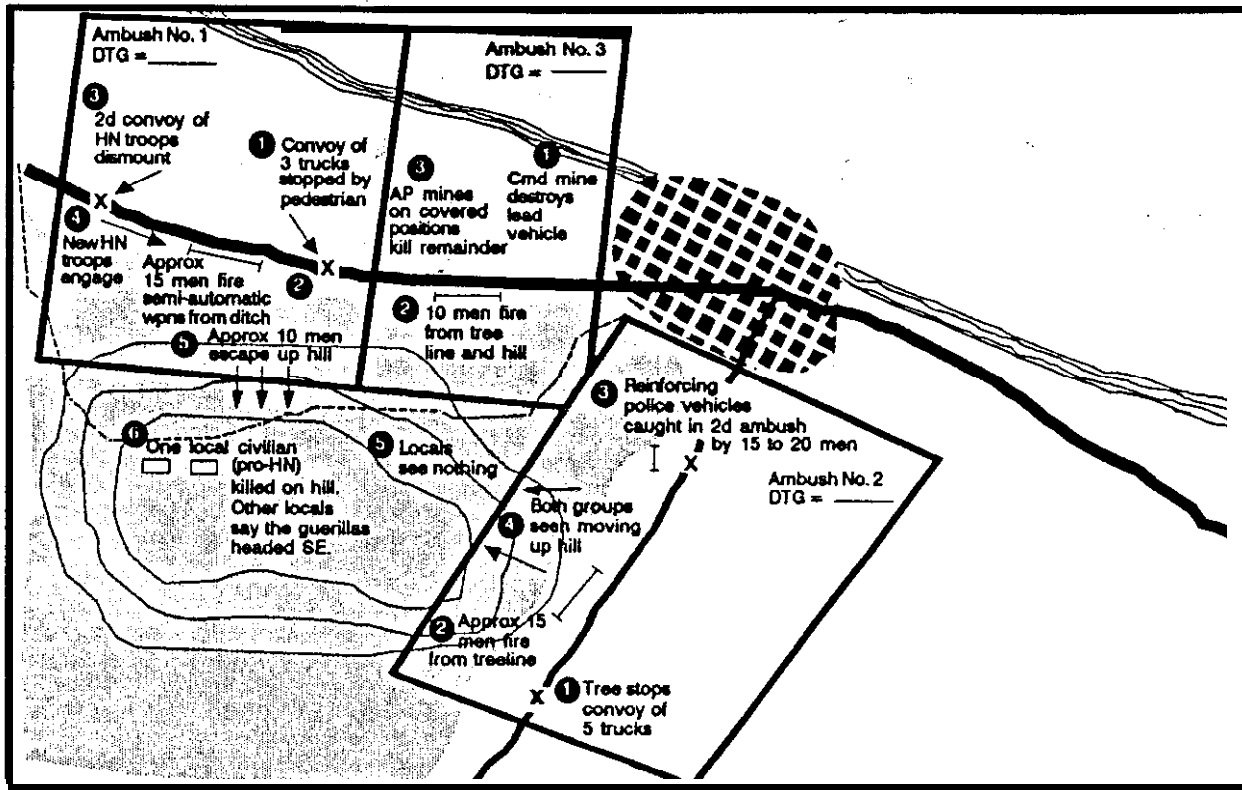

Figure 3-3-11. Coordinates register.

The S2 section also constructed a time pattern analysis worksheet to record the date and **time** of each serious incident. The rings depict days **of the** month, the segments depict hours of the day. Similar tools help distinguish patterns in activity that are tied to particular days, dates, or **times**.

figure 3-3-12  
new figure



After studying the coordinates registers, time pattern analysis worksheets and the associated intelligence reports, the analysts realize that the insurgent techniques for conducting ambushes have evolved over time. Each operation is more sophisticated than those that preceded it as the insurgents learn from their mistakes. To reflect the most current **"standard"** techniques, the section prepares doctrinal templates. The doctrinal template at Figure 3-3-13 shows the section's best **assessment** of the current procedures used by the insurgents during ambushes.

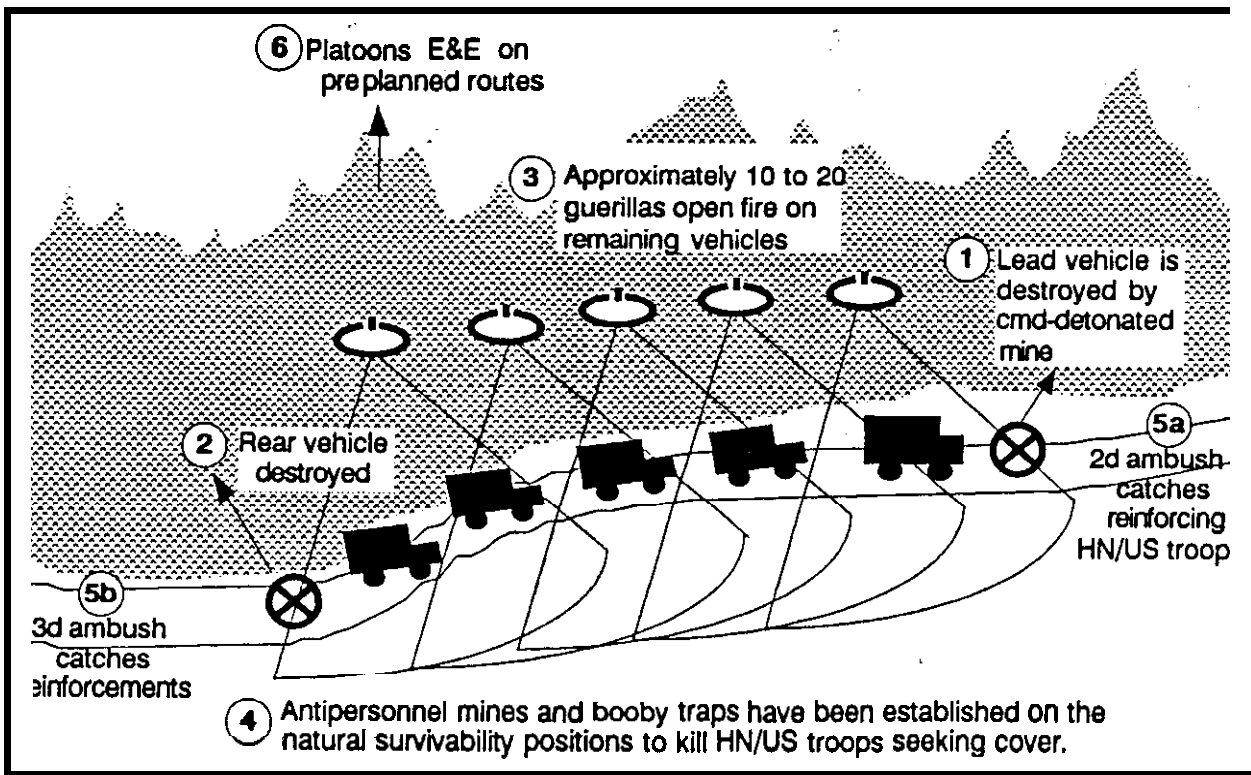

Figure 3-3-13. Doctrinal template for insurgent ambushes.

The section does the same for insurgent raids. The result is a doctrinal template that depicts current **"standard"** techniques for raids **on** facilities or installations (Figure 3-3-14).

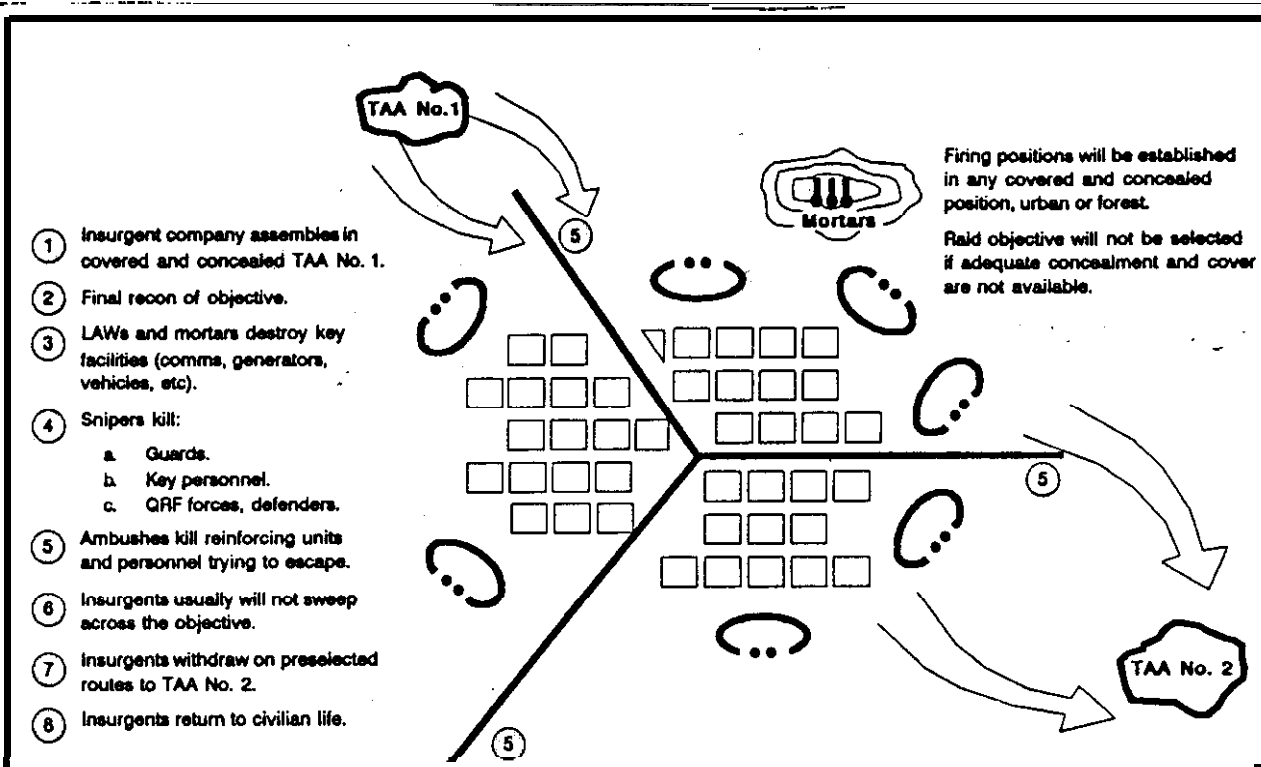

Figure 3-3-14. Doctrinal template for insurgent raid.

To study the Metropolitanian threat the **S2** section only received an a-year-old Defense Intelligence Agency handbook, some sketchy reports on recent training exercises,, and some educated assessments by analysts at the division and **regimental** levels., The battalion **S2** integrated the results of his **analysis** of these products into the doctrinal template (Figure 3-3-15).

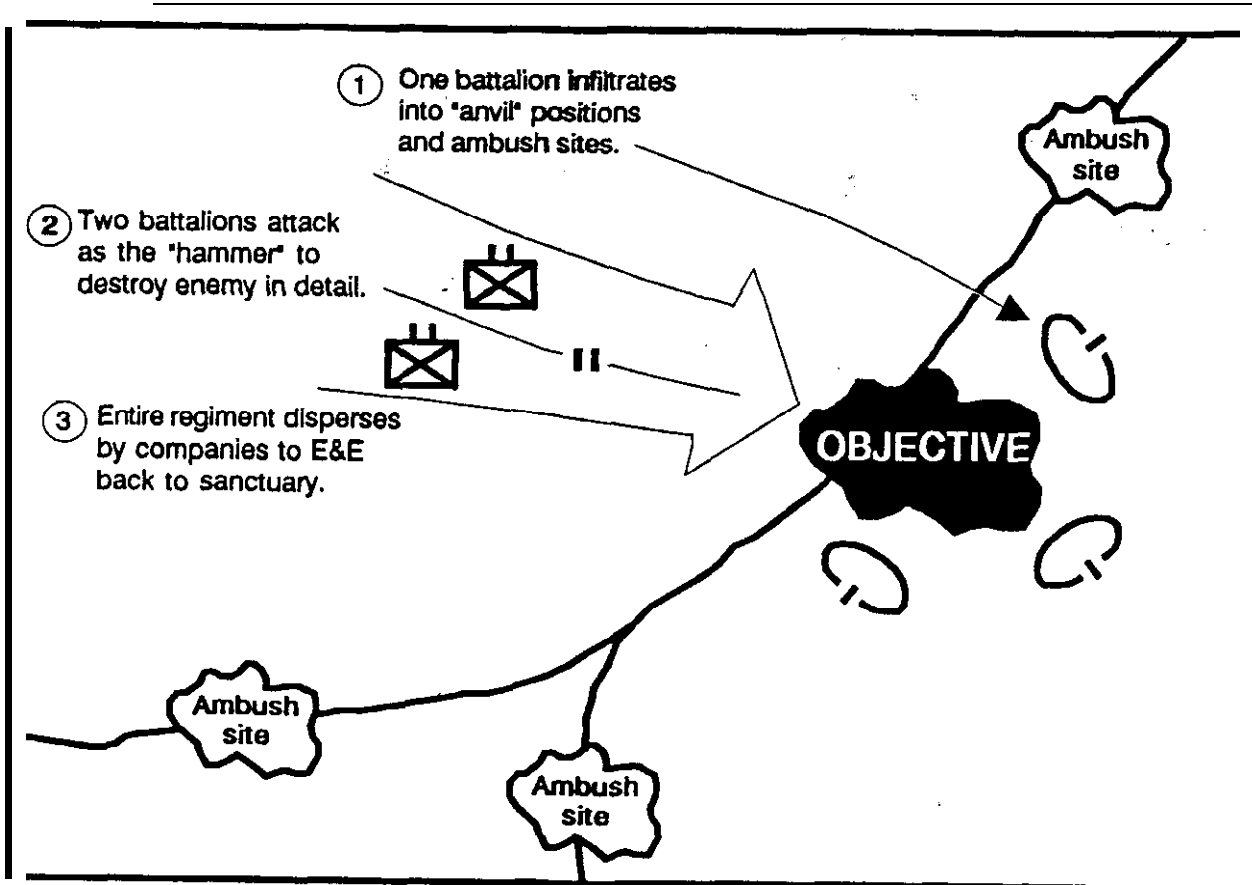

Figure 3-3-15. Doctrinal template for Metropolitanian attack.

DETERMINE THREAT COURSES OF ACTION

Having finished the initial three steps of IPB, the S2 section turned to determining **enemy COAs**. The section focused its efforts around a reliable **and credible** intelligence report that narrowed guerrilla targets down to incoming .US Army personnel and government forces within areas sympathetic to the host nation.

The **S2** prepared a situation template depicting likely insurgent **COAs**. He did this by integrating his IPB products depicting population status, availability of concealment and cover, **and** potential ambush sites **with the** threat model developed in the previous step.

In this case, the situation template takes the form of a key facilities and targets overlay, sometimes known as a "trap map," which shows likely targets for the insurgents (Figure 3-3-16). The S2 also included in the situation template the areas most likely to be used by an assembling insurgent company, and the infiltration routes between the objective sites and the assembly areas. This situation template also shows the safehouses that "wanted" personnel will probably use between insurgent operations.

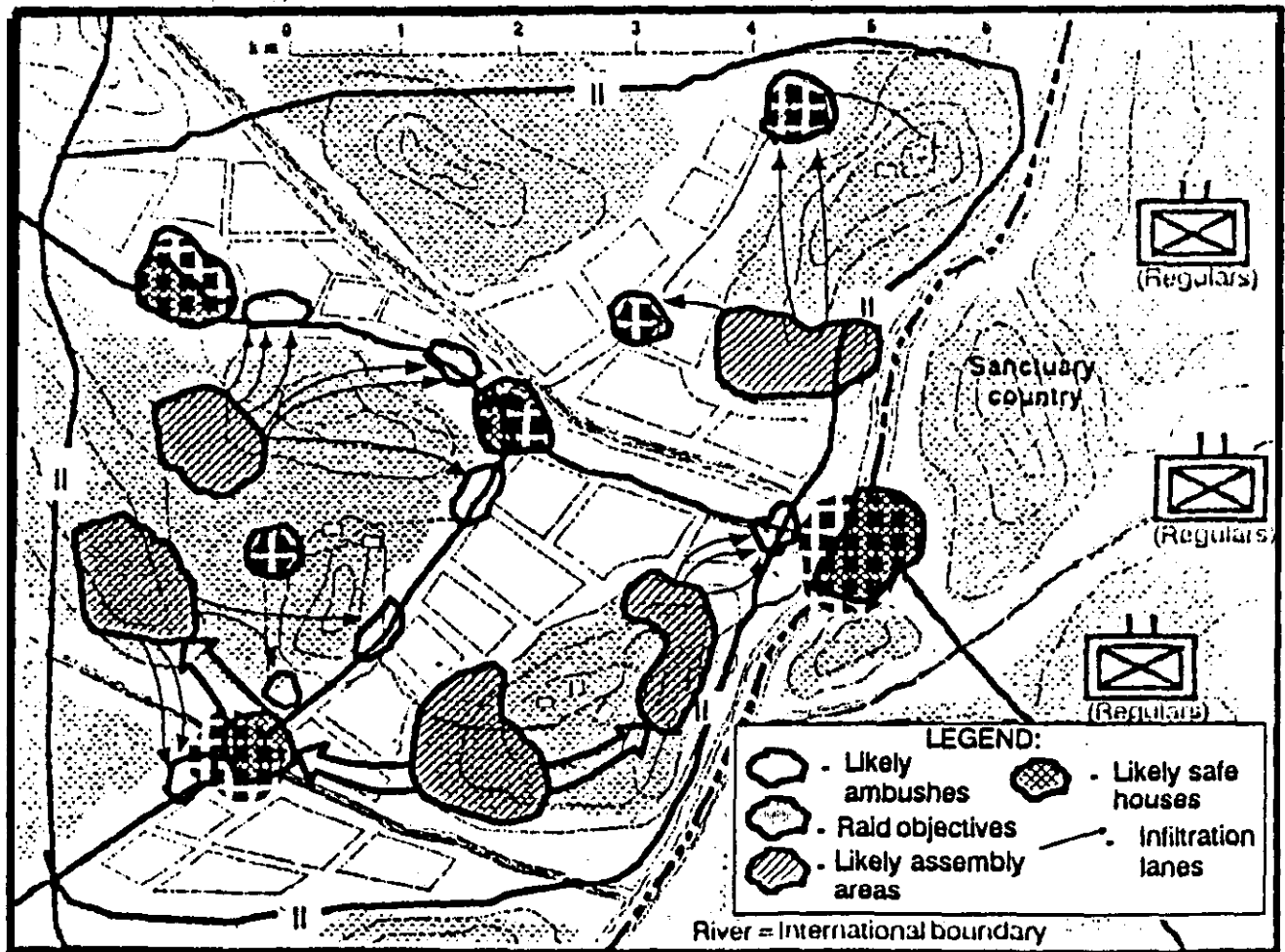

Figure 3-3-16. Situation template for insurgent ambushes.

Although an attack by the **Metropolitanian** infantry regiment is unlikely, the **S2** must evaluate all reasonable threats to mission accomplishment. He develops a situation **template showing** three **COAs** available to the NME infantry regiment should it decide to attack (Figure 3-3-17). All three **COAs** are predicated on the assumption that the friendly battalion will locate itself in one of the three objective areas and that the destruction of the battalion will be the Metropolitanian objective (Figure 3-3-17).

In all three **COAs** the Metropolitanian attack will be preceded by the infiltration of 'one battalion to establish "**anvil**" blocking positions. The remaining two battalions will attack abreast as the "**hammer**" to destroy the 2d Dattalion, 9th Infantry (L), forces within the objective areas.

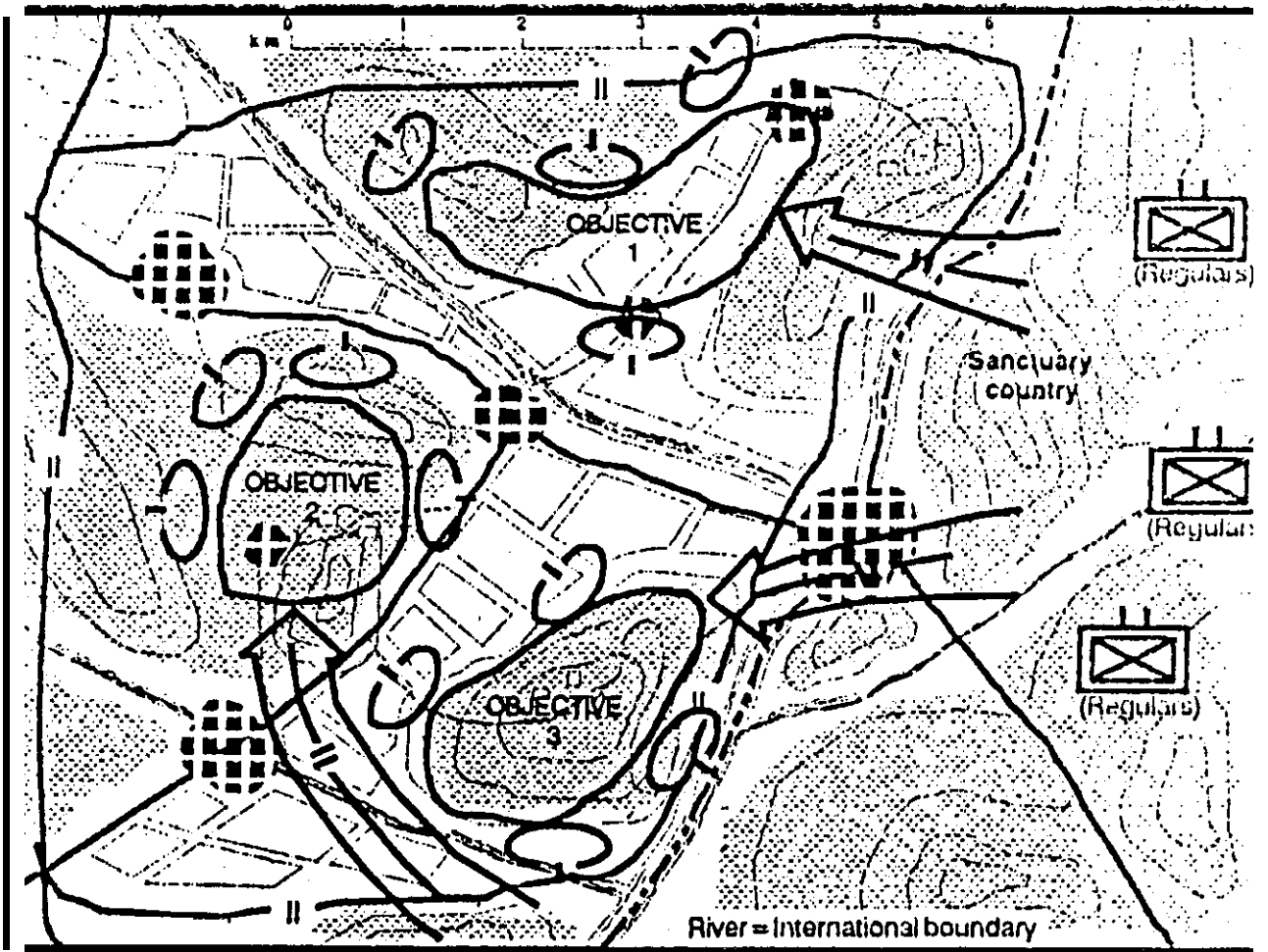

Figure 3-3-17. Situation template for Metropolitanian attack.

The **S2** section develops an event **template** that supports intelligence collection against the insurgent **COAs** and those of the Metropolitanian infantry regiment (Figure 3-3-18). The relatively limited number of **NAIs** made this possible. Alternatively, the S2 could have used a separate event template for each type of enemy threat.

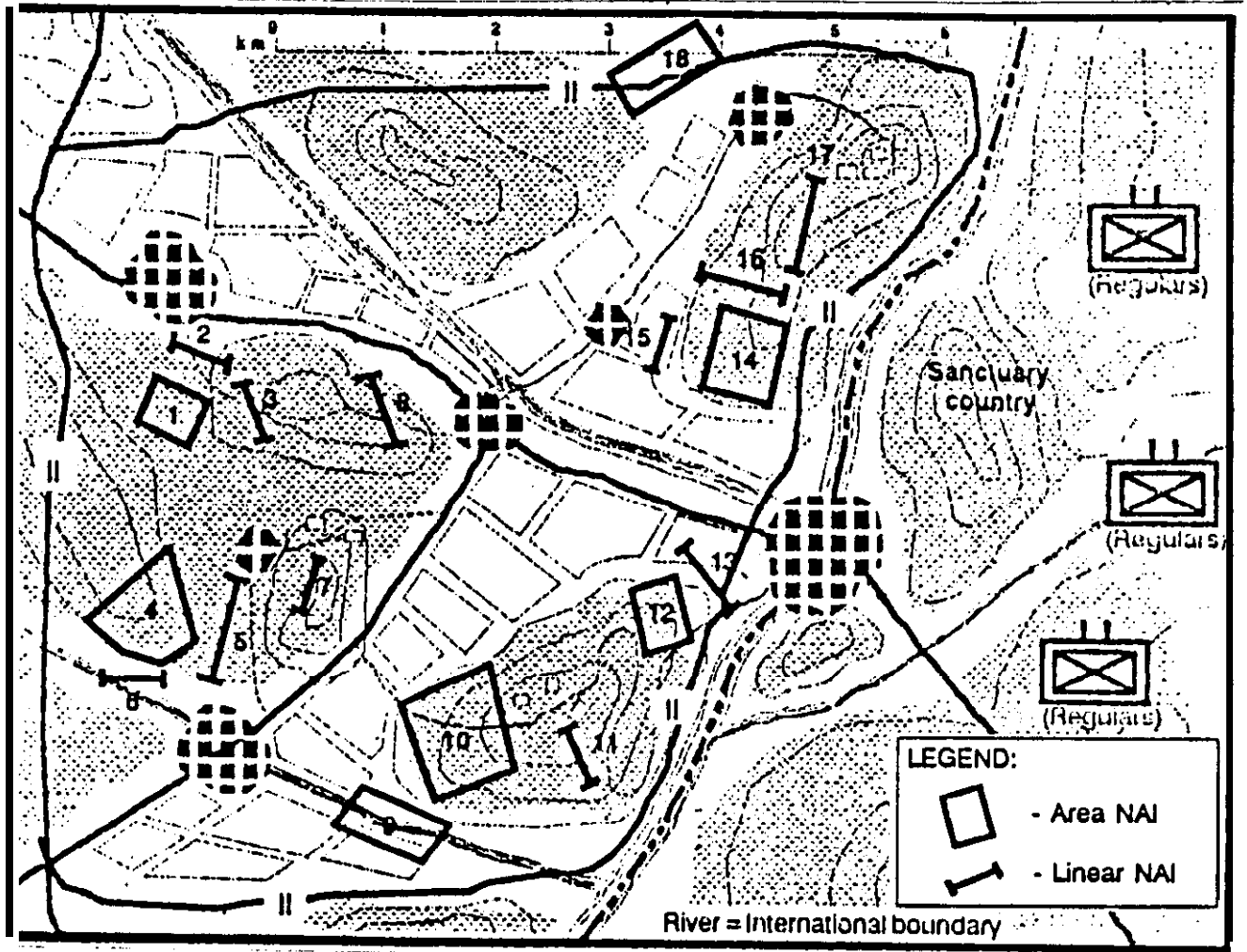

Figure 3-3-18. Event template.

To further aid collection planning, the **S2** developed an event matrix indicating the type of **activity** in each NAI (Figure 3-3-19). Cross-reference to the COA **that each** NAI and activity indicates allows the S2 to quickly determine **which** COA **the enemy has adopted.**

NAI	EXPECTATION	
	Insurgent Company	Regimental Attack
1	Insurgent TAA	
2	Infiltration/exfiltration lanes	
3	Infiltration/exfiltration lanes	
4	TAA	
5	Infiltration/exfiltration lanes	
6	Infiltration/exfiltration lanes	
7		Movement corridor for attack on objective 2
8	Infiltration/exfiltration lanes	
9	Movement corridor for assembling platoons	Movement corridor for attack on objective 2
10	TAA	
11	Infiltration/exfiltration lanes	
12	TAA	Movement corridor for attack on objective 3
13	Infiltration/exfiltration lanes	Movement corridor for attack on objective 3
14	TAA	
15	Infiltration/exfiltration lanes	
16	Infiltration/exfiltration lanes	
17		Infiltration lane for attack on objective 1
18		Possible "anvil" BP for attack on objective 1

**Figure 3-3-19. Event matrix.**

Based upon the initial set of IPB products, the battle staff completes the decision making process. As planning for the operation continues, the **S2 continues to** update his IPB products based on the intelligence received. As intelligence confirms or denies his initial evaluations, the **S2** refines and updates his IPB. As necessary, **members** of the staff meet to reevaluate the developing friendly COA in light of the **S2's** updated IPB and intelligence estimate.

Scenario Four: **Noncombatant Evacuation**

Following intense political debate over an issue of regional politics, civil war has broken out on the island nation of Lilliput. **With** most of the **island** divided between them, the two rebel factions **now** confront each other--and the remaining government police forces--over control of the capital city of Gulliver (Figure 3-4). Fighting has died down while negotiations **aimed at** a peaceful transfer of the governmental center open. But all sides involved **in the** conflict patrol the fringes of the contested area, and **there** are still occasional armed clashes.

Hemmed in **by the** two warring factions, the otherwise ineffectual government forces have thus far managed to hold **the** capital city and safeguard the American citizens living there. The Lillipution president has requested US evacuation of its citizens because he feels his forces will surrender to the first of the two factions to make a renewed assault on the city center, should negotiations collapse.

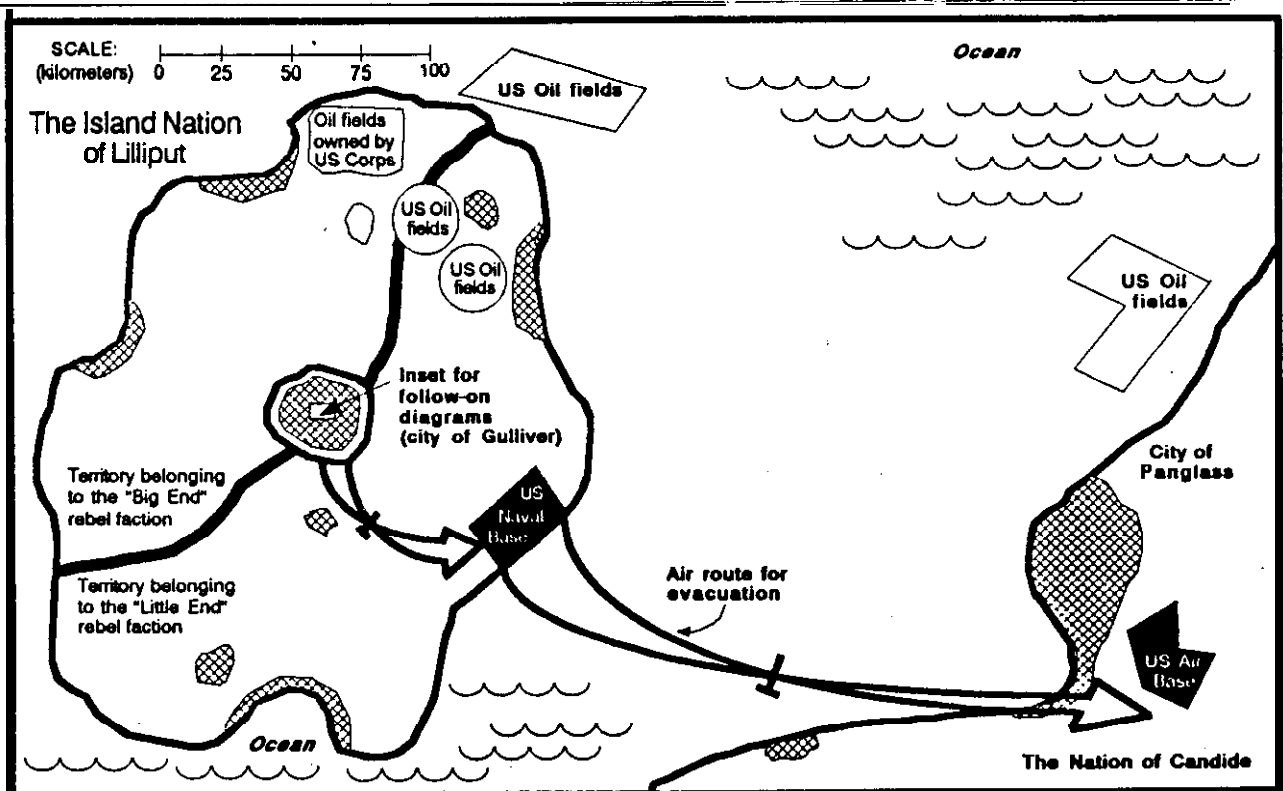

Figure 3-4. Scenario 4, general situation.



Our division has been ordered to evacuate American citizens from the capital of the island nation.

Neither of the two **warring** factions has displayed any openly anti-American sentiment. **The greatest** threat to the noncombatant evacuation operation (NEO) is posed by the resumption of fighting between the two factions. There is also a risk of interference by groups of anti-American student activists-from **the city's** university.

DEFINE THE BATTLEFIELD ENVIRONMENT .

Our brigade (the 1st Brigade) is assigned responsibility for the center of the city itself. The brigade's boundary identifies the limits of its **AO** (Figure 3-4-1).

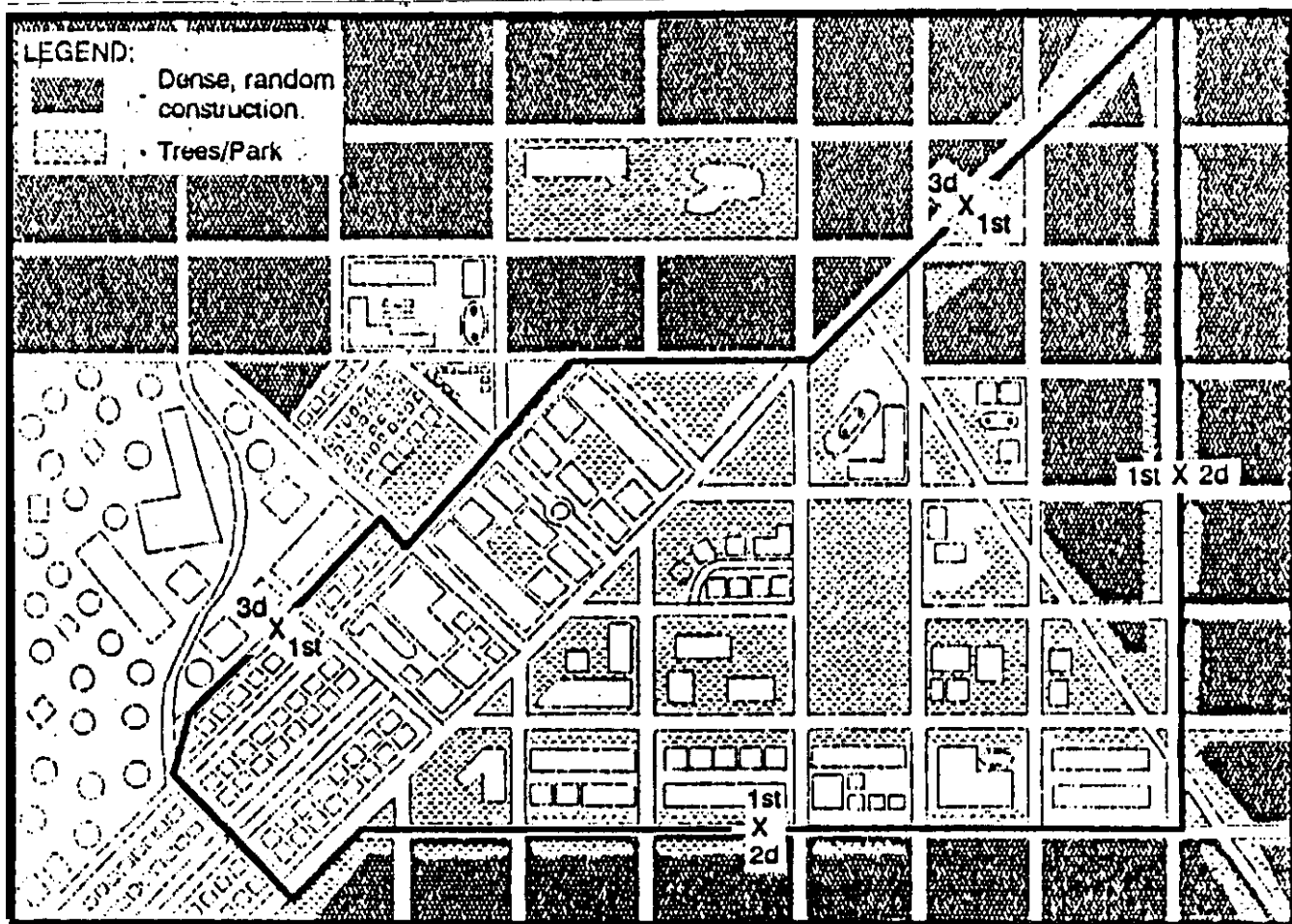

Figure 3-4-1. The area of operations.

The AI includes our routes of ingress and egress in addition to any likely threats to the mission (Figure 4-4-2). Due to the nature of the operation and the battlefield environment, most of the city is included in the AI.

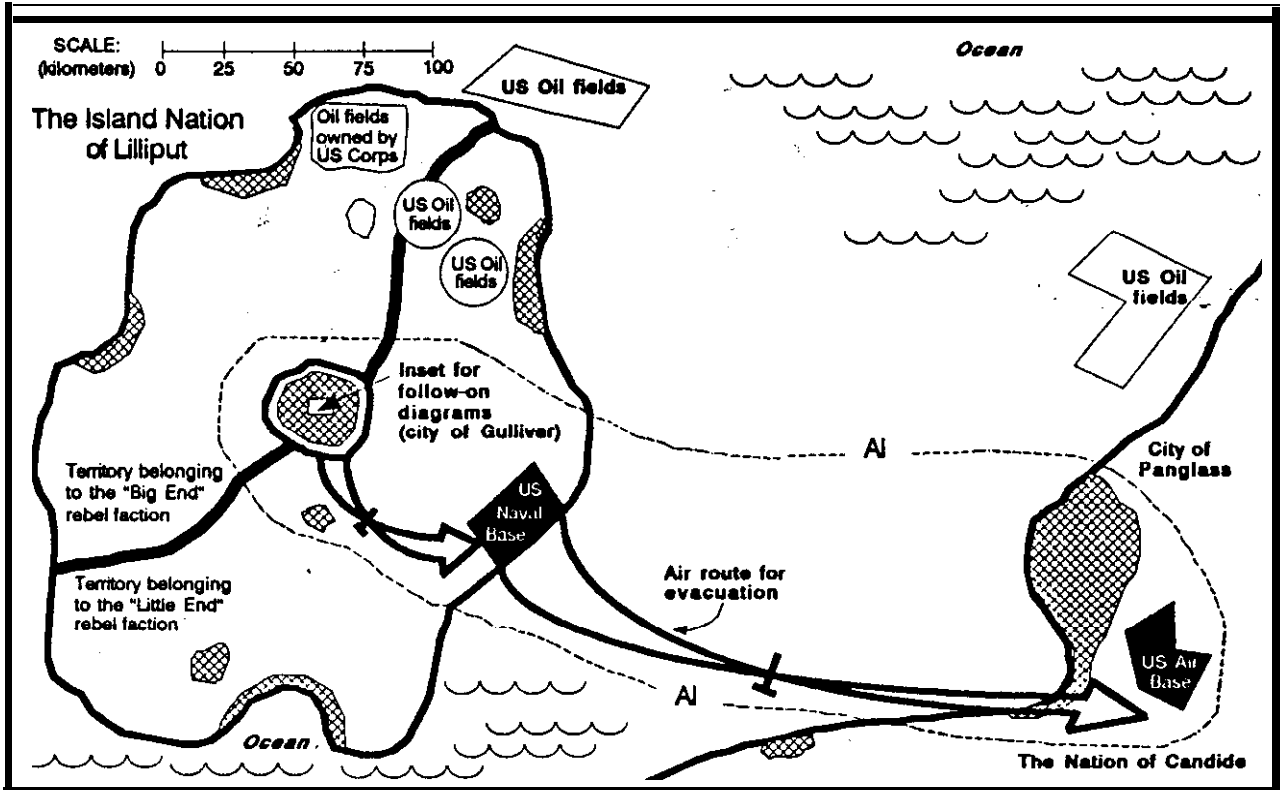

Figure 3-4-2. The area of interest.

The nature of the operation requires us to include several other factors into the definition of the battlefield environment. The politics of the capital city and its populace will have considerable impact on the ease with which we can conduct the operation. The interactions between the two rival **forces**, and their interaction with US forces and diplomats, are also critical aspects of the definition of the battlefield environment. Should the negotiations occurring within the governmental center collapse, full-scale hostilities between the two rebel factions would likely resume, regardless of the risks to US citizens. Additionally, we must consider the role of the US country team, and the missions and activities of any friendly special operations forces that may be operating within the area of interest.

DESCRIBE THE **BATTLEFIELD'S** EFFECTS

The nature of the operation requires a focus on the populace of the city and their political affiliations. This form of population status overlay allows us to identify areas where US citizens may be more or less at risk (Figure 3-4-3).

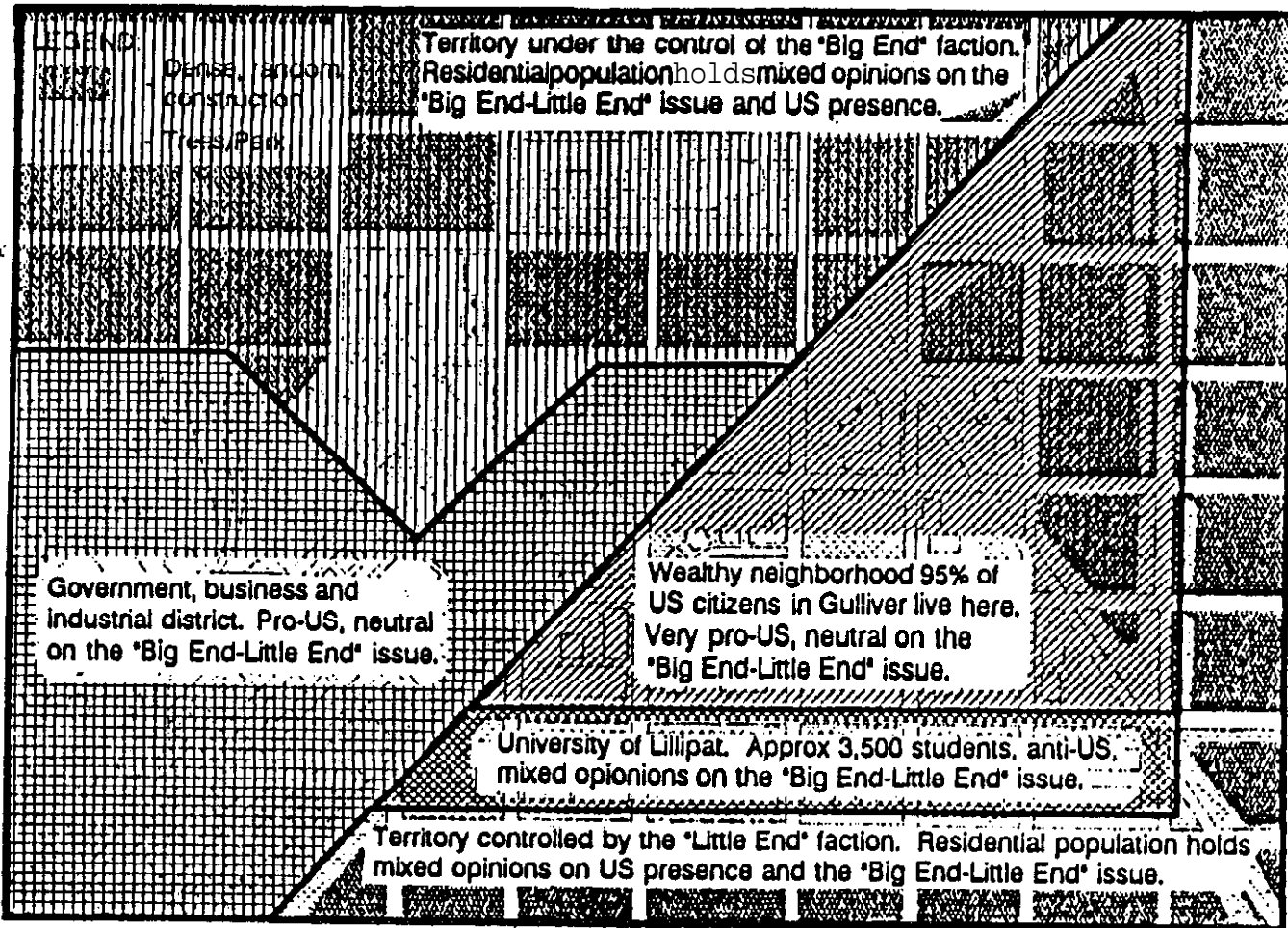

Figure 3-4-3. Population status overlay.

We examine how the battlefield environment will affect our courses of action as those of the "threat". We start with an evaluation of potential zones of entry (helicopter landing zones (Figure 3-4-4)). With this we integrate an evaluation of areas suitable for use as assembly or "holding" areas for large numbers of civilians while they await evacuation.

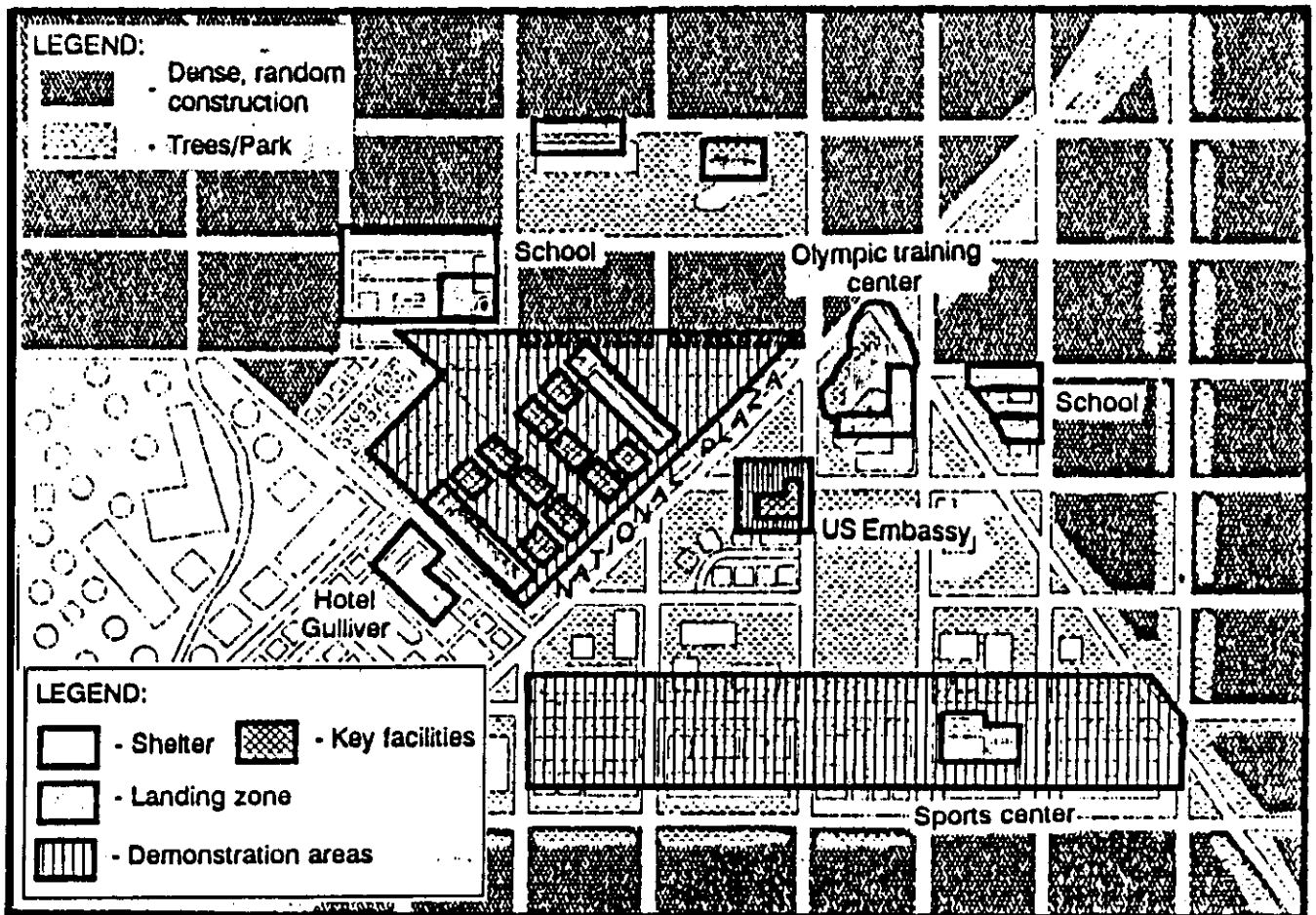
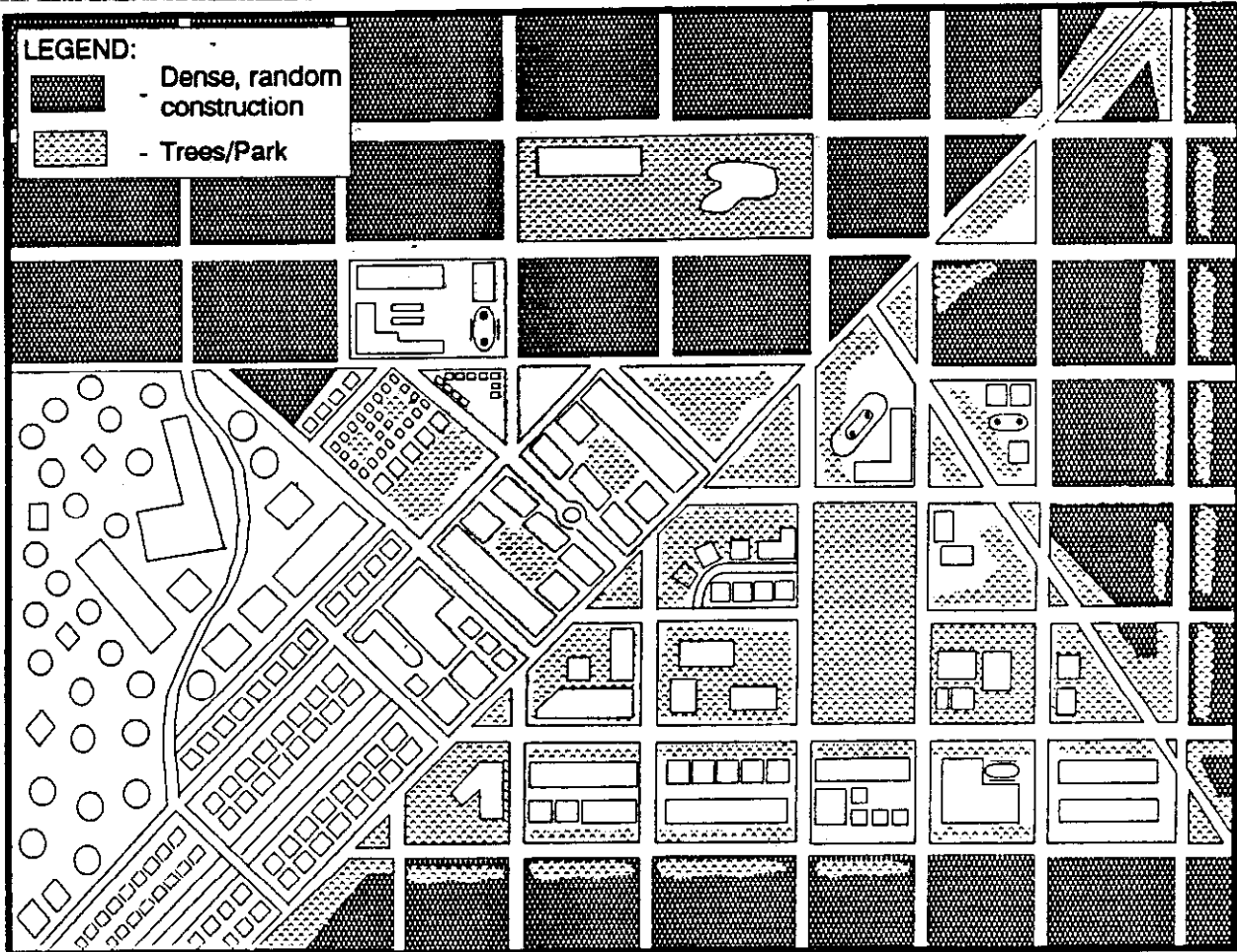

Figure 3-4-4. Zones of entry.

In urbanized terrain, the buildings themselves are the most dominating aspect of the terrain. We evaluate the type of building construction within our AI to determine its likely effects **on operations** (Figure 3-4-5). Building construction affects mobility, concealment and cover, and observation and fields of fire.



**Figure 3-4-5. Building and construction types.**

Although both rebel **forces are** now using roads to conduct their patrolling activities, we evaluate other suitable avenues of approach. The areas with densely constructed woodframe buildings offer the best general avenues of approach for dismounted-infantry (Figure 3-4-6). The nature **of the** construction type in these areas may permit the rebels to form their own infiltration lanes **by** knocking holes in the walls of adjoining buildings; **allowing** them easy movement under cover. Additionally, the dense construction also makes the use of rooftop **avenues of** approach possible. Should full-scale hostilities break out, these areas may be the focus, of a rebel faction's operations aimed at securing control of areas under the control of the opposing faction.,

Should the government's police forces collapse, other avenues of approach might be used by either faction in a **"dash"** to seize the governmental center. These areas, such as the recreational parks, offer little cover but facilitate rapid movement by both dismounted infantry or the light trucks used by both rebel factions.

Control of the high-rise buildings in the city center will give our forces the best observation points within our **AO** and over the areas contested by the two rebel **factions**.

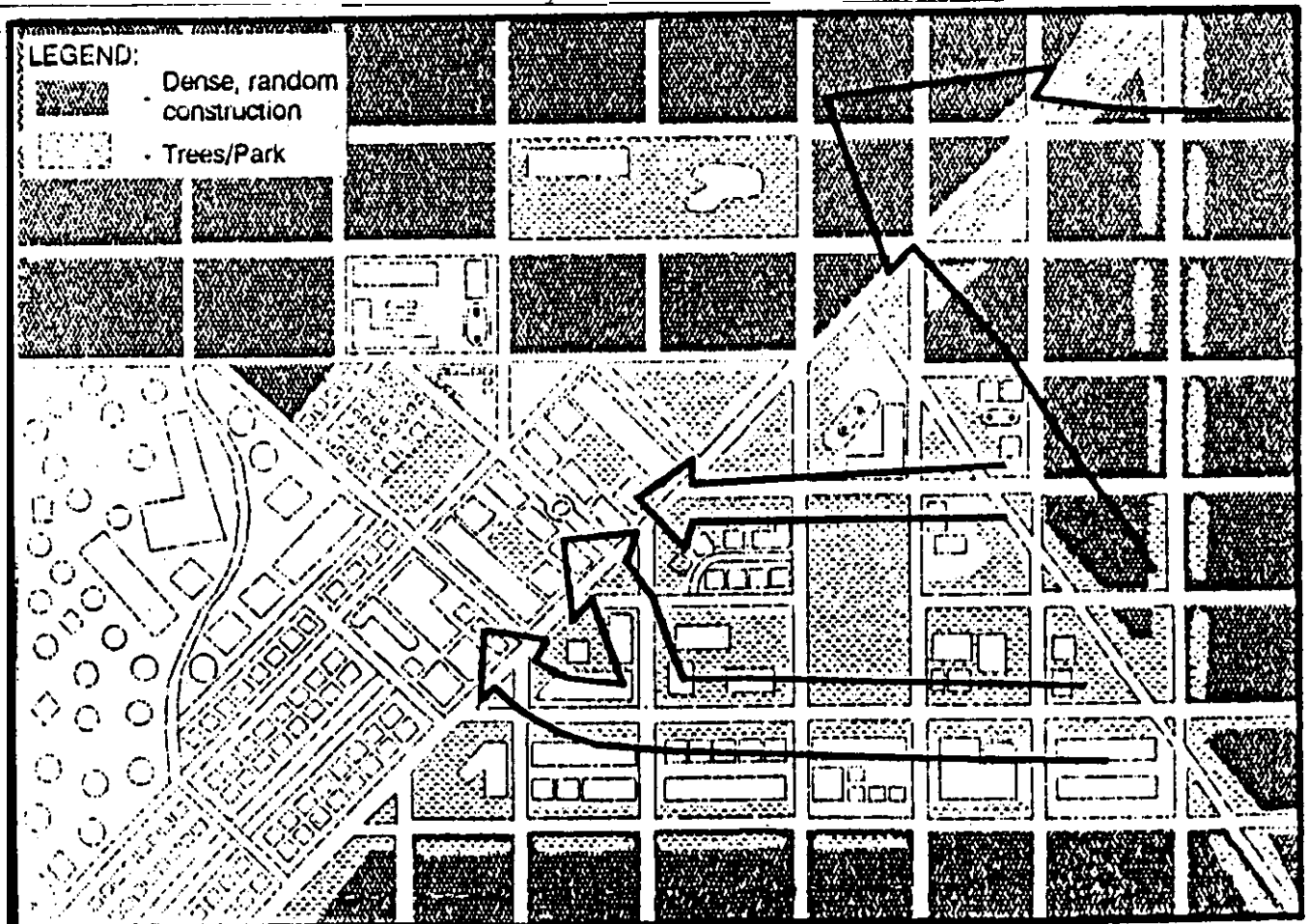

Figure 3-4-6. Avenues of approach.

FM 34-130

Another consideration in urban terrain is the possible use of underground avenues of approach provided by subway and other 'under-street' utilities, such as sewer systems (Figure 3-4-7).

figure 3-4-7  
new figure  
subways and sewers

*KK  
new figure  
ignore*

EVALUATE THE **THREAT**

We begin with an examination of the little we know about the rebel forces and activist student organizations within the country (Figure 3-4-8).

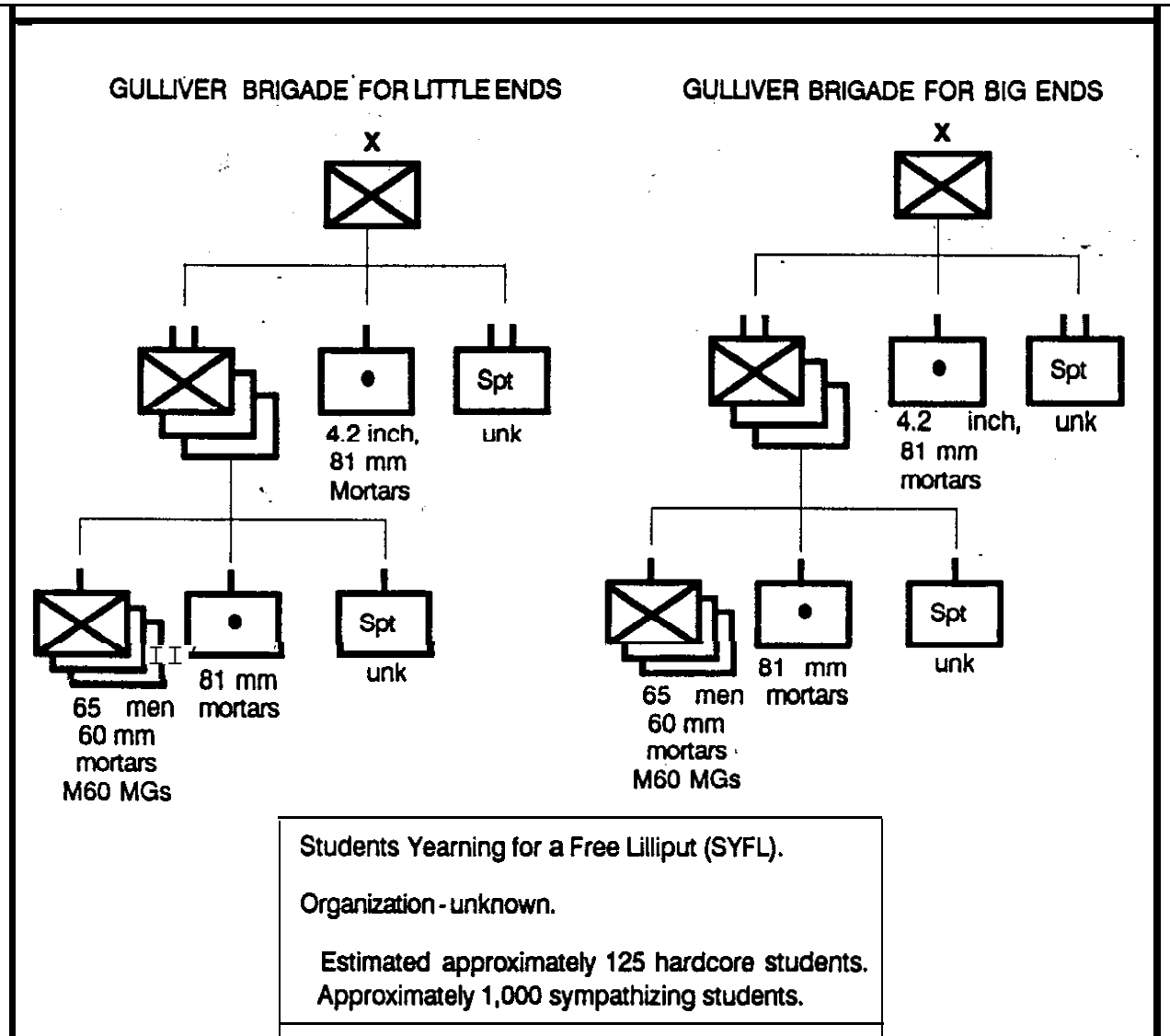

**Figure 3-4-8. Enemy organizations.**



In order to develop threat models, we examine the operations the rebel forces have conducted in the recent past (Figure 3-4-9). Although we use all available information, we **focus** on their operations within the capital city itself. This allows us to account for any peculiarities in their "normal" tactics caused by the political battle for control of the capital.

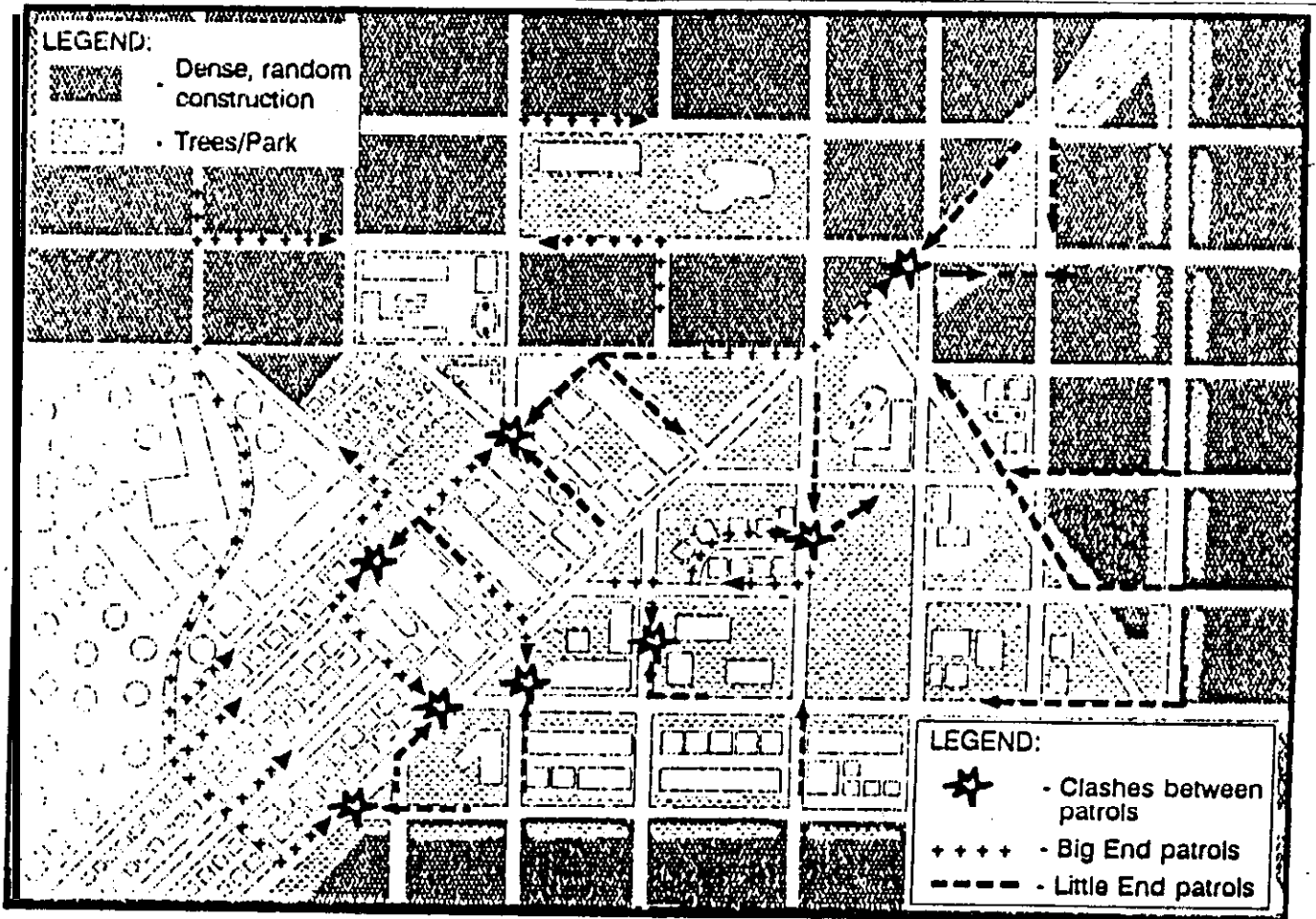

Figure 3-4-9. Situation map.

We also conduct a time-pattern analysis to determine the periods of highest threat to the evacuation operation. Patterns show up on the wheel as **"funnel"** shapes (Figure 3-4-10). Knowing the times of highest threat allows the commander to plan critical stages in the operation, such as the movement of non-combatants, for "low-threat" periods.

figure ~~3-4-10~~  
new figure  
time pattern wheel

Evaluating the **information available**, we construct a doctrinal template for the operations of both rebel groups,, which are similar (**Figure 3-4-11**). In the margins we include a description of their normal tactics and reactions, as well as **HVTs** to **complete** the threat model.

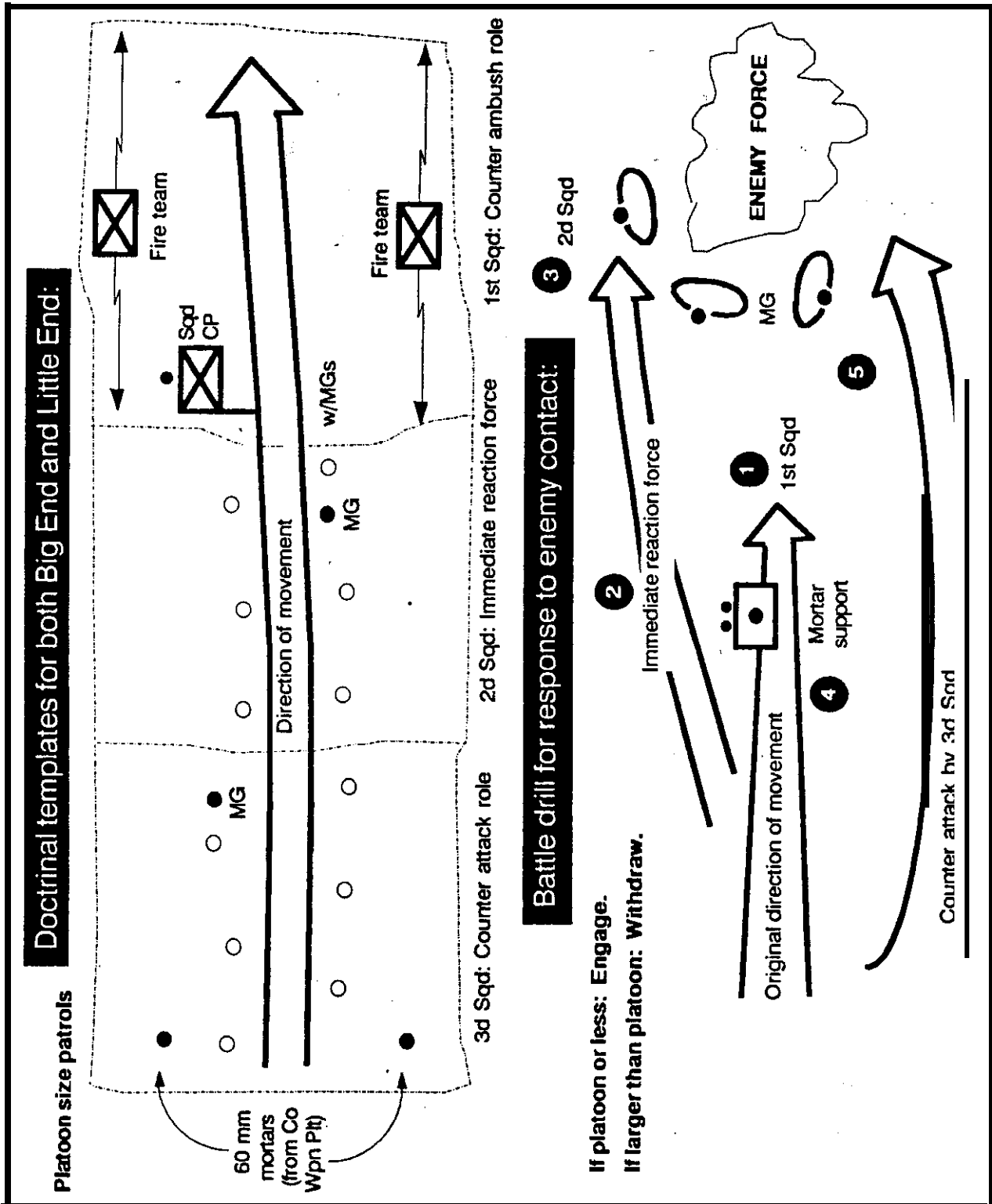

Figure 3-4-11. Threat model of militia operations.

We use similar techniques to template the activities of student demonstrators. Although more difficult, we are able to prepare a graphic depiction of their normal "operations" (Figure 3-4-12).

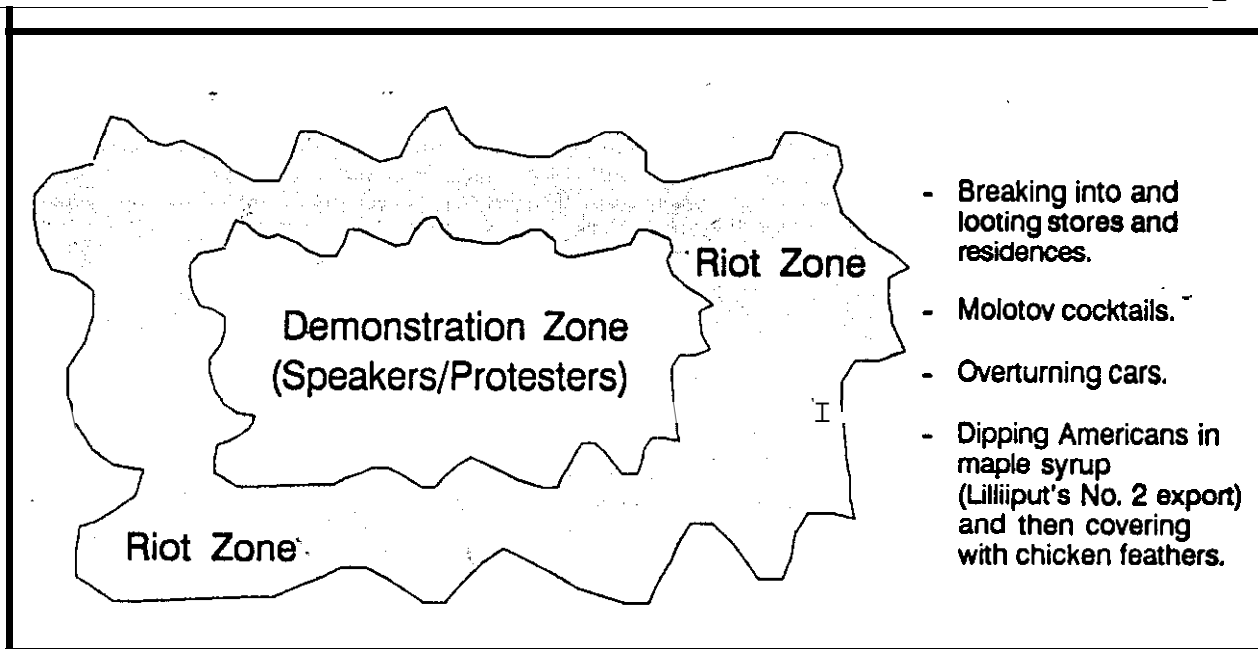

Figure 3-4-12. Threat model of student activities.

DETERMINE THREAT COURSES OF ACTION

We construct a situation template based on the threat models and patterns of recent activity (Figure 3-4-13). It focuses on likely clashes between the two rebel factions and possible demonstrations by the student activists, the most likely threats to accomplishment of our mission. Like a more traditional situation template, the staff uses it during wargaming to evaluate friendly **COAs** against the potential threats to mission accomplishment.

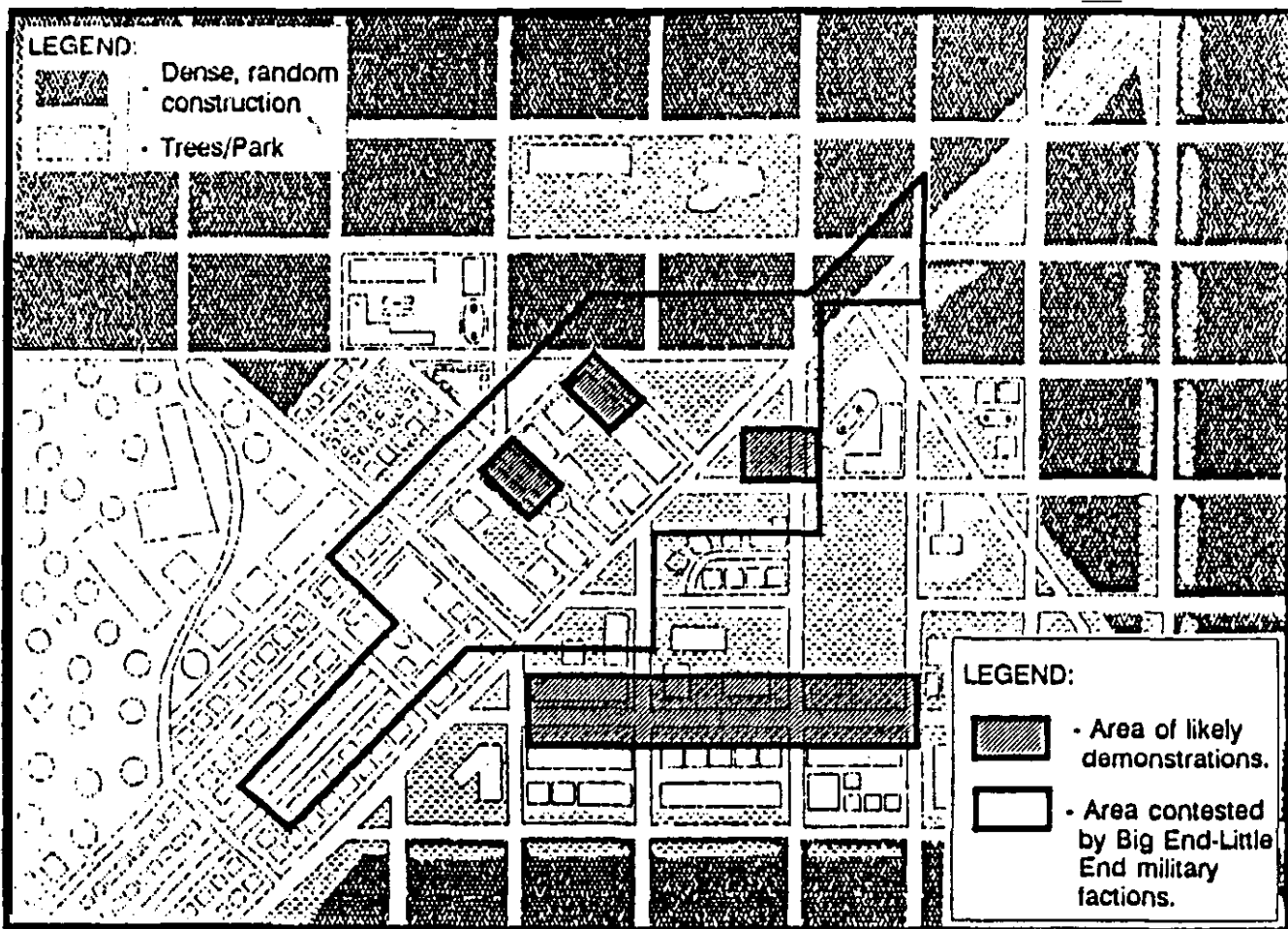

Figure 3-4-13. Situation template depicting threats to the mission.

The situation template forms the basis for the event template. In this case, the event template depicts **NAIs** that will alert us of impending clashes between the rival military factions or demonstrations by the students (Figure 3-4-14). The status of the negotiations **within the** governmental center are included on the event template and in our collection planning, since progress or failure there has a direct bearing on the **activity of the two rebel factions.**

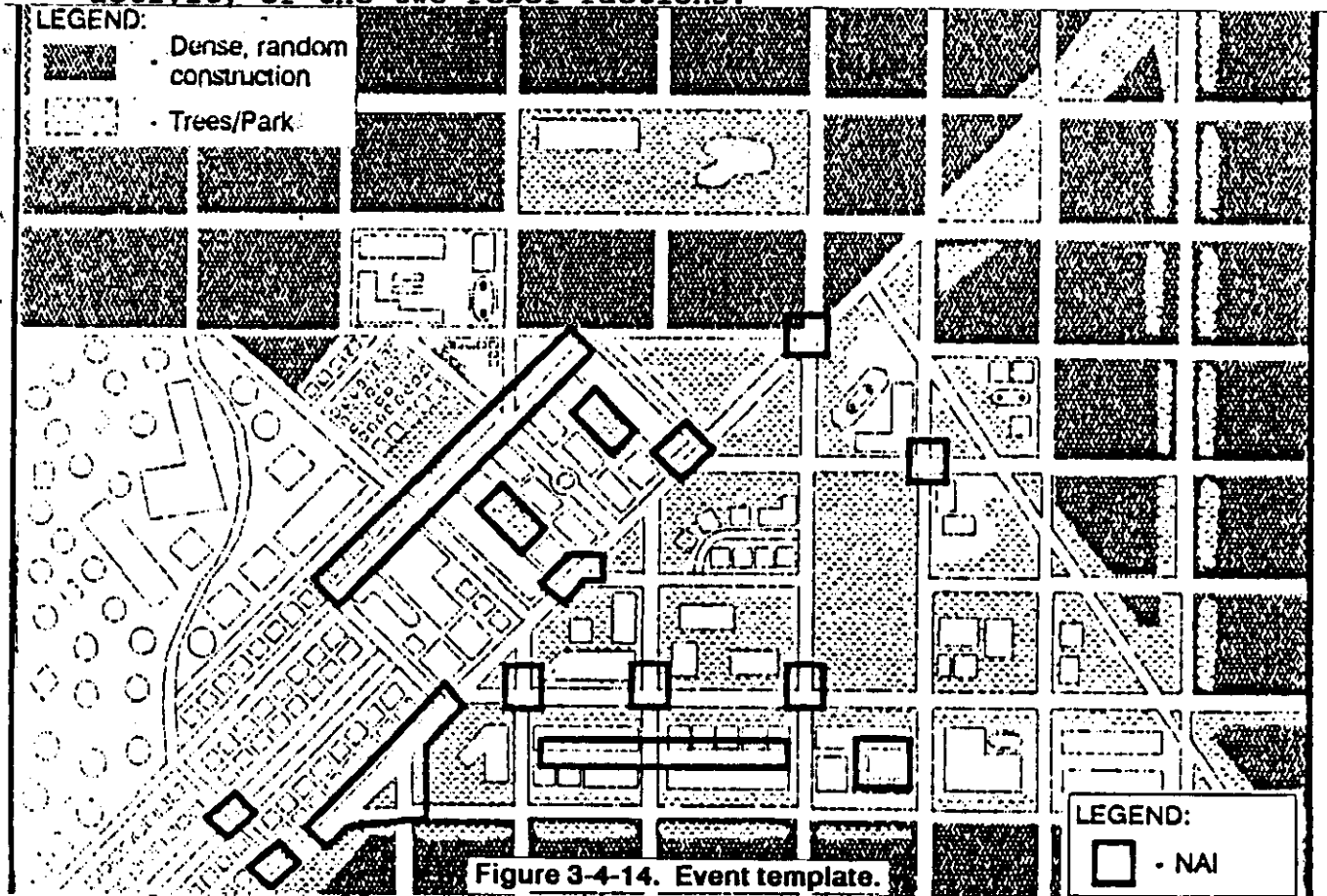

Figure 3-4-14. Event template.

As the staff completes the command estimate process and begins planning and executing of the friendly COA, we evaluate incoming intelligence against the event and situation templates to quickly identify developing threats. As incoming intelligence confirms or denies the accuracy of our initial assessments and evaluations, we continue to refine and update our IPB.



**Describe the  
Battlefield's Effects**

- o Altitude capabilities of threat aircraft.
- o Range capabilities of tactical ballistic missiles.
- o Flight profiles of tactical ballistic missiles.

As usual, this effort focuses on the effect of the battlefield **on threat** and friendly operations. Specific considerations include--

- o Probable target installations or areas. Where are the threat's likely targets located?
- o Likely air avenues of approach. Do they provide ease of navigation? Do they provide protection to the aircraft from radars and weapons? Do they allow evasive maneuver? Do they allow for the full use of aircraft speed? Do they support ground force operations?
- o Likely landing or drop zones. Are they near likely objectives? Do they provide concealment and cover to the delivered forces? Do they allow easy aircraft ingress and egress?
- o Likely standoff attack orbits.
- o Lines-of-sight from proposed ADA weapon locations.
- o Limiting and success-inducing effects of weather on air operations.
- o Expected times on target based on weather effects or light data.

---

Evaluate the Threat

---

Air defense units and staffs focus on threats posed by:

- o Unmanned aerial vehicles;
- o Missiles (cruise and ballistic);
- o Fixed wing aircraft;
- o Rotary wing aircraft; and,
- o Airborne and air assault forces.



In addition to the broad range of **OB** factors and threat capabilities air defense staffs and units evaluate--

- Flight operations tactics.
- Ordnance types and availability.
- Ordnance delivery techniques such as standoff ranges, release speeds and altitudes, and guidance system.
- Technical capabilities of aircraft such as all-weather or night capability as well as maximum and minimum speeds, ceilings, range, payloads (in terms of ordnance, numbers of types of equipment, or passengers), and aerial refueling capability.
- Target selection priorities for air strikes or attack by air assaults.
- Air strike allocation procedures.
- C<sup>3</sup> procedures and techniques.
- Navigation capabilities.
- Threats to friendly ADA assets, including threat ground forces and EW assets.

<p><b>Determine Threat Courses of Action</b></p>
--

The threat's air activities will be a part of his overall operation. Therefore, begin determining air courses of action by acquiring the supported command's basic IPB products, including situation templates. Evaluate the general courses of action they portray and determine how the threat might support them with air power. Do not attempt to determine air courses of action in isolation from the maneuver forces they support.

The employment flexibility of modern aircraft makes the determination of specific **COAs** extremely difficult. Nevertheless, you should consider--

- Likely locations of forward area arming and refueling points.
- Likely timing of air strikes or air assault operations (best presented in a matrix format, see Figures 3-2-6 through 3-2-9 in Chapter 3).
- Likely targets and objectives. Will the threat attempt destruction or neutralization?
- Likely air corridors and air avenues of approach.
- Strike package composition, flight profiles, and spacings in time and space, including altitudes (best presented in a matrix format).

- o Where do friendly air defense assets fit into the threat course of **action**? Do they need to be destroyed or suppressed **to ensure** the operation's success?
- o Threat **ground COAs** that might require movement of friendly ADA assets.

.....  
Artillery

Define the  
Battlefield Environment

The **AO** and **AI** normally will be the same as those of the supported force.

Describe the  
Battlefield's Effects

Terrain

When evaluating the terrain's effects on operations, consider--

- o Areas best suited to artillery deployments, such as--
  - Accessibility to ammunition carriers.
  - Defilading and masking effects of terrain.
  - Security from Levels I, II, and III rear area threats.
- o Potential sites for target acquisition assets, both threat and friendly. Request or conduct line-of-sight studies as required.
- o Effects of terrain on munitions' effectiveness, such as soft sand, dense trees, or shallow bedrock.
- o Areas suitable for delivery of special purpose munitions such as artillery delivered mines, etc.

Weather

When conducting weather analysis, consider effects on target acquisition systems, target activity, and munition accuracy.

## Other Characteristics

Consider factors that are associated with rear area operations. See the sections on Counterintelligence and Rear Area and Combat Service Support in this chapter.

Evaluate the Threat
---------------------

In **describing** the threat--

- o Refine standard threat models to focus on **HVTs**.
- o Evaluate the threat's ability to fight the counter-fire battle:
  - Identify target acquisition assets; describe their normal deployment patterns and tactics.
  - Describe the capability of each target acquisition **system** in terms of accuracy and timeliness.
  - Identify the **command**, control, communications, and intelligence (C<sup>3</sup>I) **system** that moves target acquisition information to decision makers or weapon systems. Describe it in terms of efficiency and timeliness.
- o Describe the threat's ability to locate and destroy your target acquisition assets.
- o Use techniques associated with the rear battle to evaluate rear area threat to artillery units. See the sections on Counterintelligence and Rear Area and Combat Service Support in this chapter.

Determine Threat Courses of Action
------------------------------------

Start with the threat COA models developed by the supported force. Refine them to focus on--

- o **HVTs**. These will be further developed into **HPTs** during staff wargaming and the targeting process.
- o Dispositions and activity of threat fire support.
- o Dispositions of threat target acquisition assets.
- o Rear area threats to your units. Use the techniques discussed in the sections on Counterintelligence and Rear Area and Combat Service Support in this chapter.

- o Focus on threat **COAs** relevant to your commander, not the supported force commander (his **G2/S2** will do that). The **COAs** you focus on should deal primarily with counter-fire against your assets, force protection, and activities that will require your units to displace.

## Aviation

Define the  
Battlefield Environment

The air AI includes--

- o All threat radars or air defense weapons that can affect flight operations within the AO. Include threat airfields within range of the AO.
- o Possible flight routes outside the AO. These could support friendly forces, with coordination, or threat counter-air aviation assets.

Describe the Battlefield's  
Effects on **COAs**

Terrain

When evaluating the terrain, identify--

- o Potential battle positions. Consider:
  - Potential engagement areas.
  - "Danger **areas**" that optimize threat ADA system fields of fire.
  - Areas that mask threat radar and air defense systems.
  - Areas that provide good terrain background (ground clutter) effects.
  - Terrain shadowing effects.
- o Potential locations for landing or pickup zones, forward area arming and refueling positions, and forward assembly areas.
- o **Avenues of approach.** Consider:
  - Obstacles to flight such as power lines, towers, or rapidly rising terrain features.
  - Areas where birds gather.
  - Contaminated areas or other man-made obstacles.

- Areas that give threat air defense systems distinct advantages in covering air avenues of approach.
  - Concealed and covered routes into potential battle positions.
  - Routes that provide for ease of navigation.
  - Potential safe areas for downed pilots. Evaluate infiltration corridors.
  - Other effects on Army Aviation Command and Control planning.
- o Bear in mind that pilots usually think in terms of feet of altitude and degree of slope (instead of meters and percentage). Make the conversions for them.

#### Weather

Focus on conditions that affect flight in general and aircraft systems in particular. Do not overlook factors that affect target acquisition and night vision capabilities. Consider--

- o Density altitude effects on performance and payload.
- o Weather effects on threat air defense systems.
- o Effects of wind speed and turbulence on flight operations, especially in close terrain.
- o How wind speed and turbulence will affect target acquisition
- o Weather effects on target acquisition systems (for example, laser or infrared).
- o Restricting effects of low ceilings in air avenues of approach.
- o Conditions that may cause **"white out"** or **"brown out."**
- o Probability of icing.
- o Precipitation effects on forward area arming and refueling activities.

#### Other Characteristics

Consider any other aspects of the battlefield environment that may affect flight operations, such as--

- o Restrictions imposed by air space managers.
- o High intensity radiation transmission areas.

Evaluate the Threat

In describing the threat, identify--

- o Units supported by ADA assets.
- o The types of ADA systems and their capabilities, such as--
  - Maximum and minimum ranges.
  - Maximum and minimum engagement altitudes.
  - Minimum engagement times.
  - Type of fusing systems in use..
  - Effectiveness against our countermeasures.
  - Type radar associated with each system.
  - Number of **firing** units per radar.
  - Range capability of radar versus **weaponsystem**.
  - Minimum altitude restrictions on radar.
  - Ability of radar detectors (APR (1) or (2)-39) to detect the radar.
- o Other threats such as lasers or artillery fire zones.
- o Artificial illumination effects on target acquisition and night vision devices.
- o Target characteristics, such as--
  - Normal deployment patterns in march or attack order.
  - Capability to detect attacking aircraft.
  - Typical reactions when attacked by aviation.
  - **HVTs within** each formation.

Determine Threat Courses of Action

Refine the higher command's threat COA model in order to--

- o Include ADA system range fans.
- o Determine where radars or weapon **systems** are masked by terrain.
- o Identify areas with least amount of ADA coverage.
- o Identify likely threat air approaches to your engagement areas and battle positions.
- o Develop situation templates for threat actions within the engagement area; include reactions to aviation attack.
- o Identify threat units along flight paths; consider their reactions and develop the appropriate situation templates.
- o Consider threat reactions to downed pilots.

Counterintelligence and Counter-reconnaissance

Refer to FM 34-60 for a full discussion of the multi-discipline counterintelligence (MDCI) analysis process.

Define the  
Battlefield Environment

The **AO** normally remains the same as that of the supported unit. Expand the AI to include **the** access of the opposing threat force to the **intelligence assets** of higher echelons. For example, if a threat corps has reasonable access to space-based intelligence systems, then the AI should be expanded to include the appropriate orbits. Also consider launch sites for aerial collection assets.

Activities or characteristics of interest are any which affect the threat's access to human intelligence (HUNINT), imagery intelligence (**IMINT**), signals intelligence (SIGINT), and other collection capabilities.

Describe the  
Battlefield's Effects

In describing the battlefield environment--

- Identify the locations that best support collection coverage by threat collection systems. Consider ground based (observation or equipment positions) and airborne (standoff positions or orbits) assets.
- Identify approach routes for each type of system. Consider the unique needs of each type. For example, covered and concealed infiltration routes and landing zones for reconnaissance and surveillance units, high speed -air avenues of approach for airborne **IMINT** systems, etc.
- Identify the areas within the **AO** that offer friendly forces concealment from threat collection systems.
- Identify populated areas that would facilitate special or clandestine HUMINT operations.
- Identify the friendly units, locations, and information vulnerable to collection through the threat capture of US prisoners of war.
- Determine the effect of weather upon collection **systems**.

- Identify political, legal, and moral constraints upon collection efforts. For example, are there unique legal or religious circumstances that might inhibit collection operations?
- Identify the effect of local culture upon collection. For example, HDMINT collection efforts might be ineffective against a closed, ethnically distinct community.

Evaluate the Threat
---------------------

In describing the threat--

- Describe the threat decision making process. Include descriptions of the threat counterparts to--
  - The IPB process.
  - The command estimate process, particularly wargaming.
  - Techniques for selecting intelligence requirements.
  - Collection planning and collection management.
  - Asset reporting system.
  - Intelligence processing architecture.
  - Dissemination procedures.
- Estimate the standard lengths of the threat decision cycle for both anticipated and unanticipated decisions. For example:
  - How long does it take the threat staff to plan and execute an entirely new mission?
  - How long does it take the threat staff to plan and execute changes to the current mission?
  - For a decision anticipated in wargaming, what is the length of time between acquisition of key indicators by collection assets until execution of that decision? How long would it take for an unanticipated decision?
- Identify the collection systems available to each threat unit. Develop doctrinal templates and descriptions for the standard employment of these systems. Rank each collection system in relative order of importance to standard threat operations.





Define the  
Battlefield Environment

As usual, the **AO** is assigned by the higher command. The AI must consider the electronic dimension. Depending on echelon, it **may** include--

- o Fixed ES or EA sites that support threat operations.
- o Airfields that support ES or EA aircraft.
- o Certain portions **of the** electro-magnetic spectrum while excluding others.

Describe the  
Battlefield's Effects

**Terrain**

Evaluate the terrain from two perspectives:

- o How it enhances and supports communications and target acquisition.
- o How it can be used to protect communications and target acquisition **systems** from exploitation or disruption.

Evaluate the terrain's effects on both threat and friendly **systems**. Consider:

- o Line-of-sight characteristics of the terrain, including effects **on both** communications and noncommunications **emitters**.
- o Vegetation and its effects on radio wave absorption and antenna height requirements.
- o Locations of high power lines and their interference with radio waves.
- o Large vertical objects, such as buildings or cliffs, that will influence radio waves.
- o Effects of soil types on the electrical grounding of equipment.

## Weather

Evaluate the effects of weather on both threat and friendly systems. Consider:

- Effects of extreme weather conditions on sensitive electronic equipment. Do not overlook high humidity or large amounts of dust in this evaluation.
- Electrical storms and other electromagnetic phenomenon.
- Effects of high winds or obscurants, such as **precipitation** or **blowing dust**, on antennas and line-of-sight systems.
- Weather effects on flight operations of **ES** or **EA** aircraft.

## Evaluate the Threat

Use the standard OB factors to structure your analysis.

Focus on--

- Types of communication equipment available.
- Types of noncommunications emitters.
- Surveillance and target acquisition assets.
- Technological sophistication of the threat.
- C<sup>3</sup> structure of the threat.
- Tactics, from a **communications** perspective, such as--
  - Deployment of their C<sup>3</sup> assets.
  - Remoting of communications systems.
  - Flexibility, or lack of, in procedures.
  - Communications security discipline.
  - Operations security discipline.
- Reliance on active or passive surveillance systems.
- Electromagnetic profiles of each node.
- Unique spectrum signatures.
- Technical data bases, such as--
  - Signal operating instructions.
  - Communications net structure.
  - Frequency allocation techniques.
  - Operating schedules.
  - Station identification methods.
  - Measurable characteristics of communications and noncommunications equipment.

**Determine Threat  
Courses of Action**

Use the supported command's situation templates as a starting point. Refine them to include--

- o Electromagnetic profiles.
- o Reactions to EA at critical junctures in the battle.
- o Threat use of ES and EA to support their own operations.

**Engineer**

**Define the  
Battlefield Environment**

The AO and the AI for an engineer unit are generally the same as that of the supported maneuver unit.

**Describe the  
Battlefield's Effects**

**Terrain**

When evaluating the terrain's effects on engineer operations--

- o Analyze the defensible terrain within each avenue of approach to determine locations which lend themselves to the use of obstacles.
- o Further identify where the terrain lends itself to breaching operations at each **locations**. This includes concealed and covered routes towards the breach site and terrain that supports suppressing fire during the breaching operation.
- o Analyze streams and rivers within the AO. Focus on bridges, ford sites, and areas that lend themselves to river-crossing operations.
- o Identify other man-made or natural obstacles within the AO, such as railroad tracks with steep embankments. Identify the effect of each obstacle upon the **movement** of different type units. Further analyze the locations where these obstacles can be easily traversed or crossed.

## Weather

When conducting weather analysis for engineer operations determine--

- The visibility constraints for each obstacle system, particularly around areas likely to be breached.
- How weather affects the performance of each type of obstacle for the local terrain. For example, how does recurring rain change the effectiveness of a standard antitank ditch in this particular soil type?
- How does weather affect trafficability?
- How does weather affect dust control?
- The effects of weather upon survivability positions,
- **The effect** of precipitation upon rivers **and streams**. During winter, also estimate the degree to which each water source would be frozen and its subsequent load capacity.

## Logistics Infrastructure of the Battlefield

When evaluating the logistics infrastructure of the battlefield--

- Identify local sources of potable water.
- Identify local sources of barrier material.
- Analyze the ability of the local road network to support anticipated traffic. Are immediate repairs required? How much maintenance will each road require to support sustained operations?
- Do local airfields require repairs or maintenance?

## Economics

When considering economics, identify the engineer projects which would **most** help the local population if time permits. Such projects are especially pertinent for nation assistance and counterinsurgency operations. Projects could include building roads, school houses, power generation facilities, water sanitation, or other public buildings and services.

## Treaties, Agreements and legal Restrictions

During peacekeeping and peacemaking operations, the unit should determine legal constraints for engineer operations.

Evaluate the Threat
---------------------

### Threat Order of Battle

Your evaluation should include--

- o **Organization**, equipment, and **standard** operations of threat engineer units. Consider the capability to conduct the following types of operations.
  - **Mobility;**
  - Counter-mobility;
  - Survivability;
  - Obstacle placement; and,
  - Breaching.
- o Capabilities of engineer units measured in--
  - Time required to lay each type of obstacle system.
  - Time needed to breach obstacles.
  - Time required to entrench a mechanized infantry company.
  - Ability of engineers to bridge different size rivers and streams, and time required for each.
  - etc.
- o Tactics that threat engineers employ while conducting each of the above operations.
- o Ability of the threat's logistical system to sustain engineer operations.
- o Capabilities of threat weapons to penetrate friendly survivability measures and systems.
- o Include information on survivability techniques. For example, threat use of chain link fences to defeat high explosive antitank rounds and missiles.
- o Engineer capabilities of threat infantry, armor, and other nonengineer units.

### Threat Models

Threat models should include--

- o Schematic drawings of standard obstacle systems.
- o Schematics of vehicle survivability positions.
- o Standard threat employment of obstacle support to defensive systems. Categorize each obstacle by its effect (disrupt, turn, fix, or block).
- o Typical employment techniques for combined arms units during breaching operations.

- Typical employment of combined arms units during river or gap crossing operations.
- Descriptions of mine warfare doctrine, marking systems, and standard patterns.
- Technical information on obstacle system material, mine fuses, delivery systems (air, artillery, etc.), and details of construction.

---

Determine Threat  
Courses of Action

---

#### Threat COA Models

In order to develop situation templates for engineers, begin with the maneuver situation templates of the supported unit. For each maneuver COA available to the threat, develop multiple engineer **COAs** that include--

- An estimate of the engineer status of each threat COA for the defense. This should be measured in the percentage of combat vehicles with entrenched primary, alternate, supplementary, and deception positions; and the likely extent of obstacle systems.
- Likely locations and extent of obstacle systems required to support each defense system. Categorize the systems by effect (disrupt, turn, fix, or block).
- An estimate of the mobility support for each threat COA for the offense. This should be measured in the breaching and fording capabilities of both the maneuver and the supporting engineer detachments.

#### Event Template

When using event templates--

- Attempt to use the same NAI system established by the supported unit. The advantage of this technique is that the supported **S2** can easily add one indicator or SOR requirement to collection assets that are already being deployed.
- If necessary, establish separate **NAIs** to support the execution of engineer operations.

### Decision Support

Decision points (**DPs**) for engineer units should focus on decisions such as--

- o Forward deployment of breaching teams.
- o The employment of artillery scatterable mines.
- o Shifting the priority of engineer missions (mobility to counter-mobility, etc.).
- o Redirecting direct support or general support **engineer** assets.
- o Closing lanes in obstacle systems (to support battle **handover** during a rearward passage of lines).
- o Forward deployment of obstacle teams to **close** breaches between the first and second echelons.

### Intelligence

Intelligence units perform a wide variety of missions. For considerations that apply to some of these functions, see relevant sections throughout this chapter. For example:

- o For aerial exploitation assets, including unmanned aerial vehicles, refer to the section on AVIATION.
- o For units involved in EW, refer to the section on ELECTRONIC WARFARE.
- o For units that operate in the rear area, refer to the sections on COUNTERINTELLIGENCE and REAR AREA AND COMBAT SERVICE SUPPORT.

Define the Battlefield Environment
---------------------------------------

As usual, the **AO** is assigned by the higher command. The AI must consider the electronic dimension. Depending on echelon, it may include--

- o Fixed ES or EA sites that support threat operations.
- o Airfields that support ES or EA aircraft.



<p><b>Describe the Battlefield's Effects</b></p>
--

## Terrain

Evaluate the terrain from **two** perspective:

- o How it enhances and supports communications and target acquisition
- o How it can be used to protect communications and target acquisition systems from exploitation or disruption.

Evaluate-the terrain's effects on both threat and friendly systems. Consider:

- o Line-of-sight characteristics of the terrain, to include both communications and noncommunications emitters.
- o Vegetation and its effects on radio wave absorption and antenna height requirements.
- o Locations of high power lines and their interference with radio waves.
- o Large vertical objects, such as buildings or cliffs, that will influence radio waves.
- o Effects of soil types on the electrical grounding of equipment.
- o Areas best suited to deployment of your systems, such as--
  - Accessibility.
  - Defilading and masking effects of terrain.
  - Security from Levels I, II, and III rear area threats.

## Weather

Evaluate weather effects on both threat and friendly systems. Consider:

- o Effects of extreme weather conditions on sensitive electronic equipment. Do not overlook high humidity or large amounts of dust in this evaluation.
- o Electrical **storms** and other electromagnetic phenomenon.
- o Effects of high winds or obscurants, such as precipitation or blowing dust, on antennas and line-of-sight **systems**.
- o Weather effects on flight operations of your collection aircraft.

---

Evaluate the Threat

---

Use the standard OB factors to structure your analysis. Focus on how the threat (targets) will appear to your collection **systems**.

- o Use the techniques detailed in the ELECTRONIC WARFARE section.
- o Identify signature items of equipment that are easily identified by your collection assets.
- o Identify the threat's **normal** OPSEC and COMSEC procedures.
- o Identify systems that are direct threats to your collectors.
- o Describe the threat's ability to locate and destroy your assets.
- o Use techniques associated with the rear battle to evaluate rear area threat to your assets. See the sections on COUNTERINTELLIGENCE AND COUNTER-RECONNAISSANCE and REAR AREA AND COMBAT SERVICE SUPPORT.

<p>Determine Threat Courses of Action</p>
---

Start with the threat COA models developed by the supported force. Refine them to focus on--

- o The targets of your collection operations. Use the techniques described in the ELECTRONIC WARFARE section.
- o Dispositions of threat target acquisition assets.
- o Rear area threats to your units. Use the techniques discussed in the sections on COUNTERINTELLIGENCE AND COUNTER-RECONNAISSANCE and REAR **AREA** COMBAT SERVICE **AND** SUPPORT.
- o Focus on threat **COAs** relevant to your commander, not the supported force commander. These **COAs** should deal primarily with collection operations, force preservation, and activities that will require your units to displace. The supported command's intelligence officer (G2 or S2) develops **COAs** relevant to the needs of the supported force commander.

## ██████████ Nuclear, Biological , and Chemical ██████████

Chemical units perform decontamination, obscurant, and NBC reconnaissance missions. NBC staffs **are interested** in both friendly and threat capabilities to employ nuclear weapons and obscurants, friendly and threat vulnerability to nuclear weapons, and friendly vulnerability to chemical and biological weapons.

Define the Battlefield Environment
---------------------------------------

The **AO** will normally be the same as that of the supported force.

The NBC AI includes--

- All threat missile and artillery weapons that can deliver NBC weapons into the AO.
- All threat aircraft capable of delivering NBC weapons into the AO.

---

Describe the'  
Battlefield's Effects

---

### Terrain

When evaluating the terrain's effects on NBC operations:

- Identify critical terrain features (e.g., defiles, choke points, rivers, key terrain).
- Analyze the avenues of approach and mobility corridors developed by the **G2/S2** for areas of vulnerability to NBC weapons or areas that are especially suitable for the use of obscurants.

### Weather

When conducting weather analysis for NBC operations:

- Identify critical weather information needed to determine **the** effects of weather on NBC weapons or

obscurants. Refer to FM 3-6, Field Behavior of NBC Agents, for more information.

#### Logistics Infrastructure of the Battlefield

When evaluating the infrastructure of the battlefield:

- Identify local sources of water suitable for decontamination operations. Consider natural and industrial or civic sources.

#### Evaluate the Threat

In addition to the-broad range of OB factors and threat capabilities, NBC staffs evaluate:

- Threat capabilities to employ NBC weapons and obscurants.
- Types of delivery systems, including minimum and maximum ranges.
- Threat NBC weapons employment doctrine and TTP. Determine if NBC weapon employment is terrain oriented, force oriented, or a combination of both. Pay particular attention to recent operations.
- Threat NBC protection capabilities.
- Indicators of preparations to employ NBC weapons.

#### Determine Threat Courses of Action

Refine the supported unit's threat COA models to focus on the considerations listed under Evaluate the Threat (above).

Evaluate the threat COA models to identify--

- Likely areas of ground force penetration of forward lines (a suitable NBC target).
- Friendly assets the threat is likely to consider HPT for engagement by NBC weapons as part of the COA.
- Existing contaminated areas that may indicate the course of action adopted by the threat.

**Signal****Define the  
Battlefield Environment**

The **AO** is the same as that of the supported unit. The AI must include--

- o Required links with higher and adjacent commands.
- o Threat jamming assets capable of affecting communication.
- o Threat SIGINT collection assets that may target your' systems or customers.

---

**Describe the  
Battlefield's Effects**

---

**Terrain**

When evaluating the terrain's effects on signal operations--

- o Evaluate location of customers and communication density.
- o Evaluate best lines-of-sight for required communication links.
- o Identify locations that provide line-of-sight defilade from potential threat collection or jamming systems.
- o Identify site access and escape routes.
- o Evaluate sites for tenability.

**Weather**

When conducting weather analysis for signal operations--

- o Evaluate effects of forecasted weather on frequencies. Identify optimal frequencies for use.
- o Identify potential communication degradation caused by high winds (antenna wobble) or precipitation.
- o Evaluate weather effects on site access or tenability.

Other factors

Other factors to consider in signal operations:

- Frequency deconfliction.
- Identify host nation frequency restrictions.
- Identify any host nation or local restrictions on terrain use.

Evaluate the Threat
---------------------

Evaluate the capabilities of the threat to disrupt or intercept communications. In particular, identify--

- Ability to locate or intercept your systems.
- Targeting accuracies of collection systems.
- Speed with which the threat can collect, process, and then target communication sites.
- EA effectiveness (equipment and techniques).
- Ability to link collection systems to indirect fire assets.
- Range capabilities of supporting indirect fire systems.
- Ability to conduct deep strikes or operations.
- Threat models, to include--
  - Deployment patterns and tactics of SIGINT collection systems.
  - Deployment patterns and tactics of EA assets.
  - Deployment patterns, tactics, and range capabilities of long-range indirect fire systems.
  - Techniques of intrusion or electronic deception.

Determine Threat Courses of Action
---------------------------------------

Use the supported unit's threat COA models as a base. Refine and supplement these to include the considerations listed under EVALUATE THE THREAT discussed above.

Evaluate the supported unit's threat COA to identify--

- Direct threats to communication due to the expected flow of battle (over-running of sites).
- Probability of Levels I, II, or III rear area threats.
- Potential requirements to move sites or replace destroyed sites.

## Special Operations

Define the  
Battlefield Environment

The **AO** is normally assigned by a higher command. The AI extends from home base, through operational bases, into the Joint Special Operations Area, to the TAI. It can also include--

- Infiltration and exfiltration routes and corridors.
- Areas or countries that provide military, political, economic, psychological, or social aid to the target forces or threats to the mission.
- The air AI, which is the same as for other aviation units.
- Psychological operations **AIs** which are tied to the target population and may include entire countries.

Describe the  
Battlefield's Effects

### T e r r a i n

When evaluating the terrain's effects on special operations--

- Include all potential zones of entry and infiltration corridors. Do not overlook waterborne access routes or rooftop zones of entry.
- Identify sources of food and potable water.
- Evaluate slopes as obstacles to fast rope assault operations.
- Identify ultra-low level flight corridors.

### Other Characteristics

Other characteristics to consider are--

- Conduct "factor analysis" to evaluate--
  - Density and distribution of population groups.
  - Composite groups based on political behavior and the strengths of each.
  - Issues motivating political, economic, social, or military behaviors of groups.

- Evaluate economic infrastructure.
- Identify economic programs which can cause desired changes in population behavior.
- Evaluate the formal and informal political structure of the government.
- Identify legal and illegal political parties.
- Identify **nonparty** political organizations and special interest groups.
- Evaluate the independence of the judiciary.
- Evaluate the independence of the mass media.
- Evaluate the administrative competence of the bureaucracy.
- Identify the origin of the incumbent government.
- Evaluate the history of political violence **in the country.**

Evaluate the Threat
---------------------

- Identify external support to the threat. Consider the probability of military intervention by third-party nations.
- Identify the threat's desired end state.
- Evaluate the groups and subgroups supporting the threat.
- Identify discord within the threat.
- Identify any groups that may have been misled about the threat's desired end state.
- Evaluate organizational structures or patterns within the threat.

<b>Determine Threat Courses of Action</b>
---

Identify the threat's likely responses to special operations, to include--

- Political.
- Social.
- Military.



## ■ ■ ■ ■ ■ ■ ■ ■ ■ ■ Rear Area and Combat Service Support ■ ■ ■ ■ ■ ■ ■ ■ ■ ■

The difference between rear area IPB and IPB for a combat service support unit is one of scope. For example, a division rear command post is responsible for the area between the rear boundaries of the maneuver brigades and the division's rear boundary. The rear command post will identify, analyze, and **wargame** level **I**, **II**, and **III** threats.

In contrast, a medical unit is responsible **only** for that small piece of terrain which the division support command has allocated to it. Within its assigned area, the staff will usually identify, analyze, and **wargame** only level **I** threats.

Furthermore, the rear command post is exclusively concerned with the rear area. combat service support units, however, will also analyze the threat to their personnel and equipment while they conduct operations in the main battle area.

Military Police apply many of the tactics, techniques and procedures of the IPB process during the planning and execution of battlefield circulation control, area security, and law and order operations. As a response force, MP units actively detect and destroy level **II** threats and support rear echelon operations in the detection, delay and defeat of level **III** threats.

Define the Battlefield Environment
---------------------------------------

The supported maneuver unit will designate the unit rear **AO** and appropriate **AO** for combat service support units. The MP **AO** will usually **be** the same as that of the supported unit. The AI must incorporate--

- o Airfields and air avenues of approach for threat air assault, airborne; and air interdiction forces.
- o Locations of threat artillery units capable of delivering NBC rounds.
- o Operational reserves capable of penetrating the MBA.
- o Insurgent forces that are capable of operating within the rear area or that can affect combat service support operations in the MBA.
- o Terrorist organizations that can attack the rear area or otherwise interfere with combat service support operations.
- o Hostile forces that could affect CSS units' moving forward in the offense.

## Threat Model

Threat models should include--

- o Pursuit and exploitation procedures for conventional forces.
- o Air assault, airborne, and light infantry techniques for deep attack.
- o unconventional warfare techniques for deep operations.'
- o **Standard** procedures for insurgent raids and ambushes.
- o **Typical procedures** for terrorist attacks.

<b>Determine Threat Courses of Action</b>
---

## Threat COA Models

Threat COA models should start with the maneuver **COAs** developed by the supported unit. For each maneuver COA available to the threat, the analyst should develop multiple combat service support **COAs** that include--

- o Likely areas of penetration for ground forces.
- o Likely objectives in the rear area that will **facilitate the** threat main attack or defense.
- o The **HVTs** and **HPTs** that the threat will identify to support their concepts of operations. This could be either key terrain in the rear area or specified combat service support activities themselves.
- o Situation templates for air assaults and airborne operations. Ensure you identify complete **COAs--air** avenues to landing and drop zones, infiltration lanes to the objective, and exfiltration lanes.
  
- o Insurgent or partisan **COAs**. Complete **COAs** should include their assembly in hide areas, movement through infiltration lanes, actions on the objective, and exfiltration. (See COUNTERINSURGENCY OPERATIONS in Chapter 6 for a complete discussion on this subject.)
- o Terrorist **COAs**. See the ANTITERRORISM OPERATIONS in Chapter 6 **for** a complete discussion.

## Event Template

In event templates--

- The rear command post of the supported unit should establish **NAIs** for levels I, II, and III rear area threats.
- The individual combat service support units should establish **NAIs** for levels I and II threats against their **specific** areas.

## Decision Support for the rear command post

This should focus on decisions, such as--

- Request for commitment of the level III tactical combat force.
- Commitment of level II response forces.
- Request for fire support to preplanned **TAIs**.

## Decision Support for combat service support Units

This should focus on decisions, such as--

- "Pushing forward" support packages that the supported unit will require given anticipated operations.
- Request for commitment of Level II response forces or the level III tactical combat force.
- Commitment of the local quick reaction force for the base or base cluster.
- Request for fire support to preplanned **TAIs**.
- "Jumping" to a new location.

CHAPTER 5 TACTICAL, OPERATIONAL, AND STRATEGIC INTELLIGENCE PREPARATION OF THE BATTLEFIELD
--

The basic IPB process remains the **same**, regardless of the level of war **at** which it is conducted. Some considerations for the application, of IPB doctrine at different levels are discussed in this chapter.

The examples given are certainly not all-inclusive. An exhaustive **list would** be impossible to present due to the dramatic variance of the situations that the US **Army might** conduct operations within. IPB at the operational and strategic levels will usually be "custom **built**" and tailored for each METT-T situation. However, the basic process of IPB will always remain the same.

▄▄▄▄▄▄▄▄▄▄▄▄ **Define the Battlefield Environment** ▄▄▄▄▄▄▄▄▄▄▄▄

Regardless of the level of execution, the **AO** is almost always confined to the geographical boundaries specified on the operations **overlay** given from higher headquarters. In terms of time, it is always for the duration of the operations specified in the operations order.

However, the nature of the AI and the types of activity with which a command is concerned vary significantly according to the level of war at which IPB is conducted. Establishing an AI that exceeds the limits of the **AO** and the command's battle space allows the command to anticipate significant developments. Following are considerations for establishing the AI at various levels.

TACTICAL
----------

- The AI is almost always confined to the physical location and avenues of approach of threat units that have the time and mobility to enter the AO.
- Significant characteristics of the battlefield during war are usually limited to--
  - Influence of the terrain and weather on **military** operations.
  - Ability of the local infrastructure to support operations.

Environmental health hazards.  
Employment of threat combat forces.  
Location of noncombatant populations.  
Refugee flows.  
Status of force agreements.  
Rules of engagement and other restraints and constraints on military operations.

- As tactical units operate in operations other than war, the characteristics they are interested in usually expand to include items such as--
  - Press coverage and threat propaganda.
  - Sympathies and reactions of local population-and organizations to friendly operations.
  - Local economy, including "black markets".
  - Local legal system.
  - Unofficial organizations, including clans, tribes, etc.
  - Local government, including unofficial parties, meeting sites, activities, contentious issues, etc.
  - Para-military organizations and police forces.
  - Governmental and non-governmental organizations that may interact with the friendly force during execution of the mission.

OPERATIONAL
-------------

At the operational level the AI expands to include items such as--

- Location of threat combat service support units.
- Local infrastructure required to **support threat** resupply operations.

The types of activity of concern during military operations at the operational level generally include--

- Potential effects of third-nation involvement.
- Press coverage and threat propaganda.
- Sympathies and reactions of regional population and organizations.
- Regional economies.
- Regional legal systems.

---

 STRATEGIC
 

---

At the strategic level the AI expands to include the entire world. Significant characteristics expand to include--

- World opinion and international law.
- US public support.
- Support base **and** political objectives of the threat government.
- Threat, host nation, and coalition partner national economies and legal system.

■■■■■■■■■■ Describe the Battlefield 's Effects ■■■■■■■■■■

---

 TACTICAL
 

---

During war, terrain considerations are usually confined to identifying terrain objectives, specific avenues of approach, and infiltration lanes that support attacks, and terrain that supports defense.

Weather considerations are usually confined to the effects of weather upon personnel, weapons systems, force mobility, and tactical military operations.

During operations other than war, other characteristics of the battlefield gain in importance. Characteristics of the battlefield are always analyzed in terms of their effect upon threat and friendly **COAs**. Some examples are--

- **"The** Carter-Torrijos Treaty does not allow us to conduct the operation being considered in the areas marked in red."
- **"The** threat cannot establish any defense larger than company size for three weeks because the militia will be harvesting."
- **"A** surprise attack on objective BUTKUS will probably convince the people in the surrounding village that the insurgent propaganda is correct and the stated US position is a lie. The people will support an attack **only** if we give reasonable opportunity for noncombatants to evacuate."

---

OPERATIONAL

---

Terrain analysis at the operational level focuses on the general effects of terrain on operations within the battlefield framework. At this level it incorporates such items as--

- o Ability of large pieces of terrain to support the combat operations of large units in the **AO** and **AI**.

Large forests generally inhibit mounted movement and favor the employment of dismounted forces. Forests complicate the employment of intelligence gathering assets, communications, and coordination between adjacent forces.

Open and gentle rolling terrain favors the employment of mounted forces.

Swamps and other wetlands limit mounted movement to road networks and hamper dismounted, off-road movement. These areas tend to be easily dominated by air units.

Deserts hamper large-scale or long movements.

Although terrain within the desert may vary greatly, deserts are characterized by a lack of natural concealment, lack of cover, lack of fresh water, **and** difficulties with **LOC**.

Mountainous terrain normally restricts operations to valley areas and passes. Lateral **LOC** are generally restricted, making it difficult to move reserves or shift main efforts.

- o Transportation networks (for example, road, rail, air, sea) and zones of entry into and through the **AO** and **AI**.
- o Ability of transportation networks to support the movement of forces and **provide** logistical support to large unit operations in various parts of the **AO** and **AI**.

Weather analysis at this level usually addresses the seasonal climatic effects on the combat, combat support, and combat service support operations of large units.

Other significant characteristics of the battlefield gain importance at the operational level. Express their influence **in** terms of their effect on threat and friendly **COAs**. Examples are--

- o **"The** Kuntz tribe will resist any attempt to establish military lines of operation through their land. They do not have the military **means to** significantly interfere with our lines, but two international treaties make operations in this region inadvisable for either **side.**"
- o **"The** Neroth **TruffleWald** supplies 100 percent of the truffles for both the Good Duchy of **Fenwick** and the Evil Emirate of Vulgaria. The truffle harvest from this region is valued so highly by both countries-that off-road **maneuver** will not be tolerated. Except for, the paved roads, it is considered SEVERELY RESTRICTED terrain."

---

STRATEGIC

---

At strategic levels the battlefield is described in terms of geography and climate rather than terrain and weather. Focus on the effects of **major** terrain features and weather patterns. How do mountain ranges, flood plains, and tracts of forest within the theater influence operations and available courses of action?

Other characteristics of the battlefield take on an increased importance at the strategic level. For example, the industrial and technological capabilities of a nation or region will influence the type of military force it fields. Similar factors may influence the ability of a nation to endure a protracted conflict without outside assistance. Political and economic factors may be the dominant factors influencing threat courses of action. Always express the evaluation of their effects in terms of operations and courses of action. For example--

- o **"The** threat's state of technological development makes him dependent on outside sources for sophisticated military equipment."
- o **"World** opinion prevents us from pursuing the enemy across the border."



- o "The enemy can prosecute the war only as long as the oil shipments continue from the west. Any significant interdiction of the oil flow will render the enemy immobile at the strategic and operational levels."
- o "At the moment, popular support for the enemy government is very precarious. However, friendly advances further into the vital northern region will rally the people around the war effort. This would probably enable the enemy to mobilize more strategic **reserves.**"
- o "The Montreal Treaty, designed to maintain the regional balance of power, forbids us to conduct any operation without the consent of all six nations."
- o "The probability of Chinese intervention increases as we approach the Yalu River."
- o "The sea lines of communication best support opening the second front in northern France. However, the second front could still be well supplied through southern France, and marginally through **Yugoslavia.**"
- o "The winter climate in this region is too severe for an army of southern Europe to endure in the field. Napoleon must either destroy the Russian **army** before winter, or conduct a strategic withdrawal."

██████████ Evaluate the Threat ██████████

TACTICAL

This usually involves analysis and evaluation of the **OB** factors (composition, disposition, strength, tactics, training status) for threat units at the tactical level. As a result of studying the threat OB factors the analyst produces threat models. Tactical examples are--

- o "Layout and defensive measures for the typical insurgent base **camp.**"
- o "Standard demonstration tactics for the Students for a Democratic Society."
- o "Typical security echelon for a mechanized infantry division in the defense."

- "Surveillance procedures that the People's Democratic Army uses prior to a terrorist attack."
- "Standard narco-terrorist security measures for the protection of cocaine-producing laboratories."

<b>OPERATIONAL</b>
--------------------

Analysis of the OB factors at this level should include weapons of mass destruction and the threat's doctrine for operational C<sup>2</sup>. This includes his doctrine for **determining operational** missions and objectives and **the TTP** associated with gaining nuclear or chemical release authority. Express vulnerabilities and **HVTs** in terms of the threat's centers of gravity.

Evaluate all military forces available. Include para-military forces and special operations forces that operate in the communications zone as well as forces operating on the battlefield.

Some examples of threat models at the operational level are--

- **"Normal** sequence of events for the conduct of a national offensive by the insurgents."
- "Typical enemy campaign plan for an operational delay."
- "Theater support structure for enemy logistics."
- "Procedures that regional paramilitary forces could use to interfere with non-combatant evacuation."
- "Standard exploitation and pursuit procedures employed by enemy tank armies."

---

**STRATEGIC**

---

OB analysis at this level includes considerations such as--

- Relationship of the military to the government. Who sets national and theater objectives? How?

FM 34-130

- o Non-military methods of exerting power and influence.
- o National will and morale.
- o Ability to field, train, and maintain large military forces.

Threat capabilities **and** models depicting them take a strategic view of operations and courses of action. Examples of threat models at the strategic level are--

- o "Possible forms of intervention by third-party countries."
- o "Normal timetables for the enemy mobilization **and** train-up of **corps-size** units."
- o "Techniques for transporting large volumes of narcotics through source, intermediate, and destination countries."
- o "Typical movement rates when shifting strategic reserves between theaters."

#### ██████████ Determine Threat Courses of Action ██████████

To determine a threat COA at any level, the analyst must first identify the threat's likely objectives, then identify the various threat models that will accomplish the objectives under the specific METT-T conditions under consideration.

#### TACTICAL

Some examples of threat course of action models at the tactical level are--

- o "Most likely response of 8th Company (Atlantica) upon a treaty violation by 3d Troop (**Pacifico**)."
- o "Likely infiltration lanes, ambush sites, and exfiltration lanes for an insurgent attack against Thursday's **convoy**."
- o "How the 35th Motorized Rifle Regiment would defend Mulvihill pass using a reserve slope defense."

OPERATIONAL
-------------

Course of action models at the operational level focus on lines of communication, lines of operation, phasing of operations, operational objectives, the movement and employment of large forces, etc.. Express high value targets in terms of centers of gravity and operational targets that expose centers of gravity to destruction.

Some examples of threat course of action models at the operational level are--

- **"Most likely COAs** of the six warring factions upon 'the introduction of US peace-enforcement troops."
- "Probable LOC if the enemy attacks in the northern half of the theater."
- "Course of action 3: The rival warlords are unable to come to an agreement and cannot generate enough force to effectively oppose the entry of US forces. In this case, they do not interfere with US operations, and might even facilitate the relief efforts, hoping for a speedy withdrawal of US forces once the mission is complete. Once US forces have withdrawn, its back to business as usual."
- "General forecast of guerrilla attacks assuming that Route 88 is successfully interdicted for the next 3 months."
- "Course of action 1: put the **army** boundary along the WHETSTONE MOUNTAINS and commit 2nd Army with four divisions against the MONS TONITRUS sector, and 3rd Army with five divisions against the TIR YSGITHER sector."
- **"The** enemy's operational center of gravity is his ability to quickly shift the two reserve corps to reinforce any one of the three front-line armies. The key to his center of gravity is the rail-transportation network centered in the RISSE-MESS-SCHMID area."

STRATEGIC

Threat course of action models at the strategic level consider the entire resources of the threat. Include non-military methods of power projection and influence. Identify theaters of main effort and the major forces committed to each. Depict national as well as strategic and theater objectives.

Some **examples** of situation templates at the strategic level are--

- o "The three best options for the Trojans if presented with a war on two fronts."
  - o "The directions that Chairman Cormier will probably issue to his military council, given the current political situation."
  - o "Military resources that the **Spartans** will probably commit to pacify the population within the occupied territories."
- "Course of action 1: the main effort is the Atlantic theater. The allies will attempt to open a second front as soon as possible while conducting a strategic defense in the Pacific."
- o "Probable reactions of Metropolania and Urbanity to US operations in support of insurgency within **Forgotonia**."
  - o "Military options available to Garraland that might break the blockade and embargo."
  - o "Course of action 3: because of political and economic ties, as well as the availability of resources, the allies will split responsibility for the **Pacific** theater. The most likely boundary is shown on sketch **C**."
  - o "The terrorist organization's strategic center of gravity is their ability to use the area along the border as a sanctuary. The lack of cooperation between the two countries in policing their common border is the key to the center of gravity."

CHAPTER 6 INTELLIGENCE PREPARATION OF THE BATTLEFIELD FOR OPERATIONS OTHER THAN WAR
---

Operations other than war can occur unilaterally or with other military operations. It is possible that US forces could **be** involved in operations other than war while the host nation is at war. Operations other than war can evolve to war; be prepared for the transition. Operations other than war include, but are not limited to, the operations described in this chapter.

The four steps of the IPB process remain constant-regardless of the mission; unit, staff section or echelon. The art of applying IPB to operations other than war is in the proper application of the steps to specific situations. The primary difference between IPB for conventional war and operations other than war is focus -the degree of detail required- and the demand for demographic analysis required to support the decision making process.

When conducting operations other than war within the United States bear in mind that there are legal restrictions on intelligence operations that gather information on US citizens. See Department of Defense Directive 5240.1, Department of Defense **Regulation** 5240.1-R and Army Regulations 380-13 and 381-10 for more information. Coordinate with legal sources, such as local law enforcement agencies, for information on US citizens required to support operations other than war in the United States.

### Humanitarian Assistance and Disaster Relief

Humanitarian assistance operations provide emergency relief to victims of natural disasters when initiated in response to domestic, foreign **government**, or international agency requests for immediate help and rehabilitation. **Disaster** relief operations include activities such as refugee **assistance**, food distribution programs, medical treatment and care, restoration of law and order, damage and capabilities assessment, and damage control (including environmental cleanup and programs such as fire fighting).

---

Define the  
Battlefield Environment

---

The **AO** will normally be assigned by higher headquarters. The AI should include--

- Potential sources of assistance from outside the disaster area.
- Areas or activities that might generate refugees moving into the AO.
- Further threats to the AO, such as severe weather patterns or para-military forces and gangs.
- Identify all military, para-military, governmental, and non-governmental (Red Cross, Hope, etc.) organizations that may interact with the friendly force.
- Establish criteria to judge extent of the disaster and track the progress of recovery operations.

---

Describe the  
Battlefield's Effects

---

- Determine the present and potential extent of the disaster. Identify the likelihood of additional floods, earthquakes, mud slides, displaced persons, etc.
- Identify the population sectors which require assistance and determine the type needed.
- Coordinate with local law enforcement agencies for information on gang "boundaries". Identify the amount of influence each group has over the local population.

- Focus on demographics. Consider the effects of--
  - population distribution patterns;
  - ethnic divisions;
  - religious beliefs;
  - language divisions;
  - tribe, clan, and sub-clan loyalties;
  - health hazards;
  - political sympathies;
  - etc.
- Consider the effects of the logistic infrastructure--
  - location, activity, and capability of care distribution points (food, health care, etc.);
  - sources of food and water;
  - housing availability;
  - hospital capabilities;
  - utility services (water, electricity, etc.);
  - law enforcement agencies and capabilities;
  - emergency services (fire department, etc.).
- Determine if the environment is permissive or hostile to the introduction of US forces. While governmental agencies may welcome US forces, other elements of the population may not.
- Use non-Department of Defense assets and host nation resources to fill voids in the data base and map coverage of the AO. For example, census data can provide demographic data, law enforcement and emergency service organizations can provide information on local infrastructure.
- Identify the limits of your commander's authority. Can he financially obligate the government? Does he have the authority to enforce laws? To assist law enforcement agencies?

Evaluate the Threat
---------------------

- Consider weather and the environment as potential threats. Weather will impact on your ability to conduct relief operations. For example, if the target of a relief effort is a village isolated by mud slides or another natural disaster, inclement weather **may** limit or curtail air operations to the site.



- The environment may pose threats to the health of both mission and host nation personnel in the forms of waterborne diseases, spoiled or contaminated foodstuffs, and other environmental hazards.
- Identify and evaluate the threat posed by any groups that may oppose friendly force operations. Consider groups that may clandestinely oppose the-operation even though they publicly pledge support.
- Consider initially neutral groups and personnel that may become hostile as the operation progresses. What action is necessary to keep them neutral?
- During support to law enforcement agencies, elements of the population may pose significant threats. Use the traditional OB factors, with modifications to fit the specific situation, to evaluate the threat posed by gangs or similar "organized" groups. Adhere to legal restriction on intelligence operations against US citizens; coordinate with law enforcement agencies for assistance.
- When confronted with riots or similar threats identify "opinion makers" and other influential members of the local population. Identify potential trouble spots and contentious issues. Adhere to legal restrictions on **intelligence operations** against US citizens.

<b>Determine Threat Courses of Action</b>
---

- Start with threat objectives and develop courses of action from there. Consider all courses **of** action. For example, if the threat objective is to get US forces out of the host nation, one course of action could be to allow the US force to complete its mission quickly. Do not focus on strictly confrontational courses of action.
- Consider the effect the threat's perception of US forces has on potential courses of action. If US forces appear overwhelmingly powerful, non-confrontational **COAs** may be preferred. **If** US forces project only minimal power, the threat may pursue higher risk **COAs**.
- Consider the interaction of each group if faced with multiple threats. Will they cooperate against US forces? Will **they engage** each other?

- Evaluate the threat imposed by a degradation of the capabilities of law enforcement agencies.
- Identify likely targets of looting and vandalism.
- Use MDCI for force protection. It provides you with vulnerability assessments and will assess all threats whether actual or **potential**. As they are identified, pursue them accordingly.

.....  
 ::::::::::: **Support to Counterdrug Operations** ::::::::::: .....

Military efforts support and complement rather **than replace** the counterdrug efforts of other US agencies, the states, and cooperating foreign governments. Army support can occur **in any** or all phases of a combined and synchronized effort to attack the flow of illegal drugs at the source, in transit, and during distribution. Army participation in counterdrug operations will normally be in support of law enforcement agencies.

Support to host nations includes assistance to their forces to destroy drug production facilities, collaboration with host nation armed forces to prevent export of illegal drugs, and nation assistance to help develop economic alternatives to drug related activities.

Support for domestic counterdrug operations includes military planning and training assistance for domestic law enforcement agencies, participation by the National Guard, equipment loans and transfers, use of military facilities, and other assistance as requested and authorized. Military support to counterdrug operations may expand as national policy and legal prohibitions evolve.

Define the  
 Battlefield Environment

AI: Consider both air and ground **AIs**. Questions include--

- What drugs is the operation directed against?
- What precursor elements are required for production and where do they originate?
- How and where do drugs and related materials enter the host nation and the AO?

Significant characteristics of the battlefield include local economic conditions, effectiveness of host nation military and law enforcement agencies, and the nature of the **host** nation government.

Describe the  
Battlefield's Effects

- Consider that map, chart, and graphics coverage of your **AO** and **AI** may be lacking.
- Identify agricultural areas for drug crops. Determine the periods that comprise their growing seasons.
- Consider the hydrography necessary to support the drug crop.
- Consider terrain and weather in relation to production, growth, and movement cycles of drug crops.
- Identify routes and techniques available to traffickers for infiltration by air, ground, and sea.
- Identify exfiltration routes, including transshipment points, and techniques for air, land, and water movement.
- Identify likely storage areas (such as caches and warehouses) for drug shipments awaiting transit.
- Identify the economic conditions and procedures that affect trafficking (such as customs inspection stations, amount of vehicle traffic across the border).

Evaluate the Threat

- Consider the structure of the drug organization:
  - Look at family relationships:
  - Identify key personnel, such as leaders, logisticians, security specialists, and chemists.
- Consider security elements and methods of production, concealment, and transportation.

- Identify narco-terrorist groups, their tactics and procedures.
- Consider support that the local government cannot or will not give to the local populace.
- Consider the threat use of **"force"** tactics such as blackmail, kidnapping, and threats of violence to gain support and control the populace and the government.
- **Bear in** mind that the threat's wealth gives him access to many high-technology **systems**. What ability does he have to detect the friendly force and their operations? Can he detect radars? What communications abilities does he have? Are his communications encrypted? What weapons and target acquisition systems does he use? What are his night vision capabilities? Use the traditional OB factors as a guide for analysis.

---

Determine Threat  
Courses of Action

---

- Template or describe the activities of drug producers in the **AO** and **AIs**.
- Template or describe production activities. Consider logistics, security, and training.
- Template or describe the specific actions of the traffickers through the **AO** and **AI**. Consider storage areas, drying areas, surface routes, and air routes. Include an evaluation of zones of entry, such as airstrips and ports, and types of vehicles or animals used by the traffickers.
- Template trafficker and producer actions upon confrontation, including legal evasion.
- Template or describe the support activities associated with trafficking in the **AO** and **AI**. Consider finances, front organizations, civic actions, money laundering, others.
- Template the security procedures and other techniques to avoid detection for all of the templates described above.



<p><b>Describe the Battlefield's Effects</b></p>
--

- Demographics.
  - What are the root **causes of** the conflict? Analyze this from the perspective of both belligerents.
  - What would cause (or **caused**) each side to agree to peace?
  - Are there any new issues that have increased tensions since peace was initiated?
  - How committed is each belligerent to keeping the peace? How much trust and faith do the belligerents have in each other to keep the peace?
  - How capable is each belligerent of keeping the peace? Can the leadership which negotiated the peace **enforce** discipline throughout the belligerent parties?
  - How do these factors affect the **COAs** of each belligerent? How do they affect the **COAs** available to the peacekeeping force?
  
- Legal. What legitimate **COAs** are available to the belligerents and the peacekeeping force? How likely is each belligerent to obey the laws and provision of treaty agreements?
  
- Terrain.
  - Does terrain lend itself to military operations? Conduct terrain analysis. Identify good infiltration lanes, engagement areas, defensive positions, attack routes, and staging areas.
  - Does the terrain lend itself to peacekeeping operations? Can the peacekeepers see and be seen? If so, the belligerents may be less likely to violate the peace. If necessary, where **can** the peacekeeping force establish blocking positions to blunt possible violations of the peace?
  - Identify the terrain that allows all belligerents equal access to the peacekeepers.
  - Analyze the terrain to identify likely current dispositions of belligerent forces.
  
- Weather.
  - Analyze the affect of weather on visibility among all parties, including the peacekeepers.

- Consider the influence of weather on mobility and operations. (See FM 34-81-1.)
- Weather may affect the turnout at activities such as demonstrations.
- o Other. Identify **and** analyze government, military, and agency support available to the peacekeeping force.

Evaluate the Threat
---------------------

- o Identify all **factions** involved **in the** peacekeeping operation. Which are likely to violate the **peace and** why?
- o What is the political organization and military **OB** of each of the belligerent groups? Who are the key personnel that **control** the rank and file of each faction?
- o Identify the political and religious beliefs that directly affect or influence the conduct of the belligerents.
- o Identify belligerent tactics for offense and defense. Use this as the basis for doctrinal templates.
- o Identify local support to all belligerent parties.

Determine Threat Courses of Action
---------------------------------------

- o Template or describe the actions of the belligerents that would violate the peace. Crossing borders, entering demilitarized zones, and initiating hostilities are examples of violations.
- o Template or describe the actions associated with violations of the **peace** such as occupation of assembly **areas**, training, **C<sup>3</sup>I**, logistics.
- o Template or describe the response of belligerents to violations of the peace.
- o Template or describe the reactions of all belligerents to US actions within the **AO** and **AI**.





FM 34-130

- If US presence, or potential presence, by itself could be a catalyst for terrorist activity.
- The identity of recent worldwide anti-US **terrorist** activity, or intent to conduct such activity.

Types of activity to consider:

- Identify the demographic issues that make protected areas or personnel attractive to **terrorists**.
- Identify any time constraints that might limit the availability of a target,.
- Coordinate with supporting MP and MI activities when preparing initial threat analyses and their updates.

<b>Describe the Battlefield's Effects</b>
---

- Demographics.
  - What demographic issues make a target attractive to terrorists?
  - How do these demographic issues shape terrorist **COAs**? For example, the political grievances of a terrorist organization might make some targets more attractive than others. Religious convictions might cause terrorists to disregard assassinations in favor of kidnaping.
- Targets and routes.
  - Identify the susceptibility of targets to terrorists.
  - Identify infiltration routes and avenues of approach.

<b>Evaluate the Threat</b>
----------------------------

- Determine the type of terrorist groups you might face. Are they state supported, non-state supported, or state directed?
- Identify which terrorist groups are present, thought to be present, or have access to your AO.
- Conduct OB analysis for each group, to include--
  - Organization and cellular composition.

- Internal discipline.
  - **Long-** and short-range goals.
  - Dedication (willingness to kill or die for the cause).
  - Religious, political, and ethnic affiliations of the groups.
  - The identity of leaders, trainers, opportunists, and idealists.
  - Group skills and specialties of each organization **such as** sniping, **demolition**, **air** or water operations, electronic surveillance, tunneling.
- o Describe the preferred tactics of each organization. These might include assassination, arson, bombing, hijacking, hostage-taking, kidnaping, maiming; raids',- seizure,- sabotage, hoaxes, or use of chemical or biological weapons. Consider the international writings on terrorist and insurgent operations such as Mao or Che Guevarra.
  - o Describe or template demonstrated terrorist activity over a **period** of time in the local area.

<p><b>Determine Threat Courses of Action</b></p>
--

- o Identify likely terrorist targets within the protected entity by matching friendly vulnerabilities against terrorist capabilities and objectives.
- o Template terrorist actions on likely objectives within the protected entity. Remember that the choice of tactics is often related to a desire for attention.
- o Template terrorist activities near the objective such as assembly areas, movement to the objective site, surveillance, and escape routes.
- o Template or describe the supporting functions for terrorism such as training, logistics, C I, and finance. During antiterrorism operations these activities will be observed to warn of coming attacks.

.....  
Shows of Force .....

A show of force is a mission carried out to demonstrate US resolve in which the US forces deploy to defuse a situation that may be detrimental to US interests or national objectives. Shows of force lend credibility to the nation's commitments, increase regional influence, and demonstrate resolve. They can take the form of combined training exercises, rehearsals, forward deployment of military forces, or introduction and buildup of military forces in a region. Shows of force may transition into combat operations; be prepared for the transition.

**Define the  
Battlefield Environment**

A0: Define the boundaries for the maneuver of US forces relative to both the host nation and the target nation. For the AI--

- o Expand the AI to include all military and paramilitary forces, or other organizations that might interact with friendly forces.
- o Identify nations that influence or are influenced by events in the A0.

Types of activity to consider:

- o Study in detail the psychology of all key decision makers. This is probably the dominant consideration for show of force operations.
- o Identify the legal parameters that bind the activities of the host nation, target nation, and US forces in the region. This includes treaties, international law, status of force agreements, and rules of engagement restrictions.
- o Identify the moral issues that affect the activities of the nation involved.
- o Identify the scope of pertinent political issues within the region. For example: Do the actions of local

politicians affect mission success, or should friendly concern be confined to decision makers at the national level?

- o Which economic issues influence the crisis?

<p><b>Describe the Battlefield's Effects</b></p>
--

- o **Psychological.** What is the **psychological** environment in which key decision makers find themselves? Is the key leadership secure, or is there a legitimate threat to their power base? How would compliance with US desires affect their positions?
- o Legal. Identify the--
  - Terrain that is legitimate for use by US Forces.
  - Legal restrictions that affect friendly terrain use and **COAs**.
- o Moral. What friendly actions would be encouraged, tolerated, discouraged, and not tolerated by--
  - US public opinion? (Consider actions that are legally correct but morally suspect.)
  - The international community?
- o Political.
  - How does the regional political situation (host nation, target nation, and neighboring states) affect friendly **COAs**?
  - How does the world political situation affect friendly **COAs**?
  - How does the political situation affect target **COAs**?
- o Economic.
  - How does the economic situation in the region affect friendly **COAs**? Would a particular-friendly action unduly interfere with a vital economic function such as farming?
  - How does the economic situation affect target **COAs**?
- o Terrain.
  - Which terrain best lends itself to the show of force operations being considered? For example, does the terrain allow for observation of and by the target audience?

- Consider that the show of force could escalate to war. Conduct a standard **OCOKA** analysis to determine terrain which best supports offensive and defensive operations.
- o Weather. Remember to evaluate the impact of weather upon any psychological operations.

Evaluate the Threat
---------------------

- o Decision makers. Develop a psychological profile of the key target decision makers. Include--
  - Personal objectives, goals, concerns, values, and perspectives of each individual. Are there any support bases, material possessions, official positions, ranks, titles, privileges, or relationships that the individuals value over the good of their country?
  - Current position, attitude, opinions, and views of each individual towards the contentious issues.
  - Decision-making procedures for each individual. Determine the influence of emotion and logic as the individual deliberates. When does each individual actively seek information? When do they allow information to come to them?
  - The ability of each individual to access information. Do the decision makers get complete, honest, and unbiased information? Are the decision makers surrounded by cowards or sycophants who would withhold or change information for personal reasons?
  - Other psychological aspects that affect decision making, to include--
    - o Ability to objectively reason.
    - o Ability to compare long-term versus short-term gain.
    - o Ability to calculate risks, and courage to take risks.
  - Doctrinal templates. What do key decision makers usually do when confronted with similar situations?
- o Target nation. What friendly **COAs** would increase or decrease popular support for target decision makers?
  - Is the target nation prepared for escalation to war?
  - Conduct traditional OB analysis and develop doctrinal templates in case the crisis escalates to war.
  - Carefully identify the willingness to fight of the target nation military. Do they believe they can

successfully fight US Forces should the crisis escalate? What friendly actions would help the US gain moral ascendancy over the target nation military?

<p><b>Determine Threat Courses of Action</b></p>
--

- Template or describe the possible decision-making processes of key target leadership. What are the crux **elements** of **each** individual's position? What are likely and unlikely leveraging forces that would lead to desired and undesired decisions?
- Template or describe threat actions to be influenced. Describe the key elements that would lead to the implementation of desired actions or the cessation of undesired actions.
- Template or describe threat support functions associated with both desired and undesired actions such as movement, C<sup>3</sup>I, rehearsals, and propaganda.
- Template or describe threat reactions to friendly actions. For example, will they fight? Will they comply? Will they resort to legal or political recourse?
- Consider illegal threat actions for which the target nation does not need to claim responsibility. For example, terrorism or agitation of the host nation.
- The G2 or S2 should role-play the target audience as well as the target nation intelligence services that can collect against friendly actions.
- **Wargame** target nation reactions to friendly actions. The psychological reactions of key decision makers should be **wargamed** in detail.
- What friendly **COAs** would influence target decision makers to comply?
- Events that would lead to the escalation to hostilities should be **wargamed** in detail. The staff judge advocate should be involved in this wargaming to determine the moral, legal, and political status of both sides during escalation.

## █ Attacks and Raids █

The Army conducts attacks and raids to create situations that permit seizing and maintaining political and military initiative. Normally, the US executes attacks and raids to achieve specific objectives other than gaining or holding terrain. Attacks by conventional forces damage or destroy high value targets or demonstrate US capability and resolve to do so. **Raids** are usually small-scale **operations** involving swift **penetration** of hostile territory to secure information, temporarily **seize an** objective, or destroy a target. Raids end with a rapid, pre-planned withdrawal.

---

### Define the Battlefield Environment

---

Most of the factors and considerations used in conventional operations apply in attacks and raids. When establishing the AI consider--

- Target areas;
- Friendly approach and withdrawal routes, including zones of entry;
- Threat reaction forces;

---

### Describe the Battlefield's Effects

---

- Attacks and raids are often dependent on speed of operation for success. Planning speedy operations requires detailed and precise information on the target area.
- Outside of the target area, focus on aspects of the battlefield that will affect the friendly forces movement to and from the objective. Also consider the effects of the battlefield on threat forces that may attempt to block or delay the friendly force.

Evaluate the Threat

- o Identify high value targets within the target area.
- o Consider available reinforcing forces as well as forces within the target area.
- o Model the decision making process used to commit reinforcing forces. Who makes the decision? What are the decision maker's sources of information? How are orders communicated to the reinforcing forces? What are the time lines involved?

Determine Threat Courses of Action

- o Develop threat COA models that depict in detail the threat's dispositions and actions in the objective area.
- o Consider the **COAs** of available reinforcing forces. Will they move to engage friendly forces within the engagement area, or block their withdrawal? Might the target force choose to engage some other friendly target instead of reacting directly to the attack or raid?

Noncombatant Evacuation Operations

Noncombatant evacuation operations relocate threatened civilian noncombatants from locations in a foreign country or host nation. These operations involve US citizens, or friendly host nation or third country nationals, whose lives are in danger. Noncombatant evacuation operations may occur in a permissive environment or require the use of force.

Define the Battlefield Environment

AI:

- o Within the nation where noncombatants will be evacuated, identify the locations of all groups that might influence operations.



- 0 Check which countries might accept evacuees.
- o Which countries might assist or hinder the operation?

Types of activity to consider:

- o Identify whether evacuation is expected to be permissive or forced.
- o Identify the operational time sensitivity.
- o Fully identify the scope of the demographic situation that has prompted the evacuation. Consider the political, social, economic, legal, and religious situations. Look at the government, military, and population, in general.

<p><b>Describe the Battlefield's Effects</b></p>
--

The staff judge advocate should identify all legal issues that impact on the evacuation.

- o Identify how local political issues will shape friendly COAs. Learn if--
  - Hostile groups oppose the evacuation of noncombatants?
  - The source of irritation can be minimized?
  - There are areas where anti-evacuation sentiment is strongest?
  - There are identified areas where sympathy for the evacuation is strongest?
- o Identify the logistics infrastructure that might support the evacuation. Choose--
  - Consolidation points that are secure from attack and well equipped with power, water, restrooms, and heat. Consider football or soccer stadiums, gymnasiums, auditoriums, large halls, and recreation centers.
  - Evacuation routes that are fast and secure.
  - Means of transportation for evacuees. Consider the local transport system.
  - Available sources of food and potable water for evacuees.
  - Communications systems that can support evacuation operations. Analyze the ability of isolated evacuees to contact evacuation authorities.

- Map the location of key facilities to include foreign embassies, military installations, hospitals, police stations, and government buildings.
- Conduct a standard OCOKA terrain analysis to--
  - Identify probable locations for ambushes of evacuation vehicles. Within urban areas, look at major thoroughfares and public transportation systems.
  - Identify infiltration routes and assembly areas for threat attacks on evacuee consolidation points.
  - Identify places suited for anti-US demonstrations and their relative position to evacuation **sites** and US installations.
- Analyze the effect of weather upon--
  - Adverse groups. Dedicated insurgents prefer poor weather conditions while casual demonstrators do not.
  - Evacuation operations. Will sudden rain, cold, or extreme heat require changing evacuation facilities?

Evaluate the Threat
---------------------

- Identify all groups that might intentionally interfere with the NEO. Consider host nation law enforcement agencies, military forces, political groups, religious factions, and the general population. Focus on hostile groups such as insurgents, terrorists, and radical extremists.
- Using a population status overlay, conduct an OB analysis for each of these potentially hostile groups:
  - Disposition. Where do **hostile** groups live and gather in relation to evacuation objectives? Focus on neighborhoods near embassies, US citizen population centers, and US businesses.
  - Composition and strength. How are these groups organized? What kind of weapons do they possess?
  - Tactics. What resistance methods and techniques can these groups employ against the evacuation? Consider attacks, raids, ambushes, sniping, bombings, hijacking, hostage taking, kidnapping, and demonstrations.
- Identify all groups that might unintentionally interfere with the evacuation. Consider groups such as students, labor unions, demonstrators, rioters, host nation forces, and criminal elements.

- Conduct OB analysis on the adverse groups. Identify their goals and objectives as well as their position towards the evacuation operation. Focus on the methods of resistance and techniques employed to **achieve these** objectives. How would they interfere with the evacuation?
  - Use a population status overlay to identify the areas most likely to harbor people who would interfere with evacuation, operations.
  - Use a coordinates register to record activities around key routes and consolidation points.
  - Use an intelligence workbook and OB files to record information about potentially hostile and adverse groups.
  - Use activities and association matrices to identify which key individuals are actively interfering with evacuation.
  - Use the LOC and key facilities and targets overlays to determine where interference will occur.

<p><b>Determine Threat Courses of Action</b></p>
--

- Consider threat influence on the logistics infrastructure. Look for control of workers such as bus drivers, dock workers, police, food service personnel, and labor groups.
- Use the key facilities and targets overlay to **identify** the most likely points of interference with the evacuation.
- Template intentional interference with the, evacuation by hostile groups at each likely interference site. Consider terrorist actions, ambushes, delays at checkpoints, demonstrations, raids on consolidation points, and sniping. Determine alternate routes or COA at these points.
- Identify unintentional interference with the evacuation by **"wild card"** groups and template their activity. Consider riots, criminal activity, arson.
- Template or describe the support functions for groups that would interfere with the evacuation. Consider planning, C<sup>3</sup>I, weapons, ammunition, food, water, shelter, training, etc.



- Identify and study obstacles **to resolutions** in detail.
  - Identify how demographics allow for, encourage, and discourage belligerent **COAs**. For example, a historical feud between two religious sects might designate certain monuments or other icons as key terrain.
  - Also identify which friendly **COAs** will be tolerated, encouraged, or discouraged given the demographic situation.' Consider the balance of forces in the area.
- o Terrain.
- Conduct a standard **OCOKA analysis** to determine where the terrain lends itself to offensive and defensive operations-for all belligerents.
  - Identify the terrain which is best suited for police action to support friendly patrols.

---

#### Evaluate the Threat

---

- o Fully identify all belligerent groups. If the relationship between two groups is in question, consider them distinct even if their political objectives are the same.
- o What is the relationship of each group to every other group? Allied, neutral, or hostile?
- o What is the political organization of each group? What are the political objectives of each group? How strong are each of their convictions?
- o How much discipline can the leadership of each group expect from their followers? How likely are rank and file members to violate a truce negotiated by their **leaders?**
- o Fully identify the military capability of each group. Start with traditional OB factors to develop doctrinal templates.
- o What friendly **COAs** would induce the belligerents to obey the law? Some options to consider are--
  - Show of force.
  - Defensive measures for key facilities, police patrols, cordon and search operations.

- Designating territorial boundaries.
- Establishment of demilitarized zones.

<b>Determine Threat Courses of Action</b>
---

- o Template or describe the belligerent actions such as raids, ambushes, occupation of contested areas that prevent peace or other desired end-states.
- o Template or describe the supporting functions associated with the belligerent actions of the warring groups such as massing at assembly areas, logistics, **finance**, CI...
- o Template or describe the responses of belligerent groups to US actions within the AO and AI. Consider terrorist actions.
- o During wargaming, the G2 and S2 should role-play each of the belligerent parties.

Support for Insurgencies and Counterinsurgencies

At the direction of the National Command Authority, US military forces may assist either insurgent movements or host nation governments opposing an insurgency. In both instances, US military forces predominantly support political, economic and informational objectives.

The US supports selected insurgencies opposing oppressive regimes that work against US interests. The feasibility of effective support and the compatibility of US, and insurgent interests are major considerations. Because support for insurgencies is often covert, special operations forces are frequently involved. General purpose forces may also be called upon when the situation requires their particular specialties or when the scope of operations is so vast that conventional forces are required.

Define the Battlefield Environment
---------------------------------------

AI:

- Consider strategic location: neighboring countries, boundaries, and frontiers.
  - The use of coastal waterways.
  - Third-country support for the insurgency.
- Types of relevant activity:
  - Analyze host nation population, government, military, demographics, and threat.
  - Evaluate political structure, economics, foreign policy and relations, policies on military use.

Describe the Battlefield's Effects
---------------------------------------

- Terrain dictates points of entry, infiltration and exfiltration routes, c structures for operations, and agricultural centers.
- Weather affects availability of food supply to insurgents. Floods limit cache sites. Drastic changes in climate may limit usefulness of existing terrain intelligence.
- Migration and settlement patterns will help indicate which areas are becoming pro-government or pro-insurgent.
- Politics may influence the people's attitude towards both threat and friendly operations.
- Economics may affect the insurgent's ability to conduct operations. A lack of money may cause the theft of equipment.
- Economics may also influence the populace's political leaning. This could contribute to an increase or decrease in insurgent capability to conduct offensive operations.

Evaluate the Threat
---------------------

- Include **"personalities"** in the OB analysis. Identify leaders, trainers, recruiters, staff members, and logistics personnel. Develop doctrinal templates based on observed operating procedures.
- In describing personalities, look at the functional specialty of each individual. The number of trainers for a **specific** weapon might indicate the type of tactics or readiness due to time and the number of personnel trained.
- Consider the types of weapons the insurgent has at his disposal. Sophisticated weaponry is an indicator of external support as well as his capability to attack more sophisticated or well-protected targets.
- Consider unit organization. It takes insurgent organizations longer than conventional units to train for major attacks. This is because larger insurgent units require more planning and training time; large training areas; and fast, effective, and secure communications. All of these are capabilities that are difficult for the insurgents to acquire.
- Analyze movement patterns. They may coincide with logistics or operational activities.
- Consider where the insurgent lives and works. He may be located near key terrain such as major LOC, agricultural areas, or government installations.

Determine Threat Courses of Action
------------------------------------

- Threat **COAs** on the objective might include--
  - Attacks and raids on military installations or other host nation government facilities.
  - Attacks on public utilities installations or other forms of economic sabotage.
  - Kidnappings and assassination of public officials.
  - Psychological operations directed against the population (for example, intimidation and propaganda).



- Ambushes of host nation or US **convoys**.
- Evasion from friendly troops.
- o To determine the most likely insurgent **COAs**, template the best locations for potential insurgent attacks, sabotage, raids and roadblocks. Use the key facilities and targets overlay as a basis for this evaluation.
- o Template insurgent activity near the objective to include--
  - Movement around objectives, such as infiltration and exfiltration routes.
  - Assembly points, rally **points**, and staging areas.
  - Surveillance positions.
- o Template insurgent activity away from their objective areas to include--
  - Locations of known and suspected base camps.
  - Locations of known and suspected training areas.
  - Centers of pro-insurgent population. Include an evaluation of individual villages and large political divisions such as states and provinces. Identify areas of guerilla influence and residences of insurgent leadership or key sympathizers.
- o Template insurgent support functions to include--
  - Logistic routes and transshipment hubs.
  - Cache sites, water sources, agricultural areas, and POL storage and production areas. Include commercial sites and those of the government.
  - Locations of communications equipment. Include commercial establishments and government installations where they may be purchased or stolen.
- o During wargaming, the **G2/S2** or the **G5/S5** (Civil Affairs officer) should role-play the population in addition to the insurgents.

Support to Domestic **Civil** Authorities

When appropriate governmental authority directs the armed forces to assist in domestic emergencies within the continental United States, the Army has primary responsibility. Army units support disaster relief, humanitarian assistance, and similar operations. Federal law also authorizes the use of military force to suppress domestic violence or insurrection.

Techniques for applying IPB in operations that provide support to domestic authorities are determined primarily by the type of operation undertaken. For example, during support to law enforcement agencies engaged in counterdrug operations, use the considerations put forth for counterdrug operations. If supporting disaster relief, use the considerations described under Humanitarian Assistance and Disaster Relief earlier in this chapter.

APPENDIX A INTELLIGENCE PREPARATION OF THE BATTLEFIELD, WARGAMING, AND INTELLIGENCE SYNCHRONIZATION
---

Staffs use wargaming to refine and compare potential friendly courses of action. Comparing potential courses of action, based **on** the results of wargaming, allows the staff to identify the best course of action for recommendation to the commander.

Wargaming is a conscious attempt to visualize the flow of an operation, given friendly strengths and dispositions, threat assets and probable courses of action, and a given battlefield environment. Wargaming attempts to foresee the action, reaction, counteraction dynamics of operations. As a result the staff--

- o Develops a shared vision of the operation.
- o Anticipates events.
- o Determines the conditions and resources required for success.
- o Identifies a course of action's strengths and weaknesses.
- o Identifies the coordination requirements to produce synchronized results.
- o Determines decision points.
- o Determines information required to plan and execute the course of action.
- o 'Identifies branches and sequels for further planning.

The entire staff participates; the G2 or S2 plays a pivotal role in the process by role-playing the threat commander. If the G2 or S2 accurately portrays a thinking, aggressive, noncooperative threat, then the staff is forced to plan for eventualities on the battlefield. The G2 or **S2** can accomplish this vital task only if he has used the IPB process to develop threat course of action models that reflect the actual **COAs** available to the threat.

During staff wargaming a designated staff officer records the results of wargaming into the decision support template (DST) and battlefield operating systems (BOS) synchronization matrix. The results of wargaming enable the staff to plan and execute operations that will accomplish the command's mission.

The G2 or S2 uses the results of wargaming to identify intelligence requirements and recommend PIR that support each friendly course of action. He also uses the results of wargaming to create a strategy for the unit collection effort. The intelligence synchronization matrix is the tool the G2 or S2 uses to link **and synchronize** the intelligence collection strategy with the expected flow of the operation. Finally, the G2 or **S2** builds a detailed collection plan from the intelligence synchronization matrix.

IPB and the **G2/S2** play a critical role in the wargaming process. Guidelines for the **G2/S2's** role in the wargaming process follow below. For a complete discussion of the wargaming process **see FM 101-5, Command and Control for Commanders and Staff.**

### General Rules

The reliability and quality of the products that result from wargaming are dependent on adherence to a few basic rules. The general rules that follow are designed to avoid introducing bias into the wargaming process.

- List the advantages and disadvantages as they become obvious during the wargaming process. Waiting until afterwards forces you to rely on your memory.
- Remain unbiased. Keep an open mind. Do not be influenced by the personality of the commander or other staff officers. Do not get emotionally involved in making any particular course of action successful. Remain impartial when comparing friendly and enemy capabilities in a given situation.
- Ensure each course of action remains feasible. If it becomes infeasible at any time during the **wargame**, stop the **wargame** and reject the course of action.
- Avoid drawing premature conclusions and then presenting facts and assumptions to support them.
- Avoid **comparing** one course of action with another during the **wargame**. Wait until the comparison phase.
- **Wargame** each course of action separately.

**Prepare for Wargaming**

Determine the amount of time available for wargaming. Time constraints may force the staff to consider only the most dangerous and most likely threat courses of action rather than the complete set. Time constraints may also limit the level of detail to which each course of action is wargamed.

Gather the tools. The G2 or S2 must bring enemy course of action models to the wargaming session that accurately reflect the sets of available threat **COAs**. The G3 or **S3** will bring potential friendly **COAs** to the wargaming session.

Prepare the wargaming **mapboard** by posting the initial dispositions of friendly and threat units. Most often the staff uses a standard military map. Some situations may require the use of sketches or detailed terrain models.

Identify assumptions. Assumptions are tools that help to shape courses of action. They address flank activities and other factors beyond the command's control. Assumptions about the threat, such as strength, rates of march, etc., are included in the threat models that generated the COA models and situation templates.

List known critical events and decision points. Critical events identified before wargaming are usually specified or implied tasks that are essential to mission accomplishment. Other critical events will become apparent during wargaming. The staff should agree to explore and pre-plan decisions that their commander might have to make during the operation. They should avoid the temptation to **wargame** decisions of higher or subordinate headquarters. If time permits the staff may identify tasks to subordinate units that require synchronization.

Identify the echelons for consideration. Usually the friendly echelon under consideration is limited to the units directly subordinate to the friendly commander. The threat echelon under consideration is usually determined by the friendly mission. Offensive missions usually require more resolution.

Identify the battlefield operating systems for consideration. The **G2** or **S2** will usually confine his discussion to the primary enemy **BOSs** under consideration for each engagement. If time permits the remainder of the staff may coordinate the effects of each friendly BOS during the wargaming of each COA.



During the action - reaction - counteraction drills the G2 or S2 describes the location and activities of enemy **HVTs**. He highlights points during the operation where these assets are of importance to the threat's COA. This may prompt the staff to nominate certain **HVTs** as **HPTs**, making their engagement an integral part of the friendly COA under consideration. The G2 or S2 updates the situation and event templates associated with the threat course of action to reflect the **TAIs** supporting engagement of those **HPTs**.

The **G2** or **S2** prompts staff planning by describing the various actions available to the threat. In addition to the basic set of threat **COAs**, the G2 or **S2** should describe the threat actions that might prompt the execution of the following friendly, decisions:

- o Commit the reserve.
- o Use attack helicopters or close air support (CAS).
- o Artillery barrages against **TAIs**.
- o Scatterable **minedelivery**.
- o Shift the main effort.
- o Advance to the next phase of the operation.
- o Change overall mission.
- o Call to higher headquarters for help.

If, while wargaming a friendly course of action the staff identifies --

- o an enemy reaction that would prevent success of the operation which the friendly force could not counteract, **or**,
- o a series of friendly actions and counteractions that deny the contradict the friendly deception story,

the battlemaster stops the **wargame** and notes the specifics of the problems encountered. The staff proceeds to **wargame** the friendly course of action against any remaining threat **COAs**. Only after the COA has been **wargamed** against all threat **COAs** should the staff decide whether to modify the course of action to correct its deficiencies, to retain the course of action as it is (noting the risk of failure), or to discard the course of action altogether.

Similarly, the G2 or **S2** uses the **wargame** to identify modifications and refinements to the threat COA models. As critical events become apparent, the G2 or **S2** prepares situation templates to "**capture**" threat dispositions during the event. He identifies any necessary modifications or refinements to the threat COA models as the **wargame** progresses, either making them immediately or noting the necessary changes for later.

The G2 or S2 should ensure that the staff considers all threat **COAs** and other, options available to the threat. The staff should NEVER **wargame against** only one threat COA. As a minimum, the staff should **wargame** against the most likely and the most dangerous threat **COAs**.

The battlemaster should ensure that all decisions identified are ones that his staff or commander will make during battle. Do not waste time wargaming the decisions of a higher or subordinate unit.

#### Record the Results of Wargaming

Each interruption in the action - reaction - counteraction drill corresponds to a decision by the commander or staff. Each time the staff identifies a decision point, the recorder makes the appropriate entries in the staff's recording tools, such as the decision support template and the BOS synchronization matrix. The recorder should "capture" enough information to allow the staff to anticipate and plan for each decision. As a minimum this includes--

- Decision criteria. What activity, event, or information prompts the decision? The decision criteria is usually related to threat activity. Sometimes it is related to friendly forces or third party activity.
- Friendly action or response. What is the result of the decision? Decisions usually result in engagement of **HPTs**, a change in the friendly COA, or the execution of an on-order or be-prepared mission by subordinate units.
- Decision point (DP). When the decision criteria is related to the threat, the DP is the location and time where collection assets will look for indicators to verify or deny that the decision criteria has occurred. If the decision criteria is related to friendly force information, the DP usually corresponds to a time-phase line. The recorder ensures that he captures both the



time and geographic location of the DP. The staff ensures they select **DPs** which allow decisions in time to properly synchronize the resulting friendly actions. When placing **DPs**, consider time **for--**

**Intelligence** collection.

Processing and disseminating the intelligence to the commander or other decision maker.

Preparation and movement time of friendly forces or assets that will execute the mission.

Activities or movement of the target or threat during the time elapsed between decision and execution.

- Target **area** of interest (TAI). **This** is the location where the effects of friendly actions are synchronized. **TAIs** are often engagement areas or sets of targets: The staff ensures that the physical distance between a DP and its associated TAI allows for the time delays involved in collecting, processing, and communicating intelligence; the movement of threat forces; and the time lines associated with friendly activities.
- Update the high payoff target (HPT) list. If the friendly action involves engaging a threat HVT, the recorder adds the HVT to the list of high payoff targets for the COA under consideration. If there is a time element involved (i.e., if the HPT is only high payoff during a particular phase of the battle) he makes the appropriate notations.
- Named areas of interest (NAI) that support the DP. The G2 or S2 usually records the NAI, but some staffs make it the responsibility of the recorder. The DP is almost always the only NAI associated with a particular decision. Sometimes, however, the G2 or S2 needs information from more than one NAI in order to confirm or deny that the decision criteria has occurred.

If time permits, the battlestaff may also discuss and record the synchronization of friendly actions not related to decision points (i.e., which will occur regardless of events on the battlefield). Examples include--

- Crossing the line of departure (LD) or line of contact (**LC**).
- Initiating preparatory fires.
- Shifting preparatory fires.

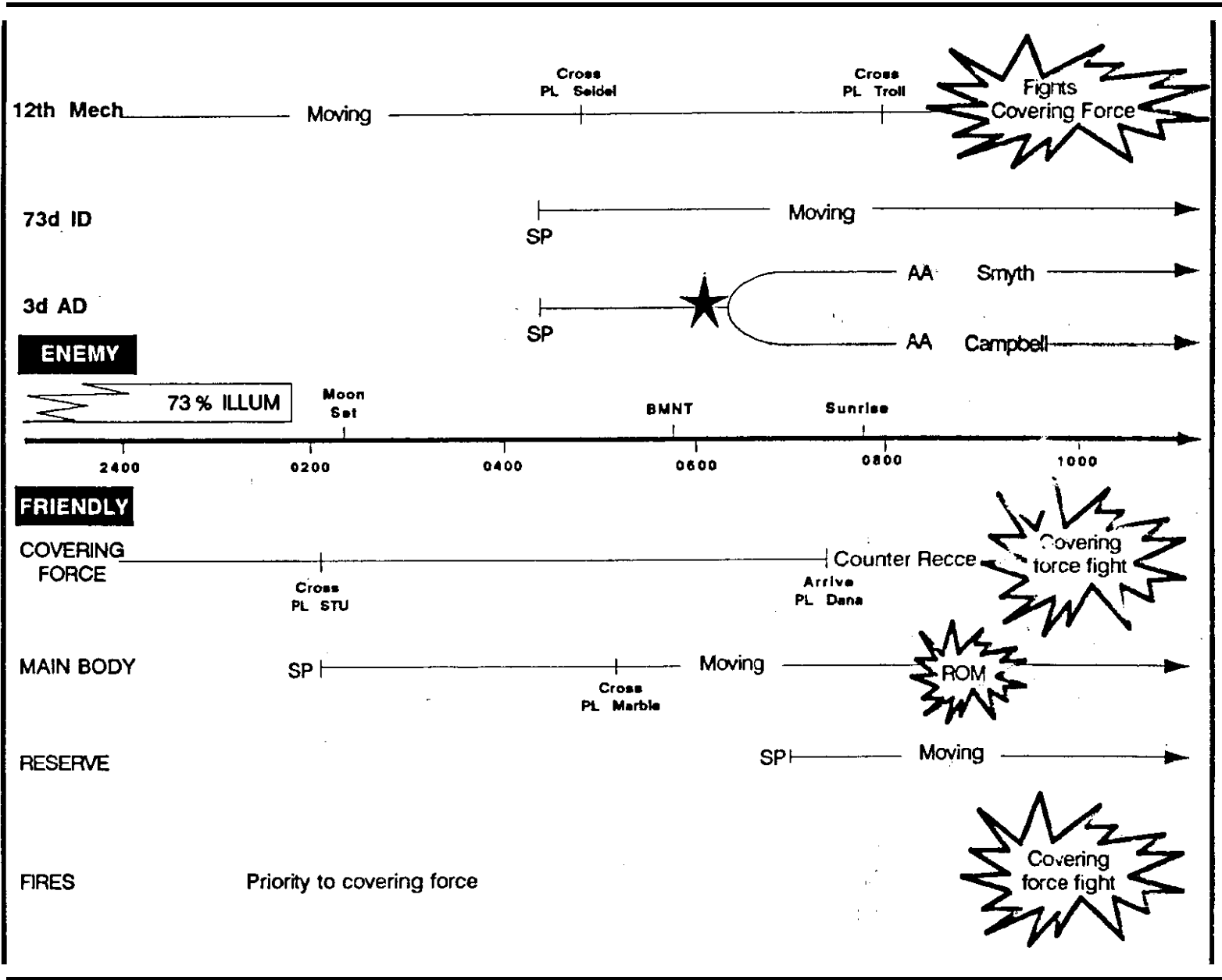

Figure A-1. The two-sided time line.

If the interaction of anticipated friendly and threat events is particularly complicated the staff might prepare a two-sided time line. The two-sided time line serves as a quick reference tool for planning the synchronization of effects in fluid situations. The example shown in Figure A-1 depicts the reaction of enemy reserve forces to an envelopment by friendly forces. In this example, the time line depicts enemy options (**DPs**) and anticipated critical events, such as the covering force battle, a refueling-on-the-move operation, etc. Friendly **DPs** and options, though not shown in this example, are also included on the time line.

After the primary wargaming session-distinct members of the battlestaff may initiate specialized sessions for their function areas. For example, the G4 or S4 support operations staffs may want to **wargame** logistics activities throughout the operation.

#### Conduct the Targeting Conference

The fire support officer almost always convenes a targeting session after the base wargaming. The targeting conference further refines **HPTs** nominated during wargaming and develops plans to engage them. During the targeting conference--

- o The staff develops recommendations on how each HPT should be engaged.
- o Using situation templates and other IPB products, the staff assesses the risk to friendly attacking assets.
- o The G3 or S3 and fire support officer develop the attack guidance matrix (see Figure 1-3).
- o The G2 or S2 identifies **NAIs** that will locate and track **HPTs** and includes them on the event template.
- o The G3 or S3 and fire support officer determine battle damage assessment needs. The G2 or S2 includes these as intelligence requirements that support the friendly COA and develops **NAIs** that support them. These **NAIs** are often the TAI where the target is engaged.

#### Compare Friendly Courses of Action

Following wargaming, the staff compares friendly **COAs** to identify the one that has the highest probability of success against the set of threat **COAs**. Each staff officer uses his own

criteria for comparing the friendly **COAs** in his own staff area of responsibility. The **G2** or **S2** compares friendly courses of action based on their ability to defeat the threat's COA and his ability to support the command with the intelligence required to execute each friendly COA.

Led by the **G3** or **S3**, each staff officer presents his findings to the remainder of the staff. Together they determine which friendly COA they will recommend to the commander. In the event they cannot reach a conclusion, the chief of staff or executive officer will determine which COA to recommend to the commander.

.....  
..... **Synchronize Intelligence** .....

The staff then presents its recommendation to the commander. The **G3** or **S3** briefs each COA, including any branches and sequels, using the results and records of wargaming such as the DST and BOS synchronization matrix. He highlights the advantages and disadvantages of each COA.

The commander decides upon a COA and announces his concept of the operation. Using the results of wargaming associated with the selected COA, the staff prepares plans and orders that implement the commander's decision.

Decisions made during wargaming form the basis for the "**Be Prepared**" and "**On Order**" tasks specified in operations order and fragmentary orders. The decision criteria associated with each DP accompanies the task as it is written into paragraph 3 of the operations order. For example: "**On order, Task Force HONABACH will attack to destroy enemy forces vicinity objective HEAD. This order will be given if the 32d Division turns southwest onto Highway 34.**"

Prioritizing Intelligence Requirements
--

The **G2** or **S2** normally discards the initial set of intelligence requirements developed during mission analysis and replaces them with the intelligence requirements developed during wargaming. The **G2** or **S2** should designate the decision criteria for each DP as an intelligence requirement. The intelligence requirement should not be larger than the decision criteria. In other words, the **G2** or **S2** should resist the temptation to combine two decision criteria into a single intelligence requirement. He should also avoid adding additional requirements

onto the intelligence requirement. If the battlestaff fully considered the G2 or **S2's** prompting during wargaming, additional information is unnecessary for the successful execution of the unit mission.

The G2 or S2 should prioritize the list of intelligence requirements to reflect his recommended PIR and present it to the commander. The commander will designate the most important intelligence requirements as PIR, prioritizing them to reflect their relative importance. The **remaining intelligence** requirements are prioritized among themselves as information requirements (**IR**).

If intelligence requirements vary over the course of operation the G2 or **S2** prepares several prioritized lists,. **For** example, PIR may-vary in importance depending on the phase of the operation. PIR during the first phase of an operation may be unnecessary in later phases.

---

The Intelligence  
Synchronization Matrix

---

The intelligence synchronization matrix is the expanded intelligence portion of the BOS synchronization matrix. The G2 or **S2** begins the intelligence synchronization matrix by establishing blank time lines for each collection asset that match the time lines on the BOS synchronization matrix.

The G2 or S2 then establishes the "**latest-time-information-of-value**" (LTIOV) times for each intelligence requirement. This is easy to determine since each intelligence requirement is exactly matched to the criteria to execute a decision identified in wargaming. The LTIOV time lines are determined from the decision points recorded on the DST.

The **S2** or collection manager then develops a collection strategy for each intelligence requirement that will ensure it is answered on time. He considers--

- Tasking time lines associated with each collection system or discipline.
- Collection and processing time lines.
- Dissemination time lines.
- Type of target or activity collected against.

- o Location of the NAI collected against.
- o Time lines associated with the expected threat activity.

The collection strategies, which are designed not **only to** collect the intelligence but to deliver it on time, are then entered onto the intelligence synchronization matrix. The **S2** or collection manager then develops a detailed collection plan using the intelligence synchronization **matrix as** the basic structure.

Execute the Battle

As the staff tracks the battle, they refer to the DST and BOS synchronization **matrix** to determine which decisions are becoming due. The G2 or S2 then looks at the intelligence synchronization matrix to determine which collection agencies owe the information and intelligence which will enable the decision to be made in a timely manner. The G2 or **S2** may have **to** re-prompt the collection asset to the upcoming intelligence requirement. This is especially true if the course of the battle is occurring faster than anticipated.

As the collection assets report, the intelligence section conducts analysis to determine if decision criteria have been **met**. If not, the collection manager must **retask** the collector or the intelligence section must make an educated guess based on available information. As each decision criteria is satisfied, the **S2** or collection manager refers to the DST and BOS synchronization matrix to ensure that all decision makers receive the appropriate intelligence.

Mini-Wargaming and  
the Dynamic,  
Recurring Nature of IPB

The DST, BOS synchronization matrix, and intelligence synchronization matrix are based on assumptions about the threat's courses of action and the dynamics of the operation. It will often occur that the assumptions prove less than 100% accurate. Often the only change is in the **time lines**; the operation may progress more or less quickly than anticipated. Sometimes, however, the threat executes a course of action not completely anticipated during wargaming, or the operation's dynamics lead to unexpected branches and sequels.

In order to anticipate the changes such eventualities dictate, the staff uses mini-wargaming to continually re-evaluate their assumptions, re-initiating the IPB and decision making processes as necessary. When any member of the staff identifies conditions which require revalidation or refinement of the plan, he initiates a mini-wargame. The G2 or S2 prompts mini-wargame sessions whenever he develops intelligence that runs counter to planning assumptions.

The G2 or S2 usually begins by discussing the current state of the common understanding of the battlefield:

- o He reviews the IPB predictions **that** have been confirmed, denied, and are yet to be confirmed. These are usually assumptions about threat **COAs** but might also be assumptions about the terrain or other factors.
- o He follows this with a full report of the unanticipated intelligence that **led** to the mini-wargame. He emphasizes the significance of the intelligence in terms of the threat **COAs** that it indicates or fails to indicate.

The G2 or S2 should then present an informal, revised set of threat **COAs** that account for the new intelligence. The revised **COAs** usually result from an abbreviated IPB process that may have been executed in only a few minutes.

If the new intelligence is too contrary to the original IPB, the commander may want to initiate a completely new planning session. Otherwise the personnel present at the mini-wargame modify the current plan based on the revised IPB. Because time during conduct of the operation is usually limited, the staff follows an abbreviated form of the wargaming and intelligence synchronization techniques discussed above.

The G3 or S3 usually prepares a fragmentary order to incorporate new tasks to subordinate units. The G2 or S2 should use this opportunity to **retask** collection assets in accordance with the revised collection plan.

The staff should conduct numerous mini-wargame sessions during the course of an operation. A good technique is to pre-schedule mini-wargame sessions every 2 to 6 hours. At each session the staff reviews the current situation and the "**health**" of its current plans.

**An Example Application**

The following example illustrate how a G2 or S2 can use products from IPB and wargaming to synchronize intelligence. It shows the process **for two** decisions only, but the same process applies to all decisions that arise from wargaming.

**SCENARIO**

The 2d Battalion, 9th Infantry (Light); is conducting counterinsurgency operations in the country of Daemonia. The battalion has a large area of operations. From the brigade intelligence estimate, the S2 learns that an insurgent company of regular infantry is expected to enter the battalion **AO** within 72 hours.

The S2 section initiated an IPB process similar in style and approach to that shown in scenario 3 of Chapter 3. Figure A-2 shows a sketch map of the AO. The battalion situation templates **highlight--**

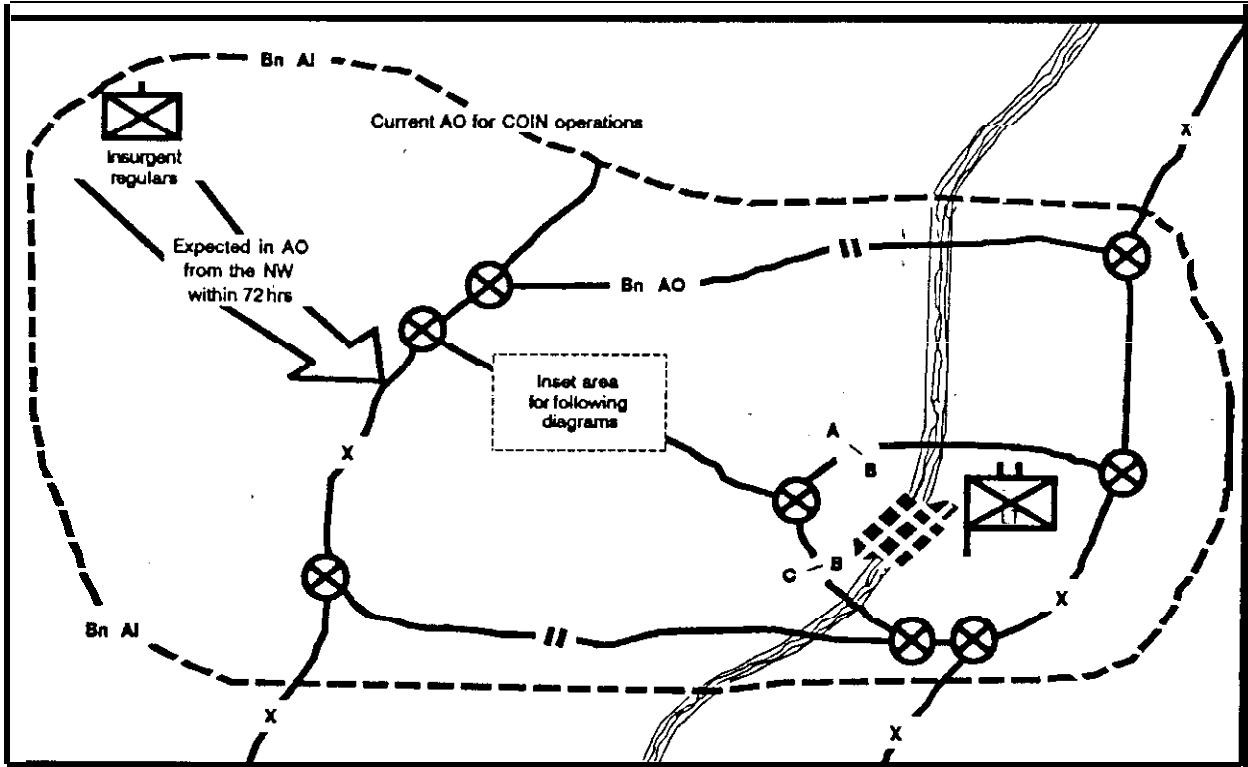

Figure A-2. The area of operations.



- Key facilities and targets overlay (potential targets for the insurgents).
- Infiltration and exfiltration routes.
- Likely base camps within the AO.
- Probable logistics, intelligence, and security activities within the AO.

Pressed for time, the commander selected a friendly COA immediately after conducting mission analysis. The friendly plan includes two phases:

- Phase I: Establish platoon-sized ambushes along the 5 likely infiltration routes while conducting reconnaissance of the 11 possible base camp areas.
- Phase II: Destroy the insurgent company in its base camp.

During both phases the battalion will accept risk at insurgent target areas identified on the key facilities and targets overlay.

The battalion will also retain a company (-) as a mobile reserve for the entire mission. The division has given the battalion operational control of enough air assault assets to conduct immediate lift of one platoon for the duration of the mission.

The S2 and S3 have verified that the commander's plan should succeed against all the threat COAs developed during IPB.

---

### Wargaming |

---

Due to the large size of the AO and the limited number of critical areas, the S2 and S3 have decided to use the box technique of wargaming. The first box includes three possible locations for enemy base camps. The wargaming begins with the S2 describing the enemy COA models for each of the three possible base camps, one each located in NAIs 1, 2, and 3 in Figure A-3. The S2 describes how each base camp would be physically arranged to include--

- Their warning system for attacks.

- Defense and security system.
- Their evacuation and exfiltration procedures.

Due to the proximity of the **three** base camps and other common features identified **during** IPB, the **S3** decides to use the same control measures for actions against any of the three base camps. The staff synchronizes their plan for phase II of the **operation** in this **box** of the battlefield:

- When the insurgent company is located in any of these three **NAIs**, **A** Company will immediately occupy tactical assembly area **BEAUTY** while **C** Company will immediately occupy tactical assembly area **LOGIC**.

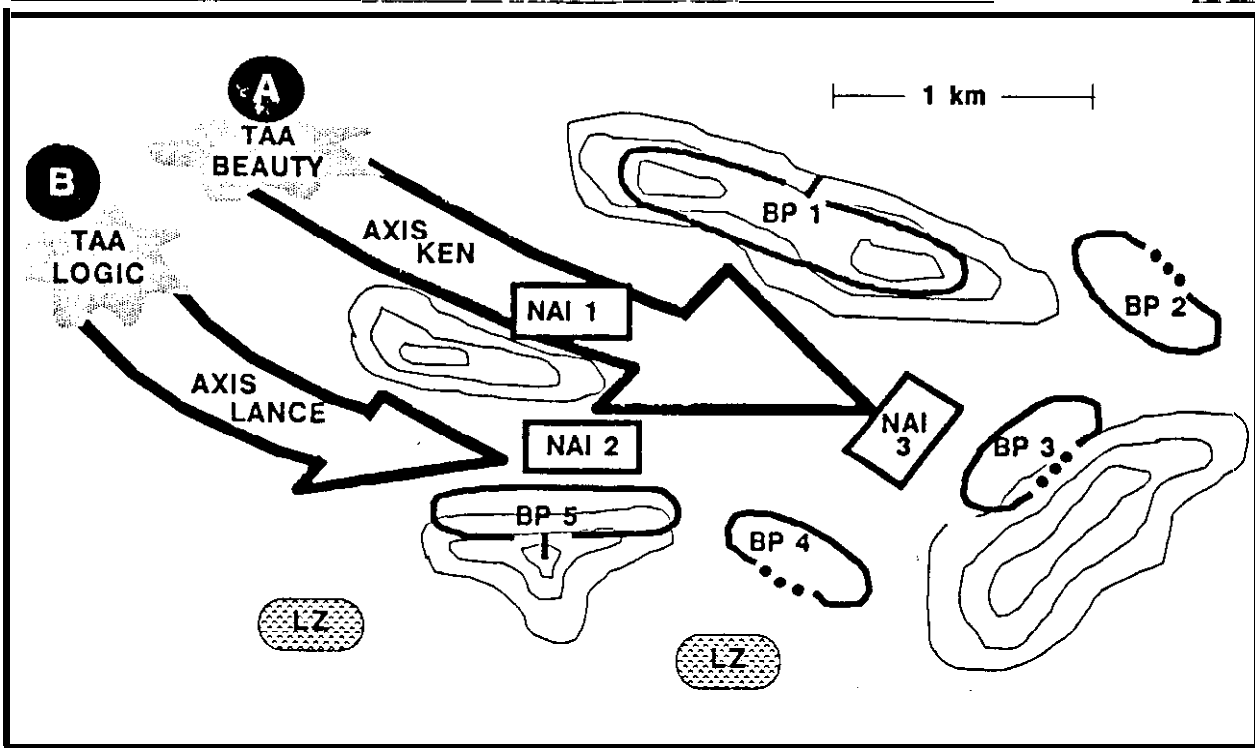

Figure A-3. Named areas of interest.

- If the insurgents are in base camp 1 or 3:
  - A Company receives 3d platoon of B Company.
  - On Order C Company will occupy battle positions 3, 4, and 5 in order to block the southern and eastern evacuation routes.
  - On Order B Company (-) will conduct air assault to occupy battle positions 1 and 2 in order to block the northern evacuation routes.

On Order A Company will conduct movement to contact along AXIS KEN as the battalion main effort to destroy insurgents vicinity objectives in NAI 1 or NAI 3.

- o If the insurgents are in base camp 2:
  - C Company receives 3d platoon of B Company.
  - On Order A Company will occupy battle positions 1, 2, and 3 in order to block **the northern** and eastern evacuation routes.
  - On Order B Company (-) will conduct air assault to occupy battle positions 4 and 5 in order to block the southern evacuation routes.
  - On Order C Company will conduct movement to contact along AXIS LANCE as the battalion main **effort to** destroy insurgents vicinity objectives in **NAI 2**.

The battle staff then plans appropriate support from each **BOS** for each scheme of maneuver.

While the staff synchronizes the concept of operations for this part of the battlefield, the recorder enters information into the DST and BOS synchronization matrix. For purposes of clarity he decides to combine the operations graphics and the DST (see Figure A-4).

After wargaming, the **S2** translates the decision criteria for each decision from the BOS synchronization matrix into an intelligence requirement (see Figure A-5). As the **S2** prioritizes the list, he places intelligence requirements number 1 and 2 at the top of the list as his recommended PIR. The commander agrees and the new PIR are--

- o PIR 1: Has the insurgent company established a base camp in **NAIs 1 or 3?**
- o PIR 2: Has the insurgent company established a base camp in **NAI 2?**

As part of his collection strategy, the **S2** decides to use the battalion scouts to answer PIR 1 and a patrol from B Company to answer PIR 2. The insurgent company is expected to occupy the base camp **only** for a limited time. Maneuver and OPSEC constraints narrow the window **even** further. The **S2** records all this information into his intelligence synchronization matrix (see Figure A-6).

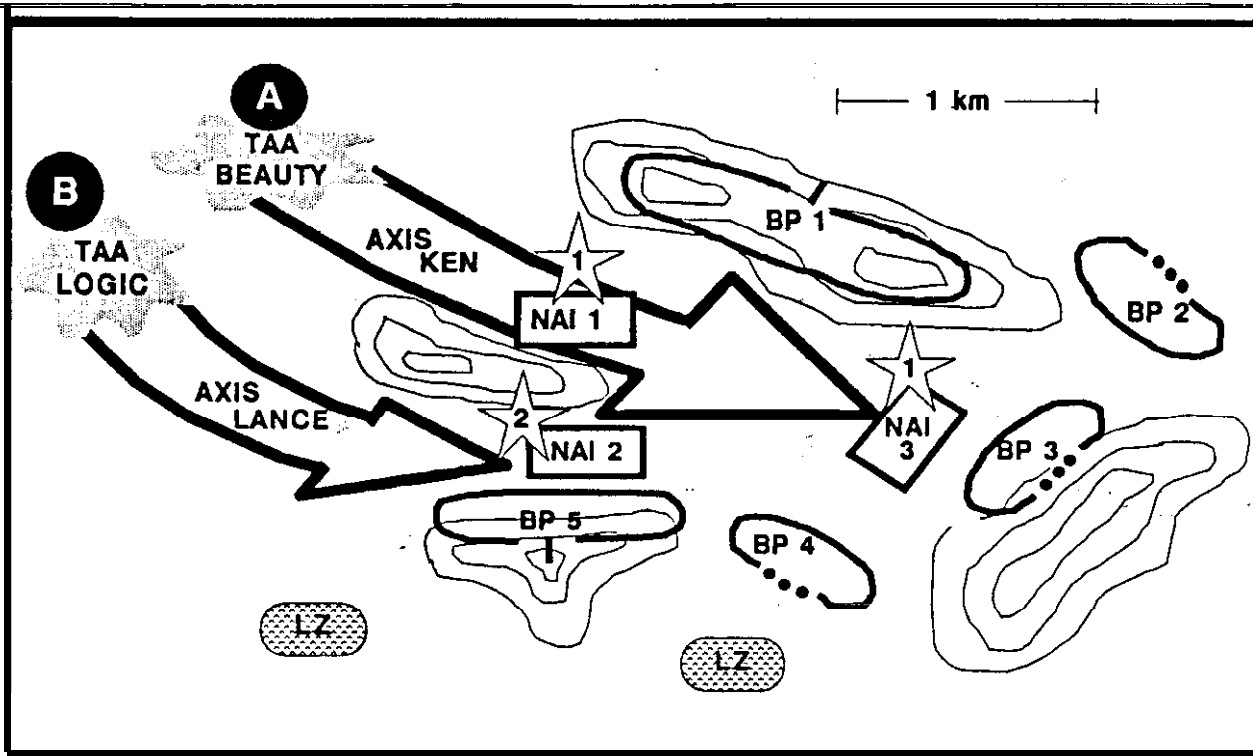

Figure A-4. Decision support template.

DP No.	No. 1	No. 2	No. 3
Decision criteria	Insurgent Camp is in NAI No. 1 or No. 3	Insurgent Camp is in NAI No. 2	
Maneuver	A Co receives 3/B, occupy TAA BAUTY O/O movement to CATK along AXIS KEN  B Co Air Assaults O/O to occupy BPs 1 and 2  C Co occupies TAA LOGIC, O/O occupy BPs 3, 4, and 5	A Co occupies TAA BEAUTY, O/O Occupy BPs 1, 2, and 3  B Co Air Assaults O/O to occupy BPs 4 and 5  C Co receives 3/B occupy TAA LOGIC, O/O movement to CATK along AXIS LANCE	
FS	Priority: A, B, C	Priority: C, B, A	
M-CMS	1/A/13th Engr to A	1/A/13th Engr to C	

Figure A-5. BOS synchronization matrix.

	21 March			22 March			23 March	
<b>Timeline:</b>	2400	1200	2400	1200	2400	1200	2400	
<b>PIR/IR No:</b>	P1	I1	P2	P3/I4	I2	I8	I4	
<b>Scouts:</b>	--	X			XX*			
<b>A Co</b>								
<b>B Co</b>								X
<b>C Co</b>								
<b>Bde</b>			X					X

• Scouts will not proceed to P3/I4 if they find the insurgent company in NAI No. 1 (PIR 1)

Figure A-6. The Intelligence synchronization matrix.

**Execution**

Eleven hours after the battalion issued the operations order, the scouts report significant insurgent activity in NAI 3, with no activity in **NAIs** 1 or 2. Additionally, the scout platoon leader, who **sat** in on the **wargaming** session, reports that the hill selected **for use** as BP 1 is actually a cliff that would not support exfiltration lanes for insurgents. However, the gap vicinity BP 4 supports **more** escape lanes than **one** infantry platoon can block.

The **S2** prompts a mini-wargame session where he presents the new intelligence provided by the scout platoon. The commander and **S3** decide to modify the original plan--

- B Company will occupy **BPs** 1, 2, and 3.
- C Company will occupy **BPs** 4 and 5 only.

The **S3** issues the appropriate fragmentary orders while the **S2** **retasks** the scout platoon to provide additional information on the guerrillas' early warning and defense **system**.

**Summary**

The synchronization that occurs during staff wargaming drastically multiplies the combat effectiveness of a unit. To make wargaming work, the G2 or **S2** needs to force the staff to consider the full set of **COAs** available to the threat. The **G2** or **S2** develops threat **COAs** during the IPB process.

FM 34-130

During wargaming the staff plans responses or preemptive actions to deal with threat actions. The **G2** or **S2** uses the records and products of wargaming, such as the DST and BOS synchronization matrix to structure the unit collection effort to deliver the intelligence the decision makers need at the times they need it. He does this through the use of intelligence requirements and the synchronization of intelligence.

Because the threat follows his own plan, the staff must constantly review the current situation and update their plan as needed to ensure success. Incorporation of **new** information into the continuous IPB process ensures that the necessary **changes** are identified, prompting additional iterations of the decision making process as necessary.

APPENDIX B GENERAL GUIDELINES FOR USE DURING INTELLIGENCE PREPARATION OF THE BATTLEFIELD
--

When conducting IPB, the analyst should endeavor to acquire facts and develop detailed products appropriate for the specific METT-T situation under consideration. This involves a significant amount of research about the threat and the battlefield environment. However, this information will not always be available.

Fortunately, the analyst can still produce quality IPB products even when some of the conclusions are **built** using "ball-park" figures based on assumptions. This appendix provides generalized rules of thumb and guidelines for each step in the IPB process for use in the absence of more exact information.

Be forewarned, these figures should be used as a last resort, and only when better information will not be available in a timely manner.

In 1939 the British and French Armies used a rule of thumb to classify the Ardennes Forest as unsuitable for use by German **panzer** units. In 1944 the American Army assumed an economy of force posture in the Ardennes for similar reasons. In both cases the Allies paid dearly for not having forecast and **wargamed** the COA the Germans actually chose.

The guidelines listed below are statistical averages, or are based on specific forces, and will sometimes be misleading when applied to a particular situation. For example; the guidelines in the section on "Evaluating the Threat" are based on Soviet style and US style forces. If you are evaluating a threat that does not follow one of these two models, you must develop the data base to the point where you can construct similar guidelines for the force under consideration.

Avoid relying on "ball-park" figures as much as possible. Acquire the information that is pertinent to your specific circumstances. Tailor your evaluations to the specific equipment types, organizations, and training status of the units you are evaluating. For example, if a unit is especially skilled in night operations, periods of low visibility or illumination are likely to have little effect on their operations. Units equipped with a particular vehicle type may be less affected by mobility constraints than the tables that follow indicate.

In a pinch, however, judicious use of the tables and guidelines that follow can help you through most situation.

**Define the Battlefield Environment**

The **AO** will almost always be established by higher headquarters. In those cases where it is not, your commander establish its limits base on his intent and desired end-state.

The **AI should be drawn to include the terrain** in which activity **may** occur that **would** affect the upcoming mission. In a **conventional war** a typical mission for a maneuver battalion might last 12 hours.- Therefore, the AI should be drawn to include any characteristics of the battlefield, including threat units, that can affect the mission's success within the next 12 hours.

Figures B-1 and B-2 give rules of **thumb** for **establishing the limits of ground and air AIs.**

<u>COMMAND ECHELON</u>	<u>AREA OF INTEREST (HOURS)</u>
Battalion	Up to 12
Brigade	Up to 24
Division	Up to 72
Corps	Upto 96
EAC	Over 96

Figure B-1. Mission times.

ORGANIZATION	OPPONENT	DEPTH OF AI	WIDTH
Division	Amy	Rotary-wing airfields and fixed TBM sites to depth of 240 km	METT-T
Corps	Front	Enemy airfields and fixed TBM sites to corps rear	METT-T

Figure B-2. Air areas of interest.



## Describe the Battlefield ' s Effects

Products of this step in the IPB process **depict the** effects of the battlefield environment on the operations and broad courses of action available to threat and friendly forces (see Chapter 3 for examples). Regardless of the detail in the initial overlays, the final product should show the options for the employment of both threat and friendly forces.

The **final product** prepared to support planning for a conventional operation by a friendly mechanized or armor unit, regardless of who is attacking or defending, should include--

- Mobility corridors for units two echelons below the level of major unit under consideration.
- Avenues of approach through the **AO** for units one echelon below the level of the major attacking unit. These are constructed by connecting mobility corridors and RESTRICTED terrain to likely objectives.
- Locations along the avenues of approach that offer defensible terrain to units two echelons below the level of major defending unit.
- Key and decisive terrain.
- The **most** important of other characteristics of the battlefield environment (such as weather, politics).

The final product prepared to support planning for a conventional offense by a light infantry command (threat or friendly) should include--

- Objective areas that allow for a surprise attack **by** light infantry. This usually means an objective area near close terrain.
- Terrain near the objective areas that allow for concealed assault positions.
- A combination of infiltration lanes, landing zones, and air avenues of approach that allow for the stealthy **movement** of light infantry to the assault positions.

The final product prepared to support planning for a conventional defense by a light infantry battalion (threat or friendly) should include--

- Chokepoints along the mechanized or armor avenues of approach that allow for strongpoints that would not be easily bypassed.
- Close terrain (usually **RESTRICTED**) within the mechanized or armor **avenues** of approach that allow large amounts of light infantry to achieve flank and rear **shots** against armored vehicles **at** ranges of 100 **meters or less**.
- Defensible terrain along light infantry avenues of approach. Ideally the defense is comprised of a network of ambushes.

See Chapters 4 through 6 for ideas on conducting IPB under conditions not listed above. Figures B-3 through B-21 provide some rules of thumb for describing the battlefield's effects.

VEHICLE	MI	M60A1	M109	M113	N35A2	M151	T62	T72	M2	M3	M48 AVLB	M60 AVLB	MLR
Maximum road speed (kph)	71	48	56	48	56	50	50	(60)	66	66	48	51	64
Maximum on-road gradability (%)	68.7	60	60	60	64	60	62	(62)	60	60	30	30	60
Maximum off-road gradability (%)	53	45	45	45	30	28	(45)	(45)					
Vehicle width (m)	3.65	3.63	3.10	2.69	2.43	1.69	3.37	3.38	6.2	6.2	4.3	4.3	2.97
Override diameter at breast height (m)	.25	.15	(.12)	.10	.06	.04	(.15)	.18					
Vehicle cone index 1 pass (VCI <sub>1</sub> )	25	20	25	17	26	19	21	(25)	15	15	26	22	
Vehicle cone index 50 passes (VCI <sub>50</sub> )	58	48	57	40	59	44	49	(60)	35	35	60	51	
Minimum turning radius (m)	9.9	9.4	6.6	4.8	5.3	5.8	9.33	9.2	6.2	6.2	9.6	9.6	6.97
Vehicle length (m)	9.9	9.4	6.6	4.8	6.7	3.35	9.33	9.2	6.2	6.2	9.6	9.6	6.97
Military load class	60	54	24	12	10	NA	42	45	24	24	62	63	28

Figure B-3. vehicle characteristics.

	SLOPE (%)	STREAMS			VEGETATION		
		DEPTH (feet)	CURRENT (fps)	WIDTH (feet)	SPACING (feet)	TRUNK DIAMETER (inches)	ROADS/TRAILS (per km)
GO	<30	<2	.....	<5	>20	<2	2/4
SLOW-GO	30 to 45	2 to 4	≤5	<AVLB length	<20 and 2 to 6		1/2
NO-GO	>45	>4	>5	>AVLB length	<20 and >6		0/<2

Figure B-4. Terrain types for mechanized or armor forces.

PARAMETER	FACTOR	CRITERIA (PERCENT)
GOOD	Slope Canopy closure Roof coverage Slope	>30 >50* >40 10 to 30
FAIR	Canopy closure Roof coverage** Slope	<50 20 to 40 <10
POOR	Non-forested Roof coverage**	<20
• Or stem spacing 5 m		
• *If evaluated		

Figure B-5. Cover from flat trajectory weapons.

ROOF COVERAGE (percentage)	CATEGORY	CONCEALMENT
75 to 100	Congested	Excellent
50 to 75	Dense	Good
25 to 50	Moderate	Fair
5 to 25	Sparse	Poor
0 to 5	Open	None

Figure B-6. Concealment from aerial detection and percentage of roof coverage.

CATEGORY	VESSEL	WATER DEPTH (meters)	OTHER (meters)
Deep draft *	Naval	10	
	Container	10 to 15	
	Bulk carrier	12 to 18	
	Tankers	10 to 28	
Shallow draft • *	Lash	2	3
	Seabee	3.4	31
	Barge	38	38

\* Each vessel hatch requires 30 meters of wharf space, with the wharf at least 30 meters wide.  
 • \* The wharf length must be 12 meters.

Figure B-7. Port categories.

Height (feet)	Nautical miles	Statute miles	Height (feet)	Nautical miles	Statute miles	Height (feet)	Nautical miles	statute miles
1	1.1	1.3	120	12.5	14.4	940	35.1	40.4
2	1.6	1.9	125	12.8	14.7	960		40.8
3	2.0	2.3	130	13.0	15.0	980	35.6 35.4	41.8
4	2.3	2.6	135	13.3	15.3	1,000		41.8
5	2.6	2.9	140	13.6	15.6	1,100	37.9 36.2	43.7
6	2.8	3.2	145	13.8	15.9	1,200		45.6
7	3.0	3.5	150	14.0	16.1	1,300	39.6	47.8
8	3.2	3.7	160	14.5	16.7	1,400	41.2	
9	3.4	4.0	170	14.9	17.2	1,500	43.8 44.6	49.6 52.0
10	3.6	4.2	180	15.3	17.7	1,600	45.6	52.8
11	3.6	4.4	190	15.6	18.2	1,800	47.2	54.8
12	4.0		200	16.2	18.6	1,900	49.9 46.5	55.9
13	4.1	4.6	210	16.6	19.1			
14	4.3		220	17.0	19.5	2,000	51.2	58.9
15	4.4	4.9	230	17.3	20.0	2,100	52.4	50.4
16	4.6		240	17.7	M 4	2,200	53.7	61.8
17	4.7	5.3	250	18.1	20.8	2,300	54.9	63.2
18	4.9	5.6	260	18.4	21.2	2,400	56.0	64.8
19	5.0	5.7	270	18.8	21.6	2,500	57.2	65.8
20	5.1	5.9	280	19.1	22.0	2,600	58.3	67.2
21	5.2		290	19.5	22.4	2,700	59.4	68.4
22	5.4	6.0	300	19.8	22.8	2,800	60.5	69.7
23	5.5	6.3	310	20.1	23.9	2,900	61.6	70.9
24	5.6	6.5	320	20.5	23.6	3,000	62.7	72.1
25	5.7	6.6	330	20.8	23.9	3,100	63.7	73.3
26	5.8		340	21.1	24.3	3,200	64.7	74.5
27	5.9	6.8	350	21.4	24.6	3,300	65.7	75.7
28	6.1	7.0	360	21.7	25.0	3,400	66.7	76.8
29	6.2	7.1	370	22.0	25.3	3,500	67.7	77.8
30	6.3	7.2	380	22.3	25.7	3,600	68.6	79.0
31	6.4	7.3	390	22.6	26.0	3,700	69.6	80.1
32	6.5	7.5	400	22.9	26.3	3,800		
33	6.6	7.6	410	23.2	26.7	3,900	70.5 71.4	81.3 82.3
34	6.7	7.7	420	23.4	27.0	4: M0	72.4	83.3
35	6.6	7.8	430	23.7	27.3	4: 100	73.3	84.3
36	6.9	7.9	440	24.0	27.6	4,200	74.1	85.4
37	7.0	8.0	450	24.3	27.9	4,300	75.0	86.4
38	7.1	8.1	460	24.5	28.2	4,400	75.9	87.4
39	7.1	8.2	470	24.6	28.6	4,500	76.7	88.8
40	7.2	8.3	480	25.1	28.9	4,600	77.6	89.3
41	7.3	6.4	490	25.3	29.2	4,700	78.4	90.3
42	7.4		500	25.6	29.4	4,800		
43	7.5	8.6	520	26.1	30.0	4,900	80.1	91.2 92.2
44	7.6	8.7	540	26.6	30.6	5,000	80.9	93.1
45	7.7	6.6	560	27.1	31.2	6,000	88.6	102.0
46	7.6		580	27.6	31.7	7,000		110.9
47	7.6	9.0	600	28.0	32.3	8,000	102.3 95.7	117.8
48	7.9	9.1	620	28.5	32.8	9,000	108.5	124.8
49	8.0		640	28.9	33.3	10: m	114.4	131.7
50	6.1	9.2	660	29.4	33.8	15,000	140.1	161.3
						20,000	161.8	
55	a. 5	9.8	680	29.8	34.3	25,000	180.9	206.2 186.3
60	6.9	10.2	700	30.3	24.8			
65	9.2		720	30.7	35.3	30,000	198.1	228.1
70	9.6	10.6	740	31.1	35.6	35,000		
75	a. 9	11.4	760	31.5	35.3	40,000	228.8	246.4 263.8
80	10.2	11.8	780	31.9	36.6	45,000	242.7	279.4
						50,000		
85	10.5	12.1	800	32.4	37.3	60,000	255.8	294.5
90	10.9	12.5	820	32.8	37.7		260.2	322.8
95	11.2	12.8		33.2	38.2	70: 0M	302.7	345.4
100	11.4	13.2	840	33.5	38.6	80,000	342.2	372.5
105	11.7	13.5	880	33.9	39.1	190,000	361.8	395.1
110	12.0	13.8	900	34.3	39.5			416.5
115	12.3	14.1	920	34.7	39.9	200,000	511.6	550.0

Figure B-8. Height of eye versus horizon range.

Ditches	Tree stumps	Hedgerows
Embankments	Stone walls	Scattered trees
Large rocks	Bushes	Barbed wire fences
Boulders	Buildings	Cemeteries
Wood fences	Minelfields	Karst topograpy
Quarries	Levees	Overhead power lines
Ruins	Towers	Overhead telephone lines
Rice paddy dikes	Cuts and fills	

Figure B-9. Potential obstacles for entry zones.

Helipad or Heliport Type	LANDING PAD				RUNWAY <sup>2</sup>		
	Length (feet)	Width (feet)	Shoulder Width (feet)	Taxi/ Hover Lane <sup>1</sup> Width (feet)	Length (feet)	Width (feet)	Shoulder Width (feet)
<b>Forward Area</b>							
OH-6A	12	12	NA	75	NA	NA	NA
UH-1H	20	20	NA	140	NA	NA	NA
CH-47	50	25	NA	180	NA	NA	NA
CH-54	50	50	NA	200	NA	NA	NA
<b>Support Area</b>							
OH-6A	12	12	10	100	NA	NA	NA
UH-1H	20	20	10	200	NA	NA	NA
CH-47	50	25	10	240	450	25	10
CH-54	50	50	10	250	450	50	10
<b>Rear Area</b>							
OH-6A	25	25	25	100	NA	NA	NA
UH-1H	40	40	25	200	NA	NA	NA
CH-47	100	50	25	240	450	40	25
CH-54	100	100	25	250	450	60	25

<sup>1</sup> Taxi/hover lane is used for takeoff and landing where provided; length is variable.  
<sup>2</sup> Where runway is not shown, takeoff and landing are on taxi/hover lane.

Figure B-10. Minimum helipad and heliport requirements.

Airfield Type	Runway Length (feet)	Runway Width (feet)	Runway Shoulder Width (feet)	Total Aircraft Traffic Area* 1,000 sq ft
<b>Battle Area:</b> Light Lift and Medium Lift	2,000	60	10	223
<b>Forward Area:</b> Liaison	1,000	50	NA	37.5
Surveillance	2,500	60	10	337
Light Lift and Medium Lift	2,500	60	10	358
<b>Support Area:</b> Liaison	1,000	50	NA	50
	3,000			490
Light Lift and Medium Lift	3,500	60	10	753.5
Heavy Lift	6,000	100	10	1,421
Tactical	5,000	60	4	1,071
<b>Rear Area:</b> Army	3,000	72	10	882
Medium Lift	6,000	72	10	2,362
Heavy Lift	10,000	156		3,926
Tactical	8,000	108	20	1,989

\* This area includes parking, runway, taxiway, and warm-up apron.

Figure B-11. Minimum airfield requirements.

DEGREE OF SLOPE CALCULATOR

Many slope calculators have been made by various terrain detachments. These calculators show different contour densities to be used on maps at various scales with various contour intervals.' They are usually reproduced on transparent plastic by photography laboratories. Figure B-12 is an example of a slope calculator.

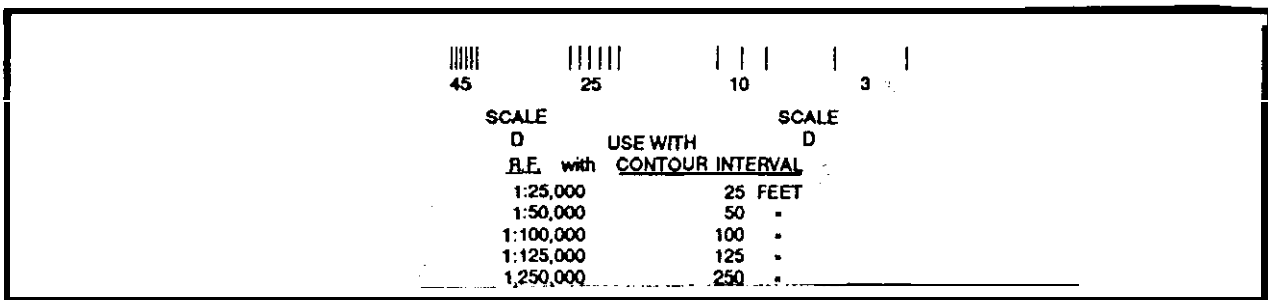

Figure B-12. Degree of slope calculator.

To construct a slope calculator, you must know:

- o The map scale, for example **1:100,000**.
- o The map contour interval, for example 10 meters.
- o The percentage of slope you wish to calculate, for example 20 percent.

To determine the amount of space between each line on your slope calculator, first determine the amount of ground distance by using the formula:

$$\frac{\text{contour interval} \times 100}{\% \text{ slope}}$$

In our example, we get:  $\frac{10 \times 100}{20} = \frac{1,000}{20} = 50 \text{ meters}$

Next, convert the ground distance into map distance with the formula:

$$\frac{\text{ground distance}}{\text{map scale}}$$

In our example we get:  $\frac{50 \text{ meters}}{100,000} = 0.0005 \text{ meters (or 0.5 mm)}$

This gives the amount of space between each line on the slope calculator. Use at least five lines. Place the slope calculator over the map section you are evaluating. If the contours on the map are **more** closely spaced than those on the calculator, the slope is greater than that depicted by the calculator. Conversely, if they are less closely spaced the slope is less than that depicted on the calculator.



	METERS	FEET
TRAIL	Less than 1.5	Less than 5
TRACK	At least 1.5 but less than 2.5	At least 5 but less than 8
ONE LANE	At least 2.5 but less than 5.5	At least 8 but less than 18
TWO LANES	At least 5.5 but less than 8.2	At least 18 but less than 28
MORE THAN TWO LANES	At least 8.2	At least 28

Figure B-13. Lane widths currently shown on US military maps.

UNIT	WIDTH
Division	6 km
Brigade or Regiment	3 km
Battalion	1.5 km
Company	500 m

Figure B-14. Widths of mobility corridors.

AVENUES OF APPROACH	MOBILITY CORRIDOR	MAXIMUM DISTANCE
Division	Brigade or Regiment	10 km
Brigade or Regiment	Battalion	6 km
Battalions	Company	2 km

Figure B-15. Maximum distance between mobility corridors.

LOAD)	MINIMUM ICE THICKNESS (CENTIMETER)	MINIMUM DISTANCE BETWEEN LOAD (METERS)
Soldier on foot	5	5
Soldier on skis or snowshoes		5
Vehicles:		
1/4-ton truck	20	15
3/4-ton truck	25	20
1 1/4-ton truck	33	25
2 1/4-ton truck	40	25
2 1/2-ton truck	40	25
5-ton truck	55	60
5-ton tanker	90	80
5-ton tractor w/loaded trailer	90	80
M561 cargo carrier	25	20
Main battle tank	80	70
M88 recovery vehicle	85	70
M108 HOW, SP, 105mm	50	40
M109 HOW, SP, 155mm	50	40
M110 HOW, SP, 8 in	55	50
M113 APC	45	25
M548 cargo carrier	45	25
M577 carrier command post	45	25
M578 recovery vehicle	65	60
BV209 SUSV	35	15

Figure B-16. Load-bearing capacity of fresh-water ice.

MARCH RATES IN EXTREME COLD	DISTANCE COVERED IN ONE DAY'S MARCH	MAXIMUM SNOW DEPTHS
Infantry (snow less than 30 cm deep) ..... 3 to 4 kmph Infantry (snow over 30 cm deep) ..... 1 to 2 kmph Soldier on skis ..... 6 to 8 kmph Subunit on skis ..... 3 to 6 kmph Tracked vehicles ..... 18 to 24 kmph Tanks and APCs in: o Snow under 50 cm . Employed as usual o Snow 50 to 75 cm .. (short moves) 10 o Snow over 75 cm ... Restricted to roads or cleared routes	Infantry . . . . . 12 to 24 km Ski Unit . . . . . 32 to 40 km Tracked Vehicles . . . 96 to 112 km  <b>THICKNESS OF ICE REQUIRED FOR PASSAGE</b> Infantry . . . . . 10 cm Medium Tanks . . . . . 70 cm	<b>WET SNOW:</b> Personnel . . . . . 12 to 18 in Wheeled Vehicles (with chains) . . . . . 18 in Tracked Vehicles . . . . 30 in  <b>DRY SNOW:</b> Personnel . . . . . 18 to 24 in Wheeled Vehicles (with chains) . . . . . 24 in Tracked Vehicles . . . . 48 in

Figure B-17. Extreme battlefield and weather conditions.

TERRAIN CHARACTERISTICS	ESTIMATED SPEED OF MOVEMENT	
	DAY	NIGHT
Sandy hills, loose sand, shale	7 to 8 kmph	5 to 6 kmph
Sandy valleys	10 to 12 kmph	8 to 10 kmph
Clay-surfaced desert	24 to 26 kmph	22 to 24 kmph

Figure B-18. Desert movement.

	TEMPERATURE			HUMIDITY		WINDS (KTS)			PRECIPITATION		CEILINGS (feet)			
	COLD	MED	HOT	LOW	HIGH	<13	13 to 30	>30	RAIN	SNOW	FOG	<1,500	1,500 to 3,000	>3,000
ATTACK	+	0	-	0	-	0	+	-1	+	-1	+	0	0	0
DEFEND	-	0	-2	0	-2	0	-	-	-	-	-	0	0	0
REINFORCE	+	0	-	0	-	0	0	-	+/-3	-	+	0	0	0
WITHDRAW	+	0	-	0	-	0	+	-	+/-3	-	+	0	0	0
ARTILLERY	-	0	0	0	-	0	-	-	-	-	-	-	0	0
AIRMOBILITY	-	0	-	0	-	0	-	X	X	X	-	-	+	+
AIRBORNE	-	0	-	0	-	0	-	X	-	-	-	-	0	+
CAS	0	0	-	0	-	0	-	X	X	X	X	-	-	+
CHEMICAL	-	0	+	0	+	+	-	-	-	-	0	0	0	+
UW		0	0	0	0	+	+	-	0	-	+	+	0	-
INTEL COL	-	0	-	0	-	0	-	-	-	-	-	-	-	0
EW/COMMO	-	0	-	0	-	0	0	-	-	-	-	0	0	0

+ = FAVORS                      0 = NEITHER FAVORS NOR DEGRADES  
 - = DISFAVORS                X = STRONGLY DISFAVORS/PRECLUDES  
 +/- = MAY FAVOR OR DISFAVOR DEPENDING ON CIRCUMSTANCES

- NOTES:
1. Does not favor any military operations; favors attack relative to defense.
  2. Does not favor most military operations; favors defense relative to attack.
  3. Hinders mobility but increases concealment.

WEATHER EFFECTS DEPEND ON TACTICAL SITUATION. USE CHART AS A GENERAL GUIDE ONLY. NOTE EFFECTS ON ATTACK AND DEFENSE ARE SHOWN IN ISOLATION, RATHER THAN AS RELATIVE TO EACH OTHER.

Figure B-19. Weather effects on courses of action.

ESTIMATED WIND SPEED (In mph)	ACTUAL TEMPERATURE READING (°F)												
	50	40	30	20	10	0	-10	-20	-30	-40	-50	-60	
	EQUIVALENT CHILL TEMPERATURE (°F)												
Calm	50	40	30	20	10	0	-10	-20	-30	-40	-50	-60	
5	48	37	27	16	6	-5	-15	-26	-36	-47	-57	-68	
10	40	28	16	4	-9	-24	-33	-46	-58	-70	-83	-95	
15	36	22	9	-5	-18	-32	-45	-58	-72	-85	-99	-112	
20	32	18	4	-10	-25	-39	-53	-67	-82	-96	-110	-121	
25	30	16	0	-15	-29	-44	-59	-74	-88	-104	-118	-133	
30	28	13	-2	-18	-33	-48	-63	-79	-94	-109	-125	-140	
35	27	11	-4	-20	-35	-51	-67	-82	-98	-113	-129	-145	
40	26	10	-6	-21	-37	-53	-69	-85	-100	-116	-132	-148	
(Wind speeds greater than 40 mph have little additional effect.)	LITTLE DANGER Is <hr with dry skin. Maximum danger of false sense of security.			INCREASING DANGER Danger from freezing of exposed flesh within one minute.					GREAT DANGER Flesh may freeze within 30 seconds.				
	Trenchfoot and immersion foot may occur at any point on this chart.												
Developed by U.S. Army Research Institute of Environmental Medicine, Natick, MA.													

Figure B-20. Windchill factor chart.

MISSION	WEATHER ELEMENT	FAVORABLE (GO)	MARGINAL (SLOW-GO)	UNFAVORABLE (NO-GO)
Maneuver: Mobility (Track vehicles, Day)	Visibility Rainfall Snow depth	> 1.5 km < 0.1 in/hr < 12 in	0.8 to 1.5 km 0.1 to 0.5 in/hr 12 to 20 in	< 0.8 km > 0.5 in/hr > 20 in
Maneuver: Mobility (Track vehicles, Night w/PVS-5 NVG)	Visibility Rainfall Snow depth	> 0.2 km < 0.1 in/hr < 12 in	0.1 to 0.2 km 0.1 to 0.5 in/hr 12 to 20 in	< 0.1 km > 0.5 in/hr > 20 in
Maneuver: Mobility (Dismounted Infantry)	Visibility Rainfall Snow depth Temperature Wind chill temperature	> 0.3 km < 0.1 in/hr < 3 in < 32° C > 0° C	0.1 to 0.3 km 0.1 to 0.5 in/hr 3 to 6 in > 32° C 0° C to -30° C	< 0.1 km > 0.5 in/hr > 6 in ..... < -30° C
Maneuver: Weapons positioning (Antiarmor direct fire)	Visibility Temperature	> 3.0 km > -18° C	0.5 to 3.0 km < -18° C	< 0.5 km .....
Fire Support (155-mm)	Visibility Ceiling Surface wind Snow depth	> 5.0 km > 800 ft < 35 kn < 4.0 in	1.5 to 5.0 km 500 to 800 ft 36 to 50 kn 4.0 to 6.0 in	< 1.5 km < 500 ft > 50 kn > 6 in
Fire Support (CAS A-10)	Visibility Ceiling	> 8.0 km > 3,000 ft	5.0 to 8.0 km 500 to 3,000 ft	< 5.0 km < 500 ft
Intelligence (Fixed-wing visual recon)	Visibility Ceiling	> 5.0 km < 3/8 clouds	3.0 to 5.0 km 3/8 to 5/8 clouds	< 3.0 km > 5/8 clouds
Air Defense Artillery (Vulcan, Chaparral, Stinger)	Visibility Ceiling Rainfall	> 5.0 km > 5,000 ft < 0.5 in/hr	3.0 to 5.0 km 3,000 to 5,000 ft 0.5 to 1.0 in/hr	< 3.0 km < 3,000 ft > 1.0 in/hr
ABC (Chemical, artillery delivery)	Wind below 16 meters Stability Temperature Humidity Precipitation	< 5 kn Stable > 21° C > 60 percent None	5 to 7 kn Neutral 4° to 21° C 40 to 60 percent Light	> 7 kn Unstable (lapse) < 4° C < 40 percent Moderate or heavy
Airborne (From C-130 to C-141)	Visibility Ceiling Surface Wind Precipitation	> 5.0 km > 500 ft < 10 kn None	1.0 to 5.0 km 300 to 500 ft 10 to 13 kn Light	< 1.0 km < 300 ft > 13 kn Freezing rain or hail
Aviation (Rotary wing)	Visibility Ceiling Surface Wind Precipitation	> 1.5 km > 500 ft < 20 kn None	0.4 to 1.5 km 300 to 500 ft 20 to 30 kn Light	> 0.4 km > 300 ft > 30 kn Freezing rain or hail

Figure B-21. Weather effects critical values.



- Develop a doctrinal narrative--describe the tasks that each subordinate unit will accomplish during the operation. The written narrative can be expressed either in paragraph form or in a standard synchronization matrix that has subordinate units on one axis and time duration on the other axis.
- Develop **HVTs** based on doctrine--what are the tactical systems that the threat depends upon for the successful accomplishment of the procedure?

Fortunately, there are certain constants affecting the operations of the military forces of any nationality. These fundamentals of tactics can be learned through--

- Effective battle-focused training.
- The study of military history.
- Mentoring by battle-seasoned soldiers.

You will discover that sustained pursuit of "battlefield common sense" greatly simplifies the development of threat models.

Learn the tactics of your own forces. This gives you a common framework that enables you to communicate with your commander and understand how best to support his operations. It also provides you with a basis against which to compare the doctrine of any threat you may face:

- How is it different from US doctrine?
- How is it the same?
- What does the threat do to minimize the vulnerabilities associated with any given operation?
- How do the details of the threat model relate to doctrine and TTP? For example, how does the spacing of units relate to weapon range capabilities? If range capabilities increase will units deploy further apart?

For *more* ideas on developing threat models, refer to the techniques on building threat **COAs** in the final section of this appendix. Remember that threat models are generalized procedures; they do not depend upon the specific battlefield environment. Threat **COAs** are tied to specific METT-T situations.

Figures B-22 through \*\*\*\*\* offer some guidelines for use in evaluating the threat.

	DIV	REGT	BN	CO
Frontage	20 to 30	10 to 15	3 to 5	0.5 to 1
Depth	15 to 20	7 to 10	2 to 3	0.5
Gaps between units			0.5 to 2	0.5 to 1.5

Tanks may deploy 200 to 300 meters apart and APCs up to 200 meters apart. Antitank obstacles are placed so that they are covered by direct fire.

Figure B-22. Frontages and depths for units in kilometers (defense).

	ARMY	DIV	REGT	BN
ZONE OF ATTACK	6010100	15 to 25	8 to 15	2 to 3
MAIN ATTACK AXIS	35 to 45	6 to 10	3 to 5	1 to 2
IMMEDIATE OBJECTIVE DEPTH	100 to 150	20 to 30	8 to 15	2 to 4
SUBSEQUENT OBJECTIVE DEPTH	250 to 350	501070	20 to 30	8 to 15

NOTE: These figures will vary with the tactical situation and terrain.

Figure B-23. Frontages and depths of objectives in kilometers (offense).



ELEMENT	DEPLOYMENT
DIVISION FIRST ECHELON	Concentrated to attack on two or three axes each several kilometers wide.
DIVISION SECOND ECHELON OR COMBINED ARMS RESERVE	Moves by bounds 15 to 30 km behind the first echelon until committed.
REGIMENTAL ARTILLERY GROUP	1 to 4 km from the FEBA.
DIVISIONAL ARTILLERY GROUP	3 to 6 km from the FEBA.
MULTIPLE ROCKET LAUNCHER BATTALION	3 to 6 km from the FEBA.
DIVISIONAL ANTITANK RESERVE	Between first and second echelons on the axis of the main attack or on a threatened flank.
DIVISION MAIN CP	Up to 15 km from the FEBA.
DIVISION FORWARD CP	Up to 5 km from the FEBA.
DIVISION REAR AREA CP	Up to 30 km from the FEBA and located near the rear service elements.
REGIMENTAL MAIN CP	Up to 5 km from the FEBA.
LOGISTIC UNITS	The divisional medical post, together with repair and evacuation elements, moves behind the first echelon. The rest of the divisional logistic units will be some 5 to 10 km behind the second echelon.

Figure B-24. Deployment of division elements in an attack.

Reaction Times to Mounting an Attack			March Column Assembly Times	
UNIT	REACTION TIME	PLANNING TIME	UNIT	MINUTES
Division	2 to 4 hours	1 to 3 hours	Motorized rifle company	5
			Motorized rifle battalion	10 to 15
Regiment	1 to 3 hours	30 minutes to 2.5 hours	Artillery battalion	15 to 20
			Artillery regiment	40 to 50
Battalion	25 to 60 minutes	20 to 45 minutes	Motorized rifle regiment (reinforced)	60 to 120

Figure B-25. Reaction and march times.

CONDITION	MARCH RATES
Day, on roads . . . . .	20 to 30 kmph
Night, on roads . . . . .	15 to 20 kmph
Cross-country . . . . .	5 to 15 kmph

Figure B-26. Average march rates for mixed columns.

TYPE OF ROAD	Per (kmph)		
	UNDAMAGED SURFACE	10% SURFACE DESTRUCTION	MORE THAN 10% SURFACE DESTRUCTION
Concrete, asphalt-concrete	40 to 50	20 to 35	10 to 20
Gravel and rubble	40 to 50	20 to 30	10 to 20
Dirt	15 to 25	8 to 15	5 to 10

Figure B-27. Average speeds of vehicles.

UNIT	NORMAL INTERVAL	VARIATIONS
Between vehicles in a company.	20 to 50 m	Increased at high speeds and when traversing contaminated or rugged terrain or on icy roads. May be decreased at night.
Between companies in a battalion.	25 to 50 m	Up to 300 m or more under nuclear conditions.
Between battalions on the same route.	3 to 5 km	
Between regiments on the same route.	5 to 10 km	Can vary as contact becomes imminent.
Between regimental rear services and main force.	3 to 5 km	
Between division rear services and main force.	15 to 20 km	

**NOTE:** Vehicles speeds are determined by road conditions.

Figure B-28. Unit dispersal intervals.

UNIT	DIESEL	GAS	TOTAL
MRR (BTR EQUIPPED)	67,860	59,990	127,859 liters
	57.7	45.0	102.7 metric tons
MRR (BMP EQUIPPED)	101,737	40,896	142,632 liters
	86.5	30.6	117.1 metric tons
TANK REGT	115,350	31,763	147,113 liters
	98.1	23.8	121.9 metric tons
INDEPENDENT TANK BN (MRD)	53,246	4,636	57,882 liters
	45.3	3.5	48.8 metric tons
ANTITANK BN (MRD)	2,835	6,132	8,967 liters
	2.4	4.6	7.0 metric tons
ARTY REGT (DIV)	2,756	38,472	41,228 liters
	2.3	28.8	31.1 metric tons
ARTY REGT (ARMY)	28,010	14,121	42,131 liters
	23.8	10.6	34.4 metric tons

NOTE: A unit's refill is the total requirement for all vehicles in the unit.

Figure B-35. POL refill.

FORCE RATIO	TYPICAL MISSION
1:6	Delay
1:3	Defend (prepared)
1:2.5	Defend (hasty)
2.5:1	Attack (hasty position)
3:1	Attack (prepared position)
1:1	Counterattack (flank)

Figure B-36. Typical planning force ratios.

### FOOT MARCHES

#### BASIC DATA TABLE, FOOT MARCHES

	Visibility	*Rate of March	Normal March (8 hours)	Forced March (12 hours)
ROADS	Day	4 kmph	32 km	48 km
	Night	3 kmph	24 km	36 km
CROSS- COUNTRY	Day	2 kmph	16 km	24 km
	Night	1 kmph	8 km	12 km

\*NOTE: Computed on a 50-minute hour, allowing for 10-minute halt each hour.

Length of a Column. To determine the length of a column occupied by a dismounted unit, multiply the estimated or known number of personnel by the applicable factor.

#### LENGTH OF COLUMN, FACTOR TABLE FOOT MARCHES

*Formation	2m/person distance	5m/person distance
Single File	2.4	5.4
Column of Twos	1.2	2.7

\*NOTE: Foot marches will vary with the tactical situation; normal formation is a column of twos with a file on either side of the road and staggered, much like US Forces. However, columns of threes and fours may be employed where conditions permit.

Pass Time. To determine the pass time in minutes for a dismounted unit, multiply the length of the column by the appropriate factor for the estimated or known rate of march.

#### PASS TIME FACTORS, FOOT MARCHES

Rate (kmph)	Factors
4	.015
3	.018
2	.020
1	.023

Figure B-29. Foot marches factors.

Degree of Resistance Attacker to Defender Ratio	PREPARED DEFENSE <sup>3</sup>						HASTY DEFENSE/DELAY <sup>4</sup>					
	GO TERRAIN		SLOW-GO TERRAIN		NO-GO TERRAIN		GO TERRAIN		SLOW-GO TERRAIN		NO-GO TERRAIN	
	Armor/Mech	Inf	Armor/Mech	Inf	Armor/Mech	Inf	Armor/Mech	Inf	Armor/Mech	Inf	Armor/Mech	Inf
Intense Resistance 1:1	2	2	1	1	.6	.6	4	4	2	2	.12	1.2
Very Heavy 2:1 (-)	5 to 6	4	2 to 3	2	1.5 to 1.8	1.2	10 to 12	8	5 to 6	4	3 to 3.6	2.4
Heavy 3:1	7 to 8	5	3 to 4	2.5	2.1 to 2.4	1.5	13 to 16	10	8	5	3.9 to 4.8	3
Medium 4:1	8 to 10	6	4 to 5	3	2.4 to 3	1.8	16 to 20	12	10	6	4.8 to 6	3.6
Light 5:1	16 to 20	10	8 to 10	5	4.8 to 6	3	30 to 40	18	20	9	9 to 12	5.4
Negligible 6:1	24 to 30	12	12 to 15	6	7.2 to 9	3.6	48 to 60	24	30	12	14.4 to 18	7.2

Source: Numbers, Predictions and War, Depuy, T. N., 1979.

<sup>1</sup> When there is surprise, multiply these figures by a surprise factor as follows:

- Complete Surprise x 5 (e.g., Germans at the Ardennes in 1944, Arabs in 1973).
- Substantial Surprise x 3 (e.g., German Invasion of Russia in 1941, Israeli invasion of Sinai in 1967).
- Minor Surprise x 1.3 (e.g., Allied Normandy landing in 1944, Pakistani attack on India in 1971).

The effects of surprise last for 3 days, being reduced by one-third on day 2 and two-thirds on day 3.

<sup>2</sup> Use the relative combat power from paragraph 2a(4) in the operations estimate.

<sup>3</sup> Prepared defense is based on defender in prepared positions (24 hours or more).

<sup>4</sup> Hasty defense is based on 2 to 12 hours' preparation time.

<sup>5</sup> The ratios used here are to determine the degree of resistance. There is no direct relationship between advance rates and force ratios. However, sustained advances probably are not possible without a 3 to 1 ratio. Advance is possible against superior forces but cannot be sustained.

<sup>6</sup> Rates greater than 6 to 1 will result in advances between these and the unopposed rates.

Figure B-30. Division opposed rates of advance.

Degree of Resistance Attacker to Defender Ratio	PREPARED DEFENSE <sup>3</sup>						HASTY DEFENSE/DELAY <sup>4</sup>					
	GO TERRAIN		SLOW-GO TERRAIN		NO-GO TERRAIN		GO TERRAIN		SLOW-GO TERRAIN		NO-GO TERRAIN	
	Armor/Mech	Inf	Armor/Mech	Inf	Armor/Mech	Inf	Armor/Mech	Inf	Armor/Mech	Inf	Armor/Mech	Inf
Intense Resistance 1:1	.6	.5	.5	.3	.15	.1	1.0	.8	.8	.5	.4	.2
Very Heavy 2:1	.9	.6	.6	.4	.3	.2	1.5	1.0	1.0	.7	.6	.3
Heavy 3:1	1.2	.7	.75	.5	.5	.3	2.0	1.2	1.3	.9	.8	.5
Medium 4:1	1.4	.8	1.0	.6	.5	.5	2.4	1.4	1.75	1.1	.9	.8
Light 5:1	1.5	.9	1.1	.7	.6	.5	2.6	1.6	2.0	1.2	1.0	.9
Negligible 6+:1	1.7+	1.0+	1.3+	.8+	.6+	.6+	3.0+	1.7+	2.3+	1.3+	1.1+	1.0

Source: Adapted from CACDA Jiffy III War Game, Vol II, Methodology.

<sup>1</sup> Units cannot sustain these rates for 24 hours. These rates are reduced by 1/2 at night.

<sup>2</sup> The relative combat power ratio must be computed for the unit under consideration.

<sup>3</sup> When there is surprise, multiply these figures by a surprise factor as follows:

- Complete Surprise x 5 (e.g., Germans at the Ardennes in 1944, Arabs in 1973).
- Substantial Surprise x 3 (e.g., German invasion of Russia in 1941, Israeli invasion of Sinai in 1967).
- Minor Surprise x 1.3 (e.g., Allied Normandy landing in 1944, Pakistani attack on India in 1971).

The effects of surprise last for 3 days, being reduced by one-third on day 2 and two-thirds on day 3.

<sup>4</sup> Prepared defense is based on defender in prepared positions (24 hours or more).

<sup>5</sup> Hasty defense is based on 2 to 12 hours' preparation time.

<sup>6</sup> The ratios used here are to determine the degree of resistance. There is no direct relationship between advance rates and force ratios. However, **•** sustained advances probably are not possible without a 3 to 1 ratio. Advance is possible against superior forces but cannot be sustained.

<sup>7</sup> Rates greater than 6 to 1 will result in advances between these and the unopposed rates.

DISTANCES	MORTARS	MULTIPLE ROCKET GUNS & HOWITZERS	LAUNCHERS
Between Weapons	16 to 60 m	20 to 40 m	15 to 50 m
Between Batteries	.....	500 to 1,500 m (normally about 1,000 m)	1,000 to 2,000 m
From the FEBA	500 to 1,000 m	5 to 8 km (AAG) 3 to 6 km (DAG) 1 to 4 km (RAG)	5 to 8 km 3 to 8 km

Figure B-32. Tactical deployment norms.

UNIT	TIMES (minutes)
Mortar battery . . . . .	1 to 1.5
Artillery battalion . . . . .	2 to 3
MRL battery . . . . .	4
RAG . . . . .	4
DAG . . . . .	5

The standard reaction time for shifting fire is 2 minutes.

Figure B-33. Reaction times for first rounds of fire.

UNIT	LOGISTIC ELEMENT	DISTANCE FROM FEBA (IN THE OFFENSE)	DISTANCE FROM FEBA (IN THE DEFENSE)
COMPANY	Ammunition Supply Point		100 to 150 m
	Rations Supply Point		Up to 1 km
	Medical Point		100 m
BATTALION	Ammunition Supply Point	4 km	2 to 3 km
	Repair Point	5 km	3 to 5 km
	Rations Supply Point	5 km	3 to 5 km
	Medical Point	1.5 to 3 km	1.5 to 3 km
REGIMENT	Ammunition Supply Point	10 to 15 km	10 to 20 km
	Repair Point	Up to 15 km	Up to 20 km
	POL Supply Point	10 to 15 km	10 to 20 km
	Rations Supply Point	10 to 15 km	10 to 20 km
	Medical Point	5 to 7 km	6 to 10 km
	Damaged Motor Vehicle Collecting Point	5 to 7 km	6 to 10 km
DIVISION	Supply Dump (Ammunition, POL, Rations)	25 to 30 km	35 to 50 km
	Repair Point (Tanks, Weapons)	20 to 40 km	35 to 50 km
	Repair Point (Wheeled Motor Vehicles)	10 to 14 km	Up to 20 km
	Medical Point	10 to 14 km	Up to 20 km

Figure B-34. Locations of tactical logistic elements.





- Linear defenses versus defenses in depth.
- Mixed defensive system.
- Delaying defenses.
- Use of battle positions, strongpoints, and defenses in sector.

For each threat COA identified, situationally template (in order):

- Engagement areas and supporting obstacle systems.
- Unit range fans covering engagement areas **with direct** fire weapons. Template units two echelons below-the **level** of the **major** defending unit.
- Counterattack force locations, routes, and firing lines. Include time-phase lines depicting the force's **movement** from assembly areas to commitment.
- Artillery locations supporting the main and covering force battles. Include range fans for the closest possible gun, howitzer, **ormortar**.
- Primary and subsequent positions for the covering force units.
- ADA positions.
- **EAs** and air avenues of approach for close-air-support aircraft and attack helicopters.
- Reconnaissance positions.
- **c<sup>2</sup>** positions.
- Combat service support unit and activity positions.
- Alternate and supplementary positions for **maneuver** forces.
- Control measures, particularly boundaries and counterattack objectives.

For each threat COA, situationally narrate or depict in a matrix the timing and sequencing of--

- Initial engagements by covering force, artillery, and the main battle forces.
- Withdrawal of the covering force.
- Commitment of threat reserves.
- Possibility of repositioning defending forces from the supporting attack area to the main attack area.
- Failure options statement for the main battle forces.

<b>Offense</b>
----------------

When developing threat **COAs** for a traditional mechanized or armor offense--

Consider the general threat COA options by studying the effects of the battlefield environment on military operations. Fully consider--

- Movement to contact versus deliberate attack procedures.
- Attack formations, such as subordinate units in column, subordinate units abreast, or in some combination.
- Attacking on multiple avenues of approach versus attacking on a single avenue of approach.
- Positioning the main attack versus supporting attack on different avenues of approach.
- Depth of threat objectives within sector.
- Threat intent. Is his objective to destroy friendly forces or seize key terrain?
- Use of follow-on forces. Will he use reserves or "follow-on and support" forces?
- Use of "**fixing**" forces or support by fire forces.

- Combined **arms** operations. Consider mixing heavy and light forces, for example, using air assaults to seize key terrain, using special forces for deep objectives, or amphibious operations to turn flanks.
- Defeat mechanisms via forms of maneuver, such as infiltration, frontal attack, envelopment, turning movement, penetration.

For each threat COA, situationally template:

- Axis of advance.
- Objectives.
- Control measures.
- Time-phase line estimates depicting movement.
- Support positions for artillery and ADA assets. Include range fans.
- **EAs** and air avenues of approach for use by CAS aircraft and attack helicopters.
- Failure option statements; for example, what might the threat do if his COA begins to fail?

For each threat COA, situationally narrate the scheme of maneuver through the duration of the attack. A particularly effective technique is to use a matrix similar to that used in scenario 2 of Chapter 3. Do not limit the description to only the maneuver forces. Examine how each battlefield operating system (BOS) supports the course of action. If time permits, the IPB analyst should prepare a full BOS synchronization matrix for each threat COA.

Another technique is to show "snapshots" of the threat COA at different times during the battle. This would include a set of situational templates with narratives to describe each threat COA at various points during its execution.

Usually, the **most** effective way to present threat **COAs is** to use the US methodology and symbols described in FM 101-5 and FM 101-5-1.

Another technique is to use the actual operational graphics of the threat force. This technique is effective only if all unit personnel who will use the IPB products are familiar with the threat's graphics and symbology techniques.

<b>Event Templates</b>
----------------------------

Event templates always focus on features of the threat's **COAs** that will allow you to confirm or deny their adoption. In the offense and defense, consider the following:

Offense:

- o Linear **NAIs** across avenues of approach.
- o NAI at intersecting points of avenues of **approach** or mobility corridors that define threat **COAs**.
- o **NAIs** on threat time-phase lines to facilitate friendly tracking of threat movement.

**NAIs** on expected locations of **HPTs**. **HPTs** and their supporting **NAIs** are developed during wargaming and the targeting process.

Defense:

- o Defensive positions, both primary and secondary.
- o Counterattack force assembly areas.
- o Counterattack routes.
- o Withdrawal routes.
- o **NAIs** on expected HPT locations. **HPTs** and their supporting **NAIs** are developed during wargaming and the targeting process.

The simplest method of calculating force ratios is a straight comparison of the number of units on each side. For example, 27 enemy battalions opposed by 9 friendly battalions gives a force ratio of **3:1**. Using this technique, count brigades and regiments as roughly equivalent and simply total the number available to each force.'

But not all units are equal. For example, **US tank battalions have** a little over 50 tanks while **some Soviet style tank battalions** have only **about** 30. To account for this size difference, convert the actual number of units into "**US equivalents.**"

We begin by dividing the number of tanks in the **Soviet** style battalion by the number of tanks in the US battalion. This gives us a value of 0.6 as the US equivalent size of one Soviet style tank battalion ( $30 \div 50 = 0.6$ ). We then multiply the total number of such battalions by this value to get a total of US equivalent strength of 16 battalions ( $27 \times 0.6 = 16.2$ ). Our force ratio is now 16 enemy battalion equivalents opposed by 9 friendly battalions, or **1.8:1**.

We can further refine this force ratio by accounting for the difference in combat capability of the type of equipment in each unit.' For example, we may decide that an M-1 tank has twice the combat power of a T-55 tank. Assuming that the tank battalions in our example are equipped with M-1s and **T-55s**, respectively, this gives us a multiplier of **2** for the **friendly battalions** and **1** for the **enemy** battalions. This now gives us battalion equivalents of 16 enemy and 18 friendly battalions, changing our force ratio to about **1:1.1**.

Assigning these values requires careful judgment of the relative capabilities of the equipment involved. Be careful to avoid letting wishful thinking cloud your judgment. YOU should also resist the temptation to attempt to account for other, less tangible factors such as leadership and flexibility.

Figure **B-37. Calculating Force Ratios.**

## GLOSSARY

AA - see Avenue of Approach.

ADA - Air Defense Artillery.

AI - see Area of Interest.

**AO** - see Area of Operations.

Area of Interest (AI) - The geographical area from which information and intelligence are **required to** permit planning or successful conduct of the command's operation. The area of interest is usually larger than the command's area of operations (q.v.) and battle space (q.v.). The area of interest includes any threat forces or characteristics of the battlefield environment that will significantly influence accomplishment of the command's mission.

Area of Operations (AO) - That portion of an area of conflict necessary for military operations. Areas of operations are geographical areas assianed to commanders for which they have responsibility and in which they have the authority to conduct military operations.

Assumptions - Information used to replace missing facts (q.v.) necessary for command and staff planning, estimating, and decision making. Assumptions may also be required for facts that change due to the time difference between receipt of the mission and the time of execution, such as threat dispositions. Assumptions should be confirmed or denied by intelligence collection whenever practical.

Avenue of Approach (AA) - An air or ground route of an attacking force of a given size leading to its objective or to key terrain in its path. Avenues of approach are based on the capabilities and opportunities offered by the battlefield environment and may not necessarily form part of a course of action. Defensive avenues of approach support counterattacks and the commitment of reserves. Note the difference between avenues of approach, axis of advance (q.v.) and direction of attack (q.v.).

Axis of Advance - A general route of advance, assigned for purposes of control, which extends toward the enemy. An axis of advance symbol graphically portrays a commander's intention, such as avoidance of built-up areas or envelopment of an enemy force.

It follows terrain suitable for the size of the force assigned the axis and is often a road, a group of roads, or a designated series of locations. A commander may maneuver his forces and supporting fires to either side of an axis of advance provided the unit remains oriented on the axis and the objective. Deviations from an assigned axis of advance must not interfere with the maneuver of adjacent units without prior approval of the higher commander. Enemy forces that do not threaten security or jeopardize mission accomplishment may be bypassed. An axis of advance is not used to direct the control of terrain or the clearance of enemy forces from specific locations. Intermediate objectives are normally assigned for these purposes. Note that an axis of advance is a control measure that is assigned as part of a course of action; the term "axis of advance" is not synonymous with avenue of approach (q.v.). See also Direction of Attack.

Battle Damage Assessment (BDA) - The timely and accurate estimate of damage resulting from the application of military force, either lethal or non-lethal, against an objective or target.

Battle Position (BP) - A defensive location oriented on the most likely enemy avenue of approach from which a unit may defend or attack. Such units can be as large as battalion task forces and as small as platoons. A unit assigned a BP is located within the general outline of the BP. Security, combat support, and combat service support forces may operate outside a BP to provide early enemy detection and all-around security. Note that although most **BPs** are based on terrain features they are control measures.

Battle Space - Components determined by the maximum capabilities of a unit to acquire and dominate the enemy; includes areas beyond the area of operations; it varies over time according to how the commander positions his assets. It depends on the command's ability to both acquire and engage targets using its own assets or those of other commands on its behalf.

Battlefield Operating Systems (BOS) - The major functions performed by the force on the battlefield to successfully execute Army operations in order to accomplish military objectives. They form a framework for examining complex operations in terms of functional operating systems. The systems include maneuver, fire support, air defense, command and control, intelligence, mobility and survivability, and combat service support.

BDA - see Battle Damage Assessment.

Beginning Morning Nautical Twilight (BMNT) - Morning nautical twilight begins when the sun is 12 degrees below the eastern horizon. It is the start of that period where, in good conditions and in the absence of other illumination, enough light is available to identify the general outlines of ground objects, conduct limited military operations, and engage in most types of ground movement without difficulty. See End Evening Nautical Twilight.

BMNT - see Beginning Morning Nautical Twilight.

Boer - A Dutch colonist or a descendant of a Dutch colonist in Southern Africa. The Boers created several independent states in Southern Africa in the early 19th century after the British annexed their lands in South Africa. Economic competition, the discovery of gold **and** diamonds, and other factors led to increased hostility between the Boers and the British, resulting in the Boer War (1899-1902).

BOS - see Battlefield Operating Systems.

BOS Synchronization Matrix - A written record of wargaming. The BOS synchronization matrix depicts the criteria that generate each anticipated friendly decision and the resulting action by each friendly BOS (q.v.). Other information required to execute a specific friendly course of action may also be included.

BP - see Battle Position.

Branch - A contingency plan (an option built into the basic plan) for changing the disposition, orientation, or direction of movement of the force.

Capability - The ability to successfully perform an operation or accomplish an objective. The evaluation of capabilities includes an assessment of a force's current situation as well as its organization, doctrine and normal tactics, 'techniques and procedures. Capabilities are stated in terms of broad courses of action and supporting operations. Generally, only capabilities that will influence accomplishment of the friendly command's mission are addressed.

COA - see Course of Action.

Common Understanding of the Battlefield - How the commander and staff perceive the battlefield environment. It includes the sum of all that is known or perceived of friendly and threat forces and the effects of the battlefield environment.



Confirmed - Confirmed intelligence is information or intelligence reported by three independent sources. The test for independence is certainty that the information report of one source was not derived from either of the two other sources, usually resulting in reliance on original reporting. Analytical judgment counts as one source-. Ensure that no more than one source is based solely on analytical judgment.

Course of Action (COA) - A possible plan open to an individual or commander that would accomplish or is related to accomplishment of the mission. A course of action is initially stated in broad terms with the details determined during staff wargaming. To develop courses of action the staff **must** focus on key information and intelligence necessary to make decisions. Courses of action include five elements: what (the type of operation), when (the time the action will begin), where (boundaries; axis, etc.), how (the use of assets), and why (the purpose or desired end-state).

Culminating Point - The point in time and space when the attacker's combat power no longer exceeds that of the defender or when the defender no longer has the capability to defend successfully.

Decision Point (DP) - The point in space and time where the commander or staff anticipates making a decision concerning a specific friendly course of action. Decision points are usually associated with threat force activity or the battlefield environment and are therefore associated with one or more NAI (q.v.). Decision points also may be associated with the friendly force and the status of ongoing operations.

Decision Support Template (DST) - A graphic record of wargaming. The decision support template depicts decision points (q.v.), timelines associated with movement of forces and the flow of the operation, and other key items of information required to execute a specific friendly course of action.

Defensible Terrain - Terrain that offers some concealment and cover to defending forces while also providing observation and fields of fire into potential engagement areas. Ideal defensible terrain is difficult to bypass, offers-concealed and covered battle positions, covered withdrawal routes, and overlooks engagement areas that allow the defending force to use all of their weapon systems at their maximum ranges. Defensible terrain must defend a likely objective or avenue of approach (otherwise, why defend it?).

**Delaying Operation** - An operation usually conducted when the commander needs time to concentrate or withdraw forces, to establish defenses in greater depth, to economize in an area, or to complete offensive actions elsewhere. In the delay, the destruction of the enemy force is secondary to slowing his advance to gain time. Delay missions are delay in sector, or delay forward of a specified line for a specified time or specified event (see FM 101-5-1).

**Direction of Attack** - A specific direction or route that the main attack or the main body of the force will follow. If used, it is normally at battalion and lower levels. Direction of attack is a more restrictive control measure than axis of advance, and units are not free to maneuver off the **assigned route**. It usually is associated with infantry units conducting night attacks, or units involved in limited visibility operations, and in counterattack. In NATO terminology it is referred to **as** an Attack Route. Note that directions of attack are control measures that are assigned as part of a course of action; the term is not synonymous **with** avenue of approach (q.v.). See also Axis of Advance.

**DMA** - Defense Mapping Agency.

**Doctrinal Template** - A model based on postulated threat doctrine. Doctrinal templates illustrate the disposition and activity of threat forces and assets (high value targets) conducting a particular operation unconstrained by the effects of the battlefield environment. They represent the application of threat doctrine under ideal conditions. Ideally, doctrinal templates depict the threat's normal organization for combat, frontages, depths, boundaries and other control measures, assets available from other commands, objective depths, engagement areas, battle positions, etc. Doctrinal templates are **usually** scaled to allow ready use on a map background. They are one part of a threat model (q.v.).

**DP** - see Decision Point.

**Drift** - A colloquial expression for a ford; a shallow place in a stream or river that can be crossed by **walking** or riding on horseback.

**DST** - see Decision Support Template.

**Duffer** - British colloquial expression for an incompetent, awkward, or stupid person.

**EA** - Electronic Attack; a sub-component of Electronic Warfare, formerly known as Electronic Counter Measures (ECM).

**EA** - see Engagement Area.

EAC - Echelon(s) Above Corps.

EENT - see End Evening Nautical Twilight.

End Evening Nautical Twilight (EENT) - Occurs when the sun has dropped 12 degrees below the western horizon, and is the instant of last available day light for the visual control of limited ground operations. At EENT there is no further sunlight available. See Beginning Morning Nautical Twilight.

Engagement Area (EA) - An area in which the commander intends to trap and destroy an enemy force with the massed fires of all available weapons. Engagement areas are routinely identified by a target reference point in the center of **the trap** area or by prominent terrain features around the area. Although engagement areas may also **be divided** into sectors of fire, it is important to understand that defensive systems are not designed around engagement areas, but rather around avenues of approach.

Envelopment - An offensive maneuver in which the main attacking force passes around or over the enemy's principal defensive positions to secure objectives to the enemy's rear.

EP - Electronic Protection; a sub-component of Electronic Warfare, formerly known as Electronic Counter-countermeasures (ECCM).

ES - Electronic Warfare Support; a sub-component of Electronic Warfare, formerly known as Electronic Support Measures (ESM).

Event Matrix - A description of the indicators and activity expected to occur in each NAI (q.v.). It normally cross-references each NAI and indicator with the times they are expected to occur and the course(s) of action they will confirm or deny. There is no prescribed format.

Event Template - A guide for collection planning. The event template depicts the named areas of interest (q.v.) where activity (or its lack) will indicate which course of action (q.v.) the threat has adopted.

EW - Electronic Warfare. Electronic warfare consists of three sub-components: Electronic Attack (EA), Electronic Warfare Support Measures (ES), and Electronic Protection (EP).

Facts - Information known to be true. In terms of intelligence, facts include confirmed (q.v.) intelligence. See Assumptions.

High Payoff Target (HPT) - High value targets (q.v.) whose loss to the threat will contribute to the success of the friendly course of action.

High Value Target (HVT) - Assets that the threat commander requires for the successful completion of a specific course of action.

HUMINT - Human Intelligence.

I&W - Indications and Warning; one of the six IEW (q.v.) tasks (see FM 34-1).

IEW - Intelligence and Electronic Warfare,

IMINT - Imagery Intelligence.

Indicators - Positive or negative evidence of threat activity or any characteristic of the area of operation which **points toward** threat vulnerabilities or the adoption or rejection by the threat of a particular capability, or which may influence the commander's selection of a course of action. Indicators may result from previous actions or from threat failure to take action.

ISOS - Intelligence System of Systems (see FM 34-1).

HPT - see High Payoff Target.

HVT - see High Value Target

Infiltration Lane - A route used by forces to infiltrate through or into an area or territory. The movement is usually conducted in small groups or by individuals. 'Normally, infiltrating forces avoid contact with the enemy until arrival at the objective area. Because of the emphasis on surprise, infiltration lanes usually make use of terrain that offers concealment and cover, even if some sacrifice in mobility results.

Information Requirement (IR) - An **intelligence** requirement (q.v.) of lower priority than the PIR (q.v.) of lowest priority.

Intelligence Preparation of the Battlefield (IPB) - The systematic, continuous process of analyzing the threat and environment in a specific geographic area. IPB is designed to support the staff estimate and military decision making process. Most intelligence requirements (q.v.) are generated as a result of the **IPB** process and its inter-relation with the decision making process.

Intelligence Requirement - A requirement for intelligence to fill a gap in the command's knowledge and understanding of the battlefield or threat forces. Intelligence requirements are designed to reduce the uncertainties associated with successful completion of a specific friendly course of action; a change in the course of action usually leads to a change in intelligence requirements. Intelligence requirements that support decisions which affect the overall mission accomplishment (such as choice of a course of action, branch, or sequel) are designated as priority intelligence requirements (PIR-q.v.). Less important intelligence requirements are designated as information requirements (IR-q.v.).

IPB - see Intelligence Preparation of the Battlefield.

IR - see **Information** Requirement

KM - Kilometer; a unit of linear measure equal to one thousand meters or 0.62137 miles. To convert miles to kilometers **multiply** the number of miles by a factor of 1.60934.

KN - Knot(s); a unit of speed roughly equal to 1.15 miles per hour. Sometimes also used to denote a linear distance measured in nautical miles (q.v.).

LC - see Line of Contact.

LD - see Line of Departure.

**LD/LC** - Line of departure is the line of contact.

Limit of Advance (**LOA**) - An easily recognized terrain feature beyond which attacking elements will not advance. Note that it is a control measure rather than a terrain restriction.

Lines of Communication (LOC) - All the routes (**land**, water, and air) that connect an operating military force with one or more bases of operations and along which supplies and military forces **move**. **Note** that not all **roads, rails, etc.**, are lines of communication; some are unsuited, others may be suitable but not used. Note also that in this context a communications center is an area where LOC converge, such as transshipment points or hub-pattern cities (e.g. Bastogne, Belgium).

Line of Contact (LC) - A general trace delineating the location where two opposing forces are engaged.

Line of Departure (LD) - A line designated to coordinate the commitment of **attacking** units or scouting elements at a specified time. A start line.

**LOA** - see Limit of Advance.

**LOC** - see Lines of Communication.

LTIOV - Latest Time Information of Value; the time by which information must be delivered to the requestor in order to provide decision makers with timely intelligence. Sometimes the LTIOV is the expected time of a decision anticipated during staff wargaming and planning. If someone other than the decision maker must first **process** the information, the LTIOV is earlier than the time associated with the decision point. The time difference accounts for delays in processing and communicating the final intelligence to the decision maker.

MASINT - Measurement and Signature Intelligence.

**MCOO** - Modified Combined Obstacle **Overlay**; a product used to depict the battlefield's effects on military operations. It is normally based on a product depicting all obstacles to mobility modified to also depict:

- o Cross country mobility classifications (Restricted, etc.)
- o Avenues of approach and mobility corridors.
- o Likely locations of counter-mobility obstacle systems.
- o Defensible terrain.
- o Likely engagement areas.
- o Key terrain.

The list is not prescriptive or inclusive.

METT-T - Commonly used acronym for "mission, enemy, terrain, troops, and time available," used to describe the factors that must be considered during the planning or execution of a tactical operation. Since these factors vary in any given situation, the term "**METT-T** dependent" is a common way of denoting that the proper approach to a problem in any situation depends on these factors and their interrelationship in that specific situation.

MI - Military Intelligence; a branch of the **United** States Army.

Mile - A unit of linear measure equal to 5,280 feet, 1,760 yards, or 1.60934 kilometers. To convert kilometers to miles multiply the number of kilometers by a factor of 0.62137.

Mobility Corridor - Areas where a force will be canalized due to terrain restrictions. They allow military forces to capitalize on the principles of mass and speed and are therefore relatively free of obstacles.

MRR - Motorized Rifle Regiment; name of a soviet-style maneuver unit normally consisting of three mechanized infantry battalions, one tank battalion, one artillery battalion, and enough combat support and combat service support assets to make it capable of independent action for at least limited periods of time. The term motorized dates from World War II when most units depended on trucks for transportation. Today most units with this name are actually mechanized.

NAI - see Named Area of Interest

Named Area of Interest (NAI) - The geographical area where information that will satisfy a specific information requirement can be collected. NAI are usually selected to capture indications of threat courses of action but also may be related to conditions of the battlefield.

Nautical Mile - a unit of linear measure equal to 1.852 kilometers or approximately 1.15 miles. Nautical miles are commonly used in sea and air navigation.

NBC - Nuclear, Biological, and Chemical; used to denote weapons or operations which depend on nuclear, biological, or chemical warheads or agents for their casualty producing effects; or which protect or defend against or react to their use.

NLT - Not later than; the time by which something must be accomplished.

NME - Nuevo Metropolitano Ejercito; a fictitious organization created for purposes of illustrating the application of the doctrinal **principles put** forth in this manual.

OB - see Order of Battle.

OCOKA - A commonly used acronym and mnemonic for the factors of terrain analysis. The acronym does not dictate the order in which the factors are evaluated; use the order best suited to the situation at hand. The factors of terrain analysis are observation and fields of fire, concealment and cover, obstacles, key terrain, and avenues of approach.

Order of Battle (OB) - Intelligence pertaining to identification, strength, command structure, and disposition of personnel, units, and equipment of any military force. The order of battle factors form the framework for analyzing military forces and their capabilities, building threat models, and hence, course of action models. See FM 34-3.

Pattern Analysis - Deducing the doctrine, tactics, techniques, and procedures of a force by careful observation and evaluation of patterns in its activities. Pattern analysis leads to the development of threat models and hence to course of action models.

Penetration - A form of offensive maneuver that seeks to break through the enemy's defensive position, widen the gap created, and destroy the continuity of his positions.

Phase Line (PL) - A line used for control and coordination of **military** operations. It is usually a recognizable terrain feature extending across the zone of action. Units normally report crossing **PLs**, but do not halt unless specifically directed. **PLs** often are used to prescribe the timing of delay operations.

PIR - see Priority Intelligence Requirement.

PL - see Phase Line.

Possible - Information or intelligence reported by only one independent source is classified as possibly true. The test for independence is certainty that the information report of a **source** was not derived from some other source, usually resulting in reliance on original reporting. A classification of possibly true cannot be based on analytical judgment alone.

Priority Intelligence Requirement (PIR) - An intelligence requirement (q.v.) associated with a decision that will affect the overall success of the command's mission. PIR are a subset of intelligence requirements of a higher priority than information requirements (q.v.). PIR are prioritized among themselves and may change in priority over the course of the operation's conduct.

Probable - Information or intelligence reported by two independent sources is classified as probably true. The test for independence is certainty that the information report of one source was not derived from the other source,, usually resulting in reliance on original reporting. Analytical judgment counts as one source. Ensure that no more than one source is based solely on analytical judgment.

R & S - see Reconnaissance, see also Surveillance.

REC - Radio Electronic Combat; a term sometimes used to denote electronic warfare (q.v.) operations in non-NATO armed forces.



Reconnaissance - A mission under taken to obtain information by visual observation, or other detection methods, about the activities and resources of an enemy or potential enemy, or about the meteorologic, hydrographic, or geographic characteristics of a particular area. Reconnaissance differs from surveillance (q.v.) primarily in duration of the mission.

Restricted - A classification indicating terrain that hinders movement. Little effort is needed to enhance mobility through restricted terrain but units may have difficulty maintaining preferred speeds, moving in combat formations or transitioning from one formation to another.

Retirement - A retrograde operation in which a force out of contact moves away from the enemy.

Retrograde - An organized movement to the rear or away from the enemy. It may be forced by the enemy or may be made voluntarily. Such movements may be classified as withdrawal-- (q.v.), retirement (q.v.), or delaying operations (q.v.).

Sequel - Major operations that follow an initial major operation. Plans for sequels are based on the possible outcome-victory, stalemate, or defeat-of the current operation.

Severely Restricted - A classification indicating terrain that severely hinders or slows movement in combat formations unless some effort is made to enhance mobility. Severely restricted terrain includes man-made **obstacles**, such as minefields, cities, etc., as well as natural barriers.

SIGINT - Signals Intelligence.

SIR - see Specific Information Requirement

**SITMAP** - Situation Map; a recording device used as an aid in situation development and pattern analysis. See FM 34-3.

Situation Template - Depictions of assumed threat dispositions, based on threat doctrine and the effects of the battlefield, if the threat should adopt a particular course of action. In effect, they are the doctrinal template (q.v.) depicting a particular operation modified to account for the effects of the battlefield environment and the threat's current situation (training and experience levels, logistic status, losses, dispositions, etc.). Normally the situation template depicts threat units two levels of command below the friendly force as

well as the expected locations of high value targets. Situation templates use time-phase lines (q.v.) to indicate movement of forces and the expected flow of the operation. Usually, the situation template depicts a critical point in the course of action. Situation templates are one part of a threat course of action model (q.v.). Models may contain more than one situation template.

SOR - see Specific Order or Request

Sortie - One aircraft making one takeoff and one landing; an operational flight by one aircraft. Hence, six sorties may **be** one flight each by six different aircraft, or six flights by a single aircraft. Threat air capabilities are often stated in terms of the number of sorties per day by a particular type of aircraft. They are based on an evaluation of the available number of aircraft and **aircrews** (ideally more than one crew per aircraft), and the threat's maintenance, logistics, and training status.

Specific Information Requirement (SIR) - Specific information requirements describe the information required to answer all or part of an intelligence requirement. A complete SIR describes the information required, the location where the required information can be collected, and the time during which it can be collected. Generally, each intelligence requirement (q.v.) generates sets of SIR.

Specific Order or Request (SOR) - The order or request that generates planning and execution of a collection mission or analysis of data base information. **SORs** sent to subordinate commands are orders. **SORs** sent to other commands are requests. **SORs** often use system-specific message formats but also include standard military operations and fragmentary orders.

Surveillance - The systematic observation of airspace or surface areas **by visual**, aural, photographic, or other means. Surveillance differs from reconnaissance (q.v.) primarily in duration of the mission.

TAI - see Target Area of Interest.

Target Area of Interest (TAI) - The geographical area where high value targets (q.v.) can be acquired and engaged by friendly forces. **Not all** TAI will form part of the friendly course of action; only TAI associated with high payoff targets (q.v.) are of **interest** to the staff. These are identified during staff planning and wargaming. **TAIs** differ from engagement areas (q.v.) in degree. Engagement areas plan for the use of **all** available weapons; **TAIs** might **be** engaged by a single weapon.

TECHINT - Technical Intelligence.

Threat Course of Action Model - A model of one course of action available to the threat. It consists of a graphic depiction (situation template - q.v.); a description (narrative or matrix), and a listing of assets important to the success of the course of action (high value targets - q.v.). The degree of detail in the model depends on available time. Ideally, threat course of action models address all battlefield operating systems'. At a minimum, threat course of action models address the five standard elements of a course of action: what (the type of operation), when (in this case, the earliest time the-action can begin), where (boundaries, axis, etc.), how (the use of assets), and why (the purpose or desired end-state). Threat course of action models should also meet the tests of suitability, feasibility, acceptability, uniqueness, and consistency with doctrine (see chapter two). Threat courses of action are derived from capabilities (q.v.).

Threat Model - A model of the threat force's doctrine and tactics, techniques, and procedures for the conduct of a particular operation. Threat models are based on a study of all available information, structured by the order of battle (q.v.) factors, of the particular threat force under consideration. Ideally, threat models consider all battlefield operating systems (q.v.) in detail. Threat models are normally prepared prior to deployment.

Time Phase Line (TPL) - A line used to represent the movement of forces or the flow of an operation over time. It usually represents the location of forces at various increments of time, such as lines that show unit locations at two hour intervals. **TPLs** should account for the effects of the battlefield environment and the anticipated effects of contact with other forces. For example, **TPLs** depicting threat movement through an area occupied by friendly forces should use movement rates based on a force in contact with the enemy rather than convoy movement speeds.

TPL - see Time Phase Line.

TR - Tank Regiment; name of a soviet-style maneuver unit normally consisting of three tank battalions, one mechanized infantry battalion, one artillery battalion, and enough combat support and combat service support assets to make it capable of independent action for at least limited periods of time.

Unrestricted - A classification indicating terrain that is free of restrictions to movement.

USAF - United States Air Force.

UTM - Universal Transverse Mercator; the geographical coordinate system used by Army and Marine ground forces. Named for the Flemish cartographer Gerhardus Mercator (1512-1594).

Withdrawal - A retrograde operation in which a force in contact with the enemy frees itself for a new mission.

FM 34-130

- 90-3 Desert Operations (How To Fight).
- 90-5 Jungle Operations (How To Fight).
- 90-6 Mountain Operations.
- 90-10** Military Operations on Urbanized Terrain (MOUT).
- 90-11** Cold Weather Operations.

Department of Army (DA) Forms

- 2028 Recommended Changes to **Publications** and Blank Forms.