

*Report of the  
Defense Science Board Task Force  
on*

**The Creation and Dissemination of  
All Forms of Information in Support  
of Psychological Operations (PSYOP)  
in Time of Military Conflict**



May 2000

Office of the Under Secretary of Defense  
For Acquisition, Technology and Logistics

Washington, D.C. 20301-3140

**DISTRIBUTION STATEMENT A**  
Approved for Public Release  
Distribution Unlimited

DTIC QUALITY INSPECTED 4

20001006 014

**This report is a product of the Defense Science Board (DSB). The DSB is a Federal Advisory Committee established to provide independent advice to the Secretary of Defense. Statements, opinions, conclusions, and recommendations in this report do not necessarily represent the official position of the Department of Defense.**

**This report is UNCLASSIFIED**





OFFICE OF THE SECRETARY OF DEFENSE

3140 DEFENSE PENTAGON  
WASHINGTON, DC 20301-3140

DEFENSE SCIENCE  
BOARD

MEMORANDUM FOR UNDER SECRETARY OF DEFENSE (ACQUISITION,  
TECHNOLOGY AND LOGISTICS)

SUBJECT: Final Report of the Defense Science Board Task Force on The Creation and Dissemination of Information in Support of Psychological Operations (PSYOP) in Time of Military Conflict

I am forwarding the final report of the Defense Science Board Task Force on The Creation and Dissemination of Information in Support of Psychological Operations (PSYOP) in Time of Military Conflict.

The Terms of Reference directed the Task Force to:

- assess the capability of the United States Armed Forces to develop programming and to broadcast factual information to a large segment of the general public;
- assess the potential of various airborne and land-based mechanisms to deliver such information; and
- assess other issues in the creation and dissemination of all forms of information in times of conflict, including satellite broadcasts and the use of emerging mobile communication technologies.

Of particular concern is the lack of an integrated PSYOP capability with the strategic International Public Information (IPI) initiative. While a national capability is not the province of DoD, DoD certainly possesses capabilities and experience which would enhance the development of the IPI initiative. The Task Force also found that content creation and dissemination lagged commercial capabilities. Incorporating commercial capabilities should significantly enhance DoD PSYOP capabilities. Finally, although PSYOP has demonstrated its usefulness over time, the incorporation of PSYOP during time of conflict is sporadic and steps need to be taken to strengthen its position within the JTF/CINC organizational structure.

The report offers several recommendations addressing these problems with a major thrust being the incorporation of commercial capability into the creation and dissemination of PSYOP products.

I endorse all of the Task Force's recommendations and propose you review the Task Force Chairman's letter and report.

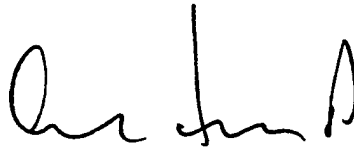
A handwritten signature in black ink, appearing to read 'Craig Fields', written in a cursive style.

Craig Fields  
Chairman



OFFICE OF THE SECRETARY OF DEFENSE

3140 DEFENSE PENTAGON  
WASHINGTON, DC 20301-3140

DEFENSE SCIENCE  
BOARD

MEMORANDUM FOR CHAIRMAN DEFENSE SCIENCE BOARD

SUBJECT: Final Report of the Defense Science Board Task Force on The Creation and Dissemination of Information in Support of Psychological Operations (PSYOP) in Time of Military Conflict

Attached is the report of the Defense Science Board Task Force on The Creation and Dissemination of Information in Support of Psychological Operations (PSYOP) in Time of Military Conflict.

The Terms of Reference charged the Task Force with reviewing PSYOP activities within the Department of Defense (DoD). The purpose of the review was to:

- assess the capability of the United States Armed Forces to develop programming and to broadcast factual information to a large segment of the general public;
- assess the potential of various airborne and land-based mechanisms to deliver such information; and
- assess other issues in the creation and dissemination of all forms of information in times of conflict, including satellite broadcasts and the use of emerging mobile communication technologies.

The Task Force was originally created because of concern over the limitations exhibited in recent military operations in the Balkans, where the *Commando Solo* (EC-130E) aircraft were unable to disseminate TV and radio broadcasts. The Task Force chose to broaden its charter and address issues associated with PSYOP as part of an overall Information Operations (IO) campaign during peace, crisis, and armed hostilities. It also evaluated organizational issues associated with PSYOP forces within DoD and addressed issues associated with the PSYOP community's relationship to the Intelligence Community. Of particular interest is the on-going worldwide explosion of information creation and dissemination technologies and capabilities. The Task Force spent considerable effort addressing modern trends in information dissemination and media content creation. With those trends as a backdrop, the Task Force then assessed the viability of the current *Commando Solo* fleet and a variety of options currently being studied by DoD.

The Task Force found that Military PSYOP offer a unique and powerful asset in military operations, both in peacetime and in war. However, outdated equipment and organizational issues often hamper the creation of PSYOP products that meet mission needs. Given the broad array of complex missions conducted by U.S. military forces, understanding the culture and preparation of the "soft" battlespace is imperative to the conduct of successful operations. A robust and flexible PSYOP capability can be an invaluable tool in these efforts.

With these issues in mind, the report offers several recommendations. The Task Force believes that a major effort is required to integrate DoD PSYOP with International Public Information initiatives to build brand identity and delivery mechanisms required to ensure the message is heard during time of conflict. Efforts at the strategic, operational, and tactical level require expert content and market analysis which is widely available in the commercial marketplace. Additionally, DoD needs to acquire the technical capability to understand emerging media dissemination techniques and technologies in order to implement emerging techniques when warranted. More robust connections with the Intelligence Community, specifically the Defense Intelligence Agency are required to enhance PSYOP products for specific countries and regions. Rank structure should be reviewed to ensure the PSYOP commander receives adequate access to the Joint Task Force Commander/CINC which will help enable PSYOP integration with the overall operational plan. Finally, the Task Force recommends against crossdecking the existing Special Mission Equipment used on the *Commando Solo* aircraft from the current EC-130E to the EC-130J. Instead, we should begin the design and development of small and easily reconfigurable information dissemination packages that would be compatible with multiple platforms.

The Task Force would like to express its appreciation for the cooperation, advice, and help provided by the government advisors, support staff, and the many presenters.



Mr. Vincent Vitto  
Task Force Chairman

## Table Of Contents

List of Figures and Tables .....	ii
Executive Summary .....	1
CHAPTER 1, Introduction .....	6
CHAPTER 2, Organizational Issues .....	15
CHAPTER 3, Reaching the Target Audience .....	23
CHAPTER 4, Future Trends in Media Creation and Dissemination .....	29
CHAPTER 5, FM and TV Broadcast from Aircraft .....	46
CHAPTER 6, Recommendations .....	52
Appendix A, Terms of Reference .....	55
Appendix B, Task Force Membership .....	57
Appendix C, Briefers.....	58
Appendix D, Congressional Language.....	59



## List of Figures and Tables

Figure 1.1 Serbian use of propaganda during the Kosovo Crisis.....	8
Figure 1.2 PSYOP integrated over all phases of conflict.....	9
Figure 1.3 PSYOP Tools Today.....	12
Figure 2.1 Current SOCOM PSYOP Structure.....	19
Figure 2.2 PSYOP relevance.....	20
Figure 4.1 Convergence of transmission networks .....	29
Figure 4.2 Projected European cable TV penetration .....	30
Figure 4.3 Conceptual schematic for DAB receiver .....	32
Figure 4.4 AsiaSat 2 TV and radio coverage in C and Ku bands .....	33
Figure 4.5 AfriStar satellite coverage and satellite radio receiver .....	34
Table 4.1 Cellular / PCS subscriber and revenue forecasts for Brazil, 1994-2004.....	36
Figure 4.7 Emerging trends in wireless telephony (cell-phone) technology.....	36
Figure 4.8 Wireless Internet devices and metropolitan wireless Internets.....	39
Figure 4.9 The build-out of Internet bandwidth in the suburban United States.....	40
Figure 4.10 Projected worldwide market for fiber optic cables .....	41
Table 4.2 Total fiber optic cable market: revenue forecasts, 1996-2006 .....	41
Table 4.3 Forecast of free Internet audio player downloads, 1995-2005.....	43
Table 4.4 Content types and distribution channels .....	44
Table 5.1 Antenna height and range to horizon .....	47
Table 5.2 Operational constraints on airborne broadcasts .....	48
Table 5.3 Effectiveness of transmissions from beyond line of sight .....	49
Table 5.4 Predicted performance of broadcast transmissions .....	50

## Executive Summary

The Defense Science Board (DSB) Task Force on the Creation and Dissemination of All Forms of Information in Support of Psychological Operations (PSYOP) in Time of Military Conflict was charged with reviewing PSYOP activities within the Department of Defense (DoD). The purpose of the review was to:

- assess the capability of the United States Armed Forces to develop programming and to broadcast factual information to a large segment of the general public;
- assess the potential of various airborne and land-based mechanisms to deliver such information; and
- assess other issues in the creation and dissemination of all forms of information in times of conflict, including satellite broadcasts and the use of emerging mobile communication technologies.

Military PSYOP offers a potentially unique and powerful asset in military operations, both in peacetime and in war. However, the creation of PSYOP products that meet mission needs is often hampered by outdated equipment and organizational issues. Given the broad array of complex missions conducted by U.S. military forces, understanding the culture and preparation of the “soft” battlespace is imperative to the conduct of successful operations. A robust and flexible PSYOP capability can be an invaluable tool in these efforts.

The Task Force’s Terms of Reference (TOR) asked that the study examine the issue of creating and disseminating information in times of military conflict. (The full TOR is shown in Appendix A, while the Task Force membership and the individuals, both inside and outside DoD, who met with members of the Task Force are presented in Appendix B and Appendix C, respectively.) The Task Force and its TOR were motivated by Congressional language in Public Law 106-65, Section 1061 of the National Defense Authorization Act for Fiscal Year 2000, shown in Appendix D, which requested that the Secretary of Defense establish a Task Force to examine (1) the use of radio and television broadcasting as a propaganda instrument in times of military conflict and (2) the adequacy of the capabilities of the U.S. Armed Forces to make such uses of radio and television during conflicts such as the one in the Federal Republic of Yugoslavia in the Spring of 1999.

After initial discussions and briefings, the Task Force broadened the focus of the study to cover the nature of PSYOP as a whole, including organizational issues, PSYOP as part of an overall Information Operations (IO) campaign, and the increase in media opportunities. From the outset, the Task Force concluded that the dissemination of information via television (TV) and radio must be viewed as part of a comprehensive PSYOP campaign covering strategic, operational, and tactical military operations. This report begins with a vision of future PSYOP capabilities as part of an integrated overall information campaign and an overview of how PSYOP activities are conducted today.

Chapter 2 then presents a discussion of the organizational issues and challenges that current PSYOP forces face. Chapter 3 discusses the characterization of target audiences and the need to create an effective and believable brand identity for disseminating the message. Chapter 4 discusses future media production and dissemination trends and how they will likely affect the dissemination of PSYOP products worldwide. Chapter 5 examines the use the *Commando Solo* aircraft to disseminate information via TV and radio broadcasts. Finally, chapter 6 summarizes the Task Force's recommendations.

The Task Force focused on current and future technologies for the dissemination of PSYOP products, organizational issues, and mission needs and requirements. However, the use of PSYOP in military operations must be viewed as an integral part of the operation, and not as an afterthought. For PSYOP to be most effective, efforts must be made to include PSYOP as part of an integrated information operation over *all* phases of conflict, from peacetime to hostilities.

## **Recommendations**

This DSB Task Force was originally created because of concern over the limitations exhibited in recent military operations in the Balkans, where the *Commando Solo* (EC-130E) aircraft were unable to disseminate TV and radio broadcasts. The Task Force chose to broaden its charter and address issues associated with PSYOP as part of an overall Information Operations (IO) campaign during peace, crisis, and armed hostilities. It also evaluated organizational issues associated with PSYOP forces within DoD and addressed issues associated with the PSYOP community's relationship to the Intelligence Community. Of particular interest is the on-going worldwide explosion of information creation and dissemination technologies and capabilities. The Task Force spent considerable effort addressing modern trends in information dissemination and media content creation. With those trends as a backdrop, the Task Force then assessed the viability of the current *Commando Solo* fleet and a variety of options currently being studied by DoD. The following recommendations were derived from all of these considerations.

If PSYOP is to be a useful tool in the future, it must be a nimble asset capable of delivering the right information quickly, and in a manner that is a technologically as sophisticated as any possible competitor within the region. In the future, the value of PSYOP will clearly be seen as best utilized before and after the conflict. PSYOP used before will help shape the military context in a favorable fashion for the U.S. forces. In the best case scenario, PSYOP actions will be coupled with other flexible deterrent options and actually prevent conflict. PSYOP after a conflict will shape the way U.S. military actions are perceived by people in the region and help to achieve the end state desired by the Theater CINC and the National Command Authorities. In the future, bombs and missiles will still determine who militarily wins or loses a conflict at tactical level. PSYOP, though, will help determine how long a conflict lasts and the impact of a military struggle on long term U.S. strategic interests.

### **Recommendation 1**

*The Task Force recommends that DoD create a PSYOP policy/planning staff, under the coordination authority of the Assistant Secretary of Defense for Special Operations and Low-Intensity Conflict (OASD(SO/LIC)). This staff should ensure the integration of operational and tactical level PSYOP with strategic International Public Information (IPI) initiatives and provide planning support for strategic PSYOP activities, as described in Presidential Decision Directive (PDD) 68.*

### **Recommendation 2**

*The Task Force recommends that rank structure and career paths within PSYOP forces should be reassessed and more specifically:*

- *the senior PSYOP Advisor to the geographical CINCs should be an O-6 or equivalent civilian and should be assigned to the CINC Special Staff, and*
- *the Commander of the Joint PSYOP Task Force supporting the Joint Task Force Commander in theater (typically a three-star flag officer) should also be an O-6.*

### **Recommendation 3**

*The Task Force recommends that the Office of OASD(SO/LIC) and U.S. Special Operations Command (USSOCOM) strive to improve overall product quality through increased reliance on commercial providers for high-quality products. Furthermore, the Task Force recommends that the PSYOP force be adequately resourced and trained to engage a stable of commercial media content providers who can deliver these quality products. The Task Force estimates this investment to be approximately \$10 million per year.*

### **Recommendation 4**

*The Task Force recommends that the Defense Intelligence Agency be tasked by the Assistant Secretary of Defense for Command, Control, Communications, and Intelligence (ASD C3I) to establish a psychological warfare intelligence element. ASD C3I should be charged to either (a) provide resources to the PSYOP community to implement a robust organic program of open source acquisition, or (b) task the Intelligence Community to fulfill the need for on-the-shelf, worldwide basic information, including the media and cultural background information necessary to adequately inform PSYOP products in a given country. The Task Force believes that this can be accomplished without incurring an additional budgetary burden.*

### **Recommendation 5**

*The Task Force recommends that ASD C3I make National Foreign Intel Program/Joint Military Intel Program (NFIP/JMIP) funds available to USSOCOM for the express purpose of acquiring available data sets, particularly for countries outside North America and Europe. The Task Force also recommends that USSOCOM work with the Foreign Military Studies Office (FMSO) to ensure the integration of these data sets with the World Basic Information Library (WBIL) and their community-wide accessibility. Moreover, the Intelligence Community should be further tasked through ASD C3I to*

*develop methods and sources to obtain media use demographic information where it is not now available but where the U.S. might plausibly have future national security interests in which PSYOP might be employed. The Task Force estimates this investment to be approximately \$5 million per year.*

#### **Recommendation 6**

*The Task Force recommends that the Office of the Secretary of Defense (OSD) work with the Department of State to fund, position, exercise, and maintain suitable distribution channels and brand identities, insofar as these can be reasonably anticipated for future PSYOP requirements. Policies with respect to the use of new and emerging transnational media need to be developed or refined. Liberal reliance on recognized professionals and the generous use of highly qualified commercial entities are highly recommended. Buying good content on which the messages will "ride" is a necessary and desirable expenditure. The Task Force estimates this investment to be approximately \$10 million per year.*

#### **Recommendation 7**

*The Task Force recommends that DoD acquire the technical capability to understand emerging media dissemination techniques and technologies. Furthermore, DoD should provide the resources to acquire (rent or purchase) emerging media content and dissemination channels from commercial organizations. Here, DoD may be able to acquire good channels very cheaply by means of being an "anchor tenant." The Task Force estimates this investment to be approximately \$10 million per year.*

#### **Recommendation 8**

*The Task Force recommends that DoD maintain the current EC-130E Commando Solo fleet with existing Special Mission Equipment (SME). The estimated cost of \$250 million to cross-deck the SME to a EC-130J platform is not justified by the marginal increase in performance offered by this option. In addition, future worldwide media dissemination trends will limit the effectiveness of radio and TV broadcasts. The Task Force recommends that USSOCOM investigate the creation of small and easily reconfigurable information-dissemination packages that would be compatible with multiple platforms, including UAVs and leased aircraft, for a variety of missions. The Task Force estimates the initial investment for design and development of these packages to be \$10 to \$20 million per year.*

#### **Recommendation 9**

*The Task Force has recommended annual funding increases (in recommendations 1 through 8) of approximately \$50 million per year. The Task Force believes that this increase would be readily supported by reprogramming the \$250 million that would be required to fund cross-decking the existing Commando Solo SME to the EC-130J platforms.*

The prompt and effective use of PSYOP in military operations can avert crises, end wars, and save lives. DoD should prioritize Psychological Operations appropriately, because the misuse of PSYOP can cause untold damage to military operations. A relatively small

investment over time can reap huge rewards for the United States and its allies, both diplomatically and militarily.

# CHAPTER 1

## Introduction

### 1.1 Purpose of the Study

The Defense Science Board (DSB) Task Force on the Creation and Dissemination of All Forms of Information in Support of Psychological Operations (PSYOP) in Time of Military Conflict was charged with reviewing PSYOP underway in the Department of Defense (DoD). The purpose of the study was to:

- assess the capability of the United States Armed Forces to develop programming and broadcast factual information that can reach a large segment of the general public;
- assess the potential of various airborne and land-based mechanisms to distribute such information; and
- assess other issues in the creation and dissemination of all forms of information in time of conflict, including satellite broadcasts and the use of emerging mobile communication technologies.

Military PSYOP offers a potentially unique and powerful asset in military operations, in both peacetime and in war. However, the creation of PSYOP products that meet mission needs is often hampered by outdated equipment and organizational issues. Given the broad array of complex military operations conducted since the end of the Cold War, and assuming these operations will continue in the future, it is imperative to understand the culture and preparation of the “soft” battlespace in order to conduct successful operations. A robust and flexible PSYOP capability can be an invaluable tool in these efforts.

The Task Force’s Terms of Reference (TOR) asked that the study examine the creation and dissemination of information in times of military conflict. (The full TOR is shown in Appendix A, while the Task Force membership and a list of experts, both inside and outside DoD, who met with members of the Task Force are presented in Appendix B and Appendix C, respectively.) The Task Force and its TOR were motivated by Congressional language in Public Law 106-65, Section 1061 of the National Defense Authorization Act for Fiscal Year 2000, shown in Appendix D, which requested that the Secretary of Defense establish a Task Force to examine (1) the use of radio and television broadcasting as a propaganda instrument in times of military conflict and (2) the adequacy of the capabilities of the U.S. Armed Forces to make use of radio and television during conflicts such as the one in the Federal Republic of Yugoslavia in the Spring of 1999.

From the outset, the Task Force concluded that dissemination of PSYOP information via TV and radio must be addressed in the context of an overall information operations campaign, in peacetime and during hostilities. It therefore broadened its focus to include information on the nature of PSYOP as a whole, including organizational issues, PSYOP

as part of an overall Information Operations (IO) campaign, the characterization of target audiences, and the increase in media opportunities. Instead of focusing merely on the dissemination of information, the Task Force began the study with an overview of how PSYOP is conducted today and then turned to a discussion of the organizational issues and challenges the current PSYOP forces face. It was agreed that the effective characterization of target audiences and the creation of an effective and believable brand identity for disseminating a credible message and product is critical to successful PSYOP. Also critical is a clearer understanding and better modeling of future media trends and how they could affect the dissemination and nature of PSYOP. Finally, the Task Force examined the issue of information dissemination and in particular the utilization, capabilities, and future applicability of the *Commando Solo* aircraft.

## **1.2 The Increased Relevance of PSYOP**

*Military Psychological Operations (PSYOP) are programs of products and/or actions that induce or reinforce the attitudes, opinions, and emotions of selected foreign target governments, organizations, groups, and individuals to create a behavior that supports U.S. national policy objectives and the theater combatant commander's intentions at the strategic, operational, and tactical levels. PSYOP events are planned, coordinated, and executed before, during, and after conflicts. PSYOP actions are a subset of Information Operations (IO) and International Public Information (IPI) as described by Presidential Decision Directive (PDD) 68.*

Psychological Operations (PSYOP) have been a part of military strategy throughout history. In the recent past, PSYOP campaigns were utilized by both sides in World War II, the Cold War, Vietnam, and the Gulf War. During these large scale conflicts, the PSYOP campaigns were predominantly effective from a United States and coalition partner perspective, except in Vietnam, where PSYOP was more effectively used by the adversary. In more recent conflicts PSYOP played a major role in the US successes in Grenada and Haiti, but has been viewed as particularly successful in the recent Balkan conflicts (Bosnia and Kosovo).

While neither the definition nor the purpose of PSYOP has significantly changed since the end of the Cold War, the nature of conflict, the available technologies, the socio-political environment, and the character of operations involving military forces have all changed dramatically.

Individuals from various backgrounds and perspectives briefed the Task Force and spoke of the growing importance of PSYOP to the success of any action the U.S. Government undertakes overseas, whether diplomatic or military. While the United States is years ahead of its competitors in terms of military technology, in terms of PSYOP there are already competitors on par with or even arguably more sophisticated than the U.S. The weakness of U.S. military PSYOP is ironic because the United States leads the world in commercial media technology and development. However, foreign rivals are often more flexible, less restricted by outdated equipment and policy, and better able to take advantage of changes in the manner in which people communicate.





Figure 1.1 Serbian use of propaganda during the Kosovo Crisis

The dense nature of the global information environment, coupled with the importance of the “media message,” was demonstrated in past military crises in populations and cultures as diverse as Iraq, Serbia, and Somalia. The trend to involve the U.S. military in peacekeeping operations, where the use of violence is carefully prescribed by restrictive rules of engagement, has furthered emphasized the need for effective information activities. In peacekeeping operations, military PSYOP forces can expect to operate for an extended period of time in an area where sophisticated, robust, indigenous media competes with the U.S. military PSYOP message. In this environment, military PSYOP will not have the ability to monopolize an area’s information outlets through destruction or jamming. In fact, PSYOP forces today must often compete with numerous international neutral entities to gain the attention of an intended foreign target audience.

In the Information Age, there is an increasing reliance on sophisticated, near-real time media dissemination. Information, and its denial, is power. The state or entity most able to effectively control or manage information, especially managing the perceptions of particular target audiences, will be the most influential. Future adversaries will be more likely to attempt to rely upon their ability to subvert U.S. foreign policy goals through the use of sophisticated propaganda -- on both its own populace and on international audiences -- than to confront the United States and its coalition partners through traditional military means. They will try to manipulate U.S. policy through selected, discriminate propaganda via both legitimate news media and non-traditional means. For military PSYOP to be effective, they must be continuous and integrated with the other elements of IO.

### 1.3 A PSYOP Future Vision

If PSYOP is to be a useful tool in the future, it must be a nimble asset capable of delivering the right information quickly, and in a manner that is as technologically sophisticated as any possible competitor within the region. In the future, the value of PSYOP will clearly be seen as best utilized before *and* after the conflict. PSYOP used before will help shape the military context in a favorable fashion for the U.S. forces. In the best case scenario, PSYOP actions will be coupled with other flexible deterrent options and actually prevent conflict. PSYOP after a conflict will shape the way U.S. military actions are perceived by people in the region and help to achieve the end state desired by the Theater CINC and the National Command Authorities. In the future, bombs and missiles will still determine who militarily wins or loses a conflict at tactical level. PSYOP, though, will help determine how long a conflict lasts and the impact of a military struggle on long term U.S. strategic interests.

If the recommendations for military PSYOP contained in this study are enacted, the future military PSYOP capability may well resemble the following description which is also captured in Figure 1.2.

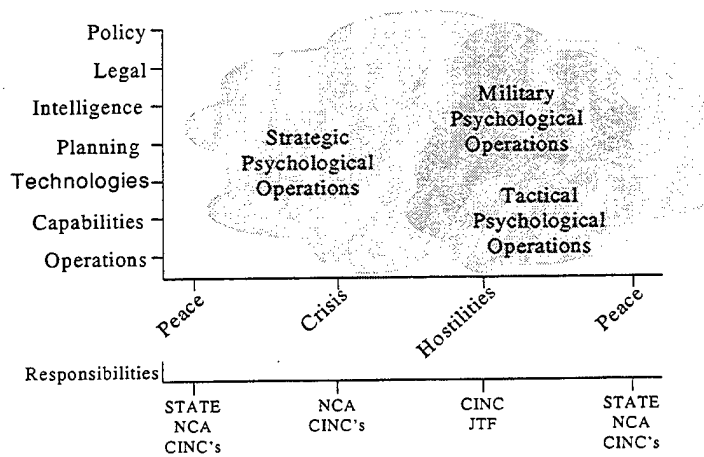

Figure 1.2 PSYOP integrated over all phases of conflict

- **Strategic PSYOP:** A permanent PSYOP staff organization under the direction of ASD SO/LIC, will work closely with U.S. Department of State Public Diplomacy staff members. Their primary purpose, in accordance with Presidential Decision Directive 68, will be to assist the Department of State in developing strategic International Public information plans and programs. Additionally, this strategic PSYOP policy and planning staff will also be able to de-conflict and synchronize the Theater CINC's PSYOP scheme with the

strategic International Public Information plan. The link between the strategic PSYOP policy/planning staff and the theaters will occur through the Joint PSYOP Headquarters. For the first time, this headquarters will bring all the military PSYOP assets under one organization. Commanded by a flag officer, the Joint PSYOP Headquarters will maintain open contracts with civilian advertising and marketing firms for assistance in PSYOP product development and links with members of academia studying the potential impact of information on the attitudes and behaviors of foreign target audiences.

- **Operational PSYOP:** In this future PSYOP structure, wartime operational PSYOP will diminish in significance. Much of what is termed today as "operational PSYOP" will occur during future conflict at the strategic or tactical level. However, in the future, operational PSYOP will still be an important contributor during peacetime. In the future, the PSYOP perspective will always reach the Theater CINC because of the existence of a senior PSYOP Advisor (PSYAD). The PSYAD position, a member of the CINC's Special Staff, in close consultation with the Political Advisor, will provide the CINC with a unique viewpoint on the motivations of the people within a specific area of operation. The PSYAD also will advise the CINC on how best to deploy the PSYOP forces organic to his theater. This will be organic PSYOP because PSYOP forces will no longer be exclusively located in CONUS but permanently assigned to their particular theater of operations. This forward deployment will eliminate the long delay caused today by the current requirement for the CINC's staff to request any and all PSYOP forces and for the Joint Staff to issue deployment orders. By having permanent in-theater PSYOP forces, CINC's, in coordination with the various U.S. Embassy Country Teams, will be able to execute a more robust peacetime PSYOP program and have far more confidence and control of their PSYOP assets. Through coordination by way of the Joint PSYOP Headquarters, the Theater CINC's PSYOP staff will provide input into strategic PSYOP plans and programs and insure their efforts are synchronized fully with the International Public Information efforts. During periods of crisis and war, the Theater PSYOP forces will use a variety of platforms, both manned and unmanned to disseminate information. Some of these assets will be based in space and owned by commercial interests, and some others will be owned by other-than-DOD agencies within the U.S. government.
- **Tactical PSYOP:** Future tactical PSYOP teams will more resemble electronic news gatherers as opposed to loudspeaker teams. PSYOP soldiers will no longer carry loudspeakers in high threat environments. Instead, PSYOP messages will be routed through a wireless network to unmanned speakers. Loudspeakers will be mounted on the outside of more survivable armored vehicles like tanks and will be dropped in the enemy's rear areas. The primary purpose of tactical PSYOP teams will be to gather video footage and send it for further editing to various PSYOP production centers.

Communications links will be robust and real time. Footage gathered by these soldiers will be sent directly back to the Joint PSYOP Headquarters and incorporated into the Department of State's Worldnet Television transmissions. In peacetime, local media contracts will be typically consummated in order to disseminate PSYOP materials.

#### **1.4 PSYOP Today**

Used properly, PSYOP can help, in the words of the Chinese philosopher Sun Tzu, "subdue the enemy's army without battle." Especially in an era when any loss of life is politically sensitive, the ability of PSYOP to be a 'combat reducer' and save the lives of U.S. troops and citizens, as well as opposing force personnel, is exceedingly important. PSYOP forces offer U.S. policymakers and warfighters a more discreet and often more politically palatable tool than conventional military activities, which are primarily designed to bring the adversary to heel through death and destruction.

However, to be a "combat reducer," PSYOP must be robust and integrated into each element of power. Unfortunately, the current PSYOP structure reflects an outdated Cold War policy, with U.S. PSYOP forces primarily oriented toward supporting tactical forces on the ground, using loudspeaker operations and face-to-face communications. Nevertheless, given the increased velocity of information at every level, and the need to react more quickly to local situations, U.S. military commanders have increasingly relied upon PSYOP forces at all levels as their conduit for information to foreign populations. These commanders depend upon their PSYOP officers and non-commissioned officers to communicate information and expectations, irrespective of local or international competition, in a manner that challenges the PSYOP organizational structure.

##### **1.4.1 Strategic PSYOP**

In the past, there were clear distinctions between the three levels of PSYOP: strategic, operational, and tactical. In the post-Cold War world, however, these distinctions have blurred to the extent that they may no longer exist. The world's almost instantaneous access to news and information makes it nearly impossible to localize any information campaign. A leaflet handed out in Bosnia is just as likely to be shown by a reporter on the nightly news in the United States or Europe as it is to be read in Sarajevo.

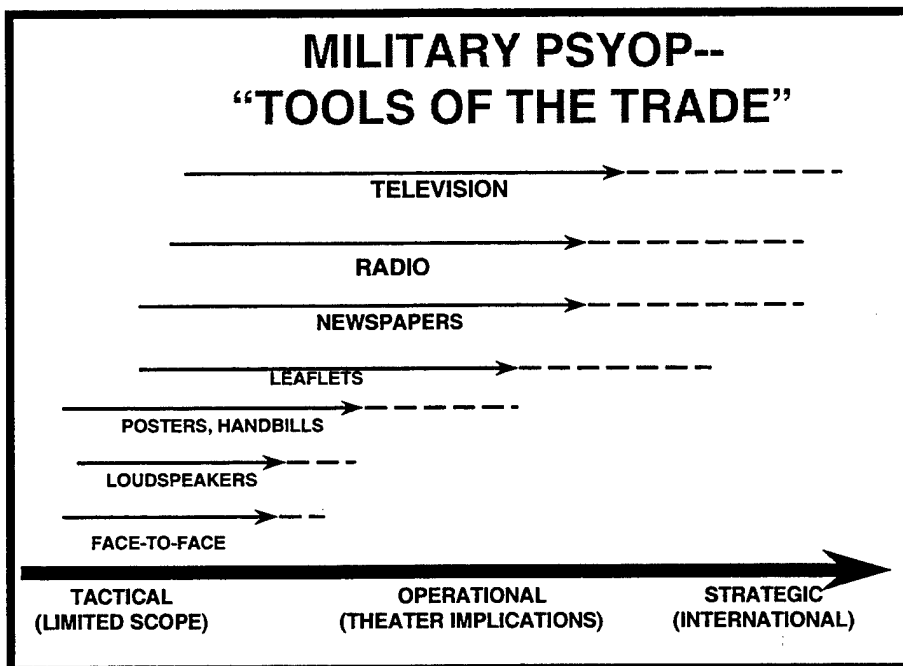

Figure 1.3 PSYOP Tools Today

Strategic PSYOP, in accordance with PDD 68, is defined as having global implications and is planned, initiated, and executed at the national level. Military PSYOP support strategic PSYOP through planning, and if tasked, through the dissemination of assets. Military PSYOP should also ensure that the geographic CINC's peacetime engagement activities are harmonized with the national strategic PSYOP plan. Despite recent attempts to ensure better coordination, PSYOP plans at the strategic level suffer from a lack of synchronization. Currently, there is not a systemic manner in which military PSYOP organizations gain insight into the strategic perception-management effort – nor is there a practiced method to de-conflict a supported CINC's theater information activities with the national information effort. While strategic PSYOP actions are most effective during peacetime, military PSYOP doctrine and organizational structure are principally configured to respond during a conflict. This over-emphasis on wartime operations is viewed by the Task Force as a deficiency of today's PSYOP force.

#### 1.4.2 Operational PSYOP

During periods of conflict, military PSYOP capabilities and doctrine are more developed and effective. During warfighting, PSYOP elements are flexible and can provide support with a small team or with a robust Joint PSYOP Task Force (JPOTF), potentially consisting of thousands of individuals. Given enough time during a crisis, PSYOP forces can provide a surge capability from bases in the United States to the theater CINC headquarters, supplementing existing PSYOP planning capabilities and/or establishing PSYOP headquarters for multiple Joint Task Forces. Operational PSYOP actions impact throughout the entire military theater of operations and typically consist of widespread

television and radio broadcasts, and newspaper, magazine, and leaflet dissemination. To be effective, PSYOP planners on the supported CINC's staff must oversee and coordinate PSYOP prior to the deployment of large forces from the United States. PSYOP planning staff billets forward in the theaters are however typically thinly and inconsistently manned.

Operational-level military PSYOP forces today are asked to compete against sophisticated local and international media organizations, which are often better funded and more technically sophisticated. Unlike their rivals, U.S. PSYOP forces today cannot readily disseminate materials over the Internet or via commercial broadcast satellites. In addition, the PSYOP force is largely composed of a rather small pool of U.S. Army personnel, who are at best media amateurs. These forces must attempt to compete against often better trained foreigners, who are less encumbered by policies and organizational structures. Ideally, PSYOP research regarding foreign audiences should be modern and sophisticated, and should utilize a wide range of national intelligence capabilities and leverage the latest in commercial marketing and polling techniques. In reality, however, U.S. PSYOP forces have difficulty making intelligence collection requirements known and accessing intelligence. In addition, PSYOP personnel are often untrained in civilian marketing, polling, and media production skills.

Moreover, the PSYOP capability to disseminate via television and radio broadcasts in denied areas is extremely deficient. The current capability for radio and television dissemination is limited to the use of *Commando Solo* aircraft, which have the capability to broadcast AM and FM radio and VHF and UHF TV signals from an altitude of 18,000 feet. The Special Mission Equipment (SME) carried on the EC-130E aircraft features technology that is decades old and vulnerable to an adversary's countermeasures. The current PSYOP operational concept features the deployment of a small element of PSYOP forces forward in the supported CINC's theater of operations. These deployed forces would be primarily supported by PSYOP plans, programs, and products developed at the PSYOP headquarters in Fort Bragg, North Carolina. This so-called "Reachback" concept is dependent upon an enormous amount of bandwidth through secure communications links. In practice, "Reachback" has often been very difficult to institute and support.

### **1.4.3 Tactical PSYOP**

Military tactical PSYOP are actions taken in a local area with focused impact. Loudspeaker operations, handbills, local radio broadcasts, and television programming are typical tactical PSYOP actions. Today's PSYOP capability at the tactical level is quite well developed. Recently, PSYOP forces supporting local military commanders were augmented with a capability to produce a limited range of PSYOP products.

In fact, one could make the argument that the current PSYOP structure is too heavily focused toward tactical PSYOP. This structure makes it difficult to support the theater CINCs, especially in an age when the power of electronic media has, in many areas of the

world, overwhelmed the print alternative. Within the current PSYOP organizational structure, the PSYOP regional battalions, primarily responsible for operational-level PSYOP, are the most heavily deployed PSYOP forces and struggle to meet the manpower requirements for the numerous contingency missions. With enough PSYOP tactical forces to support seven Army corps equivalents (one PSYOP tactical battalion is allocated to a corps equivalent), the imbalance between regional and tactical PSYOP forces in the current force structure is obvious.

A major concern regarding tactical PSYOP forces is the survivability of these units during mid- and high-intensity conflicts. With the lethality of the weaponry on the modern battlefield, the lifespan of the three-person PSYOP tactical team in a lightly armed HMMWV, equipped with a loudspeaker with a range of a mere thousand meters, would probably be measured in terms of hours, if not minutes. Should PSYOP loudspeaker operations be needed at the front lines in such difficult threat environments, they will need to be accomplished remotely via a more heavily armored manned vehicle or an unmanned vehicle (either aerial or ground). The capability to conduct remote loudspeaker operations is currently not present in the PSYOP force.

## CHAPTER 2

### Organizational Issues

The expectation that the air campaign [against Serbian forces] would last only a short time also was a detriment to the NATO psychological operations effort [in the 1999 Kosovo campaign], since those assets were not included in the initial plans. It took two weeks to start delivering products and some 30 days to develop a campaign plan. Serbia started its psychological operations campaign days earlier and won the early initiative.

*Timothy L. Thomas, "Kosovo and the Current Myth of Information Superiority," Parameters, Spring 2000, pp. 13-29.*

Although USCINCENT's approval for the theater PSYOP plan was received in late September, execution authority was not granted until December. The interagency approval process, mandated by DoD Directive 3321.1 [Overt Psychological Operations Conducted by the Military Services in Peacetime and Contingencies Short of Declared War], was glacial. Had the Saudis not requested U.S. support to encourage Iraqi desertion and defection, culminating in the formation of a combined U.S., Saudi, Egyptian, Kuwaiti and British PSYOP effort and the King's approval to execute, it is doubtful that PSYOP would have been allowed to play an active role in the [Gulf] war at all.

*Jeffrey B. Jones and Jack N. Summe, "Psychological Operations in Desert Shield, Desert Storm and Urban Freedom," AUSA Landpower Essay Series, No. 97-2, August 1997.*

The above quotes suggest that, in a crisis, DoD cannot conduct psychological operations any faster than the U.S. Government can produce its International Public Information (IPI), Public Diplomacy (PD), and coordinated PSYOP campaign plans.

#### 2.1 Strategic Relationships of Military PSYOP With Non-DoD Agencies

Organizational debates are hardly new to U.S. PSYOP. Indeed, differences over the institutionalization and organization of propaganda in U.S. national security have been a central theme in the evolution of PSYOP throughout the 20<sup>th</sup> century. Since World War I, the organization of PSYOP has been hotly debated and U.S. military PSYOP capabilities have waxed during wartime and waned during peace.

Since the early 1980s, military PSYOP have become well institutionalized within DoD. The 1983 National Security Decision Directive (NSDD) 77 ("Management of Public Diplomacy Relative to National Security"); the 1984 National Security Decision 130 ("U.S. International Information Policy"), which instructed DoD to rebuild military PSYOP capabilities; and the 1985 DoD PSYOP Master Plan reversed the post-Vietnam atrophy of military PSYOP capabilities.



This institutionalization of military PSYOP forces, however, did little to eliminate the differing opinions over the organization of PSYOP, particularly regarding national-level interagency coordination of PSYOP campaigns. Since the early 1980s, every NSDD and Presidential Decision Directive (PDD) dealing with IPI, PD, or PSYOP (for example, NSDDs 45, 77, and 130 and PDDs 56 and 68) has required broad interagency coordination of PSYOP between DoD and other national security departments and agencies, under the purview of special ad hoc groups. Nonetheless, DoD PSYOP Master Plans (1985, 1990), and critical assessments during the same period, called repeatedly for improved and streamlined interagency coordination of PSYOP plans and products.

Under PDD 68, the International Public Information Core Group (ICG), chaired by the Under Secretary of State for Public Diplomacy and Public Affairs, coordinates all agencies' IPI activities. If PSYOP campaign plans are not already prepared, the coordination required throughout the U.S. national security community will take time. As a result, the influence of PSYOP on a crisis will not be timely.

During crises PSYOP campaign plans wait upon a complex process of interagency review, coordination, and approval. The most insightful and creative processes for developing PSYOP products, and the most modern media and technologies for delivering PSYOP messages, avail nothing if organizational structures are too complex, inexperienced, or inefficient to coordinate and approve campaign plans in time to influence developing or ongoing crises. As PSYOP adapt to support "Internet War" and as future information operations occur in "Internet time," these issues become even more difficult.

The U.S. PSYOP organizational challenges offer adversaries a clear asymmetric opportunity during crises: they can beat the United States and its allies in getting out the first PSYOP messages. Moreover, if the opponent plans the actions that trigger the crisis, the opponent has that much more lead time to ready its PSYOP campaign.

*This DSB Task Force believes that a permanent, properly constituted interagency body should be established within the National Security Council charged with all U.S. Government IPI, PD, PSYOP and other peacetime management policies and operations. An authoritative standing body would ensure on-going, front-end, continuous interagency dialogue, coordination, and integration.*

PSYOP actions cue a very flexible component of an overall IO plan. During times of peace or crisis, PSYOP can support strategic international information operations through planning and, if tasked, through the dissemination of assets. *This Task Force found military PSYOP capabilities during periods of peace and crisis to be especially wanting. Traditionally focused on tactical military support, PSYOP forces are particularly challenged to provide support at the strategic level. To retain relevancy and raise effectiveness, military PSYOP forces must augment their current strategic capabilities.*

Strategic international information operations have global policy implications and, in accordance with PDD 68, are planned at the national level. Nevertheless, military

PSYOP planners can serve as a link to inform and synchronize the actions of the geographic CINC in whose theater the strategic perception-management action may be targeted. Additionally, geographic CINCs are now engaged in vigorous theater peacetime engagement activities, where PSYOP forces often play a robust and sometimes key role. As part of these engagement activities, PSYOP forces often develop an Overt Peacetime PSYOP Program (OP3) tailored for the supported geographic CINC.

This Task Force believes that strategic-level PSYOP suffer from a lack of coordination with other U.S. Government organizations that disseminate information to foreign audiences (such as, Radio Marti, Voice of America, Radio Free Europe, and Worldnet Television). This can lead to an uncoordinated effort in various regions around the world, where the U.S. Government's information dissemination power is not used to its fullest advantage. In addition, contradictory information themes could be broadcast simultaneously through the various venues. PDD 68 is designed to help make this coordination occur more effectively. Still, military PSYOP often conduct their information activities oblivious to the higher level perception-management efforts emanating from the Department of State and National Security Council. In addition, U.S. Government agencies outside DoD often do not fully exploit the expertise resident in military PSYOP with respect to knowledge of foreign audiences and information planning capabilities. *Therefore, DoD should create a small military PSYOP planning staff, under the coordination authority of the Office of the Assistant Secretary of Defense for Special Operations and Low-Intensity Conflict (OASD(SO/LIC)) to ensure that operational- and tactical-level PSYOP are integrated with strategic perception-management initiatives and that planning support is provided for strategic PSYOP activities.*

### **2.1.1 The Requirement for a PSYOP Vision and Operational Concept**

The 1985 and 1990 PSYOP Master Plans called for a Joint PSYOP vision and operational concept. The publication of *Joint Vision 2010* and the corresponding service vision statements make these recommendations even more compelling. The call for a PSYOP vision and operational concept is repeated again in the 1999 *Joint Psychological Operations Enhancement Study* and endorsed by USSOCOM's review of that study. During the revival of U.S. PSYOP capabilities over the past 15 years, there has been much consensus on the need for a PSYOP vision and operational concept but the production of this document is long overdue.

Weaknesses exposed in U.S. military PSYOP response to recent events in both Bosnia and Kosovo have awakened many to the need to make significant changes. The vast majority of U.S. military PSYOP forces reside in the U.S. Army. This rather small group has a Cold War-oriented structure, often antiquated equipment, and limited financial support. Yet, it is inundated with requests for support from the geographic CINCs to get information to foreign target audiences -- audiences that are being served by an ever expanding array of information dissemination options. The good news is that within military PSYOP forces there is both a willingness to consider new ways to conduct their mission and movement in positive directions to effect change. Nevertheless, it is clear

that this movement is neither robust enough to quickly solve identified deficiencies, nor is it sufficiently supported outside the PSYOP community.

*Until a 'road map' for the future of PSYOP is drafted and implemented, it is difficult to see how PSYOP can remain relevant and develop the capabilities to best serve the geographic CINCs. As the first step to remedy the deficiencies within military PSYOP, the Department of Defense must draft a military PSYOP Vision as well as an accompanying future PSYOP Operational Concept.*

This action should be undertaken by OASD(SO/LIC), in conjunction with the Joint Staff J39, and USSOCOM. Furthermore, the Task Force believes that these actions should be completed within 12 months. These documents need to be multi-service and interagency in scope, and revolutionary in perspective. As a touchstone, the PSYOP Vision must be in accordance with the Chairman of Joint Chiefs of Staff's *Joint Vision 2010*. To avoid the problems experienced with the previous Master Plans, the document should be signed by the Secretary of Defense and have clear implementation schedules to ensure its adoption.

## **2.2 Should PSYOP Forces Be Exclusively Under USSOCOM?**

Since the 1950s, the center of gravity of military PSYOP has been Fort Bragg, NC, and the Special Warfare Center. Indeed, the Special Warfare Center, established in 1956, evolved from the Psychological Warfare Center, established in 1952. Not surprisingly, as PSYOP capabilities were revived during the 1980s, they were aligned organizationally with special operations. Figure 2.1 shows the current organizational structure within USSOCOM where the bulk of PSYOP forces are concentrated in the 4<sup>th</sup> PSYOP Operations Group at Fort Bragg, North Carolina.

The authors of the 1985 PSYOP Master Plan, however, believed that the subordination of PSYOP to special operations "detracted from the recognition of the overall applicability of PSYOP in times of peace, crisis, and war..., contributed to the lack of understanding of PSYOP," and reduced the effectiveness of PSYOP planning at unified and specified commands. Despite guidance from the Secretary of Defense to separate PSYOP and special operations in implementing the 1985 Master Plan, after long review PSYOP were subordinated to USSOCOM in 1987.

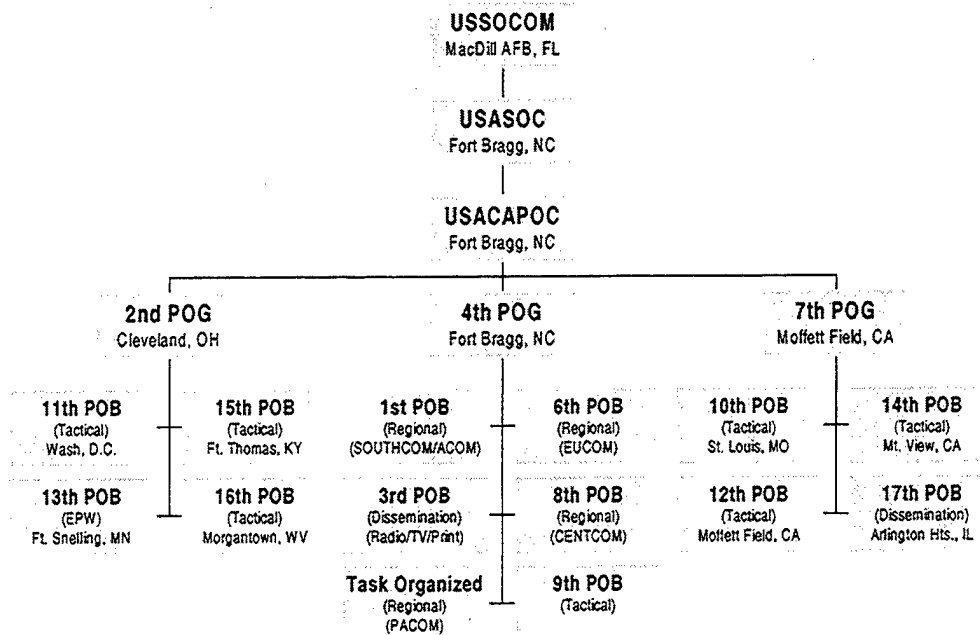

Figure 2.1 Current SOCOM PSYOP Structure

The 1997 *Critical Assessment*, authored by the former commanders of the U.S. Army's 4<sup>th</sup> PSYOP Group, called for the creation of a Joint PSYOP Command under USSOCOM.<sup>1</sup> These former commanders saw future PSYOP enhancements as being dependent on:

- far more rank and representation for PSYOP at national levels and in the unified and specified commands and their components;
- far more independence of PSYOP from special operations in staffing, planning, and execution; and
- an all-but independent national-level Joint PSYOP Command, which would coordinate PSYOP support for transnational and national strategic-level, as well as theater-level, operational plans and operations.

The Task Force's investigations led to the conclusion that during periods of conflict, military PSYOP capabilities, particularly at the tactical level (Army Corps equivalent and below), are more developed and effective. Military PSYOP doctrine and organizational structure are primarily configured to respond during a conflict.

<sup>1</sup> *Psychological Operations into the 21<sup>st</sup> Century: A Critical Assessment*, 15 May 1997, U.S. Army John F. Kennedy Special Warfare Center and School.

During warfighting, PSYOP elements are flexible and can provide tactical-level support with a small team or operational-level support with a robust Joint PSYOP Task Force (JPOTF), potentially consisting of thousands of individuals. Given enough time during a crisis, PSYOP forces can provide surge capability from bases in the United States to the theater CINC headquarters, supplementing existing PSYOP planning capabilities and/or establishing PSYOP headquarters for multiple Joint Task Forces at the operational-strategic level of war.

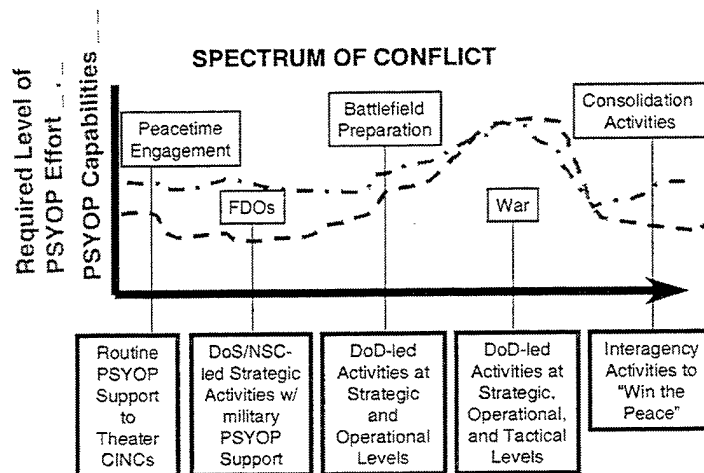

Figure 2.2 PSYOP relevance

In addition to issues regarding PSYOP organization and USSOCOM, there are other organizational issues that merit further discussion.

*Service PSYOP.* Both the U.S. Air Force and the U.S. Navy are engaged at the service level, to a relatively limited extent, in PSYOP research, training, and doctrinal development, as well as in developing PSYOP organizations. Since joint military PSYOP is subordinated to USSOCOM, PSYOP doctrine, training, and organization should come under that command's purview.

*PSYOP and Information Operations.* While USSOCOM has responsibility for joint PSYOP, joint doctrine has established PSYOP as one of the "five pillars" of information IO, and DoD has assigned authority for some elements of IO to other commands (for example, USSPACECOM). The Task Force believes that the role of PSYOP in an overall IO strategy should be considered as part of the development of a PSYOP vision and operational concept.

*Military PSYOP and Civilian Perception Management.* There are repeated instances of military PSYOP absorbing and employing the talents and resources of civilian perception-management industries during conflict, and then dismissing them entirely from post-conflict PSYOP organization, planning, doctrine, and training. This issue is discussed in chapter 3.

### 2.3 Forward PSYOP Deployment To Support CINC's

The Task Force recognizes that the shortcomings of the recent NATO PSYOP campaign in Serbia and Kosovo will revive older questions regarding the effectiveness of PSYOP planning on the staffs of the warfighting CINC's. The shortcomings can be explained in part by the inadequacy of PSYOP planning support to the geographic CINC's, and in part by the lack of resources available for ongoing theater engagements of all types, including the CINC's' overt peacetime psychological operations programs.

The 1985 PSYOP Master Plan identified numerous shortcomings in PSYOP planning in the Unified and Specified (U&S) Commands. The 1985 Master Plan led to changes in Defense Planning Guidance, the Joint Operations Planning and Execution System, and the Joint Strategic Capabilities Plan. The 1990 PSYOP Master Plan pointed out that "the effect of the 1985 Plan was to initiate measurable improvements in each identified area, ameliorating many of the problems...." While the 1990 Master Plan included recommendations to further enhance PSYOP planning, none was directed at the U&S CINC's.

More recently, J39's *Joint PSYOP Enhancement Study*, and the former PSYOP Group commanders' *Critical Assessment* identified problems in PSYOP task organization to support warfighting CINC's. For example, the *Joint PSYOP Enhancement Study* found: "Each of the supported CINC's cited inadequate [PSYOP] force commitment to theater as a root cause of many deficiencies and problems during their evaluation of PSYOP support war scenarios" (p. 2-2-12). The *Critical Assessment* recommended that "PSYOP teams forward deploy to all theater SOC's (Special Operations Commands) to coordinate and participate in deliberate and crisis planning to ensure PSYOP participation on the front end and as the lead elements for the formation of Joint Psychological Operations Task Forces (JPOTF's) when called for by OPLANS" (p. 30). Some CINC staffs recommend a "standing JPOTF" comprised of CINC staff (implying great numbers of CINC PSYOP staff and planners) and personnel from the regional PSYOP support battalions.

The CINC staff participants in the *Joint PSYOP Enhancement Study* identified PSYOP organization for allied and coalition operations as a major shortcoming. The problems include a lack of a standing JPOTF organization, lack of SOP's, and inadequate training. Compounding these problems is the lack of PSYOP forces, SOP's, or doctrine among many allies and coalition partners.

*This DSB Task Force agrees with the various recommendations offered by the Critical Assessment and by the Joint PSYOP Enhancement Study. To address the issue of PSYOP support to the CINC's, these recommendations depend on some combination of the following:*

- *more PSYOP staff and planners on the CINC staff;*
- *enhanced capabilities to task and organize rapidly to support CINC planning and crisis action;*

- *establishment of a standing "nucleus" (possibly including CINC staff) around which a JPOTF or CPOTF would be established.*
  - *the Joint Staff (J39) and USSOCCOM should examine the adequacy of the existing PSYOP force structure (active and reserve) to fully support the doctrinal recommendation that the JTF be supported by a component-level JPOTF.*

## **2.4 Rank Structure of PSYOP Forces**

There are several arguments favoring greater rank within PSYOP forces.

First, there are the high interest in and high expectations of PSYOP across the spectrum of peace, crisis, and war, coupled with demands for "wide-band" coordination up and down the chain of command. With such expectations must go commensurate responsibility and authority.

Second, the ongoing efforts to modernize and capitalize military PSYOP with advanced capabilities for production, dissemination, and delivery put PSYOP in competition with the most competitive sectors of the services and the general economy for talent and experience. Professionalization of military PSYOP requires specialization in the career field, and that field should offer the possibility of high rank.

Third, the rank of the senior PSYOP advisor in the theater is often much lower than that of the JTF principle staff that effective planning, coordination, and decision-making are severely impaired. PSYOP officers often have little direct access to the warfighting commander.

Fourth, PSYOP officers on staffs of the geographic CINCs lack the rank and the access to the CINC for effective long-range PSYOP planning, or for effectively coordinating the CINC's theater-operational PSYOP with national and transnational strategic-level international information campaigns.

*The Task Force concluded that rank structure and career paths within PSYOP forces should be reassessed and more specifically:*

- *the senior PSYOP advisor to the geographical CINCs should be an O-6 or equivalent civilian; and*
- *the commander of the Joint PSYOP Task Force supporting the Joint Task Force Commander (typically a three-star flag officer) in theater should also be an O-6.*

---

<sup>2</sup> Steven Collins, "Army PSYOP in Bosnia: Capabilities and Constraints," *Parameters*, Summer 1999, pp. 57-73.

## CHAPTER 3

### Reaching the Target Audience

#### 3.1 Packaging the Product

It bears repeating that the goal of PSYOP is to influence the behavior of the target audience. This presumes that the goal can be accomplished by influencing their perceptions. Critical, of course, is the theme of the message. But equally important is the packaging of the message, which must be suitable for the target audience and the dissemination media of choice. This requires considerable understanding of the target audience and their information milieu in order to tailor the message to the audience and choose dissemination media that can be expected to reach that audience.

Today's PSYOP force includes a small but dedicated cadre of country experts familiar with the cultures and fluent in the languages of their accounts. There is also a small and equally dedicated cadre of production personnel, operating a modest suite of production capabilities.

The Task Force considers it important for the PSYOP force to maintain some organic capability for in-house production. Situations arise that require an immediate response, and some situations may be of sufficient sensitivity that outsourcing would be undesirable. However, the Task Force also believes that consistent production of the highest quality products can be accomplished best by relying on a readily accessible set of professional firms that specialize in the desired products for the target audiences and chosen media.

*The Task Force has concluded that OASD(SO/LIC) and USSOCOM should strive to improve overall product quality and recommends increased reliance on commercial providers for high-quality products. The Task Force believes, therefore, that the PSYOP force be adequately resourced and trained to engage a stable of commercial providers who can deliver these quality products.*

In addition to training in acquisition skills, government PSYOP personnel require intensive instruction, refresher training, and hands-on familiarization with state-of-the-practice techniques across the spectrum of traditional and emerging media. This should ensure knowledgeable oversight and management of outsourced production, and likewise ensure that there are sufficient in-house skills to operate the modest organic QRC facilities. Once these in-house facilities complete their modernization changeover from analog to digital production, modest but continuing recapitalization may be required to assure compatibility with evolving media and state-of the-practice.

#### 3.2 Developing the Message



Presenting the message so that it is compelling and credible requires a careful blend of creativity and sensitivity. The product must grab the attention of the target audience -- in a wholly positive way -- and leave the message with them in an unambiguous and memorable fashion. Unless a rough-and-ready message has special cachet, the more polished and professional the message is, the better. While there surely are dedicated and creative individuals in the PSYOP force, turning to commercial producers, where possible, is recommended. As previously mentioned, the Task Force recommends that the PSYOP force be adequately resourced to engage commercial providers, and adequately trained to get the most for the expenditure. However, background information required for framing the message and selecting distribution channels, most likely, must be supplied by the government.

Three sources of intelligence contribute to a capable PSYOP program. These are perhaps best described as proprietary information, classified intelligence, and information from the public domain.

Proprietary or privately held information requires considerable diplomatic expertise to acquire. It is best acquired through organizational interchanges, either among governments or non-government entities, or through contacts, meetings, international or transnational coalitions, and the like.

Classified intelligence supports PSYOP in largely traditional ways, except that the ratio between technical collection and clandestine collection is reversed -- that is, the raw information of most value to the conduct of PSYOP is often acquired by clandestine collection. To the extent that the necessary information comes from public and private sources, it should be reinforced through clandestine means as a quality check. A cooperative effort involving intelligence agencies and country teams (coalition, perhaps) is vital.

The Task Force observes that the PSYOP community must better specify the intelligence support it requires, especially for classified collection and tailored production. Currently, the PSYOP community seems to expect that the provision of tailored intelligence and other necessary information will be serendipitous. This is decidedly not the case, and raises a risk that the planning, execution, and assessment of PSYOP effectiveness will be based upon faulty information.

*The Task Force believes that the Defense Intelligence Agency (DIA) should be tasked by the Secretary of Defense through his Assistant for C3I to establish a psychological warfare intelligence element. This element, in cooperation with the PSYOP community, should develop intelligence requirements, task the appropriate collectors (overt, technical, or clandestine), and analyze and produce finished intelligence products specifically meeting PSYOP needs. The PSYOP community should have representation within this DIA element, and DIA must be able to access the 4th PSYOP Group's research and analysis group. The DIA element should be authorized to coordinate fully with the other U.S. intelligence agencies, certain law-enforcement agencies, and U.S. and other allied information services.*

In addition to proprietary information and classified intelligence, a considerable amount of information needed for the development and employment of PSYOP products is available via open source acquisition and an increasing amount of that information is available on the public Internet. The Task Force distinguishes between two kinds of open source acquisition activities. The first is simply the use of commercial contractors to provide suitable open source products to fit PSYOP needs. This would largely be geared to derivative products and non-Internet sources. In many cases, there are contractors who already supply a market with such information and the costs are merely subscription and licensing costs. In other cases, general products could be tailored to special PSYOP needs at minor cost. Even in cases where the contractor would be required to start from scratch to collect, organize, and synthesize such materials for the PSYOP community, the Task Force anticipates that one can negotiate favorable terms insofar as the contractor is permitted to re-purpose the materials for commercial customers. The second category of open source acquisition involves direct online access. A considerable and increasing amount of the information needed for the development and dissemination of PSYOP products is available on the public Internet. Harvesting that information -- often translating it, organizing it, and providing quality assurance -- is manpower intensive. And while it can be accessed by any individual analyst or tool developer, there are major economies of scale in doing it once, centrally and making it available for the community.

Because the Intelligence Community has declined the opportunity to aggressively organize the open source effort, it falls to individual organizations, such as the 4<sup>th</sup> PSYOP Group, to shoulder the burden themselves. The Task Force is unanimous in recommending that harvesting this information be done just once and well for the PSYOP community and, moreover, that it be made broadly available within the Department of Defense.

*The Task Force believes that ASD C3I should be charged to either: (a) provide resources to the PSYOP community to implement a robust organic program of open source acquisition, or (b) task the Intelligence Community to fulfill the need for on-the-shelf, worldwide basic information, including the media and cultural background information that is necessary to adequately inform PSYOP products in a given country.*

Military reservists offer a largely untapped personnel resource that can be profitably applied to the business of mining open sources for the technical and cultural information needed for the development and dissemination of PSYOP products. Unfortunately, reserve forces are not currently structured to optimize their potential contribution to this effort. The principal mismatch -- which, indeed, reflects an active duty problem -- is that the reserve forces are organized around the reservist's wartime Military Occupational Specialty (MOS). In this day and age, however, many reservists have civilian employment in information technology areas, which makes them especially suitable for this open source mission.

The Task Force is not ready to advocate major structural changes in the active reserves. However, there is a large reservoir of individual ready reservists (IRR) and individual mobilization augmentees (IMA) who could be formed into virtual units, disconnected from their earlier active duty service but especially suited to the 21<sup>st</sup> century Information Battlespace. The potential here is to use IRR and IMA personnel in virtual units, which would participate in "distance drilling" -- participating virtually in unit activities, even from home. And, of course, there are standing reserve intelligence units whose mission would require only a modest tweak in order for them to satisfy the PSYOP information needs more directly.

A prototype effort along these lines was sponsored, originally, by the Intelligence Community's Open Source Program Office, which used such online teams to organize and populate the online World Basic Information Library (WBIL). The WBIL program is now operated by the U.S. Army Foreign Military Studies Office (FMSO). Beyond the natural desire to serve their country, the individuals are motivated to "drill for points" so that the dollar costs of this effort are quite modest.

*The Task Force also concluded that ASD C3I and Service Reserve Affairs organizations should review the WBIL program at FMSO, recognize the potential of reservists to meet, in a novel way, an otherwise languishing intelligence need, and provide the modest resources necessary to augment this effort.*

To take full advantage of efforts like the FMSO WBIL will require the deployment to the PSYOP community of state-of-the-practice data mining software, connectivity, and computing power. The Task Force also notes, in passing, the need for ever more powerful data mining tools to keep up with the explosive growth in online information, which inevitably worsens the "signal-to-noise ratio" -- more wheat, but a lot more chaff; more nuggets, but a lot more ore to be refined.

Correctly choosing the media dissemination channels that reach the target audience is an essential element of PSYOP. This requires knowing the "market penetration" of the media, and the viewing, reading and/or listening habits of the target audience. Media penetration, particularly for electronic media, is a subject of constant commercial study, especially in North America and Europe. An admittedly somewhat cursory search for media penetration data for other regions of the world indicated that there is little or no information available. Those studies that do exist are generally available by subscription or on a selective, one-time-purchase basis. For purposes of long-term planning and quick reaction, these general data sets need to be acquired and on-the-shelf. This requires a certain attention span that is sometimes lacking in the case of the Intelligence Community -- as, for example, its lassitude with respect to global (open source) coverage. Absent a reinvigorated Intelligence Community open source effort, the local solution is to ensure that the PSYOP force has the resources to purchase these materials directly. It is important, however, to acquire and maintain these data sets, where available, for easy access by the entire national security community.

*The Task Force encourages ASD C3I to make NFIP/JMIP funds available to USSOCOM for the express purpose of acquiring available data sets, particularly those for countries*

*outside North America and Europe. The Task Force also recommends that USSOCOM work with FMSO to ensure the integration of these data sets with the WBIL and their community-wide accessibility. Moreover, the Intelligence Community should be further tasked through ASD C3I to develop methods and sources to obtain media-use demographic information where it is not now available, and where the United States might plausibly have future national security interests in which PSYOP might be employed. The underlying premise is that the right business principle is to turn the "consumers" into "customers."*

### **3.3 Brand Identity**

The Task Force is persuaded that a considerable foundation must be laid well in advance of the actual need to deliver a PSYOP product to a particular audience. In general, the distribution channels need to be acquired in advance and a suitable "brand identity" needs to be established. Both need to be exercised with sufficient periodicity that good will and market penetration are ready when needed. Such channels and brand identities are at least as important as any technical dissemination platform such as *Commando Solo*, and their operations and maintenance are no less important. This will be increasingly the case as the diversity of programming choices available to target audiences continues to expand. Cable and satellite TV and radio, and especially the public Internet, offer far more choices than over-the-air networks did formerly. The development of channels and identities will be particular, in some cases, to geography and, in other cases, to transnational affinity groups -- Islamic Fundamentalism, for example -- or to more universal demographics, like teenagers. Of course, the development of brand identities must be tightly integrated with ongoing, broad public diplomacy initiatives and themes.

The Task Force notes that preliminary forays into the use of the Internet as a dissemination medium have been fraught with impediments, which the Task Force attributes to immature policy in dealing with the use of a medium that knows no national boundaries.

*The Task Force believes, therefore, that OSD should work with the Department of State to fund, preposition, exercise, and maintain suitable distribution channels and brand identities, as far as can be reasonably anticipated for future PSYOP requirements. Policies regarding the use of new and emerging transnational media must be developed or refined. The Task Force highly recommends a liberal reliance on recognized professionals and generous use of highly qualified commercial entities; buying good content on which the messages will "ride" is a necessary and desirable expenditure. In some cases, the U.S. Government has unique content that it can make available.*

It should be understood that the credibility and good will associated with a brand identity is capital that is built up over time, and in the actual event that capital may have to be depleted. If such good will has to be expended in a particular PSYOP, equivalent capacity should be restored at the earliest opportunity.

### 3.4 Measures of Effectiveness

- **Receivability:** How well did the physical message propagate to the intended area?
  - Could it be jammed?
- **Receipt:** How often did members of the target audience tune in to the message?
  - Did they have the right receivers? Could they read? Did they read and speak the language, dialect, and argot in which the message was framed?
- **Receptivity:** How favorably did the target audience respond to the message?
  - Did they change their behavior in a favorable direction? Did it matter?

Issues of receivability are the proximal cause of this Task Force study -- that is, Congressional interest in whether *Commando Solo* was sufficiently capable of propagating the desired media to the desired areas, or whether an improved platform were justified. Answers to questions about receivability are generally found in the physics of the situations -- broadcasts should be higher in the air, higher in the spectrum, higher in power, and so on. This being so, the modeling and simulation to forecast receivability is a reasonably well-established art. Moreover, simple physical measurements in the field can unambiguously answer the question of receivability -- although this is not always immediately feasible in denied areas.

The actual reception -- as opposed to the predicted "hearability" -- needs to be measured in the field, either directly or indirectly. This is necessary in the short term to improve the particular PSYOP. It is necessary in the longer term to refine the modeling and simulation tools to better reflect field conditions.

Of critical interest is the question of how favorably those in the target audience who received the message reacted. The bottom line, of course, is did they change their behavior in the desired way -- that is, did it matter? There is a need for behavioral modeling and simulation research. Again, field measurement is the ultimate test and is necessary to calibrate any models and validate any focus group pre-testing that may have been employed.

The Task Force recognizes that research in this area is most likely to be problematic. Notwithstanding, *the Task Force believes that DARPA should be encouraged to consider favorably any research that may further the goal of developing practical measures of effectiveness.*

## CHAPTER 4

### Future Trends in Media Creation and Dissemination

#### 4.1 Introduction

The Task Force recognizes that the technological revolution currently transforming the TV and radio industries, telephony, and networking will assuredly have major effects on PSYOP content and dissemination. These three types of technology -- previously quite distinct -- are now rapidly mixing and blurring. Correspondingly, the distinction between *channels* and *content* is coming into much sharper focus since technology now allows one to send virtually any type of content across any type of digital transmission channel. As one simple example, the content of a radio station can now be sent worldwide by the Internet; it no longer relies on transmission through a geographically constrained RF channel. Figure 4.1 shows this revolution in schematic form.

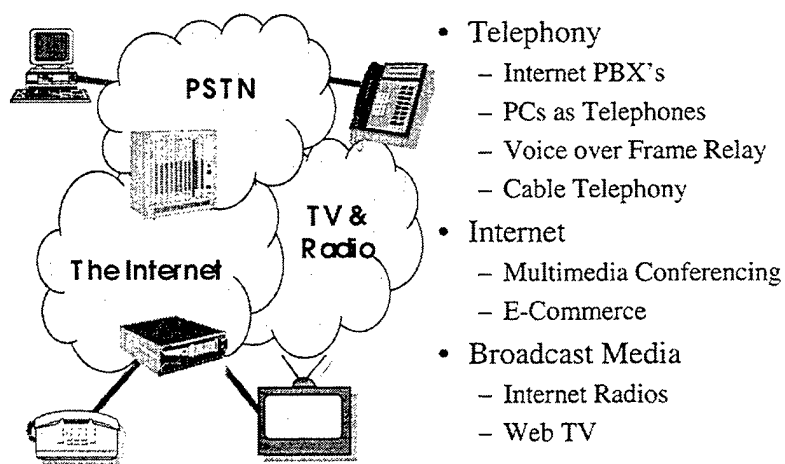

Figure 4.1 Convergence of transmission networks

This chapter provides a brief survey of current mass media trends in these three arenas: TV and radio, telephony, and the Internet. Three major themes will emerge:

- Conventional terrestrial TV and radio are rapidly being rendered obsolete by novel, digital, and “converged” types of media.
- A complex and confusing array of incompatible new technologies is currently being fielded and it is extremely difficult to predict which of these will be successful.
- Broadcasting to mass audiences is quickly being replaced by narrow-casting to much smaller, more targeted audiences, and even by tailoring media streams for individuals.

#### 4.2 Terrestrial TV and Radio

The most important contemporary trend in terrestrial TV broadcasting is the continued, seemingly inexorable cut-over from RF broadcast transmissions to cable systems. This migration is already well-advanced in many parts of the world, and it may even accelerate as cable systems begin to provide a full range of subscriber services, including telephony and high-speed Internet access. At the same time, however, broadcast High-Definition Television (HDTV) is being introduced in a number of incompatible formats across the world. Several less well-known, incompatible forms of digital radio broadcasting are now emerging for terrestrial stations and will likely be widely deployed in the next few years.

#### 4.2.1 Cable TV

Cable TV build-outs are proceeding at very different rates in the different regions of the world, depending on factors such as local regulations and population density. Nonetheless, cable TV is clearly a major factor in television systems worldwide. For example, as shown in figure 4.2, within the next few years, almost 60 million European households will subscribe to cable TV service. The subscriber growth rate has been roughly linear in recent years, but it will likely increase as cable TV systems begin to offer a full range of telecommunications services (such as, telephony and Internet access) through the cable infrastructure.

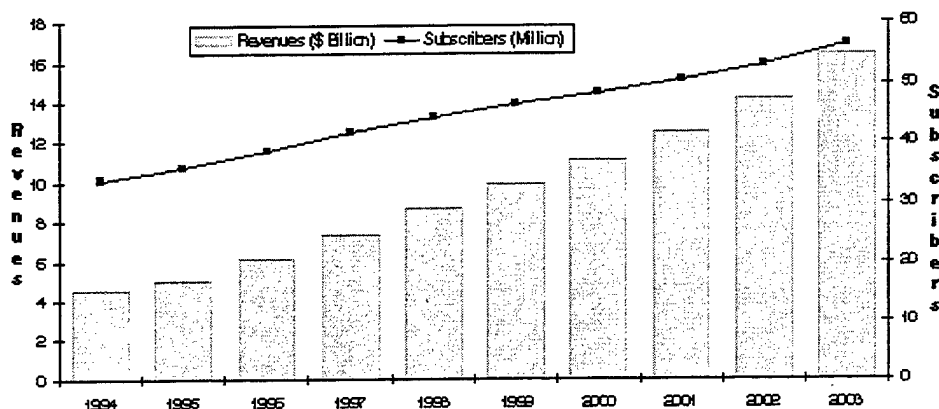

Figure 4.2 Projected European cable TV penetration (Source: Frost & Sullivan)

Since cable TV offers obvious advantages over broadcast television -- such as excellent reception, an enlarged number of channels, and the possibility of subscription-based premium services -- it is likely to become increasingly popular throughout the world as cable plants continue to be built out. The implications for PSYOP and particularly for *Commando Solo* are clear: an ever-increasing number of households worldwide will be unwilling or unable to receive RF broadcast transmissions of TV signals. In addition, U.S. PSYOP will need to compete against a very large menu of commercial TV channels.

#### 4.2.2 High-Definition Television (HDTV)

HDTV is a method of transmitting high-quality TV channels over the existing spectrum allocations for terrestrial RF transmission. As often happens, the Americans, Japanese, and Europeans have settled upon three incompatible formats, in part because of the regions' different TV spectrum allocations. The current Japanese version is analog; the Americans have settled upon a digital transmission method informally termed 8-VSB; and the Europeans prefer another method called COFDM. The technical specifications for these systems are quite complex and each allows a wide range of potential modes; the American version, for instance, allows 18 different transmission formats. Although the U.S. HDTV broadcast system is now nominally operational in at least one station in over 60 percent of the U.S. market, there appear to be recurring doubts as to whether 8-VSB provides adequate viewing quality over an entire coverage area. The FCC has rejected a petition to allow U.S. broadcasters to use COFDM. But even more recently (16 February 2000), the National Broadcasting Corporation's (NBC) Vice President for technical planning and engineering, Peter Smith, raised "extreme concerns" about the performance of 8-VSB based on field trials of both 8-VSB and COFDM. There is also some evidence the 8-VSB will not work with moving receivers (or transmitters) but that COFDM will since the European standard was explicitly designed to service mobile subscribers, such as televisions in cars and buses.

Meanwhile, the U.S. cable TV industry has shown few, if any, signs of interest in deploying a version of HDTV compatible with the U.S. broadcast industry. Rather than aim for a higher quality image in the same bandwidth, they prefer to employ digital techniques to further compress transmissions so that they can provide more channels. The Task Force does not know the plans for digital cable TV outside the United States.

It appears highly likely to this Task Force that broadcast television signals will, over time, transition from analog to digital. At this moment, however, the Task Force doubts that anyone has clear insight into how this transition will unfold, and even whether any of the current HDTV schemes will gain market acceptance in even limited geographic regions.

The implications for PSYOP are thus uncertain. If HDTV becomes widely successful, the PSYOP community would likely need to transition to creating higher quality digital media streams and to distributing them via digital broadcasts. Depending on the media encoding, such transmissions may be technically infeasible from moving platforms such as *Commando Solo*. Furthermore, the HDTV standards worldwide appear to be as fragmented as the current analog standards (NTSC, PAL, SECAM), so that PSYOP would need multiple HDTV systems in order to service all parts of the world.

#### 4.2.3 Digital Audio Broadcasting (DAB)

Several efforts are currently under way to introduce a digital form of standard terrestrial radio stations. Since these new methods are digital, they are of course incompatible with



existing *Commando Solo* equipment. Outside the United States – primarily in Europe, Canada, and Australia – there is great interest in an L-band system called Eureka-147. Within the United States, at least two incompatible systems are being tested in the conventional AM and FM bands. One of these systems is now gathering increased attention worldwide for the AM bands.

*Eureka-147.* This European-designed system will operate in either the L-Band (1452-1492 MHz) or Band III (around 221 MHz). It operates at 224 kilobits per second with Musicam audio coding. Standardization is being carried out through the European Telecommunications Standards Institute (ETSI) on behalf of two trade organizations<sup>3</sup>. Figure 4.3 shows how a Eureka-147 receiver splits its received bit stream into both compressed music and an overlaid data stream that contains such information as song titles, performers' names, and so forth.

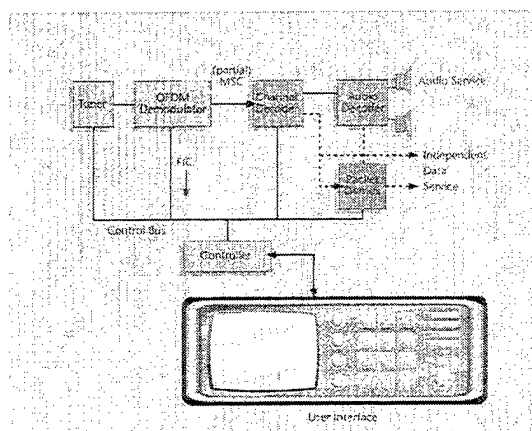

Figure 4.3 Conceptual schematic for DAB receiver

*American DAB Systems.* The Eureka-147 system has been rejected for use in the United States since its L-band spectrum is reserved for telemetry. Instead, two incompatible U.S. schemes<sup>4</sup> have been proposed for use in the current AM and FM bands. Both schemes preserve the existing analog stations but also overlay new, higher quality digital versions in the same bands. The FCC is well under way to approving these systems.

*The U.S. System Worldwide – Digital Radio Mondiale.* The U.S., legacy-compatible approach to DAB has proved appealing enough that it is now being pursued worldwide under the auspices of a consortium known as the Digital Radio Mondiale<sup>5</sup> (DRM). DRM's goal is to develop a standard for digital broadcasting in the AM bands below 30 MHz. DRM has lodged its proposal for a digital standard with the International Telecommunication Union (ITU) and aims to start broadcasting in late 2001, with receivers entering the marketplace at about the same time.

<sup>3</sup> The World Forum for Digital Audio Broadcasting ([www.worlddab.org](http://www.worlddab.org)) and the Eureka 147 Consortium ([www.eurekadab.org](http://www.eurekadab.org)).

<sup>4</sup> One is proposed by USA Digital Radio ([www.usadr.com](http://www.usadr.com)), the other by Lucent ([www.lucent.com](http://www.lucent.com)).

<sup>5</sup> Web site ([www.drm.org](http://www.drm.org)).

### 4.3 Satellite TV and Radio

The Task Force notes that space-based TV and radio systems are already widely deployed throughout the world and they too are beginning a transition to digital formats. This section provides a very brief sampling of current trends in satellite dissemination systems. Such systems are proving extremely popular in the developing world since they can be rolled out very quickly and cheaply.

These satellite systems pose several technical challenges for a mobile PSYOP dissemination platform such as *Commando Solo*. First, the media encodings are digital, and sometimes proprietary, and often encrypted. Thus, they cannot be serviced by *Commando Solo*'s current transmission suite. Second, the receivers employ satellite dishes pointed to specific slots in geosynchronous orbits. It will not be easy for a platform such as *Commando Solo* to transmit in such a way that it can be received in these dishes. Third, the satellite systems operate on a variety of bands (L, C, Ku) not currently supported by *Commando Solo*.

*Satellite TV*. Although U.S. viewers are perhaps most familiar with U.S. systems such as DirecTV, a great many non-U.S. systems currently provide service to other parts of the world. This section briefly discusses one representative system, AsiaSat<sup>6</sup>, which should provide an adequate illustration of the competition that *Commando Solo* is now encountering. AsiaSat currently operates three satellites using both the C and Ku bands. Figure 4.4 shows the footprint for its geosynchronous AsiaSat 2 satellite.

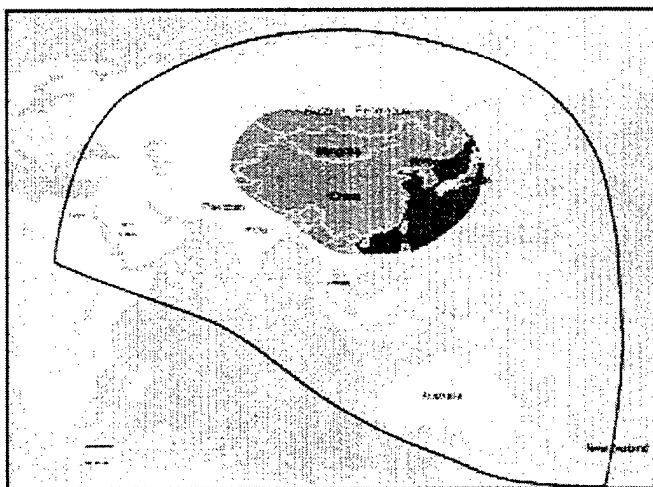

Figure 4.4 AsiaSat 2 TV and radio coverage in C and Ku bands

The AsiaSat 2 channels are broadcast in several different digital encodings. One common encoding is MPEG-2/DVB, QPSK modulation, symbol rate: 4.42 Msym/sec, FEC:  $\frac{3}{4}$ . It is instructive to peruse the TV and radio channel listings for the AsiaSat 2 C-

---

<sup>6</sup> Web site: [www.asiasat.com](http://www.asiasat.com).

band<sup>7</sup>, as it shows the very wide variety of programming already available to developing-world subscribers. This one band provides at least 25 TV channels and a number of radio channels from a variety of sources around the world. Similar menus are provided for AsiaSat 2 Ku-band and AsiaSat 3 C-band. Consumers in these regions can thus receive quite a wide and entertaining mix of TV and radio channels through typical 18" satellite dishes.

*Satellite Radio.* The Task Force received a briefing from WorldSpace Corp.<sup>8</sup> on its new satellite radio system, which is currently well on its way to becoming operational. Accordingly, this section discusses the system as an example of satellite radio. WorldSpace does, however, have competitors in the satellite radio business<sup>9</sup>. Figure 4.5 shows the beam footprint for Worldspace's AfriStar satellite alongside a Hitachi-built receiver for WorldSpace broadcasts. Corresponding satellites for Asia and South America will be launched mid- and late-2000.

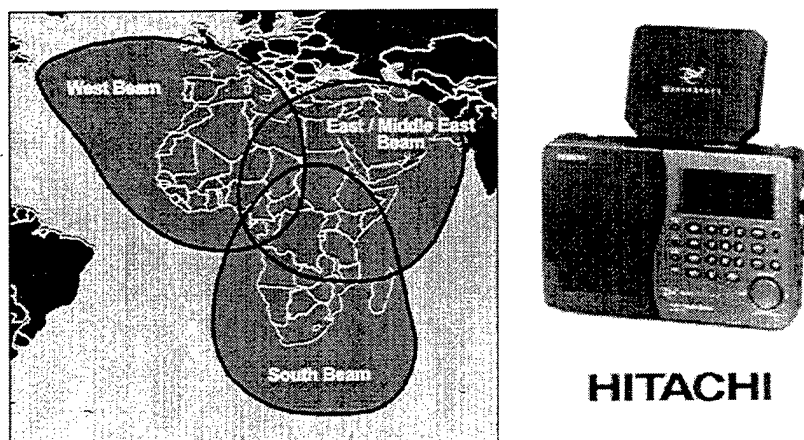

Figure 4.5 AfriStar satellite coverage and satellite radio receiver

The WorldSpace system is fully digital and transmits a number of stations simultaneously in the L-band. Each station is a separate audio stream encoded in a variant of MPEG-3 audio. Different streams can be sent at different bit-rates; each stream occupies some multiple of 16 Kbps in the overall TDMA plan. Stations can switch encodings "on the fly" so that a number of language-specific commercials can be embedded in the same program by encoding each of the commercials at a lower rate than the overall rate for that station. The total number of channels thus depends on the exact coding rates chosen for each channel, though there will likely be more than 25 channels in each satellite beam.

<sup>7</sup> Saudi (TV and 2 x radio). Myanmar TV, Chinese provincial TV (Guangxi, Shaanxi, Anhui, Jiangsu, Heilongjiang, Jilin, Henan, Qinghai, Fujian, Jiangxi, Liaoning, Inner Mongolia, Guangdong, Hunan, Hubei), Papua New Guinea TV, Egyptian Space Channel, Fashion TV, RTPi TV, Antena 1 Radio, Sky Channel, TVSN, Voice of America, Worldnet, Reuters TV, BBC, AP Television News, Voice of America, Worldnet, CCTV - Channel 4, Deutsche Welle TV and Radio, French TV5, TVE Internacional of Spain, MCM France, RAI International Italy, Radio Finland YLE, Radio France Internationale, Radio Netherlands - de Wereldomroep, World Radio Network, Radio Canada International, Swiss Radio International, Radio Exterior de Espana.

<sup>8</sup> Worldspace Corp. web site: [www.worldspace.com](http://www.worldspace.com).

<sup>9</sup> For instance Sirius Radio ([www.siriusradio.com](http://www.siriusradio.com)) has targeted U.S. consumers for a fee-based system in alliance with various car manufacturers.

Since the WorldSpace system is fully digital, it will convey data in addition to the audio streams. At the very least this will include the names of the songs and performers. WorldSpace Corp. also expects to transmit Internet web content via this means, though the Task Force believes that their system capacity may be somewhat too low for this to be commercially feasible.

Taken as a whole, increasing market penetration for satellite TV and radio poses two distinct problems for U.S. PSYOP. A narrow, technical problem is that U.S. forces have no available means to disseminate their PSYOP content to households that rely upon satellite services. In particular, the *Commando Solo* aircraft cannot provide this function for the variety reasons listed at the start of this section. A much wider problem, however, is that the PSYOP message now needs to compete against a very rich entertainment menu. As a result, it will become increasingly difficult for the PSYOP community to acquire "mindshare" in its target audiences.

On the other hand, as satellite systems become highly subscribed in one or more regions of the world, they offer an appealing medium for PSYOP dissemination since a single system generally offers full continental coverage at relatively modest cost. The insertions of PSYOP "commercials" and "specials" into existing, branded channels could prove a highly effective, and cost-effective, means for disseminating PSYOP content. Here DoD might wish to become an "anchor tenant" within new systems in order to ensure that such channels exist and are available for DoD use.

#### **4.4 Media Trends in Telephony**

As will be discussed, wireless telephony is very rapidly being built out across the world, and there is great interest in evolving cellular telephony systems into multimedia systems by providing higher data rates and non-voice services. This would then allow cellular systems to be used for dissemination of TV, radio, and web content. On a parallel, but unrelated, front the tight integration of computers with fax and voice dial-out systems has begun to allow widespread and economical delivery of voice and graphic messages through the public telephone system. Both these trends offer some promise as new ways to disseminate PSYOP content.

*Cellular, PCS, and Wireless Local Loop.* Both the developed and developing worlds are building out wireless telephony infrastructures very quickly. It is, however, difficult to provide aggregate worldwide growth figures since commercial market intelligence is generally carried out country by country. Table 4.1 shows a typical projection. Similar growth rates are expected for large areas of South America and Asia. Unfortunately, the technology base for wireless telephony is fragmented among a number of incompatible schemes (GSM, CDMA, TDMA, and various wireless local loop technologies). This makes it impossible to create a universal wireless telephony solution that is applicable worldwide.

Year	Subscriptions (000s)	Revenues (\$ millions)	Revenue
			Growth Rate (%)
1994	423.0	464.5	---
1995	1,313.5	1,407.2	202.9
1996	2,580.4	2,337.4	66.1
1997	4,414.0	4,048.0	73.2
1998	7,798.7	5,302.4	31.0
1999	12,086.4	7,215.6	36.1
2000	14,987.1	7,658.4	6.1
2001	18,134.4	8,559.4	11.8
2002	20,220.8	9,159.6	7.0
2003	22,060.9	10,147.5	10.8
2004	23,891.8	11,682.6	15.1

Table 4.1 Cellular / PCS subscriber and revenue forecasts for Brazil, 1994-2004 (Source: Frost & Sullivan)

*Data-Enabled Cellular Systems.* Cellular equipment manufacturers and service providers are currently rolling out data services as fast as possible. A confused assortment of protocols are currently vying for market share -- representative examples include Short Messaging Service (SMS), General Packet Radio Service (GPRS), Wireless Access Protocol (WAP), Cellular Digital Packet Data (CDPD), and others. Some of these are directly Internet-compatible, while others require gateways to the Internet. None has significant market share yet, although the only really widely available system, NTT DoCoMo in Japan, currently claims a million subscribers for its cellular data system with 40,000 new customers being added each month.

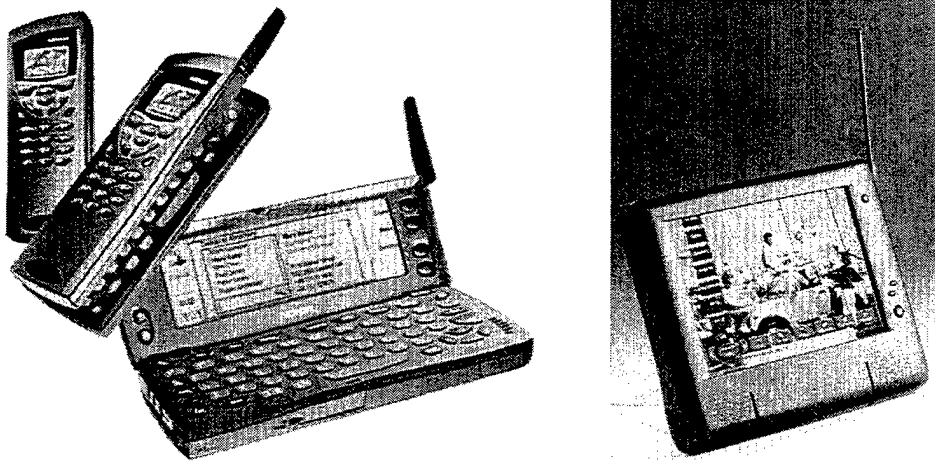

Figure 4.7 Emerging trends in wireless telephony (cell-phone) technology

As consumer interest in data service increases, today's cellular systems will need significant overhauls in order to efficiently provide high-bandwidth data services. Figure 4.7 pictures something like the current state of the art on the left, namely simple text messaging, and the hoped-for future to its right, namely full motion video and web browsing. The exact path by which current cellular systems will evolve to these future so-called "3G" systems is by no means evident. A number of potential migration paths have been proposed and a variety of incompatible upgrades are now being fielded. It is unclear to this Task Force when, and indeed if, these hoped-for upgrades will actually transform the voice cellular system into a data-centric system.

*Computer Telephony Integration (CTI) – Automated Call-Out and Fax Broadcasts.* For some years, computers have been tightly integrated with telephony systems in large call centers (for example, for telemarketing). Such systems combine the database functions of computers with voice and/or fax systems in a number of ways. Such systems can, of course, be used for delivery of arbitrary voice and graphic messages, either by call-in (where the other end places the call) or by call-out. In the most extreme form, CTI systems are used for voice and/or fax broadcast. Here, a single voice or fax message is delivered to a potentially unlimited number of recipients. In essence, an operator provides a voice recording or file containing a fax document, together with a list of thousands or tens of thousands of phone numbers, and the computers place a number of calls one after another to deliver the message to each of its intended recipients. Since the computer can tell whether a message has been fully delivered or not, it can keep placing a call or sending a fax until it has been successfully delivered. The computers can also distinguish a human respondent from a fax machine, and deliver a voice message to the former but a graphic document to the latter.

Such voice and fax broadcasts can be implemented in-house or out-sourced to any of a number of companies. Simple arithmetic shows the potential PSYOP impact of such technology. If each call takes 30 seconds, a single calling interface can place two messages per minute, or 120 per hour. Ganging 100 such interfaces can thus deliver 12,000 messages per hour, which can accommodate a mid-size town. In addition, international phone rates are falling rapidly; at today's best consumer rate of 10 cents per international minute, such a fax or voice message broadcast costs only \$1,200. This rate is likely to plummet in the near future as additional capacity comes online.

#### 4.5 The Internet

The Internet is, of course, the dominant feature of the "new media" in our time. However, since it is large and highly decentralized, there are no definitive measures of its actual size or growth rate. For this study, the Task Force has relied on the most recently published figures (December 1999) from Telcordia's Dr. Christian Huitema, a well-respected researcher who produces monthly estimates<sup>10</sup>. Overall Dr. Huitema estimates the total number of Internet users at somewhere between 295.0 and 398.8 million, though

---

<sup>10</sup> <http://ftp.telcordia.com/pub/huitema/stats/dec99.html>

of course this number is very hard to pin down. He further estimates that 78.9 million computers were directly attached to the Internet in December 1999, which is an annual increase of 36 million computers (84 percent) from the estimate of 42.9 million computers in December 1998. This figure represents those computers listed in the global Domain Name Service, and hence it represents only a subset of all computers that can access the Internet. For example, it does not include most home computers that connect via dial-in lines. The regional breakdown of Dr. Huitema's figures is as follows: United States, 60.7 percent; Europe, 24.2 percent; Asia, 12.2 percent; Latin America, 2.3 percent; and Africa, 0.7 percent. Note that even the relatively low percentage for Africa represents over half a million computers.

*Web Sites.* Web sites are so widely known that this report shall skip all discussion of them except to briefly remark that they are quite suitable for dissemination of PSYOP content.

*Email.* Email is probably the predominant means of communication for Internet consumers and could also be an excellent medium for PSYOP. It would be rather easy to find a large number of email addresses for users in a country, and then begin to send them email. This can be blocked, but such blocking is generally done by the receiving organization rather than by the service provider. Hence, one might expect a rather porous barrier to unsolicited email into a country. This email could of course contain images and sounds in addition to text. If desired, each message could be tailored to an individual recipient, thus providing some rough form of geographic tailoring and helping to keep opposing authorities somewhat in the dark about what everyone is receiving.

*Chat Rooms and Messaging.* Internet chat rooms may also have potential PSYOP uses, in that "guided discussions" could perhaps be used to influence how citizens think about certain topics. This example is already in practical use with the candidates in the U.S. presidential elections. China has begun to set up monitored chat rooms so its citizens can discuss a wide range of matters. In the Chinese approach, offending messages are deleted before, or just after, they have been sent to everyone. Such chat rooms might be a way to allow citizens of a country to air their grievances. While the originating point of a chat message is not hard to discover, there are ways around such monitoring. In China, for instance, a great many chat messages come from Internet cafes, and so cannot be traced back to specific people.

#### **4.5.1 New Forms of Wireless Internet Access**

The first "pure Internet" wireless networks are just beginning to emerge within the United States. Such networks are entirely designed for Internet devices; they are technically quite different from telephony systems, which have had the primary design goal of carrying human speech. Figure 4.8 shows a typical wireless Internet device (Palm VII™) side by side with a network schematic for the Ricochet™ network by Metricom<sup>11</sup>. The Task Force does not have detailed market estimates for wireless Internet access, but Killen & Associates has forecast a 71 percent compound annual growth rate for this

---

<sup>11</sup> Metricom web site: [www.metricom.com](http://www.metricom.com).

market, from \$1.3 billion in 1998 to \$19.2 billion in 2002. These figures include access through cellular systems as well as “pure Internet” systems.

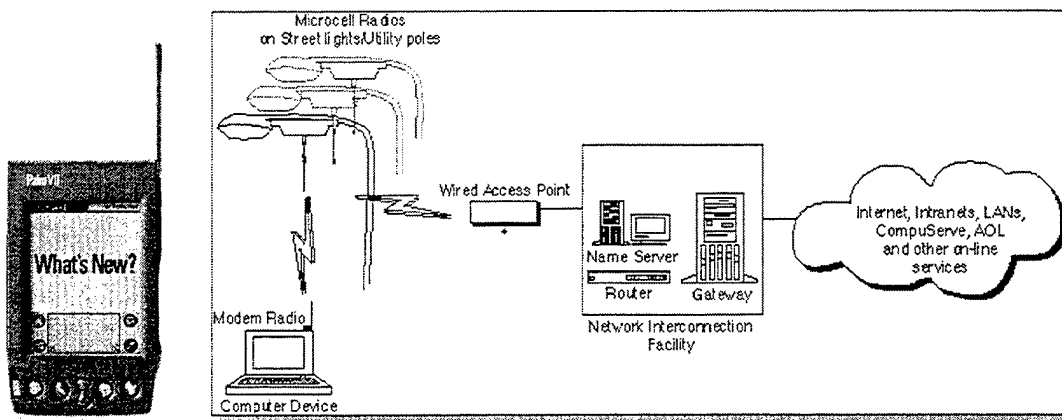

Figure 4.8 Wireless Internet devices and metropolitan wireless Internets

At present, Ricochet™ is the only wireless Internet suitable for hand-held or vehicle-mounted devices and operational on a metropolitan level. It operates solely within the United States. The current Ricochet™ network covers the San Francisco bay area, Seattle, and Washington, DC, as well as a number of U.S. airports. It employs a proprietary frequency-hopping radio that operates in the ISM band. Within the past year, however, Metricom has had a significant infusion of funds (\$1.2 billion) in order to build out a higher speed version of this network across all major U.S. cities. When operational, this network will provide relatively high-speed (128 Kbps) and secure Internet access to any device that has a Metricom modem. Interestingly, these networks are much cheaper to build than those based upon cellular telephony technology, yet they will likely provide noticeably higher performance.

Since both the Internet and mobile wireless fields are extremely active and well-funded at the moment, the Task Force expects that a number of other companies will also begin to build out such networks in the coming year or two. At present there are some regulatory barriers to building such networks in various parts of the world (particularly Europe and Japan), where lower ceilings on the maximum allowable transmission power make such metropolitan networks economically infeasible. It seems likely, however, that such systems will eventually be built throughout the world.

#### 4.5.2 The Internet and the Coming Impact of Fiber Optics

As interesting as the preceding technologies are, the Task Force believes that by far the most important technology driver for the next decade will be the extremely high-bandwidth fiber optic cables across which the Internet will run. Everything described above is an evolution of existing technology. The coming ultra-high-speed Internet technology, however, will be completely revolutionary. As a result, it is exceedingly



hard to predict. But a glance at figure 4.9 shows the magnitude of the changes that are almost literally on today's doorstep.

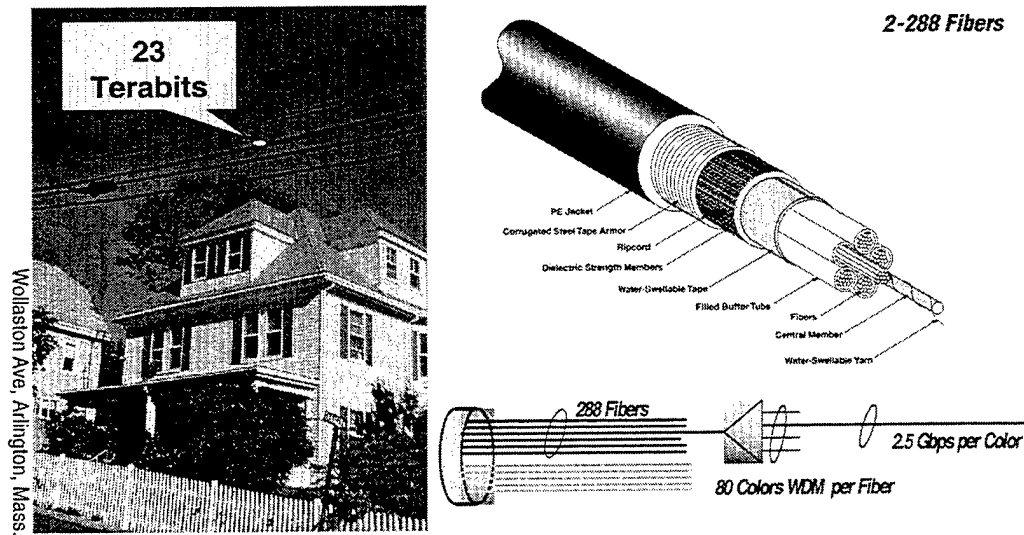

Figure 4.9 The build-out of extraordinary Internet bandwidth in the suburban United States

Figure 4.9 shows a typical Boston suburban street with a 288-fiber cable pulled by RCN Corp. during 1999 to provide a new residential communications infrastructure. Running with current top-of-the-line commercial equipment, this cable provides full-duplex bandwidth of about 23 terabits to a small region of the town. Broken down by household, that comes to more than 10 gigabits/second per house. Translating that bandwidth into TV and radio shows the extent of this revolution. A single HDTV channel occupies something less than 20 megabits/second. Thus, a given household could have as many as 500 HDTV channels streaming into it simultaneously -- with *none* of these channels shared with any other house in the town. Obviously, no house is going to receive 500 TV stations simultaneously, so if indeed the bandwidth is ever fully used, it will be used by something other than TV or radio. Thus far, of course, the driver has been the Internet, with its seemingly insatiable appetite for bandwidth.

Surprising as it may seem, the developing world probably will not lag terribly far behind the United States in Internet build-out. Today, for instance, although less than 5 percent of China's small companies have ever used Internet services, Frost & Sullivan estimates that over 50 percent are likely to go online within the next five years. Figure 4.10 shows projected annual sales of fiber optic cabling worldwide. The yearly production (and deployment) of fiber is expected to nearly double between 2000 and 2006.

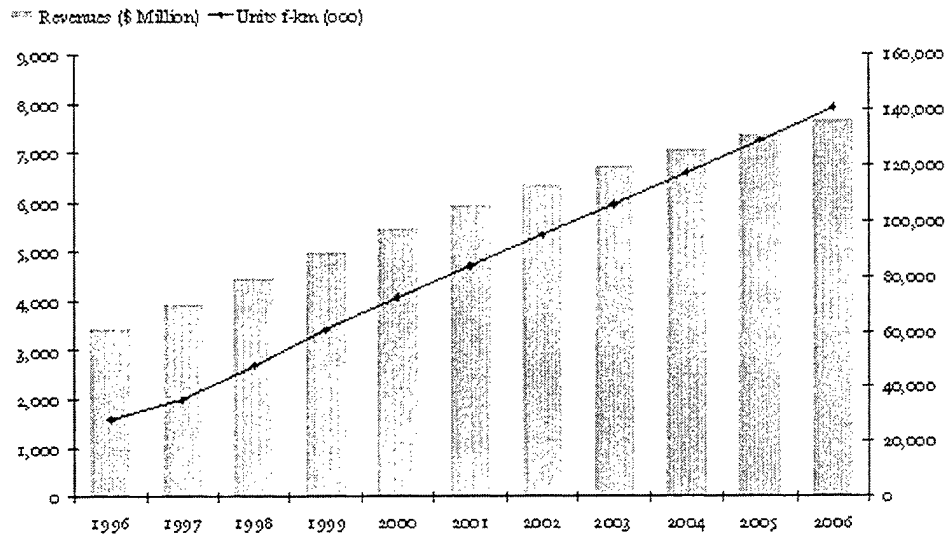

Figure 4.10 Projected worldwide market for fiber optic cables (Source: Frost & Sullivan)

As can be seen from table 4.2, the highest growth rates for fiber optic cabling occur outside North America and Europe. In particular, the least developed parts of the world are projected to have compound annual growth rates (CAGR) of over 50 percent, though of course from a very small base.

Year	North	Europe	Asia	Latin	Rest-of-world
	America		Pacific	America	
	(\$ millions)	(\$ millions)	(\$ millions)	(\$ millions)	(\$ millions)
1996	1,582.9	1,039.7	739.2	89.8	2.6
1997	1,681.2	1,228.8	895.8	154.6	3.4
1998	1,800.0	1,433.8	1,053.0	188.2	5.7
1999	1,856.0	1,650.9	1,255.7	230.1	10.0
2000	1,839.4	1,872.4	1,503.4	269.8	22.0
2001	1,826.1	2,002.1	1,790.3	316.3	32.8
2002	1,778.3	2,103.4	2,084.3	363.3	44.6
2003	1,794.7	2,189.4	2,283.7	404.2	64.7
2004	1,762.1	2,278.7	2,491.0	452.9	92.0
2005	1,784.1	2,213.4	2,746.4	510.8	148.1
2006	1,788.2	2,158.2	2,998.4	562.7	200.4
CAGR 1999-2006	(0.5)%	3.9%	13.2%	13.6%	53.4%

Table 4.2 Total fiber optic cable market: revenue forecasts, 1996-2006 (Source: Frost & Sullivan)

Even in the next few years, the Internet is likely to have a major impact on the distribution of radio and TV content within the United States and, a little later, in other parts of the world. Indeed, this process has already begun, though it is currently hampered by the very low bandwidth available in typical homes (53 thousand bits/second at most).

*Internet Radio Stations.* In recent years there has been an explosive growth of radio stations transmitting real-time audio streams through the Internet. One MIT database records more than 9,000 radio stations transmitting through the Internet<sup>12</sup>. Any of these stations can be heard anywhere in the world by anyone who has a cheap PC and an Internet connection. The list of stations already available online is perhaps even more interesting than the sheer number of such stations<sup>13</sup>.

*Internet TV Stations.* More surprisingly, a number of TV stations are already transmitting through the Internet even though the typical household bandwidths are not yet high enough for satisfactory TV quality. A quick search of one vendor's web site<sup>14</sup> found 85 TV stations broadcasting through the Internet. Transmissions originate in such countries as Brazil, Cyprus, Peru, Russia, Bahrain, Korea, Philippines, Slovenia, Croatia, and India. The Task Force expects the number of such stations to grow very rapidly once cable modems, ADSL, and other high-speed consumer Internet technologies have reached a critical mass.

*Audio and Video On Demand.* Of course it is a mistake to conceive of the Internet only as a replacement of conventional radio and TV stations. Even when restricting the discussion to only audio and video media, the Internet brings the enormous advantage of being able to supply media clips on demand. Thus, it is rapidly emerging as an important distribution medium for popular music and, in time, it will likely be a prevalent means for distributing video products. Table 4.3, which forecasts the number of free Internet audio players that will be downloaded in the coming years, gives some notion of the projected size of these markets. At present, Internet audio companies offer promotional audio files in order to entice users to use their software products. These free audio files also attract end users to purchase the full CD of the featured artist. By 2001, a wide variety of popular music content is expected to become available and the number of paid audio files is projected to rise to 28 percent of total audio downloads. By 2005, 52 percent of audio downloads are expected to be paid for, while 48 percent of audio downloads are projected to be free and used for promotional purposes.

---

<sup>12</sup> MIT Internet radio web site: <http://vmbbr.mit.edu/stations/>.

<sup>13</sup> Lists of countries taken at random, with the number of online radio stations in each country. Papua New Guinea (4), Kazakhstan (4), Kyrgyzstan (3), Philippines (30), Mongolia (2), Lebanon (10), Iran (1), Ghana (10), Madagascar (2), Saint Helena (1), and South Africa (30).

<sup>14</sup> Web site: [www.real.com](http://www.real.com).

Year	Units (millions)	Unit growth rate (%)
1995	0	---
1996	0	---
1997	5.8	---
1998	39.5	581
1999	43.4	10
2000	53.8	24
2001	65.1	21
2002	84.7	30
2003	96.4	14
2004	102.5	6
2005	126.3	23

Table 4.3. Forecast of free Internet audio player downloads, 1995-2005 (Source: Frost & Sullivan)

*Trends in Personalization of Web Pages and Media Streams.* Internet radio and TV stations will be further distinguished from their classic predecessors in that they will be highly personalized. The preferences of each customer will be maintained in a database and the media stream flowing to that customer will be tailored accordingly. Each customer will receive his or her own personalized stream of media content and commercials, targeted as carefully as the media supplier can manage. The first results of this technology are already widely deployed in personalized web pages and Internet storefronts. A "My Yahoo" page, for example, contains content tailored for the individual consumer, and the Amazon.com online store records previous purchases in an attempt to suggest tempting new offerings when a consumer re-appears. In a sense, such technology takes "narrow-casting" to an extreme -- it is precisely the *opposite* of broadcasting.

#### 4.6 Other Media

A number of other media types, and means of dissemination, are also widely popular. Video games are perhaps the most popular. They can be disseminated by a number of techniques, ranging from diskettes to web downloads. Internet games allow a number of geographically dispersed players to participate in a large, shared virtual space. Web animations are also popular, as are Java applets. Other important media at this moment include CDs, CD-ROMs, and DVDs. All are suitable for PSYOP in some situations.

#### 4.7 Summary of Media Content and Dissemination Channels

Table 4.4 shows a number of potential types of content (columns) and how such content can be mapped onto a variety of channels (rows). Those intersections marked with a "Y" are those in which a given type of content can be carried via a given medium. Shaded

areas indicate content that can be created and disseminated by traditional PSYOP. Only a very small subset of the potential types of content fall into this category.

Channel / Content	Broadcast?	Video	Audio	Text / Photo	Short Message	Interactive Voice	Interactive Web	Video Game
<b>Radio</b>								
AM / FM	Y		Y					
Shortwave	Y		Y					
Digital	Y		Y		Y			
Satellite	Y		Y					
<b>Television</b>								
VHF / UHF	Y	Y	Y	Y	Y			
Cable	a	Y	Y	Y	Y			
HDTV	Y	Y	Y	Y	Y			
Satellite	Y	Y	Y	Y	Y			
<b>Internet</b>								
Classic Web	b			Y	Y		Y	Y
Streaming Media	b	Y	Y	Y	Y		Y	Y
Email	c	Y	Y	Y	Y		Y	Y
Chat / Messaging	d				Y		Y	
<b>Telephony</b>								
PSTN			Y			Y		
Cellular	e		Y		Y	Y		
Satellite	e		Y		Y	Y		
Fax	c			Y	Y			
Paging	f				Y			
<b>Physical Media</b>								
Leaflet				Y	Y			
Cassette			Y					
CD			Y					
CD-ROM		Y	Y	Y				Y

Table 4.4 Content types and distribution channels

Notes:

- a. Cable is typically transmitted through coaxial cables. This would make it hard to insert content without permission from the cable's operator. Some parts of cable distribution systems are microwaves, however. In addition, some distribution to users is via RF (for example, MMDS and LMDS in the United States).
- b. Although these media appear to be broadcast, in fact they are implemented by a number of individual sessions much like individual phone calls. These individual sessions are generally traceable by the operators of the local Internet service; hence, privacy cannot be guaranteed. In addition, entire web site addresses can be blocked rather easily by a local Internet service.
- c. These media can be broadcast by the repeated sending of the messages to individual destinations. Since this is automated, it takes little trouble, but it does take a certain amount of transmission capacity to send so many duplicated messages. In addition, these transmissions can easily be monitored and/or blocked by the local Internet and telephone service providers.
- d. As with the classic web, these features are easily monitored and/or blocked, assuming that the local Internet service provider can determine the addresses of the chat / messaging sites.
- e. Basic cellular and satellite telephone service is one-to-one rather than broadcast. However there might be certain features of some cellular technology that would allow insertion of broadcast messages (audio or text).
- f. Basic paging service is one-to-one rather than broadcast. However many pager technologies include groups (for example, for stock market or news updates). These could probably be used for short message delivery.

## 4.8 Findings

The following are the Task Force's findings on current and future trends in media creation and dissemination.

*Fundamental Changes in Media and its Dissemination.* The Internet is the most obvious sign of media change, but in fact change is occurring on all fronts. Conventional terrestrial broadcast of TV and radio grows ever less important as consumers switch to cable and direct-to-the-home satellite. Geographic broadcasting is breaking down as satellites broadcast TV and radio channels worldwide. Many thousands of radio stations are now broadcasting through the Internet. And web sites are rapidly becoming a new and as-yet unknown blend of media sites, newspapers, and discussion forums.

*Unstable, Rapidly Changing Technology.* The worlds of media content and media dissemination are currently in a state of extraordinary flux. Technological innovations are occurring at a rapid pace and impacting deeply enough to fundamentally alter the structure of the world economy. The stable world of conventional broadcast TV and radio is rapidly vanishing and in its place a large variety of new and incompatible technologies are being fielded around the world. No one can tell which, if any, of these new technologies will emerge victorious. But it seems evident that this unstable, rapidly changing environment is likely to last for years or perhaps even decades.

*Narrow-casting.* All current media trends lead away from the old broadcasting model in which a large number of consumers all receive a relatively small number of widely shared content streams and toward a tightly targeted narrow-casting model. At present, many consumers have hundreds of media channels at their fingertips. Very quickly, even the narrow-casting model will be superceded as media streams are specifically designed for individual consumers. Very large consumer databases will ensure that each consumer receives a stream of images, sounds, and advertisements that are aimed precisely at his or her taste.

Based on these trends, the traditional use of TV and radio broadcasts from an airborne platform (*Commando Solo*) is becoming a less effective method to disseminate PSYOP products in a tactical setting. Consumers in many parts of the world have access to a very wide range of media -- indeed, many may not even be able to receive *Commando Solo* broadcasts of UHF and VHF TV because they have cable or satellite TVs. The consumer's center of gravity is rapidly shifting to the Internet. Broadcasting is no longer how the media works. Instead, everything is becoming more tightly focused as the number of distinct media channels grows ever larger.

## CHAPTER 5

### FM and TV Broadcast from Aircraft

#### 5.1 FM and TV Broadcast from Aircraft

A critical element of tactical PSYOP has been radio and TV broadcasts from a standoff airborne platform. Transmissions from aircraft altitudes offer an advantage over terrestrial transmissions because obstacles standing between transmitter and receiver in terrestrial transmissions -- such as vegetation, buildings, and terrain -- attenuate transmitted signals and degrade reception. For this reason, aircraft allow access to relatively large areas. The effective range of a transmitter generally improves with altitude, but it is subject to frequency-dependent absorption, reflection, and diffraction. In addition to the broad coverage made possible by altitude, an aircraft broadcast platform can be deployed anywhere on the globe and begin operating in a short amount of time. An element of survivability is also gained over fixed or even portable terrestrial stations.

Radio broadcasts occur in HF, VHF, or UHF. Commercial and government-sponsored radio broadcasters transmit amplitude modulated (AM) signals in the so-called AM band (535 to 1700 kHz) and in any of several short-wave (SW) bands ranging from about 2.3 MHz to 22 MHz. Frequency Modulated (FM) radio broadcasts occupy the FM band, which spans 88 MHz to 108 MHz. TV broadcasts, because of their much higher bandwidth, are confined to VHF and UHF in several TV bands: 54 to 72 and 76 to 88 MHz (VHF-L), 174 to 216 MHz (VHF-H), and 470 to 608 and 614 to 806 MHz (UHF).

The *Commando Solo* aircraft is the only current airborne asset equipped for broadcast PSYOP. A fleet of six EC-130E *Commando Solo* aircraft are operated by a reserve unit. Each is equipped with radio and TV transmitters covering HF, VHF, and UHF commercial and military bands and a variety of other equipment needed to broadcast messages in audio and video formats. The aircraft have six 1-kW transmitters -- two for VHF-L, two for VHF-H, and two for UHF -- and one 10-kW power amplifier that can be operated on VHF or UHF. Separate antennas for VHF-L, VHF-H, and UHF run along each side of the aircraft. Providing 6 to 9 dB gain, these antennas must be switched when the aircraft turns along a typical racetrack pattern. The received signal is degraded or lost during turns. When operated, *Commando Solo* transmitters saturate the front-ends of onboard communications and navigation equipment -- a problem that should be addressed and resolved with high priority.

The effective range of a broadcast transmitter is governed primarily by antenna height, effective radiated power (transmitted power multiplied by antenna gain), transmitted frequency, and receiver noise characteristics. Though the details of governing relationships are complex and usually treated by computer models, simple rules can be applied to predict overall performance.

The distance from the antenna to the earth's horizon is a very important parameter. For an idealized, spherical earth, this distance is the square root of two times the geometric

mean of antenna height and earth radius. This distance,  $d$ , scales as the square root of antenna height,

$$d = \sqrt{2 \cdot h_T \cdot R_0},$$

where  $h_T$  is the transmitter antenna height and  $R_0$  is the earth's radius. Increased antenna height improves range, but doubling the height (an ambitious proposition) increases range by only about 40 percent.

For a spherical earth, a clear line of sight exists between the transmitter and a receiver antenna on the earth's surface inside this distance. Raising the receiver antenna increases the line-of-sight range by a term identical to the above equation, so the line-of-sight range becomes

$$d = \sqrt{2 \cdot h_T \cdot R_0} + \sqrt{2 \cdot h_R \cdot R_0},$$

where  $h_R$  is the receiver antenna height. The second term in this equation is dominated by the first when  $h_T$  is an aircraft altitude. Terrain, surface material properties, vegetation, and atmospheric conditions all influence the "actual" line-of-sight range; however, as a general rule, higher transmitter and receiver antennas imply greater range and the situation improves as the square root of height of either receiver or transmitter. Table 5.1 serves as an illustrative example where the receiver antenna is assumed at zero height.

Approx. antenna height (kft)	Range to horizon (mi)	Platform
1	39	Typical TV antenna tower
20	174	EC-130E, EC130J
40	245	Widebody aircraft (eg. Boeing 767)
60	301	Global Hawk, Gulfstream

Table 5.1 Antenna height and range to horizon

Table 5.1 shows that a receiver with clear line of sight to a 1,000 ft tower 39 miles distant would also have a clear line of sight to an EC-130E at about 20,000 ft and 174 miles distant. This table and the preceding equation can be used to roughly estimate effective transmitter range so long as transmitted power is sufficient for line-of-sight communications, or sufficient to overcome so-called R-squared losses. The point is that beyond ranges shown in table 5.1, signals begin degrading in a different way (a higher power of range or even exponentially) and much more rapidly with increased range.

Table 5.2 lists distances typical of operational constraints placed on an airborne broadcast system.



Target audience	Aircraft location	Distance (mi)
Belgrade	Hungarian border	100
Belgrade	Romanian border	50
Baghdad	Saudi border	250
Teheran	Persian Gulf	>300
Teheran	Turkey border	>300
Pyongyang	Korean Sea	40-50
Pyongyang	DMZ	80-100
<b>CINC requirement for radio and TV</b>		<b>300</b>

Table 5.2 Operational constraints on airborne broadcasts

*Comparing the two tables above, it becomes clear that the current Commando Solo aircraft, the EC-130E, is inadequate for many scenarios even in an idealized situation. Given the real-world issues of obscuration by terrain, vegetation, and buildings, plus the need to fly somewhat behind a political border in order to avoid surface-to-air threats, it is clear why Commando Solo is most effective when transmitting into island or littoral nations. It is also worth noting that the CINC requirement for a 300 mile range may not be large enough to address several important scenarios.*

*The EC-130E platform currently used for Commando Solo flies at 18,000 feet. There is interest in cross-decking the existing Special Mission Equipment (SME) to an EC-130J platform that would fly at 24,000 feet. This increase in altitude would have only a marginal impact on Commando Solo performance and the Task Force is concerned that the SME hardware represents very old technology and thus projects major weight, size, and power restrictions on any platform that carries the current hardware. The Task Force is also concerned that the debate has focused on the platform and not the payload - the critical information transport mechanisms in support of PSYOP missions.*

Effective radiated power is another important parameter determining broadcast range. When transmitter and receiver antennas are within line of sight, the received signal scales inversely with the range squared -- doubling the range requires four times the power to maintain the same signal quality. Beyond line of sight, this relationship becomes much more complicated. Absorption, scattering, diffraction, and reflection of energy from the transmitter are a strong function of frequency and can vary considerably with time of day, time of year, and even solar activity. Table 5.3 provides a qualitative summary of these effects.

Transmission type	Frequency range (MHz)	Band	Beyond LOS propagation
AM radio	0.535 - 1.7	AM	Reception beyond LOS due to diffraction; much longer range at night due to ionospheric reflection, some variation with season and sunspot cycle
FM radio	88 - 108	FM	Degraded reception beyond LOS; some absorption in foliage and other obstacles; some seasonal variation with foliage
TV	54 - 88	VHF-L	Degraded reception beyond LOS; some absorption in foliage and other obstacles; some seasonal variation with foliage
TV	174-220	VHF-H	More degraded reception beyond LOS; more absorption in foliage and other obstacles; some seasonal variation with foliage
TV	470 - 800	UHF	Highly degraded reception beyond LOS; significant absorption in foliage and other obstacles; more seasonal variation with foliage
Analog and digital telephony	50 - 400	VHF & UHF	Varies with frequency, as described above

Table 5.3 Effectiveness of transmissions from beyond line of sight

The dependence of propagation strength on frequency is also illustrated by typical effective radiated power for U.S. broadcasters: AM radio  $\leq 20$  kW, FM radio  $\leq 200$  kW, VHF TV  $\leq 300$  kW, UHF TV  $\leq 5$  MW. The largest AM radio stations on clear channels reach 1,000 miles or more at night while UHF and VHF TV stations with large antenna towers and high power typically reach 100 miles or less depending strongly on receiver antenna gain and height.

Other important factors determining broadcast range are receiver quality and bandwidth. Receiver quality in the AM band is less important than for VHF and UHF because atmospheric noise tends to dominate signal quality below 30 MHz or so. In the VHF and UHF, however, noise generated by the receiver is important and so newer receivers will tend to be useful with weaker signals. This is particularly true for the UHF. Larger bandwidth implies more receiver noise, so the audio portion of a TV transmission is typically useful beyond the range where the video becomes unacceptable. This effect is, to some extent, a result of the modulation and demodulation techniques used (typically FM for audio and AM for video) and of differences in the way noise is perceived on audio and video information.

Table 5.3 illustrates why *Commando Solo* performance is best for AM radio broadcasts and poorest for UHF TV broadcasts. All *Commando Solo* systems worked well in Haiti, Panama, and Grenada, as would be expected from tables 5.1 and 5.3. Radio broadcasts worked acceptably in Iraq and Kosovo, while TV broadcasts were not satisfactory. During the Kosovo campaign, *Commando Solo* was orbiting at 18,000 to 20,000 ft over Hungary -- about 100 miles from Belgrade. Transmitting 10 kW on UHF channel 21, the video quality was unacceptable while the audio was understandable, again in general agreement with the above discussion even though many details are omitted.

The above discussion and the Kosovo experience can be used to predict, with some confidence, how various options will perform if called upon in future military operations. Table 5.4 summarizes these qualitative predictions assuming a clear channel for each case.

Target audience	AM	FM	VHF TV	UHF TV
Island nations	EC-130	EC-130	EC-130	EC-130
Pyongyang	EC-130	EC-130	EC-130 + ERP, widebody	Widebody
Belgrade	EC-130	EC-130	EC-130 + ERP, widebody	Widebody
Baghdad	EC-130 night, widebody day	Widebody	Widebody + ERP, Global Hawk	Widebody + ERP, Global Hawk
Teheran	EC-130 night, widebody day	Widebody, Global Hawk	Global Hawk	Global Hawk

Table 5.4 Predicted performance of broadcast transmissions in selected operational scenarios

Table 5.4 illustrates the limitations of the EC-130 platform (whether the EC-130E or J variants), attributable primarily to its limited altitude. A widebody platform, flying at 40,000 ft and possibly with 3 to 6 dB additional ERP, would allow radio and TV broadcasts into many additional areas of interest. A Global Hawk UAV platform or a high-altitude unarmed platform flying at 60,000 ft could potentially stand off even further than a widebody; however, issues of payload capacity and flexibility call for careful consideration when comparing the two. At 60,000 ft there is only a 22 percent increase in horizon distance over a widebody (see table 5.1). On the other hand, loss of an unmanned Global Hawk to hostile action is considerably preferable to loss of a manned aircraft.

In the discussions above, a clear channel is assumed -- that is, there is no other radio or TV station transmitting on the frequency in question and there is no jamming. The first of these is a reasonable assumption because it can be safely assumed that several radio and TV channels will be free of existing transmitters even in a dense urban area. The VHF-L TV channels are most desirable for reasons listed in table 5.3, so these will often be occupied, as they are in U.S. urban areas. Next in desirability are the VHF-H channels, and finally the UHF channels, where degradation beyond line of sight is very rapid. Transmissions from *Commando Solo* into Belgrade were confined to UHF because of existing broadcasts into Belgrade and, very importantly, because of potential interference in neighboring countries. Performance deficiencies were clearly exacerbated by operation in UHF.

The question of jamming seems a very important one. If broadcast PSYOP are having a tangible effect on an opponent, then it seems reasonable that jamming will be present. The above discussion illustrates that broadcast quality is marginal in many cases,

especially against sophisticated adversaries including North Korea, Yugoslavia, Iraq, and Iran. Given the asymmetries of today's warfare, the placement of jammers on civilian centers would make them quite immune to attack. The very real possibility of broadcast jamming should, therefore, be included in any decision to significantly upgrade system performance.

Several options might be pursued in an effort to maintain the viability of U.S. broadcast PSYOP capabilities. One extreme is to keep the EC-130E fleet and install modest upgrades. This approach does not deny that there are serious inadequacies in the current platform's altitude capability and in the suite of onboard electronics, as demonstrated in Kosovo. However, it does recognize the rapid changes taking place in broadcast telecommunications and expects other broadcast modes to become available and popular in those portions of the world where *Commando Solo* would not perform adequately today, as discussed in chapter 4. Another approach that is currently being studied by DoD is to upgrade and cross-deck current *Commando Solo* equipment to EC-130J aircraft, which have slightly better flight performance and, most likely, lower maintenance costs. On the other end of the spectrum are approaches that would develop a new widebody or even high-altitude UAV (such as Global Hawk), complete with state-of-the-art transmitters and antennas capable of reaching perhaps 300 miles with TV and radio signals -- a large improvement over *Commando Solo* that would, at best, be marginal in Teheran. Such an approach might also require fewer aircraft due to longer endurance.

*The Task Force has weighed all of these options and finds that the costs associated with cross-decking the current Commando Solo SME from the EC-130E to the EC-130J platforms (estimated to be about \$250 million) are excessive and would not result in substantively improved performance. Furthermore, the trends in future information transport discussed in chapter 4 indicate movement away from TV and radio broadcast in many parts of the world. For these reasons, the Task Force believes that these funds would be better spent for improvements in overall PSYOP capabilities, the utilization of modern media product creation and dissemination capabilities, and the development of modular TV and radio broadcast equipment to allow for their utilization on a variety of platforms.*

## CHAPTER 6

### Recommendations

This DSB Task Force was originally created because of concern over the inability of the *Commando Solo* (EC-130E) aircraft to disseminate TV and radio broadcasts during the recent military operation in the Balkans. The Task Force chose to broaden its charter and address issues associated with PSYOP as part of an overall Information Operations (IO) campaign during peace, crisis, and armed hostilities. The Task Force also evaluated organizational issues associated with PSYOP forces within DoD and addressed issues associated with the PSYOP community's relationship to the Intelligence Community. Of particular interest is the on-going worldwide explosion of information creation and dissemination technologies and capabilities. The Task Force spent considerable effort addressing modern trends in information dissemination and media content creation. With those trends as a backdrop, the Task Force then assessed the viability of the current *Commando Solo* fleet and a variety of options currently being studied by DoD. The following recommendations were derived from all of these considerations.

#### Recommendation 1

*The Task Force recommends that DoD create a PSYOP policy and planning staff, under the coordination authority of the Office of the Assistant Secretary of Defense for Special Operations and Low-Intensity Conflict (OASD(SO/LIC)), to ensure the integration of operational- and tactical-level PSYOP with strategic perception-management initiatives and to provide planning support for strategic PSYOP activities.*

#### Recommendation 2

*The Task Force recommends that rank structure and career paths within PSYOP forces should be reassessed and more specifically:*

- *the senior PSYOP Advisor to the geographical CINCs should be an O-6 or equivalent civilian, and be assigned to the CINC Special Staff, and*
- *the Commander of the Joint PSYOP Task Force supporting the Joint Task Force Commander (typically a three-star flag officer) in theater should also be an O-6.*

#### Recommendation 3

*The Task Force recommends that OASD(SO/LIC) and USSOCOM strive to improve overall product quality through increased reliance on commercial providers for high-quality products. Furthermore, the Task Force recommends that the PSYOP force be adequately resourced and trained to engage a stable of commercial media content providers who can deliver these quality products. The Task Force estimates this investment to be approximately \$10 million per year.*

#### Recommendation 4

*The Task Force recommends that the Defense Intelligence Agency be tasked by the ASD C3I to establish a psychological warfare intelligence element. ASD C3I should be charged to either (a) provide resources to the PSYOP community to implement a robust*

*organic program of open source acquisition, or (b) task the Intelligence Community to fulfill the need for on-the-shelf, worldwide basic information, including the media and cultural background information necessary to adequately inform PSYOP products in a given country. The Task Force believes that this can be accomplished without incurring an extra budgetary burden.*

#### **Recommendation 5**

*The Task Force recommends that ASD C3I make NFIP/JMIP funds available to USSOCOM for the express purpose of acquiring available data sets, particularly those for countries outside North America and Europe. The Task Force also recommends that CINCSOC work with the Foreign Military Studies Office (FMSO) to ensure the integration of these data sets with the World Basic Information Library (WBIL) and their community-wide accessibility. Moreover, the Intelligence Community should be further tasked through ASD C3I to develop methods and sources to obtain media use demographic information where it is not now available but where the United States might plausibly have future national security interests in which PSYOP might be employed. The Task Force estimates this investment to be approximately \$5 million per year.*

#### **Recommendation 6**

*The Task Force recommends that OSD work with the Department of State to fund, position, exercise, and maintain suitable distribution channels and brand identities, insofar as these can be reasonably anticipated for future PSYOP requirements. Policies with respect to the use of new and emerging transnational media should be developed and refined. Liberal reliance on recognized professionals and the generous use of highly qualified commercial entities are highly recommended. Buying good content on which the messages will "ride" is a necessary and desirable expenditure. The Task Force estimates this investment to be approximately \$10 million per year.*

#### **Recommendation 7**

*The Task Force recommends that DoD acquire the technical capability to understand emerging media dissemination techniques and technologies. Furthermore, DoD should provide the resources to acquire (rent or purchase) emerging media content and dissemination channels from commercial organizations. Here, DoD may be able to acquire good channels very cheaply by means of being an "anchor tenant." The Task Force estimates this investment to be approximately \$10 million per year.*

#### **Recommendation 8**

*The Task Force recommends that DoD maintain the current EC-130E Commando Solo fleet with existing Special Mission Equipment (SME). The estimated cost of \$250 million to cross-deck the SME to a EC-130J platform is not justified by the marginal increase in performance offered by this option. In addition, future worldwide media dissemination trends will limit the effectiveness of radio and TV broadcasts. The Task Force recommends that USSOCOM investigate the creation of small and easily reconfigurable information-dissemination packages, compatible with multiple platforms, including UAVs and leased aircraft, for a variety of missions. The Task Force estimates the initial*

*investment for design and development of these packages to be \$10 to \$20 million per year.*

**Recommendation 9**

*The Task Force has recommended annual funding increases (in recommendations 1 through 8) of approximately \$50 million per year. The Task Force believes that this increase would be readily supported by reprogramming the \$250 million that would be required to fund cross-decking of the existing Commando SME to the EC-130J platforms.*

The prompt and effective use of PSYOP in military operations can avert crises, end wars, and save lives. The Department of Defense should prioritize Psychological Operations appropriately, because the misuse of PSYOP can cause untold damage to military operations. A relatively small investment over time can reap huge rewards for the United States and its allies, both diplomatically and militarily.



OFFICE OF THE SECRETARY OF DEFENSE

3140 DEFENSE PENTAGON  
WASHINGTON, DC 20301-3140

27 October 1999

DEFENSE SCIENCE  
BOARD

MEMORANDUM FOR CHAIRMAN, DEFENSE SCIENCE BOARD

SUBJECT: Terms of Reference--Defense Science Board Task Force on the Creation and Dissemination of all Forms of Information in Support of PSYOPS in Time of Military Conflict

You are requested to form a Defense Science Board (DSB) Task Force on all forms of information creation and dissemination in support of PSYOPS in times of military conflict. The Task Force is to support the Congressional directive for the Secretary of Defense to examine the creation and dissemination of all forms of information and the adequacy of the capabilities of the United States Armed Forces in this area to deal with situations such as the conflict in the Federal Republic of Yugoslavia.

In support of this Congressional direction, the Task Force should:

1. Assess the capabilities of the United States Armed Forces to develop programming and to broadcast factual information that can reach a large segment of the general public in a country like the Federal Republic of Yugoslavia;
2. Assess the potential of various airborne or land-based mechanisms to have the capabilities described above, including but not limited to desirable improvements to the EC-130 Commando Solo aircraft, and the utilization of other airborne platforms, unmanned aerial vehicles, and land-based transmitters in conjunction with satellites;
3. Assess other issues relating to the creation and dissemination of all forms of information in time of conflict, to include satellite broadcasts and the utilization of emerging mobile communication technologies;

The Task Force should provide a progress report by February 1, 2000 to the DoD so that the Secretary of Defense can provide his assessment and recommendations to the congressional defense committees by March 1, 2000.

The Task Force will be co-sponsored by the Under Secretary



of Defense for Acquisition, Technology and Logistics, and Assistant Secretary of Defense for Special Operations & Low-Intensity Conflict. Mr. Vince Vitto will serve as Chairman of the Task Force. COL Fred Gilbert will serve as Executive Secretary; and CDR Brian Hughes, USN will serve as the DSB Secretariat Representative.

The Task Force shall have access to classified information needed to develop its assessment and recommendations.

The Task Force will be operated in accordance with the provisions of P.L. 92-463, the "Federal Advisory Committee Act," and DoD Directive 5105.4, "The DoD Federal Advisory Committee Management Program." It is not anticipated that this Task Force will need to go into any "particular matters" within the meaning of Section 208 of Title 18, U.S. Code, nor will it cause any member to be placed in the position of acting as a procurement official.

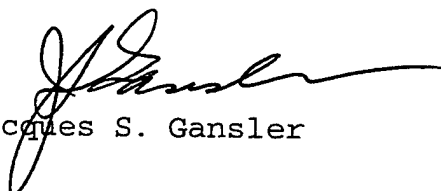

Jacques S. Gansler

## Appendix B

### TASK FORCE MEMBERSHIP

#### Chairman

Vincent Vitto\*  
*C.S. Draper Laboratories*

#### Executive Secretary

Col Fred Gilbert  
*OASD [SOLIC] PRNA*

#### Members

Jim Babcock  
*MITRE*

Denis Bovin\*  
*Bear Sterns & Co., Inc*

Ruth David\*  
*ANSER*

Chip Elliott  
*BBN Technologies*

Bran Ferren  
*Walt Disney Imagineering*

Bert Fowler  
*C.A. Fowler Assoc.*

Charlie Hawkins

Peter Marino\*

Joe Markowitz

Greg Poe  
*Logos Technologies*

Frank Stech  
*Mitretek Corp.*

Larry Wright  
*Booz, Allen, & Hamilton*

#### Advisors

LTC Steve Collins  
*USSOCOM*

COL Lawrence D. Dietz  
*351<sup>st</sup> Civil Affairs Command*

CDR Jeffrey Stratton  
*USN*

#### Support Staff

CDR Brian Hughes  
*DSB Office*

Melinda K. Baran  
*SAIC*

\* Denotes DSB Member

## Appendix C

### BRIEFERS

Buck Adams  
*World Space*

John Arnold  
*ANSER*

LtCol Eric Weller  
*193<sup>rd</sup> Special Operations Wing*

LtCol Jim Coffman  
*SOCOM*

Chuck de Caro  
*AeroBureau*

Doug Elwell  
*4<sup>th</sup> Psychological Operations Group*

LTC Scott Fedorchak  
*USCENTCOM/CCJ3PI*

Mike Furlong  
*SAIC*

Col Fred Goldstein  
*Chief Psychological Operations Division  
Air Intelligence Agency*

Paul Kolodzy  
*DARPA*

Bill Malone  
*FIWC*

Col Dusty Rhoads  
*JCS J39*

Richard Shiffrin  
*Dep Gen Counsel (Intelligence)  
DoD General Counsel*

MAJ Bill Steinhagen  
*4<sup>th</sup> Psychological Operations Group*

COL Bob Trost  
*J39*

Graham Turbiville  
*World Basic Information Library*

LTC Brad Ward  
*4<sup>th</sup> Psychological Operations Groups*

Chuck Williamson  
*OASD (SO/LIC(SOP))*

## Appendix D

### CONGRESSIONAL LANGUAGE

#### Public Law 106-65

Title – National Defense Authorization Act for Fiscal Year 2000

Subtitle G — Other Matters

Sec. 1061 — Defense Science Board Task Force on Use of Television and Radio as a Propaganda Instrument in Time of Military Conflict

- (a) Establishment of Task Force—The Secretary of Defense shall establish a task force of the Defense Science Board to examine—
- (1) the use of radio and television broadcasting as a propaganda instrument in time of military conflict; and
  - (2) the adequacy of the capabilities of the Armed Forces to make such uses of radio and television during conflicts such as the conflict in the Federal Republic of Yugoslavia in the spring of 1999.
- (b) Duties of Task Force: The task force shall assess and develop recommendations as to the appropriate capabilities, if any, that the Armed Forces should have to broadcast radio and television into a region in time of military conflict so as to ensure that the general public in that region is exposed to the facts of the conflict. In making that assessment and developing those recommendations, the task force shall review the following—
- (1) The capabilities of the Armed Forces to develop programming and to make broadcasts that can reach a large segment of the general public in a country such as the Federal Republic of Yugoslavia.
  - (2) The potential of various Department of Defense airborne or land-based mechanisms to have capabilities described in paragraph (1), including improvements to the EC-130 *Commando Solo* aircraft and the use of other airborne platforms, unmanned aerial vehicles, and land-based transmitters in conjunction with satellites.
  - (3) Other issues relating to the use of television and radio as a propaganda instrument in time of conflict.
- (c) Report: The task force shall submit to the Secretary of Defense a report containing its assessments and recommendations under subsection (b) not later than February 1, 2000. The Secretary shall submit the report, together with the comments and recommendations of the Secretary to the congressional defense committees not later than March 1, 2000.