

NUWC-NPT Technical Report 11,106-1
7 May 1999

Seasonal Performance of a High-Frequency/ Automatic Link Establishment (HF/ALE) Radio Network Operating at Mid to High Latitudes in the Southern Hemisphere (Volume 1)

Patrick E. Gilles
Joseph R. Katan
NUWC Division Newport

Robert J. Pellowski
Tele-Technologies, Inc.



**Naval Undersea Warfare Center Division
Newport, Rhode Island**

Approved for public release; distribution unlimited.

DTIC QUALITY INSPECTED 4

19991220 071

PREFACE

This report was prepared under joint sponsorship of the Office of Naval Research (ONR), Submarine Communications Block Program (program element 62232N); the National Science Foundation, Office of Polar Programs (NFS/OPP); and the Naval Undersea Warfare Center (NUWC) Division Newport, Independent Research/Independent Exploratory Development Program (program element 62936N). The principal investigator for this task was Joseph R. Katan (Code 3411); program manager for the ONR Submarine Communications Program is Frederick C. Allard (Code 3496); the NSF/OPP project engineer is Patrick Smith. The ONR project sponsor is Sherman Gee (ONR 313); program manager for ONR research funding at NUWC Division Newport is Richard B. Philips (Code 102).

The technical reviewer for this report was Basile Panoutsopoulos (Code 3413).

The authors would like to thank the many people who contributed to the success of this enormous undertaking. Special thanks to Brian L. Pease and Paul M. Mileski for their support in Antarctica and to Edwin A. Wolkoff for his creative insight. Thanks go to Patrick C. Smith, sponsor at NSF/OPP, who persisted in making the required connections, to the men and women of the U.S. Navy stationed at the U.S. Naval Support Force, Antarctica Detachment (Christchurch, New Zealand) and the personnel at the Antarctic Support Unit who have been associated with this task. Finally, a special thanks to the other half of the team, our mates down under at the Defence Science and Technology Organisation and the Australian Antarctic Division, particularly to John R. Tilbrook, our Australian counterpart.

Reviewed and Approved: 7 May 1999



Joe Perry
Head, Submarine Electromagnetic Systems Department



REPORT DOCUMENTATION PAGEForm Approved
OMB No. 0704-0188

Public reporting burden for this collection of information is estimated to average 1 hour per response, including the time for reviewing instructions, searching existing data sources, gathering and maintaining the data needed, and completing and reviewing the collection of information. Send comments regarding this burden estimate or any other aspect of this collection of information, including suggestions for reducing this burden, to Washington Headquarters Services, Directorate for Information Operations and Reports, 1215 Jefferson Davis Highway, Suite 1204, Arlington, VA 22202-4302, and to the Office of Management and Budget, Paperwork Reduction Project (0704-0188), Washington, DC 20503.

1. AGENCY USE ONLY (Leave Blank)	2. REPORT DATE 7 May 1999	3. REPORT TYPE AND DATES COVERED Final	
4. TITLE AND SUBTITLE SEASONAL PERFORMANCE OF A HIGH-FREQUENCY/AUTOMATIC LINK ESTABLISHMENT (HF/ALE) RADIO NETWORK OPERATING AT MID TO HIGH LATITUDES IN THE SOUTHERN HEMISPHERE (VOLUME 1)		5. FUNDING NUMBERS PE 62936N, 62232N	
6. AUTHOR(S) Patrick E. Gilles, Joseph R. Katan, and Robert J. Pellowski			
7. PERFORMING ORGANIZATION NAME(S) AND ADDRESS(ES) Naval Undersea Warfare Center Division 1176 Howell Street Newport, RI 02841-1708		8. PERFORMING ORGANIZATION REPORT NUMBER TR 11,106-1	
9. SPONSORING/MONITORING AGENCY NAME(S) AND ADDRESS(ES) Office of Naval Research ONR 313 800 North Quincy Street Arlington, VA 22217-5160		10. SPONSORING/MONITORING AGENCY REPORT NUMBER National Science Foundation Office of Polar Programs 1800 G Street, NW Washington, DC 20660	
11. SUPPLEMENTARY NOTES			
12a. DISTRIBUTION/AVAILABILITY STATEMENT Approved for public release; distribution is unlimited.		12b. DISTRIBUTION CODE	
13. ABSTRACT (Maximum 200 words) <p>A high-frequency (HF)/automatic link establishment network was established between four sites located in Christchurch in New Zealand, Salisbury in Australia, and McMurdo and Davis Station in Antarctica. The experiment was a joint effort between the U.S. Naval Undersea Warfare Center and the Australian Defence Science and Technology Organisation.</p> <p>Hourly link quality analysis data were collected between September 1992 and November 1994. The primary goal was to study the potential benefits of introducing an automatic frequency management system into the daily operations of the HF communications links involving mid- to high-latitude propagation paths. Ten frequencies between 5 and 26 MHz were evaluated and the data were plotted versus time-of-day and season and compared to predicted results.</p> <p>This report is presented in two volumes. Volume 1 (TR 11,106-1) contains the background, site descriptions, equipment and experiment design information, and conclusions. Volume 2 (TR 11,106-2) contains the supporting data plots.</p>			
14. SUBJECT TERMS Automatic link establishment network High-frequency communications		15. NUMBER OF PAGES 214	16. PRICE CODE
17. SECURITY CLASSIFICATION OF REPORT Unclassified	18. SECURITY CLASSIFICATION OF THIS PAGE Unclassified	19. SECURITY CLASSIFICATION OF ABSTRACT Unclassified	20. LIMITATION OF ABSTRACT SAR

TABLE OF CONTENTS

Section	Page
LIST OF ILLUSTRATIONS	iv
LIST OF TABLES.....	vii
LIST OF ABBREVIATIONS AND ACRONYMS	viii
1 INTRODUCTION	1.1
1.1 Early Explorations	1.1
1.2 Report Background	1.3
2 HIGH-FREQUENCY (HF) COMMUNICATION SERVICES IN ANTARCTICA.....	2.1
2.1 Traditional U.S. Antarctic Program (USAP) HF Communication Procedures	2.2
2.2 Current USAP Communication Practices	2.3
3 DEVELOPMENT OVERVIEW OF AUTOMATIC LINK ESTABLISHMENT (ALE) STANDARDS	3.1
4 SUMMARY OF PREVIOUS HF/ALE COMMUNICATIONS TESTS	4.1
4.1 Earlier High-Latitude, HF/ALE Communications Tests	4.1
4.1.1 Trans-Auroral Tests in Norway (1988-1989).....	4.1
4.1.2 Alaskan HF Test Network (1989-1992).....	4.4
4.1.3 Trans-Auroral Tests To Antarctica (1992).....	4.8
5 NETWORK DESIGN, IMPLEMENTATION, AND EQUIPMENT.....	5.1
5.1 Configuration of the Experiment and Data Collected.....	5.2
5.1.1 LQA Assessment	5.4
5.1.2 Bit Error Tests.....	5.6
5.1.3 Oblique Channel Sounding	5.7
5.2 Implementation, Site Descriptions, and Antenna Orientation	5.7
5.2.1 McMurdo Station and Black Island Facility, Antarctica	5.9
5.2.2 Christchurch, New Zealand.....	5.11
5.2.3 Davis, Australian Antarctic Territories	5.13
5.2.4 Salisbury, South Australia, Australia	5.14
5.3 Radio Equipment	5.16

TABLE OF CONTENTS (Cont'd)

Section	Page
5.3.1	The Harris HF/ALE Radio Family and Product Design Differences..... 5.16
5.3.2	Description of Antenna for Radio Transceivers 5.19
6	OVERVIEW OF POLICIES RELATING TO POLAR UPPER ATMOSPHERIC RESEARCH..... 6.1
6.1	The Solar-Terrestrial Environment 6.2
6.2	The Polar Ionosphere 6.4
6.3	Overview of the Ionospheric Layers 6.6
6.4	The Shift from Sunspots as Diagnostic Indicators..... 6.7
6.5	Forecasting..... 6.12
7	PREDICTED PERFORMANCE OF THE VARIOUS COMMUNICATION LINKS 7.1
7.1	Comparison of Inosospheric Communications Analysis and Prediction Program (IONCAP) with Advanced Stand-Alone Prediction System (ASAPS)..... 7.2
7.2	National Telecommunications and Information Administration/Institute of Telecommunication Sciences (NTIA/ITS) HF Propagation Models 7.3
7.3	ICEPAC Antenna Gain Calculations 7.3
7.4	ICEPAC Input Parameters 7.6
7.4.1	Seasonal Information 7.6
7.4.2	Seasonal Sunspot Activity..... 7.7
7.4.3	Effective Q-Index..... 7.7
7.4.4	Man-Made Noise 7.9
7.4.5	Required Signal-to-Noise Ratio (SNR)..... 7.9
7.4.6	Transmitter Power..... 7.9
7.4.7	Other Parameters..... 7.10
7.5	ICEPAC Prediction Plots 7.10
8	PHILOSOPHY OF THE CUSTOM SOFTWARE AND ITS DESIGN..... 8.1
8.1	Data Acquisition Software 8.1
8.1.1	Network Control Software 8.1
8.1.2	Calendars and Schedules..... 8.2
8.1.3	Message Passing Capabilities 8.2
8.2	Supplemental Packages..... 8.3
8.3	Specific Modifications for the Australian Ministry of Defence (MOD) Tests..... 8.3
8.4	International Connections via the Internet..... 8.4
8.5	Data Reduction Software 8.4
8.5.1	Conversion to Binary Files..... 8.6

TABLE OF CONTENTS (Cont'd)

Section	Page
8.5.2	Extracting Availability Files 8.6
8.5.3	Accounting for Station Downtime 8.6
8.5.4	Combining Availability Files 8.7
8.5.5	Extracting Other Files 8.7
9	PERFORMANCE OF THE NETWORK AND SELECTED EXAMPLES 9.1
9.1	Link Availability 9.1
9.2	Catalogue and Select Examples of Performance 9.2
9.2.1	Station and Circuit Uptime 9.2
9.2.2	Percent Availability of Link for Best Frequency as a Function of Time of Day for Each Season 9.5
9.2.3	Percent Availability of Link for Selected Frequencies and Selected SNR Level as a Function of Time of Day for Each Season 9.5
9.2.4	Percent LQAs with Multiple Frequencies Present as a Function of Time of Day for Each Season 9.7
9.2.5	Percent Availability of Link for Each Frequency Group as a Function of Time of Day for Each Season 9.7
9.2.6	Upper-, Median-, and Lower-Decile Exceedance of Link for Best Frequency Using a Standard Method as a Function of Time of Day for Selected Months 9.11
9.2.7	Upper-, Median-, and Lower-Decile Exceedance of Link for Best Frequency Using a Standard Method as a Function of Time of Day and Season 9.13
9.2.8	Circuit Availability by Frequency 9.13
9.2.9	Link Symmetry for the Year 9.14
9.2.10	Link Symmetry as a Function of Time of Day for the Year 9.15
9.2.11	Comparison of Measured SINAD to Channel Score for the Year 9.16
9.3	Comparison With Communication Prediction Programs 9.17
9.3.1	Discussion of June 1993 Performance 9.17
9.3.2	Further Discussions of Select Davis-to-St. Kilda Oblique Ionograms 9.21
9.3.3	An Operational Example 9.23
9.4	Summary of the Defence Science and Technology Organisation (DSTO) Bit Error Rate (BER) Modem Tests 9.25
10	CONCLUSIONS AND RECOMMENDATIONS 10.1
10.1	Conclusions 10.1
10.2	Recommendations 10.1
10.2.1	Real-Time Frequency Management 10.1
10.2.2	HF/ALE Radio Within Antarctica 10.2

TABLE OF CONTENTS (Cont'd)

Section	Page
11 REFERENCES	11.1
APPENDIX A — ANTENNA PATTERN PLOTS	A.1
APPENDIX B — LIST OF PUBLISHED 1993 AND 1994 K _p DATA	B.1
APPENDIX C — SPECIFICS OF THE INITIALIZATION (INI) FILE	C.1
APPENDIX D — UPTIME DATA FOR ALL CIRCUITS	D.1
APPENDIX E — GLOSSARY OF SOLAR-TERRESTRIAL TERMS	E.1
APPENDIX F — GLOSSARY OF IONOSPHERIC DISTURBANCES	F.1

LIST OF ILLUSTRATIONS

Figure	Page
3.1 Example of an HF/ALE Handshaking Procedure.....	3.2
4.1 European Sites During Harris HF Trials	4.2
4.2 Harris Remotely Controlled Transceiver Configuration, RF-7166 System.....	4.2
4.3 Comparison of Actual Connection Achieved vs. IONCAP Prediction.....	4.4
4.4 MITRE's HF/ALE Network Nodes During 1988-1992 Campaign	4.5
4.5 Diagram of Node Hardware Configuration.....	4.5
4.6 Percent Messages Delivered vs. Local Time for Each Season	4.6
4.7 Sites for Initial 1992 HF/ALE Trans-Auroral Study	4.8
4.8 A View of One Leg of the Sloping-Vee Antenna in Christchurch	4.9
4.9 Hardware Configuration for HF/ALE Tests at Christchurch.....	4.9
4.10 Hardware Configuration for HF/ALE Tests at Black Island (McMurdo).....	4.10
4.11 Key Solar and Geomagnetic Indices for January 1992.....	4.11
4.12 LQA Score as a Function of Frequency and Time of Day for the Christchurch to McMurdo Circuit on 18 January 1992	4.11
5.1 View of HF/ALE Network.....	5.1
5.2 HF/ALE Network and the Limits of the Antarctic Polar Region.....	5.3
5.3 Mockup at Salisbury of the BER Test Setup for Davis	5.6
5.4 Site Positions and Orientations of the Network.....	5.8

LIST OF ILLUSTRATIONS (Cont'd)

Figure		Page
5.5	View of Black Island, McMurdo Station	5.10
5.6	Local Layout of Black Island Site.....	5.10
5.7	Physical Description of Black Island Sloping-Vee Antennas.....	5.11
5.8	NASU's Receiver Site at Christchurch	5.12
5.9	Christchurch-to-McMurdo Data Link	5.12
5.10	View of Davis Station from Anchorage Island	5.13
5.11	Representative HF/ALE Deployment in Davis, Antarctica.....	5.14
5.12	Site Plan for the DSTO HF/ALE Installation.....	5.15
5.13	Photograph of Typical Paddock Where Sloping-Vee Antennas Were Erected.....	5.15
5.14	Photograph of the Buildings at the HF/ALE Campaign Site at DSTO.....	5.15
5.15	Harris RF-7200-04 Adaptive Communications System, BER Analyzer, and Data Logger at DSTO Salisbury.....	5.16
5.16	Harris 5000B-125A 125-W, HF-SSB Base Station Transceiver	5.17
5.17	Representation of the Sloping-Vee Antenna Construction	5.20
6.1	View of the Spiral Structure of the IMF.....	6.3
6.2	Polar Region of Interest	6.5
6.3	Image of the Sun Showing Sunspots and Close-up of Sunspots.....	6.7
6.4	View of the Sun Showing Filaments and Prominences	6.8
6.5	View of Changes in a Solar Cycle	6.9
6.6	X-Ray of the Sun	6.9
6.7	<i>Solar Maximum Mission's</i> Coronagraph of Helmet Streams, April 1980	6.10
6.8	Heliographic Latitude for Flares and Active Regions and Latitudinal Distribution for Coronal Helmet Streams, Prominences, and CMEs.....	6.11
6.9	<i>Solar Maximum Mission's</i> Coronagraph of CMEs, October 1989	6.11
6.10	Calcium Image and Magnetogram of the Sun	6.13
6.11	Composite of Yearly Averages of the Magnitude of the Interplanetary Field and Sunspot Numbers, 1963 to 1993.....	6.14
7.1	Typical Antenna Azimuth Pattern.....	7.5
7.2	Typical Antenna Elevation Pattern	7.5
7.3	Christchurch-to-Black Island Expected MUF Days	7.11
7.4	Christchurch-to-Black Island Service Probability	7.11
7.5	Christchurch-to-Black Island Time Availability	7.12
7.6	Christchurch-to-Black Island SNR Median Decile	7.12
9.1	Sample Circuit Availability, Salisbury to McMurdo, 1994.....	9.4
9.2	Link Availability and Circuit Availability, Salisbury to McMurdo, 1994.....	9.5
9.3	Percent Availability by Frequency, Salisbury to McMurdo, Summer 1993	9.6
9.6	Number of Usable Frequencies by Season, Salisbury to Christchurch, 1994.....	9.8

LIST OF ILLUSTRATIONS (Cont'd)

Figure		Page
9.4	Percent Availability by Frequency, Salisbury to McMurdo, Winter 1993	9.7
9.5	Number of Usable Frequencies by Season, Salisbury to McMurdo, 1994	9.8
9.7	Percent Availability of Each Frequency Group by Season, Salisbury to McMurdo	9.9
9.8	Percent Availability of Each Frequency Group by Season, Davis to McMurdo....	9.10
9.9	Exceedance (90%, 50%, and 10%) for Best Frequency, Salisbury-to-McMurdo Link by Month, Spring 1993 (6-dB Minimum Measured SINAD).....	9.11
9.10	Exceedance (90%, 50%, and 10%) for Best Frequency, Salisbury-to-McMurdo Link by Month, Spring 1993 (12-dB Minimum Measured SINAD).....	9.12
9.11	Exceedance (90%, 50%, and 10%) for Best Frequency, Salisbury-to-McMurdo Link by Month, Spring 1993 (18-dB Minimum Measured SINAD).....	9.12
9.12	Exceedance (90%, 50%, and 10%) for Best Frequency, Salisbury-to-McMurdo Link by Season, 1993 (6-dB Minimum Measured SINAD)	9.13
9.13	Circuit Availability to McMurdo from Christchurch and Davis, Spring 1993	9.14
9.14	Link Symmetry for All Links, 1993-1994.....	9.14
9.15	Link Symmetry, Salisbury to McMurdo, 0000-0400 UT	9.15
9.16	Link Symmetry, Salisbury to McMurdo, 1200-1600 UT	9.16
9.17	Measured SINAD vs. Channel Score	9.16
9.18	Oblique Ionogram Between Cocos Island and Darwin, 1 October 1991, 1133:30 UT.....	9.18
9.19	Oblique Ionogram Between Davis and Salisbury, 8 June 1993, 0513 UT.....	9.18
9.20	ASAPS Predictions for Davis to Salisbury (and St. Kilda), June 1993	9.19
9.21	Pictorial Display of the Percent of linked ALE Frequencies.....	9.20
9.22	Daily Oblique Ionograms for Davis to St. Kilda, 26 May 1993 Through 4 June 1993.....	9.21
9.23	GOES-6 Solar X-ray and Particle Information, 26 May 1993 Through 31 May 1993.....	9.21
9.24	GOES-6 Solar X-ray and Particle Information for 10 March 1993 Through 16 March 1993.....	9.22
9.25	GOES-6 Solar X-ray and Particle Information for 18 February 1994 Through 24 February, 1994.....	9.22
9.26	Example of NASU Radio Log	9.23
9.27	Radio Log Entry at Christchurch, 0855 UT, 4 November 1992	9.24
A.1	Predicted Azimuth Antenna Pattern at Christchurch, 5 MHz, 29° Azimuth.....	A.2
A.2	Predicted Azimuth Antenna Pattern at Christchurch, 10 MHz, 25° Azimuth.....	A.2
A.3	Predicted Azimuth Antenna Pattern at Christchurch, 12 MHz, 22° Azimuth.....	A.3

LIST OF ILLUSTRATIONS (Cont'd)

Figure		Page
A.4	Predicted Azimuth Antenna Pattern at Christchurch, 15 MHz, 18° Azimuth.....	A.3
A.5	Predicted Azimuth Antenna Pattern at Christchurch, 20 MHz, 14° Azimuth.....	A.4
A.6	Predicted Azimuth Antenna Pattern at Christchurch, 25 MHz, 12° Azimuth.....	A.4
A.7	Predicted Azimuth Vertical Pattern at Christchurch, 5 MHz, 332° Vertical.....	A.5
A.8	Predicted Azimuth Vertical Pattern at Christchurch, 10 MHz, 360° Vertical.....	A.5
A.9	Predicted Azimuth Vertical Pattern at Christchurch, 12 MHz, 0° Vertical	A.6
A.10	Predicted Azimuth Vertical Pattern at Christchurch, 15 MHz, 0° Vertical	A.6
A.11	Predicted Azimuth Vertical Pattern at Christchurch, 20 MHz, 0° Vertical	A.7
A.12	Predicted Azimuth Vertical Pattern at Christchurch, 25 MHz, 0° Vertical	A.7

LIST OF TABLES

Table		Page
3.1	Manufacturers of Adaptive Communications Equipment	3.1
3.2	Required SNR for Various Link Probabilities as a Function of Noise Channels	3.3
5.1	Hardware Configuration of the Network During the Campaign.....	5.5
5.2	Test Frequencies	5.5
5.3	Pointing Direction of Antennas.....	5.8
5.4	Angle of Great Circle Path with Respect to (wrt) North and Distance Information from McMurdo to Other Nodes.....	5.9
5.5	Angle of Great Circle Path with Respect to North and Distance Information from Christchurch to Other Nodes	5.11
5.6	Angle of Great Circle Path with Respect to North and Distance Information from Davis to Other Nodes	5.13
5.7	Angle of Great Circle Path with Respect to North and Distance Information from Salisbury to Other Nodes.....	5.14
5.8	Harris RF-7200-04 Adaptive Communications System	5.18
5.9	Harris 5000B-125, 125-W, HF-SSB Base Station Transceiver	5.18
5.10	Harris 5000B-125A, 125-W, HF-SSB Base Station Transceiver	5.18
5.11	Parts Description for Sloping-Vee Antenna	5.20
6.1	1982 Recommendations on Research and Policy Issues to the PRB	6.2
7.1	ICEPAC Program Parameter List for Contour Plots	7.3
7.2	Site-Specific Antenna Parameters.....	7.4
7.3	Antenna Site Elevation Characteristics	7.5
7.4	ICEPAC Input Parameters	7.6

LIST OF TABLES (Cont'd)

Table	Page
7.5 Antarctic Seasons.....	7.7
7.6 K_p to Q_c Conversion Factor.....	7.7
7.7 Definition of the K_p and Q_c Abbreviations.....	7.8
7.8 Solar Activity Parameters	7.8
7.9 CCIR Man-Made Noise Levels.....	7.9
7.10 Partial Listing of Available ICEPAC Propagation Characteristics Displays	7.10
8.1 Link File Names and Corresponding Sizes	8.5
8.2 Types of Link Analyses	8.5
8.3 File Names Corresponding to the Binary Dataset and Their Corresponding Sizes	8.6
8.4 Criteria Used to Extract Hourly Performance	8.7
9.1 Sample Salisbury Hourly Station Uptime Data, January-February 1993	9.3
9.2 Sample Salisbury-to-McMurdo Hourly Circuit Uptime Data, January-February 1993	9.3
9.3 Listing of Solar Proton Events for 1992.....	9.25
C.1 Modem Control Strings	C.6

LIST OF ABBREVIATIONS AND ACRONYMS

AAD	Australian Antarctic Division
AAE	Australasian Expedition
AFB	Air Force Base
AFSK	Audio frequency shift keying
AGC	Automatic gain control
ALE	Automatic link establishment
ALF	Absorption limiting frequency
AM	Amplitude modulation
AMD	Automated message display
A_p	Aural indices
ASAPS	Advanced stand alone prediction system
ASCII	American standard code for information exchange
AWG	American wire gauge
Azim	Azimuth
BER	Bit error rate
BOF	Best observed frequency
bps	Bits per second
BUF	Best usable frequency

LIST OF ABBREVIATIONS AND ACRONYMS (Cont'd)

CCIR	Centre for Communication Interface Research
CHC	Christchurch, New Zealand
cm	Centimeter
CME	Coronal mass ejections
CSAGI	Special Committee for International Geophysical Year
CW	Continuous wave
DAnt	Destination Antenna
DAV	Davis, Antarctica
dB	Decibel
dBW	Decibel relative to a watt
Dest	Destination
DOD	Department of Defense
DOS	Disk operating system
DSTO	Defence Science and Technology Organisation
DTM	Data Text Message
Elev	Elevation
EOW	Engineering order wire
Es	Sporadic-E value
FEC	Forward error correction
FED-STD	Federal standard
FM	Frequency modulation
FMCW	Frequency modulated continuous wave
FOT	Lower decile value
FSK	Frequency shift keying
FTP	File transfer protocol
GOES	Geostationary operational environmental satellite
GPS	Global positioning system
GUI	Graphical user interface
HAARCP	Harris advanced adaptive radio control protocol
HF	High frequency
HF-SSB	High frequency-single side band
HF/ALE	High frequency/automatic link establishment
HFANT	High Frequency Antenna Design Program
HPF	High (upper) decile value
ICEAREA	ICEPAC Area Coverage Program
ICEPAC	Ionospheric Communications Enhanced Profile Analysis and Circuit Program
IGY	International geophysical year
IMF	Interplanetary magnetic field
INI	Initialization (file)
INMARSAT	International maritime satellite
INOCAP	Ionospheric Communications Analysis and Prediction Program
IPS	Ionospheric Prediction Service

LIST OF ABBREVIATIONS AND ACRONYMS (Cont'd)

IR/IED	Independent research/independent engineering development
ITS	Institute of Telecommunication Sciences
ITSA	Institute for Telecommunication and Aeronomy
kg	Kilogram
kHz	Kilohertz
km/sec.	Kilometers per second
K _p	Mean K-index (also geomagnetic index)
kw	Kilowatt
λ	Wavelength
LEO	Low earth orbiting
LQA	Link quality analysis (assessment)
LSB	Lower side band
m	Meter
MCC	McMurdo to Christchurch
MCD	McMurdo to Davis
MCM	McMurdo, Antarctica
MeV	Mega-electronvolt
MHz	Megahertz
MIL-STD	Military Standard
MILCOM	Military communications
MOD	Ministry of Defence
MOF	Maximum observable frequency
msec	Millisecond
MUF	Maximum usable frequency
NASA	National Aeronautics and Space Administration
NASU	Naval Antarctic Support Unit
NFEC	Naval Facilities Engineering Command
NOAA	National Oceanographic and Atmospheric Administration
NSF	National Science Foundation
NTIA	National Telecommunications and Information Administration
NUWC	Naval Undersea Warfare Center
NVI	Near vertical incidence
ONR	Office of Naval Research
PBER	Pseudo bit error rate
PC	Personal computer
pfu	Proton flux unit
PRB	Polar Research Board
Q _e	Effective Q-Index
R&D	Research and development
RADARC	Radio signal prediction program
RADAY	Radio day
RADM	Rear Admiral

LIST OF ABBREVIATIONS AND ACRONYMS (Cont'd)

RAM	Random access memory
RF	Radio frequency
RG	Radio group
Ri	International sunspot number index
RS-232	Recommended standard 232
S/N	Signal over noise ratio
SAIC	Science Applications International Corporation
SAL	Salisbury, Australia
SchType	Schedule type
SINAD	Signal-plus-noise-plus-distortion-to-noise-plus-distortion ratio
SNR	Signal-to-noise ratio
SPIDR	Space Physics Interactive Data Resource
SSB	Single sideband
U.S.	United States
USAP	U.S. Antarctica Program
USB	Upper sideband
UseChan	Channel used
UT	Universal time
VSWR	Voltage standing wave ratio
VOA	Voice of America
VOACAP	Voice of America Coverage Analysis Program
W	Watt
w.r.t.	With respect to

**SEASONAL PERFORMANCE OF A HIGH-FREQUENCY/AUTOMATIC
LINK ESTABLISHMENT (HF/ALE) RADIO NETWORK
OPERATING AT MID TO HIGH LATITUDES IN
THE SOUTHERN HEMISPHERE (VOLUME 1)**

1. INTRODUCTION

I firmly believe that there is a tract of land near the Pole, which is the source of most of the ice which is spread over this vast Southern Ocean.¹

Captain James Cook, February 1775

Terra Australis Incognita—the unknown land in the south—was, at its earliest, a product of inference. Like many new ideas, its basis was derived from fundamental shifts in the conventional wisdom of the day. It is likely that the concept of a large continent, perhaps even one like Antarctica, first entered into man's consciousness sometime in the third century BCE. Great thinkers like Aristotle regarded an earth flat in extent as a breach of observational commonsense. For them, it was clear that the Earth was a sphere. Though they² would have argued for the existence of Terra Australis Incognita as a necessary artifice to balance the large landmasses of the Northern Hemisphere, the demonstration of their postulation eluded explorers for nearly two millennia.

1.1 EARLY EXPLORATIONS

More than a placeholder, Terra Australis Incognita represented man's quest for the unknown. As voyagers became bolder, they literally stumbled into new waters, forgoing temperate seas for the near-freezing surface waters of the polar seas. By late seventeenth century, explorations of the seas below the Antarctic Convergence, Polar Front, became, if not routine, certainly fairly common. Initial sightings of Australia, later coupled with those of New Zealand, the islands of the southern Pacific, and the first ever west-to-east circumnavigation at southern high latitudes, convinced the English explorer Captain James Cook to declare that the mythical continent first conjectured by early Greeks could not possibly lie north of 60° south latitude. Later explorations lead Cook to surmise in 1775 that Antarctica, indeed all else that was formerly thought to constitute Terra Australis Incognita, must lie in that land frozen within the ice somewhere near the South Pole. It was not until 1821 that Antarctica was actually first sighted. Yet as fate would have it, it was not just one, but three individuals, each leading his respective national expeditions, who recorded sightings. Who was first is still an unsettled historical matter. In any event, from that period onward the voyages of the Russian polar expedition leader

Fabian Gottlieb von Bellingshausen, the Englishman Edward Broomsfield, and Captain Nathaniel B. Palmer, an American from Connecticut, would each in his own way assert his nation's privilege. At first, these were lucrative, peripheral, commercial fishing and hunting activities that gradually, as the century progressed, shifted toward exploration and scientific studies.

Unfortunately, national interests, claims, and counterclaims often supplanted research expeditions. By the late nineteenth century, with man's desire to explore the further reaches of the planet, exploration of the Earth's extremities began in earnest. Whereas the *Heroic Era* heralded great human accomplishments in planning, discovery, and fortitude, its greatest adjective may well have been tragic. Although Robert E. Scott and his party placed



second in the race to the South Pole, less than five weeks after Roald Amundsen and his men, their triumphant return would never be. By the early 1920s, aerial exploration became an efficient, and in some ways the preferred, observation platform for polar studies. Certainly, legendary were the exploits of Admiral Richard E. Byrd (pictured above, center) and his camp at Little America, but there were many others, from many nations who contributed. Gradually the emphasis shifted from short-term individual triumphs and defeats toward collective, long-term scientific efforts. Such an example was the rather ambitious geodetic survey of the Antarctic continent by the U.S. at the end of World War II, carried out over the course of two summer seasons as the U.S. Navy Antarctic Development Project (1946-1947) and the U.S. Navy Second Antarctic Development Project (1947-1948).

In the eighteenth and nineteenth centuries, scientific data, particularly from geomagnetic and seismic observatories, were routinely published in annual station books. So, too, were expedition results, although the more celebrated voyages were venerated as well in public and private clubs and meetings. By the end of the nineteenth century, the world's scientific community was beginning to formulate a concerted international approach toward Antarctic research. The first large-scale international efforts were the International Polar Years of 1882-1883 and 1932-1933. Nearly 150 years after the multinational discovery of Antarctica, international cooperation culminated with a concord to establish the International Geophysical Year (IGY). The planning for the IGY was coordinated by the International Council of Scientific Unions³ through a Special Committee for the IGY (CSAGI). Under its direction, CSAGI coordinated scientific observation mainly in the Antarctic region, with the express purpose of understanding primarily the geophysical aspects of the earth and its environment. From 1 July 1957 to 31 December 1958, scientists from 12 nations established some 60 scientific stations and visited most parts of the Antarctic continent. The CSAGI established the World Data Center system to service the IGY and developed data management plans for each of the IGY disciplines.

Stimulated by the success of the IGY, the 12 so-called Antarctic nations signed the Antarctic Treaty in Washington, DC, in 1959. Now expanded in membership, the Antarctic Treaty provides that Antarctica shall be used only for peaceful purposes.⁴

1.2 REPORT BACKGROUND

Today the emphasis in Antarctic research has shifted toward a global viewpoint guided by the desire to understand the history of our planet, our impact on the environment, and the evolution of the universe. Likewise, the support and communication services required have quickly changed. A few short years ago, high-frequency (HF), shortwave radio was the primary means of communication both within and off the continent. Now satellite-based communication services are the backbone of international transactions to and from McMurdo Station, with similar, although more restricted, capabilities provided on station at the South Pole.

E-mail, the Internet, telemedicine, high data rate telephone circuits, and television broadcasts are just a few of the services that are now provided through satellite relay between regions rich in telecommunication resources and those traditionally remote and wanting. As low earth orbiting (LEO) satellite services increase from the short messaging type currently in service to more sophisticated universal telephone services provided by iridium-like systems of the future, both service bandwidth and geographical coverage constraints will diminish. At that point, even remote Antarctic field parties will be in a position to entertain some of the services recently acquired at McMurdo and the South Pole, but long taken for granted in much of the U.S. and elsewhere.

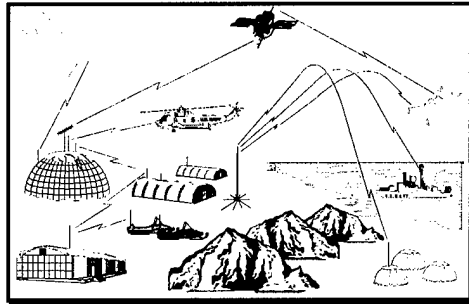

This report backs up the clock a bit. It broadly addresses the needs of a community that was less able to enjoy the benefits of satellite services. Its antecedents lie, in part, in portions of the communications recommendation of the U.S. Antarctic Program (USAP) Safety Review Panel Report⁵ of 1988. The recommendation stated that "... high priority attention should be directed to improvement of field party communications." Specifically:

- Immediate attention should be placed on improvement in the maintenance of HF equipment for remote field parties; and
- Near-term evaluation and field testing of meteor-burst communications should be performed.

An earlier report⁶ presented the details of the Naval Undersea Warfare Center's (NUWC) meteor-burst communications tests in Antarctica during December 1992. This report is a detailed examination of the comprehensive role that frequency management could play in mediating the daily operations of HF links between stations at high latitudes. The 1992 report recounts an attempt to investigate the utility of employing, within the USAP, the developing HF technology known as automatic link establishment (ALE) as a possible solution to a wide variety of both inter- and intra-continental communications needs.

2. HIGH FREQUENCY (HF) COMMUNICATION SERVICES IN ANTARCTICA

*The radio beyond doubt has ended the isolation of this ice cap. As a practical thing, its help is priceless. But I can see where it is going to destroy all peace of mind, which is half the attraction of the polar regions. Our external difficulties must always be with us.*⁷

Rear Admiral Richard E. Byrd, January 1929

The very first radio services present in Antarctica were considered to be the product of Sir David Mawson's second Antarctic expedition, known as the Australasian Expedition (AAE), that extended from December 1911 until February 1914. Mawson, perhaps Australia's greatest Antarctic explorer, established communications from Terre Adélie to Tasmania by way of a relay station on Macquarie Island. Terre Adélie, or Land Adélie, was the AAE Main Base (winter camp) at 142°40'E in King George V Land, an enlarged portion of which was formally annexed to France in 1938. In his geographical journal of 1914, Mawson wrote:⁸

It was our intention to land several self-contained wintering parties at widely separated points between longitude 90° E and 158° E, each to make continuous scientific records at the base-station, and to investigate the surrounding region by sledge journeys. On the southward voyage, a party was also to be left at Macquarie Island, a little known possession of the Commonwealth. Wireless telegraphy was to be used for the first time in Polar exploration, our Macquarie Island station transmitting Antarctic news to Hobart (Tasmania).

In less than a decade, a number of discoveries, inventions, and experiments had occurred that enhanced and altered commercial and scientific practices. In May 1925, a paper describing signal strength measurements taken at sea while circumnavigating the world via Australia was read by Captain H. J. Round before the Wireless Section of the Institute of Electrical Engineers in England. At the meeting, he spoke not only in great detail about his colleagues' tests during 1922 and 1923, but of the many researchers who supported them, noting that:⁹

Here (in Brazil) the first use of the instruments (measuring gear) was made to determine the strength of atmospherics, the strength being defined as the E.M.F. required to be inducted in the aerial in order to enable signals to be read at 20 words per minute.

This may be of questionable scientific value as a measurement, but is undoubtedly of great practical value, as it enables one to indicate how much stronger the transmitter must be to give a commercial service.

In 1925, Appleton and Barnett¹⁰ reported direct evidence that the ionosphere existed by proving experimentally that a reflecting layer was present in the upper atmosphere. A year later

in 1926, Breit and Tuve¹¹ first reported pulse sounding the ionosphere, a procedure that is repeated daily to this day.

By 1929, a diary entry by Byrd (quoted previously) revealed the mixed emotions about external communications that to this day dogs many visitors to the Polar regions. From a subsequent entry,⁷ a little more than three weeks later:

I am anxious to undertake the flight to King Edward VII Land. The Fairchild is ready, but it would be silly to attempt it until the weather man gives the word.

We further tested the radio today, and Malcolm Hanson managed to "speak" with Fred Meinholtz, chief of the radio staff of the New York Times, and the operator at the Mussel Rock Radio Station of the Robert Dollar Company, San Francisco. Signals were sent out on a wavelength of 34 meters.

2.1 TRADITIONAL U.S. ANTARCTIC PROGRAM (USAP) HF COMMUNICATION PROCEDURES

For many years, HF communications were the primary mode for long-haul communications between Antarctica and the outside world. In recent times, the two principal focal points for the USAP operations were the message centers in Christchurch, New Zealand, and in McMurdo Station, Antarctica. Traffic from various points was funneled through these operations, which routinely handled 10,000 to 20,000 messages monthly during the peak summer months. Within Antarctica, the station at the South Pole often served as a surrogate message center during periods of HF propagation disruptions, acting as an alternative routing point for traffic originating deep in the continent or at Palmer Station on the Antarctic panhandle and even for McMurdo itself.

Up until around 1994, daily HF communications for the USAP were conducted on five frequencies. Two transmitter frequencies, known as US-18, were assigned for transmissions from McMurdo and three transmitter frequencies, called US-19, were used at Christchurch. These frequencies could be spelled from a larger assigned set as propagation conditions changed. If communication disruptions lasted more than 30 minutes, site personnel were instructed to follow the procedures outlined in the site's manual for "Blackout Procedures for US-18/US-19."¹² Disruptions were caused by either a temporary communications blackout due to severe fading or a complete loss of the communication channel due to either the occurrence of a geomagnetic storm or a polar cap absorption event.

In essence, this meant that the watch supervisor at each station was required to step through a hierarchical set of coordinated procedures that combined HF voice, U.S. Navy satellite communications, and, finally, commercial or international maritime satellite (INMARSAT) links. In the first instance, if the coordination procedures proved unsuccessful, then each station was instructed to transmit in the blind, announcing that it was conducting operations using the blackout frequencies, i.e., a primary, a secondary, and four tertiary frequencies. Each station was to remain at the primary and secondary frequency until communications had been reestablished,

while the tertiary frequency changed every 30 minutes on the hour and half-hour points. In addition, given enough receivers, the procedures suggested that the last good operational frequency should also be monitored. In practice, the procedures did not work very well, as the sequencing through the various frequencies would often go awry. Once this occurred and conditions still failed to improve, the last resort to coordinate the frequency suite was to place an expensive telephone call between the two stations via INMARSAT.

Receiver equipment consisted of Harris R-101 receivers and several Rockwell-Collins MD-2002 high-speed modems. The receiver designs dated back to the late 1960s and early 1970s, though several major revisions were installed through at least the early 1980s. The exact revision of each receiver was not inventoried for this study. The transmitters, nominal 10-kW units, were also of the same vintage. Because of their age and the difficulty in maintaining not only the units themselves but a bona fide parts depot, the power amplifiers routinely operated at degraded levels usually around 4 kW.

At Christchurch,¹³ the primary receive antennas for traffic from McMurdo were two rhombic antennas thought to be RD-3, with a received gain of 13.5 to 22.5 dB in the frequency range from 6 to 26 MHz. Similar rhombic antennas were used for transmissions at the Christchurch transmitter site. Several broadband conical monopoles and a rotatable log periodic antenna, though not routinely used for message traffic, provided flight-following coverage for aircraft enroute between Christchurch and McMurdo. In McMurdo, newer rhombic antennas were installed at the receive site on Black Island, a distance of roughly 12 km from downtown McMurdo Station. A more extensive discussion of the operations, procedures, and equipment for the communications facilities at both Christchurch and McMurdo can be found in a report by Smith et al.¹⁴

2.2 CURRENT USAP COMMUNICATION PRACTICES

In later years, coincidental with the period that this campaign was active, there was a decided shift away from reliance on HF radio communications. The introduction of a T₁ satellite data service link to McMurdo late in the 1992-1993 austral summer provided a 672-kbps tie into the Internet, as well as 4 telephone lines into McMurdo Station and 20 lines out. The remaining 1/4 T₁ could either be used to improve or augment a number of other telecommunications services such as the existing Internet service or video teleconferencing. At the time, improved services were also planned for the South Pole station. A 1/3 T₁ link providing a three-hour per day accessibility via the GEOS-3 satellite (geosynchronous) was scheduled for completion during the austral summer of 1995/1996. The communications shortfall at the South Pole station remains a concern and was itself the subject of the only recommendation listed under the telecommunication heading by the USAP External Panel report of 1997.¹⁵ The recommendation was that the National Science Foundation (NSF) should seek advance arrangements with government and commercial geostationary satellite operators to make such satellites systematically available as they near the end of their economic commercial life.

Initially, the introduction of satellite communications at McMurdo Station did not remove all requirements for HF communications for the Antarctic continent. HF provided needed flight-

following coverage information, communication links to the U.S. Coast Guard and other marine operations, and remote field party communications. Because of its universality, HF remains the lowest common denominator radio communications service to all the other international research stations and facilities both on and off the continent.

It is within the context of these community needs that the results of this report are presented. A number of periodic dependencies (solar, seasonal, diurnal, etc.) and non-periodic events (magnetic storms, polar cap absorption, etc.), coupled with actual link geometry, all need to be well understood, particularly during periods of communication outages, which is a not-so-uncommon feature at these high latitudes. It is the statistical nature of these dependencies that is so vexing at HF.

3. DEVELOPMENT OVERVIEW OF AUTOMATIC LINK ESTABLISHMENT (ALE) STANDARDS

An ALE technology for high frequency/automatic link establishment (HF/ALE) radios has been developed to coordinate frequency selection between communications terminals to adapt to skywave channel conditions. This development was an outgrowth of a worldwide process that began in the early 1980s and evolved over several years. The goal was to lessen the vagaries of the HF channel through the implementation of adaptive schemes. Within this period, several radio manufacturers¹⁶ on both sides of the Atlantic actively developed their own approach. By the 1980s, communicators were faced with many choices, some of which are listed in table 3.1. The trouble was both in the number and variety of choices. Often the subjectivity of the stated measures of performance made cross-comparisons and interoperability between the various vendors difficult to impossible.

Table 3.1. Manufacturers of Adaptive Communications Equipment¹⁶

Manufacturer	Trade Name
Sunair	SCANCALL
Rhode & Schwarz	ALIS
Standard Radio & Telefon	ARTRAC
TransWorld	TRANSCALL
Harris/RF Communications	AUTOLINK
Tadiran	MESA
Rockwell/Collins	SELSCAN

During this same period, the National Security Decision Directive 97¹⁷ set in motion a U.S. government requirement for interoperable communications among functionally similar equipments. The specifics of the processes that transpired to enact this capability are well documented (see Adair¹⁸). Gene Harrison, of Mitre Corp., is generally attributed with laying the foundation for the ensuing ALE family of standards.^{19,20}

The outcome of this procedure was a set of standards, i.e., federal standard FED-STD-1045²¹ and military standard MIL-STD-188-141A.²² The federal standard specified detailed parameters for the ALE signal, automatic linking protocols, link quality analysis (LQA), and basic guidelines for radio configuration. An update to the federal standard (FED-STD-1045A²³) was issued in October 1993.

In response to the standards development process, six American vendors decided to develop implementations of the standard. As the six manufacturers displayed their offerings, it was clear that each had their individual interpretation of the standard. Some vendors chose to develop the radio system, i.e., the transceiver and ALE controller, as a set of individual modules.

Others developed the radio using a single bus system, with one manufacturer incorporating it into a standard personal computer (PC) bus architecture. Hardware and software protocols were also unique. The standard was meant to provide a common document from which all vendors could offer their individual products in the marketplace. The task of determining which vendors' products were in compliance with the federal standard fell to the Department of Commerce. Testing showed that all six of the original vendors were eventually compliant. A brief review of the federal testing procedures to determine performance and interoperability of the different implementations of the ALE HF standard was described by Wortendyke and Riddle.²⁴

Combining 8-ary frequency shift keying (FSK) with forward error correction (FEC), the specifications in the standard results in a robust modem performance in channel environments prone to high bit error. The decoder obtains a two-out-of-three majority vote to further achieve this performance. The triple redundant encoding is coupled with Golay encoding and bit-interleaving. Also a part of the standard is the three-way handshake for a selective call from station A to station B. The ALE calling sequence is structured as follows. Figure 3.1 illustrates an example of Christchurch (CHC) calling McMurdo (MCM). At time $t = 0.0$ seconds, the originator radio (CHC) initiates a scanning call at a given frequency. The scanning radio (MCM) has a 10-second window within which to respond; during this 10-second period, the scanning radio stops scanning. At $t = 10.0$ seconds, the scanning radio (MCM) will initiate a response; and by $t = 11.5$ seconds, the response is received by the originator radio (CHC). By $t = 13.0$ seconds, the originator radio sends an acknowledgment to the scanning radio and the link is established.

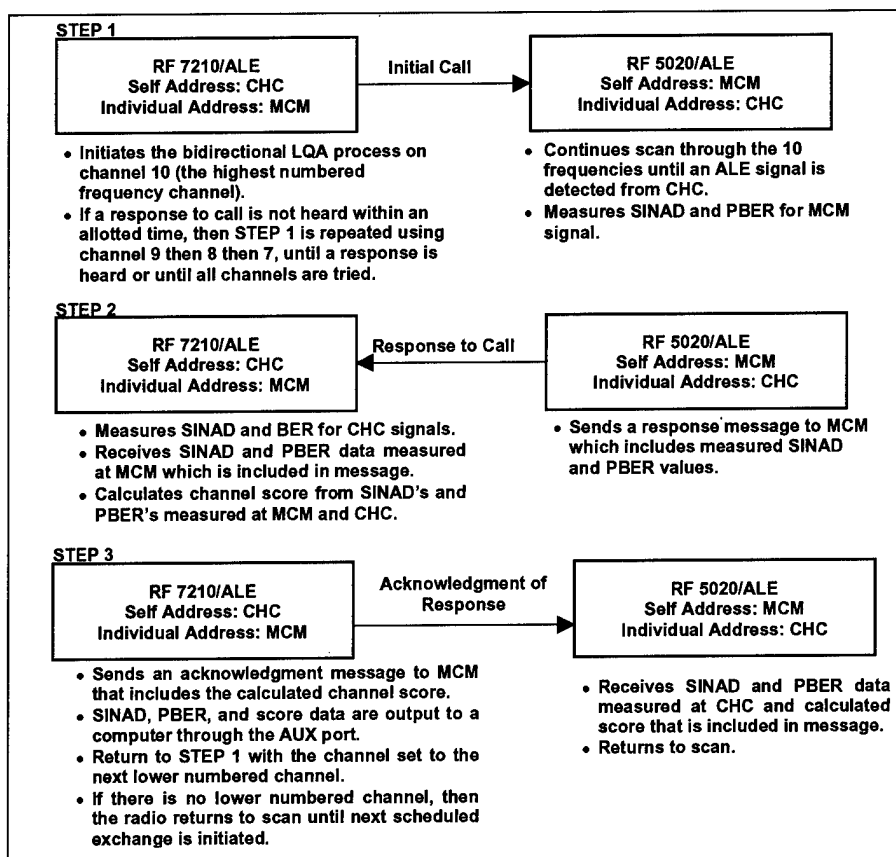

Figure 3.1. Example of an HF/ALE Handshaking Procedure²⁵

The actual prospect of linking is a function of both the signal-to-noise ratio (SNR) and the type of channel noise encountered. The probability of linking²³ as a function of SNR for several types of noise in a 3-kHz bandwidth is presented in table 3.2.

Table 3.2. Required SNR for Various Link Probabilities as a Function of Noise Channels²³

Probability of Linking	SNR in a Gaussian Noise Channel (dB)	SNR in a CCIR Good Channel (dB)	SNR in a CCIR Poor Channel (dB)
≥ 0.95	0.0	8.5	11.0
≥ 0.85	-0.5	5.5	6.0
≥ 0.50	-1.5	2.5	3.0
≥ 0.25	-2.5	0.5	1.0

4. SUMMARY OF PREVIOUS HF/ALE COMMUNICATIONS TESTS

Over the last 10 years, a number of field studies evaluated the capabilities and limitations of HF/ALE-communications systems operating primarily in mid-latitudes. Some were specific in the problem they posed, e.g., the potential use of HF/ALE for point-to-point shipboard use²⁶ or tests to evaluate HF/ALE's inherent channel sounding capability for at-sea frequency selection.²⁷ Others positioned HF/ALE as a candidate for an automated HF-communications system. In the process, simulation studies enacted several implementation strategies^{28,29,30} to best answer such questions as the maximum number of initiating nodes, traffic capacity, and network topology.

4.1 EARLIER HIGH-LATITUDE, HF/ALE-COMMUNICATIONS TESTS

The picture was somewhat different for high-latitude implementations. Before the first years of this study, there had been an attraction to HF/ALE as a surrogate frequency manager in the highly dynamic environment of the high latitudes. While initial tests and evaluations were carried out by various researchers near or within high-latitude regions, none were performed for any extended periods of time, nor compared results during both benign and disturbed propagation conditions. One of the earliest of the high-latitude tests was conducted in the late 1980s by Harris Corporation along a trans-auroral path in Norway.³¹ Other studies at sub-auroral latitudes were conducted in northern Canada under the auspices of the Canadian Ministry of Defence (MOD).³² More recent studies in the early 1990s have qualitatively compared a Rhode & Schwarz ALIS HF-communication transceiver with an ALE implementation for use between various French and Italian bases in Antarctica.³³ No studies prior to this have sought to determine the behavior of an HF/ALE FED-STD-1045/MIL-STD-188-141A-compliant network operating at geographically high latitudes.

4.1.1 Trans-Auroral Tests in Norway (1988-1989)

As noted, the Harris Corporation, through its Radio Frequency (RF) Communications Group in Rochester, NY, carried out an HF campaign over a number of links within Norway and with elements of the British Royal Navy both afloat in the Norwegian Sea and ashore in southern England, near London. Two of the sites, North Cape and Bodø (see figure 4.1), were, respectively, within and near the normal limits of the auroral region. The campaign lasted for approximately 6 months and included evaluations during the major geomagnetic storm of 13 March 1989. There were four purposes³¹ for the tests:

- Evaluation of consistent operation by minimally trained operators,
- Evaluation of HF connectivity in the Auroral Zone,
- Evaluation of high-speed data transmissions and voice communications within and across the Auroral Zone, and
- Evaluation of the adequacy of conventional, non-automated techniques for HF-link establishment and the benefits of ALE.

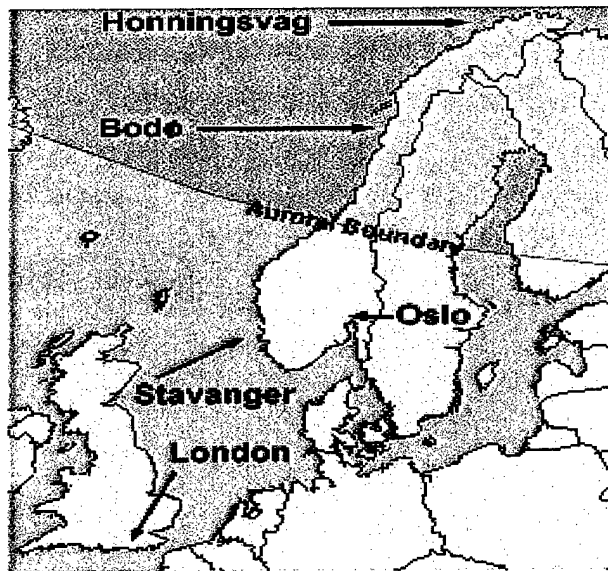

Figure 4.1. European Sites During Harris HF Trials³⁴

Link separations ranged from approximately 450 km for the Bodø to North Cape circuit to approximately 2000 km for the circuit(s) operating to the ashore site in southern England. However, as the report focuses on link performance within Norway, the later transnational circuits are not included. The equipments used (figure 4.2) included the Harris Corporation RF-7166 series 100-W adaptive HF digital data communications system, also referred to by its trade name the AUTOLINK system. This system was one of the many early ALE contenders. Many of the features of the AUTOLINK system were eventually incorporated and specified in the federal and military standards.

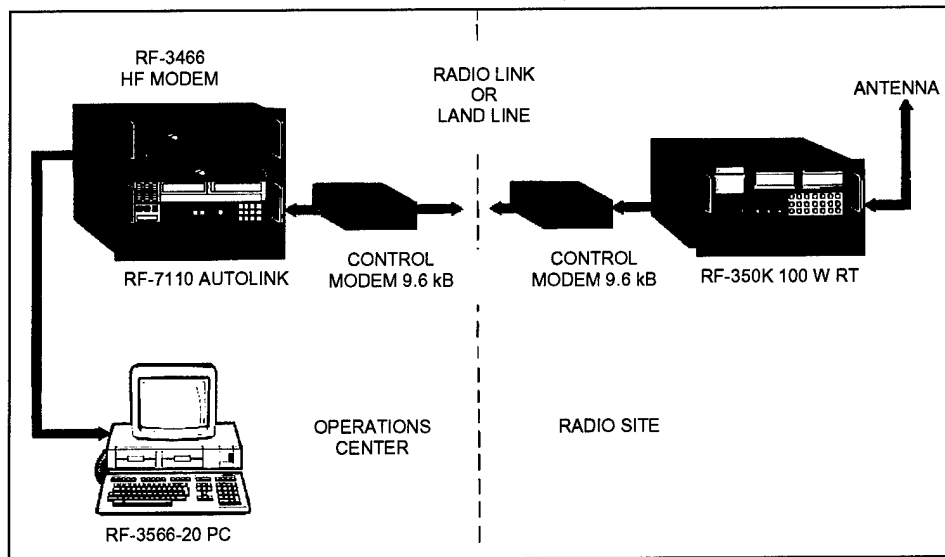

Figure 4.2. Harris Remotely Controlled Transceiver Configuration, RF-7166 System³⁴

Specifically for the tests, the optimum frequency of transmission was determined by a process similar to that contained in today's standards. The communication path was evaluated for signal quality by taking into account the effects of SNR and interference at each end of the link for each frequency (between 15 and 25 were used) that could support propagation. This procedure was called the LQA or link quality assessment and a similar LQA procedure is at the heart of the current HF/ALE standards.

For the most part, the conclusions relate interesting insights about HF communication requirements, the limitations of employing a propagation prediction program, and the capriciousness of high latitude propagation conditions. The recommendations are also applicable today for any routine regional and extra-regional point-to-point or network operation. Thus, both the Harris conclusions and recommendations are quoted below.

The Harris report³¹ concluded:

- The Ionospheric Communications Analysis and Prediction Program (IONCAP), an HF propagation prediction program, was useful in predicting daytime propagation frequencies. Predictions tended to be several megahertz low (figure 4.3), but it could be corrected using real-time measurements. Night time hours showed considerable sporadic-E propagation above the IONCAP predictions.
- Large hourly and daily variations of propagation conditions pointed to the necessity of real-time channel evaluation.
- Propagation throughout the day was normal during periods of high sunspots, though the range of frequencies propagating was not consistent ("thin" vs. "thick").
- Sporadic-E was present during most nights and was most common between 1800 and midnight. Propagation above 20 MHz was not unusual.
- Connectivity dropped during the mid-March 1989 solar disturbances, but HF propagation was still available during certain periods of the day. Propagation at midnight was the most reliable, due to enhanced development of sporadic-E.

The Harris report³¹ recommended:

- Learn the environment. Use a device that can record propagation phenomena thoroughly, automatically, and easily. Data should be collected quantitatively to allow automated numerical analysis at a later date. Propagation in both directions of the link should be measured to allow for nonreciprocity. Testing should be automated to allow routine around the clock, unmanned operation. Data collection equipment should be easy to encourage error free and non-tedious operator control.
- Apply the knowledge for channel selection. Real-time channel evaluation is the best indicator of the propagation conditions and should be the primary factor in the channel selection process. Variation of HF factors (sunspots, sporadic-E, magnetic storms, etc.) reduces the effectiveness of both propagation prediction programs and the previous

day's results, in the channel selection process. The optimum solution is to combine real time measurements, computer prediction, and recent historical data when predictions are made.

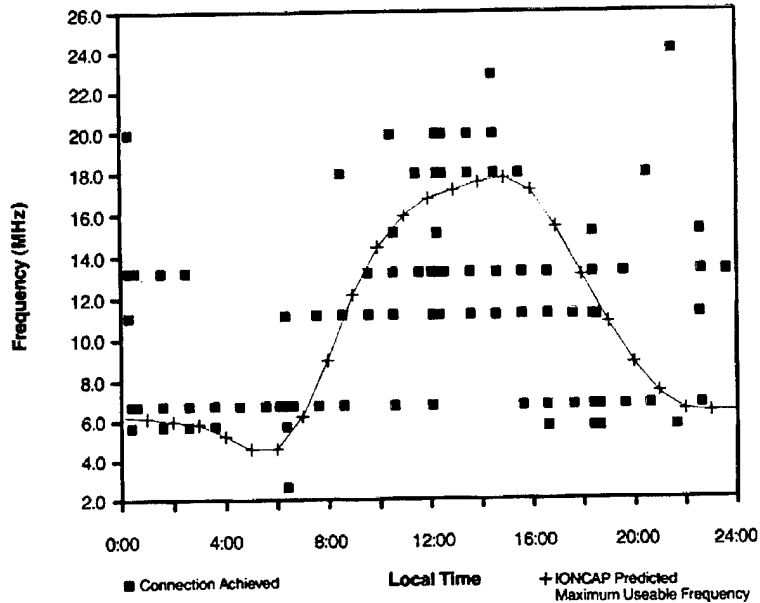

Figure 4.3 Comparison of Actual Connection Achieved vs. IONCAP Prediction³⁴

4.1.2 Alaskan HF Test Network (1989-1992)

Another test of an earlier version of ALE using the Harris AUTOLINK system was developed by the MITRE Corporation³⁵ in coordination with the U.S. Air Force's Electronic Systems Division and the Alaskan Air Command. This was by far a more ambitious program than the program in Norway, as it attempted to perfect the techniques for frequency selection, ALE, automatic route selection, and store-and-forward relaying for a network. The network itself consisted of eight nodes, all of which were subject to disruption from auroral activity. (A more thorough discussion of the 15-month campaign can be found in the MITRE report.³⁵)

Figure 4.4 shows the location of each of the eight nodes, which were all located in a military facility within Alaska. The specific sites were Elmendorf Air Force Base (AFB), Eielson AFB, Shemya AFB, Galena Air Force Station, Adak Naval Station, and long range radar sites at Cape Lisburne, Cape Romanzof, and Cold Bay. Additional test nodes existed for portions of the test at the MITRE Corporation in Bedford, MA, and Peterson AFB, CO. Path lengths for the Alaskan network ranged from approximately 400 km to 1700 km.

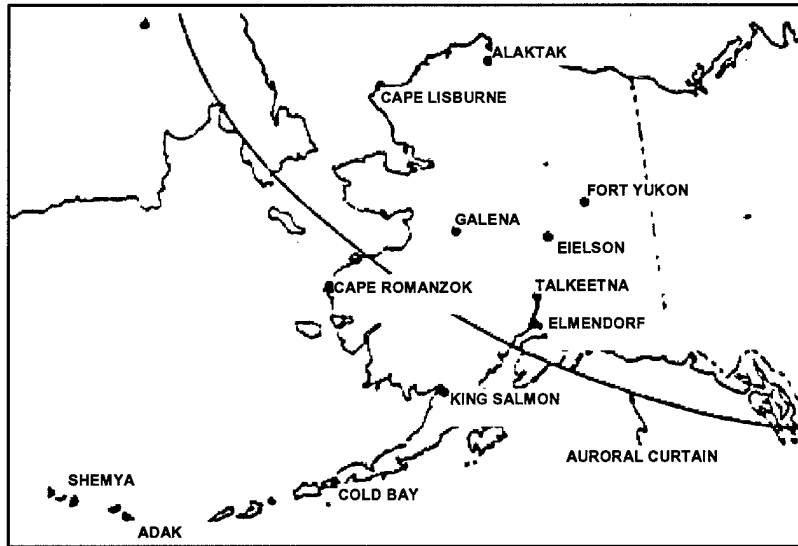

Figure 4.4. MITRE's HF/ALE Network Nodes During 1988-1992 Campaign³⁵

The AUTOLINK system at each node, as well as network control, was operated under software developed by MITRE expressly for the project. The network control software made routing decisions and automatically relayed messages when necessary. It also allowed operators to use the PC at each node to send and receive messages and to control the operation of the radio equipment. Databases were maintained on the PC that contained updated diagnostic information about node operation, as well as link and network performance. Figure 4.5 shows the typical node hardware configuration.

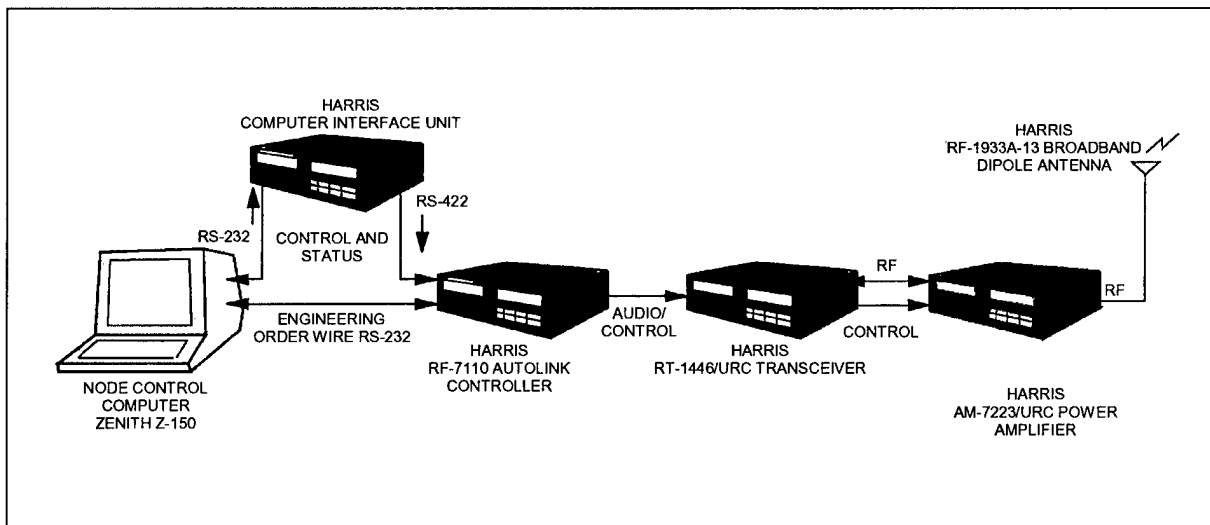

Figure 4.5. Diagram of Node Hardware Configuration³⁵

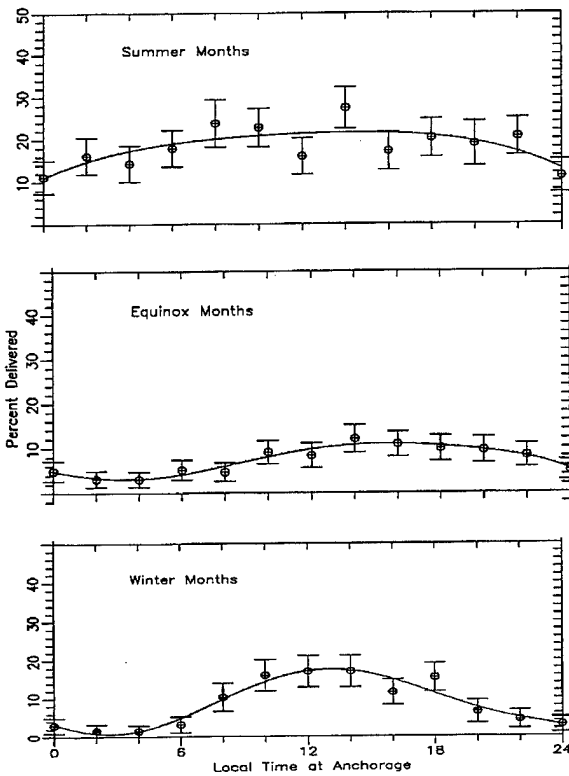

Figure 4.6 Percent Messages Delivered vs. Local Time for Each Season³⁵

The performance of the network was less than desired. It was claimed that it was difficult to maintain the radio and computer equipment in widely dispersed, remote areas for extended periods of time. The restrictive, required SNR limited actual performance. Over the 15 months that the network was in operation, the network delivered 11 percent of the messages generated. This ranged from a low for a given month of 3 percent prior to a field maintenance visit to as high as 27 percent after equipment repair.

Once a link was established, message delivery times were fairly rapid being sent either directly or by means of relay. The average delivery time was 12 minutes, with 78 percent of all messages delivered to their destinations in 10 minutes or less. Message delivery was also seasonally dependent, as shown in figure 4.6. For most of the day, all paths at Alaskan latitudes are to one degree or another predominantly sunlit during the summer season. The effect of the duration of the sunlight illumination period is evident in each of the seasonal summaries.

It is interesting to expand a bit further on the network's operations. The network's rate of success in establishing links was quite low, i.e., an average of only five percent. This was explained³⁵ as being a result of the following factors:

- low power used during link setup;
- high SNR required by the AUTOLINK system, specifically the RF-7110 to establish a link;
- signal losses due to auroral absorption and other auroral effects;.
- nodes not being able to service incoming calls because they were too busy processing their own link setup attempts, and
- noise and interference at the receivers.

MITRE³⁵ conducted a Monte Carlo simulation to determine network performance without equipment problems; the results were equally discouraging. In one such run, the simulations demonstrated a 27 percent success rate in message deliveries, counter the 13 percent that was actually delivered. Such delivery times were still wanting. The poor performance was attributed

to insufficient link gain margins among the various network links considering the variability of the prevailing propagation conditions.

Specific among the MITRE conclusions³⁵ were the following:

- The Alaskan test network was one of the first HF networks using automatic network control to be tested in the field. The test showed that maintenance of the network equipment is crucial for successful operation; it was observed in the data that the network performance improved significantly each time MITRE staff traveled to Alaska for site maintenance and steadily deteriorated in the succeeding months.
- Even in months with relatively few equipment problems, such as December 1989, the network suffered from a very low rate of success in establishing links.

... to raise the message delivery rate (from the actual 14 percent) to 90 percent without any modifications to the network protocols, it was necessary both to eliminate the equipment failures and to increase the simulated link SNRs (or reduce the SNR required to set up a link) by 15 dB. ... similar modifications would be needed for satisfactory performance in other months.

Particularly noteworthy of the MITRE recommendations³⁵ were the following:

- It is recommended that future systems in Alaska use a link establishment device conforming to the 141A standard and a robust modem conforming to the 110A standard. Use of the 141A waveform should significantly improve the network's ability to establish links. The SNR required to establish a link using a 141A device is considerably lower than that required by the RF-7110; the exact improvement depends on the type of ionospheric channel. Use of a robust data modem conforming to the 110A standard would allow the network links to operate more reliably at low data rates, comparable to the 100-bps information rate used in the Alaskan network test, and to operate at higher data rates when the ionospheric channel would support them.
- With additional link gain and with no equipment failures, the simulation predicted (based on IONCAP) that the Alaskan network could have performed satisfactorily at its experimental network traffic load of about seven messages per hour with its existing protocols for message queue management and route selection. To allow the network to handle a larger volume of traffic, modifications to those protocols would be needed. Simulation analysis of HF networking carried out since the Alaskan network was fielded have suggested possibilities for improving the protocols used in managing the message queue and making routing decisions. Because of the time used by the group LQA sounding process, and the fact that group LQA sounding is not an automatic feature in the 141A standard, it is worthwhile to

consider other route selection techniques that do not rely on group LQA information. Such protocol improvements have the potential for increasing the percent of messages delivered and allowing the network to handle a heavier traffic load.

Finally the MITRE report³⁵ noted:

In some ways the Alaskan network design has become outdated since the test network was fielded; any operational network developed from the test network would require many modifications in both hardware and software. The Alaskan network equipment does not conform to the recently adopted Department of Defense (DoD) standard for ALE (MIL-STD-188-141A), or the coordination draft standard for data modems (MIL-STD-188-110A). Compatibility with these standards is mandated.

4.1.3 Trans-Auroral Tests to Antarctica (1992)

In January 1992, tests over a trans-auroral path in the southern hemisphere were conducted by NUWC²⁵ under sponsorship of several organizations that included the NSF, the Office of Naval Research (ONR), and NUWC's Independent Research/Independent Exploratory Development (IR/IED) Program Office. The tests were set up to evaluate the potential efficacy of real-time frequency management across a trans-auroral link between Christchurch, New Zealand, and McMurdo Station, Antarctica (figure 4.7), a distance of approximately 3800 km.

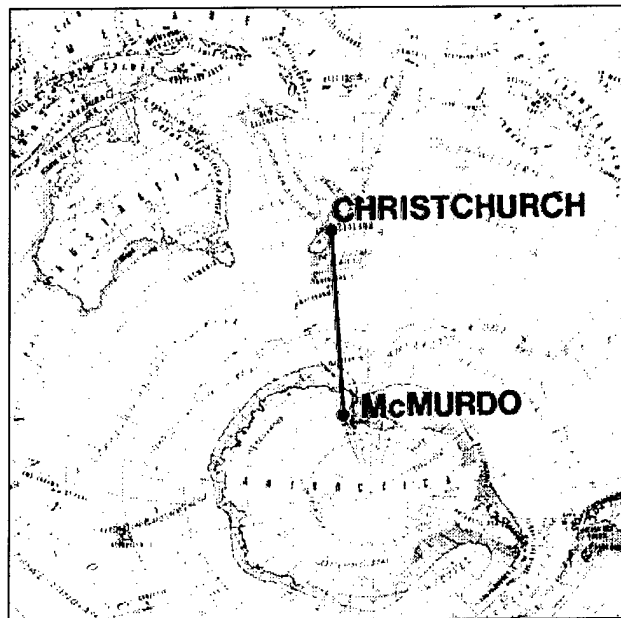

Figure 4.7. Sites for Initial 1992 HF/ALE Trans-Auroral Study²⁵

The transceivers used at the two locations complied with both federal (FED-STD-1045) and military (MIL-STD-188-141A) standards. This provided automatic HF management through a combination of selective calling, LQA, ALE, and automatic radio control. Figures 4.8, 4.9, and 4.10 show the hardware configuration used during the initial evaluations of the HF/ALE radio at both receiver sites at the U.S. Naval Antarctic Support Unit (NASU) in Christchurch and at the U.S. Naval Support Force Antarctica (NSFA) on Black Island, near McMurdo Station.



Figure 4.8. A View of One Leg of the Sloping-Vee Antenna in Christchurch

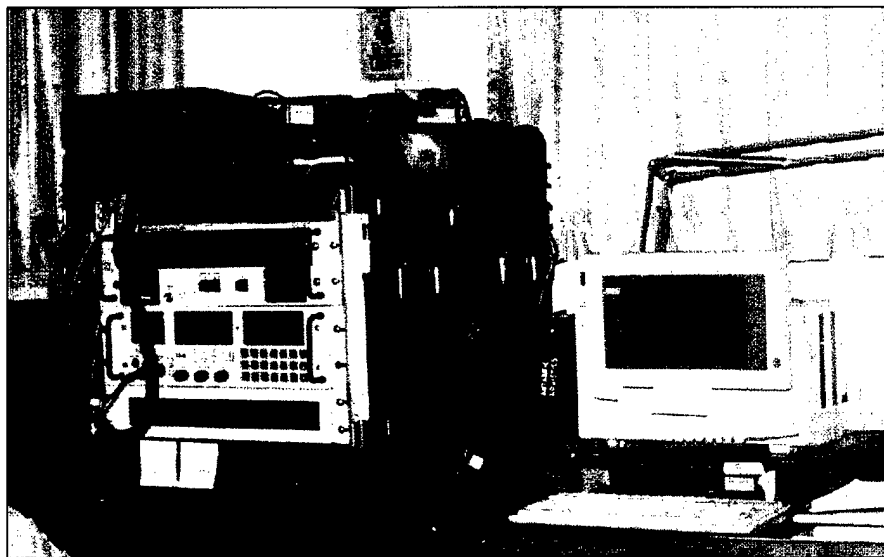

Figure 4.9. Hardware Configuration for HF/ALE Tests at Christchurch

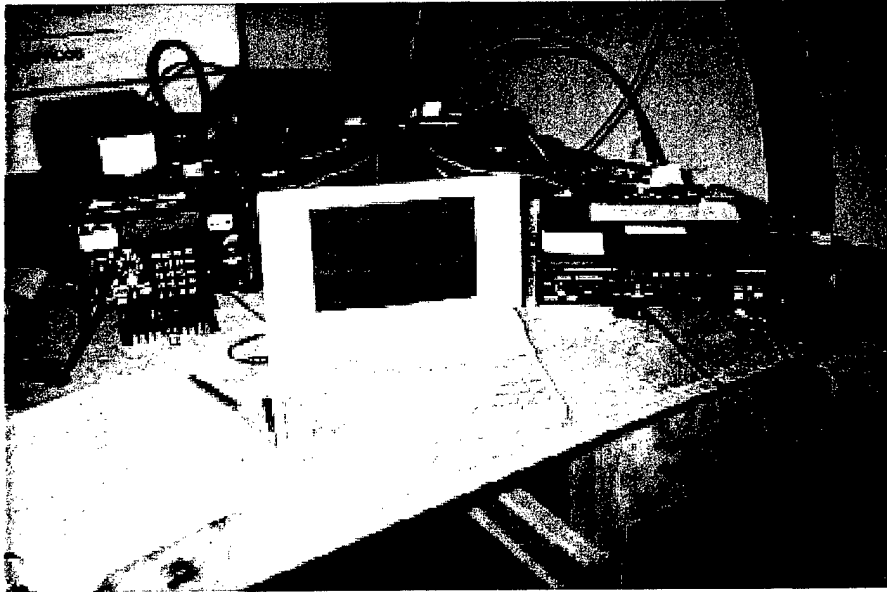

Figure 4.10. Hardware Configuration for HF/ALE Tests at Black Island (McMurdo)

The purpose of the test was to demonstrate the feasibility of using state-of-the-art HF/ALE equipment to provide better frequency management and to reduce the required transmitter power. This was to be achieved while increasing the overall reliability of the communications link for distances of several thousand kilometers over a trans-auroral path. The test verified that the use of HF/ALE equipment can indeed improve link reliability, as well as overall operations between Christchurch and McMurdo. In so doing, one can significantly lower the normal operating power, while optimizing the use of available frequency spectrum resources.

The tests, however, were not indicative of general ionospheric conditions that one may experience at high latitudes. Throughout the period of these initial tests, both solar and magnetic activity were generally quiet. Figure 4.11 depicts the geophysical conditions for January 1992, including solar, as well as the geomagnetic (K_p) and the auroral (A_p) indices. As an example of the observed performance, LQA scores (a composite measure of an HF/ALE radio link's performance at each frequency) for 18 January 1992 are depicted in figure 4.12.

The second phase of the study, the focus of this report, endeavored to provide a detailed picture of link performance over the course of 2 years for a representative communications network operating both within and exterior to the auroral oval, i.e., within and off the continent of Antarctica.

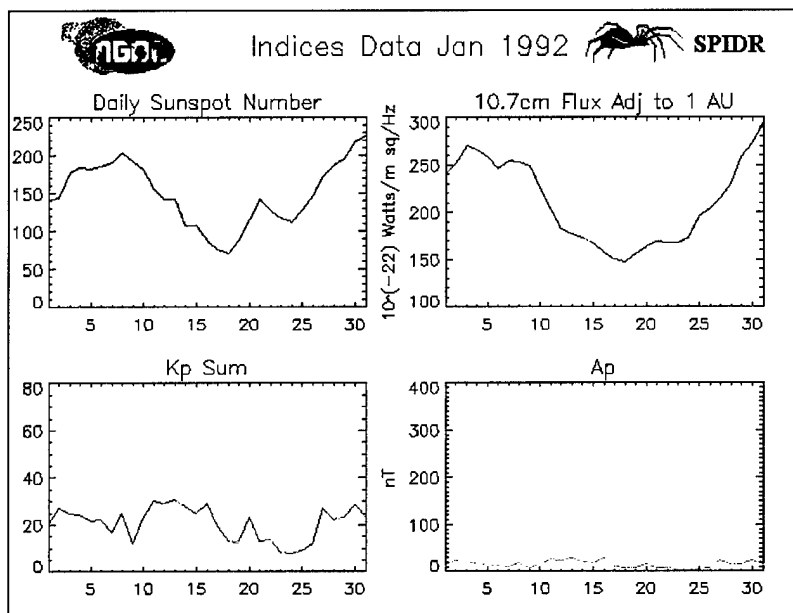

Figure 4.11. Key Solar and Geomagnetic Indices for January 1992³⁶

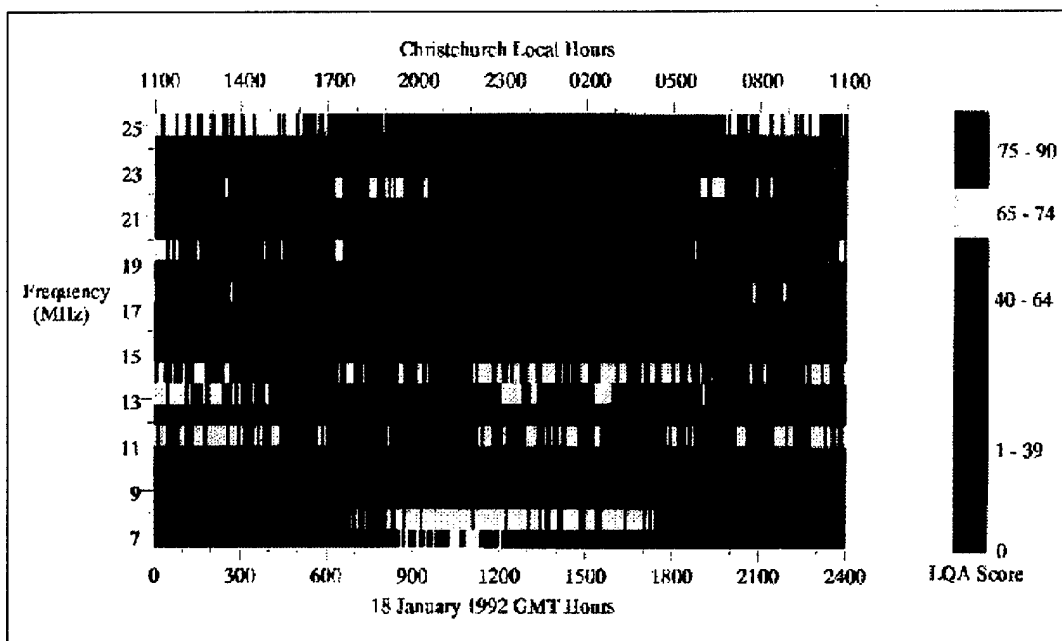

Figure 4.12. LQA Score as a Function of Frequency and Time of Day for the Christchurch to McMurdo Circuit on 18 January 1992²⁵

5. NETWORK DESIGN, IMPLEMENTATION, AND EQUIPMENT

The measurement campaign focused on the long-term evaluation of the performance of an HF/ALE network. The planned network superimposed on the outlines of the relevant land masses is pictured in figure 5.1. There were four HF/ALE nodes: one at Christchurch on South Island in New Zealand, one at McMurdo Station in the American sector in Antarctica, one at Davis in the Australian Antarctic Territory, and one at the control center at Salisbury in the state of South Australia, Australia.

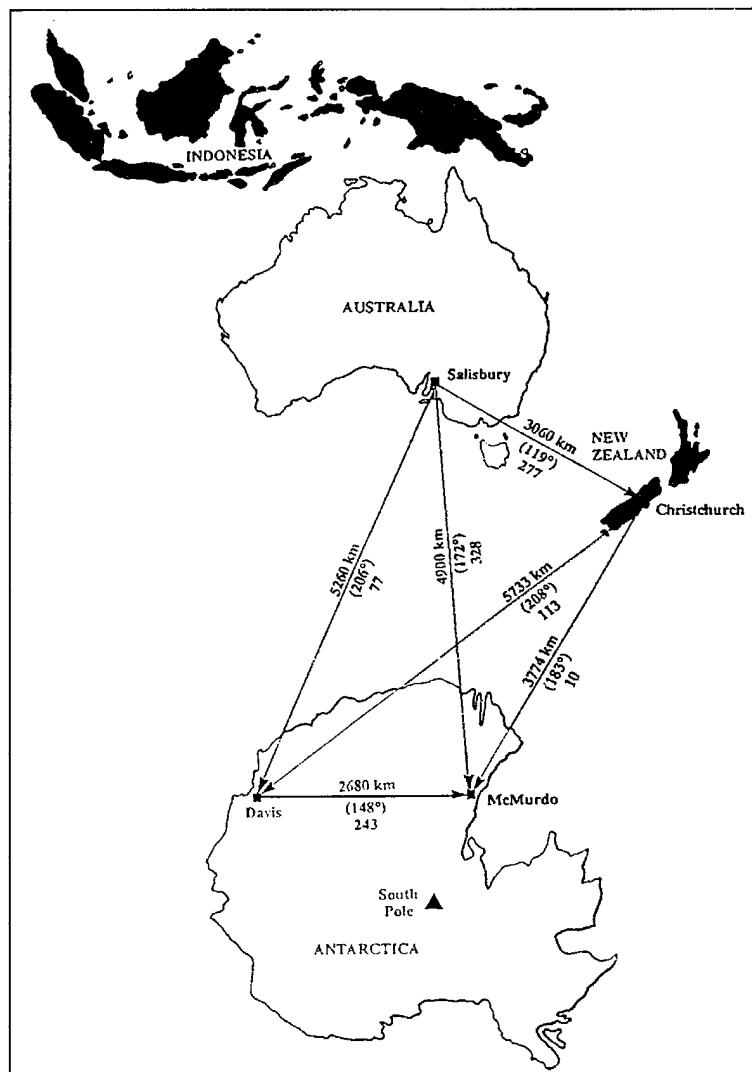

Figure 5.1. View of HF/ALE Network

The primary function of the network was to serve as a test bed to

- evaluate the performance of various links during both quiet and disturbed propagation conditions;
- determine whether alternate routing—particularly during disturbed conditions—improved message delivery time; and
- study a number of communication and ionospheric issues that were specifically relevant to high-latitude HF communication links.

In an effort to maximize working efficiency, NUWC was to oversee the test results relating to the first two objectives, and the Defence Science and Technology Organisation (DSTO) in Salisbury, South Australia, was to be the lead in achieving the third objective.

The network was installed in stages that began in mid-September 1992. An initial link to test the hardware and the control software was set up between Christchurch and Salisbury in late September 1992 and operated for about 2 months. After these initial tests, the sloping-vee antenna at each of the sites was reoriented in mid-November 1992. At that time, each site operated with its antenna essentially pointed due south, i.e., towards McMurdo and Davis, respectively. Although the network was fully operational by late December 1992, several manufacturer's equipment issues continued to plague or restrain full realization of the network's functions for the duration of the experiment. By autumn of 1994, these deficiencies were recognized by the vendor and, for the most part, corrected. There was an intermittent, but continuing, problem with the radios' memory being arbitrarily cleared under normal operation. The radios then failed to respond to any commands. The vendor eventually found the cause of the problem and provided firmware updates. However, only Christchurch benefited from the upgrade during the campaign and only for the last 3 months.

The link schedule was again modified during June 1993 with the Christchurch-to-Salisbury link rejoining the schedule. This time, however, there was no compensation for the fact that the antennas were oriented 85° to the direction of the great circle path between them. Thus, while both the New Zealand and Australia links to Antarctica were aligned boresight with respect to their antennas, the antenna patterns for the New Zealand-to-Australia link were essentially broadside.

5.1 CONFIGURATION OF THE EXPERIMENT AND DATA COLLECTED

The original thrust of the experiment was to study the potential benefits of introducing an automatic frequency management system into the daily operations of a naval communication station. This study expanded to include the evaluation of other links and, thus, an HF/ALE communications network, because it was postulated that spatial and temporal diversity might alleviate some of the disruptions to traffic transmissions during periods of minor ionospheric disturbances.

HF/ALE radio equipment was selected as the basis for implementing this assessment because of its use of a limited number of frequencies in assessing a channel; its sounding during idle periods; its ability to rank the channels based on in situ measurements; and its ability to accomplish all these items under software control. The experiment was designed to look at the following three different aspects of the HF communications problem:

- How well could one maintain a link to pass message traffic between two points, originally Christchurch and McMurdo?
- Given that one had determined the best frequency to use for that link, how well could message traffic be passed? In other words, what were the bit error ratios or bit error rate (BER)?
- How could one characterize the channel at the time of assessment?

To understand each of the aspects, three different types of data were compiled: LQA, BER, and oblique channel soundings. The first of these datasets, LQA, was collected during a 26-month period that began in November 1992 for the two trans-auroral links and one trans-polar link shown in figure 5.2. During the first six months of 1993, the other two datasets were gathered. Because of poor channel conditions, only a limited number of 2400-bps test transmissions were received to assess the BER performance between Davis and Salisbury. This also coincided with the operation between Davis and Salisbury of the DSTO³⁷ frequency modulated continuous wave (FMCW) oblique sounder to assess the channel characteristics.

The specifics of the sites for each of the locations will be discussed in section 5.2, and a detailed description of the actual radio hardware will be presented in section 5.3.

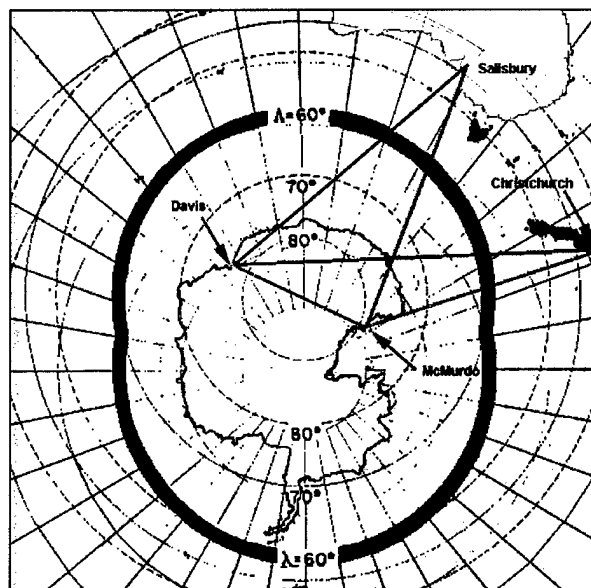

Figure 5.2. HF/ALE Network and the Limits of the Antarctic Polar Region (Denoted by the Blue Oval)

5.1.1 LQA Assessment

LQA refers to the automatic analysis (or assessment) of assigned frequencies by a radio transceiver for use in determining the best HF communication channel. Use of the term LQA in this report refers to a bi-directional LQA involving exchanges between radios during an established circuit, and use of the term *sounding* refers to a one-way broadcast transmittal of link-quality data for evaluation by other stations. The LQA function measured and reported, at each frequency, the signal-plus-noise-plus-distortion-to-noise-plus-distortion ratio (SINAD), and BER for both the initiating and destination stations in the link under evaluation. A derived channel score, based on the four measurements, was also reported at each frequency.

One of the links was intracontinental between McMurdo Station and Davis Station. The remaining two links were intercontinental, one between McMurdo and Christchurch and the other between Davis and Salisbury. The Christchurch and McMurdo sites were maintained by U.S. Navy personnel. Members of the technical staff at DSTO maintained the Salisbury site; the Davis site was maintained by the Australian Antarctic Division (AAD). Archiving of the data was a joint effort between DSTO and NUWC. DSTO served as the gateway through which all the sites' data files were transferred. The files were then passed to NUWC via the Internet's file transfer protocol (FTP) and archived. All transmissions were scheduled according to time of day as set by the Global Positioning System (GPS) receiver in DSTO Salisbury. Once per hour, Salisbury distributed its time to each of the other stations.

The sites designated to be initiating LQAs under computer control were Salisbury, McMurdo, and Davis. Christchurch was designated as a non-initiating site. Due to scheduling changes and various equipment failures, McMurdo became incapable of initiating LQAs, and Christchurch became an initiating site. From August 1993 to the completion of tests, initiating sites were Salisbury, Christchurch, and Davis. Non-initiating sites were the two McMurdo sites, using the Christchurch antenna (MCC) and the Davis antenna (MCD). Table 5.1 summarizes changes to the network configuration during the campaign. The hardware configurations 5020, 5022, and 7210 refer to the model numbers of the radios.

The campaign ran for slightly more than 2 years. While not all sites were functioning nor collecting data simultaneously, a large database of information, particularly LQA statistics, was developed. Davis was shut down in February 1994, and Christchurch was shut down in November 1994, while Salisbury and McMurdo sites were shut down in December 1994.

Ten frequencies were selected for this test. The frequencies were as evenly spaced through the HF band as possible, dictated by frequency assignments from the New Zealand Defence Radio Frequency Manager. The list of frequencies used did not change for the duration of the experiment and are listed in table 5.2.

Table 5.1. Hardware Configuration of the Network During the Campaign

Date	Christchurch	Davis	McMurdo	Salisbury	Comment*
Sep 1992	5020N			7210I	First Stage
Dec 1992	5020N	5022I	5022I 5022S	7210I	Full deployment
Mar 1993	5022N 5020S	5022I	5022I 5022S	7210I	Use of 5022 at Christchurch
Apr 1993	5022N 5020S	5022I	5022N 5022S	7210I	Failure of serial ports, McMurdo
Aug 1993	5022I 5020S	5022I	5022N 5022N	7210I	Network reconfigured to McMurdo MCC and MCD
Feb 1994	5022I 5020S		5022N 5022S	7210I	Davis shut down (also McMurdo MCD)
Nov 1994			5022N 5022N	7210I	Christchurch shut down
Dec 1994					Salisbury and McMurdo MCC shut down

*I = Initiates and responds; N = Non-initiating, responds only; S = Spare.

Table 5.2. Test Frequencies

Channel Number	Frequency (kHz)
01	5030.0
02	6767.0
03	9110.0
04	11508.0
05	13480.0
06	15088.4
07	18610.0
08	20439.0
09	22950.0
10	25110.0

Using the assigned list of frequencies, the radios were instructed under a computer-controlled schedule to scan the frequency list or perform an LQA with each of the other stations once per hour. Each station was assigned a call sign and time slot in the hour for linking with every one of the other stations. The results of LQAs were reported by the radios to the recording software. The data records were formatted into uniform length text strings and stored hourly in data files locally on the controlling computer storage disk.

5.1.2 Bit Error Tests

Separate bit error tests were performed by DSTO in parallel with LQAs. The purpose of this test was to compare actual modem performance in terms of BER to the assessed performance that was obtained indirectly by the LQA score. The tests were run for several months only between Davis and Salisbury, a trans-auroral link. It was hoped that the BER tests would provide an evaluation of the use of ALE both as a measure of HF channel support for high-speed data transmission and the application of the ALE LQA results to frequency management. The former point is of some concern as the modem in the ALE protocol is a rather low rate. Hence, there was some question as to whether the LQA scores obtained for the ALE modem and data rate would be indicative of the expected channel performance for other modem types and/or data rates.

Salisbury was the site for data collection and logging and had the Harris RF-7210 ALE transceiver, a Harris RF-3466 HF modem, and BER measurement equipment. Davis had a Harris RF-5022 with a Harris 39-tone modem option board and equipment for generating pseudorandom bit sequences (see figure 5.3). Data transmission from Davis to Salisbury was performed at 2400 bps on an hourly basis

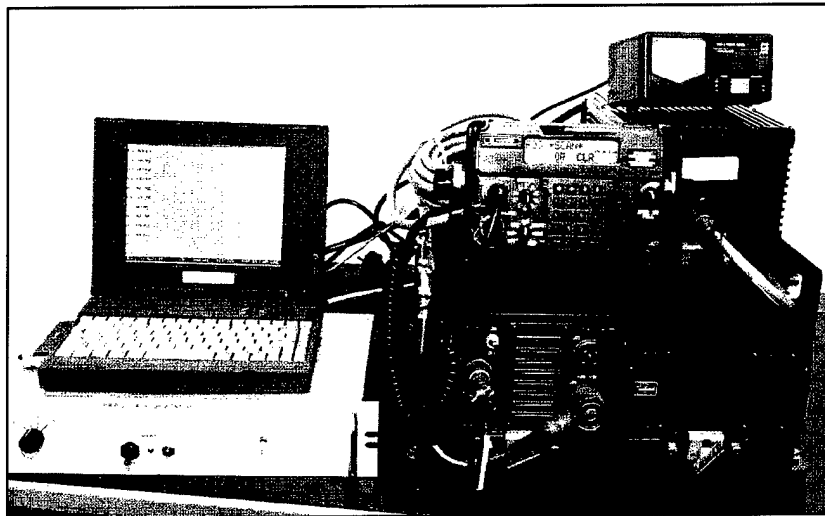

Figure 5.3. Mockup at Salisbury of the BER Test Setup for Davis³⁸

There were ten 2-minute slots in which each of the ten assigned frequencies was used for BER transmissions. After an initial 30-second ALE exchange and channel setup time, the modem and bit-generating equipment at Davis transmitted for 90 seconds. The receiver at Salisbury monitored the received data after the ALE exchange and start of the modem signal for 45 seconds, during which 108,000 data bits were sent and the results were collected and stored. There was also one 4-minute slot in which the frequency identified as the best frequency by an LQA exchange was used for a longer 90-second duration measurement in a similar manner to the

shorter slots. Initially, minimum interleaving (VOICE setting) was used, but because of poor propagation, the setting was changed to provide more interleaving (LONG setting). Most of the data collected was using the greater depth of interleaving (LONG setting).

5.1.3 Oblique Channel Sounding

In order to monitor the dynamic nature of the ionosphere, two of the twelve 4-minute time slots were expressly dedicated to evaluate the channel between Davis and Salisbury. At each time slot, the DSTO FMCW oblique sounder at Davis swept from approximately 4 MHz to 28 MHz. During these periods, the Davis rhombic antenna, directed towards Melbourne, was used for the sounding. As mentioned, the analysis of these data was primarily a DSTO function, although observations of certain ionospheric events will be discussed later.

The sounder was developed by the Radio Wave Propagation Group at DSTO. It is a synchronous system that can be used to determine the propagation delay caused by reflections in the ionosphere along a particular path. Several of these sounders are in place in various parts of the southern hemisphere providing in situ assessments of the ionosphere over various links that include at least one node in Australia. This information can then be incorporated into a real-time frequency management system.

5.2 IMPLEMENTATION, SITE DESCRIPTIONS, AND ANTENNA ORIENTATION

Christchurch, New Zealand, supports the U.S. presence in Antarctica serving McMurdo Station, a major support and research center, as well as a common gateway to a majority of the points in the interior. Large-scale HF transmit/receive stations are located at each site using high-efficiency, multiple-wavelength rhombic antennas to communicate between them. The primary intent of the NSF funding in support of this project was to quantify the quality of the HF link between Christchurch and McMurdo using the new HF/ALE technology.

In an effort to expand the usefulness of this experiment, the DSTO and AAD were invited to participate in the test. DSTO operated the HF/ALE station in Australia at its communication research facilities in Salisbury, South Australia. AAD installed and operated both HF/ALE and oblique sounder equipment at its Antarctic site at Davis. The Australian site at Salisbury was also the network administrator.

As mentioned, the first phase³⁹ of the HF/ALE Antarctic communications experiment was conducted between Christchurch and Black Island over 10 days in January 1992 to demonstrate the feasibility of using HF/ALE to manage the HF selection for the U.S. communication link between Christchurch and McMurdo Station. The second phase of the test, which was to characterize the diurnal and seasonal variations in the HF propagation path, required the compiling of long-term LQA statistics for the links of interest. The DSTO and the AAD agreed to set up and man test sites in Salisbury, Australia, and Davis, Antarctica, using NUWC antennas and radio gear. With four test sites, six potential communication paths were available.

At both Christchurch and Salisbury, only one antenna was used; two antennas were used at Davis and Black Island. The Christchurch antenna was pointed directly at Black Island. The Salisbury antenna was pointed half way between Black Island and Davis Station. At the Davis site, one antenna was pointed at Salisbury, and the other was pointed at Black Island. At Black Island, one antenna was pointed at Davis, and the other was pointed at Christchurch. Figure 5.4 is a schematic of the network, and table 5.3 lists the pointing directions for all the site antennas.

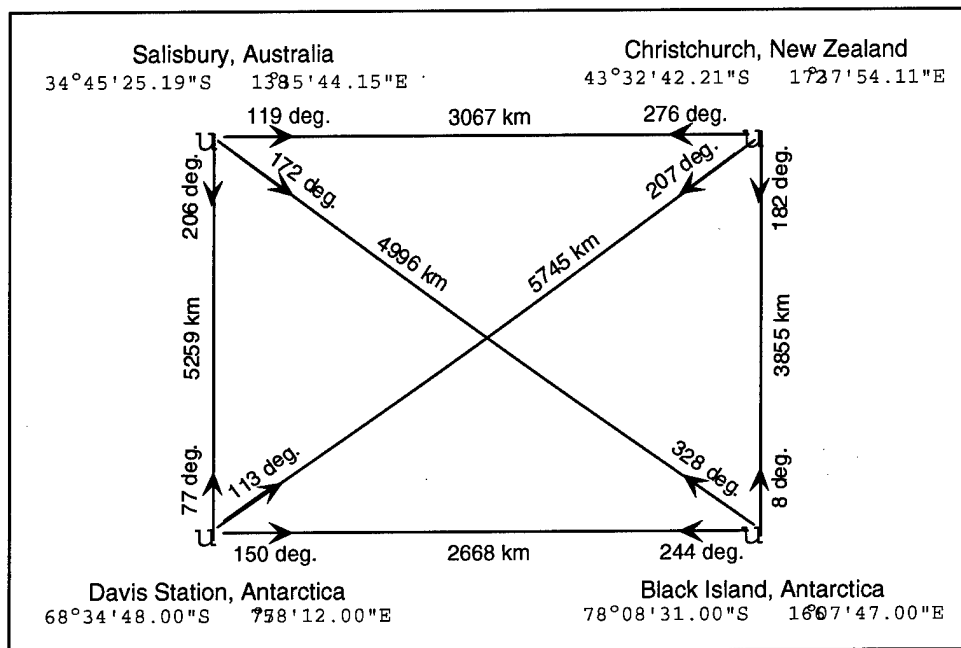

Figure 5.4. Site Positions and Orientations of the Network

Table 5.3 Pointing Direction of Antennas

Site Location	Pointing Direction of Antenna (Degrees East of North)
Salisbury	189
Christchurch	183
Black Island #1	12
Black Island #2	245
Davis #1	77
Davis #2	147

The sloping-vee antenna, described further in section 5.3.2, was utilized at all stations. The antenna was designed at NUWC to optimize frequency and pattern gain performance for the requirements of this test.

5.2.1 *McMurdo Station and Black Island Facility, Antarctica*

McMurdo Station is the gateway and logistical hub for the U.S. Antarctic Program (see table 5.4). Local ice runways at McMurdo are used to shuttle scientists, support personnel, and cargo between McMurdo and remote ice camps. Because of the high level of summer season activity and its proximity to many transmitting antennas, McMurdo has a high level of locally generated summertime noise that adversely affects RF reception.

Table 5.4. *Angle of Great Circle Path with Respect to (wrt) North and Distance Information from McMurdo to Other Nodes*

McMURDO	Latitude: 78° 08' 31.00" S	Longitude: 166° 07' 47.00" E	
From McMurdo to	Angle wrt North	Distance in Miles	Distance in km
Christchurch	8°	2397	3855
Davis	244°	1659	2668
Salisbury	328°	3106	4996

It was originally intended that the HF/ALE antenna site would be located on the outskirts of McMurdo Station where RF noise was significantly quieter than within the station. After considering all the McMurdo local sites, it was decided that the HF/ALE radio and antenna would be located at Black Island (figure 5.5), which is about 20 miles east of McMurdo. Black Island is the satellite land station and HF receive site for McMurdo. These functions are located physically away from McMurdo Station because of the need for extremely low RF site noise. Communications are relayed between Black Island and McMurdo by a multiplexed microwave link.

At Black Island, the HF/ALE radio was located in the power building next to the main building (Bldg. 152). The main building houses the sleeping, kitchen, dining, and lounge areas. The power building houses the site power distribution system and the batteries that store electric energy generated by the wind generators and solar panels. The power building has a separate room where the RF communications equipment is located. This room is where the HF/ALE radio was located and where the transmission lines for all site HF antennas are terminated. A third building (Bldg. 55) houses the multiplexer and microwave link equipment. Figure 5.6 illustrates the Black Island building arrangement.

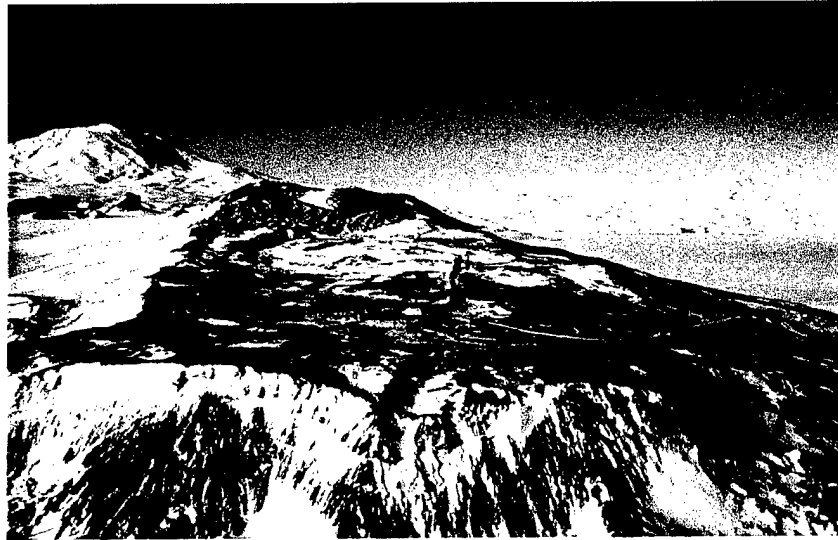

Figure 5.5. View of Black Island, McMurdo Station³⁹

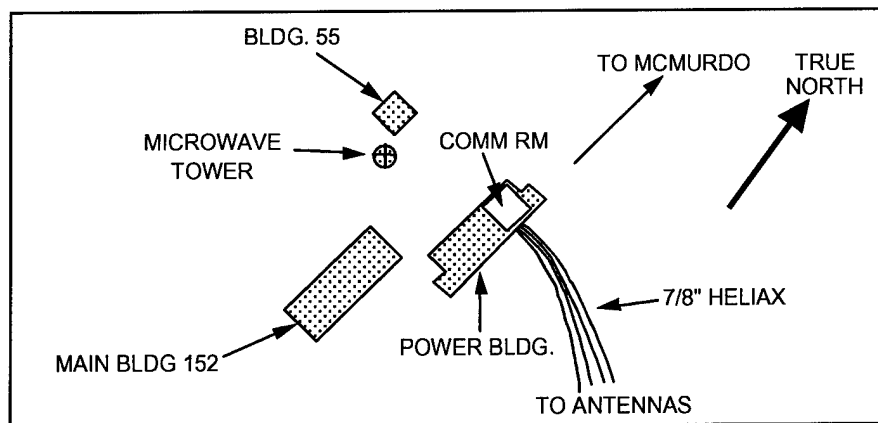

Figure 5.6. Local Layout of Black Island Site

A number of multiple-wavelength rhombic antennas exist at Black Island for receiving communications from important sites like Christchurch, Palmer Station, and the South Pole Station. Existing towers for the Palmer Station rhombic were used to elevate the apex of two sloping-vee antennas to a height of 40 feet. The antennas were pointed at Christchurch and Davis Station. At each site, a 10-foot iron pipe was partially buried in the ground at the location of each of the two terminating resistors. This elevated the resistors 6 feet off the ground. The two resistors were connected together with wire to provide an electrical ground that could not be achieved by connecting each resistor to the frozen ground. The sloping-vee antennas at Black Island are diagrammed in figure 5.7.

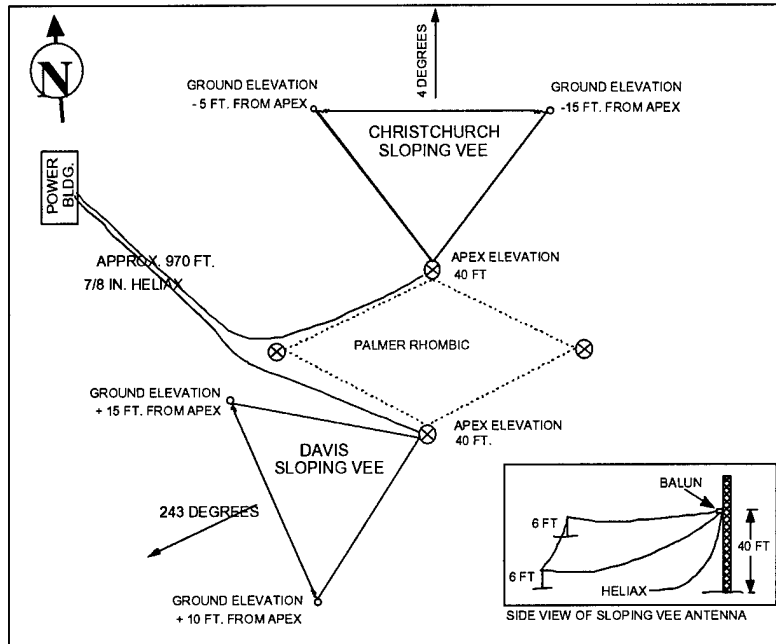

Figure 5.7. Physical Description of Black Island Sloping-Vee Antennas

5.2.2 Christchurch, New Zealand

The Christchurch HF/ALE test site (see table 5.5) was located at the U.S. NASU's site for communications with McMurdo Station. The site is located near the Christchurch International Airport. The Christchurch antenna was located in the same place as it was for the earlier HF/ALE test²⁵ in 1992.

Table 5.5. Angle of Great Circle Path with Respect to North and Distance Information from Christchurch to Other Nodes

CHRISTCHURCH	Latitude: 43° 32' 42.21" S	Longitude: 172° 37' 54.11" E	
From Christchurch to	Angle wrt North	Distance (miles)	Distance (km)
Davis	207°	3569	5745
McMurdo	182°	2397	3855
Salisbury	276°	1905	3067

Figure 5.8 shows a plan view of the receiver site. The antenna was located about 70 meters to the east of the fenced-in communications compound. The ground outside the compound where the antenna is located is used to graze sheep and is probably best described as dry prairie land. The compound consisted of three buildings and paved parking areas.

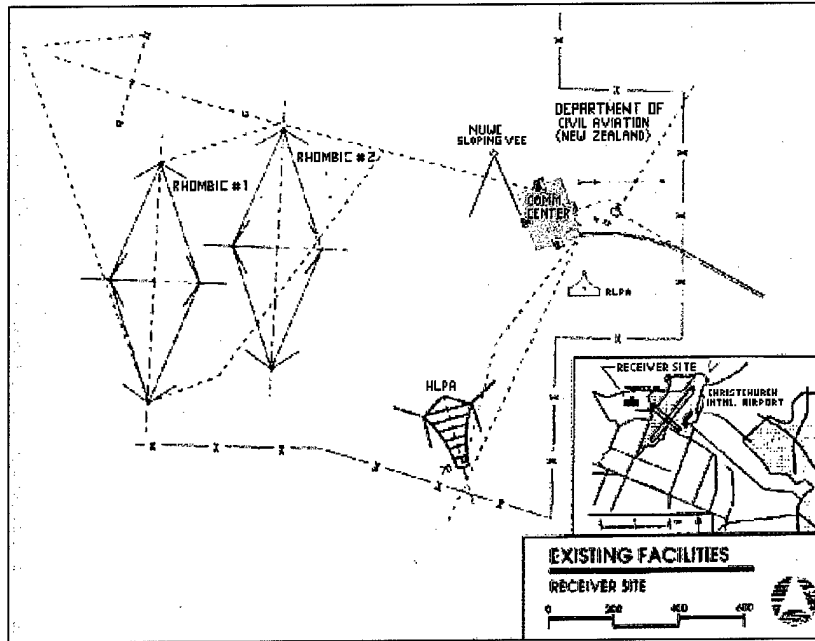

Figure 5.8. NASU's Receiver Site at Christchurch¹³

Approximately 100 meters of RG-214 coaxial transmission line connected the antenna to the Harris radio, which was located in the main compound building. The two terminated ends of the antenna were elevated about 2 meters in the air using 3-meter timbers that were secured in the ground at one end. Figure 5.9 is a block diagram of the Christchurch-to-McMurdo data link.

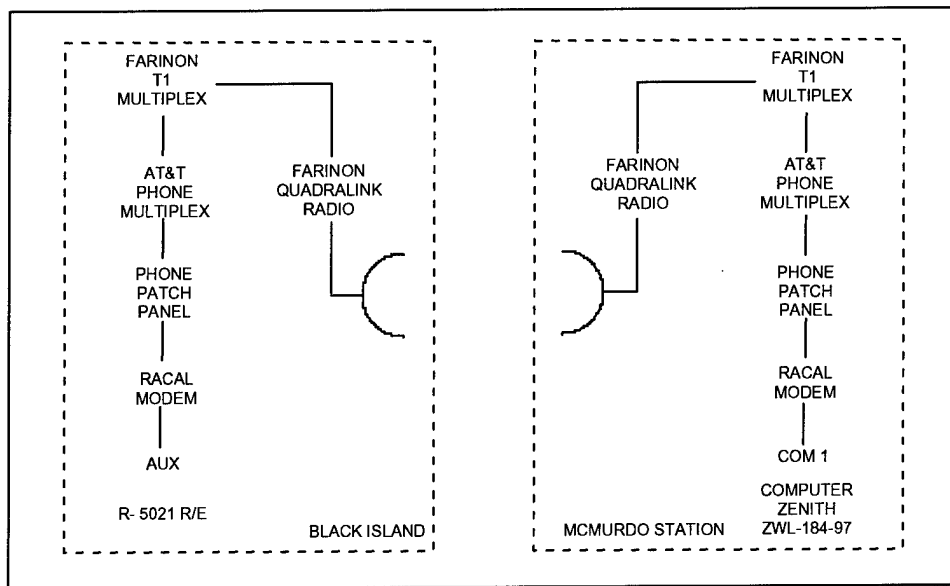

Figure 5.9. Christchurch-to-McMurdo Data Link

5.2.3 Davis, Australian Antarctic Territories

Davis is the most southern Australian Antarctic station (see table 5.6). It is the staging base for regional scientific activity in the Vestfold Hills, the polar ice cap, the Larsemann Hills, and areas farther south.

Figure 5.10 is an aerial view of the station. Scientific research—including atmospheric and space physics, biology, geology, paleontology, and botany—is conducted from the base. During the local summer, Davis serves as a long-range helicopter base supporting flights between the Australian bases at Mawson and Casey. The base population is about 70 during the local summer and drops to about 19 during the winter. Davis is comprised of approximately 25 permanent buildings located on flat ground near the shoreline. Figure 5.11 is representative of the HF/ALE deployment.

Table 5.6. Angle of Great Circle Path with Respect to North and Distance Information from Davis to Other Nodes

DAVIS	Latitude: 68° 34' 48.00" S	Longitude: 77° 58' 12.00" E	
From Davis to	Angle wrt North	Distance (miles)	Distance (km)
Christchurch	113°	3569	5745
McMurdo	150°	1659	2668
Salisbury	77°	3267	5259



(© Commonwealth of Australia, Courtesy Australian Antarctic Division⁴⁰)

Figure 5.10. View of Davis Station from Anchorage Island

Two sloping-vee antennas were deployed at Davis with one pointed at McMurdo and one pointed at Salisbury. The elevation at the site of the antenna is assumed to be 10 meters and flat although this information was not verified.



(© Commonwealth of Australia, Courtesy Australian Antarctic Division⁴⁰)

Figure 5.11. Representative HF/ALE Deployment in Davis, Antarctica

5.2.4 Salisbury, South Australia, Australia

The facility in Salisbury is one of two major research and development (R&D) laboratories operated by the DSTO. About 1300 scientists, engineers, and staff work at the facility. The facility has ranged in size from more than 600 hectares to about 280 hectares today. (See table 5.7 for location parameters.)

Table 5.7. Angle of Great Circle Path with Respect to North and Distance Information from Salisbury to Other Nodes

SALISBURY	Latitude: 34° 45' 25.19" S	Longitude: 138° 35' 44.15" E	
From Salisbury to:	Angle wrt North	Distance (miles)	Distance (km)
Christchurch	119°	1905	3067
Davis	206°	3267	5259
McMurdo	172°	3106	4996

The DSTO location in Salisbury can be characterized as residential. The climate is warm and dry during the local summer. The site is flat with an elevation of approximately 24 meters. (Figure 5.12 shows the site plan.³⁸) The two sloping-vee antennas were deployed from a single tower with one pointing toward Christchurch and the other toward Davis. Figure 5.13 presents a view of one of several paddocks that were available for siting the sloping-vee antenna.³⁸ Approximately 100 meters of RG-214 cable connected the antennas to the instrumentation in the radio shack. The paddocks were adjacent to various buildings that were used in the HF/ALE campaign (see figure 5.14).

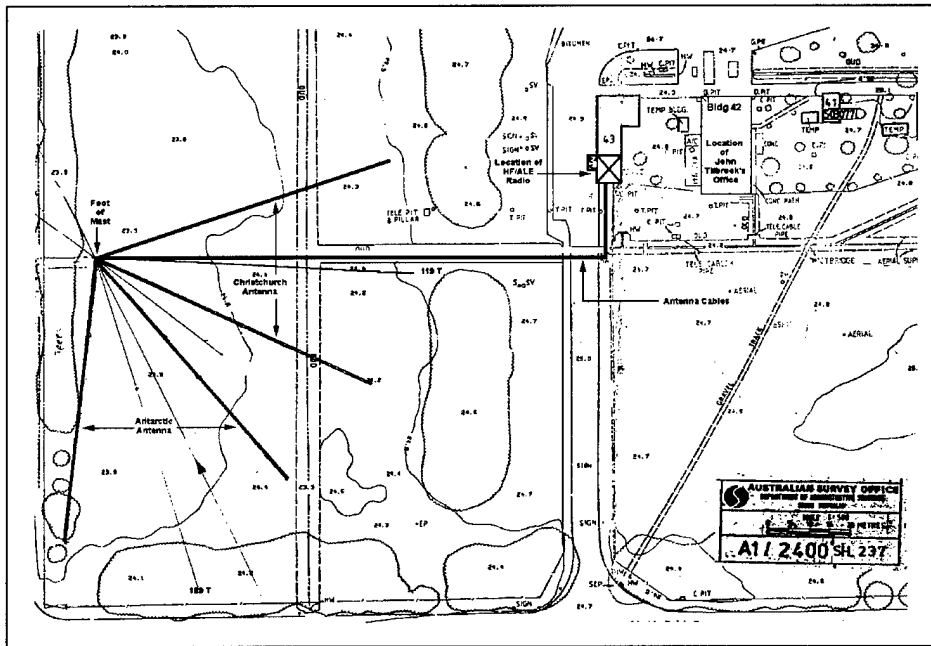

Figure 5.12. Site Plan for the DSTO HF/ALE Installation

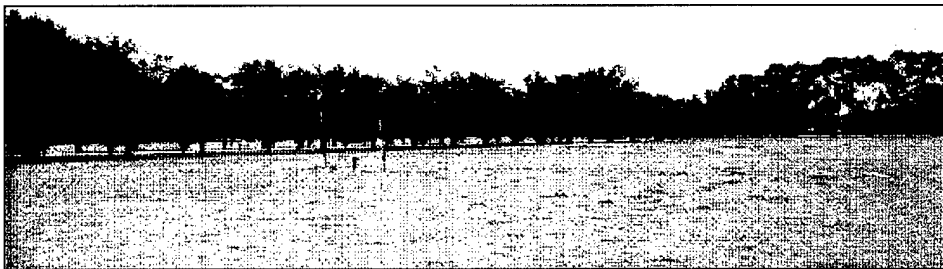

Figure 5.13. Photograph of a Typical Paddock Where Sloping-Vee Antennas Were Erected



Figure 5.14. Photograph of the Buildings at the HF/ALE Campaign Site at DSTO

5.3 RADIO EQUIPMENT

The Harris radios used in this test (the RF-7210, RF-5022, and RF-5020) are HF radio products that control transmitters, receivers, and transceivers. While providing channel scanning, ALE, and LQA, the Harris radios are compatible with FED-STD-1045 and MIL-STD-188-141A. (Appendix A contains the general requirements for the baseline radio.)

All operations, including the channel scanning, ALE, and LQA functions, can be initiated either by front panel entry or by a controlling computer using the RS-232 remote control port. The Harris radios support call techniques such as *individual, net, all, selective all, any* and *selective any*, though the only method used for this test was the individual call. The individual call is a three-way message exchange between two stations, which creates a link on that frequency, or channel, to support voice or data communications. The radios can be instructed to program radio or modem parameters, stations, channels, and automated message display (AMD) data; scan; perform LQAs; initiate automatic and manual calls; and retrieve LQA rankings.

5.3.1 The Harris HF/ALE Radio Family and Product Design Differences

The RF-7210 radio^{41,42} is a rack-mounted modular system that includes, as separate items, the ALE controller, an RF-350 transceiver unit, power supply, and RF front-end filters. Additional equipment can be added, such as the RF-3466 39-tone, HF modem used in BER tests. The RF-7210 has two serial communication ports, one for data logging and the other for remote control. The actual configuration at DSTO is shown in figure 5.15.

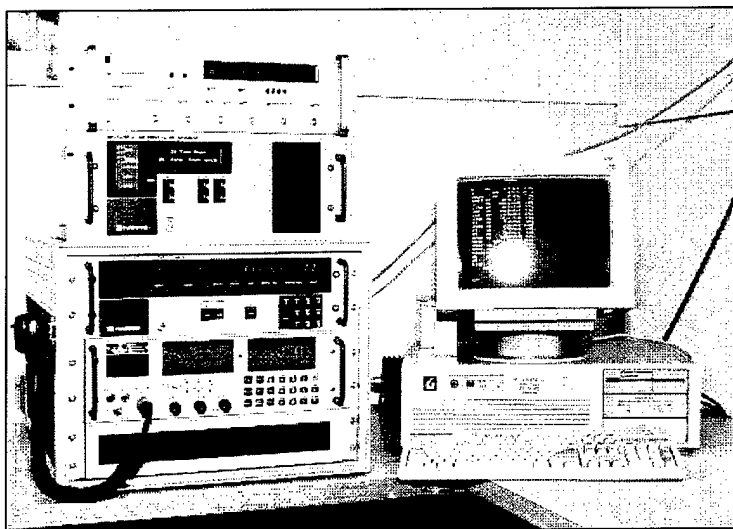

Figure 5.15. Harris RF-7200-04 Adaptive Communications System, BER Analyzer, and Data Logger at DSTO, Salisbury³⁸

Use of the remote control port by computer requires implementing a proprietary Harris protocol that allows for control of multiple units, handshaking, error detection, and priority masking. Commands are acknowledged and data are returned only when requested by the controlling computer. Available as part of the LQA data are the received/measured SINAD, received/measured BER, and channel score, which ranges from 0 to 120.

The RF-5020⁴³ series is a portable, ruggedized, single-sideband (SSB) system of modular components that provides similar functionality to the 100-W RF-7200-04 rack-mounted base station. The RF-5000B-125 and RF-5000B-125A are two versions of the 125-W system, which is packaged in a shock-mounted frame for remote deployment. The assembled RF-5000B-125A is shown in figure 5.16. The components for the three types of Harris HF/ALE radio systems used during this experiment are listed in tables 5.8, 5.9, and 5.10.



*Figure 5.16. Harris 5000B-125A 125-W, HF-SSB
Base Station Transceiver³⁸*

The 39-tone modem board used in the BER tests at Davis was the RF-5110MD high-speed data modem option. The RF-5022 has two serial communications ports: a data port that was used at Davis in the BER tests and a remote port that was used at all sites. Control of the radio is accomplished by the controlling computer sending ASCII strings, simulating an operator at the computer keyboard. Commands are equivalent to sequences of front panel keypad actions. There are help menus for the operator and responses to commands typed. The LQA data available are the received and measured SNR and the channel score which, unlike the RF-7210, ranges from 0 to 100. The RF-5020 is an earlier generation to the RF-5022 series of RF-5000 radios. The main differences between the two radios are that the RF-5022 cannot initiate LQAs and there are slight variances in the keywords and responses.

Table 5.8. Harris RF-7200-04 Adaptive Communications System^{41,42}

Nomenclature	Function
RF-350/RT-1446/URC	100-W transceiver
RF-366	Power supply for RF-350
RF-7210	Adaptive controller, MIL-STD-188-141A compatible
H-250U	Lightweight handset

Table 5.9. Harris 5000B-125, 125-W, HF-SSB Base Station Transceiver⁴³

Nomenclature	Function
RF-5020R/T	Transceiver
RF-5031PA-125	125-W, HF power amplifier
RF-5051PS-125	Power supply, 125-W base station
RF5081-BMT-125	Base station shock mount fixture
RF-5121ALE	MIL-STD-188-141A, Appendix A, ALE controller
RF-5110MD	High speed parallel tone and FSK modem
H-250U	Lightweight handset

Table 5.10. Harris 5000B-125A, 125-W, HF-SSB Base Station Transceiver⁴³

Nomenclature	Function
RF-5022R/T	Transceiver
RF-5032PA-125	125-W HF power amplifier
RF-5051PS-125	Power supply, 125-W base station
RF-5081-BMT-125	Base station shock mount fixture
RF-5122ALE	MIL-STD-188-141A, ALE controller
RF-5110MD	High-speed parallel tone and FSK modem
H-250U	Lightweight handset

The internal BER measurement (used in ALE and LQA functions) is presumed to be stored and reported in accordance with FED-STD-1045; however, during data analysis, it was discovered that certain values for BER measurements by the RF-5022 transceivers were never encountered. The manufacturer was informed of this anomaly, but no modifications to firmware were performed during the campaign. BER values are not reported explicitly by the RF-5022, although they are exchanged in (two-way) LQAs and reported by the RF-7210 as received BER.

5.3.1.1 Engineering Order Wire. The engineering order wire (EOW), or the data text message (DTM), is a feature of the RF-7210, RF-5022, and RF-5020 radio transceivers that allows messaging between stations. The stations must be linked with the modems off. When the radio is under control from the remote port, the user can have a typed message, or file, sent to the other station. Messages are sent with FEC and transferred with acknowledgment from the receiving station. This method was used on the RF-5022 to pass short messages (transmitted as 300-byte blocks (maximum)) between stations with operators at the controlling computer keyboard. GPS time was distributed from Salisbury to the other three stations.

AMD is a feature of the three types of Harris radio transceivers used during the campaign. This function allows the transfer of shorter messages automatically with each link establishment. A message of 87-character length can be programmed for each exchange. This method does not increase the overhead of the exchange; however, no error correction is performed on the message.

5.3.1.2 Site-Specific Radio Installations. Salisbury had a Harris RF-7210 radio, McMurdo had two Harris RF-5022 radios (one spare), and Davis was to have two RF-5022 radios (one spare). The Christchurch site began with a Harris RF-5020 radio, which is capable of performing an LQA exchange with another station but not capable of initiating one. However, because of procurement problems, the RF-5022 originally designated as the Davis spare was sent to Christchurch at the end of March 1993, where it was set up as a non-initiating site. (See table 5.1 for an overall view of the hardware configuration at each site.)

In mid-April 1993, the McMurdo site experienced failures on the remoting hardware, which rendered both the main RF-5022 and the spare incapable of being controlled by computer. It was decided that, since Christchurch was now capable of initiating LQAs, the McMurdo site would be a non-initiating site. Furthermore, since there were two radios at McMurdo and two sets of antennas, both radios could be used for LQA exchanges, with schedules adjusted so LQAs to each radio would not be simultaneous, avoiding possible interference.

5.3.2 Description of Antenna for Radio Transceivers

The antenna selection for this experiment was based on both electrical and mechanical considerations.^{14,44} The optimum antenna for this experiment is a multi-wavelength, 3-wire rhombic elevated at least 10 meters off the ground. This type of antenna provides excellent directive gain across a wide frequency range. Rhombic antennas were installed at Christchurch and McMurdo for use by NASU (Christchurch) and NSFA (McMurdo) in support of daily communications and were not available for utilization during this experiment. Erecting multi-wavelength rhombic antennas for use in this experiment was rejected because of prohibitive costs in terms of money, time, and effort. The sloping-vee antenna, similar in structure to the depiction in figure 5.17, was chosen as an acceptable alternative to the rhombic because of its similar bandwidth, radiation pattern, high-gain values, low cost, and ease of installation.

The sloping-vee antenna consists of two wires connected at the feedpoint, or apex, with both wires orientated in a generally horizontal direction. The wires are run in different directions from the apex, and the angle formed by these two wires is designated as the apex angle. An apex

angle of 45 degrees was chosen for the antenna because of the resulting desirable directivity, input impedance, and bandwidth characteristics. The feedpoint impedance was mostly resistive with a value near 800 ohm. The endpoints of the two wires are normally terminated to ground through terminating resistors with a value of one-half the input impedance. The feedpoint of the antenna can be matched to a 50-ohm coaxial transmission line with balanced impedance transformer. A 16:1 transformer will match an 800-ohm antenna to a 50-ohm transmission line. The two wires of the antenna slope either up or down from the feedpoint relative to horizontal. The slope has an effect on the vertical antenna pattern or takeoff angle.

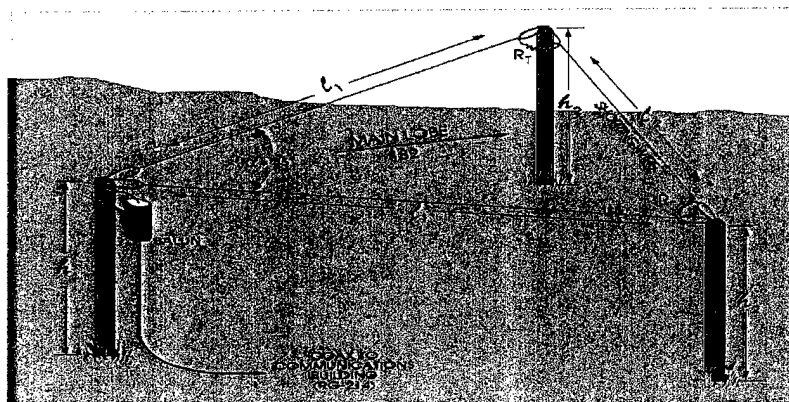

Figure 5.17. Representation of the Sloping-Vee Antenna Construction¹⁴

A previous experiment²⁵ used a sloping-vee antenna with a 16:1 ratio impedance transformer. The termination resistance was determined through experimentation by optimizing the antenna voltage standing wave ratio (VSWR) over the operational frequency range. The 16:1 transformer was not considered rugged enough to survive Antarctic weather conditions for the lengthy duration of the experiment, and a 12:1 transformer was chosen in its place. Termination resistors were determined to be 400 ohm. Considering the poor ground conditions in Antarctica, it was decided to connect the two terminating resistors together with a wire instead of connecting each resistor to the frozen ground. The antenna parts hardware are described in table 5.11.

Table 5.11. Parts Description for Sloping-Vee Antenna

Part Description	Manufacturer	Part Number
Resistor, high power, 400 Ω , 60 W, 5% tolerance and Resistor Mounting Clip	Power Film Systems Yellville, AR 72687 508-449-4093	PF-S5-401CPJ
Wire, stranded, 7 bundles of 37 wires of 36 AWG* tinned copper wire, each bundle is 12 AWG	Federal Stock	6145-00-819-0058
Balun, 12:1 ratio, 2 - 30 MHz	Polomar Engineers Escondido, CA 92046 619-747-3343	MB-12

*AWG: American Wire Gauge

6. OVERVIEW OF POLICIES RELATING TO POLAR UPPER ATMOSPHERIC RESEARCH

In many ways, the IGY, and the support and service structures that it fostered, paved the way for the surge in cooperative and coordinated investigations in the polar regions of the upper atmosphere. Over the next two decades, the launch of *Sputnik* on 4 October 1957 not only spurred the space race and accented the Cold War, but developed for many the keen awareness that developments in space and on Earth were intertwined. Concurrent developments in technology—electronic miniaturization, computation, command and control features, new materials and environments for their manufacture—embedded features and functions in researchers toolboxes at dizzying speeds. Outer space began at near-Earth space, and the Earth's window was the polar regions.

By the early 1980s, concerned that international research efforts in the polar regions on upper atmosphere and near-Earth space were funded and executed in a rather piecemeal and fragmented manner, the National Research Council's Polar Research Board (PRB) established⁴⁵ a committee to coordinate a national policy. In spring 1981, the PRB established the Ad Hoc Committee on the Upper Atmosphere and Near-Earth Space and charged it with a sixfold mission to: participate, identify, apprise, formulate, support, and recommend to the PRB on any and all matters related to the upper atmosphere and near-Earth space in polar regions.

In 1982 the committee issued its rather detailed report, necessitated, as the report⁴⁵ maintained, *by the rather special circumstances given by the charge to our Committee*. Today, almost 20 years later, the four principal recommendations (see table 6.1) stand out more for their contemporary relevance than for their historical perspective. Indeed, the three recommendation areas dealing with research (the fourth deals with policy) are still very much center stage in upper atmospheric physics.

Since the Ad Hoc Committee's report, a chain of upper-atmosphere observation facilities, sponsored by the NSF, has emerged extending from the equator to the auroral regions. Recent proposals⁴⁶ have suggested an extension of the chain to include a fifth facility, at the geomagnetic North Pole (near Resolute Bay in Canada) in time for the upcoming solar maximum in 2001. This facility, in conjunction with the other four, will enable scientists to better predict and prepare against the damaging effects of various spaceborne storms, mostly originating in the sun. In recent years, terms such as climate and weather have become more common to describe the impact of solar processes and patterns, particularly as it affects the Earth's environment.

While the 1982 report to the PRB emphasized the outstanding problems and opportunities for research in the polar regions, today the understanding gleaned from such research extends far beyond the boundaries defined by arctic and subarctic lands. As society seeks, and at times gropes its way, to comprehend the myriad effects of globalization on the Earth's environment,

Table 6.1. 1982 Recommendations on Research and Policy Issues to the PRB⁴⁵

Recommendation Area	Specific Subject Studies
Basic research in space plasma	<ul style="list-style-type: none"> • Magnetosphere-ionosphere coupling • Plasma studies in the auroral ionosphere • Cusp studies • Prediction of auroral and magnetic perturbations
Basic research in neutral atmosphere physics	<ul style="list-style-type: none"> • Neutral upper atmosphere • Solar activity effects on the polar atmosphere
Research relevant to applied fields and other disciplines	<ul style="list-style-type: none"> • Ionospheric inhomogeneities • Electromagnetic and particle radiation background at high latitudes • Geomagnetic influences on ground based systems • Astronomical and solar research
Policy Issues	<ul style="list-style-type: none"> • Coordination of polar research in upper atmosphere and near-Earth space research

singular events in the polar regions often loom as clear warning signs. Nowadays, rather than being a remote region frequented by a select few, the polar regions have advanced and captured not only the public's interest, but the attention of international policy makers as well.

6.1 THE SOLAR-TERRESTRIAL ENVIRONMENT

The Earth's magnetic field extends out into space creating a region that is called the magnetosphere. This field protects the Earth from a mixture of electrons and positive ions (mainly hydrogen) that streams from the sun known as plasma. The flow itself is known as solar wind and carries with it a weak magnetic field that is part of the sun's main magnetic field. This weak field, called the interplanetary magnetic field (IMF), appears to be frozen into the plasma, or solar wind. This is because the plasma has the greater energy density and controls the motion of the total magnetoplasma. Due to the sun's rotation, the IMF field is spiral in form, though the solar wind emanates radially from the sun. Figure 6.1 is the first instantaneous view or snapshot of the spiral structure of the IMF.⁴⁷ The snapshot was assembled by the National Aeronautics and Space Administration (NASA) physicists from observations of radio waves by a U.S.-French radio receiver on board the *Ulysses* spacecraft in 1994. The spiral IMF can be seen extending from the sun past the orbits of the planets Mercury and Venus and toward Earth.

The direction of the IMF may be either inward or outward with respect to the sun, and more significantly, up to four sectors can actually be distinguished where the direction of the IMF alternates between being inward and outward.⁴⁸ It is the solar wind that plays a central role in phenomena that are commonly called solar-terrestrial events. Geomagnetic storms, auroras, disruptions or blackouts in radio communications, and induced-power grid surges are the result of various processes involving these charged particles.

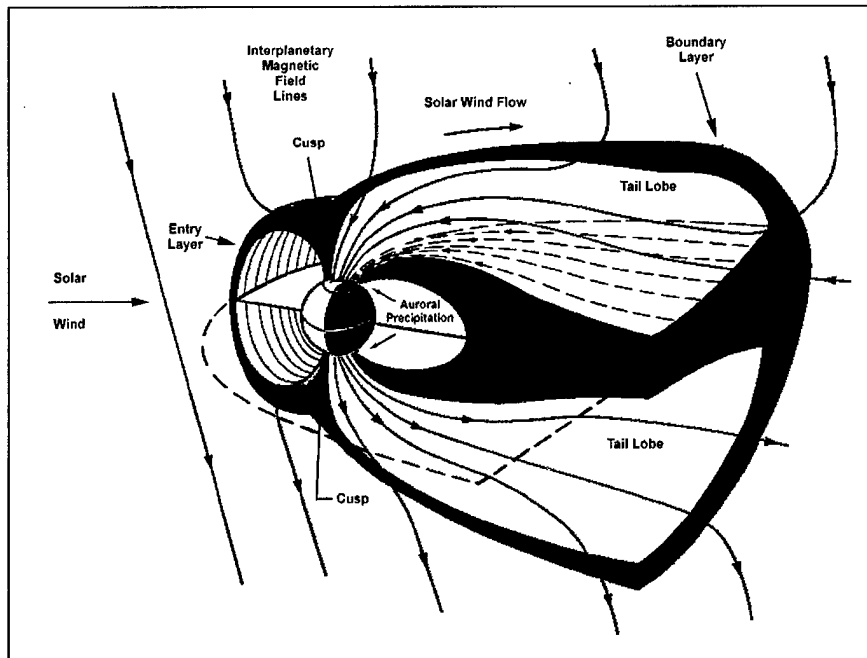

(Courtesy of NASA)

Figure 6.1. View of the Spiral Structure of the IMF

The solar wind is deflected by the Earth's magnetic field. The boundary layer, or surface, that surrounds the magnetosphere and separates it from the solar wind is known as the magnetopause. In front of and around the magnetosphere is a bow shock, the magneto-sheath, which results from the impact of the solar wind travelling at supersonic speeds. Some of the plasma, accelerated by various mechanisms, is temporarily trapped in the magnetic tail that extends some millions of kilometers, forming a plasma sheet, which continues into the dayside ring current region. The ring currents flow in closed loops around the Earth in the outer van Allen radiation belts (at distances between 2 and 10 Earth radii) in a disk shape near the geomagnetic equator. These currents are driven primarily by pressure gradient forces and are greatly augmented during magnetic storms as plasma is injected from the magnetotail. The field lines for the inner magnetotail maintain an approximate dipolar configuration, while the outer tail may extend as far as 1000 Earth radii downstream. In contrast, the tail region has a void above (the northern tail lobe) and below (the southern tail lobe) the plasma sheet that is nearly devoid of plasma. The lobe is connected to the polar cap, which is present in both hemispheres. It is here that the Earth's open magnetic field lines connect directly to the IMF. The crucial indicator of any interaction between the magnetoplasma and the magnetosphere is the direction of the IMF. For example, it is known that substorms, a short-term (50 to 150 minutes) perturbation of the Earth's magnetic field caused by the injection of charged particles into the auroral oval from the magnetotail, occur most frequently when the sign of the north-south component (B_z) of the IMF is southwards ($B_z < 0$), often coinciding with the southward turning of the IMF.

In addition to the trapped plasma in the plasma sheet, there is additional plasma stored nearer to Earth in the van Allen radiation belts. These particles bounce back and forth along the dipolar geomagnetic field lines. During periods of geomagnetic disturbances, particles precipitate

into the atmosphere and release energy. Additional penetration of the magnetosphere is possible by high-energy plasma in the solar wind that reaches the Earth's upper atmosphere above the poles. This region, known as the cusp or polar cusp, separates the closed geomagnetic field lines on the dayside from those that extend back on the nightside into the magnetospheric tail.

During a geodisturbance, solar pressure may compress the sunward-side of the Earth's magnetic field from its normal 10 Earth radii to values that, at times, are less than 5 Earth radii. One of the diagnostics that indicates this condition is the change in polarity of the H_{parallel} component of the Earth's magnetic field. Alternatively, this effect may be monitored with a ground-based neutron monitor that indirectly measures the rate at which energy is received from the upper atmosphere. A sudden drop in the count of nucleons at ground indicates that the IMF is severely disturbed.

These data reinforced the earlier correlative observations at ground level of solar energy particles with large scale solar events. These conclusions, keyed to spacecraft monitoring of energetic protons and electrons at various energy levels, have given rise to observations of proton events and subsequent warnings of an impending solar proton event.

6.2 THE POLAR IONOSPHERE

In addition to the vagaries that are generally present for HF communications, such as fading, interference, and high atmospheric noise levels, operations into and within the polar regions pose their own set of complications. In the polar regions, it is the frequent unpredictable occurrences, which are all too commonplace, that are problematic and perplexing. There are a plethora of papers and studies that document in detail many of the aspects introduced in this report. The morphology of the region can be found, for example, in the works by Akasofu,⁴⁹ Belrose,⁵⁰ Hargreaves,⁵¹ Kelley,⁴⁷ and Wagner.⁵² The behavior of the HF skywave channel during quiet and disturbed conditions are described in Canon,⁵³ Goodman,⁵⁴ Goodman and Aarons,⁵⁵ McNamara,⁵⁶ Østergaard,⁵⁷ and Poppiano and Bradley.⁵⁸ These excellent materials describe and reference further ionospheric effects on communication systems. Others, like Wagner and Goldstein,^{59,60} have characterized the channel through actual probing techniques. This has led to devising key parameters that distinguish the various channel conditions. This categorization is in many ways essential if communications engineers are to design robust modems that will allow the receipt of messages with acceptable error rates in very demanding propagation environments. In an observational twist, Blagoveshchenskij, Egorova, and Lukashkin⁶¹ used HF radio wave observations as short-term diagnostics to predict impending high-latitude events.

There are three regions of the Earth's ionosphere: the equatorial, the mid-latitude (temperate), and the polar. Researches have defined polar phenomena in terms of vicinity to the Earth's poles. In this instance, the definition⁴⁵ takes into account not only geographic position, but geomagnetic processes as well. Thus, it is the intersection of both geographic and geomagnetic coordinate systems that defines the Earth's polar, or high-latitude, regions. For the Antarctic, the polar region is defined as all points within the locus of points defined by the intersection of the 60° south geographic (Λ) latitude and 60° south magnetic invariant (λ)

latitude. The resulting locus is illustrated as a dark blue band in figure 6.2. In this study, considerable effort was made to maximize the amount of information gathered for paths operating within the polar region. The three principal circuits (Salisbury-Davis, Davis-McMurdo, and McMurdo-Christchurch) used during the campaign are illustrated as red lines.

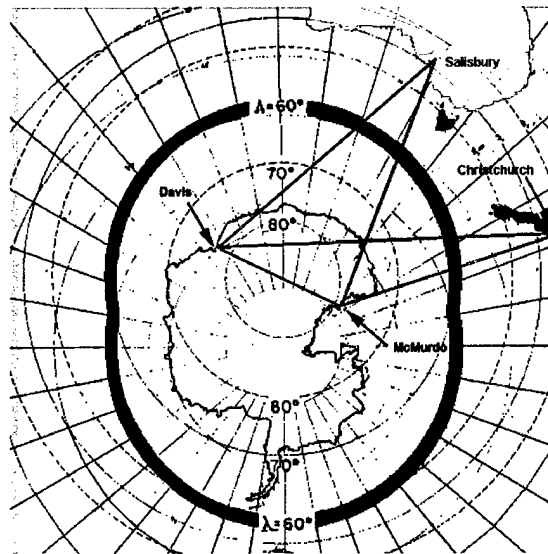

Figure 6.2. Polar Region of Interest

The polar region is divided into two regions: the auroral zone, or oval, and the polar cap. The auroral region includes all the areas of the Earth's ionosphere, the most important feature. It is an oval-shaped annulus centered at the geomagnetic pole. The active part⁵¹ of the oval is skewed in the anti-sunward direction, extending to 70° geomagnetic latitude on the sunlit side and 60° geomagnetic latitude on the nightside. During quiet periods, the oval will contract to within 20° of the geomagnetic pole. Statistically, this is the region where aurora can be seen most often. In this region, energetically charged particles from the Earth's outer radiation belts, i.e., the magnetosphere and the IMF, find their entry. Auroras are produced at about 100 kilometers as these energetically charged particles collide with atoms of the neutral atmosphere releasing energy in the form of visible light. The polar cap is the region typically within 10° to 20° of the geomagnetic pole. Phenomena in this region include sun-aligned polar arcs, F-region ionization patches, polar rain, and polar cap absorption events. The latter two are particle inputs. Polar rain is a very weak particle input, while a polar cap absorption, or solar proton event, results from the influx of high-energy protons and other particles that cause significant ionization over the entire polar cap.

Researchers⁶² are beginning to adopt a more structured approach for the magnetosphere, much as they did in distinguishing between active and quiet auroral states. At least three such states for the magnetosphere have been identified: the quiet, or baseline, state, the active polar cap state, and the active auroral oval state. As one would expect, the quiet state requires a

minimization of energy input from the solar wind, where typically there is a weak but northward IMF ($B_z > 0$). The auroral oval becomes visibly small in diameter and circular, somewhat expanded in the dawn and dusk regions, and relatively thin near midnight. During weak IMF positive ($B_z > 0$) conditions, the polar cap is relatively sizeable, given the contracted state of the auroral oval; whereas for strong IMF north ($B_z > 0$) conditions, the polar cap is often filled with burst-type soft electron conditions. It is of interest to note, without detailing the specifics of the many processes associated with either of the active states, that the active polar cap state occurs for strongly northward IMF ($B_z > 0$) conditions, while the active auroral oval state finds the southward IMF ($B_z < 0$) playing a prominent role.

6.3 OVERVIEW OF THE IONOSPHERIC LAYERS

Continuous, but not homogeneous, in plasma content, the ionosphere extends from about 50 kilometers above the Earth's surface to perhaps 400 to 500 kilometers. The ionosphere is divided into three principal layers, each exhibiting its own characteristic behavior. The altitude of the D-layer (or D-region) lies below about 90 kilometers, the E-layer forms between 90 and 120 kilometers, while the F-layer is present in the region between 200 to 400 kilometers. Some researchers also allow for a fourth layer, the C-layer, that resides at around 50 kilometers, the lowest limits of the ionosphere. Each layer, or region, is more like a band or ridge whose electron density and ion content vary in a somewhat regular fashion dependent upon altitude, time of day, season, geographic and geomagnetic latitudes, and solar activity. For radio waves, the D-region is an absorption layer. This absorption is diurnally governed, the variation of which is controlled by solar radiation. During the day, solar illumination causes photo-detachment, the production of ions, and an increase in absorption. At night, and in the Antarctic winter, the process is reversed and the absorption effects of this layer are lessened.

The E-region^{51,56,63,64} is also governed by solar radiation and is a significant reflecting layer only during the daytime. Electrons are essentially lost in recombination processes, with a net subsequent decrease in electron density that is quite rapid at sunset. In the polar regions, this rather regular diurnal behavior is oftentimes punctuated with spontaneous (and sometimes spotty) increases in electron density. Much like the sporadic-E layers that form at lower latitudes, these thin layers of dense ionization result in a strongly reflecting layer that is often present, particularly during sunspot maximum, in the late afternoons, and more apparent during the winter months. This layer can be so strong that it essentially blankets all exploration of the F-region at higher frequencies. In contrast, a second type of sporadic-E is observed at high latitudes that may have its peak occurrence prior to local midnight, particularly during the winter. This layer forms as charged particles precipitate into the auroral zone during periods of auroral activity, producing thin layers of greatly enhanced electron concentrations that bring about anomalous reflections of HF radio waves.

In general, the F-region^{51,56,63,65} is more complicated. During the daytime, the region stratifies into two layers, the F_1 and the F_2 . While the F_1 -layer is also controlled by solar radiation, there is an additional effect due to the mixing of atmospheric gases. Because of the greater mixing of these gases in the summer due to their higher concentrations, the ion loss rate is also greater. These resultant lower ion densities are attributable overall to the greater seasonal

behavior of this layer as compared to the E-layer. In contrast, the molecular concentrations in the F₂-region are lower and so too is the ion loss rate. While recombination does occur during the nighttime, its time constant is long and, at mid-latitudes, the ionization is able to persist throughout a 24-hour period. However, the behavior of the F₂-layer is far from being so straightforward. An anomalous F₂-layer is present during the Antarctic winter, when little or no photoionization is present. Seasonal dependence has also been observed with an abrupt decrease in local noon values of the critical frequency of the F₂-layer (f_0F_2) from a winter high to a summer low.

There are two general complexities with respect to the so-called normal polar ionosphere. The first, as mentioned earlier, is the presence of the sporadic-E layer in the auroral region. The second is the occurrence of spread-F, or spread echoes. The latter refers to the stretching or time-delay that a pulse would experience as it is reflected by the F-layer. The occurrence of spread-F tends to be more prevalent in the polar regions in the winter months and can occur at all hours of the day. Spread echoes are also present as E-layer phenomena, although in this case it is often considered a disturbance effect because it tends to be closely associated with E-layer enhancements that result from auroral activity. Spread-E is apparent in the summer during the early morning hours and continues on throughout the winter as the enhanced E-region is present. The early morning hours in summer and in winter are preferential times for enhanced-E, sporadic-E, and spread-E occurrences.

6.4 THE SHIFT FROM SUNSPOTS AS DIAGNOSTIC INDICATORS

At first glance, the surface of the sun appears to be rather featureless, except for sunspots that appear as black regions in the image of the sun (figure 6.4).⁶⁶ Sunspots often occur as groups and form complex active regions. They are rarely seen in isolation, but rather grouped in pairs of opposite magnetic polarities. Most begin to appear at the higher heliographic latitudes early in a new solar cycle, gradually migrating towards the sun's equator by cycle's end. The groupings generally confine themselves to between 30°N and 30°S heliographic latitudes.

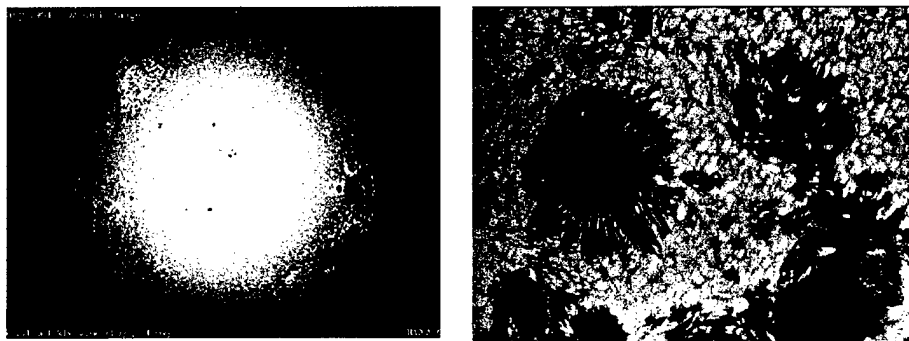

(Courtesy of National Solar Observatory and Kiepenheuer Inst. für Sonnenphysik.)

Figure 6.3. Image of the Sun (left) Showing Sunspots and Closeup of Sunspots (right)

The cyclic⁶⁶ behavior in the number of average sunspots visible on the disk was first noted by Hans Schwaber, an amateur solar astronomer, in 1843. He estimated the cycle to be about 10 years, although now it is widely regarded to be 11 years. In fact, it can vary from about 9 to 11.5 years. About 60 years later, observations by G. H. Hale showed that regions of strong magnetic fields observed on the sun are grouped in pairs of opposite magnetic polarities and that, at any given time, the ordering of positive/negative regions with respect to the east-west direction, the direction of the sun's rotation, is the same in a given hemisphere, but is reversed from northern to southern hemispheres. Further observations revealed that the magnetic polarities of sunspot pairs undergo a reversal in each hemisphere from one sunspot cycle to the next. Thus, it takes two sunspot cycles, or about 22 years, for a given pattern of magnetic polarities to reappear.

In addition to sunspots, other features of the sun are apparent when it is viewed through filters. One such view, shown in figure 6.4, is centered on a spectral line of hydrogen (α , where the wavelength $\lambda = 6563 \text{ \AA}$).⁶⁶ It shows, in addition to the sunspots and active regions, dark string-like structures called filaments and rather bright structures extending from the sun's surface called prominences. In fact, the two characteristics are one and the same feature. How the feature is viewed with respect to its background alters its appearance.

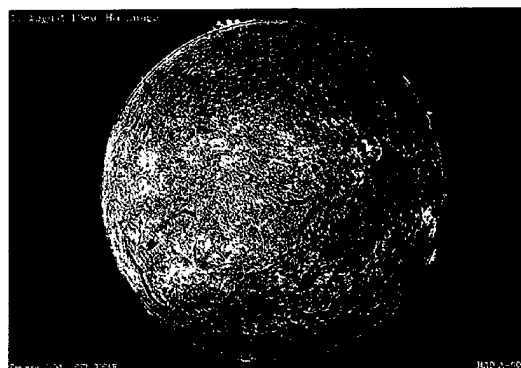

(Courtesy of National Solar Observatory and Kiepenheuer Institute für Sonnenphysik.)

Figure 6.4. View of the Sun Showing Filaments and Prominences

Traditionally, sunspot number has been viewed as the indicator of solar activity, as well as the defining parameter for denoting the solar cycle. For example, in predicting the performance of HF radio communication systems, the sunspot number appears as a primary input parameter in most computer programs that are used for radio propagation predictions.

An overall view of the general range of changes that occur during a solar cycle is presented in figure 6.5.⁶⁶ Though the solar images have not been normalized, or calibrated, to an overall relative intensity level, the changes shown are representative of what one might expect as the solar cycle progresses. (Again, the sun is presented as α images.) The images in the top row are representative images spaced one year apart during the declining phase of cycle 21 (1980 through 1984); the images in the bottom row images are for the rising phase of cycle 22 (1985 through 1989). Filaments and prominences disappear during solar minimum, 1985 through 1986,

and begin to reappear as the cycle again begins its rise. Also evident is the drift, noted earlier, of the active regions towards the equator during the descending phase and their reappearance at mid-latitudes once the next cycle begins. This migration was also noted for sunspots when the sun was observed as white light images by the amateur solar astronomer R. C. Carrington. During a solar cycle, in addition to the rise and fall of sunspot numbers manifesting themselves, one may view the solar cycle as primarily magnetic in origin since sunspot activity was spectroscopically determined at the beginning of the twentieth century to be seats of strong, concentrated magnetic fields.

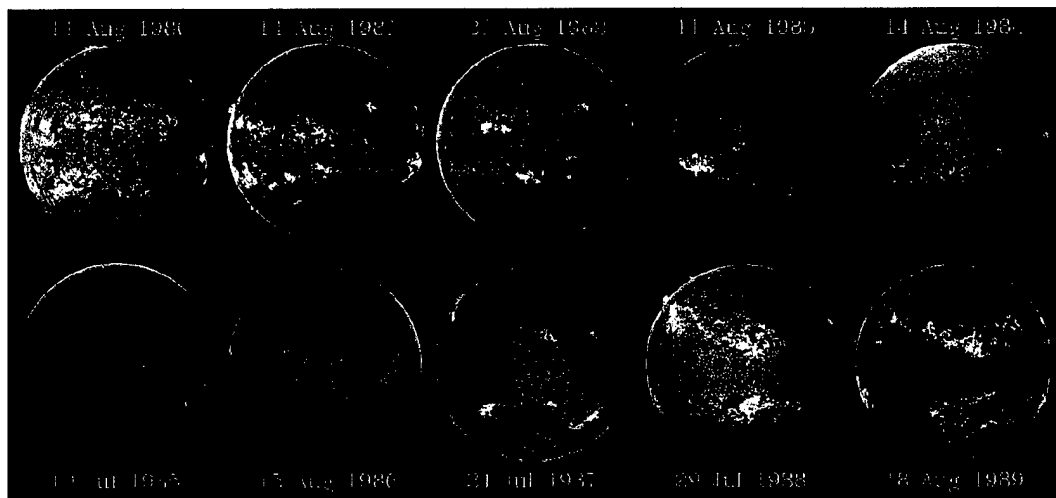

(Courtesy of Space Environmental Laboratory, National Aeronautic and Oceanographic Administration)

Figure 6.5. View of Changes in a Solar Cycle

In an x-ray image of the sun, as in figure 6.6, very bright regions of sudden, short-lived duration can be observed.⁶⁶ These events, called flares, in terms of x-ray brightness, often exceed that of the entire remaining portion of the sun. This particular feature is grouped under a class of occurrences known as solar activity. The energy source for these solar flares is thought to be the reconfiguration and dissipation of the sun's magnetic fields via reconnection. Another important feature on these images is coronal holes, which are very dark regions located usually near the solar pole, but may extend lower in heliographic latitude. Coronal holes also look dark on white light images of the sun. This suggests that not only are the gas densities less than other structures, but less heating also occurs. This would infer that coronal holes may be regions of open magnetic field lines along which coronal gas can flow outward in the form of the solar wind (plasma).

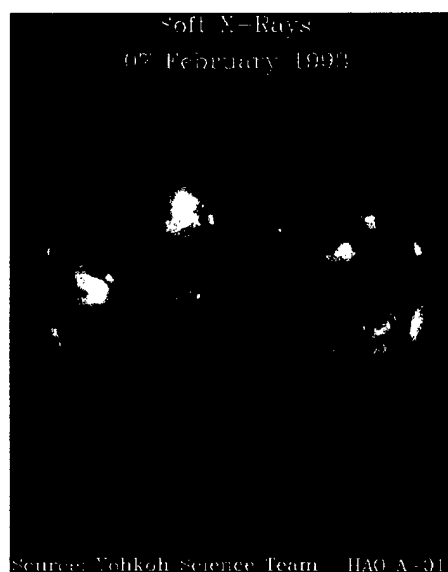

(Courtesy of Yohkoh Science Team.)

Figure 6.6. X-Ray of the Sun

From an historical point of view, sunspots were a feature observed from the very beginning through the first telescopes of Galileo and other early solar astronomers. Another characteristic that would eventually prove rather important in recent thinking about the dynamics of solar-terrestrial interactions does not appear to have entered the historical record until sometime in the early eighteenth century. This feature is associated with the sun's corona, the outermost layer of the sun's atmosphere associated with low densities and high temperatures. It is from the sun's corona that ionized gas streams away from the sun in an outflow that is known as the solar wind. During a solar eclipse, the most common structures observed on eclipse photographs are helmet streamers. These structures are also observable with a coronagraph, a device that enables one to view the sun's corona at times other than during an eclipse. As their name implies, helmet streamers are rather bright, elongated structures, broad at the base and trailing or tapering off into long, narrow spikes at one to two sun radii such as the helmet spike in the lower left of figure 6.7.⁶⁶ Unlike coronal holes, coronal material is thought to be effectively trapped by closed magnetic field lines, with enhanced density levels that lead to detectable levels of x-ray emissions. Though these structures are long-lived, their demise can occur quite suddenly. Their breakup results in an expulsion of a massive amount of coronal material in the range of 10^{12} kilograms, traveling at average speeds of 400 kilometers per second. This expulsion is considered one of the most striking aspects of solar activity and is called coronal mass ejections (CMEs).

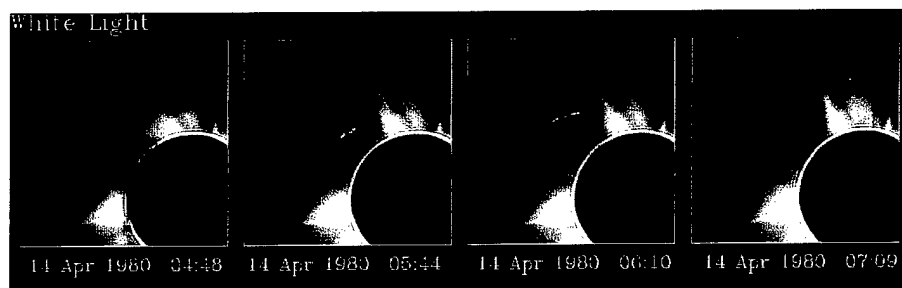

(Courtesy of High Altitude Observatory, National Center for Atmospheric Research.)

Figure 6.7. Solar Maximum Mission's Coronagraph of Helmet Streams, April 1980

CMEs occur at all heliographic latitudes, and evidence suggests that they are not directly related to localized heating events like solar flares, as these occur only at lower heliographic latitudes. Hundhauser⁶⁷ (of the National Center for Atmospheric Research) demonstrated this rather effectively for the 10-year period from 1980 through 1989, as depicted in figure 6.8. The figure on the left from Hundhauser denotes the heliographic latitudes for the occurrences of both flares and active regions as a function of time. These were confined for the most part between $\pm 30^\circ$ heliographic latitudes. The migration toward the equator during the solar minimum of 1985 thorough 1986 is apparent. Also noticeable is the jump (step function) to higher heliographic latitudes for both the active regions and the solar flares as the solar cycle begins. Figure 6.8 (right) also shows the latitudinal distribution as a function of time for coronal helmet streamers, prominences, and CMEs. As described earlier, these occur at all heliographic latitudes. It is interesting to note the decline in absolute numbers and the migration toward the solar equator during the solar minimum.

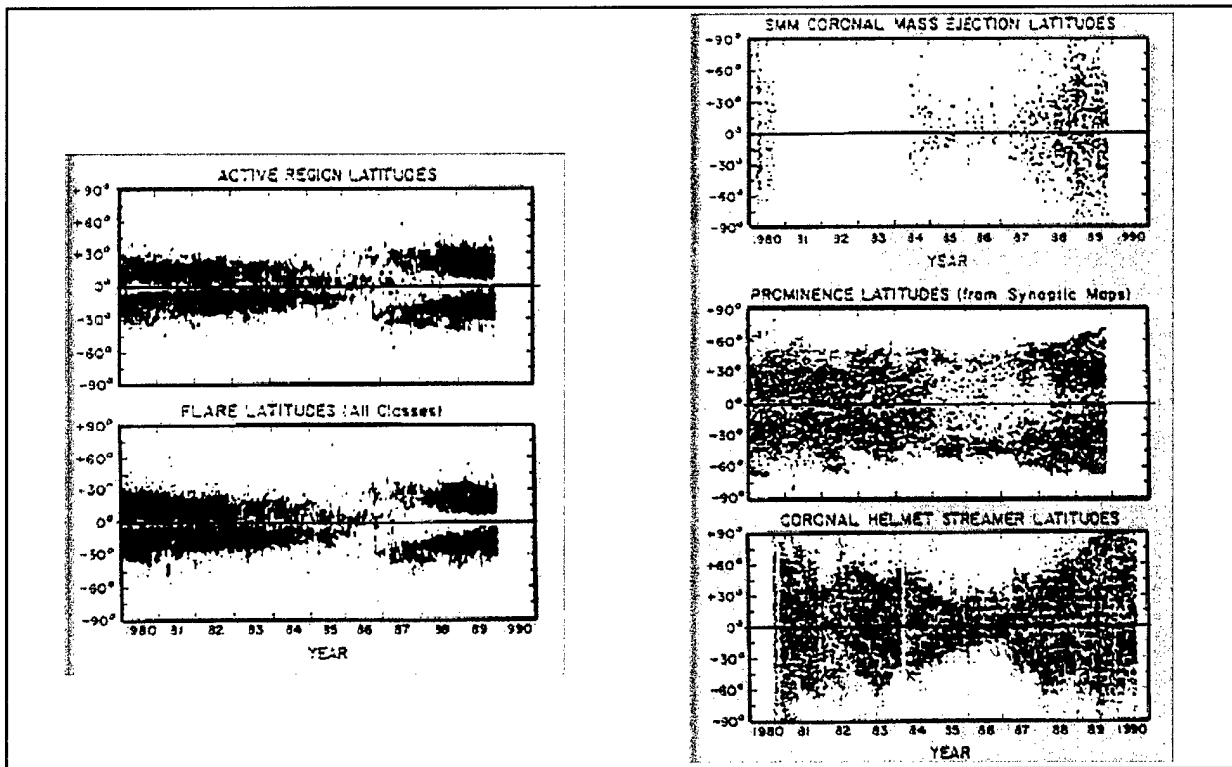

(Courtesy of High Altitude Observatory, National Center for Atmospheric Research.)

Figure 6.8. Heliographic Latitude for Flares and Active Regions (left) and Latitudinal Distribution for Coronal Helmet Streams, Prominences, and CMEs (right)

CMEs are rarely preceded by large flares (but have been noted to occur with solar flares during very large events⁶⁸) or by intense activity. These mechanisms are complexly interwoven with the dynamics of the sun's corona.⁶⁹ The triggering event for a CME is currently thought to be the loss of large-scale magnetostatic equilibrium. A coronagraph of a CME is provided in figure 6.9.⁶⁶ This series of photographs is from one of the most powerful CMEs, which occurred on 24 October 1989 and was recorded onboard the *Solar Maximum Mission's* coronagraph. Approximately 20×10^{13} kilograms of material were ejected travelling at velocities of nearly 2000 kilometers per second. This resulted in a coronal outburst nearly 100° wide.

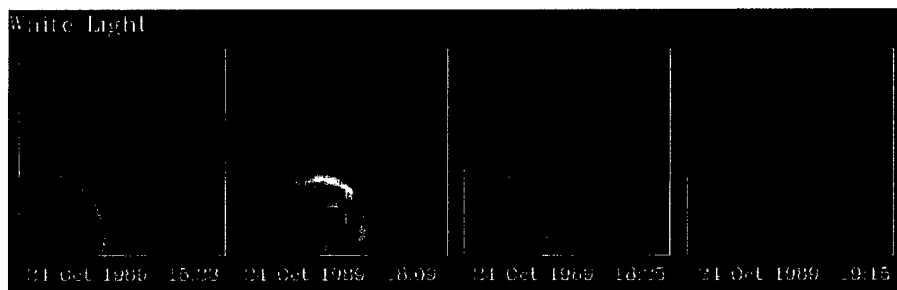

(Courtesy of High Altitude Observatory, National Center for Atmospheric Research.)

Figure 6.9. Solar Maximum Mission's Coronagraph of CMEs, October 1989

For most of the last decade, a discernible shift has occurred among space environment forecasters concerning the source(s) of solar-terrestrial events. The earlier view suggested that it was sufficient to monitor the incidents of solar flares. Once a flare was observed, chances were good that geophysical effects would be forthcoming. Observations from various satellite and *Skylab* missions further refined the causes of the geomagnetic disturbances to be linked to the onslaught of interplanetary shocks that, in all likelihood, continued to accelerate particles to the limits of the heliosphere. However, it was the space findings themselves that were clues to a new understanding of the relationship between detected particle events and large non-recurrent geomagnetic storms.

A remarkable philosophical shift occurred in the early 1990s when CMEs were attributed as the cause for various disruptions and disturbances that had heretofore been assigned to solar flares. Though short lived, large and intense solar flares, often occurring in the vicinity of sunspots on the sun's surface, were associated with major space and terrestrial disturbances. Indeed, under the old paradigm, these flares were the cause and effect responsible for alterations in the solar wind pattern, the introduction of energetic particles in interplanetary space, and deformations of the Earth's magnetic field. CMEs are now considered the mechanism for particle acceleration.^{68,70,71}

This finding has led also to a basic shift in the role of particles resulting from the ability to distinguish between two primary particle sources. Current research is concentrating on understanding the role of the specific acceleration mechanisms and their relationship to the types of proton events observed. This is a key factor in the ability to predict large nonrecurrent geomagnetic events on Earth. The CMEs' subset associated with both flares and filament eruptions is now seen as the crucial link between solar activity and geophysical disturbances, the exact nature of which is still evolving.

There are other physical mechanisms at play from which energy is extracted into the Earth's magnetic field. An example, particularly during the period after solar minimum, is the role of the ambient, or quasi-stationary, solar wind structures. These arise when gradients are present in the solar wind speed. Another is the role of the Earth's magnetosphere in regulating the extent of energy extraction. This latter phenomenon is evident in the seasonal patterns of storm occurrence and geophysical activity that fall around the spring and autumnal equinoxes.

6.5 FORECASTING

Much like terrestrial weather forecasting, space weather forecasts are roughly arranged according to the time span of forecast, e.g., current (the next 24 hours), extended (several days), long-range (next several months), and seasonal or cyclical (the next solar cycle). In terms of the next solar cycle, there are several techniques researchers employ for the prognosis of the solar-terrestrial environment. Among the six or so prominent prediction techniques, the precursor method is generally considered the most reliable, having thus far demonstrated the most success. This method relies on the notion that the imminent solar cycle actually starts in the declining phase of the previous cycle, thus, in a sense, extending the solar cycle. Key roles in this extension process are given to the occurrence of coronal holes and the strength of the solar polar

magnetic field. High-speed solar winds stream from the low-latitude coronal holes that, in turn, give rise to recurrent geomagnetic activity.

Researchers^{72,73} using these methods invoke a solar-dynamo concept. This is similar to the occurrence of the Earth's magnetic field; its weak magnetic field is amplified in its core through the fluid motions of an electrical conducting field. Unlike the sun, the Earth's magnetic field at the surface is described⁷⁴ as mainly dipolar (about 90 percent). In this case, magnetic north and south can be defined rather unambiguously. Figure 6.10 shows a calcium image (left image) and a magnetogram (right image) of the sun. The calcium image is the sun's image as it appears taken through a 10-Å wide filter centered on the K-line ($\lambda = 3933 \text{ \AA}$) of calcium. This provides better contrast of the sun's magnetically active regions against the remaining solar surface. The magnetogram, a synthetically constructed image, provides an estimate of the intensity of the magnetic field on the sun's surface. The pink-red-yellow sequence corresponds to increasingly strong positive normal magnetic field component (field lines pointing away from the sun), while the purple-blue-light blue sequence indicates the increasingly strong negative component (magnetic field lines pointing into the sun). Thus, on the sun's surface, a compass would be rather useless given the multiple region of positive and negative components, as the figure 6.10 clearly shows.⁶⁶ The calcium image also demonstrates, spectroscopically, the discovery that was determined at the beginning of the twentieth century that sunspots are the seats of strong magnetic fields.

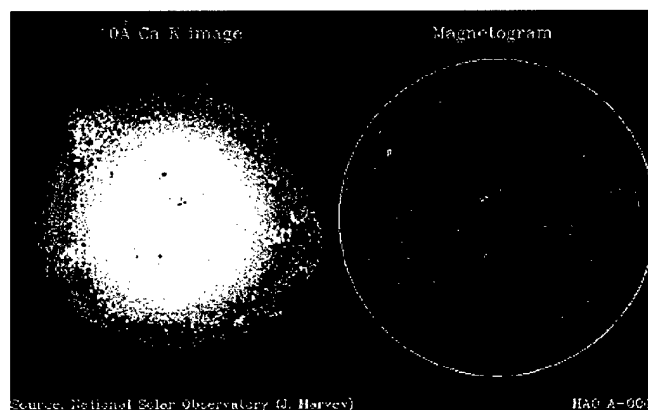

(Courtesy of High Altitude Observatory, National Center for Atmospheric Research.)

Figure 6.10. Calcium Image (left) and Magnetogram (right) of the Sun

With this solar-dynamo view⁷⁵ of the sun, the nature of the polar field at the beginning phase of the solar cycle is considered a *seed* for the future activity of the sun. For example, if at the start of a solar cycle the polar field is weak, little toroidal field is generated and few sunspots develop. On the other hand, if at the start of another cycle the polar field is strong, the reverse is true. Thus, the future solar activity and the predicted behavior of the imminent solar cycle are linked through the connections that exist between the polar field, coronal holes, the interplanetary field, and geomagnetic activity. In the end, however, the actual shape for the solar cycle cannot be forecasted. Rather, an envelope (minimum, most likely, maximum values) of shapes is estimated based on statistical analysis of the rise and fall times of past cycles with

similar sunspot maximum values. As the actual cycle develops, the projected profile provided to researchers by various solar monitoring and prediction centers is modified and corrected.

Historically, there has been a greater likelihood that particularly geomagnetically stormy months would be associated with the magnetic cycle maxima and, though not necessarily synchronous with, the well-known sunspot cycle. These maxima have varied over an 11-year cycle. (In actuality, as noted earlier, this variance is over a 22-year period.) Figure 6.11 shows this variance for three solar cycles from 1963 to 1993.⁶⁷ Displayed in the figure are the composite yearly averages of the magnitude of the interplanetary field $|B|$, shown as the upper plot with the left ordinate indicating graph values. The lower plot is the yearly average of the sunspot numbers with the ordinate on the right indicating actual graph values. The increasing phase of the solar cycle is indicated as a light green cast, while the declining phase is clear. Particularly evident for cycles 21 and 22 (less so, but with persistence for cycle 20) is the nonsynchronicity between solar activity and variations in the IMF whose magnitude increases for several years after solar maximum, before it starts a rapid decline towards solar minimum.

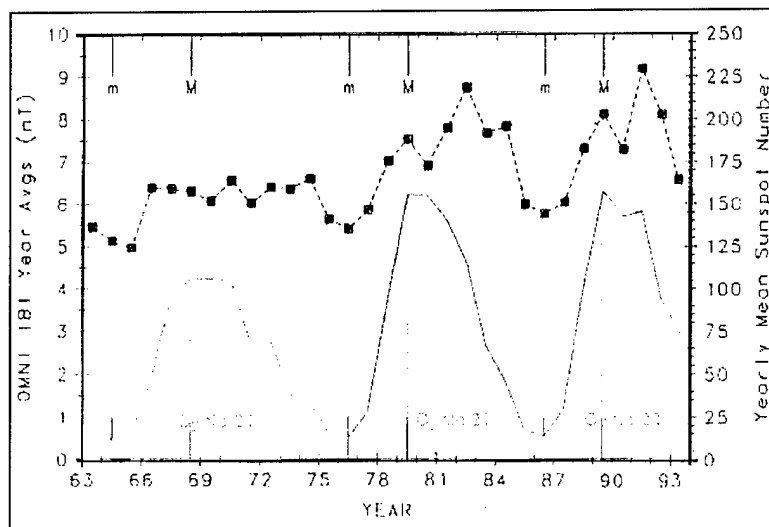

(Courtesy of High Altitude Observatory, National Center for Atmospheric Research.)

Figure 6.11. Composite of Yearly Averages of the Magnitude of the Interplanetary Field and Sunspot Numbers, 1963 to 1993

Similar in importance as impending solar cycle forecasts are geomagnetic forecasts for the new cycle. Both expected total number and annual number of geomagnetic disturbances are being estimated. This is a new objective for the scientific community.^{72,73} The prediction ability of two forecasting techniques are in the early stages of evaluation. One technique is based on the previously mentioned precursor method, which relies on recent observations; the other, the climatological technique, attempts to extend the archival record of observed geomagnetic and aural indices (K_p and A_p , respectively) into the future. Though in its infancy, these two methods are predicting similar (near cycle 22) levels for solar cycle 23.⁷¹

The limitations in current cyclical space weather forecasting is more critical to system planners than to the present communications user community. Broadcast warnings issued by governmental and/or scientific agencies usually provide communicators with current and extended forecasts. Current forecasting skills, while disappointing for disturbed conditions, remain nonetheless the primary means through which operators of communication links or networks gauge the viability of their services. For example, in a comprehensive review of the state of geomagnetic forecasting, Joselyn⁷⁶ has cited that of the 126 times a solar storm was predicted to affect the Earth between 1987 and 1993, only 47 of these predictions were realized, the remainder were false alarms. Thus, even when communicators were armed with solar weather forecasts, or the knowledge that the equinox periods (March/April and September) are most likely to be disturbed, there still is nothing to accurately forewarn the communicator that an event is in the offing. This picture may improve in the next several years, increasing the warning time to perhaps as much as one to three days, as new instrumentation is sent into space to monitor the sun. Earth orbiting instruments to image interplanetary shock waves are in the offing to provide warning of an impending disturbance heading towards the Earth. At the same time, the proposed Polar Cap Observatory⁴⁶ would provide important monitoring facilities of the upper atmosphere.

Beacons and sounders, though providing real-time, current channel and path assessments, are of particular value only to those operations that can monitor the diagnostic signals. In the end, they must have the flexibility to manage the routing of their traffic. The situation has been less sanguine for the USAP, more so prior to regular satellite services and the Internet. Notwithstanding health and safety stipulations, communicators operating short-wave circuits within and between the Antarctic theater were required to be prepared for the likelihood that HF communications would either be erratic or disrupted because of solar or geomagnetic activity. HF/ALE was, therefore, one attempt to provide parity with more sophisticated HF radio networks. Though these techniques would still be subject to the vagaries of HF propagation conditions, they would provide automated real-time channel assessment in a form environmentally robust enough to survive the many demands and needs of a disparate user community.

7. PREDICTED PERFORMANCE OF THE VARIOUS COMMUNICATION LINKS

As with many endeavors, having *a priori* information that suggests the possibilities of success has many benefits, such as being able to prepare for contingencies, to consider alternatives, and to devise backup plans. Over the last 25 years, a series of computer programs has been developed by the U.S. government for predicting HF propagation characteristics. During the last decade, one of the principal prediction programs of choice has been the IONCAP^{77,78} program, which was developed at the Institute of Telecommunications Sciences (ITS). IONCAP was an outgrowth of several earlier endeavors and many of its features had their antecedents in prediction programs such as ITSA-1,⁷⁹ ITS-78, HFMUFES4,⁸⁰ and RADARC.

In the past few years, a new prediction program, the Ionospheric Communications Enhanced Profile Analysis and Circuit (ICEPAC) program, has emerged. Its acronym is based on IONCAP's predictive capabilities for the mid-latitudes. ICEPAC, also developed at ITS, was created principally to improve the predictions in the high-latitude and polar regions by including a model to relate the geomagnetic disturbances in these regions to predicting circuit performance. An early evaluation⁸¹ of ICEPAC's ability to predict performance under these conditions was carried out for two high-latitude circuits during various geomagnetic disturbances. One path was a short path within the auroral zone between Alta and Andöya; the second path, a longer, trans-auroral path of approximately 1200 kilometers, was between Alta and Klöfta, situated near Oslo. This earlier version of the code, however, was shown to suffer from several discrepancies when compared to actual observed circuit performance. Both the channel reliability and MUFs were significantly overestimated, particularly for magnetically disturbed conditions and for the short path within the auroral zone. A further weakness was the apparently incorrect modeling of the transmission losses, especially during disturbed conditions. The ICEPAC code significantly underestimated these losses.

The Voice of America Coverage Analysis Program (VOACAP),^{82,83} also a descendent of IONCAP, is available for downloading from the Voice of America (VOA) on the Internet. This code was developed mainly under an initiative by VOA to correct several of the known, as well as newly uncovered, discrepancies in IONCAP. Many of these corrections focused on the SNR distribution. In essence, it was found that there were a number of significant changes in the required power gain for paths more than 3000 kilometers. These changes were more prevalent in high-sunspot years than low and for low latitudes as opposed to high latitudes. The most significant changes occurred for frequencies of less than 10 MHz on circuits with path lengths of less than 3000 kilometers.

An alternative approach to computer prediction is provided by the Ionospheric Prediction Service's (IPS) Radio and Space Services, an agency of the Australian Department of Administrative Services. IPS has been in the prediction business for over forty years. Their current advance system, called the Advanced Stand-Alone Predictions System (ASAPS),^{84,85} a PC-based version of earlier developments, is based on IPS models of the ionosphere and HF radio propagation, as well as on international standards (Centre for Communication Interface Research (CCIR) Reports 322 and 894 and CCIR Supplement Report 252-2).

7.1 COMPARISON OF IONOSPHERIC COMMUNICATIONS ANALYSIS AND PREDICTION PROGRAM (IONCAP) WITH ADVANCED STAND-ALONE PREDICTION SYSTEM (ASAPS)

A comparison was made between ionosonde extrapolated values of frequencies selected from the monthly cumulative distribution of hourly frequency availability and computer predictions from the IONCAP and ASAPS computer programs. The objectives of the comparison were to determine the relative prediction accuracy of the ASAPS and IONCAP programs and to validate computer model predictions in general.

The results⁸⁶ suggest that either IONCAP or ASAPS computer program provides adequate tools for HF network design in Antarctica, particularly during periods of low sunspot number. In general, the path loss predicted by both programs agrees to within 3 dB. However, because IONCAP provides additional communication tools, such as reliability calculations that are not found in the ASAPS application, some users may prefer the completeness of IONCAP to the user friendliness of ASAPS. This confidence might also be extended to HF networks operating in the Arctic if, through symmetry, the application tools are indeed predictive of high-latitude links. In general, network performance predictions may not apply during solar or geophysical disturbances. However, during benign conditions, network performance coupled with real-time ALE HF network sounding could establish procedures to minimize communication disruptions. This might be accomplished through the use of a simple ALE HF network broadcast that finds those frequencies that first open up after a disturbance to more sophisticated procedures that use alternate network routing and/or multi-band resources.

The IONCAP and ASAPS HF radio propagation prediction programs compared above were used to predict the propagating frequencies extrapolated from an existing database of ionosonde data from Scott Base in Antarctica. The ionosonde has provided many years of nearly continuous vertical incidence measurements of the critical frequencies, virtual reflection heights, and oblique-incidence MUF factors. These data provide a valuable empirical basis for the validation of radio circuit models for HF link performance prediction in the auroral environment, particularly for circuits whose reflection point is located in the vicinity above Scott Base. These predictions provide a useful analytic tool for link and network design inasmuch as frequency selection is concerned, but they fall short of establishing validated estimates of transmitter power requirements. A summary⁸⁶ of the main results suggests that

- the ASAPS and IONCAP basic MUF values (FOT, MUF, HPF) are less than ± 2 MHz in nearly all cases and are often closer than 0.5 MHz,
- both the ASAPS and IONCAP predictions are within about ± 3 MHz of ionosonde-extrapolated results for a majority of the hours and months shown, with many comparisons within 1 MHz, and
- the predicted diurnal variation of the basic MUF values appears to track the corresponding measurements in a majority of the cases.

Both IONCAP and ASAPS were shown to predict the propagating frequencies extrapolated from the Scott Base ionosonde data. Significant discrepancies between the observed data and the prediction programs did arise, but only during periods of high sunspot number and low solar zenith angle.

**7.2 NATIONAL TELECOMMUNICATIONS AND INFORMATION
ADMINISTRATION/INSTITUTE OF TELECOMMUNICATION SCIENCES
(NTIA/ITS) HF PROPAGATION MODELS**

For a number of reasons, ICEPAC⁸⁷ was selected as the prediction program of preference for the predictions and comparisons that will be presented in this report. ICEPAC, in some sense a successor to IONCAP and currently supported by ITS, was considered most likely to be available and used in the U.S. Since its earlier evaluation in Norway, ICEPAC has been greatly improved. The ICEPAC program can generate, by stepping through several menu displays, a variety of color plots for several propagation parameters versus frequency and time of day as a function of variously specified hardware, circuit, ionospheric, and site specifications. ICEPAC is packaged with a suite of programs that are intended to provide comprehensive HF propagation analysis capability. The other analysis programs are ICEPAC Area Coverage Program (ICEAREA) and the HF Antenna Design Program (HFANT). ICEAREA can be used to calculate the regional field strength distribution around sites of interest. The HFANT program can be used to model many of the commonly used HF antenna types to provide input parameters for the ICEPAC program. The parameters used for analysis in this report are listed in table 7.1.

Table 7.1 ICEPAC Program Parameter List for Contour Plots⁸⁷

Parameter	Definition
Radiation angle	Angle of propagation from the antenna referenced to the horizon
SNR median decile	The SNR value at the receive antenna terminal
Signal power lower decile	The measured signal power at the receive antenna terminal
Time availability SNR > required SNR [%]	The percent of time the calculated SNR is greater than the required SNR
Field strength, median [dBμ]	Median signal strength expected at the receive antenna terminals in decibels above 1 microvolt per meter

7.3 ICEPAC ANTENNA GAIN CALCULATIONS

The HFANT program contains built-in algorithms for several standard antenna types, including a model for the terminated sloping-vee model, which is referred to as antenna type 37. Antenna pattern plots for the terminated sloping-vee antenna model contained within the HFANT program were generated using input parameters matching the conditions at the test locations. (The plots are located in appendix A.) Each HFANT plot includes a listing of all the input parameters.

Included in the HFANT program is a table of suggested ground constant data for various ground types. Table 7.2 is a list of site-specific antenna parameters for the four test locations. The ground conditions at the two Antarctic sites vary little throughout the year because the ground never thaws. In Salisbury, the climate is very hot and dry in the summer, though often-times cool and quite wet in the winter. The climate at Christchurch is generally cooler and damper in the summer, while normally receiving some snow cover in the winter. The ground at Black Island is frozen volcanic rock. The values suggested for medium dry ground were used for both Salisbury and Christchurch, while the suggested values for poor ground were chosen for Black Island and Davis.

Table 7.2. Site-Specific Antenna Parameters

Site	Conductivity (mho/m)	Relative Dielectric Constant (ϵ_r)	Apex Height (m)*	Termination Height (m)	Trans. Line Length (m)	Trans. Line Type	Trans. Line Attenuation (dB)	Trans. Power at Antenna Feedpoint (kW)
Christchurch	0.0100	15	12.2	1.8	91	RG 214	2.7	0.067
McMurdo	0.0001	4	12.2	1.8	300	2.22-cm Heliax	1.8	0.083
Salisbury	0.0100	15	12.2	1.8	200	RG 214	6.0	0.025
Davis	0.0001	4	12.2	1.8	150	2.22-cm Heliax	0.9	0.102

*Estimate

An important input parameter to HFANT is the transmit power referenced to the input terminals of the transmit antenna. This value was calculated from the transmitter power and the transmission line loss. The RF-7210 transmitter at Salisbury had an output of 100 W while all other transmitters (from the RF-5000 series) had an output of 125 W. Transmission line loss varied significantly between locations.

The topographical characteristics of the two Antarctic test sites are vastly different from the sites at Salisbury and Christchurch. The antenna locations at Salisbury and Christchurch were very flat and there was no discernible difference in ground elevation between the apex tower and termination locations. On the other hand, there was significant slope to the area where the two sloping-vee antennas were installed at Black Island. Elevation variations are described in table 7.3. Site-specific information is not known for the Davis site, although pictures suggest that it was relatively flat and near sea level in elevation.

For the purposes of modeling the radiation patterns of the sloping-vee antennas, it was assumed that the topographic and ground conditions at Black Island and Davis Station were essentially identical. Similar assumptions were invoked for pairing the Christchurch and Salisbury sites. The effects of the varying elevation at Black Island did not affect the relative orientation of the antenna enough to significantly affect the antenna radiation patterns; thus, for simplicity, the analysis was done for the flat ground case. For these reasons, only two antenna parameter files were calculated using HFANT and utilized as input parameters for the ICEPAC

prediction calculations. One file was generated for the two Antarctic sites and another was generated for Christchurch and Salisbury. The HFANT program displays an output plot depicting either the antenna elevation pattern or the azimuth pattern at specified elevations. (Azimuth and elevation plots are presented in appendix A.) Typical plots of both the elevation and azimuth antenna patterns are shown in figures 7.1 and 7.2.

Table 7.3. Antenna Site Elevation Characteristics

Antenna Location	Pointed to:	Apex Location Height Above Sea Level (m)	Apex Height Above Ground (m)	Left Term. Ground Height Relative to Apex Ground Location (m)	Left Term. Height Above Ground (m)	Right Term. Ground Height Relative to Apex Ground Location (m)	Right Term. Height Above Ground (m)
Christchurch	McMurdo	Unknown	12.2	0*	1.8	1	1.8
McMurdo	Christchurch	30	12.2	0*	2.0	5	2.0
McMurdo	Davis	30	12.2	4*	2.0	-5	2.0
Salisbury	Christchurch	36.1	12.2	0.4	3.0	0.3	3.0
Salisbury	Davis	36.1	12.2	0.5	3.0	-0.1	2.0
Davis	Salisbury	15.2*	12.2	0*	3.0	0*	3.0
Davis	McMurdo	15.2*	12.2	0*	3.0	0*	3.0

*Estimate

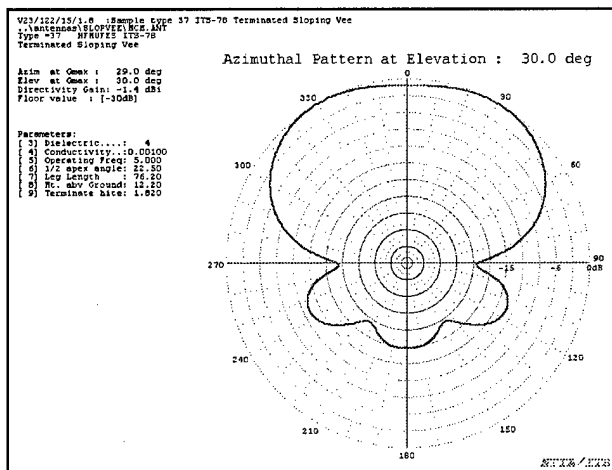

Figure 7.1. Typical Antenna Azimuth Pattern

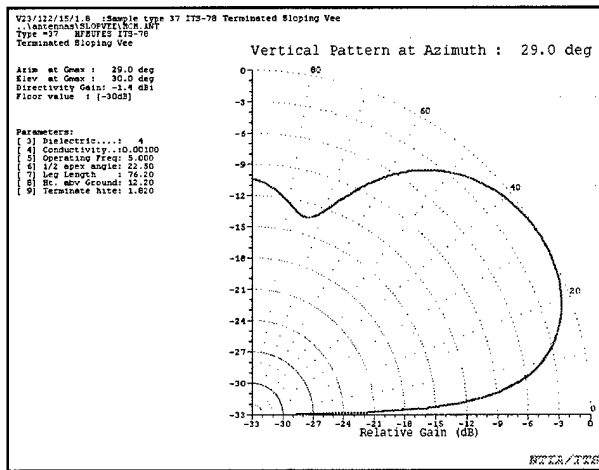

Figure 7.2. Typical Antenna Elevation Pattern

7.4 ICEPAC INPUT PARAMETERS

The parameters required by the ICEPAC program to compute the predicted propagation characteristics are listed in table 7.4. Procedures and reasons for selecting these parameters are described below.

Table 7.4. ICEPAC Input Parameters⁸⁷

Input Parameter	Description
Date	Year, month, and day
Sunspot number	Smoothed Ri sunspot number for target month
Effective Q	Monthly average value for target month
Transmitter location	Longitude and latitude of site
Receiver site	Longitude and latitude of site
Path type	Long or short path
Frequency	Up to 10 values
Man-made noise	Noise level at receive location
Minimum take-off angle	Minimum elevation above the horizon where the antennas can propagate/receive RF energy
Required circuit reliability	Percentage of time that a usable circuit is required
Required SNR	Required SNR in a 1-Hz bandwidth
Multipath power tolerance	Maximum level that can be tolerated below the primary mode power level for all other multipath modes
Maximum tolerable time delay	Maximum possible difference in delay times between multipath signals
Multiplier for f0E1, f0F1, f0F2, F0Es	Multiplication factor that raises or lowers the ionospheric reflecting layers
Receive antenna data file	Receive antenna gain and efficiency data (HFANT file)
Receive antenna orientation	Pointing direction east of north in degrees
Transmit antenna data file	Transmit antenna gain and efficiency (HFANT file)
Transmit antenna orientation	Pointing direction east of north in degrees
Transmit antenna power	Input power to transmit antenna in kilowatts

7.4.1 Seasonal Information

The seasonal breakdown of the data presented in this report is based on the Antarctic seasonal schedule with regards to access to McMurdo Station and points beyond. McMurdo is readily accessible by air from December through February. This is considered the summer Antarctic season. The other nine months are generally referred to as the winter over season. The winter over season is not perceived to include the fall and spring periods but, because auroral activity is known to be affected in a true seasonal nature, the data presented in this report are

broken down into the four seasons referenced to the Antarctic summer. The Antarctic seasonal breakdown and designated target months are listed in table 7.5.

This report presents data collected over a two-year period starting in January 1993. Propagation analysis using ICEPAC for the 9 target months of the 9 seasons spanning the 2 years is presented for comparison to measured data. The 15th day of the target month is used as the date for the ICEPAC analysis. This day was chosen because it is the approximate mid-way point of the 3-month season.

Table 7.5. Antarctic Seasons

Season	Duration	Target Month
Summer	December - February	January
Fall	March - May	April
Winter	June - August	July
Spring	September - November	October

7.4.2 Seasonal Sunspot Activity

Published^{88,89} values of the smoothed Ri sunspot number for the middle, or target, month for each season were used as an input parameter in the ICEPAC program. Ri is the official monthly sunspot number provided by the Sunspot Data Index Center, Observatoire Royal de Belgique, which is located in Brussels. The smoothed value is the average of the 13 monthly observed values that are centered on the month of interest.

7.4.3 Effective Q-Index

Another solar activity parameter used as an input for the ICEPAC program is the effective Q-index (Q_e), or the monthly average value for the target month. The ICEPAC program was written at a time when the Q_e -index was calculated and readily made available by the U.S. Air Force. The Q_e -index was abandoned by the time this test was started. This necessitated the use of the K_p -index, which compares directly to the Q_e -index using the simple relationships listed in table 7.6.

Table 7.6. K_p to Q_e Conversion Factor

$K_p < 1$	$Q_e = 3 * K_p$
$K_p > 1$	$Q_e = K_p + 2$

The K_p -index is an arithmetic mean of thirteen K-index measurements from separate observatories that lie between 46° and 63° north and south geomagnetic latitude. The K-index classifies the magnetic field into disturbance levels for 3-hour periods ranging from level 0 (quiet) to level 9 (greatly disturbed). (A complete list of the published K_p data (spreadsheets) is contained in appendix B.) Table 7.7 is a list of abbreviations for the K_p and calculated Q_e terms.

Table 7.7. Definition of the K_p and Q_e Abbreviations

Abbreviation	Definition
Q_e Avg/Mo	The Q_e -index value calculated from the monthly average K_p index value
K_p 0-3	The K_p -index value* for 0000-0300 universal time (UT) hours
K_p 3-6	The K_p -index value* for 0300-0600 UT hours
K_p 6-9	The K_p -index value* for 0600-0900 UT hours
K_p 9-12	The K_p -index value* for 0900-1200 UT hours
K_p 12-15	The K_p -index value* for 1200-1500 UT hours
K_p 15-18	The K_p -index value* for 1500-1800 UT hours
K_p 18-21	The K_p -index value* for 1800-2100 UT hours
K_p 21-24	The K_p -index value* for 2100-2400 UT hours
K_p Sum	The sum of the eight 3-hour K_p -index values for a particular day
K_p Avg/Day	The average K_p -index value for a particular day
Q_e Avg/Day	The average Q_e -index value for a particular day

*Divide listed value by 10 to obtain actual value.

Q_e is derived from the published planetary K_p -index, which is an index designed to give a global measure of geomagnetic activity. K_p values for the test duration were downloaded from the National Geophysical Data Center Internet web site.⁹⁰ The solar activity parameters that were used in the computer analysis are listed in table 7.8. Although the K_p -index was used for this evaluation, it is not particularly satisfactory for representing disturbances within the polar cap.

Table 7.8. Solar Activity Parameters⁹⁰

Year	Season	Ri Sunspot Number (Target Month Smoothed Value)	Q_e (Target Month Average)
92/93	Summer	71.4	4.8
93	Fall	63.6	4.8
93	Winter	56.1	3.9
93	Spring	48.4	4.3
93/94	Summer	36.6	3.2
94	Fall	33.7	5.3
94	Winter	28.5*	4.1*
94	Spring	26.5*	4.9*
94/95	Summer	26.6*	4.9*

*Preliminary estimates.

7.4.4 Man-Made Noise

Another input parameter used by the ICEPAC program is the level of man-made noise at the receive sites. Radio noise has been classified by the CCIR⁹¹ into four basic categories and noise levels, which are described in table 7.9.

Table 7.9. CCIR Man-Made Noise Levels⁹¹

Man-Made Noise Classification	Average Noise Level (dBW)
Industrial	-140.4
Residential	-144.7
Rural	-150.0
Remote	-163.6

The two test sites located in Antarctica, McMurdo (Black Island) and Davis, are classified as rural sites. The Christchurch site is located in a rural area, but its proximity to the international airport increases the noise to residential levels. Salisbury is classified as a residential area.

7.4.5 Required Signal-to-Noise Ratio (SNR)

The required SNR for successful transmission of data using a typical HF receiver is 6 dB for a given receiver bandwidth. The Harris HF/ALE radios operate with a receiver bandwidth of 2.7 kHz. The ICEPAC program value for SNR is referenced to a 1-Hz bandwidth and the expression

$$\text{SNR} = 6 \text{ dB} + 10 \cdot \log(\text{SQRT}(2700)) = 23 \text{ dB}$$

is the derivation value of that value.

7.4.6 Transmitter Power

The transmitter power in kilowatts (kW) is the magnitude of the power delivered to the terminals of the transmit antenna from a 50-ohm load. It is necessary to decrease the actual transmitter output power by the transmission line attenuation value to get the required transmitter power parameter values for the ICEPAC program. There are differences between the transmitter power levels and the amount of cable attenuation at each of the four test sites. (The calculated values are listed in table 7.2.)

7.4.7 Other Parameters

The transmitter and receiver site locations are described in section 5.2. The path type (between sites) was short, meaning the direct point-to-point path was used as opposed to the long path, which is in the opposite direction completely around the world. A minimum takeoff angle of 0.1° was used to include paths down to the horizon. The required reliability was set to the standard value of 90 percent. Multipath was not considered by setting the parameters to 0 dB and 0 msec. The reflecting layer multiplier parameters were set to a value of one except for the sporadic-E (E_s) value, which was set to 0.7. The multiplier values used were the default values of the ICEPAC program.

7.5 ICEPAC PREDICTION PLOTS

The ICEPAC program can display the propagation characteristics for radio sites in various formats. Table 7.10 is a description of the format types that were plotted for this report.

Table 7.10. Partial Listing of Available ICEPAC Propagation Characteristics Displays⁸⁷

Propagation Characteristic	Description
Radiation angle [degrees]	The angle in degrees from the horizon at which RF energy from the antenna is directed in order to reach its desired destination
Virtual height [km]	The height in kilometers from the ground where the RF signal is projected to have reflected from based on path geometry
MUF days expected [%]	Percent of days/month that MUF is expected to be equal to or greater than the operating frequency
SNR median decile [dB]	The decibel value of the SNR that is achieved at least 50 percent of the time.
Service probability [%]	Percent time that the usable circuit can be achieved
Time availability SNR > required SNR [%]	Percent of time that the SNR is greater than the required link SNR

Examples of each of the plot formats are shown below (figures 7.3 through 7.6). The complete set of plots is contained in volume 2 of this report (NUWC-NPT Technical Document 11,106-2).

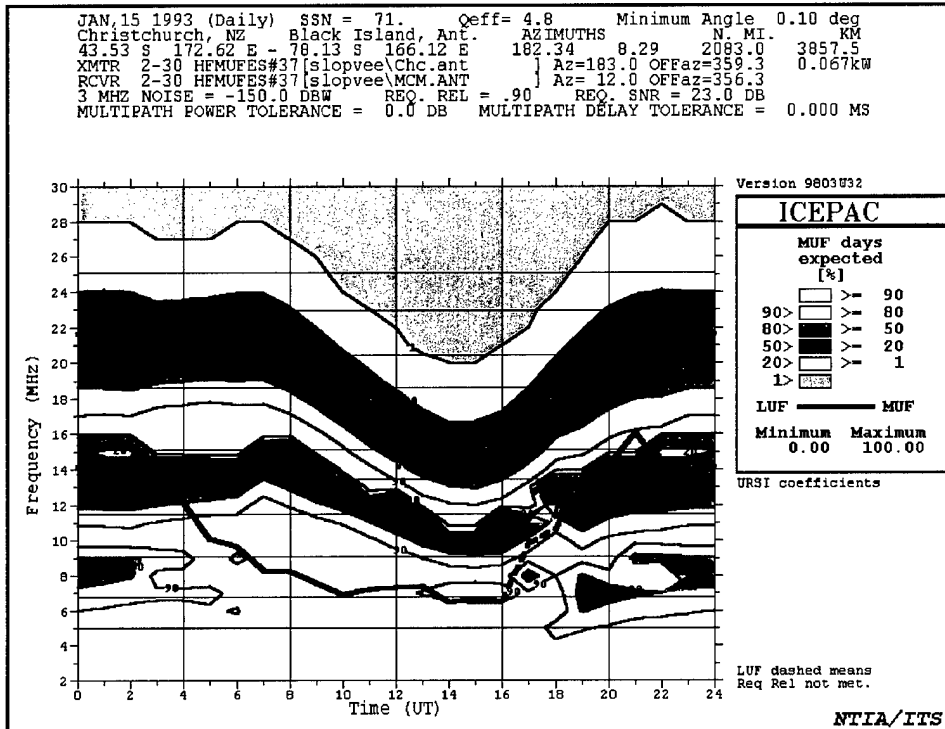

Figure 7.3. Christchurch-to-Black Island Expected MUF Days

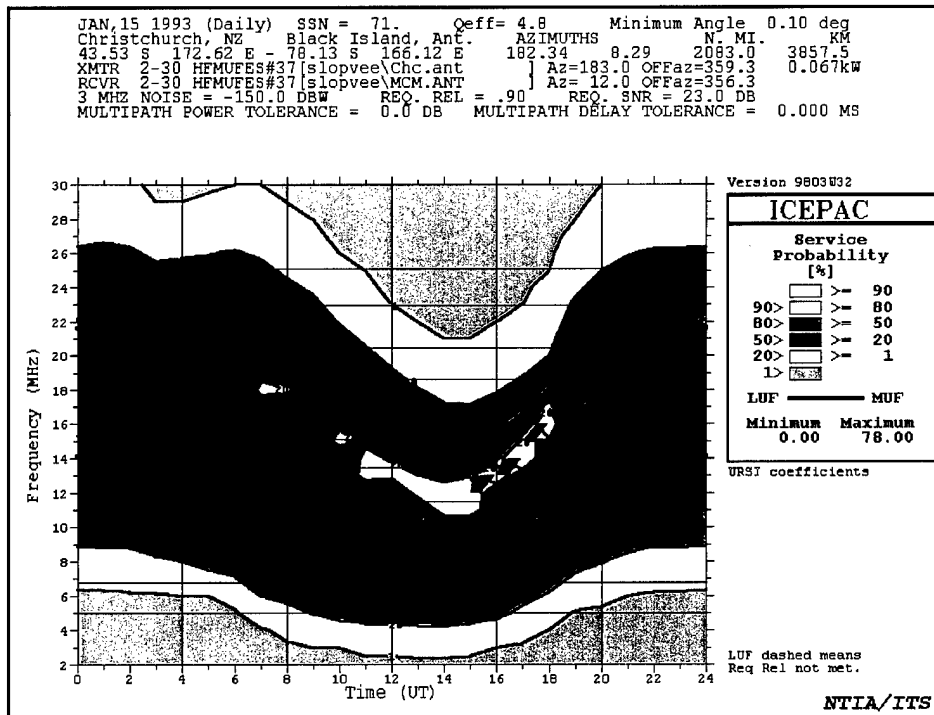

Figure 7.4. Christchurch-to-Black Island Service Probability

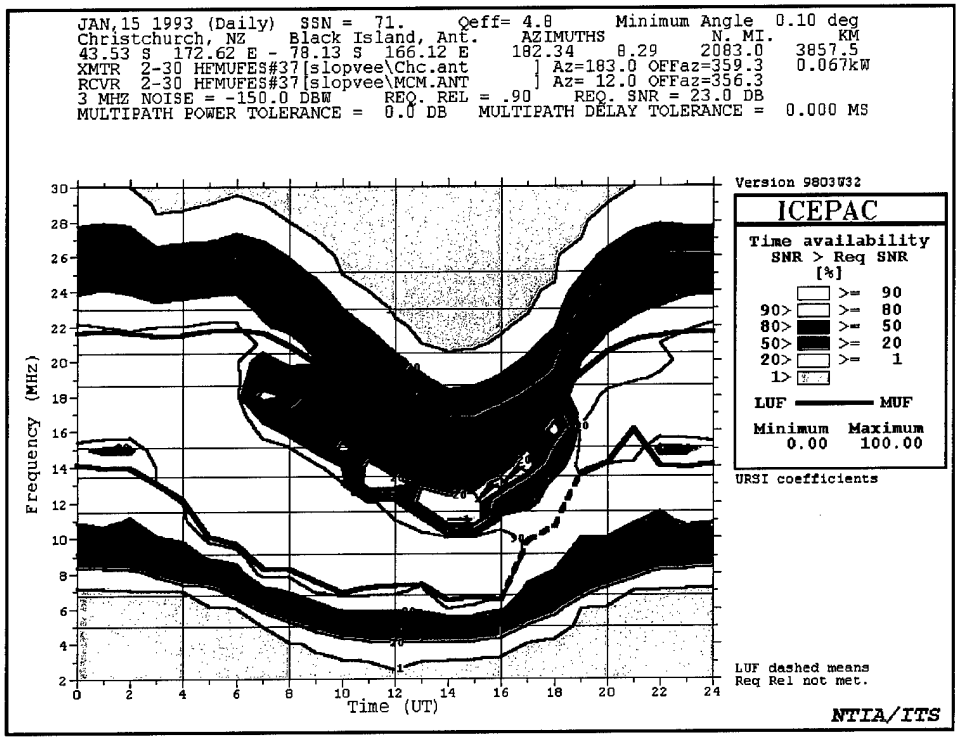

Figure 7.5. Christchurch-to-Black Island Time Availability

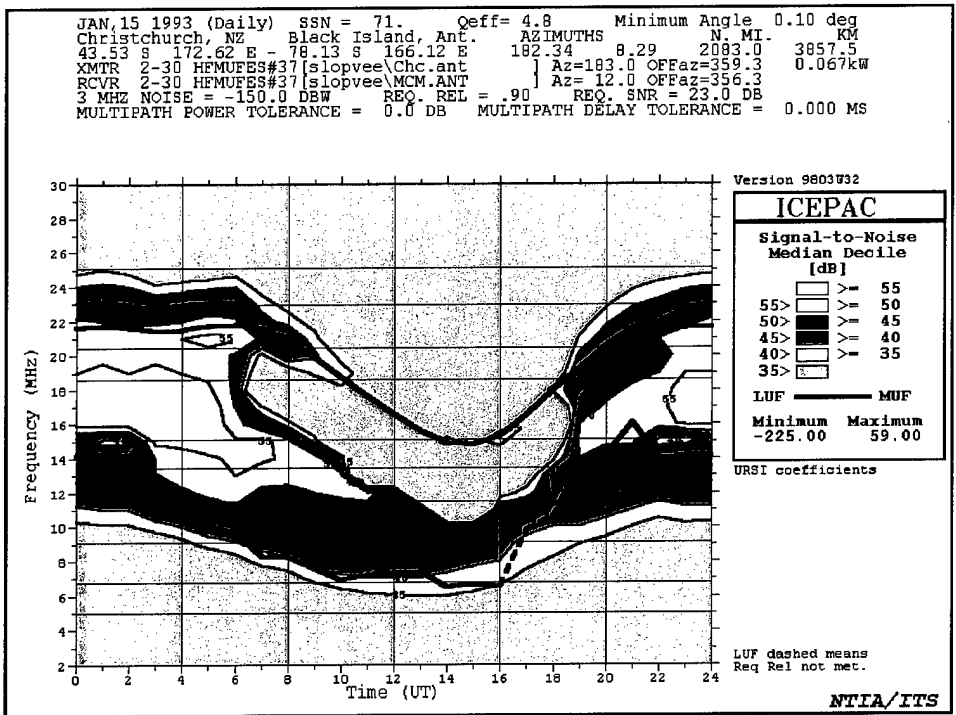

Figure 7.6. Christchurch-to-Black Island SNR Median Decile

8. PHILOSOPHY OF THE CUSTOM SOFTWARE AND ITS DESIGN

The software for controlling the Harris radios was written in Borland Pascal 7.0, which provides for a disk operating system (DOS) graphical user interface (GUI) and object-oriented programming. By using this windowing environment and the initialization (INI) file, the software allowed the user to easily see the status of the radios and the progress of the schedule. There were pulldown menus for performing calculations and changing some site-specific parameters. Scroll bars on the results windows allowed the user to recall something that had disappeared off the screen without disturbing the control software

8.1 DATA ACQUISITION SOFTWARE

The software for network control consists of an executable file (SP.EXE) and an ASCII INI file. Each site had the same executable file. The INI file was tailored for each site. On startup of the executable, the INI file would be read and site-specific operating parameters would be set. In addition, changes to the schedule could be propagated to all users as modifications to the INI file rather than as new distributions. The executable file provided support for all the Harris radios used, as well as additional site-specific hardware. Many different types of IBM-compatible computers were used as platforms. The software required a DOS, a serial port for radio control, and a disk drive for archiving the data files. The source code was approximately 20,000 lines.

The Harris RF-7210^{41,42} used in this test is controlled with a proprietary Harris protocol over an RS-232 serial link, with error checking and an acknowledge scheme. The RF-5022⁴³ is controlled using ASCII strings over an RS-232 serial link.

The ranking data from the radios were saved in ASCII format, with tab-delimited fields, which enabled easy import into a spreadsheet program, such as Microsoft Excel[®]. The data acquisition software generated one ASCII text file per hour at each station. Because of formatting on the output of each radio, the ranking data are identical between all radios, with one exception. The RF-7210 reports a channel score based on a 0 to 120 range and the reported RF-5022 channel score is based on a 0 to 100 range. These scores are saved as reported, so comparisons of scores between radios must be made with this consideration.

8.1.1 *Network Control Software*

The software that performs the networking operations runs on controller PCs connected via RS-232 serial link to each of the radios. Each computer has an identical copy of the executable code and an INI file that sets up the local configuration. Location, communications settings, radio type, scheduling, and additional hardware are all specified in the ASCII file at program startup time.

The SP.EXE program was written to control the Harris HF ALE radios via the startup file SP.INI. It was written to be inclusive of the three radio types used in the campaign (the RF-7210, RF-5022, and RF-5020). SP.INI is an ASCII file that can be edited by a text editor. A word processor can also be used if the file is output as DOS text. Some of the contents are also modified by changing settings from the pulldown menus. The updated file is written to disk when the program ends.

Many of the features of the software can be explained by reading the contents of the INI file, which is listed in appendix C. The executable supports the Harris RF-7210, RF-5022, and RF-5020 radios. An entry in the INI file determines which set of routines the software will use when communicating with the radio. Other settings are read from the INI files that are used in programming the radio.

8.1.2 Calendars and Schedules

The time slots assigned to each of the stations were unchanged through most of the duration of the experiment. The BER measurements were discontinued about the same time as reconfiguration of the network, so there were two schedules, one from the start of tests until June 1993, and the other from June 1993 until the end of tests. Time slots were divided into 4-minute durations, and further subdivided into a 2-minute duration for BER measurements. Each station was provided the same time schedule. The controlling computer determined if the station was to transmit or receive and if the transfer was to be time exchange, LQA, or BER testing. Idle time was included so that no station would be attempting measurement during the FMCW sounding, which required approximately 9 minutes to complete. (The hourly schedules can be found in appendix D.)

8.1.3 Message Passing Capabilities

The software developed for the ALE networking system made use of message passing capabilities between stations. A time slot was designated at the top of the hour on a continuing basis for message passing. The main station at Salisbury transferred GPS time information to each of the stations in turn via AMD. Though the amount of data passed in AMD transfer was limited to 87 bytes per message and had no error correction applied, the use of AMD as a valid means of messaging was demonstrated throughout the 14-month Antarctic network test.

The ability to pass data in the AMD header is independent of the ALE functions. Current software could be modified to pass message traffic at every LQA between stations. In this way, the network would be expanded in function for operational use not only for HF management, but also for any kind of networking purpose without affecting continuing link assessment functions.

The AMD was used for the synchronization of the ALE HF network. A scheduled time slot was allocated for time exchange to provide automatic updates of the clocks in each site's controlling computer. Salisbury had a GPS card that provided accurate timing, and this was distributed to each of the other stations by linking and exchanging times. Round trip times and offsets were determined, and the receiving station's clock was updated with the correction factor.

8.2 SUPPLEMENTAL PACKAGES

Two functions were added as menu items to help the operator during site setup. These functions rely on the software INI information on site locations contained in the INI file for calculations and can be invoked any time the software is running. Results are displayed in a static window that contains a summary of the requested calculations.

The capability for calculating each station's spherical geometry angles to each of the other sites for proper positioning of antennas is provided via a pulldown menu item. This was intended as a tool to be used by someone setting up an antenna and knowing only the latitude and longitude of the other site. The calculation reads the location information for all sites and generates a matrix of angles indicating a FROM station and a TO station. It is important to note that the direction is important and that the two angles calculated between two stations are not complementary. The user can read the angle and align the antenna appropriately. A related pulldown menu item allows calculation of the site distances in kilometers, miles, and nautical miles.

The sun angle calculation is another pulldown menu intended for use with the antenna angle calculation. Since magnetic compass readings are unreliable where the apparent difference between magnetic and true poles is large, a software approach is used. Through the use of an ephemeris program, the angle of the sun can be calculated for any given time of day. This is particularly useful in places with small latitudes, in the local summer when the sun is in the sky a larger amount of time. By iterating the calculation through time, the antenna angle calculated can be matched to a local time. At the appropriate time indicated, a shadow can be marked off to be used for directing the antenna properly.

8.3 SPECIFIC MODIFICATIONS FOR THE AUSTRALIAN MINISTRY OF DEFENCE (MOD) TESTS

As part of their PDC-41 program, the Australian Ministry of Defense (MOD) performed BER evaluations similar to those described in section 5.1.2. In support of these MOD tests, the controlling software was modified. To provide control of the modem with a second serial port, support was added for serial port hardware and modem control commands. For control of modem settings through scheduling, support was added to the scheduler part of the software.

The tests showed that the ALE technique was successful in automatically finding a propagation channel, in establishing the link with the called station on that channel, and in passing good quality data. However, the success rate in selecting the best channel for the transmission of data at 2400 bps was an area identified for further improvement. The success rates of 65 percent and 75 percent were achieved using the serial and parallel data modems, respectively, with short interleaver depths. Further description of these tests can be obtained from the DSTO.⁹²

8.4 INTERNATIONAL CONNECTIONS VIA THE INTERNET

Extensive use of the Internet provided for communications and data exchange across vast distances and many time zones. The result was up-to-date software and hardware problem reporting, schedule changes, information exchange, software distribution, and data collection.

Because of the smaller time zone differences from Salisbury to Christchurch and McMurdo, it was decided that DSTO would handle direct E-mail contact to those sites for day-to-day matters. In addition, since some of the schedule changes were due directly to DSTO support, updated schedules were distributed from Salisbury. E-mail messages of status were exchanged nearly every day for the duration of tests. This documented current status and provided a record of the evolution of the test.

Several updates to the software were generated to fix operational problems with the Harris radios. These were distributed from Salisbury, which ensured that all stations were running on the correct version. All versions were saved on a NUWC server. When a new version of the EXE was ready for distribution, Salisbury downloaded the copy from the NUWC server via FTP and transmitted it to the other stations, along with the appropriately configured INI file. This ensured synchronization of the network with respect to software version.

All data logged from the sites were collected and archived by Salisbury and copied to the NUWC server via FTP approximately twice per month. Any problems that affected the amount or quality of data would quickly be apparent, and turnaround time for solution was shortened by use of electronic transmittal.

8.5 DATA REDUCTION SOFTWARE

In this section, the terms *frequency* and *channel* are used interchangeably; there were 10 channels, each with an assigned frequency, labeled f_1 through f_{10} . Channel has an additional meaning in that it is assumed that the hardware and software at both the source and destination sites are operating normally and could support communications if atmospheric conditions supported propagation. The term *link* as used here refers to a channel that is propagating well enough to support communications between radios. An LQA indicates that a link exists if one or more of the ten assigned channels have supported data exchange between stations.

The entire data set for tests was located on the NUWC server. Each site's files conformed to a naming scheme that identified where the data originated. As files were collected, they were combined for the complete data set for each station and year. Table 8.1 summarizes the files comprising the data set that contain each year's results; the types of link analyses are summarized in table 8.2.

The steps involved in reducing the data were as follows:

- Conversion of the ASCII data file to a binary file for easier data handling;
- Extraction of hourly performance ratings, such as rankings recorded, connects recorded, connects exceeding 6 dB, etc. to availability files;

- Extraction of other data that could not be represented in availability files;
- Combination of the availability files to account for station downtime;
- Analysis of the resulting data to gather statistics on link performance.

Table 8.1. Link File Names and Corresponding Sizes

File Name	Size
93CHC.DAT	1,946,054
94CHC.DAT	1,411,549
94DAV.DAT	986,277
93DAV.DAT	3,572,041
93MCM.DAT	576,322
93SAL.DAT	10,753,912
94SAL.DAT	17,724,441
Total	36,970,596

Table 8.2. Types of Link Analyses

<p>Basis for Analyses:</p> <ul style="list-style-type: none"> • Station uptime (station on and performing LQAs), • Channel uptime (both stations up) for each individual path, • Channel availability summarized for each individual path.
<p>Analysis</p> <ul style="list-style-type: none"> • Percent availability of link (best frequency/6 dB criterion) as a function of time of day for each season, • Percent availability of link (selected frequency/selected SNR level) as a function of time of day for each season (frequency diversity), • Percent LQAs with multiple frequencies (0 score criterion) as a function of time of day for each season, • Percent availability of link for each frequency group (0 score criterion) as a function of time of day for each season.
<p>MUF Analysis</p> <ul style="list-style-type: none"> • 10-, 50-, and 90-percent exceedance of link for best frequency (standard method/6-, 12-, 18-dB criteria) as a function of time of day for selected months, • 10-, 50-, and 90-percent exceedance of link for best frequency (standard method/6-, 12-, 18-dB criteria) as a function of time of day for seasons, • 10-, 50-, and 90-percent exceedance of link for best frequency (Harris ALE-algorithm/6-, 12-, 18-dB criteria) as a function of time of day for seasons.
<p>System Performance</p> <ul style="list-style-type: none"> • Link symmetry for the year, • Link symmetry as a function of time of day for the year.
<p>Hardware</p> <ul style="list-style-type: none"> • Comparison of SNR to channel score for the year.
<p>Snapshot of Anomalous Events</p> <ul style="list-style-type: none"> • Effects of solar activity on link performance.

8.5.1 Conversion to Binary Files

The data files were converted into compact binary files consisting of all data from one year's worth of rankings for each station. Each individual channel ranking, which corresponds to a line of ASCII text, was packed into eight bytes of binary data. This reduces all station data to a minimal size. Rankings are sorted by time and duplicates are eliminated. The files comprising the generated binary data set are summarized in table 8.3.

Table 8.3. File Names Corresponding to the Binary Dataset and Their Corresponding Sizes

File Name	Size (bits)
93CHC.ADB	292,320
94CHC.ADB	198,168
94DAV.ADB	71,680
93DAV.ADB	477,760
93MCM.ADB	35,088
93SAL.ADB	1,389,360
94SAL.ADB	2,642,544
Total	5,106,920

8.5.2 Extracting Availability Files

The binary data sets are filtered by multiple criteria to form availability files for each source/destination channel permutation. Each file is an hourly bitmap of the station's performance for the year; the length of each file is 24 hours * 365 days/8 bits = 1095 bytes long. Table 8.4 summarizes the criteria used to extract hourly performance from the binary data files and create each of the availability bitmap files.

8.5.3 Accounting for Station Downtime

The availability files were combined logically to improve the goodness of the data by accurately separating station problems from nonpropagation. For example, a 10-channel ranking with no successful links indicates either the receiving station is down or there is excess propagation loss. The inclusion of other information, e.g., data from other sites that did succeed in linking within the same hour, will allow those nonlinking rankings to be used in the data analysis. This is based on the fundamental assumption that a station will not change its availability in a given hour. If a station's equipment is functioning and exchanging with another station during some part of an hour, then it is assumed that it is capable of functioning and exchanging with all other stations for that entire hour. The error of including more nonlinking rankings due to inaccurate assessment of uptime will only make channel percentage estimates more conservative.

Table 8.4. Criteria Used to Extract Hourly Performance

Full Ranking Recorded — The following assume that a full ranking LQA of 10 frequencies was recorded:

Best score ≥ 0

- 0 frequencies with scores ≥ 0
- 1 frequency with score ≥ 0

Best-score frequency's corresponding SNR ≥ 6 dB

- 2 frequencies with scores ≥ 0
- 3 or more frequencies with scores ≥ 0
 - ≥ 1 frequency of Group 1 (f1-f3) with score ≥ 0
 - ≥ 1 frequency of Group 2 (f4-f6) with score ≥ 0
 - ≥ 1 frequency of Group 3 (f7-f10) with score ≥ 0
- Source station SNR ≥ 0 dB
- Source station SNR ≥ 6 dB
- Source station SNR ≥ 12 dB
- Source station SNR ≥ 18 dB
- Source station SNR ≥ 24 dB
- Source station SNR ≥ 30 dB.

Partial Ranking Recorded — In addition, for use in determining uptime, additional bitmap files were created.

8.5.4 Combining Availability Files

All operations on availability files are bit-for-bit binary operations, which provided meaningful examination of the data. For example, availability with a criterion of a 6-dB received channel score was combined with the matching circuit uptime availability file. Within the specified time bins, counters accumulate those bits, which meet the specified criteria and, at the end of the analysis, output summary text files.

8.5.5 Extracting Other Files

Certain analyses could not be performed using just the availability files. Some of the data were extracted and used as spreadsheet entries for reduction by other methods. For link availability of all types, monthly and seasonal summaries were performed. For comparisons of link performance with prediction models, data were extracted using a standard method of estimation. A link symmetry analysis by year and by hourly time bin was also performed. All the above methods required the sorting, grouping, and plotting functionality of a spreadsheet analysis.

9. PERFORMANCE OF THE NETWORK AND SELECTED EXAMPLES

The purpose of the network data analysis was to characterize the network of HF radio links between stations. The definition of link, according to Federal Standard 1037C,⁹³ is *the communications facilities between adjacent nodes of a network or a radio path between two points, called a radio link*. Of main interest is the overall ability to communicate using a range of different radio frequencies and the performance of the link with respect to the variables of frequency, time of day, and season.

9.1 LINK AVAILABILITY

In principle, link availability should be easy to define. One might be tempted to say that a link is available or ready to be engaged for a specific service (such as a LQA) if the transceiver at each endpoint, or station node, is operational. However, if a station is nonrecording, the determination of uptime is not a direct measurement. An assumption that the hardware would be operational nearly 100 percent of the time turned out to be drastically wrong and led to the need for indirect calculation of hardware status after the fact.

In this instance, because of manning issues and the availability of computer hardware in both Christchurch and McMurdo, as well as the remoteness of the actual field site in McMurdo (at Black Island), it was decided that both Christchurch and McMurdo would not record data. In hindsight, what should have been done was the remote recording, e.g., by order-wire to the recording station, of a running 24-hour operational status of the nonrecording station. Lacking this feature, one must reconstruct the operational status of a particular station, or endpoint, from the data at hand. The definition chosen is predicated on the following assumption: if a nonrecording station is known to have had an interaction with at least one other recording station in a given hour, then that nonrecording station is said to be operational for that entire hour. This is an attempt to bypass the nonavailability of a particular link strictly because of poor propagation conditions. If a given link was not able to provide a service (an LQA attempt for instance) because of poor propagation conditions, it does not follow that either or both of the transceivers at each endpoint are nonfunctional. If anything, this approach will lead to a more conservative reporting of the various network measures, for it understates the actual availability values by a negligible amount. From this follows the definition of *link availability* as used in this report:

A link is available, i.e., ready to be engaged for a specific service (such as a LQA, the transmission of a message via a modem, etc.), if the transceiver at each endpoint, or station node, is operational and a propagation path exists. This determination is measured on an hourly basis and, lacking specific recorded information, is inferred to exist for that particular hour if, and only if, each endpoint has a corroborating contact from some other station(s) during that hour.

9.2 CATALOGUE AND SELECT EXAMPLES OF PERFORMANCE

The following sections define the methods of data extraction and summary. In the sections where a method is defined, sample results are shown as tables or plots. The full data set is contained in volume 2 (NUWC-NPT Technical Document 11,106-2).

9.2.1 Station and Circuit Uptime

Station and circuit uptime and availability were derived from combining data collected at each site. Since the schedule for all data collection was repeated hourly, the determination of all measures is based on a 1-hour resolution. For statistical purposes, these hourly observations have been combined into monthly, or seasonal, bins and into 4-hour time bins for time of day. This improved the measures by decreasing the variability due to small sample sizes.

The 1-hour observation resolution has some advantages. First, the number of data points becomes manageable. The total number of hours in a year can be represented by approximately 1 kilobyte using three 8-bit words for each day's worth of data. Second, comparisons of different links can only be made on an hourly basis because no two links were scheduled for simultaneous data collection. There are also disadvantages. First, a station's status could change, such as loss of power or radio hardware failure. Second, propagation conditions could vary, making comparison of links meaningless. Combining the hourly observations into statistical bins larger than 1 hour could probably minimize the effects of hourly changes and provide an accurate measure of equipment status and true propagation conditions.

To get an accurate hourly picture, bitmaps were combined in a series of Boolean operations (logical OR and AND statements). The example of determining Salisbury uptime will help clarify this procedure. Initially, Salisbury is up when it is known that Salisbury has recorded link attempt data, or when any other station reports successful linking with Salisbury. The bitmaps representing those conditions are logically ORed to get the uptime. As a slight complication, Salisbury observations were made with a radio changeout during certain time periods. From the operator logbooks, a bitmap was generated that included only those times when the hardware of interest was performing data collection. This was logically ANDed with the bitmap to give the complete uptime for Salisbury. A sample representation can be seen in table 9.1. In the sample, an asterisk represents hardware status up; a hyphen represents hardware status down, or unknown. (Uptime for all stations is given in the appendix D.)

A circuit is defined in Federal Standard 1037C as *the complete path between two terminals over which one-way or two-way communications may be provided; or an electronic path between two or more points, capable of providing a number of channels*. In this sense, the uptime of the hardware is implicit. To determine circuit uptime, the individual station source and destination uptimes were combined by logically ANDing them. A sample representation of Salisbury-McMurdo can be seen in table 9.2. In the sample, an asterisk represents both stations' hardware status up; a hyphen represents either station hardware status down, or unknown. (Uptime for all circuits is given in the appendix D.)

**Table 9.1. Sample Salisbury Hourly Station
Uptime Data, January-February 1993**

No.	Date	Status	No.	Date	Status
1	1/ 1	*****	32	2/ 1	*****
2	1/ 2	*****	33	2/ 2	*-----*
3	1/ 3	*****	34	2/ 3	-----*
4	1/ 4	*****	35	2/ 4	*-----*
5	1/ 5	*****	36	2/ 5	*****
6	1/ 6	*****	37	2/ 6	***-----
7	1/ 7	***-----	38	2/ 7	-----
8	1/ 8	*****	39	2/ 8	-----*
9	1/ 9	*****	40	2/ 9	-----*
10	1/10	*****	41	2/10	-----*
11	1/11	*****	42	2/11	-----*
12	1/12	*****	43	2/12	-----*
13	1/13	*****	44	2/13	-----*
14	1/14	*****	45	2/14	-----
15	1/15	*****	46	2/15	-----*
16	1/16	-----	47	2/16	*****
17	1/17	-----*	48	2/17	-----*
18	1/18	*****	49	2/18	*****
19	1/19	*****	50	2/19	*****
20	1/20	*****	51	2/20	*****
21	1/21	*****	52	2/21	*****
22	1/22	*****	53	2/22	*****
23	1/23	*-----*	54	2/23	*****
24	1/24	*****	55	2/24	*****
25	1/25	***-----	56	2/25	*****
26	1/26	*****	57	2/26	*****
27	1/27	-----*	58	2/27	*****
28	1/28	-----*	59	2/28	*****
29	1/29	-----*			
30	1/30	-----*			
31	1/31	*****			

**Table 9.2. Sample Salisbury-to-McMurdo Hourly
Circuit Uptime Data, January-February 1993**

No.	Date	Status	No.	Date	Status
1	1/ 1	-----*	32	2/ 1	-----*
2	1/ 2	-----	33	2/ 2	-----*
3	1/ 3	-----*	34	2/ 3	-----*
4	1/ 4	-----*	35	2/ 4	*-----*
5	1/ 5	-----*	36	2/ 5	*****
6	1/ 6	*-----*	37	2/ 6	***-----
7	1/ 7	***-----	38	2/ 7	-----
8	1/ 8	-----*	39	2/ 8	-----*
9	1/ 9	*****	40	2/ 9	-----*
10	1/10	-----	41	2/10	-----
11	1/11	-----*	42	2/11	-----*
12	1/12	-----*	43	2/12	-----*
13	1/13	***-----*	44	2/13	-----*
14	1/14	*****	45	2/14	-----
15	1/15	*****	46	2/15	-----*
16	1/16	-----	47	2/16	*****
17	1/17	-----	48	2/17	-----*
18	1/18	-----*	49	2/18	***-----*
19	1/19	***-----*	50	2/19	*****
20	1/20	-----	51	2/20	*****
21	1/21	-----	52	2/21	***-----*
22	1/22	-----*	53	2/22	*****
23	1/23	-----	54	2/23	*****
24	1/24	-----*	55	2/24	*****
25	1/25	*-----*	56	2/25	*****
26	1/26	*****	57	2/26	*****
27	1/27	-----*	58	2/27	*****
28	1/28	-----*	59	2/28	*****
29	1/29	-----*			
30	1/30	-----*			
31	1/31	*****			

Percent availability of the circuit is a ratio of circuit uptime to elapsed time and measures the status of the network hardware over time. The circuit availability data has been placed into time bins for statistical analysis. This value is used as a basis for further link calculations. Conceptually, one could determine the percent availability from the above Salisbury-McMurdo circuit uptime bitmap as follows: Select a number of columns. This is the hourly time bin. Select a number of rows. This is the month or season, depending on which rows are selected. The number of asterisks (B) is divided by the total number of characters in the set (C) to give the percent availability, or the ratio referenced here as B/C (where B is the number of times both stations are up and C represents that either station's hardware status is down or unknown).

Ideally, percent availability of the circuit should be constant throughout the day. There are two reasons for this not to be true for all stations. First, the Harris RF-5022 radios had a manufactured firmware defect, which caused them to stop working after a few hours when controlled by a computer on the RS-232 control port. This required operator intervention to reset the radio. Second, determination of the station uptime depended somewhat on propagation, which changed as a function of time of day. The reconstructed value of B is, therefore, an approximation to the real value of B. Various means were used to establish datasets that contributed to this value, including using computer-recorded successful links and handwritten operator logbooks. The best data came from the Salisbury-McMurdo link, which had consistently the largest percent availability as well as independence from time of day. Salisbury hardware, the Harris RF-7210 radio, did not suffer from the firmware defect of the RF-5022s and was also more accessible to its operators. McMurdo hardware was noninitiating and, thus, avoided the firmware crashes of an initiating site. A sample representation of the Salisbury-to-McMurdo circuit percent availability can be seen in figure 9.1.

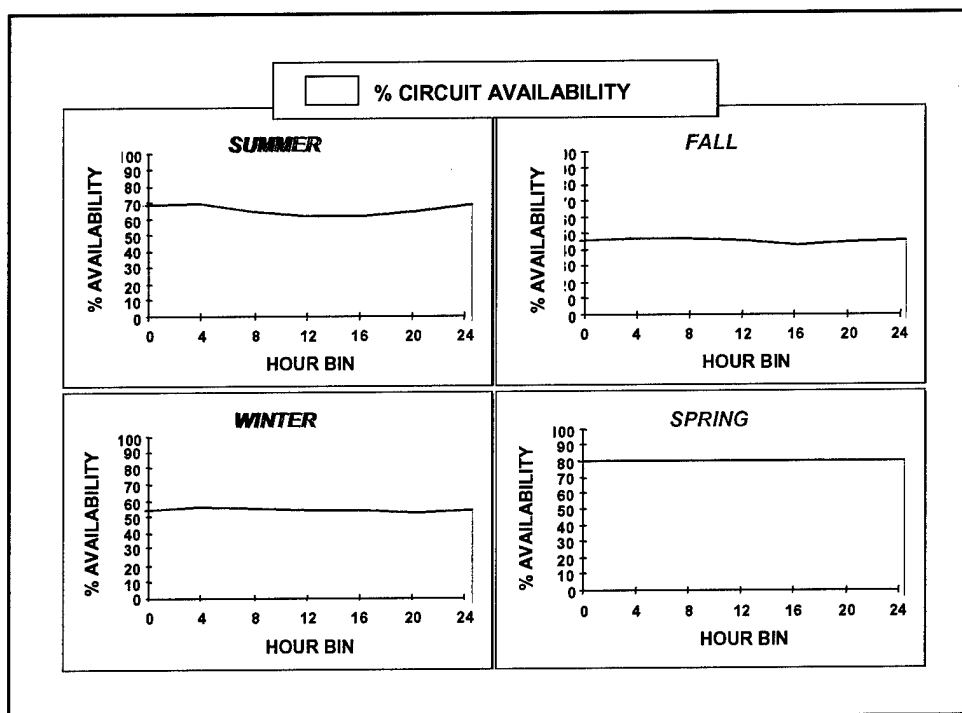

Figure 9.1. Sample Circuit Availability, Salisbury to McMurdo, 1994

9.2.2 Percent Availability of Link for Best Frequency as a Function of Time of Day for Each Season

The percent availability of a link is the ratio of successful links to attempts at linking. The number of successful links, the numerator (A), can be ascertained directly from the bitmaps, according to SNR level, or another of the criteria listed in table 8.4. The number of attempts, the denominator, is the same value as the numerator in the circuit availability ratio (B). The link availability is referenced as the ratio A/B. A good example of link availability measurement independent of circuit availability is the Salisbury-to-McMurdo link shown in figure 9.2. Note that the time bins are in universal time (UT).

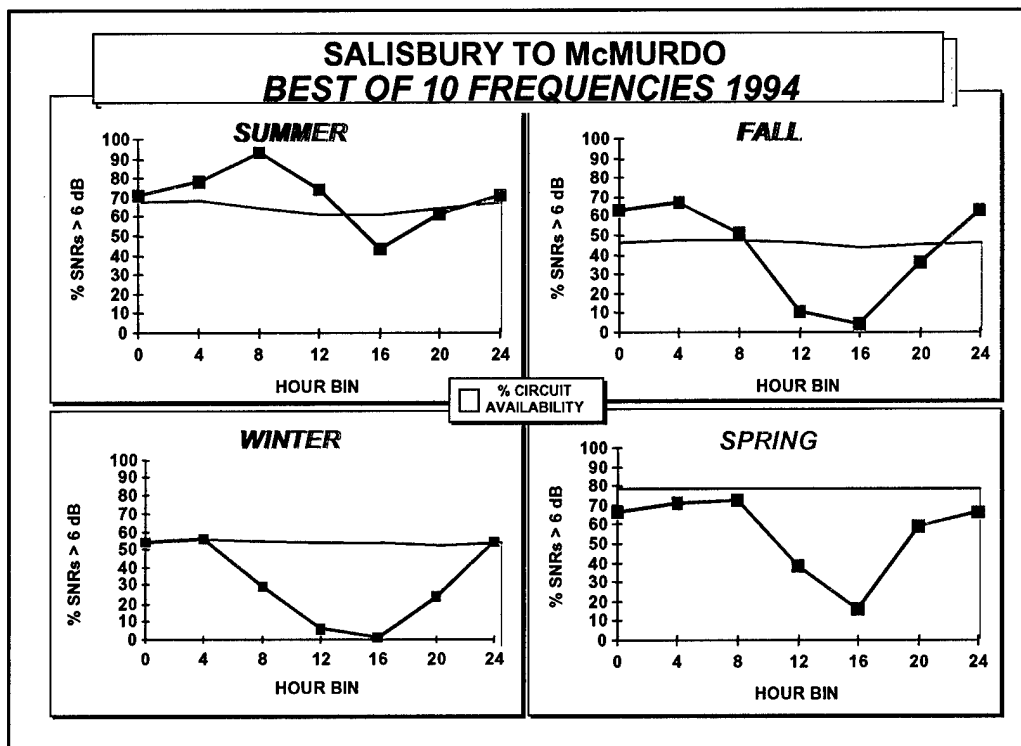

Figure 9.2. Link Availability and Circuit Availability, Salisbury to McMurdo, 1994

9.2.3 Percent Availability of Link for Selected Frequencies and Selected SNR Level as a Function of Time of Day for Each Season

The previous plots were concerned with performance of the best channel as rated by the ALE radio. This plot separates each frequency to show individual performance of the frequency as a function of time of day for each season.

It can be observed, for a given season, that the relative performance of frequencies varies over time of day, as propagation paths become more favorable to different modes. The time of a peak and then a decrease in performance differs for each frequency, with higher frequencies

leading the lower frequencies in time. For example, figure 9.3 shows the performance of the Salisbury-McMurdo link for the summer 1993 season. At 20.439 MHz, the link availability peaks during time bin 0-4UT and then shows a rapid decrease from the 0800-1200 UT to the 1200-1600 UT bin. On the other hand, at 13.490 MHz, the link availability peaks during time bin 0800-1200 UT and shows a significant decrease going from the 1200-1600 UT bin to the 1600-2000 UT bin.

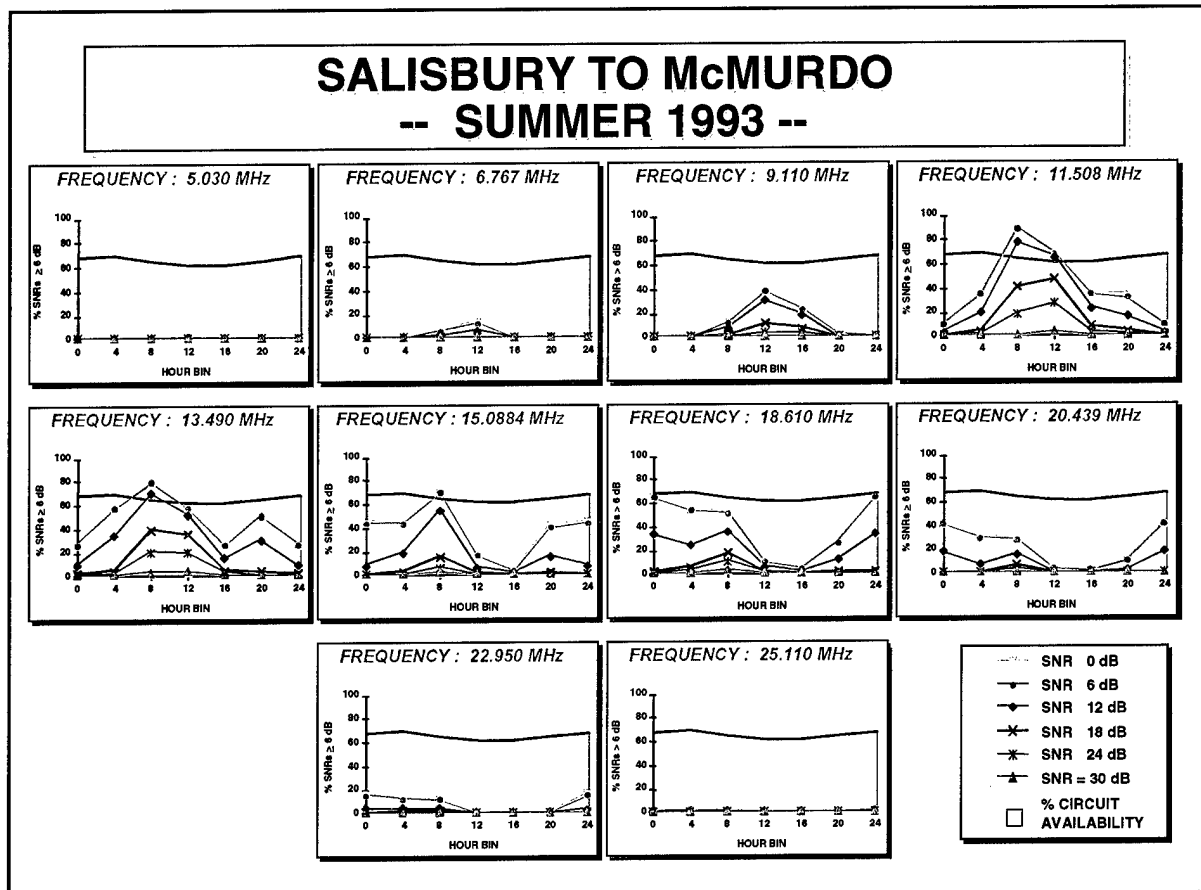

Figure 9.3. Percent Availability by Frequency, Salisbury to McMurdo, Summer 1993

In contrast, performance of the same link during a different season can be compared. Figure 9.4 shows the performance of the Salisbury-to-McMurdo link for the winter 1993 season. In this case, at 20.439 MHz, link availability shows the same time dependence as in summer 1993, though its magnitude is lower. At 13.490 MHz, however, the time dependence is now more like that of the higher frequencies in the winter, that is, maximum and minimum values occur during the same hour bins. This would indicate more drastic changes in percent availability during the winter compared to the summer (figure 9.3). The advantages of frequency diversity are not as evident for this season.

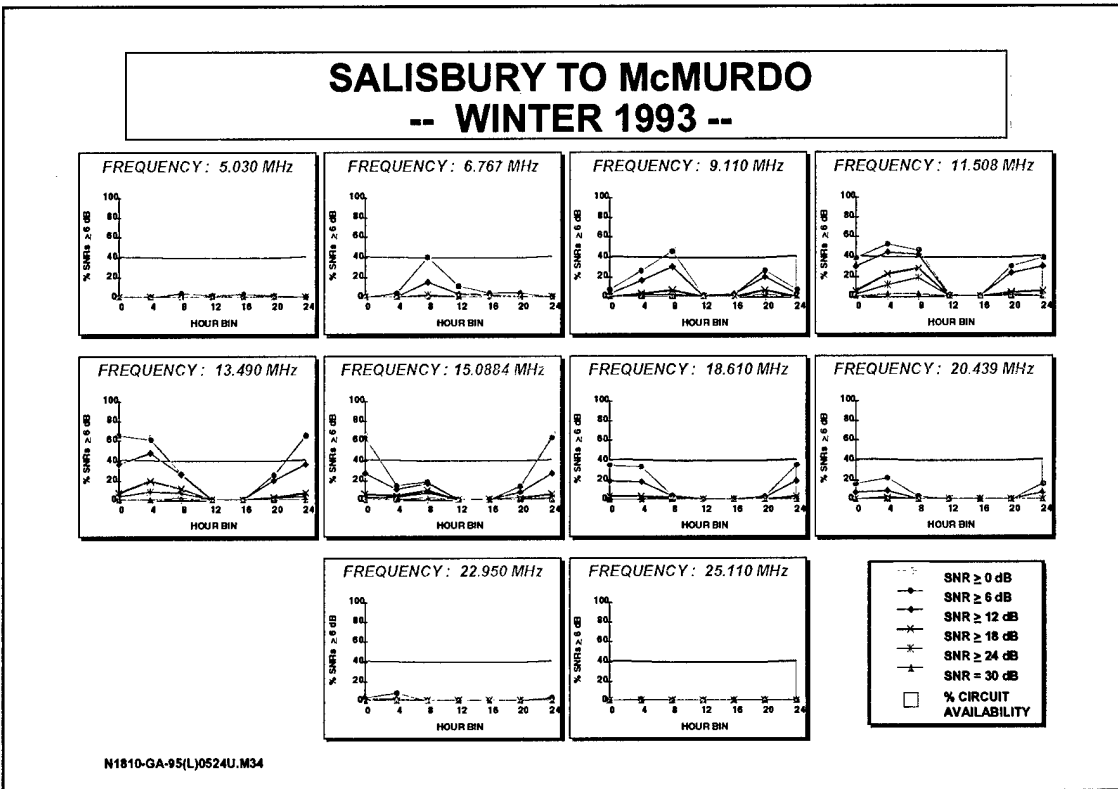

Figure 9.4. Percent Availability by Frequency, Salisbury to McMurdo, Winter 1993

9.2.4 Percent LQAS with Multiple Frequencies Present as a Function of Time of Day for Each Season

Figure 9.5 is an example of a measure of propagation at multiple frequencies. Note that for each time bin, the sum of the four points is 100 percent. The plots of 0-frequency points trace the inverse of the plots described in section 9.2.2. Generally, LQA attempts to Davis or McMurdo from any other sites show that if link attempts succeed, it is more likely that there are three or more frequencies that are usable. However, LQA attempts between Salisbury and Christchurch are less likely to have many frequencies available and more likely to have only one or two frequencies available. An example of this is shown in figure 9.6.

9.2.5 Percent Availability of Link for Each Frequency Group as a Function of Time of Day for Each Season

This method groups statistics for frequencies together. The choice for inclusion in each group assumes like propagation, i.e., the same modality affects each frequency in that group. The first sample, figure 9.7, compares the seasonal performance for the Salisbury-to-McMurdo link for 1993 and 1994.

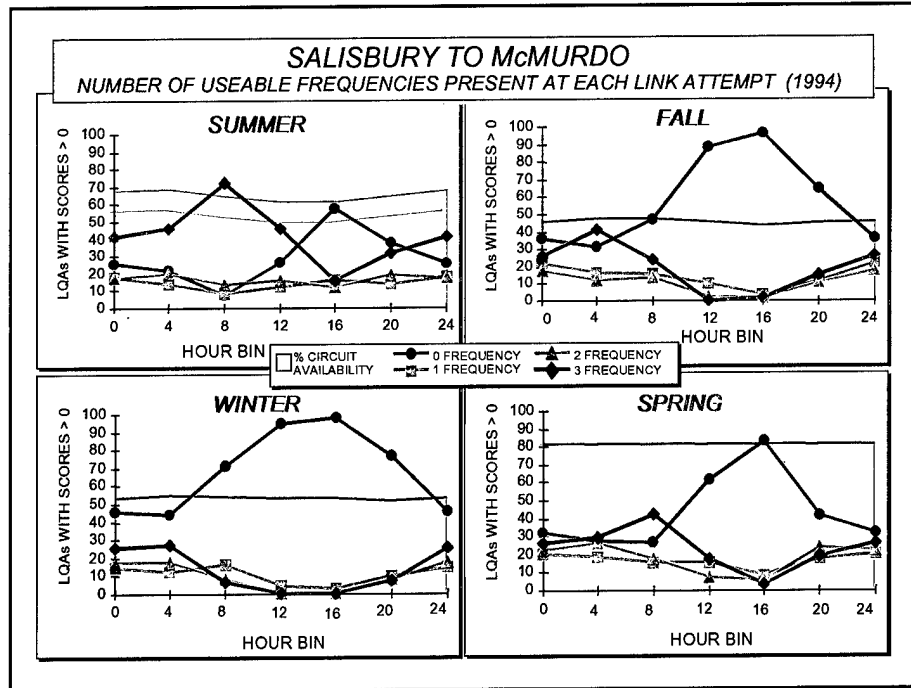

Figure 9.5. Number of Usable Frequencies by Season, Salisbury to McMurdo, 1994

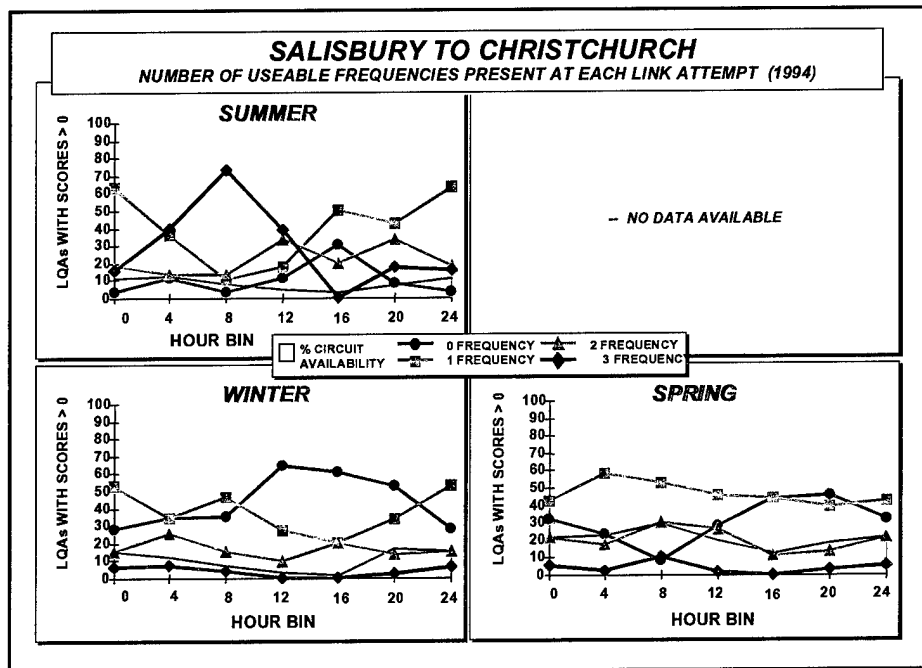

Figure 9.6. Number of Usable Frequencies by Season, Salisbury to Christchurch, 1994

The effects demonstrated in section 9.2.3 regarding frequency maximum and minimum values can be seen here as well. The summer plot shows that maxima and minima for each frequency group occur at different time bins. This indicates that while propagation over one group might not be supported, propagation over another group might be. The winter plots show that all frequency groups have similar performance, and at certain time bins no frequency groups support propagation. Fall and spring show intermediate performance.

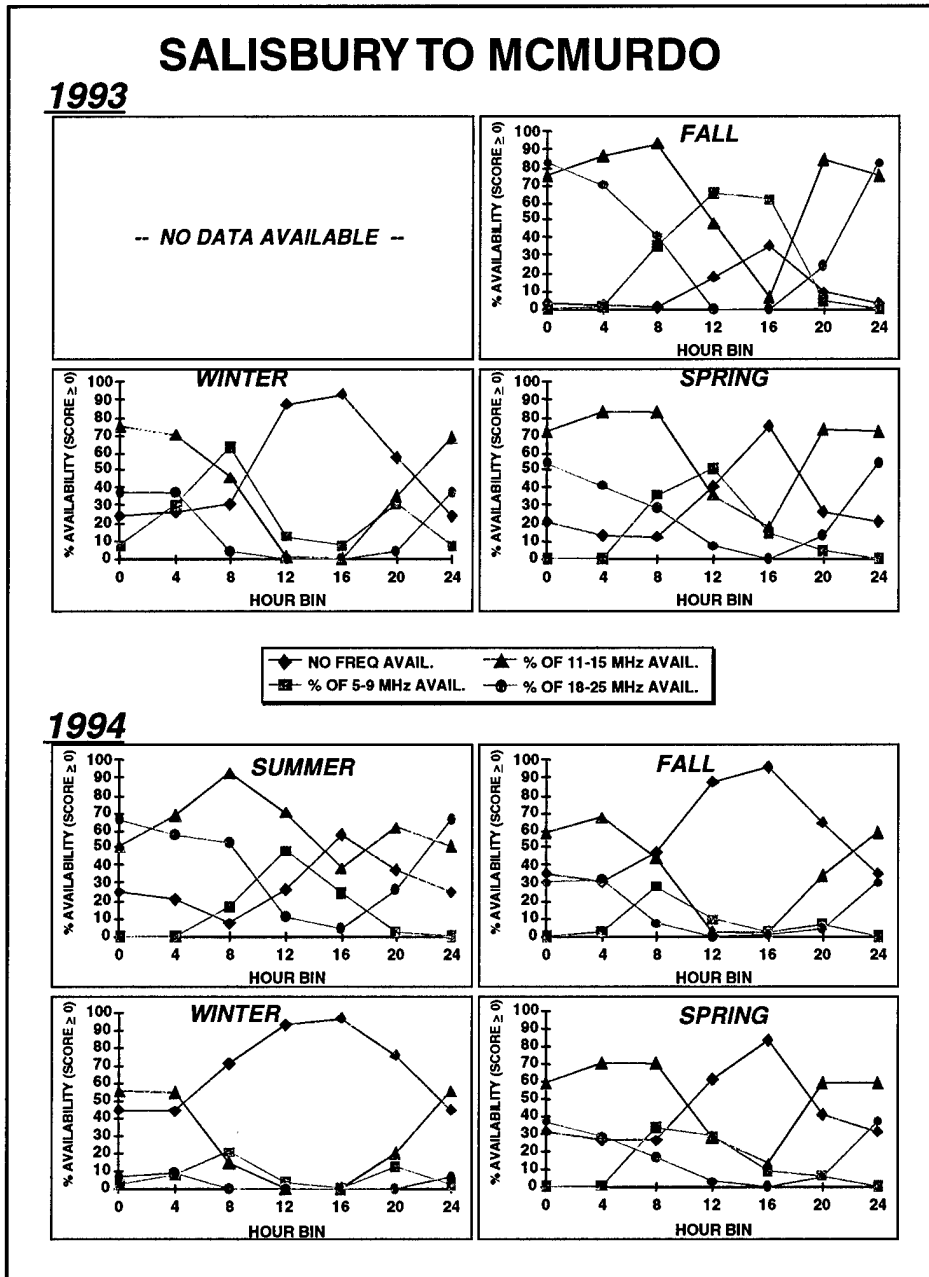

Figure 9.7. Percent Availability of Each Frequency Group by Season, Salisbury to McMurdo

The second sample, figure 9.8, shows seasonal performance of another link, Davis to McMurdo, for 1993 and 1994. The plots indicate that the lower and middle frequency groups support propagation to a much greater extent than the higher frequency group, independent of time of day or season.

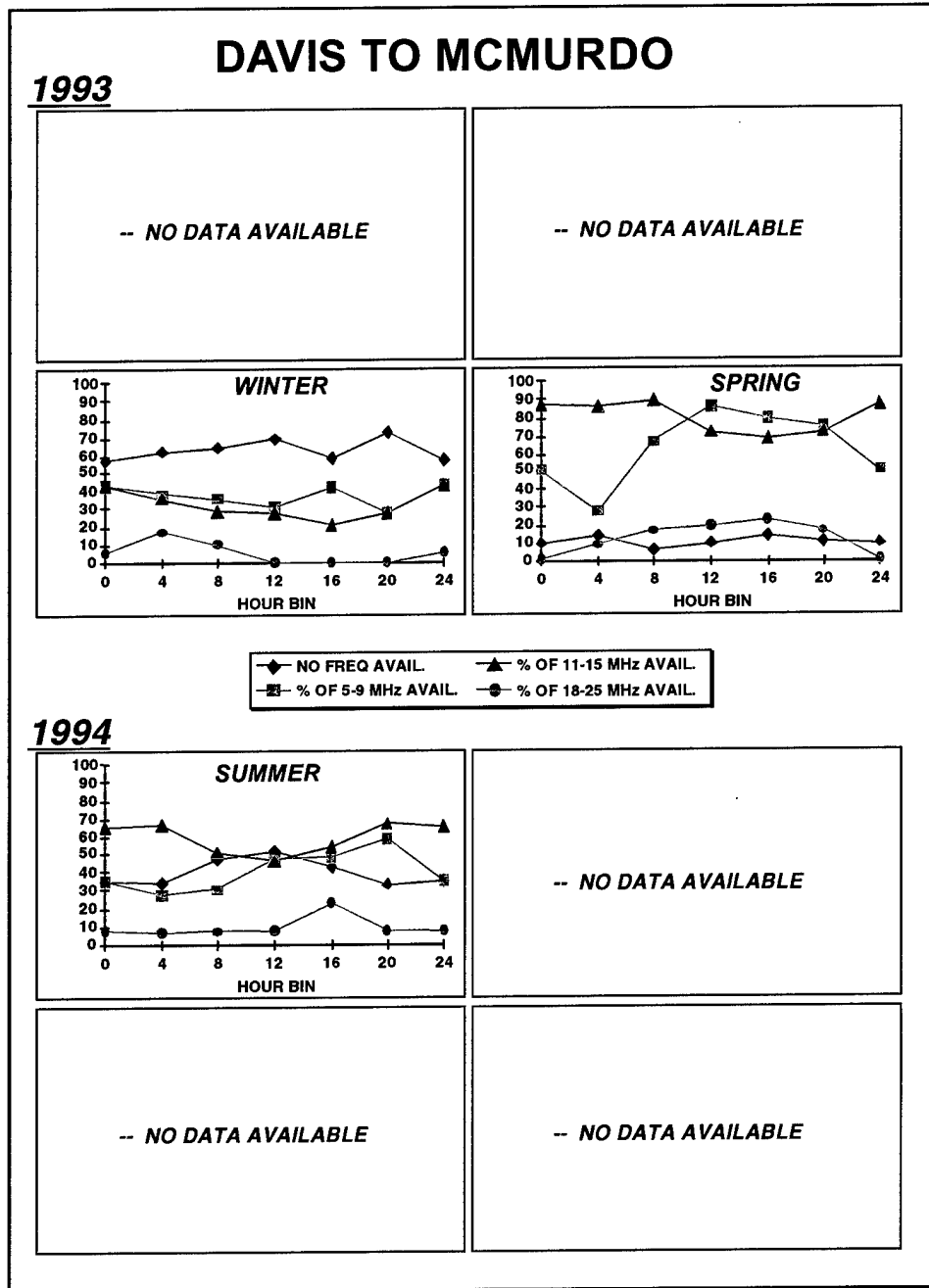

Figure 9.8. Percent Availability of Each Frequency Group By Season, Davis to McMurdo

9.2.6 Upper-, Median-, and Lower-Decile Exceedance of Link for Best Frequency Using a Standard Method as a Function of Time of Day for Selected Months

These values correspond to the lower- (FOT), median- (MUF), and upper-decile (HPF) points along the distribution. The lower-decile value, or FOT, is the frequency that was exceeded for 90 percent of the month's days for a specified 4-hour time bin. In practice, the FOT is a system-dependent frequency and not a function of propagation conditions alone. Similarly, the standard MUF value was exceeded for 50 percent of the month's days in the specified four-hour bin, and the HPF values were exceeded for only 10 percent of the month's days in the given four-hour bin.

The term *standard method* is used to differentiate best frequency from the Harris radio choice of best frequency. In the standard method, all frequencies in the time bin are sorted and the exceedance values are chosen by the accepted definition, that is, the frequencies that are greater than or equal to those percentage levels in the distribution. The algorithm used by the Harris radios to select *best* frequency calculates a score for each channel using a combination of measured SINAD, measured PBER, received SINAD, and received PBER.

The following samples, figures 9.9, 9.10, and 9.11, show the plots of exceedance for the Salisbury to McMurdo link for spring 1993 for each of the required SINAD levels: 6 dB (data), 12 dB (minimum voice), and 18 dB (good voice).

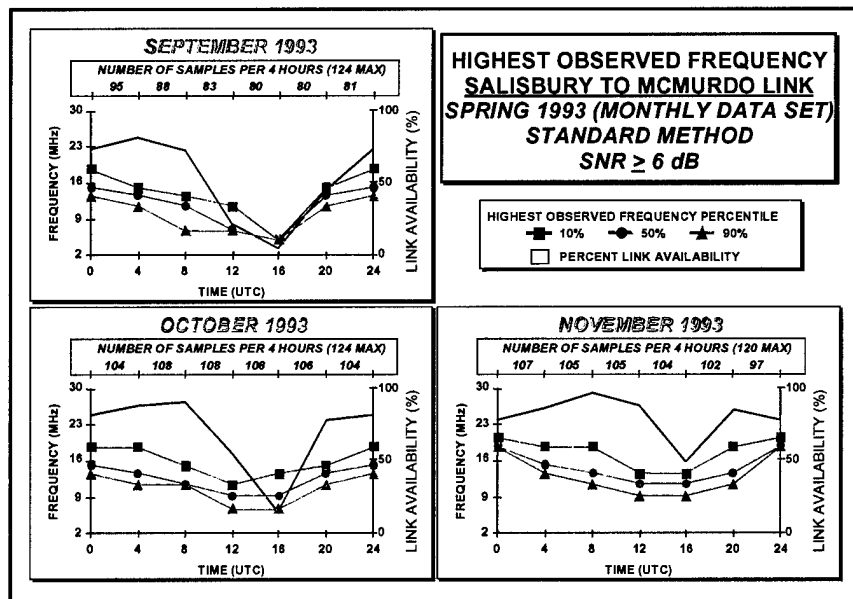

Figure 9.9. Exceedance (90%, 50%, and 10%) for Best Frequency, Salisbury-to-McMurdo Link by Month, Spring 1993 (6-dB Minimum Measured SINAD)

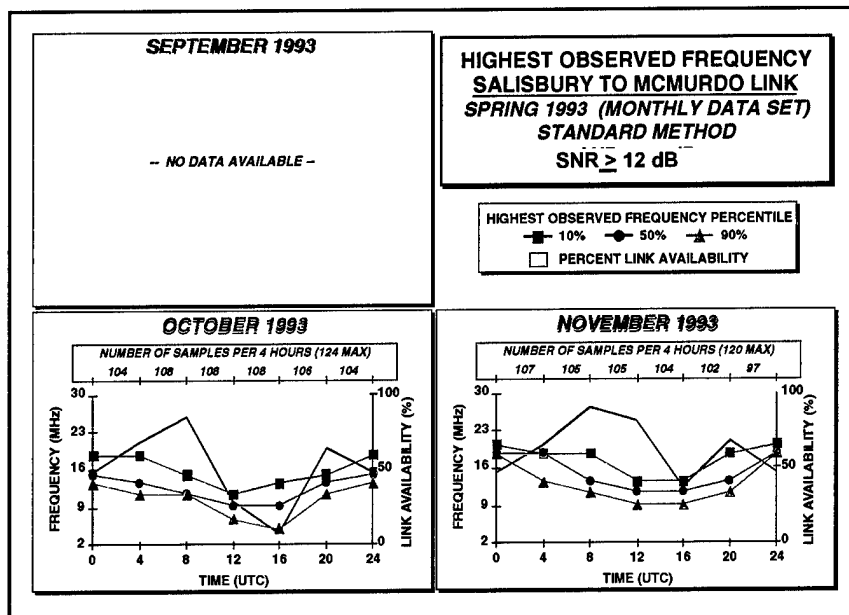

Figure 9.10. Exceedance (90%, 50%, and 10%) for Best Frequency, Salisbury-to-McMurdo Link by Month, Spring 1993 (12 dB Minimum Measured SINAD)

It should be noted that these plots display *link availability* (shaded yellow) which is defined in section 9.1 and not *circuit availability* (shaded blue), which is described in section 9.2.1 and displayed in previous plots.

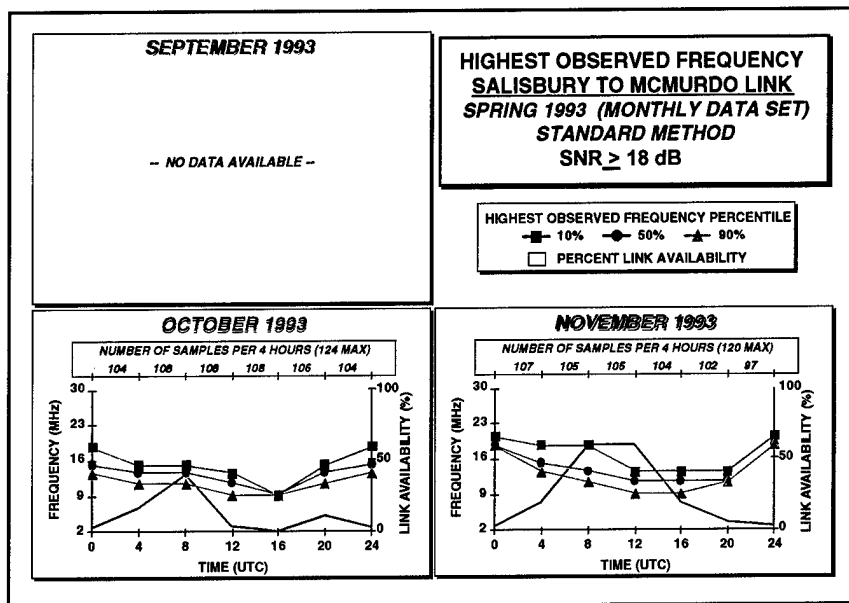

Figure 9.11. Exceedance (90%, 50%, and 10%) for Best Frequency, Salisbury-to-McMurdo Link by Month, Spring 1993 (18 dB Minimum Measured SINAD)

9.2.7 Upper-, Median-, and Lower-Decile Exceedance of Link for Best Frequency Using a Standard Method as a Function of Time of Day and Season

In this case, the data are collected into seasonal statistics. This allows for less variation due to small sample sizes. The data from the above monthly plots are combined in the spring 1993 plot of the seasonal figure 9.12.

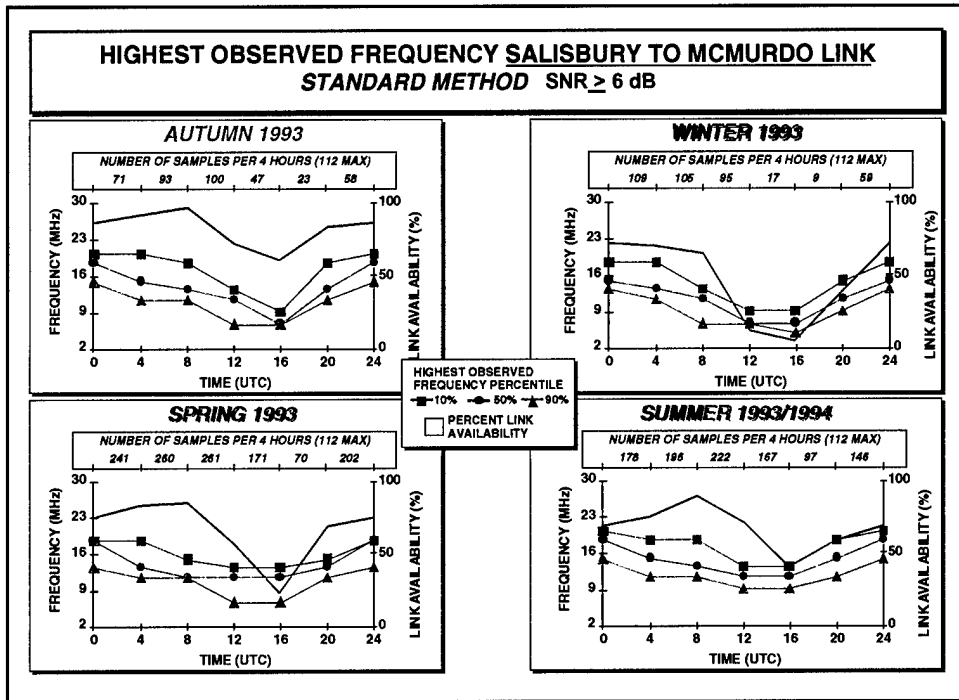

Figure 9.12. Exceedance (90%, 50%, and 10%) for Best Frequency, Salisbury-to-McMurdo Link by Season, 1993 (6 dB Minimum Measured SINAD)

9.2.8 Circuit Availability by Frequency

Measurement results were grouped into the frequency bands 5 to 9 MHz, 11 to 15 MHz, and 18 to 25 MHz for the purpose of observing band availability as a function of time of day, circuit path, and season. This presentation can help the radio operator understand the movement of the optimum operational frequency as a function of time of day and season. For example, it can be observed in figure 9.13 that, for the Christchurch-to-McMurdo link during spring 1993, around 0000 UT, the high band (18 to 25 MHz) is most available and around 1200 UT the low band (5 to 9 MHz) is most available. Observing the Davis-to-McMurdo link for the same time period, one concludes that the most available frequency at 0000 UT is the mid band (11 to 15 MHz) and at 1200 UT it is the low band (5 to 9 MHz).

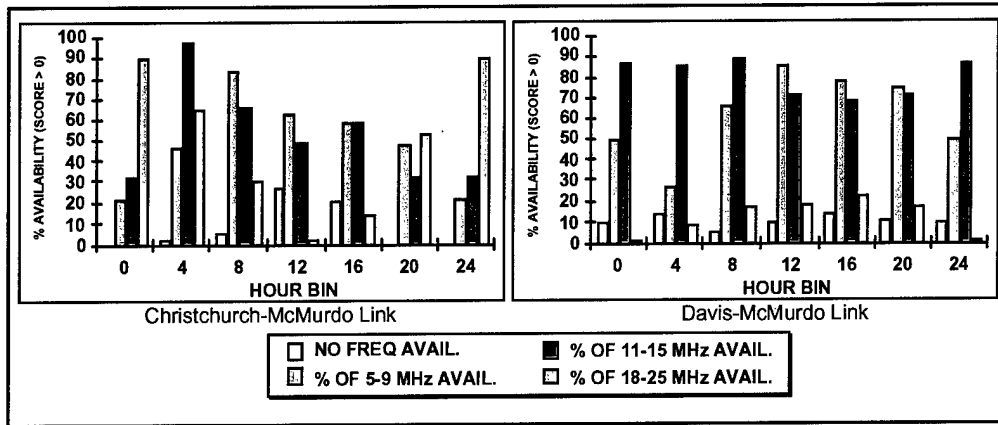

Figure 9.13. Circuit Availability to McMurdo from Christchurch and Davis, Spring 1993

9.2.9 Link Symmetry for the Year

Measured SINAD is plotted against the received SINAD for all LQA measurements during the year using a bubble plot format in figure 9.14. The size of the bubble is proportional to the number of data points at a particular x-y location.

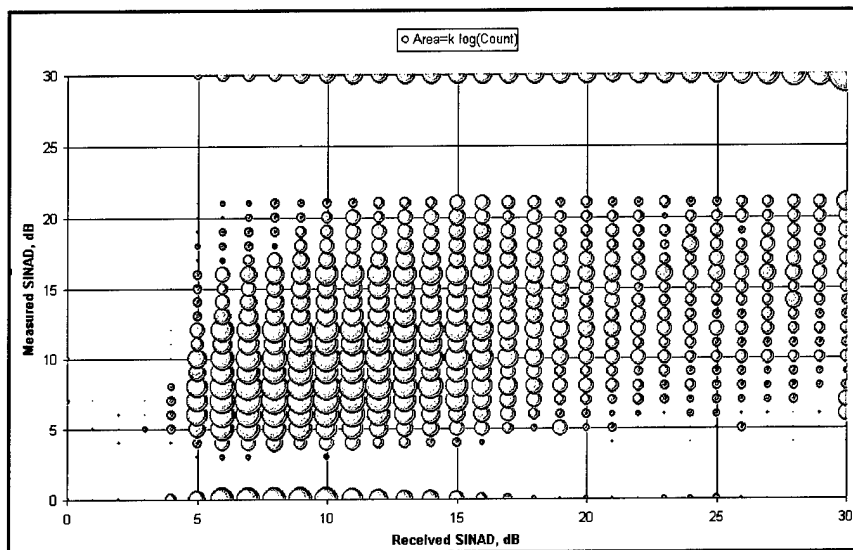

Figure 9.14. Link Symmetry for All Links, 1993-1994

The plotted data demonstrate a Harris radio software bug. The measured SINAD is stored correctly and reported to other stations correctly; however, the measured SINAD is output incorrectly from both the RF-5000 series and the RF-7210. Measured values in the range of 1 dB to 2 dB are output as another value, presumably 0 dB since the number of zeros reported was

larger than expected. Values in the range of 22 dB to 29 dB are output as another value, presumably 30 dB, again because the number of reported 30 values is larger than expected. Both types of radios used similar firmware for those calculations, according to Harris engineers who were informed of this anomaly. No fix was released by Harris during the test period. Figure 9.14 is a summary plot of the link symmetry for all links during the 1993-1994 2-year period. The data indicated that a majority of the links were symmetric, although large asymmetries were present in some paths.

9.2.10 Link Symmetry as a Function of Time of Day for the Year

Measured SINAD is plotted against received SINAD for selected links and for 4-hour bins in figure 9.15. The purpose of this series is to observe link symmetry as a function of direction and time of day. The figure shows the link symmetry for Salisbury to McMurdo during the 0000-0400 UT time bin. Note that performance is fairly symmetric and shows propagation conditions slightly favoring the measured SINAD on the path initiated by Salisbury to McMurdo. This would be the signal from McMurdo that Salisbury measures. Most points fit into the range of 5 dB to 18 dB.

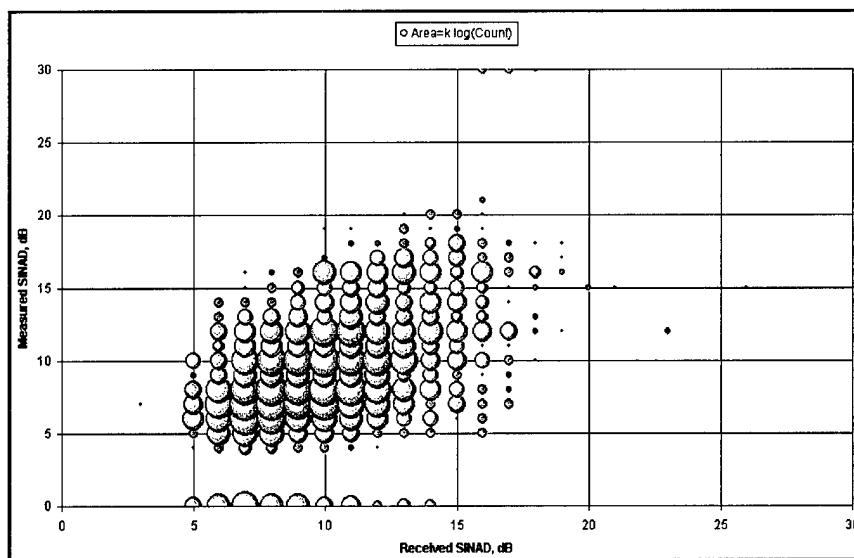

Figure 9.15. Link Symmetry, Salisbury to McMurdo, 0000-0400 UT

Figure 9.16 shows the link symmetry for Salisbury to McMurdo 12 hours later, during the 1200-1600 UT time bin. In this case, propagation conditions have changed and greatly favor the received SINAD on the path initiated by Salisbury. This would be the SINAD as measured by McMurdo and reported to Salisbury during an LQA.

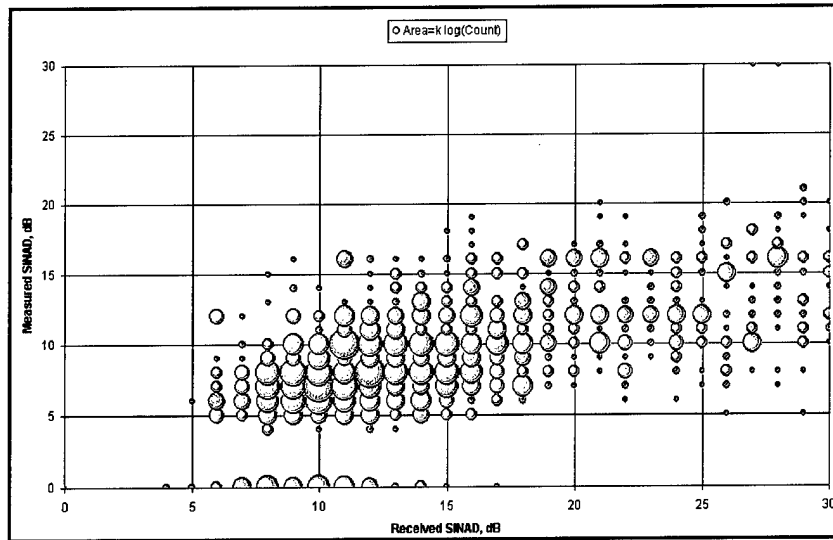

Figure 9.16. Link Symmetry, Salisbury to McMurdo, 1200-1600 UT

9.2.11 Comparison of Measured SINAD to Channel Score for the Year

Measured SINAD is plotted against channel score for all LQA measurements during the year in figure 9.17. Note that there is a lack of points in two regions (1 dB to 3 dB and 22 dB to 29 dB) due to the radio firmware incorrectly reporting measured SINAD. Also, note that the maximum channel score for the three RF-5000 series radios is 100, and that the maximum channel score for the one RF-7210 radio is 120. Figure 9.17 gives a visual picture of the Harris channel scoring algorithm. For example, a SINAD measurement of 10 will result in a channel score of about 50 most of the time. Scores that vary from that value probably have asymmetric path characteristics.

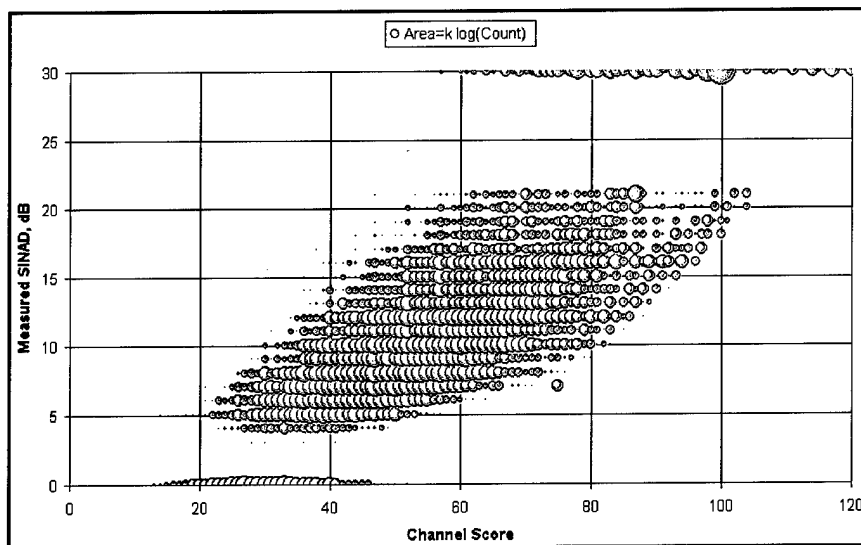

Figure 9.17. Measured SINAD vs. Channel Score

9.3 COMPARISON WITH COMMUNICATION PREDICTION PROGRAMS

Tilbrook's⁹⁴ report presented some limited comparisons between predicted and measured performance on the Davis-to-Salisbury circuit operating in autumn 1993. These comparisons showed significant differences between the predicted best usable frequency (BUF) that is computed by using ASAPS, and the observed ALE best observed frequencies (BOF), i.e., the frequency associated with the highest channel score. Among these differences were

- a noticeable time shift in channel support for the highest frequencies,
- the existence of propagation periods that were not predicted, and
- the generally higher operating frequencies as compared with the prediction program.

Apart from these general differences, there were also significant periods of time in each of the cited months during which the propagation conditions were disrupted. This resulted in a general lowering of the operating frequencies for the duration of disturbed conditions. It is also interesting to note Tilbrook's observation⁹⁴ that

The existence of the differences between predicted and measured results is evidence of the need for real-time frequency management on circuits where optimum communications performance is required.

9.3.1 Discussion of June 1993 Performance

DSTO monitored the dynamics of the ionosphere by sounding the channel obliquely between Davis and St. Kilda (about 10 km from Salisbury) 2 of the 15 time slots every hour. It is instructive first to look at a sample ionogram (figure 9.18) from a series that was taken as part of DSTO's low-latitude ionospheric sounding program.⁹⁵ The link is essentially an east-west, equatorial path between Cocos Island (Indian Ocean) and Darwin (Australia), a distance of nearly 3700 km. The link is nearly identical in length to the 3850 km north-south, trans-auroral path between Christchurch and McMurdo. Even though a fair amount of detail was lost in scanning the original figure⁹⁶ for presentation here, it shows that scaling the ionogram is relatively straightforward. The junction frequency for each of the three F modes (1F, 2F, and 3F) is easily scaled, the nose for each mode is clearly visible, and the sharp returns are indicative of very little group delay or spread.

The oblique ionograms for the Davis-to-Salisbury path (5250 km), for the 3-month period April 1993 through June 1993, were sent to the IPS in Sydney for scaling. The intention⁹⁷ was to scale the two-hop F-mode (F2) junction frequency at a given UT hour from the ionograms for each of the 3 months. A comparison would then be made on an hour-by-hour basis, between the observed monthly median F2 junction frequency and the MUF predicted by ASAPS for each of the given months. However, the structure of the ionograms was quite complex. The junction frequencies and maximum observed frequencies (MOF) for each of the modes proved quite difficult to scale on a routine basis.

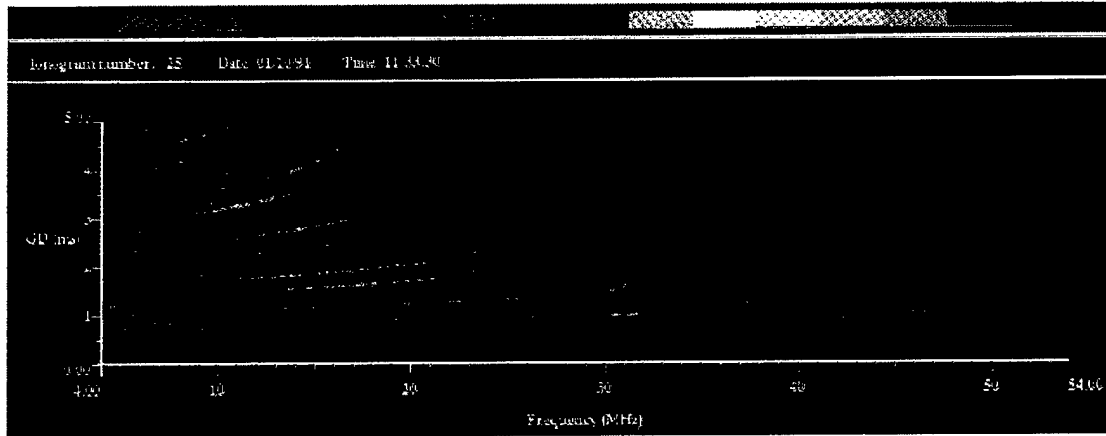

Figure 9.18. Oblique Ionogram Between Cocos Island and Darwin, 1 October 1991, 1133:30 UT⁹⁶

An example of an ionogram for the Davis-to-Salisbury path is shown in figure 9.19. As with the Cocos Island to Darwin example, the ionogram is color coded according to the intensity of the received signal. (Because of the white background, the color in this case has been adjusted to allow the distinct levels to stand out on the printed page.) Along the frequency axis, each of the 10 allocated ALE frequencies is marked in light red. The elongated light red ALE marker with an “A” next to it denotes the ALE frequency chosen by the HF/ALE equipment as the BOF 11 minutes after this particular sounding occurred. The green marker with the “M” over it, just to the right of the BOF marker, is the two-hop F-mode MUF that was predicted by ASAPS. The traces exhibit spread in group delay, suggesting multipath propagation that could very well result in signal fading.

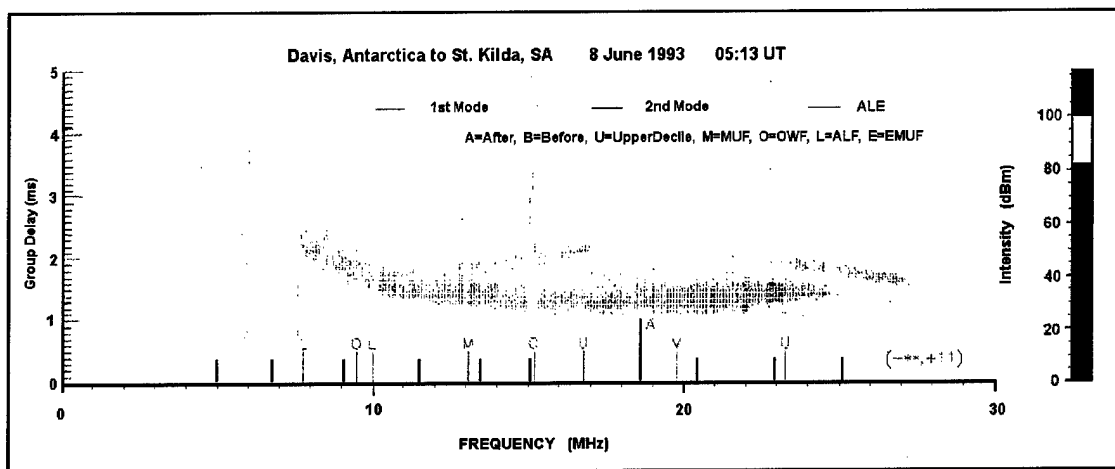

Figure 9.19. Oblique Ionogram Between Davis and Salisbury, 8 June 1993, 0513 UT⁹⁷

To economize their efforts, IPS abandoned the ionogram comparison component of their study and proceeded to a direct comparison of ASAPS predictions with the observed ALE results for the Davis to Salisbury circuit.

The ASAPS predictions for June 1993 are shown in figure 9.20. For a given hour (UT) and channel, there are three gray outlined cells. The top cell shows the prediction for the 2-hop F-mode, the middle cell shows the prediction for the 3-hop F-mode, and the bottom cell shows the prediction for the 3-hop E-mode. For a given mode, the SNR probability distribution is shown as follows. The left-hand side of the cell corresponds to -50 dB, the middle to 0 dB, and the right-hand side to 50 dB. The bar in a cell shows the position and the width of the SNR probability distribution. The left-hand side of the bar gives the 82 percentile SNR for the mode, and the right-hand side of the bar gives the 18 percentile SNR (the SNR that has an 18-percent probability of being exceeded). A thin line connects a bar to the 0-dB position. The bars are color-coded according to the probability of ionospheric support (Prob (I_s)) where

- Black: Prob (I_s) μ 90%,
- Red: 50% { Prob (I_s) < 90%, and
- Green: 10% { Prob (I_s) < 50%.

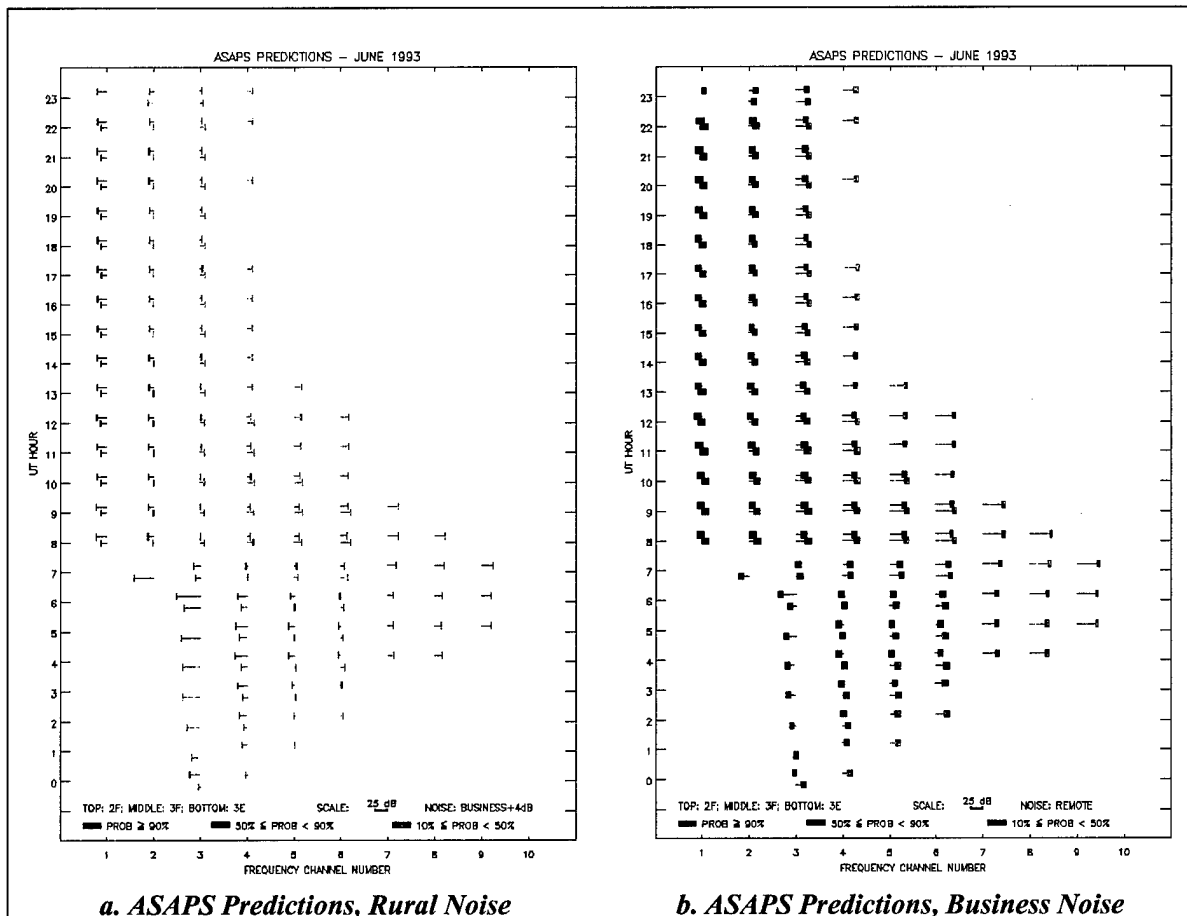

Figure 9.20. ASAPS Predictions for Davis to Salisbury (and St. Kilda), June 1993

No bar in a cell indicates that the probability of ionospheric support is less than 10 percent, or the frequency is less than the absorption limiting frequency (ALF). For figure 9.20a, the environmental noise category of *remote*, or rural, was assumed. Figure 9.20b is a similar plot for the same time period except that the business environmental noise category was chosen, i.e., an increase of 4 dB over the remote noise case.

Figure 9.21 shows the ALE results for June 1993. For a given hour (UT), let N be the total number of HF/ALE measurements. The red bar represents the percentage of N for which the best frequency was the corresponding channel. The blue bar shows the percentage of N for which the HF/ALE equipment found that no link was possible. For the red bars, the middle of a gray outlined cell corresponds to 0 and the right-hand side corresponds to 50 percent. For the blue bars, the left-hand side of the cell corresponds to 0 percent, and the right-hand side corresponds to 100 percent. After comparing figures 9.20 and 9.21, IPS⁹⁷ came to the following conclusion:

The similarity in the pattern formed by the bars indicates that ASAPS can be used to predict the frequency range of operation for the HF/ALE radio. If the HF/ALE equipment had confined its attention to the frequencies (that figure 9.20a indicates were important), then it still would have chosen the same best frequency in 94 percent of cases.

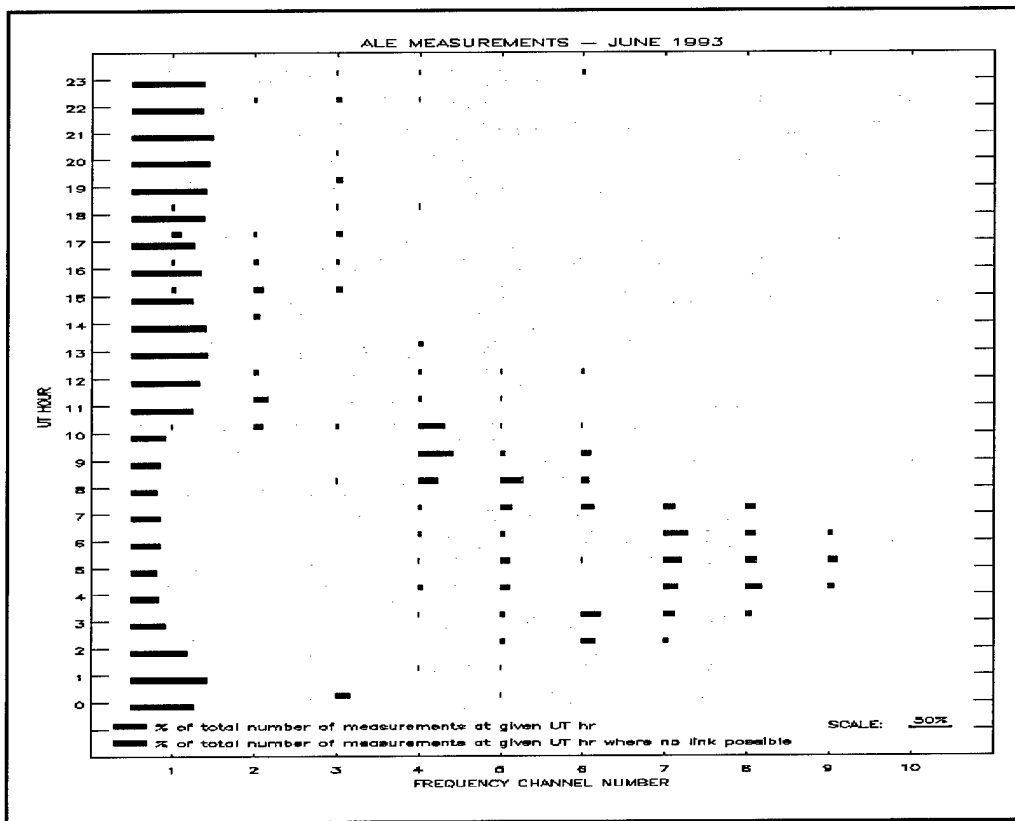

Figure 9.21. Pictorial Display of the Percent of Linked ALE Frequencies⁹⁷

9.3.2 Further Discussions of Select Davis-to-St. Kilda Oblique Ionograms

It is interesting to observe the daily variation in the oblique ionograms from Davis to Salisbury. In this instance, each oblique sounding is rotated vertically with each subsequent sounding abutted to the previous one, forming a continuous display as a function of time. The ordinate is frequency in megahertz, while the abscissa indicates time in units of days. In figure 9.22, the resultant plot for the time period extending from 27 May 1993 through 4 June 1993 is depicted. The results are not quite as ambiguous as the individual ionograms would lead one to believe. Present each day is the distinctive diurnal variation.

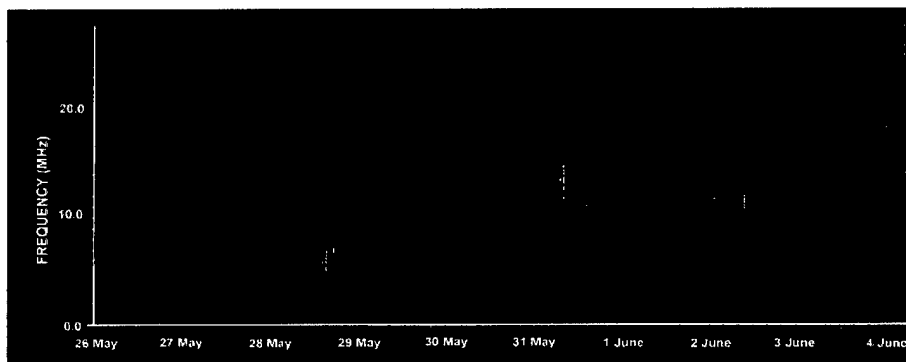

Figure 9.22. Daily Oblique Ionograms for Davis to St. Kilda, 26 May 1993 through 4 June 1993⁹⁶

As seen in figure 9.22, a noticeable lack of ionospheric support occurred on 28 May 1993. The Solar-Geophysical Summary^{98,99} for May and June 1993 indicates no geomagnetic disturbances. Additional checking of the particles (both electrons and protons), magnetic field, and solar x-ray information measured by the GOES-6 Space Environment Monitor¹⁰⁰ reported no abnormal activity. Of particular interest are the particle counts (figure 9.23) for alpha-particles with energies of 10 mega electronvolts (MeV) or greater. Note for instance that the level of the 9.9 to 21.3 particle detector (darker green color) is essentially flat and at background levels.

■ XL	1.0-8.0 Å	X-Ray Flux
■ XS	0.5-4.0 Å	X-Ray Flux
■ E1	> 2.0	MeV electrons
■ A1	3.8 -9.9	MeV alpha-particles
■ A2	9.9 -21.3	MeV alpha-particles
■ A3	21.3 -61.0	MeV alpha-particles
■ A4	60.0 -180.0	MeV alpha-particles
■ A5	160.0-260.0	MeV alpha-particles
■ A6	330.0-500.0	MeV alpha-particles
		not used
■ Hp		Northward Magnetic Flux
■ He		Earthward Magnetic Flux
■ Hn		Eastward Magnetic Flux

Figure 9.23. GOES-6 Solar X-ray and Particle Information, 26 May 1993 through 31 May 1993¹⁰⁰

Comparing the space environment monitor for two specific solar proton events shows a considerably different picture. Unfortunately, neither event matches the April 1993 to June 1993 timeframe for which IPS examined the oblique ionograms for the Davis-to-St. Kilda path. The first event, a small proton event, started on 12 March 1993 at 2010 UT with a maximum proton flux of 44 proton flux units (pfu) for energies greater than 10 MeV. Its start and effectiveness period is clearly indicated in figure 9.24. (See appendix E for a glossary of solar-terrestrial terms.)

The second event, a rather large proton event, started on 20 February 1994 at 0300 UT with a maximum proton flux of 10,000 pfu for energies greater than 10 MeV. Its start and effectiveness period is impressively displayed in figure 9.25.

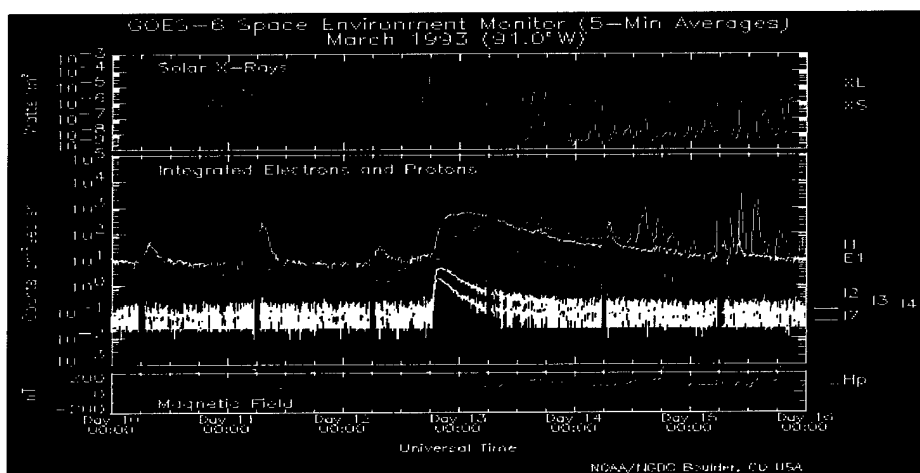

Figure 9.24. GOES-6 Solar X-ray and Particle Information for 10 March 1993 Through 16 March 1993¹⁰⁰

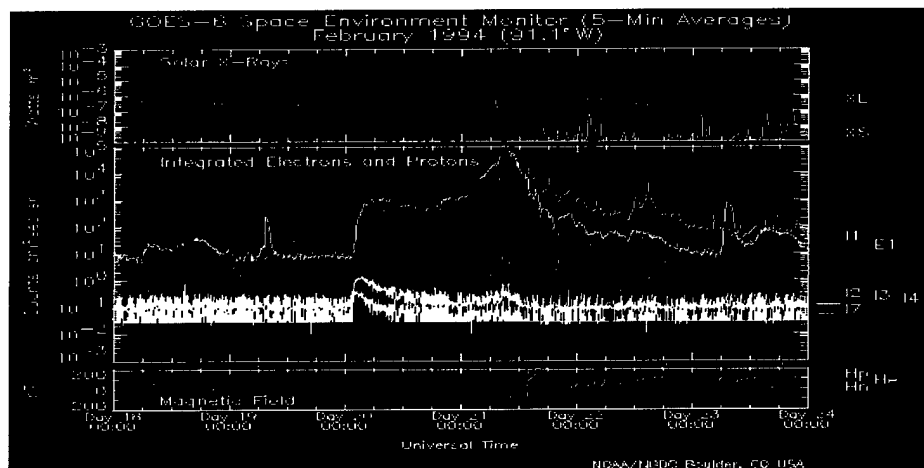

Figure 9.25. GOES-6 Solar X-ray and Particle Information for 18 February 1994 Through 24 February 1994¹⁰⁰

9.3.3 An Operational Example

It is instructive to review a few examples contained in the radio logs at NASU in Christchurch, New Zealand.^{101,102} The first of these examples began on 30 October 1992 and provides a rather vivid picture of what can and often does happen. As can be seen in figure 9.26, radio day (RADAY) 304¹⁰² began in a fairly typical manner. All radio circuits, including HF, were operating normally (indicated as NRML in the radio log). The watch continued in expected sequence. New duty sections relieved old, and current HF frequencies were vacated as better propagating frequencies were rotated into use. With the exception of the loss of a modem circuit near the middle of the second half of RADAY 304, the day was progressing quite routinely.

RADIO LOG OPNAV FORM 2810-1 (REV. 11-58) R/NM 0107-LF-708 1000						
ACTIVITY	OPERATOR	CIRCUIT	CIRCUIT	CIRCUIT	FREQUENCY	
NASU CHCH NZ	VARIOUS	VARIOUS	VARIOUS	VARIOUS	VARIOUS	
TIME	TRANSMISSION					
0001Z	BEGIN RADAY 304/30OCT91//ALL CKTS NRML SECT 4 ON WATCH ATT US-18 10516 USB HSM LSB VOX 13874 USB TDM LSB FAX US-19 14768 USB HSM LSB FAX 16153.5 USB HSM LSB RATT 17494 USB TDM LSB VOX ZBO 3 0 34P 52RRM3 TRATHEN					
0100Z	ALL CKTS NRML					
0200Z	ALL CKTS NRML					
0300Z	ALL CKTS NRML					
0400Z	ALL CKTS NRML					
0500Z	ALL CKTS NRML					
0543Z	SECT FOUR OFF TO SECT TWO A..I..P.....RM3 TRATHEN					
0546Z	SEC II ON ATT A..I..R US 19 UP ON 14768 M/F 16153.5 M/R 17494 T/L US18 ON 10516 M/L 13874 T/F HONO NRML ATT ZBO TO NGD AS FOL 3 0 33 P 22 R ZBO TO HONO AS FOL 9 P 7 R ALL CKTS NRML ATT ALL PUBLICATIONS AND CMS MATERIAL ACCOUNTED FOR ATTRM2 HOFFMAN					
0600Z	ALL CKTS NRML ATT					
0700Z	ALL CKTS NRML ATT					
0800Z	ALOL CKTS NRML ATT					
0850Z	QSY US 18 VA 13 MEG UP 11192.5 T/V VA LSB LINC OAND UP VOX ON 10516					
0900Z	ALL CKTS NRML ATT					
0911Z	QSY US 19 VA 17 MEG UP 12120 T/V					
1022Z	QSY US 19 VA 16 MEG UP 9215 M/R					
1030Z	QSY US 19 VA 12 MEG UP 7540 T/V					
1100Z	ALL CKTS NRML ATT					
1200Z	ALL CKTS NRML ATT					
1300Z	ALL CKTS NRML ATT					
1400Z	QSY US 18 VA 11 MEG UP 10130 T/V QSY US 19 VA 14 MEG UP 5080 M/V					
1401Z	ALL CKTS NRML ATT					
1500Z	ALL CKTS NRML ATT					
1545Z	SEC II OFF TO SEC III ATT A..I..P.....RM2-HOFFMAN-POH					
1600Z	ALL CKTS NRML ATT					
1700Z	ALL CKTS NRML ATT					
1745Z	SEC II OFF TO SEC-III ATT A..I..P.....RM2 HOFFMAN					
1746Z	SEC THREE ON WATCH A.I.P. PUBS EQUIP ACCOUNTED FOR US18/19 CKTS STATUS 10130 USB TDM LSB VOX 10516 USB HSM LSB VOX US19 12120 USB TDM LSB VOX 9215 USB HSM LSB RATT 11461.5 USB HSM LSB VOX NGD NOT GETTING US ON TDM ALL OTHER CKTS NRML NGD ZBZ5 ON TDM RM2.....					
1800Z	US18/19 HSM DWN ATT TDM NGD ZBZ5 ALL OTHER CKTS NRML					
1900Z	US18/19 DWN ON HSM TDM ATT DUE TO FREQS ALL OTHER CKTS NRML					
2000Z	US18/19 DWN ON HSM TDM DUE TO FREQS ALL OTHER CKTS NRML					
2100Z	US18/19 DWN ON TDM HSM DUE TO FREQS ALL OTHER CKTS NRML					
2115Z	NGD JUST CALLED ON INMARSAT QSY VA THE 9215 USB HSM LSB RATT UP 7540 USB HSM LSB RATT VA THE 11461.5 USB HSM LSB VOX UP THE 16153.5 USB HSM LSB VOX US18 QSY VA THE 10130 USB TDM LSB VOX UP THE 13874 USB TDM LSB VOX VA THE 10516 USB HSM LSB VOX UP THE 11192.5 USB HSM LSB VOX					
2200Z	US18/19 DWN ATT DUE TO FREQS ALL OTHER CKTS NRML					
2255Z	US18/19 GOING TO BLACKOUT FREQS ATT US18 P 13874 USB TDM LSB VOX T1 11192.5 USB HSM LSB VOX US19 P 12120 USB TDM LSB VOX (S) 14768 USB HSM LSB VOX T5 23197 WILL QSY FREQS EVERY HR VICE 30MICS DO TO HOW BAD FREQS ARE					
(Over)					DATE 30 OCT 92	PAGE NO. 1 OF 2

Figure 9.26. Example of NASU Radio Log

At 2115 UT, McMurdo called Christchurch via INMARSAT requesting a frequency shift. At 2200 UT, McMurdo and Christchurch HF communications were down and the stations were going to blackout frequency procedures by 2255 UT. These procedures remained in effect until 0855 UT on RADAY 309 (4 November) when Christchurch received a call from McMurdo (see figure 9.27) indicating that they were beginning to receive weak signals from Christchurch's test tape transmissions. The HF transmissions remained variable, spotty at best, until all circuits returned to normal the next morning, RADAY 310 (5 November 1992), at 0700 UT after a period of almost six full days.

0830Z	TRF VIA THE SLAT ONLY HAVE ROOTIES CALLED DCU ATT THEY ARE TALKING TO HONO VIA THE OTO AND WILL GIVE ME A CALL BACK
0855Z	JUST RECEIVED A CALL FM NGD THEY ARE STARTING TO GET A WEAK SIG US18 QSY VA THE 10516 USB TDM LSB VOX 10618 USB TDM LSB VOX UP 13874 USB TDM LSB VOX 11192.5 USB HSM LSB VOX US19 QSY VA THE LSB VOX UP RATT VA THE 14768 USB TDM UP HSM VA THE 9215 LSB RATT UP VOX ALSO
0900Z 0941Z	DCU CALLED SAID THEY HAVE THEIR TECH DOING CHECKS WITH HONO TO MAKE SURE THAT THEIR GEAR IS OK, AND THE PROB. MIGHT BE HERE HAVE DONE A IN-HOUSE CHECK AND ZBZS TALK TO A MR. HUNT US18/19 DWN BAD HF PROPS HONO CKT DWN DCU WORKING ON IT HAVE GREEN LIGHTS ACROSS THE BOARD ON TDM AND HSM BUT NGD NOT SENDING A TEST ATU BOTH TDM AND HSM ARE BOOMING IN HOUSE ATT WILL ZAI-2 FOR A WHILE LONGER

Figure 9.27. Radio Log Entry at Christchurch, 0855 UT, 4 November 1992¹⁰²

What were the conditions of the space environment during this time period? A fairly large particle event occurred at 1920 UT on 30 October 1992 with proton flux levels equal to 2000 pfu at >10 MeV. An X1 flare occurred approximately one hour earlier at 1816 UT. MFUs were reported by the IPS^{104,105} in Sydney to be depressed by 20 to 40 percent from 2100 UT on 30 October until 0800 UT on 31 October. A sudden commencement was observed at 2157 UT on 1 November at Learmonth, WA; active to minor geomagnetic storm levels were reported from 2100 UT until 0600 UT the next day, 2 November. Another solar flare, an X9 flare, was observed early 2 November. MUFs were reportedly depressed by IPS for Sydney by 15 to 30 percent from 2100 UT on 3 November to 0700 UT on 4 November.

In checking the list of solar proton events (table 9.3) affecting the Earth's environment, a rather large solar proton event is noted at 0820 UT on 23 March 1991 (RADAY 083). In this instance, the proton flux^{36,103} equaled 43,000 pfu at >10 MeV. However, the logbooks at NSAU Christchurch indicated normal circuit activity until 2000 UT on 24 March (RADAY 084), while nothing was heard from McMurdo. By 2200 UT, blackout conditions were in effect until 0900 UT, 25 March. By 1900 UT, conditions changed, becoming spotty, with circuits between McMurdo and Christchurch remaining in and out for the remainder of RADAY 085.

In general, these two cases show some of the perplexities in trying to assess the extent of service disruption in terms of a specific solar proton event. Looking at the listing of solar proton events for 1992, there is a wide range of variability in proton flux levels. With respect to disruptions in normal HF traffic between Christchurch and McMurdo, the correlation between

ionospheric disturbances and traffic disruptions, at least as recorded in the radio logs, is murky at best. It was observed that the time delay between solar proton event and propagation effect, the extent of disruption, the duration of disruption, and the quality of disruption all vary. In addition, as one might expect, there were blackout procedures in effect for situations other than solar proton events. (Appendix E contains a glossary of solar-terrestrial terms, and appendix F contains a glossary of ionospheric disturbances.)

Table 9.3. Listing of Solar Proton Events for 1992³⁶

Start Time (Day/Time)	Event Maximum (Day/Time)	Proton Flux (pfu @ > 10 MeV)
920207/0645	920207/1115	78
920316/0840	920316/0840	10
920509/1005	920509/2100	4600
920625/2045	920626/0610	390
920806/1145	920806/1210	14
921030/1920	921031/0710	2700

9.4 SUMMARY OF THE DEFENCE SCIENCE AND TECHNOLOGY ORGANIZATION (DSTO) BIT ERROR RATE (BER) MODEM TESTS

NUWC supplied DSTO with a 39-tone data modem that was part of the Harris RF-5022 radio used for transmission tests at Davis. Laboratory tests, as well as the manufacturer's specifications, suggested that an SNR of at least 30 dB in a 3-kHz bandwidth was necessary for a BER of better than 10^{-3} at a data rate of 2400 bps, and an SNR of at least 25 dB for a BER of 10^{-2} . On-air tests indicated that even with spatial diversity over the relatively stable circuit between Honolulu and Canberra, SNRs of 25 dB and 13 dB were required to achieve the respective BER of 10^{-3} and 10^{-2} .

Given this background, it came as no surprise that the BER tests that took place between Davis and Salisbury were disappointing. Computer predictions by DSTO⁹⁴ using ASAPS indicated that monthly median SNR would be in the 20- to 23-dB range. Actual measurements during the time period of the tests indicated that the maximum hourly median SNR received on the ALE BOF during the months of April through June 1993 was of the order of 15 to 20 dB.

Because of the very poor quality of data and the low SNR experienced on the Davis-to-Salisbury link, the test transmissions were aborted in June 1993 and the detailed evaluation of the HF/ALE LQA score as a channel quality metric was not performed. This was a pity, as it would have provided a preliminary understanding of the conditions under which LQA scores could reliably be used in real-time frequency management of high-speed data transmissions.

Those tests were subsequently later rekindled, albeit under entirely different propagation conditions over a rather short path of only 650 km within Australia. As reported,⁹² the Australian tests did not dispute the ability of the ALE scheme to successfully identify a propagating frequency and to establish a link. The shortfall with regard to its use as a real-time frequency management system for high-speed data transmissions was specifically its nonoptimality for serial and parallel data modem types that use differential phase shift keyed modulation methods.

DSTO¹⁰⁶ reported on modem performance discussions held between staff at NSFA (Christchurch) and DSTO. NSFA noted that they had evaluated the alternative modem waveforms available in the Rockwell MDM-2001 multi-mode modem. Test results indicated that the 16-tone enhanced waveform provided the best results on the McMurdo-to-Christchurch link. In their experience, the performance at 2400 bps was unsatisfactory and necessitated a reduction in the data rate to 300 bps in order to balance quality with throughput. Tilbrook⁹⁴ contrasted these results with tests performed by DSTO on a Honolulu to Canberra circuit, where a 39-tone modem with space diversity reception comfortably outperformed the 16-tone enhanced modem. During the tests, error-free data at 2400 bps was often obtained for periods of up to an hour.

Tilbrook and Cook¹⁰⁷ report that recent modem tests indicate a new generation of serial modems may actually benefit from the presence of multipath propagation. The tests in question were performed over a link between Melbourne and Adelaide. The authors further note, as other researchers have suggested, that ALE should perform LQAs using a waveform appropriate to the data modem to be used to transmit data, instead of using a low-signaling rate waveform.

10. CONCLUSIONS AND RECOMMENDATIONS

10.1 CONCLUSIONS

This report addressed the capabilities of HF/ALE for long-haul paths of distances of the order of magnitude in the thousands of miles with the intent to quantify the HF paths from continental New Zealand and Australia and points in Antarctica. This effort demonstrated reliable, long-haul, trans-arural HF communications using nonoptimal antennas and limited transmit power. It demonstrated that automated adaptive techniques are a significant improvement over manual procedures for preventing loss of link during periods of rapidly varying propagation conditions.

Significant strides have been made toward understanding the performance of HF/ALE radios along trans-auroral paths. In addition, the groundwork has been set to develop a robust HF/ALE communications network operating at high latitudes. On 20 February 1998, the U.S. Navy disestablished the NASU in Christchurch. At the ceremony, RADM William Sutton was quoted¹¹⁰ as saying: *This [ceremony] signifies not the end of the book on man's exploration of the Antarctic, but only the end of a chapter.* Although there are no longer any specific U.S. Navy applications in the Antarctic, there remains a real need to augment health and safety communications' requirements for scientific and logistic support operations.

Specific benefits have already been provided to the Australian Defence Forces⁹² during their emergency communication network evaluation. Additional benefits from this research include a more explicit understanding by equipment vendors of the potential of HF/ALE radios and the present inherent implementation issues, as well as a database to provide input for the evolution of HF/ALE military and federal standards. Finally, techniques developed under this program have broad application to the management of an HF/ALE radio network in general.

A significant amount of polar HF propagation data has been collected during this study that will undoubtedly be used to evaluate and improve propagation prediction models. This collection of these data is the most significant achievement of this study.

10.2 RECOMMENDATIONS

10.2.1 Real-Time Frequency Management

A number of studies to improve the real time assessment of HF communications at high latitudes were conducted. A few of these studies were performed with direct support from the Office of Polar Operations at the NSF, or at other national agencies.

Earlier studies at the NUWC Division Newport and at Science Applications International Corporation analyzed the UAG-23 formatted ionosonde data files from Scott Base in Antarctica. The first study⁸⁶ developed special-purpose software to extract and statistically analyze the data and apply the results to one-hop communication links. The second study¹⁰⁸ provided analysis of specific two-hop links. The special-purpose software could be combined with other environmental measurements, such as sunspot number and auroral activity measures, to produce an online frequency-management tool for assessment of communication links in the Antarctic. Further enhancements could include model predictions, as well as historical comparisons of predicted versus actual frequencies.

In the past few years, the Australian Government¹⁰⁹ has developed an extensive network of ionosondes operating principally at low-latitude. Initially, the network had been established to provide HF real-time frequency management in northern Australia. Without much extension, these procedures could be used to optimize the operation of HF/ALE radio networks. The inclusion of an additional node or two specifically oriented for Antarctic path assessments could provide significant improvements to frequency usage and management in Antarctica.

10.2.2 HF/ALE Radio Within Antarctica

At distances greater than line of site, a novice operator at a mobile remote camp could assemble reliable HF/ALE communication links to base camps. Remotely stationed parties could be equipped with a system consisting of a laptop computer with GPS capability and a man-pack radio that together would provide the functionality of a network node. Messages would be entered at the console and tagged automatically with time data, station, and location. In addition to providing the operator with the HF/ALE functionality, the network would route messages to specified destinations. In broadcast mode, the network could function as proxy for propagation conditions thus enabling the user to determine the nodal robustness. For example, under disturbed conditions, it may be advantageous to initiate message transfers to widely dispersed nodes for hand-off to circumvent particularly disruptive circuits.

HF communication between remote camps and base stations within Antarctica over short haul paths would utilize high-angle near vertical incidence (NVI) propagation paths. HF NVI can provide communications between local camps where line of site is obstructed by mountain ranges. ALE techniques are particularly useful in NIV situations where it is difficult to predict frequency requirements. Portable, upward-looking antennas would be used at camps for HF NVI communication, which are vastly different than the low-angle, long-haul antennas described in this report. The use of HF NVI in Antarctica requires further investigation.

11. REFERENCES

1. R. Hough, *Captain James Cook: A Biography*, W. W. Norton and Company, Inc., New York, NY, 1994.
2. A. Gurney, *Below the Convergence: Voyages Towards Antarctica 1699-1839*, W. W. Norton and Company, Inc., New York, NY, 1997.
3. "U.S. Antarctic Program, 1994-1995 Research," NSF/OPP Document NSF 94-155, National Science Foundation, Office of Polar Programs, Arlington, VA, 1994.
4. "Guide to the World Data Center System," Secretariat of the ICSU Panel on World Data Centres, International Council of Scientific Unions, Paris, France, April 1996.
5. R. L. Schweickart, "Safety in Antarctica," Report from the Chairman of the U.S. Antarctic Program Safety Review Panel, National Science Foundation, Washington, DC, 30 June 1988.
6. B. L. Pease, P. E. Gilles, P. M. Mileski, and J. R. Katan, "Antarctic Meteor Scatter Test, December 1992," NUWC-NPT Technical Report 10,417, Naval Undersea Warfare Center Division, Newport, RI, 1 February 1994.
7. R. E. Byrd, *Little America: Aerial Exploration in the Antarctic, The Flight to the South Pole*, G. P. Putnam Sons, New York, NY, 1930.
8. F. Jacka and E. Jacka, *Mawson's Antarctic Diaries*, Allen and Unwin Australia Pty, Limited, North Sydney, New South Wales, Australia, 1988.
9. H. J. Round, T. L. Eckersley, K. Tremellen, and F. C. Lunnon, "Report on Measurements Made on Signal Strength at Great Distances During 1922 and 1923 by an Expedition Sent to Australia," *Institute of Electrical Engineers*, vol. 63, no. 346, Great Britain, October 1925.
10. E. A. Appleton and M. A. F. Barnett, "Local Reflection of Wireless Waves from the Upper Atmosphere," *Nature*, vol. 115, Great Britain, 1925, pp. 333-334.
11. G. Brei and M. Tuve, "A Test of the Existence of the Conducting Layer," *Physics Review*, vol. 28, 1926, pp. 554-575.
12. "NASU Blackout Procedures for US18/US19," Naval Antarctic Support Unit (NASU), Christchurch, New Zealand, 1993.

13. "Master Plan, U.S. Naval Support Force Antarctica, Detachment Christchurch, New Zealand," NFEC Letter Ser. 2022ML/721, Naval Facilities Engineering Command, Pearl Harbor, HI, 29 January 1988.
14. P. C. Smith, R. T. Adair, and D. F. Peach, "An Investigation of Federal Standard 1045, High Frequency ALE Radio Performance in the Southern Trans-Auroral Zone," NTIA Report 94-304, National Telecommunications and Information Administration, Institute of Telecommunication Sciences, Boulder, CO, March 1994.
15. "The United States in Antarctica," U.S. Antarctic Program External Panel Report, National Science Foundation, Washington, DC, April 1997.
16. M. A. Motiwala and R. E. Heinrich, "Advances in HF Communications—A Technology Survey," *NEMA News*, March/April 1989.
17. "National Security Decision Directive 97," National Security Telecommunications Policy, Approved by the Executive Office of the President, August 1983.
18. R. T. Adair, "An Automatic Link Establishment Standard for Automatic Digital HF Radios," *Proceedings of the IEEE Military Communications Conference*, Boston, MA, 15-18 October 1989.
19. G. L. Harrison, "Functional Analysis of Link Establishment in Automatic HF Systems," MITRE Paper WP 86W00015, MITRE Corp., McLean, VA, December, 1985.
20. G. L. Harrison and F. C. Leiner, "Proposed Federal Standard 1045, High Frequency Automatic Link Establishment," MITRE Paper WP 86W00335, MITRE Corp., McLean, VA, September, 1986.
21. "Telecommunications: HF Radio Automatic Link Establishment," GSA Federal Standard FED-STD-1045, General Services Administration, Office of Information Resources Management, Washington, DC, 24 January 1990.
22. "Interoperability and Performance Standards for Medium and High Frequency Radio Equipment," NPO MIL-STD-188-141A, Naval Publications Office, Philadelphia, PA, 15 September 1988.
23. "Telecommunications: HF Radio Automatic Link Establishment," GSA FED-STD-1045A, General Services Administration, Office of Information Resources Management, Washington, DC, 18 October 1993.
24. D. R. Wortendyke and C. C. Riddle, "Adaptive HF Radio Performance Evaluation Using Automated Instrumentation," *Proceedings IEEE Military Communications Conference*, 4-7 November 1991.

25. P. E. Gilles, J. R. Katan, and B. L. Pease, "High Frequency/Automatic Link Establishment (HF/ALE)," NUWC-NPT Technical Report 10,427, Naval Undersea Warfare Center Newport Division, Newport, RI, 1 February 1994.
26. J. P. Rahilly, "High Frequency (HF) Automatic Link Establishment (ALE)," Technical Report 1383, Naval Ocean Systems Center, San Diego, CA, November 1990.
27. G. P. Francis., "Automatic Link Establishment (ALE) System for a Sea-Based High-Frequency Sounder," Technical Report 1364, Naval Ocean Systems Center, San Diego, CA, September 1990.
28. G. K. L. Smith, "IEE Fifth Conference on HF Radio Systems and Techniques," London, England, 1991.
29. G. K. L. Smith, "Traffic Capacity Comparisons of Automated HF Systems," White Paper to CCIR Study Group 9E, Response to Question 147/9, Siemens Plessey Defence Systems, England, 1992.
30. Private Communications with M. Heigl, Defence Science and Technology Organisation, Salisbury, SA, Australia, 1992.
31. M. C. Baker and R. J. Lorenz, "Trans-auroral Propagation Trials, Norway, September 1988-March 1989," Harris Report E-91174, Harris Corp., RF Communications Group, Rochester, NY, 1991.
32. Private Communications with G. Nourry, Canadian Department of Defence, Ottawa, Canada, January 1991.
33. L. Blasi and M. de Simone, "Project of a Regional HF High Speed Network Among Terra Nova Bay, Dumont D'Urville, and Dome C, with FAX, Data, Video, Voice Facility," Italian Research Programme in Antarctica, ENEA Antarctic Project Report, 1994.
34. "Reliable Trans-auroral HF Communications Through Real Time Frequency Management: Results of Automatic HF Frequency Management Trials in Norway - June 1988 to March 1989," Publication Number 10062-0004, Harris Corp., Rochester, NY, 1989.
35. P. P. Salamone, R. Callwood III, and B. K. Schmidt, "The Alaskan High Frequency Radio Network Test Results," Document MTR 11003, MITRE Corp., Bedford, MA, October 1990.
36. "Solar-Terrestrial Data for 1992," NGDC SPRIDR Web Site, National Geophysical Data Center (NGDC), Boulder, CO, 1998. (Web Site: <http://www.ngdc.noaa.gov.8080/>).
37. "Oblique Ionosonde Receiver Description Documents," Papers of the Radio Wave Propagation Group (RWPG), Defence Science and Technology Organisation, Salisbury, South Australia, Australia, 1990.

38. "Official Defence Science and Technology Organisation Photographs in Support of HF/ALE Campaign," Defence Science and Technology Organisation (DSTO), Salisbury, South Australia, Australia, 1992.
39. G. Braun, Photographs of Black Island, McMurdo Station, Antarctica, MITRE Corp., VA, 1996.
40. "AAD Official Australian Antarctic Division Photographs," Australian Antarctic Division, Hobart, Tasmania, Australia, 1998. (Available from <http://www.antdiv.gov.au>)
41. "RF-7210 Adaptive Controller Instruction Manual," Publication Number 10292-0020A, Harris Corp., RF Communications Group, Rochester, NY, October 1991.
42. "RF-350 Transceiver Instruction Manual," Publication Number 10085-0705D, Harris Corp., RF Communications Group, Rochester, NY, March 1992.
43. "Falcon Series Tactical Communications System Manual," Publication Number 10181-0042A, Harris Corp., RF Communications Group, Rochester, NY, July 1992.
44. National Telecommunications and Information Administration, Institute of Telecommunication Sciences, Boulder, CO, NTIA Web Site <http://www.NTIA.doc.gov> and ITS Web Site <http://ftp.ITS.bldrdoc.gov>.
45. J. G. Roederer, Chairman of Ad Hoc Committee on the Upper Atmosphere and Near-Earth Space, "Study of the Upper Atmosphere and Near-Earth Space in Polar Regions: Scientific Status and Recommendations for Future Directions," National Academy Press, Washington, DC, 1982
46. M. C. Kelley, "Testimony as a Major Research Equipment Account Witness on Behalf of the National Science Foundation's Polar Cap Observatory," Subcommittee on Basic Research, Committee on Science, U.S. House of Representatives, Washington, DC, 9 April 1997. (Available from: http://www.house.gov/science/kelley_4-9.html.)
47. D. Savage and J. Sahli, "First Snapshot Taken of Shape of Interplanetary Magnetic Field," NASA Press Release 95-185, National Aeronautics and Space Administration Headquarters, Washington, DC, 18 October 1995. (Available from: http://urap.gsfc.nasa.gov/WWW/reiner/nasa_press_release.txt.)
48. M. C. Kelley, *The Earth's Ionosphere: Plasma Physics and Electrodynamics*, Academic Press, San Diego, CA, 1989.
49. S. I. Akasofu, "Solar Terrestrial Relationships in the High Latitude Region," *AGARD Conference Proceedings 302*, Paper 92, Fairbanks, AK, 1985.

50. J. S. Belrose, "HF Communications and Remote Sensing in the High Latitude Region" in *Media Effects on Electronic Systems in the High Latitude Region*, AGARD Lecture Series No. 162, North Atlantic Treaty Organization, Ottawa, Ontario, Canada, 29-30 September 1988.
51. J. K. Hargreaves, *The Solar-Terrestrial Environment*, Cambridge University Press, Cambridge, England, 1992.
52. L. S. Wagner, "Morphology and Characteristics of Disturbed HF Skywave Channels," NRL Report NRL/MR/5554-93-7389, Naval Research Laboratory, Washington, DC, 3 September 1993.
53. P. S. Cannon, "Morphology of the High Latitude Ionosphere and Its Implications for HF Communications Systems," *IEE Proceedings*, vol. 136, Pt I, no. 1, February 1989.
54. J. M. Goodman, and J. Aarons, "Ionospheric Effects on Modern Electronic Systems," *Proceedings of IEEE*, vol. 78, no. 3, pp. 512-527, 1990.
55. J. M. Goodman, *HF Communications: Science and Technology*, Van Nostrand Reinhold, New York, NY, 1992.
56. L. F. McNamara, *The Ionosphere: Communications, Surveillance and Direct Finding*, Krieger Publishing Company, Malabar, FL, 1991.
57. J. Østergaard, "Short Range Communication Systems, Design and Operation at Very High Latitudes" in *Proceedings of the Fourth International Conference on HF Radio Systems and Techniques*, London England on 11-14 April 1988, Publication 284, Institution of Electrical Engineers, London, England, 1988.
58. A. J. Poppianno and P. A. Bradley, "Morphology of Background Aurora Absorption," *Journal Atmospheric and Terrestrial Physics*, vol. 47, no. 7, 1985, pp. 663-674.
59. L. S. Wagner and J. A. Goldstein, "High Resolution Probing of the HF Ionospheric Skywave Channel: F₂ Layer Results," *Radio Science*, vol. 20, no. 3, May-June 1985, pp. 287-302.
60. L. S. Wagner, J. A. Goldstein, and W. D. Meyers, "Wideband Probing of the Transauroral HF Channel: Solar Minimum," *Radio Science*, vol. 23, no. 4, July-August 1988, pp. 555-568.
61. D. V. Blagoveshchenskij, L. V. Egorova, and V. M. Lukashkin, "High-Latitude Ionospheric Phenomena Diagnostics by High Frequency Radio Wave Propagation Observations," *Radio Science*, vol. 27, no. 2, March-April 1992, pp. 267-274.

62. C. I. Ming and B. H. Mauk, "Global Auroral Morphology: Quadrennial Report To the I.U.G.G. on U.S. Contributions," *Reviews of Geophysics*, Supplement, April 1991, pp. 1028-1038.
63. C. S. Deehr and J. A. Holtet, *Exploration of the Polar Upper Atmosphere*, D. Reidel Publishing Company, Dordrecht, Holland, 1980.
64. M. Rycroft, "A View of the Upper Atmosphere from Antarctica," *New Scientist*, 28 November 1985, pp. 44-49.
65. E. F. Szuszczewicz, "Advances in Ionospheric Physics: Roles, Relevance and Predictions in the System of Solar-Terrestrial Plasmas," *Reviews of Geophysics*, Supplement, July 1995 pp. 721-728.
66. P. Charbonneau and O. R. White, "The Sun: A Pictorial Introduction," A Slide Set, High Altitude Observatory, National Center for atmospheric Research, Boulder, CO, 18 April 1995.
67. A. J. Hundhausen, "Solar Cycles from the Coronal-Heliospheric Perspective," Viewgraph Presentation Materials, Second Solar Magnetism Initiative Workshop, High Altitude Observatory, National Center for Atmospheric Research, Boulder, CO, 16-18 Jul 1996. (Available from: <http://hao.ucar.edu/public/workshop/smi/AH.sec9.html>.)
68. D. V. Reames, "Solar Energetic Particles: A Paradigm Shift," *Reviews of Geophysics*, Supplement, July 1995, pp. 585-589.
69. D. F. Webb, "Coronal Mass Ejections: The Key to Major Interplanetary and Geomagnetic Disturbances," *Reviews of Geophysics*, Supplement, July 1995, pp. 577-583.
70. J. T. Gosling, "New Findings Challenge Beliefs about Solar-Terrestrial Physics," *EOS*, vol. 74, no. 52, 28 December 1993, pp. 611-612.
71. I. G. Richardson, C. J. Farrugia, and D. Winterhalter, "Solar Activity and Coronal Mass Ejections on the Western Hemisphere of the Sun in mid-August 1989: Association with Interplanetary Observations of ICE and IMP 8 Spacecraft," *Journal of Geophysical Research*, vol. 99, no. A2, 1 February 1994, pp. 2513-2529.
72. J. A. Joselyn, J. Anderson, H. Coffey, K. Harvey, D. Hathaway, G. Heckman, E. Hildner, W. Mende, K. Schatten, R. Thompson, A. W. P. Thomson, and O. R. White, "Solar Cycle 23 Project: Summary of Panel Findings," National Oceanic and Atmospheric Administration, Space Environment Center, Boulder, CO, 9-26 September 1996. (Available from: <http://www.sel.noaa.gov/info/Cycle23.html>.)
73. "Summary Report of the Second Meeting of the Solar Cycle Prediction Panel," NSO Report, National Solar Observatory, Sacramento Peak, Sunspot, NM, 2 October 1997. (Available from: <http://www.sel.bldrdoc.gov/info/SumSept.html>.)

74. R. T. Merrill, "A Slow Moving Field," *Nature*, vol. 345, 14 June 1990, pp. 575-576.
75. K. H. Schatten and W. D. Pesnell, "An Early Solar Dynamo Prediction: Cycle 23 - Cycle 22," *Geophysical Research Letters*, vol. 20, no. 20, 22 October 1993, pp. 2275-2278.
76. J. A. Joselyn, "Geomagnetic Activity Forecasting: The State of the Art," Pre-published Version, *Reviews of Geophysics*, vol. 33, 1995, pp. 383-401.
77. L. R. Teters et al., "Estimating the Performance of Telecommunication Systems Using the Ionospheric Transmission Channel Ionospheric Communications Analysis and Prediction Program, User's Manual," NTIA Report 83-127, Institute for Telecommunications Sciences, Boulder, CO, July 1983.
78. L. R. Teters, "Ionospheric Communications Analysis and Prediction Program: IONCAP Version 78.03 (Program Listing)," Institute for Telecommunication Sciences, Boulder, CO, 1 October 1983.
79. D. L. Lucas and G. W. Haydon, "Predicting Statistical Performance Indexes for High Frequency Ionospheric Telecommunications Systems," ESSA Technical Report IER 1-ITSA 1, Institute for Telecommunication Sciences and Aeronomy, Boulder, CO, August 1966.
80. G. W. Haydon, M. Leftin, and R. Rosich, "Predicting the Performance of High Frequency Sky-Wave Telecommunication Systems (The Use of the HFMUFES 4 Program)," OT Report 76-102, Department of Commerce, Office of Telecommunications, Boulder, CO, September 1976.
81. E. V. Thrane, V. Jodalen, F. Stewart, D. J. Saleem, and J. R. Katan, "Study of Measured and Predicted Reliability of the Ionospheric Communication Channel at High Latitudes," *Radio Science*, September-October 1994, pp. 1293-1309.
82. M. Daehler, "NRL/VOA Modifications to IONCAP as of 12 July 1989," NRL Memorandum Report 6514, Naval Research Laboratory, Washington, DC, 2 August 1989.
83. G. Lane, F. J. Rhodes, and L. DeBlasio, "Voice of America Coverage Analysis Program (VOACAP): A Guide to VOACAP," B/ESA Technical Report 01-93, United States Information Agency, Bureau of Broadcasting, Washington, DC, April 1993.
84. "Advanced Stand Alone Prediction System V2.20," Ionospheric Prediction Service, Radio and Space Services, West Chatswood, New South Wales, Australia, 1992.
85. L. F. McNamara, "Advanced Stand-Alone Prediction System for HF Radio Communications—A Users Guide to ASAPS," Andrew SciConn, Inc., Garland, TX, December 1992.

86. J. R. Katan and R. I. Desourdis, "HF and Meteor Burst Communications in a Polar Environment," NUWC-NPT Technical Document 10,375, Naval Undersea Warfare Center Newport Division, Newport, RI, 30 September 1993.
87. F. G. Stewart, "Technical Description of ICEPAC Propagation Prediction Program," National Telecommunications and Information Administration, Institute for Telecommunication Sciences, Boulder, CO. (Word Perfect file available from ftp://elbert.its.blrdoc.gov/hf_prop/DOS/tecman.exe.)
88. "Preliminary Report and Forecast of Solar Geophysical Data," SESC PRF 1008, U.S. Air Force, Space Environment Services Center (SESC), Boulder, CO, 27 December 1994.
89. "Preliminary Report and Forecast of Solar Geophysical Data," SESC PRF 1032, U.S. Air Force, Space Environment Services Center (SESC), Boulder, CO, 13 June 1995.
90. "Geomagnetic Indices," National Geophysical Data Center, Boulder, CO, Internet Web Site, <http://web.ngdc.noaa.gov/stp/GEOMAG/>, 18 September 1995.
91. Characteristics and Applications of Atmospheric Radio Noise Data, CCIR Report 322-2, Centre for Communication Interface Research, International Telecommunication Union, Geneva, Switzerland, 1983.
92. Private Communications with J. R. Tilbrook, Defence Science and Technology Organisation, Salisbury, South Australia, Australia, 1994.
93. "Glossary of Telecommunications Terms," Federal Standard 1037C (FED-STD 1037C), General Services Administration, Office of Information Resources Management, Washington, DC, 1990.
94. J. R. Tilbrook, "HF ALE Evaluation Tests—Antarctic Network," Paper CSS 94/2, Defence Science and Technology Organisation, Salisbury, South Australia, Australia, 5108, 1994.
95. D. Kettler and D. F. Fyfe, "Preliminary Results from the DSTO Low-Latitude Ionospheric Sounding Program," DSTO Paper, Defence Science and Technology Organisation, Salisbury, South Australia, Australia, 1993.
96. Private Communications with D. Kettler, Defence Science and Technology Organisation, Salisbury, South Australia, Australia, 1995.
97. D. Lingard, "A Comparison of ASAPS and ALE," Technical Report IPS-TR-95-02, Ionospheric Prediction Service, IPS Radio and Space Services, West Chatswood, New South Wales, Australia, 4 December 1995.
98. "Solar-Geophysical Summary: May 1993," Ionospheric Prediction Service, IPS Radio and Space Services, West Chatswood, New South Wales, Australia, May 1993.

99. Solar-Geophysical Summary: June 1993, Ionospheric Prediction Service, IPS Radio and Space Services, West Chatswood, New South Wales, Australia, June 1993.
100. "GOES-6 Data Set for 1993," NGDC SPRIDR Web Site, National Geophysical Data Center, Boulder, CO, 1998. (Available from: <http://www.ngdc.noaa.gov.8080/>).
101. "NASU Radio Log Sheets for 24 March 1992 through 25 March 1992," Naval Antarctic Support Unit, Christchurch, New Zealand, 1992.
102. "NASU Radio Log Sheets for 30 October 1992 through 5 November 1992," Naval Antarctic Support Unit, Christchurch, New Zealand, 1992.
103. "Solar-Geophysical Summary: March 1992," Ionospheric Prediction Service, IPS Radio and Space Services, West Chatswood, New South Wales, Australia, March 1992.
104. "Solar-Geophysical Summary: October 1992," Ionospheric Prediction Service, IPS Radio and Space Services, West Chatswood, New South Wales, Australia, October 1992.
105. "Solar-Geophysical Summary: November 1992," Ionospheric Prediction Service, IPS Radio and Space Services, West Chatswood, New South Wales, Australia, November 1992.
106. Private Communications with J. R. Tilbrook, Defence Science and Technology Organisation, Salisbury, South Australia, Australia, 1995.
107. J. R. Tilbrook and S.C. Cook, "An On-Air Evaluation of ALE for High-Speed Data Traffic," *MILCOM 94*, vol. 3, 1994, p. 864.
108. J. R. Katan and R. Desourdis, "The Use of Two-Station Ionosonde Data for IONCAP/ASAPS Model Validation on Trans-Polar Two-Hop HF Skywave Links," NUWC-NPT Technical Report 10,689, Naval Undersea Warfare Center Division, Newport, RI, 8 August 1994.
109. K. J. W. Lynn, "The Application of Ionosondes to HF Real-Time Frequency Management in Northern Australia," Spatial Processing Group Working Paper 93/18, Defence Science and Technology Organisation, Salisbury, South Australia, Australia, December 1993.
110. "Navy Disestablishes Antarctic Support Unit," News Brief, *The Dolphin*, Groton, CT, 12 March 1998.

APPENDIX A ANTENNA PATTERN PLOTS

A.1 ANTENNA MODELS

Antenna patterns of the sloping-vee antenna were plotted using the high-frequency antenna design (HFANT) software program. Two antenna models were generated: one for temperate regions, which was used for the Christchurch, New Zealand, and Salisbury, Australia, locations and one for Antarctica, which was used for the McMurdo/Black Island and Davis locations. The only differences between the two models are the ground constant parameters. All antenna parameters are listed for each plot.

A.2 FREQUENCIES

Six somewhat equally spaced frequencies across the high frequency/automatic link establishment (HF/ALE) test band were chosen for evaluating the antenna models (5, 10, 12, 15, 20, and 25 MHz). Exact test frequencies are not selected because of the nature of the antenna, which does not exhibit sharp performance variations with frequency.

A.3 ANTENNA PATTERNS

Both azimuthal (figures A.1 through A.6) and vertical (figures A.7 through A.12) patterns are presented for the antenna models. The vertical pattern is defined as the antenna gain variation versus elevation height. The vertical, or elevation, height varies from 0 degrees at the horizon to 90 degrees directly over head. The antenna is pointed at 0 degrees in the azimuth direction for the vertical patterns, which is the pointing direction or boresight of the antenna. The azimuthal pattern is defined as the gain variation as horizontal pointing position is varied in a 360-degree azimuth circle. Vertical height chosen for the azimuthal patterns is the maximum gain position as shown on the corresponding vertical pattern plot.

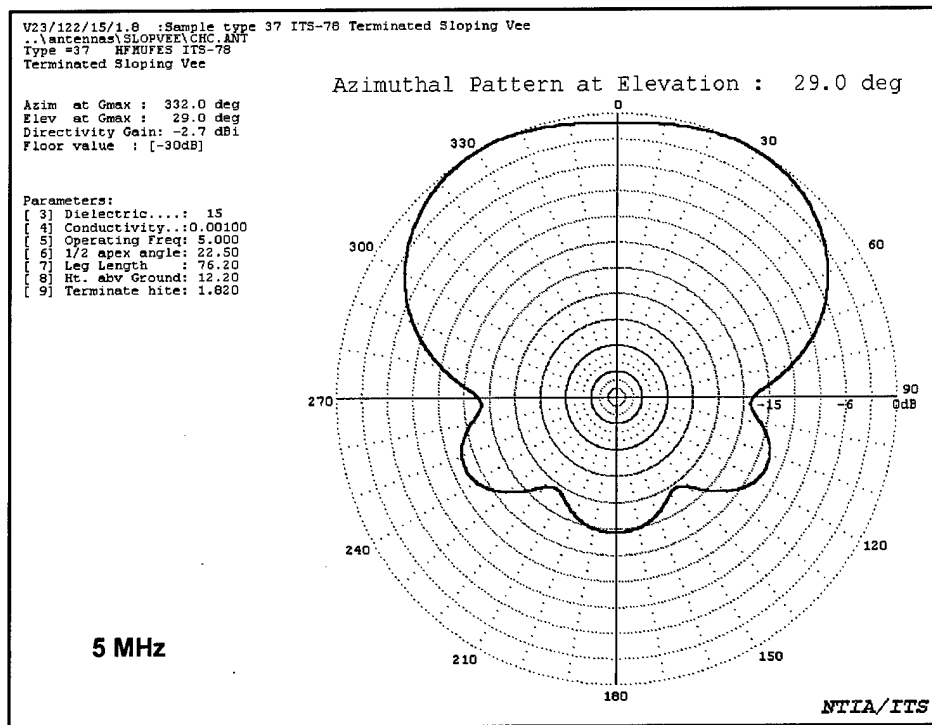

Figure A.1. Predicted Azimuth Antenna Pattern at Christchurch, 5 MHz, 29° Azimuth

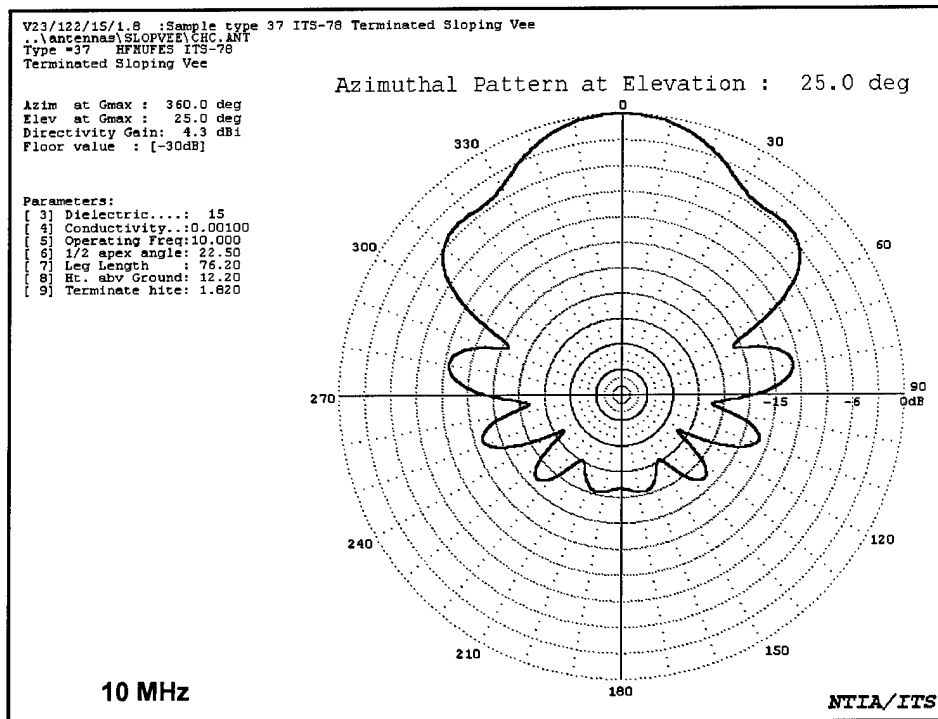

Figure A.2. Predicted Azimuth Antenna Pattern at Christchurch, 10 MHz, 25° Azimuth

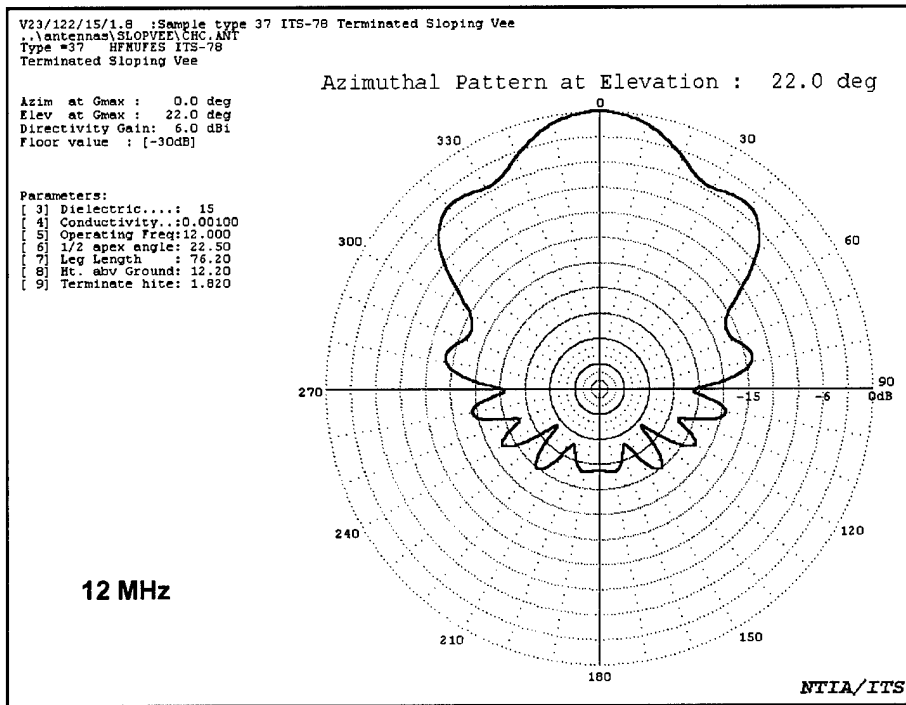

Figure A.3. Predicted Azimuth Antenna Pattern at Christchurch, 12 MHz, 22° Azimuth

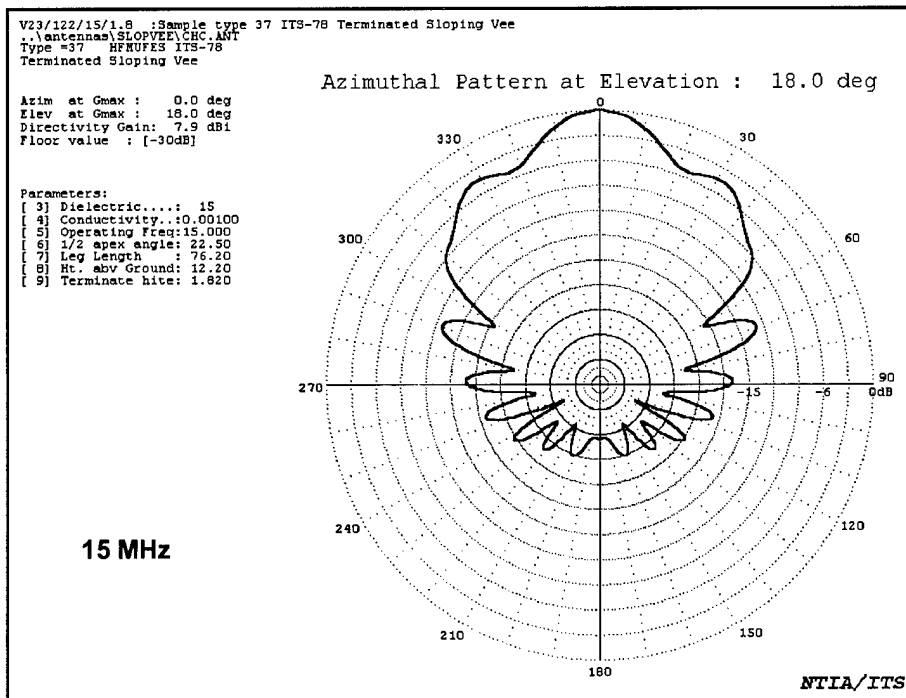

Figure A.4. Predicted Azimuth Antenna Pattern at Christchurch, 15 MHz, 18° Azimuth

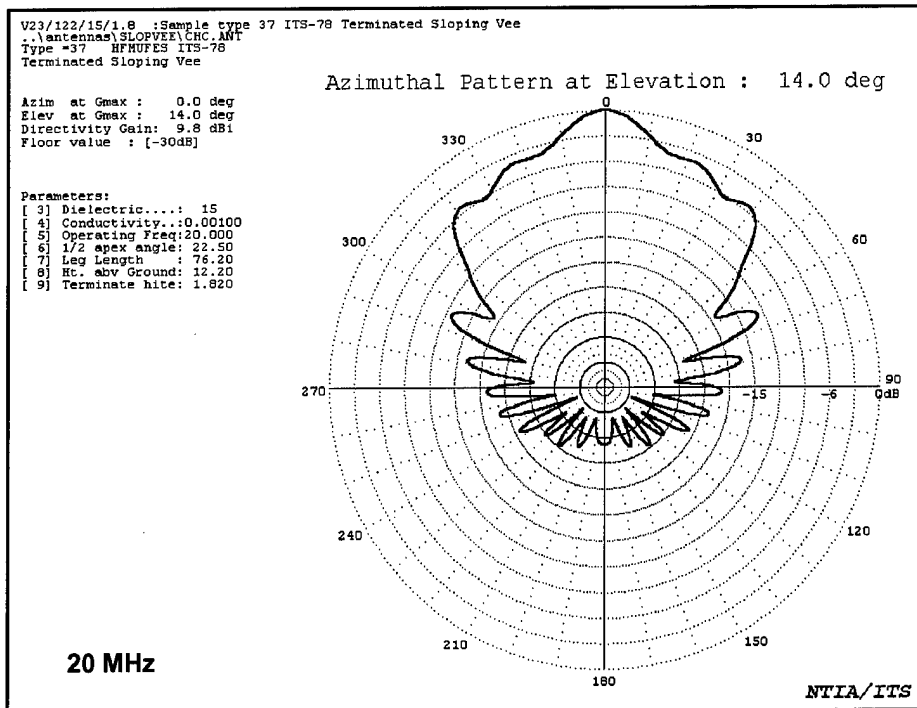

Figure A.5. Predicted Azimuth Antenna Pattern at Christchurch, 20 MHz, 14° Azimuth

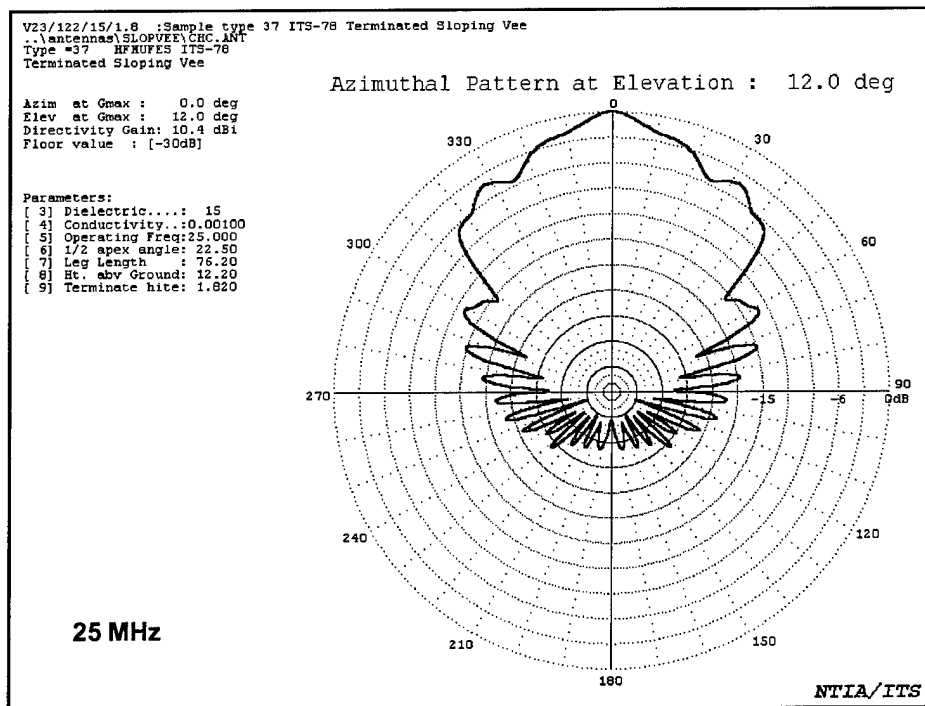

Figure A.6. Predicted Azimuth Antenna Pattern at Christchurch, 25 MHz, 12° Azimuth

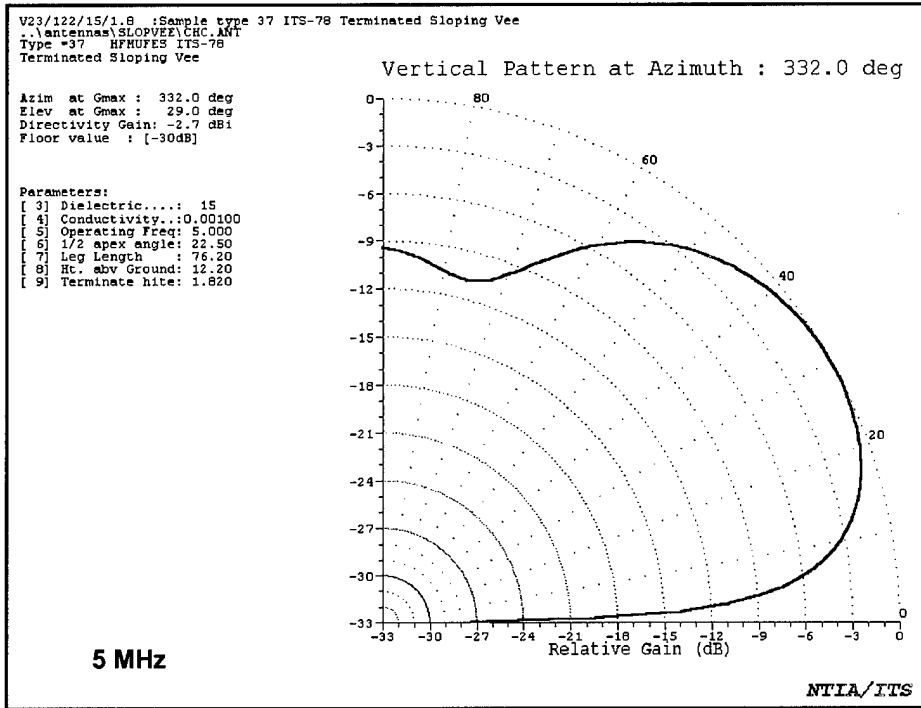

Figure A.7. Predicted Azimuth Vertical Pattern at Christchurch, 5 MHz, 332° Vertical

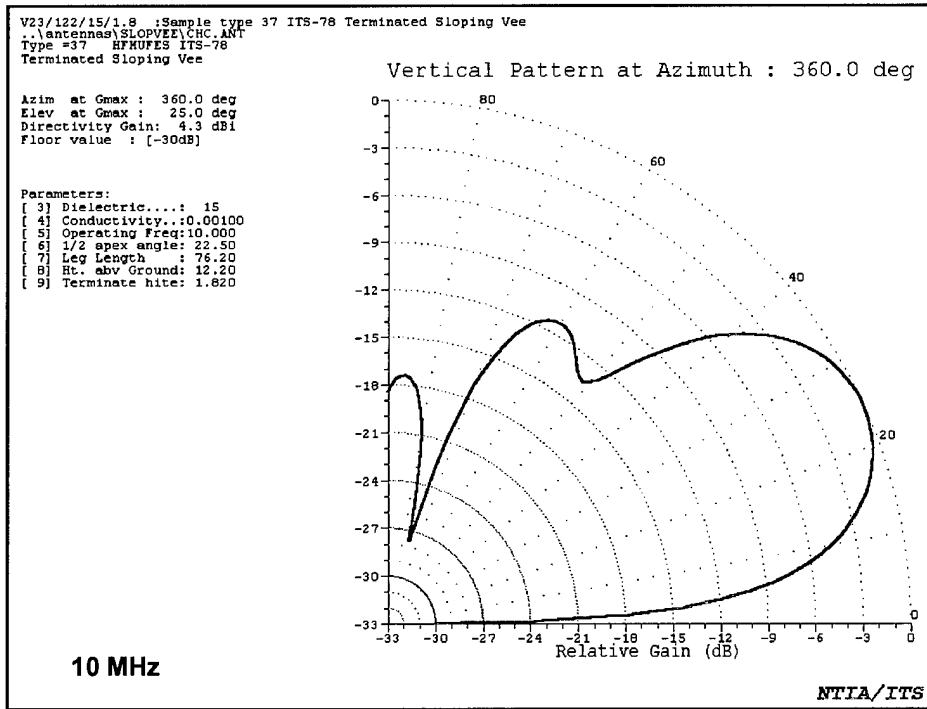

Figure A.8. Predicted Azimuth Vertical Pattern at Christchurch, 10 MHz, 360° Vertical

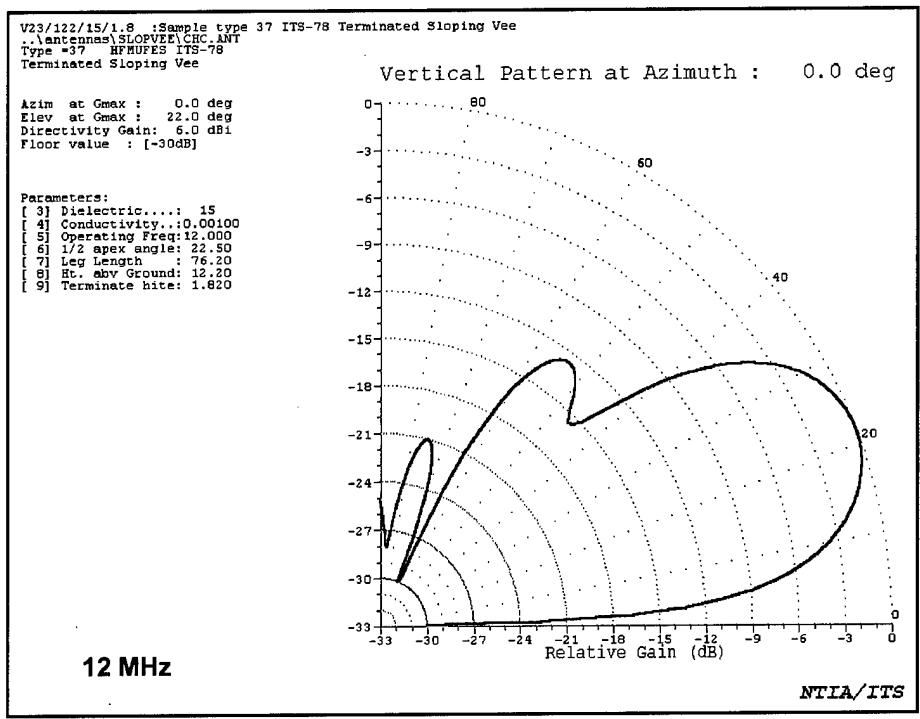

Figure A.9. Predicted Azimuth Vertical Pattern at Christchurch, 12 MHz, 0° Vertical

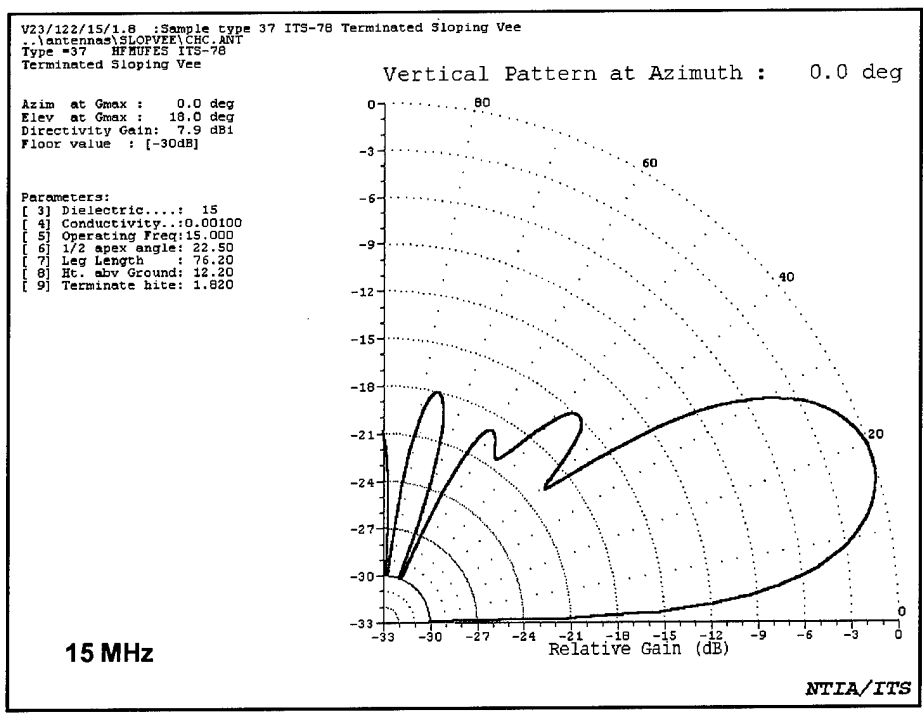

Figure A.10. Predicted Azimuth Vertical Pattern at Christchurch, 15 MHz, 0° Vertical

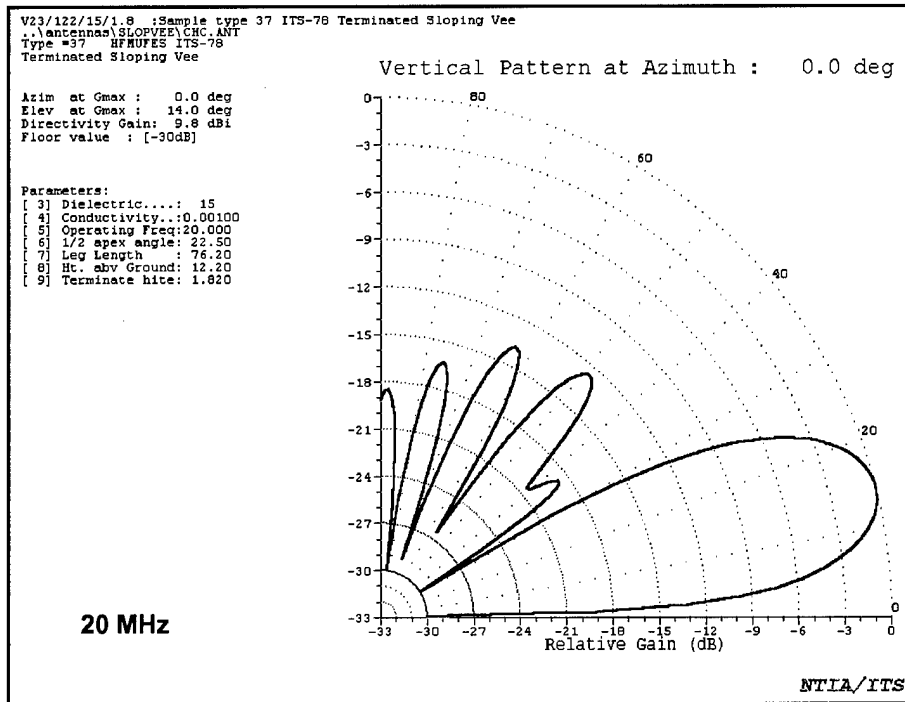

Figure A.11. Predicted Azimuth Vertical Pattern at Christchurch, 20 MHz, 0° Vertical

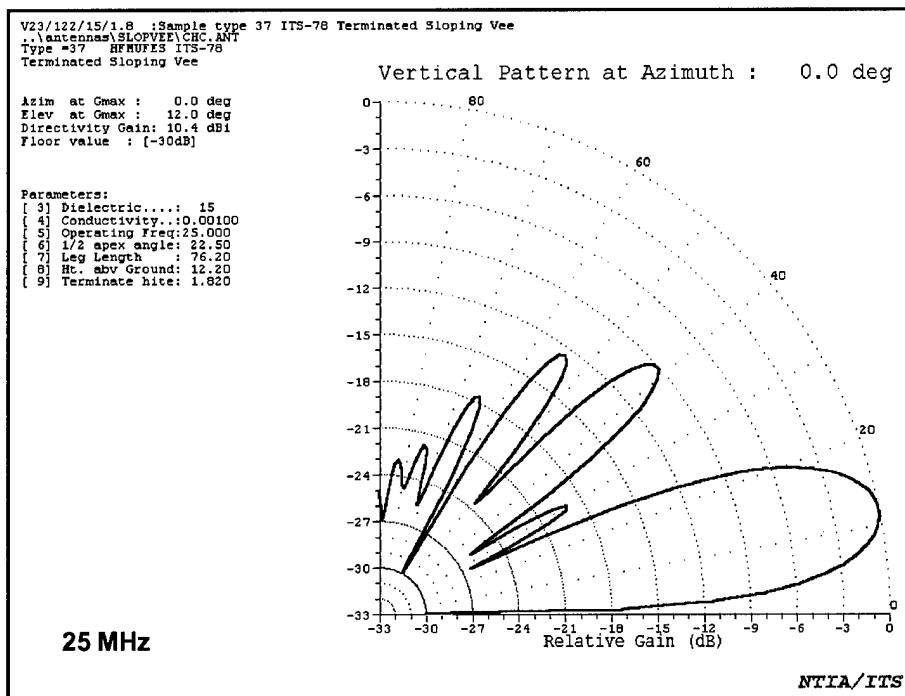

Figure A.12. Predicted Azimuth Vertical Pattern at Christchurch, 25 MHz, 0° Vertical

APPENDIX B
LIST OF PUBLISHED 1993 AND 1994 K_p DATA

The K_p index is an arithmetic mean of thirteen K-index measurements, which classify the magnetic field into disturbance levels for 3-hour periods ranging from 0 (quiet) to 9 (greatly disturbed). The following pages contain the complete list of published K_p data for 1993 and 1994. Table B.1 is a list of abbreviations for the K_p and calculated Q_e terms.

Table B.1. Definition of the K_p and Q_e Abbreviations

Abbreviation	Definition
Q _e Avg/Mo	The Q _e index value calculated from the monthly average K _p index value.
K _p 0-3	The K _p index value* for 0000-0300 UT hours.
K _p 3-6	The K _p index value* for 0300-0600 UT hours.
K _p 6-9	The K _p index value* for 0600-0900 UT hours.
K _p 9-12	The K _p index value* for 0900-1200 UT hours.
K _p 12-15	The K _p index value* for 1200-1500 UT hours.
K _p 15-18	The K _p index value* for 1500-1800 UT hours.
K _p 18-21	The K _p index value* for 1800-2100 UT hours.
K _p 21-24	The K _p index value* for 2100-2400 UT hours.
K _p Sum	The sum of the eight 3-hour K _p index values for a particular day.
K _p Avg/Day	The average K _p index value for a particular day.
Q _e Avg/Day	The average Q _e index value for a particular day.

*Divide listed value by 10 to obtain actual value

1993 K_p Data

		Month	Qc Avg/Mo											
		January	4.84											
		February	4.59											
		March	5.36											
		April	4.76											
		May	3.96											
		June	4.07											
		July	3.91											
		August	3.85											
		September	4.3											
		October	4.32											
		November	4.35											
		December	4.33											
Year	Month	Day	Kp 0-3	Kp 3-6	Kp 6-9	Kp 9-12	Kp 12-15	Kp 15-18	Kp 18-21	Kp 21-24	Kp Sum	Kp Avg/Day	Qc Avg/Day	
93	1	1	20	33	30	20	20	20	20	30	193	2.41	4.41	
93	1	2	33	33	33	47	40	40	40	37	303	3.79	5.79	
93	1	3	53	50	40	43	33	43	40	37	340	4.25	6.25	
93	1	4	53	33	37	43	47	37	40	43	333	4.16	6.16	
93	1	5	33	37	30	37	33	23	30	30	253	3.16	5.16	
93	1	6	33	37	30	27	30	30	33	30	250	3.13	5.13	
93	1	7	27	37	23	40	27	40	47	47	287	3.59	5.59	
93	1	8	33	27	20	20	23	37	37	37	233	2.91	4.91	
93	1	9	40	27	33	23	33	33	27	27	243	3.04	5.04	
93	1	10	33	40	60	40	40	30	10	10	263	3.29	5.29	
93	1	11	20	23	13	33	53	40	37	40	260	3.25	5.25	
93	1	12	40	33	27	20	20	30	23	13	207	2.59	4.59	
93	1	13	20	13	13	20	27	33	20	47	193	2.41	4.41	
93	1	14	37	47	27	33	37	33	33	40	287	3.59	5.59	
93	1	15	33	30	20	27	23	30	27	37	227	2.84	4.84	
93	1	16	27	37	20	10	20	27	23	30	193	2.41	4.41	
93	1	17	37	30	40	30	23	17	17	13	207	2.59	4.59	
93	1	18	20	27	13	20	20	27	27	40	193	2.41	4.41	
93	1	19	40	33	27	37	23	27	47	47	280	3.5	5.5	
93	1	20	37	17	33	30	37	33	10	7	203	2.54	4.54	
93	1	21	23	33	13	17	17	13	7	7	130	1.63	3.63	
93	1	22	7	17	13	10	10	13	27	30	127	1.59	3.59	
93	1	23	23	7	3	0	10	3	10	17	73	0.91	2.74	
93	1	24	10	23	23	33	20	23	33	13	180	2.25	4.25	
93	1	25	7	7	17	30	53	40	53	43	250	3.13	5.13	
93	1	26	50	37	37	33	33	33	33	23	280	3.5	5.5	
93	1	27	20	30	30	27	23	30	23	20	203	2.54	4.54	
93	1	28	13	33	20	20	17	10	10	7	130	1.63	3.63	
93	1	29	7	10	13	13	10	10	13	23	100	1.25	3.25	
93	1	30	33	37	23	20	23	20	23	33	213	2.66	4.66	
93	1	31	43	53	60	57	50	47	57	60	427	5.34	7.34	
93	2	1	50	40	47	40	33	50	33	37	330	4.13	6.13	
93	2	2	43	47	30	27	27	37	40	20	270	3.38	5.38	
93	2	3	13	27	17	13	10	13	33	37	163	2.04	4.04	
93	2	4	30	20	10	10	13	23	20	20	147	1.84	3.84	
93	2	5	13	10	23	13	7	17	17	23	123	1.54	3.54	
93	2	6	7	23	13	10	10	7	23	13	107	1.34	3.34	
93	2	7	13	40	43	40	23	37	53	47	297	3.71	5.71	
93	2	8	53	53	43	40	33	53	47	47	370	4.63	6.63	

1993 K_p Data

Year	Month	Day	Kp 0-3	Kp 3-6	Kp 6-9	Kp 9-12	Kp 12-15	Kp 15-18	Kp 18-21	Kp 21-24	Kp Sum	Kp Avg/Day	Qe Avg/Day
93	2	9	37	47	33	47	40	43	40	33	320	4	6
93	2	10	23	20	30	23	33	33	50	23	237	2.96	4.96
93	2	11	40	33	30	27	30	33	33	47	273	3.41	5.41
93	2	12	37	30	23	27	20	17	13	30	197	2.46	4.46
93	2	13	40	27	17	20	27	20	20	30	200	2.5	4.5
93	2	14	20	30	10	17	13	7	20	10	127	1.59	3.59
93	2	15	7	13	7	17	20	10	10	7	90	1.13	3.13
93	2	16	7	17	23	23	20	10	7	7	113	1.41	3.41
93	2	17	20	40	37	47	67	57	23	13	303	3.79	5.79
93	2	18	10	10	17	30	37	30	33	37	203	2.54	4.54
93	2	19	30	10	27	17	13	10	20	10	137	1.71	3.71
93	2	20	30	40	47	43	37	27	30	50	303	3.79	5.79
93	2	21	23	30	37	40	40	50	47	40	307	3.84	5.84
93	2	22	33	37	60	43	40	37	33	37	320	4	6
93	2	23	27	30	13	20	20	27	17	10	163	2.04	4.04
93	2	24	20	27	17	20	20	10	3	13	130	1.63	3.63
93	2	25	10	27	20	13	20	20	10	7	127	1.59	3.59
93	2	26	7	13	17	10	17	20	10	13	107	1.34	3.34
93	2	27	7	7	7	7	10	3	7	30	77	0.96	2.89
93	2	28	37	37	37	37	43	33	20	13	257	3.21	5.21
93	3	1	20	20	30	37	47	37	30	33	253	3.16	5.16
93	3	2	17	33	47	33	30	40	43	47	290	3.63	5.63
93	3	3	43	43	40	37	40	47	57	43	350	4.38	6.38
93	3	4	57	50	37	27	13	30	27	13	253	3.16	5.16
93	3	5	33	20	23	17	10	7	7	20	137	1.71	3.71
93	3	6	13	7	20	27	20	20	30	20	157	1.96	3.96
93	3	7	37	50	43	17	17	20	43	40	267	3.34	5.34
93	3	8	33	33	33	20	33	47	37	63	300	3.75	5.75
93	3	9	67	67	63	57	47	43	33	47	423	5.29	7.29
93	3	10	50	33	20	13	33	20	10	27	207	2.59	4.59
93	3	11	27	13	30	47	57	67	60	57	357	4.46	6.46
93	3	12	57	33	30	30	27	40	50	37	303	3.79	5.79
93	3	13	47	50	37	27	33	50	50	30	323	4.04	6.04
93	3	14	27	27	33	40	40	40	40	43	290	3.63	5.63
93	3	15	43	37	57	53	53	47	43	53	387	4.84	6.84
93	3	16	43	50	53	47	27	57	50	23	350	4.38	6.38
93	3	17	40	33	23	47	33	27	37	47	287	3.59	5.59
93	3	18	50	37	37	33	30	17	20	23	247	3.09	5.09
93	3	19	17	13	20	27	23	40	30	17	187	2.34	4.34
93	3	20	23	40	37	47	40	37	27	23	273	3.41	5.41
93	3	21	30	43	37	50	53	40	33	33	320	4	6
93	3	22	37	33	40	43	33	43	40	40	310	3.88	5.88
93	3	23	27	17	20	20	30	17	20	43	193	2.41	4.41
93	3	24	40	60	73	60	47	43	33	43	400	5	7
93	3	25	33	30	33	33	27	37	30	17	240	3	5
93	3	26	10	23	13	20	17	13	30	23	150	1.88	3.88
93	3	27	30	20	23	13	30	33	20	37	207	2.59	4.59
93	3	28	37	27	20	23	20	30	40	47	243	3.04	5.04
93	3	29	43	50	43	17	7	10	7	30	207	2.59	4.59
93	3	30	33	23	33	30	40	47	30	23	260	3.25	5.25
93	3	31	40	20	17	7	20	23	20	27	173	2.16	4.16
93	4	1	20	27	20	10	13	23	27	27	167	2.09	4.09
93	4	2	10	13	17	13	7	7	10	13	90	1.13	3.13
93	4	3	17	10	3	3	7	7	13	17	77	0.96	2.89

1993 K_p Data

Year	Month	Day	Kp 0-3	Kp 3-6	Kp 6-9	Kp 9-12	Kp 12-15	Kp 15-18	Kp 18-21	Kp 21-24	Kp Sum	Kp Avg/Day	Qc Avg/Day
93	4	4	17	17	10	13	50	60	70	77	313	3.91	5.91
93	4	5	63	73	70	57	63	57	57	33	473	5.91	7.91
93	4	6	20	23	20	27	30	30	23	47	220	2.75	4.75
93	4	7	20	30	23	20	17	30	23	40	203	2.54	4.54
93	4	8	23	30	40	40	43	43	50	30	300	3.75	5.75
93	4	9	37	30	30	17	20	53	43	57	287	3.59	5.59
93	4	10	43	37	40	23	30	30	30	27	260	3.25	5.25
93	4	11	17	27	17	20	27	13	17	27	163	2.04	4.04
93	4	12	43	53	27	17	13	7	17	17	193	2.41	4.41
93	4	13	20	50	47	57	43	40	40	20	317	3.96	5.96
93	4	14	37	43	33	33	13	37	37	37	270	3.38	5.38
93	4	15	43	47	43	33	17	17	47	53	300	3.75	5.75
93	4	16	33	47	37	20	20	30	27	23	237	2.96	4.96
93	4	17	17	20	20	27	17	33	37	17	187	2.34	4.34
93	4	18	37	43	33	43	37	33	27	13	267	3.34	5.34
93	4	19	27	17	13	27	23	30	20	20	177	2.21	4.21
93	4	20	33	50	37	33	40	37	30	27	287	3.59	5.59
93	4	21	43	40	47	37	33	57	43	40	340	4.25	6.25
93	4	22	37	27	30	17	23	40	50	43	267	3.34	5.34
93	4	23	23	23	13	23	10	27	40	33	193	2.41	4.41
93	4	24	30	17	20	23	27	27	20	13	177	2.21	4.21
93	4	25	23	27	33	23	17	13	23	27	187	2.34	4.34
93	4	26	10	10	20	10	17	13	13	7	100	1.25	3.25
93	4	27	7	7	10	7	13	13	7	17	80	1	3
93	4	28	13	10	10	10	17	17	17	7	100	1.25	3.25
93	4	29	7	10	10	17	30	30	37	40	180	2.25	4.25
93	4	30	43	30	27	17	23	23	30	20	213	2.66	4.66
93	5	1	30	33	13	23	17	3	3	3	127	1.59	3.59
93	5	2	3	10	13	13	13	13	27	20	113	1.41	3.41
93	5	3	23	13	20	23	30	20	7	13	150	1.88	3.88
93	5	4	7	13	17	3	13	23	7	10	93	1.16	3.16
93	5	5	10	17	20	13	30	7	3	10	110	1.38	3.38
93	5	6	23	20	20	20	23	27	30	20	183	2.29	4.29
93	5	7	10	27	20	20	33	33	40	50	233	2.91	4.91
93	5	8	57	37	50	47	47	37	47	50	370	4.63	6.63
93	5	9	53	60	50	40	43	40	53	53	393	4.91	6.91
93	5	10	53	63	57	57	50	30	27	40	377	4.71	6.71
93	5	11	13	17	13	7	10	7	10	17	93	1.16	3.16
93	5	12	20	30	27	30	27	30	40	40	243	3.04	5.04
93	5	13	40	23	3	3	7	17	37	27	157	1.96	3.96
93	5	14	20	27	20	37	47	23	20	20	213	2.66	4.66
93	5	15	23	17	23	23	30	30	43	27	217	2.71	4.71
93	5	16	27	43	20	17	23	17	17	30	193	2.41	4.41
93	5	17	30	40	20	17	23	23	50	40	243	3.04	5.04
93	5	18	7	10	10	13	20	17	20	37	133	1.66	3.66
93	5	19	17	23	27	20	30	27	33	17	193	2.41	4.41
93	5	20	13	23	33	17	20	17	13	3	140	1.75	3.75
93	5	21	10	3	3	7	3	7	10	7	50	0.63	1.88
93	5	22	7	13	7	13	10	13	13	3	80	1	3
93	5	23	3	3	3	3	13	3	7	0	37	0.46	1.39
93	5	24	7	7	13	10	3	3	3	3	50	0.63	1.88
93	5	25	7	7	0	0	3	3	3	3	27	0.34	1.01
93	5	26	3	7	7	7	7	10	10	23	73	0.91	2.74
93	5	27	23	40	40	33	33	20	33	33	257	3.21	5.21

1993 K_p Data

Year	Month	Day	K _p 0-3	K _p 3-6	K _p 6-9	K _p 9-12	K _p 12-15	K _p 15-18	K _p 18-21	K _p 21-24	K _p Sum	K _p Avg/Day	Q _e Avg/Day
93	5	28	33	43	27	37	30	43	43	37	293	3.66	5.66
93	5	29	37	20	20	33	10	17	17	20	173	2.16	4.16
93	5	30	7	20	10	7	13	10	10	3	80	1	3
93	5	31	10	7	7	13	23	13	17	7	97	1.21	3.21
93	6	1	20	10	7	7	17	7	7	3	77	0.96	2.89
93	6	2	10	10	13	20	27	10	17	10	117	1.46	3.46
93	6	3	23	20	30	33	33	37	27	27	230	2.88	4.88
93	6	4	40	53	57	60	47	40	57	57	410	5.13	7.13
93	6	5	57	53	43	40	37	37	50	33	350	4.38	6.38
93	6	6	33	33	40	27	27	30	40	33	263	3.29	5.29
93	6	7	33	20	33	43	43	33	33	40	280	3.5	5.5
93	6	8	37	30	27	20	30	23	37	17	220	2.75	4.75
93	6	9	23	13	10	13	13	13	13	23	123	1.54	3.54
93	6	10	0	13	17	17	10	27	53	70	207	2.59	4.59
93	6	11	40	20	17	17	17	20	23	17	170	2.13	4.13
93	6	12	17	23	27	40	23	23	20	33	207	2.59	4.59
93	6	13	23	27	37	33	27	17	23	27	213	2.66	4.66
93	6	14	10	23	17	33	17	20	17	20	157	1.96	3.96
93	6	15	20	23	20	13	13	7	7	7	110	1.38	3.38
93	6	16	7	10	13	10	7	3	3	3	57	0.71	2.14
93	6	17	7	7	10	10	13	10	20	17	93	1.16	3.16
93	6	18	7	3	0	3	7	20	7	7	53	0.66	1.99
93	6	19	3	17	17	10	17	13	17	17	110	1.38	3.38
93	6	20	7	13	23	17	17	7	13	3	100	1.25	3.25
93	6	21	3	0	0	3	3	7	3	3	23	0.29	0.86
93	6	22	10	10	10	10	7	10	20	27	103	1.29	3.29
93	6	23	27	17	13	27	33	30	53	30	230	2.88	4.88
93	6	24	33	43	47	33	43	43	30	33	307	3.84	5.84
93	6	25	30	23	43	40	30	33	27	27	253	3.16	5.16
93	6	26	27	23	17	10	17	20	13	23	150	1.88	3.88
93	6	27	20	13	13	23	13	20	13	7	123	1.54	3.54
93	6	28	10	13	13	17	10	7	7	7	83	1.04	3.04
93	6	29	20	23	17	33	33	27	10	20	183	2.29	4.29
93	6	30	27	23	23	10	13	33	27	30	187	2.34	4.34
93	7	1	30	40	30	40	43	23	37	43	287	3.59	5.59
93	7	2	37	27	23	40	40	33	47	60	307	3.84	5.84
93	7	3	53	43	40	17	27	23	27	30	260	3.25	5.25
93	7	4	30	27	17	23	13	20	10	17	157	1.96	3.96
93	7	5	20	27	7	3	7	10	10	7	90	1.13	3.13
93	7	6	3	7	7	27	10	7	13	17	90	1.13	3.13
93	7	7	30	27	20	10	13	13	23	13	150	1.88	3.88
93	7	8	23	30	33	30	33	37	27	20	233	2.91	4.91
93	7	9	27	33	23	20	40	43	20	20	227	2.84	4.84
93	7	10	23	23	20	27	30	20	33	30	207	2.59	4.59
93	7	11	37	50	43	33	20	33	20	13	250	3.13	5.13
93	7	12	23	17	23	20	20	27	13	20	163	2.04	4.04
93	7	13	23	27	30	23	27	20	17	17	183	2.29	4.29
93	7	14	7	7	7	3	7	7	7	7	50	0.63	1.88
93	7	15	10	17	13	7	17	10	17	20	110	1.38	3.38
93	7	16	7	7	3	3	7	17	10	13	67	0.84	2.51
93	7	17	10	7	7	7	10	7	3	7	57	0.71	2.14
93	7	18	10	7	13	17	20	10	10	13	100	1.25	3.25
93	7	19	13	17	10	17	13	10	13	20	113	1.41	3.41
93	7	20	13	17	27	43	20	30	43	37	230	2.88	4.88

1993 K_p Data

Year	Month	Day	K _p 0-3	K _p 3-6	K _p 6-9	K _p 9-12	K _p 12-15	K _p 15-18	K _p 18-21	K _p 21-24	K _p Sum	K _p Avg/Day	Q _e Avg/Day
93	7	21	27	37	27	27	33	23	27	27	227	2.84	4.84
93	7	22	27	23	27	27	23	17	20	27	190	2.38	4.38
93	7	23	23	23	17	13	17	10	3	10	117	1.46	3.46
93	7	24	10	3	7	13	10	20	13	7	83	1.04	3.04
93	7	25	27	20	10	10	7	7	7	7	93	1.16	3.16
93	7	26	10	13	3	10	7	17	3	7	70	0.88	2.63
93	7	27	17	7	7	20	30	30	33	23	167	2.09	4.09
93	7	28	23	20	17	13	10	13	13	20	130	1.63	3.63
93	7	29	17	10	20	20	40	43	50	27	227	2.84	4.84
93	7	30	30	23	13	10	13	10	13	10	123	1.54	3.54
93	7	31	23	23	10	17	17	7	13	13	123	1.54	3.54
93	8	1	13	3	3	3	3	10	10	7	53	0.66	1.99
93	8	2	7	10	10	3	3	3	13	10	60	0.75	2.25
93	8	3	13	7	10	13	17	20	23	20	123	1.54	3.54
93	8	4	17	17	23	23	43	50	43	53	270	3.38	5.38
93	8	5	50	47	33	27	17	20	27	13	233	2.91	4.91
93	8	6	7	20	40	33	33	37	27	17	213	2.66	4.66
93	8	7	27	40	27	30	27	20	27	37	233	2.91	4.91
93	8	8	20	20	30	27	13	17	7	10	143	1.79	3.79
93	8	9	27	23	20	33	23	23	30	17	197	2.46	4.46
93	8	10	13	7	13	30	17	17	17	20	133	1.66	3.66
93	8	11	17	17	10	10	10	3	7	7	80	1	3
93	8	12	10	23	23	17	20	13	3	17	127	1.59	3.59
93	8	13	13	17	10	10	13	13	7	10	93	1.16	3.16
93	8	14	3	0	0	3	3	7	7	3	27	0.34	1.01
93	8	15	7	3	7	10	17	43	33	50	170	2.13	4.13
93	8	16	53	50	60	63	53	57	70	63	470	5.88	7.88
93	8	17	67	53	30	17	23	17	23	13	243	3.04	5.04
93	8	18	30	37	37	33	33	33	30	27	260	3.25	5.25
93	8	19	33	27	23	20	20	20	33	30	207	2.59	4.59
93	8	20	27	17	23	20	10	13	17	7	133	1.66	3.66
93	8	21	13	17	17	13	10	7	10	7	93	1.16	3.16
93	8	22	10	13	13	23	10	10	17	23	120	1.5	3.5
93	8	23	20	10	7	3	3	7	7	3	60	0.75	2.25
93	8	24	0	7	13	20	17	7	10	17	90	1.13	3.13
93	8	25	17	3	3	10	7	7	7	13	67	0.84	2.51
93	8	26	20	7	13	13	17	13	20	20	123	1.54	3.54
93	8	27	20	10	17	27	47	60	43	40	263	3.29	5.29
93	8	28	23	20	13	30	30	27	23	30	197	2.46	4.46
93	8	29	30	30	27	20	27	7	10	30	180	2.25	4.25
93	8	30	13	13	13	7	3	7	7	17	80	1	3
93	8	31	20	17	10	7	13	10	13	13	103	1.29	3.29
93	9	1	3	3	3	3	3	10	10	7	43	0.54	1.61
93	9	2	7	7	7	17	23	13	23	17	113	1.41	3.41
93	9	3	23	30	33	37	53	43	57	57	333	4.16	6.16
93	9	4	43	43	47	33	30	43	20	37	297	3.71	5.71
93	9	5	43	30	23	17	30	20	20	27	210	2.63	4.63
93	9	6	30	27	23	27	27	17	30	27	207	2.59	4.59
93	9	7	13	30	23	10	20	17	10	27	150	1.88	3.88
93	9	8	37	23	13	17	10	10	13	23	147	1.84	3.84
93	9	9	13	3	10	13	13	13	17	13	97	1.21	3.21
93	9	10	7	17	13	10	13	17	3	10	90	1.13	3.13
93	9	11	23	10	7	17	17	13	17	23	127	1.59	3.59
93	9	12	13	3	20	13	23	33	33	57	197	2.46	4.46

1993 - K_p Data

Year	Month	Day	Kp 0-3	Kp 3-6	Kp 6-9	Kp 9-12	Kp 12-15	Kp 15-18	Kp 18-21	Kp 21-24	Kp Sum	Kp Avg/Day	Qc Avg/Day
93	9	13	57	77	73	63	57	60	53	43	483	6.04	8.04
93	9	14	50	30	50	40	37	43	33	33	317	3.96	5.96
93	9	15	40	37	37	27	30	20	27	23	240	3	5
93	9	16	17	13	10	13	20	20	23	7	123	1.54	3.54
93	9	17	7	17	20	10	10	10	7	13	93	1.16	3.16
93	9	18	7	17	13	17	7	7	7	7	80	1	3
93	9	19	20	13	10	17	13	7	0	7	87	1.09	3.09
93	9	20	7	13	17	37	37	43	40	50	243	3.04	5.04
93	9	21	53	23	10	7	17	27	27	20	183	2.29	4.29
93	9	22	17	27	20	17	10	10	7	17	123	1.54	3.54
93	9	23	3	0	3	10	30	20	30	50	147	1.84	3.84
93	9	24	40	17	27	27	30	33	40	40	253	3.16	5.16
93	9	25	20	20	17	30	30	27	27	27	197	2.46	4.46
93	9	26	23	33	23	30	20	13	13	23	180	2.25	4.25
93	9	27	33	27	20	17	17	20	27	17	177	2.21	4.21
93	9	28	3	10	7	17	20	30	30	27	143	1.79	3.79
93	9	29	20	13	27	40	40	50	50	37	277	3.46	5.46
93	9	30	40	43	27	20	13	13	20	50	227	2.84	4.84
93	10	1	50	43	43	47	30	33	30	20	297	3.71	5.71
93	10	2	10	10	17	23	17	23	27	10	137	1.71	3.71
93	10	3	0	3	10	7	10	17	27	20	93	1.16	3.16
93	10	4	3	10	10	13	13	20	33	10	113	1.41	3.41
93	10	5	13	7	3	7	7	20	23	23	103	1.29	3.29
93	10	6	40	40	33	10	10	7	17	27	183	2.29	4.29
93	10	7	17	17	3	0	13	7	3	3	63	0.79	2.36
93	10	8	13	23	47	33	40	20	23	30	230	2.88	4.88
93	10	9	30	57	53	67	40	33	43	53	377	4.71	6.71
93	10	10	40	50	43	40	47	27	43	43	333	4.16	6.16
93	10	11	40	33	33	43	43	53	30	37	313	3.91	5.91
93	10	12	40	37	33	27	40	33	20	27	257	3.21	5.21
93	10	13	30	40	30	17	17	17	23	20	193	2.41	4.41
93	10	14	33	23	20	17	23	17	7	10	150	1.88	3.88
93	10	15	13	7	10	13	7	7	3	3	63	0.79	2.36
93	10	16	13	13	13	10	10	17	13	20	110	1.38	3.38
93	10	17	33	30	10	7	10	17	20	23	150	1.88	3.88
93	10	18	20	33	13	10	17	17	10	10	130	1.63	3.63
93	10	19	27	30	17	20	10	10	23	27	163	2.04	4.04
93	10	20	17	7	10	3	7	13	20	13	90	1.13	3.13
93	10	21	17	23	20	20	17	7	3	7	113	1.41	3.41
93	10	22	40	40	27	20	20	27	30	33	237	2.96	4.96
93	10	23	20	33	40	17	23	20	30	23	207	2.59	4.59
93	10	24	43	23	17	17	10	27	23	17	177	2.21	4.21
93	10	25	20	17	27	60	63	60	30	37	313	3.91	5.91
93	10	26	23	10	23	17	20	47	37	47	223	2.79	4.79
93	10	27	40	47	47	43	50	47	50	43	367	4.59	6.59
93	10	28	30	33	37	37	37	20	27	50	270	3.38	5.38
93	10	29	40	23	17	13	27	27	13	30	190	2.38	4.38
93	10	30	20	7	7	7	7	7	0	10	63	0.79	2.36
93	10	31	10	3	20	17	17	30	23	23	143	1.79	3.79
93	11	1	30	23	17	23	30	30	30	20	203	2.54	4.54
93	11	2	23	20	10	7	7	7	7	3	83	1.04	3.04
93	11	3	3	0	7	7	13	23	33	60	147	1.84	3.84
93	11	4	67	63	53	60	60	57	60	50	470	5.88	7.88
93	11	5	40	33	53	47	43	43	43	43	347	4.34	6.34

1993 K_p Data

Year	Month	Day	Kp 0-3	Kp 3-6	Kp 6-9	Kp 9-12	Kp 12-15	Kp 15-18	Kp 18-21	Kp 21-24	Kp Sum	Kp Avg/Day	Qe Avg/Day
93	11	6	37	27	43	43	40	37	40	43	310	3.88	5.88
93	11	7	37	27	33	37	37	43	37	43	293	3.66	5.66
93	11	8	37	27	23	30	27	33	43	33	253	3.16	5.16
93	11	9	30	33	23	27	20	17	23	30	203	2.54	4.54
93	11	10	30	30	30	20	27	27	27	10	200	2.5	4.5
93	11	11	13	33	17	17	17	10	7	7	120	1.5	3.5
93	11	12	10	17	10	7	7	7	7	3	67	0.84	2.51
93	11	13	7	17	20	13	27	27	23	17	150	1.88	3.88
93	11	14	17	23	20	27	30	43	33	30	223	2.79	4.79
93	11	15	30	33	13	17	13	17	30	43	197	2.46	4.46
93	11	16	30	23	23	20	23	27	23	27	197	2.46	4.46
93	11	17	27	3	3	3	0	3	33	27	100	1.25	3.25
93	11	18	23	13	10	10	50	60	57	43	267	3.34	5.34
93	11	19	47	60	23	27	37	37	40	47	317	3.96	5.96
93	11	20	33	33	23	20	13	13	17	17	170	2.13	4.13
93	11	21	30	23	23	20	13	10	13	20	153	1.91	3.91
93	11	22	27	10	10	7	13	7	17	17	107	1.34	3.34
93	11	23	23	23	17	13	20	23	17	10	147	1.84	3.84
93	11	24	17	23	7	7	7	10	13	17	100	1.25	3.25
93	11	25	13	17	10	10	13	23	17	27	130	1.63	3.63
93	11	26	37	23	23	20	23	40	47	30	243	3.04	5.04
93	11	27	27	23	7	7	3	17	17	27	127	1.59	3.59
93	11	28	3	3	10	7	17	17	13	20	90	1.13	3.13
93	11	29	40	23	20	20	23	23	27	23	200	2.5	4.5
93	11	30	23	3	10	7	7	7	7	10	73	0.91	2.74
93	12	1	27	17	17	43	43	47	40	60	293	3.66	5.66
93	12	2	47	47	47	43	40	43	57	67	390	4.88	6.88
93	12	3	63	53	50	40	37	23	37	30	333	4.16	6.16
93	12	4	17	10	13	20	17	17	33	23	150	1.88	3.88
93	12	5	13	10	10	23	30	37	33	23	180	2.25	4.25
93	12	6	20	13	17	13	20	17	20	20	140	1.75	3.75
93	12	7	27	10	17	10	43	40	40	50	237	2.96	4.96
93	12	8	63	63	50	50	43	47	33	13	363	4.54	6.54
93	12	9	10	7	3	3	0	7	3	17	50	0.63	1.88
93	12	10	23	20	17	20	23	17	27	20	167	2.09	4.09
93	12	11	33	23	20	13	17	13	17	7	143	1.79	3.79
93	12	12	17	10	13	27	17	20	7	13	123	1.54	3.54
93	12	13	13	10	3	10	3	3	3	17	63	0.79	2.36
93	12	14	17	20	7	10	3	7	7	7	77	0.96	2.89
93	12	15	23	27	37	30	30	17	17	10	190	2.38	4.38
93	12	16	20	37	37	37	43	37	40	43	293	3.66	5.66
93	12	17	33	40	30	30	33	37	43	37	283	3.54	5.54
93	12	18	27	30	33	30	30	40	40	40	270	3.38	5.38
93	12	19	40	30	27	20	20	23	27	20	207	2.59	4.59
93	12	20	40	33	20	20	23	27	27	30	220	2.75	4.75
93	12	21	33	27	30	33	33	40	33	43	273	3.41	5.41
93	12	22	30	23	23	37	30	10	17	23	193	2.41	4.41
93	12	23	23	27	13	23	17	23	23	43	193	2.41	4.41
93	12	24	27	20	23	27	30	27	27	30	210	2.63	4.63
93	12	25	20	33	20	27	30	13	23	30	197	2.46	4.46
93	12	26	23	10	17	13	23	23	23	37	170	2.13	4.13
93	12	27	20	23	17	10	20	27	13	7	137	1.71	3.71
93	12	28	3	0	3	7	10	10	13	13	60	0.75	2.25
93	12	29	10	17	10	3	3	0	0	3	47	0.59	1.76
93	12	30	20	17	13	13	17	3	0	3	87	1.09	3.09
93	12	31	20	33	50	43	23	30	20	37	257	3.21	5.21

1994, V3, K_p Data

													Month	Qe Avg/Mo		
													January	3.16		
													February	5.48		
													March	5.32		
													April	5.28		
													May	5.38		
													June	4.60		
													July	4.13		
													August	3.66		
													September	4.22		
													October	4.93		
													November	4.42		
													December	4.51		
Year	Month	Day	Kp 0-3	Kp 3-6	Kp 6-9	Kp 9-12	Kp 12-15	Kp 15-18	Kp 18-21	Kp 21-24	Kp Sum	Kp Avg/Day	Qe Avg/Day			
94	1	1	40	40	43	43	40	40	33	30	310	3.88	5.88			
94	1	2	27	33	40	37	43	37	33	30	280	3.50	5.50			
94	1	3	30	20	30	33	30	37	37	17	233	2.91	4.91			
94	1	4	17	33	20	10	13	10	13	7	123	1.54	3.54			
94	1	5	3	10	7	10	10	7	10	23	80	1.00	3.00			
94	1	6	33	27	23	20	23	33	17	33	210	2.63	4.63			
94	1	7	7	0	3	13	20	10	23	20	97	1.21	3.21			
94	1	8	13	23	27	13	17	13	13	13	133	1.66	3.66			
94	1	9	7	0	7	10	7	10	13	3	57	0.71	2.14			
94	1	10	3	7	10	3	7	3	0	0	33	0.41	1.24			
94	1	11	7	20	30	27	30	53	53	43	263	3.29	5.29			
94	1	12	47	43	37	37	47	47	30	40	327	4.09	6.09			
94	1	13	40	43	30	33	43	40	33	47	310	3.88	5.88			
94	1	14	37	40	33	37	50	40	33	37	307	3.84	5.84			
94	1	15	37	37	27	20	30	33	47	37	267	3.34	5.34			
94	1	16	30	37	37	33	37	33	37	30	273	3.41	5.41			
94	1	17	43	50	43	33	33	37	37	37	313	3.91	5.91			
94	1	18	33	33	30	33	50	47	37	33	297	3.71	5.71			
94	1	19	40	47	47	30	37	23	40	37	300	3.75	5.75			
94	1	20	37	33	33	23	30	27	27	23	233	2.91	4.91			
94	1	21	23	23	10	13	17	23	33	27	170	2.13	4.13			
94	1	22	40	23	13	13	17	7	20	23	157	1.96	3.96			
94	1	23	20	23	13	17	13	17	17	23	143	1.79	3.79			
94	1	24	23	10	10	13	3	0	0	10	70	0.88	2.63			
94	1	25	13	23	17	3	3	7	13	23	103	1.29	3.29			
94	1	26	27	33	47	30	40	37	40	33	287	3.59	5.59			
94	1	27	33	37	37	27	33	37	37	37	277	3.46	5.46			
94	1	28	43	33	27	37	33	20	17	23	233	2.91	4.91			
94	1	29	17	27	30	23	33	23	17	23	193	2.41	4.41			
94	1	30	33	13	17	20	20	37	27	23	190	2.38	4.38			
94	1	31	33	20	17	17	17	20	13	33	170	2.13	4.13			
94	2	1	23	7	20	23	17	7	7	3	107	1.34	3.34			
94	2	2	3	23	33	40	43	30	23	3	200	2.50	4.50			
94	2	3	3	17	23	23	33	33	30	27	190	2.38	4.38			
94	2	4	20	20	20	13	27	37	43	30	210	2.63	4.63			
94	2	5	37	30	37	50	30	40	47	57	327	4.09	6.09			
94	2	6	60	43	37	53	57	63	60	60	433	5.41	7.41			
94	2	7	47	60	47	60	63	53	60	43	433	5.41	7.41			

1994, V3, K_p Data

Year	Month	Day	Kp 0-3	Kp 3-6	Kp 6-9	Kp 9-12	Kp 12-15	Kp 15-18	Kp 18-21	Kp 21-24	Kp Sum	Kp Avg/Day	Qc Avg/Day
94	2	8	63	57	57	50	57	53	53	53	443	5.54	7.54
94	2	9	43	37	40	37	43	53	50	53	357	4.46	6.46
94	2	10	53	50	43	43	47	47	43	47	373	4.66	6.66
94	2	11	50	50	40	57	47	53	53	53	403	5.04	7.04
94	2	12	47	43	37	40	47	43	47	47	350	4.38	6.38
94	2	13	47	37	33	40	37	53	63	47	357	4.46	6.46
94	2	14	47	43	43	33	37	60	43	50	357	4.46	6.46
94	2	15	40	33	33	30	43	40	43	47	310	3.88	5.88
94	2	16	50	47	30	33	40	30	33	27	290	3.63	5.63
94	2	17	27	27	27	23	27	27	27	20	203	2.54	4.54
94	2	18	17	13	13	27	13	7	3	30	123	1.54	3.54
94	2	19	40	37	43	37	43	30	43	33	307	3.84	5.84
94	2	20	47	40	30	27	20	23	33	20	240	3.00	5.00
94	2	21	23	27	33	73	77	77	60	70	440	5.50	7.50
94	2	22	77	73	53	47	47	30	23	30	380	4.75	6.75
94	2	23	27	33	27	27	20	17	33	23	207	2.59	4.59
94	2	24	17	10	13	13	17	13	10	7	100	1.25	3.25
94	2	25	20	27	40	37	27	27	30	20	227	2.84	4.84
94	2	26	33	20	13	13	23	17	7	7	133	1.66	3.66
94	2	27	7	20	20	33	27	17	7	7	137	1.71	3.71
94	2	28	3	3	33	27	20	7	23	40	157	1.96	3.96
94	3	1	40	20	33	23	17	20	20	33	207	2.59	4.59
94	3	2	40	23	20	27	27	23	40	50	250	3.13	5.13
94	3	3	37	47	53	43	30	17	20	20	267	3.34	5.34
94	3	4	10	7	17	17	7	7	7	7	77	0.96	2.89
94	3	5	17	7	7	17	10	7	20	43	127	1.59	3.59
94	3	6	27	33	23	20	7	13	27	37	187	2.34	4.34
94	3	7	53	40	40	57	50	63	57	70	430	5.38	7.38
94	3	8	50	57	57	50	47	47	53	53	413	5.16	7.16
94	3	9	47	53	63	47	47	57	63	60	437	5.46	7.46
94	3	10	43	43	50	47	50	50	50	57	390	4.88	6.88
94	3	11	37	47	50	47	50	47	43	53	373	4.66	6.66
94	3	12	47	40	53	43	47	40	47	43	360	4.50	6.50
94	3	13	47	50	27	37	30	30	30	50	300	3.75	5.75
94	3	14	43	50	40	33	47	47	47	43	350	4.38	6.38
94	3	15	50	57	43	47	53	53	47	37	387	4.84	6.84
94	3	16	40	37	37	23	37	50	37	37	297	3.71	5.71
94	3	17	40	50	53	47	40	47	43	33	353	4.41	6.41
94	3	18	40	47	37	20	33	30	17	40	263	3.29	5.29
94	3	19	43	33	33	33	20	20	23	27	233	2.91	4.91
94	3	20	33	30	20	17	17	30	37	30	213	2.66	4.66
94	3	21	30	50	37	33	37	50	43	33	313	3.91	5.91
94	3	22	50	33	20	30	47	27	23	30	260	3.25	5.25
94	3	23	37	47	37	30	37	37	30	23	277	3.46	5.46
94	3	24	33	33	23	47	37	27	20	30	250	3.13	5.13
94	3	25	40	20	20	23	33	43	37	30	247	3.09	5.09
94	3	26	30	27	20	33	13	17	17	10	167	2.09	4.09
94	3	27	17	13	17	13	20	13	27	43	163	2.04	4.04
94	3	28	13	27	20	27	33	37	27	27	210	2.63	4.63
94	3	29	23	17	20	13	10	7	13	17	120	1.50	3.50
94	3	30	13	10	13	33	37	37	37	33	213	2.66	4.66
94	3	31	27	23	13	20	17	7	7	3	117	1.46	3.46
94	4	1	3	20	20	13	23	23	20	17	140	1.75	3.75
94	4	2	37	30	33	47	50	53	70	63	383	4.79	6.79

1994, V3, K_p Data

Year	Month	Day	K _p 0-3	K _p 3-6	K _p 6-9	K _p 9-12	K _p 12-15	K _p 15-18	K _p 18-21	K _p 21-24	K _p Sum	K _p Avg/Day	Q _c Avg/Day
94	4	3	57	63	67	60	57	53	67	73	497	6.21	8.21
94	4	4	70	63	50	47	47	47	50	43	417	5.21	7.21
94	4	5	47	40	43	43	50	50	37	60	370	4.63	6.63
94	4	6	47	43	53	53	50	53	50	50	400	5.00	7.00
94	4	7	47	53	50	47	47	50	40	43	377	4.71	6.71
94	4	8	43	53	53	43	47	40	47	47	373	4.66	6.66
94	4	9	60	50	47	60	47	50	50	43	407	5.09	7.09
94	4	10	50	47	33	43	47	47	50	50	367	4.59	6.59
94	4	11	43	57	57	53	37	43	43	53	387	4.84	6.84
94	4	12	47	40	40	33	33	37	50	47	327	4.09	6.09
94	4	13	33	40	43	33	40	53	47	43	333	4.16	6.16
94	4	14	53	33	33	37	37	40	37	37	307	3.84	5.84
94	4	15	37	37	27	30	27	37	37	37	267	3.34	5.34
94	4	16	30	50	33	23	30	30	60	53	310	3.88	5.88
94	4	17	67	83	83	70	47	30	30	33	443	5.54	7.54
94	4	18	33	33	33	33	37	33	43	33	280	3.50	5.50
94	4	19	50	27	30	33	20	17	23	27	227	2.84	4.84
94	4	20	20	27	30	27	17	13	7	13	153	1.91	3.91
94	4	21	20	27	23	13	13	13	27	30	167	2.09	4.09
94	4	22	20	17	13	20	27	13	13	23	147	1.84	3.84
94	4	23	7	10	7	27	30	17	33	43	173	2.16	4.16
94	4	24	20	17	20	20	20	27	10	13	147	1.84	3.84
94	4	25	27	27	20	20	10	17	17	23	160	2.00	4.00
94	4	26	10	13	20	17	17	13	7	7	103	1.29	3.29
94	4	27	10	20	10	13	13	10	7	10	93	1.16	3.16
94	4	28	20	10	3	3	17	7	7	7	73	0.91	2.74
94	4	29	7	20	20	13	3	3	7	23	97	1.21	3.21
94	4	30	3	10	7	0	3	3	7	3	37	0.46	1.39
94	5	1	3	20	30	30	43	57	70	70	323	4.04	6.04
94	5	2	57	60	43	30	33	33	50	67	373	4.66	6.66
94	5	3	53	63	50	37	47	47	43	33	373	4.66	6.66
94	5	4	40	40	33	27	47	43	37	40	307	3.84	5.84
94	5	5	43	47	47	37	47	57	47	47	370	4.63	6.63
94	5	6	47	50	47	37	30	37	40	60	347	4.34	6.34
94	5	7	60	47	53	47	40	33	43	37	360	4.50	6.50
94	5	8	43	47	50	47	40	40	50	47	363	4.54	6.54
94	5	9	37	47	37	40	37	43	40	33	313	3.91	5.91
94	5	10	43	40	53	30	40	40	47	47	340	4.25	6.25
94	5	11	43	43	33	33	37	47	33	40	310	3.88	5.88
94	5	12	37	40	27	17	10	13	7	27	177	2.21	4.21
94	5	13	27	27	20	10	7	13	10	20	133	1.66	3.66
94	5	14	23	47	47	27	33	33	27	40	277	3.46	5.46
94	5	15	33	37	50	57	43	40	47	43	350	4.38	6.38
94	5	16	43	37	37	40	47	50	43	27	323	4.04	6.04
94	5	17	40	30	30	33	23	30	27	23	237	2.96	4.96
94	5	18	37	40	30	27	37	30	20	40	260	3.25	5.25
94	5	19	27	33	30	30	27	17	7	10	180	2.25	4.25
94	5	20	17	23	17	13	17	20	7	10	123	1.54	3.54
94	5	21	7	7	7	17	23	17	13	10	100	1.25	3.25
94	5	22	7	10	7	13	20	20	27	23	127	1.59	3.59
94	5	23	10	13	7	23	23	27	17	30	150	1.88	3.88
94	5	24	37	47	33	30	27	33	33	30	270	3.38	5.38
94	5	25	37	47	30	33	17	30	20	40	253	3.16	5.16
94	5	26	13	23	33	33	23	17	13	23	180	2.25	4.25

1994, V3, K_p Data

Year	Month	Day	Kp 0-3	Kp 3-6	Kp 6-9	Kp 9-12	Kp 12-15	Kp 15-18	Kp 18-21	Kp 21-24	Kp Sum	Kp Avg/Day	Qc Avg/Day
94	5	27	20	13	3	7	10	20	10	10	93	1.16	3.16
94	5	28	3	3	7	20	47	70	67	53	270	3.38	5.38
94	5	29	53	53	37	50	47	53	37	40	370	4.63	6.63
94	5	30	47	60	43	43	53	53	50	57	407	5.09	7.09
94	5	31	37	50	40	37	37	27	50	43	320	4.00	6.00
94	6	1	33	40	43	40	33	27	40	40	297	3.71	5.71
94	6	2	43	27	33	40	30	43	43	40	300	3.75	5.75
94	6	3	33	37	30	27	37	37	50	40	290	3.63	5.63
94	6	4	37	30	33	33	27	33	30	43	267	3.34	5.34
94	6	5	27	30	30	37	33	37	43	43	280	3.50	5.50
94	6	6	33	27	27	33	30	33	43	37	263	3.29	5.29
94	6	7	30	27	33	30	30	23	30	33	237	2.96	4.96
94	6	8	30	20	17	23	20	23	17	20	170	2.13	4.13
94	6	9	20	23	30	30	13	20	13	13	163	2.04	4.04
94	6	10	13	23	27	37	30	47	33	33	243	3.04	5.04
94	6	11	27	27	30	40	20	23	27	33	227	2.84	4.84
94	6	12	33	33	37	43	40	43	40	30	300	3.75	5.75
94	6	13	30	27	13	20	23	37	37	30	217	2.71	4.71
94	6	14	27	30	30	33	33	30	23	30	237	2.96	4.96
94	6	15	27	13	20	17	17	10	13	13	130	1.63	3.63
94	6	16	17	7	10	10	17	10	13	10	93	1.16	3.16
94	6	17	10	17	13	20	27	33	13	13	147	1.84	3.84
94	6	18	27	40	27	23	23	27	13	20	200	2.50	4.50
94	6	19	17	20	30	47	40	27	33	37	250	3.13	5.13
94	6	20	27	33	23	20	37	30	30	30	230	2.88	4.88
94	6	21	23	20	27	27	20	17	20	23	177	2.21	4.21
94	6	22	23	23	17	10	23	10	13	17	137	1.71	3.71
94	6	23	7	7	3	0	3	7	10	13	50	0.63	1.88
94	6	24	13	13	7	10	10	7	3	3	67	0.84	2.51
94	6	25	0	3	10	3	13	7	7	17	60	0.75	2.25
94	6	26	27	40	37	43	43	43	40	33	307	3.84	5.84
94	6	27	40	33	37	27	27	17	20	20	220	2.75	4.75
94	6	28	23	17	17	23	20	23	43	57	223	2.79	4.79
94	6	29	37	47	37	37	33	37	43	40	310	3.88	5.88
94	6	30	33	33	33	33	33	37	30	40	273	3.41	5.41
94	7	1	43	37	40	37	30	30	37	47	300	3.75	5.75
94	7	2	33	50	43	40	33	40	30	40	310	3.88	5.88
94	7	3	27	23	30	30	23	17	20	30	200	2.50	4.50
94	7	4	17	23	20	13	30	27	30	27	187	2.34	4.34
94	7	5	17	10	13	7	7	10	7	23	93	1.16	3.16
94	7	6	20	17	23	17	20	17	23	43	180	2.25	4.25
94	7	7	30	40	30	23	33	30	37	27	250	3.13	5.13
94	7	8	13	13	10	10	17	10	7	7	87	1.09	3.09
94	7	9	13	7	7	3	20	30	13	7	100	1.25	3.25
94	7	10	3	3	13	7	13	13	13	10	77	0.96	2.89
94	7	11	10	10	0	3	17	20	10	13	83	1.04	3.04
94	7	12	17	10	0	0	3	10	3	0	43	0.54	1.61
94	7	13	3	10	17	3	7	10	13	13	77	0.96	2.89
94	7	14	13	17	17	40	53	57	40	50	287	3.59	5.59
94	7	15	50	27	27	20	27	27	27	53	257	3.21	5.21
94	7	16	60	40	30	47	37	37	37	43	330	4.13	6.13
94	7	17	37	27	23	33	30	23	23	27	223	2.79	4.79
94	7	18	33	30	23	20	30	17	20	13	187	2.34	4.34
94	7	19	33	27	27	20	23	10	20	33	193	2.41	4.41

1994, V3, K_p Data

Year	Month	Day	Kp 0-3	Kp 3-6	Kp 6-9	Kp 9-12	Kp 12-15	Kp 15-18	Kp 18-21	Kp 21-24	Kp Sum	Kp Avg/Day	Qc Avg/Day
94	7	20	17	7	13	13	17	10	10	10	97	1.21	3.21
94	7	21	20	27	23	23	30	17	17	20	177	2.21	4.21
94	7	22	23	20	13	13	13	7	10	3	103	1.29	3.29
94	7	23	10	20	10	13	17	23	17	20	130	1.63	3.63
94	7	24	17	13	13	20	13	13	17	30	137	1.71	3.71
94	7	25	30	23	20	20	30	23	17	23	187	2.34	4.34
94	7	26	10	13	7	10	10	7	13	13	83	1.04	3.04
94	7	27	23	50	20	10	10	13	23	33	183	2.29	4.29
94	7	28	33	37	30	33	30	20	37	33	253	3.16	5.16
94	7	29	30	27	27	20	20	27	23	30	203	2.54	4.54
94	7	30	37	27	17	13	20	17	20	30	180	2.25	4.25
94	7	31	23	20	13	23	20	13	13	40	167	2.09	4.09
94	8	1	27	23	17	10	10	10	13	17	127	1.59	3.59
94	8	2	17	7	3	10	3	7	7	13	67	0.84	2.51
94	8	3	10	10	10	13	7	10	13	13	87	1.09	3.09
94	8	4	10	3	3	3	10	7	3	7	47	0.59	1.76
94	8	5	13	20	13	13	7	10	13	7	97	1.21	3.21
94	8	6	7	13	17	10	10	7	7	13	83	1.04	3.04
94	8	7	3	3	3	7	17	13	7	17	70	0.88	2.63
94	8	8	10	3	0	0	3	7	3	7	33	0.41	1.24
94	8	9	7	10	10	3	7	10	23	17	87	1.09	3.09
94	8	10	20	13	27	20	37	27	30	23	197	2.46	4.46
94	8	11	33	33	23	27	27	33	27	30	233	2.91	4.91
94	8	12	37	37	30	27	30	27	43	30	260	3.25	5.25
94	8	13	33	47	43	27	47	40	43	33	313	3.91	5.91
94	8	14	40	40	50	43	27	33	37	33	303	3.79	5.79
94	8	15	40	20	20	20	30	23	30	33	217	2.71	4.71
94	8	16	23	17	13	23	17	13	30	30	167	2.09	4.09
94	8	17	17	20	27	17	17	20	13	10	140	1.75	3.75
94	8	18	7	13	17	23	23	17	10	17	127	1.59	3.59
94	8	19	17	13	17	7	10	13	17	7	100	1.25	3.25
94	8	20	10	23	23	17	13	17	20	20	143	1.79	3.79
94	8	21	23	17	3	7	30	30	10	7	127	1.59	3.59
94	8	22	20	17	7	13	23	23	23	43	170	2.13	4.13
94	8	23	27	23	10	10	10	10	13	7	110	1.38	3.38
94	8	24	7	17	10	7	10	23	23	23	120	1.50	3.50
94	8	25	20	30	23	30	30	23	23	7	187	2.34	4.34
94	8	26	3	17	20	17	7	13	17	27	120	1.50	3.50
94	8	27	33	23	23	17	13	20	27	20	177	2.21	4.21
94	8	28	23	33	20	17	7	7	13	7	127	1.59	3.59
94	8	29	10	7	20	13	13	13	3	17	97	1.21	3.21
94	8	30	7	7	10	10	10	13	10	13	80	1.00	3.00
94	8	31	10	10	3	7	23	23	10	27	113	1.41	3.41
94	9	1	40	37	13	17	10	10	30	27	183	2.29	4.29
94	9	2	23	30	7	7	10	7	3	7	93	1.16	3.16
94	9	3	17	20	20	13	17	13	7	17	123	1.54	3.54
94	9	4	20	3	10	10	10	13	7	10	83	1.04	3.04
94	9	5	17	20	23	30	27	17	17	20	170	2.13	4.13
94	9	6	13	33	23	47	27	27	23	23	217	2.71	4.71
94	9	7	17	37	43	53	50	40	60	50	350	4.38	6.38
94	9	8	33	47	47	50	27	37	40	33	313	3.91	5.91
94	9	9	37	43	47	37	53	47	47	43	353	4.41	6.41
94	9	10	43	37	37	33	33	27	20	20	250	3.13	5.13
94	9	11	33	40	37	27	30	20	30	20	237	2.96	4.96

1994, V3, K_p Data

Year	Month	Day	Kp 0-3	Kp 3-6	Kp 6-9	Kp 9-12	Kp 12-15	Kp 15-18	Kp 18-21	Kp 21-24	Kp Sum	Kp Avg/Day	Qe Avg/Day
94	9	12	20	10	20	37	23	33	33	20	197	2.46	4.46
94	9	13	10	37	30	13	17	20	20	40	187	2.34	4.34
94	9	14	27	27	13	10	33	13	7	7	137	1.71	3.71
94	9	15	20	13	13	17	17	17	17	27	140	1.75	3.75
94	9	16	27	30	27	20	20	27	20	20	190	2.38	4.38
94	9	17	20	27	27	27	13	23	17	23	177	2.21	4.21
94	9	18	23	17	13	10	20	13	7	20	123	1.54	3.54
94	9	19	33	10	17	0	10	17	17	13	117	1.46	3.46
94	9	20	17	20	7	10	10	13	17	20	113	1.41	3.41
94	9	21	20	13	10	10	20	17	17	27	133	1.66	3.66
94	9	22	30	17	10	7	7	7	13	13	103	1.29	3.29
94	9	23	13	20	3	7	3	10	10	17	83	1.04	3.04
94	9	24	27	30	13	10	3	17	7	13	120	1.50	3.50
94	9	25	23	10	13	3	13	23	53	53	193	2.41	4.41
94	9	26	37	47	40	37	30	33	20	17	260	3.25	5.25
94	9	27	40	37	30	33	20	33	23	40	257	3.21	5.21
94	9	28	43	37	30	37	13	20	13	17	210	2.63	4.63
94	9	29	27	17	23	13	13	10	10	20	133	1.66	3.66
94	9	30	7	10	13	10	10	13	7	17	87	1.09	3.09
94	10	1	17	13	13	10	7	3	7	7	77	0.96	2.89
94	10	2	3	10	10	13	17	40	37	53	183	2.29	4.29
94	10	3	63	70	70	57	67	60	57	37	480	6.00	8.00
94	10	4	47	43	47	37	43	47	40	37	340	4.25	6.25
94	10	5	47	43	40	53	53	47	47	43	373	4.66	6.66
94	10	6	40	43	47	47	47	40	37	50	350	4.38	6.38
94	10	7	47	47	47	33	47	50	53	50	373	4.66	6.66
94	10	8	37	40	37	40	17	30	37	23	260	3.25	5.25
94	10	9	30	33	30	13	17	23	37	20	203	2.54	4.54
94	10	10	37	33	27	27	20	30	40	43	257	3.21	5.21
94	10	11	30	40	33	37	33	30	43	27	273	3.41	5.41
94	10	12	27	40	37	23	13	17	40	37	233	2.91	4.91
94	10	13	27	30	27	33	20	27	27	30	220	2.75	4.75
94	10	14	30	23	7	20	17	33	20	30	180	2.25	4.25
94	10	15	37	40	23	27	23	13	20	20	203	2.54	4.54
94	10	16	20	13	17	20	13	10	10	10	113	1.41	3.41
94	10	17	13	10	13	13	10	3	13	20	97	1.21	3.21
94	10	18	20	3	3	3	3	13	20	27	93	1.16	3.16
94	10	19	13	7	7	0	20	27	30	33	137	1.71	3.71
94	10	20	33	10	10	10	17	27	27	23	157	1.96	3.96
94	10	21	17	7	7	10	3	3	7	7	60	0.75	2.25
94	10	22	7	7	20	37	40	37	37	63	247	3.09	5.09
94	10	23	60	53	63	50	53	40	47	40	407	5.09	7.09
94	10	24	40	50	47	37	37	53	40	37	340	4.25	6.25
94	10	25	27	47	43	17	10	7	17	7	173	2.16	4.16
94	10	26	33	23	17	20	17	10	23	17	160	2.00	4.00
94	10	27	7	17	13	17	17	10	7	7	93	1.16	3.16
94	10	28	13	7	17	10	13	3	10	20	93	1.16	3.16
94	10	29	40	30	43	60	70	67	33	27	370	4.63	6.63
94	10	30	33	53	67	57	50	40	63	43	407	5.09	7.09
94	10	31	50	37	43	57	47	40	47	37	357	4.46	6.46
94	11	1	40	43	30	27	30	37	23	27	257	3.21	5.21
94	11	2	37	37	30	33	40	33	23	33	267	3.34	5.34
94	11	3	20	27	27	23	37	30	33	23	220	2.75	4.75
94	11	4	33	53	33	33	23	27	40	37	280	3.50	5.50

1994, V3, K_p Data

Year	Month	Day	Kp 0-3	Kp 3-6	Kp 6-9	Kp 9-12	Kp 12-15	Kp 15-18	Kp 18-21	Kp 21-24	Kp Sum	Kp Avg/Day	Qe Avg/Day
94	11	5	40	30	17	27	27	27	40	47	253	3.16	5.16
94	11	6	47	57	57	53	40	50	43	17	363	4.54	6.54
94	11	7	23	30	27	23	10	17	27	10	167	2.09	4.09
94	11	8	13	7	7	13	17	10	7	27	100	1.25	3.25
94	11	9	23	20	17	20	37	40	40	43	240	3.00	5.00
94	11	10	33	47	40	30	20	23	30	23	247	3.09	5.09
94	11	11	20	27	23	27	17	10	13	20	157	1.96	3.96
94	11	12	20	13	13	10	7	13	17	10	103	1.29	3.29
94	11	13	10	20	13	17	17	23	17	13	130	1.63	3.63
94	11	14	23	23	20	17	13	17	30	33	177	2.21	4.21
94	11	15	27	17	20	23	20	20	30	33	190	2.38	4.38
94	11	16	27	17	13	7	10	20	10	3	107	1.34	3.34
94	11	17	10	30	17	13	7	7	23	17	123	1.54	3.54
94	11	18	7	10	7	23	20	23	17	17	123	1.54	3.54
94	11	19	33	47	40	30	30	40	30	33	283	3.54	5.54
94	11	20	30	40	50	43	47	30	20	23	283	3.54	5.54
94	11	21	27	27	20	17	13	10	10	13	137	1.71	3.71
94	11	22	10	23	10	17	10	17	23	17	127	1.59	3.59
94	11	23	10	13	7	7	10	10	3	17	77	0.96	2.89
94	11	24	7	17	20	7	7	17	10	10	93	1.16	3.16
94	11	25	7	13	3	3	7	3	10	10	57	0.71	2.14
94	11	26	10	27	47	63	60	43	33	23	307	3.84	5.84
94	11	27	33	40	43	47	47	43	37	27	317	3.96	5.96
94	11	28	23	20	37	37	30	30	27	13	217	2.71	4.71
94	11	29	10	23	20	20	20	27	27	27	173	2.16	4.16
94	11	30	33	37	40	47	33	27	27	33	277	3.46	5.46
94	12	1	27	37	33	33	37	33	17	40	257	3.21	5.21
94	12	2	33	37	37	30	47	37	37	43	300	3.75	5.75
94	12	3	47	27	33	23	33	13	23	23	223	2.79	4.79
94	12	4	27	17	13	17	13	7	27	7	127	1.59	3.59
94	12	5	10	13	20	20	23	23	17	27	153	1.91	3.91
94	12	6	30	30	53	33	37	43	40	40	307	3.84	5.84
94	12	7	40	33	33	23	23	37	27	37	253	3.16	5.16
94	12	8	33	27	30	30	27	27	30	30	233	2.91	4.91
94	12	9	33	17	23	23	23	20	23	30	193	2.41	4.41
94	12	10	33	23	17	17	10	27	27	27	180	2.25	4.25
94	12	11	20	17	13	13	17	30	40	37	187	2.34	4.34
94	12	12	37	30	27	23	23	27	37	37	240	3.00	5.00
94	12	13	37	40	40	27	30	33	17	17	240	3.00	5.00
94	12	14	23	17	3	17	17	13	27	30	147	1.84	3.84
94	12	15	23	27	33	27	47	40	37	43	277	3.46	5.46
94	12	16	33	37	37	33	40	30	17	17	243	3.04	5.04
94	12	17	17	20	27	20	13	20	23	17	157	1.96	3.96
94	12	18	17	17	17	7	17	23	20	20	137	1.71	3.71
94	12	19	13	33	17	20	20	7	3	10	123	1.54	3.54
94	12	20	23	20	23	23	23	27	27	30	197	2.46	4.46
94	12	21	23	17	23	10	17	13	10	13	127	1.59	3.59
94	12	22	20	27	3	3	7	3	3	3	70	0.88	2.63
94	12	23	30	23	23	27	7	23	13	27	173	2.16	4.16
94	12	24	40	40	47	43	43	47	47	47	353	4.41	6.41
94	12	25	43	37	30	27	33	33	23	33	260	3.25	5.25
94	12	26	40	30	27	27	30	37	30	37	257	3.21	5.21
94	12	27	23	23	17	17	23	17	47	40	207	2.59	4.59
94	12	28	33	13	7	17	27	30	13	27	167	2.09	4.09
94	12	29	37	30	40	33	27	27	13	10	217	2.71	4.71
94	12	30	23	33	20	17	13	13	13	7	140	1.75	3.75
94	12	31	7	13	17	10	10	10	13	20	100	1.25	3.25

APPENDIX C SPECIFICS OF THE INITIALIZATION (INI) FILE

C.1 SITE-SPECIFIC SETTINGS

The settings specified in the "site-specific setting" section of the initialization file are changed at each station, according to that station's characteristics.

```
[Site Specific]
RemotePort=COM2:4800,0,8,1,BufSize:4096
Here=Salisbury
Radio=RF7210
TempDir=e:\temp
DataDir=e:\data
LogDir=e:\log\
GPSCard=0
PCClockIsUT=1
ProgramRadio=0
StartSchedule=0
AllDIDs=0
ShowAuthor=1000
NegAntenna=0
BootInterval=0
```

```
[Abbreviations]
Davis=DAV
Salisbury=SAL
McMurdo=MCM
Christchurch=CHC
```

```
;Minute=Duration, SchType, Source-Dest, SAnt-DAnt, UseChan, ModemBaud
```

```
[Schedule]
```

```
;Duration: Minutes
```

```
;SchType: (Source)Time, LQA, PBER, or Idle
```

```
;UseChan: 0 for best LQA chan
```

```
;ModemBaud: 300, 600, 2400, or Voice (Replaces [Radio] SynchModemStr=...Vo...)
```

```
00=4, Time
```

```
04=4, LQA, SAL-DAV, 1-1
```

```
08=4, LQA, CHC-DAV, 1-1
```

```
12=4, LQA, CHC-MCM, 1-1
```

```
16=4, LQA, SAL-MCM, 1-1
```

```
20=4, LQA, MCM-DAV, 2-2
```

```
24=4, LQA, DAV-SAL, 1-1
```

```
28=4, PBER, DAV-SAL, 1-1, 0
```

```
32=2, PBER, DAV-SAL, 1-1, 1
```

```
34=2, PBER, DAV-SAL, 1-1, 10
```

```
36=2, PBER, DAV-SAL, 1-1, 2
```

```
38=2, PBER, DAV-SAL, 1-1, 9
```

```
40=2, PBER, DAV-SAL, 1-1, 3
```

```
42=2, PBER, DAV-SAL, 1-1, 8
```

```
44=4, Idle
```

```
48=4, Idle
```

```
52=2, PBER, DAV-SAL, 1-1, 4
```

```
54=2, PBER, DAV-SAL, 1-1, 7
```

```
56=2, PBER, DAV-SAL, 1-1, 5
```

```
58=2, PBER, DAV-SAL, 1-1, 6
```

```

[Radio]
Frequency1=05030000
Frequency2=06767000
Frequency3=09110000
Frequency4=11508000
Frequency5=13490000
Frequency6=15088400
Frequency7=18610000
Frequency8=20439000
Frequency9=22950000
Frequency10=25110000
;Frequency3=07730000
Mode=USB
;(P.8) cw,afsk,am,usb,lsb,2isb,4isb,mcw,fm,fsk
AGC=slow
;(P.15) slow, fast, medium, off
Power=-0dB
;(P.20) -0 to -50
BandWidth=3000
UseUSBFreq=-1500
LQAWords=1
Logger=0
ButtonAlert=1
AMDAAlert=0
ShortLQA=0
TimeOut=5
MaxChan=10
ScanRate=2
TuneTime=1000
TurnaroundTime=5
BitSpeed=200
AlertTime=0
SyncModemStr=Modem Pre 0 En Sy Dat Bau 2400 Ty 39 Int Long

[Locales]
Salisbury=_____ 34°45'25.19"S, 138°35'44.15"E, 100m, -10:30:00
Christchurch=___ 43°32'42.21"S, 172°37'54.11"E, 100m, -12:00:00
McMurdo=_____ 78°08'31.00"S, 166°07'47.00"E, 10m, 0:00:00
Davis=_____ 68°34'48.00"S, 77°58'12.00"E, 10m, -10:00:00

```

C.2 SITE-SPECIFIC SETTINGS DEFINED

RemotePort=COM1:9600,0,8,1,BufSize:4096

The communications port through which the radio is programmed. This is an RS-232 serial port with Tx, Rx, and ground connections at a minimum. Additional pins (DTR and RTS) are used by certain configurations to provide a voltage level for antenna switching. These are brought out from the port by a special connector that does not send them through to the radio. The RF-7210 is programmed by the software using a Harris protocol, the Harris advanced adaptive radio control protocol (HAARCP). The RF-5020 and RF-5022 are programmed using ASCII strings. The RF-5020 and RF-5022 ASCII commands can also be typed in by a user at the computer keyboard when the scheduler is not running. The usual settings are

```

COM1:9600,0,8,1;RF7210,
COM1:4800,0,8,1;RF5000.

```

Here=Salisbury

The station's text name. Used to identify the station called *self*, so it must match a station name in the [Abbreviations] section and also used to calculate a local time from the latitude/longitude of the location whose name matches in the [Locales] section.

Radio=RF7210

This must match the radio type being operated, since the command sets for all three radios are different.

TempDir=C:\ALE

The directory that is to be used by the software for currently open files. This is usually set to a VDisk (virtual disk) to minimize wear on the disk drive while the file is continually accessed by the software. This directory must exist, or data files will not be created.

DataDir=D:\DATA

The directory where the data files reside before being copied to removable media. This directory must exist, or the files will not be copied from the temporary directory TempDir.

LogDir=A:

The removable media directory. This is set to the destination on the removable media where the files are to be copied. After the software has verified that the data has been copied from the data directory (DataDir) to this director correctly, the data are deleted from the DataDir.

GPSCard=0

If the Navstar GPS card is in the computer, this is set to 1; otherwise, it is set to 0. The stations that do not have GPS will be set from messages exchanged by the station at Salisbury during the time slot called, appropriately, *Time*.

PCClockIsUT=1

The software keeps track of two clocks, the local clock and the universal time (UT) clock. Time according to the computer's DOS clock represents one of these two. When set as normal to 1, the DOS clock is set automatically to UT by radio software time exchange commands and file names and creation times will agree. If set to 0, the DOS clock will be set to local time as calculated by the time zone and daylight correction specified under the [Locale] for the matching name to *Here* under the [Site Specific] topic. Also file name times will reflect the UT clock and file creation times will reflect the local clock.

ProgramRadio=0

When set to 0, the radio programming section is loaded from the [Radio] topic in the INI file, but the radio programming is skipped. A setting of 1 directs the software to erase the radio's RAM contents and reprogram the radio with settings specified under the [Radio] topic. This can be changed from the menu item, and if the value is changed from 0 to 1, programming of the radio is immediately performed and the updated setting is written to the INI file.

StartSchedule=1

When set to 0, exchanges with the radio are limited to user keyboard entry. Scheduling information is read from the INI file under the [Schedule] topic, but scheduling is not performed. On the RF-7000, the keyboard is mapped to provide a specific function with each keypress (to be implemented). On the RF-5000, keyboard entries are sent out the serial port and written to the *To* screen and characters received are written to the *From* screen. When set to 1, any keyboard entries (except those on the status line at the bottom of the screen) are ignored. The scheduler determines what to send out the serial port to the radio and looks for correct responses to be returned from the radio.

[Abbreviations]

The call signs for each location of the network. One of the locations on the left-hand side must agree with the *Here* value under the [Site Specific] topic. Case is ignored for string comparisons.

[Schedule]

Determines the actions performed by the radio. All radios on the network have the same schedule, and no more than two radios have actions scheduled at a given time. Each string is in the form "Minute=Duration, SchType, Source-Dest, SAnt-DAnt, UseChan, ModemBaud, ModemInter" with only the required parameters present in the string. *Minute* refers to the minute after the hour (UT) for which the schedule string is intended. *Duration* is the time in minutes during which this string is valid. *SchType* is Time, LQA, PBER, or Idle, depending on intended action. *Source* refers to the station initiating the action. *Dest* refers to the receiving station. For stations that have more than one antenna, the *SAnt* refers to the antenna number the source station will use; *DAnt* refers to the antenna number the destination (*Dest*) station will use. *UseChan*, for when a channel number is required as in the probability of bit error rate (PBER) test, specifies that channel on which the radio exchange is to occur. If a channel is specified as 0, then each radio will review channel ranking, and, based on that ranking, will set the radio to the last known best channel. It may happen that the two radios will select different channels, depending on how conditions change between one LQA and the next, but scheduling an LQA prior to that time will reduce the chances of this occurring. *ModemBaud* overrides the baud setting for an individual PBER time slot. Allowed values are 300, 600, 2400, or Voice. This replaces the default Ba(ud) setting specified under the [Radio] topic, SynchModemStr entry. Likewise, *ModemInter* overrides the default (Int)erleave setting.

[Radio]

This topic specifies programming information for the radio, independent of radio type. Because radio features are not equivalent between radio types, not all settings are used by each radio.

FrequencyN

Specifies each of the assigned frequencies, where N is the channel number. Values for N start with one.

Mode

The radio setting, which will be one of the following: CW, AFSK, AM, USB, LSB, 2ISB, 4ISB, MCW, FM, and FSK. Not all radios support all modes, and the software fully supports USB mode only.

AGC

The gain setting for voice communications only. This does not affect gain setting during linking establishment. A setting of *slow* is normally used. Setting values are *slow*, *fast*, *medium*, and *off*.

Power

Supported by some radios. For full power, as is desired for these tests, a setting of -0 dB is used. Reduction from full power can be set in a range of -0 dB to -50 dB by changing this value accordingly.

BandWidth

A setting of 3000 Hz is normally used.

UseUSBFreq

The adjustment to the assigned frequency to give the correct dial frequency. For USB, the dial setting would be 1500 Hz below the assigned frequency, requiring a value of -1500. LQAWords is always 1. This setting ensures that the channel scores are exchanged in an LQA call.

Logger

Always 1.

ButtonAlert

Always 0.

AMDAAlert

Always 1.

ShortLQA

Always 0.

TimeOut

The time limit of an ALE link in minutes. If the radio senses no change in its keyed state, the link is broken, and the radio returns to its previous state, usually scanning. This value is currently set at five minutes.

MaxChan

The largest number of channels any one of the radios on the network is set to scan. For this test, it matches the highest number of the frequency strings. Presently this number is 10. The radio calculates the amount of time to poll during an LQA, as all the radios on the network

must be given time to scan to the transmitted frequency. A larger value on this will increase the LQA times. This value will range from values of 1 to 100.

ScanRate

Set at 2 for the RF-7000. It is selectable on the RF-7000 as either 2-or 5-channels per second. The RF-5000 is fixed at 5, so changing this parameter for those radios has no effect.

TuneTime

The time in milliseconds for any station on the network that has a tunable antenna. Some Harris tunable antennas have a tune time of up to 15 seconds. For this network, the value is set to a minimum at 1 second (keyed as 1000).

TurnaroundTime

Recommended by Harris to be set to 5.

BitSpeed

Recommended by Harris to be set to 200.

AlertTime

Affects RF-7000 audible alert time. The value of 0 turns the audible alarm off.

SyncModemStr

The default string that controls the RF-5000 synchronous built-in modem for PBER tests. Further modifications are specified in the [Schedule] topic, where each time slot can have an overriding baud rate and interleave. If no baud rate, or interleave, are specified, the values set by this string are used for modem control (table C.1).

Table C.1. Modem Control Strings

Command	Value	Description
Modem	N/A	Modem command string
Pre	0	Set modem preset to 0
En	N/A	Enable the modem
Sy	Dat	Synchronous operation
Bau	Vo	Baud rate is voice
Ty	39	Modem type is the built-in 39 tone
Int	AltS	Interleave is AltShort

[Locales]

Allows for calculation of local time relative to UT and site bearings, great circle distances and sun angles. Latitude and Longitude are entered as $DDD^{\circ}MM'SS.SS''$ or as $DDD.DDDDDD$. If there are 2 or more separators (any of $^{\circ}$ $'$ $''$), the first form is assumed. For example, $41.20.45.72$ would be recognized as $41^{\circ}20'45.72''N$. If there is one separator or no separators, the second form is assumed. For example, 41.20 would be recognized as $41^{\circ}24'00.00''$. Height is in meters. Daylight correction is in $HH:MM:SS$ and, when combined with the time zone calculated from longitude, gives a correction factor for conversion of UT to local time. For example, Salisbury is in time zone +9, but for summer time, the daylight correction would be +30 minutes for the permanent correction and +1 hour for daylight savings, giving a daylight correction factor of $1:30:00$. The software would then apply a $+10:30:00$ correction factor to UT when calculating local time.

C.2 KEYBOARD KEYS

The following keys are part of the windowing framework and are active at all times.

<Tab>

Will cycle forward between all visible windows and make each one, in turn, the active window. The active window will have a double-line frame, while the others will have a single-line frame.

<Shift-Tab>

Will cycle backward through all visible windows.

<F5>

Toggles the zoom for the current active window. This allows a window to occupy the entire desktop window area. Useful for seeing commands that have been sent to the radio or strings that have been sent to the computer from the radio. If the radio is zoomed already, the window is returned to its assigned size.

<Ctl-F7>

Pressing the **<Control>** and **<F7>** keys at the same time will cause the program to exit, and the user is returned to the DOS prompt.

<Ctl-F10>

Pressing the **<Control>** and **<F10>** keys at the same time will bring up a dialog box that requests the user to type in a filename. The file specified is an ASCII file, which will be dumped to the radio, line by line. The default file extension is PRG. If the user would enter a file name, such as A5020 for an RF-5020 radio and an ASCII file named A5020.PRG, or A5022 for an RF-5022 radio to be loaded with the information in an ASCII file named A5022.PRG. If the radio is an RF-7210, this command has no effect. If the radio is an RF-5000 type and the StartSchedule flag is 1, this command has no effect. Pressing **<ESC>** at any time during the file dump will bring up a dialog box that will allow the user to continue loading, or cancel the file dump.

C.3 MENU ITEMS

There are three main level menus that provide functionality to the software: Calc, Local, and Logging.

Calc contains the submenus Site Angles, Great Circles, and Sun Angles to be used as aids in site setup. These items bring up the calculations for all sites read from the INI file. Site Angles displays a matrix of the optimum pointing angles for antennas between sites. Great Circles displays a matrix of distances between sites, and Sun Angles allows calculation of the time of day when the sun is at the proper pointing angle.

Local provides setup for the RS-232 communications port and settings for startup and radio programming.

Logging allows the user to save the contents of a window to a file for later viewing. The choices are the *From ALE* window or the *To ALE* window.

C.4 FILES SUPPLIED

The required files are the executable, SP.EXE, and the initialization file, SP.INI. The SP.EXE is a single executable distributed to all sites. Customization by site is through modifying values in SP.INI, as described in the above sections.

C.5 FILES CREATED

The output files created are ASCII text containing results of LQAs and other status messages, such as real time clock adjustment. A new file is created each hour, with the filename consisting of the timelate. An example of this file is one from SAL called 94050100.DAT. The following is the first 10 lines, or results of one LQA.

3	05/01/94 00:18:36	7	18608500	18	0	30	0	100	MCC
3	05/01/94 00:18:36	6	15086900	13	0	30	0	88	MCC
3	05/01/94 00:18:36	4	11506500	18	0	13	0	75	MCC
3	05/01/94 00:18:36	5	13488500	16	0	12	1	71	MCC
3	05/01/94 00:18:36	8	20437500	12	2	14	3	66	MCC
3	05/01/94 00:18:36	10	25108500	-1	-1	-1	-1	-2	MCC
3	05/01/94 00:18:36	9	22948500	-1	-1	-1	-1	-2	MCC
3	05/01/94 00:18:36	3	09108500	-1	-1	-1	-1	-2	MCC
3	05/01/94 00:18:36	2	06765500	-1	-1	-1	-1	-2	MCC
3	05/01/94 00:18:36	1	05028500	-1	-1	-1	-1	-2	MCC

The value of 3 indicates the results of an LQA; the remaining values are timelate, channel number, frequency, received SINAD, received PBER, measured SINAD, measured PBER, channel score, and destination station. Separators are <Tabs>. All stations reported data in this format.

C.6 SPECIAL CONFIGURATIONS

There are special configurations that differentiate some sites and that required additional software to address particular hardware. Salisbury has a GPS card that allowed the station to be the master time distribution station. The card requires an initial setup, and then is read for time distribution. It also has more data available on the state of the radio, which can be logged by the operator. McMurdo and Davis each have two antennas that are switched under software control, depending on the scheduled exchange. Also, Black Island requires separation of the Harris radios and the controlling computers, which were near operators at McMurdo, though this does not require additional software. Entries in the INI file are required to turn on the software routines for those features. The following are the values for the special sites.

For Salisbury, the GPSCard flag is set to 1, which enables routines to access the GPS card and turns on time distribution. If the operator desires to save more detailed data on the state of the RF-7210, the AllDIDs flag can be set to 1. Thus

```
[Site Specific]
GPSCard=1
AllDIDs=1.
```

For Davis, the software command toggles the RTS and DTR lines on the same serial line from of the controlling computer. Since they are toggled at opposite logic values, the appropriate signal is used to switch the antenna. If during hardware setup the wrong polarity was chosen, the computer operator could modify the INI file parameter NegAntenna to a value of 1 to invert the value of this signal. For McMurdo, the switch is enabled by a software command to turn on the front panel light. This signal is sent to the antenna switch to select the appropriate antenna for the station at the other end of the link. Exchanges with Davis require one antenna and those with Salisbury and Christchurch use the other. The antenna chosen for a given LQA is specified in the corresponding line of the schedule. An example is the time slot starting at 20 minutes, between McMurdo and Davis, which requires both sites to use their antenna number 2. Thus

```
[Site Specific]
NegAntenna=1
```

```
;Minute=Duration,SchType,Source-Dest,SAnt-DAnt,UseChan,ModemBaud
[Schedule]
20=4,LQA,MCM-DAV,2-2
```

C.7 HOURLY SCHEDULES

The following is the hourly schedule, showing the time of the exchanges between stations, the Bit Error Ratio tests, and also the ionosonde at DAV. The schedule was designed to keep interference between tests at a minimum, and also to avoid causing radio interference with other communications at the sites.

28=4,PBER,DAV-SAL,1-1,0
32=2,PBER,DAV-SAL,1-1,1
34=2,PBER,DAV-SAL,1-1,10
36=2,PBER,DAV-SAL,1-1,2
38=2,PBER,DAV-SAL,1-1,9
40=2,PBER,DAV-SAL,1-1,3
42=2,PBER,DAV-SAL,1-1,8
44=4,Idle
48=4,Idle
52=2,PBER,DAV-SAL,1-1,4
54=2,PBER,DAV-SAL,1-1,7
56=2,PBER,DAV-SAL,1-1,5
58=2,PBER,DAV-SAL,1-1,6

**APPENDIX D
UPTIME DATA FOR ALL CIRCUITS**

The status of each link uptime has been compiled into a listing as an additional parameter that is used to evaluate the high-frequency (HF) link data. The purpose of this is to remove the "no-link" data that are the result of hardware or software failure and are not the result of poor propagation conditions.

A typical data set for a single day would read as follows:

```
11 1/11 -*****-**------
```

The first value of 11 is the line number. Each new day increments the line number by one. The second argument of 1/11 is the date. For this case, the date is January 11. The remaining 24 characters are either a hyphen or an asterisk. The asterisk indicates that both stations hardware is up and the hyphen represents that either station hardware status is down or unknown. The 24 values represent the 24 hours of the day. Each page of data is made up of 365 lines, which represent every day of the year.

The recorded uptime for all links is presented in the following listing.

1993, CHC Uptime

1	1/ 1	72	3/13	144	5/24
2	1/ 2	73	3/14	145	5/25
3	1/ 3	74	3/15	146	5/26
4	1/ 4	75	3/16	147	5/27
5	1/ 5	76	3/17	148	5/28
6	1/ 6	77	3/18	149	5/29
7	1/ 7	78	3/19	150	5/30
8	1/ 8	79	3/20	151	5/31
9	1/ 9	80	3/21	152	6/ 1
10	1/10	81	3/22	153	6/ 2
11	1/11	82	3/23	154	6/ 3
12	1/12	83	3/24	155	6/ 4
13	1/13	84	3/25	156	6/ 5
14	1/14	85	3/26	157	6/ 6
15	1/15	86	3/27	158	6/ 7
16	1/16	87	3/28	159	6/ 8
17	1/17	88	3/29	160	6/ 9
18	1/18	89	3/30	161	6/10
19	1/19	90	3/31	162	6/11
20	1/20	91	4/ 1	163	6/12
21	1/21	92	4/ 2	164	6/13
22	1/22	93	4/ 3	165	6/14
23	1/23	94	4/ 4	166	6/15
24	1/24	95	4/ 5	167	6/16
25	1/25	96	4/ 6	168	6/17
26	1/26	97	4/ 7	169	6/18
27	1/27	98	4/ 8	170	6/19
28	1/28	99	4/ 9	171	6/20
29	1/29	100	4/10	172	6/21
30	1/30	101	4/11	173	6/22
31	1/31	102	4/12	174	6/23
32	2/ 1	103	4/13	175	6/24
33	2/ 2	104	4/14	176	6/25
34	2/ 3	105	4/15	177	6/26
35	2/ 4	106	4/16	178	6/27
36	2/ 5	107	4/17	179	6/28
37	2/ 6	108	4/18	180	6/29
38	2/ 7	109	4/19	181	6/30
39	2/ 8	110	4/20	182	7/ 1
40	2/ 9	111	4/21	183	7/ 2
41	2/10	112	4/22	184	7/ 3
42	2/11	113	4/23	185	7/ 4
43	2/12	114	4/24	186	7/ 5
44	2/13	115	4/25	187	7/ 6
45	2/14	116	4/26	188	7/ 7
46	2/15	117	4/27	189	7/ 8
47	2/16	118	4/28	190	7/ 9
48	2/17	119	4/29	191	7/10
49	2/18	120	4/30	192	7/11
50	2/19	121	5/ 1	193	7/12
51	2/20	122	5/ 2	194	7/13
52	2/21	123	5/ 3	195	7/14
53	2/22	124	5/ 4	196	7/15
54	2/23	125	5/ 5	197	7/16
55	2/24	126	5/ 6	198	7/17
56	2/25	127	5/ 7	199	7/18
57	2/26	128	5/ 8	200	7/19
58	2/27	129	5/ 9	201	7/20
59	2/28	130	5/10	202	7/21
60	3/ 1	131	5/11	203	7/22
61	3/ 2	132	5/12	204	7/23
62	3/ 3	133	5/13	205	7/24
63	3/ 4	134	5/14	206	7/25
64	3/ 5	135	5/15	207	7/26
65	3/ 6	136	5/16	208	7/27
66	3/ 7	137	5/17	209	7/28
67	3/ 8	138	5/18	210	7/29
68	3/ 9	139	5/19	211	7/30
69	3/10	140	5/20	212	7/31
70	3/11	141	5/21	213	8/ 1
71	3/12	142	5/22	214	8/ 2
		143	5/23	215	8/ 3
				216	8/ 4

217	8/ 5	*****	289	10/16	-----	361	12/27	-----
218	8/ 6	*****	290	10/17	-----*	362	12/28	-----
219	8/ 7	*****	291	10/18	-----***	363	12/29	-----*
220	8/ 8	*****-*	292	10/19	*****-----	364	12/30	-----***
221	8/ 9	*****-*	293	10/20	*****-----	365	12/31	****-----
222	8/10	*****-----*	294	10/21	-----			
223	8/11	*****-----*	295	10/22	-----			
224	8/12	*****-----*	296	10/23	-----			
225	8/13	*****-----*	297	10/24	-----			
226	8/14	*****-----*	298	10/25	-----***			
227	8/15	*****-----*	299	10/26	-----**			
228	8/16	*****-----*	300	10/27	-----***			
229	8/17	*****-----*	301	10/28	-----***			
230	8/18	*****-----*	302	10/29	*****-----			
231	8/19	***-----*	303	10/30	-----			
232	8/20	*-----*	304	10/31	-----***			
233	8/21	-----*	305	11/ 1	-----***			
234	8/22	-----*	306	11/ 2	*****-----			
235	8/23	****-----*	307	11/ 3	*****-----			
236	8/24	*****-----*	308	11/ 4	*****-----			
237	8/25	-----***	309	11/ 5	**-----			
238	8/26	*****-----*	310	11/ 6	-----			
239	8/27	*****-----*	311	11/ 7	-----*			
240	8/28	*****-----*	312	11/ 8	*-----*			
241	8/29	*****-----*	313	11/ 9	*****-----			
242	8/30	*****-----*	314	11/10	*****-----			
243	8/31	*****-----*	315	11/11	-----			
244	9/ 1	*****-----*	316	11/12	-----			
245	9/ 2	*****-----*	317	11/13	-----			
246	9/ 3	*****-----*	318	11/14	-----**			
247	9/ 4	*****-----*	319	11/15	*****-----			
248	9/ 5	*****-----*	320	11/16	*****-----			
249	9/ 6	*****-----*	321	11/17	*****-----			
250	9/ 7	*****-----*	322	11/18	-----			
251	9/ 8	*****-----*	323	11/19	-----			
252	9/ 9	*****-----*	324	11/20	-----			
253	9/10	**-----*	325	11/21	-----			
254	9/11	*****-----*	326	11/22	-**-----*			
255	9/12	**-----*	327	11/23	*****-----			
256	9/13	*****-----*	328	11/24	*-----*			
257	9/14	*****-----*	329	11/25	-----			
258	9/15	*-----*	330	11/26	-----			
259	9/16	*-----*	331	11/27	-----			
260	9/17	**-----*	332	11/28	-----			
261	9/18	*****-----*	333	11/29	-----			
262	9/19	*****-----*	334	11/30	-----			
263	9/20	*****-----*	335	12/ 1	-----			
264	9/21	**-----*	336	12/ 2	-----			
265	9/22	*****-----*	337	12/ 3	-----			
266	9/23	-----	338	12/ 4	-----			
267	9/24	*****-----*	339	12/ 5	-----			
268	9/25	*****-----*	340	12/ 6	-----			
269	9/26	-----	341	12/ 7	-----			
270	9/27	*****-----*	342	12/ 8	-----			
271	9/28	*****-----*	343	12/ 9	-----			
272	9/29	-----*	344	12/10	-----			
273	9/30	-**-----*	345	12/11	-----*			
274	10/ 1	*****-----*	346	12/12	-----*			
275	10/ 2	-----*	347	12/13	-----			
276	10/ 3	*-----*	348	12/14	*****-----			
277	10/ 4	*-----*	349	12/15	-----			
278	10/ 5	*****-----*	350	12/16	-----			
279	10/ 6	*****-----*	351	12/17	-----*			
280	10/ 7	*****-----*	352	12/18	-----			
281	10/ 8	*****-----*	353	12/19	-----			
282	10/ 9	-----	354	12/20	-----			
283	10/10	-----	355	12/21	*****-----			
284	10/11	-----	356	12/22	-----***			
285	10/12	-----	357	12/23	*****-----			
286	10/13	*****-----	358	12/24	**-----*			
287	10/14	-----	359	12/25	-----			
288	10/15	-----	360	12/26	-----			

1993, DAV Uptime

1	1/1	72	3/13	144	5/24
2	1/2	73	3/14	145	5/25
3	1/3	74	3/15	146	5/26
4	1/4	75	3/16	147	5/27
5	1/5	76	3/17	148	5/28
6	1/6	77	3/18	149	5/29
7	1/7	78	3/19	150	5/30
8	1/8	79	3/20	151	5/31
9	1/9	80	3/21	152	6/1
10	1/10	81	3/22	153	6/2
11	1/11	82	3/23	154	6/3
12	1/12	83	3/24	155	6/4
13	1/13	84	3/25	156	6/5
14	1/14	85	3/26	157	6/6
15	1/15	86	3/27	158	6/7
16	1/16	87	3/28	159	6/8
17	1/17	88	3/29	160	6/9
18	1/18	89	3/30	161	6/10
19	1/19	90	3/31	162	6/11
20	1/20	91	4/1	163	6/12
21	1/21	92	4/2	164	6/13
22	1/22	93	4/3	165	6/14
23	1/23	94	4/4	166	6/15
24	1/24	95	4/5	167	6/16
25	1/25	96	4/6	168	6/17
26	1/26	97	4/7	169	6/18
27	1/27	98	4/8	170	6/19
28	1/28	99	4/9	171	6/20
29	1/29	100	4/10	172	6/21
30	1/30	101	4/11	173	6/22
31	1/31	102	4/12	174	6/23
32	2/1	103	4/13	175	6/24
33	2/2	104	4/14	176	6/25
34	2/3	105	4/15	177	6/26
35	2/4	106	4/16	178	6/27
36	2/5	107	4/17	179	6/28
37	2/6	108	4/18	180	6/29
38	2/7	109	4/19	181	6/30
39	2/8	110	4/20	182	7/1
40	2/9	111	4/21	183	7/2
41	2/10	112	4/22	184	7/3
42	2/11	113	4/23	185	7/4
43	2/12	114	4/24	186	7/5
44	2/13	115	4/25	187	7/6
45	2/14	116	4/26	188	7/7
46	2/15	117	4/27	189	7/8
47	2/16	118	4/28	190	7/9
48	2/17	119	4/29	191	7/10
49	2/18	120	4/30	192	7/11
50	2/19	121	5/1	193	7/12
51	2/20	122	5/2	194	7/13
52	2/21	123	5/3	195	7/14
53	2/22	124	5/4	196	7/15
54	2/23	125	5/5	197	7/16
55	2/24	126	5/6	198	7/17
56	2/25	127	5/7	199	7/18
57	2/26	128	5/8	200	7/19
58	2/27	129	5/9	201	7/20
59	2/28	130	5/10	202	7/21
60	3/1	131	5/11	203	7/22
61	3/2	132	5/12	204	7/23
62	3/3	133	5/13	205	7/24
63	3/4	134	5/14	206	7/25
64	3/5	135	5/15	207	7/26
65	3/6	136	5/16	208	7/27
66	3/7	137	5/17	209	7/28
67	3/8	138	5/18	210	7/29
68	3/9	139	5/19	211	7/30
69	3/10	140	5/20	212	7/31
70	3/11	141	5/21	213	8/1
71	3/12	142	5/22	214	8/2
		143	5/23	215	8/3

216	8/ 4	-----	288	10/15	*****	-----	360	12/26	-----
217	8/ 5	-----	289	10/16	-----*	-----	361	12/27	-----*
218	8/ 6	-----	290	10/17	-----	-----	362	12/28	-----*
219	8/ 7	-----*	291	10/18	-----*	-----	363	12/29	-----*
220	8/ 8	-----	292	10/19	-----*	-----	364	12/30	-----*
221	8/ 9	-----*	293	10/20	-----	-----	365	12/31	****
222	8/10	-----*	294	10/21	-----*	-----			
223	8/11	-----*	295	10/22	-----*	-----			
224	8/12	*****	296	10/23	-----*	-----			
225	8/13	-----*	297	10/24	-----	-----			
226	8/14	-----*	298	10/25	-----*	-----			
227	8/15	-----	299	10/26	-----*	-----			
228	8/16	-----*	300	10/27	-----*	-----			
229	8/17	-----*	301	10/28	-----*	-----			
230	8/18	*****	302	10/29	-----*	-----			
231	8/19	-----*	303	10/30	-----	-----			
232	8/20	-----*	304	10/31	-----*	-----			
233	8/21	-----	305	11/ 1	-----*	-----			
234	8/22	-----*	306	11/ 2	-----*	-----			
235	8/23	-----*	307	11/ 3	-----*	-----			
236	8/24	-----*	308	11/ 4	-----*	-----			
237	8/25	-----*	309	11/ 5	-----*	-----			
238	8/26	-----	310	11/ 6	-----	-----			
239	8/27	-----	311	11/ 7	-----*	-----			
240	8/28	-----*	312	11/ 8	-----*	-----			
241	8/29	-----*	313	11/ 9	-----*	-----			
242	8/30	*****	314	11/10	-----*	-----			
243	8/31	-----*	315	11/11	-----	-----			
244	9/ 1	*****	316	11/12	-----*	-----			
245	9/ 2	*****	317	11/13	*****	-----			
246	9/ 3	-----*	318	11/14	-----	-----			
247	9/ 4	-----*	319	11/15	-----*	-----			
248	9/ 5	-----*	320	11/16	-----	-----			
249	9/ 6	-----*	321	11/17	-----*	-----			
250	9/ 7	-----*	322	11/18	-----*	-----			
251	9/ 8	*****	323	11/19	-----	-----			
252	9/ 9	-----*	324	11/20	-----*	-----			
253	9/10	-----*	325	11/21	-----	-----			
254	9/11	-----*	326	11/22	-----*	-----			
255	9/12	-----	327	11/23	-----*	-----			
256	9/13	-----*	328	11/24	-----	-----			
257	9/14	*****	329	11/25	-----*	-----			
258	9/15	*****	330	11/26	-----*	-----*			
259	9/16	-----*	331	11/27	-----*	-----*			
260	9/17	-----*	332	11/28	-----*	-----*			
261	9/18	-----*	333	11/29	-----*	-----*			
262	9/19	-----*	334	11/30	*****	-----*			
263	9/20	-----*	335	12/ 1	-----*	-----*			
264	9/21	-----*	336	12/ 2	*****	-----*			
265	9/22	-----*	337	12/ 3	-----*	-----			
266	9/23	-----*	338	12/ 4	-----	-----			
267	9/24	-----*	339	12/ 5	-----	-----			
268	9/25	-----*	340	12/ 6	-----	-----			
269	9/26	-----*	341	12/ 7	-----*	-----			
270	9/27	-----*	342	12/ 8	-----*	-----*			
271	9/28	-----*	343	12/ 9	-----	-----			
272	9/29	-----	344	12/10	-----*	-----*			
273	9/30	-----*	345	12/11	*****	-----*			
274	10/ 1	-----*	346	12/12	*****	-----*			
275	10/ 2	*****	347	12/13	-----*	-----			
276	10/ 3	*****	348	12/14	-----*	-----			
277	10/ 4	*****	349	12/15	-----*	-----			
278	10/ 5	-----*	350	12/16	-----*	-----*			
279	10/ 6	-----*	351	12/17	-----*	-----			
280	10/ 7	-----*	352	12/18	-----	-----			
281	10/ 8	-----*	353	12/19	-----	-----			
282	10/ 9	-----*	354	12/20	-----	-----			
283	10/10	*****	355	12/21	-----*	-----			
284	10/11	-----*	356	12/22	-----*	-----			
285	10/12	-----*	357	12/23	-----*	-----			
286	10/13	-----*	358	12/24	-----	-----			
287	10/14	-----*	359	12/25	-----*	-----			

```

1993, MCC Uptime
 1 1/ 1 -----*---
 2 1/ 2 -----
 3 1/ 3 ----*-----
 4 1/ 4 -----*-----
 5 1/ 5 ----*-----*
 6 1/ 6 *-----*-----*
 7 1/ 7 *-----*-----*
 8 1/ 8 -----*-----*
 9 1/ 9 -----*-----
10 1/10 -----
11 1/11 -----*-----
12 1/12 -----*-----
13 1/13 *-----*-----*
14 1/14 *-----*-----*
15 1/15 *-----*-----*
16 1/16 -----*-----
17 1/17 -----
18 1/18 -----*-----
19 1/19 *-----*-----*
20 1/20 -----
21 1/21 -----
22 1/22 -----*-----
23 1/23 -----
24 1/24 -----*-----*
25 1/25 *-----*-----*
26 1/26 -----*-----*
27 1/27 ----*-----*-----
28 1/28 -----*-----*
29 1/29 -----*-----*
30 1/30 -----*-----*
31 1/31 *-----*-----*
32 2/ 1 -----*-----*
33 2/ 2 -----*-----*
34 2/ 3 -----*-----*
35 2/ 4 *-----*-----*
36 2/ 5 *-----*-----*
37 2/ 6 *-----*-----*
38 2/ 7 -----*-----*
39 2/ 8 -----*-----*
40 2/ 9 -----*-----*
41 2/10 -----*-----*
42 2/11 -----*-----*
43 2/12 -----*-----*
44 2/13 -----*-----*
45 2/14 -----*-----*
46 2/15 -----*-----*
47 2/16 *-----*-----*
48 2/17 -----*-----*
49 2/18 *-----*-----*
50 2/19 *-----*-----*
51 2/20 *-----*-----*
52 2/21 *-----*-----*
53 2/22 *-----*-----*
54 2/23 *-----*-----*
55 2/24 *-----*-----*
56 2/25 *-----*-----*
57 2/26 *-----*-----*
58 2/27 *-----*-----*
59 2/28 *-----*-----*
60 3/ 1 *-----*-----*
61 3/ 2 *-----*-----*
62 3/ 3 *-----*-----*
63 3/ 4 -----*-----*
64 3/ 5 *-----*-----*
65 3/ 6 *-----*-----*
66 3/ 7 *-----*-----*
67 3/ 8 -----*-----*
68 3/ 9 -----*-----*
69 3/10 *-----*-----*
70 3/11 *-----*-----*
71 3/12 -----*-----*
 72 3/13 *-----*-----
 73 3/14 *-----*-----
 74 3/15 -----*-----
 75 3/16 *-----*-----*
 76 3/17 *-----*-----*
 77 3/18 *-----*-----
 78 3/19 -----*-----
 79 3/20 -----*-----
 80 3/21 -----*-----
 81 3/22 -----*-----*
 82 3/23 -----*-----*
 83 3/24 *-----*-----*
 84 3/25 *-----*-----*
 85 3/26 *-----*-----*
 86 3/27 -----*-----*
 87 3/28 -----*-----*
 88 3/29 -----*-----*
 89 3/30 *-----*-----*
 90 3/31 -----*-----*
 91 4/ 1 -----*-----*
 92 4/ 2 *-----*-----
 93 4/ 3 -----*-----
 94 4/ 4 -----*-----
 95 4/ 5 -----*-----*
 96 4/ 6 *-----*-----*
 97 4/ 7 -----*-----*
 98 4/ 8 -----*-----*
 99 4/ 9 *-----*-----*
100 4/10 *-----*-----*
101 4/11 -----*-----*
102 4/12 *-----*-----*
103 4/13 -----*-----*
104 4/14 -----*-----*
105 4/15 -----*-----*
106 4/16 -----*-----*
107 4/17 -----*-----*
108 4/18 -----*-----*
109 4/19 -----*-----*
110 4/20 -----*-----*
111 4/21 -----*-----*
112 4/22 -----*-----*
113 4/23 -----*-----*
114 4/24 -----*-----*
115 4/25 -----*-----*
116 4/26 -----*-----*
117 4/27 -----*-----*
118 4/28 -----*-----*
119 4/29 -----*-----*
120 4/30 -----*-----*
121 5/ 1 -----*-----*
122 5/ 2 -----*-----*
123 5/ 3 -----*-----*
124 5/ 4 -----*-----*
125 5/ 5 -----*-----*
126 5/ 6 -----*-----*
127 5/ 7 -----*-----*
128 5/ 8 -----*-----*
129 5/ 9 -----*-----*
130 5/10 -----*-----*
131 5/11 -----*-----*
132 5/12 -----*-----*
133 5/13 -----*-----*
134 5/14 -----*-----*
135 5/15 -----*-----*
136 5/16 -----*-----*
137 5/17 -----*-----*
138 5/18 -----*-----*
139 5/19 -----*-----*
140 5/20 -----*-----*
141 5/21 -----*-----*
142 5/22 -----*-----*
143 5/23 -----*-----*
144 5/24 -----*-----*
145 5/25 -----*-----*
146 5/26 -----*-----*
147 5/27 -----*-----*
148 5/28 -----*-----*
149 5/29 -----*-----*
150 5/30 -----*-----*
151 5/31 *-----*-----*
152 6/ 1 *-----*-----*
153 6/ 2 -----*-----*
154 6/ 3 -----*-----*
155 6/ 4 -----*-----*
156 6/ 5 -----*-----*
157 6/ 6 -----*-----*
158 6/ 7 -----*-----*
159 6/ 8 -----*-----*
160 6/ 9 -----*-----*
161 6/10 -----*-----*
162 6/11 -----*-----*
163 6/12 -----*-----*
164 6/13 -----*-----*
165 6/14 -----*-----*
166 6/15 -----*-----*
167 6/16 -----*-----*
168 6/17 -----*-----*
169 6/18 -----*-----*
170 6/19 -----*-----*
171 6/20 -----*-----*
172 6/21 -----*-----*
173 6/22 -----*-----*
174 6/23 -----*-----*
175 6/24 -----*-----*
176 6/25 -----*-----*
177 6/26 -----*-----*
178 6/27 -----*-----*
179 6/28 -----*-----*
180 6/29 -----*-----*
181 6/30 -----*-----*
182 7/ 1 -----*-----*
183 7/ 2 -----*-----*
184 7/ 3 -----*-----*
185 7/ 4 -----*-----*
186 7/ 5 -----*-----*
187 7/ 6 -----*-----*
188 7/ 7 -----*-----*
189 7/ 8 -----*-----*
190 7/ 9 -----*-----*
191 7/10 -----*-----*
192 7/11 -----*-----*
193 7/12 -----*-----*
194 7/13 -----*-----*
195 7/14 -----*-----*
196 7/15 -----*-----*
197 7/16 -----*-----*
198 7/17 -----*-----*
199 7/18 -----*-----*
200 7/19 -----*-----*
201 7/20 -----*-----*
202 7/21 -----*-----*
203 7/22 *-----*-----*
204 7/23 *-----*-----*
205 7/24 *-----*-----*
206 7/25 *-----*-----*
207 7/26 *-----*-----*
208 7/27 *-----*-----*
209 7/28 *-----*-----*
210 7/29 *-----*-----*
211 7/30 *-----*-----*
212 7/31 *-----*-----*
213 8/ 1 *-----*-----*
214 8/ 2 *-----*-----*
215 8/ 3 *-----*-----*

```

216	8/ 4	*****	288	10/15	*****	360	12/26	*****
217	8/ 5	*****	289	10/16	*****	361	12/27	*****
218	8/ 6	*****	290	10/17	*****	362	12/28	*****
219	8/ 7	*****	291	10/18	*****	363	12/29	*****
220	8/ 8	*****	292	10/19	*****	364	12/30	*****
221	8/ 9	*****	293	10/20	*****	365	12/31	*****
222	8/10	*****	294	10/21	*****			
223	8/11	*****	295	10/22	*****			
224	8/12	*****	296	10/23	*****			
225	8/13	*****	297	10/24	*****			
226	8/14	*****	298	10/25	*****			
227	8/15	*****	299	10/26	*****			
228	8/16	*****	300	10/27	*****			
229	8/17	*****	301	10/28	*****			
230	8/18	*****	302	10/29	*****			
231	8/19	*****	303	10/30	*****			
232	8/20	*****	304	10/31	*****			
233	8/21	*****	305	11/ 1	*****			
234	8/22	*****	306	11/ 2	*****			
235	8/23	*****	307	11/ 3	*****			
236	8/24	*****	308	11/ 4	*****			
237	8/25	*****	309	11/ 5	*****			
238	8/26	*****	310	11/ 6	*****			
239	8/27	*****	311	11/ 7	*****			
240	8/28	*****	312	11/ 8	*****			
241	8/29	*****	313	11/ 9	*****			
242	8/30	*****	314	11/10	*****			
243	8/31	*****	315	11/11	*****			
244	9/ 1	*****	316	11/12	*****			
245	9/ 2	*****	317	11/13	*****			
246	9/ 3	*****	318	11/14	*****			
247	9/ 4	*****	319	11/15	*****			
248	9/ 5	*****	320	11/16	*****			
249	9/ 6	*****	321	11/17	*****			
250	9/ 7	*****	322	11/18	*****			
251	9/ 8	*****	323	11/19	*****			
252	9/ 9	*****	324	11/20	*****			
253	9/10	*****	325	11/21	*****			
254	9/11	*****	326	11/22	*****			
255	9/12	*****	327	11/23	*****			
256	9/13	*****	328	11/24	*****			
257	9/14	*****	329	11/25	*****			
258	9/15	*****	330	11/26	*****			
259	9/16	*****	331	11/27	*****			
260	9/17	*****	332	11/28	*****			
261	9/18	*****	333	11/29	*****			
262	9/19	*****	334	11/30	*****			
263	9/20	*****	335	12/ 1	*****			
264	9/21	*****	336	12/ 2	*****			
265	9/22	*****	337	12/ 3	*****			
266	9/23	*****	338	12/ 4	*****			
267	9/24	*****	339	12/ 5	*****			
268	9/25	*****	340	12/ 6	*****			
269	9/26	*****	341	12/ 7	*****			
270	9/27	*****	342	12/ 8	*****			
271	9/28	*****	343	12/ 9	*****			
272	9/29	*****	344	12/10	*****			
273	9/30	*****	345	12/11	*****			
274	10/ 1	*****	346	12/12	*****			
275	10/ 2	*****	347	12/13	*****			
276	10/ 3	*****	348	12/14	*****			
277	10/ 4	*****	349	12/15	*****			
278	10/ 5	*****	350	12/16	*****			
279	10/ 6	*****	351	12/17	*****			
280	10/ 7	*****	352	12/18	*****			
281	10/ 8	*****	353	12/19	*****			
282	10/ 9	*****	354	12/20	*****			
283	10/10	*****	355	12/21	*****			
284	10/11	*****	356	12/22	*****			
285	10/12	*****	357	12/23	*****			
286	10/13	*****	358	12/24	*****			
287	10/14	*****	359	12/25	*****			

1993, MCD Uptime

1	1/ 1	-----*---	72	3/13	*****-----	144	5/24	-----
2	1/ 2	-----	73	3/14	*-----	145	5/25	-----
3	1/ 3	-----*	74	3/15	-----	146	5/26	-----
4	1/ 4	-----*****	75	3/16	-----*****	147	5/27	-----
5	1/ 5	-----*-----*	76	3/17	***-----*	148	5/28	-----*
6	1/ 6	*-----*	77	3/18	**-----	149	5/29	-----
7	1/ 7	***-----*	78	3/19	-----	150	5/30	-----**
8	1/ 8	-----*	79	3/20	-----	151	5/31	*****-----*
9	1/ 9	-----*	80	3/21	-----	152	6/ 1	*****-----*
10	1/10	-----	81	3/22	-----*****	153	6/ 2	-----*
11	1/11	-----*	82	3/23	-----*****	154	6/ 3	-----
12	1/12	-----*	83	3/24	-----*****	155	6/ 4	-----
13	1/13	***-----*	84	3/25	*****-----*	156	6/ 5	-----
14	1/14	*****-----*	85	3/26	*****-----*	157	6/ 6	-----
15	1/15	*****-----*	86	3/27	-----*	158	6/ 7	-----
16	1/16	-----*	87	3/28	-----*	159	6/ 8	-----
17	1/17	-----	88	3/29	-----*	160	6/ 9	-----
18	1/18	-----*	89	3/30	*****-----*	161	6/10	-----
19	1/19	***-----*	90	3/31	-----*	162	6/11	-----
20	1/20	-----	91	4/ 1	-----*	163	6/12	-----
21	1/21	-----	92	4/ 2	-----*	164	6/13	-----
22	1/22	-----*	93	4/ 3	-----	165	6/14	-----
23	1/23	-----	94	4/ 4	-----	166	6/15	-----
24	1/24	-----*	95	4/ 5	-----*	167	6/16	-----
25	1/25	***-----*	96	4/ 6	***-----*	168	6/17	-----
26	1/26	-----*	97	4/ 7	-----*	169	6/18	-----
27	1/27	-----*	98	4/ 8	-----*	170	6/19	-----
28	1/28	-----*	99	4/ 9	*****-----*	171	6/20	-----
29	1/29	-----*	100	4/10	*****-----*	172	6/21	-----
30	1/30	*****-----*	101	4/11	*****-----*	173	6/22	-----
31	1/31	***-----*	102	4/12	***-----*	174	6/23	-----
32	2/ 1	-----*	103	4/13	-----	175	6/24	-----
33	2/ 2	-----*	104	4/14	-----	176	6/25	-----
34	2/ 3	-----*	105	4/15	-----	177	6/26	-----
35	2/ 4	-----*	106	4/16	-----	178	6/27	-----
36	2/ 5	***-----*	107	4/17	-----	179	6/28	-----
37	2/ 6	*****-----	108	4/18	-----	180	6/29	-----
38	2/ 7	-----*	109	4/19	-----	181	6/30	-----
39	2/ 8	-----*	110	4/20	-----	182	7/ 1	-----
40	2/ 9	-----*	111	4/21	-----	183	7/ 2	-----
41	2/10	-----*	112	4/22	-----	184	7/ 3	-----
42	2/11	-----*	113	4/23	-----	185	7/ 4	-----
43	2/12	-----*	114	4/24	-----	186	7/ 5	-----
44	2/13	-----*	115	4/25	-----	187	7/ 6	-----
45	2/14	-----*	116	4/26	-----	188	7/ 7	-----
46	2/15	-----*	117	4/27	-----	189	7/ 8	-----
47	2/16	*****-----*	118	4/28	-----	190	7/ 9	-----
48	2/17	-----*	119	4/29	-----	191	7/10	-----
49	2/18	***-----*	120	4/30	-----	192	7/11	-----
50	2/19	*****-----*	121	5/ 1	-----*	193	7/12	-----
51	2/20	*****-----*	122	5/ 2	-----	194	7/13	-----
52	2/21	***-----*	123	5/ 3	-----	195	7/14	-----
53	2/22	*****-----*	124	5/ 4	-----	196	7/15	-----
54	2/23	*****-----*	125	5/ 5	-----	197	7/16	-----
55	2/24	*****-----*	126	5/ 6	-----	198	7/17	-----
56	2/25	*****-----*	127	5/ 7	-----	199	7/18	-----
57	2/26	*****-----*	128	5/ 8	-----	200	7/19	-----
58	2/27	*****-----*	129	5/ 9	-----	201	7/20	-----
59	2/28	*****-----*	130	5/10	-----	202	7/21	-----
60	3/ 1	*****-----*	131	5/11	-----	203	7/22	-----
61	3/ 2	***-----*	132	5/12	-----	204	7/23	*****
62	3/ 3	***-----*	133	5/13	-----	205	7/24	*****
63	3/ 4	-----*	134	5/14	-----	206	7/25	*****
64	3/ 5	-----*	135	5/15	-----	207	7/26	*****
65	3/ 6	*****-----*	136	5/16	-----	208	7/27	*****
66	3/ 7	-----*	137	5/17	-----	209	7/28	*****
67	3/ 8	-----*	138	5/18	-----	210	7/29	*****
68	3/ 9	-----*	139	5/19	-----	211	7/30	*****
69	3/10	*****-----*	140	5/20	-----	212	7/31	*****
70	3/11	*****-----*	141	5/21	-----	213	8/ 1	*****
71	3/12	*****-----*	142	5/22	-----*	214	8/ 2	*****
			143	5/23	-----*	215	8/ 3	*****

216	8/ 4	*****	288	10/15	*****	360	12/26	*****
217	8/ 5	*****	289	10/16	*****	361	12/27	*****
218	8/ 6	*****	290	10/17	*****	362	12/28	*****
219	8/ 7	*****	291	10/18	*****	363	12/29	*****
220	8/ 8	*****	292	10/19	*****	364	12/30	*****
221	8/ 9	*****	293	10/20	*****	365	12/31	*****
222	8/10	*****	294	10/21	*****			
223	8/11	*****	295	10/22	*****			
224	8/12	*****	296	10/23	*****			
225	8/13	*****	297	10/24	*****			
226	8/14	*****	298	10/25	*****			
227	8/15	*****	299	10/26	*****			
228	8/16	*****	300	10/27	*****			
229	8/17	*****	301	10/28	*****			
230	8/18	*****	302	10/29	*****			
231	8/19	*****	303	10/30	*****			
232	8/20	*****	304	10/31	*****			
233	8/21	*****	305	11/ 1	*****			
234	8/22	*****	306	11/ 2	*****			
235	8/23	*****	307	11/ 3	*****			
236	8/24	*****	308	11/ 4	*****			
237	8/25	*****	309	11/ 5	*****			
238	8/26	*****	310	11/ 6	*****			
239	8/27	*****	311	11/ 7	*****			
240	8/28	*****	312	11/ 8	*****			
241	8/29	*****	313	11/ 9	*****			
242	8/30	*****	314	11/10	*****			
243	8/31	*****	315	11/11	*****			
244	9/ 1	*****	316	11/12	*****			
245	9/ 2	*****	317	11/13	*****			
246	9/ 3	*****	318	11/14	*****			
247	9/ 4	*****	319	11/15	*****			
248	9/ 5	*****	320	11/16	*****			
249	9/ 6	*****	321	11/17	*****			
250	9/ 7	*****	322	11/18	*****			
251	9/ 8	*****	323	11/19	*****			
252	9/ 9	*****	324	11/20	*****			
253	9/10	*****	325	11/21	*****			
254	9/11	*****	326	11/22	*****			
255	9/12	*****	327	11/23	*****			
256	9/13	*****	328	11/24	*****			
257	9/14	*****	329	11/25	*****			
258	9/15	*****	330	11/26	*****			
259	9/16	*****	331	11/27	*****			
260	9/17	*****	332	11/28	*****			
261	9/18	*****	333	11/29	*****			
262	9/19	*****	334	11/30	*****			
263	9/20	*****	335	12/ 1	*****			
264	9/21	*****	336	12/ 2	*****			
265	9/22	*****	337	12/ 3	*****			
266	9/23	*****	338	12/ 4	*****			
267	9/24	*****	339	12/ 5	*****			
268	9/25	*****	340	12/ 6	*****			
269	9/26	*****	341	12/ 7	*****			
270	9/27	*****	342	12/ 8	*****			
271	9/28	*****	343	12/ 9	*****			
272	9/29	*****	344	12/10	*****			
273	9/30	*****	345	12/11	*****			
274	10/ 1	*****	346	12/12	*****			
275	10/ 2	*****	347	12/13	*****			
276	10/ 3	*****	348	12/14	*****			
277	10/ 4	*****	349	12/15	*****			
278	10/ 5	*****	350	12/16	*****			
279	10/ 6	*****	351	12/17	*****			
280	10/ 7	*****	352	12/18	*****			
281	10/ 8	*****	353	12/19	*****			
282	10/ 9	*****	354	12/20	*****			
283	10/10	*****	355	12/21	*****			
284	10/11	*****	356	12/22	*****			
285	10/12	*****	357	12/23	*****			
286	10/13	*****	358	12/24	*****			
287	10/14	*****	359	12/25	*****			

1993, SAL Uptime

1	1/ 1	*****	72	3/13	-----	144	5/24	-----
2	1/ 2	*****	73	3/14	-----	145	5/25	-----
3	1/ 3	*****	74	3/15	-----	146	5/26	-----
4	1/ 4	*****	75	3/16	-----	147	5/27	-----
5	1/ 5	*****	76	3/17	-----	148	5/28	*****
6	1/ 6	*****	77	3/18	*****	149	5/29	*****
7	1/ 7	*****	78	3/19	*****	150	5/30	*****
8	1/ 8	*****	79	3/20	*****	151	5/31	*****
9	1/ 9	*****	80	3/21	*****	152	6/ 1	*****
10	1/10	*****	81	3/22	*****	153	6/ 2	*****
11	1/11	*****	82	3/23	*****	154	6/ 3	*****
12	1/12	*****	83	3/24	*****	155	6/ 4	*****
13	1/13	*****	84	3/25	*****	156	6/ 5	*****
14	1/14	*****	85	3/26	*****	157	6/ 6	*****
15	1/15	*****	86	3/27	-----	158	6/ 7	*****
16	1/16	-----	87	3/28	-----*	159	6/ 8	*****
17	1/17	-----*	88	3/29	-----*	160	6/ 9	*****
18	1/18	*****	89	3/30	*****	161	6/10	*****
19	1/19	*****	90	3/31	-----*	162	6/11	*****
20	1/20	*****	91	4/ 1	-----*--*--*--*	163	6/12	*****
21	1/21	*****	92	4/ 2	-----*	164	6/13	*****
22	1/22	*****	93	4/ 3	-----	165	6/14	*****
23	1/23	*-----*	94	4/ 4	-----	166	6/15	*****
24	1/24	*****	95	4/ 5	*****	167	6/16	*****
25	1/25	*****	96	4/ 6	*****	168	6/17	*****
26	1/26	*****	97	4/ 7	*****	169	6/18	*****
27	1/27	-----*	98	4/ 8	*****	170	6/19	*****
28	1/28	-----*	99	4/ 9	*****	171	6/20	*****
29	1/29	-----*	100	4/10	*****	172	6/21	-----*
30	1/30	-----*	101	4/11	*****	173	6/22	-----
31	1/31	*****	102	4/12	*****	174	6/23	*****
32	2/ 1	*****	103	4/13	*****	175	6/24	*****
33	2/ 2	*-----*	104	4/14	*****	176	6/25	*****
34	2/ 3	-----*	105	4/15	*****	177	6/26	*****
35	2/ 4	*-----*	106	4/16	*****	178	6/27	*****
36	2/ 5	*****	107	4/17	*****	179	6/28	*****
37	2/ 6	*****	108	4/18	*****	180	6/29	*****
38	2/ 7	*****	109	4/19	*****	181	6/30	*****
39	2/ 8	-----*	110	4/20	*****	182	7/ 1	*****
40	2/ 9	-----*	111	4/21	*****	183	7/ 2	*****
41	2/10	-----*	112	4/22	*****	184	7/ 3	-----
42	2/11	-----*	113	4/23	-----*	185	7/ 4	-----*
43	2/12	-----*	114	4/24	*****	186	7/ 5	-----
44	2/13	-----*	115	4/25	*****	187	7/ 6	*****
45	2/14	-----*	116	4/26	*****	188	7/ 7	*****
46	2/15	-----*	117	4/27	*****	189	7/ 8	*****
47	2/16	*****	118	4/28	*****	190	7/ 9	*****
48	2/17	-----*	119	4/29	*****	191	7/10	*****
49	2/18	*****	120	4/30	*****	192	7/11	*****
50	2/19	*****	121	5/ 1	-----	193	7/12	*****
51	2/20	*****	122	5/ 2	-----	194	7/13	*****
52	2/21	*****	123	5/ 3	-----*	195	7/14	*****
53	2/22	*****	124	5/ 4	*****	196	7/15	*****
54	2/23	*****	125	5/ 5	*****	197	7/16	*****
55	2/24	*****	126	5/ 6	*****	198	7/17	-----*
56	2/25	*****	127	5/ 7	*****	199	7/18	*****
57	2/26	*****	128	5/ 8	*****	200	7/19	*****
58	2/27	*****	129	5/ 9	*****	201	7/20	*****
59	2/28	*****	130	5/10	*****	202	7/21	*****
60	3/ 1	*****	131	5/11	*****	203	7/22	*****
61	3/ 2	*****	132	5/12	*****	204	7/23	*****
62	3/ 3	*****	133	5/13	-----*	205	7/24	-----*
63	3/ 4	*****	134	5/14	-----	206	7/25	-----*
64	3/ 5	*****	135	5/15	-----	207	7/26	*****
65	3/ 6	*****	136	5/16	-----	208	7/27	*****
66	3/ 7	*****	137	5/17	-----	209	7/28	*****
67	3/ 8	*****	138	5/18	-----	210	7/29	*****
68	3/ 9	-----*	139	5/19	-----	211	7/30	*****
69	3/10	*****	140	5/20	-----	212	7/31	*****
70	3/11	*****	141	5/21	-----	213	8/ 1	*****
71	3/12	*****	142	5/22	-----	214	8/ 2	*****
			143	5/23	-----	215	8/ 3	*****

216	8/ 4	*****	288	10/15	*****	360	12/26	*****
217	8/ 5	*****	289	10/16	*****	361	12/27	***-***-----
218	8/ 6	*****	290	10/17	*****	362	12/28	-----*****-----
219	8/ 7	*****	291	10/18	*****	363	12/29	-----*-----
220	8/ 8	*****	292	10/19	*****	364	12/30	-----*****-*
221	8/ 9	*****	293	10/20	*****	365	12/31	***-----
222	8/10	*****	294	10/21	*****			
223	8/11	*****	295	10/22	*****-----			
224	8/12	*****	296	10/23	-----*****-----			
225	8/13	*****-----	297	10/24	-----			
226	8/14	-----	298	10/25	*****			
227	8/15	-----*	299	10/26	*****			
228	8/16	*****	300	10/27	*****			
229	8/17	*****	301	10/28	*****			
230	8/18	*****-----*	302	10/29	*****			
231	8/19	*****	303	10/30	*****			
232	8/20	*****	304	10/31	*****			
233	8/21	*****	305	11/ 1	*****			
234	8/22	*****	306	11/ 2	*****			
235	8/23	*****	307	11/ 3	*****-_*--*			
236	8/24	*****	308	11/ 4	*****			
237	8/25	*****	309	11/ 5	*****			
238	8/26	*****	310	11/ 6	*****			
239	8/27	*****	311	11/ 7	*****			
240	8/28	*****	312	11/ 8	*****			
241	8/29	*****	313	11/ 9	*****			
242	8/30	*****	314	11/10	*****-----*			
243	8/31	*****	315	11/11	*****			
244	9/ 1	*****	316	11/12	*****			
245	9/ 2	*****	317	11/13	*****			
246	9/ 3	*****_*-----	318	11/14	***-----*			
247	9/ 4	-----	319	11/15	-----***_*-----*			
248	9/ 5	-----	320	11/16	---*_*****			
249	9/ 6	**_*-----	321	11/17	*****			
250	9/ 7	-----*	322	11/18	*****_*			
251	9/ 8	*****	323	11/19	*****			
252	9/ 9	*****	324	11/20	*****			
253	9/10	*****	325	11/21	*****			
254	9/11	*****	326	11/22	*****			
255	9/12	*****	327	11/23	*****			
256	9/13	*****	328	11/24	*****			
257	9/14	***-----	329	11/25	*****			
258	9/15	*****-----*	330	11/26	*****			
259	9/16	*****	331	11/27	*****-----			
260	9/17	*****	332	11/28	-----*			
261	9/18	*****	333	11/29	*****			
262	9/19	*****	334	11/30	*****			
263	9/20	*****	335	12/ 1	*****			
264	9/21	*****	336	12/ 2	-----*****			
265	9/22	*****	337	12/ 3	*****			
266	9/23	*****_*-----	338	12/ 4	*****			
267	9/24	---*****	339	12/ 5	*****			
268	9/25	*****_*-----	340	12/ 6	*_******			
269	9/26	-----*	341	12/ 7	*****			
270	9/27	*****	342	12/ 8	*****			
271	9/28	*****	343	12/ 9	*****			
272	9/29	*****	344	12/10	*****			
273	9/30	*****	345	12/11	*****_*			
274	10/ 1	*****	346	12/12	*****			
275	10/ 2	*****	347	12/13	*****			
276	10/ 3	*****	348	12/14	*****			
277	10/ 4	*****	349	12/15	***-----			
278	10/ 5	*****	350	12/16	-----*_*-----			
279	10/ 6	*****	351	12/17	*****			
280	10/ 7	*****	352	12/18	**_*-----			
281	10/ 8	*****	353	12/19	-----			
282	10/ 9	*****	354	12/20	---*****			
283	10/10	*****	355	12/21	*****			
284	10/11	-----*_*-----*	356	12/22	*_*-----			
285	10/12	-----*_*-----*	357	12/23	*****			
286	10/13	*****	358	12/24	*****			
287	10/14	*****	359	12/25	*****			

1994, CHC Uptime

1	1/ 1	72	3/13	144	5/24
2	1/ 2	73	3/14	145	5/25
3	1/ 3	74	3/15	146	5/26
4	1/ 4	75	3/16	147	5/27
5	1/ 5	76	3/17	148	5/28
6	1/ 6	77	3/18	149	5/29
7	1/ 7	78	3/19	150	5/30
8	1/ 8	79	3/20	151	5/31
9	1/ 9	80	3/21	152	6/ 1
10	1/10	81	3/22	153	6/ 2
11	1/11	82	3/23	154	6/ 3
12	1/12	83	3/24	155	6/ 4
13	1/13	84	3/25	156	6/ 5
14	1/14	85	3/26	157	6/ 6
15	1/15	86	3/27	158	6/ 7
16	1/16	87	3/28	159	6/ 8
17	1/17	88	3/29	160	6/ 9
18	1/18	89	3/30	161	6/10
19	1/19	90	3/31	162	6/11
20	1/20	91	4/ 1	163	6/12
21	1/21	92	4/ 2	164	6/13
22	1/22	93	4/ 3	165	6/14
23	1/23	94	4/ 4	166	6/15
24	1/24	95	4/ 5	167	6/16
25	1/25	96	4/ 6	168	6/17
26	1/26	97	4/ 7	169	6/18
27	1/27	98	4/ 8	170	6/19
28	1/28	99	4/ 9	171	6/20
29	1/29	100	4/10	172	6/21
30	1/30	101	4/11	173	6/22
31	1/31	102	4/12	174	6/23
32	2/ 1	103	4/13	175	6/24
33	2/ 2	104	4/14	176	6/25
34	2/ 3	105	4/15	177	6/26
35	2/ 4	106	4/16	178	6/27
36	2/ 5	107	4/17	179	6/28
37	2/ 6	108	4/18	180	6/29
38	2/ 7	109	4/19	181	6/30
39	2/ 8	110	4/20	182	7/ 1
40	2/ 9	111	4/21	183	7/ 2
41	2/10	112	4/22	184	7/ 3
42	2/11	113	4/23	185	7/ 4
43	2/12	114	4/24	186	7/ 5
44	2/13	115	4/25	187	7/ 6
45	2/14	116	4/26	188	7/ 7
46	2/15	117	4/27	189	7/ 8
47	2/16	118	4/28	190	7/ 9
48	2/17	119	4/29	191	7/10
49	2/18	120	4/30	192	7/11
50	2/19	121	5/ 1	193	7/12
51	2/20	122	5/ 2	194	7/13
52	2/21	123	5/ 3	195	7/14
53	2/22	124	5/ 4	196	7/15
54	2/23	125	5/ 5	197	7/16
55	2/24	126	5/ 6	198	7/17
56	2/25	127	5/ 7	199	7/18
57	2/26	128	5/ 8	200	7/19
58	2/27	129	5/ 9	201	7/20
59	2/28	130	5/10	202	7/21
60	3/ 1	131	5/11	203	7/22
61	3/ 2	132	5/12	204	7/23
62	3/ 3	133	5/13	205	7/24
63	3/ 4	134	5/14	206	7/25
64	3/ 5	135	5/15	207	7/26
65	3/ 6	136	5/16	208	7/27
66	3/ 7	137	5/17	209	7/28
67	3/ 8	138	5/18	210	7/29
68	3/ 9	139	5/19	211	7/30
69	3/10	140	5/20	212	7/31
70	3/11	141	5/21	213	8/ 1
71	3/12	142	5/22	214	8/ 2
		143	5/23	215	8/ 3

216	8/ 4	--*--*-----*****	288	10/15	-----*---*---*---*---*---*	360	12/26	-----*---*---*---*---*---*
217	8/ 5	**-----*---*---*---*---*---*	289	10/16	-----*****---*---*---*	361	12/27	-----*---*---*---*---*---*
218	8/ 6	-----*****	290	10/17	-----*---*---*---*---*---*	362	12/28	-----*---*---*---*---*---*
219	8/ 7	-----*****	291	10/18	-----*---*---*---*---*---*	363	12/29	-----*---*---*---*---*---*
220	8/ 8	-----*****	292	10/19	-----*---*---*---*---*---*	364	12/30	-----*---*---*---*---*---*
221	8/ 9	-----*****	293	10/20	-----*---*---*---*---*---*	365	12/31	-----*---*---*---*---*---*
222	8/10	-----*****	294	10/21	-----*---*---*---*---*---*			
223	8/11	-----*****	295	10/22	-----*---*---*---*---*---*			
224	8/12	-----*****	296	10/23	-----*---*---*---*---*---*			
225	8/13	-----*****	297	10/24	-----*---*---*---*---*---*			
226	8/14	-----*****	298	10/25	-----*---*---*---*---*---*			
227	8/15	-----*****	299	10/26	-----*---*---*---*---*---*			
228	8/16	-----*****	300	10/27	-----*---*---*---*---*---*			
229	8/17	-----*****	301	10/28	-----*---*---*---*---*---*			
230	8/18	-----*****	302	10/29	-----*---*---*---*---*---*			
231	8/19	-----*****	303	10/30	-----*---*---*---*---*---*			
232	8/20	-----*****	304	10/31	-----*---*---*---*---*---*			
233	8/21	-----*****	305	11/ 1	-----*---*---*---*---*---*			
234	8/22	-----*****	306	11/ 2	-----*---*---*---*---*---*			
235	8/23	-----*****	307	11/ 3	-----*---*---*---*---*---*			
236	8/24	-----*****	308	11/ 4	-----*---*---*---*---*---*			
237	8/25	-----*****	309	11/ 5	-----*---*---*---*---*---*			
238	8/26	-----*****	310	11/ 6	-----*---*---*---*---*---*			
239	8/27	-----*****	311	11/ 7	-----*---*---*---*---*---*			
240	8/28	-----*****	312	11/ 8	-----*---*---*---*---*---*			
241	8/29	-----*****	313	11/ 9	-----*---*---*---*---*---*			
242	8/30	-----*****	314	11/10	-----*---*---*---*---*---*			
243	8/31	-----*****	315	11/11	-----*---*---*---*---*---*			
244	9/ 1	-----*****	316	11/12	-----*---*---*---*---*---*			
245	9/ 2	-----*****	317	11/13	-----*---*---*---*---*---*			
246	9/ 3	-----*****	318	11/14	-----*---*---*---*---*---*			
247	9/ 4	-----*****	319	11/15	-----*---*---*---*---*---*			
248	9/ 5	-----*****	320	11/16	-----*---*---*---*---*---*			
249	9/ 6	-----*****	321	11/17	-----*---*---*---*---*---*			
250	9/ 7	-----*****	322	11/18	-----*---*---*---*---*---*			
251	9/ 8	-----*****	323	11/19	-----*---*---*---*---*---*			
252	9/ 9	-----*****	324	11/20	-----*---*---*---*---*---*			
253	9/10	-----*****	325	11/21	-----*---*---*---*---*---*			
254	9/11	-----*****	326	11/22	-----*---*---*---*---*---*			
255	9/12	-----*****	327	11/23	-----*---*---*---*---*---*			
256	9/13	-----*****	328	11/24	-----*---*---*---*---*---*			
257	9/14	-----*****	329	11/25	-----*---*---*---*---*---*			
258	9/15	-----*****	330	11/26	-----*---*---*---*---*---*			
259	9/16	-----*****	331	11/27	-----*---*---*---*---*---*			
260	9/17	-----*****	332	11/28	-----*---*---*---*---*---*			
261	9/18	-----*****	333	11/29	-----*---*---*---*---*---*			
262	9/19	-----*****	334	11/30	-----*---*---*---*---*---*			
263	9/20	-----*****	335	12/ 1	-----*---*---*---*---*---*			
264	9/21	-----*****	336	12/ 2	-----*---*---*---*---*---*			
265	9/22	-----*****	337	12/ 3	-----*---*---*---*---*---*			
266	9/23	-----*****	338	12/ 4	-----*---*---*---*---*---*			
267	9/24	-----*****	339	12/ 5	-----*---*---*---*---*---*			
268	9/25	-----*****	340	12/ 6	-----*---*---*---*---*---*			
269	9/26	-----*****	341	12/ 7	-----*---*---*---*---*---*			
270	9/27	-----*****	342	12/ 8	-----*---*---*---*---*---*			
271	9/28	-----*****	343	12/ 9	-----*---*---*---*---*---*			
272	9/29	-----*****	344	12/10	-----*---*---*---*---*---*			
273	9/30	-----*****	345	12/11	-----*---*---*---*---*---*			
274	10/ 1	-----*****	346	12/12	-----*---*---*---*---*---*			
275	10/ 2	-----*****	347	12/13	-----*---*---*---*---*---*			
276	10/ 3	-----*****	348	12/14	-----*---*---*---*---*---*			
277	10/ 4	-----*****	349	12/15	-----*---*---*---*---*---*			
278	10/ 5	-----*****	350	12/16	-----*---*---*---*---*---*			
279	10/ 6	-----*****	351	12/17	-----*---*---*---*---*---*			
280	10/ 7	-----*****	352	12/18	-----*---*---*---*---*---*			
281	10/ 8	-----*****	353	12/19	-----*---*---*---*---*---*			
282	10/ 9	-----*****	354	12/20	-----*---*---*---*---*---*			
283	10/10	-----*****	355	12/21	-----*---*---*---*---*---*			
284	10/11	-----*****	356	12/22	-----*---*---*---*---*---*			
285	10/12	-----*****	357	12/23	-----*---*---*---*---*---*			
286	10/13	-----*****	358	12/24	-----*---*---*---*---*---*			
287	10/14	-----*****	359	12/25	-----*---*---*---*---*---*			

1994, DAV Uptime					
1	1/ 1	72	3/13	144	5/24
2	1/ 2	73	3/14	145	5/25
3	1/ 3	74	3/15	146	5/26
4	1/ 4	75	3/16	147	5/27
5	1/ 5	76	3/17	148	5/28
6	1/ 6	77	3/18	149	5/29
7	1/ 7	78	3/19	150	5/30
8	1/ 8	79	3/20	151	5/31
9	1/ 9	80	3/21	152	6/ 1
10	1/10	81	3/22	153	6/ 2
11	1/11	82	3/23	154	6/ 3
12	1/12	83	3/24	155	6/ 4
13	1/13	84	3/25	156	6/ 5
14	1/14	85	3/26	157	6/ 6
15	1/15	86	3/27	158	6/ 7
16	1/16	87	3/28	159	6/ 8
17	1/17	88	3/29	160	6/ 9
18	1/18	89	3/30	161	6/10
19	1/19	90	3/31	162	6/11
20	1/20	91	4/ 1	163	6/12
21	1/21	92	4/ 2	164	6/13
22	1/22	93	4/ 3	165	6/14
23	1/23	94	4/ 4	166	6/15
24	1/24	95	4/ 5	167	6/16
25	1/25	96	4/ 6	168	6/17
26	1/26	97	4/ 7	169	6/18
27	1/27	98	4/ 8	170	6/19
28	1/28	99	4/ 9	171	6/20
29	1/29	100	4/10	172	6/21
30	1/30	101	4/11	173	6/22
31	1/31	102	4/12	174	6/23
32	2/ 1	103	4/13	175	6/24
33	2/ 2	104	4/14	176	6/25
34	2/ 3	105	4/15	177	6/26
35	2/ 4	106	4/16	178	6/27
36	2/ 5	107	4/17	179	6/28
37	2/ 6	108	4/18	180	6/29
38	2/ 7	109	4/19	181	6/30
39	2/ 8	110	4/20	182	7/ 1
40	2/ 9	111	4/21	183	7/ 2
41	2/10	112	4/22	184	7/ 3
42	2/11	113	4/23	185	7/ 4
43	2/12	114	4/24	186	7/ 5
44	2/13	115	4/25	187	7/ 6
45	2/14	116	4/26	188	7/ 7
46	2/15	117	4/27	189	7/ 8
47	2/16	118	4/28	190	7/ 9
48	2/17	119	4/29	191	7/10
49	2/18	120	4/30	192	7/11
50	2/19	121	5/ 1	193	7/12
51	2/20	122	5/ 2	194	7/13
52	2/21	123	5/ 3	195	7/14
53	2/22	124	5/ 4	196	7/15
54	2/23	125	5/ 5	197	7/16
55	2/24	126	5/ 6	198	7/17
56	2/25	127	5/ 7	199	7/18
57	2/26	128	5/ 8	200	7/19
58	2/27	129	5/ 9	201	7/20
59	2/28	130	5/10	202	7/21
60	3/ 1	131	5/11	203	7/22
61	3/ 2	132	5/12	204	7/23
62	3/ 3	133	5/13	205	7/24
63	3/ 4	134	5/14	206	7/25
64	3/ 5	135	5/15	207	7/26
65	3/ 6	136	5/16	208	7/27
66	3/ 7	137	5/17	209	7/28
67	3/ 8	138	5/18	210	7/29
68	3/ 9	139	5/19	211	7/30
69	3/10	140	5/20	212	7/31
70	3/11	141	5/21	213	8/ 1
71	3/12	142	5/22	214	8/ 2
		143	5/23	215	8/ 3

216	8/ 4	-----	288	10/15	-----	360	12/26	-----
217	8/ 5	-----	289	10/16	-----	361	12/27	-----
218	8/ 6	-----	290	10/17	-----	362	12/28	-----
219	8/ 7	-----	291	10/18	-----	363	12/29	-----
220	8/ 8	-----	292	10/19	-----	364	12/30	-----
221	8/ 9	-----	293	10/20	-----	365	12/31	-----
222	8/10	-----	294	10/21	-----			
223	8/11	-----	295	10/22	-----			
224	8/12	-----	296	10/23	-----			
225	8/13	-----	297	10/24	-----			
226	8/14	-----	298	10/25	-----			
227	8/15	-----	299	10/26	-----			
228	8/16	-----	300	10/27	-----			
229	8/17	-----	301	10/28	-----			
230	8/18	-----	302	10/29	-----			
231	8/19	-----	303	10/30	-----			
232	8/20	-----	304	10/31	-----			
233	8/21	-----	305	11/ 1	-----			
234	8/22	-----	306	11/ 2	-----			
235	8/23	-----	307	11/ 3	-----			
236	8/24	-----	308	11/ 4	-----			
237	8/25	-----	309	11/ 5	-----			
238	8/26	-----	310	11/ 6	-----			
239	8/27	-----	311	11/ 7	-----			
240	8/28	-----	312	11/ 8	-----			
241	8/29	-----	313	11/ 9	-----			
242	8/30	-----	314	11/10	-----			
243	8/31	-----	315	11/11	-----			
244	9/ 1	-----	316	11/12	-----			
245	9/ 2	-----	317	11/13	-----			
246	9/ 3	-----	318	11/14	-----			
247	9/ 4	-----	319	11/15	-----			
248	9/ 5	-----	320	11/16	-----			
249	9/ 6	-----	321	11/17	-----			
250	9/ 7	-----	322	11/18	-----			
251	9/ 8	-----	323	11/19	-----			
252	9/ 9	-----	324	11/20	-----			
253	9/10	-----	325	11/21	-----			
254	9/11	-----	326	11/22	-----			
255	9/12	-----	327	11/23	-----			
256	9/13	-----	328	11/24	-----			
257	9/14	-----	329	11/25	-----			
258	9/15	-----	330	11/26	-----			
259	9/16	-----	331	11/27	-----			
260	9/17	-----	332	11/28	-----			
261	9/18	-----	333	11/29	-----			
262	9/19	-----	334	11/30	-----			
263	9/20	-----	335	12/ 1	-----			
264	9/21	-----	336	12/ 2	-----			
265	9/22	-----	337	12/ 3	-----			
266	9/23	-----	338	12/ 4	-----			
267	9/24	-----	339	12/ 5	-----			
268	9/25	-----	340	12/ 6	-----			
269	9/26	-----	341	12/ 7	-----			
270	9/27	-----	342	12/ 8	-----			
271	9/28	-----	343	12/ 9	-----			
272	9/29	-----	344	12/10	-----			
273	9/30	-----	345	12/11	-----			
274	10/ 1	-----	346	12/12	-----			
275	10/ 2	-----	347	12/13	-----			
276	10/ 3	-----	348	12/14	-----			
277	10/ 4	-----	349	12/15	-----			
278	10/ 5	-----	350	12/16	-----			
279	10/ 6	-----	351	12/17	-----			
280	10/ 7	-----	352	12/18	-----			
281	10/ 8	-----	353	12/19	-----			
282	10/ 9	-----	354	12/20	-----			
283	10/10	-----	355	12/21	-----			
284	10/11	-----	356	12/22	-----			
285	10/12	-----	357	12/23	-----			
286	10/13	-----	358	12/24	-----			
287	10/14	-----	359	12/25	-----			

1994, MCC Uptime

1	1/ 1	-----	72	3/13	*****	144	5/24	*****
2	1/ 2	*****	73	3/14	*****	145	5/25	*****
3	1/ 3	*****	74	3/15	*****	146	5/26	*****
4	1/ 4	*****	75	3/16	*****	147	5/27	*****
5	1/ 5	*****	76	3/17	*****	148	5/28	*****
6	1/ 6	*****	77	3/18	*****	149	5/29	*****
7	1/ 7	*****	78	3/19	*****	150	5/30	*****
8	1/ 8	*****	79	3/20	*****	151	5/31	-----
9	1/ 9	*****	80	3/21	*****	152	6/ 1	-----
10	1/10	*****	81	3/22	*****	153	6/ 2	-----
11	1/11	*****	82	3/23	*****	154	6/ 3	-----
12	1/12	*****	83	3/24	*****	155	6/ 4	*****
13	1/13	*****	84	3/25	*****	156	6/ 5	*****
14	1/14	*****	85	3/26	*****	157	6/ 6	*****
15	1/15	*****	86	3/27	*****	158	6/ 7	-----
16	1/16	*****	87	3/28	*****	159	6/ 8	-----
17	1/17	*****	88	3/29	*****	160	6/ 9	-----
18	1/18	*****	89	3/30	*****	161	6/10	*****
19	1/19	*****	90	3/31	*****	162	6/11	*****
20	1/20	*****	91	4/ 1	*****	163	6/12	*****
21	1/21	*****	92	4/ 2	*****	164	6/13	*****
22	1/22	*****	93	4/ 3	*****	165	6/14	*****
23	1/23	*****	94	4/ 4	*****	166	6/15	*****
24	1/24	*****	95	4/ 5	*****	167	6/16	*****
25	1/25	*****	96	4/ 6	*****	168	6/17	*****
26	1/26	*****	97	4/ 7	*****	169	6/18	*****
27	1/27	*****	98	4/ 8	*****	170	6/19	*****
28	1/28	*****	99	4/ 9	*****	171	6/20	*****
29	1/29	*****	100	4/10	*****	172	6/21	*****
30	1/30	*****	101	4/11	*****	173	6/22	*****
31	1/31	*****	102	4/12	*****	174	6/23	*****
32	2/ 1	*****	103	4/13	*****	175	6/24	*****
33	2/ 2	*****	104	4/14	*****	176	6/25	*****
34	2/ 3	*****	105	4/15	*****	177	6/26	-----
35	2/ 4	*****	106	4/16	*****	178	6/27	*****
36	2/ 5	*****	107	4/17	*****	179	6/28	*****
37	2/ 6	*****	108	4/18	*****	180	6/29	-----
38	2/ 7	*****	109	4/19	*****	181	6/30	-----
39	2/ 8	*****	110	4/20	*****	182	7/ 1	*****
40	2/ 9	*****	111	4/21	*****	183	7/ 2	*****
41	2/10	*****	112	4/22	*****	184	7/ 3	*****
42	2/11	*****	113	4/23	*****	185	7/ 4	*****
43	2/12	*****	114	4/24	*****	186	7/ 5	*****
44	2/13	*****	115	4/25	*****	187	7/ 6	*****
45	2/14	*****	116	4/26	*****	188	7/ 7	*****
46	2/15	*****	117	4/27	*****	189	7/ 8	*****
47	2/16	*****	118	4/28	*****	190	7/ 9	*****
48	2/17	*****	119	4/29	*****	191	7/10	*****
49	2/18	*****	120	4/30	*****	192	7/11	*****
50	2/19	*****	121	5/ 1	*****	193	7/12	*****
51	2/20	*****	122	5/ 2	*****	194	7/13	*****
52	2/21	*****	123	5/ 3	*****	195	7/14	-----
53	2/22	*****	124	5/ 4	*****	196	7/15	-----
54	2/23	*****	125	5/ 5	*****	197	7/16	-----
55	2/24	*****	126	5/ 6	*****	198	7/17	-----
56	2/25	*****	127	5/ 7	*****	199	7/18	*****
57	2/26	*****	128	5/ 8	*****	200	7/19	*****
58	2/27	*****	129	5/ 9	*****	201	7/20	*****
59	2/28	*****	130	5/10	*****	202	7/21	*****
60	3/ 1	*****	131	5/11	*****	203	7/22	*****
61	3/ 2	*****	132	5/12	*****	204	7/23	*****
62	3/ 3	*****	133	5/13	*****	205	7/24	*****
63	3/ 4	*****	134	5/14	*****	206	7/25	*****
64	3/ 5	*****	135	5/15	*****	207	7/26	*****
65	3/ 6	*****	136	5/16	*****	208	7/27	*****
66	3/ 7	*****	137	5/17	*****	209	7/28	*****
67	3/ 8	*****	138	5/18	*****	210	7/29	*****
68	3/ 9	*****	139	5/19	*****	211	7/30	*****
69	3/10	*****	140	5/20	*****	212	7/31	*****
70	3/11	*****	141	5/21	*****	213	8/ 1	*****
71	3/12	*****	142	5/22	*****	214	8/ 2	-----
			143	5/23	*****	215	8/ 3	-----

216	8/ 4	-----	288	10/15	*****	360	12/26	*****
217	8/ 5	*****	289	10/16	*****	361	12/27	*****
218	8/ 6	*****	290	10/17	*****	362	12/28	*****
219	8/ 7	*****	291	10/18	*****	363	12/29	*****
220	8/ 8	-----	292	10/19	*****	364	12/30	*****
221	8/ 9	*****	293	10/20	*****	365	12/31	*****
222	8/10	*****	294	10/21	*****			
223	8/11	*****	295	10/22	*****			
224	8/12	-----	296	10/23	*****			
225	8/13	*****	297	10/24	*****			
226	8/14	-----	298	10/25	*****			
227	8/15	-----	299	10/26	*****			
228	8/16	*****	300	10/27	-----			
229	8/17	*****	301	10/28	-----			
230	8/18	*****	302	10/29	-----			
231	8/19	-----	303	10/30	-----			
232	8/20	-----	304	10/31	-----			
233	8/21	-----	305	11/ 1	-----			
234	8/22	-----	306	11/ 2	*****			
235	8/23	-----	307	11/ 3	*****			
236	8/24	*****	308	11/ 4	*****			
237	8/25	*****	309	11/ 5	*****			
238	8/26	*****	310	11/ 6	*****			
239	8/27	*****	311	11/ 7	*****			
240	8/28	*****	312	11/ 8	*****			
241	8/29	*****	313	11/ 9	*****			
242	8/30	-----	314	11/10	*****			
243	8/31	-----	315	11/11	*****			
244	9/ 1	-----	316	11/12	*****			
245	9/ 2	*****	317	11/13	*****			
246	9/ 3	*****	318	11/14	*****			
247	9/ 4	*****	319	11/15	*****			
248	9/ 5	*****	320	11/16	*****			
249	9/ 6	*****	321	11/17	*****			
250	9/ 7	*****	322	11/18	*****			
251	9/ 8	*****	323	11/19	*****			
252	9/ 9	*****	324	11/20	*****			
253	9/10	*****	325	11/21	*****			
254	9/11	*****	326	11/22	*****			
255	9/12	*****	327	11/23	*****			
256	9/13	*****	328	11/24	*****			
257	9/14	*****	329	11/25	*****			
258	9/15	*****	330	11/26	*****			
259	9/16	*****	331	11/27	*****			
260	9/17	*****	332	11/28	*****			
261	9/18	*****	333	11/29	*****			
262	9/19	*****	334	11/30	*****			
263	9/20	*****	335	12/ 1	*****			
264	9/21	*****	336	12/ 2	*****			
265	9/22	*****	337	12/ 3	*****			
266	9/23	*****	338	12/ 4	*****			
267	9/24	-----	339	12/ 5	*****			
268	9/25	-----	340	12/ 6	*****			
269	9/26	-----	341	12/ 7	*****			
270	9/27	-----	342	12/ 8	*****			
271	9/28	-----	343	12/ 9	*****			
272	9/29	-----	344	12/10	*****			
273	9/30	-----	345	12/11	*****			
274	10/ 1	-----	346	12/12	*****			
275	10/ 2	-----	347	12/13	*****			
276	10/ 3	-----	348	12/14	*****			
277	10/ 4	*****	349	12/15	*****			
278	10/ 5	*****	350	12/16	*****			
279	10/ 6	*****	351	12/17	*****			
280	10/ 7	*****	352	12/18	*****			
281	10/ 8	*****	353	12/19	*****			
282	10/ 9	*****	354	12/20	*****			
283	10/10	*****	355	12/21	*****			
284	10/11	*****	356	12/22	*****			
285	10/12	*****	357	12/23	*****			
286	10/13	*****	358	12/24	*****			
287	10/14	*****	359	12/25	*****			

1994, MCD Uptime	72	3/13	*****	144	5/24	*****
1 1/ 1 -----	73	3/14	*****	145	5/25	*****
2 1/ 2 *****	74	3/15	*****	146	5/26	*****
3 1/ 3 *****	75	3/16	*****	147	5/27	*****
4 1/ 4 *****	76	3/17	*****	148	5/28	*****
5 1/ 5 *****	77	3/18	*****	149	5/29	*****
6 1/ 6 *****	78	3/19	*****	150	5/30	*****
7 1/ 7 *****	79	3/20	*****	151	5/31	*****
8 1/ 8 *****	80	3/21	*****	152	6/ 1	*****
9 1/ 9 *****	81	3/22	*****	153	6/ 2	*****
10 1/10 *****	82	3/23	*****	154	6/ 3	*****
11 1/11 *****	83	3/24	*****	155	6/ 4	*****
12 1/12 *****	84	3/25	*****	156	6/ 5	*****
13 1/13 *****	85	3/26	*****	157	6/ 6	*****
14 1/14 *****	86	3/27	*****	158	6/ 7	*****
15 1/15 *****	87	3/28	*****	159	6/ 8	*****
16 1/16 *****	88	3/29	*****	160	6/ 9	*****
17 1/17 *****	89	3/30	*****	161	6/10	*****
18 1/18 *****	90	3/31	*****	162	6/11	*****
19 1/19 *****	91	4/ 1	*****	163	6/12	*****
20 1/20 *****	92	4/ 2	*****	164	6/13	*****
21 1/21 *****	93	4/ 3	*****	165	6/14	*****
22 1/22 *****	94	4/ 4	*****	166	6/15	*****
23 1/23 *****	95	4/ 5	*****	167	6/16	*****
24 1/24 *****	96	4/ 6	*****	168	6/17	*****
25 1/25 *****	97	4/ 7	*****	169	6/18	*****
26 1/26 *****	98	4/ 8	*****	170	6/19	*****
27 1/27 *****	99	4/ 9	*****	171	6/20	*****
28 1/28 *****	100	4/10	*****	172	6/21	*****
29 1/29 *****	101	4/11	*****	173	6/22	*****
30 1/30 *****	102	4/12	*****	174	6/23	*****
31 1/31 *****	103	4/13	*****	175	6/24	*****
32 2/ 1 *****	104	4/14	*****	176	6/25	*****
33 2/ 2 *****	105	4/15	*****	177	6/26	*****
34 2/ 3 *****	106	4/16	*****	178	6/27	*****
35 2/ 4 *****	107	4/17	*****	179	6/28	*****
36 2/ 5 *****	108	4/18	*****	180	6/29	*****
37 2/ 6 *****	109	4/19	*****	181	6/30	*****
38 2/ 7 *****	110	4/20	*****	182	7/ 1	*****
39 2/ 8 *****	111	4/21	*****	183	7/ 2	*****
40 2/ 9 *****	112	4/22	*****	184	7/ 3	*****
41 2/10 *****	113	4/23	*****	185	7/ 4	*****
42 2/11 *****	114	4/24	*****	186	7/ 5	*****
43 2/12 *****	115	4/25	*****	187	7/ 6	*****
44 2/13 *****	116	4/26	*****	188	7/ 7	*****
45 2/14 *****	117	4/27	*****	189	7/ 8	*****
46 2/15 *****	118	4/28	*****	190	7/ 9	*****
47 2/16 *****	119	4/29	*****	191	7/10	*****
48 2/17 *****	120	4/30	*****	192	7/11	*****
49 2/18 *****	121	5/ 1	*****	193	7/12	*****
50 2/19 *****	122	5/ 2	*****	194	7/13	*****
51 2/20 *****	123	5/ 3	*****	195	7/14	*****
52 2/21 *****	124	5/ 4	*****	196	7/15	*****
53 2/22 *****	125	5/ 5	*****	197	7/16	*****
54 2/23 *****	126	5/ 6	*****	198	7/17	*****
55 2/24 *****	127	5/ 7	*****	199	7/18	*****
56 2/25 *****	128	5/ 8	*****	200	7/19	*****
57 2/26 *****	129	5/ 9	*****	201	7/20	*****
58 2/27 *****	130	5/10	*****	202	7/21	*****
59 2/28 *****	131	5/11	*****	203	7/22	*****
60 3/ 1 *****	132	5/12	*****	204	7/23	*****
61 3/ 2 *****	133	5/13	*****	205	7/24	*****
62 3/ 3 *****	134	5/14	*****	206	7/25	*****
63 3/ 4 *****	135	5/15	*****	207	7/26	*****
64 3/ 5 *****	136	5/16	*****	208	7/27	*****
65 3/ 6 *****	137	5/17	*****	209	7/28	*****
66 3/ 7 *****	138	5/18	*****	210	7/29	*****
67 3/ 8 *****	139	5/19	*****	211	7/30	*****
68 3/ 9 *****	140	5/20	*****	212	7/31	*****
69 3/10 *****	141	5/21	*****	213	8/ 1	*****
70 3/11 *****	142	5/22	*****	214	8/ 2	*****
71 3/12 *****	143	5/23	*****	215	8/ 3	*****

216	8/ 4	*****	288	10/15	*****	360	12/26	*****
217	8/ 5	*****	289	10/16	*****	361	12/27	*****
218	8/ 6	*****	290	10/17	*****	362	12/28	*****
219	8/ 7	*****	291	10/18	*****	363	12/29	*****
220	8/ 8	*****	292	10/19	*****	364	12/30	*****
221	8/ 9	*****	293	10/20	*****	365	12/31	*****
222	8/10	*****	294	10/21	*****			
223	8/11	*****	295	10/22	*****			
224	8/12	*****	296	10/23	*****			
225	8/13	*****	297	10/24	*****			
226	8/14	*****	298	10/25	*****			
227	8/15	*****	299	10/26	*****			
228	8/16	*****	300	10/27	*****			
229	8/17	*****	301	10/28	*****			
230	8/18	*****	302	10/29	*****			
231	8/19	*****	303	10/30	*****			
232	8/20	*****	304	10/31	*****			
233	8/21	*****	305	11/ 1	*****			
234	8/22	*****	306	11/ 2	*****			
235	8/23	*****	307	11/ 3	*****			
236	8/24	*****	308	11/ 4	*****			
237	8/25	*****	309	11/ 5	*****			
238	8/26	*****	310	11/ 6	*****			
239	8/27	*****	311	11/ 7	*****			
240	8/28	*****	312	11/ 8	*****			
241	8/29	*****	313	11/ 9	*****			
242	8/30	*****	314	11/10	*****			
243	8/31	*****	315	11/11	*****			
244	9/ 1	*****	316	11/12	*****			
245	9/ 2	*****	317	11/13	*****			
246	9/ 3	*****	318	11/14	*****			
247	9/ 4	*****	319	11/15	*****			
248	9/ 5	*****	320	11/16	*****			
249	9/ 6	*****	321	11/17	*****			
250	9/ 7	*****	322	11/18	*****			
251	9/ 8	*****	323	11/19	*****			
252	9/ 9	*****	324	11/20	*****			
253	9/10	*****	325	11/21	*****			
254	9/11	*****	326	11/22	*****			
255	9/12	*****	327	11/23	*****			
256	9/13	*****	328	11/24	*****			
257	9/14	*****	329	11/25	*****			
258	9/15	*****	330	11/26	*****			
259	9/16	*****	331	11/27	*****			
260	9/17	*****	332	11/28	*****			
261	9/18	*****	333	11/29	*****			
262	9/19	*****	334	11/30	*****			
263	9/20	*****	335	12/ 1	*****			
264	9/21	*****	336	12/ 2	*****			
265	9/22	*****	337	12/ 3	*****			
266	9/23	*****	338	12/ 4	*****			
267	9/24	*****	339	12/ 5	*****			
268	9/25	*****	340	12/ 6	*****			
269	9/26	*****	341	12/ 7	*****			
270	9/27	*****	342	12/ 8	*****			
271	9/28	*****	343	12/ 9	*****			
272	9/29	*****	344	12/10	*****			
273	9/30	*****	345	12/11	*****			
274	10/ 1	*****	346	12/12	*****			
275	10/ 2	*****	347	12/13	*****			
276	10/ 3	*****	348	12/14	*****			
277	10/ 4	*****	349	12/15	*****			
278	10/ 5	*****	350	12/16	*****			
279	10/ 6	*****	351	12/17	*****			
280	10/ 7	*****	352	12/18	*****			
281	10/ 8	*****	353	12/19	*****			
282	10/ 9	*****	354	12/20	*****			
283	10/10	*****	355	12/21	*****			
284	10/11	*****	356	12/22	*****			
285	10/12	*****	357	12/23	*****			
286	10/13	*****	358	12/24	*****			
287	10/14	*****	359	12/25	*****			

```

1994, SAL Uptime
 1 1/ 1 -----
 2 1/ 2 -----
 3 1/ 3 -----
 4 1/ 4 *****
 5 1/ 5 *****
 6 1/ 6 *****
 7 1/ 7 *****
 8 1/ 8 *****
 9 1/ 9 *****
10 1/10 *****
11 1/11 -----*-*-*-----
12 1/12 -----*****-----
13 1/13 -----*-*-----
14 1/14 -----*-----
15 1/15 -----
16 1/16 -----
17 1/17 -----
18 1/18 -----*****
19 1/19 *****
20 1/20 *****-*-----
21 1/21 -----
22 1/22 -----
23 1/23 -----
24 1/24 -----
25 1/25 -----
26 1/26 *****
27 1/27 *****-----
28 1/28 *****
29 1/29 *****
30 1/30 *****
31 1/31 *****
32 2/ 1 *****
33 2/ 2 *****-----**
34 2/ 3 -----
35 2/ 4 -----
36 2/ 5 -----
37 2/ 6 -----
38 2/ 7 -----
39 2/ 8 -----
40 2/ 9 -----
41 2/10 -----
42 2/11 -----
43 2/12 -----
44 2/13 -----
45 2/14 -----
46 2/15 -----
47 2/16 -----
48 2/17 -----
49 2/18 -----
50 2/19 *****
51 2/20 *****
52 2/21 *****
53 2/22 -----
54 2/23 -----
55 2/24 -----
56 2/25 -----
57 2/26 *****
58 2/27 *****
59 2/28 -----*****
60 3/ 1 -----
61 3/ 2 -----
62 3/ 3 -----
63 3/ 4 -----
64 3/ 5 -----
65 3/ 6 -----
66 3/ 7 -----
67 3/ 8 -----
68 3/ 9 -----
69 3/10 -----
70 3/11 -----
71 3/12 -----
72 3/13 -----
73 3/14 -----
74 3/15 -----
75 3/16 -----
76 3/17 -----
77 3/18 -----
78 3/19 -----
79 3/20 -----
80 3/21 -----
81 3/22 -----
82 3/23 -----
83 3/24 -----
84 3/25 -----
85 3/26 -----
86 3/27 -----
87 3/28 -----
88 3/29 -----
89 3/30 -----
90 3/31 -----
91 4/ 1 *****
92 4/ 2 *****
93 4/ 3 *****
94 4/ 4 *****
95 4/ 5 *****
96 4/ 6 *-----
97 4/ 7 -----*****
98 4/ 8 *****
99 4/ 9 *****
100 4/10 *****
101 4/11 *-----
102 4/12 -----
103 4/13 -----
104 4/14 -----
105 4/15 -----
106 4/16 -----
107 4/17 -----
108 4/18 -----*****
109 4/19 *****
110 4/20 *****
111 4/21 *****
112 4/22 *****
113 4/23 *****-----
114 4/24 -----
115 4/25 -----*-----
116 4/26 *****
117 4/27 *****
118 4/28 *****
119 4/29 *****
120 4/30 *****
121 5/ 1 *****
122 5/ 2 *****
123 5/ 3 *****-----
124 5/ 4 -----
125 5/ 5 -----
126 5/ 6 -----*****-----
127 5/ 7 -----
128 5/ 8 -----
129 5/ 9 -----*****
130 5/10 *****
131 5/11 *****-----
132 5/12 -----*****
133 5/13 **-----*****
134 5/14 *****
135 5/15 *****
136 5/16 *****
137 5/17 *****
138 5/18 *****-----**
139 5/19 *****
140 5/20 *****
141 5/21 *****
142 5/22 *****-----*-----
143 5/23 *****
144 5/24 *****
145 5/25 *****
146 5/26 *****
147 5/27 *****
148 5/28 *****
149 5/29 *****
150 5/30 *****
151 5/31 *--*-----*****
152 6/ 1 *****
153 6/ 2 *****
154 6/ 3 *****
155 6/ 4 *****
156 6/ 5 *****
157 6/ 6 *****
158 6/ 7 *****
159 6/ 8 *****
160 6/ 9 *****
161 6/10 *****-----
162 6/11 -----
163 6/12 -----
164 6/13 -----
165 6/14 -----*-----
166 6/15 *****
167 6/16 *****
168 6/17 *****
169 6/18 *****
170 6/19 *****
171 6/20 -----
172 6/21 -----*****
173 6/22 *****-----*****
174 6/23 *****
175 6/24 *****-----
176 6/25 -----
177 6/26 -----*-----
178 6/27 *****
179 6/28 *****
180 6/29 *****
181 6/30 **-----*-----
182 7/ 1 *****
183 7/ 2 *****
184 7/ 3 *****
185 7/ 4 *****
186 7/ 5 *****
187 7/ 6 *****
188 7/ 7 *****
189 7/ 8 *****
190 7/ 9 *****
191 7/10 *****
192 7/11 *****
193 7/12 *****
194 7/13 *****
195 7/14 *****
196 7/15 *****
197 7/16 *****
198 7/17 *****
199 7/18 *****
200 7/19 *****
201 7/20 *-*-----*****
202 7/21 *****
203 7/22 *****
204 7/23 **-----*-----
205 7/24 -----*-----
206 7/25 *****-----
207 7/26 -----*****
208 7/27 *****-----*-----
209 7/28 *-*-----*-----
210 7/29 *****
211 7/30 *****
212 7/31 *****
213 8/ 1 *****
214 8/ 2 *****
215 8/ 3 *****

```

216	8/ 4	*****	288	10/15	*****	360	12/26	-----
217	8/ 5	-----*	289	10/16	*****	361	12/27	-----
218	8/ 6	*****	290	10/17	*****	362	12/28	-----
219	8/ 7	-----*	291	10/18	*****	363	12/29	-----
220	8/ 8	-----*	292	10/19	*****	364	12/30	-----
221	8/ 9	*****	293	10/20	*****	365	12/31	-----
222	8/10	*****	294	10/21	*****			
223	8/11	*****	295	10/22	*****			
224	8/12	*****	296	10/23	*****			
225	8/13	*****	297	10/24	*****			
226	8/14	*****	298	10/25	*****			
227	8/15	*****	299	10/26	*****			
228	8/16	*****	300	10/27	*****			
229	8/17	*****	301	10/28	*****			
230	8/18	*****	302	10/29	*****			
231	8/19	*****	303	10/30	*****			
232	8/20	*****	304	10/31	*****			
233	8/21	*****	305	11/ 1	*****			
234	8/22	*****	306	11/ 2	*****			
235	8/23	*****	307	11/ 3	*****			
236	8/24	*****	308	11/ 4	*****			
237	8/25	*****	309	11/ 5	*****			
238	8/26	*****	310	11/ 6	*****			
239	8/27	*****	311	11/ 7	*****			
240	8/28	*****	312	11/ 8	*****			
241	8/29	-----*	313	11/ 9	*****			
242	8/30	*****	314	11/10	*****			
243	8/31	*****	315	11/11	*****			
244	9/ 1	*****	316	11/12	*****			
245	9/ 2	*****	317	11/13	*****			
246	9/ 3	*****	318	11/14	*****			
247	9/ 4	*****	319	11/15	*****			
248	9/ 5	*****	320	11/16	*****			
249	9/ 6	*****	321	11/17	*****			
250	9/ 7	*****	322	11/18	*****			
251	9/ 8	*****	323	11/19	*****			
252	9/ 9	*****	324	11/20	*****			
253	9/10	*****	325	11/21	*****			
254	9/11	*****	326	11/22	*****			
255	9/12	*****	327	11/23	*****			
256	9/13	*****	328	11/24	*****			
257	9/14	*****	329	11/25	*****			
258	9/15	*****	330	11/26	*****			
259	9/16	*****	331	11/27	*****			
260	9/17	*****	332	11/28	*****			
261	9/18	*****	333	11/29	*****			
262	9/19	*****	334	11/30	*****			
263	9/20	*****	335	12/ 1	*****			
264	9/21	*****	336	12/ 2	*****			
265	9/22	*****	337	12/ 3	*****			
266	9/23	*****	338	12/ 4	*****			
267	9/24	*****	339	12/ 5	*****			
268	9/25	*****	340	12/ 6	*****			
269	9/26	*****	341	12/ 7	*****			
270	9/27	*****	342	12/ 8	*****			
271	9/28	*****	343	12/ 9	*****			
272	9/29	*****	344	12/10	*****			
273	9/30	*****	345	12/11	*****			
274	10/ 1	*****	346	12/12	*****			
275	10/ 2	*****	347	12/13	*****			
276	10/ 3	*****	348	12/14	*****			
277	10/ 4	*****	349	12/15	*****			
278	10/ 5	*****	350	12/16	*****			
279	10/ 6	*****	351	12/17	*****			
280	10/ 7	*****	352	12/18	*****			
281	10/ 8	*****	353	12/19	*****			
282	10/ 9	*****	354	12/20	***-----			
283	10/10	*****	355	12/21	-----			
284	10/11	*****	356	12/22	-----			
285	10/12	*****	357	12/23	-----			
286	10/13	*****	358	12/24	-----			
287	10/14	*****	359	12/25	-----			

1993, CHC/DAV Link Uptime

1	1/ 1	72	3/13	144	5/24
2	1/ 2	73	3/14	145	5/25
3	1/ 3	74	3/15	146	5/26
4	1/ 4	75	3/16	147	5/27
5	1/ 5	76	3/17	148	5/28
6	1/ 6	77	3/18	149	5/29
7	1/ 7	78	3/19	150	5/30
8	1/ 8	79	3/20	151	5/31
9	1/ 9	80	3/21	152	6/ 1
10	1/10	81	3/22	153	6/ 2
11	1/11	82	3/23	154	6/ 3
12	1/12	83	3/24	155	6/ 4
13	1/13	84	3/25	156	6/ 5
14	1/14	85	3/26	157	6/ 6
15	1/15	86	3/27	158	6/ 7
16	1/16	87	3/28	159	6/ 8
17	1/17	88	3/29	160	6/ 9
18	1/18	89	3/30	161	6/10
19	1/19	90	3/31	162	6/11
20	1/20	91	4/ 1	163	6/12
21	1/21	92	4/ 2	164	6/13
22	1/22	93	4/ 3	165	6/14
23	1/23	94	4/ 4	166	6/15
24	1/24	95	4/ 5	167	6/16
25	1/25	96	4/ 6	168	6/17
26	1/26	97	4/ 7	169	6/18
27	1/27	98	4/ 8	170	6/19
28	1/28	99	4/ 9	171	6/20
29	1/29	100	4/10	172	6/21
30	1/30	101	4/11	173	6/22
31	1/31	102	4/12	174	6/23
32	2/ 1	103	4/13	175	6/24
33	2/ 2	104	4/14	176	6/25
34	2/ 3	105	4/15	177	6/26
35	2/ 4	106	4/16	178	6/27
36	2/ 5	107	4/17	179	6/28
37	2/ 6	108	4/18	180	6/29
38	2/ 7	109	4/19	181	6/30
39	2/ 8	110	4/20	182	7/ 1
40	2/ 9	111	4/21	183	7/ 2
41	2/10	112	4/22	184	7/ 3
42	2/11	113	4/23	185	7/ 4
43	2/12	114	4/24	186	7/ 5
44	2/13	115	4/25	187	7/ 6
45	2/14	116	4/26	188	7/ 7
46	2/15	117	4/27	189	7/ 8
47	2/16	118	4/28	190	7/ 9
48	2/17	119	4/29	191	7/10
49	2/18	120	4/30	192	7/11
50	2/19	121	5/ 1	193	7/12
51	2/20	122	5/ 2	194	7/13
52	2/21	123	5/ 3	195	7/14
53	2/22	124	5/ 4	196	7/15
54	2/23	125	5/ 5	197	7/16
55	2/24	126	5/ 6	198	7/17
56	2/25	127	5/ 7	199	7/18
57	2/26	128	5/ 8	200	7/19
58	2/27	129	5/ 9	201	7/20
59	2/28	130	5/10	202	7/21
60	3/ 1	131	5/11	203	7/22
61	3/ 2	132	5/12	204	7/23
62	3/ 3	133	5/13	205	7/24
63	3/ 4	134	5/14	206	7/25
64	3/ 5	135	5/15	207	7/26
65	3/ 6	136	5/16	208	7/27
66	3/ 7	137	5/17	209	7/28
67	3/ 8	138	5/18	210	7/29
68	3/ 9	139	5/19	211	7/30
69	3/10	140	5/20	212	7/31
70	3/11	141	5/21	213	8/ 1
71	3/12	142	5/22	214	8/ 2
		143	5/23	215	8/ 3

216	8/ 4	-----	288	10/15	-----	360	12/26	-----
217	8/ 5	-----	289	10/16	-----	361	12/27	-----
218	8/ 6	-----	290	10/17	-----	362	12/28	-----
219	8/ 7	-----	291	10/18	-----	363	12/29	-----*
220	8/ 8	-----	292	10/19	-----***	364	12/30	-----****
221	8/ 9	-----	293	10/20	-----	365	12/31	-----****
222	8/10	-----	294	10/21	-----			
223	8/11	-----*	295	10/22	-----			
224	8/12	-----*	296	10/23	-----			
225	8/13	-----*	297	10/24	-----			
226	8/14	-----*	298	10/25	-----***			
227	8/15	-----	299	10/26	-----			
228	8/16	-----*	300	10/27	-----			
229	8/17	-----	301	10/28	-----			
230	8/18	-----*	302	10/29	-----			
231	8/19	-----*	303	10/30	-----			
232	8/20	-----	304	10/31	-----			
233	8/21	-----	305	11/ 1	-----			
234	8/22	-----	306	11/ 2	-----*****			
235	8/23	-----*	307	11/ 3	-----*****			
236	8/24	-----	308	11/ 4	-----****			
237	8/25	-----	309	11/ 5	-----**			
238	8/26	-----	310	11/ 6	-----			
239	8/27	-----	311	11/ 7	-----*			
240	8/28	-----*	312	11/ 8	-----**			
241	8/29	-----*	313	11/ 9	-----*****			
242	8/30	-----*	314	11/10	-----**			
243	8/31	-----*	315	11/11	-----			
244	9/ 1	-----*	316	11/12	-----			
245	9/ 2	-----	317	11/13	-----			
246	9/ 3	-----	318	11/14	-----			
247	9/ 4	-----*	319	11/15	-----**			
248	9/ 5	-----	320	11/16	-----			
249	9/ 6	-----*	321	11/17	-----*			
250	9/ 7	-----**	322	11/18	-----			
251	9/ 8	-----	323	11/19	-----			
252	9/ 9	-----	324	11/20	-----			
253	9/10	-----*	325	11/21	-----			
254	9/11	-----*	326	11/22	-----			
255	9/12	-----	327	11/23	-----****			
256	9/13	-----*	328	11/24	-----			
257	9/14	-----*	329	11/25	-----			
258	9/15	-----*	330	11/26	-----			
259	9/16	-----*	331	11/27	-----			
260	9/17	-----*	332	11/28	-----			
261	9/18	-----	333	11/29	-----			
262	9/19	-----	334	11/30	-----			
263	9/20	-----*	335	12/ 1	-----			
264	9/21	-----*	336	12/ 2	-----			
265	9/22	-----*	337	12/ 3	-----			
266	9/23	-----	338	12/ 4	-----			
267	9/24	-----	339	12/ 5	-----			
268	9/25	-----	340	12/ 6	-----			
269	9/26	-----	341	12/ 7	-----			
270	9/27	-----	342	12/ 8	-----			
271	9/28	-----*	343	12/ 9	-----			
272	9/29	-----	344	12/10	-----			
273	9/30	-----*	345	12/11	-----*			
274	10/ 1	-----*	346	12/12	-----			
275	10/ 2	-----*	347	12/13	-----			
276	10/ 3	-----*	348	12/14	-----**			
277	10/ 4	-----*	349	12/15	-----			
278	10/ 5	-----*	350	12/16	-----			
279	10/ 6	-----*	351	12/17	-----			
280	10/ 7	-----*	352	12/18	-----			
281	10/ 8	-----*	353	12/19	-----			
282	10/ 9	-----	354	12/20	-----			
283	10/10	-----	355	12/21	-----****			
284	10/11	-----	356	12/22	-----***			
285	10/12	-----	357	12/23	-----			
286	10/13	-----*	358	12/24	-----			
287	10/14	-----	359	12/25	-----			

1993, CHC/MCC Circuit Uptime

1	1/ 1	72	3/13	144	5/24
2	1/ 2	73	3/14	145	5/25
3	1/ 3	74	3/15	146	5/26
4	1/ 4	75	3/16	147	5/27
5	1/ 5	76	3/17	148	5/28
6	1/ 6	77	3/18	149	5/29
7	1/ 7	78	3/19	150	5/30
8	1/ 8	79	3/20	151	5/31 *****
9	1/ 9	80	3/21	152	6/ 1 *****
10	1/10	81	3/22	153	6/ 2 *****
11	1/11	82	3/23	154	6/ 3
12	1/12	83	3/24	155	6/ 4
13	1/13	84	3/25	156	6/ 5
14	1/14	85	3/26	157	6/ 6
15	1/15	86	3/27	158	6/ 7
16	1/16	87	3/28	159	6/ 8
17	1/17	88	3/29	160	6/ 9
18	1/18	89	3/30	161	6/10
19	1/19	90	3/31	162	6/11
20	1/20	91	4/ 1	163	6/12
21	1/21	92	4/ 2	164	6/13
22	1/22	93	4/ 3	165	6/14
23	1/23	94	4/ 4	166	6/15
24	1/24	95	4/ 5	167	6/16
25	1/25	96	4/ 6	168	6/17
26	1/26	97	4/ 7	169	6/18
27	1/27	98	4/ 8	170	6/19
28	1/28	99	4/ 9	171	6/20
29	1/29	100	4/10	172	6/21
30	1/30	101	4/11	173	6/22
31	1/31	102	4/12	174	6/23
32	2/ 1	103	4/13	175	6/24
33	2/ 2	104	4/14	176	6/25
34	2/ 3	105	4/15	177	6/26
35	2/ 4	106	4/16	178	6/27
36	2/ 5	107	4/17	179	6/28
37	2/ 6	108	4/18	180	6/29
38	2/ 7	109	4/19	181	6/30
39	2/ 8	110	4/20	182	7/ 1
40	2/ 9	111	4/21	183	7/ 2
41	2/10	112	4/22	184	7/ 3
42	2/11	113	4/23	185	7/ 4
43	2/12	114	4/24	186	7/ 5
44	2/13	115	4/25	187	7/ 6
45	2/14	116	4/26	188	7/ 7
46	2/15	117	4/27	189	7/ 8
47	2/16	118	4/28	190	7/ 9
48	2/17	119	4/29	191	7/10
49	2/18	120	4/30	192	7/11
50	2/19	121	5/ 1	193	7/12
51	2/20	122	5/ 2	194	7/13
52	2/21	123	5/ 3	195	7/14
53	2/22	124	5/ 4	196	7/15
54	2/23	125	5/ 5	197	7/16
55	2/24	126	5/ 6	198	7/17
56	2/25	127	5/ 7	199	7/18
57	2/26	128	5/ 8	200	7/19
58	2/27	129	5/ 9	201	7/20
59	2/28	130	5/10	202	7/21 *****
60	3/ 1	131	5/11	203	7/22 **-*****
61	3/ 2	132	5/12	204	7/23 *****
62	3/ 3	133	5/13	205	7/24 *****
63	3/ 4	134	5/14	206	7/25 *****
64	3/ 5	135	5/15	207	7/26 *****
65	3/ 6	136	5/16	208	7/27 *****
66	3/ 7	137	5/17	209	7/28 *****
67	3/ 8	138	5/18	210	7/29 *****
68	3/ 9	139	5/19	211	7/30 *****
69	3/10	140	5/20	212	7/31 *****
70	3/11	141	5/21	213	8/ 1 *****
71	3/12	142	5/22	214	8/ 2 ***
		143	5/23	215	8/ 3 *****

216	8/ 4	*****	288	10/15	-----	360	12/26	-----
217	8/ 5	*****	289	10/16	-----	361	12/27	-----
218	8/ 6	*****	290	10/17	-----*	362	12/28	-----
219	8/ 7	*****	291	10/18	-----***	363	12/29	-----*
220	8/ 8	*****-*-	292	10/19	*****	364	12/30	-----****
221	8/ 9	*****-*-	293	10/20	*****	365	12/31	*****
222	8/10	*****	294	10/21	-----			
223	8/11	*****-*	295	10/22	-----			
224	8/12	*****	296	10/23	-----			
225	8/13	*****-*	297	10/24	-----			
226	8/14	*****-*	298	10/25	-----***			
227	8/15	-----*	299	10/26	-----**			
228	8/16	-----*	300	10/27	-----***			
229	8/17	*****	301	10/28	-----***			
230	8/18	*****	302	10/29	*****			
231	8/19	*****	303	10/30	-----			
232	8/20	*-----	304	10/31	-----***			
233	8/21	-----*	305	11/ 1	-----***			
234	8/22	-----	306	11/ 2	*****			
235	8/23	***-***	307	11/ 3	*****			
236	8/24	*****	308	11/ 4	*****			
237	8/25	-----*	309	11/ 5	**-----			
238	8/26	*****	310	11/ 6	-----			
239	8/27	*****	311	11/ 7	-----*			
240	8/28	*****-*	312	11/ 8	*-----**			
241	8/29	****-*****	313	11/ 9	*****			
242	8/30	*****	314	11/10	*****			
243	8/31	*****	315	11/11	-----			
244	9/ 1	*****	316	11/12	-----			
245	9/ 2	*****	317	11/13	-----			
246	9/ 3	*****	318	11/14	-----**			
247	9/ 4	*****	319	11/15	*****			
248	9/ 5	*****	320	11/16	*****			
249	9/ 6	*****	321	11/17	*****			
250	9/ 7	*****	322	11/18	-----			
251	9/ 8	*****-*	323	11/19	-----			
252	9/ 9	*****	324	11/20	-----			
253	9/10	**-----*	325	11/21	-----			
254	9/11	*****	326	11/22	-**-----*			
255	9/12	**--*-*	327	11/23	*****			
256	9/13	-----*	328	11/24	*-----			
257	9/14	-----*	329	11/25	-----			
258	9/15	*-----*	330	11/26	-----			
259	9/16	*-----*	331	11/27	-----			
260	9/17	***-----*	332	11/28	-----			
261	9/18	*****	333	11/29	-----			
262	9/19	*****	334	11/30	-----			
263	9/20	*****	335	12/ 1	-----			
264	9/21	**--*-*	336	12/ 2	-----			
265	9/22	*****	337	12/ 3	-----			
266	9/23	-----	338	12/ 4	-----			
267	9/24	-----	339	12/ 5	-----			
268	9/25	*****	340	12/ 6	-----			
269	9/26	-----*	341	12/ 7	-----			
270	9/27	*****	342	12/ 8	-----			
271	9/28	*****	343	12/ 9	-----			
272	9/29	-----*	344	12/10	-----			
273	9/30	-----*	345	12/11	-----*			
274	10/ 1	*****	346	12/12	-----*			
275	10/ 2	-----*	347	12/13	-----			
276	10/ 3	*-----*	348	12/14	-----			
277	10/ 4	*-----*	349	12/15	-----			
278	10/ 5	*****	350	12/16	-----			
279	10/ 6	*****	351	12/17	-----*			
280	10/ 7	*****	352	12/18	-----			
281	10/ 8	*****	353	12/19	-----			
282	10/ 9	-----	354	12/20	-----			
283	10/10	-----	355	12/21	-----*			
284	10/11	-----	356	12/22	-----***			
285	10/12	*****	357	12/23	-----***			
286	10/13	*****	358	12/24	**-----*			
287	10/14	-----	359	12/25	-----			

1993, CHC/SAL Circuit Uptime

1	1/ 1	72	3/13	144	5/24
2	1/ 2	73	3/14	145	5/25
3	1/ 3	74	3/15	146	5/26
4	1/ 4	75	3/16	147	5/27
5	1/ 5	76	3/17	148	5/28
6	1/ 6	77	3/18	149	5/29
7	1/ 7	78	3/19	150	5/30
8	1/ 8	79	3/20	151	5/31
9	1/ 9	80	3/21	152	6/ 1
10	1/10	81	3/22	153	6/ 2
11	1/11	82	3/23	154	6/ 3
12	1/12	83	3/24	155	6/ 4
13	1/13	84	3/25	156	6/ 5
14	1/14	85	3/26	157	6/ 6
15	1/15	86	3/27	158	6/ 7
16	1/16	87	3/28	159	6/ 8
17	1/17	88	3/29	160	6/ 9
18	1/18	89	3/30	161	6/10
19	1/19	90	3/31	162	6/11
20	1/20	91	4/ 1	163	6/12
21	1/21	92	4/ 2	164	6/13
22	1/22	93	4/ 3	165	6/14
23	1/23	94	4/ 4	166	6/15
24	1/24	95	4/ 5	167	6/16
25	1/25	96	4/ 6	168	6/17
26	1/26	97	4/ 7	169	6/18
27	1/27	98	4/ 8	170	6/19
28	1/28	99	4/ 9	171	6/20
29	1/29	100	4/10	172	6/21
30	1/30	101	4/11	173	6/22
31	1/31	102	4/12	174	6/23
32	2/ 1	103	4/13	175	6/24
33	2/ 2	104	4/14	176	6/25
34	2/ 3	105	4/15	177	6/26
35	2/ 4	106	4/16	178	6/27
36	2/ 5	107	4/17	179	6/28
37	2/ 6	108	4/18	180	6/29
38	2/ 7	109	4/19	181	6/30
39	2/ 8	110	4/20	182	7/ 1
40	2/ 9	111	4/21	183	7/ 2
41	2/10	112	4/22	184	7/ 3
42	2/11	113	4/23	185	7/ 4
43	2/12	114	4/24	186	7/ 5
44	2/13	115	4/25	187	7/ 6
45	2/14	116	4/26	188	7/ 7
46	2/15	117	4/27	189	7/ 8
47	2/16	118	4/28	190	7/ 9
48	2/17	119	4/29	191	7/10
49	2/18	120	4/30	192	7/11
50	2/19	121	5/ 1	193	7/12
51	2/20	122	5/ 2	194	7/13
52	2/21	123	5/ 3	195	7/14
53	2/22	124	5/ 4	196	7/15
54	2/23	125	5/ 5	197	7/16
55	2/24	126	5/ 6	198	7/17
56	2/25	127	5/ 7	199	7/18
57	2/26	128	5/ 8	200	7/19
58	2/27	129	5/ 9	201	7/20
59	2/28	130	5/10	202	7/21
60	3/ 1	131	5/11	203	7/22
61	3/ 2	132	5/12	204	7/23
62	3/ 3	133	5/13	205	7/24
63	3/ 4	134	5/14	206	7/25
64	3/ 5	135	5/15	207	7/26
65	3/ 6	136	5/16	208	7/27
66	3/ 7	137	5/17	209	7/28
67	3/ 8	138	5/18	210	7/29
68	3/ 9	139	5/19	211	7/30
69	3/10	140	5/20	212	7/31
70	3/11	141	5/21	213	8/ 1
71	3/12	142	5/22	214	8/ 2
		143	5/23	215	8/ 3

216	8/ 4	*****	288	10/15	-----	360	12/26	-----
217	8/ 5	*****	289	10/16	-----	361	12/27	-----
218	8/ 6	*****	290	10/17	-----*	362	12/28	-----
219	8/ 7	*****	291	10/18	-----***	363	12/29	-----*
220	8/ 8	*****	292	10/19	*****	364	12/30	-----***
221	8/ 9	*****	293	10/20	*****	365	12/31	-----***
222	8/10	*****	294	10/21	-----			
223	8/11	*****	295	10/22	-----			
224	8/12	*****	296	10/23	-----			
225	8/13	*****	297	10/24	-----			
226	8/14	-----	298	10/25	-----***			
227	8/15	-----	299	10/26	-----**			
228	8/16	-----*	300	10/27	-----***			
229	8/17	*****	301	10/28	-----***			
230	8/18	*****	302	10/29	*****			
231	8/19	***	303	10/30	-----			
232	8/20	*	304	10/31	-----***			
233	8/21	-----*	305	11/ 1	-----***			
234	8/22	-----	306	11/ 2	*****			
235	8/23	***	307	11/ 3	*****			
236	8/24	*****	308	11/ 4	*****			
237	8/25	-----*	309	11/ 5	**			
238	8/26	*****	310	11/ 6	-----			
239	8/27	*****	311	11/ 7	-----*			
240	8/28	*****	312	11/ 8	*			
241	8/29	-----*	313	11/ 9	*****			
242	8/30	*****	314	11/10	*****			
243	8/31	*****	315	11/11	-----			
244	9/ 1	*****	316	11/12	-----			
245	9/ 2	*****	317	11/13	-----			
246	9/ 3	*****	318	11/14	-----**			
247	9/ 4	-----	319	11/15	-----***			
248	9/ 5	-----	320	11/16	-----*			
249	9/ 6	**	321	11/17	*****			
250	9/ 7	-----*	322	11/18	-----			
251	9/ 8	*****	323	11/19	-----			
252	9/ 9	*****	324	11/20	-----			
253	9/10	**	325	11/21	-----			
254	9/11	*****	326	11/22	**			
255	9/12	**	327	11/23	*****			
256	9/13	-----*	328	11/24	*			
257	9/14	-----*	329	11/25	-----			
258	9/15	*-----*	330	11/26	-----			
259	9/16	*-----*	331	11/27	-----			
260	9/17	***	332	11/28	-----			
261	9/18	*****	333	11/29	-----			
262	9/19	*****	334	11/30	-----			
263	9/20	*****	335	12/ 1	-----			
264	9/21	**	336	12/ 2	-----			
265	9/22	*****	337	12/ 3	-----			
266	9/23	-----	338	12/ 4	-----			
267	9/24	-----*	339	12/ 5	-----			
268	9/25	*****	340	12/ 6	-----			
269	9/26	-----*	341	12/ 7	-----			
270	9/27	*****	342	12/ 8	-----			
271	9/28	*****	343	12/ 9	-----			
272	9/29	-----*	344	12/10	-----			
273	9/30	-----*	345	12/11	-----*			
274	10/ 1	*****	346	12/12	-----*			
275	10/ 2	-----*	347	12/13	-----			
276	10/ 3	*-----*	348	12/14	-----*			
277	10/ 4	*-----*	349	12/15	-----			
278	10/ 5	*****	350	12/16	-----			
279	10/ 6	*****	351	12/17	-----*			
280	10/ 7	*****	352	12/18	-----			
281	10/ 8	*****	353	12/19	-----			
282	10/ 9	-----	354	12/20	-----			
283	10/10	-----	355	12/21	-----*			
284	10/11	-----	356	12/22	-----			
285	10/12	-----*	357	12/23	-----***			
286	10/13	*****	358	12/24	**			
287	10/14	-----	359	12/25	-----			

1993, DAV/MCD Circuit Uptime

1	1/ 1	72	3/13	****	144	5/24
2	1/ 2	73	3/14		145	5/25
3	1/ 3	74	3/15		146	5/26
4	1/ 4	75	3/16	*-----**	147	5/27
5	1/ 5	76	3/17	-----*-----*	148	5/28
6	1/ 6	77	3/18	-----*	149	5/29
7	1/ 7	78	3/19	-----*	150	5/30
8	1/ 8	79	3/20	-----*	151	5/31
9	1/ 9	80	3/21	-----*	152	6/ 1
10	1/10	81	3/22	-----*	153	6/ 2
11	1/11	82	3/23	-----*	154	6/ 3
12	1/12	83	3/24	-----*	155	6/ 4
13	1/13	84	3/25	-----*	156	6/ 5
14	1/14	85	3/26	-----*	157	6/ 6
15	1/15	86	3/27	-----*	158	6/ 7
16	1/16	87	3/28	-----*	159	6/ 8
17	1/17	88	3/29	-----*	160	6/ 9
18	1/18	89	3/30	-----*	161	6/10
19	1/19	90	3/31	-----*	162	6/11
20	1/20	91	4/ 1	-----*	163	6/12
21	1/21	92	4/ 2	-----*	164	6/13
22	1/22	93	4/ 3	-----*	165	6/14
23	1/23	94	4/ 4	-----*	166	6/15
24	1/24	95	4/ 5	-----*	167	6/16
25	1/25	96	4/ 6	-----*	168	6/17
26	1/26	97	4/ 7	-----*	169	6/18
27	1/27	98	4/ 8	-----*	170	6/19
28	1/28	99	4/ 9	-----*	171	6/20
29	1/29	100	4/10	-----*	172	6/21
30	1/30	101	4/11	-----*	173	6/22
31	1/31	102	4/12	-----*	174	6/23
32	2/ 1	103	4/13	-----*	175	6/24
33	2/ 2	104	4/14	-----*	176	6/25
34	2/ 3	105	4/15	-----*	177	6/26
35	2/ 4	106	4/16	-----*	178	6/27
36	2/ 5	107	4/17	-----*	179	6/28
37	2/ 6	108	4/18	-----*	180	6/29
38	2/ 7	109	4/19	-----*	181	6/30
39	2/ 8	110	4/20	-----*	182	7/ 1
40	2/ 9	111	4/21	-----*	183	7/ 2
41	2/10	112	4/22	-----*	184	7/ 3
42	2/11	113	4/23	-----*	185	7/ 4
43	2/12	114	4/24	-----*	186	7/ 5
44	2/13	115	4/25	-----*	187	7/ 6
45	2/14	116	4/26	-----*	188	7/ 7
46	2/15	117	4/27	-----*	189	7/ 8
47	2/16	118	4/28	-----*	190	7/ 9
48	2/17	119	4/29	-----*	191	7/10
49	2/18	120	4/30	-----*	192	7/11
50	2/19	121	5/ 1	-----*	193	7/12
51	2/20	122	5/ 2	-----*	194	7/13
52	2/21	123	5/ 3	-----*	195	7/14
53	2/22	124	5/ 4	-----*	196	7/15
54	2/23	125	5/ 5	-----*	197	7/16
55	2/24	126	5/ 6	-----*	198	7/17
56	2/25	127	5/ 7	-----*	199	7/18
57	2/26	128	5/ 8	-----*	200	7/19
58	2/27	129	5/ 9	-----*	201	7/20
59	2/28	130	5/10	-----*	202	7/21
60	3/ 1	131	5/11	-----*	203	7/22
61	3/ 2	132	5/12	-----*	204	7/23
62	3/ 3	133	5/13	-----*	205	7/24
63	3/ 4	134	5/14	-----*	206	7/25
64	3/ 5	135	5/15	-----*	207	7/26
65	3/ 6	136	5/16	-----*	208	7/27
66	3/ 7	137	5/17	-----*	209	7/28
67	3/ 8	138	5/18	-----*	210	7/29
68	3/ 9	139	5/19	-----*	211	7/30
69	3/10	140	5/20	-----*	212	7/31
70	3/11	141	5/21	-----*	213	8/ 1
71	3/12	142	5/22	-----*	214	8/ 2
		143	5/23	-----*	215	8/ 3

216	8/ 4	-----	288	10/15	*****	-----	360	12/26	-----
217	8/ 5	-----	289	10/16	-----	-----	361	12/27	-----*
218	8/ 6	-----	290	10/17	-----	-----	362	12/28	-----*****
219	8/ 7	-----	291	10/18	-----	-----	363	12/29	-----*
220	8/ 8	-----	292	10/19	-----	-----	364	12/30	-----*****
221	8/ 9	-----	293	10/20	-----	-----	365	12/31	*****
222	8/10	-----	294	10/21	-----	-----			
223	8/11	-----	295	10/22	-----	-----			
224	8/12	-----	296	10/23	-----	-----			
225	8/13	-----	297	10/24	-----	-----			
226	8/14	-----	298	10/25	-----	-----			
227	8/15	-----	299	10/26	-----	-----			
228	8/16	-----	300	10/27	-----	-----			
229	8/17	-----	301	10/28	-----	-----			
230	8/18	-----	302	10/29	-----	-----			
231	8/19	-----	303	10/30	-----	-----			
232	8/20	-----	304	10/31	-----	-----			
233	8/21	-----	305	11/ 1	-----	-----			
234	8/22	-----	306	11/ 2	-----	-----			
235	8/23	-----	307	11/ 3	-----	-----			
236	8/24	-----	308	11/ 4	-----	-----			
237	8/25	-----	309	11/ 5	-----	-----			
238	8/26	-----	310	11/ 6	-----	-----			
239	8/27	-----	311	11/ 7	-----	-----			
240	8/28	-----	312	11/ 8	-----	-----			
241	8/29	-----	313	11/ 9	-----	-----			
242	8/30	-----	314	11/10	-----	-----			
243	8/31	-----	315	11/11	-----	-----			
244	9/ 1	-----	316	11/12	-----	-----			
245	9/ 2	-----	317	11/13	-----	-----			
246	9/ 3	-----	318	11/14	-----	-----			
247	9/ 4	-----	319	11/15	-----	-----			
248	9/ 5	-----	320	11/16	-----	-----			
249	9/ 6	-----	321	11/17	-----	-----			
250	9/ 7	-----	322	11/18	-----	-----			
251	9/ 8	-----	323	11/19	-----	-----			
252	9/ 9	-----	324	11/20	-----	-----			
253	9/10	-----	325	11/21	-----	-----			
254	9/11	-----	326	11/22	-----	-----			
255	9/12	-----	327	11/23	-----	-----			
256	9/13	-----	328	11/24	-----	-----			
257	9/14	-----	329	11/25	-----	-----			
258	9/15	-----	330	11/26	-----	-----			
259	9/16	-----	331	11/27	-----	-----			
260	9/17	-----	332	11/28	-----	-----			
261	9/18	-----	333	11/29	-----	-----			
262	9/19	-----	334	11/30	-----	-----			
263	9/20	-----	335	12/ 1	-----	-----			
264	9/21	-----	336	12/ 2	-----	-----			
265	9/22	-----	337	12/ 3	-----	-----			
266	9/23	-----	338	12/ 4	-----	-----			
267	9/24	-----	339	12/ 5	-----	-----			
268	9/25	-----	340	12/ 6	-----	-----			
269	9/26	-----	341	12/ 7	-----	-----			
270	9/27	-----	342	12/ 8	-----	-----			
271	9/28	-----	343	12/ 9	-----	-----			
272	9/29	-----	344	12/10	-----	-----			
273	9/30	-----	345	12/11	-----	-----			
274	10/ 1	-----	346	12/12	-----	-----			
275	10/ 2	-----	347	12/13	-----	-----			
276	10/ 3	-----	348	12/14	-----	-----			
277	10/ 4	-----	349	12/15	-----	-----			
278	10/ 5	-----	350	12/16	-----	-----			
279	10/ 6	-----	351	12/17	-----	-----			
280	10/ 7	-----	352	12/18	-----	-----			
281	10/ 8	-----	353	12/19	-----	-----			
282	10/ 9	-----	354	12/20	-----	-----			
283	10/10	-----	355	12/21	-----	-----			
284	10/11	-----	356	12/22	-----	-----			
285	10/12	-----	357	12/23	-----	-----			
286	10/13	-----	358	12/24	-----	-----			
287	10/14	-----	359	12/25	-----	-----			

1993, DAV/SAL Circuit Uptime

1	1/ 1	-----	72	3/13	-----	144	5/24	-----
2	1/ 2	-----	73	3/14	-----	145	5/25	-----
3	1/ 3	-----	74	3/15	-----	146	5/26	-----
4	1/ 4	-----	75	3/16	-----	147	5/27	-----
5	1/ 5	-----	76	3/17	-----	148	5/28	-----
6	1/ 6	-----	77	3/18	-----	149	5/29	-----
7	1/ 7	-----	78	3/19	-----	150	5/30	-----
8	1/ 8	-----	79	3/20	-----	151	5/31	-----
9	1/ 9	-----	80	3/21	-----	152	6/ 1	-----
10	1/10	-----	81	3/22	-----	153	6/ 2	-----
11	1/11	-----	82	3/23	-----	154	6/ 3	-----
12	1/12	-----	83	3/24	-----	155	6/ 4	-----
13	1/13	-----	84	3/25	-----	156	6/ 5	-----
14	1/14	-----	85	3/26	-----	157	6/ 6	-----
15	1/15	-----	86	3/27	-----	158	6/ 7	-----
16	1/16	-----	87	3/28	-----	159	6/ 8	-----
17	1/17	-----	88	3/29	-----	160	6/ 9	-----
18	1/18	-----	89	3/30	-----	161	6/10	-----
19	1/19	-----	90	3/31	-----	162	6/11	-----
20	1/20	-----	91	4/ 1	-----	163	6/12	-----
21	1/21	-----	92	4/ 2	-----	164	6/13	-----
22	1/22	-----	93	4/ 3	-----	165	6/14	-----
23	1/23	-----	94	4/ 4	-----	166	6/15	-----
24	1/24	-----	95	4/ 5	-----	167	6/16	-----
25	1/25	-----	96	4/ 6	-----	168	6/17	-----
26	1/26	-----	97	4/ 7	-----	169	6/18	-----
27	1/27	-----	98	4/ 8	-----	170	6/19	-----
28	1/28	-----	99	4/ 9	-----	171	6/20	-----
29	1/29	-----	100	4/10	-----	172	6/21	-----
30	1/30	-----	101	4/11	-----	173	6/22	-----
31	1/31	-----	102	4/12	-----	174	6/23	-----
32	2/ 1	-----	103	4/13	-----	175	6/24	-----
33	2/ 2	-----	104	4/14	-----	176	6/25	-----
34	2/ 3	-----	105	4/15	-----	177	6/26	-----
35	2/ 4	-----	106	4/16	-----	178	6/27	-----
36	2/ 5	-----	107	4/17	-----	179	6/28	-----
37	2/ 6	-----	108	4/18	-----	180	6/29	-----
38	2/ 7	-----	109	4/19	-----	181	6/30	-----
39	2/ 8	-----	110	4/20	-----	182	7/ 1	-----
40	2/ 9	-----	111	4/21	-----	183	7/ 2	-----
41	2/10	-----	112	4/22	-----	184	7/ 3	-----
42	2/11	-----	113	4/23	-----	185	7/ 4	-----
43	2/12	-----	114	4/24	-----	186	7/ 5	-----
44	2/13	-----	115	4/25	-----	187	7/ 6	-----
45	2/14	-----	116	4/26	-----	188	7/ 7	-----
46	2/15	-----	117	4/27	-----	189	7/ 8	-----
47	2/16	-----	118	4/28	-----	190	7/ 9	-----
48	2/17	-----	119	4/29	-----	191	7/10	-----
49	2/18	-----	120	4/30	-----	192	7/11	-----
50	2/19	-----	121	5/ 1	-----	193	7/12	-----
51	2/20	-----	122	5/ 2	-----	194	7/13	-----
52	2/21	-----	123	5/ 3	-----	195	7/14	-----
53	2/22	-----	124	5/ 4	-----	196	7/15	-----
54	2/23	-----	125	5/ 5	-----	197	7/16	-----
55	2/24	-----	126	5/ 6	-----	198	7/17	-----
56	2/25	-----	127	5/ 7	-----	199	7/18	-----
57	2/26	-----	128	5/ 8	-----	200	7/19	-----
58	2/27	-----	129	5/ 9	-----	201	7/20	-----
59	2/28	-----	130	5/10	-----	202	7/21	-----
60	3/ 1	-----	131	5/11	-----	203	7/22	-----
61	3/ 2	-----	132	5/12	-----	204	7/23	-----
62	3/ 3	-----	133	5/13	-----	205	7/24	-----
63	3/ 4	-----	134	5/14	-----	206	7/25	-----
64	3/ 5	-----	135	5/15	-----	207	7/26	-----
65	3/ 6	-----	136	5/16	-----	208	7/27	-----
66	3/ 7	-----	137	5/17	-----	209	7/28	-----
67	3/ 8	-----	138	5/18	-----	210	7/29	-----
68	3/ 9	-----	139	5/19	-----	211	7/30	-----
69	3/10	-----	140	5/20	-----	212	7/31	-----
70	3/11	-----	141	5/21	-----	213	8/ 1	-----
71	3/12	-----	142	5/22	-----	214	8/ 2	-----
			143	5/23	-----	215	8/ 3	-----

216	8/ 4	-----	288	10/15	*****	-----	360	12/26	-----
217	8/ 5	-----	289	10/16	-----*	-----	361	12/27	-----*
218	8/ 6	-----	290	10/17	-----	-----	362	12/28	-----*
219	8/ 7	-----*	291	10/18	-----*	-----	363	12/29	-----*
220	8/ 8	-----	292	10/19	-----*	-----	364	12/30	-----*
221	8/ 9	-----*	293	10/20	-----	-----	365	12/31	-----*
222	8/10	-----*	294	10/21	-----*	-----			
223	8/11	-----*	295	10/22	-----*	-----			
224	8/12	*****	296	10/23	-----*	-----			
225	8/13	-----*	297	10/24	-----	-----			
226	8/14	-----	298	10/25	-----*	-----			
227	8/15	-----	299	10/26	-----*	-----			
228	8/16	-----*	300	10/27	-----*	-----			
229	8/17	-----*	301	10/28	-----*	-----			
230	8/18	*****	302	10/29	-----*	-----			
231	8/19	-----*	303	10/30	-----	-----			
232	8/20	-----*	304	10/31	-----*	-----			
233	8/21	-----	305	11/ 1	-----*	-----			
234	8/22	-----*	306	11/ 2	-----*	-----			
235	8/23	-----*	307	11/ 3	-----*	-----			
236	8/24	-----*	308	11/ 4	-----*	-----			
237	8/25	-----*	309	11/ 5	*****	-----			
238	8/26	-----	310	11/ 6	-----	-----			
239	8/27	-----	311	11/ 7	-----*	-----			
240	8/28	-----*	312	11/ 8	*****	-----			
241	8/29	-----*	313	11/ 9	*****	-----			
242	8/30	*****	314	11/10	-----*	-----			
243	8/31	*****	315	11/11	-----	-----			
244	9/ 1	*****	316	11/12	-----*	-----			
245	9/ 2	*****	317	11/13	*****	-----			
246	9/ 3	-----	318	11/14	-----	-----			
247	9/ 4	-----	319	11/15	-----*	-----			
248	9/ 5	-----	320	11/16	-----	-----			
249	9/ 6	-----	321	11/17	-----*	-----			
250	9/ 7	-----*	322	11/18	-----*	-----			
251	9/ 8	*****	323	11/19	-----	-----			
252	9/ 9	*****	324	11/20	-----*	-----			
253	9/10	-----*	325	11/21	-----	-----			
254	9/11	-----*	326	11/22	-----*	-----			
255	9/12	-----	327	11/23	-----*	-----			
256	9/13	-----*	328	11/24	-----	-----			
257	9/14	****	329	11/25	-----*	-----			
258	9/15	*****	330	11/26	-----*	-----			
259	9/16	*****	331	11/27	-----*	-----			
260	9/17	-----*	332	11/28	-----*	-----			
261	9/18	-----*	333	11/29	-----*	-----			
262	9/19	-----*	334	11/30	*****	-----			
263	9/20	-----*	335	12/ 1	*****	-----			
264	9/21	-----*	336	12/ 2	-----*	-----			
265	9/22	*****	337	12/ 3	-----*	-----			
266	9/23	-----*	338	12/ 4	-----	-----			
267	9/24	-----*	339	12/ 5	-----	-----			
268	9/25	-----*	340	12/ 6	-----	-----			
269	9/26	-----*	341	12/ 7	-----*	-----			
270	9/27	-----*	342	12/ 8	-----*	-----			
271	9/28	-----*	343	12/ 9	-----	-----			
272	9/29	-----	344	12/10	-----*	-----			
273	9/30	-----*	345	12/11	*****	-----			
274	10/ 1	*****	346	12/12	*****	-----			
275	10/ 2	*****	347	12/13	-----*	-----			
276	10/ 3	*****	348	12/14	-----*	-----			
277	10/ 4	*****	349	12/15	-----*	-----			
278	10/ 5	-----*	350	12/16	-----*	-----			
279	10/ 6	-----*	351	12/17	-----*	-----			
280	10/ 7	-----*	352	12/18	-----*	-----			
281	10/ 8	-----*	353	12/19	-----*	-----			
282	10/ 9	*****	354	12/20	-----*	-----			
283	10/10	*****	355	12/21	-----*	-----			
284	10/11	-----*	356	12/22	-----*	-----			
285	10/12	-----*	357	12/23	-----*	-----			
286	10/13	-----*	358	12/24	-----*	-----			
287	10/14	-----*	359	12/25	-----*	-----			

1993, SAL/MCC Circuit Uptime

1	1/ 1	-----*--	72	3/13	-----	144	5/24	-----
2	1/ 2	-----	73	3/14	-----	145	5/25	-----
3	1/ 3	-----	74	3/15	-----	146	5/26	-----
4	1/ 4	-----	75	3/16	-----	147	5/27	-----
5	1/ 5	-----	76	3/17	-----	148	5/28	-----
6	1/ 6	-----	77	3/18	-----	149	5/29	-----
7	1/ 7	-----	78	3/19	-----	150	5/30	-----
8	1/ 8	-----	79	3/20	-----	151	5/31	-----
9	1/ 9	-----	80	3/21	-----	152	6/ 1	-----
10	1/10	-----	81	3/22	-----	153	6/ 2	-----
11	1/11	-----	82	3/23	-----	154	6/ 3	-----
12	1/12	-----	83	3/24	-----	155	6/ 4	-----
13	1/13	-----	84	3/25	-----	156	6/ 5	-----
14	1/14	-----	85	3/26	-----	157	6/ 6	-----
15	1/15	-----	86	3/27	-----	158	6/ 7	-----
16	1/16	-----	87	3/28	-----	159	6/ 8	-----
17	1/17	-----	88	3/29	-----	160	6/ 9	-----
18	1/18	-----	89	3/30	-----	161	6/10	-----
19	1/19	-----	90	3/31	-----	162	6/11	-----
20	1/20	-----	91	4/ 1	-----	163	6/12	-----
21	1/21	-----	92	4/ 2	-----	164	6/13	-----
22	1/22	-----	93	4/ 3	-----	165	6/14	-----
23	1/23	-----	94	4/ 4	-----	166	6/15	-----
24	1/24	-----	95	4/ 5	-----	167	6/16	-----
25	1/25	-----	96	4/ 6	-----	168	6/17	-----
26	1/26	-----	97	4/ 7	-----	169	6/18	-----
27	1/27	-----	98	4/ 8	-----	170	6/19	-----
28	1/28	-----	99	4/ 9	-----	171	6/20	-----
29	1/29	-----	100	4/10	-----	172	6/21	-----
30	1/30	-----	101	4/11	-----	173	6/22	-----
31	1/31	-----	102	4/12	-----	174	6/23	-----
32	2/ 1	-----	103	4/13	-----	175	6/24	-----
33	2/ 2	-----	104	4/14	-----	176	6/25	-----
34	2/ 3	-----	105	4/15	-----	177	6/26	-----
35	2/ 4	-----	106	4/16	-----	178	6/27	-----
36	2/ 5	-----	107	4/17	-----	179	6/28	-----
37	2/ 6	-----	108	4/18	-----	180	6/29	-----
38	2/ 7	-----	109	4/19	-----	181	6/30	-----
39	2/ 8	-----	110	4/20	-----	182	7/ 1	-----
40	2/ 9	-----	111	4/21	-----	183	7/ 2	-----
41	2/10	-----	112	4/22	-----	184	7/ 3	-----
42	2/11	-----	113	4/23	-----	185	7/ 4	-----
43	2/12	-----	114	4/24	-----	186	7/ 5	-----
44	2/13	-----	115	4/25	-----	187	7/ 6	-----
45	2/14	-----	116	4/26	-----	188	7/ 7	-----
46	2/15	-----	117	4/27	-----	189	7/ 8	-----
47	2/16	-----	118	4/28	-----	190	7/ 9	-----
48	2/17	-----	119	4/29	-----	191	7/10	-----
49	2/18	-----	120	4/30	-----	192	7/11	-----
50	2/19	-----	121	5/ 1	-----	193	7/12	-----
51	2/20	-----	122	5/ 2	-----	194	7/13	-----
52	2/21	-----	123	5/ 3	-----	195	7/14	-----
53	2/22	-----	124	5/ 4	-----	196	7/15	-----
54	2/23	-----	125	5/ 5	-----	197	7/16	-----
55	2/24	-----	126	5/ 6	-----	198	7/17	-----
56	2/25	-----	127	5/ 7	-----	199	7/18	-----
57	2/26	-----	128	5/ 8	-----	200	7/19	-----
58	2/27	-----	129	5/ 9	-----	201	7/20	-----
59	2/28	-----	130	5/10	-----	202	7/21	-----
60	3/ 1	-----	131	5/11	-----	203	7/22	-----
61	3/ 2	-----	132	5/12	-----	204	7/23	-----
62	3/ 3	-----	133	5/13	-----	205	7/24	-----
63	3/ 4	-----	134	5/14	-----	206	7/25	-----
64	3/ 5	-----	135	5/15	-----	207	7/26	-----
65	3/ 6	-----	136	5/16	-----	208	7/27	-----
66	3/ 7	-----	137	5/17	-----	209	7/28	-----
67	3/ 8	-----	138	5/18	-----	210	7/29	-----
68	3/ 9	-----	139	5/19	-----	211	7/30	-----
69	3/10	-----	140	5/20	-----	212	7/31	-----
70	3/11	-----	141	5/21	-----	213	8/ 1	-----
71	3/12	-----	142	5/22	-----	214	8/ 2	-----
			143	5/23	-----	215	8/ 3	-----

216	8/ 4	*****	288	10/15	*****	360	12/26	*****
217	8/ 5	*****	289	10/16	*****	361	12/27	*****
218	8/ 6	*****	290	10/17	*****	362	12/28	*****
219	8/ 7	*****	291	10/18	*****	363	12/29	*****
220	8/ 8	*****	292	10/19	*****	364	12/30	*****
221	8/ 9	*****	293	10/20	*****	365	12/31	*****
222	8/10	*****	294	10/21	*****			
223	8/11	*****	295	10/22	*****			
224	8/12	*****	296	10/23	*****			
225	8/13	*****	297	10/24	*****			
226	8/14	*****	298	10/25	*****			
227	8/15	*****	299	10/26	*****			
228	8/16	*****	300	10/27	*****			
229	8/17	*****	301	10/28	*****			
230	8/18	*****	302	10/29	*****			
231	8/19	*****	303	10/30	*****			
232	8/20	*****	304	10/31	*****			
233	8/21	*****	305	11/ 1	*****			
234	8/22	*****	306	11/ 2	*****			
235	8/23	*****	307	11/ 3	*****			
236	8/24	*****	308	11/ 4	*****			
237	8/25	*****	309	11/ 5	*****			
238	8/26	*****	310	11/ 6	*****			
239	8/27	*****	311	11/ 7	*****			
240	8/28	*****	312	11/ 8	*****			
241	8/29	*****	313	11/ 9	*****			
242	8/30	*****	314	11/10	*****			
243	8/31	*****	315	11/11	*****			
244	9/ 1	*****	316	11/12	*****			
245	9/ 2	*****	317	11/13	*****			
246	9/ 3	*****	318	11/14	*****			
247	9/ 4	*****	319	11/15	*****			
248	9/ 5	*****	320	11/16	*****			
249	9/ 6	*****	321	11/17	*****			
250	9/ 7	*****	322	11/18	*****			
251	9/ 8	*****	323	11/19	*****			
252	9/ 9	*****	324	11/20	*****			
253	9/10	*****	325	11/21	*****			
254	9/11	*****	326	11/22	*****			
255	9/12	*****	327	11/23	*****			
256	9/13	*****	328	11/24	*****			
257	9/14	*****	329	11/25	*****			
258	9/15	*****	330	11/26	*****			
259	9/16	*****	331	11/27	*****			
260	9/17	*****	332	11/28	*****			
261	9/18	*****	333	11/29	*****			
262	9/19	*****	334	11/30	*****			
263	9/20	*****	335	12/ 1	*****			
264	9/21	*****	336	12/ 2	*****			
265	9/22	*****	337	12/ 3	*****			
266	9/23	*****	338	12/ 4	*****			
267	9/24	*****	339	12/ 5	*****			
268	9/25	*****	340	12/ 6	*****			
269	9/26	*****	341	12/ 7	*****			
270	9/27	*****	342	12/ 8	*****			
271	9/28	*****	343	12/ 9	*****			
272	9/29	*****	344	12/10	*****			
273	9/30	*****	345	12/11	*****			
274	10/ 1	*****	346	12/12	*****			
275	10/ 2	*****	347	12/13	*****			
276	10/ 3	*****	348	12/14	*****			
277	10/ 4	*****	349	12/15	*****			
278	10/ 5	*****	350	12/16	*****			
279	10/ 6	*****	351	12/17	*****			
280	10/ 7	*****	352	12/18	*****			
281	10/ 8	*****	353	12/19	*****			
282	10/ 9	*****	354	12/20	*****			
283	10/10	*****	355	12/21	*****			
284	10/11	*****	356	12/22	*****			
285	10/12	*****	357	12/23	*****			
286	10/13	*****	358	12/24	*****			
287	10/14	*****	359	12/25	*****			

1994, CHC/DAV Circuit Uptime

1	1/ 1	72	3/13	144	5/24
2	1/ 2	73	3/14	145	5/25
3	1/ 3	74	3/15	146	5/26
4	1/ 4	75	3/16	147	5/27
5	1/ 5	76	3/17	148	5/28
6	1/ 6	77	3/18	149	5/29
7	1/ 7	78	3/19	150	5/30
8	1/ 8	79	3/20	151	5/31
9	1/ 9	80	3/21	152	6/ 1
10	1/10	81	3/22	153	6/ 2
11	1/11	82	3/23	154	6/ 3
12	1/12	83	3/24	155	6/ 4
13	1/13	84	3/25	156	6/ 5
14	1/14	85	3/26	157	6/ 6
15	1/15	86	3/27	158	6/ 7
16	1/16	87	3/28	159	6/ 8
17	1/17	88	3/29	160	6/ 9
18	1/18	89	3/30	161	6/10
19	1/19	90	3/31	162	6/11
20	1/20	91	4/ 1	163	6/12
21	1/21	92	4/ 2	164	6/13
22	1/22	93	4/ 3	165	6/14
23	1/23	94	4/ 4	166	6/15
24	1/24	95	4/ 5	167	6/16
25	1/25	96	4/ 6	168	6/17
26	1/26	97	4/ 7	169	6/18
27	1/27	98	4/ 8	170	6/19
28	1/28	99	4/ 9	171	6/20
29	1/29	100	4/10	172	6/21
30	1/30	101	4/11	173	6/22
31	1/31	102	4/12	174	6/23
32	2/ 1	103	4/13	175	6/24
33	2/ 2	104	4/14	176	6/25
34	2/ 3	105	4/15	177	6/26
35	2/ 4	106	4/16	178	6/27
36	2/ 5	107	4/17	179	6/28
37	2/ 6	108	4/18	180	6/29
38	2/ 7	109	4/19	181	6/30
39	2/ 8	110	4/20	182	7/ 1
40	2/ 9	111	4/21	183	7/ 2
41	2/10	112	4/22	184	7/ 3
42	2/11	113	4/23	185	7/ 4
43	2/12	114	4/24	186	7/ 5
44	2/13	115	4/25	187	7/ 6
45	2/14	116	4/26	188	7/ 7
46	2/15	117	4/27	189	7/ 8
47	2/16	118	4/28	190	7/ 9
48	2/17	119	4/29	191	7/10
49	2/18	120	4/30	192	7/11
50	2/19	121	5/ 1	193	7/12
51	2/20	122	5/ 2	194	7/13
52	2/21	123	5/ 3	195	7/14
53	2/22	124	5/ 4	196	7/15
54	2/23	125	5/ 5	197	7/16
55	2/24	126	5/ 6	198	7/17
56	2/25	127	5/ 7	199	7/18
57	2/26	128	5/ 8	200	7/19
58	2/27	129	5/ 9	201	7/20
59	2/28	130	5/10	202	7/21
60	3/ 1	131	5/11	203	7/22
61	3/ 2	132	5/12	204	7/23
62	3/ 3	133	5/13	205	7/24
63	3/ 4	134	5/14	206	7/25
64	3/ 5	135	5/15	207	7/26
65	3/ 6	136	5/16	208	7/27
66	3/ 7	137	5/17	209	7/28
67	3/ 8	138	5/18	210	7/29
68	3/ 9	139	5/19	211	7/30
69	3/10	140	5/20	212	7/31
70	3/11	141	5/21	213	8/ 1
71	3/12	142	5/22	214	8/ 2
		143	5/23	215	8/ 3

216	8/ 4	-----	288	10/15	-----	360	12/26	-----
217	8/ 5	-----	289	10/16	-----	361	12/27	-----
218	8/ 6	-----	290	10/17	-----	362	12/28	-----
219	8/ 7	-----	291	10/18	-----	363	12/29	-----
220	8/ 8	-----	292	10/19	-----	364	12/30	-----
221	8/ 9	-----	293	10/20	-----	365	12/31	-----
222	8/10	-----	294	10/21	-----			
223	8/11	-----	295	10/22	-----			
224	8/12	-----	296	10/23	-----			
225	8/13	-----	297	10/24	-----			
226	8/14	-----	298	10/25	-----			
227	8/15	-----	299	10/26	-----			
228	8/16	-----	300	10/27	-----			
229	8/17	-----	301	10/28	-----			
230	8/18	-----	302	10/29	-----			
231	8/19	-----	303	10/30	-----			
232	8/20	-----	304	10/31	-----			
233	8/21	-----	305	11/ 1	-----			
234	8/22	-----	306	11/ 2	-----			
235	8/23	-----	307	11/ 3	-----			
236	8/24	-----	308	11/ 4	-----			
237	8/25	-----	309	11/ 5	-----			
238	8/26	-----	310	11/ 6	-----			
239	8/27	-----	311	11/ 7	-----			
240	8/28	-----	312	11/ 8	-----			
241	8/29	-----	313	11/ 9	-----			
242	8/30	-----	314	11/10	-----			
243	8/31	-----	315	11/11	-----			
244	9/ 1	-----	316	11/12	-----			
245	9/ 2	-----	317	11/13	-----			
246	9/ 3	-----	318	11/14	-----			
247	9/ 4	-----	319	11/15	-----			
248	9/ 5	-----	320	11/16	-----			
249	9/ 6	-----	321	11/17	-----			
250	9/ 7	-----	322	11/18	-----			
251	9/ 8	-----	323	11/19	-----			
252	9/ 9	-----	324	11/20	-----			
253	9/10	-----	325	11/21	-----			
254	9/11	-----	326	11/22	-----			
255	9/12	-----	327	11/23	-----			
256	9/13	-----	328	11/24	-----			
257	9/14	-----	329	11/25	-----			
258	9/15	-----	330	11/26	-----			
259	9/16	-----	331	11/27	-----			
260	9/17	-----	332	11/28	-----			
261	9/18	-----	333	11/29	-----			
262	9/19	-----	334	11/30	-----			
263	9/20	-----	335	12/ 1	-----			
264	9/21	-----	336	12/ 2	-----			
265	9/22	-----	337	12/ 3	-----			
266	9/23	-----	338	12/ 4	-----			
267	9/24	-----	339	12/ 5	-----			
268	9/25	-----	340	12/ 6	-----			
269	9/26	-----	341	12/ 7	-----			
270	9/27	-----	342	12/ 8	-----			
271	9/28	-----	343	12/ 9	-----			
272	9/29	-----	344	12/10	-----			
273	9/30	-----	345	12/11	-----			
274	10/ 1	-----	346	12/12	-----			
275	10/ 2	-----	347	12/13	-----			
276	10/ 3	-----	348	12/14	-----			
277	10/ 4	-----	349	12/15	-----			
278	10/ 5	-----	350	12/16	-----			
279	10/ 6	-----	351	12/17	-----			
280	10/ 7	-----	352	12/18	-----			
281	10/ 8	-----	353	12/19	-----			
282	10/ 9	-----	354	12/20	-----			
283	10/10	-----	355	12/21	-----			
284	10/11	-----	356	12/22	-----			
285	10/12	-----	357	12/23	-----			
286	10/13	-----	358	12/24	-----			
287	10/14	-----	359	12/25	-----			

1994, CHC/MCC Circuit Uptime

1	1/ 1	72	3/13	144	5/24
2	1/ 2	73	3/14	145	5/25
3	1/ 3	74	3/15	146	5/26
4	1/ 4	75	3/16	147	5/27
5	1/ 5	76	3/17	148	5/28
6	1/ 6	77	3/18	149	5/29
7	1/ 7	78	3/19	150	5/30
8	1/ 8	79	3/20	151	5/31
9	1/ 9	80	3/21	152	6/ 1
10	1/10	81	3/22	153	6/ 2
11	1/11	82	3/23	154	6/ 3
12	1/12	83	3/24	155	6/ 4
13	1/13	84	3/25	156	6/ 5
14	1/14	85	3/26	157	6/ 6
15	1/15	86	3/27	158	6/ 7
16	1/16	87	3/28	159	6/ 8
17	1/17	88	3/29	160	6/ 9
18	1/18	89	3/30	161	6/10
19	1/19	90	3/31	162	6/11
20	1/20	91	4/ 1	163	6/12
21	1/21	92	4/ 2	164	6/13
22	1/22	93	4/ 3	165	6/14
23	1/23	94	4/ 4	166	6/15
24	1/24	95	4/ 5	167	6/16
25	1/25	96	4/ 6	168	6/17
26	1/26	97	4/ 7	169	6/18
27	1/27	98	4/ 8	170	6/19
28	1/28	99	4/ 9	171	6/20
29	1/29	100	4/10	172	6/21
30	1/30	101	4/11	173	6/22
31	1/31	102	4/12	174	6/23
32	2/ 1	103	4/13	175	6/24
33	2/ 2	104	4/14	176	6/25
34	2/ 3	105	4/15	177	6/26
35	2/ 4	106	4/16	178	6/27
36	2/ 5	107	4/17	179	6/28
37	2/ 6	108	4/18	180	6/29
38	2/ 7	109	4/19	181	6/30
39	2/ 8	110	4/20	182	7/ 1
40	2/ 9	111	4/21	183	7/ 2
41	2/10	112	4/22	184	7/ 3
42	2/11	113	4/23	185	7/ 4
43	2/12	114	4/24	186	7/ 5
44	2/13	115	4/25	187	7/ 6
45	2/14	116	4/26	188	7/ 7
46	2/15	117	4/27	189	7/ 8
47	2/16	118	4/28	190	7/ 9
48	2/17	119	4/29	191	7/10
49	2/18	120	4/30	192	7/11
50	2/19	121	5/ 1	193	7/12
51	2/20	122	5/ 2	194	7/13
52	2/21	123	5/ 3	195	7/14
53	2/22	124	5/ 4	196	7/15
54	2/23	125	5/ 5	197	7/16
55	2/24	126	5/ 6	198	7/17
56	2/25	127	5/ 7	199	7/18
57	2/26	128	5/ 8	200	7/19
58	2/27	129	5/ 9	201	7/20
59	2/28	130	5/10	202	7/21
60	3/ 1	131	5/11	203	7/22
61	3/ 2	132	5/12	204	7/23
62	3/ 3	133	5/13	205	7/24
63	3/ 4	134	5/14	206	7/25
64	3/ 5	135	5/15	207	7/26
65	3/ 6	136	5/16	208	7/27
66	3/ 7	137	5/17	209	7/28
67	3/ 8	138	5/18	210	7/29
68	3/ 9	139	5/19	211	7/30
69	3/10	140	5/20	212	7/31
70	3/11	141	5/21	213	8/ 1
71	3/12	142	5/22	214	8/ 2
		143	5/23	215	8/ 3

216	8/ 4	-----	288	10/15	-----*-----**	360	12/26	-----
217	8/ 5	**-----	289	10/16	---*****--*--	361	12/27	-----
218	8/ 6	-----	290	10/17	---*****--*--	362	12/28	-----
219	8/ 7	*****-----	291	10/18	---*****--*--	363	12/29	-----
220	8/ 8	-----	292	10/19	*--*-----	364	12/30	-----
221	8/ 9	*****-----	293	10/20	***-----***	365	12/31	-----
222	8/10	*-----**	294	10/21	-----*-----*			
223	8/11	*****-----	295	10/22	---*-----*			
224	8/12	-----	296	10/23	-----*			
225	8/13	-----	297	10/24	---*-----*			
226	8/14	-----	298	10/25	*****-----*			
227	8/15	-----	299	10/26	-----			
228	8/16	---**-----**	300	10/27	-----			
229	8/17	**-----	301	10/28	-----			
230	8/18	-----**	302	10/29	-----			
231	8/19	-----	303	10/30	-----			
232	8/20	-----	304	10/31	-----			
233	8/21	-----	305	11/ 1	-----			
234	8/22	-----	306	11/ 2	-----			
235	8/23	-----	307	11/ 3	-----			
236	8/24	**-----**	308	11/ 4	-----			
237	8/25	-----	309	11/ 5	-----			
238	8/26	-----	310	11/ 6	-----			
239	8/27	-----	311	11/ 7	-----			
240	8/28	-----**	312	11/ 8	-----			
241	8/29	*****-----	313	11/ 9	-----			
242	8/30	-----	314	11/10	-----			
243	8/31	-----	315	11/11	-----			
244	9/ 1	-----	316	11/12	-----			
245	9/ 2	**-----	317	11/13	-----			
246	9/ 3	-----	318	11/14	-----			
247	9/ 4	-----	319	11/15	-----			
248	9/ 5	-----*	320	11/16	-----			
249	9/ 6	-----**	321	11/17	-----			
250	9/ 7	***-----	322	11/18	-----			
251	9/ 8	---*****-----	323	11/19	-----			
252	9/ 9	****-----	324	11/20	-----			
253	9/10	-----	325	11/21	-----			
254	9/11	-----	326	11/22	-----			
255	9/12	-----	327	11/23	-----			
256	9/13	---*****-----	328	11/24	-----			
257	9/14	-----***-	329	11/25	-----			
258	9/15	---*****-----	330	11/26	-----			
259	9/16	****-----	331	11/27	-----			
260	9/17	-----	332	11/28	-----			
261	9/18	-----	333	11/29	-----			
262	9/19	-----	334	11/30	-----			
263	9/20	*****-----	335	12/ 1	-----			
264	9/21	---*-----*	336	12/ 2	-----			
265	9/22	---*****-----	337	12/ 3	-----			
266	9/23	-----	338	12/ 4	-----			
267	9/24	-----	339	12/ 5	-----			
268	9/25	-----	340	12/ 6	-----			
269	9/26	-----	341	12/ 7	-----			
270	9/27	-----	342	12/ 8	-----			
271	9/28	-----	343	12/ 9	-----			
272	9/29	-----	344	12/10	-----			
273	9/30	-----	345	12/11	-----			
274	10/ 1	-----	346	12/12	-----			
275	10/ 2	-----	347	12/13	-----			
276	10/ 3	-----	348	12/14	-----			
277	10/ 4	*****-----*	349	12/15	-----			
278	10/ 5	-----*-----*	350	12/16	-----			
279	10/ 6	-----**	351	12/17	-----			
280	10/ 7	-----	352	12/18	-----			
281	10/ 8	-----**	353	12/19	-----			
282	10/ 9	*--*-----*	354	12/20	-----			
283	10/10	*****-----	355	12/21	-----			
284	10/11	-----*-----*	356	12/22	-----			
285	10/12	-----	357	12/23	-----			
286	10/13	-----*	358	12/24	-----			
287	10/14	*--*-----*	359	12/25	-----			

1994, CHC/SAL Circuit Uptime

1	1/ 1	72	3/13	144	5/24
2	1/ 2	73	3/14	145	5/25
3	1/ 3	74	3/15	146	5/26
4	1/ 4	75	3/16	147	5/27
5	1/ 5	76	3/17	148	5/28
6	1/ 6	77	3/18	149	5/29
7	1/ 7	78	3/19	150	5/30
8	1/ 8	79	3/20	151	5/31
9	1/ 9	80	3/21	152	6/ 1
10	1/10	81	3/22	153	6/ 2
11	1/11	82	3/23	154	6/ 3
12	1/12	83	3/24	155	6/ 4
13	1/13	84	3/25	156	6/ 5
14	1/14	85	3/26	157	6/ 6
15	1/15	86	3/27	158	6/ 7
16	1/16	87	3/28	159	6/ 8
17	1/17	88	3/29	160	6/ 9
18	1/18	89	3/30	161	6/10
19	1/19	90	3/31	162	6/11
20	1/20	91	4/ 1	163	6/12
21	1/21	92	4/ 2	164	6/13
22	1/22	93	4/ 3	165	6/14
23	1/23	94	4/ 4	166	6/15
24	1/24	95	4/ 5	167	6/16
25	1/25	96	4/ 6	168	6/17
26	1/26	97	4/ 7	169	6/18
27	1/27	98	4/ 8	170	6/19
28	1/28	99	4/ 9	171	6/20
29	1/29	100	4/10	172	6/21
30	1/30	101	4/11	173	6/22
31	1/31	102	4/12	174	6/23
32	2/ 1	103	4/13	175	6/24
33	2/ 2	104	4/14	176	6/25
34	2/ 3	105	4/15	177	6/26
35	2/ 4	106	4/16	178	6/27
36	2/ 5	107	4/17	179	6/28
37	2/ 6	108	4/18	180	6/29
38	2/ 7	109	4/19	181	6/30
39	2/ 8	110	4/20	182	7/ 1
40	2/ 9	111	4/21	183	7/ 2
41	2/10	112	4/22	184	7/ 3
42	2/11	113	4/23	185	7/ 4
43	2/12	114	4/24	186	7/ 5
44	2/13	115	4/25	187	7/ 6
45	2/14	116	4/26	188	7/ 7
46	2/15	117	4/27	189	7/ 8
47	2/16	118	4/28	190	7/ 9
48	2/17	119	4/29	191	7/10
49	2/18	120	4/30	192	7/11
50	2/19	121	5/ 1	193	7/12
51	2/20	122	5/ 2	194	7/13
52	2/21	123	5/ 3	195	7/14
53	2/22	124	5/ 4	196	7/15
54	2/23	125	5/ 5	197	7/16
55	2/24	126	5/ 6	198	7/17
56	2/25	127	5/ 7	199	7/18
57	2/26	128	5/ 8	200	7/19
58	2/27	129	5/ 9	201	7/20
59	2/28	130	5/10	202	7/21
60	3/ 1	131	5/11	203	7/22
61	3/ 2	132	5/12	204	7/23
62	3/ 3	133	5/13	205	7/24
63	3/ 4	134	5/14	206	7/25
64	3/ 5	135	5/15	207	7/26
65	3/ 6	136	5/16	208	7/27
66	3/ 7	137	5/17	209	7/28
67	3/ 8	138	5/18	210	7/29
68	3/ 9	139	5/19	211	7/30
69	3/10	140	5/20	212	7/31
70	3/11	141	5/21	213	8/ 1
71	3/12	142	5/22	214	8/ 2
		143	5/23	215	8/ 3

216	8/ 4	--*-----****	288	10/15	-----*--*--****-----**	360	12/26	-----
217	8/ 5	-----	289	10/16	---*****-----*--*--	361	12/27	-----
218	8/ 6	-----*	290	10/17	---*-----*****--*--	362	12/28	-----
219	8/ 7	---*-----*****--*--	291	10/18	---*-----*****--*--	363	12/29	-----
220	8/ 8	-----****	292	10/19	*--*--*****-----	364	12/30	-----
221	8/ 9	*****-----**	293	10/20	***--*-----*****	365	12/31	-----
222	8/10	*-----****	294	10/21	-----*--*--*--*--*--			
223	8/11	*****-----****	295	10/22	-*--*-----*--*--			
224	8/12	*****-----	296	10/23	-----*			
225	8/13	-----	297	10/24	---*-----*****			
226	8/14	-----****	298	10/25	*****-----*--*--			
227	8/15	*****-----	299	10/26	-----			
228	8/16	---**-----****	300	10/27	-----			
229	8/17	**-----	301	10/28	-----			
230	8/18	-----**	302	10/29	-----			
231	8/19	*****-----	303	10/30	-----			
232	8/20	-----	304	10/31	-----			
233	8/21	-----	305	11/ 1	-----*****--*--			
234	8/22	-----***	306	11/ 2	-----			
235	8/23	*****-----*--	307	11/ 3	-----			
236	8/24	**-----****	308	11/ 4	-----			
237	8/25	-----	309	11/ 5	-----			
238	8/26	-----	310	11/ 6	-----			
239	8/27	-----	311	11/ 7	-----			
240	8/28	-----****	312	11/ 8	-----			
241	8/29	*****-----***	313	11/ 9	-----			
242	8/30	**-----	314	11/10	-----			
243	8/31	-----	315	11/11	-----			
244	9/ 1	-----****	316	11/12	-----			
245	9/ 2	**-----	317	11/13	-----			
246	9/ 3	-----	318	11/14	-----			
247	9/ 4	-----	319	11/15	-----			
248	9/ 5	-----*	320	11/16	-----			
249	9/ 6	-----****	321	11/17	-----			
250	9/ 7	***-----	322	11/18	-----			
251	9/ 8	-----*****	323	11/19	-----			
252	9/ 9	*****-----	324	11/20	-----			
253	9/10	-----	325	11/21	-----			
254	9/11	-----	326	11/22	-----			
255	9/12	-----	327	11/23	-----			
256	9/13	-----*****	328	11/24	-----			
257	9/14	-----***	329	11/25	-----			
258	9/15	-----*****	330	11/26	-----			
259	9/16	*****-----	331	11/27	-----			
260	9/17	-----	332	11/28	-----			
261	9/18	-----	333	11/29	-----			
262	9/19	-----	334	11/30	-----			
263	9/20	*****-----	335	12/ 1	-----			
264	9/21	---*-----*--	336	12/ 2	-----			
265	9/22	-----*****	337	12/ 3	-----			
266	9/23	-----	338	12/ 4	-----			
267	9/24	-----	339	12/ 5	-----			
268	9/25	-----	340	12/ 6	-----			
269	9/26	-----	341	12/ 7	-----			
270	9/27	---*-----*****	342	12/ 8	-----			
271	9/28	*****-----	343	12/ 9	-----			
272	9/29	*****-----	344	12/10	-----			
273	9/30	*****-----	345	12/11	-----			
274	10/ 1	*****-----	346	12/12	-----			
275	10/ 2	*****-----	347	12/13	-----			
276	10/ 3	*****-----	348	12/14	-----			
277	10/ 4	*****-----*	349	12/15	-----			
278	10/ 5	-----*-----*	350	12/16	-----			
279	10/ 6	-----*****	351	12/17	-----			
280	10/ 7	-----**	352	12/18	-----			
281	10/ 8	-----*	353	12/19	-----			
282	10/ 9	*--*-----*****	354	12/20	-----			
283	10/10	*****-----	355	12/21	-----			
284	10/11	-----*-----*	356	12/22	-----			
285	10/12	-----	357	12/23	-----			
286	10/13	-----*	358	12/24	-----			
287	10/14	*--*-----*****	359	12/25	-----			

1994, DAV/MCD Circuit Uptime

1	1/ 1	72	3/13	144	5/24
2	1/ 2	73	3/14	145	5/25
3	1/ 3	74	3/15	146	5/26
4	1/ 4	75	3/16	147	5/27
5	1/ 5	76	3/17	148	5/28
6	1/ 6	77	3/18	149	5/29
7	1/ 7	78	3/19	150	5/30
8	1/ 8	79	3/20	151	5/31
9	1/ 9	80	3/21	152	6/ 1
10	1/10	81	3/22	153	6/ 2
11	1/11	82	3/23	154	6/ 3
12	1/12	83	3/24	155	6/ 4
13	1/13	84	3/25	156	6/ 5
14	1/14	85	3/26	157	6/ 6
15	1/15	86	3/27	158	6/ 7
16	1/16	87	3/28	159	6/ 8
17	1/17	88	3/29	160	6/ 9
18	1/18	89	3/30	161	6/10
19	1/19	90	3/31	162	6/11
20	1/20	91	4/ 1	163	6/12
21	1/21	92	4/ 2	164	6/13
22	1/22	93	4/ 3	165	6/14
23	1/23	94	4/ 4	166	6/15
24	1/24	95	4/ 5	167	6/16
25	1/25	96	4/ 6	168	6/17
26	1/26	97	4/ 7	169	6/18
27	1/27	98	4/ 8	170	6/19
28	1/28	99	4/ 9	171	6/20
29	1/29	100	4/10	172	6/21
30	1/30	101	4/11	173	6/22
31	1/31	102	4/12	174	6/23
32	2/ 1	103	4/13	175	6/24
33	2/ 2	104	4/14	176	6/25
34	2/ 3	105	4/15	177	6/26
35	2/ 4	106	4/16	178	6/27
36	2/ 5	107	4/17	179	6/28
37	2/ 6	108	4/18	180	6/29
38	2/ 7	109	4/19	181	6/30
39	2/ 8	110	4/20	182	7/ 1
40	2/ 9	111	4/21	183	7/ 2
41	2/10	112	4/22	184	7/ 3
42	2/11	113	4/23	185	7/ 4
43	2/12	114	4/24	186	7/ 5
44	2/13	115	4/25	187	7/ 6
45	2/14	116	4/26	188	7/ 7
46	2/15	117	4/27	189	7/ 8
47	2/16	118	4/28	190	7/ 9
48	2/17	119	4/29	191	7/10
49	2/18	120	4/30	192	7/11
50	2/19	121	5/ 1	193	7/12
51	2/20	122	5/ 2	194	7/13
52	2/21	123	5/ 3	195	7/14
53	2/22	124	5/ 4	196	7/15
54	2/23	125	5/ 5	197	7/16
55	2/24	126	5/ 6	198	7/17
56	2/25	127	5/ 7	199	7/18
57	2/26	128	5/ 8	200	7/19
58	2/27	129	5/ 9	201	7/20
59	2/28	130	5/10	202	7/21
60	3/ 1	131	5/11	203	7/22
61	3/ 2	132	5/12	204	7/23
62	3/ 3	133	5/13	205	7/24
63	3/ 4	134	5/14	206	7/25
64	3/ 5	135	5/15	207	7/26
65	3/ 6	136	5/16	208	7/27
66	3/ 7	137	5/17	209	7/28
67	3/ 8	138	5/18	210	7/29
68	3/ 9	139	5/19	211	7/30
69	3/10	140	5/20	212	7/31
70	3/11	141	5/21	213	8/ 1
71	3/12	142	5/22	214	8/ 2
		143	5/23	215	8/ 3

216	8/ 4	-----	288	10/15	-----	360	12/26	-----
217	8/ 5	-----	289	10/16	-----	361	12/27	-----
218	8/ 6	-----	290	10/17	-----	362	12/28	-----
219	8/ 7	-----	291	10/18	-----	363	12/29	-----
220	8/ 8	-----	292	10/19	-----	364	12/30	-----
221	8/ 9	-----	293	10/20	-----	365	12/31	-----
222	8/10	-----	294	10/21	-----			
223	8/11	-----	295	10/22	-----			
224	8/12	-----	296	10/23	-----			
225	8/13	-----	297	10/24	-----			
226	8/14	-----	298	10/25	-----			
227	8/15	-----	299	10/26	-----			
228	8/16	-----	300	10/27	-----			
229	8/17	-----	301	10/28	-----			
230	8/18	-----	302	10/29	-----			
231	8/19	-----	303	10/30	-----			
232	8/20	-----	304	10/31	-----			
233	8/21	-----	305	11/ 1	-----			
234	8/22	-----	306	11/ 2	-----			
235	8/23	-----	307	11/ 3	-----			
236	8/24	-----	308	11/ 4	-----			
237	8/25	-----	309	11/ 5	-----			
238	8/26	-----	310	11/ 6	-----			
239	8/27	-----	311	11/ 7	-----			
240	8/28	-----	312	11/ 8	-----			
241	8/29	-----	313	11/ 9	-----			
242	8/30	-----	314	11/10	-----			
243	8/31	-----	315	11/11	-----			
244	9/ 1	-----	316	11/12	-----			
245	9/ 2	-----	317	11/13	-----			
246	9/ 3	-----	318	11/14	-----			
247	9/ 4	-----	319	11/15	-----			
248	9/ 5	-----	320	11/16	-----			
249	9/ 6	-----	321	11/17	-----			
250	9/ 7	-----	322	11/18	-----			
251	9/ 8	-----	323	11/19	-----			
252	9/ 9	-----	324	11/20	-----			
253	9/10	-----	325	11/21	-----			
254	9/11	-----	326	11/22	-----			
255	9/12	-----	327	11/23	-----			
256	9/13	-----	328	11/24	-----			
257	9/14	-----	329	11/25	-----			
258	9/15	-----	330	11/26	-----			
259	9/16	-----	331	11/27	-----			
260	9/17	-----	332	11/28	-----			
261	9/18	-----	333	11/29	-----			
262	9/19	-----	334	11/30	-----			
263	9/20	-----	335	12/ 1	-----			
264	9/21	-----	336	12/ 2	-----			
265	9/22	-----	337	12/ 3	-----			
266	9/23	-----	338	12/ 4	-----			
267	9/24	-----	339	12/ 5	-----			
268	9/25	-----	340	12/ 6	-----			
269	9/26	-----	341	12/ 7	-----			
270	9/27	-----	342	12/ 8	-----			
271	9/28	-----	343	12/ 9	-----			
272	9/29	-----	344	12/10	-----			
273	9/30	-----	345	12/11	-----			
274	10/ 1	-----	346	12/12	-----			
275	10/ 2	-----	347	12/13	-----			
276	10/ 3	-----	348	12/14	-----			
277	10/ 4	-----	349	12/15	-----			
278	10/ 5	-----	350	12/16	-----			
279	10/ 6	-----	351	12/17	-----			
280	10/ 7	-----	352	12/18	-----			
281	10/ 8	-----	353	12/19	-----			
282	10/ 9	-----	354	12/20	-----			
283	10/10	-----	355	12/21	-----			
284	10/11	-----	356	12/22	-----			
285	10/12	-----	357	12/23	-----			
286	10/13	-----	358	12/24	-----			
287	10/14	-----	359	12/25	-----			

1994, DAV/SAL Circuit Uptime

1	1/ 1	72	3/13	144	5/24
2	1/ 2	73	3/14	145	5/25
3	1/ 3	74	3/15	146	5/26
4	1/ 4	75	3/16	147	5/27
5	1/ 5	76	3/17	148	5/28
6	1/ 6	77	3/18	149	5/29
7	1/ 7	78	3/19	150	5/30
8	1/ 8	79	3/20	151	5/31
9	1/ 9	80	3/21	152	6/ 1
10	1/10	81	3/22	153	6/ 2
11	1/11	82	3/23	154	6/ 3
12	1/12	83	3/24	155	6/ 4
13	1/13	84	3/25	156	6/ 5
14	1/14	85	3/26	157	6/ 6
15	1/15	86	3/27	158	6/ 7
16	1/16	87	3/28	159	6/ 8
17	1/17	88	3/29	160	6/ 9
18	1/18	89	3/30	161	6/10
19	1/19	90	3/31	162	6/11
20	1/20	91	4/ 1	163	6/12
21	1/21	92	4/ 2	164	6/13
22	1/22	93	4/ 3	165	6/14
23	1/23	94	4/ 4	166	6/15
24	1/24	95	4/ 5	167	6/16
25	1/25	96	4/ 6	168	6/17
26	1/26	97	4/ 7	169	6/18
27	1/27	98	4/ 8	170	6/19
28	1/28	99	4/ 9	171	6/20
29	1/29	100	4/10	172	6/21
30	1/30	101	4/11	173	6/22
31	1/31	102	4/12	174	6/23
32	2/ 1	103	4/13	175	6/24
33	2/ 2	104	4/14	176	6/25
34	2/ 3	105	4/15	177	6/26
35	2/ 4	106	4/16	178	6/27
36	2/ 5	107	4/17	179	6/28
37	2/ 6	108	4/18	180	6/29
38	2/ 7	109	4/19	181	6/30
39	2/ 8	110	4/20	182	7/ 1
40	2/ 9	111	4/21	183	7/ 2
41	2/10	112	4/22	184	7/ 3
42	2/11	113	4/23	185	7/ 4
43	2/12	114	4/24	186	7/ 5
44	2/13	115	4/25	187	7/ 6
45	2/14	116	4/26	188	7/ 7
46	2/15	117	4/27	189	7/ 8
47	2/16	118	4/28	190	7/ 9
48	2/17	119	4/29	191	7/10
49	2/18	120	4/30	192	7/11
50	2/19	121	5/ 1	193	7/12
51	2/20	122	5/ 2	194	7/13
52	2/21	123	5/ 3	195	7/14
53	2/22	124	5/ 4	196	7/15
54	2/23	125	5/ 5	197	7/16
55	2/24	126	5/ 6	198	7/17
56	2/25	127	5/ 7	199	7/18
57	2/26	128	5/ 8	200	7/19
58	2/27	129	5/ 9	201	7/20
59	2/28	130	5/10	202	7/21
60	3/ 1	131	5/11	203	7/22
61	3/ 2	132	5/12	204	7/23
62	3/ 3	133	5/13	205	7/24
63	3/ 4	134	5/14	206	7/25
64	3/ 5	135	5/15	207	7/26
65	3/ 6	136	5/16	208	7/27
66	3/ 7	137	5/17	209	7/28
67	3/ 8	138	5/18	210	7/29
68	3/ 9	139	5/19	211	7/30
69	3/10	140	5/20	212	7/31
70	3/11	141	5/21	213	8/ 1
71	3/12	142	5/22	214	8/ 2
		143	5/23	215	8/ 3

216	8/ 4	-----	288	10/15	-----	360	12/26	-----
217	8/ 5	-----	289	10/16	-----	361	12/27	-----
218	8/ 6	-----	290	10/17	-----	362	12/28	-----
219	8/ 7	-----	291	10/18	-----	363	12/29	-----
220	8/ 8	-----	292	10/19	-----	364	12/30	-----
221	8/ 9	-----	293	10/20	-----	365	12/31	-----
222	8/10	-----	294	10/21	-----			
223	8/11	-----	295	10/22	-----			
224	8/12	-----	296	10/23	-----			
225	8/13	-----	297	10/24	-----			
226	8/14	-----	298	10/25	-----			
227	8/15	-----	299	10/26	-----			
228	8/16	-----	300	10/27	-----			
229	8/17	-----	301	10/28	-----			
230	8/18	-----	302	10/29	-----			
231	8/19	-----	303	10/30	-----			
232	8/20	-----	304	10/31	-----			
233	8/21	-----	305	11/ 1	-----			
234	8/22	-----	306	11/ 2	-----			
235	8/23	-----	307	11/ 3	-----			
236	8/24	-----	308	11/ 4	-----			
237	8/25	-----	309	11/ 5	-----			
238	8/26	-----	310	11/ 6	-----			
239	8/27	-----	311	11/ 7	-----			
240	8/28	-----	312	11/ 8	-----			
241	8/29	-----	313	11/ 9	-----			
242	8/30	-----	314	11/10	-----			
243	8/31	-----	315	11/11	-----			
244	9/ 1	-----	316	11/12	-----			
245	9/ 2	-----	317	11/13	-----			
246	9/ 3	-----	318	11/14	-----			
247	9/ 4	-----	319	11/15	-----			
248	9/ 5	-----	320	11/16	-----			
249	9/ 6	-----	321	11/17	-----			
250	9/ 7	-----	322	11/18	-----			
251	9/ 8	-----	323	11/19	-----			
252	9/ 9	-----	324	11/20	-----			
253	9/10	-----	325	11/21	-----			
254	9/11	-----	326	11/22	-----			
255	9/12	-----	327	11/23	-----			
256	9/13	-----	328	11/24	-----			
257	9/14	-----	329	11/25	-----			
258	9/15	-----	330	11/26	-----			
259	9/16	-----	331	11/27	-----			
260	9/17	-----	332	11/28	-----			
261	9/18	-----	333	11/29	-----			
262	9/19	-----	334	11/30	-----			
263	9/20	-----	335	12/ 1	-----			
264	9/21	-----	336	12/ 2	-----			
265	9/22	-----	337	12/ 3	-----			
266	9/23	-----	338	12/ 4	-----			
267	9/24	-----	339	12/ 5	-----			
268	9/25	-----	340	12/ 6	-----			
269	9/26	-----	341	12/ 7	-----			
270	9/27	-----	342	12/ 8	-----			
271	9/28	-----	343	12/ 9	-----			
272	9/29	-----	344	12/10	-----			
273	9/30	-----	345	12/11	-----			
274	10/ 1	-----	346	12/12	-----			
275	10/ 2	-----	347	12/13	-----			
276	10/ 3	-----	348	12/14	-----			
277	10/ 4	-----	349	12/15	-----			
278	10/ 5	-----	350	12/16	-----			
279	10/ 6	-----	351	12/17	-----			
280	10/ 7	-----	352	12/18	-----			
281	10/ 8	-----	353	12/19	-----			
282	10/ 9	-----	354	12/20	-----			
283	10/10	-----	355	12/21	-----			
284	10/11	-----	356	12/22	-----			
285	10/12	-----	357	12/23	-----			
286	10/13	-----	358	12/24	-----			
287	10/14	-----	359	12/25	-----			

1994, SAL/MCC Circuit Uptime

1	1/ 1	72	3/13	144	5/24
2	1/ 2	73	3/14	145	5/25
3	1/ 3	74	3/15	146	5/26
4	1/ 4	75	3/16	147	5/27
5	1/ 5	76	3/17	148	5/28
6	1/ 6	77	3/18	149	5/29
7	1/ 7	78	3/19	150	5/30
8	1/ 8	79	3/20	151	5/31
9	1/ 9	80	3/21	152	6/ 1
10	1/10	81	3/22	153	6/ 2
11	1/11	82	3/23	154	6/ 3
12	1/12	83	3/24	155	6/ 4
13	1/13	84	3/25	156	6/ 5
14	1/14	85	3/26	157	6/ 6
15	1/15	86	3/27	158	6/ 7
16	1/16	87	3/28	159	6/ 8
17	1/17	88	3/29	160	6/ 9
18	1/18	89	3/30	161	6/10
19	1/19	90	3/31	162	6/11
20	1/20	91	4/ 1	163	6/12
21	1/21	92	4/ 2	164	6/13
22	1/22	93	4/ 3	165	6/14
23	1/23	94	4/ 4	166	6/15
24	1/24	95	4/ 5	167	6/16
25	1/25	96	4/ 6	168	6/17
26	1/26	97	4/ 7	169	6/18
27	1/27	98	4/ 8	170	6/19
28	1/28	99	4/ 9	171	6/20
29	1/29	100	4/10	172	6/21
30	1/30	101	4/11	173	6/22
31	1/31	102	4/12	174	6/23
32	2/ 1	103	4/13	175	6/24
33	2/ 2	104	4/14	176	6/25
34	2/ 3	105	4/15	177	6/26
35	2/ 4	106	4/16	178	6/27
36	2/ 5	107	4/17	179	6/28
37	2/ 6	108	4/18	180	6/29
38	2/ 7	109	4/19	181	6/30
39	2/ 8	110	4/20	182	7/ 1
40	2/ 9	111	4/21	183	7/ 2
41	2/10	112	4/22	184	7/ 3
42	2/11	113	4/23	185	7/ 4
43	2/12	114	4/24	186	7/ 5
44	2/13	115	4/25	187	7/ 6
45	2/14	116	4/26	188	7/ 7
46	2/15	117	4/27	189	7/ 8
47	2/16	118	4/28	190	7/ 9
48	2/17	119	4/29	191	7/10
49	2/18	120	4/30	192	7/11
50	2/19	121	5/ 1	193	7/12
51	2/20	122	5/ 2	194	7/13
52	2/21	123	5/ 3	195	7/14
53	2/22	124	5/ 4	196	7/15
54	2/23	125	5/ 5	197	7/16
55	2/24	126	5/ 6	198	7/17
56	2/25	127	5/ 7	199	7/18
57	2/26	128	5/ 8	200	7/19
58	2/27	129	5/ 9	201	7/20
59	2/28	130	5/10	202	7/21
60	3/ 1	131	5/11	203	7/22
61	3/ 2	132	5/12	204	7/23
62	3/ 3	133	5/13	205	7/24
63	3/ 4	134	5/14	206	7/25
64	3/ 5	135	5/15	207	7/26
65	3/ 6	136	5/16	208	7/27
66	3/ 7	137	5/17	209	7/28
67	3/ 8	138	5/18	210	7/29
68	3/ 9	139	5/19	211	7/30
69	3/10	140	5/20	212	7/31
70	3/11	141	5/21	213	8/ 1
71	3/12	142	5/22	214	8/ 2
		143	5/23	215	8/ 3

216	8/ 4	-----	288	10/15	*****	360	12/26	-----
217	8/ 5	-----	289	10/16	*****	361	12/27	-----
218	8/ 6	*****	290	10/17	*****	362	12/28	-----
219	8/ 7	-----	291	10/18	*****	363	12/29	-----
220	8/ 8	-----	292	10/19	*****	364	12/30	-----
221	8/ 9	*****	293	10/20	*****	365	12/31	-----
222	8/10	*****	294	10/21	*****			
223	8/11	*****	295	10/22	*****			
224	8/12	-----	296	10/23	*****			
225	8/13	*****	297	10/24	*****			
226	8/14	-----	298	10/25	*****			
227	8/15	-----	299	10/26	*****			
228	8/16	*****	300	10/27	-----			
229	8/17	*****	301	10/28	-----			
230	8/18	*****	302	10/29	-----			
231	8/19	-----	303	10/30	-----			
232	8/20	-----	304	10/31	-----			
233	8/21	-----	305	11/ 1	-----			
234	8/22	-----	306	11/ 2	*****			
235	8/23	-----	307	11/ 3	*****			
236	8/24	*****	308	11/ 4	*****			
237	8/25	*****	309	11/ 5	*****			
238	8/26	*****	310	11/ 6	*****			
239	8/27	*****	311	11/ 7	*****			
240	8/28	*****	312	11/ 8	*****			
241	8/29	*****	313	11/ 9	*****			
242	8/30	-----	314	11/10	*****			
243	8/31	-----	315	11/11	*****			
244	9/ 1	-----	316	11/12	*****			
245	9/ 2	*****	317	11/13	*****			
246	9/ 3	*****	318	11/14	*****			
247	9/ 4	*****	319	11/15	*****			
248	9/ 5	*****	320	11/16	*****			
249	9/ 6	*****	321	11/17	*****			
250	9/ 7	*****	322	11/18	*****			
251	9/ 8	*****	323	11/19	*****			
252	9/ 9	*****	324	11/20	*****			
253	9/10	*****	325	11/21	*****			
254	9/11	*****	326	11/22	*****			
255	9/12	*****	327	11/23	*****			
256	9/13	*****	328	11/24	*****			
257	9/14	*****	329	11/25	*****			
258	9/15	*****	330	11/26	*****			
259	9/16	*****	331	11/27	*****			
260	9/17	*****	332	11/28	*****			
261	9/18	*****	333	11/29	*****			
262	9/19	*****	334	11/30	*****			
263	9/20	*****	335	12/ 1	*****			
264	9/21	*****	336	12/ 2	*****			
265	9/22	*****	337	12/ 3	*****			
266	9/23	*****	338	12/ 4	*****			
267	9/24	-----	339	12/ 5	*****			
268	9/25	-----	340	12/ 6	*****			
269	9/26	-----	341	12/ 7	*****			
270	9/27	-----	342	12/ 8	*****			
271	9/28	-----	343	12/ 9	*****			
272	9/29	-----	344	12/10	*****			
273	9/30	-----	345	12/11	*****			
274	10/ 1	-----	346	12/12	*****			
275	10/ 2	-----	347	12/13	*****			
276	10/ 3	-----	348	12/14	*****			
277	10/ 4	*****	349	12/15	*****			
278	10/ 5	*****	350	12/16	*****			
279	10/ 6	*****	351	12/17	*****			
280	10/ 7	*****	352	12/18	*****			
281	10/ 8	*****	353	12/19	*****			
282	10/ 9	*****	354	12/20	****			
283	10/10	*****	355	12/21	-----			
284	10/11	*****	356	12/22	-----			
285	10/12	*****	357	12/23	-----			
286	10/13	*****	358	12/24	-----			
287	10/14	*****	359	12/25	-----			

APPENDIX E
GLOSSARY OF SOLAR-TERRESTRIAL TERMS

The following glossary of solar and terrestrial terms is derived directly from that provided by the National Geophysical Data Center in Boulder, CO. The glossary is provided not only as an aid, or explanatory vocabulary list, for the contents of this report, but also because it enjoys a wide circulation, including a growing number of Internet sites worldwide. It has become a common reference, or standard, in the field. (Words capitalized within a definition are also defined in the glossary.)

The URL for the web version is

<http://meridian.ngdc.noaa.gov/stp/GLOSSARY/glossary.html>.

a-INDEX

A 3-hour equivalent amplitude index of local geomagnetic activity; the a-index is related to the 3-hour K-INDEX according to the following scale:

K	0	1	2	3	4	5	6	7	8	9
a	0	3	7	15	27	48	80	140	240	400

A-INDEX

A daily index of geomagnetic activity derived as the average of the eight 3-hourly a-indices.

ACTIVE

Geomagnetic levels such that $15 \leq A_p < 30$.

ACTIVE DARK FILAMENT (ADF)

An ACTIVE PROMINENCE seen on the DISK.

ACTIVE LONGITUDE

The approximate center of a range of heliographic longitudes in which ACTIVE REGIONS are more numerous and more FLARE-active than the average.

ACTIVE PROMINENCE

A PROMINENCE displaying material motion and changes in appearance over a few minutes of time.

ACTIVE PROMINENCE REGION (APR)

A portion of the solar limb displaying active prominences.

ACTIVE REGION (AR)

A localized, transient volume of the solar atmosphere in which PLAGES, SUNSPOTS, FACULAE, FLARES, etc., may be observed.

ACTIVE SURGE REGION (ASR)

An ACTIVE REGION that exhibits a group or series of spike-like surges that rise above the LIMB.

AFRED

Abbreviation for the A-INDEX for Fredericksburg.

ANGSTROM

A unit of length = $1.0E-08$ cm.

Ap-INDEX

An averaged planetary A-INDEX based on data from a set of specific stations.

ARCH FILAMENT SYSTEM (AFS)

A bright, compact PLAGE crossed by a system of small, arched FILAMENTS, which is often a sign of rapid or continued growth in an ACTIVE REGION.

ASTRONOMICAL UNIT (AU)

The mean earth-sun distance, equal to 1.496×10^{13} cm, or 214.94 solar radii.

AURORA

A faint visual phenomenon associated with geomagnetic activity, which occurs mainly in the high-latitude night sky; typical auroras are 100 to 250 km above the ground.

AURORAL OVAL

An oval band around each geomagnetic pole that is the locus of structured AURORAS.

AUTUMNAL EQUINOX

The EQUINOX that occurs in September.

BARTEL'S ROTATION NUMBER

Serial number assigned to 27-day rotation periods of solar and geophysical parameters. Rotation 1 in this sequence was assigned arbitrarily by Bartel to begin in January 1833.

BRIGHT SURGE ON THE DISK (BSD)

A bright gaseous stream (SURGE) emanating from the CHROMOSPHERE.

BRIGHT SURGE ON THE LIMB (BSL)

A large gaseous stream (SURGE) that moves outward more than 0.15 solar radius above the LIMB.

BURST

A transient enhancement of the solar RADIO EMISSION, usually associated with an ACTIVE REGION or FLARE.

CARRINGTON LONGITUDE.

A system of fixed longitudes rotating with the sun.

CENTIMETER BURST

A solar radio burst in the centimeter wavelength range.

CENTRAL MERIDIAN PASSAGE (CMP)

The passage of an ACTIVE REGION or other feature across the longitude meridian that passes through the apparent center of the solar DISK.

CHROMOSPHERE

The layer of the solar atmosphere above the PHOTOSPHERE and beneath the TRANSITION REGION and the CORONA.

CONJUGATE POINTS

Two points on the earth's surface at opposite ends of a geomagnetic field line.

CONTINUUM STORM (CTM)

General term for solar noise lasting for hours and sometimes days.

COORDINATED UNIVERSAL TIME

By international agreement, the local time at the prime meridian, which passes through Greenwich, England. Therefore, it is also known as GREENWICH MEAN TIME, or sometimes simply UNIVERSAL TIME.

CORONA

The outermost layer of the solar atmosphere, characterized by low densities ($<1.0E+09$ per cc) and high temperatures ($>1.0E+06^{\circ}K$).

CORONAL HOLE

An extended region of the CORONA, exceptionally low in density and associated with unipolar photospheric regions.

CORONAL RAIN (CRN)

Material condensing in the CORONA and appearing to rain down into the CHROMOSPHERE as observed in H-ALPHA at the solar LIMB above strong SUNSPOTS.

CORONAL TRANSIENTS

A general term for short-time-scale changes in the CORONA, but principally used to describe outward-moving PLASMA clouds.

COSMIC RAY

An extremely energetic (relativistic) charged particle.

CROCHET

A sudden deviation in the sunlit geomagnetic field (H component; see GEOMAGNETIC ELEMENTS) associated with large solar FLARE X-ray emission.

D REGION

A daytime layer of the earth's IONOSPHERE approximately 50 to 90 km in altitude.

DARK SURGE ON DISK (DSD)

Dark gaseous ejections visible in H-ALPHA.

DIFFERENTIAL ROTATION

The change in SOLAR ROTATION RATE with latitude. Low latitudes rotate at a faster angular rate (approximately 14 degrees per day) than high latitudes (approximately 12 degrees per day).

DISAPPEARING SOLAR FILAMENT (DSF)

The sudden (timescale of minutes to hours) disappearance of a solar FILAMENT (PROMINENCE).

DISK

The visible surface of the sun (or any heavenly body) projected against the sky.

Dst-INDEX

A geomagnetic index describing variations in the equatorial RING CURRENT.

E REGION

A daytime layer of the earth's ionosphere between the altitudes of 85 and 140 km.

EMERGING FLUX REGION (EFR)

An area on the sun where new magnetic flux is erupting.

ERUPTIVE PROMINENCE ON LIMB (EPL)

A solar PROMINENCE that becomes activated and is seen to ascend from the sun

EXTREMELY LOW FREQUENCY (ELF)

That portion of the radio frequency spectrum from 30 to 3000 Hertz.

EXTREME ULTRAVIOLET (EUV)

A portion of the electromagnetic spectrum from approximately 100 to 1000 angstroms.

F CORONA

The portion of the white-light CORONA (the corona seen by the eye at a total solar ECLIPSE), that is caused by sunlight scattered or reflected by solid particles (dust) in interplanetary space.

F REGION

The upper layer of the IONOSPHERE, approximately 120 to 1500 km in altitude. The F region is subdivided into the F1 and F2 regions. The F2 region is the most dense and peaks at altitudes between 200 and 600 km. The F1 region is a smaller peak in electron density, which forms at lower altitudes in the daytime.

FACULA

A bright region of the PHOTOSPHERE seen in white light, seldom visible except near the solar LIMB.

FIBRIL

A linear pattern in the H-ALPHA CHROMOSPHERE of the sun, as seen through an H-alpha filter, occurring near strong SUNSPOTS and PLAGE or in FILAMENT channels

FILAMENT

A mass of gas suspended over the PHOTOSPHERE by magnetic fields and seen as dark lines threaded over the solar DISK. A filament on the LIMB of the sun seen in emission against the dark sky is called a PROMINENCE.

FILAMENT CHANNEL

A broad pattern of FIBRILS in the CHROMOSPHERE, marking where a FILAMENT may soon form or where a filament recently disappeared.

FLARE

A sudden eruption of energy on the solar DISK lasting minutes to hours, from which radiation and particles are emitted.

 f_{MIN}

The lowest radiowave frequency that can be reflected from the IONOSPHERE.

foEs

The maximum ORDINARY MODE radiowave frequency capable of reflection from the SPORADIC E REGION of the IONOSPHERE.

foF2

The maximum ORDINARY MODE radiowave frequency capable of reflection from the F2 REGION of the IONOSPHERE.

FORBUSH DECREASE

An abrupt decrease, of at least 10%, of the background galactic COSMIC RAY intensity as observed by neutron monitors.

GAMMA

A unit of magnetic field intensity equal to $1 \times 10.0\text{E-}05$ GAUSS, also equal to 1 NANOTESLA.

GAMMA RAYS

High energy radiation (energies in excess of 100 keV) observed during large, extremely energetic solar FLARES.

GAUSS

The unit of magnetic induction in the centimeter-gram-second (cgs) system.

GEOMAGNETIC ELEMENTS

The components of the geomagnetic field at the surface of the earth. In SESC use, the

northward and eastward components are often called the H and D components, where the D component is expressed in gammas and is derived from D (the declination angle) using the small angle approximation.

GEOMAGNETIC FIELD

The magnetic field observed in and around the earth. The intensity of the magnetic field at the earth's surface is approximately 0.32 gauss at the equator and 0.62 gauss at the north pole.

GEOMAGNETIC STORM

A worldwide disturbance of the earth's magnetic field, distinct from regular diurnal variations.

Intensity Descriptor	Description
Minor Geomagnetic Storm	A storm for which Ap-index was >29 and <50.
Major Geomagnetic Storm	A storm for which Ap-index was >49 and <100.
Severe Geomagnetic Storm	A storm for which Ap-index was 100 or more.

Phase Descriptor	Description
Initial Phase	Of a geomagnetic storm, that period when there may be an increase of the MIDDLE-LATITUDE horizontal intensity (H).
Main Phase	Of a geomagnetic storm, that period when the horizontal magnetic field at middle latitudes is generally decreasing.
Recovery Phase	Of a geomagnetic storm, that period when the depressed northward field component returns to normal levels

GEOSYNCHRONOUS

Term applied to any equatorial satellite with an orbital velocity equal to the rotational velocity of the earth. The net effect is that the satellite is virtually motionless with respect to an observer on the ground.

GMT

Greenwich Mean Time. (See COORDINATED UNIVERSAL TIME.)

GRADUAL COMMENCEMENT

The commencement of a geomagnetic storm that has no well-defined onset.

GRANULATION

Cellular structure of the PHOTOSPHERE visible at high spatial resolution.

GREEN LINE

The green line is one of the strongest (and first-recognized) visible coronal lines. It identifies moderate temperature regions of the CORONA.

Greenwich Mean Time

See COORDINATED UNIVERSAL TIME.

GROUND-LEVEL EVENT (GLE)

A sharp increase in ground-level COSMIC RAY count to at least 10% above background, associated with solar protons of energies >500 MeV. GLEs are relatively rare, occurring only a few times each SOLAR CYCLE.

H-ALPHA

This ABSORPTION LINE of neutral hydrogen falls in the red part of the visible spectrum and is convenient for solar observations. The H-alpha line is universally used for patrol observations of solar flares.

H-component of the Geomagnetic Field

See GEOMAGNETIC ELEMENTS.

HIGH FREQUENCY (HF)

That portion of the radio frequency spectrum between 3 and 30 MHz.

HIGH LATITUDES

With specific reference to zones of geomagnetic activity, *high latitudes* refers to 50° to 80° geomagnetic.

HIGH-SPEED STREAM

A feature of the SOLAR WIND having velocities that are about double average solar wind values.

HOMOLOGOUS FLARES

Solar flares that occur repetitively in the same ACTIVE REGION, with essentially the same position and with a common pattern of development.

HYDER FLARE.

A FILAMENT-associated TWO-RIBBON FLARE, often occurring in spotless regions. The flare presumably results from the impact on the CHROMOSPHERE of infalling FILAMENT material.

INTERPLANETARY MAGNETIC FIELD (IMF)

The magnetic field carried with the SOLAR WIND.

IONOSPHERE

The region of the earth's upper atmosphere containing a small percentage of free electrons and ions produced by photoionization of the constituents of the atmosphere by solar ultraviolet radiation at very short wavelengths (<1000 angstroms). The ionosphere significantly influences radiowave propagation of frequencies <30 MHz.

IONOSPHERIC STORM

A disturbance in the F REGION of the IONOSPHERE, which occurs in connection with geomagnetic activity.

K CORONA

Of the white-light CORONA (i.e., the corona seen by the eye at a total solar eclipse), that portion which is caused by sunlight scattered by electrons in the hot outer atmosphere of the sun.

K-INDEX

A 3-hourly quasi-logarithmic local index of geomagnetic activity relative to an assumed quiet-day curve for the recording site. The range of values is from 0 to 9. The K-index measures the deviation of the most disturbed horizontal component.

KELVIN

A unit of absolute temperature.

Kp-INDEX

A 3-hourly planetary geomagnetic index of activity generated in Gottingen, Germany, based on the K-INDEX from 12 or 13 stations distributed around the world.

LEADER SPOT

In a magnetically bipolar or multipolar SUNSPOT group, the western part precedes and the main spot in that part is called the leader.

LIGHT BRIDGE

Observed in white light, a bright tongue or streaks penetrating or crossing SUNSPOT UMBRAe. The appearance of a light bridge is frequently a sign of impending region division or dissolution.

LIMB

The edge of the solar DISK.

LIMB FLARE

A solar FLARE seen at the edge (LIMB) of the sun.

LOOP PROMINENCE SYSTEM (LPS)

A system of loop prominences associated with major FLARES.

LOW FREQUENCY (LF)

That portion of the radio frequency spectrum from 30 to 300 kHz.

M 3000

The optimum HIGH FREQUENCY radio wave with a 3000-km range, which reflects only once from the IONOSPHERE (single hop transmission).

MAGNETIC BAY

A relatively smooth excursion of the H (horizontal) component (see GEOMAGNETIC ELEMENTS) of the geomagnetic field away from and returning to quiet levels.

MAGNETOGRAM

Solar magnetograms are a graphic representation of solar magnetic field strengths and polarity.

MAGNETOPAUSE

The boundary layer between the SOLAR WIND and the MAGNETOSPHERE.

MAGNETOSPHERE

The magnetic cavity surrounding the earth, carved out of the passing SOLAR WIND by virtue of the GEOMAGNETIC FIELD, which prevents, or at least impedes, the direct entry of the solar wind PLASMA into the cavity.

MeV

Mega (million) electronvolt. A unit of energy used to describe the total energy carried by a particle or photon.

MEDIUM FREQUENCY (MF)

That portion of the radio frequency spectrum from 0.3 to 3 MHz.

MICROWAVE BURST

A radiowave signal associated with optical and/or X-ray FLAREs.

MIDDLE LATITUDES.

With specific reference to zones of geomagnetic activity, *middle latitudes* refers to 20-degree to 50-degree geomagnetic.

MOUNT WILSON MAGNETIC CLASSIFICATIONS

Classification	Description
Alpha	Denotes a unipolar SUNSPOT group.
Beta	A sunspot group having both positive and negative magnetic polarities, with a simple and distinct division between the polarities.
Beta-Gamma	A sunspot group that is bipolar but in which no continuous line can be drawn separating spots of opposite polarities.
Delta	A complex magnetic configuration of a solar sunspot group consisting of opposite polarity UMBRAe within the same PENUMBRA.
Gamma	A complex ACTIVE REGION in which the positive and negative polarities are so irregularly distributed as to prevent classification as a bipolar group.

NANOTESLA (nT)

A unit of magnetism 10.0E-09 tesla, equivalent to a gamma (10.0E-05 gauss).

NEUTRAL LINE

The line that separates longitudinal magnetic fields of opposite polarity.

PENUMBRA

The SUNSPOT area that may surround the darker UMBRA or umbrae. It consists of linear bright and dark elements radial from the sunspot umbra.

PERSISTENCE.

Continuation of existing conditions. When a physical parameter varies slowly, the best prediction is often persistence.

PHOTOSPHERE

The lowest layer of the solar atmosphere; corresponds to the solar surface viewed in WHITE LIGHT. SUNSPOTS and FACULAE are observed in the photosphere.

PLAGE

An extended emission feature of an ACTIVE REGION that exists from the emergence of the first magnetic flux until the widely scattered remnant magnetic fields merge with the background.

PLAGE CORRIDOR

A space in chromospheric (see CHROMOSPHERE) PLAGE lacking PLAGE intensity, coinciding with polarity inversion line.

PLASMA

Any ionized gas, that is, any gas containing ions and electrons.

POLAR CAP ABSORPTION (PCA)

An anomalous condition of the polar IONOSPHERE whereby HF and VHF (3 MHz - 300 MHz) radiowaves are absorbed, and LF and VLF (3 kHz - 300 kHz) radiowaves are reflected at lower altitudes than normal. In practice, the absorption is inferred from the proton flux at energies >10 MeV, so that PCAs and PROTON EVENTS are simultaneous. Transpolar radio paths may still be disturbed for days, up to weeks, following the end of a proton event.

POST-FLARE LOOPS

A LOOP PROMINENCE SYSTEM often seen after a major TWO-RIBBON FLARE, which bridges the ribbons.

PROMINENCE

A term identifying cloud-like features in the solar atmosphere that appear as bright structures in the CORONA above the solar LIMB and as dark FILAMENTS when seen projected against the solar DISK.

PROTON EVENT

By definition, the measurement of at least 10 protons/sq.cm/sec/steradian at energies >10 MeV.

PROTON FLARE

Any FLARE producing significant FLUXes of >10 MeV protons in the vicinity of the earth.

QUIESCENT PROMINENCE (FILAMENT)

Long, sheet-like prominences nearly vertical to the solar surface.

QUIET

A descriptive word specifically meaning geomagnetic levels such that $A_p < 8$ (see Ap INDEX).

RADIO EMISSION

Emissions of the sun in radio wavelengths from centimeters to decameters, under both quiet and disturbed conditions.

Intensity Descriptor	Description
Type I	A noise storm composed of many short, narrowband bursts in the metric range (300 MHz - 50 MHz).
Type II	Narrowband emission that begins in the meter range (300 MHz) and sweeps slowly (tens of minutes) toward decameter wavelengths (10 MHz). Type II emissions occur in loose association with major FLAREs and are indicative of a SHOCK wave moving through the solar atmosphere.
Type III	Narrowband bursts that sweep rapidly (seconds) from decimeter to decameter wavelengths (500 MHz - 0.5 MHz). They often occur in groups and are an occasional feature of complex solar ACTIVE REGIONS.
Type IV	A smooth continuum of broadband bursts primarily in the meter range (300 MHz - 30 MHz). These bursts are associated with some major flare events beginning 10 to 20 minutes after the flare maximum, and can last for hours.

RECURRENCE

Used especially in reference to the recurrence of physical parameters every 27 days (the rotation period of the sun).

RIOMETER (Relative Ionospheric Opacity meter)

A specially designed radio receiver for continuous monitoring of COSMIC NOISE. The absorption of cosmic noise in the polar regions is very sensitive to the solar low-energy cosmic ray flux.

SECTOR BOUNDARY

In the SOLAR WIND, the area of demarcation between sectors, which are large-scale features distinguished by the predominant direction of the interplanetary magnetic field, toward or away from the sun.

SHORT WAVE FADE (SWF)

A particular ionospheric solar flare effect under the broad category of sudden ionospheric

disturbances (SIDs) whereby short-wavelength radio transmissions, VLF, through HF, are absorbed for a period of minutes to hours.

SMOOTHED SUNSPOT NUMBER

An average of 13 monthly RI numbers, centered on the month of concern.

SOLAR COORDINATES

Central Meridian Distance (CMD). The angular distance in solar longitude measured from the central meridian.

SOLAR CYCLE

The approximately 11-year quasi-periodic variation in frequency or number of solar active events.

SOLAR MAXIMUM

The month(s) during the SOLAR CYCLE when the 12-month mean of monthly average SUNSPOT NUMBERS reaches a maximum. The most recent solar maximum occurred in December 1979.

SOLAR MINIMUM

The month(s) during the SOLAR CYCLE when the 12-month mean of monthly average SUNSPOT NUMBERS reaches a minimum.

SOLAR SECTOR BOUNDARY (SSB)

The apparent solar origin, or base, of the interplanetary SECTOR BOUNDARY marked by the larger-scale polarity inversion lines.

SOLAR WIND

The outward flux of solar particles and magnetic fields from the sun. Typically, solar wind velocities are near 350 km/s.

SPORADIC E

A phenomenon occurring in the E REGION of the IONOSPHERE, that significantly affects HF radiowave propagation. Sporadic E can occur during daytime or nighttime and it varies markedly with latitude.

SUDDEN COMMENCEMENT(SC, or SSC for Storm Sudden Commencement)

An abrupt increase or decrease in the northward component of the geomagnetic field, which marks the beginning of a GEOMAGNETIC STORM.

SUDDEN IMPULSE (SI+ or SI-)

A sudden perturbation of several gammas in the northward component of the low-latitude geomagnetic field, not associated with a following GEOMAGNETIC STORM. (An SI becomes an SC if a storm follows.)

SUDDEN IONOSPHERIC DISTURBANCE (SID)

HF propagation anomalies due to ionospheric changes resulting from solar FLAREs, PROTON EVENTS and GEOMAGNETIC STORMs.

SUNSPOT

An area seen as a dark spot on the PHOTOSPHERE of the sun. Sunspots are concentrations of magnetic flux, typically occurring in bipolar clusters or groups. They appear dark because they are cooler than the surrounding photosphere.

SUNSPOT GROUP CLASSIFICATION

Sunspot group classification is as follows

Zurich Sunspot Classification (Modified)	Description
A	A small single unipolar SUNSPOT or very small group of spots without PENUMBRA.
B	Bipolar sunspot group with no penumbra.
C	An elongated bipolar sunspot group. One sunspot must have penumbra.
D	An elongated bipolar sunspot group with penumbra on both ends of the group.
E	An elongated bipolar sunspot group with penumbra on both ends. Longitudinal extent of penumbra exceeds 10 degrees but not 15 degrees.
F	An elongated bipolar sunspot group with penumbra on both ends. Longitudinal extent of penumbra exceeds 15 degrees.
H	A unipolar sunspot group with penumbra.

SUNSPOT NUMBER

A daily index of SUNSPOT activity (R), defined as $R = k(10g + s)$ where S = number of individual spots, g = number of sunspot groups, and k is an observatory factor.

SURGE

A jet of material from ACTIVE REGIONs that reaches coronal heights and then either fades or returns into the CHROMOSPHERE along the trajectory of ascent.

TWO-RIBBON FLARE

A FLARE that has developed as a pair of bright strands (ribbons) on both sides of the main inversion (neutral) line of the magnetic field of the ACTIVE REGION.

TYPE I, II, III, IV

See RADIO EMISSION

U BURST

A fast radio burst spectrum of a FLARE. It has a U-shaped appearance in an intensity versus frequency plot.

ULTRA HIGH FREQUENCY (UHF)

Those radio frequencies exceeding 300 MHz.

UMBRA

The dark core(s) (umbrae) in a SUNSPOT with PENUMBRA, or a sunspot lacking penumbra.

UNIVERSAL TIME (UT)

See COORDINATED UNIVERSAL TIME.

UNSETTLED

With regard to geomagnetic levels, a descriptive word specifically meaning that $7 < \text{the Ap INDEX} < 15$.

VERY HIGH FREQUENCY (VHF)

That portion of the radio frequency spectrum from 30 to 300 MHz.

VERY LOW FREQUENCY (VLF)

That portion of the radio frequency spectrum from 3 to 30 kHz.

WHITE LIGHT (WL)

Sunlight integrated over the visible portion of the spectrum (4000 to 7000 angstroms) so that all colors are blended to appear white to the eye.

WHITE LIGHT FLARE

A major FLARE in which small parts become visible in white light. Such flares are usually strong X-ray, radio, and particle emitters.

WOLF NUMBER

An historic term for SUNSPOT NUMBER. In 1849, R. Wolf of Zurich originated the general procedure for computing the sunspot number.

X-RAY BACKGROUND

A daily average background X-ray FLUX in the 1 to 8 angstrom range. It is a midday minimum designed to reduce the effects of FLARES

X-RAY BURST

A temporary enhancement of the X-ray emission of the sun. The time-intensity profile of soft X-ray bursts is similar to that of the H-ALPHA profile of an associated FLARE.

X-RAY FLARE CLASS

Rank of a FLARE based on its X-ray energy output. Flares are classified by the order of magnitude of the peak burst intensity (I) measured at the earth in the 1 to 8 angstrom band as follows

Class	Peak Flux (W/sq. meter)
B	$I < 10.0E-06$
C	$10.0E-06 \leq I \leq 10.0E-05$
M	$10.0E-05 \leq I \leq 10.0E-04$
X	$I \geq 10.0E-04$

ZURICH SUNSPOT CLASSIFICATION

A sunspot classification system that has been modified for SESC use.

APPENDIX F
GLOSSARY OF IONOSPHERIC DISTURBANCES

The following descriptions of ionospheric disturbances are provided by the National Geophysical Data Center in Boulder, CO. The glossary provides a description of a variety of occurrences that one often encounters when investigating the performance of communication systems at high latitudes, particularly in the high-frequency band. (Words capitalized within a definition are also defined in the glossary.)

Auroral Activity Classifications

Auroral activity is rated as either not visible, low, moderate, high, very high, or extremely high. These classifications are defined according to the brightness achieved by auroral activity, visual activity (i.e., changes of form or structure), whether the aurora is pulsating, and according to the intensity and fluctuations of color in the aurora. The various levels of activity are defined below:

Not visible: Self-explanatory.

Low: Low intensity auroras consisting mostly of diffuse, dim, and lifeless activity. Generally no rapid changes in form or structure are discerned with auroral activity that is classified as low.

Moderate: Moderate intensity auroral activity consists of diffuse auroras intermixed with curtain auroras or other forms of relatively low-activity auroras. Moderate activity may include beams or rays of auroras that travel either east or west with time. No color fluctuations or significant brightenings are associated with moderate intensity auroras.

High: High intensity auroral activity is activity associated with very bright, active displays that may exhibit changes of color and rapid pulsations. High activity is generally confined to curtain auroras and moderate-intensity pulsating auroras.

Very High: Very high intensity auroral activity is usually only experienced over the high latitude regions where zenith auroras and significant auroral displays occur. Activity classified as very high consists of most auroral forms of activity, but the activity is always very bright and extremely active. Curtain auroras may change form and color rapidly. Zenith auroras may become exceedingly bright and colorful.

Extremely High: Extremely high auroral activity is only rarely encountered. Activity at this level of intensity is most often experienced within the middle and/or low latitude zones during significant periods of geomagnetic activity. The expansion of the auroral zone equatorward and poleward produces the intense activity over regions equatorward of the normal position of the auroral oval. This activity usually consists of exceedingly bright, rapidly fluctuating, strongly pulsating, color-varying auroral activity. Levels of auroral activity this high are usually only associated with *rogue flares*, which may occur only once or twice during a solar cycle.

The approximate latitudinal boundaries for observing auroras (biased for North America and Australia/New Zealand) follow. The locations of these boundaries for Europe will be higher than for North America, and the locations for Asia will be correspondingly higher than for Europe. The Southern Hemisphere estimates are valid for Australia and New Zealand. Locations of the boundaries for southern areas of South America will be higher than for Australia and New Zealand.

Northern Hemisphere	Southern Hemisphere
High latitudes: $\geq 55^{\circ}\text{N}$	High latitudes: $\geq 55^{\circ}\text{S}$
Middle latitudes: $\geq 40^{\circ}\text{N} < 55^{\circ}\text{N}$	Middle latitudes: $\geq 30^{\circ}\text{S} < 55^{\circ}\text{S}$
Low latitudes: $< 40^{\circ}\text{N}$	Low latitudes: $< 30^{\circ}\text{S}$

Electron Fluence

This term will seldom be referenced within reports. It is analogous to *proton fluence*, but is measured for electrons with energies >2 MeV. Fluence measurements are the same as those for proton fluence.

Flare Classifications

Flares are classified using one of two different systems. The first classification ranks the event by measuring its peak x-ray intensity in the 1-8 angstrom band as measured by the GOES satellites. This x-ray classification offers at least two distinct advantages compared with the second system of classification (optical): it gives a better measure of the geophysical significance of the event and it provides an objective means of classifying geophysically significant activity regardless of its location on the solar disk or near the solar limb. The classification scheme is as follows:

Class	Peak Flux (1-8 Angstroms in Wm^{-2})
A	$< 10E-7$
B	$< 10E-6$ but $>$ class A
C	$< 10E-5$ but $>$ class B
M	$< 10E-4$ but $>$ class C
X	$> 10E-4$

The letter designates the order of magnitude of the peak value. Following the letter the measured peak value is given. For descriptive purposes, a number from 1.0 to 9.9 is appended to the letter designation. The number acts as a multiplier. For example, a C3.2 event indicates an x-ray burst with a peak flux of $3.2 \times 10E-6 Wm^{-2}$. Since x-ray bursts are observed as a full-sun value, bursts below the x-ray background level are not discernible. The background drops to class A level during solar minimum; only bursts that exceed B1.0 are classified as x-ray events. During solar maximum, the background is often at the class M level, and therefore class A, B and C x-ray bursts cannot be seen. Bursts greater than $1.2 \times 10^{-3} Wm^{-2}$ may saturate the GOES detectors. If saturation occurs, the estimate peak flux values are reported.

The second system of classification involves a purely optical method of observation. A flare event is observed optically (in H-alpha light) and is both measured for size and brightness. This classification therefore includes two items of information: a descriptor defining the size of the flare and a descriptor defining the peak brightness of the flare. They are listed below:

Importance	Description
S	Subflare area ≤ 2.0 square degrees.
1	$2.1 \leq$ Subflare area ≤ 5.1 square degrees.
2	$5.2 \leq$ Subflare area ≤ 12.4 square degrees.
3	$12.5 \leq$ Subflare area ≤ 24.7 square degrees.
4	Subflare area ≥ 24.8 square degrees.

Brightness	Description
F	Faint
N	Normal
B	Brilliant

Example: A major flare rated as a class M7.4/2B event indicates that the flare attained a maximum x-ray intensity of $7.4 \times 10E-5 \text{ Wm}^{-2}$. The 2B portion of this specification indicates that the flare was an importance 2 flare (≥ 5.2 and ≤ 12.4 square degrees) and was optically brilliant (B). This sample flare is a powerful event. Flares that reach x-ray levels in excess of class M4 can begin to have an impact on the Earth. Likewise, flares rated 2B or greater are generally capable of influencing the Earth, particularly if accompanied by Type II and IV radio sweeps (see SWEEP FREQUENCY EVENTS).

Magnetic A-Index

The geomagnetic A-Index represents the severity of magnetic fluctuations occurring at local magnetic observatories. During magnetic storms, the A-index may reach levels as high as 100. During severe storms, the A-index may exceed 200. Great *rogue* storms may succeed in producing index values in excess of 300, although storms associated with indices this high are very rare indeed. The A-index varies from observatory to observatory, since magnetic fluctuations can be very local in nature. The A-index for Boulder, CO (the same value reported on WWV and WWVH) will be the one referenced most often within reports). Occasionally, the A-index for higher latitude stations may also be referenced for purposes of comparison. Magnetic fluctuations monitored locally here at Solar Terrestrial Dispatch will also be referenced, particularly during storm periods for descriptive purposes.

Magnetic K-Index

The geomagnetic K-Index is related to the A-index. K-indices are scaled by comparing the H and D magnetometer traces (representing the horizontal and declination magnetic components) to assumed *quiet-day curves* for H and D. Each UT day is divided into 8 three-hour intervals, starting at 0000 UT. In each 3-hour period, the maximum deviation from the quiet day curve is measured for both (H and D) traces, and the largest deviation (the most disturbed trace) is selected. It is then input into a quasi-logarithmic transfer function to yield the K-index for the period.

The K-index ranges from 0 to 9 and is a dimensionless number. It is assigned to the end of the 3 hour period. The K-Index is useful in determining the state of the geomagnetic field, the quality of radio signal propagation and the condition of the ionosphere. Generally, K index values of 0 and 1 represent Quiet magnetic conditions and imply good radio signal propagation conditions. Values between 2 and 4 represent Unsettled to Active magnetic conditions and generally correspond to less-impressive radio propagation conditions. K-index values of 5 represent Minor Storm conditions and are usually associated with Fair to Poor propagation on many HF paths. K-index values of 6 generally represent Major Storm conditions and are almost always associated with poor radio propagation conditions. K-index values of 7 represent Severe Storm conditions and are often accompanied by *radio blackout* conditions (particularly over higher latitudes). K-indices of 8 or 9 represent Very Severe Storm conditions and are rarely encountered (except during exceptional periods of solar activity). K-indices this high most often produce radio blackouts for periods lasting in excess of 6 to 10 hours (depending upon the intensity of the event).

Magnetic Class

The magnetic class of sunspots is important in determining how potentially volatile particular active regions may be. Sunspots are regularly observed using instruments capable of determining the magnetic polarity of sunspots and active regions. By also applying laws which have been formulated over the years, visual observations can also be used to establish the magnetic polarity and complexity of spot groups. There are basically 7 magnetic types of sunspots that are classified. They are described as follows:

Type	Description
A	Alpha (single polarity spot).
B	Beta (bipolar spot configuration).
G	Gamma (atypical mixture of polarities).
BG	Beta-Gamma (mixture of polarities in a dominantly bipolar configuration).
D	Delta (opposite polarity umbrae within single penumbra).
BD	Beta with a Delta configuration.
BGD	Beta-Gamma with a Delta configuration.

Example: A region labeled as having a magnetic classification of BG indicates that the sunspot region contains a mixture of magnetic polarities, but the dominant polarity of the group is bipolar. Potentially very powerful and potent regions are those which have classifications of BG, BD and BGD. As magnetic complexity increases, the ability of an active region to spawn major energetic events likewise increases.

Polar Cap Absorption Event (PCA Event)

A PCA is almost always produced by an intense solar proton flare. PCAs are the result of copious quantities of high-energy solar protons penetrating the Earth's atmosphere to levels of the order of 50 km, producing intense ionospheric ionization. The result is a complete (or near-complete) radio blackout over polar latitudes. A typical PCA lasts from 1 to 5 days and can severely effect the propagation of radio signals near or through polar regions. In intense, long-lasting events, direct entry of the high-energy solar protons to the upper atmosphere can extend equatorward as far as about 50 degrees geomagnetic latitude. They occur almost coincident with satellite-level proton events, maximize in intensity within a few hours and then begin a slow decay that can last up to 10 days for intense events. A PCA is often followed within 48 hours by a SSC and a subsequent Minor to Major geomagnetic storm about 3 to 8 hours later.

Proton Fluence

Although this term will seldom be referenced within a report, it may be of use to make a note of it. Proton fluence is simply the total number proton particle fluxes measured by the GOES spacecraft at geosynchronous altitudes for protons of energies >1 Million electron Volts (MeV), >10 MeV and >100 MeV. The higher the proton fluence, the more intense proton bombardments are at geosynchronous altitudes. It can also be used implicitly to determine the approximate amount of ionization occurring in the upper atmosphere, as well as the proton penetration level into the atmosphere and possible satellite anomalies caused by the solar proton bombardments. Fluence for particles are given in the units $\text{particles cm}^{-2} \text{steradian}^{-1} \text{day}^{-1}$.

Satellite Proton Event

Proton events are almost always associated with energetic solar activity such as major flares. They are periods of increased proton bombardments at satellite altitudes. They can affect satellite transmission/reception if intense enough and can cause other satellite anomalies. Proton events may affect the ability of a HAM operator to establish contact with a satellite, and may affect the quality of television signals received by satellite (i.e., cable TV may be affected). Satellite proton events occur within a few hours of a major proton flare. They are also often followed by a PCA event.

Solar Activity Description

Solar activity is described (also applicable on WWV and WWVH) according to the number of flares which occur during the day. Activity is basically classified as follows:

Activity Level	Description
Very Low	X-ray events less than class C.
Low	C-class x-ray events.
Moderate	Isolated (one to 4) M-class x-ray events.
High	Several (5 or more) M-class x-ray events or isolated (1 to 4) M5 or greater x-ray events.
Very High	Several M5 or greater x-ray events.

Solar Flux

The 10.7-cm (2800-MHz) radio flux is the amount of solar noise that is emitted by the sun at 10.7-cm wavelengths. The solar flux is measured and reported at approximately 1700 universal time (UT) daily by the Penticton Radio Observatory in British Columbia, Canada. Values are not corrected for variations resulting from the eccentric orbit of the Earth around the sun. The solar flux is used as a basic indicator of solar activity. It can vary from values below 50 to values in excess of 300 (representing very low solar activity and high to very high solar activity, respectively). Values in excess of 200 occur typical during the peak of the solar cycles. The solar flux is closely related to the amount of ionization taking place at F2 layer heights (heights sensitive to long-distance radio communication). High solar flux values generally provide good ionization for long-distance communications at higher than normal frequencies. Low solar flux values can restrict the band of frequencies that are usable for long distance communications. The solar flux is measured in *solar flux units* (sfu). One sfu is equivalent to $10E-22 \text{ Wm}^{-2} \text{ Hz}^{-1}$.

Sudden Storm Commencement (SSC)

An SSC is the magnetic signature of an interplanetary shockwave most often produced by solar flares. It is always a precursor to increased geomagnetic activity, most often followed within 3 to 8 hours by a Minor to Major geomagnetic storm. It appears on the H (horizontal) trace of magnetometers. This phenomenon is detectable at almost all magnetic observatories world-wide within 4 minutes of each other.

Sudden Impulse (SI)

A sudden magnetic impulse is similar to an SSC. It represents a rapid momentary fluctuation of the geomagnetic field over a period of only a few minutes. It is generally associated with interplanetary shockwaves produced by energetic solar events and can (but need not always) be followed by increased geomagnetic activity.

Sunspot Classifications

Sunspots are classified according to size, shape and spot density. They are classified using a set of three coded letters (Zpc) as follows.

Z	Modified Zurich Classification (A through F plus H)
A	Single small spot (single magnetic polarity).
B	Very small distribution of small spots.
C	Two or more small spots, at least one of which has a detectable penumbra.
D	Moderately sized group of spots, several of which may have noticeable penumbrae. Magnetic complexity of D-type regions are usually capable of producing C and low-intensity M-class flares.
E	Moderate to large area of a fairly complex system of sunspots, several of which have noticeable penumbrae and good definition. Often capable of producing minor C-class as well as major M-class flares.
F	Large to very large area of a complex system of sunspots. These regions are often capable of producing major X-class flares as well as numerous major M-class and many C-class events (depending on their magnetic complexity).
H	Single large to very large sunspot (not usually capable of producing significant energetic events) and is usually manifest in the dying phase of a sunspot group.

p	Penumbra Type of the Largest Spot in the Group
x	Single spot
r	Rudimentary
s	Small symmetric
a	Small asymmetric
h	Large symmetric
k	Large asymmetric

c	Relative Sunspot Distribution or Compactness of the Group
x	Single spot
o	Open group (separated by quite a wide space)
i	Intermediate (moderate sunspot compactness in the group)
c	Compact (very dense and complex spots within the group)

Example: A sunspot group classified as type DKO would be of moderate overall size (i.e., the region encompassing all of the sunspots within the group would be of moderate size), the penumbra of the largest spot within the group would be large and asymmetric, and the group would be *open* indicating that the sunspots within the region are not notably close together.

Sunspot Number

This term is basically self-explanatory. It represents the number of observed sunspots and sunspot groups on the solar surface. It is computed according to the Wolf Sunspot Number formula: $R = k(10g + s)$, where g is the number of sunspot groups (regions), s is the total number of individual spots in all the groups, and k is a scaling factor that corrects for seeing conditions at various observatories. Sunspot number varies in phase with the solar flux. Sunspot numbers can vary between zero (for sunspot minimum periods) to values in excess of 350 or 400 (in the very active *solar maximum* period of the sun's 11 year cycle). Solar flux is related to the sunspot number, since sunspots produce radio emissions at 10.7-cm wavelengths (as well as at other wavelengths).

Sweep Frequency Events (Type II, III, IV and V events)

Energetic solar events often produce characteristic radio *bursts*. These bursts are generated by solar material plunging through the solar corona. Type III and type V events are caused by particles being ejected from the solar environment at near relativistic speeds. Type II and IV events are caused by slower-moving solar material propagating outward at speeds varying between approximately 800 and 1600 kilometers per second. Type II and IV radio bursts are of particular importance.

These sweep frequency radio events are signatures of potentially dense solar material which has been ejected from the solar surface. If the region responsible for these events is well positioned, the expelled solar material may succeed in impacting with the Earth. Such an impact often causes an SSC followed by Minor to Major geomagnetic storm conditions and significantly degraded radio propagation conditions. It is therefore interesting to pay attention to events which cause Type II and/or IV radio sweep events, since they may indicate the potential for increased magnetic activity (and decreased propagation quality) within 48 hours. It should be noted, however, that predicting degraded terrestrial conditions is significantly more complex than simply observing whether the energetic event had an associated Type II or IV radio sweep. Flare position, proton spectra, flare size, event duration, event intensity and a host of other variables must be analyzed before a qualitative judgment can be made.

It should also be noted that sweep frequency radio events are capable of producing short wave fades (SWFs) and sudden ionospheric disturbances (SIDs). Depending on the severity of the event, the duration of SWFs and SIDs may last in excess of several hours with typical values being approximately 30 minutes. SWFs and SIDs cause absorption of radio signals (due to intense ionization) at frequencies up to and well in excess of 500 MHz. Microwave continuum bursts can affect frequencies up to 30 GHz. Frequencies in the HF region can be completely blacked out for a period of time during intense energetic events.

Tenflare

A tenflare is associated with optical and x-ray flares. Solar flares emit radiation over a very wide range of frequencies. One of the more significant frequencies observed is the 10.7-cm wavelength band (2695 MHz). When a solar flare erupts, *noise* from the flare is received over this very wide range of frequencies. When the noise received on the 10.7-cm wavelength band surpasses 100 percent of the background noise level during a solar flare, a Tenflare is said to be

in progress. The more intense solar flares are associated with tenflares. Almost all major flares are associated with tenflares. Generally, the greater the intensity of the burst of noise observed at the 10.7 cm wavelength band, the more significant the flare is said to be. The duration of the tenflare can also be used to determine the severity of the flare. Other important flare characteristics are also determined from the radio data observed from flares, which are closely related to the various physical processes which occur in flares. These characteristics are far beyond the scope of this document.

X-Ray Background Flux

This represents the average background x-ray flux as measured on the primary GOES satellite. This value basically represents the amount of x-ray radiation that is being received at the Earth by the sun. Generally, active regions emit more x-ray radiation than non-active solar regions. Therefore, this value can be of use in determining the overall state of the solar hemisphere facing the Earth. This value is also useful for propagation prediction models (i.e., PROPHET models), since ionospheric layer ionization is closely correlated with the background X-ray flux. This flux is stated using the same classification scheme for x-ray FLARES.

INITIAL DISTRIBUTION LIST

Addressee	No. of Copies
National Science Foundation, Office of Polar Programs	6
Office of Naval Research (ONR 313)	2
Defense Technical Information Center	6
Tele-Technologies, Inc. (Robert Pellowski)	1
Joseph Katan	3
John Tillbrook	1