

# REPORT DOCUMENTATION PAGE

*Form Approved*  
*OMB No. 0704-0188*

Public reporting burden for this collection of information is estimated to average 1 hour per response, including the time for reviewing instructions, searching existing data sources, gathering and maintaining the data needed, and completing and reviewing the collection of information. Send comments regarding this burden estimate or any other aspect of this collection of information, including suggestions for reducing this burden, to Washington Headquarters Services, Directorate for Information Operations and Reports, 1215 Jefferson Davis Highway, Suite 1204, Arlington, VA 22202-4302, and to the Office of Management and Budget, Paperwork Reduction Project (0704-0188), Washington, DC 20503.

1. AGENCY USE ONLY <i>(Leave blank)</i>		2. REPORT DATE <p style="text-align: center;">May 26, 1999</p>		3. REPORT TYPE AND DATES COVERED <p style="text-align: center;">Presentation</p>	
4. TITLE AND SUBTITLE <p>Wireless Propagation Measurements, Analysis, and Modeling</p>		5. FUNDING NUMBERS PE: 0603764E AN: DN307753			
6. AUTHOR(S) <p>C. R. Hendrickson(1), C. R. Yerkes(1), and Dr. G. C. Gerace(2)</p>		8. PERFORMING ORGANIZATION REPORT NUMBER			
7. PERFORMING ORGANIZATION NAME(S) AND ADDRESS(ES) SSC San Diego(1)      Science Applications International Corporation(2) San Diego, CA      4035 Hancock Street 92152-5001      San Diego, CA 92110-5155		10. SPONSORING/MONITORING AGENCY REPORT NUMBER			
9. SPONSORING/MONITORING AGENCY NAME(S) AND ADDRESS(ES) Defense Advanced Research Project Agency 3701 North Fairfax Drive Arlington, VA 22022		11. SUPPLEMENTARY NOTES			
12a. DISTRIBUTION/AVAILABILITY STATEMENT <p style="text-align: center;">Approved for public release; distribution is unlimited.</p>			12b. DISTRIBUTION CODE		
13. ABSTRACT <i>(Maximum 200 words)</i> <p>This presentation displays analysis of performed propagation measurements, including measurement goals and capabilities, sample results, and model comparisons.</p> <div style="text-align: center; font-size: 2em; font-weight: bold; margin: 20px 0;">19991220 067</div> <p>Presentation given at the IEEE Joint Signal Processing and Communications Society Meeting, San Diego State University, May 26, 1999.</p>					
14. SUBJECT TERMS Mission Area: Communications propagation measurements receiver antenna transmitter antenna				15. NUMBER OF PAGES	
17. SECURITY CLASSIFICATION OF REPORT <p style="text-align: center;">UNCLASSIFIED</p>				16. PRICE CODE	
18. SECURITY CLASSIFICATION OF THIS PAGE <p style="text-align: center;">UNCLASSIFIED</p>		19. SECURITY CLASSIFICATION OF ABSTRACT <p style="text-align: center;">UNCLASSIFIED</p>		20. LIMITATION OF ABSTRACT <p style="text-align: center;">SAME AS REPORT</p>	

# Wireless Propagation Measurements, Analysis, and Modeling

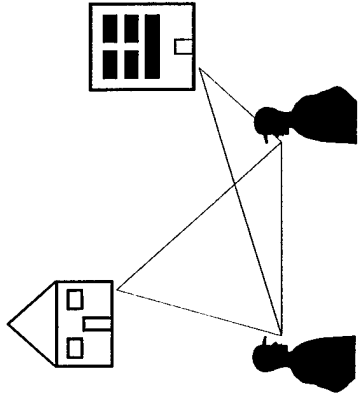

SSC-SD D855

Clark Hendrickson, Chris Yerkes

[clark@spawar.navy.mil](mailto:clark@spawar.navy.mil), [yerkes@spawar.navy.mil](mailto:yerkes@spawar.navy.mil)

SAIC

Dr. Gerald C. Gerace

[gerald.c.gerace@cpmx.saic.com](mailto:gerald.c.gerace@cpmx.saic.com)

# Outline

- Measurement Goals and Capabilities
- Multipath Tutorial
- Sample Results
  - Urban Channel
    - HMMWV Motion
    - Human Mount w/Motion
    - Various Antenna Heights
  - Many Channels
    - Path Loss vs. Delay Spread
- Model Comparisons

# SSC-SD Measurement Goals

- **Measure Channel Responses**
  - **Urban/Suburban, Hills/Trees, Airfield**
  - **Antennas close to buildings**
  - **Antennas mounted on humans in motion**
  - **Low antenna heights**
  - **VHF, UHF, ISM, LBand**
- **Compare w/existing Propagation Models**

# Measurement System Capabilities

- Long Duration (25s)
- High Resolution (12m)
- Long Range (10km)
- Frequency Versatile (30MHz-2GHz)
- Severe Environments (Heavy Urban)
- Arbitrary Waveform Capability

# Data Applications



- **Propagation Science**
- **Radio Design**
  - **Algorithm development/testing**
  - **Waveform development/testing**
  - **Antenna development/testing**
  - **Transmit power selection/power control design**
  - **Frequency and BW selection**
  - **Computation update requirements**
- **Network Modeling**
- **Network Design**

# Transmitter/Receiver

Receiver Antennas

Transmitter Antennas

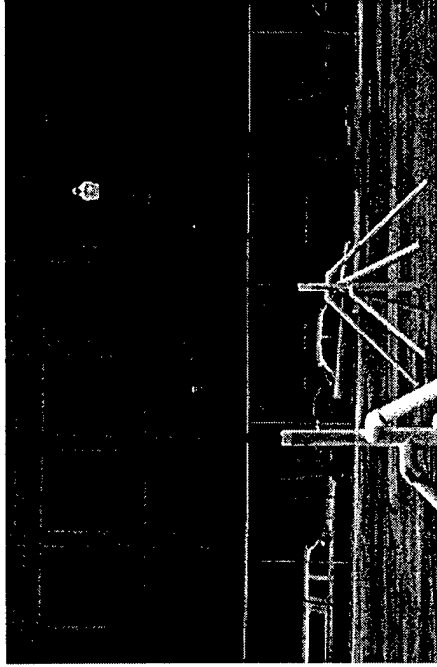
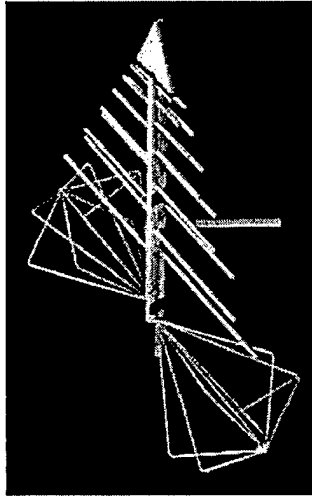
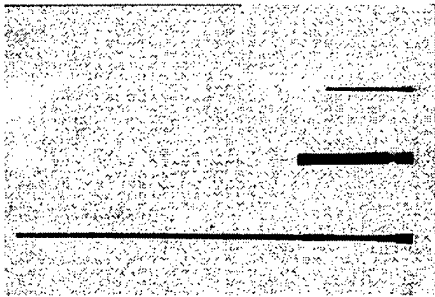

110 MW AC Power  
for Transmitter

Navy Van for Receiver Equipment

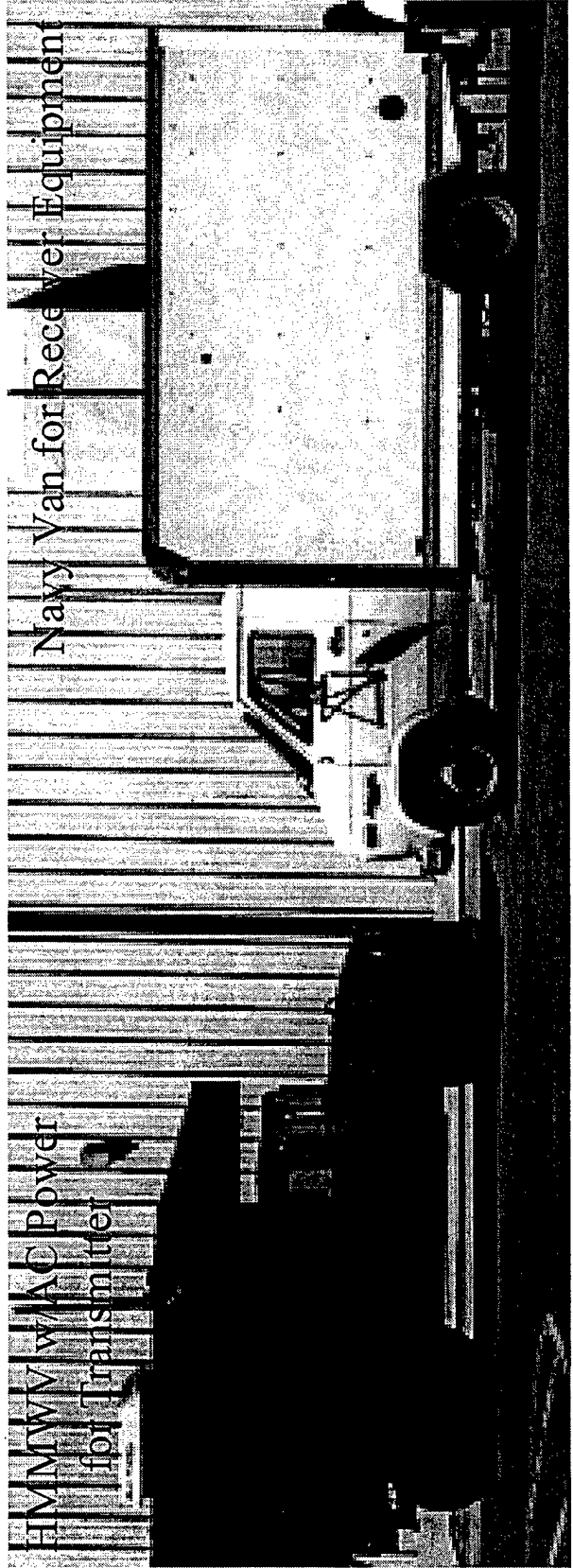

# Propagation Testbed

30MHz-2GHz

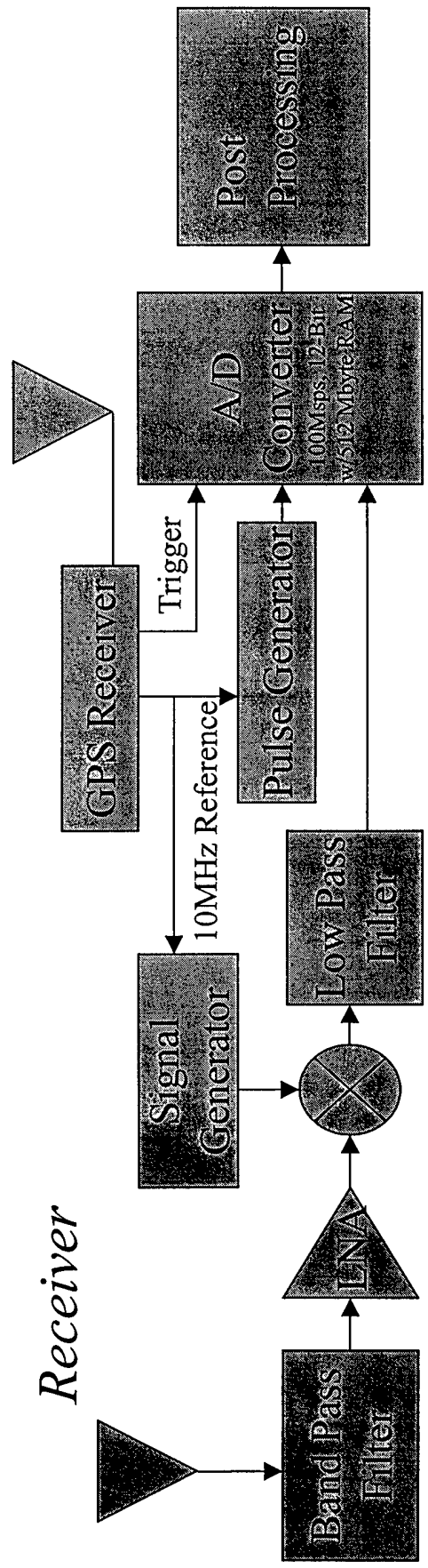
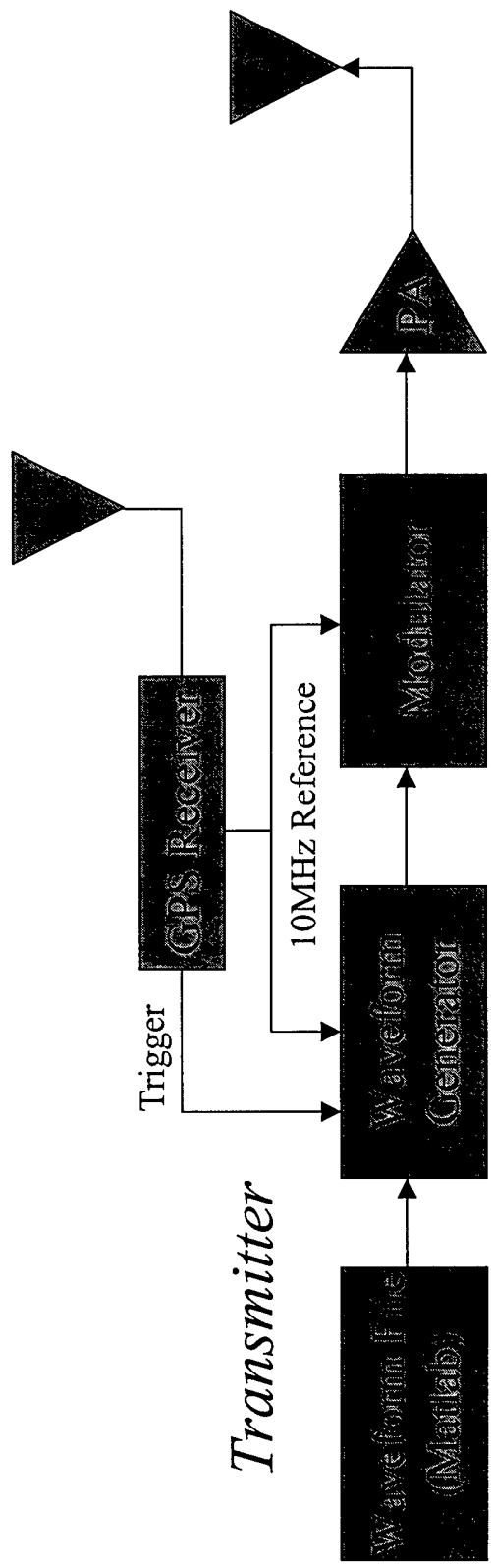



# Adaptive Channel Estimation

- Channel Modeling Algorithm:

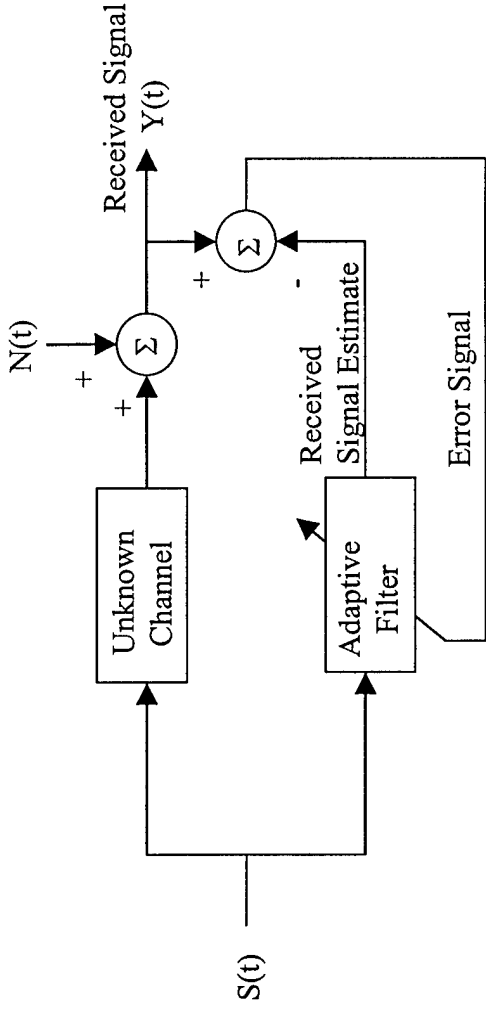

- Adaptive FIR Channel Estimation Filter:
  - 3 Phases:
    - Acquisition - Recursive Least Squares (RLS)
    - Training - Normalized Gradient Decent (NLMS)
    - Tracking - Normalized Gradient Decent (NLMS)
  - Filter Tap Length - 240 Taps

# Outline

- Measurement Goals and Capabilities
- » Multipath Tutorial
- Sample Results
  - Urban Channel
    - HMMWV Motion
    - Human Mount w/Motion
    - Various Antenna Heights
  - Many Channels
    - Path Loss vs. Delay Spread
- Model Comparisons

# Multipath

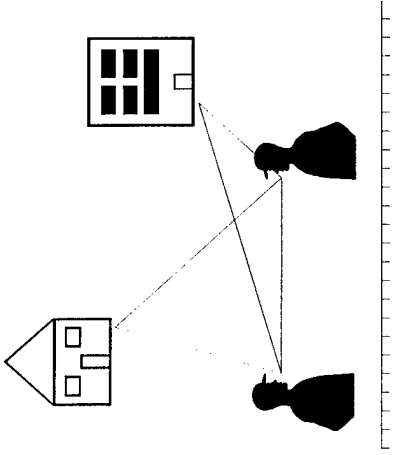

- Exact solution: Maxwell's equations and Boundary Conditions
- Approximate solution: Trace rays using geometric optic rules
- Better: Add edge diffraction and transmission through wall
- But: Need a good geometrical description of the environment
- Alternative: STATISTICAL DESCRIPTION

# Narrowband Signals

$$p_{\tau} = p_o \left| \sum_{i=1}^L \frac{a_i}{d_i} e^{j\phi_i} \right|^2$$

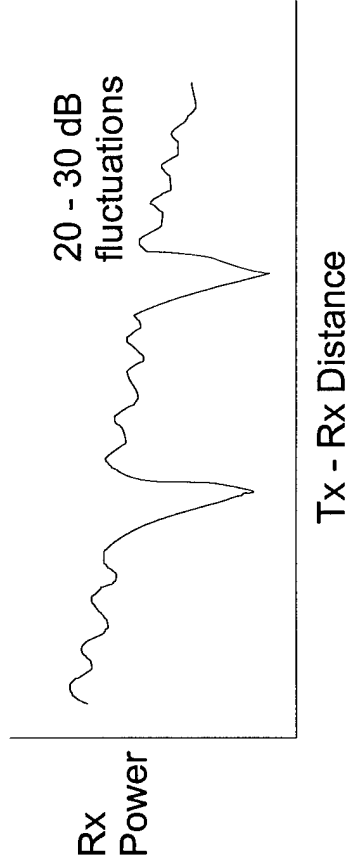

# Wideband Signal

$$h(\tau, t) = \sum_{i=1}^L \beta_i e^{j\varphi_i} \delta(t - \tau_i)$$

$$y(t) = \int x(t - \tau') h(\tau, \tau') d\tau'$$

$$= \int x(t - \tau') \sum_{i=1}^L \beta_i e^{j\varphi_i} \delta(\tau' - \tau_i) d\tau'$$

$$= \sum_{i=1}^L \beta_i e^{j\varphi_i} x(t - \tau_i)$$

# Ideal Case (Infinite BW)

$$\begin{aligned}
 \text{Let } x(t) &= \delta(t) \\
 \Rightarrow y(t) &= h(\tau, t) \\
 |y(t)|^2 &= y(t)y^*(t) \\
 &= \sum_{i=1}^L \sum_{k=1}^L \beta_i \beta_k^* e^{j(\varphi - \varphi_k)} \int \delta(t - \tau_i) \delta(t - \tau_k) dt \\
 p &= \int |y(t)|^2 dt = \\
 &= \sum_{i=1}^L \sum_{k=1}^L \beta_i \beta_k^* e^{j(\varphi - \varphi_k)} \int \delta(t - \tau_i) \delta(t - \tau_k) dt \\
 &= \sum_{i=1}^L |\beta_i|^2
 \end{aligned}$$

# Power Delay Profile (Practical Case)

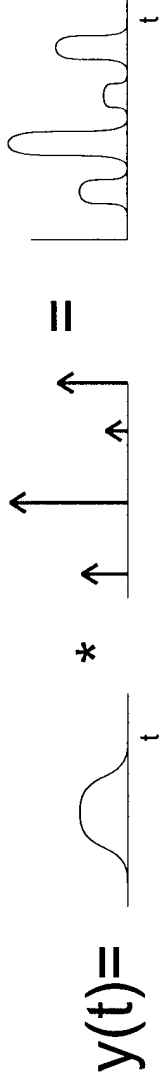

$\sigma =$  delay spread

Smearing due to convolution.

# Channel Frequency Response

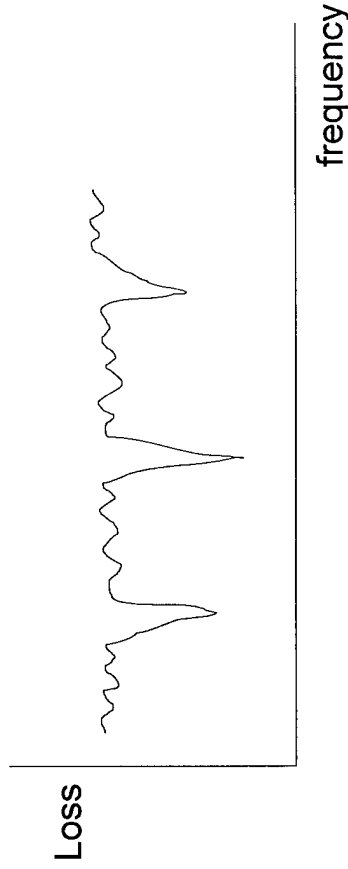



# Modeling

- Path Loss (JTC)

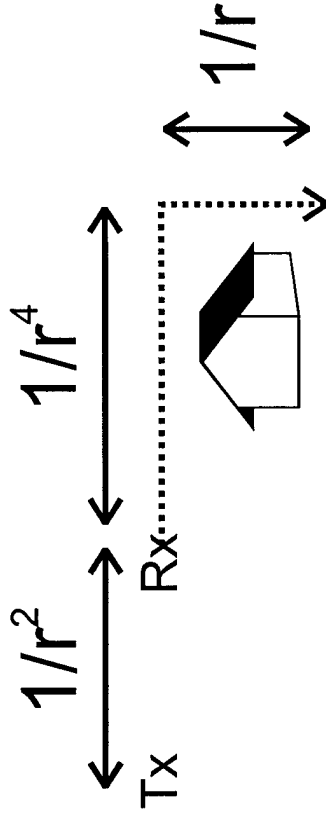

# Canonical Tapped Delay Line Model

Urban High Rise

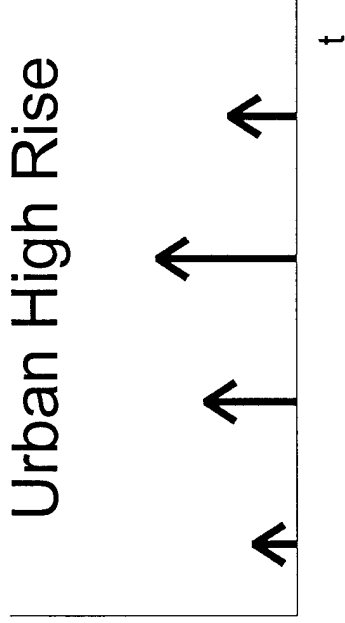

Urban Low Rise

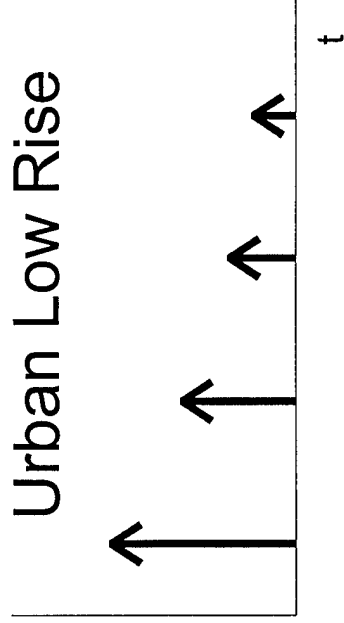

# Motion Measurements (8 Sec)

- A collection of channel realization in a single measurement

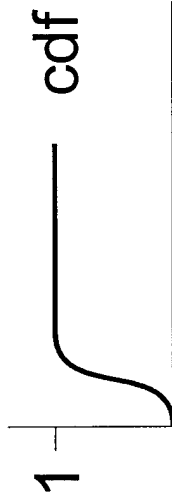
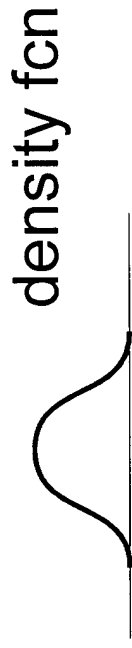

Loss on Delay Sprea

# Motion Measurements (8 Sec)

- Compute means and
  - 1) Compare to each other
    - different carrier freqs
    - different environments
  - 2) Compare to Models
    - JTC
    - Hata
    - TIREM

# Outline

- Measurement Goals and Capabilities
- Multipath Tutorial
- » Sample Results
  - Urban Channel
    - HMMWV Motion
    - Human Mount w/Motion
    - Various Antenna Heights
  - Many Channels
    - Path Loss vs. Delay Spread
- Model Comparisons



# Urban San Diego

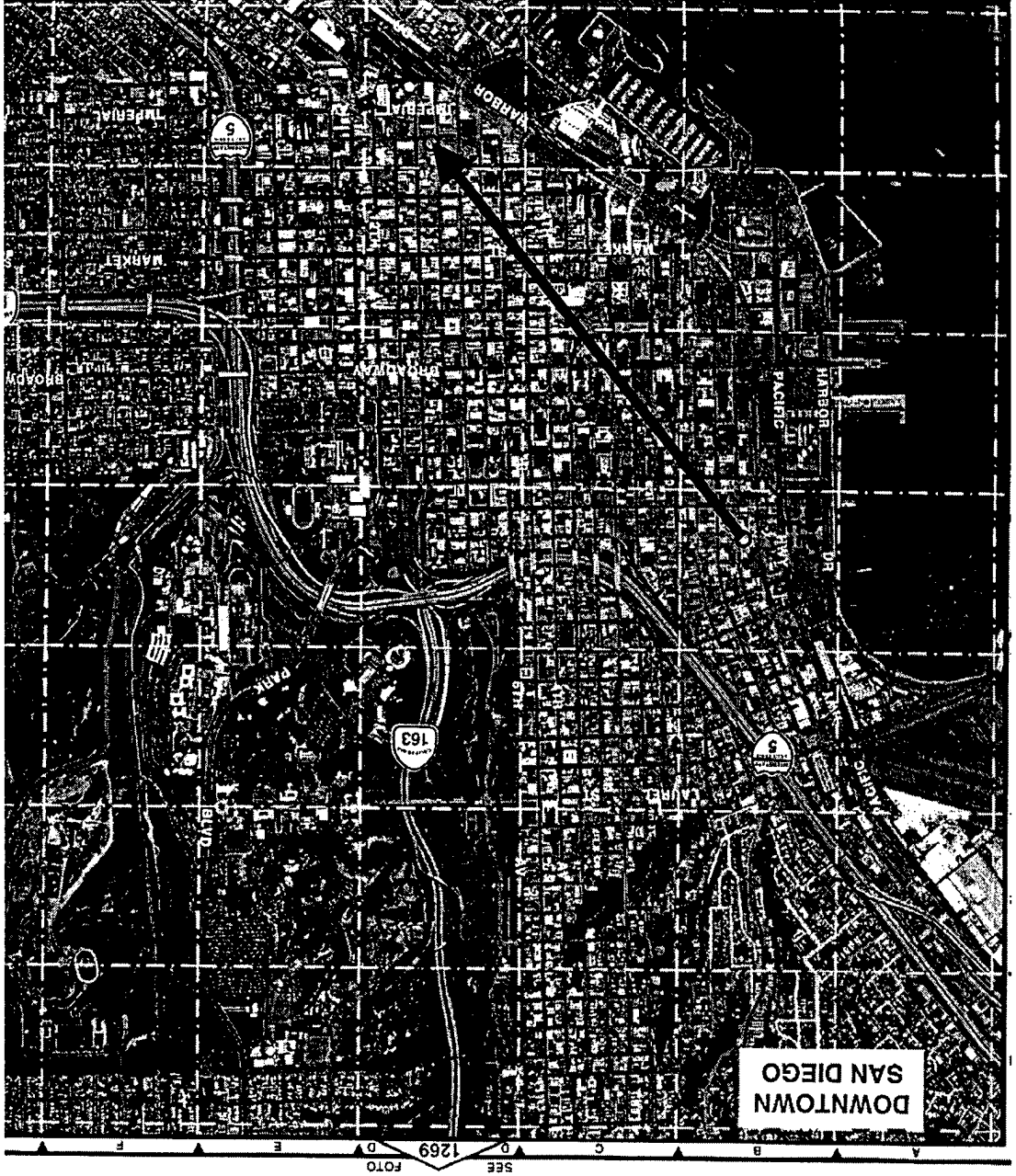

# Airfield and Urban Delay

## Profiles

**Airfield**  
(3.48 km; 237 MHz)

**Urban**  
(2.15 km; 237 MHz)

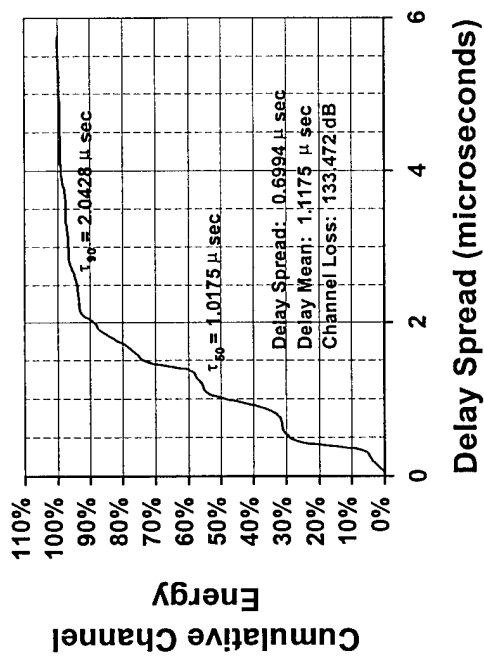
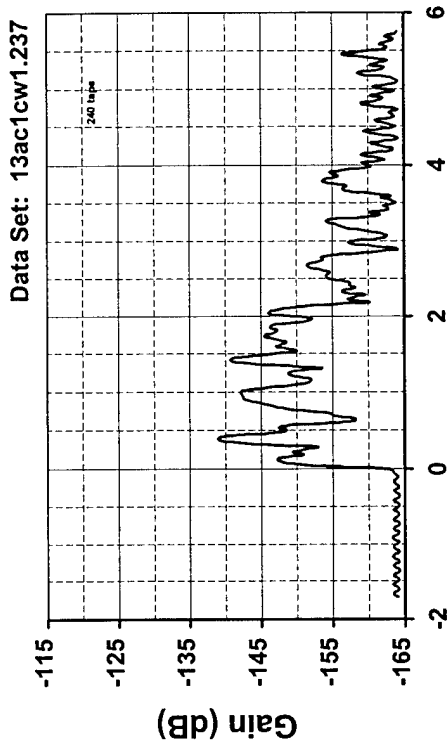
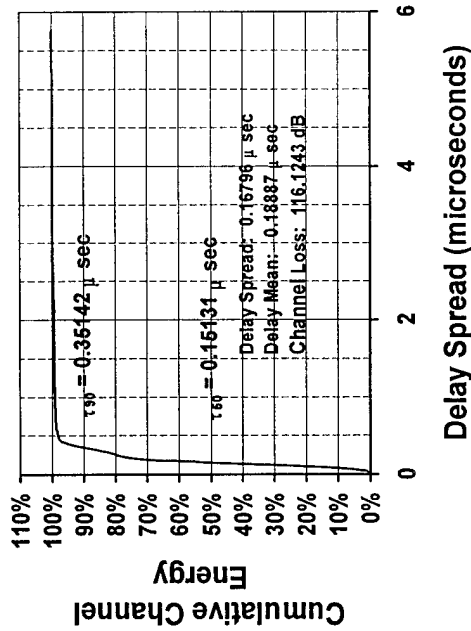
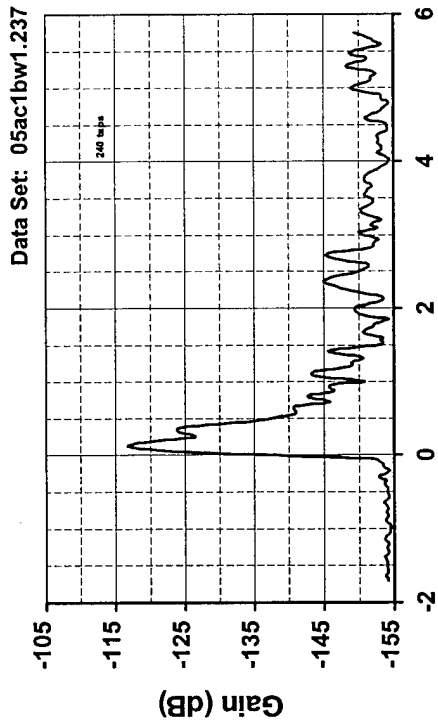

# Channel Estimates - Motion

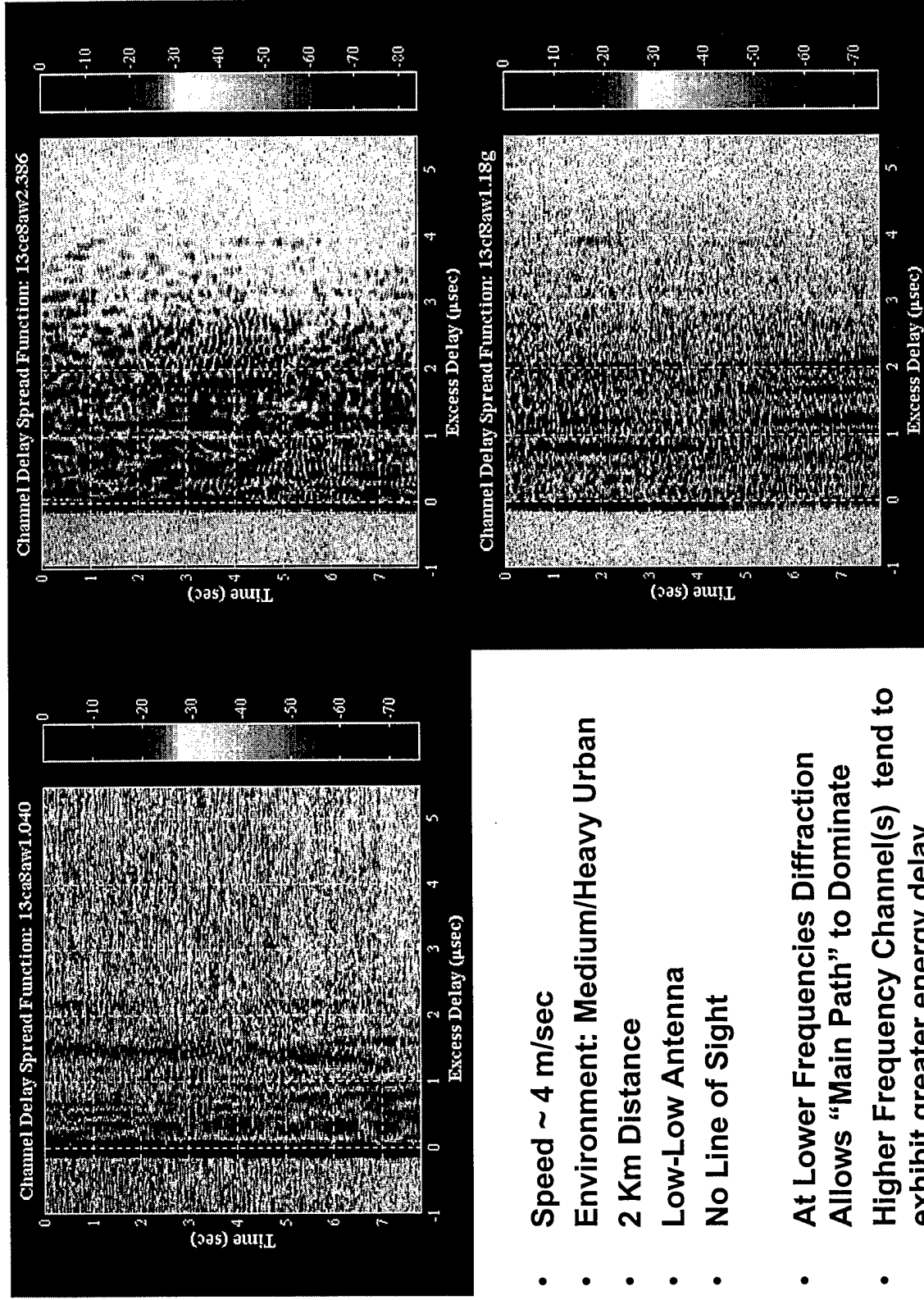

- Speed ~ 4 m/sec
- Environment: Medium/Heavy Urban
- 2 Km Distance
- Low-Low Antenna
- No Line of Sight
- At Lower Frequencies Diffraction Allows "Main Path" to Dominate
- Higher Frequency Channel(s) tend to exhibit greater energy delay



# Scattering Functions - Motion

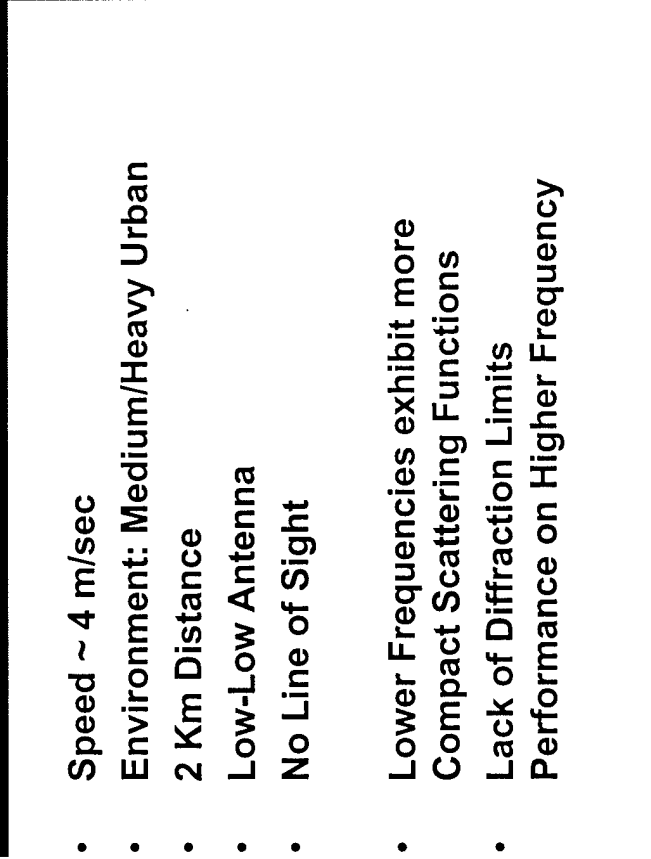
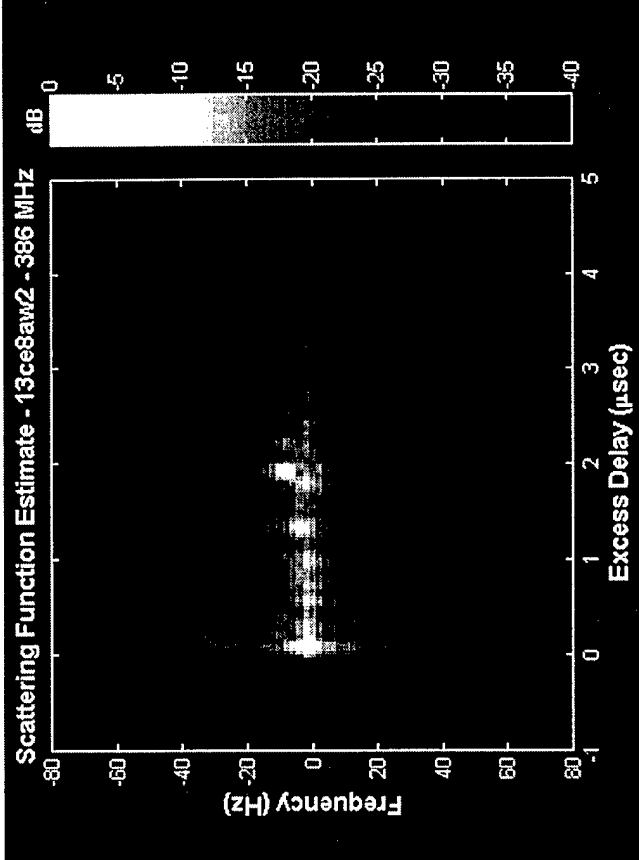
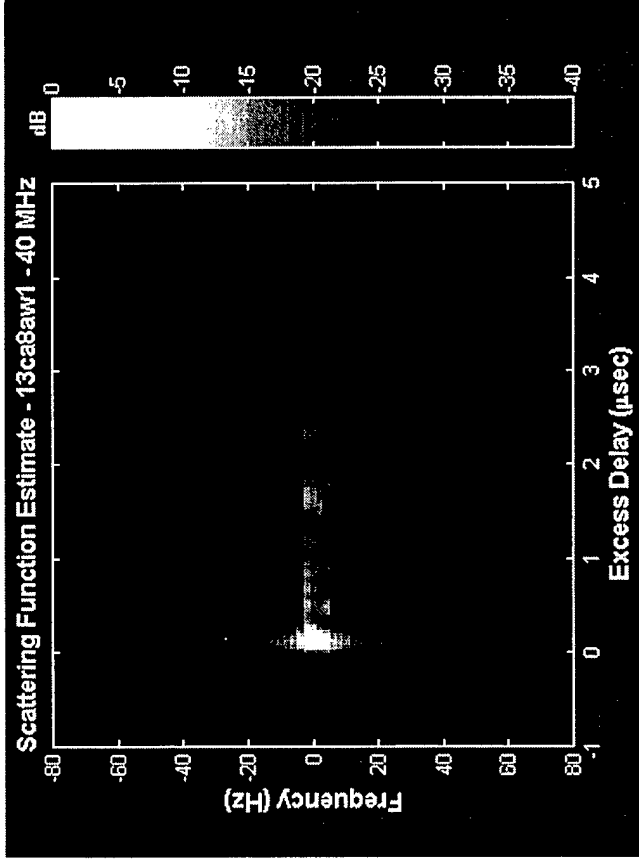

- Speed ~ 4 m/sec
- Environment: Medium/Heavy Urban
- 2 Km Distance
- Low-Low Antenna
- No Line of Sight
- Lower Frequencies exhibit more Compact Scattering Functions
- Lack of Diffraction Limits Performance on Higher Frequency

## Channel Response

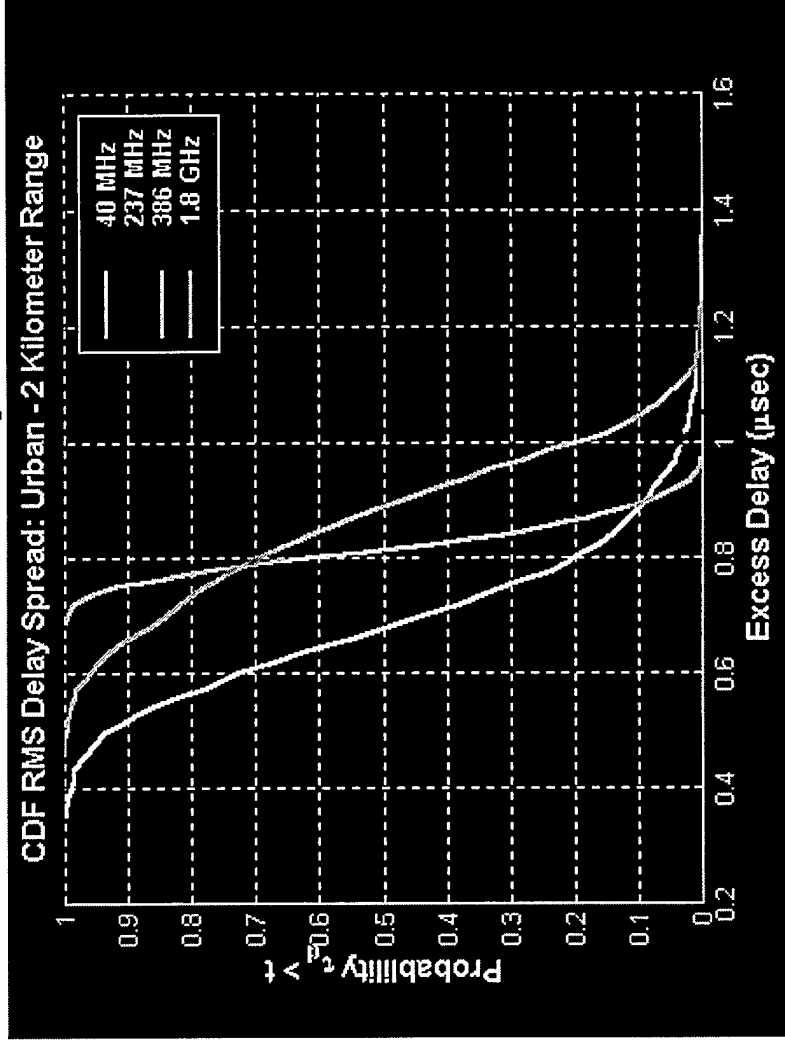

- ~320,000 Channel Estimates taken at 44 kHz
- Averaged to 100 Hz for Power Delay Profiles to Estimate Delay Spread (and Loss)

# Channel Loss

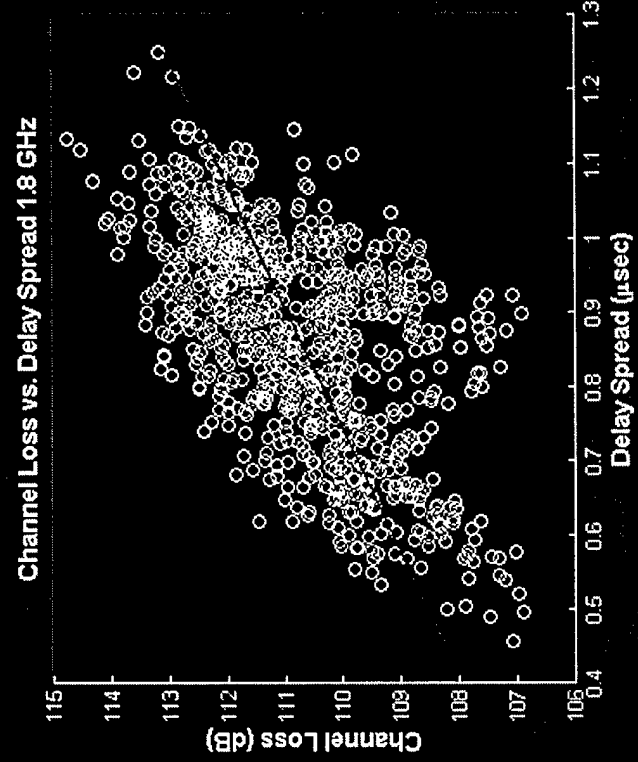
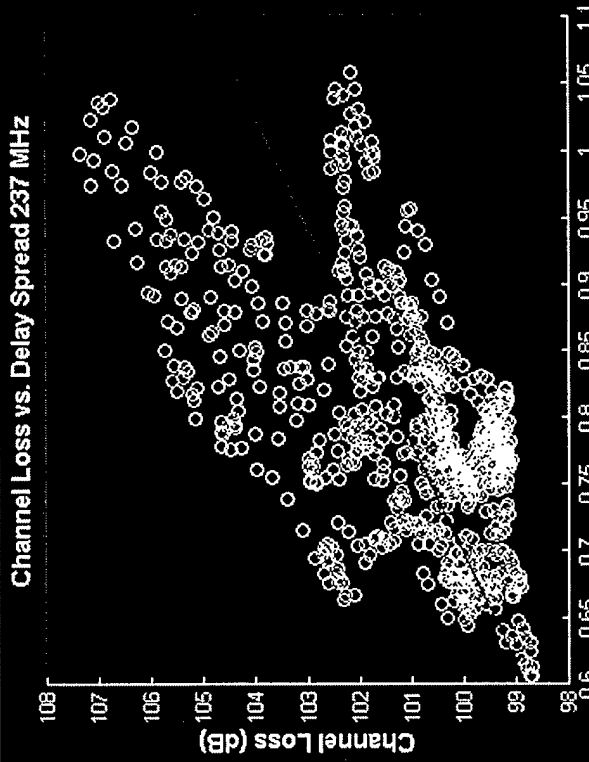
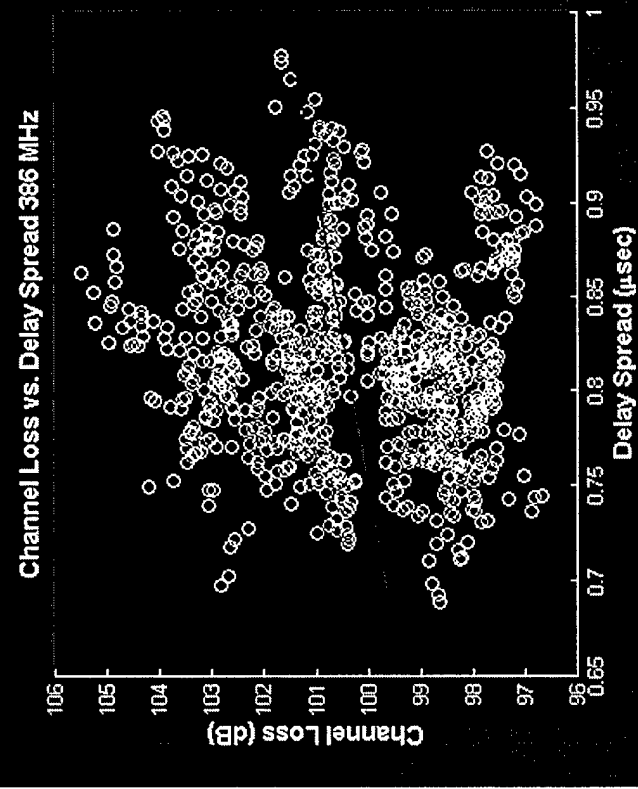
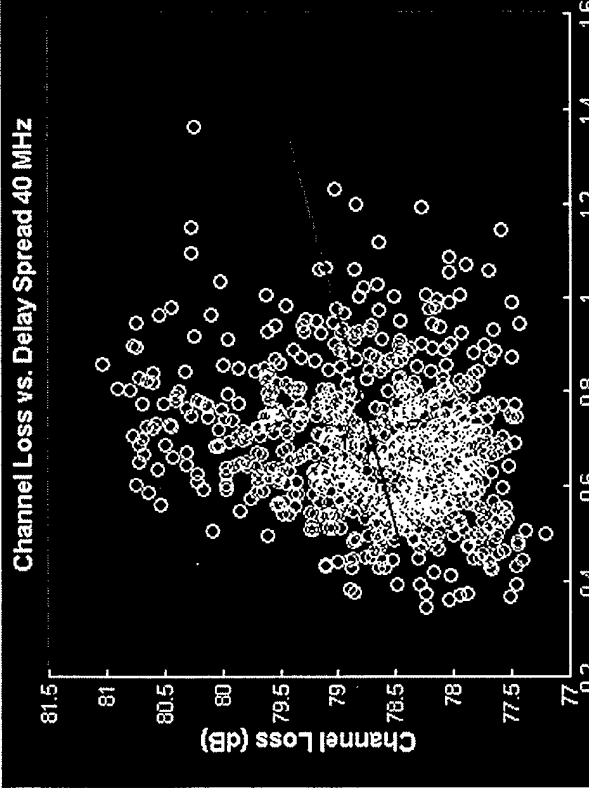

# Channel Loss

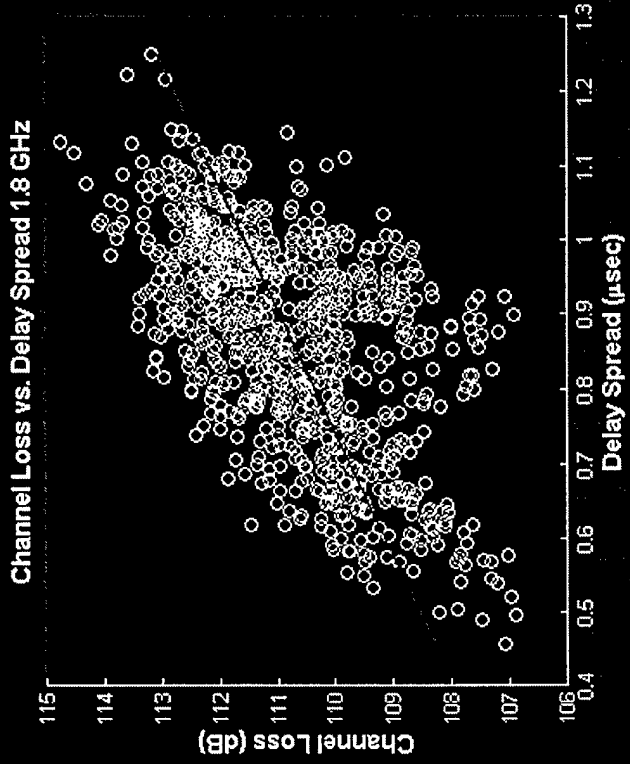
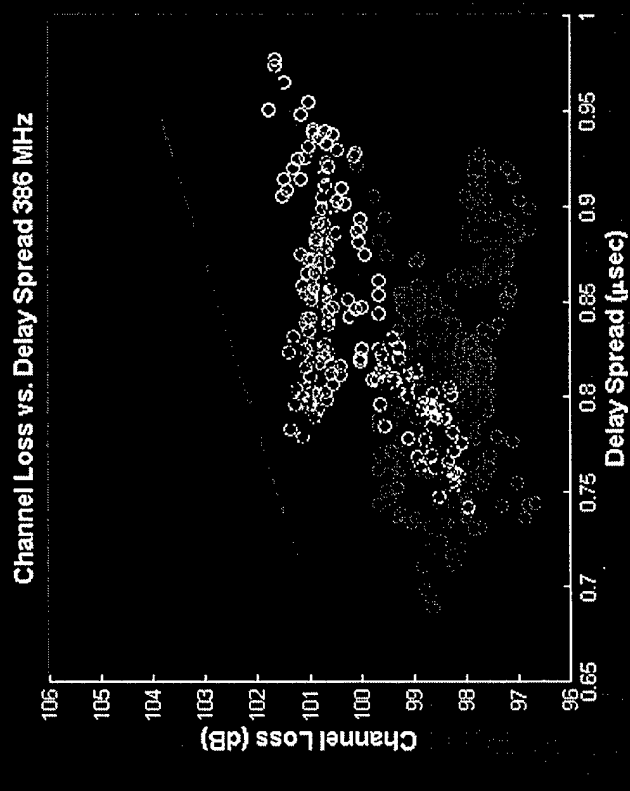
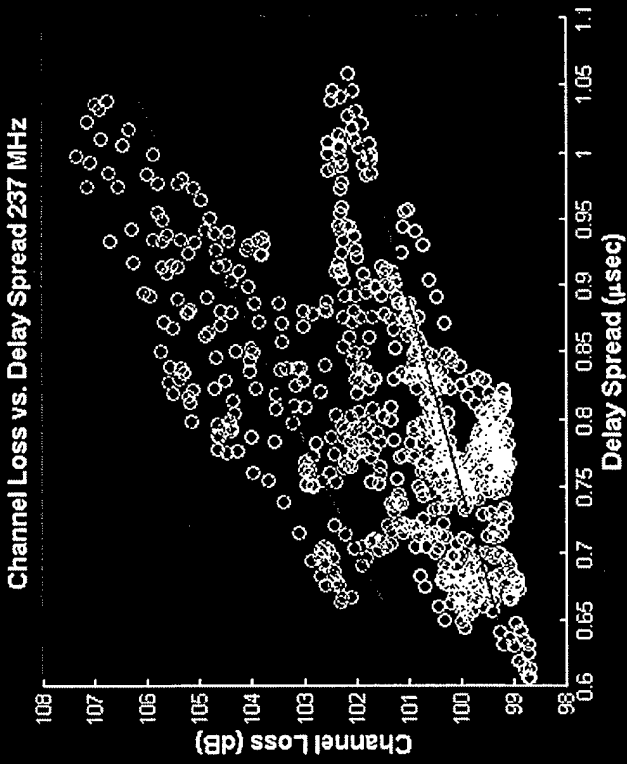
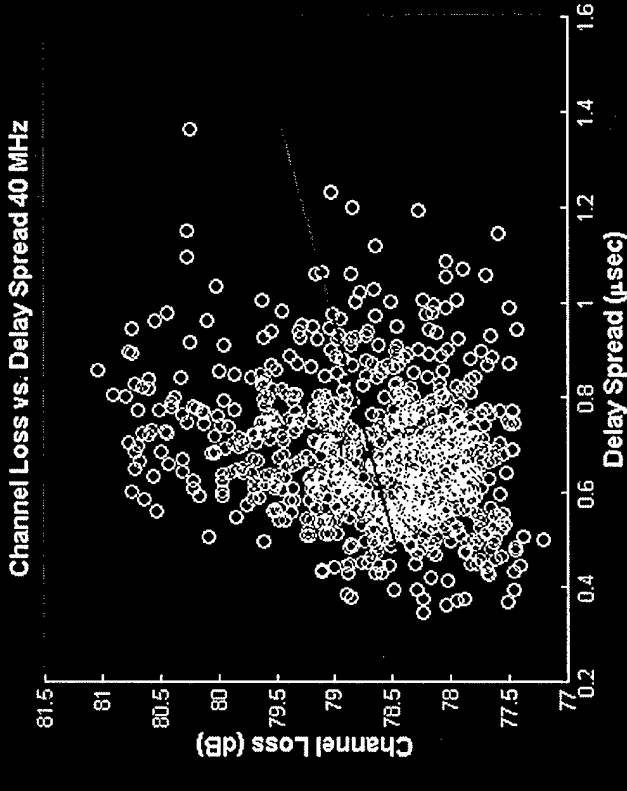

# Urban Path Loss

Urban Environment, (Ch. 13; HMMVV Motion)

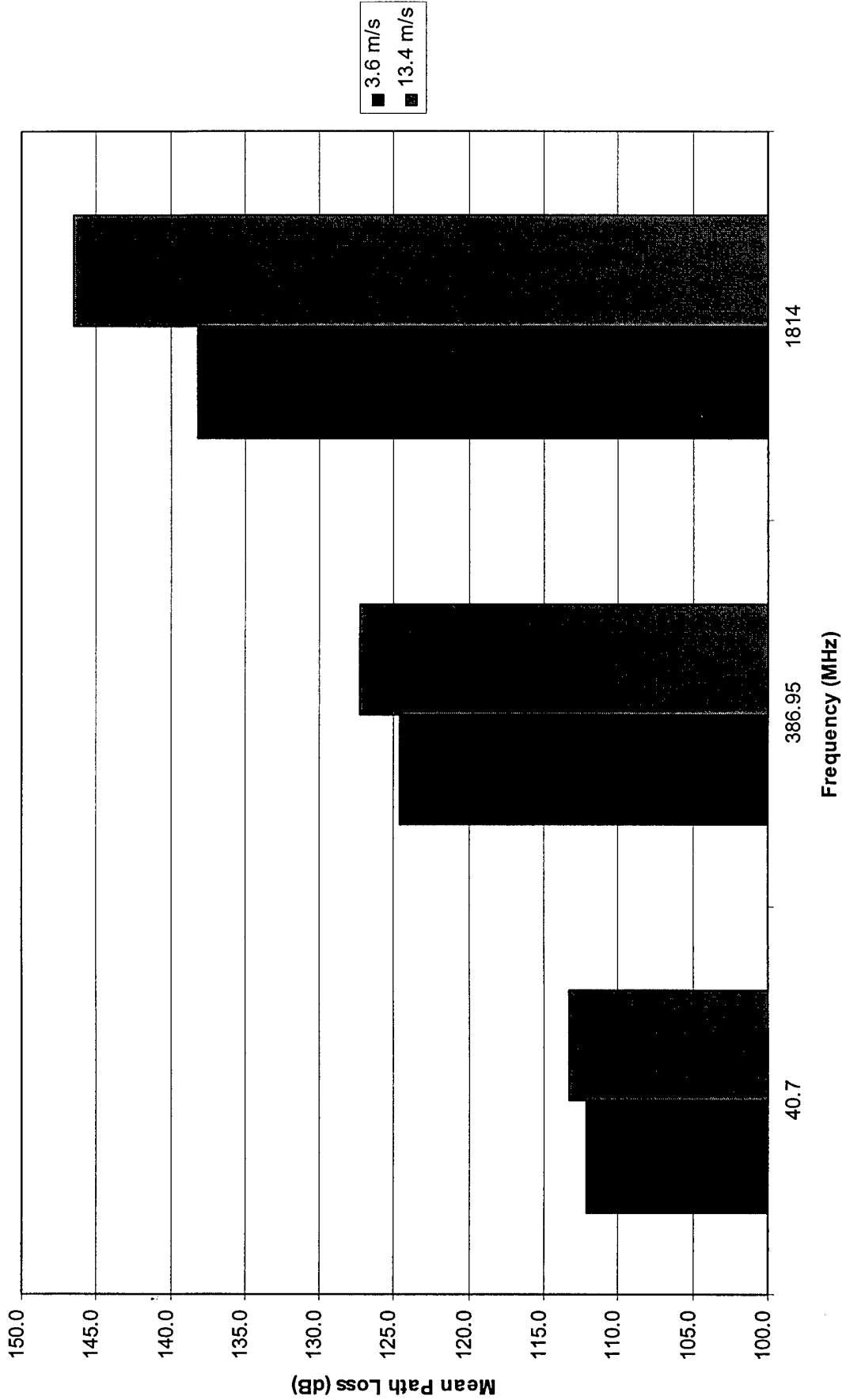

# Urban Delay Spread



Urban Environment, (Ch. 13; HMMWV Motion)

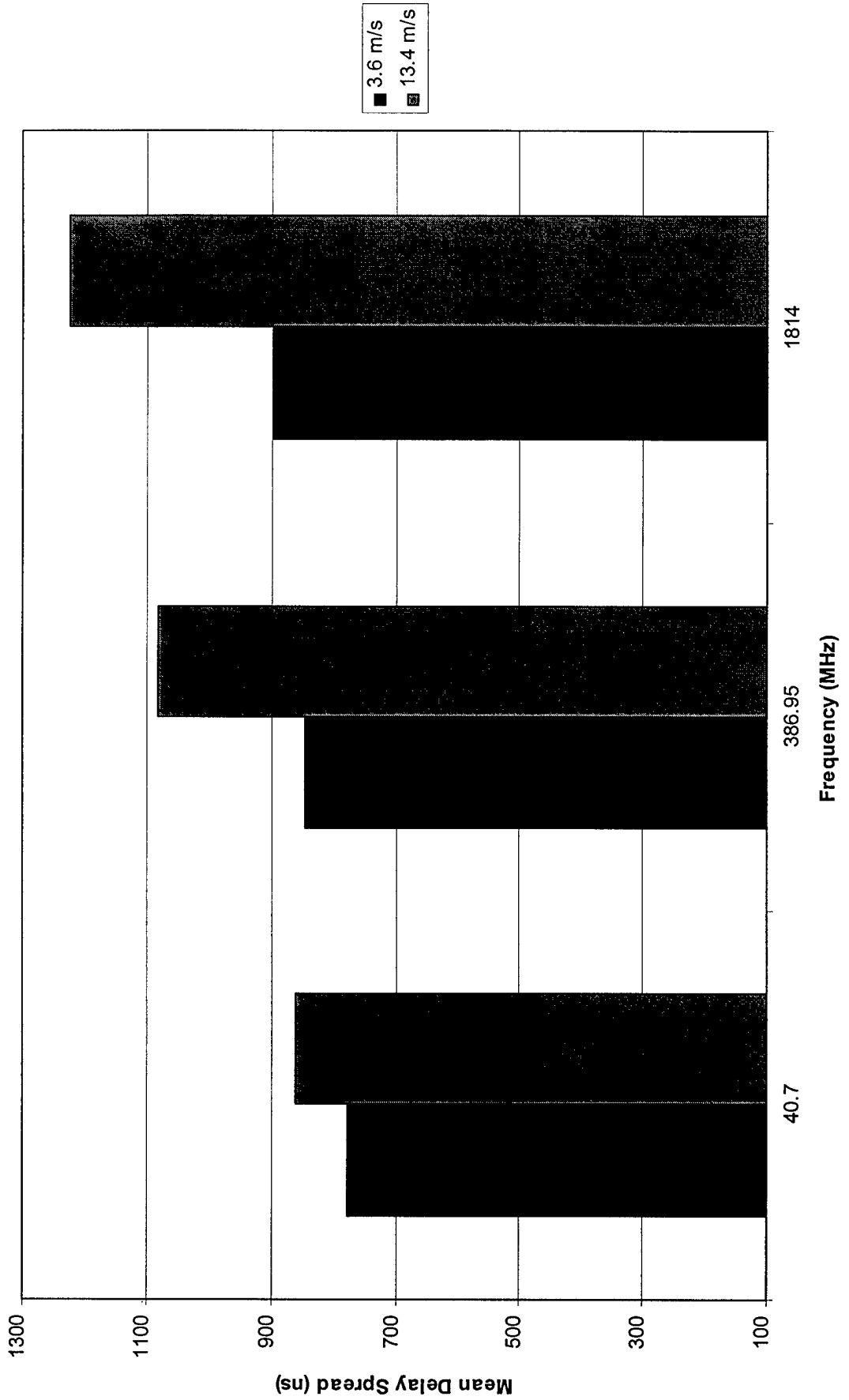



# Soldier Mount

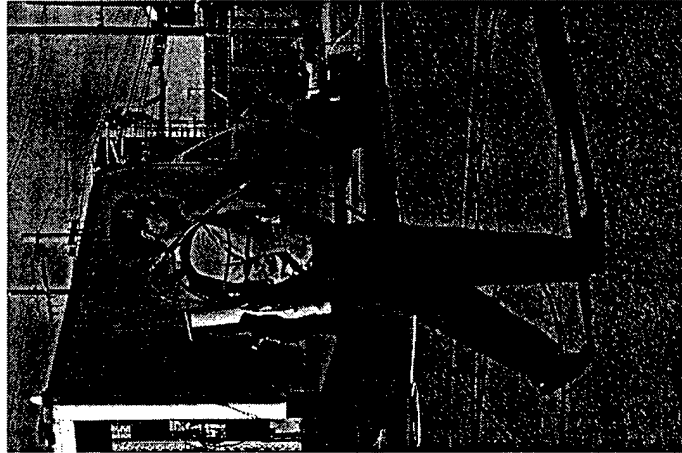

# Soldier Mount

Urban Soldier Mount, 2 Km Range

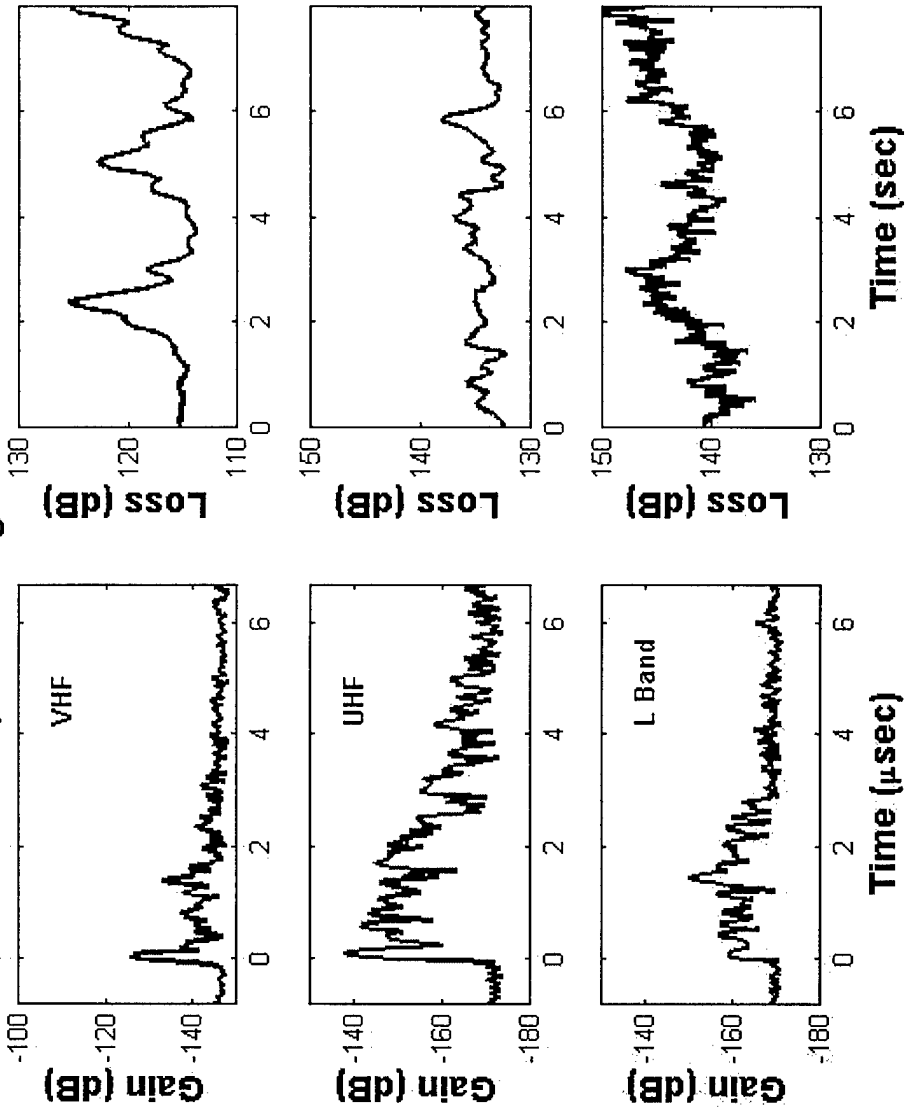



# Urban Path Loss vs. Height

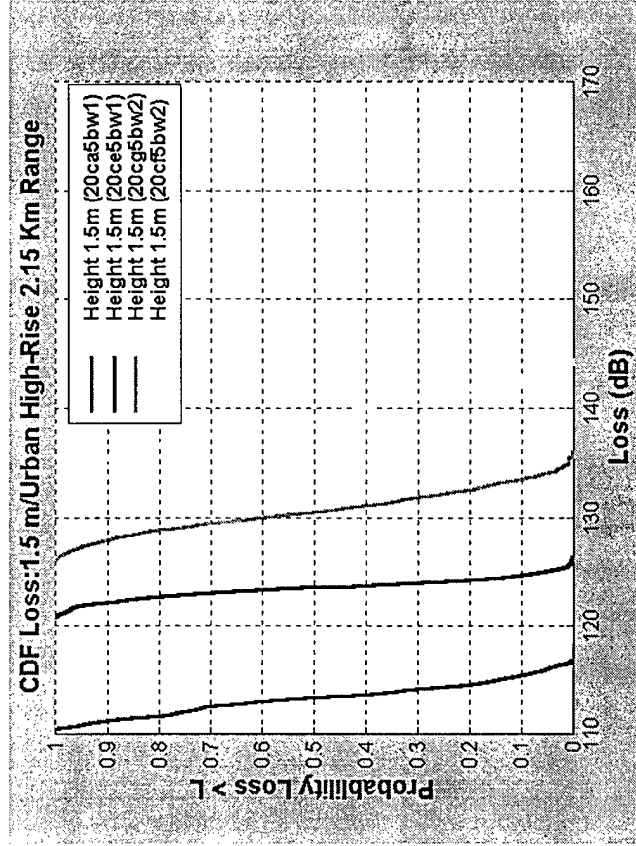
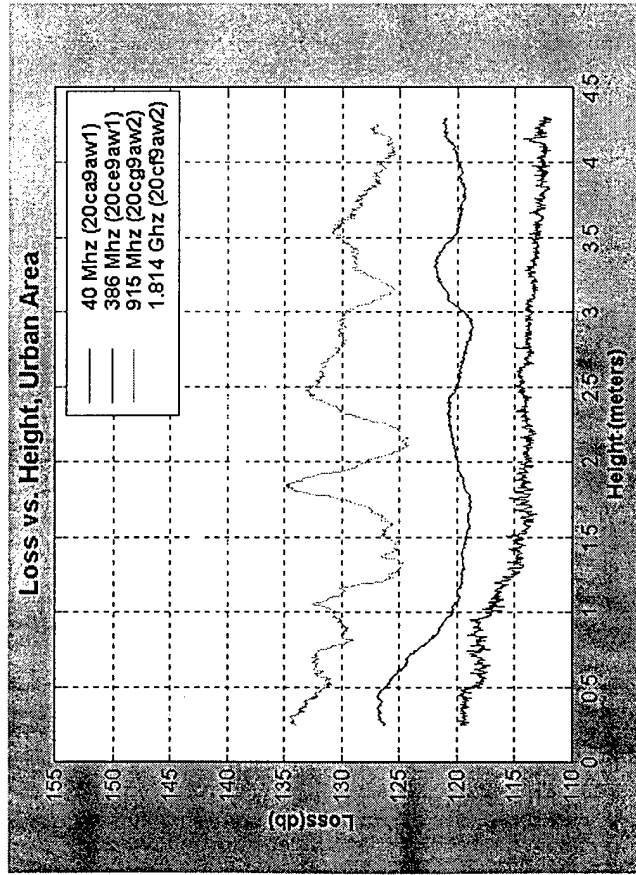



# Balboa Park, Block Building

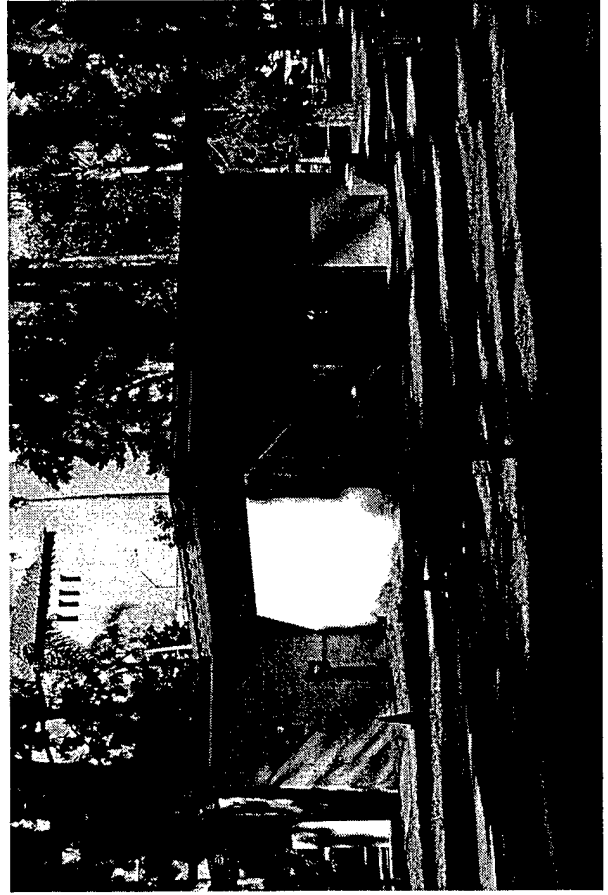
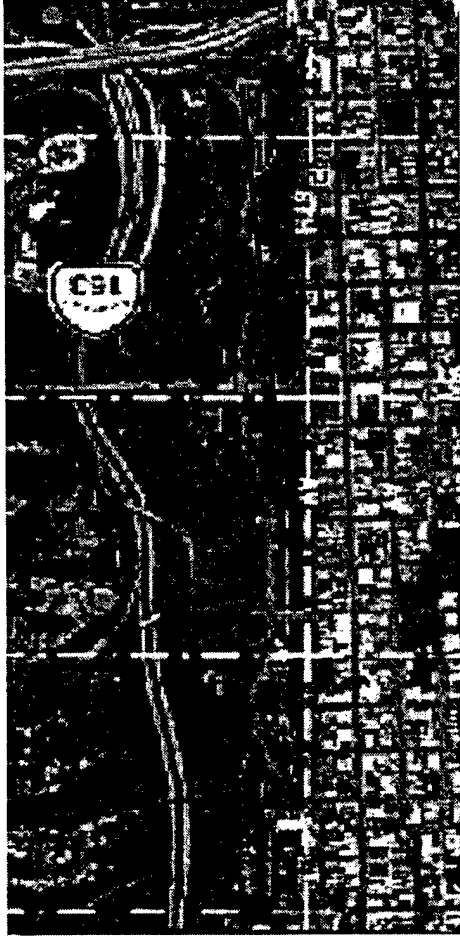

# North Island - Metal Building

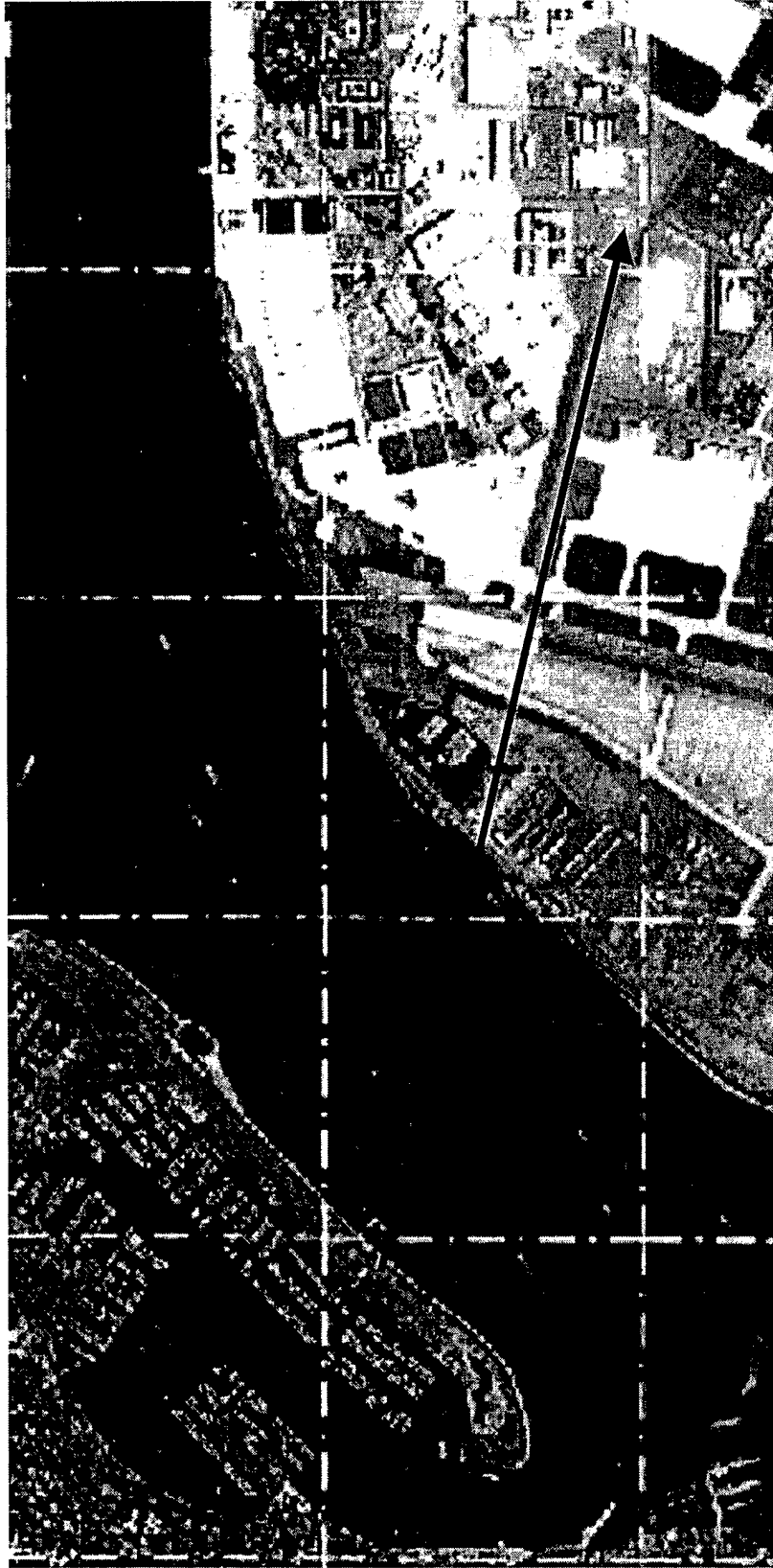

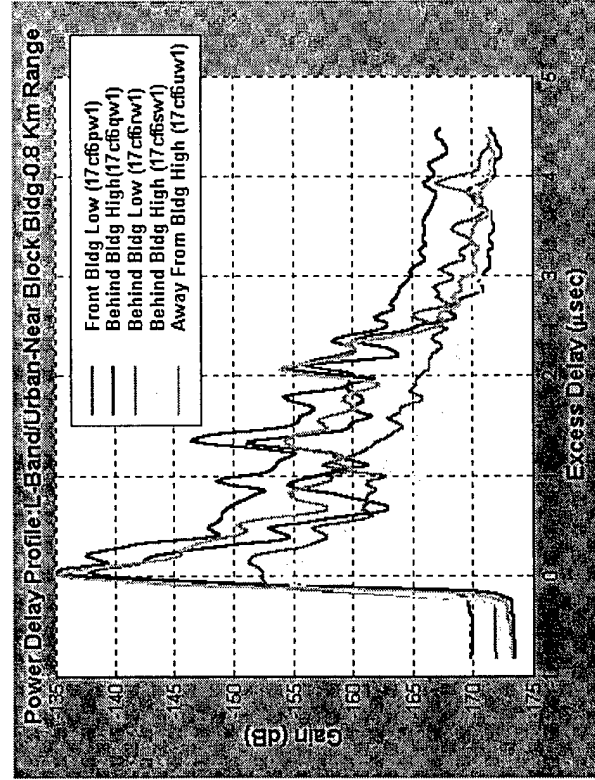
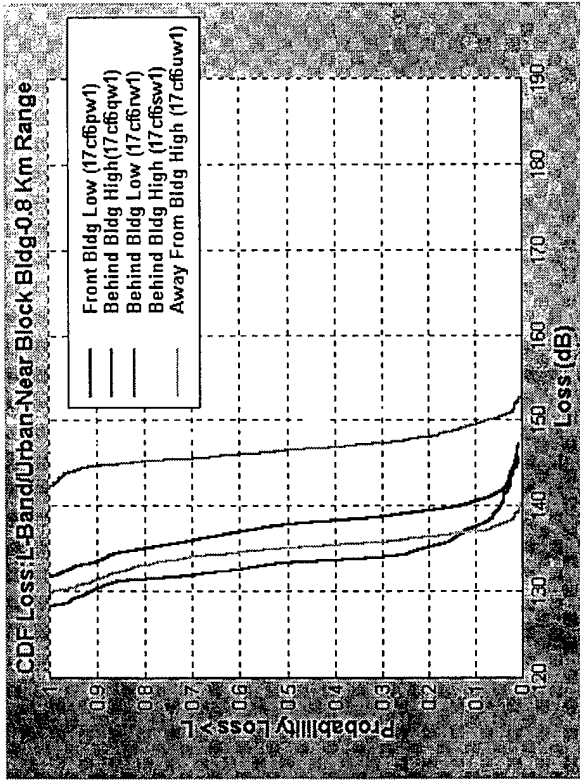
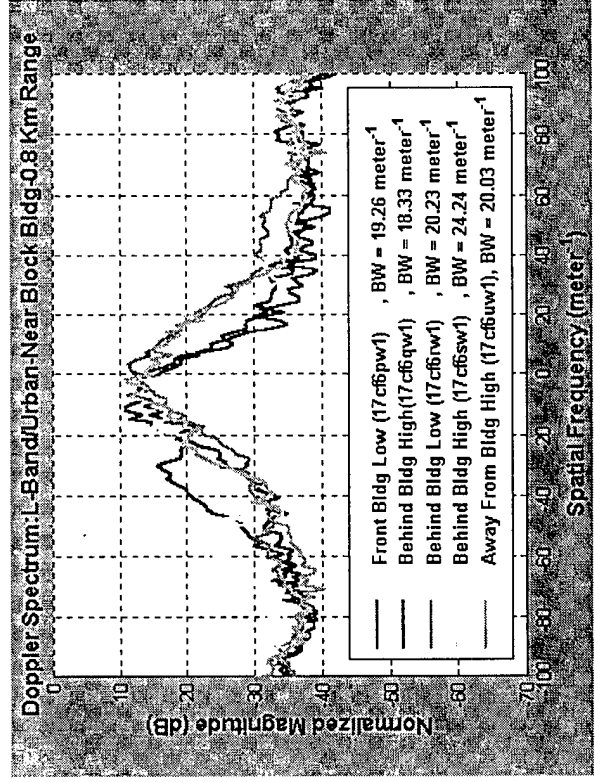
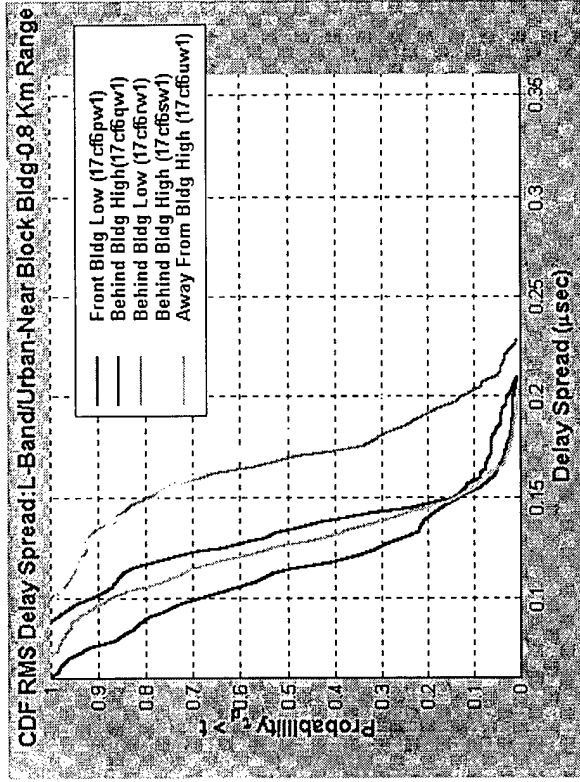

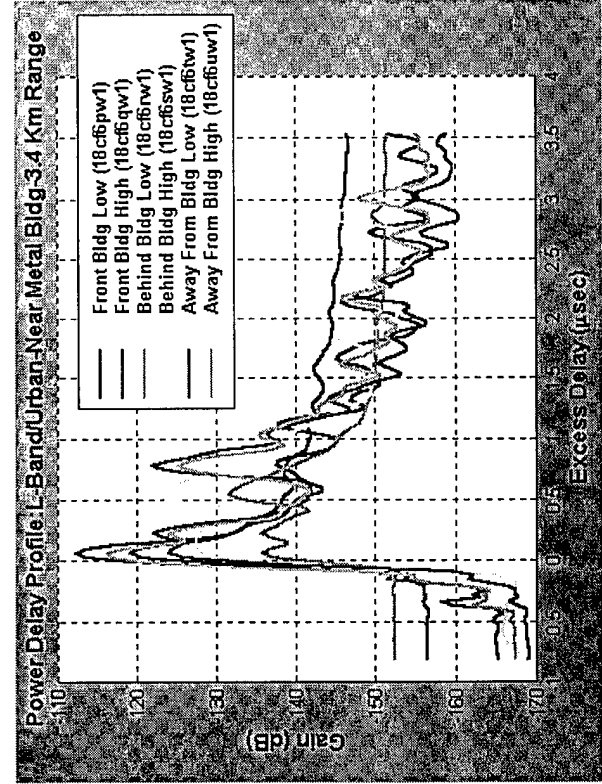
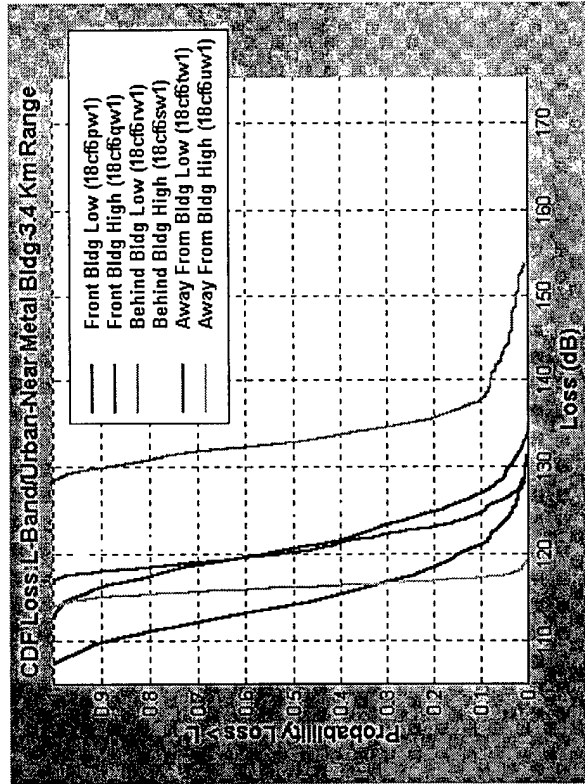
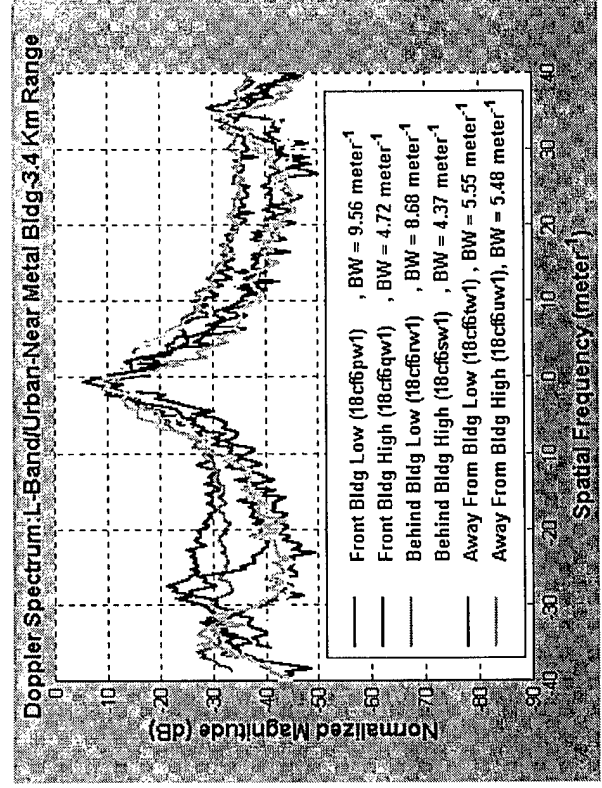
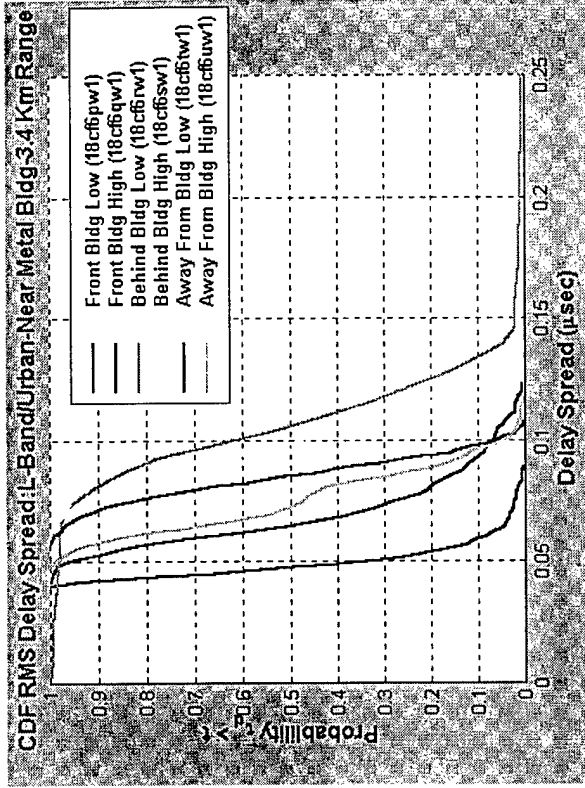

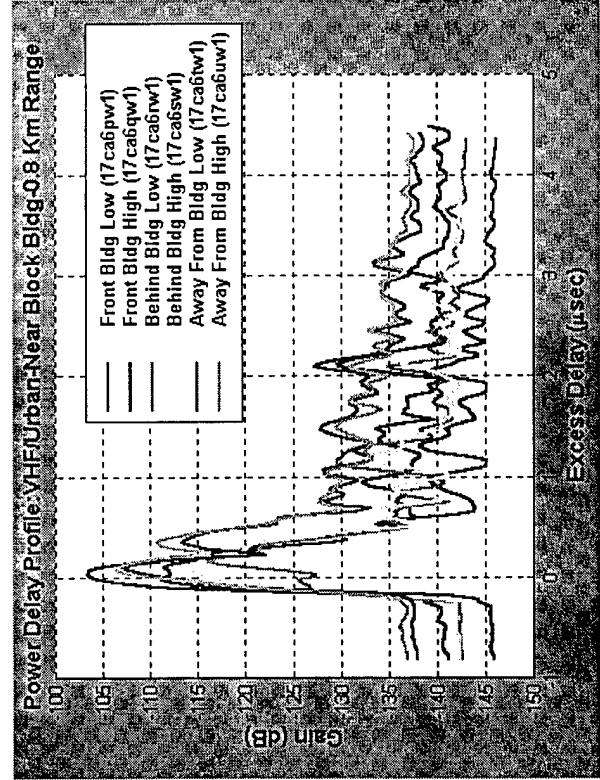
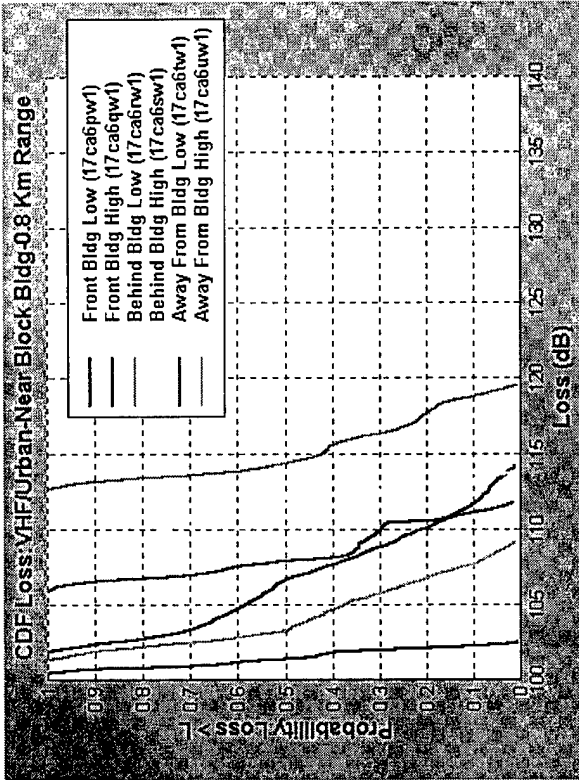
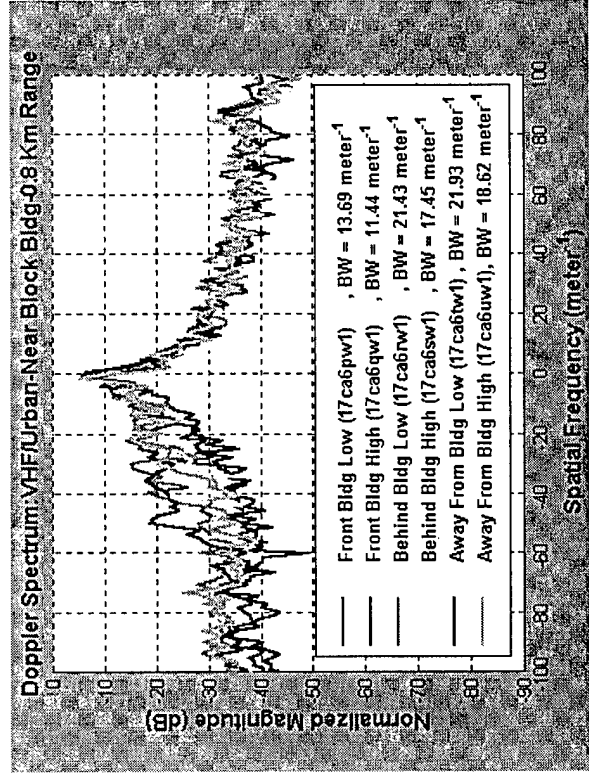
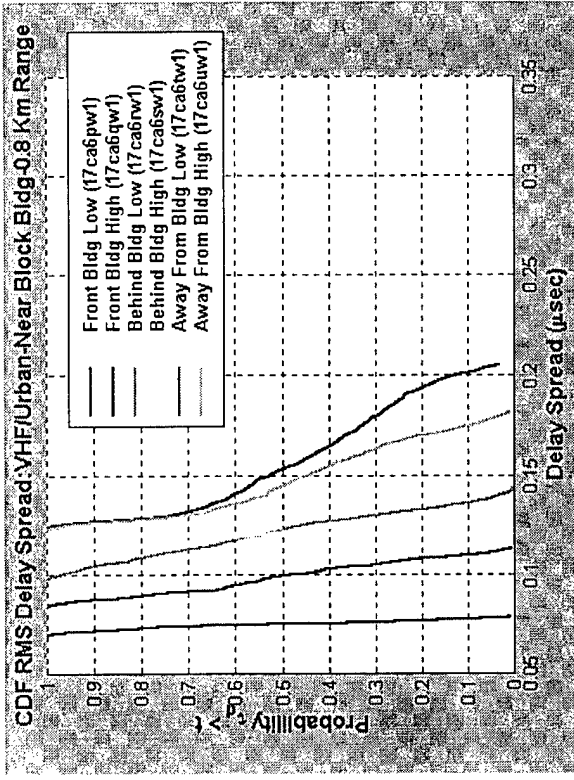

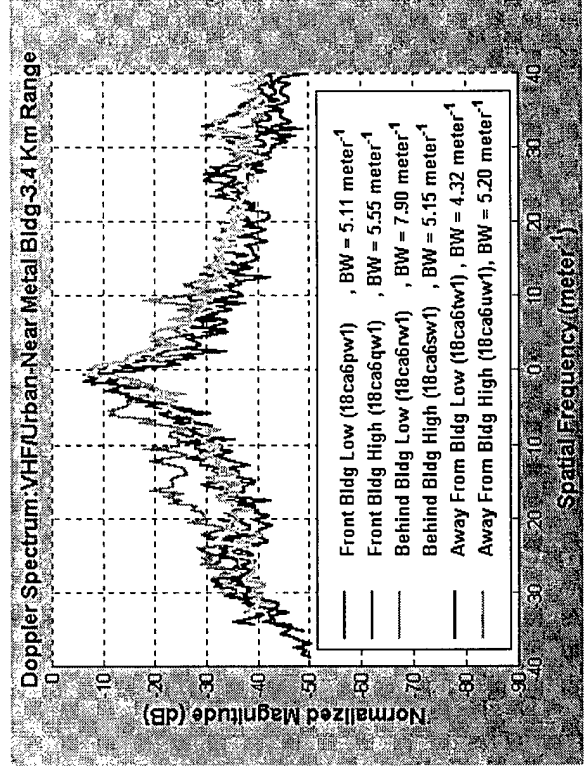
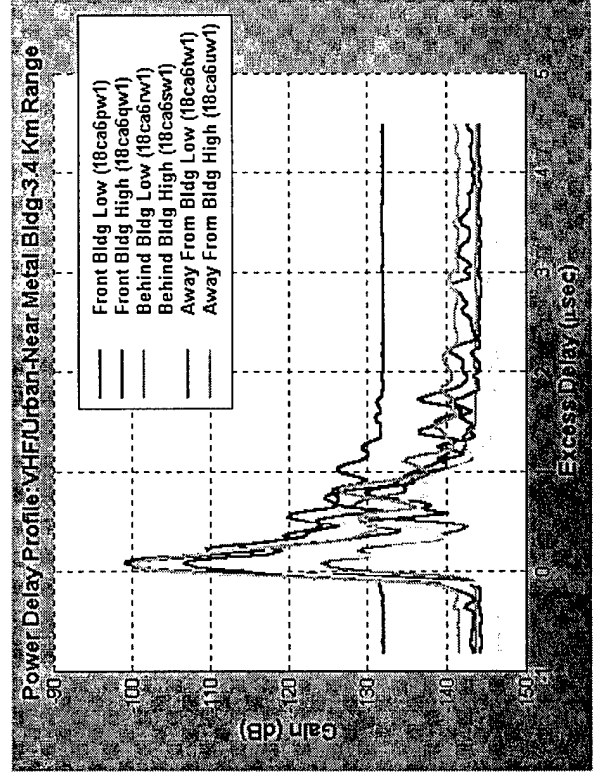
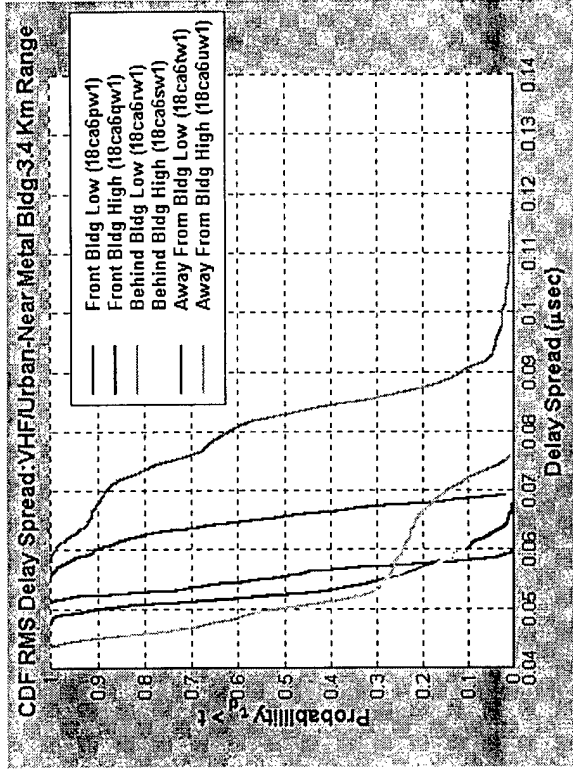
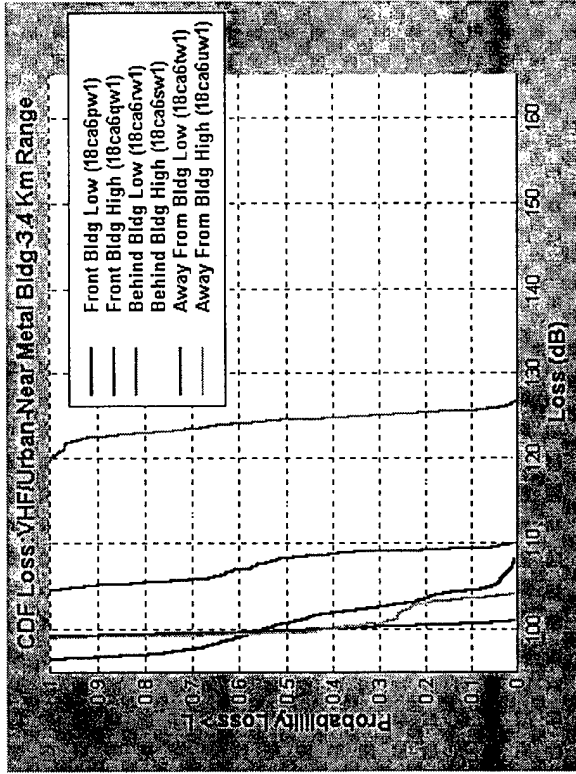

# Path Loss vs.



# Frequency & Environment

Various Environments (Ch 16, 13, 19; 3.6 m/s HMMWV Motion)

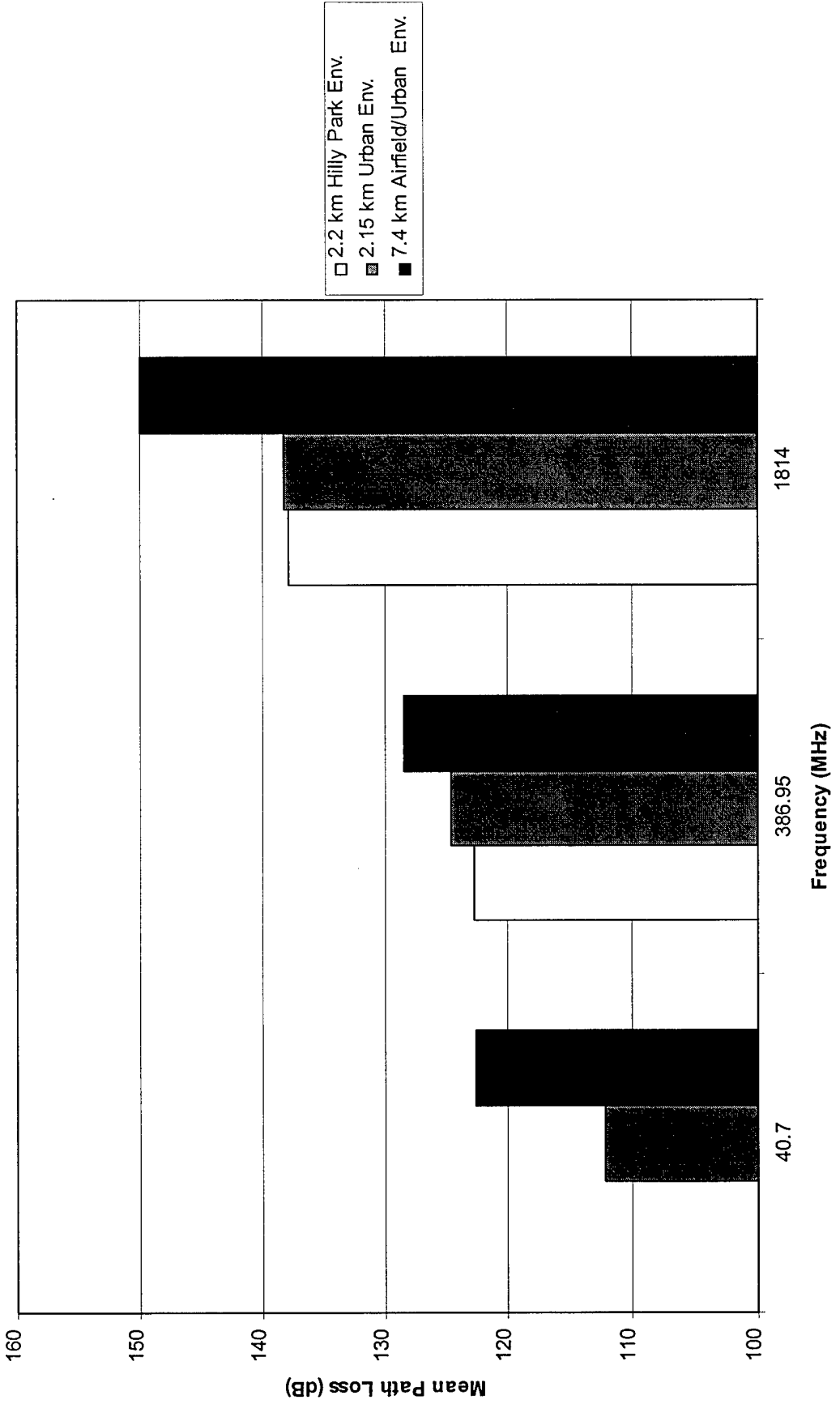



# Delay Spread vs.

# Frequency & Environment

Various Environments (Ch 16, 13, 19; 3.6 m/s HMMWV Motion)

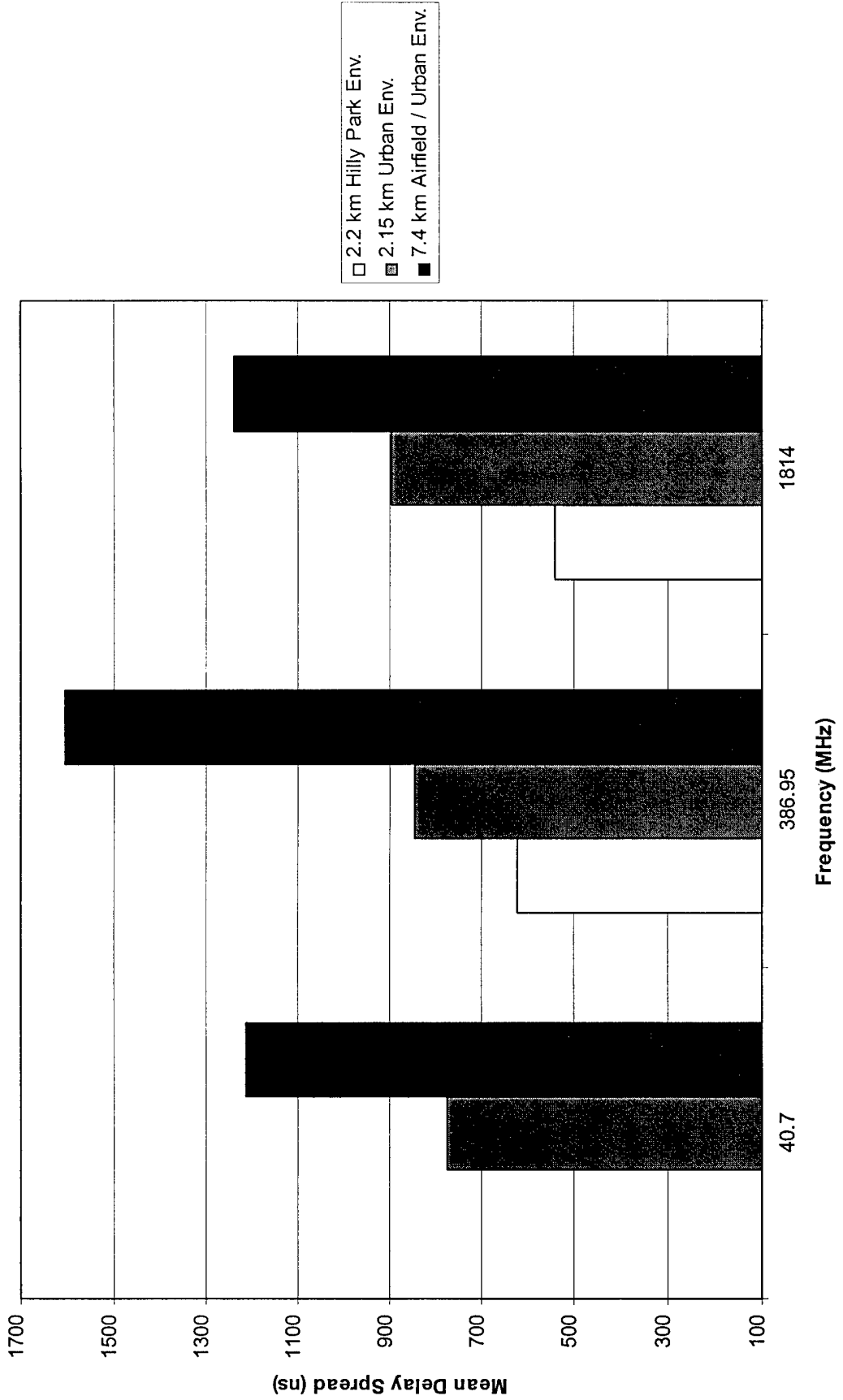

# PL-DS Scatter Plot

(All Cases Combined)

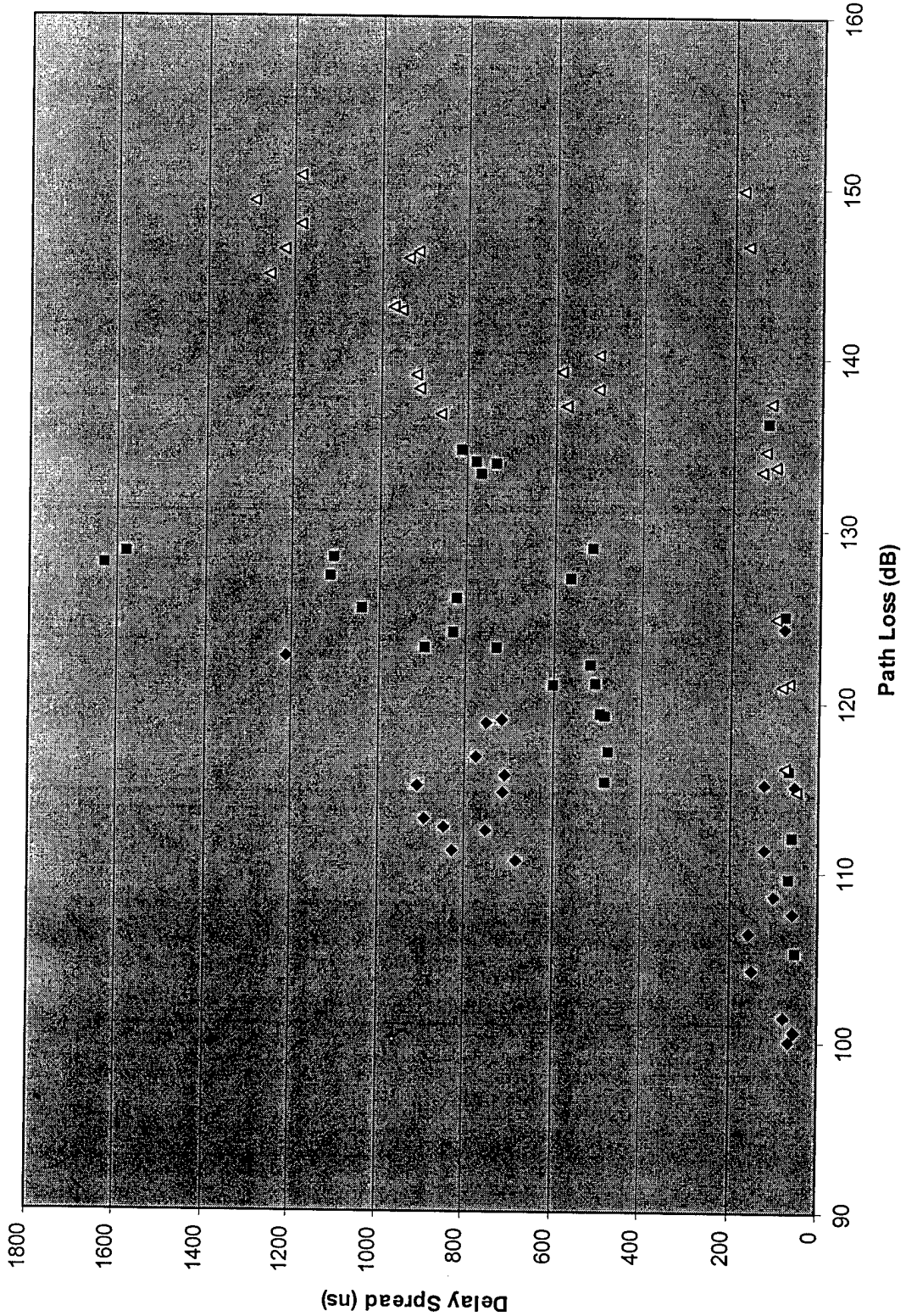

◆ 40.7 MHz  
■ 386.95 MHz  
△ 1814 MHz

# Balboa Park Hills/Trees (2.2 Km)

PL-DS Scatter Plot (Hilly Balboa Park, Ch.16)

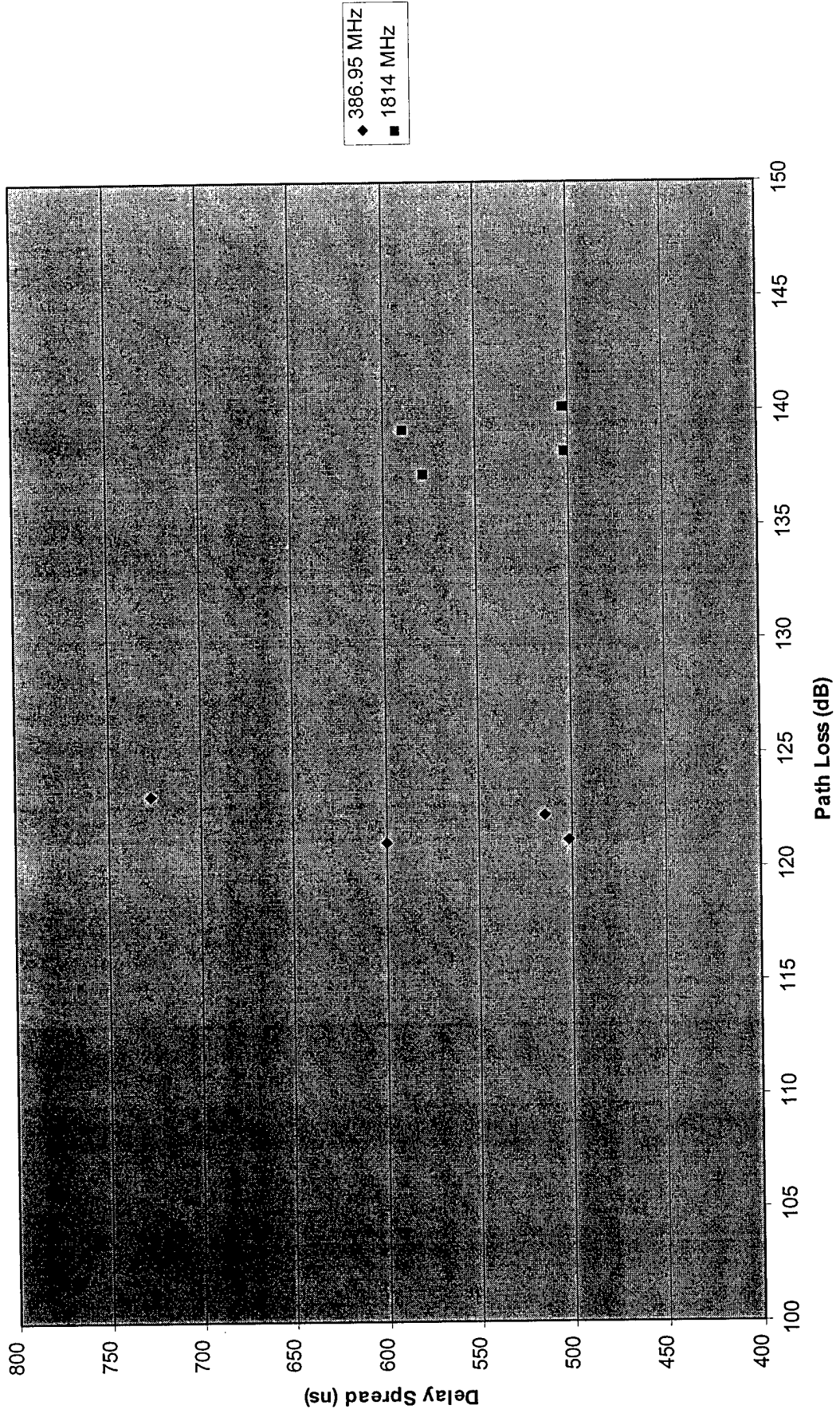

# Urban Soldier Mount (2.1 Km)

PL - DS Scatter Plot (Soldier Motion, Ch. 13 & 20)

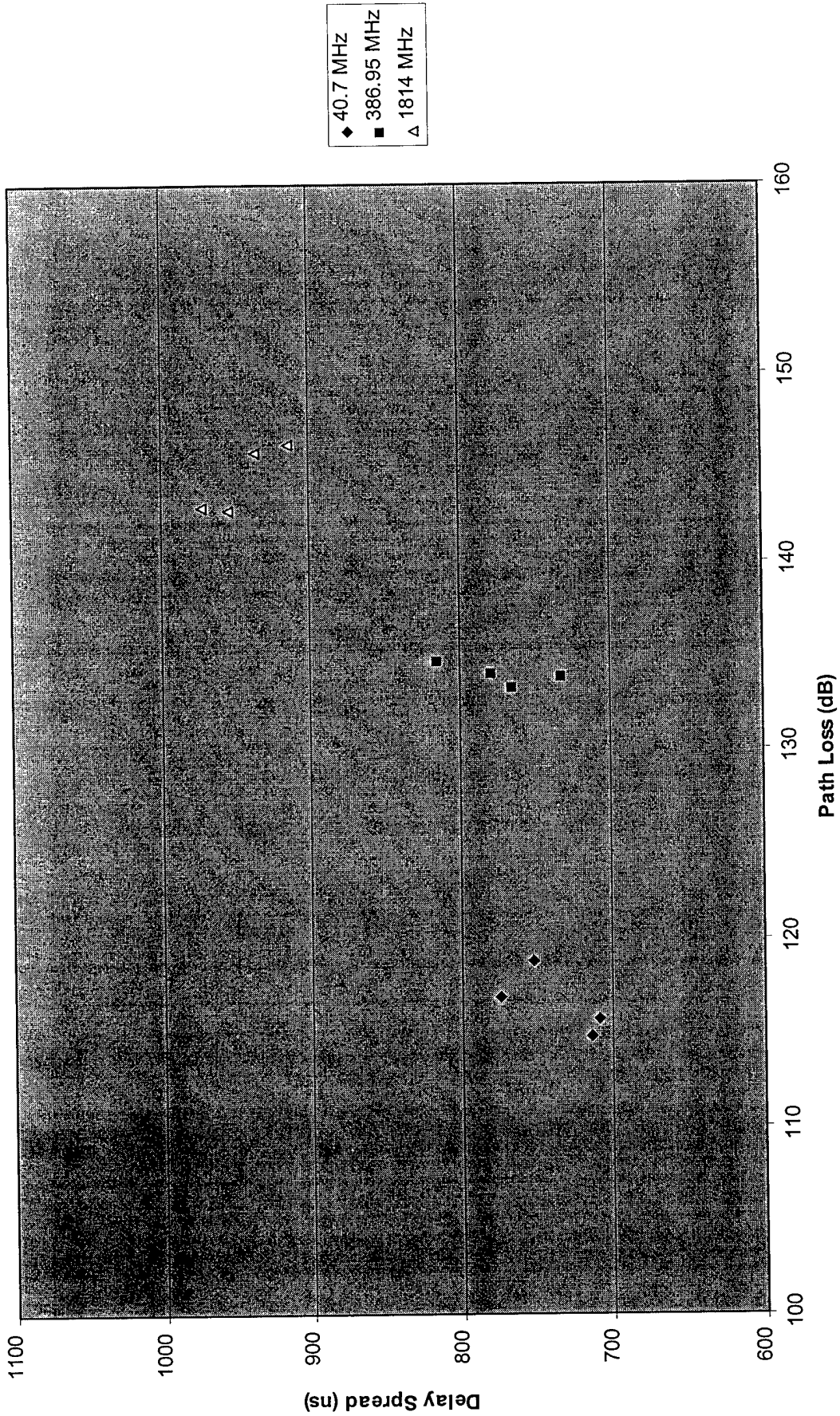



# Balboa Park (0.8 Km)

PL - DS Scatter Plot (Block Bldg, Ch. 17)

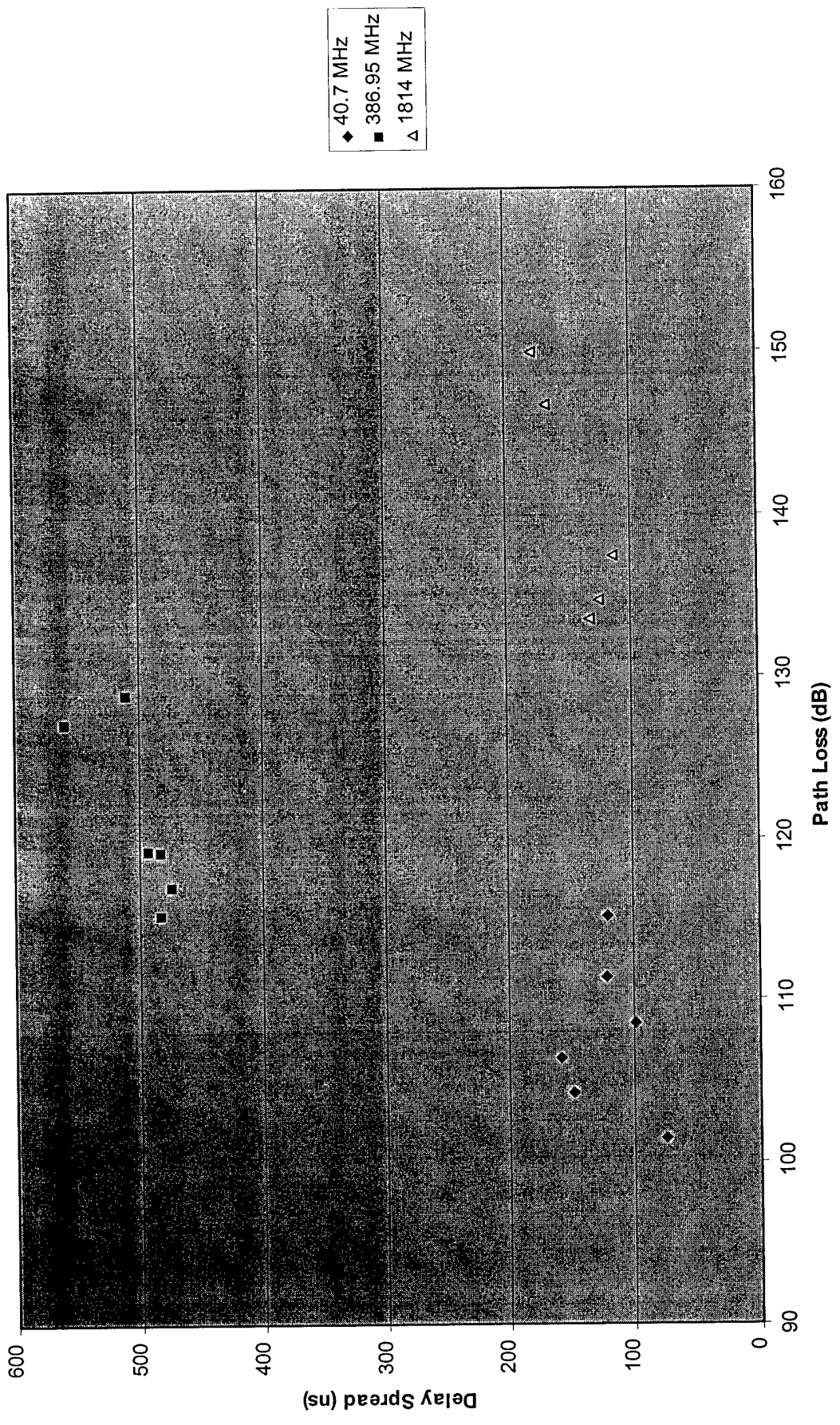

# Airfield (3.4 Km)



PL - DS Scatter Plot (Near Metal Bldg, Ch. 18)

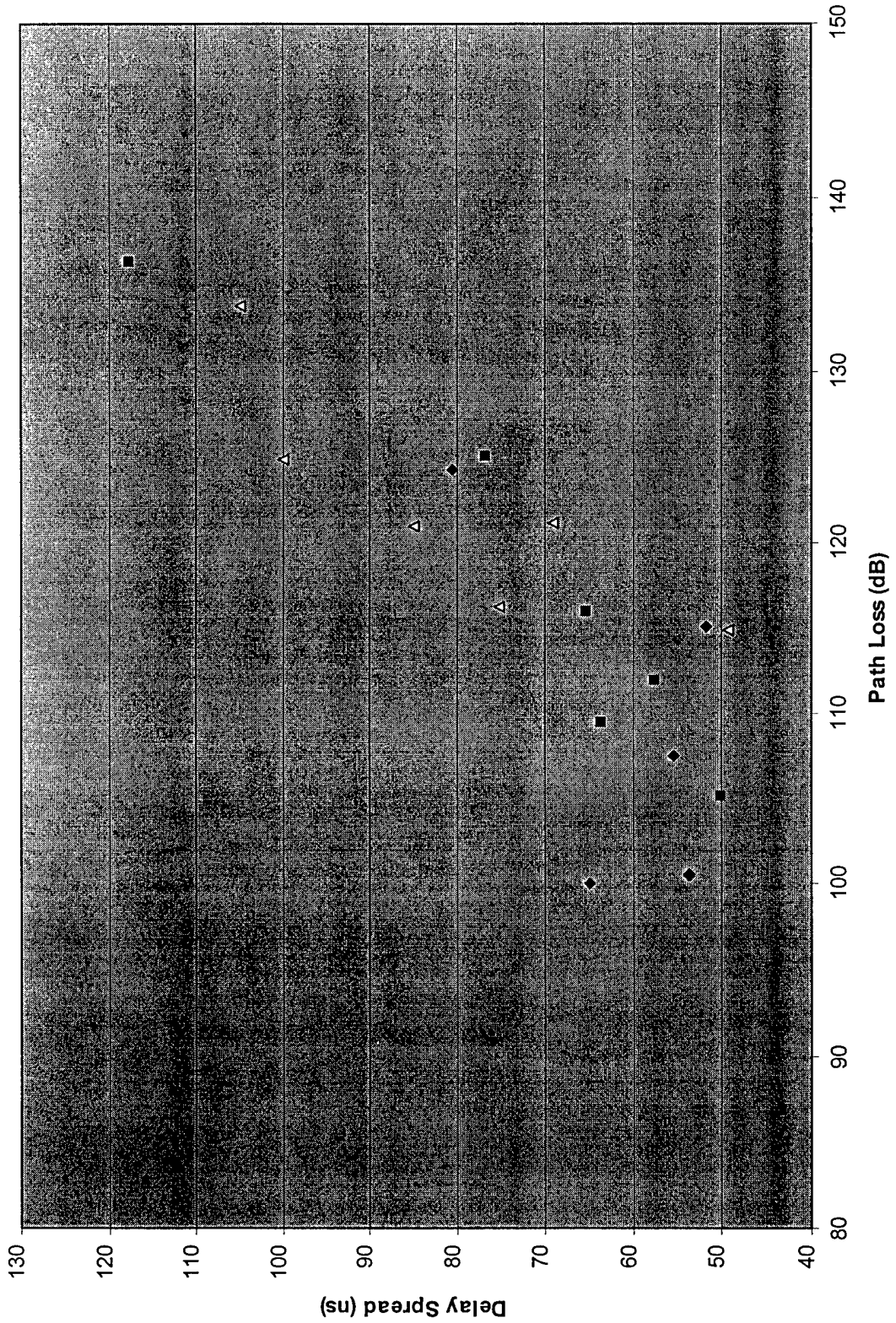

◆ 40.7 MHz  
■ 386.95 MHz  
△ 1814 MHz

# Urban HMMWV Mount (2.1 Km)

PL - DS Scatter Plot (Urban, Ch. 13)

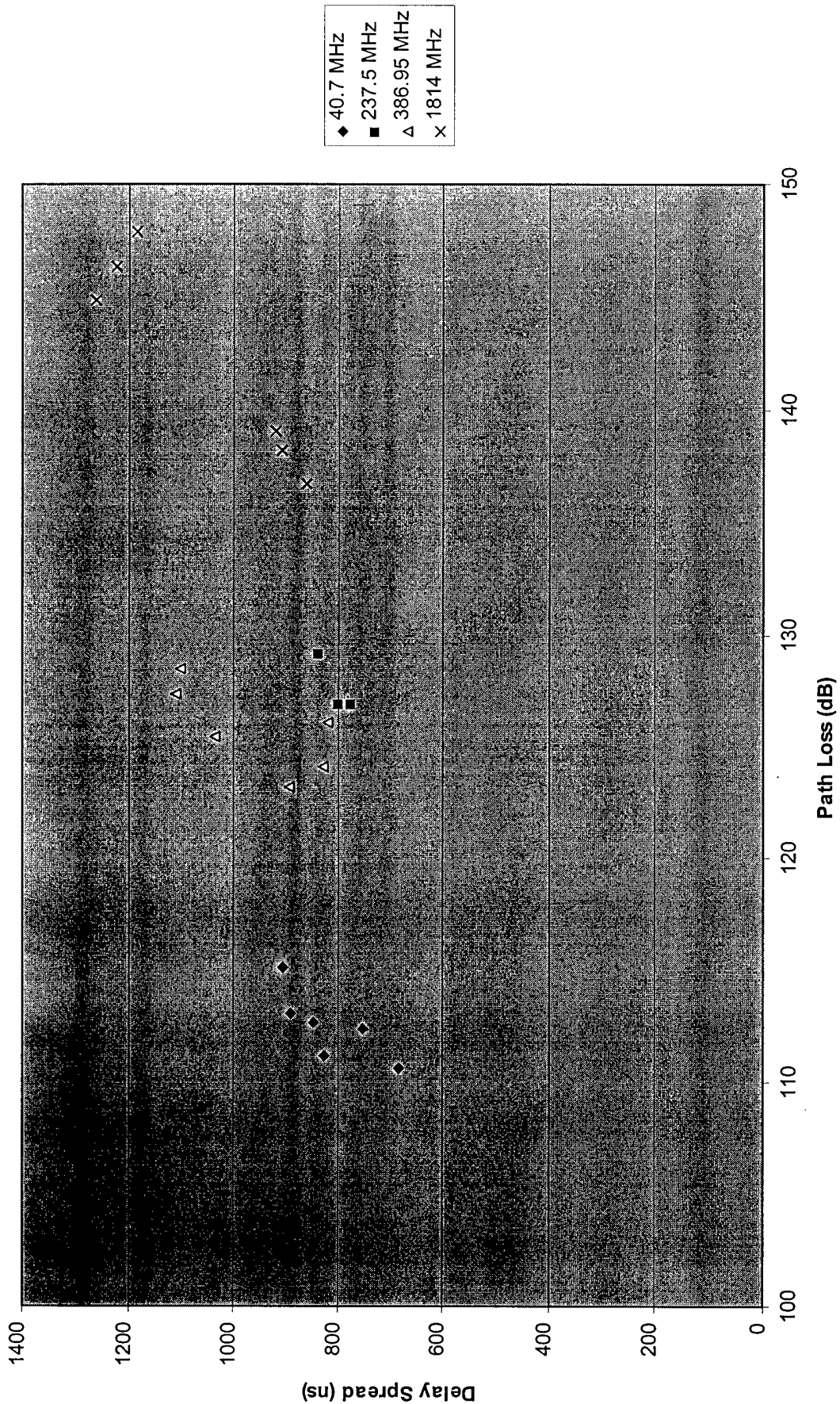

# Outline

- Measurement Goals and Capabilities
- Multipath Tutorial
- Sample Results
  - Urban Channel
    - HMMWV Motion
    - Human Mount w/Motion
    - Various Antenna Heights
  - Many Channels
    - Path Loss vs. Delay Spread
- » Model Comparisons



# JTC Model Comparison

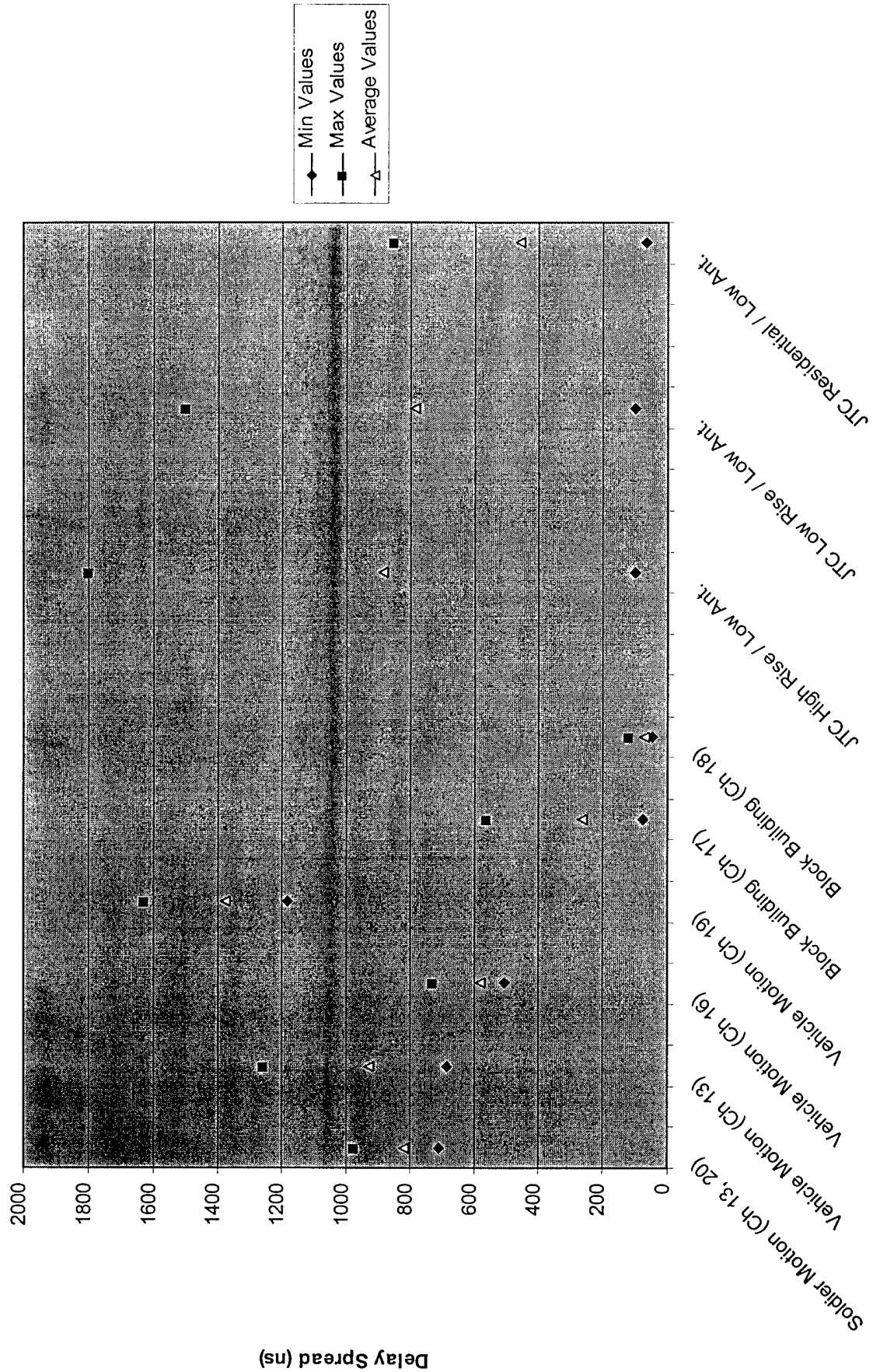

# JTC Model Comparison

Measured - JTC (dB)  
Sorted by Frequency/Distance/Channel

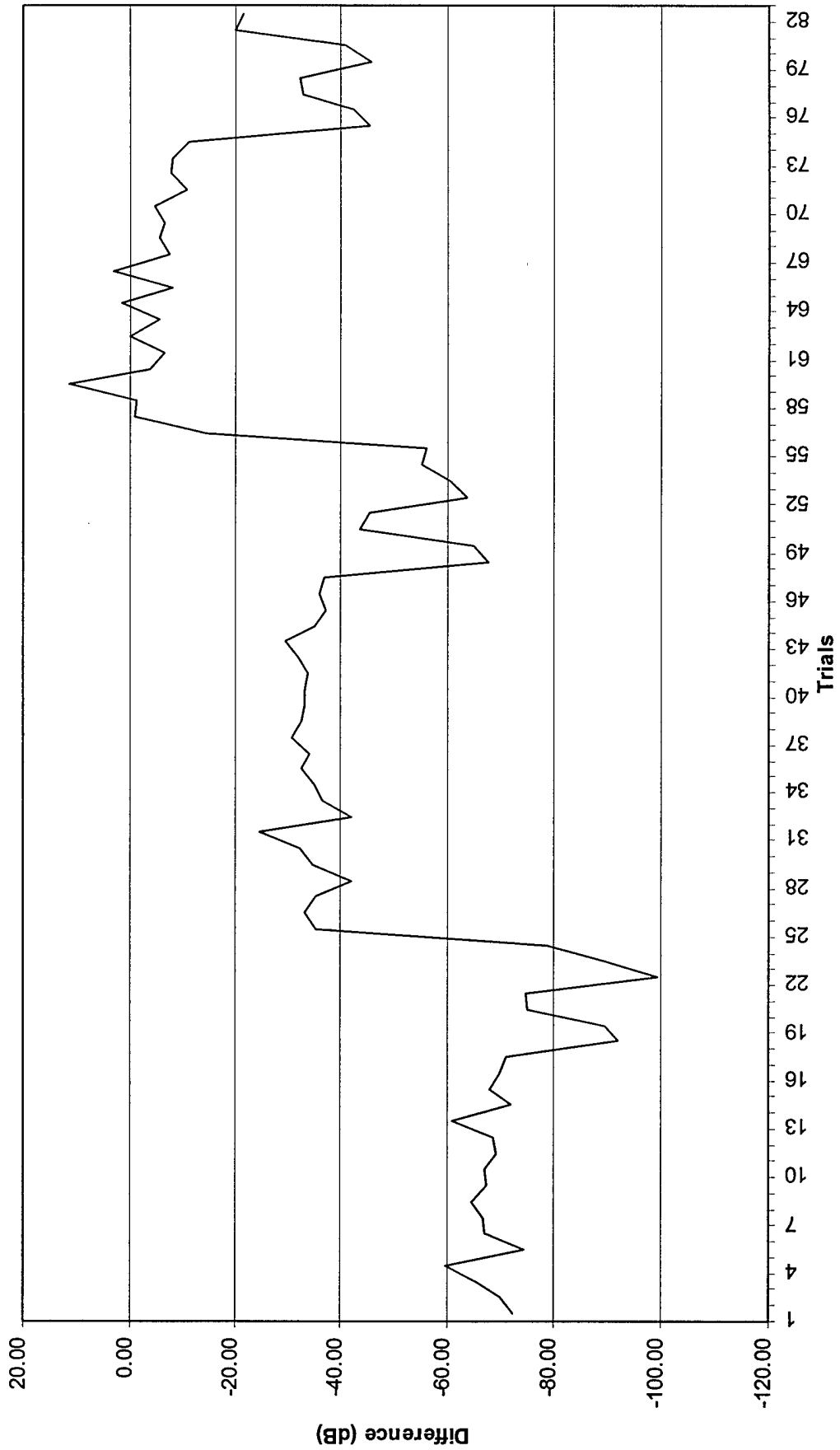

# Hata Model Comparison

Measured - HATA (dB)  
Sorted by Frequency/Distance/Channel

