

**Final Report for**

**Miniature Filters and Multiplexers for  
Advanced Multifunction RF Systems**

**--- AMRFSCET on Transmit/Receive Isolation**

**Prepared for:**

**Office of Naval Research**

**Prime Contract Number: N00014-98-C-0086**

**Sales Number: 67878**

**Prepared by:**

**Ming J. Shiau**

**TRW Inc.,**

**One Space Park,**

**Redondo Beach, CA**

**DTIC QUALITY INSPECTED 4**

**19991222 023**

**DISTRIBUTION STATEMENT A**  
Approved for Public Release  
Distribution Unlimited

## **Abstract:**

**A miniature, low cost and high performance multiplexer has been successfully developed. The multiplexer provides two contiguous channel filters, DC to 2.5 GHz for channel 1 and 2.5 to 5.0GHz for channel 2. The diplexer has very high channel-to-channel isolation (> 60dB), low insertion loss (< 0.7dB @center) and good VSWR (< 17dB return loss over the entire band). The printed diplexer has low production and small size ( 1.05''x0.10''x2.40'') that is an ideal candidate for affordable phase array applications.**

## TABLE OF CONTENTS

	Page
SUMMARY.....	vi
1. INTRODUCTION.....	1
1.1 System Requirements .....	1
1.2 Array Filter and Multiplexer Requirements .....	3
1.3 Filter and Multiplexer Technology Background .....	4
1.4 Objective .....	5
2. DESIGN.....	6
2.1 Requirements and Design Goals .....	6
2.2 Multiplexer Design Tradeoffs .....	7
2.2.1 Multiplexing Topology .....	7
2.2.2 Channel Filter Topology .....	7
2.2.3 Implementation Medium .....	10
2.3 Diplexer Design .....	13
2.3.1 Diplexer Equivalent Network .....	14
2.3.2 Miniature Channel Filter Technology .....	14
2.3.3 Diplexer Theoretical Responses .....	16
3. HARDWARE DEVELOPMENT.....	20
3.1 EM Simulated Results .....	20
3.2 Diplexer Fabrication and Test .....	23
3.2.1 First Iteration Diplexer .....	23
3.2.2 Second Iteration Diplexer.....	29
3.3 Diplexer Thermal Test.....	35
3.4 Diplexer High Power Test .....	43
3.5 Diplexer Tracking Performance.....	44
3.6 Conclusion.....	66

## LIST OF ILLUSTRATIONS

Figure		Page
1.1	Diplexer provides out-of-band signal isolation and rejects wideband noise as well as signal from adjacent sub-band HPAs .....	2
1.2	Dual-band system vs. single wideband system .....	2
1.3	Diplexer and module packaging possibilities .....	3
1.4	Diplexer development objective .....	5
2.1	Miniature diplexer requirements and design goals .....	6
2.2	Multiplexing topologies .....	8
2.3	Elliptical vs. Chebyshev designs .....	9
2.4	Size and performance of channel filters (2.5 to 5.0 GHz) on microstrip and suspended substrates. ....	10
2.5	Size and performance of channel filters (2.5 to 5.0 GHz) on quartz and alumina microstrip substrates. ....	11
2.6	Multiplexer layout configuration.....	12
2.7	Miniature diplexer block diagram .....	13
2.8	Equivalent network of miniature, common-junction, contiguous diplexer ....	15
2.9	Calculated transmission loss or channel isolation of miniature diplexer .....	17
2.10	Calculated return loss of miniature diplexer at the input port. ....	18
2.11	Calculated channel insertion loss of miniature diplexer .....	19
3.1	EM simulated diplexer input return loss.....	21
3.2	EM simulated diplexer channel transmission loss .....	22
3.3	Photo of miniature broadband diplexer (1st iteration).....	25
3.4	First iteration diplexer measured results-- input return loss.....	26
3.5	First iteration diplexer measured results-- channel isolation .....	27
3.6	First iteration diplexer measured results-- channel insertion loss .....	28
3.7	Photo of miniature broadband diplexer (2nd iteration).....	31
3.8	Second iteration diplexer measured results-- input return loss .....	32
3.9	Second iteration diplexer measured results-- channel isolation.....	33
3.10	Second iteration diplexer measured results-- channel insertion loss .....	34
3.11	Channel 1 passband insertion loss variation on temperature (unit#3).....	36
3.12	Channel 1 passband phase variation on temperature (unit#3).....	37
3.13	Channel 2 passband insertion loss variation on temperature (unit#3).....	38
3.14	Channel 2 passband phase variation on temperature (unit#3).....	39
3.15	Channel 1 out-of-band rejection variation on temperature (unit#3).....	40

3.16	Channel 2 out-of-band rejection variation on temperature (unit#3).....	41
3.17	Diplexer input return loss variation on temperature (unit#3).....	42
3.18	High power test results of miniature diplexer.....	43
3.19	Unit-to-unit tracking on channel 1 insertion loss over 6 units .....	45
	-- at ambient	
3.20	Unit-to-unit tracking on channel 1 passband phase over 6 units.....	46
	-- at ambient	
3.21	Unit-to-unit tracking on channel 2 insertion loss over 6 units .....	47
	-- at ambient	
3.22	Unit-to-unit tracking on channel 2 passband phase over 6 units.....	48
	-- at ambient	
3.23	Unit-to-unit tracking on channel 1 out-of-band rejection over 6 units.....	49
	-- at ambient	
3.24	Unit-to-unit tracking on channel 2 out-of-band rejection over 6 units.....	50
	-- at ambient	
3.25	Unit-to-unit tracking on diplexer input return loss over 6 units .....	51
	-- at ambient	
3.26	Unit-to-unit tracking on channel 1 insertion loss over 6 units .....	52
	-- at T=43C	
3.27	Unit-to-unit tracking on channel 1 passband phase over 6 units.....	53
	-- at T=43C	
3.28	Unit-to-unit tracking on channel 2 insertion loss over 6 units .....	54
	-- at T=43C	
3.29	Unit-to-unit tracking on channel 2 passband phase over 6 units.....	55
	-- at T=43C	
3.30	Unit-to-unit tracking on channel 1 out-of-band rejection over 6 units.....	56
	-- at T=43C	
3.31	Unit-to-unit tracking on channel 2 out-of-band rejection over 6 units.....	57
	-- at T=43C	
3.32	Unit-to-unit tracking on diplexer input return loss over 6 units .....	58
	-- at T=43C	
3.33	Unit-to-unit tracking on channel 1 insertion loss over 6 units .....	59
	-- at T=73C	
3.34	Unit-to-unit tracking on channel 1 passband phase over 6 units.....	60
	-- at T=73C	
3.35	Unit-to-unit tracking on channel 2 insertion loss over 6 units .....	61
	-- at T=73C	
3.36	Unit-to-unit tracking on channel 2 passband phase over 6 units.....	62
	-- at T=73C	

3.37	Unit-to-unit tracking on channel 1 out-of-band rejection over 6 units.....	63
	-- at T=73C	
3.38	Unit-to-unit tracking on channel 2 out-of-band rejection over 6 units.....	64
	-- at T=73C	
3.39	Unit-to-unit tracking on diplexer input return loss over 6 units .....	65
	-- at T=73C	

## SUMMARY

### BACKGROUND

One of the driving needs for Advanced Multifunction RF Systems (AMRFS) program is simultaneous operation of multiple functions using multiple simultaneous beams out of each of the many separate high and low band from transmit and receive arrays. The high isolation between those arrays, beams and functions are therefore critical for a practical operation. In addition, these arrays will need to operate on board large multifunction ships (e.g. DD-21) who themselves operating within a large fleet of ships, likely situated in a littoral region. The harsh radio frequency interference (RFI) environment surrounding these arrays needs to be rejected.

Conventional multiplexer technologies are not applicable for AMRF systems. The bulky, expensive waveguide multiplexers are inherently narrowband technology. The wideband combline multiplexers are still too bulky; requiring precision machined parts and labor-intensive assembly, tuning and testing, and results in an unacceptably high recurring cost. The conventional wideband suspended substrate multiplexers use highpass/lowpass multiplexing topology. This results in more circuit elements, larger size, more VSWR interaction and higher insertion loss. They are not compatible with array lattice spacing. The other conventional printed multiplexer technologies such as stripline or microstrip multiplexers are limited to either narrow bandwidth or poor out-of-band rejection performance or impractical or unrealizable circuit elements and physical dimensions. As a result, for many phased array systems, the filter and multiplexer technology becomes the limiting factor in meeting array module performance, size and weight requirements necessary to incorporate advanced multifunction array designs into practical operating systems.

### OBJECTIVE:

The overall objective of the Miniature Filter Technology (MFT) is to demonstrate the critical enabling filter and multiplexer technology to provide **very high transmit/receive isolation**, low insertion loss, small size and affordable components for Advanced Multifunction RF Systems (AMRFS) Program.

The specific objective is to design and develop a miniature, broadband pre-selector diplexer at S/L-band. This will allow simultaneous transmit and receive operations in two sub-bands with high channel-to-channel isolation.

### **DELIVERABLES:**

The deliverables of the MFT Program are:

- Final Report

The hardware and measured results are described in Chapter 3.

### **TECHNICAL APPROACH AND ACCOMPLISHMENTS:**

A new miniature, high performance, broadband contiguous preselector multiplexer technology at X/L-band has been successfully developed.

The miniature diplexer consists of two contiguous channels, DC to 2.5 GHz for channel 1 and 2.5 to 5.2 GHz for channel 2. The diplexer utilizes common-junction, self-annulling multiplexing topology for compactness. The channel 1 is a 17-th order elliptical function lowpass filter and the channel 2 is an 8-pole elliptical function bandpass filter. The elliptical function response achieves optimum filter size and insertion loss for a given required out-of-band rejection by making use of finite transmission zeroes on each side of the passband. The circuit elements of the channel filter are less than one-eighth wavelength long, instead of one-half wavelength for conventional parallel-coupled-line (PCL) or hairpin-line microstrip bandpass filters. Electrically short filter elements minimize the size and the effects of the frequency dispersion on bandwidth; out-of-band attenuation is improved as well.

The preselector diplexer is implemented in a planar configuration. Two channel filters are placed side-by-side with a metallic wall in between to provide high channel isolation. The circuit elements (line width and line length) in the miniature diplexer are optimized for a 25-mil thick fused quartz microstrip substrate. No chip capacitors or via holes are required. The overall diplexer dimensions are 1.20 x 0.10 x 2.40 inches for the



first iteration design, and 1.05 x 0.10 x 2.40 inches for the second iteration design. The miniaturized diplexers are well fitted in an array lattice or cell size for the operation up to 5.20GHz. The state-of-the-art performance of the miniature diplexer has been achieved. The passband channel insertion loss is less than 1.0dB over at least 80% of each channel passband. The channel isolation is greater than 60dB over the entire adjacent band. The diplexer is well matched. The return loss at the common-junction input port is better than 18dB over the entire band (DC to 5.2 GHz) including the cross-over frequency region. The diplexer is a thermal stable unit. The in-band insertion loss variation is less than 0.2dB, and the phase variation is less than 4.0 degrees as the temperature varies from ambient to 73degrees (in C).

The successful hardware demonstration of the miniature, broadband, printed preselector multiplexer at X/L-band represents a breakthrough in filter/multiplexer technologies. This paves the way toward the fully integrated microwave assembly of multifunction phased array systems with high transmit and receive isolation, as the filter/multiplexer technology is no longer the critical limiting factor to meet the size, cost and performance requirements.

# 1. INTRODUCTION

## 1.1 System Requirements

One of the driving needs for Advanced Multifunction RF Systems (AMRFS) program is simultaneous operation of multiple functions using multiple simultaneous beams out of each of the many separate high and low band from transmit and receive arrays. The high isolation between those arrays, beams and functions are therefore critical for a practical operation. In addition, these arrays will need to operate on board large multifunction ships (e.g. DD-21) who themselves operating within a large fleet of ships, likely situated in a littoral region. The harsh radio frequency interference (RFI) environment surrounding these arrays needs to be rejected.

Both isolation and RFI are clearly the driving rationales for incorporating filters or multiplexers into AMRFS. There are, however, some other reasons to consider multiplexers:

- 1). Increase the number of beam simultaneity,
- 2). Reduce intermodulation products (IM) caused by RFI or multiple signals in single Amplifiers,
- 3). Allow the use of narrow band components to span an array wide operating bandwidth, thereby offering better RF performance, higher efficiency and possibly better radar cross section (RCS) match.

First, since a multiplexer subdivides the operating wide bands into separate operating sub-bands (e.g. a diplexer provides two sub-bands), the multiple beams operation through a single array become much more feasible. For example, when diplexers are employed at both transmit and receive element level as shown in Figure 1.1, the out-of-band signals are isolated, the wideband noise as well as signal from adjacent sub-band high power amplifier (HPA) are rejected. Secondly, when the single signal and/or waveform are amplified, the spurious signals or harmonics are amplified as well. However, when these sub-bands are of sub-octave bandwidths, the amount of spurious signals generated via amplifiers is minimized due to the out-of-band rejection provided by the diplexer (see Figure 1.2). Further, when operating in a sub-band or narrow band, the RF components (e.g. circulator, amplifier) are easily designed to have much better match over their operating band and therefore provide better efficiency as well as better return loss which benefits RCS reduction.

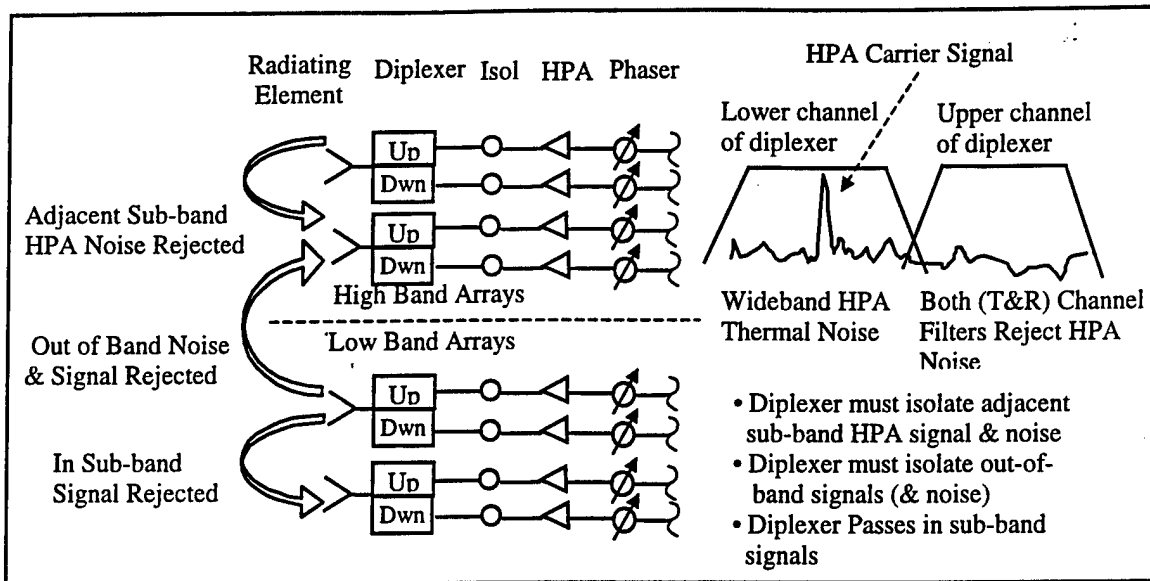

Figure 1.1 Diplexers provides out-of-band signal isolation and rejects wideband noise as well as signal from adjacent sub-band HPAs.

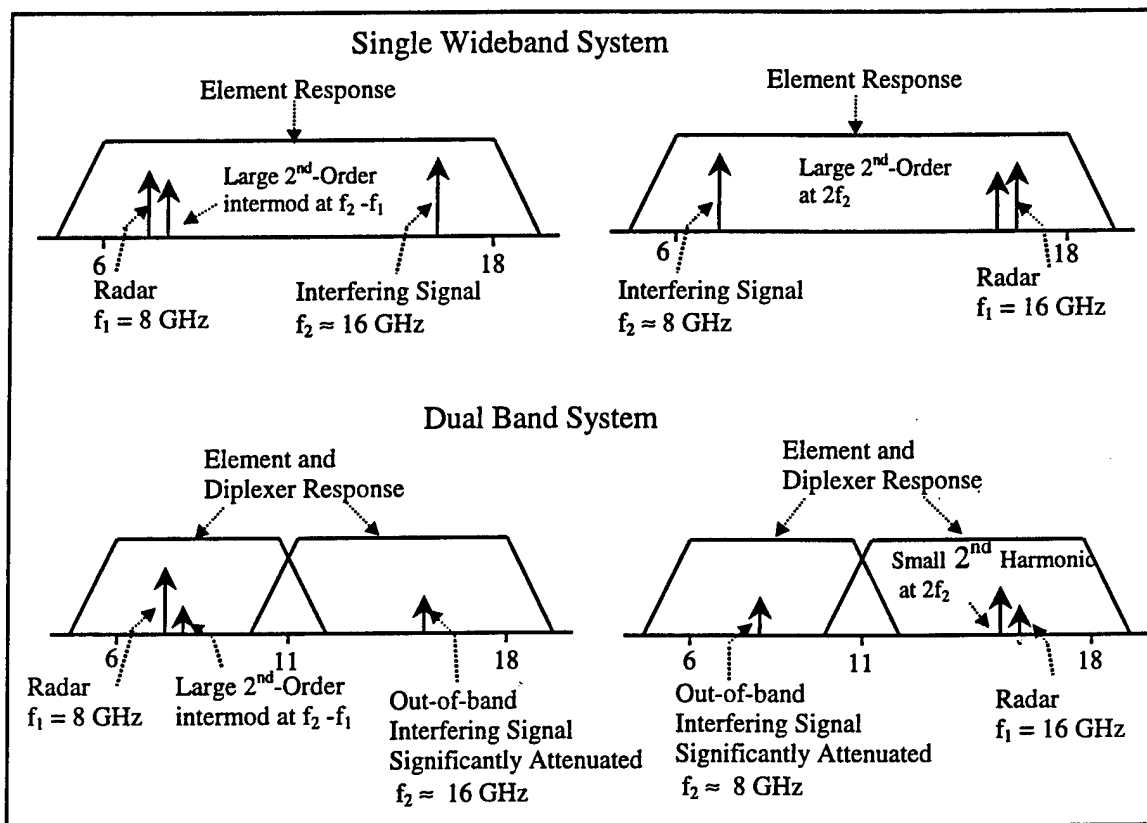

Figure 1.2. Dual-band system vs single wideband system. Second-order intermods and harmonic signals are a problem in a single wideband system with more than one octave bandwidth. The dual-band approach, operating over suboctave bandwidths prevents such interference.

## 1.2. Array Filter and Multiplexer Requirements

In addition to the above AMRFS system issues which drive the key requirements for filters and multiplexers, several special filter and multiplexer requirements are imposed as well for phased array applications.

For a fully density 2-D electronically scanned arrays (ESA), all elements are packed roughly one-half wavelength at the highest frequency of operation. In many applications, it is also dual polarized or two radiators at each element position; two multiplexers are therefore required at each element position. Figure 1.3 suggests various packaging possibilities for modules and diplexer orientations relative to a given lattice spacing. For a better efficiency and low RCS reflection, it is desirable that both the diplexer and circulator be directly connected to the radiator. In other words, both the diplexer and circulator should be incorporated into the radiator structure. This implies that the size of the diplexer needs to be about the size of a single radiator. At the same time, the need for high efficiency in the array places a requirement on the maximum insertion loss allowable for the diplexer at less than 1.0dB. The constraints on size and insertion loss requirements require a special array diplexer technology.

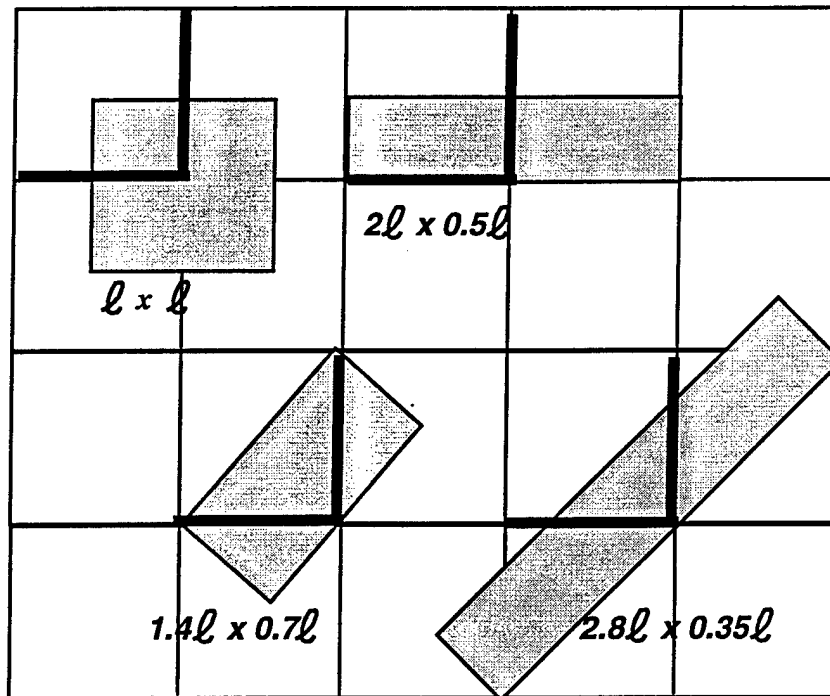

Figure 1.3 Diplexer and module packaging possibilities.

Once the diplexer embedded within the array structure, the normal per-element ESA driven requirements then apply to the diplexer. The typical requirements of per-element ESA residual phase and amplitude errors are: one standard deviation ( $\sigma$ ) of less than 10 degrees and 1 dB, respectively. These requirements become requirements on the diplexer parameters such as: voltage-standing-wave-ratio (VSWR) and return loss, insertion loss, out-of-band rejection, and crossover frequency over the array operating environment (thermal, shock, vibration...) and operating frequency range.

Due to normal ESA needs and low RCS needs, the diplexer crossover frequency and return loss (vs. frequency) must be consistent from unit to unit across the full operating environment of the array. The desired return loss across the operating band is better than 20dB (goal is 25dB, depending on RCS goal for the platform). The channel-to-channel isolation or the out-of-band rejection needs to be 60dB or greater, at 10% bandwidth away from the crossover frequency point. For the transmit application, the diplexer must be able to handle the single element power with only conductive cooling. The goal is >10watts for the high band, and > 100s of watts (maybe 500watts) for the low band. As with all other ESA components, there is also a strong desire to have lower recurring cost. The goal is \$50~\$100 per diplexer in small quantities and approaching ~\$10 per diplexer in large quantities.

### **1.3 Filter and Multiplexer Technology Background**

Stringent requirements on size, cost, weight, and performance, as outlined in sections 1.1 and 1.2 are imposed for array filters and multiplexers. Conventional multiplexer technologies are not applicable for AMRF systems.

The bulky, expensive waveguide multiplexers are inherently narrowband technology. The wideband combline multiplexers are still too bulky; requiring precision machined parts and labor-intensive assembly, tuning and testing, and results in an unacceptably high recurring cost. The conventional wideband suspended substrate multiplexers use highpass/lowpass multiplexing topology. This results in more circuit elements, larger size, more VSWR interaction and higher insertion loss. They are not compatible with array lattice spacing. The other conventional printed multiplexer technologies such as stripline or microstrip multiplexers are limited to either narrow bandwidth or poor out-of-band rejection performance or impractical or unrealizable circuit elements and physical dimensions. As a result, for many phased array systems, the filter and multiplexer technology becomes the limiting factor in meeting array module performance, size

and weight requirements necessary to incorporate advanced multifunction array designs into practical operating systems.

### 1.4 Objective

The overall objective of the Miniature Filter Technology (MFT) is to demonstrate the critical enabling filter and multiplexer technology to provide **very high transmit/receive isolation**, low insertion loss, small size and affordable components for Advanced Multifunction RF Systems (AMRFS) Program.

The specific objective is to design and develop a miniature, broadband pre-selector diplexer at S/L-band. This will allow simultaneous transmit and receive operations in two sub-bands with high channel-to-channel isolation (Figure 1-4).

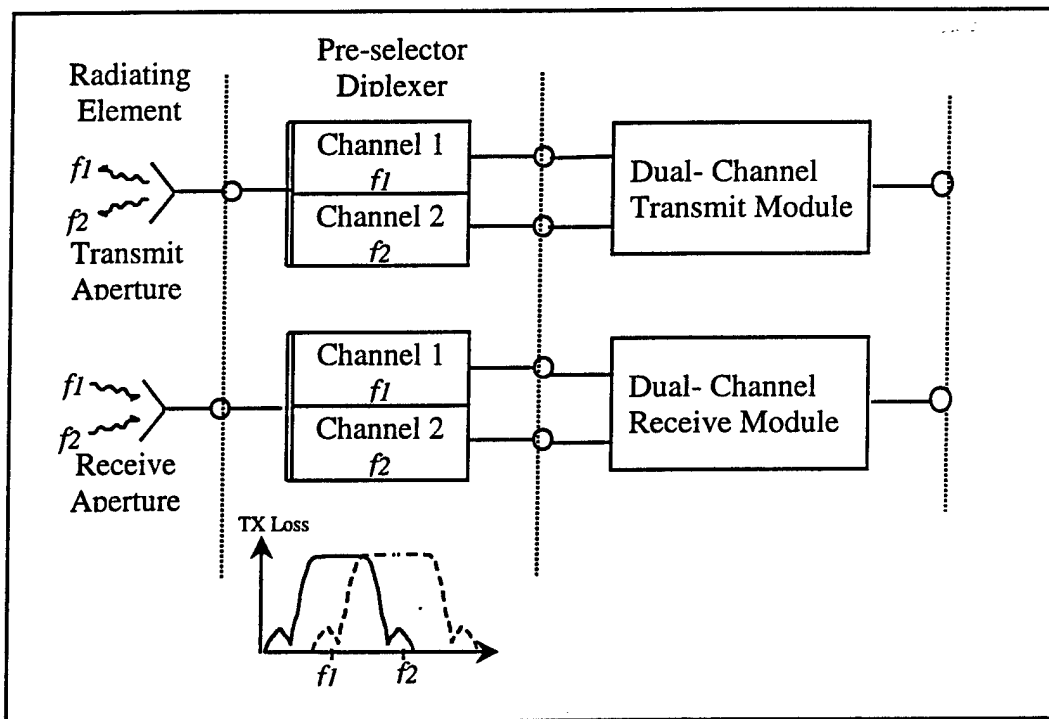

Figure 1.4 Diplexer development objective--allow simultaneous transmit and receive operations in two sub-bands with high channel-to-channel isolation

## 2. DESIGN

This chapter describes the trade-off study, RF design and circuit modeling of the miniature broadband preselector diplexer at S/L-band.

In Section 2.1, the trade-off study starts from the multiplexing topologies, proceeds to the choice of type of the channel filter, and then to the choice of implementation media. After the multiplexing topology and the type of channel filter has been chosen, the RF design and circuit modeling of a new, miniature broadband diplexer are described.

### 2.1 Requirements and Design Goals

As discussed in Chapter 1, key requirements for the broadband preselector diplexer are extremely small size, very high channel-to-channel isolation, low loss, high power handling capability and low recurring cost. These requirements are based on the units' location at the front end of the T/R module system just behind the radiating element. The general requirements and design goals for the miniature preselector diplexer are summarized in Figure 2.1.

	General Requirements (Preselector MUX)	Design Goals (POC Development)
Frequency range	At least 1.0 to 5.2 GHz	DC to 5.2 GHz
Number of channels	2	2
Passband insertion loss	< 1.0 dB (80% of passband)	< 1.0 dB (80% of passband)
Rejection	> 60 dB (@ 10% away from cross-over frequency)	> 65 dB (@ 10% away from cross-over frequency)
Return loss	> 15 dB	> 15 dB
Power handling (Avg)	> 2 W/channel	> 2 W/channel
Size (W x H x L)	< 1.35" x 1.35" x TBD"	< 1.20" x 1.20" x 2.50"

Figure 2.1 Miniature diplexer requirements and design goals

## 2.2 Multiplexer Design Tradeoffs

The design of a contiguous, wideband multiplexer for advanced multifunction array modules is determined by the following factors:

- Small size
- High Performance
- Low cost
- Fabrication producibility

Based on these factors, the trade-off studies of the multiplexer design are categorized into the following areas:

- Choice of multiplexing topologies
- Choice of channel filter design
- Choice of filter implementation medium
- Choice of multiplexer layout configuration

### 2.2.1 Multiplexing Topology

Two possible multiplexing topologies are evaluated for multioctave-band applications for the preselector diplexer design. They are: common-junction, and highpass/lowpass (Figure 2.2). Each type has its own merit. The common-junction multiplexing topology is chosen because it uses a minimum number of circuit elements to define a channel and avoids VSWR accumulation inherent in the highpass/lowpass multiplexing topologies. As a result, minimum size and insertion loss, as well as improved VSWR required for low RCS and high dynamic range can be achieved.

### 2.2.2 Channel Filter Topology

The channel filter of a common-junction multiplexer can be either Chebyshev or elliptical function designs. The channel filter topology has a significant impact on the in-band insertion loss, out-of-band rejection, and the order or size of the filter. Figure 2.3 shows the comparison between Chebyshev and elliptical function filters. Both filters are designed to provide 35dB rejection at 6% and 3% away from the lower and higher bandedges, respectively. The passband covers 2.50 to 5.0 GHz or 67% fractional bandwidth. The Chebyshev function filter is a 16-pole design and has insertion of 1.3dB. The elliptical function filter requires only 8 poles and



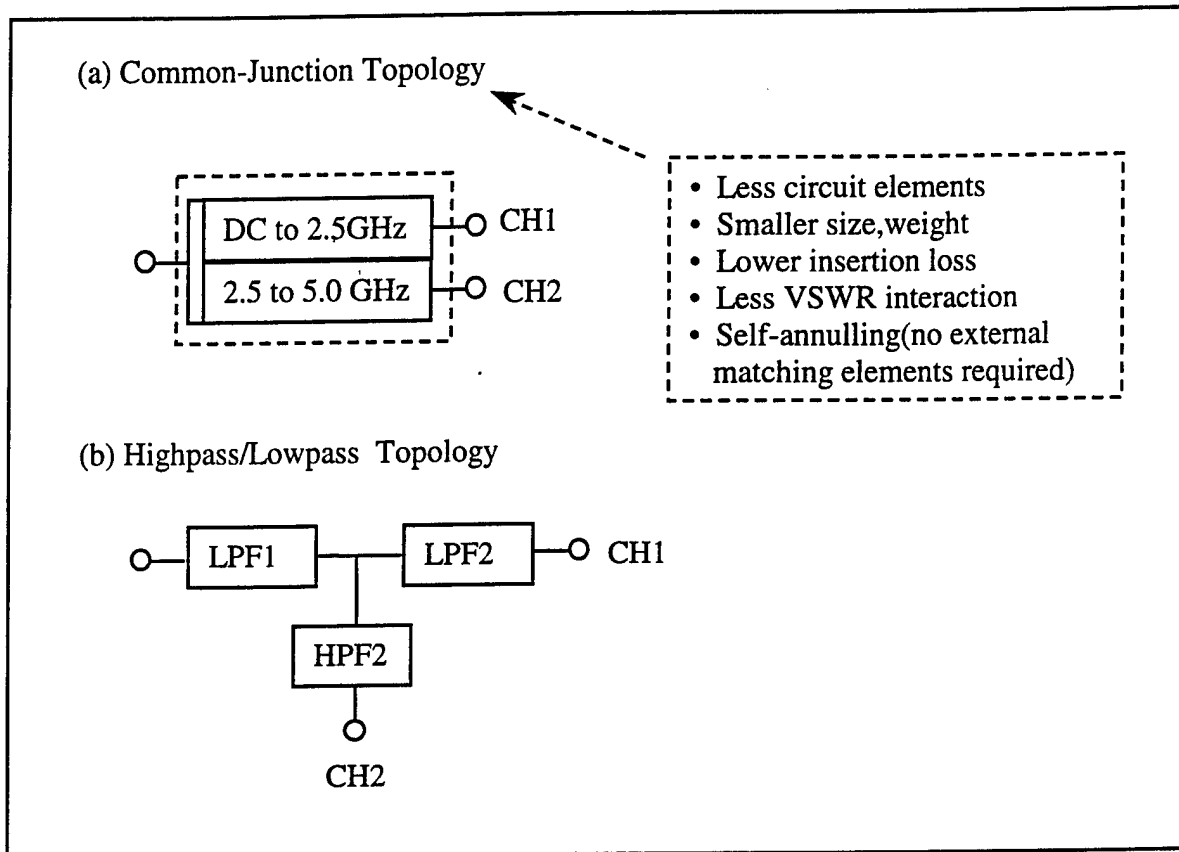

Figure 2.2. Multiplexing topologies--- Common-junction vs Highpass/Lowpass

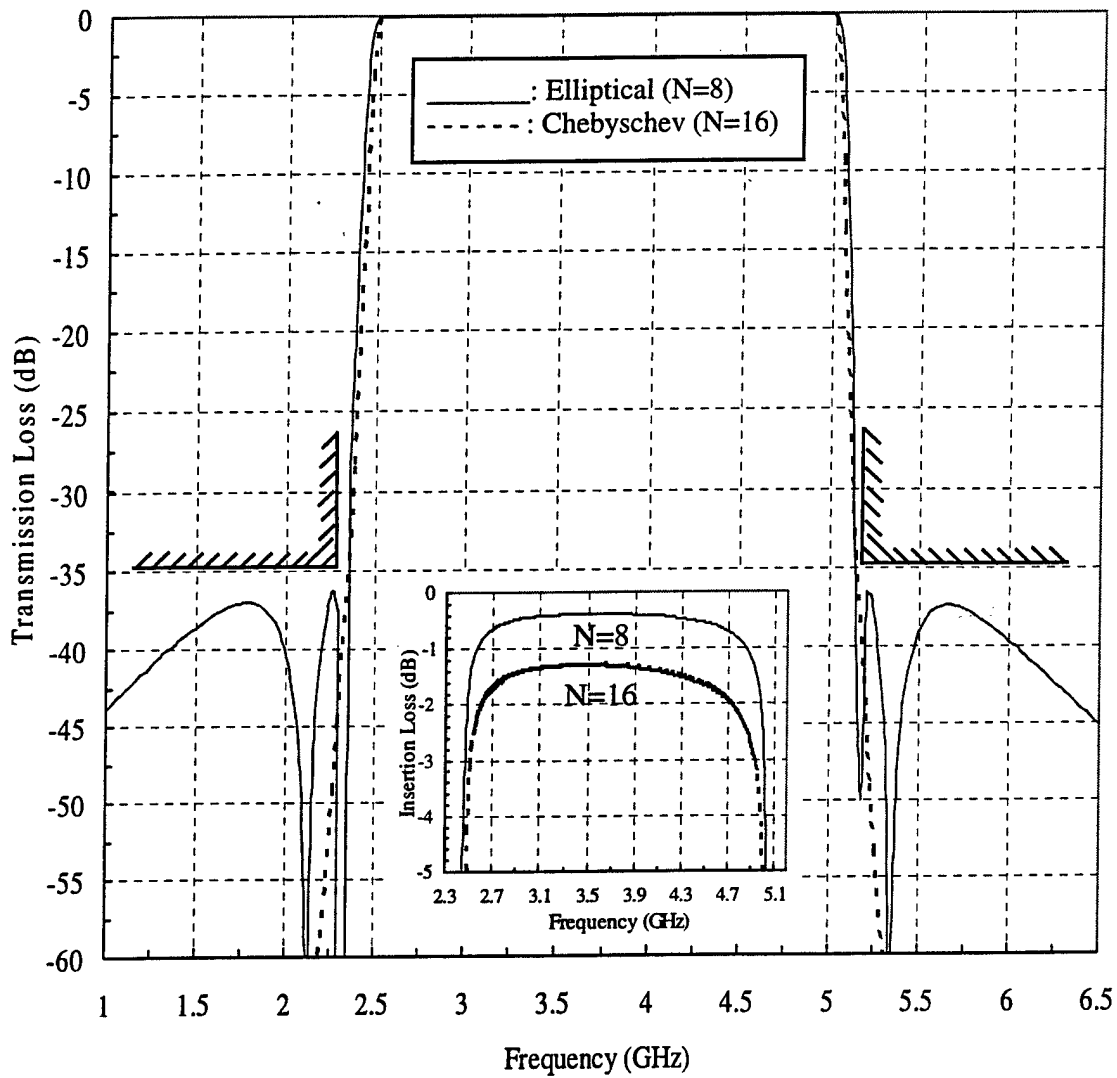

Figure 2.3 Elliptical vs. Chebyshev designs—passband (2.5 to 5.0 GHz), rejection (35dB @ 2.333/5.150 GHz), 25 mil thick fused quartz microstrip substrate.

has better insertion loss (0.4dB). It is clear that the elliptical function channel filter offers a much smaller size and better rejection and insertion loss than the Chebyshev counterparts.

### 2.2.3 Implementation Medium

#### Effect on Different Media

Two propagation media—microstrip substrate and suspended substrate—are suitable for the implementation of this new miniature, low cost channel filter/multiplexer. To assess the impact of different media on the filter performance quantitatively, an 8-pole, 67% bandwidth (2.5 to 5.0 GHz), elliptical function filter is investigated. The size, loss and unloaded Q-value of the filter implemented on these two different media are compared and summarized in Figure 2.4. The microstrip design is based on 25-mil-thick fused quartz substrate and the suspended substrate is a 20-mil-thick duroid substrate. The performance on both microstrip and suspended substrates are based on the measured results of TRW built filters/multiplexers for other various projects.

	Microstrip Substrate (25-mil-thick Quartz)	Suspended Substrate (20-mil-thick Duroid)
Q-Value (@4.0 GHz)	160	330
Insertion Loss (dB)*	0.70 dB*	0.45 dB*
Size (W x H x L)	0.60" x 0.10" x 2.40"	0.90" x 0.15" x 4.40"
*: Including a pair of SMA connectors loss of 0.1dB (@ 4.0 GHz)		

Figure 2.4 Size and performance of channel filters (2.5 to 5.0 GHz) on microstrip and suspended substrates

It is clear that if small size is the design driver and the moderate loss is tolerable, the microstrip approach is preferred. On the other hand, if low loss and low cost are the key design drivers, the suspended substrate approach will be the alternative of choice at the expense of larger size. The microstrip substrate is chosen for the miniature diplexer development because it provides a smaller size at lower cost while meeting insertion loss (< 1.0dB) requirements.

### Effect on Dielectric Constant/Microstrip Substrate Thickness:

Since the size of a microstrip filter is inversely proportional to the effective dielectric constant of the substrate, the higher the dielectric constant, the smaller the size of the filter and the higher its insertion loss. If small size is a design driver, a higher dielectric constant microstrip substrate can be used to further reduce the size of a filter. However, to avoid the surface wave modes in a high dielectric constant microstrip structure, the substrate thickness has to be reduced appropriately. This results in higher insertion loss. Figure 2.5 shows the size and performance comparisons for an 8-pole, 67% bandwidth (2.5 to 5.0 GHz), elliptical function on both alumina ( $\epsilon_r = 9.9$ , 25-mil-thick) and fused quartz ( $\epsilon_r = 3.78$ , 25-mil-thick) substrates.

	Quartz (25-mil-thick)	Alumina (25-mil-thick)
Dielectric Constant	$\epsilon_r = 3.78$	$\epsilon_r = 9.9$
Insertion Loss (dB)* (@ center of Passband)	0.70 dB*	1.05 dB*
Size (W x H x L)	0.60" x 0.10" x 2.40"	0.36" x 0.10" x 1.50"

\*: Including a pair of SMA connectors loss of 0.1dB (@4.0 GHz)

Figure 2.5 Size and performance of channel filters (2.5 to 5.0 GHz) on quartz and alumina microstrip substrates

Between two microstrip substrates, fused quartz and alumina, the former (25-mil-thick fused quartz) substrate is chosen for the miniature diplexer development because it provides better insertion loss and still fits in an array module of 1.35 x 1.35 inch.

### Multiplexer Layout Configuration

Both "stacked" and "planar" diplexer layout configurations (Figure 2.6) are evaluated. As shown in Figure 2.1.6, in the stacked configuration, two channel filters are deposited on separate substrates, which are then assembled back-to-back with a middle ground plane providing the required isolation between the channel filters. The stacked configuration has an aspect ratio very

close to 1:1, which matches optimally with a T/R module array form factor. In the planar configuration, the two channel filters are arranged side-by-side at the same level and connected at a single common input port. The cross-section is rectangular with an aspect ratio of approximately 3:1. Since the planar configuration is easier to implement and the overall size of the diplexer is still within the allocated array lattice spacing, it is therefore chosen as the baseline layout configuration for the miniature diplexer development.

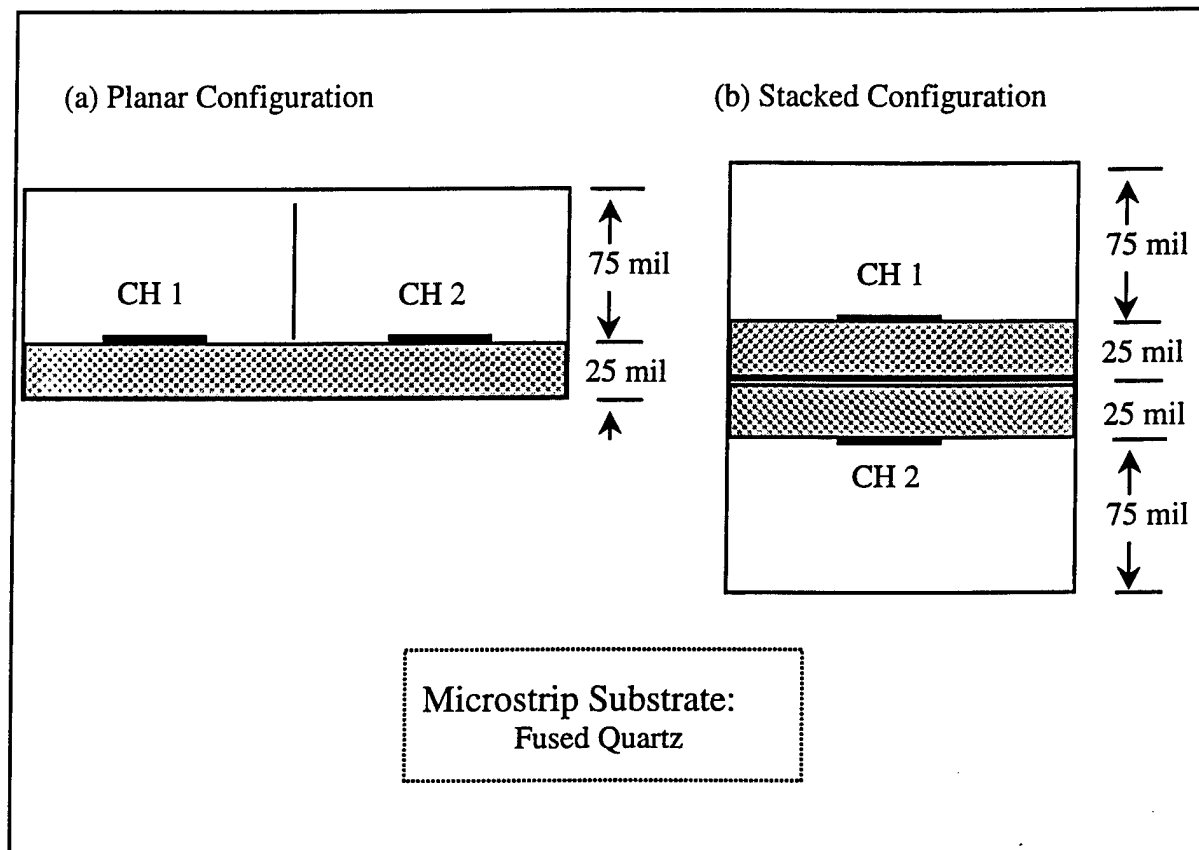

Figure 2.6 Multiplexer layout configuration

### 2.3 Diplexer Design

The miniature wideband, contiguous preselector diplexer consists of two channel filters, DC to 2.5 GHz for channel 1 and 2.5 to 5.2 GHz for channel 2, as shown in Figure 2.7. The common-junction multiplexing topology is used. Both channel filters are connected at the same input point. The diplexer is a self-annulling design and no external matching networks are required. The distributed elements, instead of lumped elements, are used in channel filters. The miniature diplexer designs combine the size and performance advantages of the common-junction multiplexing topology with a low cost printed circuit implementation suitable for mass production.

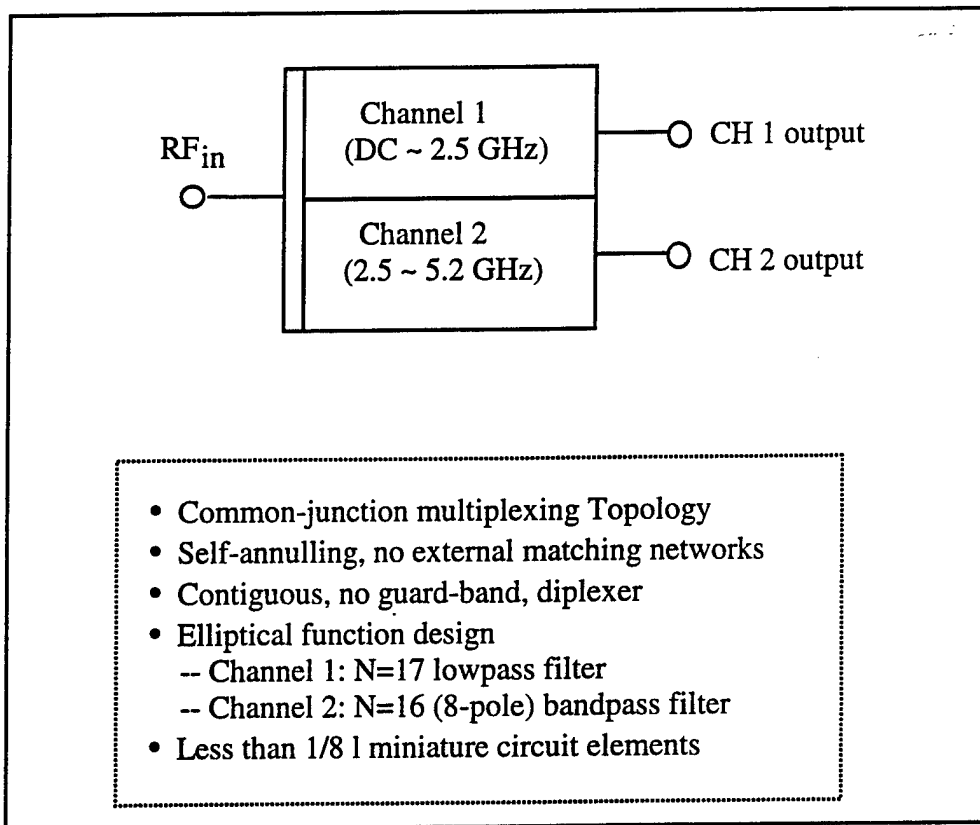

Figure 2.7 Miniature diplexer block diagram

### 2.3.1 Diplexer Equivalent Network

The contiguous diplexer is designed so that the RF signal band (DC to 5.2 GHz) is received at the common-junction port, and is frequency-multiplexed into two contiguous channels covering the DC to 2.5 GHz and 2.5 to 5.2 GHz. Each channel receives the specified frequency band signal with minimum loss, while rejecting unwanted out-of-band signals. Figure 2.8 shows the equivalent network of the preselector diplexer. The distributed circuit elements are used in the network, where UE represents a section of transmission line, the shunt "capacitor" (CP) represents a shunt open-stub transmission line, the series "capacitor" (CS) represents a series open-stub transmission line and the series inductor (LS) represents a series short-stub transmission line. In the diplexer design, two contiguous channels are connected directly to the common port and do not require external matching circuits.

The adjacent channel rejection is 60 dB at 10% away from the crossover frequency. To meet 60 dB adjacent channel rejection requirements, the channel 1 is a 17-order elliptical function lowpass filter, and the channel 2 is a 16-order (or 8-pole) elliptical function bandpass filter. The channel lowpass filter has four finite transmission zeroes nearby the band edges. The channel 2 bandpass filter has four finite transmission zeroes, two at the low side and the other two at the high side of the passband. Each finite transmission zero or Brune section is represented by a shunt LC resonator as indicated in Figure 2.8. The impedance values of the transmission lines in each channel filter are optimized and are physically realizable on 25-mil-thick fused quartz microstrip substrate.

### 2.3.2 Miniature Channel Filter Technology

The miniature filter/multiplexer technology, developed by TRW IR&D programs and the WL AFT and MFT programs, has been applied for AMRFS program. The key features for the miniature filter design include:

- (1) Electrically short circuit elements (less than one-eighth wavelength) in length, compared to conventional half-wavelength coupled line elements in a PCL filter. This effectively eliminates the effects of frequency dispersion on the even and odd mode propagation





constants of coupled lines, which is the main cause for poor performance of conventional microstrip parallel coupled line (PCL) filters.

- (2) Elliptic function design that provides lower in-band loss, higher out-of-band rejection and smaller size than a conventional Chebyshev filter design.
- (3) Extended spurious-free response, providing high frequency rejection without the use of additional lowpass filters required by conventional designs. Thus, additional insertion loss and size associated with the incorporation of lowpass filters are eliminated.
- (4) High out-of-band rejection, minimizing the harmonic interaction with higher channel filters in a multiplexer. This makes possible wideband multiplexer designs of at least 6:1 bandwidth.
- (5) No degradation of the in-band loss, as the unloaded Q-value of the distributed circuit elements is comparable with conventional microstrip PCL filters.

### **2.3.3 Diplexer Theoretical Responses**

The calculated responses of the miniature diplexer are shown in Figures 2.9-2.11. The channel transmission loss is shown in Figure 2.9. The channel-to-channel isolation is more than 60dB over the entire adjacent band with the minimum crossover region. Figure 2.10 shows the theoretical response of the return loss at the input port of the miniature diplexer. The diplexer is well matched with a better than 20 dB return loss over 90% of each band and is about 17dB at the crossover frequency region. The good return loss indicates that the mutual interactions between two contiguous channels (particularly at 3-dB crossover frequency regions) are well taken into account. Figure 2.11 shows the theoretical results of in-band insertion loss of the diplexer. The insertion loss is predicted based on the unloaded Q-values of 100 at 1.5 GHz for Channel 1 and 160 at 4.0 GHz for Channel 2. These Q-values are obtained based on measured results from similar filters developed at TRW for other projects. The mid-band insertion loss is much less than 1.0dB.

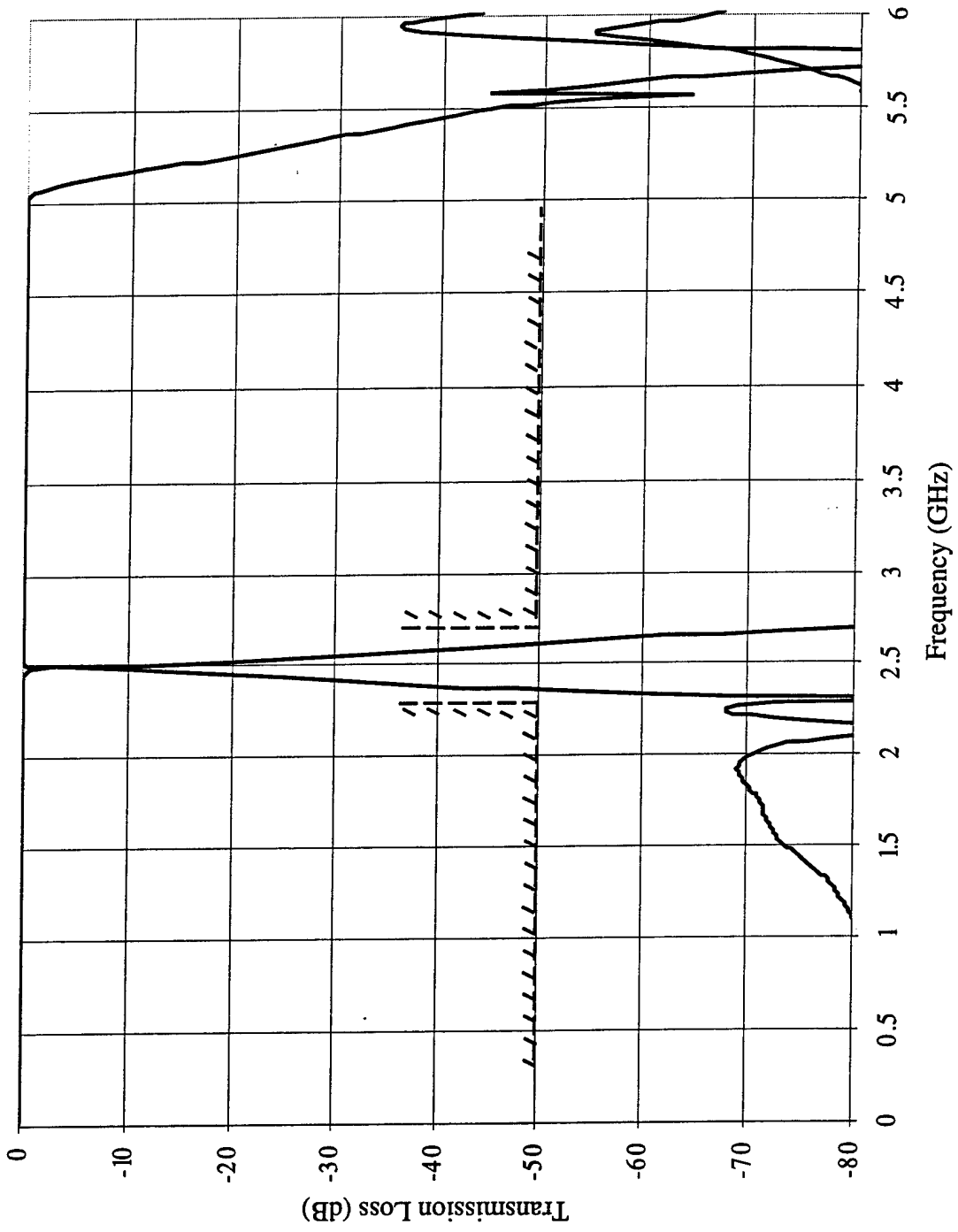

Figure 2.9 Calculated transmission loss or channel isolation of miniature diplexer

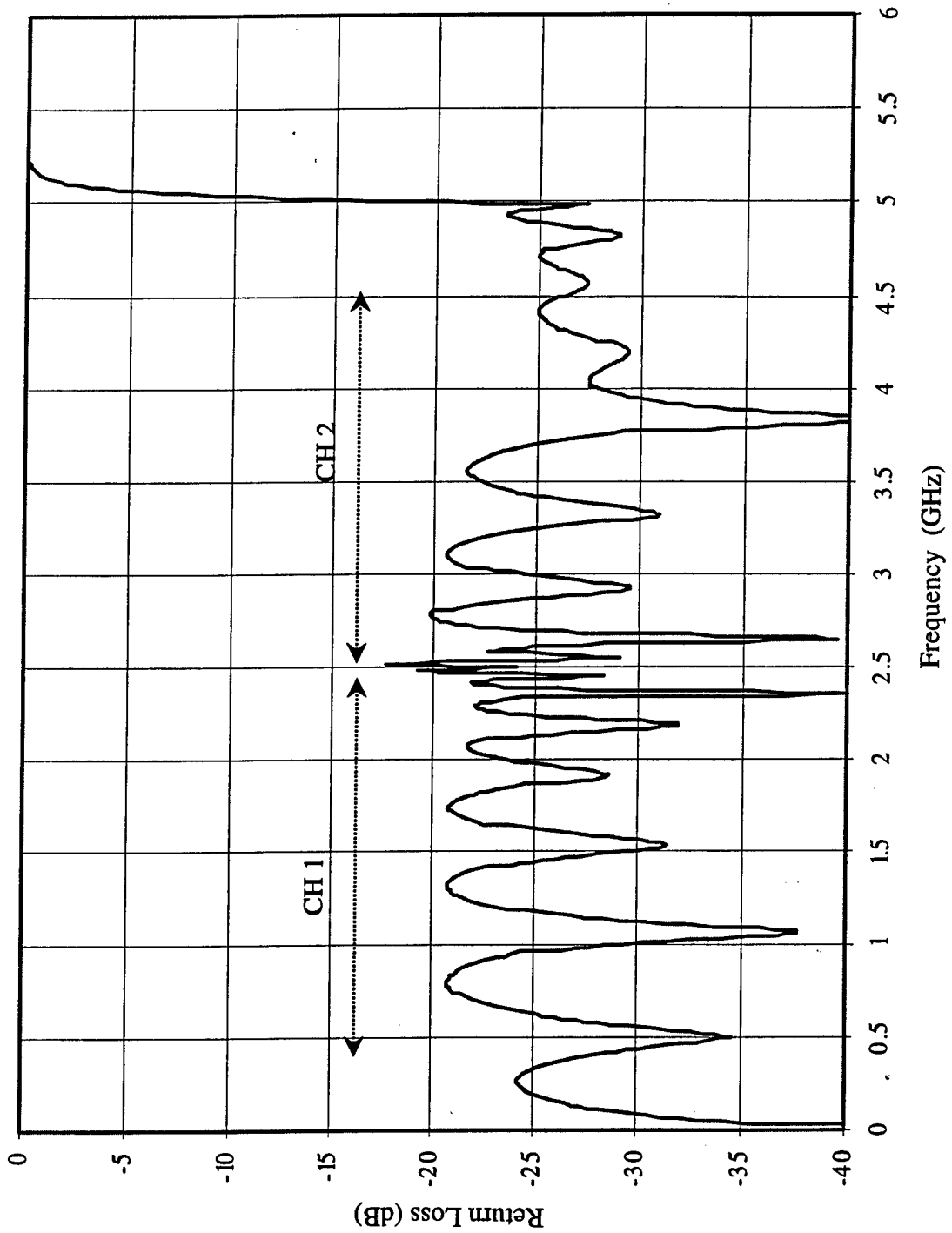

Figure 2.10 Calculated return loss of miniature diplexer at the input port

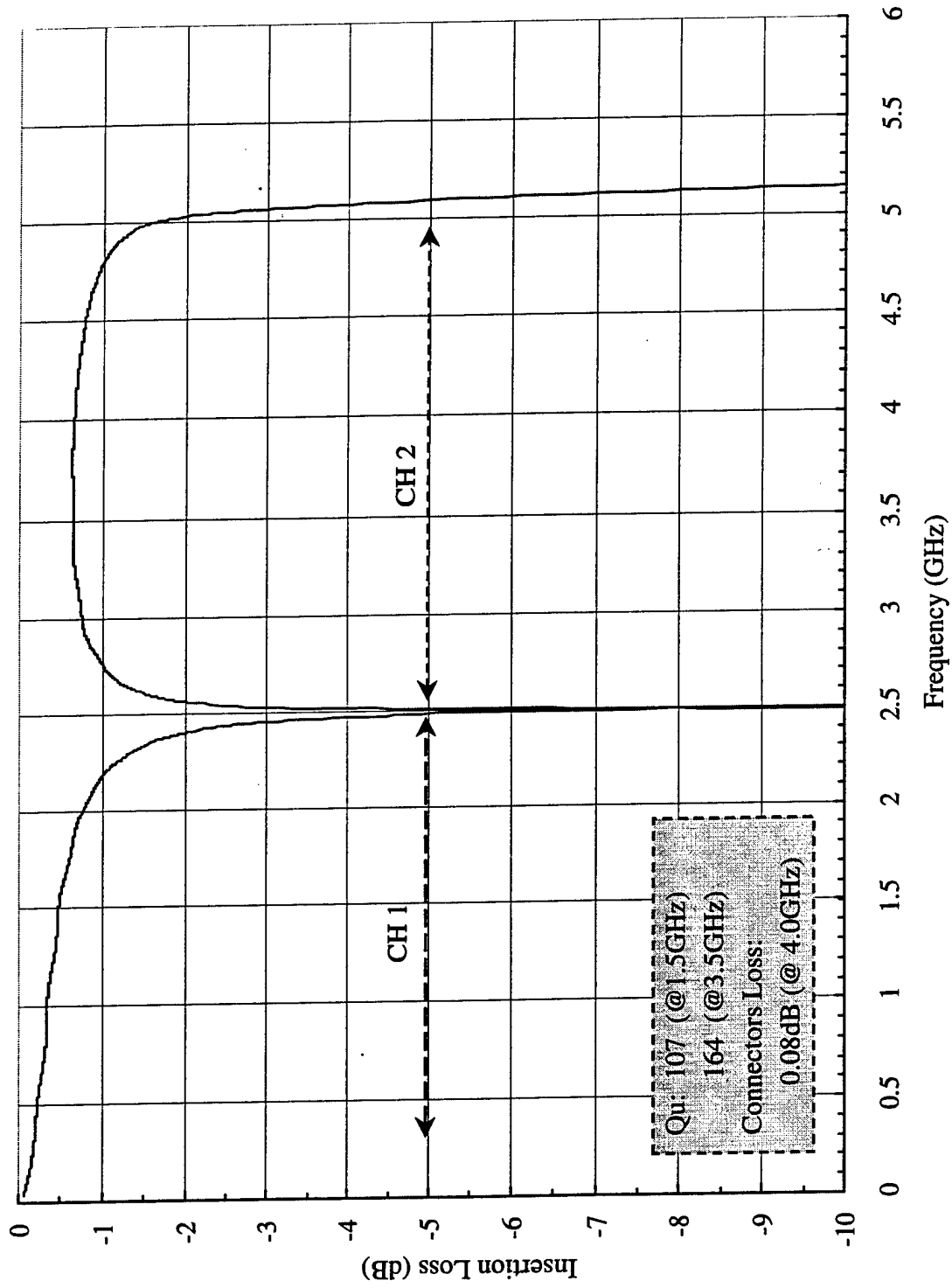

Figure 2.11 Calculated channel insertion loss of miniature diplexer

### 3. HARDWARE DEVELOPMENT

This chapter describes the fabrication, assembly, test and iteration of the miniature broadband contiguous X/L-band Diplexer discussed in Chapter 2.

#### 3.1 EM Simulated Results

As discussed in chapter 2, the miniature, broadband, contiguous diplexer covers DC to 5.2 GHz. The layout of the diplexer basically follows the equivalent network of the diplexer as shown in Figure 2.8. It consists of two channel filters that are connected in parallel at the input common-junction port. The channel 1 is a lowpass filter that constitutes of various interconnecting transmission lines, shunt open-stub transmission lines, and shunt combination of transmission lines for finite transmission zeros (or Brune sections). The channel 2 is a bandpass filter that constitutes of interconnecting transmission lines, pi-of-capacitor sub-circuits, shunt open-stub transmission lines and shunt combination of transmission lines for finite transmission zeros (or Brune sections).

The dimensions of the circuit elements of channel filters are verified through the Sonnet EM simulation first before any hardware is actually built. Figures 3.1 and 3.2 show the EM simulated input return loss and channel transmission loss, respectively. The EM simulated responses are very close to the theoretical responses. This step, via EM simulation, greatly reduces the hardware development cycle time and cost. The circuit elements of the diplexer, mainly the transmission line impedance, are optimized for implementation on 25-mil-thick quartz microstrip substrates. The narrowest line width or the minimum gap between coupled lines is at least 2 mils or larger. The typical etching tolerance on a quartz substrate is about  $\pm 0.15$  mil. The wider lines or circuit elements are therefore less sensitive to the processing or etching variation. This is a critical parameter for good unit-to-unit tracking performance.

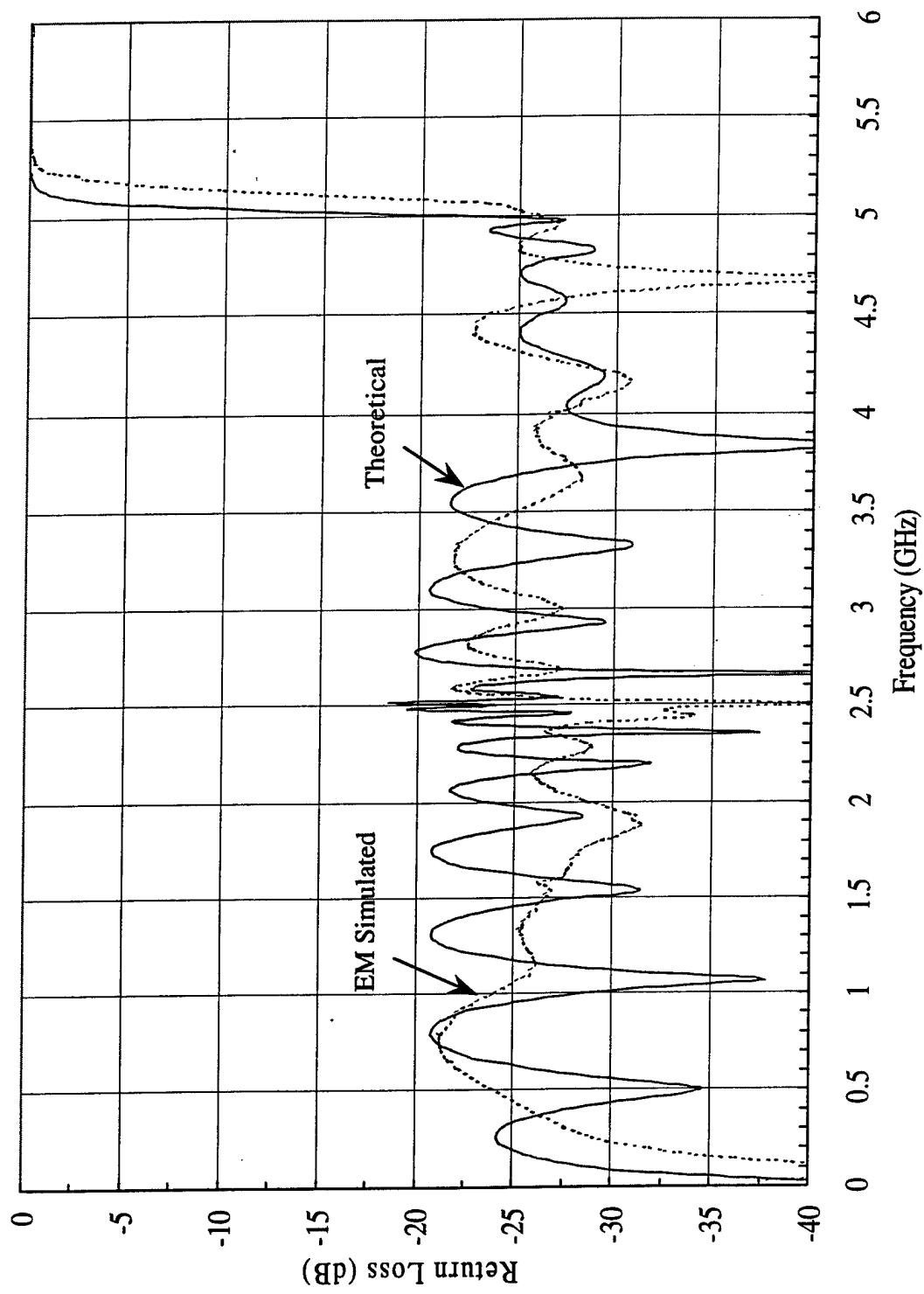

Figure 3.1 EM simulated diplexer input return loss

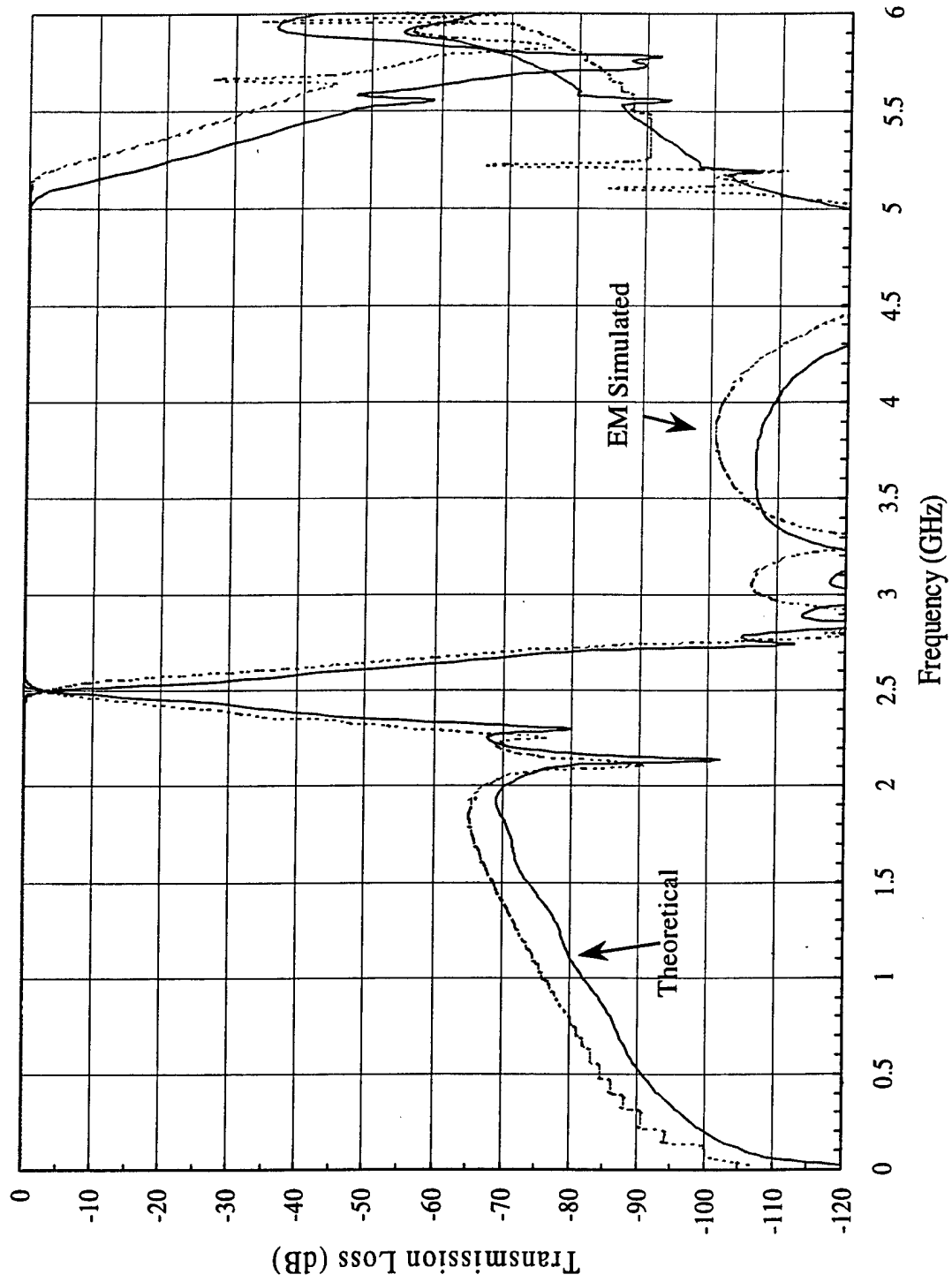

Figure 3.2 EM simulated diplexer channel transmission loss

### 3.2 Diplexer Fabrication and Test

The miniature contiguous X/L-band diplexer has been fabricated, assembled and tested in two iterations. The iterations focus on the structure or diplexer/channel width minimization, not in the RF performance optimization. The diplexer is implemented in a planar configuration. A 3.00" by 3.00" fused quartz with 0.5oz thick gold substrate is used. Since the overall size of the diplexer is relatively, each channel filter is etched in a separate substrate and then bonded with gold ribbon in aluminum housing.

#### 3.2.1 First Iteration Diplexer

Figure 3.3 shows the photo of the first iteration miniature X/L-band diplexer. The overall size of the diplexer is 1.20 inch in width; 0.10 inch in height and 2.40 inch in length. The length includes interconnecting 50-ohm lines.

#### Measured RF Results

The miniature X/L-band diplexer is measured in a Wiltron 360 automated network analyzer. Three key RF parameters are measured. They are: return loss at input port, channel in-band insertion loss and channel transmission loss (or channel isolation). The results are shown in Figures 3.4 to 3.6. All measured results are 'out-of-box' or 'as-is' responses. No tuning screws or trimmings on any circuit elements are needed.

Figure 3.4 shows the measured return loss at the input port. The diplexer is well matched. It has better than 20dB return loss for channel 1 (DC to 2.5 GHz) and most of passband for channel 2 (2.5 to 5.2 GHz). Even in the crossover frequency region that is the most sensitive area to circuit modeling and processing tolerance, the return loss is still at least 15dB. Considering the complexity of the diplexer and no tuning screws are involved, this excellent return loss in a contiguous diplexer represents a state of the art. The measured return loss agrees very well with EM simulated results.

Figure 3.5 shows the measured channel transmission loss or channel-to-channel isolation. The design goal of the channel isolation is 60dB. The unit meets this design goal. Better than 60dB channel isolation at the lower frequency (DC to 2.5 GHz) and 80dB at the higher frequency (2.5 to 5.2 GHz) are measured. The EM simulated isolation is at least 100dB at the higher frequency side. The slight discrepancy is due to



the leakage through the center metallic wall that separates the two channels. As shown in Figure 3.5, the frequency duplexing is clearly demonstrated with good channel isolation between channels 1 and 2. Again, the measured channel transmission loss follows closely with the EM simulated values. In fact, one can hardly distinguish the difference between these two values at the lower frequency.

Figure 3.6 shows the measured channel passband insertion loss. The design goal of insertion loss is less than 1.0dB over at least 80% of the passband. The measured insertion loss exceeds this goal. The insertion loss is better than 1.0dB in the center of the passband and rolls off at the bandedges. The loss is 0.7dB at the center of the channel 2 passband ( $f=3.75\text{GHz}$ ) and 6.0dB at the crossover frequency ( $f=2.5\text{ GHz}$ ). The corresponding unload Q-value is 160 that is consistent with the prediction as discussed in section 2.3.3.

It should be mentioned again that the measured results are 'as is'. There are no tuning screws and/or trimming elements involved. This is a critical step for phased array applications since large quantity involved. The most challenging part for a contiguous multiplexer is in the crossover region where the bandwidth and skirt of each channel filter have to be accurately modeled. Since adjacent channel filters interact with each other in the crossover region, a lot of design efforts are focused on the performance improvement in the crossover region. Gold ribbons are often bonded where necessary to improve RF performance. This complicates the assembly and results in higher production cost and poorer unit-to-unit amplitude and phase tracking.

Summary of size and RF the performance of the first iteration diplexer

- o Size (W x H x L): 1.20" x 0.10" x 2.40"
- o Return Loss: ~ 20dB over DC to 5.2 GHz
- o Insertion loss: < 1.0dB
- o Out-of-Band Rejection: > 60dB

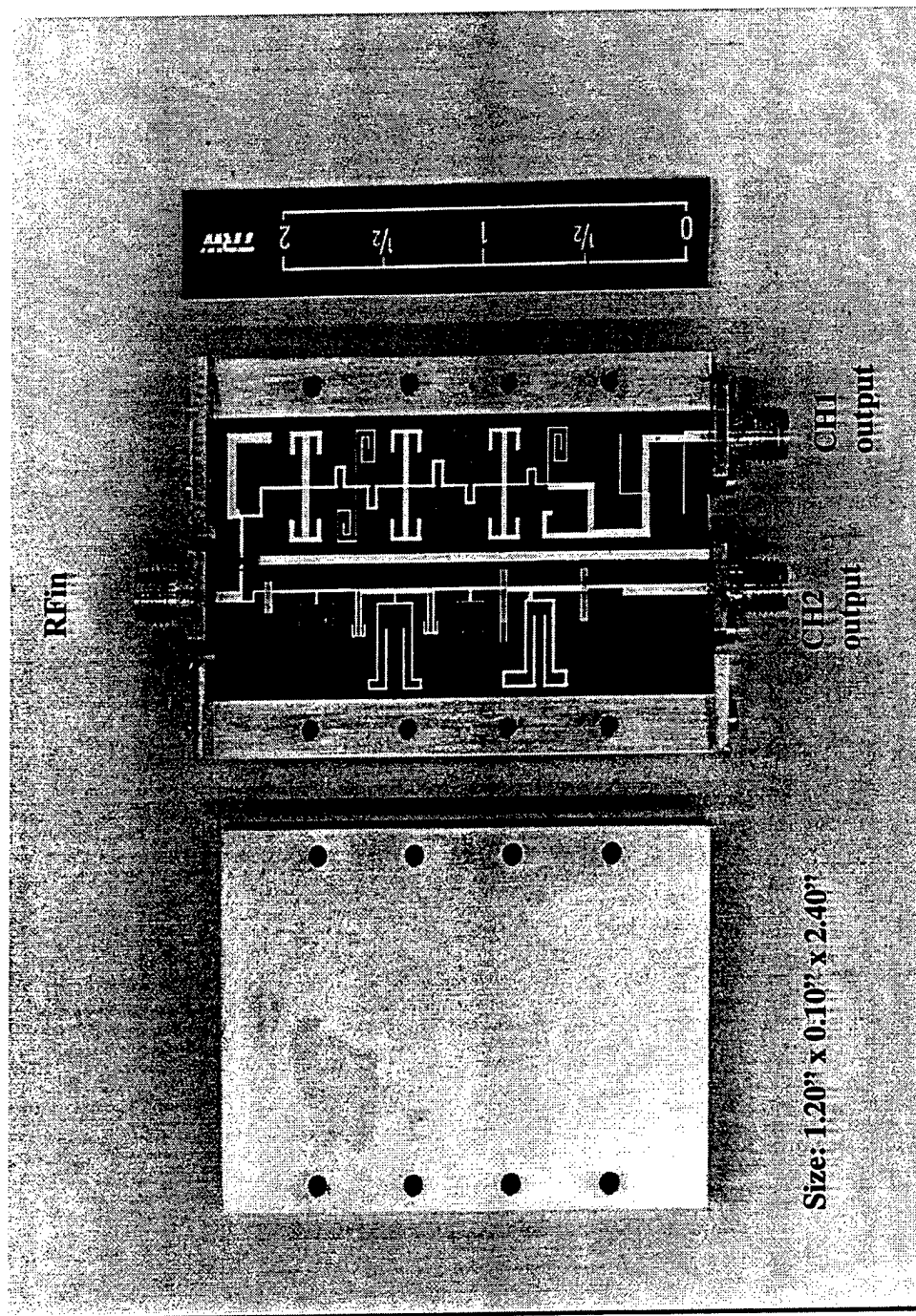

Figure 3.3 Photo of miniature broadband diplexer (1st iteration)

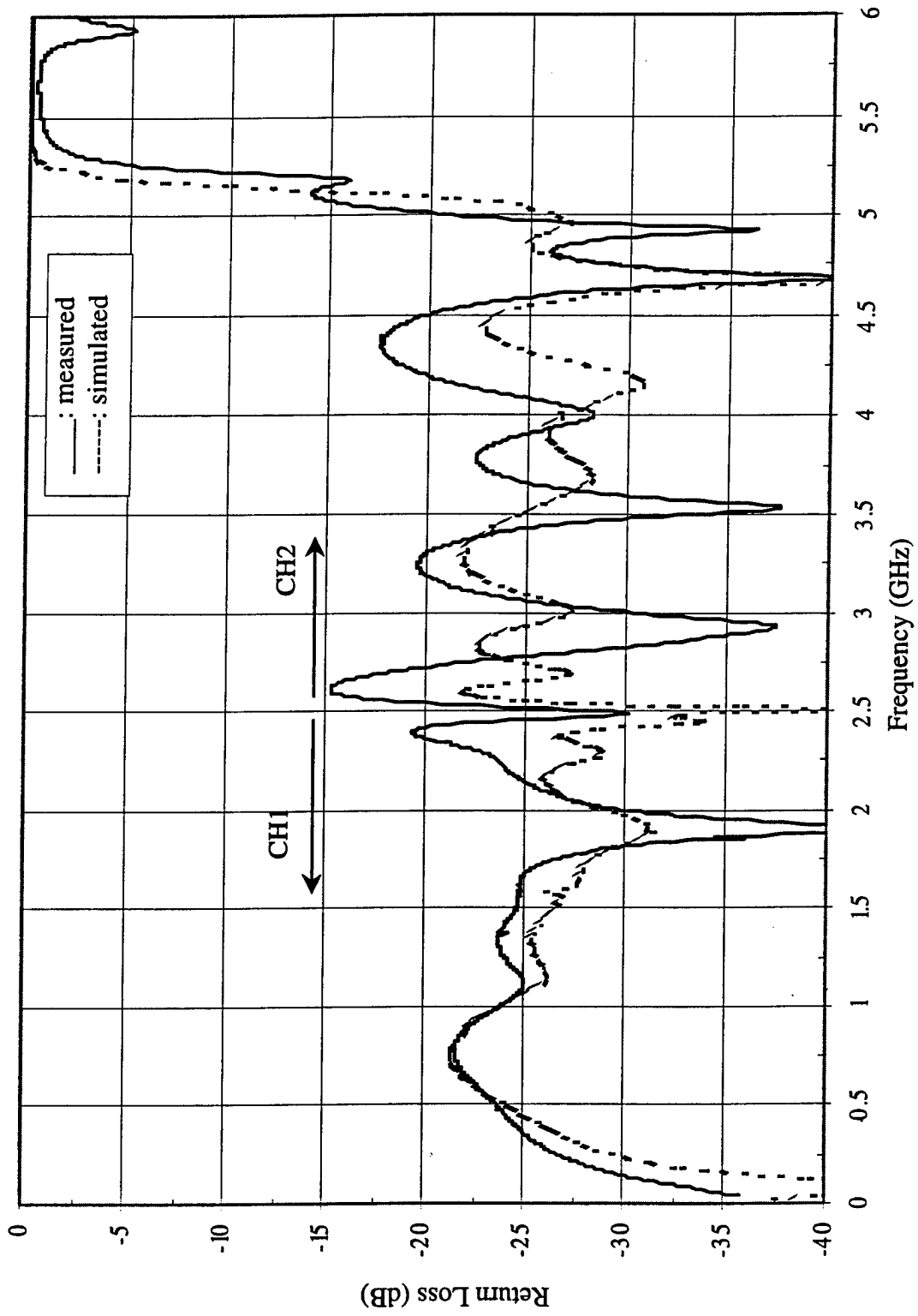

Figure 3.4 First iteration diplexer measured results-- input return loss. Excellent correlation between measured and EM simulated results; better than 15 dB input return loss.

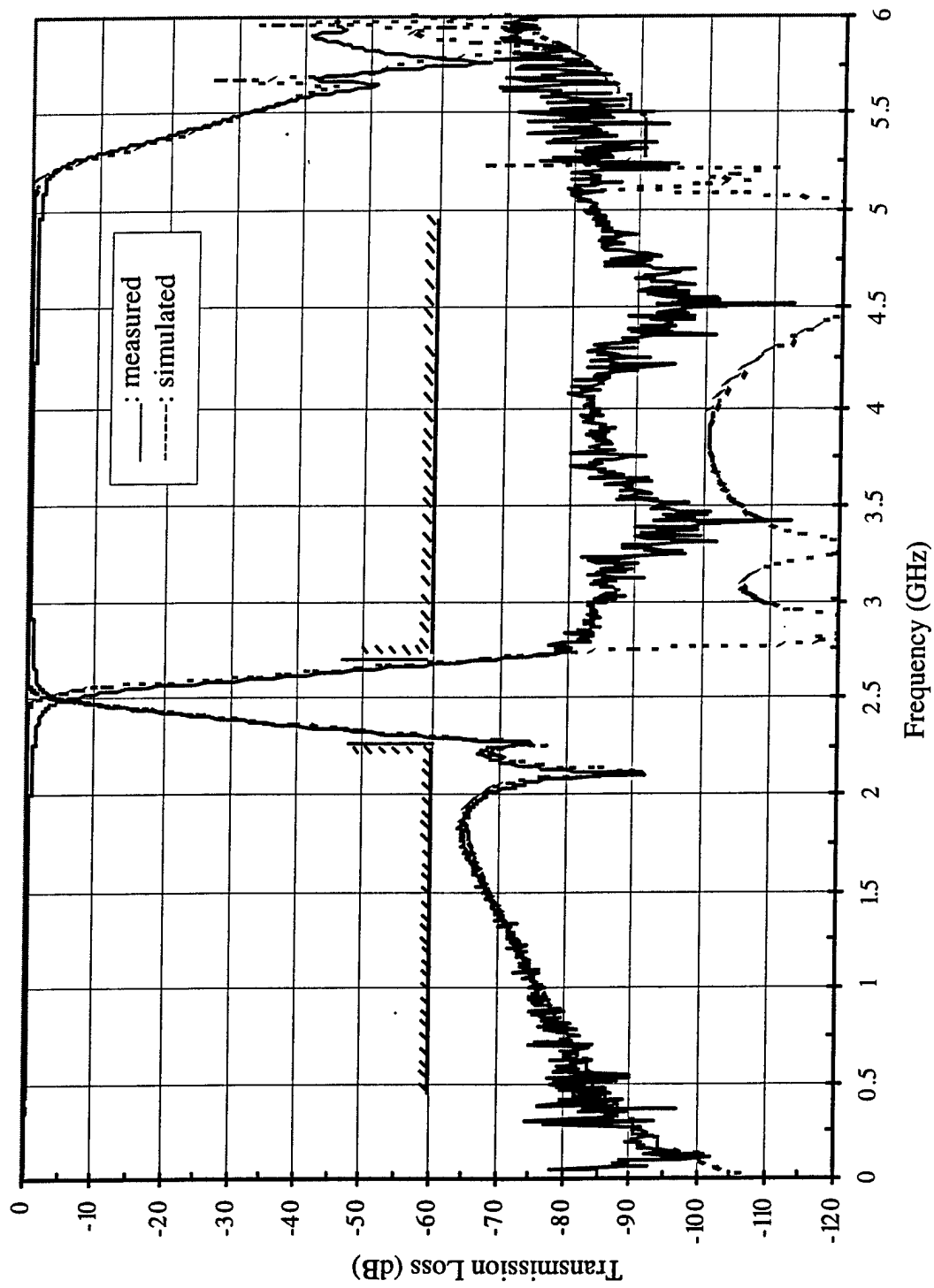

Figure 3.5 First iteration diplexer measured results -- channel isolation. Excellent correlation between measured and EM simulated results ; better than 60 dB channel isolation.

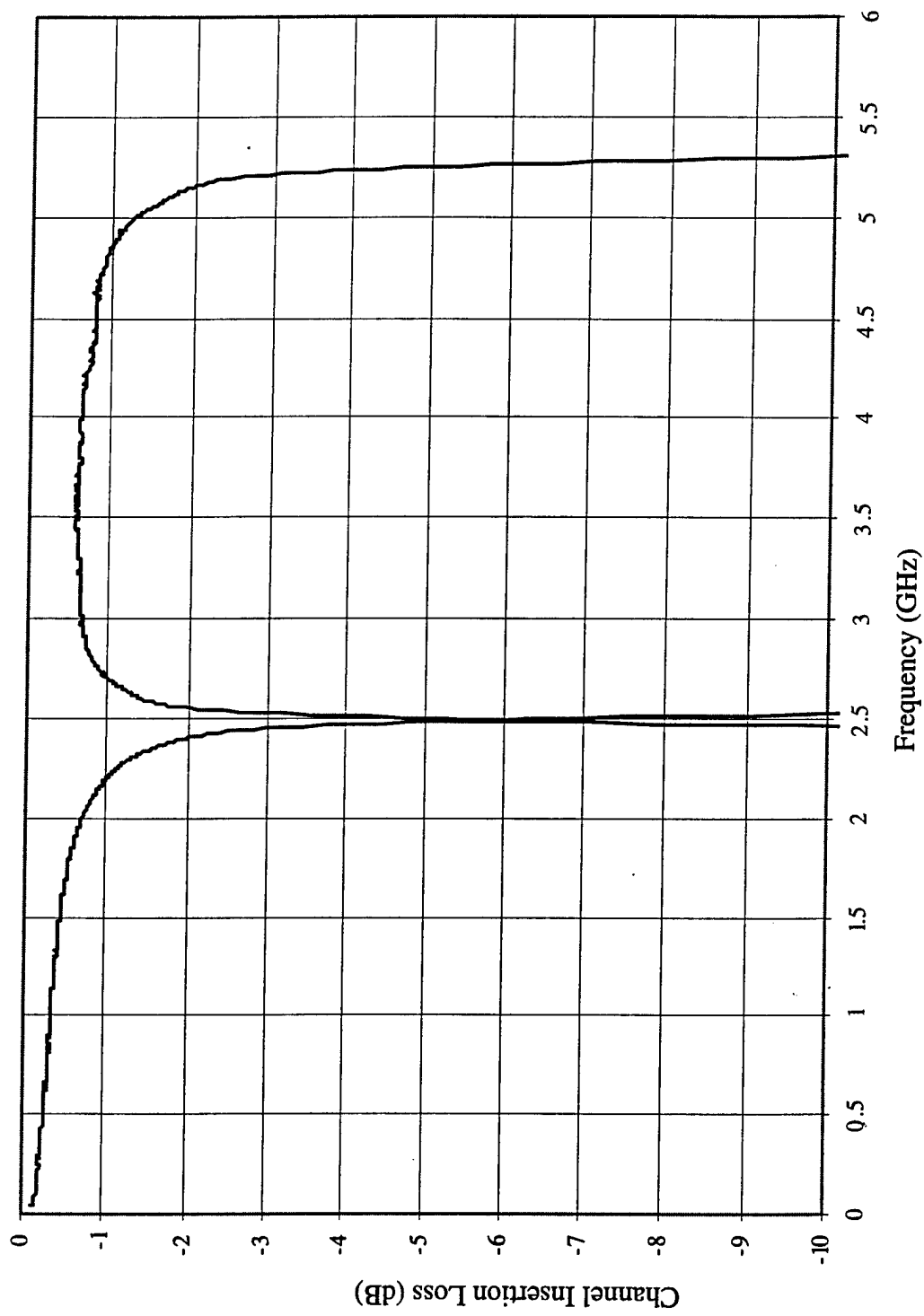

Figure 3.6 First iteration diplexer measured results -- channel insertion loss. Low insertion loss (< 0.7dB at the center and < 1.0dB over 80% of passband).

### 3.2.2 Second Iteration Diplexer

In the second iteration, the overall size of the diplexer is further reduced. The layouts of shunt open-stub transmission lines in channel 2 are re-arranged. As a result, the overall width of the diplexer is reduced from 1.20 " (1<sup>st</sup> iteration) to 1.05" that is well fitted within array lattice spacing. The second iteration diplexer is fabricated, assembled and tested in the same way as done in the first iteration unit.

Figure 3.7 shows the photo of the miniature X/L-band diplexer for the second iteration. The overall size of the diplexer is 1.20 inch in width; 0.10 inch in height and 2.40 inch in length. The length includes interconnecting 50-ohm lines.

#### Measured RF Results

Again, the second iteration preselector diplexer is measured in a Wiltron 360 network analyzer. Three key RF parameters are measured. They are: return loss at input port, channel in-band insertion loss and channel transmission loss (or channel isolation). The results are shown in Figures 3.8 to 3.10. Like the 1<sup>st</sup> iteration diplexer, all measured results for the 2<sup>nd</sup> iteration diplexer are 'out-of-box' or 'as-is' responses. No tuning screws or trimmings on any circuit elements are needed.

Figure 3.8 shows the measured return loss at the input port. It has better than 20dB return loss is for both channel 1 (DC to 2.5 GHz) and channel 2 (2.5 to 5.2 GHz). Even in the crossover frequency region, the return loss is at least 20dB. Considering the high complexity of the diplexer and no tuning screws are involved, this excellent return loss in a contiguous diplexer over the entire band including the crossover region represents a multiplexer technology breakthrough. The measured return loss again agrees very well with EM simulated results.

Figure 3.9 shows the measured channel transmission loss or channel-to-channel isolation. The design goal of the channel isolation is 60dB. The unit exceeds this design goal. The channel-to-channel isolation is very high. Better than 60 dB at the lower frequency (DC to 2.5 GHz) and nearly 100dB at the higher frequency (2.5 to 5.2 GHz) are measured. The noise floor of the test setup is about 100dB. In other words, any channel rejection higher than 100dB will not be measured presently due to the noise floor of the test setup. Nevertheless, such a high channel isolation from a printed diplexer is very encouraging. As shown in Figure 3.9, the frequency diplexing is clearly

demonstrated with good channel isolation between channels 1 and 2. Again, the measured channel transmission loss follows closely with the EM simulated values. In fact, one can hardly distinguish the difference between these two values at the lower frequency.

Figure 3.10 shows the measured channel passband insertion loss. The design goal of insertion loss is less than 1.0dB over at least 80% of the passband. The measured insertion loss exceeds this goal. The insertion loss is better than 1.0dB in the center of the passband and rolls off at the bandedges. The loss is 0.7dB at the center of the channel 2 passband ( $f=3.75\text{GHz}$ ) and 6.0dB at the crossover frequency ( $f=2.5\text{ GHz}$ ). Again, the corresponding unload Q-value is 160 that is consistent with the prediction as discussed in section 2.3.3.

Summary of size and RF performance of the second iteration diplexer :

- o Size (W x H x L): 1.050" x 0.10" x 2.40"
- o Return Loss: ~ 20dB over DC to 5.2 GHz
- o Insertion loss: < 1.0dB (including a pair of SMA connector loss)
- o Out-of-Band Rejection: > 60dB

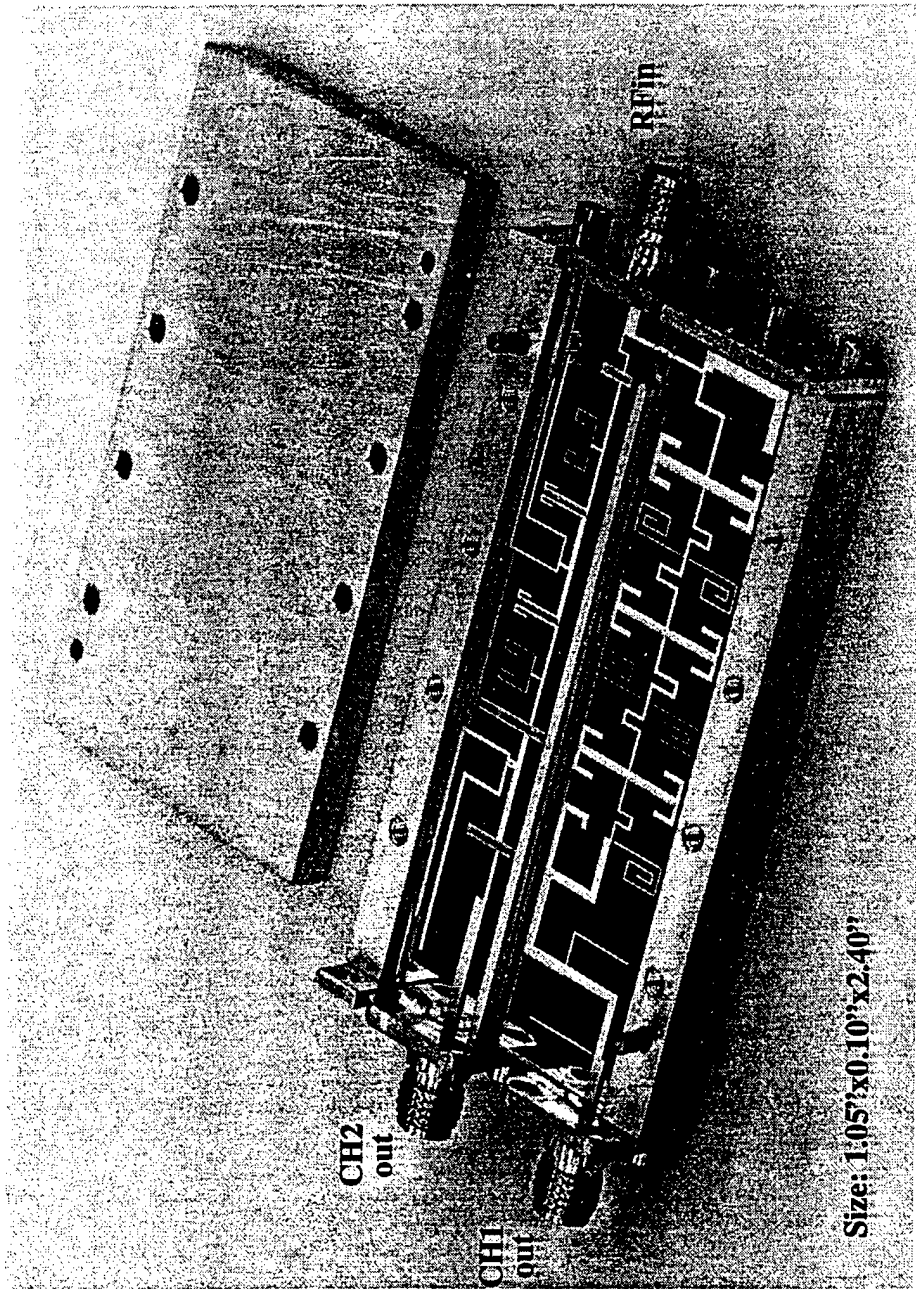

Figure 3.7 Photo of miniature broadband diplexer (2nd iteration)



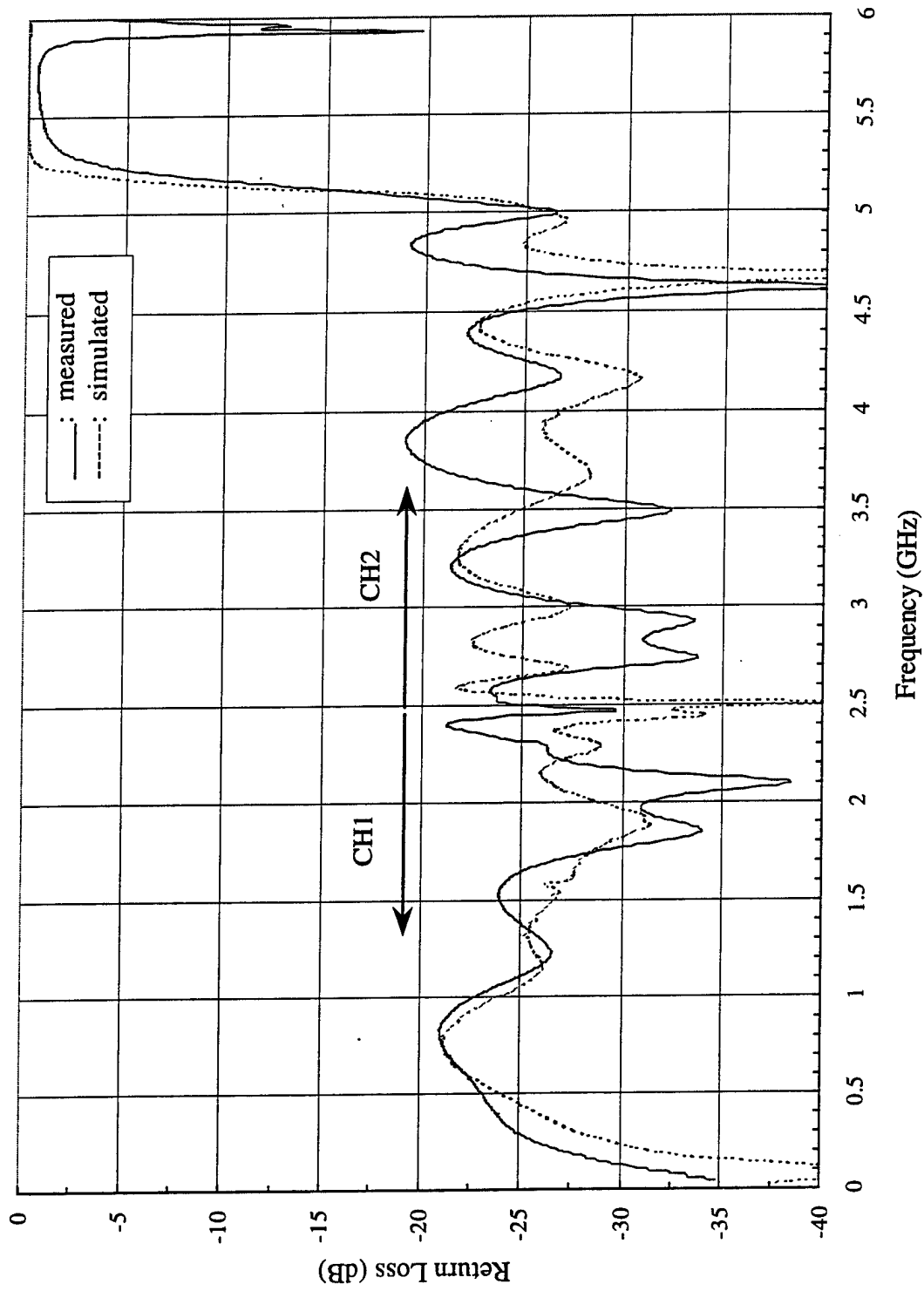

Figure 3.8 Second iteration diplexer measured results -- input return loss. Excellent correlation between measured and EM simulated results; better than 18 dB input return loss over entire band.

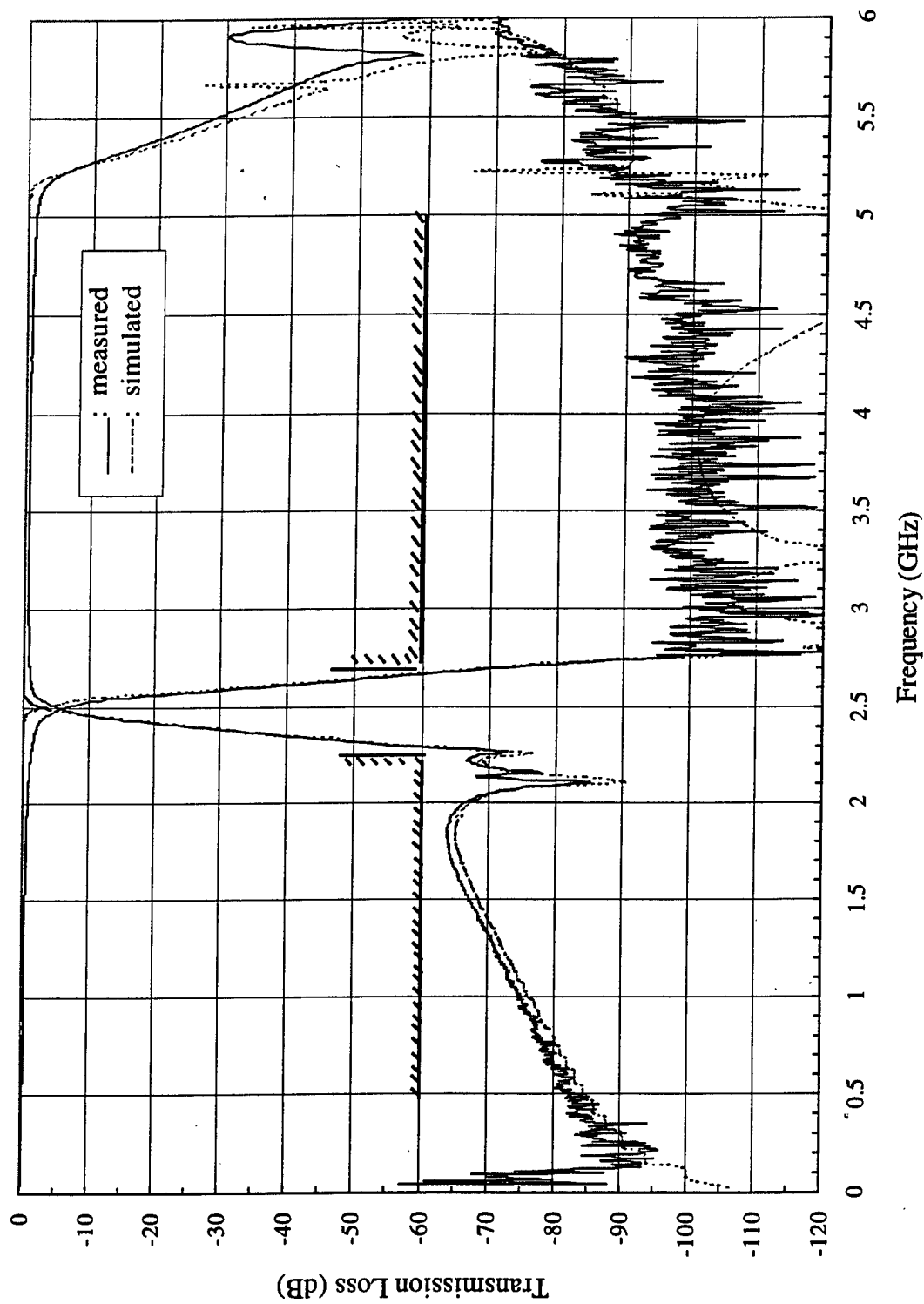

Figure 3.9 Second iteration diplexer measured results -- channel isolation. Excellent correlation between measured and EM simulated results; better than 60 dB channel isolation.

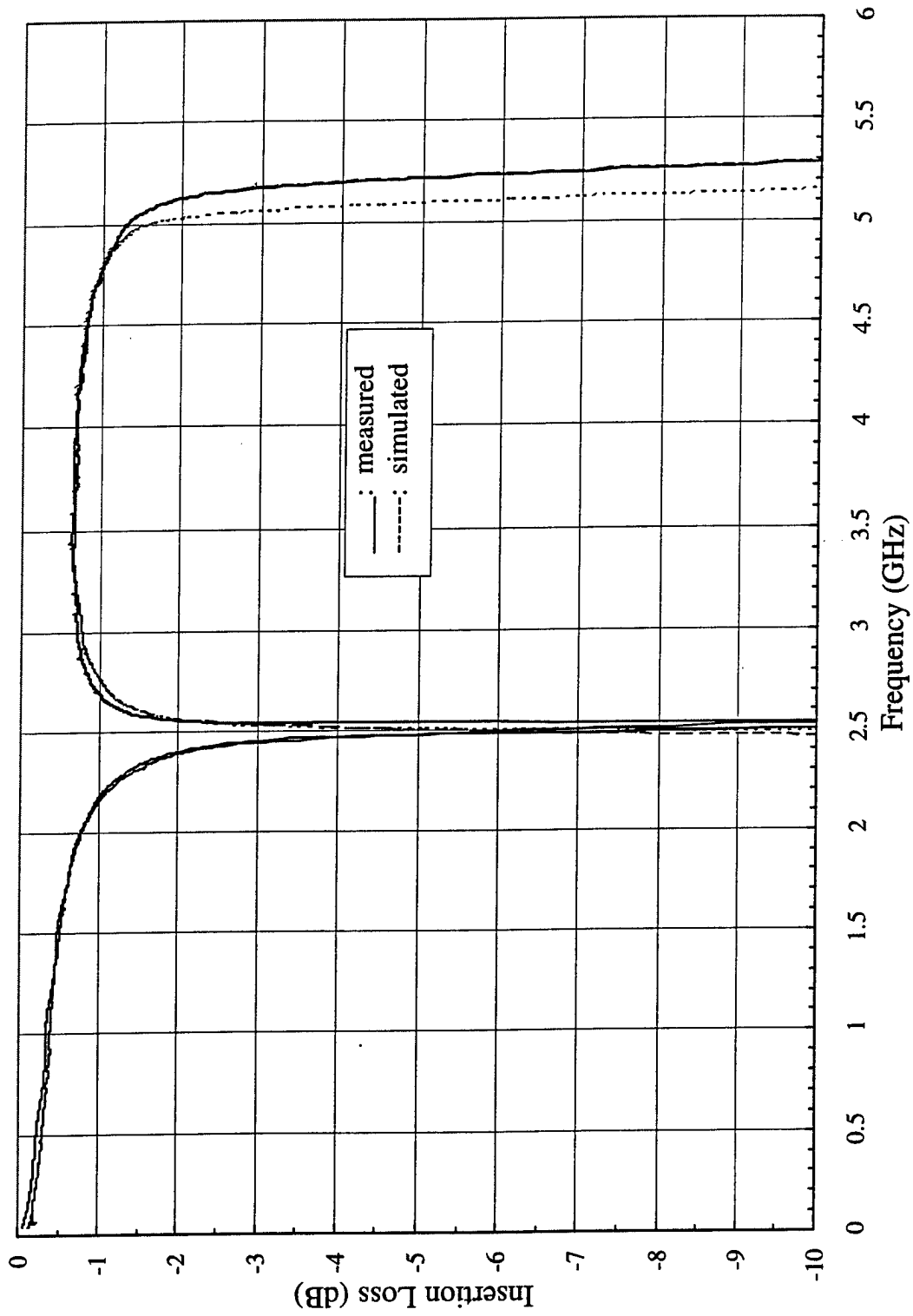

Figure 3.10 Second iteration diplexer measured results -- channel; insertion loss. Excellent correlation between measured and simulated results; low insertion loss (< 0.7dB at the center and < 1.0dB over 80% of passband).

### 3.3 Diplexer Thermal Test

To evaluate the temperature stability of the miniature, broadband contiguous diplexer, the unit has been mounted on a hot plate and monitored at three different temperatures; namely ambient ( $T=23^{\circ}\text{C}$ ),  $T=43^{\circ}\text{C}$  and  $T=73^{\circ}\text{C}$ . Both amplitude and phase responses of each channel are recorded at these three temperatures. The results are shown in Figures 3.11 to 3.17.

The unit is less sensitive to the temperature variation as evident in Figures 3.11 to 3.17. The typical in-band insertion loss peak-to-peak variation is less than 0.2dB, and the passband phase peak-to-peak variation is less than 3.0 degrees for both channels as the temperature varies from ambient to  $73^{\circ}\text{C}$  (in F). The variation of channel-to-channel isolation on temperature is negligible and within measurement accuracy. The input return loss varies slightly as temperature increases from ambient to  $73^{\circ}\text{C}$ , but still better than 17dB for most of operating frequency range (1 to 5 GHz). This remarkable thermal performance of the printed diplexer is very comparable to the conventional machined combline multiplexers.

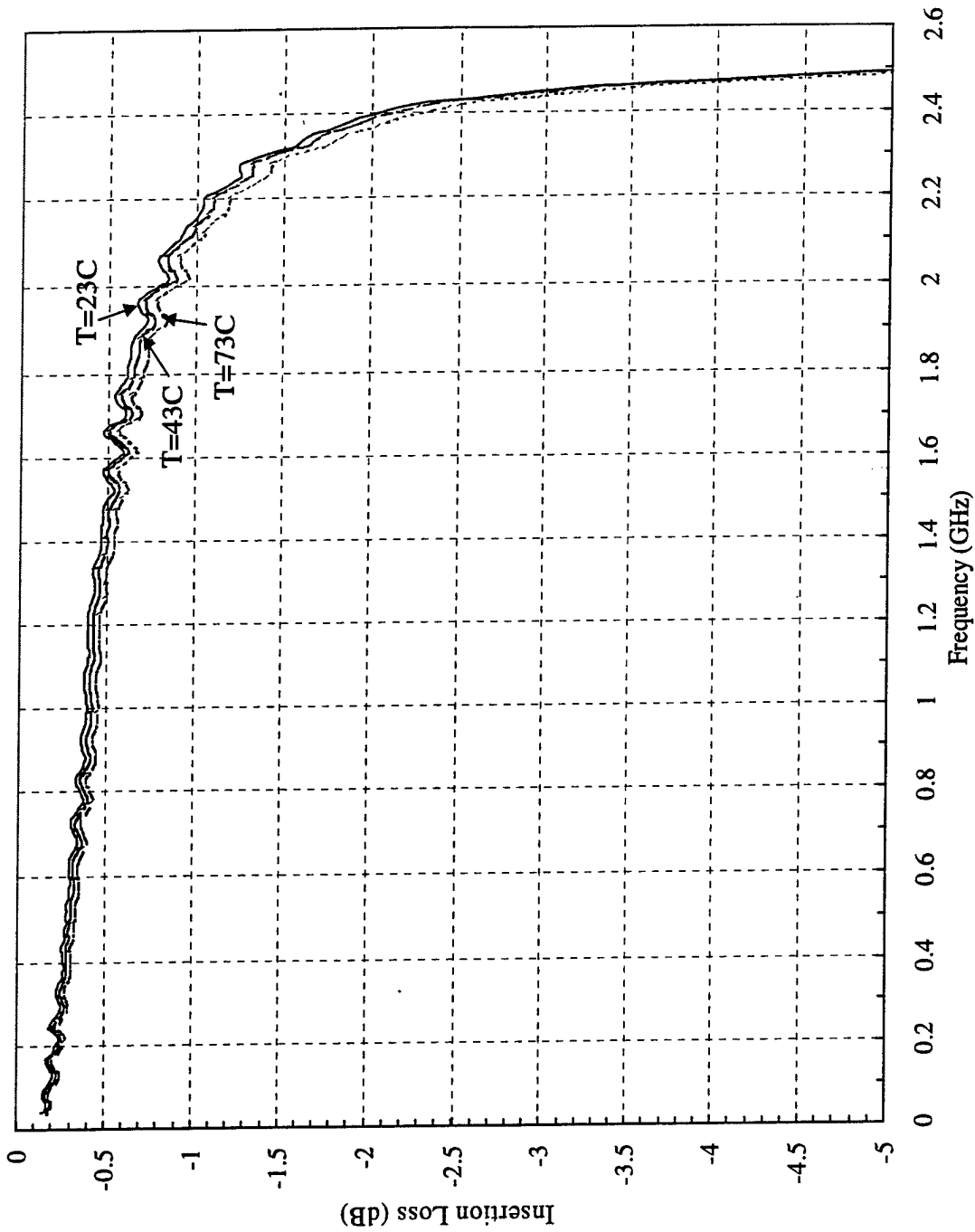

Figure 3.11 Channel 1 passband insertion loss variation on temperature (unit#3)

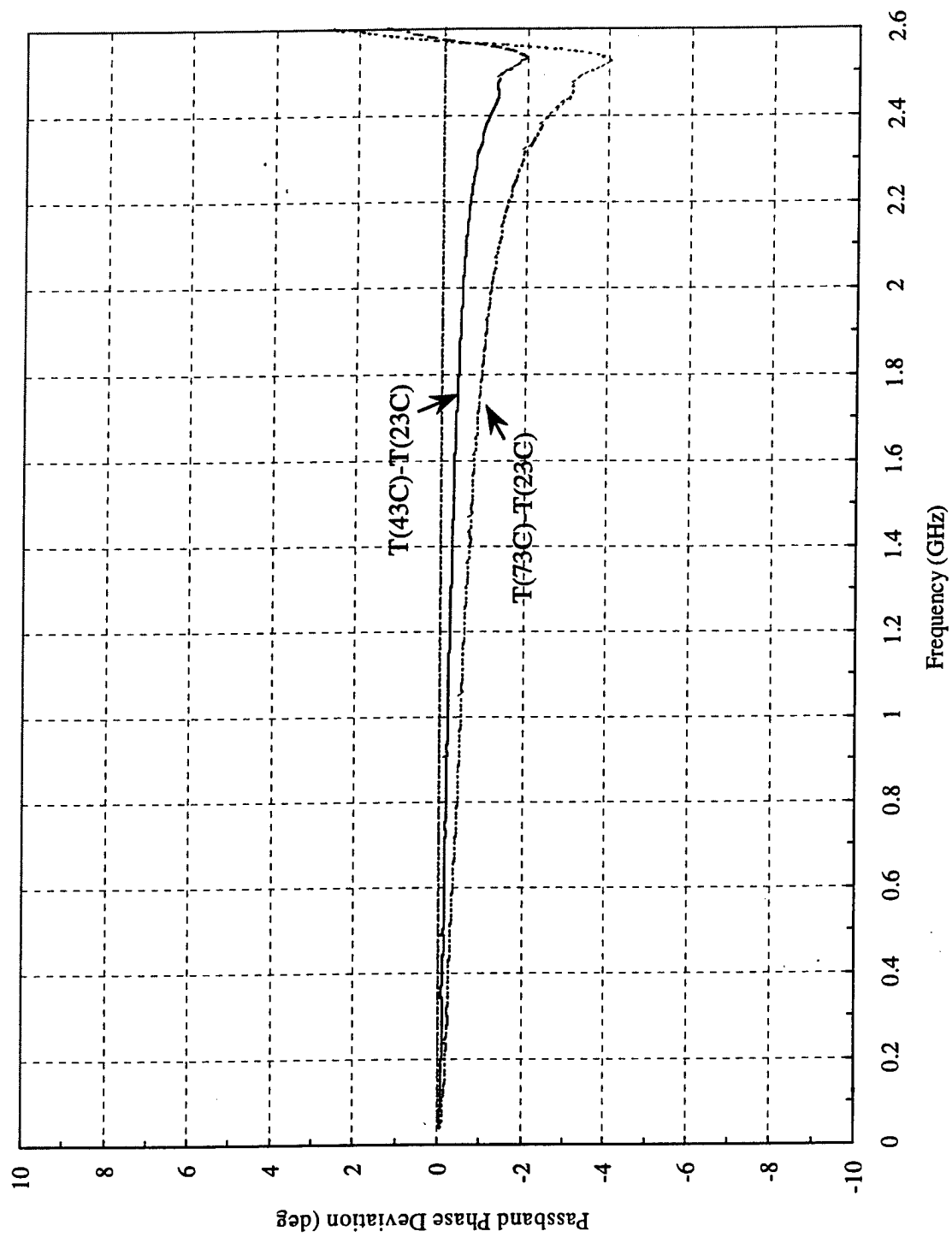

Figure 3.12 Channel 1 passband phase variation on temperature (unit#3)

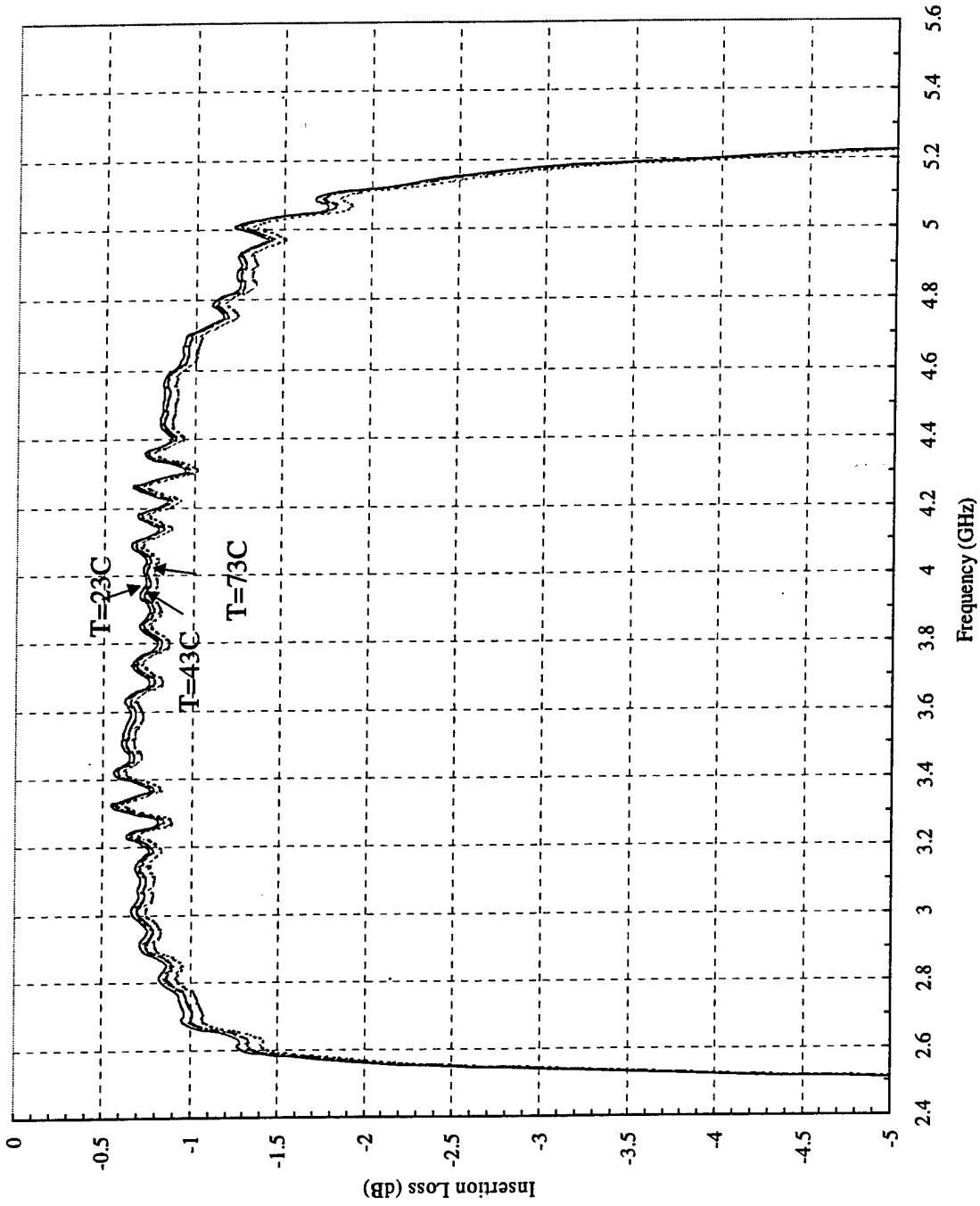

Figure 3.13 Channel 2 passband insertion loss variation on temperature (unit#3)

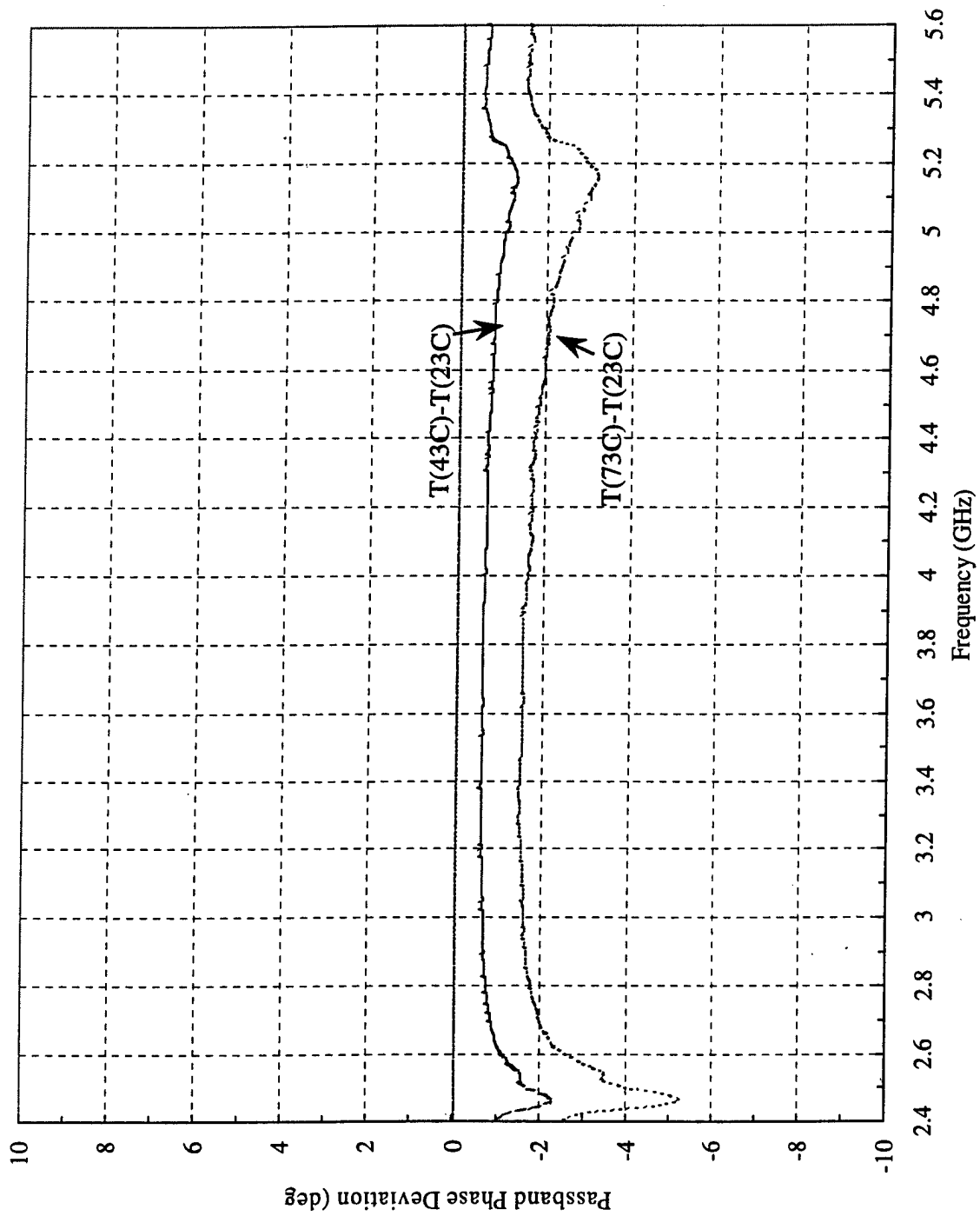

Figure 3.14 Channel 2 passband phase variation on temperature (unit#3)



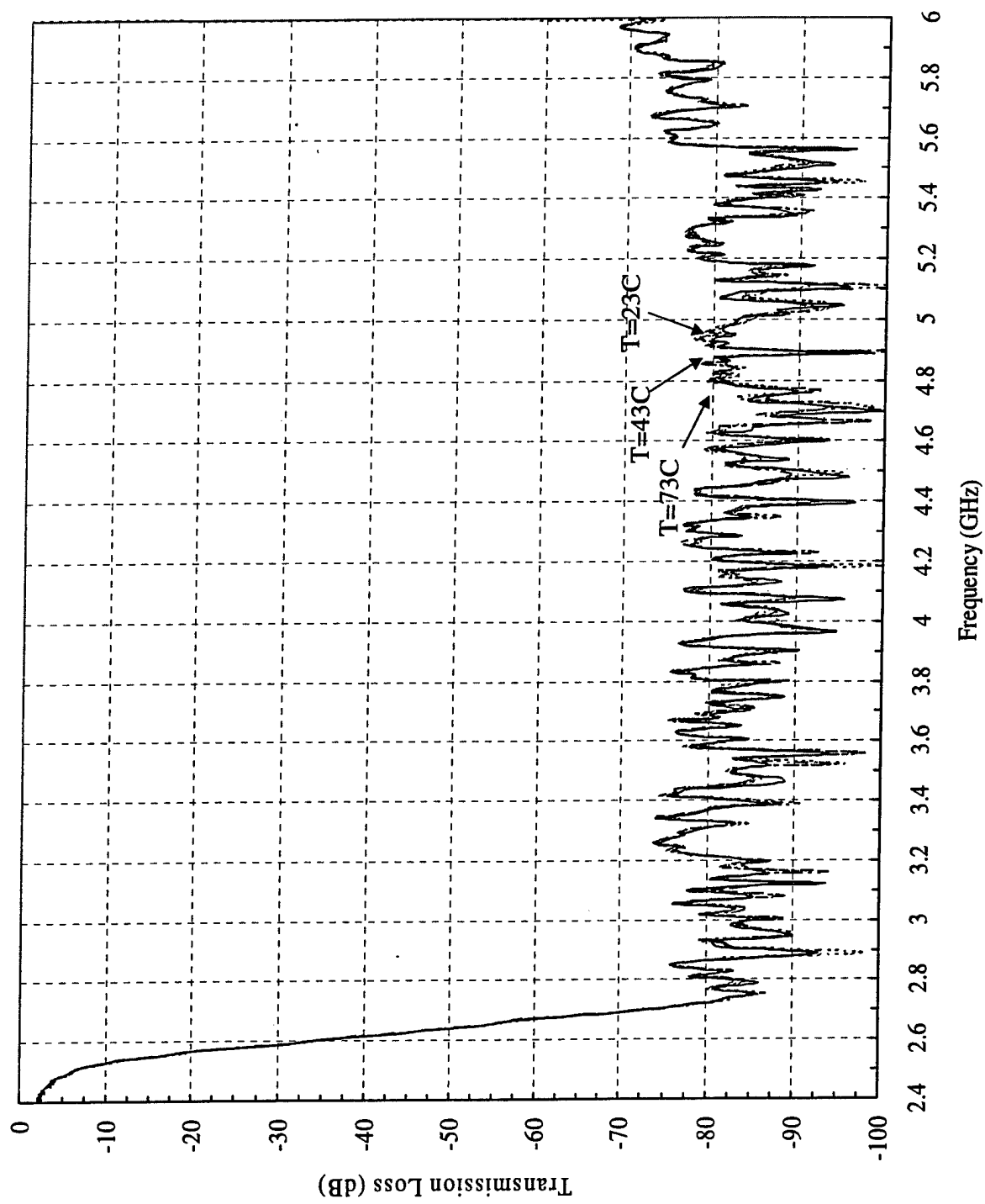

Figure 3.15 Channel 1 out-of-band rejection variation on temperature (unit#3)

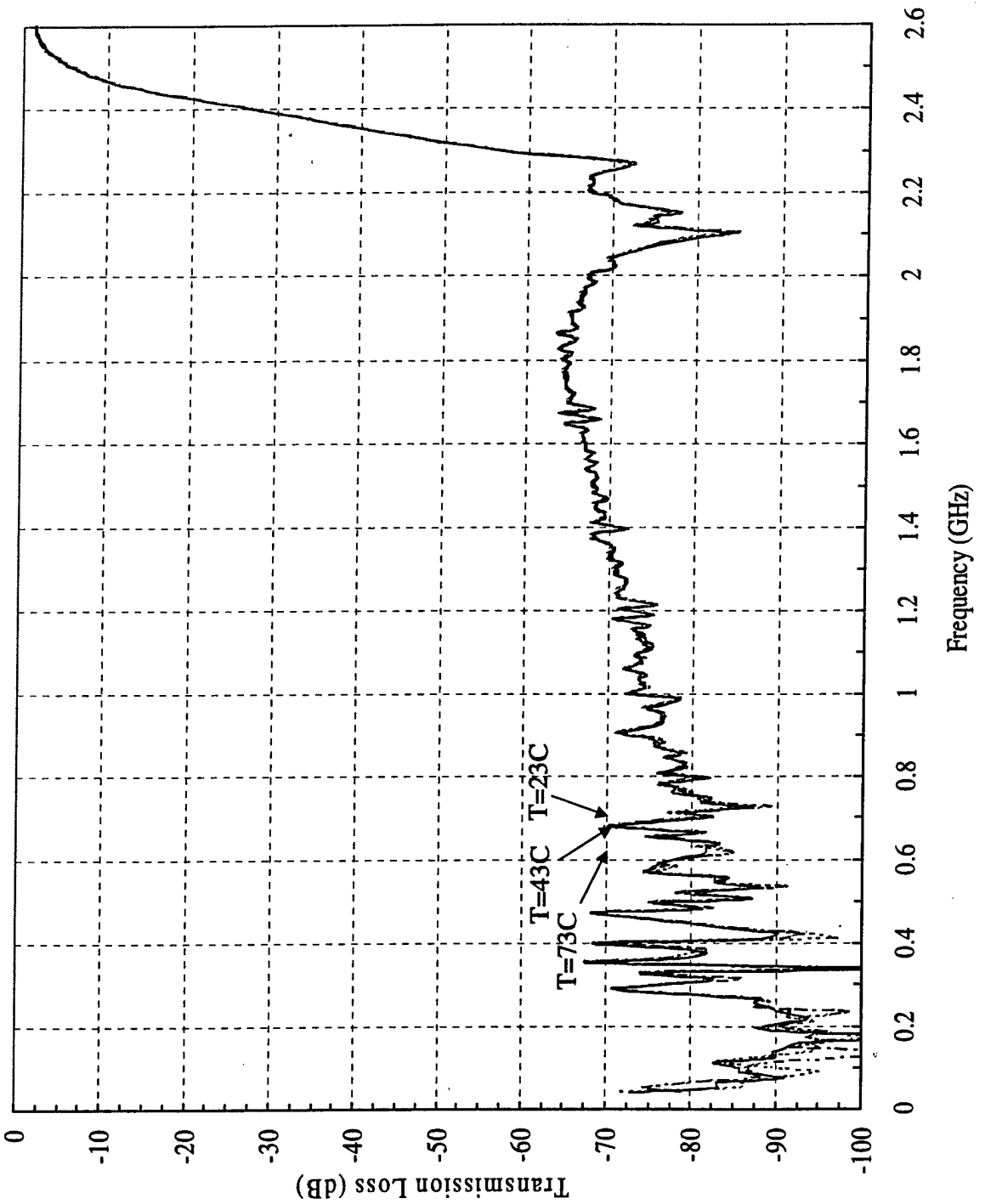

Figure 3.16 Channel 2 out-of-band rejection variation on temperature (unit#3)

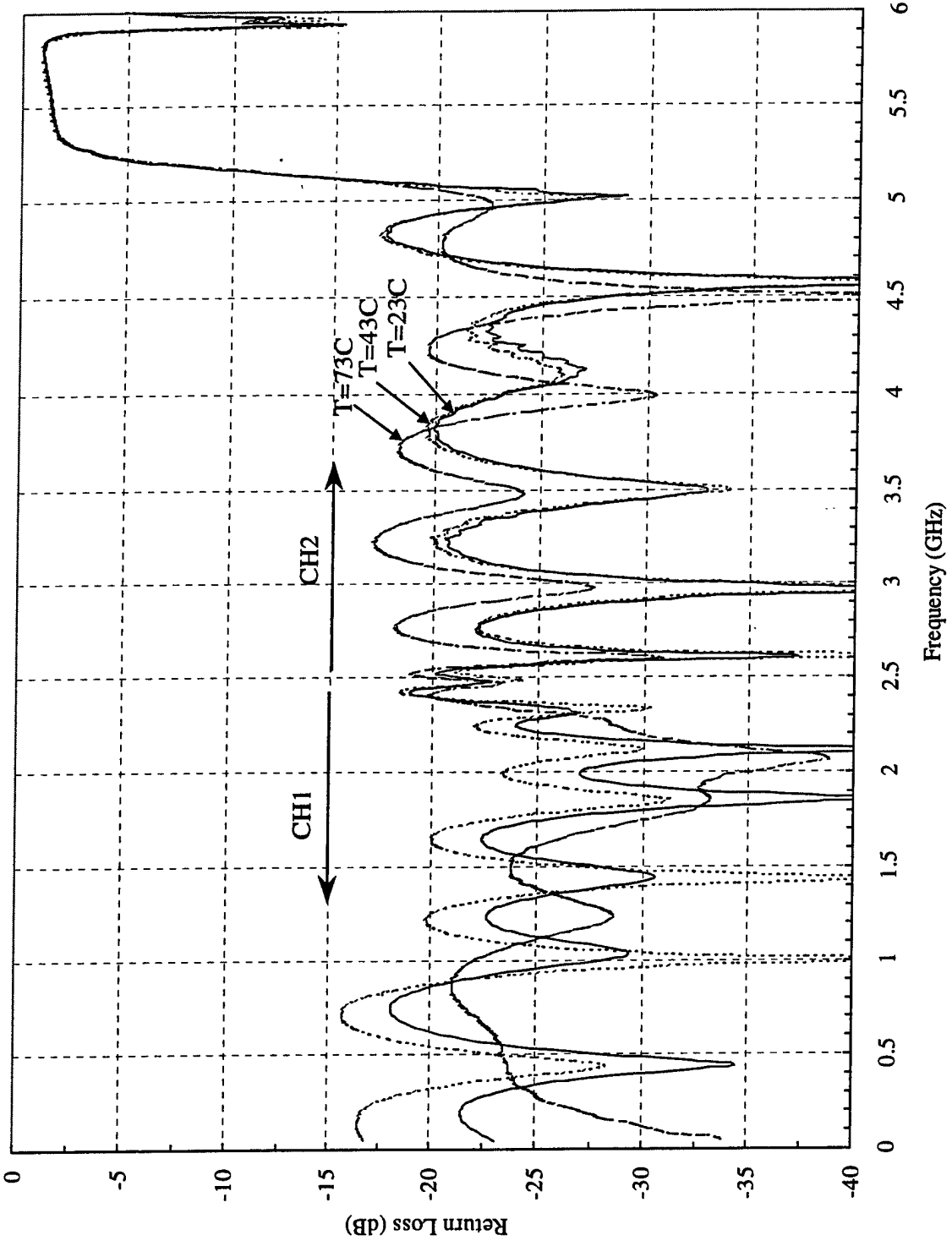

Figure 3.17 Diplexer input return loss variation on temperature (unit#3)

### 3.4 Diplexer High Power Test

To ensure the survivability of the miniature broadband contiguous diplexer in a harsh RFI environment, the high power test was performed. The output CW power of the available TWTA is about 15watts at 3.75 GHz and then degrades substantially at 2.0 GHz. To assess the diplexer power capability to the highest available TWTA output power, the test was performed at  $f=3.75\text{GHz}$  only. Both in-band insertion loss and housing temperature were monitored as the input power was increased from 1miliwatts to 10 watts. Figure 3.18 summarizes the high power test results. The diplexer survived with no damage at 10W input power. The in-band loss degradation is less than 0.2dB and the housing temperature increase is less than 30degrees (in F) for input power up to 8 watts.

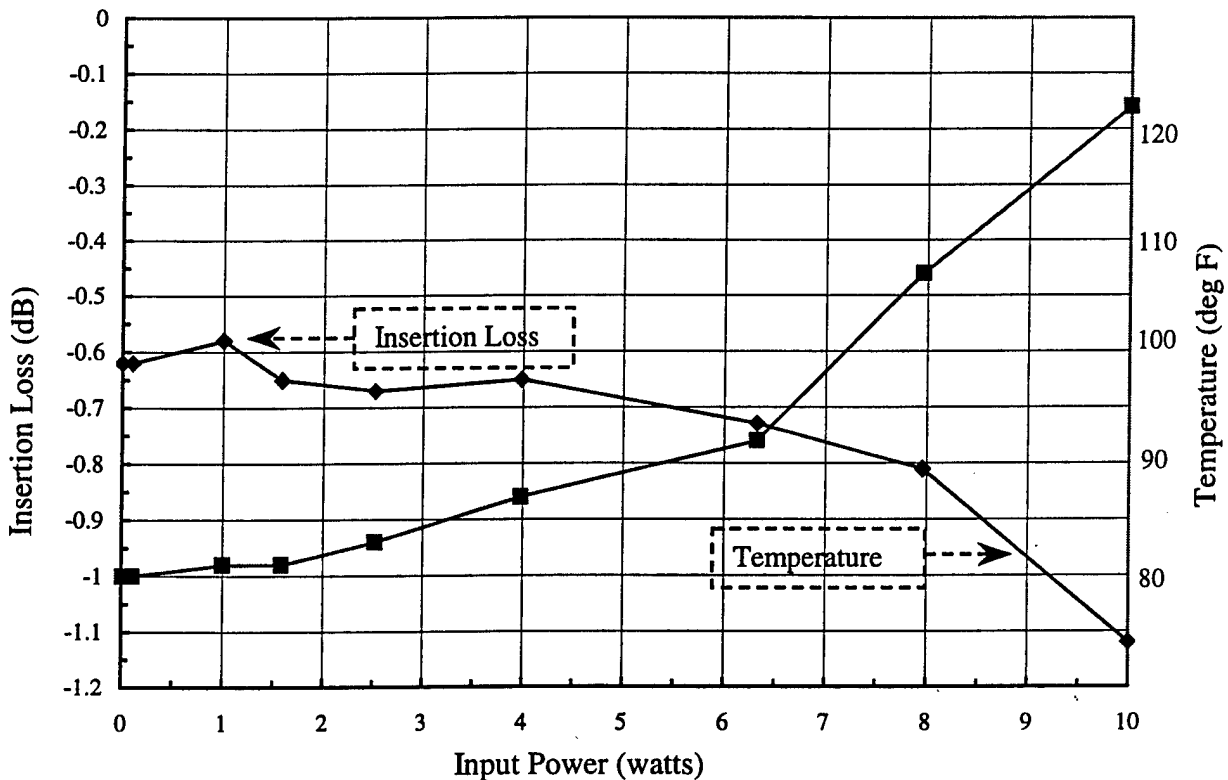

Figure 3.18 High power test results of miniature diplexer

### 3.5 Diplexer Tracking Performance

Good unit-to-unit tracking performance in both amplitude and phase is necessary for array applications. It preserves array beam characteristics, minimizes random scattering lobes off the array and minimizes the integrating cost at the array level. To evaluate the unit tracking performance, six miniature contiguous X/L-band diplexers (2<sup>nd</sup> iteration design) were fabricated, assembled and test. Units #1 to #4 were fabricated first, units #5 and #6 were done three months later. The RF functional tests were performed at three different temperatures, ambient (23C), 43C and 73C. The unit tracking performance can therefore be assessed not only at the ambient but also at other temperatures.

Figures 3.19 to 39 shows the unit-to-unit tracking performance on passband insertion loss, passband phase, out-of-band rejection and input return loss among six diplexers at three different temperatures. The results are summarized as follows:

- (a) CH1 insertion loss tracking :  $\leq 0.1\text{dB}$  (p-p)
- (b) CH1 Passband phase tracking:  $\leq 3\text{deg}$  (p-p)
- (c) CH1 out-of-band rejection tracking: track well in noise floor level ( $\sim 75\text{dB}$ )
- (d) CH1 passband return loss tracking: track well ( $\leq 20\text{dB}$  return loss for all units)
- (e) CH2 insertion loss tracking :  $\leq 0.15\text{dB}$  (p-p) most of band,  
 $\leq 0.30\text{dB}$  (p-p) 80% of passband
- (f) CH2 Passband phase tracking:  $\leq 8\text{deg}$  (p-p) most of band and  
 $\leq 10\text{deg}$  (p-p) 80% of passband for units #1 to #4  
 $\leq 6\text{deg}$  (p-p) 80% of passband for units #5 and #6
- (g) CH2 out-of-band rejection tracking: track well ( $\leq 3\text{dB}$ ,p-p) above noise floor level  
( $\sim 75\text{dB}$ )
- (h) CH2 passband return loss tracking: track well ( $\leq 17\text{dB}$  return loss for all units,  
 $15\text{dB}$  worst case at bandedges)

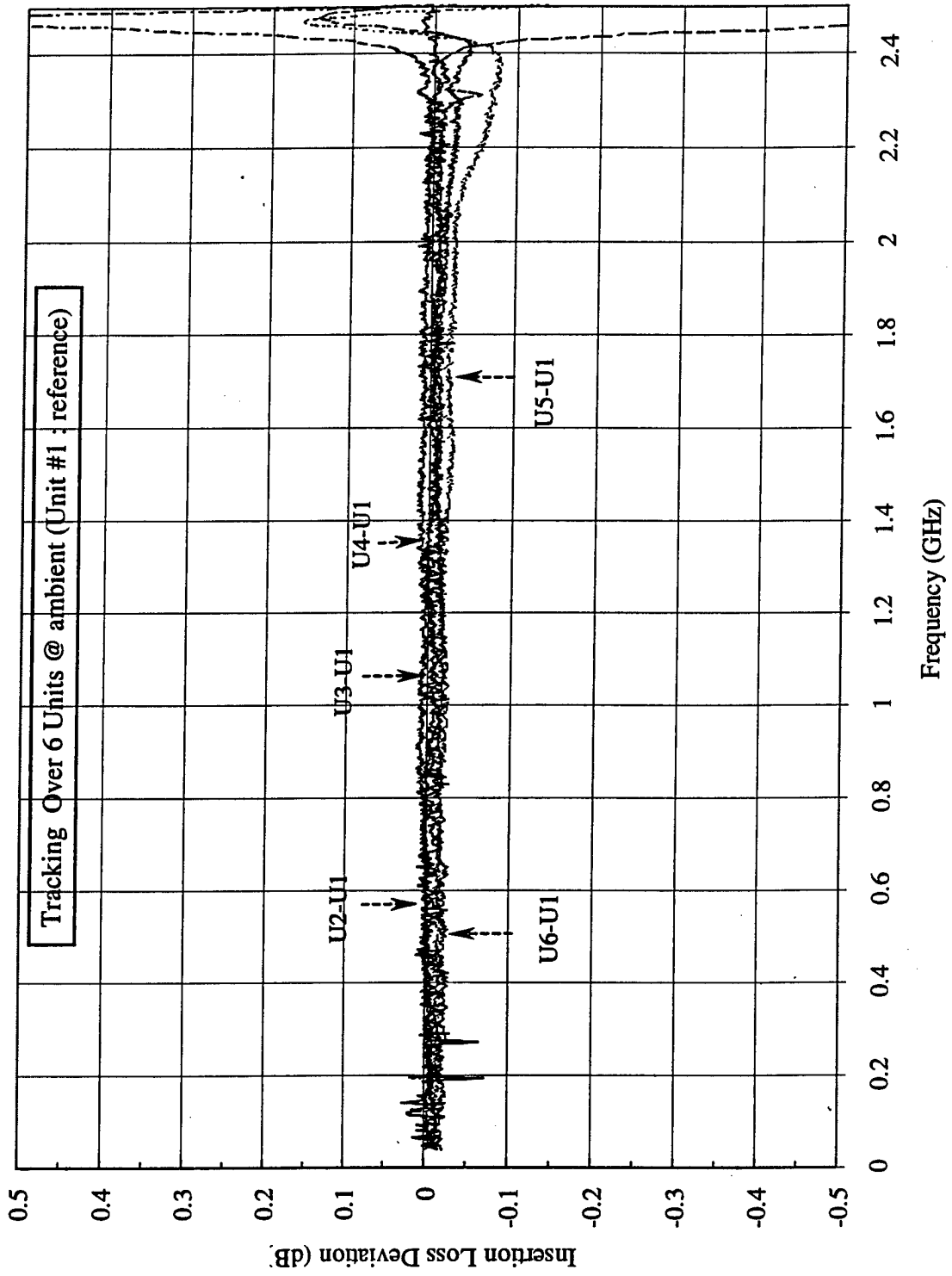

Figure 3.19 Unit-to-unit tracking on channel 1 insertion loss over 6 units-- at ambient

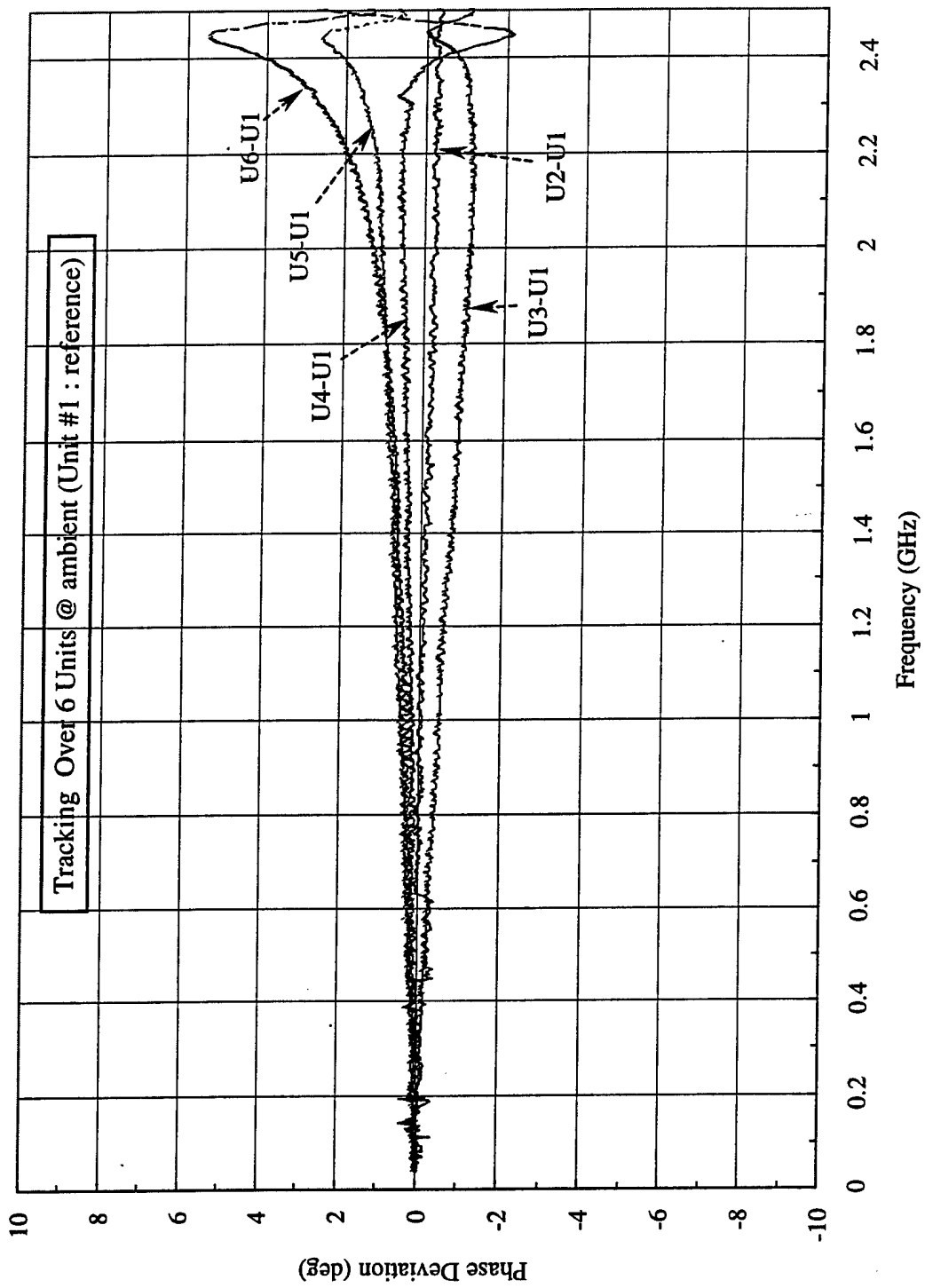

Figure 3.20 Unit-to-unit tracking on channel 1 passband phase over 6 units-- at ambient

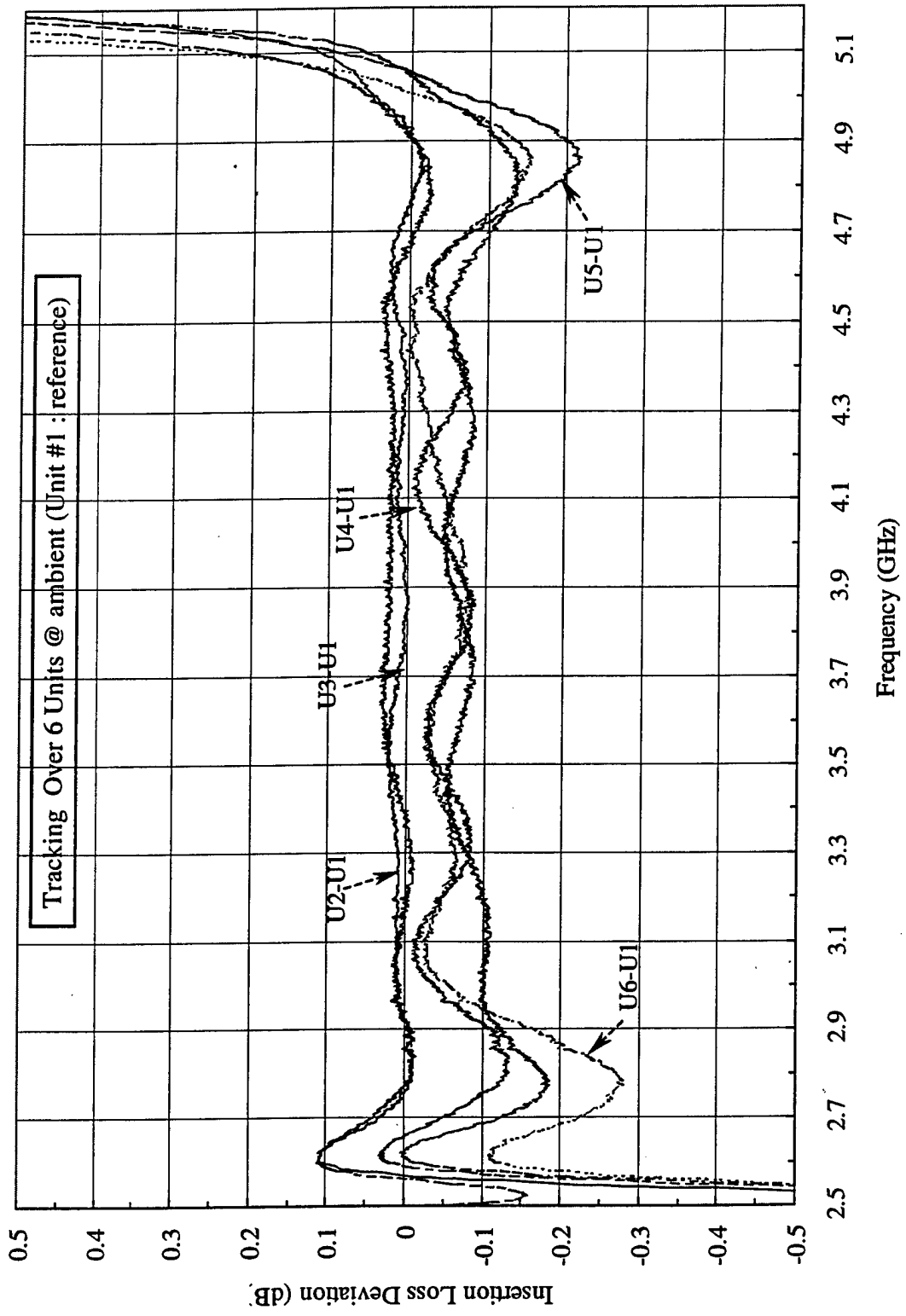

Figure 3.21 Unit-to-unit tracking on channel 2 insertion loss over 6 units-- at ambient



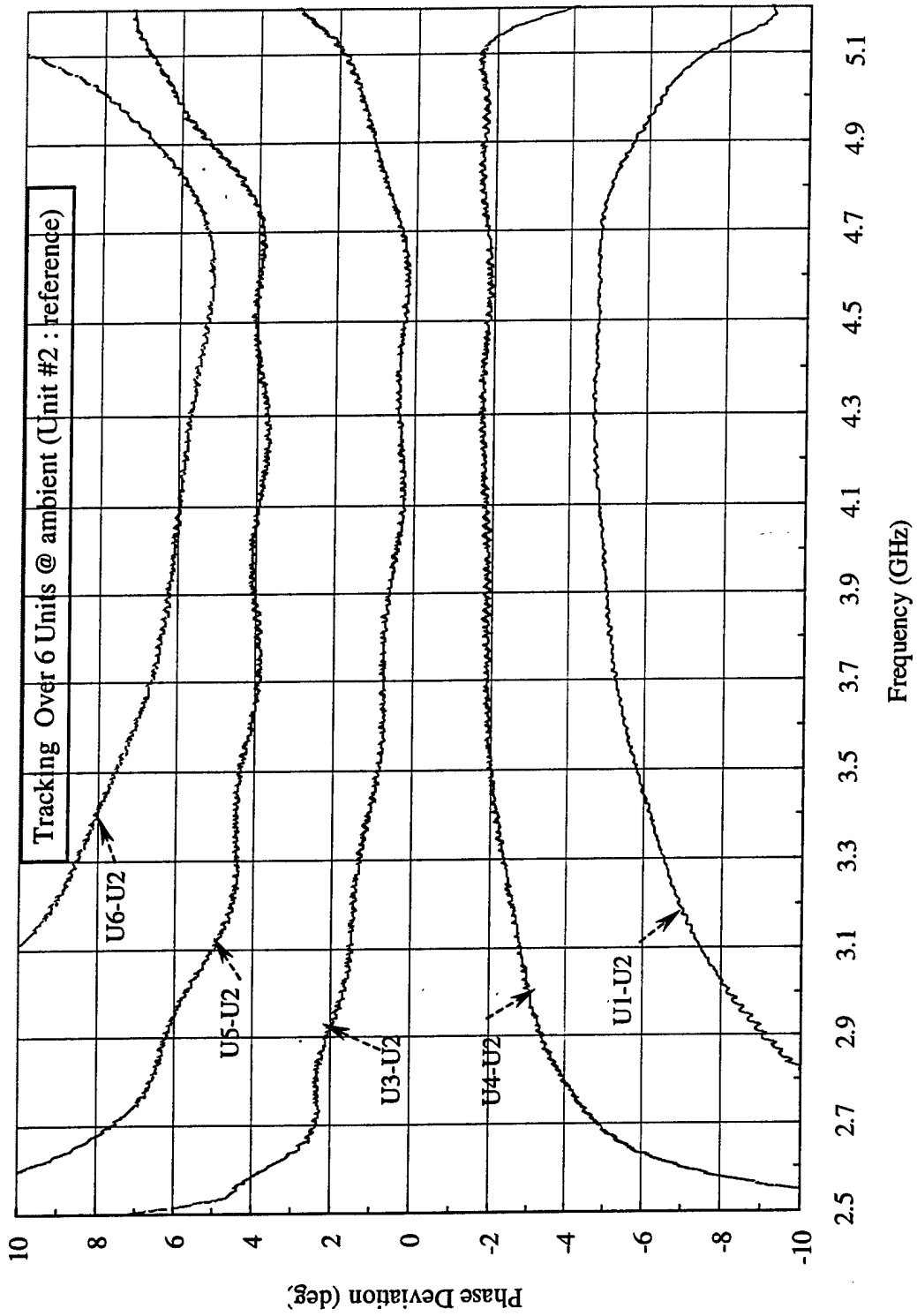

Figure 3.22 Unit-to-unit tracking on channel 2 passband phase over 6 units-- at ambient

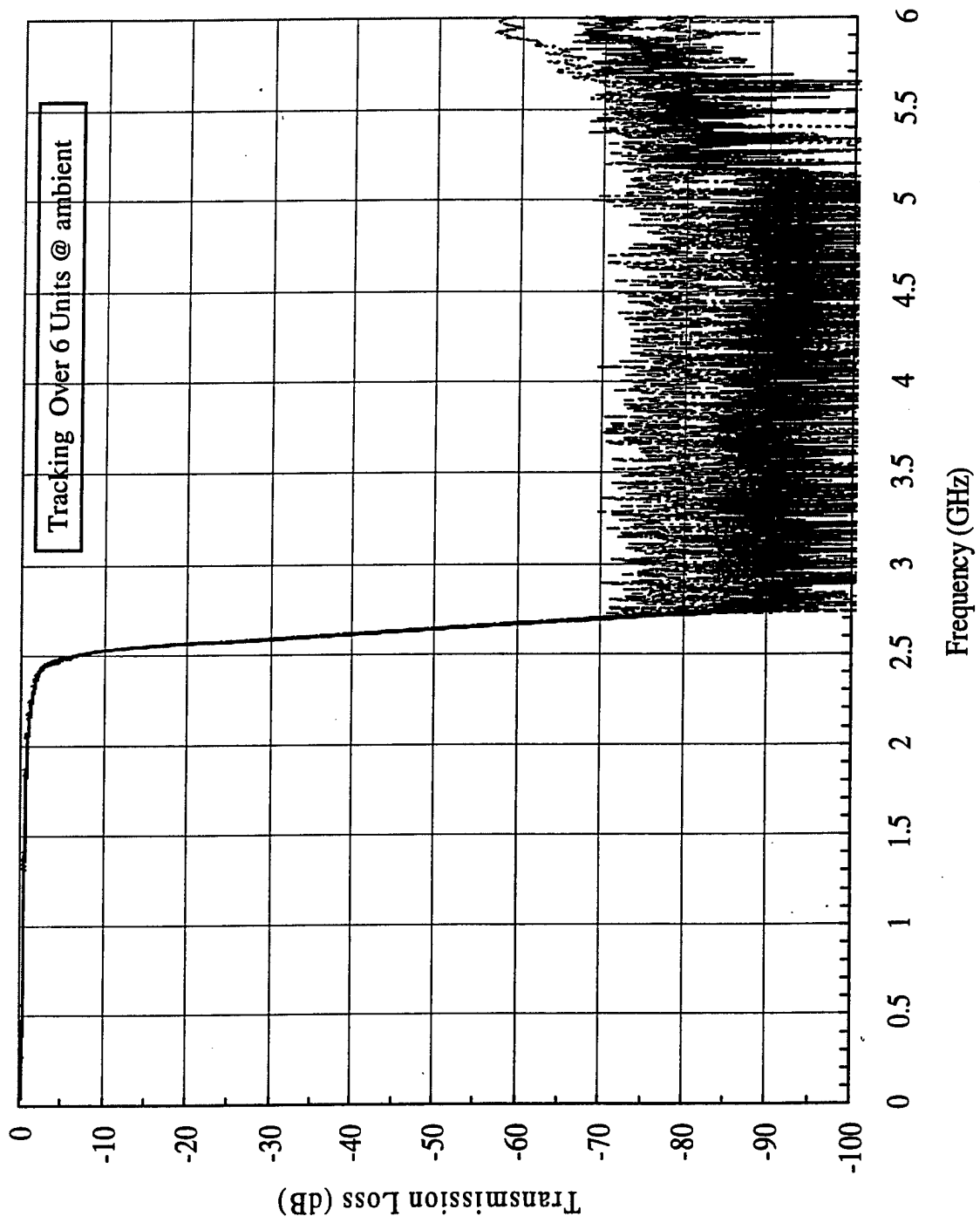

Figure 3.23 Unit-to-unit tracking on channel 1 out-of-band rejection over 6 units-- at ambient

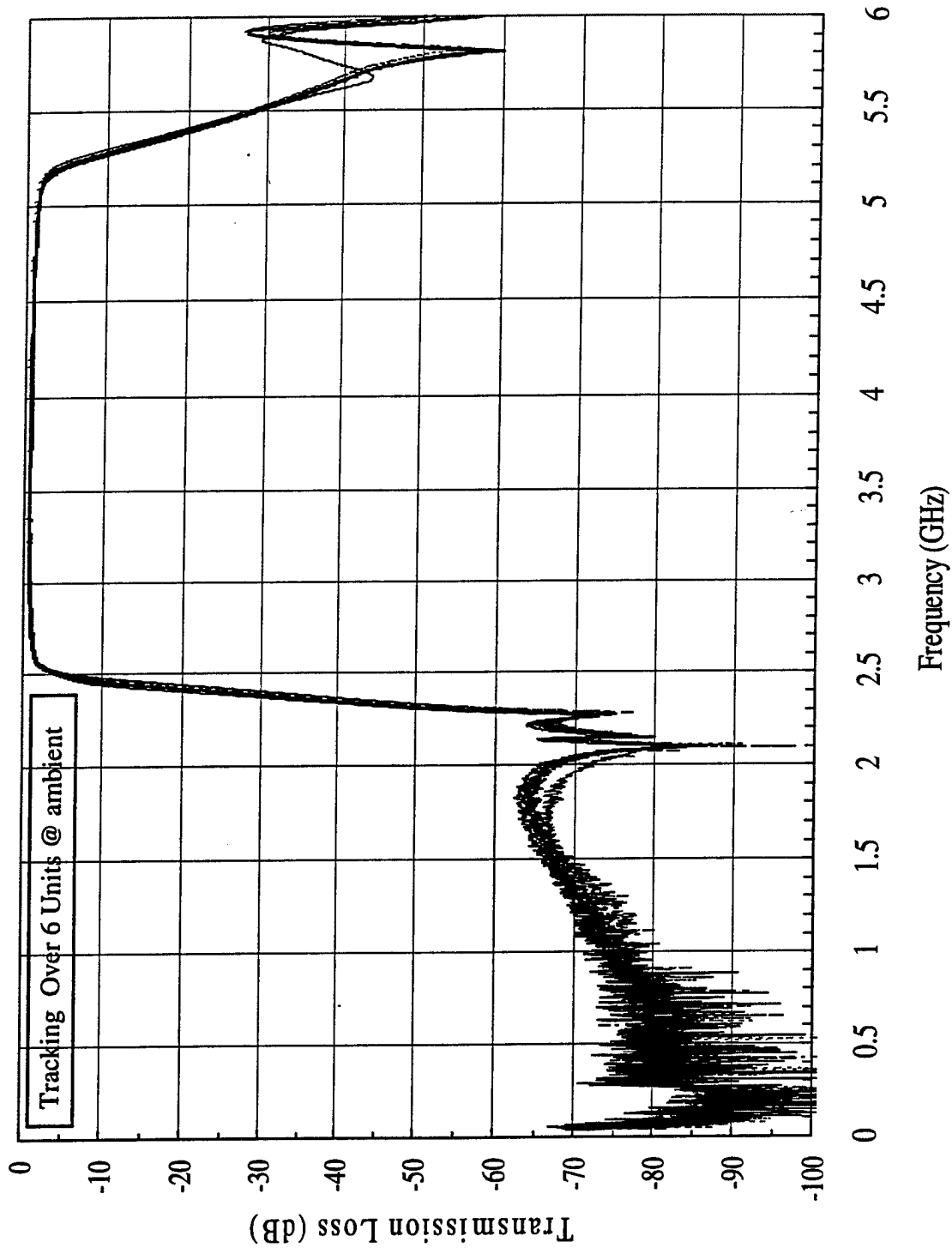

Figure 3.24 Unit-to-unit tracking on channel 2 out-of-band rejection over 6 units-- at ambient

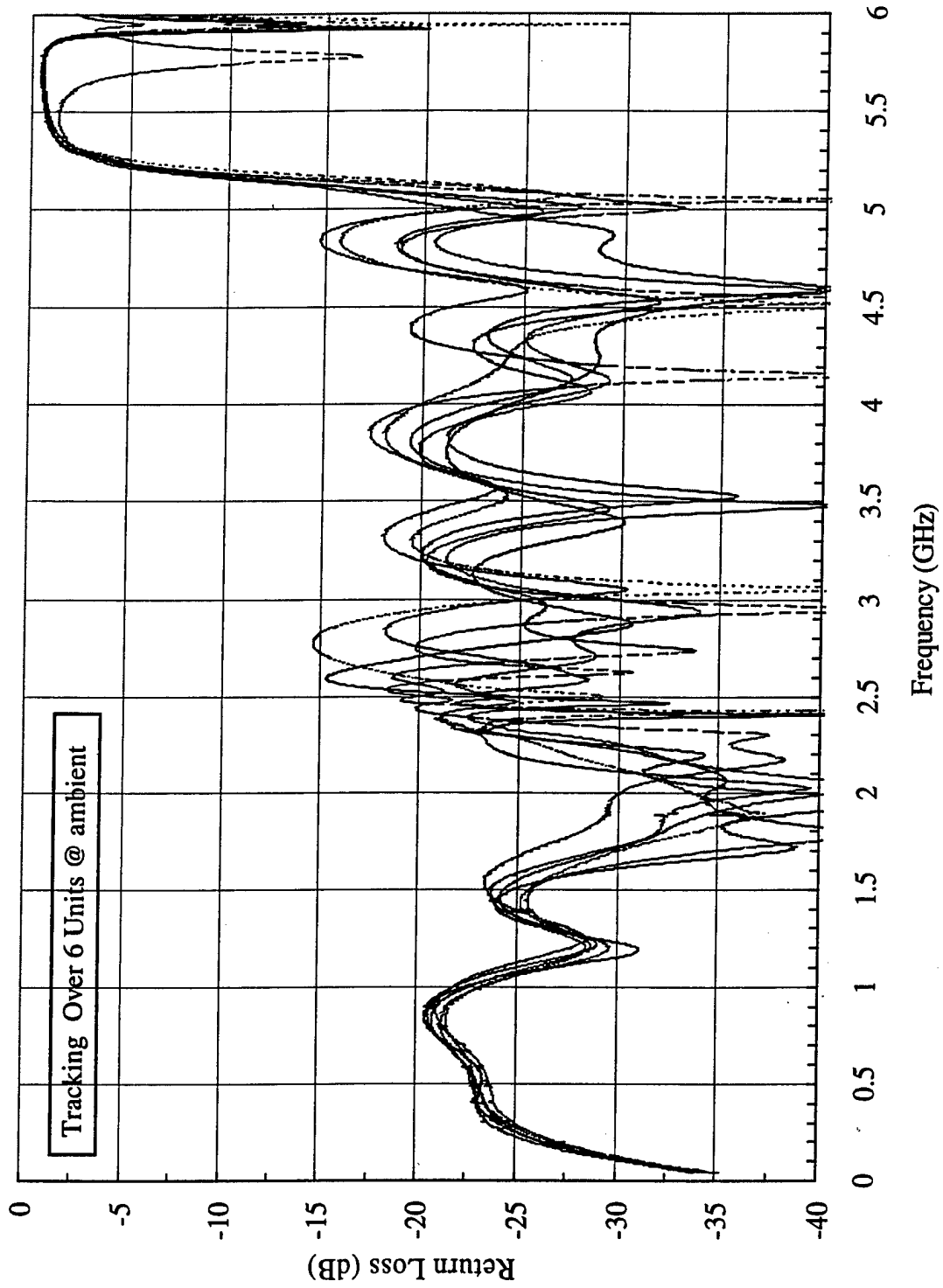

Figure 3.25 Unit-to-unit tracking on diplexer input return loss over 6 units-- at ambient

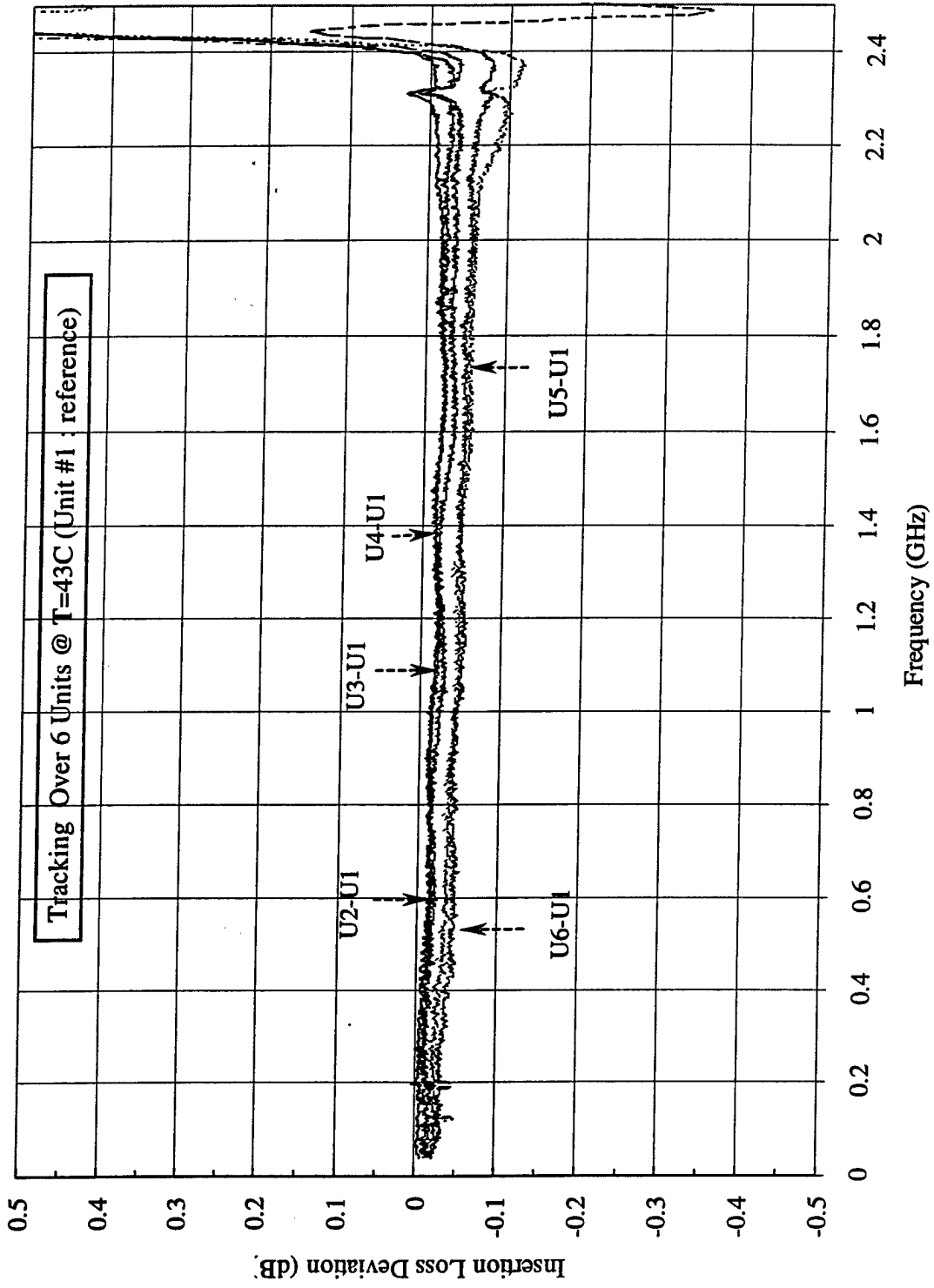

Figure 3.26 Unit-to-unit tracking on channel 1 insertion loss over 6 units-- at T=43C

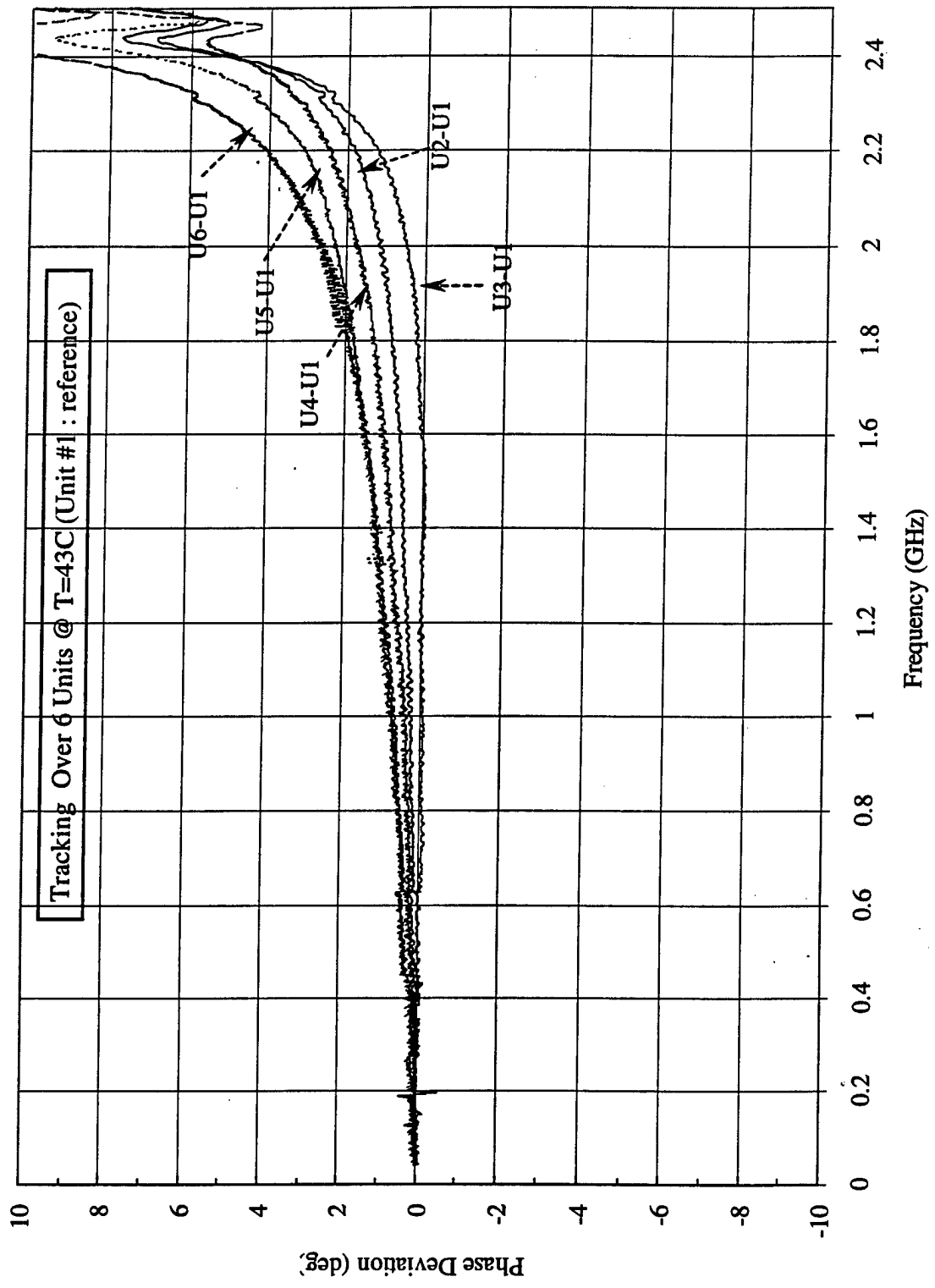

Figure 3.27 Unit-to-unit tracking on channel 1 passband phase over 6 units-- at T=43C

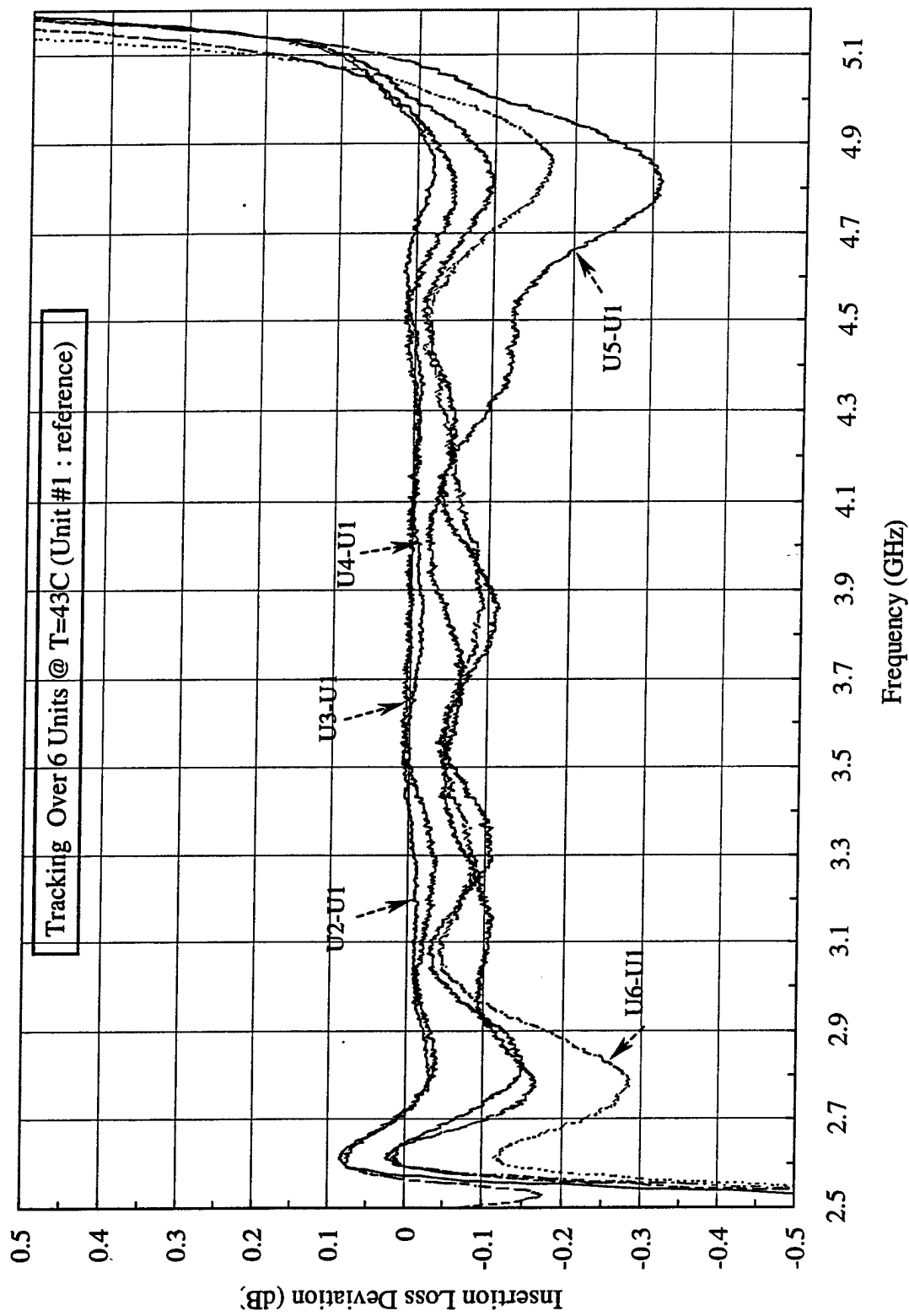

Figure 3.28 Unit-to-unit tracking on channel 2 insertion loss over 6 units-- at T=43C

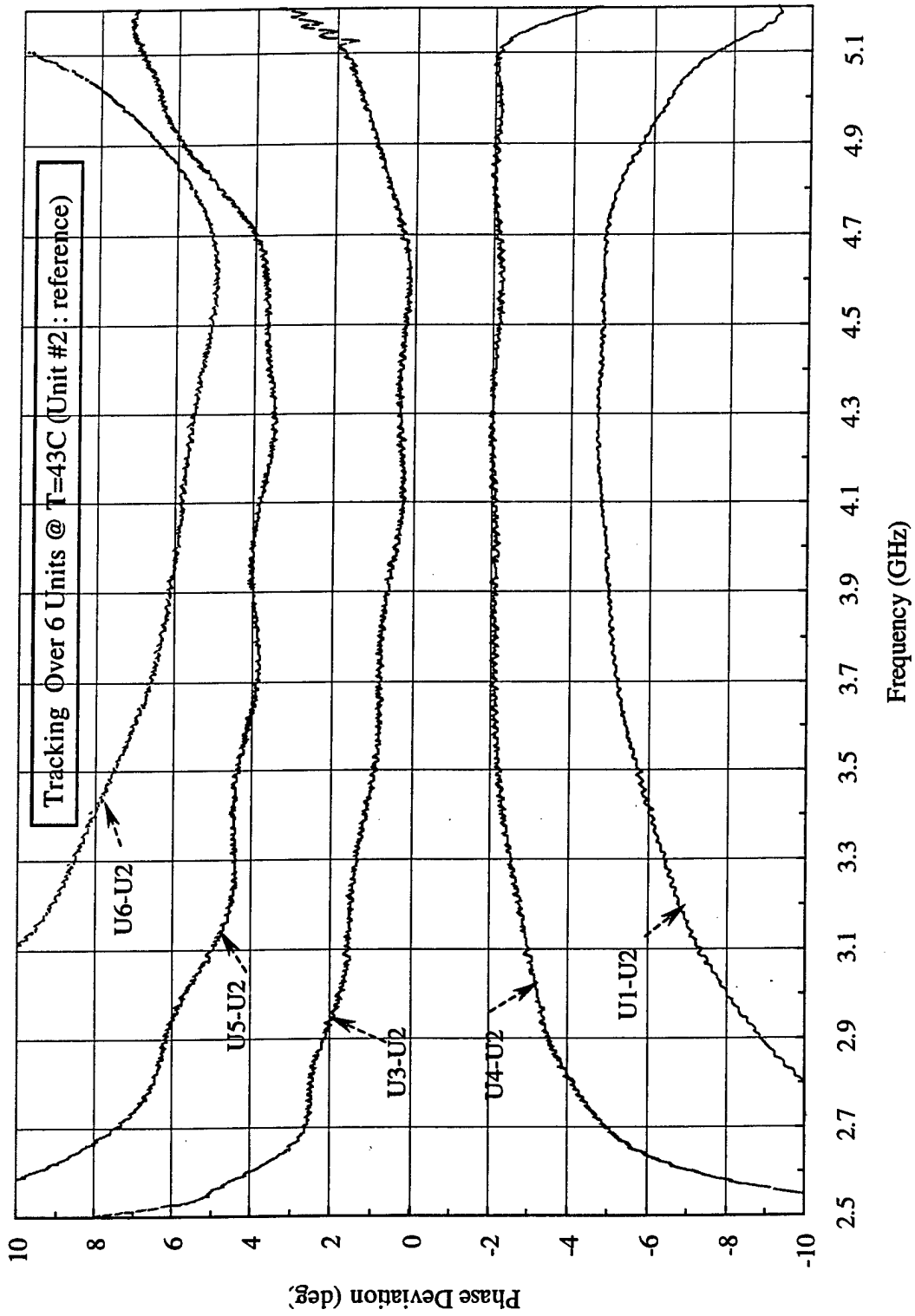

Figure 3.29 Unit-to-unit tracking on channel 2 passband phase over 6 units-- at T=43C



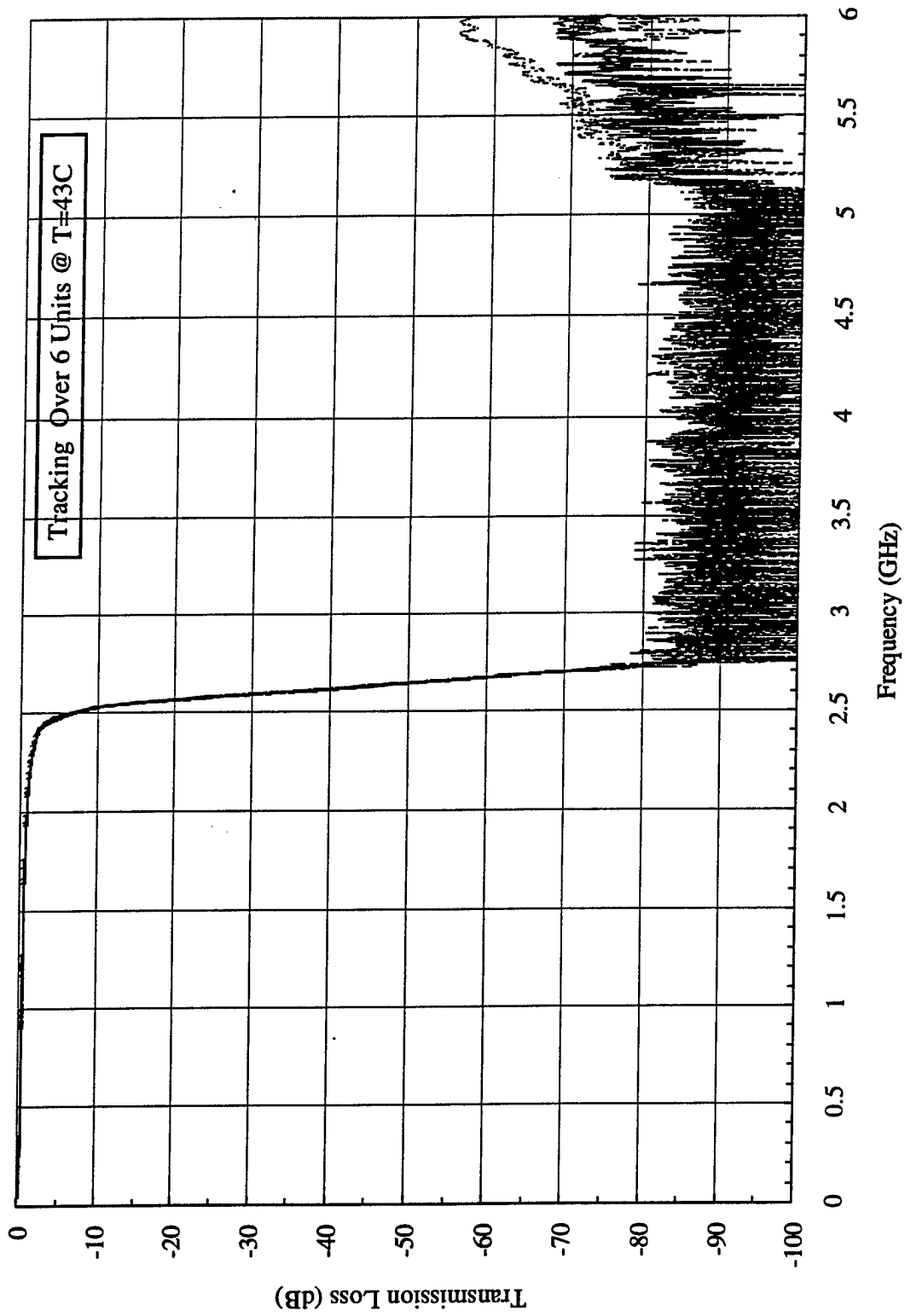

Figure 3.30 Unit-to-unit tracking on channel 1 out-of-band rejection over 6 units-- at T=43C

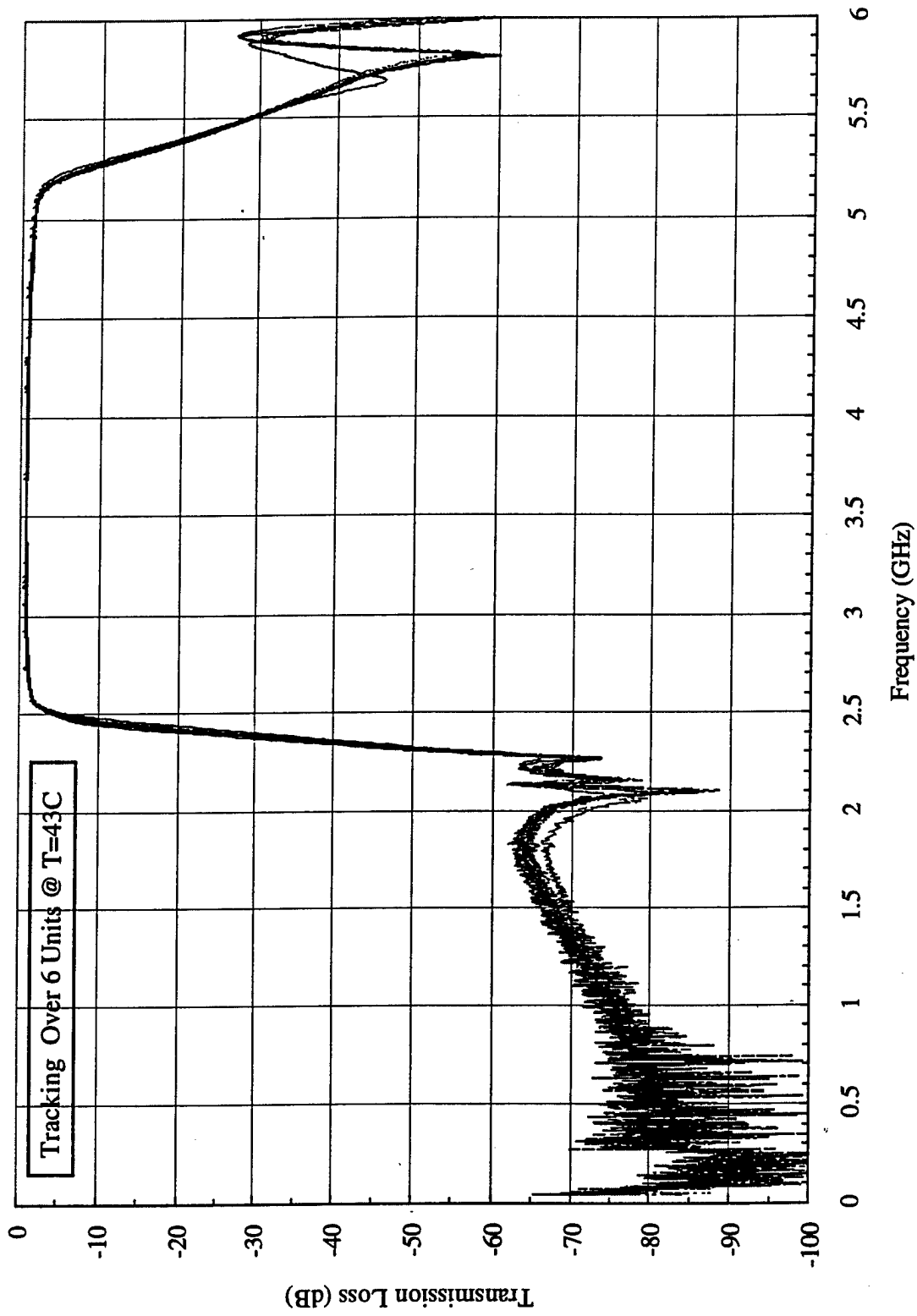

Figure 3.31 Unit-to-unit tracking on channel 2 out-of-band rejection over 6 units-- at T=43C

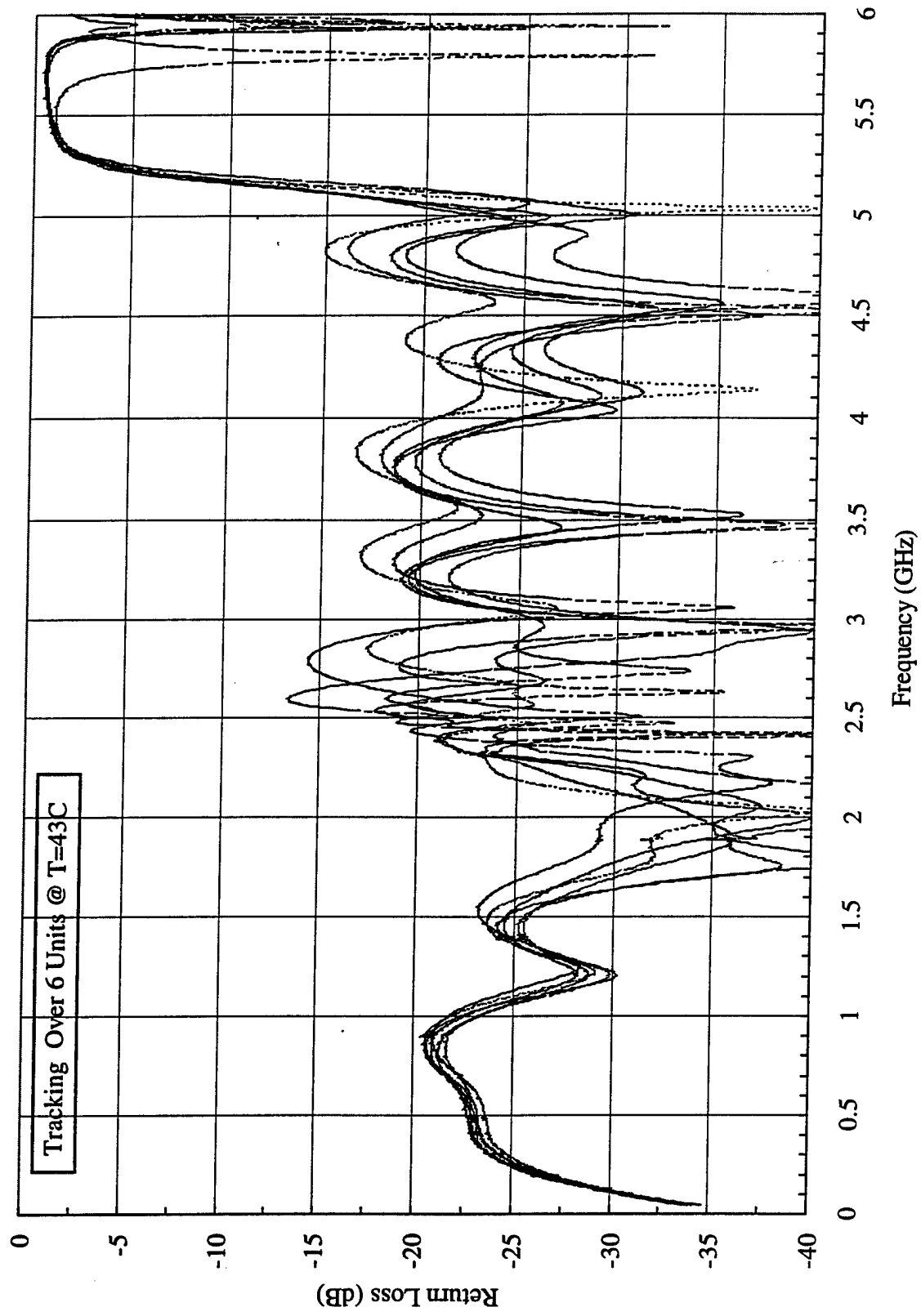

Figure 3.32 Unit-to-unit tracking on diplexer input return loss over 6 units-- at T=43C

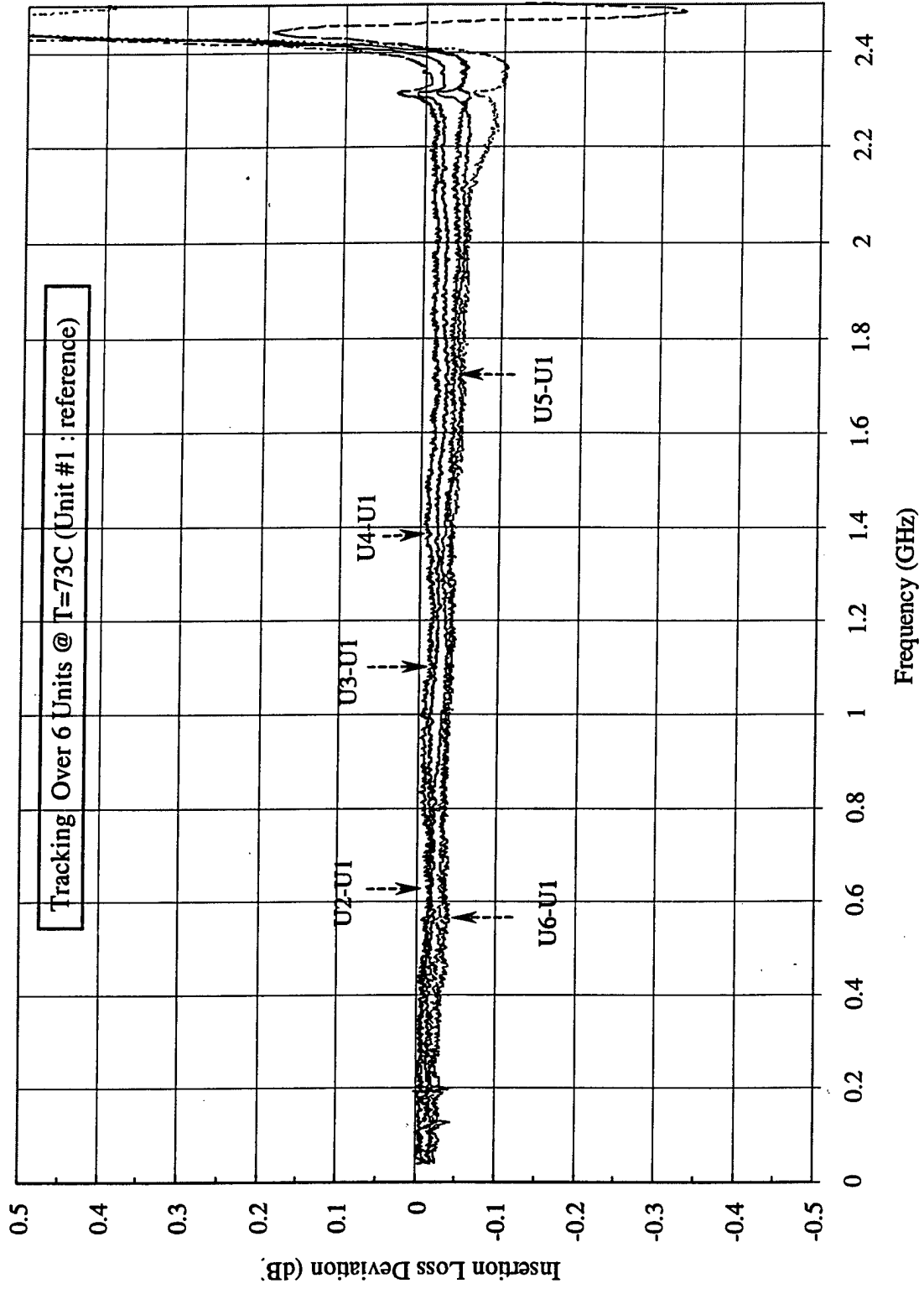

Figure 3.33 Unit-to-unit tracking on channel 1 insertion loss over 6 units-- at T=73C

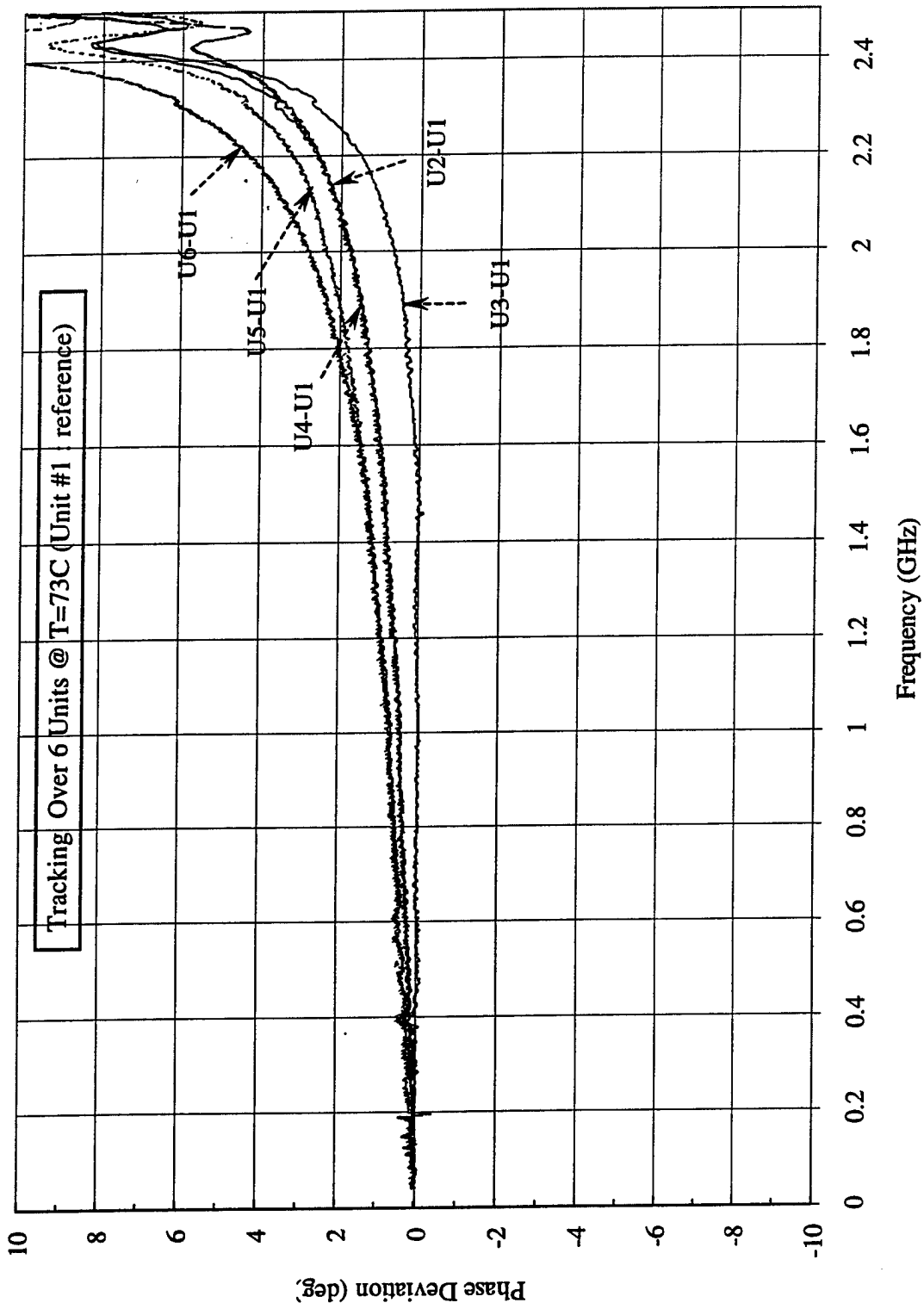

Figure 3.34 Unit-to-unit tracking on channel 1 passband phase over 6 units-- at T=73C

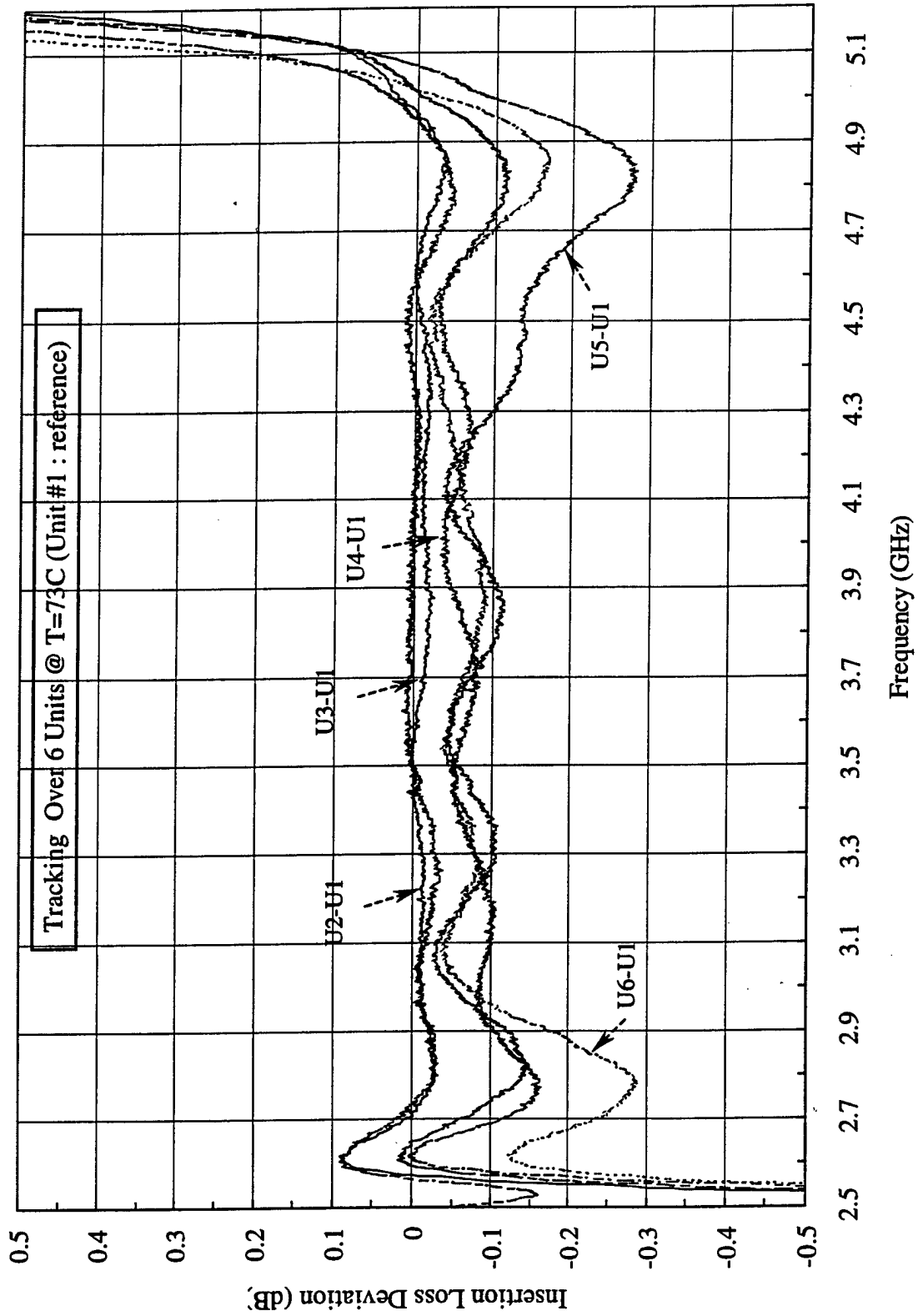

Figure 3.35 Unit-to-unit tracking on channel 2 insertion loss over 6 units-- at T=73C

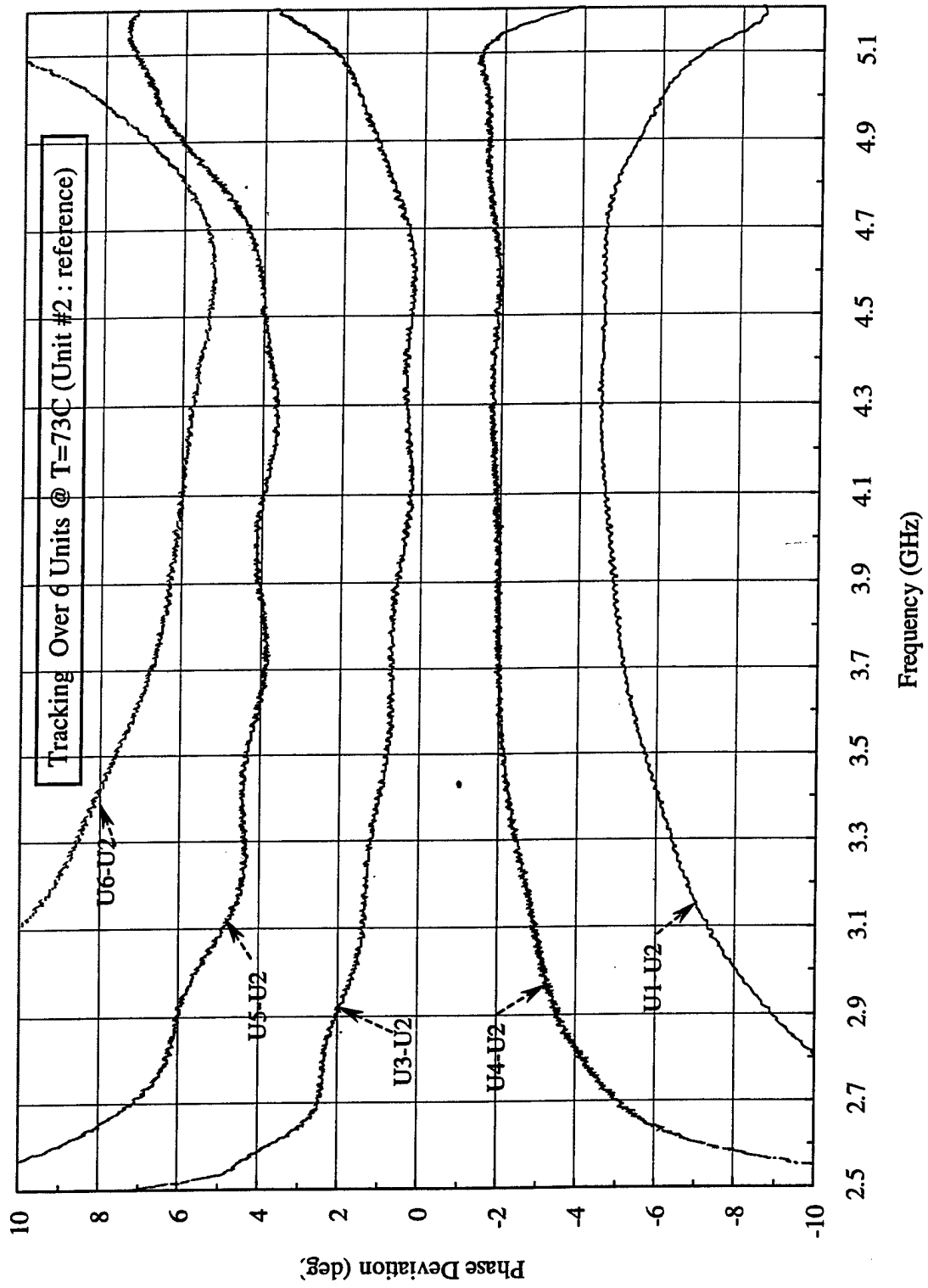

Figure 3.36 Unit-to-unit tracking on channel 2 passband phase over 6 units-- at T=73C

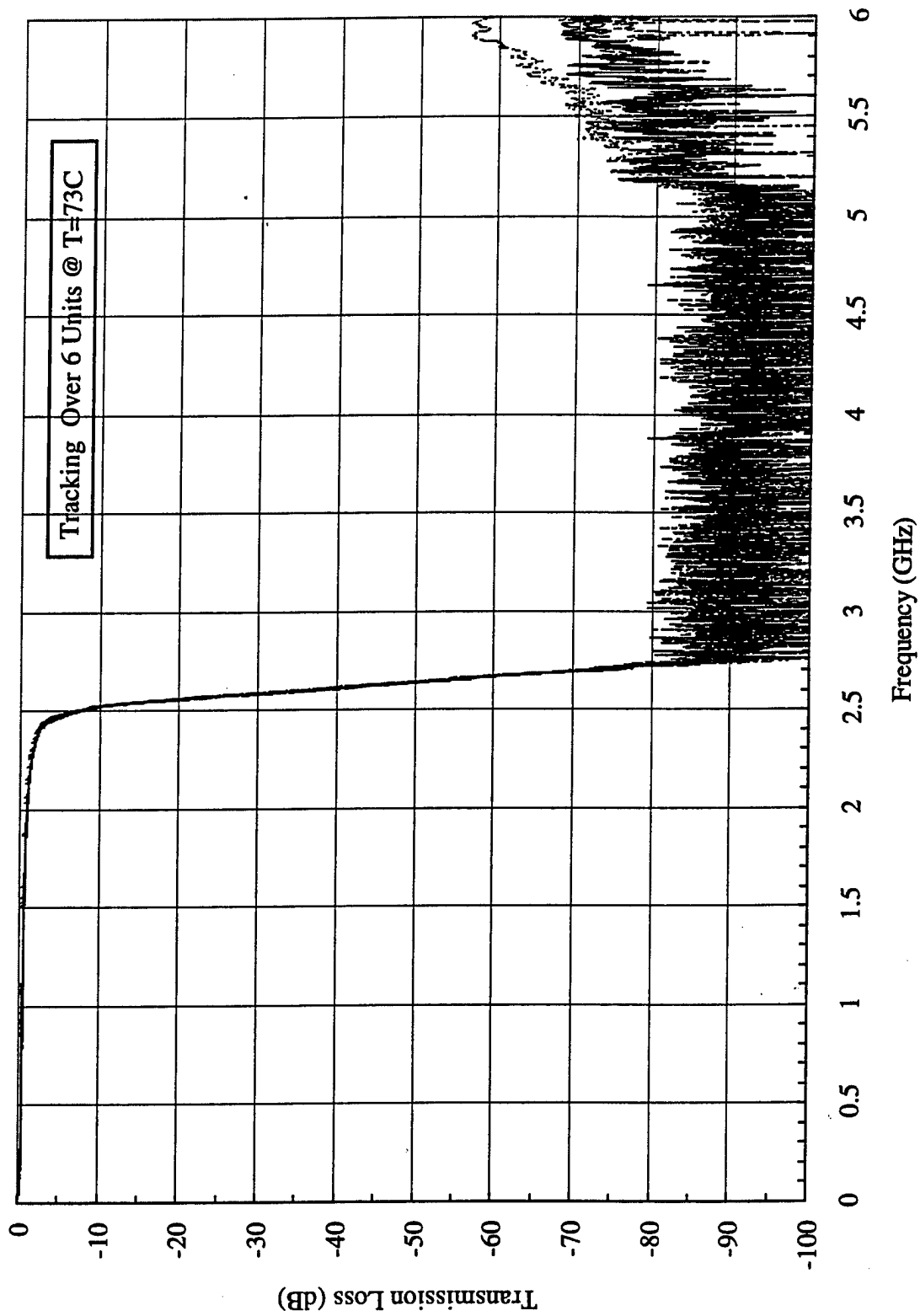

Figure 3.37 Unit-to-unit tracking on channel 1 out-of-band rejection over 6 units-- at T=73C



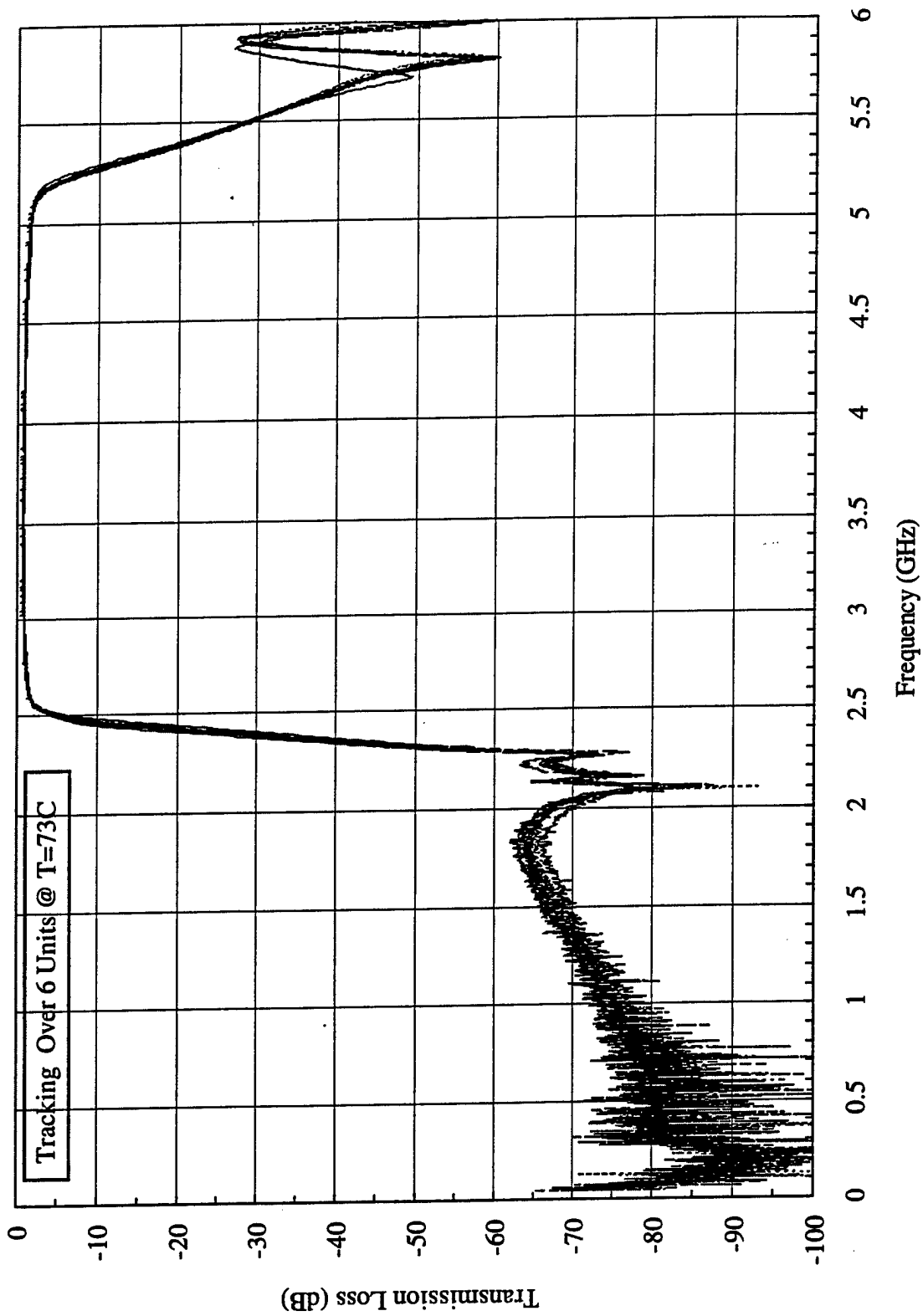

Figure 3.38 Unit-to-unit tracking on channel 2 out-of-band rejection over 6 units-- at T=73C

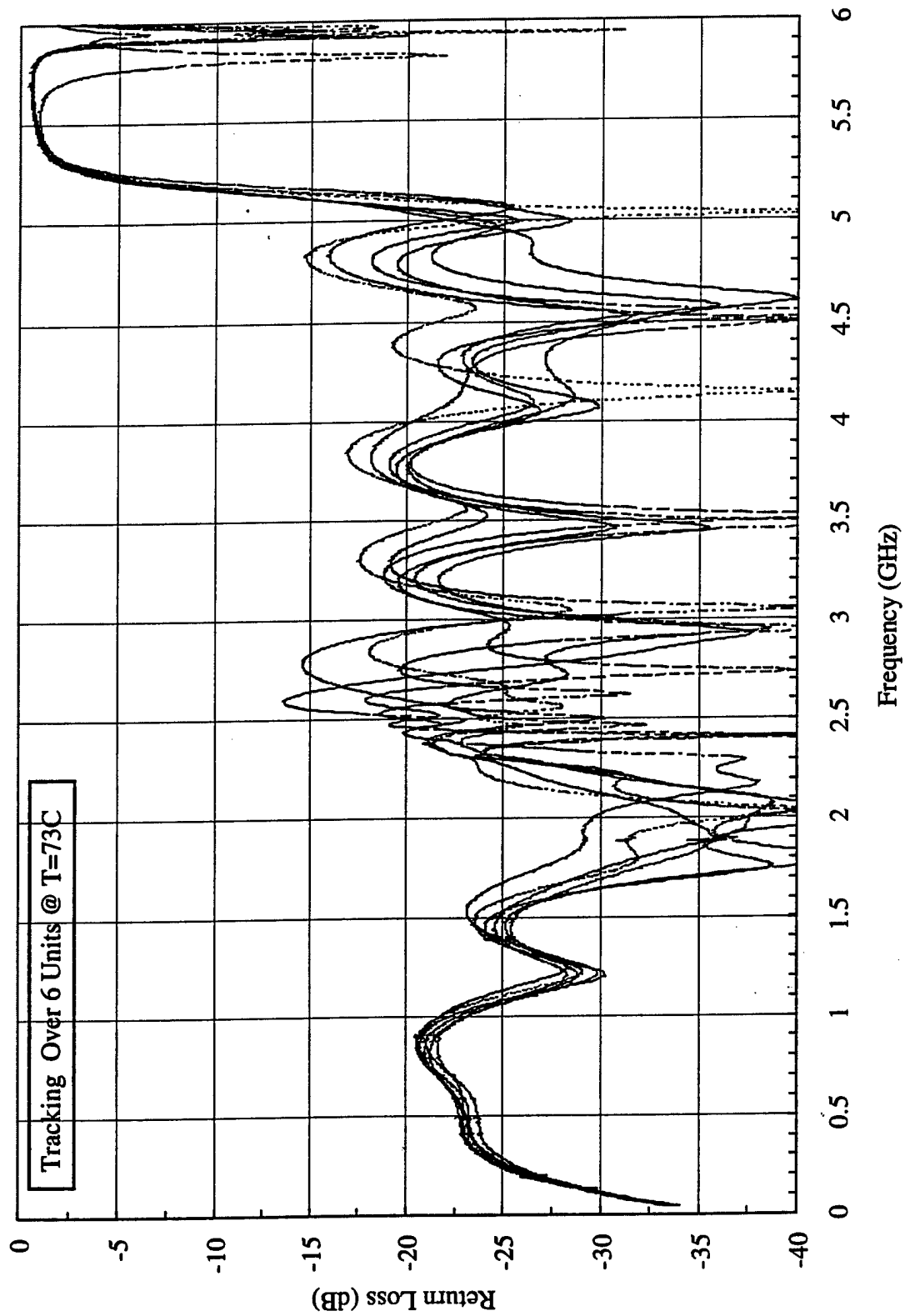

Figure 3.39 Unit-to-unit tracking on diplexer input return loss over 6 units-- at T=73C

### 3.6 Conclusion

A miniature, broadband contiguous X/L-band diplexer technology has been successfully developed. Diplexers have been designed, fabricated, assembled and tested. The state-of-the-art performance is demonstrated. The diplexer covers both X and L bands (or DC to 5.20 GHz). The in-band insertion loss is less than 1.0dB, the channel isolation is greater than 60 dB, and the input return loss is better than 20dB across the entire frequency band. The size of the diplexer is 2.40 inch (length), 0.10 inch (height) and 1.20 inch (width) for the first iteration and 1.05 inch (width) for the second iteration. The miniature diplexers are implemented on a printed substrate. No tuning screws, chip capacitors and via holes are required. It is an ideal candidate for affordable mass production applications. The measured results clearly demonstrate that a miniature, high performance and low cost preselector multiplexer is achievable. The success of this miniature diplexer represents a breakthrough in filter/multiplexer technology. No such miniature, common-junction, contiguous microstrip X/L-band multiplexer has yet been reported in the literature. This is a significant step toward the integration of the preselector multiplexer into actual T/R modules for advanced multifunction array systems.