

TECHNICAL MEMORANDUM NO. I-68

**AUTOMATIC TRACKING DEVICE
FOR
VISUAL ACCUMULATION TUBE ANALYSIS**

LIBRARY
CORPS OF ENGINEERS
Property of the U. S. Government
US-CE-C

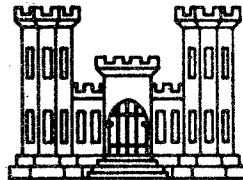

April 1968

Copies Furnished to DTIC
Reproduced From
Bound Original

19990525 047

DEPARTMENT OF THE ARMY
Missouri River Division, Corps of Engineers
DIVISION LABORATORY
OMAHA, NEBRASKA

DISTRIBUTION STATEMENT A
Approved for Public Release
Distribution Unlimited

REPORT DOCUMENTATION PAGE

Form Approved
OMB No. 0704-0188

Public reporting burden for this collection of information is estimated to average 1 hour per response, including the time for reviewing instructions, searching existing data sources, gathering and maintaining the data needed, and completing and reviewing the collection of information. Send comments regarding this burden estimate or any other aspect of this collection of information, including suggestions for reducing this burden, to Washington Headquarters Services, Directorate for Information Operations and Reports, 1215 Jefferson Davis Highway, Suite 1204, Arlington, VA 22202-4302, and to the Office of Management and Budget, Paperwork Reduction Project (0704-0188), Washington, DC 20503.

1. AGENCY USE ONLY (Leave blank)	2. REPORT DATE <i>April 1968</i>	3. REPORT TYPE AND DATES COVERED	
4. TITLE AND SUBTITLE <i>Automatic Tracking Device for Visual Accumulation Tube Analysis</i>		5. FUNDING NUMBERS	
6. AUTHOR(S)		7. PERFORMING ORGANIZATION NAME(S) AND ADDRESS(ES)	
7. PERFORMING ORGANIZATION NAME(S) AND ADDRESS(ES)		8. PERFORMING ORGANIZATION REPORT NUMBER	
9. SPONSORING / MONITORING AGENCY NAME(S) AND ADDRESS(ES) <i>Missouri River Division, Corps of Engineers Division Laboratory Omaha, Nebraska</i>		10. SPONSORING / MONITORING AGENCY REPORT NUMBER <i>Technical Memorandum No. 1-68</i>	
11. SUPPLEMENTARY NOTES			
12a. DISTRIBUTION / AVAILABILITY STATEMENT <i>The contents of this report are not to be used for advertising, publication, or promotional purposes. Citation of trade name does not constitute an official endorsement or approval of the use of such commercial products.</i>		12b. DISTRIBUTION CODE	
13. ABSTRACT (Maximum 200 words) <i>This report discusses the construction and operation of an automatic tracking device for following the level of sediment in the visual accumulation tube in sedimentation analysis of sands. The device consists of a light beam and photocell tracking assembly which is attached to the recorder mechanism of the apparatus described in Report K, "Operator's manual on the Visual-Accumulation Tube method for Sedimentation Analysis of Sands," prepared by the Subcommittee on Sedimentation of the Inter-Agency Committee on Water Resources.</i>			
14. SUBJECT TERMS <i>Visual accumulation tube method sediment-accumulation</i>		15. NUMBER OF PAGES <i>4</i>	
14. SUBJECT TERMS <i>Visual accumulation tube method sediment-accumulation</i>		16. PRICE CODE	
17. SECURITY CLASSIFICATION OF REPORT <i>Unofficial</i>	18. SECURITY CLASSIFICATION OF THIS PAGE <i>Unofficial</i>	19. SECURITY CLASSIFICATION OF ABSTRACT <i>Unofficial</i>	20. LIMITATION OF ABSTRACT

THE CONTENTS OF THIS REPORT ARE NOT TO BE
USED FOR ADVERTISING, PUBLICATION, OR
PROMOTIONAL PURPOSES. CITATION OF TRADE
NAMES DOES NOT CONSTITUTE AN OFFICIAL
INDORSEMENT OR APPROVAL OF THE USE OF
SUCH COMMERCIAL PRODUCTS.

PREFACE

This report discusses the construction and operation of an automatic tracking device for following the level of sediment in the visual accumulation tube in sedimentation analyses of sands. The device consists of a light beam and photocell tracking assembly which is attached to the recorder mechanism of the apparatus described in Report K, "Operator's Manual on the Visual-Accumulation Tube Method for Sedimentation Analysis of Sands", prepared by the Subcommittee on Sedimentation of the Inter-Agency Committee on Water Resources.

The device was designed and constructed by Messrs. R. F. Anderson and C. H. Zahn under the supervision of Mr. J. W. Coate in the Soil Section of the Missouri River Division Laboratory. The Soil Section is headed by Mr. A. W. Bradbury. The report was prepared by Messrs. R. F. Anderson and C. H. Zahn.

Mr. E. J. Deklotz was Director of the Missouri River Division Laboratory during development of the device. The Laboratory operates under Mr. K. S. Lane, Chief, Geology, Soils, and Materials Branch, Missouri River Division.

AUTOMATIC TRACKING DEVICE

FOR

VISUAL ACCUMULATION TUBE ANALYSIS

INTRODUCTION

1. During the past ten years the Missouri River Division Laboratory has analyzed approximately 16,000 suspended sand samples by the Visual Accumulation Tube Method, a procedure developed by the Subcommittee on Sedimentation of the Inter-Agency Committee on Water Resources. In this method an accumulation curve is drawn on a recording drum by means of a pen, as the surface of the sand accumulation is visually tracked. Tracking is accomplished by viewing the level of sediment accumulation through a small low-power telescope mounted on the apparatus. At the beginning of test the telescope cross hair is zeroed at the top of the plug located in the bottom of the visual tube. As soon as the first particles of sediment reach the bottom, a hand wheel is turned to keep the cross hair on the upper surface of the sediment accumulation. In this manner a continuous grain size accumulation curve is recorded. The top of the accumulation will not always be level and when it is not, the cross hair is kept as near the average elevation of the accumulation as possible. Tracking of the sample is continuous until the elevation of the accumulation reaches the 53 micron level at which point the test is discontinued.
2. The accumulation curve is recorded in approximately five minutes with the entire procedure requiring 10 to 12 minutes to complete. Tracking becomes monotonous and causes eyestrain and fatigue to the operator when tests are conducted on a continuing basis. The automatic tracking device not only eliminates operator fatigue but permits increased production as two visual accumulation tubes can be operated in an alternate manner without difficulty.

CONTROL CIRCUIT

3. The control circuit for the automatic tracking device consists of a servo-loop arrangement as shown in Figure 1. This device detects the level or changing level of sediment in the accumulation section of the tube. The control circuit is mounted on a sleeve attached to the telescope arm. The circuit consists of a light source that passes through the accumulation section of the tube and is focused on a cadmium sulphide photoelectric cell (P-1 on the circuit diagram, Figure 1). The level of light on the photocell

determines the resistance through the cell. This resistance is used to control the tracking motor.

4. The motor control circuit consists of a triac-diac arrangement. The triac limits the amount of voltage fed to the motor. By adjusting the potentiometer, R-4, a balance is set up through the divider network, R-3, R-4, and P-1, biasing the triac to a shut-off point. When the sediment begins to accumulate in the collecting section, part of the light is cut off from the photocell causing its resistance to increase, changing the voltage at the junction of P-1 and R-4. This change is felt by the triac which allows a current flow through it in proportion to the change in resistance. Since the drive motor gets its voltage through the triac, its speed is in direct proportion to the change in resistance of the photocell.

5. The motor is coupled through a gear reducer (746 to 1) to the lead screws on the plotting unit. As the motor runs, the lead screws lift the photocell and light source up the accumulation section of the tube restoring the original amount of light to the photocell. This changes its resistance, setting up a balance at the P-1 R-4 junction, and stops the motor. Because of the rather constant fall of the sediment and the large gear ratio of the motor drive, the motor runs at all times with only its speed changing in relation to the sediment accumulation rate. As no relays are involved, the device plots a continuous curve. This arrangement permits the device to follow the average height of the sand accumulation with more consistency than is possible to accomplish manually.

6. A reversing switch, S-3, and a by-pass switch, S-2, are included in the device so that it can be run up or down quickly without disconnecting the motor. The motor is mounted on a swing-away table with a quick disconnect coupling so that it can be swung out of the way for manual operation.

7. Calibration tests for sensitivity of the device show that it will detect a change in column height of 0.0005-inch.

INSTALLATION

8. Figure 2 is a schematic drawing showing the attachment of the automatic tracking device to the visual accumulation tube. Two modifications were made on the original visual accumulation recorder to accommodate the automatic tracking mechanism. A flex coupling was attached to the handwheel (Part No. 32 on the original recorder) and the telescope arm (Part No. 26) was modified by replacing the sleeve which holds the telescope. The replacement sleeve upon which the photocell and light source are mounted, is approximately three inches long. The diameter of the sleeve is slightly greater than the

diameter of the telescope to allow for focusing. The control box is mounted on the board above the switch box on the present recorder.

9. The device was installed at a cost of approximately \$50.00 for parts and 16 man-hours for assembly and installation. Table 1 is a list of parts required. Figures 3 and 4 are photographs of the installed device.

PROCEDURE FOR ANALYSIS

10. Assuming that the photocell and exciter lamp assembly are at the base of the tube, switch S-2 is positioned on MANUAL and switch S-3 is set in the UP position. Switch S-1 is then turned ON and the assembly moved two or three inches up the lead screws so that the rubber plug can be inserted in the bottom of the visual accumulation tube. The tube is then filled with water and the lamp assembly lowered. Switch S-1 is turned to the OFF position when the lamp reaches the desired height. With switch S-2 still on MANUAL and switch S-3 on the DOWN position, switch S-1 is turned ON until the light from the light source descends to the area of the rubber plug. A micro-switch (limit switch S-4) automatically stops the light-photocell assembly when it reaches this area. Switches S-2 and S-3 are now set on the AUTO and UP positions respectively causing the light assembly to move up to the point where the top of the rubber plug splits the light source. If the light assembly should advance too far, due to overrun, it can be adjusted manually by reversing the hand wheel. The sample is now introduced into the tube and the remainder of the test continued in the usual manner.

PERFORMANCE TESTS

11. Approximately 70 analyses were made in performance tests to determine the reliability of results provided by the device. Two tests were made on each sample. One was made by manual operation of the hand wheel and after recovery of the sample, the second test was made using the automatic tracking device. Minor technical problems were eliminated during the first 50 tests. A summary of the last 20 tests is shown in Table 2. Excluding the 100 percent values, the following is an analysis of the 284 percentage values (observations) tabulated.

<u>Variation Between Manual and Auto. Tracking Values, percentage points,</u>	<u>Number of Observations</u>	<u>Percent of Total Number (284) of Observations</u>
0.0	144	50.7
0.0 to 0.5	204	71.8
0.0 to 1.0	250	88.0
0.0 to 2.0	276	97.2
Over 2.0	8	2.8

12. With respect to accuracy and reproducibility of results, paragraph 12 of the operator's manual*, by way of example, states, "If an analysis shows 45 percent of the total sample to be finer than 125 microns fall diameter, a large portion of the results will be within 45 ± 2 and most will be within 45 ± 5 percent." For the performance tests shown in Table 2, the results of which are analyzed in paragraph 11 above, it will be observed that a "large" portion (88.0 percent of the observations) fall within ± 1 percentage point and essentially all results fall within 2.0 percentage points. Thus it is concluded that the accuracy of results obtained by the automatic tracking device is easily equal to, and in fact much greater than, that set forth in the reference manual.

13. Figure 5 is a grain size accumulation curve for Sample No. 17 and is typical of that produced by the automatic tracking device.

CONCLUSION

14. The automatic tracking device is constructed of parts that are inexpensive, readily available, and relatively easy to assemble. The device is simple to operate. Accuracy of results is more consistent than that obtained by manual operation. Operator fatigue is eliminated in the case when prolonged continuous testing is required. Finally a monetary advantage will result in reduced cost per test particularly when two tubes are so equipped and operated in an alternate manner.

* "Operator's Manual on the Visual Accumulation Tube Method for Sedimentation Analysis of Sands", Report K, Revised October 1958. Prepared by the Subcommittee on Sedimentation of the Inter-Agency Committee on Water Resources.

APPENDIX

Tables and Figures

TABLE 1 -- PARTS LIST - AUTOMATIC TRACKING DEVICE

<u>Part Number</u>	<u>Part Type</u>
Cabinet	BUD Box CU2107A
Motor M-1	Dayton Gear Motor Model 4K869
Flex Coupling	Boston
F-1 Fuse	3AG 1.5 amp.
S-1 Switch	DPST Toggle
S-2 Switch	SPDT Toggle
S-3 Switch	DPDT Toggle
S-4 Limit Switch	Micro switch, Leaf type, normally closed.
Triac	GE X-12
Diac	GE X-13
Thyrector	GE X-14
P-1 Photocell	GE X-6
Cord Set	Belden 17328-S
L-1 Lamp	GE No. 222
L-2 Lamp	NE-51
L-2 Socket	Dialco 52-0408-099-0241
R-1 Resistor	68K ohm 1/2 watt 10%
R-2 Resistor	47K ohm 1/2 watt 10%
R-3 Resistor	4700 ohm 1/2 watt 10%
R-4 Potentiometer	250K ohm 2 watt OHMITE CU-2541 with shaft lock EMC No. A 061
R-5 Resistor	500 ohm 25 watt

TABLE 2 -- PERFORMANCE TESTS OF AUTOMATIC TRACKING DEVICE

Sample No. & Test Condition	Percent of Total Sample Coarser Than Size Shown in Microns									
	1190	840	590	420	297	210	149	105	074	053
<u>Sample No. 1</u> Manual			0.0	1.0	33.0	45.5	73.5	83.0	96.0	100.0
Auto. Tracking			0.0	0.5	33.0	45.5	73.0	82.5	96.0	100.0
<u>Sample No. 2</u> Manual				0.0	14.5	40.0	72.5	92.5	98.5	100.0
Auto. Tracking				0.0	15.0	40.0	72.5	92.0	98.5	100.0
<u>Sample No. 3</u> Manual				0.0	8.5	35.5	68.5	91.5	98.0	100.0
Auto. Tracking				0.0	7.5	34.5	69.5	91.5	98.0	100.0
<u>Sample No. 4</u> Manual			0.0	2.5	20.0	54.5	82.5	96.5	100.0	100.0
Auto. Tracking			0.0	2.0	18.5	54.0	84.5	97.0	100.0	100.0
<u>Sample No. 5</u> Manual				0.0	9.5	48.0	84.0	96.0	100.0	100.0
Auto. Tracking				0.0	9.5	50.5	86.5	97.0	100.0	100.0
<u>Sample No. 6</u> Manual			0.0	2.5	19.0	47.5	75.0	88.0	97.0	100.0
Auto. Tracking			0.0	3.5	19.5	46.5	74.5	89.0	97.0	100.0
<u>Sample No. 7</u> Manual			0.0	7.0	25.0	44.0	59.5	74.0	88.5	100.0
Auto. Tracking			0.0	7.0	25.0	44.0	47.5 59.5	75.0	89.5	100.0
<u>Sample No. 8</u> Manual				0.0	16.5	44.5	77.0	92.0	98.0	100.0
Auto. Tracking				0.0	16.0	49.5	79.0	93.0	98.0	100.0
<u>Sample No. 9</u> Manual			0.0	3.0	12.5	18.0	29.5	50.5	83.5	100.0
Auto. Tracking			0.0	2.5	12.0	18.0	29.5	50.5	83.5	100.0
<u>Sample No. 10</u> Manual			0.0	3.0	22.5	43.5	61.5	74.5	92.0	100.0
Auto. Tracking			0.0	3.0	22.0	44.5	60.5	74.5	92.0	100.0
<u>Sample No. 11</u> Manual	0.0	4.0	9.0	9.0	23.0	53.0	86.0	97.0	99.0	100.0
Auto. Tracking	0.0	4.0	8.5	8.5	22.0	54.0	86.0	97.0	99.0	100.0

Table 2 (Continued)

<u>Sample No. 12</u>										
Manual		0.0	2.0	5.0	16.0	32.0	57.5	82.5	95.5	100.0
Auto. Tracking		0.0	2.0	4.0	14.0	31.0	57.0	81.5	95.5	100.0
<u>Sample No. 13</u>										
Manual			0.0	2.5	16.5	28.5	43.5	64.0	85.5	100.0
Auto. Tracking			0.0	2.5	14.5	27.0	43.5	64.0	86.0	100.0
<u>Sample No. 14</u>										
Manual	0.0	4.0	8.0	12.5	28.5	56.0	86.0	97.0	99.0	100.0
Auto. Tracking	0.0	5.5	7.0	12.5	28.5	56.0	85.5	96.0	99.0	100.0
<u>Sample No. 15</u>										
Manual			0.0	3.5	13.5	31.0	57.5	80.5	94.0	100.0
Auto. Tracking			0.0	2.5	11.5	30.5	58.0	80.5	94.0	100.0
<u>Sample No. 16</u>										
Manual			0.0	1.5	9.5	21.5	40.5	65.0	87.0	100.0
Auto. Tracking			0.0	1.5	9.5	21.5	39.5	64.5	87.5	100.0
<u>Sample No. 17</u>										
Manual		0.0	2.5	6.5	20.0	30.5	43.5	59.0	84.0	100.0
Auto. Tracking		0.0	2.5	6.5	18.5	30.5	43.5	58.0	81.0	100.0
<u>Sample No. 18</u>										
Manual		0.0	2.0	5.0	11.5	21.5	40.0	64.0	86.0	100.0
Auto. Tracking		0.0	2.0	4.5	11.5	22.0	40.0	64.0	86.0	100.0
<u>Sample No. 19</u>										
Manual				0.0	2.0	17.0	44.0	72.0	92.5	100.0
Auto. Tracking				0.0	1.5	16.5	44.5	73.0	93.0	100.0
<u>Sample No. 20</u>										
Manual	0.0	1.5	3.0	3.0	4.0	15.5	31.5	52.5	80.0	100.0
Auto. Tracking	0.0	1.0	3.0	3.0	4.0	13.5	30.0	50.5	78.5	100.0

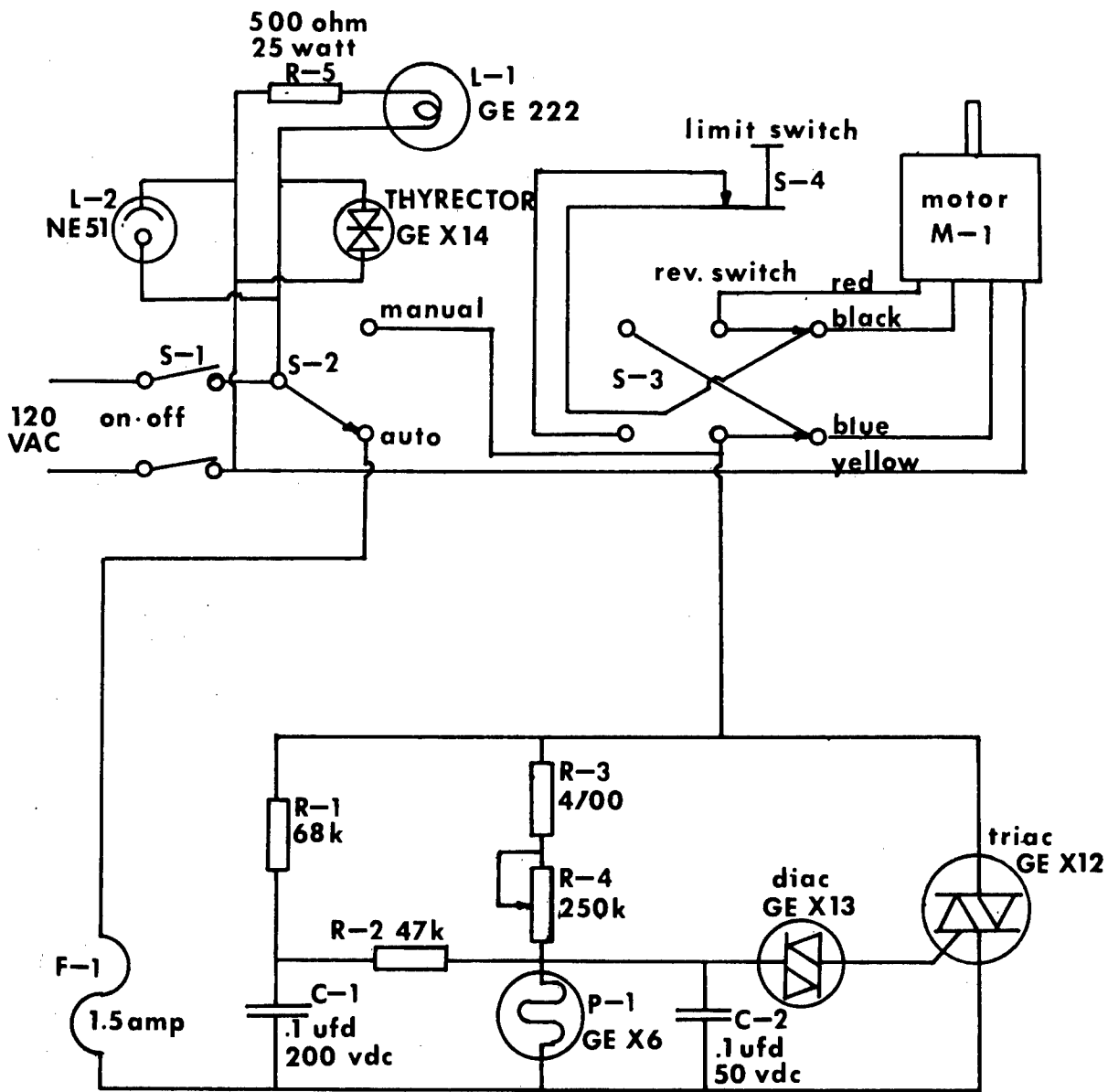

CIRCUIT DIAGRAM - AUTOMATIC TRACKING DEVICE

FIGURE 1

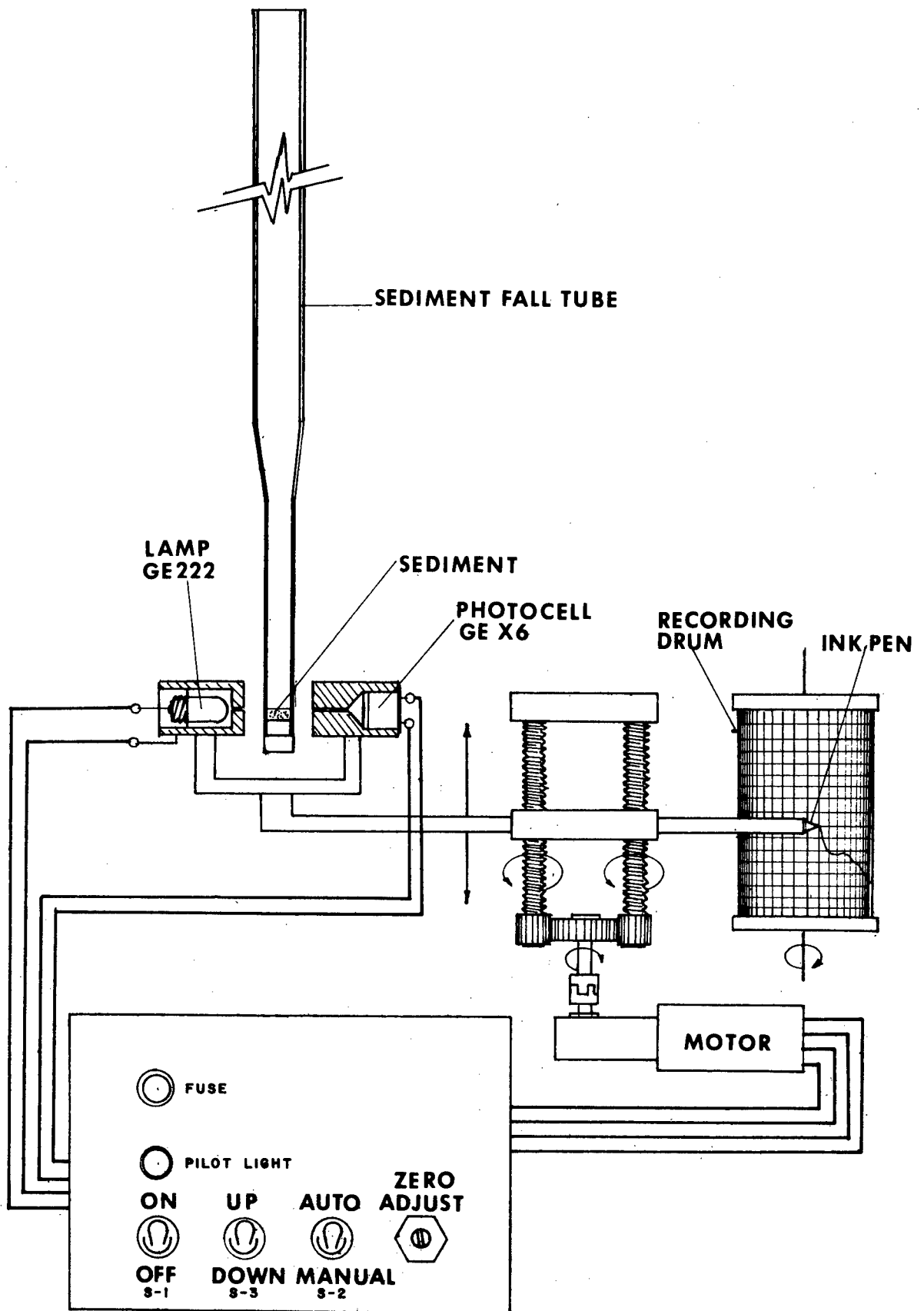

VISUAL ACCUMULATOR WITH AUTOMATIC TRACKING DEVICE

FIGURE 2

DEPARTMENT OF THE ARMY
Missouri River Division, Corps of Engineers
Division Laboratory
Omaha, Nebraska

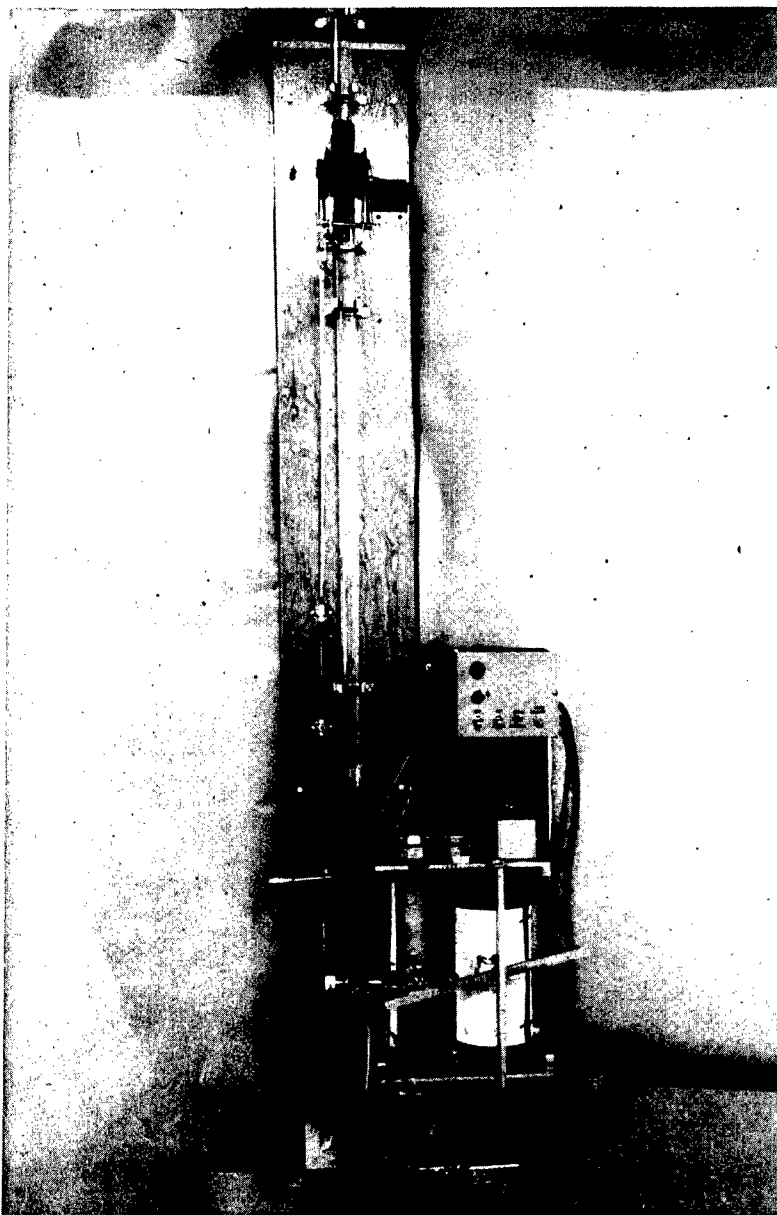

VISUAL ACCUMULATOR WITH AUTOMATIC TRACKING DEVICE

FIGURE 3

DEPARTMENT OF THE ARMY
Missouri River Division, Corps of Engineers
Division Laboratory
Omaha, Nebraska

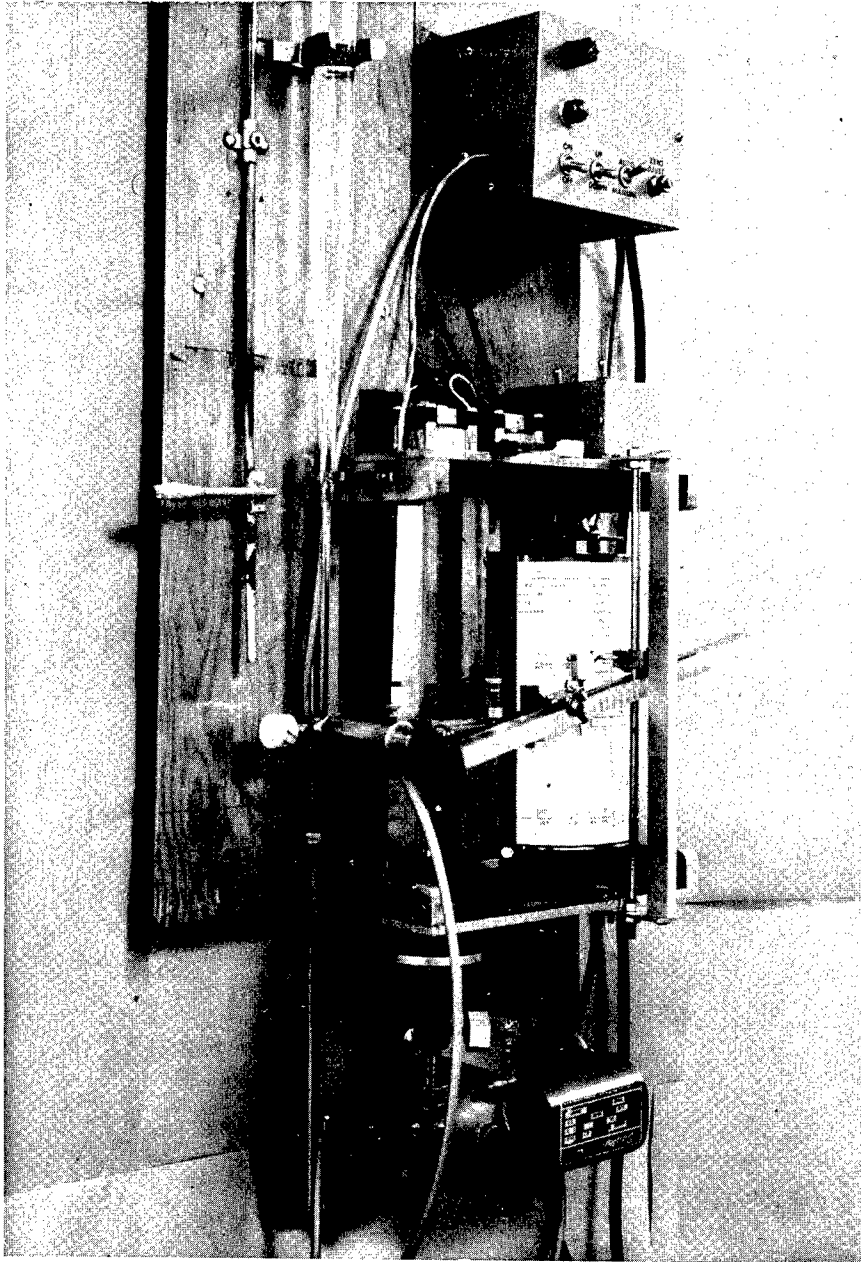

AUTOMATIC TRACKING DEVICE

FIGURE 4

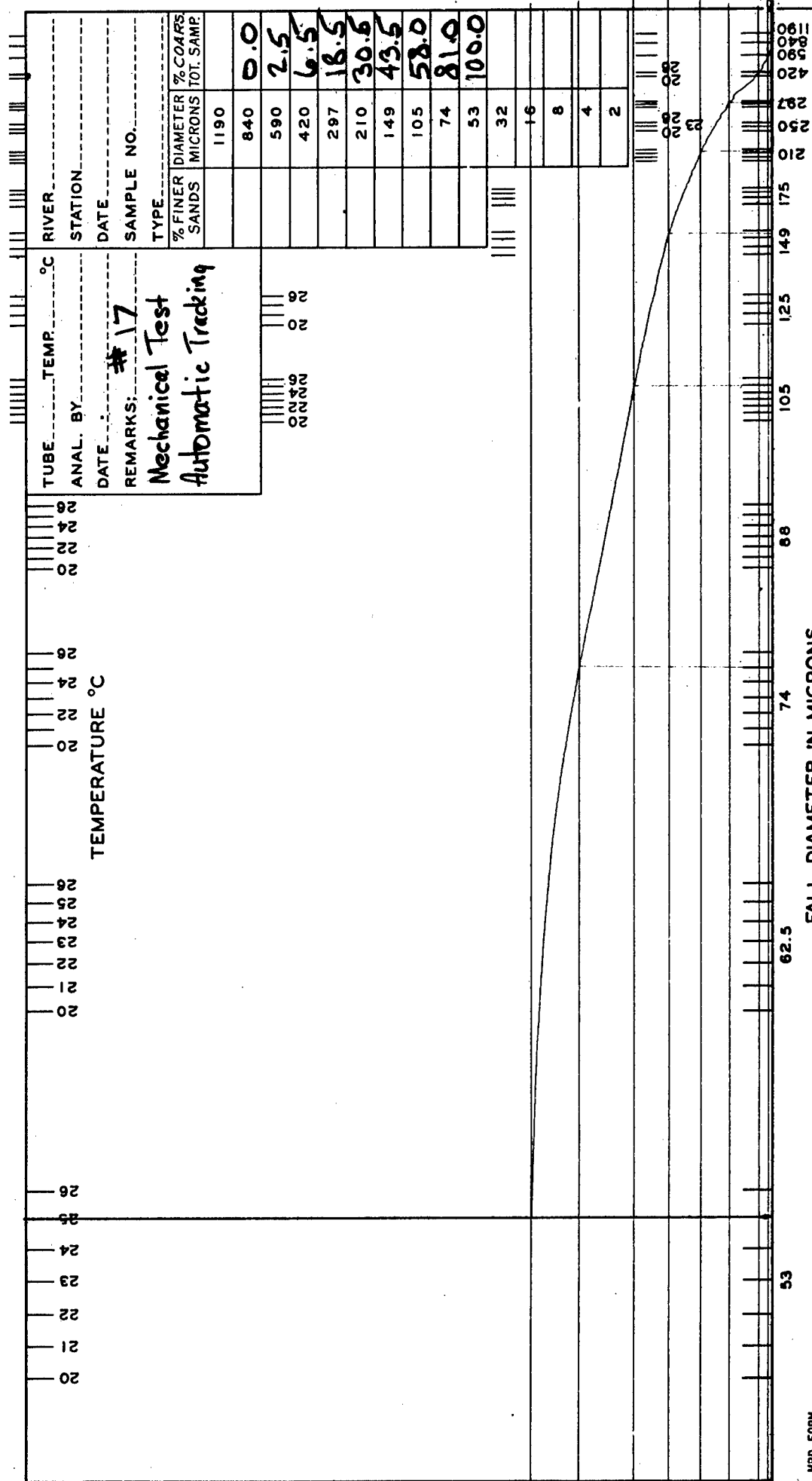

MRD FORM 0640 REPLACES MRD FORM 640, 1 AUG 60, WHICH IS OBSOLETE.

FALL DIAMETER IN MICRONS

TYPICAL GRAIN SIZE ACCUMULATION CURVE PRODUCED BY AUTOMATIC TRACKING DEVICE

FIGURE 5

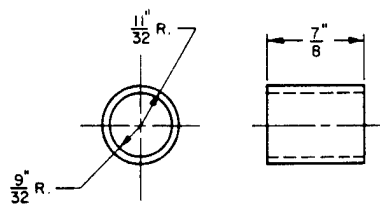
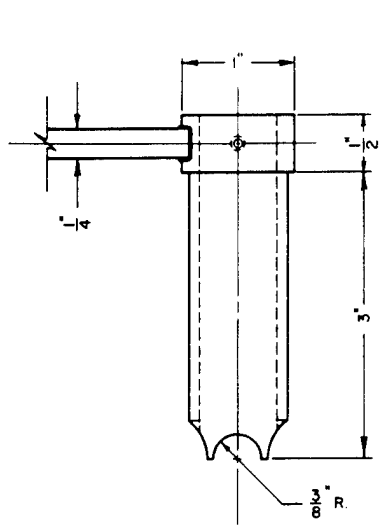

DETAIL B

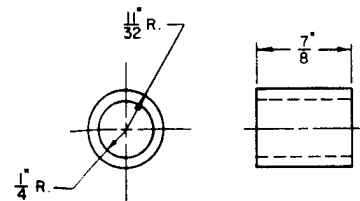

DETAIL C

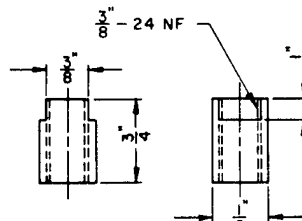

Extension for part No. 31
Stainless Steel

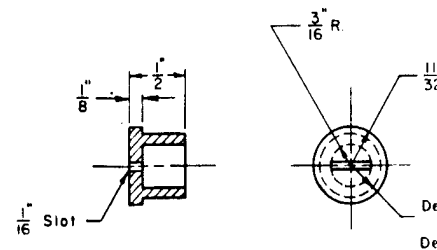

DETAIL D & E

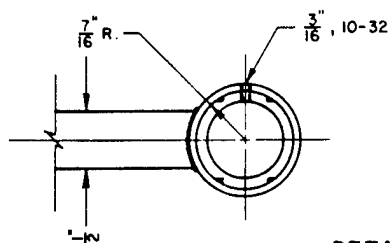

DETAIL A

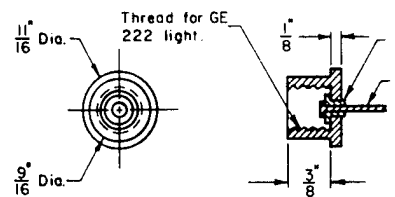
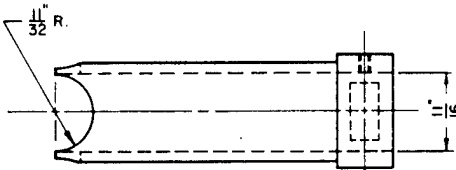

DETAIL F

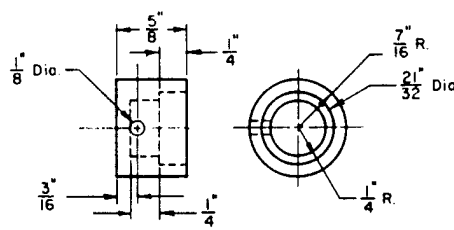

DETAIL G

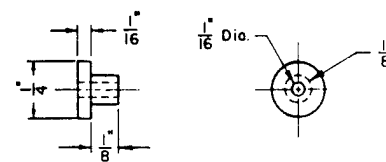

DETAIL F-1

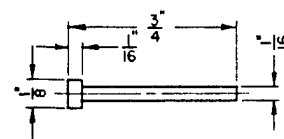
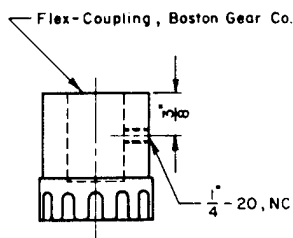
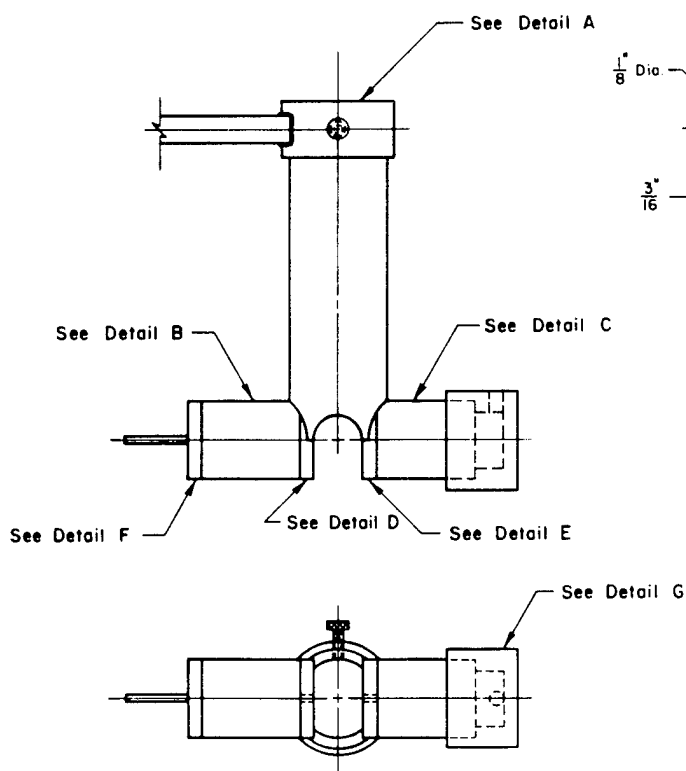

DETAIL F-2

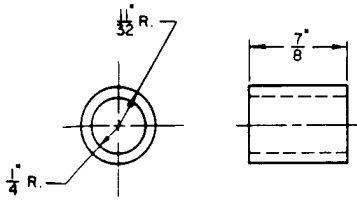

DETAIL C

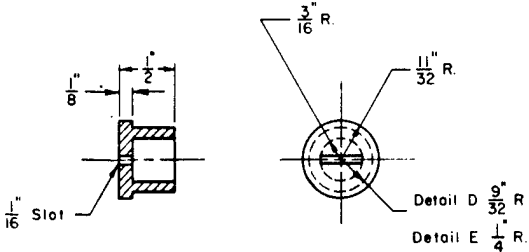
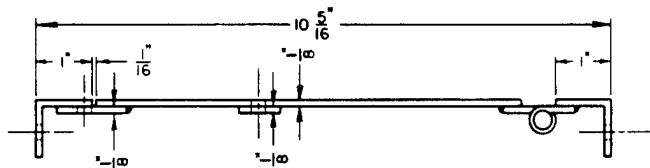

DETAIL D & E

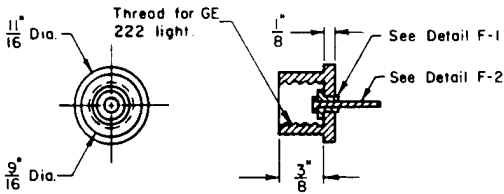

DETAIL F

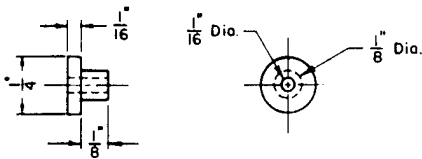

DETAIL F-1

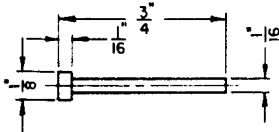

DETAIL F-2

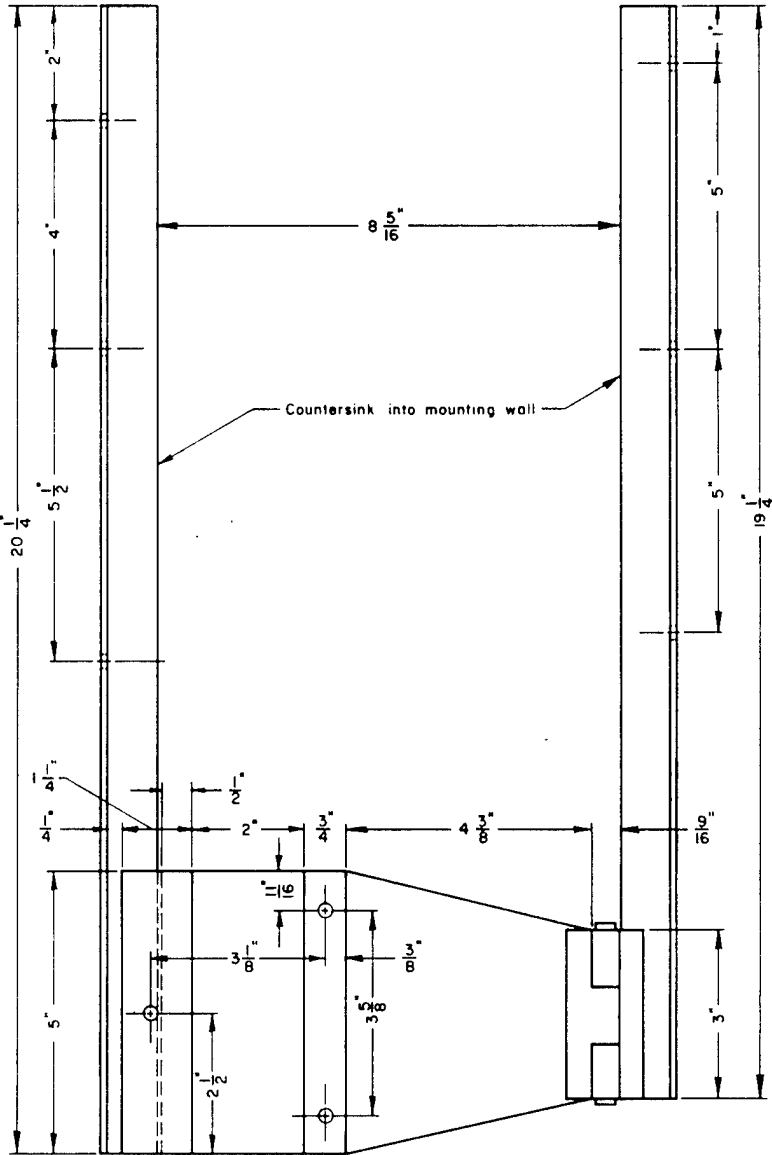

Motor Mounting Assembly

NOTES:
 Details A-F and F-2, are brass and
 details F-1 and G are plastic

DEPARTMENT OF THE ARMY Missouri River Division, Corps of Engineers DIVISION LABORATORY OMAHA, NEBRASKA			
DESIGNED BY:	VISUAL ACCUMULATION TUBE AUTOMATIC TRACKING DEVICE DETAILS		
DRAWN BY:			
TRACED BY:			
CHECKED BY:			
SUBMITTED BY:			
APPROVED BY:			
DATE:	SCALE:	DWG. NO.	
13 June 68		SHEET 1 OF 1	