



The Performance of Three Alternative Coatings to Electroplated Cadmium for Corrosion Protection in Fastener Applications

by Sean Peterson, Gary Wechsler,
and Marc Pepi

ARL-TR-1952

May 1999

19990623 043

Approved for public release; distribution is unlimited.

DTIC QUALITY INSPECTED 4

The findings in this report are not to be construed as an official Department of the Army position unless so designated by other authorized documents.

Citation of manufacturer's or trade names does not constitute an official endorsement or approval of the use thereof.

Destroy this report when it is no longer needed. Do not return it to the originator.

Army Research Laboratory

Aberdeen Proving Ground, MD 21005-5069

ARL-TR-1952

May 1999

The Performance of Three Alternative Coatings to Electroplated Cadmium for Corrosion Protection in Fastener Applications

Sean Peterson
Case Corporation

Gary Wechsler
Eaton Corporation

Marc Pepi
Weapons and Materials Research Directorate, ARL

Abstract

The Army uses cadmium over a broad range of applications, including the production, maintenance, and repair of weapons systems and related components. The useful properties of this element have made it the number one choice for fasteners and similar components where corrosion resistance and lubricity are a concern. However, cadmium is a known carcinogen and poses health risks to those coming in contact with it. Executive Order 12856, "Federal Compliance With Right-to-Know Laws and Pollution Prevention Requirements," was enacted in 1993 with the intent of reducing the total release of toxic chemicals into the environment by 50% by 1999. As such, intense research efforts have been underway to develop a coating or coating system that provides similar, if not better, properties than cadmium. ARL examined three alternatives to cadmium for corrosion protection in AH-64 fastener applications, including ion-vapor-deposited (IVD) aluminum, a MIL-T-83483 antiseize compound, and a MIL-C-16173 corrosion preventative compound. It was concluded that the antiseize compound and the corrosion preventative compound were not adequate replacements for cadmium based upon unacceptable fastener and aluminum block corrosion. IVD was deemed comparable to cadmium based upon the torque values, fastener corrosion, and block corrosion results.

Table of Contents

	<u>Page</u>
List of Figures	v
List of Tables	xiii
1. Introduction	1
2. Base Material and Coating Description	2
3. Materials Preparation	4
3.1 Fasteners Utilized.....	4
3.1.1 <i>Inconel 718 Fasteners</i>	4
3.1.2 <i>H11 Fasteners</i>	4
3.2 Fastener Coatings.....	4
3.2.1 <i>IVD Aluminum Coating</i>	4
3.2.2 <i>Cadmium Coating</i>	7
3.2.3 <i>MIL-T-83483 Antiseize Thread Compound Coating</i>	7
3.2.4 <i>MIL-C-16173 Corrosion Preventative Compound</i>	8
3.3 Test Block Preparation.....	10
3.4 Salt Fog Testing	11
4. Test Results	13
4.1 Torque Values	13
4.2 Visual Inspection.....	16
4.2.1 <i>Salt Fog Duration: 15 days</i>	16
4.2.2 <i>Salt Fog Duration: 30 days</i>	16
4.2.3 <i>Salt Fog Duration: 44 days</i>	18
4.2.4 <i>Salt Fog Duration: 60 days</i>	18
4.3 Pit Depth Measurement.....	18
5. Discussion	19
5.1 IVD vs. Cadmium Coefficient of Friction.....	19
5.2 Fastener Corrosion	23
5.3 Aluminum Block Corrosion.....	24
5.4 Torque Measurement	25

	<u>Page</u>
6. Conclusions	27
7. Pertinent Standards and Specifications.....	28
8. References.....	77
Distribution List	79
Report Documentation Page	81

List of Figures

<u>Figure</u>	<u>Page</u>
1. Schematic of a Representative Test Block Showing Dimensions.....	29
2. Inconel 718 Nickel-Based Superalloy Bolt Heads With IVD Al Coating Before Salt Spray Exposure	29
3. Inconel 718 Nickel-Based Superalloy Nuts With IVD Al Coating Before Salt Spray Exposure.....	30
4. Inconel 718 Nickel-Based Superalloy Bolt Heads With Cadmium Electroplate Before Salt Spray Exposure	30
5. Inconel 718 Nickel-Based Superalloy Nuts With Cadmium Electroplate Before Salt Spray Exposure	31
6. Inconel 718 Nickel-Based Superalloy Bolt Heads With Antiseize Solid Film Lubricant (MoS ₂) Before Salt Spray Exposure.....	31
7. Inconel 718 Nickel-Based Superalloy Nuts With Antiseize Solid Film Lubricant (MoS ₂) Before Salt Spray Exposure.....	32
8. Inconel 718 Nickel-Based Superalloy Bolt Heads With MIL-C-16173 Grade 4 Corrosion Preventative Compound Before Salt Spray Exposure.....	32
9. Inconel 718 Nickel-Based Superalloy Nuts With MIL-C-16173 Grade 4 Corrosion Preventative Compound Before Salt Spray Exposure.....	33
10. H11 Chromium Hot Work Tool Steel Bolt Heads With IVD Al Coating Before Salt Spray Exposure	33
11. H11 Chromium Hot Work Tool Steel Nuts With IVD Al Coating Before Salt Spray Exposure.....	34
12. H11 Chromium Hot Work Tool Steel Bolt Heads With Cadmium Electroplate Before Salt Spray Exposure	34
13. H11 Chromium Hot Work Tool Steel Nuts With Cadmium Electroplate Before Salt Spray Exposure	35

<u>Figure</u>	<u>Page</u>
14. H11 Chromium Hot Work Tool Steel Bolt Heads With Antiseize Solid Film Lubricant (MoS ₂) Before Salt Spray Exposure.....	35
15. H11 Chromium Hot Work Tool Steel Nuts With Antiseize Solid Film Lubricant (MoS ₂) Before Salt Spray Exposure.....	36
16. H11 Chromium Hot Work Tool Steel Bolt Heads With MIL-C-16173 Grade 4 Corrosion Preventative Compound Before Salt Spray Exposure.....	36
17. H11 Chromium Hot Work Tool Steel Nuts With MIL-C-16173 Grade 4 Corrosion Preventative Compound Before Salt Spray Exposure.....	37
18. A1 Control Block Before Salt Spray Exposure	37
19. Inconel 718 Nickel-Based Superalloy Bolt Heads With IVD Al Coating After 15 Days of Salt Spray	38
20. Inconel 718 Nickel-Based Superalloy Nuts With IVD Al Coating After 15 Days of Salt Spray	38
21. Inconel 718 Nickel-Based Superalloy Bolt Heads With Cadmium Electroplate After 15 Days of Salt Spray.....	39
22. Inconel 718 Nickel-Based Superalloy Nuts With Cadmium Electroplate After 15 Days of Salt Spray	39
23. Inconel 718 Nickel-Based Superalloy Bolt Heads With Antiseize Solid Film Lubricant (MoS ₂) After 15 Days of Salt Spray.....	40
24. Inconel 718 Nickel-Based Superalloy Nuts With Antiseize Solid Film Lubricant (MoS ₂) After 15 Days of Salt Spray.....	40
25. Inconel 718 Nickel-Based Superalloy Bolt Heads With MIL-C-16173 Grade 4 Corrosion Preventative Compound After 15 Days of Salt Spray.....	41
26. Inconel 718 Nickel-Based Superalloy Nuts With MIL-C-16173 Grade 4 Corrosion Preventative Compound After 15 Days of Salt Spray	41
27. H11 Chromium Hot Work Tool Steel Bolt Heads With IVD Al Coating After 15 Days of Salt Spray	42

<u>Figure</u>	<u>Page</u>
28. H11 Chromium Hot Work Tool Steel Nuts With IVD Al Coating After 15 Days of Salt Spray	42
29. H11 Chromium Hot Work Tool Steel Bolt Heads With Cadmium Electroplate After 15 Days of Salt Spray.....	43
30. H11 Chromium Hot Work Tool Steel Nuts With Cadmium Electroplate After 15 Days of Salt Spray	43
31. H11 Chromium Hot Work Tool Steel Nuts With Antiseize Solid Film Lubricant (MoS ₂) After 15 Days of Salt Spray.....	44
32. H11 Chromium Hot Work Tool Steel Nuts With Antiseize Solid Film Lubricant (MoS ₂) After 15 Days of Salt Spray.....	44
33. H11 Chromium Hot Work Tool Steel Bolt Heads With MIL-C-16173 Grade 4 Corrosion Preventative Compound After 15 Days of Salt Spray.....	45
34. H11 Chromium Hot Work Tool Steel Nuts With MIL-C-16173 Grade 4 Corrosion Preventative Compound After 15 Days of Salt Spray	45
35. Aluminum Control Block After 15 Days of Salt Spray.....	46
36. Inconel 718 Nickel-Based Superalloy Bolt Heads With IVD Al Coating After 30 Days of Salt Spray	46
37. Inconel 718 Nickel-Based Superalloy Nuts With IVD Al Coating After 30 Days of Salt Spray	47
38. Inconel 718 Nickel-Based Superalloy Bolt Heads With Cadmium Electroplate After 30 Days of Salt Spray.....	47
39. Inconel 718 Nickel-Based Superalloy Nuts With Cadmium Electroplate After 30 Days of Salt Spray	48
40. Inconel 718 Nickel-Based Superalloy Bolt Heads With Antiseize Solid Film Lubricant (MoS ₂) After 30 Days of Salt Spray.....	48
41. Inconel 718 Nickel-Based Superalloy Nuts With Antiseize Solid Film Lubricant (MoS ₂) After 30 Days of Salt Spray.....	49

<u>Figure</u>	<u>Page</u>
42. Inconel 718 Nickel-Based Superalloy Bolt Heads With MIL-C-16173 Grade 4 Corrosion Preventative Compound After 30 Days of Salt Spray.....	49
43. Inconel 718 Nickel-Based Superalloy Nuts With MIL-C-16173 Grade 4 Corrosion Preventative Compound After 30 Days of Salt Spray	50
44. H11 Chromium Hot Work Tool Steel Bolt Heads With IVD Al Coating After 30 Days of Salt Spray	50
45. H11 Chromium Hot Work Tool Steel Nuts With IVD Al Coating After 30 Days of Salt Spray	51
46. H11 Chromium Hot Work Tool Steel Bolt Heads With Cadmium Electroplate After 30 Days of Salt Spray.....	51
47. H11 Chromium Hot Work Tool Steel Nuts With Cadmium Electroplate After 30 Days of Salt Spray	52
48. H11 Chromium Hot Work Tool Steel Bolt Heads With Antiseize Solid Film Lubricant (MoS ₂) After 30 Days of Salt Spray.....	52
49. H11 Chromium Hot Work Tool Steel Nuts With Antiseize Solid Film Lubricant (MoS ₂) After 30 Days of Salt Spray.....	53
50. H11 Chromium Hot Work Tool Steel Bolt Heads With MIL-C-16173 Grade 4 Corrosion Preventative Compound After 30 Days of Salt Spray.....	53
51. H11 Chromium Hot Work Tool Steel Nuts With MIL-C-16173 Grade 4 Corrosion Preventative Compound After 30 Days of Salt Spray	54
52. Aluminum Control Block After 30 Days of Salt Spray.....	54
53. Inconel 718 Nickel-Based Superalloy Bolt Heads With IVD Al Coating After 44 Days of Salt Spray	55
54. Inconel 718 Nickel-Based Superalloy Nuts With IVD Al Coating After 44 Days of Salt Spray	55
55. Inconel 718 Nickel-Based Superalloy Bolt Heads With Cadmium Electroplate After 44 Days of Salt Spray.....	56

<u>Figure</u>	<u>Page</u>
56. Inconel 718 Nickel-Based Superalloy Nuts With Cadmium Electroplate After 44 Days of Salt Spray	56
57. Inconel 718 Nickel-Based Superalloy Bolt Heads With Antiseize Solid Film Lubricant (MoS ₂) After 44 Days of Salt Spray	57
58. Inconel 718 Nickel-Based Superalloy Nuts With Antiseize Solid Film Lubricant (MoS ₂) After 44 Days of Salt Spray.....	57
59. Inconel 718 Nickel-Based Superalloy Bolt Heads With MIL-C-16173 Grade 4 Corrosion Preventative Compound After 44 Days of Salt Spray.....	58
60. Inconel 718 Nickel-Based Superalloy Nuts With MIL-C-16173 Grade 4 Corrosion Preventative Compound After 44 Days of Salt Spray	58
61. H11 Chromium Hot Work Tool Steel Bolt Heads With IVD Al Coating After 44 Days of Salt Spray	59
62. H11 Chromium Hot Work Tool Steel Nuts With IVD Al Coating After 44 Days of Salt Spray	59
63. H11 Chromium Hot Work Tool Steel Bolt Heads With Cadmium Electroplate After 44 Days of Salt Spray.....	60
64. H11 Chromium Hot Work Tool Steel Nuts With Cadmium Electroplate After 44 Days of Salt Spray	60
65. H11 Chromium Hot Work Tool Steel Nuts With Antiseize Solid Film Lubricant (MoS ₂) After 44 Days of Salt Spray.....	61
66. H11 Chromium Hot Work Tool Steel Nuts With Antiseize Solid Film Lubricant (MoS ₂) After 44 Days of Salt Spray.....	61
67. H11 Chromium Hot Work Tool Steel Bolt Heads With MIL-C-16173 Grade 4 Corrosion Preventative Compound After 44 Days of Salt Spray.....	62
68. H11 Chromium Hot Work Tool Steel Nuts With MIL-C-16173 Grade 4 Corrosion Preventative Compound After 44 Days of Salt Spray	62
69. Aluminum Control Block After 44 Days of Salt Spray.....	63

<u>Figure</u>	<u>Page</u>
70. Inconel 718 Nickel-Based Superalloy Bolt Heads With IVD Al Coating After 62 Days of Salt Spray	63
71. Inconel 718 Nickel-Based Superalloy Nuts With IVD Al Coating After 62 Days of Salt Spray	64
72. Inconel 718 Nickel-Based Superalloy Bolt Heads With Cadmium Electroplate After 62 Days of Salt Spray.....	64
73. Inconel 718 Nickel-Based Superalloy Nuts With Cadmium Electroplate After 62 Days of Salt Spray	65
74. Inconel 718 Nickel-Based Superalloy Bolt Heads With Antiseize Solid Film Lubricant (MoS ₂) After 62 Days of Salt Spray.....	65
75. Inconel 718 Nickel-Based Superalloy Nuts With Antiseize Solid Film Lubricant (MoS ₂) After 62 Days of Salt Spray.....	66
76. Inconel 718 Nickel-Based Superalloy Bolt Heads With MIL-C-16173 Grade 4 Corrosion Preventative Compound After 62 Days of Salt Spray.....	66
77. Inconel 718 Nickel-Based Superalloy Nuts With MIL-C-16173 Grade 4 Corrosion Preventative Compound After 62 Days of Salt Spray	67
78. H11 Chromium Hot Work Tool Steel Bolt Heads With IVD Al Coating After 62 Days of Salt Spray	67
79. H11 Chromium Hot Work Tool Steel Nuts With IVD Al Coating After 62 Days of Salt Spray	68
80. H11 Chromium Hot Work Tool Steel Bolt Heads With Cadmium Electroplate After 62 Days of Salt Spray.....	68
81. H11 Chromium Hot Work Tool Steel Nuts With Cadmium Electroplate After 62 Days of Salt Spray	69
82. H11 Chromium Hot Work Tool Steel Nuts With Antiseize Solid Film Lubricant (MoS ₂) 62 Days of Salt Spray	69
83. H11 Chromium Hot Work Tool Steel Nuts With Antiseize Solid Film Lubricant (MoS ₂) After 62 Days of Salt Spray.....	70

<u>Figure</u>	<u>Page</u>
84. H11 Chromium Hot Work Tool Steel Bolt Heads With MIL-C-16173 Grade 4 Corrosion Preventative Compound After 62 Days of Salt Spray.....	70
85. H11 Chromium Hot Work Tool Steel Nuts With MIL-C-16173 Grade 4 Corrosion Preventative Compound After 62 Days of Salt Spray.....	71
86. Aluminum Control Block After 62 Days of Salt Spray.....	71
87. Macrograph Showing Pitting of the Aluminum Test Blocks Representing Pit Classification A-1 (Block No. 4), A-2 (Block No. 2), A-3 (Block No. 1), A-4 (Block No. 9), and A-5 (Block No. 31), Respectively	72
88. Torque-Tension Results Reproduced From a McDonnell Douglas Report Showing the Lowest Torque Values for the IVD/Lubricant System	72
89. Graph Showing the Torque Value at Four Different Stages for the IVD Aluminum-Coated Fasteners.....	73
90. Graph Showing the Torque Value at Four Different Stages for the Cadmium-Coated Fasteners	73
91. Graph Showing the Torque Value at Four Different Stages for the Molybdenum Disulfide-Coated Fasteners	74
92. Graph Showing the Torque Value at Four Different Stages for the MIL-C-16173-Coated Fasteners	74
93. Graph Showing the Torque Value at Four Different Stages for the Systems Which Exhibited the Heaviest Salt and Corrosion Product Buildup (Molybdenum Disulfide Coating/H11 Fasteners and MIL-C-16173 Coating/H11 Fasteners).....	75

INTENTIONALLY LEFT BLANK.

List of Tables

<u>Table</u>	<u>Page</u>
1. Sample Number, Fastener Coating, and Fastener Material	5
2. Bolt Dimensions	6
3. Processing History of IVD-Coated Fasteners	6
4. Processing History of Cadmium-Plated Fasteners.....	8
5. Processing History of MoS ₂ -Coated Fasteners	9
6. Processing History of the MIL-C-16173-Coated Fasteners	9
7. Aluminum Block Dimensions.....	10
8. Processing History of the Aluminum Blocks	10
9. Layout of Fasteners/Blocks Within the Salt Spray Chamber	12
10. Nominal Torque Values Used for Testing	13
11. Torque Values at Different Intervals (in-lb)	14
12. Notes From Visual Examination of the Fasteners and Test Blocks.....	17
13a. Aluminum Block Pit Depth Measurements (Top).....	20
13b. Aluminum Block Pit Depth Measurements (Bottom).....	21
14. ASTM G46 Pit Ratings of Top and Bottom of Aluminum Blocks.....	22
15. ASTM G46 Pit Rating Chart.....	23
16. Systems Exhibiting Increased Fastener Corrosion Resistance	24
17. Systems Exhibiting Increased Aluminum Block Corrosion Resistance	25

INTENTIONALLY LEFT BLANK.

1. Introduction

Cadmium is widely used by the Army in multitudes of applications because of its many useful characteristics. Cadmium provides [1]:

- (1) Effective marine and industrial atmosphere corrosion control performance when applied over low alloy steels.
- (2) Effective natural atmosphere corrosion control performance on complex parts.
- (3) Effective corrosion control performance when applied in a thin layer (i.e., thicknesses between 0.2 and 1.0 mil).
- (4) A sacrificial coating that will minimize hydrogen embrittlement in high-strength steels.
- (5) Galvanic compatibility between aluminum and low-alloy steel components.
- (6) A consistently lubricious surface that does not gall or bind under load.
- (7) A surface film that can be painted.
- (8) An aesthetically appealing, corrosion-free surface on parts that will be stored for an extended period.
- (9) Effective corrosion control performance without the evolution of voluminous corrosion products.

Although the combination of these properties makes it difficult to choose a candidate replacement for cadmium, many coatings have promise. The thrust to find alternatives to cadmium

has uncovered many potential candidates. The U.S. Army Aviation and Troop Command (ATCOM) requested that the U.S. Army Research Laboratory-Materials Directorate (ARL-MD) compare the corrosion protection provided by three environmentally compliant coatings as an alternative to cadmium for use on Inconel 718 and H11 fasteners. The difference in coating lubricity and how this affected the stress of the fasteners was beyond the scope of this program. Cadmium plating has been incorporated on 220-ksi fasteners in AH-64 Apache helicopter joints for lubricity and corrosion protection. Current fastener drawings for 220-ksi Inconel 718 bolts and nuts specify cadmium plating per QQ-P-416, Type II, Class 2 for bolts [2], and vacuum cadmium per MIL-C-8837, Type II, Class 3 for barrel nuts [3]. For 220-ksi H11 (alloy steel) fasteners, cadmium fluoborate plating per NAS 672 for bolts [4] and cadmium electroplating per QQ-P-416, Type II, Class 2 for barrel nuts [5] are specified. The alternative coatings tested in this study at the request of ATCOM were (1) ion-vapor-deposited (IVD) aluminum, (2) a corrosion preventative compound, and (3) a molydisulfide antiseize thread compound. Stress corrosion cracking test conditions were created by torquing the coated fasteners through aluminum blocks and placing the fastened assemblies in a salt fog chamber. The fastener/block samples (representative of fastener applications in an Apache helicopter) were checked regularly for torque loss to determine if and when fracture occurred. The fasteners were also photographed periodically to document the extent of corrosion. At the conclusion of the salt fog testing, the fasteners as well as the aluminum test blocks were examined for corrosion damage.

2. Base Material and Coating Description

Inconel 718 is a nickel-base superalloy utilized for its high-strength capabilities and resistance to corrosion. The corrosion protection provided to the Inconel 718 is due to the relative nobility of nickel. Nickel alloys are protected from corrosion by a protective, passive, oxide film [6]. However, under the “right” conditions, Inconel alloys are susceptible to pitting and crevice corrosion. Pitting corrosion may occur in areas of microinhomogeneities in surface chemical composition.

H11 is a chromium hot work tool steel used for highly stressed structural parts, especially in aerospace applications. The material offers moderate toughness and ductility at room temperature but is best known for keeping its hardness at elevated temperatures. H11 steel is susceptible to hydrogen embrittlement and must be protected with a corrosion-resistant coating even in mild atmospheric environments. Similarly, H11 must be protected against oxidation if exposed to air for prolonged times at temperatures above 400° C [7].

Electrodeposited cadmium is a soft-white metal with the unique engineering properties previously mentioned. Chromating after plating provides additional corrosion resistance. However, as mentioned previously, cadmium is toxic and costly and is being replaced wherever possible. Alkaline cyanide or noncyanide acid baths are used for the electroplating process. While cyanide baths have a greater throwing power and are widely used by industry, the risk of hydrogen embrittlement is higher than with acid baths. No matter which bath is used, high-strength components (35 HRC or above) are required to be baked within 4 hr of plating at 375° F ± 25° F for at least 23 hr, to mitigate the risk of hydrogen embrittlement.

IVD aluminum was originally developed as a corrosion protection coating to replace cadmium. IVD aluminum is soft, dense, ductile, uniform, and adherent with properties virtually identical to those of pure aluminum [8]. The IVD process is nontoxic and nonpolluting and does not introduce hydrogen into the coated part. However, IVD aluminum (as well as the antiseize and corrosion preventative compounds) has a different lubricity than cadmium, which must be addressed for fastener applications where a certain torque level is required.

Molybdenum disulfide-petrolatum per MIL-T-83483 is an antiseize, thread compound, solid film lubricant. Molybdenum disulfide is one of the most commonly used lubricating pigments in solid film lubricants. It offers a low coefficient of friction, high load carrying capability, and high resistance to corrosion.

The coating per MIL-C-16173, Grade 4, is a solvent-dispersed, corrosion preventative compound that deposits thin and is easily removed after solvent evaporation. Grade 4 is transparent and nontacky and is primarily used for general-purpose indoor and limited outdoor preservation of corrodible metals. It is also used to protect components where salt fog contamination is likely to occur.

3. Materials Preparation

3.1 Fasteners Utilized. Table 1 shows the sample number, fastener coating, and fastener material for each of the 32 fasteners used in this study.

3.1.1 Inconel 718 Fasteners. Eleven new Inconel 718 bolts were received from SPS Technologies and shipped to Aniston Army Depot for cadmium plating and supplementary chromate treatment. Five bolts, which had been removed from an Apache Helicopter, were received from ATCOM. The cadmium coating on these five bolts appeared worn. Bolt dimensions are listed in Table 2. All sixteen Inconel nuts used in this experiment were received new from SPS Technologies and had been coated with a dry film lubricant. The inner diameters of these nuts were 1/2 in.

3.1.2 H11 Fasteners. All sixteen H11 bolts and nuts received from ATCOM had been removed from Apache helicopters. These fasteners had been covered with a zinc-chromate coating. Dimensions of the bolts are listed in Table 2. Eight of the nuts had an inner diameter of 1/2 in, while the other eight had an inner diameter of 9/16 in.

3.2 Fastener Coatings.

3.2.1 IVD Aluminum Coating. Bolts and nuts that were to have an IVD aluminum coating were sent to Aniston Army Depot to be stripped of their original coatings. Two of the new

Table 1. Sample Number, Fastener Coating, and Fastener Material

Sample Number	Fastener Coating	Fastener Material
1	IVD Aluminum (MIL-C-83488)	Inconel 718
2	IVD Aluminum (MIL-C-83488)	Inconel 718
3	IVD Aluminum (MIL-C-83488)	Inconel 718
4	IVD Aluminum (MIL-C-83488)	Inconel 718
5	Cadmium (QQ-P-416)	Inconel 718
6	Cadmium (QQ-P-416)	Inconel 718
7	Cadmium (QQ-P-416)	Inconel 718
8	Cadmium (QQ-P-416)	Inconel 718
9	MoS ₂ (MIL-T-83483)	Inconel 718
10	MoS ₂ (MIL-T-83483)	Inconel 718
11	MoS ₂ (MIL-T-83483)	Inconel 718
12	MoS ₂ (MIL-T-83483)	Inconel 718
13	MIL-C-16173	Inconel 718
14	MIL-C-16173	Inconel 718
15	MIL-C-16173	Inconel 718
16	MIL-C-16173	Inconel 718
17	IVD Aluminum (MIL-C-83488)	H11
18	IVD Aluminum (MIL-C-83488)	H11
19	IVD Aluminum (MIL-C-83488)	H11
20	IVD Aluminum (MIL-C-83488)	H11
21	Cadmium (QQ-P-416)	H11
22	Cadmium (QQ-P-416)	H11
23	Cadmium (QQ-P-416)	H11
24	Cadmium (QQ-P-416)	H11
25	MoS ₂ (MIL-T-83483)	H11
26	MoS ₂ (MIL-T-83483)	H11
27	MoS ₂ (MIL-T-83483)	H11
28	MoS ₂ (MIL-T-83483)	H11
29	MIL-C-16173	H11
30	MIL-C-16173	H11
31	MIL-C-16173	H11
32	MIL-C-16173	H11
33	MIL-P-23377	Test Block

Table 2. Bolt Dimensions

Material	Quantity	Diameter (in)	Total Length (in)	Shank Length (in)	Thread Length (in)
Inconel 718	11	1/2	2-1/2	1	7/8
Inconel 718	5	1/2	2-3/4	1-1/4	7/8
H11	8	1/2	3	1-5/8	7/8
H11	8	9/16	2-1/2	7/8	1

Inconel 718 bolts were stripped of the cadmium coating along with the two used Inconel 718 bolts and four H11 bolts. The four Inconel 718 nuts were stripped of their dry film lubricant coating, whereas the H11 nuts were stripped of their coating typically used in service. All of the nuts and bolts were coated with aluminum and chromated per MIL-C-83488, Type II, Class 2. All of the nuts were later subjected to a dry film lubricant coating per MIL-L-46010, Type I. A description of the IVD aluminum processing sequence is listed in Table 3.

Table 3. Processing History of IVD-Coated Fasteners

Step	Process
1	Degrease - trichloroethylene
2	Aluminum oxide blast; acid spot test indicated cadmium was still present - discontinued after two bolts were processed
3	Alkaline clean - alkaline corrosion-removing compound
4	Hot-water rinse
5	HCl - hydrochloric acid
6	Rinse
7	Neutralize acid - alkaline corrosion-removing compound
8	Hot-water rinse
9	Hydrogen embrittlement relief
10	Aluminum oxide blast
11	Coat - Aluminum
12	Glass bead peen - 40 psi, maximum
13	Chromate dip
14	Rinse
15	Coat - dry film lubricant (nuts only)

MIL-C-83488, Type II, Class 2 specifies that the aluminum coatings have a minimum thickness of 0.0005 in (0.013 mm) and have a supplementary chromate treatment in accordance with MIL-C-5541, Class 1A. The coating thickness of the bolts was measured by Aniston Army Depot. The minimum coating thickness was 0.00053 in, with the maximum measurement being 0.00127 in. The average coating thickness was 0.00084 in.

Prior to insertion into the test block, each aluminum-coated block was given an additional coating of a MIL-T-83483 antiseize threading compound, which was applied to the threads, shaft, and under the bolt head.

3.2.2 Cadmium Coating. The four cadmium-coated Inconel 718 bolts tested were new. They had been plated with cadmium and chromated per QQ-P-416, Type II, Class 2 by SPS Technologies. In addition, four Inconel 718 nuts, four H11 bolts and four H11 nuts were sent to Aniston Army Depot and stripped of their original coatings and recoated with cadmium and chromated per QQ-P-416, Type II, Class 2. The Inconel 718 and H11 nuts were subsequently dry film lubricated per MIL-L-46010, Type I. A complete processing history of the cadmium-plated Inconel 718 nuts, H11 bolts, and H11 nuts is listed in Table 4.

Specification QQ-P-416 specifies that the Type II, Class 2 condition should have a minimum cadmium coating thickness of 0.0003 in. According to measurements performed at Aniston Army Depot, the average coating thickness on each of the parts was 0.00035 in.

Prior to insertion into the test blocks, all cadmium-coated bolts were given a coating of MIL-T-83483 antiseize threading compound, which was applied to the threads, shaft, and under the bolt head.

3.2.3 MIL-T-83483 Antiseize Thread Compound Coating. Another group of four Inconel (two new and two used) and four H11 fasteners was sent to Aniston Army Depot to be stripped of their respective coatings. The fasteners were then sent back to ARL for testing. The fasteners were cleaned with acetone and dried. Prior to insertion into the test blocks, the bolts were coated with an

Table 4. Processing History of Cadmium-Plated Fasteners

Step	Process
1	Degrease - trichloroethylene
2	Alkaline clean - alkaline corrosion-removing compound
3	Hot-water rinse
4	HCl - hydrochloric acid
5	Rinse
6	Neutralize acid - alkaline corrosion-removing compound
7	Hot-water rinse
8	Hydrogen embrittlement relief
9	Aluminum oxide blast
10	Plate - cadmium
11	Rinse, stagnate
12	Rinse
13	Hot rinse
14	Chromate dip
15	Rinse
16	Hot rinse
17	Hydrogen embrittlement relief
18	Coat - dry film lubricant (nuts only)

antiseize molybdenum disulfide thread compound conforming to MIL-T-83483. The coating was applied to the bolt head, threads, and shaft of each bolt. Processing steps describing the application on the MoS₂ coating are given in Table 5.

3.2.4 MIL-C-16173 Corrosion Preventative Compound. Four new Inconel 718 nuts, two new and two used Inconel 718 bolts, along with four used H11 nuts and bolts were sent to Aniston Army Depot and stripped of their original coatings. After their coatings were stripped, the nuts and bolts were sent back to ARL. The fasteners were subsequently cleaned with acetone and coated with the MIL-C-16173, Grade 4 corrosion preventative compound. The corrosion preventative compound was applied by suspending the bolts on a string and dipping them into the compound. The bolts were subsequently slowly pulled out of the liquid. The coating was approximately 0.002 in thick. The complete processing steps are listed in Table 6.

Table 5. Processing History of MoS₂-Coated Fasteners

Step	Process
1	Degrease - trichloroethylene
2	Aluminum oxide blast; acid spot test indicated cadmium was still present - discontinued after two bolts were processed
3	Alkaline clean - alkaline corrosion-removing compound
4	Hot-water rinse
5	HCl - hydrochloric acid
6	Rinse
7	Neutralize acid - alkaline corrosion-removing compound
8	Hot-water rinse
9	Hydrogen embrittlement relief
10	Aluminum oxide blast
11	Application of MoS ₂ coating

Table 6. Processing History of the MIL-C-16173-Coated Fasteners

Step	Process
1	Degrease - trichloroethylene
2	Aluminum oxide blast; acid spot test indicated cadmium was still present - discontinued after two bolts were processed
3	Alkaline clean - alkaline corrosion-removing compound
4	Hot-water rinse
5	HCl - hydrochloric acid
6	Rinse
7	Neutralize acid - alkaline corrosion-removing compound
8	Hot-water rinse
9	Hydrogen embrittlement relief
10	Aluminum oxide blast
11	Oil dip - MIL-C-16173, Grade 3
12	Cleaned
13	Dried

3.3 Test Block Preparation. A large slab of 7075-T6 aluminum was machined into 33 blocks for fastener testing. Each block measured 1.75 in × 1.75 in, with the final dimension (height) varying with the length of the bolt inserted into the block. Two holes of 1/8 in diameter were drilled near the edge on one side of each block to enable consistent orientation of the blocks. After the blocks were machined, they were sent to Aniston Army Depot to be treated with a chemical conversion coating per MIL-C-5541, Class 1A. Clearance holes of either 1/2 in or 9/16 in diameter were subsequently drilled in order to accommodate the H11 bolts. The holes were reamed out to allow the bottom of the bolt head to sit flat on the test block. The bolt holes were touched up with a MIL-P-23377, Class 1, Type II primer. See Table 7 for block dimensions, Table 8 for a complete list of processing steps, and Figure 1 for a schematic of a representative test block.

Table 7. Aluminum Block Dimensions

Quantity	Block Height (in)	Bolt Hole Diameter (in)
8	1 1/4	9/16
11	1 1/4	1/2
6	1 1/2	1/2
7	1 3/4	1/2

Table 8. Processing History of the Aluminum Blocks

Step	Process
1	7075-T6 aluminum slab sectioned into 33 test blocks
2	Chemical film applied per MIL-C-5541, Class 1A
3	Holes drilled
4	Holes reamed out
5	Blocks cleaned with acetone
6	MIL-P-23377, Class 1, Type II applied

3.4 Salt Fog Testing. Prior to initial placement into the salt fog chamber, the fasteners were placed into the test blocks and incrementally torqued to a value that depended on the diameter of the bolts. The nuts on the 1/2-in-diameter bolts were initially torqued to 975 ± 25 in-lb, and then to 1225 ± 25 in-lb. The nuts on the 9/16-in-diameter bolts were initially torqued to 1250 ± 25 in-lb, and then to 1560 ± 25 in-lb. Torque values were recorded for each fastener using a digital Snap-On torque wrench at the initial, bolt rotation initiation, and final torques.

The fastener/test block assemblies were placed in the salt fog chamber as shown in Table 9 and subjected to an atmosphere of 95° F and 100% relative humidity. The salt fog chamber utilized a 5 weight-percent saline solution per ASTM B117. After 10 days in the salt fog chamber, the fasteners were inspected every 48 to 72 hr for cracks in the nut. After 15 days in the chamber, the fasteners were removed and photographed.

After 30 days in the salt fog chamber, the fasteners were removed, inspected for cracking, and photographed. The nuts on the 1/2-in-diameter bolts were subsequently torqued up to 1550 ± 25 in-lb. The nuts on the 9/16-in-m bolts were torqued up to 1950 ± 25 in-lb. The bolt rotation initiation torque and the final torques were recorded, and the fasteners were returned to the salt fog chamber.

Every 7 days, the fasteners were inspected for cracks. After 14 additional days (44 days total), the fasteners were taken out of the chamber, photographed, and returned.

After 62 days total, the fasteners were taken out of the salt fog chamber. The bolts and nuts were subsequently photographed and inspected for cracks. Each fastener was subjected to an increase in torque, and the torque where bolt rotation initiated was recorded. Each fastener was then untorqued, and the breakaway torque was recorded. Each nut and bolt, as well as the test block, was visually inspected to determine the extent of corrosion. No fasteners had cracked as a result of this testing.

Table 9. Layout of Fasteners/Blocks Within the Salt Spray Chamber

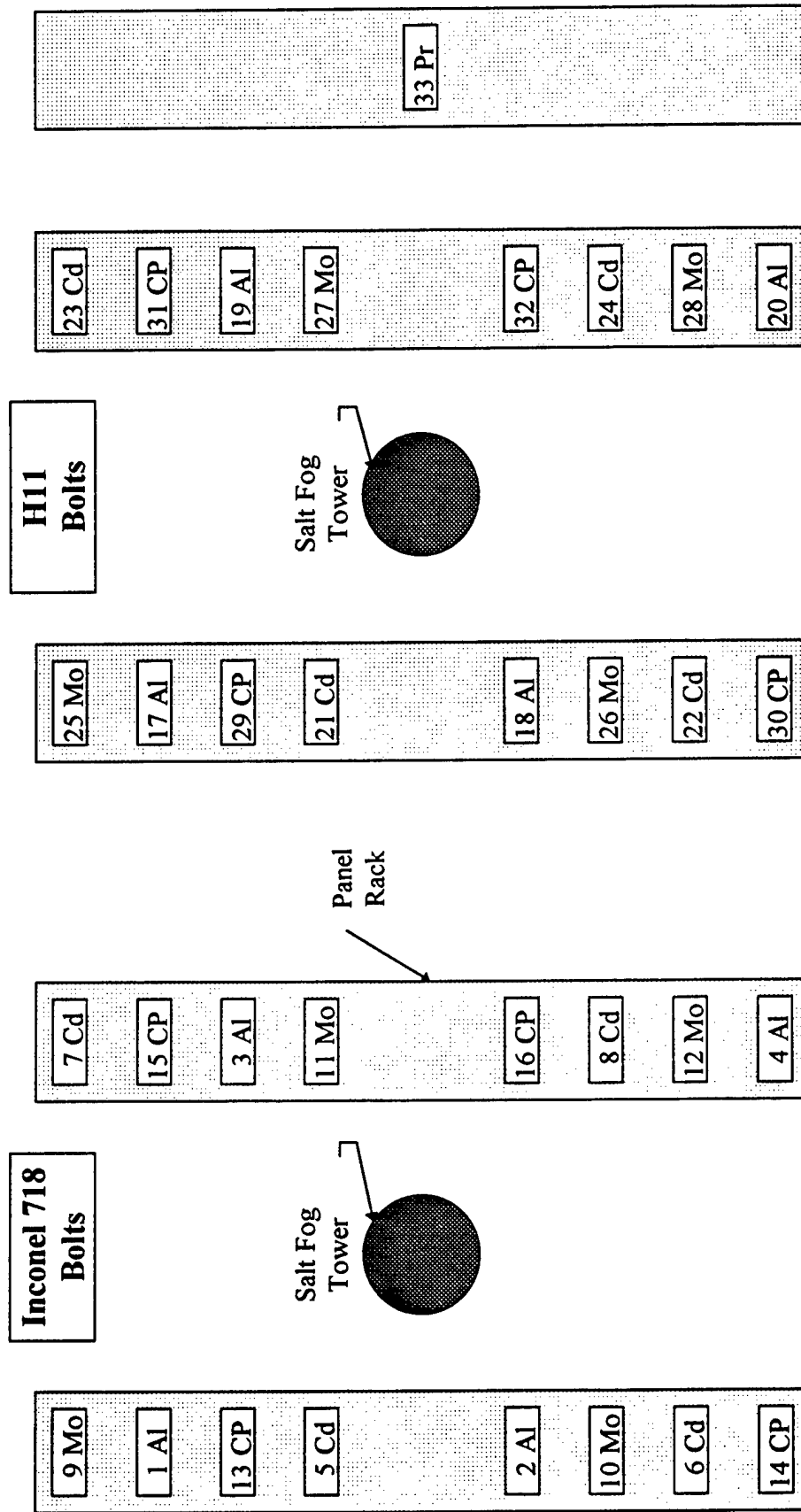

Note: Each small square represents an aluminum block. For each block, the sample number and a code for identifying the coating used are given. Mo: MIL-T-83483 molybdenum disulfide antiseize threading compound. Al: IVD aluminum. Cd: Cadmium plating. CP: MIL-C-16173, Grade 4, corrosion preventative compound. Pr: MIL-P-23377, Type II, Class 1, epoxy primer. For testing, the nut of each fastener was oriented to the nearest salt fog tower. Block 33 does not have a fastener in it.

4. Test Results

4.1 Torque Values. Table 10 lists the nominal values of torque used during each phase of testing. Table 11 lists the recorded torque values at different intervals of testing. The preload and final torque values were determined using Table 1 of ATCOM Memorandum 334-87-Methods Sum-03, dated 12 June 1987, entitled, "Summary of the Standardized Method for Fastener Torque-Up Analysis" [9]. The preload value was determined from the 90-ksi Nominal Axial Stress, Tension Nuts, Torque - Lubricated column, for the 1/2- and 9/16-in fasteners. For the 1/2-in fasteners, a preload value of 975 in-lb was used, while a value of 1250 in-lb was used for the 9/16-in fasteners. These values were multiplied by 1.25 (scatter factor) to obtain the final torque before insertion into the salt fog chamber (1220 in-lb for the 1/2-in, and 1560 in-lb for the 9/16-in fasteners). These values were subsequently multiplied by 1.25 to obtain the final torque values (1525 in-lb and 1950 in-lb, respectively) before insertion into the chamber for the final 30 days (60 days total).

Table 10. Nominal Torque Values Used for Testing

Nominal Preload (in-lb)	Final Nominal Torque Before Insertion Into Salt Fog Chamber for First 30-Day Interval (in-lb)	Final Nominal Torque Before Insertion Into Salt Fog Chamber for Final 30-Day Interval (in-lb)
975 - 1/2-in fasteners	1220 - 1/2-in fasteners	1525 - 1/2-in fasteners
1250 - 9/16-in fasteners	1560 - 9/16-in fasteners	1950 - 9/16-in fasteners

It was understood from the outset that the different coatings had different coefficients of friction, affecting lubricity. Employing the same torque threshold for each system resulted in higher stresses in bolts with a coefficient of friction lower than that of cadmium, and lower stresses in bolts with a coefficient of friction higher than cadmium. As mentioned previously, the effect of coating lubricity on the tension within the bolts was beyond the scope of this study.

Table 11. Torque Values at Different Intervals (in-lb)

Sample	Fastener Material	Fastener Coating	Block Size ^a	Outset			30-Day Salt Fog		60-Day Salt Fog	
				Preload	Rotation ^b	Final ^c	Rotation	Final	Rotation	Breakaway ^d
1	INC-718	IVD Al	A	973	1013	1223	1077	1548	1508	1339
2	INC-718	IVD Al	A	957	878	1226	1235	1578	1774	1570
3	INC-718	IVD Al	B	957	1054	1250	1178	1543	1642	1492
4	INC-718	IVD Al	B	976	1038	1223	1373	1552	1884	1406
5	INC-718	Cadmium	A	964	1028	1203	1237	1573	1900	1452
6	INC-718	Cadmium	A	964	980	1200	1229	1550	1775	1469
7	INC-718	Cadmium	A	961	1020	1215	1339	1556	1840	1525
8	INC-718	Cadmium	A	969	954	1250	1230	1550	1810	1389
9	INC-718	MoS ₂	A	981	926	1229	1281	1551	1765	1540
10	INC-718	MoS ₂	A	980	950	1218	1239	1547	1734	1533
11	INC-718	MoS ₂	B	972	964	1234	1239	1563	1719	1544
12	INC-718	MoS ₂	B	995	948	1204	1276	1553	1776	1479
13	INC-718	MIL-C-16173	A	965	932	1204	1272	1557	1709	1456
14	INC-718	MIL-C-16173	A	989	975	1220	1255	1548	1626	1409
15	INC-718	MIL-C-16173	B	968	1003	1216	1256	1537	1758	1493
16	INC-718	MIL-C-16173	B	972	1007	1226	1305	1554	1650	1208
17	H11	IVD Al	C	954	1033	1209	1210	1544	1895	1562
18	H11	IVD Al	C	1268	990	1213	1255	1549	1870	1595
19	H11	IVD Al	D	1257	1374	1555	1256	1932	1835	1669
20	H11	IVD Al	D	1272	1344	1286	1305	1951	>2000	1677

^a Block sizes: A = 1-1/4 in with 1/2 in diameter, B = 1-1/2 in with 1/2 in diameter, C = 1-3/4 in with 1/2 in diameter, D = 1-1/4 in with 9/16 in diameter.

^b Rotation = Torque required to initiate bolt rotation in the tightening direction.

^c Final = Torque at which assembly was placed into the salt fog chamber.

^d Breakaway = Torque required to initiate bolt rotation in the loosening direction.

Table 11. Torque Values at Different Intervals (in-lb) (continued)

Sample	Fastener Material	Fastener Coating	Block Size ^a	Outset			30-Day Salt Fog		60-Day Salt Fog	
				Preload	Rotation ^b	Final ^c	Rotation	Final	Rotation	Breakaway ^d
21	H11	Cadmium	D	1236	1051	1556	1433	1971	>2000	1588
22	H11	Cadmium	D	1274	1034	1544	1234	1930	>2000	1703
23	H11	Cadmium	D	1274	1015	1538	1208	1975	1991	1611
24	H11	Cadmium	D	1244	1338	1565	1537	1961	1976	1755
25	H11	MoS ₂	C	975	1051	1213	1263	1568	1787	1540
26	H11	MoS ₂	C	958	1034	1216	1318	1548	1718	1419
27	H11	MoS ₂	C	961	1015	1237	1285	1553	1731	1354
28	H11	MoS ₂	D	1275	1338	1536	1688	1975	>2000	1642
29	H11	MIL-C-16173	C	976	1045	1212	1353	1551	1800	1571
30	H11	MIL-C-16173	C	969	1007	1218	1297	1549	1799	1568
31	H11	MIL-C-16173	C	967	1007	1221	1249	1563	1846	1450
32	H11	MIL-C-16173	D	1239	1396	1538	1663	1925	1993	1587
33	Test Block	MIL-P-23377	A	N/A	N/A	N/A	N/A	N/A	N/A	N/A

^a Block sizes: A = 1-1/4 in with 1/2 in diameter, B = 1-1/2 in with 1/2 in diameter, C = 1-3/4 in with 1/2 in diameter, D = 1-1/4 in with 9/16 in diameter.

^b Rotation = Torque required to initiate bolt rotation in the tightening direction.

^c Final = Torque at which assembly was placed into the salt fog chamber.

^d Breakaway = Torque required to initiate bolt rotation in the loosening direction.

In general, the fastener systems that had accumulated the most voluminous corrosion product buildup experienced increased torques to initiate bolt rotation from the previous torque level. The torque required to initiate bolt rotation after 30 days was notably higher for the H11 fasteners coated with MoS₂ and MIL-C-16173. These values were also consistently higher for the Inconel 718 fasteners coated with MoS₂ and MIL-C-16173. After 60 days, the torque required to initiate bolt rotation showed an increase for each system, including the fasteners coated with IVD aluminum and cadmium.

4.2 Visual Inspection. Figures 2–86 represent the extent of corrosion noted on the fastener assemblies (top: bolt and bottom: nut) at the outset and after 15, 30, 44, and 62 days within the salt fog chamber. Table 12 contains notes concerning visual examination of the fastener assemblies at each of the aforementioned intervals. A summary of the findings is as follows.

4.2.1 Salt Fog Duration: 15 Days. Minimal salt and corrosion products were noted under both the bolt head and the nut of the Inconel fasteners coated with MoS₂ and MIL-C-16173. Rust was observed within the recesses in the Inconel bolt heads coated with MIL-C-16173. The H11 bolt heads, bolt ends, and nuts coated with MoS₂ were covered with a heavy layer of rust. Also observed was a heavy buildup of salt. The H11 bolt heads (except no. 31), bolt ends, and nuts were covered with a moderate layer of rust and also showed a heavy buildup of salt. Each remaining system appeared unaffected by the salt fog exposure.

4.2.2 Salt Fog Duration: 30 Days. The salt and corrosion products on the Inconel fasteners coated with MoS₂ and MIL-C-16173 grew slightly heavier. Salt buildup was also observed on the H11 bolts coated with IVD aluminum. In addition, bolt head no. 20 (H11 steel coated with IVD aluminum) exhibited rust. The salt buildup and rust appeared slightly heavier on the H11 fasteners coated with MoS₂ and MIL-C-16173; however, bolt head no. 31 (H11 steel coated with MIL-C-16173) still did not show any rusting.

Table 12. Notes From Visual Examination of the Fasteners and Test Blocks

Blocks	System	Salt Fog Duration			
		15 Days	30 Days	44 Days	62 Days
1 to 4	718/IVD Al	N/A	Minimal salt buildup.	Minimal salt buildup.	Minimal salt buildup.
5 to 8	718/Cd	N/A	N/A	N/A	N/A
9 to 12	718/MoS ₂	Minimal salt buildup. Minimal corrosion products.	Light salt buildup. Light corrosion products.	Light salt buildup. Light corrosion products.	Moderate salt buildup. Light corrosion products.
13 to 16	718/MIL-C	Minimal salt buildup. Minimal corrosion products. Rust in bolt head recesses.	Light salt buildup. Light corrosion products. Rust in bolt head recesses.	Moderate salt buildup. Light corrosion products. Rust in bolt head recesses.	Moderate salt buildup. Light corrosion products. Rust in bolt head recesses.
17 to 20	H11/IVD Al	N/A	Minimal salt buildup. Moderate bolt head no. 20 rust.	Light salt buildup. Heavy bolt head no. 20 rust. Heavy bolt head no. 19 rust. Heavy bolt end no. 19 rust.	Moderate salt buildup. Heavy bolt head no. 20 rust. Heavy bolt head no. 19 rust. Heavy bolt end no. 19 rust.
21 to 24	H11/Cd	N/A	N/A	Minimum rust in bolt no. 23 recess.	Moderate rust in bolt no. 23 recess.
25 to 28	H11/MoS ₂	Minimal salt buildup. Moderate corrosion products. Heavy bolt head rust. Heavy bolt end and nut rust.	Moderate salt buildup. Heavy corrosion products. Heavy bolt head rust. Heavy bolt end and nut rust.	Heavy salt buildup. Heavy corrosion products. Heavy bolt head rust. Heavy bolt end and nut rust.	Heavy salt buildup. Heavy corrosion products. Heavy bolt head rust (no. 31). Heavy bolt end and nut rust.
29 to 32	H11/MIL-C	Moderate salt buildup. Moderate corrosion products. Moderate bolt head rust (no. 31). Moderate bolt end and nut rust.	Heavy salt buildup. Heavy corrosion products. Heavy bolt head rust (no. 31). Heavy bolt end and nut rust.	Heavy salt buildup. Heavy corrosion products. Heavy bolt head rust (no. 31). Heavy bolt end and nut rust.	Heavy salt buildup. Heavy corrosion products. Heavy bolt head rust (no. 31). Heavy bolt end and nut rust.
33	Al Block	N/A	N/A	N/A	N/A

4.2.3 Salt Fog Duration: 44 Days. Minimal salt buildup was noted on the Inconel bolt heads, bolt ends, and nuts coated with IVD aluminum. Bolt heads nos. 19 and 20, as well as bolt end no. 19 (H11 steel coated with IVD aluminum), exhibited rust. The salt and rust appeared slightly heavier on the H11 fasteners coated with MIL-C-16173. Bolt head no. 31 still did not show evidence of rust.

4.2.4 Salt Fog Duration: 60 Days. Salt buildup was slightly heavier on the Inconel bolt heads, bolt ends, and nuts coated with IVD aluminum. Slight rust was noted on bolt head no. 3 (Inconel bolt coated with IVD aluminum). Minimal salt was observed on the Inconel fasteners coated with cadmium. Heavy salt and minimal corrosion products were noted on the Inconel fasteners coated with MoS₂ and MIL-C-16173. The H11 fasteners, which were IVD aluminum coated, showed a heavier buildup of salt. Bolt heads nos. 19 and 20, as well as bolt end no. 19 (H11 steel coated with IVD aluminum), exhibited heavy rust. The cadmium-coated H11 fasteners exhibited minimal salt buildup. Bolt head no. 23 (H11 steel coated with cadmium) showed slight rust. The H11 bolt heads and bolt ends coated with MoS₂ and MIL-C-16173 (except bolt head no. 31) displayed heavy rusting and salt buildup. The threads and shanks of each bolt, which exhibited rusting, did not show evidence of corrosion. In general, aluminum block pitting was most severe with the Inconel and H11 fasteners coated with MoS₂ and MIL-C-16173, while the pitting was minimal with the Inconel and H11 fasteners coated with IVD aluminum and cadmium. An exception to this generality was the top surfaces of the aluminum blocks containing the no. 19 and no. 20 fasteners (H11 steel coated with IVD aluminum), which exhibited a pitting density of A-4. (The following section contains a description of the rating.)

4.3 Pit Depth Measurement. Each test block was cleaned with distilled water and a nylon brush, removing most of the corrosion products. The deepest pit was identified, measured, and recorded on the top and bottom faces of each aluminum test block. The face that contacted the bolt head was labeled "Top," while the face that contacted the nut was labeled "Bottom." Microscopical pit depth measurements were performed in accordance with ASTM G46 with an Olympus PME metallurgical microscope with a calibrated fine focus adjustment knob marked off in 0.002-mm (0.0008 in) increments. For these measurements, the bottom of the deepest pit was brought into

focus and then the surface of the test block was brought into focus. The number of increments between focusing planes was noted, which readily gave the pit depth. Tables 13a and b contain the results of pit depth measurements for each block and list the measurement of the deepest pits observed. Table 14 contains the results of pit rating for both the tops and bottoms of each block, based on the chart shown in Figure 2 of ASTM G46 (Table 15). Although the specification requires this rating system to be used for average pit size, ARL used this system to rate the deepest pit on each block face. In addition, with respect to density (category A), ratings were based upon a comparison of each block to the other blocks. In other words, the worst pitted blocks were rated an A-5, while the blocks with minimal pitting were rated an A-1. Blocks with various amounts of pitting between the best and worst cases were rated accordingly. Figure 87 shows an example of pit density ratings A-1—A-5. The figure shows the bottoms of blocks no. 4 (A-1), no. 2 (A-2), no. 1 (A-3), no. 9, (A-4), and no. 31 (A-5). The pit size (category B) was determined by which size pit shown in Figure 2 of ASTM G46 (Table 15) could fit within the largest pit on the test blocks.

5. Discussion

5.1 IVD vs. Cadmium Coefficient of Friction. As shown, IVD aluminum offered comparable corrosion protection to cadmium. However, aluminum has a higher coefficient of friction than cadmium, which indicates that the fasteners coated with IVD aluminum were subjected to a lower stress than those coated with cadmium. This would not be acceptable in critically joined systems. Testing previously performed by McDonnell Douglas Corporation revealed that for the same bolt stress, up to 36% greater torque was required using IVD aluminum vs. cadmium when the torque was applied to the bolts with cadmium-plated, dry film-lubricated, self-locking gang channel nuts [10]. The use of a lubricant, namely cetyl alcohol, on the IVD aluminum fasteners acted to eliminate or greatly reduce the differences in torque-tension. Figure 88 contains the torque-tension results attained by McDonnell Douglas comparing IVD/lubricant, IVD aluminum, cadmium, and IVD aluminum bolt/cadmium nut systems. As shown, the torque required to obtain a particular load was lowest for the IVD/lubricant system. For IVD aluminum to be a true replacement for cadmium, it is suggested that a lubricant be used, such that the fastener surface friction coefficient approaches that of cadmium.

Table 13a. Aluminum Block Pit Depth Measurements (Top)

Block	Face	Objective	Start	Finish	Depth (mm)	Depth (in)
1	Top	20	0	22	0.044	0.002
2	Top	20	45	65	0.040	0.002
3	Top	20	21	66	0.090	0.004
4	Top	10	80	360	0.560	0.022
5	Top	10	10	325	0.630	0.025
6	Top	10	31	454	0.846	0.033
7	Top	10	0	0	0.000	0.000
8	Top	10	13	270	0.514	0.020
9	Top	10	88	765	1.354	0.053
10	Top	10	50	647	1.194	0.047
11	Top	10	65	749	1.368	0.054
12	Top	10	10	644	1.268	0.050
13	Top	10	65	912	1.694	0.067
14	Top	10	9	634	1.250	0.049
15	Top	10	57	914	1.714	0.067
16	Top	10	1	645	1.288	0.051
17	Top	10	48	379	0.662	0.026
18	Top	10	13	171	0.316	0.012
19	Top	10	23	542	1.038	0.041
20	Top	10	6	663	1.314	0.052
21	Top	10	20	67	0.094	0.004
22	Top	10	55	267	0.424	0.017
23	Top	10	92	240	0.296	0.012
24	Top	10	83	264	0.362	0.014
25	Top	10	33	617	1.168	0.046
26	Top	10	64	673	1.218	0.048
27	Top	10	23	543	1.040	0.041
28	Top	10	34	827	1.586	0.062
29	Top	10	48	600	1.104	0.043
30	Top	10	0	562	1.124	0.044
31	Top	10	89	594	1.010	0.040
32	Top	10	83	735	1.304	0.051

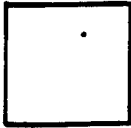

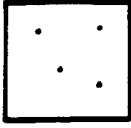

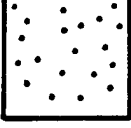

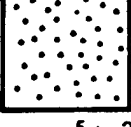

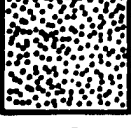

Table 13b. Aluminum Block Pit Depth Measurements (Bottom)

Block	Face	Objective	Start	Finish	Depth (mm)	Depth (in)
1	Bottom	10	94	550	0.912	0.036
2	Bottom	10	60	362	0.604	0.024
3	Bottom	40	52	62	0.020	0.001
4	Bottom	10	92	330	0.476	0.019
5	Bottom	10	10	555	1.090	0.043
6	Bottom	10	58	542	0.968	0.038
7	Bottom	20	77	254	0.354	0.014
8	Bottom	10	85	446	0.722	0.028
9	Bottom	10	14	873	1.718	0.068
10	Bottom	10	0	1015	2.030	0.080
11	Bottom	10	0	810	1.620	0.064
12	Bottom	10	0	1000	2.000	0.079
13	Bottom	10	68	878	1.620	0.064
14	Bottom	10	66	808	1.484	0.058
15	Bottom	10	94	909	1.630	0.064
16	Bottom	10	85	1040	1.910	0.075
17	Bottom	10	31	265	0.468	0.018
18	Bottom	10	16	68	0.104	0.004
19	Bottom	10	34	438	0.808	0.032
20	Bottom	10	67	320	0.506	0.020
21	Bottom	10	20	274	0.508	0.020
22	Bottom	10	33	265	0.464	0.018
23	Bottom	10	97	246	0.298	0.012
24	Bottom	10	87	260	0.346	0.014
25	Bottom	10	0	1015	2.030	0.080
26	Bottom	10	10	767	1.514	0.060
27	Bottom	10	0	1015	2.030	0.080
28	Bottom	10	0	910	1.820	0.072
29	Bottom	10	22	893	1.742	0.069
30	Bottom	10	52	745	1.386	0.055
31	Bottom	10	0	1015	2.030	0.080
32	Bottom	10	30	663	1.266	0.050

Table 14. ASTM G46 Pit Ratings of Top and Bottom of Aluminum Blocks

System	Block	Top	Bottom	System	Block	Top	Bottom
718/IVD	1	A-1, B-1, C-1	A-3, B-3, C-2	H11/IVD	17	A-2, B-2, C-1	A-2, B-2, C-1
	2	A-1, B-1, C-1	A-2, B-2, C-1		18	A-2, B-1, C-1	A-2, B-1, C-1
	3	A-1, B-1, C-1	A-1, B-1, C-1		19	A-4, B-4, C-2	A-2, B-2, C-2
	4	A-1, B-1, C-1	A-1, B-1, C-1		20	A-4, B-4, C-3	A-2, B-2, C-1
718/Cd	5	A-1, B-1, C-2	A-2, B-2, C-2	H11/Cd	21	A-1, B-1, C-1	A-2, B-2, C-1
	6	A-1, B-2, C-2	A-2, B-2, C-1		22	A-2, B-1, C-1	A-2, B-2, C-1
	7	A-1, B-1, C-1	A-1, B-1, C-1		23	A-2, B-2, C-1	A-2, B-2, C-1
	8	A-1, B-2, C-1	A-3, B-3, C-2		24	A-2, B-2, C-1	A-2, B-2, C-1
718/MoS ₂	9	A-4, B-4, C-3	A-4, B-4, C-3	H11/MoS ₂	25	A-5, B-5, C-2	A-5, B-5, C-3
	10	A-4, B-4, C-2	A-4, B-4, C-3		26	A-5, B-5, C-2	A-5, B-5, C-3
	11	A-4, B-4, C-3	A-4, B-4, C-3		27	A-5, B-5, C-2	A-5, B-5, C-3
	12	A-4, B-4, C-3	A-4, B-4, C-3		28	A-5, B-5, C-3	A-5, B-5, C-3
718/MIL-C	13	A-4, B-4, C-3	A-4, B-4, C-3	H11/MIL-C	29	A-4, B-5, C-2	A-5, B-5, C-3
	14	A-4, B-4, C-2	A-4, B-4, C-3		30	A-5, B-5, C-2	A-5, B-5, C-3
	15	A-4, B-4, C-3	A-4, B-4, C-3		31	A-4, B-4, C-2	A-5, B-5, C-3
	16	A-5, B-5, C-2	A-4, B-4, C-3		32	A-5, B-5, C-3	A-4, B-5, C-3

Table 15. ASTM G46 Pit Rating Chart

	<u>A</u> <u>DENSITY</u>	<u>B</u> <u>SIZE</u>	<u>C</u> <u>DEPTH</u>
1	 $2.5 \times 10^3/m^2$	 0.5 mm^2	 0.4 mm
2	 $1 \times 10^4/m^2$	 2.0 mm^2	 0.8 mm
3	 $5 \times 10^4/m^2$	 8.0 mm^2	 1.6 mm
4	 $1 \times 10^5/m^2$	 12.5 mm^2	 3.2 mm
5	 $5 \times 10^5/m^2$	 24.5 mm^2	 6.4 mm

5.2 Fastener Corrosion. With respect to resistance to fastener corrosion after 62 days within the salt spray chamber, the Inconel 718/IVD aluminum, Inconel 718/cadmium, Inconel 718/MoS₂, and the H11/cadmium systems outperformed the remaining systems by a considerable amount. Each of the four Inconel bolt heads coated with MIL-C-16173 had slight corrosion within the recesses. Two of the four H11/IVD aluminum bolt heads and one of the bolt ends exhibited heavy

corrosion. The fact that all of the fasteners within each group did not exhibit similar characteristics, perhaps, could be attributed to an improperly applied or damaged coating. Otherwise, bolts within each group would most likely have had the same amount of corrosion. The four H11 bolt heads coated with MoS₂ also showed heavy corrosion, as did the bolt ends. The corresponding nuts showed varying degrees of corrosion. Three of the four H11 bolt heads coated with MIL-C-16173 showed heavy corrosion, as did the bolt ends and nuts. Table 16 lists each system rated in order of decreasing fastener corrosion resistance.

Table 16. Systems Exhibiting Increased Fastener Corrosion Resistance

System	Comments
Inconel 718/cadmium	No fastener corrosion.
Inconel 718/MoS ₂	No fastener corrosion.
Inconel 718/IVD aluminum	Slight bolt head corrosion (no. 3).
H11/cadmium	Moderate bolt head recess corrosion (no. 23).
Inconel 718/MIL-C-16173	Bolt head recess corrosion.
H11/IVD aluminum	Heavy bolt head corrosion (nos. 19 and 20), heavy bolt end corrosion (no. 19).
H11/MIL-C-16173	Heavy bolt head corrosion (nos. 29, 30, and 32), heavy bolt end corrosion, moderate nut corrosion.
H11/MoS ₂	Heavy bolt head corrosion, heavy bolt end corrosion, moderate nut corrosion.

5.3 Aluminum Block Corrosion. The pitting of the 7075-T6 aluminum blocks was not a function of traditional crevice corrosion, since the pitting occurred outside the boundary of the bolt heads and nuts (i.e., the fastener/block interface was intact). Similarly, galvanic coupling was ruled out as a contributing factor to the pitting corrosion. Pitting was attributed to the localized buildup of foreign matter, namely, the salt and corrosion products. With respect to local deposits of foreign matter, pitting does resemble crevice attack [11]. Usually, metals that are prone to pitting will also be sensitive to crevice attack, such as with 7075-T6 aluminum. The increased pitting was directly proportional to the salt and corrosion product buildup on the aluminum blocks, which initiated corrosion that penetrated the weak spots on the surface of the block, causing the subsequent pits. The fasteners that were coated with cadmium and IVD aluminum produced the least amount of salt

and corrosion product buildup and, subsequently, the least amount of aluminum block pitting. In contrast, fasteners coated with MoS₂ and MIL-C-16173 produced the greatest amount of salt and corrosion products, along with the greatest amount of block pitting. Table 17 rates each system in order of increased aluminum block pitting.

Table 17. Systems Exhibiting Increased Aluminum Block Corrosion Resistance

System	Average ASTM G46 Pit Rating
Inconel 718/IVD aluminum	A-1, B-1, C-1
Inconel 718/cadmium	A-1, B-2, C-2
H11/cadmium	A-2, B-2, C-1
H11/IVD aluminum	A-3, B-2, C-2
Inconel 718/MoS ₂	A-4, B-4, C-3
Inconel 718/MIL-C-16173	A-4, B-4, C-3
H11/MIL-C-16173	A-5, B-5, C-3
H11/MoS ₂	A-5, B-5, C-3

5.4 Torque Measurement. The purpose of applying a torque to the fasteners was to determine the onset of crack initiation. This could be achieved by the observance of a significant drop in the torque required to rotate the bolt from its previously loaded torque value. Although a slight drop was noted in some fasteners, none of the fasteners cracked as a result of this testing. A drop in torque value over a short-term timeframe (assuming the fasteners were not cracked) would be explained by the “embedment” of the hard fastener into the soft aluminum block [12]. Embedment is a common cause of short-term relaxation in a fastened joint and has been shown to result in a 10–15% dropoff in torque (the maximum dropoff torque values in Table 11 are 21%). Since the surfaces of the fasteners and the blocks that come in contact are not perfectly flat and are characterized by peaks and valleys on a microscale, first contact takes place only with the high spots on the respective parts. Since the initial contact areas are relatively small, the metal at the contact points cannot stand the pressures [13]. Plastic deformation subsequently occurs at these contact points, accounting for this relaxation. Since embedment is worse on new parts than on reused ones (because the high contact points are smoothed down during subsequent loadings), this may have

attributed to the fact that only a couple of bolts exhibited a dropoff after the bolts were retorqued after 60 days of salt fog exposure.

In attempting to explain the increase in torque noted to initiate bolt rotation from the previous torque value, attention was focused on the interface of the bolt head and nut with the aluminum block as well as the amount of salt and corrosion product buildup for each system. The data listed in Table 10 show that the IVD-coated fastener/aluminum test block and the cadmium-coated fastener/aluminum test block systems exhibited the greatest dropoffs with respect to 30-day bolt rotation torques from the prior torqued value (see graphs in Figures 89 and 90). Conversely, the molybdenum disulfide coating/aluminum block and MIL-C-16173 coating/aluminum block systems showed significant increases in bolt rotation torque, most likely due to the buildup of salt and corrosion products (see Figures 91 and 92). The stages from 1 to 2 and 3 to 4 on each graph represent the torque required to initiate bolt rotation at the 30- and 60-day intervals from the prior final torque value.

In systems with the heaviest salt and corrosion buildup (molybdenum disulfide coating/H11 fasteners and MIL-C-16173 coating/H11 fasteners), the torque required to initiate bolt rotation after 30 days showed an increase in torque, again, due to the increased frictional forces caused by the buildup. This has been documented in open literature, notably, Brickford [13], which states, "...systems with severely corroded nut/bolt interfaces will typically exhibit increased breaking torque values" [14]. Figure 93 graphically shows the increases in bolt rotation initiation torque (Stages 1–2 and 3–4) on the systems with the heaviest salt and corrosion buildup. After 60 days of salt fog exposure, almost every rotational value was higher than the prior torque value, most likely due to the presence of some degree of salt and corrosion product buildup that would have increased the frictional forces upon fastener rotation.

Therefore, in systems that showed a dropoff in torque, it can be assumed that the lack of salt and corrosion products meant that a lower frictional force was inherent at the interface of the fasteners and the aluminum block. This indicates that a lower torque would be needed to initiate

bolt rotation, than in those systems where the salt and corrosion products were present. Without the increased frictional forces, the measurement of the short-term relaxation was not hindered.

6. Conclusions

- Each coating prevented stress corrosion cracking failures of the fasteners subjected to prolonged salt fog exposure combined with induced stress.
- In general, the Inconel 718 and 1/2-in-diameter H11 fasteners held the respective torque when subjected to torque increases after prolonged salt fog exposure.
- In general, the molybdenum disulfide and MIL-C-16173-coated fasteners showed the most significant increases in the amount of torque required to initiate bolt rotation from the previous applied torque value after 30 days of salt fog exposure. This was due to the amount of salt and corrosion product buildup present, compared to the IVD aluminum and cadmium-coated fasteners. The systems that exhibited the heaviest salt and corrosion product buildup (i.e., molybdenum disulfide coating/H11 fasteners and MIL-C-16173 coating/H11 fasteners) showed the greatest amount of torque required to initiate bolt rotation from the previous applied torque value after 30 days of salt fog exposure.
- With respect to fastener corrosion, the Inconel 718/cadmium and Inconel 718/MoS₂ systems outperformed each of the remaining systems after 62 days of a salt fog atmosphere. The H11/MIL-C-16173 and H11/MoS₂ systems produced the greatest amount of fastener corrosion.
- The aluminum blocks exhibited minimal pitting in conjunction with the Inconel 718/IVD aluminum and Inconel 718/cadmium systems. The H11/MIL-C-16173 and H11/MoS₂ systems produced the most salt and corrosion products and, subsequently, the most aluminum block pitting.

- It was concluded that MoS₂ and MIL-C-16173 are not adequate replacements for cadmium based upon unacceptable fastener and aluminum block corrosion.
- Based upon the torque, fastener corrosion, and block corrosion results, IVD aluminum compared most favorably to cadmium. However, a supplementary lubricant should be utilized with IVD aluminum in order that the induced stress of the fasteners during torquing approximate that for cadmium.

7. Pertinent Standards and Specifications

ASTM B117	Standard Test Method of Salt Spray (Fog) Testing
MIL-C-5541	Chemical Conversion Coatings on Aluminum and Aluminum Alloys
MIL-C-16173	Corrosion Preventative Compound, Solvent Cutback, Cold-Application
MIL-P-23377	Primer Coatings: Epoxy, Chemical, and Solvent Resistant
MIL-L-46010	Lubricant, Solid Film, Heat-Cured, Corrosion Inhibiting
MIL-T-83483	Thread Compound, Antiseize, Molybdenum Disulfide-Petrolatum
MIL-C-83488	Coating, Aluminum, Ion Vapor Deposited
MIL-C-8837	Coating, Cadmium (Vacuum Deposited)
QQ-P-416	Plating, Cadmium, Electrodeposited

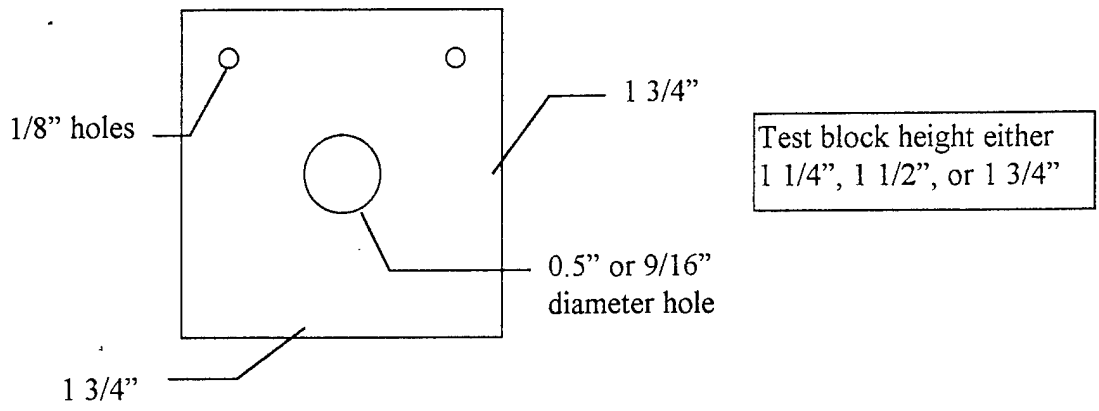

Figure 1. Schematic of a Representative Test Block Showing Dimensions.

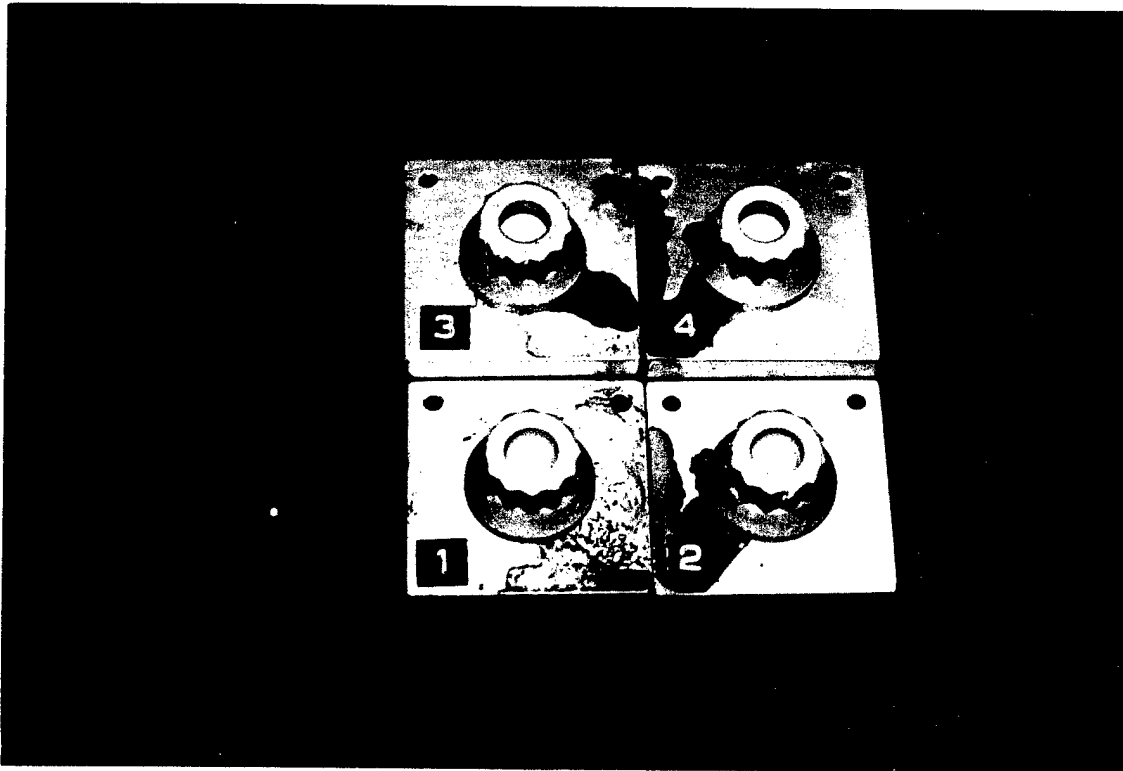

Figure 2. Inconel 718 Nickel-Based Superalloy Bolt Heads With IVD Al Coating Before Salt Spray Exposure. Reduced 25%.

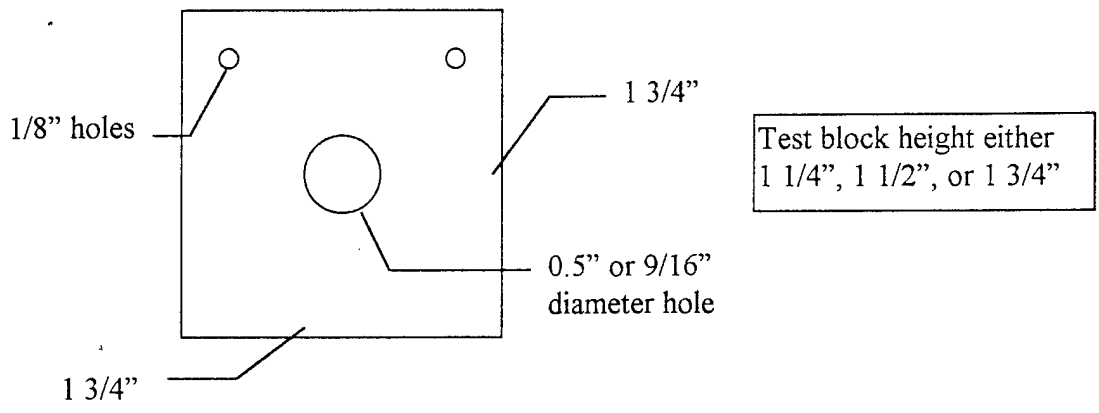

Figure 1. Schematic of a Representative Test Block Showing Dimensions.

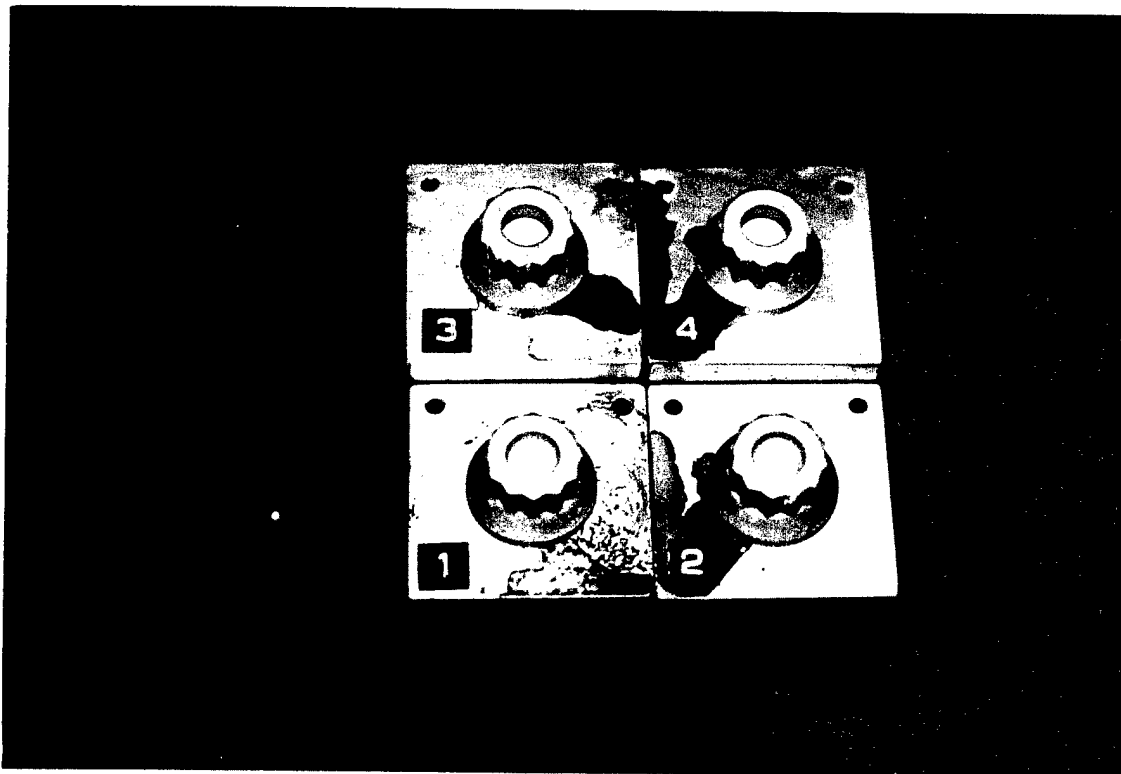

Figure 2. Inconel 718 Nickel-Based Superalloy Bolt Heads With IVD Al Coating Before Salt Spray Exposure. Reduced 25%.

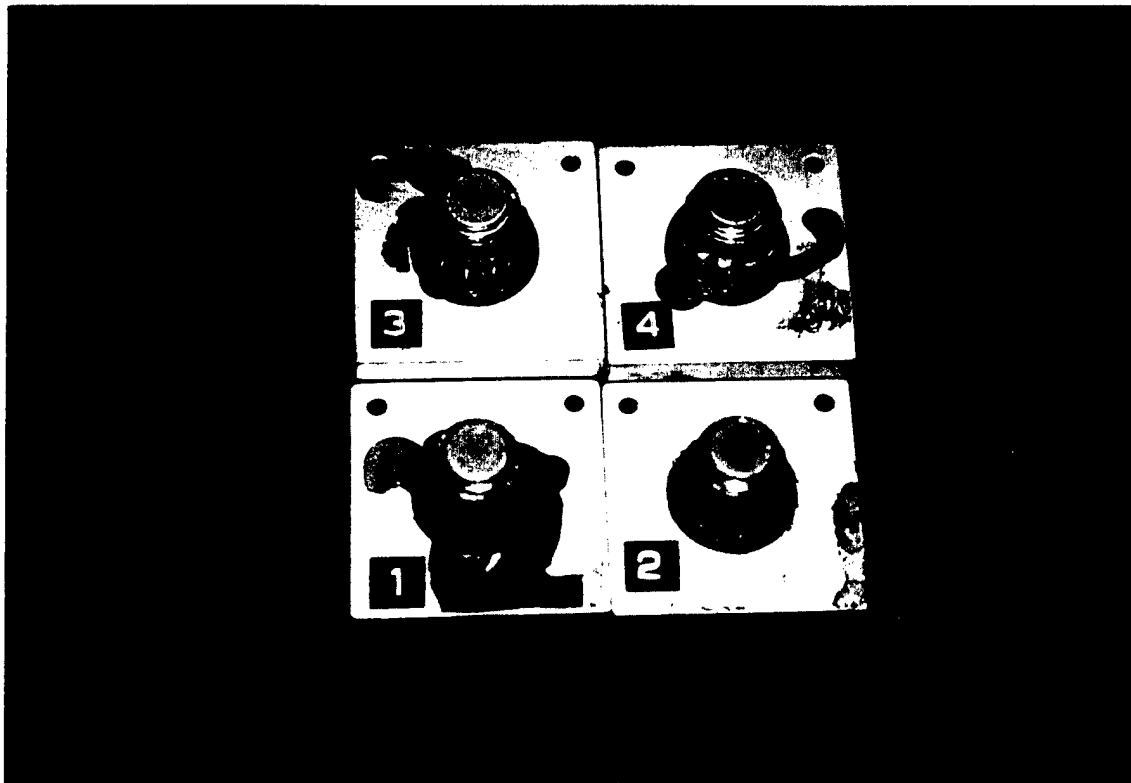

Figure 3. Inconel 718 Nickel-Based Superalloy Nuts With IVD Al Coating Before Salt Spray Exposure. Reduced 25%.

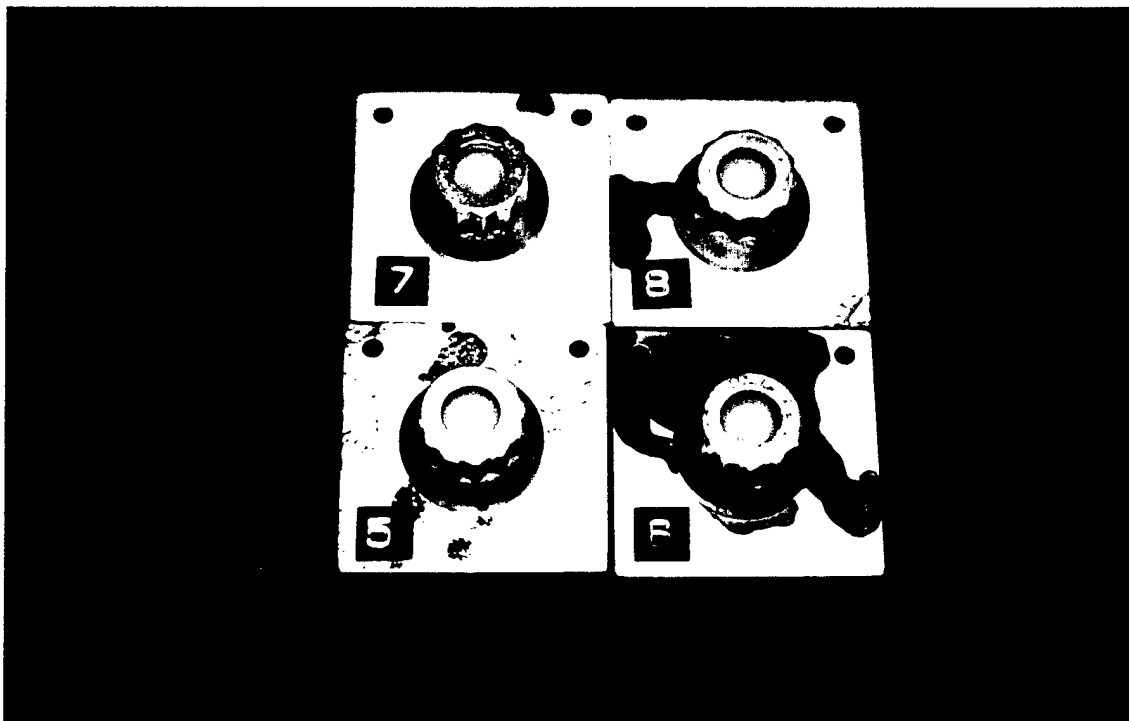

Figure 4. Inconel 718 Nickel-Based Superalloy Bolt Heads With Cadmium Electroplate Before Salt Spray Exposure. Reduced 25%.

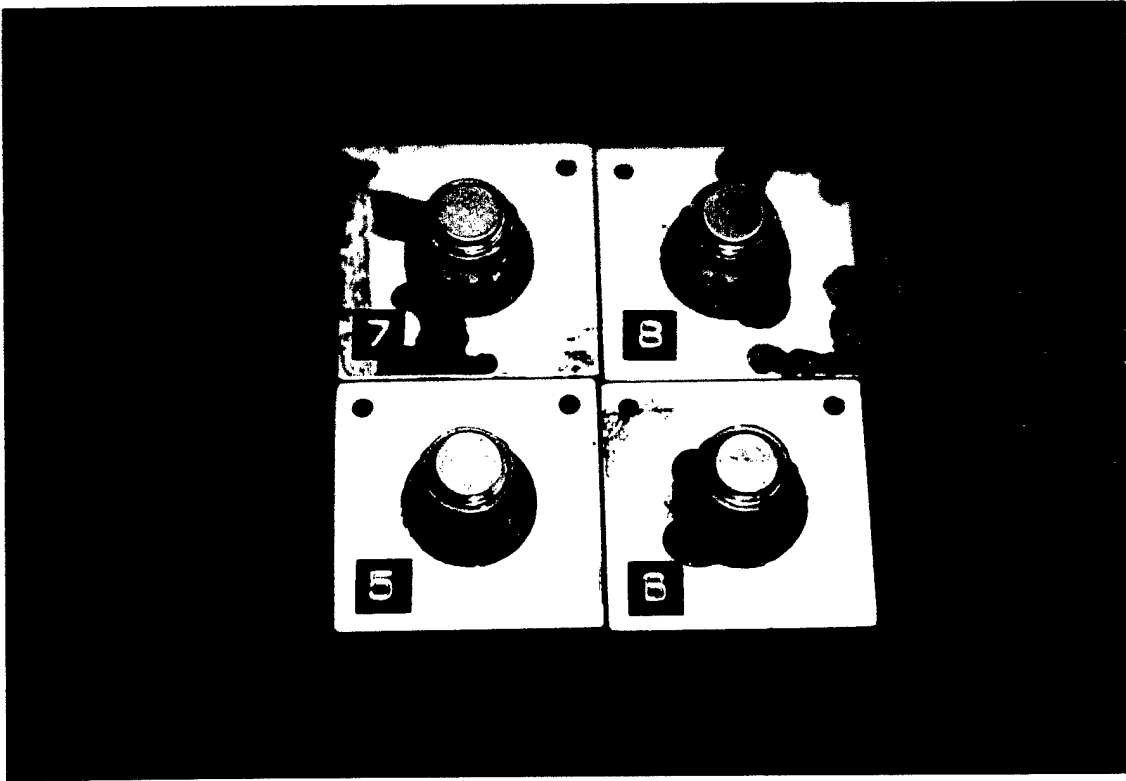

Figure 5. Inconel 718 Nickel-Based Superalloy Nuts With Cadmium Electroplate Before Salt Spray Exposure. Reduced 25%.

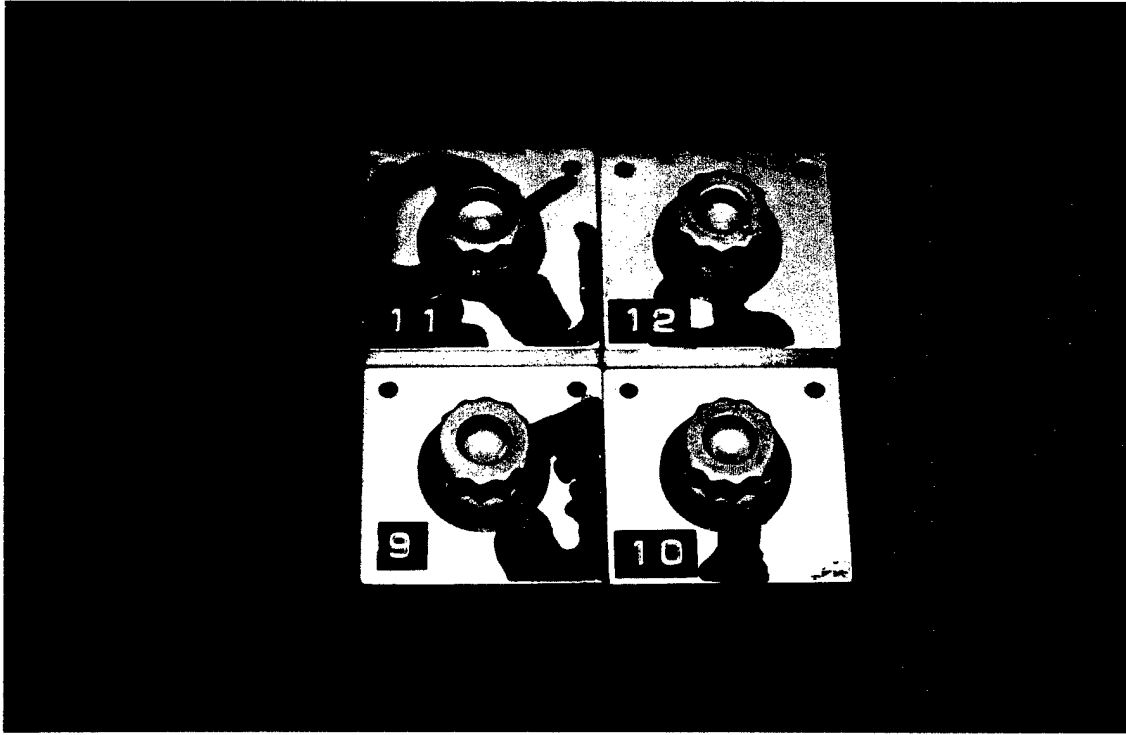

Figure 6. Inconel 718 Nickel-Based Superalloy Bolt Heads With Antiseize Solid Film Lubricant (MoS₂) Before Salt Spray Exposure. Reduced 25%.

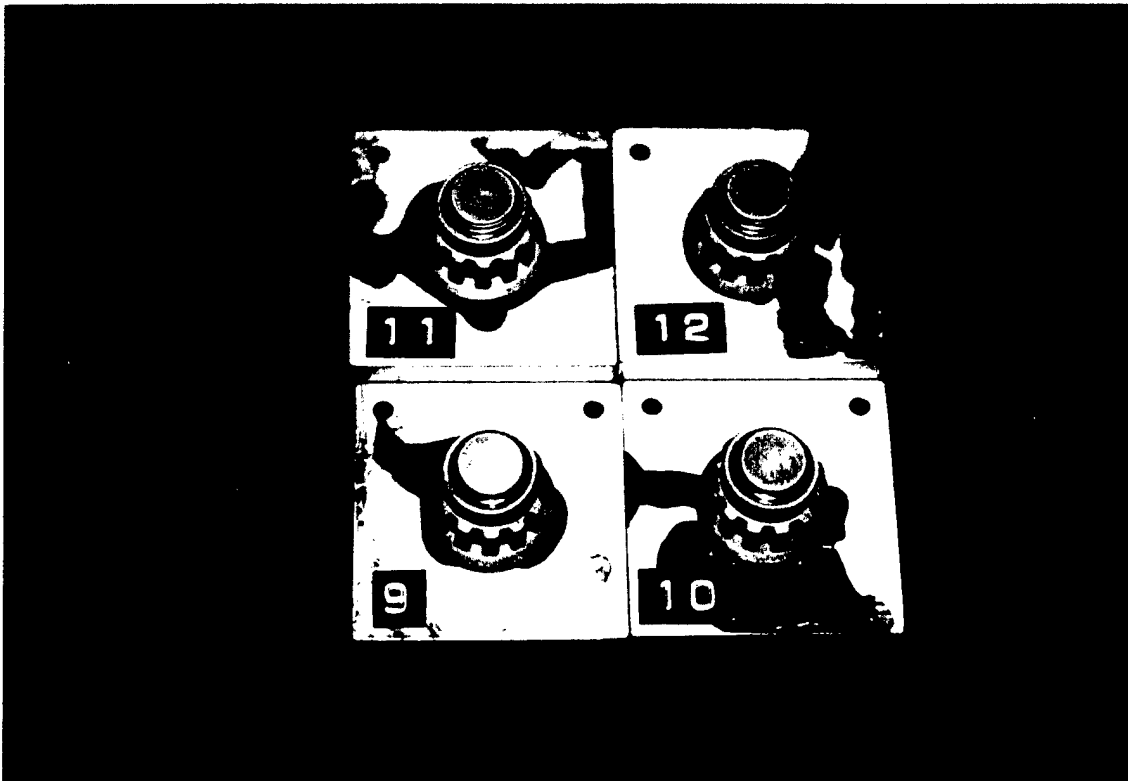

Figure 7. Inconel 718 Nickel-Based Superalloy Nuts With Antiseize Solid Film Lubricant (MoS₂) Before Salt Spray Exposure. Reduced 25%.

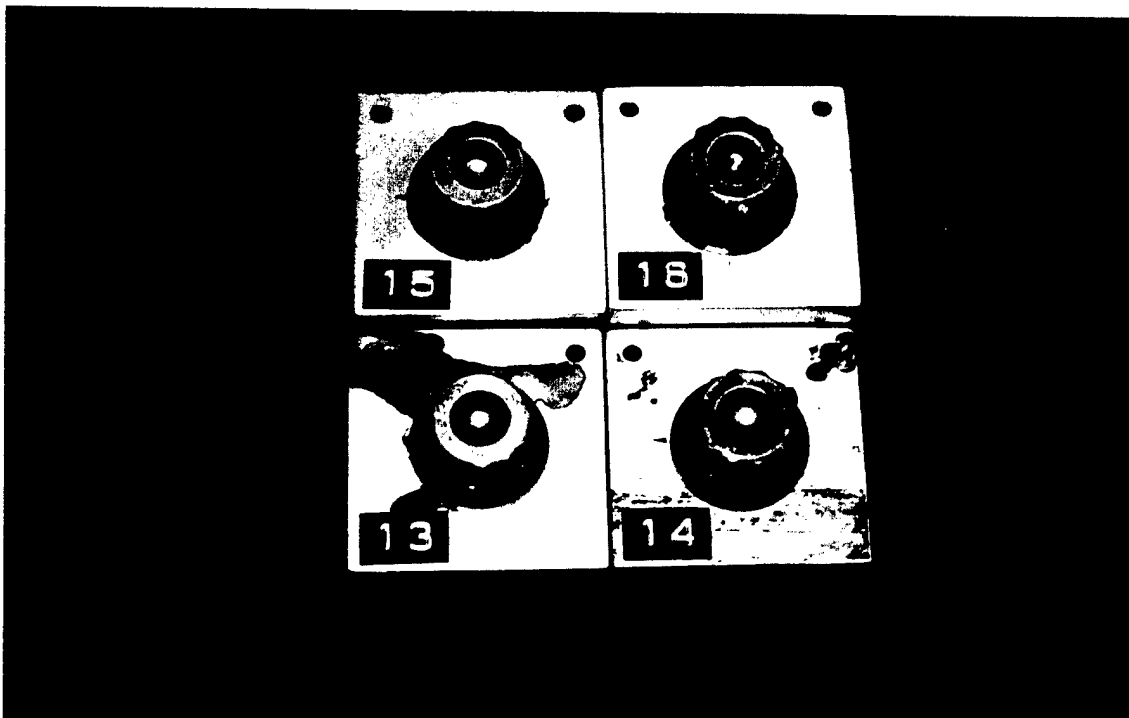

Figure 8. Inconel 718 Nickel-Based Superalloy Bolt Heads With MIL-C-16173 Grade 4 Corrosion Preventative Compound Before Salt Spray Exposure. Reduced 25%.

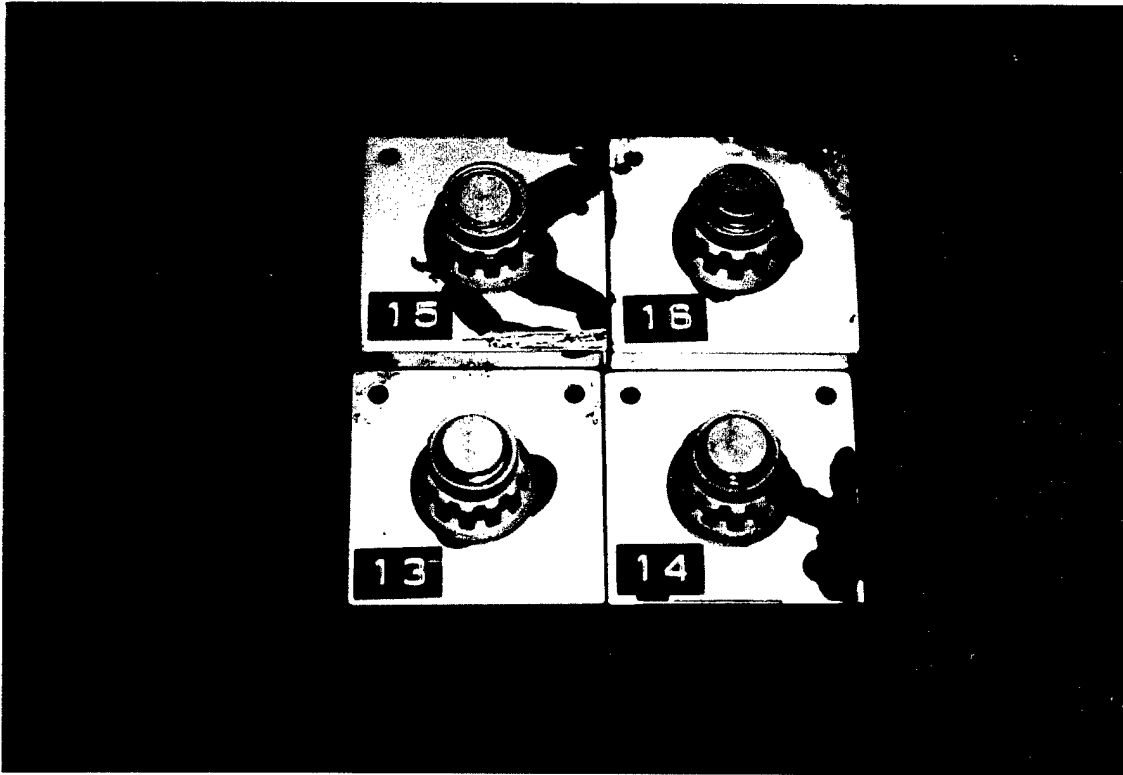

Figure 9. Inconel 718 Nickel-Based Superalloy Nuts With MIL-C-16173 Grade 4 Corrosion Preventative Compound Before Salt Spray Exposure. Reduced 25%.

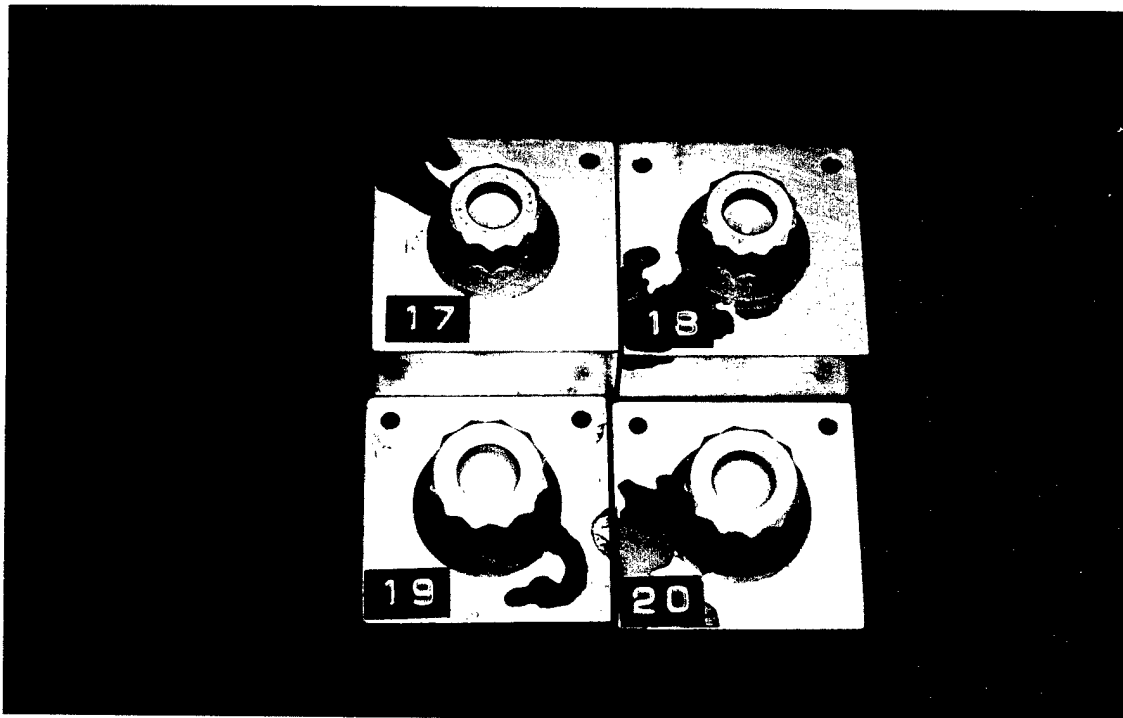

Figure 10. H11 Chromium Hot Work Tool Steel Bolt Heads With IVD Al Coating Before Salt Spray Exposure. Reduced 25%.

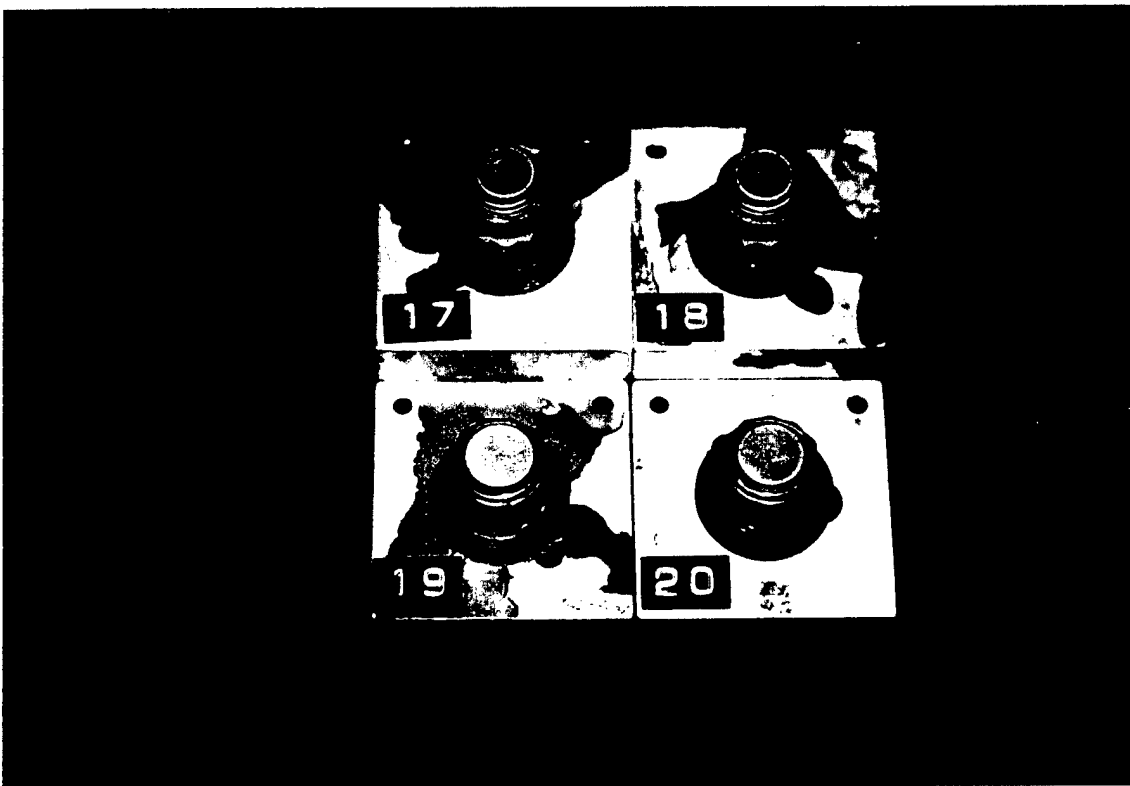

Figure 11. H11 Chromium Hot Work Tool Steel Nuts With IVD Al Coating Before Salt Spray Exposure. Reduced 25%.

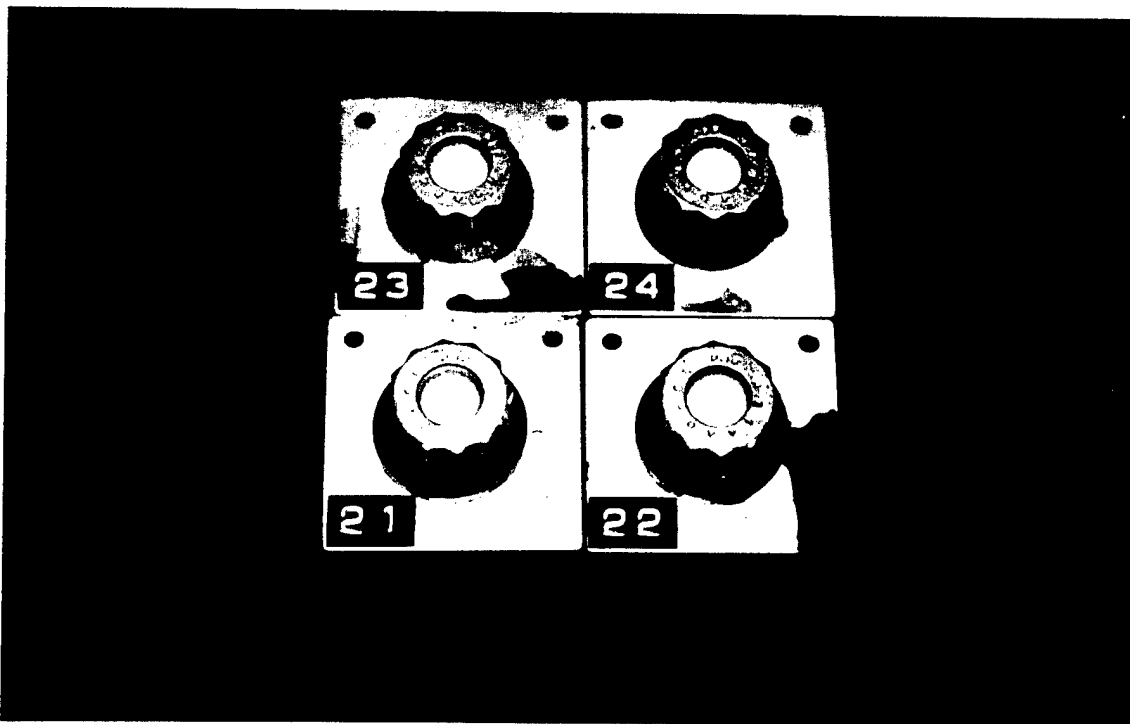

Figure 12. H11 Chromium Hot Work Tool Steel Bolt Heads With Cadmium Electroplate Before Salt Spray Exposure. Reduced 25%.

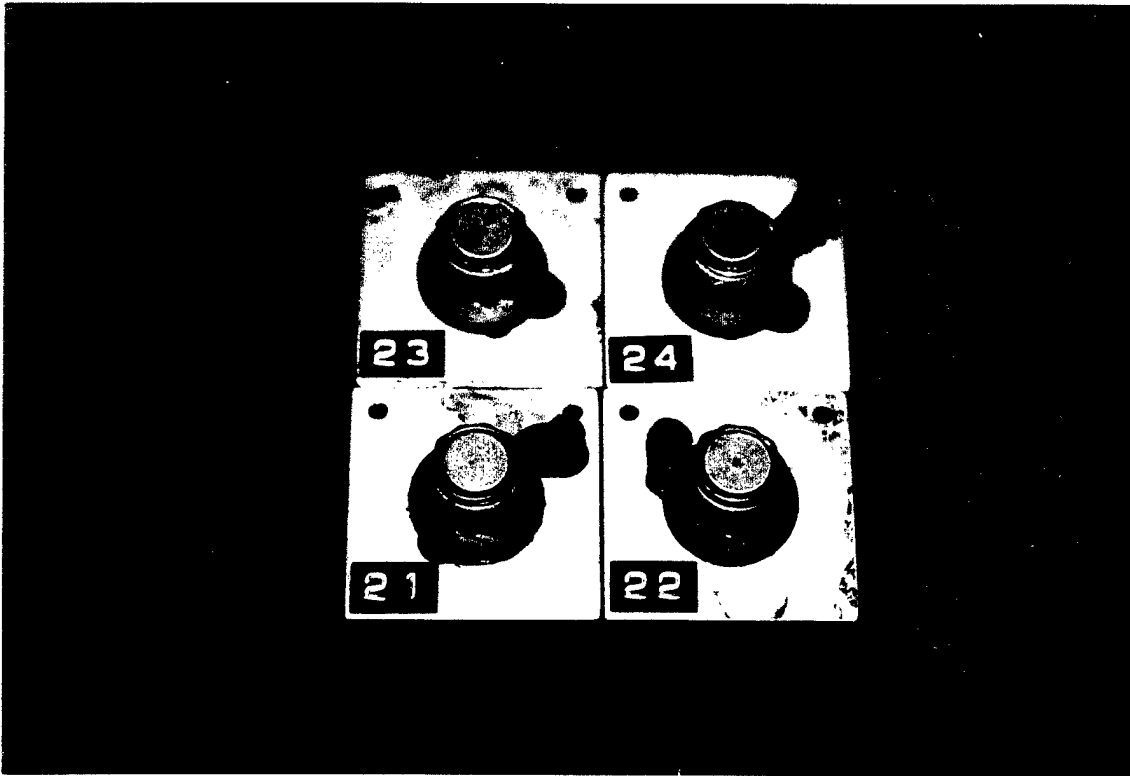

Figure 13. H11 Chromium Hot Work Tool Steel Nuts With Cadmium Electroplate Before Salt Spray Exposure. Reduced 25%.

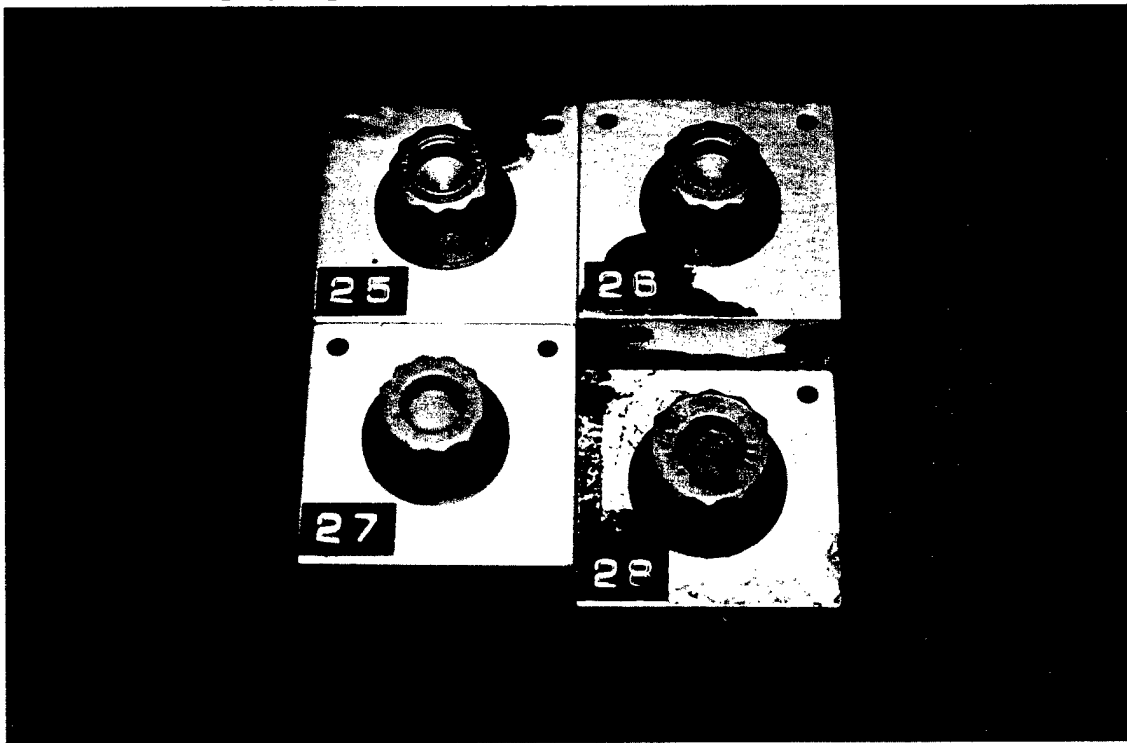

Figure 14. H11 Chromium Hot Work Tool Steel Bolt Heads With Antiseize Solid Film Lubricant (MoS₂) Before Salt Spray Exposure. Reduced 25%.

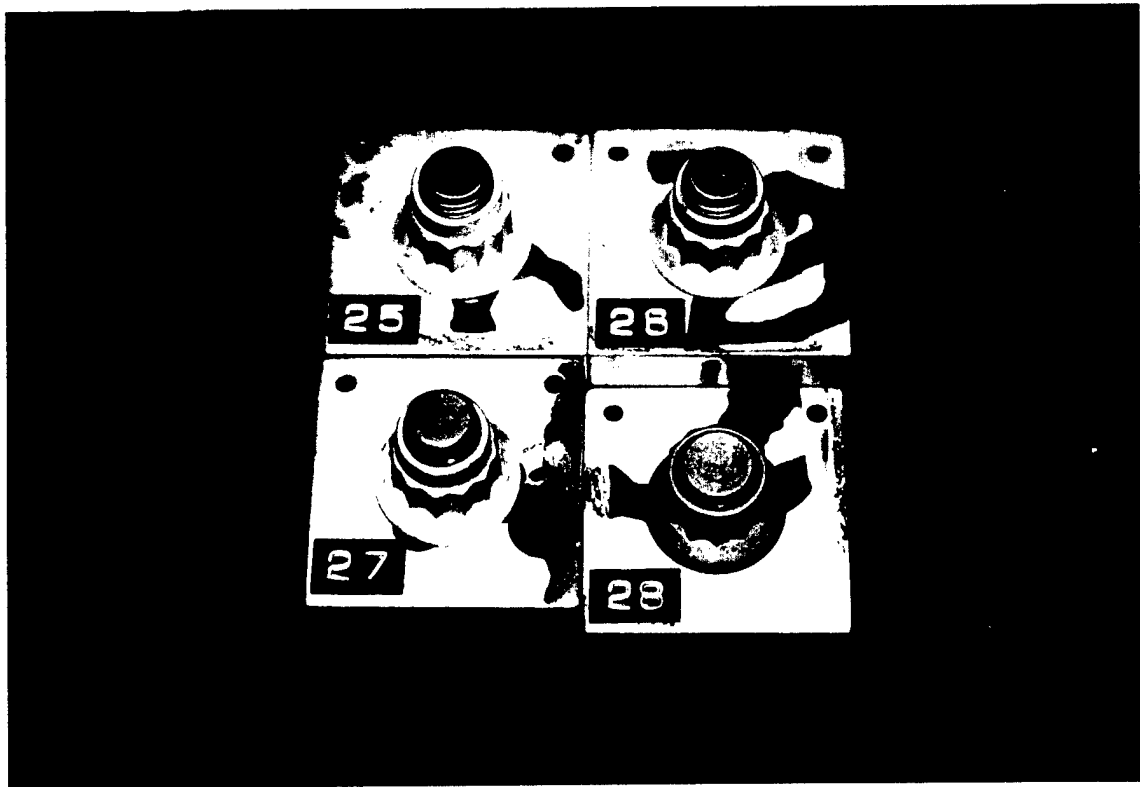

Figure 15. H11 Chromium Hot Work Tool Steel Nuts With Antiseize Solid Film Lubricant (MoS_2) Before Salt Spray Exposure. Reduced 25%.

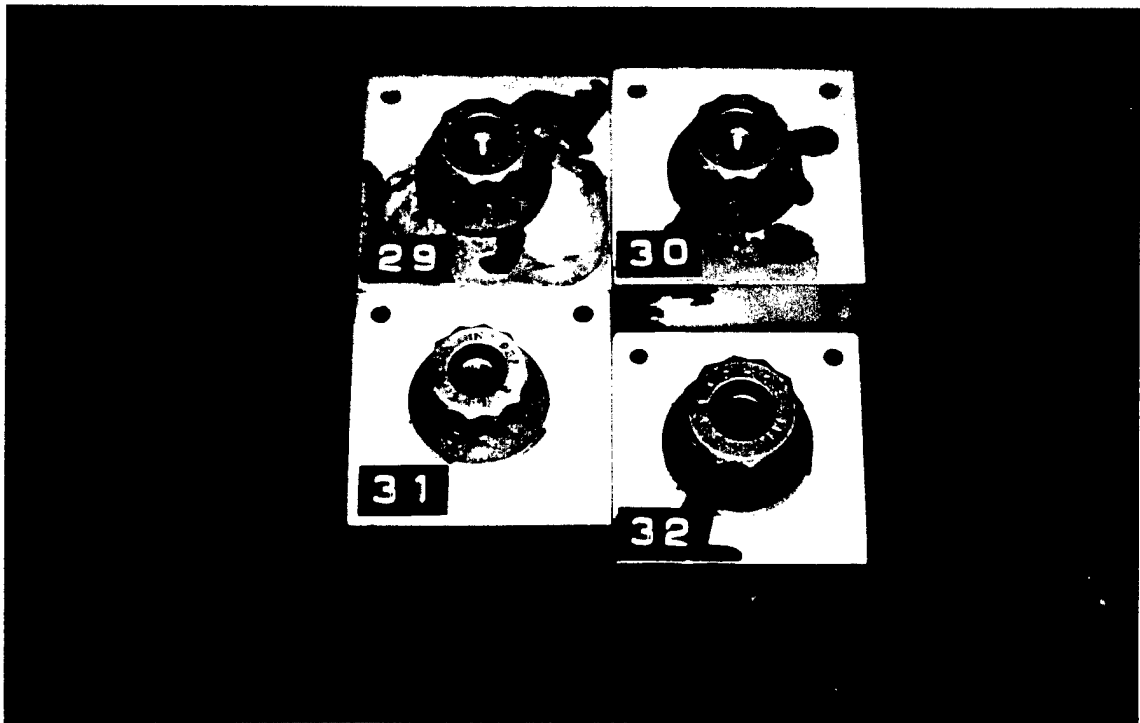

Figure 16. H11 Chromium Hot Work Tool Steel Bolt Heads With MIL-C-16173 Grade 4 Corrosion Preventative Compound Before Salt Spray Exposure. Reduced 25%.

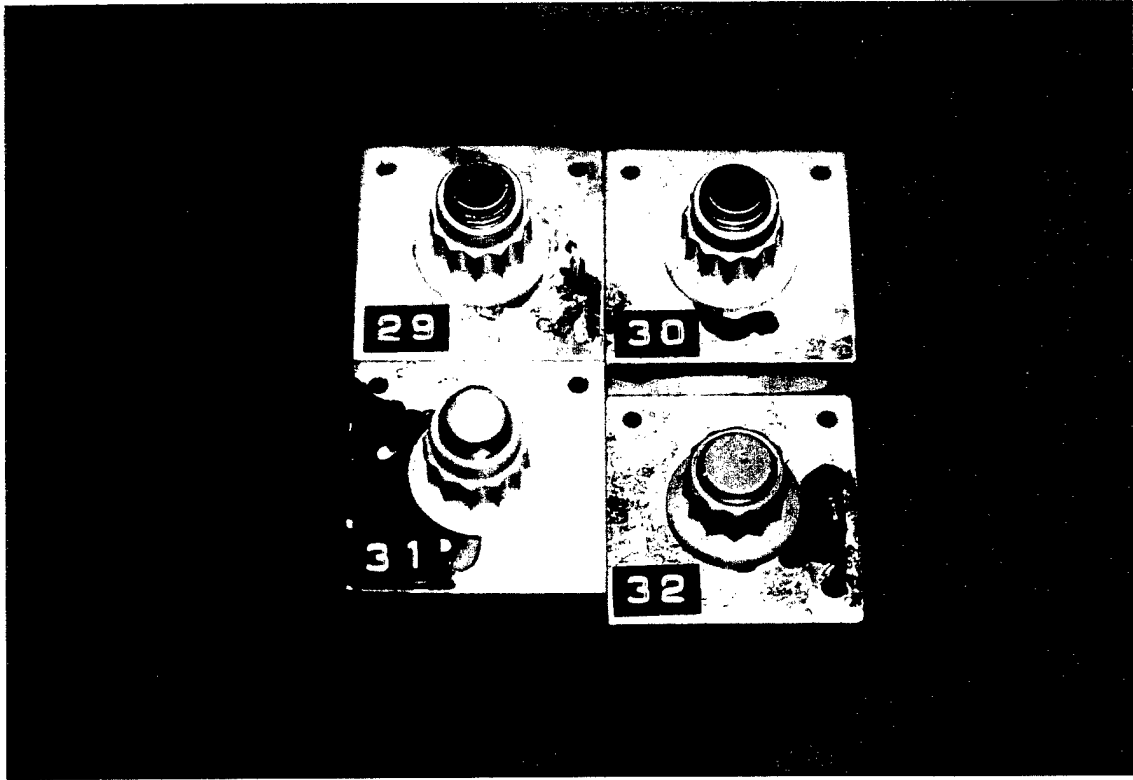

Figure 17. H11 Chromium Hot Work Tool Steel Nuts With MIL-C-16173 Grade 4 Corrosion Preventative Compound Before Salt Spray Exposure. Reduced 25%.

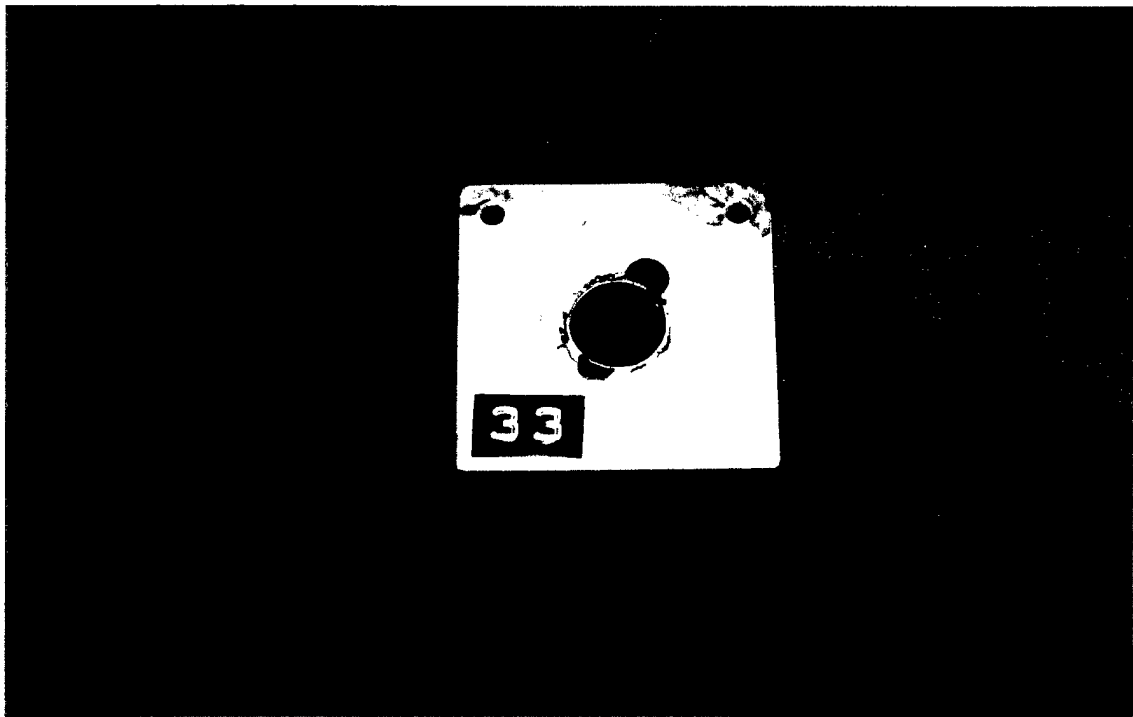

Figure 18. A1 Control Block Before Salt Spray Exposure. Reduced 25%.

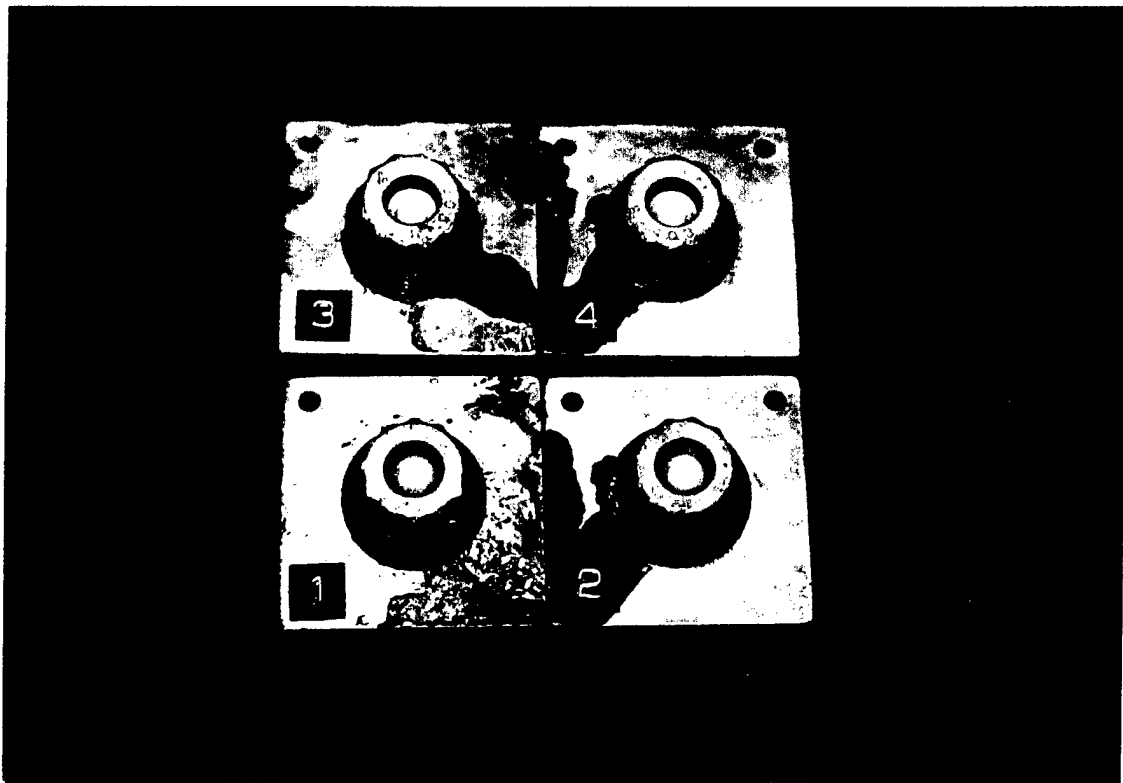

Figure 19. Inconel 718 Nickel-Based Superalloy Bolt Heads With IVD Al Coating After 15 Days of Salt Spray. Reduced 25%.

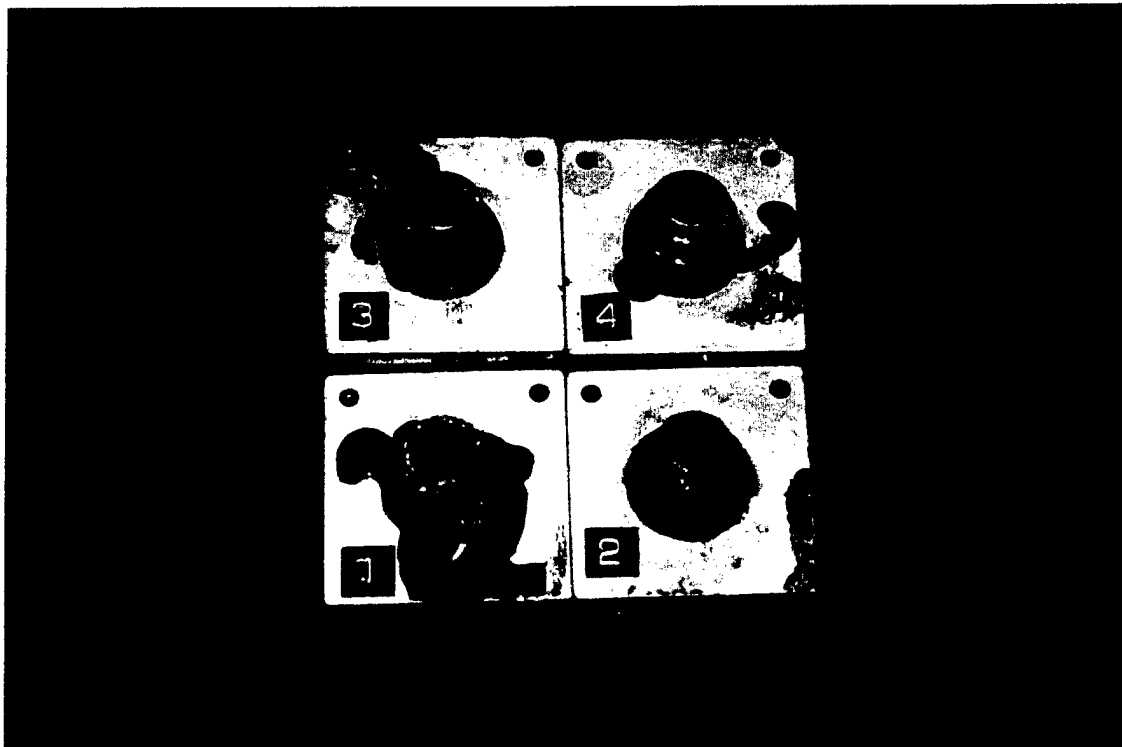

Figure 20. Inconel 718 Nickel-Based Superalloy Nuts With IVD Al Coating After 15 Days of Salt Spray. Reduced 25%.

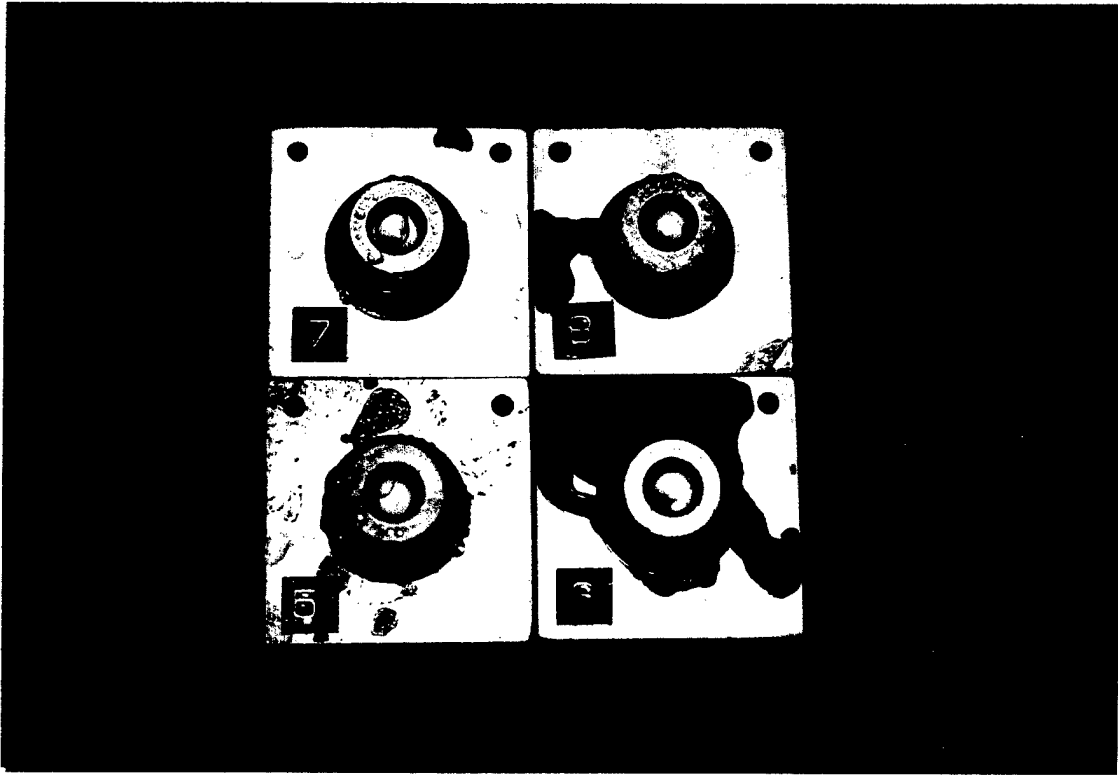

Figure 21. Inconel 718 Nickel-Based Superalloy Bolt Heads With Cadmium Electroplate After 15 Days of Salt Spray. Reduced 25%.

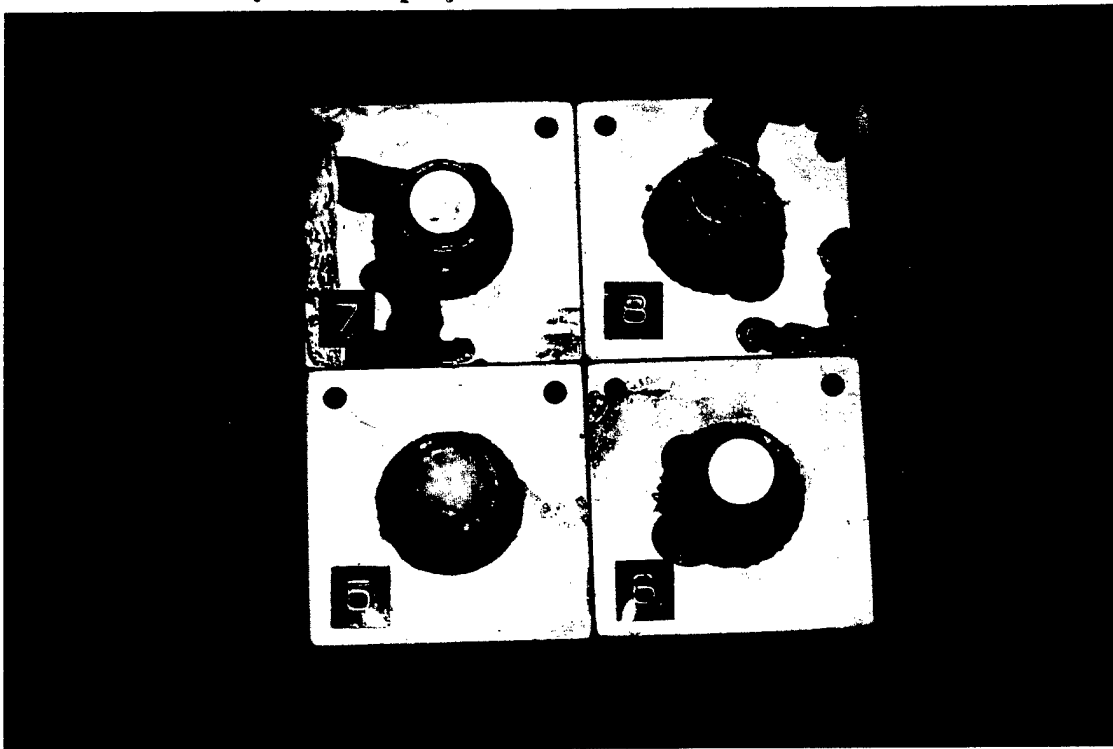

Figure 22. Inconel 718 Nickel-Based Superalloy Nuts With Cadmium Electroplate After 15 Days of Salt Spray. Reduced 25%.

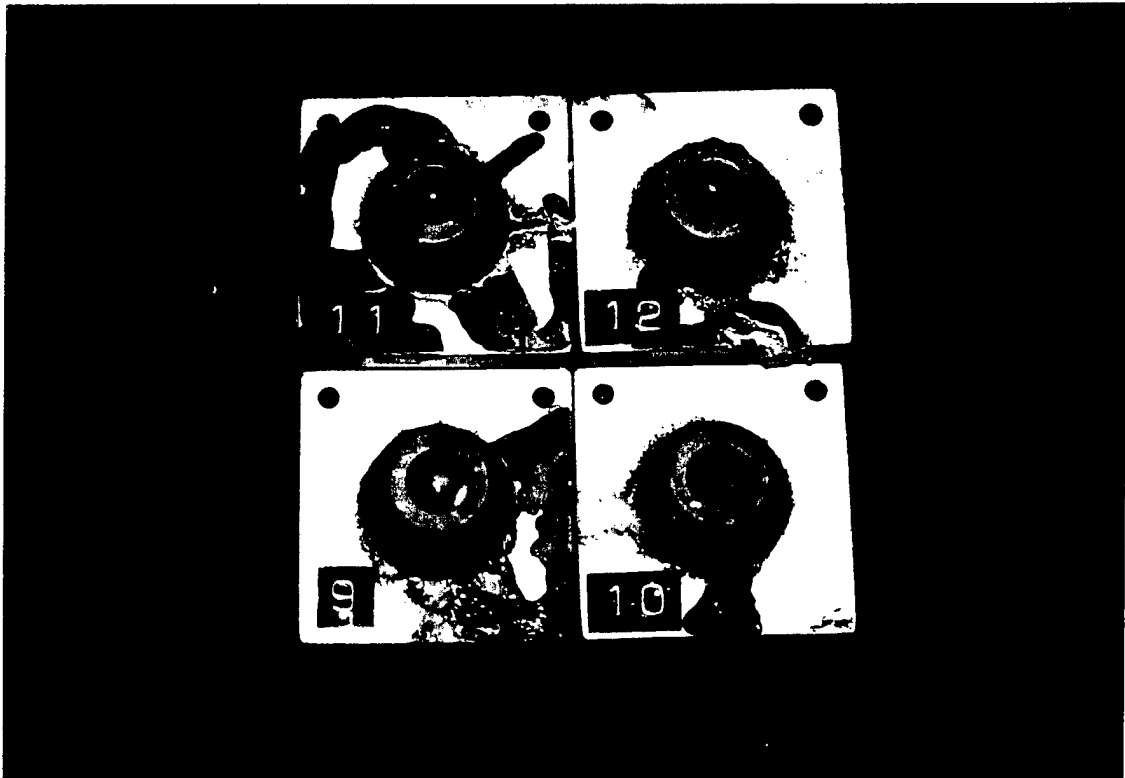

Figure 23. Inconel 718 Nickel-Based Superalloy Bolt Heads With Antiseize Solid Film Lubricant (MoS_2) After 15 Days of Salt Spray. Reduced 25%.

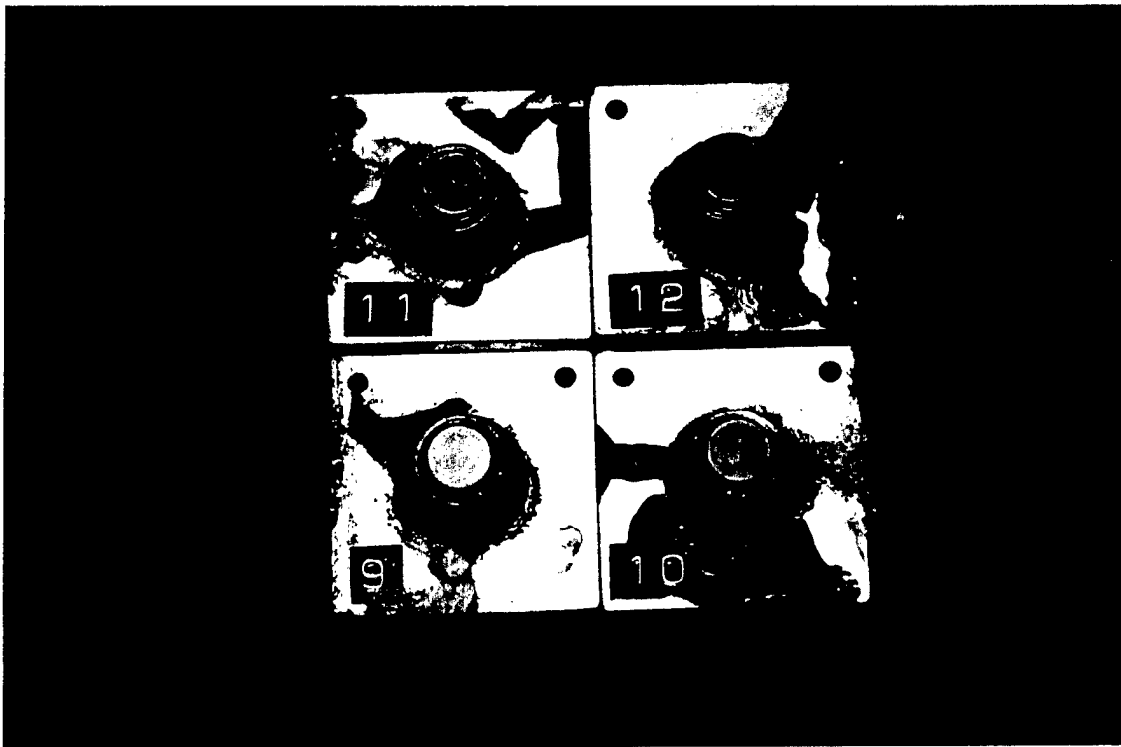

Figure 24. Inconel 718 Nickel-Based Superalloy Nuts With Antiseize Solid Film Lubricant (MoS_2) After 15 Days of Salt Spray. Reduced 25%.

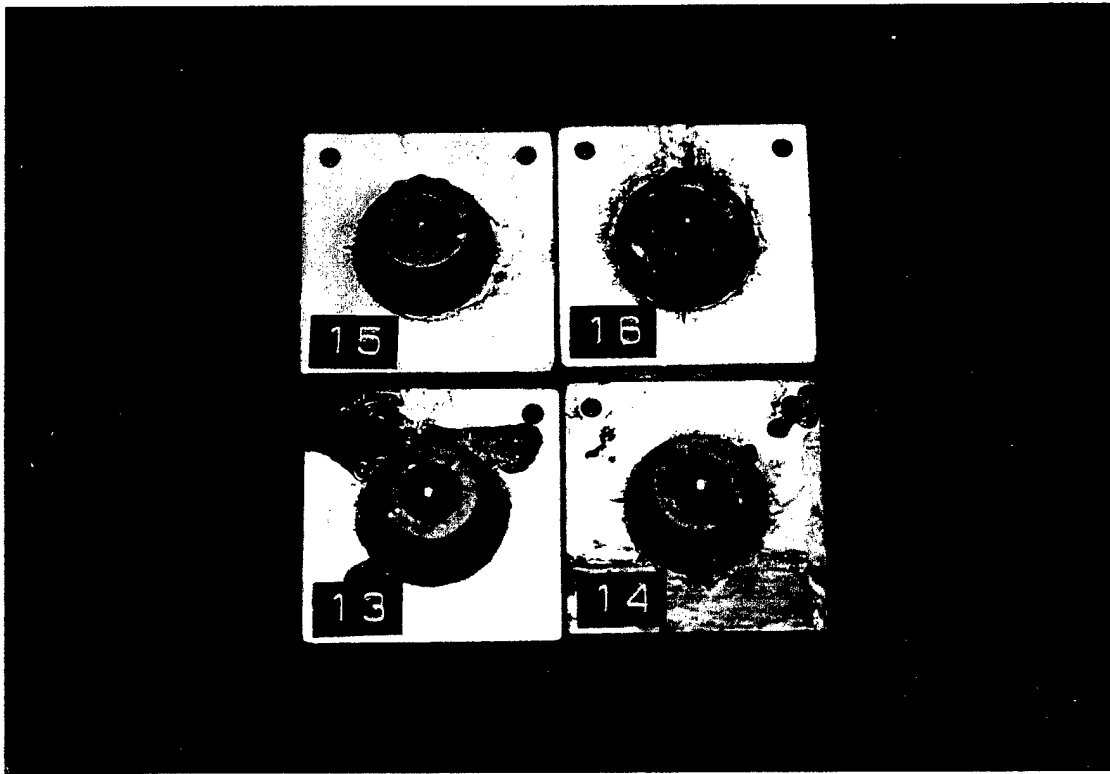

Figure 25. Inconel 718 Nickel-Based Superalloy Bolt Heads With MIL-C-16173 Grade 4 Corrosion Preventative Compound After 15 Days of Salt Spray. Reduced 25%.

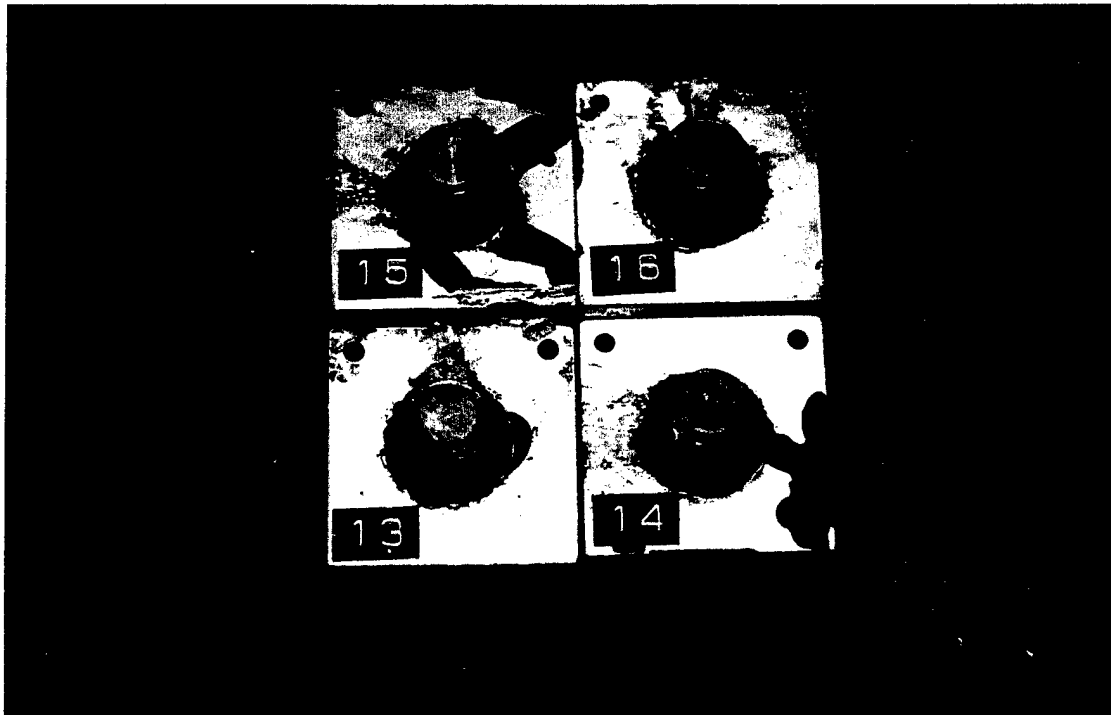

Figure 26. Inconel 718 Nickel-Based Superalloy Nuts With MIL-C-16173 Grade 4 Corrosion Preventative Compound After 15 Days of Salt Spray. Reduced 25%.

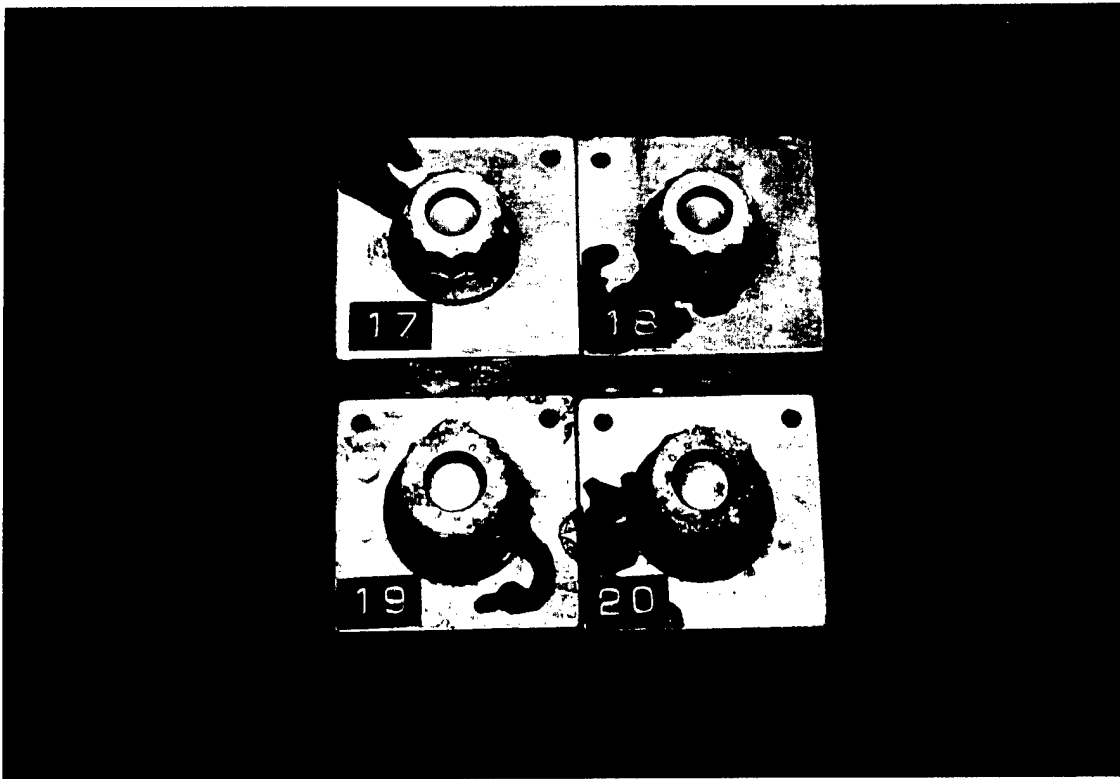

Figure 27. H11 Chromium Hot Work Tool Steel Bolt Heads With IVD Al Coating After 15 Days of Salt Spray. Reduced 25%.

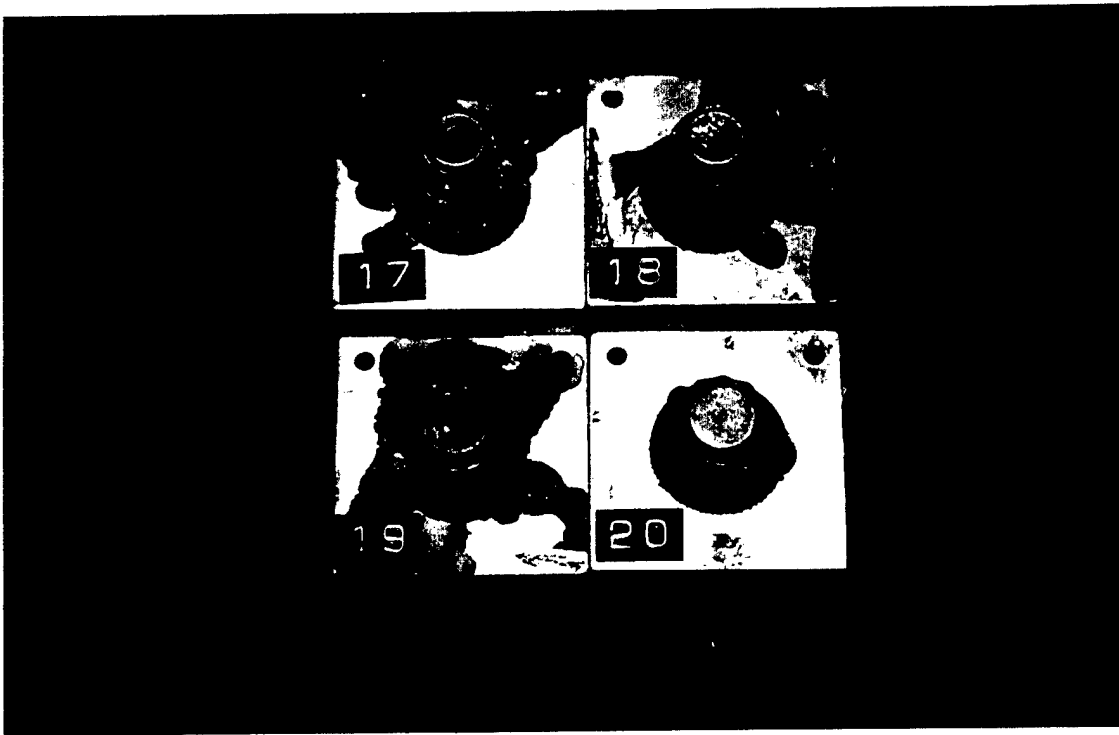

Figure 28. H11 Chromium Hot Work Tool Steel Nuts With IVD Al Coating After 15 Days of Salt Spray. Reduced 25%.

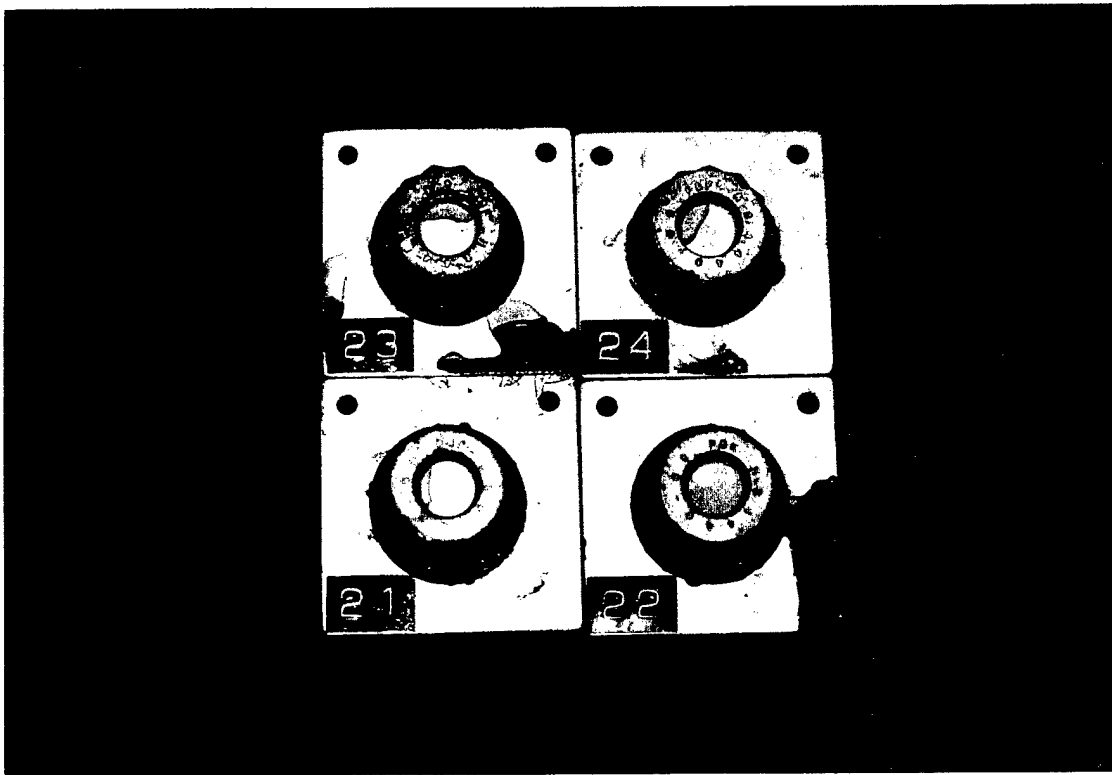

Figure 29. H11 Chromium Hot Work Tool Steel Bolt Heads With Cadmium Electroplate After 15 Days of Salt Spray. Reduced 25%.

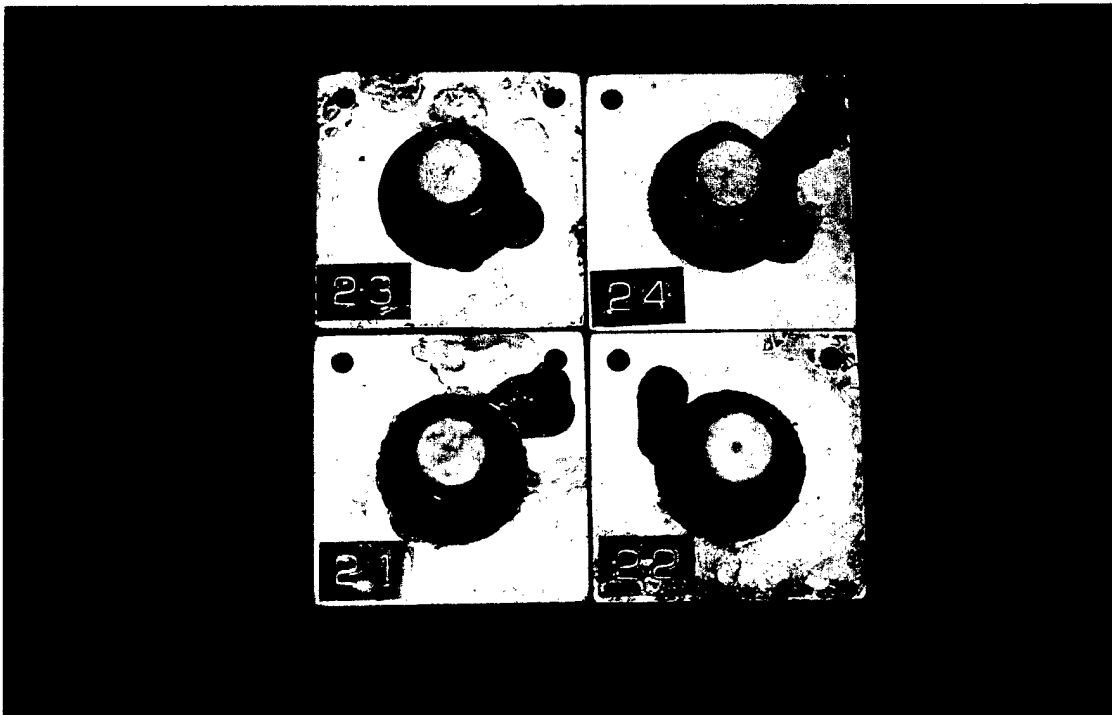

Figure 30. H11 Chromium Hot Work Tool Steel Nuts With Cadmium Electroplate After 15 Days of Salt Spray. Reduced 25%.

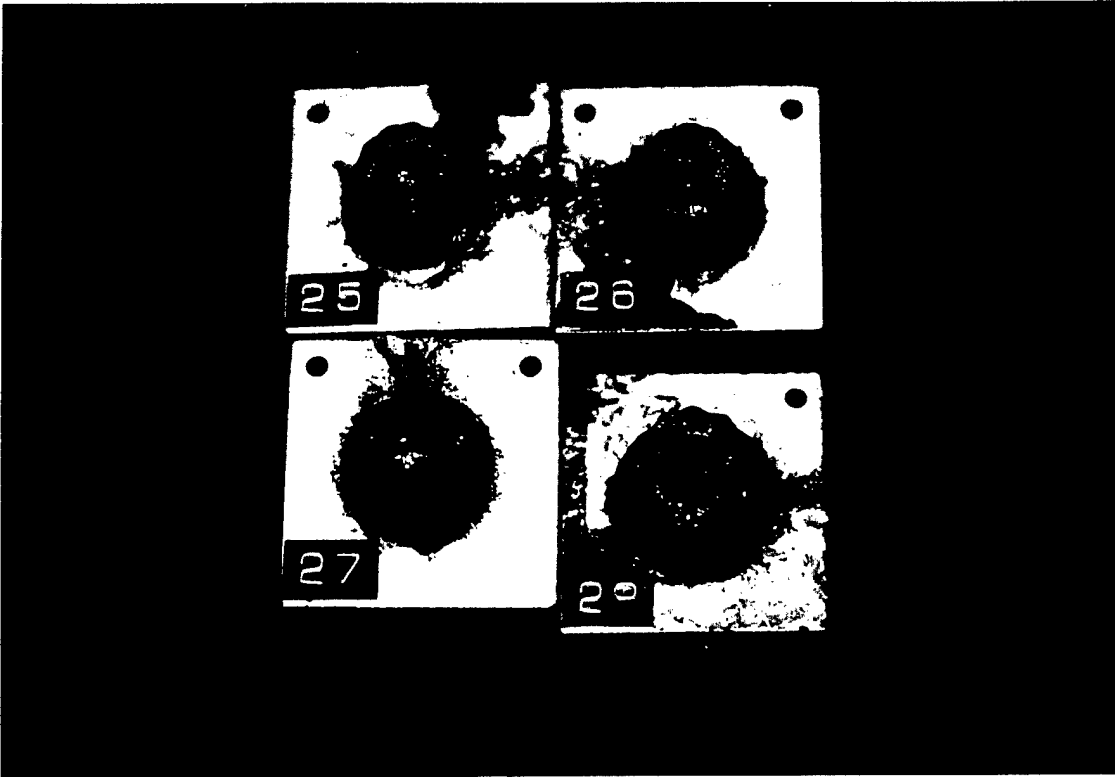

Figure 31. H11 Chromium Hot Work Tool Steel Nuts With Antiseize Solid Film Lubricant (MoS₂) After 15 Days of Salt Spray. Reduced 25%.

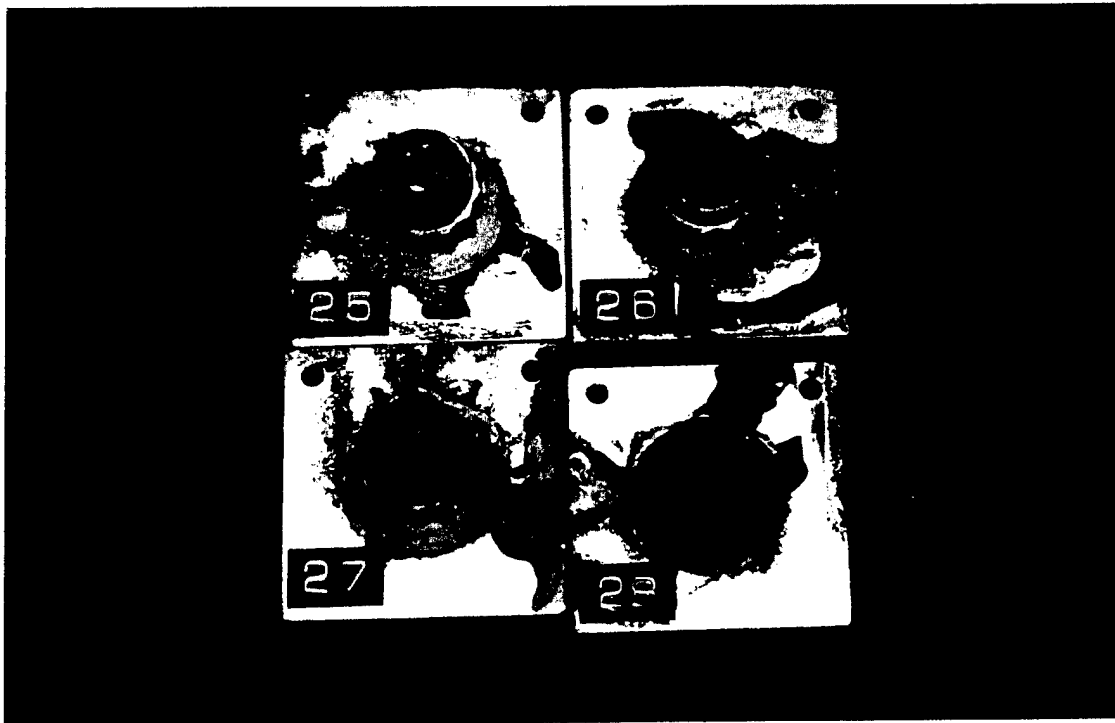

Figure 32. H11 Chromium Hot Work Tool Steel Nuts With Antiseize Solid Film Lubricant (MoS₂) After 15 Days of Salt Spray. Reduced 25%.

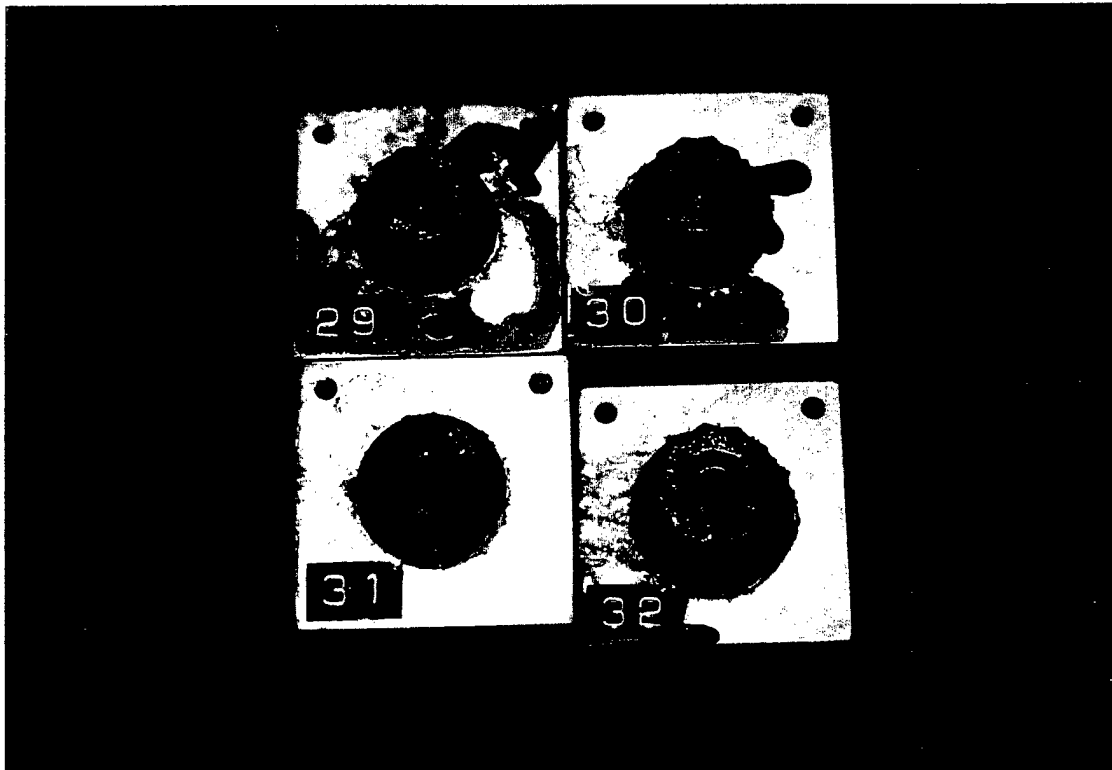

Figure 33. H11 Chromium Hot Work Tool Steel Bolt Heads With MIL-C-16173 Grade 4 Corrosion Preventative Compound After 15 Days of Salt Spray. Reduced 25%.

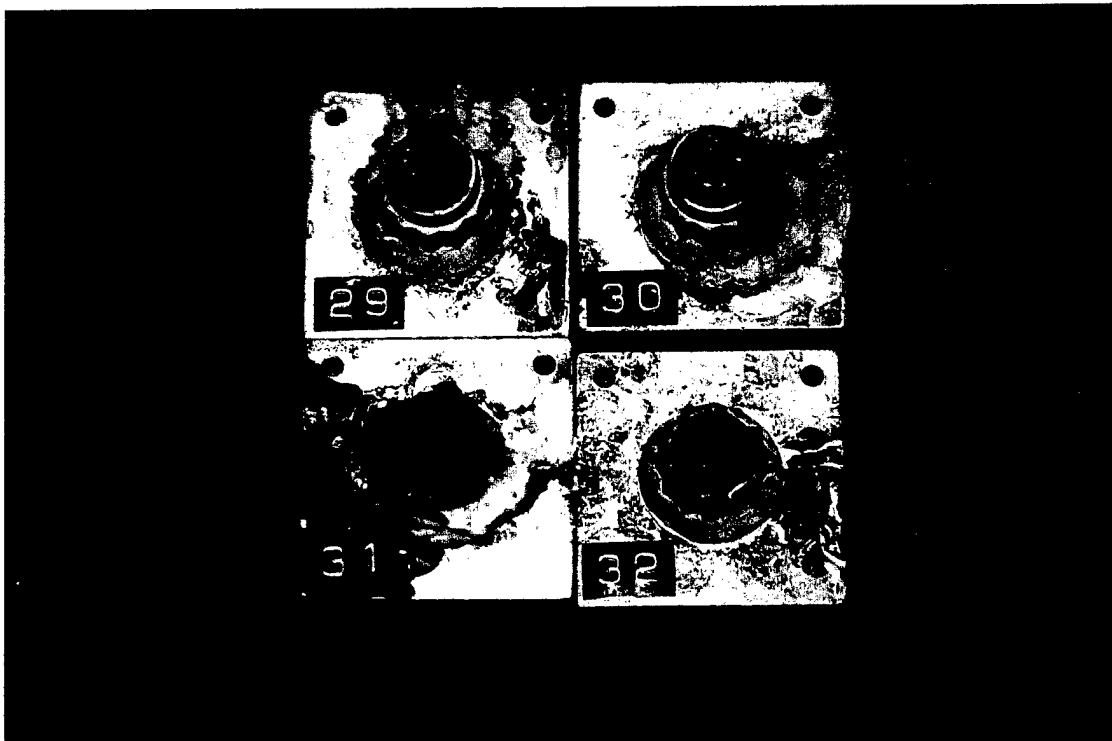

Figure 34. H11 Chromium Hot Work Tool Steel Nuts With MIL-C-16173 Grade 4 Corrosion Preventative Compound After 15 Days of Salt Spray. Reduced 25%.

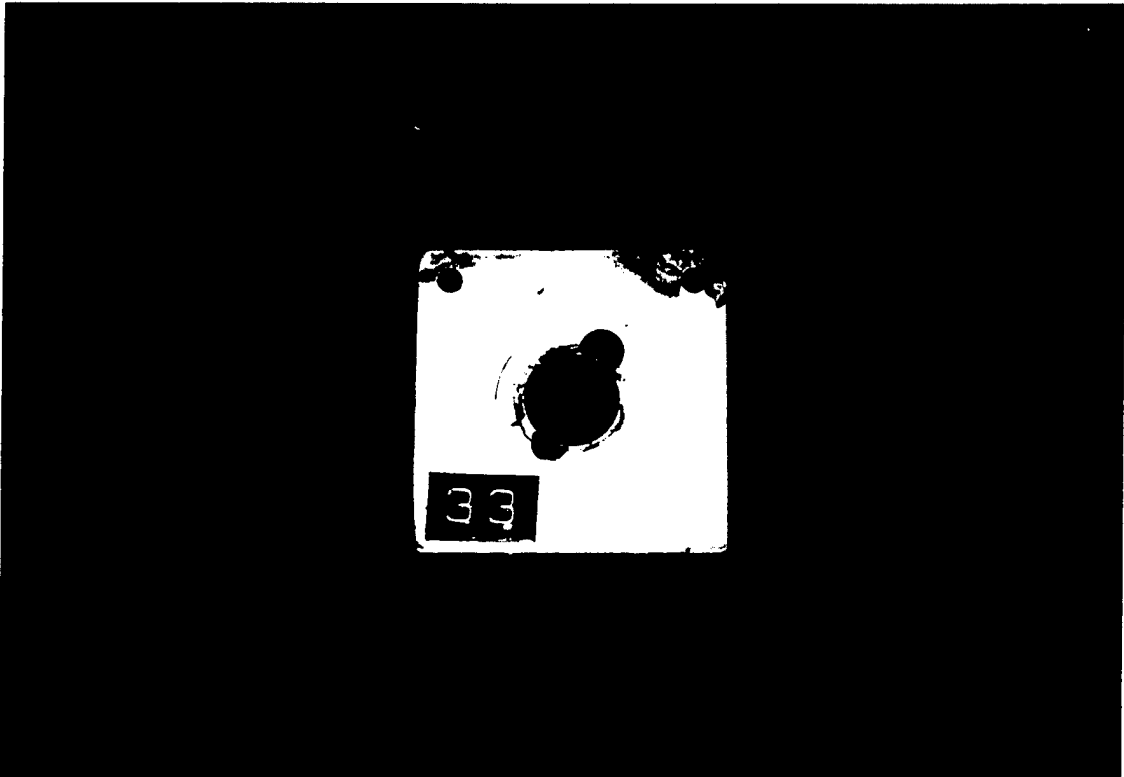

Figure 35. Aluminum Control Block After 15 Days of Salt Spray. Reduced 25%.

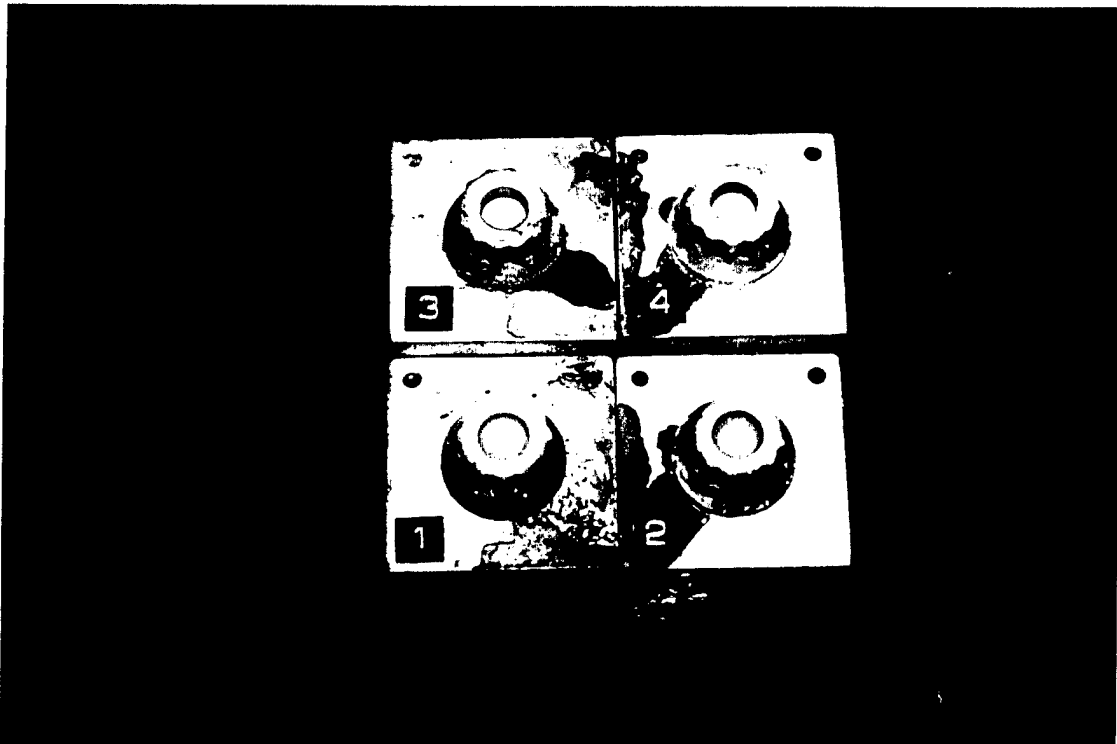

Figure 36. Inconel 718 Nickel-Based Superalloy Bolt Heads With IVD Al Coating After 30 Days of Salt Spray. Reduced 25%.

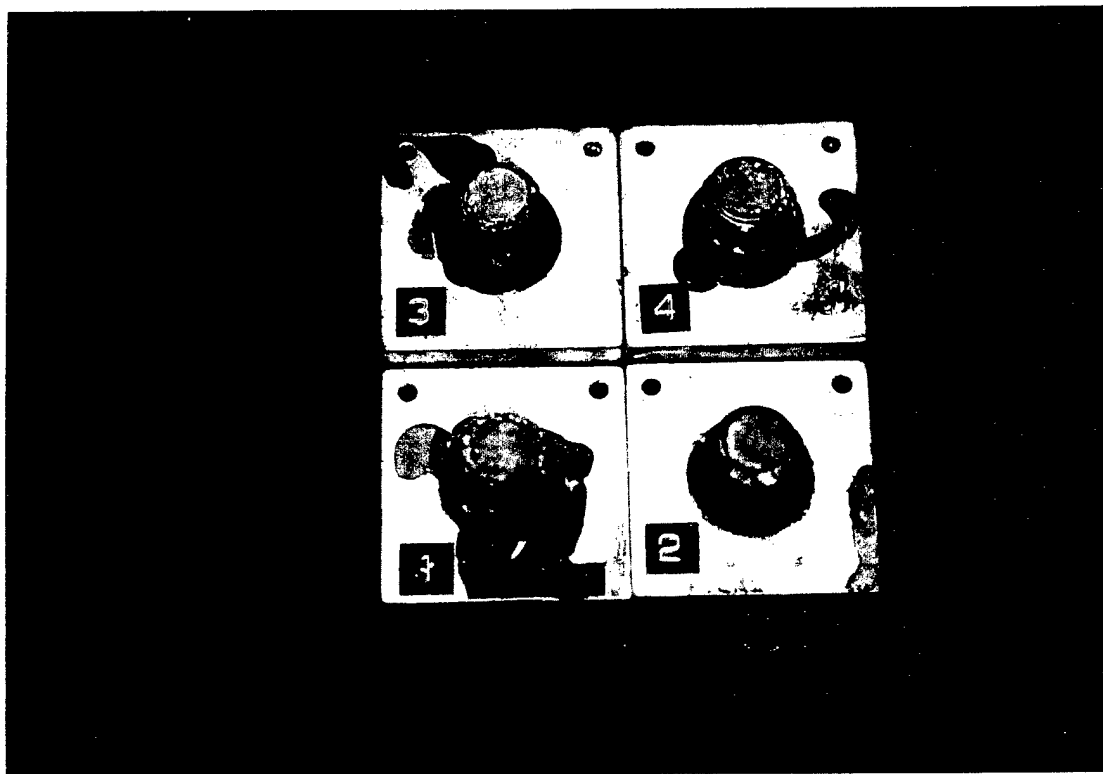

Figure 37. Inconel 718 Nickel-Based Superalloy Nuts With IVD Al Coating After 30 Days of Salt Spray. Reduced 25%.

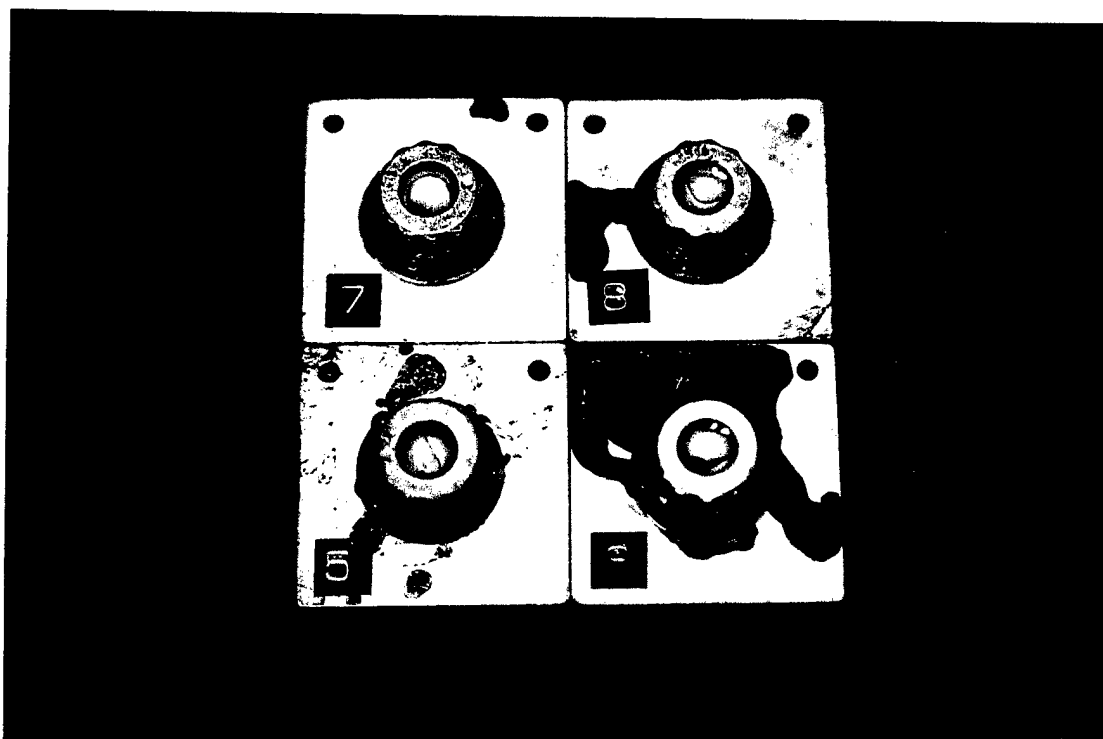

Figure 38. Inconel 718 Nickel-Based Superalloy Bolt Heads With Cadmium Electroplate After 30 Days of Salt Spray. Reduced 25%.

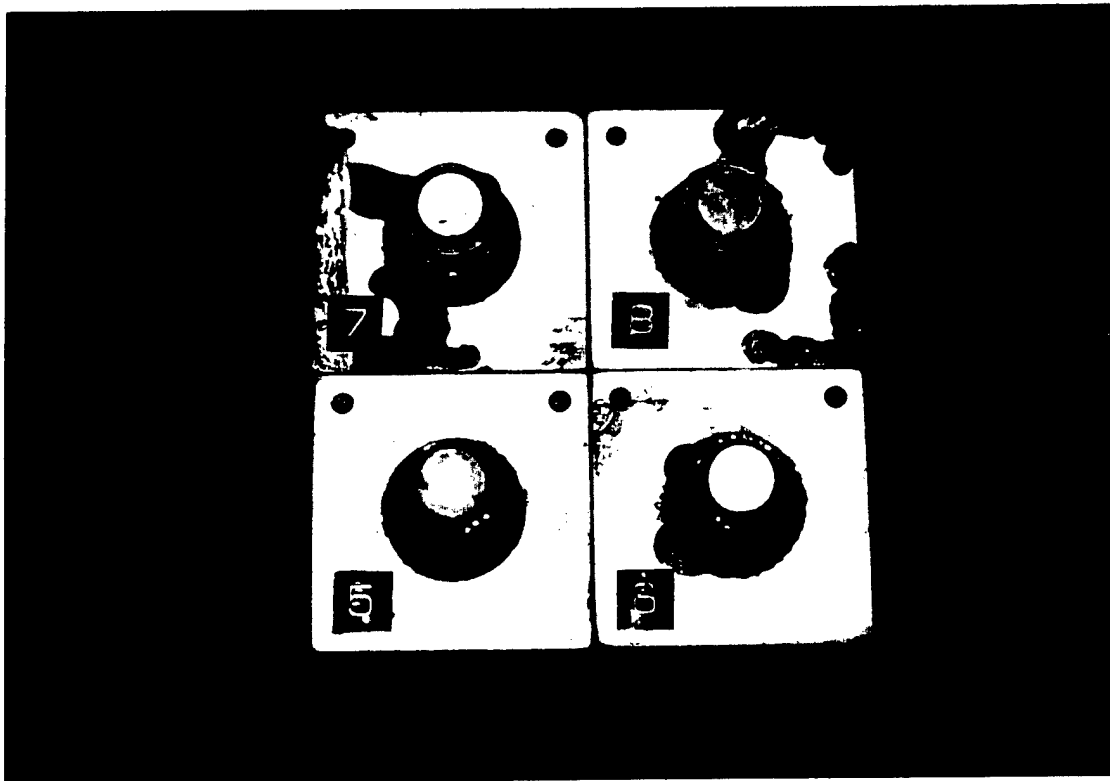

Figure 39. Inconel 718 Nickel-Based Superalloy Nuts With Cadmium Electroplate After 30 Days of Salt Spray. Reduced 25%.

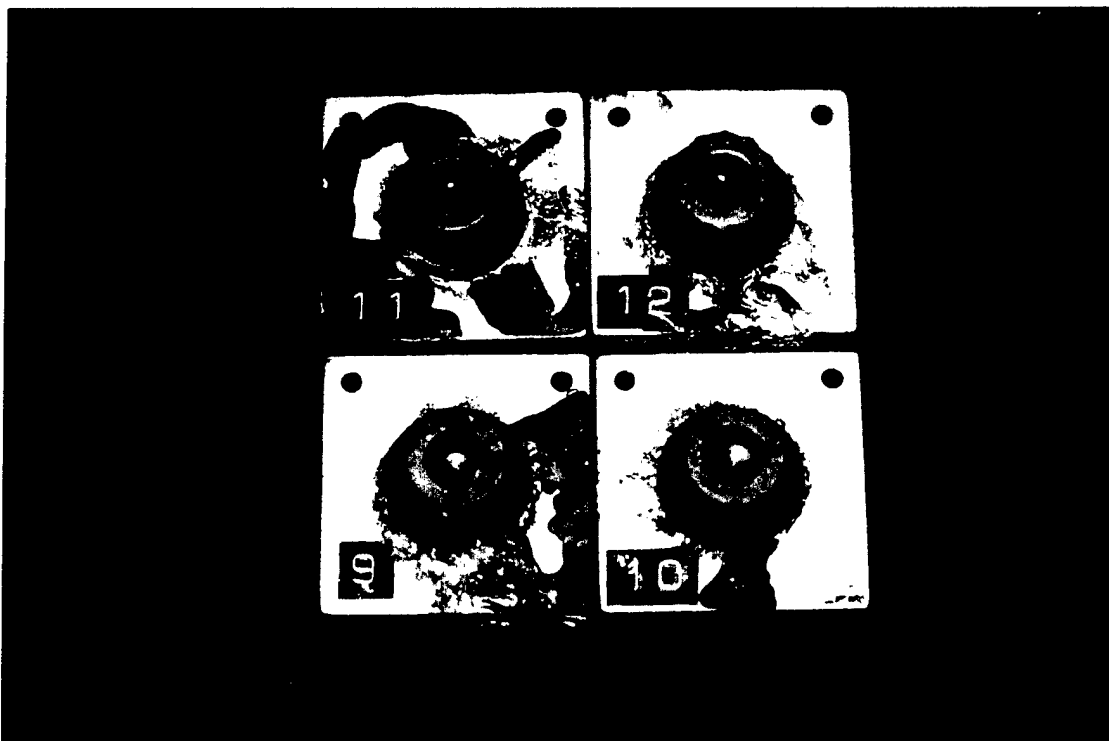

Figure 40. Inconel 718 Nickel-Based Superalloy Bolt Heads With Antiseize Solid Film Lubricant (MoS_2) After 30 Days of Salt Spray. Reduced 25%.

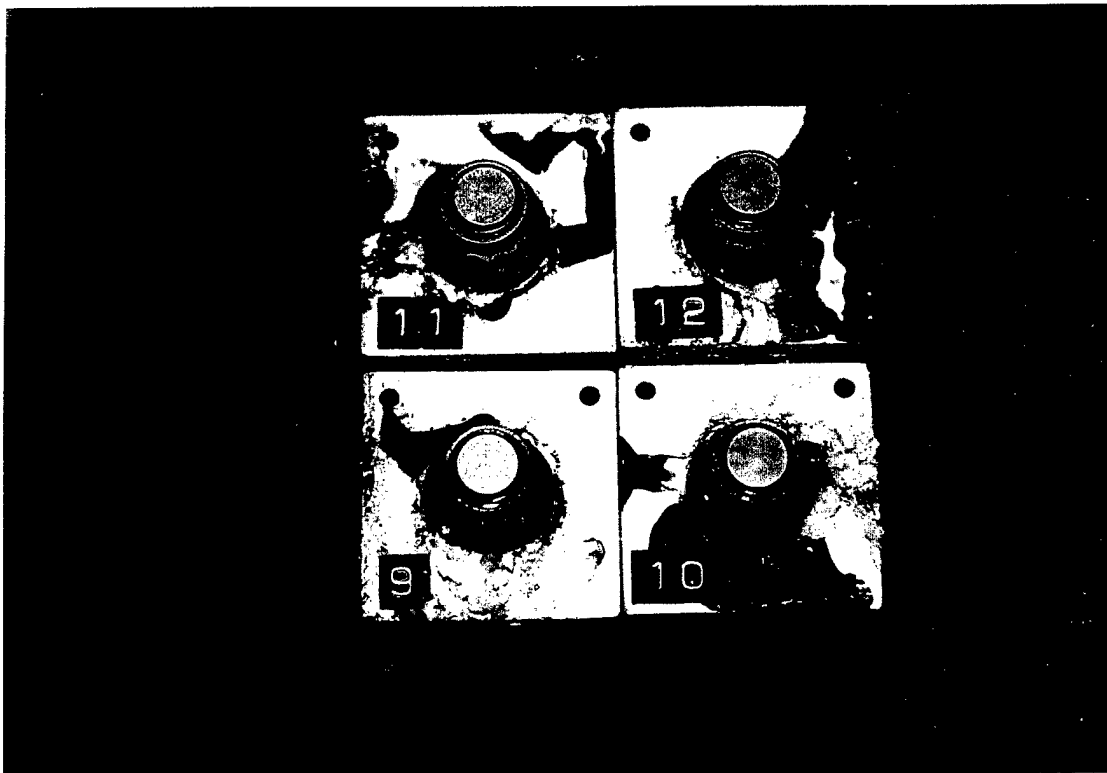

Figure 41. Inconel 718 Nickel-Based Superalloy Nuts With Antiseize Solid Film Lubricant (MoS₂) After 30 Days of Salt Spray. Reduced 25%.

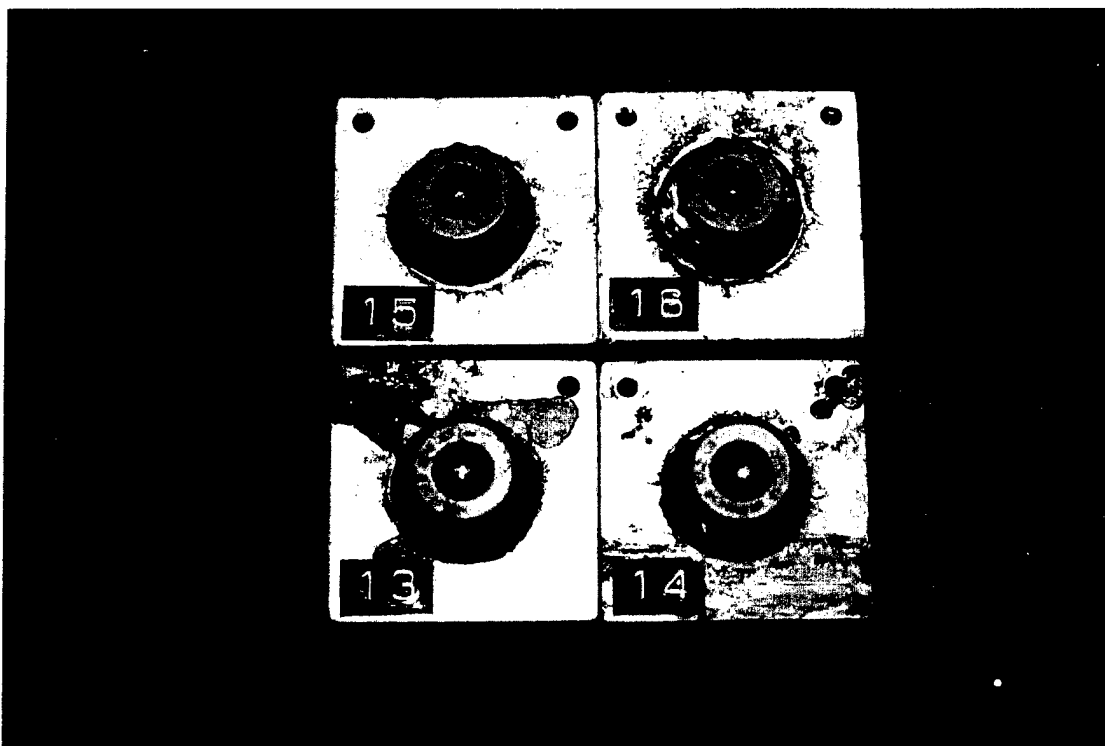

Figure 42. Inconel 718 Nickel-Based Superalloy Bolt Heads With MIL-C-16173 Grade 4 Corrosion Preventative Compound After 30 Days of Salt Spray. Reduced 25%.

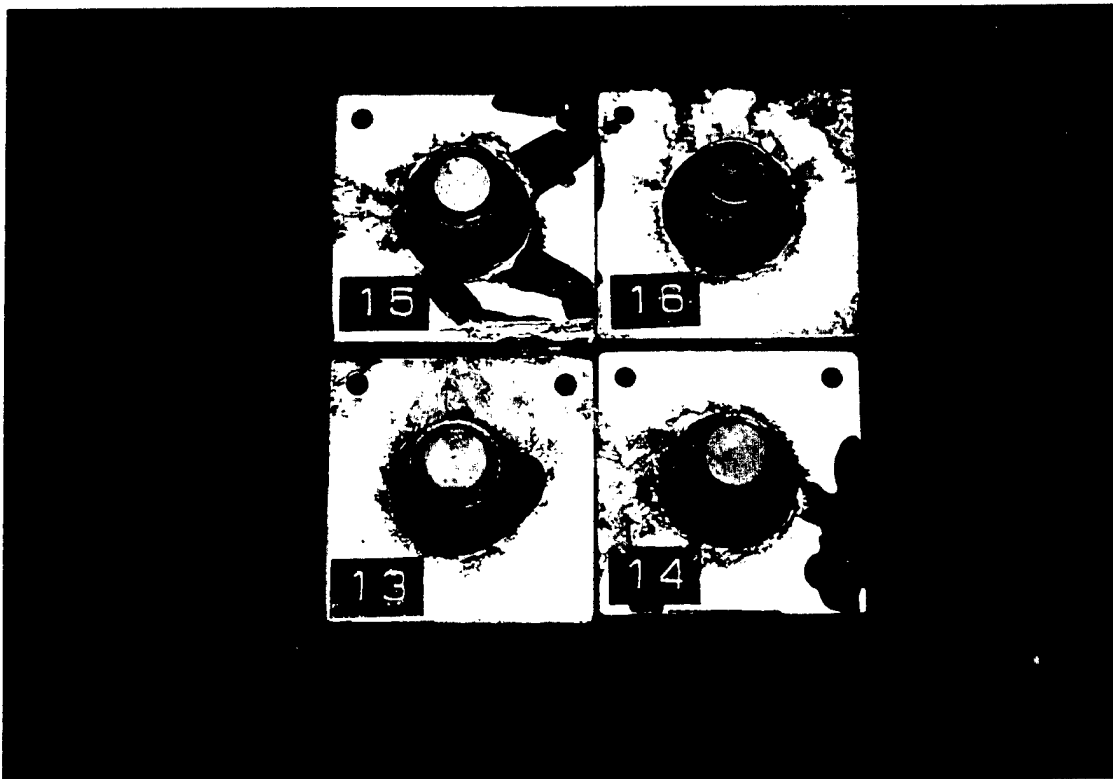

Figure 43. Inconel 718 Nickel-Based Superalloy Nuts With MIL-C-16173 Grade 4 Corrosion Preventative Compound After 30 Days of Salt Spray. Reduced 25%.

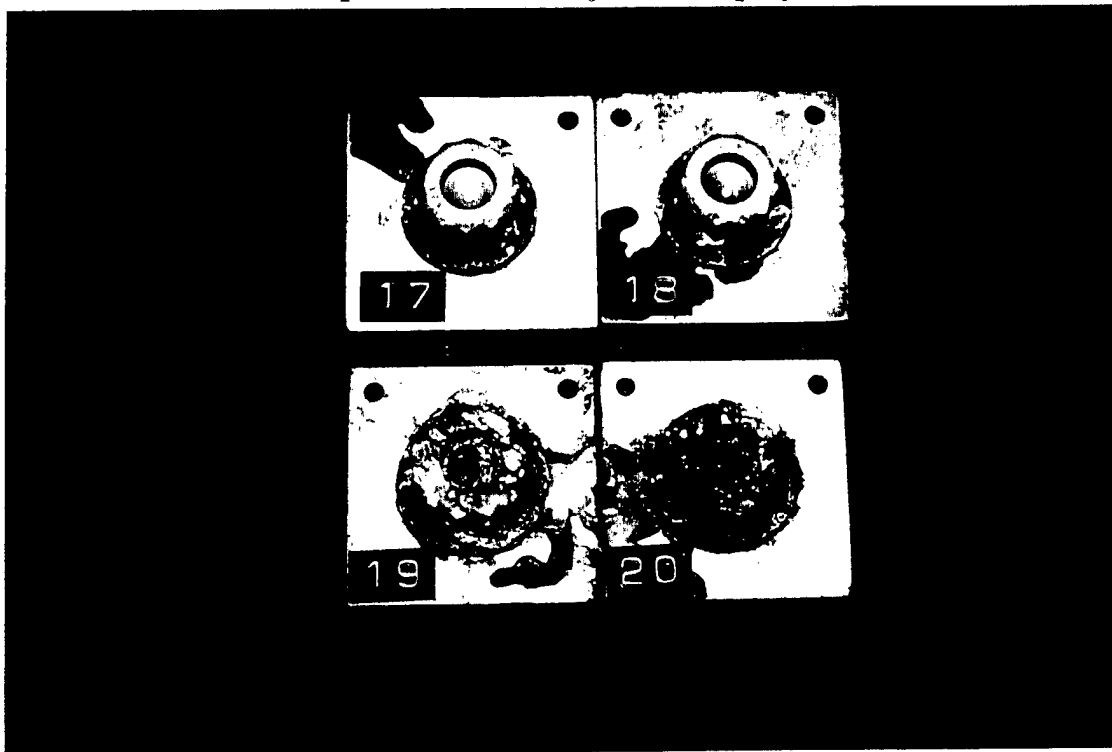

Figure 44. H11 Chromium Hot Work Tool Steel Bolt Heads With IVD Al Coating After 30 Days of Salt Spray. Reduced 25%.

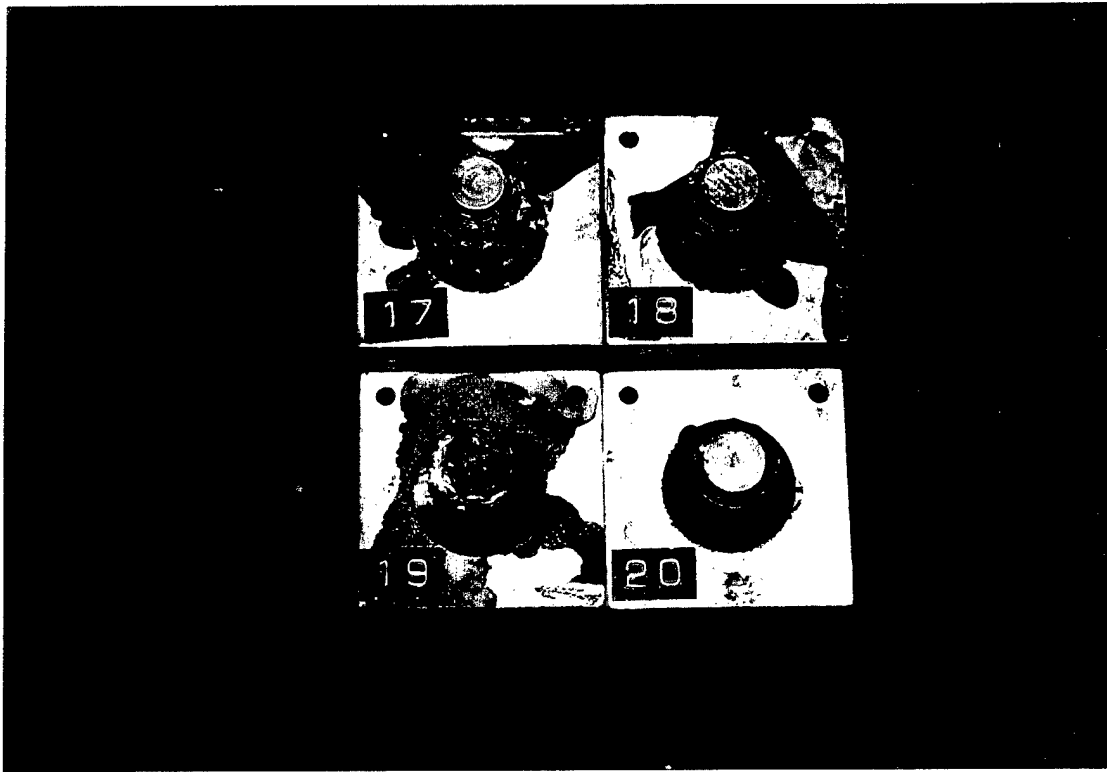

Figure 45. H11 Chromium Hot Work Tool Steel Nuts With IVD Al Coating After 30 Days of Salt Spray. Reduced 25%.

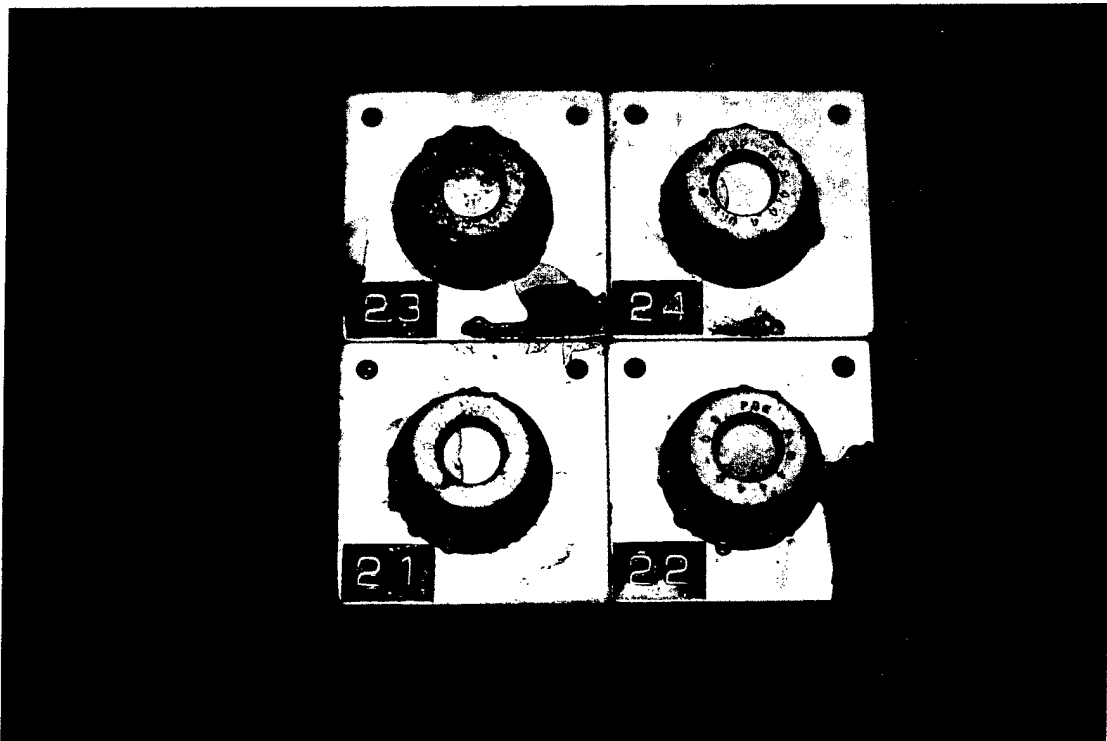

Figure 46. H11 Chromium Hot Work Tool Steel Bolt Heads With Cadmium Electroplate After 30 Days of Salt Spray. Reduced 25%.

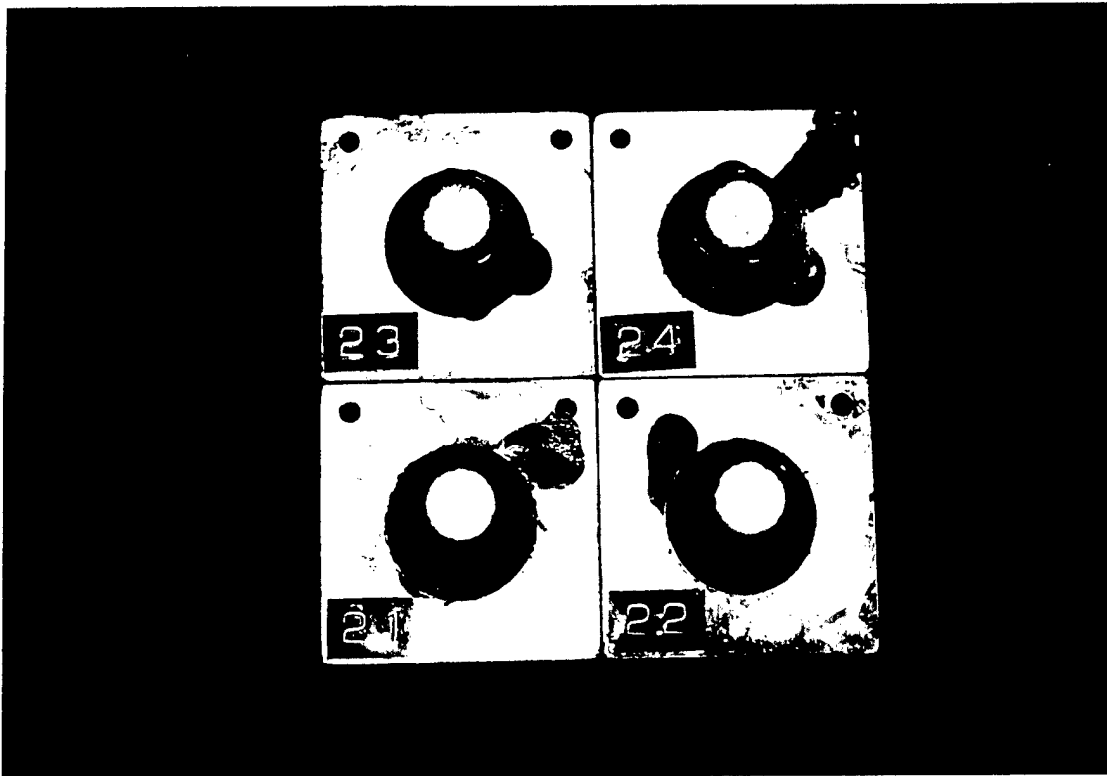

Figure 47. H11 Chromium Hot Work Tool Steel Nuts With Cadmium Electroplate After 30 Days of Salt Spray. Reduced 25%.

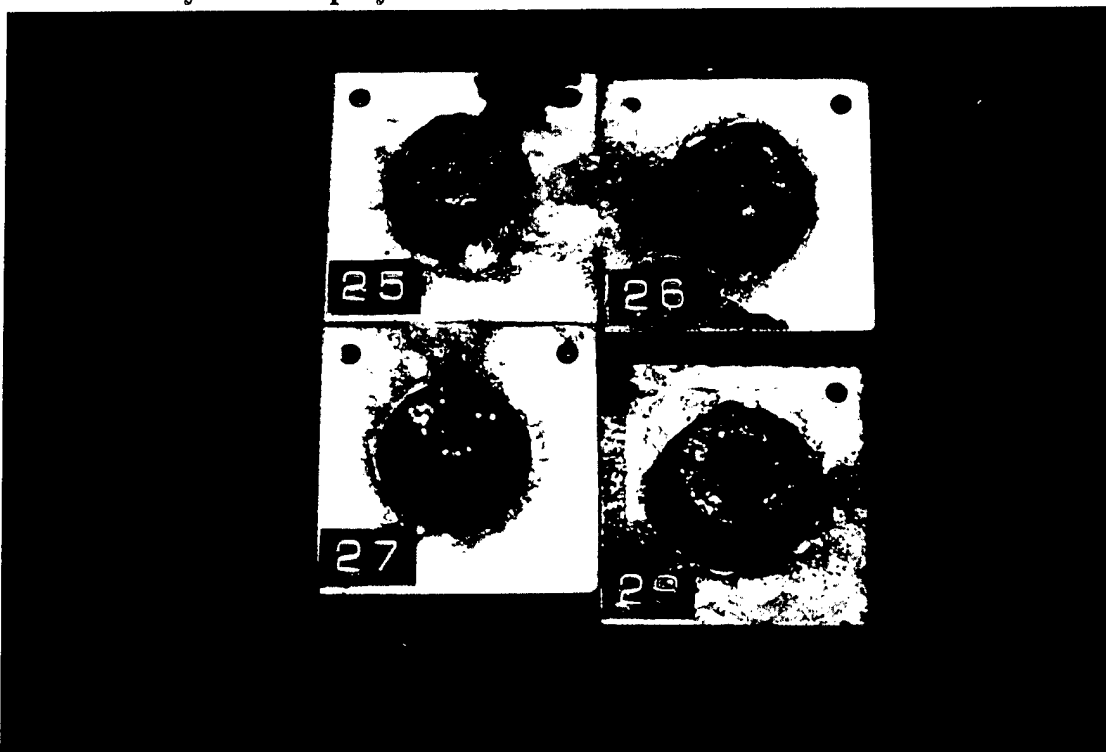

Figure 48. H11 Chromium Hot Work Tool Steel Bolt Heads With Antiseize Solid Film Lubricant (MoS_2) After 30 Days of Salt Spray. Reduced 25%.

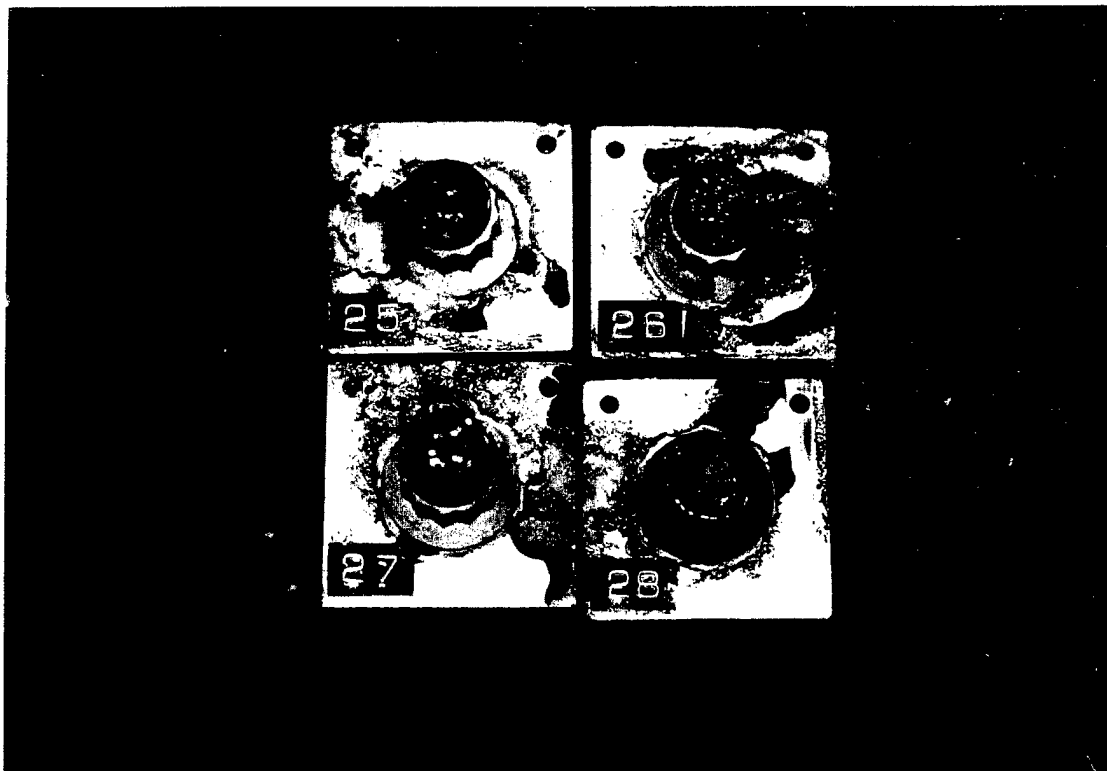

Figure 49. H11 Chromium Hot Work Tool Steel Nuts With Antiseize Solid Film Lubricant (MoS_2) After 30 Days of Salt Spray. Reduced 25%.

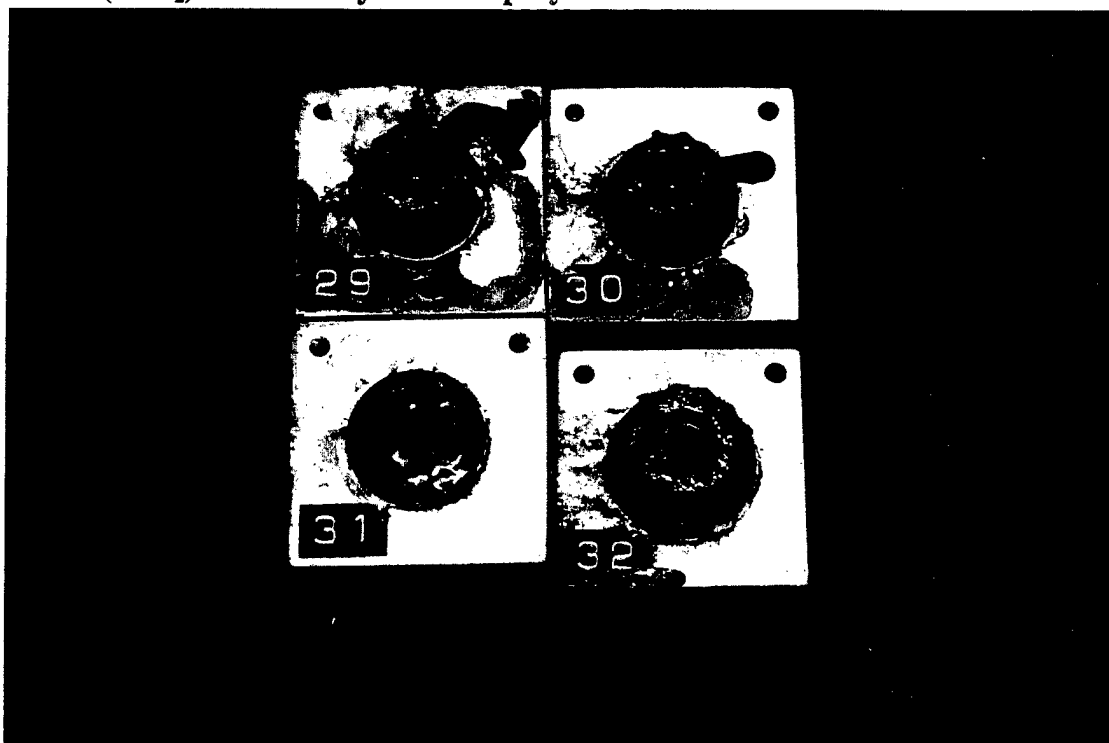

Figure 50. H11 Chromium Hot Work Tool Steel Bolt Heads With MIL-C-16173 Grade 4 Corrosion Preventative Compound After 30 Days of Salt Spray. Reduced 25%.

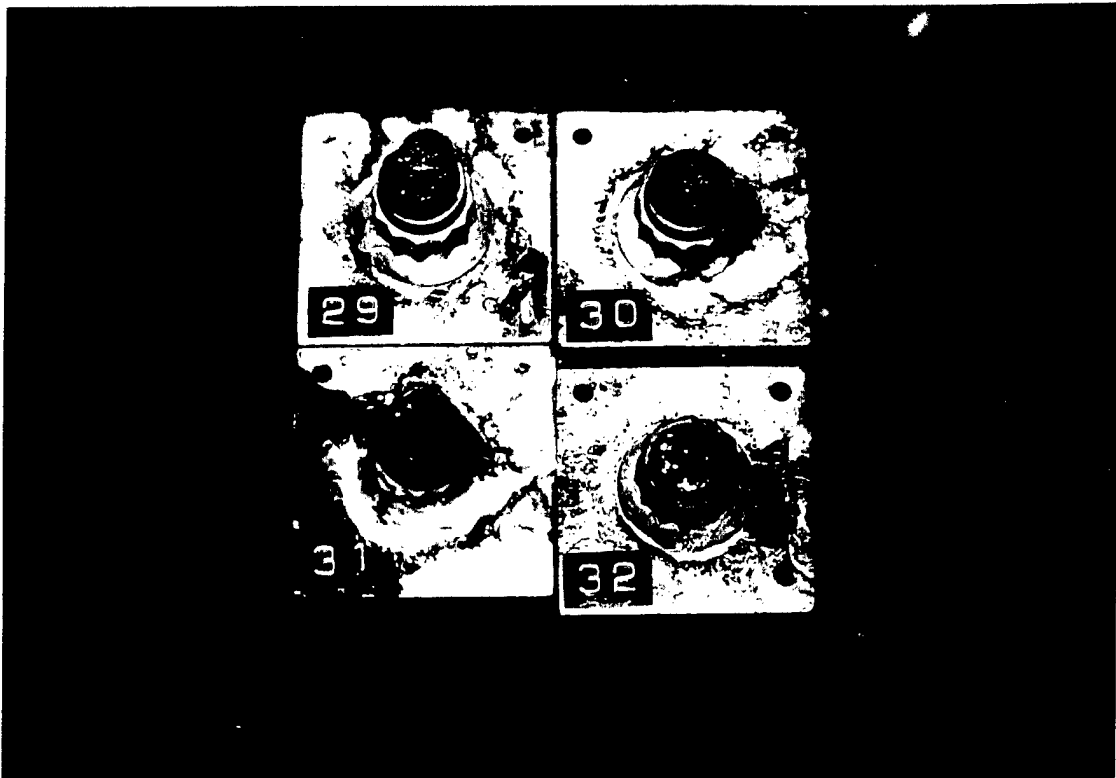

Figure 51. H11 Chromium Hot Work Tool Steel Nuts With MIL-C-16173 Grade 4 Corrosion Preventative Compound After 30 Days of Salt Spray. Reduced 25%.

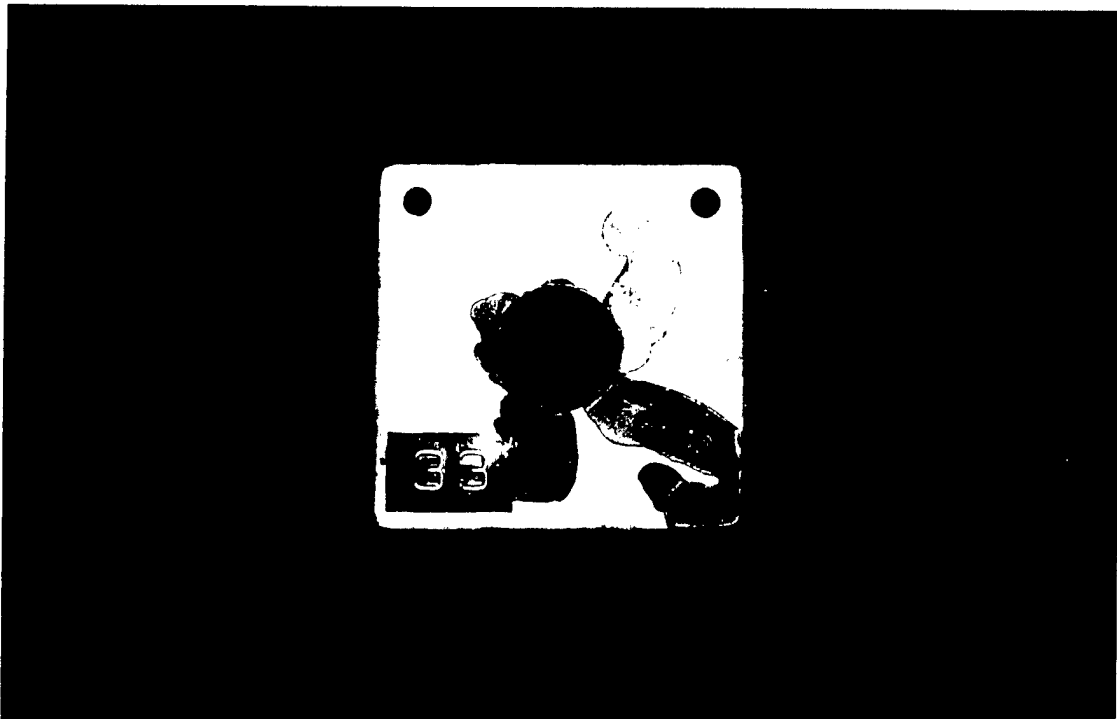

Figure 52. Aluminum Control Block After 30 Days of Salt Spray. Reduced 25%.

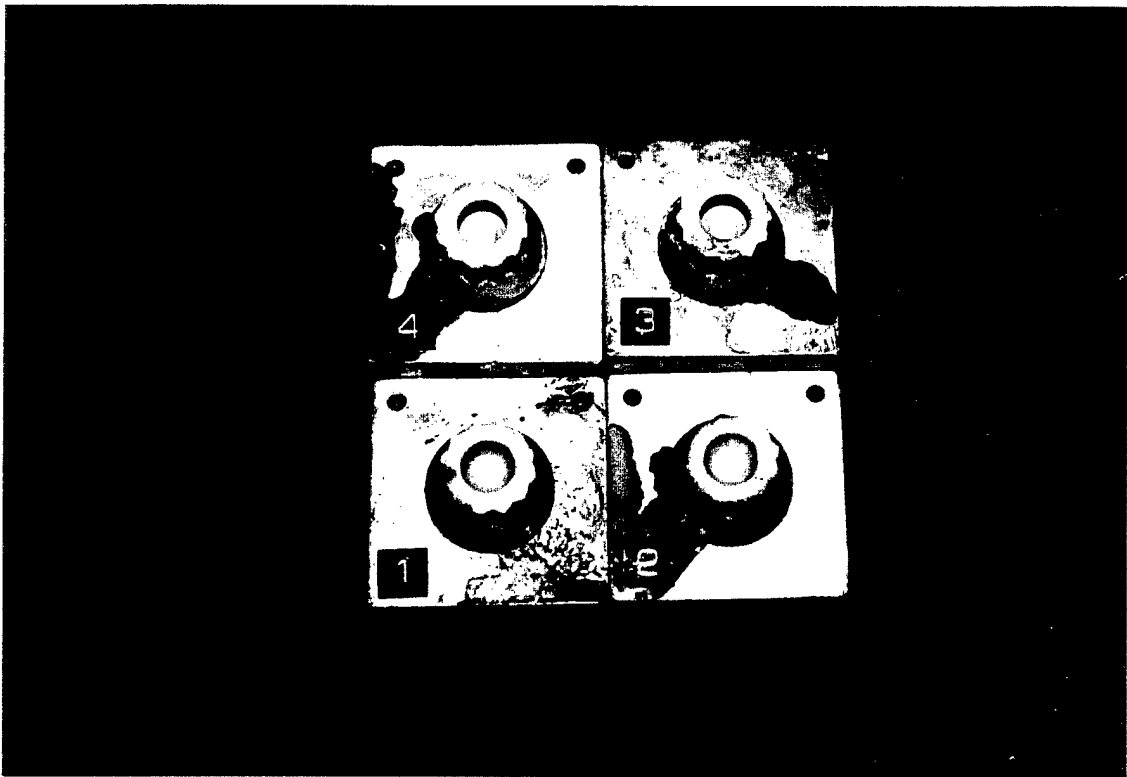

Figure 53. Inconel 718 Nickel-Based Superalloy Bolt Heads With IVD Al Coating After 44 Days of Salt Spray. Reduced 25%.

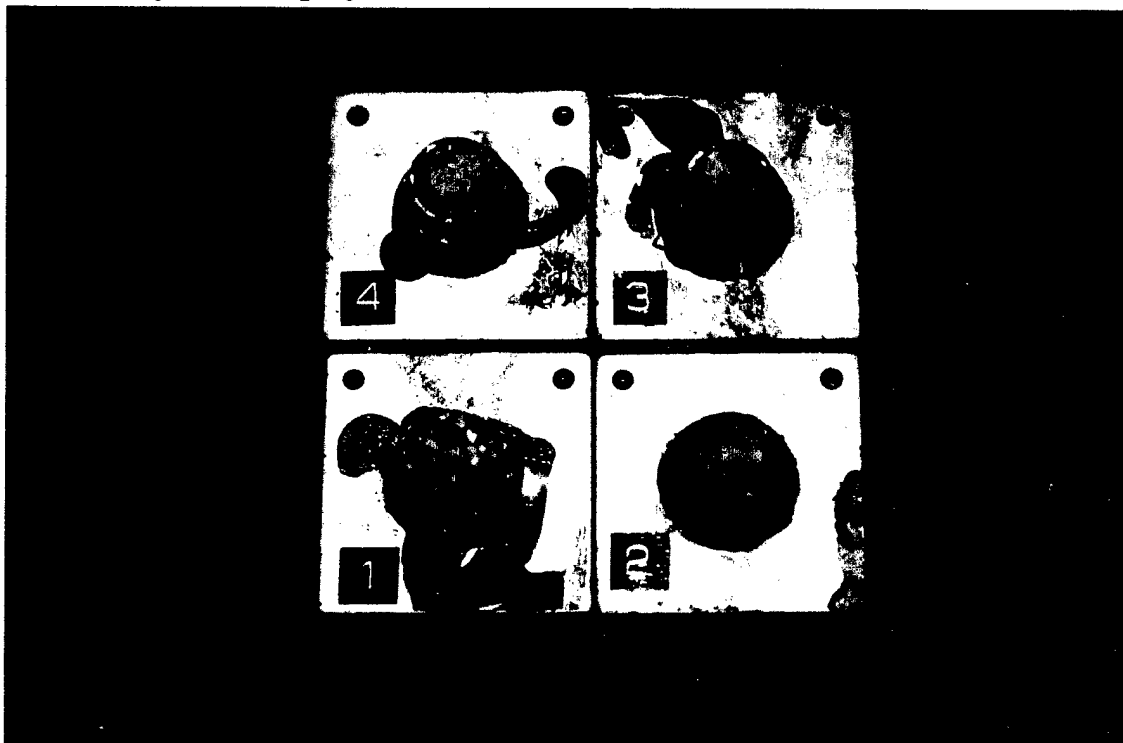

Figure 54. Inconel 718 Nickel-Based Superalloy Nuts With IVD Al Coating After 44 Days of Salt Spray. Reduced 25%.

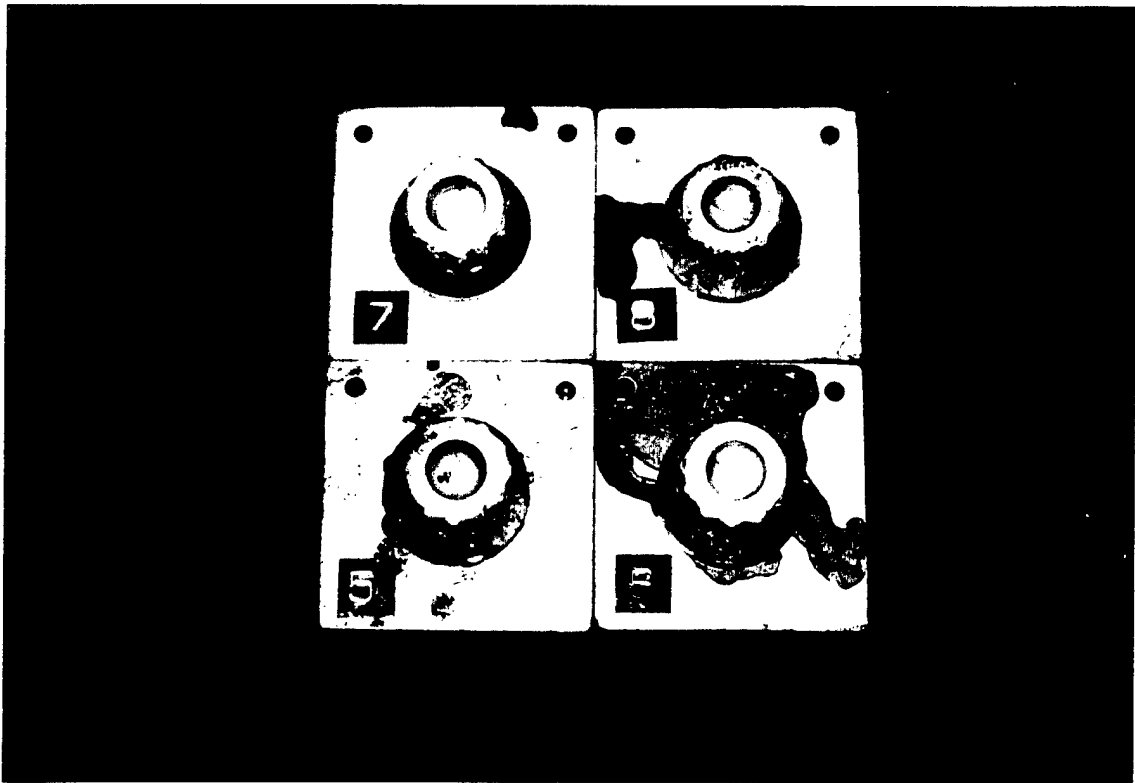

Figure 55. Inconel 718 Nickel-Based Superalloy Bolt Heads With Cadmium Electroplate After 44 Days of Salt Spray. Reduced 25%.

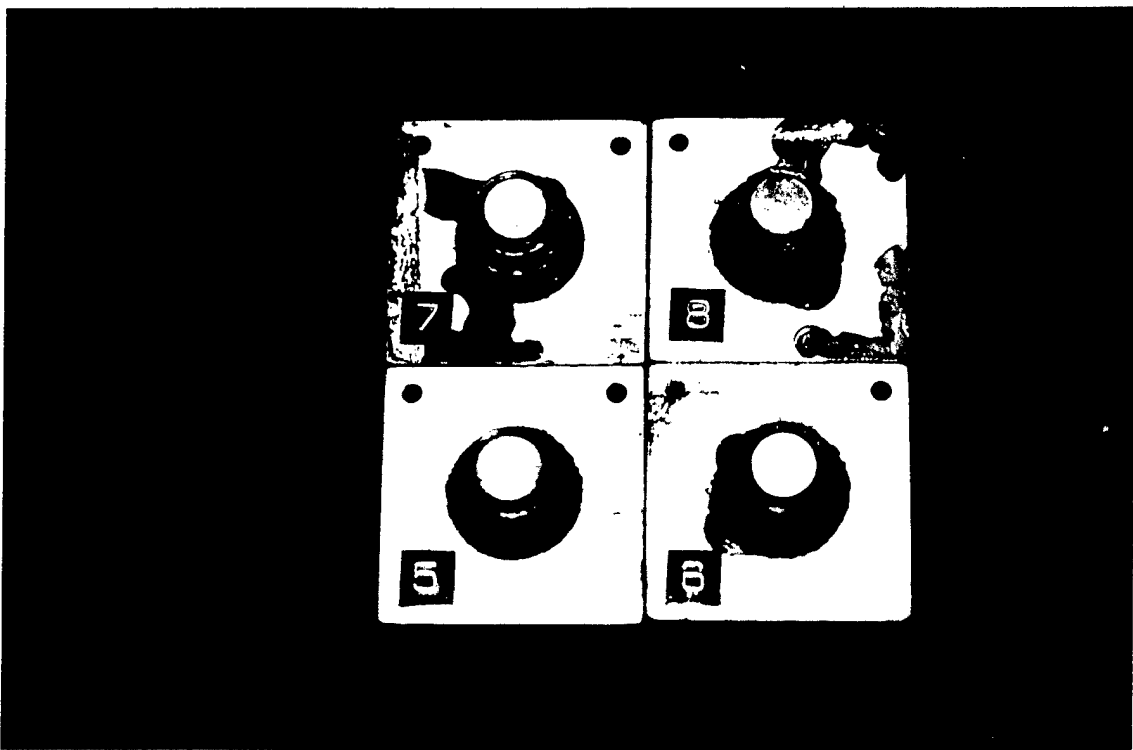

Figure 56. Inconel 718 Nickel-Based Superalloy Nuts With Cadmium Electroplate After 44 Days of Salt Spray. Reduced 25%.

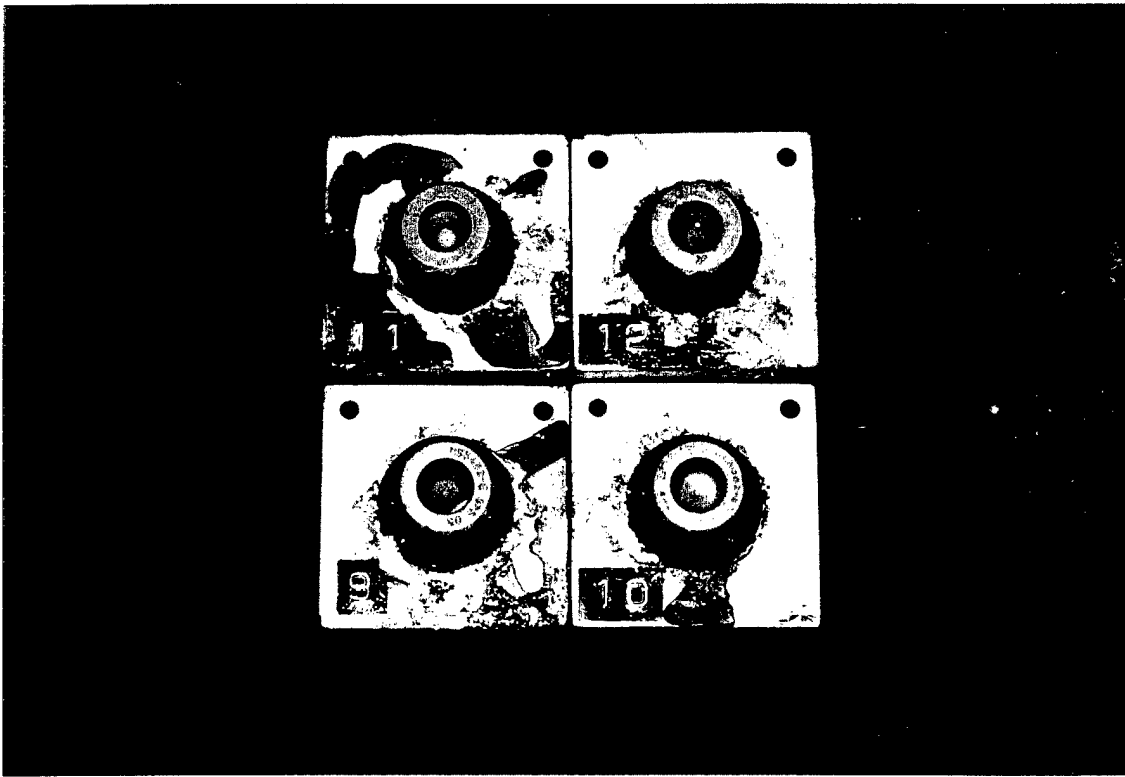

Figure 57. Inconel 718 Nickel-Based Superalloy Bolt Heads With Antiseize Solid Film Lubricant (MoS_2) After 44 Days of Salt Spray. Reduced 25%.

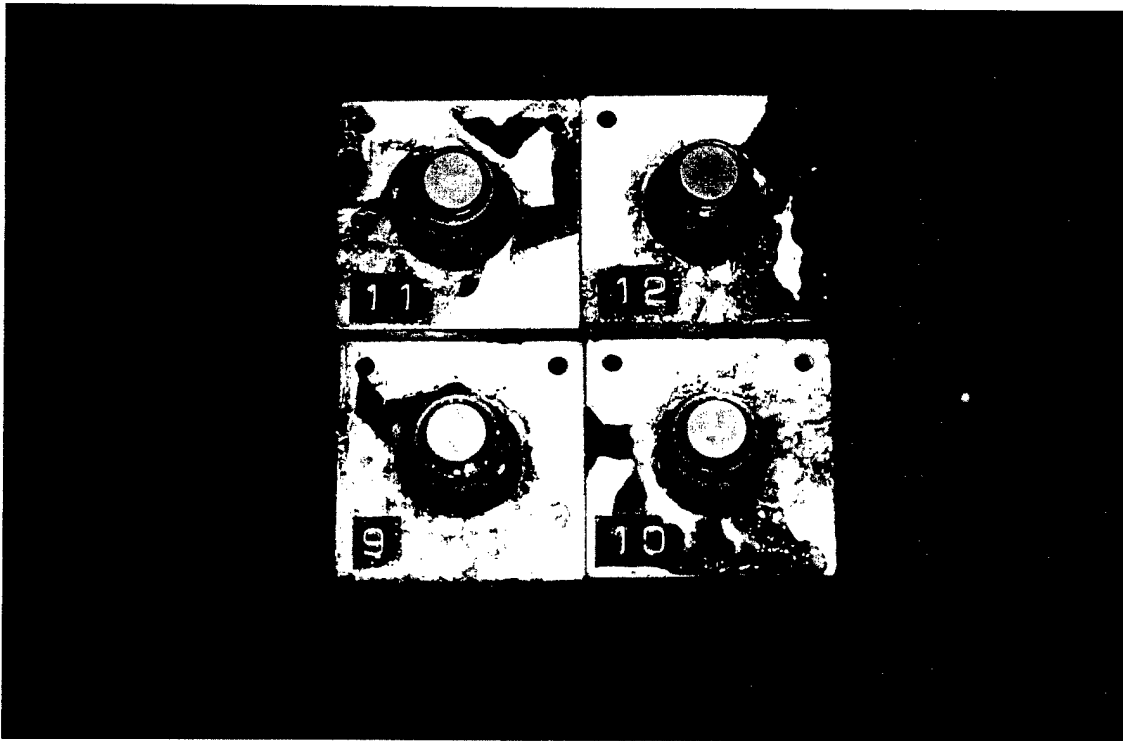

Figure 58. Inconel 718 Nickel-Based Superalloy Nuts With Antiseize Solid Film Lubricant (MoS_2) After 44 Days of Salt Spray. Reduced 25%.

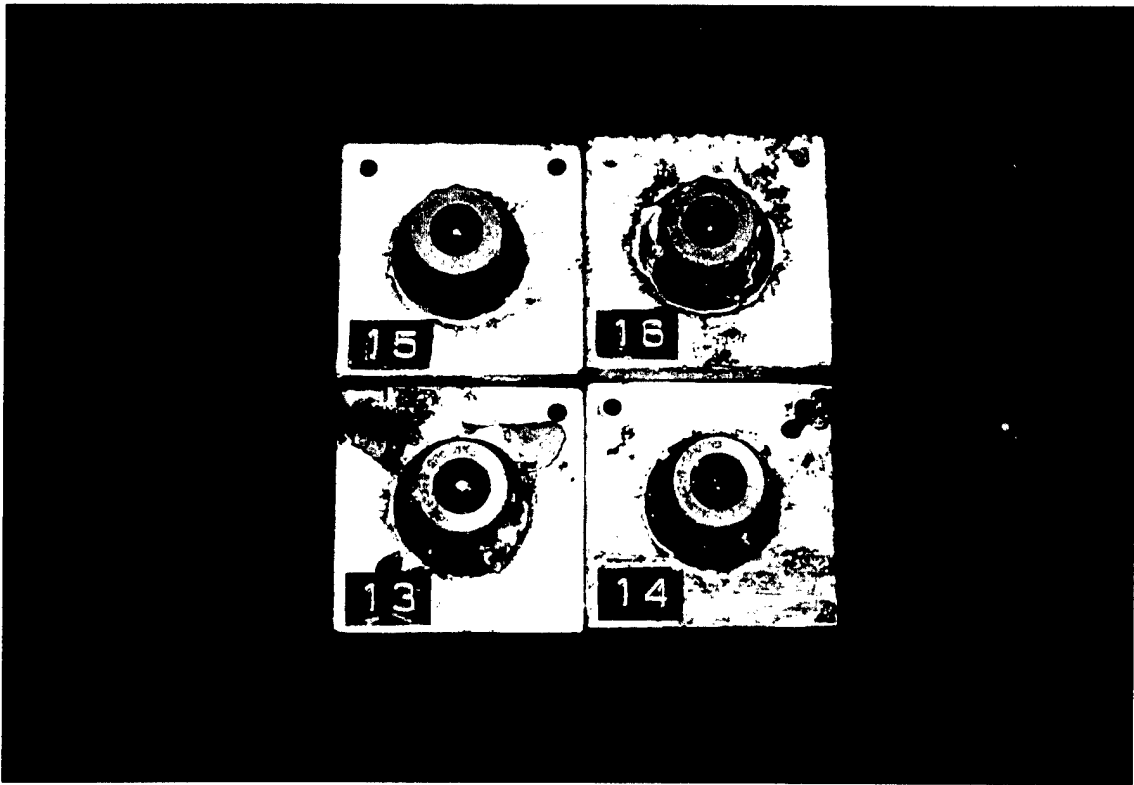

Figure 59. Inconel 718 Nickel-Based Superalloy Bolt Heads With MIL-C-16173 Grade 4 Corrosion Preventative Compound After 44 Days of Salt Spray. Reduced 25%.

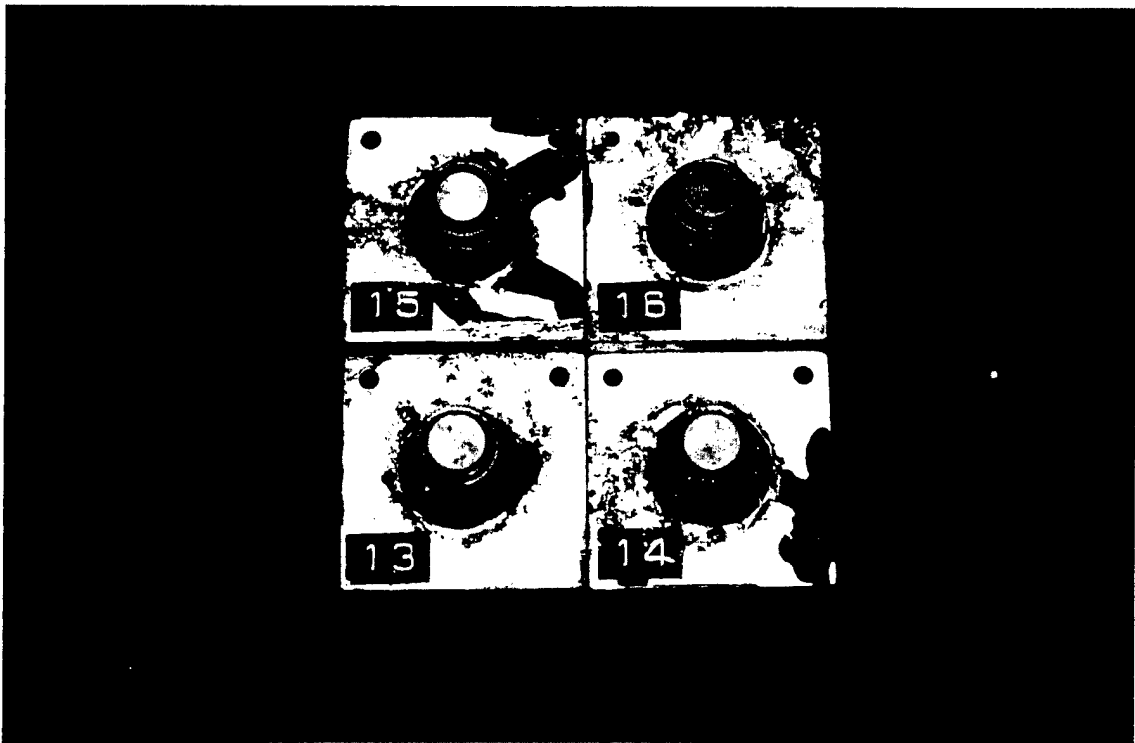

Figure 60. Inconel 718 Nickel-Based Superalloy Nuts With MIL-C-16173 Grade 4 Corrosion Preventative Compound After 44 Days of Salt Spray. Reduced 25%.

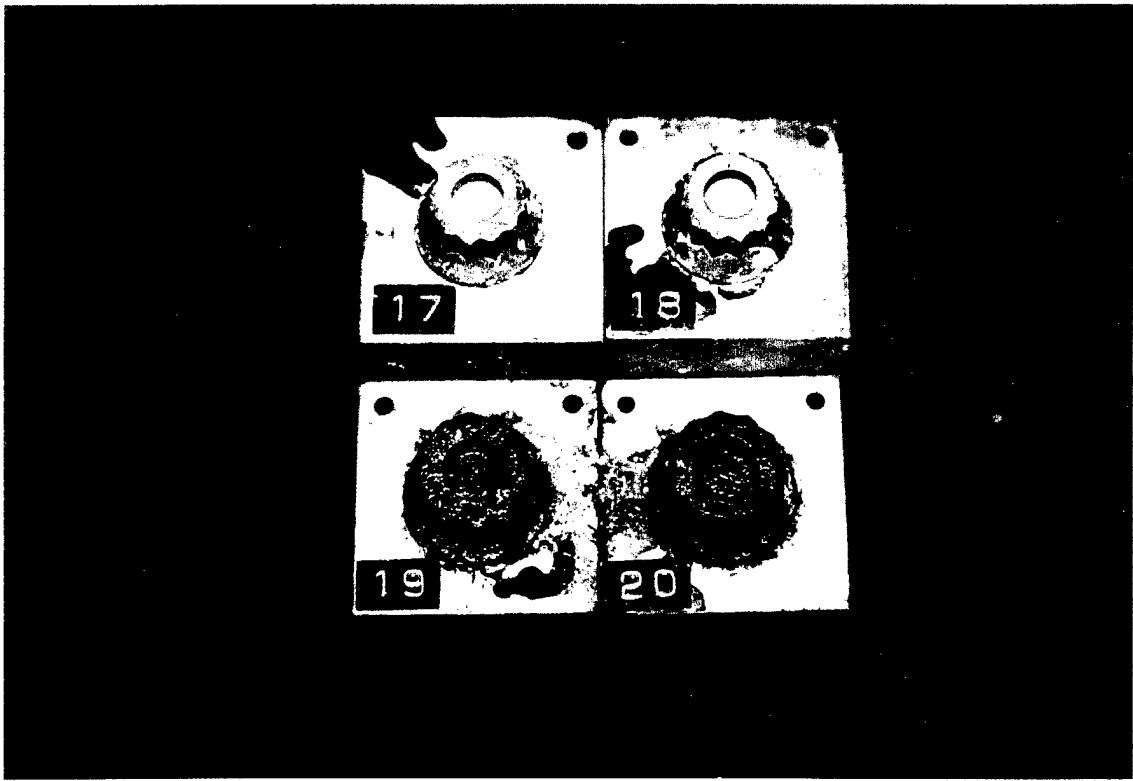

Figure 61. H11 Chromium Hot Work Tool Steel Bolt Heads With IVD Al Coating After 44 Days of Salt Spray. Reduced 25%.

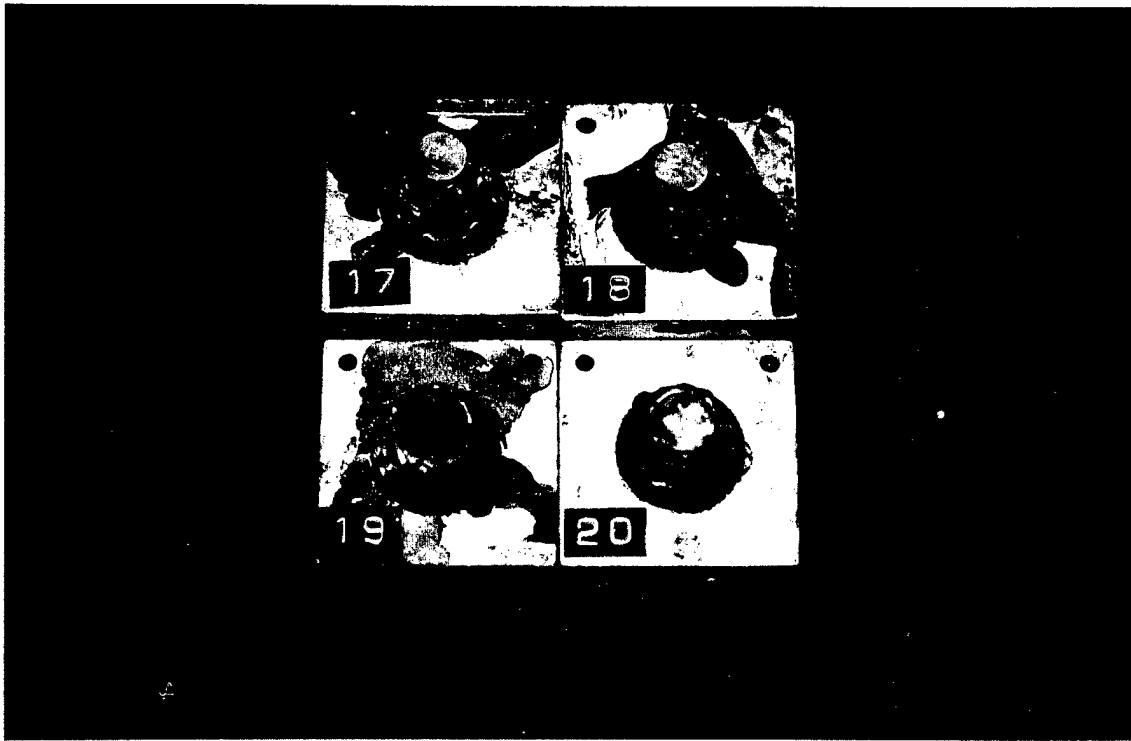

Figure 62. H11 Chromium Hot Work Tool Steel Nuts With IVD Al Coating After 44 Days of Salt Spray. Reduced 25%.

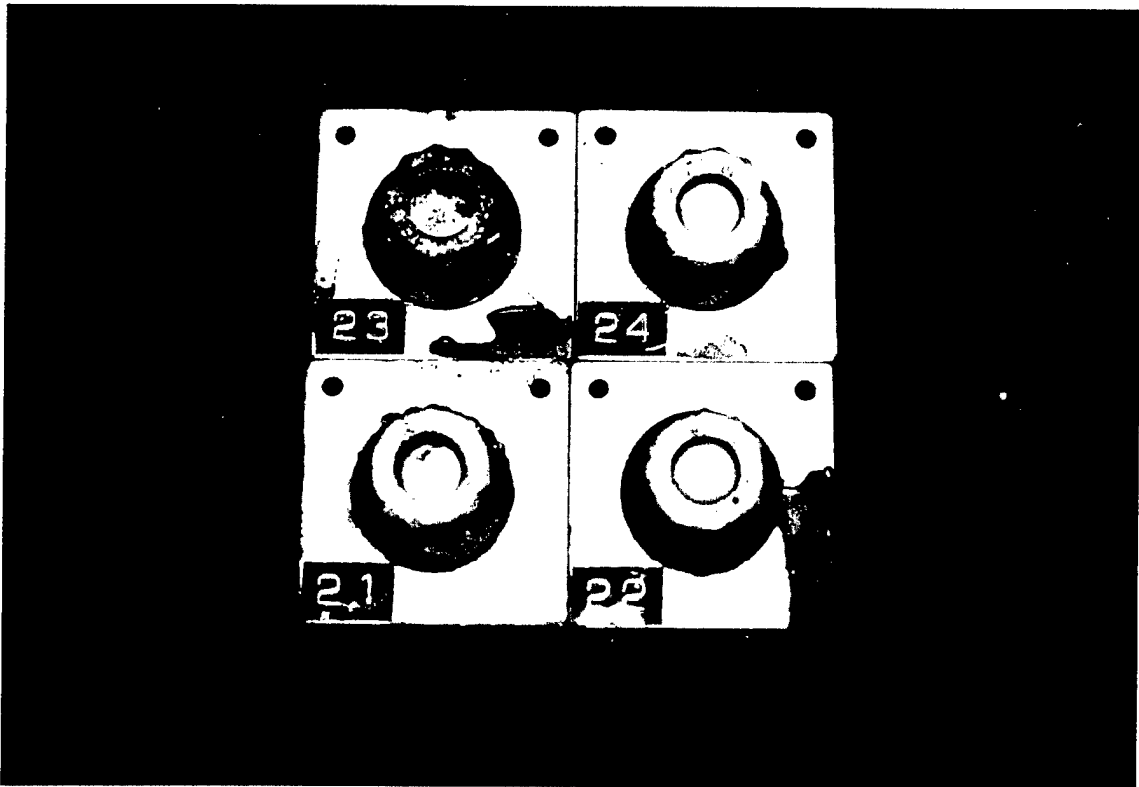

Figure 63. H11 Chromium Hot Work Tool Steel Bolt Heads With Cadmium Electroplate After 44 Days of Salt Spray. Reduced 25%.

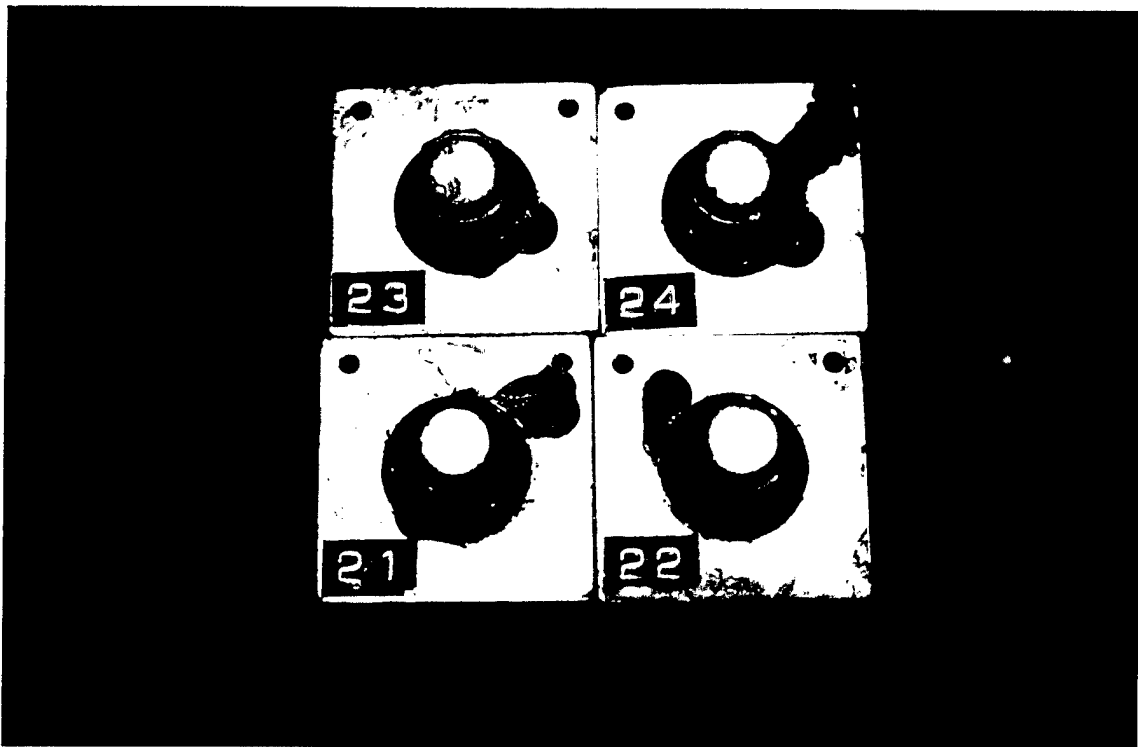

Figure 64. H11 Chromium Hot Work Tool Steel Nuts With Cadmium Electroplate After 44 Days of Salt Spray. Reduced 25%.

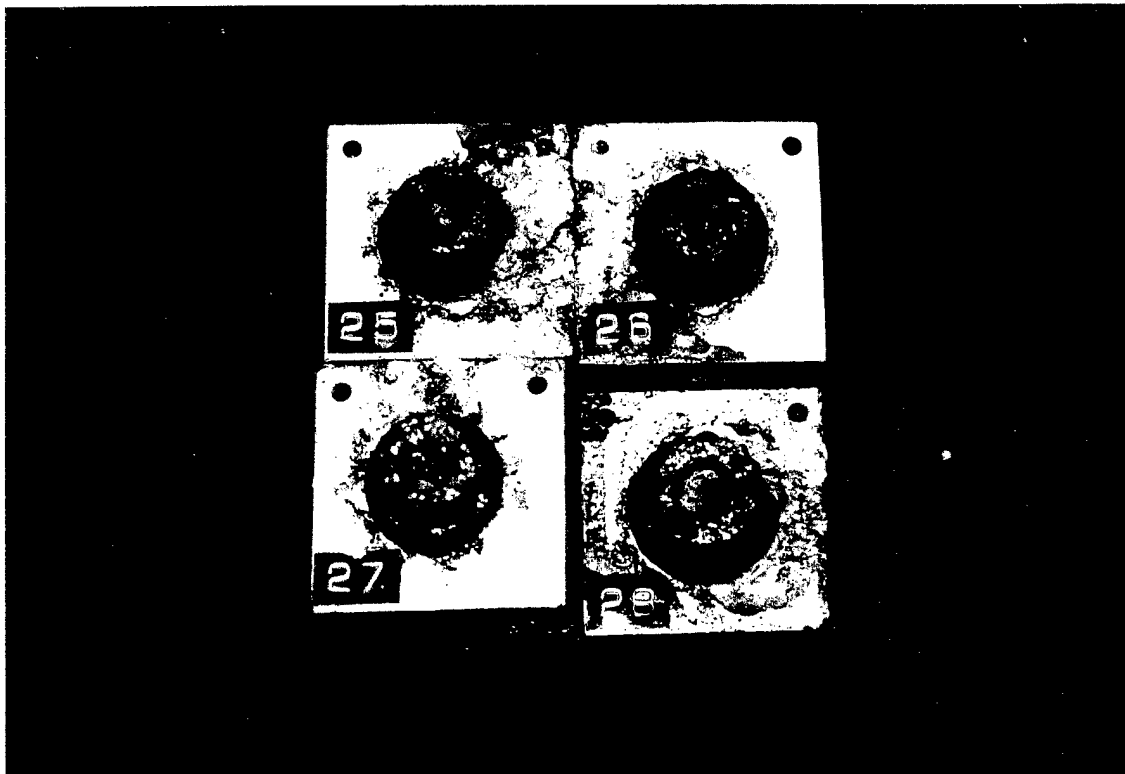

Figure 65. H11 Chromium Hot Work Tool Steel Nuts With Antiseize Solid Film Lubricant (MoS_2) After 44 Days of Salt Spray. Reduced 25%.

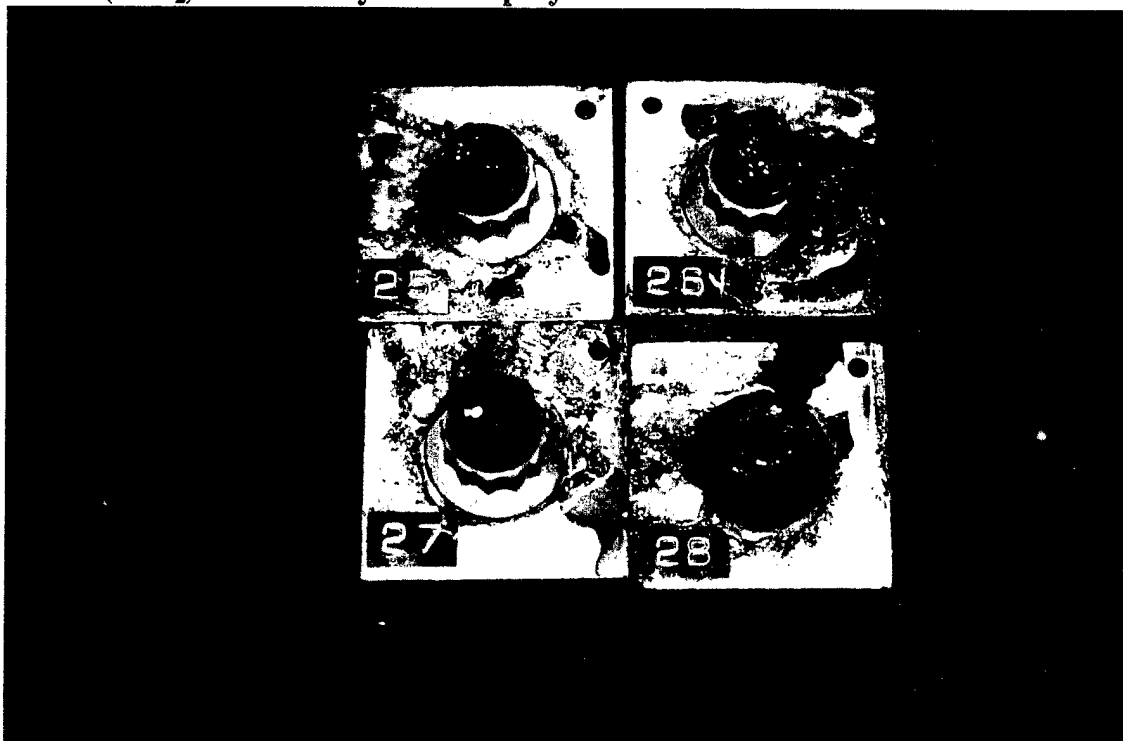

Figure 66. H11 Chromium Hot Work Tool Steel Nuts With Antiseize Solid Film Lubricant (MoS_2) After 44 Days of Salt Spray. Reduced 25%.

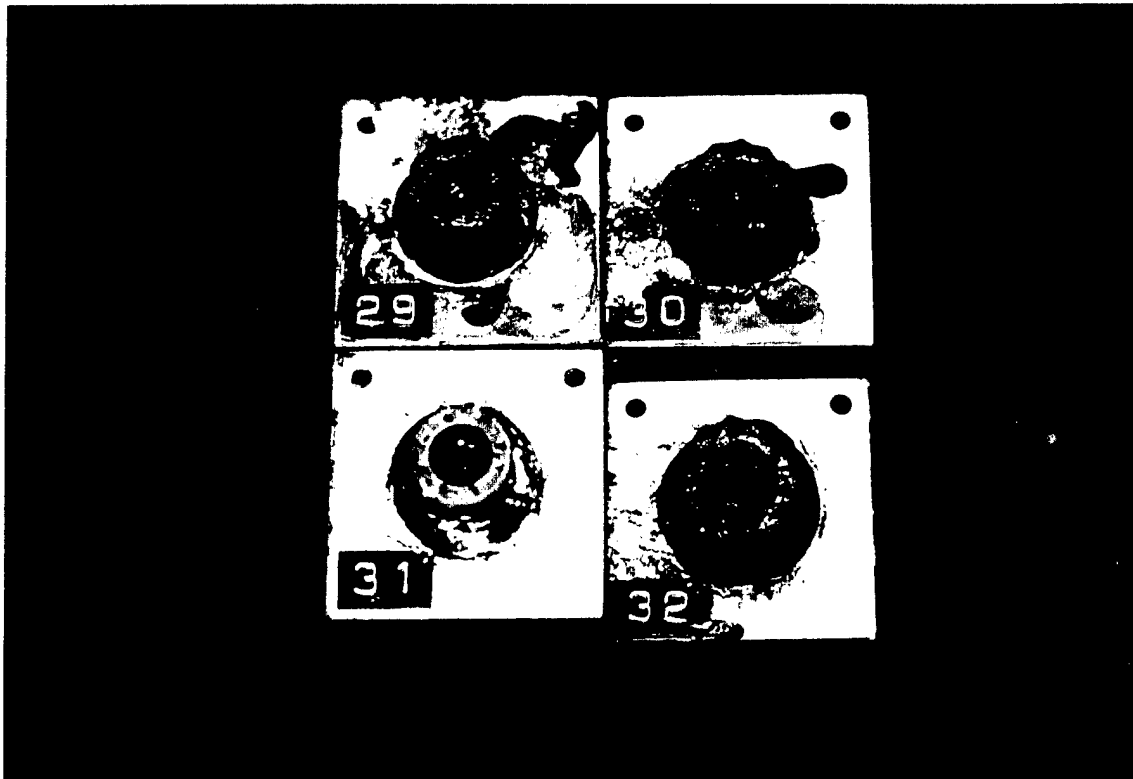

Figure 67. H11 Chromium Hot Work Tool Steel Bolt Heads With MIL-C-16173 Grade 4 Corrosion Preventative Compound After 44 Days of Salt Spray. Reduced 25%.

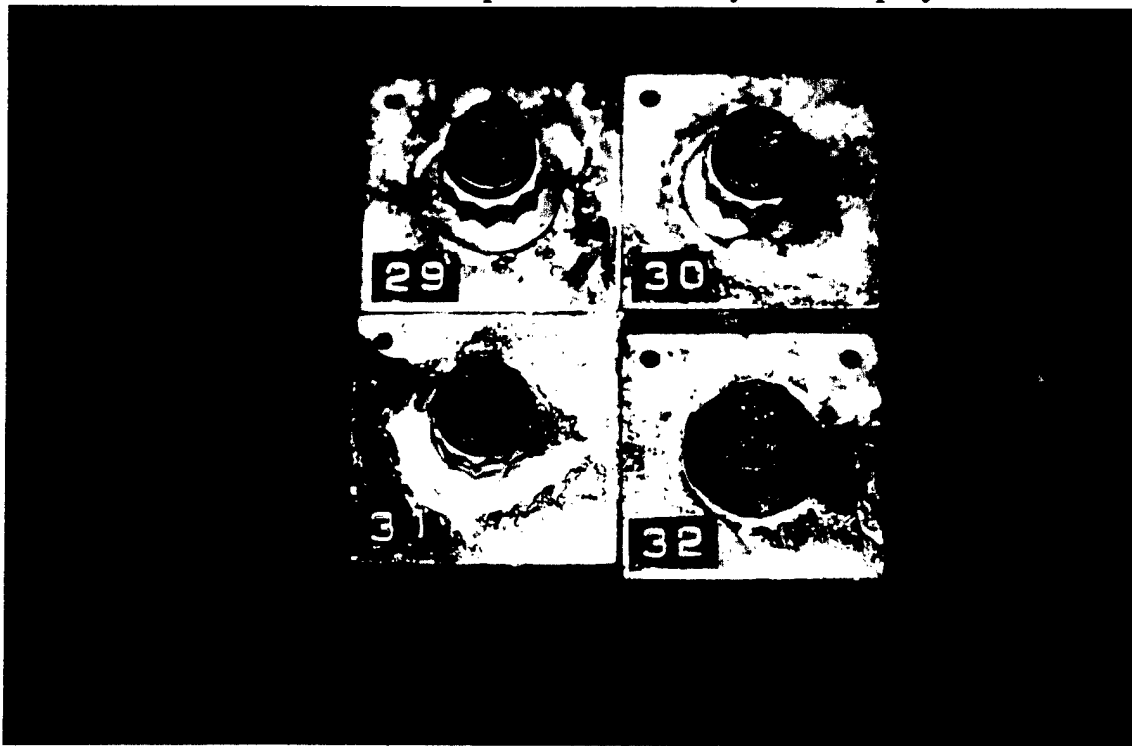

Figure 68. H11 Chromium Hot Work Tool Steel Nuts With MIL-C-16173 Grade 4 Corrosion Preventative Compound After 44 Days of Salt Spray. Reduced 25%.

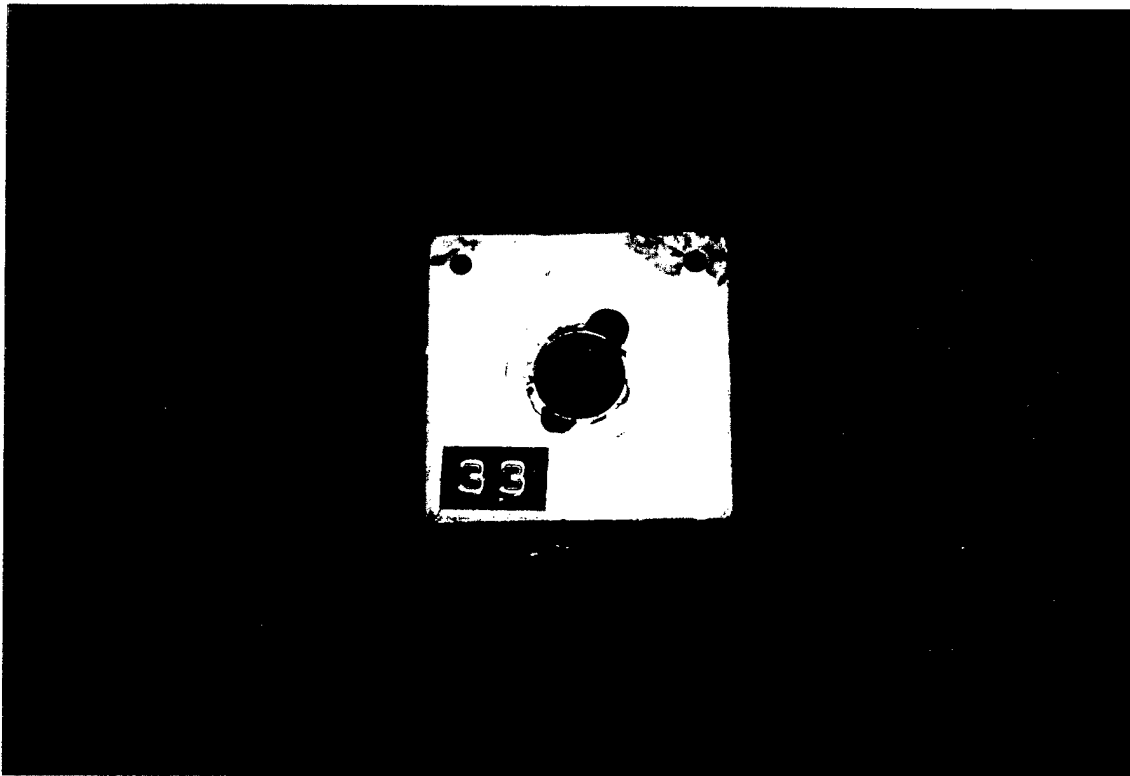

Figure 69. Aluminum Control Block After 44 Days of Salt Spray. Reduced 25%.

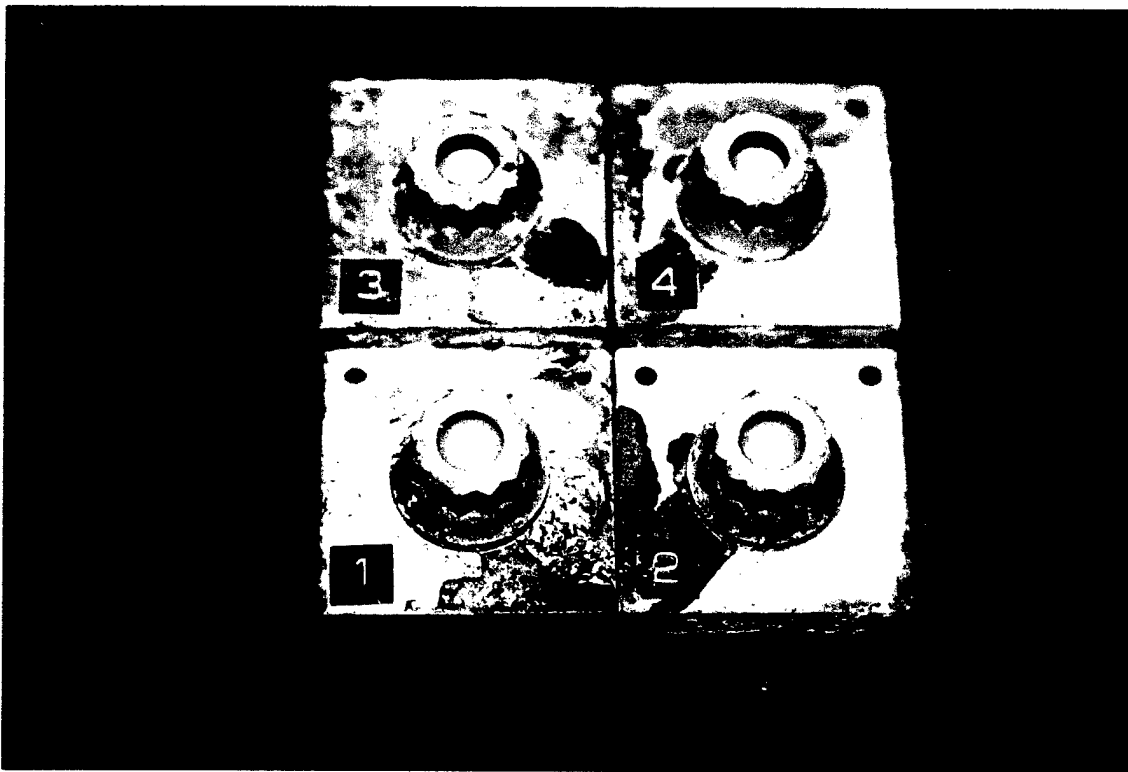

Figure 70. Inconel 718 Nickel-Based Superalloy Bolt Heads With IVD Al Coating After 62 Days of Salt Spray. Reduced 25%.

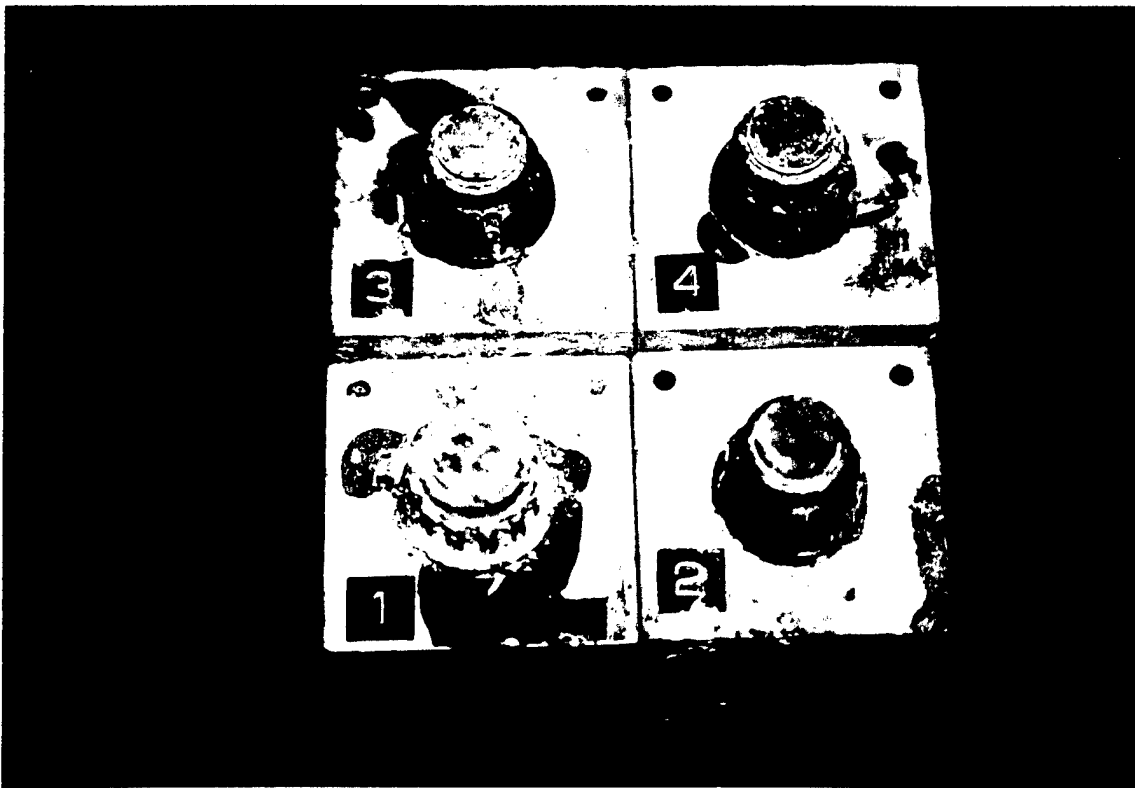

Figure 71. Inconel 718 Nickel-Based Superalloy Nuts With IVD Al Coating After 62 Days of Salt Spray. Reduced 25%.

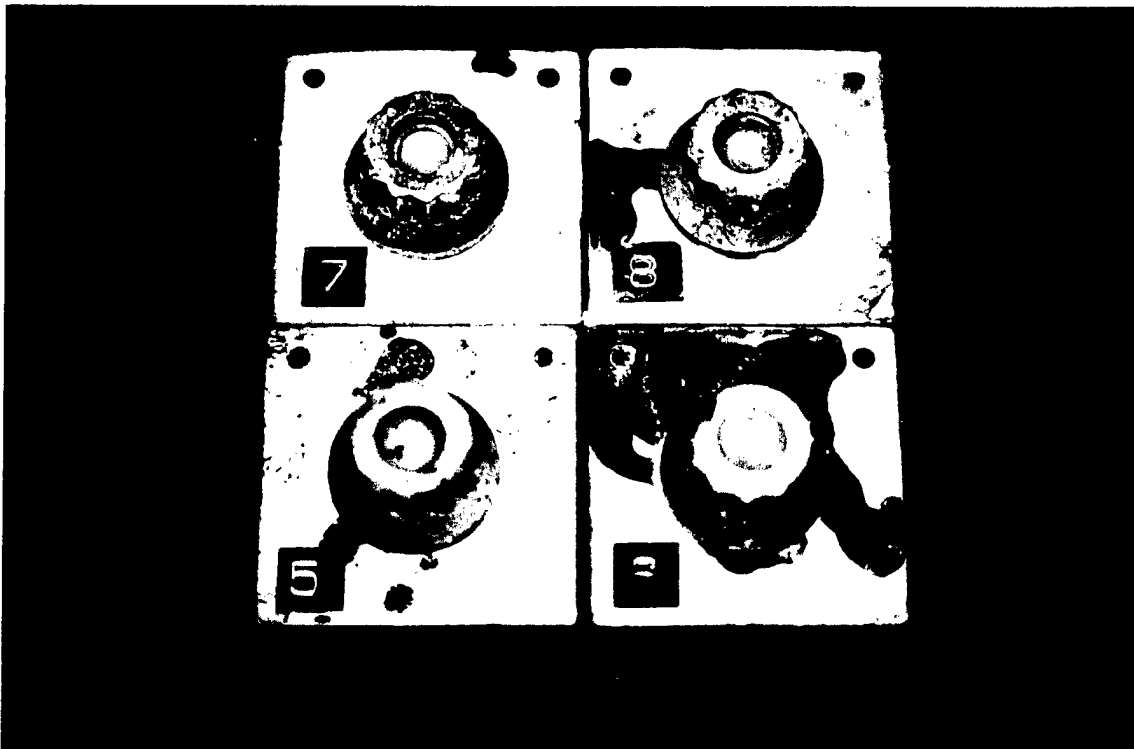

Figure 72. Inconel 718 Nickel-Based Superalloy Bolt Heads With Cadmium Electroplate After 62 Days of Salt Spray. Reduced 25%.

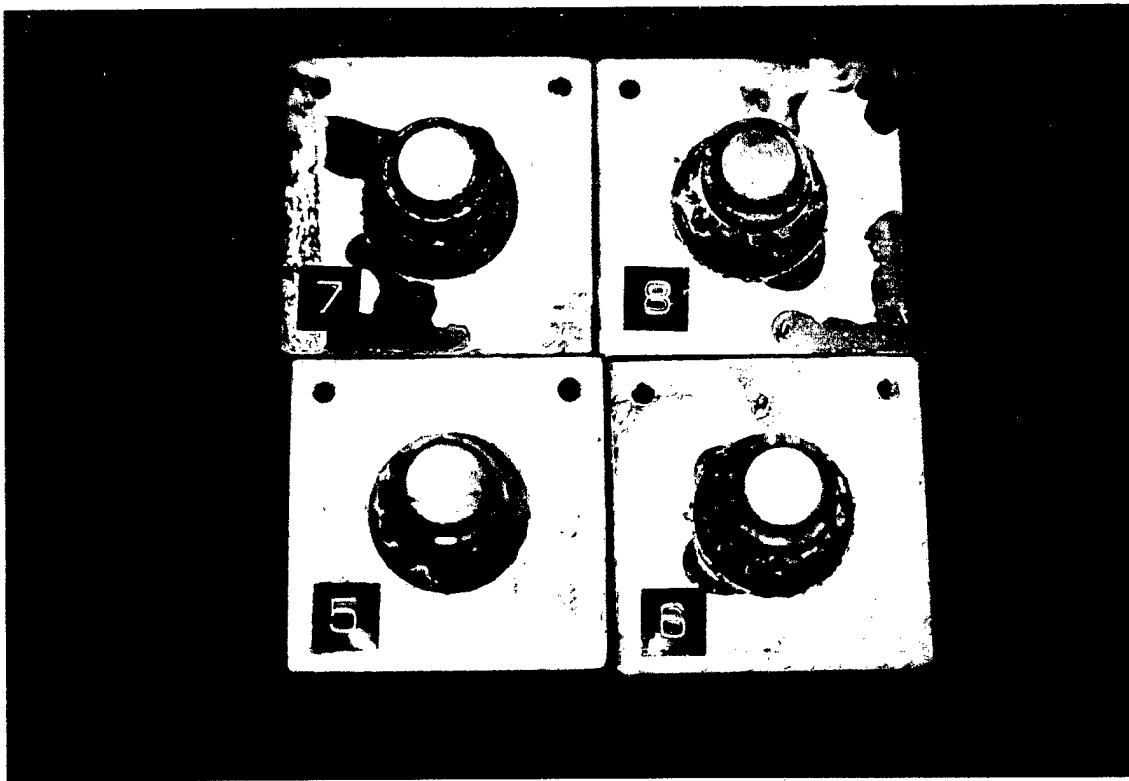

Figure 73. Inconel 718 Nickel-Based Superalloy Nuts With Cadmium Electroplate After 62 Days of Salt Spray. Reduced 25%.

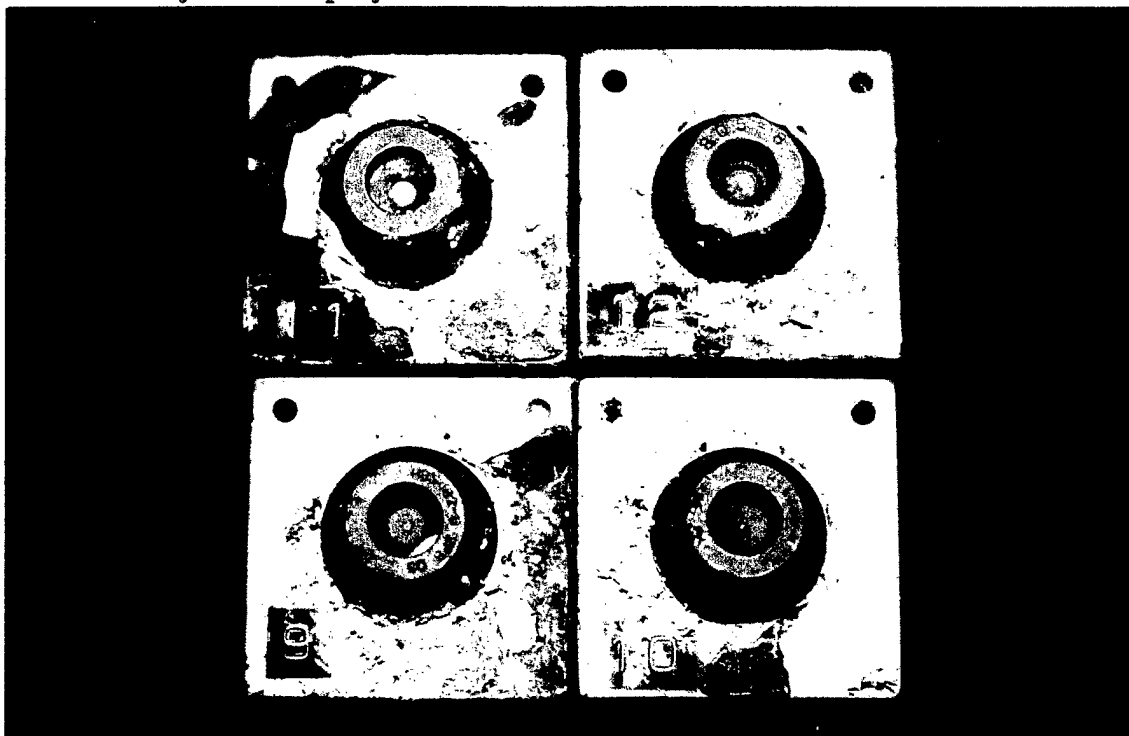

Figure 74. Inconel 718 Nickel-Based Superalloy Bolt Heads With Antiseize Solid Film Lubricant (MoS_2) After 62 Days of Salt Spray. Reduced 25%.

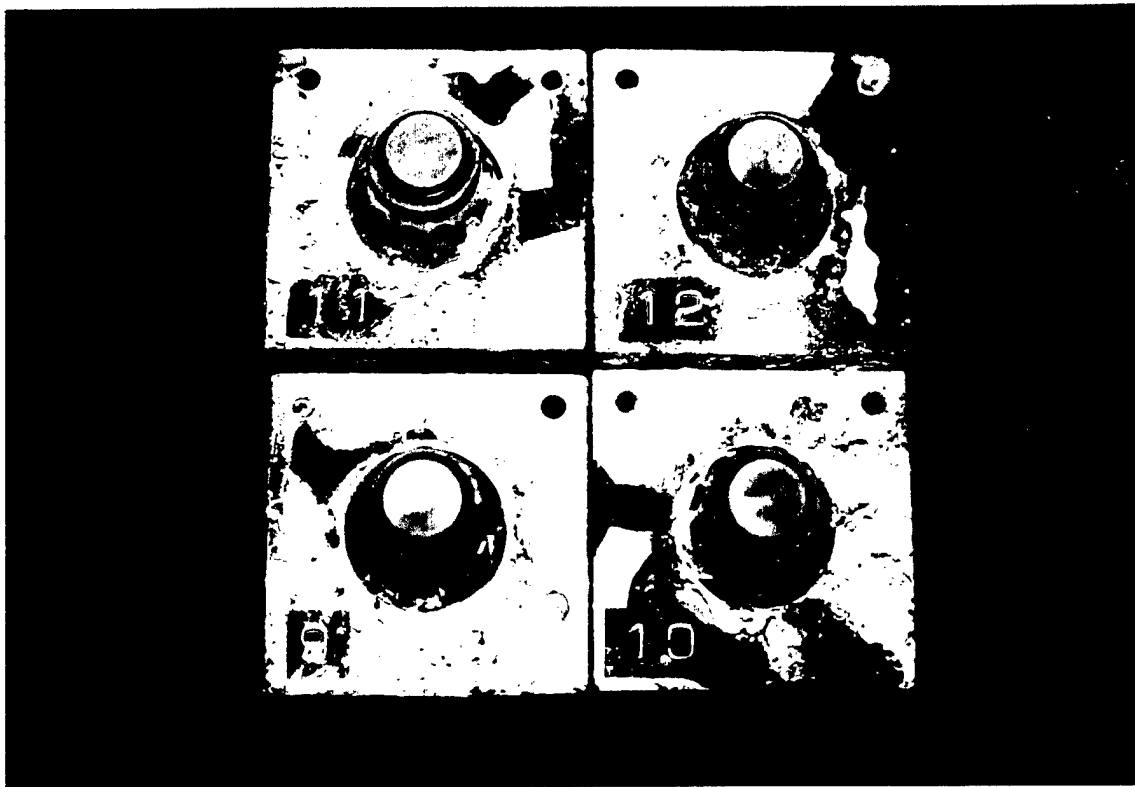

Figure 75. Inconel 718 Nickel-Based Superalloy Nuts With Antiseize Solid Film Lubricant (MoS₂) After 62 Days of Salt Spray. Reduced 25%.

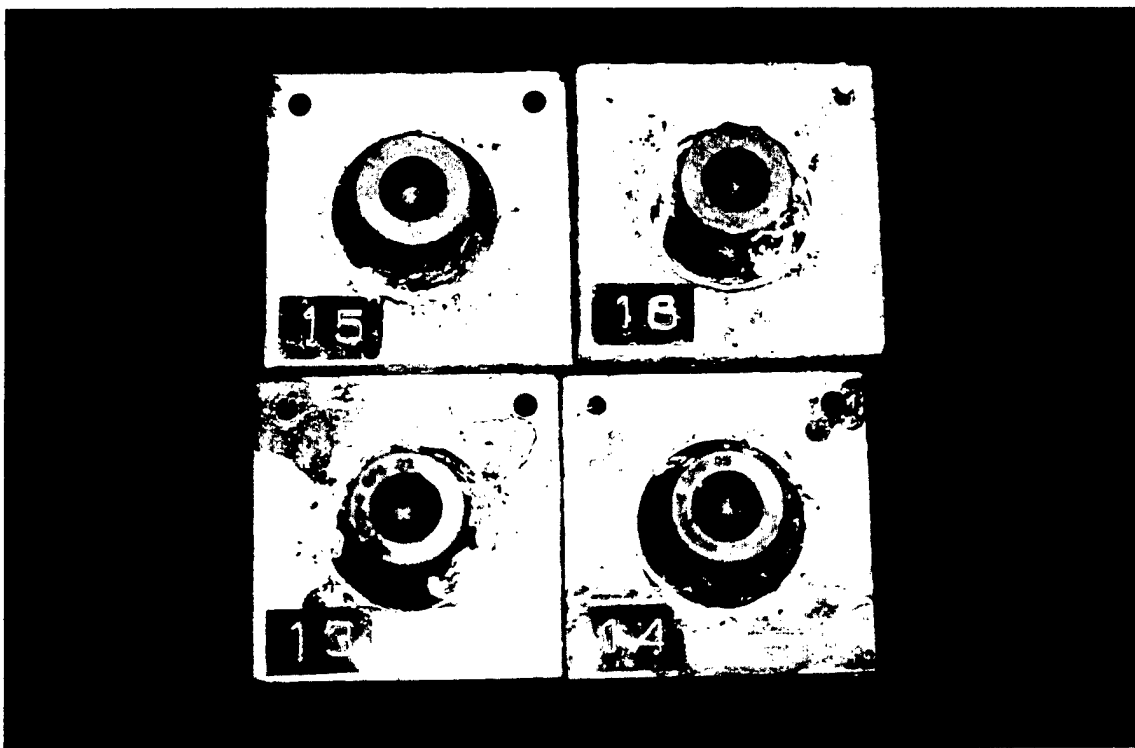

Figure 76. Inconel 718 Nickel-Based Superalloy Bolt Heads With MIL-C-16173 Grade 4 Corrosion Preventative Compound After 62 Days of Salt Spray. Reduced 25%.

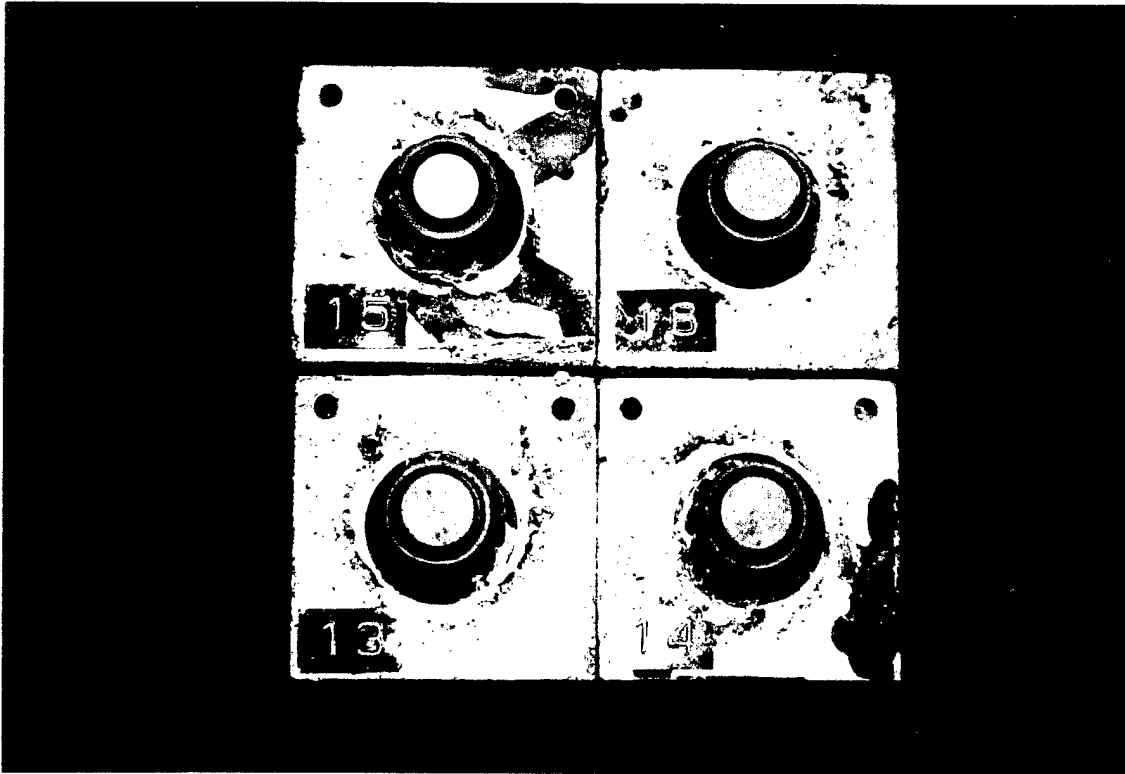

Figure 77. Inconel 718 Nickel-Based Superalloy Nuts With MIL-C-16173 Grade 4 Corrosion Preventative Compound After 62 Days of Salt Spray. Reduced 25%.

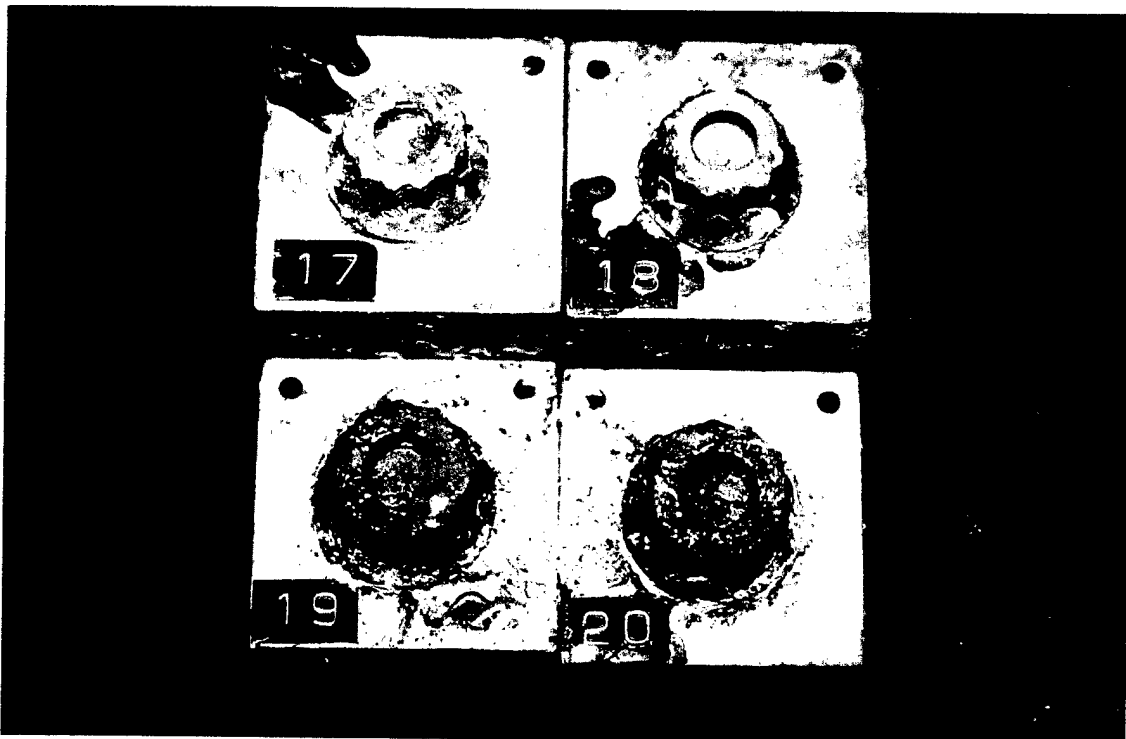

Figure 78. H11 Chromium Hot Work Tool Steel Bolt Heads With IVD Al Coating After 62 Days of Salt Spray. Reduced 25%.

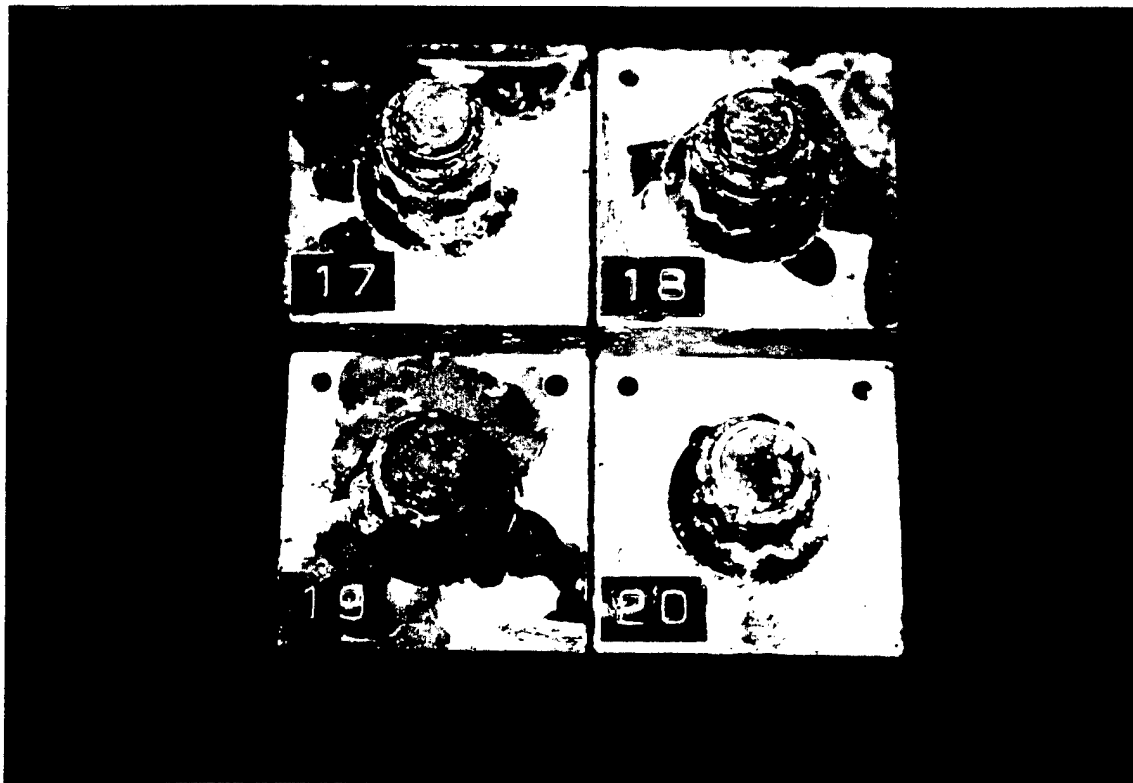

Figure 79. H11 Chromium Hot Work Tool Steel Nuts With IVD Al Coating After 62 Days of Salt Spray. Reduced 25%.

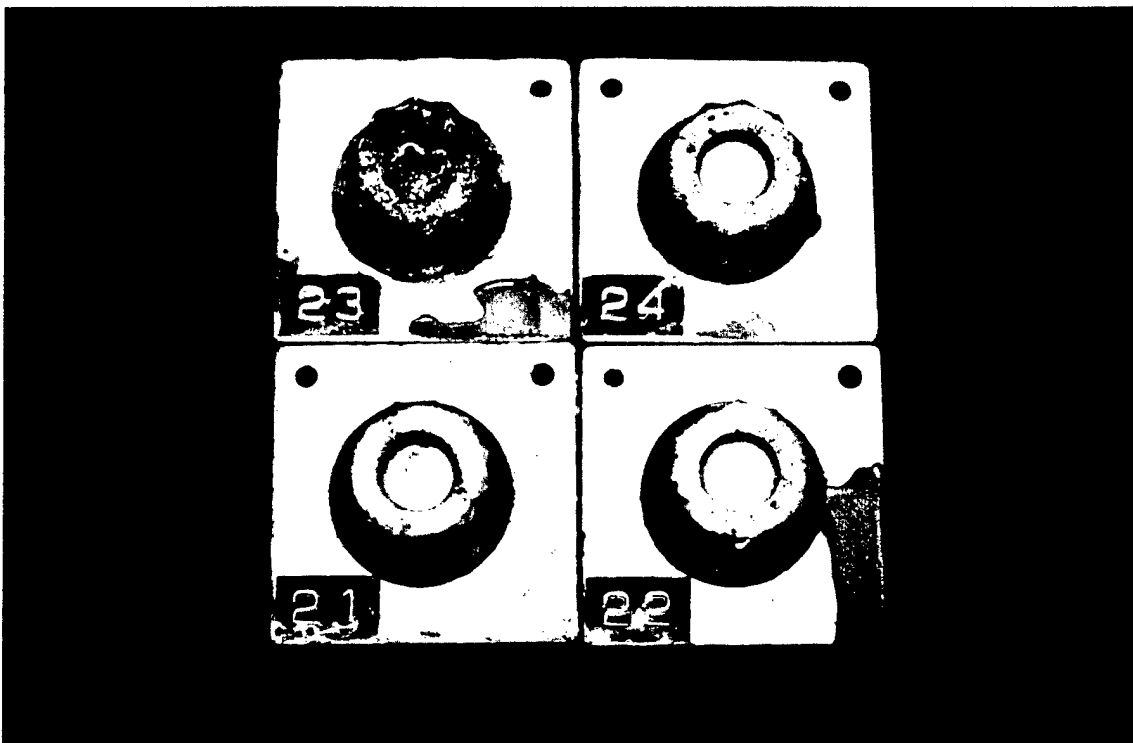

Figure 80. H11 Chromium Hot Work Tool Steel Bolt Heads With Cadmium Electroplate After 62 Days of Salt Spray. Reduced 25%.

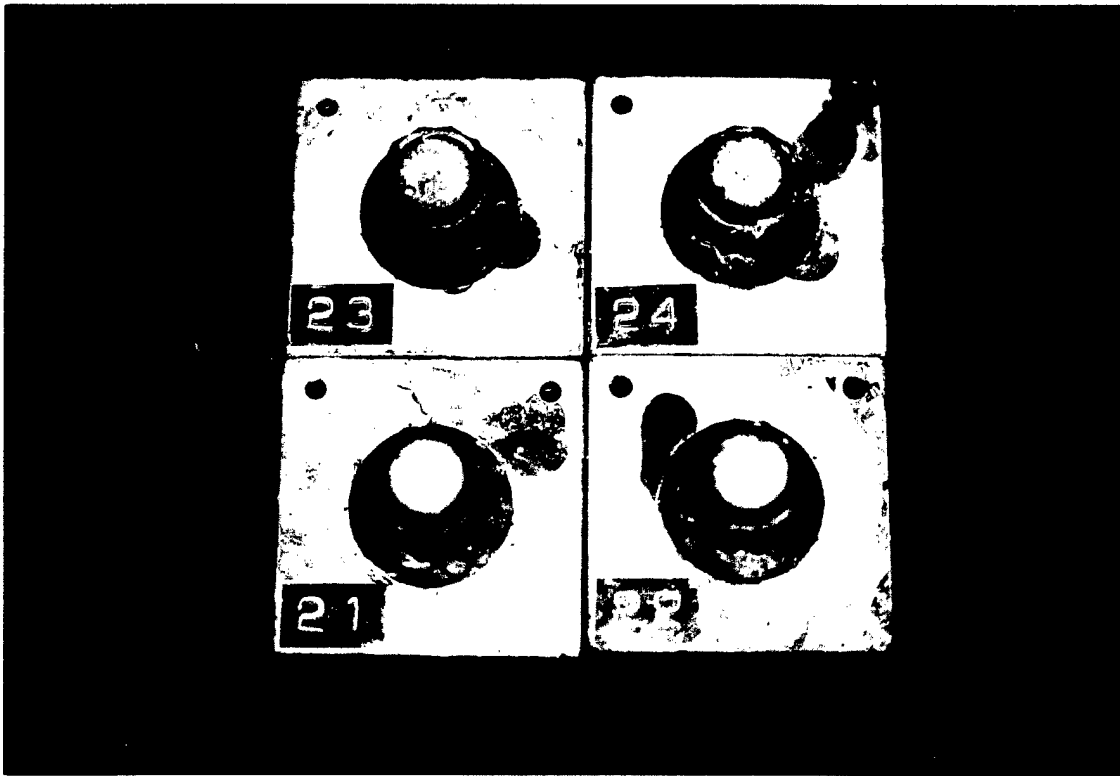

Figure 81. H11 Chromium Hot Work Tool Steel Nuts With Cadmium Electroplate After 62 Days of Salt Spray. Reduced 25%.

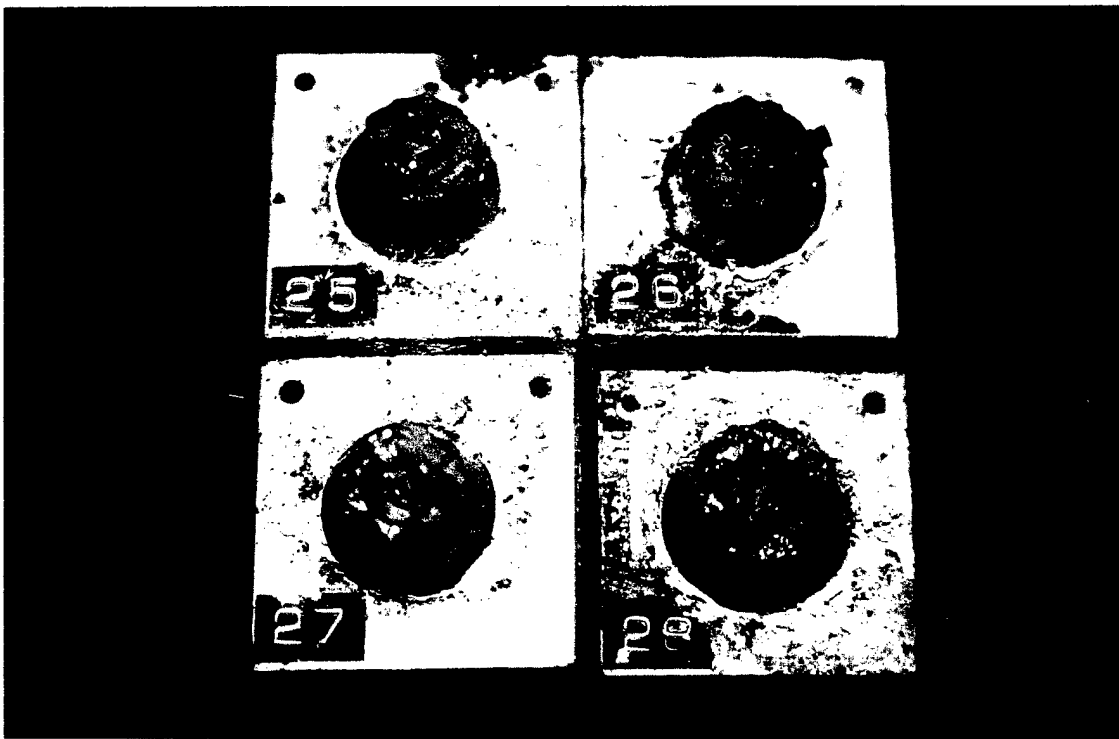

Figure 82. H11 Chromium Hot Work Tool Steel Nuts With Antiseize Solid Film Lubricant (MoS₂) 62 Days of Salt Spray. Reduced 25%.

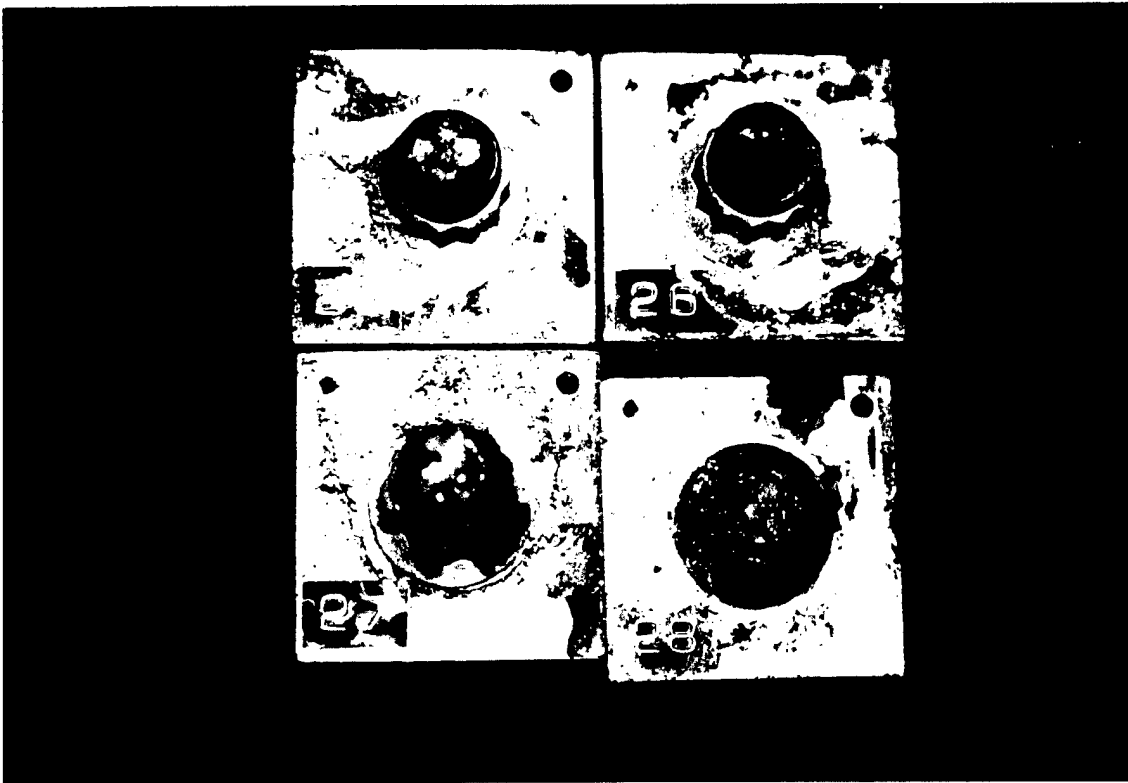

Figure 83. H11 Chromium Hot Work Tool Steel Nuts With Antiseize Solid Film Lubricant (MoS_2) After 62 Days of Salt Spray. Reduced 25%.

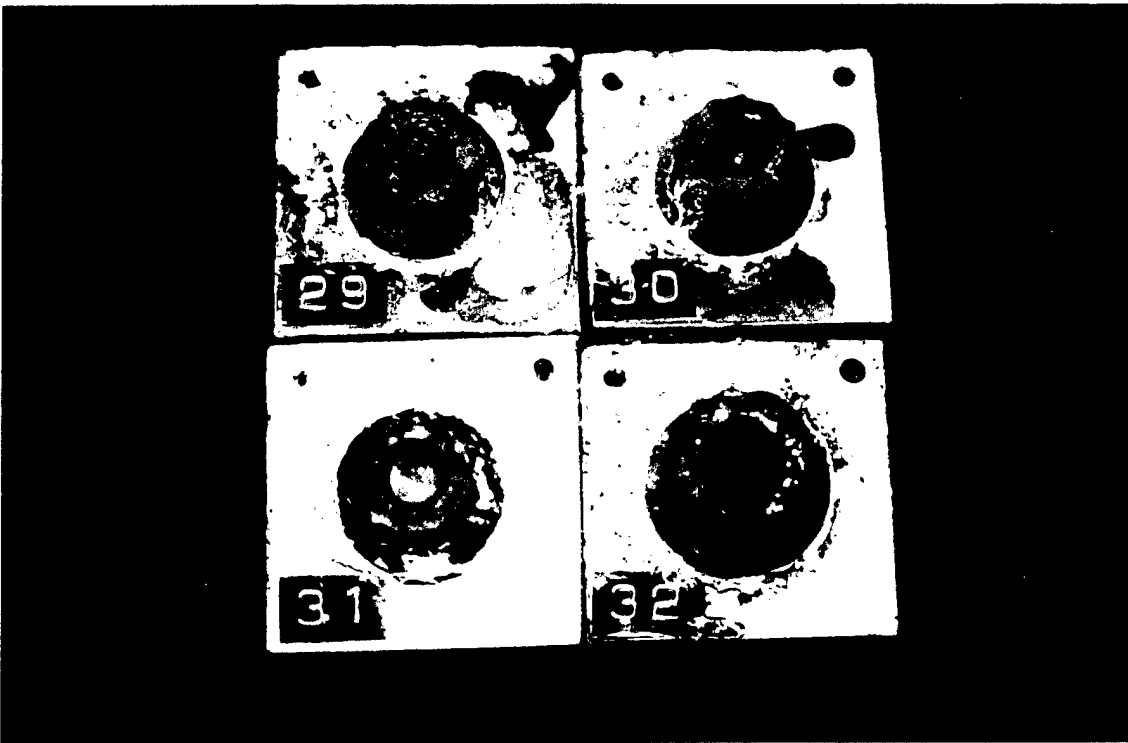

Figure 84. H11 Chromium Hot Work Tool Steel Bolt Heads With MIL-C-16173 Grade 4 Corrosion Preventative Compound After 62 Days of Salt Spray. Reduced 25%.

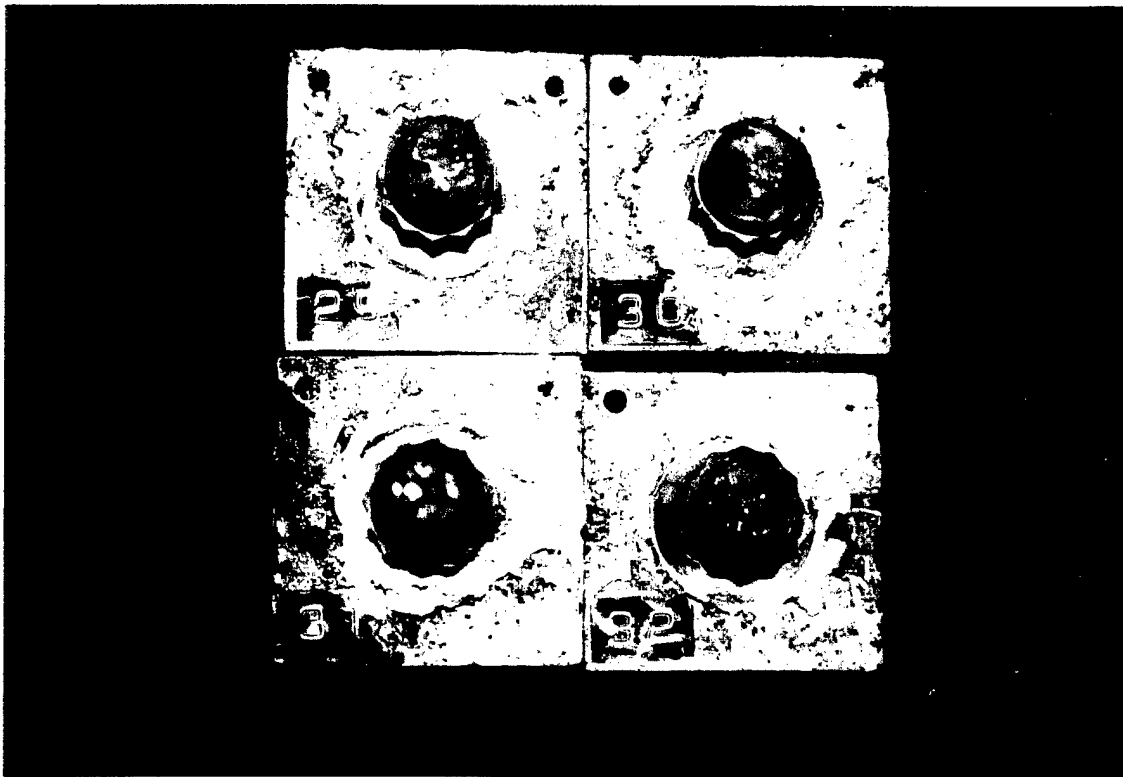

Figure 85. H11 Chromium Hot Work Tool Steel Nuts With MIL-C-16173 Grade 4 Corrosion Preventative Compound After 62 Days of Salt Spray. Reduced 25%.

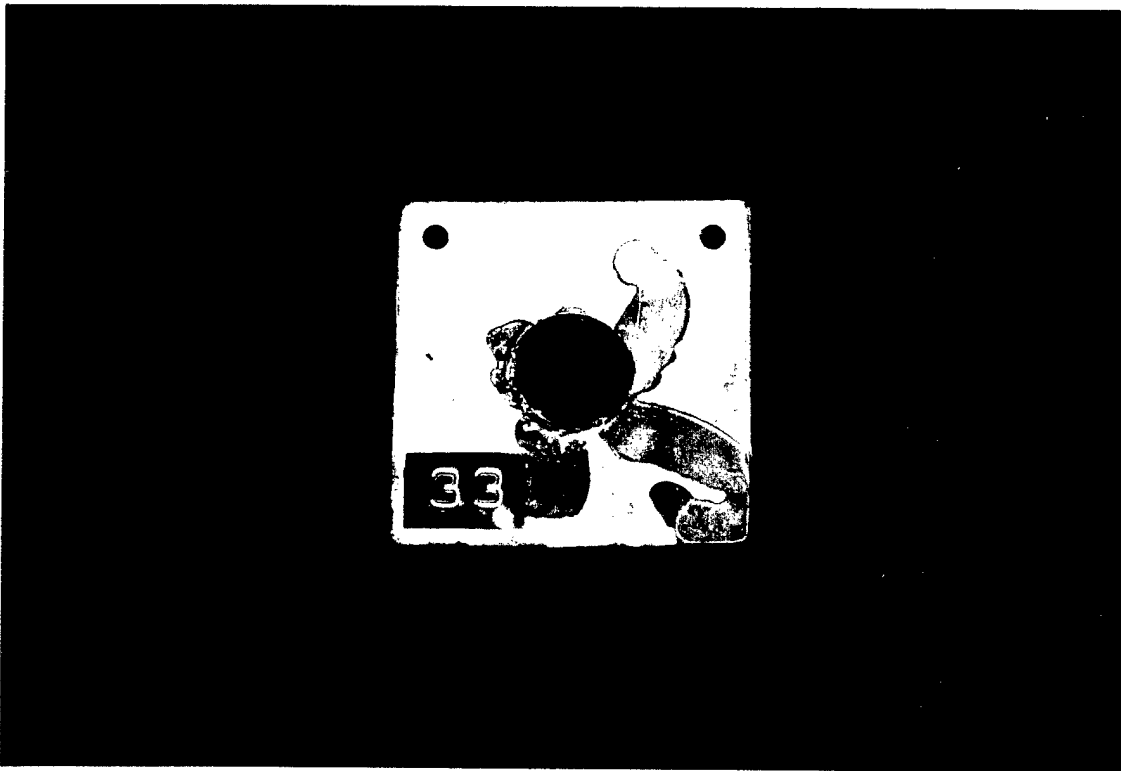

Figure 86. Aluminum Control Block After 62 Days of Salt Spray. Reduced 25%.

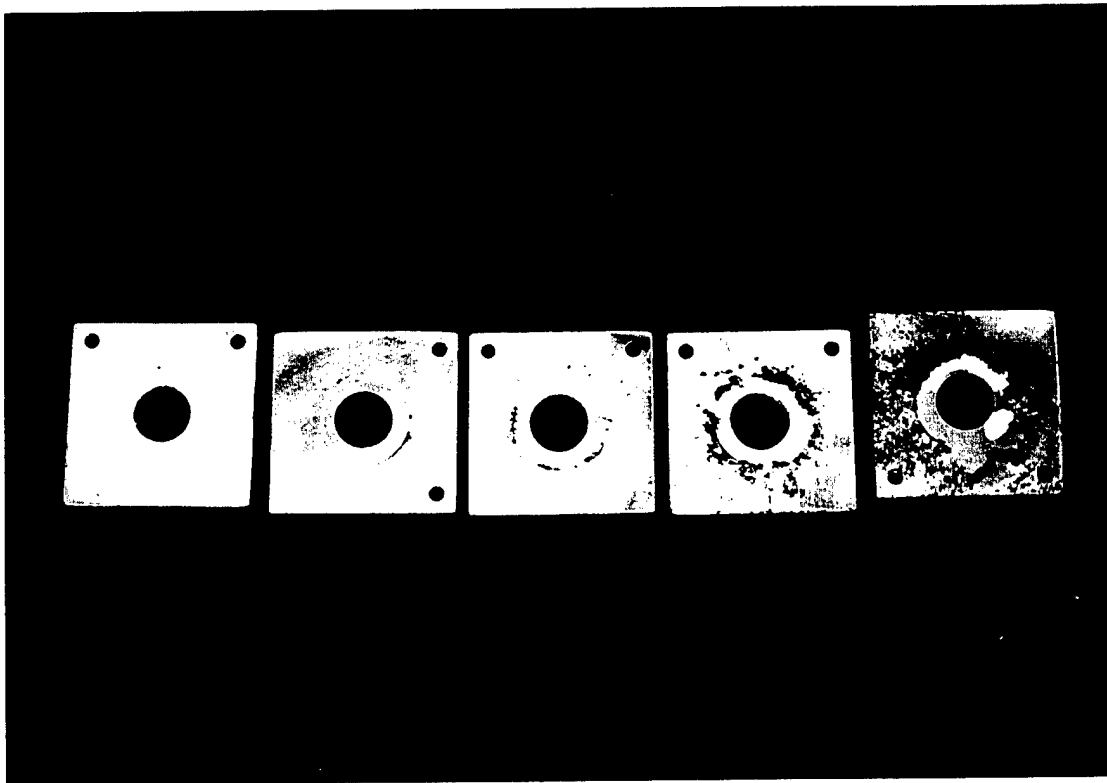

Figure 87. Macrograph Showing Pitting of the Aluminum Test Blocks Representing Pit Classification A-1 (Block No. 4), A-2 (Block No. 2), A-3 (Block No. 1), A-4 (Block No. 9), and A-5 (Block No. 31), Respectively. Reduced 50%.

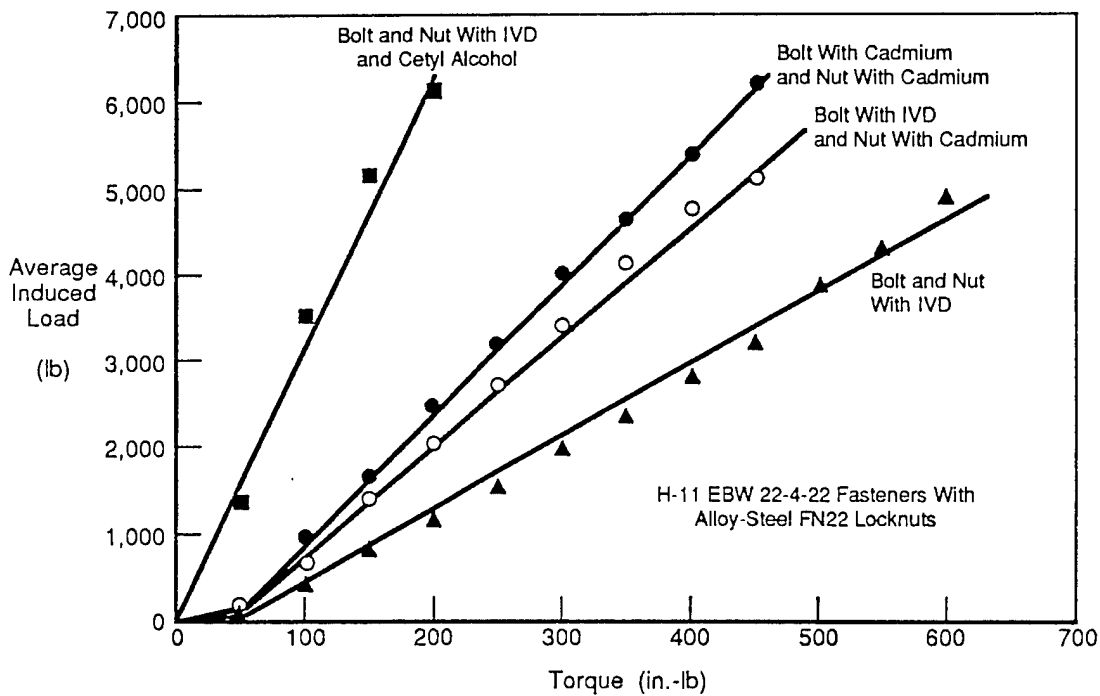

Figure 88. Torque-Tension Results Reproduced From a McDonnell Douglas Report Showing the Lowest Torque Values for the IVD/Lubricant System.

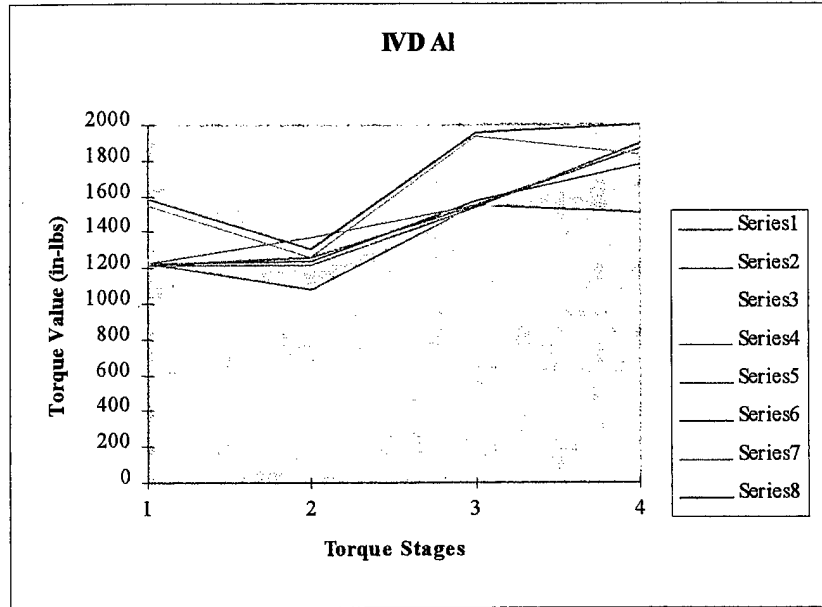

Figure 89. Graph Showing the Torque Value at Four Different Stages for the IVD Aluminum-Coated Fasteners. Stage 1 Is the Final Torque Before the Specimens Were Placed Into the Salt Fog Chamber, Stage 2 Is the Torque Required to Initiate Bolt Rotation After 30 Days, Stage 3 Is the Final Torque Before the Specimens Were Placed Into the Chamber Again, and Stage 4 Is the Torque Required to Initiate Bolt Rotation After 60 Days. No Trends Were Noted, Since the (1-2) and the (3-4) Torques Increased as Well as Decreased.

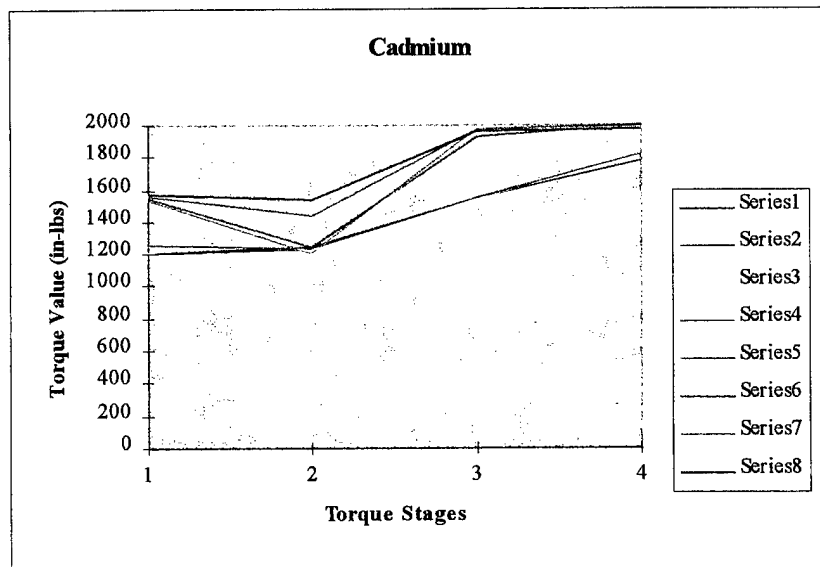

Figure 90. Graph Showing the Torque Value at Four Different Stages for the Cadmium Coated Fasteners. No Trends Were Noted, Since the (1-2) and the (3-4) Torques Increased as Well as Decreased.

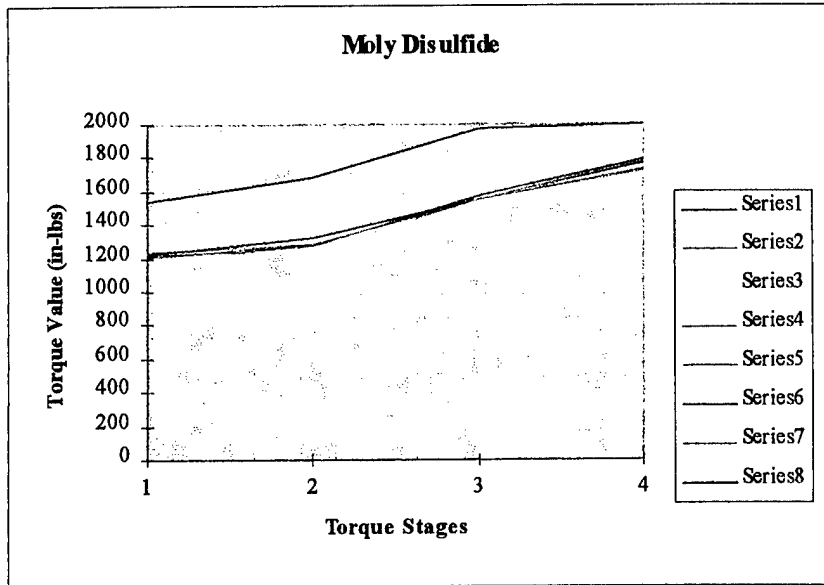

Figure 91. Graph Showing the Torque Value at Four Different Stages for the Molybdenum Disulfide-Coated Fasteners. Note That the Torque Values Consistently Increased From the (1-2) Stage and From the (3-4) Stage.

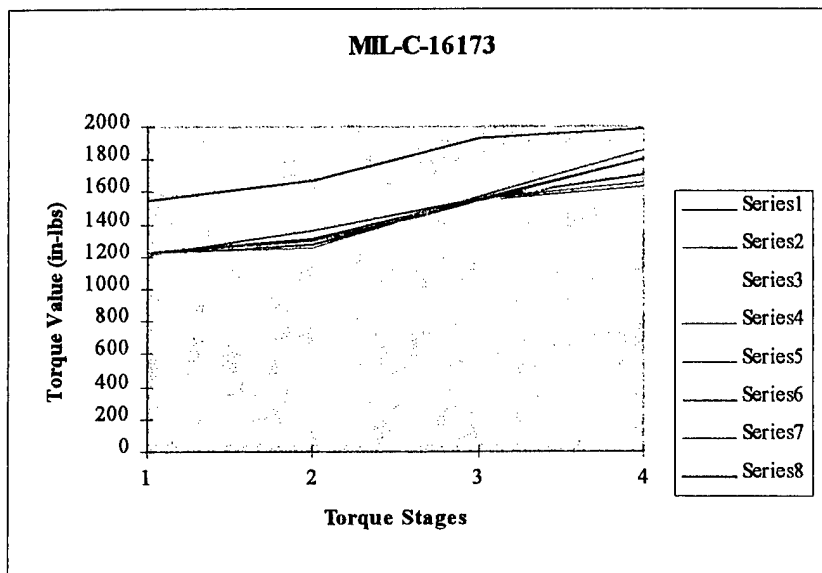

Figure 92. Graph Showing the Torque Value at Four Different Stages for the MIL-C-16173-Coated Fasteners. Note That the Torque Values Consistently Increased From the (1-2) Stage and From the (3-4) Stage.

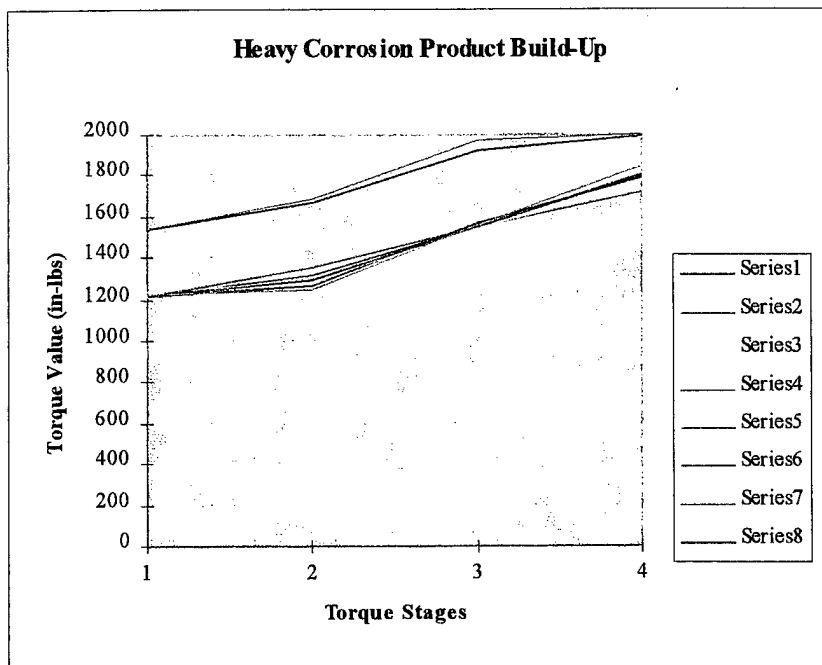

Figure 93. Graph Showing the Torque Value at Four Different Stages for the Systems Which Exhibited the Heaviest Salt and Corrosion Product Buildup (Molybdenum Disulfide Coating/H11 Fasteners and MIL-C-16173 Coating/H11 Fasteners). Note That the Torque Values Consistently Increased From the (1-2) Stage and From the (3-4) Stage.

INTENTIONALLY LEFT BLANK.

8. References

1. Department of the Army. "Guidance for Eliminating Cadmium From U.S. Army Weapon Systems." U.S. Army Acquisition Pollution Prevention Support Office, April 1996.
2. McDonnell Douglas Drawing Number HS5482, Mesa, AZ, 28 April 1995.
3. McDonnell Douglas Drawing Number HS5813, Mesa, AZ, 24 November 1998.
4. McDonnell Douglas Drawing Number HS4440, Mesa, AZ, 3 December 1992.
5. McDonnell Douglas Drawing Number HS4504, Mesa, AZ, 29 August 1973.
6. MIL-HDBK-729. "Corrosion and Corrosion Prevention Metals." Custodians Army-MR, Navy SH, Air Force II, 21 November 1983.
7. American Society for Metals Handbook. *Properties and Selection: Stainless Steels, Tool Materials and Special-Purpose Metals*. Vol. 3, 9th edition, "Selection of Tool Materials for Structural Components," p. 559, 1980.
8. Tool and Manufacturing Engineers Handbook. *Materials, Finishing and Coating*. Vol. 3, 4th edition, "Vapor Deposition Processes," pp. 24-7, 1985.
9. Garrett, R. A., and L. C. Koch. "Summary of the Standardized Method for Fastener Torque-Up Analysis." ATCOM Memorandum 334-87-Methods Sum-03, Table 1, 12 June 1987.
10. Holmes, V. L., D. E. Muehlberger, and J. J. Reilly. "The Substitution of IVD Aluminum for Cadmium." McDonnell Aircraft Company, McDonnell Douglas Corporation, Final Report ESL-TR-88-75, p. 63, August 1989.
11. Fink, F. W., and W. K. Boyd. "The Corrosion of Metals in Marine Environments." Bayer & Company, p. 8, 1970.
12. Conversation between Sean Peterson and Dr. Frank Akstens of the Industrial Fastener Institute, 10 August 1996.
13. Bickford, J. *An Introduction to the Design & Behavior of Bolted Joints*. NY, NY: Marcel Dekker, Inc., 3rd edition, pp. 190-191, 1995.

14. Ingle, M. W., I. C. Handsy, and B. S. Schorr. "Evaluation of Environmentally Acceptable Multi-Layer Coating Systems as Direct Substitutes for Cadmium Plating on Threaded Fasteners." Ocean City Research Corporation Report No. 932348, p. 237, 1993.

<u>NO. OF COPIES</u>	<u>ORGANIZATION</u>
2	DEFENSE TECHNICAL INFORMATION CENTER DTIC DDA 8725 JOHN J KINGMAN RD STE 0944 FT BELVOIR VA 22060-6218
1	HQDA DAMO FDQ D SCHMIDT 400 ARMY PENTAGON WASHINGTON DC 20310-0460
1	OSD OUSD(A&T)/ODDDR&E(R) R J TREW THE PENTAGON WASHINGTON DC 20301-7100
1	DPTY CG FOR RDE HQ US ARMY MATERIEL CMD AMCRD MG CALDWELL 5001 EISENHOWER AVE ALEXANDRIA VA 22333-0001
1	INST FOR ADVNCD TCHNLGY THE UNIV OF TEXAS AT AUSTIN PO BOX 202797 AUSTIN TX 78720-2797
1	DARPA B KASPAR 3701 N FAIRFAX DR ARLINGTON VA 22203-1714
1	NAVAL SURFACE WARFARE CTR CODE B07 J PENNELLA 17320 DAHLGREN RD BLDG 1470 RM 1101 DAHLGREN VA 22448-5100
1	US MILITARY ACADEMY MATH SCI CTR OF EXCELLENCE DEPT OF MATHEMATICAL SCI MAJ M D PHILLIPS THAYER HALL WEST POINT NY 10996-1786

<u>NO. OF COPIES</u>	<u>ORGANIZATION</u>
1	DIRECTOR US ARMY RESEARCH LAB AMSRL DD J J ROCCHIO 2800 POWDER MILL RD ADELPHI MD 20783-1145
1	DIRECTOR US ARMY RESEARCH LAB AMSRL CS AS (RECORDS MGMT) 2800 POWDER MILL RD ADELPHI MD 20783-1145
3	DIRECTOR US ARMY RESEARCH LAB AMSRL CI LL 2800 POWDER MILL RD ADELPHI MD 20783-1145
	<u>ABERDEEN PROVING GROUND</u>
4	DIR USARL AMSRL CI LP (305)

NO. OF
COPIES ORGANIZATION

2 DIRECTOR
AVIATION AND MISSILE CMD
AMSAM AR EF
K BHANSALI
BLDG 8027
REDSTONE ARSENAL AL 35898-5000

ABERDEEN PROVING GROUND

15 DIR USARL
AMSRL WM MD
M PEPI

REPORT DOCUMENTATION PAGE			Form Approved OMB No. 0704-0188	
Public reporting burden for this collection of information is estimated to average 1 hour per response, including the time for reviewing instructions, searching existing data sources, gathering and maintaining the data needed, and completing and reviewing the collection of information. Send comments regarding this burden estimate or any other aspect of this collection of information, including suggestions for reducing this burden, to Washington Headquarters Services, Directorate for Information Operations and Reports, 1215 Jefferson Davis Highway, Suite 1204, Arlington, VA 22202-4302, and to the Office of Management and Budget, Paperwork Reduction Project (0704-0188), Washington, DC 20503.				
1. AGENCY USE ONLY (Leave blank)		2. REPORT DATE May 1999	3. REPORT TYPE AND DATES COVERED Final, Sep 95 - Sep 96	
4. TITLE AND SUBTITLE The Performance of Three Alternative Coatings to Electroplated Cadmium for Corrosion Protection in Fastener Applications			5. FUNDING NUMBERS N/A	
6. AUTHOR(S) Sean Peterson,* Gary Wechsler,† and Marc Pepi‡				
7. PERFORMING ORGANIZATION NAME(S) AND ADDRESS(ES) U.S. Army Research Laboratory ATTN: AMSRL-WM-MD Aberdeen Proving Ground, MD 21005-5069			8. PERFORMING ORGANIZATION REPORT NUMBER ARL-TR-1952	
9. SPONSORING/MONITORING AGENCY NAME(S) AND ADDRESS(ES) U.S. Army Aviation and Troop Command St. Louis, MO 63120			10. SPONSORING/MONITORING AGENCY REPORT NUMBER	
11. SUPPLEMENTARY NOTES *Materials Engineer, Case Corporation. †Materials Engineer, Eaton Corporation. ‡Materials Engineer, U.S. Army Research Laboratory.				
12a. DISTRIBUTION/AVAILABILITY STATEMENT Approved for public release; distribution is unlimited.			12b. DISTRIBUTION CODE	
13. ABSTRACT (Maximum 200 words) The Army uses cadmium over a broad range of applications, including the production, maintenance, and repair of weapons systems and related components. The useful properties of this element have made it the number one choice for fasteners and similar components where corrosion resistance and lubricity are a concern. However, cadmium is a known carcinogen and poses health risks to those coming in contact with it. Executive Order 12856, "Federal Compliance With Right-to-Know Laws and Pollution Prevention Requirements," was enacted in 1993 with the intent of reducing the total release of toxic chemicals into the environment by 50% by 1999. As such, intense research efforts have been underway to develop a coating or coating system that provides similar, if not better, properties than cadmium. ARL examined three alternatives to cadmium for corrosion protection in AH-64 fastener applications, including ion-vapor-deposited (IVD) aluminum, a MIL-T-83483 antiseize compound, and a MIL-C-16173 corrosion preventative compound. It was concluded that the antiseize compound and the corrosion preventative compound were not adequate replacements for cadmium based upon unacceptable fastener and aluminum block corrosion. IVD was deemed comparable to cadmium based upon the torque values, fastener corrosion, and block corrosion results.				
14. SUBJECT TERMS electroplated cadmium, fasteners			15. NUMBER OF PAGES 92	
			16. PRICE CODE	
17. SECURITY CLASSIFICATION OF REPORT UNCLASSIFIED	18. SECURITY CLASSIFICATION OF THIS PAGE UNCLASSIFIED	19. SECURITY CLASSIFICATION OF ABSTRACT UNCLASSIFIED	20. LIMITATION OF ABSTRACT UL	

INTENTIONALLY LEFT BLANK.

USER EVALUATION SHEET/CHANGE OF ADDRESS

This Laboratory undertakes a continuing effort to improve the quality of the reports it publishes. Your comments/answers to the items/questions below will aid us in our efforts.

- 1. ARL Report Number/Author ARL-TR-1952 (Peterson [POC: Pepi]) Date of Report May 1999
- 2. Date Report Received _____
- 3. Does this report satisfy a need? (Comment on purpose, related project, or other area of interest for which the report will be used.) _____

- 4. Specifically, how is the report being used? (Information source, design data, procedure, source of ideas, etc.) _____

- 5. Has the information in this report led to any quantitative savings as far as man-hours or dollars saved, operating costs avoided, or efficiencies achieved, etc? If so, please elaborate. _____

- 6. General Comments. What do you think should be changed to improve future reports? (Indicate changes to organization, technical content, format, etc.) _____

CURRENT ADDRESS	_____
	Organization
	Name _____ E-mail Name _____
	Street or P.O. Box No. _____
	City, State, Zip Code _____

7. If indicating a Change of Address or Address Correction, please provide the Current or Correct address above and the Old or Incorrect address below.

OLD ADDRESS	_____
	Organization
	Name _____
	Street or P.O. Box No. _____
	City, State, Zip Code _____

(Remove this sheet, fold as indicated, tape closed, and mail.)
(DO NOT STAPLE)