

**UNITED STATES AIR FORCE  
IERA**

---

**Aircraft Engine and Auxiliary Power  
Unit Emissions Testing: Vol. 3,  
Particulate Matter Results**

**Thomas Gerstle**

**Environmental Quality Management, Inc.  
1310 Kemper Meadow Drive, Suite 100  
Cincinnati, Ohio 45240**

**Peter Virag**

**Roy F. Weston, Inc.  
1 Weston Way  
Westchester, Pennsylvania 19380-1499**

**Mark Wade**

**KARTA  
Brooks AFB TX 78235-5123**

**Larry Kimm, Major, USAF, BSC**

**March 1999**

160 90706661  
19990406 091

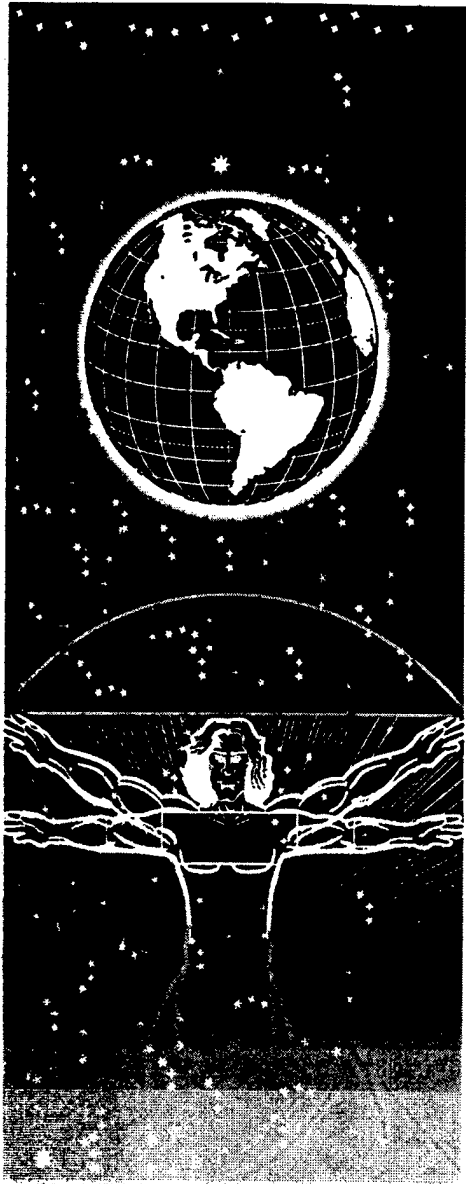

*Approved for public release;  
distribution is unlimited.*

**Institute for Environment, Safety and  
Occupational Health Risk Analysis  
Risk Analysis Directorate  
Environmental Analysis Division  
2513 Kennedy Circle  
Brooks Air Force Base TX 78235-5123**

**DTIC QUALITY INSPECTED 2**

## NOTICES

When Government drawings, specifications, or other data are used for any purpose other than in connection with a definitely Government-related procurement, the United States Government incurs no responsibility or any obligation whatsoever. The fact that the Government may have formulated or in any way supplied the said drawings, specifications, or other data, is not to be regarded by implication, or otherwise in any manner construed, as licensing the holder or any other person or corporation; or as conveying any rights or permission to manufacture, use, or sell any patented invention that may in any way be related thereto.

The mention of trade names or commercial products in this publication is for illustration purposes and does not constitute endorsement or recommendation for use by the United State Air Force.

The Office of Public Affairs has reviewed this report, and it is releasable to the National Technical Information Service, where it will be available to the general public, including foreign nationals.

This report has been reviewed and is approved for publication.

Government agencies and their contractors registered with Defense Technical Information Center (DTIC) should direct requests for copies to: Defense Technical Information Center, 8725 John J. Kingman Rd., STE 0944, Ft. Belvoir, VA 22060-6218.

Non-Government agencies may purchase copies of this report from: National Technical Information Services (NTIS), 5285 Port Royal Road, Springfield, VA 22161-2103.

  
GRANT T. JOHNSON, Capt, USAF, BSC  
Technical Project Manager

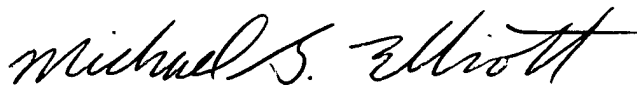
  
MICHAEL G. ELLIOTT, Maj, USAF, BSC Ph.D, PE  
Chief, Environmental Analysis Division

**REPORT DOCUMENTATION PAGE**

*Form Approved  
OMB No. 0704-0188*

Public reporting burden for this collection of information is estimated to average 1 hour per response, including the time for reviewing instructions, searching existing data sources, gathering and maintaining the data needed, and completing and reviewing the collection of information. Send comments regarding this burden estimate or any other aspect of this collection of information, including suggestions for reducing this burden, to Washington Headquarters Services, Directorate for Information Operations and Reports, 1215 Jefferson Davis Highway, Suite 1204, Arlington, VA 22202-4302, and to the Office of Management and Budget, Paperwork Reduction Project (0704-0188), Washington, DC 20503.

<b>1. AGENCY USE ONLY (Leave blank)</b>		<b>2. REPORT DATE</b> March 1999	<b>3. REPORT TYPE AND DATES COVERED</b> Final, November 1998	
<b>4. TITLE AND SUBTITLE</b> Aircraft Engine and Auxiliary Power Unit Emissions Testing: Vol. 3, Particulate Matter Results			<b>5. FUNDING NUMBERS</b> C - F41624-95-D-9019	
<b>6. AUTHOR(S)</b> Thomas Gerstle, EQ; Peter Virage, Weston; Maj Larry Kimm, IERA: Mark Wade, Karta				
<b>7. PERFORMING ORGANIZATION NAME(S) AND ADDRESS(ES)</b> Environmental Quality Management, Inc. 1310 Kemper Meadow Drive, Suite 100 Cincinnati, Ohio 45240			<b>8. PERFORMING ORGANIZATION REPORT NUMBER</b>	
<b>9. SPONSORING/MONITORING AGENCY NAME(S) AND ADDRESS(ES)</b> Institute for Environment, Safety, Occupational Health Risk Analysis (IERA) Risk Analysis Directorate Environmental Analysis Division 2513 Kennedy Circle Brooks Air Force Base TX 78235-5123			<b>10. SPONSORING/MONITORING AGENCY REPORT NUMBER</b>  IERA-RS-BR-TR-1999-0006-Vol. 3	
<b>11. SUPPLEMENTARY NOTES</b>				
<b>12a. DISTRIBUTION AVAILABILITY STATEMENT</b> Approved for public release; distribution unlimited.			<b>12b. DISTRIBUTION CODE</b>	
<b>13. ABSTRACT (Maximum 200 words)</b> This report is the product of a 2-year emissions testing program designed to document, characterize, and evaluate emissions from sixteen aircraft engines, two helicopter engines, and two auxiliary power units (APUs) burning JP-8 fuel. The purpose of this engine testing program was to develop emission factors for the tested engines under representative engine load conditions. All testing was performed by the Environmental Quality Management Inc. (EQ) and Roy F. Weston, Inc. (Weston) team. Testing was conducted for criteria pollutants and select hazardous air pollutants (HAPs), e.g., aldehyde/ketones and semivolatile and volatile organic compounds.				
<b>14. SUBJECT TERMS</b> Aircraft engine and auxiliary power unit emissions testing			<b>15. NUMBER OF PAGES</b> 226	
			<b>16. PRICE CODE</b>	
<b>17. SECURITY CLASSIFICATION OF REPORT</b> UNCLASSIFIED	<b>18. SECURITY CLASSIFICATION OF THIS PAGE</b> UNCLASSIFIED	<b>19. SECURITY CLASSIFICATION OF ABSTRACT</b> UNCLASSIFIED	<b>20. LIMITATION OF ABSTRACT</b> UL	

## TABLE OF CONTENTS

<b>Section</b>		<b>Page</b>
1.0	Introduction	1 of 13
1.1	Engine Emission Testing Considerations/Complications	1 of 13
1.2	Emission Sampling Approach	3 of 13
1.2.1	Pretest Measurements	4 of 13
1.2.2	Emission Test Methods	4 of 13
1.2.3	Flowrate Measurement	5 of 13
1.2.4	Pollutant Distribution at the Outlet of the Test Cells	7 of 13
1.2.5	Tracer Gas Methodology	8 of 13
1.3	Pollutant Background Concentrations	9 of 13
1.3.1	Particulates	12 of 13
1.4	Engine Test Cycle Data	12 of 13
1.5	JP-8 Fuel Sampling and Analysis	13 of 13
2.0	Site-Specific Sampling Protocols	1 of 57
2.1	Kelly AFB, Test Cell 58	1 of 57
2.2	Kelly AFB, Test Cell 54A	6 of 57
2.3	Kelly AFB, APU Test Cell	10 of 57
2.4	Corpus Christi Army Depot, Test Cell 14	15 of 57
2.5	Laughlin AFB, Test Cell 18	19 of 57
2.6	Tinker AFB, Test Cell 9	25 of 57
2.7	Charleston AFB, Test Cell	29 of 57
2.8	Edwards AFB, Test Cell 4	36 of 57
2.9	Edwards AFB, Test Cell 2	40 of 57
2.10	Naval Aviation Depot, Cherry Point, Test Cell	47 of 57
2.11	Barnes Air National Guard Base, Hush House	52 of 57
3.0	Exhaust Flow Determination	1 of 16
3.1	Calculation of Airflow Using Carbon Balance	2 of 16
3.2	Calculation of Airflow Using F-Factors	5 of 16
3.3	Calculation of Airflow Using Tracer Gas	9 of 16
3.4	Measurement of Inlet Airflow	12 of 16
3.5	Comparison of Exhaust Flow Determination Method with Historical Emission Calculation Methodology	13 of 16

(continued)

## TABLE OF CONTENTS (continued)

<u>Section</u>		<u>Page</u>
4.0	Results	1 of 105
4.1	Correction of Particulate Data for Background Concentration	1 of 105
4.1.1	Calculation of Pollutant Averages	2 of 105
4.2	Source Analytical Data	2 of 105
4.3	Engine Specific Emission Discussion	4 of 105
4.3.1	Engine T56-A-7	9 of 105
4.3.2	Engine TF39-GE-1C	15 of 105
4.3.3	APU GTCP85-180	21 of 105
4.3.4	APU GTCP165-1	24 of 105
4.3.5	Engine J69-T-24	27 of 105
4.3.6	Engine J85-GE-5A	32 of 105
4.3.7	Engine T700-GE-700	38 of 105
4.3.8	Engine TF33-P-102	44 of 105
4.3.9	Engine TF33-P-7/7A	50 of 105
4.3.10	Engine F108-CF-100	56 of 105
4.3.11	Engine F101-GE-102	62 of 105
4.3.12	Engine F110-GE-100	69 of 105
4.3.13	Engine F117-PW-100	76 of 105
4.3.14	Engine F118-GE-100	81 of 105
4.3.15	Engine F404-GE-F1D2/400	87 of 105
4.3.16	Engine T64-GE-100	94 of 105
4.3.17	Engine TF34-GE-100A	100 of 105
5.0	Particulate Matter Results	1 of 24
5.1	Alternate Particulate Sampling Method	1 of 24
5.1.1	Aircraft Environmental Support Office	1 of 24
5.1.2	Batelle Columbus Division	3 of 24
5.2	Comparison of Results	4 of 24
5.3	Engine Modifications	6 of 24

Test Report	
Volume:	<u>3</u>
Section:	<u>1.0</u>
Revision:	<u>2</u>
Date:	<u>November 1998</u>
Page:	<u>1 of 13</u>

## SECTION 1

### INTRODUCTION

This volume presents engine emissions particulate results obtained through conventional EPA Method 5 sampling protocol as well as a custom Method 5 sampling methodology. This volume outlines the theory involved in method development, the site-specific sampling methodologies, emission results for particulate matter, and a discussion of the emission results. Section 5 of this volume compares the custom Method 5 procedures to other sampling methodologies and presents the particulate matter results.

Due to unique exhaust configurations at select facilities, a source-specific sampling methodology was developed that was economical and representative. Each of these various engine types and facilities presented a unique challenge to the accurate measurement of particulate emission rates. Numerous constraints and unknown parameters presented themselves in this program that are not associated with more traditional emissions testing programs. These variables were difficult to anticipate because of the inability to measure outlet exhaust parameters at some of the facilities, such as flowrates, temperature, and dilution by ambient air in the exhaust gas stream. The test program was designed to allow for those variables so that representative data could be collected in a timely and economic manner.

#### 1.1 ENGINE EMISSION TESTING CONSIDERATIONS/COMPLICATIONS

The unique feature in the determination of the emissions from the test facilities is that the exhaust stream is significantly diluted with ambient air. The sampling locations for four of the engine tests were contained in a single accessible exhaust duct, and

Test Report	
Volume:	<u>3</u>
Section:	<u>1.0</u>
Revision:	<u>2</u>
Date:	<u>November 1998</u>
Page:	<u>2 of 13</u>

conventional test methods were used to determine the mass emission rates at those locations. These facilities were the APU test cell at Kelly AFB, Test Cell 14 at Corpus Christi Army Depot, and the test cell at the Naval Aviation Depot, Cherry Point (these results are also presented and discussed in Volume 2). The physical structure of the sampling locations at the other seven facilities required the use of innovative techniques for the determination of volumetric flow during the test program. This section discusses those innovative techniques.

The impact of large and/or fluctuating quantities of ambient air in the exhaust of turbine engines required modifications of the sampling and calculation methods used to determine emissions. The SAE Aerospace Information Report 1533 "Procedure for the Calculation of Basic Emission Parameters for Aircraft Turbine Engines," which was used historically, applies a mass balance to the combustion equation to determine the mass emission rate for priority pollutants with the explicit measurement of a volumetric flowrate. This approach was not practical for this test program since a significant portion of the test effort was directed at measuring trace hazardous compounds. The formation of trace compounds cannot be predicted by the combustion equation used in the SAE procedure. It was necessary to develop a technique to measure the total volumetric flowrate from the test facilities. Several methods were evaluated to determine the exhaust flowrate.

A carbon balance was calculated using fuel firing data, emission concentrations of CO, CO<sub>2</sub>, and total hydrocarbons, and ambient measurements of CO<sub>2</sub> and total hydrocarbons. This approach closely resembles the SAE method, but the calculation was modified to produce a volumetric flowrate that could be used for mass emission calculations. A comparison of these methods is provided in Section 4.3 of Volume 2.

A tracer gas study was conducted that released a small quantity of sulfur hexafluoride into the engine exhaust stream, and measured the minute concentrations of SF<sub>6</sub> at the sampling location. The dilution of the tracer gas by the emission stream was calculated, and the total volumetric flowrate was determined.

Test Report	
Volume:	<u>3</u>
Section:	<u>1.0</u>
Revision:	<u>2</u>
Date:	<u>November 1998</u>
Page:	<u>3 of 13</u>

A traditional emission testing F-factor combustion equation based on fuel composition and oxygen content of the emission stream was employed to calculate the flowrate. Each method was evaluated for each sampling run, and the most representative flow was selected.

## 1.2 EMISSION SAMPLING APPROACH

Emissions testing was performed on a series of engines at various power settings. Aircraft engines were tested at actual flight settings that varied between three and five, depending on the engine type. The engine conditions for emissions sampling are provided below:

- o Idle
- o Approach
- o Intermediate
- o Military
- o Afterburner (Between Zone 1 and Zone 3).

Emissions testing was comprised of three 1-hour emissions tests for each pollutant at each power setting for each engine. Certain engines could not be operated continuously at maximum power (military, afterburner) because engine and/or test cell damage may have occurred. Sample run times in these operative modes were reduced to the "safe" operating duration. EQ adjusted the sample collection procedures to accommodate the reduced operating time. In order to reach the analytical detection limit for the target pollutants, EQ paused the sample run at the end of the safe operating period, waited to allow the engine to cool, then resumed sampling for the next operating period until the 1-hour sample run was completed. In the case of the F117-PW-100 engine, the engine could not be operated at the military setting for the necessary duration. No emissions data was collected for this setting.

Ambient air sampling was conducted only during emissions testing. Ambient samples were composited for each of the three 1-hour test runs at that power setting.



Test Report	
Volume:	<u>3</u>
Section:	<u>1.0</u>
Revision:	<u>2</u>
Date:	<u>November 1998</u>
Page:	<u>4 of 13</u>

The test program was structured in such a manner that the first series of engine tests at Kelly AFB was used to provide the necessary information to assess the sampling program for the remaining engines. Based on the results of these tests, the program was modified by considering an additional particulate matter sampling method (hi-volume sampler) at the engine exhaust stream. This was done in an effort to collect a measurable amount of particulate in case the custom Method 5 sample had zero or negative filter weight.

### 1.2.1 Pretest Measurements

Preliminary test data was obtained at the engine exhaust locations during 10-minute shakedown runs at each engine setting. Stack geometry measurements were obtained and recorded. A preliminary velocity measurement was performed at each exhaust stack where sampling took place. A calibrated S-type pitot tube and a Dwyer inclined manometer were used for these measurements. Flue gas temperatures were observed with a calibrated direct readout pyrometer equipped with a chromel-alumel thermocouple. Water vapor content was measured using EPA Method 4.

A check for the presence or absence of cyclonic flow was conducted at each test location. The cyclonic flow checks were less than 20°, thus verifying the suitability of each test site for obtaining representative samples.

Preliminary test data was used for nozzle sizing and sampling rate determinations. Probe nozzles, pitot tubes, metering systems, and temperature measurement devices were calibrated as specified in Section 5 of EPA Method 5 test procedures.

### 1.2.2 Emission Test Methods

Particulate matter sampling was performed using a custom Method 5 approach. The pollutants and sampling/analytical methods described below were sampled for to determine flowrate and particulate loading:

Test Report	
Volume:	<u>3</u>
Section:	<u>1.0</u>
Revision:	<u>2</u>
Date:	<u>November 1998</u>
Page:	<u>5 of 13</u>

- Filterable and condensable particulate (EPA Methods 5 and 202).
- Oxygen and carbon dioxide (EPA Method 3A).
- Carbon monoxide (EPA Method 10).
- Total hydrocarbons (THCs) (EPA Method 25A).

### 1.2.3 Flowrate Measurement

As stated previously, standard flowrate measurements (EPA Methods 1-4) could be performed at only three of the test locations. These facilities were the APU test cell at Kelly AFB, Test Cell 14 at Corpus Christi Army Depot, and the test cell at the Naval Aviation Depot, Cherry Point.

Traditional isokinetic sampling methodologies could not be employed due to the physical structure of Test Cells 54A and 58 at Kelly AFB, Test Cell 18 at Laughlin AFB, Test Cell 9 at Tinker AFB, the test cell at Charleston AFB, Test Cells 2 and 4 at Edwards AFB, and the hush house at Barnes ANGB. Some of the engine test cells contained as many as 56 separate stacks, and it was not economical nor practical to sample each stack. Based on these complications, several mass balance approaches were employed to determine total flowrate. These methods were tracer gas dilution rates, carbon balance, and F-factor calculations. A summary of the exhaust flow determination method used at each site is summarized in Table 1-1. The multiple flow measurement/calculation methods were used to provide a firm basis for identifying and rejecting outlier data. The flow data collected by any one method at a given condition was compared against the alternate measurement data collected at that same condition, as well as the flow data collected by all methods for the same engine/test cell configuration at different operating conditions. Engine operating level is directly related to total flow, and all flow measurement methods provide valid data at one or more operating conditions. The data evaluation identified which measurement deviates from that relationship, and whether that deviation can be attributed to a physical parameter such as temperature, oxygen concentration, etc. If the deviation was predicted (e.g., high oxygen concentration impact on F-factor calculation), that data was discarded.

Test Report

Volume: 3  
 Section: 1.0  
 Revision: 2  
 Date: November 1998  
 Page: 6 of 13

**Table 1-1. Site-Specific Exhaust Flow Determination Summary**

Engine Test Location	Engine	Flow Determination Method
Kelly AFB	T56-A-7	Calculated by carbon balance, tracer gas and F-factor. <sup>1</sup>
	TF39-GE-1C	Calculated by carbon balance, tracer gas and F-factor <sup>1</sup>
	GTCP85-180	Measured using EPA Methods 1-4
	GTCP-165-1	Measured using EPA Methods 1-4
Corpus Christi Army Depot	T700-GE-700	Measured using EPA Methods 1-4
Laughlin AFB	J69-T-25	Calculated by carbon balance, tracer gas and F-factor <sup>1</sup>
	J85-GE-5A	Calculated by carbon balance, tracer gas and F-factor <sup>1</sup>
Tinker AFB	F110-GE-100	Calculated by carbon balance, tracer gas and F-factor <sup>1</sup>
	F108-CF-100	Calculated by carbon balance, tracer gas and F-factor <sup>1</sup>
	TF33-P-7/7A	Calculated by carbon balance, tracer gas and F-factor <sup>1</sup>
	F101-GE-102	Calculated by carbon balance, tracer gas and F-factor <sup>1</sup>
	TF33-P-102	Calculated by carbon balance, tracer gas and F-factor <sup>1</sup>
Charleston AFB	F117-PW-100	Calculated by carbon balance, tracer gas and F-factor <sup>1</sup>
Edwards AFB	F118-GE-100	Calculated by carbon balance, tracer gas and F-factor <sup>1</sup>
	F404-GE-F102/400	Calculated by carbon balance, tracer gas and F-factor <sup>1</sup>
	F110-GE-129	Calculated by carbon balance, tracer gas and F-factor <sup>1</sup>
	F100-PW-100	Calculated by carbon balance, tracer gas and F-factor <sup>1</sup>
	F100-PW-229	Calculated by carbon balance, tracer gas and F-factor <sup>1</sup>
Naval Aviation Depot, Cherry Point, NC	T64-GE-100	Measured using EPA Methods 1-4
Barnes ANGB	TF34-GE-100A	Calculated by carbon balance, tracer gas and F-factor <sup>1</sup>

<sup>1</sup> The exhaust flow was calculated by these three methods and the most representative method was selected to determine the exhaust flowrate.

Test Report	
Volume:	<u>3</u>
Section:	<u>1.0</u>
Revision:	<u>2</u>
Date:	<u>November 1998</u>
Page:	<u>7 of 13</u>

If there was no obvious physical explanation, best-fit estimates at other loads were used to identify and reject the outlier. This evaluation showed that the F-factor mass balance calculation which relied on oxygen concentration dilution factors was unreliable due to the near ambient oxygen concentrations present in most exhaust streams. These items are discussed in more detail in Section 4.

As an additional verification of outlet flows, anemometers were used to measure inlet flowrates. Up to 12 hot-wire anemometers (mass flow meters) were attached to the inlet locations of the test cells. The hot-wire outputs terminated at a data logger, where data was measured once per second and recorded as 1-minute averages during each test run. The flow data then was used to calculate inlet flowrates. EPA Method 1 was used to determine the placement of the hot-wire anemometers. Due to potential interference caused by the extreme turbulence at the test locations, the hot-wire anemometer data did not correlate with outlet flows. The data was rejected as suspect and not included in this report.

As part of the theoretical flow determination method using carbon balance and F-factors, the inlet concentration for select compounds was measured. At the inlet to each test cell/hush house, THC was measured using a hydrocarbon analyzer identical to the one that measured engine exhaust gas THC. The THC analyzer was challenged with a zero and span gas at the beginning and end of each test condition to calibrate and assess the instrument's calibration. An inlet carbon dioxide (CO<sub>2</sub>) measurement was required as input to the theoretical flow model. An ambient CO<sub>2</sub> monitor was used to measure the inlet CO<sub>2</sub> concentration during each test run. The CO<sub>2</sub> monitor was challenged with a zero and span gas at the beginning and end of each test condition to calibrate and assess the instrument's calibration.

#### **1.2.4 Pollutant Distribution At The Outlet Of The Test Cells**

The test program was based on the assumption that by the time the exhaust gas exits the test cell, the exhaust stream from the engine and the dilution air have reached

Test Report	
Volume:	<u>3</u>
Section:	<u>1.0</u>
Revision:	<u>2</u>
Date:	<u>November 1998</u>
Page:	<u>8 of 13</u>

a homogeneous mixture. This assumption was validated during testing conducted for this delivery order.

Particulate size distribution in the engine exhaust has been shown to be significantly less than 10 microns ( $\mu\text{m}$ ) in size (Characterization of Chemicals on Engine Exhaust Particles: F101 and F110 Engines, ESL-TR-89-20, Air Force Engineering and Services Center Engineering and Services Laboratory and Source Sampling and Testing of Aerospace Equipment and Jet Engines - Test Protocol - Edwards AFB, CA, EQ December 1995). Because of the size of the particles, it was assumed that the particles would behave as an aerosol or gas, and that pollutants will be distributed evenly throughout each of the test cell stacks. Since it was assumed that all particulate (and those contaminants bound to the particulate) will behave as an aerosol, each stack or any point in the stack will have the same concentration of pollutants. This assumption was used as the basis to conduct single-point isokinetic sampling on only one stack or one point in the stack that is representative of all other stacks or points in a given test cell.

Although it was assumed that pollutant concentrations in the stack would be homogeneous, the assumption was verified by using tracer gas at facilities where the exhaust was not emitted through a single stack. The tracer gas, sulfur hexafluoride ( $\text{SF}_6$ ), was dispersed into the exhaust gas stream and measured at the outlet. Based on the turbulent flow of the exhaust and the passage of the exhaust gases through the blast room, the  $\text{SF}_6$  was dispersed equally in the exhaust. A random number of stacks were sampled at various engine settings to test that the tracer gas was dispersed equally. The results of the tracer gas dispersion are provided in Section 5 of Volume 2.

### 1.2.5 Tracer Gas Methodology

Tracer gas was used at Kelly AFB, Laughlin AFB, Tinker AFB, Edwards AFB, and Barnes ANGB where exhaust flow could not be measured using standard EPA methods. The amount of dilution that had occurred was determined by inputting a

Test Report	
Volume:	<u>3</u>
Section:	<u>1.0</u>
Revision:	<u>2</u>
Date:	<u>November 1998</u>
Page:	<u>9 of 13</u>

known amount of tracer gas into the exhaust stream and measuring a concentration at the outlet. The dilution rate was then used to calculate exhaust flowrates. Section 3 of Volume 2 details those calculations.

The tracer gas release points within the augments tube were also monitored for temperature. It was important to monitor for temperature since SF<sub>6</sub> is stable up to 500° F before it begins to degrade. The tracer gas injection apparatus included thermocouples to determine temperatures at the injection point. The 500° F threshold was very conservative, because SF<sub>6</sub> will not decompose until 932° F. However, EQ intended to maintain the conservative threshold as the point where the tracer method must be more seriously examined due to the more extreme conditions present in the test cell. During test cell operation, the temperature in the augments tube at the tracer release points did not exceed 500° F in a nonafterburner power setting. Temperature measurements were not collected when the tracer gas release points were placed on the outside edge of the augments tube. The tracer gas was released opposite the flow to prevent the exhaust gas pressure from impacting the opening in the tracer gas manifold and possibly affecting tracer gas distribution. Tracer gas was introduced into the release manifold through a mass flow controller calibrated to SF<sub>6</sub>. It then flowed into adjustable flow meters which regulated equal amounts of tracer gas into each of the tracer release steel tubes. Temperature was measured using a Type K thermocouple and recorded by a data logger.

### 1.3 POLLUTANT BACKGROUND CONCENTRATIONS

The procedures found in 40 CFR, Part 60, Appendix B were used to perform ambient air sampling for particulate matter inside the test cells. The ambient air sampling was conducted in conjunction with emissions testing to quantify and qualify background emissions concentrations.

Test Report	
Volume:	<u>3</u>
Section:	<u>1.0</u>
Revision:	<u>2</u>
Date:	<u>November 1998</u>
Page:	<u>10 of 13</u>

Table 1-2 provides a comparison of emissions test method detection limits, ambient air test method detection limits, and actual observed maximum ambient concentrations. It should be noted that the 24-hour ambient values consist of an integrated sample collected over a 24-hour period, which consists of periods of lower ambient pollutant levels and higher pollutant levels, to arrive at a result for the integrated 24-hour sample. Therefore, it is reasonable to suspect that in any given 1-hour period the ambient air pollutant value could be higher than the exhaust concentration for that pollutant. The proximity of large local sources (i.e., exhaust from other test cells) can further add to the ambient air concentrations that already may be present. It can be concluded that the potential exists for ambient air concentrations to bias emissions estimates high, as the observed ambient concentrations may be detectable by emissions test methods. Therefore, it is important to quantify the background pollutant concentrations and qualify the exhaust emissions accordingly. This was the procedure utilized for this study.

Ambient air sampling, equipment operations, and calibration followed standard operating procedures (SOPs) for each method. All ambient air sampling was performed in conjunction with all emissions testing. Ambient air sampling commenced at the start of each emissions test run and concluded at the completion of the final emissions test run. The ambient air samples were composited over the three 1-hour test runs for each engine power setting. Representative ambient air samples were collected inside the test cell. Samplers were turned on and off from inside the test cell. These results were used to correct for any bias introduced by pollutants found in the ambient air.

The following subsection presents a brief description of the ambient air sampling and analytical method that was used to determine particulate matter concentrations. The description includes overviews of the sampling equipment, collection media, and analytical techniques used in the sampling for each pollutant.

Test Report

Volume: 3

Section: 1.0

Revision: 2

Date: November 1998

Page: 11 of 13

Table 1-2. Comparison of Emission Test Method, Ambient Test Method and Observed Ambient Results

Compound Class	Source				Ambient				
	Analytical Detection Limit	Sample Volume		Analytical Detection Limit	Method Detection Limit <sup>a</sup>	Sample Volume		Method Detection Limit <sup>b</sup>	Noted Maximum 24-hr ambient Values
		cu ft	m <sup>3</sup>			cu ft	m <sup>3</sup>		
Particulate	0.1 mg	50	1.416	0.07 mg/m <sup>3</sup>	0.1 mg	7200	203.904	0.0005 mg/m <sup>3</sup>	<0.1 mg/m <sup>3</sup>

Notes: a - Source emissions limits are based on the total expected sample volume.

b - Ambient sample detection limits are based on a 3-hour sample.



Test Report	
Volume:	<u>3</u>
Section:	<u>1.0</u>
Revision:	<u>1</u>
Date:	<u>November 1998</u>
Page:	<u>12 of 13</u>

### 1.3.1 Particulates

General Metal Works high-volume (Hi-Vol) air samplers with volumetric flow controllers were used to sample particulate matter (total suspended particulates). The particulate sampling program was operated according to EPA guidelines as described in the Quality Assurance Requirements for Prevention of Significant Deterioration, 40 CFR, Part 50, Appendix B. Sample filters were analyzed by a gravimetric method using pre- and post-weights to determine total particulates. During each 1-hour sample run, 68 m<sup>3</sup> of sample was collected. For the composite 3-hour sample, a total of 204 m<sup>3</sup> of volume was sampled. With an analytical detection limit of 0.1 milligram (mg), the method detection is 0.5 µg/m<sup>3</sup>.

### 1.4 ENGINE TEST CYCLE DATA

In order to correlate the aircraft engine emissions data with the engine operation, selected engine test cycle data was compiled by government personnel during testing. The engine test monitoring system at each test cell/hush house can monitor a variety of engine parameters during engine testing. For the purpose of emissions sampling, a select number of these parameters was monitored during testing for emission factor development. It is important, for example, to distinguish between afterburner settings. The engine operating mode designated as afterburner is comprised of five zones. These zones are classified as one through five and directly correlate to an increase in fuel flow and thrust as the zones increase in value. During this sampling program all engines were tested at zone one except the F404-GE-F1D2/400, which was tested in zone 3. These parameters assisted in correlating the effect of a specific pollutant for a specific engine load condition. The following list is a portion of the data that was compiled by government personnel:

- JP-8 fuel flow at each load
- Engine rpm at each load

- Thrust/horsepower at each load
- Engine pressure ratio (EPR)
- Test cell humidity and temperature.

### 1.5 JP-8 FUEL SAMPLING AND ANALYSIS

The JP-8 fuel proximate/ultimate analysis and level of nitrogen were determined for each facility to develop a custom F-factor and to document fuel characteristics during emissions testing. Table 1-3 lists the fuel analysis parameters analyzed. Two fuel samples were collected at each testing location during testing. These samples were collected and shipped to the appropriate Government laboratory for analysis.

**Table 1-3. JP-8 Fuel Parameters Analyzed**

Parameter	Analytical Method
Trace Sulfur	ASTM <sup>1</sup> D-2622
Carbon, Hydrogen, and Oxygen	ASTM D-5291
Trace Nitrogen	ASTM 4629 (chemiluminescence)
Heating Value (Net and Gross)	ASTM D-240
Density	ASTM D-1480
API Gravity/Density	ASTM D-1298

<sup>1</sup> American Society of Testing and Material.

Test Report	
Volume:	<u>3</u>
Section:	<u>2.0</u>
Revision:	<u>2</u>
Date:	<u>November 1998</u>
Page:	<u>1 of 57</u>

## SECTION 2

### SITE-SPECIFIC SAMPLING PROTOCOLS

A Custom Method 5 particulate matter sampling methodology was performed within eight different engine test cells at six separate base locations: Kelly AFB, TX; Laughlin, AFB, TX; Tinker AFB, OK; Charleston AFB, SC; Edwards AFB, CA; and Barnes Air National Guard Base (ANGB), MA. The sampling locations for four of the engine test cells were contained in a single accessible exhaust duct, and conventional emission test methods were used to determine the mass emission rate of particulate matter at those locations. These facilities were the APU test cell at Kelly AFB, Test Cell 14 at Corpus Christi Army Depot, and the test cell at the Naval Aviation Depot, Cherry Point (these results are also presented and discussed in Volume 2)

This section provides a summary of how emission sampling was conducted at each test cell. Findings and results are presented in Section 4 of this Volume.

#### 2.1 KELLY AFB, TEST CELL 58

Figure 2-1 illustrates the general configuration of test cell 58. As can be seen in Figure 2-1, this exhaust configuration did not facilitate the use of conventional sampling methodologies. Therefore single point sampling was performed and the flowrate was determined through calculation (carbon balance, tracer gas, F-factor). There are a total of 42 individual exhaust stacks over a 1,400-square-foot (ft<sup>2</sup>) area. Airflow into the test cell is the result of the air draw created by the engine during operation. Engine exhaust gas is directed through the augments tube, through the perforated section of the augments tube into the blast room, and then exits through the multiple stacks. Because of the turbulent flow from the engine exhaust and the circuitous path that the exhaust gases must travel, it was assumed that there would be no stratification of the

Test Report

3

Volume:

2.0

Section:

2

Revision:

November 1998

Date:

2 of 57

Page:

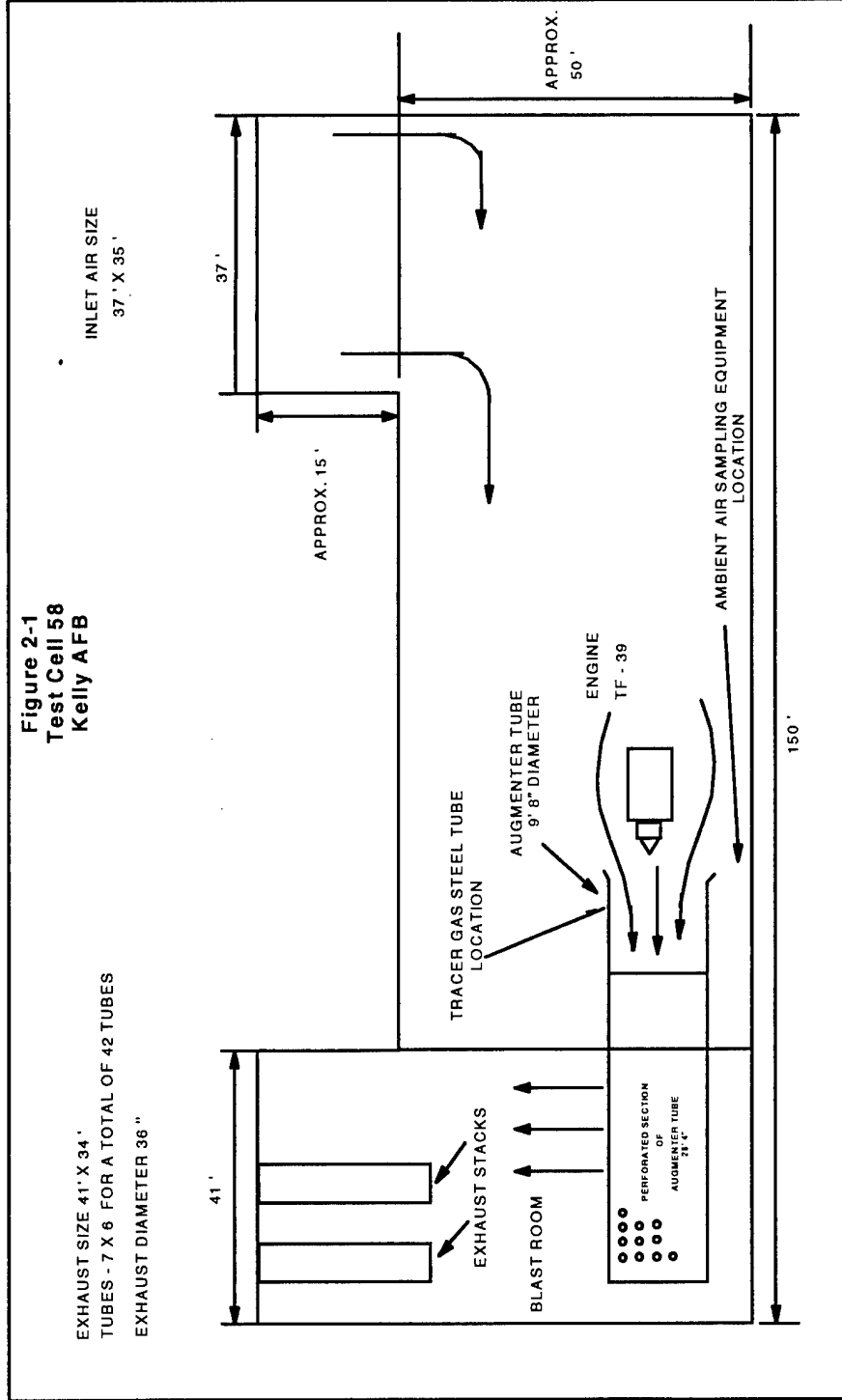

Test Report	
Volume:	<u>3</u>
Section:	<u>2.0</u>
Revision:	<u>2</u>
Date:	<u>November 1998</u>
Page:	<u>3 of 57</u>

exhaust gases. Therefore single point sampling would be representative of the entire gas stream.

In order to calculate the exhaust flowrate by tracer gas and determine homogeneity, a tracer gas distribution system was set up inside the test cell near the corner against the augments tube wall. As shown in Figure 2-2, four stainless steel tubes (0.25-inch I.D.) were attached to the face of the augments tube entrance. Eight tracer gas collection points were selected from the 42 exhaust stacks (Figure 2-3). Dedicated pumps set at a constant pull rate were used at each point to collect the SF<sub>6</sub> sample in Tedlar bags during each run for analysis by FTIR. The assumption of a homogeneous exhaust mixture was demonstrated by these tracer gas measurements. The inlet flow rate was measured by 12 hot-wire anemometers that were placed over the air intake screen in a Method 1 configuration. However, as described in Section 1.2.3, due to potential interferences, the data did not correlate and was rejected as suspect. Inlet air pollutant concentrations were determined by placing the ambient samplers in the rear corner against the augments tube wall inside the test cell, in a manner that did not present a foreign object damage (FOD) hazard to the engine.

The stacks at the outlet of the blast room are flush with the top of the test cell. This presented both a safety hazard and a sampling dilemma. It was not possible to remain on the temporary test scaffolding during engine operation above idle conditions due to exhaust temperature and velocity. The configuration of the stacks also did not allow the stacks to be traversed in a reasonable amount of time as required by EPA Method 1. Since access to the platform and stacks was limited, all sampling was conducted at a single point for each sample train. In order to minimize wind interference for each sample train (PM, SVOC, VOC, CEM, ALD/KEY), it was necessary to install 4-foot stack extensions with 4-inch-diameter sample ports on six of the exhaust stacks. Figure 2-3 illustrates which exhaust stacks had extensions, the placement of sampling opening, and which pollutants were sampled from each stack. The size and placement of the scaffolding platform are also presented.

Figure 2-2  
Tracer gas distribution system for the augmenter tube

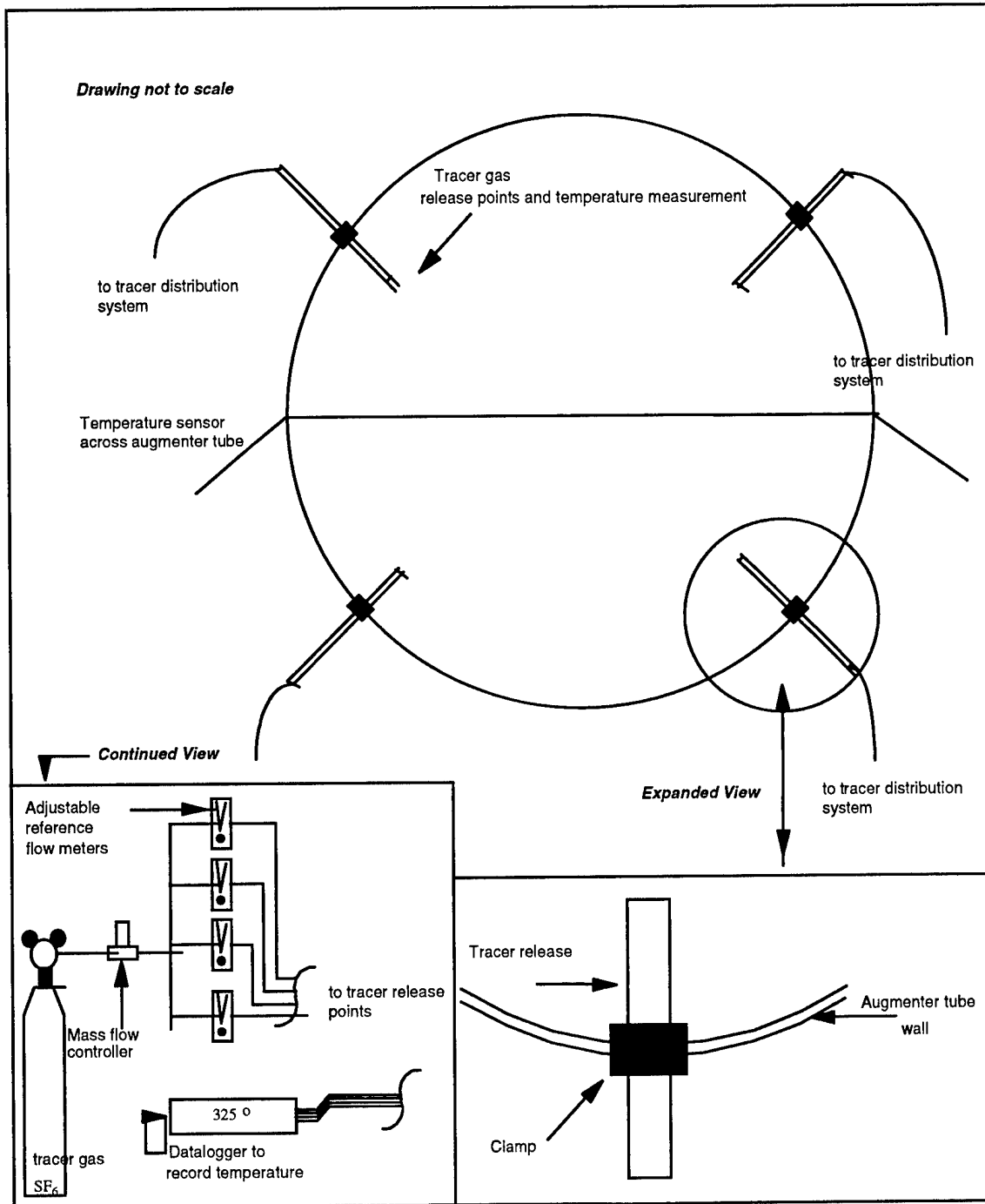

Test Report

Volume: 3

Section: 2.0

Revision: 2

Date: November 1998

Page: 5 of 57

**Figure 2-3  
Kelly AFB Test Cell 58  
Sample Locations**

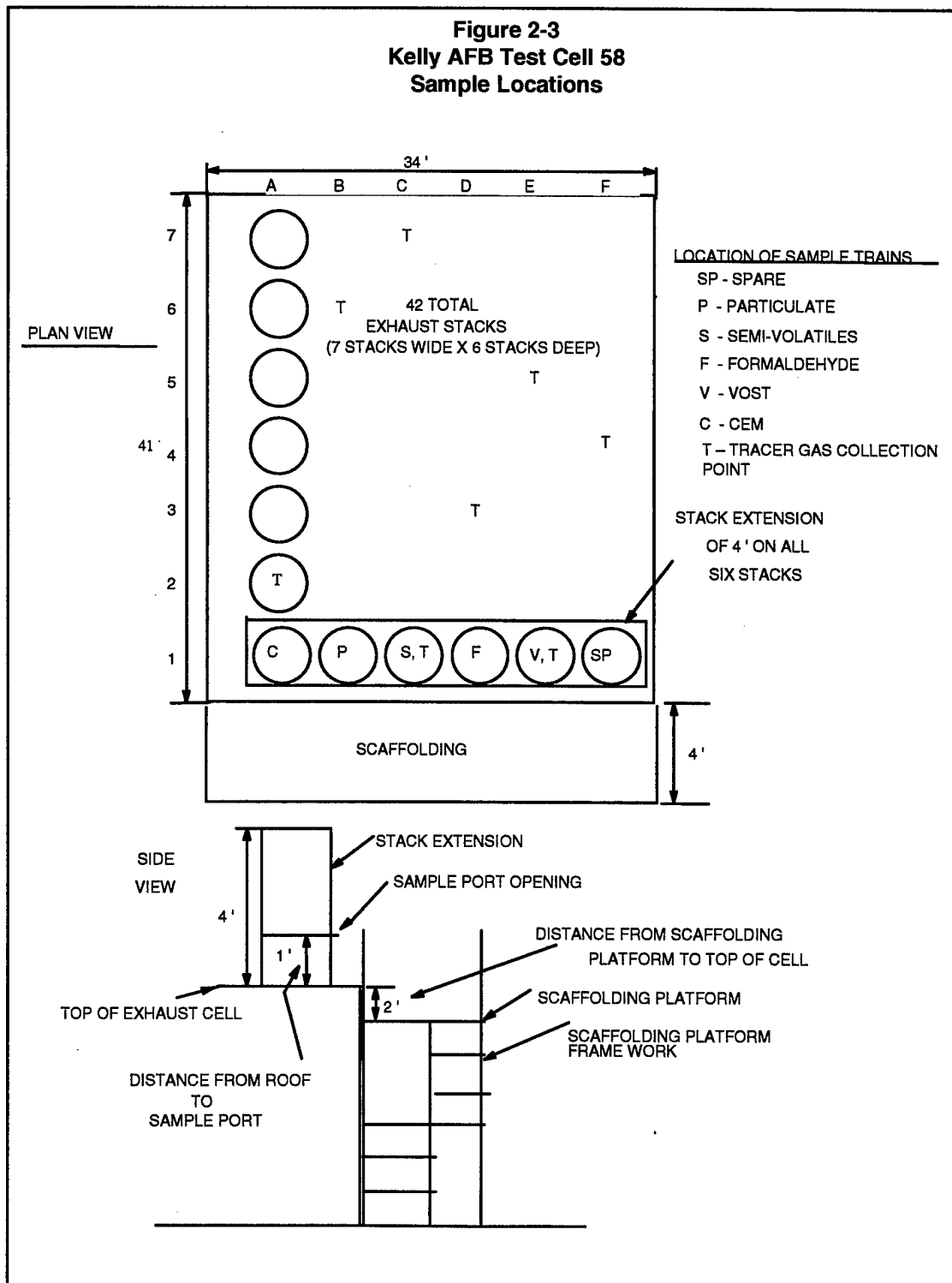

Test Report	
Volume:	<u>3</u>
Section:	<u>2.0</u>
Revision:	<u>2</u>
Date:	<u>November 1998</u>
Page:	<u>6 of 57</u>

Velocity measurements were collected at each sampling point in order to maintain isokinetics. These velocity data were not used to calculate the entire exhaust flowrate since the face of the exhaust could not be traversed. The exhaust flowrate was calculated using either carbon balance, tracer gas, or F-factor.

## 2.2 KELLY AFB, TEST CELL 54A

Figure 2-4 illustrates the general configuration of test cell 54A. As can be seen in Figure 2-4, this exhaust configuration did not facilitate the use of conventional sampling methodologies. Therefore single point sampling was performed and the flowrate was calculated (carbon balance, tracer gas, F-factor). The exhaust outlet terminates in a triangular-shaped stack with rectangular outlets on either side. The engine exhaust is directed through the augments tube, into the blast box, which directs the exhaust gases to the roof outlet. Inlet air into the cell is provided by a fan, which was designed to simulate airflow during flight.

Because of turbulent flow from the engine exhaust through the augments tube and into the blast box, it was assumed that there would be no stratification of the exhaust gases and that the tracer gases introduced to the system would be mixed equally. Therefore, single point sampling would be representative of the entire gas stream. The tracer gas distribution system was set up inside the test cell behind the rectangular exhaust duct. Four stainless steel distribution tubes (0.25-inch I.D.) were attached to the rear of the short augments tube near the blast box in the configuration shown in Figure 2-5. One tracer gas collection point at the exhaust was placed in each of the four sample ports as shown in Figure 2-6. Dedicated pumps set at a constant pull rate were used on each collection point to collect the SF<sub>6</sub> sample in Tedlar bags during each run for analysis by FTIR. The assumption of a homogeneous exhaust mixture was demonstrated by these tracer gas measurements.



Test Report

3

Volume:

2.0

Section:

2

Revision:

November 1998

Date:

7 of 57

Page:

Figure 2-4. Test Cell 54A Kelly AFB

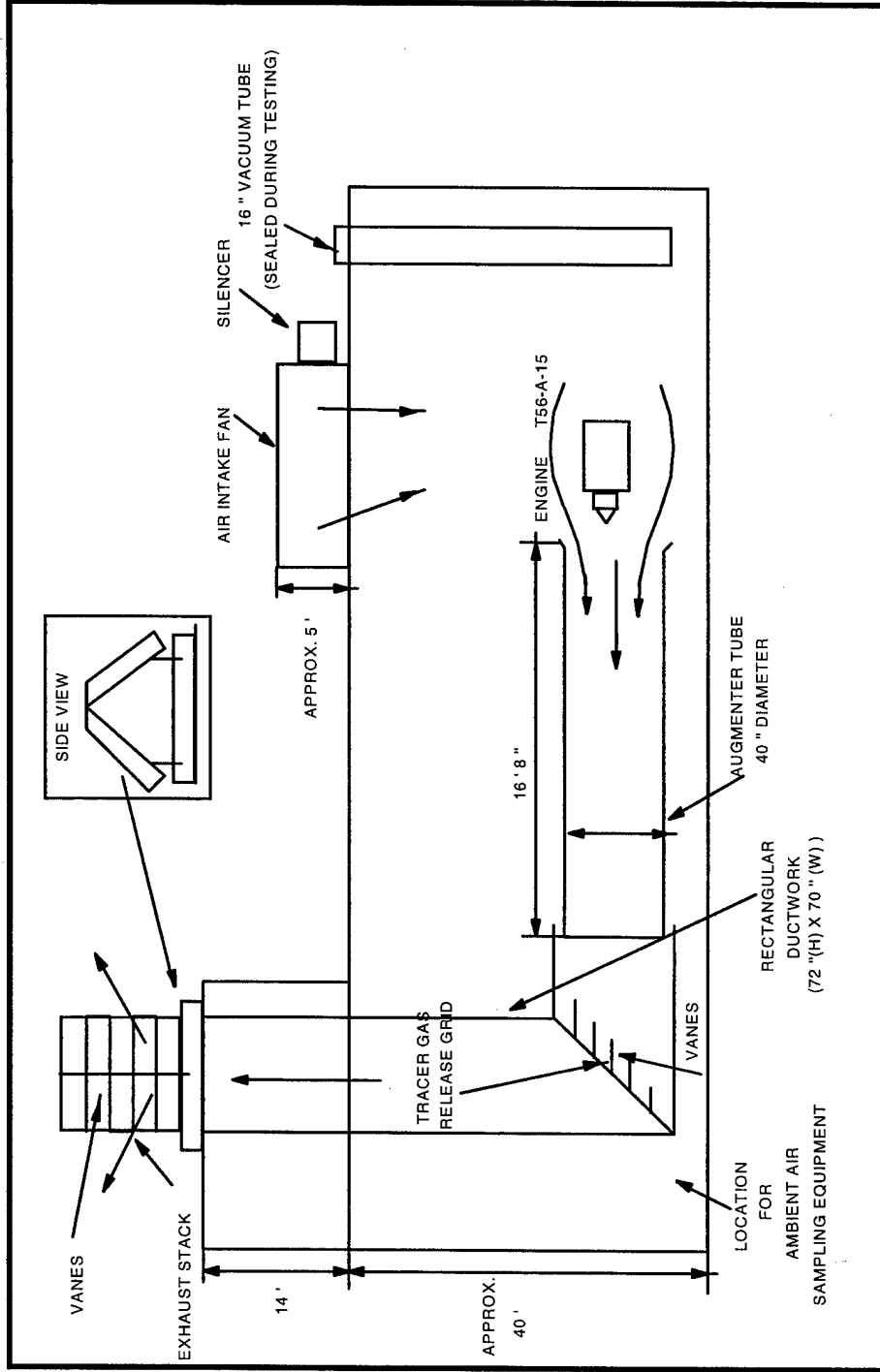

**Figure 2-5**  
**Tracer gas distribution system for the augmenter tube**

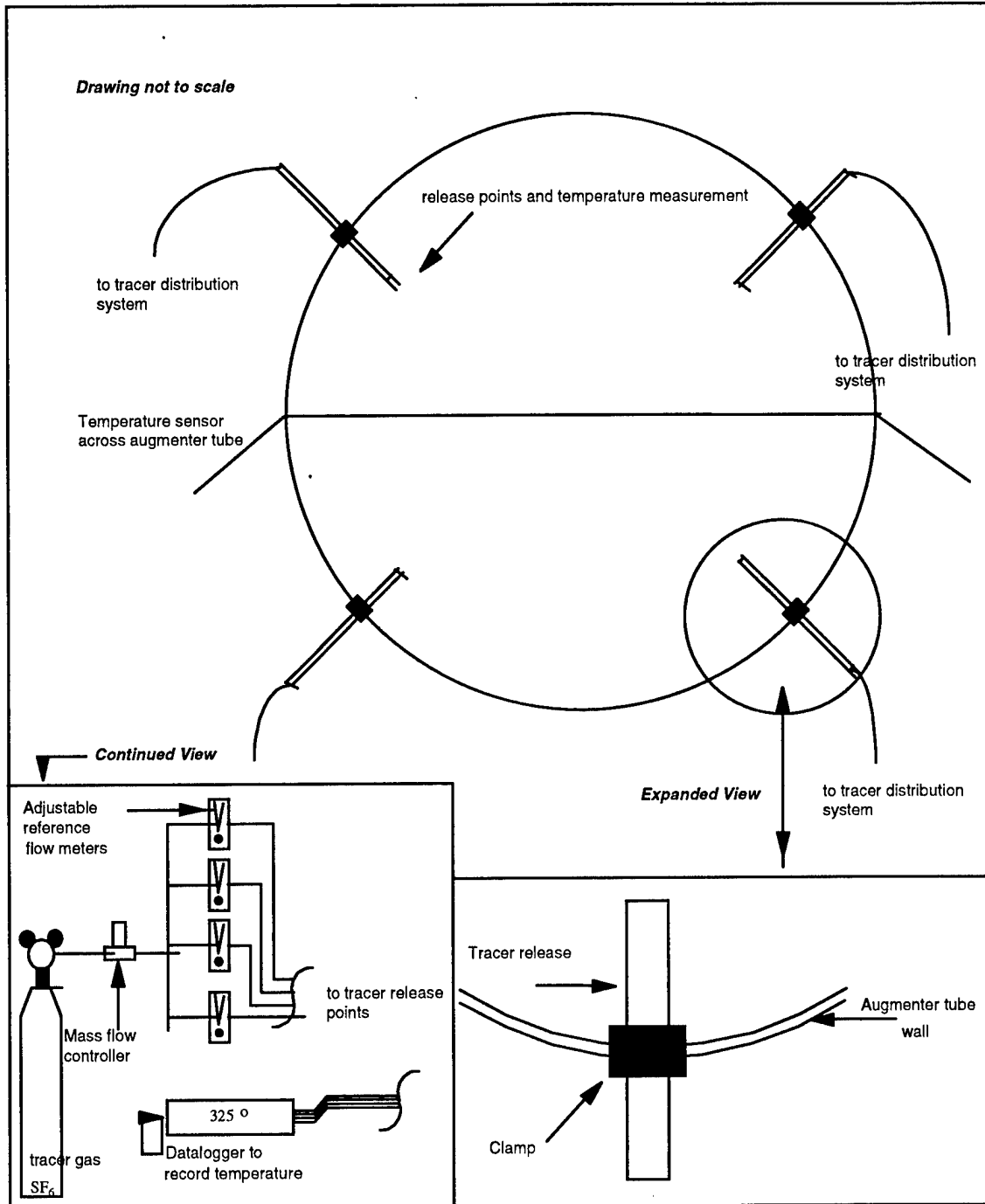

Test Report

Volume:	<u>3</u>
Section:	<u>2.0</u>
Revision:	<u>2</u>
Date:	<u>November 1998</u>
Page:	<u>9 of 57</u>

**Figure 2-6**  
**Kelly AFB Test Cell 54A**  
**Sample Locations**

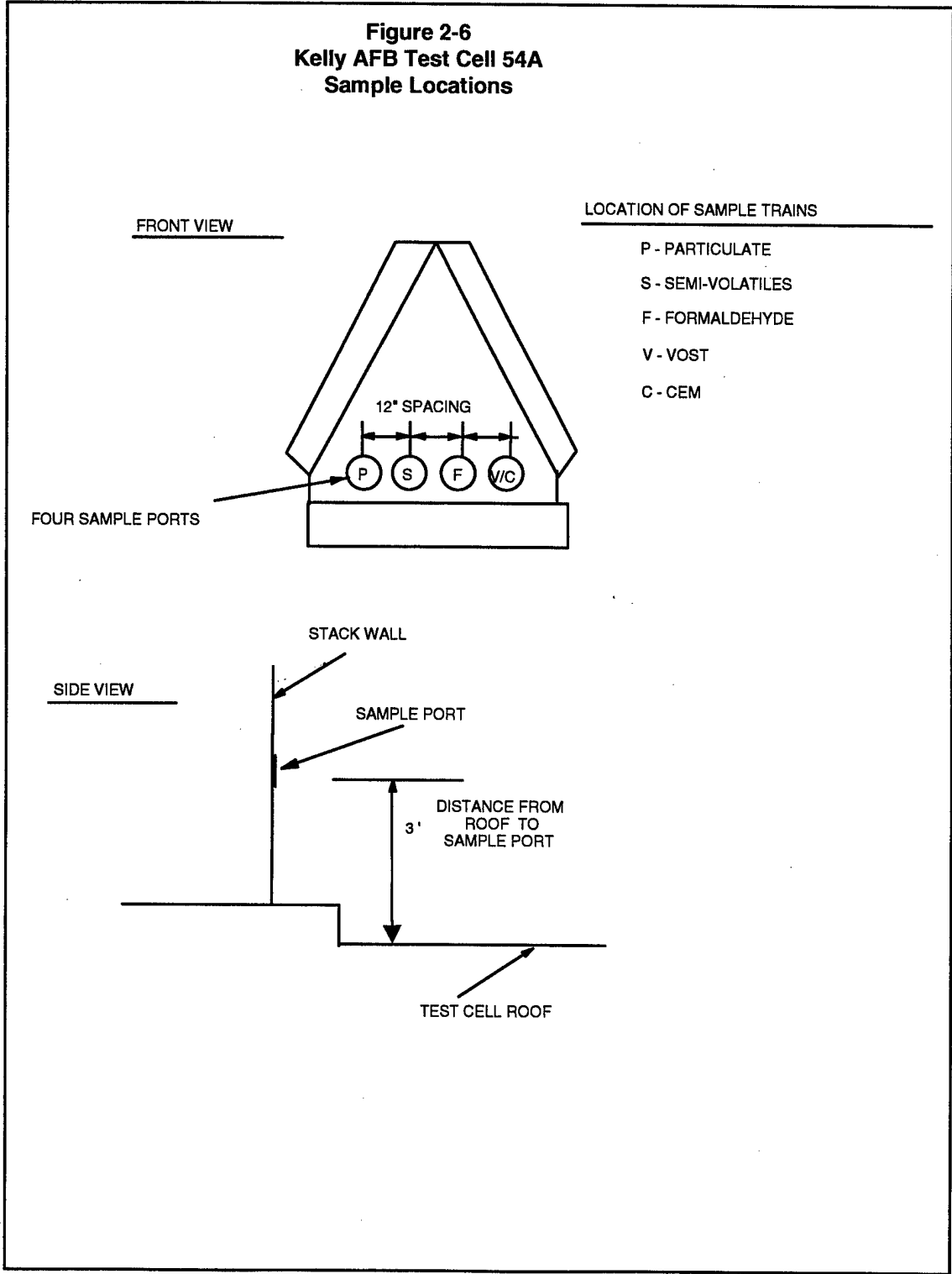

Test Report	
Volume:	<u>3</u>
Section:	<u>2.0</u>
Revision:	<u>2</u>
Date:	<u>November 1998</u>
Page:	<u>10 of 57</u>

The inlet flow rate was measured by anemometers placed over the air intake screen. To facilitate these flow measurements, the 16-inch vacuum line inside the test cell was sealed temporarily during testing to limit air intake to only the main air stream. Again, these flow measurements were considered suspect and rejected due to interferences.

Inlet air pollutant concentrations were determined by placing the ambient samplers behind the rectangular exhaust duct inside the test cell, in a location that did not present a FOD hazard to the engine.

With the triangular exhaust stack it was not possible to remain on the roof during engine operation above idle. Therefore, the exhaust could not be safely traversed as required by EPA Method 1. Since access to the platform and exhaust stack was limited during engine operation, all sampling was conducted at a single point. Exhaust gases could not be sampled from the sides of the triangular stack, because wind interference made it difficult to sample isokinetically and collect a representative sample. Therefore, four sample ports were cut in the side of the exhaust stack. Figure 2-6 illustrates the placement of the sampling ports on the test cell 54A exhaust and which pollutants were sampled from each port.

Velocity measurements were collected at each sampling point in order to maintain isokinetics. These velocity data were not used to calculate the entire exhaust flowrate since the cross section of the exhaust could not be traversed. The exhaust flowrate was calculated using either carbon balance, tracer gas, or F-factor.

### **2.3 KELLY AFB, APU TEST CELL**

Figure 2-7 illustrates the general configuration of the APU test cell at Kelly AFB. The 28-inch-diameter exhaust outlet terminates on the roof of the APU facility and is shielded by a cap. The configuration of this test cell allowed the use of conventional emission sampling methodologies. Inlet air into the cell is provided by a fan in a square

Test Report

Volume: 3

Section: 2.0

Revision: 2

Date: November 1998

Page: 11 of 57

Figure 2-7  
APU Test Facility  
Kelly AFB

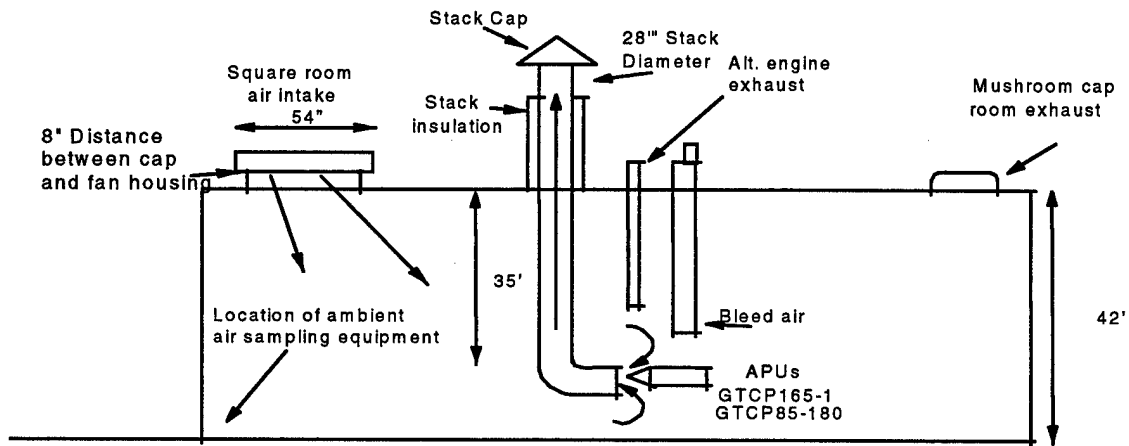

Note: Not to Scale  
Dimensions approximate

Test Report  
Volume: 3  
Section: 2.0  
Revision: 2  
Date: November 1998  
Page: 12 of 57

room air intake. APU engine exhaust is directed through the augments tube to the roof outlet. Since emissions were exhausted through a single stack, conventional isokinetic sampling methodologies were applicable at this test cell. The exhaust flowrate was determined by direct measurement during sampling.

Inlet flow rates were measured by 12 anemometers placed under the test cell air intake. The mushroom cap room exhaust and alternate engine exhaust were sealed temporarily during testing to limit air intake to the main inlet air intake, which facilitated inlet flow measurements. Three anemometers were placed on each of the four faces to this inlet. As discussed previously, the measurements provided by these instruments were considered suspect and were rejected. Inlet air pollutant concentrations were determined by placing the ambient samplers under the air intake inside the test cell, in a location that did not present a FOD hazard to the engine.

The APU test cell stack needed to be temporarily modified so that testing could be performed according to EPA Method guidelines. Figure 2-8 illustrates the modification that was required on the APU stack. The weather cap on the stack was removed, and a 6-foot extension with five sample ports was placed on the stack. Figure 2-9 illustrates the sampling port specifications. The size and placement of the scaffolding platform also are presented in Figure 2-8. Particulate, semivolatiles, and aldehyde and ketone sampling trains were rotated among the four ports offset by 90 degrees during the sample run. It took 5 to 10 additional minutes per traverse to rotate the trains among the sample ports. This added approximately 15 to 30 minutes to each 60-minute sample run and resulted in an overall 75- to 90-minute operational period for the APU per test. All continuous emission monitoring (CEM) parameters and volatile organic sampling trains (VOST) were sampled from the one sample port offset by 45 degrees from the other four sampling ports.

**Figure 2-8**  
**Kelly AFB**  
**APU Test Facility Sampling Locations**

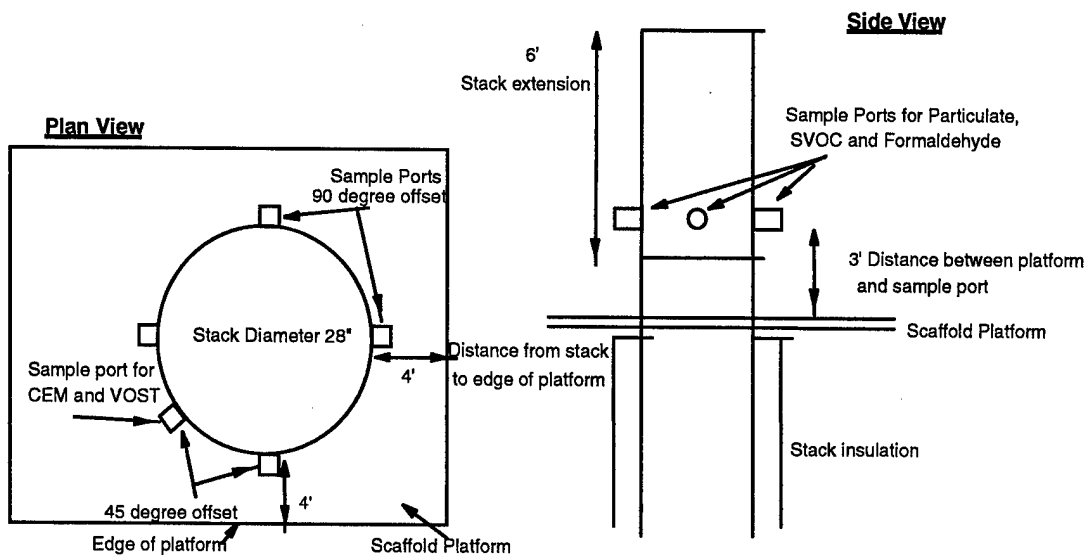

Note: Not to Scale  
Dimensions approximate

Test Report

Volume: 3

Section: 2.0

Revision: 2

Date: November 1998

Page: 14 of 57

**Figure 2-9**  
**Side-View of Sampling Port**

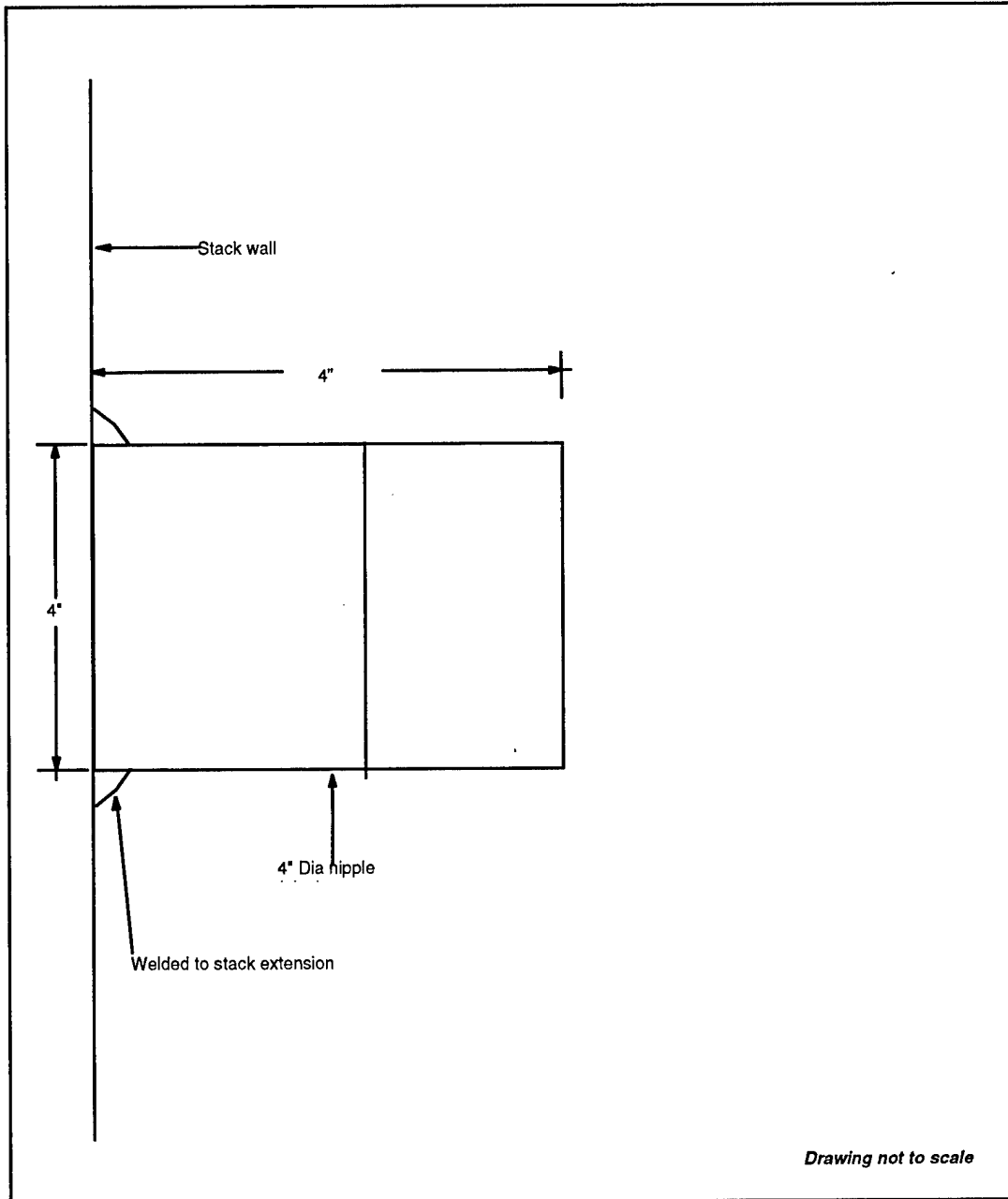



Test Report	
Volume:	<u>3</u>
Section:	<u>2.0</u>
Revision:	<u>2</u>
Date:	<u>November 1998</u>
Page:	<u>15 of 57</u>

## 2.4 CORPUS CHRISTI ARMY DEPOT, TEST CELL 14

The general configuration of engine test cell 14 at CCAD is illustrated in Figure 2-10. The approximately 44-inch-diameter exhaust outlet terminates on the roof of the test cell facility, which allowed the use of conventional emission test methodologies. Airflow into the cell air intake is the result of the air draw created by the engine during operation. Engine exhaust is directed through the augments tube to the roof outlet. Since conventional isokinetic sampling methodologies were applicable at this source, the exhaust flowrate was measured directly from the exhaust stack.

The inlet flow rate was measured by 12 anemometers positioned at the air intake. The inlet air tube for other engine types was sealed temporarily during testing to limit air intake to only the main air intake, which facilitated inlet flow measurements. However, as discussed previously the inlet airflow numbers are suspect due to interference and have been rejected. Inlet air pollutant concentrations were determined by placing the ambient samplers under the air intake inside the test cell in a location that did not present an FOD hazard to the engine.

Test cell 14 was sampled using conventional isokinetic sampling methodologies; however, the stack was permanently modified so that testing could be performed according to EPA Method guidelines. Figure 2-11 illustrates the modifications to the test cell stack. A total of five sample ports were installed on the stack. Figure 2-12 illustrates the sampling port specifications. The size and placement of the scaffolding platform are also presented in Figure 2-11. Particulate, semivolatiles, and aldehyde and ketone sampling trains were rotated among the four ports which are offset by 90 degrees during the sample run. It took 5 to 10 additional minutes per traverse to rotate the trains among the sample ports. This added approximately 15 to 30 minutes to each 60-minute sample run and resulted in an overall 75- to 90-minute test period for the helicopter engine. All CEM parameters and VOST were sampled from the single sample port at the base of the stack.

Test Report  
 Volume: 3  
 Section: 2.0  
 Revision: 2  
 Date: November 1998  
 Page: 16 of 57

Figure 2-10  
 Test Cell 14  
 Corpus Christi Army Depot

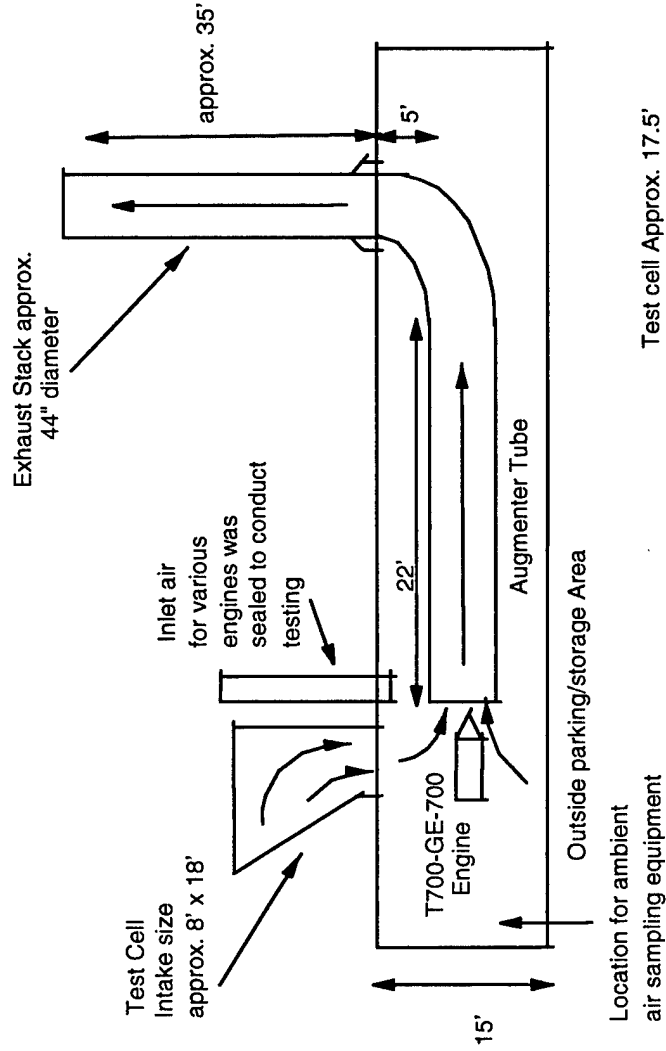

Note: Not to Scale  
 Dimensions approximate

Test Report  
 Volume: 3  
 Section: 2.0  
 Revision: 2  
 Date: November 1998  
 Page: 17 of 57

Figure 2-11  
 Corpus Christi Army Depot  
 Test Cell 14 Sampling Locations

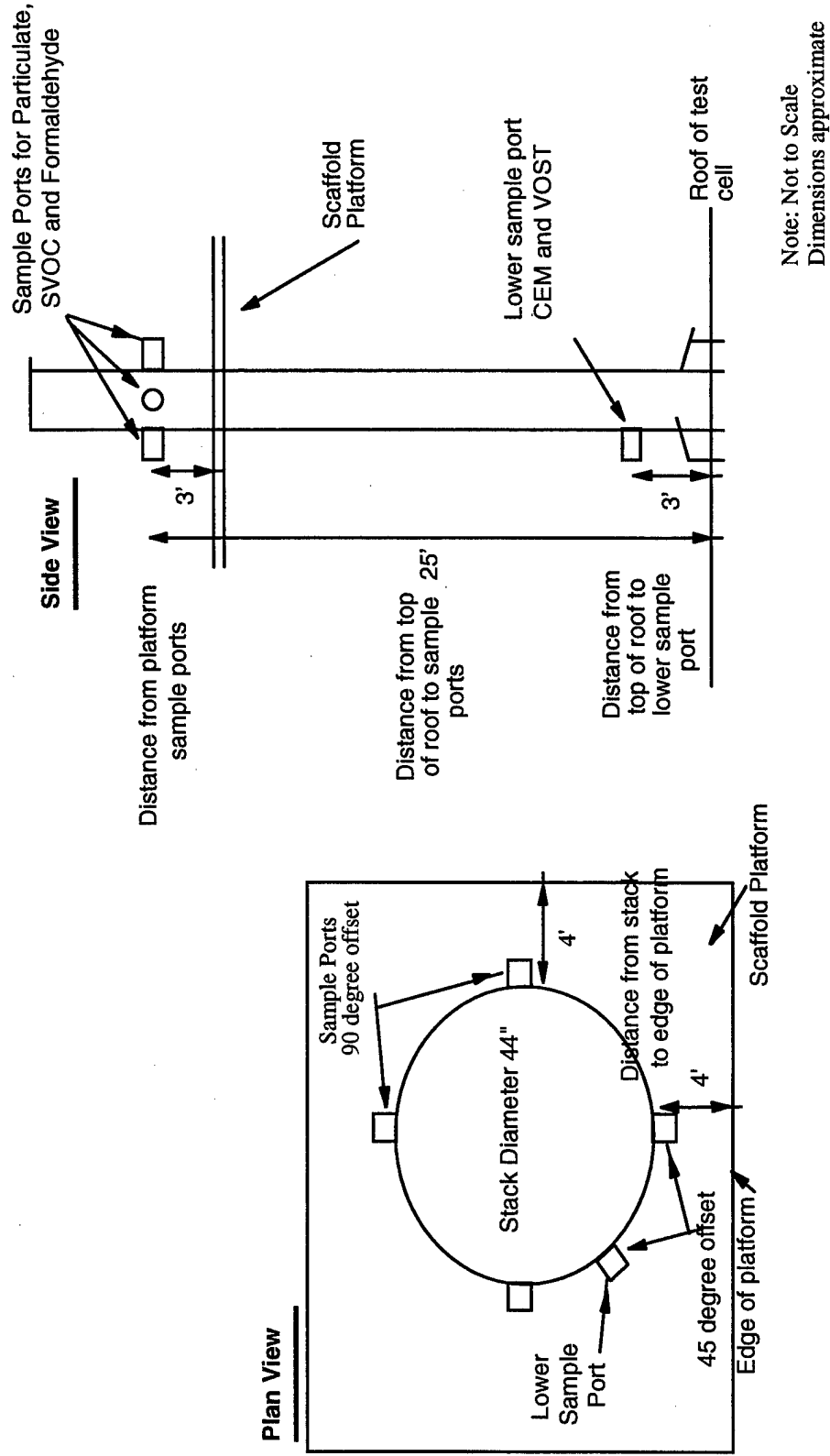

**Figure 2-12**  
**Side-View of Sampling Port**

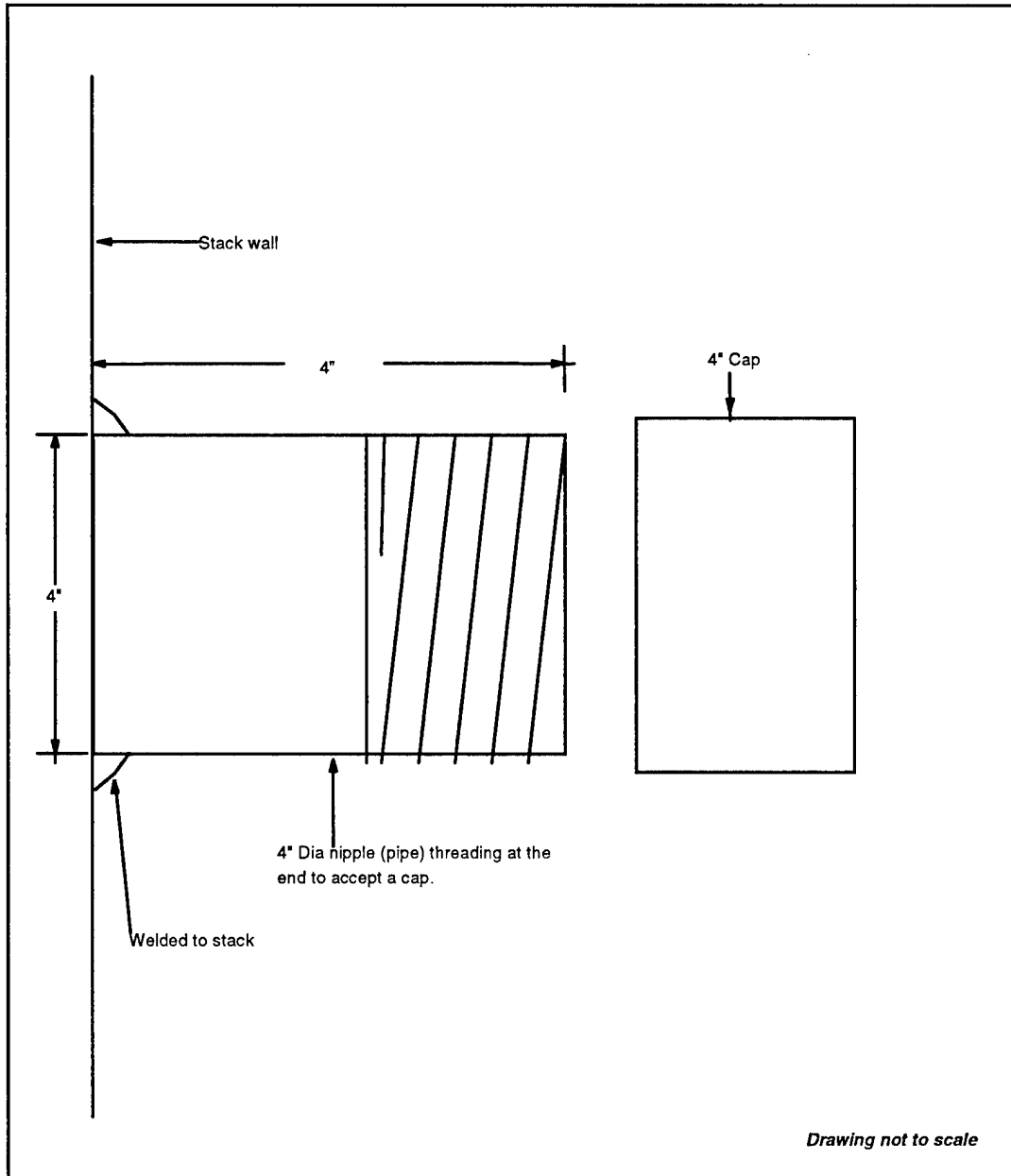

Test Report	
Volume:	<u>3</u>
Section:	<u>2.0</u>
Revision:	<u>2</u>
Date:	<u>November 1998</u>
Page:	<u>19 of 57</u>

## 2.5 Laughlin AFB, Test Cell 18

Figures 2-13 through 2-15 illustrate the general configuration of test cell 18. As can be seen in these figures, this test cell configuration did not facilitate the use of conventional sampling methodologies. Therefore, single point sampling was performed and the exhaust flowrate was determined through calculation (carbon balance, tracer gas, F-factor).

Airflow into the test cell is the result of the air draw created by the engine during operation. Because of the turbulent flow from the engine exhaust and the circuitous path that the exhaust gases must travel, it was assumed that there would be no stratification of the exhaust gases. Engine exhaust gas is directed through an augments tube into a blast room, and then exits through a rectangular stack.

In order to verify homogeneity throughout the exhaust cross section, tracer gas was injected to the exhaust stream and sampled at a representative number of points at the outlet. The tracer gas manifold was located at the side of the test cell near the entrance doors. The four stainless steel (0.25-inch I.D.) tracer gas distribution tubes were located at the rear of the cooling tube near the entrance of the augments tube as shown in Figure 2-16. Seven of the eight tracer gas collection points were placed over the exhaust using wires strapped across the rectangular opening as shown in Figure 2-15. The eighth was placed in the sampling port also used by the semi-volatile sampling train as shown in Figure 2-15. Dedicated pumps set at a constant pull rate were used at each point to collect the SF<sub>6</sub> sample in Tedlar bags during each run for analysis by FTIR. The inlet flow rate was measured by six anemometers placed over each of the front and rear air intakes. These flow rates were rejected due to interferences. Inlet air pollutant concentrations were determined by placing the ambient samplers under the air intake inside the test cell, in a manner that did not present a FOD hazard to the engine.

Since the exhaust configuration did not allow for safe collection of exhaust emission samples, a slipstream sample was collected to quantify engine emissions.

Test Report

3

Volume:

2.0

Section:

2

Revision:

November 1998

Date:

Page: 20 of 57

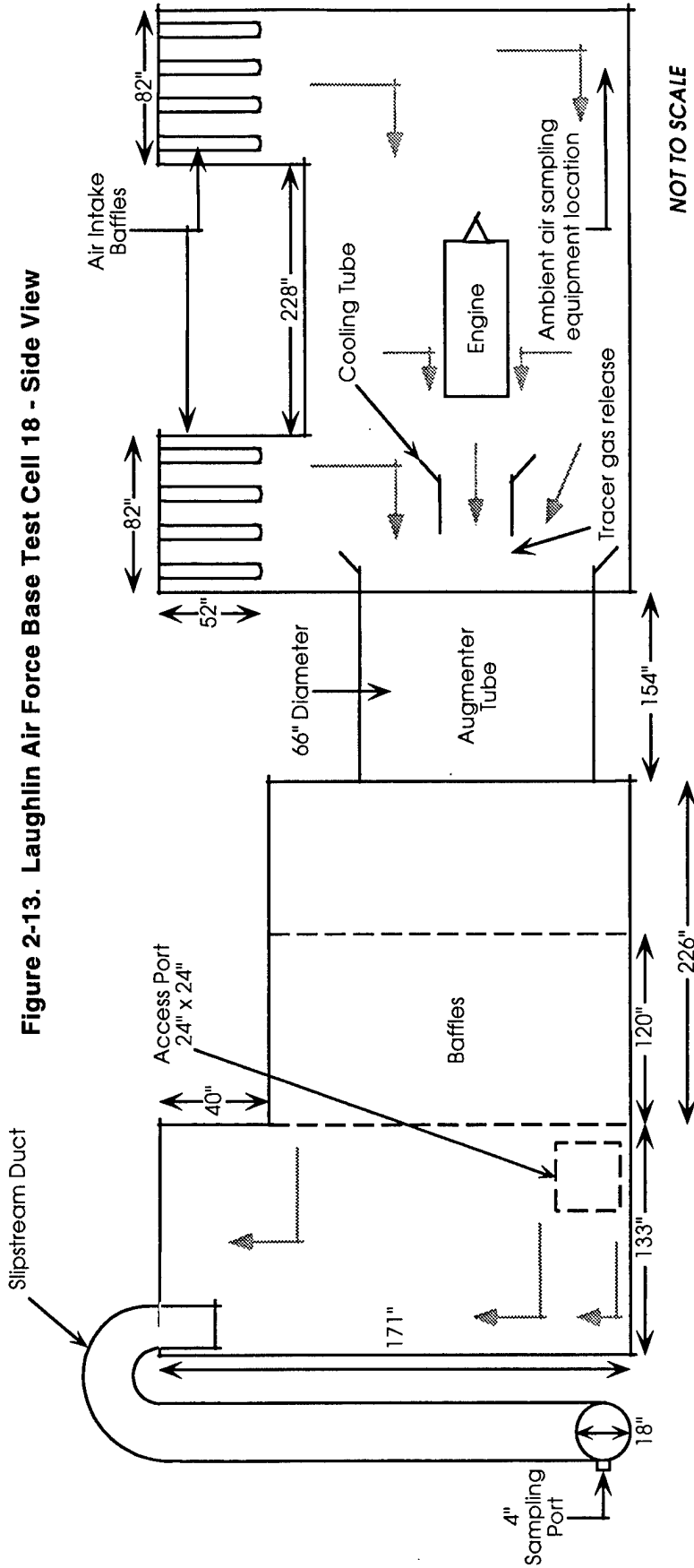
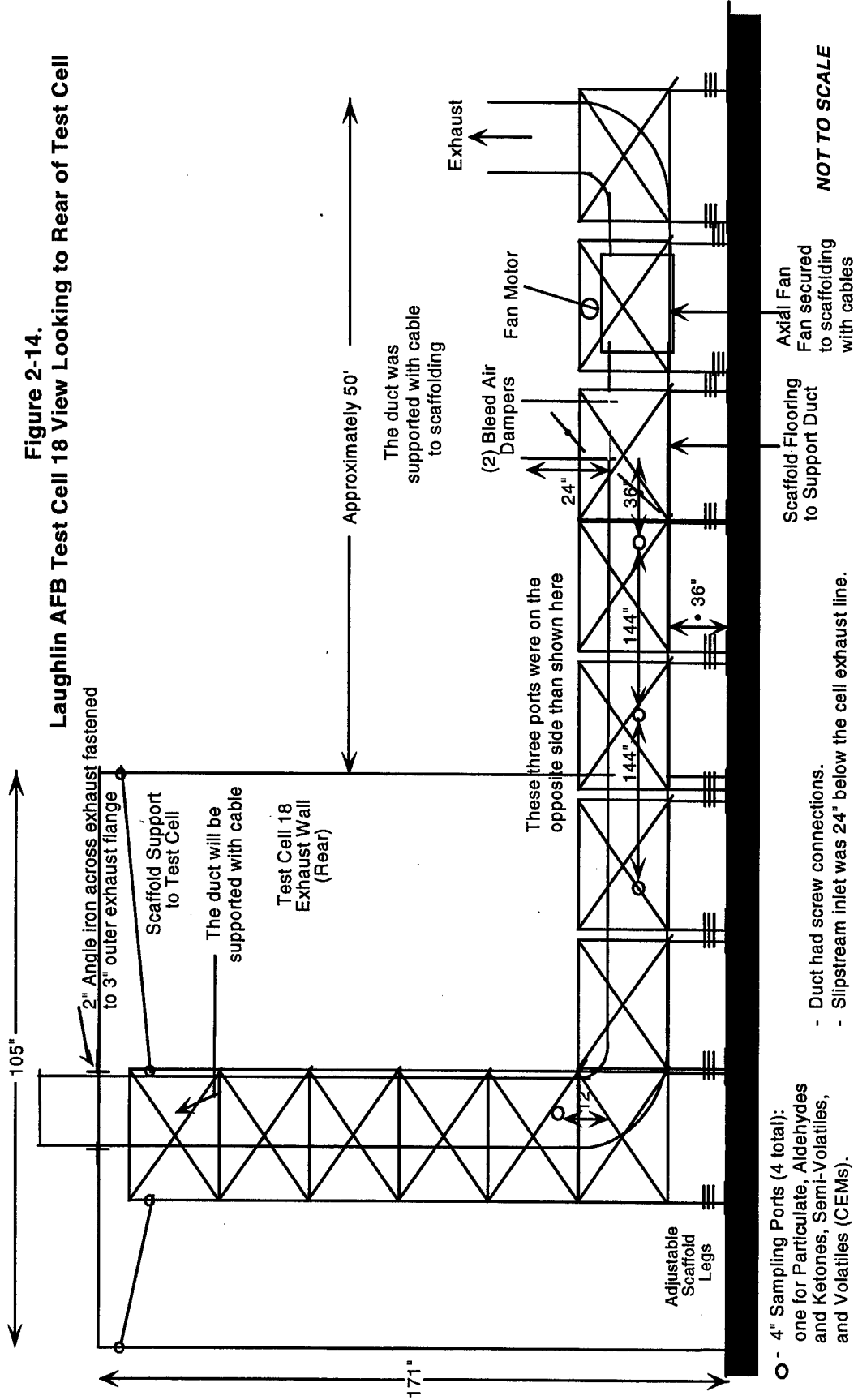
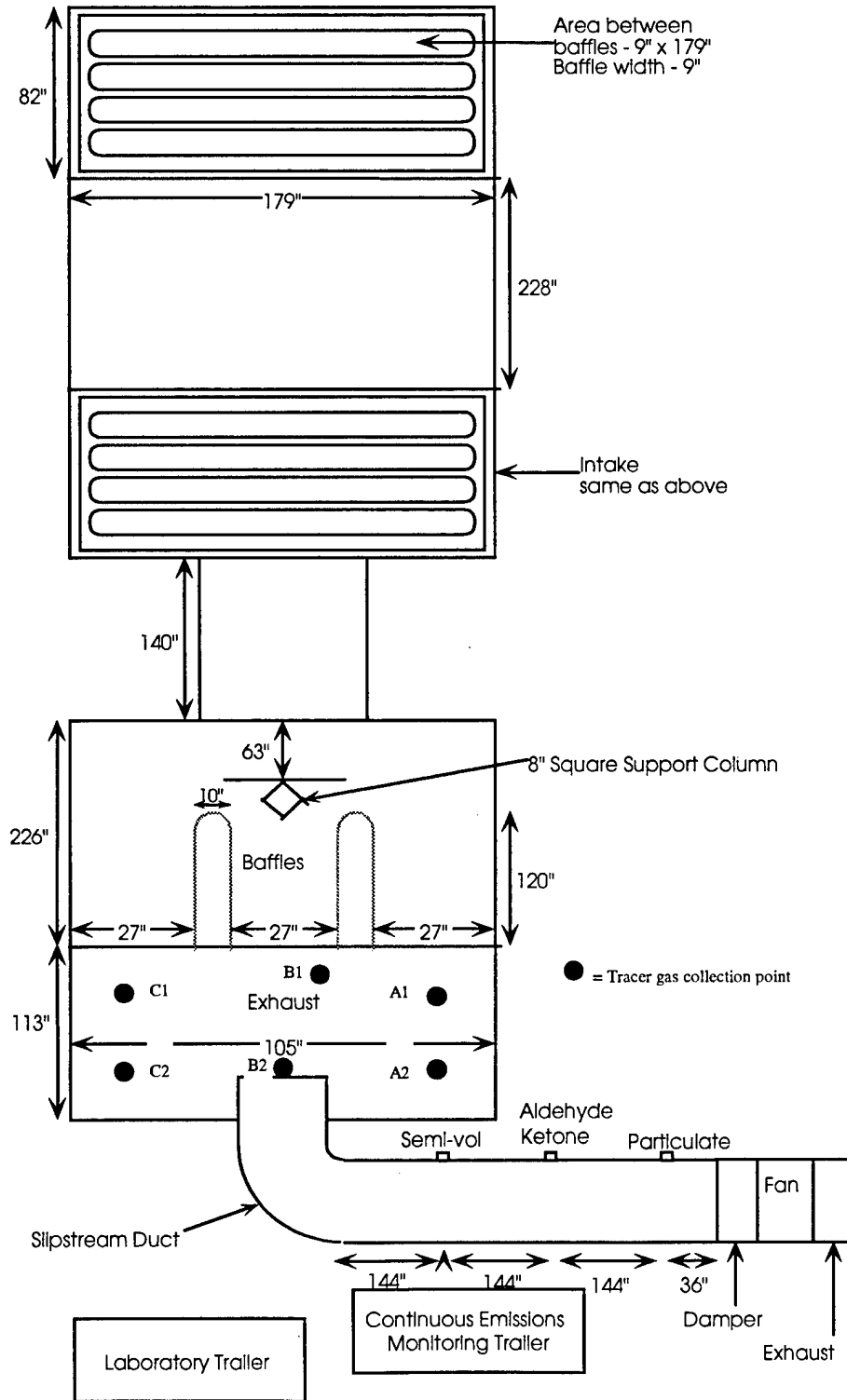

Figure 2-13. Laughlin Air Force Base Test Cell 18 - Side View



- - 4" Sampling Ports (4 total): one for Particulate, Aldehydes and Ketones, Semi-Volatiles, and Volatiles (CEMs).
- Duct had screw connections.
- Slipstream inlet was 24" below the cell exhaust line.

Figure 2-15. Test Cell 18  
Laughlin AFB





**Figure 2-16**  
**Tracer gas distribution system for the augmenter tube**  
**at Laughlin AFB**

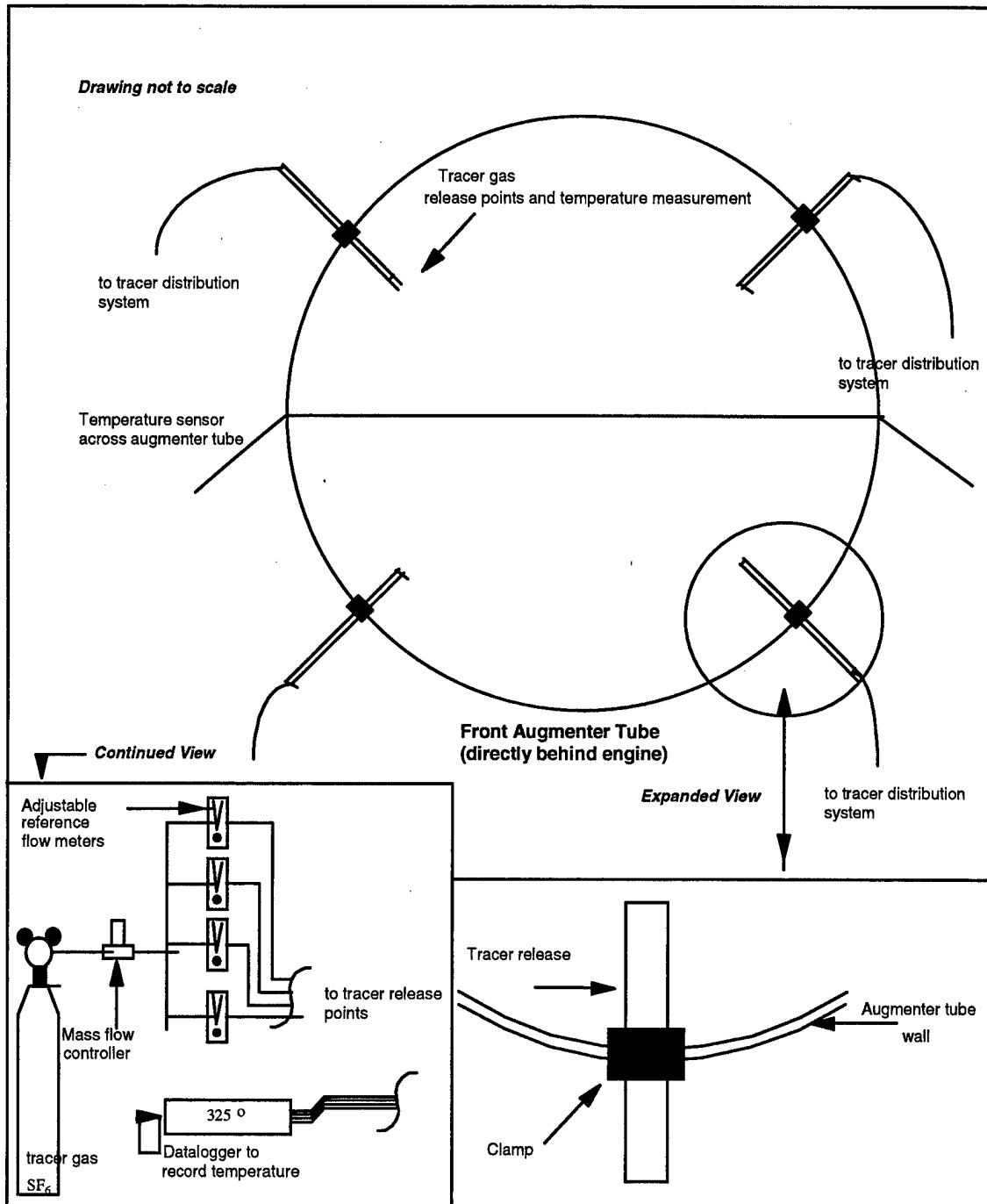

Test Report	
Volume:	<u>3</u>
Section:	<u>2.0</u>
Revision:	<u>2</u>
Date:	<u>November 1998</u>
Page:	<u>24 of 57</u>

A slipstream flow was diverted from the rear of the test cell exhaust to a location outside the exhaust path. The slipstream consisted of 18-inch-diameter, 18-gauge galvanized ductwork. The duct faced into the exhaust flow, traversed along the rear wall, and made a 90-degree bend towards the sampling location.

The slipstream approach is similar to that taken for many pilot-scale air pollution control device studies in industry to determine the applicability of a control device for a particular gas stream. The slipstream approach was also demonstrated at Edwards AFB, Langley AFB, and Cannon AFB to determine pollutant emission rates from aircraft engines. The slipstream sampling configuration allowed for safe, economical, and unobstructed emission sampling and minimal test cell modifications when compared to alternative scenarios collected from ground level at ports positioned to meet the criteria established in EPA Method 1. A single-speed in-line fan was incorporated into the slipstream. The purpose of the fan was to assure adequate sample flow at the idle engine setting. It was anticipated that at the lower engine setting, the exhaust flow might have bypassed the slipstream since the duct creates a path of resistance. The fan allowed for exhaust to be pulled through the slipstream at a rate comparable to the engine test cell exhaust. A velocity pressure drop was measured simultaneously at the test cell exhaust and in the slipstream. The velocity pressure within the slipstream was balanced to the test cell velocity pressure via damper adjustment. Two bleed air dampers were incorporated into the slipstream for velocity adjustment and gas temperature control to the fan. However, flow within the slipstream duct was not the critical parameter for determining the aircraft engine pollutant emission rate. The objective of the slipstream was to provide for a representative sampling environment for determining pollutant concentration. The tracer gas methodology was used to quantify the test cell exhaust rate.

The slipstream was supported at the test cell exhaust via two angle irons fastened to the cell exhaust. The slipstream duct was fastened to the angles and supported by scaffolding along the rear of the test cell and out to the sampling

Test Report	
Volume:	<u>3</u>
Section:	<u>2.0</u>
Revision:	<u>2</u>
Date:	<u>November 1998</u>
Page:	<u>25 of 57</u>

locations. The slipstream and fan were fastened to the scaffolding. The scaffolding was secured to the test cell during sampling.

## 2.6 TINKER AFB, TEST CELL 9

Figure 2-17 illustrates the general configuration of test cell 9 at Tinker AFB. There are a total of 56 individual exhaust stacks over a 1,000-ft<sup>2</sup> area. This configuration did not facilitate the use of conventional sampling methodologies. The air inlet is also approximately 1,000 ft<sup>2</sup> and is covered by a roof. There is approximately 4 feet of screened overhang between the edge of the roof and the air intake wall. Inlet flow measurements were collected in this overhang area. Engine exhaust is directed through the augments tube, through the perforated section of the augments tube into the blast room, and then exits through the various stacks. Because of the turbulent flow from the engine exhaust and the circuitous path the exhaust gases must travel, it was assumed that there would be no stratification of the exhaust gases.

In order to verify exhaust homogeneity throughout the cross section, tracer gas was injected to the exhaust stream and sampled at a representative number of points at the outlet. The tracer gas manifold was located against the wall midway downstream inside the augments tube. Stainless steel tracer gas distribution tubes (0.25-inch I.D.) were placed through holes in the augments tube shell located approximately 20 feet downstream in the augments tube. The tubes were placed in the configuration shown in Figure 2-18. Eight tracer gas collection points were selected from the 56 exhaust stacks as shown in Figure 2-19. Dedicated pumps set at a constant pull rate were used at each collection point to collect the SF<sub>6</sub> sample in Tedlar bags during each run for analysis. The assumption of a homogeneous exhaust mixture was demonstrated by SF<sub>6</sub> tracer gas measurements. The inlet flow rate was measured by 12 anemometers placed over the screened overhangs to the air intake. Three anemometers were placed on each of the four faces to the air inlet screen. Once again, the flow rate

Test Report

3

Volume:

2.0

Section:

2

Revision:

November 1998

Date:

Page: 26 of 57

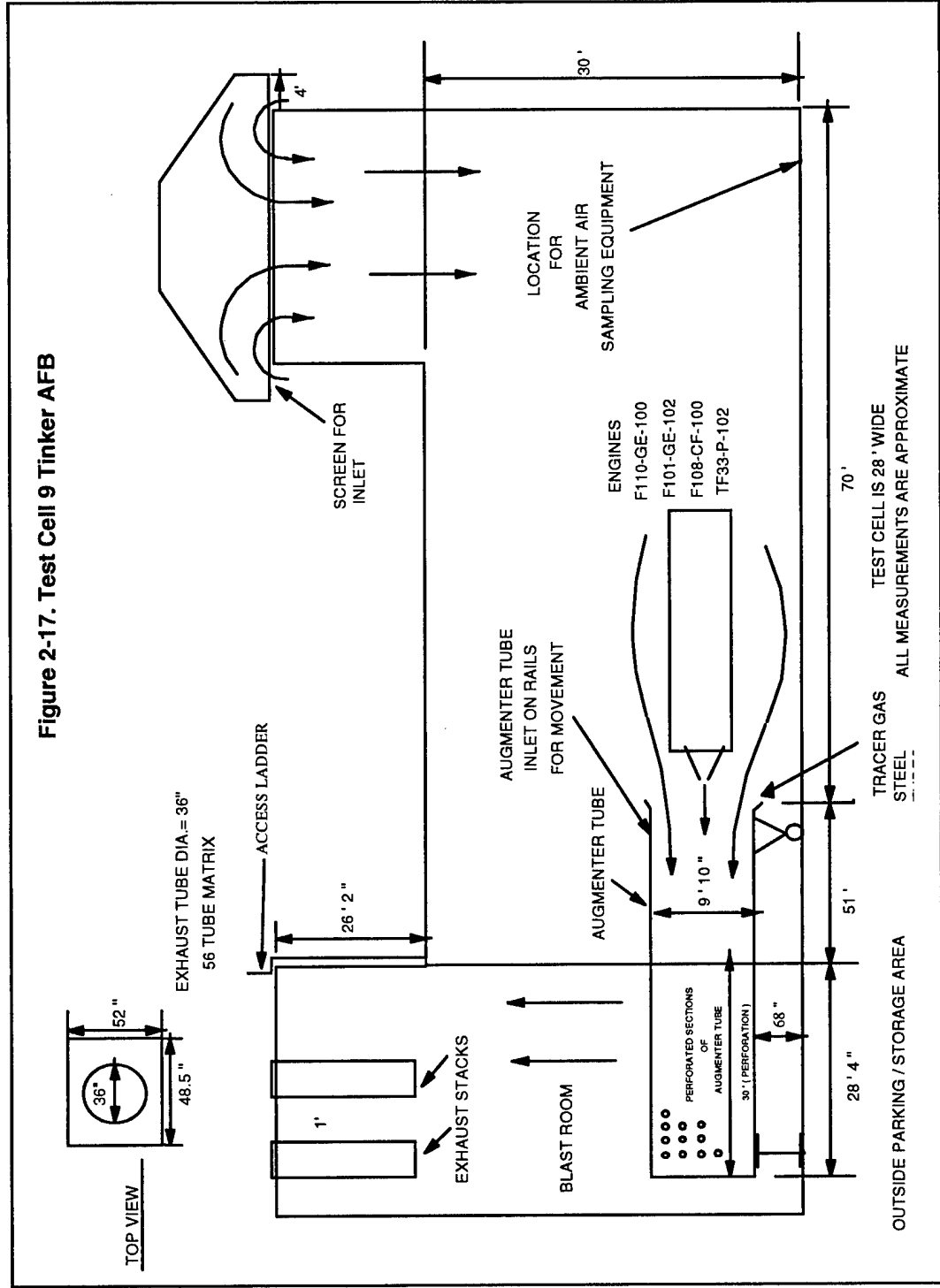
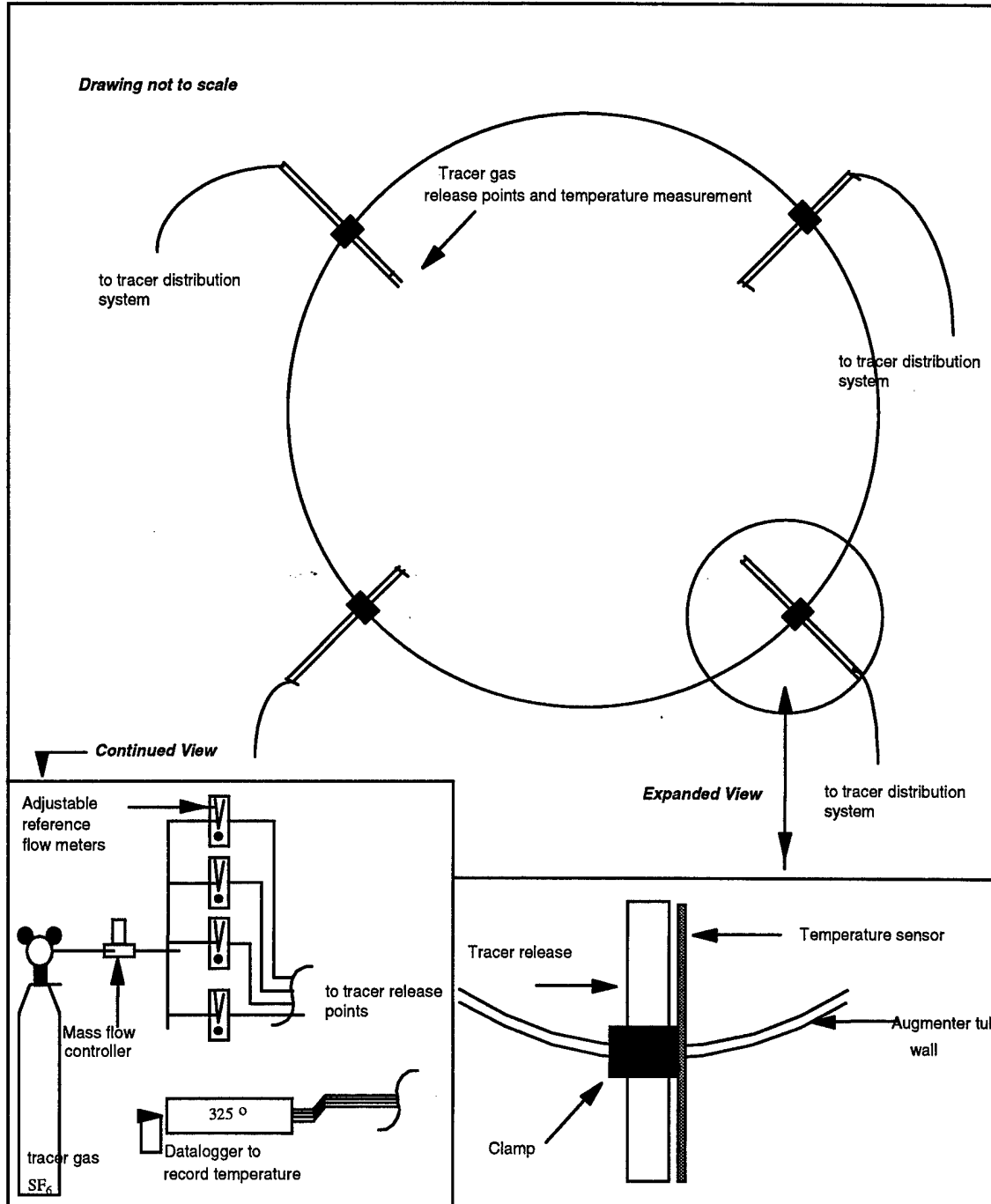
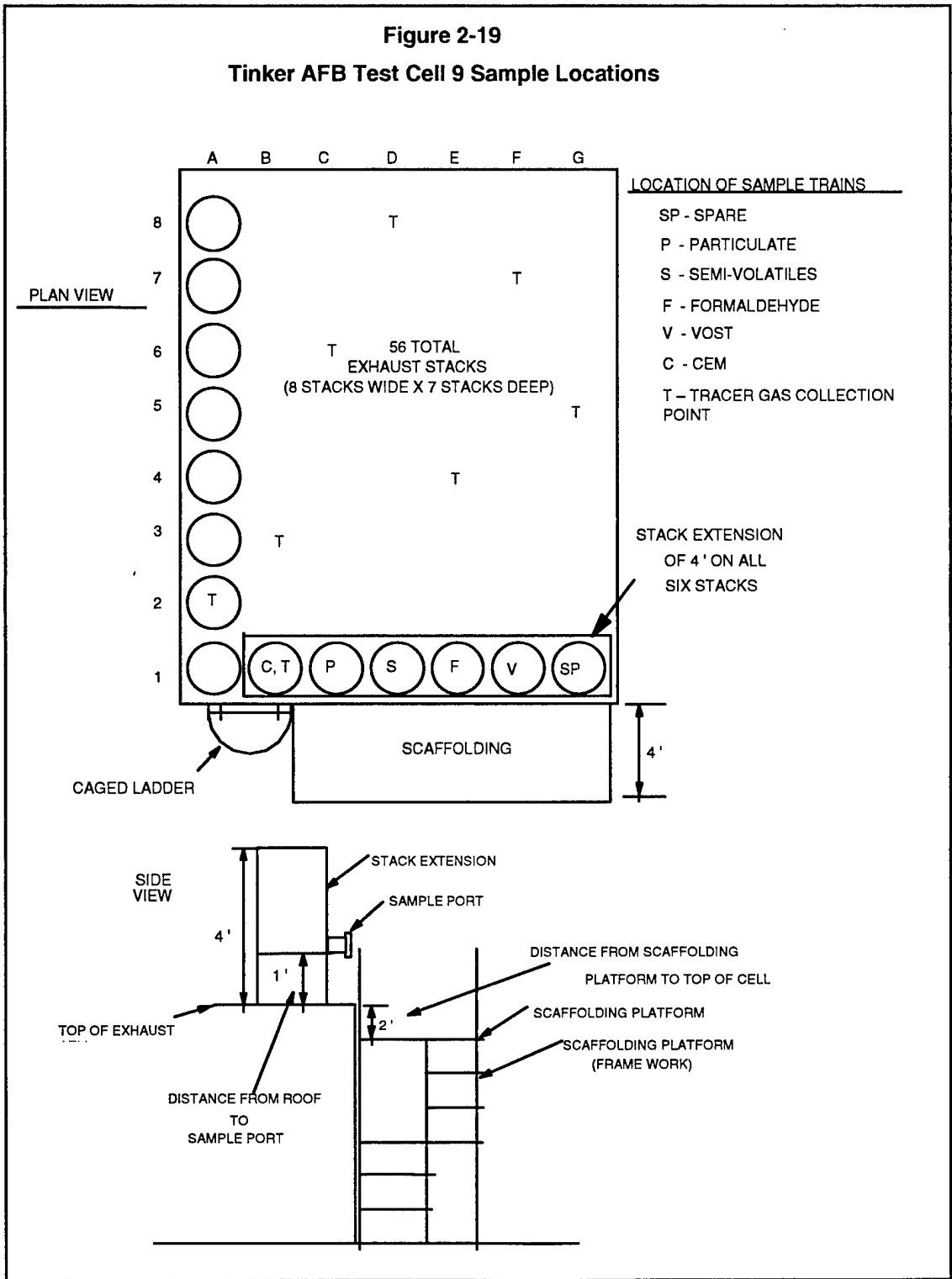

Figure 2-18  
Tracer gas distribution system for an augmeter tube



**Figure 2-19**  
**Tinker AFB Test Cell 9 Sample Locations**



Test Report	
Volume:	<u>3</u>
Section:	<u>2.0</u>
Revision:	<u>2</u>
Date:	<u>November 1998</u>
Page:	<u>29 of 57</u>

values measured by this method were rejected due to interferences. Inlet air pollutant concentrations were determined by placing the ambient samplers under the air intake inside the test cell in a location that did not present an FOD hazard to the engine.

The stacks at the outlet of the blast room are flush with the top of the test cell, making it unsafe to remain on the scaffolding during engine operation above idle conditions. This configuration of the stacks also did not allow the stacks to be safely traversed, as required by EPA methodology. Since access to the platform and the stacks was limited, all sampling was conducted at a single point for each sampling train. In order to minimize wind interference for each sample train, it was necessary to install 4-foot stack extensions with 4-inch-diameter sample ports on six of the exhaust stacks. Figure 2-19 illustrates which exhaust stacks required extensions, the placement of sampling ports, and which pollutants were sampled from each stack.

Velocity measurements were collected at each sampling point in order to maintain isokinetics. These velocity data were not used to calculate the entire exhaust flowrate since the face of the exhaust could not be traversed. The exhaust flowrate was calculated using either carbon balance, tracer gas, or F-factor.

## 2.7 CHARLESTON AFB, TEST CELL

Figure 2-20 illustrates the general configuration of the test cell. The configuration of this test cell does not facilitate the use of conventional isokinetic sampling methodologies. The baffles in this cell impeded a stack traverse required to collect a sample using traditional methodologies. Single point sampling was performed and the exhaust flowrate was determined through calculations (carbon balance, tracer gas, F-factor). Airflow into the test cell is the result of the air draw created by the engine during operation. Inlet flow measurements were not conducted at this facility. Engine exhaust gas is directed through the augments tube, through the perforated section of the augments tube into the blast room, and then out through the sound-

Test Report

Volume: 3

Section: 2.0

Revision: 2

Date: November 1998

Page: 30 of 57

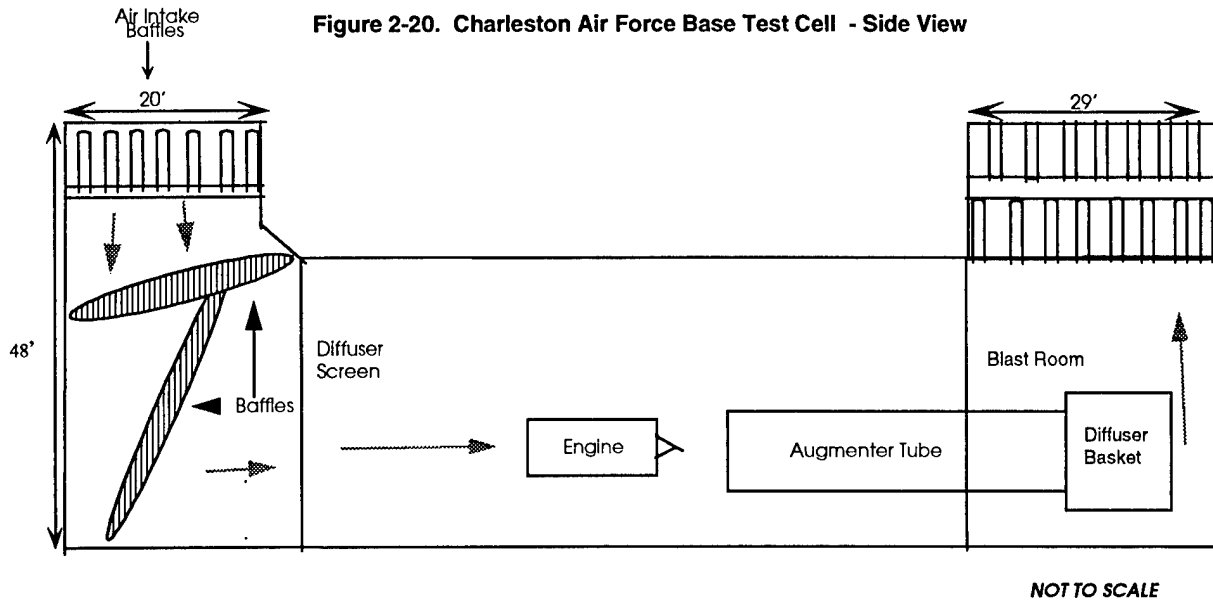



Test Report	
Volume:	<u>3</u>
Section:	<u>2.0</u>
Revision:	<u>2</u>
Date:	<u>November 1998</u>
Page:	<u>31 of 57</u>

dampening baffles and the rectangular stack. Because of the turbulent flow from the engine exhaust and the circuitous path that the exhaust gases must travel, it is assumed that there will be no stratification of the exhaust gases and that the tracer gases will be mixed equally. The assumption of a homogeneous exhaust mixture was demonstrated by tracer gas measurements. The tracer gas manifold and supporting steel tracer gas distribution tubes were located at the beginning of the augments tube as shown in Figure 2- 21. The exhaust flow rate was determined by the tracer gas release rate and the measured concentration at the exhaust. Eight tracer gas collection points at the exhaust were configured as shown in Figure 2-22. Tracer gas was drawn through a manifold and heated sample line for independent point sampling and direct analysis as opposed to the tedlar bag analysis used at previous facilities. This improved data collection and provided real time examination. This analysis verified that the single-point sample collection methodology, as opposed to a full exhaust cross section traverse, was representative of the engine emissions.

Inlet air pollutant concentrations were determined by placing ambient samplers under the air intake inside the test cell. The ambient sampling equipment was temporarily installed in a manner that did not present a FOD hazard to the engine.

The rectangular stack at the outlet of the blast room presented both a safety hazard and a sampling dilemma. The configuration of the exhaust stack (29 ft x 25 ft) did not allow it to be traversed, as required by EPA Method 1 methodology. Since access to the platform and stack was limited, all sampling was conducted at a single point between the acoustical baffles. Based on the proposed sampling strategy, it was necessary to install five 4-inch-diameter sample ports on the side of the test cell exhaust stack. Each port allowed access for each sample train. One port was dedicated for each sample type, VOST, semi-volatiles, formaldehyde, particulate matter, and the continuous emission monitor probe. Figures 2-23 and 2-24 illustrate the placement of sampling ports and the support scaffolding.

**Figure 2-21**  
**Tracer gas distribution system for an augmenter tube**

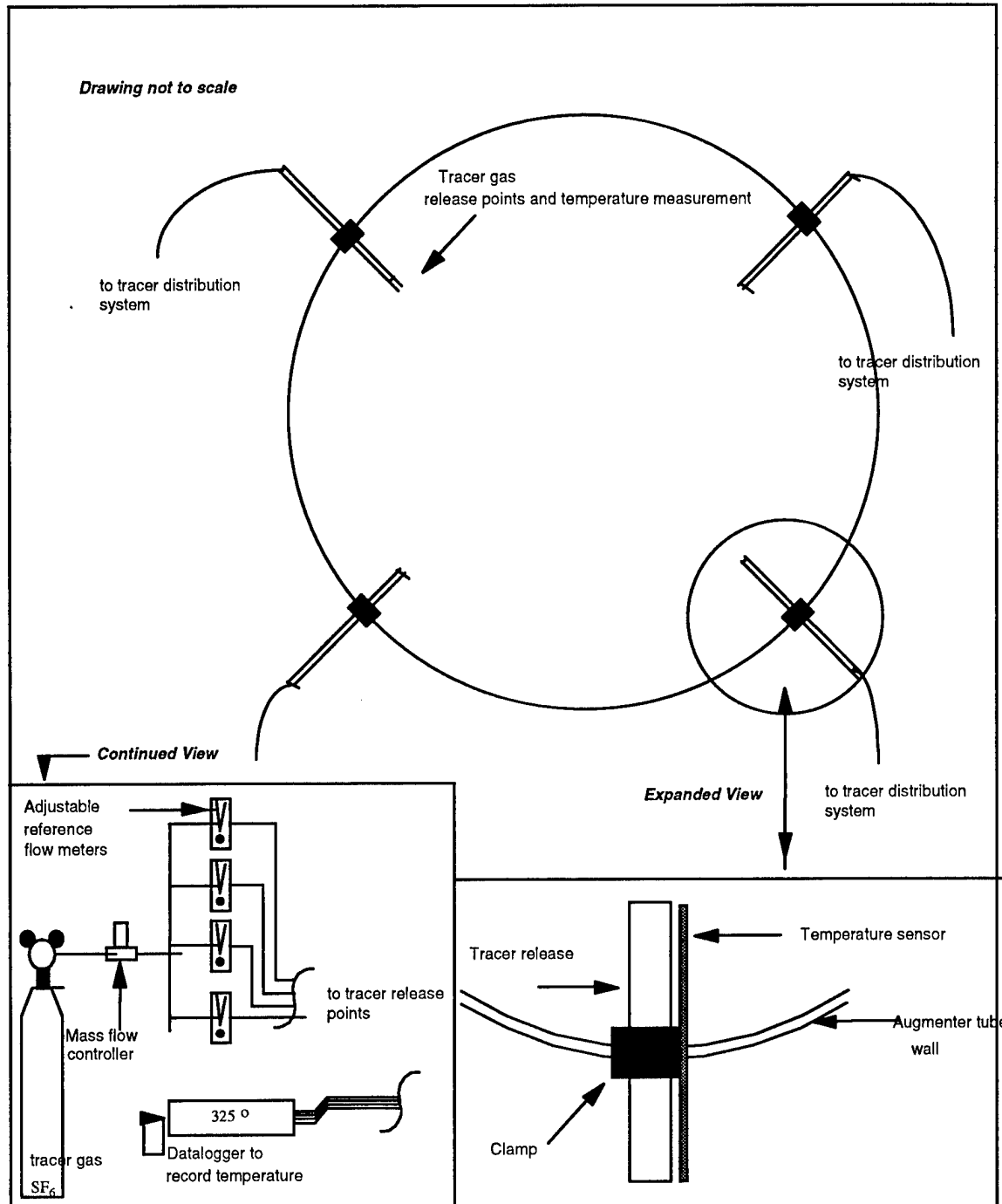

Test Report  
 Volume: 3  
 Section: 2.0  
 Revision: 2  
 Date: November 1998  
 Page: 33 of 57

Figure 2-22. Charleston AFB Engine Test Cell  
 Tracer Gas Sampling Points and Typical Concentrations (ppb) at Approach

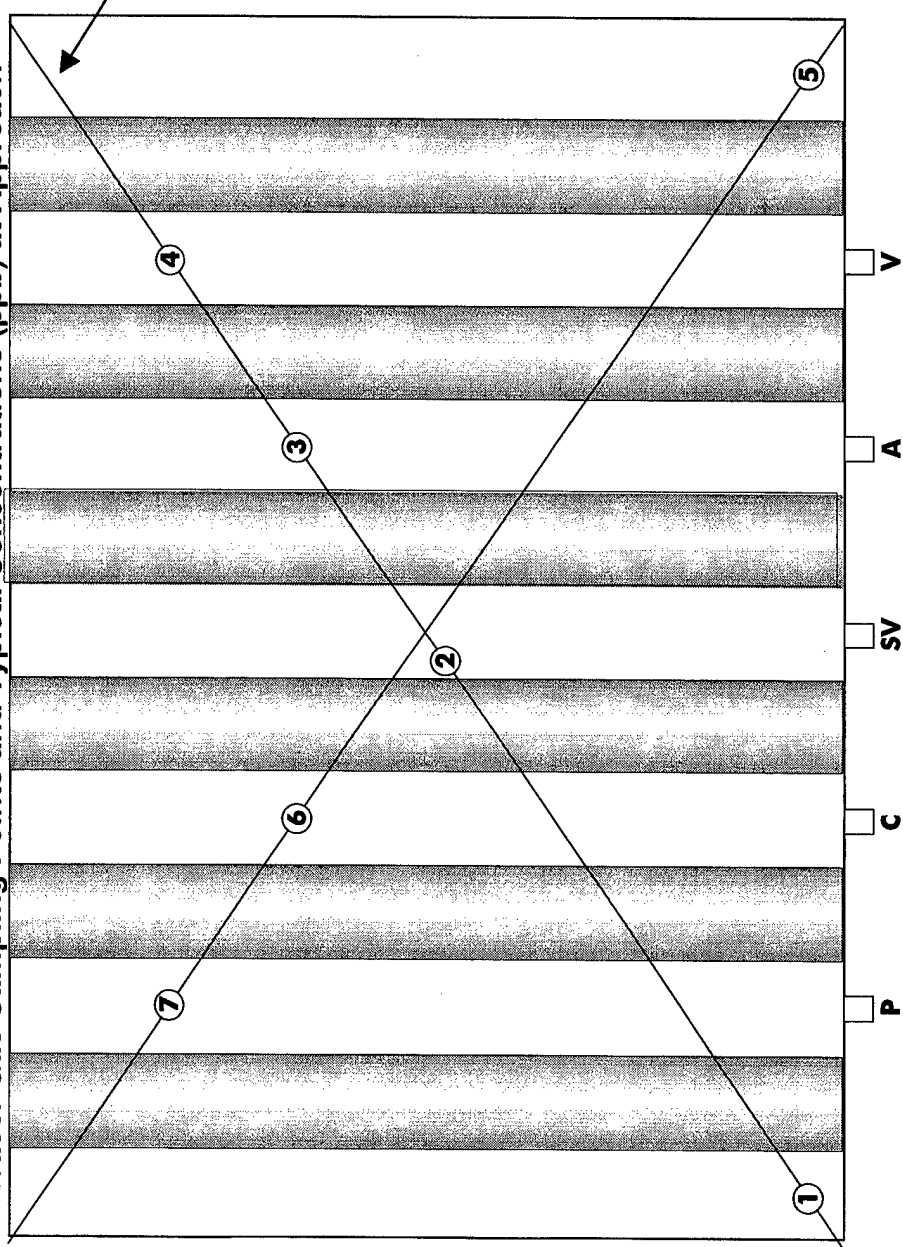

Existing  
 Thermocouple  
 Support Cable

- P** - Particulate
  - C** - CEM
  - SV** - Semi Volatiles
  - A** - Aldehyde
  - V** - Volatiles
- Sample Ports with  
 Stack Extension**

② - Tracer gas sampling point

**Figure 2-23. Charleston AFB, Engine Test Cell Exhaust Top View  
 Requested Base Support**

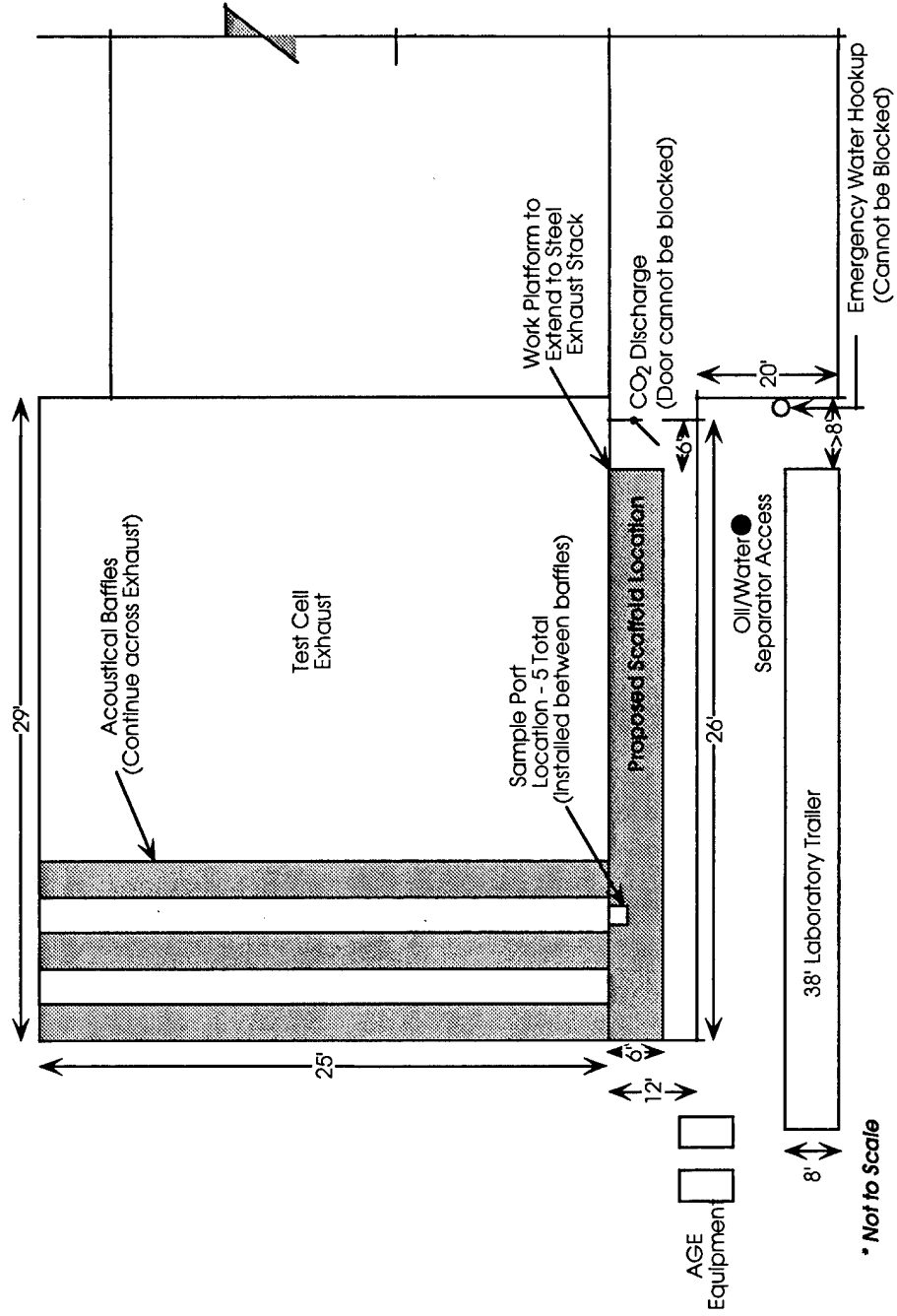

**Figure 2-24. Charleston AFB, Engine Test Cell Exhaust Side View  
Requested Base Support**

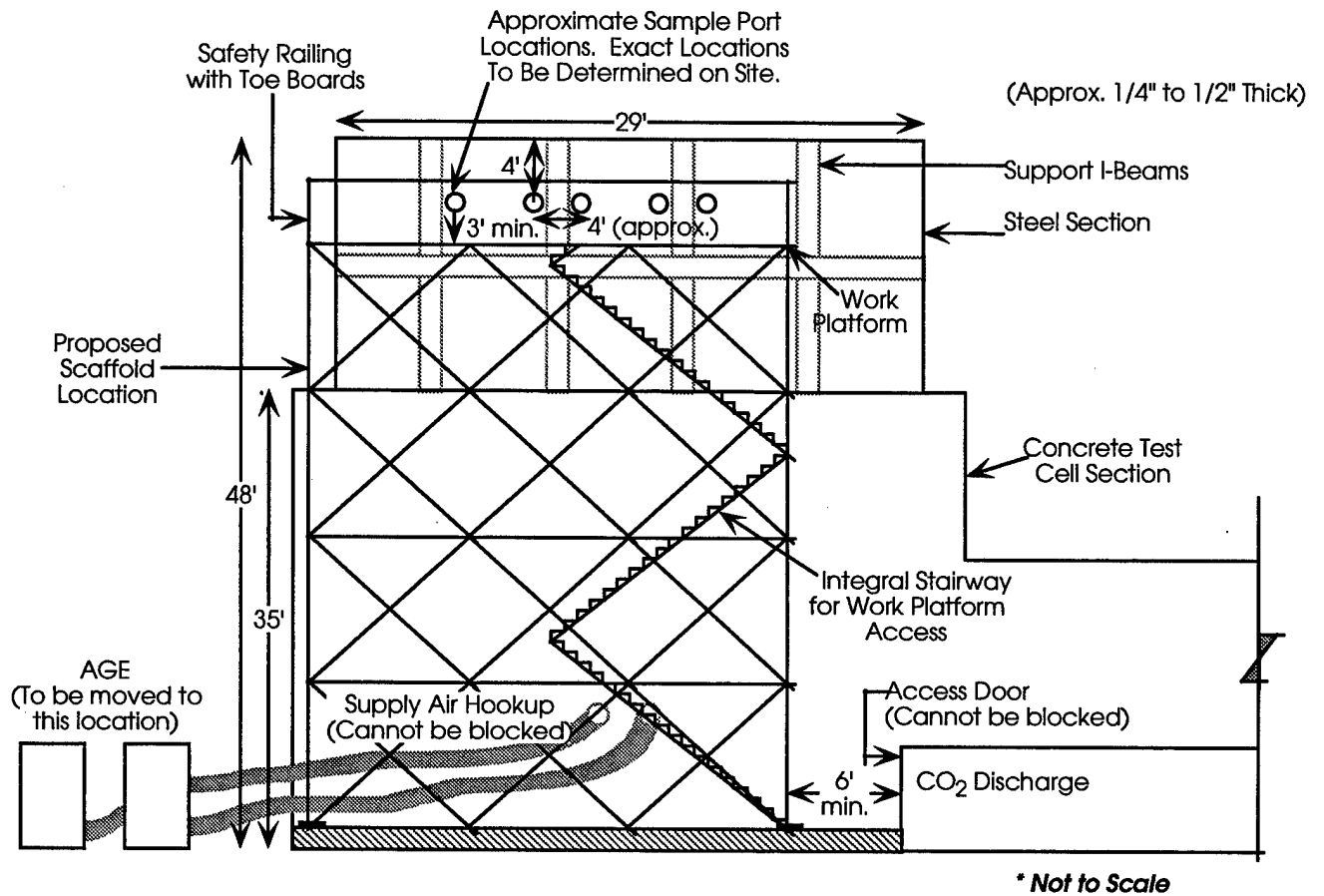

Test Report  
Volume: 3  
Section: 2.0  
Revision: 2  
Date: November 1998  
Page: 36 of 57

Velocity measurements were collected at each sampling point in order to maintain isokinetics. These velocity data were not used to calculate the entire exhaust flowrate. The exhaust flowrate was calculated using either carbon balance, tracer gas, or F-factor.

## 2.8 EDWARDS AFB, TEST CELL 4

The general configuration of Test Cell 4 at Edwards AFB is illustrated in Figure 2-25. There are a total of 64 individual exhaust stacks over a 1,500-ft<sup>2</sup> area. This configuration did not facilitate the use of conventional emission sampling methodologies. Airflow into the test cell results from air draw created by the engine during operation. Engine exhaust gas is directed through the augments tube, through the perforated section of the augments tube into the blast room, and then out through the exhaust stacks. Because of the turbulent flow from the engine exhaust and the circuitous path that the exhaust gases must travel, it was assumed that there was no stratification of the exhaust gases.

The assumption of a homogeneous exhaust mixture was demonstrated by tracer gas measurements. The tracer gas manifold and supporting steel distribution tubes were located at the beginning of the augments tube as shown in Figure 2-26. The exhaust flow rate was determined by the tracer gas release rate and the measured concentration at the exhaust. Eight tracer gas collection points at the exhaust were configured as shown in Figure 2-27. Tracer gas was drawn through a manifold and heated sample line for independent point sampling and direct analysis as opposed to the tedlar bag analysis used at previous facilities. This provided real time examination. The analysis verified that the single point sample collection methodology was representative of the engine emissions.

Test Report

Volume: 3

Section: 2.0

Revision: 2

Date: November 1998

Page: 37 of 57

Figure 2-25. Test Cell 4 at Edwards Air Force Base - Side View

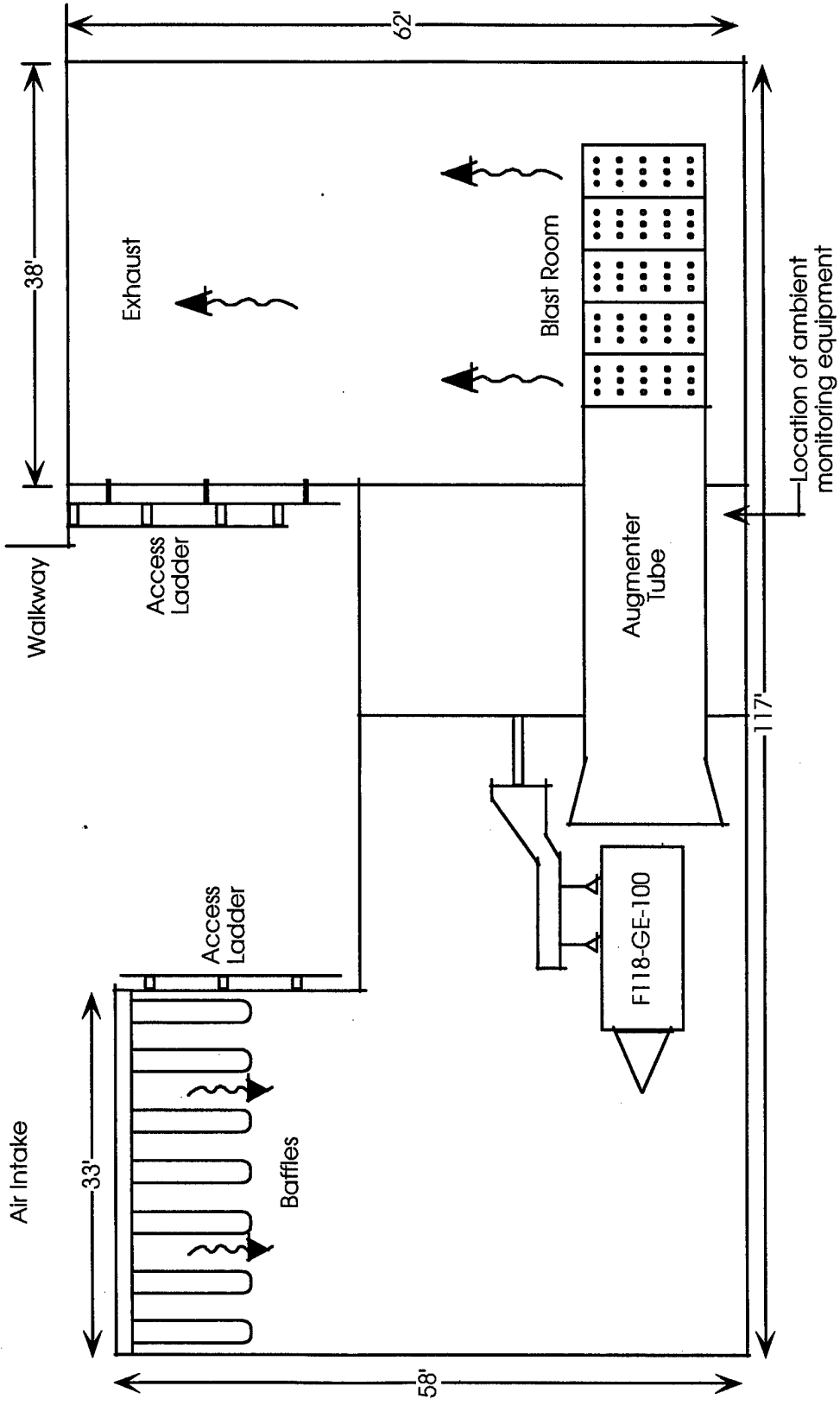
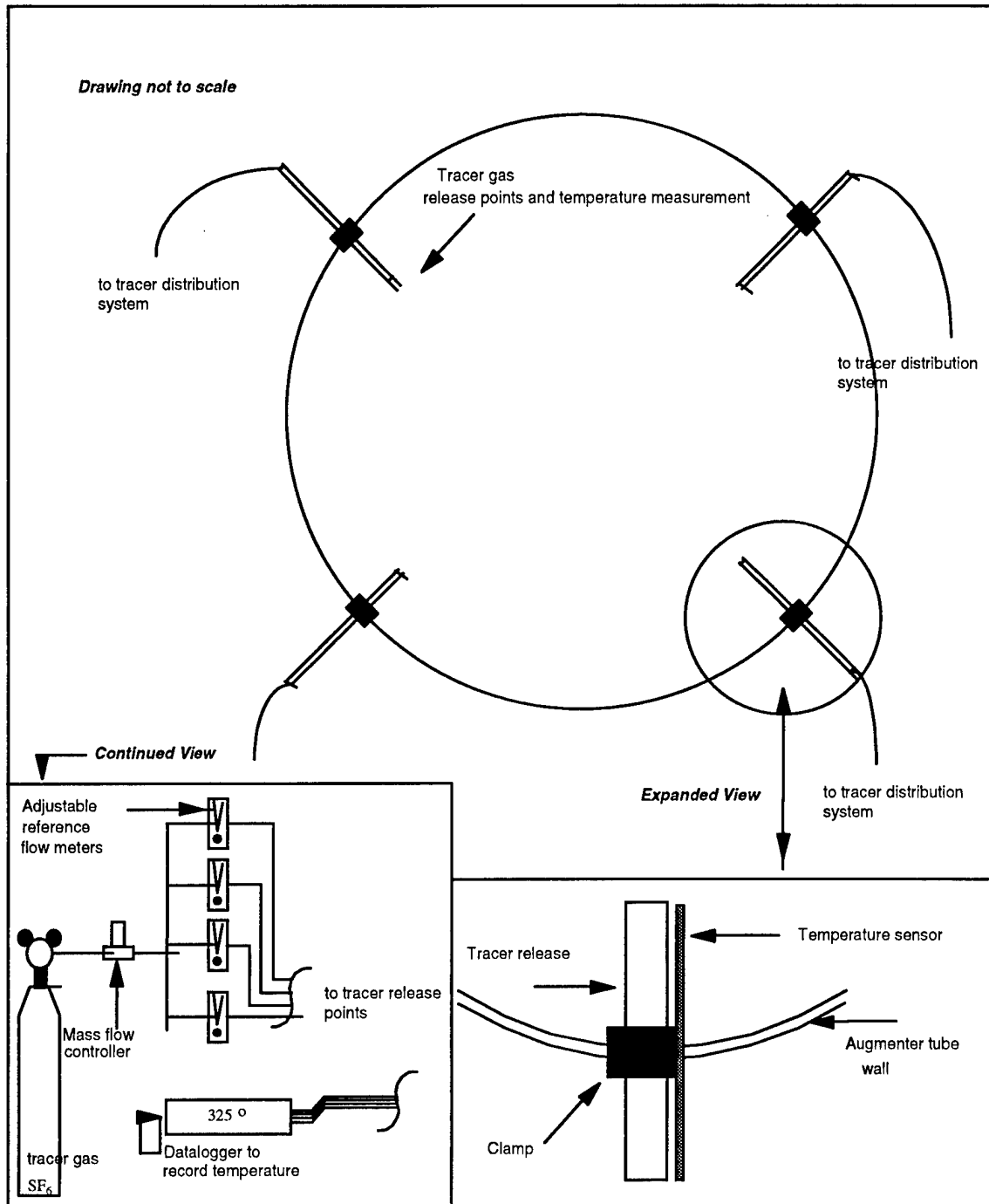

Figure 2-26.  
Tracer gas distribution system for an augmeter tube





Test Report

Volume: 3

Section: 2.0

Revision: 2

Date: November 1998

Page: 39 of 57

Figure 2-27. Edwards AFB Test Cell 4 Exhaust - Top View

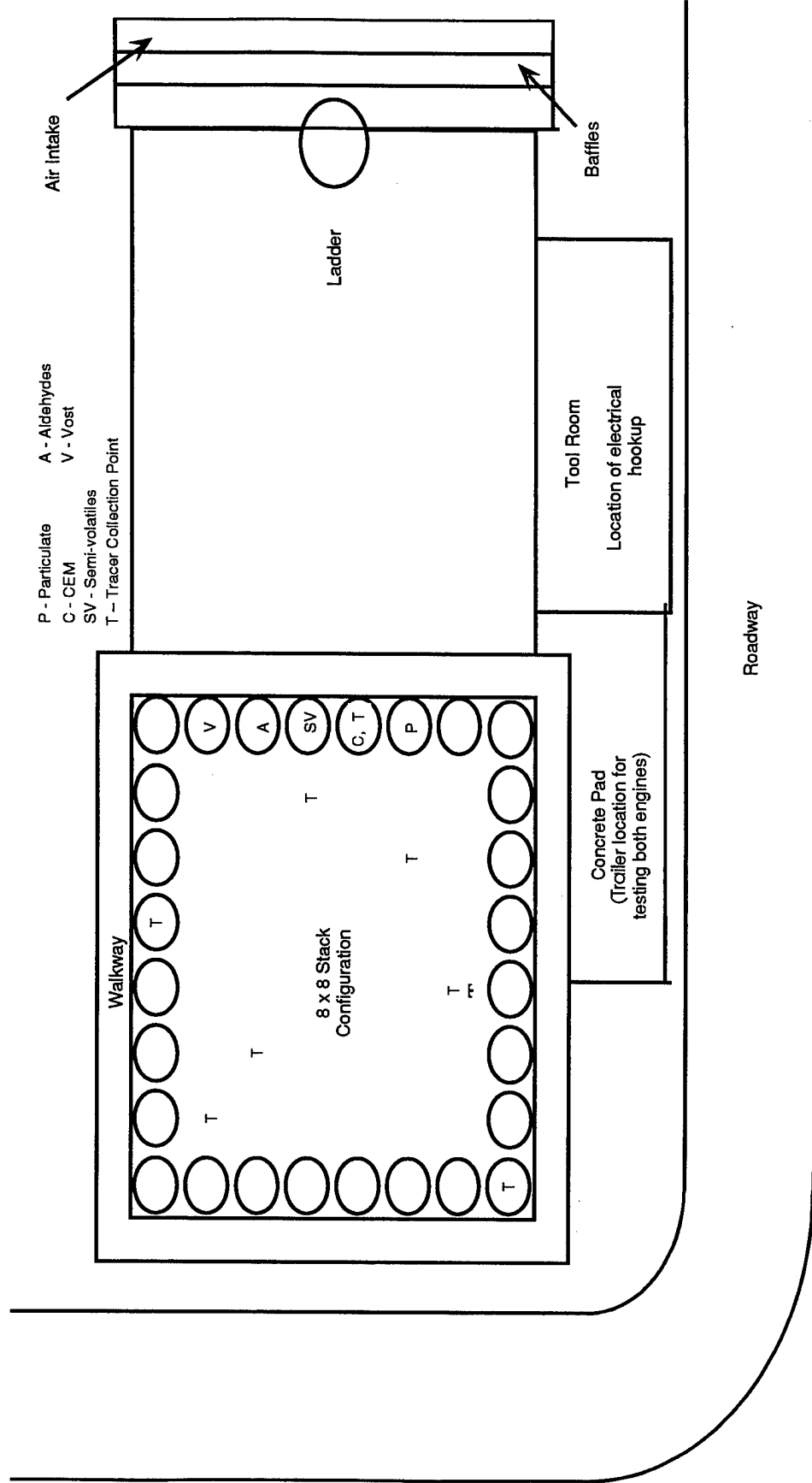

Test Report	
Volume:	<u>3</u>
Section:	<u>2.0</u>
Revision:	<u>2</u>
Date:	<u>November 1998</u>
Page:	<u>40 of 57</u>

Inlet air pollutant concentrations were determined by placing the ambient samplers under the air intake inside the test cell. The ambient sampling equipment was temporarily installed in a manner that did not present a FOD hazard to the engine.

The stacks at the outlet of the blast room are flush with the top of the test cell. It was not possible to remain on the scaffolding during engine operation above idle conditions. The configuration of the stacks did not allow them to be traversed, as required by EPA methodology. Since access to the platform and stacks was limited, all sampling was conducted at a single point. The termination of the blast room stacks at the top of the test cell could have made it difficult to collect a representative sample due to wind interference. It was necessary to install stack extensions with a 4-inch-diameter sample port on five of the exhaust stacks. Figure 2-27 illustrates the exhaust stacks that had extensions installed and which pollutants were sampled from each stack. Figure 2-28 shows a side view of the roof for the test cell exhaust and a sample stack extension.

Velocity measurements were collected at each sampling point in order to maintain isokinetics. These velocity data were not used to calculate the entire exhaust flowrate since the exhaust flowrate was calculated using either carbon balance, tracer gas, or F-factor.

## 2.9 EDWARDS AFB, TEST CELL 2

Figure 2-29 illustrates the general configuration of Test Cell 2 at Edwards AFB. There are a total of 40 individual exhaust stacks over a 650-ft<sup>2</sup> area. This configuration did not facilitate the use of conventional emission sampling methodologies. Airflow into the test cell is the result of the air draw created by the engine during operation. Engine exhaust gas is directed through the augments tube, through the perforated section of the augments tube into the blast room, and then out through the exhaust stacks. Because of the turbulent flow from the engine exhaust and the circuitous path that the

Test Report  
 Volume: 3  
 Section: 2.0  
 Revision: 2  
 Date: November 1998  
 Page: 41 of 57

Figure 2-28. Edwards AFB Test Cell 4 Exhaust - Stack Extension Dimensions

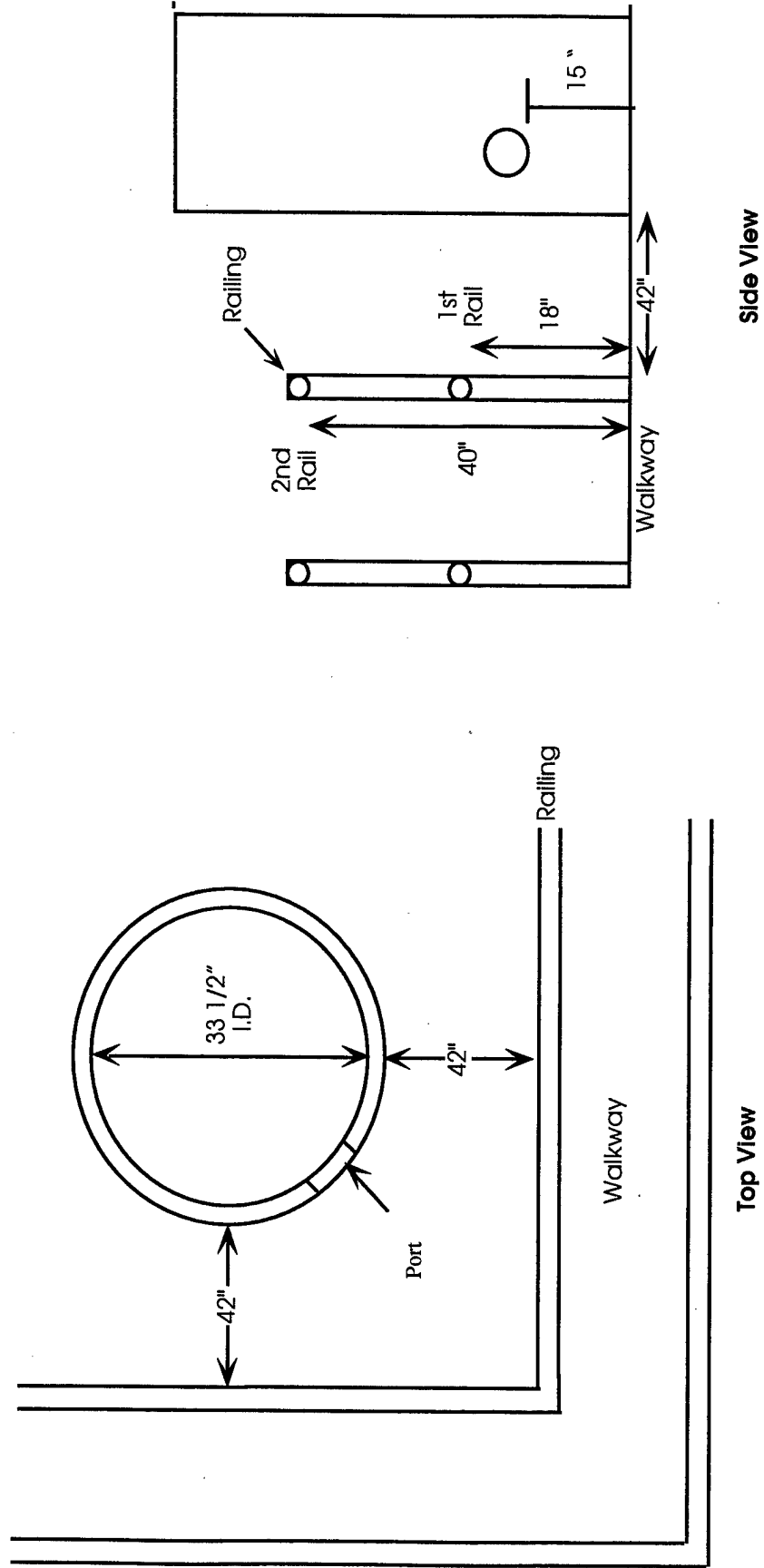

Test Report  
 Volume: 3  
 Section: 2.0  
 Revision: 2  
 Date: November 1998  
 Page: 42 of 57

Figure 2-29. Test Cell 2 at Edwards AFB - Side View

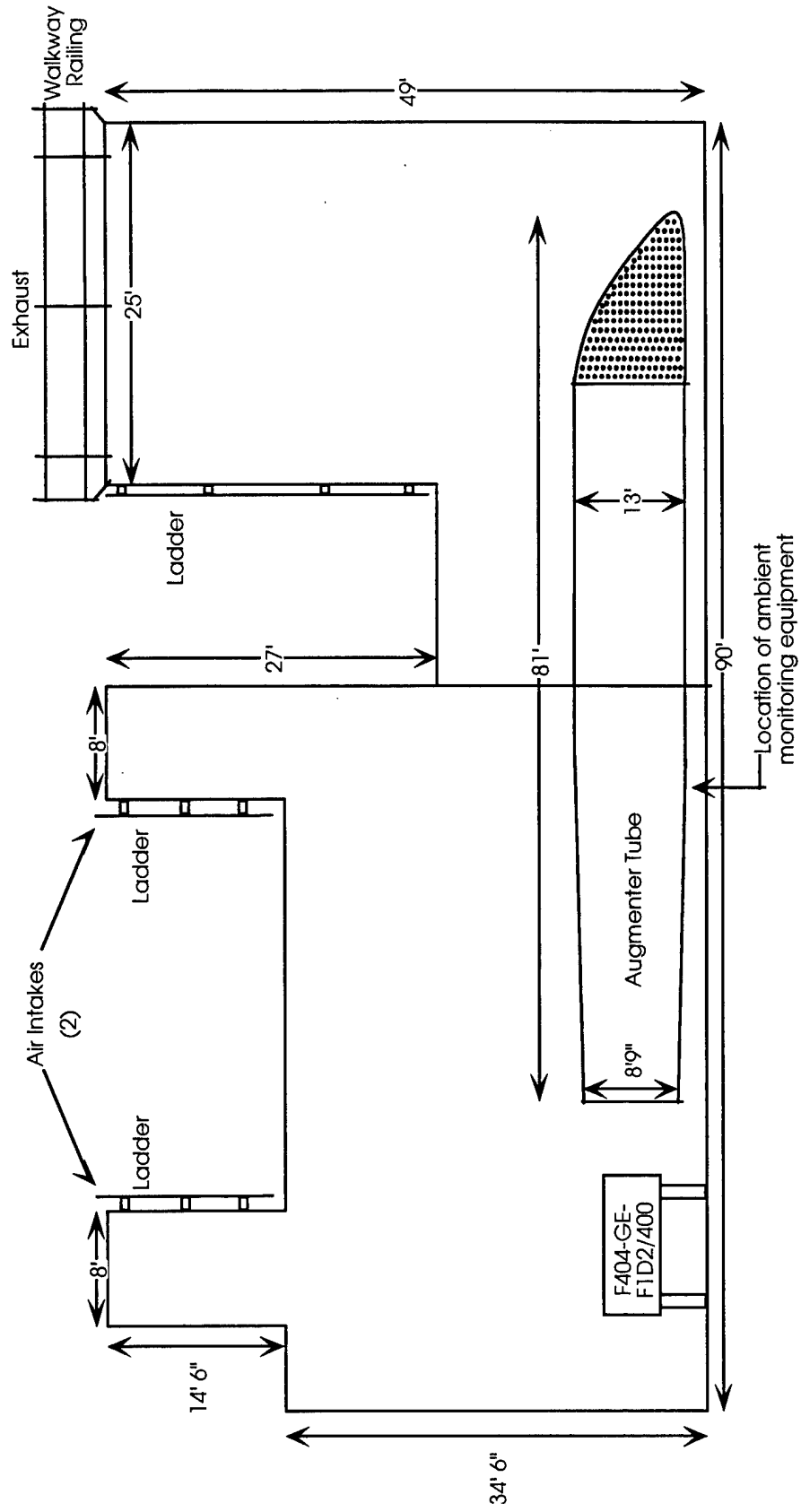

Test Report	
Volume:	<u>3</u>
Section:	<u>2.0</u>
Revision:	<u>2</u>
Date:	<u>November 1998</u>
Page:	<u>43 of 57</u>

exhaust gases must travel, it was assumed there was no stratification of the exhaust gases.

The assumption of a homogeneous exhaust mixture was demonstrated by tracer gas measurements. The tracer gas manifold and supporting steel distribution tubes were located at the beginning of the augments tube as shown in Figure 2-30. The exhaust flow rate was determined by the tracer gas release rate and the measured concentration at the exhaust. Eight tracer gas collection points at the exhaust were configured as shown in Figure 2-31. Tracer gas was drawn through a manifold and heated sample line for independent point sampling and direct analysis as opposed to the tedlar bag analysis used at previous facilities. This provided real time examination. The analysis verified that the single point sample collection methodology was representative of the engine emissions.

Inlet air pollutant concentrations were determined by placing the ambient samplers under the air intake, next to the augments tube, inside the test cell. The ambient sampling equipment was temporarily installed in a manner that did not present a FOD hazard to the engine. The stacks at the outlet of the blast room are recessed below the top of the test cell. Therefore it was not possible to remain on the walkway during engine operation above idle conditions. The configuration of the stacks did not allow a full traverse of the exhaust, as required by EPA methodology. Since access to the platform and stacks was limited, all sampling was conducted at a single point. The termination of the blast room stacks at the top of the test cell would have made it difficult to collect a representative sample due to wind interference. It was necessary to temporarily install 9-foot-tall stack extensions with a 4-inch-diameter sample port on five of the exhaust stacks. Figure 2-31 illustrates which exhaust stacks required extensions and which pollutants were sampled from each stack. Figure 2-32 shows a side view of the roof for the test cell exhaust and a sample stack extension.

Figure 2-30  
Tracer gas distribution system for an augments tube

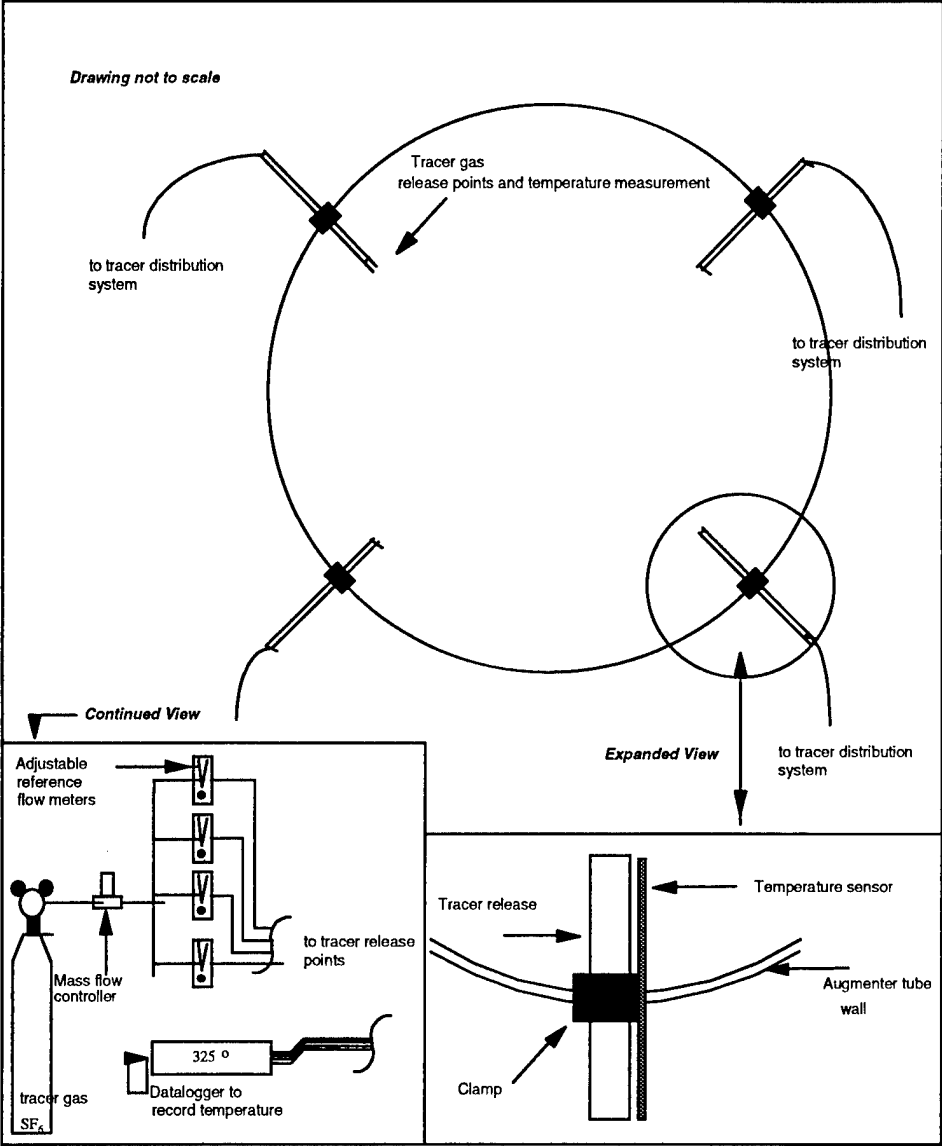

Test Report

3

Volume:

2.0

Section:

2

Revision:

November 1998

Date:

45 of 57

Page:

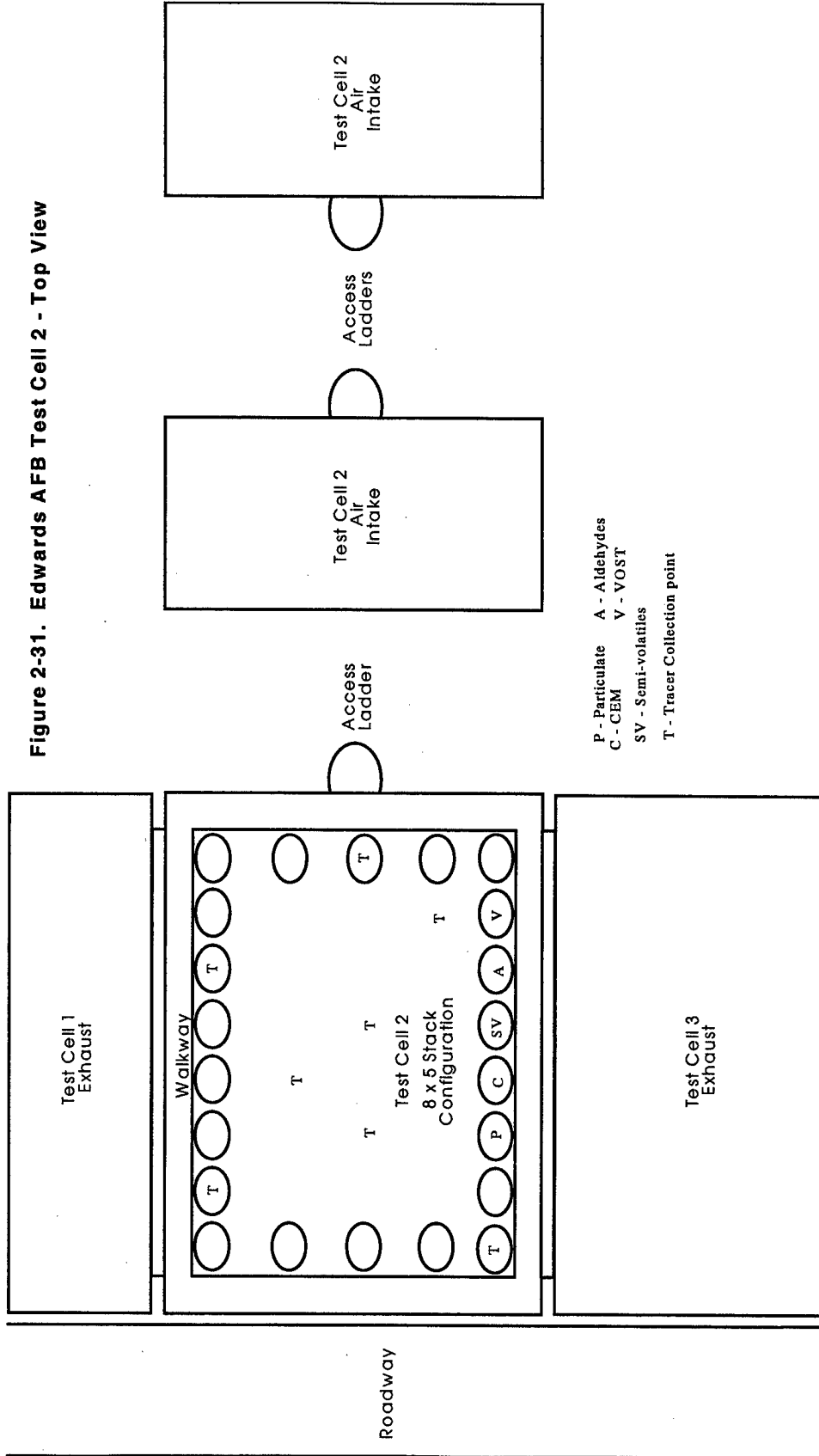
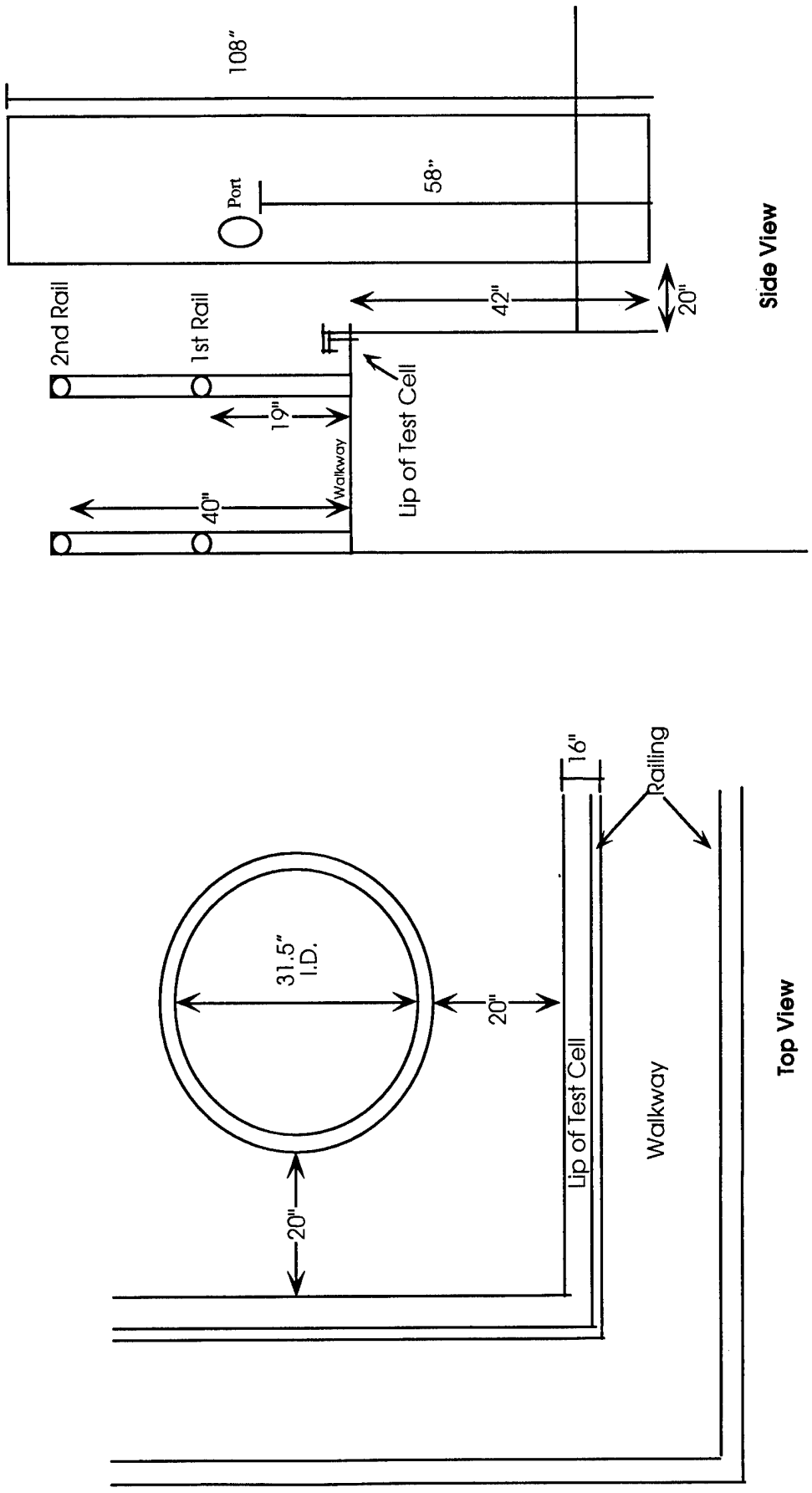

Figure 2-31. Edwards AFB Test Cell 2 - Top View

P - Particulate  
C - CBM  
SV - Semi-volatiles  
A - Aldehydes  
V - VOST  
T - Tracer Collection point

Test Report  
 Volume: 3  
 Section: 2.0  
 Revision: 2  
 Date: November 1998  
 Page: 46 of 57

Figure 2-32. Edwards AFB Test Cell 2 Exhaust - Stack Extension Dimensions





Test Report	
Volume:	<u>3</u>
Section:	<u>2.0</u>
Revision:	<u>2</u>
Date:	<u>November 1998</u>
Page:	<u>47 of 57</u>

Velocity measurements were collected at each sampling point in order to maintain isokinetics. These velocity data were not used to calculate the entire exhaust flowrate since the exhaust flowrate was calculated using either carbon balance, tracer gas, or F-factor.

## 2.10 NAVAL AVIATION DEPOT, CHERRY POINT, TEST CELL

Figures 2-33 and 2-34 illustrate the general configuration of the engine test cell at Cherry Point. The configuration of this test cell allowed the use of conventional emission sampling methodologies. The 36-inch-diameter exhaust stack terminated out the side of the test cell facility. Airflow into the cell is the result of the air draw created by the engine during operation. Engine exhaust is directed through the augments tube to the stack outlet. Since conventional isokinetic sampling methodologies are applicable at this source, tracer gas was not needed to determine exhaust gas stratification. Inlet air pollutant concentrations were determined by placing the ambient samplers near the air intake inside the test cell in a location that did not present an FOD hazard to the engine.

The engine exhaust was sampled using conventional isokinetic sampling methodologies; however, the stack needed to be temporarily modified so that testing could be performed according to EPA Method 1 guidelines. Figures 2-35 and 2-36 illustrate the modifications necessary for the test cell stack. A total of four sample ports were installed on the stack so that samples could be collected per EPA methodology. Figure 2-36 illustrates the sampling port specifications. The size and placement of the scaffolding platform also are presented in Figures 2-33 and 2-35. Particulate and semivolatiles sampling trains were rotated between the two upper ports, and the aldehyde and ketone sampling train was rotated between the lower ports. Each pair of sampling ports (upper and lower) was offset by 90 degrees. It took 5 to 10 minutes to rotate the trains among the sample ports. This added approximately 15 to 30 minutes

Test Report  
 Volume: 3  
 Section: 2.0  
 Revision: 2  
 Date: November 1998  
 Page: 48 of 57

Figure 2-33. Naval Aviation Depot, Cherry Point Engine Test Cell

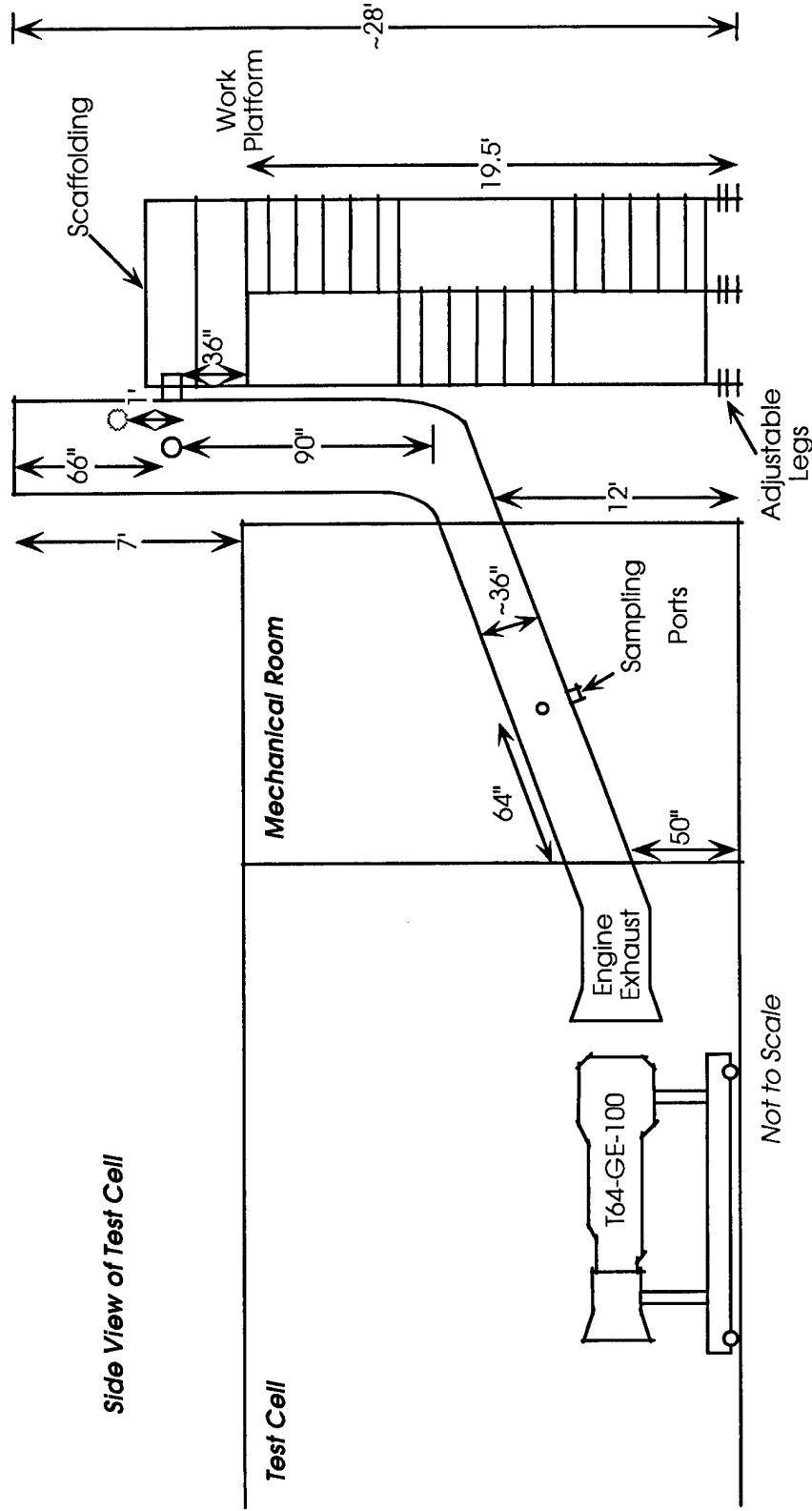

Test Report  
Volume: 3  
Section: 2.0  
Revision: 2  
Date: November 1998  
Page: 49 of 57

Figure 2-34. Naval Aviation Depot, Cherry Point General Test Cell Layout

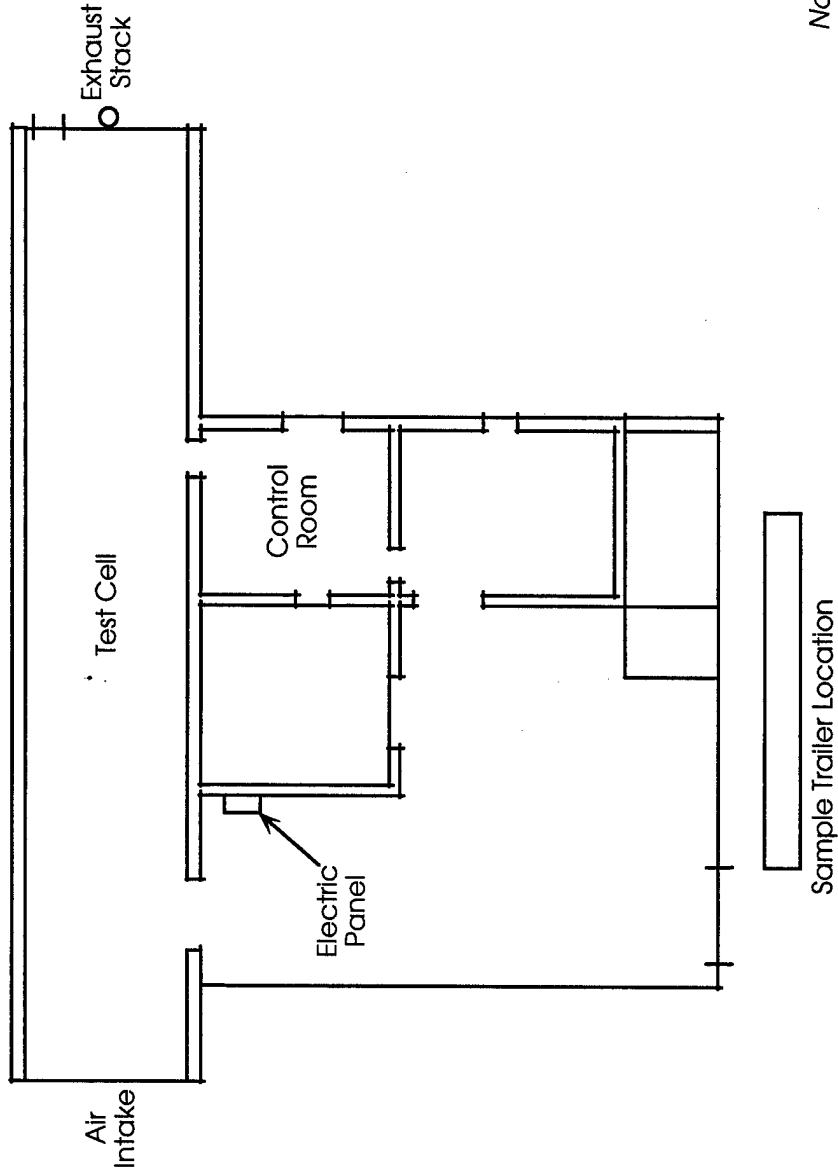

**Figure 2-35. Naval Aviation Depot, Cherry Point  
Engine Test Cell - Top View**

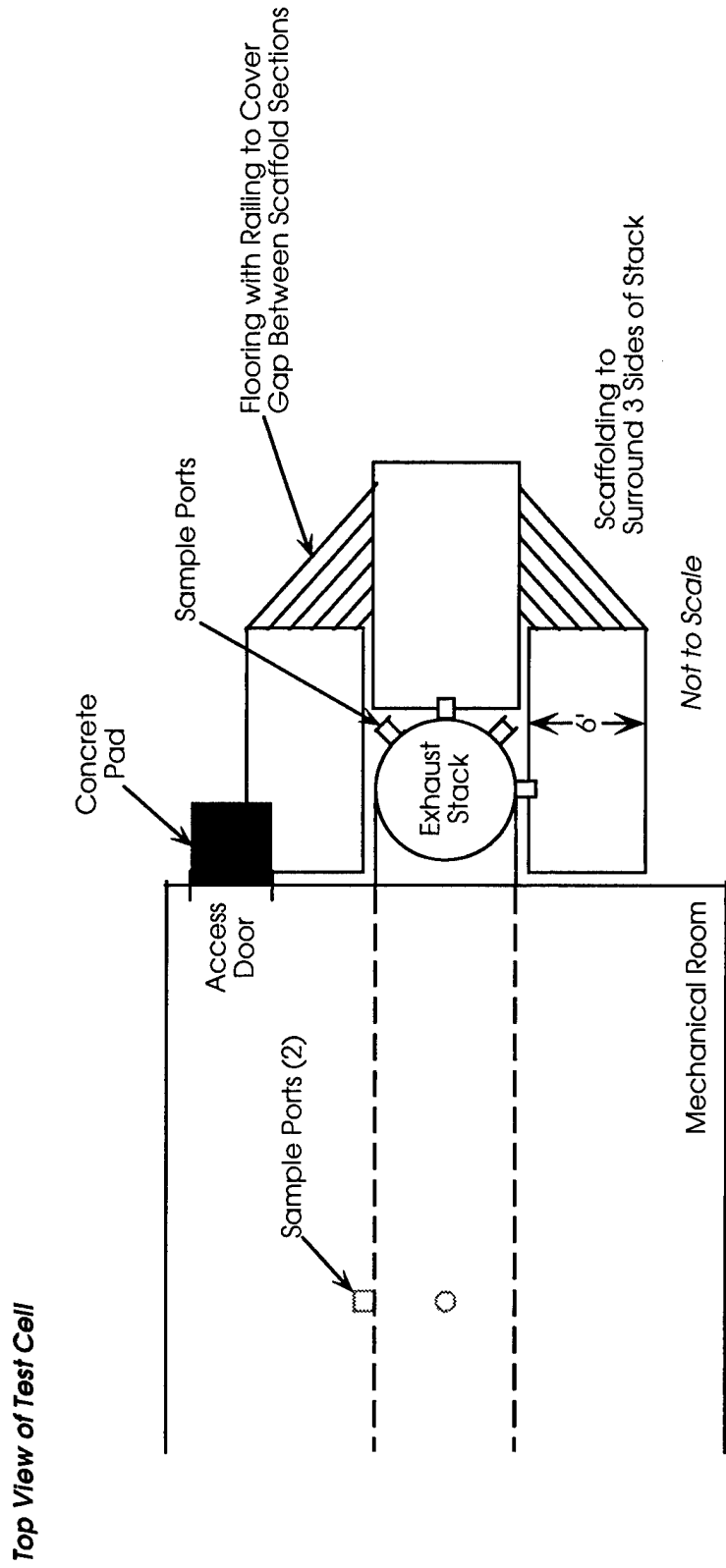

Test Report

Volume: 3

Section: 2.0

Revision: 2

Date: November 1998

Page: 51 of 57

Figure 2-36. Naval Aviation Depot, Cherry Point Engine Test Cell, Sample Port Detail

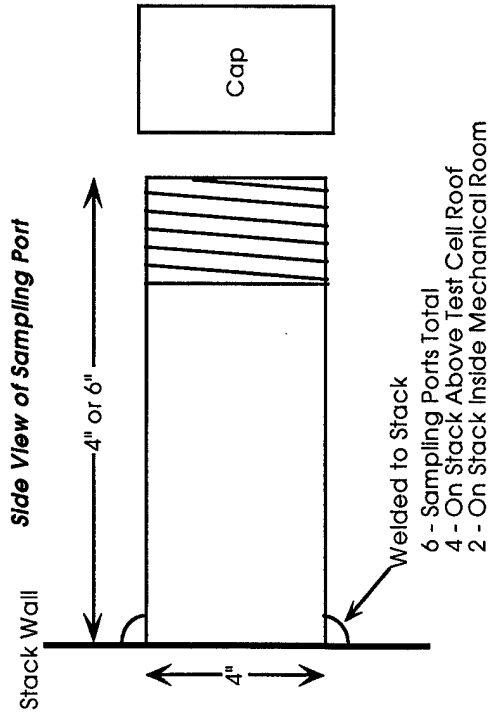

Top View of Exhaust Stack

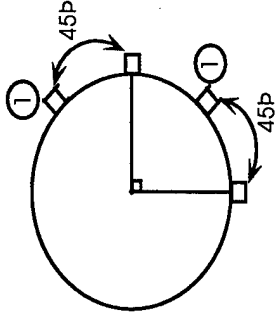

① These 2 Ports are in the Same Horizontal Plane 1 ft. Above Other set of Ports.

Side View of Exhaust Stack Inside Mechanical Room

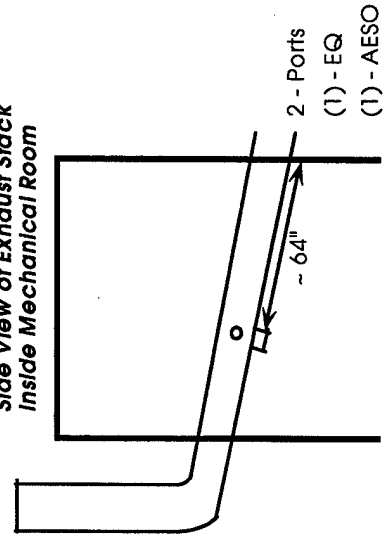

Exhaust Stack Side View

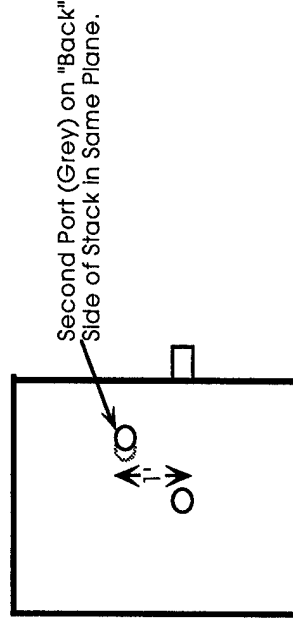

Not to Scale

Test Report	
Volume:	<u>3</u>
Section:	<u>2.0</u>
Revision:	<u>2</u>
Date:	<u>November 1998</u>
Page:	<u>52 of 57</u>

to each 60-minute sample run and resulted in an overall 75- to 90-minute test period for the helicopter engine. Two additional sample ports were installed for CEM and VOST sampling. Sampling for these parameters was conducted at a single point. These ports were located in the mechanical room, as shown in Figures 2-33 and 2-36.

## **2.11 BARNES AIR NATIONAL GUARD BASE, HUSH HOUSE**

Figures 2-37 and 2-38 illustrate the general configuration of the Hush House at Barnes Air National Guard Base. The configuration of the Hush House did not facilitate the use of conventional emission sampling methodologies. Engine exhaust gas was directed upward to the top of the augments tube, then onto a deflector plate, and then out through a short rectangular blast box. Because of the turbulent flow from the engine exhaust and the circuitous path that the exhaust gases must travel, it was assumed that there was no stratification of the exhaust gases. To verify exhaust homogeneity, tracer gas was released into the engine exhaust and sampled at the test cell terminus. The tracer gas stainless steel distribution tubes (0.25-inch I.D.) were placed around the engine on the engine test stand as shown in Figure 2-39. Tracer gas measurements were collected across one diagonal at the exit of the augments tube as depicted in Figure 2-40. Eight sample points were selected based on Method 1 criteria. Some stratification was noted at the base of the augments tube. All sampling for the pollutant parameters was conducted in the upper half of the augments tube. Inlet air pollutant concentrations were determined by placing the ambient samplers inside the Hush House, in a manner that did not present a FOD hazard to the engine.

Since the exhaust configuration did not allow for safe collection of exhaust emission samples via typical stack test methodologies, an alternative approach was utilized. The augments tube terminus is shielded on three sides by the exhaust deflector plate and exhaust stack; therefore, samples were collected at the end of the augments tube. Each sample train (particulate, VOST, semi-volatiles, aldehyde/

Test Report

3

Volume:

2.0

Section:

2

Revision:

November 1998

Date:

53 of 57

Page:

Figure 2-37. Barnes Air National Guard Base Augmenter Tube Detail

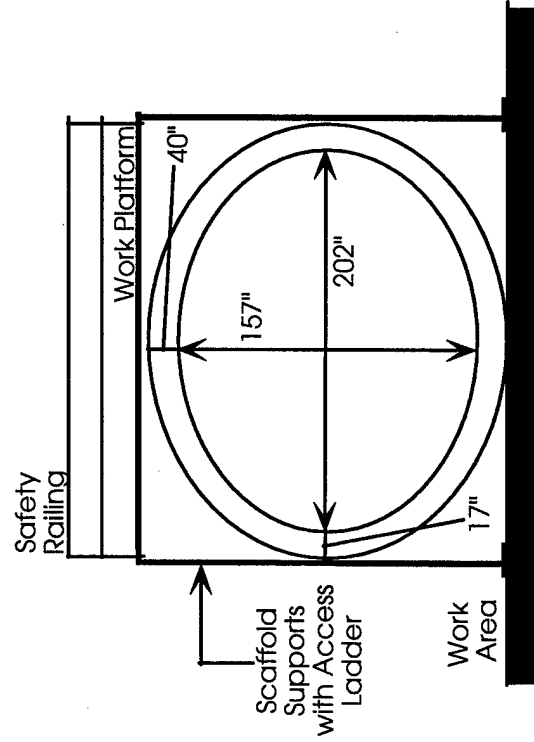

View Looking from Blast Box into Augmenter Tube

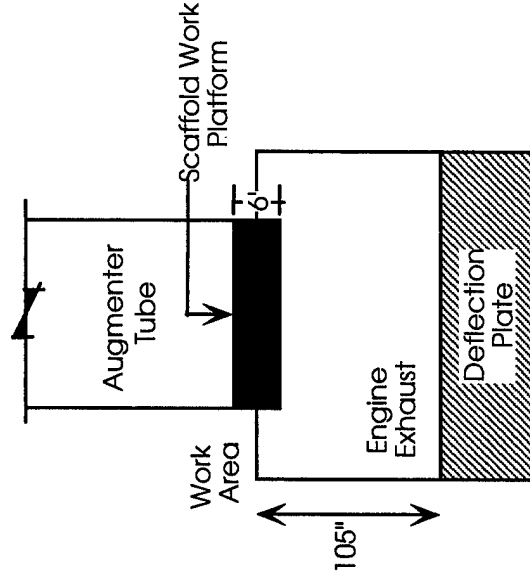

Top View of Augmenter Tube and Blast Box

Test Report  
 Volume: 3  
 Section: 2.0  
 Revision: 2  
 Date: November 1998  
 Page: 54 of 57

Figure 2-38. Barnes Air National Guard Base Overview of Hush House

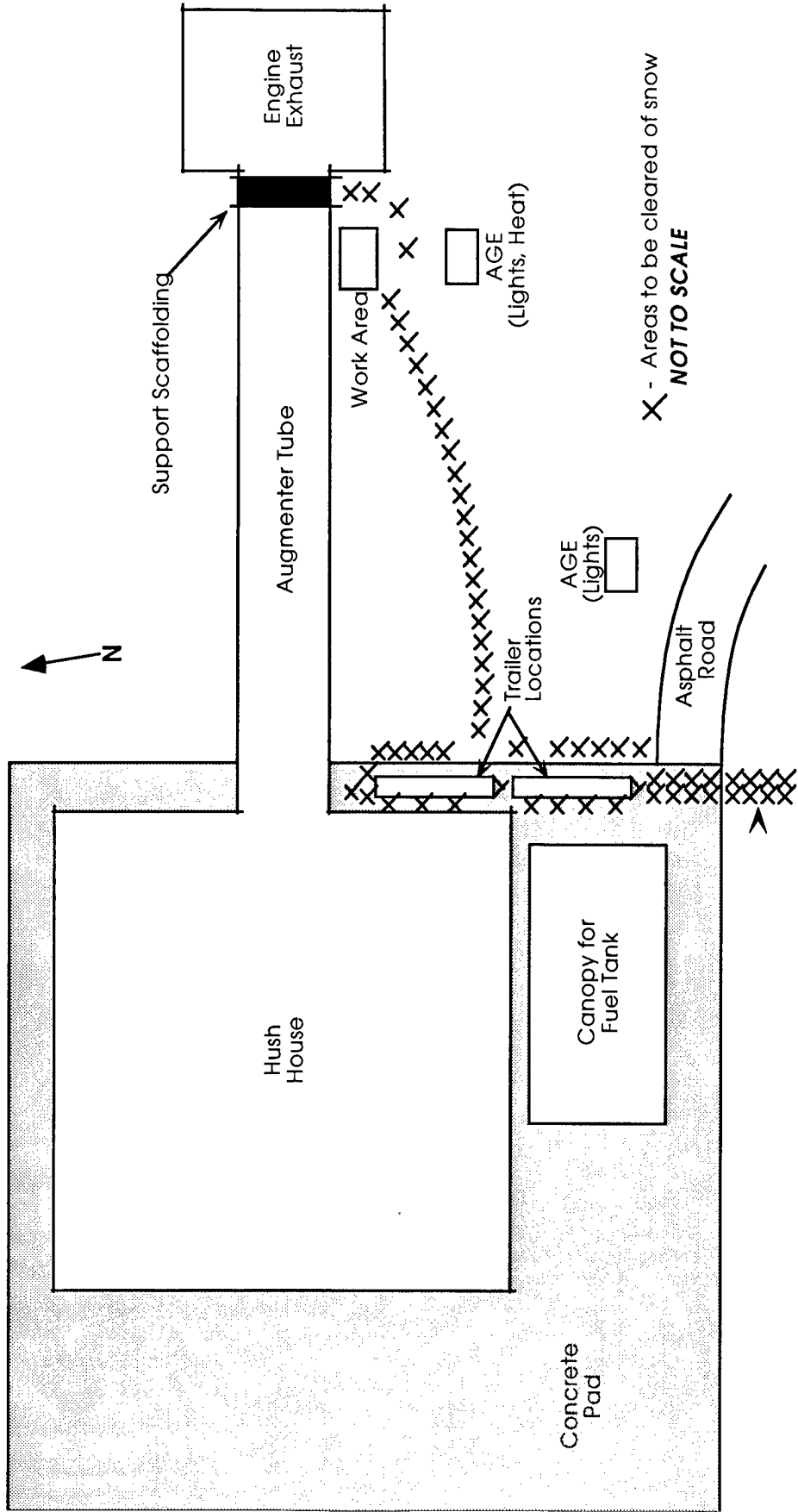



**Figure 2-39.**  
**Tracer gas distribution system for an augmeter tube**

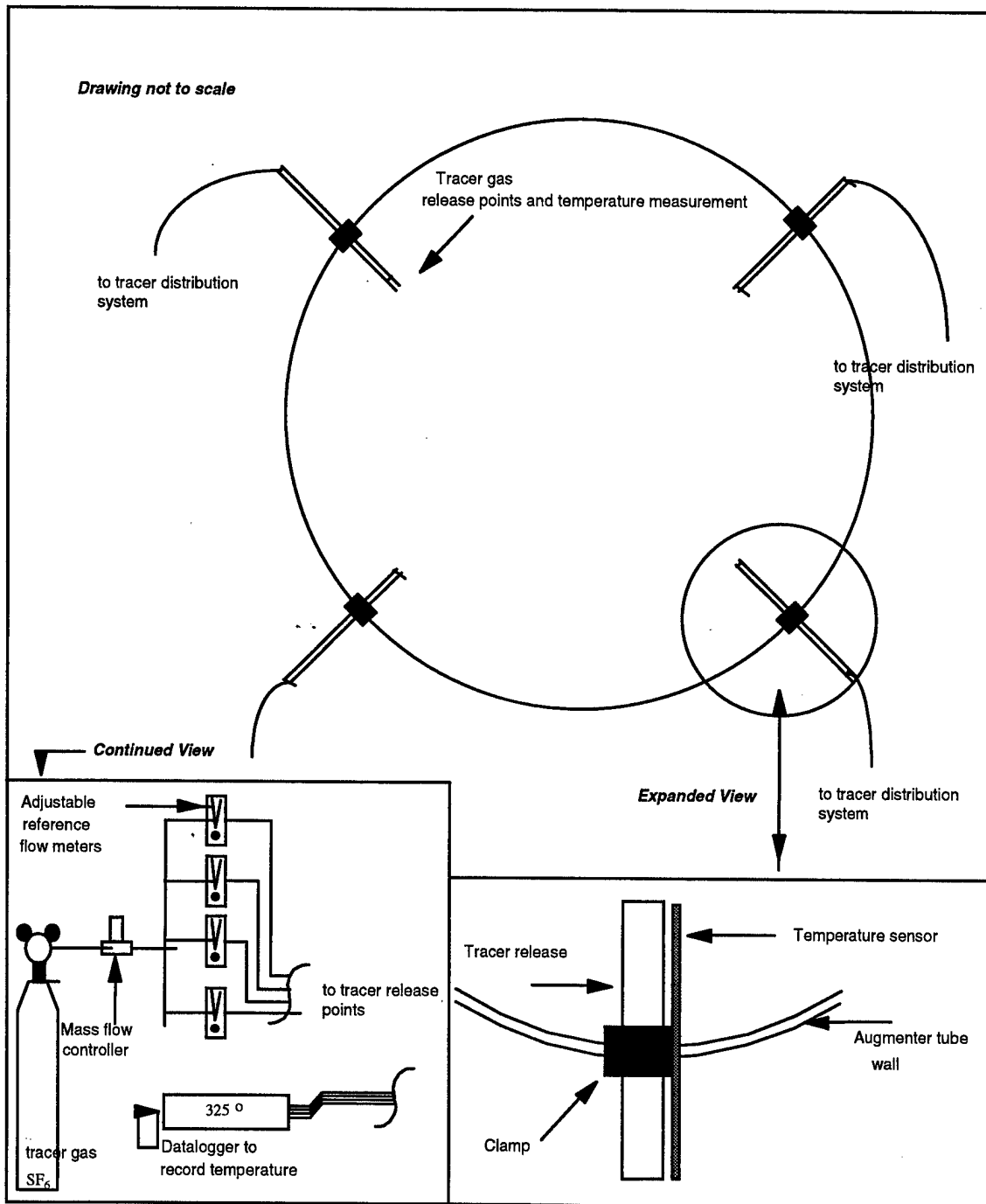

Test Report

Volume: 3

Section: 2.0

Revision: 2

Date: November 1998

Page: 56 of 57

**Figure 2-40. Barnes Air National Guard Base Tracer Collection Points**

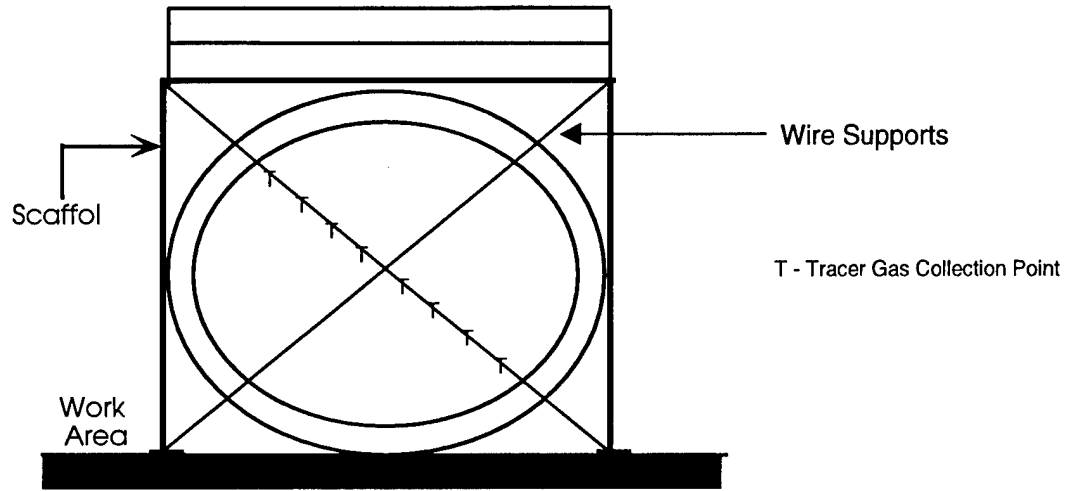

View Looking from Blast Box into Augmenter

Test Report

Volume:	<u>3</u>
Section:	<u>2.0</u>
Revision:	<u>2</u>
Date:	<u>November 1998</u>
Page:	<u>57 of 57</u>

ketones) as well as the CEM inlet were set up on top of the augments tube at the exhaust exit. A vertical sampling probe was extended from each train, down into the engine exhaust stream at approximately the top third of the augments tube cross-section. Samples were collected from a single point in the same manner as was done for Kelly AFB, Tinker AFB, Charleston AFB, and Edwards AFB. The sample probes were secured with cable in the face of the exhaust stream.

To verify that the sample location was representative of the entire engine exhaust, the tracer gas concentration was monitored at approximately eight locations across the end of the augments tube. The gas stratification and exhaust flow rate were determined through the use of tracer gas. The eight tracer gas intake points were secured in the exhaust stream via cables.

Test Report	
Volume:	<u>3</u>
Section:	<u>3.0</u>
Revision:	<u>1</u>
Date:	<u>November 1998</u>
Page:	<u>1 of 16</u>

## SECTION 3

### EXHAUST FLOW DETERMINATION

The calculation of particulate emission rates for this test program required determination of the total exhaust flow (combustion products plus excess air). The total exhaust flow is required to quantify mass emission rates for the parameters measured. The concentration of each pollutant is incorporated with the exhaust flow rate to calculate the mass emission rate.

The sampling locations for four of the engines contained a single accessible exhaust duct, and conventional EPA test methods were used to determine the exhaust flow rate at those locations. These facilities included the APU test cell at Kelly AFB, Test Cell 14 at Corpus Christi Army Depot, and the test cell at the Naval Aviation Depot, Cherry Point. Test locations at Kelly AFB, Laughlin AFB, Tinker AFB, Charleston AFB, Edwards AFB, and Barnes ANGB were not configured to permit flow measurement using traditional EPA methods. This section provides descriptions of the four alternate flow measurement techniques that were used to calculate flow rate at each of these locations. These measurement techniques are the following:

- Carbon balance for the calculation of inlet and total exhaust flow.
- F-factor for the calculation of inlet and total exhaust flow.
- Tracer gas concentration for total exhaust flow.
- Mass flow meters for measurement of inlet airflow.

Each method has advantages, disadvantages, and limitations that vary in significance depending on the specific conditions of each test run. The objective of the test program was to evaluate all flow measurement/calculation methodologies and results and select the most representative methodology for each engine and setting.

### 3.1 CALCULATION OF AIRFLOW USING CARBON BALANCE

This method was used to calculate both inlet and outlet airflow rates using a carbon mass balance. Conservation of matter requires that the total carbon mass rate in the exhaust (MCE) equal the sum of the total carbon mass rate in the fuel (MCF) and the carbon mass rate in the inlet air (MCI).

$$MCE = MCF + MCI \quad (\text{Equation 1})$$

A similar conservation of total mass states that the total mass rate in the exhaust (ME) equals the total mass rate in the fuel (MF) plus the total mass rate at the inlet (MI).

$$ME = MF + MI \quad (\text{Equation 2})$$

Finally, the mass rate of carbon also can be derived as the total mass rate at each location, times the percent carbon by weight (% C<sub>x</sub>) in each stream.

$$MCE = ME \times \% C_e / 100 \quad (\text{Equation 3})$$

$$MCF = MF \times \% C_f / 100 \quad (\text{Equation 4})$$

$$MCI = MI \times \% C_i / 100 \quad (\text{Equation 5})$$

The percent carbon by weight can be measured in all streams and the mass rate of fuel burned also can be measured. This leaves four unknown variables (ME, MI, MCE, and MCI) and five independent equations.

To solve for inlet mass flow rate, substitute Equation 2 into Equation 3.

$$MCE = (MF \times \% C_f / 100) + (MI \times \% C_e / 100)$$

Then substitute that equation into Equation 1.

$$(MF \times \% C_f / 100) + (MI \times \% C_e / 100) = MCF + MCI$$

Substitute Equations 4 and 5 to get:

Test Report

Volume:	3
Section:	3.0
Revision:	1
Date:	November 1998
Page:	3 of 16

$$(MF \times \% C_o/100) + (MI \times \% C_o/100) = (MF \times \% C_f/100) + (MI \times \% C_f/100)$$

Rearrange factors to get the inlet mass rate.

$$MI = MF \left( \frac{\% C_f - \% C_e}{100} \right) / \left( \frac{\% C_e - \% C_i}{100} \right)$$

By similar derivation, rearrange Equation 2, substitute into Equation 5, substitute the results into Equation 1, and then substitute Equations 3 and 4 to get the following:

$$MI = ME - MF \quad \text{(Equation 2)}$$

$$MCI = (ME \times \% C_f/100) - (MF \times \% C_f/100) \quad \text{(Equation 5 using Equation 2)}$$

$$MCE = MCF + (ME \times \% C_f/100) - (MF \times \% C_f/100) \quad \text{(Equation 1 using Equation 5)}$$

$$\left( ME \times \frac{\% C_e}{100} \right) = \left( MF \times \frac{\% C_f}{100} \right) + \left( ME \times \frac{\% C_i}{100} \right) - \left( MF \times \frac{\% C_i}{100} \right) \quad \text{(Substitute Equations 3 \& 4)}$$

$$ME = MF \left( \frac{\% C_f - \% C_i}{100} \right) / \left( \frac{\% C_e - \% C_i}{100} \right)$$

The mass emission rates can be converted to volumetric flow rates by dividing by molecular weight and multiplying by standard volume. For example:

$$QE = \frac{ME \times 385.35}{MW_e}$$

Where:

$$QE = \text{Wet standard volumetric flow rate, } \frac{\text{wscf}}{\text{min}}$$

$$ME = \text{Total exhaust flow rate, } \frac{\text{lb}}{\text{min}}$$

$$MW_e = \text{Wet molecular weight exhaust stream, } \frac{\text{lb}}{\text{lb mole}}$$

$$385.35 = \text{Standard molar volume, } \frac{\text{scf}}{\text{lb mole}}$$

Test Report

Volume:	<u>3</u>
Section:	<u>3.0</u>
Revision:	<u>1</u>
Date:	<u>November 1998</u>
Page:	<u>4 of 16</u>

The fuel mass rate was measured directly during each test run, and the % C<sub>i</sub> was determined by the fuel analysis.

The wet molecular weights of the exhaust gas streams was determined by EPA Reference Methods 3A and 4 (40 CFR 60). These methods measure the percent moisture (% M) of the gas stream and percent carbon dioxide (% CO<sub>2</sub>) and oxygen (% O<sub>2</sub>) in the gas stream on a dry basis, which was used to calculate the molecular weight as follows:

$$MW_e = \left[ \left\{ (\% CO_2 \times 0.44) + (\% O_2 \times 0.32) + ((\% CO + \% N_2) * 0.28) \right\} * \left( 1 - \frac{\% M}{100} \right) \right] + (\% M \times 0.18)$$

Where:

% M = Moisture content as a percent.

For the purpose of calculating a molecular weight, (% CO + % N<sub>2</sub>) is assumed to be (100- % CO<sub>2</sub> - % O<sub>2</sub>). Calculation of the carbon content of the exhaust gas stream used the % CO<sub>2</sub> as determined by Method 3A, plus additional measurements of carbon monoxide (% CO) and total hydrocarbons (% THC) by EPA Reference Methods 10 and 25A (40 CFR 60, Appendix A), respectively. The % THC is stated on the basis of methane (CH<sub>4</sub>). The carbon monoxide (CO) and carbon dioxide (CO<sub>2</sub>) concentrations were measured on a dry basis and were converted to a wet basis using the measured moisture content of the exhaust gas. THC was measured on a wet basis.

$$\% CO_2 \text{ (wet)} = \% CO_2 \text{ (dry)} \times \left( 1 - \frac{\% M}{100} \right)$$

$$\% CO \text{ (wet)} = \% CO \text{ (dry)} \times \left( 1 - \frac{\% M}{100} \right)$$

Test Report	
Volume:	<u>3</u>
Section:	<u>3.0</u>
Revision:	<u>1</u>
Date:	<u>November 1998</u>
Page:	<u>5 of 16</u>

The total carbon content of the exhaust gas stream is equal to the sum of % CO<sub>2</sub>, % CO, and % THC on a wet basis times the ratio of carbon molecular weight to the total wet molecular weight of the gas stream.

$$\% C_e = (\% CO_2 \text{ wet} + \% CO \text{ wet} + \% THC) \times \frac{12.01}{MW_e}$$

A similar calculation is required for the inlet air volumetric flow rate, but the following simplifying assumptions can be made:

- Dry ambient air is composed of 20.9% oxygen and 79.1% nitrogen.
- Ambient humidity represents the moisture content of the inlet air.

The major drawback to this measurement method is the use of extremely low carbon concentration values at the inlet, and relatively low concentrations at the exhaust compared with the very high carbon concentrations in the fuel. As excess air increases, the inlet flow becomes indistinguishable from the outlet flow. The major advantage of this procedure is that the only additional data that are required to calculate flow are the inlet flow; CO, CO<sub>2</sub>, and THC values; and ambient humidity.

### 3.2 CALCULATION OF AIRFLOW USING F-FACTORS

F-factors relate the volume of combustion products to the heat content of fuel. F-factors generally are used for combustion sources when the exhaust stream flow rate is known but the fuel heat input must be determined. In this case, the fuel input was determined but the exhaust stream flow rate needed to be determine. The F-factor relationship was used to calculate the total airflow based on the fuel-firing rate.

F-factors are published for a variety of fuels and usually are expressed in units of dry standard cubic feet per British thermal unit [(dscf/Btu or dscm/joule (J)]. For this test program, specific F-factors were determined through ultimate analysis (i.e.,



Test Report

Volume:	<u>3</u>
Section:	<u>3.0</u>
Revision:	<u>1</u>
Date:	<u>November 1998</u>
Page:	<u>6 of 16</u>

hydrogen, carbon, sulfur, nitrogen, and oxygen) of the fuel components on a weight percent basis and fuel density (lb/gal).

To determine the air volumetric flow rate, the following additional information was required:

- Concentrations of oxygen, carbon monoxide, and moisture content in the exhaust stream after combustion.
- Fuel firing rate, gallons per minute (gal/min).

The F-factor, dry basis, can be calculated from the ultimate analysis of the jet fuel as follows:

$$F_d = K[(K_{hd} \% H) + (K_c \% C) + (K_s \% S) + (K_n \% N) - (K_o \% O)]/GCV$$

(Equation 19-13, 40 CFR 60, Appendix A, Method 19)

If the heat input components (K, GCV) are eliminated from the equation, an F-factor based on fuel mass is derived.

$$F_{md} = [(K_{hd} \% H) + (K_c \% C) + (K_s \% S) + (K_n \% N) - (K_o \% O)]$$

Where:

$F_d$  = Volume of combustion components per unit of heat content, scf/million Btu.

$F_{md}$  = Volume of combustion component on a dry basis per pound of fuel, scf/lb.

% H, % C, % S, % N, % O = Weight percents of hydrogen, carbon, sulfur, nitrogen, and oxygen in the jet fuel.

GCV = Gross calorific value of the fuel consistent with the ultimate analysis, Btu/lb.

K = Conversion factor,  $10^{-5}$ .

$K_{hd}$  = 3.64 (scf/lb)/(%).

$K_c$  = 1.53 (scf/lb)/(%).

$K_s$  = 0.53 (scf/lb)/(%).

$K_n$  = 0.14 (scf/lb)/(%).

$K_o$  = 0.46 (scf/lb)/(%).

Test Report

Volume:	3
Section:	3.0
Revision:	1
Date:	November 1998
Page:	7 of 16

Stoichiometric combustion calculations assume that the carbon in the fuel is burned completely to produce carbon dioxide and water with no excess air (and no significant formation of nitrogen dioxide or carbon monoxide). The air stoichiometric volumetric flow rate (dry basis) can be determined by simply multiplying the measured fuel-firing rate by the F-factors.

$$\left( \text{Fuel firing rate, } \frac{\text{gal}}{\text{min}} \right) \left( \text{fuel density, } \frac{\text{lb}}{\text{gal}} \right) \left( F_{\text{md}}, \frac{\text{scf}}{\text{lb}} \right)$$

$$= \text{dry combustion air flow, } \frac{\text{scf}}{\text{min}}$$

The percent excess air (EA) during actual combustion can be calculated using the following formula:

$$\% \text{ EA} = \left[ \frac{\% \text{ O}_2 - 0.5\% \text{ CO}}{20.9 - (\% \text{ O}_2 - 0.5\% \text{ CO})} \right] \times 100$$

Where:

% O<sub>2</sub>, % CO = Measured percents of oxygen, and carbon monoxide, in the exhaust gas. 20.9 is the percent dry oxygen in ambient air.

Total dry combustion flow (including) excess air equals:

$$\text{Total dry air flow} = \left[ (\text{dry combustion air flow}) \left( 1 + \frac{\% \text{ EA}}{100} \right) \right]$$

This simplifies to:

$$\text{Total dry combustion flow, } \frac{\text{scf}}{\text{min}} = (\text{dry combustion air})$$

$$* \left( \frac{20.9}{20.9 - \% \text{ O}_2 + 0.5 \% \text{ CO}} \right)$$

Test Report

Volume:	<u>3</u>
Section:	<u>3.0</u>
Revision:	<u>1</u>
Date:	<u>November 1998</u>
Page:	<u>8 of 16</u>

The inlet airflow is equal to the total dry combustion air plus the fraction of oxygen in the inlet used for the combustion of hydrogen in the fuel. The nitrogen associated with this oxygen fraction of the inlet air was included in the  $F_d$  calculation.

This inlet oxygen fraction can be derived from the same F-factor calculations presented in EPA Method 19.

$$F_{mo} = K [K_{hi} \% H]$$

Where:

$F_{mo}$  = Volume of inlet oxygen used to combust hydrogen per unit of fuel fired, scf/lb.

$K_{hi}$  = 0.96 (scf/lb)/%.

% H = Weight percent of hydrogen in the fuel as stated previously.

Then the total dry inlet airflow is the following:

$$\text{Dry inlet air} = \left[ \text{fuel firing rate, } \frac{\text{gal.}}{\text{min}} \right] \left[ \text{fuel density, } \frac{\text{lb}}{\text{gal.}} \right] [F_{md} + F_{mo}]$$

$$* \left[ \frac{20.9}{20.9 - \% O_2 + 0.5 \% CO} \right]$$

The inlet air then can be corrected back to actual conditions using the ambient temperature and humidity. The total exhaust flow can be adjusted to actual conditions using the measured exhaust moisture content and temperature.

There are limitations to the use of these F-factors for calculations of airflow from jet engines. The concentration of carbon monoxide in the combustion stream normally is so low that it is insignificant in the excess air calculation, but it has been included to cover operation during periods of incomplete combustion. If the combustion is so incomplete that large quantities of the fuel are exhausted as carbon (soot) or volatile hydrocarbons (THC), the % C of the fuel must be reduced to account for the reduced formation of combustion products.

Test Report	
Volume:	<u>3</u>
Section:	<u>3.0</u>
Revision:	<u>1</u>
Date:	<u>November 1998</u>
Page:	<u>9 of 16</u>

The second limitation is that high levels of excess air are present. At high excess air levels, the carbon monoxide concentration becomes zero, but the oxygen content of the combustion gas approaches ambient concentrations (20.9 % O<sub>2</sub>). The excess air equation becomes unreliable at a concentration at or near 20.9 % oxygen as this equation is undefined due to division by zero. As a general rule, these F-factor calculations will be unreliable any time the combustion gas contains more than 18.5 % oxygen.

### 3.3 CALCULATION OF AIRFLOW USING TRACER GAS

At Kelly AFB Test Cells 58 and 54A, Laughlin AFB, Tinker AFB Test Cell 10, Charleston AFB Test Cell, Edwards AFB Test Cells 2 and 4, and Barnes Air National Guard Base, flow could not be measured by EPA Reference Methods. The exhaust flow was calculated from tracer gas dilution ratios. In the tracer gas flow measurement technique, a precise mass flow of the sulfur hexafluoride (SF<sub>6</sub>) tracer gas was injected into the exhaust stream after the engine and sampled at the exhaust of the test cell to the atmosphere. The tracer gas flow calculation is based on the assumption that the SF<sub>6</sub> is dispersed uniformly throughout the exhaust gas. If this assumption is correct, then the following flow determination is valid simply by mass balance.

- The tracer gas flow calculation is based on the assumption that the SF<sub>6</sub> is dispersed uniformly throughout the exhaust gas.

$$S_m = Q_s \times C_s \times K$$

Where:

- Q<sub>s</sub> = Total exhaust flow, cubic meters per minute (m<sup>3</sup>/min), wet basis.
- S<sub>m</sub> = Metered injection of SF<sub>6</sub>, milligrams per minute (mg/min).
- C<sub>t</sub> = Concentration of SF<sub>6</sub> in sample, parts per billion (ppb).
- C<sub>s</sub> = Average concentration of SF<sub>6</sub> in the exhaust gas.
- K = Physical constants required to attain consistent units.

Test Report

Volume:	<u>3</u>
Section:	<u>3.0</u>
Revision:	<u>1</u>
Date:	<u>November 1998</u>
Page:	<u>10 of 16</u>

Since the SF<sub>6</sub> is distributed uniformly, then the concentration in any sample will be equal to the average concentration; thus, by substitution and rearrangement, the following calculation can be derived:

$$Q_s \frac{\text{m}^3}{\text{min}} = \frac{1.64795 \times 10^5 \text{ Sm}}{C_f}$$

Where:

1.6745 x 10<sup>3</sup> = Conversion constants times standard molar volume divided by molecular weight of SF<sub>6</sub>  $\left[ \left( \frac{24.05 \times 10^{-3} \text{ m}^3}{\text{gm - mole}} \right) \times \left( \frac{\text{gm - mole}}{146 \text{ gm}} \right) \times \left( \frac{10^{-3} \text{ g}}{\text{mg}} \right) \times \left( \frac{\text{ppb}}{1 \times 10^{-9}} \right) \right]$   
 with units of  $\frac{\text{m}^3 - \text{ppb}}{\text{mg}}$

The flow rate calculation was presented on a metric basis for clarity. All flow rates and emissions were presented in both English and metric units.

Tracer gas was used as the primary method for flow determination, and carbon balance was used as the secondary method. Flow rates by F-factor were highly erratic and not comparable to either tracer gas or carbon balance. Differences were due to the high oxygen measurements resulting from high dilution of the exhaust gases. F-factor calculations would have been more reasonable if the measured oxygen results were not near ambient levels. By comparison, tracer gas and carbon balance showed good agreement. However, carbon balance is also a calculated flow and the exhaust gases were highly diluted with ambient air. Therefore, small differences in measured gaseous concentrations by the CEM resulted in occasional erratic results for carbon balance. The tracer gas method was biased at certain engine settings due to pollutant interference and sampling difficulties.

Ethylene was present as a product of incomplete combustion at all engine conditions, with the highest levels occurring in the afterburner mode. Ethylene

Test Report

Volume:	<u>3</u>
Section:	<u>3.0</u>
Revision:	<u>1</u>
Date:	<u>November 1998</u>
Page:	<u>11 of 16</u>

concentrations were negligible when they were in the same range as the SF<sub>6</sub>. In the afterburner mode, ethylene concentrations were several orders of magnitude greater than the SF<sub>6</sub> infrared signature. Ethylene presented itself as an interferent in data analysis. The ethylene peak had to be subtracted from the SF<sub>6</sub>, which tended to reduce the total SF<sub>6</sub> response and resulted in a high biased calculated flow rate.

During the first phase of testing (Kelly AFB, CCAD, Laughlin AFB, and Tinker AFB), tracer gas was collected at up to eight points across the exhaust face. Each sample was drawn into a tedlar bag and a pump set at a constant rate. This system provided adequate results but at times the bags would leak, the power to the pump would be lost, or the bag sample would be lost due to high winds. This collection method was improved.

During the second phase (testing conducted at Charleston AFB, Edwards AFB, and Barnes ANG Base) of the engine testing program, a simplified tracer gas collection system was used. This system consisted of eight sample points placed across the test cell/hush house exhaust. Samples from each point were drawn through a heated sample line directly to the FTIR for analysis. Each point was sampled individually. One sample was drawn from each point and was measured during a one-hour period. Because of the consistent nature of emissions from the engines, concentrations at each tracer gas sample point did not vary over time and thus integrated sampling was not necessary. Also during the second phase of the monitoring program, a standardized approach was adopted on how tracer gas could be uniformly distributed with the engine exhaust. The new approach adopted during the second phase of the monitoring program significantly reduced the biases encountered from tracer gas distribution and sample collection that occurred during previous engine testing. Though the tracer gas method was improved, all flow data, calculated and measured, and engine operations data was reviewed before selecting a method for flow determination.

### 3.4 MEASUREMENT OF INLET AIRFLOW

In the early stages of the test program, the inlet flow was measured in an attempt to provide a fourth data point to evaluate. At four test locations, up to 12 mass flow meters (anemometers) were attached to the inlet air screens. Each mass flow meter was fixed in a stub stack constructed from a short piece of 6-inch-diameter duct. The arrangement was different for the four test cells requiring anemometer inlet measurements. A description of the anemometer arrangement follows:

Tinker AFB Test Cell 9 - 12 anemometers were positioned inside the inlet stack, three per side. The placement was centered on the three equal areas that comprise each side to the extent that was possible from the catwalk access.

Kelly AFB Test Cell 58 - 12 anemometers were placed in a 4 x 3 grid across the screen that was in place at the inlet. Each grid section represented 1/12th of the total inlet area, consistent with EPA Reference Method 1.

Kelly AFB Test Cell 54A - The 12 anemometers were positioned across this opening by attaching them to the grid at locations representing equal areas, consistent with EPA Reference Method 1.

Laughlin AFB Test Cell - 6 anemometers were positioned across each of 2 inlet screens by attaching them at locations representing equal areas, consistent with EPA Reference Method 1.

The flow calculation averaged the flow measurements made over the equal areas to determine total flow. If one equal area was inaccessible due to safety concerns, that area was weighted equally with the average of the other measurements. Blocked areas were considered as zero flow. The sum of the airflow measured by the mass flow meters was multiplied by the ratio of the inlet area to the sum of the area of the 12 assemblies to determine inlet flow.

$$Q_i = \frac{A_i \cdot K}{2.3562} \times \sum m_i$$

Test Report	
Volume:	<u>3</u>
Section:	<u>3.0</u>
Revision:	<u>1</u>
Date:	<u>November 1998</u>
Page:	<u>13 of 16</u>

Where:

$Q_i$  = Inlet airflow, standard cubic feet per minute (scfm).

$A_i$  = Inlet duct area, square feet (ft<sup>2</sup>).

2.3562 = Total area of 6-inch mass flow measurement assemblies, ft<sup>2</sup>.

$K$  = Conversion factors for air at standard conditions,  $0.2227 \frac{\text{scf} \cdot \text{hr}}{\text{lb} \cdot \text{min}}$ .

$\sum m_i$  = Sum of mass flow meter measurements, pounds per hour (lb/hr).

This method was intended to be used in conjunction with the tracer-gas-flow measurement method. It had the advantage of simplicity since the data from the 12 flow meters was collected in a data logger and required minimal attention after installation. The major disadvantage of this method was the assumption of uniform flow across the inlet. At some inlet locations, wind direction and speed altered the flow distribution. Also it is suspected that turbulence around the flow meters biased the results. The measured inlet flows did not compare well to the calculated and tracer outlet flow methods. Therefore, the inlet flow measurements misrepresent the total flow and are not included in this report. The test cell inlet flow was not measured at Charleston AFB, Edwards AFB, Naval Aviation Depot Cherry Point, and Barnes Air National Guard Base.

### 3.5 COMPARISON OF EXHAUST FLOW DETERMINATION METHOD WITH HISTORICAL EMISSION CALCULATION METHODOLOGY

A review was made of the SAE Aerospace Information Report 1533, "Procedure for the Calculation of Basic Emission Parameters for Aircraft Turbine Engines" in an effort to complete particular emission index calculations for comparison with the results published in this report. In brief, the emission index values that were calculated using the carbon balance volumetric flowrate were nearly identical to the values that are



Test Report  
Volume: 3  
Section: 3.0  
Revision: 1  
Date: November 1998  
Page: 14 of 16

determined by the SAE 1533 calculation. This is not surprising because the two methods are based on the same mass balance principles.

The SAE 1533 procedure is based on a mass balance for the combustion equation with  $\text{CO}_2$ ,  $\text{CO}$ ,  $\text{C}_x\text{H}_y$ ,  $\text{NO}/\text{NO}_2$ , and  $\text{H}_2\text{O}$ . The intent of the method is to determine an emission index (lb pollutant/ 1000 lb fuel) by measuring only  $\text{CO}_2$ ,  $\text{CO}$ ,  $\text{NO}/\text{NO}_2$  and THC (as  $\text{C}_1\text{H}_a$ ) in the exhaust, and analyzing the fuel. A significant portion of the procedure is spent determining instrument measurement interferences that have been eliminated by improvements in instrument design since 1982. The instruments used during the test program (with the exception of the  $\text{CO}_2$  analyzer) are not affected by the type of interferences treated in the method, and the  $\text{CO}_2$  analyzer is now measured on a dry basis to remove the known  $\text{H}_2\text{O}$  interference. Other details of the mass balance manipulations are not meaningful for our specific program because of the large amount of excess air present in the test cell exhaust. The SAE 1533 method also assumed a steady inlet  $\text{CO}_2$  concentration of 320 ppm. The measurements throughout this test program indicated the test cells frequently experienced an elevated  $\text{CO}_2$  level.

Despite these differences, it was relatively easy to input actual test cell concentration measurements for  $\text{CO}_2$ ,  $\text{CO}$ , THC (as  $\text{CH}_4$ ),  $\text{NO}_x$  (as  $\text{NO}_2$ ), as well as a few fuel parameters and ambient humidity, to calculate the emission indexes which are compared to the results reported in this section. Corrections for measured concentrations of  $\text{CO}_2$  and THC at the inlet were included in the calculations. Table 3-1 presents the comparison of emission indices between calculation methods for the F101-GE-102 engine from Tinker AFB at idle, military, and afterburner.

Test Report	
Volume:	<u>3</u>
Section:	<u>3.0</u>
Revision:	<u>1</u>
Date:	<u>November 1998</u>
Page:	<u>15 of 16</u>

**Table 3-1. Emission Index Comparison**

<b>F101-GE-102 (B-1B)</b>			
<b>Engine Setting</b>	<b>NOx (lbs/1,000 lbs fuel)</b>	<b>CO (lbs/1,000 lbs fuel)</b>	<b>THC (lbs/1,000 lbs fuel)</b>
IDLE SAE1533	3.67	20.62	0 <sup>1</sup>
EQ/WESTON – Carbon Balance	3.47	20.70	0 <sup>1</sup>
EQ/WESTON – Tracer Gas	4.10	24.47	0 <sup>1</sup>
MILITARY SAE1533	11.36	0.768	0.17
EQ/WESTON – Carbon Balance	11.62	0.75	0.10
EQ/WESTON – Tracer Gas	12.83	0.83	0.37
<b>Afterburner</b>			
SAE1533	16.19	44.33	61.09
EQ/WESTON – Carbon Balance	16.69	42.94	61.03
EQ/WESTON – Tracer Gas	16.91	43.47	61.82

<sup>1</sup> The measured outlet concentration was less than the measured inlet concentration.

The close comparison between the values calculated in this report and the values calculated by the SAE 1533 method was expected. As stated previously, the SAE Method uses an extensive mass balance equation, which at one point was used to determine the fuel to air ratio of the exhaust. The fuel-to-air ratio is directly dependent on the volumetric flowrate of the exhaust. This fuel-to-air ratio was then used to calculate the emission index. The carbon balance calculation used in this report's procedure focuses on the single carbon mass balance to determine the fuel-to-air ratio, then uses the measured fuel consumption to solve for the volumetric flow rate. The

Test Report

Volume: 3  
Section: 3.0  
Revision: 1  
Date: November 1998  
Page: 16 of 16

volumetric flow rate was then used to calculate the mass emission rate, and the mass rate was converted back to the emission index by dividing by fuel consumption.

Test Report	
Volume:	<u>3</u>
Section:	<u>4.0</u>
Revision:	<u>2</u>
Date:	<u>November 1998</u>
Page:	<u>1 of 105</u>

## SECTION 4

### RESULTS

Particulate matter was sampled by a custom Method 5 procedure at Kelly AFB, Laughlin AFB, Tinker AFB, Charleston AFB, Edwards AFB, and Barnes ANGB. The procedures used in the custom method are described in Section 1 of this volume. Particulate matter results, which were obtained utilizing strict EPA Method 5 Protocol (full traverse), are also presented in this Volume. The following sections discuss the particulate matter emission results. The results are discussed to note data outliers, pollutant trends, and pollutant corrections for ambient concentrations.

#### 4.1 CORRECTION OF PARTICULATE DATA FOR BACKGROUND CONCENTRATIONS

The concentration of particulate matter measured in the exhaust stream was corrected for ambient background concentrations. The following hierarchy was used in the correction of the source (engine exhaust) data.

- If the exhaust concentration was below the analytical detection limit, then the value reported is the method detection limit.
- If both the exhaust and the ambient background concentrations are above the detection limit, the ambient value is subtracted from the source value. If the ambient sample exhibited excessive blank contamination, the source value was not corrected for ambient background.
- Ambient corrections for the F118-GE-100 engine were not made. The engine exhaust was re-entrained into the test where the ambient sampling equipment was located. These ambient data were biased high.

Test Report	
Volume:	<u>3</u>
Section:	<u>4.0</u>
Revision:	<u>2</u>
Date:	<u>November 1998</u>
Page:	<u>2 of 105</u>

The correction of the source data with the ambient data was based on the concentrations measured. Correction was possible because the mass of air entering the test cell was nearly equal to the mass exiting the test cell. The increase in mass flow at the exhaust as a result of fuel combustion was negligible.

Particulate matter collected as part of the filterable portion of the sample train was corrected for the ambient background particulate concentration level. The condensable particulate portion of the sample was not corrected for ambient concentrations. Total particulate matter reported in this section is equal to the sum of the filterable particulate, corrected for the ambient background, and condensable particulate.

#### 4.1.1 Calculation of Pollutant Averages

The particulate matter emission averages are typically the average of each of the three sample runs. If a sample run was void, however, the data is not included in the average.

#### 4.2 SOURCE ANALYTICAL DATA

Blank samples were collected for each sample group. Where appropriate, the analytical results were adjusted to reflect constant blank contamination in the sample media.

All particulate data were corrected for solvent blank contamination as specified by EPA Methods 5 and 202. The filterable particulate portion of the sample was corrected for residue found in the acetone blank sample. The condensable portion was corrected for residue in both the distilled water and methylene chloride blank samples.

A substantial influence in the particulate sample results and other measured parameters was the amount of dilution air that was present in the exhaust stream. Dilution air was the result of both ambient air drawn through the non-combustion

Test Report	
Volume:	<u>3</u>
Section:	<u>4.0</u>
Revision:	<u>2</u>
Date:	<u>November 1998</u>
Page:	<u>3 of 105</u>

portion of the engines and from the induced draft through the test cell from engine operation. The addition of dilution air resulted in very low particulate concentrations at the exhaust. The low particulate concentrations at the exhaust were compounded by the fact that many of the newer engines emit lower quantities of pollutants. This resulted in particulate concentrations that were near the method detection limit.

Results near a method detection limit fluctuate as a result of normal method variability.

For particulate sampling, method variability is the combination of three factors: analytical, sample media, and sample collection variability. Both analytical and sample media variability can be estimated based on the method allowable differences and results from media blanks. Sample collection variability is more uncertain and can be based on many factors including sampling technique, sample recovery and cleanup methods, and the individual performing each task. Therefore it is difficult to quantify. The analytical method requires that each pre-test and post-test sample fraction be weighed a minimum of two times with the difference between the two weighings not to exceed +/- 0.5 mg. This would equate to a maximum variation of 0.25 mg/m<sup>3</sup> based on both pre and post sample weights and a 70-cubic foot sample volume. The results from media blank samples also vary and are dependent on several factors: media lot, blank media collection methods, laboratory handling, and analytical procedures. Based on several blanks collected during this program, it was not uncommon to have variations of 1.0 mg for the same media. The levels of contamination or the variation are not significant but indicate that variations between individual samples do occur due to handling and analytical practices. A variation of 1.0 mg would equate to 0.5 mg/m<sup>3</sup>. Sample results were extremely low and results from individual particulate runs were often less than 2.0 mg/m<sup>3</sup> where method variability would have a significant influence.

To decrease the effects of method variability, the sample size was increased. This was done for all sampled parameters that benefited from an increased sample size. The particulate sample size collected was generally greater than 70 cubic feet (normally 30-50 cubic feet are collected in a typical test) over a one-hour sample period

Test Report	
Volume:	<u>3</u>
Section:	<u>4.0</u>
Revision:	<u>2</u>
Date:	<u>November 1998</u>
Page:	<u>4 of 105</u>

while maintaining an isokinetic sampling rate (70 cubic feet is near the limit for the sampling equipment over a one-hour period). Alternatively, sample size can also be increased by extending the sample period. This was performed for the other methods, but it was thought beneficial to see if there was variability from run to run for the particulate samples. It appears the variability in the results is from method variability rather than engine variability. The conclusion is supported by the CEM data, which showed virtually no difference from hour to hour, indicating that combustion parameters, which affect particulate emissions, remained constant. The three-run average for the particulate samples accounts for method variability and therefore presents the most representative value.

### 4.3 ENGINE SPECIFIC EMISSION DISCUSSION

This section provides descriptions of any testing or operational anomalies that occurred during this sampling program. This section is designed to supplement and provide additional information so emissions for each engine can be properly evaluated. The tabulated emission results follow each one of the discussion sections. Please note that particulate matter emission factors for the GTCP85-180, GTCP165-1, T700-GE-700 and T64-GE-100 are provided in the following sections. These engines were tested at facilities where strict EPA Method 5 procedures were followed. In addition, the following sections contain particulate matter results for the remaining engines, which were sampled using a custom Method 5 sampling procedure. These results were calculated using flowrates calculated by tracer gas dilution and carbon balance. The results are currently under review and will therefore be treated as sampling data for emission estimation as opposed to emission factors.

All emissions data are reported as pounds per hour (lb/hr) and pounds per 1,000 pounds of fuel usage (lbs/1,000 lbs fuel). The average of the three runs for each engine condition is also reported. Emission rate averages include both detected values and the values that are reported as the detection limit. When a run was lost for any

reason, however, a blank is shown in the summary table and the reason for losing the run is discussed in the write-up preceding the tables.

The origin of the flow method (tracer gas, carbon balance, F-factor) used to calculate the emissions data is noted in the header of each table. Flow rate was calculated by tracer gas, carbon balance calculation, or F-factor calculation.

A review of individual sampling runs for the same engine power setting identified inconsistencies between the runs. The evaluation of the significance of the run-to-run differences is made more difficult because many of the samples were at or near the detection limit of the method. This is the result of analytical and sampling method uncertainties that occur at, or near, the detection limit. It is important to note that the relative differences in mass loading are very small even though the relative concentration is sometimes two to three times that of another run at the same engine setting. As the measured concentration increases, the percent difference between replicate samples decreases. Uncertainties are reduced when sample results are not near the detection limit. A general summary of the particulate results obtained using the custom Method 5 procedure is provided in Table 4-1.



**Table 4-1  
Particulate Matter Emission Summary**

Engine/Setting	Fuel Flow lbs/hr	Filterable Particulate		Total Particulate	
		lbs/hr	lbs/1,000 lb fuel	lbs/hr	lbs/1,000 lb fuel
<b>T56-A-7</b>					
Idle	724	1.27	1.75	2.63	3.64
Approach	880	1.47	1.67	3.38	3.85
Intermediate	1742	1.57	0.90	2.54	1.46
Military	2262	2.01	0.89	2.76	1.22
<b>TF39-GE-1C</b>					
Idle	1448	0.59	0.41	4.05	2.77
Approach	10477	7.92	0.75	12.52	1.19
Intermediate	12541	6.47	0.52	11.15	0.89
Military	13862	5.77	0.42	16.40	1.18
<b>GTCP85-180 (APU)</b>					
Constant Setting	270	0.15	0.55	0.19	0.72
<b>GTCP165-1 (APU)</b>					
Constant Setting	273	0.09	0.35	0.13	0.48
<b>J69-25</b>					
Idle	167	0.28	1.68	0.53	3.16
Intermediate	872	0.47	0.54	0.82	0.93
Military	1085	0.32	0.29	0.73	0.67
<b>J85-5A</b>					
Idle	434	0.35	0.68	2.40	4.70
Intermediate	950	0.88	1.10	1.43	1.79
Military	2740	2.68	1.08	2.79	1.13
Afterburner (Zone 1)	8138	1.26	0.16	1.93	0.25
<b>F110-GE-100</b>					
Idle	1111	1.65	1.49	2.89	2.61
Approach	5080	2.34	0.46	6.94	1.37
Intermediate	7332	1.22	0.17	4.22	0.57
Military	11358	1.58	0.14	1.58	0.14
Afterburner (Zone 1)	18088	6.72	0.37	60.57	3.34

**Table 4-1  
Particulate Matter Emission Summary**

Engine/Setting	Fuel Flow lbs/hr	Filterable Particulate		Total Particulate	
		lbs/hr	lbs/1,000 lb fuel	lbs/hr	lbs/1,000 lb fuel
<b>F108-CF-100</b>					
Idle	1136	2.17	1.91	2.35	2.07
Approach	2547	2.02	0.79	3.95	1.55
Intermediate	5650	1.64	0.29	3.66	0.65
Military	6458	3.66	0.57	10.27	1.59
<b>TF33A-P-7</b>					
Idle	1093	2.54	2.33	6.69	6.13
Approach	4884	10.81	2.21	17.95	3.68
Intermediate	6356	22.65	3.57	33.59	5.29
Military	8264	19.35	2.34	29.55	3.58
<b>F101-GE-102</b>					
Idle	1117	1.36	1.21	2.43	2.17
Approach	4533	2.15	0.47	19.10	4.23
Intermediate	6557	4.10	0.63	8.84	1.35
Military	7828	3.68	0.47	13.11	1.68
Afterburner (Zone 1)	15314	7.11	0.46	43.87	2.86
<b>T700-GE-700</b>					
Idle	134	0.07	0.51	0.20	1.48
Flight Idle	469	0.56	1.19	0.59	1.26
Flight Max	626	0.81	1.29	1.39	2.22
Overspeed	725	1.01	1.39	1.89	2.60
<b>TF33-P-102</b>					
Idle	1114	1.00	0.90	5.53	4.98
Approach	4737	8.98	1.90	16.82	3.55
Intermediate	5782	9.99	1.73	18.22	3.15
Military	7561	11.28	1.49	19.02	2.52
<b>F117-PW-100</b>					
Idle	978	1.88	1.90	10.43	10.54
Approach	4645	2.00	0.43	25.69	5.52
Intermediate	10408	9.32	0.90	24.06	2.31

**Table 4-1  
Particulate Matter Emission Summary**

Engine/Setting	Fuel Flow lbs/hr	Filterable Particulate		Total Particulate	
		lbs/hr	lbs/1,000 lb fuel	lbs/hr	lbs/1,000 lb fuel
<b>F118-GE-100</b>					
Idle	1097	0.23	0.21	1.37	1.25
Approach	3773	8.99	2.41	17.73	4.47
Intermediate	6350	2.08	0.19	19.37	1.78
Military	10887	1.76	0.16	17.89	1.64
<b>F404-GE-F1D2/400</b>					
Idle	685	0.94	1.37	3.06	4.48
Approach	3111	1.81	0.58	4.53	1.46
Intermediate	6464	4.35	0.67	10.17	1.57
Military	7739	5.58	0.72	12.48	1.61
Afterburner (Zone 3)	15851	5.75	0.36	56.55	3.57
<b>T64-GE-100</b>					
Ground Idle	298	0.06	0.21	0.70	2.36
75% Normal	941	1.43	1.52	1.85	1.96
Normal	1698	1.24	0.73	2.73	1.60
Military	1848	1.53	0.83	1.69	
<b>TF34-GE-100A</b>					
Idle	498	2.26	4.38	4.05	8.00
Approach	933	3.82	4.09	5.79	6.19
Intermediate	1512	2.99	1.98	13.50	8.93
Military	2628	2.58	0.98	6.99	2.67

Test Report	
Volume:	<u>3</u>
Section:	<u>4.0</u>
Revision:	<u>2</u>
Date:	<u>November 1998</u>
Page:	<u>9 of 105</u>

#### 4.3.1 Engine T56-A-7

Tracer gas was used for flow determination since it yielded the most consistent and reasonable results. The carbon balance calculations indicate that flow rates during idle and approach conditions were similar. Carbon balance flow at the intermediate power setting had a higher calculated flow than the flow at the military power setting. Also, the velocity measurements collected during single point manual sampling confirmed the reasonableness of the flow rate calculated using tracer gas flow data.

Tables 4-2 through 4-6 present the emissions factor summary and the engine operating parameter summary for T56-A-7.

**Table 4-2**  
**Emissions Factor Summary**  
**Particulates**  
**T56-A-7 (C-130)**  
**Idle**

Flow by Tracer

	Run Number						Average	
	1		2		3			
Flow Rate, dscfm	113779		152061		227856			
Analyte	lb/hr	lbs/1,000	lb/hr	lbs/1,000	lb/hr	lbs/1,000	lb/hr	lbs/1,000
		lbs fuel		lbs fuel		lbs fuel		lbs fuel
Particulate (filterable)	1.302	1.803	1.223	1.688	1.282	1.770	1.269	1.754
Particulate (condensable)	0.868	1.202	1.773	2.447	1.448	2.000	1.363	1.883
Particulate (total)	2.171	3.005	2.995	4.135	2.730	3.770	2.632	3.637

**Table 4-3**  
**Emissions Factor Summary**  
**Particulates**  
**T56-A-7 (C-130)**  
**Approach**  
 Flow by Tracer

	Run Number						Average
	1		2		3		
Flow Rate, dscfm	12884		121210		126865		
Analyte	lb/hr	lbs/1,000 lbs fuel	lb/hr	lbs/1,000 lbs fuel	lb/hr	lbs/1,000 lbs fuel	lb/hr lbs/1,000 lbs fuel
	0.850	0.963	1.960	2.225	1.597	1.820	1.469
Particulate (filterable)	0.829	0.940	0.374	0.425	4.543	5.178	1.915
Particulate (condensable)	1.678	1.903	2.335	2.650	6.140	6.999	3.384
Particulate (total)							3.851

**Table 4-4**  
**Emissions Factor Summary**  
**Particulates**  
**T56-A-7 (C-130)**  
**Intermediate**

Flow by Tracer

Flow Rate, dscfm	Run Number													
	1				2				3				Average	
	lb/hr	lbs/1,000 lbs fuel	lb/hr	lbs/1,000 lbs fuel	lb/hr	lbs/1,000 lbs fuel	lb/hr	lbs/1,000 lbs fuel	lb/hr	lbs/1,000 lbs fuel	lb/hr	lbs/1,000 lbs fuel	lb/hr	lbs/1,000 lbs fuel
	125142		125162		125964									
<b>Analyte</b>														
<b>Particulate (filterable)</b>	1.405	0.800	1.405	0.807	1.896	1.094	1.896	1.094	1.896	1.094	1.896	1.094	1.896	1.094
<b>Particulate (condensable)</b>	0.188	0.107	0.658	0.378	2.067	1.193	2.067	1.193	2.067	1.193	2.067	1.193	2.067	1.193
<b>Particulate (total)</b>	1.592	0.907	2.063	1.185	3.963	2.287	3.963	2.287	3.963	2.287	3.963	2.287	3.963	2.287

**Table 4-5**  
**Emissions Factor Summary**  
**Particulates**  
**T56-A-7 (C-130)**  
**Military**

Flow by Tracer

	Run Number						Average
	1		2		3		
Flow Rate, dscfm	143531		143785		150265		
Analyte	lb/hr	lbs/1,000 lbs fuel	lb/hr	lbs/1,000 lbs fuel	lb/hr	lbs/1,000 lbs fuel	lb/hr lbs/1,000 lbs fuel
Particulate (filterable)	2.731	1.202	1.434	0.633	1.872	0.838	2.012
Particulate (condensable)	0.826	0.363	1.100	0.486	0.322	0.144	0.749
Particulate (total)	3.557	1.565	2.534	1.119	2.194	0.982	2.762



**Table 4-6**  
**Engine Operating Parameter Summary**  
**T56-A-7 (C-130)**

Parameter	Idle	Approach	Intermediate	Military
Throttle position (PLA), degrees	20	34	72	90
Engine speed (N1) , rpm	13,505	13,427	13,823	13,828
Barometric pressure (BAROM) , in.Hg	29.10	29.51	29.72	29.51
Compressor inlet temperature (CIT), deg. F	64	35	31	33
Fuel flow (WF), lbs/hr	723.6	880.2	1,741.9	2,261.7
Torque (TORQUE), inch pounds	1,011	3,231	12,802	18,754
Shaft horsepower	217	688	2,808	4,115
Percent maximum horsepower	4.7	15.0	61.2	89.6

### 4.3.2 Engine TF39-GE-1C

Carbon balance flow rate calculations yielded the most consistent results. Several problems occurred with the tracer gas distribution system during testing. The very high velocities in the augments tube damaged the original tracer gas distribution system. The tracer gas mass flow meter was also damaged by JP-8 fuel when the test cell experienced a fuel leak.

Tables 4-7 through 4-11 present the emissions factor summary and the engine operating parameter summary for TF39-GE-1C.

**Table 4-7  
Emissions Factor Summary  
Particulates  
TF39-GE-1C (C-5)  
Idle**

**Flow by Carbon Balance**

Flow Rate, dscfm	Run Number						Average					
	1			2				3				
	lb/hr	lbs/1,000 lbs fuel	517942	lb/hr	lbs/1,000 lbs fuel	515699		lb/hr	lbs/1,000 lbs fuel	502514		
<b>Analyte</b>												
<b>Particulate (filterable) <sup>1</sup></b>	0.585	0.399	0.602	0.412	0.127	0.088	0.594	0.406				
<b>Particulate (condensable)</b>	5.729	3.907	3.074	2.104	2.028	1.414	3.611	2.475				
<b>Particulate (total)</b>	6.315	4.306	3.677	2.516	2.155	1.503	4.049	2.775				

<sup>1</sup> Values in the field blank exceeded the source value for filterable particulate in Run 3.  
The analytical detection limit value of 0.1 mg was used for emission rate calculations.

**Table 4-8**  
**Emissions Factor Summary**  
**Particulates**  
**TF39-GE-1C (C-5)**  
**Approach**

Flow by Carbon Balance

	Run Number						
	1		2		3		Average
Flow Rate, dscfm	1813616		1904586		1856384		
Analyte	lb/hr	lbs/1,000 lbs fuel	lb/hr	lbs/1,000 lbs fuel	lb/hr	lbs/1,000 lbs fuel	lb/hr lbs fuel
Particulate (filterable)	4.049	0.393	1.188	0.110	18.533	1.759	7.924 0.754
Particulate (condensable)	6.340	0.615	3.090	0.286	4.357	0.413	4.596 0.438
Particulate (total)	10.389	1.008	4.278	0.395	22.891	2.172	12.519 1.192

**Table 4-9**  
**Emissions Factor Summary**  
**Particulates**  
**TF39-GE-1C (C-5)**  
**Intermediate**

Flow by Carbon Balance

Flow Rate, dscfm	Run Number						Average	
	1 1995085		2 2019638		3 2071746			
Analyte	lb/hr	lbs/1,000 lbs fuel	lb/hr	lbs/1,000 lbs fuel	lb/hr	lbs/1,000 lbs fuel	lb/hr	lbs/1,000 lbs fuel
Particulate (filterable)	4.280	0.342	0.198	0.016	14.931	1.195	6.469	0.518
Particulate (condensable)	3.490	0.279	7.487	0.593	3.064	0.245	4.680	0.372
Particulate (total)	7.769	0.622	7.685	0.609	17.994	1.440	11.150	0.890

**Table 4-10**  
**Emissions Factor Summary**  
**Particulates**  
**TF39-GE-1C (C-5)**  
**Military**

Flow by Carbon Balance

Flow Rate, dscfm	Run Number						Average
	1		2		3		
	2140043		2163941		2137957		
<b>Analyte</b>	lb/hr	lbs/1,000 lbs fuel	lb/hr	lbs/1,000 lbs fuel	lb/hr	lbs/1,000 lbs fuel	lb/hr lbs fuel
<b>Particulate (filterable)</b>	9.739	0.702	7.289	0.524	0.281	0.020	5.770 0.415
<b>Particulate (condensable)</b>	16.224	1.169	0.699	0.050	14.982	1.086	10.635 0.768
<b>Particulate (total)</b>	25.962	1.870	7.989	0.575	15.263	1.106	16.405 1.184

**Table 4-11**  
**Engine Operating Parameter Summary**  
**TF39-GE-1C (C-5)**

Parameter	Idle	Approach	Intermediate	Military
Actual fan speed (N1), rpm	961	2,963	3,170	3,281
Percent maximum fan speed (PERCENT N1)	27	85	91	94
Actual core speed (N2), rpm	6,573	8,823	9,098	9,333
Percent maximum core speed (PERCENT N2)	67	90	93	95
Screen temperature (T2), deg. F	44	37	43	44
Engine pressure ratio (EPR)	1	4	5	5
Average thrust, lbs	2,955	31,880	36,617	39,486
Percent maximum thrust	7	76	87	94
Fuel flow (WF), lbs/hr	1,448.3	10,477.4	12,541.3	13,861.8

Test Report

Volume:	<u>3</u>
Section:	<u>4.0</u>
Revision:	<u>2</u>
Date:	<u>November 1998</u>
Page:	<u>21 of 105</u>

### 4.3.3 APU GTCP85-180

Actual flows were measured following EPA Method 2 procedures because emissions were exhausted through a single stack. The concentration and mass emission rate of particulate matter was determined using the protocol outlined in EPA Reference Methods 1-5.

Tables 4-12 and 4-13 present the emissions factor summary and the engine operating parameter summary for GTCP85-180.



**Table 4-12**  
**Emissions Factor Summary**  
**Particulates**  
**GTCP85-180 (APU)**  
**Constant**

Flow as Measured

Flow Rate, dscfm	Run Number						Average		
	1		2		3				
	5478	5362	5517	5517	5517	5517	lbs/1,000 lbs fuel	lb/hr	
Analyte	lb/hr	lbs/1,000 lbs fuel	lb/hr	lbs/1,000 lbs fuel	lb/hr	lbs/1,000 lbs fuel	lb/hr	lb/hr	lbs/1,000 lbs fuel
Particulate (filterable)	0.167	0.622	0.153	0.566	0.123	0.453	0.148	0.148	0.547
Particulate (condensable)	0.040	0.150	0.008	0.031	0.091	0.334	0.047	0.047	0.172
Particulate (total)	0.207	0.772	0.161	0.597	0.214	0.787	0.194	0.194	0.719

**Table 4-13**  
**Engine Operating Parameter Summary**  
**GTCP85-180**

Parameter	Constant Setting
Engine speed (N1) , rpm	42,054
Compressor inlet temperature (CIT), degrees F	85
Fuel flow (WF), lbs/hr	270.3
Torque (TORQUE), inch pounds	100
Shaft horsepower	67
Barometric pressure, in. Hg	29.4

Test Report  
Volume: 3  
Section: 4.0  
Revision: 2  
Date: November 1998  
Page: 24 of 105

**4.3.4 APU GTCP165-1**

Actual flows were measured following EPA Method 2 procedures because emissions were exhausted through a single stack. The concentration and mass emission rate of particulate matter was determined using the protocol outlined in EPA Reference Methods 1-5.

Tables 4-14 and 4-15 present the emissions factor summary and the engine operating parameter summary for GTCP165-1.

**Table 4-14**  
**Emissions Factor Summary**  
**Particulates**  
**GTCP165-1 (APU)**  
**Constant**

Flow as Measured

Flow Rate, dscfm	Run Number						Average
	1		2		3		
	5173		5210		5005		
<b>Analyte</b>	lb/hr	lbs/1,000 lbs fuel	lb/hr	lbs/1,000 lbs fuel	lb/hr	lbs/1,000 lbs fuel	lb/hr
<b>Particulate (filterable)</b>	0.086	0.304	0.118	0.427	0.078	0.311	0.094
<b>Particulate (condensable)</b>	0.044	0.154	0.046	0.167	0.021	0.084	0.037
<b>Particulate (total)</b>	0.130	0.458	0.163	0.594	0.099	0.395	0.131

**Table 4-15**  
**Engine Operating Parameter Summary**  
**GTCP165-1**

Parameter	Constant Setting
Engine speed (N1), rpm	38,166
Compressor inlet temperature (CIT), degrees F	96
Fuel flow (WF), lbs/hr	272.6
Torque (TORQUE), inch pounds	217
Shaft horsepower	132
Barometric pressure, in. Hg	29.4

Test Report

Volume:	<u>3</u>
Section:	<u>4.0</u>
Revision:	<u>2</u>
Date:	<u>November 1998</u>
Page:	<u>27 of 105</u>

#### 4.3.5 Engine J69-T-25

Tracer gas was used to determine the flow rate at each power setting. This provided the most consistent flow rate values for each sampling run and engine setting.

Tables 4-16 through 4-19 present the emissions factor summary and the engine operating parameter summary for J69-T-25.

**Table 4-16**  
**Emissions Factor Summary**  
**Particulates**  
**J69-T-25 (T-37)**  
**Idle**

Flow by Tracer

Flow Rate, dscfm	Run Number						Average
	1		2		3		
	37225		37272		37992		
<b>Analyte</b>	lb/hr	lbs/1,000 lbs fuel	lb/hr	lbs/1,000 lbs fuel	lb/hr	lbs/1,000 lbs fuel	lbs/1,000 lbs fuel
<b>Particulate (filterable)</b>	0.442	2.645	0.099	0.594	0.299	1.790	0.280
<b>Particulate (condensable)</b>	0.148	0.888	0.447	2.675	0.148	0.886	1.483
<b>Particulate (total)</b>	0.591	3.533	0.547	3.269	0.448	2.676	0.528

**Table 4-17**  
**Emissions Factor Summary**  
**Particulates**  
**J69-T-25 (T-37)**  
**Intermediate**

Flow by Carbon Balance

	Run Number						Average
	1		2		3		
<b>Flow Rate, dscfm</b>	165026		160032		158869		
<b>Analyte</b>	lb/hr	lbs/1,000 lbs fuel	lb/hr	lbs/1,000 lbs fuel	lb/hr	lbs/1,000 lbs fuel	lb/hr
<b>Particulate (filterable)</b>	0.794	0.910	0.351	0.402	0.274	0.314	0.473
<b>Particulate (condensable)</b>	0.528	0.605	0.286	0.328	0.212	0.243	0.342
<b>Particulate (total)</b>	1.322	1.516	0.637	0.730	0.486	0.557	0.815



**Table 4-18**  
**Emissions Factor Summary**  
**Particulates**  
**J69-T-25 (T-37)**  
**Military**

Flow by Tracer

Flow Rate, dscfm	Run Number						Average
	1		2		3		
	183933		179954		177185		
<b>Analyte</b>	lbs/hr	lbs/1,000 lbs fuel	lb/hr	lbs/1,000 lbs fuel	lb/hr	lbs/1,000 lbs fuel	lbs/1,000 lbs fuel
<b>Particulate (filterable)</b>	0.483	0.445	0.113	0.104	0.358	0.330	lb/hr 0.318
<b>Particulate (condensable)<sup>1</sup></b>	0.091	0.084	1.118	1.030	0.030	0.028	0.413
<b>Particulate (total)</b>	0.574	0.529	1.231	1.134	0.388	0.357	0.731 0.674

<sup>1</sup> Values in the field blank exceeded the source value for condensible particulate in Run 3. The analytical detection limit value of 0.1 mg was used for emission rate calculations.

**Table 4-19**  
**Engine Operating Parameter Summary**  
**J69-25 (T-37)**

Parameter	Idle	Intermediate	Military
Fuel flow, gpm	0.42	2.18	2.71
Engine speed, rpm	7,884	19,548	21,709
Cell humidity, %	29.00	28.68	28.56
Cell temperature, deg. F	57.83	67.95	82.48
Thrust, pounds	73.22	643	864
Percent maximum thrust	4.3	62.7	84.3

#### 4.3.6 Engine J85-GE-5A

Carbon balance was used to determine the flow rate at each power setting. Carbon balance was the most consistent. The flow rates calculated using tracer gas methodology matched the carbon balance at all power settings except afterburner. Tracer gas was not used in the afterburner power setting due to high temperatures in the augments tube. The tracer gas release points were located directly in the afterburner flame. A significant portion of the SF<sub>6</sub>, if used, would have been dissociated. Carbon balance calculations indicate a higher flow rate at the military power setting than at the afterburner power setting. This does not compare favorably with anticipated engine operating conditions. The flow at the afterburner power setting should be considered biased low.

A zero was reported for the condensable particulate of Run 1 for the military setting. This is attributed to a blank concentration. The sample was corrected against a blank that contained more particulate than the sample.

Tables 4-20 through 4-24 present the emissions factor summary and the engine operating parameter summary for J85-GE-5A.

**Table 4-20**  
**Emissions Factor Summary**  
**Particulates**  
**J85-GE-5A (T-38)**  
**Idle**

Flow by Carbon Balance

	Run Number						Average
	1		2		3		
Flow Rate, dscfm	56332		54662		51913		
Analyte	lb/hr	lbs/1,000 lbs fuel	lb/hr	lbs/1,000 lbs fuel	lb/hr	lbs/1,000 lbs fuel	lb/hr lbs/1,000 lbs fuel
Particulate (filterable)	0.487	0.955	0.221	0.431	0.330	0.643	0.346
Particulate (condensable)	2.620	5.138	1.653	3.216	1.903	3.710	2.059
Particulate (total)	3.107	6.093	1.875	3.647	2.233	4.353	2.405
							4.698

**Table 4-21**  
**Emissions Factor Summary**  
**Particulates**  
**J85-GE-5A (T-38)**  
**Intermediate**

Flow by Carbon Balance

	Run Number						Average
	1		2		3		
<b>Flow Rate, dscfm</b>	132643		124121		124375		
<b>Analyte</b>	lb/hr	lbs/1,000 lbs fuel	lb/hr	lbs/1,000 lbs fuel	lb/hr	lbs/1,000 lbs fuel	lb/hr lbs fuel
<b>Particulate (filterable)</b>	1.665	2.084	0.527	0.658	0.446	0.556	0.879
<b>Particulate (condensable)</b>	0.592	0.740	0.407	0.508	0.657	0.819	0.689
<b>Particulate (total)</b>	2.257	2.825	0.934	1.166	1.102	1.374	1.431

**Table 4-22**  
**Emissions Factor Summary**  
**Particulates**  
**J85-GE-5A (T-38)**  
**Military**

Flow by Carbon Balance

Flow Rate, dscfm	Run Number						Average
	1		2		3		
	286753		283704		279354		
Analyte	lb/hr	lbs/1,000 lbs fuel	lb/hr	lbs/1,000 lbs fuel	lb/hr	lbs/1,000 lbs fuel	lb/hr
	1.325	0.530	3.244	1.307	3.464	1.413	2.677
Particulate (filterable)	0.000	0.000	0.050	0.020	0.280	0.114	0.165
Particulate (condensable) <sup>1</sup>	1.325	0.530	3.294	1.328	3.744	1.527	2.788
Particulate (total)							

<sup>1</sup> - Data outliers that can be explained by process, sampling or analytical phenomena are described in Section 4.3.6 of this report.

**Table 4-23**  
**Emissions Factor Summary**  
**Particulates**  
**J85-GE-5A (T-38)**  
**Afterburner (Zone 1)**  
 Flow by Carbon Balance

Flow Rate, dscfm <sup>1</sup>	Run Number						Average
	1		2		3		
	228390		227162		242999		
<b>Analyte</b>	lb/hr	lbs/1,000 lbs fuel	lb/hr	lbs/1,000 lbs fuel	lb/hr	lbs/1,000 lbs fuel	lb/hr lbs fuel
<b>Particulate (filterable)</b>	1.299	0.168	1.450	0.188	1.038	0.135	1.263
<b>Particulate (condensable)</b>	0.201	0.026	0.084	0.011	1.732	0.225	0.672
<b>Particulate (total)</b>	1.500	0.194	1.534	0.199	2.770	0.359	1.935

<sup>1</sup> - Data outliers that can be explained by process, sampling or analytical phenomena are described in Section 4.3.6 of this report.

**Table 4-24**  
**Engine Operating Parameter Summary**  
**J85-5A (T-38)**

Parameter	Idle	Intermediate	Military	Afterburner (Zone 1)
Fuel flow, gpm	1.28	2.00	6.19	19.28
Engine speed, rpm	8,162	12,479	16,542	16,542
Cell humidity, %	29.18	28.89	28.90	28.87
Cell temperature, deg. F	64.44	86.67	67.33	71.45
Thrust, pounds	97	400	2,349	3,310
Percent maximum thrust	3.6	15.0	88.0	116.0



#### 4.3.7 Engine T700-GE-700

Actual flows were measured following EPA Method 2 procedures because emissions were exhausted through a single stack. Measured flows were consistent between the particulate, semivolatile, and formaldehyde sampling trains. However, measured flow values were inconsistent between engine power settings. The exhaust flow rate was less during the overspeed power setting than at the flight max power setting even though the engine combusted more JP-8 and created more shaft horsepower. The flow rate was measured in the field by several individuals and three sets of independent sampling equipment. After review, the field data confirmed that the flow rate results presented are valid.

It is possible that the test cell is undersized for the particular engine setting. The test cell exhaust represents a critical orifice above a certain exhaust volume, resulting in a decrease in the total flow. This assumption is logical, as there was a significant increase in the exhaust temperature between flight max and overspeed conditions. The increased temperature would result in the exhaust gas occupying a greater volume within the augments tube. Since the engine was not starved for combustion air (based on the engine operating parameters), the concentrations in our measurements may be higher since the dilution air and flow through the tube is decreased. The high concentration with the lowered exhaust flow results in the same mass flow of pollutants at the theoretical exhaust rate. For example, if the flow rate increased with a properly sized exhaust, the concentration would decrease resulting in a comparable mass emission rate to those presented in the report.

PM results between Run 2 and Runs 1 and 3 differed greatly at the flight max setting. The raw data for Run 2 was reviewed to note any errors. Field and analytical data showed no errors. The difference can be attributed to method variability, since results are at or near the method detection limit.

Tables 4-25 through 4-29 present the emissions factor summary and the engine operating parameter summary for T700-GE-700.

**Table 4-25**  
**Emissions Factor Summary**  
**Particulates**  
**T700-GE-700 (UH-60A)**  
**Idle**

Flow as Measured

Flow Rate, dscfm	Run Number						Average
	1		2		3		
	15111		15063		14988		
<b>Analyte</b>	lb/hr	lbs/1,000 lbs fuel	lb/hr	lbs/1,000 lbs fuel	lb/hr	lbs/1,000 lbs fuel	lb/hr lbs fuel
<b>Particulate (filterable)</b>	0.132	0.985	0.059	0.442	0.013	0.095	0.068 0.507
<b>Particulate (condensable)</b>	0.214	1.601	0.099	0.740	0.079	0.589	0.131 0.977
<b>Particulate (total)</b>	0.346	2.585	0.158	1.182	0.092	0.684	0.199 1.484

**Table 4-26**  
**Emissions Factor Summary**  
**Particulates**  
**T700-GE-700 (UH-60A)**  
**Flight Idle**

Flow as Measured

Flow Rate, dscfm	Run Number						Average
	1		2		3		
	32079		32989		32133		
<b>Analyte</b>	lb/hr	lbs/1,000 lbs fuel	lb/hr	lbs/1,000 lbs fuel	lb/hr	lbs/1,000 lbs fuel	lb/hr
<b>Particulate (filterable)</b>	0.514	1.103	0.661	1.406	0.496	1.053	0.557
<b>Particulate (condensable)</b>	0.034	0.072	0.048	0.102	0.014	0.029	0.032
<b>Particulate (total)</b>	0.548	1.176	0.709	1.508	0.509	1.082	0.589

**Table 4-27**  
**Emissions Factor Summary**  
**Particulates**  
**T700-GE-700 (UH-60A)**  
**Flight Max**  
**Flow as Measured**

	Run Number					
	1		2		3	
<b>Flow Rate, dscfm</b>	35643		36402		36050	
<b>Analyte</b>	lbs/hr	lbs/1,000 lbs fuel	lbs/hr	lbs/1,000 lbs fuel	lbs/hr	lbs/1,000 lbs fuel
<b>Particulate (filterable)</b>	1.177	1.853	0.025	0.040	1.225	1.983
<b>Particulate (condensable)</b>	0.836	1.317	0.033	0.053	0.879	1.423
<b>Particulate (total) <sup>1</sup></b>	2.013	3.170	0.059	0.094	2.103	3.406
					lb/hr	lbs/1,000 lbs fuel
					0.809	1.292
					0.583	0.931
					1.392	2.223

<sup>1</sup> - Data outliers that can be explained by process, sampling or analytical phenomena are described in Section 4.3.7

**Table 4-28**  
**Emissions Factor Summary**  
**Particulates**  
**T700-GE-700 (UH-60A)**  
**Overspeed**

Flow as Measured

	Run Number						Average
	1		2		3		
<b>Flow Rate, dscfm</b>	31204		31273		30949		
<b>Analyte</b>	lb/hr	lbs/1,000 lbs fuel	lb/hr	lbs/1,000 lbs fuel	lb/hr	lbs/1,000 lbs fuel	lb/hr
<b>Particulate (filterable)</b>	1.342	1.826	0.176	0.243	1.512	2.111	1.010
<b>Particulate (condensable)</b>	1.262	1.718	0.060	0.083	1.311	1.830	0.878
<b>Particulate (total)</b>	2.604	3.544	0.237	0.327	2.824	3.941	1.888
							2.604

**Table 4-29  
Engine Operating Parameter Summary  
T700-GE-700 (UH-60A)**

<b>Parameter</b>	<b>Ground Idle</b>	<b>Flight Idle</b>	<b>Flight Max</b>	<b>Overspeed</b>
Engine speed, rpm	10,031	21,161	20,958	21,078
Barometric pressure, in. Hg	30	30	30	30
Inlet temperature, degrees F	74	58	66	72
Fuel flow, lbs/hr	134	469	626	725
Torque ft-lbs	32	225	334	404
Horsepower	62	906	1,333	1,620
Percent maximum horsepower	3.8	55.9	82.2	99.8

Test Report

Volume:	<u>3</u>
Section:	<u>4.0</u>
Revision:	<u>2</u>
Date:	<u>November 1998</u>
Page:	<u>44 of 105</u>

#### 4.3.8 Engine TF33-P-102

Tracer gas was used to determine the flow rate at each power setting. Carbon balance was not consistent with the expected flows at each engine power setting.

Tables 4-30 through 4-34 present the emissions factor summary and the engine operating parameter summary for TF33-P-102.

**Table 4-30**  
**Emissions Factor Summary**  
**Particulates**  
**TF33-P-102(C/EC/RC-135E)**  
**Idle**

Flow by Tracer

	Run Number						Average
	1		2		3		
Flow Rate, dscfm	382061		385835		375791		
Analyte	lb/hr	lbs/1,000 lbs fuel	lb/hr	lbs/1,000 lbs fuel	lb/hr	lbs/1,000 lbs fuel	lb/hr lbs fuel
Particulate (filterable)	0.614	0.545	1.508	1.356	0.878	0.796	1.000
Particulate (condensable)	2.812	2.497	4.053	3.645	6.713	6.086	4.526
Particulate (total)	3.426	3.042	5.561	5.001	7.592	6.883	5.526
							4.975



**Table 4-31**  
**Emissions Factor Summary**  
**Particulates**  
**TF33-P-102(C/EC/RC-135E)**  
**Approach**  
 Flow by Tracer

	Run Number						Average
	1		2		3		
<b>Flow Rate, dscfm</b>	1181795		1103247		1128825		
<b>Analyte</b>	lb/hr	lbs/1,000 lbs fuel	lb/hr	lbs/1,000 lbs fuel	lb/hr	lbs/1,000 lbs fuel	lb/hr lbs fuel
<b>Particulate (filterable)</b>	8.170	1.722	9.372	1.967	9.401	1.996	8.981
<b>Particulate (condensable)</b>	11.030	2.325	6.658	1.398	5.825	1.237	7.838
<b>Particulate (total)</b>	19.200	4.047	16.030	3.365	15.226	3.233	16.819

**Table 4-32**  
**Emissions Factor Summary**  
**Particulates**  
**TF33-P-102(C/EC/RC-135E)**  
**Intermediate**

Flow by Tracer

	Run Number						Average
	1		2		3		
Flow Rate, dscfm	1198407		1175858		1224347		
Analyte	lb/hr	lbs/1,000 lbs fuel	lb/hr	lbs/1,000 lbs fuel	lb/hr	lbs/1,000 lbs fuel	lb/hr lbs fuel
Particulate (filterable)	12.377	2.142	3.240	0.563	14.358	2.472	9.992
Particulate (condensable)	11.999	2.076	6.100	1.059	6.585	1.134	1.726
Particulate (total)	24.376	4.218	9.340	1.622	20.943	3.606	11.718
							18.220
							3.149

**Table 4-33**  
**Emissions Factor Summary**  
**Particulates**  
**TF33-P-102(C/EC/RC-135E)**  
**Military**

Flow by Tracer

	Run Number						Average
	1		2		3		
<b>Flow Rate, dscfm</b>	1657173		1346781		1377390		
<b>Analyte</b>	lb/hr	lbs/1,000 lbs fuel	lb/hr	lbs/1,000 lbs fuel	lb/hr	lbs/1,000 lbs fuel	lb/hr lbs fuel
<b>Particulate (filterable)</b>	12.832	1.698	10.652	1.408	10.365	1.371	11.283
<b>Particulate (condensable)</b>	2.265	0.300	11.280	1.491	9.680	1.280	7.742
<b>Particulate (total)</b>	15.097	1.998	21.932	2.900	20.045	2.651	19.025
							2.516

**Table 4-34  
Engine Operating Parameter Summary  
TF33-P-102 (C/EC/RC-135E)**

<b>Parameter</b>	<b>Idle</b>	<b>Approach</b>	<b>Intermediate</b>	<b>Military</b>
Barometric pressure, in. Hg	28.38	28.24	28.31	28.41
Throttle position (PLA), degrees	53	74	79	87
Fuel flow, lbs/hr	1,114	4,737	5,782	7,561
Fan speed, rpm	1,988	5,215	5,607	6,112
Core speed, rpm	5,742	8,927	9,211	9,556
Cell temperature, deg. F	75	63	68	70
Average thrust, lbs.	976	8,783	10,676	13,551
Percent maximum thrust	5.4	49	59	75

#### 4.3.9 Engine TF33-P-7/7A

Carbon balance was used to determine the flow rate at each power setting. The tracer gas system was not available until the military power setting. The spare SF<sub>6</sub> cylinder leaked during storage and was empty upon arrival for testing. During testing at the approach power setting, Run 2, an oil leak occurred in the engine. Due to the probe and nozzle exhibiting an oil residue when pulled from the stack, particulate matter results were biased high and voided.

Tables 4-35 through 4-39 present the emissions factor summary and the engine operating parameter summary for TF33-P-7/7A.

**Table 4-35**  
**Emissions Factor Summary**  
**Particulates**  
**TF33-P-77A (C-141)**  
**Idle**

Flow by Carbon Balance

Flow Rate, dscfm	Run Number													
	1				2				3				Average	
	400715				407177				409929					
<b>Analyte</b>	lb/hr	lbs/1,000 lbs fuel	lb/hr	lbs/1,000 lbs fuel	lb/hr	lbs/1,000 lbs fuel	lb/hr	lbs/1,000 lbs fuel	lb/hr	lbs/1,000 lbs fuel	lb/hr	lbs/1,000 lbs fuel	lb/hr	lbs/1,000 lbs fuel
<b>Particulate (filterable)</b>	3.727	3.470	1.759	1.596	2.135	1.932	2.540	2.333	4.597	4.160	4.155	3.793	6.695	6.126
<b>Particulate (condensable)</b>	3.430	3.194	4.436	4.026	6.732	6.092								
<b>Particulate (total)</b>	7.157	6.664	6.196	5.622										

**Table 4-36**  
**Emissions Factor Summary**  
**Particulates**  
**TF33-P-77A (C-141)**  
**Approach**

Flow by Carbon Balance

Flow Rate, dscfm	Run Number						Average	
	1		2 <sup>1</sup>		3		lb/hr	lbs/1,000 lbs fuel
	1208116		1226820		1176182			
<b>Analyte</b>	lb/hr	lbs/1,000 lbs fuel	lb/hr	lbs/1,000 lbs fuel	lb/hr	lbs/1,000 lbs fuel	lb/hr	lbs/1,000 lbs fuel
<b>Particulate (filterable)</b>	6.138	1.273	NA	NA	15.479	3.141	10.809	2.207
<b>Particulate (condensable)</b>	8.624	1.788	NA	NA	5.661	1.149	7.142	1.469
<b>Particulate (total)</b>	14.762	3.061	NA	NA	21.140	4.290	17.951	3.676

NA - Results voided due to engine oil leak.

<sup>1</sup> - Data outliers that can be explained by process, sampling or analytical phenomena are described in Section 4.3.9 of this report.

**Table 4-37**  
**Emissions Factor Summary**  
**Particulates**  
**TF33-P-77A (C-141)**  
**Intermediate**  
**Flow by Carbon Balance**

Flow Rate, dscfm	Run Number						Average
	1		2		3		
	1396614		1406587		1396170		
<b>Analyte</b>	lb/hr	lbs/1,000 lbs fuel	lb/hr	lbs/1,000 lbs fuel	lb/hr	lbs/1,000 lbs fuel	lb/hr lbs fuel
<b>Particulate (filterable)</b>	32.960	5.200	16.358	2.561	18.625	2.937	22.648 3.566
<b>Particulate (condensable)</b>	13.107	2.068	11.952	1.871	7.755	1.223	10.938 1.721
<b>Particulate (total)</b>	46.067	7.267	28.310	4.432	26.381	4.160	33.586 5.286



**Table 4-38**  
**Emissions Factor Summary**  
**Particulates**  
**TF33-P-77A (C-141)**  
**Military**

Flow by Carbon Balance

	Run Number						Average
	1		2		3		
Flow Rate, dscfm	1420504		1407211		1412142		
Analyte	lb/hr	lbs/1,000	lb/hr	lbs/1,000	lb/hr	lbs/1,000	lbs/1,000
		lbs fuel		lbs fuel		lbs fuel	lbs fuel
Particulate (filterable)	22.652	2.724	20.559	2.502	14.850	1.798	19.353
Particulate (condensable)	9.103	1.095	10.474	1.275	11.020	1.334	2.341
Particulate (total)	31.755	3.819	31.032	3.776	25.869	3.132	29.552
							3.576

**Table 4-39**  
**Engine Operating Parameter Summary**  
**TF33-P-77A (C141)**

Parameter	Idle	Approach	Intermediate	Military
Barometric pressure, in. Hg	28.53	28.56	28.70	28.72
Throttle position (PLA), degrees	54	82	93	105
Fuel flow, lbs/hr	1,093	4,884	6,356	8,264
Fan speed, rpm	1,854	5,095	5,555	6,076
Core speed, rpm	5,408	8,594	8,902	9,224
Cell temperature, deg. F	65	63	58	58
Average thrust, lbs	814	9,349	12,236	15,349
Percent maximum thrust	4	45	58	73

Test Report  
Volume: 3  
Section: 4.0  
Revision: 2  
Date: November 1998  
Page: 56 of 105

#### 4.3.10 Engine F108-CF-100

Tracer gas was used to determine the flow rate at each power setting. It showed more consistent results than carbon balance, which gave erratic results from run-to-run.

A zero was reported for the condensable particulate of Run 2 for the idle setting, Run 1 for the approach setting, and Run 3 for the intermediate setting. In each case, this is attributed to a blank concentration. The sample was corrected against a blank that contained more particulate than the sample.

Tables 4-40 through 4-44 present the emissions factor summary and the engine operating parameter summary for F108-CF-100.

**Table 4-40**  
**Emissions Factor Summary**  
**Particulates**  
**F108-CF-100 (KC-135R)**  
**Idle**

Flow by Tracer

Flow Rate, dscfm	Run Number												
	1			2			3			Average			
	569976			553813			556598						
<b>Analyte</b>	lb/hr	lbs/1,000 lbs fuel	lbs/1,000 lbs fuel	lb/hr	lbs/1,000 lbs fuel	lbs/1,000 lbs fuel	lb/hr	lbs/1,000 lbs fuel	lb/hr	lbs/1,000 lbs fuel	lbs/1,000 lbs fuel	lb/hr	lbs/1,000 lbs fuel
<b>Particulate (filterable)</b>	2.887	2.549	1.382	1.572	1.382	1.801	2.051	1.801	2.170	1.911	2.170	1.911	2.170
<b>Particulate (condensable)<sup>1</sup></b>	0.372	0.329	0.000	0.000	0.000	0.157	0.179	0.157	0.184	0.162	0.184	0.162	0.162
<b>Particulate (total)</b>	3.260	2.877	1.382	1.572	1.382	1.958	2.230	1.958	2.354	2.073	2.354	2.073	2.073

<sup>1</sup> - Data outliers that can be explained by process, sampling or analytical phenomena are described in Section 4.3.10 of this report.

**Table 4-41**  
**Emissions Factor Summary**  
**Particulates**  
**F108-CF-100 (KC-135R)**  
**Approach**  
 Flow by Tracer

Flow Rate, dscfm	Run Number						Average
	1		2		3		
	1017798	982281	1004572				
<b>Analyte</b>	lb/hr	lbs/1,000 lbs fuel	lb/hr	lbs/1,000 lbs fuel	lb/hr	lbs/1,000 lbs fuel	lb/hr lbs fuel
<b>Particulate (filterable)</b>	2.542	0.998	1.888	0.742	1.644	0.644	2.025
<b>Particulate (condensable)</b> <sup>1</sup>	0.000	0.000	2.614	1.027	3.162	1.239	2.888
<b>Particulate (total)</b>	2.542	0.998	4.502	1.769	4.806	1.883	3.950

<sup>1</sup> - Data outliers that can be explained by process, sampling or analytical phenomena are described in Section 4.3.10 of this report.

**Table 4-42**  
**Emissions Factor Summary**  
**Particulates**  
**F108-CF-100 (KC-135R)**  
**Intermediate**

Flow by Tracer

	Run Number						Average
	1		2		3		
Flow Rate, dscfm	1527540		1490509		1484511		
Analyte	lb/hr	lbs/1,000	lb/hr	lbs/1,000	lb/hr	lbs/1,000	lbs/1,000
		lbs fuel		lbs fuel		lbs fuel	lbs fuel
Particulate (filterable)	3.087	0.548	1.476	0.261	0.346	0.061	1.636
Particulate (condensable) <sup>1</sup>	4.597	0.816	1.468	0.260	0.000	0.000	3.032
Particulate (total)	7.683	1.364	2.943	0.521	0.346	0.061	3.658

<sup>1</sup> - Data outliers that can be explained by process, sampling or analytical phenomena are described in Section 4.3.10 of this report.

**Table 4-43**  
**Emissions Factor Summary**  
**Particulates**  
**F108-CF-100 (KC-135R)**  
**Military**

Flow by Tracer

	Run Number						Average
	1		2		3		
<b>Flow Rate, dscfm</b>	1582971		1603917		1582971		
<b>Analyte</b>	lb/hr	lbs/1,000	lb/hr	lbs/1,000	lb/hr	lbs/1,000	lbs/1,000
<b>Particulate (filterable)</b>	4.432	0.686	2.857	0.444	3.693	0.571	lbs fuel
<b>Particulate (condensable)</b>	8.064	1.248	4.505	0.699	7.256	1.121	0.567
<b>Particulate (total)</b>	12.496	1.933	7.361	1.143	10.949	1.692	1.023
					10.269		1.589

**Table 4-44**  
**Engine Operating Parameter Summary**  
**F108-CF-100 (KC-135R)**

<b>Parameter</b>	<b>Idle</b>	<b>Approach</b>	<b>Intermediate</b>	<b>Military</b>
Barometric pressure, in. Hg	28.48	28.54	28.55	28.45
Compressor discharge pressure, in. Hg	46.78	201.82	280.05	399.08
Fuel flow, lbs/hr	1,136	2,547	5,650	6,458
Fan speed, rpm	1,636	2,850	4,080	4,313
Core speed, rpm	10,884	12,286	13,465	13,802
Cell temperature, deg. F	63	50	57	67
Average thrust, lbs	1,990	6,591	15,123	16,978
Percent maximum thrust	9	30	70	78



Test Report

Volume:	<u>3</u>
Section:	<u>4.0</u>
Revision:	<u>2</u>
Date:	<u>November 1998</u>
Page:	<u>62 of 105</u>

#### 4.3.11 Engine F101-GE-102

Tracer gas was used to determine the flow rate at each power setting.

For the approach setting, the catch weights for the condensable fraction are ~17, 9, and 1. Close observation of the lab data indicates a possible error on the tare weight of the run 3 back half water.

Tables 4-45 through 4-50 present the emissions factor summary and the engine operating parameter summary for F101-GE-102.

**Table 4-45**  
**Emissions Factor Summary**  
**Particulates**  
**F101-GE-102 (B-1B)**  
**Idle**

Flow by Tracer

Flow Rate, dscfm	Run Number													
	1				2				3				Average	
	lb/hr	lbs/1,000 lbs fuel	lbs/1,000 lbs fuel	377929	lb/hr	lbs/1,000 lbs fuel	lbs/1,000 lbs fuel	427661	lb/hr	lbs/1,000 lbs fuel	lbs/1,000 lbs fuel	369070	lb/hr	lbs/1,000 lbs fuel
<b>Analyte</b>														
<b>Particulate (filterable)</b>	2.353	2.084	0.624	0.561	1.100	0.990	1.359	1.212	1.074	0.959	2.171	2.433	1.074	0.959
<b>Particulate (condensable)</b>	1.672	1.481	1.106	0.995	0.445	0.401	1.074	0.959	1.074	0.959	2.171	2.433	1.074	0.959
<b>Particulate (total)</b>	4.025	3.565	1.730	1.557	1.545	1.391	2.433	2.171	2.148	1.958	4.342	4.866	2.148	1.958

**Table 4-46**  
**Emissions Factor Summary**  
**Particulates**  
**F101-GE-102 (B-1B)**  
**Approach**  
**Flow by Tracer**

	Run Number						Average
	1		2		3		
<b>Flow Rate, dscfm</b>	1059046		1079710		1060185		
<b>Analyte</b>	lb/hr	lbs/1,000 lbs fuel	lb/hr	lbs/1,000 lbs fuel	lb/hr	lbs/1,000 lbs fuel	lb/hr lbs fuel
<b>Particulate (filterable)</b>	2.083	0.463	1.548	0.341	2.815	0.617	2.148
<b>Particulate (condensable)</b>	33.600	7.475	16.653	3.670	0.587	0.129	16.947
<b>Particulate (total)</b>	35.683	7.938	18.201	4.012	3.403	0.746	19.095

<sup>1</sup> - Data outliers that can be explained by process, sampling or analytical phenomena are described in Section 4.3.11 of this report.

**Table 4-47**  
**Emissions Factor Summary**  
**Particulates**  
**F101-GE-102 (B-1B)**  
**Intermediate**  
 Flow by Tracer

	Run Number						Average	
	1		2		3			
Flow Rate, dscfm	1267737		1253283		1319553			
Analyte	lb/hr	lbs/1,000 lbs fuel	lb/hr	lbs/1,000 lbs fuel	lb/hr	lbs/1,000 lbs fuel	lb/hr	lbs/1,000 lbs fuel
Particulate (filterable)	3.624	0.552	3.619	0.552	5.055	0.772	4.099	0.625
Particulate (condensable)	8.147	1.241	2.632	0.401	3.437	0.525	4.738	0.722
Particulate (total)	11.771	1.794	6.250	0.953	8.492	1.297	8.838	1.348

**Table 4-48**  
**Emissions Factor Summary**  
**Particulates**  
**F101-GE-102 (B-1B)**  
**Military**

Flow by Tracer

	Run Number						Average
	1		2		3		
Flow Rate, dscfm	1480754		1517840		1475604		
Analyte	lb/hr	lbs/1,000 lbs fuel	lb/hr	lbs/1,000 lbs fuel	lb/hr	lbs/1,000 lbs fuel	lb/hr
	1.505	0.193	5.425	0.693	4.120	0.525	3.683
Particulate (filterable)	26.733	3.425	0.260	0.033	1.293	0.165	9.429
Particulate (condensable)	28.238	3.618	5.685	0.726	5.413	0.689	13.112
Particulate (total)							1.678

**Table 4-49**  
**Emissions Factor Summary**  
**Particulates**  
**F101-GE-102 (B-1B)**  
**Afterburner (Zone 1)**

Flow by Tracer

	Run Number					
	1		2		3	
Flow Rate, dscfm	1659885		1631678		1707188	
Analyte	lb/hr	lbs/1,000 lbs fuel	lb/hr	lbs/1,000 lbs fuel	lb/hr	lbs/1,000 lbs fuel
Particulate (filterable)	8.845	0.581	5.276	0.342	7.200	0.470
Particulate (condensable)	37.236	2.445	36.980	2.398	36.076	2.356
Particulate (total)	46.081	3.025	42.256	2.740	43.276	2.826
					lb/hr	lb/hr
					7.107	36.764
					43.871	2.864

**Table 4-50**  
**Engine Operating Parameter Summary**  
**F101-GE-102 (B-1B)**

Parameter	Idle	Approach	Intermediate	Military	Afterburner (Zone 1)
Barometric pressure, in. Hg	28.25	28.38	28.47	28.51	28.54
Throttle position (PLA), degrees	19	41	50	59	79
Fuel flow, lbs/hr	1,117	4,533	6,557	7,828	15,314
Fan speed, rpm	3,262	6,172	6,799	7,030	7,475
Core speed, rpm	10,538	12,890	13,536	13,885	14,490
Cell temperature, deg. F	79	64	64	65	61
Average thrust, lbs	892	8,143	11,507	13,477	18,460
Percent maximum thrust	3	26	37	44	60

#### 4.3.12 Engine F110-GE-100

Tracer gas was used to determine the flow rate at each power setting. The tracer gas methodology exhibited consistency between all engine power settings except afterburner. There was an increase in the exhaust flow rate when moving from the military to the afterburner power setting. However, the increase in the flow rate was less than expected. The flow measured at the afterburner power setting may be biased low due to excessive interference of ethylene with the tracer gas during FTIR analysis. Ethylene was measured to be approximately 10 ppm, whereas SF<sub>6</sub> was measured to be 150 ppb. Alternately, the exhaust volume may have exceeded the test cell capacity for this engine. This was explained previously in Section 4.4.7 of Volume 2 and in Section 4.3.7 of this volume for the T700-GE-700 helicopter engine.

Tables 4-51 through 4-56 present the emissions factor summary and the engine operating parameter summary for F110-GE-100.



**Table 4-51**  
**Emissions Factor Summary**  
**Particulates**  
**F110-GE-100 (F16 C/D)**  
**Idle**

Flow by Tracer

	Run Number						Average
	1		2		3		
<b>Flow Rate, dscfm</b>	320783		305459		311208		
<b>Analyte</b>	lb/hr	lbs/1,000 lbs fuel	lb/hr	lbs/1,000 lbs fuel	lb/hr	lbs/1,000 lbs fuel	lb/hr lbs fuel
<b>Particulate (filterable)</b>	0.796	0.718	1.325	1.195	2.828	2.550	1.650 1.488
<b>Particulate (condensable)</b>	2.337	2.107	0.873	0.787	0.517	0.467	1.242 1.120
<b>Particulate (total)</b>	3.133	2.825	2.198	1.982	3.345	3.016	2.892 2.608

**Table 4-52**  
**Emissions Factor Summary**  
**Particulates**  
**F110-GE-100 (F16 C/D)**  
**Approach**  
 Flow by Tracer

	Run Number						Average
	1		2		3		
Flow Rate, dscfm	1080116		1041068		1064411		
Analyte	lb/hr	lbs/1,000 lbs fuel	lb/hr	lbs/1,000 lbs fuel	lb/hr	lbs/1,000 lbs fuel	lb/hr lbs fuel
Particulate (filterable)	2.539	0.501	3.172	0.624	1.302	0.256	2.338
Particulate (condensable)	9.046	1.786	2.796	0.550	1.954	0.384	4.599
Particulate (total)	11.585	2.287	5.968	1.174	3.256	0.640	6.936

**Table 4-53**  
**Emissions Factor Summary**  
**Particulates**  
**F110-GE-100 (F16 C/D)**  
**Intermediate**  
**Flow by Tracer**

	Run Number						Average
	1		2		3		
Flow Rate, dscfm	1355147		1328044		1363494		
Analyte	lb/hr	lbs/1,000	lb/hr	lbs/1,000	lb/hr	lbs/1,000	lbs/1,000
		lbs fuel		lbs fuel		lbs fuel	lbs fuel
Particulate (filterable)	0.756	0.101	0.691	0.094	2.200	0.302	1.216
Particulate (condensable)	3.183	0.426	4.451	0.607	1.393	0.191	3.009
Particulate (total)	3.939	0.527	5.142	0.701	3.593	0.493	4.225
							0.574

**Table 4-54**  
**Emissions Factor Summary**  
**Particulates**  
**F110-GE-100 (F16 C/D)**  
**Military**  
 Flow by Tracer

Flow Rate, dscfm	Run Number						Average
	1		2		3		
	1516032		1428004		1449829		
<b>Analyte</b>	lb/hr	lbs/1,000 lbs fuel	lb/hr	lbs/1,000 lbs fuel	lb/hr	lbs/1,000 lbs fuel	lbs/1,000 lbs fuel
<b>Particulate (filterable)</b>	1.444	0.126	0.826	0.073	2.467	0.219	1.579
<b>Particulate (condensable)</b>	0.006	0.000	0.001	0.000	0.002	0.000	0.000
<b>Particulate (total)</b>	1.450	0.127	0.827	0.073	2.469	0.219	1.582

**Table 4-55**  
**Emissions Factor Summary**  
**Particulates**  
**F110-GE-100 (F16 C/D)**  
**Afterburner (Zone 1)**

Flow by Tracer

Flow Rate, dscfm <sup>1</sup>	Run Number						Average
	1		2		3		
	1651796		1470502		1357918		
<b>Analyte</b>	lb/hr	lbs/1,000	lb/hr	lbs/1,000	lb/hr	lbs/1,000	lbs/1,000
<b>Particulate (filterable)</b>	9.083	0.492	3.171	0.177	7.915	0.443	6.723
<b>Particulate (condensable)</b>	67.321	3.644	50.367	2.812	43.851	2.453	53.846
<b>Particulate (total)</b>	76.404	4.136	53.537	2.989	51.765	2.895	60.569
							3.340

<sup>1</sup> - Data outliers that can be explained by process, sampling or analytical phenomena are described in Section 4.3.12 of this report.

**Table 4-56**  
**Engine Operating Parameter Summary**  
**F110-GE-100 (F16 C/D)**

Parameter	Idle	Approach	Intermediate	Military	Afterburner (Zone 1)
Barometric pressure, in. Hg	28.91	28.87	28.91	28.83	28.63
Compressor discharge pressure, in. Hg	46.79	201.85	280.05	399.08	395.11
Throttle position (PLA), degrees	17	41	60	87.58	97
Fuel flow, lbs/hr	1,111	5,080	7,332	11,358	18,088
Fan speed, rpm	3,410	6,667	7,419	8,255	8,226
Cell temperature, deg. F	55	57	58	68	64
Average thrust, lbs	592	7,645	11,595	17,460	19,780
Percent maximum thrust	2	27	41	61	69

### 4.3.13 Engine F117-PW-100

Tracer gas was used to determine the flow rate at each power setting. Emissions sampling was only conducted at three power settings: idle, approach and intermediate. Testing could not be conducted at the military power setting due to this engine's operational time limitation within a test cell environment.

During the particulate matter sample collection at the idle power setting for Run 2, the impinger water backwashed into the filter holder and wetted the filter during the final leak check. If all the moisture was not removed from the filter during filter desiccation, the filterable particulate fraction may be biased high. The result for the filterable particulate fraction from idle Run 2 is in fact higher than that for either of Run 1 or Run 3. Because of the typical variability noted for particulate samples, however, the difference may be the result of normal method variability and not a bias induced during sample collection. Therefore, the result is included.

The final sample train leak check for the particulate sample, intermediate power setting, Run 3 had an excessive leak. The leak occurred when the connection between the probe and the sample filter was jarred during the sample train removal from the stack. The sample data confirmed that the leak was not present during this test. The moisture collected during the sample run was consistent with moisture volumes collected during Run 1 and Run 2.

Tables 4-57 through 4-60 present the emissions factor summary and the engine operating parameter summary for F117-PW-100 (C-17)

**Table 4-57  
Emissions Factor Summary  
Particulates  
F117-PW-100 (C-17)  
Idle**

Flow by Tracer

Flow Rate, dscfm	Run Number						Average
	1		2		3		
	360323		358433		356676		
<b>Analyte</b>	lbs/1,000 lbs fuel	lb/hr	lbs/1,000 lbs fuel	lb/hr	lbs/1,000 lbs fuel	lb/hr	lbs/1,000 lbs fuel
<b>Particulate (filterable)</b>	0.754	4.808	4.856	0.074	0.074	1.878	1.897
<b>Particulate (condensable) 1</b>	6.417	6.914	6.984	12.327	12.452	8.553	8.639
<b>Particulate (total)</b>	7.171	11.722	11.840	12.401	12.526	10.431	10.537

<sup>1</sup> - Data outliers that can be explained by process, sampling or analytical phenomena are described in Section 4.3.13 of this report.



**Table 4-58**  
**Emissions Factor Summary**  
**Particulates**  
**F117-PW-100 (C-17)**  
**Approach**  
**Flow by Tracer**

	Run Number						Average
	1		2		3		
Flow Rate, dscfm	1263280		1252281		1235224		
Analyte	lb/hr	lbs/1,000	lb/hr	lbs/1,000	lb/hr	lbs/1,000	lbs/1,000
		lbs fuel		lbs fuel		lbs fuel	lbs fuel
Particulate (filterable)	1.708	0.367	2.827	0.608	1.451	0.312	1.996
Particulate (condensable)	43.628	9.382	12.382	2.663	15.077	3.242	23.696
Particulate (total)	45.337	9.750	15.209	3.271	16.528	3.554	25.691
							5.525

**Table 4-59**  
**Emissions Factor Summary**  
**Particulates**  
**F117-PW-100 (C-17)**  
**Intermediate**  
**Flow by Tracer**

	Run Number						Average
	1		2		3 <sup>1</sup>		
<b>Flow Rate, dscfm</b>	1915415		1829600		1913469		
<b>Analyte</b>	lb/hr	lbs/1,000 lbs fuel	lb/hr	lbs/1,000 lbs fuel	lb/hr	lbs/1,000 lbs fuel	lb/hr lbs fuel
<b>Particulate (filterable)</b>	11.704	1.125	2.790	0.268	13.452	1.293	9.315
<b>Particulate (condensable)</b>	17.573	1.690	7.867	0.756	18.804	1.808	14.748
<b>Particulate (total)</b>	29.277	2.815	10.657	1.025	32.256	3.102	24.063

<sup>1</sup> - Data outliers that can be explained by process, sampling or analytical phenomena are described in Section 4.3.13 of this report.

**Table 4-60**  
**Engine Operating Parameter Summary**  
**F117-PW-100 (C-17)**

Parameter	Idle	Approach	Intermediate
Barometric pressure, in. Hg	30.02	30.06	30.00
Throttle position (PLA), degrees	38	49	68
Fuel flow, lbs/hr	978	4,645	10,408
Fan speed, rpm	982	2,749	3,759
Core speed, rpm	7,719	10,157	11,209
Average thrust, lbs	1,478	13,088	28,526
Percent maximum thrust	4	31	68

Test Report	
Volume:	<u>3</u>
Section:	<u>4.0</u>
Revision:	<u>2</u>
Date:	<u>November 1998</u>
Page:	<u>81 of 105</u>

#### 4.3.14 Engine F118-GE-100

Tracer gas was used to determine the flow rate at each power setting. The particulate matter sample collected during the approach power setting Run 1 was void due to broken glassware that resulted in an excessive leak during sampling. This is shown as a blank in Table 4-62.

Tables 4-61 through 4-65 present the emissions factor summary and the engine operating parameter summary for F118-GE-100.

**Table 4-61**  
**Emissions Factor Summary**  
**Particulates**  
**F118-GE-100 (B-2)**  
**Idle**

Flow by Tracer

	Run Number						Average
	1		2		3		
Flow Rate, dscfm	308039		303165		301646		
Analyte	lb/hr	lbs/1,000	lb/hr	lbs/1,000	lb/hr	lbs/1,000	lbs/1,000
		lbs fuel		lbs fuel		lbs fuel	lbs fuel
Particulate (filterable)	0.165	0.151	0.473	0.431	0.065	0.059	0.214
Particulate (condensable)	1.383	1.262	0.702	0.640	1.313	1.196	1.033
Particulate (total)	1.548	1.413	1.175	1.071	1.378	1.255	1.247

**Table 4-62**  
**Emissions Factor Summary**  
**Particulates**  
**F118-GE-100 (B-2)**  
**Approach**  
 Flow by Tracer

Flow Rate, dscfm	1		2		3		Average	
	lb/hr	lbs/1,000 lbs fuel	lb/hr	lbs/1,000 lbs fuel	lb/hr	lbs/1,000 lbs fuel	lb/hr	lbs/1,000 lbs fuel
Analyte								
Particulate (filterable)	2.396	0.636	15.584	4.181	8.990	2.409		
Particulate (condensable)	9.016	2.393	8.465	2.271	8.740	2.332		
Particulate (total)	11.412	3.029	24.049	6.453	17.730	4.471		

Run 1 voided due to sample train leak.

**Table 4-63**  
**Emissions Factor Summary**  
**Particulates**  
**F118-GE-100 (B-2)**  
**Intermediate**

Flow by Tracer

	Run Number						Average
	1		2		3		
Flow Rate, dscfm	1076278		1064220		1033653		
Analyte	lb/hr	lbs/1,000	lb/hr	lbs/1,000	lb/hr	lbs/1,000	lbs/1,000
	2.706	0.246	2.712	0.248	0.815	0.076	lb/hr
Particulate (filterable)	15.206	1.381	18.441	1.688	18.220	1.699	2.078
Particulate (condensable)	17.911	1.627	21.153	1.936	19.035	1.775	17.289
Particulate (total)							19.367
							1.589
							1.779

**Table 4-64**  
**Emissions Factor Summary**  
**Particulates**  
**F118-GE-100 (B-2)**  
**Military**  
**Flow by Tracer**

Flow Rate, dscfm	Run Number													
	1				2				3				Average	
	1076278				1064220				1033653					
<b>Analyte</b>	lb/hr	lbs/1,000 lbs fuel	lb/hr	lbs/1,000 lbs fuel	lb/hr	lbs/1,000 lbs fuel	lb/hr	lbs/1,000 lbs fuel	lb/hr	lbs/1,000 lbs fuel	lb/hr	lbs/1,000 lbs fuel	lb/hr	lbs/1,000 lbs fuel
<b>Particulate (filterable)</b>	0.839	0.076	4.206	0.385	0.239	0.022	1.761	0.161	16.279	1.518	16.124	1.481	17.885	1.642
<b>Particulate (condensable)</b>	15.729	1.429	16.363	1.497	16.279	1.518	16.124	1.481	16.279	1.518	16.124	1.481	17.885	1.642
<b>Particulate (total)</b>	16.568	1.505	20.569	1.882	16.518	1.540	17.885	1.642	16.518	1.540	17.885	1.642	17.885	1.642



**Table 4-65**  
**Engine Operating Parameter Summary**  
**F118-GE-100 (B-2)**

Parameter	Idle	Approach	Intermediate	Military
Throttle position (PLA), degrees	17	37	46	73
Fuel flow, lbs/hr	1,097	3,773	6,350	10,887
Fan speed, rpm	3,341	6,228	7,339	8,275
Core speed, rpm	10,568	12,687	13,808	14,783
Average thrust, lbs	NA	NA	NA	NA
Percent maximum thrust	---	---	---	---

NA - Engine thrust value not available on engine operating parameter printout.

Test Report	
Volume:	<u>3</u>
Section:	<u>4.0</u>
Revision:	<u>2</u>
Date:	<u>November 1998</u>
Page:	<u>87 of 105</u>

#### 4.3.15 Engine F404-GE-F1D2/400

Tracer gas was used to determine the flow rate at each power setting.

The afterburner power setting was run between afterburner zones 2 and 3 (mid afterburner) power setting. All other engines tested during this program were run at afterburner zone 1 (minimum afterburner) power setting. The higher afterburner setting appears to have resulted in relatively lower emissions when compared to other engines tested during this program.

The particulate matter sample collected during the idle power setting Run 3 had an overall negative moisture catch in the sample train. It appears that the sample train did not start with the correct liquid volume. The average of the moisture values from the Idle power setting Run 1 and Run 2 was substituted for Run 3.

Tables 4-66 through 4-71 present the emissions factor summary and the engine operating parameter summary for F404-GE-F1D2/400.

**Table 4-66**  
**Emissions Factor Summary**  
**Particulates**  
**F404-GE-F1D2/400 (F-117A & F/A-18C/D)**  
**Idle**

Flow by Tracer

Flow Rate, dscfm	Run Number						Average	
	1		2		3 <sup>1</sup>		lb/hr	lbs/1,000 lbs fuel
	151484		147428		145179			
<b>Analyte</b>	lb/hr	lbs/1,000 lbs fuel	lb/hr	lbs/1,000 lbs fuel	lb/hr	lbs/1,000 lbs fuel	lb/hr	lbs/1,000 lbs fuel
<b>Particulate (filterable)</b>	1.125	1.655	1.024	1.506	0.660	0.958	0.937	1.373
<b>Particulate (condensable)</b>	2.416	3.554	2.029	2.984	1.921	2.788	2.122	3.109
<b>Particulate (total)</b>	3.542	5.208	3.053	4.490	2.582	3.747	3.059	4.482

<sup>1</sup> - Data outliers that can be explained by process, sampling or analytical phenomena are described in Section 4.3.15 of this report.

**Table 4-67**  
**Emissions Factor Summary**  
**Particulates**  
**F404-GE-F1D2/400 (F-117A & F/A-18C/D)**  
**Approach**  
 Flow by Tracer

Flow Rate, dscfm	Run Number						Average	
	1		2		3			
	554469		561488		563186			
<b>Analyte</b>	lb/hr	lbs/1,000 lbs fuel	lb/hr	lbs/1,000 lbs fuel	lb/hr	lbs/1,000 lbs fuel	lb/hr	lbs fuel
<b>Particulate (filterable)</b>	2.093	0.673	3.102	1.001	0.250	0.080	1.815	0.584
<b>Particulate (condensable)</b>	3.598	1.156	0.803	0.259	3.740	1.199	2.714	0.871
<b>Particulate (total)</b>	5.691	1.829	3.905	1.260	3.990	1.279	4.529	1.456

**Table 4-68**  
**Emissions Factor Summary**  
**Particulates**  
**F404-GE-F1D2/400 (F-117A & F/A-18C/D)**  
**Intermediate**  
**Flow by Tracer**

	Run Number										Average
	1			2			3			884511	
	lb/hr	lbs/1,000 lbs fuel	lbs/1,000	lb/hr	lbs/1,000 lbs fuel	lbs/1,000	lb/hr	lbs/1,000 lbs fuel	lbs/1,000		
<b>Flow Rate, dscfm</b>	892460			897875			884511				
<b>Analyte</b>											
<b>Particulate (filterable)</b>	4.549	0.692		2.808	0.440		5.686	0.883		4.348	0.672
<b>Particulate (condensable)</b>	6.317	0.960		6.632	1.040		4.521	0.702		5.823	0.901
<b>Particulate (total)</b>	10.865	1.652		9.440	1.481		10.208	1.585		10.171	1.573

**Table 4-69**  
**Emissions Factor Summary**  
**Particulates**  
**F404-GE-F1D2/400 (F-117A & F/A-18C/D)**  
**Military**

Flow by Tracer

Flow Rate, dscfm	Run Number						Average
	1		2		3		
	987066	985084	986075				
<b>Analyte</b>	lbs/hr	lbs/1,000 lbs fuel	lb/hr	lbs/1,000 lbs fuel	lb/hr	lbs/1,000 lbs fuel	lb/hr
<b>Particulate (filterable)</b>	6.331	0.818	8.032	1.036	2.378	0.308	5.580
<b>Particulate (condensable)</b>	4.956	0.640	11.116	1.434	4.638	0.601	6.903
<b>Particulate (total)</b>	11.287	1.458	19.148	2.470	7.016	0.909	12.484

**Table 4-70**  
**Emissions Factor Summary**  
**Particulates**  
**F404-GE-F1D2/400 (F-117A & F/A-18C/D)**  
**Afterburner (Zone 3)**

Flow by Tracer

	Run Number										Average
	1			2			3				
<b>Flow Rate, dscfm</b>	1007868			1028865			1027830				
<b>Analyte</b>	lb/hr	lbs/1,000 lbs fuel		lb/hr	lbs/1,000 lbs fuel		lb/hr	lbs/1,000 lbs fuel		lb/hr	lbs/1,000 lbs fuel
<b>Particulate (filterable)</b>	5.966	0.376		6.018	0.379		5.252	0.332		5.745	0.362
<b>Particulate (condensable)</b>	53.282	3.360		46.362	2.920		52.762	3.331		50.802	3.204
<b>Particulate (total)</b>	59.248	3.736		52.380	3.299		58.014	3.663		56.547	3.566

**Table 4-71**  
**Engine Operating Parameter Summary**  
**F404-GE-F1D2/400 (F-117A & F/A-18C/D)**

Parameter	Idle	Approach	Intermediate	Military	Afterburner (Zone 3)
Barometric pressure, in. Hg	26.81	27.77	26.92	27.76	27.35
Fuel flow, lbs/hr	685	3,111	6,464	7,739	15,851
Fan speed, rpm	5,159	10,492	12,486	13,167	13,109
Core speed, rpm	10,960	14,176	15,414	15,994	15,876
Average thrust, lbs	632	4,057	8,305	9,608	12,034
Percent maximum thrust	6	38	79	91	114



Test Report	
Volume:	<u>3</u>
Section:	<u>4.0</u>
Revision:	<u>2</u>
Date:	<u>November 1998</u>
Page:	<u>94 of 105</u>

#### **4.3.16 Engine T64-GE-100**

Actual flows were measured following EPA Method 2 procedures because emissions were exhausted through a single stack. Measured flows were consistent between the particulate, semivolatile, and formaldehyde sampling trains.

Due to severe weather conditions while testing at the ground idle engine setting, testing was terminated after two hours.

Tables 4-72 through 4-76 present the emissions factor summary and the engine operating parameter summary for T64-GE-100.

**Table 4-72**  
**Emissions Factor Summary**  
**Particulates**  
**T64-GE-100 (MH53J)**  
**Ground Idle**  
**Flow as Measured**

Flow Rate, dscfm	Run Number					
	1		2		Average	
	9655		10213			
<b>Analyte</b>	lb/hr	lbs/1,000 lbs fuel	lb/hr	lbs/1,000 lbs fuel	lb/hr	lbs/1,000 lbs fuel
<b>Particulate (filterable)</b>	0.077	0.259	0.051	0.170	0.064	0.215
<b>Particulate (condensable)</b>	0.602	2.026	0.675	2.264	0.638	2.145
<b>Particulate (total)</b>	0.679	2.285	0.725	2.434	0.702	2.360

Refer to Section 4.3.16 for discussion of Run 3.

**Table 4-73**  
**Emissions Factor Summary**  
**Particulates**  
**T64-GE-100 (MH53J)**  
**75% Normal**

Flow as Measured

	Run Number						Average
	1		2		3		
Flow Rate, dscfm	25138		24707		25701		
Analyte	lb/hr	lbs/1,000	lb/hr	lbs/1,000	lb/hr	lbs/1,000	lbs/1,000
		lbs fuel		lbs fuel		lbs fuel	lbs fuel
Particulate (filterable)	1.346	1.433	1.439	1.528	1.503	1.596	1.429
Particulate (condensable)	0.512	0.545	0.605	0.642	0.141	0.150	0.419
Particulate (total)	1.858	1.978	2.044	2.170	1.645	1.746	1.849
							1.965

**Table 4-74**  
**Emissions Factor Summary**  
**Particulates**  
**T64-GE-100 (MH53J)**  
**Normal**

Flow as Measured

Flow Rate, dscfm	Run Number											
	1			2			3			Average		
	27932			28054			28099					
<b>Analyte</b>	lb/hr	lbs/1,000 lbs fuel	lb/hr	lbs/1,000 lbs fuel	lb/hr	lbs/1,000 lbs fuel	lb/hr	lbs/1,000 lbs fuel	lb/hr	lbs/1,000 lbs fuel	lb/hr	lbs/1,000 lbs fuel
<b>Particulate (filterable)</b>	1.029	0.602	1.430	0.845	1.257	0.742	1.239	0.730	1.492	0.875	2.731	1.605
<b>Particulate (condensable)</b>	3.414	1.998	0.439	0.259	0.625	0.369	1.492	0.875	1.492	0.875	1.492	0.875
<b>Particulate (total)</b>	4.442	2.599	1.869	1.104	1.882	1.111	2.731	1.605	2.731	1.605	2.731	1.605

**Table 4-75  
Emissions Factor Summary  
Particulates  
T64-GE-100 (MH53J)  
Military**

Flow as Measured

	Run Number						Average
	1		2		3		
<b>Flow Rate, dscfm</b>	29597		28655		27495		
<b>Analyte</b>	lb/hr	lbs/1,000 lbs fuel	lb/hr	lbs/1,000 lbs fuel	lb/hr	lbs/1,000 lbs fuel	lb/hr lbs fuel
<b>Particulate (filterable)</b>	1.517	0.822	1.751	0.947	1.318	0.712	1.529 0.827
<b>Particulate (condensable)</b>	0.149	0.081	0.065	0.035	0.273	0.147	0.162 0.088
<b>Particulate (total)</b>	1.666	0.902	1.816	0.983	1.591	0.860	1.691 0.915

**Table 4-76**  
**Engine Operating Parameter Summary**  
**T64-GE-100**

Parameter	Ground		75% Normal	Normal	Military
	Idle				
Barometric pressure, in. Hg	29.73	29.36	29.93		29.82
Fuel flow, lbs/hr	298	941	1,698		1,848
Engine speed, rpm	12,259	16,008	17,462		17,704
Torque, ft-lbs	107	547	1,318		1,465
Shaft horsepower, SHP	85	1,458	3,521		3,873
Percent maximum SHP	2	34	81		90

#### 4.3.17 Engine TF34-GE-100A

Tracer gas was used to determine the flow rate at each power setting. The combination of the high by-pass design of the TF34-GE-100A and large amount of dilution air (as the result of induced draft in the hush house configuration) resulted in very low pollutant concentrations. The measured concentrations were very low and concentrations showed little change between various engine operating conditions. Also noted during testing was stratification of the engine exhaust in the augments tube. This was probably the result of the upward angle of the engine directing exhaust towards the top of the augments tube. Sampling for all pollutant parameters was not affected by the stratification as samples were collected in the upper half of the augments tube where the central part of the exhaust plume was located.

Particulate sample collected during the intermediate power setting Run 3 exceeded the allowable final leak rate (0.038 cfm). It appears that the slight leak was present during testing, thus biasing the sample result low. The sample was not corrected for the leak, as the correction would be less than 1.5%.

Tables 4-77 through 4-81 present the emissions factor summary and the engine operating parameter summary for TF34-GE-100A.

**Table 4-77**  
**Emissions Factor Summary**  
**Particulates**  
**TF34-GE-100A (A-10)**  
**Idle**

Flow by Tracer

	Run Number						Average	
	1		2		3			
Flow Rate, dscfm	227691		22238		225157			
Analyte	lb/hr	lbs/1,000 lbs fuel	lb/hr	lbs/1,000 lbs fuel	lb/hr	lbs/1,000 lbs fuel	lb/hr	lbs/1,000 lbs fuel
Particulate (filterable)	2.963	5.310	2.808	5.463	0.997	2.368	2.256	4.380
Particulate (condensable)	2.090	3.745	1.619	3.150	1.670	3.967	1.793	3.621
Particulate (total)	5.052	9.055	4.427	8.614	2.667	6.335	4.049	8.001



**Table 4-78**  
**Emissions Factor Summary**  
**Particulates**  
**TF34-GE-100A (A-10)**  
**Approach**  
**Flow by Tracer**

	Run Number						Average
	1		2		3		
<b>Flow Rate, dscfm</b>	675472		661413		676883		
<b>Analyte</b>	lb/hr	lbs/1,000 lbs fuel	lb/hr	lbs/1,000 lbs fuel	lb/hr	lbs/1,000 lbs fuel	lb/hr lbs fuel
<b>Particulate (filterable)</b>	2.564	2.775	7.853	8.390	1.036	1.103	3.818
<b>Particulate (condensable)</b>	0.139	0.150	0.107	0.114	5.676	6.045	1.974
<b>Particulate (total)</b>	2.703	2.925	7.959	8.503	6.712	7.148	5.792

**Table 4-79**  
**Emissions Factor Summary**  
**Particulates**  
**TF34-GE-100A (A-10)**  
**Intermediate**

Flow by Tracer

Flow Rate, dscfm	Run Number											
	1			2			3 <sup>1</sup>			Average		
	lb/hr	lbs/1,000 lbs fuel	889798	lb/hr	lbs/1,000 lbs fuel	881785	lb/hr	lbs/1,000 lbs fuel	893404	lb/hr	lbs/1,000 lbs fuel	lbs/1,000 lbs fuel
<b>Analyte</b>												
<b>Particulate (filterable)</b>	3.086	2.040		3.425	2.273		2.462	1.623		2.991	1.978	
<b>Particulate (condensable)</b>	24.345	16.090		4.349	2.886		2.835	1.869		10.510	6.948	
<b>Particulate (total)</b>	27.431	18.130		7.774	5.159		5.296	3.491		13.500	8.927	

<sup>1</sup> - Data outliers that can be explained by process, sampling or analytical phenomena are described in Section 4.3.17 of this report.

**Table 4-80**  
**Emissions Factor Summary**  
**Particulates**  
**TF34-GE-100A (A-10)**  
**Military**

Flow by Tracer

Flow Rate, dscfm	Run Number						Average	
	1		2		3			
	1175846	1175846	1175846	1146190	1146190	1146190	1146190	1146190
<b>Analyte</b>	lb/hr	lbs/1,000	lb/hr	lbs/1,000	lb/hr	lbs/1,000	lb/hr	lbs/1,000
<b>Particulate (filterable)</b>	2.473	0.937	1.467	0.558	3.799	1.452	2.580	0.982
<b>Particulate (condensable)</b>	0.213	0.081	0.445	0.169	12.562	4.802	4.407	1.684
<b>Particulate (total)</b>	2.686	1.017	1.912	0.728	16.361	6.254	6.986	2.666

**Table 4-81**  
**Engine Operating Parameter Summary**  
**TF34-GE-100A (A-10)**

Parameter	Idle	Approach	Intermediate	Military
Barometric pressure, in. Hg	30.16	30.16	30.16	30.16
Fuel flow, lbs/hr	498	933	1,512	2,628
Percent of maximum engine speed	64	79	83	88
Average thrust, lbs	665	2,550	4,200	7,100
Percent maximum thrust	7	28	46	78

Test Report	
Volume:	<u>3</u>
Section:	<u>5.0</u>
Revision:	<u>2</u>
Date:	<u>November 1998</u>
Page:	<u>1 of 24</u>

## SECTION 5

### PARTICULATE MATTER RESULTS COMPARISON

Particulate matter (PM) results provided in this volume included results measured by a custom Method 5 procedure and results measured by traditional EPA procedures. This section describes two alternate sampling methods that have been employed in previous emission sampling programs. Results obtained in those sampling programs have been compared to the data gathered by the custom Method 5 procedures. A discussion of the comparison is provided that explains differences and similarities between the methods.

#### 5.1 ALTERNATE PARTICULATE SAMPLING METHODS

The Aircraft Environmental Support Office (AESO) and Battelle Laboratories conducted previous emission sampling programs. The sampling methods used during each program for measuring particulate matter are discussed in the following subsections.

##### 5.1.1 Aircraft Environmental Support Office

The sampling was performed at the exit plane of a concrete stack. The stack contained acoustical baffles that remained intact during the test project. The design of the test cell baffle assembly divided the stack into 15 rectangles of equal area.

Preliminary velocity measurements were made in 2 of the 15 rectangles. Each of these rectangles was subdivided into 15 points. Therefore, measurements were taken at a total of 30 points. The consistency of the data demonstrated minimal flow

Test Report	
Volume:	<u>3</u>
Section:	<u>5.0</u>
Revision:	<u>2</u>
Date:	<u>November 1998</u>
Page:	<u>2 of 24</u>

stratification and showed that the baffles did not affect the sampling strategy. It was determined from the velocity traverses that the plane of the stack would be divided into 45 rectangles, the center of each constituting a representative sampling point.

No ports were installed on the test cell. All testing was performed over the lip of the rectangular stack. A monorail system was used to support the sampling train so that the distance between the probe and the lip of the stack would not exceed 4 inches.

Two sampling trains, designated as north and south, were used to traverse the entire stack. The north train sampled 18 points and the south train sampled the remaining 27 points. During several tests, only 15 points were used to traverse the stack area. The data obtained from the simultaneous north/south sampling trains were composited for presentation as a single test.

The particulate emissions were measured at the stack exit in accordance with guidelines outlined in the San Diego APCD Reference Method 5. The methodology was modified by placing a heated glass fiber filter between the probe and condenser train to distinguish between solid and condensable particulate. Also, the fifth impinger, before the vacuum line, was filled with 300 grams of dry, indicating silica gel. EPA and San Diego APCD Reference Methods 1-4 were used to determine the sampling points, velocity, molecular composition and moisture content, respectively. Based upon preliminary measurements, a sampling nozzle of appropriate diameter was selected to sample isokinetically.

A representative sample of exhaust was drawn through a stainless steel nozzle and heated stainless steel sampling probe to a heated 90-mm glass fiber filter. The filter was maintained at 248 °F ±25 °F. The impinger train consisted of numbers 1, 3, 4, and 5 being modified impingers, with number 2 being the standard Greenburg-Smith design. Numbers 1 and 2 were initially filled with 100 ml of deionized water while numbers 3 and 4 remained empty. Number 5 contained the silica gel. Exhaust gases were scrubbed a final time, and an unheated fiber filter was placed between impinger numbers 4 and 5.

Test Report	
Volume:	<u>3</u>
Section:	<u>5.0</u>
Revision:	<u>2</u>
Date:	<u>November 1998</u>
Page:	<u>3 of 24</u>

Temperatures of the exhaust stream and the impinger exit were monitored by using type-K thermocouples connected to a multi-switch Gordon Digital Temperature Indicator. The inlet and outlet temperatures of the dry gas meter were monitored with dial stem thermometers.

Velocity head pressures were measured at each point with calibrated S-type pitot tubes. At military and 85% RPM power settings, the pitot tubes were connected to Dwyer inclined-vertical manometers with an inclined range of 0.00 to 1.00 inch of water and a vertical range of 1.00 to 10.00 inches of water. Measurements at idle used a hook gage accurate to  $\pm 0.00025$  inch of water over a 0- to 2-inch water column range.

During the sampling period, the sample rates were adjusted to maintain isokinetic sampling conditions. The pressure differential across the orifice was determined by York Research Consultants' HP41C/CV sampling rate software program.

Leak checks were conducted prior to each test run and before and after every component change in the sampling trains. At the conclusion of the test run, the system was leak checked at the highest vacuum pulled during the sampling period. The allowable leak rate of Reference Method 5 is 0.02 cubic foot per minute, or 4% of the average sampling rate, whichever is less.

### **5.1.2 Battelle Columbus Division**

The particulate sampling system utilized for testing was designed to determine the size distribution as well as the mass loading of particles in the engine exhaust. The system consisted of a sampling rake exhaust collection system directly behind the engine equipment with a smoke meter, a filter preceding the main sampling pump, and a dilution system followed by particle sizing instrumentation.

Particulate mass was determined gravimetrically from the filter preceding the pump. This filter was maintained at 150 °C during sampling. The sample tubing between the rake and the filter also was held at 150 °C during sampling. The sample tubing consisted of 125 feet of electrically grounded carbon-impregnated Teflon®

Test Report	
Volume:	<u>3</u>
Section:	<u>5.0</u>
Revision:	<u>2</u>
Date:	<u>November 1998</u>
Page:	<u>4 of 24</u>

tubing designed to minimize buildup of static charge. Bends in the tubing were kept at a minimum and were of large diameter to minimize particulate loss. Filter sampling was initiated when the valve of the rake was opened (about 10 minutes before the start of the test) and continued through the 20-minute sample collection period. Between 0.3 and 1.5 cubic meters of exhaust was sampled through the filter for each test, depending on power setting. A 6-inch-diameter Teflon® coated glass fiber filter was used for particulate sampling. The filters were equilibrated for 24 hours at 40 percent relative humidity prior to weighing, both before and after sample collection. After collection, each filter was folded in half and sealed in a glassine envelope within a polyethylene bag for transport to the laboratory. The filters were stored in a freezer before equilibration and weighing. Several blank filters were handled in the same manner in the field as the actual samples.

## 5.2 COMPARISON OF RESULTS

Particulate matter samples were collected by the sample team at a single point at each site with the custom Method 5 procedure. The location of the single sample point differed from test cell to test cell. A similar particulate concentration was measured at each location, even though the sampling point was at a different point in the exhaust stream. Isokinetic samples collected by strict Method 5 procedures at other locations within this test program (full traverse) were in the range of the samples collected at a single point.

Similar variations in particulate data were noticed in the current published data from previous studies. For example, the March 1982 AESO report for the J52 had a variation at the idle condition of 260%. At the military setting, similarly, results varied by 100% for both the J52 and J79.

In former testing at Edwards AFB, a composite sample (3-hour duration) was collected during the three 1-hour sample runs at the same location. The results



Test Report	
Volume:	<u>3</u>
Section:	<u>5.0</u>
Revision:	<u>2</u>
Date:	<u>November 1998</u>
Page:	<u>5 of 24</u>

showed similar variation even though they were collected at the same time and same location.

The particulate matter emission results presented in this report represent a correction for ambient concentrations. This was not always considered in past sampling efforts. In addition, exhaust flow was measured by Method 2 (pitot tube) in previous studies. Flow is difficult to measure manually at low- and high-flow conditions due to large manometer deflections.

Particulate matter results from previous sampling programs were reviewed. Sampling programs that measured particulate matter emissions for engines similar to those in the EQ/Weston program are listed below.

1. Aircraft Engines and Power Unit Emissions Testing Report, Environmental Quality Management, Inc., May 1998.
2. Engine and Hush House Emissions from a F100-PW-200, Volume 1, Radian, February 1997.
3. Engine and Hush House Emissions from a F100-PW-100, Volume 1, Radian, November, 1996.
4. Engine and Hush House Emissions from a TF30-P109, Volume 1, Radian, June, 1996.
5. Calculation Methods for Criteria Air Pollutant Emission Inventories, Table 1-1, Armstrong Laboratories, July 1994. (Book 2, 11)
6. PM and NO<sub>x</sub> Emission Factors for Jet Engine Testing (AQUIS), Table 3.1.7-1, May 1994. (File 13)
7. Engine Exhaust Emissions Data Bank Issue 1, ICAO, October 1993. Taken from Pratt Whitney Manufacturing Data. (File 9)
8. Engine Exhaust Emissions Data Bank Draft First Edition, ICAO, December 1993. Taken from Pratt Whitney Manufacturing Data. (File 7)

Test Report	
Volume:	<u>3</u>
Section:	<u>5.0</u>
Revision:	<u>2</u>
Date:	<u>November 1998</u>
Page:	<u>6 of 24</u>

9. Summary Tables of Gaseous and Particulate Emissions from Aircraft Engines, AESO, June 1990. (Files 3 and 6 and Book 2, 12)
10. Manufacturing Data from Navy Aircraft Environmental Support Office, 1981. (File 6)
11. AFESC Aircraft Emissions Characterizations, Battelle, August 1987. (Book 2, 1)
12. Aircraft Engine Emissions Estimator, AFESO, September 1985. (Book 2, 10)
13. Report No. 110-01-82 Particulate Emissions Test Program (AESO), Volume 1, March 1982. (Book 1, 1)
14. Internal Combustion Engine Sources, Table II-1-7, February 1980.
15. Source Sample of Aerospace Ground Equipment and Jet Engines, Environmental Quality Management, Inc., August 1996.

The particulate matter emissions were reviewed from each of the above sources and summarized in Table 5-1. The reference numbers above correspond to the source numbers in Table 5-1.

Particulate matter results for the engines tested by the sample team have been summarized graphically, on a fuel flow basis, in Figure 5-1. Using the data provided in Table 5-1, comparison graphs were created for each engine family. The results of like engines were compared on a fuel flow basis. Graphic results of these comparisons for engine families are provided in Figures 5-2 through 5-13. The graphs provide a representation of the variability in the particulate results regardless of the sampling method employed.

### 5.3 ENGINE MODIFICATIONS

The Navy performed particulate matter sampling in the 1970's and early 1980's. In the period since these tests were performed, some engines have undergone design changes that may greatly influence particulate matter emission reductions. This point

Test Report

Volume:	<u>3</u>
Section:	<u>5.0</u>
Revision:	<u>2</u>
Date:	<u>November 1998</u>
Page:	<u>7 of 24</u>

was defended in the AESO 12-90 report which discusses engine emission reduction with engine design improvement. Technological differences that have been identified are listed below:

- Smokeless can.
- Modified fuel delivery system.
- Increased fuel economy.
- Smoke numbers have decreased over time. For example, the F100 series Pratt & Whitney engines in the 70's had smoke numbers of 18 – 40. In the 80's the smoke number decreased to the 7 – 20 range. During the 90's smoke numbers have been consistently 5 or less.
- In older engines, fuel was atomized by fuel pressure. Today, fuel is atomized by air blast.

Table 5-1. Aircraft Engine Particulate Emissions Summary

Engine Family	Engine	Source	Jet Fuel	Idle			Approach			Intermediate			Military			Afterburner		
				fuel flow (lb/hr)	PM (lbs/hr)	PM (lbs/k lbs fuel)	fuel flow (lb/hr)	PM (lbs/hr)	PM (lbs/k lbs fuel)	fuel flow (lb/hr)	PM (lbs/hr)	PM (lbs/k lbs fuel)	fuel flow (lb/hr)	PM (lbs/hr)	PM (lbs/k lbs fuel)	fuel flow (lb/hr)	PM (lbs/hr)	PM (lbs/k lbs fuel)
T56	T56-A-7	1 - EQ	JP-8	726	1.27	1.75	880	1.47	1.67	1,744	1.57	0.90	2,258	2.01	0.89	--	--	--
	T56-7	5 - A/L	JP-4	720	0.59	0.82	830	0.81	0.98	1,850	0.94	0.51	1,960	0.98	0.50	--	--	--
	T56-07	11 - AESO	JP-4	147	0.12	0.82	164	0.16	0.97	376	0.19	0.51	409	0.21	0.50	--	--	--
TF39	TF39-GE-1C	1 - EQ	JP-8	1,439	0.59	0.41	10,560	7.92	0.75	12,442	6.47	0.52	13,738	5.77	0.42	--	--	--
	TF39-01	5 - A/L	JP-4	1,130	0.02	0.02	1,500	0.02	0.01	12,020	0.36	0.03	12,690	0.32	0.03	--	--	--
	TF39-01C	6 - AQUIS	JP-8	--	0.02	--	--	0.02	--	--	0.36	--	--	0.32	--	--	0.00	--
TF30	TF39-01	11 - AESO	JP-4	229	0.00	0.01	311	0.01	0.02	2,487	0.08	0.03	2,618	0.07	0.02	--	--	--
	TF30-P109	4 - Radian	JP-4	818	0.72	0.88	2,090	1.86	0.89	--	--	--	7,179	2.01	0.28	40,500	8.10	0.20
	TF30-111	5 - A/L	JP-4	952	0.68	0.89	1,918	1.17	0.61	2,942	3.06	1.04	6,306	3.09	0.49	37,933	5.69	0.15
J69	TF30-P-414	9 - AESO	JP-5	1,040	4.78	4.60	--	--	--	2,885	13.78 (@85% rpm)	4.776 (@85% rpm)	8,009	14.79	1.85	--	--	--
	TF30-P-414	12 - SCOTT	JP-4	--	5.00	--	--	--	--	--	13,000 (@85% rpm)	--	--	14.00	--	--	--	--
J69	J69-25	1 - EQ	JP-8	167	0.28	1.68	--	--	--	870	0.47	0.54	1,103	0.32	0.29	--	--	--
	J69-25	5 - A/L	JP-4	231	0.13	0.56	288	0.08	0.28	700	0.01	0.01	1,100	0.02	0.02	--	--	--
	J69-25	6 - AQUIS	JP-8	--	0.13	--	--	0.08	--	--	0.01	--	--	0.02	--	--	0.00	--
	J69-25	11 - AESO	JP-4	47	0.03	0.55	65	0.02	0.28	147	0.00	0.02	229	0.01	0.02	--	--	--

**Table 5-1. Aircraft Engine Particulate Emissions Summary**

Engine Family	Engine	Source	Jet Fuel	Idle			Approach			Intermediate			Military			Afterburner			
				fuel flow (lb/hr)	PM (lbs/hr)	PM (lbs/k lbs fuel)	fuel flow (lb/hr)	PM (lbs/hr)	PM (lbs/k lbs fuel)	fuel flow (lb/hr)	PM (lbs/hr)	PM (lbs/k lbs fuel)	fuel flow (lb/hr)	PM (lbs/hr)	PM (lbs/k lbs fuel)	fuel flow (lb/hr)	PM (lbs/hr)	PM (lbs/k lbs fuel)	
J85	J85-5A	1 - EQ	JP-8	515	0.35	0.68	--	--	800	0.88	1.10	2,481	2.68	1.08	7,875	1.26	0.16		
	J85-5A	5 - A/L	JP-4	450	0.01	0.02	0.01	1,000	0.02	0.01	1,460	0.02	0.01	2,630	0.05	0.02	8,320	0.07	0.01
	J85-5A	6 - AQUIS	JP-8	--	0.01	--	0.01	--	--	0.02	--	--	0.05	--	--	0.07	--	--	
	J85-05	11 - AESO	JP-4	98	0.00	0.00	0.00	213	0.00	0.01	458	0.01	0.01	540	0.01	0.02	1,718	0.01	0.01
T33 TF33-102	TF33-P-102	1 - EQ	JP-8	1,111	1.00	0.90	1.90	4,726	8.98	9.99	1.73	5,775	9.99	2.65	7,547	20.00	--		
	TF33-P-102	6 - AQUIS	JP-8	--	0.56	--	--	--	7.87	8.06	--	--	7.70	--	0.00	--	--		
TF33-7	TF33-102	11 - AESO	JP-4	229	0.12	0.50	--	--	--	--	--	1,980	1.58	0.80	--	--	--		
	TF33-100A	5 - A/L	JP-4	1,204	0.13	0.11	0.39	2,500	0.98	9.40	1.30	11,758	10.70	0.91	--	--	--		
	T33-P-77A	1 - EQ	JP-8	1,090	2.54	2.33	2.21	4,891	10.81	22.65	3.57	8,269	8.93	1.08	--	--	--		
	T33-7	5 - A/L	JP-4	1,070	0.12	0.11	0.39	2,500	0.98	9.40	1.30	8,710	7.93	0.91	--	--	--		
	TF33-P7	10 - BATELLE	JP-4	--	0.83	--	--	--	2.85 (@ 30%)	9.70 (@ 75%)	--	--	10.07 (@ 100%)	--	--	--	--	--	
	TF33-P3	10 - BATELLE	JP-4	--	0.78	--	--	--	3.60 (@ 30%)	11.68 (@ 75%)	--	--	16.02 (@ 100%)	--	--	--	--	--	
TF33-7/JT3D	TF33-007	11 - AESO	JP-4	213	0.02	0.11	0.39	524	0.20	1.94	1.30	1,489	1.64	0.91	--	--	--		
	TF33-7/JT3D	7 - P/W	JP-4	1,070	0.12	0.11	0.39	2,500	0.98	9.40	1.30	8,710	7.93	0.91	--	--	--		
	TF33-P-007	6 - AQUIS	JP-8	--	0.12	--	--	--	0.98	9.40	--	--	7.93	--	0.00	--	--		
JT3D-7	13		JP-4	1,013	0.45	0.44	2.59	3,084	8.00	8.25	0.83	8,188	8.50	1.04	--	--	--		

**Table 5-1. Aircraft Engine Particulate Emissions Summary**

Engine Family	Engine	Source	Jet Fuel	Idle			Approach			Intermediate			Military			Afterburner		
				fuel flow (lb/hr)	PM (lbs/hr)	PM (lbs/k lbs fuel)	fuel flow (lb/hr)	PM (lbs/hr)	PM (lbs/k lbs fuel)	fuel flow (lb/hr)	PM (lbs/hr)	PM (lbs/k lbs fuel)	fuel flow (lb/hr)	PM (lbs/hr)	PM (lbs/k lbs fuel)	fuel flow (lb/hr)	PM (lbs/hr)	PM (lbs/k lbs fuel)
(TF33 Cont'd) J52	J52-P-6B	9 - AESO	JP-5	852	11.08	13.00	2,669	23.43 (@ 30%)	8.78	--	--	6,765	29.12	4.30	--	--	--	
	J52-P-6B	12 - SCOTT	JP-4	--	11.00	--	--	--	--	23.00 (@ 85% rpm)	--	--	31.00	--	--	--		
TF34	TF34-GE-100A	1 - EQ	JP-8	515	2.26	4.38	934	3.82	4.09	1,512	2.99	1.98	2.58	0.98	--	--	--	
	TF34-100	6 - AQUIS	JP-8	--	0.31	--	--	4.28	--	--	7.35	--	7.79	--	--	0.00	--	
	TF34-GE-400A	9-AESO	JP-5	450	1.47	3.26	--	--	--	500	3.43 (@ 75% rpm)	6.85 (@ 75% rpm)	5.92 (@ 94% rpm)	2.11 (@ 94% rpm)	--	--	--	
T64	T64-GE-100	1 - EQ	JP-8	298	0.06	0.22	905	1.429 (@ 75% norm)	1.58	1,697	1.239 (@ norm)	0.73	1.53	0.83	--	--	--	
F100	F101-GE-102	1 - EQ	JP-8	1,124	1.36	1.21	4,574	2.15	0.47	6,508	4.10	0.63	3.68	0.47	15,457	7.11	0.46	
	F101-102	5 - A/L	JP-4	410	0.04	0.10	--	--	--	--	--	--	0.20	0.02	66,730	3.34	0.05	
	F101-GE-102	6 - AQUIS	JP-8	--	0.40	--	--	0.09	--	--	0.14	--	0.20	--	--	3.34	--	
	F101-100	11 - AESO	JP-4	82	0.01	0.09	--	--	--	--	--	--	0.04	0.02	13,762	0.69	0.05	
	F100-200	14 - EQ	JP-8	1,026	1.80	1.71	3,024	1.60	0.54	5,161	2.70	0.53	9.80	1.15	40,371	37.90	0.93	
	F100-220	14 - EQ	JP-8	2,086	2.40	1.17	3,837	3.70	0.96	5,770	4.10	0.70	8.90	0.92	41,682	16.10	0.38	
F100-200	6 - AQUIS	JP-8	--	0.12	--	--	0.81	--	--	--	2.40	--	3.60	--	--	7.76	--	
F100-PW-200	2 - Radian	JP-8	1,038	0.27	0.26	3,211	0.61	0.19	5,567	1.67	0.30	2.65	0.32	24,000	0.24	0.01		
F100-PW-100	3 - Radian	JP-8	1,122	1.01	0.90	2,800	0.84	0.30	7,690	2.23	0.29	4.93	0.45	51,667	3.10	0.06		
F100-100	5 - A/L	JP-4	1,417	0.17	0.12	3,000	0.81	0.27	5,106	2.40	0.47	3.50	0.34	46,000	6.90	0.15		
F100-100	6 - AQUIS	JP-8	--	0.17	--	--	0.81	--	--	2.40	--	3.50	--	--	6.90	--		

Table 5-1. Aircraft Engine Particulate Emissions Summary

Engine Family	Engine	Source	Jet Fuel	Idle			Approach			Intermediate			Military			Afterburner		
				fuel flow (lb/hr)	PM (lbs/hr)	PM (lbs/k lbs fuel)	fuel flow (lb/hr)	PM (lbs/hr)	PM (lbs/k lbs fuel)	fuel flow (lb/hr)	PM (lbs/hr)	PM (lbs/k lbs fuel)	fuel flow (lb/hr)	PM (lbs/hr)	PM (lbs/k lbs fuel)	fuel flow (lb/hr)	PM (lbs/hr)	PM (lbs/k lbs fuel)
F108 <i>(F100 Cont'd)</i>	F108-CF-100	1 - EQ	JP-8	1,137	7.56	6.65	2,538	2.03	0.80	5,655	1.64	0.29	6,421	3.66	0.57	--	--	--
	F108-100	6 - AQUIS	JP-8	--	0.15	--	--	0.81	--	--	2.40	--	--	3.50	--	--	0.00	--
F110	F110-GE-100	1 - EQ	JP-8	1,107	1.65	1.49	5,087	2.34	0.46	7,176	1.22	0.17	11,286	1.58	0.14	18,162	6.72	0.37
	F110-100	6 - AQUIS	JP-8	--	0.15	--	--	0.81	--	--	3.50	--	--	4.60	--	--	5.70	--
F117	F117-PW-100	1 - EQ	JP-8	990	1.88	1.90	4,653	2.00	0.43	10,396	9.32	0.90	--	--	--	--	--	--
	F117-PW-100	8 - P/W	Jet A	1,230	0.11	0.09	3,913	1.29	0.33	11,429	9.49	0.83	--	--	--	--	--	--
F118	F118-GE-100	1 - EQ	JP-8	1,105	0.10	0.09	3,731	8.65	2.32	--	(-0.17)	(-0.02)	--	(-0.494)	(-0.045)	--	--	--
F404	F404-GE-FID2/400	1 - EQ	JP-8	682	0.94	1.37	3,108	1.82	0.58	6,470	4.35	0.67	7,739	5.58	0.72	15,870	5.75	0.36
	F404-400	6 - AQUIS	JP-8	--	10.30	--	--	16.00	--	--	21.70	--	--	24.10	--	--	24.10	--
GTC (APU)	F404-GE-400	9A - AESO	Jet A	814	10.08	12.38	3,108	18.96 (@ 37%)	6.10	--	--	--	8,587	24.13	2.81	--	--	--
	F404-GE-400	9 - AESO	JP-5	836	6.10	7.30	--	--	--	3,563	2.06	2.06	8,577	18.44	2.15	--	--	--
T700	GTCP85-180	1 - EQ	JP-8	275, 0.150, 0.550 @ constant condition														
	GTCP165-1	1 - EQ	JP-8	257, 0.09, 0.35 @ constant condition														
T700	T700-GE-700	1 - EQ	JP-8	135	0.20	1.48	468	0.59	1.26	626	1.39	2.22	727	1.89	2.60	--	--	--

LEGEND: -- = no data provided

**Figure 5-1. Aircraft Engine Particulate Emissions Summary  
(EQ/Weston Test Results)**

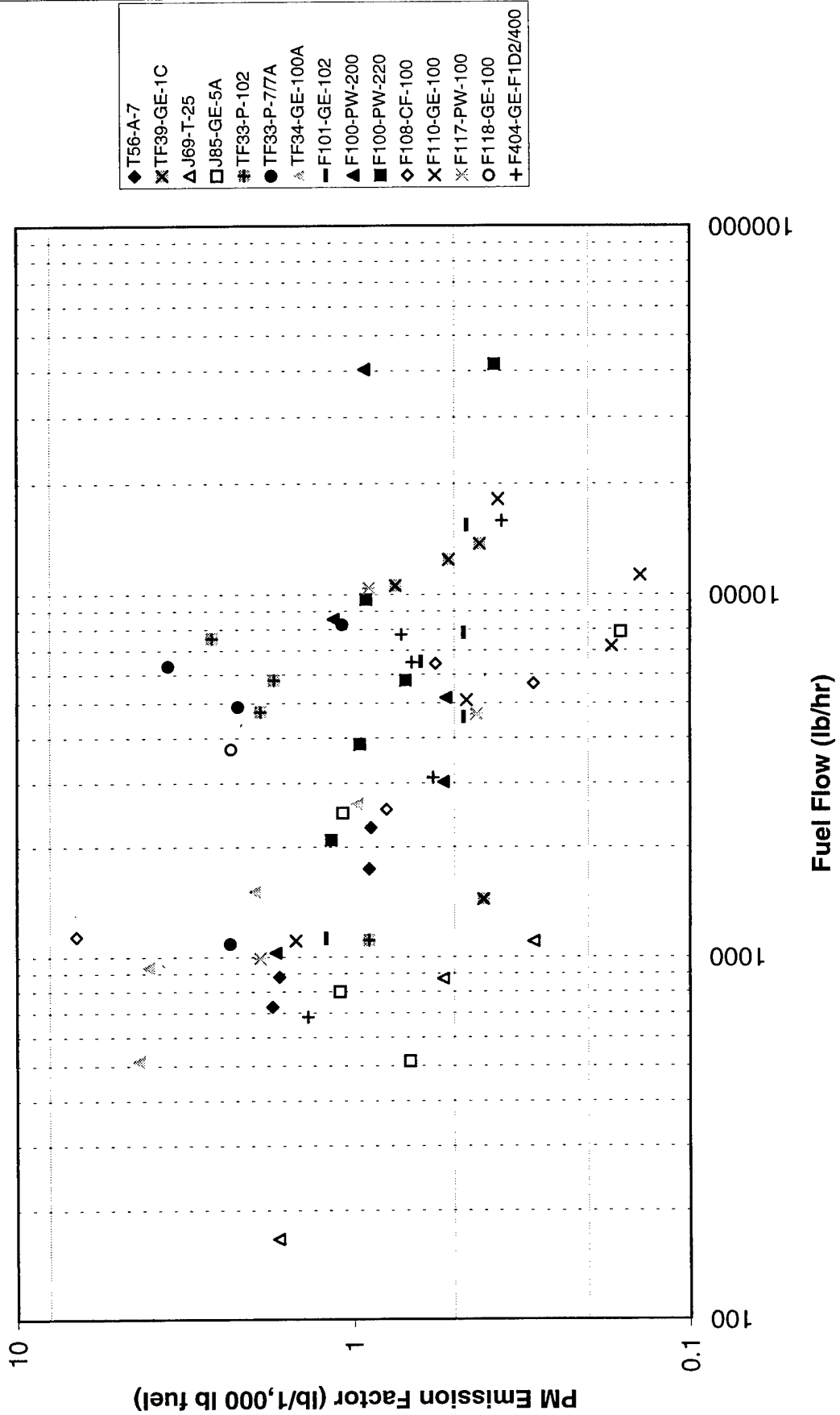



Figure 5-2. Aircraft Engine Particulate Emission Data  
Engine Family T56

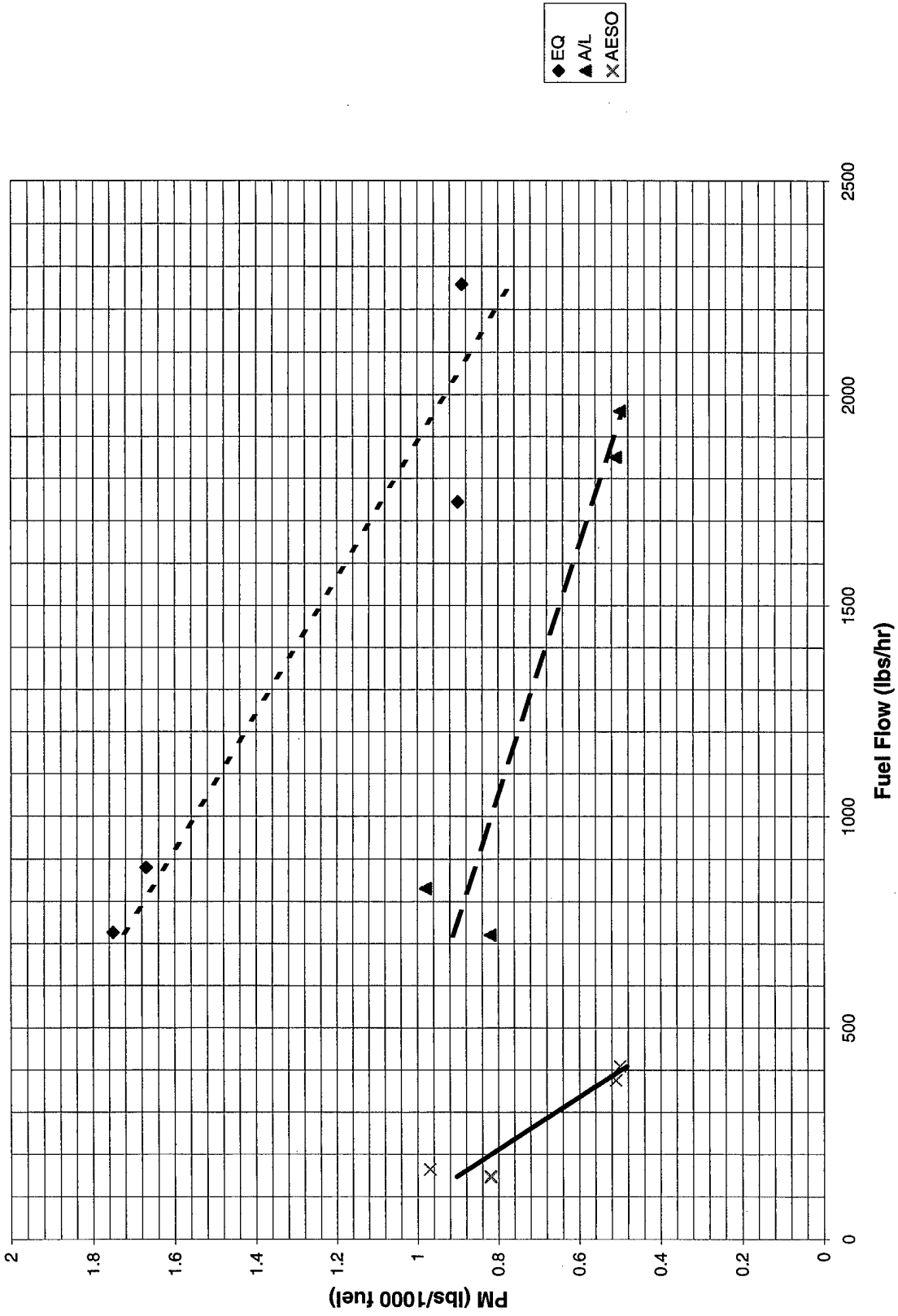

Figure 5-3. Aircraft Engine Particulate Emissions

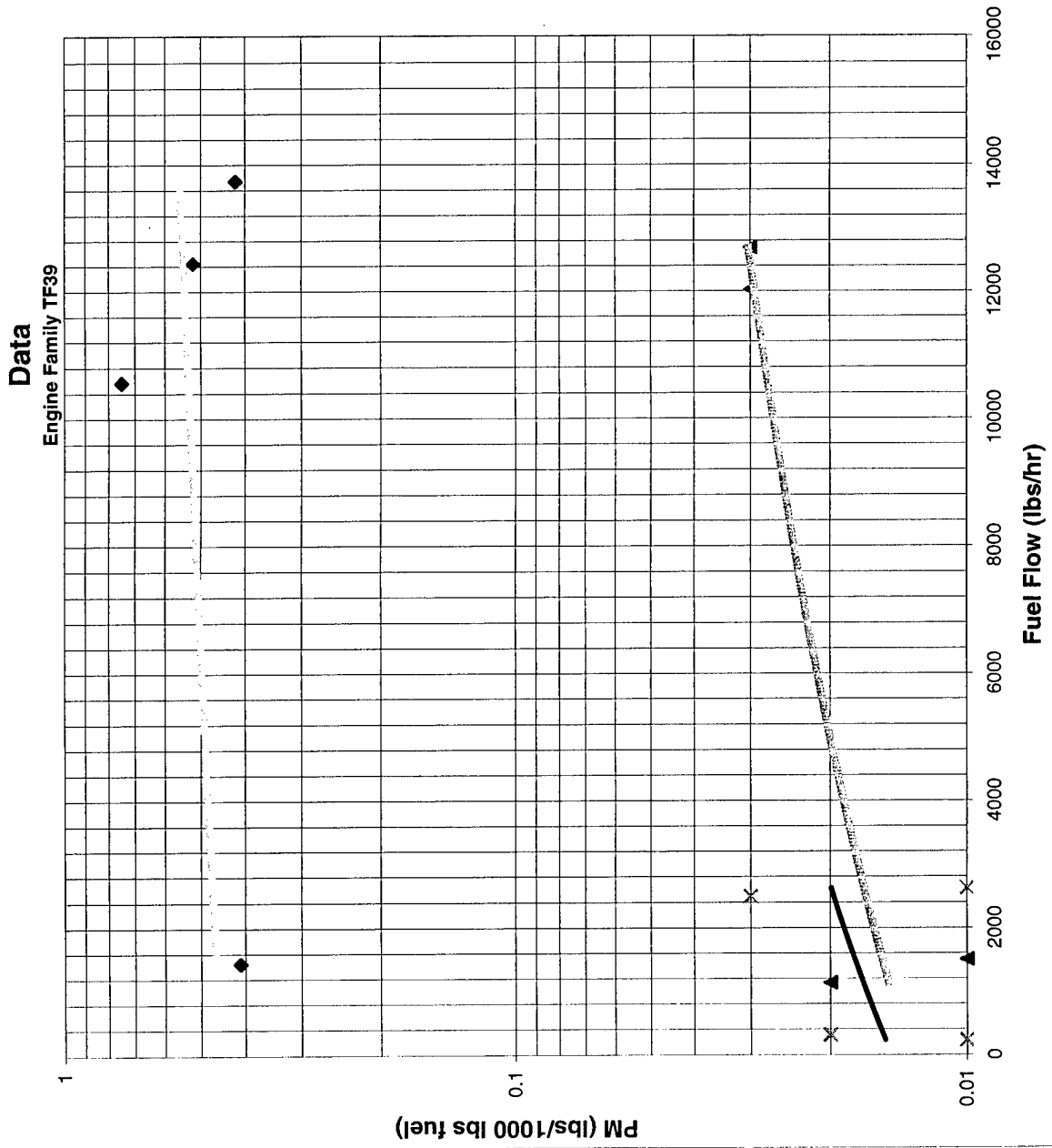
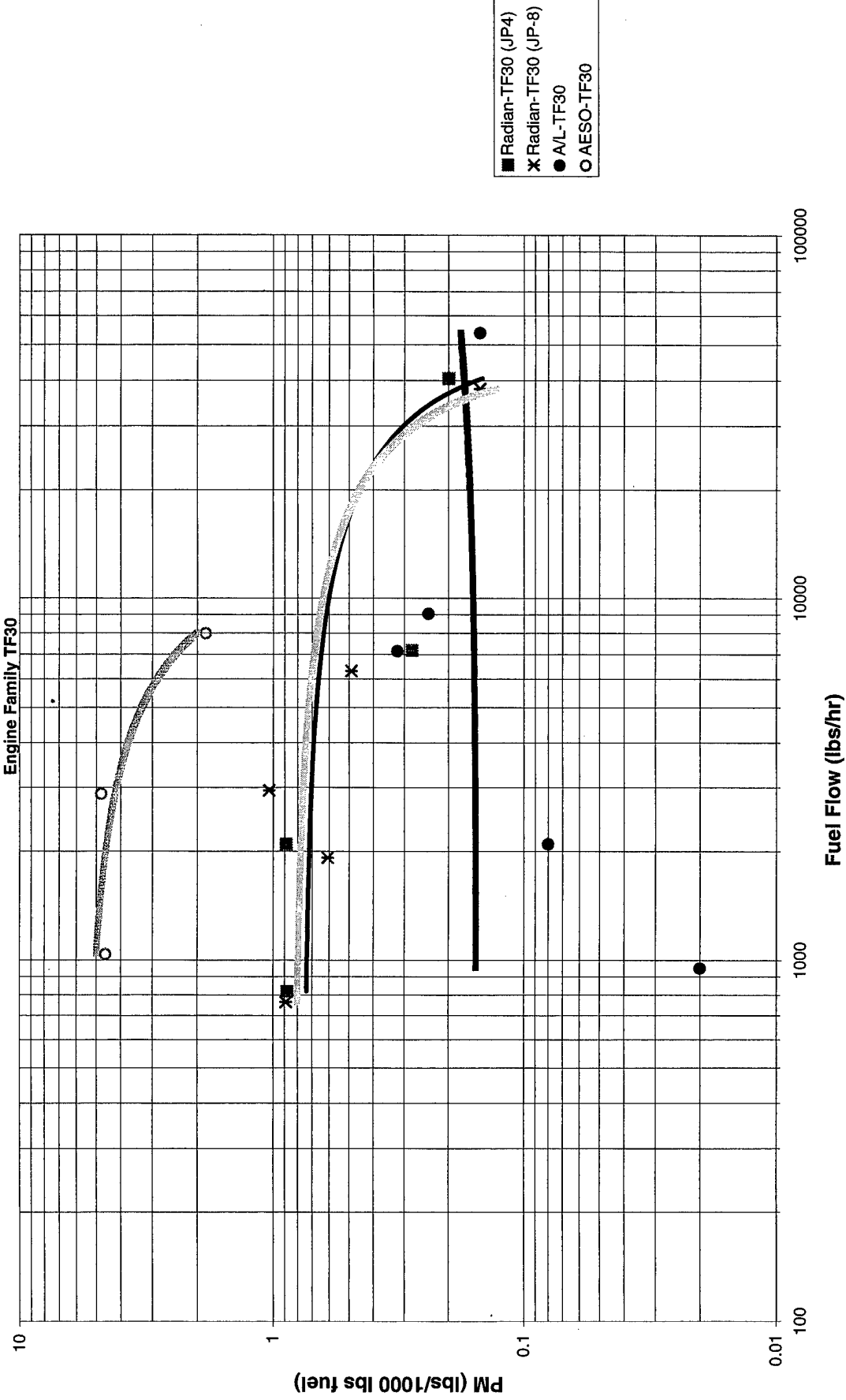

Figure 5-4. Aircraft Engine Particulate Emission Data



Radian, June 1996  
 A/L - Armstrong Laboratories, July 1994  
 AESO - Aircraft Environmental Support Office, June 1990

Figure 5-5. Aircraft Engine Particulate Emission Data  
Engine Family J69

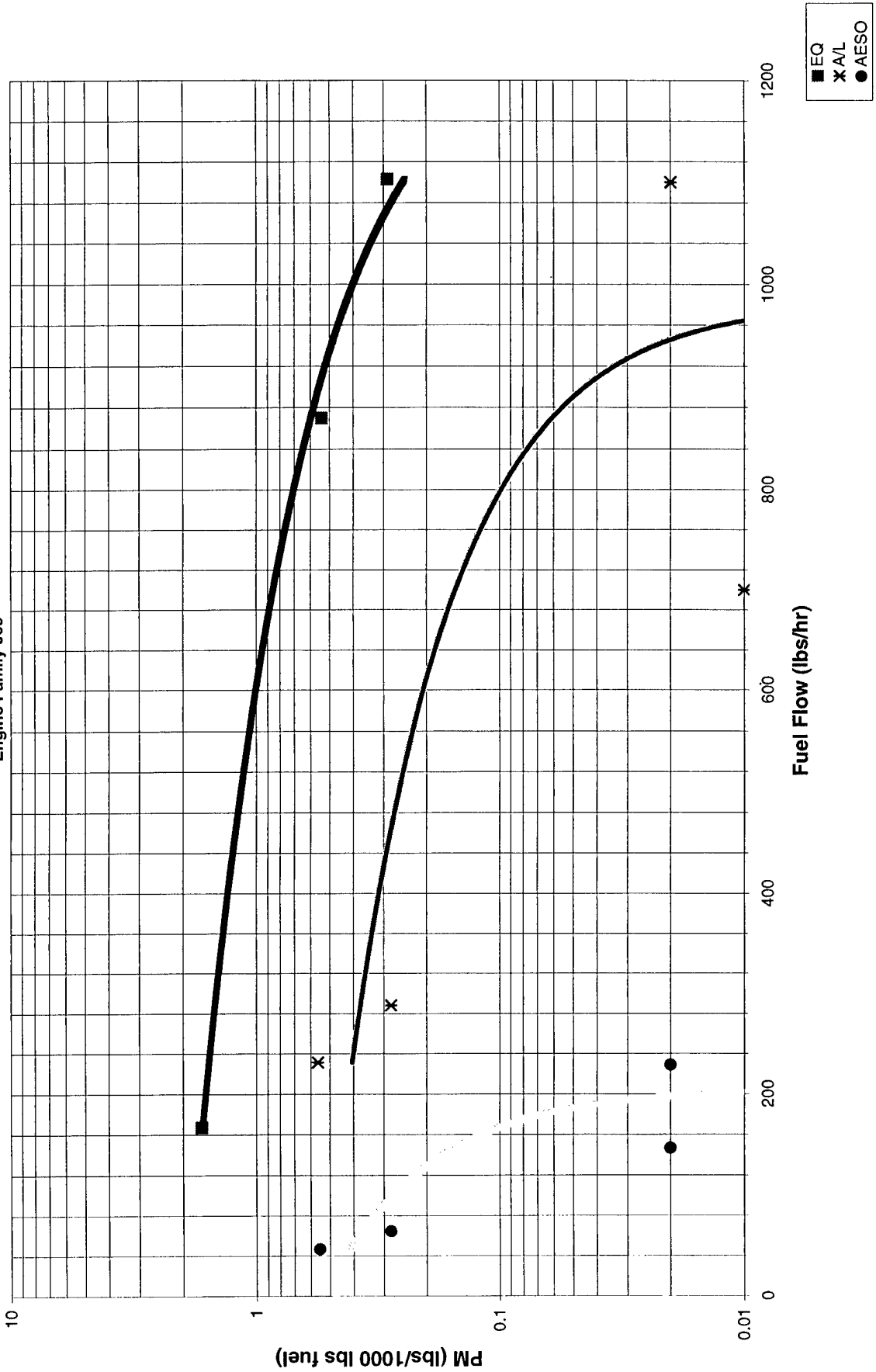
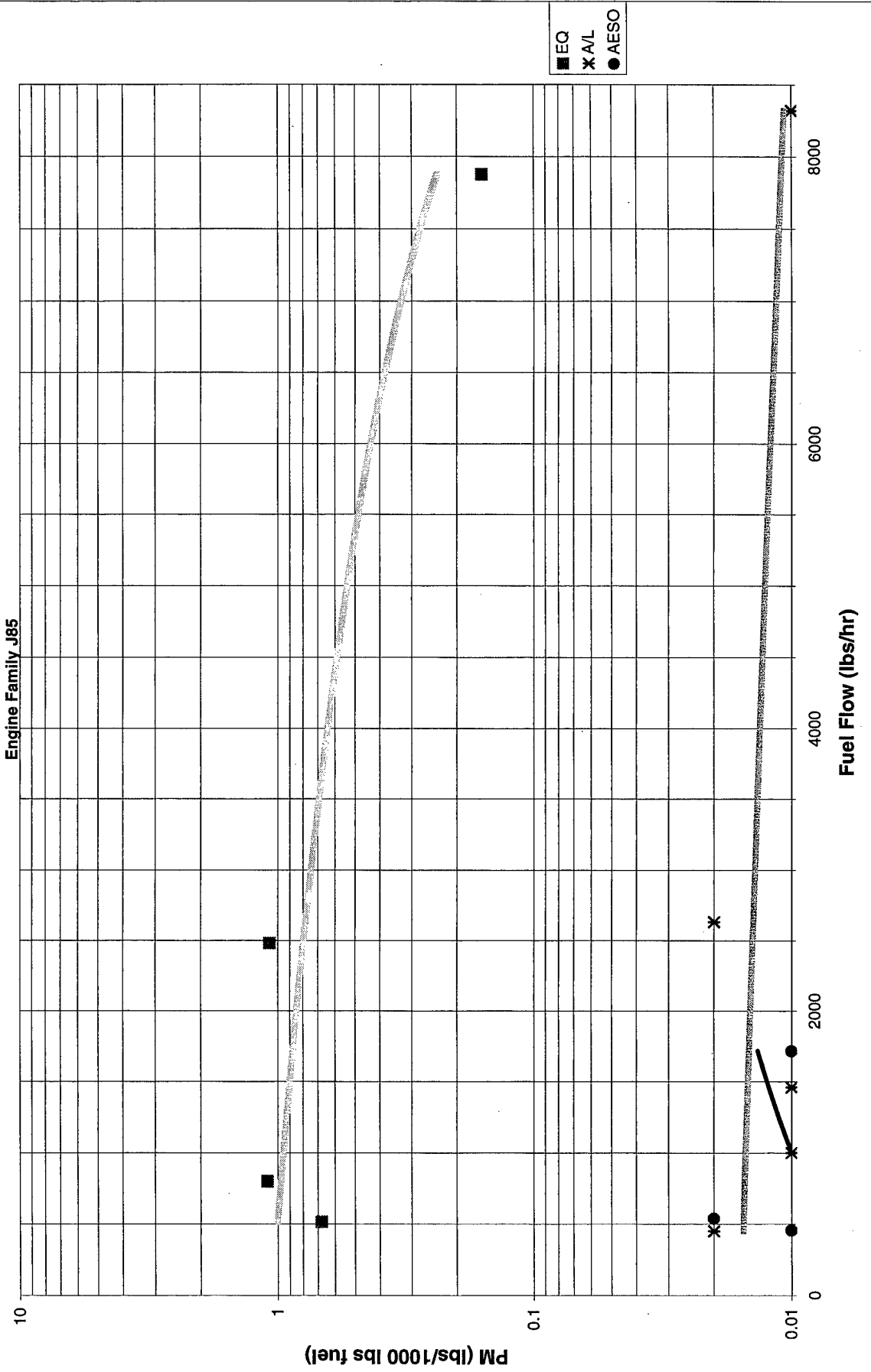

Figure 5-6. Aircraft Engine Particulate Emission Data



EQ - Environmental Quality Management, Inc., May 1998

A/L - Armstrong Laboratories, July 1994

AESO - Aircraft Environmental Support Office, September 1985

Figure 5-7. Aircraft Engine Particulate Emission Data

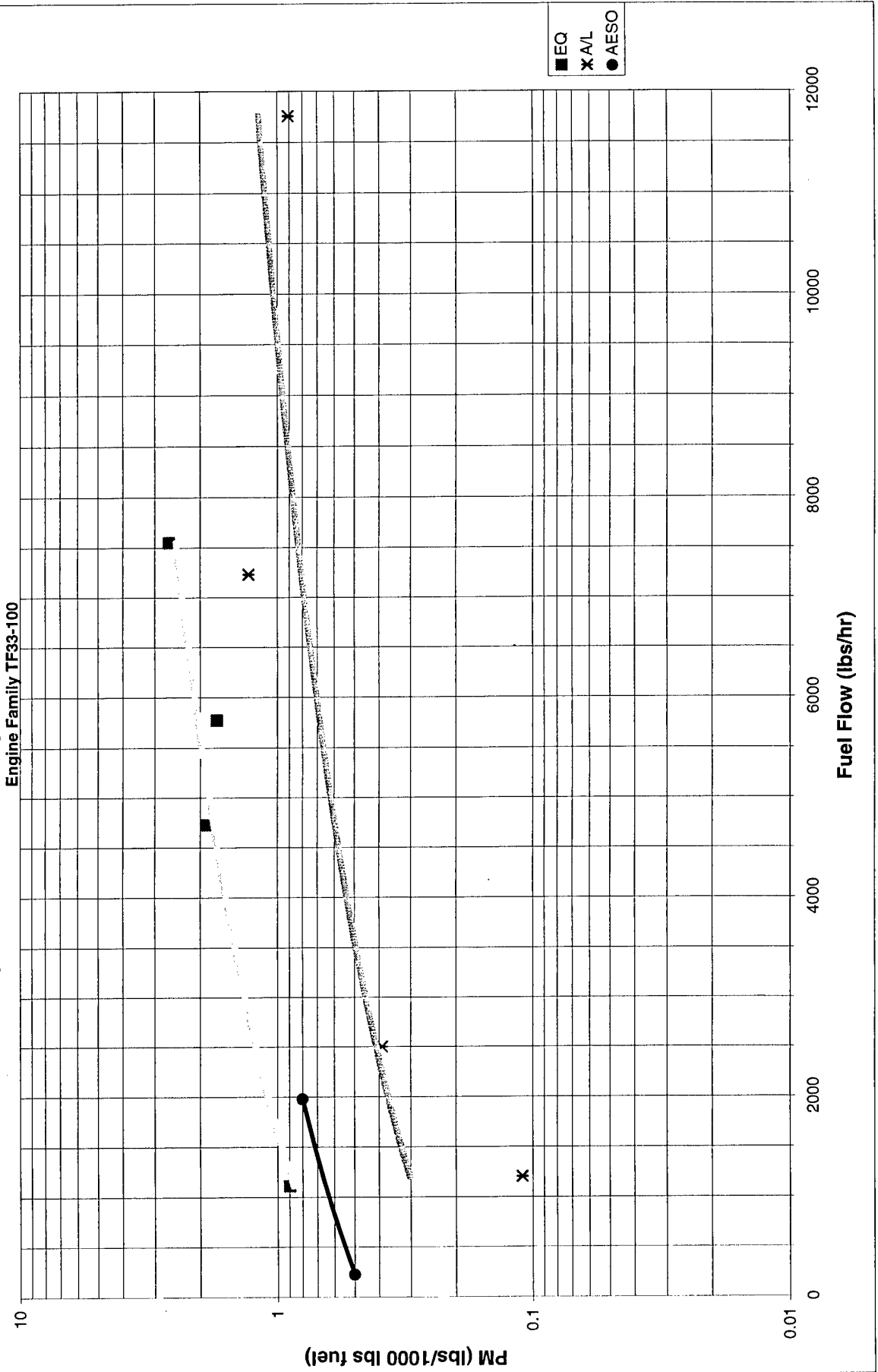

EQ - Environmental Quality Management, Inc., May 1998

A/L - Armstrong Laboratories, July 1994

AESO - Aircraft Environmental Support Office, September 1985

Figure 5-8. Aircraft Engine Particulate Emission Data

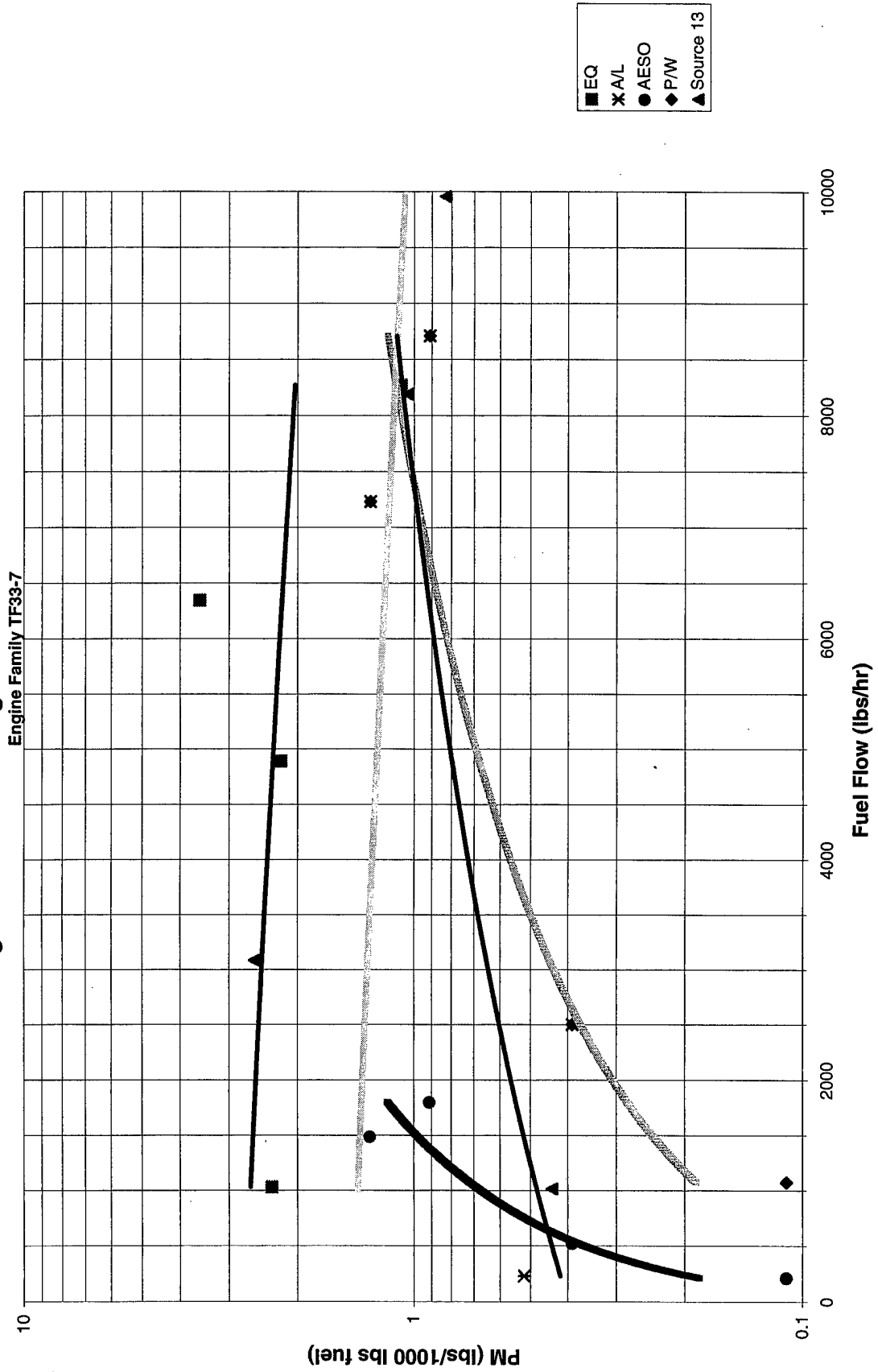

EQ - Environmental Quality Management, Inc., May 1998  
 A/L - Armstrong Laboratories, July 1994  
 AESO - Aircraft Environmental Support Office, September 1985  
 P/W - Pratt Whitney, October 1993

Figure 5-9. Aircraft Engine Particulate Emission Data

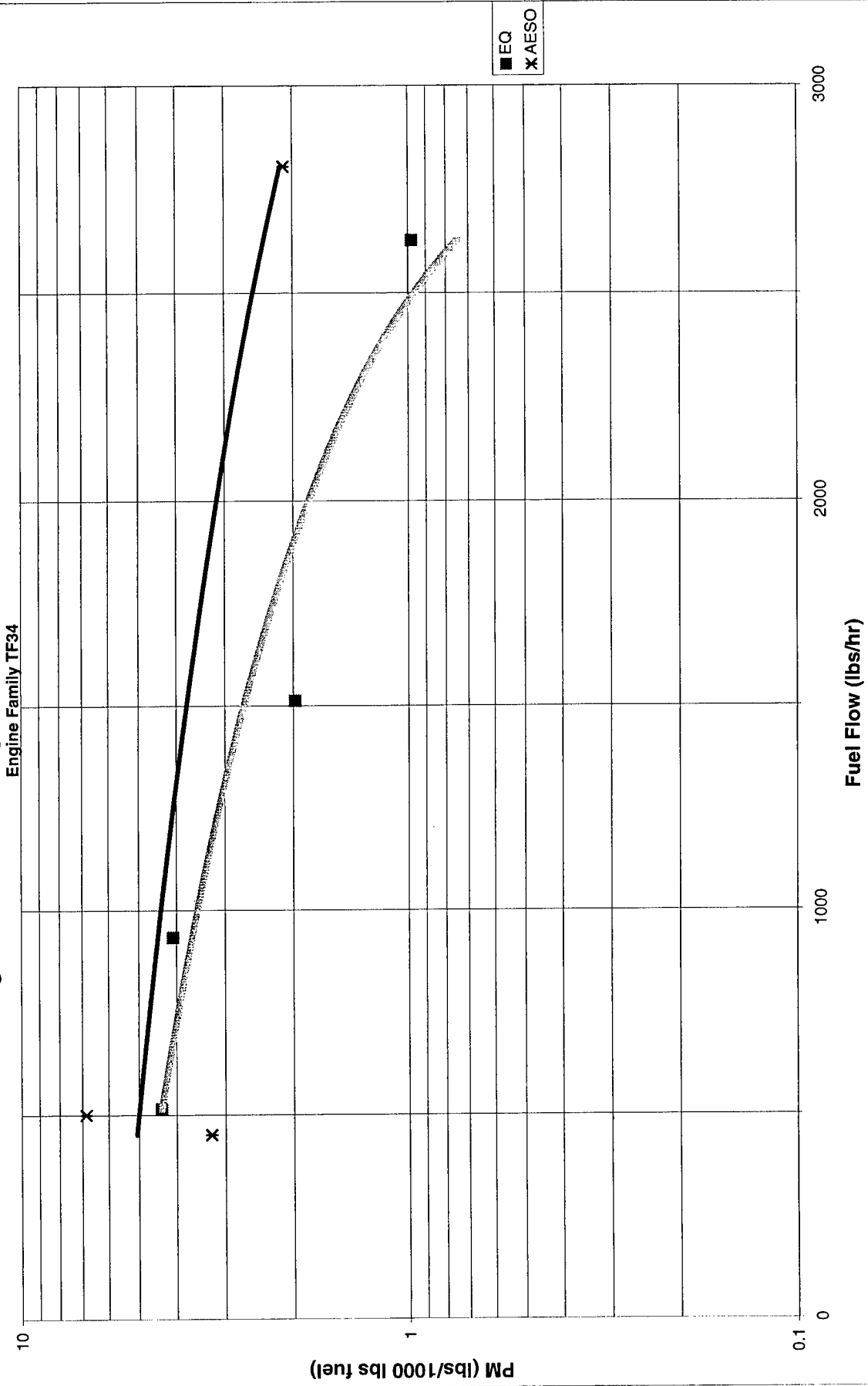
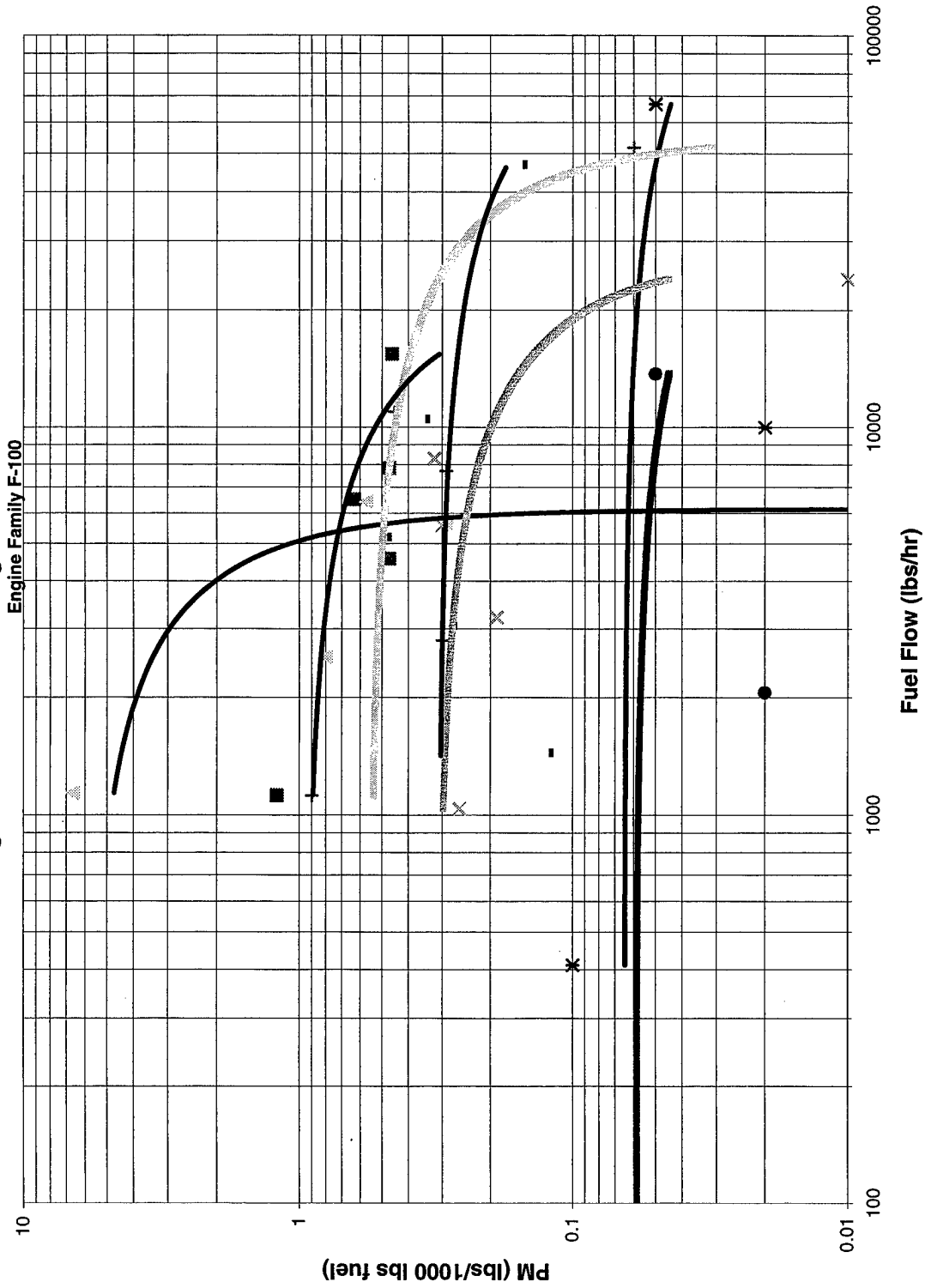



Figure 5-10. Aircraft Engine Particulate Emission Data



EQ - Environmental Quality Management, Inc., August 1996

Radian F100-200, February 1997

Radian F100-100, November 1996

A/L - Armstrong Laboratories, July 1994

Figure 5-11. Aircraft Engine Particulate Emission Data

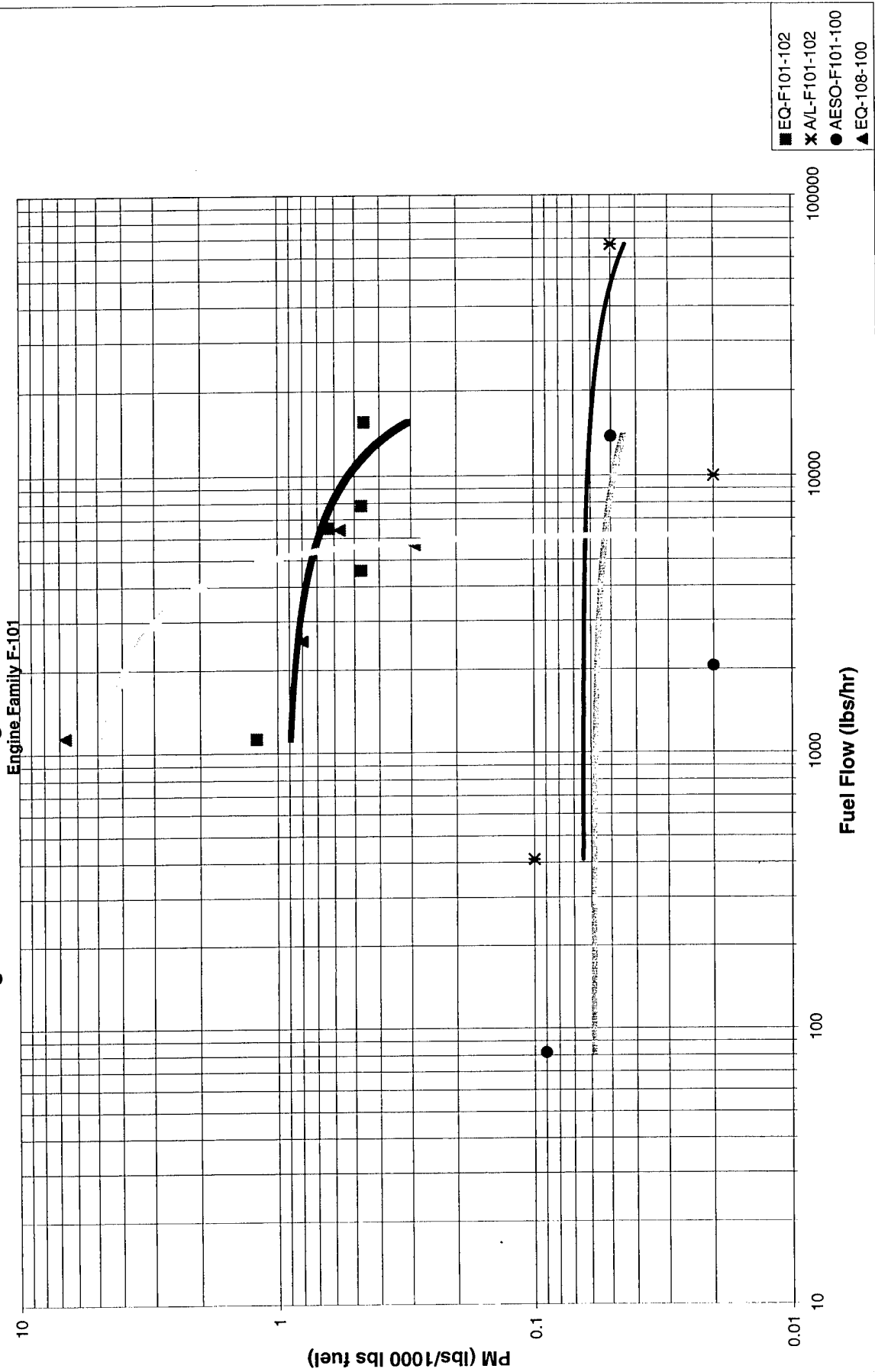
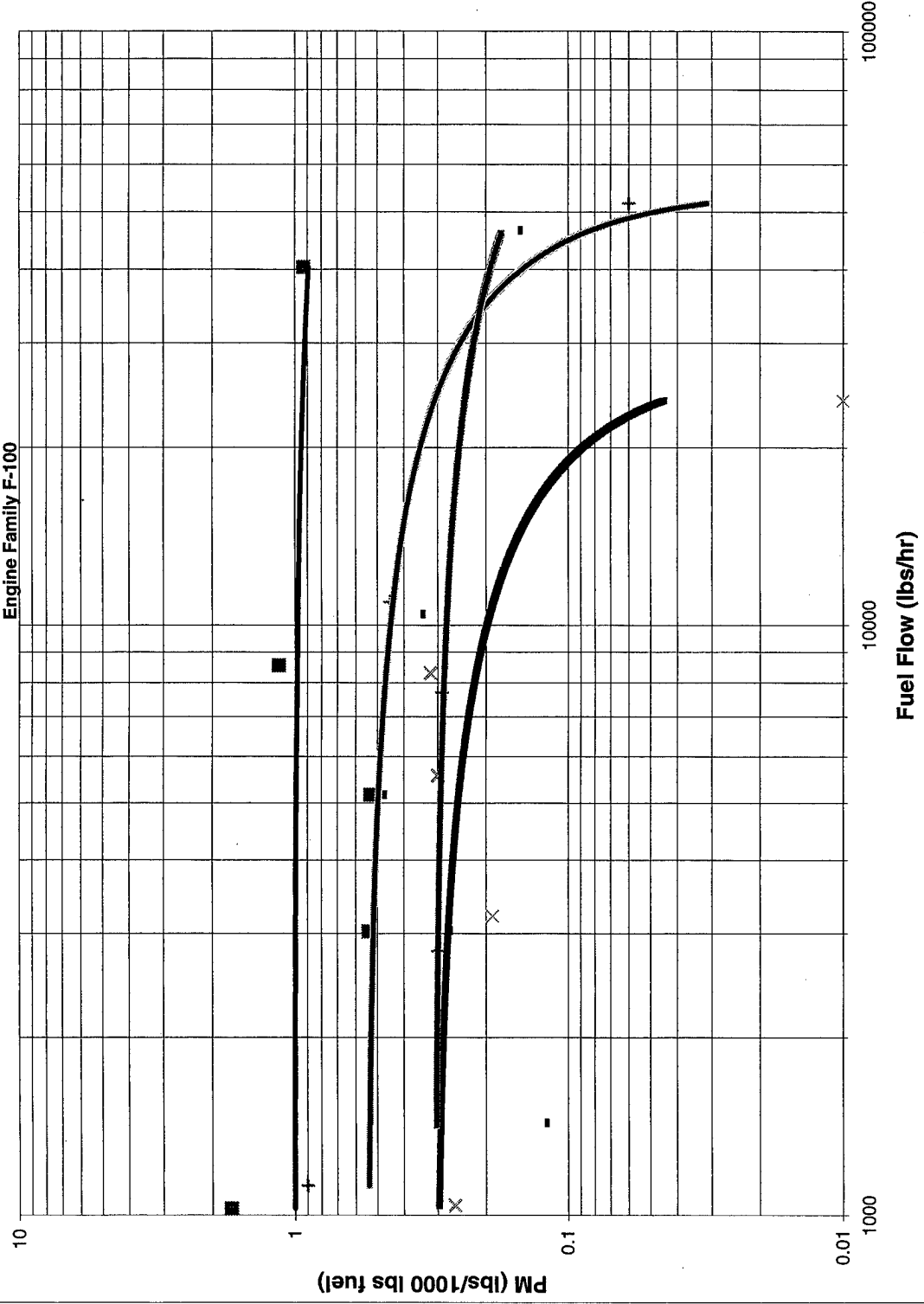
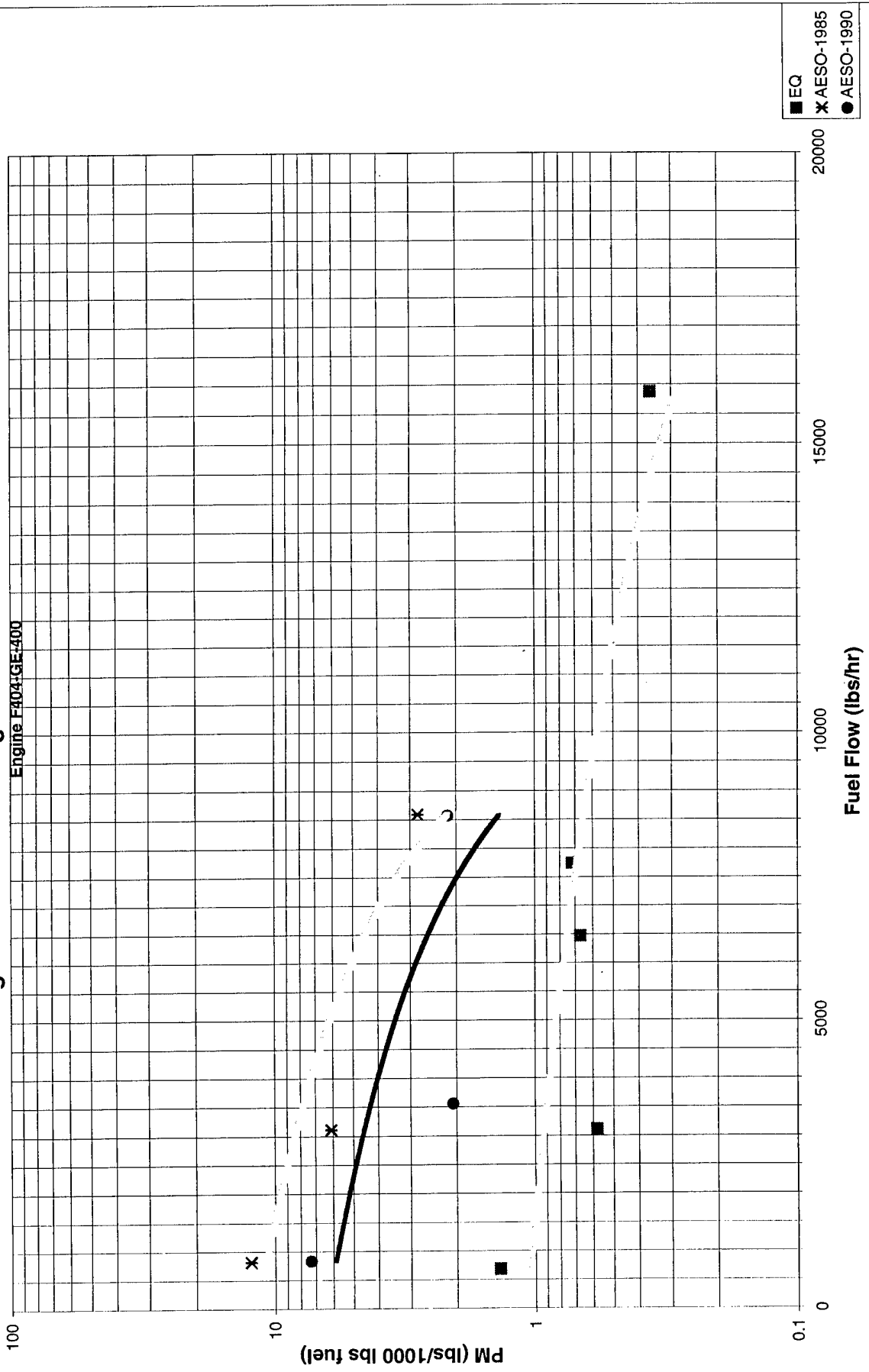

Figure 5-12. Aircraft Engine Particulate Emission Data



EQ - Environmental Quality Management, Inc., August 1996  
 Radian F100-200, February 1997  
 Radian F100-100, November 1996  
 A/L - Armstrong Laboratories, July 1994

Figure 5-13. Aircraft Engine Particulate Emission Data



EQ - Environmental Quality Management, Inc., May 1998  
 AESO 1985 - Aircraft Environmental Support Office, 1981  
 AESO 1990 - Aircraft Environmental Support Office, August 1987