

ite technical note techn

The Interim Runway Visual Range/ Automated Surface Observing System Interface Instruction and Operational User Guide

William Benner
Michael McKinney

19990209 075

March 1998

DOT/FAA/CT-TN98/3

Document is on file at the William J. Hughes Technical Center
Library, Atlantic City International Airport, NJ 08405



U.S. Department of Transportation
Federal Aviation Administration
William J. Hughes Technical Center
Atlantic City International Airport, NJ 08405

DTIC QUALITY INSPECTED 2

DISTRIBUTION STATEMENT A

Approved for public release;
Distribution Unlimited

NOTICE

This document is disseminated under the sponsorship of the U.S. Department of Transportation in the interest of information exchange. The United States Government assumes no liability for the contents or use thereof.

The United States Government does not endorse products or manufacturers. Trade or manufacturers' names appear herein solely because they are considered essential to the objective of this report.

1. Report No. DOT/FAA/CT-TN98/3		2. Government Accession No.		3. Recipient's Catalog No.	
4. Title and Subtitle The Interim Runway Visual Range/Automated Surface Observing System Interface Instruction and Operational User Guide				5. Report Date March 1998	
				6. Performing Organization Code ACT-320	
7. Author(s) William Benner, Michael McKinney; Michael Jones, Raytheon Service Co.				8. Performing Organization Report No. DOT/FAA/CT-TN98/3	
9. Performing Organization Name and Address U.S. Department of Transportation Federal Aviation Administration William J. Hughes Technical Center Atlantic City International Airport, N.J. 08405				10. Work Unit No. (TRAIS)	
				11. Contract or Grant No.	
12. Sponsoring Agency Name and Address U.S. Department of Transportation Federal Aviation Administration William J. Hughes Technical Center Atlantic City International Airport, N.J. 08405				13. Type of Report and Period Covered Technical Note	
				14. Sponsoring Agency Code	
15. Supplementary Notes					
16. Abstract The Interim Runway Visual Range/Automated Surface Observing System Interface (Interim RVR/ASOS Interface) Instruction and Operational User Guide is intended to inform users of Interim RVR/ASOS Interface performance features. It is designed to allow users to become familiar with proper use of the interface to facilitate data transfer from the New Generation RVR System to the ASOS at required locations. Successful operation of the interface will enable automated Long-Line RVR service from equipped ASOSs. After reading this guide, users should be able to properly install, configure, start, and stop operation of the interface as well as trouble-shoot most problems that may occur during use. The guide is typically packaged as part of a kit containing equipment and accessories for unaided installation by airport technicians. As of January 31, 1998, operation of the interface exists at seven international airports including: Los Angeles, CA; Denver, CO; Chicago, IL; Portland, OR; Nashville, TN; Seattle, WA; and San Francisco, CA. Federal Aviation Administration (FAA) plans include installation and operation of the interface at approximately 110 airports throughout the U.S. Current system requirements for installation of the interface are: 1. New Generation RVR National Deployment Baseline version software; and 2. ASOS software version 2.49.					
17. Key Words Interim RVR/ASOS interface, HP Palmtop RS-232 to EIA-530 Level Converter, Application Data Unit, External User, Acquisition Control Unit, Block Check Code, Cable			18. Distribution Statement Document is on file at the Federal Aviation Administration William J. Hughes Technical Center Library Atlantic City International Airport, NJ 08405		
19. Security Classif. (of this report) Unclassified		20. Security Classif. (of this page) Unclassified		21. No. of Pages 39	22. Price

TABLE OF CONTENTS

	Page
OPERATIONAL USER GUIDE SUMMARY	v
1. INTRODUCTION	1
1.1 Hewlett Packard 200 LX Palmtop PC	1
1.2 Serial Data Cables	1
1.3 RS-232 to EIA-530 Level Converter	3
2. INTERIM RVR/ASOS INTERFACE INSTALLATION	3
3. INITIALIZING THE INTERIM RVR/ASOS INTERFACE	5
3.1 RVR System Configuration Settings	5
3.2 ASOS Configuration Settings	6
3.3 Hardware Connections	6
3.4 Executing HP Palmtop RVR-ASOS Software	6
4. INTERIM RVR/ASOS SHUTDOWN PROCEDURES	11
5. TECHNICAL SUPPORT	12
5.1 Maintenance Coordination Personnel	12
6. ACRONYMS	13
 APPENDIXES	
A - RVR and Interim RVR/ASOS Interface Maintenance Actions	
B - HP Palmtop On-Screen Messages	
C - Troubleshooting	
D - Special Instructions	
E - Internal Drive/PCMCIA Memory Card Directory Trees and File Contents	
F - New Generation RVR MDT Screen Flowchart	

LIST OF ILLUSTRATIONS

Figure		Page
1.2-1	Cable 1	2
1.2-2	Cable 2	2
1.2-3	Cable 3	2
1.3-1	Connections To/From Signal Level Converter	3
2-1	Interim RVR/ASOS Interface Connectivity	4

OPERATIONAL USER GUIDE SUMMARY

The Interim Runway Visual Range/Automated Surface Observing System Interface (Interim RVR/ASOS Interface) Instruction and Operational User Guide is intended to inform users of the operational specifics for the Interim RVR/ASOS Interface. It is designed to allow users to become familiar with proper use of the interface to facilitate data transfer from the New Generation RVR System to ASOS at required locations. After reading this guide, users should be familiar with how to properly install, configure, start, and stop this interface, as well as trouble-shoot most problems that may occur during usage.

Although not specifically addressed in this guide, it should be noted that communication distance limitations of the Interim RVR/ASOS Interface may create the need for additional engineering at some locations. This guide addresses installations in which the distance between the RVR Data Processing Unit (DPU) and ASOS Acquisition Control Unit (ACU) are less than 4000 feet. Installations in which the distance between the RVR DPU and ASOS ACU are greater than 4000 feet will require alternative communication media to ensure successful data transfer. If the circumstances at your location require alternative communication media, please contact the RVR Program Office for additional assistance. Refer to section 5 for points of contact.

In the event content within this document should need revision, please contact:

FAA William J. Hughes Technical Center
Weather Branch, ACT-320
Atlantic City International Airport
Atlantic City, NJ 08405
POC: Mike McKinney
Phone: (609) 485-5516

1. INTRODUCTION.

The Interim Runway Visual Range (RVR) /Automated Surface Observing System (ASOS) Interface includes components required to:

- a. receive engineering data from the New Generation RVR system,
- b. convert engineering data to ASOS application data units (ADUs), and
- c. send ASOS ADUs to the ASOS Acquisition Control Unit (ACU).

These components are listed below and discussed in the following paragraphs:

- d. Hewlett Packard 200 LX Palmtop PC,
- e. Serial Data Cables, and
- f. RS-232 to EIA-530 Level Converter.

1.1 HEWLETT PACKARD 200 LX PALMTOP PC.

The primary component of the Interim RVR/ASOS Interface is the Hewlett Packard 200LX Palmtop PC (HP Palmtop). As the name implies, the HP Palmtop is a small, hand-held portable PC. The HP Palmtop operates with DOS version 5.0, internal RAM and data storage, and a 5- or 6-megabyte (MB) Personal Computer Memory Card International Association (PCMCIA) memory card which functions similar to a floppy disk in a standard PC.

The required software for your HP Palmtop has been installed on the internal disk and configured prior to shipment to your site. The PCMCIA memory card contains a backup copy of the RVR/ASOS application program, configuration files, and supporting utilities (refer to appendix E). The HP Palmtop also contains two rechargeable nicad batteries (refer to appendix D) and a 3-volt coin cell battery for backup.

1.2 SERIAL DATA CABLES.

Two serial data cables are provided with your Interim RVR/ASOS installation kit and are identified in this guide as "Cable 1" and "Cable 2." Cable 1 is a split cable designed to connect to the RVR Data Processing Unit (DPU) External User (EU) port, an HP Palmtop serial cable, and an RS-232 to EIA-530 level converter. This cable contains three connectors, two 9-pin male (DB-9M) and one 25-pin female (DB-25F). Figure 1.2-1 illustrates the connectors, connection points, and pinout for Cable 1.

Cable 2 provides a connection to Cable 1 and to the HP Palmtop serial port. Figure 1.2-2 indicates the connector, connection points, and pinout for Cable 2.

An additional cable identified as "Cable 3" is not included with the installation kit, but is required for the installation. Cable 3 provides a connection from the EIA-530 side of the RS-232 to EIA-530 level converter to the ASOS ACU RVR port. The length of Cable 3 is unique for each installation site. The pinout for Cable 3 is shown in figure 1.2-3. The recommended construction of the cable includes the use of solder-type connectors with metallic shells and shielded twisted pair (24 AWG) telephone cable. As indicated in figure 1.2-3, a DB-25M connector provides the connection to the level converter, and a DB-25M connector provides the connection to ASOS.

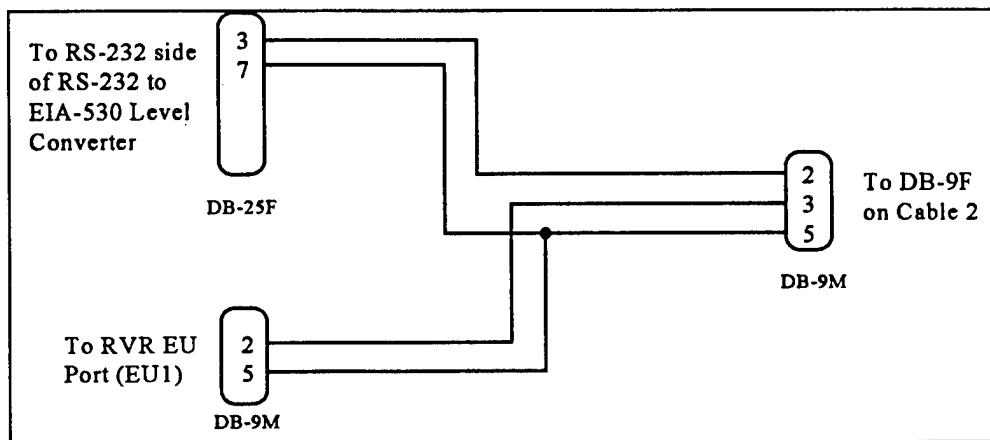

FIGURE 1.2-1. CABLE 1

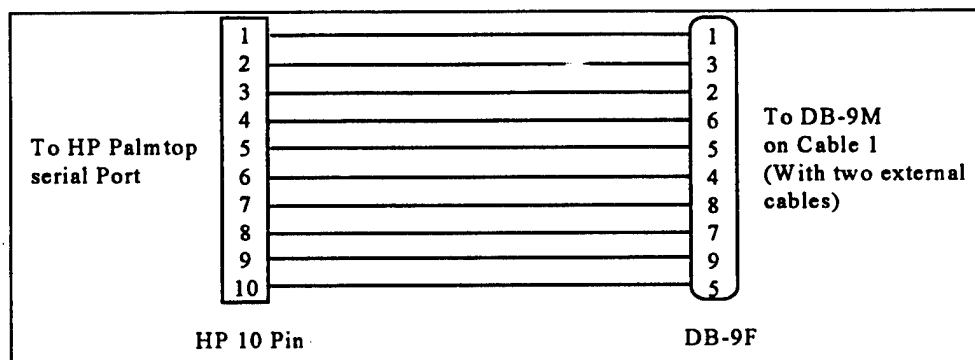

FIGURE 1.2-2. CABLE 2

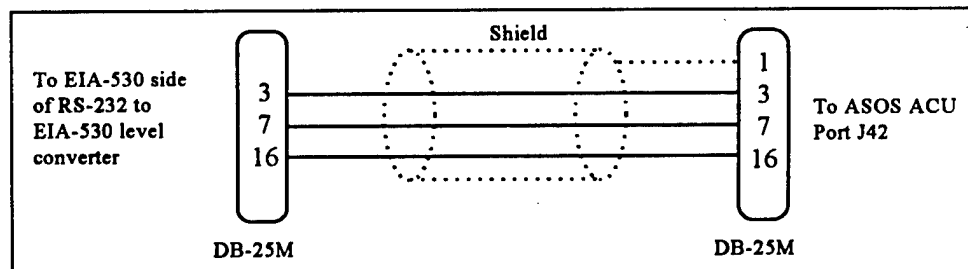

FIGURE 1.2-3. CABLE 3.

1.3 RS-232 to EIA-530 LEVEL CONVERTER.

An RS-232 to EIA-530 level converter adapts the RS-232 electrical signal from the HP Palmtop to EIA-530 levels compatible with the ASOS ACU RVR port. The converter requires power from a polarized three-prong outlet rated at 120 volts alternating current (VAC). Figure 1.3-1 shows the required connections from the level converter to Cable 1 and Cable 3.

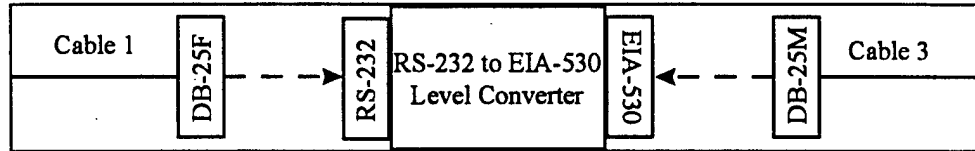

FIGURE 1.3- 1. CONNECTIONS TO/FROM SIGNAL LEVEL CONVERTER

2. INTERIM RVR/ASOS INTERFACE INSTALLATION.

This section details installation procedures for the Interim RVR/ASOS Interface. Personnel required for the installation include both Federal Aviation Administration (FAA) RVR technicians and National Weather Service (NWS) ASOS technicians. Contact the appropriate FAA/NWS personnel to plan the installation. The following steps should be followed for proper installation of the Interim RVR/ASOS Interface. Figure 2-1 shows a diagram of the overall Interim RVR/ASOS Interface connectivity.

- a. Verify all components on the enclosed packing slip were received.
- b. Ensure that all powered Interim RVR/ASOS components are off.
- c. Construct and install Cable 3 between the RVR and ASOS equipment cabinets. Refer to section 1.2 for cable pinouts and recommended cable materials. Verify cable continuity, but do not connect the cable ends to the HP Palmtop or ASOS during this step.
- d. Attach the DB-9M connector on Cable 1 (which contains one external cable) to the New Generation RVR EU port (EU1). Secure this connection with connector screws.
- e. Attach the DB-25F connector of Cable 1 to the RS-232 end of the RS-232 to EIA-530 level converter. The label on top of the level converter indicates the interface for each end. Secure this connection with connector screws.
- f. Attach the other DB-9M connector on Cable 1 (which contains two external cables) to the DB-9F connector on Cable 2. Secure connection with connector screws.

- g. Attach the 10-pin HP custom connector to the HP Palmtop serial port. The serial port is keyed for proper insertion.
- h. Attach the DB-25M connector on Cable 3 to the EIA-530 side of the level converter. Secure the connection with connector screws.
- i. Attach the DB-25M connector on Cable 3 to the ASOS ACU port labeled "RVR". The port is also labeled "J42". Secure the connection with the connector screws.
- j. Connect the Alternating Current (AC) adapter to the RS-232 to EIA-530 level converter and plug the AC adapter into a 120-VAC outlet inside the RVR equipment cabinet. If possible, secure both ends of the connection with cable ties.

NOTE: If power to the level converter is disabled or the power cable becomes dislodged, the level converter will not operate and data transmission to the ASOS will be disabled.

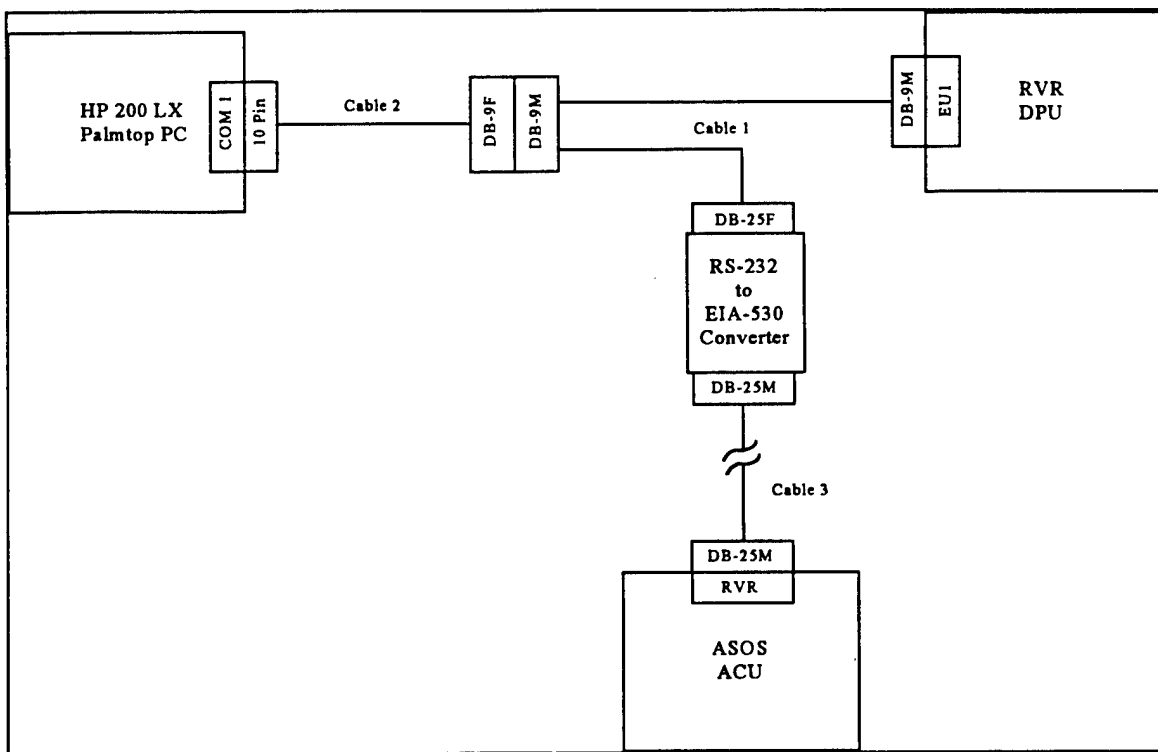

FIGURE 2-1. INTERIM RVR/ASOS INTERFACE CONNECTIVITY

3. INITIALIZING THE INTERIM RVR/ASOS INTERFACE.

This section describes how to start operation of the Interim RVR/ASOS Interface. As mentioned in section 1.1, RVR/ASOS software and supporting utilities have been loaded on the HP Palmtop's internal drive prior to shipping to your site. Your HP Palmtop should be ready for initialization.

Prior to initialization, technicians/users will need to identify the RVR Visibility Sensor (VS) Sensor Interface Electronics (SIE) number and the runway designated for long-line RVR reporting (e.g., VS 03 and runway 36L). By definition, the long-line VS SIE should correspond to the touchdown location of the designated runway. For some locations, the New Generation RVR long-line VS will replace the remaining Tasker sensor as the long-line reporting VS.

Completion of the initialization process will require a verification of the transmitted data on ASOS display screens. As a result, the participation of NWS technicians or Contract Weather observers is required. Contact the appropriate FAA/NWS personnel (section 5) to coordinate this event.

3.1 RVR SYSTEM CONFIGURATION SETTINGS.

New Generation RVR system configuration modifications may be required to ensure proper operation of the Interim RVR/ASOS Interface. The following parameters should be set/verified from the RVR Maintenance Data Terminal (MDT) for operation with the Interim RVR/ASOS Interface.

From the "Configuration.Limits.Product" screen (refer to appendix F for a flowchart of RVR MDT screens), set/verify the following parameters:

- a. ENGINEERING DATA OUTPUT INTERVAL: Set to "006" seconds
- b. OUTPUT FILTERED VS AND ALS VALUES (Y/N): Set to "Y"

If entry of new parameters is required, the user must execute the configuration change field to properly initiate the modification.

Additionally, the long-line RVR VS should be configured on the MDT "Configuration.Runway-specification" and "Configuration.options" screens. Verify these configuration settings from the aforementioned screens.

3.2 ASOS CONFIGURATION SETTINGS.

Proper configuration is also required at the ASOS to ensure data from the Interim RVR/ASOS Interface can be processed and reported as the long-line RVR. The configuration process includes verifying that the proper software version is installed at ASOS as well as configuring the ASOS RVR serial port. Officially fielded ASOS ACU software Version 2.45 or higher has been qualified to support long-line RVR reporting. Consult your local NWS Technician or Contract Weather Observer to ensure the ASOS is properly configured for long-line RVR reporting.

3.3 HARDWARE CONNECTIONS.

Before executing RVR/ASOS software, physical connections to each Interim RVR/ASOS component should be verified. This includes all cable connections (including power) to the RVR, HP Palmtop, level converter, and ASOS. If possible, all cable connections should be secured to prevent accidental disconnection. If not performed previously, a MDT should also be connected to the RVR DPU.

3.4 EXECUTING HP PALMTOP RVR-ASOS SOFTWARE.

[1] ACTION: *Attach the HP Palmtop AC adapter to the HP Palmtop and plug into a 120-VAC outlet inside the RVR equipment rack. If possible, secure both ends of the connection with cable ties.*

RESULT: HP Palmtop display should illuminate with text characters from the boot process or operating system prompt. If this occurs, skip step [2] and proceed to step [3].

[2] ACTION: *Turn on HP Palmtop by pressing the "ON" key located in the upper right corner.*

RESULT: As long as the HP Palmtop has AC power and charged internal batteries, the liquid crystal display (LCD) should illuminate with text characters from the boot process or operating system prompt.

[3] ACTION: *Reboot HP Palmtop hardware and software by simultaneously pressing the "CTRL", "ALT", and "DEL" keys.*

RESULT: Immediate execution of the "autoexec.bat", "config.sys", and RVR/ASOS software files should occur. See appendix E for a listing of the autoexec.bat and config.sys files. Text characters from the boot process will scroll across the HP Palmtop display screen. After approximately 10 seconds, the RVR/ASOS program will start. The program will display the current configuration along with a message prompting the user to accept or change the current settings. The message and prompt are shown below:

*****CURRENT SETTINGS ARE SET AS:

ASOS RVR VS Sensor = VS 01

Runway = 36L Com Port = COM1 Timer Interval = 30 seconds

Maximum EDP message length = 2500 bytes

ACCEPT CURRENT DEFAULT SETTINGS? (Y/N)

EXAMPLE. CURRENT SETTINGS MESSAGE

NOTE: The user has approximately 20 seconds to press the “N” key to change the currently stored settings. Otherwise, the program will continue to execute using the currently stored values for runway and VS.

[4] ACTION: *Enter “N” if these settings do not match the long-line RVR VS and runway number for your airport.*

RESULT: Message will be displayed prompting user to enter the long-line VS number and then runway identifier.

ENTER RUNWAY NUMBER (example : 22L):

ENTER VS NUMBER (1 to 18):

EXAMPLE. VS AND RUNWAY MESSAGE PROMPT

Any valid one- or two-digit runway number (e.g., 1 to 36) and identifier (e.g., L, R, C, or blank) must be entered. Lower or uppercase letters can be used for the runway identifier. If the runway identifier is a blank, press the “enter” key immediately after entry of the runway number. Entry of invalid runway numbers and identifiers will not be accepted and will result in the user being prompted to re-enter parameters.

[4a] Identify the VS number to be entered on the HP Palmtop for long-line reporting.
Long-line VS number: _____

[4b] Via the RVR MDT, verify that the long-line VS entered in step 4a is the same VS number shown on the runway and touchdown location of the “Configuration.Runway-specification” MDT screen. If not, the VS number to be entered is incorrect or the RVR VS has not been properly configured.

NOTE: The label “Long-Line VS” will not appear on your MDT screen. Verify the VS number to be entered corresponds to the Touchdown VS on the runway designated for Long-Line RVR reporting.

[4c] If the VS number entered in step 4a has been verified in step 4b, proceed to step 5. Otherwise, determine the cause for the mismatch, correct, and repeat steps 4a, 4b, and 4c.

[5] ACTION: *Enter runway identification and VS number, e.g., 27C, 12.*

RESULT: RVR/ASOS software will continue to initialize. The entered runway identifier and VS number will be stored in the "info.dat" file. The initialization process ends after the HP Palmtop receives and acknowledges data frames from the RVR EU port. The example below illustrates the messages that will appear on your HP Palmtop display. The messages will scroll off the palmtop display in approximately 45 seconds.

```
ASOS RVR VS Sensor = VS 12
Runway = 27C Com Port = COM1 Time Interval = 30 seconds
Maximum EDP message length = 2500 bytes
*****get_started(0) byte_count = -1675*****
*****get_started(1) byte_count = 929*****
*****get_started(0) byte_count = 963*****
*****get_started(1) byte_count = 963*****
*****get_started(2) byte_count = 963*****
*****NEW RLIM BYTE COUNT 963*****
```

EXAMPLE. RVR/ASOS SOFTWARE INITIALIZATION MESSAGES

Note that the numeric values for the "VS Sensor =", "Runway =", and "...byte_count =", are site specific and may be different for your RVR system configuration.

[6] ACTION: *Verify the appearance of the ASOS ADU message on the HP Palmtop display indicating that an ADU was transmitted to ASOS. Refer to the example ASOS ADU message shown below.*

```
<SOH>222616<STX>27C60+<ETX><BCC>
```

EXAMPLE. ASOS ADU MESSAGE

Each ASOS ADU message displayed on the HP Palmtop should have the format shown in the example. Definition of each field in the ADU message is shown below.

<SOH>	Start of header Character
222616	Active Product Processing Unit (PPU) time stamp
<STX>	Start Of Text Character
27C60+	Runway Identifier and Long-line RVR Product
<ETX>	End Of Text Character
<BCC>	Block Check Code

As long as EU data frames are consistently received by the HP Palmtop without interruption or variation in frame size, the RVR/ASOS software will create and transmit an ASOS ADU every

30 seconds. Interruptions in EU data frames or changes in the size of EU data frames may cause the output interval of ASOS ADUs to momentarily change.

[7] ACTION: *On the HP Palmtop, verify that the RVR/ASOS software is receiving RVR EU data frames every 6 seconds (± 2 seconds). Note the difference in time stamp for each message displayed.*

RESULT: Messages acknowledging that the RVR/ASOS software is receiving RVR EU data frames should appear on the HP Palmtop display approximately every 6 seconds, as shown in the example below.

Note: 6-second difference

01/26/97	23:04:53	←
LAST GOOD MESSAGE WAS AT: 01/26/97 10:09:41		
01/26/97	23:04:59	←
LAST GOOD MESSAGE WAS AT: 01/26/97 10:09:41		
01/26/97	23:05:05	←
LAST GOOD MESSAGE WAS AT: 01/26/97 10:09:41		

EXAMPLE. RVR EU DATA FRAME ACKNOWLEDGMENT MESSAGE

[8] ACTION: *Verify the transmitted ASOS ADUs appear on the ASOS "12 HR ARCHIVE", "1-MINUTE CURRENT SENSOR DATA" and "1-MINUTE" display screens.*

RESULT: RVR products appearing on ASOS display screens should match RVR values contained within the recently transmitted ADU. Refer to the example below.

HP PALMTOP DISPLAY SCREEN:

ASOS Message: <SOH>222616<STX>27C60+<ETX><BCC>

ASOS 12 HR ARCHIVE SCREEN:

RVR product match

16:15:04 01/26/97 2215Z MEMPHIS INTERNATIONAL ARPT

UTC	VIS1	D/N1	VIS3	D/N3	WIND	DIR/SPD	5SEC WIND	RVR
2149	.050	D	.050	D	186	11	187 13	27C60+
2150	.050	D	.052	D	186	12	181 14	27C60+

12 HR ARCHIVE

ASOS CURRENT SENSOR DATA SCREEN:

RVR product match

16:15:04 01/26/97 2215Z MEMPHIS INTERNATIONAL ARPT

UTC	VIS1	D/N1	VIS3	D/N3	TEMP	DEWPT	5SEC WIND	RVR
2149	.050	D	.050	D	60	59	187 13	27C60+
2150	.050	D	.052	D	60	59	181 14	27C60+

RAW SENSOR DATA

ASOS 1-MINUTE SCREEN:

RVR product from HP PALMTOP ASOS ADU

SKY	= CLR BLO 120		
VISIBILITY	= 5	TEMP/DEWPT	= 15.6/15.0 C 60/59 F
RVR	= R27C/60+	WIND DIR/SPD	= 130/11
PRESENT WX	= -RA BR	ALTIMETER	= 29.99
REMARKS	= RMK AO2 P0001 TSNO		
TESTM KMEM 041356Z AUTO 13010KT 4SM -RA BR SCT035 BKNO48 OVC095 16/14 A2999 RMK A02 RAB1258 SLP155 P0001 T01560144 TSNO			

[9] ACTION: Place and secure the HP Palmtop on a shelf inside New Generation RVR equipment cabinet.

Completion of all of the aforementioned steps concludes the initialization process.

4. INTERIM RVR/ASOS SHUTDOWN PROCEDURES.

To gracefully shutdown operation of RVR/ASOS software, press the "Q" key. This will stop execution of the RVR/ASOS software and return the HP Palmtop to the DOS environment. Access to the PCMCIA memory card or built-in applications on the internal drive is now possible via DOS commands. At this point, although the RVR/ASOS program has been disabled, the watch-dog timer is still active.

The watch-dog timer is designed to detect when the RVR/ASOS program is not operating and automatically reboot the HP Palmtop hardware and RVR/ASOS software. This feature is intended to reduce maintenance actions such as restarting the HP Palmtop in the event the RVR/ASOS software stops operating. The HP Palmtop is configured to produce a brief audible alarm when the watch-dog timer detects a 1-minute period of keyboard or display inactivity. This will result in a reboot being scheduled. Refer to appendix B, section B.4 for additional specifics concerning the watch-dog timer.

If need arises to turn off the HP Palmtop display, disconnect the Palmtop's AC adapter from the outlet and press the "ON" key. This should result in the removal of backlighting and characters/graphics observed on the display. Turning off the HP Palmtop display also disables operation of the watch-dog timer. Pressing the "ON" key again will initialize the display at the point where it was turned off; e.g., DOS prompt, application, etc. A hardware/software restart will not occur.

5. TECHNICAL SUPPORT.

If additional technical support is required to resolve problems with the installation or operation of your Interim RVR/ASOS Interface, please contact one of the offices listed below.

Mike Monroney Aeronautical Center
Field Support Engineering, AOS-240
Oklahoma City, OK 73125
POC: Jerry Ouillette
Phone: (405) 954-5163

FAA William J. Hughes Technical Center
Weather Branch, ACT-320
Atlantic City International Airport
Atlantic City, NJ 08405
POC: Mike McKinney
Phone: (609) 485-5516

Federal Aviation Administration Headquarters
Navigation and Landing Product Team, AND-520
RVR Program Office
Washington, DC 20590
POC: Deborah Lucas
Phone: (202) 358-5112

5.1 MAINTENANCE COORDINATION PERSONNEL.

Contact personnel from the list below to report and resolve Interim RVR/ASOS Interface maintenance issues:

ASOS Operations and Monitoring Center (AOMC) 800-242-8194

FAA NAV/COM SUPERVISOR * FAA NAV/COM SUPERVISOR

* Refer to your local airport directory for the FAA NAV/COM Supervisor's telephone number.

6. ACRONYMS.

AC	Alternating Current
ACU	Acquisition Control Unit
ALS	Ambient Light Sensor
ADU	Application Data Unit
AOMC	ASOS Operations Monitoring Center
ASOS	Automated Surface Observing System
AWG	American Wire Gauge
BCC	Block Check Code
CD	Controller Display
CWO	Contract Weather Observer
DOS	Disk Operating System
DCE	Data Communication Equipment
DTE	Data Terminal Equipment
DPU	Data Processing Unit
EIA	Electronics Industries Association
EU	External User
ETX	End of Text
FAA	Federal Aviation Administration
HP	Hewlett Packard
HR	Hour
ID	Identification
LCD	Liquid Crystal Display
MDT	Maintenance Data Terminal
NWS	National Weather Service
OT&E	Operational Test and Evaluation
POC	Point of Contact
PC	Personal Computer
PPU	Product Processing Unit
RAM	Random Access Memory
RLIM	Runway Light Intensity Monitor
RS	Required Standard
RVR	Runway Visual Range
SOH	Start Of Header
SIE	Sensor Interface Electronics
STX	Start of Text
VAC	volts alternating current
VS	Visibility Sensor

APPENDIX A
RVR AND INTERIM RVR/ASOS INTERFACE MAINTENANCE ACTIONS

A. RVR & INTERIM RVR/ASOS INTERFACE MAINTENANCE ACTIONS.

This section discusses maintenance actions or modifications to the New Generation RVR and respective coordination efforts between the FAA and NWS. By prior agreement between the FAA and NWS, all RVR maintenance/modifications which will affect long-line RVR data should be coordinated with the ASOS Operations and Monitoring Center (AOMC). In general, any action that could affect the RVR EU output frame size or long-line RVR data should be coordinated through the AOMC. The following sections provide procedures which should be followed for specific RVR system actions.

A-1 LONG-LINE RVR VS MAINTENANCE OR CALIBRATION.

When performing maintenance or calibration on the long-line RVR VS, precautionary measures must be taken to ensure that incorrect long-line RVR products are not sent to ASOS. Procedural steps for conducting maintenance and calibration of the long-line RVR VS sensor are addressed below.

Maintenance/Calibration Procedure:

1. Notify the Contract Weather Observer (CWO) or AOMC that maintenance will be performed on the long-line RVR VS.
2. Via the MDT Product editing screen, manually fail the long-line RVR product. Refer to TI 6560.17, dated August 1, 1995, section 6.8.9 for details on manually failing RVR products.
3. Perform maintenance/calibration actions on the RVR VS in accordance with TI 6560.17.
4. Via the MDT Product editing screen, manually unfail the long-line RVR product. Refer to TI 6560.17, dated August 1, 1995, section 6.8.9c for details on unfailling RVR products.
5. Verify that the HP Palmtop is generating ASOS ADUs with numeric RVR values.
6. Verify that ASOS is receiving ADUs from the HP Palmtop by reviewing the ASOS "12 Hour Archive" screen.
7. Verify that the RVR values shown in the ASOS "12 Hour Archive" screen match the RVR values generated by the HP Palmtop.
8. Notify the CWO or AOMC that maintenance is completed on the long-line RVR VS.

A-2 AMBIENT LIGHT SENSOR (ALS) MAINTENANCE OR CALIBRATION.

When performing maintenance or calibration on the RVR ALS, the following procedure should be followed.

Maintenance/Calibration Procedure:

1. Notify the CWO or AOMC that maintenance/calibration will be performed on the RVR ALS.
2. Via the MDT Product editing screen, manually fail the long-line RVR product. Refer to TI 6560.17, dated August 1, 1995, section 6.8.9c for details on manually failing RVR products.
3. Perform maintenance/calibration actions on the RVR ALS in accordance with TI 6560.17.
4. Via the MDT Product editing screen, manually unfail the long-line RVR product. Refer to TI 6560.17, dated August 1, 1995, section 6.8.9c for details on unfailling RVR products.
5. Verify the HP Palmtop is generating ASOS ADUs with numeric RVR values.
6. Verify the ASOS is receiving ADUs from the HP Palmtop by reviewing the ASOS "12 Hour Archive" screen.
7. Verify the RVR values shown in the ASOS "12 Hour Archive" screen match the RVR values generated by the HP Palmtop.
8. Notify the CWO or AOMC that maintenance is completed on the long-line RVR VS.

A-3 RESOLVING SYSTEM OR COMPONENT FAILURE.

When troubleshooting a system or component failure, the following procedure should be followed.

System Troubleshooting Procedure:

1. Notify the CWO or AOMC that troubleshooting/maintenance will be performed on the RVR system and that RVR long-line data will not be available.
2. Disconnect Cable 2 from the HP Palmtop.
3. Perform troubleshooting/maintenance actions on the RVR system in accordance with TI 6560.17.
4. When the system or component failure has been corrected, reconnect cable 2 to the HP Palmtop serial port.
5. Verify the HP Palmtop is generating ASOS ADUs with numeric RVR values.
6. Verify the ASOS is receiving ADUs from the HP Palmtop by reviewing the ASOS "12 Hour Archive" screen.
7. Verify the RVR values shown in the ASOS "12 Hour Archive" screen match RVR values generated by the HP Palmtop.
8. Notify the CWO or AOMC that maintenance is completed on the long-line RVR VS.

A-4 PERFORMING RVR SYSTEM OR COMPONENT RESET.

When performing RVR system or component resets, the following procedure should be followed.

RVR Reset Procedure:

1. Notify the CWO or AOMC that maintenance will be performed on the RVR system.
2. Via the MDT Product editing screen, manually fail the long-line RVR product. Refer to TI 6560.17, dated August 1, 1995, section 6.8.9c for details on manually failing RVR products.
3. Perform RVR system or component reset actions in accordance with TI 6560.17.
4. Via the MDT Product editing screen, manually unfail the long-line RVR product. Refer to TI 6560.17, dated August 1, 1995, section 6.8.9c for details on unfailing RVR products.
5. Verify that the HP Palmtop is generating ASOS ADUs with numeric RVR values.
6. Verify that ASOS is receiving ADUs from the HP Palmtop by reviewing the ASOS "12 Hour Archive" screen.
7. Verify that the RVR values shown in the ASOS "12 Hour Archive" screen match the RVR values generated by the HP Palmtop.
8. Notify the CWO or AOMC that maintenance is completed on the long-line RVR VS.

APPENDIX B
HP PALMTOP ON-SCREEN MESSAGES

B. HP PALMTOP ON-SCREEN MESSAGES.

This section provides examples of HP Palmtop on-screen messages that could occur during operation of the Interim RVR/ASOS Interface. On-screen messages discussed in earlier sections of this guide are not repeated.

B-1 EU DATA FRAME.

The EU data frame which appears on the HP Palmtop display as an ASOS ADU is being transmitted is illustrated as Message B-1. The message displays the following information:

- a. New Generation RVR date and time stamp,
- b. VS and ALS sensor data from the most recent EU data frame,
- c. Extinction coefficient (sig) and ambient light (al) values used to calculate the long-line RVR,
- d. Calculated raw data long-line RVR (rv), and
- e. ASOS ADU message sent to ASOS.

01/27/00	02:02:23	22:30		
VS 01	2.62	11	10	
VS 02	1.70	4	12	
VS 03	3.25	9	3	
VS 04	2.22	10	8	
ALS	2.0	6		
sig=2.620000 al=2.000000 rv=7199.891113				
ASOS Message: <SOH>020223<STX>27C60+<ETX><BCC>				

MESSAGE B-1. EU DATA FRAME

The New Generation RVR date and time stamp are shown on the first line of the message, followed by the configured VS and ALS sensors. Numerical entries to the right of the VS identifier indicate the extinction coefficient measurement and window contamination readings for the transmitter and receiver, respectively. Numerical entries to the right of the ALS indicate the ambient light measurement and window contamination reading. These readings should match readings contained on the applicable MDT screens.

The line in the message containing the "sig", "al", and "rv" values identify the extinction coefficient of the long-line VS (sig), the ALS measurement (al), and the raw calculated long-line RVR product (rv). Note that the "sig" value matches the long-line extinction coefficient and the "al" value matches the ALS value in the message. Note also that the raw "rv" calculation is rounded appropriately in the ASOS message from 7199.891113 feet to 60+.

This message should be displayed every 30 seconds on the HP Palmtop's display.

B-2 VS NOT FOUND.

If the VS ID identified as the long-line RVR VS does not appear in the EU output data, a "message indicating the VS was not found will be displayed. A sample "VS NOT FOUND" message is shown in Message B-2:

```
***** VS 05 NOT FOUND *****  
MESSAGE B-2. HP PALMTOP VS NOT FOUND MESSAGE
```

In this scenario, ASOS ADUs are not transmitted to ASOS until the long-line VS is detected in the EU output data.

B-3 CORRUPTED DATA INDICATION.

The RVR/ASOS software operating on the HP Palmtop uses the Runway Light Intensity Monitor (RLIM) field to determine the end of the EU data frame. If the RLIM field or other fields within the EU data frame become corrupted or are not recognized by the RVR/ASOS software, no data will be transmitted to ASOS and an error message will be displayed on the HP Palmtop display. The error message, such as the message shown in Message B-3, will be preceded by a screen dump of the data received by the RVR/ASOS software.

```
*****  
*****ERROR: PACKET NOT RECEIVED IN PAST 500 SECONDS  
*****1000 BYTES HAVE BEEN READ  
*****
```

MESSAGE B-3. EU DATA NOT RECOGNIZED

If the RVR/ASOS software detects a transient change in the EU data frame, a message such as the one shown in Message B-4 will be displayed on the HP Palmtop.

```
BAD DATA RECEIVED ---100 bytes LAST GOOD MESSAGE WAS AT 15:44  
MESSAGE B-4. BAD DATA RECEIVED
```

If the EU data frame changes to a new size which is consistent, the RVR/ASOS software will restart the EU data frame acknowledgment process. An example of the acknowledgment process is shown in Message B-5:

```
*****get_started(0) byte_count = -1675*****
*****get_started(1) byte_count = 929*****
*****get_started(0) byte_count = 963*****
*****get_started(1) byte_count = 963*****
*****get_started(2) byte_count = 963*****
*****NEW RLIM BYTE COUNT 963*****
```

MESSAGE B-5. EU DATA FRAME SIZE ACKNOWLEDGMENT

B-4 RVR/ASOS SOFTWARE NOT OPERATING.

Since the Interim RVR/ASOS Interface is automated and unmanned, a watch-dog timer has been incorporated into the HP Palmtop configuration. The watch-dog timer's purpose is to detect if/when the RVR/ASOS software is not operating, and its function is to reboot the HP Palmtop when display screen or keyboard inactivity exceeds 1 minute. When the display screen or keyboard inactivity exceeds 1 minute, the message shown in Message B-6 will be displayed on the screen. If the countdown period for the scheduled reboot expires prior to keyboard activity, the HP Palmtop will automatically reboot and the RVR/ASOS software will be restarted. The RVR/ASOS software will initialize using the last entered RVR VS and runway identification. Watch-dog timer initiated reboot dates and times are stored in a log file entitled "reboot.log". See section D.3, Special Instructions for specifics concerning the watch-dog timer log file.

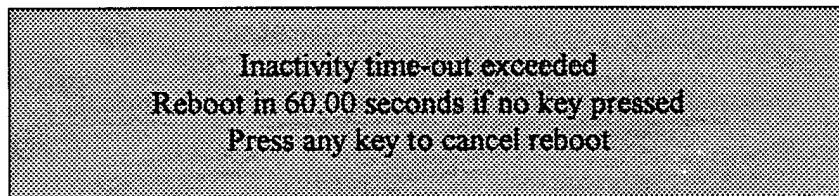

MESSAGE B-6. REBOOT PENDING

APPENDIX C
TROUBLESHOOTING

C. TROUBLESHOOTING.

This appendix provides information in troubleshooting problems associated with the HP Palmtop and resident RVR/ASOS software. A set of troubleshooting flowcharts has been developed to provide assistance. When using the flow chart, begin at the "start" indicator and proceed to the box indicating the particular problem. Follow the flowchart to "end", executing the actions described along the way. In the event the system problem is not indicated on the flowchart, contact a Technical Support Office listed in section 5.

Sections C-1 and C-2 and figure C-1 are expanded instructions referenced within the troubleshooting flowcharts.

Note: Prior to performing troubleshooting activities on the Interim RVR/ASOS Interface, notify the AOMC that maintenance will be performed on the RVR system.

08:52:37 04/04/97

MEMPHIS INTERNATIONAL AIRPORT

PORT	MOD	FUNCTION	PORT	MOD	FUNCTION	PORT	MOD	FUNCTION
1-1			4-1					
2			2		UPS			
3		RVR	3	7	PRESSURE			
4			4	6	VDU-1			
2-1		ACU-DCP A			PRINTER			
2		PRESSURE #1						
3		OID-4 USER 1						
4		VOICE						
3-1		ACU-DCP B						
2		PRESSURE #2						
3	5	OID-5 USER 2						
4		OID-1 USER						
		FUNCTION RVR						
STATUS		ENABLED	HANDSHAKE		NONE	ACU SERIAL COMMS		
BAUD RATE		2400	CONNECTION		HARD-WIRE			
PARITY SELECT		EVEN						
BITS/CHAR		7						
STOP BITS		1						

FIGURE C-1. ASOS PORT MOD FUNCTION SCREEN

C-1. COPYING FILES FROM THE PCMCIA CARD.

An "autoexec.bat" and/or "config.sys" file can be copied from the PCMCIA memory card supplied with your Interim RVR/ASOS Interface Installation Kit. Follow the following procedure to copy a file from the PCMCIA memory card onto the HP Palmtop's "c:\\" drive.

1. From the "c:\\" dos prompt, remove power from the HP Palmtop by pressing the "ON" key.
2. Insert the PCMCIA memory card by holding the card, logo facing up, and sliding it into the slot on the left side of the HP Palmtop. The card is properly inserted when the inserted card edge is flush with the HP Palmtop's case.
3. Turn the HP Palmtop on by pressing the "ON" key.
4. If not at the "c:\\" drive, type "c:\\" at the dos prompt to go to the "c:\\" drive.
5. At the "c:\\" dos prompt, type "copy a:*filename.fil* c:\\". Insert the proper filename in place of *filename.fil*.
6. Verify the file was copied through acknowledgment of the file transfer confirmation message "1 file(s) copied" displayed on the HP Palmtop.
7. Repeat steps 5 and 6 for each file which needs copied.
8. Turn the HP Palmtop off by pressing the "ON" key.
9. Remove the PCMCIA memory card by sliding the card eject switch to the left.
10. Turn the HP Palmtop on by pressing the "ON" key.

C-2. TROUBLESHOOTING FLOWCHART.

The following pages provide a flowchart that can be used for isolating and troubleshooting problems occurring on the Interim RVR/ASOS Interface, the ASOS or the New Generation RVR.

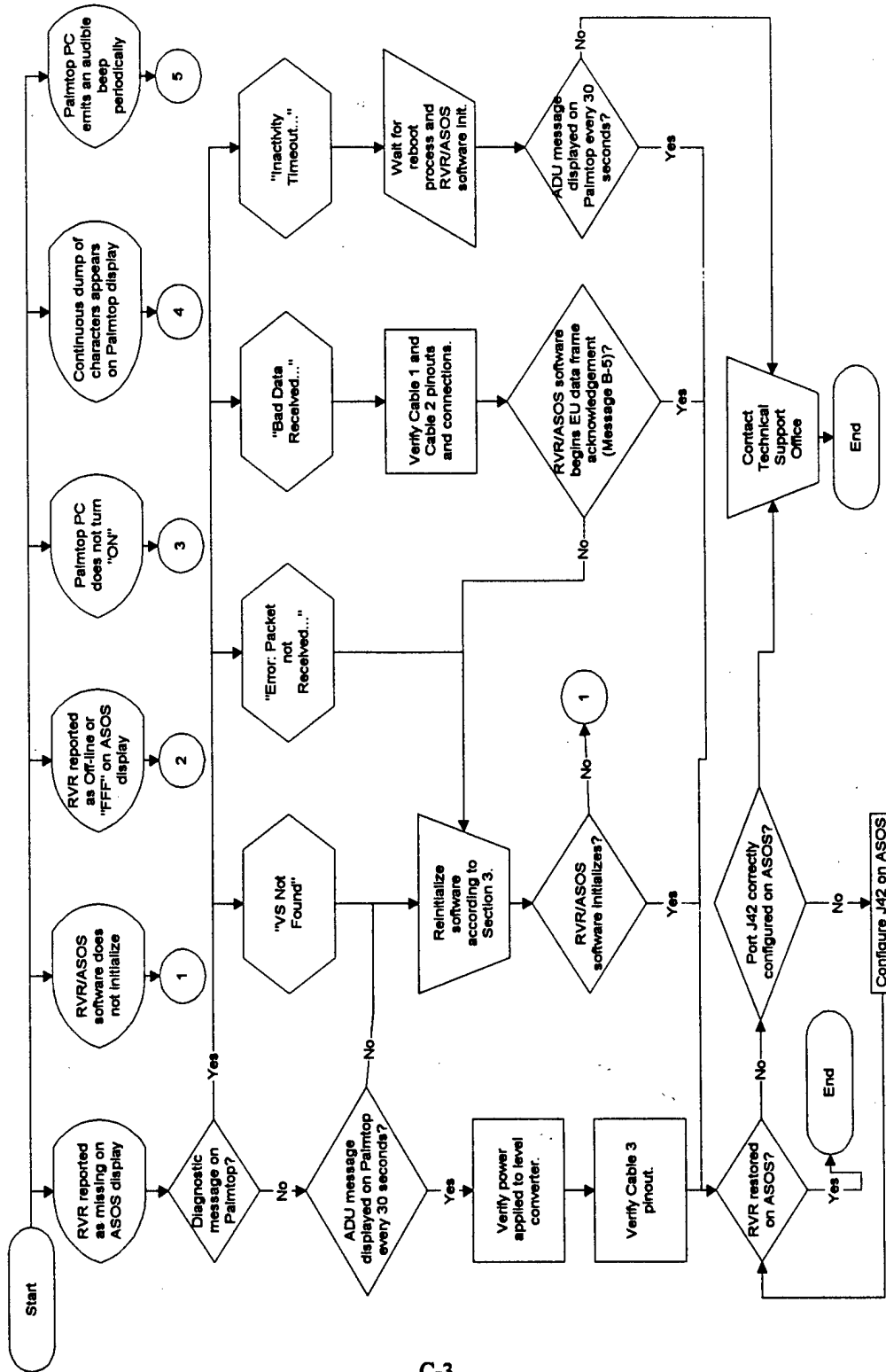

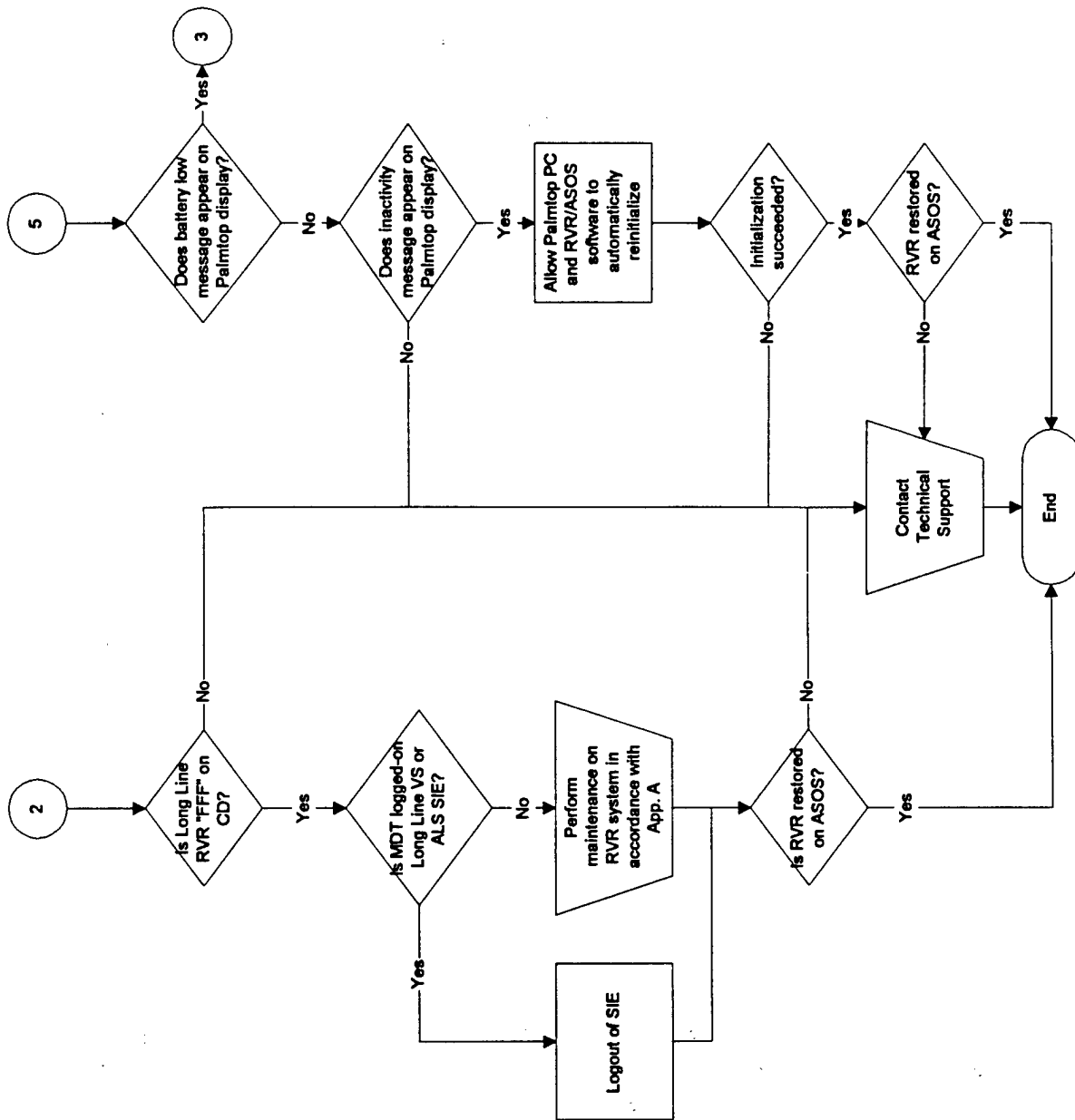

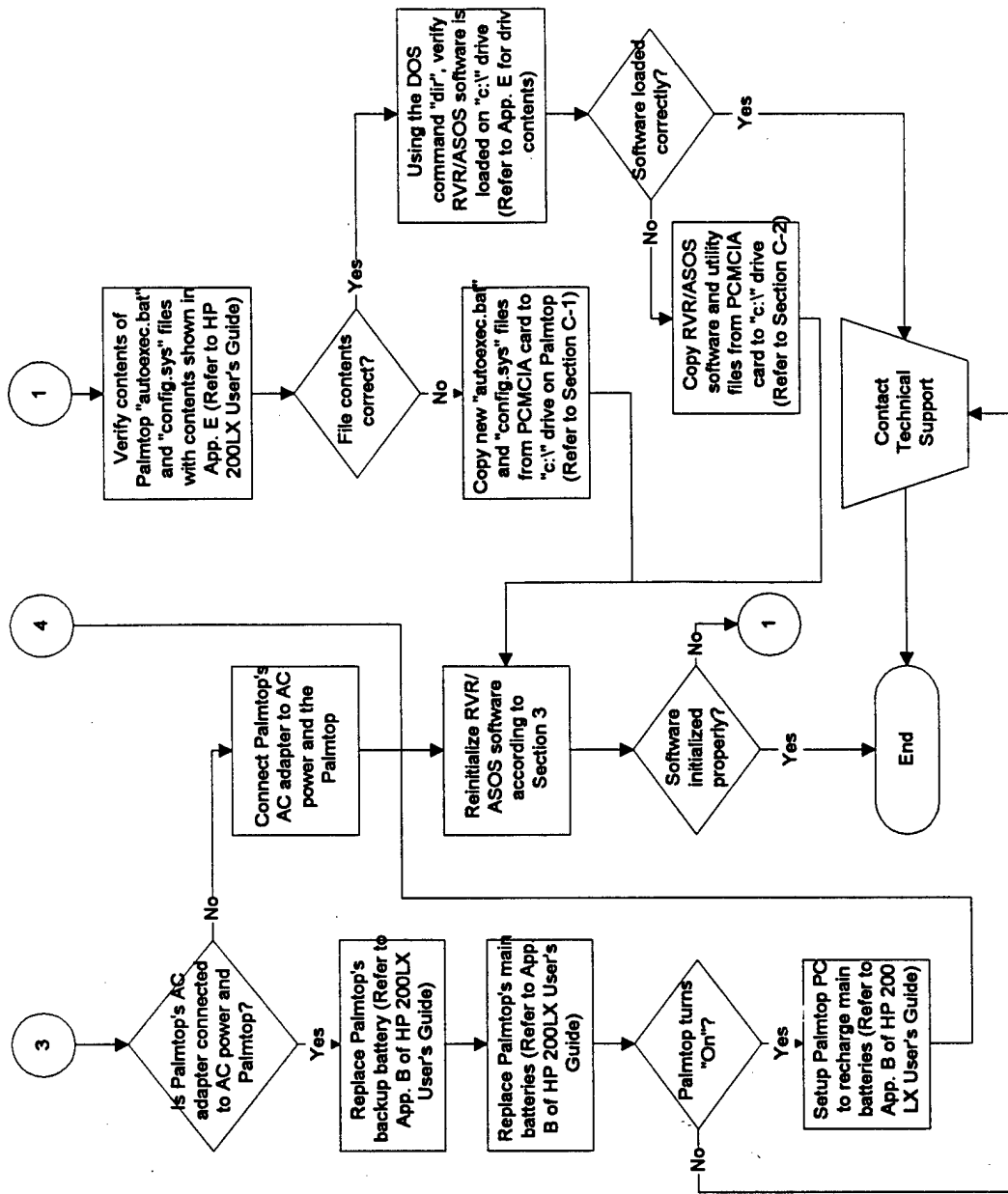

APPENDIX D
SPECIAL INSTRUCTIONS

D. SPECIAL INSTRUCTIONS.

This section briefly describes precautions that should be taken to prevent otherwise unnecessary maintenance actions on the HP Palmtop and RVR/ASOS software.

NOTE: Loss of all data on the HP Palmtop internal disk and/or memory card could result if these precautions are not followed.

D-1 HP PALMTOP BATTERIES.

Your HP 200LX Palmtop computer has been equipped with two size "AA" Nickel-Cadmium rechargeable main batteries and a lithium coin cell battery for backup. The backup battery prevents data loss when the main batteries are dead or out of the system. The backup battery should be replaced once a year. When changing batteries, please follow the instructions given below.

1. Halt operation of the RVR/ASOS program and turn off HP Palmtop display as described in section 4.
2. If inserted, remove the PCMCIA memory card by sliding the card eject switch to the left.
3. Replace batteries in accordance with appendix B of the HP 200LX User's Guide.
4. After batteries have been installed, turn on the HP Palmtop by plugging in the AC adapter and pressing the "ON" key.
5. Enter the HP Palmtop's setup utility and verify that the HP Palmtop is configured for Nickel-Cadmium batteries and that recharging is selected (follow the instructions in appendix B of the HP 200LX User's Guide).
6. Reinitialize RVR/ASOS software as defined in section 3.

D-2 PCMCIA MEMORY CARD.

Never insert or eject the PCMCIA memory card while the HP Palmtop is on. Loss of data on the memory card could result. Additionally, ensure that the DOS prompt is not set on drive "a:\\" when ejecting the PCMCIA card. Enter "c:", "d:", or "e:" on the HP Palmtop to change the DOS drive, turn the power off, and then eject the card.

D-3 WATCH-DOG TIMER REBOOT.

A log file resident on the PCMCIA card and HP Palmtop internal drive can be used to determine if restarts of the RVR/ASOS software have occurred during periods when a user has not examined the HP Palmtop display. This log file is entitled "reboot.log" and is located on the internal drive "c:\\" and the PCMCIA card drive "a:\\". The reboot.log file records the date and time of reboots initiated by the watch-dog timer. Follow the procedure below to view the "reboot.log" file.

1. Notify the AOMC that the Interim RVR/ASOS Interface will be out of service.
2. Exit the RVR/ASOS software in accordance with section 4.
3. From the "c:\\" dos prompt, type "type reboot.log". A sample listing of the reboot.log file is shown below.

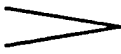
Feb 24 10:09:41 1997		<i>Date and time of reboot</i>
Feb 24 11:10:25 1997		

Sample Listing of "Reboot.log" File

APPENDIX E

**INTERNAL DRIVE/PCMCIA MEMORY CARD DIRECTORY TREES AND
FILE CONTENTS**

E. INTERNAL DRIVE/PCMCIA MEMORY CARD DIRECTORY TREES and FILE CONTENTS

AUTOEXEC.BAT CONTENTS

@echo off

Rem To customize DOS startup files, copy config.sys and
Rem autoexec.bat from the D drive to the C drive and
Rem edit the C drive versions to meet your needs.

Rem

Rem

Rem Set prompt, path, and select C drive.

Rem

prompt \$p\$g

path c:\;d:\;d:\bin;d:\dos

c:

Rem

Rem Following assign enables referencing the plug-in card as
Rem drive E (in addition to A). Using E allows some programs
Rem to run which refuse to run from a drive that is normally
Rem associated with a floppy drive.

Rem

assign e:=a:

@echo on

Rem

Rem Load the Card Installation Client TSR to provide support
Rem for PCMCIA modem cards. If these cards will not be used,
Rem prefacing with Rem will save system RAM.

Rem

d:\bin\cic100\gen 1

Rem

Rem Load the first LapLink Remote Access TSR as required by the
Rem Server application. If the Server will not be used,
Rem prefacing with Rem will save system RAM.

Rem

call d:\bin\lras

Rem Following 200 command starts the System Manager which
Rem provides access to the built-in applications.

Rem

REM 200

Rem

Rem Need to power up and activate COM 1 port

AUTOEXEC.BAT CONTENTS (continued)

```
serctl /w  
  
Rem Need to set COM 1 port  
mode com1: 2400, n, 8, 1  
Rem  
c:  
REM start watchdog timer  
deadman /A1  
Rem Need to run software to get data  
rvr_asos
```

CONFIG.SYS CONTENTS

```
files = 20  
buffers = 20  
device = c:\stacker\stacker.com
```

INFO.DAT CONTENTS

```
VS_01 22R com1 2500 30
```

FILES & DIRECTORIES REQUIRED ON PCMCIA MEMORY CARD [A:\]

FILE NAME	SIZE (BYTES)
a:\stacker	----
a:\ ¹ info.dat	21
a:\wear.exe	3,519
a:\ ¹ deadman.exe	17,788
a:\ ¹ rvr_asos.exe	38,732
a:\ ¹ autoexec.bat	1,305
a:\config.sdp	35
a:\ ¹ config.sys	80
a:\ ² stacker.exe	TBD
a:\ ² stacker.ins	TBD
a:\reboot.log	----
a:\asossave.exe	33,054

FILES & DIRECTORIES REQUIRED ON INTERNAL DRIVE [C:\]

FILE NAME	SIZE (BYTES)
c:\info.dat	21
c:\deadman.exe	17,788
c:\rvr_asos.exe	38,732

¹ These files will not be viewable on drive a:\ if the stacker program is not operating.

² These files will not be viewable on drive a:\ if the stacker program is operating.

c:\autoexec.bat	1,305
c:\config.sys	80
c:\stacker	----
c:\stacker\stacker.com	43,727
c:\stacker\install.exe	14,112
c:\check.exe	41,945
c:\sdir.exe	35,689
c:\config.sdp	80
c:\wear.exe	3519
c:\asossave.exe	33,054

FILES & DIRECTORIES REQUIRED ON INTERNAL DRIVE [D:\]

FILE NAME	SIZE (BYTES)
d:_DAT	----
d:_SYS	----
d:\BIN	----
d:\DOS	----
d:\config.sys	80
d:\123.dyn	----
d:\123.set	----
d:\123vs.ri	----
d:\autoexec.bat	1266

FILES & DIRECTORIES REQUIRED ON INTERNAL DRIVE [E:\]

FILE NAME	SIZE (BYTES)
e:\stacker	----
e:\1\info.dat	21
e:\wear.exe	TBD
e:\1\deadman.exe	TBD
e:\1\rvr_asos.exe	38,732
e:\1\autoexec.bat	1266
e:\config.sdp	80
e:\1\config.sys	80
e:\2\stacker.exe	14,112
e:\2\install.exe	14,112
e:\reboot.log	----
e:\asossave.exe	33,054

¹ These files will not be viewable on drive a:\ if the stacker program is not operating.

² These files will not be viewable on drive a:\ if the stacker program is operating.

APPENDIX F

NEW GENERATION RVR MDT SCREEN FLOWCHART

F. NEW GENERATION RVR MDT SCREEN FLOWCHART.

