

DOT/FAA/AR-97/85

Office of Aviation Research
Washington, D.C. 20591

Response and Failure of Composite Plates With a Bolt-Filled Hole

June 1998

Interim Report

This document is available to the U.S. public
through the National Technical Information
Service (NTIS), Springfield, Virginia 22161.



U.S. Department of Transportation
Federal Aviation Administration

19990210 004

DNIG QUALITY INSPECTED 2

DISTRIBUTION STATEMENT A
Approved for public release;
Distribution Unlimited

NOTICE

This document is disseminated under the sponsorship of the U.S. Department of Transportation in the interest of information exchange. The United States Government assumes no liability for the contents or use thereof. The United States Government does not endorse products or manufacturers. Trade or manufacturer's names appear herein solely because they are considered essential to the objective of this report.

1. Report No. DOT/FAA/AR-97/85		2. Government Accession No.		3. Recipient's Catalog No.	
4. Title and Subtitle RESPONSE AND FAILURE OF COMPOSITE PLATES WITH A BOLT-FILLED HOLE				5. Report Date June 1998	
				6. Performing Organization Code	
7. Author(s) U.M. Yan, H.T. Sun, W.D. Wei, and F.K. Chang				8. Performing Organization Report No.	
9. Performing Organization Name and Address Stanford University School of Engineering Department of Aeronautics and Astronautics 496 Lomita Mall Stanford, CA 94305-4035				10. Work Unit No. (TRAIS)	
				11. Contract or Grant No. Grant No. 95-G-012	
12. Sponsoring Agency Name and Address U.S. Department of Transportation Federal Aviation Administration Office of Aviation Research Washington, DC 20591				13. Type of Report and Period Covered Interim Report	
				14. Sponsoring Agency Code	
15. Supplementary Notes The FAA William J. Hughes Technical Center COTR is Peter Shyprykevich					
16. Abstract <p>This progress report summarizes the activities that have been performed under the sponsorship of the Federal Aviation Administration (FAA) under contract no. DEPT/95-G-012-0001 from May 1, 1996 to June 1, 1997. This program is considered to be a part of a special joint project between the FAA and the Boeing Company on the design of composite bolted joints. The major effort of the joint project is to develop the most advanced computer code for the analysis and design of bolted composite joints for the Boeing Company and the FAA. The major focus of the FAA program is on net-tension failure of composites containing a circular cutout with or without a mechanically tightened bolt, while the Boeing program focuses on the bearing damage of bolted joints in both double and single lap joints. This report describes the activities under FAA funding. Both experimental and analytical work have been conducted.</p>					
17. Key Words Bolted composite joint, Filled-hole tension, Open-hole tension, Tensile strength, Laminated composites			18. Distribution Statement This document is available to the public through the National Technical Information Service (NTIS), Springfield, Virginia 22161.		
19. Security Classif. (of this report) Unclassified		20. Security Classif. (of this page) Unclassified		21. No. of Pages 81	22. Price

ACKNOWLEDGEMENTS

The support of the Federal Aviation Administration for the project is gratefully appreciated. Mr. Peter Shyprykevich is the program monitor.

TABLE OF CONTENTS

	Page
EXECUTIVE SUMMARY	ix
INTRODUCTION	1
PROBLEM STATEMENT	1
EXPERIMENTS	2
Open- and Filled-Hole Tension Tests	2
Bolted-Joint Tests	2
OPEN- AND FILLED-HOLE TENSION TEST RESULTS	2
Ply Orientation Effect	3
Clamp-Up Effect	3
Washer Size Effect	5
Friction Effect	5
BOLTED-JOINT TEST RESULTS	5
ANALYTICAL MODEL	6
CONCLUDING REMARKS	9
REFERENCES	10
APPENDICES	
A—Filled-Hole Tension Test Data	
B—Double Lap Bolted-Joint Test Data	

LIST OF FIGURES

Figure		Page
1	Description of the Activities of the FAA-Boeing Joint Project	13
2	Geometries of the Specimens for Open- and Filled-Hole Tension Tests	13
3	Geometries of the Bolted-Joint Test Setup	14
4	Comparison of Net-Tension Strength Between Open- and Filled-Hole Laminates	14
5	Damage Pattern of the Net-Tension Failure of Damage-Resistant Laminates	15
6	Damage Pattern of Net-Tension Failure of Damage-Prone Laminate	15
7	Damage Pattern of Net-Tension Failure of Damage-Prone Laminate	16
8	Typical Tensile Failure Modes in Composite Laminates Containing a Circular Hole	16
9	Notch Strength Reduction Due to the Insertion of a Tightened Bolt	17
10	Effect of Clamping Pressure on Tensile Strength of Filled-Hole Laminates	17
11	Radiographs of Damaged [90/0 _s /90] and [90/0 _s /90] Laminates	18
12	Effect of Clamping Force on Tensile Strength of Filled-Hole Laminates	18
13	Radiographs of Filled-Hole Specimens at Various Clamping Loads	19
14	Effect of Implanted Delamination on Tensile Strength of Open- and Filled-Hole Laminates	19
15	Effect of Washer Size on Notch Strength of Filled-Hole Laminates Subjected to a Constant Clamping Load	20
16	Effect of Washer Size on Notch Strength of Filled-Hole Laminates (Constant Clamping Load)	20
17	Effect of Washer Size on Notch Strength of Filled-Hole Laminates	21

18	Effect of Washer Size on Notch Strength of Filled-Hole Laminates (Constant Clamping Pressure)	21
19	Schematic of the Test Setup for Measuring Friction Coefficient Between a Composite Plate and a Washer	22
20	Effect of Friction of the Filled-Hole Tensile Strength T800H/3900-2 [(45/0/90/-45) ₂]s	22
21	Effect of Friction on the Filled-Hole Tensile Strength T800H/3900-2 [(0/90) ₄]s	23
22	The Load-Deflection Responses of Bolted Composite Joints	23
23	The Definition of Failure Loads in Bolted Composite Joints	24
24	Effect of Washer Size on the Strength of Bolted Composite Joints Failed in a Net-Tension Mode	24
25	Effect of Washer Size on the Failure Load of Bolted Composite Joints	25
26	Radiographs of Bolted [45/0/0/-45/0/90/0/90]s Composite Joints in the Net-Tension Failure Mode	25
27	The Schematic of the Progressive Failure Modeling Used in the Study	26
28	A Typical Finite Element Mesh Used in the Calculations	26
29	Comparison of Stress-Strain and Crack Density-Strain Relationships Between the Measurements and the Predictions	27
30	Comparison of Filled-Hole Strength Between the Predictions and the Test Data for Various Washer Sizes	27
31	(Left) The Predicted Damage Accumulation in a Laminate at the Given Load (Right) The Predicted Load-Deflection Curve for the Laminate	28

EXECUTIVE SUMMARY

This progress report summarizes the activities that have been performed under the sponsorship of the Federal Aviation Administration (FAA) under Contract No. DEPT/95-G-012-0001 from May 1, 1996 to June 1, 1997. This program is considered to be a part of a special joint project between the FAA and the Boeing Company on the Design of Composite Bolted Joints. The major effort of the joint project is to develop the most advanced computer code for the analysis and design of bolted composite joints for the Boeing Company and the FAA.

The major focus of the FAA program is on net-tension failure of composites containing a circular cutout with or without a mechanically tightened bolt, while the Boeing program focuses on the bearing damage of bolted joints in both double and single lap joints. This report describes the activities under FAA funding. This report will summarize both the experimental and the analytical results of the study.

INTRODUCTION

Joining by mechanical fasteners is one of the common practices in the assembly of structural components. Since the failure of the joints can lead to the catastrophic failure of the structures, an accurate design methodology is essential for an adequate design of the joints. Because of the complex failure modes of composite materials, the mechanical joining of structures made of composite materials demands much more rigorous design knowledge and techniques than those currently available to the traditional methodology for metallic joints.

There are three basic failure modes in composite joints: net-tension, shear-out, and bearing. Net-tension failure is associated with matrix and fiber tension failures due to stress concentrations. Shear-out and bearing failures result primarily from the shear and compression failures of fiber and matrix.

Both open- and filled-hole tension tests have been widely used in the industry as a means for characterization of the tensile strength of bolted joints. However, it has been shown that the filled-hole tensile strength can be quite different from the open-hole tensile strength and can be sensitive to those factors such as ply orientation, lateral constraints, and washer sizes. Unfortunately, there is still a lack of fundamental understanding of the causes of the difference between the filled- and open-hole strengths and the variations due to these factors. Most of the previous studies have been focused on open-hole strength or the strength of pin-loaded joints [1-15]. There are limited studies, mostly experiments, concerning the clamp-up effect [16-23].

Accordingly, a significant amount of test data may be needed in order to characterize the tensile strength of bolted joints. Furthermore, inadequate data may lead to a design that is either too conservative or unsafe. Therefore, the objective of the investigation is to study the strength and failure of both open- and filled-hole composite laminates. This study is part of a joint program sponsored by both the FAA and Boeing at Stanford University to develop a computer code for the analysis and design of bolted composite joints. A schematic description of the joint program is illustrated in figure 1.

PROBLEM STATEMENT

Consider laminated composites with a circular hole. The ply orientations of the laminates can be arbitrary but must be symmetric. Three types of loading configurations were considered in the study:

1. Open-Hole Tension: The laminates were subjected to uniaxial tension. No constraint was imposed on the hole.
2. Filled-Hole Tension: The laminates were subjected to uniaxial tension. A bolt was inserted inside the hole of the laminates with and without a clamp-up load. A washer was

inserted between a bolt head and tail and the composite laminate to distribute the clamp-up load.

3. Bolted Joint: Double lap bolted joints were subjected to a uniaxial load. Clamp-up load was considered. Failure of the joint must be in a net-tension mode.

EXPERIMENTS

More than three hundred specimens were tested. T800/3900-2 graphite/epoxy prepregs were selected for the study. The same material is currently used in the design of the Boeing 777 airplane. Various geometries, loading conditions, and ply orientations were considered as shown in appendix A. All the tests followed the ASTM standards and procedures. All the specimens were X-rayed before and after tests to assess the internal damage that may have been introduced during the manufacturing or processing or generated as a result of mechanical loading. Specimens which contained manufacturing defects were discarded.

OPEN- AND FILLED-HOLE TENSION TESTS.

The geometries and test configurations of the open- and filled-hole tension tests are schematically described in figure 2. For the filled-hole test, a load cell was mounted on the bolt to monitor the clamp-up load. The load cell consists of a hollow cylinder made of stainless steel and two strain gauges which were mounted on two sides of the cylinder where the surfaces were flattened. The load cell was calibrated to establish the relationship between the applied load and the strain measurements.

Before the filled-hole tests, the amount of clamping force applied to the bolt was determined by comparing the strain measurements with the calibration curve. During the test, the clamping force was monitored continuously from recorded strain measurements. For the filled-hole tests, besides ply orientation and geometry, the following three design variables were also considered in the test matrix: clamping force (clamp-up load), washer size, and friction.

BOLTED-JOINT TESTS.

Tests were also conducted to evaluate the strength of bolted composite joints in a net-tension failure mode. A schematic description of the specimen and fixture geometry is shown in figure 3. Again, the load cell was used to measure the clamping load.

OPEN- AND FILLED-HOLE TENSION TEST RESULTS

Based on the experiments, the results of the tests were summarized in four categories that interrogate the effect of ply orientation, clamp-up load, washer size, and friction.

PLY ORIENTATION EFFECT.

The strengths of the filled-hole specimens for various ply orientations were compared with those of the open-hole specimens. For this series of tests the clamp-up load was 1500 lbf. Figure 4 shows the reduction of the filled-hole strength as compared to the open-hole strength for nine different ply orientations.

Clearly, the presence of a bolt with a clamp-up load of 1500 lbf can affect the notch strength of laminates containing a circular hole. For A, B, C, and D laminates of figure 4 (Group 1), no strength reduction was found for filled-hole specimens as compared to open-hole specimens. However, for laminates E, F, G, H, and I (Group 2), the notch strengths of filled-hole laminates were lower than those of the open-hole laminates.

By examining the radiographs of tested specimens, it was found that the failure patterns of specimens within each group were quite similar but were significantly different between the two groups. In Group 1 laminate D, as shown in figure 5 for two specimens, damage was mostly confined near the stress concentration areas and propagated from the hole region toward the free edges as a function of the applied load. The damage consisted mostly of matrix cracking and fiber breakage.

However, for Group 2, damage was widespread in laminates G and I as shown in figures 6 and 7 (three different specimens) due to two additional damage modes, delamination and fiber-matrix splitting, which were not evident in Group 1. A schematic description of the damage pattern for each laminate group is shown in figure 8. For Group 1, damage is localized to the stress concentration areas before final failure. For Group 2, edge delamination occurred in both open- and filled-hole specimens at an early loading stage. The edge delamination grew across the width of the open-hole specimens. In addition, a fiber-matrix splitting mode occurred along the zero degree plies (in the direction of the applied load) in Group 2 laminates upon loading.

For those laminates which were not prone to damage (Group 1), the reduction of the notch strength due to the insertion of a tightened bolt into an open hole appeared to be negligible. However, those laminates which were prone to damage (Group 2) contained a high percentage of zero degree plies. In Group 2, the reduction of the notch strength resulting from a filled hole with a tightened bolt could be significant as shown in figure 9. The plotted data is an average of at least three tests. Apparently, the reduction of notch strength in Group 2 laminates can be attributed to either fiber-matrix splitting or delamination or both.

CLAMP-UP EFFECT.

To further understand the clamp-up effect on the notch strength reduction, laminates that are prone to delamination or fiber-matrix splitting were selected for evaluation. Besides Group 2 laminates, four additional laminates were selected ([0₈], [0₆], [90/0₈/90] and [90/0₆/90]). All the additional specimens are prone to fiber-matrix splitting under tension but only the 0/90 laminates

are prone to delamination. Tests were performed at various levels of clamp-up load on filled-hole specimens. Figure 10 shows the effect of clamping pressure on the strength of filled-hole laminates for three different washer sizes. The clamping pressure is defined as the clamping load divided by the washer area. For the three different washer sizes used, the data clearly indicate that the higher the clamping pressure, the lower the net-tension strength of the laminates considered.

The strength reduction of the additional specimens compared to the open-hole strength is as much as 15%. It is noted that $[0_8]$ and $[0_6]$ laminates do not produce delamination, but they exhibited the same trend as the $[90/0_8/90]$ and $[90/0_6/90]$ laminates. Furthermore, although $[90/0_8/90]$ and $[90/0_6/90]$ laminates delaminated between the surface 90-degree ply and the adjacent 0-degree plies, significant fiber-matrix splitting along the 0-degree plies initiated from the edge of the hole could also be seen in radiographs in figure 11.

Since the 0-degree plies in the $[90/0_8/90]$ and $[90/0_6/90]$ laminates are the primary load-carrying plies and not the two surface 90-degree plies, the strength reduction due to the clamp-up load can be attributed primarily to the stress redistribution in the 0-degree plies near the hole, resulting from fiber-matrix splitting. It can be concluded from the experiments that the delamination effect on the strength reduction is negligible for $[90/0_8/90]$ and $[90/0_6/90]$ as well as similar laminates.

Figure 12 shows the clamping effect on the notch strength of the laminates which are prone to delamination and fiber-matrix splitting. Again, a higher clamping force resulted in a lower tensile strength. The strength reduction trend was quite similar to that of $[90/0_8/90]$ and $[90/0_6/90]$ laminates. Figure 13 shows the sequences of radiographs of two specimens near the final failure at different clamping forces. Clearly, delamination and fiber-matrix splitting appeared in all the laminates; however, the extent of the fiber-matrix splitting diminished as the clamp-up load increased.

Based on the above results, it seems to indicate that fiber-matrix splitting plays a more important role for strength reduction in filled-hole laminates than delaminations. Fiber-matrix splitting apparently reduced the stress concentrations in the 0-degree plies near the hole and, as a consequence, improved the notch strength. However, with added clamping load, fiber-matrix splitting was suppressed by the lateral constraints. This led to higher stress concentrations in the 0-degree plies and resulted in lower notch strength.

In order to further verify the above observation that the fiber-matrix splitting is the major factor causing the strength reduction in filled-hole laminates, special tests were conducted on laminates with implanted delaminations. A 1.5" long, 1" wide (same as the width of the specimen) Teflon film was embedded at the middle plane of the laminates of $[(0/45/90/-45)_2/\text{Teflon}]_s$ and $[(45/0/0/-45/0/0/90/0/0/90)/\text{Teflon}]_s$. The former laminate represents a nondelamination prone lay-up while the latter is delamination prone. Both open- and filled-hole tensile tests were performed on those laminates with the implanted delamination. The results of the study are presented in figure 14 which showed that both open- and filled-hole strengths for those laminates were

practically unaffected by the presence of the implanted delamination. If delamination failure is essential for improving filled-hole strength, the pre-implanted delamination would have improved the filled-hole strengths. Accordingly, it is believed that fiber-matrix splitting is essential for leading to the reduction of the tensile strength of filled-hole laminates. The delamination effect is secondary, compared to fiber-matrix splitting. The second conclusion is somewhat tentative as the Teflon was placed in only one interface and not necessarily the most critical.

WASHER SIZE EFFECT.

The effect of washer size on the filled-hole tensile strength is shown in figures 15-17. For a fixed clamping load, the test results showed that the filled-hole strength was less with a smaller washer. When the washer-hole-diameter ratio was equal to two ($D_w/D=2$), clamp-up could result in as much as a 20% reduction in the tensile strength of filled-hole laminates. Because the clamping pressure is inversely proportional to the square of the diameter for a given clamp-up load, a smaller washer results in higher clamping pressure. According to these results, the smaller washer would produce higher clamping pressure, leading to a higher reduction in the tensile strength of filled-hole laminates.

Figure 18 shows the effect of washer size on the notch strength based on different constant clamping pressures. Clearly, the data showed that the larger the washer, the higher the reduction of tensile strength at a constant clamping pressure for various clamping pressures.

FRICITION EFFECT.

Friction between the washer and the composite laminate was also measured. Washers made of composite material and stainless steel were used. Special specimens were designed to measure the friction coefficient between the washer and the composite laminate. Figure 19 illustrates the test setup for measurement of the friction coefficient. The measured friction coefficient between the composite plate and the stainless steel washer was about 0.1 and 0.36 for a composite plate and a composite washer.

Tests on the tensile strength of both open- and filled-hole laminates were conducted with both steel and composite washers. The results of the tests for three lay-ups are presented in figures 20 and 21. Friction coefficients within the range of the study (0.1-0.36) did not affect the notch strength of either the open-hole or filled-hole laminates. However, the laminates used for this study were not delamination prone and the conclusions are only tentative.

BOLTED-JOINT TEST RESULTS

The results of bolted composite joint tests are presented in this section. The [$\pm 45/0/0/45/0/90/0/90$]s laminate, which is prone to fiber-matrix splitting and delamination, was selected for the test. Specimens with width-to-diameter ratios of 2.5 and 3 were prepared to ensure a net-tension failure in the bolted joint test. The configuration of the test is shown in figure 3. The

load-deflection curves were recorded for every specimen. Radiographs were also taken for every specimen before and after the tests. Three different washer sizes were used to transmit the clamp-up force to the laminate.

Figure 22 shows the typical load-deflection curves of the bolted joints for the two different width-to-diameter ratios. For $W/D=2.5$, the joint response was nearly linear with respect to the applied load, up to the final failure. However, for $W/D=3$, the deflection curve showed some degree of nonlinearity. Because of the nonlinearity, the joint elongation, which is due to bearing damage may exceed the 4% of hole diameter limit which is commonly used in the industry to determine the joint allowable as shown in figure 22. For pin joined specimens it was impossible to force a net-tension failure even for such small edge distances.

Accordingly, in this study, the joint strength is defined as either the absolute maximum load (F_{MAX}) or the 4% load limit ($F_{4\%}$), whichever occurs first (see figure 23). F_{MAX} could be either a bearing or net-tension failure while $F_{4\%}$ is always a bearing failure. Figures 24 and 25 show the joint strength distributions compared to the pin-joint strength as a function of washer size. Clearly, the bolt joint strength increased significantly with the support of washers. The effect of the washers and the clamp-up are such that they are sufficient to prevent bearing failure and shift the failure to net-tension for these artificially narrow specimens. For the D_w/D ratios tested (D_w/D between 2 to 3), the washer size is unimportant particularly for the narrowest specimens ($W/D = 2.5$), figure 24. For wider specimens ($W/D = 3.0$), the interpretation on the effect of washers on net tension strength is more difficult as there is more interaction between bearing displacement and damage, see figure 25. This is reflected by the nonlinear behavior of the load-displacement curve and the appearance of $F_{4\%}$ failure points.

Radiographs of the failed joint specimens as shown in figure 26 revealed that although both filled-hole and bolted laminates failed in the net-tension mode, the bolted joints showed significantly less fiber-matrix splitting than did the filled-hole laminates. In addition, some bearing damage was also visible from the radiographs in the bolted joints. It is believed that the localized bearing load on the bolt altered the stress profile around the hole considerably from that of filled-hole laminates.

It was shown experimentally that the tensile behavior of filled-hole laminates differed from that of bolted joints failed in the net-tension mode. Although both filled-hole laminates and bolted joints failed in a similar mode, bolted joints apparently benefit from clamp-up as compared to a pin joint regardless of the size of the washer (for D_w/D between 2 and 3) and clamping force. For filled-hole laminates, clamping pressure may decrease the tensile strength of the notched laminates which are prone to fiber-matrix splitting and delaminations.

ANALYTICAL MODEL

A failure mechanism-based progressive damage analysis was postulated for analyzing the tension failure of filled-hole laminates and bolted composite joints. The schematic description of the analysis is described in figure 27.

The progressive failure model used in the study consists of two parts: failure criteria for predicting accumulated damage and mode of failure in composites and the material degradation models for estimating the effective properties of the laminates which contain a known state of damage. The five in-plane failure criteria which were proposed by Shahid and Chang [24, 25] were adopted in the study for predicting five corresponding failure modes in laminates, namely, fiber tension, matrix cracking, fiber compression, matrix compression, and fiber-matrix shearing. These can be stated in equation form as

Fiber Tension	$\left(\frac{\sigma_1}{X_t}\right)^2 \geq 1$	$\sigma_1 \geq 0$
Fiber Compression	$\left(\frac{\sigma_2}{X_c}\right)^2 \geq 1$	$\sigma_1 < 0$
Fiber-Matrix Shearing	$\frac{\sigma_1^2}{X_t^2} + \frac{\sigma_6^2}{S^2(\phi)} \geq 1$	$\sigma_1 > 0$
Matrix Compression	$\frac{\sigma_2^2}{Y_c^2} + \frac{\sigma_6^2}{S^2(\phi)} \geq 1$	$\sigma_2 < 0$
Matrix Tension	$\frac{\sigma_2^2}{Y_t^2(\phi)} + \frac{\sigma_6^2}{S^2(\phi)} \geq 1$	$\sigma_2 > 0$

where ϕ is the matrix crack density.

σ_1 and σ_2 are the in-plane normal stresses parallel and normal to the fiber direction of the ply under consideration in a laminate, respectively, and σ_1^2 is the in-plane shear stress of the ply. X_t and X_c are the tensile and compressive strengths of the ply along the fiber direction, respectively. $Y_t^2(\phi)$, Y_c^2 , and $S^2(\phi)$ are the transverse tensile strength, transverse compressive strength, and the shear strength of the ply under consideration in a laminate. ϕ is the crack density of the ply.

It is important to point out that both $Y_t^2(\phi)$ and $S^2(\phi)$ are not constants and may vary from ply to ply in the laminate and depend upon the crack density. The distributions of $Y_t^2(\phi)$ and $S^2(\phi)$ as a function of ϕ can significantly affect the prediction of the accumulation of matrix cracks for a given stress state. The values of $Y_t^2(\phi)$ and $S^2(\phi)$ can be estimated from fracture mechanics and the theory of elasticity [24, 25]. The compressive strength X_c is determined from a compressive test of a [0/90]_s laminate along the 0-degree fiber direction [20].

Once damage is predicted from any one of the criteria, material properties of the ply will be degraded according to the mode of failure. The description of the material degradation models for each mode of failure will not be presented here in this report, but will be summarized in the final report. No delamination was considered in the present model and no attention has been paid to specifically model the fiber-matrix splitting near the hole edge, both of which will be taken into consideration in the continuing development of the analytical model.

A mesh generator was developed to produce a three-dimensional finite element mesh for the laminates with and without side supports. A typical mesh used in the calculations is presented in figure 28.

The commercial finite element code ABAQUS was used to calculate the stresses and strains inside the laminates. A three-dimensional composite brick element was used in ABAQUS. Slip-contact conditions were strictly reinforced between the washers and composite plates and between the bolt and the hole boundary of the laminates. An interface module was developed to integrate the damage module with ABAQUS. From input data such as loading, geometry, lay-up, and material properties of the laminates, ABAQUS will calculate the load-deflection response, the extent of damage, and the failure load, in addition to stresses and strains for a given state of stresses. Damage visualization is also part of the output.

To verify the code, comparisons were made between the data available in the literature as well as those that generated from the current experiments and the predictions from the code. Figure 29 shows the comparison of stress and crack density distribution as a function of the applied strain between the data and the prediction. The predictions agreed with the test data very well. The crack density data were taken from Kistner et al. [26].

Using the model, numerical simulations of the test results that were conducted during this investigation were generated. Only selected results from the comparisons are presented in this report, and the remaining results of the comparisons will be provided in the final report. Overall, the results of the predictions agreed very well with the laminates which are not prone to delamination and matrix splitting. However, for the laminates which are prone to fiber-matrix splitting and delamination, the predictions in general underestimated the failure loads as shown in figure 30. For the washer-to-hole diameter ratio at 2.0, the predictions agreed with the data quite well, because the extent of the fiber-matrix splitting was found to be minimal from the radiographs in the experiments due to the lateral constraining effect. Figure 31 also shows a snapshot of the predicted damage accumulation in a laminate at a given amount of the applied load and the predicted load-deflection curve of the laminate.

Based on the simulations, it is clear that the proposed model could provide reasonable accuracy in the estimation of the failure load and the response of laminates which are not prone to matrix splitting. However, the model would underestimate the failure load by as much as 15% for the laminates which are prone to fiber-matrix splitting, unless the fiber-matrix splitting is suppressed by the lateral constraints in the laminates.

CONCLUDING REMARKS

Based on the studies, the following remarks can be made:

1. Tensile strength of filled-hole composite laminates which are not prone to fiber-matrix splitting and delamination is insensitive to the bolt clamp-up effect.
2. Tensile strength of filled-hole composite laminates which are prone to fiber-matrix splitting and delamination is sensitive to the bolt clamp-up effect.
3. Higher clamping pressure may decrease the tensile strength of filled-hole laminates which are prone to fiber-matrix splitting and delaminations.
4. A washer-to-hole diameter ratio (D_w/D) of two has the most negative effect on the tensile strength of filled-hole laminates.
5. Effect of fiber-matrix splitting may be more important than delamination for the increase or reduction in the tensile strength of filled-hole laminates.
6. The behavior of bolted joints that failed in a net-tension mode can be quite different from that of filled-hole laminates under a uniaxial tensile load.
7. Unlike filled-hole laminates, bolted joints can benefit from bolt clamp-up, even if the laminates are prone to fiber-matrix splitting and delamination, as the mode of failure can be shifted from bearing to net-tension.
8. For a D_w/D ratio less than 3, the clamp-up load has the most positive effect on joint strength.

Experimental work is being continued to study the clamp-up effects on different material systems. Analytical work has also been performed to develop a model to simulate the response of both filled-hole laminates and bolted composite joints which are characterized by fiber splitting and delaminations. Additional numerical results and test data on different material systems will be summarized and presented in the final report.

REFERENCES

1. Agarwal, B.L., "Static Strength Prediction of Bolted Joints in Composite Material," AIAA/ASME/ASCE/AHS 20th Structure, Structural Dynamics and Material Conference, St. Louis, MO, April 1979, pp. 303-309.
2. Garbo, S.P. and Gallo, R.L., "Strength of Laminates with Loaded Holes," presented at the 5th DOD/NASA Conference on Fibrous Composites in Structural Design, New Orleans, LA, January 1981.
3. Chang, F.-K., Scott, R.A., and Springer, G.S., "Failure of Composite Laminates Containing a Pin Loaded Holes Method of Solution," *Journal of Composite Materials*, Vol. 18, 1984, pp. 255-278.
4. Chang, F.-K., Scott, R.A., and Springer, G.S., "Failure Strength of Nonlinear Elastic Composite Laminates Containing Pin Loaded Holes," *Journal of Composite Materials*, Vol. 18, 1984, pp. 467-477.
5. Waszczak, J.P. and Cruse, T.A., "Failure Mode and Strength Predictions of Anisotropic Bolt-Bearing Specimens," *Journal of Composite Materials*, Vol. 5, 1971, pp. 421-425.
6. Chu, G.D. and Sun, C.T., "Failure Initiation and Ultimate Strength of Composite Laminates Containing a Center Hole," *Composite Materials Fatigue and Fracture*, ASTM STP 1156, Vol. 4, Edited by Stinchcomb and Ashbaugh, 1993, pp. 35-54.
7. Awerbuch, J. and Madhukar, M.S., "Notched Strength of Composite Laminates: Predictions and Experiments - A Review," *Journal of Composite Materials*, Vol. 4, January 1985, pp. 3-159.
8. Soni, S.R., "Stress and Strength Analysis of Bolted Joints in Composite Laminates," *Composite Structures*, I. H. Marshall, Ed., Applied Science Publishers, New Jersey, 1981, pp. 50-62.
9. Tsujimoto, Y. and Wilson, D., "Elasto-Plastic Failure Analysis of Composite Bolted Joints," *Journal of Composite Materials*, Vol. 20, 1986, pp. 236-252.
10. Eriksson, L.I., "On the Bearing Strength of Bolted Graphite/Epoxy Laminates," *Journal of Composite Materials*, Vol. 24, 1990, pp. 1246-1269.
11. Chiang, Y.J. and Rowlands, R.E., "Finite Element Analysis of Mixed-Mode Fracture of Bolted Composite Joints," *Journal of Composite Technology Research*, Vol. 13, No. 4, Winter 1990, pp. 227-235.

12. Tsai, M.Y. and Morton, J., "Stress and Failure Analysis of a Pin-Loaded Composite Plate: An Experimental Study," *Journal of Composite Materials*, Vol. 24, 1990, pp. 1101-1120.
13. Chang, F.-K. and Chang, K.-Y., "Post-Failure Analysis of Bolted Composite Joints in Tension or Shear-Out Mode Failure," *Journal of Composite Materials*, Vol. 21, 1987, pp. 809-827.
14. Hart-Smith, L.J., "Bolted Joints in Graphite/Epoxy Composites," NASA Cr-144899, National Aeronautics and Space Administration, Washington, DC, January 1977.
15. Stockdale, J.H. and Matthews, F.L., "The Effect of Clamping Pressure of Bolt Bearing Loads in Glass Fiber-Reinforced Plastics," *Composites*, Vol. 7, 1971, pp. 34-38.
16. Crews, J.H., "Bolt-Bearing Fatigue of a Graphite/Epoxy Laminate," *Journal of Composite Materials*, ASTM STP 749, K.T. Kedward, Ed., American Society for Testing and Materials, Philadelphia, PA, 1981, pp. 131-144.
17. Matthews, F.L., Roshan, A.A., and Philips, L.N., "The Bolt Bearing Strength of Glass/Carbon Hybrid Composites," *Composites*, Vol. 13, 1982, pp. 225-227.
18. Collings, T.A., "On the Bearing Strength of CFRP Laminates," *Composites*, Vol. 13, 1982, pp. 241-252.
19. Akay, M., "Bearing Strength of As-Cured and Hydrothermally Conditioned Carbon Fiber/Epoxy Composites under Static and Dynamic Loading," *Composites*, Vol. 23, No. 2, March 1989, pp. 101-108.
20. Hung, C.-L. and Chang, F.-K., "Bearing Failure of Bolted Composite Joints, Part II: Model and Verification," *Journal of Composite Materials*, Vol. 30, No. 12, 1996, pp. 1359-1400.
21. Wang, H.-S., Hung, C.-L., and Chang, F.-K., "Bearing Failure of Bolted Composite Joints, Part I: Experimental Characterization," *Journal of Composite Materials*, Vol. 30, No. 12, 1996, pp. 1248-1313.
22. Smith, P.A., Ashby, M.F., and Pascoe, K.J., "Modeling Clamp-Up Effects in Composite Bolted Joints," *Journal of Composite Materials*, Vol. 21, No. 12, 1987, pp. 878-897.
23. Sun, H.-T., "Three-Dimensional Effect of Mechanically Fastened Composite Joints," Ph.D. dissertation, Stanford University, 1997.

24. Shahid, I. and Chang, F.-K., "An Accumulated Damage Model for Tensile and Shear Failures of Laminated Composite Plates," *Journal of Composite Materials*, Vol. 29, No. 8, 1995, pp. 926-981.
25. Shahid, I. and Chang, F.-K., "Predicting Scaling Effect on the Notched Strength of Prepreg and Fiber-Tow-Placed Laminated Composites," *Journal of Composite Materials*, Vol. 29, No. 8, 1995, pp. 1063-1095.
26. Kistner, M.D., Whitney, J.M., and Browning, C.E., "First-Ply Failure of Graphite/Epoxy Laminates," *Recent Advances in Composites in the USA and Japan*, ASTM STP 864, Philadelphia, 1985, pp. 44-61.

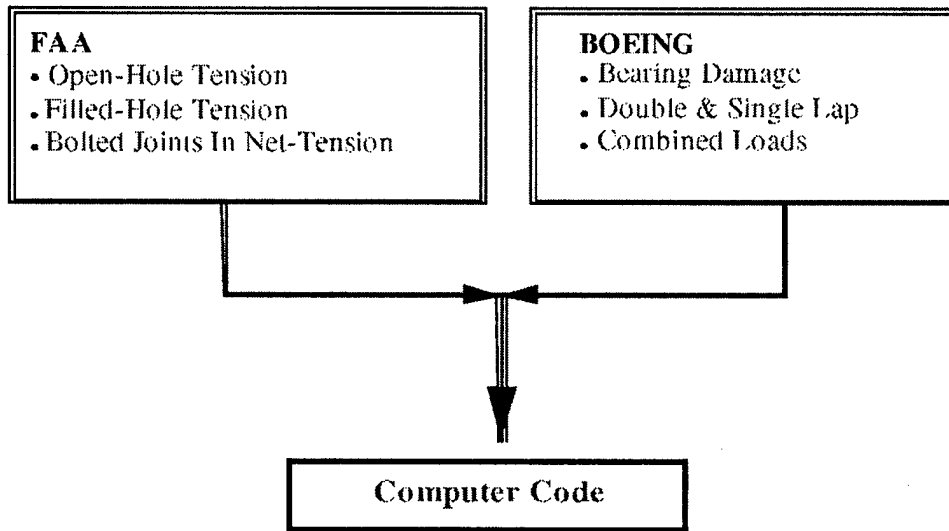

FIGURE 1. DESCRIPTION OF THE ACTIVITIES OF THE FAA-BOEING JOINT PROJECT

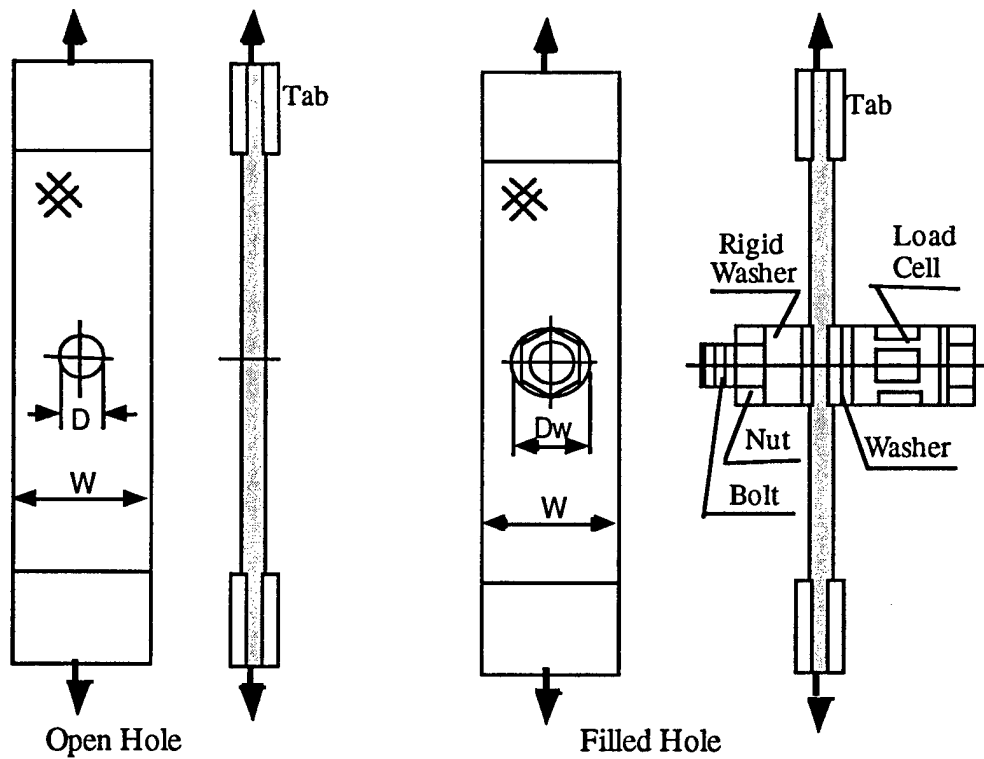

FIGURE 2. GEOMETRIES OF THE SPECIMENS FOR OPEN- AND FILLED-HOLE TENSION TESTS

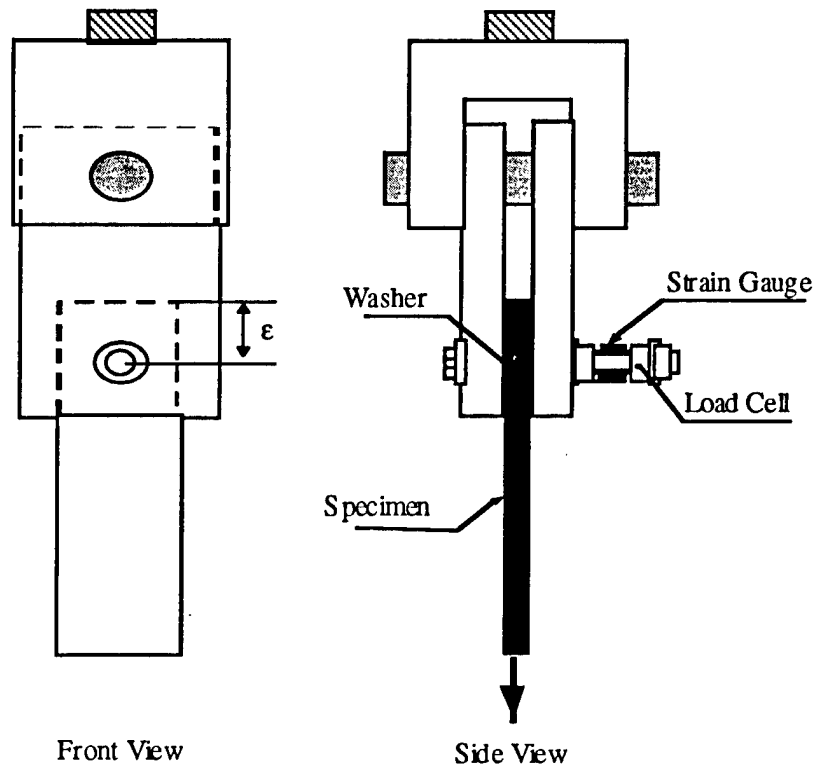

FIGURE 3. GEOMETRIES OF THE BOLTED-JOINT TEST SETUP

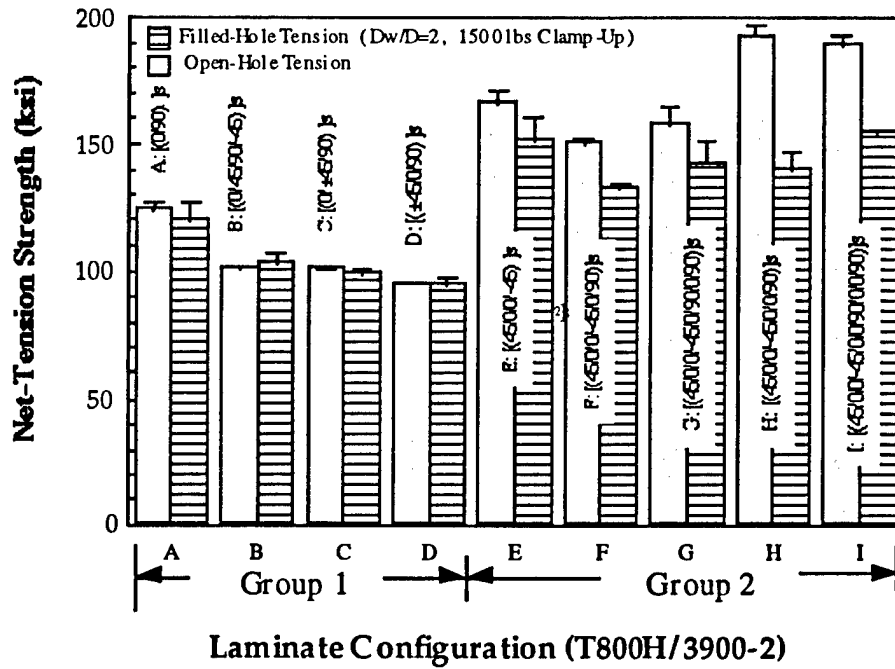
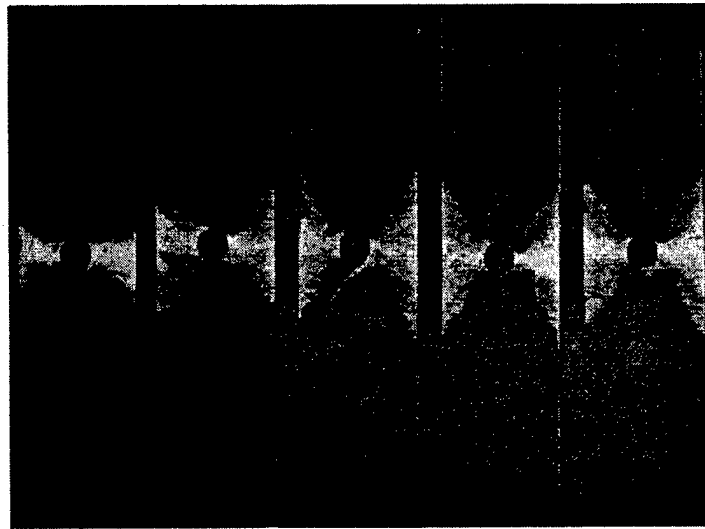

FIGURE 4. COMPARISON OF NET-TENSION STRENGTH BETWEEN OPEN- AND FILLED-HOLE LAMINATES

Group 1, Laminate D
Lay-Up: $[(\pm 45/0/90)_2]_s$



a, b: Open-Hole Tension; c, d, e: Filled-Hole Tension, $D_w/D=2$, Finger Tight

FIGURE 5. DAMAGE PATTERN OF THE NET-TENSION FAILURE OF DAMAGE-RESISTANT LAMINATES

Group 2, Laminate G
Lay-Up: $[45/0/0/-45/(0/90)_2]_s$ ($\% \pm 45 - \% 0 = -25\%$)

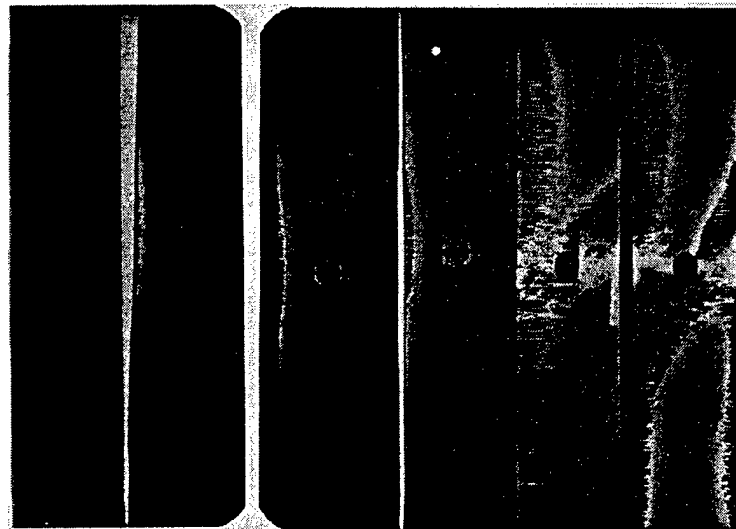

Load Level: 68% 79% 88% 95% 100% 100%
Open Hole Tension

FIGURE 6. DAMAGE PATTERN OF NET-TENSION FAILURE OF DAMAGE-PRONE LAMINATE

Group 2, Laminate I

Lay-Up: [45/0/0/-45/(0/0/90/2)]s

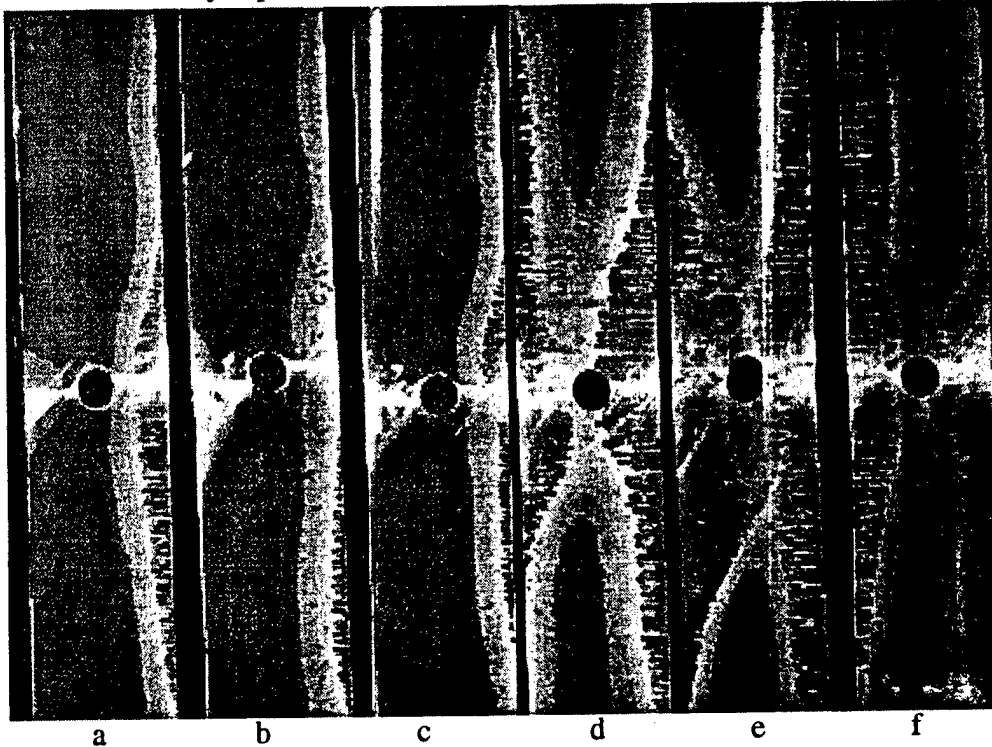

a,b,c: Filled-Hole, $D_w/D=2$, 3000 lbs Clamp-Up; d,e,f: Open-Hole Tension

FIGURE 7. DAMAGE PATTERN OF NET-TENSION FAILURE OF DAMAGE-PRONE LAMINATE

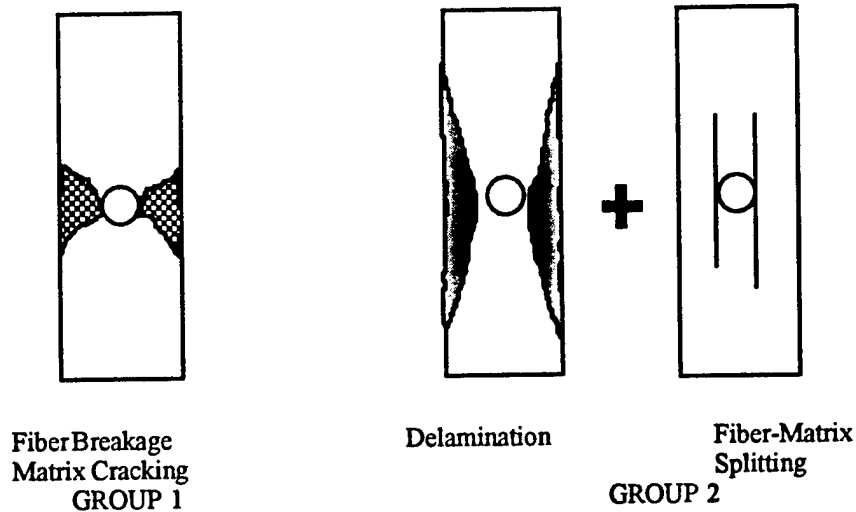

FIGURE 8. TYPICAL TENSILE FAILURE MODES IN COMPOSITE LAMINATES CONTAINING A CIRCULAR HOLE

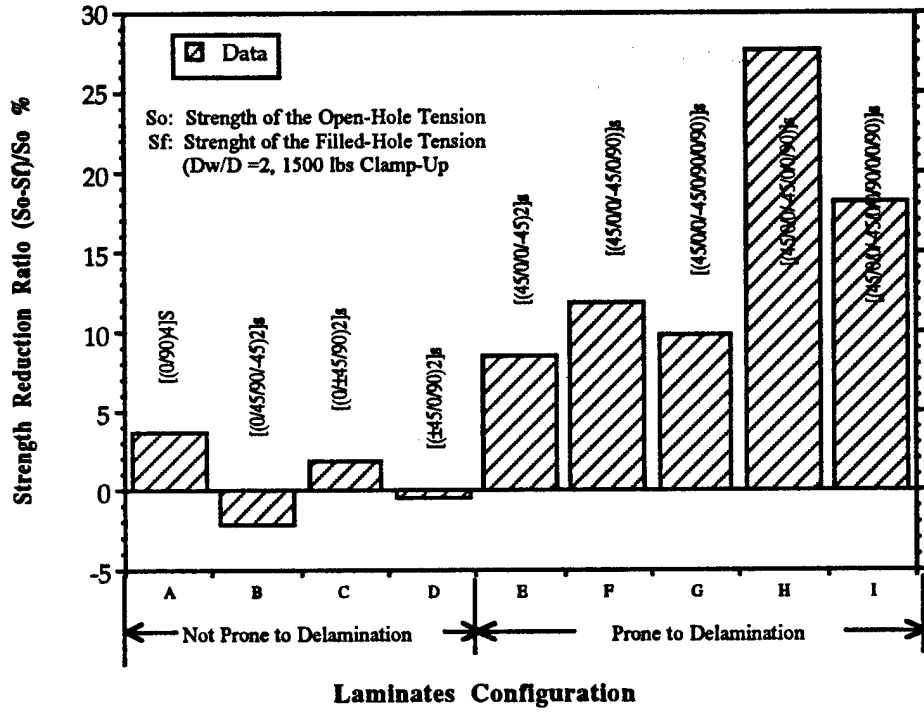

FIGURE 9. NOTCH STRENGTH REDUCTION DUE TO THE INSERTION OF A TIGHTENED BOLT

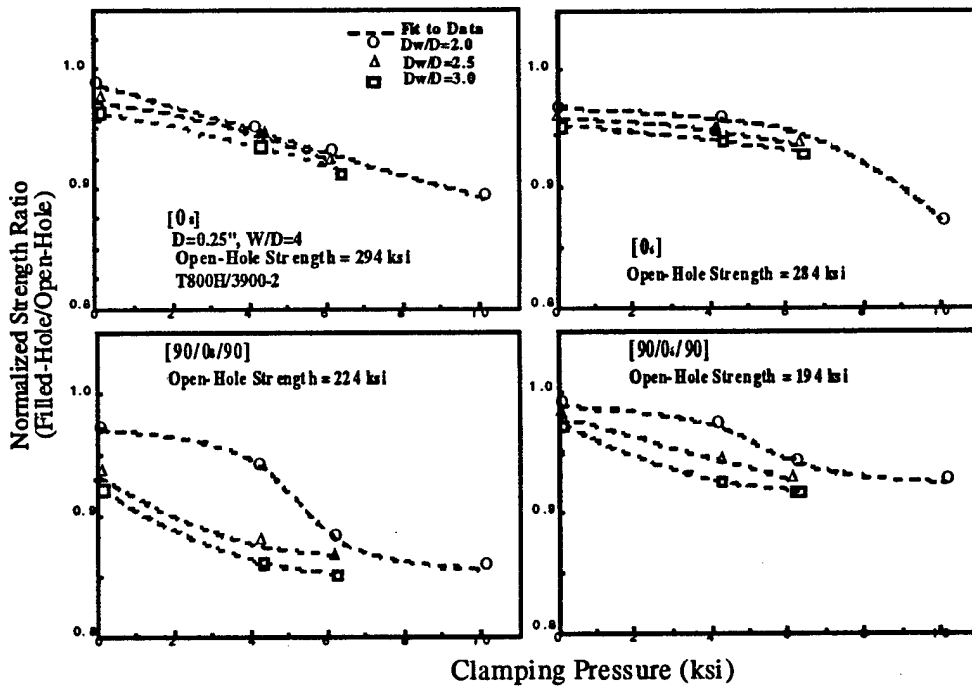

FIGURE 10. EFFECT OF CLAMPING PRESSURE ON TENSILE STRENGTH OF FILLED-HOLE LAMINATES

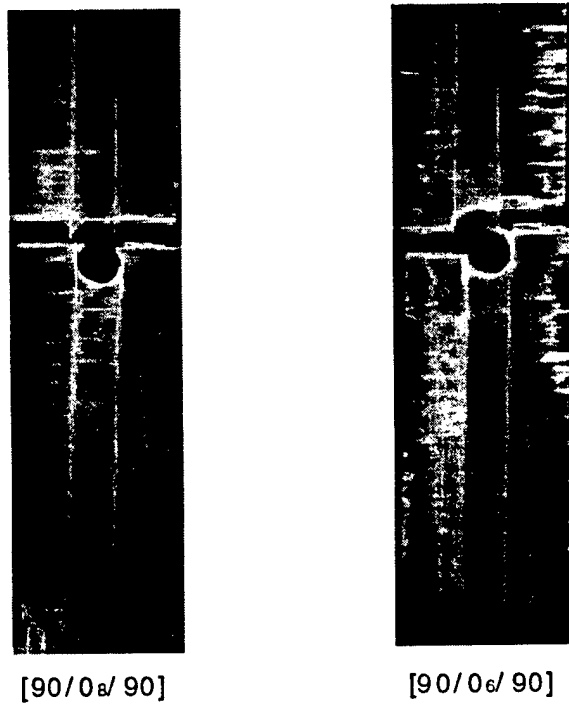

FIGURE 11. RADIOGRAPHS OF DAMAGED [90/0_a/90] AND [90/0_e/90] LAMINATES

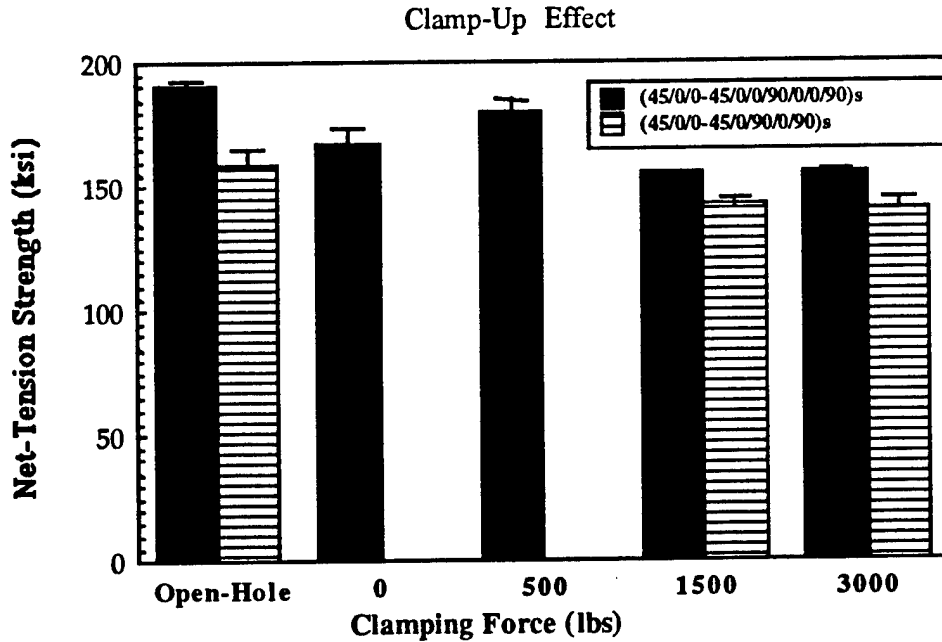
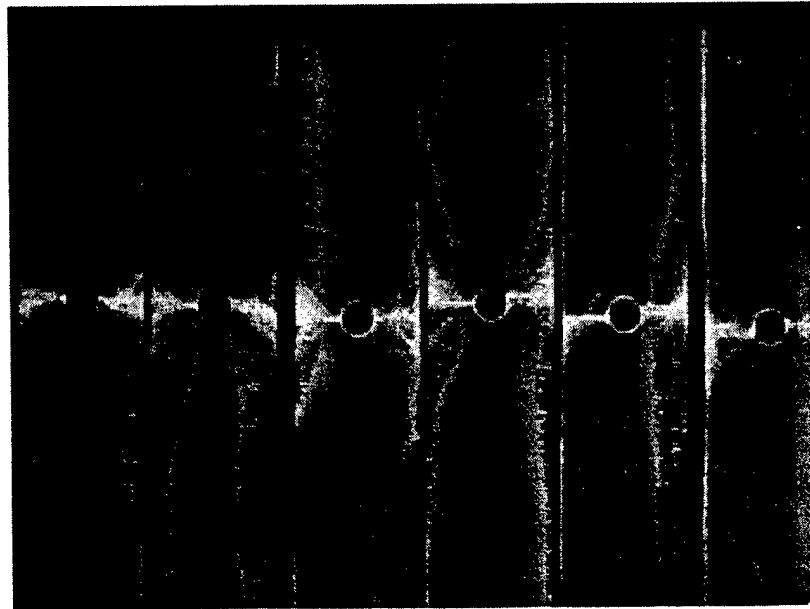

FIGURE 12. EFFECT OF CLAMPING FORCE ON TENSILE STRENGTH OF FILLED-HOLE LAMINATES

Lay-Up: [(45/0/0/-45/0/0/90/0/0/90)]s



a 562 lbs Clamp -Up
 b 562 lbs Clamp -Up
 c 1500 lbs Clamp -Up
 d 1500 lbs Clamp -Up
 e 3000 lbs Clamp -Up
 f 3000 lbs Clamp -Up

Filled-Hole Tension: $Dw/D = 2$, Stainless Steel Washer

FIGURE 13. RADIOGRAPHS OF FILLED-HOLE SPECIMENS AT VARIOUS CLAMPING LOADS

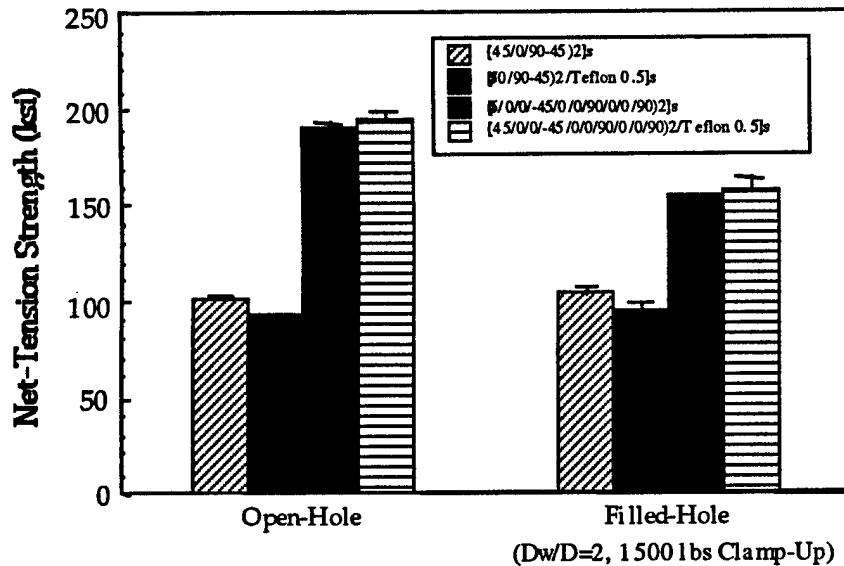

FIGURE 14. EFFECT OF IMPLANTED DELAMINATION ON TENSILE STRENGTH OF OPEN- AND FILLED-HOLE LAMINATES

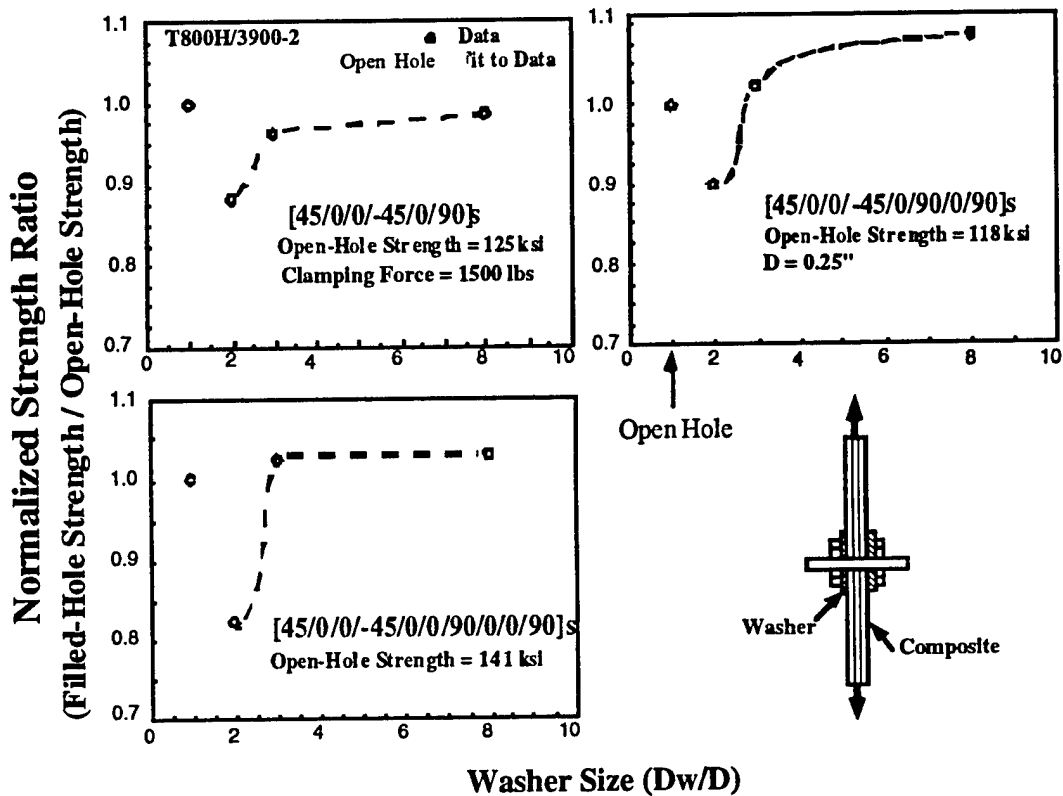

FIGURE 15. EFFECT OF WASHER SIZE ON NOTCH STRENGTH OF FILLED-HOLE LAMINATES SUBJECTED TO CONSTANT CLAMPING LOAD (NOTE: WASHER SIZE 1 CORRESPONDS TO OPEN HOLE)

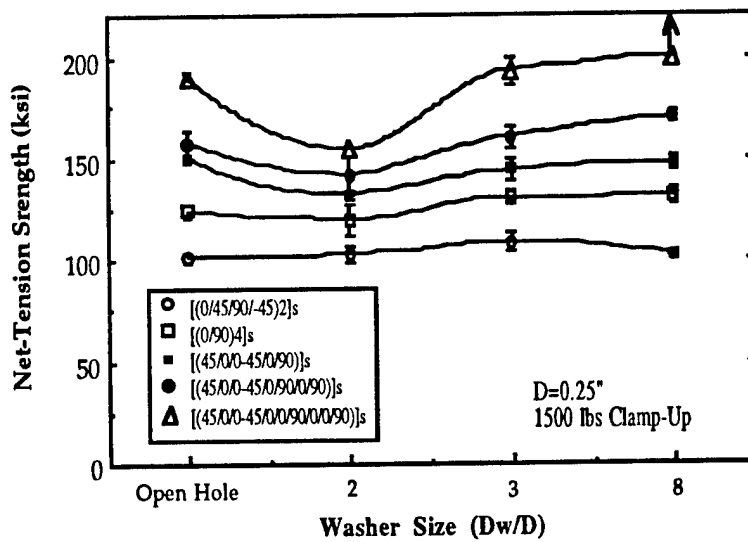

FIGURE 16. EFFECT OF WASHER SIZE ON NOTCH STRENGTH OF FILLED-HOLE LAMINATES (CONSTANT CLAMPING LOAD)

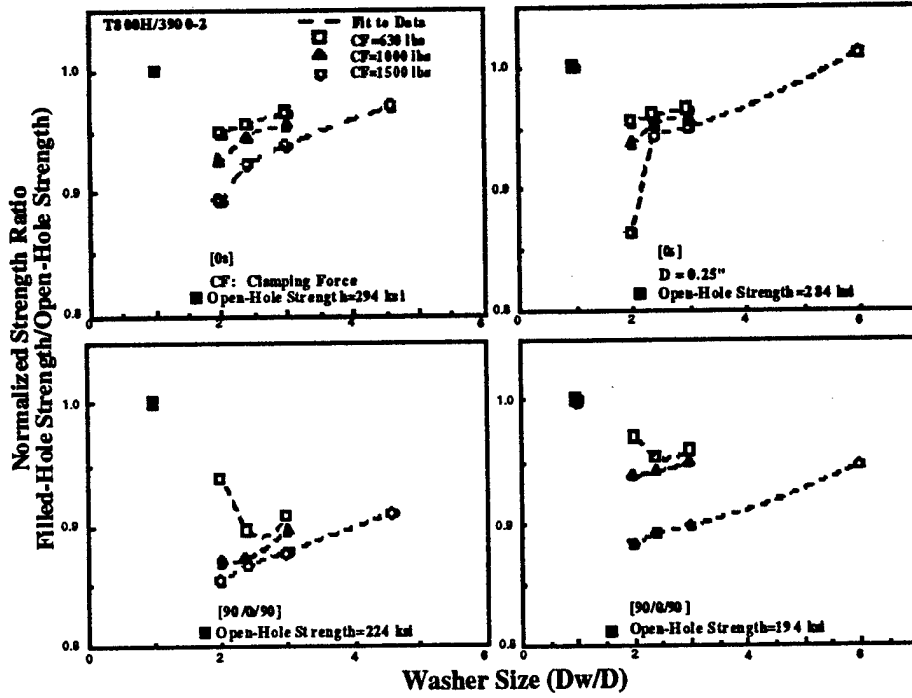

FIGURE 17. EFFECT OF WASHER SIZE ON NOTCH STRENGTH OF FILLED-HOLE LAMINATES

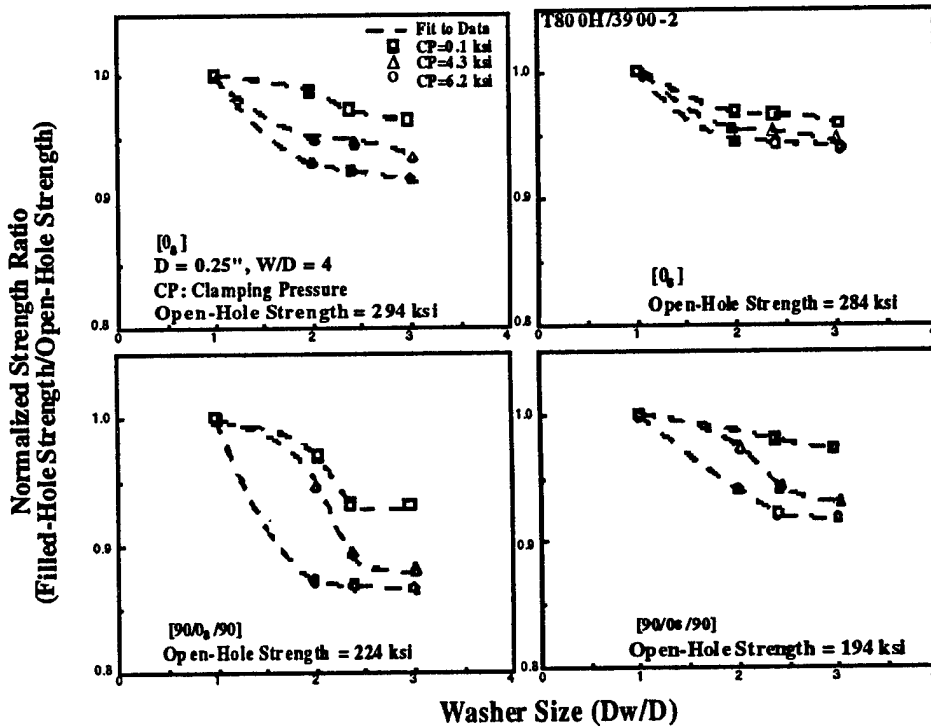

FIGURE 18. EFFECT OF WASHER SIZE ON NOTCH STRENGTH OF FILLED-HOLE LAMINATES (DIFFERENT CONSTANT CLAMPING PRESSURES)

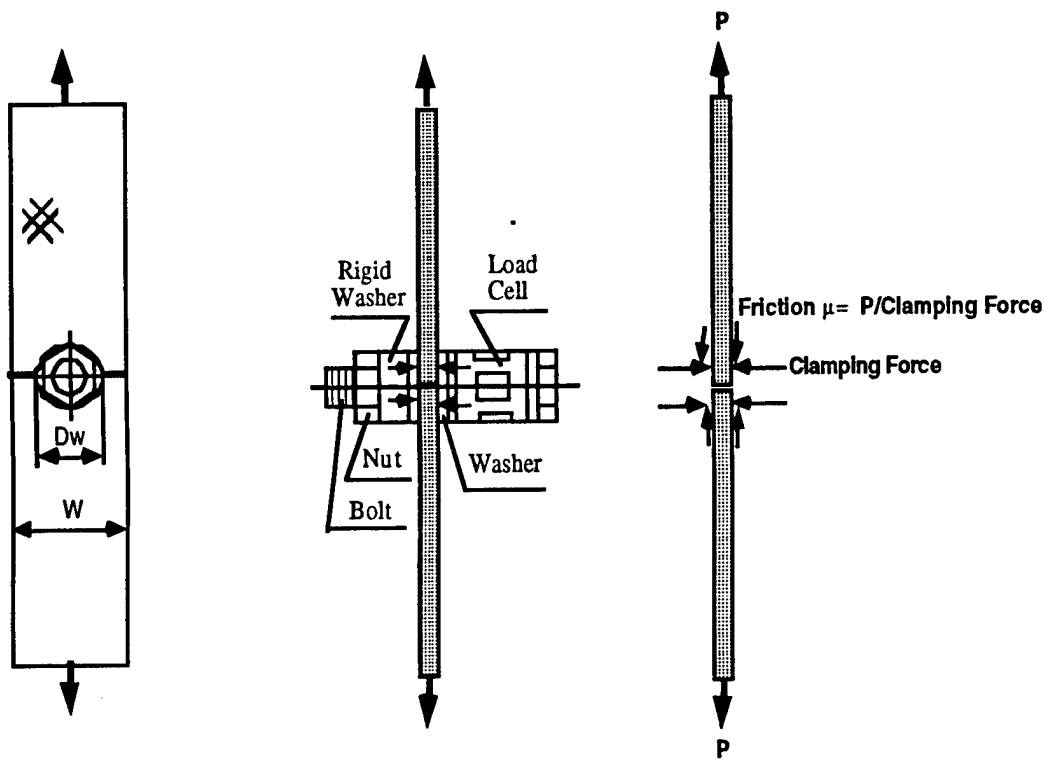

FIGURE 19. SCHEMATIC OF THE TEST SETUP FOR MEASURING FRICTION COEFFICIENT BETWEEN A COMPOSITE PLATE AND A WASHER

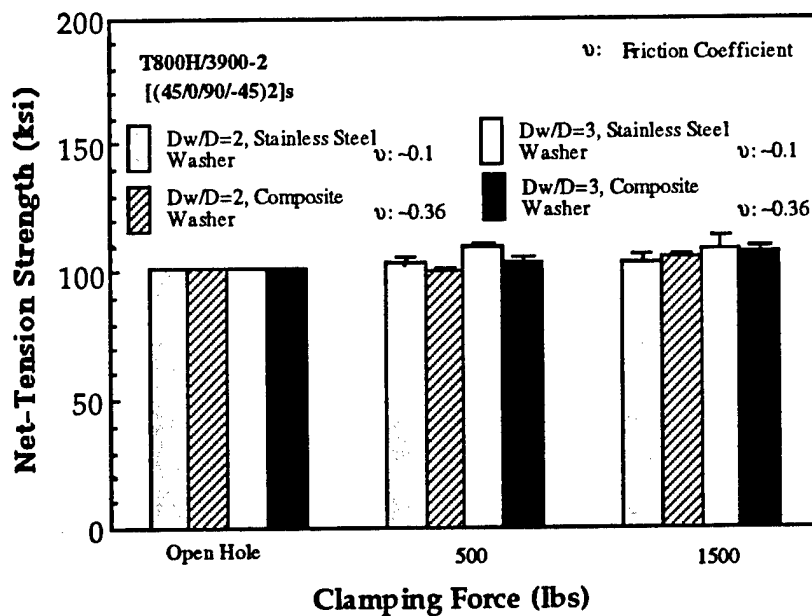

FIGURE 20. EFFECT OF FRICTION ON THE FILLED-HOLE TENSILE STRENGTH T800H/3900-2 [(45/0/90/-45)2]s

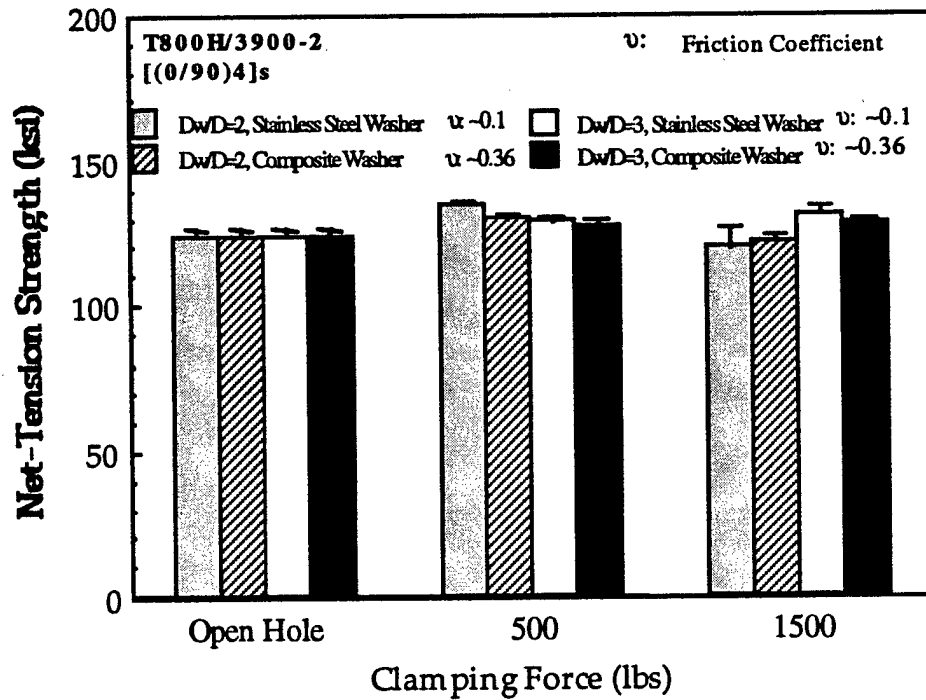
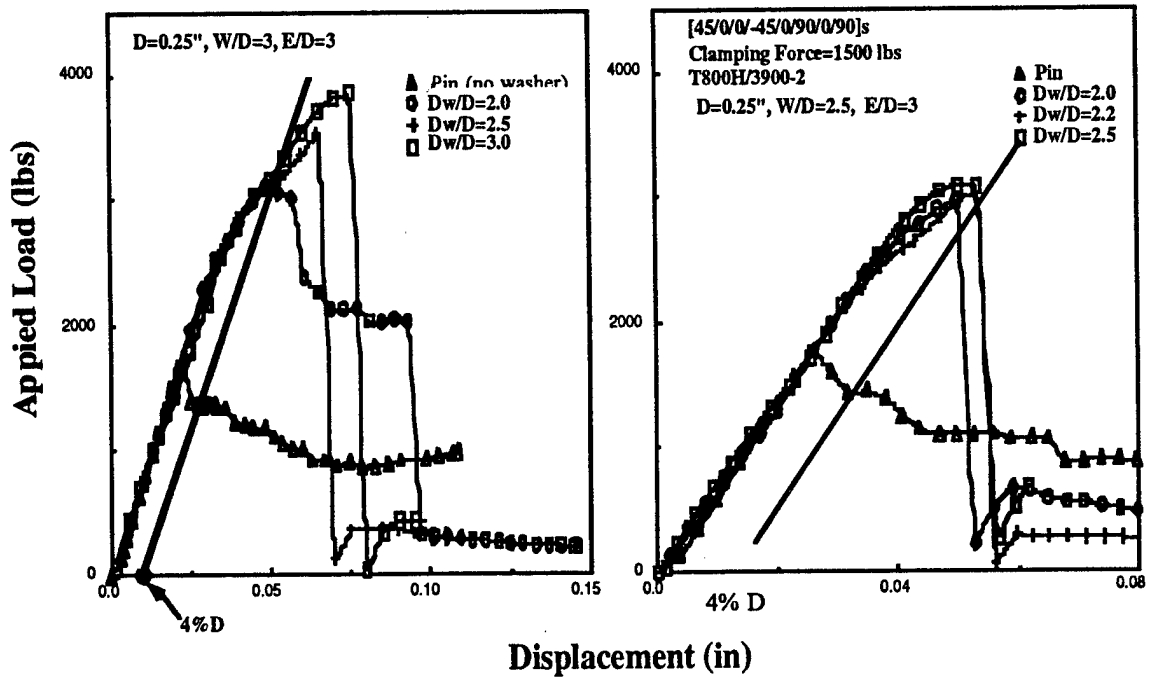

FIGURE 21. EFFECT OF FRICTION ON THE FILLED-HOLE TENSILE STRENGTH T800H/3900-2 [(0/90)4]s



Note: Except for pin and W/D, Dw/D = 2.0 specimens all other specimens failed in net tension at maximum load

FIGURE 22. THE LOAD-DEFLECTION RESPONSES OF BOLTED COMPOSITE JOINTS

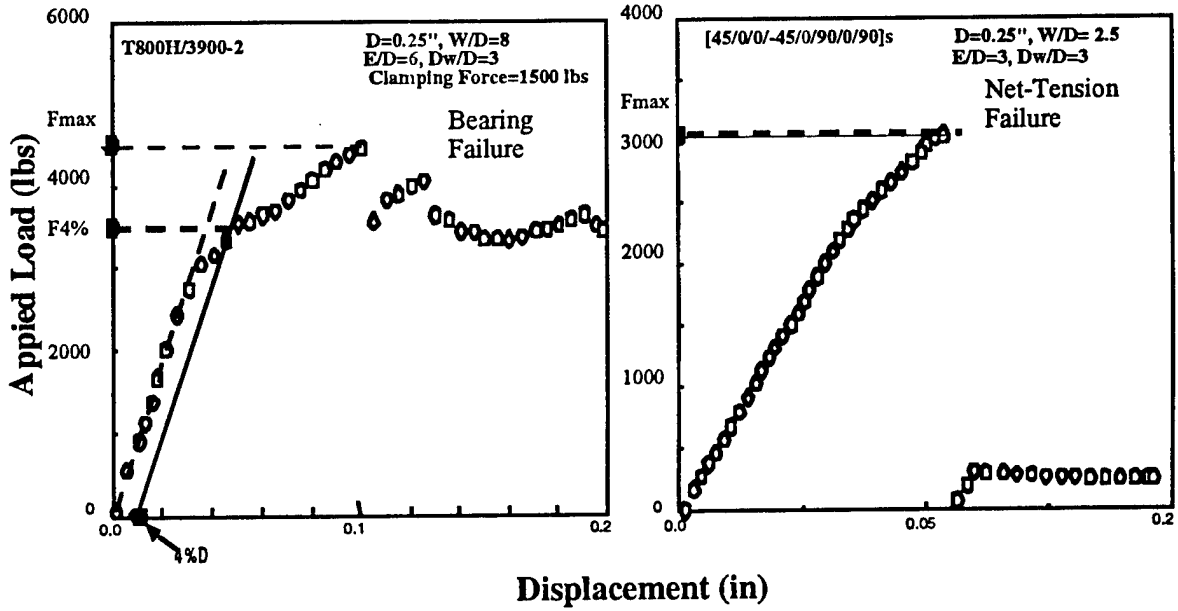

FIGURE 23. THE DEFINITION OF FAILURE LOADS IN BOLTED COMPOSITE JOINTS

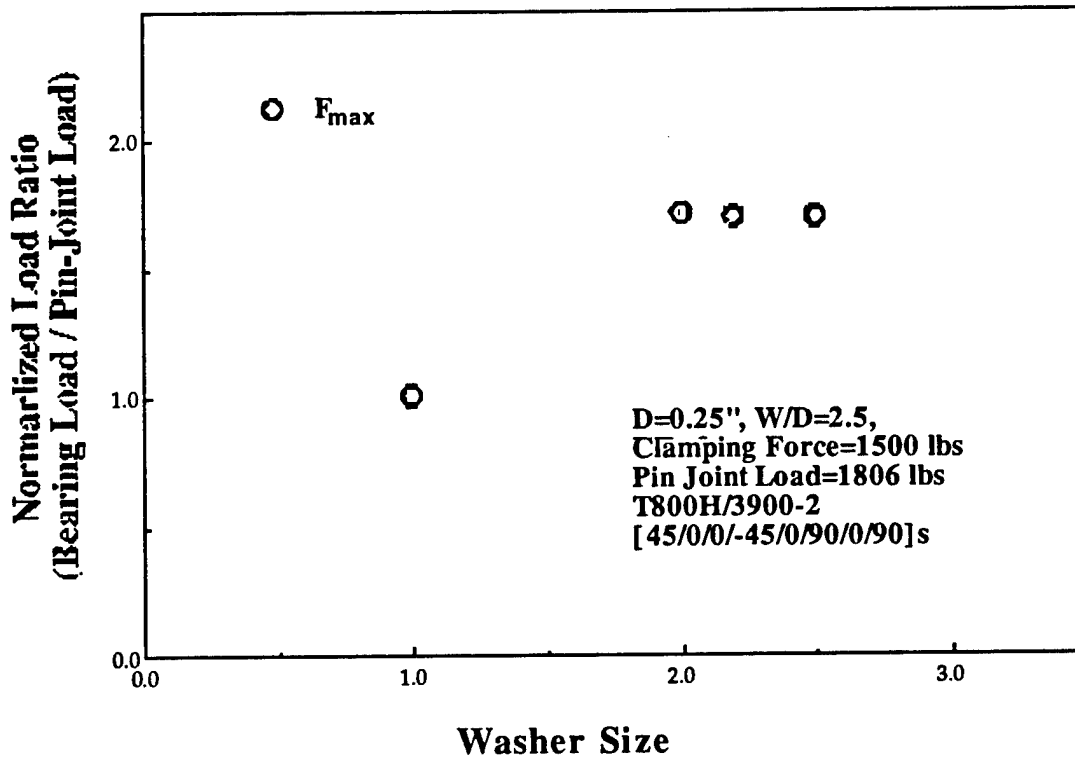

FIGURE 24. EFFECT OF WASHER SIZE ON THE STRENGTH OF BOLTED COMPOSITE JOINTS FAILED IN A NET-TENSION MODE

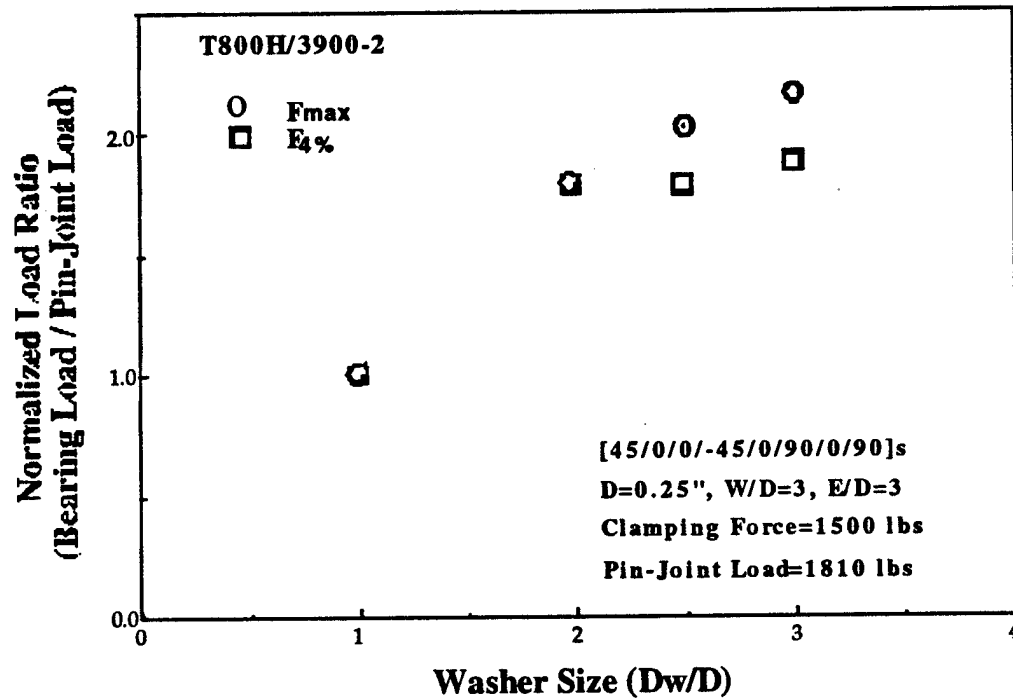

FIGURE 25. EFFECT OF WASHER SIZE ON THE FAILURE LOAD OF BOLTED COMPOSITE JOINTS

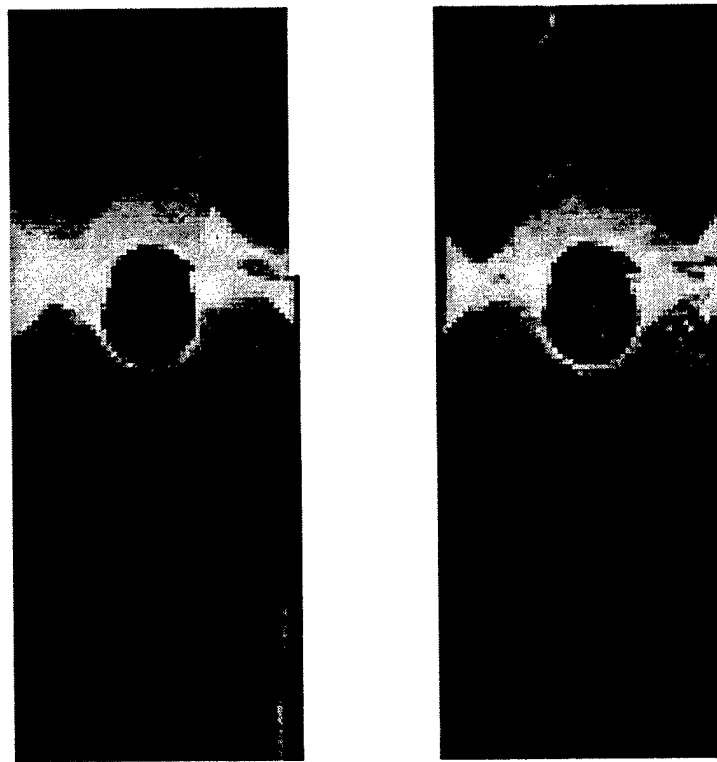

FIGURE 26. RADIOGRAPHS OF BOLTED [45/0/0/-45/0/90/0/90]s COMPOSITE JOINTS IN THE NET-TENSION FAILURE MODE

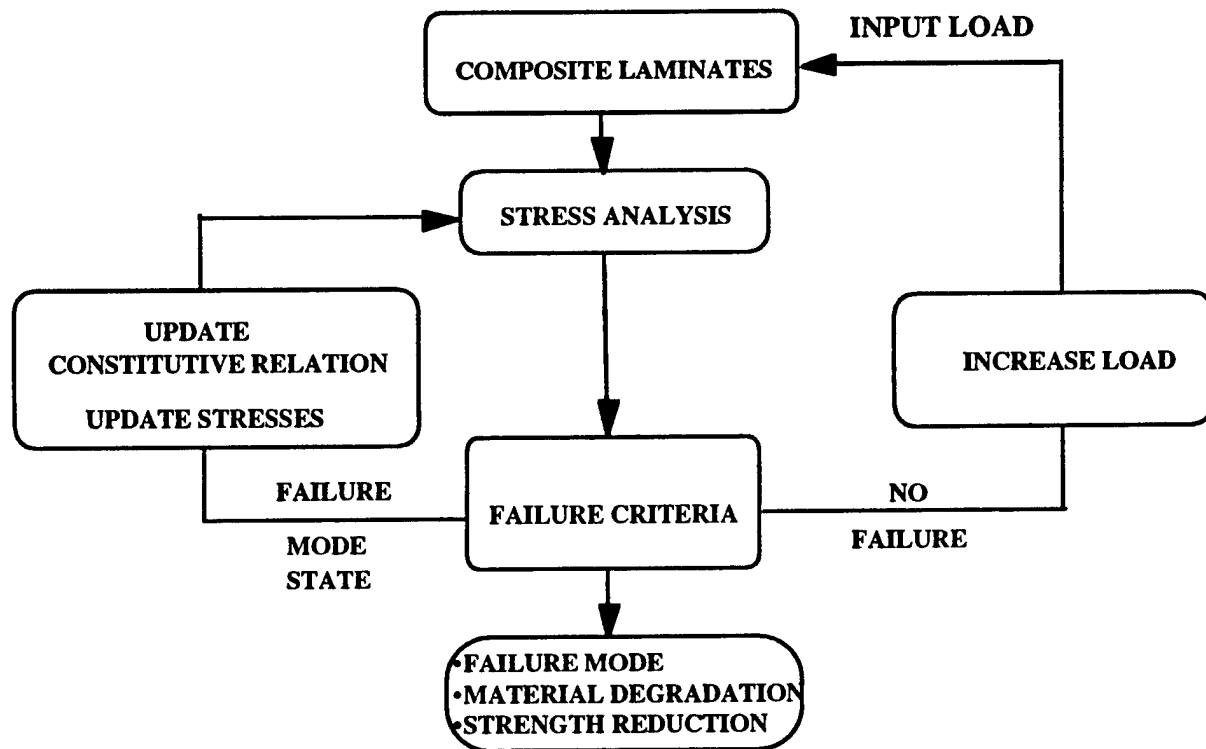

FIGURE 27. THE SCHEMATIC OF THE PROGRESSIVE FAILURE MODELING USED IN THE STUDY

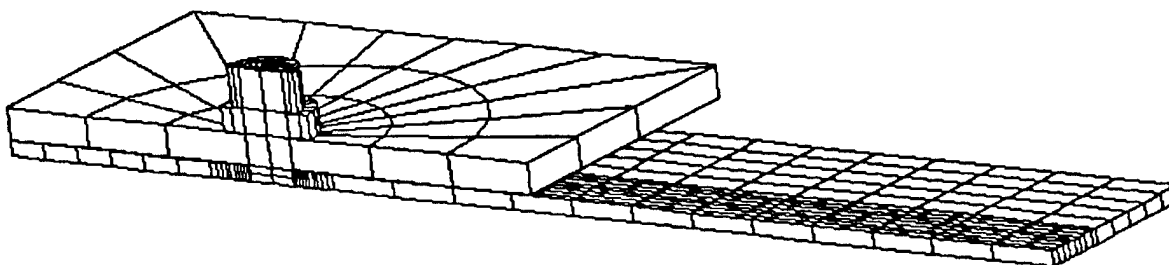

FIGURE 28. A TYPICAL FINITE ELEMENT MESH USED IN THE CALCULATIONS (Only a quarter of the specimen was modeled due to symmetry)

AS4/3502
 [60/90/-60/90/60/90/-6 0/90]_s
 (Kistner et. al, 1985)

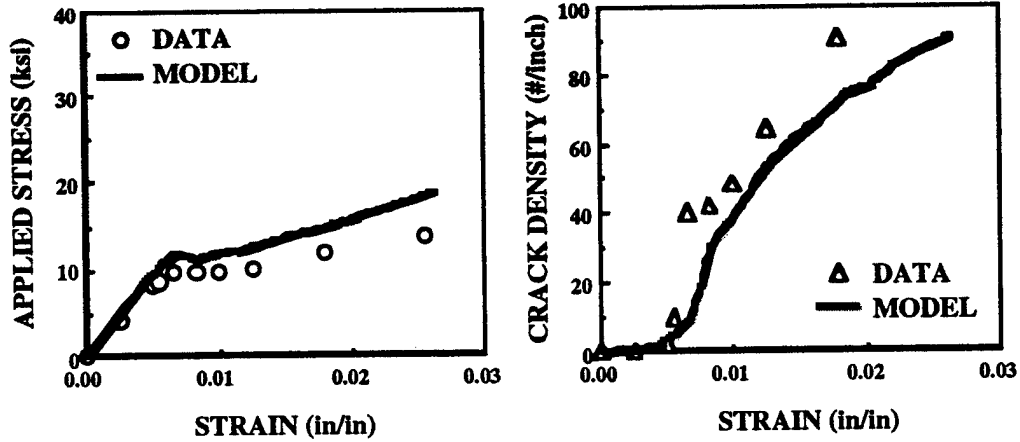

FIGURE 29. COMPARISON OF STRESS-STRAIN AND CRACK DENSITY-STRAIN RELATIONSHIPS BETWEEN THE MEASUREMENTS AND THE PREDICTIONS

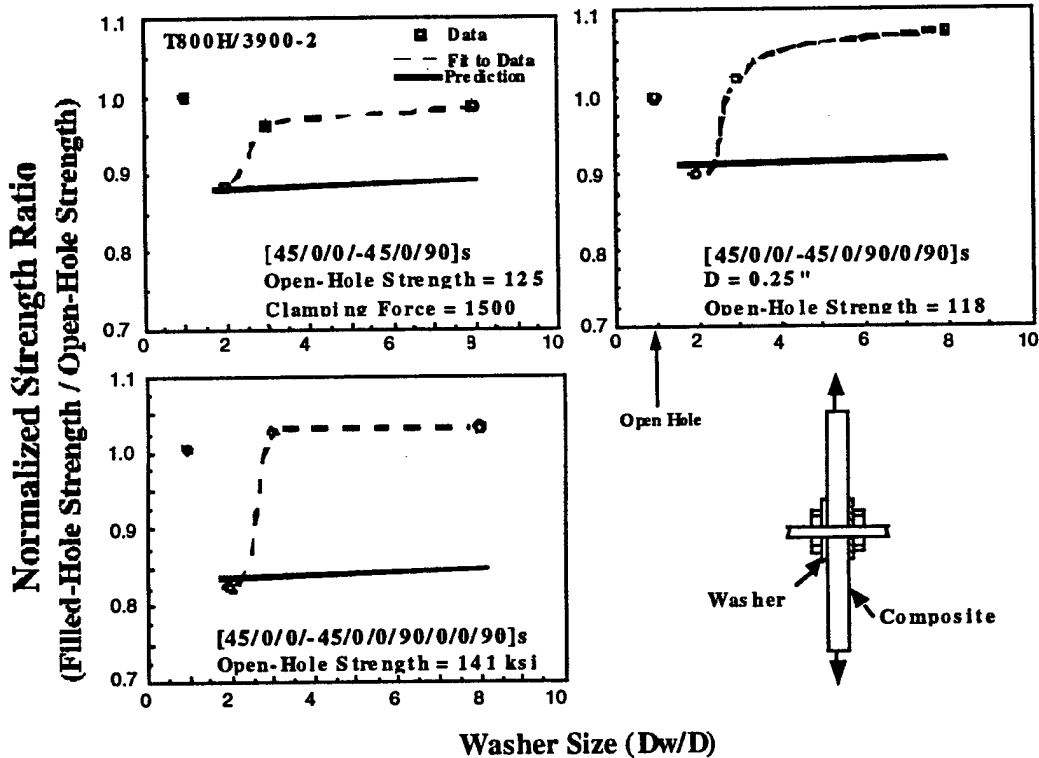

FIGURE 30. COMPARISON OF FILLED-HOLE STRENGTH BETWEEN THE PREDICTIONS AND THE TEST DATA FOR VARIOUS WASHER SIZES

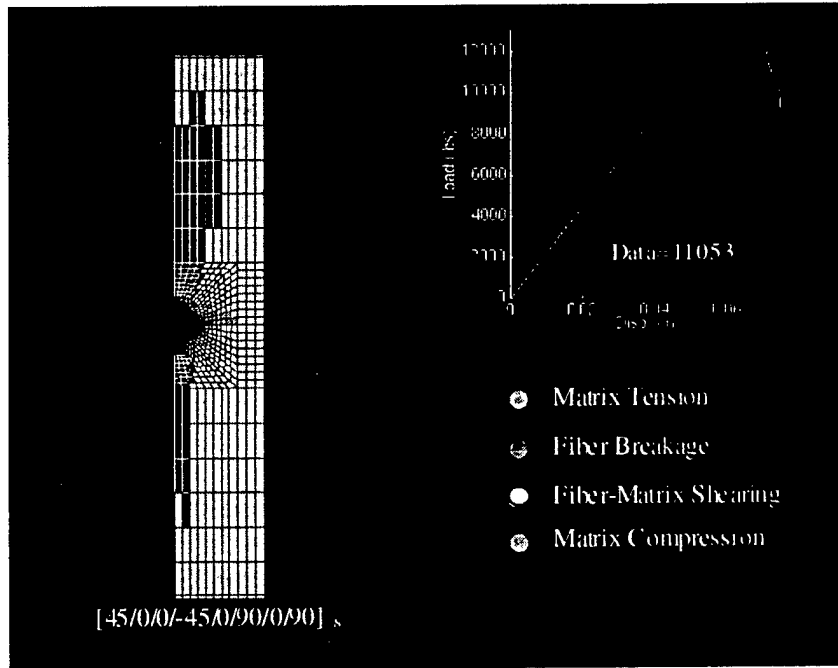

FIGURE 31. (LEFT) THE PREDICTED DAMAGE ACCUMULATION IN A LAMINATE AT THE GIVEN LOAD, (RIGHT) THE PREDICTED LOAD-DEFLECTION CURVE FOR THE LAMINATE

APPENDIX A—FILLED-HOLE TENSION TEST DATA

FILLED-HOLE TENSION TEST DATA

Material: TORAY T800H/3900-2 Prepreg
 Test temperature: Room Temperature
 Hole Geometry: D=0.25 in
 Washer: Stainless Steel
 CP: Clamping Pressure; CF: Clamping Force

Spec.No.	Lay-up	CP(ksi)/CF(lbs)	W/D	Dw/D	Load(lbs)	Strength*(ksi)	Strength**(ksi)
OHT-1	[0/0/0/0]s	open hole	4		15778	294.14	400.55
OHT-2	[0/0/0/0]s	open hole	4		16030	295.46	400.71
OHT-3	[0/0/0/0]s	open hole	4		15776	293.6	399.57
Average					15861	294.40	400.28
Stand. Dev.					146	0.96	0.62
sw2cp3-1	[0/0/0/0]s	0.128/19	4	2	14878	281.2	384.85
sw2cp3-2	[0/0/0/0]s	0.128/19	4	2	15576	279.41	375.36
sw2cp3-3	[0/0/0/0]s	0.128/19	4	2	15962	298.58	407.09
Average					15472	286.40	389.10
Stand. Dev.					549	10.59	16.29
sw2cp2-1	[0/0/0/0]s	4.28/630	4	2	14136	264.88	361.37
sw2cp2-2	[0/0/0/0]s	4.28/630	4	2	14844	272.43	368.91
sw2cp2-3	[0/0/0/0]s	4.28/630	4	2	15812	288.12	389.17
Average					14931	275.14	373.15
Stand. Dev.					841	11.86	14.38
sw2cp1-1	[0/0/0/0]s	6.42/945	4	2	14446	264.58	358.02
sw2cp1-2	[0/0/0/0]s	6.42/945	4	2	15610	279.45	375.15
sw2cp1-3	[0/0/0/0]s	6.42/945	4	2	14452	264.15	357.18
Average					14836	269.39	363.45
Stand. Dev.					670	8.71	10.14
sw2cp4-1	[0/0/0/0]s	10.20/1500	4	2	14012	254.8	343.92
sw2cp4-2	[0/0/0/0]s	10.20/1500	4	2	14818	270.01	364.71
sw2cp4-3	[0/0/0/0]s	10.20/1500	4	2	13798	251.94	340.55
Average					14209	258.92	349.73
Stand. Dev.					538	9.71	13.08

* Strength=Load/Gross Area

**Strength=Load/Net Area

FILLED-HOLE TENSION TEST DATA

Spec No.	Lay-up	CP(ksi)/CF(lbs)	W/D	Dw/D	Load(lbs)	Strength*(ksi)	Strength**(ksi)
sw2.4cp3-1	[0/0/0/0]s	0.128/30	4	2.4	15988	287.81	387.11
sw2.4cp3-2	[0/0/0/0]s	0.128/30	4	2.4	15684	281.64	378.49
sw2.4cp3-3	[0/0/0/0]s	0.128/30	4	2.4	15480	277.41	372.55
Average					15717	282.29	379.38
Stand. Dev.					256	5.23	7.32
sw2.4cp2-1	[0/0/0/0]s	4.28/1000	4	2.4	16024	286.56	384.56
sw2.4cp2-2	[0/0/0/0]s	4.28/1000	4	2.4	15358	275.78	370.61
sw2.4cp2-3	[0/0/0/0]s	4.28/1000	4	2.4	14362	260.37	351.06
Average					15248	274.24	368.74
Stand. Dev.					836	13.16	16.83
sw2.4cp1-1	[0/0/0/0]s	6.24/1500	4	2.4	14412	263.68	356.67
sw2.4cp1-2	[0/0/0/0]s	6.24/1500	4	2.4	15422	281.01	379.57
sw2.4cp1-3	[0/0/0/0]s	6.24/1500	4	2.4	14226	258.69	349.17
Average					14687	267.79	361.80
Stand. Dev.					644	11.71	15.84
sw3cp3-1	[0/0/0/0]s	0.128/50	4	3	15550	281.62	379.58
sw3cp3-2	[0/0/0/0]s	0.128/50	4	3	15516	283.88	383.99
sw3cp3-3	[0/0/0/0]s	0.128/50	4	3	14456	273.17	373.84
Average					15174	279.56	379.14
Stand. Dev.					622	5.65	5.09
sw3cp2-1	[0/0/0/0]s	4.28/1680	4	3	14470	268.04	364.17
sw3cp2-2	[0/0/0/0]s	4.28/1680	4	3	15448	277.39	372.78
sw3cp2-3	[0/0/0/0]s	4.28/1680	4	3	14910	267.59	359.54
Average					14943	271.01	365.50
Stand. Dev.					490	5.53	6.72
sw3cp1-1	[0/0/0/0]s	6.24/2520	4	3	14318	261.43	353.37
sw3cp1-2	[0/0/0/0]s	6.24/2520	4	3	15418	277.14	372.57
sw3cp1-3	[0/0/0/0]s	6.24/2520	4	3	14040	259.22	351.77
Average					14592	265.93	359.24
Stand. Dev.					729	9.77	11.57

FILLED-HOLE TENSION TEST DATA

Spec No.	Layup	CP(ksi)/CF(lbs)	W/D	Dw/D	Load(lbs)	Strength*(ksi)	Strength**(ksi)
sw4.6cp5-1	[0/0/0/0]s	1.52/1500	4.6	4.6	18804	289.88	371.49
sw4.6cp5-2	[0/0/0/0]s	1.52/1500	4.6	4.6	18536	286.26	367.03
sw4.6cp5-3	[0/0/0/0]s	1.52/1500	4.6	4.6	18304	281.44	360.41
Average					18548	285.86	366.31
Stand. Dev.					250	4.23	5.57

FILLED-HOLE TENSION TEST DATA

Material: TORAY T800H/3900-2 Prepreg
 Test temperature: Room Temperature
 Hole Geometry: D=0.25 in
 Washer: Stainless Steel
 CP: Clamping Pressure; CF: Clamping Force

Spec No.	W/D	Dw/D	Load(lbs)	Strength*(ksi)	Strength**(ksi)
OHT-1	4		11890	281.58	374.77
OHT-2	4		12212	289.79	385.96
OHT-3	4		11818	281.88	376.06
Average			11973	284.42	378.93
Stand. Dev.			209.8	4.66	6.12
sw2cp3-1	4	2	11170	270.28	362.34
sw2cp3-2	4	2	11356	277.59	373.44
sw2cp3-3	4	2	11308	273.34	366.31
sw2cp3-4	4	2	11400	275.56	369.29
Average			11308	274.19	367.85
Stand. Dev.			99.68	3.14	4.69
sw2cp2-1	4	2	11474	277.63	372.19
sw2cp2-2	4	2	11488	271.78	361.61
sw2cp2-3	4	2	10936	264.88	355.22
Average			11299	271.43	363.01
Stand. Dev.			314.73	6.38	8.57
sw2cp1-1	4	2	11244	266.55	354.89
sw2cp1-2	4	2	10992	270.51	364.77
Average			11118	268.53	359.83
Stand. Dev.			178.19	2.76	6.99
sw2cp4-1	4	2	10218	247.01	331.04
sw2cp4-2	4	2	10384	245.17	325.98
Average			10301	246.09	328.51
Stand. Dev.			117.38	1.31	3.58

FILLED-HOLE TENSION TEST DATA

Spec No.	Lay-up	CP(ksi)/CF(lbs)	W/D	Dw/D	Load(lbs)	Strength*(ksi)	Strength**(ksi)
sw2.4cp3-1	[0/0/0]s	0.128/30	4	2.4	11264	272.27	364.88
sw2.4cp3-2	[0/0/0]s	0.128/30	4	2.4	11528	274.12	365.34
sw2.4cp3-3	[0/0/0]s	0.128/30	4	2.4	11358	274.83	368.44
Average					11383	273.74.	366.22
Stand. Dev.					133.81	1.31	1.94
sw2.4cp2-1	[0/0/0]s	4.28/1000	4	2.4	10954	265.59	356.29
sw2.4cp2-2	[0/0/0]s	4.28/1000	4	2.4	11194	271.69	364.61
sw2.4cp2-3	[0/0/0]s	4.28/1000	4	2.4	11330	275.83	370.55
Average					11159	271.03	363.82
Stand. Dev.					190.38	5.15	7.16
sw2.4cp1-1	[0/0/0]s	6.24/1500	4	2.4	11087	267.99	359.14
sw2.4cp1-2	[0/0/0]s	6.24/1500	4	2.4	11430	270.96	360.76
sw2.4cp1-3	[0/0/0]s	6.24/1500	4	2.4	10878	264.63	355.42
Average					11132	267.93	358.44
Stand. Dev.					278.69	3.07	2.74
sw3cp3-1	[0/0/0]s	0.128/50	4	3	11180	271.62	364.64
sw3cp3-2	[0/0/0]s	0.128/50	4	3	11180	271.35	364.15
sw3cp3-3	[0/0/0]s	0.128/50	4	3	11046	267.82	359.87
sw3cp3-4	[0/0/0]s	0.128/50	4	3	11524	279.69	375.34
Average					11233	272.62	366.00
Stand. Dev.					204.34	5.02	6.58
sw3cp2-1	[0/0/0]s	4.28/1680	4	3	10802	261.64	350.88
sw3cp2-2	[0/0/0]s	4.28/1680	4	3	11828	281.83	375.87
sw3cp2-3	[0/0/0]s	4.28/1680	4	3	10692	259.76	327.83
sw3cp2-4	[0/0/0]s	4.28/1680	4	3	11146	270.25	362.55
Average					11117	268.37	354.28
Stand. Dev.					511.93	10.07	20.38
sw3cp1-1	[0/0/0]s	6.24/2520	4	3	11174	266.25	355.09
sw3cp1-2	[0/0/0]s	6.24/2520	4	3	10972	265.76	356.41
sw3cp1-3	[0/0/0]s	6.24/2520	4	3	11082	268.97	360.96
Average					11076	266.99	273.21
Stand. Dev.					101.13	1.73	168.57

FILLED-HOLE TENSION TEST DATA

Spec No.	Lay-up	CP(ksi)/CF(lbs)	W/D	Dw/D	Load(lbs)	Strength*(ksi)	Strength**(ksi)
sw6cp6-1	[0/0/0]s	0.873/1500	6	6	18056	284.88	341.45
sw6cp6-2	[0/0/0]s	0.873/1500	6	6	18534	292.28	350.28
sw6cp6-3	[0/0/0]s	0.873/1500	6	6	18660	295.21	354.02
Average					18417	290.78	348.58
Stand. Dev.					318.64	5.33	6.45

FILLED-HOLE TENSION TEST DATA

Material: TORAY T800H/3900-2 Prepreg
 Test temperature: Room Temperature
 Hole Geometry: D=0.25 in
 Washer: Stainless Steel
 CP: Clamping Pressure; CF: Clamping Force

Spec No.	Lay-up	CP(ksi)/CF(lbs)	W/D	Dw/D	Load(lbs)	Strength*(ksi)	Strength**(ksi)
OHT-1	[90/0/0/0/0]s	open hole	4		16142	236.27	317.63
OHT-2	[90/0/0/0/0]s	open hole	4		14810	215.89	289.83
OHT-3	[90/0/0/0/0]s	open hole	4		15024	220.13	296.04
Average					15325	224.09	301.17
Stand. Dev.					715	10.75	14.59
sw2cp3-1	[90/0/0/0/0]s	0.128/19	4	2	15022	220.78	297.23
sw2cp3-2	[90/0/0/0/0]s	0.128/19	4	2	14738	215.94	290.41
Average					14880	218.36	293.82
Stand. Dev.					201	3.42	4.82
sw2cp2-1	[90/0/0/0/0]s	4.28/630	4	2	14486	211.17	283.49
sw2cp2-2	[90/0/0/0/0]s	4.28/630	4	2	14524	213.81	288.01
sw2cp2-3	[90/0/0/0/0]s	4.28/630	4	2	14952	217.52	291.81
Average					14654	213.83	287.77
Stand. Dev.					259	3.29	4.17
sw2cp1-1	[90/0/0/0/0]s	6.42/945	4	2	13686	200.53	269.68
sw2cp1-2	[90/0/0/0/0]s	..	4	2	13124	192.89	259.68
sw2cp1-3	[90/0/0/0/0]s	..	4	2	13080	192.64	259.53
Average					13297	195.35	262.96
Stand. Dev.					338	4.49	5.82
sw2cp4-1	[90/0/0/0/0]s	10.20/1500	4	2	12742	186.51	250.74
sw2cp4-2	[90/0/0/0/0]s	..	4	2	12866	188.51	253.51
sw2cp4-3	[90/0/0/0/0]s	..	4	2	13532	198.68	267.38
Average					13047	191.23	257.21
Stand. Dev.					424	6.52	8.92

FILLED-HOLE TENSION TEST DATA

Spec No.	Lay-up	CP(ksi)/CF(lbs)	W/D	Dw/D	Load(lbs)	Strength*(ksi)	Strength**(ksi)
sw2.4cp3-1	[90/0/0/0/0]s	0.128/30	4	2.4	14138	207.15	278.58
sw2.4cp3-2	[90/0/0/0/0]s	0.128/30	4	2.4	14116	206.83	278.15
sw2.4cp3-3	[90/0/0/0/0]s	0.128/30	4	2.4	14692	215.27	289.51
sw2.4cp3-4	[90/0/0/0/0]s	0.128/30	4	2.4	14180	205.87	275.99
Average					14282	208.78	280.56
Stand. Dev.					275	4.36	6.07
sw2.4cp2-1	[90/0/0/0/0]s	4.28/1000	4	2.4	13054	193.85	261.91
sw2.4cp2-2	[90/0/0/0/0]s	4.28/1000	4	2.4	13564	199.76	269.12
sw2.4cp2-3	[90/0/0/0/0]s	4.28/1000	4	2.4	13192	194.29	261.75
sw2.4cp2-4	[90/0/0/0/0]s	4.28/1000	4	2.4	13486	195.79	262.48
Average					13324	195.92	263.82
Stand. Dev.					241	3.29	3.55
sw2.4cp1-1	[90/0/0/0/0]s	6.24/1500	4	2.4	13616	202.19	273.18
sw2.4cp1-2	[90/0/0/0/0]s	6.24/1500	4	2.4	13140	193.12	259.99
sw2.4cp1-3	[90/0/0/0/0]s	6.24/1500	4	2.4	12860	188.04	252.71
Average					13205	194.45	261.96
Stand. Dev.					382	7.17	10.38
sw3cp3-1	[90/0/0/0/0]s	0.128/50	4	3	14438	212.42	286.08
sw3cp3-2	[90/0/0/0/0]s	0.128/50	4	3	13884	205.75	288.88
sw3cp3-3	[90/0/0/0/0]s	0.128/50	4	3	14212	208.02	279.65
sw3cp3-4	[90/0/0/0/0]s	0.128/50	4	3	14324	207.96	278.79
Average					14215	208.54	283.35
Stand. Dev.					238	2.79	4.92
sw3cp2-1	[90/0/0/0/0]s	4.28/1680	4	3	13768	203.82	275.09
sw3cp2-2	[90/0/0/0/0]s	4.28/1680	4	3	13220	194.69	262.29
sw3cp2-3	[90/0/0/0/0]s	4.28/1680	4	3	12738	187.59	252.74
Average					13242	195.37	263.37
Stand. Dev.					515	8.13	11.21

FILLED-HOLE TENSION TEST DATA

Spec No.	Lay-up	CP(ksi)/CF(lbs)	W/D	Dw/D	Load(lbs)	Strength*(ksi)	Strength**(ksi)
sw3cp1-1	[90/0/0/0/0]s	6.24/2520	4	3	13596	197.78	265.32
sw3cp1-2	[90/0/0/0/0]s	6.24/2520	4	3	13016	191.11	257.19
sw3cp1-3	[90/0/0/0/0]s	6.24/2520	4	3	13238	192.97	259.05
Average					13283	193.95	260.52
Stand. Dev.					292	3.45	4.26
sw4.6cp5-1	[90/0/0/0/0]s	1.52/1500	4.6	4.6	15684	201.38	259.74
sw4.6cp5-2	[90/0/0/0/0]s	1.52/1500	4.6	4.6	14910	192.11	248.04
sw4.6cp5-3	[90/0/0/0/0]s	1.52/1500	4.6	4.6	15364	202.25	262.79
sw4.6cp5-4	[90/0/0/0/0]s	1.52/1500	4.6	4.6	16428	216.06	280.66
Average					15597	202.95	262.81
Stand. Dev.					638	9.87	13.49

FILLED-HOLE TENSION TEST DATA

Material: TORAY T800H/3900-2 Prepreg
 Test temperature: Room Temperature
 Hole Geometry: D=0.25 in
 Washer: Stainless Steel
 CP: Clamping Pressure; CF: Clamping Force

Spec No.	Lay-up	CP(ksi)/CF(lbs)	W/D	Dw/D	Load(lbs)	Strength*(ksi)	Strength**(ksi)
OHT-1	[90/0/0/0]s	open hole	4		10244	194.39	266.437
OHT-2	[90/0/0/0]s	open hole	4		10902	196.57	264.54
OHT-3	[90/0/0/0]s	open hole	4		10616	191.41	257.59
OHT-4	[90/0/0/0]s	open hole	4		10426	192.13	260.55
Average					10547	193.65	262.28
Stand. Dev.					281	2.34	3.97
sw2cp3-1	[90/0/0/0]s	0.128/19	4	2	10168	187.19	253.76
sw2cp3-2	[90/0/0/0]s	0.128/19	4	2	10672	192.82	259.68
sw2cp3-3	[90/0/0/0]s	0.128/19	4	2	10834	193.37	259.33
Average					10558	191.13	257.59
Stand. Dev.					347	3.42	3.32
sw2cp2-1	[90/0/0/0]s	4.28/630	4	2	10504	188.23	252.78
sw2cp2-2	[90/0/0/0]s	4.28/630	4	2	10842	195.09	262.36
sw2cp2-3	[90/0/0/0]s	4.28/630	4	2	10424	187.76	252.59
Average					10590	190.36	255.91
Stand. Dev.					222	4.11	5.59
sw2cp1-1	[90/0/0/0]s	6.42/945	4	2	9996	183.08	247.74
sw2cp1-2	[90/0/0/0]s	6.42/945	4	2	10294	185.79	250.12
sw2cp1-3	[90/0/0/0]s	6.42/945	4	2	9884	177.49	237.71
Average					10058	182.12	245.19
Stand. Dev.					212	4.23	6.59
sw2cp4-1	[90/0/0/0]s	10.20/1500	4	2	9266	167.59	225.78
sw2cp4-2	[90/0/0/0]s	10.20/1500	4	2	10404	187.21	251.77
sw2cp4-3	[90/0/0/0]s	10.20/1500	4	2	10178	182.21	244.61
Average					10110	179.01	240.72
Stand. Dev.					587	10.13	13.42

FILLED-HOLE TENSION TEST DATA

Spec No.	Lay-up	CP(ksi)/CF(lbs)	W/D	Dw/D	Load(lbs)	Strength*(ksi)	Strength**(ksi)
sw2.4cp3-1	[90/0/0/0]s	0.128/30	4	2.4	9822	181.38	246.16
sw2.4cp3-2	[90/0/0/0]s	0.128/30	4	2.4	10530	191.24	258.01
sw2.4cp3-3	[90/0/0/0]s	0.128/30	4	2.4	10778	192.16	257.61
sw2.4cp3-4	[90/0/0/0]s	0.128/30	4	2.4	10816	194.22	261.01
Average					10486	189.75	255.70
Stand. Dev.					460	5.71	6.54
sw2.4cp2-1	[90/0/0/0]s	4.28/1000	4	2.4	10192	184.72	249.04
sw2.4cp2-2	[90/0/0/0]s	4.28/1000	4	2.4	10002	180.91	243.73
sw2.4cp2-3	[90/0/0/0]s	4.28/1000	4	2.4	10134	181.97	244.54
Average					10109	182.53	245.77
Stand. Dev.					97	1.97	2.86
sw2.4cp1-1	[90/0/0/0]s	6.24/1500	4	2.4	9822	181.56	246.49
sw2.4cp1-2	[90/0/0/0]s	6.24/1500	4	2.4	10132	181.57	243.84
sw2.4cp1-3	[90/0/0/0]s	6.24/1500	4	2.4	9696	175.01	235.61
sw2.4cp1-4	[90/0/0/0]s	6.24/1500	4	2.4	9960	178.67	240.08
Average					9903	179.38	241.51
Stand. Dev.					187	3.28	4.73
sw3cp3-1	[90/0/0/0]s	0.128/50	4	3	10124	182.36	245.33
sw3cp3-2	[90/0/0/0]s	0.128/50	4	3	10934	197.55	266.05
sw3cp3-3	[90/0/0/0]s	0.128/50	4	3	10260	184.61	248.27
sw3cp3-4	[90/0/0/0]s	0.128/50	4	3	10540	188.69	253.31
Average					10465	188.31	253.24
Stand. Dev.					357	6.71	9.15
sw3cp2-1	[90/0/0/0]s	4.28/1680	4	3	9860	186.12	254.61
sw3cp2-2	[90/0/0/0]s	4.28/1680	4	3	9616	173.92	234.31
sw3cp2-3	[90/0/0/0]s	4.28/1680	4	3	9804	177.32	238.89
Average					9760	179.12	242.60
Stand. Dev.					127	4.51	10.65

FILLED-HOLE TENSION TEST DATA

Spec No.	Lay-up	CP(ksi)/CF(lbs)	W/D	Dw/D	Load(lbs)	Strength*(ksi)	Strength**(ksi)
sw3cp1-1	[90/0/0/0]s	6.24/2520	4	3	9860	177.24	238.28
sw3cp1-2	[90/0/0/0]s	6.24/2520	4	3	9728	174.86	235.02
sw3cp1-3	[90/0/0/0]s	6.24/2520	4	3	10162	180.81	242.23
Average					9917	177.64	238.51
Stand. Dev.					222	2.99	3.61
sw6cp6-1	[90/0/0/0]s	0.873/1500	6	6	14914	183.81	222.97
sw6cp6-2	[90/0/0/0]s	0.873/1500	6	6	15233	186.71	226.22
sw6cp6-3	[90/0/0/0]s	0.873/1500	6	6	14708	180.27	218.41
Average					14952	183.36	222.53
Stand. Dev.					264	3.22	3.92

FILLED-HOLE TENSION TEST DATA

Material: TORAY T800H/3900-2 Prepreg
 Test temperature: Room Temperature
 Hole Geometry: D=0.25 in
 Washer: Composite
 CF: Clamping Force

Spec No.	Lay-up	CF(lbs)	W/D	Dw/D	Load(lbs)	Strength*(ksi)	Strength**(ksi)
CW3D1C500-1	[(0/90)4]s	500	4	3	9352	93.36	126.94
CW3D1C500-2	[(0/90)4]s	500	4	3	9300	92.74	125.63
CW3D1C500-3	[(0/90)4]s	500	4	3	9360	95.79	129.61
Average					9337	93.96	127.39
Stand. Dev.					3.3	1.61	2.03
CW3D1C1000-1	[(0/90)4]s	1000	4	3	8784	89.23	122.53
CW3D1C1000-2	[(0/90)4]s	1000	4	3	9278	96.05	131.88
CW3D1C1000-3	[(0/90)4]s	1000	4	3	10024	99.57	135.03
Average					9362	94.95	129.81
Stand. Dev.					624	5.26	6.50
CW3D1C1500-1	[(0/90)4]s	1500	4	3	9554	93.22	126.56
CW3D1C1500-2	[(0/90)4]s	1500	4	3	9578	95.42	129.21
CW3D1C1500-3	[(0/90)4]s	1500	4	3	9318	94.81	128.92
Average					9483	94.48	128.23
Stand. Dev.					144	1.14	1.45

* Strength=Load/Gross Area

* Strength=Load/Net Area

FILLED-HOLE TENSION TEST DATA

Material: TORAY T800H/3900-2 Prepreg
 Test temperature: Room Temperature
 Hole Geometry: D=0.25 in
 Washer: Stainless Steel
 CF: Clamping Force

Spec No.	Lay-up	CF(lbs)	W/D	Dw/D	Load(lbs)	Strength*(ksi)	Strength**(ksi)
SW3D1FT-1	[(0/90)4]s	Finger Tight	4	3	9228	95.53	131.17
SW3D1FT-2	[(0/90)4]s	Finger Tight	4	3	9128	95.6	130.9
SW3D1FT-3	[(0/90)4]s	Finger Tight	4	3	9136	95.17	130.53
Average					9164	95.43	130.87
Stand. Dev.					56	0.23	0.32
SW3D1C500-1	[(0/90)4]s	500	4	3	9344	95.08	129.28
SW3D1C500-2	[(0/90)4]s	500	4	3	8898	92.21	126.67
SW3D1C500-3	[(0/90)4]s	500	4	3	9474	95.99	130.32
Average					9239	94.43	128.76
Stand. Dev.					302	1.97	1.88
SW3D1C1500-1	[(0/90)4]s	1500	4	3	9676	96.45	129.75
SW3D1C1500-2	[(0/90)4]s	1500	4	3	9550	95.14	128.83
SW3D1C1500-3	[(0/90)4]s	1500	4	3	9360	97.64	1334.45
Average					9529	96.41	531.01
Stand. Dev.					159	1.25	695.80
SW8D1C1500-1	[(0/90)4]s	1500	4	8	10206	95.48	127.35
SW8D1C1500-2	[(0/90)4]s	1500	4	8	11042	101.77	135.07
SW8D1C1500-3	[(0/90)4]s	1500	4	8	10660	99.23	132.13
Average					10636	98.83	131.52
Stand. Dev.					419	3.16	3.90

FILLED-HOLE TENSION TEST DATA

Material: TORAY T800H/3900-2 Prepreg
 Test temperature: Room Temperature
 Hole Geometry: D=0.25 in
 Washer: Composite
 CF: Clamping Force

Spec No.	Lay-up	CF(lbs)	W/D	Dw/D	Load(lbs)	Strength*(ksi)	Strength**(ksi)
CW3D1C500-1	[(0/45/90/-45)2]s	500	4	3	7826	77.97	104.53
CW3D1C500-2	[(0/45/90/-45)2]s	500	4	3	7804	75.92	101.95
CW3D1C500-3	[(0/45/90/-45)2]s	500	4	3	7818	77.97	104.57
Average					7816	77.29	103.68
Stand. Dev.					11	1.18	1.50
CW3D1C1000-1	[(0/45/90/-45)2]s	1000	4	3	7776	75.57	101.45
CW3D1C1000-2	[(0/45/90/-45)2]s	1000	4	3	8141	80.54	107.71
CW3D1C1000-3	[(0/45/90/-45)2]s	1000	4	3	7736	77.27	104.03
Average					7884	77.79	104.40
Stand. Dev.					223	2.53	3.15
CW3D1C1500-1	[(0/45/90/-45)2]s	1500	4	3	8468	82.92	111.23
CW3D1C1500-2	[(0/45/90/-45)2]s	1500	4	3	8364	81.03	108.67
CW3D1C1500-3	[(0/45/90/-45)2]s	1500	4	3	7892	78.79	105.71
CW3D1C1500-4	[(0/45/90/-45)2]s	1500	4	3	7918	78.21	104.87
Average					8161	80.24	107.62
Stand. Dev.					298	2.16	2.91

FILLED-HOLE TENSION TEST DATA

Material: TORAY T800H/3900-2 Prepreg
 Test temperature: Room Temperature
 Hole Geometry: D=0.25 in
 Washer: Stainless Steel
 CF: Clamping Force

Spec No.	Lay-up	CF(lbs)	W/D	Dw/D	Load(lbs)	Strength*(ksi)	Strength**(ksi)
OHT-1	[(0/45/90/-45)2]s	open hole	4		7258	74.72	102.03
OHT-2	[(0/45/90/-45)2]s	open hole	4		7370	73.74	99.67
Average	[(0/45/90/-45)2]s	open hole			7314	74.23	100.85
Stand. Dev.					79	0.69	1.67
SW3D1C500-1	[(0/45/90/-45)2]s	500	4	3	8078	79.42	106.69
SW3D1C500-2	[(0/45/90/-45)2]s	500	4	3	7948	78.14	104.98
SW3D1C500-3	[(0/45/90/-45)2]s	500	4	3	8136	80.36	107.76
Average					8054	79.31	106.48
Stand. Dev.					96	1.11	1.40
SW3D1C1500-1	[(0/45/90/-45)2]s	1500	4	3	7882	78.07	105.48
SW3D1C1500-2	[(0/45/90/-45)2]s	1500	4	3	8540	83.88	112.27
SW3D1C1500-3	[(0/45/90/-45)2]s	1500	4	3	8258	83.52	112.92
SW3D1C1500-4	[(0/45/90/-45)2]s	1500	4	3	7428	76.18	103.15
Average					8027	80.41	108.46
Stand. Dev.					482	3.88	4.88
SW3D1C1500-1	[(0/45/90/-45)2]s	1500	4	8	7096	73.09	99.74
SW3D1C1500-2	[(0/45/90/-45)2]s	1500	4	8	7384	76.02	103.81
SW3D1C1500-3	[(0/45/90/-45)2]s	1500	4	8	7274	75.45	104.08
Average					7251	74.85	102.54
Stand. Dev.					145	1.55	2.43

FILLED-HOLE TENSION TEST DATA

Material: TORAY T800H/3900-2 Prepreg
 Test temperature: Room Temperature
 Hole Geometry: D=0.25 in
 Washer: Stainless Steel
 CF: Clamping Force

Spec No.	Lay-up	CF(lbs)	W/D	Dw/D	Load(lbs)	Strength*(ksi)	Strength**(ksi)
OHT-1	[(0/90)4]s	open hole	4		9738	92.42	123.48
OHT-2	[(0/90)4]s	open hole	4		9926	91.54	126.58
OHT-3	[(0/90)4]s	open hole	4		9703	101.08	122.33
Average					9789	95.01	124.13
Stand. Dev.					120	5.27	2.20
SW2D1C500-1	[(0/90)4]s	500	4	2	10204	99.41	133.13
SW2D1C500-2	[(0/90)4]s	500	4	2	10192	101.34	135.76
Average					10198	100.38	134.45
Stand. Dev.					8	1.36	1.86
SW2D1C1500-1	[(0/90)4]s	1500	4	2	8034	81.19	110.12
SW2D1C1500-2	[(0/90)4]s	1500	4	2	8094	86.16	118.26
SW2D1C1500-3	[(0/90)4]s	1500	4	2	8780	92.55	127.04
SW2D1C1500-4	[(0/90)4]s	1500	4	2	9038	91.02	122.91
Average					8487	87.73	119.58
Stand. Dev.					500	5.14	7.26
SW3D1C3000-1	[(0/90)4]s	3000	4	3	9086	83.54	111.14
SW3D1C3000-2	[(0/90)4]s	3000	4	3	9892	93.28	123.96
SW3D1C3000-3	[(0/90)4]s	3000	4	3	9436	87.02	115.88
Average					9471	87.95	116.99
Stand. Dev.					404	4.94	6.48

FILLED-HOLE TENSION TEST DATA

Material: TORAY T800H/3900-2 Prepreg
 Test temperature: Room Temperature
 Hole Geometry: D=0.25 in
 Washer: Stainless Steel
 CF: Clamping Force

Spec No.	Lay-up	CF(lbs)	W/D	Dw/D	Load(lbs)	Strength*(ksi)	Strength**(ksi)
SW2D1C500-1	[(0/45/90/-45)2]s	500	4	2	7644	75.06	100.62
SW2D1C500-2	[(0/45/90/-45)2]s	500	4	2	7808	75.84	101.46
SW2D1C500-3	[(0/45/90/-45)2]s	500	4	2	8025	78.68	105.48
Average					7826	76.53	102.52
Stand. Dev.					191	1.91	2.60
SWD2C1500-1	[(0/45/90/-45)2]s	1500	4	2	7884	76.57	102.44
SWD2C1500-2	[(0/45/90/-45)2]s	1500	4	2	8168	79.82	107.01
SWD2C1500-3	[(0/45/90/-45)2]s	1500	4	2	7478	74.28	99.48
Average					7843	76.89	102.98
Stand. Dev.					347	2.78	3.79

FILLED-HOLE TENSION TEST DATA

Material: TORAY T800H/3900-2 Prepreg
 Test temperature: Room Temperature
 Hole Geometry: D=0.25 in
 Washer: Composite
 CF: Clamping Force

Spec No.	Lay-up	CF(lbs)	W/D	Dw/D	Load(lbs)	Strength*(ksi)	Strength**(ksi)
CW2D1C500-1	[(0/90)4]s	500	4	2	9540	95.01	127.75
CW2D1C500-2	[(0/90)4]s	500	4	2	9720	97.84	131.62
CW2D1C500-3	[(0/90)4]s	500	4	2	9696	96.41	129.16
Average					9652	96.42	129.51
Stand. Dev.					98	1.42	1.96
CW2D1C1500-1	[(0/90)4]s	1500	4	2	9302	91.04	121.71
CW2D1C1500-2	[(0/90)4]s	1500	4	2	9052	90.14	121.22
CW2D1C1500-3	[(0/90)4]s	1500	4	2	9158	91.95	124.01
Average					9171	91.04	122.31
Stand. Dev.					125	0.91	1.49

FILLED-HOLE TENSION TEST DATA

Material: TORAY T800H/3900-2 Prepreg
 Test temperature: Room Temperature
 Hole Geometry: D=0.25 in
 Washer: Composite

Spec.No.	Lay-up	CF(lbs)	W/D	Dw/D	Load(lbs)	Strength*(ksi)	Strength**(ksi)
OHT-1	[(0/45/90/-45)2]s	open hole	4		7258	73.31	100.11
OHT-2	[(0/45/90/-45)2]s	open hole	4		7370	75.19	101.61
Average	[(0/45/90/-45)2]s	open hole			7314	74.25	100.86
Stand. Dev.					79	1.33	1.06
CW2D1FT-1	[(0/45/90/-45)2]s	Finger Tight	4	2	8112	79.51	106.71
CW2D1FT-2	[(0/45/90/-45)2]s	Finger Tight	4	2	7512	74.71	100.73
CW2D1FT-3	[(0/45/90/-45)2]s	Finger Tight	4	2	7712	76.59	102.59
Average					7779	76.94	103.34
Stand. Dev.					306	2.42	3.06
CW2D1C500-1	[(0/45/90/-45)2]s	500	4	2	7430	73.42	98.81
CW2D1C500-2	[(0/45/90/-45)2]s	500	4	2	7616	75.07	100.59
CW2D1C500-3	[(0/45/90/-45)2]s	500	4	2	7470	74.64	99.99
Average					7505	74.38	99.80
Stand. Dev.					98	0.86	0.91
CW2D1C1500-1	[(0/45/90/-45)2]s	1500	4	2	8098	71.38	106.97
CW2D1C1500-2	[(0/45/90/-45)2]s	1500	4	2	7920	76.46	105.05
CW2D1C1500-3	[(0/45/90/-45)2]s	1500	4	2	7818	75.86	103.55
Average					7945	74.57	105.19
Stand. Dev.					142	2.78	1.71
CW8D1C1500-1	[(0/45/90/-45)2]s	1500	4	8	7096	79.82	97.48
CW8D1C1500-2	[(0/45/90/-45)2]s	1500	4	8	7384	78.31	104.41
CW8D1C1500-3	[(0/45/90/-45)2]s	1500	4	8	7274	77.22	104.07
Average					7251	78.45	101.99
Stand. Dev.					145	1.31	3.91

FILLED-HOLE TENSION TEST DATA

Material: TORAY T800H/3900-2 Prepreg
 Test temperature: Room Temperature
 Hole Geometry: D=0.25 in
 Washer: Stainless Steel

Spec No.	Lay-up	CF(lbs)	W/D	Dw/D	Load(lbs)	Strength*(ksi)	Strength**(ksi)
OHT-1	[(0/45/90/-45)2]s	open hole	4		7258	73.31	100.11
OHT-2	[(0/45/90/-45)2]s	open hole	4		7370	75.19	101.61
Average	[(0/45/90/-45)2]s	open hole			7314	74.25	100.86
Stand. Dev.					79	1.33	1.06
SW2D1FT-1	[(0/45/90/-45)2]s	Finger Tight	4	2	6826	68.29	93.09
SW2D1FT-2	[(0/45/90/-45)2]s	Finger Tight	4	2	7360	74.81	102.03
SW2D1FT-3	[(0/45/90/-45)2]s	Finger Tight	4	2	6962	70.91	96.79
Average					7049	71.34	97.30
Stand. Dev.					278	3.28	4.49
SW2D1C500-1	[(0/45/90/-45)2]s	500	4	2	7038	71.42	97.53
SW2D1C500-2	[(0/45/90/-45)2]s	500	4	2	7332	75.21	102.92
SW2D1C500-3	[(0/45/90/-45)2]s	500	4	2	7108	71.44	97.75
Average					7159	72.69	99.40
Stand. Dev.					154	2.18	3.05
SW2D1C1500-1	[(0/45/90/-45)2]s	1500	4	2	6936	74.4	102.51
SW2D1C1500-2	[(0/45/90/-45)2]s	1500	4	2	6944	72.69	99.69
SW2D1C1500-3	[(0/45/90/-45)2]s	1500	4	2	6992	72.84	99.54
Average					6957	73.31	100.58
Stand. Dev.					30	0.95	1.67

FILLED-HOLE TENSION TEST DATA

Material: TORAY T800H/3900-2 Prepreg
 Test temperature: Room Temperature
 Hole Geometry: D=0.25 in
 Washer: Stainless Steel

Spec No.	Lay-up	CF(lbs)	W/D	Dw/D	Load(lbs)	Strength*(ksi)	Strength**(ksi)
OHT-1	[(0/45/90/-45)2/T0.5]s	open hole	4		7612	70.09	92.99
OHT-2	[(0/45/90/-45)2/T0.5]s	open hole	4		7586	69.92	92.81
OHT-3	[(0/45/90/-45)2/T0.5]s	open hole	4		7606	70.52	93.78
Average	[(0/45/90/-45)2/T0.5]s	open hole			7601	70.18	93.19
Stand. Dev.					14	0.31	0.52
SW2D1C1500-1	[(0/45/90/-45)2/T0.5]s	1500	4	2	7178	70.99	96.52
SW2D1C1500-2	[(0/45/90/-45)2/T0.5]s	1500	4	2	7896	72.35	95.84
SW2D1C1500-3	[(0/45/90/-45)2/T0.5]s	1500	4	2	7948	73.11	96.97
SW2D1C1500-4	[(0/45/90/-45)2/T0.5]s	1500	4	2	7424	68.16	90.34
Average					7612	71.15	94.92
Stand. Dev.					373	2.18	3.09

***T0.5: Teflon Film , one layer

FILLED-HOLE TENSION TEST DATA

Material: TORAY T800H/3900-2 Prepreg
 Test temperature: Room Temperature
 Hole Geometry: D=0.25 in
 Washer: Stainless Steel
 CF: Clamping Force

Spec No.	Lay-up	CF(lbs)	W/D	Dw/D	Load(lbs)	Strength*(ksi)	Strength**(ksi)
OHT-1	[(0/90)7]s	open hole	4		15436	87.29	119.81
OHT-2	[(0/90)7]s	open hole	4		15666	88.59	121.6
Average					15551	87.94	120.71
Stand. Dev.					163	0.92	1.27
SW2D1FT-1	[(0/90)7]s	Finger Tight	4	2	14878	281.2	119.82
SW2D1FT-2	[(0/90)7]s	Finger Tight	4	2	15576	279.41	121.31
SW2D1FT-3	[(0/90)7]s	Finger Tight	4	2	15962	298.58	119.03
Average					15472	286.40	120.05
Stand. Dev.					549	10.59	1.16
SW2D1C500-1	[(0/90)7]s	500	4	2	14982	84.61	116.16
SW2D1C500-2	[(0/90)7]s	500	4	2	14856	83.24	114.29
SW2D1C500-3	[(0/90)7]s	500	4	2	14698	84.12	115.29
Average					14845	83.99	115.25
Stand. Dev.					142	0.69	0.94
SW2D1C1500-1	[(0/90)7]s	1500	4	2	14012	254.8	114.61
SW2D1C1500-2	[(0/90)7]s	1500	4	2	14818	270.01	124.45
SW2D1C1500-3	[(0/90)7]s	1500	4	2	13798	251.94	111.57
Average					14209	258.92	116.88
Stand. Dev.					538	9.71	6.73

* Strength=Load/Gross Area

* Strength=Load/Net Area

FILLED-HOLE TENSION TEST DATA

Material: TORAY T800H/3900-2 Prepreg
 Test temperature: Room Temperature
 Hole Geometry: D=0.25 in
 Washer: Stainless Steel
 CF: Clamping Force

Spec No.	Lay-up	CF(lbs)	W/D	Dw/D	Load(lbs)	Strength*(ksi)	Strength**(ksi)
OHT-1	[(0/45/90/-45)4]s	open hole	4		13838	67.52	92.76
OHT-2	[(0/45/90/-45)4]s	open hole	4		14408	69.91	96.01
Average					14123	68.72	94.39
Stand. Dev.					403	1.69	2.30
SW2D1FT-1	[(0/45/90/-45)4]s	Finger Tight	4	2	14072	69.31	95.04
SW2D1FT-2	[(0/45/90/-45)4]s	Finger Tight	4	2	14104	68.68	94.12
SW2D1FT-3	[(0/45/90/-45)4]s	Finger Tight	4	2	14384	70.17	96.07
Average					14187	69.39	95.08
Stand. Dev.					172	0.75	0.98
SW2D1C500-1	[(0/45/90/-45)4]s	500	4	2	13372	65.83	90.58
SW2D1C500-2	[(0/45/90/-45)4]s	500	4	2	13660	67.03	92.11
SW2D1C500-3	[(0/45/90/-45)4]s	500	4	2	14210	69.32	94.91
Average					13747	67.39	92.53
Stand. Dev.					426	1.77	2.20
SW2D1C1500-1	[(0/45/90/-45)4]s	1500	4	2	13952	72.02	97.93
SW2D1C1500-2	[(0/45/90/-45)4]s	1500	4	2	13344	65.33	89.71
SW2D1C1500-3	[(0/45/90/-45)4]s	1500	4	2	13356	64.25	87.94
Average					13551	67.20	91.86
Stand. Dev.					348	4.21	5.33

FILLED-HOLE TENSION TEST DATA

Material: TORAY T800H/3900-2 Prepreg
 Test temperature: Room Temperature
 Hole Geometry: D=0.25 in
 Washer: Stainless Steel
 CF: Clamping Force

Spec.No.	Lay-up	CF(lbs)	W/D	Dw/D	Load(lbs)	Strength*(ksi)	Strength**(ksi)
OHT-1	[(0/45/90/-45)4]s	open hole	4		13838	67.52	92.76
OHT-2	[(0/45/90/-45)4]s	open hole	4		14408	69.91	96.01
Average					14123	68.72	94.39
Stand. Dev.					403	1.69	2.30
SW3D1C500-1	[(0/45/90/-45)4]s	500	4	3	14282	70.24	96.45
SW3D1C500-2	[(0/45/90/-45)4]s	500	4	3	13728	67.95	93.69
SW3D1C500-3	[(0/45/90/-45)4]s	500	4	3	14204	70.08	96.51
Average					14071	69.42	95.55
Stand. Dev.					300	1.28	1.61
SW3D1C1500-1	[(0/45/90/-45)4]s	1500	4	3	13732	67.85	93.16
SW3D1C1500-2	[(0/45/90/-45)4]s	1500	4	3	13750	67.69	93.14
SW3D1C1500-3	[(0/45/90/-45)4]s	1500	4	3	13838	71.61	97.64
Average					13773	69.05	94.65
Stand. Dev.					57	2.22	2.59

FILLED-HOLE TENSION TEST DATA

Material: TORAY T800H/3900-2 Prepreg
 Test temperature: Room Temperature
 Hole Geometry: D=0.25 in
 Washer: Composite
 CF: Clamping Force

Spec No.	Lay-up	CF(lbs)	W/D	Dw/D	Load(lbs)	Strength*(ksi)	Strength**(ksi)
OHT-1	[(0/45/90/-45)4]s	open hole	4		13838	67.52	92.76
OHT-2	[(0/45/90/-45)4]s	open hole	4		14408	69.91	96.01
Average					14123	68.72	94.39
Stand. Dev.					403	1.69	2.30
CW3D1C500-1	[(0/45/90/-45)4]s	500	4	3	14352	71.17	97.53
CW3D1C500-2	[(0/45/90/-45)4]s	500	4	3	14174	69.25	95.01
CW3D1C500-3	[(0/45/90/-45)4]s	500	4	3	14646	67.33	91.25
Average					14391	69.25	94.60
Stand. Dev.					238	1.92	3.16
CW3D1C1500-1	[(0/45/90/-45)4]s	1500	4	3	14230	69.75	95.81
CW3D1C1500-2	[(0/45/90/-45)4]s	1500	4	3	14346	70.81	97.18
CW3D1C1500-3	[(0/45/90/-45)4]s	1500	4	3	14080	69.32	95.37
Average					14219	69.96	96.12
Stand. Dev.					133	0.77	0.94

FILLED-HOLE TENSION TEST DATA

Material: TORAY T800H/3900-2 Prepreg
 Test temperature: Room Temperature
 Hole Geometry: D=0.25 in
 Washer: Stainless Steel

Spec No.	Lay-up	CF(lbs)	W/D	Dw/D	Load(lbs)	Strength*(ksi)	Strength**(ksi)
OHT-1	[(0/45/-45/90)2]s	open hole	4		8290	101.13	
SW2D1FT-1	[(0/45/-45/90)2]s	Finger Tight	4	2	8182	75.37	100.62
SW2D1FT-2	[(0/45/-45/90)2]s	Finger Tight	4	2	8282	75.4	99.98
Average					8232	75.39	100.30
Stand. Dev.					71	0.02	0.45
SW2D1C500-1	[(0/45/-45/90)2]s	500	4	2	8386	76.81	102.03
SW2D1C500-2	[(0/45/-45/90)2]s	500	4	2	8114	74.68	99.38
SW2D1C500-3	[(0/45/-45/90)2]s	500	4	2	8072	74.79	99.43
Average					8191	75.43	100.28
Stand. Dev.					170	1.20	1.52
SW2D1C1000-1	[(0/45/-45/90)2]s	1000	4	2	8138	75.13	100.07
SW2D1C1000-2	[(0/45/-45/90)2]s	1000	4	2	8118	74.31	98.71
Average					8128	74.72	99.39
Stand. Dev.					14	0.58	0.96
SW2D1C1500-1	[(0/45/-45/90)2]s	1500	4	2	7946	74.66	100.03
SW2D1C1500-2	[(0/45/-45/90)2]s	1500	4	2	8186	75.16	99.93
SW2D1C1500-3	[(0/45/-45/90)2]s	1500	4	2	8110	73.96	97.98
Average					8081	74.59	99.31
Stand. Dev.					123	0.60	1.16
SW2D1C3000-1	[(0/45/-45/90)2]s	3000	4	2	8486	80.42	107.05
SW2D1C3000-2	[(0/45/-45/90)2]s	3000	4	2	7940	75.88	105.54
SW2D1C3000-3	[(0/45/-45/90)2]s	3000	4	2	7468	70.91	94.45
Average					7965	75.74	102.35
Stand. Dev.					509	4.76	6.88

* Strength=Load/Gross Area

** Strength=Load/Net Area

FILLED-HOLE TENSION TEST DATA

Material: TORAY T800H/3900-2 Prepreg
 Test temperature: Room Temperature
 Hole Geometry: D=0.25 in
 Washer: Stainless Steel

Spec No.	Lay-up	CF(lbs)	W/D	Dw/D	Load(lbs)	Strength*(ksi)	Strength**(ksi)
OHT-1	[(45/-45/0/90)2]s	open hole	4		7543	70.76	94.77
OHT-2	[(45/-45/0/90)2]s	open hole	4		7545	70.66	94.27
OHT-3	[(45/-45/0/90)2]s	open hole	4		7674	73.86	98.83
Average					7587	71.76	95.96
Stand. Dev.					7.5	1.82	2.50
SW2D1FT-1	[(45/-45/0/90)2]s	Finger Tight	4	2	7807	72.53	96.97
SW2D1FT-2	[(45/-45/0/90)2]s	Finger Tight	4	2	7319	67.89	90.86
SW2D1FT-3	[(45/-45/0/90)2]s	Finger Tight	4	2	7514	70.01	93.26
Average					7547	70.14	93.70
Stand. Dev.					246	2.32	3.08
SW2D1C500-1	[(45/-45/0/90)2]s	500	4	2	7639	71.74	96.11
SW2D1C500-2	[(45/-45/0/90)2]s	500	4	2	7503	70.83	94.76
SW2D1C500-3	[(45/-45/0/90)2]s	500	4	2	7570	71.02	95.11
Average					7571	71.20	95.33
Stand. Dev.					68	0.48	0.70
SW2D1C1500-1	[(45/-45/0/90)2]s	1500	4	2	7313	68.78	92.19
SW2D1C1500-2	[(45/-45/0/90)2]s	1500	4	2	7619	71.52	95.65
SW2D1C1500-3	[(45/-45/0/90)2]s	1500	4	2	7643	72.14	96.81
Average					7525	70.81	94.88
Stand. Dev.					184	1.79	2.40
SW2D1C3000-1	[(45/-45/0/90)2]s	3000	4	2	8486	80.42	107.05
SW2D1C3000-2	[(45/-45/0/90)2]s	3000	4	2	7940	75.88	101.54
SW2D1C3000-3	[(45/-45/0/90)2]s	3000	4	2	7468	71.52	95.53
Average					7965	75.94	101.37
Stand. Dev.					509	4.45	5.76

FILLED-HOLE TENSION TEST DATA

Material: TORAY T800H/3900-2 Prepreg
 Test temperature: Room Temperature
 Hole Geometry: D=0.25 in
 Washer: Stainless Steel

Spec.No.	Lay-up	CF(lbs)	W/D	Dw/D	Load(lbs)	Strength*(ksi)	Strength**(ksi)
OHT-1	[45/-45/0/90]s	open hole	4		3119	57.75	77.47
OHT-2	[45/-45/0/90]s	open hole	4		3405	62.92	84.09
Average					3262	60.34	80.78
Stand. Dev.					202	3.66	4.68
SW2D1FT-1	[45/-45/0/90]s	Finger Tight	4	2	3401	61.91	82.56
SW2D1FT-2	[45/-45/0/90]s	Finger Tight	4	2	3482	64.79	86.81
Average					3442	63.35	84.69
Stand. Dev.					57	2.04	3.01
SW2D1C500-1	[45/-45/0/90]s	500	4	2	3526	64.66	86.46
SW2D1C500-2	[45/-45/0/90]s	500	4	2	3421	63.47	85.21
Average					3474	64.07	85.84
Stand. Dev.					74	0.84	0.88
SW2D1C1500-1	[45/-45/0/90]s	1500	4	2	3698	67.71	90.49
SW2D1C1500-2	[45/-45/0/90]s	1500	4	2	3652	66.73	89.13
Average					3675	67.22	89.81
Stand. Dev.					33	0.69	0.96
CW2D1C1500-1	[45/-45/0/90]s	1500	4	2	3620	66.03	87.86
SW2D1C3000-1	[45/-45/0/90]s	1500	4	3	3774	69.42	92.92
SW2D1C3000-2	[45/-45/0/90]s	1500	4	3	3639	67.04	89.77
Average					3707	68.23	91.35
Stand. Dev.					95	1.68	2.23

FILLED-HOLE TENSION TEST DATA

Material: TORAY T800H/3900-2 Prepreg
 Test temperature: Room Temperature
 Hole Geometry: D=0.25 in
 Washer: Stainless Steel

Spec No.	Lay-up	CF(lbs)	W/D	Dw/D	Load(lbs)	Strength*(ksi)	Strength**(ksi)
OHT-1	[45/0/0/-45/90]s	open hole	4		12856	123.31	167.99
OHT-2	[45/0/0/-45/90]s	open hole	4		13252	127.23	170.09
OHT-3	[45/0/0/-45/90]s	open hole	4		12500	119.65	159.81
Average					12869	123.40	165.96
Stand. Dev.					376	3.79	5.43
SW2D1C1500-1	[45/0/0/-45/90]s	1500	4	2	12386	118.79	158.76
SW2D1C1500-2	[45/0/0/-45/90]s	1500	4	2	12030	115.03	153.58
SW2D1C1500-3	[45/0/0/-45/90]s	1500	4	2	10952	106.32	142.69
Average					11789	113.38	151.68
Stand. Dev.					747	6.40	8.20

Spec No.	Lay-up	CF(lbs)	W/D	Dw/D	Load(lbs)	Strength*(ksi)	Strength**(ksi)
OHT-1	[45/0/0/-45/90]s	open hole	4		16316	151.58	201.71
OHT-2	[45/0/0/-45/90]s	open hole	4		18150	168.61	224.37
Average					17233	160.10	213.04
Stand. Dev.					1297	12.04	16.02
SW2D1C1500-1	[45/0/0/-45/90]s	1500	4	2	16166	153.58	205.26
SW2D1C1500-2	[45/0/0/-45/90]s	1500	4	2	15156	142.55	189.88
Average					15661	148.07	197.57
Stand. Dev.					714	7.80	10.88

FILLED-HOLE TENSION TEST DATA

Material: TORAY T800H/3900-2 Prepreg
 Test temperature: Room Temperature
 Hole Geometry: D=0.25 in
 Washer: Stainless Steel

Spec No.	Lay-up	CF(lbs)	W/D	Dw/D	Load(lbs)	Strength*(ksi)	Strength**(ksi)
OHT-1.	[(45/0/0/-45/0/90)]s	open hole	6		15286	126.49	151.95
OHT-2	[(45/0/0/-45/0/90)]s	open hole	6		15042	123.97	148.81
OHT-3	[(45/0/0/-45/0/90)]s	open hole	6		15164	125.23	150.38
Average				173		1.78	2.22
Stand. Dev.							
SW2C562-1	[(45/0/0/-45/0/90)]s	562	6	2	14224	117.71	141.39
SW2C562-2	[(45/0/0/-45/0/90)]s	562	6	2	13825	113.86	136.65
SW2C562-3	[(45/0/0/-45/0/90)]s	562	6	2	13522	111.14	133.34
Average				13857		114.24	137.13
Stand. Dev.				352		3.30	4.05
SW2C1500-1	[(45/0/0/-45/0/90)]s	1500	6	2	13264	110.21	132.49
SW2C1500-2	[(45/0/0/-45/0/90)]s	1500	6	2	13104	107.85	129.42
SW2C1500-3	[(45/0/0/-45/0/90)]s	1500	6	2	13560	112.96	135.88
Average				13309		110.34	132.60
Stand. Dev.				231		2.56	3.23
SW3C1500-1	[(45/0/0/-45/0/90)]s	1500	6	3	13984	115.09	138.11
SW3C1500-2	[(45/0/0/-45/0/90)]s	1500	6	3	14954	123.01	147.58
SW3C1500-3	[(45/0/0/-45/0/90)]s	1500	6	3	14792	122.73	147.51
Average				14577		120.28	144.40
Stand. Dev.				520		4.49	5.45
SW8C1500-1	[(45/0/0/-45/0/90)]s	1500	6	8	14900	122.84	147.46
SW8C1500-2	[(45/0/0/-45/0/90)]s	1500	6	8	15292	126.07	151.33
SW8C1500-3	[(45/0/0/-45/0/90)]s	1500	6	8	14700	121.07	145.31
Average				14964		123.33	148.03
Stand. Dev.				301		2.54	3.05

FILLED-HOLE TENSION TEST DATA

Material: TORAY T800H/3900-2 Prepreg
 Test temperature: Room Temperature
 Hole Geometry: D=0.25 in
 Washer: Stainless Steel

Spec No.	Lay-up	CF(lbs)	W/D	Dw/D	Load(lbs)	Strength*(ksi)	Strength**(ksi)
OHT-1	[45/0/0/-45/0/90/0/90]s	open hole	4		12248	116.13	155.11
OHT-2	[45/0/0/-45/0/90/0/90]s	open hole	4		12958	123.73	165.64
OHT-3	[45/0/0/-45/0/90/0/90]s	open hole	4		12048	114.46	152.97
Average					12418	118.11	157.91
Stand. Dev.					478	4.94	6.78
SW2C1500-1	[45/0/0/-45/0/90/0/90]s	1500	4	2	10684	101.91	136.39
SW2C1500-2	..	1500	4	2	11422	110.29	148.22
Average					11053	106.10	142.31
Stand. Dev.					522	5.93	8.37
SW3C1500-1	[45/0/0/-45/0/90/0/90]s	1000	4	3	13132	123.27	164.09
SW3C1500-2	..	1000	4	3	12518	117.74	156.83
Average					12825	120.51	160.46
Stand. Dev.					434	3.91	5.13
SW8C1500-1	[45/0/0/-45/0/90/0/90]s	1500	4	8	13324	126.33	168.72
SW8C1500-2	..	1500	4	8	13724	129.15	172.06
Average					13524	127.74	170.39
Stand. Dev.					283	1.99	2.36
SW2C3000-1	[45/0/0/-45/0/90/0/90]s	3000	4	2	10838	103.17	137.98
SW2C3000-2	..	3000	4	2	11588	107.81	143.09
Average					11213	105.49	140.54
Stand. Dev.					530	3.28	3.61

* Strength=Load/Gross Area

** Strength=Load/NET Area

FILLED-HOLE TENSION TEST DATA

Material: TORAY T800H/3900-2 Prepreg
 Test temperature: Room Temperature
 Hole Geometry: D=0.25 in
 Washer: Stainless Steel

Spec No.	Lay-up	CF(lbs)	W/D	Dw/D	Load(lbs)	Strength*(ksi)	Strength**(ksi)
OHT-1	[45/0/0/-45/0/0/90]s	open hole	4		12722	144.87	195.53
OHT-2	[45/0/0/-45/0/0/90]s	open hole	4		12400	141.06	190.31
Average					12561	142.97	192.92
Stand. Dev.					228	2.69	3.69
SW2C1500-1	[45/0/0/-45/0/0/90]s	1500	4	2	8672	98.24	132.36
SW2C1500-2	[45/0/0/-45/0/0/90]s	1500	4	2	9034	103.48	139.41
SW2C1500-3	[45/0/0/-45/0/0/90]s	1500	4	2	9614	109.03	146.94
Average					9107	103.58	139.57
Stand. Dev.					475	5.40	7.29
SW3C1500-1	[45/0/0/-45/0/0/90]s	1500	4	3	11864	137.31	185.67
SW3C1500-2	[45/0/0/-45/0/0/90]s	1500	4	3	12196	142.59	192.73
Average					12030	139.95	189.20
Stand. Dev.					235	3.73	4.99

Spec No.	Lay-up	CF(lbs)	W/D	Dw/D	Load(lbs)	Strength*(ksi)	Strength**(ksi)
OHT-1	[45/0/0/-45/0/0/90]s	open hole	6		>19626	>145.67	>174.87
SW2C1500-1	[45/0/0/-45/0/0/90]s	1500	6	2	14550	107.6	129.36
SW2C1500-2	[45/0/0/-45/0/0/90]s	1500	6	2	17100	124.91	150.14
SW2C1500-3	[45/0/0/-45/0/0/90]s	1500	6	2	15170	112.03	134.66
Average					15607	114.85	138.05
Stand. Dev.					1330	8.99	10.80
SW3C1500-1	[45/0/0/-45/0/0/90]s	1500	6	3	>19562	>143.60	>172.39

FILLED-HOLE TENSION TEST DATA

Material: TORAY T800H/3900-2 Prepreg: Test temperature: Room Temperature
 Hole Geometry: D=0.25 in; Washer Size: Stainless Steel

Spec No.	Lay-up	CF(lbs)	W/D	Dw/D	Load(lbs)	Strength*(ksi)	Strength**(ksi)
OHT-1	[45/0/0/-45/0/0/90/0/0/90]s	open hole	4		18786	139.95	187.43
OHT-2	[45/0/0/-45/0/0/90/0/0/90]s	open hole	4		19414	146.15	195.92
OHT-3	[45/0/0/-45/0/0/90/0/0/90]s	open hole	4		18968	140.17	186.96
OHT-4	[45/0/0/-45/0/0/90/0/0/90]s	open hole	4		18042	138.78	187.44
OHT-5	[45/0/0/-45/0/0/90/0/0/90]s	open hole	4		18096	139.19	188.01
Average					18661	140.85	189.15
Stand. Dev.					587	3.02	3.80
SW2FT-1	[45/0/0/-45/0/0/90/0/0/90]s	Finger Tight	4	2	15362	118.22	158.88
SW2FT-2	[45/0/0/-45/0/0/90/0/0/90]s	Finger Tight	4	2	16578	127.19	170.75
SW2FT-3	[45/0/0/-45/0/0/90/0/0/90]s	Finger Tight	4	2	17202	127.25	170.01
Average					13678	124.22	166.55
Stand. Dev.					7414	5.20	6.65
SW2C562-1	[45/0/0/-45/0/0/90/0/0/90]s	562	4	2	16696	127.37	171.53
SW2C562-2	[45/0/0/-45/0/0/90/0/0/90]s	562	4	2	17826	135.15	181.63
SW2C562-3	[45/0/0/-45/0/0/90/0/0/90]s	562	4	2	18004	136.22	182.92
SW2C562-4	[45/0/0/-45/0/0/90/0/0/90]s	562	4	2	17370	132.92	179.21
Average					17474	132.92	178.82
Stand. Dev.					583	3.94	5.10
SW2C1500-1	[45/0/0/-45/0/0/90/0/0/90]s	1500	4	2	15202	115.46	154.46
SW2C1500-2	[45/0/0/-45/0/0/90/0/0/90]s	1500	4	2	15470	115.91	154.76
Average					15336	115.69	154.61
Stand. Dev.					190	0.32	0.21
SW3C1500-1	[45/0/0/-45/0/0/90/0/0/90]s	1500	4	3	18596	140.89	188.81
SW3C1500-2	[45/0/0/-45/0/0/90/0/0/90]s	1500	4	3	19274	147.27	197.44
Average					18935	144.08	193.13
Stand. Dev.					479	4.51	6.10
SW8C3000-1	[45/0/0/-45/0/0/90/0/0/90]s	3000	4	8	>19276	>149	>200
SW8C3000-2	[45/0/0/-45/0/0/90/0/0/90]s	3000	4	8	>19584	>149	>200
Average					>19430	>149	>200
Stand. Dev.					218	0.18	0.29

FILLED-HOLE TENSION TEST DATA

Material: TORAY T800H/3900-2 Prepreg
 Test temperature: Room Temperature
 Hole Geometry: D=0.25 in
 Washer: Stainless Steel

Spec No.	Lay-up	CF(lbs)	W/D	Dw/D	Load(lbs)	Strength*(ksi)	Strength**(ksi)
OHT-1	[45/0/0/-45/0/0/90/0/0/90/0/90/Teflon]	open hole	4		19562	147.91	198.08
OHT-2	[45/0/0/-45/0/0/90/0/0/90/0/90/Teflon]	open hole	4		19016	143.21	191.51
Average					19289	145.56	194.80
Stand. Dev.					386	3.32	4.65
SW2C1500-1	[45/0/0/-45/0/90/0/90]	1500	4	2	15176	114.86	153.88
SW2C1500-2	[45/0/0/-45/0/90/0/90]	1500	4	2	15838	121.11	162.81
Average					15507	117.99	158.35
Stand. Dev.					468	4.42	6.31
SW3C3000-1	[45/0/0/-45/0/90/0/90]	3000	4	2	15464	114.01	152.88
SW3C3000-2	[45/0/0/-45/0/90/0/90]	3000	4	2	12690	93.36	125.1
SW3C3000-3	[45/0/0/-45/0/90/0/90]	3000	4	2	13470	99.69	133.89
Average					13875	102.35	137.29
Stand. Dev.					1431	10.58	14.20
SW8C1500-1	[45/0/0/-45/0/90/0/90]	1500	4	3	18380	139.25	186.62
SW8C1500-2	[45/0/0/-45/0/90/0/90]	1500	4	3	17456	132.98	178.08
Average					17918	136.12	182.35
Stand. Dev.					653	4.43	6.04
SW2C3000-1	[45/0/0/-45/0/90/0/90]	3000	4	8	19480	148.04	198.6
Average						>148	>198

FILLED-HOLE TENSION TEST DATA

Material: TORAY T800H/3900-2 Prepreg
 Test temperature: Room Temperature
 Hole Geometry: D=0.25 in
 Washer: Stainless Steel

Spec No.	Lay-up	CF(lbs)	W/D	Dw/D	Load(lbs)	Strength*(ksi)	Strength**(ksi)
SW2C3000-1	[45/0/0/-45/0/90/0/90]s	3000	4	2	15362	116.39	155.98
SW2C3000-2	[45/0/0/-45/0/90/0/90]s	3000	4	2	14942	113.78	152.75
SW2C3000-3	[45/0/0/-45/0/90/0/90]s	3000	4	2	15380	116.05	155.31
Average					15228	115.41	154.68
Stand. Dev.					248	1.42	1.70
SW3C3000-1	[45/0/0/-45/0/90/0/90]s	3000	4	2	16950	131.79	177.75
SW3C3000-2	[45/0/0/-45/0/90/0/90]s	3000	4	2	17312	133.33	179.69
SW3C3000-3	[45/0/0/-45/0/90/0/90]s	3000	4	2	16650	125.94	168.26
Average					16971	130.35	175.23
Stand. Dev.					331	3.90	6.12

FILLED-HOLE TENSION TEST DATA

Material: T300
 Test temperature: Room Temperature
 Hole Geometry: D=0.25 in
 Washer: Stainless Steel

Spec.No.	Lay-up	CF(lbs)	W/D	Dw/D	Load(lbs)	Strength*(ksi)	Strength**(ksi)
OHT-1	[(0/45/90/-45/)/4]s	open hole	4		9620	41.98	56.61
OHT-2	[(0/45/90/-45/)/4]s	open hole	4		9652	41.72	56.17
Average					9636	41.85	56.39
Stand. Dev.					23	0.18	0.31
SW2D1FT-1	[(0/45/90/-45/)/4]s	Finger Tight	4	2	10036	44.51	60.46
SW2D1FT-2	[(0/45/90/-45/)/4]s	Finger Tight	4	2	10470	15.49	61.36
SW2D1FT-3	[(0/45/90/-45/)/4]s	Finger Tight	4	2	10584	46.08	62.19
Average					10363	35.36	61.34
Stand. Dev.					289	17.23	0.87
SW2D1C500-1	[(0/45/90/-45/)/4]s	500	4	2	9958	43.97	59.56
SW2D1C500-2	[(0/45/90/-45/)/4]s	500	4	2	10556	46.58	62.51
SW2D1C500-3	[(0/45/90/-45/)/4]s	500	4	2	10348	44.61	59.78
Average					10287	45.05	60.62
Stand. Dev.					304	1.36	1.64
SW2D1C1500-1	[(0/45/90/-45/)/4]s	1500	4	2	10270	46.12	61.89
SW2D1C1500-2	[(0/45/90/-45/)/4]s	1500	4	2	10220	45.06	60.99
SW2D1C1500-3	[(0/45/90/-45/)/4]s	1500	4	2	10732	46.82	63.24
Average					10407	46.00	62.04
Stand. Dev.					282	0.89	1.13

* Strength=Load/Gross Area

** Strength=Load/NET Area

FILLED-HOLE TENSION TEST DATA

Material: T300
 Test temperature: Room Temperature
 Hole Geometry: D=0.25 in
 Washer: Stainless Steel

Spec No.	Lay-up	CF(lbs)	W/D	Dw/D	Load(lbs)	Strength*(ksi)	Strength**(ksi)
B5D1C500-1	[(0/45/90/-45)/2]s	500	4	2	5306	50.34	67.47
B5D1C500-2	[(0/45/90/-45)/2]s	500	4	2	5004	48.52	65.21
B5D1C500-3	[(0/45/90/-45)/2]s	500	4	2	5034	48.69	65.71
Average					5115	49.18	66.13
Stand. Dev.					166	1.01	1.19
B5D1C1500-1	[(0/45/90/-45)/2]s	1500	4	2	5020	49.01	65.67
B5D1C1500-2	[(0/45/90/-45)/2]s	1500	4	2	5534	52.26	70.25
B5D1C1500-3	[(0/45/90/-45)/2]s	1500	4	2	4964	50.97	68.56
Average					5173	50.75	68.16
Stand. Dev.					314	1.64	2.32

Spec No.	Lay-up	CF(lbs)	W/D	Dw/D	Load(lbs)	Strength*(ksi)	Strength**(ksi)
B5D1C500-1	[(0/90)4]s	500	4	2	6794	63.28	85.07
B5D1C500-2	[(0/90)4]s	500	4	2	6590	61.59	82.92
B5D1C500-3	[(0/90)4]s	500	4	2	6628	59.63	80.19
Average					6671	61.50	82.73
Stand. Dev.					108	1.83	2.45
B5D1C1500-1	[(0/90)4]s	1500	4	2	6308	59.79	80.22
B5D1C1500-2	[(0/90)4]s	1500	4	2	6290	58.53	78.65
B5D1C1500-3	[(0/90)4]s	1500	4	2	6626	59.37	79.73
Average					6408	59.23	79.53
Stand. Dev.					189	0.64	0.80

FILLED-HOLE TENSION TEST DATA

Material: PM4010 Textile Prepreg
 Test temperature: Room Temperature
 Hole Geometry: D=0.25 in
 Washer: Stainless Steel

Spec No.	Lay-up	CF(lbs)	W/D	Dw/D	Load(lbs)	Strength*(ksi)	Strength**(ksi)
OHT-1	[(45/-45)/(0/90)]s	open hole	4		2044	34.51	46.19
OHT-2	[(45/-45)/(0/90)]s	open hole	4		2177	37.29	49.75
Average					2111	35.90	47.97
Stand. Dev.					9.4	1.97	2.52
SW2FT-1	[(45/-45)/(0/90)]s	Finger Tight	4	2	2412	40.65	54.39
SW2FT-2	[(45/-45)/(0/90)]s	Finger Tight	4	2	2445	41.16	55.07
Average					2429	40.91	54.73
Stand. Dev.					2.3	0.36	0.48
SW2C500-1	[(45/-45)/(0/90)]s	500	4	2	2354	40.55	54.36
SW2C500-2	[(45/-45)/(0/90)]s	500	4	2	2456	41.91	56.16
SW2C500-3	[(45/-45)/(0/90)]s	500	4	2	2406	41.52	55.38
Average					2405	41.33	55.30
Stand. Dev.					5.1	0.70	0.90
SW2C1500-1	[(45/-45)/(0/90)]s	1500	4	2	2618	44.07	58.96
SW2C1500-2	[(45/-45)/(0/90)]s	1500	4	2	2653	46.34	62.06
SW2C1500-3	[(45/-45)/(0/90)]s	1500	4	2	2473	42.13	56.26
Average					2581	44.18	59.09
Stand. Dev.					9.5	2.11	2.90

FILLED-HOLE TENSION TEST DATA

Material: PM4010 Textile Prepreg
 Test temperature: Room Temperature
 Hole Geometry: D=0.25 in
 Washer: Stainless Steel

Spec No.	CF(lbs)	W/D	Dw/D	Load(lbs)	Strength*(ksi)	Strength**(ksi)
OHT-1	open hole	4		4555	39.69	53.19
OHT-2	open hole	4		4594	40.01	53.52
Average				4575	39.85	53.36
Stand. Dev.				28	0.23	0.23
SW2FT-1	Finger Tight	4	2	4413	38.39	51.34
SW2FT-2	Finger Tight	4	2	4455	38.75	51.83
Average				4434	38.57	51.59
Stand. Dev.				30	0.25	0.35
SW2C500-1	500	4	2	4682	40.52	54.11
SW2C500-2	500	4	2	5068	44.27	59.28
SW2C500-3	500	4	2	4494	39.59	53.02
Average				4748	41.46	55.47
Stand. Dev.				293	2.48	3.34
SW2C1500-1	1500	4	2	4843	42.75	57.29
SW2C1500-2	1500	4	2	5082	44.61	59.85
SW2C1500-3	1500	4	2	5017	43.42	57.98
Average				4981	43.59	58.37
Stand. Dev.				124	0.94	1.32

APPENDIX B—DOUBLE-LAP BOLTED JOINT TEST DATA

DOUBLE LAP BOLTED JOINT TEST DATA

Material: TORAY T800H/3900-2 Prepreg
 Test Temperature: Room Temperature
 Hole Geometry: D=0.25 in; W/D=3; E/D=3
 Washer: Stainless Steel

Spec No.	Lay-up	Clamping Force(lbs)	Dw/D	Load(lbs)	Strength*(ksi)
BW-1	[45/0/0/-45/90/0/90/0]s	Pin		1786	67.53
BW-2	[45/0/0/-45/90/0/90/0]s	Pin		1834	69.35
Average				1810	68.44
Stand. Dev.				34	1.29
BW2-1	[45/0/0/-45/90/0/90/0]s	1500	2	3090	119.63
BW2-2	[45/0/0/-45/90/0/90/0]s	1500	2	3286	124.26
Average				3188	121.95
Stand. Dev.				139	3.27
BW2.5-1	[45/0/0/-45/90/0/90/0]s	1500	2.5	3601	136.17
BW2.5-2	[45/0/0/-45/90/0/90/0]s	1500	2.5	3701	139.95
Average				3651	138.06
Stand. Dev.				71	2.67
BW3-1	[45/0/0/-45/90/0/90/0]s	1500	3	3820	144.32
BW3-2	[45/0/0/-45/90/0/90/0]s	1500	3	3982	150.58
Average				3901	147.45
Stand. Dev.				115	4.43

DOUBLE LAP BOLTED JOINT TEST DATA

Material: TORAY T800H/3900-2 Prepreg
 Test Temperature: Room Temperature
 Hole Geometry: D=0.25 in; W/D=2.5; E/D=3
 Washer: Stainless Steel

Spec No.	Lay-up	Clamping Force(lbs)	Dw/D	Load(lbs)	Strength*(ksi)
BW-1	[45/0/0/-45/90/0/90/0]s	Pin		1926	72.83
BW-2	[45/0/0/-45/90/0/90/0]s	Pin		1864	70.48
BW-3	[45/0/0/-45/90/0/90/0]s	Pin		1630	61.64
Average				1807	68.32
Stand. Dev.				156	5.90
BW2-1	[45/0/0/-45/90/0/90/0]s	1500	2	3031	114.62
BW2-2	[45/0/0/-45/90/0/90/0]s	1500	2	3194	120.78
BW-3	[45/0/0/-45/90/0/90/0]s	1500		3051	115.37
Average				3092	116.92
Stand. Dev.				89	3.36
BW2.2-1	[45/0/0/-45/90/0/90/0]s	1500	2.2	3094	116.99
BW2.2-2	[45/0/0/-45/90/0/90/0]s	1500	2.2	2965	112.12
BW2.2-3	[45/0/0/-45/90/0/90/0]s	1500	2.2	3131	118.39
Average				3063	115.83
Stand. Dev.				87	3.29
BW2.5-1	[45/0/0/-45/90/0/90/0]s	1500	2.5	3127	118.25
BW2.5-2	[45/0/0/-45/90/0/90/0]s	1500	2.5	2996	113.29
Average				3062	115.77
Stand. Dev.				93	3.51

DOUBLE LAP BOLTED JOINT TEST DATA

Material: TORAY T800H/3900-2 Prepreg
 Test Temperature: Room Temperature
 Hole Geometry: D=0.25 in; W/D=8; E/D=6
 Washer: Stainless Steel

Spec No.	Lay-up	Clamping Force(lbs)	Dw/D	Load(lbs)	Strength*(ksi)
BW-1	[45/0/0/-45/90/0/90/0]s	Pin		1927	72.72
BW-2	[45/0/0/-45/90/0/90/0]s	Pin		1964	74.12
BW-3	[45/0/0/-45/90/0/90/0]s	Pin		1974	74.49
BW-4	[45/0/0/-45/90/0/90/0]s	Pin		1935	73.02
Average				1950	73.59
Stand. Dev.				23	0.85
BW2-1	[45/0/0/-45/90/0/90/0]s	1500	2	3790	143.03
BW2-2	[45/0/0/-45/90/0/90/0]s	1500	2	3616	136.46
BW2-3	[45/0/0/-45/90/0/90/0]s	1500		3610	136.23
Average				3672	138.57
Stand. Dev.				102	3.86
BW3-1	[45/0/0/-45/90/0/90/0]s	1500	3	4632	175.52
BW3-2	[45/0/0/-45/90/0/90/0]s	1500	3	4432	167.59
BW3-3	[45/0/0/-45/90/0/90/0]s	1500	3	4662	176.29
Average				4575	173.13
Stand. Dev.				125	4.82
BW5-1	[45/0/0/-45/90/0/90/0]s	1500	5	4936	186.65
BW5-2	[45/0/0/-45/90/0/90/0]s	1500	5	5004	189.22
BW5-3	[45/0/0/-45/90/0/90/0]s	1500	5	4962	187.63
Average				4967	187.83
Stand. Dev.				34	1.30
BW8-1	[45/0/0/-45/90/0/90/0]s	1500	8	5437	205.59
BW8-2	[45/0/0/-45/90/0/90/0]s	1500	8	5293	200.15
BW8-3	[45/0/0/-45/90/0/90/0]s	1500	8	5310	200.79
Average				5347	202.18
Stand. Dev.				79	2.97