



DEMONSTRATION OF PHYSICAL SEPARATION/LEACHING METHODS FOR THE REMEDIATION OF HEAVY METALS CONTAMINATED SOILS AT SMALL ARMS RANGES

DISTRIBUTION STATEMENT A
Approved for public release;
Distribution Unlimited

SEPTEMBER 1997

19980414 177

DTIC QUALITY INSPECTED 8

This Document Contains Missing Page/s That Are Unavailable In The Original Document

REPORT DOCUMENTATION PAGE

Form Approved
OMB No. 0704-0188

Public reporting burden for this collection of information is estimated to average 1 hour per response, including the time for reviewing instructions, searching existing data sources, gathering and maintaining the data needed, and completing and reviewing the collection of information. Send comments regarding this burden estimate or any other aspect of this collection of information, including suggestions for reducing this burden, to Washington Headquarters Services, Directorate for Information Operations and Reports, 1215 Jefferson Davis Highway, Suite 1204, Arlington, VA 22202-4302, and to the Office of Management and Budget, Paperwork Reduction Project (0704-0188), Washington, DC 20503.

1. AGENCY USE ONLY <i>(Leave blank)</i>	2. REPORT DATE September 1997	3. REPORT TYPE AND DATES COVERED Technology Demonstration, Nov 1995-Sep 1997	
4. TITLE AND SUBTITLE Demonstration of Physical Separation/Leaching Methods for the Remediation of Heavy Metals Contaminated Soils at Small Arms Ranges		5. FUNDING NUMBERS	
6. AUTHOR(S) BDM Engineering Services Company		8. PERFORMING ORGANIZATION REPORT NUMBER	
7. PERFORMING ORGANIZATION NAME(S) AND ADDRESS(ES) BDM Engineering Services Company 1801 Randolph Road, S.E. Albuquerque, NM 87106		10. SPONSORING / MONITORING AGENCY REPORT NUMBER SFIM-AEC-ET-CR-97047	
9. SPONSORING / MONITORING AGENCY NAME(S) AND ADDRESS(ES) U.S. Army Environmental Center Aberdeen Proving Ground, MD 21010-5401		11. SUPPLEMENTARY NOTES	
12a. DISTRIBUTION / AVAILABILITY STATEMENT Approved for Public Release; distribution is unlimited		12b. DISTRIBUTION CODE	
13. ABSTRACT <i>(Maximum 200 words)</i> The U.S. Army Environmental Center in partnership with the Naval Facilities Engineering Services Center and the U.S. Army Engineer Waterways Experiment Station demonstrated Physical Separation/Leaching methods for the remediation of small arms range soils. The demonstration occurred at Fort Polk, Louisiana. The primary objective was to demonstrate and evaluate the technical capability and document the cost effectiveness of the physical separation/leaching family of technologies. The secondary objective was to identify technology sources, provide implementation guidance and transfer the technology to the user. After conduction a world-wide search, two vendors were selected to demonstrate two variations of the physical separation/leaching technologies. The first using a process based on acetic (weak) acid chemistry and the second based on hydrochloric (strong) acid chemistry. Following completion of the bench treatability studies, each vendor performed a full scale (5-10 tons per hour, 1000 tons total) demonstration of their respective technologies. This report documents the demonstration to include site planning, lessons learned and recommendations for additional developmental work.			
14. SUBJECT TERMS Soil Washing Physical Separation Acid Leaching		Heavy Metals Small Arms Ranges Lead Remediation	Recycling Technology Demonstration
17. SECURITY CLASSIFICATION OF REPORT Unclassified		15. NUMBER OF PAGES 247	
18. SECURITY CLASSIFICATION OF THIS PAGE Unclassified		16. PRICE CODE	
19. SECURITY CLASSIFICATION OF ABSTRACT Unclassified		20. LIMITATION OF ABSTRACT UL	

Final Report

**U.S. Army Environmental Center
Demonstration of Physical
Separation/Leaching Methods
for the Remediation
of Heavy Metals Contaminated Soils
at Small Arms Ranges**

September 1997

This report was prepared for the United States Department of Defense by BDM. The data reported and interpretations made are based on the rules of good science, and are reported here in good faith. However, in no case will either the Department of Defense nor BDM and its subcontractors have any responsibility or liability for any consequences of its use, misuse, inability to use, or reliance on the information in this report, nor does either warrant or otherwise represent in any way the accuracy, adequacy, or applicability of these contents.

TABLE OF CONTENTS

SECTION		PAGE
	EXECUTIVE SUMMARY.....	ES-1
1.0	INTRODUCTION	1
1.1	STATEMENT OF THE PROBLEM WITHIN DOD	2
1.2	BACKGROUND.....	2
1.3	CURRENT SOLUTIONS AVAILABLE.....	3
1.4	POTENTIAL IMPACTS OF BRAC.....	4
1.5	IMPORTANCE OF COST EFFECTIVENESS.....	4
2.0	SCOPE OF WORK.....	6
2.1	OBJECTIVES.....	6
2.2	EVALUATION CRITERIA.....	10
3.0	WORLDWIDE SEARCH.....	11
3.1	OBJECTIVE.....	11
3.2	SEARCH PARAMETERS.....	11
3.3	SEARCH LOCATIONS.....	11
3.4	TECHNOLOGIES FOUND.....	11
3.5	RESULTING PRODUCT.....	13
4.0	DEMONSTRATION BACKGROUND.....	14
4.1	SITE CHARACTERIZATION.....	14
4.2	TECHNOLOGIES CHOSEN.....	17
4.3	PERFORMANCE STANDARDS.....	17
4.4	VENDOR SELECTION.....	19
4.5	TECHNICAL PEER REVIEW.....	20
5.0	ENVIRONMENTAL PLANNING.....	21
5.1	COMMUNICATIONS WITH STAKEHOLDERS.....	21
5.2	REGULATORY DRIVERS.....	21
5.3	PERMITS AND LICENSES.....	27
5.4	NEPA/ENVIRONMENTAL ASSESSMENT.....	28
5.5	OTHER LESSONS LEARNED.....	28
6.0	HEALTH AND SAFETY.....	30
6.1	BASELINE HEALTH AND SAFETY PLAN.....	30
6.2	CONSOLIDATED DOCUMENT (SPCC AND SWPP).....	30
6.3	VENDOR SUPPLEMENTS.....	31
6.4	TRAFFIC MANAGEMENT IN ZONES.....	31
6.5	PERSONAL PROTECTIVE EQUIPMENT (PPE).....	31
6.6	LEAD HEALTH IMPACTS.....	33

TABLE OF CONTENTS (Continued)

SECTION		PAGE
	6.7 RESULTS OF AIR MONITORING	34
	6.8 INCIDENTS	34
7.0	SITE PLANNING	36
	7.1 SPLIT OPERATING SITES - PROS AND CONS	36
	7.2 SITE B-4700 PRIOR USES	36
	7.3 BACKGROUND LEVELS OF LEAD	36
	7.4 PLANNING ELEMENTS NEEDING TO BE ADDRESSED	39
	7.5 SOLUTIONS UTILIZED	39
	7.6 PRECONSTRUCTION CONFERENCE	40
	7.7 SOIL STAGING AND STOCKPILING	41
8.0	SITE PREPARATION	42
	8.1 BLOCK 4700 SITE DESCRIPTION OVERVIEW	42
	8.2 SECURITY FENCING	42
	8.3 OPERATIONS PAD	42
	8.4 STORM WATER HOLDING POND	45
	8.5 SOIL STORAGE BINS	46
	8.6 ELECTRIC UTILITY SERVICE AND METERING	48
	8.7 WATER SERVICE	49
	8.8 WIND SOCK	50
	8.9 SILT TRAP	50
	8.10 BATTELLE SAMPLE PREPARATION AREA	50
	8.11 RANGE 5 EXCAVATION PLAN	51
	8.12 COMPONENTS THAT NEEDED MAINTENANCE, REPAIR AND REPLACEMENT	51
	8.13 SUMMARY	54
9.0	PROCESS CLEANUP STANDARDS	55
	9.1 CONTRACTUAL OPTIONS FOR VENDORS TO BID AGAINST	55
	9.2 IMPACT OF IMPOSING TCLP CRITERIA	56
	9.3 RISK-BASED APPROACH	57
	9.4 CORRELATION OF FIELD VERSUS ANALYTICALLY GENERATED DATA	58
	9.5 ON-SITE LABORATORY CONSIDERATIONS	61
	9.6 SUMMARY	61
10.0	CONCEPT OF OPERATIONS	62
	10.1 CONCEPTUAL PROCESS	62
	10.2 MOBILE VERSUS REGIONAL/FIXED SYSTEMS	64
	10.3 SINGLE VERSUS SPLIT-SITE OPERATIONS	65
	10.4 SUMMARY	66

TABLE OF CONTENTS (Continued)

SECTION		PAGE
11.0	LEACHING ALTERNATIVES UTILIZED	67
11.1	DISSOCIATION CHEMISTRY	67
11.2	PROCESS RANGE	69
11.3	SUITABILITY BY SOIL TYPE	71
11.4	ENVIRONMENTAL IMPACTS OF ACIDS	72
11.5	UNIT COSTS OF ACIDS	74
12.0	PROCESS METHODS	76
12.1	INTRODUCTION	76
12.2	VENDOR 1 PROCESSES	77
12.3	VENDOR 2 PROCESSES	81
12.4	PROCESS LINE ALTERNATIVES	83
12.5	BENCHSCALE TREATABILITY TESTING SCALE-UP	84
12.6	PEER GROUP OBSERVATIONS	86
12.7	SUMMARY	87
13.0	EQUIPMENT RELIABILITY AND EFFECTIVENESS	89
13.1	FEED HOPPERS	89
13.2	ATTRITION SCRUBBERS	90
13.3	LOG WASHERS	90
13.4	JIGS	90
13.5	SAND SCREWS	91
13.6	BELT PRESSES	91
13.7	FILTER PRESSES	91
13.8	LEACHING TANKS	93
13.9	PRECIPITATION TANKS	93
13.10	CLARIFIERS	93
13.11	CENTRIFUGES	95
13.12	SUMMARY	95
14.0	ANALYTICAL METHODS	97
15.0	PROCESS CONTROL	98
15.1	INTRODUCTION	98
15.2	VENDOR 1 PROCESS CONTROLS	99
15.3	VENDOR 2 PROCESS CONTROLS	101
15.4	QUANTITY OF CHEMICALS CONSUMED	101
15.5	OPPORTUNITIES FOR SYSTEM OPTIMIZATION	102
15.6	SUMMARY	102

TABLE OF CONTENTS (Concluded)

SECTION		PAGE
16.0	RESULTS	103
16.1	ACETIC ACID LEACHING	103
16.2	HYDROCHLORIC ACID LEACHING	105
16.3	FATE OF OTHER METALS	107
16.4	SUMMARY	112
17.0	DEMOBILIZATION	114
17.1	HOST EVALUATION OF BLOCK-4700 SITE IMPROVEMENTS AND DISPOSITION	114
17.2	IMPACT OF WEATHER	114
17.3	RANGE 5 BERM RECONSTITUTION	114
17.4	DISPOSAL OF HAZARDOUS WASTE	115
17.5	DEMOBILIZATION AND DECONTAMINATION STRATEGY	116
17.6	DISPOSITION OF RECLAIMABLE METALS	116
17.7	IMPLEMENTATION OF D&D STRATEGY	117
17.8	ACCOUNTABILITY AND FINAL DISPOSITION OF GFE	118
18.0	PUBLIC ACCEPTANCE	121
18.1	WHY THIS IS IMPORTANT	121
18.2	GERMANE OBSERVATIONS MADE IN THE FIELD	121
18.3	POTENTIAL IMPACTS	122
18.4	SUMMARY	123
19.0	COSTS	124
19.1	ENVIRONMENTAL PLANNING COSTS	124
19.2	SITE CHARACTERIZATION	125
19.3	SITE PLANNING COSTS	125
19.4	SITE PREPARATION COSTS	125
19.5	UTILITY CONSUMPTION COSTS	127
19.6	CHEMICAL CONSUMPTION COSTS	128
19.7	DISPOSAL OF HAZARDOUS WASTES COSTS	129
19.8	ANALYTICAL LABORATORY SERVICES COSTS	129
19.9	RECLAMATION OF METALS COSTS	129
19.10	SITE DEMOBILIZATION COSTS	130
19.11	VENDOR COSTS REPORTED	130
20.0	LESSONS LEARNED	135
21.0	SUMMARY	138
22.0	CONCLUSIONS	140

TABLE OF CONTENTS (Concluded)

SECTION		PAGE
23.0	RECOMMENDATIONS FOR FUTURE APPLICATIONS.....	141
23.1	COMPLETE RANGE PROTOTYPE CLEANUP.....	141
23.2	POLLUTION PREVENTION AND PREVENTIVE MAINTENANCE.....	141
24.0	RECOMMENDATIONS FOR ADDITIONAL DEVELOPMENTAL WORK.....	143
24.1	FINAL VERSION OF THE RANGE RULE.....	143
24.2	ACETIC ACID DEMONSTRATION.....	143
24.3	RATE OF OXIDATION TO METAL SALTS.....	143
24.4	POLYMER INTEGRATION.....	143
24.5	REVEGETATION.....	144
24.6	FATE OF OTHER METALS.....	144
24.7	RECLAMATION COSTS.....	144

APPENDICES

A	GENERIC ASSESSMENT CONSIDERATIONS
B	EPA'S FINAL MILITARY MUNITIONS RULE
C	ANALYTICAL DATA SETS
D	VENDOR 1 FINAL REPORT
E	VENDOR 2 FINAL REPORT
F	ACRONYMS
G	GLOSSARY
H	CONVERSION FACTORS, NON-SI UNITS OF MEASUREMENT

LIST OF FIGURES

FIGURE		PAGE
1	Demonstration Program Plan	8
2	Range 5 Pop-up Target Coffins	15
3	Soil Washing Process Flow Diagram	22
4	Hazardous Materials Storage and Consumption Vendor 2 Hydrochloric Acid Demonstration	23
5	Estimated Runoff Pond Volume Acetic Acid Demonstration	30
6	Estimated Runoff Pond Volume Hydrochloric Acid Demonstration	31
7	Operations Area (B-4700)	32
8	Site B-4700 Prior to the Demonstration	37
9	Surface Lead Distribution	37
10	Lead Distribution (Depth 8 - 12 inches)	37
11	Background Lead Profile Prior to Site Mobilization Block 4700 Ft. Polk, LA	38
12	North - South Profiles	43
13	East - West Profiles	44
14	Site Security Fencing	45
15	Operations Pad Block 4700	45
16	Storm Water Holding Pond	46
17	Block 4700 Operations Site Pad Details	47
18	Soil Storage Bins	48
19	Power Distribution Station	49
20	Water Supply System	50
21	Wind Sock	50
22	Sample Preparation Shed	51
23	Soil Drying Oven	52
24	Berm Extraction Lane Range 5	52
25	Range 5 Extraction Plan	53
26	Battelle ICP vs. Battelle X-RF; $Y=0.35X+122.23$, $R^2=0.04$	60
27	Battelle ICP vs. BESCORP X-RF; $Y=1.13X+22.89$, $R^2=0.57$	60
28	ICP vs. X-RF (All Data); $Y=0.75X+75.54$, $R^2=0.23$	60
29	TCLP vs. Total (Pb) Acetic Acid Demonstration; $Y=0.03X-1.48$, $R^2=0.98$	60

LIST OF FIGURES

FIGURE		PAGE
30	TCLP vs. Total (Pb) Hydrochloric Acid Demonstration; Y=0.40X+0.01, R ² =0.24	60
31	Soil Input Feed Hopper	89
32	Attrition Scrubber	90
33	Mineral Jig	91
34	Sandscrew	92
35	Frame Filter Press	92
36	Fines Leach Tanks	93
37	Reactor-Clarifier Tank	94
38	Precipitation Tank	94
39	Centrifuge	95
40	Levels of Copper in Range Soil (Acetic Acid Leaching)	108
41	Levels of Antimony in Range Soil (Acetic Acid Leaching)	109
42	Levels of Zinc in Range Soil (Acetic Acid Leaching)	109
43	Levels of Copper in Range Soil (Hydrochloric Acid Leaching)	110
44	Levels of Antimony in Range Soil (Hydrochloric Acid Leaching)	111
45	Levels of Zinc in Range Soil (Hydrochloric Acid Leaching)	111
46	Total Lead and TCLP Lead Treatment Results (Acetic Acid Demonstration)	112
47	Total Lead and TCLP Lead Treatment Results (Hydrochloric Acid Demonstration)	113
48	Former Holding Pond Area	114
49	Berm 3 Regraded	115

LIST OF TABLES

TABLE		PAGE
1	Listing of Technology Vendors	12
2	Background Profile Samples Across Lookout Road from Range 5	16
3	Background Profile Samples Block 4700	16
4	Wet Sieve Analysis Comparisons on Range 5 Soil	17
5	Airborne Acetic Acid Vapor Concentration.....	27
6	Air Monitoring Results Acetic Acid Demonstration	34
7	Air Monitoring Results Hydrochloric Acid Demonstration.....	34
8	Analytical X-RF and ICP Results of Processed Soil	59
9	Reagent Unit Costs for Hydrochloric Acid Leach Demonstration	75
10	Total and TCLP Lead in System Input and Output Soil (mg/kg and mg/L respectively), Acetic Acid Demonstration	103
11	Approximate Mass Balance of Soil.....	105
12	Total and TCLP Lead in System Input and Output Soil (mg/kg and mg/L respectively), Hydrochloric Acid Demonstration ..	106
13	Remediation Goals for Antimony and Copper in mg/kg	107
14	Total and Soluble Levels of Copper in Range Soil in mg/kg and mg/L respectively (Acetic Acid Leaching)	108
15	Total and Soluble Levels of Antimony in Range Soil in mg/kg and mg/L respectively (Acetic Acid Leaching)	108
16	Total and Soluble Levels of Zinc in Range Soil in mg/kg and mg/L respectively (Acetic Acid Leaching)	109
17	Total and Soluble Levels of copper in Range Soil in mg/kg and mg/L respectively (Hydrochloric Acid Leaching).....	110
18	Total and Soluble Levels of Antimony in Range Soil in mg/kg and mg/L respectively (Hydrochloric Acid Leaching).....	110
19	Total and Soluble Levels of Zinc in Range Soil in mg/kg and..... mg/L respectively (Hydrochloric Acid Leaching).....	111
20	Results of Removal of Other Metals of Concern	112
21	Soil Wet Sieve Analysis Acetic Acid Demonstration	115
22	GFE List	119
23	Generic Remediation Phases.....	124
24	Overall Costs by Subtask	125
25	Costs Incurred During Site Preparation	126

LIST OF TABLES (Concluded)

TABLE		PAGE
26	Approximate Cost for Individual Reagents (Acetic Acid Leaching)	128
27	Approximate Cost for Individual Reagents (Hydrochloric Acid Leaching)	128
28	Line Item Demobilization Costs	130
29	Hydrochloric Acid Leaching Demonstration Costs	130
30	Estimated Cost for Operation	134

ACKNOWLEDGMENTS

This major project undertaking was truly a joint effort by both the U.S. Army and the U.S. Navy, with the kind support of the Environmental Security Technology Certification Program (ESTCP) of the Office of the Secretary of Defense.

Within the Army, both the U.S. Army Environmental Center (AEC), located at Aberdeen Proving Ground, Maryland, and the staff of the Environmental and Natural Resources Division at Fort Polk, Louisiana, provided strong support, guidance, direction, and encouragement. Within the Navy, the Naval Facilities Engineering Services Center (NFESC) at Port Hueneme, California, provided similar strong support. Within the Department of Defense, the Defense Evaluation Support Activity (DESA) also provided similar strong support.

The Environmental Management staff at Fort Polk, and especially Dr. Charles Stagg, Mr. Greg Prudhomme, Dr. Christine Hull, and Mr. David Marsh, served as excellent hosts for the two demonstrations, and without their support and good advice, this project would not have been successful. We are especially grateful for their contributions. In addition, the local community support for this effort, especially ESP, Tanner Construction Company, and Sherry Labs is greatly appreciated.

Special thanks is deserving to the following persons:

- ◆ Major Greg Wright, Mr. Sean McMorrow, and Mr. John Verner of DESA
- ◆ Ms. Joan Vandervort of ATSC
- ◆ Mr. Rick O'Donnell and Ms. Lisa Miller of AEC
- ◆ Ms. Barbara Nelson of NFESC
- ◆ Mr. Mark Brica of the U.S. Army Corps of Engineers Waterways Experiment (WES)
- ◆ BDM's Al Beckett of the BDM staff at Fort Polk who served for a year as our site superintendent
- ◆ Fort Polk BDM's Don Loftis, Jim Walding, and Leah McConnell
- ◆ Battelle's Eric Drescher, Arun Gavaskar, Dan Janke, and Emmett Black
- ◆ ASI's Martin Vorum
- ◆ Peer Review Group members Richard Kunter, Douglas Halbe, and Dr. Manoranjan Misra
- ◆ ContraCon's Tom Leggiere, Don Lance, and Rusty Foyle
- ◆ BESCORP's Al Brice, Craig Jones and many others
- ◆ Albuquerque BDM's John Toohey, Bernie Lauctes, Brad Rudd, Lori Long, Leta Babb, and Marshall Nay.

Thanks everyone,

Gary Sams
Subtask Leader

EXECUTIVE SUMMARY

This report describes a major undertaking with the potential for DoD-wide application and more. Detailed investigations, to include two different demonstrations of commercial technology sets, were carried out in an effort to fully understand the mechanisms of soil washing for the removal of metals from contaminated soils at small arms firing ranges. The principal heavy metal of concern is lead, but other associated metals are also of concern; these include copper, antimony, and zinc. Copper is a common jacketing material for the bullets, and the other two metals are used as hardeners with the lead.

At this time, there are approximately 2,600 small arms firing ranges in the DoD. Most are active, but as the DoD infrastructure downsizes, more of these ranges are moving to the categories of inactive, closed, and transferred. With this change in nomenclature comes the regulatory impacts for cleaning up such properties to stringent standards. Remediation tools previously used to address such environmental remediation requirements have included excavation and landfilling, on-site stabilization, and surface capping. Each of these can be effective, but the one concern they have in common is that the lead and other heavy metals that contaminate the soil, and possibly local surface waters, are not recovered and returned to beneficial economic reuse. Instead, these metals remain in the soil, representing future long-term liabilities. Also, with the land ban now in effect for these metals, treatment is required prior to placing them in a landfill, which can be costly. Further complicating the matter is that,

with the infrastructure downsizing, those remaining installations are host to a broader cross-section of missions. Many installation master plans are being revised to accommodate a myriad of mission realignments and many land use changes. As a result, there is more interest in removing these metals from the soil, so as to not to pose future land use restrictions.

The soil washing technology set is a transferred technology from the mining industry and typically involves two actions. The first is physical separation, in which some of the metals and the sand fractions are removed from the soil mass; the second is acid leaching, in which the majority of the remainder of metals are removed from the fines fraction of the soil mass. Depending on the unique soil chemistry at any given site, acid leaching may also be applied to the sand fractions. With significant improvements in the effectiveness of this technology set having been reported, this project effort attempted to scope that level of capability in the private sector, choose two promising methods, and demonstrate such at a DoD range under as close to actual operational conditions as possible. The demonstrations were accomplished at Fort Polk, Louisiana, on an active firing range. The strong support and assistance provided by the Fort Polk's Environmental Management staff contributed greatly to the success of this effort.

The first major task accomplished was a worldwide search for commercial companies and technology sets that could potentially provide such services to the DoD. As a result of

this search, 75 firms were identified and grouped into eight different categories. In February 1997, an independent technical report was published with this information. After detailed characterization of the range soil at Fort Polk and a careful review of the performance criteria and specific technologies desired to be evaluated, two vendors were selected. The first vendor was to demonstrate the potential effectiveness of a soil washing system utilizing acetic acid as the leaching agent, and the second vendor was to demonstrate a parallel system, but using hydrochloric acid as the leaching agent. ContraCon Northwest, which performed the acetic acid leaching demonstration, is referred to as Vendor 1 in the body of this technical report. Brice Environmental Services Corporation (BESCORP), which performed the hydrochloric acid leaching demonstration, is referred to as Vendor 2.

Significant site planning and site preparation to include NEPA documentation; health and safety plan; storm water pollution prevention plan; and, spill prevention, control, and countermeasures plans had to be developed and executed to support these demonstrations. Site preparation activities included constructing a sidebermed impervious asphalt-paved operations pad and a storm water holding pond, and providing major utility connections, security fencing, weather shelters for the soil, and more.

Both demonstrated systems performed satisfactorily in removing total lead. However, the acetic acid system did not consistently meet the TCLP criterion for lead nor operate consistently at steady state conditions, while the hydrochloric acid system did. The measurement units used to describe the support infrastruc-

ture, processing equipment, soil movement, and more are, for the most part, expressed in the common English system routinely used in the remediation and construction industry in the CONUS today. We recognize that there is some interest in the SI system. To aid those who wish to visualize the performance reported here in such unit nomenclature, a conversion table is provided in Appendix H.

The two pilot scale plants employed in the field for the demonstrations were essentially field scale prototypes capable of operating at soil throughput rates of at least 10 tons per hour. As an example, the hydrochloric acid leaching system operated at approximately 6 tons per hour, and the input soil had a total lead load that averaged approximately 3,500 mg/kg. Output total lead levels averaged approximately 200 mg/kg, producing a removal rate of better than 90 percent. In addition, the TCLP criterion for lead was always satisfied and averaged approximately 2 mg/L. Similar successful removal of the other three metals of concern reasonably paralleled the observations for lead.

Because the range that hosted these demonstrations was an active range adjacent to other active ranges, in the interest of safety and not interrupting training schedules, a split site profile was adopted. The extra logistics requirements this generated added to project costs and should be avoided in the future, if possible.

Many lessons were learned during these operational demonstrations, the more significant of which included:

- ◆ A relationship exists between total lead concentrations and TCLP values. As performance standards are determined, this must be kept in mind in order to specify realistic

goals. This relationship will vary from soil to soil and needs to be evaluated during characterization and benchscale testing. For the soils at Fort Polk, total lead at or about 300 mg/kg would seem to satisfy the TCLP criterion (5 mg/L).

- ◆ The concentration of lead in the soil on small arms ranges will vary, and one must expect to encounter hot spots.
- ◆ This technology set generates a number of by-products, one of which can be the generation of hazardous waste.
- ◆ The potential exists to change the grain size distribution of the final processed soil, especially if significant attrition washing methods are employed that will produce more soil fines.
- ◆ This technology set is not just specific for lead, but will, in fact, remove many other heavy metals.

This technology set is essentially a soil recycling activity: It can readily be done on site to remove the metals from the soil (which can then be returned to the range to be reused for its original beneficial purpose), and the metals removed can be resmelted and returned to economic reuse. These metals are commodities that have real economic value if the concentrations recovered are high enough, although this value and concentration is market driven and varies.

There was concern that the final processed soil would not serve as an effective construction material and would not support revegetation. We were very sensitive to this, but found that we were able to use it to reconstruct the berms from which it came, and the material supported revegetation well. Soil erosion problems have not manifested themselves.

Because of Fort Polk's high humidity and the acidic nature of its soil, many of the bullet metals had been oxidized from their metallic form to the ionic salt form. This is a concern, because in the ionic salt form, their solubility in water is much greater, and the potential for them to be mobile in the hydrologic cycle is a greater risk. In soils with high clay content, most such ions will be quickly adsorbed to the clay plate surfaces, and thus migration to groundwater is an extremely low risk. However, movement in surface water runoff is a much greater risk. At the beginning of this project, the end-result focus was to determine if installations could cost-effectively use this technology set for full-scale remediation at contaminated sites. We determined that such was indeed the case. However, we now recognize that there is another application for this technology set, and that is as a pollution prevention tool—by performing periodic range maintenance and removing the bullet fragments while they are still in their metallic state and before they begin to oxidize to the ionic salt form. This process can be done at a much lower cost than the full-scale application, involving physical separation with acid leaching, by just accomplishing physical separation alone. The maintenance cycle period will be range specific and will have to be determined.

Based on the success of this demonstration, this technology set should be very applicable to other DoD ranges for full-scale remediation assignments. Independent efforts are under way now, via the Interstate Technology and Regulatory Cooperation (ITRC) Working Group, to demonstrate to Federal and state regulatory groups the capabilities of this new technology set and to satisfactorily demonstrate

its effectiveness, implementability, and cost competitiveness.

Thus, the basic issue becomes cost effectiveness. Because of the high site preparation and equipment mobilization costs associated with this technology, the unit costs will vary depending on the scope of the project. Much data were collected during these demonstrations in an effort to begin defining parametric relationships, and such are reported in Section 19. It seems that the minimum mass of soil required to warrant a mobile system being set

up at an installation is 15,000 tons. At this level, the soil could probably be processed (both physical separation and acid leaching) for less than \$200 per ton (our scale-up forecast \$177 per ton). In addition, the rules of quantity of scale apply here: The greater the mass of soil to be processed, the lower the unit cost. Our Vendor 2 has forecast even slightly lower unit costs and, for physical separation alone, has forecast \$40 per ton as possible. The Naval Facilities Engineering Service Center's Independent Evaluator has also studied this topic and has forecast similar unit costs.

Technical Report

FINAL REPORT
**U.S. ARMY ENVIRONMENTAL CENTER DEMONSTRATION OF PHYSICAL SEPARATION/
LEACHING METHODS FOR THE REMEDIATION OF HEAVY METALS
CONTAMINATED SOILS AT SMALL ARMS RANGES**

1.0 INTRODUCTION

This report addresses the significant efforts put forth during an 18-month investigation and demonstration of the use of physical separation and acid leaching technologies to remove heavy metals from soils on small arms firing ranges. Technical and economic issues were investigated for applying this innovative remediation technology set. When used in the context of this report, this technology set, routinely referred to as soil washing, implies a combination of physical separation and acid leaching together in an integrated series of compatible unit processes.

This work was performed on behalf of the Defense Evaluation Support Activity (DESA) and largely consisted of a technology demonstration in which the investigative rules of good science were adhered to. Among the principal deliverables was a comprehensive Worldwide Search Report that has already been published. This effort attempted to identify in detail the parallel efforts being conducted by others to minimize duplication of effort and identify sources that had successfully performed similar services for others. DESA performed this work on behalf of the U.S. Army Environmental Center (USAEC). Financial support for this effort was provided by the Environmental Security Technology Certification Program (ESTCP) of the Office of the Assistant Undersecretary of Defense (ADUSD-ES/ET).

The primary work performed during this project consisted of physically demonstrating

two different commercially-based physical separation/acid leaching processes in the field. The intent was to select the two processes from the commercial sector that appeared to have the most promise for application to Department of Defense (DoD) needs, demonstrate them under realistic field conditions on-site, measure all applicable parameters, document the removal efficiencies achieved, and predict the life cycle capital and operating costs. The Naval Facilities Engineering Service Center (NFESC) and their contractor, Battelle, served as the independent evaluator of the field demonstration efforts.

The demonstrations were conducted at Ft. Polk, Louisiana. The support of the hosts at this installation is gratefully acknowledged here. Much of the demonstration's success was because of the support and stewardship the staff of the Ft. Polk Environmental Management office provided to the project team.

Two different processes were demonstrated at Ft. Polk. One process was based on acetic acid leaching technology, and the other was based on hydrochloric acid leaching technology. Thus, both a weak acid and a strong acid were used independently of one another. The results achieved were different and are reported in detail later in this report. The pilot scale footprint of the equipment sets demonstrated here used a 90' x 130' (27.4 m x 39.6 m) impervious pad, and processed soil at rates of up to 8 tons (7260 kg) per hour. For the first demonstration, 269 tons (244,000 kg) of soil were pro-

cessed. For the second demonstration, 834 tons (756,000 kg) of soil were processed. Putting this in context, cleaning up a typical small arms range today will involve operating at throughput rates between 10 and 20 tons of soil per hour, with a total tonnage of soil processed being between 10 and 20 thousand tons of soil total. Thus, the equipment used in these pilot scale demonstrations is fairly close to what would be employed at an actual small arms range cleanup, except that it would be operated for much longer periods of time. The target metal of greatest concern was lead. Other metals were of concern as well, and these other metals are addressed in this report, in Section 16.3.

1.1 STATEMENT OF THE PROBLEM WITHIN DOD

Best estimates available are that there are some 2,600 small arms ranges within the DoD today. A small arms range is a range that supports the discharge of hand- and shoulder-fired weapons firing 50 caliber bullets or less. Examples include the M-1, M-14, and M-16 rifles and the 38 and 45 caliber and 9 mm pistols. Most of these ranges are active, but many are inactive, closed, transferred, or scheduled to be closed and/or transferred as the DoD infrastructure downsizes. Moreover, many have been in operation since World War I and have received limited major scheduled maintenance. As a result, there has been a steady accumulation of metals, mostly lead. However, other metals such as copper, antimony, and zinc are a potential concern. Because military bullets are almost always jacketed, it was noted that such could be contributing to a higher rate of metal salts found in soils today.

Common jacketing material is either steel or copper, with the latter being predominant. It was observed that at Ft. Polk, such bullets had the copper oxidized and much of the lead was gone from the bullets, oxidized and transported as a lead salt into the soil with the hydrologic cycle. This dissimilar metal activity, or galvanic cell reaction, may be contributing to enhanced problems on military ranges today. At Ft. Polk, the soil has a high moisture content and acidic conditions prevail. This is discussed in more detail in Section 4.1. As a result, over the years there has been an accumulation of metals on these ranges and in the surrounding environment. The result has been a build up of metals in soils.

1.2 BACKGROUND

From an environmental safety and health perspective, the accumulation of such metals can become a risk because of the toxicity associated with them. Not only do they interfere with certain metabolic processes in humans, such as the kidneys, they can also adversely impact the central nervous system. Moreover, they can accumulate in food chains in ecosystems. Lead has most visibly been singled out. Its negative side effects to human health are widely recognized and currently addressed in many laws and regulations.

These metals, often referred to as heavy metals, are regulated under the Resource Conservation and Recovery Act (RCRA). Currently RCRA regulated heavy metals include arsenic, barium, cadmium, chromium, lead, mercury, selenium, and silver. Detailed toxicity tests have been performed on these metals, and toxicity thresholds have been established that can be measured for via the Toxicity Characteristic

Leaching Procedure (TCLP). Should concentrations reach or exceed these published values, then the material, if it is to be discarded, becomes categorized as a RCRA hazardous waste. This has serious implications when one must deal with it at a closing small arms firing range. During these demonstrations, lead became the target metal of concern. Its published TCLP value is 5.0 mg/L. This level was established as one of the two processing goals to work towards in the demonstrations reported here. The principal goal was to reduce the total lead level to two optional concentrations of either 1,000 or 500 mg/kg lead.

This decision was based on literature reviews of the spectrum band of levels achievable with systems, and not on any specific regulatory imposed cleanup level. Moreover, this level is for total lead, not leachable lead measured as TCLP. Reviewers need to be sensitive to the fact that there is a soil and site-specific relationship that exists between total and TCLP lead levels, and such harmony needs to be identified and included in cleanup standards. This is a major lesson learned and is addressed in Section 20.0

1.3 CURRENT SOLUTIONS AVAILABLE

There have been some accepted methods for dealing with the cleanup of heavy metals from soils on small arms ranges. The three most common methods that have been applied have been:

- ◆ Excavation and landfill
- ◆ On-site stabilization with polymers and cements
- ◆ Surface capping.

These solutions are beginning to lose favor for a variety of reasons. Excavating and

landfilling has been a frequently applied strategy for many years and should always be considered when searching for a solution, because it may offer some initial economies. However, it is not a permanent solution, as the target pollutant is still in the mass of material disposed, and can represent a future liability. In addition, the landban rules are now fully in effect, and there are prohibitions against such action. For more information, reviewers should refer to 40 CFR 268.x, specifically 268.40. Such material must be treated to not exhibit a toxic characteristic (i.e., the TCLP value must be reduced to less than 5.0 mg/L). This could impact costs in the future. On-site stabilization offers much potential benefit on a short-term basis. Reviewers need to be cautioned that if stabilization chemicals are added to soils to tie up soluble metals, the increased mass of soil that will result could require regrading of the job site to maintain positive control of surface runoff from storm water and routine grounds maintenance. In addition, such stabilization may not last forever and could make follow-up treatment for removal of contaminants and/or volume reduction much more difficult and costly. Thus, leaching could commence again and require treatment. Also, should land use change, the contaminant will still be present and may become an issue as the environmental assessment for the projected new use is considered. In some instances, capping the area might be a worthwhile approach. It is a readily executable technology, but can be costly and may input the future use of land. If the water table at the site is high, excessive annual maintenance costs could be significant.

1.4 POTENTIAL IMPACTS OF BASE REALIGNMENT AND CLOSURE (BRAC)

As the DoD reduces its infrastructure size, the potential for such action to impact the technologies applied to cleaning up small arms ranges increases. Since 1991, there have been four BRAC rounds. As a result, 97 installations have been directed to close, and multiple hundreds of organizational realignments have been directed. Even now, there is discussion of a fifth round of such action to occur, although no timetable has been announced, and such action will require additional enabling legislation. For installations that are closing and as their land and real property improvements are transferred to civilian control with the hopes of new economic use, there are situations that definitely involve changes of land use. This greatly impacts the manner of remedial action applied. Solutions that only immobilize the lead in the soil for long periods of time may not be well received in the future. Solutions such as soil washing that actually remove the lead and associated heavy metals from the soil and ambient environment so there are no pathways for exposure to future land users seem much more acceptable, because they offer permanent solutions that do not expose the DoD to future liabilities.

The key determining factor besides methods and procedures that can be readily applied without risk of environmental consequence is cost effectiveness.

1.5 IMPORTANCE OF COST EFFECTIVENESS

At the end of the last decade, the driving goal of the DoD's Installation Restoration Program (IRP) was to have every contaminated

site in long-term remediation by the turn of the century. A few years ago, the fiscal realities of the DoD budget became apparent. Efforts were made to reduce the number of paper studies being done and to attempt partnering with the regulators, installations, neighboring communities, and other stakeholders via Remediation Advisory Boards (RABs) in the interest of cost consciousness. In addition, relative risk management tools began to be applied, so that limited remediation funds were only spent on sites that truly represented the greatest risk to the human population and the local ambient environment/ecology.

This fiscal realization has placed a tremendous new focus on innovative remedial technology development. As early as 1991, the Air Force (via its laboratory complex at Tyndall AFB in Florida) and the Environmental Protection Agency (EPA) sat down and began scoring all the technologies that had surfaced as remediation method candidates. The result of this collaboration was a report entitled "Remediation Technologies Screening Matrix and Reference Guide" (EPA 542-B-93-005, July 1993). Much effort was put into EPA's Superfund Innovative Technology Evaluation (SITE) Program, and a number of non-profit clearinghouses were established. During this same time period, DoD's ESTCP was established. Cost is definitely a factor today.

There are new technologies that appear to have much potential on paper, or at the laboratory scale, and there are technologies that work in the field at the pilot scale. The issues are what they cost, and whether they can be scaled up and operated efficiently. This is a close parallel to conducting constructibility and maintainability reviews of construction projects

before they are built. In the case of this technology set's two demonstrations, it was observed that the technology set worked in the field at the pilot scale. The pilot scales used in these two demonstrations are essentially a scale fairly close to the visioned product, and one system operated for a long enough period of time to collect data that will allow investigators to predict how the technologies would handle full scale operational assignments.

With regards to operating costs, there was an informal goal to attempt to scale up the

actual operating costs for a prototype to less than \$200 per ton (\$0.22 /kg) of soil processed. This appears achievable; however, reviewers should not take this out of context. There are many work elements associated with a cleanup, and it is easy to take a number out of context and make a serious project programming error. An attempt was made to define the application of costs in Section 19 and establish a common baseline for reviewers. Please review this section in close detail before attempting to apply this technology set to satisfy a requirement.

2.0 SCOPE OF WORK

This project was comprised of several tasks. The initial tasking was to search and identify all physical separation/acid leaching technologies for the removal of heavy metals from small arms ranges, and to investigate their technical and economic applicability. This effort would then culminate with the demonstration of two selected technology systems based on specific evaluation factors.

2.1 OBJECTIVES

The objectives of the Soil Washing/Acid Leaching Demonstration were to perform a Worldwide Search for manufacturers of soil remediation equipment using physical separation/leaching technology; to select two vendors to demonstrate the physical separation/leaching remediation technologies at a Ft. Polk, Louisiana small arms range; and then to plan, conduct, and report on these demonstrations. In support of the above objectives, BDM developed the necessary program and environmental planning, together with site planning and site preparation.

The Worldwide Search was performed to identify suppliers of soil remediation equipment and companies that have successfully completed similar remediation projects for the separation of lead and associated heavy metals (primarily copper, antimony, and zinc). During the study, 75 companies were identified and categorized into eight general technology areas, including acid leaching, soil washing, solidification/stabilization, chemical treatment, solvent extraction, electro-technologies, steam injection technologies, and other potentially applicable technologies. A report on this was published February 7, 1997.

A source selection process was conducted to identify and select, based on established criteria, described in Section 2.2, two vendors with the most appropriate technologies for the execution of the Ft. Polk demonstrations. The first process sought for demonstration was a physical separation and an acetic acid leaching technology as specified in the Statement of Work (SOW), and the second was a physical separation and an acid leaching technology other than acetic acid. Pursuing two different acids was based on the interest of whether or not one would be more effective than the other chemically and/or economically, and also to determine if there were any health and safety benefits of one over the other. This source selection process was designed to identify those firms with a record for successful performance that could reliably, safely, and economically remove the lead from Ft. Polk small arms range soils using one of the specified technologies.

After selecting the full scale remediation processes, benchscale treatability studies were conducted to confirm the operational concepts and to select and size the unit processes to be employed; the effort then culminated with the demonstration of each technology at Ft. Polk and the evaluation of the performance of those technologies based upon pre-established processing criteria. These criteria were established in the SOW, and in the subsequent vendor contracts were not to exceed 1000 mg/kg for total lead and to satisfy TCLP criteria for lead for the acetic acid leaching demonstration; and, not to exceed 500 mg/kg for total lead, and to satisfy TCLP criteria for lead for the hydrochloric acid leaching demonstration.

As part of the overall evaluation of the technology demonstrations, two independent

technical experts, one from academia and one from industry, were to be selected for peer reviews and to provide technical papers for subsequent publication in support of the demonstrations. Two other subject matter experts, one from the consulting community, and one

from the U.S. Army Corps of Engineers Waterways Experiment Station, augmented the peer review team.

The schedule of this demonstration project is illustrated in Figure 1, the Demonstration Program Plan.

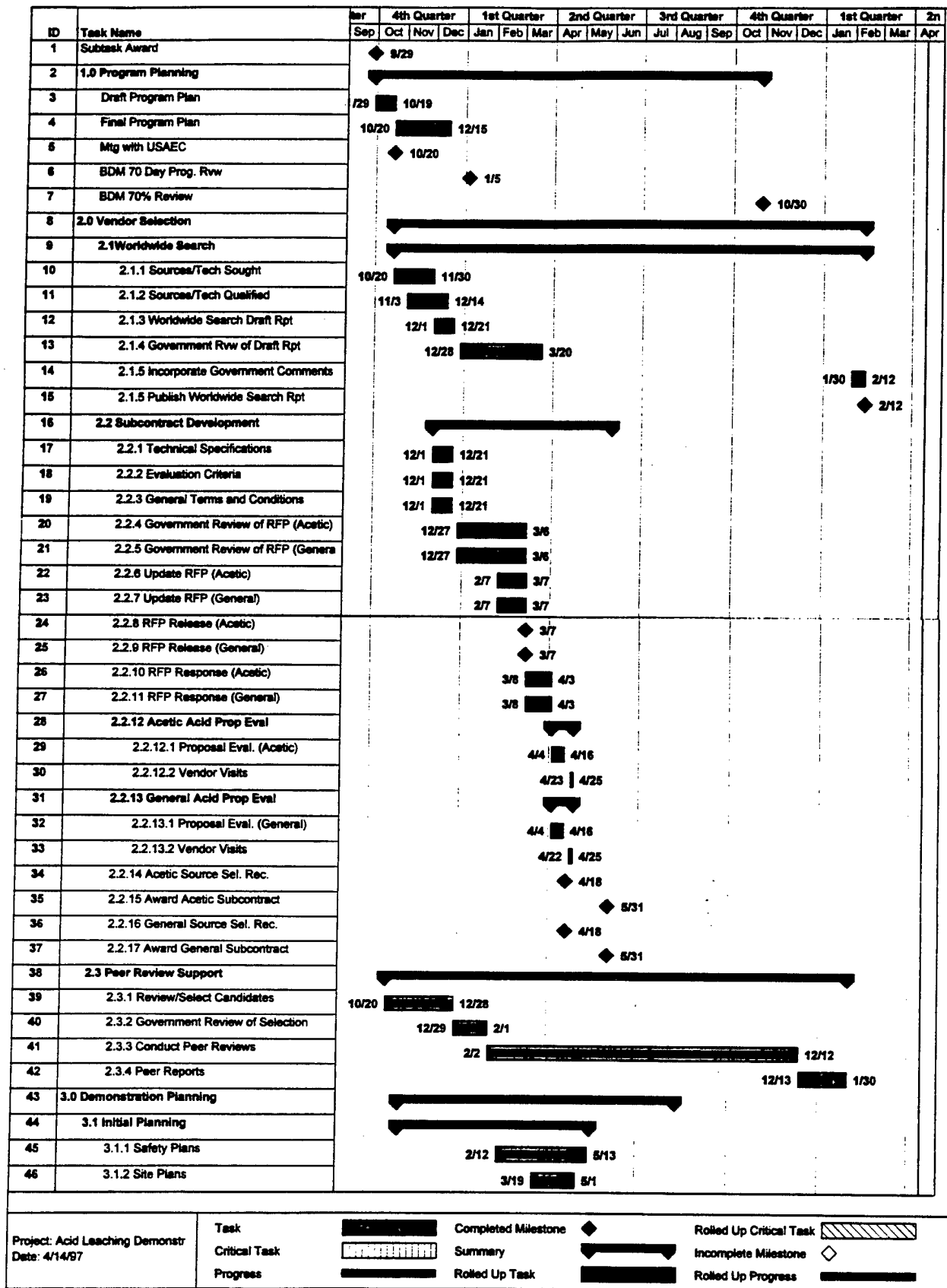

Figure 1. Demonstration Program Plan

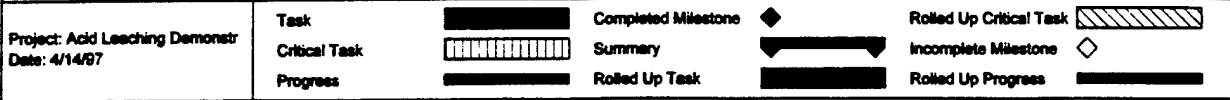
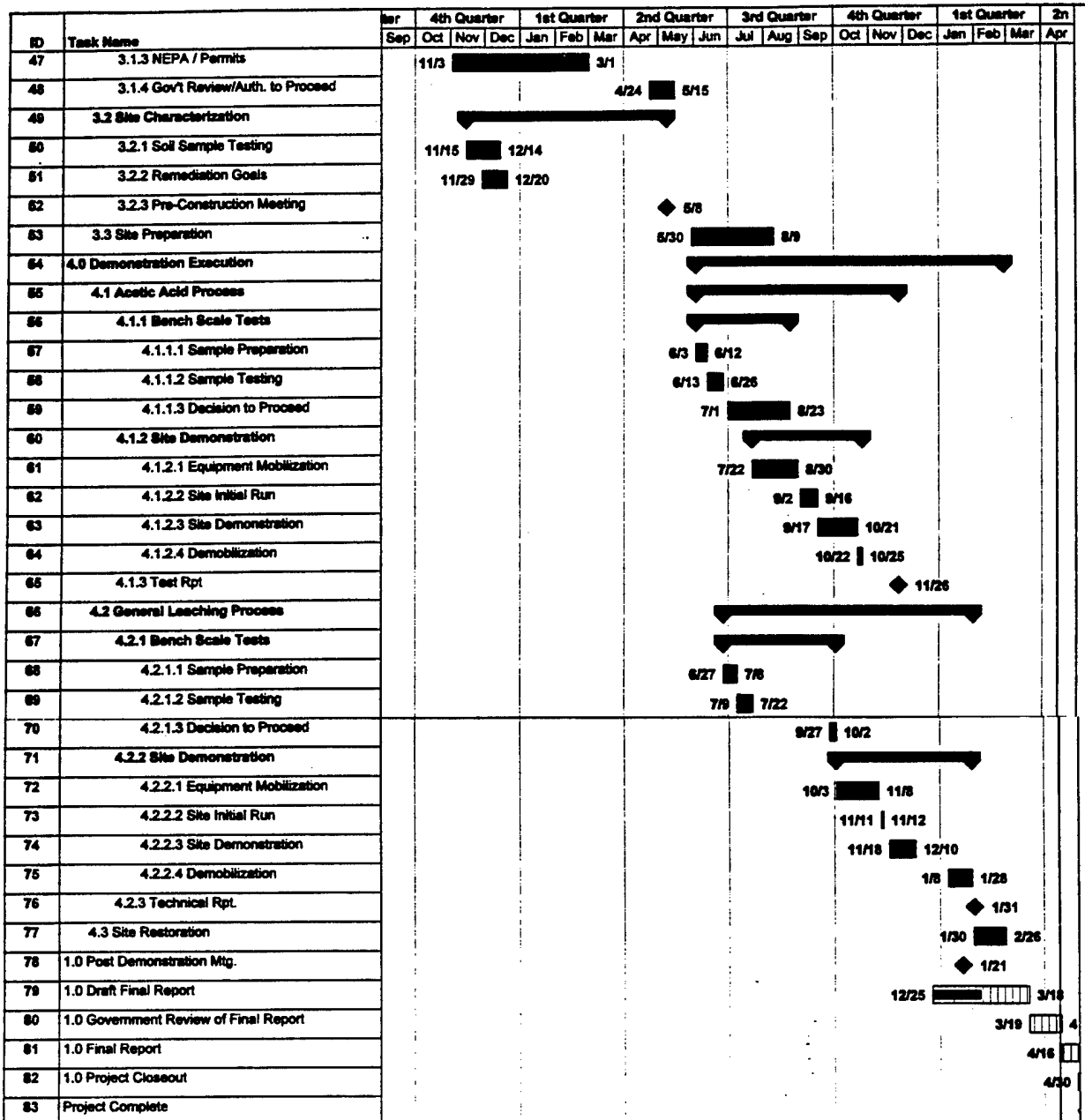

Figure 1. Demonstration Program Plan (Concluded)

2.2 EVALUATION CRITERIA

During the vendor source selection process, BDM developed a detailed SOW and evaluation criteria for both of the demonstrations to be conducted at Ft. Polk. These criteria were intended to identify those firms that could best meet the technical and cost performance objectives of the demonstrations. These same criteria were also used by Battelle in their evaluation of the demonstrations conducted for the NFESC. These evaluation criteria included:

- ◆ Mechanism of operation (physical separation/acid leaching)
- ◆ Unit cost
- ◆ Projected operational costs
- ◆ Projected maintenance and upkeep costs
- ◆ Required facilities support for installation (site construction/preparation, electrical, plumbing, etc.)
- ◆ Projected public, regulatory, and user acceptance
- ◆ A demonstrated ability to remediate soils contaminated with heavy metals or compounds with similar chemical properties to regulatory acceptable concentration levels
- ◆ Technical approach and understanding of the physical separation/acid leaching process as it applies to treatment of heavy metals contaminated soils
- ◆ Reliability data or projected reliability
- ◆ Safety considerations
- ◆ Cost per ton of remediated soil
- ◆ Cost to participate and perform in the treatability demonstration
- ◆ Projected cost to remediate the site at Ft. Polk
- ◆ Projected cost of decommissioning the equipment.

3.0 WORLDWIDE SEARCH

An initial tasking of this project was to execute a worldwide search to identify manufacturers of soil remediation equipment using physical separation/leaching technology and produce a stand-alone report of the findings.

3.1 OBJECTIVE

The Worldwide Search was performed to identify and evaluate suppliers of soil remediation equipment and contractors who had successfully completed similar remediation projects. The study objective sought out those technologies and vendors with a high probability to achieve a significant volume reduction in lead contaminated soil by successfully processing the majority of the soil and producing a metal concentrate to be recycled.

3.2 SEARCH PARAMETERS

The study examined a wide variety of soil separation technologies that are available or could have potential for remediation efforts similar to that at Ft. Polk. Many variations of soil separation technologies were considered. However, for the purposes of conducting this project and focusing on the specific demonstration requirements at Ft. Polk, priority was given to physical separation and acid leaching technologies. Priority was also given to successful demonstrations that have used full scale or large pilot plant processes. A wide number of information sources, including experts at government and Research and Development (R&D) institutions, libraries, professional journals, the Commerce Business Daily, on-line services, academia, and industry contacts, were used to complete the search.

3.3 SEARCH LOCATIONS

During the Worldwide Search, the investigators focused their study efforts on technologies that had been demonstrated within the United States, Canada, Europe, and Australia since the preponderance of work accomplished to date has been performed in those locations. Given the exponential growth of information available on-line, a major portion of the search was conducted via the Internet. Domestic and international servers were accessed and searched in an effort to provide as complete coverage of the market as possible. A listing of the Internet sites searched was provided in the Worldwide Search Report to assist individuals interested in other environmental problems or other technologies not considered in this search.

3.4 TECHNOLOGIES FOUND

The Worldwide Search identified several suppliers of soil remediation equipment and companies that have successfully completed similar remediation projects for the separation of lead and associated heavy metals (primarily copper, antimony, and zinc). During the study, 75 companies were identified and categorized into eight general technology areas, including acid leaching, soil washing, solidification/stabilization, chemical treatment, solvent extraction, electro-technologies, steam injection technologies, and other potentially applicable technologies. Table 1 presents a listing of the vendors that were identified by general category. Identified technologies and vendors often overlap or fall into more than one category, but for the purpose of the search, vendors were placed in what was determined to be their predominant category.

Table 1. Listing of Technology Vendors**ACID LEACHING**

ACCEL Industrial and Mineral Processes Ltd.
 ADI/Tallon
 Center for Hazardous Material Research
 Cognis, Inc.
 Earth Decontaminators, Inc. (EDI)
 Earth Treatment Technologies, Inc.
 IT Corporation
 Lewis Environmental Services Inc./Hickson Corp.
 Lockheed Corporation

SOIL WASHING TECHNOLOGIES

AEA Technology
 Alternative Remedial Technologies, Inc.
 Benchem
 Bergmann USA
 Biogenesis Enterprises, Inc.
 Biotriol, Inc.
 Brice Environmental Services Corp. (BESCOP)
 Canonie Environmental Services Corp.
 ENSR Consulting and Engineering
 Geochem Division of Terra Vac
 Geocycle Environment, Inc.
 Harbauer
 Heidemji Utivoering
 Heijman Milieutechniek BV
 HMZ Bodemsanering BV
 Hydriplex, Inc.
 Intera
 Kinit Enterprises
 Lockheed Corporation
 MARCOR Management, Inc.
 Metcalf & Eddy
 Montana College of Mineral Science & Tech.
 New Jersey Institute of Technology
 On-Site Technologies, Inc.
 Pittsburgh Mineral & Environ. Tech., Inc.
 Risk Reduction Engineering Laboratory
 Scientific Ecology Group
 Smith Environmental Technologies Corp.
 Soil Technology, Inc.
 Technology Scientific, Ltd.
 Toronto Harbour Commission
 Tuboscope VETCO Environmental Services
 Western Environmental Science & Technology
 Westinghouse Remediation Services, Inc.

SOLIDIFICATION/STABILIZATION

Advanced Remediation Mixing, Inc.
 ANDCO Environmental Processes, Inc.
 Best Sulfur Products
 ContraCon Northwest
 GEOCON, Inc.
 Monteverde Inc.
 PSI Technologies
 RMT, Inc.
 Solucorp
 STC Omega, Inc.
 TECHTRAN Environmental, Inc.
 WASTECH, Inc.
 West Central Environmental Consultants

CHEMICAL TREATMENT TECHNOLOGIES

CORPEX Technologies, Inc.
 Davy International, Environmental Div.
 Delphi Research, Inc.
 ETUS, Inc.
 Integrated Chemistries, Inc.
 Severson Environmental Services, Inc.
 Solucorp Industries, Ltd.
 Viking Industries

SOLVENT EXTRACTION

Terra-Kleen Response Group, Inc.
 University of Houston

ELECTRO TECHNOLOGIES

Battelle Memorial Institute
 Electrokinetics, Inc.
 IT Corporation

STEAM INJECTION TECHNOLOGIES

Hughes Environmental Systems, Inc.

OTHER TECHNOLOGIES

ASI Environmental Technologies, Inc.
 Center for Hazardous Materials Research
 Filter Flow Technology, Inc.
 Risk Reduction Engineering Laboratory

3.5 RESULTING PRODUCT

A standalone report that documents the results of the Worldwide Search was published on February 7, 1997. The report briefly discusses the principal technologies that were involved in the search and presents the results of the 75 firms identified. The discussions on

each of the companies provides a brief description of the primary technology and projects in which the company is involved, highlights or features of the specific technology application, limitations of the technology, and other comments relative to the firm and the projects it has completed.

4.0 DEMONSTRATION BACKGROUND

The purpose of this section is to describe the site chosen for this demonstration and the two technologies that were chosen; including, how many potential vendors were identified, how many responded, and the selection criteria used. The performance standards for each of the two demonstrations are discussed as well.

4.1 SITE CHARACTERIZATION

Two sites were ultimately characterized for this demonstration. Initially, Range 26 was characterized. After reconsideration by the installation, Range 5 was chosen for the demonstration and was subsequently characterized. A considerable amount of the data that were obtained for Range 26 also applied to Range 5 and were very useful to the project effort. These data principally involved the commonality that existed between the metal oxides and metal salts in this regional humid and acidic environment.

While both ranges were primarily used for small arms fire, other activities had occurred on both ranges over the years. No unexploded ordinance was found on either range although grenade fragments and dummy land mines used for training aids were observed and cleared by the installation's EOD staff.

Over the years, a considerable amount of topsoil and other soil stabilizers, such as asphalt emulsion, had eroded off the top of the berms. Range 26 had a single berm that was mostly a natural ground rise and used as the impact bank. The erosion of the topsoil covering had left a patina of metal fragment enriched material right on the surface. In erosion gullies, these had concentrated into a metal placer

material with lead alloy bullets with copper jacketing present as well as a considerable amount of copper jacketing material with the lead alloy corroded away from the jacket. Some of the copper jacketing was coated with a green sulfide salt; however, the majority of the copper had a black oxide coating. Microscopy of these fragments indicated that a shrinking core model of galvanic corrosion of the lead alloys has been taking place over the years. The bullet fragments had a copper jacket with the lead alloy in contact with the copper corroded into lead carbonate salts containing some antimony salts and antimony blebs. The interior of the fragment was still a metallic lead alloy. The lead had frequently been alloyed with antimony as a hardener. The antimony was slower to corrode than the lead. The lead alloy in contact with the copper jacketing in the presence of moist low pH soils (4.5) was corroded primarily into a lead carbonate salt, white colored in appearance. The presence of substantial quantities of relatively soluble lead carbonate salts in both ranges indicated that a weak acid, such as acetic acid, could be effective in leaching these salts and thereby useful in remediating the site.

The Waterways Experiment Station (WES) had conducted experimental work that confirmed the mechanism of lead corrosion into a salt. Additionally, WES had conducted a considerable number of profile samples on Range 26 to determine the contamination depth.

Range 5 was chosen as more representative of an active range at Fort Polk. There were many similarities with Range 26. The lead salts and the corrosion mechanisms with the copper jacket shells were identical to Range 26. There were three berms at Range 5. The second and

third berms were the largest and were ultimately chosen to provide the material for the vendor characterization samples as well as the actual demonstration tonnages. Range 5 had pop-up target coffins present on the back side of the berms as well as buried electrical conduits and concrete vaults. Figure 2 shows pop-up target coffins on Berm 2 of Range 5. Since sufficient material was present without disturbing these fixtures, the material for the demonstrations was taken from the front of the berms. Both Berm 2 and Berm 3 had been surface dressed in the past and partially constructed with imported gravel material. Broken road asphalt had been used to top dress Berm 2, probably to suppress dust during range use. Berm 3 had a red nodules dressing in portions of the berm. This apparently imported material would have been relatively unremarkable except that it also contained elevated lead con-

centrations and was relatively coarse in size, which could cause some difficulty during processing.

Depth profile samples were taken of cross sections of all three berms to determine the depth of lead contamination for subsequent stripping as process feed material. The lead contamination was concentrated in the top 6 inches of soil and decreased considerably with depth. A 12- to 14-inch-deep strip for process material was judged to be adequate to remove the lead contaminated soils.

Samples were taken across the road from Range 5, analysis results are shown in Table 2. These samples were found to have higher antimony contents than lead contents. This would be consistent with the sample area having been used as an exercise area some time in the past (40 to 50 years) as the lead that originally would have been 20 or so times more abundant than



Figure 2. Range 5 Pop-up Target Coffins.

Table 2. Background Profile Samples Across Lookout Road from Range 5

Sample Identification	Lead mg/kg	Copper mg/kg	Antimony mg/kg
R5B WA	5.2	11.1	9.8
R5B WB	2.8	6.9	10.6
R5B WC	4.3	6.6	12.9
R5B EA	7.8	13.6	11.4
R5B EB	4.3	7.7	11.3
R5B EC	3.5	8.2	11.5

0063G_18

the antimony had leached away, leaving the more persistent antimony. On an installation such as Ft. Polk, which has had continual use over a very long period time as a major training center, there is likely to be a high background level of lead contained in the soils.

Background profile samples were also taken of the process operations area, which was designated as B-4700. Analysis results are shown in Table 3.

This area had been used in the past as a major cantonment area for the reception, processing, and training of new recruit soldiers. There were as many as 27 definitive two-story wooden barracks and supporting parking lots and ancillary facilities. The buildings had utilized lead soldered pipes and lead paint. Two wooden structures were reported as having been burned as part of a fire training exercise. The balance of the buildings were demolished. As a result, there were some elevated areas of lead contained in the soils of the process site that existed prior to any current processing activities. We observed levels in the 50 mg/kg range in this area with hot spots in the 300 mg/kg range. These results are discussed in more detail in Section 7.3.

Bulk samples were obtained from Range 5 for some abbreviated testing to provide actual leach and sizing data to the vendors. This information had already been provided from Range 26 in considerably more detail in the original Request for Proposal (RFP). The test data from Range 5 were made available, along with a bulk sample, to the short list of vendors being considered by the selection team. A second composite sample of soil from Berm 2 and Berm 3 was provided to the two chosen vendors for their benchscale tests.

Table 4 shows the results of the sieve analyses obtained by Battelle compared with the results reported by both vendors on benchscale test samples sent to them by BDM.

One of the issues associated with this demonstration project was the amount of fines (i.e., silts and clays in the target contaminated soil) and the associated amount of ionic lead salts contained. Fines are considered any soil material that will pass through the number 200 mesh sieve (74 micron). The original soil classification work was accomplished on Range 26 in

Table 3. Background Profile Samples Block 4700

Sample Identification	Arsenic mg/kg	Lead mg/kg	Copper mg/kg	Beryllium mg/kg
TA1A	<10	18.4	8.1	<0.2
TA1B	<10	7.8	7.0	<0.2
TA1C	<10	7.0	5.3	<0.2
TA2A	<10	245.0	6.7	<0.2
TA2B	<10	217.0	5.4	0.2
TA3A	<10	47.9	5.1	<0.2
TA3B	<10	6.9	5.8	<0.2
TA3C	<10	6.7	6.5	<0.2
TA4A	<10	8.3	6.8	0.2
TA4B	<10	6.2	5.5	<0.2
TA4C	<10	5.2	8.3	<0.2
TA5A	<10	46.8	10.0	<0.2
TA5B	<10	5.9	3.7	<0.2
TA5C	<10	17.1	4.3	<0.2

0063G_25

Table 4. Wet Sieve Analysis Comparisons on Range 5 Soil

Battelle Screen Size	Battelle % Distribution	Vendor 2 Screen Size	Vendor 2 % Distribution	Vendor 1 Screen Size	Vendor 1 % Distribution
> 3/8"	2.1%				
3/8" x 4M	5.3%	> 4M	7.83%	> 1/4"	3.4%
4 x 8M	1.1%	4 x 20M	1.66%	1/4" x 20M	2.3%
8 x 50M	15.2%	20 x 60M	0.15%		
50 x 100M	47.2%	60 x 140M	55.87%	20 x 100M	63.7%
100 x 200M	13.5%	140 x 200M	6.94%	< 100M	30.6%
< 200M	15.6%	< 200M	27.56%		

Battelle Sample Date: 9/7/96

Vendor Samples: Composite Benchscale Test Sample taken by BDM in June 1996.

0063G_26.AI

March 1996. This effort showed that although the value jumped around somewhat, an average of approximately 31 percent weight fraction in the fines category, with the fines containing approximately 2900 mg/kg of lead. Later, when the host project range was changed to Range 5, this value decreased considerably to an average value of 5 percent, with a range in values from a low of slightly more than 1 percent to a high of 10 percent. This supplemental testing was accomplished in April 1996, and reported in May 1996.

As stated, a representative sample of soil from Range 5 was collected and sent to Vendor 1 for benchscale testing as a part of their treatability study. Their sieve analysis (reported on July 24, 1996) showed that 30.6 percent of the soil sample passed a 100 mesh sieve.

The independent evaluator (Battelle) sampled soils going into Vendor 1's unit process train during the demonstration, and reported that the percent fines was approximately 16 percent.

Representative soil samples from Range 5 were also sent to Vendor 2 for their benchscale

treatability testing. Their sieve analysis results were reported in August 1996. These results showed the following for fines, based on a percentile weight fraction:

- ◆ Berm 2: 23 percent
- ◆ Berm 3: 24 percent.

The average lead concentration in these fines was approximately 1800 mg/kg.

In summary, the percentage of fines in the soil to be processed varied greatly from Range 5, but was less than reported in the RFP SOW for Range 26.

4.2 TECHNOLOGIES CHOSEN

As specified in the subtask SOW, two remediation technologies were to be demonstrated at Ft. Polk. The first involved a physical separation process coupled with an acetic acid leaching process. The second was to be a physical separation process with another acid leaching agent. Vendor 1 was selected to perform the physical separation/acetic acid leaching demonstration, and Vendor 2 was selected to perform the demonstration with the alternative leaching acid. Vendor 2 proposed a physical separation process coupled with a hydrochloric acid leaching system, which was accepted as the alternative acid leaching process. Both pilot processing plants were to be designed to process 10 tons of soil per hour.

4.3 PERFORMANCE STANDARDS

Performance standards for each of the two demonstrations were detailed in the Technical Performance Specifications for that demonstra-

tion. These standards, except for the specification of the acid to be used in the leaching process, were identical and included environmental, process, and performance requirements. The performance standards for total lead removal provided vendors alternatives to bid against (1000 mg/kg base and 500 mg/kg optional). The contracting officer could choose the one desired and it did not have to be the same for both demonstrations. The specifications guidelines were based on preliminary soil and contaminant characterization and benchscale testing that had been performed by the U.S. Army WES at Vicksburg, Mississippi, and Advanced Sciences, Inc. under a subcontract to BDM. Each of the demonstrations was to treat 1,000 tons [later changed to 15 days of operational performance, which offered vendors the opportunity to actually exceed the 1000-ton goal] of berm materials from the demonstration site so that it could be returned to the site for continued use as an active small arms range.

Each of the vendors selected was first required to perform a benchscale treatability test on Range 5 soils in order to demonstrate that they could adequately perform and satisfy the processing criteria specified for their demonstration. Moreover, these data were to be used to choose the unit processes to be deployed to the field at Fort Polk. The resulting report was to document performance for all metals, and was to also address the scale-up of the system and the chemicals such as bases, flocculents, and polymers that were to be used.

Analyses included evaluation of the TCLP results from the process. Only after acceptance of the benchscale test report were the demonstrations to proceed.

The intent of the demonstrations was to utilize as much modular unit process equipment as possible, in order to support the concept of mobility and minimize site mobilization and demobilization costs.

On-site fabrication was to be kept to a minimum. Each vendor was required to have supervisory personnel attend a 40-hour Environmental Compliance Officer course that was provided by the staff at Ft. Polk. The vendors' process equipment was required to provide secondary containment for each acid leaching tank or hazardous chemical holding tank, and such containers and piping had to be labeled as to content. At the conclusion of mobilization, the vendor was required to proceed with an initial run, limited to approximately 10 tons to validate the start-up process and demonstrate that the process meets minimum specifications for the removal of lead. Each of the vendors was then allowed 8 weeks to process the remaining stockpile of range soils. The vendor was required to properly store, mark, and dispose of any hazardous wastes and hazardous recyclable materials generated. Upon completion of the demonstration, each of the vendors was to demobilize and clean the site within 2 weeks of receipt of the authorization to demobilize. During the operation, each of the demonstrations was required to reduce the total lead content of the soils to be returned to the range to less than 1000 mg/kg for total lead during the acetic acid leaching demonstration; and, 500 mg/kg for total lead during the hydrochloric acid (non-acetic) demonstration. During both demonstrations, TCLP criteria were to be satisfied. Recovered lead was to be processed by an approved recycler.

All vendor operations were required to comply with applicable local, state, federal, and Army regulations in the mobilization, on-site construction, operation, and demobilization of their process equipment. All operations were to be in accordance with the conditions imposed by any Environmental Safety and Health permits and authorizations. More detail on the individual processes, equipment used, and results obtained for each of the demonstrations is detailed in subsequent sections of this report. Within 30 days of conclusion of the demobilization, each of the vendors was to provide a report on the results of the demonstration. The report was to include data and requisite analyses of all process results, a discussion of the management of wastes generated, an inventory of all materials used, an assessment of the costs of the demonstration, and potential full-sized applications in the future, significant occurrences, "lessons learned" from the demonstrations, and a summary and assessment of activities involved in the mobilization and demobilization processes.

These reports are included in the Appendices to this technical report.

4.4 VENDOR SELECTION

The following describes the procedures used to select the demonstration vendors.

4.4.1 CBD Sources Sought

A sources-sought announcement was placed in the Commerce Business Daily (CBD) in November 1995. Fifty-one vendors responded to the CBD announcement, and their inputs were used in the Worldwide Search as well as the subsequent vendor selection process.

4.4.2 Request For Proposal

Based upon the standards discussed in paragraph 4.3, an RFP for each of the demonstrations was developed and provided to 19 vendors on March 7, 1996. The 19 vendors were selected from the sources developed as a result of the CBD sources sought announcement and Worldwide Search as the firms having the technology and experience best suited to the demonstration requirements at Ft. Polk. The RFPs consisted of a detailed Technical Performance Specification, Site Characterization Data, Evaluation Criteria, a Vendor Selection Questionnaire, and the accompanying model contractual documentation. Six proposals for each of the two demonstrations were received on April 3, 1996. Proposals were received from the following firms for each of the demonstrations:

ACETIC ACID LEACHING

- ◆ Scientific Ecology Group
- ◆ Metcalf & Eddy
- ◆ ContraCon Northwest
- ◆ Environmental Technologies International
- ◆ TVIES
- ◆ Cognis

GENERAL ACID LEACHING

- ◆ Pittsburgh Mineral & Environmental Technology
- ◆ Metcalf & Eddy
- ◆ ContraCon Northwest
- ◆ Environmental Technologies International
- ◆ BESCORP
- ◆ Cognis

4.4.3 Source Selection Process

The three principal objectives of the source selection were to choose highly qualified vendors for each of the demonstrations, minimize

technical and management risks, and meet budget targets. Each of the proposals was evaluated by the Source Selection Panel composed of individuals with experience in environmental, mining, and process technologies. The initial review was a technical review only of the proposals aimed at rating the technical merit, technical risk, management, and management risk of each of the proposals. Scores were given in each of the four areas and totaled. Selected proposals were provided to the Peer Review Group, for further evaluation. Questions developed during the review process were provided to the vendors for response and subsequent evaluation by the source selection panel. Concurrently, major references were checked for the higher scoring proposals. Costs were then evaluated and compared with the technical merit and risks associated with each of the proposals. Recommendations were then made to the source selection authority (BDM Subtask Leader) and approved. On April 18, 1996, the results of the source selection process were presented to the USAEC. The evaluation process, the strengths and weaknesses of each proposal, the evaluations, and the selections were discussed in detail. Three preferred vendors were recommended for visits to verify their capabilities, incorporate changing range requirements, and conduct final negotiations. These vendor pre-award visits were conducted from April 23 to April 25, 1996. At the conclusion of the visits, contracts were awarded to ContraCon Northwest (Vendor 1) for the physical separation/acetic acid

leaching demonstration, and to BESCORP (Vendor 2) for the physical separation/general (hydrochloric) acid leaching demonstration.

4.5 TECHNICAL PEER REVIEW

To provide information of the highest possible quality to DESA and the USAEC, a peer review panel of two technical experts from academia and industry were identified to support this effort. Dr. Manoranjan Misra from the Department of Chemical and Metallurgical Engineering, the Mackay School of Mines at the University of Nevada, Reno, and Mr. Doug Halbe, an international metallurgical consultant to the mining industry, were selected for the Peer Review Group. Both of these individuals are published and have recognized expertise in several of the technical areas critical to the performance and evaluation of the soil washing demonstrations at Ft. Polk. Representative areas of their expertise include lead chemistry, gravity-dependent separation processes, surface chemistry-dependent separation processes, and size-dependent separation processes.

As the project progressed the Peer Review Group was provided site characterization data and benchscale test data, and they visited each of the field demonstrations to observe and evaluate the process, equipment, and overall operations for each of the demonstrations. Finally, each of the Peer Review Group members contributed to the preparation and publication of technical papers that discuss the demonstrations and their results and conclusions.

5.0 ENVIRONMENTAL PLANNING

This section addresses environmental planning efforts for this project. National Environmental Policy Act (NEPA) considerations, as well as a number of complex compliance issues involving EPA and DoD policy rulings were considered. Specifically, these are the EPA's "Military Munitions Rule," which is now final (40 CFR Part 260, February 12, 1997), and the DoD's "Range Rule," which at the time of the writing of this report is not yet in final form. These will be addressed in more detail in this section, and in Appendices A and B. Each small arms range must be considered as a unique facility resource and evaluated independently against appropriate criteria.

5.1 COMMUNICATIONS WITH STAKEHOLDERS

In the planning and execution of this demonstration it became clear from the very beginning the BDM team needed to work closely with the installation commander's staff, which was entrusted with the environmental stewardship of the installation. This principally was the staff of the District Public Works office, especially the Environmental Management staff. This installation has a critical training mission that is operated in the midst of a national forest that is closely monitored by the Department of Agriculture's U.S. Forest Service and was the home to an endangered species, the red cockaded woodpecker. Communication with interested agencies was through the Environmental Management office, and they kept stakeholders aware of the facts and circumstances of the Project activities. The installation maintained a very disciplined hazardous materials and hazardous waste management

program and required Project supervisors to attend and successfully complete a week-long environmental compliance course before operations could commence. Among the many activities they assisted us with was coordinating on our behalf with the Louisiana Office of Environmental Quality (LADEQ) board who visited our site twice to observe operations. The Ft. Polk Environmental Management Office authorized the use of their EPA identification number for this project, and they monitored progress on a regular basis.

5.2 REGULATORY DRIVERS

In the past, range maintenance has been more related to human safety issues than ecological/environmental issues. Examples include berm repair in response to erosion; removal of gross accumulated bullet mass and equivalent to avoid ricochet potential; target repair; and clearing of unexploded ordnance if the range had supported exercise events. Major preventive maintenance and pollution prevention initiatives are fairly recent initiatives. It has only been recently that contamination remediation has become an item of interest with matters that relate to Formally Used Defense Sites (FUDS) and BRAC-driven requirements, influenced by RCRA.

As previously discussed, the principal heavy metal of concern in these scenarios is lead (Pb). However, other metals of concern can exist, and are discussed in detail in Section 16.3. Lead is the target contaminant of concern in all the deliberations on the subject of range maintenance. If large quantities of lead contaminate the soil, and the TCLP value is 5.0 mg/L or greater, the reuse of the land can be greatly restricted. Although not a RCRA regu-

lated metal, copper can display undesirable environmental characteristics, and is toxic to some degree to certain species in aquatic ecosystems. As an example, it has been used in the past to control algae in surface bodies of water. During the course of these demonstrations, its presence and concentration changes was documented and these results are presented in Section 16.3. In addition, the leaching process demonstrated here is not just specific for lead, but will impact other heavy metals. During the application of these processes on range soils, the potential for concentration of all RCRA metals was observed. No thresholds were exceeded, as these metals were only present in minute background concentrations, but reviewers must remain sensitive to such a potential.

The soil washing processes demonstrated here include a combination of physical separation and acid leaching and are basically soil recycling operations. Figure 3 demonstrates the generic unit processes involved.

As one can see from the flow diagram, there are five by-products from this process series. Different vendors may have different specific unit processes, but the process train has the same series of by-products, including:

- ◆ **Clean soil** to go back to the range from which it came and be used for the same beneficial purpose it was previously serving (most likely a berm)

- ◆ **Reclaimable metals** to go to a recycler to recover the metals and put them back into the economy for beneficial reuse
- ◆ **Solid waste** that needs to be properly disposed of in a landfill or other acceptable means. An example of solid waste includes vegetation removed from the soil that has total and TCLP values below action levels.
- ◆ **Hazardous waste** that needs to be sent to a licensed Treatment, Storage, and Disposal Facility (TSDF) for proper treatment and disposal. An example of hazardous waste is processed soil, the TCLP value of which exceeds the action level. Another example would be recovered metals, the concentration of which is not sufficient to warrant being processed by a reclaimer/recycler.
- ◆ **Process washwater** will need to be disposed of at the end of the operation. Commercial

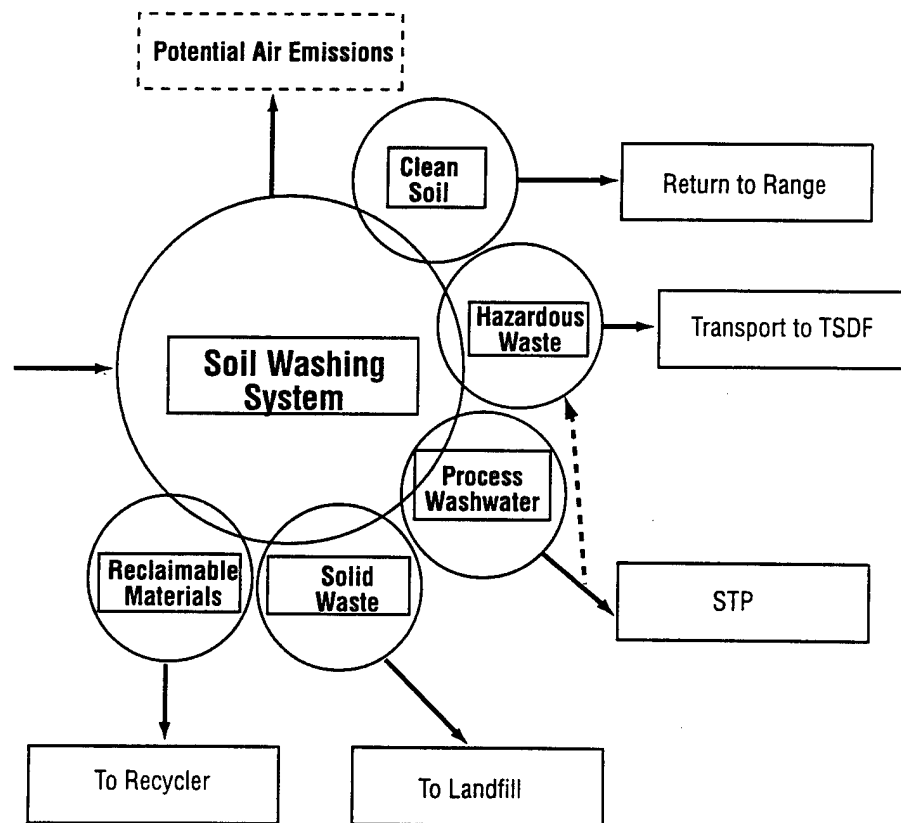

Figure 3. Soil Washing Process Flow Diagram

0063G_05

systems should be able to clean up the water internally so that its parameters (pH, pb, and TDS) are benign and it can be discharged to a STP/Publicly Owned Treatment Works (POTW) or permitted for discharge to a receiving stream. If not, it could become a hazardous waste.

In addition, the unit processes will have washwater that will have to be handled and disposed of after its chemical potential has been consumed. In one of the demonstrations, the process washwater could not be treated within the unit, possibly because of antagonistic reactions between the two polymers that had been used earlier in the recycling process. As a consequence, this water had to be removed from the site and disposed of as a hazardous waste at great cost, as the volume was approximately 25,000 gallons. In the second demonstration, the washwater could be treated and discharged to the sanitary sewer. Also, depending on the acid used in the leaching process, vapors can be emitted that could cause a concern. Moreover, the process requires large volumes of both acid and bases to be stored on-site. For these demonstrations there normally was approximately 5,000 gallons stored on-site at a time. Figure 4 displays the volume of hydrochloric acid (HCl) and sodium hydroxide (NaOH) stored and consumed during the second demonstration. As a consequence, Emergency Planning and Community-Right-to-Know Act (EPCRA) requirements could be triggered.

From the many dozens of environmental acts and regulations that have been established, the following are the major ones that impact the application of this technology set, listed and discussed in order of significance:

- ◆ NEPA
- ◆ RCRA (Potentially)
- ◆ Clean Water Act (CWA)
- ◆ Clean Air Act (CAA)
- ◆ EPCRA

Certainly, NEPA must always be considered when dealing with such activities. A blanket document cannot be produced, but a generic document for programmatic purposes can be presented; however, it must be evaluated for its site-specific impact. A first effort to prepare such a document is included in Appendix A. The potential application of a Categorical Exclusion (CATEX) with a Record of Environmental Consideration (REC) is a possibility. Provisions for such are described in Chapter 4 of AR 200-2.

RCRA has the single greatest potential impact on the application of this technology

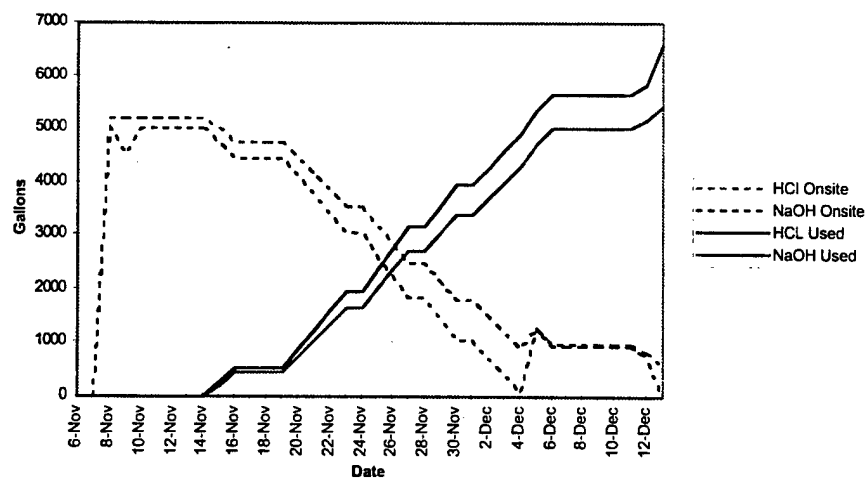

Figure 4. Hazardous Materials Storage and Consumption Vendor 2 Hydrochloric Acid Demonstration

set especially at closed and transferred ranges. The salient point here is that the lead in the soil could satisfy the criteria of a RCRA characteristic hazardous waste (D-008), based on toxicity, by not satisfying the TCLP criteria (5.0 mg/L). Both the EPA and the DoD have attempted to add clarity to this point by releasing procedural rulings on this important matter. As previously described, the EPA has now finalized its "Military Munitions Rule" (40 CFR Part 260, February 12, 1997). The DoD's proposed "Range Rule" was released on March 19, 1996. A final rule is expected in the fall of 1997. They are mutually supportive. An interpretive review of the EPA's Military Munitions Rule is included in Appendix B.

CWA concerns must be addressed when considering applying this technology set to a range cleanup assignment. By its very nature, soil washing can be a messy process, and care must be taken to ensure that spills and system leaks are controlled and prevented. These systems employ closed loops of process washwater that are enhanced by acids and polymers. Both pilot scale systems employed for the demonstrations addressed here contained approximately 20,000 gallons of washwater. The weak acid system, utilizing acetic acid, operated with a pH as low as 3.1. The strong acid system, utilizing hydrochloric acid, operated with a pH as low as 1.5. Make-up water was required on a daily basis during system operations, due to not only evaporation, but also to water loss with the soil being processed.

One vendor was monitored and used approximately 80 gallons of make-up water per ton of soil processed. Every effort was made to control moisture content in the final soil

through a variety of dewatering systems ranging from sand screws to a centrifuge. Nonetheless some water went with the final clean soil. The target moisture content in the final processed soil was approximately 20 percent, but it was not always achieved. The 20 percent value was chosen because this allowed the soil to be handled fairly readily as a construction material by the equipment available at the site. Sooner or later the spent process washwater will have to be disposed of properly. The equipment employed for both demonstrations was designed to treat this water so that it could be safely disposed of via the nearby sewer with the permission from the sewer treatment plant officials.

Reviewers contemplating applying this technology set to their own future requirements need to plan this action well and prior to mobilization. If discharge to a sewer is not a viable option, then permitting discharge to a receiving stream may be a possibility. However, if that receiving stream is a source of water for public consumption of drinking water via a water treatment plant, this option would be less feasible. The closed loop processing system observed with this project for process washwater, during the second demonstration, was able to reduce the lead concentration to around 2 mg/L and near neutral pH, but had a high Total Dissolved Solids (TDS) concentration (approximately 5 percent). This was the intent of the first demonstration; however, they were unable to do so, and the process washwater had to be subsequently removed and taken away from the site by a hazardous waste contractor. This type of treatment was very costly and detracted somewhat from the overall success of the system being evaluated.

During the first demonstration, considerable difficulty was experienced with maintaining acceptable hydraulic discipline. There were numerous system leaks. During the second demonstration, excellent hydraulic discipline was maintained, with basically no leaks or spills on the impervious pad. This demonstrated to all that this technology set can be employed in a manner that does not expose the environment to the risk of runoff. Nonetheless, when planning to employ this technology set, one must provide suitable engineering controls to contain any such spill or a lack of hydraulic discipline. The engineering controls envisioned include an impervious pad to host the process equipment, process chemicals, soil to be processed, soil processed but awaiting analytical corroboration that the chemical cleanup standards have been satisfied, and more depending on the specific nature of the unit processes being applied. In addition, a sound Spill Prevention, Control, and Countermeasures (SPCC) Plan must be in effect, as well as a sound Storm Water Pollution Prevention Plan (SWPPP).

The impact of rainfall on a job site can be serious, and a sound Stormwater Pollution Prevention Plan (SWPPP) must be developed and implemented in order to control stormwater runoff.

The risk is that if the rainwater (especially acid rainwater) falls on soil waiting to be processed, or the processing equipment it could be come contaminated with heavy metals, flow off the job site, and contaminate the local environment. For this demonstration, an impervious asphalt pad was constructed with proper slopes and curbed retention walls and linked to a 30,000-gallon holding pond. This protected the local environment from any runoff contami-

nation. Such collected water can readily be used for project make-up water. Each such setup will have to consider the local site conditions. An SWPPP is critical to the success of any such application. During the site planning phase of this project, much consideration was given to providing a weather shelter to protect the operations site (process equipment, chemical holding tanks, soil stockpiles, etc.) but was not pursued due to unknowns as to what the vendor equipment profiles and costs would be. Initial inquiries revealed that to pursue such a course of action would have been too costly. In future applications, this should be reconsidered from an economic perspective. For operating periods longer than experienced with these demonstrations, such a structure may be more cost effective.

CAA has at least two major issues associated with it when considering applying this technology set to a specific range. If the installation is in a geographic area identified by the EPA as a "non-attainment" zone, then such specific issues will need an independent evaluation against the regionally specific primary and secondary ambient air quality standards that are currently applicable. Our discussions here do not address such specific issues. The two areas that are generically impacted with this technology set are fugitive emissions associated with:

- ◆ Potential for acid fumes to exist in the ambient atmosphere
- ◆ Potential for lead dust to exist in the ambient atmosphere.

The second issue is very OSHA focused. As an example, there are serious matters that must be considered not only in site planning, preparing the site-specific health and safety

plan, and more, but also in site operations, which dictate the level of personnel protective equipment required to be worn. Specifically, as one example, it makes the difference as to whether or not level "C" or level "D" Personal Protective Equipment (PPE) is worn. This of course impacts workforce productivity and overall project cost. Level "C" PPE requires the use of air purifying respirators. For productivity estimating, level "C" use allows a worker to be 50 percent efficient compared to one in street clothes, as compared to level "D" utilization, which impacts labor productivity by 75 percent of street clothes efficiency. PPE requirements for the demonstration are discussed in Section 6.5. Level D was the baseline PPE worn for all project demonstration operations.

Lead exposure in construction is covered in 29 CFR 1926.62. BDM performed air monitoring for lead during both demonstrations, and did not exceed any thresholds. Our results were similar to those observed at the EPA site effort at Twin Cities Army Ammunition Plant (TCAAP) in 1994 and 1995. This is reported in detail in the Section 6.6, Health and Safety.

Unfortunately, on a few occasions, the acetic acid fumes were a problem. Industrial grade acetic acid (84 percent) was used as opposed to glacial acetic acid (99 percent). Nonetheless, the vinegary fumes were still noticeable (most prominently in output processed soil and exposed process washwater). Better process control, especially soil dewatering, would have reduced this occasional nuisance. The odor threshold for this acid is 0.48 ppm or 1.2 ug/M³, and the permissible exposure limit is 25 ug/M³ over an 8-hour, time-weighted average. The extremely high relative humidity encoun-

tered in this region (typically 95 percent) may have contributed to this situation. The vendor that demonstrated the acetic acid leaching system was very sensitive to this matter, and reported on it in detail in their vendor operations performance report:

"Vapors generated from the use of acetic acid resulted in airborne levels exceeding 20 ppm in areas immediately adjacent to the plant during occasional periods when the ambient humidity approached saturation. Plant personnel wore respirators equipped with acid-vapor filter cartridges whenever airborne acid vapor levels exceeded 20 ppm. These vapors were measured with a Senidine/Gastec air pump with colorimetric detector tubes. Vapor concentrations varied widely in the vicinity of the plant as a function of wind direction, humidity, process pH, and soil throughput rate. Concentrations were most pronounced during operations with plant pH at 3.0 or lower under conditions of high ambient humidity. Increasing the process pH to 3.2 or greater, significantly reduced the vapor levels and the associated odors. Table 5 summarizes airborne vapor concentration measurements taken during the demonstration."

In addition, there was one excursion when neighbors expressed concern about the odors emanating from the demonstration site. This incident occurred on September 9, 1996. Ft. Polk Industrial Hygiene specialists responded and investigated. There were no serious findings associated with this incident. Again, it is suspected that high relative humidity may have contributed.

In summary, air quality matters can impact the successful utilization of this technology set. The principal issue is the nature of the vapor

Table 5. Airborne Acetic Acid Vapor Concentration

Date	Location	Concentration (ppm)	mg/M3
Sep 7	Adjacent to Hydro-cyclone tank	3	7.5
Sep 7	Adjacent to No.2 Flocculant Tank	5	12.5
Sep 14	Adjacent to Hydro-cyclone Tank	17, 22, 9	42.5, 55, 22.5
Sep 14	Beneath No.2 Jig	20, 20, 7	50, 50, 17.5
Sep 14	Operator's Control Station	9	22.5
Sep 15	Adjacent to Hydro-cyclone Tank	7, 30	17.5, 75
Sep 15	Walkway adjacent to No.2 Jig	4, 21	10, 52.5

0063G_01

pressure of the leaching agent being employed, local weather conditions, operating system pH, and siting of the recycling operation.

EPCRA requires facility owners who accumulate and store hazardous materials in excess of threshold planning quantities (TPQs), to report such presence to local fire fighting and emergency response agencies. Fully scaled-up systems, employing acid leaching circuits, could be impacted by this depending on the acid they employ. Should this occur, there would be some additional paperwork involved, and possibly even a bit more health and safety risk at the job site. However, implementation of proper engineering controls can quickly abate such additional risk. There are a number of candidate acids and bases that may be employed in the leaching circuit in this technology set. The choice of such is dependent on the cleanup standards being sought and the soil chemistry. Some of these acids and bases are extremely hazardous substances. In the case of the two demonstrations being reported upon here, none of the acids or bases employed were. However, these chemicals are Occupational Safety and Health Administration (OSHA) hazardous chemicals and are subject to emergency planning requirements, with a

planning action level of 10,000 pounds (4536 Kg) (Tier I and/or Tier II submittals). An example of a general acid that is considered an EPCRA toxic chemical is nitric acid. If used, it is subject to Toxic Release Inventory (TRI) reporting. Its TPQ action

level is only 1000 pounds (454 Kg). Figure 4 illustrates the volumes on hand during the second vendor demonstration.

5.3 PERMITS AND LICENSES

In a full scale operation, at a closing range especially, there is good likelihood that a RCRA part B permit would be required. Reviewers contemplating applying this technology set need to review carefully the recently released final EPA "Military Munitions Rule" (40 CFR 260, February 12, 1997, Appendix A) and the complementing DoD "Range Rule," when it is available in final form. There is some relief to such requirements dependent on whether or not the range is "active" and whether or not the operations are contiguous to the range being maintained. Details of this are still being established. For this demonstration, the Post Environmental Management office provided the LADEQ an administrative notice of intent to conduct these demonstrations. This agency operated a delegated authorized program from the EPA for the control and management of solid and hazardous waste. The LADEQ in turn responded and inspected the operation twice, once during site preparation and mobilization, and once during actual op-

erations. In addition, during Visitor's Day, held on December 12, 1996, EPA officials visited the site.

The installation required us to obtain a tenant license to operate this system on Post. There were strict rules governing operation. This included our key people attending the Ft. Polk Environmental Compliance Officer course presented at the Ft. Polk Environmental Training Center. This demonstration was operated under the Ft. Polk EPA identification number, LAA3389847, and they maintained strict surveillance of all activities during the demonstrations and reviewed and approved all manifests of material leaving the Post.

This site license to operate has not yet been retired. BDM has demobilized the operations site and reconstructed the range berms.

5.4 NEPA/ENVIRONMENTAL ASSESSMENT

In approaching the environmental impact of this technology set demonstration, consideration was given to similar work that had been successfully completed at Twin Cities Army Ammunition Plant in 1994 and 1995. That opened the opportunity for us to explore the application of a CATEX with a REC. Army Regulation 200-2, Environmental Effects of Army Actions, Chapter 4, provides guidance for such actions. The team successfully documented this around CATEX A-12, (developmental and operational testing on a military installation), where the tests are conducted in conjunction with normal military training or maintenance activities so that the tests produce only incremental impacts (if any), and provided that the training and maintenance activities have been adequately assessed (where required), in other Army environmental docu-

ments. In addition CATEX codes A-5, A-11, and A-26 supported the effort. A REC was required to support this effort. Although a programmatic assessment cannot be offered here, as a result of working in the field with this technology set for 6 months, a generic response to a series of issues that must be addressed in any environmental assessment is included in Appendix A. Hopefully, this material will assist reviewers that are contemplating applying this technology set to their own requirements. In using this information, reviewers are reminded that each site must be evaluated on its own merits after a thorough site inspection and discussions with local cognizant authorities.

5.5 OTHER LESSONS LEARNED

The following are lessons learned from these demonstrations that apply to environmental planning, in addition to those described in Appendices A and B.

- ◆ In all likelihood, some of the by-products of this technology set will be hazardous waste. Plan accordingly, and have a strategy for their temporary safe storage and timely disposal.
- ◆ Avoid a split operations site if at all possible. The need to haul the soil off the range to the process recycling operations pad, and the significant site preparations work that must be done is costly and can become a major friction point in process throughput. As an example, in these demonstrations, if the soil failed to meet the cleanup criteria, it was held on the pad and recycled a second time. The end result was that more soil would occupy the operations pad than could be readily processed if the materials handling cycle was not stopped, causing

greater risk of a release, especially during bad weather.

- ◆ If a leaching agent with a high vapor pressure is employed in the processes, there is

more opportunity for air quality issues in the form of fugitive air emissions to become a concern.

6.0 HEALTH AND SAFETY

In undertaking this important DoD assignment, BDM's first goal was to ensure that all work was carried out in an incident- and accident-free manner. One of BDM's primary responsibilities was the development of a site-specific Baseline Health and Safety Plan (HASP) to govern the demonstration.

6.1 BASELINE HEALTH AND SAFETY PLAN (HASP)

The BDM vision was that this Baseline HASP would be augmented by an SPCC plan and an SWPPP as well as by HASP supplements from each of the demonstration vendors. Because of the investigatory nature of this demonstration, job site conditions were expected to be variable. Therefore, the HASP was considered a living document to account for such changes.

6.2 CONSOLIDATED DOCUMENT (SPCC AND SWPPP)

BDM created a "Consolidated HASP" that contained the demonstration SPCC and SWPPP. The intent of these plans was to proactively address spill prevention and control and stormwater pollution prevention. The SPCC Plan specifically applied to the Operations Area at Block 4700 as no hazardous material was stored at Range 5. However, due to the environmentally sensitive nature of the area immediately behind Range 5 (a wetland/endangered species habitat and an area containing cultural prehistoric artifacts), spill management equipment including adsorbents, shovels, and containers were always readily available in the event of a vehicle fuel, hydraulic oil, transmis-

sion, or cooling system spill. Spill kits and adsorbent clays were also readily available for use at Block 4700.

Ft. Polk is located in a geographic area characterized by significant rainfall. Therefore, stormwater pollution prevention and stormwater management was a critical factor. The operations area at Block 4700 was designed for effective stormwater management. The operations pad was sloped for positive drainage into the stormwater runoff pond and a silt trap was used between the pad and pond to minimize the amount of sediment washed into the pond. The stormwater runoff pond was designed to contain pad runoff from a 5-year design storm of 2.6 inches per hour for one hour. This design storm would produce 20,000 gallons of runoff from the 130 x 90 foot pad. After construction, the pad had an actual containment volume of approximately 30,000 gallons. Figures 5 and 6 show the estimated runoff volume in the pond during the vendor demonstrations. Both vendors used some rainwater as process make-up water.

Best management practices (BMP) used to reduce the negative impacts of soil excavation and hauling included suspension of excavation and hauling activities during periods of heavy

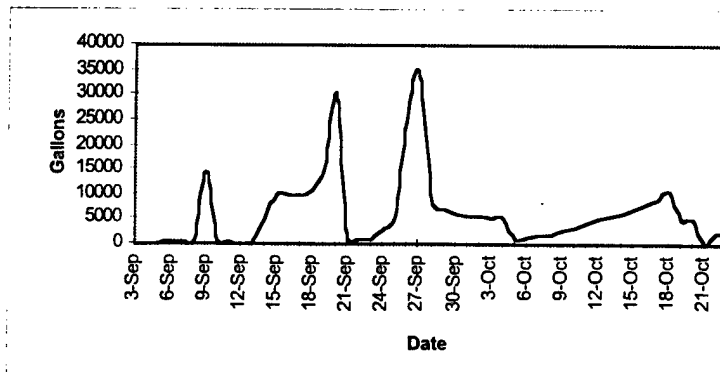

Figure 5. Estimated Runoff Pond Volume Acetic Acid Demonstration

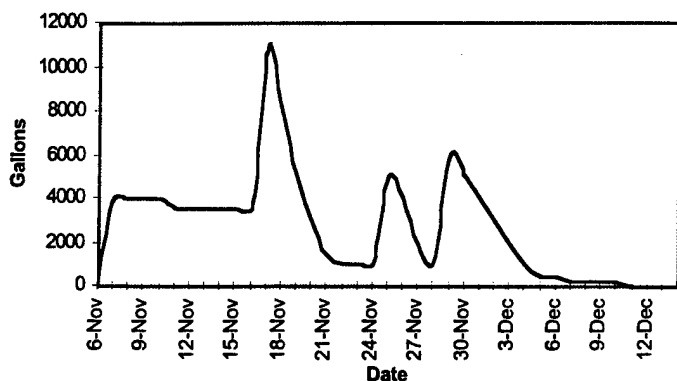

Figure 6. Estimated Runoff Pond Volume Hydrochloric Acid Demonstration

rainfall; tarping of all soil stockpiles; and re-seeding, fertilization, and mulching of all processed soils. Silt fencing and hay bales were used as well.

6.3 VENDOR SUPPLEMENTS

Because of the anticipated proprietary nature of the soil washing/acid leaching demonstrations, the selected vendors were required to prepare supplements to the Baseline HASP that addressed their unique equipment and processes. These supplements also included Material Safety Data Sheets (MSDSs) for all chemicals used by the vendors. These supplements were presented to BDM and the Ft. Polk Environmental Management staff hosts for approval. The vendors were not given authorization to mobilize on-site until this administrative action had been accomplished.

6.4 TRAFFIC MANAGEMENT IN ZONES

Range 5, as well as the adjacent Ranges 4, 4a, and 6, were active during this demonstration. As the ranges were contiguous to each other, their cones of lethal fire overlapped. Consequently, indiscriminate visits were unacceptable. All visits and excavation activities

were coordinated with Range Control in advance.

The operations area at Block 4700 was surrounded by a 6-foot galvanized wire fence fabric with a 3-strand outrigger and barbed wire security fence with two access gates, one to the north and one to the south. The layout of the operations area is shown in Figure 7. All vendor equipment was placed on the operations pad in the exclusionary zone. All decontamination activities were conducted at

the decontamination station on the west end of the pad in the contaminant reduction zone. The decontamination station included buckets, boot wash tanks, an eyewash, brushes, detergents, and a field sink with running water and hoses. The support zone west of the operations pad included the BDM administration trailer, vendor trailers, and the Battelle sample perpetration area, and a pole-mounted wind sock was also erected.

The health and safety of all visitors was aggressively protected. Visitors were restricted to the support area unless qualified through training to enter operational areas. During Visitor's Day on December 12, no visitors were allowed to enter this area. Visitors were informed of all relevant hazards at the site according to the Hazardous Communications (HAZCOM) standard and the site HASP, and were required to wear the appropriate PPE.

6.5 PERSONAL PROTECTIVE EQUIPMENT (PPE)

The minimum level of protection for all site personnel during this demonstration was Level D, which consisted of:

OPERATIONS AREA (B-4700)

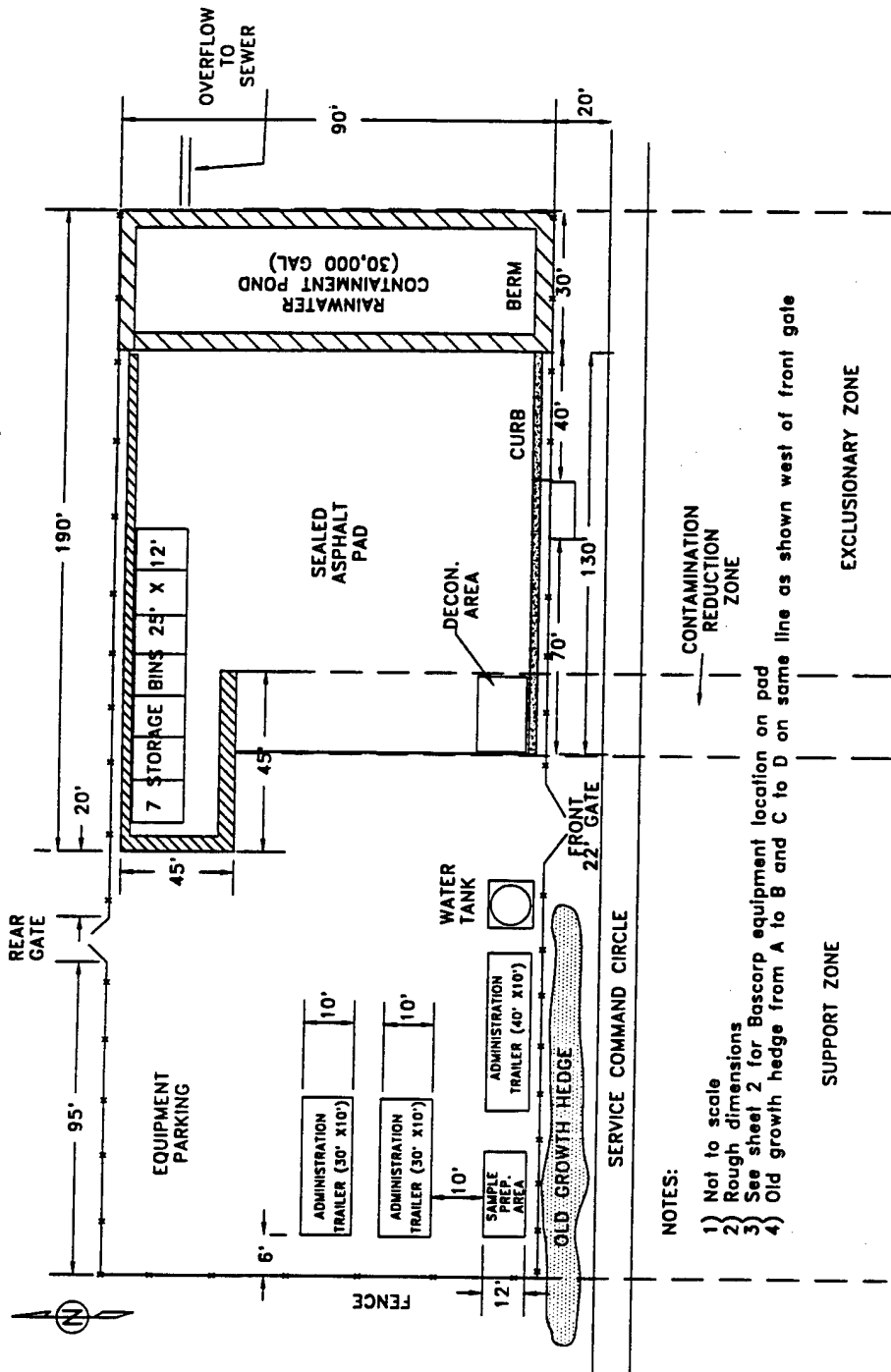

- NOTES:**
- 1) Not to scale
 - 2) Rough dimensions
 - 3) See sheet 2 for Bascorp equipment location on pad
 - 4) Old growth hedge from A to B and C to D on same line as shown west of front gate

CLIENT: A.E.C.
 DATE: 03/31/97
 AUTHOR: WBR
 CK'D BY: WBR

REV. NO.: 0
 DRN BY: DL
 FILE: FIG5



**FIGURE 7
 BLOCK 4700
 OPERATIONS SITE**

Figure 7. Operations Area (B-4700)

D:\POLK\1007\opsite.dwg

- ◆ Hard hat
- ◆ Coveralls or similar full-body work clothing
- ◆ Chemical splash goggles or safety glasses with side protection
- ◆ Steel-toed safety shoes or boots
- ◆ Leather gloves.

A higher level of PPE was required for all personnel involved during acid and base transfer operations. The PPE required included:

- ◆ Chemical resistant clothing
- ◆ Chemical resistant overboots
- ◆ Chemical resistant gloves
- ◆ Air-purifying respirators equipped with appropriate cartridges.

Additional PPE as required by environmental monitoring included hearing protection. Vendor 1 performed noise monitoring and found that near some unit processes the TLV of 85 decibels was occasionally exceeded. Vendor 2 did not perform noise monitoring but required that hearing protection be worn on the job by all personnel at all times.

6.6 LEAD HEALTH IMPACTS

Occupational exposure to lead is regulated by OSHA under the General Industry Lead Standard (29 CFR 1910.1025) or the Construction Industry Lead Standard (29 CFR 1926.62). This project was regulated under the Construction Industry Standard.

When absorbed into the body in certain doses, lead is a toxic substance. Lead can be absorbed into the body through ingestion and inhalation. Lead (except for certain organic lead compounds) is not absorbed through the skin. Inhalation of airborne lead is the most common exposure pathway; however, handling

food, cigarettes, or chewing tobacco that have lead on them or handling them with hands contaminated with lead will contribute to ingestion. Consumption of food or use of tobacco products was not allowed at the jobsite.

Both short-term and long-term overexposure to lead can cause medical problems. Taken in large enough doses, lead can be fatal. A condition affecting the brain called acute encephalopathy may arise, which develops quickly to seizures, coma, and death from cardiorespiratory arrest. Short-term exposures of this magnitude are rare but not impossible. Long-term overexposure to lead may result in severe damage to blood-forming, nervous, urinary, and reproductive systems. Some common symptoms of long-term exposure include loss of appetite, metallic taste in the mouth, anxiety, constipation, nausea, fatigue, weakness, insomnia, headache, muscle and joint pain, numbness, dizziness, hyperactivity, and colic.

The Permissible Exposure Limit (PEL) for lead is 50 micrograms per cubic meter of air (50 ug/M³). This is the highest level of lead in air to which workers may be permissibly exposed over an 8-hour workday. Since it is an 8-hour average, it permits short exposures above the PEL so long as for each 8-hour workday, the average exposure does not exceed the PEL. Exposures at or above the lead action level of 30 ug/M³ require implementation of many policies, including medical monitoring, air monitoring, and further training. Air monitoring data from a previous industry study of this same type of operation indicated results far below the PEL and the action level. BDM also performed air monitoring during this op-

eration to ensure compliance and the safety of workers involved. The results of this monitoring are in Section 6.7.

6.7 RESULTS OF AIR MONITORING

Air monitoring for lead was conducted during both vendor demonstrations by Environmental Safety Professionals, Inc., at the request of the BDM Site Health and Safety Officer (HSO). The results of this monitoring are shown in Table 6 and Table 7.

Table 6. Air Monitoring Results Acetic Acid Demonstration

Sample #	Date	Location/Job Task	[Pb] (ug/m3)
10196-BL	Oct 1	Field Blank	< 0.12
10196-C	Oct 1	Backhoe Operator	< 0.42
10296-A	Oct 2	South Perimeter of Work Area	< 0.945
10296-B	Oct 2	North Perimeter of Work Area	< 0.330
10296-C	Oct 2	Battelle Sample Area	< 0.330
10296-BL	Oct 2	Field Blank	BDL

0063G_02

Table 7. Air Monitoring Results Hydrochloric Acid Demonstration

Sample #	Date	Location/Job Task	[Pb] (ug/m3)
12496-A	Dec 4	East Perimeter of Work Area	< 1.28
12496-B	Dec 4	West Perimeter of Work Area	< 0.86
12496-C	Dec 4	South Perimeter of Work Area	BDL
12496-D	Dec 4	Field Blank	BDL
12596-A	Dec 5	Battelle Sample Room	< 0.81
12596-B	Dec 5	Feed Hopper / Conveyor Belt	BDL
12596-C	Dec 5	Perimeter Downwind	BDL
12596-D	Dec 5	Field Blank	BDL
12696-A	Dec 6	Center of Work Pad	< 0.79
12696-B	Dec 6	Perimeter Downwind	1.56
12696-C	Dec 6	Perimeter Upwind	1.56
12696-D	Dec 6	Field Blank	BDL

0063G_03

As can be seen in the results, lead air concentrations were far below both the action level of 30 ug/M³ and the permissible exposure limit of 50 ug/M³ during both demonstrations.

6.8 INCIDENTS

This demonstration caused no serious health and safety incidents. However, there were a few minor incidents during the demonstration that are worth noting.

On September 3, 1996, there was a hydraulic fluid leak from a backhoe at Range 5. The BDM Site Superintendent and the Site HSO responded with absorbents. Ft. Polk Spill Response was notified and staff from the Environmental Resource and Management Division (ERMD) arrived on-site. The spill was quickly captured by the absorbent materials and Ft. Polk officials deemed no more action was necessary.

On September 9, 1996, Ft. Polk personnel at the motor pool south of the operations area complained of the odor associated with acetic acid. The odor threshold for this material is approximately 1.2 mg/M³ and the permissible exposure limit is 25 mg/M³. Ft. Polk Industrial Hygiene Specialists responded and investigated. There were no serious findings. For more information, reviewers may wish to re-examine the data in Table 5 in Section 5.2.

On September 17, 1996, at the Block 4700 Operations Site, a Vendor 1 employee sustained an injury to the ring finger on her right hand. She

was working with a hand drill on some process equipment when the drill slipped and lacerated her finger. Another Vendor 1 employee transported the employee to the Ft. Polk Hospital, where she was treated for the injury. The doctor cleaned the wound, bound it with sterile strips, x-rayed the finger, and bandaged the finger. X-rays showed that there was no bone, muscle, or tendon damage. The employee returned to work on the morning of September 18, 1996.

On December 11, 1996, the BDM Site Superintendent and Site HSO vented a 55-gallon drum with a bulging lid. The drum contained gravel, bullet fragments, and acetic acid. The BDM Site HSO notified the Ft. Polk Safety Office and received instruction and authorization from Ft. Polk before the drum was vented. The drum was vented without incident although a strong vinegar odor was noticed from the drum initially after the venting.

7.0 SITE PLANNING

After the National Environmental Policy Act (NEPA) documentation was satisfactorily executed, site planning was completed and presented to the Department of Public Works (DPW) staff for comment and approval. Approval was subsequently received and site preparation was executed.

7.1 SPLIT OPERATING SITES—PROS AND CONS

Due to the fact that Range 5, as well as adjacent Ranges 4, 4a, and 6, were active during this demonstration, access was limited. Deadly fire cones from Ranges 4a and 6 partially impacted Range 5. For this reason it was impossible to establish the operations area at Range 5. The recycling operations site was located in an area known as Block 4700. The soil removal (Range 5) and soil processing areas (Block 4700) were separated by approximately 2 miles. Soil loaded at the removal area was transported to the operations recycling area.

There were several advantages to locating the operations area at Block 4700. Access to water and power were readily available. The area was clear, fairly level, and consisted of a well-established crushed asphalt and compacted gravel parking lot of the approximate dimensions 91' x 290'. This aided in subsurface preparation for the asphalt operations pad. Security at Block 4700 was also more prevalent than the more remote Range 5.

Disadvantages to locating the operations area at Block 4700 stemmed from the need to transport material for processing. Prevention of contamination at Block 4700 was a critical issue. All material handling and storage concerns were more stringent than would have

been necessary if soil processing was done on the range. Storm water management practices were also exacting at Block 4700.

7.2 SITE B-4700 PRIOR USES

The recycling operations site at Block 4700 consisted of one large block parcel bounded by Service Command Drive and Texas Avenue. The parcel of approximately 2 acres in size was once known as the Troop Replacement Depot and hosted 27 World War II era, two-story wooden framed barracks from approximately 1940 to 1980. Today, only five such buildings remain, and only three are used on an active basis. The closest building to the operations site houses an analytical laboratory. Across the street and upwind from the operations site was a large motor pool, the Organizational Maintenance Center for both the 603d Transportation Company and the 142d Corps Support Battalion of the Warrior Brigade, which relocated elsewhere during these demonstrations. Prior to the demonstration, the area was used for overflow parking from the motor pool. Figure 8 shows B-4700 prior to any construction on the site. As stated previously in Section 4.1, 22 buildings were leveled and removed from the site; therefore, there was the potential for buried construction debris in the area that could include asbestos materials, lead-based paints, and lead soldered pipes. For this reason, digging was minimized. During background soil sampling prior to site mobilization, such debris was randomly encountered.

7.3 BACKGROUND LEVELS OF LEAD

Prior to any construction at the operations area, BDM performed background soil sampling on a 50'-grid throughout Block 4700.



Figure 8. Site B-4700 Prior to the Demonstration

Over 150 samples were taken from depths of 0 to 4 inches and 8 to 12 inches. These samples were then measured for lead via x-ray fluorescence (X-RF) by Battelle. The results of this background analysis are shown in Figures 9 and 10 and illustrated in Figure 11. It should be noted that construction debris was encountered during sampling. It is hypothesized that lead found in the soil samples in this area is due to lead-based paint in construction debris, lead solder in construction debris, background levels in the soil, and tetra-ethyl lead from vehicle exhaust from the motor pool and the site being used as an unofficial parking lot. Reports also indicated that two barracks buildings had burned to the

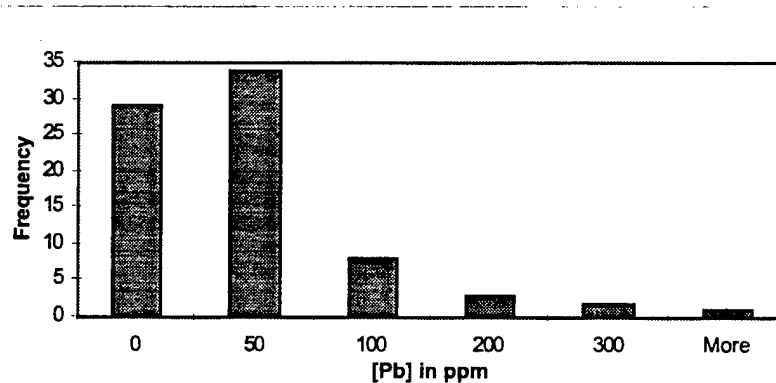

Figure 9. Surface Lead Distribution

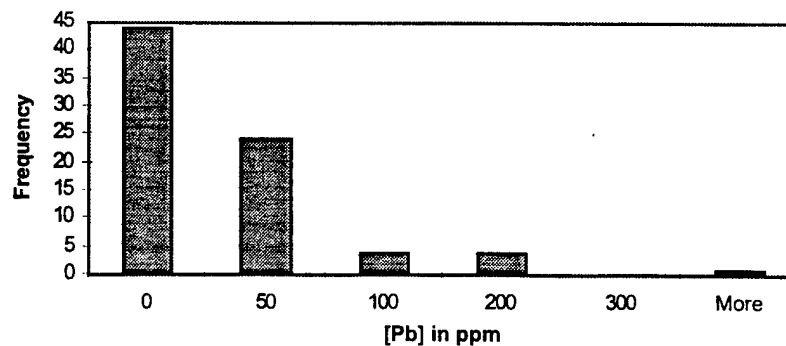
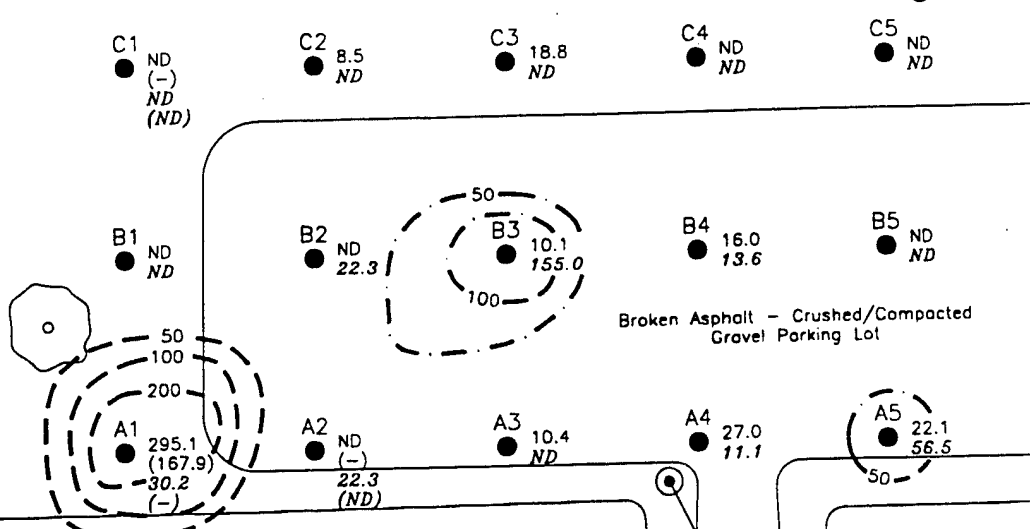
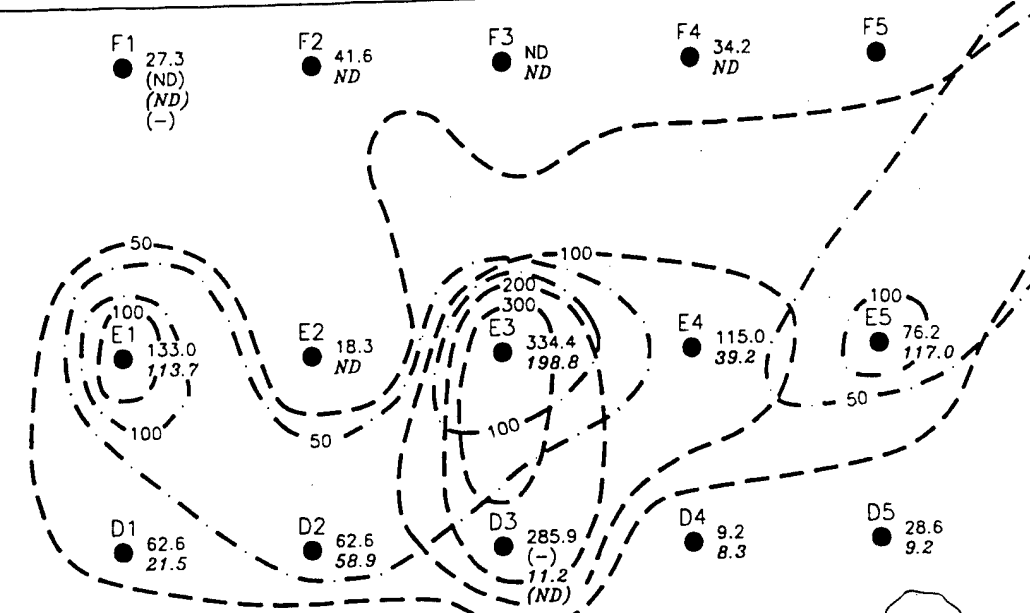

Figure 10. Lead Distribution (Depth 8 - 12 inches)

SERVICE COMMAND ROAD

Original Troop Replacement Depot
1940-1980
(Repro Depot)



Broken Asphalt - Crushed/Compacted Gravel Parking Lot

SERVICE COMMAND ROAD

FIRE HYDRANT

TEMPORARY BENCHMARK
BM 31' 2" 11.92' N
93' 11" 59.63' W
ELEVATION 143 FEET AMSL
(+/- 3 FEET)

LEGEND

- A1 ● TEST POINT
- 295.1 0-4" SURFACE LEAD CONCENTRATION (ppm)
- (167.9) 0-4" SURFACE LEAD CONCENTRATION (ppm) DUPLICATE
- 30.2 8"-12" DEPTH LEAD CONCENTRATION (ppm)
- (22.3) 8"-12" DEPTH LEAD CONCENTRATION (ppm) DUPLICATE
- ND NO DETECT
- - - SURFACE LEAD CONTAMINATION CONTOUR
- - - DEPTH LEAD CONTAMINATION CONTOUR

(P) (P) (P)

(1)

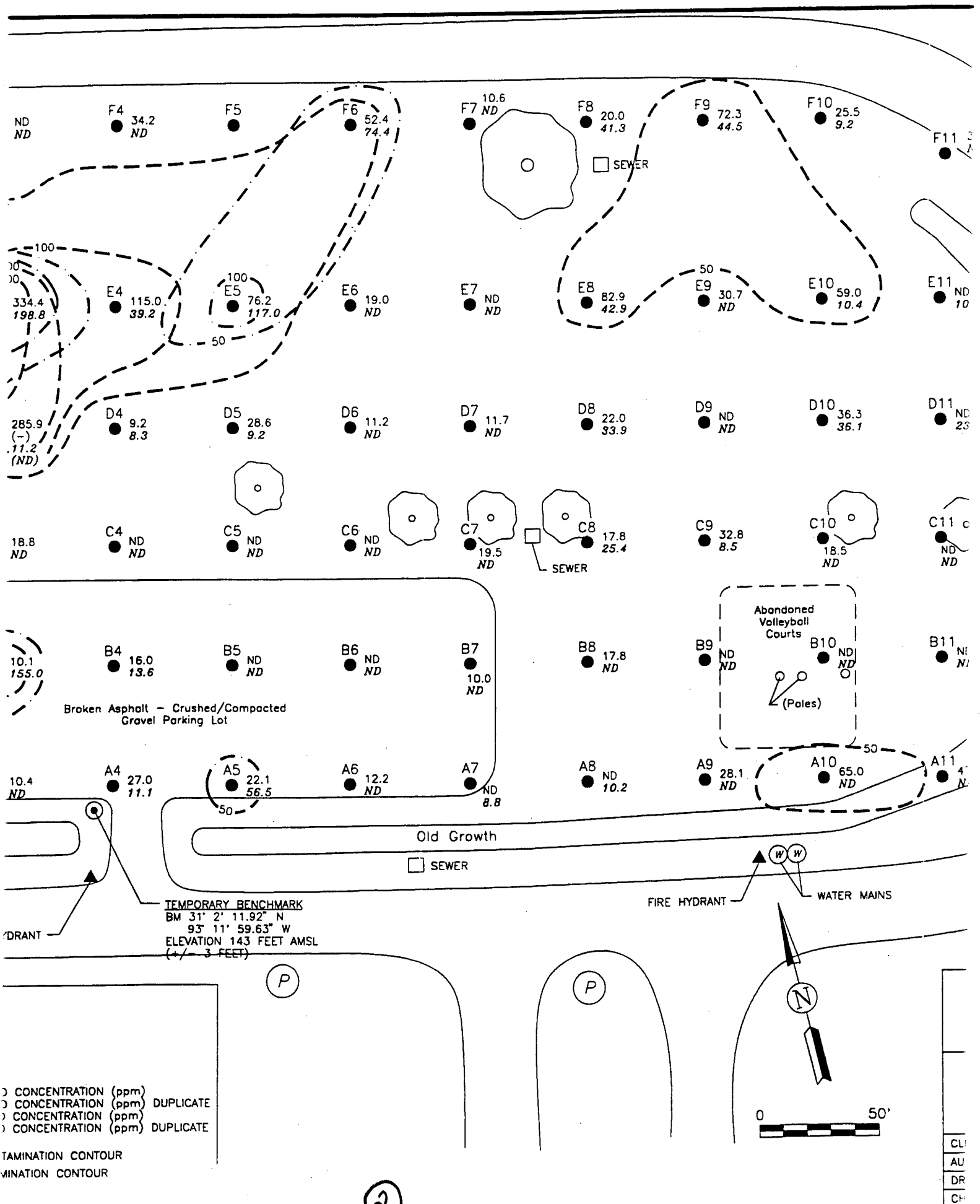

2

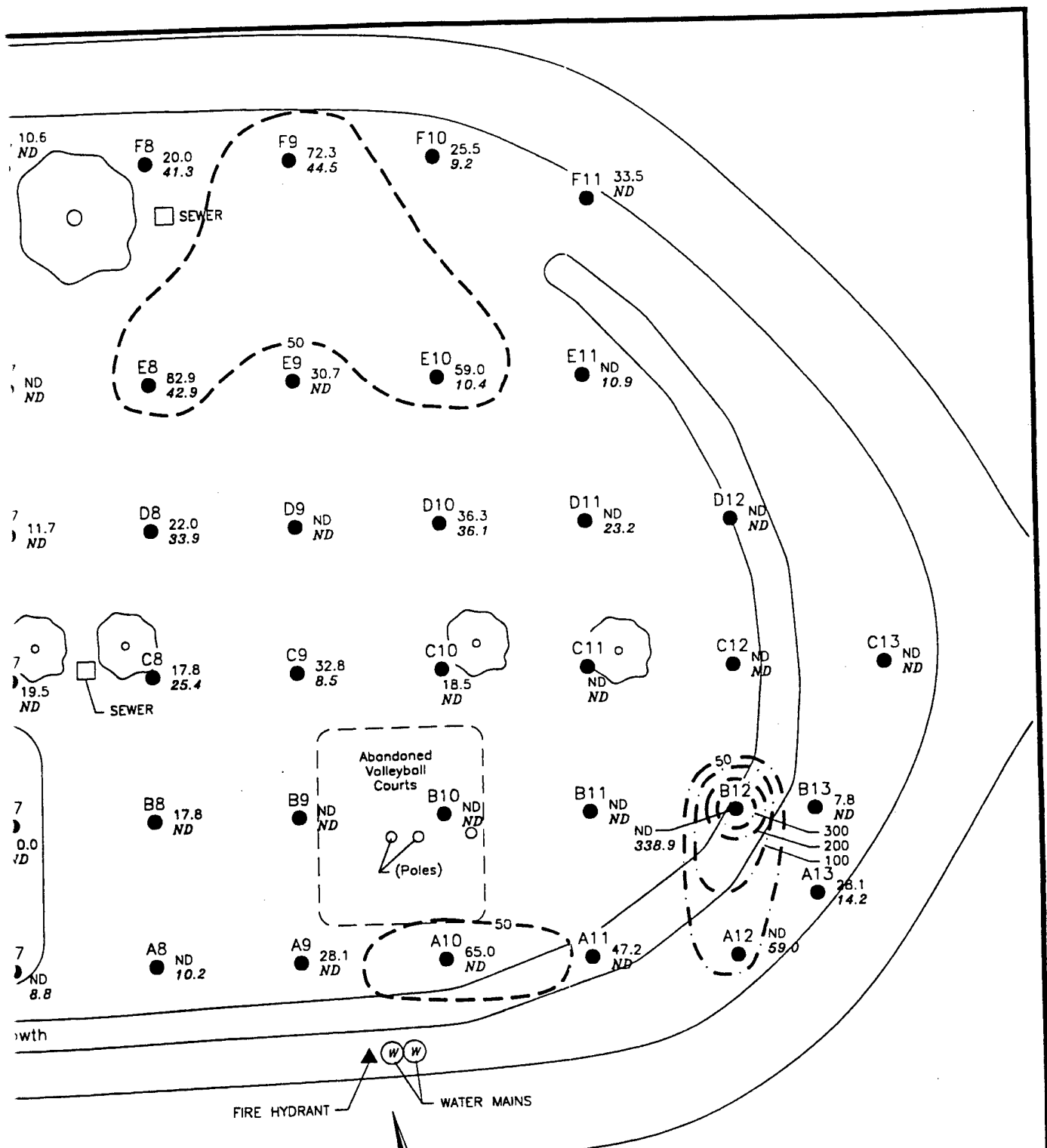

BDM

**FIGURE 1 BACKGROUND
LEAD PROFILE PRIOR TO
SITE MOBILIZATION
BLOCK 4700
FORT POLK, LA**

CLIENT: AEC	
AUTHOR: WBR	DATE: 1-17-97
DRAWN BY: FJG	REV. NO.: 0
CHECKED BY: WBR	FILE: D:\POLK\1007\LEAD



3

ground at the site, one as part of a fire training exercise.

7.4 PLANNING ELEMENTS NEEDING TO BE ADDRESSED

A great deal of planning went into the design of the operations area at Block 4700. Vendor needs were at the heart of this planning. The following list includes many of the more critical planning concerns.

Operational Area Required. How much area would be required for each demonstration? The area must include operational zones, support zones, and room for material handling.

Pad Size and Type. What size of operations pad would accommodate both vendors? What type of construction should be used: concrete, asphalt, or a sandwich membrane? Should the pad be modular, and therefore mobile, or should it be "cast" in place?

Storm Water Holding Pond. What type of containment system should be designed and where would it be most effectively located?

Soil Storage. What design would be the most effective from a material handling and weather-protected storage perspective?

Utilities. What level of power and water would the vendors require, and what would be available at Ft. Polk? Would electric generators or water storage tanks be needed?

Security. OSHA guidance concerning site security must be followed. What fencing would be adequate and acceptable to Ft. Polk?

Shelter. Should the demonstration be conducted under some type of structure? This would aid in storm water management but increase risks of airborne contamination.

Safety. The safety of all personnel involved with this project was a critical issue from the

beginning. The HASP was updated and completed before each vendor demonstration to ensure the safety of all personnel.

7.5 SOLUTIONS UTILIZED

Operational Area Required. An area 100' x 350' was decided upon for the operational area with entrances to the north and south. The operations pad was constructed on the east end of the area in the exclusionary zone, while the west end of the area was used as the support zone.

Pad Size and Type. A 90' x 130' pad was constructed to meet the needs of both vendors. The asphalt pad was a nominally thick 4" pad surface leveled for runoff control, which made it 6" thick in some places, with curbs along the north and south ends and positive drainage to the east into the storm water runoff pond.

Storm Water Holding Pond. A bermed pond on the east edge of the operations pad was constructed using a high density polyethylene (HDPE) liner. The operations pad was sloped for positive drainage into the storm water runoff pond, and a silt trap was used between the pad and pond to minimize the amount of sediment washed into the pond. The storm water runoff pond was designed to contain pad runoff from a 5-year design storm of 2.6 inches per hour for one hour. This design storm would produce 20,000 gallons of runoff from the 130' x 90' pad. After construction, the pad had an actual containment volume of approximately 30,000 gallons.

Soil Storage. Five soil storage bins, 24' deep and 12' wide, were constructed on the northwest corner of the operations pad. Each bin was designed to accommodate approximately 80 tons of heaped soil. The bins were

constructed of rough-sawn white oak planks nailed and through-bolted to 12'-diameter telephone poles at 12' intervals, set 4' in the ground. A wood-frame superstructure was constructed above the bins to provide weather protection to stored soil. Upon completion of the first demonstration, two additional bins were constructed in a similar fashion on a dogleg to the northwest of the original pad.

Utilities. Ft. Polk authorized BDM to use a fire main located at Block 4700 as a water source for the project. They required that an air gap be maintained between the supply and the vendors' process equipment at all times to ensure that no backflow contamination of the Post water supply system could occur. BDM accommodated this requirement by using the water main to fill an 1100-gallon tank from which vendors could pump water into their system. Ft. Polk had 13.8 kVA, 3-phase power readily available at Block 4700. BDM constructed a transformer substation to step the voltage down to 480 volts (3-phase) for vendor use.

Security. A 6' galvanized wire fence fabric with a 3-strand outrigger barbed wire security fence with two access gates, one to the north and one to the south, were constructed around the perimeter of the operations area. Both gates were secured and locked at the end of each operating day. Two security lights were mounted on the electrical pole for the support trailers. One light covered the exclusionary zone and operations pad, while the other covered the support zone.

Shelter. The Team decided that the cost of and logistical problems associated with constructing a temporary shelter, such as a clamshell, large enough to cover the vendors'

process equipment outweighed the benefits it would have provided storm water management.

Safety. The safety of all personnel involved with this project was a critical issue from the beginning. The HASP was updated and completed before each vendor demonstration to ensure the safety of all personnel.

7.6 PRECONSTRUCTION CONFERENCE

A Preconstruction Conference was held at Ft. Polk, Louisiana, on May 7, 1996, for the purpose of informing all interested parties as to the intent and current status of soil washing/acid leaching test and evaluation effort, and to specifically focus on site planning since the split-site operations were announced in April. Technical comments were raised and resolved throughout the presentation including the following issues:

- ◆ The nearby motor pool staff, which had been using Block 4700 as a parking area, would temporarily use the parking area at the nearby softball field until the completion of the units rotation.
- ◆ The asphalt pad to be constructed at Block 4700 would be left at the conclusion of the demonstration.
- ◆ It would be possible to discharge accumulated storm water to the sanitary sewer after the water was analyzed.
- ◆ BDM was authorized to install an electrical substation.
- ◆ BDM was authorized to use a nearby fire hydrant as a temporary source of water providing an air break to prevent backflow.

It was also announced at this meeting that Ft. Polk would host a "Public Day" that would

open the project to the community and the media.

7.7 SOIL STAGING AND STOCKPILING

Soil at Range 5 was extracted by backhoe in lanes approximately 12 to 14 inches deep down the faces of Berms 2 and 3. The extraction plan used by BDM during this demonstration is described in detail in Section 8.11. This soil was then transported by truck to a nearby stockpile southeast of Range 5 with easy access to Lookout Road. (The site was approximately 100 meters from Lookout Road.) This

continuously replenished 240-ton stockpile was maintained during the demonstration to enable BDM to supply soil to the vendors when access down-range was not possible or when weather restricted excavation at Range 5. The stockpile at Range 5 was covered by tarps, and hay bales were used to prevent runoff and control erosion around the base of the pile. The daily vendor supply of soil was staged on the operations pad at Block 4700 and was also covered by tarps when not in use. The concept of operations was to limit the amount of soil stored at B-4700.

8.0 SITE PREPARATION

BDM performed all preliminary actions required to prepare the site at Ft. Polk for the installation of the selected soil washing equipment. BDM developed and executed a soil excavation, blending, and transport plan to provide material from the excavation site at the range to the operations site. BDM also provided support facilities, including an administrative trailer, phone services, and sanitation facilities.

8.1 BLOCK 4700 SITE DESCRIPTION OVERVIEW

The Operations Site approved by the Ft. Polk, Department of Public Works (FP-DPW), was located in Block 4700, Service Command Circle. The site was a former barracks complex that had been cleared, leaving a partially stabilized parking area upon a knoll with good drainage characteristics. A stable, secure, impervious pad of minimum 90' x 130' was designated for the vendors to locate their demonstration equipment with additional (variable) fenced space for support equipment, administrative trailers, and parking. An area outside the security fence was requested for additional temporary parking of the equipment used for transportation of operational components. The Block 4700 elevation profile cross-sections are shown in Figures 12 and 13. The existing topography drove site planning since minimal excavation was directed by FP-DPW. It should be noted that west to east alignment of the pad and fenced operation area conformed to existing drainage, while increased slope (W to E @ 300' to 400') suggested an appropriate location for the stormwater runoff pond.

8.2 SECURITY FENCING

850' of security fence was erected around the 100' x 325' Operations Site (Figure 14). The fencing was conventional 6', 12-gauge chain link wire fabric with a 1', outward facing, 3-strand barbed wire cap. 24'-wide (center split) locking gates were installed at north and south lines adjacent to the edge of the pad. Additional fencing was installed with interior locking gates around the electrical substation and electrical power disconnect. OSHA conforming warning signs were installed at required intervals. Support posts were driven into the ground every 20' (not set in concrete since removal was necessary), and in accordance with Ft. Polk safety regulations, the lower edge of the fencing was at no position greater than 2" from the ground level.

8.3 OPERATIONS PAD

Subgrade stabilization had previously been accomplished throughout the pad and western areas of the site as a result of removal and restoration of the barracks complex formerly occupying the area. Only moderate grading was necessary to ensure positive runoff control to the storm water holding pond. Two 2" courses of asphalt, with tack coats applied in between lifts, were laid and compacted for this 90' x 130' structure (Figure 15). The entire pad area was then sprayed with sealer to improve pad impermeability. Scheduling permitted only a 7-day cure prior to traffic entry. After the first vendor's demonstration, a dogleg to the pad was constructed containing two additional soil storage bins to accommodate storage of vendor-processed soil requiring further processing. Six 10-foot-long concrete road barriers were installed to provide a stable pe-

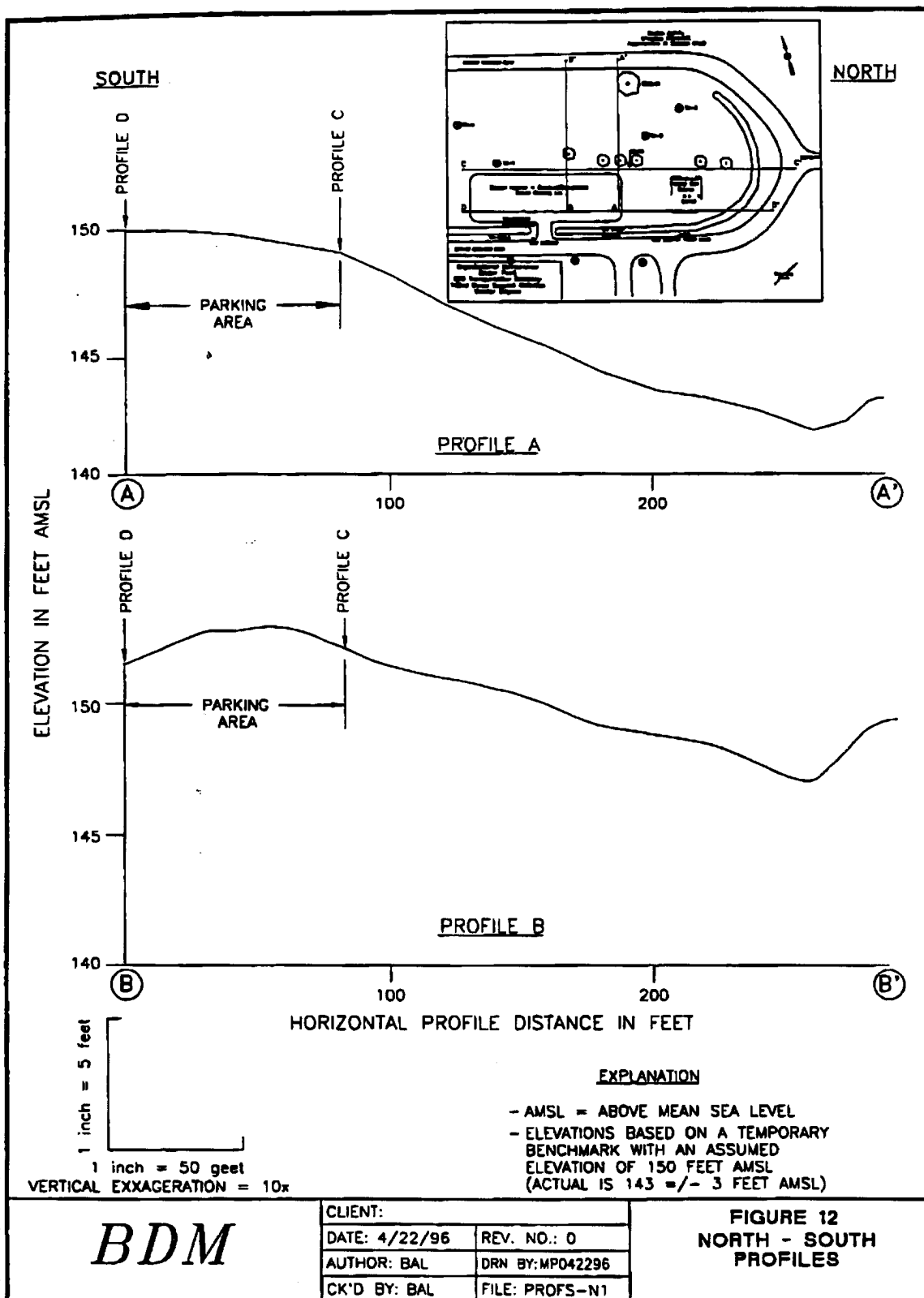

Figure 12. North - South Profiles

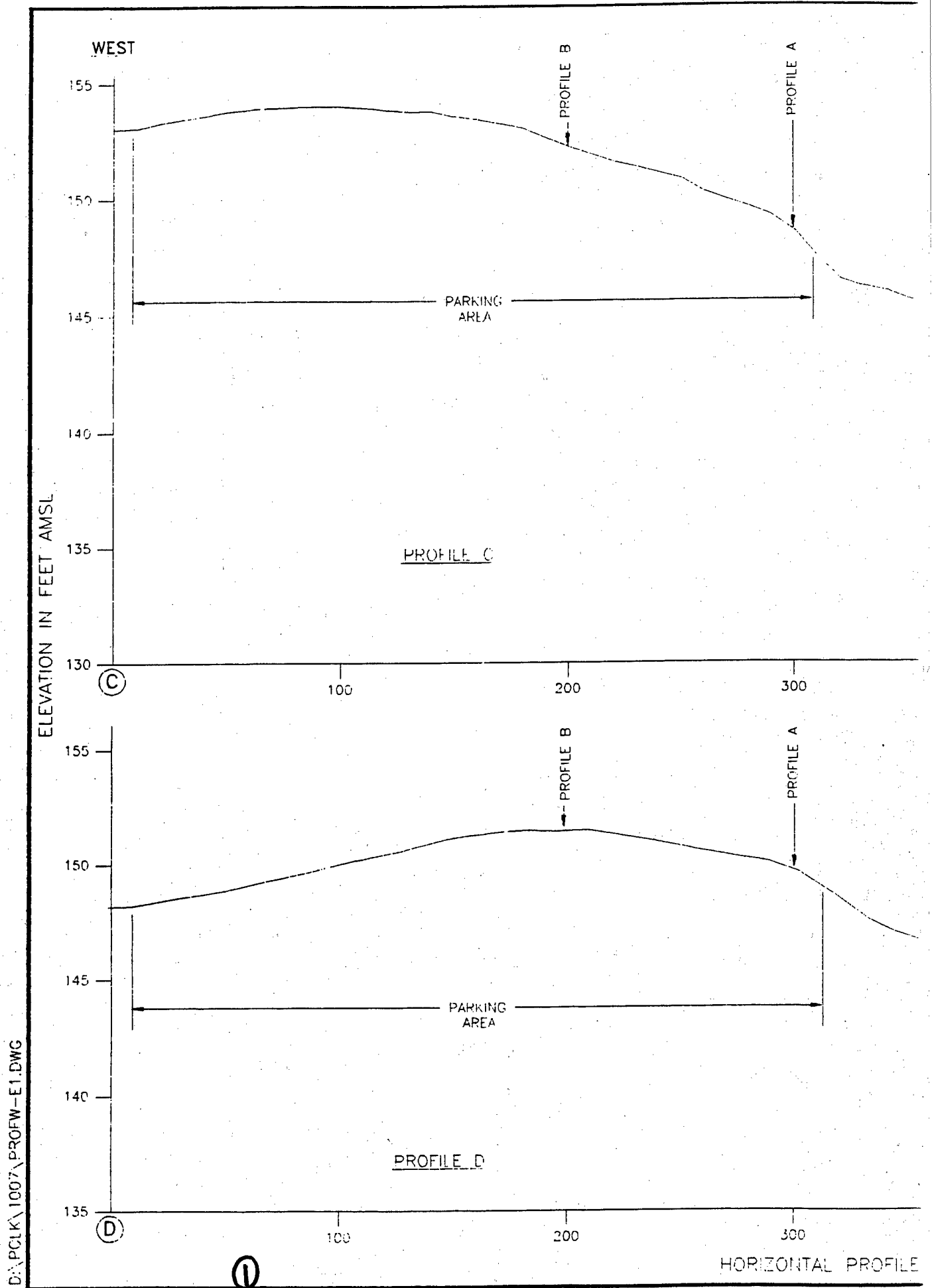
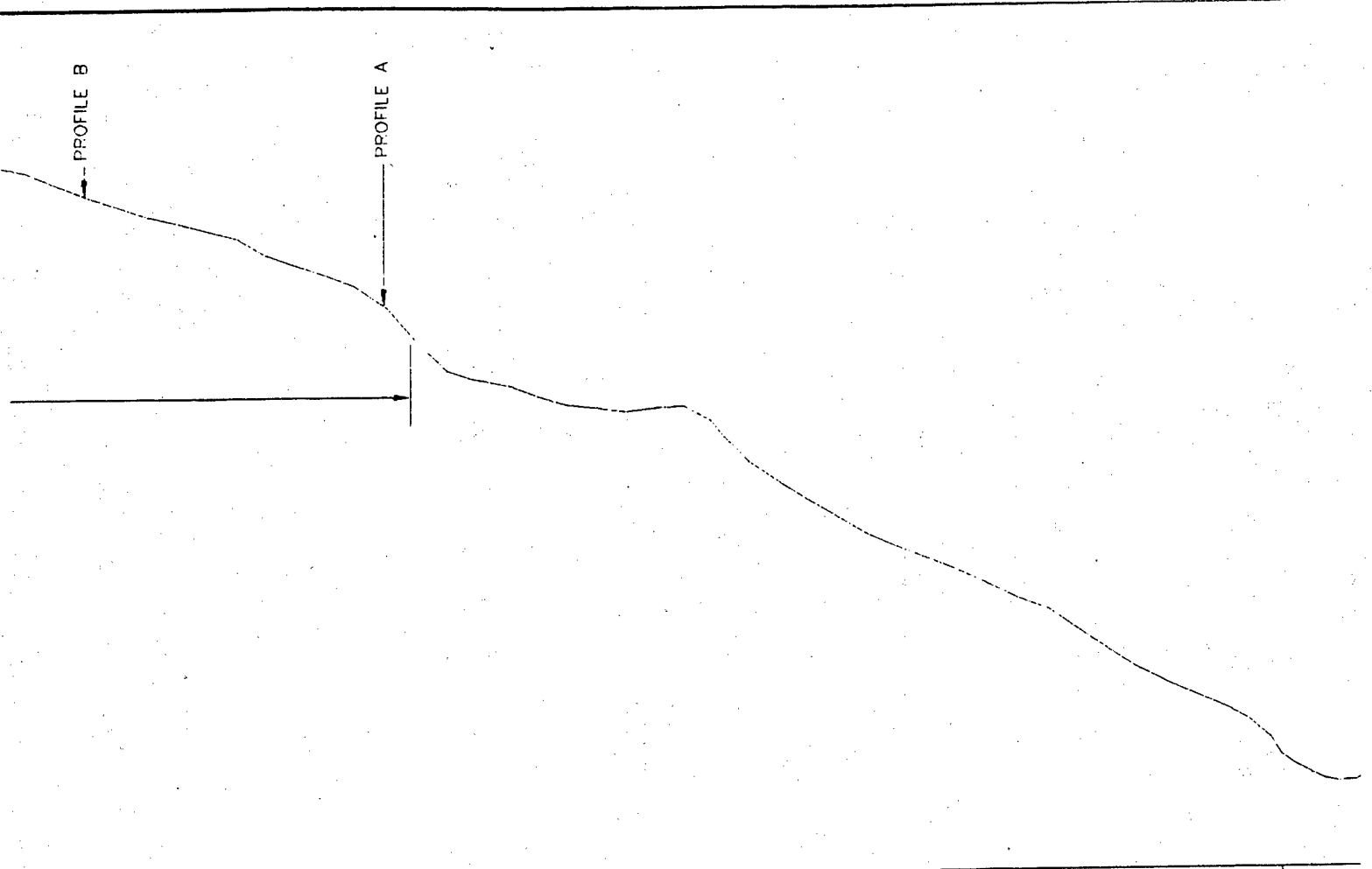
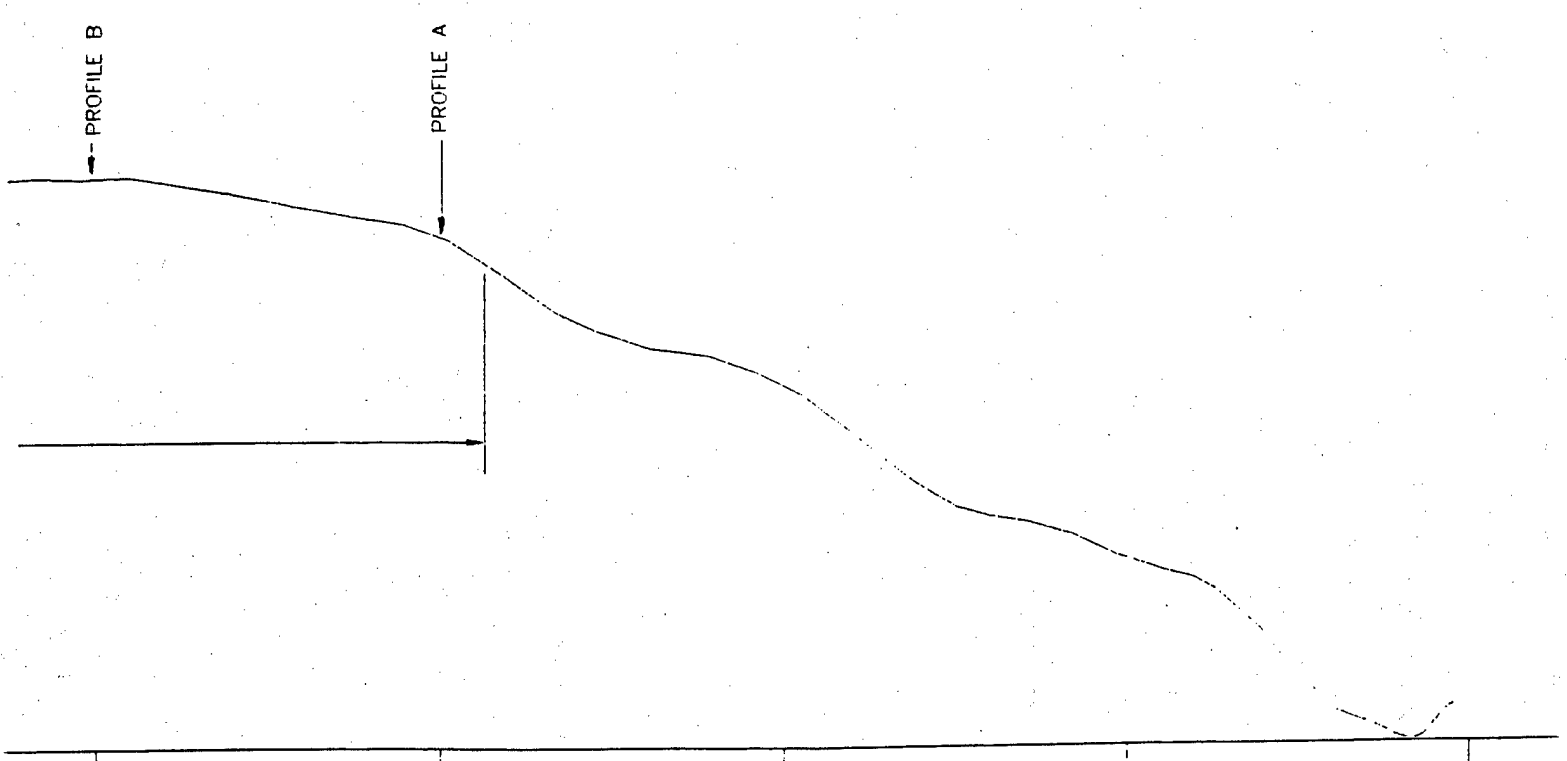

Figure 13. East - West Profiles



200 300 400 500 600



200 300 400 500 600

② HORIZONTAL PROFILE DISTANCE IN FEET

EAST

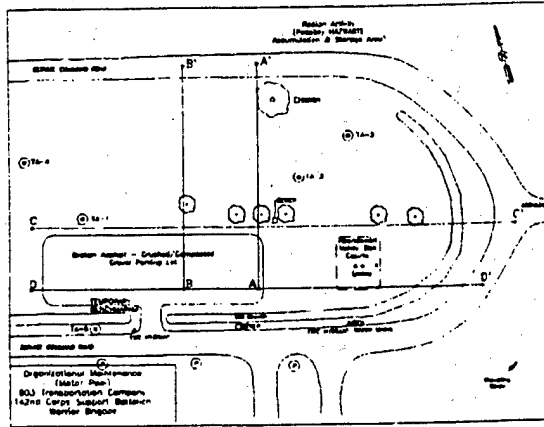

EXPLANATION

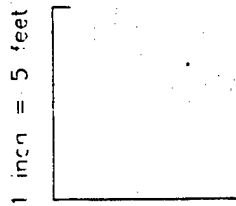

1 inch = 50 feet

VERTICAL EXAGGERATION = 10x

- AMSL = ABOVE MEAN SEA LEVEL
- ELEVATIONS BASED ON A TEMPORARY BENCHMARK WITH AN ASSUMED ELEVATION OF 150 FEET AMSL (ACTUAL IS 143 +/- 3 FEET AMSL)

BDM

FIGURE 13
EAST-WEST
PROFILES

CLIENT:

AUTHOR: BAL

DRAWN BY: MPO4169C

CHECKED BY: BAL

DATE: 4/16/96

REV. NO.: C

FILE: PPOFW-EN.DWG

500

600

(C)

500

600

(D)

ET

(3)



Figure 14. Site Security Fencing

rimeter for the built-up dogleg extension of the pad. They were installed with an 8" asphalt curb to ensure a good seal with the pad.

8.4 STORM WATER HOLDING POND

Minimal excavation was authorized at the Operations Site, so berm height surrounding the storm water holding pond (Figure 16) was adjusted to contain 30,000 gallons of water to the lip of the asphalt pad. Details of berm construction are shown in Figure 17. The berm was extended to the west of the asphalt pad at the control height to provide an additional 10,000 gallons of water containment through shallow flooding of the pads, should predicted rainwater accumulation be exceeded. Clean fill was employed and compacted in building the berm. Prior to placing the asphalt on the pad, a 30-mm UV-resistant HDPE overlaid the pond and the surrounding berm completely to ensure both pond impermeability and erosion prevention of the fill employed. A tight seal

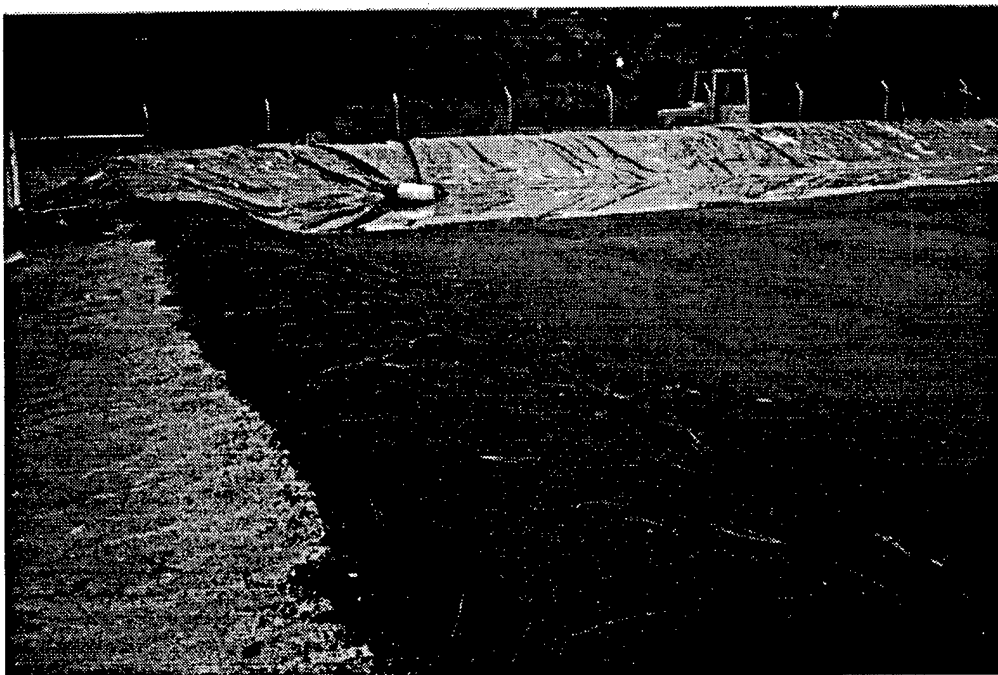

Figure 15. Operations Pad Block 4700

between pond and pad was ensured by 24-inch overlayment of the sheet by the asphalt pad. A 12-inch diameter, heavy-duty overflow drainage pipe with control valve was installed to an existing sanitary sewer manhole approximately 90 feet to the east of the pond.

A patented sealing process using a polyethylene pipe boot was employed to ensure no leakage occurred where the 12-inch diameter pipe penetrated the barrier sheeting. An adjustable elbow was installed on the pipe inlet to ensure no sediment escaped to the Ft. Polk sanitary sewer system. A pond sump was excavated below the pipe elbow to enable complete drainage of the pond. Construction debris and "dead" electrical cable was encountered when excavating the sump giving evidence to the prudence of minimized excavation. A portable 30,000 gallon per hour (gph)

pump with 100' of outlet hose was acquired and kept on standby for emergency use in emptying the pond from the sump.

8.5 SOIL STORAGE BINS

Each storage bin was 24' x 12' to accommodate approximately 80 tons of heaped soil. In elevation, the bins were 6' high at the rear (12' north face) sloping in 2' steps on the 24' sides to 3' in the front (south face) where they were open for access by material handling equipment. The bins were constructed of 12" x 2" rough-sawn white oak planks nailed and through-bolted (to provide vertical support) to 12" telephone pole sections at 12' intervals set 4' in the ground. The holes in the asphalt pad necessary for earth augering to seat the poles were sealed by a 24" poured concrete ring. Weather protection of the soil stored in the bins

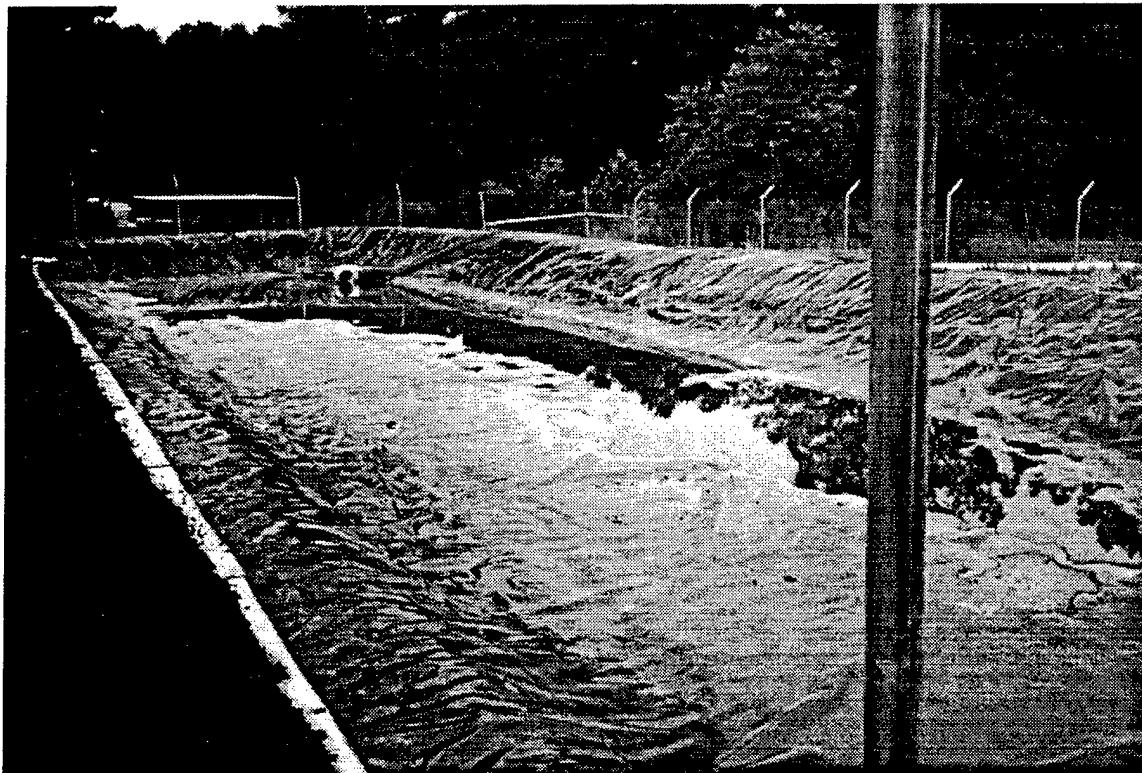

Figure 16. Storm Water Holding Pond

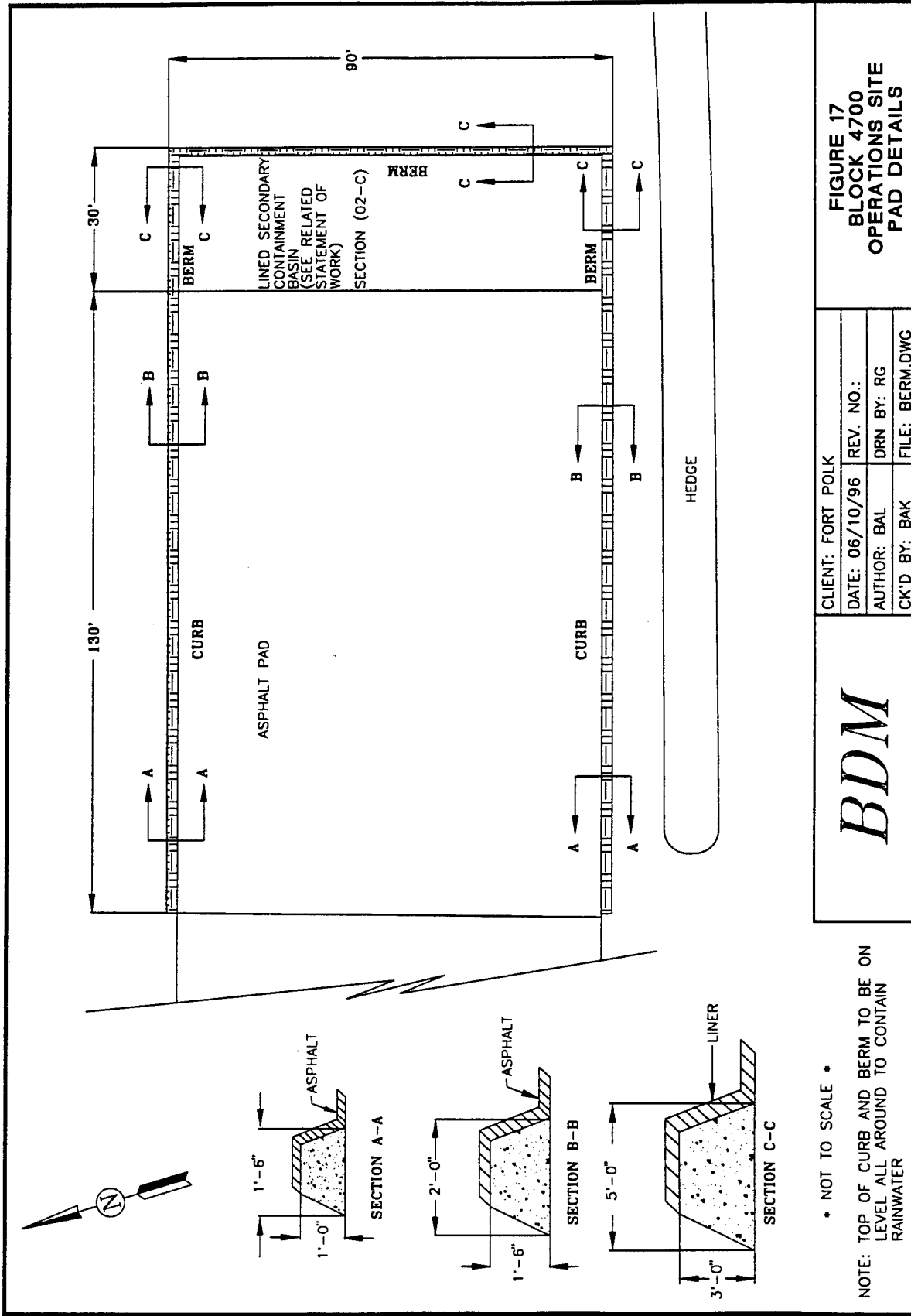

Figure 17. Block 4700 Operations Site Pad Details

D:\POLK\1007\BERM.DWG

was provided by erection of a sloped, wood-frame superstructure located on the bin lines 3' above the planks for support of plastic tarps. The bins were normally open during operations (as necessary for access) since front end loaders require up to 12' of vertical clearance to heap soil. The fragile nature of lightweight plastic tarps suitable for convenient management made a network of reinforcing polypropylene lines necessary to prevent damage to the tarps during periods of high wind. These support lines were arrayed for maximum anchoring support and were easy to attach. Additional weather protection of the soil in the bins was provided by overlaying the heaps directly with small lightweight tarps. This redundancy provided an additional safety factor. The bins are pictured in Figure 18.

8.6 ELECTRIC UTILITY SERVICE AND METERING

Coordination with FP-DPW resulted in temporary use of high capacity transformers to step down voltage from the existing Ft. Polk 13.8 KVA grid accessible on the south side of Service Command Circle to the 480V/3-phase/300A service required for vendor operating equipment. A 6' x 20' x 6" reinforced concrete pad was poured in and is shown in Figure 19. National Electric Code (NEC)-compliant wiring and fusible links were erected on poles set adjacent to the concrete pad for connection of the transformers to the Ft. Polk grid and the 480V/3-phase/300A fused disconnect to be accessed by the vendor power distribution station. A 480V/3-phase digital power and demand meter was installed conforming to

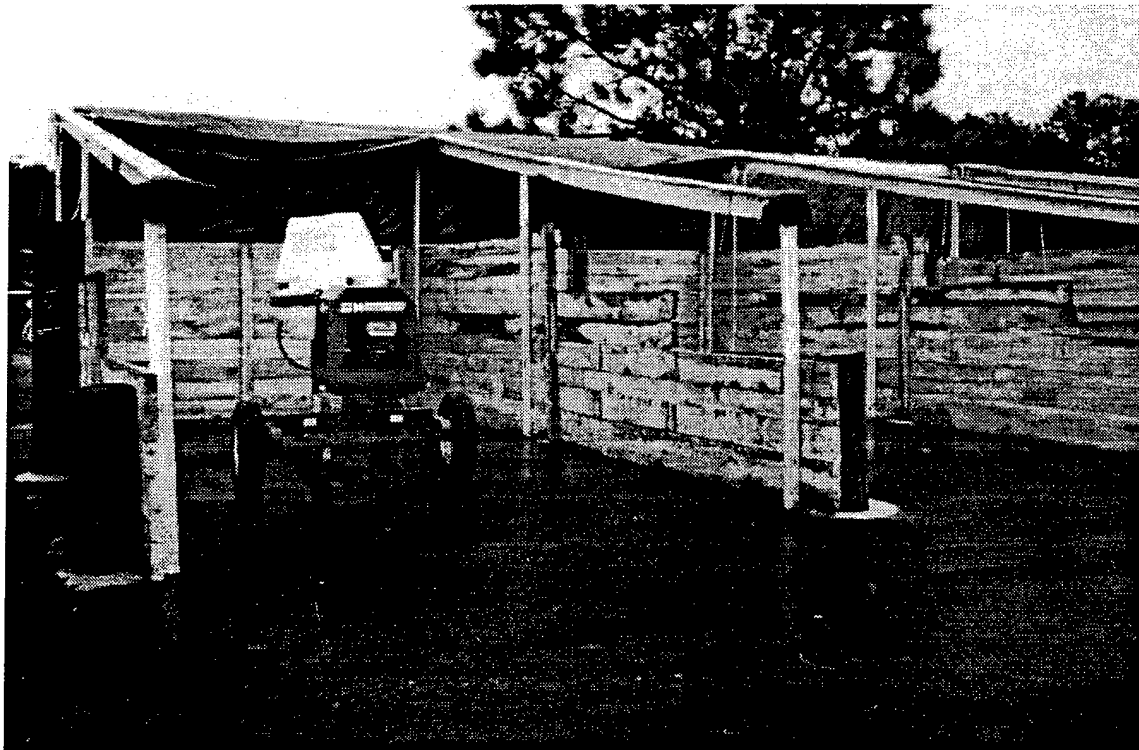

Figure 18. Soil Storage Bins

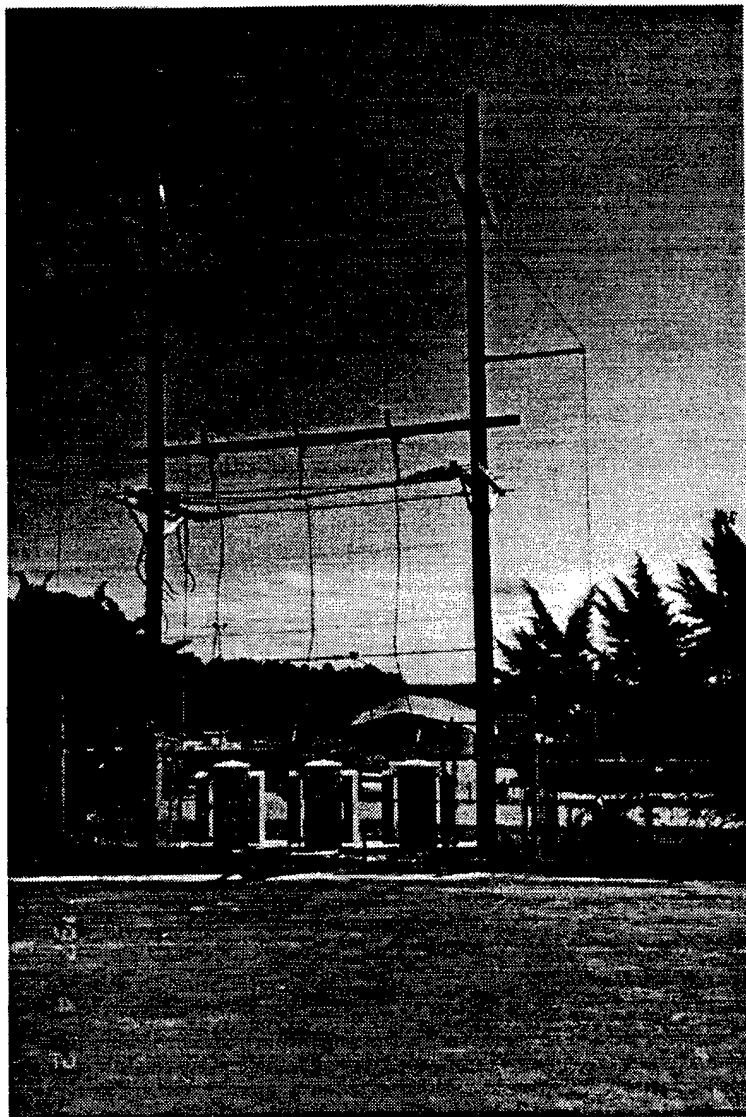

Figure 19. Power Distribution Station

adjacent to the south gate. FP-DPW personnel connected all links to the grid after a thorough safety inspection of the substation.

8.7 WATER SERVICE

Prevention of back flow to the Ft. Polk water mains necessitated acquisition and use of a vented 1100-gallon holding tank between the Ft. Polk main and the Operations Site hose bibs (Figure 20). This tank and a 20-gallon well pump (necessary to pressurize water for the trailers and decontamination station) were mounted on a 10' x 10' x 6" reinforced concrete pad adjacent to the south gate. Underground, 3/4" supply piping was installed between the pump and pressurized hose bibs. A 2-inch underground, unpressurized line was installed to a hose bib midway on the south edge of the pad for use by vendors for process water makeup. A 2" water meter was acquired and installed in the 2" line in accordance with analytical requirements for the demonstration. A fire hydrant in the vicinity of the south gate was accessed for water, and a manually operated gate valve was installed in the 2" line to maintain the

water level in the holding tank at working level. Automatic control of the water level in the tank was determined inadvisable due to the high pressure at the hydrant. FP-DPW personnel connected the system to the hydrant upon inspection of the piping and back flow prevention, and provided a wrench for manual shutoff of the hydrant in event of emergency shutdown. Continuation of the demonstration beyond the original period scheduled required the addition of pipe insulation for exposed pipe

demonstration analytical requirements; and, due to expense and the temporary nature of the installation, the meter was provided and installed, on a loaner basis, by the Louisiana Power and Light Company who provides commercial primary power Ft. Polk. Separate 240V/single-phase/200A service was installed for the administrative trailers, water supply pump, area floodlighting, and the sample preparation shelter. Power was accessed through the Ft. Polk grid, and service entry, meter, lights, etc., were mounted on a pole set

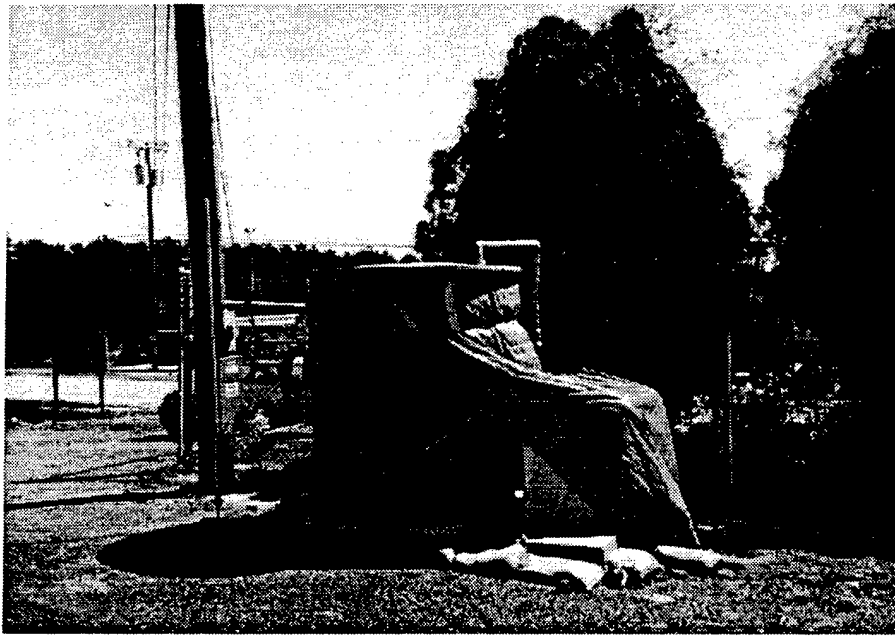

Figure 20. Water Supply System

and the pressure pump. All exposed piping was insulated, and an insulated housing for the pump equipment was installed with internal 200W heating.

8.8 WIND SOCK

A 15' high pole with a small windsock was positioned on the north perimeter fence at the Block 4700 operations site (Figure 21). The pole was stabilized with guy wires to the north, south, east, and west. The windsock's primary purpose was to provide immediate information to the BDM Site HSO and emergency response personnel concerning wind direction should a spill incident occur at the site.

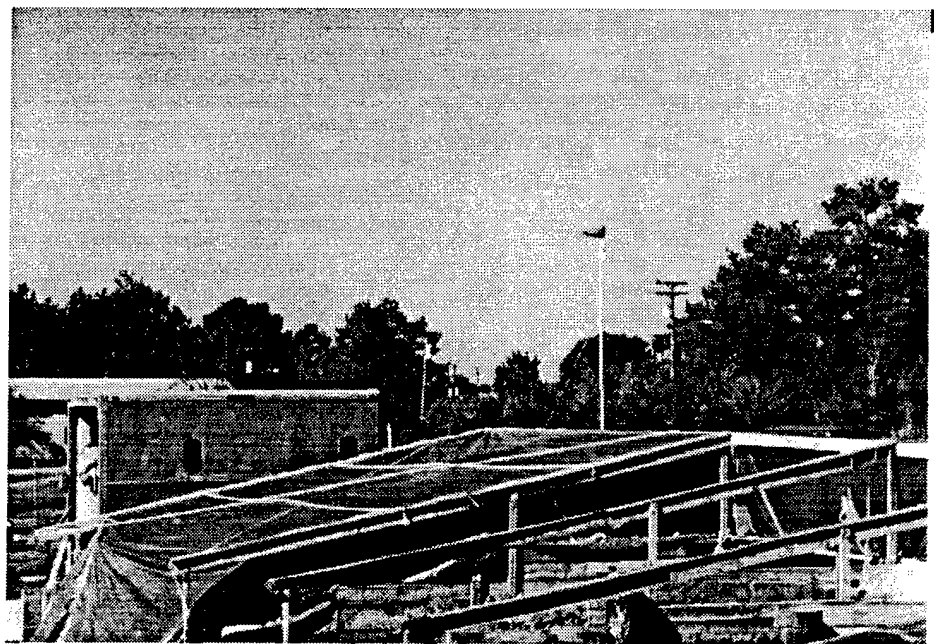

Figure 21. Wind Sock

8.9 SILT TRAP

Two types of silt traps were constructed during this demonstration to retain soil from washing into the pond. The first design was constructed of thin galvanized metal roofing material; however, this material did not hold up well. The second design consisted of 2' x 10' corrugated fiberglass panels that were secured by a grid composed of 2" rigid plastic pipe, which was flooded with water for weight to prevent movement. This system worked very well.

8.10 BATTELLE SAMPLE PREPARATION AREA

The sampling protocol used by Battelle during this demonstration required that 140-lb increments of soil be collected for analysis. This soil had to be dried, milled, and split into

smaller representative samples before it was shipped to the lab for digestion and ICP analysis. BDM erected a Sample Preparation Shed to locate the pugmill, shaker, and other necessary equipment. This area is shown in Figure 22. Soil drying was performed using a 240V/3-phase Rockwell Oven. As no 240-volt, 3-phase power drop was readily at hand, a diesel generator was brought in to power the oven. Initially one oven was used to dry soil samples; however, sample preparation was still limited so another was brought in. The ovens were located on a constructed concrete pad adjacent to the Battelle sample preparation area. The first oven is shown in Figure 23.

8.11 RANGE 5 EXCAVATION PLAN

At Range 5, soil was extracted by backhoe in lanes approximately 12 to 14 inches deep down the faces of Berms 2 and 3. Excavation

of Berm 1 was considered but disregarded due to its small size. Figure 24 shows one of these extraction lanes. Figure 25 shows the extraction plan used by BDM during this demonstration. Extraction lanes were approximately 16.5' wide by 40' long on Berm 3, and 20' long on Berm 2.

This soil was then transported by truck to a stockpile staying area on Range 5. This stockpile was discussed in more detail in Section 7.7.

8.12 COMPONENTS THAT NEEDED MAINTENANCE, REPAIR, AND REPLACEMENT

Most of the facilities constructed at Block 4700 held up well throughout the demonstrations. However, it is worth noting that some items needed maintenance, replacement, or modification.



Figure 22. Sample Preparation Shed

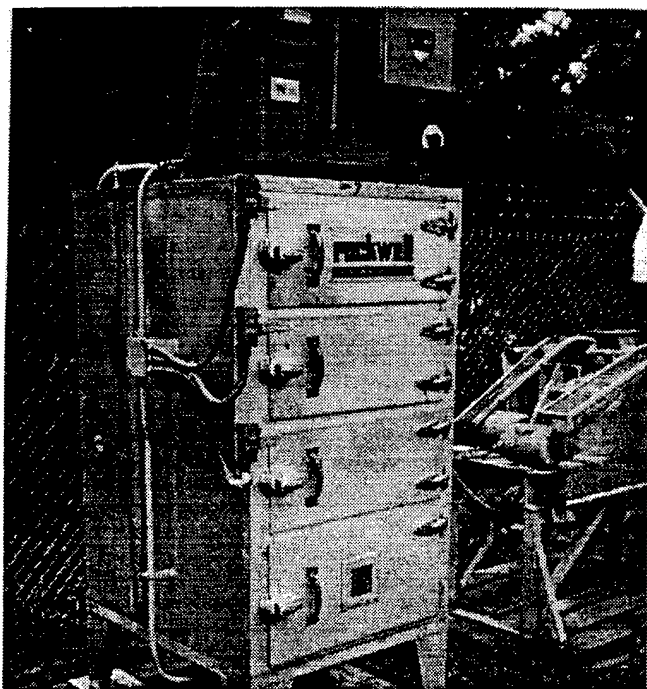

Figure 23. Soil Drying Oven

The water supply from the fire main was very high pressure in order to satisfy the fireflow demand. The gate valve used between the fire main and the 1100-gallon water tank was under considerable hydrostatic pressure.



Figure 24. Berm Extraction Lane Range 5

Two valves failed during the course of the demonstrations. In these instances, the fire main was quickly closed at the source with a wrench supplied by the FP-DPW, the valve was replaced, and the fire main was then reopened.

The wood-frame storage bin superstructure was vulnerable to the material handling equipment used to load and unload soil in the storage bins. On two occasions, the front-end loader cracked the wooden superstructure during material handling operations. On both occasions, the superstructure was quickly repaired by BDM personnel.

The tarps used on the storage bin superstructure to shelter stored soil from the weather were subjected to environmental extremes during the demonstration. High temperatures, rain, and wind took their toll on the tarps. Although a network of reinforcing polypropylene lines was used to strengthen and protect the tarps, periodic patching and reinforcing of the tarps was necessary.

As stated previously, the acidic nature of process waters used during this demonstration and area rainwater (which had a pH of 4.7) had a negative impact on the silt trap used during the first demonstration. The trap, which was constructed of thin galvanized metal roofing material, had rusted and deteriorated severely by the end of

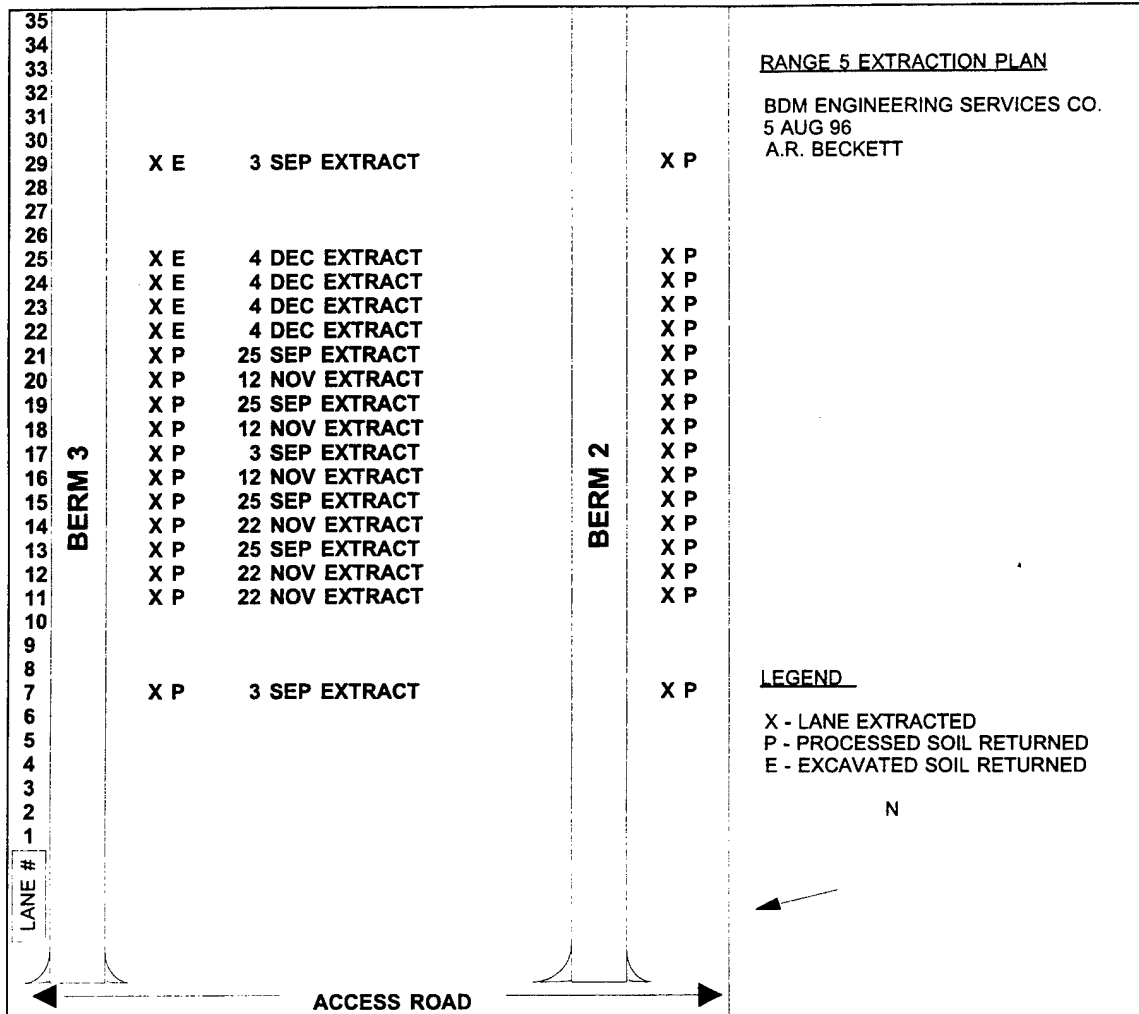

(CORRECTED ON BASIS OF SOIL MASS - 11/5/96)

1. AN EXCAVATED LANE WILL EXTRACT:
 42 TONS FROM BERM 3 (40' x 16.5' x 18")
 21 TONS FROM BERM 2 (20' x 16.5' x 18")
 TOTAL APPROXIMATELY 63 TONS
2. A SINGLE LANE WILL BE EXTRACTED COMPLETELY BEFORE STARTING ON ANOTHER LANE FOR EITHER STOCKPILING OR HAULING TO THE OPERATION SITE.
3. ONLY ODD NUMBERED LANES WILL BE EXTRACTED FOR THE FIRST DEMONSTRATION, EVEN NUMBERED LANES FOR THE SECOND DEMONSTRATION.
4. INITIALLY OPERATIONS LANES 17, 7, & 29 WILL BE EXTRACTED AND STOCKPILED.
5. THE 235 TON STOCKPILE WILL BE MAINTAINED THROUGHOUT THE DEMONSTRATION FOR USE DURING THOSE DAYS WHEN ACCESS TO THE BERMS IS PROHIBITED. IT WILL BE REPLENISHED AS SOON AS ACCESS TO THE BERMS PERMITS.
6. THE BDM SITE ENGINEER WILL MARK LANES AND DIRECT THOSE LANES TO BE EXTRACTED AND DIFFERED.

Figure 25. Range 5 Extraction Plan

the first demonstration. This situation was corrected before the second demonstration with the installation of a corrugated fiberglass silt trap that was secured by a grid of water flooded 2" PVC pipe.

As stated previously, the soil storage bins were constructed of rough-sawn white oak planks nailed and through-bolted (to provide vertical support) to 12" diameter telephone pole sections at 12' intervals set 4' in the ground. The planks used were very green. The weight and high moisture content of the processed soil began to adversely impact the bins over time. The rear walls of the bins started to bow out, and the side planks also began to warp. This situation was resolved by installing 4' x 10' x 1/2" plywood boards in the rear of the bins and covering the inner walls of the bins with heavy sheet plastic. This alteration distributed the pressure loading and placed less acute stress on the structural components.

As the demonstration continued into November, weather changes prompted the insulation of Operations Site water supply piping. It also necessitated the construction of an insulated housing with internal 200W heating for the administrative trailer and decontamination station water supply pump.

8.13 SUMMARY

Although there were logistical challenges associated with performing this demonstration on a split site, the measures implemented in the preparation of the Operations Site at Block 4700 effectively overcame these challenges. The combined facilities constructed at Block 4700 created an excellent platform for this type of demonstration or support of other hazardous waste or materials management. Decommissioning of the site included removal of the storm water runoff pond and all administrative support facilities. However, Ft. Polk requested that all other facilities remain at Block 4700.

9.0 PROCESS CLEANUP STANDARDS

At this moment, there are no national cleanup standards for metals on small arms ranges. As discussed in Appendix B, when the EPA finalized its Military Munitions Rule, they gave some consideration to adopting "Uniform National Standards" for ranges, but retired the initiative recognizing that states may adopt broader or more stringent standards. A few states have published action levels for lead in soil and lead in water, but for the most part, such standards are site-specific, depending on what receptors are exposed to the potential toxic harm that exists and at what level. Receptors and pathways need to be considered, and biokinetic and risk uptake modeling needs to be accomplished to best address cleanup standards.

As discussed in Section 5.4, NEPA/Environmental Assessment, the baseline demonstration for this technology set's debut to the technical and regulatory community was accomplished at the TCAAP in Minnesota in August 1994, under the auspices of the EPA's SITE Program.

Current levels of contamination by lead in soil on small arms ranges will vary. There will certainly be hot spots, and, depending on the soil grain size, pH, moisture content, buffering capacity, cation exchange capacity, and more, the lead will vary greatly in its distribution as metallic, particulate lead-to-lead salts. The latter are more difficult to deal with as their increased solubility and tendency to chemically bond to soil fines; impedes physical separation and requires acid leaching for effective removal. The average concentration in the soils at Range 5 at Ft. Polk was approximately 3500 mg/kg. However, BDM recently encountered a similar

range in another state where the average concentration was approximately 4000 mg/kg, with hot spots as high as 10,000 mg/kg. At TCAAP, the average concentration was closer to 1000 mg/kg.

The cleanup standard targeted at TCAAP was 300 mg/kg for total lead. This cleanup standard was enforceable as a remediation goal. If the process met this goal and satisfied the TCLP criteria, the soil was not considered a hazardous waste under RCRA.

Other related cleanup standards for lead, depending on land use in the state of Minnesota, included 100 mg/kg for residential property and playground use, and 1200 mg/kg for industrial land use. Moreover, in July 1994, the EPA announced an action level of 400 mg/kg, above which additional focus on potential risk and physical exposure reduction methods were to be evaluated.

This wide range of values influenced us in establishing the envelope of values to which our demonstrations would perform. Again, an important point to remember at this time is that the TCAAP SITE project was an actual remedial activity carried out at a DoD IRP site. Our demonstration was not. It was strictly process-focused to determine how well this technology set worked and to capture costs and other related data performance elements.

9.1 CONTRACTUAL OPTIONS FOR VENDORS TO BID AGAINST

Based on the experience at TCAAP and the findings of cleanup goals noted during the Worldwide Search activities of this project, the performance envelope chosen for the demonstration vendors selected to work towards was 1000 mg/kg or 500 mg/kg. Prospective ven-

dors could performance bid against either or both. In addition, they were required to satisfy the TCLP criterion for lead, which was less than 5.0 mg/L. The addition of the latter criterion required us to reconsider the total lead reduction performance envelope, specifically the relationship between total lead and TCLP lead, as the project progressed. This subject is addressed in the following section.

9.2 IMPACT OF IMPOSING TCLP CRITERIA

Notwithstanding the spirit and intent of EPA's "Military Munitions Rule" and the companion DoD "Range Rule," the importance of satisfying the TCLP criterion for lead (i.e., less than 5.0 mg/L) was to avoid the pitfalls of processing soil from a range, removing a significant amount of total lead, but then not satisfying the TCLP criteria. This would most probably be an issue at closed and transferred ranges, and could possibly be an issue at active or inactive ranges. The concern of note under this scenario was twofold and consisted of:

- ◆ Has a RCRA hazardous waste, based on the Toxicity Characteristic for Lead (D008) been generated by this process?
- ◆ Can you put such soil back on the range under the argument that it is probably cleaner than it was before?

The answer to the first question seemed to be "yes;" a RCRA hazardous waste has just been generated because as the material has been excavated from the range, the lead in the soil can no longer be considered "used for its intended purpose" and laboratory data have indicated that the soil has failed the TCLP criterion for lead of less than 5.0 mg/L. Therefore, the soil would be classified as a RCRA hazardous waste, and unless the installation or con-

tractor has the proper licenses, treatment of it is prohibited.

The answer to the second question seemed to be, "no;" now that the soil is classified as a RCRA hazardous waste, it may not go back on the range from which it came, as it is not proper to dispose of it in such a manner because of the landban ruling (40 CFR 268).

These were the rules of engagement at TCAAP. For this reason, the performance standards of these demonstrations at Ft. Polk included the requirement to satisfy the TCLP criteria. Initially, some potential vendors petitioned to use polymers and other additives that would drive up the pH and chemically fix the soluble lead by solidification and stabilization of the material so leaching would not occur. Much consideration was focused on these options, but in the end, it was decided to not pursue this route. Among the concerns for pursuing such a course of action, were:

- ◆ Adopting such a standard and subsequently satisfying it ensures that the chain of liability is broken and removed with the successful implementation and execution of the planned remediation.
- ◆ Solidification and stabilization may not be a long-term solution and require reapplication sometime in the future, potentially exposing the DoD to long-term, third-party liability.
- ◆ Action to transfer lands that were changing utilization to more stringent standards (such as via BRAC) to another entity, or utilization changing the land use from industrial to community or family housing, could cause liabilities.
- ◆ On previous applications, so much fixing material was required that the volume of

the affected area noticeably increased and required careful regrading for storm water management and erosion control.

In the end, it was determined to make every effort to satisfy TCLP criteria without stabilization agents. Currently, at Eielson AFB in Alaska, a range is being cleaned up, and the cleanup standards being imposed there are 400 mg/kg for total lead and to satisfy the TCLP criterion for lead. This independent decision by Air Force authorities reinforces the direction pursued in this project. Further reinforcing these performance criteria is the recent Fort Benjamin Harrison cleanup, where the lead cleanup standard is 440 mg/kg.

This demonstration decision was fairly realistic, and it put great emphasis on the chemical effectiveness of the leaching circuits employed by the two independent vendors. In the end, the results showed that the vendor who employed acetic acid as the leaching agent struggled to satisfy this requirement. After the demonstration, 161 tons of processed soil had to be disposed of as a RCRA hazardous waste, at considerable cost to the project effort. The vendor who employed hydrochloric acid as the leaching agent easily satisfied the TCLP criteria. However, reviewers should not reach any conclusions prematurely as to the effectiveness of one acid (hydrochloric acid), which was able to completely dissociate and more effectively lower the pH to 1.5 than the weak acid (acetic acid), which only partially dissociates. Process performance here is a function of lead availability, which is a function of solubility versus pH. Acid dosage will determine the resulting pH, and the qualification issue is that there is a practical limit for weak acids. In addition, economics must be considered, and the bal-

ance between acid cost and required dosing must be considered as well. Another factor that very strongly impacted these demonstrations was the ability to dewater processed soil and thus remove soluble lead bearing process washwaters and reduce leachate "dragout." Washwater chemical rejuvenation was an impacting corollary issue. Acetic acid is more costly than hydrochloric acid and this must be considered. There are far more complex actions here that will be addressed in Section 11. Cost issues are addressed in Section 19. Such a decision as to what acid to use as a leaching agent certainly can affect the unit costs of applying this technology set, but if such a criterion (i.e., satisfy TCLP) is chosen as part of the required system performance, reviewers need to recognize that this technology set can achieve this.

9.3 RISK-BASED APPROACH

As available funds for site remediation have become limited, strategies have been put in place to characterize contaminated sites based on the risk they represent to people and ecosystems. Receptors and pathways are identified and quantified, and analyses are performed to assess specific sites.

Initially, risk-based approaches were used to evaluate and score sites so that available funds could be used to remediate those sites that represented the most risk. Risk-based approaches are now being used to actually establish cleanup standards for specific sites.

Within the DoD, this program approach is referred to as the Relative Risk Assessment Program. It was introduced in 1994, and implemented during Fiscal Year 1995. The requirement was for all DoD IRP sites to be scored by

the end of the fiscal year. In addition, the DOE adopted a parallel program referred to as the Probabilistic Risk Evaluation and Characterization Investigative System (PRECIS).

The application of risk to environmental management has also been used under CERCLA to score candidate Superfund sites for many years and has now expanded into state regulatory programs because most states now operate their own EPA-authorized hazardous waste management programs. Accordingly, the American Society for Testing Materials (ASTM) has developed a standardized Risk Based Corrective Action (RBCA) program protocol based on EPA-established default parameter values.

Specifically, impacting environmental parameters are determined with regard to human exposure rates and contaminant attenuation factors gleaned from fate and transport models. After a series of calculations, the maximum allowable source area contaminant concentrations that will provide sufficient protection to people are determined for the exposure scenarios applicable, and the cleanup standards are evaluated.

Many states are now adopting this methodology and are applying it to contaminated sites to define site-specifically what cleanup standards must be achieved during a remediation project. The specific ASTM standard protocol is E-1739 RBCA. Reviewers of this document contemplating applying this technology set in the future to one of their site-specific requirements should become familiar with this ASTM protocol as it may be used to determine the required remedial system performance they will have to achieve.

9.4 CORRELATION OF FIELD VERSUS ANALYTICALLY GENERATED DATA

During this demonstration the independent evaluator provided near record turnaround service for TCLP analysis—which typically was 4 days. With the laboratory off-site and in another state, this was greatly appreciated. These parameters were analyzed via methods EPA 3051 for digestion of soil samples, EPA 1311 for nonvolatile TCLP extraction, and 6010A for ICP atomic emission spectroscopy (AES) for metals of concern in extracts. Nonetheless, with TCLP criteria being a requirement to be satisfied, before the processed soil could be put back on the range, occasionally large stockpiles of processed soil accumulated on the operations pad.

This created an occasional logistics challenge and had the potential to hinder the rate at which soil was processed. Processed soil had to be stored in weather protected shelters until this confirmation was in hand. Such situations as this need to be considered in process planning, and workarounds needs to be harmonized. Possible options include ensuring that your operations pad is sufficiently sized, and the economics of an on-site analytical laboratory needs to be explored. We had hoped that field screening could assist here, but efforts to correlate such did not provide adequate statistical reliability.

A Spectratrace 9000 X-RF instrument was used for sample screening and process control at the job site. It ably measured total lead values, and a sample could be read in about 15 minutes. Some consistency is desirable between sample analysis with this device and the analytical laboratory. BDM has made a strong

effort to search for consistency at the end of the demonstrations with all the data available. The results of that effort are presented in Table 8 and Figures 26, 27, and 28.

It is obvious from the data that X-RF analysis consistently gave a lower measure of lead concentration in a sample than did digestion followed by ICP analysis in the lab. Efforts to develop a linear relationship between X-RF and ICP on this data set have not been very successful (as can be seen by the low correlation coefficients). It should be noted, however, that when a processed soil sample was dried prior

to X-RF analysis, the X-RF gave a higher reading of lead concentration. Perhaps water in soil pore space in the sample was interfering with the analysis. If all of the samples were dried prior to analysis, it might be possible to develop a realistic linear relationship between the X-RF and ICP results. However, this would impact the speed at which X-RF analysis can be done in the field. It is also important to note that any relationship developed between X-RF and ICP would be site-soil-specific.

Efforts have also been made to establish a relationship between TCLP [Pb], and Total [Pb]

Table 8. Analytical X-RF and ICP Results of Processed Soil

Sample Date	Bescorp X-RF (Wet)	Battelle ICP	Battelle X-RF	Battelle XT (Dry)
	(ppm)	(ppm)*	(ppm)	(ppm)
15-Nov	82.7	113	82.038	
16-Nov	94	115	111.32	
20-Nov	98.4	123	55.306	
21-Nov	92	125	94.314	
22-Nov	107	127	117.96	
23-Nov	108	132	142.78	
25-Nov	166	134	137.96	202.21
26-Nov	134	165	121.73	
27-Nov	120	177	106.27	
29-Nov	127	181	160.4	232.26
30-Nov	163	230	140.89	201.03
2-Dec	149	232	109.75	
3-Dec	131	233	111.28	
4-Dec	192	235	77.71	
5-Dec		127	96.42	
6-Dec		123	92.05	

* ICP by EPA Methods 3051 and 6010A.

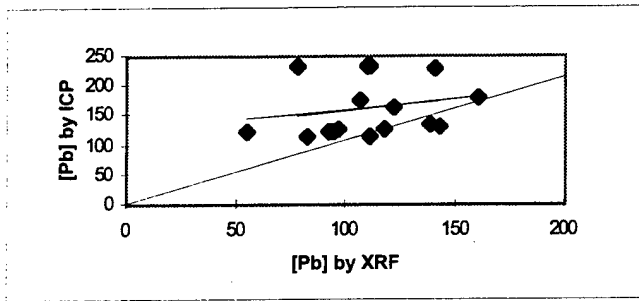

Figure 26. Battelle ICP vs. Battelle X-RF;
 $Y=0.35X+122.23, R^2=0.04$

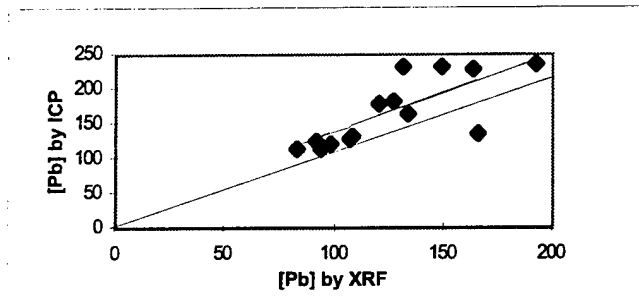

Figure 27. Battelle ICP vs. BESCORP X-RF;
 $Y=1.13X+22.89, R^2=0.57$

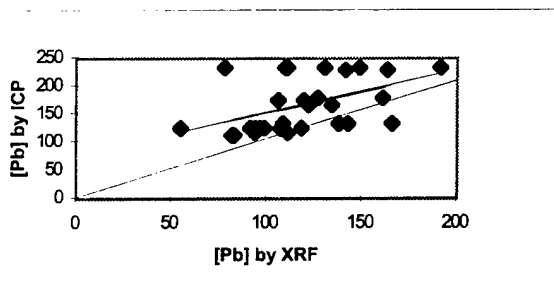

Figure 28. ICP vs. X-RF (All Data);
 $Y=0.75X+75.54, R^2=0.23$

with mixed results. In Figures 29 and 30 it can be seen that while TCLP and Total [Pb] were linearly related during the Acetic Acid Leaching Demonstration, they were not linearly related during the Hydrochloric Acid Leaching Demonstration. However, it should be noted that all of the Hydrochloric Acid Leaching Demonstration data are for tests that passed the TCLP criterion for lead and subsequently had

total lead values less than 250 mg/kg. The fact that all the sample data showed total lead values less than 250 mg/kg and all samples passed the TCLP criterion of less than 5.0 mg/L indicates a scientifically defensible correlation.

It is important to consider that any theoretical correlation between total lead concentration and TCLP lead concentration would be site-specific. The relationship would be dependent on the characteristics of the soil matrix and the concentration of the contaminant. Therefore, such a relationship could not be applied universally with any degree of confidence.

The advantage to being able to use quickly determined X-RF based surrogate lead readings, in lieu of TCLP values, is the potential to

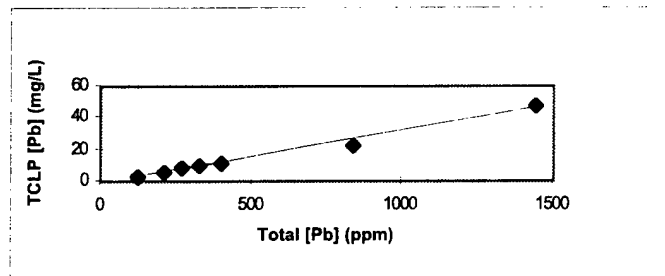

Figure 29. TCLP vs. Total (Pb) Acetic Acid Demonstration;
 $Y=0.03X-1.48, R^2=0.98$

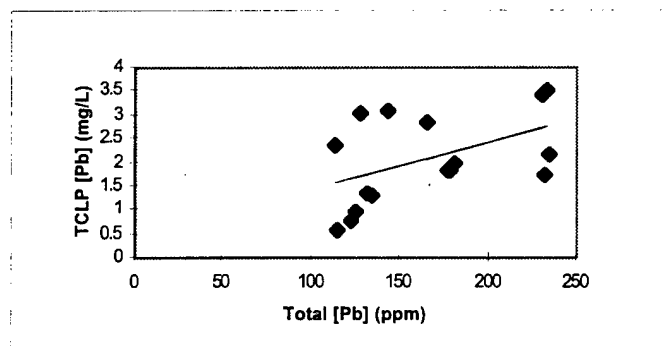

Figure 30. TCLP vs. Total (Pb) Hydrochloric Acid Demonstration;
 $Y=0.40X+0.01, R^2=0.24$

achieve good economies for field operations employing this technology set. In this case, X-RF readings of less than 250 mg/kg were a good indicator of samples that would most likely pass TCLP. However, it is important to note that data and performance results tend to be site-specific, and therefore derived empirical correlations would also be site-specific. It is speculated that salt masking between carbonates may be an issue as well as sample preparation for X-RF analysis (moisture content and pH). The potential benefits to having such a field screening tool available are significant enough to warrant further work. It should be noted that it is the TCLP value, not the total lead concentration in a soil, that is used to classify the material as a hazardous waste.

9.5 ON-SITE LABORATORY CONSIDERATIONS

As already described, an off-site analytical laboratory was used in support of these demonstrations. Although the turnaround service was a near record performance, the impact on process throughput was potentially negative. The logistics of handling the samples and the digestion times required by the test protocols contributed to an excessive time period, and not the laboratory itself. For future applications, discounting process control requirements, every effort should be made to have the sup-

port analytical laboratory on-site, if economically justifiable and acceptable by the cognizant regulatory authority. When doing the economic analysis, reviewers need to be certain to gather and account for all the external costs.

9.6 SUMMARY

Before this technology set is applied to a given site requirement, the cleanup standards that must be achieved need to be very well defined and understood. Those applying the technology will, in all probability, not have had inputs into these standards. However, those planning the application will have. Soil washing can probably achieve processed soil lead concentrations in the 250 to 350 mg/kg range fairly readily and satisfy the TCLP criterion depending on soil characteristics. Reviewers are cautioned that performance of such systems is greatly impacted by soil characteristics and distribution of the heavy metals contamination within the soil matrix. Satisfying TCLP criteria are difficult, but achievable, and such criteria are very likely to be a cleanup standard. Use of field screening methods for correlation to cleanup standards has economic merit in the field. Efforts to demonstrate such correlation were not entirely successful, and more work in this area is warranted.

10.0 CONCEPT OF OPERATIONS

As a result of these demonstrations, two separate soil washing systems have been deployed, operated, and demobilized. One of the two demonstrations worked especially well in the field, and both together demonstrated that this technology set works.

The issue to be addressed now is how these pilot plant systems might be scaled up in the field as prototypes and operated cost effectively and at high reliability. There is much interest in this subject at the moment. Concerns are focused on a few major areas:

- ◆ How long will it take to process soil at a typical range?
- ◆ What will it cost?
- ◆ Describe a typical range—how much soil is there to be processed and what is the typical lead concentration? Are there categories of ranges based on size or mass of soil to be processed where economy of throughput rate scale might be used to categorize them (e.g., less than 10 tons per hour, 10 to 30 tons per hour, greater than 30 tons per hour, or fixed regional plants)?
- ◆ Is physical separation sufficient, or is acid leaching also required?
- ◆ Is a mobile system better than a fixed regional system?
- ◆ What are the pros and cons of a split versus a single site operation?

We are introducing some of these issues here, so reviewers can become aware of them now and be considering them as they read the balance of this technical report.

During the execution of this project, because it involved metals recycling, there was an occasional reference to a current metals recycling program within DoD. The program being re-

ferred to here is the Defense Logistics Agency's Precious Metals Recovery Program (PMRP). This program is described in DoD Manual 4160.21M, and describes the recycling of gold, silver, and platinum. The project being addressed in this technical report is independent of this program, as lead is not a precious metal.

10.1 CONCEPTUAL PROCESS

This technology set is basically a recycling operation as was illustrated previously in Figure 3. That figure is repeated here for ease of use.

As previously stated, there are five by-products from such a system:

- ◆ Clean soil to go back to the range it came from and used for the same beneficial purpose it was previously serving—most likely a berm
- ◆ Reclaimable metals to go to a recycler to put them back into the economy for beneficial reuse
- ◆ Solid waste that needs to be properly disposed of in a landfill or other acceptable means
- ◆ Hazardous waste that needs to be sent to a licensed TSDF for proper treatment and disposal
- ◆ Process washwater will need to be disposed of at the end of the operation. Commercial systems should be able to clean up this water internally such that its key parameters (pH, Pb, and TDS) are benign and it can be discharged to a STP/POTW or permitted for discharge to a receiving stream. If not, it could become a hazardous waste.

The visualized concept of operations for a full scale field activity is listed below. Prior to these activities occurring, it is assumed that

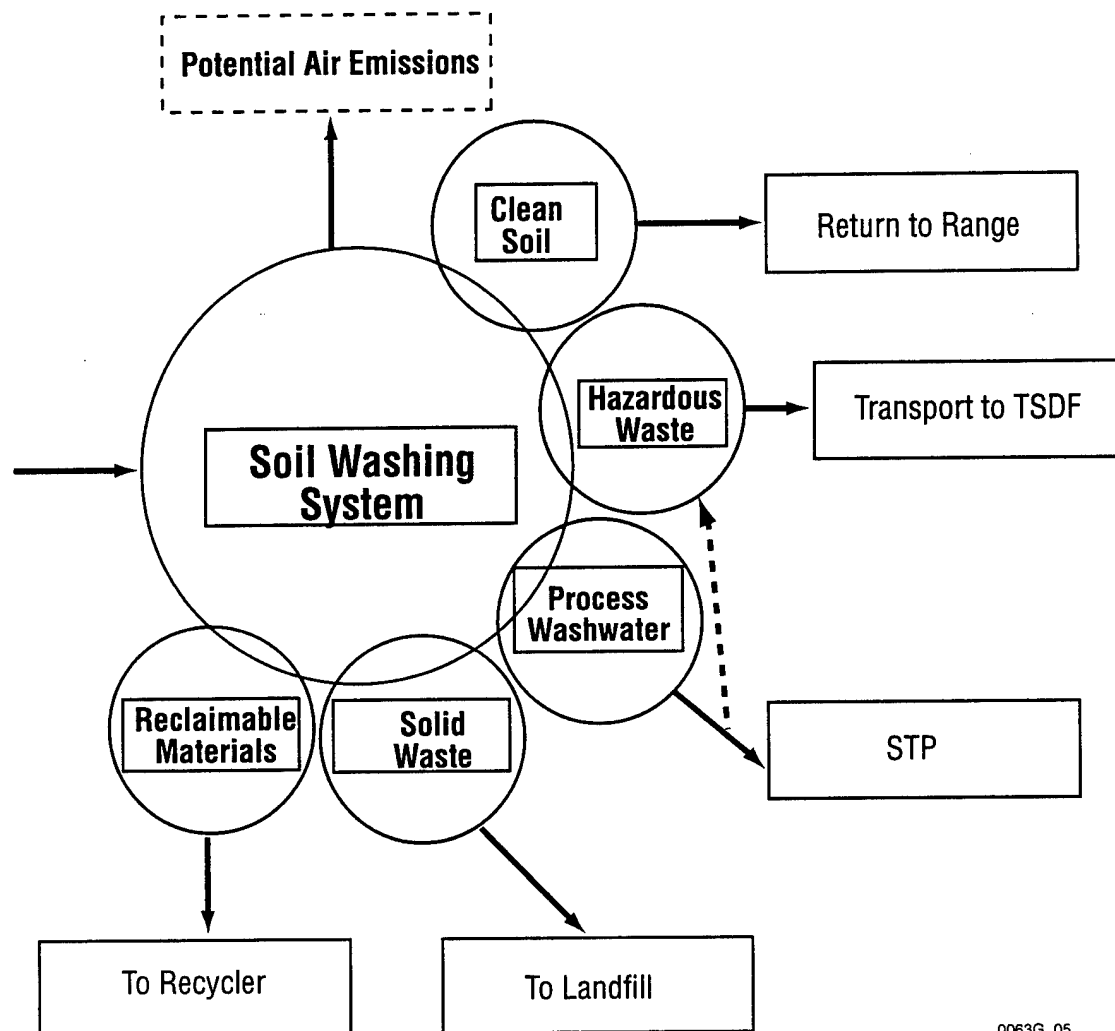

0063G_05

Figure 3. Soil Washing Process Flow Diagram

a representative series of soil samples were collected, a benchscale treatability study was performed to confirm that the technology set would achieve the cleanup goals identified, and that the unit processes chosen matched the laboratory results and were properly scaled up and are compatible with one another. Moreover, the site planning and site-preparation was complete, and all NEPA and other compliance requirements had been satisfied. Here are the visualized steps:

- ◆ Deploy the unit process equipment to the range to be serviced.
- ◆ Temporarily shut down the range, complete site preparation, mobilize the equipment, and excavate the berms to be recycled.
- ◆ Pass the soil through the unit process equipment.
- ◆ Remove the metals.
- ◆ Return the processed soil to the berm after confirmatory analytical testing, and reconstruct the range so it can be returned to normal beneficial use.
- ◆ Reclaim the metals via a licensed smelter.
- ◆ Properly dispose of any solid and hazardous waste generated by the recycling operation.

- ◆ Demobilize the site and allow the range to return to active service.

10.2 MOBILE VERSUS REGIONAL/FIXED SYSTEMS

There has been much interest recently in fixed systems on a regional basis. The source of this interest is the Interstate Technology and Regulatory Cooperation (ITRC) Working Group Metals in Soils team. This group, jointly sponsored by the EPA and the DoD, is made up of representatives of 25 state environmental agencies and also includes federal, industrial, tribal, and other public member representation. Based on the observation that certain legal and regulatory uncertainties associated with the cleanup of hazardous waste sites discourage the use of potentially more cost effective innovative technologies, this group is working proactively to first gain regulatory approval on the use of such innovative technologies, and then developing methods to better utilize selected innovative technologies. One of the mechanisms currently under study is the development of a baseline regulatory requirement and standardized protocols for verifying a technology's cost and performance. Soil washing is one of the innovative technologies the ITRC is very interested in. Some members visited the job site at Ft. Polk when the demonstration was being performed. Recently, ITRC members have become aware of the successes with soil washing that have been enjoyed in Europe and Canada, especially at large, fixed, regional facilities. It is not clear if there are institutional or regulatory barriers to these in the continental United States. A case study is planned for execution shortly.

A fixed regional site could operate at a very high throughput rate and process very large masses of contaminated soils. Thus, it could optimize process costs and be very economically competitive. Offsetting this would be the need for collecting the soil and transporting it long distances. Such material would be considered, in all probability, a hazardous waste when being shipped to the regional site and require detailed manifesting. The cost of return shipment for successfully treated soils would be as non-hazardous materials. The costs associated with shipping could be considerable and offset the costs saved by having the soil processed at a large regional facility. Where that break point is located is not yet known. What is important at the moment is for reviewers to be aware that this is occurring. We also recognize that at some installations there are small scaled ranges, often supporting pistol qualifications only, that have a small volume of soil that eventually becomes contaminated with bullet fragments. Not only are these ranges small in soil volume, but often the soil in question is imported sands and is weather protected. Thus, there would be no soil fines to contend with and little if any oxidized metal salts. There is interest in the commercial sector at the moment in developing small scale highly mobile processing units to service such ranges if there is sufficient commercial opportunity. Vendor 2 is currently preparing to carry out a remediation assignment at one such facility and intends to accomplish density separation using air rather than water. This rapidly developing technology tool set offers the potential to serve such ranges that are unique with regard to soil volume and contamination.

Under what scenario would it be more conducive for an installation to have soil from one of its small arms ranges transported to a regional facility, as opposed to having a mobile system set up at the range in question and do the processing there? The decision will be based on how long the active range would not be available to support training or testing and the total cost of the cleanup.

There is probably a minimum or floor value of soil mass to economically warrant the deployment and mobilization of a plant at an installation. That value right now is estimated to be approximately 10,000 tons. There is more or less a typical range, with the variable being the number of firing positions available. A typical range may have approximately 15,000 tons of soil in and immediately in front of the berms that could become heavy metal contaminated. Many large installations have multiple ranges.

A deployed mobile unit will probably have the capability to operate at a process throughput rate of between 10 to 20 tons per hour. Moreover, it will be most desirable to operate such a system 24 hours per day, probably 6 days per week, with the seventh day for preventive maintenance and crew rest. For example, if a system was deployed to an installation with 10,000 tons of soil, and it was to operate at a throughput rate of 10 tons per hour, it would take 7 weeks to process the soil (10,000 tons/ [10 tons/hr] [24 hours/day] [6 days/week]=6.9). Recognizing that it might take 4 weeks for site preparation and equipment mobilization, and another 2 weeks to demobilize and fully reconstruct the berms, we have this range being out of service for 13 weeks, or 3 months.

If we deployed a larger mobile unit, such as one that operated at 20 tons per hour, then it would take 3-1/2 weeks of processing time, for a total range down time of 9-1/2 weeks. Such equipment would be more costly, and the excavation and soil handling would be more intense and thus more costly, but you would save in range downtime. This example illustrates the tradeoffs that must be considered when planning out such a project. A very detailed cost/benefit analysis must be accomplished for every project.

Costs are addressed in Section 19. It appears that in the range addressed in the example, soil washing (to include acid leaching) will cost approximately \$175 to \$200 per ton. If the soil washing activity only involves physical separation, the cost may be more in the range of \$60 to \$80 per ton, or less. This determination is more a factor of what the cleanup standards are, and the soil characteristics (soil particle size distribution, soil chemistry, and distribution of the contamination).

Perhaps an ideal situation is to have a mobile unit come to an installation and service a number of ranges at the same time. Recognizing that we only want to do site preparation and mobilize the unit processes system train once, we would find ourselves in a split-site operation profile. Such an activity is addressed in the next subsection.

10.3 SINGLE VERSUS SPLIT-SITE OPERATIONS

During our two demonstrations at Ft. Polk, because we were operating on an active range, in the interest of safety, we were forced to operate in a split-site configuration. Based on our experience with these activities, we would

make every effort to avoid a split site in the future. The limited space to store segregated soil on an impervious pad, the complex logistics of moving soil to and from the active range, and the time awaiting analytical laboratory results so we could return the soil to the range were burdensome and detracted at times from the true purpose of the demonstration. As we described in Section 5.2, when the final version of the recently published EPA Military Munitions Rule goes into effect in August 1997, notwithstanding any policy change brought about by the final version of the DoD Range Rule, such split-site operations will, in all probability, be managed under normal RCRA protocol. There is the potential exception that if the site is so close as to be considered contiguous and meet the on-site test, this may not be the case. Hypothetically, if the ranges being maintained are so close to one another, as they often are, this criterion may be satisfied and other documentation might not be required.

Nonetheless, economics may dictate that the most cost effective approach to small arms range maintenance is to service a number of ranges in the same general time period when a mobile soil washing system is deployed to an installation. Should this be the case, every effort should be made to carefully execute detailed environmental planning and site planning activities to remain in full compliance with the regulations in force at the time of work execution, so the fullest cost saving opportunities can be realized.

10.4 SUMMARY

The currently envisioned concept of operations is to operate soil washing systems as recycling activities on-site via mobile systems that are tailored for the unique attributes of the range after detailed benchscale treatability studies have been performed on representative contaminated soil samples. If the range to be maintained is an active range, there may be pressures to operate via a split site. This profile should be avoided if possible, but if there is no alternative, such operations are achievable. For each application, a cost/benefit analysis should be executed, in as much as there are so many variables to consider. In the end, range downtime and total cost will be the driving factors. If there are a number of ranges on the installation, consideration should be given to maintaining them all within the same general time period due to the potential for cost savings associated with only one mobilization and economy of scale parameters. The ITRC is interested in closely examining the potential for what large regional soil washing centers might offer customers. Such opportunities do not exist now, but may be available in the future. The transportation costs necessary to get the soil to these and back to reconstruct the range berms may work against the economics of this, and a cost/benefit analysis will have to be accomplished to ensure it offers the most savings to the client.

11.0 LEACHING ALTERNATIVES UTILIZED

One of the purposes of this demonstration was to determine the effectiveness of two different acid leachants, one being acetic acid, which is a weak dissociable acid, and the other a strong mineral acid. While the strong acid can be used in much lower pH ranges, giving a stronger driving force for dissolution of metallic lead fragments, there are some potential advantages of using a weak acid at a higher pH range if the mode of occurrence of the lead is such that it can be solubilized at the higher pH.

The potential advantages of a weak acid over a mineral acid include:

- ◆ Less hazardous material to store and handle
- ◆ Less impact to a local ecosystem if spilled out or released
- ◆ Possibly less costly.

Each application must be evaluated based on specific site conditions. There were limited advantages to using acetic acid over hydrochloric acid. Our experience at the time of the demonstration was that acetic acid was five or six times more expensive than hydrochloric acid. Moreover, the few concerns raised by the odor may work against acetic acid. With regard to EPCRA-based hazardous material statutes, they were considered equal. Should there have been a release to the environment, the hydrochloric acid would have been more deleterious because of the chlorides, whereas the acetic acid would be biodegradable. Although one acid may be admittedly less severe than the other, the precautions against both prospects would most likely be equally rigorous, and therefore equally costly.

Since 60 percent of the firing ranges operated by the military are in similar low pH soil

types to that found at Ft. Polk and many have had ranges in operation for sufficiently long periods of time for lead corrosion to occur, there is a probability that many of these ranges may contain lead in a form that will be leachable by a weak acid. Such is the case at Ft. Polk, where galvanic corrosion of the lead alloy preferentially against the copper jacketing of the bullets has formed significant amounts of lead carbonate salts.

11.1 DISSOCIATION CHEMISTRY

In chemistry, the words strong and weak do not refer to the concentration of the acid, which is simply described as either concentrated or dilute. Rather, they refer to the amount of acid that reacts with water to form hydronium ion, H_3O^+ . The strength of an acid depends upon the number of hydronium ions produced per mole of acid. Acids of similar concentration can differ in the amount of hydronium ions produced. This is what happens in the solutions of hydrochloric acid and acetic acid used by the two vendors in this demonstration.

When HCl ionizes in water, a large number of the HCl molecules react to form hydronium ions. In fact, almost all the HCl molecules react with water, making HCl a strong acid:

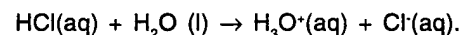

Essentially all of the HCl molecules ionize, so a single arrow is used; the HCl is said to be 100 percent ionized.

When acetic acid ionizes in water, at equilibrium, a considerable number of CH_3COOH molecules remain un-ionized:

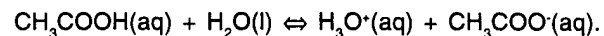

Only a small proportion of hydronium ions and acetate ions are present, so the solution is weakly ionized. Acids such as acetic acid that do not ionize completely in an aqueous solution are called weak acids.

Since the reactions of HCl and CH₃COOH with water are two-way equilibria, the reverse of these equations is shown here:

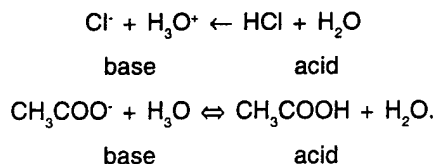

Both the chloride ion, Cl⁻, and the acetate ion, CH₃COO⁻, function as proton acceptors in these equations, and, as such, may be called bases.

These equations illustrate a relationship often referred to as a conjugate acid-base pair, where conjugate means paired together. Two substances such as HCl and Cl⁻ that are related to each other by the donating and accepting of a single proton are sometimes referred to as a conjugate acid-base pair. The conjugate base of acetic acid CH₃COOH is CH₃COO⁻.

The strength of HCl as compared to CH₃COOH can be better understood by considering the relationship between the acid and its conjugate base. In the case of HCl, water has a stronger attraction for the proton than the Cl⁻ ion, making Cl⁻ a relatively weak conjugate base:

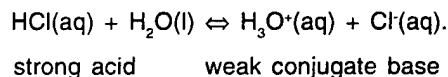

By comparison, a weak acid has a strong conjugate base. In the reaction of acetic acid and water, the water molecule is not a strong enough base to remove the H⁺ ion from all the

acetic acid molecules. This means that the acetate ion is a stronger base than water since it has a greater attraction for the H⁺ ion.

Both strong acids and weak acids will leach metals from soils. By comparison with HCl acid, greater concentrations of acetic acid are required to reach low pH levels in solution (greater concentrations of H⁺), as much of the H⁺ is still associated with the acetic acid molecule. Therefore, there is also less of the acetate ion to react with positive metal ions to form metal acetates. In comparison, almost all of the Cl⁻ ions are free to react with positive metal ions in aqueous HCl solutions. The practical result of this chemistry is that strong acids, such as hydrochloric acid, have a more powerful driving force to leach metals at equal concentrations than do weak acids, such as acetic acid. Greater concentrations of weak acids will be required to react with metal ions as there are less available conjugate base ions available. This translates into potentially higher costs, as greater quantities of weak acid are required to leach the same amount of metal ions compared to a strong acid. Leaching metallic lead requires higher concentrations of a conjugate base available to provide a driving force for the reaction than can readily be supplied by acetic acid. However, much of the lead at Ft. Polk has been corroded by galvanic action with the copper jackets of the bullets and has formed lead carbonate, which will react with acetic acid considerably more rapidly than it will react with lead metal.

Acetic acid will leach and can form metal acetate compounds with several of the metals contained in the soils, such as iron, copper, zinc, and lead. Hydrochloric acid can form metal chloride compounds with all of the same ele-

ments listed above. Defining the nature of the occurrence of the metal compounds to be leached is one of the first steps in choosing an appropriate acid for leaching.

11.2 PROCESS RANGE

Acetic acid will leach metals from soils, particularly if the metals are in the form of a metal salt. Because acetic acid is a weak dissociable acid, greater concentrations of acetic acid need to be used than with strong acids (such as hydrochloric acid) to achieve low pH leaching conditions. The practical lowest pH levels that can be achieved by acetic acid in mineral systems is about 3.0. This is because only a portion of the acid dissociates and yields H^+ ions to the aqueous leaching solutions. A practical pH range for a leaching plant using acetic acid to leach metals from the soil is in the range of 3.2 to 3.5. Lower pHs will increase acid requirements considerably.

Using a gravity concentration and screening process prior to the leaching step in a processing facility will eliminate the largest and heaviest pieces of metal from the firing range. These larger, heavier fragments are the hardest to leach, typically requiring long leach times and lower pHs. Since low pHs are difficult to achieve with acetic acid, plants using acetic acid as a leachant should have physical recovery steps in the plant prior to the leaching steps to remove the metal most difficult to leach.

As with most acids, several metals will leach with acetic acid. During the Ft. Polk demonstration, iron was the most abundant species leached by the acetic acid, followed by lead and copper. Metal species that are already in an ionic state as a metal salt are considerably easier to leach with acetic acid than

reduced metal species. Lead contained in the soils at Ft. Polk was metallic lead as well as lead carbonate. The lead carbonate was readily leachable by acetic acid at a pH of about 3.2.

Once the lead and other metals were in solution and removed from the soils, it was necessary to precipitate the metals in a subsequent step prior to recycling the solution to the leaching step. The solubilized metals will readily precipitate from solution at higher pHs. A base can be added to the solubilized metal stream, which will raise the pH. At a pH of 9 or 10, the metal will precipitate as a carbonate or a hydroxide, depending on whether calcium carbonate or sodium hydroxide is used as the base. An advantage of precipitating at a higher pH is the relative ease of flocculation of the fine precipitates with a polymer to help clarify the return leachant. It is possible to precipitate lead at a low pH using a sulfide salt or sparging hydrogen sulfide gas into the metal-containing solutions. The vendor demonstrating acetic acid leaching at Ft. Polk chose to use a proprietary precipitant called Thio Red®, which is a long-chain polycarbonate-based precipitant with sulfide receptors on the polycarbonate. The lead in solution reacts with the sulfide receptors and forms lead sulfide embedded in the carbonate polymer. The weight of the long-chain molecules causes the precipitate to sink, clarifying the solution prior to recycle. The advantage of using a precipitant on the low pH side is that the unreacted acid remaining in the metal-loaded solutions is recycled after precipitation to be used again. When the pH is raised with a base addition, the H^+ ions remaining in solution are also reacted with the base and are no longer available for leaching on recycle of the solution after

precipitation. A disadvantage of precipitation on the low pH side is that the precipitated solids are more difficult to flocculate and settle. Longer settling times are required, and filtration of the precipitated solution may be necessary.

In the case of acetic acid leaching, the acetic acid is a relatively expensive acid, and reuse of the remaining acid is an important economic consideration in plant operation. This reuse of the remaining acetate ions contained in solution is only possible if the precipitation of the metal sulfide-carbonates is achieved in a low pH solution.

Hydrochloric acid is strong acid, and, in concentrated amounts, will achieve very low pH in solution because almost all of the H^+ ions are available in aqueous solutions. At low pHs, hydrochloric acid will strongly leach metals, including those in metallic form. The solution pH used during a leach of soil should be sufficiently low that the metal of interest is leached to the desired level, but not so low that more of other metals are leached in addition to the desired metal. A high percentage of the leached metal must be precipitated prior to the recycle of leaching solutions. Additional amounts of other leached metals in the precipitate will reduce the concentration of the desired metal, making it more difficult to sell to a recycling facility.

The leaching solution pH of about 1.5 was maintained by the vendor using hydrochloric acid at the Ft. Polk demonstration. An advantage of using a strong acid such as hydrochloric is that a much larger range of pH levels is available for use in the process, which gives more flexibility to reach required residual metal levels in the leached soils. If residual metal

levels are too high in the soil to achieve required limits, it is possible to reduce the pH level in the leach solutions by an increased acid addition to achieve lower residual metal values. This will also likely increase acid consumption and, therefore, cost.

Leached metal precipitation from a strong acid has basically the same considerations that were discussed for the precipitation of metal acetates from acetic acid. Low pH precipitation will allow the reuse of residual acid in the leach solutions; however, the precipitates are more difficult to flocculate than precipitates formed at a higher pH. While there are proprietary long-chain molecules that can be used for precipitation of metal cations at low pH, the flocs tend to be fairly fragile and will not withstand much handling. Flocs produced at high pH precipitation tend to be larger and much more robust, facilitating flocculation. The cost of hydrochloric acid is considerably less than the cost of acetic acid, so the economic penalty of raising the pH to precipitate with relatively inexpensive lime or caustic (sodium hydroxide) is not as great. The residual acid contained in the leach solutions is lost for recycle and additional acid is needed to return the recycle solution to the chosen leachant pH. However, the cost of lime or caustic plus the cost of the extra acid can be much less than the cost of many proprietary low pH precipitation agents. Additionally, metal hydroxide flocs are very stable and easily pumped to a filter press or other dewatering device. Hydrogen sulfide gas is an alternative low pH precipitation agent, again forming metal sulfide precipitates. While hydrogen sulfide is and has been used very successfully in this application, there are addi-

tional environmental and safety concerns that are associated with its use.

The second vendor at Ft. Polk used a hydrochloric acid leach, which they routinely operated at about a pH of 1.5. They chose to use caustic soda to precipitate all of the dissolved metal chlorides as metal hydroxides at a pH of 10.5 to 11.

11.3 SUITABILITY BY SOIL TYPE

Many of the DoD training bases are located in a soil type similar to that at Ft. Polk, Louisiana. These southeastern arc soils tend to be low pH (4.5) and in areas with substantial amounts of moisture. These conditions can actively promote the slow corrosion of lead into lead salts. When metallic lead is in contact with the copper jacketing of a bullet, a galvanic cell is created under moist conditions that preferentially corrodes the lead. At Ft. Polk, the lead forms lead carbonate salts due to the other constituents in the soil and carbon dioxide in the atmosphere. The copper also has surface coatings. Some of the surface coatings are green from the formation of copper sulfate salts. There also are numerous examples of copper jackets with a black copper oxide coating.

Some of the firing ranges used in these areas, including Ft. Polk, have been active for decades. Long environmental exposure in these soil types has allowed a considerable amount of the lead to corrode into lead salts. The presence of lead salts increases the options available for treatment because the salts are more mobile in the environment and easier to leach with acids than metallic species. Weak acids (such as acetic acid, which was demonstrated at Ft. Polk) are readily able to solubilize the

lead salts in these berms. For initial cleanup of these old firing ranges, both weak and strong acids can be considered.

For ongoing cleanup of ranges that have already been remediated with an acid leaching process and whose soils now contain fresh lead bullets, it may not be necessary to leach the soil a second time. There would be insufficient time for the new lead bullets to have significantly corroded into lead salts. In which case, a mechanical removal may be sufficient, such as screening and gravity separation. If simple mechanical separation was not sufficient to achieve metal removal to a specified limit and acid leaching was required, a strong acid will need to be used—the weak acids will not be able to leach the metallic lead because they are not capable of achieving the low pH range required to drive lead into solution.

Firing ranges located in soil types such as those in Nevada and other dry areas can be expected to be much lower in lead salts than at Ft. Polk. The presence of the metallic lead will require considerably more stringent leaching conditions than soils with lead salts, if physical separation is not entirely effective in lead removal. A strong acid, such as hydrochloric acid, would be a better choice for meeting stringent conditions than would acetic acid. It is strongly suggested that the nature of the lead occurrence be known prior to issuing any requests for proposals and that this knowledge be passed on in the bid documents.

Dry conditions, high pH soils, frozen soils, and permafrost will all tend to reduce the amount of corrosion of the lead bullets into lead salts. The nature of the occurrence of the lead will impact the choice of technology for cleaning up the soils. Depending upon the

presence of other contaminants or environmental considerations, nitric acid would be an alternative strong oxidizing acid for leaching metallic lead and lead alloys.

11.4 ENVIRONMENTAL IMPACTS OF ACIDS

Both the acetic acid and hydrochloric acid leach demonstrations at Ft. Polk were designed as recycling systems to minimize the amount of metal salts and unreacted acid returned to the environment. As with any metallurgical process system, acid leaching soil washing systems are not 100 percent effective at recycling all unreacted acids or in precipitating all solubilized metals. In particular, both systems demonstrated at Ft. Polk were dependent upon the effectiveness of the final filtration/dewatering step to remove entrained acids and solubilized metals. Incorporating an additional wash stage in the leached residue filtration step would have further reduced the amount of interstitial fluid containing metals that was recycled with the processed soils. At one point during the acetic acid leach, the solubilized metals had not been sufficiently precipitated; the unrinsed interstitial fluid retained in the filtered soils may have contained sufficient dissolved lead to cause the material to fail the TCLP test for lead. This could potentially have been rectified by changes in the precipitation chemistry and reaction times to reduce the amount of solubilized metals retained in the soil. A displacement water rinse would have removed about 80 percent of the solubilized metals retained in the processed soils. These are known unit operations commonly used in industrial practice and can be incorporated into process systems as necessary to mitigate the

environmental impact of metal salts back to the environment.

Inevitably, small amounts of solubilized metal salts and some unreacted acid will be returned with the processed soils. Neutralization steps, including lime slurries or caustic solutions like sodium hydroxide added to the final processed soils, will react with any unreacted acid present and will partially precipitate any remaining metal salts. A neutral pH of 7 is too low to precipitate the metals as a stable hydroxide. Furthermore, the soil pH at Ft. Polk is close to 4.5, at which pH some of the precipitated metal ions will likely be remobilized. In the low pH soils, such as at Ft. Polk, it is particularly important to reduce the entrained solubilized salts to a minimum. This can be accomplished through effective dewatering and rinsing procedures. The combination of low pH soils and, at times, generous rainfall will mobilize some of the solubilized metals into the environment. This impact will be considerably mitigated in alkali soil types more common in the arid western part of the U.S. The higher pH of these soils will precipitate and retain any solubilized metals present, and the lower rainfall in these areas will reduce the mechanism for mobilization of metal ions.

Serpentine soil types, which occur in California and elsewhere, are generally very impermeable to water flow to the extent that serpentine has been allowed as a natural lining for tailings impoundment areas in California. Additionally, serpentine has a high ion retardation rate, which considerably slows the rate of mobilization of metal ions in the environment. The presence of metal salts in this soil

environment will also be considerably mitigated due to the low hydraulic conductivity of water inherent in the soil. It should be noted that the high ion exchange capacity of the soil, which slows the rate of mobilization of metal ions in the environment, would greatly increase the difficulty in leaching lead (or other metals). However, it will also improve the ability of the soil to pass TCLP with relatively high total lead concentrations.

Some discussion is needed concerning the various metal salts derived from the use of different acids in the leaching process. Hydrochloric acid will produce metal chlorides. In an area such as Louisiana, which is very close to the ocean and has a high water table, the chloride content of the water is already considerable. This is also true of those areas where deep aquifers have been drawn down over the years by agricultural wells (e.g., the midwest). Another example is Australia, where much of the water of the inland basins is saline in nature. Some of the water there is more saline than sea water. Where chlorides are present in reasonable amounts in ground and surface waters, the impact of small additional amounts of metal chlorides and chloride ions in the soil will be minimal.

In areas where the chloride contents of soils is minimal and the local flora may not be very salt tolerant, extra processing may be required (e.g., a wash/filter step) to ensure minimal impact on the environment of the returned soil. Acetic acid leaching could also be a viable alternative if the occurrence of lead is amenable. If the soil leached with acetic acid is not well washed and neutralized, a higher percentage of acid may carry over compared to strong mineral acids, because less of the acetic acid

has dissociated into acetate ions. The metals, acetates, and other ions returned with the processed soils will likely mobilize in low pH soils during high rainfall events. Mobilized residual acetic acid will likely leach less metals in the soil than a strong acid such as hydrochloric. Not to be minimized in the discussions of acid choice for process should be the public acceptance or perceived benignancy of using acetic acid. Although public acceptance should not override good science for a process choice, public acceptance may become an important consideration if there are possibilities of using either acid, such as at Ft. Polk. Acetic acid may be more noticeable than other acids because it has a strong, sharp aroma, although not a particularly noxious one. Despite the sharp aroma, the public association of acetic acid with common household vinegar is advantageous for its choice.

Nitric acid might also be considered for processing soils with fine metallic shards. Nitric is a strong acid and a strong oxidizer. It might become an acid of choice where the carbonaceous content of soils is high or where petroleum products have caused additional contamination. Nitric acid is commonly used in the gold industry for acid washing activated carbon to remove adsorbed metal complexes. The residual salts in processed soils would be nitrate compounds. Nitrates are fairly common in soils; they are generated by the leaching of animal manure, from the runoff of septic systems, and by NO_x emissions from automobiles washed into the soils by rain. Nitrates present in the soil can be mitigated by the choice of plant cover on the soil, which can help fix the nitrogen contents into the soils. With regard to the potential use of nitric acid,

we must also recognize the potential risk of eutrophication in nearby surface bodies of water, should a rigorous Storm Water Pollution Prevention Plan not be in place. Basically, if there was a release that would impact the nutrient balance of carbon, nitrogen and phosphorous (typically 20:5:1) and nitrogen ceased to be the limiting nutrient, algae blooms could erupt and diminish the beneficial use of the water body. In addition, if the nitrate should enter the drinking water source, either surface or groundwater, and exceed the SDWA criteria, the health concern, methemoglobinemia (Blue Baby Syndrome) could set in.

11.5 UNIT COSTS OF ACIDS

There is a considerable difference in the stated reagent consumptions and cost with the two acid leaching systems demonstrated at Ft. Polk. The acetic acid leach used greater quantities of acid than the hydrochloric acid leach to achieve the lowest practical pH levels. Additionally, the cost of acetic acid was nearly six times the cost of hydrochloric acid.

There is some difficulty in reporting costs for the demonstration and translating these costs into full scale production. The cost of reagents is very sensitive to the amount of reagents that are purchased at one time. For instance, the cost of hydrochloric acid was \$0.45/gallon when purchased in bulk with a 4800 gallon tanker load. A subsequent smaller purchase of 800 gallons (also by tanker but not a full bulk shipment) cost \$1.30/gallon. Larger bulk purchases for sustained production operations will make possible substantial savings in reagent costs.

Reagent consumptions are site-specific. The amount of acid required to leach lead from soils

will vary with the amount of lead present, the form of the lead (i.e., lead carbonate salts, other salts, or metal), the regulatory level required to be reached, and the other base constituents contained in the soil, such as carbonates, which will also consume acid. Notwithstanding the above comments, it is instructive to look at the comparative acid and reagent costs of the two acid leaching systems demonstrated at Ft. Polk. The demonstration protocols required the soils to be returned to a neutral pH prior to replacement in the firing berms. This required the application of a base to the leached soils to neutralize the acids. Additional reagent costs were incurred with the choice of precipitant for the solubilized metals, flocculating agents to help settle the precipitated fines, and filter aids such as diatomaceous earth (DE).

As discussed earlier, the acetic acid demonstration vendor opted to use a low pH precipitant, Thio Red®, rather than neutralize all of the unreacted acetic acid to reach a higher pH where the precipitation and settling of the metal precipitants would have been easier. This choice was driven by the cost of acetic acid compared to hydrochloric acid. Thio Red® was also an expensive reagent.

The hydrochloric acid demonstration vendor chose to neutralize the complete leach stream with sodium hydroxide, which not only precipitated the lead and other metals as hydroxides, but enabled easier flocculation and settling. The flocculated precipitates were robust, which allowed pumping. The sodium hydroxide also neutralized all of the remaining hydrochloric acid in the leach solution. The recycled leach solution was reacidified with fresh hydrochloric acid prior to returning to the leach circuit. This choice of chemistry and

easier operating considerations was again predicated on the costs of the hydrochloric acid and caustic, but in this case because these two reagents are relatively inexpensive compared to acetic acid and Thio Red®.

The acetic acid leach demonstration vendor processed less soil (269 tons) than the hydrochloric acid leach demonstration vendor (834 tons). The acetic acid leach system had higher reagent costs partly because the demonstration did not really achieve a complete steady state operation for sufficient time to optimize the reagent consumptions. The vendor has made an effort to extrapolate the costs from the low tonnages of the demonstration to the costs and consumptions for a full scale operation to help counter the unoptimized leach conditions. The acetic acid leach total reagent cost was \$239.50 per ton of material. The vendor estimated cost for reagents for full scale operations is \$97 per ton. The acetic acid portion of this cost is estimated to be about

\$47 per ton with about 17.7 gallons per ton consumption. The cost for the Thio Red® precipitant is \$10.91 per gallon.

Based on the processing of 834 tons of soil, the reagent unit costs for the hydrochloric acid leach demonstration are shown in Table 9.

Table 9. Reagent Unit Costs for Hydrochloric Acid Leach Demonstration

CHEMICAL	TOTAL COST	UNIT COST \$/TON
HCl (33%)	\$3,141.47	\$3.77
NaOH (25%)	\$3,516.74	\$4.21
Diatomaceous Earth (DE)	\$6,044.26	\$7.25
Flocculant	\$3,310.53	\$3.97
TOTALS	\$16,013.00	\$19.20

0063G_08

The hydrochloric acid consumption for this demonstration was estimated to be 6.7 gallons per ton at an average HCl cost of \$0.56 per gallon.

12.0 PROCESS METHODS

This section of the report describes the unit process employed by the two different demonstration vendors, some of the similarities and differences, and the process considerations concerned with each acid leachant. Some operational modifications were made to both unit process systems to accommodate characteristics of the Ft. Polk soils at larger process tonnages.

12.1 INTRODUCTION

Both vendors incorporated physical and gravity separation of the metal-bearing Ft. Polk soils with acid leaching of the metal content in the finer soil fractions to remove particulate lead metal and lead salts. While different equipment was utilized by both vendors to accomplish the separations, there are some generic similarities to the two processes.

Lead in the Ft. Polk soils was present as both metallic lead (copper jacketed and free) and as lead salts. These lead salts resulted primarily from the long exposure to the elements, low pH soil conditions, high humidity and rainfall, and as a product of galvanic corrosion from the contact of lead alloys and their copper jackets. Other metals present included copper (from the copper jacketed bullets), antimony and zinc (contained primarily in the lead alloy originally as hardeners for the lead), and iron (from iron cores in some rounds and from iron in the soils). All of the above metals solubilized in part during both the acetic acid and hydrochloric acid leaches.

There was a twin objective to the demonstration requirements to be obtained for lead: less than 500 mg/kg for hydrochloric acid

leaching and less than 1000 mg/kg for acetic acid leaching for total lead concentration and to pass TCLP for lead at less than the 5 mg/L maximum allowed level in the leachant. Because of the nature of occurrence of lead salts, the TCLP requirement became the more stringent of the two. Total lead levels near the 200 mg/kg level were required in order for the lead from the TCLP to be below the 5 mg/L maximum allowed in the leachant. Theoretically a soil with 100 mg/kg should, at the very maximum if 100 percent of the lead leached, have a maximum TCLP of 5 mg/L lead because of the 20 to 1 dilution of leachant to solids. So soils reduced to below 100 mg/kg lead should pass TCLP.

It should be noted that other firing range soils at different locations are likely to have different characteristics. Younger ranges that have had less time for the lead bullets to corrode and ranges located in drier locations will have higher proportions of metallic lead and lower lead salts compared to the low pH soil types typified by the Ft. Polk soils.

Sampling soils containing coarse metallics of the material being assayed is a subject worthy of considerable discussion. Large samples must be taken if reproducibility is to be achieved. The sample must then be screened for removal of the coarse metal fragments and size reduced prior to resampling. Samples for TCLP need to be taken at a coarser size than the samples destined for total lead analysis. This is because the sample should reflect the actual size of the material being returned to the firing berms. If the material is crushed prior to the exposure to the TCLP leachant, the greatly increased surface area of the solids will

allow more metal to leach than if left at the size of particles being returned to the firing berms. Several TCLPs should be run in duplicate and the analyses averaged to obtain reasonably good results. The balance of the sample to be used for total lead analysis should be size reduced prior to splitting off representative smaller samples. Battelle developed a sampling protocol for these difficult to analyze soils containing metallic lead chunks that incorporated weight averaging of the coarse metalics with multiple leaches of the fines to give a combined answer. The sampling protocol required a considerable amount of work to enable the 140-lb lead sample to be dried and reduced to the required TCLP samples and the analytical samples. The sampling protocol did give very reproducible results, which is what was intended.

Both vendors utilized log washers and attrition scrubbing to clean the fines from the coarser particles contained in the soil. Screens and jigs were employed by both contractors to help remove the coarser lead particles and copper jackets from the soil. Jigs incorporate a dense steel bed (stainless steel shot was used because of the acidic solution in the process) to help separate the dense particles from the soil. Metal fragments were removed by the jigs and from the middling size from the screens. Both vendors initiated their acid leaching for metalics and lead salts at the attrition scrubbing/washing stage to increase their leach time available in their systems. Leaching from the onset also reduced the complexity of the water circuit and plant. If water had been used in the front part of the plant, a separate water circuit would have been required to keep the fresh water from commingling with the acid

circuit and the size of the acid circuit would have to have been increased to accommodate the amount of leach time needed. In both circuits, the sands were leached in acidic solutions for shorter periods of time than the fines, which tended to be where the lead was concentrated both as fine metalics and lead salts. The hydrochloric acid plant had a considerably longer leach for the sands utilizing sand screws. The fines were leached by both plants, and the leached residues were removed for filtering. In the acetic acid plant, the fines were ultimately dewatered using a plate and frame filter with the clarified solution returning to the leach circuit. A centrifuge was employed in the hydrochloric acid circuit to dewater the fines. The coarse sands were recombined with the fines along with any neutralizing base to return the soil to a neutral pH. The rich solutions containing the solubilized metals (primarily lead, copper, and iron) were precipitated to remove the metals. The metal precipitates were filtered and held in storage containers pending recycling at the end of the project. The precipitation was conducted on the low pH end for the acetic acid leach by using a polythiocarbonate precipitant and by raising the pH with a caustic for the hydrochloric acid leach.

The next two sections describe the specific system flows for each vendor with commentary on the efficiency and the design.

12.2 VENDOR 1 PROCESSES

Vendor 1 demonstrated the use of physical and gravity separation of coarser lead and other metalics from Ft. Polk soil and utilized acetic acid to leach the fine metallic lead and lead salts also contained in the soil. Several field

modifications were made to the vendor's plant to adapt the plant to the operating conditions experienced when actually running Ft. Polk soil. A schematic flow diagram of the unit process system train employed for this demonstration is included in the vendor report contained in Appendix D.

The log washer/attrition scrubber employed was not efficiently breaking up clay balls in the soil and may have contributed to generating them. A twin screw attrition scrubber was installed in front of the washer to break up any clay balls.

The vacuum-belt filter in the fines dewatering system was very undersized for dewatering the clay content of the leached residue, leaving excess moisture in the processed soils. This unit operation became the limiting factor for plant throughput. Feed tonnage was reduced to accommodate the capacity of the system. Bypassing the filter with a portion of the leached residues left excessive moisture in the processed soils. The moisture in the soils also contained solubilized lead, which contributed to higher lead values for TCLP extractions. To help resolve this problem, a 3.5 yd³ plate and frame filter was procured and utilized to dewater the leached residue. Residual moisture retained in the cake still contained solubilized lead. At the time the large filter was obtained, several events may have potentially increased the amount of solubilized lead in the circuit: insufficient precipitation agent used in the precipitation circuit allowed solubilized lead to recycle with the leach solution, helping to create an increasing content of solubilized lead in the circuit; fine particulate lead did not settle in the clarifier and was recycled with the leach solution, which increased the lead content in

the leached residue; some TCLP-failed soils containing additional solubilized lead were reprocessed, which then probably helped contribute to the system inventory buildup of solubilized lead; and the precipitation dosing system was not capable of meeting the increased demand required to remove the solubilized lead in the system, which was at maximum output. The large plate and frame filter would have been considerably more effective if it had been employed during steady state operations and if a water wash system had been installed to rinse the filtered cake contained in the press. This would have displaced the interstitial solutions containing solubilized lead with clean water, reducing the solubilized lead reporting to the TCLP leach solutions. Additionally, the water wash would have helped to neutralize the leached residue prior to its return to the firing range as processed soil.

Three modifications were made to the sand dewatering system to reduce the moisture content of the processed clean sands. Leach solution was being discharged along with the clean sands, not only contributing to excessive moisture content of the processed soils, but also recycling solubilized lead, which contributed to higher lead TCLP leach values. The first modification was a solid state speed controller that was installed on the sand screw drive motor to slow the rotation of the feed screw, increasing the retention time of the sand in the unit. The sand screw retention pool area was enlarged to reduce the ratio of process water to sand since more sand was being retained in the system with the slower screw speed. The enlarged area also reduced the turbulence in the pool area to allow more effective drainage of the material in the feed screw prior to dis-

charge. The vacuum filter, which was no longer needed in the fines dewatering system, was reconfigured to dewater the treated sand fraction being discharged from the plant, which resulted in a significant decrease of retained moisture in the sand content being discharged from the plant. The filter worked well in this capacity.

Absolutely critical to the operation of a recycled, closed loop leach system is the precipitation chemistry control that allows the barren recycled leach solution to be returned to the front end of the circuit where it starts to pick up lead content as lead in the incoming soils is leached. Buildup of lead content in the leach solutions start ripple effects throughout the whole system. As discussed earlier in the plate and frame filter discussion, the precipitation circuit may have been incapable of dosing sufficient precipitation agent to reduce the recycled solution to a barren. The result was processed soils out of compliance for TCLP lead. The fact that this occurred should not be used to condemn the leaching system or process. The possible root of the problem (insufficient precipitant dosing capacity) is very readily resolved once identified. On subsequent reflection, the color of the leaching solutions at this time (a cherry red color) should have been investigated a bit earlier, revealing the nature of the problem before it became an operational problem. The significance of the color (which was due to the presence of large amounts of metal acetate salts including iron acetate) was not initially appreciated because the first batch of acetic acid delivered to the site had a rose color of its own, and it was assumed that the color was mostly due to the color of the acetic acid and the possible leach-

ing of some of the organics present in the soils. The second and subsequent batches of acetic acid were devoid of any color. This was not obvious until an aliquot was pulled from the tank, however, as the acid tank was a black opaque color and the color of the acid was not visible directly or by light into the top port. The acid delivery lines were also opaque. The other misleading bit of information was the use of Thio Red®, a polythiocarbonate precipitant, for the precipitating agent. The Thio Red® was red colored and, coupled with the belief that the acetic acid was rose/red colored (which was initially true), it was a reasonable but incorrect explanation that too much Thio Red® might be dosed into the system, giving rise to the red color of the recycled leach solutions. A small amount of test work in the lab quickly revealed that when excess Thio Red® was in the leach solutions beyond that required to precipitate the metal acetates, the leach solutions went clear colored and the red color disappeared. There was also evolution of some hydrogen sulfide gas at that point, giving rise to a noticeable odor. In the future, the red color could be an indicator of insufficient Thio Red® dosing.

The vendor installed an ion-specific control and monitoring system to automatically inject the precipitant reagent into the precipitation tank to aid in more effective on-line control of the precipitant dosing.

Duplex bag filters were installed on the recycled solution manifold inlet from the clarifiers to remove any unsettled lead precipitate contained in the solution. The precipitates flocculated and settled much better when the precipitant dosing was close to the correct amount. It is more difficult to precipitate and flocculate

in low pH conditions than in high pH conditions. The cost of acetic acid and the need to recycle the unused acetic acid in the leach solutions necessitated the requirement for a low pH precipitation agent and a flocculant that would work in the low pH environment.

The coarse metal removal system included the removal of the minus 1/2" plus 5/16" size from the vibrating screen, which included most of the coarse bullets and copper jackets along with gravel of that size. The balance of the heavy metal removal system was the jig subsystem. The overflow from the coarse sand scrubber/log washer was passed through a hydrocyclone. The fines from the cyclone overflow were passed on to the leach circuit; the cyclone underflow was pumped to the primary jig circuit. Initially, the jig underflow hutch product was dropped by gravity to a cleaner jig that was being operated in a closed circuit with the primary jig, and the cleaner jig tails were being returned to the primary jig. The cleaner jig hutch product containing any heavy metal concentrates was passed to a small sand screw/auger for removal to drums. The primary jig passed too much sand into the hutch concentrate, which overloaded the cleaner jig, which was then recycling large quantities of sand back to the primary jig. Very little heavy metal was being caught in the primary jig initially as the total system was loading with coarse material and taking time and tonnage to be pushed as far as the jig circuit. This would have reached steady state with the processing of more tonnage, and a flow of metal particulates would have been pushed to the jig circuit. Two corrections were made to the jig circuit to help the sand overloading problem. Additional steel jig ragging was installed in

the primary jig to increase the ragging bed depth and help exclude the sand from the hutch. The cleaner jig was taken out of closed circuit, and the cleaner jig tails were returned directly to the coarse sand screw rather than returned to the primary jig. This helped to unload the system, and since little metal was being presented to the jigs at that time, it caused no deterioration of recovery. Additional hutch water flow to create a higher rising flow velocity would also have been helpful, but capacity was insufficient in the sand screw to accommodate more solution volume. The addition of a concentrating table or a small gravity strake on the cleaner jig concentrate probably would have improved the metal content of the concentrate and would have allowed the entrained sand to be returned to the system as clean processed material. The cleaner jig concentrate as produced did not have sufficient lead content to be payable by a recycler.

Utilizing wash solutions containing acid from the first contact with incoming soils has the effect of considerably increasing the contact time of the acid with the metals contained in the soils. This not only makes use of the equipment to do both leaching and other functions, but also reduces the chance that fine particulate lead or lead salts might become entrained with the clean processed solids and returned to the site. The acid aids in the attritioning of the coarse material and ensuring that the coarse sands are clean. The corollary to this is that the dewatering systems must remove solutions effectively or the lead may be recycled as solubilized lead. It is also imperative that the washing recycle solutions be barren. That is, the precipitation circuit must be working correctly and in control. Other-

wise the recycle solution containing solubilized lead creates a building inventory of lead in solution and also increases the amount of solubilized lead leaving the system entrained with the processed solids as interstitial moisture.

Washing in neutral solutions would considerably reduce the risk of solubilized lead, leaving the coarse sand circuit in the interstitial moisture. However, the fines are going to the leach circuit anyway, where they will be in contact with acid and need to be filtered and washed to remove solubilized lead. The use of a neutral wash circuit allows different and less expensive metal choices for equipment construction and protective coatings compared to the materials and coatings required to withstand the corrosive nature of acid solutions. However, a total acid circuit does increase the leach residence time in the system. If a longer leach residence time is required, based on site-specific soil characteristics, a discrete leaching system would have to have a large enough leach circuit to provide adequate residence time. The extra cost of this capacity might offset the reduction of material protection requirements in the wash circuit. Additionally, the use of a neutral wash circuit requires two water circuits and additional settling and flocculation equipment for the neutral circuit.

Smaller tonnage capacity mobile plants employed in potentially environmentally sensitive areas are easier to move, to site on location, and to control runoff if they are as contained and compact with as few a number of unit operations as are required. The smaller, the footprint of the plant, the smaller the pad requirements, which may save considerable cost. All of the above tend to favor the smaller all acid leach plants rather than the dual cir-

cuit plants, which may have advantages for permanently located, large tonnage operations.

12.3 VENDOR 2 PROCESSES

Vendor 2 demonstrated the use of physical and gravity separation of coarser lead and other metallics from Ft. Polk soil and used a hydrochloric acid leaching process to fulfill the requirement of using a non-specified general acid leaching. A schematic flow diagram of the unit process system train employed for this demonstration is included in the vendor report contained in Appendix E. The hydrochloric acid leached the fine metallic lead and lead salts also contained in the soil. The vendor's plant was relatively unmodified from the initial plant configuration, other than to change sand screw angles and other equipment adjustments.

Benchscale tests of physical separation and hydrochloric acid leaching indicated that the entire soil fraction required leaching after the physical treatment for removal of the coarser particulate metal fragments. The plant was designed based on benchscale tests, which indicated that the sands required sufficient retention time to leach the lead from the surfaces and the lead contained in small fragments and as lead salts. Therefore, three sand screws (in series) were incorporated into the leaching of the sands, which provided for relatively long retention times. The fines were determined to require multiple fresh solution contacts, rather than longer retention times, to remove lead effectively. The leaching was more like a desorption reaction reaching an equilibrium between solution and solid lead values fairly quickly. This was accomplished by leaching

the fines in a separate circuit with two stages of leaching and clarification.

Vendor 2 originally removed the oversize fraction of particulate metals contained in the sand fraction using a wet vibrating screen deck and water and a coarse metals jig. Use of fresh water on the screen deck where coarse heavy metals were removed minimized the amount of heavy metals solubilized in subsequent leaching steps. The undersized soil from the screen deck soil passed to a log washer/attritioning screw that was run in solution containing hydrochloric acid. This unit did the initial separation of the soil clays from the sands. The sands passed to a sand screw for additional leaching and then into a mineral jig for recovery of large and fine metal particulates not removed by the screen. The jig tailings passed into the second in a series of leaching sand screws for additional leaching time. The solution overflows from the sand leaching screws were passed onto the fines leaching circuit, along with the fines from the initial log washer/attrition sand screw. The sand discharge from the second sand leaching sand screw was passed onto a small sand screw, which was used to blend the centrifuge discharge of dewatered leached fines with the leached sands and to neutralize the soil.

The fines were leached in two clarifier/settlers in series as discussed above. Metal recovery from the leaching system was achieved with a single precipitation clarifier. Heavy metals were recovered from the leachant by neutralizing with sodium hydroxide, which precipitated the metals as hydroxides. These hydroxides were pumped to one of two storage tanks for holding for batch processing and dewatering through a recessed plate and frame

filter. The filtered precipitates were discharged directly into 10-yard roll on/roll off boxes located directly under the filter. The leachant flow to the precipitation clarifier came from leachant overflow from the leaching clarifiers. Clean leachant was returned to the leaching circuit via piping to all of the leaching components.

During the initial field test run, the use of the vibrating wet screen deck resulted in clay ball formation regardless of attempts to improve performance by adding water. The vendor decided using the screen deck would result in the formation of clay balls. The clay balls would have fouled the large particulate recovery unit with a mat of clay. Therefore, the vendor removed the screen deck and bypassed the density treatment process jig planned for recovery of the large particulate metal fragments. This change exposed a larger percentage of metal to the leaching solution, resulting in a greater mass of leached metals requiring removal from solution. There was sufficient capacity in the selected equipment to accommodate this increased precipitation requirement.

Particulate metals were removed from the feed soil in a duplex mineral jig. Based on observation and soil assays, the particulate removal approached 100 percent.

The leaching circuit was effective in dissolving lead carbonates into solution. Lead carbonates were dissolved as a result of dissociating the lead ion from the carbonate ion and subsequently converting the carbonate into carbonic acid at low pH. The leaching circuit was operated at a pH of 1.5 with the flexibility to go lower (nearer a pH of 1.0) should that have been required. This process exploited the

solubility of lead chloride. The chloride ions were in solution at this low pH, which was achieved by the use of hydrochloric acid. During the first day of processing, supplemental chloride was also added in the form of calcium chloride. The presence of a high chloride ion concentration in solution favored the dissolution of metallic lead to satisfy the solubility product of lead chloride.

Process monitoring confirmed benchscale study findings with respect to salt buildup in the leaching circuit over time and its potential impact on leaching efficiency in a closed loop system. Benchscale study results indicated that processing treatment efficiency improved once total dissolved solids, measured as percent NaCl, ranged from 2 percent to 4 percent. During the 15-day processing period, the concentration of NaCl was not observed to exceed 4 percent. This level was the approximate equilibrium NaCl concentration attained with HCl and NaOH as the salt ion sources. The residual moisture in the treated soil served as the steady state sink for the Na and Cl ions.

Carbonate buffering was controlled by the reduction of leachant pH following chemical precipitation of metals from solution. Excess carbonate ions in solution sequestered during the metal precipitation step were evolved from the solution as CO₂ when HCl was added to bring the leachant back to the circulation pH of about 1.5. Acid rain in the site vicinity was assumed to have removed calcium carbonate concentrations from the site soils. Therefore, the reagent requirements needed to satisfy carbonate equilibrium during pH changes in the leachant solution were presumed to be governed by atmospheric CO₂ and CO₃ ions

from the lead carbonate salts leached in the process.

12.4 PROCESS LINE ALTERNATIVES

An example of alternative equipment options that were used by the two vendors is dewatering. Both vendors used plate and frame filters for dewatering differing applications. Vendor 1 initially used a small vacuum-belt filter to dewater the leached fines. The filter became the limiting factor in plant throughput as the unit was too small for the required duty. It was replaced for the job of fines dewatering with a large plate and frame filter that operated satisfactorily. The small vacuum-belt filter was also used to dewater sands coming off of the sand screw and did an excellent job in that capacity as it was then sized appropriately for the duty.

Vendor 2 used a medium sized plate and frame filter to dewater precipitated metal hydroxides that appeared to be satisfactory in that application. Vendor 2 also used a centrifuge for dewatering the leached fines from the system. The centrifuge operated very well in that capacity but may have been a limiting factor in tonnage considerations. The capacity of the centrifuge was about 2 to 4 tons per hour. While it is easy to consider that the centrifuge did a good job and should therefore be used in dewatering of leached clay fines, centrifuges have high capital and maintenance costs compared to some other filtering devices. While this was a very appropriate piece of equipment for the tonnage treated and at the rate treated, larger scale treatment facilities would probably not have centrifuges as the dewatering device of choice. Multiple centrifuges necessary to

treat higher tonnage may not be cost effective with respect to capital or operating costs. An alternative might be a pressure belt filter for difficult materials or a large vacuum belt filter. These filters are manufactured in standard sizes of 5' in width and more than 20' long and can be configured to both filter and rinse.

Another example of process equipment to accomplish similar process options is the use of simple settler/clarifiers or the use of inclined plate clarifiers, which provide considerably more surface area to aid in settling. Vendor 2 used inclined plate settler/clarifiers to settle leached solids and precipitates, while Vendor 1 used simpler settler/clarifier units to settle precipitated leached metal values.

All acid circuits versus dual fresh water circuits on the front end with an acid leaching circuit for the fines have already been discussed to some extent, particularly in the Vendor 1 process descriptions. Small, relatively portable plants probably favor single water balance circuits with acid leaching in the whole circuit because they give greater leach time with less equipment and require smaller footprints than dual water and acid leach circuit plants. However, it may be easier to contain more hazardous operations on a larger scale with the latter when permanent installations are contemplated.

Another process option (discussed in Section 11) of this report is the decision to precipitate solubilized metals at a low pH, saving any unreacted acid for reuse, but this may incur more expensive precipitation reagents and more difficult flocculation. The alternative is to precipitate at high pH and use the base as the precipitation agent. Flocculants and settling tend to be more effective at the higher

pHs; however, excess unreacted acid is also neutralized using both the unreacted acid and the base required to neutralize it. In the end, this is an economic and technical decision. Vendor 1, using acetic acid, chose to use low pH precipitation with a proprietary precipitation reagent (Thio Red®) because the cost of acetic acid outweighed the advantages of higher pH precipitation. Vendor 2 chose high pH precipitation because acid and base were relatively inexpensive compared to the alternative. Vendor 2 had also looked at a proprietary precipitation reagent (TMT), which was tested. The flocs produced with TMT turned out to be fairly fragile and tended to break up on handling. The agent also worked better at higher pHs than at lower pHs and was relatively expensive. The decision was made to use a caustic and produce very stable hydroxide flocs that could be pumped to dewatering with little loss of integrity.

12.5 BENCHSCALE TREATABILITY TESTING SCALE-UP

Benchscale treatability testing for characterization and to allow potential vendors to test responses to various unit operations is absolutely essential to the choice of unit operations and for sizing requirement. The mining industry has utilized benchscale testing on every new mineralized area considered for process as a matter of course. Benchscale testing will confirm amenability to the existing process and establish the necessary unit operations for new mineral occurrences.

Physical separation and acid leaching for the remediation of lead containing soils is a direct application of mining and mineral processing industry unit operations to an environ-

mental remediation application. There are no "black box" processes that can be applied universally to all problems. A more logical approach is to determine the type of unit operations required with benchscale testing and then design the plant accordingly.

Vendor 2's approach to this was quite a typical mining industry approach. They benchscale tested each of the unit operations they proposed utilizing in the scaled-up plant. Some unit operations have very good databases for scaling to larger applications and do not require running at large sample sizes or in pilot scale to design an appropriately sized, full scale unit. However, some operations may be sufficiently novel or untried in specific applications that prudence requires testing at a larger scale. As an example, Vendor 2 tested the precipitation of lead from solution at full scale plant size with a plant sized, inclined plate clarifier as they did not have scale-up information on the proposed precipitant TMT. The result of the larger scale test of that specific concern was to decide that the flocs produced with TMT were quite fragile and might have difficulty retaining integrity if they were handled and pumped. Rather than chance that this might be an operational problem in the demonstration plant they were assembling for Ft. Polk, they opted for precipitation with caustic forming very stable lead hydroxides that could be handled with ease and about which there is considerable scale-up data.

Vendor 2 formally stated in their report that the demonstration was an unparalleled success for two important reasons: the first was that "the solicitation requirement that a vendor-based benchscale treatability study be performed was the best investment to ensure full

scale success. Benchscale studies allow the vendor to evaluate site-specific process parameters for the purpose of delineating the process approach and costs. By conducting benchscale studies, the vendor is placed in a position of decreased risk and can price the remediation with fewer contingencies." The second reason was that "the demonstration succeeded because of willingness of all parties to work together and identify potential project impacts before they occurred." An example of the last reason was the participation of a technical representative from the contracting group in a portion of the benchscale testing by the chosen vendors and the sampling protocol ultimately adopted by Battelle, which addressed vendor concerns over how representative the sampling was.

Vendor 1's benchscale testing identified successful unit operation and options for the integrated unit process train. Because of unavailability of larger scale test facilities, Vendor 1's benchscale testing was conducted on a fairly small scale. The smaller the sample, the more acute the potential for the sample to not be totally representative of the material to process. Certain unit operations are definitively more sensitive to certain aspects of sample characteristics, such as filtering being very sensitive to the amount and nature of the fines to be filtered. Some unit operations can be scaled extremely effectively from very small sample sizes (e.g., leaching and precipitation parameters). It should be noted that the leaching section of Vendor 1's plant performed very well. However, some difficulty was encountered in other areas of their plant when ratios of fines to coarse particulates varied beyond the unit operation's ability to accommodate the variation. Testing larger samples may have

assisted them in expecting this variation in the feed.

12.6 PEER GROUP OBSERVATIONS

The peer group maintained active involvement with this project, especially during the period of time when the two demonstrations were under way.

Their collective efforts focused on:

- ◆ Equipment reliability during the acetic acid leaching demonstration
- ◆ Process control during the acetic acid leaching demonstration
- ◆ Amount of fines in soil to be processed during the acetic acid leaching demonstration
- ◆ Sampling protocol
- ◆ Data error screening methods
- ◆ Chemical consumption optimization during the hydrochloric acid demonstration
- ◆ Unit process cost scale-up.

Various members of the peer group visited the job site a number of times to observe activities and offer advice. Their proactive consulting advice extended to the vendors as well.

Much concern was raised over the mechanical problems associated with the process equipment utilized during the acetic acid leaching demonstration. The attrition scrubbers, sand screws, belt filter for fines dewatering, and the belt feed hopper all experienced numerous problems that impacted the system from operating at steady state conditions. One peer group member observed during the operations that the belt feeder was bypassed for a period of time in order to raise the rate of soil throughput. This operational decision allowed high amounts of acetic acid and dissolved lead acetate to remain in the final product processed

soil. This operational action may have contributed to the problem the soil had in satisfying the TCLP criteria. The belt feeder was put back in operational service after the peer group member raised the issue. The jig was not working very effectively either, and a peer group member suggested adding more steel shot to the bed to increase the rate of sand excluding. This was accomplished with more satisfactory results. Other members of the peer group expressed similar concerns over the mechanical reliability of the unit process equipment, and also that more attention needed to be paid to process chemistry control and hydraulic maintenance due not only to the dewatering problems, but also to system leaks.

In response to comments concerning the fines in the process soil being so much different, a peer group member took a representative sample of soil that had been taken from the range and was stockpiled for processing by this vendor and reaccomplished the sieve analyses with the help of the independent evaluator. These data were then compared with the similar results of what went to both vendors. The conclusions from this proactive effort were that, "The distribution among the three tests are very close and within probable sampling, testing, and reasonable field variations. The minus-100 mesh Battelle and ContraCon NW sample are only 1.5 % different, indicating the amount of current feed fines at the plant site is very similar to the amount in the test sample sent to ContraCon NW."

Most comments and observations relative to the demonstration involving the hydrochloric acid leaching method were focused on optimizing a system that was operating fairly well and at steady state conditions, but may have

been using an excessive amount of chemicals. Some members of the peer group wished to conduct some experimental adjustments to the reagent feed rates in order to see if they could reduce chemical usage and scaled-up system costs, without any serious drop in unit efficiency. These were valuable observations, but the demonstration vendor was hesitant to experiment with the system operational parameters, for fear that such activity would invite excessive risk that would appear in the performance data, especially with regard to satisfying TCLP criteria.

Another member of the peer group observed that the hydrochloric acid leaching demonstration was so labor intensive that it would negatively skew scaled-up labor data. In response, a series of intense discussions ensued to sensitize all associated with this activity to not fall into such a trap.

The peer group also provided much insight on how best to migrate the lessons learned from these demonstrations through technology transfer.

12.7 SUMMARY

Both vendors demonstrated the effectiveness of physical separation and acid leaching to remediate soils contaminated with heavy metals at small arms ranges. In this regard, the demonstration appears to have been a success.

Vendor 1 utilized acetic acid to leach the metals and metal salts present in Ft. Polk soils. While the acetic acid system processed less tonnage (269 tons) than the hydrochloric acid leach demonstration (834 tons), sufficient tonnage was processed to determine the technical feasibility of utilizing acetic acid for a leachant

and to obtain some estimates of scale-up costs for a full scale system.

Vendor 1 required more extensive equipment modifications than Vendor 2 to adapt their equipment to the requirements of processing Ft. Polk soil; however, they were, for the most part, successful in achieving these modifications, at the expense of some downtime. Additionally, there is much less scale-up experience for utilizing acetic acid as a large scale leachant for heavy metals compared to hydrochloric acid. The acetic acid leach circuit for the fines worked very well. Difficulties were encountered in the precipitation circuit, with the low pH precipitation producing flocs that were difficult to settle and in dosing sufficient precipitant to totally precipitate the solubilized metals present as acetates. The problem was exacerbated it seemed by the lack of a water wash of the leached, filtered residues, which allowed a high solubilized lead content interstitial moisture to remain in the processed soils. The content was sufficiently high that the soils were pushed over the maximum allowable lead limits for TCLP extractions that extracted all of the solubilized lead. The TCLP extractions utilize acetic acid to leach lead so 100 percent of this solubilized lead acetate would be expected to report to the TCLP extraction. While the failure to pass some TCLP extractions caused some of the soil lots to fail, there is an excellent understanding of the cause, which can readily be corrected. The precipitation chemistry must be very carefully monitored and controlled at all times to ensure a near barren solution returning for recycle to the leach circuit. Vendor 1 realized this problem and installed an automatic, specific ion monitoring system coupled with the dosing

system. There was insufficient time to continue the processing of the failed lots with the newly installed system. Vendor 1 should be commended for making sincere attempts to rectify identified problems promptly.

Vendor 2 had a very successful demonstration of the concept of physical separation and hydrochloric acid leaching of heavy metal contaminated soils. During the contracted 15 days of soil processing, plant availability time was very high (near 98 percent). The average soil processing rate for the plant was 6 tons per hour, which was lower than initially contemplated but within the requested range. The fines content leaching and filtering by centrifuge were the limiting unit operations in times of high fines content. Wash and leachant water was recirculated in the plant, and fresh water was utilized only to replace water lost to processed soil moisture. Pad runoff rainwater was used as make-up water as water requirements allowed. The soils treated by this vendor never exceeded the criteria for 500 mg/kg total lead or the greater than 5 mg/L solubilized lead in the TCLP leachant on any day of processing. The vendor demonstrated the ability to reduce project finish wash and leachant water lead concentrations to less than 5 ppm via chemical precipitation and filtration prior to disposing of the water to the local sewage treatment plant.

Approximately 7.5 tons of particulate lead and approximately 4 tons of lead concentrate from the leaching circuit were sent to the Doe Run Smelter in Missouri for recycling. This illustrated another significant point of the demonstration, i.e., the ability to utilize the lead as a recycled product rather than a waste for land disposal.

Acetic acid leach costs were shown to be significantly higher than hydrochloric acid leach costs. However, acetic acid leaching was effective in remediating the soil at Ft. Polk. Acetic acid can be particularly effective when lead salts are present because they are considerably more soluble than metallic lead. Approximately 60 percent of the DoD small arms ranges are believed to be in soil types similar to those at Ft. Polk, and since many of these ranges have had a long time for lead to have corroded into lead salts by galvanic action with the copper jacketing, there may be a considerable number of possible application sites for which acetic acid might be considered. Acetic acid might have site-specific applications where environmental concerns mitigate against the use of strong acids because of sensitivity to chloride or nitrate ions. There may be applications where public acceptance of a more "benign" acid may weigh heavily in favor of acetic acid.

13.0 EQUIPMENT RELIABILITY AND EFFECTIVENESS

This section discusses the reliability and effectiveness of the various unit processes used by the two vendors during these demonstrations. These types of systems require extensive piping, numerous pumps, and large solids and slurry transport devices. The rigors of soil washing can stress the individual process units used; therefore, it is important to analyze the reliability of selected equipment and its effectiveness. Because of the nature of these activities, some leaks and spills will occur; therefore, a well prepared and implemented SPCC plan is critical to success. Moreover, the selection of the appropriate unit process must be done after a detailed and successful benchscale treatability study has been accomplished.

13.1 FEED HOPPERS

The vendors had mixed results with their respective feed hoppers (Figure 31) during this demonstration. Vendor 1 had some problems with the base of the feed hopper plugging with soil. Vendor 1 installed a vibratory plate on one wall of the feed hopper to help alleviate this problem. However, because the vibratory plate had little effect and was excessively loud, the unit was not used. Vendor 1 then placed a catwalk around the feed hopper to enable personnel to break up soil in the hopper manually with a shovel. This fixed the problem but was labor intensive. Vendor 2 used a larger feed hopper than Vendor 1 and did not encounter the same problems. Note that the higher the clay content in a soil, the more likely a feed hopper will plug.

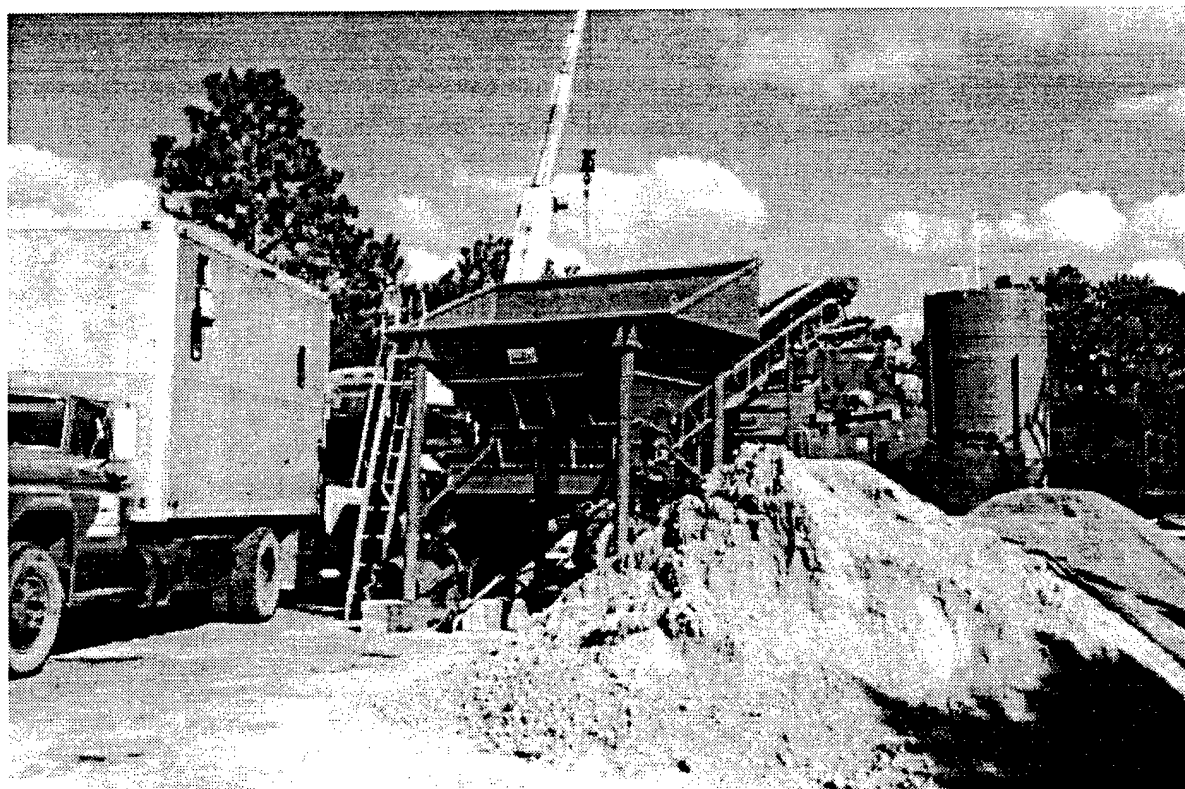

Figure 31. Soil Input Feed Hopper

13.2 ATTRITION SCRUBBERS

Vendor 1 used an attrition scrubber (Figure 32) to break up clays in the soil. Vendor 1 did not have an attrition scrubber in their treatment train initially, but added one soon after the start of their demonstration when clay ball formation was noted in their coarse material washer. The attrition scrubber they installed appeared to be well used—the unit was rusted and leaked severely. However, minor repairs along with soil and gravel build-up in the bottom of the unit stopped the leak. The unit was effective in breaking up high plasticity clays but may have increased the overall percentage of fines input into the plant.

13.3 LOG WASHERS

Both vendors used log washers to break down the soil matrix and impart the attrition

energy required to effectively scrub contaminants from input soil. Vendor 1 noticed clay ball formation in their log washer and added dedicated attrition scrubbers upstream of the log washer. The coarse material washing systems employed by the vendors worked well with only minor repairs to supply hoses. Vendor 2 had more success with their log washer and did not need a dedicated attrition scrubber.

13.4 JIGS

Both vendors used mineral jigs (Figure 33) to density-treat sands for the removal of particulate metal. Vendor 1 had to fill their jig with additional steel shot for effective operation. Vendor 2 had success with their jig and produced a high-grade metallic lead concentrate; however, they had to repair the seal of

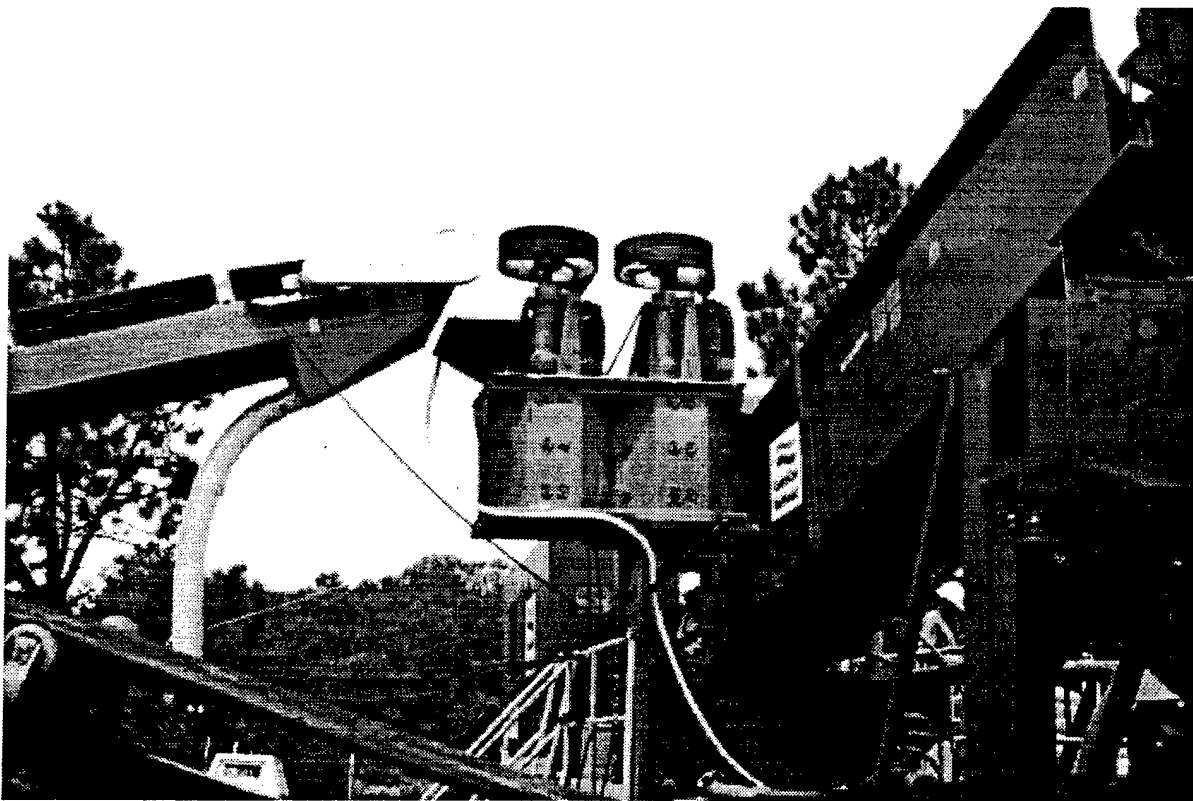

Figure 32. Attrition Scrubber

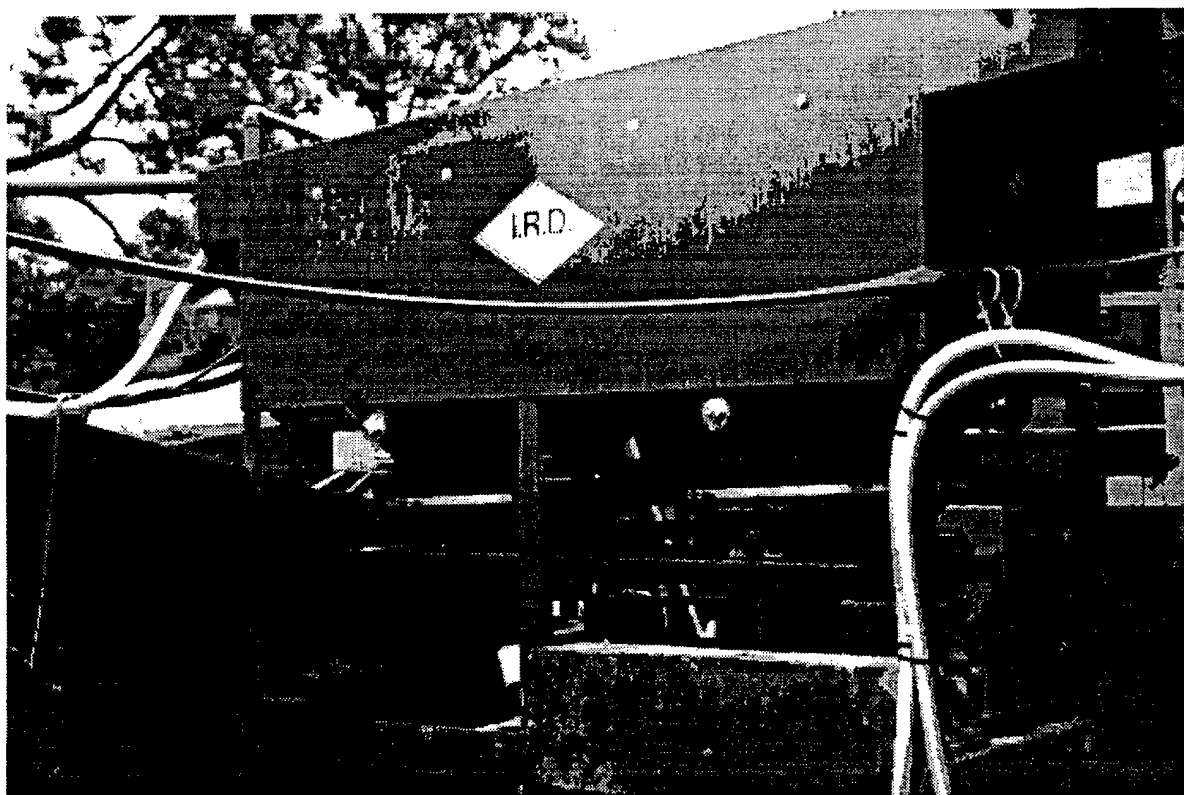

Figure 33. Mineral Jig

the jig diaphragm, which held for the rest of the demonstration.

13.5 SAND SCREWS

Both vendors used sand screws (Figure 34) to separate soil clays from soil sands and to dewater sands. The sand screws had excellent mechanical reliability; however, both vendors repeatedly raised the pitch of their screws to improve performance. Vendor 1 made other screw modifications to enhance performance, including installation of a new motor controller to slow the rotational speed of the screw and enlarging the volume at the base of the screw, thereby reducing turbulence.

13.6 BELT PRESSES

Initially, Vendor 1 used a small (3 tons per hour) belt press to dewater fines. However,

the small capacity of the press had a negative impact on its performance, so a large frame filter press was brought in. The belt press was then used to further dewater sands that had already passed through a sand screw. The belt performed well and required little maintenance throughout the demonstration.

13.7 FILTER PRESSES

Both vendors used filter presses (Figure 35) during the demonstration, but for different jobs. Vendor 1 used a large frame press for dewatering fines, while Vendor 2 used a smaller frame press for dewatering hydroxide precipitates. Both presses performed well. However, Vendor 1 did not precoat their filter with DE; therefore, the filters plugged and had to be replaced. Vendor 2 used a DE precoat step before dewatering their hydroxide stream; con-

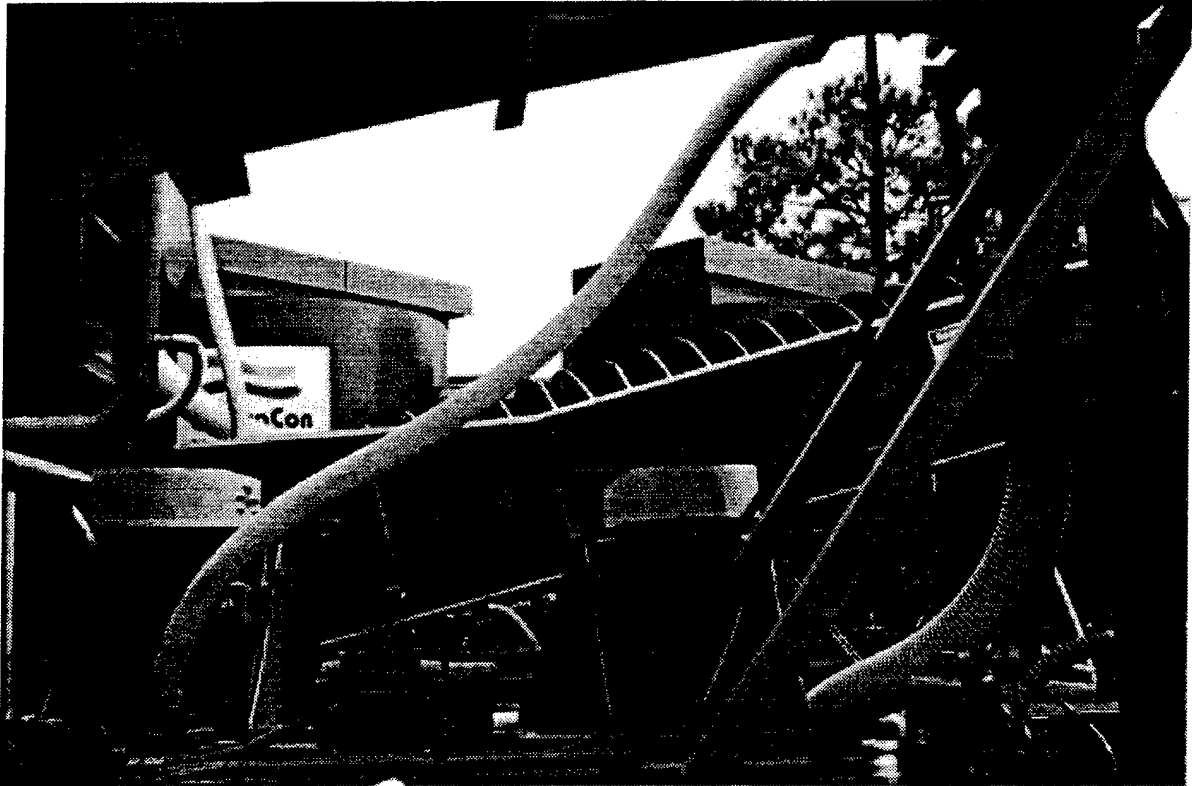

Figure 34. Sandscrew

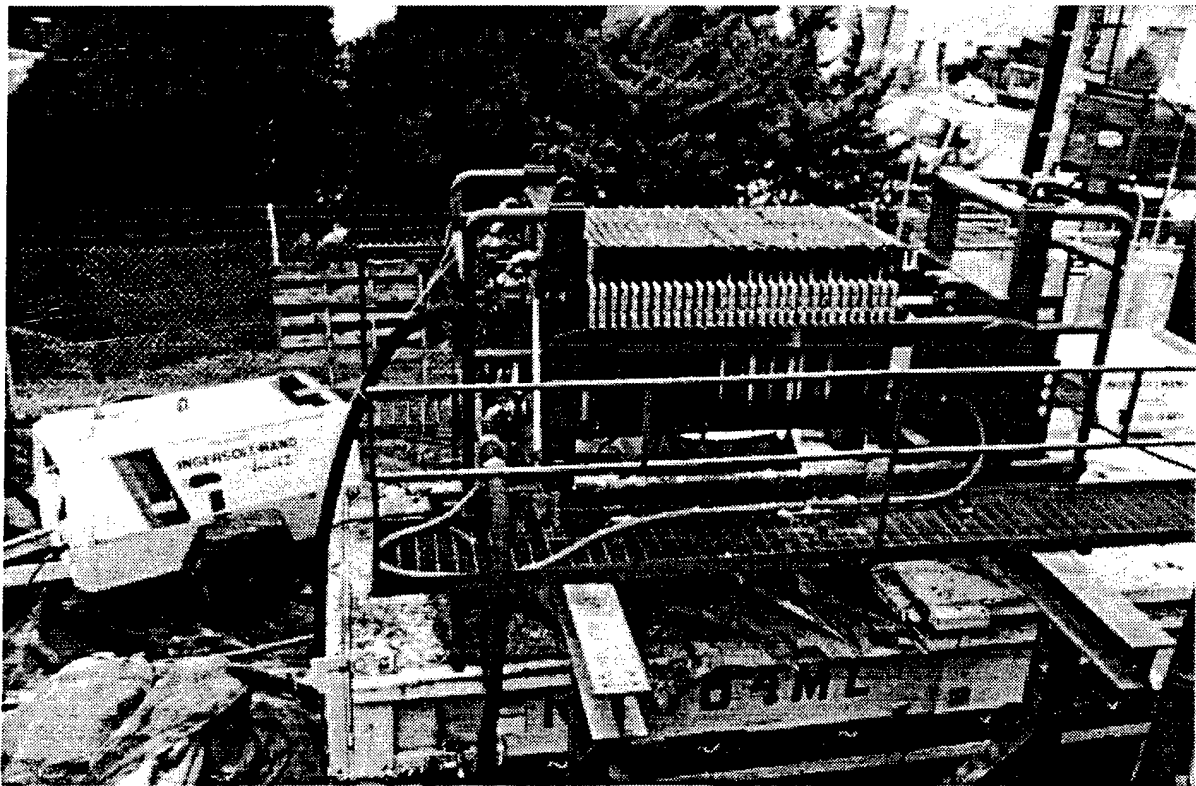

Figure 35. Frame Filter Press

sequently, their frame press performed more reliably. The cost of using DE was substantial and is discussed in Subsection 19.6.

13.8 LEACHING TANKS

Both vendors had success with the leach circuits in their process trains. A fines leach tank is shown in Figure 36. Vendor 1 used a series of three reactor-clarifier leach tanks (Figure 37) followed by a fourth reactor-clarifier tank for metals recovery. Vendor 1 had some trouble with fines sludge building up in the three leach tanks. This hampered their ability to reach steady state, because they had to stop input to the plant periodically and pump settled sludge from the leach tanks into the filter press.

13.9 PRECIPITATION TANKS

The two vendors used different types of metal precipitation tanks (Figure 38). Vendor 1 used a circular reactor clarifier tank similar

to their three fines-leaching tanks followed by a series of two small polishing basins separated by a flow-over weir. Vendor 2 used a single plate settler tank. Both systems performed fairly well; however, Vendor 1 had problems with floating lead sulfide floc formation, which had to be removed by the installation of bag filters.

13.10 CLARIFIERS

Vendor 2 used two clarifier tanks in series for fines leaching. Fines that settled in the tanks were pumped into a centrifuge for dewatering, while the overflow was sent to the plate settler precipitation tank. Vendor 2 also used two similar tanks to flocculate and settle lead hydroxide precipitate pumped from the plate settler precipitation tank. Two were used to enable continuous processing of the lead hydroxide precipitate. Hydroxide floc could be pumped into the filter press from one clarifier,

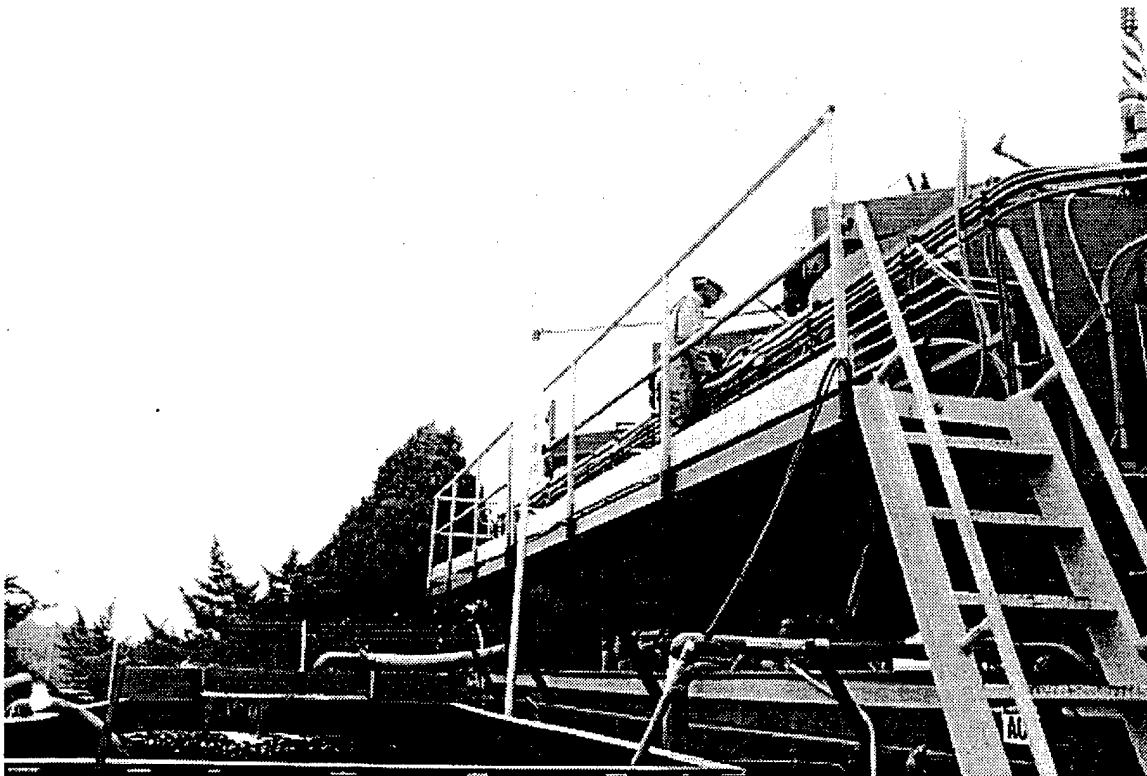

Figure 36. Fines Leach Tanks

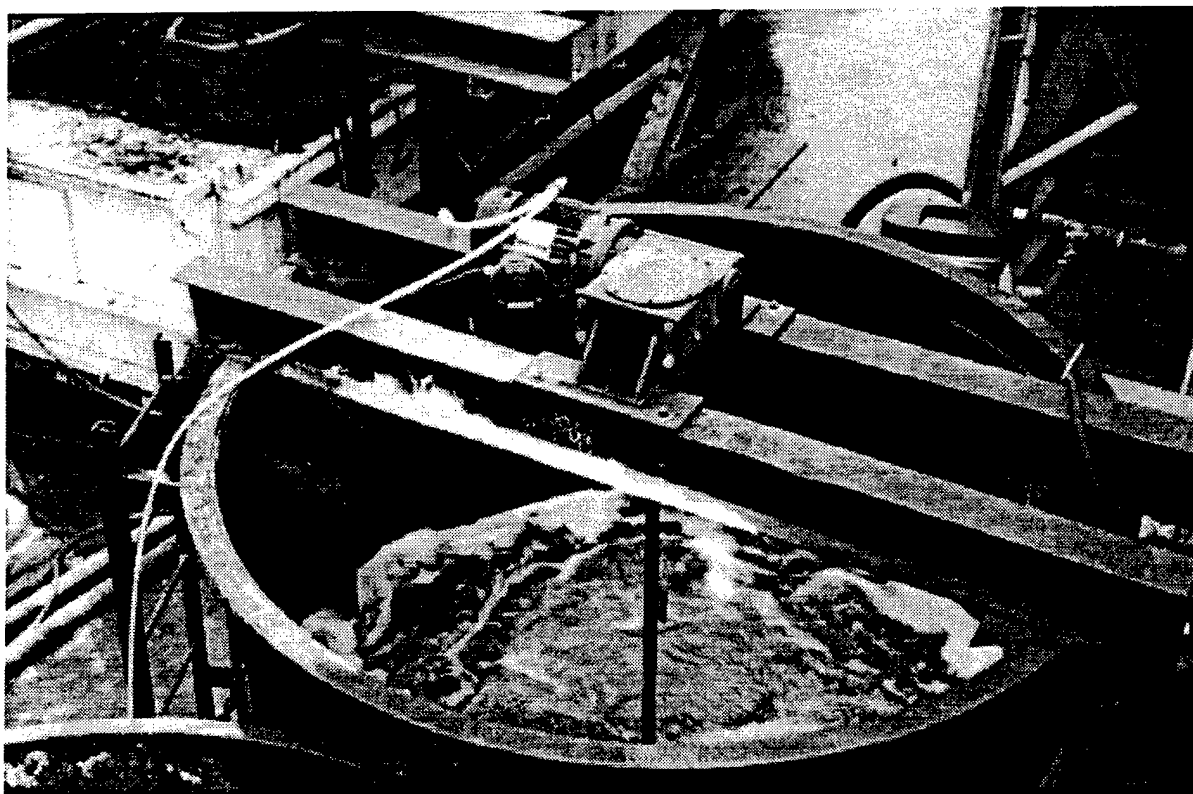

Figure 37. Reactor-Clarifier Tank



Figure 38. Precipitation Tank

while hydroxide precipitate from the plate settler could be pumped into the other clarifier. Both systems worked very well with little maintenance.

13.11 CENTRIFUGES

During this demonstration, Vendor 2 used a centrifuge (Figure 39) for dewatering fines. This device was very effective. The centrifuge required some minor mechanical maintenance, but did not adversely detract from system performance. In using such a device, there is the potential for air entrainment in process water overflow discharge, which could contribute to some flotation in the system. The unit used was not excessively loud. There is mixed opinion as to their long-term reliability. During this demonstration, this unit seemed to perform better than the frame filter press

(which had not been precoated with DE). Any unit process used to dewater fines for future application of this technology set should be well considered and rely heavily on the results of the benchscale treatability study. Also, system redundancy and the ability to make quick repairs in the field should be included in the mobilization plan.

13.12 SUMMARY

Most of the equipment employed by the vendors to accomplish the various singular tasks through their system unit processes train performed very well. However, all equipment needed minor maintenance throughout the demonstration. Obviously, the great deal of hydraulic piping and the numerous pumps required by these systems increases the probability of leaks and requires careful operator

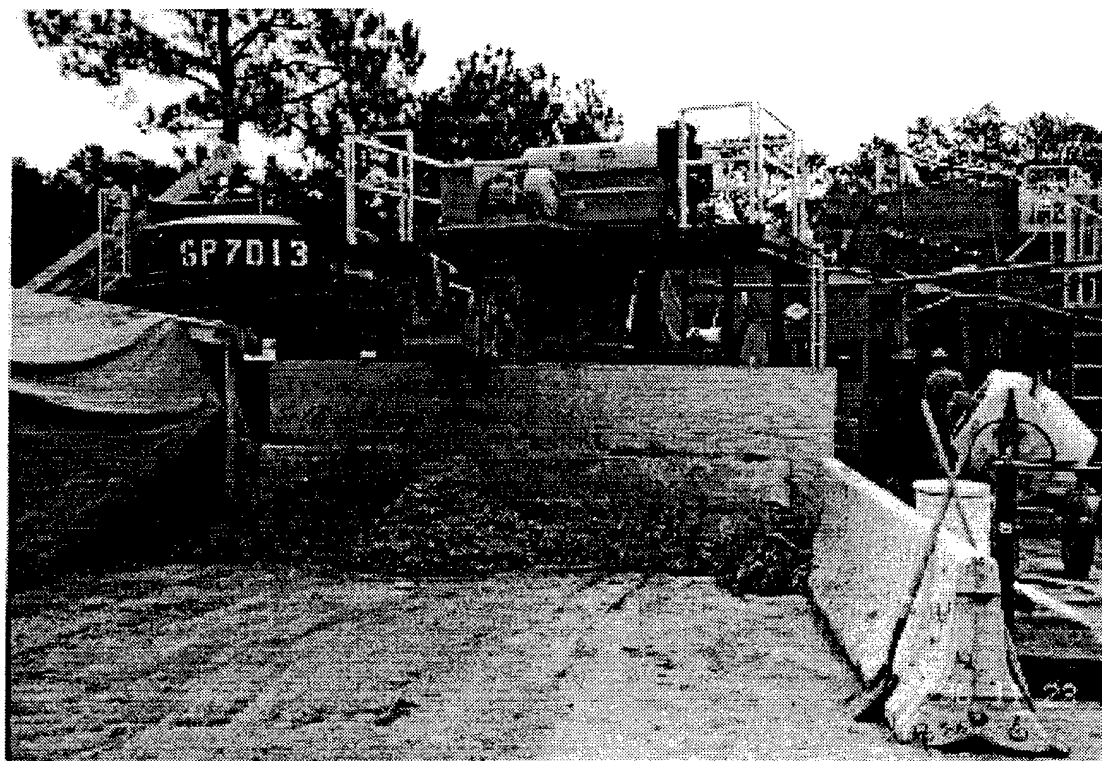

Figure 39. Centrifuge

attention and an effectively implemented SPCC plan.

The successful deployment and operation of a system unit processes train for a soil washing operation will require:

- ◆ A successfully executed benchscale treatability study in which the proper unit processes

are chosen and scaled to be compatible with one another

- ◆ A well prepared and executed SPCC plan
- ◆ A well thought out preventive maintenance plan to include a benchstock of components on site to repair the components most likely to fail during the project.

14.0 ANALYTICAL METHODS

Standard EPA methods were used to extract and analyze aliquots from samples. The primary analytical methods were EPA Method 3051 for digestion of soil samples (for total metals analysis), EPA Method 1311 for non-volatile TCLP extraction, and Method 6010A for ICP AES for the analysis of metals of con-

cern in extracts. Analysis of selected coarse lead fragments collected during sample preparation was conducted by Optical Emission Spectroscopy (OES) using ASTM Method E1476 as a guide. OES is an established mining industry technique for obtaining a semiquantitative analysis of minor elements in a mineral sample.

15.0 PROCESS CONTROL

Process control is very important in a soil washing system. At any plant there should be a mix of manual, automatic, or semiautomatic controls (as warranted by cost and criticality of the unit operation). Controls should be redundant so that there is a backup to monitor any critical parameters. Controls can vary from spot routine checks to fully automated sampling devices and can be used to control a unit operation with a feedback loop or to monitor operations with no automated control. Procedures that are critical to plant operation should have real-time or nearly real-time information available. If there are delays in obtaining plant process data, responses may be incorrect, as real-time events may have dramatically changed in some circumstances. Therefore, process controls must respond to current events rather than historical events.

15.1 INTRODUCTION

Pilot plants and new plants pose difficult control problems because precise parameters may not be known until after an operation. Operations may have to be varied frequently to learn how to optimize a process and a plant. No matter what controls are in place, observations from competent, trained people are very important. One should always apply real and reasonable criteria to discrete system observations, particularly instrumentation numbers. With technology allowing for so much on-line control, the value of trained insight is more important than ever because too much trust can be placed on our electronic systems. When possible, instrumentation should have checks based on alternate technologies. However, much instrumentation is now available to as-

sist the process engineer in controlling systems far more closely than in the past.

During the Ft. Polk demonstration, Battelle was responsible for analytical sampling and determining whether the vendors met project criteria of less than 500 mg/kg of total contained lead, during the hydrochloric acid demonstration and 1,000 mg/kg during the acetic acid demonstration, and less than 5 mg/L lead in TCLP extractants. A very difficult sampling problem arises when sampling material contains "nuggets" of substantial weight and size that contain the elements being analyzed. In the case of small arms firing ranges, we have lead bullets and, in the case of Ft. Polk, lead carbonate salts, which must be accounted for in any analytical scheme. Large samples are required that must be meticulously prepared to screen and weight-average coarse lead particulate material and reduced in size and well randomized prior to taking a sampled subset.

As important as these sample preparations were for the project management, especially for determining the passing and failing of soil lots, this information was very limited for running and optimizing the running plant as the answers to the analytical questions were not received for several days. For this reason, the two demonstration vendors had independent analytical capabilities on-site. Soil washing systems need real-time data for successful operations. Battelle operated an X-RF unit on-site that was capable of providing reproducible, quick answers as to the contents of a sample for a number of elements of interest. Other analytical units, such as atomic absorption flame spectroscopy (AA) are able to provide quick process answers, particularly for solubilized metals, so long as sample dilutions

are carefully performed to ensure the metal content lies within the range of previously prepared standards.

Manual process checks are useful and necessary, such as pH and eH readings on a system. Dissolved oxygen probes are very useful for determining oxygen content of solutions when monitoring reactions that require the presence or reaction of oxygen. There are also instruments that help maintain a safe work environment when there are possibilities of explosive mixtures or noxious gases. Manual dosing jar tests are useful to determine if precipitation doses are accurate and to determine the response to such things as flocculants. Quite frequently, flocculants and other reagents are metered into reaction vessels to control reactions. Perhaps as important as any of the above is the availability of someone who is knowledgeable and responsible for checking on the control of the process and the amounts of reagents being dosed to the system. This person may not actually run the tests as long as there is a competent person doing so, but they must be responsible for the reliability of data they are getting so that decisions can be made confidently.

15.2 VENDOR 1 PROCESS CONTROLS

Vendor 1 set up an analytical control trailer on-site that had an AA unit set up for process samples and was capable of digestions for solid samples and dilutions for liquid samples. Lead solution standards were available to calibrate the AA. Vendor 1 also made arrangements to have Battelle personnel run samples on the X-RF, which was capable of multi-element analysis in a 5- to 10-minute time frame, so long as the sample was able to be contained in the

mylar-covered sample holders, which were about an inch in diameter and 3/4 of an inch in height. Battelle also had a sample preparation area with drying ovens, screens, a roll crusher, and splitters, which the vendor was able to use if needed or could request Battelle personnel to prepare and run a sample.

The process plant for Vendor 1 was mounted on three trailer beds, with the equipment connected by pipes and hoses strung between the trailers. The feed hopper, feed conveyor, and clarifiers/settlers were mounted on the ground adjacent to the process trailers. The trailer bed housing the fine soils leach plant also housed the chemical reagent makeup and pumping area, where reagents were dosed from manifolded supply lines. Peristaltic dosing pumps were used for pumping reagents, such as Thio Red® precipitant and flocculants. Acetic acid was supplied by pump from the acetic acid storage tank, which was located adjacent to the trailers but isolated in a large storage tank with secondary containment. Several remote-reading pH meters were installed in the plant, reporting to remote readouts in the reagent area of the leach vessel trailer. It is believed that these were readouts only with no feedback loop for controlling dose rate. Meters were available for the three leach vessels and the precipitation vessel. The pH of the primary sand screw/attritioner was monitored. The pH of the front end of the circuit where sand/slime separation was occurring was somewhat higher (at about 3.2) than in the leaching circuit, where it was attempted to keep the pH as close to 3.0 as possible.

It is unfortunate that the acetic acid additions never really approached steady state operating conditions, which would have been

possible had the plant processed a greater tonnage. The plant spent a fair amount of time attempting to reprocess out-of-specification leached residues. It was during this time that the plant experienced difficulties with its precipitation circuit. Possibly insufficient Thio Red® was being dosed to the plant to precipitate the lead and other metals in solution. As a result, solubilized lead was recycled to the front leach circuit in high quantities where additional lead was solubilized from the new feed. Lead levels rose on a short-term basis to high levels. The recycled soils returning to the plant exacerbated the situation because these soils contained high levels of solubilized lead and acetic acid, which further increased the solution inventory. It was necessary for the plant to stop processing the feed for part of a day while solutions were recycled and precipitated. Shortly thereafter, the vendor installed a specific ion electrode to determine the Thio Red® level in the solutions; the electrode was linked to the dosage pumps. The lead precipitant pumps contributed to the lead solution levels, and were operating at maximum but only capable of delivering half of the required dosage. Increased dosage capacity was then installed by the vendor.

The plant had some continuing problems with filtration that allowed acetic acid and solubilized lead to remain in the processed soil. The large plate and frame filter used to filter the leached slimes was a suitable piece of equipment; however, the lack of a water rinse capability allowed acetic acid-rich solutions containing solubilized lead to remain as interstitial moisture.

Vendor 1 reported that consumption figures for acetic acid for the actual plant run were nearly twice the levels estimated for a larger scale operation of an acetic acid system. Even at those lower numbers of about 18 gallons of acetic acid per ton, the acetic acid consumption is three times the hydrochloric acid consumption derived from Vendor 2's report. More acetic acid consumption was expected compared to hydrochloric because acetic acid is a weak acid. Real acetic acid consumptions were nearly six times the hydrochloric acid consumptions. These high consumptions were contributed to by two things: one, the acetic acid remaining in the processed soils in the interstitial moisture, and two, the vendor's attempt to lower the pH by increasing the acid delivery to lower the total lead content of the soil. These high consumptions were perhaps exacerbated by operations based on the belief that a leaching problem existed when the problem could potentially have been very high soluble lead in the leaching circuit itself. It would appear that there is opportunity to reduce the acetic acid consumption in a steady state soil washing system. Because of the cost of acetic acid, reliable instrumentation with feedback control loops linked to dosage pumps should be considered. The acetic acid consumption is the most likely place where considerable savings may be achieved. The cost of even the steady state projected plant consumptions of acetic acid is approximately 15 times the cost of hydrochloric acid (three times the consumption times five times the cost per gallon). Reduced acetic acid consumptions would readily pay for a washing step in the filtration of the fines.

15.3 VENDOR 2 PROCESS CONTROLS

Vendor 2 utilized the same analytical control trailer initially set up on-site by Vendor 1. Vendor 2 had both AA and X-RF analytical capabilities. The AA unit was very useful for determining solubilized metal values of process solutions. The X-RF unit was used for heavy metal determinations of solid samples. Initially, samples were cross checked by digestions and solution analysis by AA. The X-RF has the excellent advantage of rapid turnaround time for analytical data for solid samples with minimal sample preparation. This makes the X-RF a useful process control tool for solid process samples. Sample turnaround time for the determination of Pb, Cu, and Fe was about 5 to 10 minutes, depending on metal concentrations. Likewise, the AA unit is a rapid turnaround analytical device to provide metal concentrations in solution. If proper matrix standard samples have been prepared, dilutions are performed accurately, and values are read within the limits of the standards, then the AA can be very effective in aiding process control.

Vendor 2 maintained a full-time chemist on-site during the demonstration to provide process control information. This presence and continuing input of real-time data provided great positive value to Vendor 2's success and ability to maintain control of the process during the entire demonstration with naturally occurring variations in feeds.

Their soil washing system was a series of skid-mounted mobile units that were placed individually rather than mounted on trailer beds. This arrangement required a longer setup time and consumed more pad space; however, it provided for a more flexible plant.

The plant utilized instrumentation for pH control and the addition of hydrochloric acid in the leach circuit and sodium hydroxide in the precipitation circuit. The instrumentation required for control was somewhat simpler in this plant than in the acetic acid plant because pH control with sodium hydroxide to pH of about 10 was sufficient to ensure that the acid solubilized metals were precipitated as metal hydroxides. The acetic acid plant required precipitation in acid solutions where a specific ion probe for the precipitant concentration was necessary to maintain control of the plant.

Vendor 2's process control success can be attributed in part to the presence of a full-time chemist who was charged with the responsibility of providing real-time process control data upon which decisions could be made by the operator.

15.4 QUANTITY OF CHEMICALS CONSUMED

Vendor 1 used 84 percent acetic acid and hydrated lime (calcium hydroxide) to adjust pH during their demonstration. They also used the polymer Thio Red® for low pH lead precipitation and the flocculant Pol E Z 652® to improve precipitate settling characteristics. The following lists the amount of each reagent consumed during the acetic acid demonstration.

- ◆ Acetic Acid—9,415 gallons
- ◆ Hydrated Lime—2,000 lbs
- ◆ Thio Red®—1210 gallons
- ◆ Flocculant—110 gallons.

Vendor 2 used 33 percent hydrochloric acid and 25 percent sodium hydroxide to adjust pH during their demonstration. DE was used to precoat their lead hydroxide precipitate dewatering filter press. The vendor also used a flocculant to improve precipitate handling char-

acteristics and hydrated lime to neutralize processed soil. The following lists the amount of each reagent consumed during the hydrochloric acid demonstration.

- ◆ Hydrochloric Acid—5,600 gallons
- ◆ Sodium Hydroxide—5,850 gallons
- ◆ Diatomaceous Earth (DE)—8,700 lbs
- ◆ Flocculant—1,000 gallons
- ◆ Hydrated Lime—1,275 lbs.

The costs associated with chemical consumption during these demonstrations are detailed in Section 19.6, Chemical Consumption Costs.

15.5 OPPORTUNITIES FOR SYSTEM OPTIMIZATION

Some opportunities for system optimization exist. As an example, for acetic acid leaching, Vendor 1 had projected considerably decreased acid consumption rates. Reducing the entrained acid in the processed soils by a water wash after filtration will not only recover unused acid, but will also decrease the amount of base required to neutralize the soils, as the base additions do not have to neutralize the recovered acid. This is applicable to any type of acid leaching; however, it is particularly applicable for acetic acid due to the cost of the acid. Additionally the water wash will remove salt ions from the soil that would otherwise remain if the soil was just neutralized with the acid in place. Water washing on plate and frame filters is relatively easy and inexpensive. Vacuum belt filters can be set up with two zones for filtration: the first for removing extra acid, and the second for a displacement wash to displace entrained acid.

The use of DE is an excellent aid in the filtration of slimy precipitates, such as the metal hydroxides produced by Vendor 2 with the

hydrochloric acid leach. The DE, however, was the most expensive single reagent on a unit cost basis. For processing larger tonnages of material, consideration should be given to using an alternative filtration system, such as a pressure belt filter. The capital cost of these filters is higher than plate and frame filters; however, with sufficient tonnage to process, the extra capital cost could be readily justified by the decreased operating costs over a period of time.

15.6 SUMMARY

Process control is critical to the success in operating the unit processes associated with this technology set.

Operating with real-time instrumentation, via sensing with feedback loops is essential for effective operations. The mechanical speed of a unit process and the chemical dosage rate must be controlled. The latter may be more important, especially if TCLP criteria must be satisfied.

The principal driver here is the variability of the metals concentrations in the soils to be processed. Soil washing unit processes must be able to have the capacity and flexibility to be responsive to variable metal loadings and variables in soil characteristics. To effectively process the soils, changes in unit process, mechanical speed and chemical dosing rates will have to be adjusted. The larger the plant and the greater the throughput rate, the more critical this becomes.

Sensors properly placed with feedback loops for immediate rate adjustments and a dedicated full-time chemist at the job site, will assist significantly in achieving successful operations.

16.0 RESULTS

This section presents the results of both demonstrations in detail, beginning with the benchscale testing. The intent here is to describe the results of the demonstrations independently of each other. It is important that reviewers not frame their analysis within a context of competition between acid types. Selection of acid in this technology set is very site-specific. Different soil types will respond more effectively to different acid types discussed in Section 11.0. As this was a demonstration, two types of acid were employed at the same site, in order to obtain performance data.

16.1 ACETIC ACID LEACHING

The preliminary results available at the conclusion of the demonstration are included in Appendix C. These data were provided by Battelle, the independent evaluator. In some cases, the data are still undergoing Battelle's quality assurance review. The following data packages are provided:

- ◆ Daily Operating Summary for Acetic Acid Demonstration
- ◆ Acetic Acid Leaching Data Summary
- ◆ RCRA Metals.

The concept of operations for this demonstration directed Vendor 1 to operate the process equipment at a steady state condition and allow detailed samples of various process

streams for laboratory analysis to be taken. However, the process equipment did not achieve a steady state condition for a sufficient time to allow full implementation of the sampling plan, as shown by the data in Appendix C. The soil feed rate was low and erratic, and the process train suffered numerous malfunctions. Consequently, data for the complete throughput sample were very limited, as depicted in Appendix C. Only 269 tons of soil were processed, and only seven throughput data sets were generated. Results observed for lead removal are shown in Table 10.

Table 10. Total and TCLP Lead in System Input and Output Soil (mg/kg and mg/L respectively), Acetic Acid Demonstration

Date	Soil Tonnage	Total Pb In	Total Pb Out	TCLP Pb In	TCLP Pb Out
Sep 15	18.5	2254	122	34.6	3.07
Sep 20-21 *	23.3	1613	208	21.0	5.98
Sep 23-25 *	27	4122	330	22	10.03
Oct 1-2 *	37.4	3435	404	40.5	11.2
Oct 3-4 *	58.5	•	269	•	7.80
Oct 5-10 *	28.4	•	839	•	21.7
Oct 12	14.9	5732	1443	106.0	48.0
Average	30	3431	516	44.8	15.4

*Feed rates slow, therefore samples taken over multiple day runs.
 •Preprocessed soil.

0063G_06

The following observations are reported. Total lead was removed from the soil at a rate of 85 percent. Leachable lead was removed from the soil at an average rate of 66 percent, but did not satisfy the TCLP criterion of 5 mg/L or less after the initial run on September 15, 1996. The TCLP values tended to increase with time as the pilot plant was operated, suggesting that some process chemical reagents may have become contaminated or may have lost much of their chemical potential during the

demonstration. In addition, the high moisture content in the final processed soil and the fact that it was not clean-water rinsed may also have been sources. The concentration of lead in the raw soil was not constant, although the soil was blended. A number of hot spots contain much more lead than other parts of the range.

Benchscale Treatability Test. The benchscale testing was conducted in July 1996. The overall results for total lead removal were excellent. Vendor 1 achieved a total lead removal rate of nearly 97 percent and reduced the concentration of total lead in the soil from 28,300 parts per million (ppm) to 465 ppm. However, Vendor 1 did not achieve the TCLP goal; initial results were about 14 mg/L. After several modifications and improvements to their methodology (log washer simulation), Vendor 1 projected an achievable TCLP from their data of just below 5 mg/L. The BDM team approved their benchscale test results in August 1996. Vendor 1 also introduced the concept using the polymer Thio Red®. However, the BDM team did not support their proposed use of a polymer for stabilization because the goal was to satisfy TCLP criteria by removal of the target material (i.e. the soluble lead).

Thio Red® is a polythiocarbonate organic sulfur compound precipitant. During the acetic acid demonstration, it was used to precipitate solubilized lead from rich leachate at low pH, thereby regenerating the leachate as "barrens." This prevented the need for a pH change to precipitate the lead and would therefore conserve acetic acid use.

Thio Red® performed well during benchscale studies showing strong lead re-

moval and low residual Thio Red® levels in regenerated leachate. However, use of Thio Red® in the field at pilot scale proved difficult to control. For more information, see Appendix D, page 15.

Vendor 1 also proposed the use of Thio Red® as a stabilizing agent in processed soil. The concept being that lead remaining in the soil could be tied up as a relatively insoluble species and therefore not exhibit a toxic leachate characteristic. However, as Thio Red® is reportedly a biodegradable organic compound, it would not make an effective long-term stabilizing agent.

30-Ton Test. The 30-ton test was successful, and Battelle provided the analytical results on September 19, 1996. Total lead in the final recycled product was 122 ppm, and the TCLP was a low 3.07 mg/L. Based upon these results, Vendor 1 was authorized to proceed with the 1,000-ton test, with direction to pay more attention to hydraulic maintenance and improved equipment reliability.

1,000-Ton Test. The 1,000-ton test run was not as successful. Although Vendor 1 was able to maintain a satisfactory removal rate for total lead until the last 2 days of processing, TCLP values increased. As previously discussed, this highlights the need to resolve the issue of setting pairs of decontamination goals with a TCLP criterion and a total lead criterion. In this case, meeting the total lead levels had no bearing on meeting the TCLP goal. Numerous hydraulic leaks contributed to localized contamination of the operations pad, and the throughput rate was low. The highest rate achieved was only 4.2 tons per hour, and the average rate during the entire demonstration was 1.7 tons per hour. At the end of 41 days,

demonstration operations ceased. Altogether, Vendor 1 processed 269 tons of soil, including 58 tons of reprocessed soil. From this total effort, only 10 tons of soil satisfied the TCLP criterion and were subsequently returned to the range. An additional 161 tons of processed soil, which failed TCLP for lead, remained at the operations area to be reprocessed. The balance of the soil became part of the contaminated process sludge that was disposed of as a hazardous waste at a TSDF in Oklahoma. An approximate mass balance of this soil is provided in Table 11.

Several problems appeared to occur on a continuing basis and adversely affected overall performance during the demonstration. The apparent lack of control over internal chemistry processes resulted in inability to optimize the acid-base reactions required to maximize removal of metal salts. Excessive mechanical energy in the system may have caused floc to be broken up by sheer forces and dispersed throughout the system. Moisture content in the output soil product was frequently excessive. This contributed to material handling problems and probably to the high TCLP values observed in the final processed soil. The

Table 11. Approximate Mass Balance of Soil

Soil (tons)	Remarks
269	Total amount processed
58	Total amount reprocessed
211	Total amount removed from the range
10	Total amount returned to the range
201	Total amount removed but not returned to the range
161	Total amount remaining at B-4700 to be reprocessed
40	Total amount of potential waste resulting
(9)	Total number of drums of metals awaiting reclamation
(82)	Total number of drums of waste (sludge, etc.)

0063G_07

pH of the output soil may not have been sufficiently high; as a result, the process wash water may have become contaminated, especially at the end.

16.2 HYDROCHLORIC ACID LEACHING

The preliminary results available at the conclusion of the demonstration are included in Appendix C. These data were provided by Battelle, the independent evaluator. In some cases, the data are still undergoing Battelle's quality assurance review. The following data packages are provided:

- ◆ Daily Operating Summary for Hydrochloric Acid Demonstration
- ◆ Hydrochloric Acid Leaching Data Summary.

The concept of operations for this demonstration was identical to the previous demonstration. Specifically, Vendor 2 was to operate their unit process equipment at a steady state condition so that the independent evaluator could take detailed and representative samples of various process streams for laboratory analysis. Both the independent evaluator and Vendor 2 had independent X-RF devices on-site to support rapid field analysis used for analysis. In addition, Vendor 2 had an AA unit on hand,

a dedicated chemist, and pH meters built on-line into their unit processes that they constantly monitored and used to manage their process chemistry. Once they commissioned their system, it quickly gained momentum and reached steady state soil throughput conditions (measured in tons per hour) without any major operational problems. Their equipment routinely operated for 9 to 10 hours per day.

Total lead concentration in the soil was reduced by 96 percent, and the concentration of leachable lead was reduced by 94 percent. In every instance, the critical TCLP criteria (less than 5 mg/L) was satisfied. The low TCLP values achieved are worth noting. TCLP and total lead values are reported in Table 12.

All recovered particulate metals and metal hydroxide filter cake sludge was shipped to the Doe Run Smelter Facility. Vendor 2 generated 15 drums (7.5 tons) of recovered particulate metals and four roll-off bins of lead hydroxide filter cake. Approximately 58,800 pounds of filter cake material were sent to Doe Run.

Benchscale Treatability Test.

The initial benchscale treatability test report from Vendor 2 was reviewed in early August 1996. It was considered well done, but was missing clearly presented analytical data to substantiate the results. In addition, some concerns were raised about the planned polymer to be used and whether a stabilizing agent could be used with the final processed soil. A revised version of the benchscale treatability test report was received in late September and found to be acceptable. They performed their benchscale treatability study with great detail and used the data to lay out the specific unit processes train for their process system. The results of their effort produced total effluent lead of 240 milligrams per kilogram (mg/kg) and TCLP

Table 12. Total and TCLP Lead in System Input and Output Soil (mg/kg and mg/L respectively), Hydrochloric Acid Demonstration

Date	Soil Tonnage	Total Pb In	Total Pb Out	TCLP Pb In	TCLP Pb Out
Nov 15	32.0	N/A	143	N/A	3.07
Nov 16	42.0	4,819	178	18.4	1.83
Nov 20	43.0	4,152	125	20.7	0.96
Nov 21	50.0	3,567	134	37.3	1.32
Nov 22	63.0	4,068	115	33.5	0.56
Nov 23	51.0	4,068	232	33.5	1.75
Nov 25	47.0	5,194	235	31.9	2.15
Nov 26	48.0	5,040	181	36.3	1.97
Nov 27	56.0	5,040	165	36.3	2.84
Nov 29	43.0	5,040	230	36.3	3.44
Nov 30	64.0	5,040	233	36.3	3.53
Dec 2	65.0	5,040	177	36.3	1.85
Dec 3	52.0	3,351	132	40.4	1.36
Dec 4	50.0	2,743	113	13.7	2.35
Dec 5	51.0	2,743	127	13.7	3.06
Dec 6	56.0	2,743	123	13.7	0.76
Average	50	3,916	155	27.4	1.93
Dec 12*	22	2743	671	13.7	2.67

* Visitors' day demonstration.

0063G_09

lead of 4.15 mg/L. These were very encouraging numbers, not only from the perspective of high percentage removals (on the order of 90 percent), but because the results satisfied the required TCLP. Their benchscale treatability work was accepted in early October 1996.

30-Ton Test. The 30-ton test was successful. Battelle provided the analytical results on November 19, 1996. Total lead in the final recycled product was 178 ppm, and the TCLP was a low 1.83 mg/L; their lead removal rates achieved were 96 percent total and 90 percent soluble. Based upon these results, Vendor 2

was authorized to proceed with the 1,000-ton test.

1,000-Ton Test. Vendor 2 continued to succeed throughout the 1,000-ton test. They performed this test from November 20, 1996 through December 12, 1996, and processed 834 tons of soil in 15 days. The total lead concentration in the processed soil averaged 165 ppm, and the average TCLP value was 2.05 mg/L without any excursions over the 5 mg/L criterion. Their lead removal rates averaged 96 percent total and 93 percent soluble.

16.3 FATE OF OTHER METALS

Although the two demonstrations completed during this project principally focused on the ability of soil washing to remove lead from contaminated small arms range soils, there were other metals of concern, specifically, copper (Cu), antimony (Sb), and zinc (Zn). This section provides the results of those efforts.

These three other metals are not considered RCRA metals because they do not have published TCLP action levels that could be used to ascertain whether the soil that contains them could be considered a RCRA hazardous waste based on their toxicity characteristics. Still, their presence could represent the potential for an environmental consequence. Lead does have a published TCLP action level (5 mg/L), and this is why it was the major target metal of concern in this project.

As previously stated, just because there is no RCRA-based TCLP action level does not mean that the presence of these three other metals (Cu, Sb, and Zn) does not represent potential environmental consequences. The fact is such presence could, especially copper. As a case in point, in 1994-1995, during the EPA

SITE demonstration of a similar technology at the Twin Cities Army Ammunition Plant near Minneapolis, Minnesota, as the Applicable or Relevant and Appropriate Requirements (ARARs) were established under CERCLA procedures to determine cleanup standards, the metals antimony and copper had remediation targets and remediation goals established that addressed such. The metal zinc was not considered at this site. The remediation goals for these two metals as total metals established are shown in Table 13.

Table 13. Remediation Goals for Antimony and Copper in mg/kg

Metal	Remediation Target*	Remediation Goal*
Sb	2.0	4.0
Cu	11.2	80.0

*Targets were demonstration specific objectives, whereas goals were regulatory enforceable performance standards. 0063G_9a

Reviewers who intend to apply this technology set to their requirements need to consider the presence of other metals. Based on the precedent set at TCAAP, where remediation goals were established as part of the cleanup criteria, the potential for having to address such is a possibility. Thus, while maintaining a strong focus on lead, other metals need to be considered. In addition, at another location (Fort Benjamin Harrison) there are three closing ranges being transferred to the state for use as a state park. There are five metals of concern here, and all now leave risk based performance standards that are regulatory enforceable. Copper is a very common bullet jacketing material, and antimony and zinc are occasionally used to harden the lead. The

potential is high for encountering these metals in measurable quantities at small arms ranges. If a range that has hosted the firing of shotguns with pellet shot is being considered for cleanup, the metal arsenic should also be sampled for and analyzed. Published RCRA action level for TCLP (5.0 mg/L) for arsenic could require the soil to be handled as RCRA hazardous waste based on the toxicity characteristic. Moreover, it is also prudent to do a complete RCRA metals sweep, as this technology set will have the potential at least to concentrate some of these other metals slightly.

What follows is a summary of the observations of the fate of copper, antimony, and zinc as they moved through the two different demonstrations evaluated with this technology set. These observations were encouraging for the most part, but do contain a few dichotomies. Table 14 and Figure 40 show total and soluble levels of copper in range soil before and after processing in the soil washing system demonstrated by Vendor 1, in which acetic acid was used as the leaching agent.

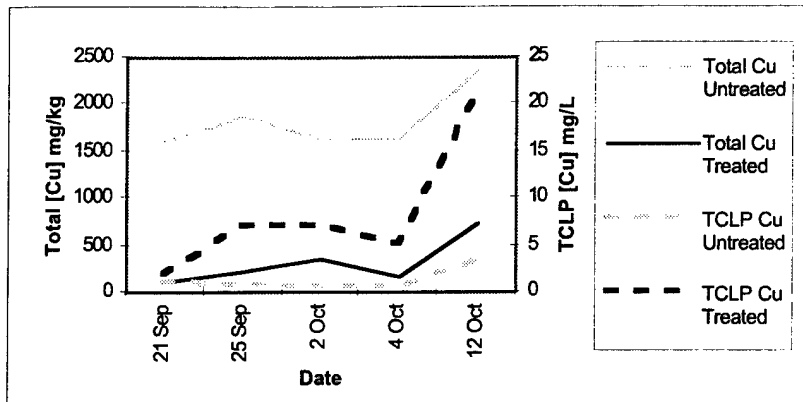

Figure 40. Levels of Copper in Range Soil (Acetic Acid Leaching)

Total average copper removal achieved was 83 percent. However, no removal efficiency of soluble copper was observed. In fact, there was an average sevenfold increase in soluble copper produced during this soil processing.

Total average antimony removal achieved was a limited 21 percent. This was not considered to be very positive. However, an 85 percent removal was noted for soluble antimony. Both raw and processed soil levels influent and effluent numbers were measured at values less than 1 mg/L. Table 15 and Figure 41 show total and soluble levels of antimony in range soil before and after processing in the soil washing system.

Table 14. Total and Soluble Levels of Copper in Range Soil in mg/kg and mg/L respectively (Acetic Acid Leaching)

Date	Total Cu Untreated	Total Cu Treated	TCLP Cu Untreated	TCLP Cu Treated
21 Sep	1608	99	1	1.78
25 Sep	1871	215	0.736	7.01
2 Oct	1621	359	0.562	7.08
4 Oct	1621	165	0.562	5.14
12 Oct	2364	729	3.3	21.3
Average	1817	313	1.232	8.462

0063G_10.AI

Table 15. Total and Soluble Levels of Antimony in Range Soil in mg/kg and mg/L respectively (Acetic Acid Leaching)

Date	Total Sb Untreated	Total Sb Treated	TCLP Sb Untreated	TCLP Sb Treated
21 Sep	83	44	0.132	0.067
25 Sep	155	55	0.233	0.012
2 Oct	115	92	0.67	0.057
4 Oct	115	64	0.67	0.066
12 Oct	189	261	0.671	0.143
Average	131	103	0.475	0.069

0063G_11.AI

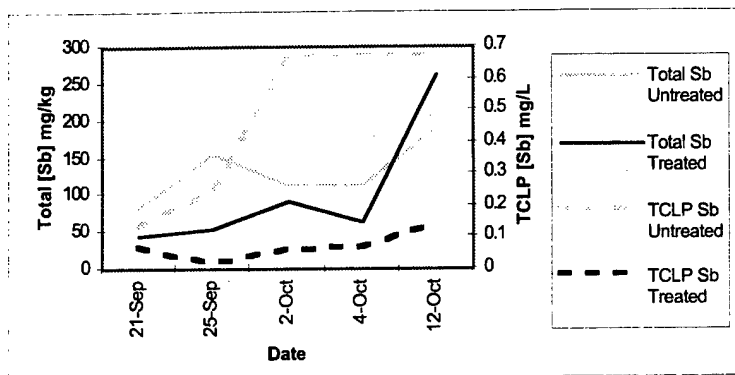

Figure 41. Levels of Antimony in Range Soil (Acetic Acid Leaching)

Total average zinc removal achieved was 52 percent. Again, as with copper, an average fivefold increase in soluble zinc was observed. This also is a concern. Table 16 and Figure 42 show total and soluble levels of zinc in range

Table 16. Total and Soluble Levels of Zinc in Range Soil in mg/kg and mg/L respectively (Acetic Acid Leaching)

Date	Total Zn Untreated	Total Zn Treated	TCLP Zn Untreated	TCLP Zn Treated
21 Sep	153	19	0.442	0.662
25 Sep	73	32	0.448	2.46
2 Oct	55	45	0.293	1.96
4 Oct	55	23	0.293	0.925
12 Oct	92	88	0.572	3.31
Average	86	41	0.410	1.863

0063G_12.AI

soil (in ppm) before and after processing in the soil washing system.

Table 17 and Figure 43 show total and soluble levels of copper in range soil (in ppm) before and after processing in the soil washing system demonstrated by Vendor 2, in which hydrochloric acid was used as the leaching agent. Total average copper removal achieved was 98 per-

cent; an average removal of 89 percent was achieved for soluble copper. This was considered to be encouraging. Increases in soluble copper were not observed with hydrochloric acid leaching as they were with acetic acid leaching.

Total average antimony removal achieved was only 65 percent and the soluble antimony increased through the process system by a factor of approximately 1.5. This is perplexing and is somewhat reversed from that observed with acetic acid leaching. As was the case in the acetic acid demonstration, both raw and processed soil levels were measured at values less than 1 mg/L. Table 18 and Figure 44 show total and soluble levels of antimony in range soil before and after processing in the soil washing system.

Total average zinc removal was 89 percent; an average of 51 percent was achieved for soluble zinc. This was better than observed with the acetic acid leaching system, in that there was no increase in soluble zinc, but instead a moderate reduction. Table 19 and Figure 45 show total and soluble levels of zinc in range soil (in ppm) before and after processing in the soil washing system.

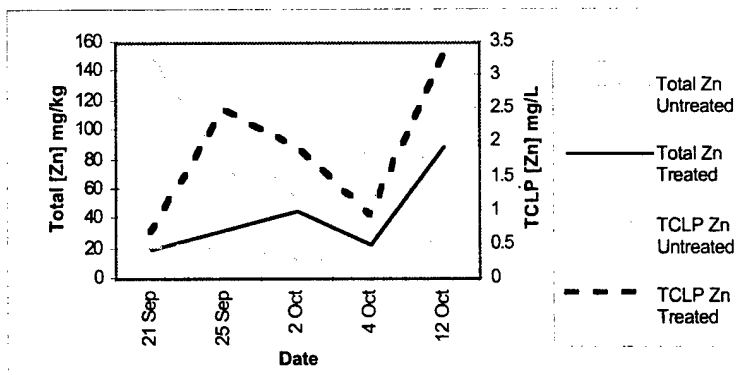

Figure 42. Levels of Zinc in Range Soil (Acetic Acid Leaching)

Table 17. Total and Soluble Levels of Copper in Range Soil in mg/kg and mg/L respectively (Hydrochloric Acid Leaching)

Date	Total Cu Untreated	Total Cu Treated	TCLP Cu Untreated	TCLP Cu Treated
16 Nov	2302	49	1.12	0.164
20 Nov	1958	54	1.1	0.08
21 Nov	1659	60	1.16	0.155
22 Nov	1975	63	0.913	0.022
26 Nov	2461	52	0.854	0
3 Dec	1612	48	0.676	0.095
4 Dec	1329	54	2.02	0.33
Average	1899	54	1.120	0.121

0063G_13.AI

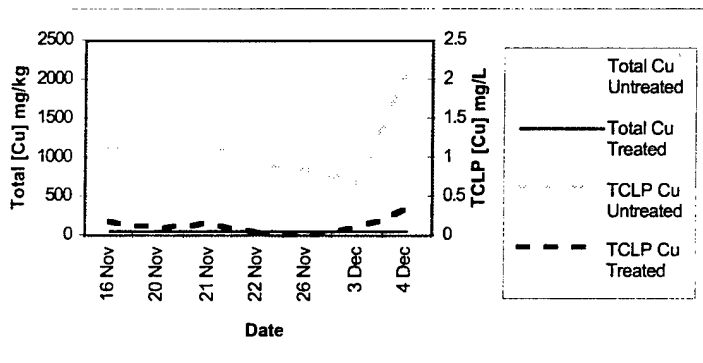

Figure 43. Levels of Copper in Range Soil (Hydrochloric Acid Leaching)

The following listing shows the average concentrations of lead, antimony, zinc, and copper in the untreated range soil during the hydrochloric acid leaching demonstration:

- ◆ Average [Pb] = 3500 mg/kg
- ◆ Average [Sb] = 205 mg/kg
- ◆ Average [Zn] = 152 mg/kg
- ◆ Average [Cu] = 1900 mg/kg

Vendor 2 used a filter press precoated with DE for hydroxide precipitate dewatering after the leaching circuit. The following metal per-

centages were measured in the precipitate filter cake:

- ◆ Pb = 3.9 percent (39,000 ppm)
- ◆ Cu = 0.2 percent (2,000 ppm)
- ◆ Fe = 1.0 percent (10,000 ppm)
- ◆ Sb = 0.2 percent (2,000 ppm)
- ◆ Na = 5.5 percent (55,000 ppm)

Note that the concentration of copper is relatively high in input soil, but relatively low in precipitate filter cake. Conversely, the concentration of antimony is relatively low in input soil, but relatively high in precipitate filter cake. Based on the known solubilities of metal salts as a function of pH, it is possible that copper, after being solubilized by acidic washwater, is not completely precipitated by pH elevation and is leaving the system in retained moisture in the soil and is possibly retained in process waters. Relatively insoluble in water, antimony is more easily precipitated, which accounts for its relatively high percentage in precipitate filter cake. The high percentage of sodium in

Table 18. Total and Soluble Levels of Antimony in Range Soil in mg/kg and mg/L respectively (Hydrochloric Acid Leaching)

Date	Total Sb Untreated	Total Sb Treated	TCLP Sb Untreated	TCLP Sb Treated
16 Nov	255	65	0.154	0.369
20 Nov	216	54	0.098	0.34
21 Nov	190	80	0.188	0.485
22 Nov	206	89	0.179	0.677
26 Nov	248	74	0.405	0.483
3 Dec	172	69	0.906	0.306
4 Dec	149	65	0.157	0.147
Average	205	71	0.298	0.401

0063G_14.AI

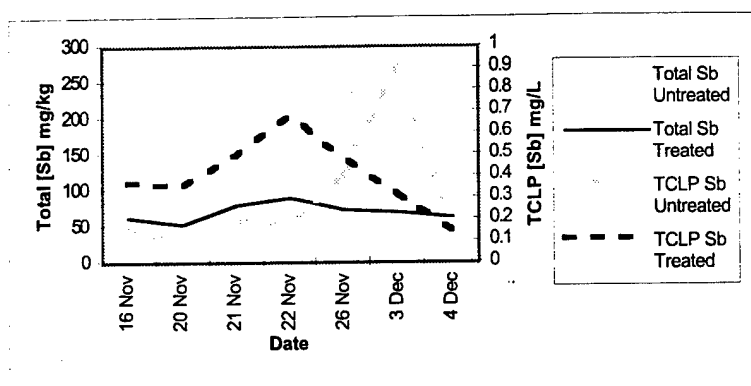

Figure 44. Levels of Antimony in Range Soil (Hydrochloric Acid Leaching)

the precipitate filter cake is due to the fact that NaOH was used as the precipitating base.

Table 19. Total and Soluble Levels of Zinc in Range Soil in mg/kg and mg/L respectively (Hydrochloric Acid Leaching)

Date	Total Zn Untreated	Total Zn Treated	TCLP Zn Untreated	TCLP Zn Treated
16 Nov	182	14	0.348	0.166
20 Nov	158	17	0.33	0.087
21 Nov	136	19	0.389	0.435
22 Nov	157	21	0.367	0.145
26 Nov	190	15	0.379	0.131
3 Dec	127	14	0.359	0.091
4 Dec	111	15	0.275	0.156
Average	152	16	0.350	0.173

0063G_15.AI

The results of the removals noted for the other metals of concern are summarized in Table 20.

In summary, based only on these limited observations from this project, the metals' responses to the two acids used for the leaching were somewhat reversed. With acetic acid leaching, the solubility

of both copper and zinc actually increased. Whereas with hydrochloric acid leaching, the solubility of antimony increased. Reasonably good success was attained during the hydrochloric acid leaching for the removal of copper and zinc, both total and soluble. Total copper removal was fairly good with both acid leaching systems.

These preliminary data indicate that soil washing will remove a portion of other heavy metals besides lead normally encountered on small arms ranges. The specific acid used in the leaching circuit appears to impact the outcome of such effectiveness, however. The solubility product of the various salts these other metals can form, and their solubility product properties within the pH ranges the washwater environment creates, may be a controlling factor. Should a regulatory agency establish cleanup criteria that address other metals besides lead, the choice of the acid to be used in the leaching circuit could be a critical decision. In such situations, reviewers applying this technology set to such new requirements need to pay close attention to the results of their benchscale treatability studies.

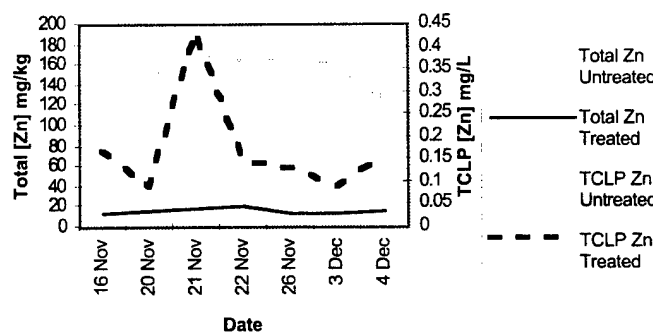

Figure 45. Levels of Zinc in Range Soil (Hydrochloric Acid Leaching)

Table 20. Results of Removal of Other Metals of Concern

METAL	ACETIC ACID LEACHANT (PERCENT REMOVED)	HYDROCHLORIC ACID LEACHANT (PERCENT REMOVED)
Cu (Total)	83	98
Cu (Soluble)	7-Fold Increase	89
Sb (Total)	21	65
Sb (Soluble)	85	1.5-Fold Increase
Zn (Total)	52	89
Zn (Soluble)	5-Fold Increase	51

0063G_16

16.4 SUMMARY

It can be observed from the first demonstration that for lead removal, the remediation concept using acetic acid as the leaching agent has the potential to work in the field with pilot-scale process equipment, but did not consistently satisfy the TCLP goal of the demonstration. The demonstration seemed to work for total lead removal but not quite as well for TLCP lead. The efforts were somewhat inhibited by problems with process equipment reliability and process chemistry control. The final process results are illustrated in Figure 46.

With regard to its effectiveness on other associated metals, limited conclusions can be drawn, but the preliminary data indicated that the acetic acid leaching system had the tendency to significantly increase the solubility of copper and zinc, but it effectively removed soluble antimony. For total metals removal, acetic acid leaching was very effective for copper removal, but of limited effectiveness for antimony and zinc.

The second demonstration, utilizing hydrochloric acid as the leaching agent, clearly showed that this technology train can remove sufficient total lead from con-

taminated soil and satisfy TCLP criteria. The final process results are illustrated in Figure 47.

With regard to its effectiveness on other associated metals, the results were similar to that observed with acetic acid leaching, only reversed somewhat with regard to impact on total and soluble constituents. Soluble antimony increased instead of being removed. All other constituent categories were removed, especially total copper.

In summary, the key to successfully using this technology set in the field is to make it available in a cost-effective manner. Through these vendor demonstrations, sufficient data have been collected to make an initial assessment of its technical effectiveness. Although hydrochloric acid was more effective than acetic acid at lead reduction during this demonstration, acid selection is a site-specific issue, and, in some cases, acetic acid might be a very effective leaching agent. Benchscale treatability studies need to be accomplished to make this determination. Effective removal of other associated metals was observed, but not uni-

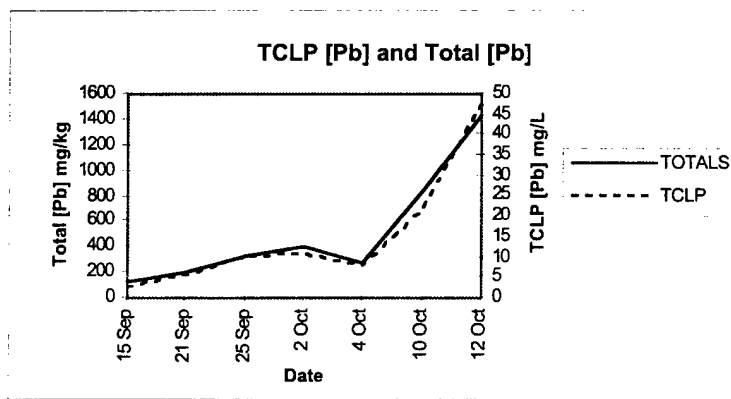

Figure 46. Total Lead and TCLP Lead Treatment Results (Acetic Acid Demonstration)

formly when compared by metal category from one leaching agent to the other. Again, benchscale treatability studies must be carefully

planned and executed to determine the specific cleanup standards being applied to the site.

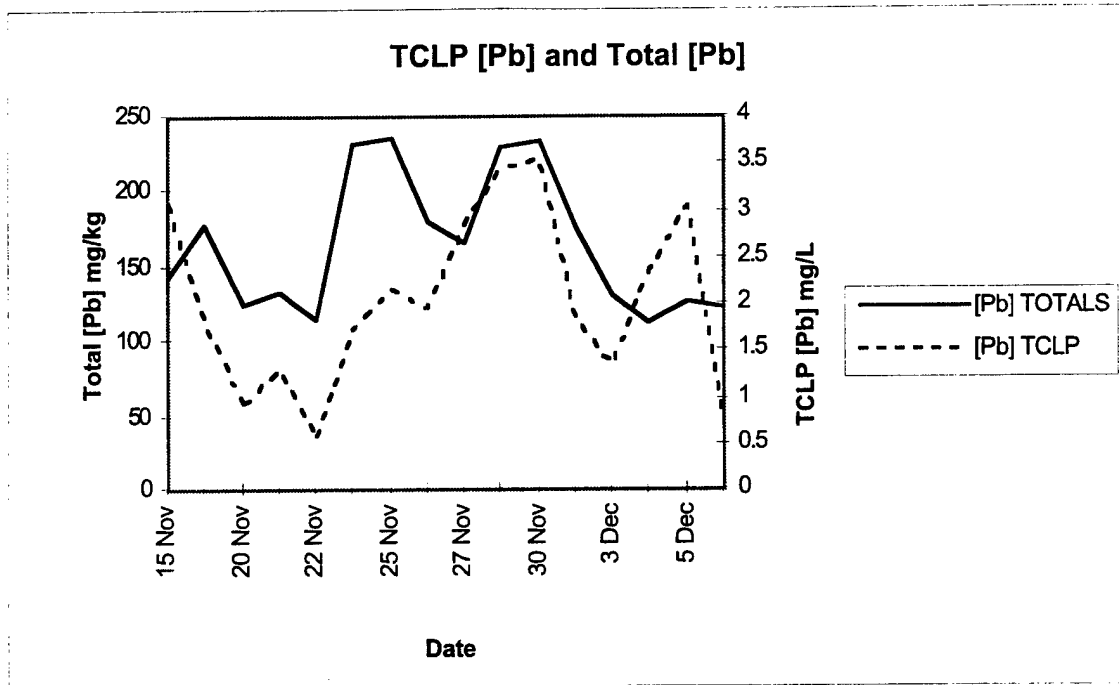

Figure 47. Total Lead and TCLP Lead Treatment Results (Hydrochloric Acid Demonstration)

17.0 DEMOBILIZATION

This section documents the many activities performed to satisfactorily demobilize the operations site at Block 4700, Ft. Polk, Louisiana, and reconstitute Range 5. It was important that these activities be performed to the satisfaction of Ft. Polk Environmental Resources Management Division (ENRMD) and DPW personnel to enable retirement of the site license and its associated liabilities. The intention here is to document those actions that have been accomplished.

The demonstration by Vendor 2 was concluded on December 12, 1996, and cleanup operations began on December 13, 1996. However, demobilization of their equipment started in January after the winter holiday season. Vendor 2 took approximately 1 week to demobilize their equipment and clean up the operations area. BDM maintained on-site administrative support to supervise all demobilization activities.

17.1 HOST EVALUATION OF BLOCK-4700 SITE IMPROVEMENTS AND DISPOSITION

BDM was given direction for demobilization of Block 4700 on February 25, 1997. Ft. Polk officials decided that all improvements to the site would remain, with the exception of the stormwater runoff pond, which was to be removed by BDM. This instruction was provided verbally to BDM's Al Beckett at Ft. Polk on February 25, 1997. This area will now be

used as a new dedicated secure Hazardous Materials (HAZMAT) Management Area for Ft. Polk. Figure 48 shows the edge of the operations pad where the stormwater runoff pond has been removed.



Figure 48. Former Holding Pond Area

17.2 IMPACT OF WEATHER

Inclement weather greatly affected the timetable for demobilization of Block 4700 and the reconstitution of Range 5. Rainy weather began almost immediately following the demonstration by Vendor 2 and continued periodically for approximately 2 months. Although some demobilization activities were able to continue at Block 4700, reconstitution of the berms at Range 5 was delayed due to inaccessibility caused by high soil moisture content.

17.3 RANGE 5 BERM RECONSTITUTION

When inclement weather finally allowed, the berms at Range 5 were reconstituted in the following manner. Processed soil was blended with a mixture of Bermuda, Bahia, and Rye

grass seed, fertilized with 625 pounds of fertilizer, and mulched with 150 bales of hay. The soil was then placed back into the excavation cuts and was graded and compacted to match the existing profiles of the berms. Figure 49 shows Berm 3 regraded at Range 5.

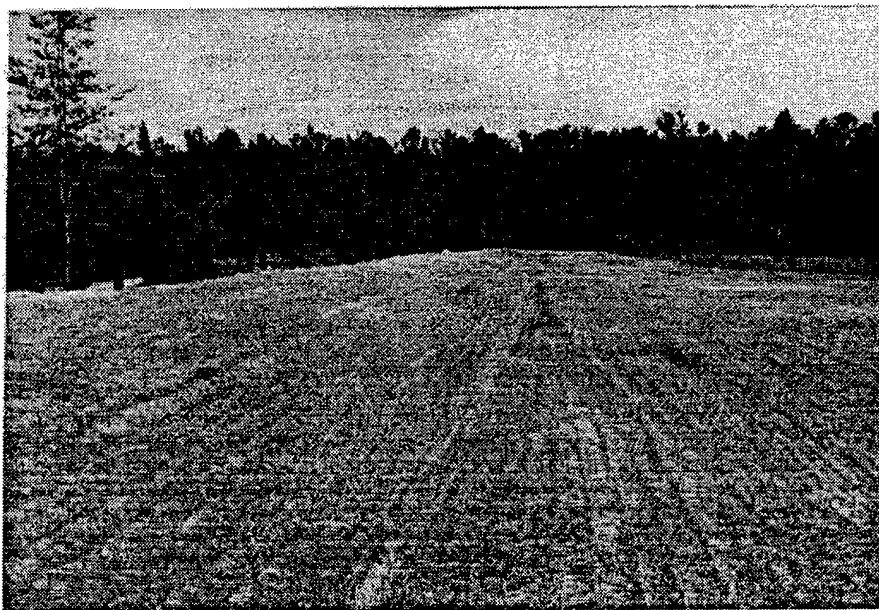

Figure 49. Berm 3 Regraded

Table 21 presents wet sieve analysis performed by Battelle on range soil before and after processing.

Table 21. Soil Wet Sieve Analysis Acetic Acid Demonstration

Sieve #	Unprocessed % Passing	Processed % Passing
+3/8	2.1	0.0
+4	5.3	1.3
-4 to +8	1.1	1.3
-8 to +50	15.2	28.0
-50 to +100	47.2	52.0
-100 to +200	13.5	12.0
-200	15.6	5.4
Totals	100.	100.

0063G_17

As can be seen from the Vendor 1 demonstration data, the soil washing process removed some gravel and fines from the soil. This is important from a material handling and construction standpoint, because the gravel component in a soil is important in its constructability. During the acetic acid leaching demonstration the vendor had some trouble separating gravel from bullet fragments in the mineral jig. During the hydrochloric acid leaching demonstration, the vendor had more success separating gravel from bullet fragments and was able to remix the gravel component with the processed soil.

As stated previously, Figure 25 shows the extraction plan used by BDM during this demonstration. Extraction lanes were approximately 16.5 feet wide by 40 feet long on Berm 3, and 20 feet long on Berm 2. Soil was replaced on the range in the same cuts from which it was extracted. As can be seen in the figure, five cuts on the east side of Berm 3 were filled in with soil that had not been processed but only excavated and placed in the stockpile at Range 5.

17.4 DISPOSAL OF HAZARDOUS WASTE

Approximately 161 tons of soil processed during the acetic acid demonstration remained on-site to be reprocessed during the hydrochloric acid demonstration. However, these plans were cancelled. This material was then classified as a hazardous waste and had to be transported off-site, treated, and disposed of accord-

ingly. Lead is a land-restricted waste with a third third listing. Although 40 CFR 268 does not require a specific treatment before land disposal, it does require a performance-based treatment standard. This performance criterion is a TCLP of less than 5.0 mg/L of lead.

The material was transported and disposed of as hazardous waste by Chemical Waste Management, Inc., Sulphur, Louisiana. Chemical Waste Management transported and disposed of the first load on February 4, 1997. Upon certification that this load was treated to pass the land ban TCLP criteria, Chemical Waste Management proceeded to dispose of the remaining hazardous waste. Chemical Waste Management certified TCLP requirements on February 6 and disposed of all remaining hazardous waste on February 10, 11, 12, and 21, 1997.

17.5 DEMOBILIZATION AND DECONTAMINATION STRATEGY

BDM developed a demobilization and decontamination (D&D) strategy to govern the cleanup and decommissioning of the Block 4700 Operations Site and the reconstitution of Range 5. This strategy included: repair of facilities, swipe sampling of construction materials for detection of lead contamination to classify materials and ensure proper disposal, removal of the stormwater runoff pond, soil sampling, disposition of water and electrical service, cleanup of the operations pad, and ensured security at Block 4700.

17.6 DISPOSITION OF RECLAIMABLE METALS

Two types of reclaimable metals were generated during this demonstration. These included particulate metal (bullets, jackets, and

metal fragments) and metal hydroxide precipitate. Both types were transported under a bill of lading to the Doe Run Smelter Facility in Missouri. Doe Run accepts smelter feed with a wide range of lead concentration; however, they only pay for feed with a lead concentration of at least 70 percent. Doe Run charges a fee to accept any material below this percentage. The particulate metal recycled by Vendor 2 was predominately bullets and bullet fragments but had a lead concentration of approximately 50 percent. The metal hydroxide precipitate filter cake produced during this demonstration had a relatively low percentage lead and a high percentage of DE. This is common when concentrating metals by precipitation and dewatering the precipitate in a DE precoat filter frame press. However, the silicate component in the DE is beneficial in the smelting process and is therefore a viable recyclable material. Metals percentages in the filter cake material were as follows:

- ◆ Pb = 3.9 percent,
- ◆ Cu = 0.2 percent,
- ◆ Fe = 1.0 percent,
- ◆ Sb = 0.2 percent,
- ◆ Na = 5.5 percent.

The percentage of filter cake components were approximately as follows:

◆ Moisture	50 percent	(29,000 lbs)
◆ DE	15 percent	(8,700 lbs)
◆ Flocculant	15 percent	(8,700 lbs)
◆ Metals	10 percent	(5,800 lbs)
◆ Hydroxides	10 percent	(5,800 lbs)
and Salts	100 percent	(58,000 lbs).

Approximately 58,800 lbs of filter cake material and approximately 27,720 lbs of particulate metals were sent to Doe Run. The cost to transport this material was approximately

\$13,000.00, and Doe Run charged \$6,600 to reclaim the material. Therefore, the material was reclaimed at a cost of approximately \$457.00 per ton. Considering that it resulted from the processing of 834 tons of soil, the unit cost per ton of soil processed for reclamation/metals recovery was \$23.50.

Reviewers contemplating application of this technology set need to seek out a licensed reclaimer close to their job site to minimize costs associated with reclaiming these types of materials. Although it is unlikely that lead precipitates could be created of high enough grade to generate revenue, it might be possible to generate revenue through reclaimed particulate metals. For discussion of the DoD Precious Metals Recovery Program, reviewers are referred back to Section 10.0. The metal lead is not included in this program. In addition, reviewers need to understand that reclaimable heavy metals costs, as briefly mentioned here, are commodity costs, and will vary in the marketplace based on demand. If the metals in the soil of a small arms range are principally in ionic salt form, the opportunity for their recycling recovery to generate revenue at a smelter is very limited. However, if such metals are still in their metallic form, and the soil washing unit processes can effectively concentrate such metals through soil mass reduction, the opportunity to generate revenue via secondary smelting is much improved.

17.7 IMPLEMENTATION OF D&D STRATEGY

BDM implemented the D&D Strategy from February 26, 1997 through March 5, 1997. Specific activities performed follow.

Soil Storage Bins. All bin damage was repaired. Tarp covers were secured to the rear

of the bins. The entire bin area was swept clean of loose soil. Subsequently, the bins were pressure-washed twice, and all dislodged soil was removed from both the pad and the curb on the north side of the bins. The following day, the oak planking in the constructed soil storage bins was tested using HybriVet Systems Lead Check instant lead testing swabs. A 30-second swipe can evaluate lead contamination on many surfaces, including metal, paint, wood, and soil. Six lead checks were performed on the planking. Four of these tests indicated no lead, while two tests showed red coloring on the tip of the swabs, indicating some potential lead contamination. It is doubtful that any lead in these 2 inch by 12 inch oak planks penetrated much below the surface because they were procured directly from the sawmill and were still curing (off-gassing chemically treated wood preservatives) when used to construct the bins.

Storm Water Runoff Pond. On March 5, 1997 the 30-mil high-density polyethylene membrane used to line the stormwater runoff pond was tested using HybriVet Systems Lead Check instant lead testing swabs. Twelve tests were performed on the membrane. None revealed pink or bright red coloring, indicating no lead contamination. Several of the tests were performed on membrane areas containing residual soil, which indicated no lead contamination. The membrane was then removed and deposited with accumulated trash for normal solid waste disposal.

Water Supply. The supply line to the administrative trailer was capped and pressure-tested, and the accessed hydrant was closed. The hydrant wrench was left with the pump for future use. The system was not drained,

since the danger for freeze-up has passed for this season, another contractor will probably utilize the site in the near future, and it is impossible to completely drain the system without damaging the PVC piping installed. The insulating box around the pump remained, as did the tarp cover that protects it somewhat from rain damage.

Electrical Service. The fusible links for the 480V/3-Phase/300A supply were disconnected by Ft. Polk DPW at both the pole and the substation. The 3-phase meter was removed by LP&L. The entry panel was also switched off.

All 120V/single phase/200A underground wiring and conduit servicing the administrative trailers and shelter at the west end of the operations site was removed, and the circuit breakers were unseated. The branch line serving the BDM administrative trailer was disconnected, the circuit breaker was unseated, and the conduit and three-wire conductors were left in place for future use (the load end was capped to minimize leakage of rainwater into the conduit). The main breaker and branch breaker for the pump and security lighting remain active.

Concrete Barriers. The six concrete barriers surrounding the asphalt pad extension were left in place. They were pressure-washed to remove soil particles. The five portable concrete barriers were stored adjacent to the north fenceline.

Asphalt Pad. The asphalt pad was swept clear. Also, during demobilization, the pad received approximately 14 inches of rain. All refuse within the fenceline was policed, put into a roll-on trash container, and removed for disposal.

Security. Both the front and rear gates were padlocked, as well as the electrical transformer cage. Keys will be turned over to Ft. Polk DPW when the property is transferred.

17.8 ACCOUNTABILITY AND FINAL DISPOSITION OF GFE

All government furnished equipment (GFE) was reported to the contracting officer and was disposed of in accordance with Federal Acquisition Regulation (FAR) requirements. All transferred GFE was transferred to LB&M Associates, Inc., for use on other DoD projects. Table 22 lists all GFE.

Table 22. GFE List

Part #	Item Description	Q	Cond. Code	Unit Price	Ext Price	Deposition*
22229	Box Tool, Heavy Duty 16"	1	A	\$8.63	\$8.63	T
20273	Hammer, Ball Pin 10oz	1	A	\$19.44	\$19.44	T
21691	Pilers, Tongue/Groove 12"	1	A	\$14.83	\$14.83	T
2227	Screwdriver, Std, Handyman 8"	1	A	\$3.95	\$3.95	T
24373	Wrench Adj. 12"	1	A	\$6.96	\$6.96	T
23749	Screwdriver, Stanley 3/16 x 6"	1	A	\$1.96	\$1.96	T
24360	Wrench, Adj. 8"	1	A	\$3.96	\$3.96	T
23754	Screwdriver, Phil #2 1/4 x 4"	1	A	\$1.98	\$1.98	T
23743	Screwdriver, Stanley 1/4 x 4"	1	A	\$1.96	\$1.96	T
23753	Screwdriver, Phil #1 3/16 x 3"	1	A	\$1.69	\$1.69	T
26037	Pliers, Long Nose, Enco 6-1/2	1	A	\$3.96	\$3.96	T
2082	Chisel, Cold 5/8"	1	A	\$4.96	\$4.96	R
11124	Scraper, Wall, Flexible 3"	1	A	\$4.99	\$4.99	R
	Valve, Butterfly	1	A	\$1,080.00	\$1,080.00	T
	Pump, 10HP, #3P654	1	A	\$2,195.00	\$2,195.00	T
	Pump, 1/2HP, SW	1	A	\$189.00	\$189.00	R
	Bladder Tank	1	A	\$125.00	\$125.00	R
	Tank Storage, 1100 gallon	1	A	\$1,195.00	\$1,195.00	R
	Hose, 20ft, Suction	1	A	\$95.00	\$95.00	T
	Hose 50ft, Discharge	1	A	\$75.00	\$75.00	T
	Hose Intel 4" x 10"	1	A	\$125.00	\$125.00	T
	Hose, Discharge 4" x 100'	1	A	\$230.00	\$230.00	T
B-SMB-4H	Extinguisher, Fire 51lbs	2	A	\$32.35	\$64.70	T
B-H2025	Kit, First aid, 25 Person	1	A	\$36.00	\$36.00	R
B-E01011	Eye Wash, Emergency	1	A	\$290.00	\$290.00	T
C-463942	Hat, Hard	6	A	\$5.75	\$34.50	T
	Hat, Hard	3	A	\$9.25	\$27.75	T
A-MSH	Airhorn, Safety	2	A	\$37.50	\$75.00	T

0063G_27

- *T = Transferred to LB&M Associates
- R = Retained at Fort Polk
- A = Condition Code "A", i.e., fully serviceable and reusable

Table 22. GFE List (Concluded)

Part #	Item Description	Q	Cond. Code	Unit Price	Ext Price	Disposition*
1710	Answering Machine, Digital	1	A	\$49.96	\$49.96	T
	Ramps, Loading	1	A	\$129.00	\$129.00	T
E237-10	Radio, Deluxe, Weather WX-70	1	A	\$34.95	\$34.95	T
	Printer, Laser Deskjet, Clr 680C	1	A	\$329.00	\$329.00	T
	SN# HP-DJ680C-01		A			
	Poly Tarp 16 x 20	2	A	\$23.72	\$47.44	R
	Tarps, Blue Poly 5 x 7	2	A	\$2.49	\$4.98	R
	Tarps, Blue Poly 12 x 16	2	A	\$11.37	\$22.74	R
	Tarps, Blue Poly 15 x 30	2	A	\$22.50	\$45.00	R
	Tarps, Blue Poly 25 x 40	8	A	\$49.95	\$399.60	T
	Tarps, Blue Poly 40 x 50	4	A	\$99.95	\$399.80	R
	Tarps, Blue Poly 40 x 60	7	A	\$118.95	\$832.65	T
	Tarp, Poly 9 x 12	1	A	\$7.88	\$7.88	R
	Hose, Vinyl 5/8 x 60	2	A	\$15.87	\$31.74	T
	Watermeter	1	A	\$289.78	\$289.78	R
	Barriers, Concrete	11	A	\$352.50	\$3,877.50	R
	Cylinder, Oxygen, Prtble	1	A	\$220.55	\$220.55	T
	Ratchet, 3/8"	1	A	\$9.23	\$9.23	T
	Wrench, Bx Ratching 3/8 x 7/16	1	A	\$3.27	\$3.27	T
	Ladder, Aluminum	2	A	\$37.88	\$75.78	T
	Hammer, Graphite	1	A	\$26.76	\$26.76	T
	Hose, Reinforced Cord 5/8 x 50'	2	A	\$7.89	\$15.78	T
	Hose, 4" x 3'	1	A	\$64.95	\$64.95	T
	Flange	2	A	\$115.00	\$230.00	T
	Cord, Extension 50'	1	A	\$32.95	\$32.95	T
	Electric Meter W/Base	1	A	\$125.00	\$125.00	R
	Electric Switch Box 250 amp	1	A	\$1,833.00	\$1,833.00	R
	Electric Switch Box 400 amp	1	A	\$3,840.00	\$3,840.00	R
	SN# 0531969956					
8214614	Camera, Canon 35MM Sure Shot	1	A	\$149.87	\$149.87	R
Total					\$19,174.38	

0063G_28

- *T = Transferred to LB&M Associates
- R = Retained at Fort Polk
- A = Condition Code "A", i.e., fully serviceable and reusable

18.0 PUBLIC ACCEPTANCE

It is critical that innovative technologies be understood and accepted by both the regulatory community and the general public. For DoD remediation efforts where this technology set would be applied, each installation should have an RAB where such issues are scrutinized. Based on the limited exposure the technology set has had to date, it is anticipated that it should be well received by the public and the regulatory community. The ITRC is currently supporting this technology set, and no major obstacles have been identified to date. For our demonstration activities at Ft. Polk, a Visitor's Day was held on December 12, 1996. It was considered fairly successful and attended by approximately 45 well informed and interested personnel. For another data point, one of the authors of this technical report attended an RAB at another Army installation in February 1997, and soil washing was discussed as a possible technical tool to apply for the remediation of three small arms ranges. During this meeting, it was apparent that the technology set was not well understood, not only with regard to relative unit costs, but how it actually worked. A continued effort at technology transfer and informing the public in terms that are easily understood will be required for some time to successfully move this technology set to a mature and fully developed state. In November 1996, the EPA released a pamphlet titled "The Model Plan for Public Participation" (EPA 300-K-96-003). What follows in this section is information intended to assist reviewers in implementing the suggestions in this pamphlet.

18.1 WHY THIS IS IMPORTANT

From the very beginning, when the project is scoped and NEPA considerations are addressed, the problem and the proposed technical solution fall under scrutiny. In Appendix A, a first attempt has been made to provide generic Environmental Assessment (EA) elements that can assist in the preparation of such documentation. If an EA is required, it will be posted in local clearinghouses for the general public to review and comment upon. Reviewers and future technology set users need to communicate with the general public effectively on this matter and involve them in the decision making process as early as possible. Moreover, during the RAB meetings, the technology set needs to be fully understood by the regulatory community and the general public. There is ample material provided in this technical report to allow a presenter to fully explain this technology set.

18.2 GERMANE OBSERVATIONS MADE IN THE FIELD

This technology set actually removes the contaminants from the soil media, rather than masking them with a polymer or stabilizing agent so they won't exhibit a hazardous waste characteristic. Thus, if there is a land use change in the future, there will be no need to worry about long term liabilities, or executing another remediation project some time in the future if this technology set is applied, because the contaminant will have been physically removed. Moreover, the problem has not been simply taken from the installation to a landfill where years from now it may have to be revisited. This technology set helps solve a real problem

today permanently and satisfies current EPA guidance associated with Superfund cleanup criteria and public acceptance. If this technology set is not used to totally solve the problem, at a minimum it significantly reduces the volume of soil that needs another approach applied to it. A final note worth presenting is that this technology set is a recycling activity that allows metal resources to be put back to beneficial use and reduces the relentless attack on the environment by continued mining of the Earth's natural resources. In this regard, it should assist installations to obtain credit for various hazardous waste generation reduction programs as well as pollution prevention goals.

18.3 POTENTIAL IMPACTS

We need to also realize that there are potential impacts that could alert the general public to express some concerns. Here are a few points that bear consideration, and the application of sound engineering controls to address these are offered:

- ◆ *The site can look like a muddy mess.* Proper hydraulic discipline in the operations area must be maintained along with proper moisture content in the final processed soil so the soil can be effectively handled to avoid a risk and avoid casual negative impressions that could taint the effort. Casual public first perceptions can have a long lasting impact on the acceptability of a remedy. Site disciplined preventive maintenance is a worthy investment.
- ◆ *Thousands of gallons of acid are stored on-site.* These acids may or may not be extremely hazardous materials, but they warrant safe handling, secondary containment, proper storage and transfer, and reporting to emer-

gency response officials as required under EPCRA.

- ◆ *Some RCRA hazardous waste can be generated with this technology set.* Such generation of waste must be minimized, properly stored, and disposed of by licensed Treatment, Storage, and Disposal (TSD) contractors as quickly as possible.
- ◆ *There can be between 20,000 and 30,000 gallons of process wastewater in the system that is highly contaminated with metals, acids, bases, salts, polymers, and such.* If sound process chemistry control is not maintained, there can be serious problems. Effective control needs to be maintained over process chemistry at all times, and a sound SPCC plan must be in effect. A secondary benefit of the stormwater holding pond provided at this job site was the redundant spill control it provided. Certainly, its principal purpose was to support the Stormwater Pollution Prevention Plan, but it also provided tertiary containment capability had a spill and unit process reservoir failed.
- ◆ *If we allow fugitive lead-borne dust or other air emissions, such as VOCs from the organic acid leaching agents, to be generated at the site, we run the potential risk of exposing our workforce, as well as our neighbors, to health risks.* However, air monitoring efforts accomplished at this site did not produce any results that were above the PEL for lead. Proper engineering controls and good site housekeeping are critical.
- ◆ *If certain acids with high vapor pressures are used, especially during periods of high temperature and humidity, we run the risk of complaints of odor excursion.* This occurred once during the first demonstration when acetic acid

was used as the leaching agent. The workforce can wear respiratory protection to abate this, but then the casual passerby will observe such and possibly become more concerned by the heightened level of PPE being employed. Careful downwind siting of the operations area away from population centers may be prudent.

- ◆ *What if unexploded ordnance is uncovered during soil washing?* Prior to mobilizing to a range site, Explosive Ordnance Disposal (EOD) specialists carefully clear the range of any such dangers and make every effort to lower such risk to zero. Additionally, a site-specific HASP is prepared, alerting the workforce to this important subject, and stop-work instructions are specified should a suspect item be disconnected.

18.4 SUMMARY

The general public should readily accept the application of this technology set as an improvement over the previous alternatives, as it has much to offer. However, it should not be taken for granted. There are some potential problem areas, and these were candidly described in Subsection 18.3. However, sound engineering controls can readily counter them. Efforts have been made to provide sufficient tools in this technical report to allow a proactive program to be made in the development of EAs and before RABs to effectively communicate the facts about this technology set to the public.

19.0 COSTS

Here we have a new technology set that works at the pilot plant scale, a scale that is physically very close to a prototype profile. The remaining question is, What it will cost to clean up a complete range under realistic field conditions and against actual regulatory cleanup standards? What follows is a first effort at scaling up the costs from this demonstration series to a full-scale prototype. This is based on a mass of 15,000 tons of soil being processed.

This report contains the costs incurred for the entire project (including the two vendor demonstrations) and then focuses on costs incurred on the Block-4700 demonstration, starting with the site preparation costs. We then attempt to scale these costs up and predict what a full scale field application would cost. We will use the data from Vendor 2, because so much more data was obtained.

When reviewing cost data for a new application, reviewers need to be especially sensitive about ensuring that they compare the same cost element of the baseline project to their new requirement.

There are a number of critical phases in executing a remediation project, and each phase has a cost burden associated with it. Seldom are these projects executed via turnkey protocol. Thus, these costs burden a variety of stakeholders. Without trying to get bogged down in the specifics of compliance under either RCRA or CERCLA, the generic phases that must be included are shown in Table 23.

We will refer back to these phases when we address the matter of scaling these demon-

Table 23. Generic Remediation Phases

PHASE	ACTION
1*	Site Assessment and Characterization
2*	Feasibility Study
3*	Environmental Planning (NEPA and Compliance to include Regulatory Negotiations and Permitting)
4*	Site Planning
5*	Project Planning, SOW Preparation and Contracting
6	Benchscale Treatability Study
7	Systems Design (Unit Processes Planning and Preparation)
8	Site-Specific HASP Preparation
9	Site Mobilization
10	Site Preparation
11	Soil Excavation, Movement, and Staging
12	Site Recycling System Operations
13*	Analytical Laboratory Support
14	Range Reconstitution Back to Beneficial Use
15	Site Demobilization and Cleanup
16*	Final Report to Document Clean Site Conditions

*Owner/Consultant Executed

0063G_19

stration costs up to a full scale prototype application. Certainly there is room to present different versions of who does which phase during the execution of a remediation project. For the sake of discussion in this report, we are assuming that the owner and his or her consultants will do Phases 1, 2, 3, 4, 5, 13, and 16, and the remediation contractor will do the balance. This baseline will become more important later in this section. Table 24 presents the overall costs incurred in the execution of this project broken down by subtask as the draft technical report was written, but before the project was completed.

19.1 ENVIRONMENTAL PLANNING COSTS

This initial work element involved preparing the NEPA documentation and a number of trips to Ft. Polk to work with numerous officials. The costs incurred for these work elements were \$73,198.66. The costs incurred here

Table 24. Overall Costs by Subtask

SUBTASK	SUBTASK COST
Management	\$183,212.71
Vendor Selection	
World Wide Search	\$35,685.50
Source Selection	155,089.22
Peer Group Selection/Review	61,457.24
Task Integration	23,177.05
Demonstration Planning	
Site Characterization	100,584.96
Site Planning	52,534.77
HASP Development	12,634.12
NEPA	73,198.66
Site Preparation	208,219.35
Bench Scale Tests Review	18,230.85
Task Integration	119,724.10
Demonstration Execution	
Acetic Acid Demo	453,543.00
Hydrochloric Acid Demo	618,345.43
Demobilization	45,088.88
Task integration	352,199.58
TOTAL	\$2,512,925.42

0063G_31

stration RFP (March 1996 - 00653-96) in Appendix A/Enclosure 3. The soil was reported as being slightly acidic and oxidizing. The costs associated with this element were approximately \$100,584.96.

19.3 SITE PLANNING COSTS

With the realization that we would be operating under a split-site configuration, we had much work to do in preparing site Block-4700 to host the recycling operations area, beginning with surveying the area in order to quantitatively understand what our physical resources and constraints were. In carrying out the planning effort, our highest priority was designing a layout that would protect the local population and ambient environment, including the local ecosystems. During this phase, we also prepared the baseline project Consolidated Health and Safety Plan. This plan included our SPCC Plan and SWPPP. After considerable effort, the Ft. Polk host officials granted us a tenant license, authorizing us to mobilize and commission our operations site at Block-4700. The costs associated with these work elements were \$65,168.89.

19.4 SITE PREPARATION COSTS

With NEPA compliance, site planning, and licensing complete, we mobilized and established our presence at site Block-4700. It took approximately 16 weeks to complete site preparation. The costs shown in Table 25 were incurred in completing site preparation. After the site preparation work and vendor equipment mobilization, they inspected the site again and then authorized us and to carry on with our demonstrations.

were high, because the initial planning was done on Range 26 and had to be repeated for Range 5.

19.2 SITE CHARACTERIZATION

This work element involved soil characterization studies to include sample collection, shipping, and analytical laboratory work. In addition, exploratory bench scale treatability work with physical separation and acid leaching was accomplished to confirm the potential of this approach. Detailed composite samples as well as grab samples were collected. In addition to the acid leaching work being accomplished, x-ray diffraction work to understand the metals distribution in the soil, to include the fines (to include photomicrographs) were also accomplished. Detailed site characterization data was included in the vendor demon-

Table 25. Costs Incurred During Site Preparation

Element	Cost	Remarks
• Site Administration Trailer	\$1614.00	rented for 5 months
• Phone Service	\$900.00	service for 5 months
• Dumpster	\$145.00	service for 5 months
• Wind Sock	\$169.95	
• Sanitary Service	\$225.00	service for 5 months
• Security Fencing	\$3165.50	6 feet high chain link
• Concrete Barricades	\$3877.50	11 @ \$352.50
• Asphalt Pad	\$18,574.00	90 feet x 130 feet, two 2-1/2 inch lifts
• Storm Water Holding Pond	\$10,769.95	
- Earthwork & Labor	(\$4935.00)	
- 30 mil liner	(\$1740.00)	
- Pump	(\$2195.00)	
- Gate Valve	(\$1080.00)	
- Pipe	(\$1000.00)est	
- Hoses & Flange	(\$ 819.95)	
• Water Supply Tank with Backflow Prevention	\$3368.09	
• Electric Service with Substation	\$31,372.81	
• Concrete Pad for Soil Drying Ovens	\$1569.31	
• Tarps	\$1835.49	11 @ various sizes
• Rain Gauge	\$13.95	
• Project Signs	\$1522.00	two wood signs
• Soil Storage Bins	\$20,038.00	
• Sample Preparation Shelter	\$1500.00	rented for 4 months
• Decontamination Area and Safety Equipment	\$3614.93	
Grand Total	\$104,274.99	

0063G_21

These figures are fairly representative of what it might cost to mobilize a site to carry out a remediation assignment with this technology set. If a split site could be avoided and the recycling operation carried out at or in a contiguous location to the active range being maintained, perhaps the security fencing cost could be avoided. Some other fixed costs could also possibly be reduced dependent on the job site. Some examples would be the need for an administration trailer, phone service, dumpster service, sanitary service, project signage, and the size and capacity of the soil storage bins.

An impervious pad will be required to support the unit process train, as well as the SWPPP and SPCC Plans. These are critically important, but are site-specific and are also dependent on historic weather patterns. Rain-fall history (amount, duration, and intensity) must be studied. The size of the impervious pad is also site-specific and needs to be sized to meet the needs of the operation. It does not need to be made of asphalt. We considered other expeditious material, including heavy mil HDPE or PVC sandwiches with uniformly graded sand. If there is a parking lot immediately adjacent to the range being maintained, then that might be suitable. Any improvements made to such a parking lot in support of the range maintenance/remediation activity could then be an added benefit to the installation population after the project is complete. Storm water management will be necessary. A cover over the unit processes is probably the best approach if one can be obtained cost effectively. In all probability, a holding pond will be necessary as well. The size will be dependent on the surface area of the impervious pad and the rainfall history at the site. Soil storage bins may not necessarily be required, but a method to keep processed soil dry is necessary until the material can be analytically cleared against whatever regulatory cleanup standard is being imposed.

We felt that the electrical support costs were relatively high. This was especially the case when we borrowed the transformers from Ft. Polk and the electric meter from the local public utility company. However, this technology set is very dependent on electric service, and this will have to be evaluated for each job site. We provided 3-phase, 480 volt service. The

other utility of concern was water. Independent of the need to have a water source for health and safety matters, this technology set requires make up water daily. We were able to provide much of this from the collected rain water in the storm water holding pond. However, this cannot be fully depended upon. A stable source from the local utility system with the proper backflow prevention systems required by local utility authorities will be required.

In summary, site preparation costs of approximately \$100,000 are programmatically what will probably be incurred in support of a similar project. This is very site-specific and can probably be reduced with very careful site planning. Avoiding a split-site operation will also probably offer additional site preparation cost savings. The greater the amount of soil processed at such a recycling site, the lower the unit cost of site preparation. An on-site, contiguous operation serving multiple active ranges would offer excellent economy of scale.

We encountered two additional costs somewhat associated with site preparation, inasmuch as they were initiated with site mobilization, but really need to be accounted for as part of the operations and maintenance activities. These cost elements were:

- ◆ Air Monitoring: \$3445 (\$3020 labor and equipment, plus \$425 lab analysis)
- ◆ Soil Excavation and Hauling: \$24,838.

On a unit cost basis, using a total mass of approximately 1100 tons of soil processed, air monitoring cost \$3.13 per ton, and soil excavation and hauling cost \$22.50 per ton. We believe that economy of scale would reduce air monitoring by an order of magnitude in an actual remediation. With regard to the latter,

because we operated a split site on the installation, the costs could be reduced about 25 percent if an on-site operation could be pursued.

Costs to reestablish the berms to include reseeding were \$4,528.72, \$4.12 per ton, or \$2,500 per acre.

19.5 UTILITY CONSUMPTION COSTS

During this demonstration, power was provided free of charge to the vendors by Ft. Polk. However, there is a real cost associated with power consumption that is important to consider. Vendor 1 used 6200 kWh of power during their demonstration, while Vendor 2 used 9800 kWh of power. Electrical power costs are geographically variable; however, a unit cost for this area is \$0.065/kWh. Therefore, Vendor 1 and Vendor 2 electrical power costs would be \$403.00 and \$637.00 respectively, for a total cost of \$1040.00. On a unit cost per ton basis, Vendor 1 processed 269 tons of soil, for a unit cost of \$1.50 per ton of soil processed (23 kWh/ton), and Vendor 2 processed 834 tons of soil for a unit cost of \$0.76 per ton of soil processed (11.7 kWh/ton).

Both vendors required make up water during the demonstrations, as system water was lost due to evaporation and as retained moisture in output processed soil left the system. A water meter was used to log water usage during the second vendor demonstration. Vendor 2 used both supplied water and storm water runoff pond water as make up water during their demonstration. Vendor 2 used 49,300 gallons of supplied water and approximately 16,000 gallons of pond water to process 834 tons of soil. Therefore, Vendor 2 required approximately 80 gallons per ton of processed soil as make up water. Water costs are also

geographically variable, and it is important to note that maximizing the use of storm water runoff as process make up water will minimize utility costs associated with water use.

19.6 CHEMICAL CONSUMPTION COSTS

Vendor 1 used industrial grade acetic acid (84 percent) and hydrated lime (calcium hydroxide) as well as a precipitating agent (Thio Red®) and a flocculating agent (Pol E Z 652®). Another option would have been to use glacial acetic acid (99 percent). This was not used because of its low flashpoint. It also has a high freezing point that could limit its use in colder climates. When this acid is diluted slightly with water, this property is normalized. The individual quantities of reagents used by Vendor 1 were listed in Section 15.4. Total chemical costs for Vendor 1 were reported as \$63,000.00. The approximate cost breakdown for individual reagents used is shown in Table 26.

A unit chemical consumption cost is difficult to calculate for Vendor 1, as the vendor processed 269 tons of soil, 58 of which were reprocessed, and only 10 of which were returned to Range 5. An approximate mass balance of Vendor 1 processed soil was shown in Table 11 in Section 16.1.

The cost of acetic acid during this demonstration was quite high (approximately \$5.17 per gallon). Industry reported costs for bulk shipments of acetic acid are approximately \$0.40 per pound or \$3.50 per gallon. The fact that this demonstration required smaller shipments of

Table 26. Approximate Cost for Individual Reagents (Acetic Acid Leaching)

Chemical	Quantity	Total Cost
Acetic Acid	9,415 gallons	\$48,635.00
Hydrated Lime	2,000 lbs	\$800.00
Thio Red	1,210 gallons	\$13,201.00
Flocculant	110 gallons	\$364.00
TOTAL		\$63,000.00

0063G_29

acetic acid accounts for the higher cost of the acid. Thio Red® was also a very expensive reagent at a cost of \$600.00 per 55-gallon drum or \$10.91 per gallon.

Vendor 2 used hydrochloric acid (33 percent); sodium hydroxide (25 percent); and DE, hydrated lime, and a flocculent. The individual quantities of reagents used by Vendor 2 were listed in Section 15.4. Total chemical costs (excluding hydrated lime) for Vendor 2 were reported as \$16,523.00. The approximate cost breakdown for individual reagents used to process 834 tons of soil is shown in Table 27.

An interesting lesson learned during this demonstration was the difference in cost for bulk chemical shipments versus the cost of smaller quantity shipments required by these demonstrations. Industry reported unit costs

Table 27. Approximate Cost for Individual Reagents (Hydrochloric Acid Leaching)

Chemical	Quantity	Total Cost	Unit Cost (per ton of soil processed)
Hydrochloric Acid	5,600 gallons	\$3,140.00	\$3.77
Sodium Hydroxide	5,800 gallons	\$3,517.00	\$4.22
Diatomaceous Earth	8,700 lbs	\$6,044.00	\$7.24
Flocculant	1,000 gallons	\$3,311.00	\$3.97
Hydrated Lime	1,275 lbs	\$510.00	\$0.61
TOTALS		\$16,523.00	\$19.91

0063G_30

for 70 percent hydrochloric acid are approximately \$0.35 per gallon. The first shipment received by Vendor 2 was a complete bulk shipment of 4,800 gallons, at a unit cost of \$0.45 per gallon. Later, more acid was needed, but not enough to warrant a complete bulk shipment. The order was for only 800 gallons, and the unit cost for this partial shipment was \$1.30 per gallon. Therefore, the average unit cost to Vendor 2 for hydrochloric acid was \$0.56 per gallon. In a full scale operation, economy of scale for chemicals would prevail, and full bulk shipments would be utilized at considerable savings. It should also be noted that the price of sodium hydroxide is very volatile. This price volatility is due to the fact that sodium hydroxide is a byproduct of chlorine production. As the demand for chlorine in products such as polyvinyl chloride (PVC) fluctuates, so does the price of sodium hydroxide. Current industry pricing for 50 percent sodium hydroxide is approximately \$150.00 per ton.

19.7 DISPOSAL OF HAZARDOUS WASTES COSTS

BDM incurred costs from the disposal of two waste streams; rain runoff contaminated with lead, and range soil processed by acetic acid leaching that failed the TCLP criterion of 5.0 ppm lead. Chemical Waste Management disposed of approximately 19,000 gallons of rain water at a cost of \$23,633.60 (\$1.25 per gallon), and 161 tons of soil at a cost of \$43,496.30 (\$270.16 per ton), for a total cost of \$67,129.90. BDM also leased a storage tank from Baker Tanks at a cost of \$1,225.19. The water that accumulated in the holding pond in October was pumped from the pond into this tank, and temporarily stored for a week, until

the hazardous waste disposal contractor could arrive on-site and properly dispose of it. Therefore, the total cost associated with hazardous waste disposal during this demonstration was \$68,355.09. Vendor 1 incurred an additional \$60,000 cost for disposal of hazardous waste.

19.8 ANALYTICAL LABORATORY SERVICES COSTS

The independent evaluator did the majority of the analytical work to monitor the effectiveness of the two demonstrations, including the required sampling and sample preparation. The independent evaluator also had an X-RF device on-site that was used for rapid screening of samples. Both vendors also had some analytical capability for use in process control. On occasion, there was the need for rapid analytical turnaround, and in these situations, a local laboratory (Sherry Labs, Baton Rouge) was used. A total of \$3,190 was spent using their services (\$1,385 for water, \$425 for air, and, \$1,380 for soil).

19.9 RECLAMATION OF METALS COSTS

As stated previously, all recovered particulate metals and metal hydroxide filter cake sludge was shipped to the Doe Run Smelter Facility. The acetic acid leaching demonstration generated nine drums of gravel and recovered particulate metals. The hydrochloric acid leaching demonstration generated 15 drums (7.5 tons) of recovered particulate metals and two roll-off bins of lead hydroxide filter cake. Approximately 58,800 pounds of filter cake material were sent to Doe Run at a cost of \$4,850. Approximately 27,720 pounds of particulate metals were sent Doe Run. In the future, we would not recommend the use

of DE because of its cost as a chemical and also because of the mass of filter cake produced. Efforts must be put forth to reduce the volume of reclaimable materials and further increase the reclaimable metals concentration. As reported in Section 17.6, with the DE and moisture content of 50 percent in the filter cake, we incurred a unit metals reclamation cost of \$23.50 per ton of soil processed. Without DE, and with a drier sludge cake and more reasonable transportation, we feel this cost can be reduced to about \$12 per ton of new soil processed. If the lead could be concentrated even more, the material could be a revenue generator.

19.10 SITE DEMOBILIZATION COSTS

The costs associated with the demobilization of the operations site at Block 4700 and the reconstruction of the disturbed berms at Range 5 are reported here. The activities involved were discussed in detail in Section 17.0, Demobilization. The line item costs listed in Table 28 were incurred.

19.11 VENDOR COSTS REPORTED

The following costs were collected from the hydrochloric acid leaching demonstration. As reviewers study these costs, keep in mind that this was only a demonstration in which a limited mass of soil was processed (specifically 834 tons). Moreover, it was done in a manner that allowed detailed observations to be made and samples taken, and was restricted to a single shift with daily start-up and shut-down procedures being followed. These costs are reported in Table 29.

Certainly a cost of \$650 per ton is not very conducive to implementing this technology set on a job site. However, remember that this was a demonstration that only processed 834 tons of soil in a 140-hour period. A closer examination of these costs and how they would be impacted by application to an actual cleanup of a small arms range will now be attempted. Each cost item will be briefly discussed.

Table 28. Line Item Demobilization Costs

ACTIVITY	COST
Demobilization and Transfer of GFE to LB & M Associates in Lawton, OK	\$600.00
Removal of the Stormwater Holding Pond, Repair and Restoration of the operations Area at Block 4700	\$23,427.00
Transport of Processed Soil From Block 4700 To Range 5 and Reconstruction of the disturbed berms at Range 5	\$13,945.00
Revegetating the disturbed berms at Range 5	\$1,387.00
Analytical Laboratory Testing	\$535.00
Engineering & Management Support	\$5,194.88
Total Cost	\$45,088.88

0063G_33

Table 29. Hydrochloric Acid Leaching Demonstration Costs

NO	ITEM	TOTAL COST	COST/TON
1	Site Mobilization	\$133,786.00	\$160.41
2	Chemicals	16,013.00	19.20
3	Electricity *	637.00	.76
4	Equipment O&M	233,075.00	279.47
5	Material Handling	12,825.00	15.38
6	On-Site Labor	51,844.50	62.18
7	Process Analytical	13,987.50	16.77
8	Administrative	41,571.00	49.85
9	Recycling Fees	18,348.00	22.00
10	Demobilization	20,000.00	23.98
	TOTAL	\$542,087.00	\$649.98

* Paid for by Host

0063G_23

1. Site Mobilization. These are the costs incurred to ship the unit process equipment from Fairbanks, Alaska, to Ft. Polk, Louisiana, and assemble the unit processes adjacent to the job site. This equipment was not mobile, pre-packaged equipment, but discrete unit processes. In the future, on a competitive-bid, IFB-type of contract, this would be competed in the marketplace. Many components that were not fabricated beforehand now are, and we would expect to see this cost reduced significantly, perhaps by half.

2. Chemicals. Because of the variability of fines in the soil at this range, this vendor began the leaching circuit at the very beginning of the unit processes. The DE for the filter press was a fairly high-cost item. Use of it again for a full scale operation should be looked at carefully because of its expense. In addition, there was insufficient time to fully optimize the system stoichiometry. As a result, there were some inefficiencies here. The opportunity to reduce chemical costs exists (e.g., taking advantage of full bulk shipments as already described in Subsection 19.6), but the real driver here is the chemical nature of the soil, especially its distribution of contamination, grain size distribution, cation exchange capability, and buffering capacity. A unit cost of \$12 per ton may be a good baseline cost for planning purposes.

3. Electricity. These systems are energy consumers, and a cost of \$0.76 per ton may be a reasonable cost for planning purposes.

4. Equipment Operation and Maintenance (O&M). Vendor 2 went to great extremes to accomplish significant preventive maintenance on their process equipment. These costs reflect this, and the resulting incommission rate of greater than 98 percent was noteworthy. Addi-

tionally, some of Vendor 2's amortized costs for their capital equipment was included here, and much of the equipment was rented on short notice for a short period of time due to the short timeline duration nature of the demonstration. Recognizing that market competition will primarily deal with this factor, the unit cost reported is currently not competitive. Amortization should be addressed independently of equipment O&M. A few dollars per ton for equipment O&M would be reasonable. In addition, on an actual job, vendor owned equipment would be used, and the capitalization would produce much lower rates.

5. Material Handling. These costs reported were for Vendor 2's activities of moving the soil around on the operations pad only. So as to not distract the demonstration vendor from the principal activity of demonstrating their process equipment, and because we were operating a split-site operation, others excavated the soil from the range, moved the soil to and from the range to the operations area and back, and reconstituted and reseeded the affected berms. For much of the time, Vendor 2's large front-end loader sat unused. For an on-site operation, costs for excavating and moving the soil and reconstituting the berms will probably cost about \$20 per ton.

6. On-Site Labor. Vendor 2 had many more people at the demonstration than would normally be used to conduct an actual recycling event. We estimate there were twice as many. We believe that such labor costs would be approximately \$35 per ton.

7. Process Analytical Control. This element is critical to the success of the system. If process chemistry control is not maintained at all times, then this technology set will not be suc-

cessful. This equipment sat idle for approximately two-thirds of the time at the job site, as the site only operated at the most for 9 hours a day. For full scale field operations, such process equipment will operate 24 hours per day, so the reported unit cost can be reduced by two-thirds (approximately \$6 per ton).

8. Administrative. This cost element was unique to the demonstration. Research, development, test, and evaluation (RDT&E) efforts have an extraordinary amount of paperwork associated with them, and that was apparent here. In a full scale operation, there will still be the need for administrative support, such as maintaining personnel records, accounting for and maintaining benchstock and supplies, and manifesting hazardous materials and hazardous wastes. This will be approximately \$10 per ton.

9. Recycling Fees. As reported in Subsection 19.9, the reclamation efforts were costly primarily because of the high moisture content in the filter cake and the large mass of DE present. The transportation costs to Missouri from Louisiana were high as well. We believe with prudent planning and operations, recycling fees can be reduced to the range of \$12 per ton of new soil processed.

10. Demobilization. The value reported here is low. Most of the material was returned to the rental source, or stored in state pending redeployment to another assignment. This category of cost will be a matter of where the equipment is next going to be employed. Future users need to be careful that they do not pay for mobilization to another job site. In addition, demobilization should address those costs necessary to totally clean up the current

job site and reconstitute the berms where the soil came from.

It should be apparent that the focus on cost here is Phase 12 from Table 23. Nonetheless, other phases relate directly to the work element that a soil washing vendor would probably accomplish during a remediation. These related phases are:

- ◆ Phase 6, Benchscale Treatability Study
- ◆ Phase 7, Systems Design (Unit Processes Planning and Preparation)
- ◆ Phase 8, Site Specific HASP Preparation
- ◆ Phase 9, Site Mobilization
- ◆ Phase 10, Site Preparation
- ◆ Phase 11, Soil Excavation, Movement, and Staging
- ◆ Phase 14, Range Reconstitution Back to Beneficial Use
- ◆ Phase 15, Site Demobilization and Cleanup

Phase 12 represents the greatest cost and has the most visibility. However, the other related phases cannot be overlooked. There are a number of variables that impact the cost of these phases, especially Phase 12. Many have a parametric relationship to one another. That is, if one changes, all the others are influenced by that change. This suggests that a cost model should be built, these variables identified with regard to a range of upper and lower values, and a default value selected that would allow users to begin using the model without having to know very much about their job site initially. If such a model was developed, and the database was updated with more information each time this technology set was applied, the use of this technology set would become much less of a risk.

Here are the variables as we see them, with a first effort at defining the range of values, to

include a default value. The range is presented from highest cost to lowest cost.

- ◆ Cleanup Standards.
 - TCLP criteria imposed or not imposed
Default Value: TCLP criteria not imposed
 - 100 mg/kg total lead to 500 mg/kg total lead
Default Value: 400 mg/kg total lead
- ◆ Mass of Soil to be Processed
 - 10,000 to 100,000 tons
Default Value: 15,000 tons
- ◆ Soil Characterization
 - Low fines to high fines
Default Value: high fines
- ◆ Site Assessment Risk
 - Wetlands adjacent or wetlands not adjacent
Default Value: wetlands not adjacent
 - ESA habitat adjacent or ESA habitat not adjacent
Default Value: ESA habitat not adjacent
- ◆ Operational Setup
 - Split site or on-site
Default Value: on-site
- ◆ Throughput Rate
 - 10 tons per hour to 40 tons per hour
Default Value: 20 tons per hour
- ◆ Operational Envelope
 - 8 hours/day to 24 hours/day
Default Value: 16 hours/day
- ◆ Analytical Laboratory Support
 - Off-site or on-site
Default Value: off-site
- ◆ Weather Conditions
 - High precipitation or low precipitation
Default Value: rain once per week
- ◆ Chemicals Required
 - EHS acids, non EHS acids, or no acids
Default Value: non-EHS acid employed

- ◆ Level of PPE Required
 - Level "C" to Level "D"
Default Value: Level "D"
- ◆ Utilities
 - Not readily available or readily available
Default Value: Available, but require a service drop with a transformer
- ◆ Availability of Metals Reclaimer
 - Out-of-state or in state within 200 miles
Default Value: In state

What follows here is a first effort at scaling up the preliminary cost data now available as a result of these demonstration efforts towards real, but hypothetical, full scale field scenarios. The discussion that follows is an application to a 15,000-ton mass of soil, on-site, employing a full soil washing technology set (physical separation with acid leaching). The suggested default throughput rate of 20 tons per hour is assumed here, and the system will operate 24 hours per day, 6 days per week. Assumed times on the job site are:

- ◆ Site preparation: 45 days
- ◆ Site mobilization for unit process equipment: 14 days
- ◆ Site recycling operations: 35 days
- ◆ Site unit process equipment demobilization: 14 days
- ◆ Range berm reconstitution: 5 days
- ◆ Site final cleanup: 5 days.

TOTAL Number of Calendar Days: 118 days (unit process equipment days on-site is 63)

The estimated cost for this scaled up hypothetical operation is \$2.66 million and is itemized in Table 30.

Dividing by 15,000 tons, this gives us a unit cost value of approximately \$177 per ton. If

Table 30. Estimated Cost for Operation

NO	WORK ITEM	CALCULATIONS	COSTS
1	Benchscale Treatability Test	Lump Sum	\$15,000
2	HASP Preparation	Lump Sum	\$5,000
3	Site Preparation	Lump Sum	\$100,000
4	Process Equipment Mobilization	Lump Sum	\$67,000
5	Electricity	(15,000 tons)(\$0.76/ton)	\$11,400
6	Equipment O&M	(15,000 tons)(\$2.00/ton)	\$30,000
7	Equipment Amortization/ Rental	\$27/ton/30days, thus (15,000 tons)(\$27/ton)(63/30)	\$850,000
8	Materials Handling	(15,000 tons)(\$20/ton)	\$300,000
9	Chemicals	(15,000 tons)(\$12/ton)	\$180,000
10	On-Site Labor	(15,000 tons)(\$35/ton)	\$525,000
11	Process Analytical Control	(15,000 tons)(\$6/ton)	\$90,000
12	Administration	(15,000 tons)(\$10/ton)	\$150,000
13	Recycling/Reclamation	(15,000 tons)(\$12/ton)	\$180,000
14	Air Monitoring	(15,000 tons)(\$3.13/ton)	\$46,950
15	Demobilization	Lump Sum	\$50,000
16	Range Reconstitution and Cleanup	(15,000 tons)(\$4/ton)	\$60,000
SUBTOTAL			\$2,660,350

0063G_24

you apply a 10 to 15 percent load on this projected scaled up value, you approach the \$200 per ton rate. A goal going into this effort was to determine if this technology set can be employed at lower than the potential \$200 per ton rate, which was considered to be the economic baseline. It appears that this can potentially be done. Through vendor competition and optimizing the activities associated with the various line items described above, there are opportunities for cost reductions. In addition, economies of scale also apply here.

Vendor 2 has gone through an independent cost scale up analysis of their own against

a 40,000-ton range requirement. Details of their specific cost analysis are masked to protect their commercial proprietary rights. Nonetheless, they forecast a unit cost of \$135 per ton, which is very encouraging and supportive of the discussion just presented. Moreover, they are forecasting a unit cost of only \$40 per ton for physical separation only against a 40,000-ton range assignment. This positive indication suggests a cost-competitive vehicle for active range preventive maintenance or a low-cost method for pre-remediation of a range, by concentrating so much of the contaminated soil.

20.0 LESSONS LEARNED

The following lessons were learned from conducting the demonstrations associated with this technology set:

- ◆ It is difficult to develop a relationship between total lead concentration values and TCLP lead concentration values. Any developed relationship would be site specific. This is important with the cleanup standards that apply. Should cleanup standards specify both a total and TCLP value to be achieved, the two parameters must be compatible with one another. As an example, standards of 1000 mg/kg for total lead, and TCLP would not be compatible. 500 mg/kg for total lead and TCLP might be, whereas, 300 mg/kg for total lead and TCLP probably would be compatible. These relationships should be explored and attempted to be identified during the site characterization phase. Should incompatible standards be directed that cannot be challenged, the unit process systems train will be governed by the TCLP criteria.
- ◆ The concentration of lead in soils on small arms ranges is not uniform. One needs to anticipate "hot spots." Although soil was blended during these demonstrations to provide a uniform baseline for the demonstrations, "hot spots" were still encountered. Blending operations consisted of a "checkerboard" excavation extraction plan on the range. Input lead varied from 2700 to 5200 mg/kg. BDM has recently been involved with the characterization of three other DoD small arms ranges and observed similar concentration distributions, with one "hot spot" being about 10,000 mg/kg. For pro-

grammatic planning purposes, perhaps an average input concentration of 3500 mg/kg is notionally what could be expected for system loadings. BDM considered attempting to mass balance blend the soil by drying it and running such through a pug mill, but avoided this in the end because of the extra cost and the environmental health consequence that generated dusts could cause. Field scaled up systems employed for future operational use will have to be able to accommodate loadings with variable metals concentrations. In addition, metals "hot spots" should be anticipated, and soil characteristics such as fines may also vary. Some ranges may have used "imported soils" to develop elevated berms. Erosion, range maintenance, and range reconfiguration may contribute to soil characterization discontinuities. Recycling systems need to be able to accommodate such variations.

- ◆ There are a number of by-products one must anticipate from this technology set, and one of them is hazardous waste, which can be minimized by optimal systems operation, but needs to be anticipated and properly planned for to include proper temporary storage and timely disposal.
- ◆ There is the potential for a change in the soil grainsize distribution and chemistry as the soil is recycled through this technology set. It was observed that the coarser material disappeared somewhat (gravels), and because the process was not specific for just lead, other metals were reduced in concentration, and the salt level in the clean soil increased. This change in soil characteristics gives rise to two questions that will be

further addressed in Section 24, Recommendations for Additional Developmental Work. The two questions are:

- 1) Is the constructability of the clean soil adversely impacted by this technology set?
 - 2) How readily can this clean soil be revegetated?
- ◆ Because this technology set was demonstrated on an active range, a split-site operation was used in the interest of safety and not disrupting training schedules. This was a logistics burden and may have impeded achieving maximum throughput rate. It was necessary to stockpile soil to be recycled and also stockpile processed soil awaiting confirmation that TCLP criteria had been satisfied. This added to project costs in terms of transportation and weather-secure storage. Moreover, the impermeable pad size may have also been operations-rate limited. In the future, we should work especially hard to avoid a split-site operation because of its impact on operational costs, and with the EPA's final Military Munitions Rule announced, we may encounter added administrative compliance burdens as well.
 - ◆ Acid leaching agents that have fairly high vapor pressures and thus evaporate more rapidly could pose a problem on job-sites using this technology set. It was noted that acetic acid as used in the first demonstration could often be identified by odor on or adjacent to the job site and, on one occasion, led to complaints from a neighboring site. We suspect that high ambient temperatures combined with a very high humidity may have contributed to this singular unpleasant situation.
 - ◆ The acid leaching portion of this technology set was not just specific to lead. Many other metals present in trace amounts were impacted by this process and had the tendency to have their concentration increase somewhat in waste product streams and thus be removed from processed soils. Because some of the metals affected were other RCRA targeted metals, there was the potential to approach their respective TCLP limits (some of which are as low as 0.2 mg/L). As a consequence, care should be taken so there are no surprises after processing a specific soil. Full RCRA metals sweeps during site characterization, during the benchscale treatability studies, and during processing should be carried out.
 - ◆ There are other metals besides lead that are common to small arms ranges, such as copper, antimony, and zinc. The potential for cleanup standards to address these exists and is site-specific. This technology set was able to remove these other metals, but not uniformly, with the exception of total copper, which both leaching systems did effectively. There was some increase of soluble metals observed, which is a concern. The specific acid used as a leachant is important here, as the results differed between the two. Should one of these other metals be addressed by the cleanup standards to be imposed, a benchscale treatability study is a must, and the leaching acid choice is critical. This was discussed in detail in Subsection 16.3.

◆ Maintaining positive control of the system process chemistry at all times is critical to successful operations. Failing to do so will result in fouling of the washwater, and the consequences can be perilous. The washwater could have to be replaced with new reagents to re-establish its chemical potential, and the washwater may not be rehabilitated, requiring disposal as a hazardous waste. When you consider that such systems may hold as much as 20,000 to 30,000 gallons of water, the costs of such

action could be significant. Moreover, the impact on work schedules could also be very negative.

◆ The potential exists to generate revenue from recycling the recovered lead. Care needs to be exercised in choosing the reclaimer to prevent such generated revenues from being consumed by excessive transportation costs. Achieving the most concentrated forms of reclaimable metals will positively impact such pricing.

21.0 SUMMARY

Observations resulting from this overall project effort, including operating two large and different commercially-based pilot scale soil washing plants under realistic field conditions (one using an acetic acid leaching circuit and the other using a hydrochloric acid leaching circuit) demonstrated that this technology set works sufficiently well to be used at full field scale for an actual remediation assignment. Although one pilot plant performed much better than the other, total lead removal in the 90 percent range was achieved, and total lead levels in the final processed soil were in the 200 mg/kg range. The input total lead concentrations in range soils was not uniform, and varied greatly, but averaged around 3500 mg/kg.

These demonstrations also targeted satisfying TCLP criteria for lead (less than 5.0 mg/L), and it was demonstrated that this could be achieved. The general acid demonstration, in which the strong acid (hydrochloric acid) was used as the leaching agent, performed much better, consistently producing TCLP values in the final recycled soil of approximately 2 mg/L. The weak acid demonstration, in which acetic acid was used as the leaching agent, struggled to satisfy this criteria, having only done so once.

We have given much thought as to why this was the case. The hydrochloric acid, being a strong acid, will dissociate completely and place many more hydrogen ions into the reactive washwater solution, and we were able to drop the pH to very low levels (as low as 1.5), whereas the acetic acid, being a weak acid, does not totally dissociate. The lowest pH reached with acetic acid was approximately 3.

This may have contributed to this observation and was discussed in detail in Sections 11 and 12. In addition, during the early phase of this project, when the contaminated soil was being characterized, an experiment was conducted to determine how amenable the soil in the minus 200 fraction was to leaching. Three acids were evaluated: acetic, hydrochloric, and nitric. The acetic acid solubilized 62 percent of the lead, whereas the other two acids solubilized 90 percent of the lead.

However, there were some problems with process chemistry control and equipment reliability that impacted steady state operations during the acetic acid demonstration, and this may have contributed more to the problem of satisfying the TCLP criteria. Moreover, it appears that effective fines dewatering is a critical element with regard to TCLP values in the final processed soil.

Notwithstanding the occasional nuisance odor problem that was encountered with the use of acetic acid on a few occasions, acetic acid should not be ruled out from further efforts. There will likely be cases where acetic acid might serve as an effective leaching agent. This would become apparent during benchscale treatability studies. Soils that are already highly weathered, where the lead has been oxidized from its useful metallic states to lead salts, may be very amenable to acetic acid leaching. In addition, if other metal salts are regulatorily targeted in the cleanup standards, acetic acid may also be a viable candidate. Costs must be considered, and acetic acid was more costly than other acids during the time in which these demonstrations were performed. However, the costs of acids and bases are volatile at the moment and need to be considered

during the cost analysis of future projects as they are being planned. The key parameters that would need careful examination during the bench scale treatability study would be the buffering capacity of the target soil and its cation exchange profile. A further brief demonstration with acetic acid has merit.

This technology set also demonstrated that other metals of potential environmental concern found on small arms ranges, i.e. copper, antimony, and zinc, could also be removed from the soil but not in a uniform manner. This limited removal is encouraging, but more work is warranted to better define the sensitivity of acid leachant used in the system. Future users of this technology set need to be alert for the possibility of other metals besides lead becoming target contaminants for small arms range cleanups.

Because the EPA chose not to pursue Uniform National Standards for cleanup criteria on ranges when they published their final version of their Military Munitions Rule in February, it is difficult to predict what such cleanup standards might be in the future. This is an important issue, as it drives the decision as to what the most cost effective technology set is to apply for the remedial action. We suspect that such targets will be no greater than 400 mg/kg total lead and will probably be less, depending on the risk-based, site-unique conditions and current intended land use. Whether

or not TCLP criteria can be included is a critical question, and one that will have to be answered over time. If the total lead target drops to 100 to 200 mg/kg, TCLP criteria can be inferred because of the relationship that exists between the two parameters (but are probably unique to each soil type). These relationships are probably empirical and site-specific as well, and efforts to determine them should be pursued in order to define cleanup standards that are national and co-achievable. If the range is adjacent to surface bodies of water, has soil that is acidic, has soil that has limited buffering capacity, or has demonstrated the tendency to leach, the need to impose TCLP criteria is probably justified. Reviewers who intend to apply this technology set to their own unique requirements should plan to satisfy this criteria, if there is doubt. Based on observations from this project, soil washing can satisfy such criteria.

The pilot scale plants that were deployed and mobilized were essentially field scale prototypes and could, with little change, operate at least at the 10 tons per hour rate of soil throughput. We believe that little effort will have to be put forth to assemble prototypes ready for immediate field deployment. The scaled up costs from these demonstrations are heartening, and we encourage this innovative technology set to be used.

22.0 CONCLUSIONS

The observations and results of this project lead us to the following conclusions:

- ◆ The soil washing technology set works in the field with the commercially based pilot scale process equipment utilized.
- ◆ Both total lead and TCLP lead criteria were consistently satisfied by the pilot plant that utilized the hydrochloric acid leaching circuit. The pilot plant that utilized the acetic acid leaching circuit struggled to reach steady state operating conditions, and as a result, it is difficult to draw conclusions from the limited data gathered. In its favor, observations gathered did show it was successful in total lead removal, but it struggled in satisfying TCLP criterion for lead.
- ◆ The pilot scale plants deployed and mobilized for these demonstrations are essentially field scale prototypes that can be easily adjusted and deployed for immediate prototype application.
- ◆ The weak acid (acetic) can generate occasional nuisance odor problems.
- ◆ Air sampling results did not exceed any PEL standard for lead in air.
- ◆ Maintaining process chemistry control of the washwater leaching circuit at all times is critical to success.
- ◆ Split operations sites should be avoided in the future if at all possible.
- ◆ On-site or very accessible local analytical laboratory support should be employed if at all possible.
- ◆ Among the by-products of this technology set is hazardous waste. The amount generated can be minimized by sound unit processes management, but some will be generated.
- ◆ This technology set is metal non-specific and will remove other RCRA metals besides lead.
- ◆ Efforts to statistically correlate XRF-generated data to laboratory-generated analytical data (by ICP) were not generally successful.
- ◆ Process washwater can be treated internal to the unit processes to render it benign.
- ◆ A well thought-out SWPPP is critical to success, as is an SPCC plan.
- ◆ Other small arms range bullet associated metals (Cu, Sb, and Zn) can be partially removed by soil washing technology as a by-product of lead removal.
- ◆ Revenue can possibly be generated by recycling the lead removed by soil washing with a reclaimer.
- ◆ There are some NEPA-based environmental consequences from employing soil washing, but they can be adequately managed through proper engineering controls. (These are addressed in Appendix A)

23.0 RECOMMENDATIONS FOR FUTURE APPLICATIONS

As this project is concluded, we have observed that this technology set worked at the pilot scale, and the cost scale up is encouraging. However, we only processed approximately 1100 tons of soil, and a typical range is going to have at least 10,000 to 15,000 tons of soil that will need recycling. In addition, recognizing that the EPA's final Military Munitions Rule provides good insight to future protocols (not withstanding some deferral on certain actions until the publication of the DoD's final Range Rule later this fall), there is clearly the opportunity to start defining some active range maintenance/remediation concepts that should be considered.

23.1 COMPLETE RANGE PROTOTYPE CLEANUP

Because of the successful removal observed and the encouraging projected costs, it would seem prudent to search for a suitable candidate range (active, inactive, closed, or transferred) and use this technology set to completely clean up the range against realistic regulatory standards and fully document performance on unit processes and complete costs. This application should be on a range(s) where there is sufficient soil mass to be processed and where the anticipated economy of scale can be fully economically tested (at least 10,000 tons, but the more the better). This, more than anything else, would satisfy potential users and regulators alike of the potential of this technology set. The quicker this can be accomplished the better.

23.2 POLLUTION PREVENTION AND PREVENTIVE MAINTENANCE

Notwithstanding the fact that there are some 2,600 small arms ranges in DoD, and many others with DOE, the Coast Guard, and the National Guard that need cleanup attention, the sooner the source of contamination is abated, the sooner this potentially large problem will go away. There are efforts underway at this moment to develop more effective targets and bullet traps, as well as different types of bullets that use dense material other than lead. The quicker these new technology tools can be fully developed, procured, and put in place the better. In the meantime, there may be some preventive maintenance methods under the pollution prevention pillar that could be implemented and could help eliminate much of the source.

The greatest problem on these ranges is with the metal salts that result from long-term weathering and oxidation. Dissimilar metals reactions and oxidation that occur from bullets' presence in moist, acidic environments contribute to this, but do not occur immediately after the bullet has been fired (and used for its intended beneficial purpose). The problem becomes even more acute when these metal salts bind with soil fines, especially clays, because of the separation difficulties that arise. It is in response to these conditions that the acid leaching elements of the soil washing unit processes train must be employed.

Recognizing that the soil washing technology set consists of two distinct unit process sets, namely physical separation and acid leach-

ing, that can be discretely separated, and that there is a time period before the metal salts form in the range soils, if physical separation methods only were applied cyclically perhaps every 18 to 24 months, much of the particulate lead (which can be very soluble in acidic environments, and create a contamination problem) could be removed before the salts were formed.

We recommend that physical separation only be applied to some active ranges as a maintenance procedure for the removal of particulate lead. This might serve as an excellent preventive maintenance tool and prevent much new pollution from occurring until the next generation of bullet traps and bullets can be fully developed, procured, and fielded.

24.0 RECOMMENDATIONS FOR ADDITIONAL DEVELOPMENTAL WORK

This technology set demonstration has been successful and the cost scale up results are encouraging. We feel that this technology set is ready to be used in the field at the prototype level against some real project requirements. Nonetheless, as with any innovative tool, there is the need to always do some more developmental work. Such recommendations are described here.

24.1 FINAL VERSION OF THE RANGE RULE

There is much concern today with regard to the regulatory compliance roadblocks in applying innovative technology tools to actual field requirements. Some of these may be real, and some may be perceived. The former seems to have some merit, and the ITRC is seriously attempting to streamline such implementation for selected technologies, including soil washing. With regard to applying soil washing to clean up DoD's small arms ranges, all involved have been waiting for the EPA's final Military Munitions Rule, which is now out, and the companion DoD Range Rule in final form, which is not out. Because the former has deferred certain key points to the latter, and the latter will not be available until the fall of 1997, there are still loose ends. Once the final version appears in the Federal Register, four public involvement forums are planned to be held on a regional basis. Depending on such outcome, and the results of the EPA's review, some additional changes could be made. As a result the final official DoD Range Risk will probably not be available for field implementation until early 1998. Clearly, vigilance needs to be maintained on the final version of the Range Rule,

and once released, it needs to be studied to ensure there are no friction points. If these surface, they must be identified and addressed through the ITRC or other forum.

24.2 ACETIC ACID DEMONSTRATION

As a result of this technical report, some reviewers may feel that acetic acid has little if any merit as a leaching agent in soil washing applications for heavy metals removal. The one excursion observed with nuisance odors, the high cost of the acid, and the failure to routinely satisfy TCLP criteria would certainly support that interpretation. However, to be fair, because of some of the process-related problems experienced with this demonstration, there is merit in giving it another chance sometime in the future, and conducting a very focused and limited duration further demonstration.

24.3 RATE OF OXIDATION TO METAL SALTS

If we are to seriously pursue identifying a preventive maintenance schedule for active ranges in which we apply the lower cost (physical separation element only) of soil washing in an attempt to remove the majority of the metallic particulate bullet debris before metal salts are created, then we need to determine, under controlled weathering conditions, how long it takes for such reactions to begin occurring under various soil and weather conditions. By knowing the kinetics of such activity, we can predict the best preventive maintenance cycle to follow, and also possibly learn how to better manufacture jacketed bullets.

24.4 POLYMER INTEGRATION

Throughout this demonstration, considerable focus was maintained on the importance

of satisfying TCLP criteria for lead. This was hopefully apparent in this technical report. We purposely avoided polymer issues, but we recognize that there has been considerable interest in not only their prudent use, but also that the chemical technology industry has developed a new generation of such additives that may offer a sound economic application if the land use is not scheduled to change. It may be appropriate now to conduct a worldwide search for these compounds, choose those that offer the most merit, and conduct a series of well thought out demonstrations to evaluate their technical effectiveness, half-life/longevity of chemical effectiveness, and cost.

24.5 REVEGETATION

In this technical report, we have stated that the soil particle size distribution has the potential to change slightly along with the metallic makeup of the soils processed. We lost some of the coarser material (gravels) in one demonstration, and many of the metals were removed besides lead. In addition, the salt concentration measured as total dissolved solids increased. We need to remember that this soil being recycled is a construction material. During process optimization, we were sensitive to its final moisture content, and we attempted to keep it below 20 percent so it could be readily handled and moved, as well as to keep dissolved metals common to the process washwater out of it. An equally important point is being sure that this processed soil still can be recompacted and placed at sufficient angles of repose to re-establish berm configuration and return the ranges to their beneficial use. The loss of some gravel can adversely affect such. That was not noticed initially when

Range 5 was reconstituted and returned to active status, but it remains a concern that needs to be monitored. With so much of the metal mass now gone and the additional salt content in the soil, we also have some concerns as to how readily amenable this soil is to revegetation. On Range 5 we have reseeded with a mixture of Bahia, Bermuda, and Rye grasses. We believe this mix will work, but we don't know how well. Based on a 90 day observation, it is off to a good start, but monitoring is needed. The major concern is whether or not the soil is now more or less vulnerable to erosion damage. We believe this needs to be investigated under controlled conditions.

24.6 FATE OF OTHER METALS

We noted that other bullet associated metals (copper, antimony, and zinc) were partially removed, but at different rates by the two different leaching acids employed. In addition, there were some unusual increases in solubility in some (Subsection 16.3). Should a cleanup standard for a future range cleanup include one of these other metals, extreme care needs to be exercised in choosing the best leaching agent, after a well thought out and executed bench scale treatability study. A focused work effort to better understand the chemistry associated with increased solubility under certain conditions with selected leaching acids may be prudent.

24.7 RECLAMATION COSTS

As reported, the potential exists to generate revenues from the recycling of the recovered lead, if transportation costs can be minimized and the recovered metallic lead concentrated well. A useful product for instal-

lation level users may be a geographical listing of EPA-authorized reclamation centers with cost rates and instructions on how to communicate with them and ship material to them.

With a tool such as this, users could determine which cost beneficial reclamation center to utilize.

Appendix A

APPENDIX A GENERIC ASSESSMENT CONSIDERATIONS

What follows in this appendix is a series of generic responses to questions that must be considered when assessing the environmental consequences of applying soil washing to candidate small arms range remediation sites. The responses provided are based on the observations made from conducting the soil washing demonstrations at Ft. Polk, Louisiana in 1996.

- ◆ *Does the proposed activity conform with the installation master plan?* It should. The ranges are being maintained to either support their continued beneficial use, or to support a change in land use. If it is the latter, it is very likely that more stringent cleanup standards will apply.
- ◆ *Would the proposed project alter land use on the installation?* It would, but only in the sense that while the project was underway, the range would be disturbed, but then would be returned to normal beneficial use.
- ◆ *Describe project activities that could affect the archeological and/or cultural resources and the qualities of air, land, and water (e.g., clearing, digging, or leveling).* These actions must be coordinated with the environmental management office. Here, engineering controls that prevent or minimize such action and/or their consequences must be implemented.
- ◆ *Is prior use of the property and condition of the equipment involved?* Here, the subtle differences between active, inactive, closed, and transferred ranges must be taken into consideration. If there are changes, RCRA compliance provisions might become issues. Consult the EPA's "Military Munitions Rule" and the DoD "Range Rule" for case-

by-case guidance. In the majority of applications, an active range will be undergoing maintenance, and, upon completion, the range will continue to be active.

- ◆ *What is the proposed use of the property, equipment and/or completed project?* If changes are to be set in place upon completion of this action, then an EA or EIS may be required. In most cases, an active range will be undergoing maintenance, and, upon completion, will continue to be active. In these cases, little if any environmental consequence will surface as long as good planning and sound engineering controls are being implemented. These are further discussed in the text that follows.

Areas of potential impact during implementation and operations are as follows:

- ◆ *Is there a potential to cause air pollution?* Yes, but not necessarily too serious, depending on what leaching agent you employ and whether or not there are fugitive soil dust emissions containing lead above the PEL. Here, good engineering controls are a must, as well as sound site planning. Minor adverse impacts could be encountered.
- ◆ *Is there a potential to cause water pollution?* Yes, it is critical that proper site planning be executed with the most rigid engineering controls, and that a sound SWPPP and an SPCC plan be developed and implemented. Moderate to major adverse impacts could be encountered.
- ◆ *Is there a potential to impact quality or quantity of groundwater?* Again, such potential exists, so the need exists to adhere to the

provisions of the applicable SWPPP and SPCC plan. In addition, an impervious pad will need to be provided for the equipment train, process chemicals, and soil to be processed and placed upon. Moderate to major adverse impacts could be encountered.

- ◆ *Is there a potential to affect wetlands, floodplains, wild and scenic rivers, and other related areas of critical environmental concern?* If the answer is "yes" to any of these, replan the effort and try to avoid such potential. On a scalar basis, if the reply is greater than a minor adverse impact, consider another technical approach.
- ◆ *Is there a potential for discharging or releasing of a hazardous substance?* Yes, especially with leaching, as this will bring acids and bases to the job site in great amounts, not to mention the process washwater that will eventually lose its chemical potential and need to be disposed of. In addition, large quantities of potential recyclable metals will be generated. Secondary containment on storage tanks, double-walled pipes, and other engineering controls will need to be developed so that there is only a minor adverse impact potential.
- ◆ *Is there a potential to generate hazardous waste?* Yes, some hazardous waste will probably be generated during the utilization of this technology set. As was shown in Figure 1, this is a normal part of the system. The key is to select the series of unit processes carefully (and after a thorough benchscale treatability study has been accomplished) in order to minimize this potential generation, and then operate the system optimally as soon as possible. If these criteria can be

satisfied, there remains only the potential to experience minor adverse impact.

- ◆ *Is there a potential to cause soil contamination?* There really should not be because trying to remove such contamination is the purpose of soil washing. However, if acid leaching is employed, there is the potential for heavy metals to be somewhat concentrated. Maintain sensitivity to this, and have an RCRA metals scan done both during the benchscale treatability test and on the final processed soil (periodically) to evaluate such potential. In all probability, improvements will take place in this category, assuming sound engineering controls are in place.
- ◆ *Is there a potential to violate safety, health, or noise standards?* Yes, this potential exists, especially for lead dust in the air. Good engineering controls and air monitoring must be done to abate such potential. Few noise excursions above 85 dBA were noticed during these two demonstrations. Again, proper engineering controls and a good site HASP that people are trained on will minimize this exposure and present the potential for only minor adverse impacts. For more information on the lead dust concerns, see Section 6.6.
- ◆ *Is there a potential to impact protected or endangered species or their habitat?* If there is the potential to get caught up in the issue of habitat loss or "taking" under the ESA, all efforts should be made to avoid this project work site. Certainly an EA will be required, because no matter how bullet-proof the engineering controls envisioned are, the potential for moderate or adverse impact will exist.

- ◆ *Is there a potential to affect cultural resources that are either on or eligible for the national register or unstudied?* If there is such potential, then the same remarks from the previous consideration apply.
- ◆ *Is there a potential impact to the labor force?* No, this technology set is not very labor intensive. Moreover, the results of the cleanup effort will make the subject ranges safer and healthier for the personnel that train on them.
- ◆ *Is there a potential impact upon recreational areas and/or prime farmland?* As long as proper engineering controls are in effect to control any source of water pollution, air pollution, and hazardous substance release, there should be no potential for adverse impact.
- ◆ *Is there a potential to affect energy demand?* Yes. The two demonstrations conducted with this project used a considerable amount of electricity. During the acetic acid leaching demonstration, 6,200 kWh were consumed to process 269 tons of soil (23.0 kWh/ton of soil). During the hydrochloric acid leaching demonstration, 9,700 kWh were used to process 834 tons of soil (11.6 kWh/ton of soil). In addition, great efforts during site preparation were expended to providing 480-volt service to the operations area. Special planning needs to be accomplished in order to avoid impacting the installation population. The potential is there, although the Ft. Polk demonstrations did not adversely impact the remainder of the installation. One vendor reported routine voltage spikes in midafternoon, but that situation has not been corroborated.
- ◆ *Is there a potential for environmental controversy?* Maybe. This technology set in itself may not be controversial, but it may be controversial that work is occurring on a range where the potential for munitions to be uncovered could be a concern to some citizens. Reviewers who are considering applying this technology to a new requirement must remain sensitive to this subject. Since 1994, the DoD has required its installations to form RABs. The intent is to encourage stakeholder participation to include the local regulatory community and citizens from the area. Such groups could possibly defuse or prevent such situations. Reviewers considering applying this new technology set may wish to use this forum to present this technology as a meaningful solution to requirements and defuse any such potential as early as possible. In November 1996, the EPA released a very succinct pamphlet entitled, "The Model Plan for Public Participation" (EPA 300-K-96-003). This booklet addresses the methods and procedures to effectively involve the public in environmental activities. Reviewers contemplating applying this technology set for future applications are encouraged to review this EPA pamphlet. This subject is addressed in Section 18.

Reviewers who are contemplating applying this technology set to their own requirements will hopefully benefit from these candid environmental assessment considerations. Each site must be evaluated on its own merits, and after a thorough site inspection in the field and discussions with local cognizant and informed authorities.

Appendix B

APPENDIX B
EPA'S FINAL MILITARY MUNITIONS RULE

The paragraphs that follow contain a brief interpretive summary of the final version of the EPA's Military Munitions Rule, as it applies to this technology set. This interpretation is neither endorsed by the EPA nor the DoD. Reviewers are cautioned that they should not cite it as applied to their unique job sites, nor quote from it out of context. Instead, they are highly encouraged to read the entire document and carefully apply its contents to their own job site. Moreover, their staff regulatory coordinator and/or environmental attorney should likewise review their interpretive application.

This final Rule was published in the Federal Register on February 12, 1997. It impacts and alters a number of paragraphs in 40 CFR 260 and first appeared before the public as a draft on November 8, 1995. The public comment period closed on February 26, 1996. Six major issues were raised in 124 organizational/individual comment sets. The major topic addressed is the handling and management of munitions products. Range management is a corollary topic, but very germane to the future application of this technology set. Of the many important topics addressed in this Rule, a principal concern was, When did a munitions product become a hazardous waste under RCRA? This critical question is addressed in this final Rule. In addition, this Rule applies to both conventional and chemical munitions, but not nuclear munitions. It has applicability to not only the DoD, but to the Department of Energy (DOE), the Coast Guard (Department of

Transportation [DOT]), and contractors and manufacturers supporting these departments.

There are a number of categories of military ranges. A military range is any designated land and water area set aside, managed, and used to conduct research on, develop, test, and evaluate military munitions and explosives, other ordnance, or weapons systems, or to train military personnel in munitions use and handling. Ranges include firing lines and positions, maneuver areas, firing lanes, test pads, detonation pads, impact areas, and buffer zones with restricted access and exclusionary areas. Small arms ranges are an example of these, and include the following range subcategories:

- ◆ Active range
- ◆ Inactive range
- ◆ Closed range
- ◆ Transferred range.

An active range is a military range that is currently in service and is being regularly used for range activities. An inactive range is a military range that is not currently being used but is still under military control, considered by the military to be a potential range area, and has not been put to new use that is incompatible with range activities. The range at Ft. Polk that hosted the demonstrations that are the subject of this technical report was an active range (Range 5). This final Rule principally addresses active and inactive ranges. The draft DoD Range Rule addressed closed and transferred ranges. It is very important to note that in this final Rule, the EPA postponed final action on the status of military munitions left

on closed and transferred ranges, and is deferring to the final DoD Range Rule. Closed and transferred ranges will most likely be associated with either FUDS activities or installations impacted by a BRAC round. In the latter case, CERCLA or RCRA may already be directing regulatory site activities. If the installation is only impacted by mission and unit realignments where the master plan is being revitalized in order to accommodate more activities, then this issue becomes more important. It is apparent that the EPA is giving the DoD every possible opportunity to control their own destiny in this important area, assuming that the DoD satisfactorily demonstrates adequate protection of human health and the ambient environment.

In addressing the principal concern of when a munitions product becomes a hazardous waste under RCRA, the final Rule first considered when such a munition became a solid waste. Two points are clear in this Rule:

- ◆ When military munitions are used for their intended purpose, such as firing, they will not automatically fall within the regulatory scope of RCRA.
- ◆ Range management, including maintenance, is an integral part of DoD's safe use of munitions for their intended purpose. It is not EPA's intent to become involved with this until the munitions material is shipped off range for treatment and disposal. It is important that used or fired munitions are to be considered solid wastes when they are removed from their landing spot and either managed off-range or disposed of on-range. However, if they are recycled on-range, they probably will not be considered a solid waste, but the byproducts of recy-

cling would be. Soil washing as a technology set demonstrated and reported here is a recycling operation and, if done on the range itself, should not fall under the regulatory auspices of RCRA. However, if a split-site activity were to be pursued, then the chances of such occurring would be much more probable. The issues of on-site and contiguous were discussed in detail in this final Rule and may provide some opportunity to operate without adversely impacting training schedules on active ranges. In applying this technology set, time and cost will be critical if operations are carried out on an active range. Consider the following hypothetical case in point:

- ◆ A preventive maintenance program is established such that the berm impact area on a small arms range is maintained by on-site reconstruction of the berm to include physical separation of the metallic bullet fragments every 18 months, before dissimilar metal reactions and oxidation can occur and generate soluble metal salts. This activity is carried out on the range proper, the collected metals are recycled, and no solid or hazardous wastes are generated. In order to minimize range downtime and avoid a negative impact on the training schedule, this work must proceed as quickly as possible (perhaps in 30 days). Based upon this final Rule, it appears that such activity should not be subject to RCRA.

One final point that this Rule makes is regarding Uniform National Standards. It would appear that there was some consideration to attempt to adopt a common cleanup standard for ranges, but in the end, this approach was retired. Individual states may adopt broader

and more stringent requirements. Moreover, this policy position allows individual site risk assessments to guide such critical decisions.

In summary, the conclusion of this regulatory aspect will not be resolved until the final version of the DoD Range Rule is published in the Federal Register. This action may not occur until fall 1997. With that action complete, a series of four regional public involvement forums are anticipated and the final rule published in early 1998. In the interim, the EPA's final Rule, scheduled to take effect in August 1997, provides insight for how this technology

can be put to work. Operating on-site on active ranges appears feasible, without an RCRA conflict. Split operations will, in all likelihood, be adversely impacted and, unless they are contiguous, they would probably meet the regulatory criteria for both solid and hazardous waste. It is highly likely that in response to the recent release of this final Rule, the Department of Defense Explosive Safety Board (DDESB) and the individual Service branches will provide policy guidance to field commanders as to how to comply with this Rule.

Appendix C

Sample No.	Process Stream	Analysis Type	Results				
			Units	Cu	Pb	Sb	Zn
C-SP04-FB	field blank	TCLP	ug/mL	0.000	0.000	0.008	0.288
		METALS	ug/g	3.57	3.28	0.000	4.02
C-SP12-Z	organic	TCLP	ug/mL	1.94	11.1	0.064	1.15
		METALS	ug/g	4005	6457	32.9	1672
C-SP15-T	treated soil	TCLP	ug/mL	0.768	3.07	0.141	1.07
		METALS	ug/g	59.8	122	31.7	16.9
C-SP15-U	untreated soil	TCLP	ug/mL	0.754	34.6	0.325	0.49
		METALS	ug/g	812	1854	104.6	72.2
C-SP15-L	leach circuit feed	TCLP	ug/mL	1.77	21.3	0.080	1.08
		METALS	ug/g	247	832	138	51.9
C-SP21-T ⁽¹⁾	treated soil	TCLP	ug/mL	1.78	5.99	0.067	0.662
		METALS	ug/g	99.0	208	44.1	18.7
C-SP21-U	untreated soil	TCLP	ug/mL	1.00	21.0	0.132	0.442
		METALS	ug/g	1516	1407	89.3	168
C-SP25-T	treated soil	TCLP	ug/mL	7.01	10.3	0.012	2.46
		METALS	ug/g	215	330	54.5	32.2
C-SP25-U	untreated soil	TCLP	ug/mL	0.736	22.0	0.233	0.448
		METALS	ug/g	1525	3347	180	127.1
C-OC02-C	coarse treated soil fraction	TCLP	ug/mL	16.4	6.49	0.038	2.37
		METALS	ug/g	415	252	38.5	50.8
C-OC02-T	treated soil	TCLP	ug/mL	7.08	11.2	0.057	1.96
		TCLP - pH 6	ug/mL	6.51	9.02	0.131	1.16
		TCLP - WW	ug/mL	6.51	8.79	0.042	0.878
		METALS	ug/g	359	404	91.8	45.4
C-OC02-U ⁽¹⁾	untreated soil	TCLP	ug/mL	0.562	40.5	0.670	0.293
		METALS	ug/g	1317	2741	139	103
C-OC02-F	fine treated soil fraction from leach	TCLP	ug/mL	7.84	15.1	0.170	1.29
		METALS	ug/g	1001	947	265	71.4
C-OC02-L ⁽²⁾	leach circuit feed	TCLP	ug/mL	12.1	49.3	0.042	4.90
		METALS	ug/mL	704	5347	259	120
C-OC02-Q	liquid from precipitation tank	METALS	ug/mL	21.5	627	5.08	39.2
C-OC03-M	metal concentrate from jig	TCLP	ug/mL	6.70	17.59	0.12	1.26
		METALS	ug/g	228	484	53.6	32.0
C-OC04-T	treated soil	TCLP	ug/mL	5.14	7.80	0.066	0.925
		TCLP - pH 6	ug/mL	4.09	6.40	0.069	0.669
		TCLP - WW	ug/mL	4.74	6.31	0.108	0.532
		METALS	ug/g	165	269	64.2	22.7
C-OC05-FB	field blank	TCLP	ug/mL	0.042	0.057	0.002	0.166
		METALS	ug/g	11.6	2.70	0.311	7.29
C-OC07-P	precipitate	TCLP	ug/mL	0.000	321	0.105	9.38
		METALS	ug/g	2438	11990	457	348
C-OC07-Q	liquid from precipitation tank	METALS	ug/mL	0.647	29.3	0.080	17.5
C-OC07-U	untreated soil	+10 METALS	ug/g	333000	638000	163000	8230
C-OC10-T	treated soil	TCLP	ug/mL	10.9	21.7	0.142	2.29
		TCLP - pH 6	ug/mL	6.87	23.6	0.327	1.86
		TCLP - pH 8	ug/mL	6.41	15.8	0.263	1.11
		TCLP - pH 11	ug/mL	8.35	14.9	0.487	1.40
		TCLP - WW	ug/mL	9.58	17.8	0.111	1.33
C-OC11-U	untreated soil	METALS	ug/g	797	839	171	65
		TCLP	ug/mL	3.30	106	0.671	0.572
C-OC11-O	oversize from attrition scrubber	METALS	ug/g	1943	4789	219	158.6
		METALS	ug/g	125000	239000	6107	3083
C-OC12-P	precipitate	TCLP	ug/mL	0.200	262	0.344	9.67
		METALS	ug/g	2649	8885	592	320
		DECANT	ug/mL	0.134	357	2.22	58.6
C-OC12-T	treated soil	TCLP	ug/mL	21.3	48.0	0.143	3.31
		METALS	ug/g	729	1443	261	88.1

(1) +30 mesh data missing

(2) +30 mesh data missing or never existed

DRAFT

Table 1. Operating Summary for Acetic Acid Demonstration

Date	Daily Soil Feed (tons)	New (N) vs. Reprocessed (R) Soil	Feed Belt Operating Time (hrs)	Feed Rate (tons/hr)	Treated Belt Operating Time (hrs)	Down Time (hrs)	Cumulative Soil Feed (tons)	Process Streams Sampled for Offsite Analysis	Comments
9/3/96	1.0	N	1.0	1.0	1.5	7.5	1.0	none	First untreated soil was processed
9/4/96	1.0	N	1.0	1.0	1.5	7.5	2.0	none	
9/5/96	3.0	N	2.0	1.5	3.0	6.0	5.0	none	
9/6/96	8.5	N/R	4.0	2.1	5.0	4.0	13.5	none	
9/7/96	0.0	N/A	0.0	0.0	0.0	9.0	13.5	none	
9/8/96	0.0	N/A	0.0	0.0	0.0	SUN	13.5	none	
9/9/96	0.0	N/A	0.0	0.0	0.0	9.0	13.5	none	Dry sieve analysis of untreated soil performed
9/10/96	0.0	N/A	0.0	0.0	0.0	9.0	13.5	none	
9/11/96	0.0	N/A	0.0	0.0	0.0	9.0	13.5	none	
9/12/96	0.0	N/A	0.0	0.0	1.5	7.5	13.5	FB	Organic stream sampled and shipped
9/13/96	6.0	N/R	3.0	2.0	4.0	5.0	19.5	none	Some soil that was treated on 9/3/96 - 9/6/96 was reprocessed
9/14/96	6.0	N/R	3.0	2.0	4.0	5.0	25.5	none	Some soil that was treated on 9/3/96 - 9/6/96 was reprocessed
9/15/96	18.5	N	8.0	2.3	9.0	0.0	44.0	T,U,L	ContraCon estimated that 33 tons were processed
9/16/96	0.0	N/A	0.0	0.0	0.0	9.0	44.0	none	Wet sieve analysis of untreated soil performed
9/17/96	0.0	N/A	0.0	0.0	4.5	4.5	44.0	none	
9/18/96	0.0	N/A	0.0	0.0	3.5	5.5	44.0	none	

DRAFT
Table 1. Operating Summary for Acetic Acid Demonstration

Date	Daily Soil Feed (tons)	New (N) vs. Reprocessed (R) Soil	Feed Belt Operating Time (hrs)	Feed Rate (tons/hr)	Treated Belt Operating Time (hrs)	Down Time (hrs)	Cumulative Soil Fed (tons)	Process Streams Sampled for Offsite Analysis	Comments
9/19/96	2.0	N	1.0	2.0	3.5	5.5	46.0	none	Startup of 1000 ton test delayed due to rain
9/20/96	10.5	N	4.0	2.6	6.0	3.0	56.5	none	
9/21/96	12.8	N	7.0	1.8	9.0	0.0	69.3	T,U	Feed rates are so low soil samples will be collected over 2 days
9/22/96	0.0	N/A	0.0	0	0.0	SUN	69.3	none	
9/23/96	16.2	N	5.5	2.9	7.5	1.5	85.5	none	
9/24/96	0.0	N/A	0.0	0.0	9.0	0.0	85.5	none	Processing Time = Treat Belt Operating Time according to BDM and ContraCon
9/25/96	10.8	N	5.5	2.0	8.5	0.5	96.3	T,U	
9/26/96	9.8	N	5.5	1.8	8.5	0.5	106.1	none	
9/27/96	6.9	N	2.6	2.7	9.0	0.0	113.0	none	
9/28/96	0.0	N/A	0.0	0.0	0.0	9.0	113.0	none	Current vacuum press cannot handle the throughput of untreated soil; a new plate press has been ordered to raise the throughput
9/29/96	0.0	N/A	0.0	0.0	0.0	SUN	113.0	none	New plate press is being hooked up to the system
9/30/96	0.0	N/A	0.0	0.0	2.5	6.5	113.0	none	
10/1/96	17.9	N	4.5	4.0	9.0	0.0	130.9	none	
10/2/96	19.5	N	6.0	3.3	9.0	0.0	150.4	T,F,Q,C,L,U	
10/3/96	27.0	R	4.5	6.0	10.0	1.0	177.4	M,O	Soil that has failed TCLP testing is being reprocessed; 58.5 tons of soil has been reprocessed to date
10/4/96	31.5	N/R	6.0	5.3	7.5	1.5	208.9	none	1.2 tons of new soil was fed to the system for 1/2 hour

DRAFT

Table 1. Operating Summary for Acetic Acid Demonstration

Date	Daily Soil Feed (tons)	New (N) vs. Reprocessed (R) Soil	Feed Belt Operating Time (hrs)	Feed Rate (tons/hr)	Treated Belt Operating Time (hrs)	Down Time (hrs)	Cumulative Soil Feed (tons)	Process Streams Sampled for Offsite Analysis	Comments
10/5/96	14.4	N	4.0	3.6	9.0	0.0	223.3	none	
10/6/96	0.0	N/A	0.0	0.0	0.0	SUN	223.3	none	
10/7/96	14.0	N	4.5	3.1	9.0	0.0	237.3	Q,P	
10/8/96	0.0	N/A	0.0	0.0	8.0	1.0	237.3	none	New plate press is clogged; filter cloths will be replaced; old vacuum belt also clogged and must be replaced
10/9/96	0.0	N/A	0.0	0.0	0.0	9.0	237.3	none	
10/10/96	0.0	N/A	0.0	0.0	0.0	9.0	237.3	T (pH adj.)	
10/11/96	0.0	N/A	0.0	0.0	0.0	9.0	237.3	O	
10/12/96	14.9	N	6.5	2.3	6.5	2.5	252.2	P	
10/13/96	9.7	N	4.5	2.2	4.5	4.5	261.9	C,F	

1.0

Date	Daily Soil Feed (tons)	Cumulative Soil Feed (tons)	Cumulative Power Used (KWH)	Cumulative Water Used (gal)	Cumulative Acetic Acid Used (gal)	Cumulative Lime Used (lbs)	Cumulative Thio-Red Used (gal)	Cumulative Floculant Used (gal)	Comments
9/3/96	1.0	1.0	< 200	15000	35	0	0	0.4	System shutdown; note: the minimum increment on the power meter was 200 kWH
9/4/96	1.0	2.0	< 200	15000	70	0	0	0.8	
9/5/96	3.0	5.0	< 200	15000	175	0	0	2.1	
9/6/96	8.5	13.5	200	15500	473	0	55	5.6	
9/7/96	0.0	13.5	200	16200	473	0	55	5.6	
9/8/96	0.0	13.5	200	17000	473	0	110	5.6	
9/9/96	0.0	13.5	200	17800	473	0	110	5.6	
9/10/96	0.0	13.5	200	24000	473	0	110	5.6	
9/11/96	0.0	13.5	200	29500	473	0	110	5.6	
9/12/96	0.0	13.5	200	30100	473	0	110	5.6	
9/13/96	6.0	19.5	200	30750	683	0	135	8.2	
9/14/96	6.0	25.5	400	31500	893	0	135	10.7	
9/15/96	18.5	44.0	800	32250	1540	0	165	18.4	Pilot Test started
9/16/96	0.0	44.0	800	33900	1540	0	165	18.4	Awaiting TCLP and total metals results
9/17/96	0.0	44.0	1000	34600	1540	0	165	18.4	Awaiting TCLP and total metals results

DRAFT

Table 2. Utilities and Reagents Usage Summary - Acetic Acid Demonstration

Date	Daily Soil Feed (tons)	Cumulative Soil Feed (tons)	Cumulative Power Used (KWH)	Cumulative Water Used (gal)	Cumulative Acetic Acid Used (gal)	Cumulative Lime Used (lbs)	Cumulative Thio-Red Used (gal)	Cumulative Floculant Used (gal)	Comments
9/18/96	0.0	44.0	1000	35800	1540	0	165	18.4	Awaiting TCLP and total metals results
9/19/96	2.0	46.0	1000	36600	1610	1000	220	19.2	Pond was pH adjusted and emptied; awaiting TCLP and total metals results
9/20/96	10.5	56.5	1200	37500	1978	1000	220	23.6	Received TCLP and total metals results; passed TCLP and total metals criteria
9/21/96	12.8	69.3	1600	38600	2426	1000	275	29.0	
9/22/96	0.0	69.3	1600	38600	2426	1000	275	29.0	
9/23/96	16.2	85.5	2000	39350	2993	1000	305	35.7	
9/24/96	0.0	85.5	2200	40200	2993	1000	305	35.7	
9/25/96	10.8	96.3	2400	40450	3371	1750	330	40.3	
9/26/96	9.8	106.1	2800	40600	3714	1750	330	44.3	
9/27/96	6.9	113.0	3000	41550	3955	1800	365	47.2	
9/28/96	0.0	113.0	3000	42100	3955	1850	365	47.2	
9/29/96	0.0	113.0	3000	42100	3955	1850	365	47.2	
9/30/96	0.0	113.0	3000	42850	3955	2900	365	47.2	Pond was pH adjusted and emptied
10/1/96	17.9	130.9	3400	43550	4582	3000	385	54.7	
10/2/96	19.5	150.4	3800	44050	5264	3600	435	62.9	

DRAFT
Table 2. Utilities and Reagents Usage Summary - Acetic Acid Demonstration

Date	Daily Soil Feed (tons)	Cumulative Soil Feed (tons)	Cumulative Power Used (KWH)	Cumulative Water Used (gal)	Cumulative Acetic Acid Used (gal)	Cumulative Lime Used (lbs)	Cumulative Thio-Red Used (gal)	Cumulative Floculant Used (gal)	Comments
10/3/96	27.0	177.4	4200	44500	6209	3700	485	74.2	
10/4/96	32.7	210.1	4600	45400	7312	6500	550	87.8	Pond was pH adjusted and emptied
10/5/96	14.4	224.5	4800	46200	7858	6700	770	93.8	Thio-Red addition was quadrupled because lead in system water was too high
10/6/96	0.0	224.5	4800	46200	7858	6700	770	93.8	
10/7/96	13.9	238.4	5200	46950	8344	8400	770	99.7	Pond was pH adjusted and emptied
10/8/96	0.0	238.4	5400	47450	8344	8500	990	99.7	
10/9/96	0.0	238.4	5600	48250	8624	8600	990	99.7	
10/10/96	0.0	238.4	5600	49000	8624	9000	990	99.7	
10/11/96	0.0	238.4	5800	49700	8624	9000	990	99.7	
10/12/96	14.9	253.3	6000	50300	8939	9200	1100	105.9	
10/13/96	9.7	263.0	6200	51250	9415	9400	1210	109.9	

DRAFT
Table 4. Offsite Samples Summary

Date	Process Stream	Sample No.	Analysis Requested	Wet Wt./Vol. of Composite (lbs/L)	Moisture Content (%)	Minus 10 mesh soil dry weight (lbs)	Lead (g) in +10 mesh	Comments
9/10/96	FB	C-SP10-FB	TCLP/METALS	2 L	0.0	---	---	Field Blank sample collected by running clean sand through processing equipment.
9/12/96	Z	C-SP12-Z	TCLP/METALS	20 lbs.	---	---	---	Organic material screened out and collected in 55-gal. drums. Sample taken from drum.
9/15/96	T	C-SP15-T	TCLP/METALS	346 lbs.	45.7	---	---	Treated sample collected from the initial pilot test (Test = 18 tons processed).
9/15/96	U	C-SP15-U	TCLP/METALS	270 lbs.	6.4	252	313.3	Untreated sample collected from the soil delivered to pad on 9/3/96 - 9/4/96.
9/15/96	L	C-SP15-L	TCLP/METALS	79 lbs.	59.3	---	---	Sample collected from log washer basin; Feeds the leaching circuit.
9/21/96	T	C-SP21-T	TCLP/METALS	307 lbs.	---	---	---	Treated sample collected on 10/20/96 - 10/21/96
9/21/96	U	C-SP21-U	TCLP/METALS	241 lbs.	9.2	218.6	140.6	Untreated sample collected from the soil delivered to pad on 9/20/96 - 9/21/96.
9/25/96	T	C-SP25-T	TCLP/METALS	318 lbs.	---	---	---	Treated sample collected from runs on 9/23/96 - 9/25/96 On 9/24/96 only leached fines were discharged.
9/25/96	U	C-SP25-U	TCLP/METALS	262 lbs.	7.6	240.9	582.6	Untreated sample collected from the soil delivered to pad on 9/20/96 - 9/21/96.
10/2/96	T	C-OC02-T	TCLP/METALS	302 lbs.	---	---	---	Treated sample collected from runs on 10/1/96 - 10/2/96 from two separate piles.
10/2/96	U	C-OC02-U	TCLP/METALS	240 lbs.	8.4	239	458.7	Untreated sample collected from the soil delivered to pad on 9/20/96 - 9/21/96.
10/2/96	F	C-OC02-F	TCLP/METALS	23 lbs.	32.3	---	---	Collected sample of leach circuit output after it had been dewatered in the plate press.
10/2/96	C	COC02-C	TCLP/METALS	45 lbs.	11.8	---	---	Collected sample of sand screw (coarse) output after it has been dewatered in the small vacuum press.
10/2/96	L	COC02-L	TCLP/METALS	86 lbs.	42.1	---	---	Sample collected from the log washer basin. Feeds the leaching circuit. (Volume = 27 gal)
10/2/96	Q	C-OC02-Q	TCLP/METALS	2 L	liquid	---	---	Sample collected from the output pipe of Precipitation Tank (Inlet to clarifying tanks).
10/3/96	M	C-OC03-M	TCLP/METALS	111 lbs.	20.4	---	---	Sample taken from 55-gallon drum which collects the jig underflow.

DRAFT

Table 4. Offsite samples Summary

Date	Process Stream	Sample No.	Analysis Requested	Wet Wt./Vol. of Composite (lbs/L)	Moisture Content (%)	Minus 10 mesh soil dry weight (lbs)	Lead (g) in +10 mesh	Comments
10/3/96	O	C-OC03-O	TCLP/METALS	202 lbs.	14.1	173.5	2.4	Sample taken from 55-gallon drum which collects [(+3/8") - (-1/2")] from the screen deck.
10/5/96	FB	C-OC05-FB	TCLP/METALS	2 L	---	---	---	Field Blank sample collected by running clean sand through processing equipment.
10/7/96	Q	C-OC07-Q	TCLP/METALS	1 L	liquid	---	---	Sample collected from the output pipe of Precipitation Tank after large Thio-Red addition.
10/7/96	P	C-OC07-P	TCLP/METALS	2 L	60.9	---	---	Sample collected from Precipitation Tank by CNW.
10/10/96	T	C-OC10-T	TCLP/METALS	2 L	17.7	---	---	Sample 1/2 solids - 1/2 liquid.
10/10/96	T	C-OC10-T	TCLP	1 L	---	---	---	pH = 3.7; No neutralization to sample; 500 mL collected for water wash test.
10/10/96	T	C-OC10-T	TCLP	1 L	---	---	---	pH = 5.8; Neutralization Test; Additional sample given to M. Bricka.
10/10/96	T	C-OC10-T	TCLP	1 L	---	---	---	pH = 7.6; Neutralization Test; Additional sample given to M. Bricka.
10/11/96	U	C-OC11-U	TCLP/METALS	100 lbs.	7.2	92.2	271.6	pH = 11.5; Neutralization Test; Additional sample given to M. Bricka.
10/11/96	O	C-OC11-O	TCLP/METALS (Hand Sort)	19.58 lbs	3.2	11.9	3221	Untreated soil sample collected from material delivered on 10/3/96 - 10/4/96
10/12/96	P	C-OC12-P	TCLP/METALS	2 L	55.6	---	---	Samples came from log washer which was emptied on 10/10/96 - 10/11/96.
10/12/96	C	C-OC12-C	TCLP/METALS	---	18.8	---	---	Precipitate sample taken on 10/12/96; Collected directly from tank by R. Foyle.
10/12/96	F	C-OC12-F	TCLP/METALS	---	48.4	---	---	Samples combined with C-OC12-F to make sample C-OC13-T.
								Combined with C-OC12-C to make sample C-OC13-T

DRAFT

Table 3. XRF Measurements Summary for ContraCon Demonstration

Date	Process Stream	Sample No.	XRF Basis (Wet/Dry)	XRF Lead (mg/kg)	XRF Cu (mg/kg)	XRF Zn (mg/kg)	XRF Sb (mg/kg)	XRF Totals (mg/kg)
9/21/96	U	C-SP21-U-D1	D	377.586	44.057	0.000	44.642	466.284
9/21/96	T	C-SP21-T-D1	D	76.065	21.339	0.000	15.386	112.789
9/21/96	T	C-SP21-T-D2	D	344.134	111.636	29.621	118.684	604.075
9/21/96	T	C-SP21-T-D3	D	70.765	71.830	0.000	38.604	181.199
9/21/96	T	C-SP21-T-D4	D	96.071	66.969	0.000	37.624	200.664
9/21/96	T	C-SP21-T-D5	D	61.876	0.000	0.000	24.512	86.388
9/21/96	T	C-SP21-T-D6	D	365.794	128.170	0.000	113.632	607.596
9/21/96	T	C-SP21-T-W1	W	64.475	20.556	0.000	32.603	117.633
9/21/96	T	C-SP21-T-W2	W	279.562	119.432	24.767	81.398	505.160
9/21/96	T	C-SP21-T-W3	W	74.045	22.248	0.000	22.182	118.476
9/21/96	T	C-SP21-T-W4	W	83.973	19.508	0.000	29.977	133.458
9/21/96	T	C-SP21-T-DW	D	186.463	91.771	0.000	85.462	363.696
9/21/96	T	C-SP21-T-P1	D	263.113	118.149	0.000	69.945	451.207
9/23/96	M	C-SP23-M-W1	W	174.702	51.919	0.000	39.739	266.360
9/23/96	M	C-SP23-M-W2	W	248.778	79.112	0.000	33.132	361.022
9/23/96	T	C-SP23-T-W1	W	143.302	74.855	0.000	16.548	234.705

DRAFT

Table 3. XRF Measurements Summary for ContraCon Demonstration

Date	Process Stream	Sample No.	XRF Basis (Wet/Dry)	XRF Lead (mg/kg)	XRF Cu (mg/kg)	XRF Zn (mg/kg)	XRF Sb (mg/kg)	XRF Totals (mg/kg)
9/23/96	T	C-SP23-T-W2	W	328.340	235.611	21.597	47.285	632.834
9/23/96	T	C-SP23-T-D2	D	114.011	101.431	0.000	45.763	261.205
9/23/96	T	C-SP23-T-D5	D	172.104	65.393	18.563	46.780	302.839
9/23/96	T	C-SP23-T-D5	D	150.431	46.339	16.843	45.656	259.269
9/23/96	T	C-SP23-T-D9	D	155.024	67.343	0.000	50.947	273.314
9/25/96	T	C-SP25-T-W3	W	163.378	205.363	29.233	44.696	442.670
9/25/96	T	C-SP25-T-W4	W	203.212	101.357	0.000	37.431	342.000
9/25/96	U	C-SP25-U-D2	D	386.840	30.881	0.000	54.794	472.515
9/25/96	T	C-SP25-T-D3	D	145.959	136.578	0.000	80.557	363.094
9/25/96	T	C-SP25-T-D4	D	104.567	98.984	0.000	60.747	264.298
9/26/96	T	C-SP26-T-W1	W	213.851	208.719	17.646	21.718	461.933
9/26/96	T	C-SP26-T-D1	D	298.816	186.030	0.000	55.322	540.168
9/26/96	T	C-SP26-T-D2	D	359.606	129.118	47.036	94.202	629.962
9/26/96	T	C-SP26-T-D3	D	313.178	182.559	77.594	90.891	664.223
9/26/96	T	C-SP26-T-D4	D	367.030	173.244	42.548	58.409	641.230
10/1/96	T	C-OC01-T-V1	W	175.347	44.983	0.000	42.153	262.484

DRAFT

Table 3. XRF Measurements Summary for ContraCon Demonstration

Date	Process Stream	Sample No.	XRF Basis (Wet/Dry)	XRF Lead (mg/kg)	XRF Cu (mg/kg)	XRF Zn (mg/kg)	XRF Sb (mg/kg)	XRF Totals (mg/kg)
10/1/96	T	C-OC01-T-V1	D	172.652	110.217	0.000	68.802	351.671
10/1/96	T	C-OC01-T-V2	W	137.489	57.588	24.107	29.701	248.885
10/1/96	T	C-OC01-T-V2	D	169.466	105.103	0.000	82.755	357.324
10/1/96	T	C-OC01-T-F1	W	801.604	484.876	68.677	272.790	1627.947
10/1/96	T	C-OC01-T-F1	D	814.750	587.033	76.498	296.187	1774.468
10/1/96	T	C-OC01-T-F2	W	659.771	436.749	34.082	261.833	1392.435
10/1/96	T	C-OC01-T-F2	D	817.279	548.036	0.000	322.127	1687.442
10/1/96	T	C-OC01-T-F3	D	686.197	482.155	63.303	255.470	1487.125
10/1/96	T	C-OC01-T-F4	D	706.452	447.661	56.147	231.902	1442.162
10/1/96	T	C-OC01-T-C1	D	225.822	10.961	0.000	59.464	296.247
10/1/96	T	C-OC01-T-C2	D	235.016	157.436	0.000	50.758	443.210
10/1/96	T	C-OC01-T-C3	D	195.559	116.809	0.000	44.356	356.724
10/1/96	T	C-OC01-T-C4	D	226.401	55.986	0.000	63.135	345.522
10/1/96	T	C-OC01-T-S1	W	284.537	388.636	43.732	61.890	778.794
10/1/96	T	C-OC01-T-S2	W	269.724	427.741	0.000	72.171	769.636
10/1/96	T	C-OC01-T-S2	D	275.018	88.096	0.000	72.620	435.733

DRAFT

Table 3. XRF Measurements Summary for ContraCon Demonstration

Date	Process Stream	Sample No.	XRF Basis (Wet/Dry)	XRF Lead (mg/kg)	XRF Cu (mg/kg)	XRF Zn (mg/kg)	XRF Sb (mg/kg)	XRF Totals (mg/kg)
10/1/96	T	C-OC01-T-P1	W	524.980	393.583	32.630	264.430	1215.623
10/1/96	T	C-OC01-T-P2	W	562.890	366.321	37.357	290.650	1257.218
10/1/96	T	C-OC01-T-W1	W	204.081	108.257	20.802	48.717	381.856
10/1/96	U	C-OC01-U-D1	D	291.726	54.037	0.000	28.117	373.880
10/1/96	U	C-OC01-U-D2	D	294.135	0.000	18.604	45.390	358.129
10/2/96	T	C-OC02-T-C1	D	202.701	72.870	43.527	49.879	368.977
10/2/96	T	C-OC02-T-C2	D	143.418	139.631	0.000	49.075	332.124
10/2/96	T	C-OC02-T-C3	D	204.980	120.615	17.831	24.284	367.710
10/2/96	T	C-OC02-T-C4	D	211.682	157.812	0.000	37.813	407.307
10/2/96	T	C-OC02-T-C5	D	512.311	476.515	31.126	66.575	1086.527
10/2/96	T	C-OC02-T-F1	D	802.410	512.946	40.174	283.670	1639.200
10/2/96	T	C-OC02-T-F2	D	1179.180	975.889	90.245	397.087	2642.401
10/3/96	T	C-OC03-T-C1	D	203.474	241.459	39.232	42.179	526.343
10/3/96	T	C-OC03-T-C2	D	135.100	54.277	38.980	46.096	274.452
10/3/96	T	C-OC03-T-C3	D	146.696	103.680	0.000	45.389	295.765
10/4/96	T	C-OC04-T-C1	D	141.874	74.261	24.059	16.565	256.759

DRAFT

Table 3. XRF Measurements Summary for ContraCon Demonstration

Date	Process Stream	Sample No.	XRF Basis (Wet/Dry)	XRF Lead (mg/kg)	XRF Cu (mg/kg)	XRF Zn (mg/kg)	XRF Sb (mg/kg)	XRF Totals (mg/kg)
10/4/96	T	C-OC04-T-C2	D	89.985	0.000	40.915	24.754	155.654
10/4/96	M	C-OC04-M-W1	W	198.900	201.295	52.665	62.798	515.658
10/4/96	M	C-OC04-M-W2	W	341.662	170.597	0.000	29.975	542.234
10/4/96	M	C-OC04-M-W3	W	337.848	266.377	0.000	51.863	656.088
10/4/96	M	C-OC04-M-W4	W	192.567	36.019	20.619	19.045	268.249
10/5/96	T	C-OC05-T-C1	W	217.147	203.495	0.000	45.672	466.314
10/5/96	T	C-OC05-T-C2	W	179.308	134.837	20.691	47.679	382.515
10/5/96	T	C-OC05-T-C3	W	220.403	280.187	25.154	62.819	588.562
10/5/96	T	C-OC05-T-C4	D	116.571	165.505	0.000	51.432	333.508
10/5/96	T	C-OC05-T-C5	D	488.293	415.361	46.233	79.038	1028.925
10/5/96	T	C-OC05-T-F1	D	797.470	875.914	81.663	343.999	2099.046
10/5/96	Q	C-OC05-Q-PA	W	0.000	0.000	120.128	0.000	120.128
10/5/96	Q	C-OC05-Q-PB	W	0.000	0.000	113.462	0.000	113.462
10/5/96	Q	C-OC05-Q-B1	W	1537.680	0.000	264.511	0.000	1802.191
10/5/96	Q	C-OC05-Q-T3	W	1752.890	50.780	272.447	0.000	2076.117
10/5/96	Q	C-OC05-Q-T4	W	1424.890	0.000	219.114	0.000	1644.004

DRAFT

Table 3. XRF Measurements Summary for ContraCon Demonstration

Date	Process Stream	Sample No.	XRF Basis (Wet/Dry)	XRF Lead (mg/kg)	XRF Cu (mg/kg)	XRF Zn (mg/kg)	XRF Sb (mg/kg)	XRF Totals (mg/kg)
10/5/96	RC	C-OC05-RC	W	5604.240	1081.650	636.681	59.809	7382.380
10/5/96	U	C-OC05-U-D1	D	480.179	0.000	0.000	42.273	522.452
10/7/96	P	C-OC07-P-W1	W	7824.130	1384.270	268.279	296.788	9773.467
10/7/96	P	C-OC07-P-W2	W	8279.520	1335.290	358.616	264.058	10237.484
10/7/96	P	C-OC07-P-W3	W	3100.290	2569.940	179.625	346.493	6196.348
10/7/96	T	C-OC07-T-C1	W	385.385	317.562	44.176	93.087	840.210
10/7/96	T	C-OC07-T-C2	W	361.295	253.090	20.694	110.549	745.628
10/7/96	T	C-OC07-T-C3	W	305.491	240.741	0.000	83.373	629.605
10/7/96	T	C-OC07-T-C4	W	274.333	313.703	28.511	77.160	693.707
10/7/96	RC	C-OC07-RC	W	5754.940	2901.550	685.968	58.120	9400.578
10/7/96	U	C-OC07-U-D1	D	695.142	88.769	36.617	76.289	896.817
10/8/96	T	C-OC08-T-C1	W	765.697	975.764	113.997	155.174	2010.632
10/8/96	T	C-OC08-T-C6	D	865.663	1041.940	90.309	168.641	2166.553
10/8/96	T	C-OC08-T-F1	W	743.801	959.608	59.918	302.629	2065.956
10/8/96	T	C-OC08-T-F2	W	983.934	2002.010	97.568	343.455	3426.967
10/8/96	T	C-OC08-T-F3	W	785.315	934.872	40.072	310.856	2071.115

DRAFT

Table 3. XRF Measurements Summary for ContraCon Demonstration

Date	Process Stream	Sample No.	XRF Basis (Wet/Dry)	XRF Lead (mg/kg)	XRF Cu (mg/kg)	XRF Zn (mg/kg)	XRF Sb (mg/kg)	XRF Totals (mg/kg)
10/9/96	T	C-OC09-T-F1	W	867.479	1530.600	127.553	395.536	2921.168
10/9/96	T	C-OC09-T-F2	W	932.756	1856.160	67.788	472.796	3329.500
10/9/96	T	C-OC09-T-C1	W	371.028	391.438	47.480	78.383	888.329
10/9/96	T	C-OC09-T-C2	W	330.751	587.339	55.498	62.739	1036.326
10/9/96	T	C-OC09-T-C3	W	475.578	393.031	45.500	107.155	1021.264
10/9/96	T	C-OC09-T-C4	W	600.764	703.008	50.291	137.631	1491.694
10/9/96	T	C-OC09-U-D3	D	735.683	93.951	17.582	86.858	934.074
10/10/96	T	C-OC10-T-F1	T	555.613	299.977	35.047	238.392	1129.029

DRAFT

Table 4. Onsite Samples Summary

Date	Process Stream	Sample No.	Analysis Requested	Wet Wt./Vol. of Composite (lbs/L)	Moisture Content (%)	Minus 10 mesh soil dry weight (lbs)	Plus 10 mesh dry weight (g)	Comments
11/15/96	Z	B-NV15-Z	TCLP/TOTALS	10 lbs.	40	----	----	Organic sample
11/15/96	T	B-NV15-T	TCLP/TOTALS	70 lbs.	23	----	----	Treated sample taken from output produced on 11/15/96 storage bin #1
11/16/96	U	B-NV16-U	TCLP/TOTALS	150 lbs.	8.2	136.6	491.3	
11/16/96	T	B-NV16-T	TCLP/TOTALS	150 lbs.	35.7	----	----	
11/20/96	U	B-NV20-U	TCLP/TOTALS	225 lbs.	9.1	203.2	617.7	Samples were completely dried and taken through entire sampling process. Lead fraction removed and weighed.
11/20/96	T	B-NV20-T	TCLP/TOTALS	225 lbs.	23.1	----	----	Samples were completely dried and taken through entire sampling process.
11/21/96	U	B-NV21-U	TCLP/TOTALS	150 lbs.	9.6	134.8	357.9	Collected 3-50 lb samples from the input pile, grabbed as front loader removed dirt from pad.
11/21/96	T	B-NV21-T	TCLP/TOTALS	150 lbs.	24.2	----	----	Collected 3-50 lb samples of treated output from the Bescorp soil washing plant.
11/22/96	U	B-NV22-U	TCLP/TOTALS	150 lbs.	8.7	136.0	426.7	Sample of untreated soil from the input pile.
11/22/96	T	B-NV22-T	TCLP/TOTALS	150 lbs.	21.0	----	----	Sample of treated soil from output pile.
11/22/96	C	B-NV22-C	TCLP/TOTALS	42 lbs.	43.1	----	----	Collected sample of 2nd sand screw (coarse) prior to pH adjustment. Collected in conjunction with streams M & K
11/22/96	K	B-NV22-K	TCLP/TOTALS	51 lbs.	39.6	30.4	186.1	Collected 51 lbs. of input soil to the jig. Sample taken from the outlet of 1st screw. Taken with C & M
11/22/96	M	B-NV22-M	TCLP/TOTALS	50 lbs.	57.8	----	----	Sample from soil from jig bed underflow. Stream becoming more concentrated, but still added back to untreated pile
11/23/96	T	B-NV23-T	TCLP/TOTALS	150 lbs.	22.3	----	----	Sample of treated soil from output pile.
11/25/96	U	B-NV25-U	TCLP/TOTALS	136 lbs.	10.3	121.0	465.5	Sample of untreated soil from the input pile.

DRAFT

Table 4. Offsite Samples Summary

Date	Process Stream	Sample No.	Analysis Requested	Wet Wt./Vol. of Composite (lbs/L)	Moisture Content (%)	Minus 10 mesh soil dry weight (lbs)	Plus 10 mesh dry weight (g)	Comments
11/25/96	T	B-NV25-T	TCLP/TOTALS	157 lbs.	22.9	----	----	Sample of treated soil from output pile.
11/25/96	P	B-NV25-P	TCLP/TOTALS	41 lbs	63.3	----	----	Sample of precipitate sludge from roll-off bin
11/26/96	U	B-NV26-U	TCLP/TOTALS	136 lbs.	9.2	122.4	483.6	Sample of untreated soil from the input pile.
11/26/96	T	B-NV26-T	TCLP/TOTALS	155 lbs.	22.4	----	----	Sample of treated soil from output pile. Soil is being stored in front of Bin #6 and Bin #7
11/26/96	Qc,Qf	B-NV26-Qc,Qf	TCLP/TOTALS	1 L	liquid	----	----	Collected 500mL of process sol'n from circulation tank and 500mL of process sol'n from overflow of clarifier #1
11/27/96	T	B-NV27-T	TCLP/TOTALS	156 lbs.	21.6	----	----	Collected 156 lbs. of treated soil from output pile.
11/29/96	T	B-NV29-T	TCLP/TOTALS	151 lbs.	----	----	----	Sample of treated soil from Bin #1 soil pile.
11/30/96	T	B-NV30-T	TCLP/TOTALS	147 lbs.	----	----	----	Sample of treated soil from Bin #2 soil pile.
12/2/96	T	B-DC02-T	TCLP/TOTALS	158 lbs.	22.4	----	----	Sample of treated soil from output pile.
12/2/96	F	B-DC02-F	TCLP/TOTALS	77 lbs.	20.5	----	----	Collected 77 lbs. of soil from the fines output from the centrifuge.
12/2/96	L	B-DC02-L	TCLP/TOTALS	97 lbs.	liquid	----	----	Collected 97 lbs. of liquid/soil from the overflow of the first sand screw.
12/3/96	U	B-DC03-U	TCLP/TOTALS	139 lbs.	8.7	126.2	324.2	Sample of untreated soil from the input pile.
12/3/96	T	B-DC03-T	TCLP/TOTALS	157 lbs.	22.1	----	----	Sample of treated soil from output pile.
12/3/96	FB	B-DC03-FB	TCLP/TOTALS	52 lbs.	0.0	----	----	Processed 52 lbs. of Decon sand through the sampling equipment.
12/4/96	U	B-DC04-U	TCLP/TOTALS	136 lbs.	8.8	123.5	250.3	Sample of untreated soil from the input pile.

DRAFT

Table 4. Offsite Samples Summary

Date	Process Stream	Sample No.	Analysis Requested	Wet Wt./Vol. of Composite (lbs/L)	Moisture Content (%)	Minus 10 mesh soil dry weight (lbs)	Plus 10 mesh dry weight (g)	Comments
12/4/96	T	B-DC04-T	TCLP/TOTALS	159 lbs.	19.4	----	----	Sample of treated soil from output pile.
12/5/96	T	B-DC05-T	TCLP/TOTALS	155 lbs.	19.1	----	----	Sample of treated soil from output pile.
12/5/96	Z	B-DC05-Z	TCLP/TOTALS	30 lbs.	----	----	----	Organic dried overnight and placed into 2-500mL jars, combined for analyzation.
12/5/96	C	B-DC05-C	TCLP/TOTALS	76 lbs.	20.2	----	----	Collected sample of coarse output from sand screw.
12/5/96	K	B-DC05-K	TCLP/TOTALS	90 lbs.	18.2	73.6	26.5	Sample collected from output of first sand screw.
12/6/96	T	B-DC06-T	TCLP/TOTALS	152 lbs.	21.1	----	----	Sample of treated soil from output pile.
12/6/96	F	B-DC06-F	TCLP/TOTALS	55 lbs.	20.9	----	----	Collected 55 lbs. of soil from the fines output from the centrifuge.
12/6/96	L	B-DC06-L	TCLP/TOTALS	66 lbs.	liquid	----	----	Liquid/soil from the overflow of first sand screw
12/6/96	P	B-DC06-P	TCLP/TOTALS	52 lbs.	62.5	----	----	Sample of precipitate sludge from 2nd sludge bin.
12/6/96	Qc, Qf	B-DC06-Qc, Qf	TCLP/TOTALS	1 L	liquid	----	----	Collected 500mL of process sol'n from circulation tank and 500mL of process sol'n from overflow of clarifier #1
12/12/96	T	B-DC12-T	TCLP/TOTALS	50 lbs.	22.3	----	----	Sample of treated soil from output pile.

Table 5: Laboratory Sample Preparation and Data for Bescorp Field Demonstration

DRAFT

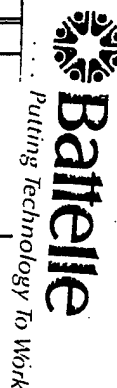

Sample No.	Type Analysis	pH	Wet Wt. (lbs)	Dry Wt. (lbs)	Moisture Content	+30 Mesh Wt. (g)	Comments
B-NV14-FB-1A	TCLP						
B-NV15-T-1A	TCLP	5.70	3	3	0.00%	-	
B-NV15-T-1B	TCLP	5.90	3.03	3.03	0.00%	-	
B-NV15-T-1D	Metals	-	2.97	2.7	9.09%	1.7	
B-NV15-T-1E	Metals	-	2.7	2.45	9.26%	1	
B-NV15-Z-1A	TCLP		0.54	-	-	-	100g taken for TCLP before drying. (.316 lbs. left for metals)
B-NV15-Z-1A	Metals	-	0.316	0.16	49.37%	2.3	
B-NV16-U-1A	TCLP	5.00	3.34	3.34	0.00%	-	
B-NV16-U-1B	TCLP	5.00	3.32	3.32	0.00%	-	
B-NV16-U-1D	Metals	-	1.20	1.176	1.84%	5.8	
B-NV16-U-1E	Metals	-	3.464	3.37	2.71%	10.7	
B-NV16-U-1L	Weight	-	1.082	1.082	0.00%	-	
B-NV16-T-1A	TCLP	6.84	3	3	0.00%	-	
B-NV16-T-1B	TCLP	7.01	3.00	3	0.00%	-	
B-NV16-T-1D	Metals	-	3.16	3.16	0.00%	8.3	
B-NV16-T-1E	Metals	-	3.44	3.44	0.00%	10.90	
B-NV20-U-1A	TCLP	5.17	3.71	3.71	0.00%	-	Use proc. 7.1.4.3 pH=2.0
B-NV20-U-1B	TCLP	-	3.7	3.7	0.00%	-	
B-NV20-U-1D	Metals	-	3.356	3.326	0.89%	14.2	
B-NV20-U-1E	Metals	-	3.352	3.334	0.54%	13.4	
B-NV20-T1-A	TCLP	6.50	3.128	3.128	0.00%	-	
B-NV20-T1-B	TCLP	-	2.994	2.994	0.00%	-	
B-NV20-T1-D	Metals	-	2.892	2.83	2.14%	13.3	
B-NV20-T1-E	Metals	-	2.99	2.93	2.01%	8.2	
B-NV21-U-1A	TCLP	5.10	3.32	3.32	0.00%	-	
B-NV21-U-1B	TCLP	-	3.58	3.58	0.00%	-	
B-NV21-U-1D	Metals	-	3.646	3.65	0.00%	6.5	
B-NV21-U-1E	Metals	-	3.396	3.396	0.00%	16	
B-NV21-U-1L	Weight	-	0.786	0.786	0.00%	-	
B-NV21-T-1A	TCLP	6.70	3.2	damp		-	
B-NV21-T-1B	TCLP	-	2.95	damp		-	
B-NV21-T-1D	Metals	-	2.862	2.86	0.00%	3.9	
B-NV21-T-1E	Metals	-	2.83	2.83	0.00%	6.4	
B-NV22-T-1A	TCLP	8.91	3.104	3.104	0.00%	-	bone dry
B-NV22-T-1B	TCLP	-	3.146	3.146	0.00%	-	bone dry
B-NV22-T-1D	Metals	-	3.018	3.018	0.00%	3.2	
B-NV22-T-1E	Metals	-	2.986	2.986	0.00%	6.7	
B-NV22-U-1A	TCLP	5.12	2.968	2.968	0.00%	-	
B-NV22-U-1B	TCLP	-	3.256	3.256	0.00%	-	Lost? Used NV22URT
B-NV22-U-RT	TCLP	-	2.996	2.996	0.00%	-	
B-NV22-U-1D	Metals	-	2.904	2.79	3.93%	10.2	
B-NV22-U-1E	Metals	-	2.856	2.748	3.78%	10.1	
B-NV22-C-1A	TCLP/Metals	5.59	3.504	3.504	0.00%	22.0	5.59 initial pH then w/ HCl pH=2.03
B-NV22-C-1B	TCLP	-	3.64	3.64	0.00%	30.6	
B-NV22-K-1A	TCLP	-	3.362	3.362	0.000%	-	
B-NV22-K-1A	Metals	-	2.916	2.904	0.412%	22.6	
B-NV22-K-1B	TCLP	-	3.424	3.424	0.000%	-	
B-NV22-K-1B	Metals	-	3.2	3.18	0.625%	11.0	
B-NV22-M-1A	TCLP	-	3.592	3.592	0.00%	-	
B-NV22-M-1A	Metals	-	3.138	3.128	0.319%	38.3	Weights of sample after TCLP taken (100g)
B-NV23-T-1A	TCLP	7.50	2.74	2.63	3.70%	-	
B-NV23-T-1B	TCLP	-	2.724	2.62	3.70%	-	
B-NV23-T-1D	Metals	-	2.76	2.66	3.70%	7.8	
B-NV23-T-1E	Metals	-	2.86	2.75	3.70%	11.5	

- = Not Requested/Applicable

Table 5: Laboratory Sample Preparation and Data for Bescorp Field Demonstration

DRAFT



Sample No.	Type Analysis	pH	Wet Wt. (lbs)	Dry Wt. (lbs)	Moisture Content	+30 Mesh Wt. (g)	Comments
B-NV25-T-1A	TCLP	9.60	3.028	3.03	0.00%	-	
B-NV25-T-1B	TCLP	-	3.15	3.15	0.00%	-	
B-NV25-T-1D	Metals	-	3.25	3.25	0.00%	12.1	
B-NV25-T-1E	Metals	-	3.234	3.23	0.00%	12.1	
B-NV25-U-1A	TCLP	-	3.324	3.324	0.00%	-	
B-NV25-U-1B	TCLP	-	3.256	3.256	0.00%	-	
B-NV25-U-1D	Metals	-	3.442	3.442	0.00%	23.6	
B-NV25-U-1E	Metals	-	3.37	3.37	0.00%	15	
B-NV25-U-1L	TCLP/Metals	-	1.03	1.03	0.00%	-	
B-NV25-P-1A	TCLP/Metals	7.74	1.208	1.208	0.00%	0.9	
B-NV26-T-1A	TCLP	7.54	3.402	3.402	0.00%	-	
B-NV26-T-1B	TCLP	-	3.306	3.306	0.00%	-	
B-NV26-T-1D	Metals	-	3.386	3.386	0.00%	14.8	
B-NV26-T-1E	Metals	-	3.38	3.38	0.00%	4.6	
B-NV26-U-1A	TCLP	5.51	3.498	3.498	0.00%	-	
B-NV26-U-1B	TCLP	-	3.514	3.514	0.00%	-	
B-NV26-U-1D	Metals	-	3.432	3.432	0.00%	4.6	
B-NV26-U-1E	Metals	-	3.4	3.4	0.00%	3.7	
B-NV26-U-1L	TCLP/Metals	-	1.078	1.078	0.00%	-	
B-NV26-Qf-1A	Metals	1.56	1.526	-	-	-	
B-NV26-Qc-1A	Metals	1.45	1.430	-	-	-	
B-NV27-T-1A	TCLP	4.94	3.612	3.612	0.00%	-	
B-NV27-T-1B	TCLP	-	3.54	3.54	0.00%	-	
B-NV27-T-1D	Metals	-	3.512	3.512	0.00%	8.6	
B-NV27-T-1E	Metals	-	3.51	3.51	0.00%	6.8	
B-NV29-T-1A	TCLP	4.72	3.182	3.182	0.00%	-	
B-NV29-T-1B	TCLP	-	3.154	3.154	0.00%	-	
B-NV29-T-1D	Metals	-	3.324	3.324	0.00%	15.9	
B-NV29-T-1E (C)	Metals	-	3.482	3.482	0.00%	15.7	
B-NV30-T-1A	TCLP	4.96	3.44	3.44	0.00%	-	
B-NV30-T-1B	TCLP	-	3.364	3.364	0.00%	-	
B-NV30-T-1D	Metals	-	3.324	3.324	0.00%	6.8	
B-NV30-T-1E (C)	Metals	-	3.296	3.296	0.00%	15	
B-DC02-T-1A	TCLP	9.02	3.054	moist	-	-	pH kept creeping up
B-DC02-T-1B	TCLP	-	3.088	moist	-	-	
B-DC02-T-1D	Metals	-	2.902	2.862	1.38%	7.5	
B-DC02-T-1E	Metals	-	2.918	2.826	3.15%	8.7	
B-DC02-L-1A	TCLP/Metals	-	2.976	2.976	0.00%	7.3	
B-DC02-F-1A	TCLP/Metals	-	3.128	3.128	0.00%	1.7	
B-DC03-T-1A	TCLP	6.99	3.516	3.516	0.00%	-	
B-DC03-T-1B	TCLP	-	3.488	3.488	0.00%	-	
B-DC03-T-1D	Metals	-	3.422	3.422	0.00%	8.7	
B-DC03-T-1E	Metals	-	3.376	3.376	0.00%	10.5	
B-DC03-U-1A	TCLP	5.52	3.570	3.570	0.00%	-	
B-DC03-U-1B	TCLP	-	3.440	3.440	0.00%	-	
B-DC03-U-1D	Metals	-	3.578	3.578	0.00%	2.2	
B-DC03-U-1E	Metals	-	3.564	3.564	0.00%	0.3	
B-DC03-U-1L	+10	-	0.71	0.71	0.00%	-	
B-DC03-FB-1A	TCLP/Metals	-	3.850	3.850	0.00%	20.1	
B-DC04-T-1A	TCLP	5.53	2.322	2.322	0.00%	-	
B-DC04-T-1B	TCLP	-	2.306	2.306	0.00%	-	
B-DC04-T-1D	Metals	-	2.262	2.262	0.00%	3.2	
B-DC04-T-1E	Metals	-	2.232	2.232	0.00%	3	

- = Not Requested/Applicable

Table 5: Laboratory Sample Preparation and Data for Bescorp Field Demonstration

DRAFT

Sample No.	Type Analysis	pH	Wet Wt. (lbs)	Dry Wt. (lbs)	Moisture Content	+30 Mesh Wt. (g)	Comments
B-DC04-U-1A	TCLP	5.05	3.478	3.478	0.00%	-	
B-DC04-U-1B	TCLP	-	3.434	3.434	0.00%	-	
B-DC04-U-1D	Metals	-	3.528	3.528	0.00%	4.8	
B-DC04-U-1E	Metals	-	3.518	3.518	0.00%	5.4	
B-DC05-T-1A	TCLP	-	2.992	2.992	0.00%	-	
B-DC05-T-1B	TCLP	-	2.984	2.984	0.00%	-	
B-DC05-T-1D	Metals	-	3.072	2.934	4.48%	2.3	
B-DC05-T-1E	Metals	-	3.050	2.905	4.76%	8.9	
B-DC05-C-1A	TCLP/Metals	-	3.600	3.600	0.00%	21.5	
B-DC05-C-1B	TCLP/Metals	-	3.672	3.672	0.00%	13.6	
B-DC05-K-1A	TCLP/Metals	-	3.852	3.852	0.00%	20.8	+30 contains lead bullets
B-DC05-K-1B	TCLP/Metals	-	3.828	3.828	0.00%	27.8	+30 contains lead bullets
B-DC05-Z1A/B	TCLP/Metals	-	0.120	0.114	5.00%	0.8	Sample 1A and 1B combined into one(1A)
B-DC06-T-1A	TCLP	8.05	3.332	3.332	0.00%	-	
B-DC06-T-1B	TCLP	-	3.228	3.228	0.00%	-	
B-DC06-T-1D	Metals	-	3.178	3.120	1.82%	1.6	
B-DC06-T-1E	Metals	-	3.248	3.210	1.17%	6.0	
B-DC06-L-1A	TCLP/Metals	-	2.628	2.628	0.00%	5.8	+30 Contains some organic material
B-DC06-F-1A	TCLP/Metals	-	3.376	3.376	0.00%	0.0	
B-DC06-P-1A	TCLP	-	1.678	-	moist	-	first tumbing/grinding developed cakes of soil (some material lost during cleanup)
B-DC06-P-1A	Metals	-	1.108	0.88	20.58%	10.8	solution
B-DC06-Qc-1A	Metals	1.40	-	-	-	-	
B-DC06-Qf-1A	Metals	1.50	-	-	-	-	
B-DC12-T-1A	TCLP	8.36	3.11	3.11	0.00%	-	
B-DC12-T-1B	TCLP	-	3.498	3.498	0.00%	-	
B-DC12-T-1D	Metals	-	3.428	3.428	0.00%	2.7	
B-DC12-T-1E	Metals	-	3.27	3.27	0.00%	5.2	

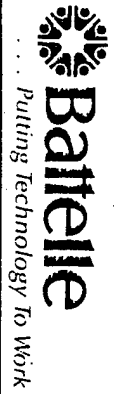

- = Not Requested/Applicable

Sample No.	Process Stream	Analysis Type	Units	Results			
				Cu	Pb	Sb	Zn
B-NV14-FB	field blank	TCLP METALS	µg/mL µg/g	0.000 0.000	0.000 0.008	0.008 0.288	0.288
B-NV15-Z	organic	TCLP METALS	µg/mL µg/g	1.94 4005	11.1 6457	0.064 32.9	1.15 1672
B-NV15-T	treated soil	TCLP METALS	µg/mL µg/g	0.768 50.0	3.07 143	0.14 56.1	1.07 17.6
B-NV16-T	treated soil	TCLP METALS	µg/mL µg/g	0.164 48.6	1.83 178	0.369 64.5	0.166 14.3
B-NV16-U	untreated soil	TCLP METALS	µg/mL µg/g	1.12 2302	18.4 4819	0.154 255	0.348 182
B-NV20-T	treated soil	TCLP METALS	µg/mL µg/g	0.080 54	0.958 125	0.340 54	0.087 17
B-NV20-U	untreated soil	TCLP METALS	µg/mL µg/g	1.10 1958	20.7 4152	0.098 216	0.330 158
B-NV21-T	treated soil	TCLP METALS	µg/mL µg/g	0.155 60.3	1.32 134	0.485 80.3	0.435 18.5
B-NV21-U	untreated soil	TCLP METALS	µg/mL µg/g	1.16 1659	37.3 3567	0.188 190	0.389 136.1
B-NV22-T	treated soil	TCLP METALS	µg/mL µg/g	0.022 63	0.56 115	0.677 89.0	0.145 21.2
B-NV22-U	untreated soil	TCLP METALS	µg/mL µg/g	0.913 1975	33.5 4068	0.179 205.6	0.367 156.5
B-NV22-C	coarse treated soil fraction	TCLP METALS	µg/mL µg/g	0.272 111	4.41 135	0.011 29.1	0.118 14.8
B-NV22-M	metal concentrate from jig	TCLP METALS	µg/mL µg/g	1.13 99	36.6 1644	1.56 208	0.434 15.8
B-NV22-K	feed to jig	TCLP METALS	µg/mL µg/g	1.01 277	13.9 360	0.253 47.8	0.189 34.5
B-NV23-T	treated soil	TCLP METALS	µg/mL µg/g	0.005 70.7	1.75 232	0.575 105	0.402 19.6
B-NV25-T	treated soil	TCLP METALS	µg/mL µg/g	0.000 81	2.15 235	1.11 115	0.059 23
B-NV25-P	precipitate	TCLP METALS	µg/mL µg/g	48.5 4262	1474 16455	0.066 309	10.7 689
B-NV25-U	untreated soil	TCLP METALS	µg/mL µg/g	0.790 2456	31.9 5194	0.080 262	0.246 193
B-NV26-T	treated soil	TCLP METALS	µg/mL µg/g	0.00 51.5	1.97 181	0.483 73.6	0.131 14.8
B-NV26-U	untreated soil	TCLP METALS	µg/mL µg/g	0.854 2461	36.3 5040	0.405 248	0.379 190
B-NV26-Qf	leachate-first leach	METALS	µg/mL	7.52	103	0.434	2.33
B-NV26-Qc	leachate-clean(recycle)	METALS	µg/mL	0.656	7.66	0.029	0.105
B-NV27-T	treated soil	TCLP METALS	µg/mL µg/g	0.197 63.1	2.84 165	0.137 77.8	0.192 16.4
B-NV29-T	treated soil	TCLP METALS	µg/mL µg/g	0.455 85.3	3.44 230	0.212 127.8	0.227 21.9
B-NV30-T	treated soil	TCLP METALS	µg/mL µg/g	0.367 62.5	3.53 233	0.041 93.5	0.220 14.8

Sample No.	Process Stream	Analysis Type	Units	Results			
				Cu	Pb	Sb	Zn
B-DC02-T	treated soil	TCLP	µg/mL	0.106	1.85	0.433	0.038
		METALS	µg/g	53.3	177	65.5	13.4
B-DC02-L	leach circuit feed	TCLP	µg/mL	1.08	9.98	0.124	0.423
		METALS	µg/g	99.8	428	155	27.3
B-DC02-F	fine treated soil fraction from leach circuit	TCLP	µg/mL	0.367	2.78	0.054	0.217
		METALS	µg/g	82.5	175	94.3	23.4
B-DC03-FB	field blank	TCLP	µg/mL	0.000	0.000	0.000	0.031
		METALS	µg/g	6.19	6.58	1.09	6.25
B-DC03-T	treated soil	TCLP	µg/mL	0.095	1.36	0.306	0.091
		METALS	µg/g	48.1	132	68.6	14.1
B-DC03-U	untreated soil	TCLP	µg/mL	0.676	40.4	0.906	0.359
		METALS	µg/g	1612	3351	172	127
B-DC04-T	treated soil	TCLP	µg/mL	0.330	2.35	0.147	0.156
		METALS	µg/g	54.2	113	65.0	15.2
B-DC04-U	untreated soil	TCLP	µg/mL	2.02	13.7	0.157	0.275
		METALS	µg/g	1329	2743	149	111
B-DC05-T	treated soil	TCLP	µg/mL	0.118	3.06	0.256	0.161
		METALS	µg/g	58	127	77.4	16.2
B-DC05-C	coarse treated soil fraction	TCLP	µg/mL	1.42	44.2	0.042	0.441
		METALS	µg/g	114	214	32.3	13.4
B-DC05-Z	organic	TCLP	µg/mL	2.99	7.84	0.103	0.944
		METALS	µg/g	2084	10896	44.2	190
B-DC05-K	feed to jig	TCLP	µg/mL	2.18	64.5	1.16	0.292
		METALS	µg/g	418	1249	111	53
B-DC06-T	treated soil	TCLP	µg/mL	0.061	0.757	0.551	0.119
		METALS	µg/g	50	123	89	17
B-DC06-Qf-1A	leachate-first leach	METALS	µg/mL	7.36	88.2	0.347	1.36
B-DC06-Qc-1A	leachate-clean(recycle)	METALS	µg/mL	1.15	15.3	0.024	0.411
B-DC06-L	leach circuit feed	TCLP	µg/mL	1.24	11.9	0.240	0.656
		METALS	µg/g	106	405	150	29.2
B-DC06-P	precipitate	TCLP	µg/mL	59.5	2235	0.000	16.6
		METALS	µg/g	8828	21571	478	1462
B-DC06-F	fine treated soil fraction from leach circuit	TCLP	µg/mL	0.203	1.95	0.220	0.138
		METALS	µg/g	88.5	150	105	20.7
B-DC12-T	treated soil	TCLP	µg/mL	0.166	2.67	0.662	0.145
		METALS	µg/g	121	671	79.2	26.1

UNCLASSIFIED
Table 1. Operating Summary for Hydrochloric Acid Demonstration

Date	Daily Soil Fed (tons)	Cumulative Soil Feed (tons)	New (N) vs. Reprocessed (R) Soil	Feed Belt Operating Time (hrs)	Feed Rate (tons/hr)	Treated Belt Operating Time (hrs)	Down Time (hrs)	Process Streams Sampled for Offsite Analysis	Comments
11/15/96	32.0	32.0	N	5.0	6.4	10.0	-	FB,Z,T	Pre-coated filter press with DE; made minor adjustments.
11/16/96	42.0	74.0	N	6.5	6.5	10.0	-	U,T	Raised pitch on the first sand screw.
11/20/96	43.0	117.0	N	8.5	5.1	9.5	0.5	U,T	Downtime: Raised pitch on the first sand screw.
11/21/96	50.0	167.0	N	8.5	5.9	10.0	-	U,T	
11/22/96	63.0	230.0	N	8.5	7.4	10.0	-	U,T,C,K,M	
11/23/96	51.0	281.0	N	8.5	6.0	9.5	0.5	T	Downtime: Replaced motor on jig bed.
11/25/96	47.0	328.0	N	8.5	5.5	10.0	-	U,T,P	
11/26/96	48.0	376.0	N	8.5	5.6	10.0	-	U,T,Q ₆ Q _r	
11/27/96	56.0	432.0	N	8.5	6.6	10.0	-	T	
11/29/96	43.0	475.0	N	8.5	5.1	10.0	-	T	
11/30/96	64.0	539.0	N	8.5	7.5	10.0	-	T	
12/2/96	65.0	604.0	N	8.5	7.6	10.0	-	T,F,L	
12/3/96	52.0	656.0	N	7.5	6.9	9.0	-	U,T,FB	Shut down early; bin capacity has been reached.
12/4/96	50.0	706.0	N	8.5	5.9	9.5	0.5	U,T	Downtime: fixed pipe leak on attrition scrubber.
12/5/96	51.0	757.0	N	8.5	6.0	10.0	-	T,Z,C,K	
12/6/96	56.0	813.0	N	8.5	6.6	9.5	0.5	T,Q ₆ Q _r F,I,P	
12/12/96	22.0	835.0	N	4.0	5.5	10.0	-	T	
Totals	-	835.0	-	133.5	6.3	167.0	2.0		

DRAFT

Table 2. Utilities and Reagents Usage Summary - Hydrochloric Acid Demonstration

Date	Daily Soil Feed (tons)	Cumulative Soil Feed (tons)	Cumulative Power Used (KWH)	Cumulative Water Used (gal)	Cumulative Pond Water Used (gal)	Daily Hydrochloric Acid Used (gal)	Daily Lime Used (lbs)	Daily Sodium Hydroxide Used (gal)	Daily Diatomaceous Earth Used (lbs)	Daily Flocculant Used (lbs)	Daily Organic Accumulation (lbs.)
11/15/96	32.0	32.0	7,000	26,700	0	245	75	300	400	150.0	75.0
11/16/96	42.0	74.0	7,400	27,800	0	250	100	350	400	50.0	90.0
11/20/96	43.0	117.0	7,800	28,500	3,000	300	50	345	550	50.0	192.0
11/21/96	50.0	167.0	8,400	29,500	4,000	300	100	345	450	50.0	200.0
11/22/96	63.0	230.0	9,000	31,700	5,500	315	50	345	750	50.0	210.0
11/23/96	51.0	281.0	9,600	34,200	5,500	300	50	345	650	50.0	190.0
11/25/96	47.0	328.0	10,200	35,200	5,500	345	75	390	900	50.0	230.0
11/26/96	48.0	376.0	10,800	36,600	5,500	345	100	390	200	50.0	156.0
11/27/96	56.0	432.0	11,400	37,900	5,500	345	75	390	900	50.0	320.0
11/29/96	43.0	475.0	12,000	38,200	7,000	345	100	390	200	50.0	206.0
11/30/96	64.0	539.0	12,600	38,400	14,000	345	75	390	900	50.0	190.0
12/2/96	65.0	604.0	13,200	39,600	14,000	305	75	300	500	100.0	193.0
12/3/96	52.0	656.0	13,800	42,000	15,000	305	100	300	450	50.0	263.0
12/4/96	50.0	706.0	14,400	44,100	16,500	305	50	300	550	50.0	503.0
12/5/96	52.0	758.0	15,000	46,000	20,500	400	75	400	450	50.0	253.0

Table 2. Utilities and Reagents Usage Summary - Hydrochloric Acid Demonstration

Date	Daily Soil Feed (tons)	Cumulative Soil Feed (tons)	Cumulative Power Used (kWH)	Cumulative Water Used (gal)	Cumulative Pond Water Used (gal)	Daily Hydrochloric Acid Used (gal)	Daily Lime Used (lbs)	Daily Sodium Hydroxide Used (gal)	Daily Diatomaceous Earth Used (lbs)	Daily Flocculant Used (lbs)	Daily Organic Accumulation (lbs.)
12/6/96	55.0	813.0	15,600	47,000	21,500	300	100	400	200	50.0	190.0
12/12/96	22.0	835.0	16,000	49,300	21,500	150	25	200	200	50.0	60.0
Totals	835.0	835.0	16,000	49,300	21,500	5,200	1,275	5,880	8,650	1,000	3,521

DRAFT

Table 3. Bescorp XRF Samples - Hydrochloric Acid Demonstration

Date	Process Stream	Sample No.	XRF Basis (Wet/Dry)	XRF Lead (mg/kg)	XRF Cu (mg/kg)	XRF Zn (mg/kg)	XRF Sb (mg/kg)	XRF Totals (mg/kg)
11/15/96	T	B-NV15-T-W1	W	113.862	34.029	0.000	85.741	233.632
11/15/96	T	B-NV15-T-W2	W	50.213	0.000	0.000	0.000	50.213
11/16/96	T	B-NV16-T-W1	W	125.825	33.114	28.605	0.000	187.544
11/16/96	T	B-NV16-T-W2	W	29.627	0.000	0.000	0.000	29.627
11/16/96	T	B-NV16-T-W2-DUP	W	86.940	106.068	0.000	98.306	291.314
11/16/96	T	B-NV16-T-W3	W	113.560	51.430	26.087	64.713	255.790
11/16/96	T	B-NV16-T-W4	W	148.761	66.804	0.000	58.861	274.426
11/16/96	T	B-NV16-T-W5	W	140.502	71.281	0.000	55.546	267.329
11/16/96	T	B-NV16-T-W6	W	133.999	0.000	0.000	63.099	197.098
11/16/96	U	B-NV16-U-W1	W	135.728	0.000	40.797	0.000	176.525
11/16/96	U	B-NV16-U-W2	W	153.509	0.000	26.794	0.000	180.303
11/16/96	K	B-NV16-K-W1	W	58.880	0.000	24.744	0.000	83.624
11/16/96	K	B-NV16-K-W2	W	207.883	59.617	0.000	99.656	367.156
11/16/96	M	B-NV16-M-W1	W	110.253	0.000	0.000	49.016	159.269
11/16/96	M	B-NV16-M-W2	W	126.623	0.000	0.000	0.000	126.623
11/16/96	F	B-NV16-F-W1	W	226.050	33.878	0.000	91.329	351.258
11/16/96	F	B-NV16-F-W2	W	220.669	117.017	49.222	158.691	545.599
11/16/96	C	B-NV16-C-W1	W	59.561	0.000	0.000	0.000	59.561
11/19/96	P	B-NV19-P-W1	W	31136.200	3585.520	556.590	104.811	35383.121
11/19/96	P	B-NV19-P-W2	W	25919.200	3035.750	500.908	96.057	29551.915
11/20/96	T	B-NV20-T-W1	W	37.408	0.000	0.000	23.853	61.261
11/20/96	T	B-NV20-T-W2	W	56.578	65.914	68.091	45.731	236.314
11/20/96	T	B-NV20-T-W3	W	69.736	0.000	0.000	46.631	116.367
11/20/96	T	B-NV20-T-W4	W	89.270	0.000	0.000	67.801	157.071
11/20/96	T	B-NV20-T-W5	W	39.171	26.042	0.000	0.000	65.213
11/20/96	T	B-NV20-T-W6	W	39.602	0.000	29.043	0.000	68.645
11/20/96	C	B-NV20-C-W1	W	22.944	0.000	31.530	30.743	85.217

DRAFT

Table 3. Bescorp XRF Samples - Hydrochloric Acid Demonstration

Date	Process Stream	Sample No.	XRF Basis (Wet/Dry)	XRF Lead (mg/kg)	XRF Cu (mg/kg)	XRF Zn (mg/kg)	XRF Sb (mg/kg)	XRF Totals (mg/kg)
11/20/96	C	B-NV20-C-W2	W	58.832	0.000	0.000	30.785	89.616
11/20/96	C	B-NV20-C-W3	W	66.000	0.000	0.000	0.000	66.000
11/20/96	F	B-NV20-F-W1	W	145.154	81.198	0.000	124.506	350.858
11/20/96	F	B-NV20-F-W2	W	197.596	54.092	32.468	95.618	379.773
11/20/96	F	B-NV20-F-W3	W	224.905	65.530	54.620	65.806	410.861
11/20/96	K	B-NV20-K-W1	W	21.815	0.000	0.000	0.000	21.815
11/20/96	K	B-NV20-K-W2	W	75.573	29.731	0.000	34.785	140.088
11/20/96	K	B-NV20-K-W3	W	92.354	41.953	0.000	81.971	216.279
11/20/96	M	B-NV20-M-W1	W	30.183	0.000	0.000	0.000	30.183
11/20/96	M	B-NV20-M-W2	W	73.003	40.229	0.000	49.468	162.699
11/20/96	M	B-NV20-M-W3	W	106.235	0.000	0.000	0.000	106.235
11/20/96	P	B-NV20-P-W1	W	23872.900	2491.840	452.375	83.550	26900.665
11/20/96	P	B-NV20-P-W2	W	15593.600	1717.150	310.494	55.079	17676.323
11/20/96	P	B-NV20-P-W3	W	11134.500	942.371	225.242	61.190	12363.303
11/21/96	T	B-NV21-T-W1	W	100.303	0.000	30.871	108.575	239.749
11/21/96	T	B-NV21-T-W2	W	111.556	0.000	0.000	138.068	249.624
11/21/96	T	B-NV21-T-W3	W	72.030	0.000	26.063	59.168	157.261
11/21/96	T	B-NV21-T-W4	W	39.847	43.717	53.317	71.311	208.192
11/21/96	T	B-NV21-T-W5	W	119.102	35.840	37.692	46.316	238.949
11/21/96	T	B-NV21-T-W6	W	169.218	37.455	49.266	95.993	351.932
11/21/96	T	B-NV21-T-W7	W	69.149	0.000	21.074	90.839	181.062
11/21/96	T	B-NV21-T-W8	W	73.304	0.000	0.000	0.000	73.304
11/21/96	C	B-NV21-C-W1	W	67.746	0.000	0.000	0.000	67.746
11/21/96	C	B-NV21-C-W2	W	25.671	0.000	0.000	0.000	25.671
11/21/96	C	B-NV21-C-W3	W	43.027	0.000	0.000	0.000	43.027
11/21/96	F	B-NV21-F-W1	W	191.606	68.812	0.000	88.694	349.112
11/21/96	F	B-NV21-F-W1-DUP1	W	215.063	30.277	43.275	154.362	442.977

DRAFT

Table 3. Bescorp XRF Samples - Hydrochloric Acid Demonstration

Date	Process Stream	Sample No.	XRF Basis (Wet/Dry)	XRF Lead (mg/kg)	XRF Cu (mg/kg)	XRF Zn (mg/kg)	XRF Sb (mg/kg)	XRF Totals (mg/kg)
11/21/96	F	B-NV21-F-W1-DUP2	W	148.861	147.812	47.348	115.829	459.850
11/21/96	F	B-NV21-F-W2	W	173.289	85.920	36.247	97.320	392.776
11/21/96	F	B-NV21-F-W3	W	177.810	65.510	21.832	109.131	374.283
11/21/96	K	B-NV21-K-W1	W	67.714	66.224	43.331	0.000	177.268
11/21/96	K	B-NV21-K-W2	W	86.989	0.000	0.000	0.000	86.989
11/21/96	K	B-NV21-K-W3	W	136.645	0.000	0.000	66.154	202.799
11/21/96	M	B-NV21-M-W1	W	145.772	27.171	59.041	101.623	333.607
11/21/96	M	B-NV21-M-W2	W	115.677	0.000	0.000	79.250	194.927
11/21/96	M	B-NV21-M-W3	W	160.404	0.000	35.320	63.352	259.076
11/21/96	P	B-NV21-P-W1	W	337.1280	337.750	117.107	57.257	3883.394
11/21/96	P	B-NV21-P-W2	W	5323.910	434.823	147.147	35.648	5941.528
11/21/96	P	B-NV21-P-W3	W	19840.700	2489.640	461.057	71.675	22863.072
11/22/96	T	B-NV22-T-W1	W	126.114	54.807	21.518	102.663	305.102
11/22/96	T	B-NV22-T-W2	W	88.171	45.206	0.000	57.862	191.240
11/22/96	T	B-NV22-T-W3	W	107.625	56.911	0.000	77.393	241.929
11/22/96	T	B-NV22-T-W4	W	149.932	34.465	0.000	112.999	297.396
11/22/96	C	B-NV22-C-W1	W	65.278	0.000	0.000	26.854	92.131
11/22/96	C	B-NV22-C-W2	W	108.900	0.000	0.000	49.447	158.347
11/22/96	F	B-NV22-F-W1	W	227.953	39.873	0.000	149.017	416.843
11/22/96	F	B-NV22-F-W2	W	182.955	24.860	0.000	82.690	290.504
11/22/96	K	B-NV22-K-W1	W	47.828	0.000	0.000	0.000	47.828
11/22/96	K	B-NV22-K-W2	W	121.374	0.000	0.000	66.603	187.977
11/22/96	M	B-NV22-M-W1	W	182.114	0.000	0.000	86.253	268.367
11/22/96	M	B-NV22-M-W2	W	419.153	0.000	0.000	146.905	566.058
11/22/96	P	B-NV22-P-W1	W	5041.960	437.865	107.955	0.000	5587.780
11/22/96	P	B-NV22-P-W2	W	23956.500	2878.800	463.162	129.441	27427.903
11/23/96	T	B-NV23-T-W1	W	164.519	46.560	0.000	78.241	289.319

DRAFT

Table 3. Bescorp XRF Samples - Hydrochloric Acid Demonstration

Date	Process Stream	Sample No.	XRF Basis (Wet/Dry)	XRF Lead (mg/kg)	XRF Cu (mg/kg)	XRF Zn (mg/kg)	XRF Sb (mg/kg)	XRF Totals (mg/kg)
11/23/96	T	B-NV23-T-W2	W	142.753	47.279	0.000	112.247	302.279
11/23/96	T	B-NV23-T-W3	W	84.643	111.061	26.108	54.689	276.501
11/23/96	T	B-NV23-T-W4	W	159.568	0.000	0.000	72.029	231.597
11/23/96	T	B-NV23-T-W5	W	134.467	42.398	0.000	72.727	249.592
11/23/96	T	B-NV23-T-W6	W	170.709	38.782	0.000	76.916	286.407
11/23/96	C	B-NV23-C-W1	W	66.040	0.000	42.453	22.769	131.261
11/23/96	C	B-NV23-C-W2	W	74.060	0.000	0.000	74.222	148.282
11/23/96	F	B-NV23-F-W1	W	238.843	87.831	79.586	86.582	492.841
11/23/96	F	B-NV23-F-W2	W	233.771	72.781	56.386	180.042	542.980
11/23/96	K	B-NV23-K-W1	W	141.871	0.000	44.088	0.000	185.959
11/23/96	K	B-NV23-K-W2	W	226.408	0.000	0.000	42.795	269.203
11/23/96	M	B-NV23-M-W1	W	252.836	0.000	0.000	128.749	381.585
11/23/96	M	B-NV23-M-W2	W	293.771	0.000	0.000	114.720	408.491
11/23/96	P	B-NV23-P-W1	W	24332.900	2355.640	373.379	135.545	27197.464
11/23/96	P	B-NV23-P-W2	W	33626.000	2948.430	472.265	116.555	37163.250
11/25/96	T	B-NV25-T-W1	W	148.561	73.244	0.000	119.904	341.709
11/25/96	T	B-NV25-T-W2	W	143.880	49.643	0.000	117.107	310.630
11/25/96	T	B-NV25-T-W3	W	110.370	0.000	0.000	89.222	199.592
11/25/96	T	B-NV25-T-W4	W	95.047	0.000	0.000	78.098	173.145
11/25/96	T	B-NV25-T-W5	W	167.950	49.431	35.818	86.450	339.649
11/25/96	T	B-NV25-T-W6	W	161.976	41.288	25.262	101.451	329.976
11/25/96	T	B-NV25-T-D1	D	192.359	86.176	0.000	106.027	384.562
11/25/96	T	B-NV25-T-D2	D	202.844	0.000	0.000	129.621	332.465
11/25/96	T	B-NV25-T-D3	D	216.307	41.193	0.000	87.695	345.195
11/25/96	T	B-NV25-T-D4	D	212.038	67.492	33.638	108.536	421.704
11/25/96	T	B-NV25-T-D4-DUP	D	187.524	37.777	0.000	90.772	316.073
11/25/96	U	B-NV25-U-W1	W	352.248	34.568	0.000	92.542	479.358

DRAFT
Table 3. Bescorp XRF Samples - Hydrochloric Acid Demonstration

Date	Process Stream	Sample No.	XRF Basis (Wet/Dry)	XRF Lead (mg/kg)	XRF Cu (mg/kg)	XRF Zn (mg/kg)	XRF Sb (mg/kg)	XRF Totals (mg/kg)
11/25/96	U	B-NV25-U-W2	W	341.765	25.823	33.462	30.368	431.418
11/25/96	U	B-NV25-U-W3	W	382.289	55.521	0.000	0.000	437.810
11/25/96	U	B-NV25-U-W4	W	279.302	33.056	0.000	30.251	342.609
11/25/96	C	B-NV25-C-W1	W	122.285	0.000	0.000	37.383	159.668
11/25/96	C	B-NV25-C-W2	W	70.968	0.000	0.000	0.000	70.968
11/25/96	C	B-NV25-C-W3	W	76.525	0.000	0.000	0.000	76.525
11/25/96	F	B-NV25-F-W1	W	297.010	0.000	0.000	161.003	458.013
11/25/96	F	B-NV25-F-W2	W	216.689	76.318	0.000	141.678	434.685
11/25/96	K	B-NV25-K-W1	W	226.806	130.276	0.000	165.365	522.447
11/25/96	K	B-NV25-K-W2	W	96.176	0.000	0.000	0.000	96.176
11/25/96	M	B-NV25-M-W1	W	225.665	0.000	0.000	78.578	304.243
11/25/96	P	B-NV25-P-W1	W	33074.200	3403.610	541.951	100.825	37120.586
11/25/96	P	B-NV25-P-W2	W	35028.400	3147.680	457.028	138.939	38772.047
11/25/96	P	B-NV25-P-W3	W	24363.400	1466.090	301.652	120.892	26252.034
11/25/96	P	B-NV25-P-D1	D	34021.100	2467.200	475.743	217.838	37181.881
11/25/96	P	B-NV25-P-D2	D	31678.800	2621.580	441.486	107.254	34849.120
11/25/96	P	B-NV25-P-D3	D	32979.500	2340.600	502.211	203.161	36025.472
11/26/96	T	B-NV26-T-W1	W	120.042	62.636	0.000	66.131	248.809
11/26/96	T	B-NV26-T-W2	W	172.275	0.000	0.000	149.699	321.974
11/26/96	T	B-NV26-T-W3	W	52.712	0.000	0.000	30.081	82.793
11/26/96	T	B-NV26-T-W4	W	31.445	0.000	29.849	0.000	61.294
11/26/96	T	B-NV26-T-W5	W	190.500	85.551	28.834	164.005	468.890
11/26/96	T	B-NV26-T-W6	W	163.408	77.594	38.402	166.371	445.775
11/26/96	U	B-NV26-U-W1	W	379.051	0.000	30.876	55.472	465.399
11/26/96	U	B-NV26-U-W2	W	369.297	0.000	0.000	23.975	393.272
11/26/96	C	B-NV26-C-W1	W	70.358	0.000	0.000	0.000	70.358
11/26/96	C	B-NV26-C-W2	W	95.996	0.000	0.000	0.000	95.996

DRAFT

Table 3. Bescorp XRF Samples - Hydrochloric Acid Demonstration

Date	Process Stream	Sample No.	XRF Basis (Wet/Dry)	XRF Lead (mg/kg)	XRF Cu (mg/kg)	XRF Zn (mg/kg)	XRF Sb (mg/kg)	XRF Totals (mg/kg)
11/26/96	C	B-NV26-C-W3	W	86.972	0.000	0.000	73.508	160.480
11/26/96	F	B-NV26-F-W1	W	205.708	83.199	0.000	129.221	418.128
11/26/96	F	B-NV26-F-W2	W	159.537	33.225	35.727	84.278	312.767
11/26/96	F	B-NV26-F-W3	W	213.548	81.646	43.314	141.836	480.344
11/26/96	K	B-NV26-K-W1	W	45.115	0.000	0.000	87.682	132.797
11/26/96	K	B-NV26-K-W2	W	146.487	0.000	0.000	50.662	197.149
11/26/96	P	B-NV26-P-W1	W	37124.200	2516.630	427.670	239.257	40307.757
11/26/96	P	B-NV26-P-W2	W	33406.600	2351.810	421.132	241.027	36420.569
11/27/96	T	B-NV27-T-W1	W	106.992	52.671	0.000	76.859	236.522
11/27/96	T	B-NV27-T-W2	W	102.391	0.000	0.000	36.676	139.067
11/27/96	T	B-NV27-T-W3	W	124.237	31.969	27.033	118.869	302.108
11/27/96	T	B-NV27-T-W4	W	139.327	25.838	45.201	70.284	280.650
11/27/96	T	B-NV27-T-W5	W	94.311	57.287	0.000	30.431	182.028
11/27/96	T	B-NV27-T-W6	W	70.391	0.000	25.018	38.437	133.846
11/27/96	C	B-NV27-C-W1	W	71.084	0.000	0.000	0.000	71.084
11/27/96	C	B-NV27-C-W2	W	52.893	0.000	0.000	0.000	52.893
11/27/96	C	B-NV27-C-W3	W	89.071	0.000	0.000	47.104	136.175
11/27/96	F	B-NV27-F-W1	W	268.462	0.000	48.759	40.982	358.203
11/27/96	F	B-NV27-F-W2	W	165.072	0.000	0.000	55.616	220.688
11/27/96	F	B-NV27-F-W3	W	178.046	36.846	41.649	60.785	317.326
11/27/96	K	B-NV27-K-W1	W	152.551	0.000	41.897	43.621	238.069
11/27/96	K	B-NV27-K-W2	W	128.443	0.000	57.882	62.487	248.812
11/27/96	K	B-NV27-K-W3	W	77.521	30.083	45.628	50.723	203.955
11/27/96	P	B-NV27-P-W1	W	27789.400	2159.110	389.456	251.315	30589.281
11/27/96	P	B-NV27-P-W2	W	32779.100	2200.960	407.568	186.722	35574.350
11/27/96	P	B-NV27-P-W3	W	44324.700	3962.450	773.362	286.078	49346.590
11/29/96	T	B-NV29-T-W1	W	163.556	50.676	28.140	128.873	371.245

DRAFT

Table 3. Bescorp XRF Samples - Hydrochloric Acid Demonstration

Date	Process Stream	Sample No.	XRF Basis (Wet/Dry)	XRF Lead (mg/kg)	XRF Cu (mg/kg)	XRF Zn (mg/kg)	XRF Sb (mg/kg)	XRF Totals (mg/kg)
11/29/96	T	B-NV29-T-W2	W	143.141	45.082	50.867	161.053	400.142
11/29/96	T	B-NV29-T-W3	W	184.925	83.396	39.537	76.496	384.354
11/29/96	T	B-NV29-T-W4	W	149.966	61.864	0.000	115.722	327.552
11/29/96	T	B-NV29-T-D1	D	243.087	61.298	0.000	139.672	444.057
11/29/96	T	B-NV29-T-D2	D	230.894	97.023	0.000	174.342	502.259
11/29/96	T	B-NV29-T-D3	D	222.788	38.609	20.300	153.873	435.570
11/30/96	T	B-NV30-T-W2	W	132.456	31.026	0.000	91.347	254.829
11/30/96	T	B-NV30-T-W3	W	116.007	42.566	25.052	65.915	249.541
11/30/96	T	B-NV30-T-W4	W	174.221	44.758	28.791	122.519	370.289
11/30/96	T	B-NV30-T-D1	D	221.743	105.319	0.000	116.233	443.295
11/30/96	T	B-NV30-T-D2	D	200.772	67.893	0.000	92.383	361.048
11/30/96	T	B-NV30-T-D3	D	179.406	59.886	0.000	81.455	320.747
11/30/96	T	B-NV30-T-D4	D	202.199	64.197	0.000	154.786	421.182
12/2/96	T	B-DC02-T-W1	W	128.933	33.511	0.000	103.535	265.979
12/2/96	T	B-DC02-T-W2	W	92.870	0.000	0.000	72.023	164.893
12/2/96	T	B-DC02-T-W3	W	98.148	0.000	0.000	110.501	208.649
12/2/96	T	B-DC02-T-W4	W	119.030	46.921	37.825	80.707	284.483
12/2/96	C	B-DC02-C-W1	W	26.781	0.000	0.000	54.532	81.313
12/2/96	C	B-DC02-C-W2	W	27.982	0.000	0.000	0.000	27.982
12/2/96	F	B-DC02-F-W1	W	177.506	59.792	0.000	158.166	395.464
12/2/96	F	B-DC02-F-W2	W	199.631	55.242	0.000	158.806	413.679
12/2/96	K	B-DC02-K-W1	W	93.912	0.000	0.000	48.814	142.725
12/2/96	K	B-DC02-K-W2	W	107.552	0.000	41.671	30.238	179.460
12/2/96	P	B-DC02-P-W1	W	15572.100	1179.850	254.996	0.000	17006.946
12/2/96	P	B-DC02-P-W2	W	15805.400	1217.580	298.136	98.274	17419.390
12/3/96	T	B-DC03-T-W1	W	150.235	0.000	0.000	68.512	218.747
12/3/96	T	B-DC03-T-W2	W	104.527	0.000	25.809	0.000	130.336

DRAFT

Table 3. Bescorp XRF Samples - Hydrochloric Acid Demonstration

Date	Process Stream	Sample No.	XRF Basis (Wet/Dry)	XRF Lead (mg/kg)	XRF Cu (mg/kg)	XRF Zn (mg/kg)	XRF Sb (mg/kg)	XRF Totals (mg/kg)
12/3/96	T	B-DC03-T-W3	W	121.682	0.000	73.319	57.381	252.382
12/3/96	T	B-DC03-T-W4	W	98.065	0.000	0.000	0.000	98.065
12/3/96	T	B-DC03-T-W5	W	105.550	26.370	0.000	47.783	179.702
12/3/96	T	B-DC03-T-W6	W	87.644	0.000	0.000	42.370	130.014
12/3/96	C	B-DC03-C-W1	W	40.545	0.000	25.780	0.000	66.325
12/3/96	C	B-DC03-C-W2	W	36.851	0.000	0.000	0.000	36.851
12/3/96	F	B-DC03-F-W1	W	145.048	101.452	22.108	147.616	416.224
12/3/96	F	B-DC03-F-W2	W	191.260	72.851	48.280	146.935	459.326
12/3/96	K	B-DC03-K-W1	W	1581.210	100.575	40.150	241.395	1963.330
12/3/96	K	B-DC03-K-W2	W	1577.990	0.000	29.730	261.278	1868.998
12/3/96	P	B-DC03-P-W1	W	42679.600	3986.440	724.280	256.783	47647.103
12/3/96	P	B-DC03-P-W2	W	42399.900	3956.640	640.157	222.774	47219.471
12/3/96	-	LEAD-METALS	D	60888.700	101668.000	9299.050	4341.930	176197.680
12/4/96	T	B-DC04-T-W1	W	54.472	0.000	26.240	29.329	110.042
12/4/96	T	B-DC04-T-W2	W	77.038	0.000	37.031	40.222	154.291
12/4/96	T	B-DC04-T-W3	W	82.384	0.000	35.811	73.999	192.194
12/4/96	T	B-DC04-T-W4	W	94.387	32.909	0.000	24.373	151.669
12/4/96	T	B-DC04-T-W5	W	71.588	0.000	0.000	0.000	71.588
12/4/96	T	B-DC04-T-W6	W	86.389	58.935	0.000	30.699	176.022
12/4/96	C	B-DC04-C-W1	W	44.428	0.000	0.000	0.000	44.428
12/4/96	C	B-DC04-C-W2	W	91.526	0.000	0.000	0.000	91.526
12/4/96	C	B-DC04-C-W3	W	83.868	0.000	30.131	0.000	113.999
12/4/96	C	B-DC04-C-D1	D	97.134	0.000	0.000	0.000	97.134
12/4/96	C	B-DC04-C-D2	D	79.165	0.000	0.000	84.215	163.381
12/4/96	F	B-DC04-F-W1	W	111.430	41.040	39.428	44.118	236.016
12/4/96	F	B-DC04-F-W2	W	113.340	0.000	65.756	75.609	254.705
12/4/96	F	B-DC04-F-W3	W	93.049	0.000	0.000	73.389	166.437

DRAFT

Table 3. Bescorp XRF Samples - Hydrochloric Acid Demonstration

Date	Process Stream	Sample No.	XRF Basis (Wet/Dry)	XRF Lead (mg/kg)	XRF Cu (mg/kg)	XRF Zn (mg/kg)	XRF Sb (mg/kg)	XRF Totals (mg/kg)
12/4/96	K	B-DC04-K-W1	W	42.183	39.784	61.676	48.747	192.390
12/4/96	K	B-DC04-K-W2	W	75.074	0.000	55.946	61.030	192.050
12/4/96	K	B-DC04-K-W3	W	112.219	0.000	0.000	0.000	112.219
12/4/96	K	B-DC04-K-D1	D	585.564	0.000	0.000	60.651	646.215
12/4/96	K	B-DC04-K-D2	D	882.012	0.000	0.000	77.237	959.249
12/4/96	P	B-DC04-P-W1	W	44447.000	3777.060	657.750	358.803	49240.613
12/4/96	P	B-DC04-P-W2	W	42818.900	3569.260	527.092	211.280	47126.532
12/4/96	P	B-DC04-P-W3	W	42374.900	3538.550	592.265	245.375	46751.090
12/5/96	T	B-DC05-T-W1	W	146.958	0.000	43.182	122.192	312.332
12/5/96	T	B-DC05-T-W2	W	119.725	35.598	33.369	92.582	281.274
12/5/96	T	B-DC05-T-W3	W	75.403	0.000	30.937	59.207	165.547
12/5/96	T	B-DC05-T-W4	W	89.801	45.449	33.350	82.716	251.316
12/5/96	T	B-DC05-T-W5	W	88.006	0.000	42.804	79.591	210.401
12/5/96	T	B-DC05-T-W6	W	58.627	37.329	0.000	0.000	95.956
12/5/96	C	B-DC05-C-W1	W	57.931	0.000	0.000	23.210	81.141
12/5/96	C	B-DC05-C-W2	W	102.930	0.000	0.000	49.283	152.213
12/5/96	C	B-DC05-C-W3	W	35.146	0.000	0.000	0.000	35.146
12/5/96	F	B-DC05-F-W1	W	91.783	38.484	52.901	81.346	264.514
12/5/96	F	B-DC05-F-W2	W	97.125	28.271	42.945	79.391	247.733
12/5/96	F	B-DC05-F-W3	W	129.369	39.122	21.582	98.515	288.588
12/5/96	K	B-DC05-K-W1	W	351.459	0.000	0.000	44.276	395.735
12/5/96	P	B-DC05-P-W1	W	31113.800	2532.550	515.930	240.721	34403.001
12/5/96	P	B-DC05-P-W2	W	30939.000	2549.070	516.954	144.903	34149.927
12/5/96	P	B-DC05-P-W3	W	30454.800	2602.560	430.851	178.015	33666.226
12/6/96	T	B-DC06-T-W1	W	94.300	0.000	30.413	63.044	187.756
12/6/96	T	B-DC06-T-W2	W	121.953	61.801	0.000	101.754	285.508
12/6/96	T	B-DC06-T-W3	W	89.503	0.000	36.016	162.486	288.006

DRAFT

Table 3. Bescorp XRF Samples - Hydrochloric Acid Demonstration

Date	Process Stream	Sample No.	XRF Basis (Wet/Dry)	XRF Lead (mg/kg)	XRF Cu (mg/kg)	XRF Zn (mg/kg)	XRF Sb (mg/kg)	XRF Totals (mg/kg)
12/6/96	T	B-DC06-T-W4	W	91.170	26.959	46.728	112.317	277.174
12/6/96	T	B-DC06-T-W5	W	87.777	51.741	0.000	72.323	211.840
12/6/96	T	B-DC06-T-W5-DUP	W	67.599	42.982	21.523	74.697	206.802
12/6/96	C	B-DC06-C-W1	W	55.198	0.000	0.000	49.552	104.749
12/6/96	C	B-DC06-C-W2	W	83.268	0.000	0.000	51.201	134.469
12/6/96	C	B-DC06-C-W3	W	29.810	26.019	23.674	0.000	79.503
12/6/96	F	B-DC06-F-W1	W	145.412	0.000	32.885	136.845	315.142
12/6/96	F	B-DC06-F-W2	W	108.905	0.000	26.722	71.164	206.790
12/6/96	F	B-DC06-F-W3	W	78.516	72.525	32.697	84.215	267.952
12/6/96	K	B-DC06-K-W1	W	108.747	0.000	28.045	0.000	136.792
12/6/96	K	B-DC06-K-W2	W	97.572	0.000	0.000	24.330	121.902
12/6/96	K	B-DC06-K-W3	W	94.670	0.000	20.266	0.000	114.935
12/6/96	P	B-DC06-P-W1	W	26723.700	2122.290	424.966	180.410	29451.366
12/6/96	P	B-DC06-P-W2	W	26667.900	2026.100	455.526	181.425	29330.951
12/6/96	P	B-DC06-P-W3	W	26171.800	2018.250	403.056	92.738	28685.844

Appendix D

FINAL PROJECT REPORT

**Pilot Scale Treatability Demonstration
Physical Separation / Acetic Acid Leaching
Fort Polk, Louisiana**

for

**BDM Engineering Services Company
1801 Randolph Road, SE
Albuquerque, New Mexico 87106**

Subcontract GDESA-96009

November 22, 1996
Revised January 31, 1997



**ContraCon
Northwest^{uc}**
4519 - 131st Place SW
Mukilteo, WA 98275

1.0	SCOPE of WORK	1
2.0	OBJECTIVES and RESULTS ACHIEVED	1
2.1	Performance Criteria and Results – Contaminant Lead Concentrations	1
2.2	Performance Criteria and Results – Process Through-Put Rate	4
3.0	SITE MOBILIZATION	6
3.1	Commissioning the Plant at the Job-Site	6
3.2	Problems Encountered and Solutions Implemented in Commissioning the Plant	6
3.3	Evaluation of Site Facilities and Support Utilities	6
3.4	Evaluation of Conducting Treatment Operations at a Location Remote from the Range	8
4.0	DEMONSTRATION SCHEDULE	8
4.1	Original Work Schedule	8
4.2	Schedule Changes Arising During the Course of the Demonstration	9
4.3	Synopsis of Daily Operations Over Course of the Demonstration	9
4.4	Overview of Typical Daily Operations	11
4.5	Impact of System Problems on the Work Schedule	12
4.5.1	Impacts Related to the High Clay Content of the Feed Soils	12
4.5.2	Other Plant-Related Impacts	12
5.0	UNIT PROCESS SYSTEM DESCRIPTION	13
5.1	Original System Design and Unit Process Methods Employed	13
5.1.1	Material Feed System	13
5.1.2	Coarse Fraction Treatment – Attrition Scrubbing and Wet Screening System	14
5.1.3	Particulate Metals Removal – Gravity Separation System	14
5.1.4	Organic Material Removal and Sand Fraction Separation – Hydro-cyclone System	14
5.1.5	Fine Fraction Treatment	15
5.1.6	Dissolved Metals Recovery – Precipitation and Water Treatment Systems	15
5.1.7	Fines Dewatering System	15
5.2	System Modifications Made in Preparation for Demonstration at Fort Polk	16
5.3	System Modifications Made as a Result of Problems Encountered at Fort Polk	16
5.3.1	Formation of Clay Balls in the Coarse Material Washer	16
5.3.2	Production of Excess Residual Sludge in the Leaching/Settling Tanks	19
5.3.3	Retention of Excessive Water in the Treated Soils Discharged from the Plant	19
5.3.4	Retention of Excessive Dissolved Lead in the Leaching Solution	19
5.4	Future Modifications Planned as a Result of Lessons Learned at Fort Polk	20
5.4.1	Improvements to the Sludge Dewatering System	20
5.4.2	Improvements to the Dissolved Metals Recovery System	20

	5.4.3	Improvements to the Gravity Separation System	20
	5.4.4	Reconfiguration of the physical-separation and acid-leaching subsystems	22
6.0		MISCELLANEOUS ISSUES RELATED TO PROCESS OPERATIONS AND SAFETY	22
	6.1	Correlation Between Total Lead and Soluble Lead (TCLP) Concentration	22
	6.2	Impact on Treatment of Non-target Metals in the Soil	22
	6.3	Market Value Materials and Residual Wastes Generated	23
	6.4	Health and Safety	23
	6.4.1	Storage and Handling of Concentrated Acetic Acid	23
	6.4.2	Acetic Acid Vapors	24
	6.4.3	Airborne Dust	24
	6.4.4	Noise	24
	6.5	Potential Use of Select Reagents to Reduce Soluble Lead (TCLP)	25
7.0		COSTS	26
	7.1	Demonstration Project Costs	26
	7.2	Projected Unit Costs for Full-Scale Operations	27
8.0		SUMMARY	28
	8.1	Scope and Objective	28
	8.2	Results	28
	8.3	Conclusions and Recommendations	29

1.0 SCOPE of WORK

The Pilot-Scale Treatability Demonstration at Fort Polk, Louisiana, was undertaken in support of Department-of-Defense small-arms firing range maintenance and closure programs to allow evaluation of physical-separation / acid-leaching technology for remediation of lead contaminated soils. The leaching agent employed by ContraCon Northwest for this demonstration was, as required by contract, acetic acid.

ContraCon Northwest was tasked to process berm materials from Range 5 at Fort Polk to a cleanup criteria of 1000 mg/kg total lead concentration, and to undertake a good-faith effort to achieve a soluble lead concentration of 5 mg/L (TCLP). Operations were required to proceed over a period of 15 days, up to a maximum of 1000 tons of soil processed.

2.0 OBJECTIVES and RESULTS ACHIEVED

2.1 Performance Criteria and Results – Contaminant Lead Concentrations

The objective of the subject treatability study was to evaluate the efficacy of applying physical-separation / acid-leaching technology, employing acetic acid as the lixivant, to remediate soils contaminated with lead and copper fragments. The criteria for the demonstration were as follows:

- To remediate soils as efficiently as possible over a period of 15 days, up to a maximum of 1000 tons total material processed.
- To achieve a total lead concentration of 1000 mg/kg or lower in the recombined processed soils. Processed soils which exceeded a total lead concentration of 1000 mg/kg were required to be reprocessed until the concentration was 1000 mg/kg or lower.
- To undertake a good-faith effort to achieve a soluble lead concentration in the processed soils of 5 mg/L (TCLP) or lower. Processed soils which exceeded a soluble lead concentration of 5 mg/L were required to be reprocessed until the concentration was 5 mg/L or lower; however, failure to achieve the soluble lead criteria of 5 mg/L was not grounds for a claim of non-compliance under the terms of the subcontract. Soils reprocessed in an effort to achieve the soluble lead criteria of 5 mg/L were credited against the total number of required production days (15) and/or the total volume of soil to be processed (1000 tons).

Process verification sampling was carried out by Battelle, the independent technical evaluation contractor. In all cases for which valid samples were collected total lead levels were reduced below 1000 mg/kg, with the optimum run exhibiting a reduction of 94.6 percent, from 2254 mg/kg (total Pb) in the feed soil to 122 mg/kg (total Pb) in the associated treated soil. The average reduction over the course of the demonstration was 90 percent based upon Gas Chromatograph analysis results obtained by Battelle in their laboratory, and 91 percent based upon X-ray Fluorescence analysis results obtained by Battelle in the field. These results are 15 to 20 percent higher than achieved during bench scale tests. Efficiencies decreased as the demonstration progressed, almost certainly due to a persistent buildup of lead in the process water over time.

The soluble lead concentration in the treated soils was reduced to less than 5 mg/L (TCLP) during the first run only (3.07 mg/L). During all subsequent runs the resulting soluble lead concentration exceeded 5 mg/L, again, almost certainly due to a buildup of lead in the process water over time. The initial success

does confirm that acetic acid can be used to effectively lower soluble lead contamination levels, and remains a viable technical option in range maintenance; however, as will be discussed in Section 7.0 of this report, the high cost of the acetic acid required to achieve these results may limit its application.

The following tables summarize the available data:

Table 2.1-1 – Acetic Acid Leaching Data Summary from Lab-GC Data¹

Sample Number	Date	Input Soil Total Pb (mg/kg)	Input Soil Soluble Pb (mg/L by TCLP)	Output Soil Total Pb by GC (mg/kg)	Output Soil Soluble Pb (mg/L by TCLP)	Percent Reduction (Total Pb)	Percent Reduction (Soluble Pb)
C-SP-15	9/15/96	2,254	34.6	122	3	94.6	91.3
C-SP-21	9/21/96	1,613	21	208	6	87.1	71.4
C-SP-25	9/25/96	4,122	22	330	10.3	92	53.2
C-OC-02	10/1/96	3,435	40.5	404	9	88.2	77.8
C-OC-04	10/4/96	3,435	40.5	269	6.4	92.2	84.2
C-OC-10	10/10/96	5,732	106	839	23.6	85.4	77.7
C-OC-12	10/12/96	5,732	106	1,443 ²	48	74.8	54.7

¹ This Table derived from data presented in Battelle's *Acetic Acid Leaching Data Summary* dated 10/22/96.

² Outlying data point. Required sampling protocol not followed; sample results not used in evaluation.

Table 2.1-2 – Evaluation of Total Pb Results from Lab-GC Data Summary

Percent Reduction (mean, not including 10/12/96 data):	90%
Standard Deviation of Percent Reduction (not including 10/12/96 data):	3.5
Percent Reduction (mean, <u>including</u> 10/12/96 data):	88%
Standard Deviation of Percent Reduction (<u>including</u> 10/12/96 data):	6.6

Note that inclusion of the outlying data point from Sample No. C-OC-12 decreases the mean percent-reduction for these test runs by only 2%, but nearly doubles the standard deviation. This datum cannot be considered to lie within the same population as the remaining data points. Since no field operational parameters were changed for this test run, and the only change from previous test runs was the use of an unapproved sampling protocol, the outlying data point from Sample No. C-OC-12 can be attributed to sampling error and must be excluded.

Table 2.1-3 – Acetic Acid Leaching Data Summary from Field-XRF Data¹

Batch Number	Date	Soil Fraction	Input Soil Total Pb (mg/kg)	Output Soil Total Pb (mg/kg)	Weighted Average ² Output Soil Total Pb (mg/kg)	Percent Reduction
A	9/15/96	Whole	2,254	124	124	94.5
B	9/20/96	Whole	1,613	172	-	91.6
	9/21/96		-	99	135	
C	9/23/96	Whole	4,122	137	160	96
	9/25/96			183		
D	9/26/96	Whole	4,122	300	320	92.2
	9/27/96			340		
E	10/1/96	Sand	-	216	360	89.9
		Fines	3,435	714		
	10/2/96	Sand		162	339	90.1
		Fines	3,435	771		
F	10/3/96	Sand		136	337	90.2
		Fines	3,435	828		
	10/4/96	Sand		174	355	89.7
		Fines	3,435	798		
G	10/5/96	Sand		244	404	93
		Fines	5,732	797		
	10/7/96	Sand		331	476	91.7
		Fines	5,732	831		
	10/8/96	Sand		386	502	91.2
		Fines	5,732	785		
	10/9/96	Sand		445	577	89.9
		Fines	5,732	900		

¹ This Table derived from data presented in Battelle's Draft *Results of Treated Soil Samples* dated 10/9/96.

² Weighted average based on Battelle calculations which assumed the soil matrix consisted of 71% "coarse" fraction and 29% "fine" fraction.

In order to ensure that the results of soil samples analyzed were representative of actual conditions, Battelle developed a detailed sampling protocol based on statistical guidelines from the Taggart *Handbook of Mineral Processing*. These guidelines dictate the volume of material required to be collected, as a function of contaminant particle size and ore (soil) characteristics, to achieve a desired level-of-confidence that the resultant samples are representative of the whole. In the case of the soil and contaminant characteristics found at Fort Polk, the protocol called for collecting 200 to 300 pounds of material from which to prepare each set of samples to be analyzed. The 200 to 300 pounds of material

collected for each sample set was dried, screened, and split in accordance with a detailed procedure in order to obtain representative samples suitable for laboratory analysis. This protocol was followed in all cases except in the case of the samples identified above under the label C-OC-12, where a protocol was followed which was subject to neither peer review nor approval of all parties under the demonstration contract. The volume of material collected (250 grams per sample) was not sufficient to be considered representative of the material processed under the required protocol (only "grab" samples were collected), nor was the preparation procedure dictated by the protocol used. Because of this, the analysis results cannot be considered together with the remaining data in evaluating cleanup levels achieved and process efficiencies realized.

2.2 Performance Criteria and Results – Process Through-Put Rate

The nominal capacity of the MET-TECH Plant, given a balanced soil matrix with a minimum of 10% coarse content and a maximum of 10% clay content, is 10 tons per hour. If the coarse content of the soil matrix is low, the screening process in the plant operates under capacity, resulting in a lowering of overall plant capacity for the given soil matrix. If the clay content is high, the capacity of the leaching process is exceeded, also limiting overall plant capacity for the given soil matrix. During this demonstration the soils exhibited both a low coarse content and a high clay content which the plant could not accommodate efficiently. As a result the nominal capacity of the plant could not be achieved. Through-put rates varied from 2 tons/hour to 5.4 tons/hour, depending on the characteristics of the feed stock. The following table summarizes plant through-put over the course of the demonstration:

Table 2.2-1 Summary of Plant Through-Put

Date	Daily Through-Put (Tons)	Cumulative Through-Put (Tons)	Operating Hours ¹	Average Through-Put (Tons/Hour)
9/3/96	1	1	0.5	2
9/4/96	1	2	0.5	2
9/5/96	3	5	1	3
9/6/96	8.5	13.5	2.5	3.4
9/7/96	0	13.5		
9/8/96	0	13.5		
9/9/96	0	13.5		
9/10/96	0	13.5		
9/11/96	0	13.5		
9/12/96	0	13.5		
9/13/96	6	19.5	2	3
9/14/96	6	25.5	2	3
9/15/96	18.5	44	8	2.3
9/16/96	0	44		
9/17/96	0	44		
9/18/96	0	44		
9/19/96	2	46	1	2

Table 2.2-1 Summary of Plant Through-Put

Date	Daily Through-Put (Tons)	Cumulative Through-Put (Tons)	Operating Hours ¹	Average Through-Put (Tons/Hour)
9/20/96	10.5	56.5	3	3.5
9/21/96	12.8	69.3	4	3.2
9/22/96	0	69.3		
9/23/96	16.2	85.5	5.5	2.9
9/24/96	0	85.5		
9/25/96	10.8	96.3	5.5	2
9/26/96	9.8	106.1	4.5	2.2
9/27/96	6.9	113	4	1.7
9/28/96	0	113		
9/29/96	0	113		
9/30/96	0	113		
10/1/96	17.9	130.9	4.5	4
10/2/96	19.5	150.4	6	3.3
10/3/96	27	177.4	5	5.4
10/4/96	32.7	210.1	6.5	5
10/5/96	14.4	224.5	4	3.6
10/6/96	0	224.5		
10/7/96	13.9	238.4	4	3.5
10/8/96	0	238.4		
10/9/96	0	238.4		
10/10/96	0	238.4		
10/11/96	0	238.4		
10/12/96	9.2	247.6	4	2.3
10/13/96	14.6	262.2	5	2.9

¹ Actual soil feed/processing time only.

The average through-put rate achieved over the course of the demonstration was 3 tons per hour – 30% of nominal capacity. The lower than expected through-put can be attributed to the limited flexibility of the plant design to handle the difficult soil conditions encountered, and to intentional changes to operational parameters in an effort to achieve low levels of soluble lead in the treated soils.

3.0 SITE MOBILIZATION

3.1 Commissioning the Plant at the Job-Site

ContraCon's physical-separation / acid-leaching plant consists of three self-contained, 45-foot trailers, together with associated support equipment. The support equipment is transported on two separate flat-bed trailers, and is staged for operation adjacent to the three self-contained units.

Setup of the plant on the treatment pad provided at Fort Polk was somewhat difficult due to restrictions in pad size and configuration which resulted in limited maneuvering room. Nevertheless, the plant was set up and ready for shakedown operations within two days of arrival (see Figure 3.1-1 – Site Layout).

Bulk acetic acid was stored in a 6500 gallon vertical tank. The storage tank itself was staged within a secondary containment berm with a capacity of 7500 gallons. The limited size of the operations pad precluded an arrangement which would allow convenient access to the storage tank from outside the exclusion area. While this did not cause undo disruption, it did require that the supply tankers enter the exclusion area during operations, and that a longer than desired hose be used for transfer of the acid.

Shakedown operations were completed and test runs using feed soil from Range 5 were started six days from arrival of the equipment on site.

3.2 Problems Encountered and Solutions Implemented in Commissioning the Plant

ContraCon's Met-Tech Plant, although highly mobile and designed for rapid setup, nevertheless requires a level or nearly level work pad to allow gravity flow between various stages in the process stream. A decision was made during the design process to utilize gravity flow in certain areas to reduce the number of large pumps required. While this approach results in fewer maintenance problems, it does make the relative elevations between equipment more critical. The surface of the pad available at Fort Polk was not level, and as a result it was necessary to use shoring to level and adjust the elevations of the unit trailers, and to lower fluid levels and tank inflow levels to accommodate the conditions encountered. These adjustments were made without undo difficulty, but at a cost of approximately \$2600 and a delay of 1/2 day.

3.3 Evaluation of Site Facilities and Support Utilities

The site facilities and support utilities provided were adequate for a demonstration of limited scope, but will require expansion to support full scale remediation.

Improved design of treatment pad sumps, retaining walls, and curbs would allow more positive control rain water and plant runoff, and thereby minimize the requirements to treat liquids prior to final discharge.

An adequate water supply is essential for efficient operation of any soil washing system. The water supply provided at the treatment pad consisted of a gravity-flow storage tank, filled by water from the Fort Polk water supply. This configuration had reportedly been specified to ensure that process water could not

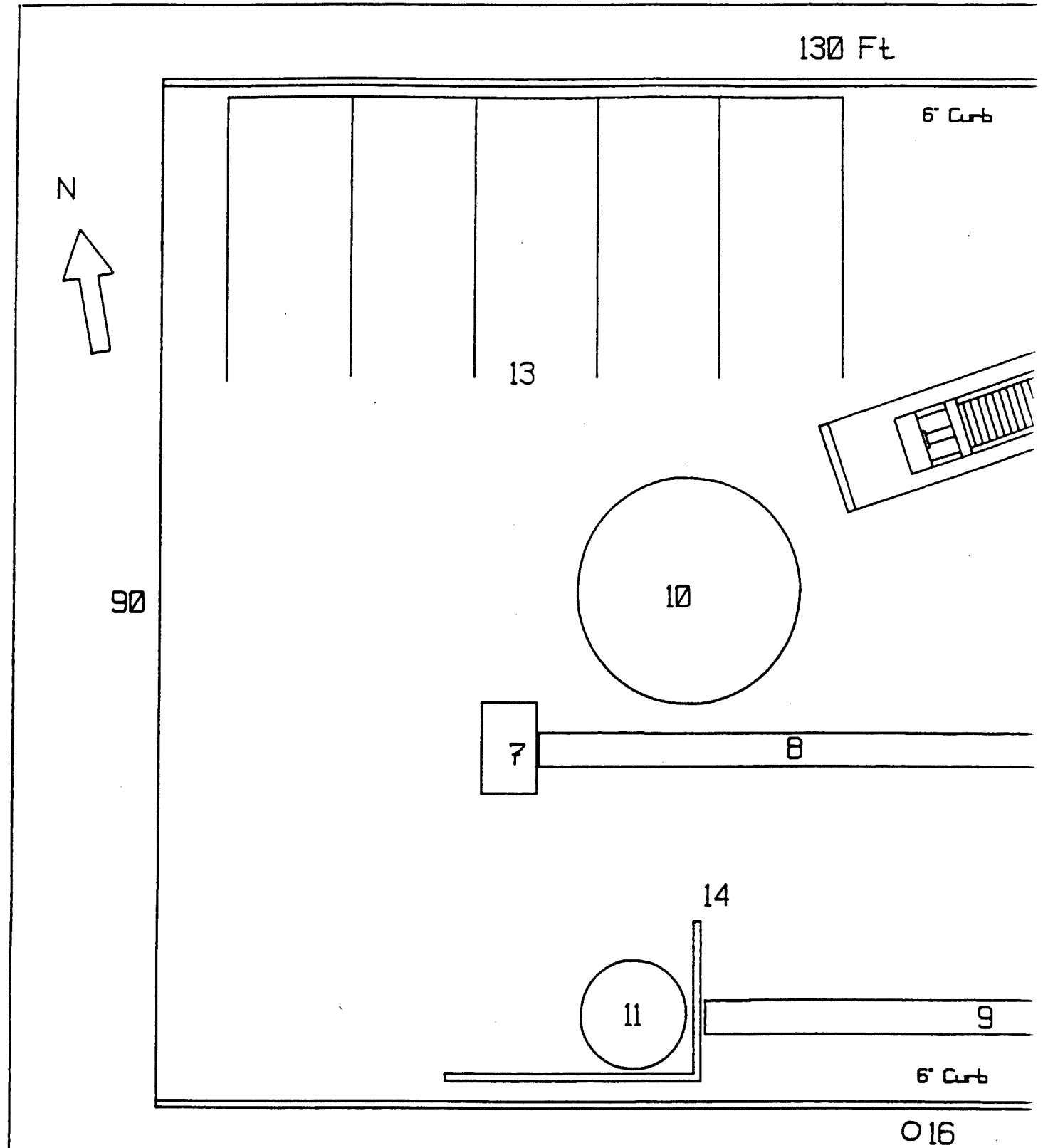

- 1 Logwasher Trailer 2 Jig Trailer 3 Thickener Tra
- 5 Vacuum Belt Filter 6 Pump Skid 7 Feeder 9 Stacker
- 11 Clean Soil 12 Heavy Metals Out 13 Clean soil cribs
- 15 Acid storage 16 Water supply 17 Attrition scrubbe
- 19 Frame Press 20 Bag Filters 21 Pump Skid

130 Ft

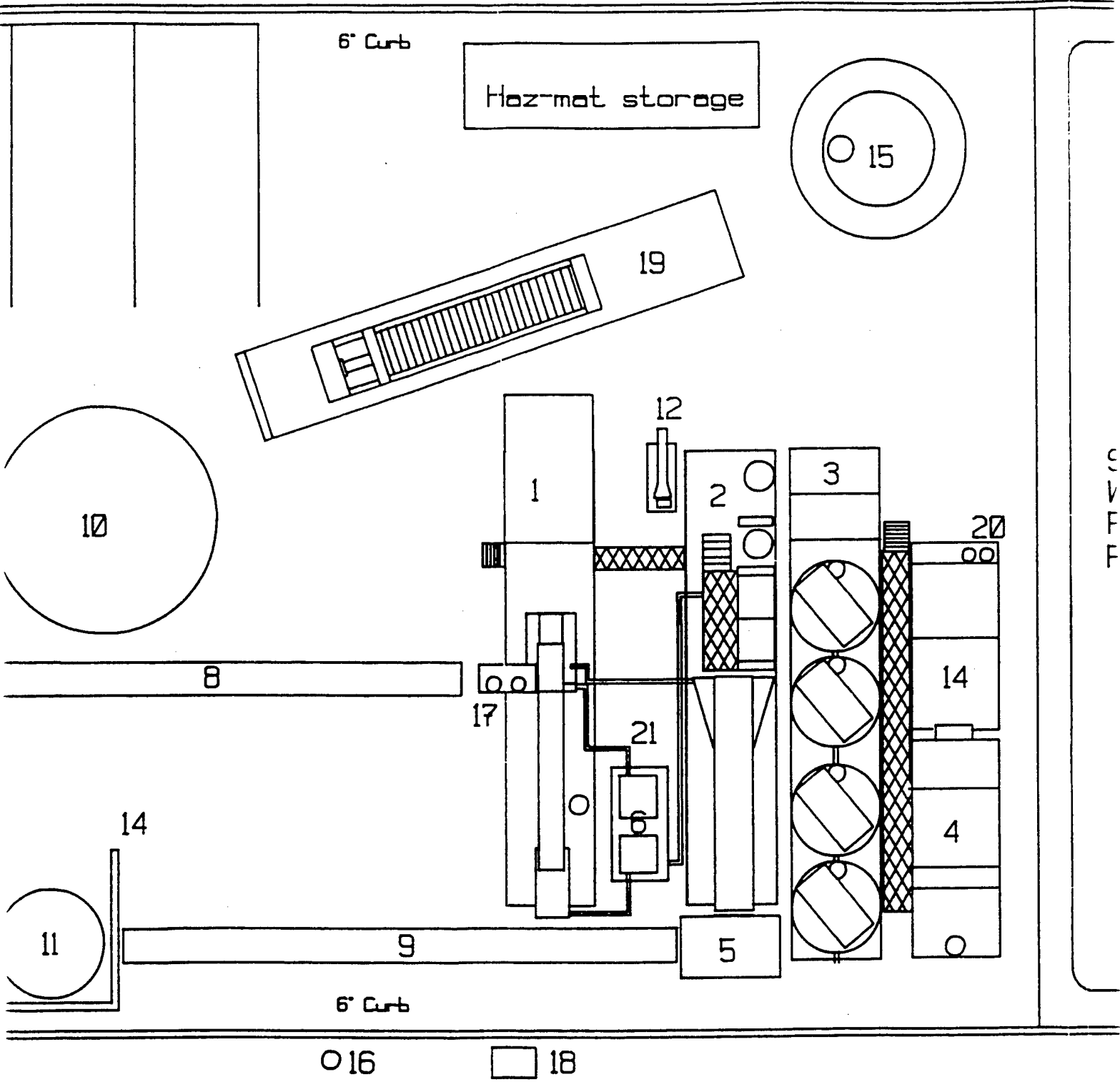

S
V
F
F

Jig Trailer 3 Thickener Trailer 4 Polishing Tank 14 Surge Tank
 mp Skid 7 Feeder 9 Stacker Belt 10 Dirty Soil
 als Out 13 Clean soil cribs 14 Clean soil containment
 supply 17 Attrition scrubber 18 Electrical Supply
 ters 21 Pump Skid

②

Revision	Date
Moved cribs	7/17/98
Added curbs	7/17/98
As built	9/3/98

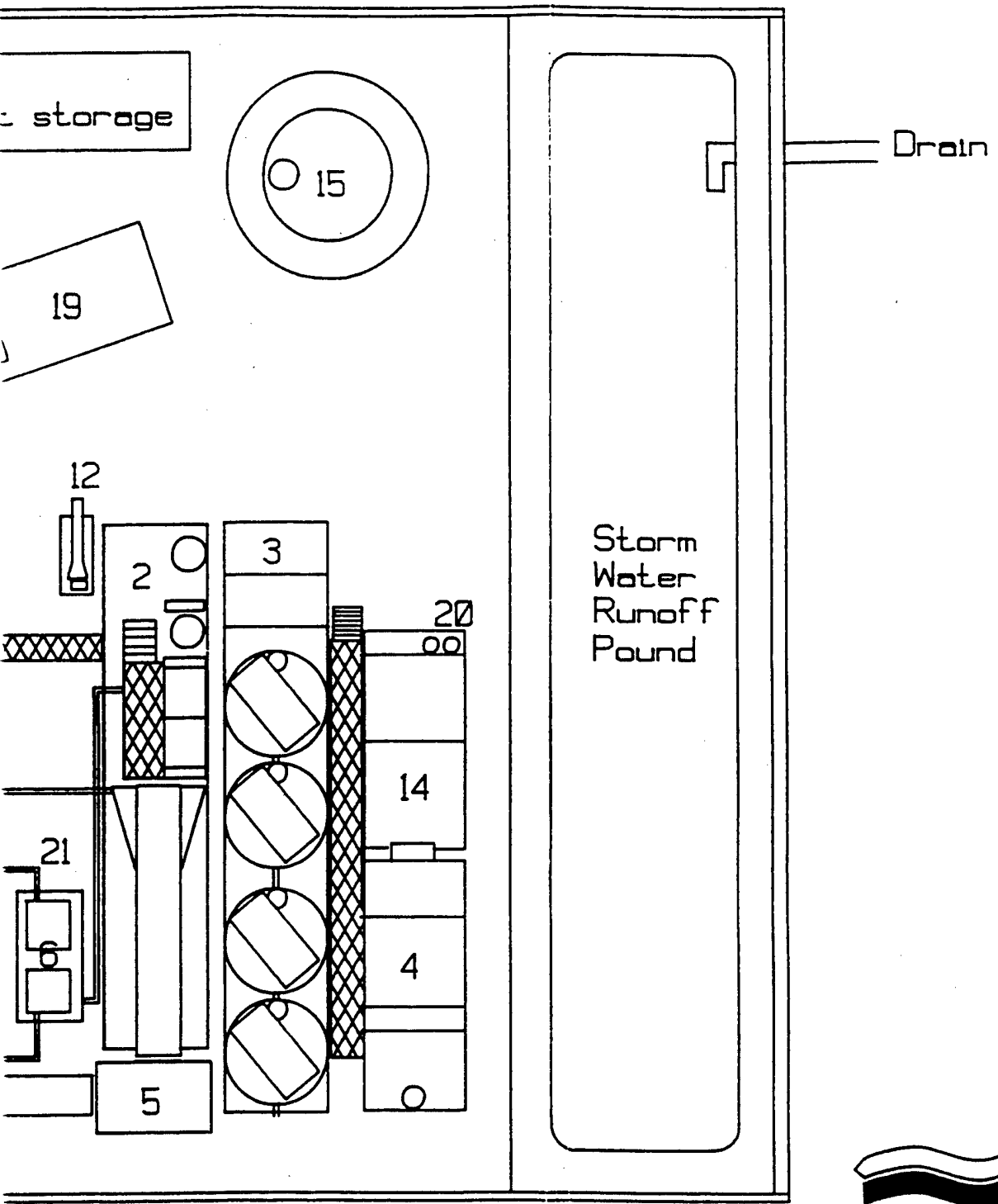

Figure 3.1-1 - Site Layout



Washing Tank 14 Surge Tank
Dirty Soil
soil containment
Electrical Supply

③

Revision		Date		MET-TECH Plant	
Moved cribs	7/17/96	Project	Fort Polk		
Added curbs	7/17/96	Drawn By	rmf	Scale	none
As built	9/3/96	Date	6/24/96	Sheet #	Layout

back-flow into the base water system. However, the flow rate of the system provided was insufficient, and required connection of external pumps to provide even marginally adequate flow.

Acetic acid, although less dangerous to handle than stronger, inorganic acids, nevertheless exhibits a pungent odor which must be controlled, especially during periods of high ambient humidity. The use of a treatment pad enclosure or of a point-of-origin enclosure for odor control should be seriously considered for any extended operation in close proximity to the general public. In areas of high rainfall, a weather covering for the plant, as well as for feed soil and processed soil piles, would also be helpful in controlling contamination of rainwater. Such an enclosure would require a positive ventilation system with organic vapor filtration to be effective. Shelter size would be highly project dependent, but would ideally require no interior support that could interfere with placement of the plant or maneuvering of equipment during operations. Light-frame, fabric-covered shelters are readily available in the market for purchase or rental.

3.4 Evaluation of Conducting Treatment Operations at a Location Remote from the Range

Because Range 5 at Fort Polk remained active during the course of this demonstration, it was necessary to establish a treatment pad at a remote location and to transport the soil to be treated from the range to the treatment pad to support remediation operations. This situation did not adversely effect the demonstration in any way. The only impact on the overall project was the cost of trucking the material from the range to process site. Given the limited volume of material processed during this demonstration, the incremental cost of trucking was diminimus.

The impact would be greater if a project required transportation of material over greater distances, or to an off-site treatment location.

4.0 DEMONSTRATION SCHEDULE

4.1 Original Work Schedule

The original work schedule called for total performance time of fourteen weeks, allocated as follows:

- Bench-scale testing – two weeks
- Mobilization – four weeks
- Initial test run and field demonstration – six weeks
- Completion and demobilization – two weeks

Because ContraCon was optimistic regarding the time required to complete the demonstration, the schedule was modified as follows:

- Site set-up and plant check-out – five days
- Conduct initial test run – one day
- Suspend operations while awaiting test and verification by the Government – four days
- Conduct full-scale operations – nineteen days

Formal Notice-to-Proceed was issued on August 28, 1996. The plant equipment was delivered to the site on August 29, 1996. Set-up was completed on August 31, 1996, and the plant filled with 16,300 of water on September 1st. Bulk acetic acid was delivered to the site on September 3rd, and 700 gallons of acid was pumped into the plant on September 4th. A system flow balance was conducted and soil feed commenced on September 5th.

4.2 Schedule Changes Arising During the Course of the Demonstration

Delays which impacted the schedule were encountered throughout the demonstration for various reasons, which can be generally summarized as follows:

- Set-up of the plant and preparation for operations required sixteen days, nine days longer than planned. Three days (two of which fell over a weekend) were lost due to late delivery of bulk acetic acid. The remaining days lost arose from the necessity to procure and install additional equipment to allow the plant to handle the higher-than-anticipated fines content in the feed soils.
- Full-scale operations required twenty-six days, seven days longer than planned. One day was lost due to breakdown of the input feed hopper. While various other minor problems were encountered, virtually all of the remaining days lost arose from problems directly related to processing and dewatering residual fines.
- Delays caused by weather were minimal, but did have a nominal impact on the schedule. Operations were suspended for up to two hours on several occasions during severe lightning storms due to the inherent hazards of working in an open area. These concerns were compounded due to the close proximity of the treatment pad to a power distribution substation.

Additional information concerning system problems and their impact on the demonstration schedule can be found in Section 4.5, below.

4.3 Synopsis of Daily Operations Over Course of the Demonstration

Table 4.3-1 – Summary from Daily Operations Log

Date	Notes
8/29	Plant arrived on site
8/30	Commenced setting up plant
8/31	Completed setting up plant
9/1	Filled plant with water – 16300 gallons
9/2	Day Off
9/3	Bulk acid delivered to site – 4500 gallons
9/4	Transferred 700 gallons acid to plant

Table 4.3-1 – Summary from Daily Operations Log

Date	Notes
9/5	Commissioned plant, conducted water balance, commenced feeding soil
9/6	Conducted shakedown testing
9/7	Clay in feed soil "balling" in material washer. Purchased attrition machine.
9/8	Day Off.
9/9	Awaiting delivery of attrition machine and associated parts.
9/10	Installed jig hutch launders and make-up water line.
9/11	Installed mount for attrition machine.
9/12	Installed attrition machine.
9/13	Completed installation and conducted test run on attrition machine.
9/14	Completed shakedown testing of plant.
9/15	Commenced soil treatment. 954 gallon's acid used (51 gallons/ton). pH set point 2.7
9/16	Routine maintenance. Awaiting analytical results.
9/17	Routine maintenance. Awaiting analytical results.
9/18	Routine maintenance. Awaiting analytical results.
9/19	Test run met criteria and goals. Received notice-to-proceed. System pH 3.21. Leaching pH 3.14. Commenced processing soil.
9/20	Shut down after 6 hours operation due to broken feeder-belt and leaks in water manifold.
9/21	Completed repairs. Continued processing soil (7 hours).
9/22	Day Off
9/23	Cleanup in morning. Continued processing soil for balance of day (5.5 hours) No problems. System pH 3.31. 340 Gallons acid used (21 gallons/ton).
9/24	Planned shutdown. Installed new sandscrew basin. Pumped sludge from thickeners (vacuum belt would not keep up with sludge levels)
9/25	Completed sand screw basin modification. Processed soil for balance of day (6.5 hours) Good run. System pH 3.5
9/26	Continued processing soil. Stopped feeding after 4.5 hours due to high levels of sludge.
9/27	Continued processing soil. Shut down after 4.5 hours due to high sludge levels.
9/28	Pumped sludge for 10 hours. No additional soil fed into plant. Rented frame press.
9/29	Day Off
9/30	Installed frame press. Filtered pond water, pumped sludge from thickeners 1 and 2.
10/1	Continued processing soil. Secured feed after 4.5 hours due to high sludge levels. Pumped sludge for 6 hours.
10/2	Continued processing soil without incident. Drew down feed pile after 6 hours.
10/3	Installed bag filters. Commenced reprocessing soil from earlier runs (5 hours).
10/4	Continued reprocessing soil from earlier runs until complete (6.5 hours).
10/5	Conducted housekeeping in morning until new feed soil delivered to pad. Commenced processing. Shut down at end of day (4 hours). System pH 3.09
10/6	Day Off

Table 4.3-1 – Summary from Daily Operations Log

Date	Notes
10/7	Repaired pumps on rented frame press. Continued processing soils. Shut down after 4 hours due to high sludge levels. System pH 3.12
10/8	Planned maintenance. Installed automatic process control equipment for chemical injection into precipitation tank. Installed new filter cloths on frame press, and new vacuum belt filter cloth.
10/9	Completed installation of filter cloths on frame press. No operations.
10/10	Pumped sludge from thickeners to frame press for dewatering. No operations.
10/11	Cleaned out material from coarse material washer. Pumped sludge to frame press from Leaching Tanks 1 and 3 .
10/12	Completed cleaning of blade mill. Recommended soil processing (6 hours).
10/13	Continued processing soil. Drew down feed pile after 6.5 hours. System pH 3.0
10/14	Commenced demobilization

4.4 Overview of Typical Daily Operations

Summary from Work Log – Run No. 5, October 2, 1996

07:00	Safety meeting.
07:20	Start up mixers on Lime and Flocc Tank.
07:30	Startup plant, circulate water to set water balance and add water to plant to achieve operating level due to drain-down overnight.
07:45	Inspect plant for leaks; start air compressor.
08:00	Fill feed hopper and start feeding soil to plant.
08:15	Observe and adjust feed rate. Activate Acetic Acid control system. Startup under-flow pumps. Inspect plant.
08:30	Plant on line steady state. Make 1/2 hour checks and log results (pH, sludge depth, conductivity readings in water tanks). Adjust controls to maintain established operational parameters for this run. Collect water and soil samples, maintain logs. Check operation of jigs; clean out if plugged with sand. Check pH of solution approximately hourly. Maintain flocc tanks and lime tank, adjust flocc pumps to maintain good flocc formation in flocc tanks.
11:00	Remove compressed fines cake from filter press (2 hour job).
14:00	Stop feeding soil to plant.
15:00	Complete soil processing for the day. Commence plant shutdown.
15:45	Complete plant shut down plant, except for sludge pumps.
16:00	Start daily cleanup of pad and plant.
17:00	Secure sludge pumps.
17:15	Remove compressed fines cake from filter press (2 hour job). Fill lime tank, top off flocc tanks, check acetic acid tank level and shut valve. Conduct daily maintenance.
20:00	Secure for the day. Lock gate. Tons run this day 19.4.

4.5 Impact of System Problems on the Work Schedule

4.5.1 Impacts Related to the High Clay Content of the Feed Soils

The higher than anticipated clay content of the feed soils, which resulted in high levels of residual sludge in the system, was the largest factor contributing to down-time related delays. The short-term nature of the demonstration, in conjunction with the requirement to minimize operational delays, left insufficient opportunity to fully resolve this problem. ContraCon did strive continually to implement design changes to improve system performance, but the success of those efforts was limited.

Upon commencement of remediation operations, balls of clay were observed to form in the coarse material washer. It was immediately obvious that the high clay content of the feed soils would require the addition of a dedicated attrition machine at the inlet of the plant, upstream of the coarse material washer. The addition of the attrition machine significantly improved the ability of the plant to process high clay-content soils through the coarse material washer, but the increased attrition energy may have resulted in actually increasing the relative fraction of fine material in the soil matrix, and thus may have inadvertently contributed to the production of excessive residual sludge. Locating, shipping, and installing the machine caused a five day delay in operations.

As operations proceeded, the production of excess residual sludge in the leaching/settling tanks significantly reduced the ability of the plant to operate efficiently. The capacity of the original belt-filter press was insufficient to dewater the residual sludges effectively. In an effort to compensate, ContraCon rented a 3.1 yd³ rigid-frame press and redirected the output of the settling tanks from the belt-filter press to the frame press. Use of the frame press improved the volume of material which could be treated; however, the capacity of the frame press was still insufficient to fully handle the volume of sludge produced. Installation of the frame press caused a one day delay in operations.

The inability to efficiently process all the residual sludge generated severely limited the amount of time over which the plant could be operated in any given day. The capacity of the plant to process residual sludges was typically exceeded after only four to six hours of continuous operation, after which it was necessary to secure feeding soil into the plant until processing of the accumulate sludge was complete. While this did not directly affect the project schedule, it did severely limit the volume of material which could be treated in the time frame allowed.

4.5.2 Other Plant-Related Impacts

The sandscrew employed to dewater treated sands discharged from the jig circuit was allowing excess water to be retained in the sands prior to discharge. In an effort to correct this, the base of the sandscrew was modified to provide a larger pool area, which lowered the level and reduced the velocity (and accompanying turbulence) of water in the screw. This resulted in decreasing the water content of sands being discharged from the system, allowing easier handling and staging of the discharged soils. Field modification of the sandscrew caused a one day delay in operations.

Modifications such as reconfiguring the jig under-flow system, providing more durable process hoses, increasing the volume of ragging in the jig beds, installing rubber skirting on feed areas of material belts all contributed to improved gravity separation and control of plant hydraulics. These changes were made during normal operations or when the plant was secured for other reasons, and had virtually no impact on the project schedule.

A number of other, minor problems were encountered and addressed with little impact on the project schedule. These can be summarized as follows:

- Undersized magnetic starter trip units, installed in error by the electrical fabricator, were causing associated electric motors to trip-out upon starting or upon being loaded down in the high ambient temperatures encountered at the job site. This was resolved by installing higher capacity trip units (heaters) in the control circuits.
- The electrical windings on the jig underflow sand-screw drive motor failed when excess moisture caused the windings to short circuit. A new motor was purchased and installed.
- Failed welds on the plant water manifold resulted in numerous leaks. These were repaired on site as they developed.
- Several pumps developed shaft seal leaks which could not be repaired on site. Efforts were made to minimize the volume of water lost from the plant, both during operations and when the plant was secured each night.
- Nuisance shutdowns were routinely experienced as a result of a voltage spike of unknown origin in the base electrical system. These voltage spikes occurred daily at 14:00 hours, five days a week, and caused the plant speed control devices to trip-out on over voltage. The devices were reset with no impact on the schedule of operations.

Overall, systems failures were minimal. Downtime attributed to equipment failures was 7 hours out of more than 360 hours of operations, less than 2%, not including planned downtime for installation of equipment modifications to improve process performance.

5.0 UNIT PROCESS SYSTEM DESCRIPTION

5.1 Original System Design and Unit Process Methods Employed

ContraCon's MET-TECH[®] soil-separation and acid-leaching technology was designed for remediation of soils contaminated with heavy metals, and represents the third generation of the application of this technology in the United States. The plant was originally designed for use with hydrochloric acid and adapted for use with acetic acid as required for the demonstration project at Fort Polk. The unit processes employed in the system are as follows:

5.1.1 Material Feed System

Contaminated soil is loaded into a feed hopper from which it is conveyed by a feeder-belt into the plant for processing. The feeder-belt is equipped with an automatic weighing system which monitors and stores input feed rate and total weight of material processed. The belt is also equipped with a magnetic device to remove ferrous metal from the feed material before it enters the plant.

5.1.2 Coarse Fraction Treatment – Attrition Scrubbing and Wet Screening System

Upon entering the plant the feed material is processed through a coarse material washer which breaks down the soil matrix and imparts the attrition energy required to scrub contaminants from the soil particles. The primary discharge from the coarse material washer feeds directly into a vibrating sieve deck, which separates the various fractions of the soil matrix by particle size. Overflow from the lower basin of the coarse material washer is directed to the cyclone surge tank for subsequent treatment.

Three screens were employed in the vibrating sieve, including 3/4" mesh, 1/2" mesh, and 3/8" mesh. Gravel trapped on the 3/4" screen inch is diverted directly to the clean output pile. The minus 1/2" to plus 3/8" material includes lead bullets and copper shell casings together with a quantity of gravel; this material is diverted to collection barrels for recycling. The 3/8" minus material passes through the screen and is pumped to the gravity separation circuit for further processing.

The wash solution in the attrition scrubbing and wet screening systems was controlled at a pH of 3.6. The use of low pH process water in the soil separation circuit was intended to remove ionic lead compounds from this fraction, and reduce the quantity of acetic acid required for overall treatment. Retention time in the systems is approximately 15 minutes.

5.1.3 Particulate Metals Removal – Gravity Separation System

The gravity separation system is composed of a primary and a secondary jig, and a de-watering sand screw. The input to the jigs flows from the hydro-cyclone system and from the underflow of the vibrating sieve deck. Each jig removes as underflow approximately 10% of the material that traverses its bed. The underflow from the primary jig feeds the secondary jig where, again, approximately 10% of the feed material is removed. The discharge (underflow) from the secondary jig contains approximately 99 % of the heavy metals removed by the gravity separation system. Overflow from the secondary jig is returned to the primary jig in a closed-loop circuit to improve overall removal efficiency.

The underflow from the secondary jig enters a dewatering sandscrew from which it is discharged from the system and collected in barrels for disposal or recycling.

Overflow from the primary jig is directed to the primary sandscrew where it is dewatered and rinsed before being discharged onto a stacker belt to be recombined with the treated oversized material. Overflow from the sand screw is discharged to the hydro-cyclone tank for reprocessing.

The process solution in the gravity separation system is controlled at a pH of approximately 3.5 - 3.7 to facilitate the removal of ionic lead in sand fraction. Process retention time in the gravity circuit is approximately 20 minutes. The total leaching time for the sand fraction is approximately 35 minutes.

5.1.4 Organic Material Removal and Sand Fraction Separation – Hydro-cyclone System

Suspended fines and organic material flows out of the coarse material washer basin, through a fixed screen deck, and into the hydro-cyclone tank. The liquid in the hydro-cyclone tank is recirculated in a closed loop through a hydro-cyclone separator where suspended material greater than approximately 175 mesh (underflow) is removed and discharged to the gravity separation system for further processing. Overflow from the hydro-cyclone is returned to the hydro-cyclone tank. Approximately 75% of the liquid in the hydro-cyclone subsystem is retained and redirected through the hydro-cyclone, while approximately 25% is discharged to the gravity separation system for further processing.

5.1.5 Fine Fraction Treatment – Acid Leaching System

The Fine Fraction Treatment System consists of three two-thousand gallon open-topped tanks, each equipped with a bottom sweep which rotates at one revolution-per-minute (rpm) to provide for continual mixing of the flocculated fines in the leaching acid.

Liquid discharge from the hydro-cyclone tank is pumped to the No. 1 Leach Tank at the rate of approximately 80 gallons/minute. The mostly liquid slurry, which carries all minus 175 mesh material from the hydro-cyclone system, is directed into a 40 gallon baffled pre-mix tank where the slurry is flash-mixed with acetic acid and flocculant. The pH in this tank is automatically maintained by means of a constant-pressure transfer system which uses solenoid valves to control the flow of acid into the mixing tanks. Flocculant injection is controlled by manual adjustment of variable-volume piston pumps. Based on the results of bench scale tests using acetic acid, the leaching system was configured to maintain a pH of 3, more or less, and a material retention time of 200 minutes.

Sludge generated by the flocculation process settles to the bottom of the leaching tank, where the rotating action of the bottom sweep prevents the sludge from packing and optimizes contact of the sludge with the leaching acid. The overflow from No. 1 Leach Tank flows to the inlet of No. 2 Leach Tank, while the underflow (sludge) is pumped into No. 3 Leach Tank. When processing is completed in No. 3 Leach Tank, the sludge is pumped into No. 2 Leach Tank. The treatment process is the same in each of the three leach tanks. Underflow from the No. 2 Leach Tank is discharged to fines de-watering system.

This leaching process, using acetic acid, achieved a reduction in ionic lead concentration in the fine fraction of approximately 60%. This correlates closely with the results of laboratory testing reported¹ by Advanced Sciences, Inc. (ASI) which achieved 55% solubility of lead in acetic acid. Varying pH from 2.7 (34 gallons per ton) to pH 3.0 (21 gallons per ton) showed virtually no difference in the reduction efficiency.

5.1.6 Dissolved Metals Recovery – Precipitation and Water Treatment Systems

Leach System Tank No. 4 is used in this process to precipitate dissolved metals from the leach solution using proprietary chemicals. The underflow from the Precipitation Tank contains approximately 30% heavy metal. The overflow is pumped to a Polishing Tank where further clarification is achieved through passive settling of suspended solids.

For this demonstration the proprietary reagent, ThioRed® (polythiocarbonate), was used as the precipitant. Although ThioRed® showed good results in the bench scale test, it proved difficult to control at full scale. Dissolved metals were effectively precipitated from solution; however, the reaction resulted in the formation of small particles which floated on the surface of the liquid in the precipitant and polishing tanks, and which, when filtered out in the dewatering press, recontaminated the leached fines. Batch treatment of the leachate resulted in reduction of lead concentration in solution from more than 100 mg/L to less than 5 mg/L.

5.1.7 Fines Dewatering System

The fines dewatering circuit consists of a 3 ton-per-hour vacuum belt and associated recirculation pump which returns water removed from the fines to the No. 4 Leachate Tank.

¹ Test data provided in BDM RFP dated March 7, 1996 for Fort Polk demonstration, Table 4 – Leach Test Results.

5.2 System Modifications Made in Preparation for Demonstration at Fort Polk

ContraCon's MET-TECH[®] physical-separation / acid-leaching system was originally designed for use with hydrochloric acid as the leaching reagent. Modifications were made to the plant in preparation for the demonstration at Fort Polk to accommodate the required process change from hydrochloric acid to acetic acid. Acetic acid is weak and non-aggressive, when compared to the common non-organic acids. As a result, more than twice the volume of acetic acid is required for efficient operation, compared to hydrochloric acid, and the unit cost is approximately four times higher.

In addition to modifications required due to the change from the use of hydrochloric acid to the use of acetic acid, modifications were also made to account for the uncharacteristically high concentration of ionic lead in the sand fraction of the soil matrix as discovered during bench-scale testing. The concentration of lead contamination in the sand fraction exceeded 400 mg/kg, and physical-separation alone at near neutral pH did not appear to have any significant impact on these levels. The relative inefficiency of acetic acid to leach lead made it necessary to recover as much (ionic) lead as possible from the sand fraction, in addition to that recovered from the fine fraction, to ensure that the overall reduction in the recombined soil matrix met the cleanup criteria.

These conditions were addressed by changing the original two-loop plant configuration to a single loop configuration utilizing a low pH wash solution throughout (see Figure 5.2-1). By starting the leaching process at the first stage of the process, ionic lead was removed from the coarse and the sand fractions of the soil matrix, as well as from the fine fraction. In addition, use of a single loop system eliminated the necessity to neutralize the leach solution each time it was recirculated from the leaching system to the attrition scrubbing system, and to reduce the pH of the wash solution each time it was recirculated to the leaching system. Thus overall plant efficiency was improved, and the volume of acetic acid consumed was reduced by an estimated factor of three times.

In addition to the modifications describe above, a number of minor changes were made to the hydro-cyclone system, to the attrition scrubbing system, and to the gravity separation system to provide lower fluid flow rates through these systems. This had the effect of increasing leaching time in the fines treatment system, while at the same time reducing acid consumption.

5.3 System Modifications Made as a Result of Problems Encountered at Fort Polk

A number of significant modifications were implemented in the field to address a series of problems which arose in the course of operations. The modifications addressed four major problems – the formation of clay balls in the coarse material washer, the production of excess residual sludge in the leaching/settling tanks, the retention of excessive water in the treated soils discharged from the plant, and the retention of excessive dissolved lead in the leaching solution. See Figure 5.3-1.

5.3.1 Formation of Clay Balls in the Coarse Material Washer

Upon commencement of full-scale operations large balls of clay were observed to form in the coarse material washer, the first stage of soil processing in the plant. The formation of the clay balls inhibited proper attrition scrubbing which, because it occurred at a critical stage in the overall process, threatened to render the entire process ineffective. The shaft and blades in the coarse material washer had been designed to handle material with a minimum gravel content of 10% and a maximum clay content of 10%.

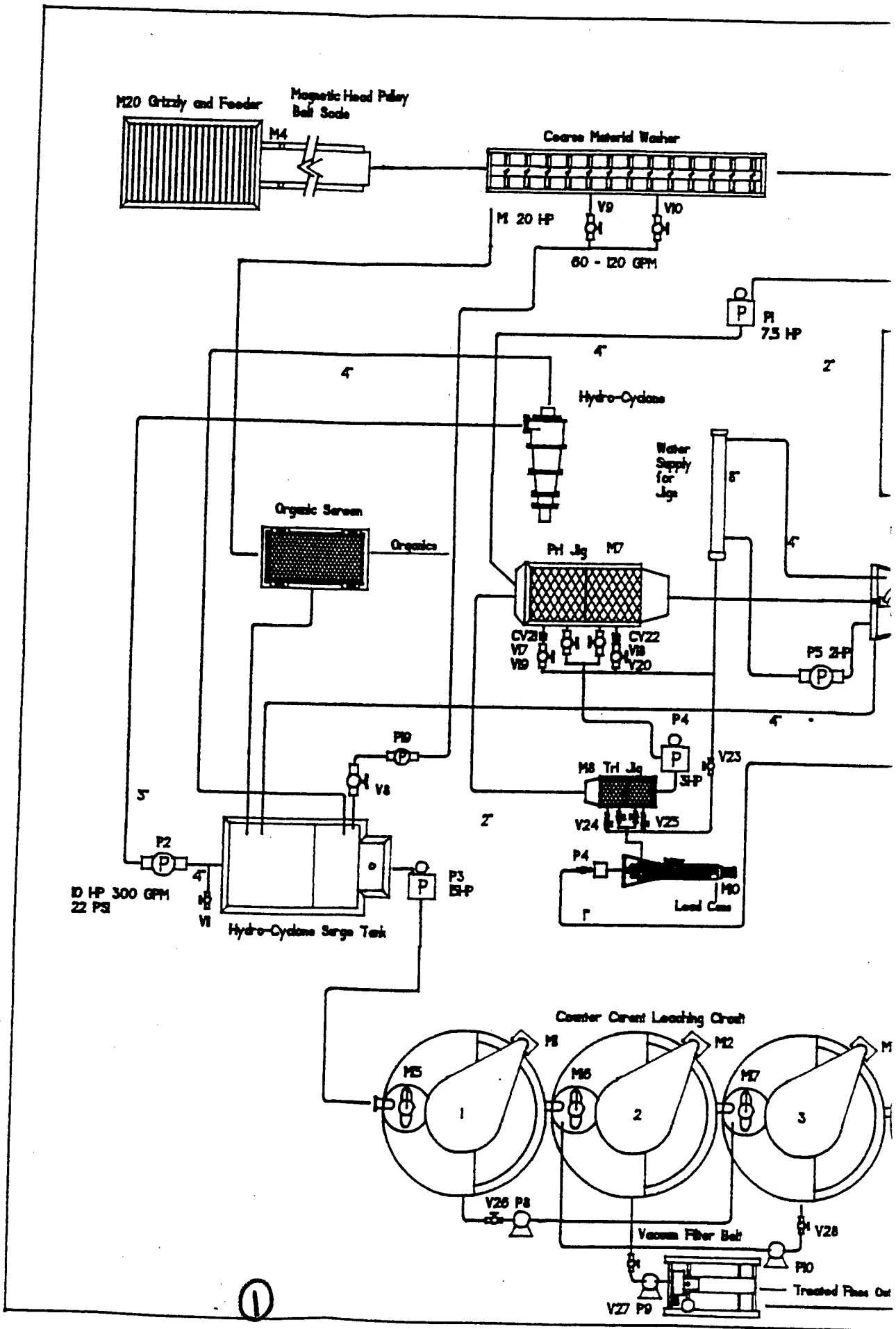

①

Top Deck 3/4"
 Second Deck 1/2"
 Bottom Deck 3/8"
 M2 3 HP
 Tripple Deck Screen

PROCESS FU

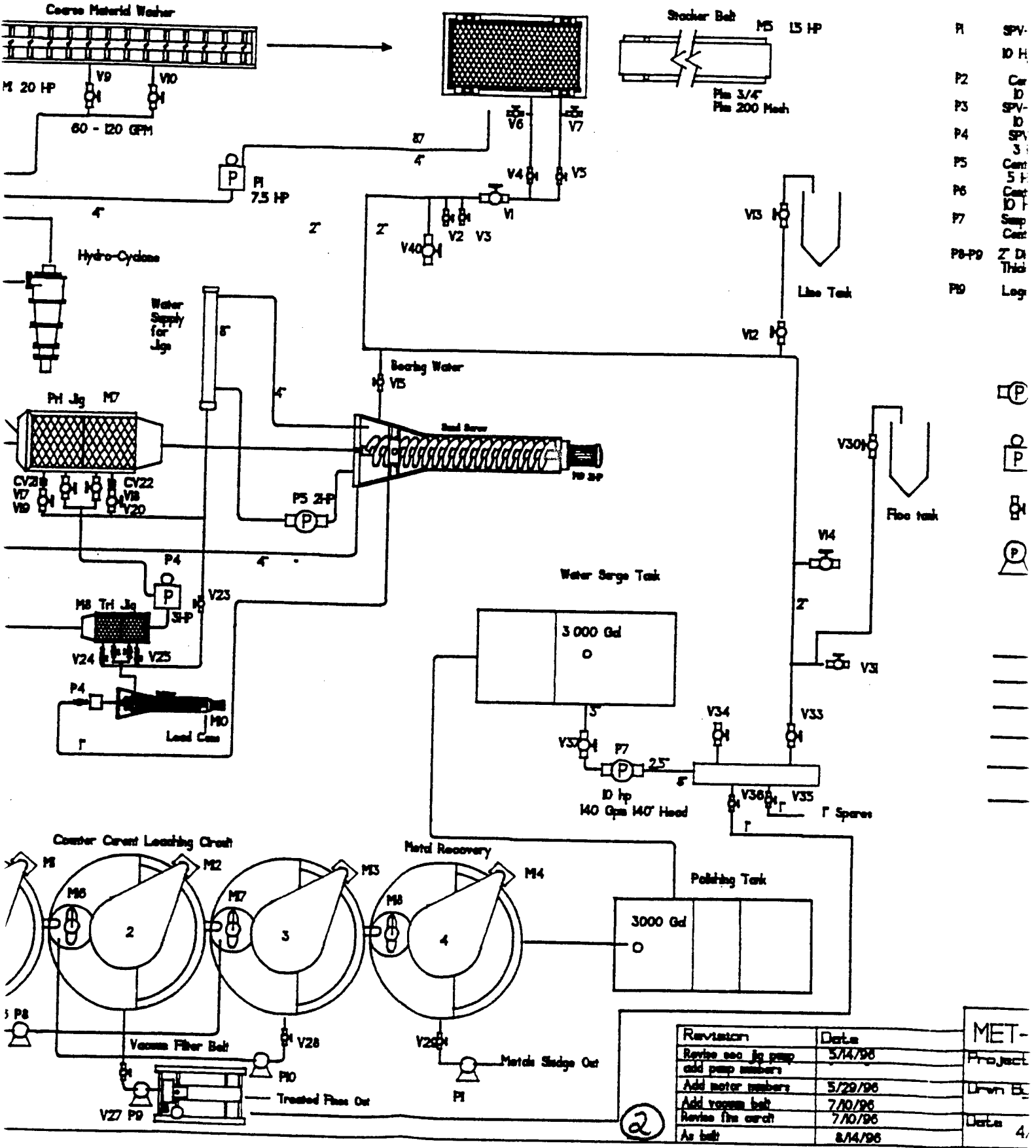

- P1 SPV-ID H
- P2 Car-ID
- P3 SPV-ID
- P4 SPV-ID
- P5 Cont-5 F
- P6 Cont-ID T
- P7 Sump Cont
- P8-P9 Z Di Thick
- P8 Log



Revision	Date	
Revise see jig pump add pump numbers	5/14/96	Project
Add motor numbers	5/29/96	Unwn E
Add vacuum belt	7/10/96	
Revise the circuit	7/10/96	Date
As belt	8/14/96	4

②

Deck 3/4"
 2nd Deck 1/2"
 3rd Deck 3/8"
 M2 3 HP
 3rd Deck Screens

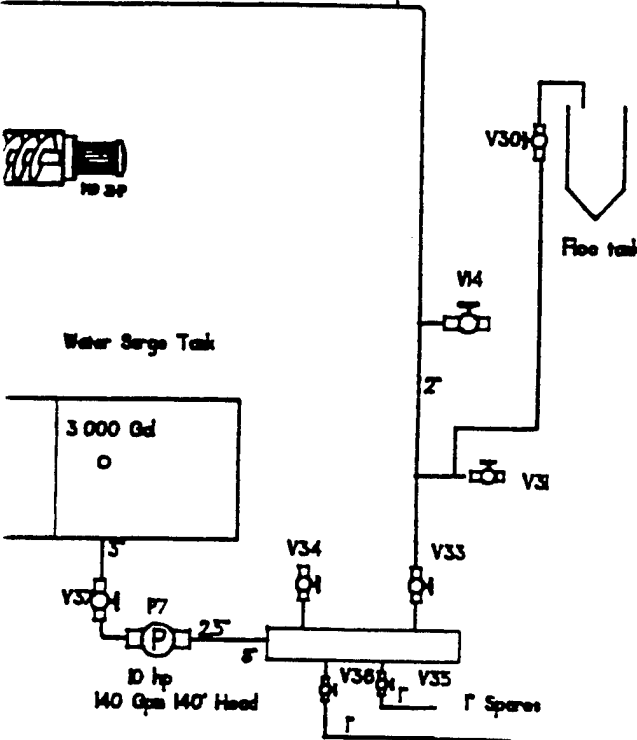
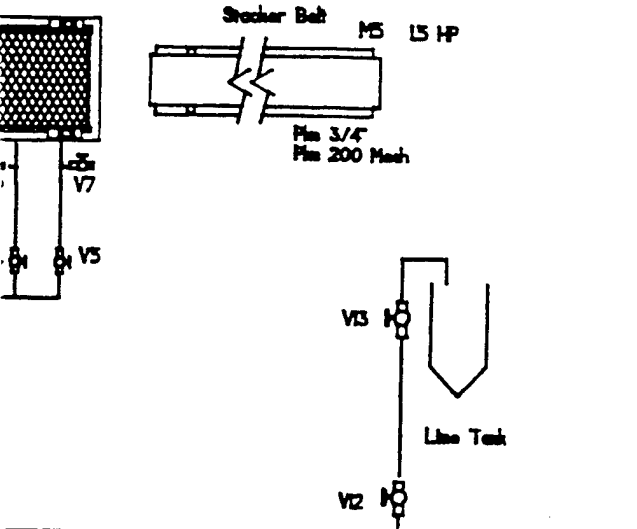

PROCESS PUMP LIST

- P1 SPV-304-4" Sole Vertical Slurry Pump
10 Hp @ 900 RPM
- P2 Centrifugal Pump 400 GPM @ 22 PSI
10 Hp Rubber Lined
- P3 SPV-304-4" Sole Vertical Pump
10 Hp @ 900 RPM Rubber lined
- P4 SPVC-HD-232-2" Vertical Slurry Pump
3 Hp @ 1200 RPM
- P5 Centrifugal Pump 300 GPM @ 20 ft Head
5 Hp Hatch Water Pump
- P6 Centrifugal Pump 350 @ 60 PSI Clean Water
10 hp @ 158 ft Head
- P7 Sump Pump H/4" 40 GPM @ 20 ft Head
Centrifugal Pump 3 Hp @ 10 ft Head
- P8-P9 Z Diaphragm Air Pump
Thicker Under Flow
- P10 Logwasher Supply Pump 1/2 hp

- Centrifugal Pump
- Sole Pump
- Valve
- Air Pump
- Hydro Cyclone
- Clean Wash Water
- Mesh 200 Mesh Circuit
- Jig Under flow
- Mesh 3/8" Circuit
- Metals Output

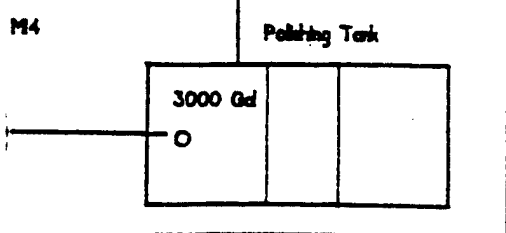

Revision	Date	MET-TECH Leaching Plant	
Revised ssg jig pump add pump numbers	5/14/96	Project Fort Polk	
Add motor numbers	5/29/96	Drawn By raf	Scale None
Add vacuum belt	7/10/96	Date 4/22/96	Sheet # ccf96
Revised fine catch	7/10/96		
As belt	8/14/96		

Figure 5.2-1 - Original Plant Configuration

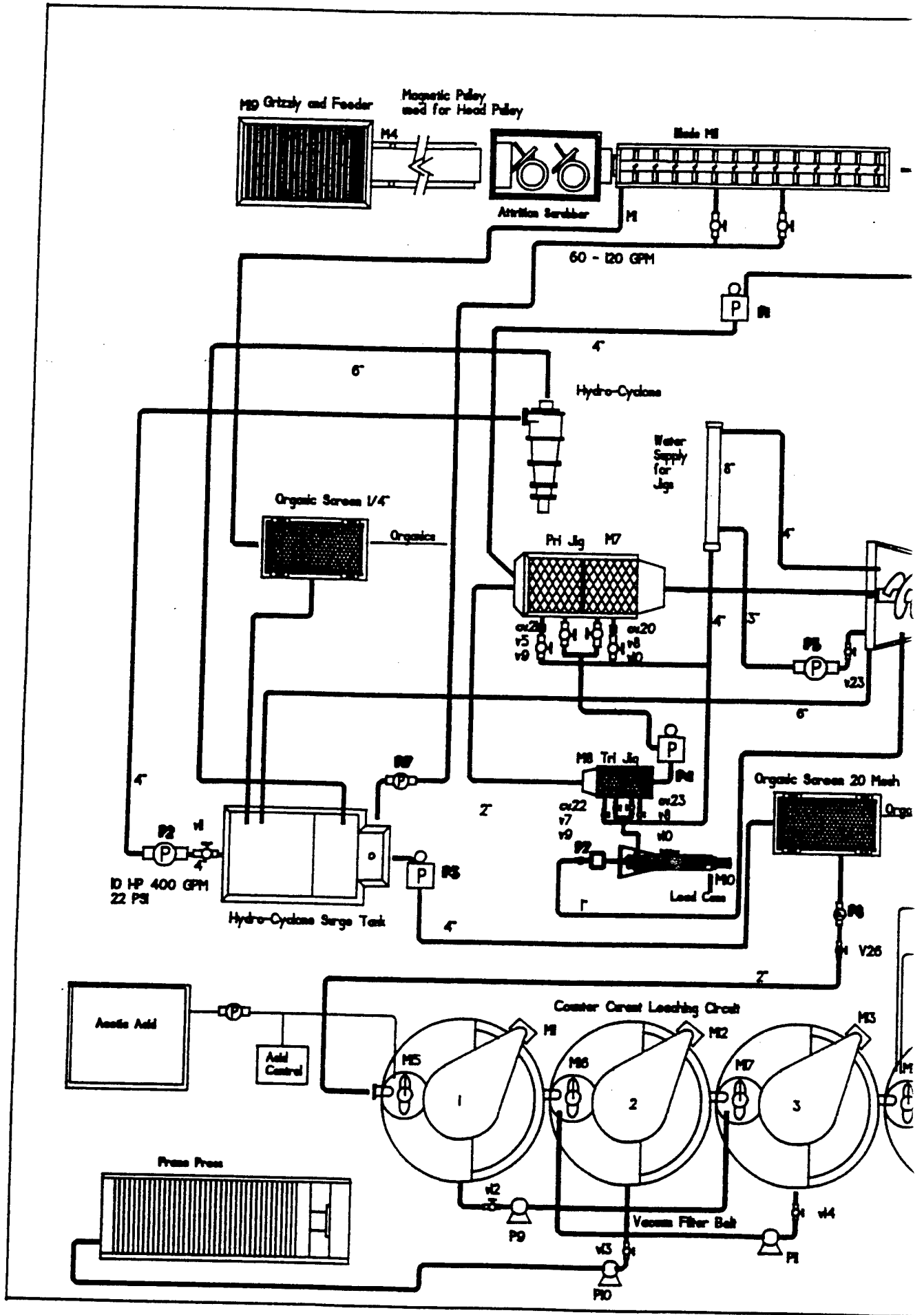

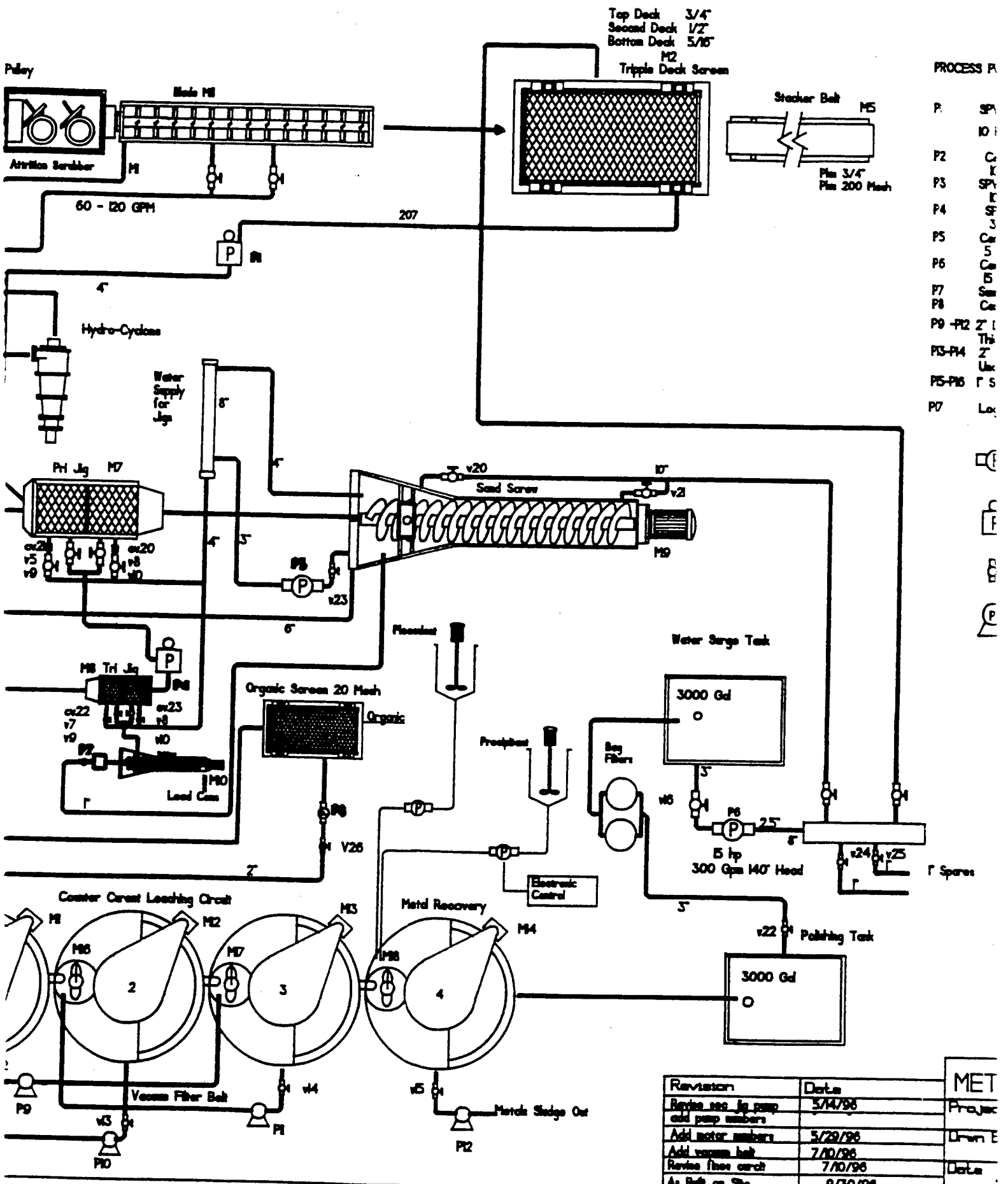

PROCESS P

P1	SP
P2	CK
P3	SP
P4	SP
P5	CK
P6	CK
P7	CK
P8	CK
P9-P12	Z
P13-P14	Th
P15-P16	F S
P17	Lx

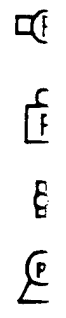

Revision	Date	MET
Revise nec jig pump add pump numbers	5/14/96	Project
Add motor numbers	5/29/96	Draw E
Add vacuum belt	7/10/96	
Revise free circuit	7/10/96	Date
As Belt on Site	9/30/96	

Top Deck 3/4"
 Second Deck 1/2"
 Bottom Deck 5/16"
 M2
 Tripple Deck Screen

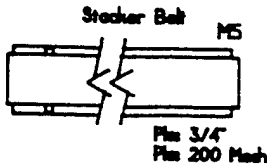

PROCESS PUMP LIST

- P1 SPV-304-4" Solu Vertical Slurry Pump
10 Hp @ 900 RPM
- P2 Centrifugal Pump 400 GPM @ 22 PSI
10 Hp Rubber Lined
- P3 SPV-304-4" Solu Vertical Pump
10 Hp @ 900 RPM Rubber lined
- P4 SPVC+HD-232-2" Vertical Slurry Pump
3 Hp @ 1200 RPM
- P5 Centrifugal Pump 300 GPM @ 20 ft Head
5 Hp Hatch Water Pump
- P6 Centrifugal Pump 350 @ 60 PSI Clean Water
5 Hp @ 138 ft Head
- P7 Sump Pump 1/4" 40 GPM @ 20 ft Head
- P8 Centrifugal Pump 3 Hp @ 10 ft Head
- P9 -P12 2" Diaphragm Air Pump
Thickener Under Flow
- P13-P14 2" Sump Pumps Centrifuge
Under Floor With Auto Level Switches
- P15-P16 1" Sump Pumps De-Watering
- P17 Logwasher Supply Pump

Centrifugal Pump

Solu Pump

Valve

Air Pump

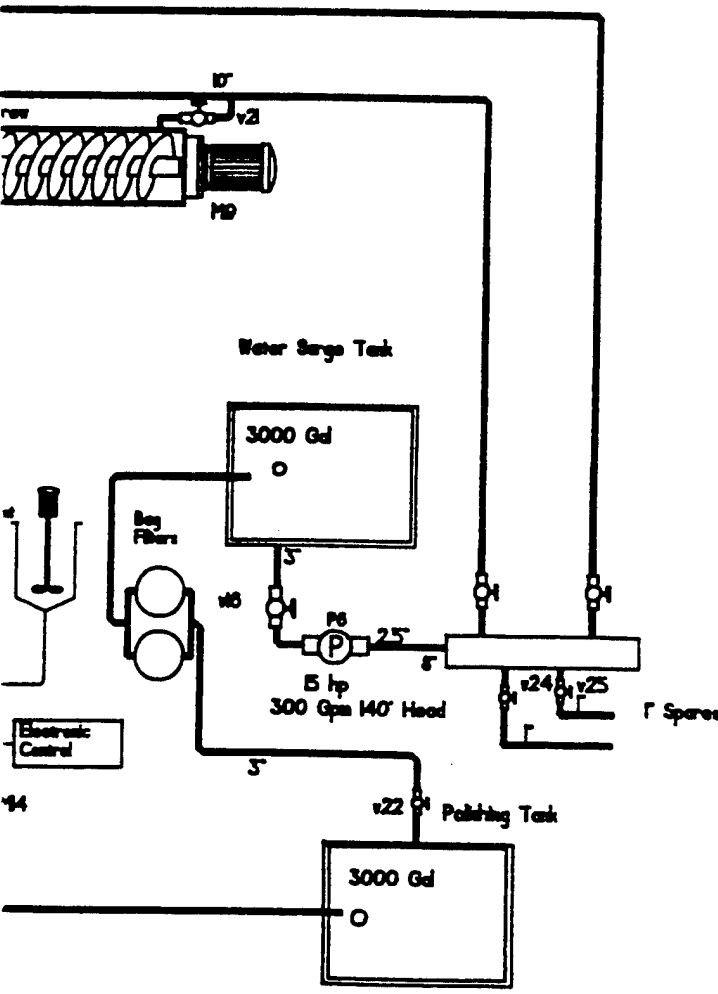

**ContraCon
 Northwest**

Revision	Date	MET-TEC Leaching Plant	
Revise see log pump add pump numbers	5/14/96	Project Fort Polk Project	
Add motor numbers	5/29/96	Drawn By raf	Scale None
Add vapour belt	7/10/96	Date 4/22/96	Sheet #
Revise flow chart	7/10/96		ccflow96
As Built on Site	9/30/96		

Figure 5.3--1 -- Plant Configuration as Modified at Site

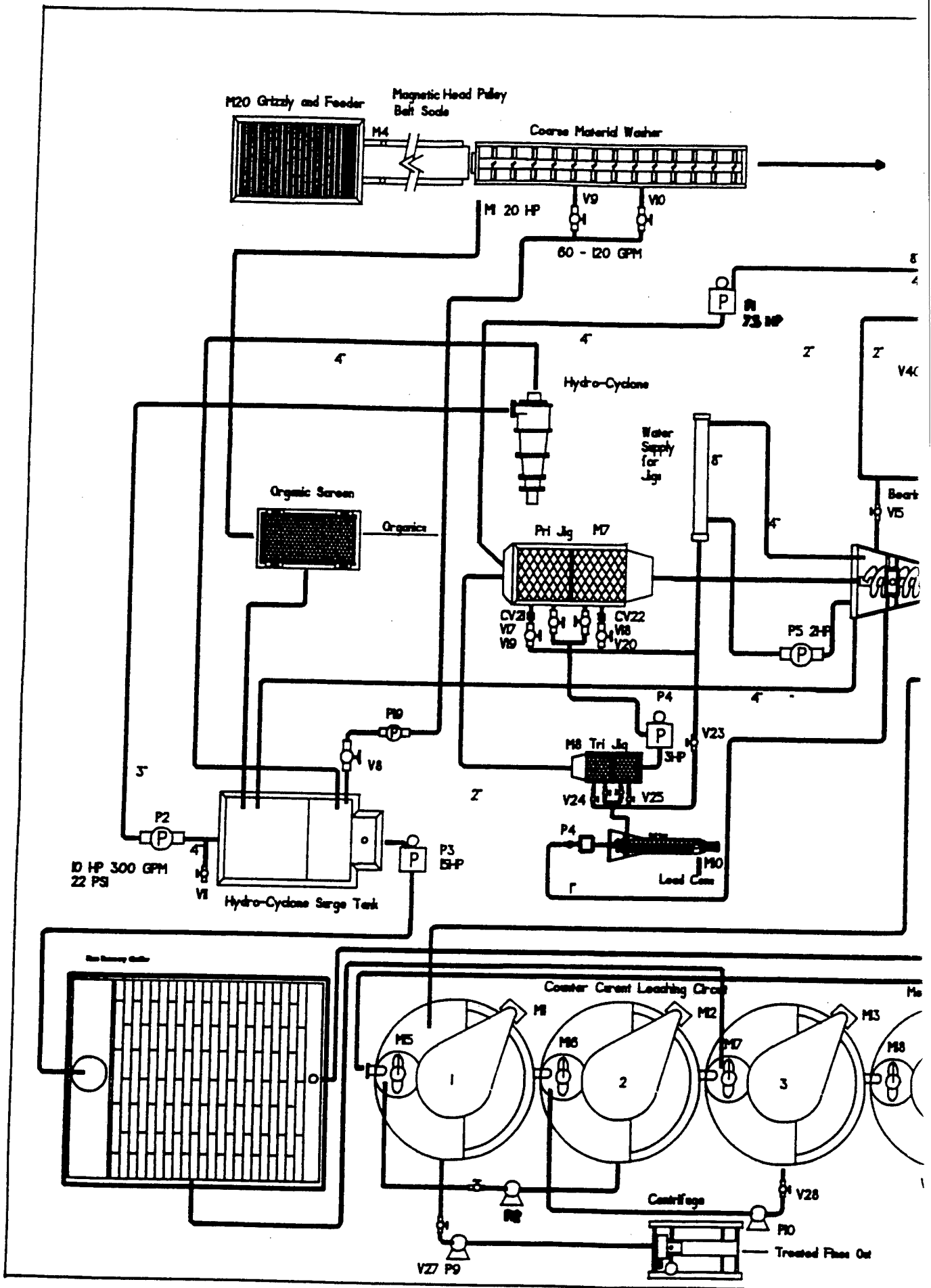

Top Deck 3/4"
 Second Deck 1/2"
 Bottom Deck 3/8"
 M2 3 HP
 Tripple Deck Screen

PROCESS PUMP LIST

P1	SPV-304-
	10 Hp @ 9
P2	Centrifugal
	10 Hp R/c
P3	SPV-304-
	10 Hp @
P4	SPVC-HD-
	3 Hp @ 1
P5	Centrifugal
	5 Hp Horiz
P6	Centrifugal
	10 hp @ 1
P7	Seep Pump
	Centrifugal
P8-P9	Z Diaphragm
	Thickener U
P9	Lograsher

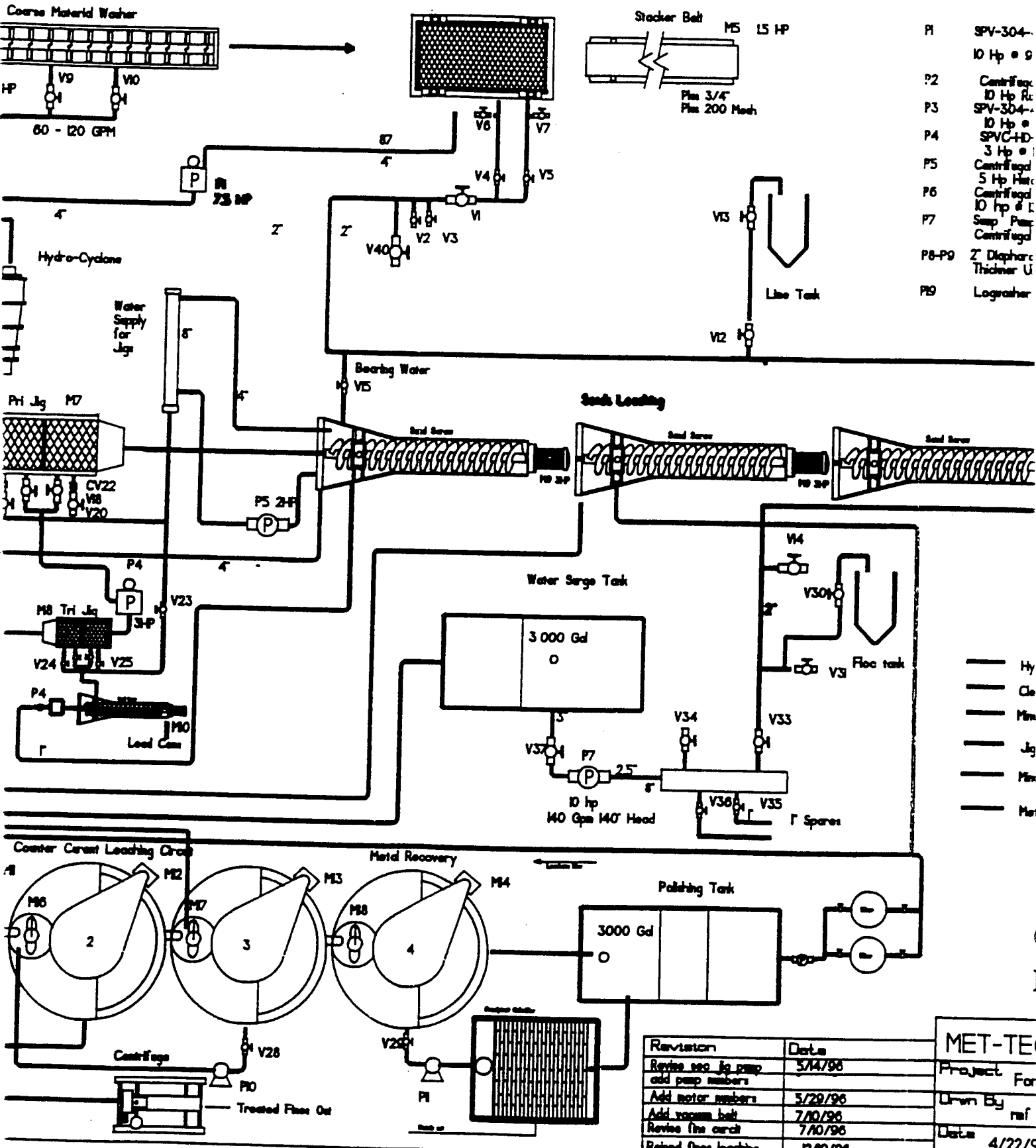

- Hy
- Cl
- Mm
- Jg
- Mm
- Mm

Revision	Date
Revise sec. Jg pump	5/14/96
add pump numbers	
Add water tanks	5/29/96
Add vacuum belt	7/10/96
Revise fine circuit	7/10/96
Revised fines leaching	12/10/96

MET-TEC	
Project For	
Drawn By	ref
Date	4/22/96

3/4"
1/2"
3/8"
3 HP
ck Screen

PROCESS PUMP LIST

- P1 SPV-304-4" Solo Vertical Slurry Pump
10 Hp @ 900 RPM
- P2 Centrifugal Pump 400 GPM @ 22 PSI
10 Hp Rubber Lined
- P3 SPV-304-4" Solo Vertical Pump
10 Hp @ 900 RPM Rubber lined
- P4 SPVC-HD-232-2" Vertical Slurry Pump
3 Hp @ 1200 RPM
- P5 Centrifugal Pump 300 GPM @ 20 ft Head
5 Hp Hatch Water Pump
- P6 Centrifugal Pump 350 @ 60 PSI Clean Water
10 hp @ 138 ft Head
- P7 Sump Pump 1/4" 40 GPM @ 20 ft Head
- P8 Centrifugal Pump 3 Hp @ 10 ft Head
- P8-P9 2" Diaphragm Air Pump
Thickener Under Flow
- P9 Logwasher Supply Pump 1/2 hp

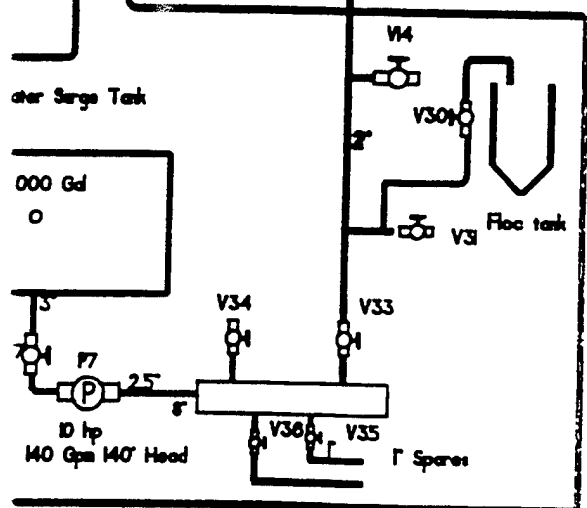
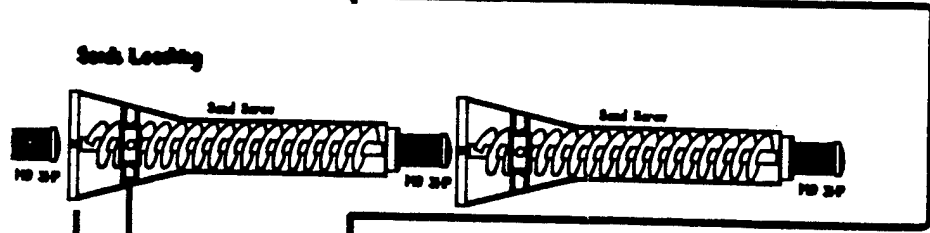
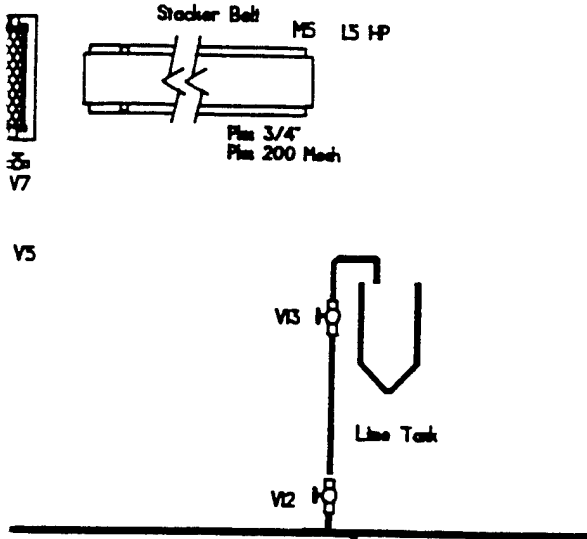

- Hydro Cyclone
- Clean Wash Water
- Pins 200 Mesh Circuit
- Jig Under flow
- Pins 3/8" Circuit
- Metals Output

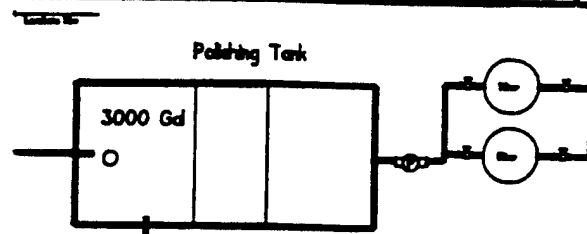

Revision		Date	MET-TECH Leaching Plant	
Revise sump jig pump	add pump numbers	5/14/96	Project Fort Polk	
Add motor numbers		5/29/96	Drawn By raf	Scale None
Add vacuum belt		7/10/96	Date 4/22/96	Sheet # ccfloor96
Revise line circuit		7/10/96		
Revised fines leaching		12/10/96		

Figure 5.4-1 - Planned Configuration Modifications

The gravel content of the soils encountered was significantly less than 10%, and the clay content significantly higher. To overcome the inability of the coarse material washer to handle the soils encountered, ContraCon purchased and installed a dual-cell 24"x24" attrition machine designed specifically to prevent the clayey constituents in the soil from balling in the course of processing. A five day delay resulted from efforts to locate, ship, and install the attrition machine. The total cost to implement this change was more than \$18,000. No clay balls were formed in the course treatment system after the attrition machine was installed.

5.3.2 Production of Excess Residual Sludge in the Leaching/Settling Tanks

Due to higher than anticipated clay content in the feed soil, the capacity of the vacuum-belt filter in the fines dewatering system was exceeded. As a result, volume of material that could be processed through the plant became limited by the capacity of the leaching system. Early modifications to the filter system were not effective in correcting the problem, so a decision was taken to rent a 3.5 yd³ press frame filter and to redirect the discharge of residual sludge from the vacuum filter to the frame press. Two sets of filter cloths were used over the course of the remainder of operations. Installing the frame filter and subsequent changing of the filter cloths caused a two day delay in operations. The total cost to implement this change was approximately \$22,000. The frame press did improve performance to some extent, however, its use did not fully resolve the problem of dewatering the residual sludge generated. Further, use of the frame press appeared to reduce the overall lead removal efficiency of the system by concentrating colloidal lead particles in the filter cakes.

5.3.3 Retention of Excessive Water in the Treated Soils Discharged from the Plant

Three modifications were made to the sand dewatering subsystem to reduce the moisture content of outgoing clean sands. The high moisture content was complicating the handling of the treated material on the work pad. First, a solid-state speed control was installed on the sandscrew drive motor to slow the rotation of the feed screw and thus increase retention time of the sand in the unit. Second, the sandscrew retention pool area was enlarged to reduce the ratio of process water to sand, as well as to reduce the turbulence in the pool area to allow more effective draining of the material in the feed screw. These modifications resulted in a reduction in moisture content by an estimated 10%. The total cost was approximately \$4,500. Operations were delayed for one day while the modifications were made.

Lastly, when the vacuum-filter press was no longer needed in the fines dewatering system (see Section 5.3.2, above), it was reconfigured to dewater the treated sand fraction being discharged from the plant. This modification resulted in a significant decrease in the moisture content of the output sand from approximately 40% to approximately 25%.

5.3.4 Retention of Excessive Dissolved Lead in the Leaching Solution

As operations proceeded it appeared that excessive use of precipitation reagents was inadvertently causing the concentration of soluble lead to increase in the leach solution, rather than to decrease as expected. A series of tests was conducted in ContraCon's on-site laboratory in an effort to gain a more complete understanding of the reactions occurring in the leaching system. The tests clearly indicated that, likely due to high concentrations of iron in the soils being treated and/or in the water supplied for charging the plant, the process would require nearly twice the volume of precipitant than was being added. To more effectively control precipitant dosing, ContraCon purchased and installed an ion-specific control and monitoring system to automatically inject the precipitant reagent into the precipitation tank. The total cost of this modification was approximately \$3,500. The modification was made without delay to system

operations. Definite improvement was noted in the control of soluble lead in the leach solution after the control system was installed.

In a further effort to improve the clarity of leach solution being recirculated from the storage tanks to the plant, ContraCon installed a duplex bag filter on the water plant water supply manifold. The cost of this modification was approximately \$2,500. This modification was made when the plant was idle for scheduled maintenance, and therefore had no effect on the project schedule.

5.4 Future Modifications Planned as a Result of Lessons Learned at Fort Polk

Modifications are being considered to increase the range of soils which can be handled efficiently in the plant, and to better control the precipitation of dissolved metals from the leaching solution. The modifications being considered can be summarized as follows. A schematic diagram depicting the plant modifications being considered is provided in Figure 5.4-1.

5.4.1 Improvements to the Sludge Dewatering System

The generation of higher than anticipated volumes of residual sludge in the acid-leaching system was the largest factor contributing to down-time related delays during the demonstration at Fort Polk. The sludge dewatering system was originally designed to process one to two tons of material per hour. At Fort Polk the system capacity was routinely exceeded by fifty percent to one hundred percent.

The decision during initial design to employ a vacuum filter-press for dewatering the residual sludge generated in the leaching process was influenced in part by the high cost of alternative methods. The vacuum filter-press was designed to handle one to two tons of material per hour, sufficient for most soils encountered. In retrospect, this capacity was insufficient to process the soils encountered at Fort Polk. To improve capacity with high fines-content soils, the vacuum filter-press in the sludge dewatering filter system will be replaced with a 90 gpm solid-bowl centrifuge. Centrifuges are more capable of processing large volumes of fine material, such as the sludges formed in the acid-leaching tanks. The cost for this modification is estimated to be \$225,000.

5.4.2 Improvements to the Dissolved Metals Recovery System

The automatic sensing and control system installed during the course of the demonstration to maintain the optimum concentration of precipitant in the precipitation tank will remain. In addition, a second clarifier will be provided to provide improved settling of precipitated material from the treated leach solution before it is discharged to the system polishing tank.

5.4.3 Improvements to the Gravity Separation System

A third jig will be added to allow more efficient separation of particulate metals from the treated sand fraction. This modification will effectively increase the concentration of lead in the underflow discharged from the jig sub-system, and reduce the volume of residual material required to be handled and transported to a smelter for recycling.

In addition, future systems will incorporate shaker tables to further separate from the gravel pieces of similar mass and configuration, the metallic lead and copper fragments collected. This would increase the unit value of the material collected, and enhance the potential of the material for recycling.

5.4.4 Reconfiguration of the physical-separation and acid-leaching subsystems

Figure 5.4-1 depicts a double-loop leaching system which utilizes a neutral or nearly neutral pH wash solution in the physical-separation stages of the process, and a low pH solution in the acid-leaching stages of the process. The potential benefit is the reduction or elimination of collateral solubilization of particulate metals during the first stages of processing, and the related reduction of soluble metals in the leach solution requiring treatment in the metals recovery system. The double-loop system is intended for use with hydrochloric acid. While the system could be operated employing acetic acid, the resultant cost to lower the pH of the slurry discharged from the gravity separation system to the leaching system and to increase the pH of the leaching solution discharged from the leaching system to the physical-separation system would be prohibitive.

6.0 MISCELLANEOUS ISSUES RELATED TO PROCESS OPERATIONS AND SAFETY

6.1 Correlation Between Total Lead and Associated Soluble Lead (TCLP) Concentration

A regression analysis was conducted using total lead (mg/kg) and soluble lead (mg/L TCLP) analysis results as listed in Table 2.1-1 of this report. The following relationship between total lead concentration and soluble lead concentration can be derived:

$$\text{Soluble Lead Concentration (mg/L TCLP)} = [0.03 \times \text{Total Lead Concentration (mg/kg)}] - 2.21$$

This relationship is linear, and has a correlation coefficient of 0.994.

Given this relationship, any soil with a total lead concentration of 195 mg/kg or greater would exhibit a soluble lead concentration which exceeds the 5 mg/L criteria desired for this demonstration.

It must be noted that the theoretical correlation between total lead concentration and soluble lead concentration suggested by the regression equation shown above applies only to the data used. Such a relationship is highly dependent upon the characteristics of the soil matrix, the concentration and form of the contaminants, and the presence of non-target contaminants in the soils. There is insufficient data at this time to apply these results universally with any reasonable degree of confidence.

6.2 Impact on Treatment of Non-target Metals in the Soil

The two major non-targeted metals found in the soil and removed during treatment were iron (steel bullet jackets and cores) and copper (bullet jackets). Of these, copper was the most significant. Based on chemical analysis, the concentration of copper averaged 1787 mg/kg in the untreated soil and 346 mg/kg in the treated soil. The average concentration of soluble copper was 7.6 mg/L (TCLP), however, a concentration of 0.768 mg/L (TCLP) was achieved during the first test run.

In addition to the iron attributable to the presence of steel jackets and cores in the soils being treated, the soil itself contained high levels of iron. These high levels resulted in the parasitic consumption of precipitation reagent, which contributed significantly to the cost of treatment.

6.3 Market Value Materials and Residual Wastes Generated

Metallic lead and copper, jig tailings containing particulate metals, and lead sludge generated in the precipitating tanks and discharged from the dewatering filter were collected for subsequent disposition. The following table lists the types of materials collected, together with the approximate quantities:

Table 6.3-1 – Listing of Market Value Materials and Residual Wastes Generated

Type	Amount
Bullets and copper casings	7 barrels
Jig concentrate	16 barrels
Sludge	48 barrels
Spent filter cloths	5 barrels
Used PPE	1 barrel
Steel cores and copper	1 barrels
Organic material	2 barrels
Used de-coned drums	10
Waste process water	21,500 gallons

Due to the small quantity of bullets and copper casings collected, together with the low value of the lead sludges generated, the selected smelter would not accept any of the material for recycling. All generated waste were disposed by LAIDLAW Environmental Services at a total direct cost of over \$68,000.

6.4 Health and Safety

6.4.1 Storage and Handling of Concentrated Acetic Acid

The potential risk of spillage of concentrated acetic acid during transfer to and from the bulk storage tank was of serious concern during operations. Formal safe-handling procedures were established, and the following safety features employed:

- A secondary containment unit with a capacity of 15,000 gallons was provided for the bulk storage tank.
- Double-wall piping was provided from the bulk storage tank to the transfer hose supply connection. All piping was manufactured from industrial duty, Schedule 80 PVC.
- A solenoid control valve was installed at the outlet of the bulk storage tank to provide automatic as well as manual emergency shutdown capability. The solenoid valve was designed to fail closed upon loss of power.

6.4.2 Acetic Acid Vapors

Vapors generated from the use of acetic acid resulted in airborne levels exceeding 20 ppm in areas immediately adjacent to the plant during occasional periods when the ambient humidity approached saturation. Plant personnel wore respirators equipped with acid-vapor filter cartridges whenever airborne acid vapor levels exceeded 20 ppm. Vapor concentrations varied widely in the vicinity of the plant as a function of wind direction, humidity, process pH, and soil throughput rate. Concentrations were most pronounced during operations with plant pH at 3.0 or lower under conditions of high ambient humidity. Increasing process pH to 3.2 or greater significantly reduced the vapor levels and the associated odors. Table 6.4-1 summarizes airborne vapor concentration measurements taken during the demonstration.

Table 6.4-1 – Airborne Acetic Acid Vapor Concentration¹

Date	Location	Concentration Reading(s) (ppm)
9/7/96	Adjacent to Hydro-cyclone Tank	3
9/7/96	Adjacent to No.2 Flocculant Tank	5
9/14/96	Adjacent to Hydro-cyclone Tank	17 / 22 / 9
9/14/96	Beneath No. 2 Jig	20 / 20 / 7
9/14/96	Operator's Control Station	9
9/15/96	Adjacent to Hydro-cyclone Tank	7 / 30
9/15/96	Walkway adjacent to No. 2 Jig	4 / 21

¹ Measured using Sensidyne/Gastec air pump with colorimetric detector tubes.

6.4.3 Airborne Dust

Lead-laden airborne dust did not pose a problem during operations. Periodic site monitoring was performed by Sherry Laboratories. No airborne lead concentrations exceeded 0.50 ppm.

6.4.4 Noise

Ambient noise levels were monitored using a portable sound-level meter. The highest sustained noise levels generated during plant operations were measured in the vicinity of the air-driven Weldon pumps on the rented frame press, where impulse readings approached 100 decibels. The rental company did not equip its pumps with mufflers, which would have reduced the noise level considerably. Operating personnel were required to wear hearing protection devices when steady-state noise levels exceeded 85 decibels. No other equipment in the process plant generated sustained noise levels greater than the 85 decibels action level. Table 6.4-2 summarizes ambient noise measurements taken during the demonstration.

Table 6.4-2 – Ambient Noise Levels During Operations

Date	Location	Sound Level (dba)
9/15/96	Operator's Control Station	77
"	Base of ladder adjacent to gravity jigs	82
"	On catwalk adjacent to No. 1 Jig	84
"	Adjacent to Hydro-cyclone Tank	82
"	Interior of shop/storage enclosure on Trailer No. 2	
"	Ground level below Attrition Machine	82
"	Ten feet east of Vibrating Sieve	83
"	Ten feet beyond outlet of No. 1 Sandscrew	82
"	Five feet north of Clarifier Tank	77
"	Base of ladder at bulk acid storage tank	71
"	Operator's panel at (diesel) air compressor	84
"	Base Feeder Hopper	72
10/1/96	Frame filter press adjacent to air-driven pumps	100 ¹
"	Ground level adjacent to ladder at frame filter press	90 ²

¹ Impulse readings to 100 dba at each pump cycle

² Impulse readings to 90 dba at each pump cycle

6.5 Potential Use of Select Reagents to Reduce Soluble Lead (TCLP)

It does not appear that acetic acid can be employed economically to reduce the concentration of soluble lead contaminants in soil to less than 5 mg/L (TCLP), when the total lead concentration in the untreated soil exceeds approximately 2000 mg/kg. The successful use of acetic acid will require that the residual sludge generated during soil leaching be chemically treated using carbonate-based reagents which transform the contaminants into insoluble complexes, or phosphate-based reagents which transform the contaminants into insoluble mineral apatites. Such reagents add no significant volume to the soil, and in many cases actually decrease the volume by releasing bound hydroxides.

ContraCon has successfully employed the proprietary chemical reagent THIO-RED[®], a biodegradable polythiocarbonate liquid, to treat lead-contaminated soils. Tests conducted by Custom Biologicals of Boca Raton, Florida demonstrated that THIO-RED[®] was non-toxic, and actually served as a nutrient and growth stimulator for both heterotrophic and petrophilic bacteria. Mid-South Testing, Inc. conducted toxicity testing; the results are presented in Table 6.5-1 – MICROTOX.

MICROTOX Evaluation of THIO-RED^{®1}

Sample	EC-50 ²	
	5-Minute	15-Minute
Lead Sulfate	1.7	0.1
Lead Thiocarbonate	232.1	56.1

¹ April 25, 1994

² ppm dry weight, based on 50% by weight slurry samples

The EC-50 value represents a concentration of sample which caused a 50% effect on the organisms exposed. The more toxic a substance, the lower the associated EC-50 value (concentration) required to cause the negative effect.

The HMIS ratings for THIO-RED[®] are as follows: Health=1, Flammability=0, Reactivity=0.

7.0 COSTS

The following tables depict the costs associated with the subject demonstration at Fort Polk, as well as the projected costs for conducting full-scale operations to treat 20,000 tons and 40,000 tons of similar soils.

7.1 Demonstration Project Costs

Tables 7.1-1 and 7.1-2 present a summary of project costs by phase and breakdown of project costs by category, respectively.

Table 7.1-1 – Summary of Project Costs

Project Phase	Amount (\$)
Administration	34,000
Bench Testing	26,000
Demobilization	48,000
Mobilization	63,000
Site Operations	383,000
Waste Disposal	68,000
Total	622,000

Table 7.1-2 – Project Cost Breakdown

Expense Category	Amount (\$)
Demobilization	47,600
Field Equip., Ops. & Maintenance	20,700
Health & Safety	18,750
Insurance	600
Labor & Payroll Expenses	119,800
Mobilization	63,000
Outside Laboratory	16,850
Outside Consultants	7,300
Heavy Equipment	105,800
Reagents	63,000
Site Laboratory - Process Monitoring	19,600
Site Work & Material Handling	36,900
Transportation & Lodging	31,300
Utilities ¹	2,019
Waste Disposal	68,600
Total	621,819
Unit Cost (\$/ton) (263 tons processed)	2,364.3
Reagent Cost (\$/ton) (263 tons processed)	239.5

¹ Includes only telephone. Power and water were provided by the client.

7.2 Projected Unit Costs for Full-Scale Operations

Table 7.2-1 presents a breakdown by category of estimated costs for full-scale operations at 20,000 tons and at 40,000 tons of material processed.

Table 7.2-1 – Estimated Costs for Full-Scale Operations¹

Expense Category	Amount (\$) (20,000 tons)	Amount (\$) (40,000 tons)
Demobilization	66,640	66,640
Field Equip., Ops. & Maintenance	30,000	40,000
Health & Safety	25,000	35,000
Insurance	1,000	1,500
Labor & Payroll Expenses	658,900	1,317,800
Mobilization	88,200	88,200

Table 7.2-1 – Estimated Costs for Full-Scale Operations¹

Expense Category	Amount (\$) (20,000 tons)	Amount (\$) (40,000 tons)
Outside Laboratory	25,000	35,000
Outside Consultants	10,000	10,000
Heavy Equipment	581,900	750,000
Reagents	1,940,800	3,881,600
Site Laboratory - Process Monitoring	40,000	50,000
Site Work & Material Handling	368,500	737,000
Transportation & Lodging	150,000	250,000
Utilities	20,000	40,000
Waste Disposal	50,000	75,000
Credit for Salvage (6% by weight @ \$0.19/lb)	-456,000	-912,000
Transportation of Salvage Material	45,000	90,000
Total	3,644,940	6,555,740
Unit Cost (\$/ton)	182.3	163.9
Reagent Cost (\$/ton)	97	97

¹ These costs do NOT include construction of a work pad, nor excavation and transportation of contaminated soils from the range to the work pad.

8.0 SUMMARY

8.1 Scope and Objective

The subject Pilot-Scale Treatability Demonstration was undertaken to allow evaluation of physical-separation / acid-leaching technology for remediation of lead contaminated soils. ContraCon Northwest was tasked to process berm materials from Range 5 at Fort Polk to a cleanup criteria of 1000 mg/kg total lead concentration, and to undertake a good-faith effort to achieve a soluble lead concentration of 5 mg/L (TCLP). Operations were required to proceed over a period of 15 days, up to a maximum of 1000 tons of soil processed.

8.2 Results

In all cases for which valid samples were collected total lead levels were reduced below 1000 mg/kg, with the optimum run exhibiting a reduction of 94.6 percent, from 2254 mg/kg (total Pb) in the feed soil to 122 mg/kg (total Pb) in the associated treated soil. The average reduction over the course of the demonstration was 90 percent based upon Gas Chromatograph analysis results obtained by Battelle in their laboratory, and 91 percent based upon X-ray Fluorescence analysis results obtained by Battelle in the field.

The soluble lead concentration in the treated soils was reduced to less than 5 mg/L (TCLP) during the first run only (3.07 mg/L). During all subsequent runs the resulting soluble lead concentration exceeded 5 mg/L, almost certainly due to a buildup of lead in the process water over time. The initial success does confirm that acetic acid can be used to effectively lower soluble lead contamination levels, and remains a viable technical option in range maintenance; however, the high cost of the acetic acid required to achieve these results may limit its application.

The average through-put rate achieved over the course of the demonstration was 3 tons per hour – 30% of nominal capacity. The lower than expected through-put can be attributed to the limited flexibility of the plant design to handle the difficult soil conditions encountered, and to intentional changes to operational parameters in an effort to achieve low levels of soluble lead in the treated soils.

The higher than anticipated clay content of the feed soils, which resulted in high levels of residual sludge in the system, was the largest factor contributing to down-time related delays. The necessity to address the problem of clay balls forming in the coarse material washer arose on the first day of full-scale operations. As operations proceeded, the production of excess residual sludge in the leaching/settling tanks significantly reduced the ability of the plant to operate efficiently. The capacity of the plant to process residual sludges was typically exceeded after only four to six hours of continuous operation, after which it was necessary to secure feeding soil into the plant until processing of the accumulate sludge was complete.

8.3 Conclusions and Recommendations

The data obtained during this demonstration clearly show that acetic acid can be effective in leaching soluble lead from contaminated soil, but that the high cost of the acid and associated reagents renders the process impractical for large-scale application.

The highest practical concentration of lead contaminants in soil which can be treated using acid-leaching technology with acetic acid appears to be approximately 10,000 mg/kg to achieve a final total lead concentration of 1000 mg/kg, and 2000 mg/kg to achieve a final soluble lead concentration of 5 mg/L (TCLP).

The results confirm that hydrochloric acid is more efficient and more cost effective than acetic acid for remediation of soils contaminated with particulate and ionic lead.

Appendix E

BRICE ENVIRONMENTAL SERVICES CORPORATION



**Technology Demonstration:
Physical Separation/Hydrochloric Acid Leaching Method
for the
Remediation of Heavy-Metals-Contaminated Soil
at Small Arms Ranges**

**Fort Polk, LA
Fall 1996**

Final Report

BDMESC / ABQ-ART-00116-96

Environmental Remediation & Engineering Services

3200 Shell Street
P.O. Box 73520
Fairbanks, Alaska 99707
tel (907) 456-1955
fax (907) 452-5018

554 Route 31
P.O. Box 78
Ringoes, NJ 08551
tel (908) 806-3655
fax (908) 806-3293

TABLE OF CONTENTS

Figures and Tables	ii
Executive Summary	iii
1 Introduction	1
1.1 Scope of Work	1
1.2 Objectives	1
2 Field Activities	2
2.1 Site Mobilization	2
2.2 Unit Process System	2
2.3 Demonstration Schedule	6
3 Soil Processing Results	7
3.1 Equipment Reliability	7
3.2 Process Methods	8
3.3 Regulatory Compliance	8
4 Costs	10
4.1 Hypothetical Full-Scale Treatment Costs	10
4.2 Fort Polk Demonstration Costs	18
5 Public Acceptance	19
5.1 Regulatory Community Acceptance	19
5.2 Client Acceptance	19
5.3 General Public Acceptance	19
6 Summary	21
7 Conclusions	22
8 Recommendations for Future Applications	23

FIGURES AND TABLES

Figures

1	Bench-scale Treatability Study-Based Treatment Process Schematic	4
2	Demonstration Treatment Process Schematic	5
3	Hypothetical Full-Scale Treatment Costs	11

Tables

1	Fort Polk Treatment Cost Breakdown	18
---	------------------------------------	----

EXECUTIVE SUMMARY

The U.S. Department of Defense oversees more than 2,000 active small arms firing ranges as well as the closure, or pending closure, of 200 more. Both active and closed ranges contain lead and other heavy metals such as copper, antimony, and zinc that can leach from bullets and fragments, thereby contaminating soils and possibly surface water and groundwater.

In 1996, Brice Environmental Services Corporation demonstrated its lead removal technology, based on mining methods, on soil from a Fort Polk, LA, firing range. Objectives were to: 1) attain a cleanup level of 500 mg/kg total lead and 5 mg/L Toxicity Characteristic Leaching Procedure (TCLP) lead; 2) demonstrate mechanical and performance reliability; and 3) estimate the cost of full-scale treatment.

After the demonstration, lead in 834 tons of physically and chemically treated soil were well below the cleanup objective, averaging 157 mg/kg total lead and 2.08 mg/L TCLP lead. No soil required re-processing, and all soil was replaced on-site. Wash and leach fluids were tested and discharged to the post sewage treatment plant. The more than 7.5 tons of particulate lead recovered were profiled, determined to meet the standards of a smelter, and recycled. Plant up-time during the demonstration exceeded 99 percent.

The unit cost of a 40,000-ton project under a treatment-for-closure scenario such as Fort Polk's would be about \$135 per ton. Alternatively, a viable range maintenance program, involving only the physical separation of particulate lead from 40,000 tons of material could cost about \$40 per ton.

Public acceptance criteria were applied to the technology demonstration. The public strongly supports technologies that recover heavy metals from soil as a means to end the current heavy metal waste cycle of disposal. Use of this technology for heavy metals soil remediation fulfills the intent of the Resource Conservation and Recovery Act (RCRA) and effectively replaces technologies that offer non-permanent solutions, such as merely chemically stabilizing the soils and hauling them to a landfill.

Clearly, treatment that combines physical and chemical elements is ideal when applied to small arms firing ranges. Mining technology offers a permanent solution to lead contamination, as opposed to stabilizing, transporting or capping soil in place. Furthermore, mining-based methods are innovative only in their application. By meeting or exceeding established criteria for performance, cost, technical maturity, and public acceptance, this technology has clearly proven its worth and is now ready for application to the full-scale remediation of small arms ranges.

1 INTRODUCTION

1.1 Scope of Work

Brice Environmental Services performed a pilot-scale treatment demonstration under subcontract to BDM Federal, as part of RFP BDM/ABQ-ART-00654-96, Pilot-Scale Treatability Demonstration of a Physical Separation/General Acid Leaching Process. The scope of work for this project included the performance of a bench-scale treatability study using soils provided by the client and the performance of a pilot-scale treatment demonstration. The bench- and pilot-scale demonstration utilized soils from an active small arms firing range at Fort Polk, LA. The bench-scale treatability study and plant design phases of the project were completed in August 1996.

The scope of work required the successful demonstration of a soil-washing and soil-leaching technology suitable for the removal of particulate and ionic heavy metal contamination from active small arms range soil. To perform a definitive demonstration, the scope of work required that up to 1,000 tons of such soils be treated using a continuous, closed-loop process.

1.2 Objectives

Specific objectives of this demonstration included:

- (1) Operation of the plant with continuous throughput at 10 tons of soil per hour
- (2) Cycling of wash/leachant water within the plant in a closed system
- (3) Reduction of total lead levels in treated soil to less than 500 mg/kg
- (4) Reduction of TCLP lead in the treated soil to less than 5 mg/L
- (5) Process treatment of plant water to less than 5 mg/L lead and a neutral pH, for discharge to the base sewage treatment plant.
- (6) Recycling of all lead removed from the soil

2 FIELD ACTIVITIES

2.1 Site Mobilization

Brice Environmental selected plant components necessary to meet the contract requirements of production rate and treatment levels based on bench-scale treatability findings. Skid-mounted unit componentry was determined to be superior to trailer-mounted componentry because they offered higher flexibility for process modifications in the field. Brice Environmental-owned and locally available componentry was evaluated for cost, efficiency and availability. Once processing equipment was selected, a preliminary schedule for shipping equipment to Fort Polk and erecting the equipment on-site was developed.

Brice Environmental personnel inspected the treatment pad and staging area during a pre-mobilization trip to Fort Polk. They spoke directly with local vendors of rental equipment, in-state and out-of-state smelters and transporters, as well as BDM project personnel regarding the preliminary mobilization approach and schedule. As part of the pre-mobilization meeting at Fort Polk, logistics regarding excavation, haulage, treatment, and back-hauling were reviewed for potential effects on the schedule, along with packaging and transport documentation requirements for the lead recovered during processing.

Brice Environmental mobilized in an adjacent field to ensure that all equipment was ready to be moved onto the treatment pad when it became available.

Over the course of two weeks, Brice Environmental mobilized on the pad and prepared to perform the validation run. The mobilization schedule was adhered to and the demonstration project started on time.

2.2 Unit Process System

Regarding the physical treatment approach, bench-scale treatability study test results indicated that on a mass basis, the majority of the lead contamination consisted of large intact bullets and bullet fragments, with minor amounts of sand-size metal particulates. Therefore, the development of the physical treatment system was directed at a system for free particulate recovery.

Regarding chemical treatment, bench-scale treatability study test results indicated that leaching of the entire soil fraction was required following physical treatment. Bench-scale results indicated that while retention time in the same leach solution provided effective leaching of the settleable soil fraction (sands), removal of lead from the fines fraction (soil clays) required a series of contacts with fresh leachant.

The unit process system treatment train deployed on site consisted of physical and chemical system componentry integrated into one continuous process.

Figure 1 presents a treatment process schematic based on bench-scale treatability study results depicting treatment steps discussed below.

Bench-scale treatability study results indicated that site soils were composed primarily of sands containing an oversize fraction of particulate metal. Therefore, the process approach was designed to physically remove large particulate metal using a wet vibrating screen deck and water (Step 1) to maximize physical removal and minimize the amount of heavy metals dissolved in subsequent leaching steps. Following physical treatment for the removal of large particulate metal, the soil fraction was submerged in a leaching solution (Step 2), attrited, and sized to separate soil clays from sands, while the sands fraction was density treated for removal of fine particulate metal (Step 3). Clay fines separated at Step 2 were then contacted with fresh leachant in a series of clarifiers (Step 4) and dewatered (Step 5). Sands were retained in leachant followed by dewatering (Step 6). After leaching and dewatering, the sands and clays were recombined, mixed, neutralized, and discharged (Step 7).

Physical removal processes consisted of two mineral jigs for recovering large and fine particulate metal for placement into barrels. Metal recovery from the leaching system was achieved with a single precipitation clarifier (Step 8). Heavy metals recovered from the leachant as a precipitant were then dewatered using a recessed plate-frame filter press (Step 9) and discharged into 10-yard, roll-on/roll-off boxes. Leachant flow to the precipitation clarifier came from leachant overflow from the clarifiers in Step 4. Clean leachant was returned to the leaching circuit via delivery lines to all leaching components.

Once mobilization was complete, a small amount of soil was processed prior to the validation test to confirm the treatment approach and representativeness of bench-scale samples upon which the treatment train was predicated. It quickly became obvious that feed soils varied when compared to the bench-scale treatability study sample soils. Excavated feed soils contained a high percentage of clays with an extremely high plasticity, whereas bench-scale sample soils did not. Processing feed soils on the vibrating wet screen deck resulted in clay-ball formation regardless of attempts to improve performance by adding water. Utilizing the screen deck would have resulted in the formation of clay balls. The clay balls would have fouled the large particulate recovery unit with a mat of clay.

The modification made in the field prior to commencement of the validation test consisted of removing the screen deck and bypassing the density treatment process planned for recovery of large particulate metal. Figure 2 presents the finalized treatment process schematic. This modification was performed inside of two hours.

Brice Environmental personnel were aware that the change noted above would result in exposing a large percentage of additional metals to the leaching solution, resulting in a greater mass of leached metals requiring removal from solution. However, bench-scale treatability study and field treatment results verified that this alteration did not compromise leaching process efficiency.

**FIGURE 1 BENCH-STUDY BASED TREATMENT
PROCESS SCHEMATIC (SOLIDS-ONLY)**

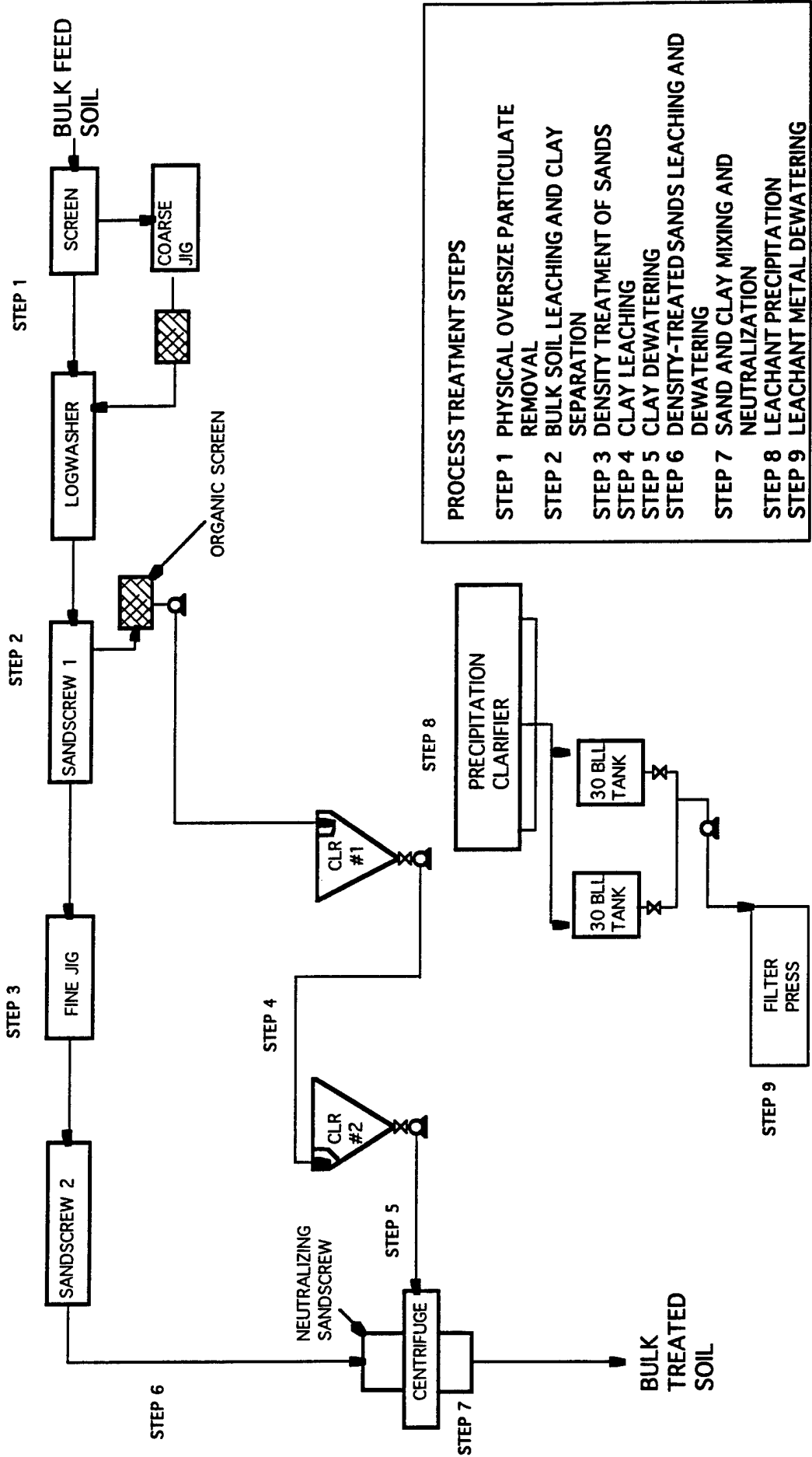

PROCESS TREATMENT STEPS	
STEP 1	PHYSICAL OVERSIZE PARTICULATE REMOVAL
STEP 2	BULK SOIL LEACHING AND CLAY SEPARATION
STEP 3	DENSITY TREATMENT OF SANDS
STEP 4	CLAY LEACHING
STEP 5	CLAY DEWATERING
STEP 6	DENSITY-TREATED SANDS LEACHING AND DEWATERING
STEP 7	SAND AND CLAY MIXING AND NEUTRALIZATION
STEP 8	LEACHANT PRECIPITATION
STEP 9	LEACHANT METAL DEWATERING

**FIGURE 2 DEMONSTRATION TREATMENT PROCESS
SCHEMATIC (SOLIDS-ONLY)**

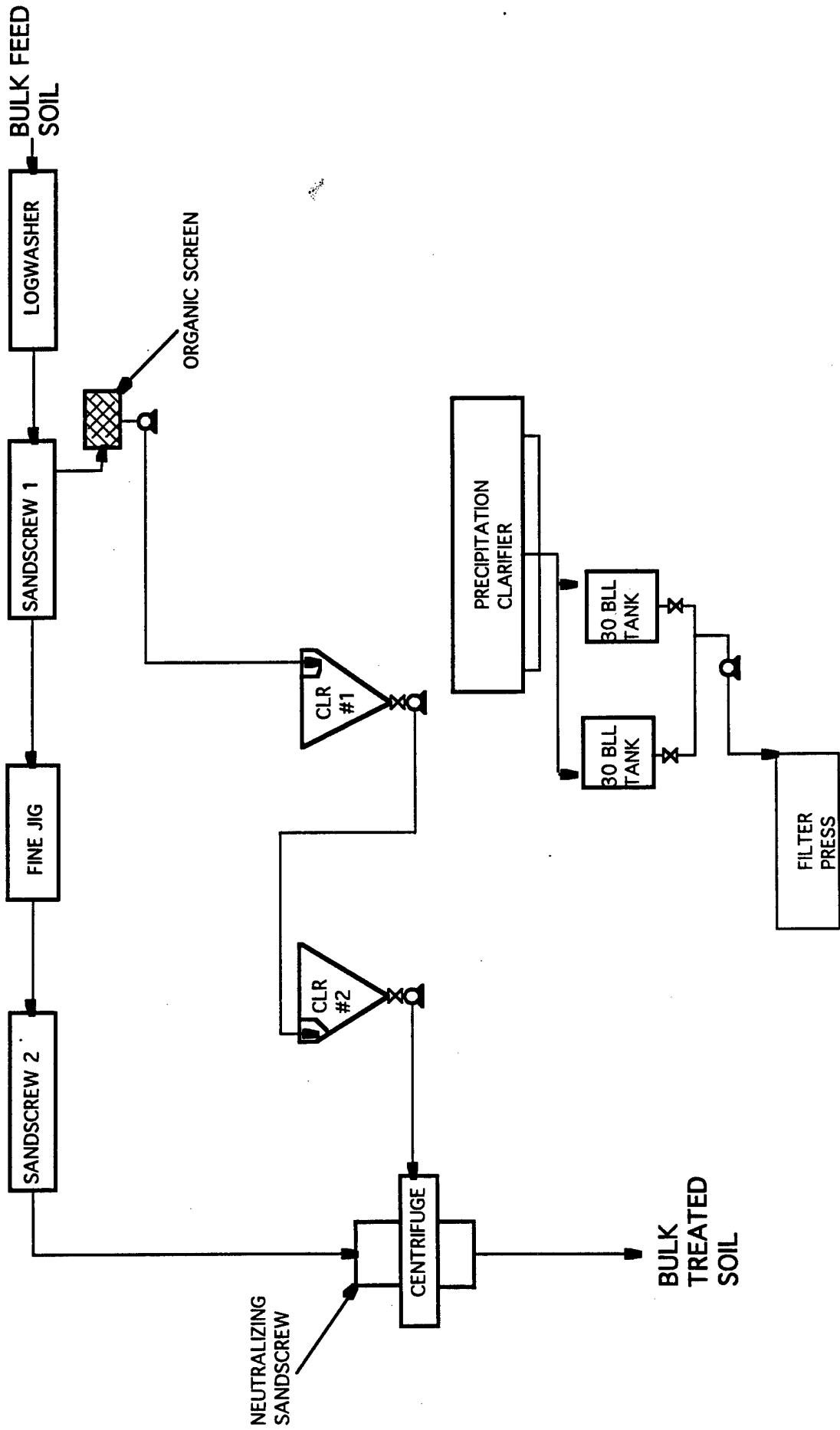

2.3 Demonstration Schedule

The work schedule finalized prior to the demonstration reflected a contract agreement that emphasized production, minimized delays and down time, and increased overall costs. Two weeks were allocated for placing and configuring equipment, testing for leaks, and filling plant componentry with material. Subsequently, a one-day validation run required nine hours of continuous operation. Three days of down time for analytical testing confirming treatment success followed the validation run. After process validation, fifteen days of processing were required.

The contract stipulated that the plant operate nine continuous hours per day with no more than one hour per day of down time. Brice Environmental agreed that if daily down time exceeded more than one hour, personnel would remain on-site and process additional material at cost for the totality of those hours accumulated during the fifteen days. BDM agreed that any delays not attributable to Brice Environmental would be subtracted from the fifteen-day, nine-hour-per-day continuous operations schedule.

Risk-sharing between Brice Environmental and BDM demonstrated commitment on the part of both vendor and client to work closely and identify potential delays before they occurred. In the end, neither party affected the schedule in a way that caused any delay.

3 SOIL PROCESSING RESULTS

All of the performance objectives were met or exceeded:

- During the 15 days of soil processing, plant up time exceeded 99 percent.
- The average soil processing rate was 6 tons per hour.
- Wash/leachant water was recirculated in the plant and fresh water was taken on only to replace water lost to processed soil moisture.
- Whenever possible, rainwater pad runoff was used as makeup water.
- Treated soils never exceeded 500 mg/kg total lead or 5 mg/L TCLP lead on any day of soil processing.
- All process liquids (19,000 gallons) were cycled through the leachant treatment process at the end of the demonstration, resulting in an average lead concentration of 2.35 mg/. The water was neutralized and released to the base sewage treatment plant.
- Approximately 7.5 tons of particulate lead and approximately 4 tons of lead concentrate from the leaching circuit were sent to a smelter for recycling.

3.1 Equipment Reliability

During the demonstration, there were fewer than 2 hours of equipment down time due to mechanical failure. The plant operated for a total of 140 hours. Therefore, up time during the demonstration was approximately 99 percent. No systematic trends of mechanical failure were observed during the course of the demonstration. The largest mechanical down time event was for the repair of a jig diaphragm. A leak was observed in the seal, and the system was temporarily stopped to repair it. Once repaired, the seal held for the rest of the demonstration.

The average soil processing rate during the demonstration was 6 tons per hour. Processing was limited to this average rate due to increased fines in the site soils. The plant was designed for a throughput of 10 tons per hour, and that rate was attained during periods of feed soil matching bench-scale treatability soils. Treatability study samples indicated the presence of approximately 25 percent minus 200 fine material in the soil. During processing, fines in the soil ranged from a low of 30 percent to a high of 90 percent. Control of the soil feed rate was the primary means of preventing an uncontrollable buildup of soil fines in the leaching circuit clarifiers.

3.2 Process Methods

Particulate metals were removed from the feed soil in a duplex mineral jig. Based on observations of the treated soil, particulate removal was nearly 100 percent effective.

The leaching circuit was effective in dissolving ionic lead, primarily lead carbonates, into solution. Lead carbonates were dissolved as a result of dissociating the lead ion from the carbonate ion and subsequently converting the carbonate into carbonic acid at low pH. Excess carbonic acid was driven out of the leachant solution in the form of carbon dioxide.

As illustrated by the bench-scale treatability study, this dissolution process also dissolved fine (minus-200) metallic lead particulates. This process exploited the solubility of lead chloride. Chloride was in solution via pH reduction using hydrochloric acid. During the first day of processing, supplemental chloride was also added in the form of calcium chloride. The presence of a high-chloride ion concentration in solution favored the dissolution of metallic lead to satisfy the solubility product of lead chloride.

Of particular interest during the bench-scale treatability study was process performance over time with respect to salt buildup in the leaching circuit and its potential impact on leach efficiency in a closed-loop system. Process monitoring confirmed bench-scale findings. Bench-scale treatability findings indicated that processing treatment efficiency improved once total dissolved solid (TDS), measured as percent NaCl, ranged from 2 percent to 4 percent. During the 15-day processing period, the concentration of NaCl was not observed to exceed 4 percent. This level was the approximate equilibrium NaCl concentration attained with HCl and NaOH as the salt ion sources, while residual moisture in the treated soil served as the steady-state sink.

Carbonate buffering was controlled by the reduction of leachant pH following chemical precipitation of metals from solution. Excess carbonate ion in solution sequestered during the metal precipitation step was evolved from the solution as CO₂ when HCl was added to bring the leachant back to circulation pH. Acid rain in the site vicinity was assumed to have removed calcium carbonate concentrations from the site soils. Therefore, the reagent requirements required to satisfy carbonate equilibria during pH changes in the leachant solution were estimated to be governed by atmospheric CO₂ alone.

3.3 Regulatory Compliance

Treatment activities at Fort Polk were compliant with local, state, and federal regulations. Regulatory standards governed several aspects of the technology demonstration. Processing performance was measured against soil target cleanup goals for total lead and TCLP lead concentrations in the treated soil. The shipping and handling of chemical reagents used during the demonstration was performed within contract specifications and U.S. Department of

Transportation (DOT) regulations. Similarly, the shipping and handling of metal concentrates produced by the treatment system were handled according to regulations imposed by Fort Polk, state, and federal regulations.

Soil treated during the technology demonstration met the regulatory-influenced demonstration criteria of 500 mg/kg total lead and 5 mg/L TCLP lead. In fact, total lead concentrations in treated soils did not exceed 250 mg/kg.

Chemical reagents were handled according to contract specifications. Chemical storage tanks were surrounded by secondary containment berms. Reagent delivery lines were enclosed in chemical resistant secondary containment hoses to prevent leakage in the event of primary line breakthrough.

Metal concentrates from the physical and leaching treatment circuits were containerized according to DOT specifications and shipped via a licensed carrier to a recycling facility. The metal concentrates were shipped under bills of lading as scrap metal and recyclable material. Therefore, no hazardous waste manifesting was required for this phase of the project.

4 COSTS

Unit treatment costs for the demonstration were typical in the sense that they were higher than for an actual project. Demonstration costs should not be scaled up directly to predict larger-scale treatment costs. Demonstration costs were higher for several reasons, including: (1) personnel and analytical needs associated with oversight and verification purposes for compliance with Quality Assurance/Quality Control under the Environmental Security Technology Certification Program (ESTCP); (2) the small volume of soil requiring treatment (the economy of scale); and, (3) extra staffing on the part of Brice Environmental to ensure the best possible presentation of the technology to the client, regulators, and the public.

Demonstration treatment costs do provide an economic model, however, which can be applied to actual projects. Treatment of small arms ranges utilizing this technology fits a mining-type economic model based on mass production. The volume of soil is the driving force behind reduced treatment costs on a per-ton basis. Typical of a mass production model, cost elements such as chemical reagents, mobilization/demobilization, labor, and capital outlay decrease in a non-linear fashion, on a per-ton basis, with increased quantity.

From a vendor perspective, the quantity of work the plant will perform over time is still unknown. Miners accurately forecast the amount of material requiring processing over time and the reserves, and can spread their ownership and operating costs over a known period of time. Brice Environmental and other vendors, however, have to allocate development and ownership costs on a per-project basis because of uncertainty regarding the market. If large, full-scale projects requiring the technology were to develop, then forecasted treatment costs would decrease.

4.1 Hypothetical Full-Scale Treatment Costs

Figure 3, Hypothetical Full-Scale Treatment Costs, presents a comparison of costs for physical and chemical treatment, based on the quantity of soil. Costs depicted in Figure 3 are based on the Fort Polk Demonstration, as well as costs resulting from a similar project at the Twin Cities Army Ammunition Plant outside Minneapolis, MN, in which physical and chemical technology was used to treat 20,000 tons of heavy metal contaminated soils at production rates upwards of 200 tons per day. Depending on site specifics, the costs presented in Figure 3 could be reduced by over 60 percent if physical treatment alone was utilized for the purpose of removing particulate metals for range maintenance.

The per-ton treatment costs are based on on-specific variables matching Fort Polk. It is important to realize that a great majority of sites however will not match Fort Polk. A number of variables impact treatment costs when considering this technology for full-scale implementation at small-arms shooting ranges. Site-

**Figure 3
Hypothetical Full-Scale Treatment Costs**

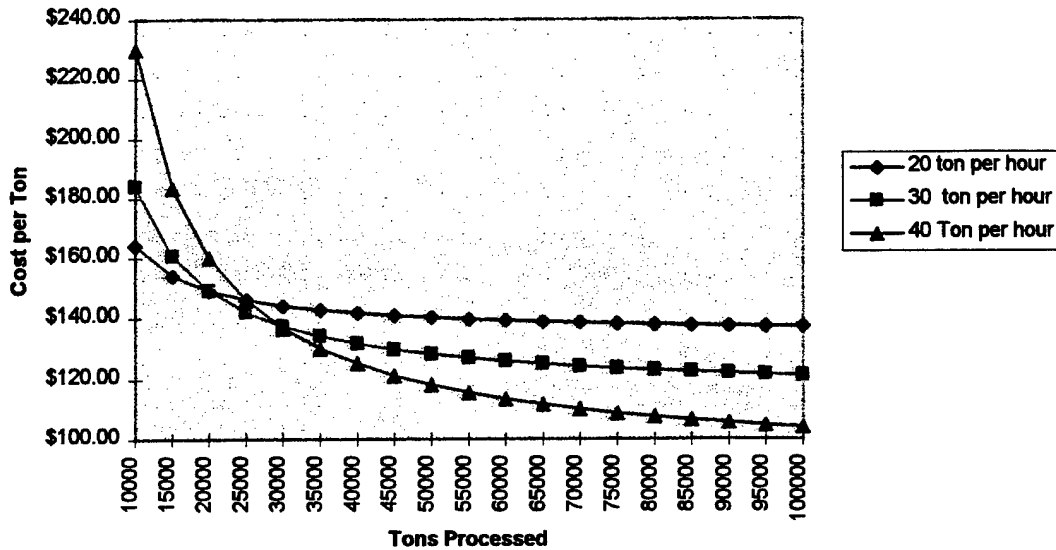

Factors Used in Developing Figure 3

- Soil gradation similar to Ft. Polk soils
- Contamination levels similar to Ft. Polk soils
- Assumes TCLP and totals required same as Ft. Polk
- Plant operation 24 hrs. a day, 5 days a week at volumes above 15,000 tons
- Soil testing methods that were employed by Battelle
- The 20 ton plant based on expected market of at least four 15,000-30,000 ton cleanups
- The 30 ton plant based on expected market of three 30,000-60,000 ton cleanups
- The 40 ton plant based on expected market of three 60,000-plus ton cleanups
- Price of smelting residuals same as demonstration
- Utilities and water furnished by owner
- Includes constructing adequate processing pads for the various plants
- Includes lab and chemist for process control
- Assumes rapid turnaround on lab results
- Assumes reasonable Health and Safety requirements
- Assumes contaminated material excavated and hauled
- Assumes clean material hauled from plant

specific variables are listed below, with discussion on their particular impact to the costs presented in Figure 3.

Site Specific Variables:

- Mass of soil to be processed
- Clean-up standards
- Soil characterization (grain size distribution and chemistry, including contamination)
- Site assessment risks
- Split- or single-operations site
- Throughput rate required
- Hours per day to operate (8 to 24 hrs/day), as well as number of days per week
- On-site or off-site analytical laboratory support
- Weather conditions/time of year to operate
- Chemicals required
- Level of PPE required
- Availability and cost of utilities
- Availability of a reclaimer to accept recovered metals and the associated economics
- Sampling and sample preparation

Mass of Soil to be Processed

Figure 3 illustrates that treatment costs are tied directly to elements of production rate (or capital outlay) and labor. Labor is one of the biggest cost elements and, typical of a mining process, labor does not increase proportionally with plant scale. Hence, as the production rate increases, the cost of labor on a per-ton basis decreases. Capital outlay is a major cost element. As illustrated in Figure 3, capital costs for a larger plant with a higher production rate are offset by large quantities of material and reduction in total project labor costs.

Cleanup Standards

Cleanup standards for total lead are typically site-specific and based on risk assessment in lieu of nationally set standards. The level established is important because it affects whether or not chemical treatment is required in conjunction with physical treatment at a particular site and, subsequently, treatment costs.

Liberal total lead cleanup standards (greater than 500 mg/kg) may result in reduced treatment costs, but only if the soil does not have to meet the 5 mg/L TCLP standard, as may be the case for range maintenance. Our bench-scale treatability study experience evaluating small-arms shooting range soils has shown that when the TCLP standard applies, as in the case of site closure, the amount of total lead above 100 mg/kg that can be left in the soil is site specific.

The bench-scale treatability study conducted for Fort Polk determined that treated soils containing up to 300 ppm total lead will meet the TCLP standard. Therefore, meeting the contractual obligation of 500 ppm total lead was not the

driving factor. Bench-scale treatability studies conducted on lead contaminated soils from other sites have shown TCLP passage to be successful at residual total lead levels varying from 500 mg/kg to 150 mg/kg.

Mathematically, the soil cannot fail TCLP at total lead levels below 100 mg/kg. While a treatment criteria below 100 mg/kg total lead offer insurance that all treated soils will pass TCLP, treatment requirements will drive costs higher than those depicted in Figure 3.

Soil Characterization

Variations in soil structure, gradation, chemistry and contaminant concentrations result in treatment processes that are site specific and cannot be universally applied. Plastic clays require highly specialized attrition equipment, while the percentage of clay affects the scale of the fines leach circuit. Soil at one site may contain some gravel, requiring washing and separation, while soil at another site may only contain sands, silts, and clays. The cation exchange capacity of clays influences the buffering capacity, and hence chemical requirements. One site may contain a high level of leachable lead due to acidic soil conditions, while another site may contain predominately particulate lead due to neutral soil conditions.

Although sand, silt, and clay are the predominant soil matrices used in berm construction, the examples above show that one type of treatment process cannot be applied to all small-arms shooting ranges. The ideal treatment plant approach is to utilize unit components pre-determined by the bench-scale treatability study as required for insertion in the overall treatment process.

In many respects, Fort Polk soils represented a worst-case type of matrix likely to be encountered at future sites. Berm soils were acidic and contained a very high percentage of tough plastic clays. When considering Figure 3, treatment costs could be less for those sites that contain predominately sands and a low percentage of clays.

Site Assessment Risks

The locale chosen for treatment operations influences costs. Locating near offices or other populated areas may affect operational hours (schedule) due to noise associated with treatment operations, i.e., loaders, trucks, etc. Treatment locations near rivers and streams may result in additional environmental protection measures as well.

A highly visual project may result in additional treatment costs due to the need for maintaining an appearance beyond that normally required.

Site security is another important aspect in evaluating site costs. Although operations may be secured within a fence and locked gate, security personnel may be required.

Split- or Single-Operations Site

Locating treatment operations in close proximity to the small-arms shooting range is ideal because the complete process of excavation, haulage, treatment, and replacement can be readily scrutinized and performed more efficiently compared to split operations.

Hauling soil off the range on roads is invariably more expensive. Timing for hauling feed soil and treated soil becomes critical as well. Most importantly, additional regulations and their associated cost impacts may come into play when treatment operations are performed outside of the range area.

Throughput Rate Required

Figure 3 depicts the relationship between throughput rate, quantity of soil requiring treatment, and treatment costs. Processing contaminated soils from small arms ranges utilizing this technology fits a mining-type economic model based on mass production. The volume of soil and throughput rate are the driving forces behind reduced treatment costs on a per-ton basis. Typical of a mass production model, cost elements such as chemical reagents, mobilization/demobilization, labor, and capital outlay decrease in a non-linear fashion, on a per-ton basis, with increased quantity.

As illustrated in Figure 3, a 20 ton-per-hour plant offers the lowest treatment costs for under 25,000 tons of material. At volumes above 25,000 tons, increasing the throughput rate to 40 tons-per-hour offers significant cost savings with increasing quantities of soil.

High production operations require increased attention to logistics for timely delivery of soil for processing, adequate storage space for treated soils, and replacement of treated soils.

Hours Per Day to Operate (8 to 24 hrs/day), As Well As Number of Days Per Week

Mining processes are nearly universally operated 24 hours per day, in part due to the expense associated with start-up and shut-down. As much as 10 percent of total project labor costs can be attributed to time required to start-up and shut-down the treatment process on a daily basis. Continuous operation is the best utilization of labor for this type of treatment at large sites.

Typically, when the total quantity of material requiring treatment is 15,000 or more tons, 24 hour operations becomes economical. At quantities less than that, single shift operations are more economical. Site specifics need to be considered. Increasing production with more than one shift even with a small quantity (less than 15,000 tons) may be advantageous and cheaper in some situations.

On-Site or Off-Site Analytical Laboratory Support

On-site analytical support offers faster turnaround times than an off-site laboratory. Rapid results for feed and product metal levels facilitates process optimization. Daily processed soils require stockpiling as discreet batches in

order to confirm treatment success. Shipping samples off-site for confirmational analysis can add several days to the turnaround time, and additional storage for processed soil is required. This results in larger, more expensive, pad requirements and larger pad area.

On-site analytical would reduce the costs depicted in Figure 3 due to decreased pad requirements.

Weather Conditions/Time of Year to Operate

Operations must be scheduled with local weather conditions in mind. Operations performed during extremely hot months impacts treatment costs by limiting the duration personnel can work in direct sunlight. Scheduling operations for rainy months can potentially impact treatment costs with project delays if no provisions are made to handle and dispose of accumulated rainwater. In addition, personnel have to cease operations during periods of severe thunderstorms. Cold weather is invariably difficult to work in and can halt production altogether.

Placing the operation under a roof is potentially cost effective if operations are planned for rainy months.

Bad weather has the potential to increase the treatment costs depicted in Figure 3 through schedule impacts.

Chemicals Required

Chemical costs are typically thought to be a more expensive element when forecasting per-ton treatment costs utilizing the technology. When utilizing the chemical process employed by Brice Environmental, however, chemical costs are in fact among the cheaper elements of per-ton treatment costs. Optimizing the treatment process during an actual project would result in further reduction in chemical costs.

Chemical requirements are site-specific and are dependent on the cleanup criteria and chemical/physical characteristics of the soil and contaminants. The length of time a particular small-arms shooting range has been utilized and quantity of bullets and fragments that have been exposed to environmental leaching influences the amount of non-particulate lead requiring recovery via chemical leaching.

Treatment to closure criteria for lead does not necessarily imply the entire soil gradation requires leaching. Soil chemistry influences the degree of lead-salt and ionic lead formation, while the soil gradation aids in determining the soil fractions requiring leaching. Sites containing a high percentage of soil that does not require leaching, but only physical treatment may result in lower per ton treatment costs than shown in Figure 3, depending on the cleanup criteria.

Level of PPE Required

PPE requirements are based on the health and safety requirements for the contaminants and hazards associated with the soil treatment process. As the level of worker protection increases, more time is spent suiting up and less time

processing. Regarding PPE, health hazards of concern for physical/chemical treatment include lead contaminated dust inhalation and dermal contact, along with contact hazards with concentrated chemicals. Based on air sampling and post-worker physicals, Level D protection is adequate for range treatment operations in order to keep dirt and process fluids off worker clothing.

When PPE requirements are higher than Level D, treatment costs are higher than those depicted in Figure 3 because of decreased worker efficiency and increased PPE costs.

Availability and Cost of Utilities

Utilizing existing utilities is invariably cheaper than having to provide them. Tying into a fire hydrant is a very convenient means of providing water to fill plant components and supply make-up water. 460 Volt 3-phase power is typically the type of electricity required for the treatment plant.

For the demonstration at Fort Polk, a total of 9,800 kilowatts of electricity was used, at a rate of 11.6 kilowatts per ton. Total water from the hydrant was 49,300 gallons for the project.

Generators can be provided for plant power, and water can be hauled in via tanker truck. Depending on plant scale, costs for these will typically add several dollars per ton to the processing costs, hence vendor supplied utilities will increase the treatment costs depicted in Figure 3.

Availability of a Reclaimer to Accept Recovered Metals and the Associated Economics

Recycling fees (packaging, labeling, transporting, and smelting costs) associated with the demonstration are among the more expensive per-ton cost elements. Metals recovered from the physical and chemical process were shipped a long distance to a St. Louis, MO, smelter on completion of the demonstration. Personnel at the Missouri facility were certain of its regulatory standing governing acceptance, whereas personnel at the Louisiana facility stated that, although the profiled materials met acceptance criteria, they were reluctant to accept it based on their unfamiliarity with the process by which the metals were produced and their uncertainty regarding regulatory standing.

Recycling fees incorporated into costs in Figure 3 were based on those resulting from the demonstration. However, future recycling fees would probably be much lower following the streamlining of shipping and recycling protocols. This will enable receivers closer to an actual site to understand the process and regulatory guidelines governing acceptance of the recovered metals for recycling.

Sampling and Sample Preparation Procedures

Proper sampling and sample preparation methods must be used when dealing with soils containing particulate metal ranging in size from intact bullets to very fine fragments. These methods are necessary to reduce sample variation and ensure adequate material representation.

Treatment costs will be significantly higher than those depicted in Figure 3 if proper sampling and sample preparation techniques are not utilized. The risk of having to reprocess treated soils deemed failures due to non-representative sampling or inappropriate sample preparation forces the vendor to increase treatment costs.

Sampling and sample preparation protocols developed by the mining industry are appropriate for soils from small-arms shooting ranges. This involves taking samples sizes according to the diameter of the largest piece in the material, followed by sample preparation according to the type of analysis to be performed, (i.e., total lead or TCLP lead). Mining-based sampling and sample preparation adds costs to the project, but these costs are less than the costs associated with schedule impacts caused by re-processing material and not achieving data quality objectives.

If mining-based sampling and sample preparation procedures are not followed, treatment costs depicted in Figure 3 can be 30 to 40 percent higher. This is a risk contingency because an unknown quantity of soil may be misrepresented and require reprocessing.

4.2 Fort Polk Demonstration Treatment Costs

Table 1 depicts cost elements associated with the Fort Polk Demonstration.

Table 1
Fort Polk Demonstration Cost Breakdown (834 Tons)

	Cost Item	Total Cost	Cost/Ton
1	Site Mobilization	\$133,786.00	\$160.41
2	Chemicals	\$ 16,013.00	\$ 19.20
3	Utility Costs*	\$ -	\$ -
4	Equipment O&M	\$233,075.00	\$279.47
5	Material Handling	\$ 12,825.00	\$ 15.38
6	On-Site Labor	\$ 51,844.50	\$ 62.18
7	Process Analytical	\$ 13,987.50	\$ 16.77
8	Administrative	\$ 41,571.00	\$ 49.85
9	Recycling Fees	\$ 18,348.00	\$ 22.00
10	Demobilization	<u>\$ 20,000.00</u>	<u>\$ 23.98</u>
	Total	\$541,450.00	\$649.22

* Utilities Provided by Owner, 9,800 kilowatts were used at a cost of \$0.065/kWhr

5 Public Acceptance

Public acceptance of the Brice Environmental soil-washing/hydrochloric acid leaching technology was very positive. This positive response was related to key elements in the application of this technology, as seen by the regulatory community, the client, and the general public at large.

5.1 Regulatory Community Acceptance

Heavy metal complexing agents are commonly used to stabilize soil for ensuring TCLP passage. With this approach, the complexing agents do nothing to reduce residual Total Metals concentrations, and the resulting soil must be shipped to a landfill for indefinite storage. The only true benefit of this approach is that the soil can be shipped to a non-hazardous landfill with lower tipping fees than a landfill designed to receive hazardous waste.

The technology demonstration showed the regulatory community that Total Metals and TCLP Metals cleanup criteria can be simultaneously met in all soil fractions without the use of chemical stabilizing agents. Thus, transport, manifesting, and landfill costs can be minimized or eliminated and site closure secured within a short time frame.

5.2 Client Acceptance

Of particular interest to the Department of Defense is the reasonable cost of site closure when applying this technology to large shooting range cleanup projects. As presented in Section 4, the anticipated full-scale cost of this technology using shooting range soils is competitive with currently used stabilization techniques that do not offer site closure without landfilling the "cleaned" product. Soil-washing followed by hydrochloric acid leaching offers site closure without long-term environmental monitoring or high transport and disposal costs associated with landfills. This approach has the added benefit of recycling all the reclaimed heavy metal contaminants. Thus, the client also gains a proactive public image with respect to resource recycling.

5.3 General Public Acceptance

The technology demonstration at Fort Polk, LA, presented a positive image to the general public. The recycling of metals reclaimed from the contaminated soil was key to generating this positive public image. In general, the public image of landfilling wastes is negative. The technology demonstration illustrated that effective soil treatment can be performed without relying on stabilizing the contaminants or landfilling soils that fail the cleanup criteria.

In addition, Brice Environmental successfully used standard control measures to avoid generating excessive noise or noticeably unpleasant odors at the work site. The work site was maintained in an orderly fashion from site mobilization through processing and demobilization. Demonstrating the minimal aesthetic impact of this process was critical in gaining public acceptance for on-site treatment of contaminated sites in the vicinity of residential areas or within the boundaries of military facilities.

Further, Brice Environmental demonstrated that wash water used to clean the work area can be taken into the plant as make-up water. Rainwater runoff from the pad was also stored and used for pad cleanup and subsequently used as process water. In the past, these liquid sources have represented difficult treatment and disposal issues. The Brice Environmental plant is designed to use these liquids in lieu of an additional demand on the public water supply.

6 SUMMARY

The objective of the technology demonstration was to operate a soil-washing/soil-leaching plant at a continuous throughput for 15 days while attaining cleanup standards of 500 mg/kg Total Lead and 5 mg/L TCLP lead. These objectives were met during the 15 days of soil processing. Average Total Lead and TCLP lead cleanup levels attained were 160 mg/kg and 2.1 mg/L, respectively. Mechanical down time was approximately 1 percent of the total operational time.

The unit soil processing cost for the demonstration totaled \$649 per ton, including mobilization, processing, and demobilization. For an actual assignment, a 20,000 ton closure project utilizing physical and chemical treatment would cost approximately \$145 per ton, and a 40,000 ton project approximately \$135 per ton. An actual reduction of processing costs would be directly related to the number of tons of soil to be treated. Cost trends illustrated in Figure 3 present approximate cost reductions based on job size and initial capital outlay.

The demonstration focused on physical and chemical soil treatment processing for meeting simulated treatment for closure criteria. Using only the up-front physical process for removing particulate lead is an inexpensive means of reducing the threat of ricochets at active ranges. Depending on site specifics, this type of range maintenance operation would cost approximately \$60 per ton with 20,000 tons of material and \$40 per ton with 40,000 tons of material.

The demonstration was an unparalleled success for two important reasons: (1) The solicitation requirement that a vendor-based bench-scale treatability study be performed was the best investment to ensure full-scale success. Bench-scale treatability studies allow the vendor to evaluate site-specific process parameters for the purpose of delineating the process approach and costs. By conducting these studies, the vendor is placed in a position of decreased risk and can price the remediation with fewer contingencies. (2) In addition, the demonstration succeeded because of willingness of all parties to work together and identify potential project impacts before they occurred.

7 CONCLUSIONS

The contractual objectives of the demonstration were met with respect to performance, reliability, throughput, and disposition of treated soils and recovered metals.

In the course of the demonstration, Brice Environmental demonstrated that its technology represents a cost-effective means to satisfactorily remove heavy-metal contamination from soils that is superior to traditional remediation alternatives. Brice Environmental predicts that the best value would be achieved if the technology was applied to a large site or a group of sites in one area.

Using this technology, soils can be treated and replaced on site, while recovered metals can be recycled. Recovered metals can be shipped as recyclable materials under bills of lading. Thus, no hazardous wastes are generated or shipped as a result of this process.

Public acceptance of this technology is high because it meets regulatory requirements without landfilling any contaminated soils, and it reclaims hazardous contaminants for recycling in the process. In addition, because contaminants are removed and not just shifted to a landfill, potential long-term risks to human health and the environment are eliminated. The technology demonstration also proved that this technology can be implemented with minimal environmental or aesthetic impact to the processing area.

This project illustrated the importance of conducting bench-scale treatability studies on representative site soils to develop a field-scale treatment process. The Brice Environmental treatment plant was designed using parameters that resulted almost exclusively from bench-scale treatability findings.

8 RECOMMENDATIONS FOR FUTURE APPLICATIONS

Based on the results and implementation of the treatability study findings for the design of the Brice Environmental technology demonstration plant, our firm recommends that every soil-washing solicitation include a vendor-conducted bench-scale treatability study for effective costing and plant design. This recommendation is based on the results and findings of more than a dozen such studies. The bench-scale treatability study represents an effective method for fully defining a remediation problem, associated treatment parameters, and plant design.

Clean-up standards for shooting range remediation projects must be standardized between states. Such standardization would take the guesswork out of many aspects of plant design and costing for a series of remediation projects within one region of the United States. Developing consistent cleanup standards from state to state might be costly initially, but the effort would pay for itself within a short time once range clean-ups began.

Brice Environmental recommends that plant operation hours be extended to minimize down time associated with daily start up and shut down. Our firm estimates that up to 1.5 hours of processing time are lost daily when only a single shift is used. Continuous operation would eliminate start up and shut down processing losses altogether.

Site layout should be developed on a site-by-site basis. Layout should be based on job size, plant throughput, plant componentry, equipment staging requirements, and confirmation laboratory analysis turnaround time.

For facilities requiring range clean-up for closure under RCRA, the establishment of a Corrective Action Management Unit (CAMU) would facilitate large-scale treatment. Soils from a large site or several sites could then be excavated and stockpiled without violating EPA land ban regulations.

Appendix F

APPENDIX F

AA	Atomic Absorption Flame Spectroscopy
ADUSD-ES/ET	Office of the Assistant Undersecretary of Defense
AES	Atomic Emission Spectroscopy
AFB	Air Force Base
ARARs	Applicable, Relevant, and Appropriate Requirements
ASTM	American Society for Testing Materials
BESCORP	Brice Environmental Services Corporation
BMP	Best Management Practices
BRAC	Base Realignment and Closure
CAA	Clean Air Act
CATEX	Categorical Exclusion
CBD	Commerce Business Daily
CERCLA	Comprehensive Environmental Response, Compensation, and Liability Act
CWA	Clean Water Act
D&D	Demobilization and Decontamination
DDESB	Department of Defense Explosive Safety Board
DE	Diatomaceous Earth
DESA	Defense Evaluation Support Activity
DoD	Department of Defense
DOE	Department of Energy
DOT	Department of Transportation
DPW	Department of Public Works
EA	Environmental Assessment
ECO	Environmental Compliance Officer
EDI	Earth Decontaminators, Inc.
EIS	Environmental Impact Statement
ENRMD	Environmental Resources Management Division
EOD	Explosive Ordnance Disposal
EPA	Environmental Protection Agency
EPCRA	Emergency Planning and Community-Right-to-Know Act
ERMD	Environmental Resource and Management Division
ESA	Endangered Species Act
ESTCP	Environmental Security Technology Certification Program
FAR	Federal Acquisition Regulation
FP-DPW	Ft. Polk, Department of Public Works
FUDS	Formally Used Defense Sites

GFE	Government-Furnished Equipment
HASP	Health and Safety Plan
HAZCOM	Hazardous Communications
HAZMAT	Hazardous Materials
HDPE	High Density Polyethylene
HSO	Health and Safety Officer
ICP	Inductively Coupled Plasma
IRP	Installation Restoration Program
ITRC	Interstate Technology and Regulatory Cooperation
LADEQ	Louisiana Department of Environmental Quality
MSDS	Material Safety Data Sheet
NEPA	National Environmental Policy Act
NFESC	Naval Facilities Engineering Service Center
O&M	Operation and Maintenance
OES	Optical Emission Spectroscopy
OSHA	Occupational Safety and Health Administration
PEL	Permissible Exposure Limit
PMRP	Precious Metals Recovery Program
POC	Point of Contact
POTW	Publicly Owned Treatment Works
PPE	Personal Protective Equipment
PRECIS	Probabilistic Risk Evaluation and Characterization Investigative System
PVC	Polyvinyl Chloride
R&D	Research and Development
RAB	Remediation Advisory Boards
RBCA	Risk Based Corrective Action
RCRA	Resource Conservation Recovery Act
RDT&E	Research, Development, Test, and Evaluation
REC	Record of Environmental Consideration
RFP	Request for Proposal
SITE	Superfund Innovative Technologies Evaluation
SOW	Statement of Work
SPCC	Spill Prevention, Control, and Countermeasures
STP	Sewage Treatment Plant
SWPPP	Stormwater Pollution Prevention Plan
TCAAP	Twin Cities Army Ammunition Plant
TCLP	Toxicity Characteristic Leaching Procedure
TDS	Total Dissolved Solids
TLV	Threshold Limit Value

TPQ	Threshold Planning Quantities
TRI	Toxic Release Inventory
TSD	Treatment, Storage, and Disposal
TSDF	Treatment, Storage, and Disposal Facility
USAEC	U.S. Army Environmental Center
WES	Waterways Experiment Station
X-RF	X-ray Fluorescence

Appendix G

**APPENDIX G
GLOSSARY**

- acid leaching..... the removal of soluble constituents from a material by the action of percolation or agitation with an acid.
- acute encephalopathy a disease of the brain.
- aliquot an exact divisor or factor of a quantity.
- attrition to wear or break down through friction.
- barren process fluids (washwaster) devoid or containing very low levels of lead.
- buffering capacity the chemical ability to neutralize acids or bases with little change in pH.
- cation exchange capacity the sum total of exchangeable cations that a sediment or soil can adsorb. The CEC is expressed in milliequivalents of negative charge per 100 grams (meq/100g) or milliequivalents of negative charge per gram (meq/g).
- close loop processing system... an enclosed system that returns process fluid to the process with no discharge to the outside environment.
- conjugate inversely or oppositely related with respect to one or a group of otherwise identical properties. (*In Chemistry*) The base that formed by an acid that has given up a proton is that acid's conjugate base, and inversely, the acid that is formed by a base that has accepted a proton is that base's conjugate acid.
- decommission to remove (as a facility) safely from service and reduce residual contamination to a level that permits release of the property and termination of license.
- demobilize to dismiss from service or use.
- dewater to remove water from or reduce the amount of water in a material.
- entrain to trap bubbles in water either mechanically through turbulence or chemically through a reaction.
- filtration a processes for removing particulate matter from water by passage through porous media.
- finer the clay content in a soil expressed as the percentage of the soil that will pass through a 200-mesh sieve (74-micron).
- floc an agglomerate of solids formed in water by biological or chemical action.
- flocculate a process to enhance agglomeration or collection of smaller floc particles into larger, more easily settleable particles through chemical addition or mixing by hydraulic or mechanical means.

- galvanic cell reaction a primary cell reaction producing direct-current electricity through chemical means.
- galvanic corrosion the dissolution or wearing away of a material through a galvanic cell reaction.
- hydrologic cycle the natural process of recycling water from the atmosphere down to (and through) the earth and back to the atmosphere again.
- hydroxide floc an agglomerate of solids comprised of cations bonded to hydroxide ions.
- interstitial of, pertaining to, or occurring in the small space between things or parts.
- jig an apparatus for cleaning or separating ore by agitation in water.
- landban phasing out of land disposal of most untreated hazardous wastes, as mandated by the 1984 RCRA amendments.
- manifesting the tracking of hazardous waste from "cradle to grave" (generation through disposal) with accompanying documentation identifying the quantity, composition, origin, routing, and destination of hazardous waste during its transportation from the point of generation to the point of treatment, storage, or disposal.
- mobilization to assemble, prepare, or put into operation.
- mole (also mol) the amount of a substance that has a weight in grams numerically equal to the molecular weight of the substance.
- parametric based on a variable or an arbitrary constant appearing in a mathematical expression, each value of which restricts or determines the specific form of the expression.
- peristaltic wave-like contractions that propel contained matter along tubular pathways.
- physical separation the separation of materials through strictly physical means.
- polymer a natural or synthetic chemical substance of usually high molecular weight that consists of many repeated links, each link being a relatively light and simple molecule.
- pug mill a machine for grinding and mixing clays or soils.
- reagent a substance used in a chemical reaction to detect, measure, examine, or produce other substances
- remediation cleanup or other methods used to remove or contain toxic or hazardous materials from a site.
- serpentine a common and widely distributed mineral, usually found as an alteration of magnesium silicates.
- silica a white or colorless crystalline compound, SiO_2 , occurring abundantly as quartz, sand, flint, agate, and many other minerals.

- siliceous containing, resembling, pertaining to, or consisting of silica.
- sieve a utensil of wire mesh or closely perforated metal used for straining or sifting (n); to put through a sieve or other straining device in order to separate finer from coarser materials (v).
- slag the vitreous mass left as a residue by the smelting of metallic ore.
- slurry a mixture of liquid, especially water, and any of several finely divided substances, such as cement or clay particles.
- smelter a facility for melting ores, separating their metal constituents.
- soil stabilizers materials such as lime, cements, or polymers used to bind up contaminants in soil and prevent contaminant leaching.
- soil washing a technology combining both physical separation and acid leaching to remove selected contaminants from soil.
- soluble capable of being dissolved in liquid, especially water.
- sparging the process of introducing air or gas into a material (usually a liquid).
- stoichiometry the methodology and technology by which the quantities of reactants and products in chemical reactions are determined.
- tetra-ethyl lead a colorless, poisonous, oily liquid, $Pb(C_2H_5)_4$, used in gasoline for internal-combustion engines as an antiknock agent.

Appendix H

APPENDIX H
CONVERSION FACTORS, NON-SI TO SI UNITS OF MEASUREMENT

Non-SI units of measurement used in this report can be converted to SI (metric) units as follows:

Multiply	By	To Obtain
Acres	4,046.873	square meters
Feet	0.3048	meters
Gallons (U.S. liquid)	3.785412	liters
Inches	2.54	centimeters
Miles (U.S. statute)	1.609347	kilometers
Pounds (mass)	0.4535924	kilograms

0063G_32