

REPORT DOCUMENTATION PAGE

Form Approved
OMB No. 074-0188

Public reporting burden for this collection of information is estimated to average 1 hour per response, including the time for reviewing instructions, searching existing data sources, gathering and maintaining the data needed, and completing and reviewing this collection of information. Send comments regarding this burden estimate or any other aspect of this collection of information, including suggestions for reducing this burden to Washington Headquarters Services, Directorate for Information Operations and Reports, 1215 Jefferson Davis Highway, Suite 1204, Arlington, VA 22202-4302, and to the Office of Management and Budget, Paperwork Reduction Project (0704-0188), Washington, DC 20503

1. AGENCY USE ONLY (Leave blank)		2. REPORT DATE 30 Sep 1997	3. REPORT TYPE AND DATES COVERED Final	
4. TITLE AND SUBTITLE Apparel Research Network (ARN) Apparel Order Processing Module (AOPM) System for Special Measurement Clothing Orders			5. FUNDING NUMBERS \$200,833.96	
6. AUTHOR(S) Dennis A. Brekhus				
7. PERFORMING ORGANIZATION NAME(S) AND ADDRESS(ES) EDI Integration Corporation Suite 303, 2200 Defense Highway Crofton, MD 21114			8. PERFORMING ORGANIZATION REPORT NUMBER AOPM0001	
9. SPONSORING / MONITORING AGENCY NAME(S) AND ADDRESS(ES) Defense Logistics Agency (DLA) DLA-MMPRT, Suite 2533 8725 John J. Kingman Road Ft. Belvoir, VA 22060-6221			10. SPONSORING / MONITORING AGENCY REPORT NUMBER AOPM0001	
11. SUPPLEMENTARY NOTES			19980623 057	
12a. DISTRIBUTION / AVAILABILITY STATEMENT A - Approved for public release; distribution unlimited.			12b. DISTRIBUTION CODE	
13. ABSTRACT (Maximum 200 Words) The Apparel Research Network (ARN) was initiated by the Defense Logistics Agency (DLA) for the purpose of modernizing the ordering, distribution, and manufacturing of military uniforms, and transferring technology from twenty-three companies and universities, the ARN Partners, to the defense apparel manufacturers. The Apparel Order Processing Module (AOPM) is designed to respond to the critical need for an ability to order clothing expeditiously for military recruits and for other military personnel. This application program primarily supports the ordering of special sized clothing. The objective is to reduce the delivery cycle for an order from three to six weeks to fifteen days. Measuring personnel and issuing clothing may take place at a military base, ROTC, or Jr. ROTC location. It is important that measurements are complete and accurate to insure that personnel requiring special measurements do not lack required clothing. While most personnel are fitted with standard size garments, the special measurement problem is relatively low volume, but is an issue in terms of cost and delivery time.				
14. SUBJECT TERMS Apparel Order Processing Module; AOPM; RIC; CIIP; EDI; Internet ; VAN; Special Measurement Order			15. NUMBER OF PAGES 15	
			16. PRICE CODE	
SECURITY CLASSIFICATION OF REPORT UNCLASSIFIED	18. SECURITY CLASSIFICATION OF THIS PAGE UNCLASSIFIED	19. SECURITY CLASSIFICATION OF ABSTRACT UNCLASSIFIED	20. LIMITATION OF ABSTRACT UL	

NSN 7540-01-280-5500

Standard Form 298 (Rev. 2-89)
Prescribed by ANSI Std. Z39-18
298-102

DTIC QUALITY INSPECTED 1

**Apparel Research Network (ARN) Apparel Order Processing Module
(AOPM)
Application Program
for
Management of Special Measurement and Stock Clothing Orders**

Submitted To

**Defense Logistics Agency (DLA)
DLA-MMPRT
8725 John J. Kingman Road, Suite 2533, Box 31-510
Ft. Belvoir, VA 22060-6221**

by

**Dennis Brekhus
EDI Integration Corporation
Suite 303, 2200 Defense Highway
Crofton, MD 21114**

**Prepared By
Dennis A. Brekhus**

**30 Sep 1997
DO # 0005
SPO100-95-D-1004**

Approved for public release; Distribution Unlimited.

Apparel Research Network (ARN) Apparel Order Processing Module (AOPM)

Application Program
for

Management of Special Measurement and Stock Clothing Orders

The Apparel Research Network (ARN) Apparel Order Processing Module (AOPM) is designed to respond to the critical need for an ability to order clothing expeditiously for military recruits and for other military personnel. This application program primarily supports the ordering of special sized clothing. The objective is to reduce the delivery cycle for an order from three to six weeks to fifteen days. Measuring personnel and issuing clothing may take place at a military base, ROTC, or Jr. ROTC location. It is important that measurements are complete and accurate to insure that personnel requiring special measurements do not lack required clothing. While most personnel are fitted with standard size garments, the special measurement problem is relatively low volume, but is an issue in terms of cost and delivery time.

The ARN includes representatives from DoD organizations, defense apparel manufacturers (DAM), universities, and companies with technology to transfer to the apparel manufacturing process. A secondary objective of this project is to commercialize the techniques proven in the ARN AOPM, so that the benefits from the decrease in ordering cycles may be extended to the private sector.

Abbreviation / Symbol List

AAFES	Army and Air Force Exchange service
ARN	Apparel Research Network
DAM	Defense Apparel Manufacturer
DoD	Department of Defense
DPSC	Defense Personnel Support Center (Clothing/Textile; Food/Subsistence; Medical)
OPM	Order Processing Module
DFAS	Defense Finance and Accounting Service
OA	Ordering Activity
CIIP	Clothing Initial Issue Point
or	
RIC	Recruit Induction Center
	(CIIP and RIC are used interchangeably)

Table Of Contents

1 - INTRODUCTION.....	1
2 - ASSUMPTIONS (SYSTEM CONSTRAINTS), METHODS AND PROCEDURES	1
ASSUMPTIONS (SYSTEM CONSTRAINTS)	1
METHODS.....	3
PROCEDURES	4
3 - RESULTS	5
THE APPAREL ORDER PROCESSING SCREEN	5
THE MEASUREMENTS SCREENS	5
THE PROFILE SCREENS.....	8
THE APPAREL ORDER LINE ITEMS (GARMENT) SCREEN.....	9
TURNAROUND TRANSACTIONS	9
4 - CONCLUSION	10

1 - Introduction

A. Subject. The ARN AOPM Application System was a Short Term Project (STP) to develop a system to create and transmit special measurement orders for military clothing, and to receive and process corresponding transactions related to the orders.

B. Purpose. To investigate the use of electronic data interchange (EDI) and the Internet as a method of transmitting special measurement data between RICs/CIIPs, DPSC, and DAMs.

C. Scope.

- 1) Assess the technology that could be used to enable the creation, transmission and management of special measurement order data, to include computer technology, electronic data interchange (EDI), VANs and the Internet.
- 2) Develop, integrate, test, and implement the AOPM Application System.

2 - Assumptions (System Constraints), Methods and Procedures

Assumptions (System Constraints)

The following constraints guided the design and development of the AOPM system:

- 1) The AOPM must work in a variety of situations:
 - As an application extension of an Eagle¹ EDI system.
 - As application software with a standard flat file interface to any EDI system.
 - As a standalone application with an Internet interface.
 - As an application in a laptop system with a laplink interface to a system with EDI capability.The total application system which includes the AOPM must also include 1) windows for reviewing and adjusting the measurement data before transmission, and 2) a means for follow-up and recording status of an order. Communications options must include Internet and VAN options.
- 2) The programs and databases will be constructed with FoxPro for Windows, version 2.6a.
- 3) The ARN AOPM must be able to operate under Microsoft Windows or Windows 95 as both 1) an application invoked from the Eagle *Application* menu, or 2) a standalone application.
- 4) For the Eagle alternative, the program type may be an FXP file or a separate APP, either of which must operate from the base Eagle directory.
- 5) For the standalone alternative, an EXE file is preferred. (Other options may be used if approved in advance.)
- 6) Regardless of alternative, the window characteristics must be of other Eagle windows including the comprehensive *Find* functions, the general Eagle "look and feel", and the schemes described in this specification.
- 7) The output from the application will be database records as specified in *ARN Order Processing Module and Related Transactions*, Tables 10-12.

¹ Eagle is a standard EDI software product offered by EDI Integration Corporation.

- 8) The format for downloading from application database records will be the Eagle "@H@" 850 format (see the specification document, *ARN Order Processing Module and Related Transactions, Specification M*), so that it may be readily translated to EDI. The same format may be used as input to alternative EDI systems, but it is the responsibility of the user to provide any required linkages from the flat file to that EDI system. (Downloading processes includes data mapping.)
- 9) For the standalone alternative, the output from the database records will be in the same format as (7) above, but will be transmitted via the Internet as a [formatted] text message. Only a designated military installation will be the recipient of such [flat file] messages.
- 10) The recipient's @H@ 850 formatted data (*ARN Order Processing Module and Related Transactions, Specification M*) will use the data to create a record as though the data were entered locally. The recipient user may then review such orders on screen, modify any of them if necessary, and release them individually for EDI transmissions to DPSC. A field in the database will identify the source of the order.
- 11) The AOPM screen scenarios are:
 - Prompt for heading-type data relative to the person being measured.
 - Prompt for items of clothing which have been checked for this person.
 - Prompt for measurements for garments ordered.
 - Garments and measurements are connected in that the garments are used to specify what measurements will be required. All garments may be entered before any measurements are required, for example.
 - If the same measurement was already entered for a previous garment for this person, display that value on screen. Do not allow an empty value for a mandatory measurement (REQ="M").
 - Check each measurement for acceptability within its range.
 - When all measurements are entered, check for biological sense. If weight or height are not entered, skip this check.
- 12) The AOPM measurement windows will include silhouettes (male and female figures) to indicate where measurements are to be made. These silhouettes were provided by Clemson and others. Examples are shown in the section titled *3 - Results* on page 5. The measurement windows must include the silhouettes (BMP files). Silhouettes must be associated with radio buttons. In addition to the radio button, include a short description of the posture or shoulders. The *Profile* window for female *Posture, Prominent Seat* and *Large Abdomen* requires radio buttons and check boxes. Also display shoulder and bust profile groups with radio buttons.
- 13) The edits required for each field are to be shown as Min and Max values for each measurement.
- 14) The system must check that the validity of measurements makes biological sense. The criteria for testing will be supplied in a database. The biological sense check will be made after each measurement is entered. The scheme is to find the person's sex measurement type. Then check that the measurement given falls within the specified minimum and maximum range. If the check fails, the operator is notified with a system message.
- 15) The display of windows (and silhouettes) is governed by the choice for type of person (man, woman, boy, girl) made from the initial window. (Boy and girl will not be included in the pilot test windows.)
- 16) A method must be provided for reviewing and modifying the measurements similar to the Eagle *Next/Previous/List/Find/Edit/Delete* push buttons and functions provided with other Eagle windows. However, modifications will not be permitted after the relevant EDI for outbound transmission has been created.
- 17) A release check box must be included on the window in order to indicate that a measurement set is released for transmission. The window will also include an EDI check box to show when the EDI data map was created.
- 18) A release will ultimately result in an 850 transaction set to be sent from either the measurement site or the site which received the @H@ 850 Internet transmission. (A release from a non-EDI site will result in transmission of the @H@ 850 formatted data.)
- 19) The system must include a corresponding report program for each transaction set (other than 997) used in the pilot application. This must include *Print* and *Preview* options.

Methods

Assessing Technology. The enabling technology available today to support preparation and transparent transfer of transactions among ARN Partners include:

A. Computer Technology. Microcomputers are available with sufficient power to be used for preparation and transmission of Special Measurement Orders (and Stock Orders) for military clothing, and generation of EDI transaction format containing the order information.

B. Electronic Data Interchange (EDI). EDI encompasses the ANSI X12 EDI Standards, EDI Translator Software, and Value Added Networks (VANs) or the Internet. Together they permit the transparent exchange of processable data between computers, data bases and applications at dispersed locations. VANs and the Internet were chosen by ARN as the primary methods of communication, due to the availability of these connections at many of the ARN Partner sites.

C. Requirements Analysis. The requirements of AOPM were analyzed and available technology was reviewed prior to the development and implementation of the ARN AOPM. In the system, as proposed, the ordering points (CIIPs, RICs) prepare Measurement and Profile information and create electronic Purchase Orders in the AOPM Software. The Purchase Order data was data mapped to the X12 850 Purchase Order transaction set, and the follow-on data from DPSC and the DAMs was mapped to X12 Transaction Sets 855, 860, 856, 824 and 810. Comprehensive process flow analysis was performed at all concerned ARN pilot sites. The analysis and resultant specification are included in the document entitled *ARN Order Processing Module and Related Transactions*, prepared by EDI Integration Corporation. The sites analyzed include:

- Special Measurement Area, CIIP, Ft. Jackson, SC
- Administrative Area, CIIP, Ft. Jackson, SC
- Special Measurement Office, DPSC
- ROTC & JrROTC Units
 1. U.S. Army ROTC Cadet Command, Ft. Monroe, VA.
 2. U.S. Navy ROTC, Naval Education and Training, Pensacola, FL
 3. U.S. Air Force ROTC Logistics, Maxwell AFB, Montgomery, AL
- Navy Exchange Service
- Army & Air Force Exchange Service Stores
- CIIP, Lackland AFB, San Antonio, TX
- Clemson Apparel Research (CAR) Demo Site
- Cal Poly Demo Site
- The HAAS Tailoring Company
- Maryland Clothing Manufacturing, Inc. Baltimore, MD

D. Systems Development and Integration. The AOPM application software was developed in the Microsoft FoxPro data base language. The application software was integrated with the data mapping of the ANSI X12 transaction sets listed above, and with the EAGLE EDI translator. The EAGLE EDI translator contains all the ANSI X12 EDI transaction sets, and the communications external reference (EXREF) for the Internet and for the MCI and GEIS VANs. The FTP EXREF was prepared with the flexibility to work with any of the Internet Service Providers (ISP) that the ARN Partners might subscribe to for service.

Procedures

System development and integration was a straight-forward effort of requirements analysis, programming of the application screens, and integration of the application software with the EDI translator, EDI transaction set, and the Internet FTP and VAN connections.

The system was tested by creation of special measurement orders at Fort Jackson, South Carolina. Purchase Orders (X12 850) were transmitted to DPSC, and then on to Clemson Apparel Research (CAR). Advance Ship Notices were created at CAR and transmitted to Fort Jackson. Additional testing has been performed with Purchase Order Changes (860) and Purchase Order Acknowledgments (855) between DPSC and the Cal Poly demo site. Using pcAnywhere, EDI Integration Corporation provided on-line assistance and maintenance support to the ARN Partners.

3 - Results

The Apparel Order Processing Screen

The Apparel Order Processing Screen is the main transaction entry and review screen in AOPM. It is designed to perform many different functions, and the use of these functions varies depending upon the location at which AOPM is installed. The possible functions include: Creation of outbound transactions, such as Purchase Orders (X12 850), including all Garment, Measurement and Profile information, Purchase Order Acknowledgments (855), Advance Ship Notices (ASN) (856), ASN Responses (824), and Invoices (810); receipt and review of inbound transactions, including Purchase Orders (850), Purchase Order Acknowledgments (855), Purchase Order Changes (860), Advance Ship Notices (ASN) (856), ASN Responses (824), and Invoices (810). All needed data entered into an original Purchase Order is returned automatically in subsequent (related) documents when the P.O. is responded to by another AOPM system, and thus the relevant data is carried throughout the transaction cycle, from Purchase Order to Invoice.

Apparel Order Processing...																				
From	Document: OUTBOUND Purchase Order			Status: Pending Release																
FORT-JACK	PD/Doc #	DODAAC71749300	Date	06/23/97	Requested //															
To	Contract	N20001-94X-1001	Terms																	
DPSC					Release <input type="checkbox"/> By <input type="checkbox"/>															
Date //																				
Ship To	DODAAC	DODAAC	Supplemental DODAAC	Carrier	UPSS															
	Address			Country	US															
	City	Ft. Jackson	State/Prov	SC	Postal Code	29207														
Clothing For	Name	Ronald A. Smith		SSN	111-23-1313															
	Age	23	Rank	CP	Component	Active Duty														
	Org	Default Individual Organization				<input checked="" type="radio"/> Male <input type="radio"/> Female														
	Notes					Transfer from San Diego														
<input type="button" value="Garments"/> <input type="button" value="Measurements"/> <input type="button" value="Profile"/>		Total Amount	160.00																	
		<input type="button" value="Admin"/>	<input type="button" value="N/A"/>																	
<table border="1"> <thead> <tr> <th></th> <th>NSN/Article Number</th> <th>Description</th> <th>Quantity</th> <th>Ext. Amt.</th> </tr> </thead> <tbody> <tr> <td>Garments</td> <td>8405L083043048/AWC580</td> <td>All Weather Coat</td> <td>1.00</td> <td>125.00</td> </tr> <tr> <td></td> <td>8415L083193048/CAP741</td> <td>BDU Caps</td> <td>1.00</td> <td>35.00</td> </tr> </tbody> </table>							NSN/Article Number	Description	Quantity	Ext. Amt.	Garments	8405L083043048/AWC580	All Weather Coat	1.00	125.00		8415L083193048/CAP741	BDU Caps	1.00	35.00
	NSN/Article Number	Description	Quantity	Ext. Amt.																
Garments	8405L083043048/AWC580	All Weather Coat	1.00	125.00																
	8415L083193048/CAP741	BDU Caps	1.00	35.00																
<input type="button" value="Next"/> <input type="button" value="Previous"/> <input type="button" value="Find"/> <input type="button" value="New"/> <input type="button" value="Edit"/> <input type="button" value="Save"/> <input type="button" value="Delete"/> <input type="button" value="Print"/> <input type="button" value="Close"/>																				

The Measurements Screens

When the Measurements button on the Apparel Order Processing Screen is pressed, a set of gender-specific screens is displayed with prompts for measurements. If the Clothing For individual is male, the Coat and Shirt Measurements Screen and the Male Trouser Measurements Screen are displayed in sequence, as shown below:

Apparel Order Processing **Coat and Shirt Measurements**

From: FORT-JACH
To: DPSC



Document: PD/Doc # [] Contract [] DODAAC [] Address [] City []

Ship To: []



Clothing For: Name [] Age [] Org [] Notes []

Garments: Measure []

NSN/Article: 8405L083 8415L083

Back  0.00 Coat/Waist  0.00 Chest  0.00

Collar-Waist 0.00
Waist-Length 0.00

Waist  0.00 Collar/Sleeve  0.00 Over Shoulder  0.00

Collar 0.00
Sleeve 0.00

Height 0.00
Weight 0.00
Head 0.00

OK Cancel

Release

Release [] By []
Date / /

Next
Previous
Find
New
Edit
Save
Cancel
Print
Close

Quantity Ext. Amt.
0.00 125.00
0.00 35.00

Apparel Order Processing **Male Trouser Measurements**







From: FORT-JACH
To: DPSC

Document: OUTROUND Purchase Order Status: Pending Release

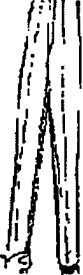
Ship To: []

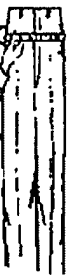
Clothing For: []

Garments: []

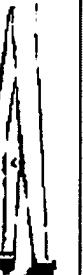
Outseam  0.00 Inseam  0.00 Waist  0.00 Abdomen  0.00 Thigh  0.00 Seat  0.00 Knee  0.00 Bottom  0.00

Inseam 0.00
Abdomen 0.00
Seat 0.00
Bottom 0.00

OK Cancel

If the Clothing For individual is female, the Body Measurements Screen and the Finished Garment Measurements Screen are displayed in sequence, as shown below:

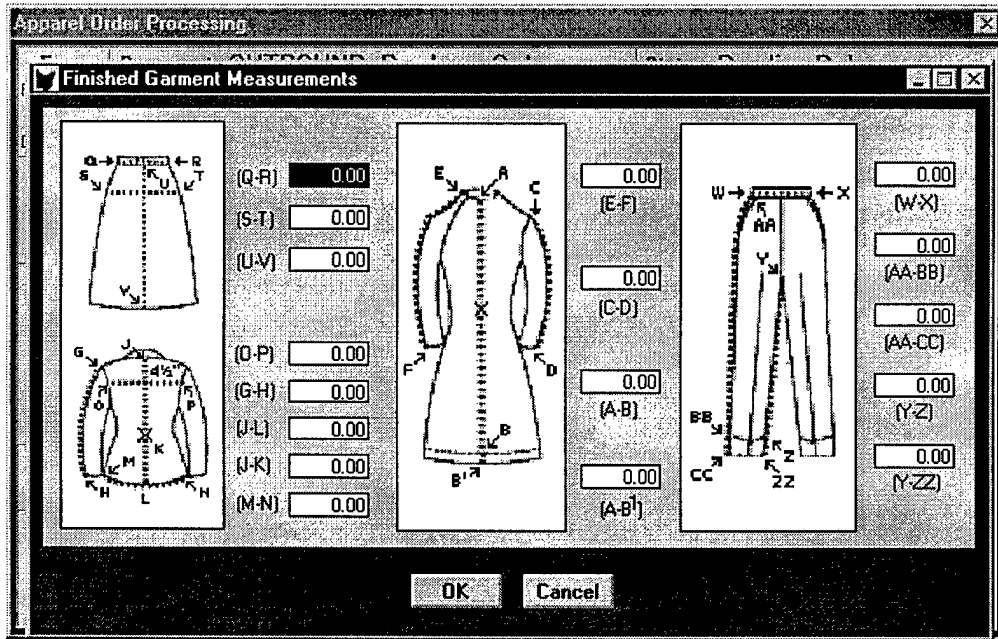
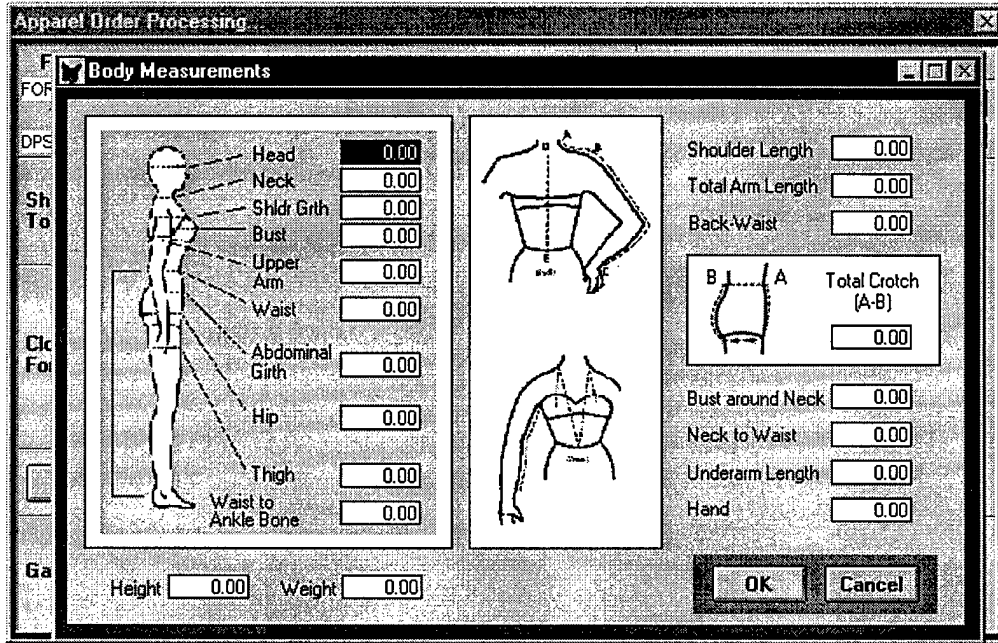

The Profile Screens

When the Profile button on the Apparel Order Processing Screen is pressed, a gender-specific screen is displayed with prompts for profile information. If the Clothing For individual is male, the following screen is displayed:

Apparel Order Processing

From: FORT-JAC To: DPSC

Document: **OUTBOUND Purchase Order** Status: **Pending Release**

Male Profile...

POSTURE

Normal Erect Forward Stoop

BUILD

Normal Half-Stout Stout Corpulent

SHOULDERS

Sloping Regular Square High/Short

Buttons: **OK** **Cancel**

If the Clothing For individual is female, the following screen is displayed:

Apparel Order Processing

From: FORT-JAC To: DPSC

Document: **OUTBOUND Purchase Order** Status: **Pending Release**

Female Profile...

POSTURE

Normal Sway Back

BUILD

Prominent Seat Large Abdomen

SHOULDERS

Normal Sloping Square

Full Regular Flat

Buttons: **OK** **Cancel**

The Apparel Order Line Items (Garment) Screen

The Apparel Order Line Items Screen is displayed when the Garments button on the Apparel Order Processing Screen is pressed. Garments may be selected from a popup list, which automatically inserts all stored data about the chosen garment. The measurements screens may be reviewed from this screen as well as the Apparel Order Processing Screen.

Turnaround Transactions

A *turnaround* transaction is an outbound transaction that uses data from an incoming transaction to populate some of its fields. AOPM provides a method for automatically generating the major portion of each turnaround transaction. Specific turnaround relationships are defined for ARN transactions. Details are presented in Table 1 below:

Table 1. Turnaround Relationships

Receive	Turnaround To	Send To
850 Purchase Order at Property Management from ROTC, Jr. ROTC	850 (Approve; add data per Property Management requirements)	DPSC
850 Purchase Order at DAM from DPSC	855 Purchase Order Acknowledgment	DPSC
850 Purchase Order at DAM from DPSC	856 Ship Notice	"Ship To" ordering activity; DPSC; DCMC
856 Ship Notice at "Ship To" ordering activity from DAM	824 Application Advice (Proof of delivery)	DAM and payment location
850 Purchase Order from DAM at DPSC	810 Invoice	DPSC or DFAS
850 Purchase Order from Property Management at DPSC	Flat file to mainframe or internal application (Optional)	Mainframe or internal application

4 - Conclusion

AOPM is an inexpensive and effective system for the creation and transmission of special measurement and stock orders and the follow-on documents between the RICs/CIIPs, DPSC, and DAMs, using EDI, VANs and the Internet.

Version

1

APPAREL RESEARCH NETWORK (ARN)

Apparel Order Processing Module (AOPM)

Field User Manual

A R N / A O P M

Field User Manual

Submitted To

Defense Logistics Agency (DLA)
DLA-MMPRT
8725 John J. Kingman Road, Suite 2533, Box 31-510
Ft. Belvoir, VA 22060-6221

By

Denise Carley
EDI Integration Corporation
2200 Defense Highway - Suite 303
Crofton, MD 21114
Phone 410.850.5051 • Fax 410.850.5053
BBS 301.621.1418 • Email - mrktng@eic-corp.com

30 September 1997
DO # 0001
SPO100-95-D-1004

Table of Contents

SYSTEM OVERVIEW1

EDI Transaction Types.....2

 Table 1. EDI Transaction Sets Processed By AOPM.....2

 Data Mapping4

SETTING UP AOPM.....5

 THE AOPM LOGIN SCREEN5

 SYSTEM SETUP SCREENS.....6

The Site Information Screen.....6

 Keystrokes6

 Field Definitions.....7

Ordering Official Screens9

 Select Ordering Official Dialogue.....9

 Buttons9

 Ordering Official Information Screen10

 Field Definitions.....10

 Navigation and Control Buttons11

Measurement Taker Screens.....12

 Select Measurement Taker Dialogue.....12

 Buttons12

 Measurement Taker Information Screen.....13

 Field Definitions.....13

 Navigation and Control Buttons13

THE APPAREL ORDER PROCESSING SCREEN.....15

 CREATING OUTBOUND TRANSACTIONS16

Select Transaction Type Dialogue16

Turnaround Transactions.....16

 Figure 1. Turnaround Processes17

 Table 2. Turnaround Relationships17

 OUTBOUND PURCHASE ORDER (X12 850)18

 Keystrokes18

 Field Definitions.....18

 Subordinate Screen Buttons20

 Navigation and Control Buttons20

Administrative Contacts Screen21

 Field Definitions and Buttons.....21

Garment Screen for Purchase Order22

 Navigation and Control Buttons.....24

 Garment Selection Screen24

 THE MEASUREMENTS BUTTON.....25

Coat and Shirt Measurements Screen (Male).....25

 Field Definitions and Buttons.....25

Male Trouser Measurements Screen26

Field Definitions and Buttons.....	26
<i>Body Measurements Screen (Female)</i>	27
Field Definitions and Buttons.....	27
<i>Finished Garment Measurements Screen (Female)</i>	28
Field Definitions and Buttons.....	28
THE PROFILE BUTTON.....	29
<i>Male Profile Screen</i>	29
Radio Buttons.....	30
<i>Female Profile Screen</i>	30
Radio Buttons and Check Boxes.....	30
INBOUND ASN (DD250/X12 856).....	31
Subordinate Screen Buttons.....	31
<i>DD250 Address Information Screen</i>	31
Keystrokes.....	32
Field Definitions and Buttons.....	32
OUTBOUND ASN RESPONSE (X12 824).....	33
<i>Select Transaction Type Dialogue for Outbound ASN Response</i>	33
Field Definitions and Buttons.....	33
<i>ASN Response - Additional Information</i>	34
Field Definitions and Buttons.....	34
INBOUND PURCHASE ORDER (X12 850).....	36
Subordinate Screen Buttons.....	36
OUTBOUND PURCHASE ORDER ACKNOWLEDGMENT (X12 855).....	37
<i>Select Transaction Type Dialogue</i>	37
INBOUND PURCHASE ORDER CHANGE REQUEST (X12 860).....	39
Subordinate Screen Buttons.....	39
<i>Garment Screen for Inbound Purchase Order Change Request</i>	40
<i>Purchase Order Change Contact Information</i>	40
Field Definitions.....	41
OUTBOUND ASN (DD250/X12 856).....	42
<i>Garment Screen for Outbound ASN</i>	43
<i>DD250 Address Information Screen</i>	43
OUTBOUND INVOICE SCREEN (X12 810).....	44
<i>Commercial Invoice Additional Information Screen</i>	45
Field Definitions.....	45
<i>Outbound Invoice Garment Screen</i>	46
INBOUND INVOICE SCREEN (X12 810).....	47
Subordinate Screen Buttons.....	47
APPENDIX A - INTRODUCTION TO ARN DATA MAPPING.....	A-1
APPENDIX B - EDI DATA MAPPING.....	B-1
<i>Table B1. ARN Industry Flat File Record Formats (Purchase Order) to X12 850</i>	<i>B-1</i>
<i>Table B2. ARN Industry Flat File Record Formats (Invoice) to X12 810</i>	<i>B-4</i>
<i>Table B3. ARN Industry Flat File Record Formats (Ship Notice) to X12 856</i>	<i>B-5</i>
<i>Table B4. ARN Industry Flat File Record Formats (Receiving Report) to X12 824</i>	<i>B-7</i>
<i>Table B5. ARN Industry Flat File Record Formats (Purchase Order Ack) to X12 855</i>	<i>B-10</i>

Table B6. ARN Industry Flat File Record Formats (Purchase Order Change Req.) to X12 860.....B-11

APPENDIX C - AIMS DATA MAPPING SPECIFICATIONS C-1

Table C1. ARN Industry Flat File Record Formats (Purchase Order) to ARN-AIMS.....C-1

Table C2. ARN Industry Flat File Record Formats (Invoice) to ARN-AIMS.....C-3

Table C3. ARN Industry Flat File Record Formats (Ship Notice) to ARN-AIMSC-4

Table C4. ARN Industry Flat File Record Formats (Receiving Report) to ARN-AIMSC-6

APPENDIX D - AOPM SPECIAL ORDER PROCESSES..... D-1

Flow D1: Special Measurement Area, CIIP, Ft. Jackson, SC..... D-1

Diagram D1.1: Special Measurement FormD-1

Diagram D1.2: Purchase Order FlowD-2

Diagram D1.3: DD250/ASN and ASN ResponseD-2

Diagram D1.4: P.O./DD250 Overall Flow.....D-3

Diagram D1.5: ROTC Satellite Entry for CPBD-3

Diagram D1.6: ROTC Satellite Entry for MPBD-4

Diagram D1.7: ROTC Manual Entry for MPB or CPE.....D-4

Flow D2: CIIP, Lackland AFB, San Antonio, TX..... D-5

Diagram D2.1: Special Measurement FormD-5

Diagram D2.2: Purchase Order FlowD-6

Diagram D2.3: DD250/ASN and ASN ResponseD-6

Flow D3: Clemson Apparel Research (CAR) Demo Site D-7

Flow D4: The HAAS Tailoring Company D-8

Flow D5: Maryland Clothing Manufacturing, Inc., Baltimore, MD..... D-9

System Overview

This manual applies to Version I of the Apparel Research Network (ARN) Apparel Order Processing Module (AOPM). The AOPM is a PC-based application system that creates or receives electronic orders, shipping documents and invoices for military clothing. It is designed for use at any activity involved in the processing of these orders, including Clothing Initial Issue Points (CIIPs), Defense Apparel Manufacturers (DAMs), and the Defense Personnel Support Center (DPSC). After the creation of order, shipping or invoice transaction via the AOPM entry screen, the transaction data is translated to Electronic Data Interchange (EDI) format and transmitted to the intended recipient. At a receiving location, after EDI translation, the AOPM may be used to review and respond to the transaction.

This manual describes the transaction entry screen and associated maintenance screens for creating or reviewing inbound or outbound documents related to military clothing orders, including measurement, profile, shipment information, status messages, invoices, and other related documents. Also described are the mapping and translation processes associated with conversion of data to various file formats and the transmission of data to intended recipients.

The Apparel Research Network (ARN) is a working group formed to address issues relative to ordering clothing expeditiously for military recruits and for other military personnel. The ARN Order Processing Module (AOPM) was created to support the electronic ordering of special measurement and stock clothing. The objective is to reduce the delivery cycle for an order from three to six weeks to fifteen days. Measuring personnel and issuing clothing may take place at a military base, ROTC, or Jr. ROTC location. It is important that measurements are complete and accurate to insure that personnel requiring special measurements do not lack required clothing.

While the AOPM may be used at a DoD site for preparing special measurement orders, it may also be used at DPSC and the DAM for both stock orders and special measurement orders.

Acronyms

AAFES	Army and Air Force Exchange service
ARN	Apparel Research Network
ASN	Advance Shipping Notice
DAM	Defense Apparel Manufacturer
DoD	Department of Defense
DPSC	Defense Personnel Support Center (Clothing/Textile; Food/Subsistence; Medical)
OPM	Order Processing Module
DFAS	Defense Finance and Accounting Service
OA	Ordering Activity
CIIP	Clothing Initial Issue Point
	or
RIC	Recruit Induction Center
	(CIIP and RIC are used interchangeably)

The AOPM is designed to operate in a variety of different system environments:

- As an integrated application within an Eagle¹ EDI system.
- As a standalone application software with a standard flat file interface to any EDI system.
- As a standalone application with an interface to an Internet file transfer method, such as FTP or MIME.
- As a standalone application in a laptop system with a laplink or other interface to a system with EDI capability.

EDI Transaction Types

There are six transaction types supported by Version 1 of the AOPM. They are listed below with their corresponding EDI Transaction Set ID numbers², transaction flow, and function. For more detailed information on AOPM data flow, see *Appendix D - AOPM Special Order Processes* on page D-1.

Table 1. EDI Transaction Sets Processed By AOPM

Table 1. EDI Transaction Sets Processed By AOPM			
Transaction Type	ID#	Flow	Function
Purchase Order	850	Orderer to DPSC; DPSC to Manufacturer	This transaction set is sent by a DoD site to DPSC or to a DAM and will include all information necessary to fill an order including special measurement data.
Purchase Order Acknowledgment	855	Manufacturer to DPSC	This transaction set is sent by the manufacturer to DPSC to acknowledge receipt of the order.
Purchase Order Change	860	Orderer to DPSC; DPSC to Manufacturer	This transaction set is sent by a DoD site to DPSC or to a DAM and modifies a Purchase Order which was previously transmitted.
Advance Ship Notice (ASN)	856	DAM to Recipient of garments	This transaction set is sent by the DAM to the DoD receiving locations.
ASN Response	824	DoD orderer to	This transaction set is sent by a

¹ Eagle is a standard EDI software product offered by EDI Integration Corporation.

² EDI Transaction Set ID numbers are assigned by the American National Standards Institute (ANSI) Accredited Standards Committee (ASC) X12.

Table 1. EDI Transaction Sets Processed By AOPM			
Transaction Type	ID#	Flow	Function
		DAM	DoD ordering activity to a DAM after an Advance Ship Notice (856) has been received. It is used to confirm that a reported delivery was received and to note discrepancies in the delivery, if any.
Invoice	810	DAM to Payer	This transaction set is sent by the manufacturer to DPSC to initiate the payment process.

Data Mapping

The AOPM system includes data mapping interfaces to several systems. In an EAGLE environment, this data mapping is done automatically as part of the “Do All Moves” or “Move Data To/From Host” options. In a non-Eagle system, such as DPSC, this function is performed via extra Process Menu options in AOPM. For more information on Data Mapping, see *Appendix A - Introduction to ARN Data Mapping* on page A-1.

- EDI to flat file formats (all sites)—

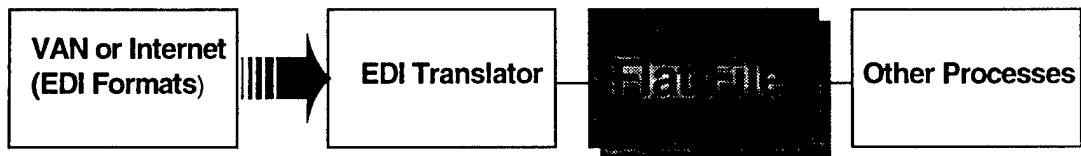

- AOPM databases to flat file formats (DoD AOPM Sites)—

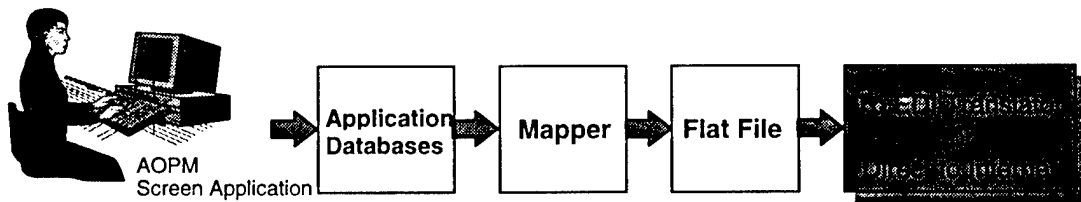

- Flat file or database formats to EDI (all sites)—



- Flat file formats to AOPM databases (DoD and DAM Sites)—

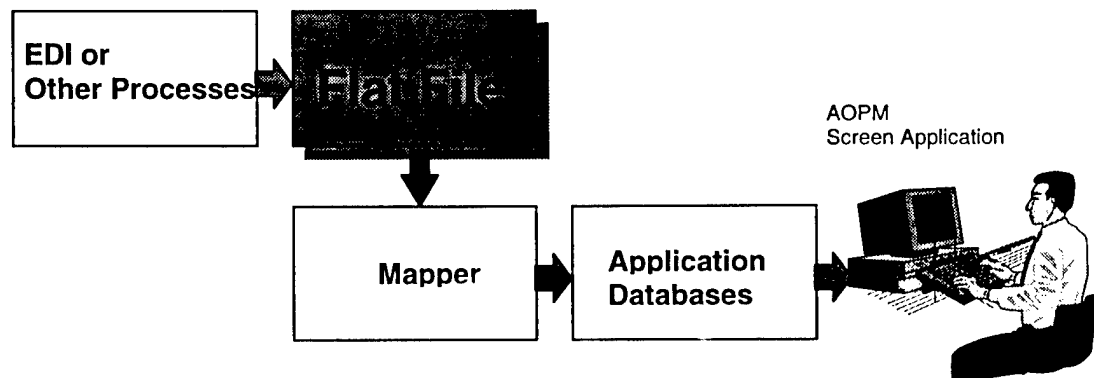

Setting Up AOPM

The AOPM Login Screen

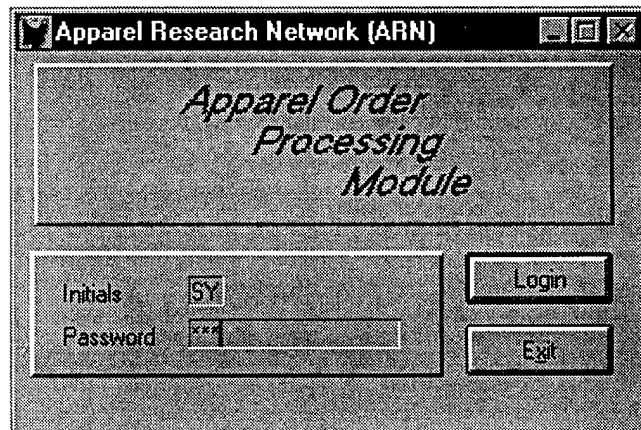

The first login to AOPM should be with the initials "SY" (part of the "System" entry in the Ordering Official Screen—see below), and the password "ARN", then click the "Login" button (or press <Enter> twice).

System Setup Screens

The Site Information Screen

The Site Information Screen contains information about the DODAAC site at which the AOPM is installed. Certain fields of information are derived from the EAGLE Translator Databases, if present, otherwise they are key entered. This screen must be completed before AOPM is used.

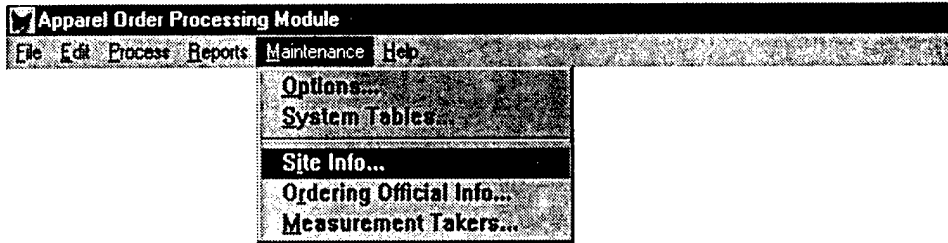

The Site Information Screen is available from the Maintenance Menu on the AOPM Menu Bar.

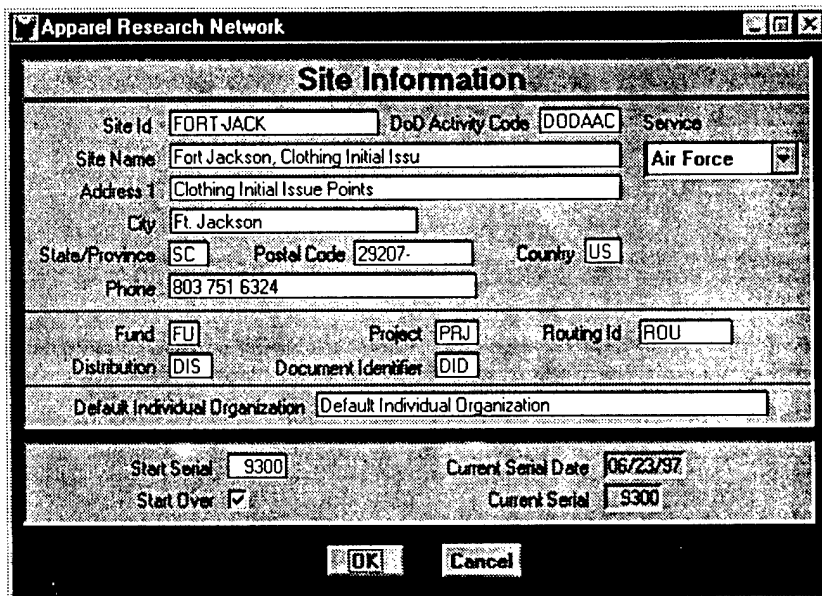

Keystrokes

The following are the keystrokes available for the Site Information Screen.

- To move within the fields on the application screen, you may use the **TAB** or **Shift-TAB** keys, or click on a field of your choosing with the mouse.

Field Definitions

- Site ID If this is an Eagle site, this value is automatically entered from the EAGLE databases. If this is a non-Eagle site, enter a code to be used for identifying the site to the EDI translator and/or to any Internet recipients of data entered at this site.
- DoD Activity Code DoD Activity Code (DODAAC).
- Site Name If this is an Eagle site, this value is automatically entered from the EAGLE databases. If this is a non-Eagle site, enter the DODAAC site name.
- Service Branch of service code used to determine which set of clothing applies:

Army	Navy
Air Force	JRROTC
Marine Corps	SRROTC
- Address 1 If this is an Eagle site, this value is automatically entered from the EAGLE databases. If this is a non-Eagle site, enter the street address of the DODAAC site.
- City If this is an Eagle site, this value is automatically entered from the EAGLE databases. If this is a non-Eagle site, enter the city name of the DODAAC site.
- State/
Province If this is an Eagle site, this value is automatically entered from the EAGLE databases. If this is a non-Eagle site, enter two-character state code for the DODAAC site.
- Postal Code If this is an Eagle site, this value is automatically entered from the EAGLE databases. If this is a non-Eagle site, enter the zip code or other postal delivery code for the DODAAC site.
- Country If this is an Eagle site, this value is automatically entered from the EAGLE databases. If this is a non-Eagle site, two-character country code for the DODAAC site.
- Phone If this is an Eagle site, this value is automatically entered from the EAGLE databases. If this is a non-Eagle site, enter the telephone number of the DODAAC site.
- Fund DoD fund code
- Project Project
- Routing ID Routing identifier (Example: for DPSC, use "S9T".)
- Distribution Distribution code
- Document Identifier Document identification

- **Default Individual Organization** Enter a default value for the “clothing for” individual’s organization. This value will be placed in the Individual Organization field for all new Purchase Orders created on the AOPM Main Screen.
- **Start Serial** Starting serial number (Orders are numbered sequentially each day starting with this number. If this field is empty, starting value will default to 1). If the Start Over check box is checked, this value will be used at the start of each day.
- **Current Serial Date** *System field: Displays the date of the last serial number used.*
- **Start Over** If this check box is checked, the value in the Start Serial field (or 1 if that field is empty) will be used at the start of each day.
- **Current Serial** *System field: Displays the value of the last serial number used.*
- **OK Button** Closes the Site Information Screen, saving changes.
- **Cancel Button** Closes the Site Information Screen, abandoning changes.

Ordering Official Screens

The Ordering Official Screens are provided for setting up all operators of the AOPM. All individuals who enter transaction should enter their information on this screen, and use their specific logon and password when entering AOPM.

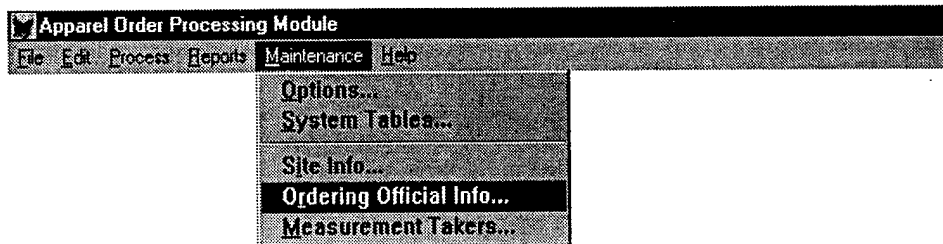

The Ordering Official screens are available via the Maintenance Menu on the AOPM Menu Bar.

Select Ordering Official Dialogue

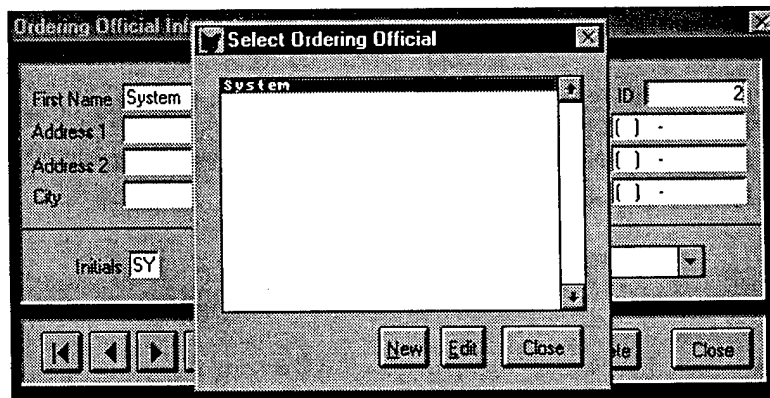

The Select Ordering Official Dialogue is the first to appear. This screen allows existing Ordering Officials to be selected for editing, or for new Ordering Officials to be added.

Buttons

- **New** To add a new Ordering Official, press the New button
- **Edit** To edit an existing Ordering Official, select the desired name and press the Edit button
- **Close** Press close to pass this screen, and the currently selected Ordering Official will appear on the Ordering Official Information Screen.

Ordering Official Information Screen

Field Definitions

- First Name The first name of the Ordering Official
- MI The middle initial of the Ordering Official
- Last Name The last name of the Ordering Official
- ID *System field: Displays the system-assigned ID number for this Ordering Official. This number is used internally by AOPM.*
- Address 1 The first line of the street address for the Ordering Official
- Address 2 The second line of the street address for the Ordering Official
- City The city name for the Ordering Official
- State The two-character state code for the Ordering Official
- Zip The zip or postal code for the Ordering Official
- Phone The telephone number for the Ordering Official
- Pager The pager number for the Ordering Official
- Fax The fax number for the Ordering Official
- Initials Two initials (i.e. first and last) for this Ordering Official which will be used to sign on via the AOPM Logon Screen
- Password Up to 8 characters which will be entered at sign-on in the AOPM Logon Screen
- Security The security level applied to this Ordering Official

Navigation and Control Buttons

- | | |
|----------|---|
| ⏪ | Displays the <i>first</i> Ordering Official record stored in AOPM |
| ◀ | Displays the <i>previous</i> Ordering Official record stored in AOPM |
| ▶ | Displays the <i>next</i> Ordering Official record stored in AOPM |
| ⏩ | Displays the <i>last</i> Ordering Official record stored in AOPM |
| • Browse | Causes the Select Ordering Official Dialogue to reappear, showing all Ordering Official records stored in AOPM. The user may select an Ordering Official and press Close. |
| • New | Allows a new Ordering Official to be created. |
| • Edit | Allows the currently displayed Ordering Official's data to be edited. |
| • Print | Allows the currently displayed Ordering Official's data to be printed. |
| • Save | Saves the Ordering Official data currently being edited. |
| • Cancel | If present, Abandons any changes made in the current editing session to the currently displayed Ordering Official. |
| • Delete | If present, deletes the currently displayed Ordering Official. |
| • Close | Closes the Ordering Official screen. |

Measurement Taker Screens

The Measurement Taker Screens are provided for setting up the names and addresses of all individuals who take measurements that are entered into AOPM. This information should be entered prior to the creation of outbound Purchase Orders in AOPM.

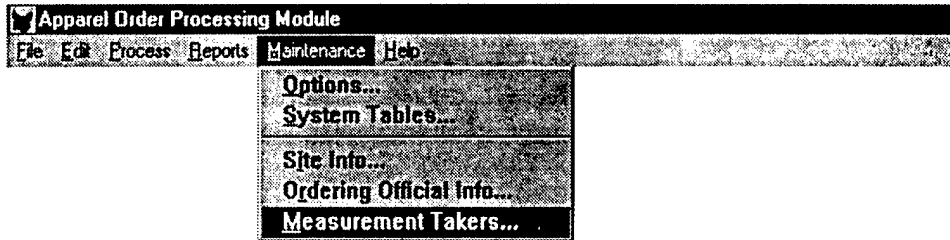

The Measurement Taker screens are available via the Maintenance Menu on the AOPM Menu Bar.

Select Measurement Taker Dialogue

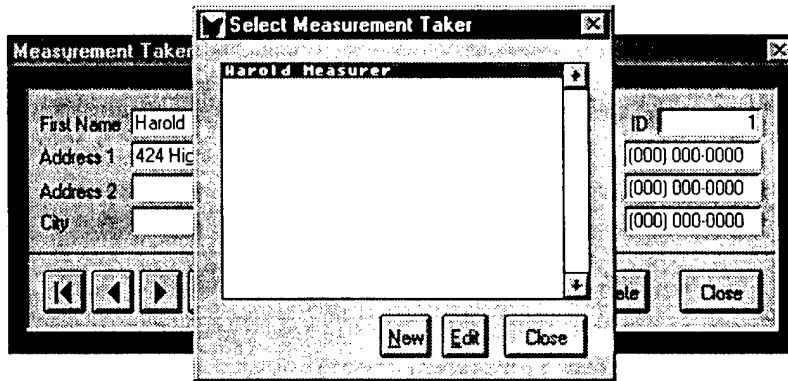

Buttons

- **New** To add a new Measurement Taker, press the New button
- **Edit** To edit an existing Measurement Taker, select the desired name and press the Edit button
- **Close** Press close to pass this screen, and the currently selected Measurement Taker will appear on the Measurement Taker Information Screen.

Measurement Taker Information Screen

Field Definitions

- First Name The first name of the Measurement Taker
- MI The middle initial of the Measurement Taker
- Last Name The last name of the Measurement Taker
- ID *System field: Displays the system-assigned ID number for this Measurement Taker. This number is used internally by AOPM.*
- Address 1 The first line of the street address for the Measurement Taker
- Address 2 The second line of the street address for the Measurement Taker
- City The city name for the Measurement Taker
- State The two-character state code for the Measurement Taker
- Zip The zip or postal code for the Measurement Taker
- Phone The telephone number for the Measurement Taker
- Pager The pager number for the Measurement Taker
- Fax The fax number for the Measurement Taker

Navigation and Control Buttons

- ◀ Displays the *first* Measurement Taker record stored in AOPM
- ◀ Displays the *previous* Measurement Taker record stored in AOPM
- ▶ Displays the *next* Measurement Taker record stored in AOPM
- ▶ Displays the *last* Measurement Taker record stored in AOPM

- Browse Causes the Select Measurement Taker Dialogue to reappear, showing all Measurement Taker records stored in AOPM. The user may select an Measurement Taker and press Close.
- New Allows a new Measurement Taker to be created.
- Edit Allows the currently displayed Measurement Taker's data to be edited.
- Print Allows the currently displayed Measurement Taker's data to be printed.
- Save Saves the Measurement Taker data currently being edited.
- Cancel If present, Abandons any changes made in the current editing session to the currently displayed Measurement Taker.
- Delete If present, deletes the currently displayed Measurement Taker.
- Close Closes the Measurement Taker screen.

The Apparel Order Processing Screen

The Apparel Order Processing Screen is the main transaction entry and review screen in AOPM. It is designed to perform many different functions, and the use of these functions varies depending upon the location at which AOPM is installed. The possible functions include: Creation of outbound transactions, such as Purchase Orders (X12 850), Purchase Order Acknowledgments (855), Advance Ship Notices (ASN) (856), ASN Responses (824), and Invoices (810); receipt and review of inbound transactions, including Purchase Orders (850), Purchase Order Acknowledgments (855), Purchase Order Changes (860), Advance Ship Notices (ASN) (856), ASN Responses (824), and Invoices (810). All needed data entered into an original Purchase Order is returned automatically in subsequent (related) documents when the P.O. is responded to by another AOPM system, and thus the relevant data is carried throughout the transaction cycle, from Purchase Order to Invoice.

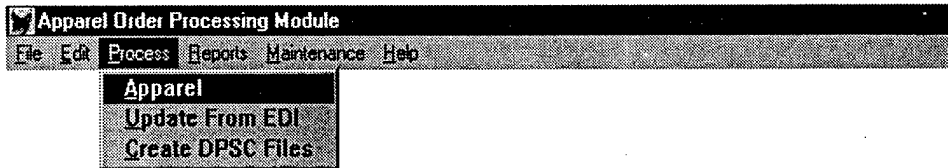

The Apparel Order Processing Screen is available from the Process Menu on the AOPM Menu Bar. Note: The other two options on this menu are available for use only at the DPSC Site.

Apparel Order Processing...

From: **Document: OUTBOUND Purchase Order** Status: **Pending Release**

FORT-JACH PG/Doc # Date Requested
 To DPSC Contract Terms Release By
 Date

Ship To DDDAAC Supplemental DDDAAC Carrier
 Address Country
 City State/Prov Postal Code

Clothing For Name SSN
 Age Rank Component Male Female
 Org
 Notes

Total Amount Admin

Garments	NSN/Article Number	Description	Quantity	Ext. Amt.
	8405L083043048/AMC580	All Weather Coat	1.00	125.00
	8415L083193048/CAP741	BDU Caps	1.00	35.00

Creating Outbound Transactions

To create any outbound transaction, press the *New* button on the Apparel Order Processing Screen. The Select Transaction Type window will appear. Select the desired transaction type on the left side of the window. Ignore the right side of the window *unless* you are creating a turnaround transaction (see *Turnaround Transactions* on page 16) or you are using a previous purchase order as a template for a new one.

Select Transaction Type Dialogue

On the left side of the dialogue box, select the outbound transaction type (in this case, “850 Purchase Order”). Enter a code (i.e. “DPSC”) for the Transmit To field. The Transmit From field is automatically filled in from the Site ID field in the Site Information Screen. For a new transaction that is not a turnaround transaction, such as a purchase order, the right side of this dialogue is ignored. If it is to be a turnaround transaction, check the “Turnaround From” check box on the right side of the dialogue (see *Turnaround Transactions* below). Press the OK button to return to the Apparel Order Processing Screen.

Turnaround Transactions

A *turnaround* transaction is an outbound transaction that uses data from an incoming transaction to populate some of its fields. Details are presented in Figure 1 and Table 2 below. The identifying data from the original inbound transaction should appear on the right side of the dialogue. If this information is incorrect, click Cancel and make sure that the correct inbound transaction is displayed on the Apparel Order Processing Screen. If the information is correct, press the OK button to begin creating the turnaround transaction.

Figure 1. Turnaround Processes

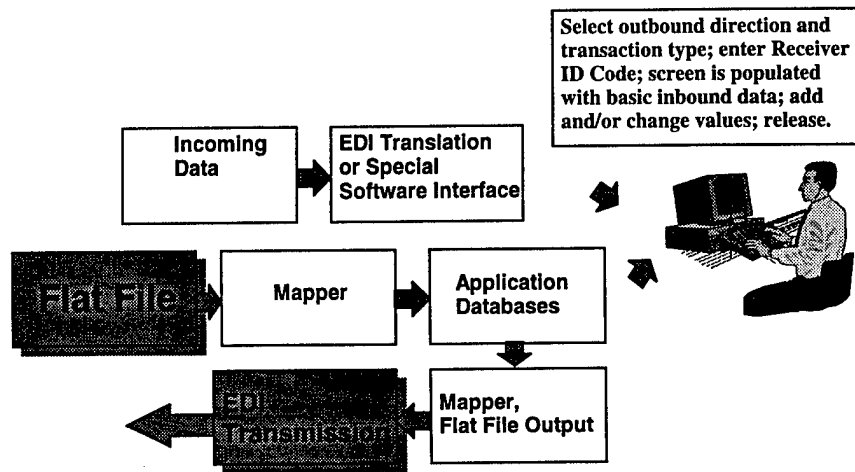

Table 2. Turnaround Relationships

Receive	Turnaround To	Send To
850 Purchase Order at Property Management from ROTC, Jr. ROTC	850 (Approve; add data per Property Management requirements)	DPSC
850 Purchase Order at DAM from DPSC	855 Purchase Order Acknowledgment	DPSC
850 Purchase Order at DAM from DPSC	856 Ship Notice	"Ship To" ordering activity; DPSC; DCMC
856 Ship Notice at "Ship To" ordering activity from DAM	824 Application Advice (Proof of delivery)	DAM and payment location
850 Purchase Order from DAM at DPSC	810 Invoice	DPSC or DFAS
850 Purchase Order from Property Management at DPSC	Flat file to mainframe or internal application (Optional)	Mainframe or internal application

Outbound Purchase Order (X12 850)

The creation of an outbound Purchase Order is the start of an AOPM trading cycle, and involves the largest volume of data and number of screens for any AOPM transaction. To create an outbound Purchase Order, press the *New* button on the Apparel Order Processing Screen (see next page). The Select Transaction Type window will appear. Select “850 Purchase Order” on the left side of the window. Ignore the right side of the window *unless* you are using a previous purchase order as a template for the new one. For more information, see *Turnaround Transactions* on page 16.

The screenshot shows the 'Apparel Order Processing...' window. At the top, it displays 'Document: OUTBOUND Purchase Order' and 'Status: Pending Release'. Below this, there are sections for 'From' (FORT-JACH) and 'To' (DPSC) with fields for PO/Doc # (D0DAAC71749300), Date (06/23/97), Requested (//), Release (//), Contract (N20001-94-X-1001), and Terms. A 'Ship To' section includes D0DAAC, Supplemental D0DAAC, Carrier (UPSS), Address (Clothing Initial Issue Points), Country (US), City (Ft. Jackson), State/Prov (SC), and Postal Code (29207). A 'Clothing For' section includes Name (Ronald A. Smith), SSN (111-23-1313), Age (23), Rank (CP), Component (Active Duty), Gender (Male/Female), and Organization (Default Individual Organization). Notes include 'Transfer from San Diego'. A summary bar shows 'Total Amount' of 160.00 and an 'Admin' button. A table at the bottom lists items:

Garments	NSN/Article Number	Description	Quantity	Ext. Amt.
	8405L083043048/AMC580	All Weather Coat	1.00	125.00
	8415L083193048/CAP741	BDU Caps	1.00	35.00

Keystrokes

The following are the keystrokes available for the AOPM Application Screen.

- To move within the fields on the application screen, you may use the **TAB** or **Shift-TAB** keys, or click on a field of your choosing with the mouse.

Field Definitions

- From** *System field: Displays the EAGLE EDI Partner code for the sender of an inbound or outbound transaction.*
- To** *System field: Displays the EAGLE EDI Partner code for the receiver of an inbound or outbound transaction.*
- PO/Doc #** The document number for the Purchase Order.

- Date The date of the Purchase Order.
- Requested Date Requested.
- Contract Contract number.
- Terms Terms applicable to the current transaction.
- Release Check this box to release the Purchase Order for transmission in the next communications session.
- By *System field: Displays the initials of the Ordering Official logged into AOPM when the release box is checked.*
- Date *System field: Displays the date of release of the current transaction.*
- DODAAC Ship-to Department of Defense Activity Code. This field is filled automatically from the Site Information Screen.
- Supplemental DODAAC Supplemental Department of Defense Activity Code.
- Carrier Carrier Code.
- Address Ship-to address. This field is filled automatically from the Site Information Screen.
- Country Ship-to country code (2-character code). This field is filled automatically from the Site Information Screen.
- City Ship-to city. This field is filled automatically from the Site Information Screen.
- State/Prov Ship-to state or province (2-character code). This field is filled automatically from the Site Information Screen.
- Postal Code Ship-to postal code (up to 10 digits). This field is filled automatically from the Site Information Screen.
- Name Clothing-for individual name.
- SSN Clothing-for individual Social Security Number.
- Age Clothing-for individual age.
- Rank Clothing-for individual rank.
- Component Clothing-for individual component: Active Duty, National Guard, Reserve, or None (blank).
- Male/Female Clothing-for individual's gender. Determines which measurement and profile screens are presented.
- Org Clothing-for individual's organization.
- Notes Transaction note.
- Total Amount *System field: Displays the total price of all garments entered on the Garment (line item) Screen.*

Subordinate Screen Buttons

- Garments Displays the Garment Screen.
- Measurements Displays the Measurement Screens in sequence, depending on the value of the Male/Female radio button.
- Profile Displays the Profile Screens in sequence, depending on the value of the Male/Female radio button.
- Admin Displays the Administrative Contacts Screen.
- n/a This button is not active for the current transaction type.

Navigation and Control Buttons

- Next Displays the next transaction in the AOPM database.
- Previous Displays the previous transaction in the AOPM database.
- Find Allows a search of all transactions in the AOPM database. The selected transaction is displayed.
- New Permits creation of a new transaction, via the New Transaction Dialogue.
- Edit Permits editing of the currently displayed transaction.
- Save Saves any changes to the currently displayed transaction.
- Delete Deletes the currently displayed transaction.
- Print Prints the currently displayed transaction.
- Close Closes the Apparel Order Processing Screen.

Administrative Contacts Screen

When the Admin button on the Apparel Order Processing (Purchase Order) Screen is pressed, the Administrative Contacts Screen appears. *Note: This screen appears once automatically when creating a new Purchase Order via the "New" button.*

The screenshot shows the 'Administrative Contacts' window within the 'Apparel Order Processing' application. The window title is 'Apparel Order Processing'. At the top, it displays 'Document: OUTBOUND Purchase Order' and 'Status: Pending Release'. Below this, there are fields for 'From' (MDCM-ARM), 'To' (DPSC), 'PO/Doc #' (D0DAAC71749300), 'Date' (06/23/97), 'Requested' (//), and 'Release' (//). The main area is divided into two sections: 'Ordering Official' and 'Measurement Taker'. The 'Ordering Official' section has a 'Name' field with 'System' entered, and 'Telephone' and 'Fax' fields. The 'Measurement Taker' section has a 'Name' field with 'Harold R. Measur' entered. At the bottom, there is a table of garments:

Garments	NSN/Article Number	Description	Quantity	Ext. Amt.
	8405L083043048/AWC580	All Weather Coat	1.00	125.00
	8415L083193048/CAP741	BDU Caps	1.00	35.00

To select an Ordering Official or Measurement Taker from the AOPM databases, press the button marked "..." to the right of the Name field for each. For more information on these values, see *Ordering Official Screens* on page 9 and *Measurement Taker Screens* on page 12.

Field Definitions and Buttons

- Site Code *System field: Displays the Site Code from the Site Information Screen.*

Ordering Official

- Name The name of the Ordering Official logged into AOPM when the transaction was created.
- Telephone The telephone number of the Ordering Official.
- Fax The fax number of the Ordering Official.

Measurement Taker

- Name The name of the Measurement Taker.
- OK Button Closes the Administrative Contact Screen, saving any changes.
- Cancel Button Closes the Administrative Contact Screen, abandoning any changes.

Garment Screen for Purchase Order

PO Information Fields (header information - display only)

- Date Purchase Order Date.
- Requested Date Requested.
- Ship To Ship-to DODAAC code.
- Released If checked, indicates transaction has been released from AOPM.
- PO/Doc # Document Number.
- Carrier Carrier Code.
- Date Date released (if applicable).

Garment Line Item Fields

- CLIN Contract Line Item Number
- Unit Unit of Measure for item (i.e. "EA").
- Delivery Date *Not applicable for purchase orders.* For ASN (DD250) transactions, this field is used for the DAM's delivery date for the current line item.
- Garment The internal Garment Code for the selected garment. This field is automatically filled after a garment is selected, but it may be modified if necessary.
- Select Garment Button This button, to the right of the Garment field, presents a list of valid garments for the Service currently set up in the Site Information Screen.

- Measurements This button presents the measurement screens for the gender of the "Clothing For" individual.
- NSN/Art.# The National Stock Number or Article Number for the selected garment. This field is automatically filled after a garment is selected, but it may be modified if necessary.
- Dest./Req. *System field: Destination/Requisition*
(This value is determined from the 3-character code Distribution Code in the Site Information Screen, plus the character "/", plus the first 5 characters of the NSN/Art.# for the selected garment)
- Description The description for the selected garment. This field is automatically filled after a garment is selected, but it may be modified if necessary.
- Qty Ordered The number of garments ordered.
- Price The price of each garment.
- Qty Approved *Not applicable for purchase orders.* For ASN Response transactions, this field is used for the approved quantity for the current line item. For P.O. Change transactions (which may only be created at DPSC), this field becomes the "New Quantity" field.
- Amount *System field: The extended amount of the current line item (quantity multiplied by price).*
- Item Acknowledgment Code *Not applicable for purchase orders.* For ASN Response transactions, item acceptance or rejection is indicated here. The options are *LA - Item Accept*, *IR - Item Reject*, and *IP - Item Partial Accept*. If the value is [empty], no Item Acknowledgment Code will be transmitted.
- Order Notes Free-form note related to the line item.
- Ship Notes *Not applicable for purchase orders.* For ASN (DD250) transactions, this field can be used for notes related to shipment of the current line item.

Navigation and Control Buttons

- Next Displays the next garment (line item) for the current transaction.
- Previous Displays the previous garment (line item) for the current transaction.
- Find Allows a search of all line items for the current transaction. The selected transaction is displayed.
- New Permits addition of a new line item.
- Edit Permits editing of the currently displayed line item.
- Save Saves any changes to the currently displayed line item.
- Cancel Deletes the currently displayed line item.
- Print Prints the currently displayed line item.
- Close Closes the Garment Screen.

Garment Selection Screen

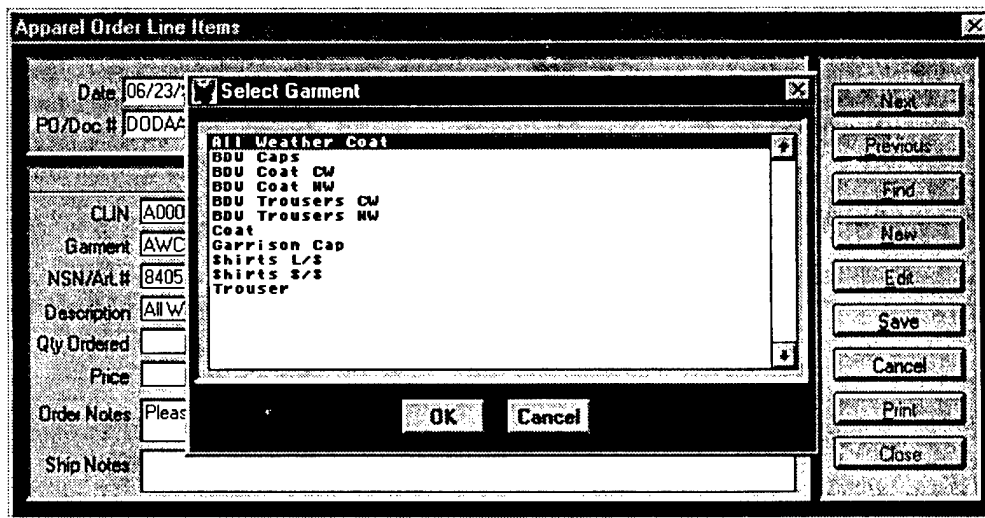

To select a garment for the current line item, press the button marked “...” to the right of the Garment field. The *Select Garment* list will appear. Highlight the desired garment from the list and press the OK button. This will cause the Garment, NSN/Art.#, Description and Dest/Req fields to be filled automatically. Each of these fields can be manually modified except for the Dest/Req field, which is updated when the Garment or NSN field is changed.

The Measurements Button

Coat and Shirt Measurements Screen (Male)

The screenshot shows the 'Coat and Shirt Measurements' window. On the left, there are fields for 'From' (FORT-JAC), 'To' (DPSC), 'Ship To', 'Clothing For', 'Garments', and 'Measure'. The central area contains diagrams for 'Back', 'Coat/Waist', 'Chest', 'Waist', 'Collar/Sleeve', and 'Over Shoulder' with corresponding input fields. The right sidebar includes 'Release' information, a 'Date' field, and buttons for 'Next', 'Previous', 'Find', 'New', 'Edit', 'Save', 'Cancel', 'Print', and 'Close'. At the bottom right, there are 'Qty' and 'Ext. Amt' fields with values 00, 125.00, and 00, 35.00.

Field Definitions and Buttons

- Back Coat length, back width (Min=10 in; Max=20 in).
- Collar-Waist Coat length, collar to waist (Min=15 in; Max=25 in).
- Waist-Length Coat length, waist to length desired (Min=30 in; Max=60 in).
- Chest At breast level, inhale (Min=30 in; Max=50 in).
- Waist Around waist at navel (just above hips), stomach natural position (Min=25 in; Max=51 in).
- Collar Around neck at center (Min=12 in; Max=19 in).
- Sleeve Base of neck to top of hand, arm straight down (Min=30 in; Max=39 in).
- Over Shoulder Shoulder circumference (Min=38 in; Max=56 in).
- Height Height, barefoot (Min=60 in; Max=81 in).
- Weight Weight, no shoes (Min=90 lb; Max=310 lb).
- Head Around head at the center of the forehead (Min=12 in; Max=20 in).
- OK Button Closes this screen, saving any changes.
- Cancel Button Closes this screen, abandoning any changes.

Male Trousers Measurements Screen

Field Definitions and Buttons

- Outseam Top of hip to bottom of ankle (Min=36 in; Max=72 in).
- Inseam Crotch to bottom of ankle (Min=25 in; Max=40 in).
- Waist Around waist at navel (just above hips), stomach natural position (Min=25 in; Max=51 in).
- Abdomen Around body just above top of legs (Min=22 in; Max=60 in).
- Thigh Around thigh near crotch (Min=12 in; Max=22 in).
- Seat Around body at center of seat (Min=35 in; Max=60 in).
- Knee Around knee at knee cap (Min=10 in; Max=18 in).
- Bottom Desired circumference at bottom or hem of trousers (Min=15 in; Max=25 in).
- OK Button Closes this screen, saving any changes.
- Cancel Button Closes this screen, abandoning any changes.

Body Measurements Screen (Female)

Field Definitions and Buttons

- Head Around head at just above forehead (Min=9 in; Max=18 in).
- Neck Neck to dress hemline (Min=30 in; Max=50 in).
- Shldr Grth Shoulder girth (Min=15 in; Max=30 in).
- Bust Bust point to bust point around neck (Min=20 in; Max=40 in).
- Upper Arm Upper arm, around fullest part (Min=12 in; Max=22 in).
- Waist Around waist at navel (just above hips), stomach natural position (Min=20 in; Max=51 in).
- Abdominal Girth Abdominal girth (Min=22 in; Max=50 in).
- Hip Around body at hips (Min=35 in; Max=60 in).
- Thigh Around thigh near crotch (Min=10 in; Max=20 in).
- Waist to Ankle Bone Waist to ankle bone (Min=28 in; Max=56 in).
- Shoulder Length Shoulder length (Min=15 in; Max=25 in).
- Total Arm Length Total arm length from center back (Min=25 in; Max=42 in).
- Back-Waist Center back at neck to waist length (Min=24 in; Max=36 in).
- Total Crotch (A-B) Waist front through crotch to waist back (Min=28 in; Max=46 in).
- Bust around Neck Bust point to bust point around neck (Min=20 in; Max=40 in).

- Neck to Waist Around neck to waist (Min=30 in; Max=50 in).
- Underarm Length Underarm length (Min=16 in; Max=30 in).
- Hand Around hand below thumb (Min=5 in; Max=9 in).
- Height Height, barefoot (Min=60 in; Max=77 in).
- Weight Weight, no shoes (Min=85 lb; Max=250 lb).
- OK Button Closes this screen, saving any changes.
- Cancel Button Closes this screen, abandoning any changes.

Finished Garment Measurements Screen (Female)

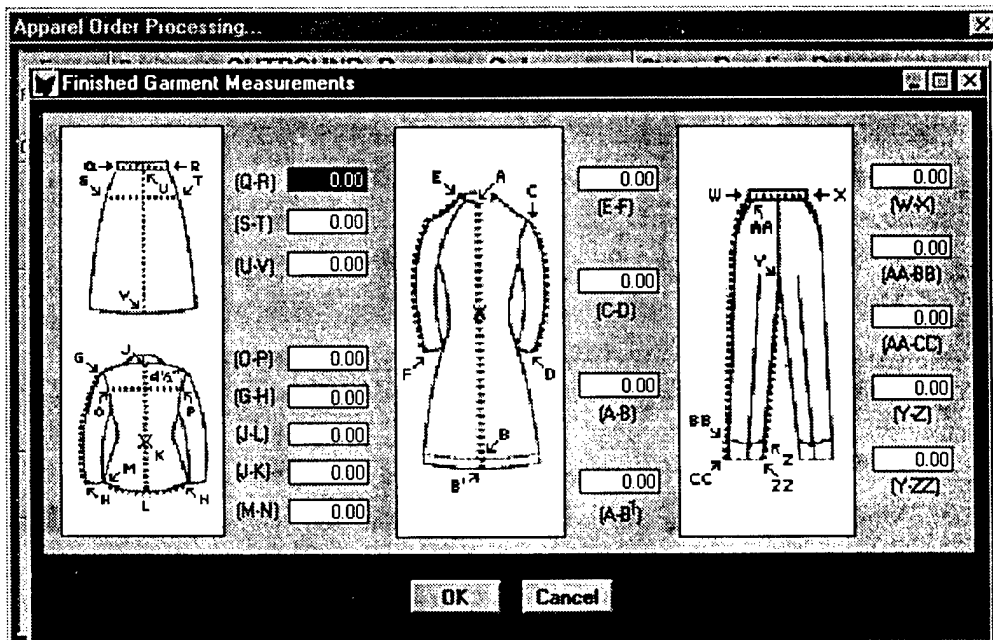

Field Definitions and Buttons

- (Q-R) Around waist at navel (just above hips), stomach natural position (Min=20 in; Max=51 in).
- (S-T) Around body at hips (Min=35 in; Max=60 in).
- (U-V) Hemmed skirt length (Min=15 in; Max=45 in).
- (O-P) Coat length, back width (Min=10 in; Max=20 in).
- (G-H) Total arm length from center back (Min=25 in; Max=42 in).
- (J-L) Jacket length (Min=20 in; Max=45 in).

- (J-K) Coat length, collar to waist (Min=15 in; Max=23 in).
- (M-N) Around body at hips (Min=35 in; Max=60 in).
- (E-F) Base of neck to top of hand, arm straight down (Min=25 in; Max=35 in).
- (C-D) Total arm length from center back (Min=25 in; Max=42 in).
- (A-B) Neck to dress hemline (Min=30 in; Max=50 in).
- (A-B1) Neck to unhemmed dress length (Min=32 in; Max=52 in).
- (W-X) Around waist at navel (just above hips), stomach natural position (Min=20 in; Max=51 in).
- (AA-BB) Top of hip to trouser hemline (Min=30 in; Max=50 in).
- (AA-CC) Top of hip to unhemmed trouser length (Min=32 in; Max=52 in).
- (Y-Z) Crotch to trouser hemline (Min=20 in; Max=35 in).
- (Y-ZZ) Crotch to unhemmed trouser length (Min=22 in; Max=37 in).
- OK Button Closes this screen, saving any changes.
- Cancel Button Closes this screen, abandoning any changes.

The Profile Button

Male Profile Screen

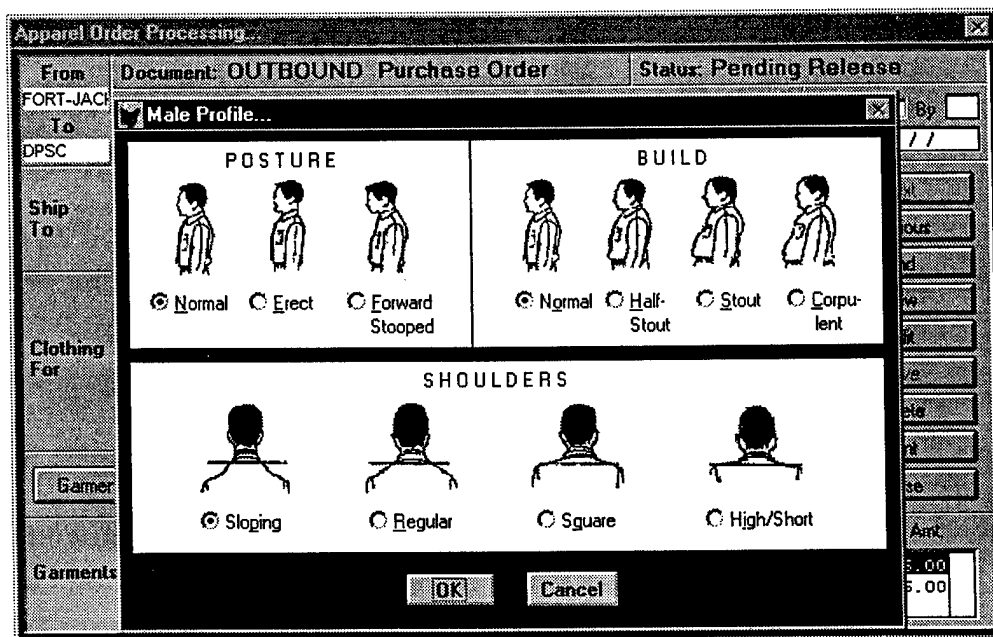

Radio Buttons

- Posture Select Normal, Erect, or Forward Stooped.
- Build Select Normal, Half-Stout, Stout, or Corpulent.
- Shoulders Select Sloping, Regular, Square, or High/Short.
- OK Button Closes this screen, saving any changes.
- Cancel Button Closes this screen, abandoning any changes.

Female Profile Screen

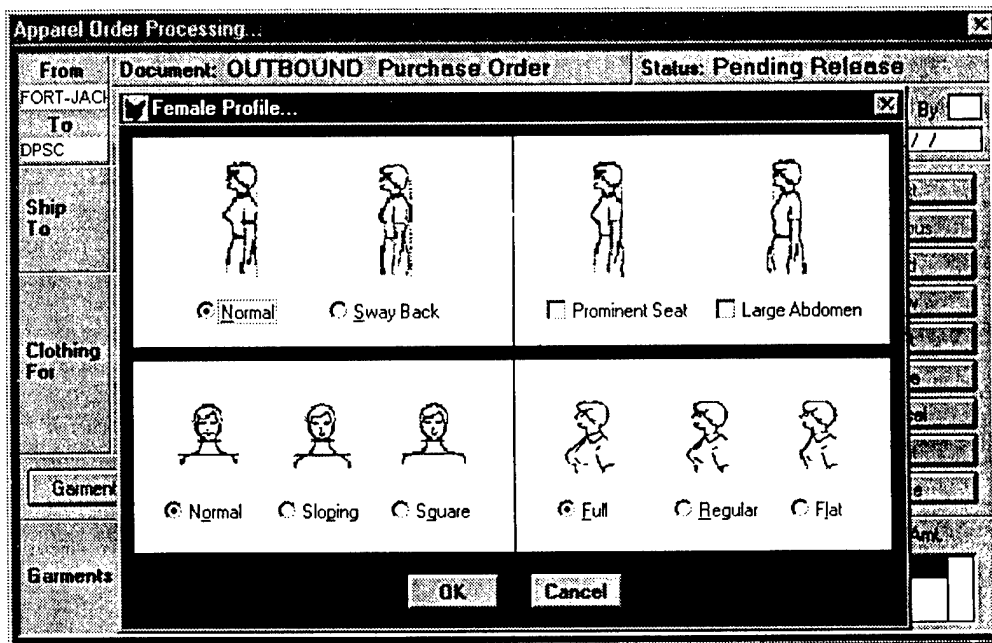

Radio Buttons and Check Boxes

- Posture Select Normal or Sway Back.
- Abdomen If applicable, check Prominent Seat and/or Large Abdomen.
- Shoulders Select Normal, Sloping, or Square.
- Bust Select Full, Regular, or Flat.
- OK Button Closes this screen, saving any changes.
- Cancel Button Closes this screen, abandoning any changes.

Inbound ASN (DD250/X12 856)

All fields on the Apparel Order Processing Screen are the same as the Purchase Order. The DD250 button replaces the n/a button:

Subordinate Screen Buttons

- **Garments** Displays the Garment Screen.
- **Measurements** Displays the Measurement Screens in sequence, depending on the value of the Male/Female radio button.
- **Profile** Displays the Profile Screens in sequence, depending on the value of the Male/Female radio button.
- **Admin** Displays the Administrative Contacts Screen. For more information, see page 21.
- **DD250** This button presents the DD250 Address Information Screen.

DD250 Address Information Screen

The screenshot shows the 'DD250 Address Information' dialog box. The 'From' field is 'CLEM-ARN' and the 'To' field is 'FORT-JACK'. The 'Prime Contractor' field is split into 'CLEM-ARN' and 'FORT-JACK'. The 'Administered By' field is 'DNRRD'. The 'Shipped From' field is 'SAME'. The 'Payment Made By' field is 'DFAS'. There are also fields for 'Terms', 'Percent' (0.000), 'Days' (0), 'Shipment ID', 'Method', 'Address', and 'City/ST/Zip/Ctry'. On the right side, there are buttons for 'Next', 'Previous', 'Find', 'New', 'Edit', 'Save', 'Delete', 'Print', and 'Close'. At the bottom, there are 'OK' and 'Cancel' buttons. The background shows a partial view of the main Apparel Order Processing screen with a 'Garments' button highlighted.

Keystrokes

The following are the keystrokes available for the DD250 Address Information Screen.

- To move within the fields on the application screen, you may use the **TAB** or **Shift-TAB** keys, or click on a field of your choosing with the mouse.

Field Definitions and Buttons

The following are the field definitions and buttons available for the DD250 Address Information Screen, which is a subordinate screen to the Apparel Order Processing Screen when an Inbound or Outbound ASN is displayed.

- **Terms** Terms code.
- **Percent** Terms discount percent.
- **Days** Terms discount days.
- **Shipment ID** Shipment or Bill of Lading Number.
- **Method** Shipment Method.
- **Ship To Name** The name of the organization to ship to.
- **Prime Contractor** The *Name* of the Prime Contractor, with additional *DODAAC Code* (to the right of the *Name* field), *Address* and *City/St/Zip/Cntry* fields.
- **Administered By** The *Name* of the Administered By organization, with additional *DODAAC Code* (to the right of the *Name* field), *Address* and *City/St/Zip/Cntry* fields.
- **Shipped From** The *Name* of the Shipped From organization, with additional *DODAAC Code* (to the right of the *Name* field), *Address* and *City/St/Zip/Cntry* fields.
- **Payment Made By** The *Name* of the Payment Made By organization, with additional *DODAAC Code* (to the right of the *Name* field), *Address* and *City/St/Zip/Cntry* fields.
- **OK Button** Closes the current screen.
- **Cancel Button** Closes the current screen (has the same effect as the OK button, since there are no edits permitted on inbound transactions).

Outbound ASN Response (X12 824)

To create an ASN Response transaction in response to an inbound ASN, display that inbound ASN, and press the New button. In the Select Transaction Type Dialogue, insure that the 824 ASN Response is selected, enter the EDI Trading Partner code in the Transmit To field, and check the Turnaround From check box. For more information, see *Turnaround Transactions* on page 16.

Select Transaction Type Dialogue for Outbound ASN Response

Field Definitions and Buttons

- “Create New” radio buttons Allows selection of the Transaction Type.
- Transmit To The EDI Partner Code for the receiver of the new transaction.
- Transmit From Your AOPM Site ID. This field is filled automatically.
- Turnaround From Check this box if you are creating a turnaround transaction. For ASN Response, this box should be checked.

- OK Button Closes this screen, saving any changes.
- Cancel Button Closes this screen, abandoning any changes.

When you create an outbound ASN Response, the ASN Response - Additional Information Screen will appear. After you press OK on that screen, the ASN Response document will be visible. The Resp button will bring up the ASN Response - Additional Information Screen if further changes are needed.

ASN Response - Additional Information

The screenshot shows the 'Apparel Order Processing' window with the following data:

From	Document: INBOUND ASN	Status: No Edits
CLEM-ARN	PO/Doc # 12345670789300	Date 05/30/97 Requested / /
To	Contract	Terms
FORT-JAC		Release <input checked="" type="checkbox"/> By SY
		Date 05/30/97
Ship To	DODAAC 123456 Supplemental DODAAC 123456	Country US
	Address 123 Lake Forest Drive	
	City Gaithersburg State/Prov MD Postal Code 20879	
Clothing For	Name JAN	
	Age 0	
	Org	
	Notes	
Garments	Measurements	

NSN/Article Number	Description	Quantity	Est. Amt.
8410L083223048/AMC342	/8410L	1.00	0.00
8415L083213048/TRS268	/8415L	1.00	0.00

Field Definitions and Buttons

- Shipped From DODAAC Code for the Shipped From organization
- Payment To Be Made By DODAAC Code for the Payment To Be Made By organization
- OK Button Closes this screen, saving any changes.
- Cancel Button Closes this screen, abandoning any changes.

Apparel Order Processing...

From: **Document: OUTBOUND ASN Response** Status: **New**

PORT-JAC To: PO/Doc # **12345670789300** Date: **07/11/97** Requested: **//** Release: By:

CLEM-ARN Contract: Items: Date: **//**

Ship To: DODAAC: **123456** Supplemental DODAAC: **123456** Carrier:

Address: **123 Lake Forest Drive** Country: **US**

City: **Gaithersburg** State/Prov: **MD** Postal Code: **20879**

Clothing For: Name: **JANE DOE** SSN: **--**

Age: Rank: Component: **None (Blank)** Male

Sex: Female

Dip:

Notes:

Garments Measurements Profile Total Amount: **0.00** Admin **Resp**

	NSN/Article Number	Description	Quantity	Ext. Amt.
Garments	8410L083223048/AMC342	/8410L	1.00	0.00
	8415L083213048/TRS268	/8415L	1.00	0.00

The basic ASN Response Transaction is created automatically. Data may be changed or added as needed. Fields which can be modified are editable when in Edit mode (this is the default mode for a new transaction, and is available at other times by pressing the Edit button). The same is true on the Apparel Order Line Items Screen, which is available by pressing the Garments button.

Unique Subordinate Screen Button

- Resp Brings up the ASN Response - Additional Information Screen if further changes are needed.

Inbound Purchase Order (X12 850)

The Inbound Purchase Order may not be edited. All information may be reviewed on the screen. Subordinate screens are available by pressing the appropriate buttons: Garments, Measurements, Profile and Admin. For more information on these screens, see page 18.

From	Document	INBOUND	Purchase Order	Status	No Edit
DPS	PO/Doc #	DODAAC71749300	Date	06/23/97	Requested //
MDCM-ARM	Contract	N20001-94-X-1001	Terms		Date //
Ship To	DODAAC	DODAAC	Supplemental DODAAC		Carrier UPSS
	Address	Clothing Initial Issue Points			Country US
	City	Ft. Jackson	State/Prov	SC	Postal Code 29207
Clothing For	Name	Ronald A. Smith		SSN	111-23-1313
	Age	23	Rank	CP	Component Active Duty
				<input checked="" type="radio"/> Male <input type="radio"/> Female	
	Org	Default Individual Organization			
	Notes	Transfer from San Diego			
Garments		Measurements		Profile	
		Total Amount		160.00	
		Admin		n/a	
Garments		NSN/Article Number	Description	Quantity	Ext. Amt
		8405L083043048/AMC590	All Weather Coat	1.00	125.00
		8415L083193048/CAP741	BDU Caps	1.00	35.00

Subordinate Screen Buttons

- Garments Displays the Garment Screen.
- Measurements Displays the Measurement Screens in sequence, depending on the value of the Male/Female radio button.
- Profile Displays the Profile Screens in sequence, depending on the value of the Male/Female radio button.
- Admin Displays the Administrative Contacts Screen.
- n/a This button is not active for the current transaction type.

Outbound Purchase Order Acknowledgment (X12 855)

To create an outbound Purchase Order Acknowledgment, display the Inbound Purchase Order and press the New button. The Select Transaction Type Dialogue will appear.

Select Transaction Type Dialogue

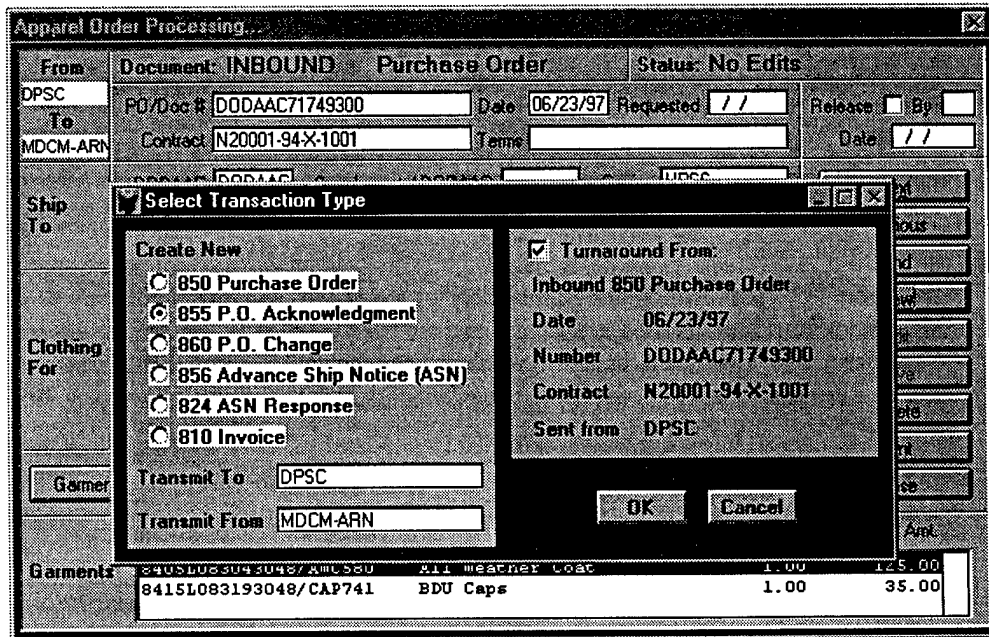

Click on 855 P.O. Acknowledgment, enter the Transmit To EDI Partner Code (i.e. DPSC), and check the Turnaround From check box. The Inbound Purchase Order date, number and contract should appear on the right side of the dialogue. If this information is incorrect, click Cancel and make sure that the correct Inbound Purchase Order is displayed on the Apparel Order Processing Screen. If the information is correct, press the OK button to begin creating the P.O. Acknowledgment.

Apparel Order Processing...							
From		Document: OUTBOUND P.O. Acknowledgment			Status: Pending Release		
MDCM-ARM	PO/Doc #	DODAAC71749300	Date	08/04/97	Requested	//	
To	Contract	N20001-94X-1001	Terms		Released	//	
DPSC					Date	//	
Ship To	DODAAC	DODAAC	Supplemental DODAAC		Carrier	UPSS	
	Address		Clothing Initial Issue Points		Country	US	
	City	Ft. Jackson	State/Prov	SC	Postal Code	29207	
Clothing For	Name	Ronald A. Smith		SSN	111-23-1313		
	Age	23	Rank	CP	Component	Active Duty	
	Org	Default Individual Organization					<input checked="" type="radio"/> Male <input type="radio"/> Female
	Notes	Transfer from San Diego					
Garments		Measurements	Profile	Total Amount	160.00	Admin	
						<input type="button" value="New"/> <input type="button" value="Previous"/> <input type="button" value="Find"/> <input type="button" value="Edit"/> <input type="button" value="Save"/> <input type="button" value="Delete"/> <input type="button" value="Print"/> <input type="button" value="Done"/>	
		NSN/Article Number	Description	Quantity	Est. Amt.		
Garments		8405L083043048/AMC580	All Weather Coat	1.00	125.00		
		8415L083193048/CAP741	BDU Caps	1.00	35.00		

The basic P.O. Acknowledgment transaction is created automatically. Data may be changed or added as needed. Fields which can be modified are editable when in Edit mode (this is the default mode for a new transaction, and is available at other times by pressing the Edit button). The same is true on the Apparel Order Line Items Screen, which is available by pressing the Garments button.

Inbound Purchase Order Change Request (X12 860)

The Inbound Purchase Order Change Request may not be edited. All information may be reviewed on the screen. Subordinate screens are available by pressing the appropriate buttons: Garments and Contact.

Apparel Order Processing...

Document: **INBOUND P.O. Change Request** Status: **No Edits**

From: DPSC To: MDCM-ARI

PO/Doc #: **DODAAC71749300** Date: **08/04/97** Requested: **//** Release: By: Date: **//**

Contract: **N20001-94-X-1001** Terms:

Ship To: DODAAC: **DODAAC** Supplemental DODAAC: Carrier: **UPSS**

Address: **Clothing Initial Issue Points** Country: **US**

City: **Ft. Jackson** State/Prov: **SC** Postal Code: **29207**

Clothing For: Name: **Ronald A. Smith** SSN: **111-23-1313**

Age: **23** Rank: **CP** Component: **Active Duty** Male Female

Org: **Default Individual Organization**

Notes: **Transfer from San Diego**

Buttons: **Garments** **Measurements** **Profile** **Total Amount: 160.00** **Admin** **Contact** **Next** **Previous** **Find** **New** **Edit** **Save** **Delete** **Print** **Close**

Garments	NSN/Article Number	Description	Quantity	Ext. Amt
	8405L083043048/AMC580	All Weather Coat	2.00	250.00
	8415L083193048/CAP741	BDU Caps	2.00	70.00

Subordinate Screen Buttons

- **Garments** Displays the Garment Screen.
- **Contact** Displays the Purchase Order Change Contact Information Screen.

Garment Screen for Inbound Purchase Order Change Request

Apparel Order Line Items

Date: 08/04/97 Requested: // Ship To: DODAAC Released:
 PO/Doc #: DODAAC71749300 Carrier: UPS Date: //

Garments

CLIN: A0001 Unit: EA Delivery Date: 07/01/97
 Garment: AWCOAT M
 NSN/Art #: 8405L083043048/AWC580 Dest./Req: DIS/8405L
 Description: All Weather Coat
 Qty Ordered: 2.0000 New Quantity: 0.0000 Item Acknowledgement Code:
 Price: 125.00 Amount: 250.00 [Empty]
 Order Notes: Please expedite - Quantity changed to 2 instead of 1
 Ship Notes:

Navigation buttons: Next, Previous, Find, New, Edit, Save, Delete, Print, Close

Purchase Order Change Contact Information

Apparel Order Processing...

From: DPSC Document: INBOUND P.O. Change Request Status: No Edits
 To: MDCM-ARN
 Ship To: DODAAC
 Clothing For: Garments

PO/Doc #: DODAAC71749300 Date: 08/04/97 Requested: // Released: By:
 Contract: N20001.94.V.1001
 NSN/A: 8405L, 8415L

Purchase Order Change Contact Information

DPSC Office Symbol: [DPS]
 PCO Name: PCO-NAME
 PCO Telephone: 222-333-4444
 Buyer Name: BUYERNAME
 Buyer Telephone: 111-222-3333
 FOB Location Code:
 FOB Location: FOBLOCATION

Buttons: OK, Cancel

Navigation buttons: Next, Previous, Find, New, Edit, Save, Delete, Print, Close

Est. Amt: 250.00, 70.00

Field definitions for this screen are on the following page.

Field Definitions

- DPSC Office Symbol A code identifying the DPSC Office.
- PCO Name The name of the Primary Contracting Officer.
- PCO Telephone The telephone number of the Primary Contracting Officer.
- Buyer Name The name of the buyer.
- Buyer Telephone The telephone number of the buyer.
- FOB Location Code A code identifying the FOB location.
- OK Button Closes the current screen.
- Cancel Button Closes the current screen (has the same effect as the OK button, since there are no edits permitted on inbound transactions).

Outbound ASN (DD250/X12 856)

To create an outbound ASN, display the Inbound Purchase Order and press the New button. The Select Transaction Type Dialogue will appear. For more information on this screen, see page 16.

Click on 856 Advance Ship Notice, enter the Transmit To EDI Partner Code (i.e. FT-JACK), and check the Turnaround From check box. The Inbound Purchase Order date, number and contract should appear on the right side of the dialogue. If this information is incorrect, click Cancel and make sure that the correct Inbound Purchase Order is displayed on the Apparel Order Processing Screen. If the information is correct, press the OK button to begin creating the ASN.

You may also enter an Outbound ASN without an Inbound Purchase Order in the database, by leaving blank the Turnaround From check box on the Select Transaction Type Dialogue.

The screenshot shows the 'Apparel Order Processing...' dialog box. It is divided into several sections:

- Document Information:** From: MDCM-ARM To: DPSC. Document: **OUTBOUND ASN**. Status: **Pending Release**. PO/Doc #: DDDAAC71749300. Date: 08/04/97. Requested: // // . Release: [] By: [] Date: // // . Contract: N20001-94-X-1001. Terms: TERMS.
- Ship To:** DDDAAC: DDDAAC. Supplemental DDDAAC: []. Carrier: UPSS. Address: Clothing Initial Issue Points. Country: US. City: Ft. Jackson. State/Prov: SC. Postal Code: 29207.
- Clothing For:** Name: Ronald A. Smith. SSN: 111-23-1313. Age: 23. Rank: CP. Component: Active Duty. Gender: Male (selected). Org: Default Individual Organization. Notes: Transfer from San Diego.
- Summary:** Garments, Measurements, Profile. Total Amount: 160.00. Admin: DD250.
- Garments Table:**

NSN/Article Number	Description	Quantity	Ext. Am.
8405L083043048/AMC580	All Weather Coat	1.00	125.00
8415L083193048/CAP741	BDU Caps	1.00	35.00

The basic ASN transaction is created automatically. Data may be changed or added as needed. Fields which can be modified are editable when in Edit mode (this is the default mode for a new transaction, and is available at other times by pressing the Edit button). The same is true on the Apparel Order Line Items Screen, which is available by pressing the Garments button.

Subordinate Screen Buttons

- Garments Displays the Garment Screen.
- DD250 Displays the DD250 Address Information Screen.

Garment Screen for Outbound ASN

Apparel Order Line Items

Date: 08/04/97 Requested: / / Ship To: DDDAAC Released:
 PO/Doc #: DDDAAC71749300 Carrier: UPSS Date: / /

Garments

CLIN: A0001 Unit: EA Delivery Date: / / Measurements:
 Garment: AWCOAT M
 NSN/Alt #: 8405L083043048/AWC580 Dest./Req: DIS/8405L
 Description: All Weather Coat
 Qty Ordered: 1.0000 Qty Approved: 0.0000 Item Acknowledgement Code: [Empty]
 Price: 125.00 Amount: 125.00
 Order Notes: Please expedite
 Ship Notes: This item has been shipped

Navigation buttons: Next, Previous, Find, New, Edit, Save, Delete, Print, Close

The Apparel Order Line Item Screen displays the data from the original Purchase Order, and permits modification of the Garment fields, as well as the addition of a Delivery Date and Ship Notes.

DD250 Address Information Screen

Apparel Order Processing

From: MDCM-ARM To: DPSC Document: OUTBOUND ASN Status: Pending Release
 PO: DD250 Address Information

Terms: TERMS Percent: 10.000 Days: 10
 Shipment ID: SHIPMENT ID NUMBER 2929 Method: MT
 Ship To Name:
 Prime Contractor: PRIMECONTRACTOR DPSC
 Address: PRIMECONTRACTOR
 City/ST/Zip/Ctry: PRIME CITY CA 92929292 US
 Administered By: ADMIN BY FORT JACK
 Address: ADMIN BY ADDRESS
 City/ST/Zip/Ctry: ADMIN BY CITY WA 993939393 US
 Shipped From: SHIP FROM SHIPF CODE
 Address: SHIP FROM ADDRESS
 City/ST/Zip/Ctry: SHIP FROM CITY RI 320403923 US
 Payment Made By: PAYMENT PAYM CODE
 Address: PAYMENT ADDRESS
 City/ST/Zip/Ctry: PAYMENT CITY DE 304302923 US

Buttons: OK, Cancel

Navigation buttons: Next, Previous, Find, New, Edit, Save, Delete, Print, Close

Ext. Amt: 125.00, 35.00

Outbound Invoice Screen (X12 810)

Apparel Order Processing...

From: MDCM-ARN **Document:** OUTBOUND Invoice **Status:** Pending Release

To: DPSC **Inv #:** DDDAAC24506650001 **Date:** 08/04/97 **Requested:** // **Received:** //

PO#:PIN: DDDAAC71749300 **Term:** // **By:** //

Ship To: DDDAAC DDDAAC Supplemental DDDAAC **Carrier:** UPS **Country:** US

Address: Clothing Initial Issue Points **City:** Ft. Jackson **State/Prov:** SC **Postal Code:** 29207

Clothing For: **Name:** Ronald A. Smith **SSN:** 111-23-1313 **Age:** 23 **Rank:** CP **Component:** Active Duty **Gender:** Male Female

Org: Default Individual Organization **Notes:** Transfer from San Diego

Garments **Measurements** **Profile** **Total Amount:** 160.00 **Admin** **Invoice** **Print** **Close**

Garments	NSN/Article Number	Description	Quantity	Ext. Amt.
	8405L083043048/AMC580	All Weather Coat	1.00	125.00
	8415L083193048/CAP741	BDU Cap	1.00	35.00

Subordinate Screen Button

- **Garments** Displays the Garment Screen.
- **Admin** Displays the Administrative Contacts Screen.
- **Invoice** Displays the Commercial Invoice Additional Information Screen.

Commercial Invoice Additional Information Screen

NSN/Article Number	Description	Quantity	Ext. Amt
84051083043048/AMC580	All Weather Coat	1.00	125.00
84151083193048/CAP741	BDU Caps	1.00	35.00

Field Definitions

- Shipment ID The Shipment ID for the garments shipped.
- Method The shipment method.
- Ship To Name The Ship-to Name
- Terms The terms percent and days applied to the invoice.
- Amount Subj to Disc The portion of the invoice amount to which a terms-based discount would be applied.
- Indicator Enter "A" for allowance; "C" for charge.
- Amount Any allowance or charge (as indicated in the *Indicator* field) that is applied to the invoice.
- OK Button Closes this screen, saving any changes.
- Cancel Button Closes this screen, abandoning any changes.

Outbound Invoice Garment Screen

The screenshot shows a software window titled "Apparel Order Line Items". At the top, there are fields for Date (08/04/97), Request (//), Ship To (DODAAC), Release (checkbox), PD/PO (DODAAC24506650001), Carrier (UPSS), and Date (//). Below this is a section titled "Garments" with a sub-section for "A0001". Fields include Unit (EA), Delivery Date (//), a "Measurements" button, Garment (AWCOAT M), ASN/Alt (8405L083043048/AWC580), Dist/Flag (DIS/8405L), Description (All Weather Coat), Qty Ordered (1.0000), Qty Approved (0.0000), Price (125.00), Amount (125.00), and Item Acknowledgement Code ([Empty]). There are also fields for Order Notes (Please expedite) and Ship Notes. A vertical toolbar on the right contains buttons for New, Edit, Print, and Close.

The Apparel Order Line Items Screen for the Outbound Invoice contains all data from the original Purchase Order, when created as a turnaround transaction. For more information on the fields of this screen, see *Garment Screen for Purchase Order* on page 22.

Inbound Invoice Screen (X12 810)

The Inbound Purchase Order Change Request may not be edited. All information may be reviewed on the screen. Subordinate screens are available by pressing the appropriate buttons: Garments, Admin and Invoice. For more information on Invoice fields and subordinate screens, see *Outbound Invoice Screen (X12 810)* on page 44.

The screenshot shows a software window titled "Apparel Order Processing...". The main area is divided into several sections:

- Document Information:** From: MDCM-ARM, To: DPSC, Document: INBOUND Invoice, Status: No Edits.
- Invoice Details:** Inv # DDDAAC24506650001, Date 08/04/97, Requested //, Release By, PO#/PIIN DDDAAC71749300, Terms, Date //.
- Ship To:** DDDAAC, DDDAAC, Supplemental DDDAAC, Carrier: UPS, Address: Clothing Initial Issue Points, Country: US, City: Ft. Jackson, State/Prov: SC, Postal Code: 29207.
- Clothing For:** Name: Ronald A. Smith, SSN: 111-23-1313, Age: 23, Rank: CP, Component: Active Duty, Gender: Male, Org: Default Individual Organization, Notes: Transfer from San Diego.
- Summary:** Garments, Measurements, Profile, Total Amount: 160.00, Admin, Invoice.
- Table:**

Garments	NSN/Article Number	Description	Quantity	Est. Amt
	8405L083043048/AMCS80	All Weather Coat	1.00	125.00
	8415L083193048/CAP741	BDU Caps	1.00	35.00

Subordinate Screen Buttons

- Garments Displays the Garment Screen.
- Admin Displays the Administrative Contacts Screen.
- Invoice Displays the Commercial Invoice Additional Information Screen.

Appendix A - Introduction to ARN Data Mapping

1. The flat file containing purchasing data is constructed for the following purposes:
 - Providing from the AOPM application any data intended for transmission:
 - ⇒ Data to be translated to EDI (by Eagle or an alternative. This data may be transmitted by the EDI system via an EDI VAN or the Internet.)
 - ⇒ Data to be transmitted via the Internet as a flat file.

In both cases, the flat file formats are identical.

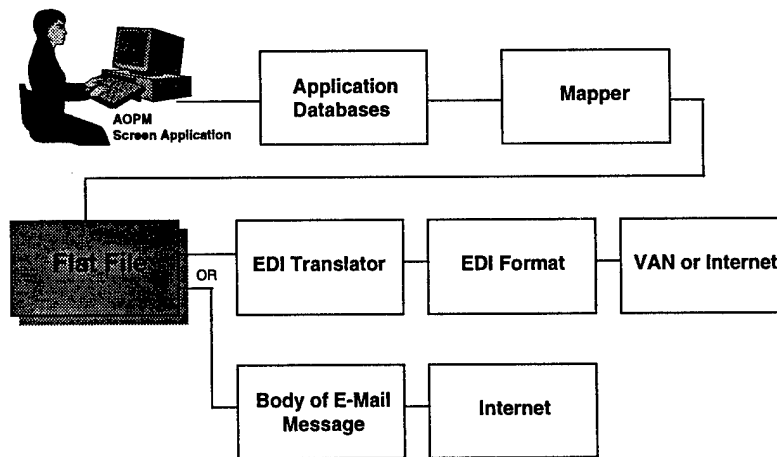

Diagram A1. Position of Flat Files In Data Flow From the Application

- Providing data from the EDI system to an application system. The application system may be the AOPM application or any other application at a user's site, such as the Apparel Information Management System (AIMS).

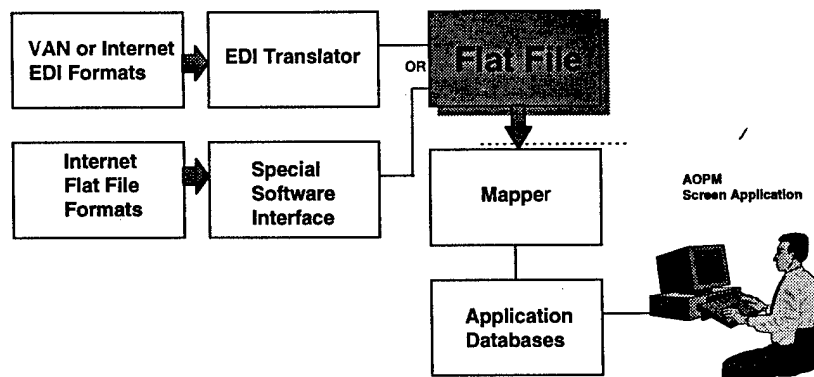

Diagram A2. Position of Flat Files In Data Flow To the Application

- Providing flat file data directly from the Internet to be used by an application.

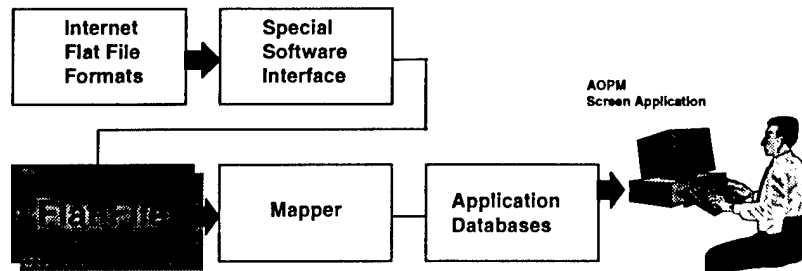

Diagram A3. Position of Flat Files In Data Flow To the Application When No EDI Is Employed

2. The flat file scheme for an ARN purchase order consists of three types of variable length records. Each record contains a record identifier code and several fields, each separated by a delimiter. Details are presented in Table A1-A4.
3. The record types are:
 - H—Fields for the header section of the purchase order.
 - M—Fields for a measurements associated with a particular line item.
 - N—Fields for names and addresses and related items.
 - L—Fields for the line item section of the purchase order.
 - S—Fields for the summary section of the purchase order.
4. The code "H", "M", "N", "L", or "S" is at the beginning of each line. This is followed by a vertical bar (|) delimiter and field for each of the fields in the record. All fields are accounted for in the record, even empty fields. The delimiter is a place marker.
5. Fields may be trimmed with trailing spaces for character fields removed and leading zeros for numeric fields removed.
6. Negative numbers will have a minus sign (-) prefix. Positive numbers will have no prefix. Decimal place markers (decimal points) are used where required to indicate fractional values.
7. The format for the purchase order flat file records is shown in Table A1. Each line in the table corresponds to a field in a record.

For more information on the EDI data mapping specifications, see *Appendix B - EDI Data Mapping* on page B-1. For more information on the AIMS data mapping specifications, see *Appendix C - AIMS Data Mapping Specifications* on page C-1.

Appendix B - EDI Data Mapping

Where ARN data is transmitted via EDI, it is mapped between the ARN Flat File format and the X12 EDI formats for the different transaction types. See *EDI Transaction Types* on page 2 for more information. Below are the specifications for mapping from the ARN AOPM Flat File to the various X12 EDI transaction types.

Table B1. ARN Industry Flat File Record Formats (Purchase Order) to X12 850

Table B1. ARN Industry Flat File Record Formats (Purchase Order)					
REC CODE	FLD	MSG SET	Industry Name	QUAL	EDIREF
H	1	850	Header record code (H)		
H	2	850	Transaction set code (850)		
H	3	850	Control number (serial number)		
H	4	850	Trading partner (sent to)		
H	5	850	Trading partner (received from)		
H	6	850	PO Purpose Code (00=Original)		353 M ID 2 2 BEG01: Transaction Set Purpose Code
H	7	850	PO Type Code (BK=Blanket Order)		92 M ID 2 2 BEG02: Purchase Order Type Code
H	8	850	Contract Number + Call		324 M AN 1 22 BEG03: Purchase Order Number
H	9	850	Date of Delivery Order		323 M DT 6 6 BEG05: Purchase Order Date
H	10	850	Accounting Data		3 M AN 1 60 NTE02: Accounting Data
H	11	850	Ordering Site		93 O AN 1 35 PER02: Ordering Site Name
H	12	850	Ordering Contact	OC	93 O AN 1 35 PER02: Submitting Contact Name
H	13	850	Ordering Contact Telephone	TE	364 C AN 7 25 PER04: Telephone Number
H	14	850	Submitted By (Originator)	SM	93 O AN 1 35 PER02: Submitting Contact Name
H	15	850	Submitted By Telephone	TE	364 C AN 7 25 PER04: Communication Number
M	1	850	Measurement record code (M)		
M	2	850		F	349 M ID 1 1 PID01: Item Description Type
M	3	850		08	750 O ID 2 3 PID02: Product

Table B1. ARN Industry Flat File Record Formats (Purchase Order)					
REC CODE	FLD	MSG SET	Industry Name	QUAL	EDIREF
M	4	850	Measurement Details <u>Format:</u> Meascode (2 char) (space fill if the code is one character)+Space+Measure (6 digits) (space fill on left if less than 6 digits; format 999.99)+Space+Measureme nt description (from d_mdscr.measinst)		352 C AN 1 80 PID05: Special Measurement - In EDI, data from the LM records will be transmitted in PID segments in the haeading section of the transaction set, preceeding the N1 segments. Each PID segment in this position will include a measurement or profile data.
N	1	850	Names/Addresses record code (N)		
N	2	850	Ship To Site Name	ST	93 O AN 1 35 N102: Ordering Contact
N	3	850	Ship To Site DODAAC	10	67 C AN 2 17 N104: Identification Code
N	4	850	Name of Individual to Receive the Apparel		93 M AN 1 35 N201: Individual Name
N	5	850	Measurement Taker Name		93 M AN 1 35 N202: Measurement Taker Name
N	6	850	Ship To Site Address -line 1		166 M AN 1 35 N301: Address Information
N	7	850	Ship To Site Address - line 2		166 M AN 1 35 N301: Address Information
N	8	850	Ship To Site City		19 C AN 2 30 N401: City Name
N	9	850	Ship To Site State		156 O ID 2 2 N402: State or Province Code
N	10	850	Ship To Site Postal Code		116 O ID 3 9 N403: Postal Code
N	11	850	Ship To Site Country		26 O ID 2 3 N404: Country Code
N	12	850	Sex/Profile identification <u>Format:</u> Sex (1 char)+Space+Shoulders (3 char)+Bust (3 char) (space fill for male)+Space+Posture (3 char)+Space+Seat (3 char) (space fill)+Space+Abdomen (3char)+(space fill for male)+Build (3 char)	JD	127 C AN 1 30 REF02: Reference number-(User identification)
L	1	850	Line item record code (L)		
L	2	850	CLIN		350 O AN 1 11 PO101: CLIN
L	3	850	Quantity Ordered		330 M R 1 9 PO102: Quantity Ordered
L	4	850	Unit of Measurement Code [for quantity]		355 M ID 2 2 PO103: Unit of Measurement Code
L	5	850	Unit Price		212 C R 1 14 PO104: Unit Price

Table B1. ARN Industry Flat File Record Formats (Purchase Order)					
REC CODE	FLD	MSG SET	Industry Name	QUAL	EDIREF
L	6	850	Delivery Date	ZZ	234 C AN 1 30 PO107: Delivery Date YYNDD
L	7	850	Destination/Requisition	ZZ	234 C AN 1 30 PO109: Destination/Requisition
L	8	850		F	349 M ID 1 1 PID01: Item Description Type
L	9	850		08	750 O ID 2 3 PID02: Product/Process
L	10	850	National Stock Number///Garment Code - Note: For special measurement orders, add to the NSN//Garment Code the string "-SPECIAL ME" instead of a Size value.		352 C AN 1 80 PID05: Description
L	11	850	Nomenclature (Article description)		3 M AN 1 60 NTE02: Nomenclature
L	12	850	Line item note	LIN	3 M AN 1 60 NTE02: Line Item Note
S	1	850	Summary record code (S)		
S	2	850	Quantity/Dollar Totals		3 M AN 1 60 NTE02: Quantity/Dollars
S	3	850	Number of Line Items		354 M NO 1 6 CTT01: Number of Line Items
S	4	850	Purchase Order Amount		782 M R 1 15 AMT02: Amount of Order
S	5	850	Tracing note		3 M AN 1 60 NTE02: Nomenclature
S	6	850	Operator ID at time of release	PUR	3 M AN 1 60 NTE02: Operator ID Note
S	7	850	Age (2 digits) =Rank (2 char) +Component (AD, NG, AR, NR, FR, MR or blank)	EMC	3 M AN 1 60 NTE02: Personal Data Note

Table B2. ARN Industry Flat File Record Formats (Invoice) to X12 810

Table B2. ARN Industry Flat File Record Formats (Invoice) (Each line in the table corresponds to a field in a record.)					
REC CODE	FLD	MSG SET	Industry Name	QUAL	EDIREF
H	1	810	Header record code (H)		
H	2	810	Transaction set code (810)		
H	3	810	Control number (serial number)		
H	4	810	Trading partner (sent to or received from)		
H	5	810	Invoice Date		245 M ID 6 6 BIG01: Invoice Date YYMMDD
H	6	810	Invoice Number		76 M ID 2 22 BIG02: Invoice Number (DFAS limit 8 characters)
H	7	810	Purchase Order Number - PIIN and CALL		324 M AN 1 22 BIG04: Purchase Order Number PIIN and CALL (DFAS limit 13 characters)
H	8	810	Transaction Type Code ("DI")		323 M DT 2 2 BIG07: Transaction Type Code ("DI"=Debit Invoice)
H	9	810	Ship To Site Name	ST	93 O AN 1 35 N102: Ordering Contact
H	10	810	Ship To Site DODAAC	10	67 C AN 2 17 N104: Identification Code
H	11	810	Terms Discount Percent		338 C AN 2 17 ITD03: Terms Discount %
H	12	810	Terms Discount Days Due (Number of days)		351 C AN 2 17 ITD05: Terms Discount Days Due
H	13	810	Date Shipped	011	373 C AN 6 6 DTM02: Date YYMMDD
H	14	810	Ship ID	SI	127 C AN 1 30 REF02: Reference Number
L	1	810	Line item record code (L)		
L	2	810	CLIN		350 O AN 1 11 IT101: CLIN
L	3	810	Quantity Invoiced		358 M R 1 9 IT102: Quantity Ordered
L	4	810	Unit of Measurement Code [for quantity]		355 M ID 2 2 IT103: Unit of Measurement Code
L	5	810	Unit Price		212 C R 1 14 IT104: Unit Price (Format 00.00)
L	6	810	Product/Service ID	FS	234 C AN 1 30 IT107: NSN - National Stock Number
L	7	810		F	349 M ID 1 1 PID01: Item Description Type

Table B2. ARN Industry Flat File Record Formats (Invoice) (Each line in the table corresponds to a field in a record.)					
REC CODE	FLD	MSG SET	Industry Name	QUAL	EDIREF
L	8	810		08	750 O ID 2 3 PID02: Product/Process
L	9	810	Item Description		352 C AN 1 80 PID05: Description
S	1	810	Summary record code (S)		
S	2	810	Total Invoice Amount		361 M R 1 15 TDS01: Total Invoice Amount
S	3	810	Amount Subject to Time Discount		390 M R 1 15 TDS02: Amount Subject to Time Discount
S	4	810	Transportation Method Code		91 M ID 1 1 CAD01: Transportation Method Code
S	5	810	Shipment Identifying Number		127 M AN 1 17 CAD08: Shipment Identifying Number (8char)
S	6	810	Allowance or Charge Indicator		248 M ID 1 1 ITA01: Allowance or Charge Indicator Code)
S	7	810	Allowance or Charge Amount (For Premium Transportation Authorized)		360 M R 1 15 ITA07: Allowance or Charge Amount
S	8	810	Number of Line Items		354 M N0 1 6 CTT01: Number of Line Items

Table B3. ARN Industry Flat File Record Formats (Ship Notice) to X12 856

Table B3. ARN Industry Flat File Record Formats (Ship Notice) (Each line in the table corresponds to a field in a record.)					
REC CODE	FLD	MSG SET	Industry Name	QUAL	EDIREF
H	1	856	Header record code (H)		
H	2	856	Transaction set code (856)		
H	3	856	Control number (serial number)		
H	4	856	Trading partner (sent to or received from) STCODE		
H	5	856	Purchase Order Number - PIIN and CALL	00	396 M AN 2 30 BSN02: Shipment Identification
H	6	856	Transaction Date		373 M DT 6 6 BSN03: Date
H	7	856	Transaction Time		337 M TM 4 6 BSN03: Time
H	8	856	Contract Number	CT	127 M AN 1 30 REF02: Reference Number
H	9	856	Shipment ID	CT	127 M AN 1 30 REF02: Reference Number
N	1	856	Name record code (N)		
N	2	856	Operator ID at time of release	PC	N1 O 1 200 N1 Name

Table B3. ARN Industry Flat File Record Formats (Ship Notice)					
(Each line in the table corresponds to a field in a record.)					
REC CODE	FLD	MSG SET	Industry Name	QUAL	EDIREF
N	3	856	Prime Contractor Name	PG	N1 O 1 200 N1 Name
N	4	856	Address		N3 O 2 [N1] Address Information
N	5	856	City		19 C AN 2 19 N401: City Name
N	6	856	State		156 O ID 2 2 N402: State or Province Code
N	7	856	Postal Code		116 O ID 3 9 N403: Postal Code
N	8	856	Country		26 O ID 2 3 N404: Country Code
N	9	856	Admin Name	NG	93 C AN 1 35 N102: Ship From Name (SF)
N	10	856	Address		166 M AN 1 35 N301: Address Information, line 1
N	11	856	City		19 C AN 2 19 N401: City Name
N	12	856	State		156 O ID 2 2 N402: State or Province Code
N	13	856	Postal		116 O ID 3 9 N403: Postal Code
N	14	856	Country		26 O ID 2 3 N404: Country Code
N	15	856	Administrative Contact Name	AM	93 O AN 1 35 PER02: Administrative Contact Name
N	16	856	Telephone	TE	365 C ID 2 2 PER03: Comm Number Qualifier
N	17	856	Fax	FX	364 C AN 7 25 PER05: Communication Number
N	18	856	Ship From Name	SF	93 C AN 1 35 N102: Ship From Name (SF)
N	19	856	Address		166 M AN 1 35 N301: Address Information, line 1
N	20	856	City		19 C AN 2 19 N401: City Name
N	21	856	State		156 O ID 2 2 N402: State or Province Code
N	22	856	Postal		116 O ID 3 9 N403: Postal Code
N	23	856	Country		26 O ID 2 3 N404: Country Code
N	24	856	Pay BY Contact Name	PT	93 C AN 1 35 N102: Pay Contact Name (PR)
N	25	856	Address		166 M AN 1 35 N301: Address Information, line 1
N	26	856	City		19 C AN 2 19 N401: City Name
N	27	856	State		156 O ID 2 2 N402: State or Province Code
N	28	856	Postal code		116 O ID 3 9 N403: Postal Code

Table B3. ARN Industry Flat File Record Formats (Ship Notice) (Each line in the table corresponds to a field in a record.)					
REC CODE	FLD	MSG SET	Industry Name	QUAL	EDIREF
N	29	856	Country		26 O ID 2 3 N404: Country Code
N	30	856	Ship To Site Name	ST	93 C AN 1 35 N102: Ship To Site Name (ST)
N	31	856	DODAAC	10	67 C AN 2 17 N104: DODAAC
N	32	856	Clothing For		93 C AN 1 35 N102: Clothing for [name]
N	33	856	Address		166 M AN 1 35 N301: Ship To Address Information, line 1
N	34	856	City		19 C AN 2 19 N401: Ship To City Name
N	36	856	State		156 O ID 2 2 N402: State or Province Code
N	37	856	Postal code		116 O ID 3 9 N403: Postal Code
N	38	856	Country		26 O ID 2 3 N404: Country Code
N	39	856	Transaction Note	GEN	30 M AN 1 60 NTE02: Transaction Note
L	1	856	Line item record code (L)		
L	2	856	Hierarchial ID Number	V	628 M AN 1 12 HL01: Hierarchial ID Number
L	3	856	National stock Number	FS	234 M AN 1 40 LIN03: CLIN
L	4	856	Garment Code	F7	234 M AN 1 40 LIN03: CLIN
L	5	856	CLIN	BV	350 O AN 1 11 SN101: CLIN
L	6	856	Quantity Shipped	39	382 M R 1 10 SN102: Quantity
L	7	856	Unit of Measurement Code [for quantity]		355 M ID 2 2 SN103: Unit of Measurement Code
L	8	856	Shipping Note	DEL	30 C AN 1 60 NTE02: Description

**Table B4. ARN Industry Flat File Record Formats
(Receiving Report) to X12 824**

Table B4. ARN Industry Flat File Record Formats (Receiving Report) (Each line in the table corresponds to a field in a record.)					
REC CODE	FLD	MSG SET	Industry Name	QUAL	EDIREF
H	1	824	Header record code (H)		
H	2	824	Transaction set code (824)		
H	3	824	Control number (serial number)		
H	4	824	Trading partner (sent to or received from)		
H	5	824	Purchase Order Number - PIIN and CALL	00	127 M AN 1 30 BGN02: Reference Number

Table B4. ARN Industry Flat File Record Formats (Receiving Report) (Each line in the table corresponds to a field in a record.)					
REC CODE	FLD	MSG SET	Industry Name	QUAL	EDIREF
H	6	824	Transaction Date		373 M DT 6 6 BGN03: Date
H	7	824	Contract Number		127 M AN 1 30 BGN06: Reference Number
N	1	824	Header record code (N)		
N	2	824	Operator ID at time of release	FJ	93 O AN 1 35 N102: Operator ID
N	3	824	Prime Contractor Site Name	PG	93 O AN 1 35 N102: Selling Contact
N	4	824	Prime Contractor Site Address, line 1		166 M AN 1 35 N301: Address Information
N	5	824	Prime Contractor Site City		19 C AN 2 30 N401: City Name
N	6	824	Prime Contractor Site State		156 O ID 2 2 N402: State or Province Code
N	7	824	Prime Contractor Site Postal Code		116 O ID 3 9 N403: Postal Code
N	8	824	Prime Contractor Country		26 O ID 2 3 N404: Country Code
N	9	824	Administered By Site Name	NG	93 O AN 1 35 N102: Administrative Contact
N	10	824	Administered By Site Address, line 1		166 M AN 1 35 N301: Address Information
N	11	824	Administered By Site City		19 C AN 2 30 N401: City Name
N	12	824	Administered By Site State		156 O ID 2 2 N402: State or Province Code
N	13	824	Administered By Site Postal Code		116 O ID 3 9 N403: Postal Code
N	14	824	Administered By Site Country		26 O ID 2 3 N404: Country Code
N	15	824	Administrative Contact	AM	93 O AN 1 35 PER02: Contact
N	16	824	Administrative Contact Telephone	TE	364 C AN 7 25 PER04: Communication Number
N	17	824	Administrative Contact Fax	FX	364 C AN 7 25 PER06: Communication Number
N	18	824	Ship From Site Name	SF	93 O AN 1 35 N102: Ordering Contact
N	19	824	Ship From Site Address line 1		166 M AN 1 35 N301: Address Information
N	20	824	Ship From Site City		19 C AN 2 30 N401: City Name
N	21	824	Ship From Site State		156 O ID 2 2 N402: State or Province Code
N	22	824	Ship From Site Postal Code		116 O ID 3 9 N403: Postal Code
N	23	824	Ship From Site Country		26 O ID 2 3 N404: Country Code
N	24	824	Pay By Site Name	PR	93 O AN 1 35 N102: Selling Contact

Table B4. ARN Industry Flat File Record Formats (Receiving Report)					
(Each line in the table corresponds to a field in a record)					
REC CODE	FLD	MSG SET	Industry Name	QUAL	EDIREF
N	25	824	Pay By Site Address, line 1		166 M AN 1 35 N301: Address Information
N	26	824	Pay By Site City		19 C AN 2 30 N401: City Name
N	27	824	Pay By Site State		156 O ID 2 2 N402: State or Province Code
N	28	824	Pay By Site Postal Code		116 O ID 3 9 N403: Postal Code
N	29	824	Pay By Country		26 O ID 2 3 N404: Country Code
N	30	824	Shipped To Site Name	ST	93 O AN 1 35 N102: Selling Contact
N	31	824	Ship To Site DODAAC	10	67 C AN 2 17 N104: Identification Code
N	32	824	Clothing For Name		93 O AN 1 35 N201: Selling Contact
N	33	824	Shipped To Site Address, line 1		166 M AN 1 35 N301: Address Information
N	34	824	Shipped To Site City		19 C AN 2 30 N401: City Name
N	35	824	Shipped To Site State		156 O ID 2 2 N402: State or Province Code
N	36	824	Shipped To Site Postal Code		116 O ID 3 9 N403: Postal Code
N	37	824	Shipped To Country		26 O ID 2 3 N404: Country Code
L	1	824	Line item record code (L)		
L	2	824	Application [item] acknowledgment code		110 M ID 1 2 OTI01: Ack code: IA Item Accept IR Item Reject IP Item Partial Accept
L	3	824	CLIN	BV	350 O AN 1 11 OTI03: CLIN
L	4	824	Unit Price	LI	782 C R 1 15 AMT02: Amount (Format 00.00)
L	5	824	Quantity Shipped	39	380 M R 1 15 QTY02: Quantity
L	6	824	Unit of Measurement Code [for quantity]		355 M ID 2 2 QTY03: Unit of Measurement Code
L	7	824	Quantity Approved	QA	380 M R 1 15 QTY02: Quantity
L	8	824	Unit of Measurement Code [for quantity]		355 M ID 2 2 QTY03: Unit of Measurement Code
L	9	824	Receiving Note	QTY	30 C AN 1 60 TED02: Description

**Table B5. ARN Industry Flat File Record Formats
(Purchase Order Acknowledgment) to X12 855**

Table B5. ARN Industry Flat File Record Formats (Purchase Order Acknowledgment)						
REC CODE	Fld Seq	Set	Field	Source/Value	Data Type	EDI Reference
H	001	855	Header record code (H)	H	S	
H	002	855	Transaction set code (855)	855	S	
H	003	855	Control number (serial number)	head.UNIQUEID	V	
H	004	855	Trading partner (sent to)	head.TPCODE	V	
H	005	855	Trading partner (received from)	head.FMCODE	V	
H	006	855	P.O./Doc. Number from original P.O.	head.TRANSKEY	V	324 M AN 1 22 BAK03: Purchase Order Number
H	007	855	Purchase Order Date	head.PIDATE	V	323 M DT 6 6 BAK04: Purchase Order Date
L	001	855	Line item (garment) record code (L)	L	S	POC O 1 100000 3000 Line Item Change
L	002	855	CLIN	line.ASSIGND	V	350 O AN 1 11 PO101: CLIN
L	003	855	Quantity Ordered	ALLTRIM(STR(line.QUANTITY))	P	330 C R 1 9 PO102: Quantity Ordered
L	004	855	Unit of Measurement Code	line.UNIT	V	355 O ID 2 2 PO103: Unit of Measurement Code
L	005	855	Unit Price	ALLTRIM(STR(line.UNITPRCE,13,2))	P	212 C R 1 14 PO104: Unit Price
L	006	855	Delivery Date	line.DELDATE	V	234 C AN 1 30 PO107: Delivery Date (YYMMDD)
L	007	855	Destination/Requisition	line.dest_req (from original P.O.)	P	234 C AN 1 30 PO109: Destination/Requisition
L	008	855	National Stock Number/Size	stock_sz()	P	352 C AN 1 80 PID05: Description
S	001	855	Summary record code (S)	S	S	
S	002	855	Number of Line Items	num_itms	V	354 M NO 1 6 CTT01: Number of Line Items

**Table B6. ARN Industry Flat File Record Formats
(Purchase Order Change Request) to X12 860**

Table B6. ARN Industry Flat File Record Formats (Purchase Order Change Request)						
REC CODE	Fld Seq	Set	Field	Source/Value	Data Type	EDI Reference
H	001	860	Header record code (H)	H	S	
H	002	860	Transaction set code (860)	860	S	
H	003	860	Control number (serial number)	head.UNIQUEID	V	
H	004	860	Trading partner (sent to)	head.TPCODE	V	
H	005	860	Trading partner (received from)	head.FMCODE	V	
H	006	860	P.O./Doc. Number from original P.O.	head.TRANSKEY	V	324 M AN 1 22 BCH03: Purchase Order Number
H	007	860	Date of Delivery Order	head.PIDATE	V	323 M DT 6 6 BCH06: Purchase Order Date
H	008	860	Modification Date	head.DATEREQ	V	323 M DT 6 6 BCH11: P.O. Change Request Date
H	009	860	Related Information	head.NOTE_T	V	NTE F 100 0 Note/Special Instruction
H	010	860	DPSC Office Symbol	head.ADMINCDE	V	93 O AN 1 35 PER02: DPSC Office Symbol
H	011	860	PCO Name	head.ADMINCON	V	93 O AN 1 35 PER02: PCO Name
H	012	860	PCO Telephone	head.ADMINTEL	V	364 C AN 7 25 PER04: PCO Telephone Number
H	013	860	Buyer Name	head.SUBMITBY	V	93 O AN 1 35 PER02: Buyer Name
H	014	860	Buyer Telephone	head.SUBMITTEL	V	364 C AN 7 25 PER04: Buyer Telephone Number
H	015	860	FOB Location Qualifier	head.FOBCODE	V	309 C ID 1 2 FOB02: Location Qualifier
H	016	860	FOB Location	head.NOTE_A	V	352 O AN 1 80 FOB03: FOB Location
L	001	860	Line item (garment) record code (L)	L	S	POC O 1 10000 3000 Line Item Change
L	002	860	CLIN	line.ASSIGND	V	350 O AN 1 11 POC01: CLIN
L	003	860	Line Item Change or Response Type Code	line.NOTE_L	V	670 M ID 2 2 POC02: Change or Response Type Code
L	004	860	Quantity Ordered	ALLTRIM(STR(line.QUANTITY))	P	330 O R 1 9 POC03: Quantity Ordered
L	005	860	Quantity Left to Receive	ALLTRIM(STR(line.QTYRECV))	P	671 C R 1 9 POC04: Quantity Left to Receive

Table B6. ARN Industry Flat File Record Formats (Purchase Order Change Request)						
REC CODE	Fld Seq	Set	Field	Source/Value	Data Type	EDI Reference
L	006	860	Unit of Measurement Code	line.UNIT	V	355 C ID 2 2 POC05: Unit of Measurement Code
L	007	860	Unit Price	ALLTRIM(STR(line.UNITPRCE,13,2))	P	212 C R 1 14 POC06: Unit Price
L	008	860	Delivery Date	line.DELDATE	V	234 C AN 1 30 POC09: Delivery Date
L	009	860	Destination/Requisition	m.distri+"/"+LEFT(LINE.stock,5)	P	234 C AN 1 30 POC11: Destination/Requisition
L	010	860	National Stock Number/Size	stock_sz()	P	352 C AN 1 80 PID05: Description
S	001	860	Summary record code (S)	S	S	
S	002	860	Quantity/Dollar Totals	head.NOTE_Q	V	NTE F 100 0 Note/Special Instruction
S	003	860	Number of Line Items	num_itms	V	354 M NO 1 6 CTT01: Number of Line Items

Appendix C - AIMS Data Mapping Specifications

The Apparel Information Management System receives data from EDI translation and AOPM screen processes via the same interim flat file as is used between EDI and AOPM. See *Appendix A - Introduction to ARN Data Mapping* on page 1 for more information on system-to-system data mapping. Below are the specifications for mapping from the ARN AOPM Flat File to the AIMS Flat File.

Table C1. ARN Industry Flat File Record Formats (Purchase Order) to ARN-AIMS

Table C1. ARN Industry Flat File Record Formats (Purchase Order)					
REC CODE	FLD	MSG SET	Industry Name	Qual	ARN-AIMS
H	1	850	Header record code (H)		Edi850.RecordCode
H	2	850	Transaction set code (850)		Edi850.TransSetCode
H	3	850	Control number (serial number)		Edi850.ControlNo
H	4	850	Trading partner (sent to)		Edi850.TradPartSentTo
H	5	850	Trading partner (received from)		Edi850.TradPartSentFrom
H	6	850	PO Purpose Code (00=Original)		Edi850.PurposeCode
H	7	850	PO Type Code (BK=Blanket Order)		Edi850.POTypeCode
H	8	850	Contract Number + Call		Sales Plan.PlanSeqNo
H	9	850	Date of Delivery Order		Shipping Order.DateRecd
H	10	850	Accounting Data		Edi850.AccountingData
H	11	850	Ordering Site		Customer.CustomerCode
H	12	850	Ordering Contact	OC	Customer.CusContact
H	13	850	Ordering Contact Telephone	TE	Customer.CusTelephone
H	14	850	Submitted By (Originator)	SM	Customer.CustomerName
H	15	850	Submitted By Telephone	TE	Edi850.SubmitByTel
M	1	850	Measurement record code (M)		Measurement.MeasuredId
M	2	850		F	-
M	3	850		08	-
M	4	850	Measurement Details <u>Format</u> : Meascode (2 char) (space fill if the code is one character)+Space+Measure (6 digits) (space fill on left if less than 6 digits: format 999.99)+Space+Measurement description (from d_mdscr.measinst)		Measurement.MeasuredId +Space+Edi850.Measure+Space+Measurement.Comments
N	1	850	Names/Addresses record code (N)		Edi850.NameAddRecCode
N	2	850	Ship To Site Name	ST	ShipLocation.ShipLocName
N	3	850	Ship To Site DODAAC	10	ShipLocation.ShipLocCode

Table C1. ARN Industry Flat File Record Formats (Purchase Order)					
REC CODE	FLD	MSG SET	Industry Name	Qual	ARN-AIMS
N	4	850	Name of Individual to Receive the Apparel		ShipLocation.MarkedFor
N	5	850	Measurement Taker Name		Edi850.MeasTakerName
N	6	850	Ship To Site Address -line 1		ShipLocation.ShipLocAddr Street1
N	7	850	Ship To Site Address - line 2		ShipLocation.ShipLocAddr Street2
N	8	850	Ship To Site City		ShipLocation.ShipLocAddr City
N	9	850	Ship To Site State		ShipLocation.ShipLocAddr State
N	10	850	Ship To Site Postal Code		ShipLocation.ShipLocAddr Zip
N	11	850	Ship To Site Country		ShipLocation.ShipLocAddr Country
N	12	850	Sex/Profile identification Format: Sex (1 char)+Space+Shoulders (3 char)+Bust (3 char) (space fill for male)+Space+Posture (3 char)+Space+Seat (3 char) (space fill)+Space+Abdomen (3char)+(space fill for male)+Build (3 char)	JD	Measurement.Sex+Space+ Measurement.Shoulders+ Space+Measurement.Bust+ Space+Measurement.Postur e+Space+Measurement.Seat +Space+Measurement.Abdom en+Measurement.Build
L	1	850	Line item record code (L)		Edi850.LineItemRecCode
L	2	850	CLIN		ShipOrdItem.ShipOrdItNo
L	3	850	Quantity Ordered		PlanItem.PlanItemQty
L	4	850	Unit of Measurement Code [for quantity]		Measurement.MeasUnitCode
L	5	850	Unit Price		ShipNotice.UnitPrice
L	6	850	Delivery Date	ZZ	ShipNotice.DeliveryDate
L	7	850	Destination/Requisition	ZZ	PlanItem.PlanCusLotNo
L	8	850		F	-
L	9	850		08	-
L	10	850	National Stock Number///Garment Code - Note: For special measurement orders, add to the NSN//Garment Code the string "-SPECIAL ME" instead of a Size value.		PlanItem.NSN
L	11	850	Nomenclature (Article description)		ShippingOrderItem.Descrip tion
L	12	850	Line item note	LIN	ShippingOrderItem.Commen ts
S	1	850	Summary record code (S)		Edi850.SummaryRecCode
S	2	850	Quantity/Dollar Totals		Edi850.DollarTotal
S	3	850	Number of Line Items		Edi850.NoLineItem
S	4	850	Purchase Order Amount		Edi850.POAmount
S	5	850	Tracing note		Edi850.TracingNote
S	6	850	Operator ID at time of release	PUR	Edi850.OperatorId
S	7	850	Age (2 digits) =Rank (2 char) +Component (AD, NG, AR,NR, FR, MR or blank)	EMC	Edi850.AgeRankComp

Table C2. ARN Industry Flat File Record Formats (Invoice) to ARN-AIMS

Table C2. ARN Industry Flat File Record Formats (Invoice) (Each line in the table corresponds to a field in a record.)					
REC CODE	FLD	MSG SET	Industry Name	QUAL	ARN-AIMS
H	1	810	Header record code (H)		Edi810.RecordCode
H	2	810	Transaction set code (810)		Edi810.TransSetCode
H	3	810	Control number (serial number)		Edi810.ControlNo
H	4	810	Trading partner (sent to or received from)		Edi850.TradPartSentTo
H	5	810	Invoice Date		ShippingNotice.ShipDate
H	6	810	Invoice Number		ShippingNotice.ShipNoticeNo
H	7	810	Purchase Order Number - PIIN and CALL		ShipOrdNo.ShipOrdNo
H	8	810	Transaction Type Code ("DI")		Edi850.TransTypeCode
H	9	810	Ship To Site Name	ST	ShipLocation.ShipLocName
H	10	810	Ship To Site DODAAC	10	ShipLocation.ShipLocCode
H	11	810	Terms Discount Percent		SalesPlan.DiscountTerms
H	12	810	Terms Discount Days Due (Number of days)		SalesPlan.DiscountTerms
H	13	810	Date Shipped	011	ShippingNotice.ShipDate
H	14	810	Ship ID	SI	ShippingNotice.ShipNoticeNo
L	1	810	Line item record code (L)		Edi850.LineItemRecCode
L	2	810	CLIN		ShippingOrderItem.ShipOrderItemNo
L	3	810	Quantity Invoiced		ShippingOrderItem.ShipOrderActualQty
L	4	810	Unit of Measurement Code [for quantity]		Measurement.MeasUnitCode
L	5	810	Unit Price		ShippingNoticeItem.UnitPrice
L	6	810	Product/Service ID	FS	PlanItem.NSN
L	7	810		F	-
L	8	810		08	-
L	9	810	Item Description		ShippingOrderItem.Description
S	1	810	Summary record code (S)		Edi850.SummaryRecCode
S	2	810	Total Invoice Amount		ShippingNotice.ShipNoticeTotal
S	3	810	Amount Subject to Time Discount		SalesPlan.DiscountAmount
S	4	810	Transportation Method Code		ShippingNotice.TransCode
S	5	810	Shipment Identifying Number		ShippingNotice.ShipNoticeNo
S	6	810	Allowance or Charge Indicator		ShippingNotice.ShipNoticeTotal
S	7	810	Allowance or Charge Amount (For Premium Transportation Authorized)		ShippingNotice.FreightCharge
S	8	810	Number of Line Items		Edi810.NoLineItem

Table C3. ARN Industry Flat File Record Formats (Ship Notice) to ARN-AIMS

Table C3. ARN Industry Flat File Record Formats (Ship Notice)					
(Each line in the table corresponds to a field in a record.)					
REC CODE	FLD	MSG SET	Industry Name	QUAL	ARN-AIMS
H	1	856	Header record code (H)		Edi856.RecordCode
H	2	856	Transaction set code (856)		Edi856.TransSetCode
H	3	856	Control number (serial number)		Edi856.ControlNo
H	4	856	Trading partner (sent to or received from) STCODE		Edi850.TradPartSentTo
H	5	856	Purchase Order Number - PIIN and CALL	00	ShippingOrder.ShipOrdNo
H	6	856	Transaction Date		ShippingNoticeItem.ActualDeliveryDate
H	7	856	Transaction Time		Edi856.TransTime
H	8	856	Contract Number	CT	SalesPlan.PlanSeqNo
H	9	856	Shipment ID	CT	ShippingNotice.ShipNoticeNo
N	1	856	Name record code (N)		Edi856.NameRecCode
N	2	856	Operator ID at time of release	PC	Edi856.OperatorIdRel
N	3	856	Prime Contractor Name	PG	ShippingOrder.PCCName
N	4	856	Address		ShippingOrder.PCCAddr1&2
N	5	856	City		ShippingOrder.PCCCity
N	6	856	State		ShippingOrder.PCCState
N	7	856	Postal Code		ShippingOrder.PCCZip
N	8	856	Country		ShippingOrder.PCCCountry
N	9	856	Admin Name	NG	Customer.CustName
N	10	856	Address		Customer.CustAddrStr1&2
N	11	856	City		Customer.CusCity
N	12	856	State		Customer.CusState
N	13	856	Postal		Customer.CusZip
N	14	856	Country		Customer.CusCountry
N	15	856	Administrative Contact Name	AM	Customer.CusContact
N	16	856	Telephone	TE	Customer.CusTelephone
N	17	856	Fax	FX	Customer.CusFax
N	18	856	Ship From Name	SF	ApparelMfg.Name
N	19	856	Address		ApparelMfg.Address
N	20	856	City		ApparelMfg.City
N	21	856	State		ApparelMfg.State
N	22	856	Postal		ApparelMfg.POBox
N	23	856	Country		ApparelMfg.Country
N	24	856	Pay BY Contact Name	PI	SalesPlan.PayContactName
N	25	856	Address		SalesPlan.PayContactAddr
N	26	856	City		SalesPlan.PayContactCity
N	27	856	State		Salesplan.PayContactState
N	28	856	Postal code		SalesPlan.PayContactZip
N	29	856	Country		SalesPlan.PayContactCountry
N	30	856	Ship To Site Name	ST	ShipLocation.ShipLocName
N	31	856	DODAAC	10	ShipLocation.ShipLocCode

Table C3. ARN Industry Flat File Record Formats (Ship Notice) (Each line in the table corresponds to a field in a record.)					
REC CODE	FLD	MSG SET	Industry Name	QUAL	ARN-AIMS
N	32	856	Clothing For		ShipLocation.MarkedFor
N	33	856	Address		ShipLocation.ShipLocAddrStr1&2
N	34	856	City		ShipLocation.ShipLocCity
N	36	856	State		ShipLocation.ShipLocState
N	37	856	Postal code		ShipLocation.ShipLocZip
N	38	856	Country		ShipLocation.ShipLocCountry
N	39	856	Transaction Note	GEN	Edi856.TransNote
L	1	856	Line item record code (L)		Edi856.LineItemNote
L	2	856	Hierarchial ID Number	V	Edi856.HierIDNo
L	3	856	National stock Number	FS	PlanItem.NSN
L	4	856	Garment Code	F7	GarmentUnit.GarUnitNo
L	5	856	CLIN	BV	ShipNoticeItem.ShipOrdItNo
L	6	856	Quantity Shipped	39	ShipNoticeItem.ShipItQty
L	7	856	Unit of Measurement Code [for quantity]		Measurement.MeasUnitCode
L	8	856	Shipping Note	DEL	ShipNotice.ShipNoticeNo

**Table C4. ARN Industry Flat File Record Formats
(Receiving Report) to ARN-AIMS**

Table C4. ARN Industry Flat File Record Formats (Receiving Report)					
(Each line in the table corresponds to a field in a record.)					
REC CODE	FLD	MSG SET	Industry Name	Qual	ARN-AIMS
H	1	824	Header record code (H)		Edi824.RecordCode
H	2	824	Transaction set code (824)		Edi824.TransSetCode
H	3	824	Control number (serial number)		Edi824.ControlNo
H	4	824	Trading partner (sent to or received from)		Edi850.TradPartSentTo
H	5	824	Purchase Order Number - PIIN and CALL	00	ShippingOrder.ShipOrdNo
H	6	824	Transaction Date		ShippingNoticeItem.ActualDeliveryDate
H	7	824	Contract Number		SalesPlan.PlanSeqNo
N	1	824	Header record code (N)		Edi824.HeadRecCode
N	2	824	Operator ID at time of release	FJ	Edi856.OperatorIdRel
N	3	824	Prime Contractor Site Name	PG	ShippingOrder.PCCName
N	4	824	Prime Contractor Site Address, line 1		ShippingOrder.PCCAddr1&2
N	5	824	Prime Contractor Site City		ShippingOrder.PCCCity
N	6	824	Prime Contractor Site State		ShippingOrder.PCCState
N	7	824	Prime Contractor Site Postal Code		ShippingOrder.PCCZip
N	8	824	Prime Contractor Country		ShippingOrder.PCCCountry
N	9	824	Administered By Site Name	NG	Customer.CustName
N	10	824	Administered By Site Address, line 1		Customer.CustaddrStreet1&2
N	11	824	Administered By Site City		Customer.CustAddrCity
N	12	824	Administered By Site State		Customer.CustAddrCity
N	13	824	Administered By Site Postal Code		Customer.CustAddrZip
N	14	824	Administered By Site Country		Customer.CustAddrCountry
N	15	824	Administrative Contact	AM	Customer.CusContact
N	16	824	Administrative Contact Telephone	TE	Customer.CusContactTel
N	17	824	Administrative Contact Fax	FX	Customer.CusContactFax
N	18	824	Ship From Site Name	SF	ApparelEnterprise.Name
N	19	824	Ship From Site Address line 1		ApparelEnterprise.Address
N	20	824	Ship From Site City		ApparelEnterprise.City
N	21	824	Ship From Site State		ApparelEnterprise.State
N	22	824	Ship From Site Postal Code		ApparelEnterprise.POBox
N	23	824	Ship From Site Country		ApparelEnterprise.Country
N	24	824	Pay By Site Name	PR	SalesPlan.PayContactName
N	25	824	Pay By Site Address, line 1		SalesPlan.PayContactAddr
N	26	824	Pay By Site City		SalesPlan.PayContactCity

Table C4. ARN Industry Flat File Record Formats (Receiving Report)					
(Each line in the table corresponds to a field in a record.)					
REC CODE	FLD	MSG SET	Industry Name	Qual	ARN-AIMS
N	27	824	Pay By Site State		Salesplan.PayContactState
N	28	824	Pay By Site Postal Code		SalesPlan.PayContactZip
N	29	824	Pay By Country		SalesPlan.PayContactCountry
N	30	824	Shipped To Site Name	ST	ShipLocation.ShipLocName
N	31	824	Ship To Site DODAAC	10	ShipLocation.ShipLocCode
N	32	824	Clothing For Name		ShipLocation.MarkedFor
N	33	824	Shipped To Site Address, line 1		ShipLocation.ShipLocAddr
N	34	824	Shipped To Site City		ShipLocation.ShipLocCity
N	35	824	Shipped To Site State		ShipLocation.ShipLocState
N	36	824	Shipped To Site Postal Code		ShipLocation.ShipLocZip
N	37	824	Shipped To Country		ShipLocation.ShipLocCountry
L	1	824	Line item record code (L)		Edi824.LineItemrecCode
L	2	824	Application [item] acknowledgment code		Edi824.AckCode
L	3	824	CLIN	BV	ShippingOrderItem.ShipOrdItNo
L	4	824	Unit Price	LI	ShippingNoticeItem.UnitPrice
L	5	824	Quantity Shipped	39	ShippingNoticeItem.ShipItQty
L	6	824	Unit of Measurement Code [for quantity]		Measurement.MeasUnitCode
L	7	824	Quantity Approved	QA	Edi824.QuantityApproved
L	8	824	Unit of Measurement Code [for quantity]		Measurement.MeasUnitCode
L	9	824	Receiving Note	QTY	Edi824.ReceivingNote

Appendix D - AOPM Special Order Processes

The data flow diagrams below represent the Special Order scenarios that are addressed by AOPM. The AOPM software is intended for RICs, ROTC, Jr. ROTC, DPSC, and DAM sites. Although the applications specifically address special measurements, the intent is to include stock item orders in the applications if desired by the trading partner participants.

Flow D1: Special Measurement Area, CIIP, Ft. Jackson, SC

Diagram D1.1: Special Measurement Form

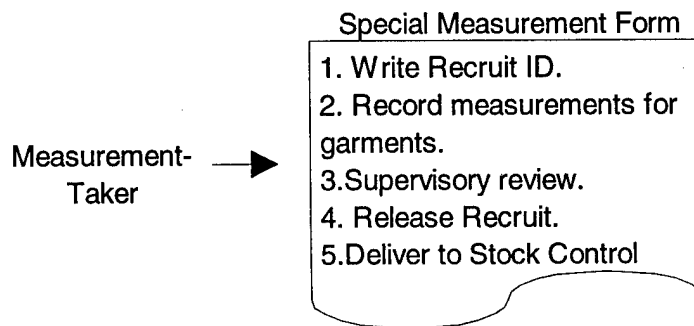

Diagram D1.2: Purchase Order Flow

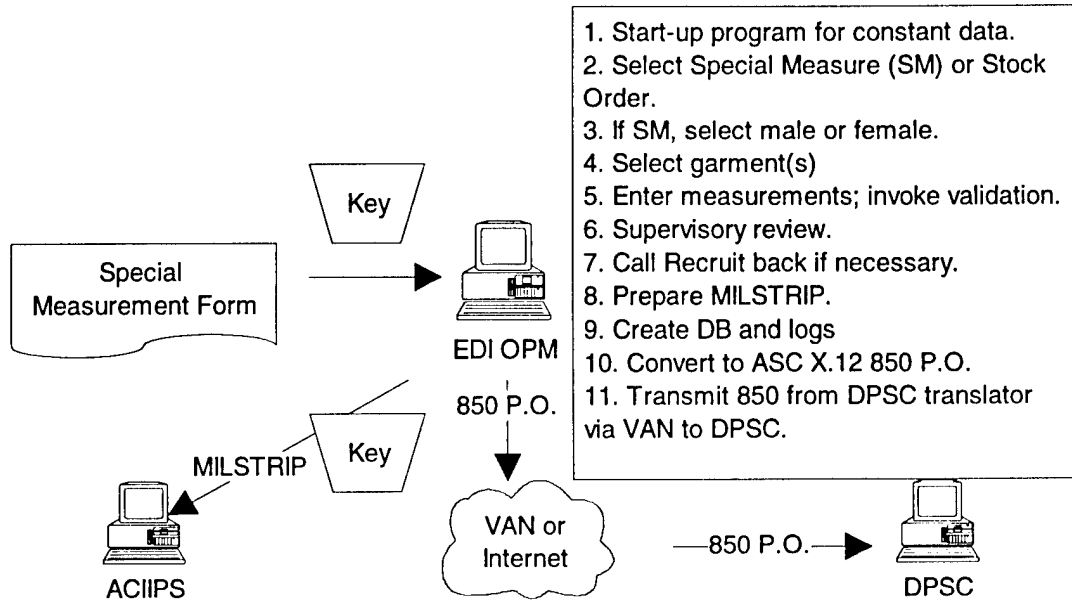

Diagram D1.3: DD250/ASN and ASN Response

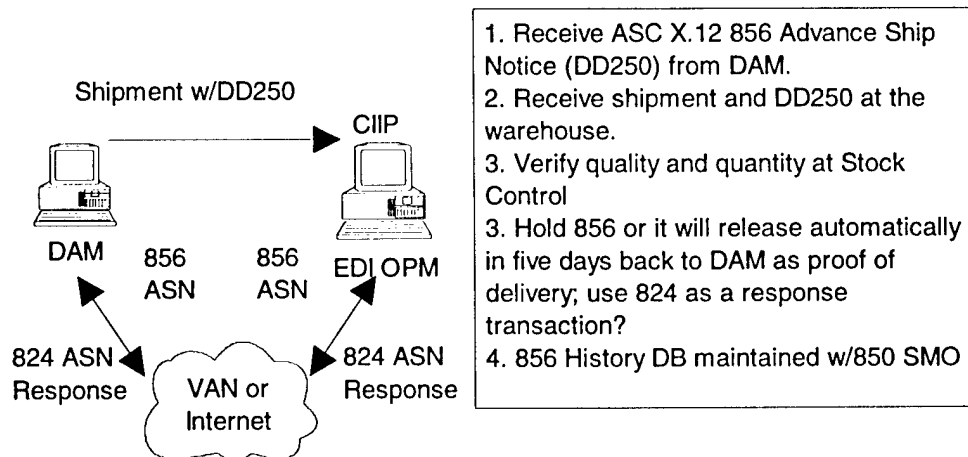

Diagram D1.4: P.O./DD250 Overall Flow

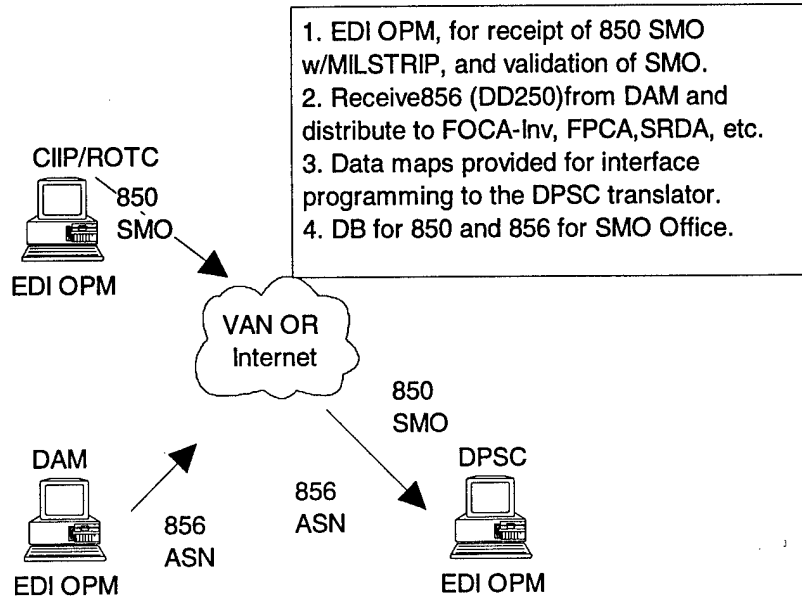

Diagram D1.5: ROTC Satellite Entry for CPB

Army ROTCs w/Computers Satellited on Consolidated Property Book (CPB)

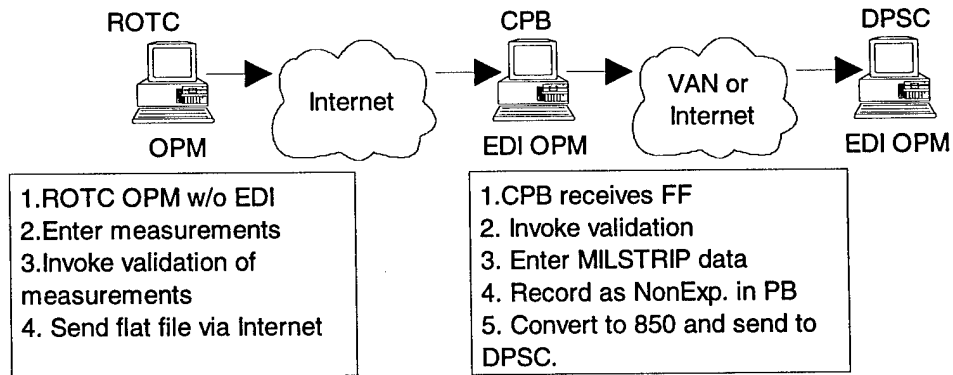

Diagram D1.6: ROTC Satellite Entry for MPB

Army ROTCs w/Computers Satellited on Manual Property Book (MPB)

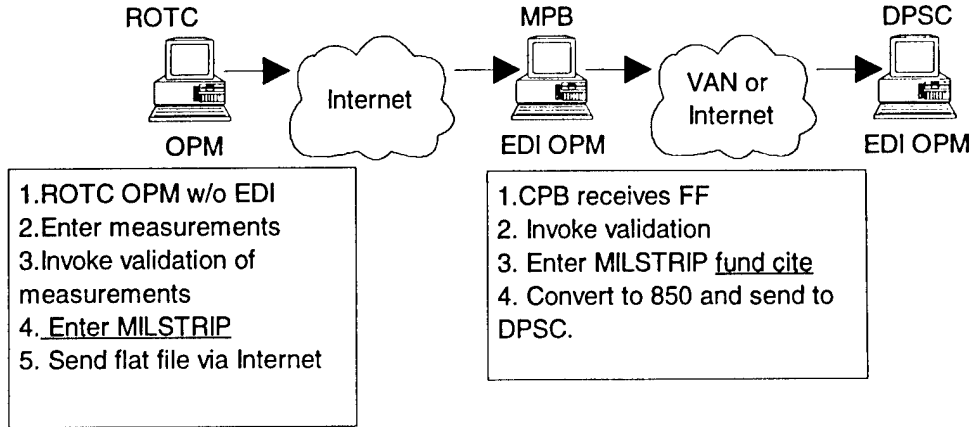
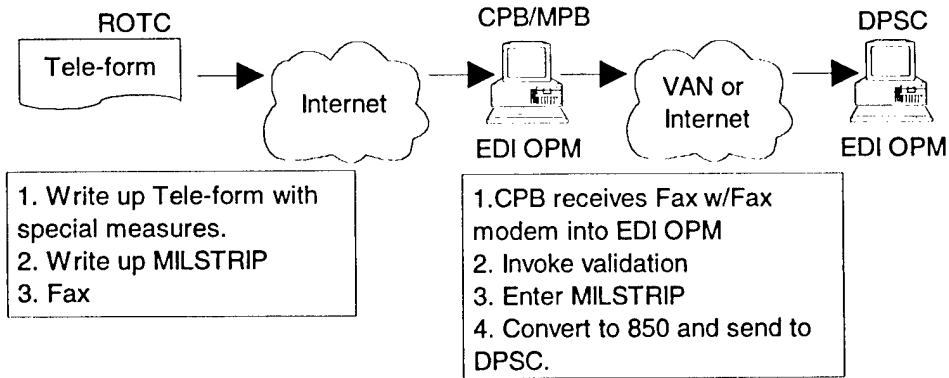

Diagram D1.7: ROTC Manual Entry for MPB or CPE

Army ROTCs w/o Computers Satellited on MPB or CPB



Flow D2: CIIP, Lackland AFB, San Antonio, TX

Diagram D2.1: Special Measurement Form

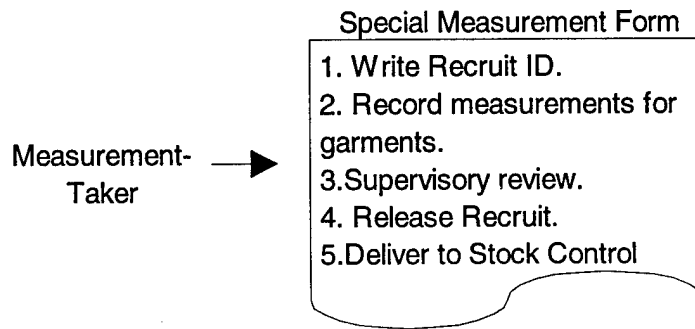

Diagram D2.2: Purchase Order Flow

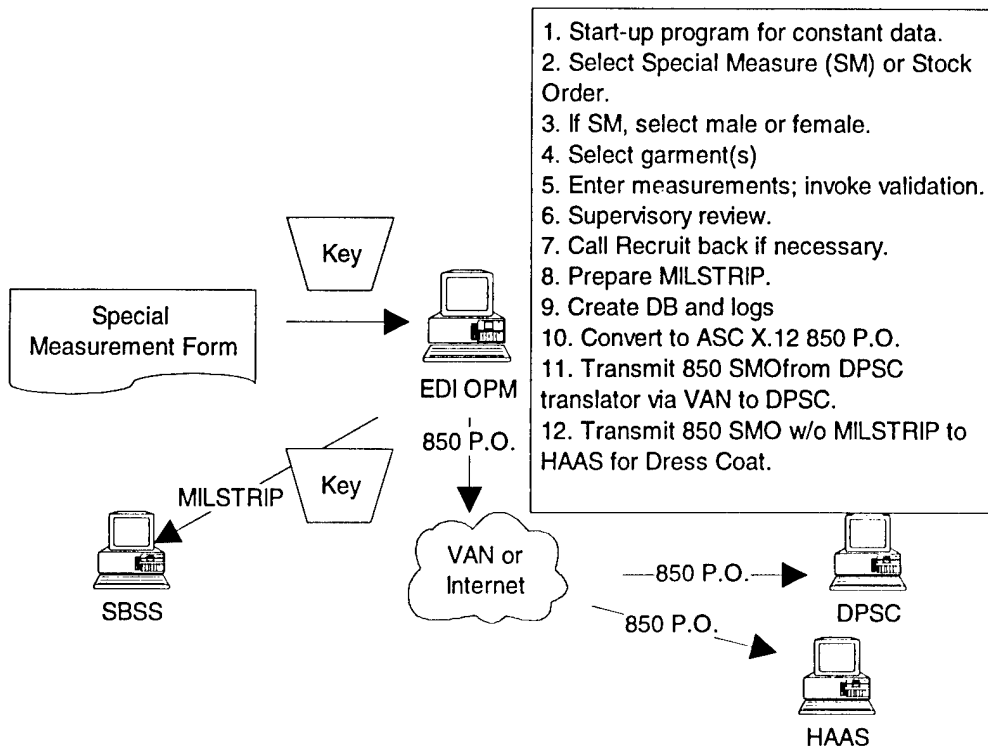
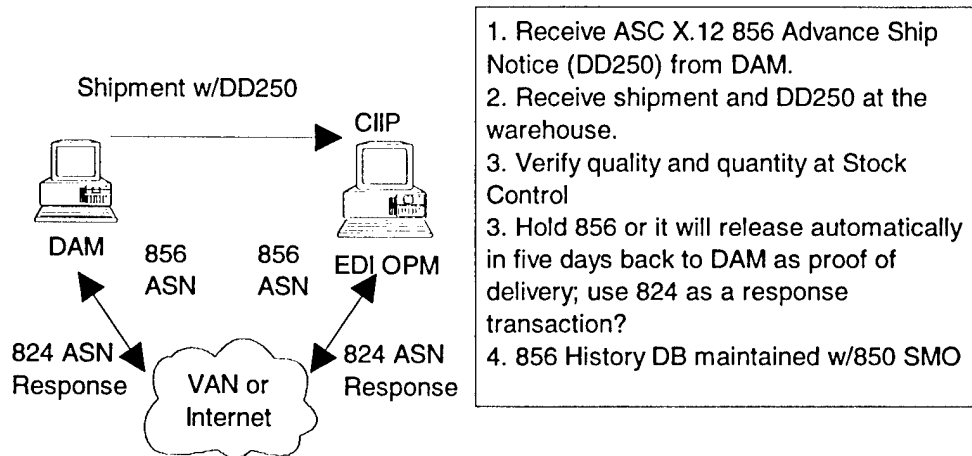
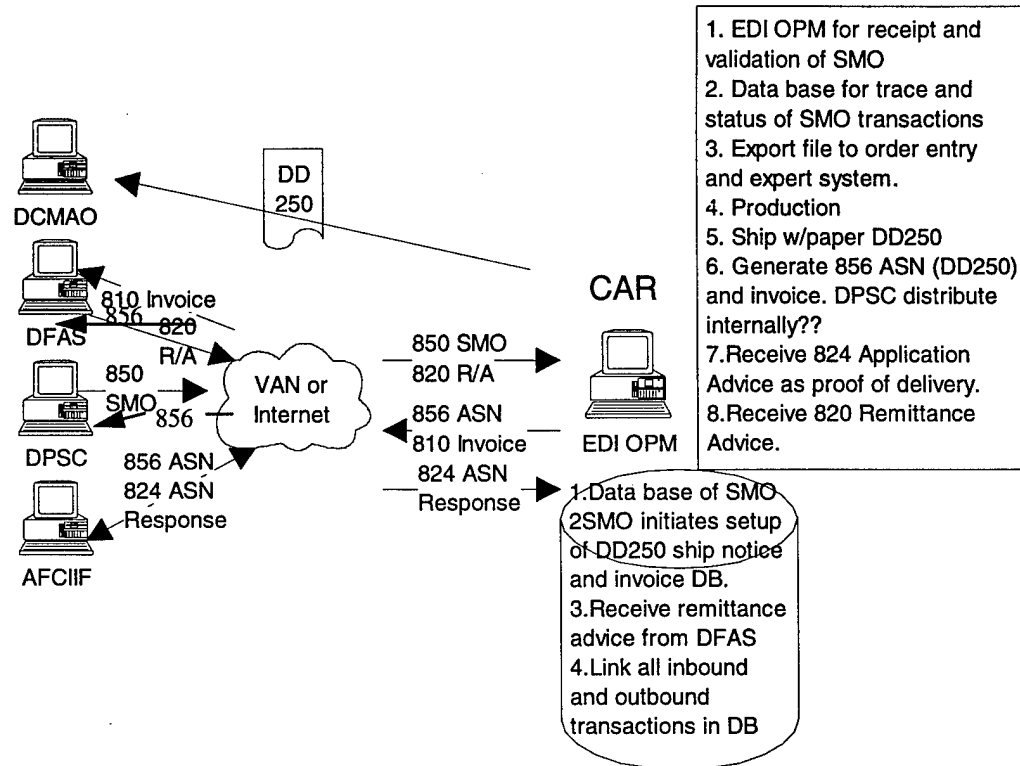

Diagram D2.3: DD250/ASN and ASN Response



Flow D3: Clemson Apparel Research (CAR) Demo Site



Flow D4: The HAAS Tailoring Company

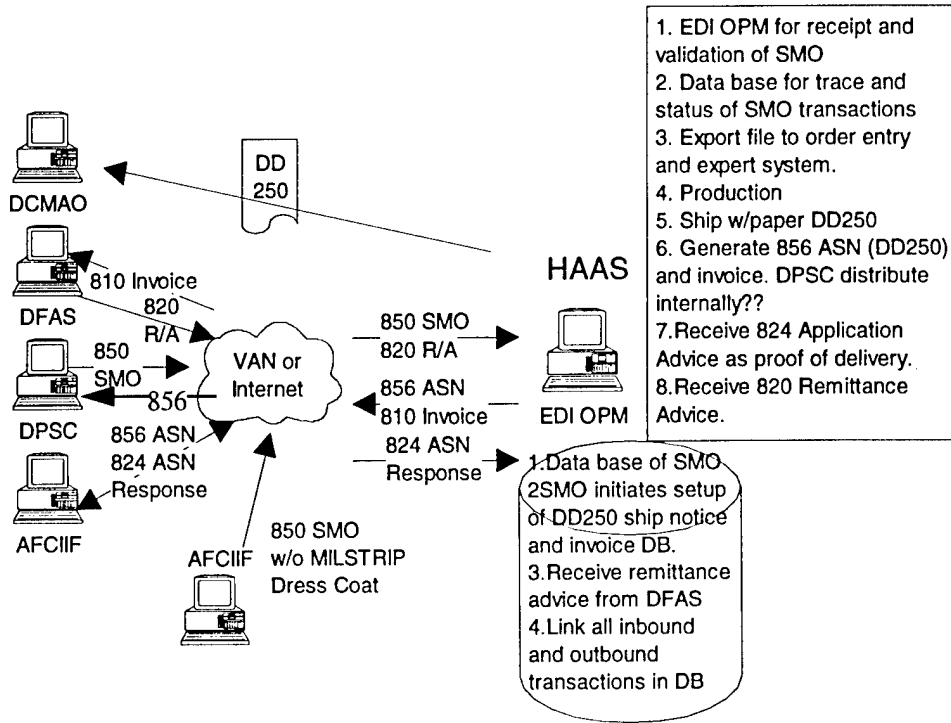

Flow D5: Maryland Clothing Manufacturing, Inc., Baltimore, MD

