

REDESIGN OF THE INSTITUTIONAL ARMY

Phase I

Final Report

Volume III

*Appendix S -
Appendix W*

DISTRIBUTION STATEMENT E
Approved for public release;
Distribution Unlimited

May 1998

F O R C E

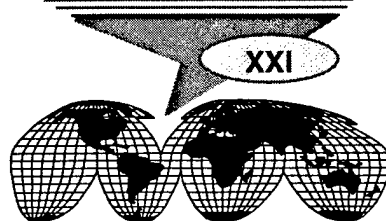

19980617 141

Prepared by:



Bentley, Adams, Hargett, Riley and Company, Inc.

2323 Wilson Boulevard, Suite 202
Arlington, VA 22201
(703) 525-6566 phone
(703) 525-5955 fax
e-mail: phase1.finalreport@bahrinc.com

List of Appendices

Volume II

Appendix A	Campaign Plan
Appendix B	Charter
Appendix C	FORSCOM FAA Briefing
Appendix D	Umbrella Power Projection Briefing
Appendix E	TRADOC Doctrine FAA Briefing
Appendix F	Umbrella Doctrine FAA Briefing
Appendix G	TRADOC Organize and Materiel Requirements Determination FAA Briefing
Appendix H	Umbrella Organize FAA Briefing
Appendix I	TRADOC Training and Leader Development Briefing
Appendix J	Umbrella Training and Leader Development Briefing
Appendix K	ISC Information Management FAA Briefing
Appendix L	Umbrella Information Management FAA Briefing
Appendix M	ISC Personnel Management and Recruit FAA Briefing and Finite Detail of the Life Cycle Processes
Appendix N	Umbrella Acquire and Sustain People Briefing
Appendix O	USACE Construct FAA Briefing
Appendix P	Umbrella Construct FAA Briefing
Appendix Q	AMC Equip, Supply, Maintain FAA Briefing
Appendix R	Umbrella Equip, Supply, Maintain FAA Briefing

Volume III

Appendix S	HQDA Redesign Final Report, Phase I
Appendix T	FAA Phase I Leadership Decisions
Appendix U	CSA Message, Force XXI BOD Decisions and Guidance
Appendix V	BOD Institutional Axis Update Briefing
Appendix W	General Order announcing ISC becoming an ASC

DTIC QUALITY INSPECTED 1

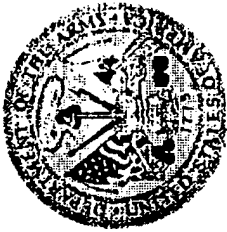

HEADQUARTERS, DEPARTMENT OF THE ARMY

WASHINGTON, DC

FINAL REPORT

Phase I, HQDA Redesign

1995-1996

A chartered Working Group study for redesign of the Department of the Army Headquarters (HQDA), its staff support agencies (SSA) and field operating agencies (FOA).

Our Army . . . Into the 21st Century

F O R C E

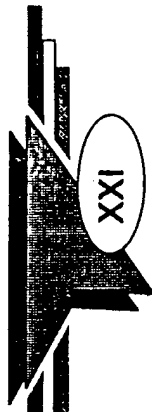

Executive Summary

Overview:

These are times of profound change. Geopolitical developments and domestic considerations require that our Army refine its strategic vision, develop implementing concepts and structures, experiment, and change. The Army's core values, its unique character and competencies are constant; however, the Army of the 21st Century must be smaller, more efficient and more effective.

Institutional Army Redesign:

In concert with the Force XXI redesign of operational forces, the Army is committed to a comprehensive redesign and restructure of its institutional organizations. Redesign of the Institutional Army encompasses three separate, inter-related, long-term study efforts:

- ◆ In-depth examination of Army Title 10 responsibilities.
- ◆ Major Army Command (MACOM) restructuring, including examination of the number of commands required.
- ◆ Army Headquarters redesign, including Staff Support Agencies (SSA) and Field Operating Agencies (FOA).

HQDA Redesign:

The Headquarters, Department of the Army (HQDA) redesign studies, summarized in this report, began with the formation of a Secretariat-Army Staff study team ("The Working Group") in May 1995 and concluded in March 1996 with the submission of "Phase I" redesign input to POM 98-03. The redesign approach included:

- ◆ historical research, benchmarking, data calls and staff discussions -- all aimed at developing a baseline for further research (see Section 3)

- ◆ comparison of various organizational designs coupled with interviews of staff principals from the Army Secretariat and Army Staff, senior officials from JCS and OSD, and MACOM commanders (see Section 5)
- ◆ Functional Area Reviews -- structured staff discussions, organized around key headquarters functions (see Section 7)

Central to the study effort was the development of an over-arching conceptual framework, consistent with Institutional Army redesign precepts, which identifies essential headquarters' functions, and the relationship of these functions to the core processes resident within the MACOM's. This framework was key to the development of recommendations which are intended to transform HQDA into a leaner, flatter, more focused headquarters (see Section 4).

Recommendations:

The Working Group recommendations summarized below are detailed in Section 8:

- ◆ **HQ Staff:**
 - Standup two new offices: The Deputy Under Secretary for International Activities and the Assistant Vice Chief of Staff for Program Development and Requirements.
 - Restructure Office, Deputy Chief of Staff for Operations and Plans.

- ◆ **HQ Staff (continued)**

Executive Summary

- Downsize:

Secretary of the Army
Under Secretary of the Army
ASA for Manpower & Reserve Affairs
ASA for Financial Management &
Comptroller
ASA for Research, Development &
Acquisition
ASA for Installations, Logistics &
Environment
ASA for Civil Works
Administrative Assistant
General Counsel
Dir, Information Systems Command,
Control, Communications &
Computers
The Inspector General
Chief, Public Affairs

Chief, Legislative Liaison
Dir, Office of Small & Disadvantaged
Business Utilization
Chief of Staff
Deputy Chief of Staff for Personnel
Deputy Chief of Staff for Intelligence
Deputy Chief of Staff for Operations and Plans
Deputy Chief of Staff for Logistics
Asst. Chief of Staff for Installations
Management
The Surgeon General
The Judge Advocate General
Chief of Chaplains
Chief of Engineers
Chief, National Guard Bureau
Chief, Army Reserve

- ◆ Staff Support Agencies:

- Realign key policy functions to the staff.

◆ **Staff Support Agencies (continued)**

• **Eliminate/Merge:**

General Officers' Mess
Army Environmental Policy Institute
Military Police Operations Agency
Panama Treaty Implementation Agency

Test and Evaluation Management Agency
Sensitive Records Information Agency
Base Realignment and Closure Office
Army Environmental Office

• **Downsize:**

Army Acquisition Executive Support Agency
Information Management Support Agency

Intelligence Staff Support Agency
Command and Control Support Agency
Concepts Analysis Agency

Executive Summary

◆ **Field Operating Agencies:**

- Divest operational functions to the field.
- Eliminate/Merge:

Model Improvement and Study
Management Agency
Directed Military Overhire Det.
USA Civilian Personnel Field Agency
Personnel & Employment Services -
Washington
Space & Building Mgmt - Wash
Hometown News Service
Military Postal Services Agency

Army Research Institute
Chaplain Support Agency
USA Space Program Office
Special Operations Agency
DCSOPS Support Agency
Center of Military History
Army Claims Service
Army National Guard Finance Service
Center

- Transfer:

USA Broadcasting Service
Army Management Staff College
Information Systems Selection &
Acquisition Agency
Army Recruiting Command
Military Entrance Processing Cmd
USA War College
USA Aeronautical Services Agency

USA Nuclear and Chemical Agency
Inter-American Defense Board
Joint Mexican-US Defense Commission
USA Space and Strategic Defense
Command
Logistics Integration Agency
Army National Guard Professional
Education Center

THIS PAGE INTENTIONALLY LEFT BLANK

Section 1: Institutional Army Redesign

- A. Force XXI Campaign Plan**
- B. Institutional Army Redesign Axis**
- C. Framework for Redesign**
- D. Core Competency**
- E. Core Capabilities**
- F. Core Processes**

Figures:

Framework for Redesign

Core Competency/Capabilities/Processes

FORCE XXI Campaign Plan

...a comprehensive, multi-year effort to posture the Army for the 21st Century

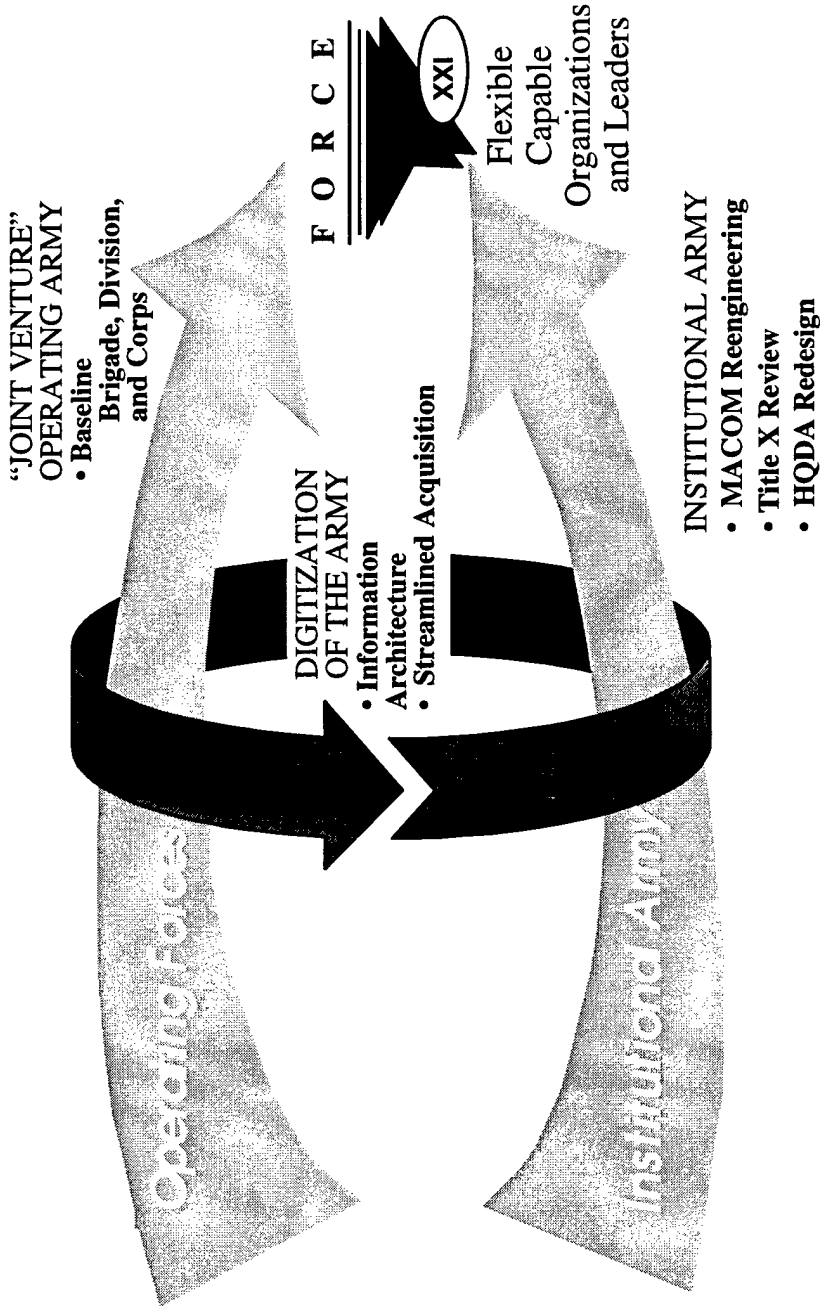

Figure 1-1

Section 1: Institutional Army Redesign

Institutional Army Redesign is one three simultaneous Army Force XXI efforts

A. Force XXI Campaign Plan

In March 1994, the Chief of Staff, Army announced his intention to transform the Army forces required to meet national security interests of the early 21st century. Those forces would reflect dramatic changes in organizational design and orientation based on equally dramatic changes in the world order, an information technology revolution, and the emergence of unpredictable, highly volatile third world nation states. In August 1994, the Vice Chief of Staff, Army issued guidance which integrated efforts to redesign Army operating forces with emerging technology in the form of digitization along with the redesign of the Army's institutional forces. These three simultaneous efforts are the primary axes of the Army's Force XXI Campaign Plan.

B. Institutional Army Redesign Axis

The Institutional Army is that part of the Army organized under Tables of Distribution and Allowances (TDA). The redesign of the Institutional Army focuses on the development of strategies that will enable institutional forces to effectively and efficiently perform Title 10 functions in support of redesigned Army warfighting organizations during the next century. Like the Force XXI Campaign Plan, the Institutional Army Redesign Axis involves a number of simultaneous and interrelated efforts:

- ◆ Major Army Command (MACOM) restructuring, including not only internal MACOM reorganization but review of the number, type, and function of MACOMs required.
- ◆ Functional Area Assessments (FAAs) as a means of assessing and developing redesign issues for Title 10 functions.
- ◆ Redesign of HQDA (e.g., the Departmental Headquarters, its assigned Staff Support Agencies (SSAs) and Field Operating Agencies (FOAs)).

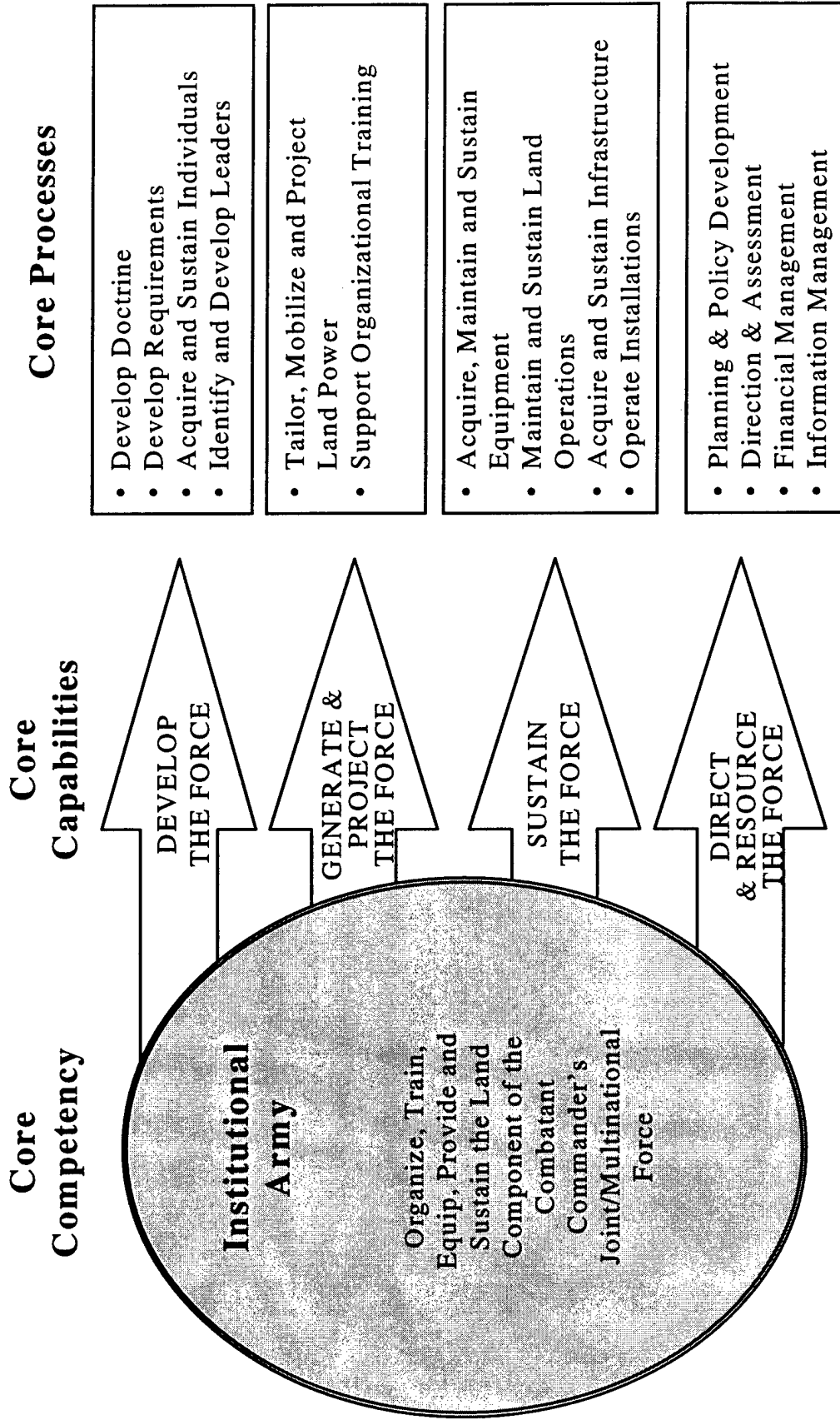

Figure 1-2

Institutional Army Redesign

C. Framework for Redesign

The conceptual foundation of Institutional Army redesign rests upon the recognition and understanding of its core competency, core capabilities and core processes (figure 1-2).

D. Core Competency

The Institutional Army core competency, “**Organize, Train, Equip, Provide and Sustain the Land Component of the Combatant Commander’s Joint/Multinational Force**”, recognizes the essential supporting nature of institutional forces, underscores the “product” (a trained and ready land component force) and focuses on the ultimate “customer” (the joint/multi-national force commander).

E. Core Capabilities

The Institutional Army’s four core capabilities are (each with associated core processes):

- ◆ **Develop the Force.** The “organizing” and “preparing” processes which encompass the functions necessary to create operational forces. The U.S. Army Training and Doctrine Command (TRADOC) currently performs these functions.
- ◆ **Generate and Project the Force.** The functions associated with unit readiness, mobilization, projection and return of operational forces. Together, Forces Command (FORSCOM) and the Military Traffic Management Command (MTMC) perform these functions.
- ◆ **Sustain the Force.** The general sustaining functions associated with support for the generation and employment of forces. The U.S. Army Materiel Command (AMC) performs these functions.
- ◆ **Direct and Resource the Force.** The broad oversight and management functions related to the departmental headquarters, encompassing the statutory responsibilities of both the Secretary of the Army and the Chief of Staff, Army.

F. Core Processes

An Institutional Army core process is a structured, measured set of activities designed to produce a specified output for a particular end user of the product or service. Graphically depicted, a process would include an end-to-end systematically ordered set of work activities across time and space, with a clearly identified beginning, an end, and inputs and outputs. For instance, a graphic depiction of work flow of the PPBES process would result in systematically ordered set of activities that has a specified beginning and ending and produces an output for the Army in terms of an executable budget.

Section 2: Analytical Approach

- A. Baseline Review of HQDA**
- B. Force XXI HQ Model Review**
- C. Zero-based Review of SSAs/FOAs**
- D. Functional Area Reviews**
- E. HQDA Functional Area Assessment/POM 98-03**

Figure:

HQDA Redesign Axis

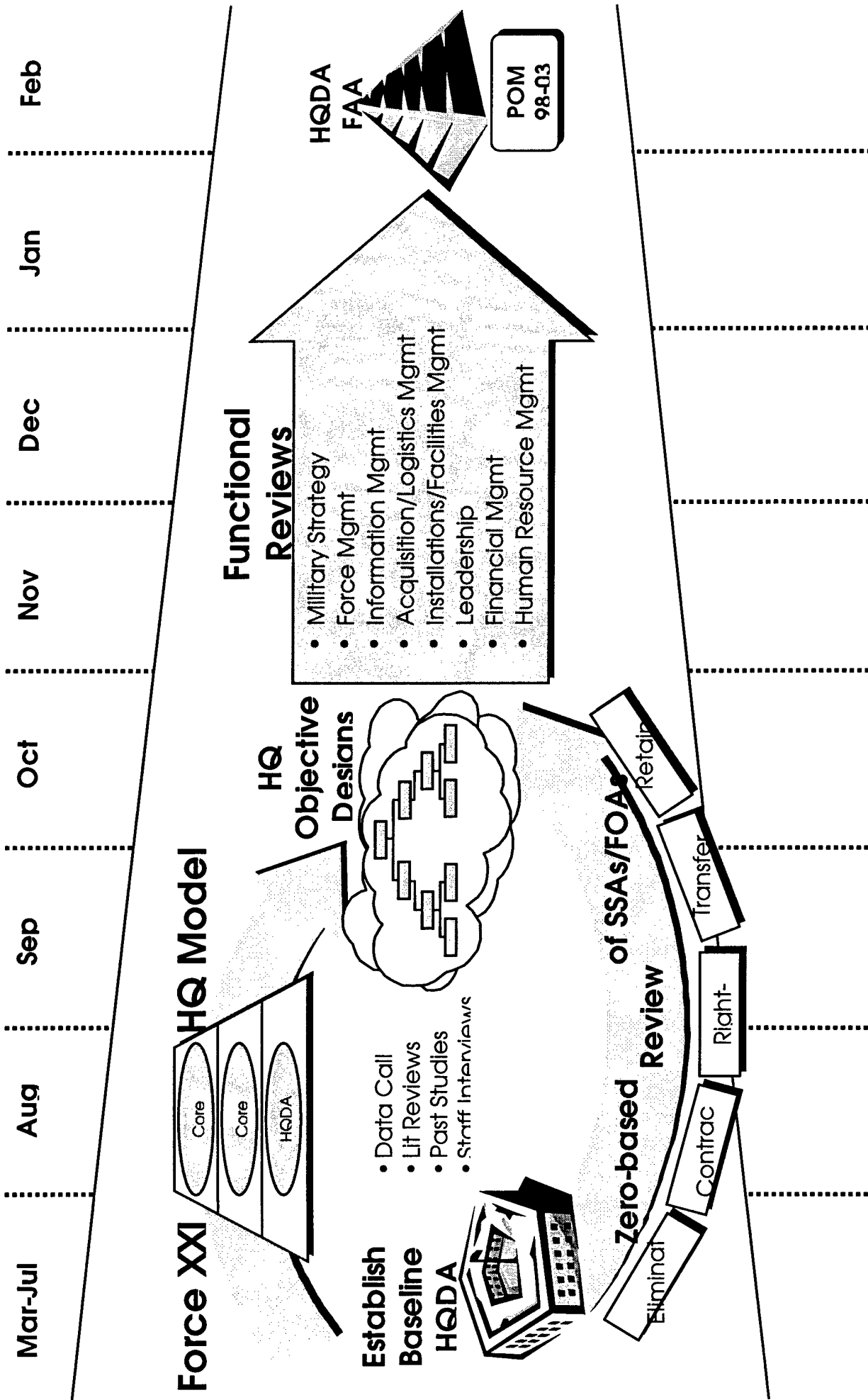

Figure 2-1

Section 2: Analytical Approach

The examination of HQDA was composed of a baseline review and a number of coordinated studies, each employing a variety of analytical methods and tools..

- A. Baseline Review of HQDA.** The Working Group began its work with a baseline review, undertaken to develop an appreciation of how the current HQDA is organized and operates. The review included a literature review, historical research, an assessment of previous study recommendations, a data call, a study of TDA and manpower documents, as well as numerous staff interviews (see Section 3).
- B Force XXI HQ Model Review.** The Group conducted a separate study to select the most promising organizational options that would enable HQDA to more effectively and efficiently perform its Title 10 functions in support of the Force XXI Army. The study drew upon guidance provided by the Secretary of the Army, numerous interviews with senior officials and Institutional Army redesign precepts (see Section 5).
- C. Zero-based Review of SSA/FOA.** The Group undertook a comprehensive evaluation of SSAs and FOAs to clarify missions and outputs and to evaluate opportunities for increasing effectiveness and efficiency within the context of the HQDA conceptual model (see Section 6).
- D. Functional Area Reviews.** The Working Group also conducted eight Functional Area (FARs). Each FAR was organized around a single headquarters function derived from the HQDA conceptual model. The objective of the FARs was to bring together functional principals in structured meetings to share perspectives and discuss issues critical to headquarters redesign. The FARs examined the results of previous analytical work, including the Force XXI Model Review and the Zero-based Review of SSAs/FOAs (see Section 7).

E. HQDA Functional Area Assessment/POM 98-03. The Working Group presented the HQDA Functional Area Assessment (FAA) at the conclusion of the study effort. Results of the FAA were subsequently developed for submission to POM 98-03.

Section 3: Baseline Review

- A. Past Studies**
- B. Recurring Themes**
- C. Data Call**
- D. HQDA Today**
- E. HQDA In Perspective**

Figures:

- Past Studies**
- Initial Data Call Results**
- HQDA Today**
- HQDA in Perspective**

THIS PAGE INTENTIONALLY LEFT BLANK

Section 3: Baseline Review

A baseline review helped develop an appreciation for how current HQDA is organized and operates.

A. Past Studies

In the past decade, six major studies have examined HQDA. The scope of these study efforts is summarized below:

- ◆ 1986 -- Goldwater-Nichols:
 - Strengthened CJCS/JCS Role
 - Established statutory ceiling for HQDA (3,105 TDA spaces)
 - Realigned comptroller, research, development & acquisition functions
- ◆ 1988 -- Redistribution of BASOPS Unit Structure within TDA (ROBUST):
 - Recommended increased support to the War Fighting CINCs
 - Attempted to simplify & clarify TDA structure

Past Studies

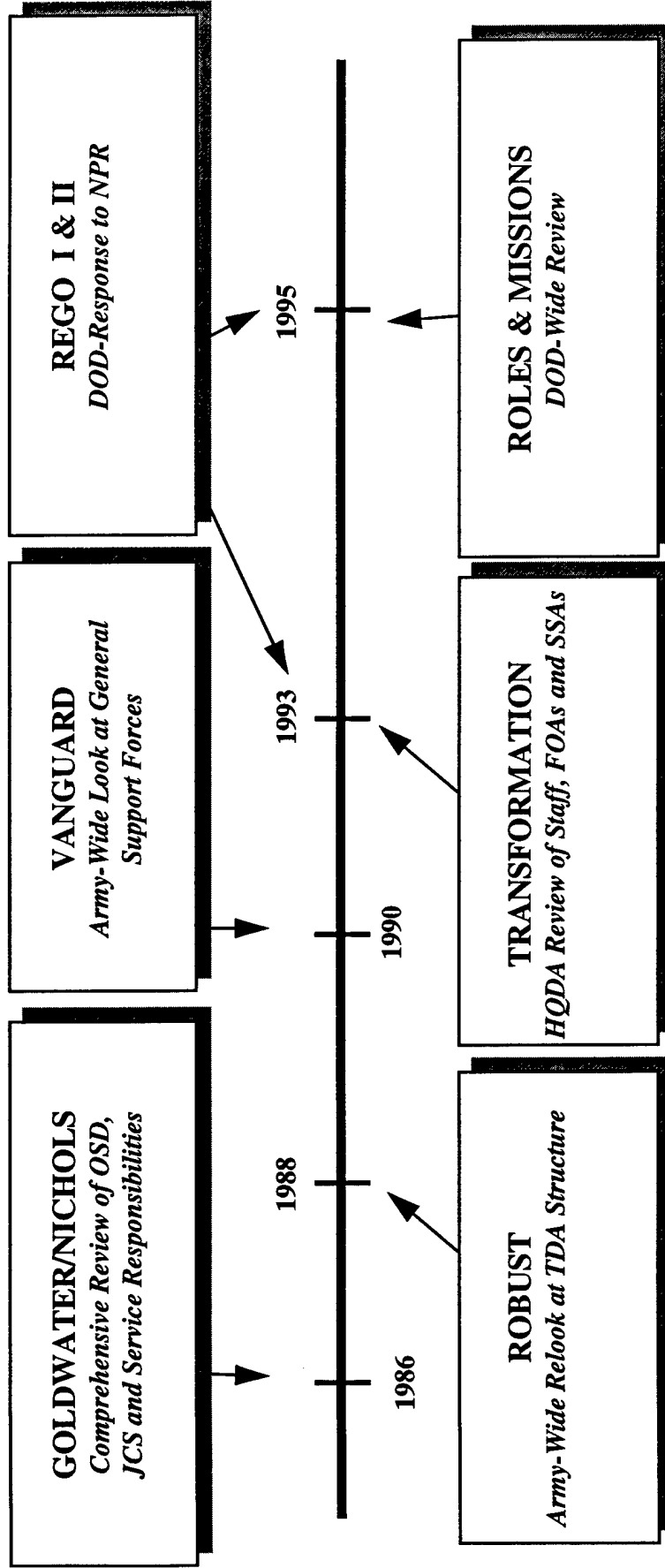

Figure 3-1

Baseline Review

- ◆ 1990 -- Project Vanguard:
 - Reduced HQDA manpower
 - Considered a reduction in the number of MACOMs
 - Established ACSIM
- ◆ 1993 -- Transformation Study:
 - Further consolidated budget functions
 - Consolidated information management support services
- ◆ 1993 - 1995 -- Reinventing Government (REGO) I and II:
 - Focused on reducing cost of government operations
 - Increasing privatization
 - Improving joint requirements process
- ◆ 1995 -- Commission on Roles and Missions (CORM):
 - Recommended further consolidation of Secretariat and ARSTAF
 - Recommended reduction in political appointees
 - Suggested increased focus on joint requirements

B. Recurring Themes

In reviewing these studies, the Working Group identified the following recurring themes:

- ◆ Reduce the size, scope of responsibility, and cost of HQDA organizations.

Initial Data Call Results

HQ Staff reported 67% of effort devoted to the HQ's Core Capability: *Direct & Resource the Force* or other HQs "housekeeping" functions.

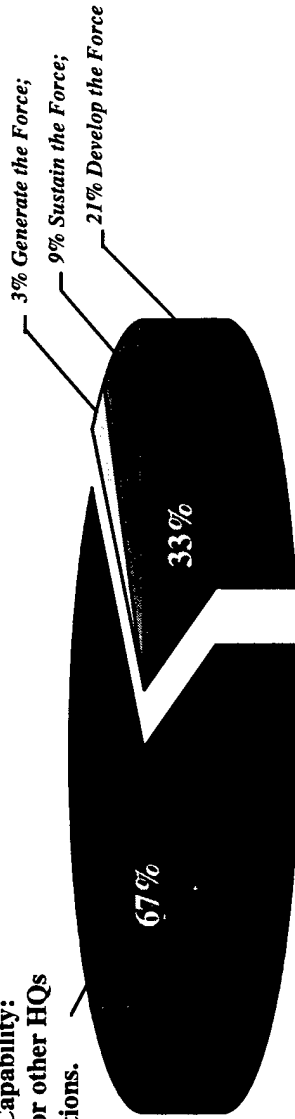

Secretariat & Army Staff

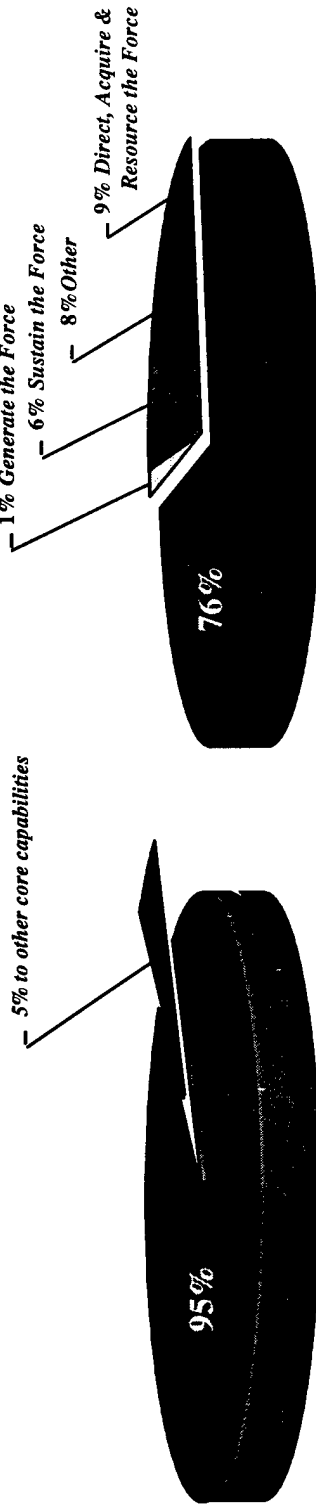

Staff Support Agencies

95% of SSA effort is *Sustaining the Force* (AAESA is the driver)

Field Operating Agencies

76% of FOA effort is *Developing the Force* (USAREC & USMA are drivers)

Figure 3-2

Baseline Review

- ◆ Utilize state-of-the-art technology to simplify and better integrate the information management systems necessary to support improved HQDA management.
- ◆ Establish and institutionalize cross-cutting, integrating offices and functions.
- ◆ Improve installation management oversight.
- ◆ Formalize and institutionalize rules of efficiency to ensure new organizations and changes to existing organizations do not result in layering, redundancy of missions or functions or the resourcing of unnecessary functions.
- ◆ Clarify and improve HQDA management processes and organizational relationships within the joint arena.
- ◆ Recognize the unique role of both the Secretary of the Army (SA) and the Chief of Staff, Army (CSA).

D. Data Call

The Working Group developed a three part, 13 page questionnaire/data call (see Appendix E) for headquarters' staff, SSA, and FOA response. The purpose of the data call was multi-fold, but aimed primarily at assessing the percent of workyear effort devoted to each of the following Institutional Army Core Capabilities:

- ◆ Direct and Resource the Force (The HQDA-specific Core Capability)
- ◆ Generate the Force
- ◆ Develop the Force
- ◆ Sustain the Force

Data call results, summarized in Figure 3-2, indicated that nearly two thirds of the Secretariat and Army Staff work effort was devoted to activities associated with the HQDA specific core capability, "Direct and Resource the Force" or housekeeping functions. Surprisingly, about one third of the reported HQDA work was related

Baseline Review

to core capabilities generally associated with MACOM responsibilities. The majority of SSA workload was attributed to the core capability, "Sustain the Force," while FOA workload was largely associated with "Develop the Force" activities.

HQDA Today

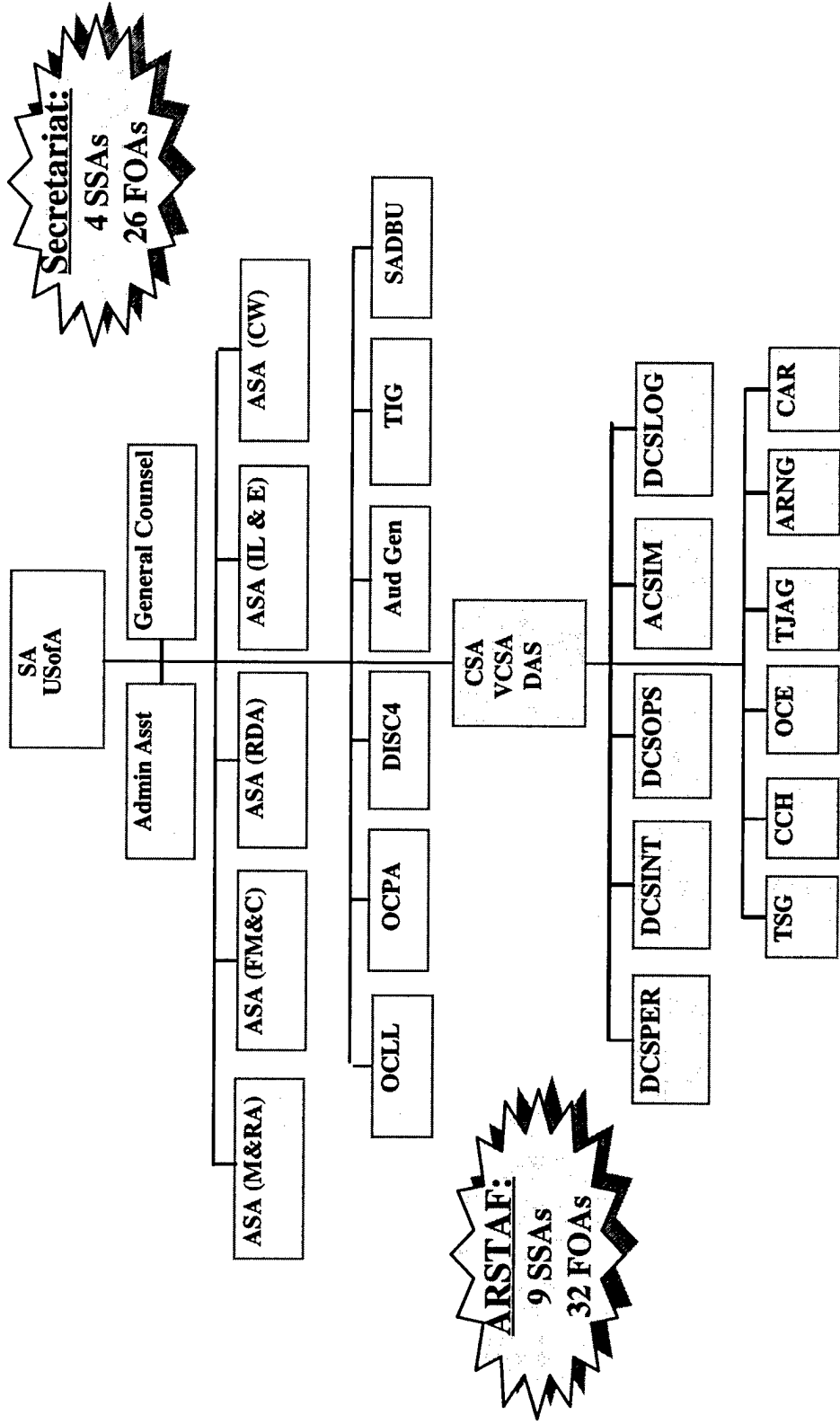

Secretariat:
4 SSAs
26 FOAs

ARSTAF:
9 SSAs
32 FOAs

Figure 3-3

D. HQDA Today

The current department headquarters traces its origin to the National Security Act of 1947, subsequent reorganizations in the 1950s and changes brought about by the Goldwater-Nichols Act of 1986. The headquarters is organized as a bimodal staff, consisting of a Secretariat and an Army Staff (ARSTAF), each with oversight of SSAs and FOAs.

- ◆ **The Secretariat has a total of 15 separate offices including:**
 - Secretary of the Army (SA)
 - Undersecretary of the Army (USofA)
 - General Counsel
 - Five Assistant Secretaries -- all presidential appointees
- ◆ **4 SSAs and 26 FOAs report directly to the Secretariat**
- ◆ **The ARSTAF has a total of 12 separate offices including:**
 - Office, Chief of Staff, Army,
 - Four Deputy Chiefs of Staff
 - One Assistant Chief of Staff
 - The Director of the Army National Guard
 - The Chief of Army Reserve
- ◆ **9 SSAs and 32 FOAs report directly to the ARSTAF**

HQDA In Perspective*

Total: 37,110 Spaces/98 Agencies

Staff Support Agencies

13 Agencies/3,693 Spaces

STAFF

Secretariat	841
ARSTAF	1,616
Total	2,457

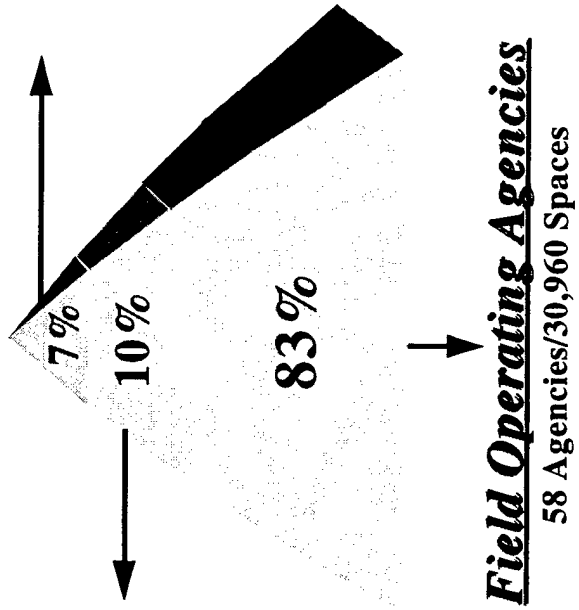

* FY98 authorized strength from FY96 Pres Bud

Figure 3-4

E. HQDA in Perspective

Viewed from another perspective, HQDA is composed of three distinct elements:

- ◆ **Staff.** Secretariat and ARSTAF, with 2,457 TDA spaces, represent 7% of the total HQDA personnel account.

The five largest are:

- ODCSOPS (426)
- ODCSLOG (237)
- ASA (FM &C) (178)
- ODCSPER (160)
- ASA (RDA) (153)

- ◆ **Staff Support Agencies.** HQDA is made up of 13 SSAs, with 3,693 TDA spaces, which account for 10% of the aggregate headquarters. SSAs provide assistance to the staff in terms of policy formulation, as well as necessary administrative and/or logistical support.

The five largest are:

- Army Acquisition Executive Support Agency (3,194)
- Concepts Analysis Agency (178)
- Intelligence Staff Support Agency (91)
- Command and Control Support Agency (69)
- Information Management Support Agency (66)

Section 4: Conceptual Framework

- A. HQDA Core Process**
- B. HQDA Key Management Functions**
- C. HQDA Enabling Functions**
- D. Model Implications**

Figure:

HQDA Model

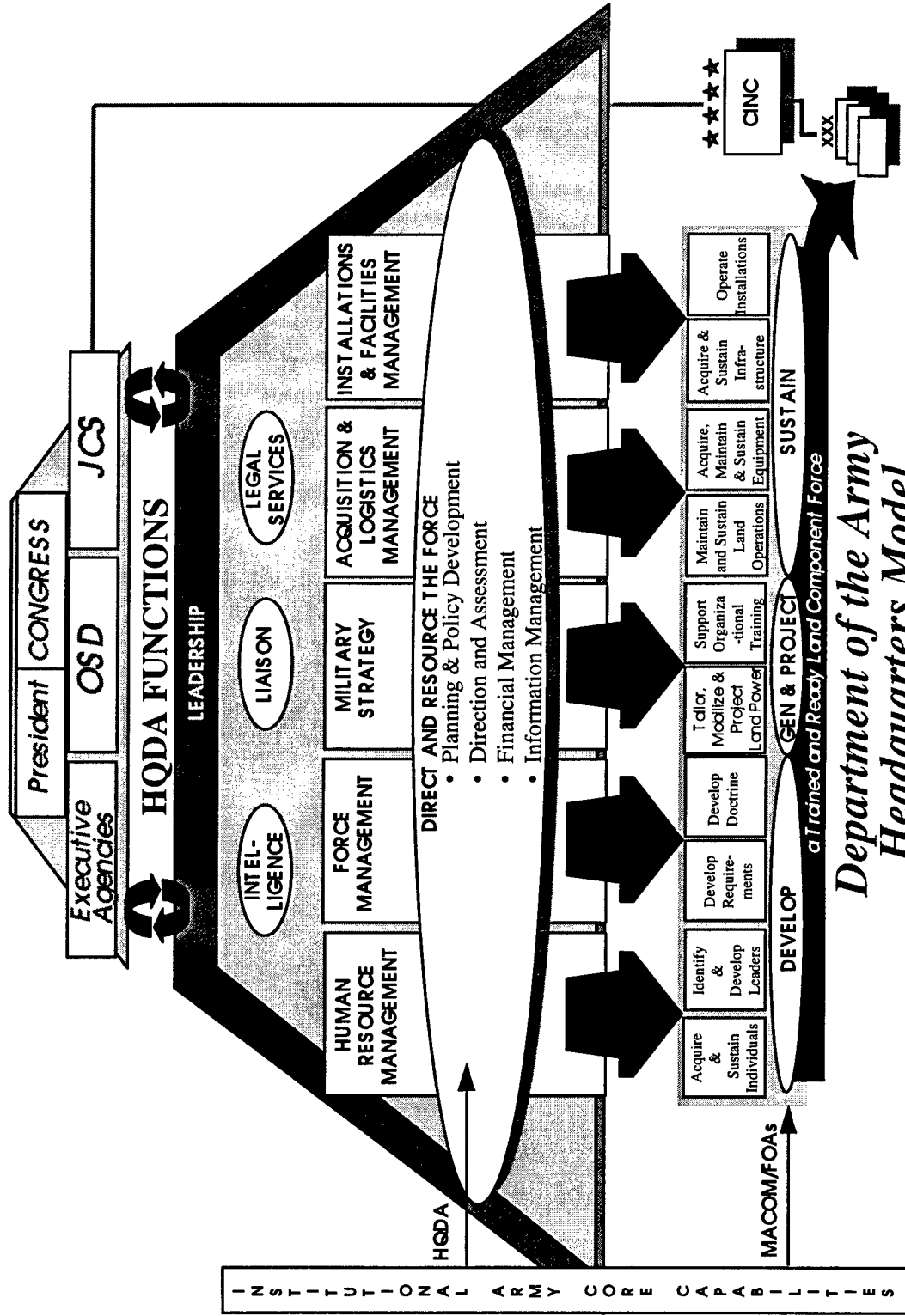

Figure 4-1

Section 4: Conceptual Framework

The Institutional Army core capability, "Direct and Resource the Force" is analogous to the broad oversight and management functions encompassing the statutory responsibilities of both the Secretary of the Army and the Chief of Staff, Army. It includes four core processes: Planning and Policy Development; Direction and Assessment; Financial Management; and Information Management. These are the cross-cutting processes that link together key management functions within HQDA. The essential management functions (similar to the business activities of a corporate headquarters), are: Leadership; Human Resource Management; Force Management; Military Strategy; Acquisition and Logistics Management; and, Installations and Facilities Management. A conceptual framework that illustrates this complex integration of essential headquarters management functions, its core processes, and linkages to the broader core processes of the Institutional Force, is shown in figure 4-1.

A. HQDA Core Processes

The Institutional Army core capability, "Direct and Resource the Force" is composed of four core processes. The scope and definition of each process is summarized below:

- ◆ **Planning and Policy Deployment.** This process incorporates the elements of strategic management that enables the Army's leaders to chart the long range and near term course they expect the Army to follow in meeting the program and operational guidance of OSD and OJCS. It is the process that combines the function of leadership with the strategic planning needed to develop the policies and guidance for the Army to operate.
- ◆ **Direction and Assessment.** The Direction and Assessment core process is the mechanism that translates the planning and policy development process into the programs that empower the Army's

many missions, both operational and institutional. Direction involves the essential management functions for which HQDA is responsible and that are directly linked to the Institutional Force's core processes. An essential counterbalance to the management process is the function of performance assessment; those measures taken to evaluate and, if necessary, correct the management outputs in terms of operational, programmatic and economic effectiveness.

- ◆ **Financial Management.** Financial management is the process of efficient acquisition, allocation and use of resources in order to effectively accomplish assigned missions. The process is cyclic and includes planning, programming, budgeting, allocation, execution, accounting and reprogramming.
- ◆ **Information Management.** Information management process ensures a valid technological architecture exists to support the full range of functional decision making and cross-functional operations Army-wide. It starts with identifying the information needed to run the organization. It also ensures appropriate information use. The objective is that timely, accurate and relevant information is used in all decisions and operations.

B. HQDA Key Management Functions

The HQDA key management functions are those stovepiped functions analogous to business activities. The scope and definition of each HQDA function is summarized below:

- ◆ **Leadership.** This function provides the Army vision, integrated objectives, requirements and programs; and prioritized resource allocation.
- ◆ **Human Resource Management.** This function includes setting long range strategic direction and policies that govern the management, utilization and potential of all active and reserve component military personnel and civilian employees. Human resource management encompasses all facets of personnel life cycle management from recruitment to separation and helps ensure a quality force.

Conceptual Framework

- ◆ **Force Management.** This function encompasses the determination of requirements for doctrine, personnel, materiel, training and organizations. It culminates with the translation of these requirements into programs and force structure. HQDA is the coordinator and final arbiter for this function, with the participation of the Army's MACOMs.
- ◆ **Military Strategy.** This function is primarily concerned with coordination and implementation of the Army's planning and support of the JSPS. The function includes supervision of the Army's force requirements planning process that results in the program and budget forces, and the Army's response to the Joint Operation Planning and Execution System (JOPEs), which supports the combatant commanders' OPLAN and CONPLAN.
- ◆ **Acquisition and Logistics Management.** The Acquisition and Logistics Management function includes oversight of the entire equipment life cycle from research and development through acquisition and sustainment, and finally, to disposal. The function includes oversight of the Army's logistics systems for sustaining the force.
- ◆ **Installation and Facilities Management.** This function includes oversight of the Army's force projection platforms that includes facilities, housing, utilities, real property and real estate. It also includes the broader responsibilities of base support; interservice and interdepartmental activities; area, tenant and reserve component support; environmental policy on compliance, restoration, prevention and conservation; military construction; and overall quality of life for soldiers and their families and for civilian employees.

C. HQDA Enabling Functions

In addition to the key management functions, described above, there are other enabling activities that round out HQDA's departmental responsibilities. These enabling activities or "enabling functions" enhance the efficiency and effectiveness of HQDA outputs and provide the Army with the means, knowledge or opportunity to operate in DoD and to compete for limited resources. The scope and definition of each of the HQDA functions are summarized below:

- ◆ **Intelligence.** Intelligence is the product resulting from the collection, processing and analysis of all available information the Army needs to protect U.S. interests from actual or potential foreign threats.
- ◆ **Legal Services.** This activity involves providing competent legal review and advice to support senior level decision-making. The essential nature of HQDA requires the ready availability of expert legal advice on a wide range of issues. In order to make fully informed decisions, the senior leadership must be advised on the legal implications of various options.
- ◆ **Liaison.** Liaison is the activity of establishing policies for telling the Army's story and communicating the Army's position to various audiences. HQDA is responsible for insuring dissemination mechanisms exist for articulating the Army's approved vision, philosophy, strategies, programs and vital interests, not only to external audiences such as the Congress, but also internally to its military and civilian community.

D. Model Implications

The model provides the basis for:

- ◆ Identifying core and non-core functions and activities.
- ◆ Relating HQDA outputs to MACOM managed capabilities and processes.
- ◆ Grouping functions and activities on a core process basis.
- ◆ Clarifying cross-cutting, integrating functions.

Section 5: Review of Organizational Models

- A. Purpose of the Review**
- B. The Approach**
- C. Early Guidance**
- D. Organizational Model Options:**
 - #1, The Current HQDA Model**
 - #2, The CORM Model**
 - #3, The Combined Model**
 - #4, Integration Options**
- E. Summary**

Section 5: Review of Organizational Models

A. Purpose of the Review

The review was conducted to select the most promising organizational options that would enable the HQDA to more effectively and efficiently perform its Title 10 functions in support of the Force XXI Army.

B. The Approach

The Working Group considered multiple sources of guidance for the task of selecting the most promising organizational structures for analysis. Various elements of guidance were found in the Charter for Redesigning the Institutional/TDA Army, dated January 13, 1995; in the draft of DA PAM 100-XX, Force XXI Institutional Army Redesign, dated June 26, 1995; in the Secretary of the Army's Memorandum for the Deputy Secretary of Defense (DEPSECDEF), Subject: Commission on Roles and Missions (CORM) Recommendations on Restructuring the Military Department Staffs, dated October 16, 1995; and in the content of the comments made by senior leaders (Army Secretariat and Staff) during interviews conducted with them by Lieutenant General (Retired) Charles P. Otstott, the Senior Advisor to the HQDA Redesign Working Group.

The guidance gathered from these multiple sources was applied with consideration for the direction and spirit of the National Performance Review, The Commission on Roles and Missions Report, and the constrained resource environment attendant on the post Cold War drawdown of the Armed Forces of the United States. A significant factor considered in this process was the continuing evolution of the Joint Staff and the processes embodied in Service participation in the Joint Requirements Oversight Council (JROC) and the Joint Warfighting Capabilities Assessments (JWCA), as well as the growing importance of the Chairman's Program Review (CPR) and the Chairman's Program Assessment (CPA).

The organizational models developed and considered represented alternative approaches to meeting the majority of the guidance while remaining within the bounds of feasibility formed by practical considerations of legal obligations, the history and culture of the Army as an institution, and other practical matters which could not be ignored.

Review of Organizational Models

C. Early Guidance

This paragraph provides a summary of the early guidance which guided the selection of organizational alternatives.

- ◆ Charter for the Redesign of the Institutional/TDA Army
 - Ensure enduring Army values and ethics guide the redesign effort.
 - Keep the six Army imperatives as the bedrock of the Institutional/TDA Army.
 - Use Army core competencies as the foundation for redesign.
 - Link the redesign to the National Military Strategy:
 - Power Projection Total Army
 - Increasingly joint operations environment
 - Conform to National Performance Review principles:
 - Eliminate layering of functions
 - Reduce size of HQDA and number of FOAs and SSAs
 - Reduce number of MACOM HQs
 - Capitalize on strengths of each component-active, reserve, and civilian.
 - Leverage information technology, management practices and processes to improve effectiveness and provide efficiencies.
 - Resource functions in most cost effective manner.
 - Experiment as required in GHQ exercises.

Review of Organizational Models

- ◆ SA's October 16, 1996, Memorandum to DEPSECDEF, Subject: Commission on Roles and Missions Recommendations on Restructuring Military Department Staffs.
 - General:
 - Divest HQ of non-essential functions
 - Remove layers
 - Fully empower commanders in the field
 - Consolidate some ARSTAF and Secretariat functions
 - Focus HQ on policy making, not policy execution
 - Eliminate unnecessary duplications
 - Preserve and enhance operational effectiveness
 - Guiding Principles:
 - Any reorganization must continue and not vitiate civilian control of the military
 - Commanders must be free to carry out their responsibilities with as much authority and flexibility as we can provide
 - The Army's primary responsibility is to provide forces trained and ready to carry out the National Security Strategy
 - Secretariat and ARSTAF each have important independent roles
 - Operational functions belong in the field
 - ◆ Additional Operative Criteria and Principles Gathered from Interviews with Senior Leadership
 - HQDA must have the ability to operate effectively in the NCA environment--effective and appropriate performance in the arenas of Congress, OSD, and OJCS must be assured.
 - HQDA must have the ability to provide appropriate guidance, direction, and oversight to the MACOMs.

Review of Organizational Models

- HQDA must satisfy all Title 10 requirements.
- HQDA should divest itself of as much operational and implementation activity as possible and let the restructured MACOMs pick up those activities.
- The CSA must have direct control over an ARSTAF which supports him in his Title X duties--specifically in his role as a member of the JCS.
- HQDA should be streamlined and smaller at the end of this exercise.
- HQDA should be capable of leveraging the benefits of third wave technology and should be positioned to lead in the information age of the 21st century.
- Staff entities which have outlived their usefulness should be eliminated.
- Merge as many MACOMs as possible into the CONUS integrating MACOMs where it makes organizational and economic sense to do so.
- Status quo is not the answer.
- Full staff integration reporting into a single block of leaders with ambiguous lines of authority is not the answer
- Carefully thought out redesign--which allows the HQ to perform its mission more effectively and efficiently, while institutionalizing a better staff arrangement that will allow the HQ to be a high performing unit in the future, despite normal leadership changes--is the answer.

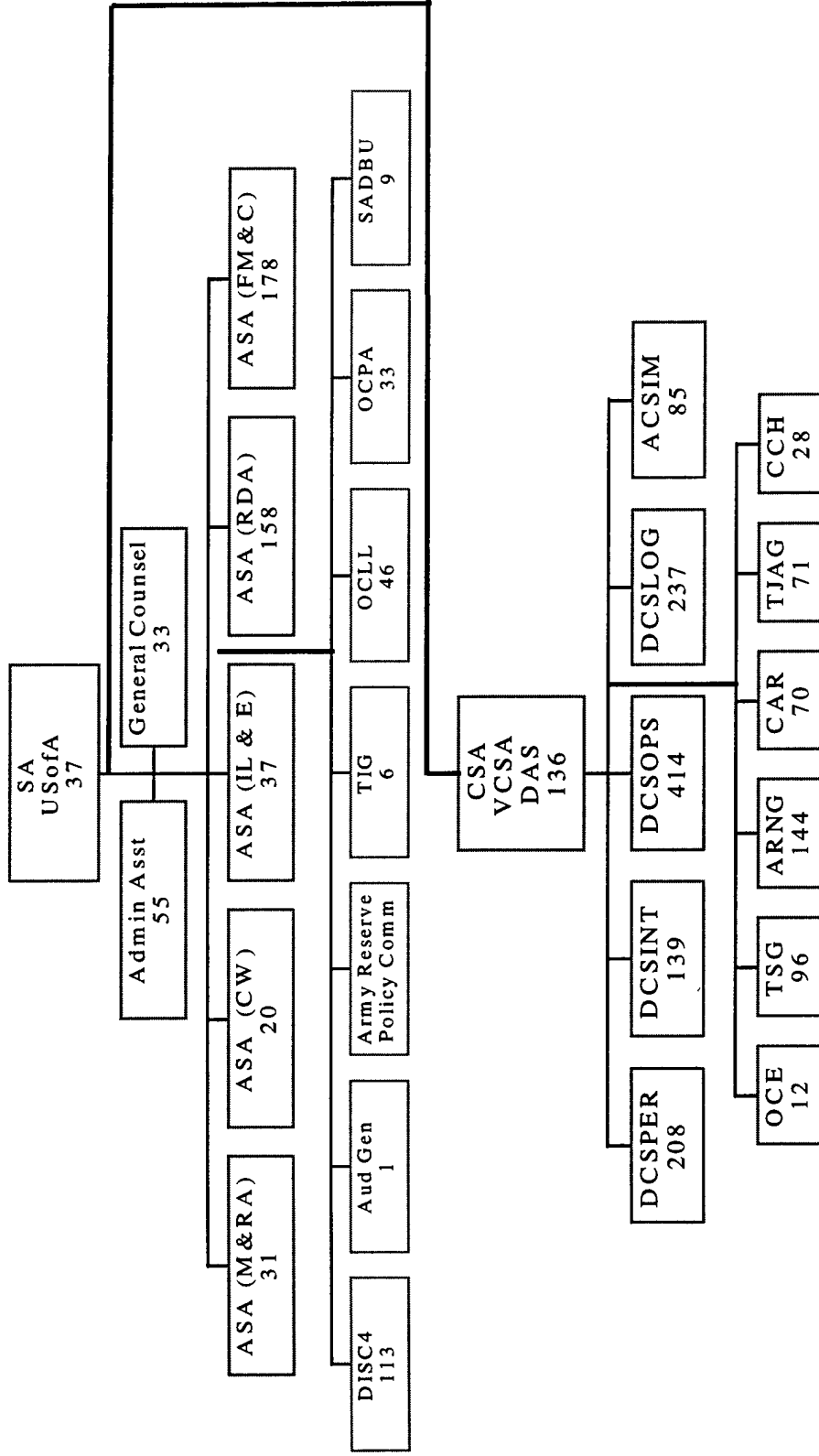

Figure 5-1, The Current HQDA Model

D. Organizational Model Options: #1, The Current HQDA Model

The first organizational model considered was the current HQDA organization. It was clear from the beginning that the "...blank piece of paper..." approach would be too risky and probably infeasible in the first phase of this long term reengineering effort. The redesign group therefore took this organizational design as the start point for the thought processes that would yield practical, feasible alternative solutions. The consensus was that there is a great deal that is right about the current staff arrangements, and care should be exercised in changing anything that is not "broken" just for the sake of change.

◆ Current Model Characteristics

- Bimodal with ARSTAF and Secretariat
- Placement of several staff entities done in response to legal requirements (e.g., Goldwaters-Nichols Act, etc.)
- Both the SA and the CSA have required independent advice to support them in fulfilling all Title 10 requirements
- Secretariat entities provide policy oversight to ARSTAF entities which provide guidance and direction to field elements
- HQDA consists of a large number of SSA's and FOA's, some of which are more operational than is appropriate for the HQ core functions

- ◆ **Assessment:** While efforts over the last decade to downsize the HQDA had been successful in bringing the HQ numbers down by 34% while the overall Army was being reduced by 30%, there were still functions being performed on the staff which did not fall in the core capabilities of Direct and Resource the Force. Operational functions needed to be devolved to appropriate field operating commands. Redundancies and overlaps between the ARSTAF and the Secretariat needed to be addressed.
- ◆ **Conclusion:** This staff model represented the status quo, and was unacceptable.

Organizational Model Options: #2, The CORM Model

Another organizational model was based on the recommendation made in the CORM Report. The CORM advocated consolidation of the Service and Secretariat staffs into a single, integrated staff reporting through the Service Chief to the Military Department Secretary. CORM also recommended reduction of the number of political appointees assigned to positions in the Military Departments, limiting these positions to three or four. CORM acknowledged the perceived need for independent advice and support for the Service Secretaries and for the Service Chiefs, but concluded that the advantages of separate headquarters staffs are outweighed by disadvantages in several important respect. They cited the difficulty of integrating staff efforts and the forcing of choices between "civilian business functions" and "military functions". They noted the confusion, unnecessary friction, and cumbersome management processes caused by split responsibilities between Secretariat and Service staffs. Finally, they cited the artificial splitting of activities into "sole responsibility" categories which were perceived to be of less concern to the leader not charged with that responsibility. The Working Group's proposal to implement the CORM recommendation is shown below.

♦ CORM Model Characteristics

- Single staff; principals respond to SA through the CSA
- Eliminates ASA's; reduces Presidential appointees to 4 (*)
- Positions the CSA to function as a true Chief of Staff
- Staff directorates led by General Officers or Senior Civil Servants
- DISC4 consolidates with DCSINT; combines information management with intelligence
- ASA (RDA) functions are transferred to DCSLOG.

Review of Organizational Models

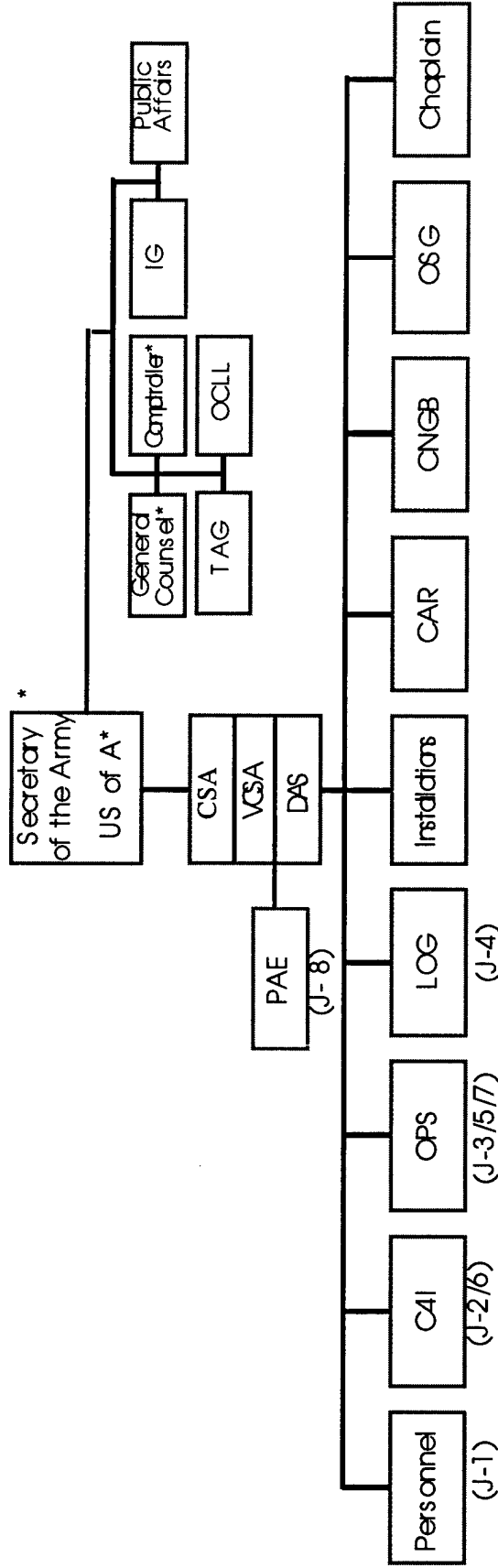

Figure 5-2, The CORM Model

- ◆ **Assessment:** This model seemed to have great potential to streamline the HQDA while increasing effectiveness and efficiency. It laid out an organization which closely paralleled the organization of the Joint Staff. It was not subjected to serious review and analysis by the Working Group because the Secretary of the Army sent a memorandum to the Secretary of Defense on 25 July 1995, which rejected the concept of the single staff reporting through the Chief of Service to the Secretary as well as the idea of limiting the number of political appointees to three or four.
- ◆ **Conclusion:** This model was declared unacceptable by the Secretary of the Army.

Organizational Model Options: #3, The Combined Model

A third model was produced during an off-site attended by members of the Secretariat. This model attempted to accommodate the concept of a single integrated staff, but without the limitation on the number of political appointees or the reporting channel through the CSA. In this model, the Deputy Chiefs of Staff and the Assistant Secretaries are on essentially the same level of authority with all reporting to the same block on the organizational chart. The "box of four" at the head of this organization contains the Secretary, the Under-Secretary, the Chief of Staff and the Vice Chief of Staff. The exact lines of authority between and among the four were expected to be in keeping with tradition, but not necessarily codified for broad dissemination. There were a number of functional realignments associated with this proposal. The Combined Model is shown on the following page.

◆ **Combined Model Characteristics**

- Single staff, ambiguous lines of authority
- Consolidates personnel, finance, installations, and logistics under ASA's
- Eliminates a separate ASA for Civil Works and DCS's for Logistics and Intelligence
- Creates a Director of Requirements and a DCS for C4 and Intelligence
- Places PA&E under the ASA (FM&C)

◆ **Assessment:** The Working Group judged this model to be fatally flawed by the ambiguous nature of the reporting lines into the "box of four". The notion that the "...ASA's would report to the SA and support the CSA, while the DCS's would report to the CSA and support the ASA's..." appeared to be a prescription for endless counterproductive tension between Secretariat and ARSTAF. The CSA agreed with the Working Group that this was an unacceptable solution. It was clear, however, that a number of the consolidation proposals contained in this model should be considered in the selection of an acceptable model.

◆ **Conclusion:** This model was declared unacceptable by the Chief of Staff, Army.

Review of Organizational Models

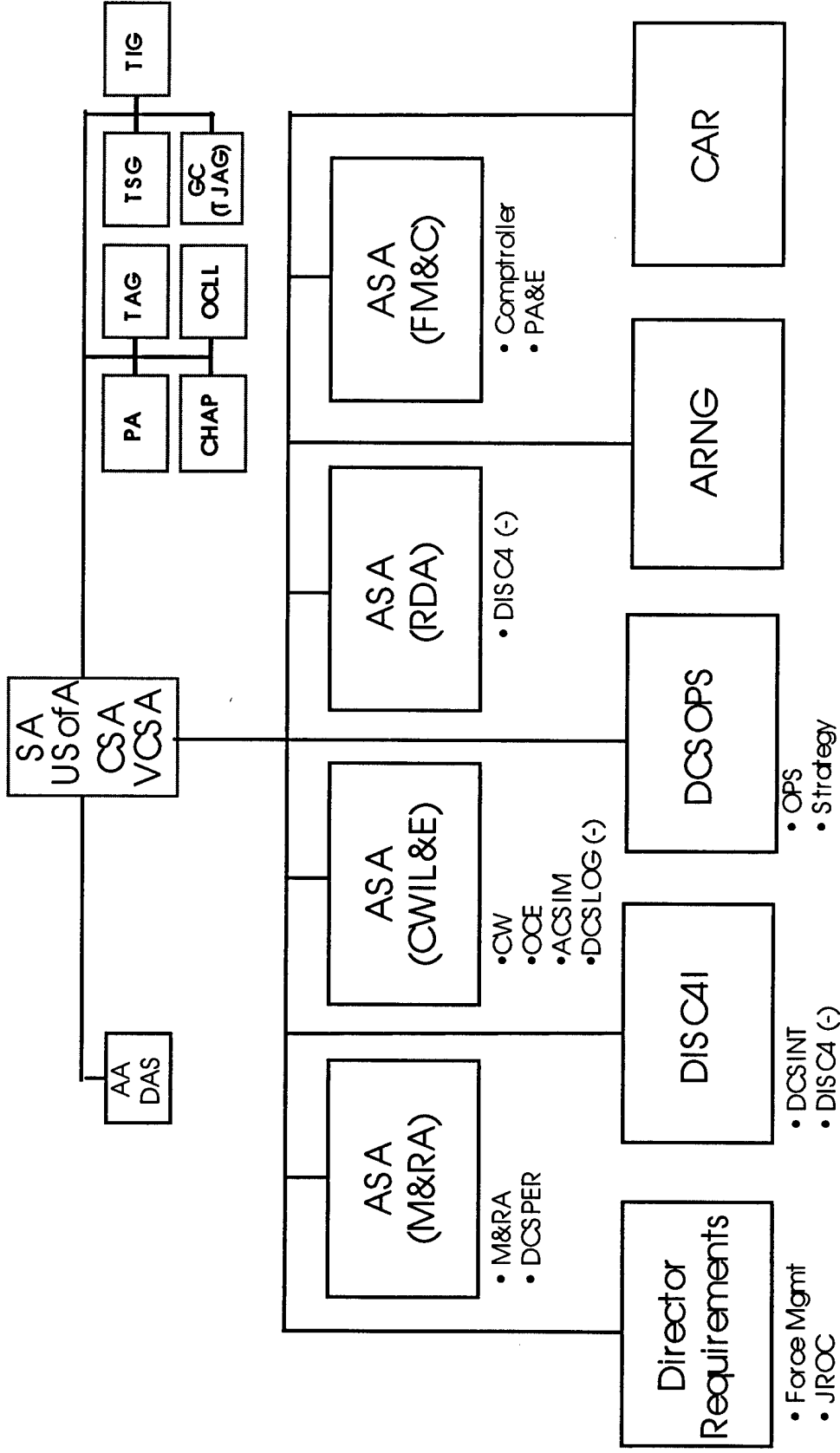

Figure 5-3, The Combined Model

Organizational Model Options: #4, Integration Options

The final option considered by the Working Group recognized the need to retain the bimodal staff foundation and proposed various consolidations and integrations which appeared to hold potential for streamlining and increasing staff effectiveness and efficiency. This option is the most promising option remaining after rejection of the two fully integrated models due to the reporting relationships to the Army leadership. The Working Group saw potential improvement in the integration of ASA (M&RA) with DCSPER; some consolidation of DISC4 and ASA (RDA); certain consolidation opportunities within and between the offices of ASA (CW), ASA (IL&E), DCSLOG, ACSIM, and OCE; and the integration of OCSA and DCSOPS with the standup of the Assistant Vice Chief of Staff, Army (AVCSA) office. The Integration Options Model is shown below.

- ◆ **Integration Options Model Characteristics**
 - Retains independence of SA and CSA
 - SA and CSA cleanly supported in Title 10 functions
 - Establishes 3 star AVCSA position in OCSA
 - Has the potential to eliminate significant perceived redundancies and overlap
 - Does not agree with CORM recommendation

- ◆ **Assessment:** This model led to the consideration of a number of specific organizational adjustments which were to be accompanied by appropriate functional adjustments. The issue became fitting the conceptual model of the HQDA to the many functions being performed by the present HQ, deciding which functions to devolve to MACOMs, and finally, where the remaining functions should be performed. The Working Group made specific proposals which would be examined in the course of the Functional Area Reviews (FARs). The idea was to engage the senior staff proponents in a serious attempt to streamline the staff and make it better in the course of the FARs. Creative thought and full engagement of the key process stewards were considered necessary to any real progress in the redesign effort. The FARs were to be the fora for that engagement and the expression of those thoughts. A full depiction of the various options to be considered can be found in the HQDA Redesign Analysis: The Most Promising Organizational Options, dated 25 October 1995.

- ◆ **Conclusion:** The various options for integration on the bimodal chassis would be the basis of the FARs.

E. Summary

The HQDA organization has evolved over time to its current design. The history of that evolution is filled with lessons learned, risks taken, legislated changes, visionary gambles, and responses to changes in modern warfare. In the last ten years alone, there have been six different formal restructuring actions which have affected the HQDA. This redesign effort has been viewed by many as merely an extension of the previous efforts to downsize the headquarters in the post Cold War era.

The initial guidance received from the Army leaders was fairly general in nature. The Working Group met that guidance by starting with the current HQDA design in its evolutionary state, and attempted to develop functional changes and adjustments which would carry concomitant changes to the organization. The point of this was to match the HQDA staff as closely as possible to the theoretical model of what the staff should be and do as set forth in DA PAM 100-XX. Neither of the potential fully integrated staff models suggested by the CORM recommendation were acceptable to the most senior Army leaders. The only feasible alternative was a modification to the existing bimodal staff chassis which would achieve greater effectiveness and efficiencies and streamline the staff by moving operational functions to the field and by consolidating and integrating staff elements where it made sense to do so.

The proposals sent to the FARs for discussion were considered to be reasonable alternative ways to perform the proper business of the Army Headquarters. The vetting of the proposals is discussed in Section 7. This phase of the Working Group's effort closed with the following conclusions and recommendations.

◆ Conclusions

- HQDA will continue as a partially integrated staff with independent Secretariat and Army staff responsibilities.
- HQDA will be streamlined by eliminating most redundancy and overlap and devolving functions to the field.
- Integration of certain elements of the ARSTAF and Secretariat must be analyzed and directed if found appropriate.

Review of Organizational Models

◆ **Recommendations**

- Recognize the bimodal staff as the appropriate HQDA chassis.
- Continue the dialogue with the MACOM Commanders on devolution of non-core HQDA functions.
- Use the Functional Area Review process as the principal mechanism for issue development and airing of organizational options.
- Focus on potential integration options.

THIS PAGE INTENTIONALLY LEFT BLANK

SECTION 6: SSA and FOA Assessment

A. Approach

B. General Findings

B. Manpower trends

Figures:

HQ and Its SSAs/FOAs

Manpower Trends

Section 6: SSA and FOA Assessment

Opportunities for redesign proceeded with a detailed analysis of HQDA Staff Support and Field Operating Agencies

A. Approach.

Results of the data call provided the basis for a more detailed assessment of SSAs and FOAs. The purpose of the detailed assessment was to discover opportunities for increasing the effectiveness of the SSAs and FOAs in the context of the HQDA conceptual model. The HQDA Redesign Working Group analysts conducted interviews with representatives from each SSA/FOA and their parent organization to develop insight and ideas for functional improvement. Five preliminary assessment outcomes were identified:

- ◆ Eliminate the SSA or FOA
- ◆ Contract or outsource SSA/FOA activities
- ◆ Right-size SSA/FOA staff
- ◆ Transfer SSA/FOA mission to MACOM (or other organizations)
- ◆ Retain SSA/FOA (either as-is or with functional improvements)

Using decision trees and other analytical tools (see Appendix G), the working group developed three redesign options for each SSA/FOA. Three options were identified and grouped based on degree of impact: low, medium, and high. SSA/FOA analysis and redesign options formed one basis for the issues discussion and refinement that occurred during the FAR review. Figure 6-1 provides an overview of the staff, SSAs and FOAs as they appeared at the start of analysis. Numbers in each box in the figure represent the authorized FY98 strength from the FY96 President's Budget. Short title abbreviations are identified in Appendix F.

HQ and its SSAs/FOAs*

Totals: 37,110 Spaces/98 Agencies

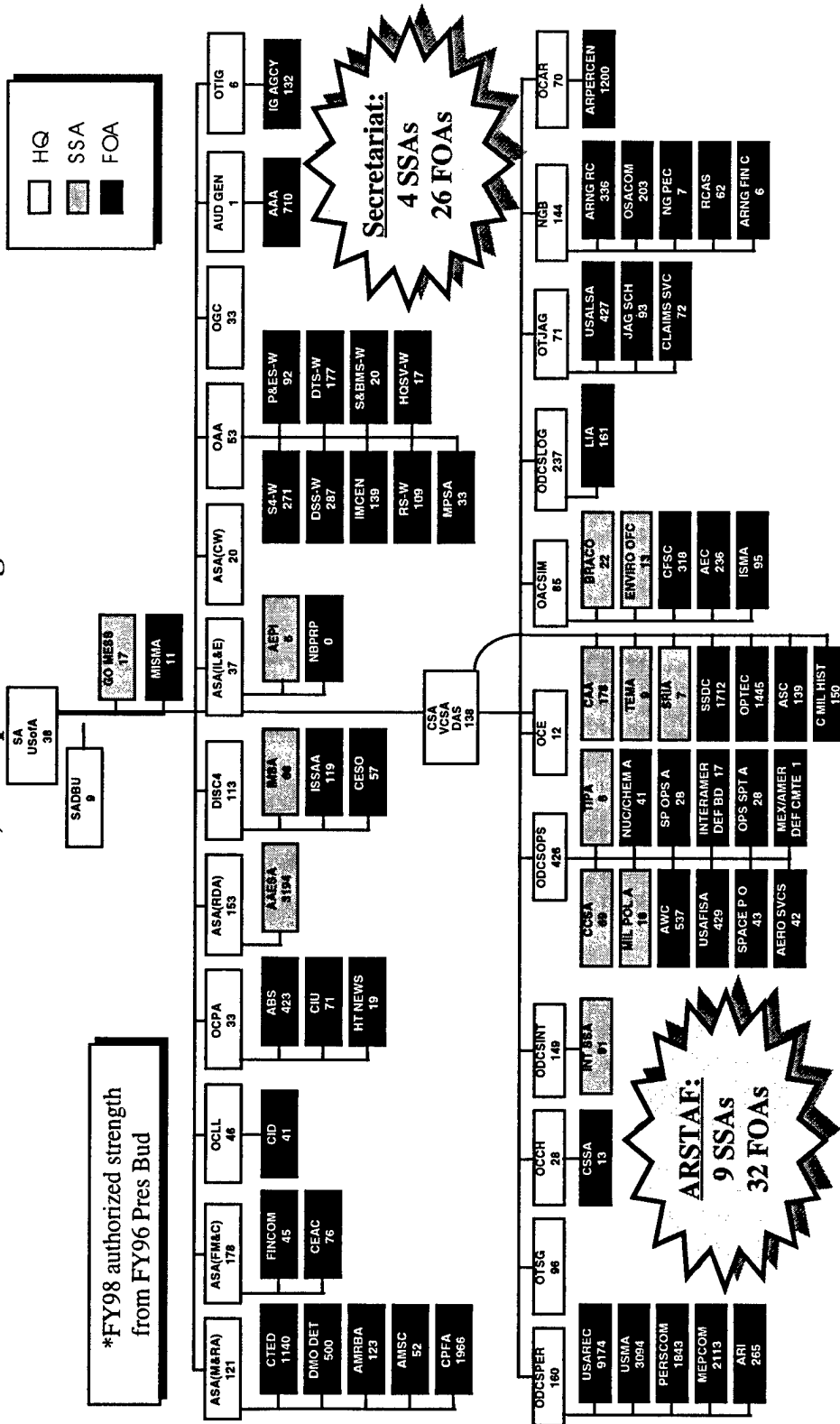

Figure 6-1

B. General Findings

Based on the data call and interview results, the Working Group confirmed the following:

- ◆ SSAs and FOAs represent 93% of HQDA's authorized personnel spaces.
- ◆ HQDA currently has 14 SSAs and 58 FOAs for a total of 34,653 spaces.
- ◆ SSAs and FOAs vary widely in size and responsibility.
- ◆ Some agencies appear functionally similar.
- ◆ Distinctions between headquarters staff, SSA, and FOA responsibilities have blurred.
- ◆ A number of FOAs resemble unifunctional MACOMs.
- ◆

C. Manpower Trends

As shown on **Figure 6-2**, SSA and FOA manpower trends since FY 1985 display the following characteristics:

- ◆ FOA's manpower trends have generally matched those of HQDA at large.
- ◆ SSA's staffing levels increased with the establishment of the Army Acquisition Executive Support Agency (AAESA).

Manpower Trends

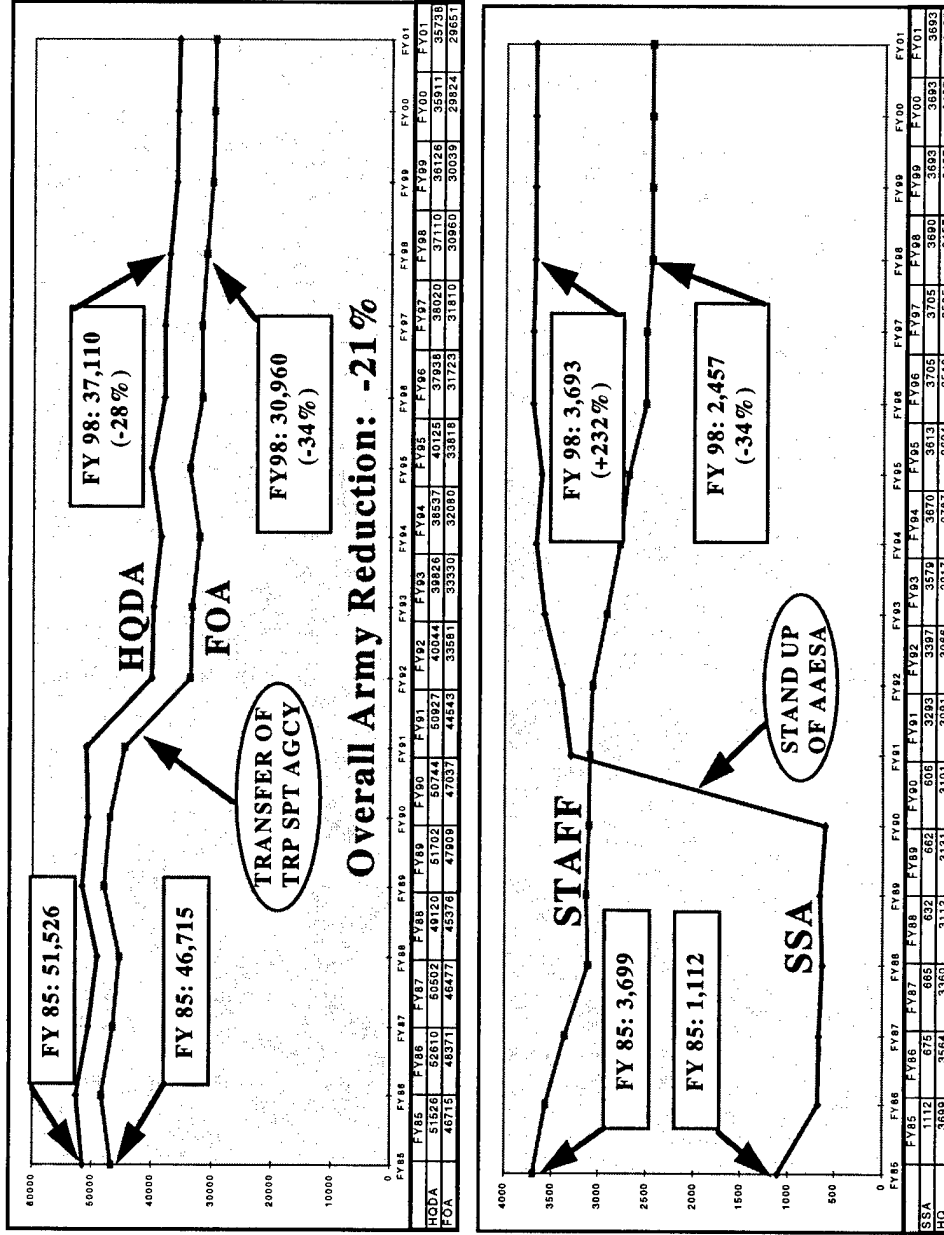

Figure 6-2

THIS PAGE INTENTIONALLY LEFT BLANK

Section 7: Functional Area Reviews

A. Functional Area Review Introduction

B. Functional Area Review Summaries

Figure:

FAR Participants

Section 7: Functional Area Reviews (FARs)

FARs were structured meetings scheduled to allow functional principals within each HQDA process an opportunity to share perspectives and discuss issues critical to headquarters redesign.

A. Functional Area Review Introduction

As discussed in earlier sections, redesign of HQDA involved a comprehensive review of headquarters processes and functions. Prior to conducting FARs, the Working Group enlisted senior leadership participation at a number of stages: a data call inventory of HQDA work year levels, informal staff discussions, and formal interviews by the senior advisor to the Working Group, LTG (Ret.) Charles P. Otstott. In addition, the VCSA and ASA(M&RA) wrote to each staff principal soliciting their views and good ideas on HQDA redesign. As a result of this interaction, a framework for future headquarters design was developed which clarified the headquarters role in terms of directing and resourcing the force. Moreover, the group had identified a variety of restructure alternatives relating to the number and size of Field Operating Agencies and Staff Support Agencies supporting HQDA.

In order to properly integrate all HQDA redesign efforts and gain staff insights, the Working Group conducted a series of FARs. FARs were meetings that allowed Secretariat and Army Staff principals the opportunity to share perspectives on HQDA redesign. The objective of each FAR was to bring together those principals who reflected the broadest involvement in the functions under review. Two weeks prior to each FAR, a readahead packet was delivered to each invited principal. Each readahead packet contained FAR Objectives, FAR Ground Rules (for meeting management), Principles for Redesign (as an orientation to invitees), Summary of the Army's response to CORM Recommendations, "HQDA Today" Statistics (determined from Phase 1 analysis data call), Graphical Representations of Current and Possible Organizational Models, Functional Definition, and Functional Improvement Issues.

During each FAR, attendees attempted to reach consensus on functional improvement issues, identify functional redundancies and overlaps, and develop creative and positive ideas for overall HQDA improvement. Topics of concurrence were recorded, as were issues requiring additional discussion and analysis. These later issues were vetted with functional area principals and senior Army leadership and were used as input in the formulation of Working Group final recommendations and topics for additional study.

Functional Area Reviews (FARs)

DATE	FUNCTIONAL AREA	KEY PARTICIPANTS
13 Nov 95	Military Strategy	DUSA(IA), ASA(M&RA), ASA(FM&C), OGC, DCSINT, DCSOPS, DCSLOG, ACSIM, COE, PA&E, ARNG, OCAR, DM
30 Nov 95	Force Management	ASA(M&RA), ASA(RDA), DISC4, OGC, DCSPER, DCSINT, DCSOPS, ACSIM, OCE, ARNG, OCAR, DM, AMC, FORSCOM, TRADOC, SDDC
12 Dec 95	Information Management	DUSA(IA), ASA(M&RA), ASA(FM&C), ASA(RDA), OGC, AA, DISC4, OCPA, DCSPER, DCSINT, DCSOPS, DCSLOG, ACSIM, OCE, ARNG, OCAR, DM, AMC, FORSCOM, TRADOC
14 Dec 95	Acquisition & Logistics Management	DUSA(OR), DUSA(IA), ASA(M&RA), ASA(FM&C), ASA(IL&E), DISC4, OGC, AA, DCSOPS, DCSLOG, ACSIM, ARNG, OCAR, DM, AMC, FORSCOM, TRADOC, SDDC, TEMA
19 Dec 95	Installations & Facilities Management	DUSA(IA), ASA(M&RA), ASA(IL&E), ASA(CW), ASA(FM&C), ASA(RDA), OGC, AA, DAS, DCSPER, DCSINT, DCSOPS, DCSLOG, ACSIM, COE, ARNG, OCAR, AMC, FORSCOM, TRADOC
18 Jan 96	Financial Management	DUSA(IA), ASA(M&RA), ASA(IL&E), ASA(FM&C), ASA(RDA), OGC, AA, OTAG, OTIG, DAS, DCSPER, DCSINT, DCSOPS, DCSLOG, ACSIM, COE, OTJAG, ARNG, OCAR, DM, PA&E, AMC, FORSCOM, TRADOC, ASC
18 Jan 96	Leadership	DUSA(IA), ASA(M&RA), ASA(IL&E), ASA(FM&C), ASA(RDA), OGC, AA, OTAG, OTIG, DAS, DCSPER, DCSINT, DCSOPS, DCSLOG, ACSIM, COE, OTJAG, ARNG, OCAR, AMC, FORSCOM, TRADOC, ASC
23 Jan 96	Human Resource Management	ASA(MRA), ASA(FMC), GC, AA, DCSPER, DCSOPS, ACSIM, ARNG, OTJAG, CCH, OCAR, DM, FORSCOM, TRADOC, PERSCOM, USAREC, USMA

Figure 7-1

A summary of each of the eight FARs is shown on the following pages. For each summary, the following information is provided:

- Major FAR issues
- Consensus reached by FAR attendees
- Working Group's analysis of these issues
- Working Group Recommendations

In addition, an option summary is provided for each SSA/FOA discussed during the FAR. The summary presents a proposed redesign action and resulting impact on personnel spaces for each FAR consensus and Working Group recommendation.

B. FAR Summaries **Military Strategy FAR - Option Summary**

Baseline	FAR Consensus	Working Group Recommendation
DUSA(LA) 1	Organize at Policy Oversight & Integration level (60+ through realignment)	Concur
DCSOPS 426	Study	Receive various policy elements (+73); transfer FD to Requirements Org (-181)
Chief, Army Reserve 70	No change	Concur
Chief, National Guard Bureau 144	No change	Concur
Command & Control Support Agency (CCSA) 69	No change	Eliminate 21 through increased contracting
DCSOPS Support Agency 28	Transfer policy functions to DCSOPS (25); transfer CLIC to USASOC (3)	Concur
Concepts Analysis Agency (CAA) 178	Rightsize through increased contracting (-140)	Concur, also receive 15 from Log Eval Agcy (CAA endstate: 53)
Military Police Operations Agency 16	Retain MP Cell in DCSOPS (11); transfer 5 to TRADOC	Concur
Nuclear & Chemical Agency 41	Retain cell in DCSOPS (15); trans 26 to TRADOC	Concur
Special Operations Agency 28	Retain FOA (10), transfer 18 to USASOC	Eliminate FOA & transfer functions to USASOC
Operational Support Airlift Command 203	Retain	Concur
Inter-American Defense Board (IADB) 17	Retain	Gain sponsor approval to eliminate FOA; transfer functions/spaces (-17) to MDW
Joint Mexican-US Defense Command 1	Retain	Gain sponsor approval to eliminate FOA; transfer function/space (-1) to MDW

Functional Area Reviews (FARs)

Military Strategy FAR Issues, 15 Nov 95

- ◆ **Issue 1. HQDA Interface with the Joint Staff & DoD Planning Environment.**
 - **FAR Consensus:** *JSPS and OSD's PPBS would operate more effectively if key decision documents were published in a timely fashion. JROC and JWCA processes should be formally integrated into PPBS.*
 - **Working Group Analysis:** *Concur.*
 - **Recommendation:** *SA/CSA should provide a candid assessment to OSD/JCS.*
- ◆ **Issue 2. Requirements & Resource Integration in HQDA.**
 - **FAR Consensus:** *Further evaluate AVCSA/A-8 options before making a recommendation.*
 - **Working Group Analysis:** *The Army needs a full-time three-star Resource Integrator, responsible for requirements and program development, to remain competitive in the DoD environment. AVCSA would also serve as a bridge between the ARSTAF and Secretariat during PPBS. Implement ODCSOPS' reorganization plan separating out FD.*
 - **Recommendation:** **Appoint a three-star Resource Integrator.**
- ◆ **Issue 3. Army International Activities.**
 - **FAR Consensus:** *Organize the DUSA (IA) to serve both the SA and CSA similar to the SARDA model.*
 - **Working Group Analysis:** *Concur.*
 - **Recommendation:** **Resource the DUSA (IA) at the "Policy Oversight & Integration" level (60+ spaces) through space transfers.** Assess the initial results and study resourcing for the "policy development" option.

- ◆ **Issue 4. FORSCOM's Role in Mobilization.**
 - **FAR Consensus:** HQDA retain mobilization policy making. Staff to work with FORSCOM in identifying operational aspects of mobilization to devolve.
 - **Working Group Analysis:** Congressional interest in unit activations require HQDA (M&RA/DCSOPS) to maintain an active role in mobilization.
 - **Recommendation:** Requires follow-on study.

Force Management FAR - Option Summary

Baseline	FAR Consensus	Working Group Recommendation
DCSINT 149	Receive Intel SSA (91)	Receive portion of Intel SSA (73)
Intelligence Staff Support Agency 91	Merge with DCSINT	Merge with DCSINT (73); transfer FID (18) to INSCOM
Model Improvement & Study Mgt Agency 11	Models Tm to DCSOPS (8); Studies Tm to DUSA(OR) (3)	Concur
Force Integration Support Agency 429	Rightsize by eliminating 129 (30%)	Eliminate 129; retain Manpower Survey & Database (48); transfer balance to TRADOC (252)
Army Space Program Office (ASPO) 43	Eliminate; transfer functions to SSDC w/o spaces	Concur
Space & Strategic Defense Command (SSDC) 1712	Absorb ASPO functions	Should designate as a MACOM (ACC)
Aeronautical Service Agency 42	Retain	Transfer to TRADOC
National Guard Readiness Center 336	Receive ARNG Finance Center (6)	Concur

Force Management FAR Issues, 30 Nov 95

- ◆ **Issue 1. Requirements Determination Process.**
 - **FAR Consensus:** *Material requirements process is evolving. TRADOC should incorporate enhancements into policy & regulation.*
 - **Working Group Analysis:** *Concur*
 - **Recommendation:** *None*
- ◆ **Issue 2. Total Army Analysis (TAA).**
 - **FAR Consensus:** *Transfer of TAA to TRADOC offers few immediate payoffs. Reexamine to identify streamlining/contracting opportunities.*
 - **Working Group Analysis:** *Developing the force should be a MACOM responsibility with HQDA providing planning guidance and oversight. Much of the current TAA process could be devolved to TRADOC.*
 - **Recommendation:** *Retain TAA at HQDA but conduct follow-on study.*
- ◆ **Issue 3. Documenting the Force.**
 - **FAR Consensus:** *TOE/TDA documentation could be transferred to TRADOC; however, functional improvements are not apparent. Downsize USAFISA by 30%.*
 - **Working Group Analysis:** *TRADOC, the "force developer MACOM," should develop TOE/TDA.*
 - **Recommendation:** *Rightsize USAFISA and transfer TOE/TDA documentation to TRADOC.*

Functional Area Reviews (FARs)

- ◆ **Issue 4. Training Policy & Resources.**
- **FAR Consensus:** *DAMO-TR provides essential advocacy & resource integration. Consolidation of HQDA civilian & military training oversight deserves more evaluation.*
- **Working Group Analysis:** *Concur*
- **Recommendation:** *Conduct study on the feasibility of consolidating HQ oversight of civilian and military training.*

Information Management FAR - Option Summary

Baseline	FAR Consensus	Working Group Recommendation
DISC4 113	No change	Concur
Information Mgt Support Agency 66	No change	Concur
Communications-Elec Services Agency (CESO) 57	No change	Concur
Hometown News Service 19	No change	Eliminate FOA (-19)
Army Broadcasting Service (ABS) 423	Pursue elimination of FOA and 85 spaces; transfer 7 to CIU & 331 to OSD	Pursue elimination of FOA and 92 spaces; transfer 331 to OSD
Military Postal Services Agency (MPSA) 33	Eliminate FOA; transfer 33 to PERSCOM	Concur
Sensitive Records Info Agency (SRIA) 7	Retain	Eliminate SSA, transfer to TMO (OCSA)

Functional Area Reviews (FARs)

Information Management FAR Issues, 12 Dec 95

- ◆ **Issue 1. Who should exercise executive level information management?**
 - **FAR Consensus:** *DISC4 oversees information technology for the Army but does not exercise "Chief Information Office" responsibilities.*
 - **Working Group Analysis:** *HQDA needs a single HQ integrator of information needs.*
 - **Recommendation:** **Requires follow-on study effort.**
- ◆ **Issue 2. How should HQDA leverage information technology?**
 - **FAR Consensus:** *Unorchestrated individual fixes have predominated. HQDA's Information Management Advisory Council is increasingly performing de facto functions.*
 - **Working Group Analysis:** *Acquisition and resourcing processes for information technology require central direction.*
 - **Recommendation:** **Requires follow-on study effort.**
- ◆ **Issue 3. Consolidating HQ Information Systems Support.**
 - **FAR Consensus:** *The SOMA study suggests that RDAISA and PERSINSCOM be realigned with HQDA. If transferred to HQDA they should be further aligned with the organizations they support.*
 - **Working Group Analysis:** *Concur.*
 - **Recommendation:** **If realigned, consolidate RDAISA and PMs with AAESA and PERSINSCOM with PERSCOM. Examine opportunities for contracting out hardware functions.**

Acquisition & Logistics Management FAR - Option Summary

Baseline	FAR Consensus	Working Group Recommendation
ASA(RD&A) 153	No change	Concur
SADBU 9	Not considered	Rightsize, eliminate 2 spaces
DCSLOG 237	No change	Receive 13 from SLA
Army Acquisition Executive Support Agency 3194	No change	Rightsize 20% (-639)
Logistics Evaluation Agency (LEA) 148	Retain as Logistics Integration Agency (LIA)	Eliminate FOA (-133); transfer 15 to CAA
Strategic Logistics Agency (SLA) 13	Retain as Logistics Integration Agency (LIA)	Eliminate SSA, transfer 13 to DCSLOG
Test & Evaluation Mgt Agency (TEMA) 9	No change	Eliminate SSA, transfer 9 to ODCSOPS
Operational Test & Evaluation Command 1445	Rightsize (-145), study T&E consolidation	Concur
Info Systems Selection & Acquisition Agency 119	Transfer to AMC	Eliminate 24 (20% reduction) & transfer 95 to AMC
PMO-Reserve Component Automation System (RCAS) 62	Retain	Concur

Functional Area Reviews (FARs)

Acquisition & Logistics Management FAR Issues, 14 Dec 95

- ◆ **Issue 1. Consolidating ASA(RDA) & DISC4 Acquisition Functions.**
 - **FAR Consensus:** *DISC4 oversight of information technology PEOs does not appear duplicative of ASA(RDA) effort. Retain as is.*
 - **Working Analysis:** *Concur.*
 - **Recommendation:** *None.*
- ◆ **Issue 2. Consolidating/Realigning Logistics Management Oversight.**
 - **FAR Consensus:** *No staff overlap is apparent. Consolidation of DCSLOG and ASA(IL&E) offers few streamlining opportunities or space reductions.*
 - **Working Analysis:** *Concur.*
 - **Recommendation:** *Retain as is.*
- ◆ **Issue 3. Test and Evaluation Oversight.**
 - **FAR Consensus:** *Consolidation of operational and developmental T&E is logical.*
 - **Working Group Analysis:** *Concur*
 - **Recommendation:** *Right-size OPTEC. Examine consolidation options.*

Installations & Facilities Management FAR - Option Summary

Functional Area Reviews (FARs)

Baseline	FAR Consensus	Working Group Recommendation
ASA(CW) 20	No change	Concur
ASA(IL&E) 37	No change	Concur
ACSIM 85	Evolve to DCSBOS; receive AEO (+13)	Concur
Office, Chief of Engineers (Pentagon) 12	No change	Transfer to USACE without spaces
Installation Support Mgt Agency (ISMA) 95	Retain	Concur, also receive BRACO (+22)
Base Realignment & Closure Office (BRACO) 22	Retain	Merge with ISMA
Treaty Implementation Plan Agency (Panama Canal) (TIPA) 5	No change	Eliminate, transfer 5 spaces to DCSOPS
Army Environmental Center (AEC) 236	Rightsize (-80) & transfer DERA functions to USACE	Concur
Army Environmental Office (AEO) 13	Merge with ACSIM	Concur
Army Environmental Policy Institute (AEPI) 6	No change	Eliminate SSA & transfer functions to AEC
Community & Family Support Center (CFSC) 318	No change	Rightsize by eliminating 64 spaces

Functional Area Reviews (FARs)

Installation & Facilities FAR Issues, 19 Dec 95

- ◆ **Issue 1. Merger of ASA(Civil Works) and ASA(Installations, Logistics & Environment).**
 - **FAR Consensus:** *Retain separate ASA responsibilities. Merger of disparate functions would produce "span of control" difficulties.*
 - **Working Group Analysis:** *Concur. However, integrating command element of USACE into ASA(CW) provides an opportunity to integrate/streamline engineering functions.*
 - **Recommendation:** "Dual-hat" Cdr, USACE as Military Deputy, ASA(CW).
- ◆ **Issue 2. Merger of ASA(Installations, Logistics & Environment) and ACSIM.**
 - **FAR Consensus:** *There would be few, if any, functional or space efficiencies realized in a merger of these two agencies.*
 - **Working Group Analysis:** *Concur.*
 - **Recommendation:** None
- ◆ **Issue 3. Maturing OACSIM Under a DCSBOS Concept.**
 - **FAR Consensus:** *ACSIM should evolve into a DCSBOS structure. The Army Environmental Office (AEO) should be realigned into the ACSIM staff.*
 - **Working Group Analysis:** *Concur.*
 - **Recommendation:** Support the DCSBOS concept and rightsize related staff.

- ◆ **Issue 4. Streamlining of Army Environment Organizations.**
- **FAR Consensus:** *ASA(IL&E) and ACSIM should develop an efficient organization for environmental, safety and occupational health policy proponency. Retain AEPI. Divest AEC DERA functions. Eliminate AEO and transfer some spaces to the staff.*
- **Working Group Analysis:** *Concur with minor exceptions.*
- **Recommendation:** **Eliminate AEPI. Transfer AEC DERA functions to USACE.**

Financial Management FAR - Option Summary

Baseline	FAR Consensus	Working Group Recommendation
ASA(FM&C) 178	No change	Concur, also receive Pentagon element of FINCOM (17)
Cost and Economic Analysis Center (CEAC) 76	No change	Rightsize by eliminating 10 spaces
Finance Command (FINCOM) 45	No change	Merge Pentagon elements with ASA(FM&C) (17)
ARNG Financial Services Center 6	Merge with ARNG Readiness Center	Concur

Financial Management FAR Issues, 18 Jan 96

- ◆ **Issue 1. Efficiencies Needed in PPBES.**
 - **FAR Consensus:** *The PPBES process is sound. Efforts should continue to further improve and streamline the PPBES.*
 - **Working Group Analysis:** *Process lacks timely OSD direction and is excessively labor intensive.*
 - **Recommendation:** **Continue PPBES process improvements and streamlining. SA and CSA should forward improvements and streamlining suggestions to OSD.**
- ◆ **Issue 2. Establishment of an AVCSA/DCS for Resource Management.**
 - **FAR Consensus:** *SA and CSA will decide on the establishment of an AVCSA.*
 - **Working Group Analysis:** *Establishing an AVCSA would consolidate requirements and program development under one individual on the Army staff.*
 - **Recommendation:** **Establish an AVCSA for Requirements and Program Development.**
- ◆ **Issue 3. Organizational placement of the Program Analysis and Evaluation Directorate.**
 - **FAR Consensus:** *SA and CSA will make the decision concerning the organizational placement of PAED, in conjunction with the AVCSA decision.*
 - **Working Group Analysis:** *Placement of the PAED under the proposed AVCSA would facilitate consolidation of requirements and program development under one individual on the Army staff.*
 - **Recommendation:** **AVCSA should exercise direct management oversight of PAED.**

Leadership FAR - Option Summary

Baseline	FAR Consensus	Working Group Recommendation
OSA 17	Not considered	Rightsize (-2)
OUSofA 21	Stand up DUSA(IA), receive 3 from MISMA	Concur, also rightsize OUSofA (-2)
OCSA 138	Not considered	Rightsize (-14); receive SRIA (+7); transfer CAD (-7) to OCLL
Administrative Assistant to SA 53	No change	Concur
The Auditor General 1	No change	Concur
The Inspector General 6	No change	Concur
General Counsel 33	No change	Concur
The Judge Advocate General 71	No change	Concur
OCLL 46	No change	Receive CAD from OCSA (+7)
OCPA 33	No change	Concur
HQ Services-Wash 17	No change	Become a single BASOPS FOA (+1003)
Defense Supply Services-Wash (DSS-W) 287	No change	Merge into a single BASOPS FOA
Defense Telecom-munication Service-Wash (DTS-W) 177	No change	Merge into a single BASOPS FOA
Information Mgt Support Center (IMCEN) 139	No change	Merge into a single BASOPS FOA; transfer common support (41) to SAM
Personnel & Employment 92	No change	Transfer MILPO to MDW (-68) and CPO element to HQS-W (-24)

Leadership FAR Issues, 12 Jan 96

- ◆ **Issue 1. Consolidate The General Counsel and The Judge Advocate General.**
 - **FAR Consensus:** *Would reduce effectiveness of overall HQDA legal function by blurring policy/oversight role with delivery of legal services. Do not consolidate.*
 - **Working Group Analysis:** *Concur*
 - **Recommendation:** **Retain as is.**
- ◆ **Issue 2. Consolidate The Inspector General and The Auditor General.**
 - **FAR Consensus:** *Different missions require independent organizations. Self-direction of audit function key to credibility with OSD/GAO. Do not consolidate.*
 - **Working Group Analysis:** *Concur*
 - **Recommendation:** **Retain as is.**
- ◆ **Issue 3. Streamline HQDA BASOPS Functions under the AA.**
 - **FAR Consensus:** *No efficiencies gained by consolidating FOAs. Many executive agent responsibilities argue against divestment to MACOM level.*
 - **Working Group Analysis:** *Consolidation of related FOAs aligns to garrison BASOPS model and may result in space reductions.*
 - **Recommendation:** **FOAs performing Pentagon BASOPS function should be consolidated.**

Leadership FAR - Option Summary (continued)

Functional Area Reviews (FARs)

Baseline	FAR Consensus	Working Group Recommendation
Safety, Security & Support Services-Wash (S4-W) 271	No change	Merge into a single BASOPS FOA
Resource Services-Wash (RS-W) 109	No change	Merge into a single BASOPS FOA
Space & Building Mgt Services-Wash 20	No change	Merge into a single BASOPS FOA
General Officer Mess 17	No change	Merge with single BASOPS FOA
Army Audit Agency 710	No change	Eliminate all "Suggested Category" audits (-31)
Inspector General Agency 132	No change	Concur
Army Legal Services Agency 427	No change	Receive Army Claims Service
Army Claims Service 72	No change	Eliminate FOA; transfer 72 to Legal Services Agency
Nat'l Bd for Promotion of Rifle Practice (NBPRP) 0	Eliminate	Concur
Congressional Inquiry Division (CID) 41	No change	Concur
Command Information Unit (CIU) 71	Receive 7 from ABS	No change
Army Safety Center 139	No change	Rightsize (-22)

Functional Area Reviews (FARs)

- ◆ **Issue 4. Realign Army Safety Center Functions.**
- **FAR Consensus:** *There may be opportunities for transfer of selected training functions to TRADOC, but separate safety and collateral investigations are essential. Review results of Safe Force XXI reengineering study.*
- **Working Group Analysis:** *Army Safety Center provides essential support to the CSA in his role as "the Army Safety Officer."*
- **Recommendation:** **Retain and rightsize based on reengineering study**

Human Resource Management FAR - Option Summary

Baseline	FAR Consensus	Working Group Recommendation
ASA(M&RA) 121	Study	Concur
DCSPER 160	Study	Concur
The Surgeon General 96	Not considered	No change
Chief of Chaplains 28	No change	Concur; receive 11 from Chaplaincy Services Support Agency
DA Military Review Boards Agency 123	No change	Concur
PERSCOM 1843	Study as a restructured Personnel Command; receive MPESA (+33)	Concur; also receive 2 from Chaplaincy Services Support Agency
Civilian Training Ed Dev Student Det (ACTED) 1140	Study consolidation of CTED account w/ TTHS under PERSCOM	Transfer instructor elements to TRADOC (-65)

Human Resource Management FAR - Option Summary (continued)

Baseline	FAR Consensus	Working Group Recommendation
Center of Military History (CMH) 150	Study transfer to AWC	Eliminate FOA and 70 spaces; transfer 80 to AWC; consider increased support
US Military Academy (USMA) 3094	Study consolidation with Cadet Cmd (TRADOC); develop issue for SA/CSA Decision	Concur
Army War College (AWC) 537	Transfer to TRADOC	Concur, also rightsize by eliminating LAM spaces (-49); and receive 80 from CMH
Army Management Staff College (AMSC) 52	Transfer to TRADOC	Concur
The Judge Advocate General's School 93	Study transfer to TRADOC	Transfer to TRADOC
NG Professional Education Center (PEC) 7	Eliminate	Transfer to TRADOC
ARPERCEN 1200	Study consolidation with PERSCOM	Concur
USAREC 9174	Expand mission & study transfer to TRADOC	Transfer to TRADOC
MEPCOM 2113	Transfer to TRADOC	Concur
USA Civilian Personnel Field Agency 966	Study consolidation with PERSCOM	Concur
Army Research Inst for Behavioral Sciences (ARI) 265	Study transfer of elements to TRADOC & PERSCOM	Eliminate FOA (-265), contract required services
Chaplaincy Services Support Agency 13	No change	Eliminate FOA; transfer 11 spaces to CCH; transfer 2 to PERSCOM
Directed Military Overhire Det 500	Study right-sizing by documenting semi-perm positions	Rightsize (-150)

Human Resources Management FAR Issues, 23 Jan 96

- ◆ **Issue 1. Integration of OASA(M&RA) and ODCSPER.**
 - **FAR Consensus:** *The future of these agencies is still under study. A decision will be made at a later date by the Senior Leadership.*
 - **Working Group Analysis:** *Recent initiatives have reduced duplication/redundancy/overlap. Integration may not produce significant space reductions.*
 - **Recommendation:** **Retain as is.**
- ◆ **Issue 2. Consolidation of Personnel Management functions.**
 - **FAR Consensus:** *None*
 - **Working Group Analysis:** *Consolidation of personnel management functions of special branches (Chaplain, JAGC) offers potential for improved integration of officer management.*
 - **Recommendation:** **Study consolidation of Chaplain and TJAG branch proponenty at PERSCOM.**
- ◆ **Issue 3. Consolidation of Schools under TRADOC.**
 - **FAR Consensus:** *TRADOC, the "force developer MACOM," should exercise oversight over all Army schools.*
 - **Working Group Analysis:** *Concur.*
 - **Recommendation:** **As a general proposition, transfer proponenty for all Army schools to TRADOC.**

THIS PAGE INTENTIONALLY LEFT BLANK

Section 8: Recommendations

- A. HQ Staff
- B. Staff Support Agencies (SSAs)
- C. Field Operating Agencies (FOAs)
- D. Summary

Figures:

HQ and its
SSAs/FOAs
SA, USofA, &
SADBU
ASA(M&RA)
ASA(FM&C)
OCLL
OCPA
ASA(RDA)
DISC4
ASA(IL&E)
ASA(CW)
OAA
OGC
AUD GEN
OTIG

OTSG
OCCH
ODCSINT
ODCSOPS
OCE
OACSIM
ODCSLOG
OTJAG
NGB
OCAR
Transfers
HQDA Recommendation
Recommendation Summary

CSA, VCSA, DAS
ODCSPER

Section 8: Recommendations for HQDA Redesign

"It is clear that HQDA needs to be smaller and more focused on its core processes to improve management functions, gain efficiencies and achieve real resource cost savings " ...General Griffith, VCSA

A. The HQ Staff

The Working Group's initial assessment is that the current bimodal staff framework, i.e., a Secretariat and Army staff, is sound. The Group considered the consolidation of Secretariat and ARSTAF offices in a number of common functional areas, including personnel, engineering, environment and legal affairs. In general the analysts found few reduction opportunities or streamlining efficiencies to support merger. With regard to the HQ Staff, the Working Group proposes:

- To eliminate non-essential functions or "shadow staffs."
- To realign key policy functions from SSAs and FOAs.
- To consolidate like staff functions and responsibilities by standing up two new offices: the Deputy Under Secretary for International Activities and the Assistant Vice Chief of Staff for Programs and Requirements.

In the Working Group's analysis of across-the-board staff cuts, the Group concludes that reducing the HQ by 20% risks essential core functions and any greater reduction i.e., 30%, is not feasible at this time. The Group recommends a modest 10% reduction to HQ Staff offices and encourages staff principals to identify additional staff reduction goals.

The Working Group's recommendations result in an overall 6% reduction to the size of the HQ Staff.

Recommendations

B. Staff Support Agencies (SSAs)

The Working Group recommends eliminating or merging 8 of the 13 SSAs by:

- Realigning key policy functions to the HQ Staff.
- Transferring operational functions to MACOMs.
- Consolidating analysis functions with the Concepts Analysis Agency which becomes the *Center for Army Analysis*.

The Group also recommends downsizing 3 of the remaining 4 SSAs by at least 10% and reducing the Army Acquisition Executive Support Agency by 20% in keeping with the reduced modernization budget and streamlining from acquisition reform initiatives. These recommendations result in an overall 21% reduction in SSA spaces.

C. Field Operating Agencies (FOAs)

The Working Group recommends eliminating or merging 15 FOAs and transferring 13; decreasing the number of HQDA FOAs down from 58 to 30. The Group proposes:

- Transferring or otherwise divesting by contract, the HQDA training FOAs (e.g., Army War College, Army Management Staff College) to TRADOC.
- Consolidating base support functions beginning with the merger of Personnel & Employment Services-Washington (P&ES-W) and Space & Building Management-Washington (S&BMS-W) with Headquarters Services-Washington (HQS-V-W).
- The Group recommends moving environmental policy functions into the ACSIM's office and realigning all environmental policy execution with the Army Environmental Center.

The Group also recommends downsizing the remaining 30 FOAs by at least 10%. The result is 54% reduction in infrastructure.

Recommendations

D. Summary

The Working Group's recommendations are consistent with National Performance Review precepts and the goals of the Institutional Army Campaign Plan. The Group's recommendations:

- Divest non-core functions.
- Remove layers and duplication.
- Empower commanders.
- Focus the HQ staff on policy making rather than policy execution.

The following chart depicts the FY98 baseline HQ Staff with SSAs and FOAs. Page 8-6 through 8-29 present recommendation summaries for each staff element and agency. A summary of recommendations is included on pages 8-32 and 8-33. A listing of staff elements and agencies by full name and short titles is at Appendix D.

SA, USofA & SADBUs

Before

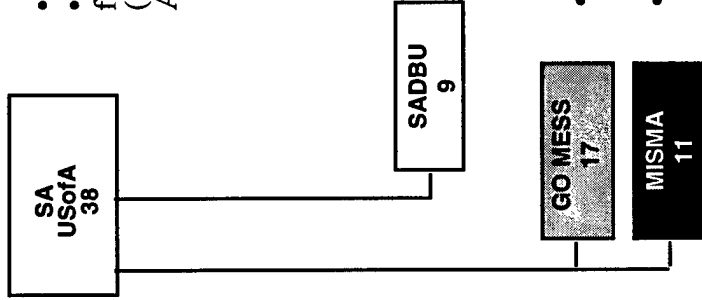

- Downsize by 4; receive 3 from MISMA
- Stand-up DUSA(IA) by transfer of functions and spaces from Secretariat and ARSTAF: ASA(RDA) 6, DCSINT (17), DCSOPS(14), DCSOPS Spt Gp (14),DCSLOG(24), AMC (2), downsize (6)

• Downsize by 2

- Eliminate, downsize by 2, transfer 15 to HQSV-W
- Eliminate, transfer 8 to DCSOPS and 3 to DUSA(OR)

Total 75

Spaces Eliminated: 14
Spaces Divested: 0

After

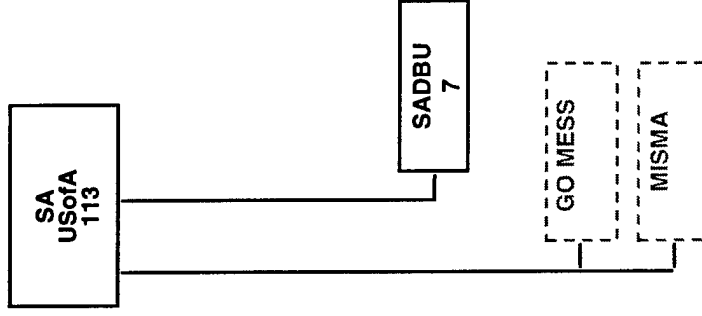

Total 120

ASA(M&RA)

Before

ASA(M&RA)
121



- Downsize by 12
- Transfer instructors to TRADOC (65), downsize by 107
- Downsize by 200, merge into PERSCOM (300)
- Downsize by 18
- Transfer to TRADOC
- Consolidate w/PERSCOM after final regionalization

Total 3,902

After

ASA(M&RA)
109

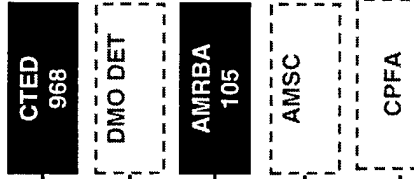

Total 1,182

Spaces Eliminated: 337
Spaces Divested: 117

ASA(FM&C)

Before

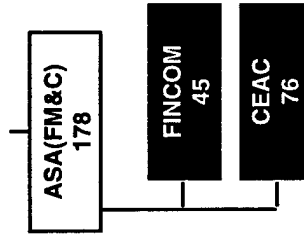

Total 299

- Receive Pentagon element of FINCOM (+17), downsize by 19
- Realign Pentagon element to ASA(FM&C)(-17), downsize by 3
- Downsize by 10

After

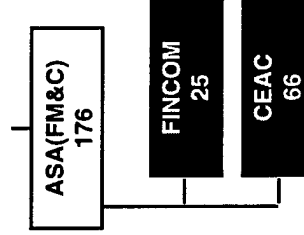

Total 267

Spaces Eliminated: 32
Spaces Divested: 0

OCLL

Before

OCLL
46

CID
41

Total 87

• Receive CAD (7) from OCSA, Downsize by 5

• Downsize by 4

After

OCLL
48

CID
37

Total 85

Spaces Eliminated: 9
Spaces Divested: 0

OCPA

Before

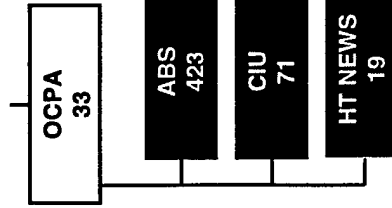

Total 546

- Downsize by 3
- Downsize by 92, pursue transfer (331) to AFIS
- Downsize by 7
- Eliminate FOA (19), OCPA continues policy oversight

Before

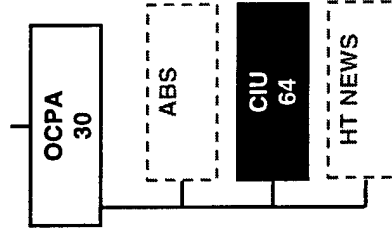

Total 94

Spaces Eliminated: 121
Spaces Divested: 331

ASA(RDA)

Before

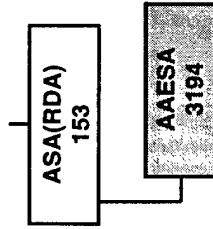

- Transfer 6 to DUSA(IA), downsize by 15
- Downsize by 639

Total 3,347

After

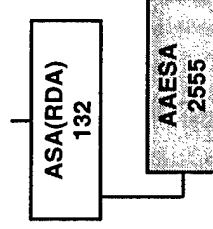

Total 2,687

Spaces Eliminated: **654**
Spaces Divested: **0**

DISC4

Before

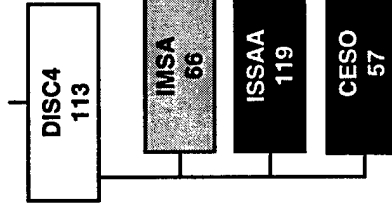

- Downsize by 11
- Downsize by 7
- Downsize by 24 & transfer 95 to AMC
- Downsize by 6

Total 355

After

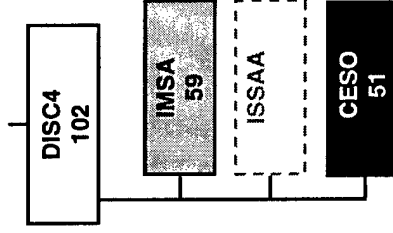

Total 212

Spaces Eliminated: 48
Spaces Divested: 95

ASA(IL&E)

Before

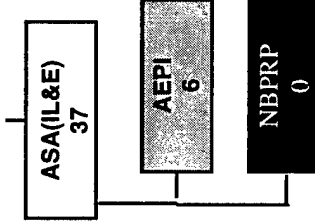

- Downsize by 4
- Eliminate SSA
- No change

Total 43

Before

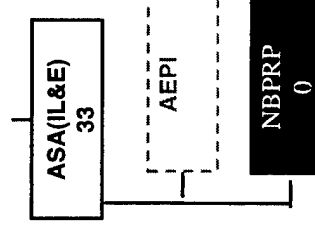

Total 33

Spaces Eliminated: 10
Spaces Divested: 0

ASA(CW)

Before

ASA(CW)
20

• Downsize by 2

Total 20

After

ASA(CW)
18

Total 18

Spaces Eliminated: 2
Spaces Divested: 0

AA

Before

OAA
53



- Downsize by 5

- Receive P&ES-W (85), S&BMS-W (20) & GO MESS (15) downsize by 3

- Downsize by 30

- Downsize by 26

- Downsize by 13, transfer general spt (14) to SAM

- Downsize by 12

- Downsize by 3, merge into PERSCOM

- Downsize MILPO by 7 & merge 85 into HQSV-W

- Downsize by 18

- Merge into HQSV-W

Total 1,198

Spaces Eliminated: 117
Spaces Divested: 14

After

OAA
48

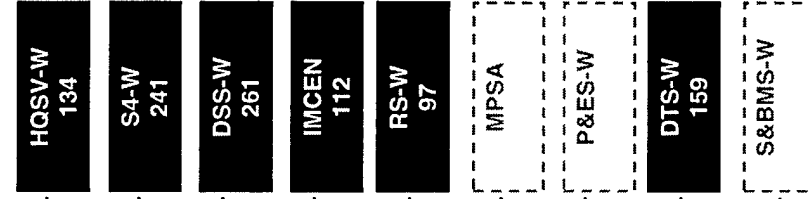

Total 1,052

OGC

Before

OGC
33

• Downsize by 3

Total 33

After

OGC
30

Total 30

Spaces Eliminated: 3
Spaces Divested: 0

AUD GEN

Before

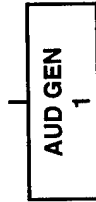

• No change

• Downsize by 107 (includes 58 programmed reduction)

Total 711

After

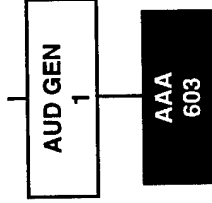

Total 604

Spaces Eliminated: 107
Spaces Divested: 0

OTIG

Before

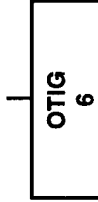

• Downsize by 1



• Downsize by 13

Total 138

After

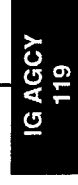
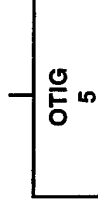

Total 124

Spaces Eliminated: 14
Spaces Divested: 0

OCSA

Before

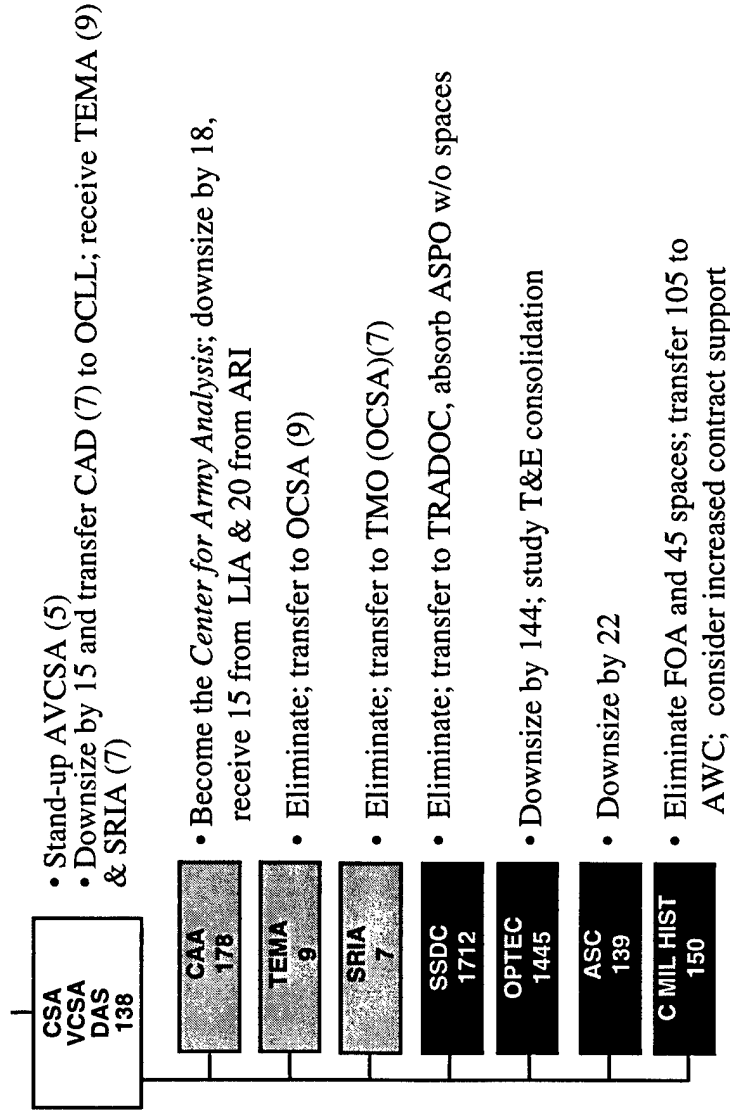

Total: 3,778

Spaces Eliminated: 244
Spaces Divested: 1712

After

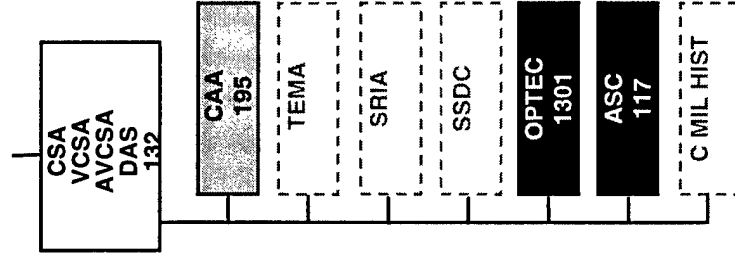

Total: 1,745

ODCSPER

Before

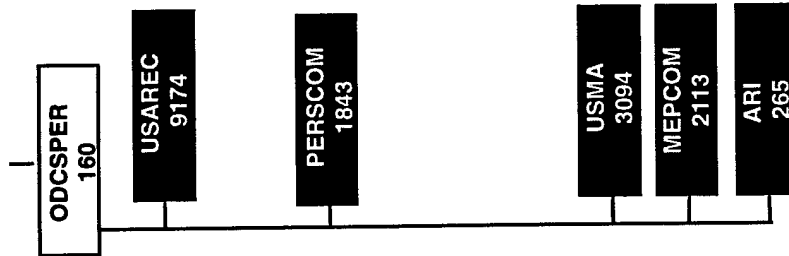

- Downsize by 16
- Transfer to TRADOC
- Downsize by 381 (5 from ACES Program); study as a restructured Personnel Cmd
- Receive: 2298 total
 - 30 from MPSCA
 - 2 from Chap Svcs Spt Agcy
 - 300 from DMO Det
 - 1966 from CPFA
- Downsize by 31, study expanded role of USMA in officer accessions
- Transfer to TRADOC
- Eliminate 245, transfer 20 to CAA

Total: 16,649

Spaces Eliminated: 673
Spaces Divested: 11,287

After

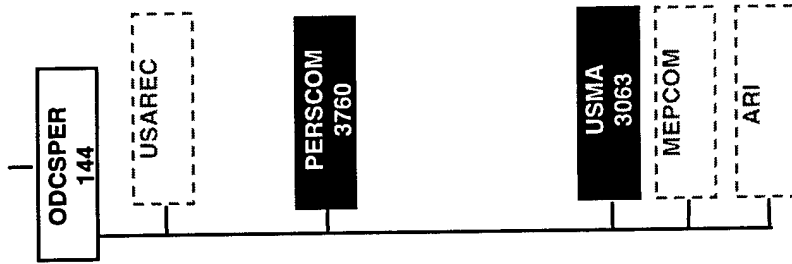

Total: 6,967

OTSG

Before

OTSG
96

- Downsize by 10

Total: 96

After

OTSG
86

Total: 86

Spaces Eliminated: 10
Spaces Divested: 0

OCCH

Before

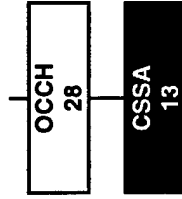

- Receive 11 from Chaplaincy Svcs Spt Agcy, Downsize by 4
- Eliminate; transfer 11 to OCCH; 2 to PERSCOM

Total: 41

After

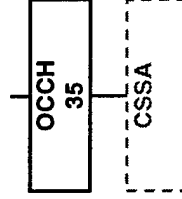

Total: 35

Spaces Eliminated: 4
Spaces Divested: 0

ODCSINT

Before

ODCSINT
149

INT SSA
91

- Downsize by 15, transfer 12 to DCSOPS, 17 to DUSA(IA)
- Transfer FID (18) to INSCOM, downsize by 7

Total: 240

After

ODCSINT
105

INT SSA
66

Total: 171

Spaces Eliminated: 22
Spaces Divested: 18

Before

ODCSOPS
426

CCSA 69
MIL POL A 16
TIPA 5
AWC 537
USAFISA 429
SPACE PO 43
AERO SVCS 42
NUC/CHEM A 41
SP OPS A 28
INTERAMER DEF BD 17
OPS SPT A 28
MEX/AMER DEF CMTE 1

• Downsize by 45, transfer 14 to DUSA(IA), Receive: 8 from MISMA, 11 from MP Agcy, 12 from DCSINT, and 14 from Ops Spt Agcy

- Downsize by 21 through increased contracting
- Downsize by 5, merge cell into DCSOPS (11)
- Eliminate; transfer 5 & function to DUSA(IA)
- Downsize by 49 -- eliminating LAM spaces; receive 105 from CMH & transfer 593 to TRADOC
- Downsize by 142
- Eliminate(43); transfer to SSDC w/o spaces
- Transfer to TRADOC
- Downsize by 10, transfer 31 to TRADOC
- Downsize by 14, transfer 14 to USASOC
- Gain sponsor approval to eliminate FOA, transfer functions & spaces to MACOM
- Eliminate, merge policy functions into DCSOPS (14), transfer to DUSA(IA) 14
- Gain sponsor approval to eliminate FOA, transfer functions & spaces to MACOM

Total: 1,682

Spaces Eliminated: 329
Spaces Divested: 698

After

ODCSOPS
412

CCSA 48
MIL POL A
TIPA
AWC
USAFISA 287
SPACE PO
AERO SVCS
NUC/CHEM A
SP OPS A
INTERAMER DEF BD
OPS SPT A
MEX/AMER DEF CMTE

Total: 747

OCE

Before

OCE 12

- Transfer 11 to USACE

Total: 12

After

OCE 1

Total: 1

Spaces Eliminated: 0
Spaces Divested: 11

OACSIM

Before

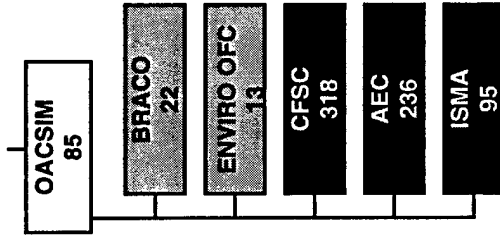

- Receive functions from Army Environmental Office w/o spaces
- Merge with ISMA
- Eliminate and transfer function to ACSIM w/o spaces
- Downsize by 70
- Downsize by 57 and transfer DERA functions to USACE w/o spaces
- Downsize by 30, receive BRACO (22)

After

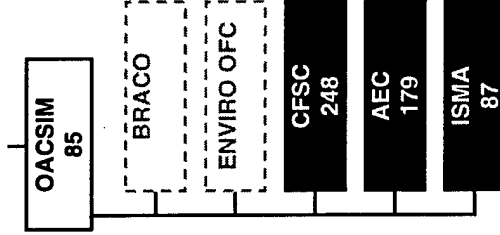

Spaces Eliminated: 170
 Spaces Divested: 0

ODCSLOG

Before

ODCSLOG
237

LIA
161

After

ODCSLOG
192

LIA

- Downsize by 21, transfer 24 to DUSA(IA)
- Downsize by 44, transfer 15 to CAA & 102 to AMC

Total: 398

Total: 192

Spaces Eliminated: 65
Spaces Divested: 102

OTJAG

Before

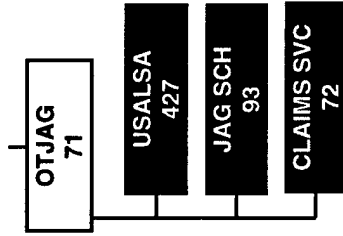

Total: 663

After

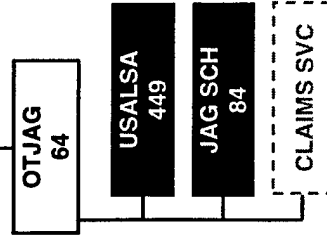

Total: 597

- Downsize by 7
- Downsize by 50, receive Army Claims Service (72),
- Downsize by 9, study transfer to TRADOC
- Eliminate; merge 72 into USALSA

Spaces Eliminated: **66**
Spaces Divested: **0**

NGB

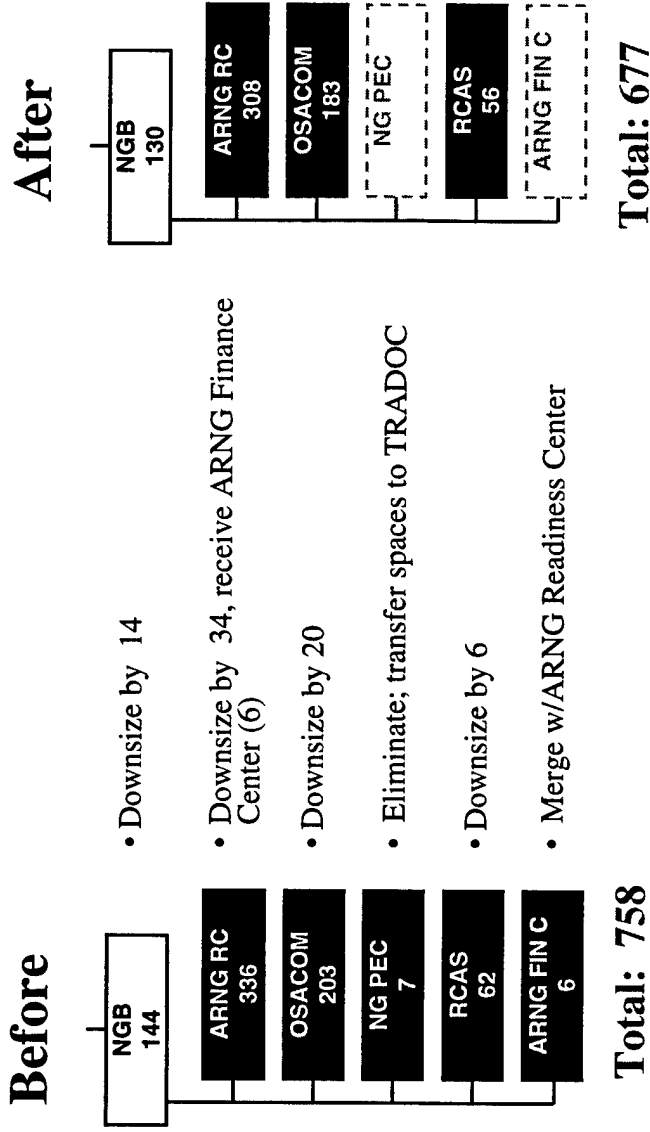

Spaces Eliminated: 74
Spaces Divested: 7

OCAR

Before

OCAR 70

- Downsize by 7

ARPERCEN 1200

- Downsize by 120, study consolidation with PERSCOM

Total: 1,270

After

OCAR 63

ARPERCEN 1080

Total: 1,143

Spaces Eliminated: 127
Spaces Divested: 0

Transfers

12 FOAs/ 14,392 spaces

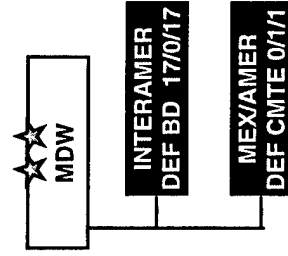
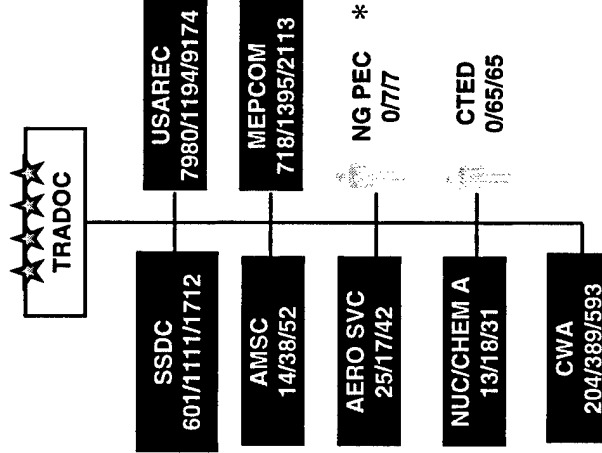
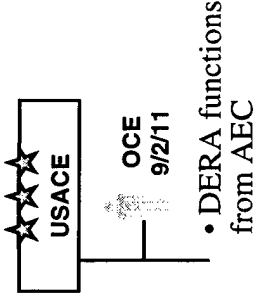
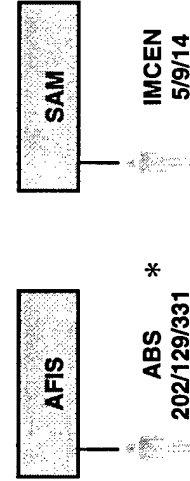
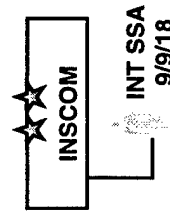
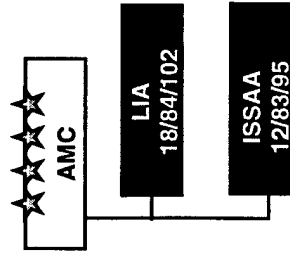

44
0039

* 2 FOAs ELIMINATED BY TRANSFER OF SPACES

SPACES

Summary

FY98 Base

HQ Staff
2,457

SSAs
3,693

FOAs
30,960

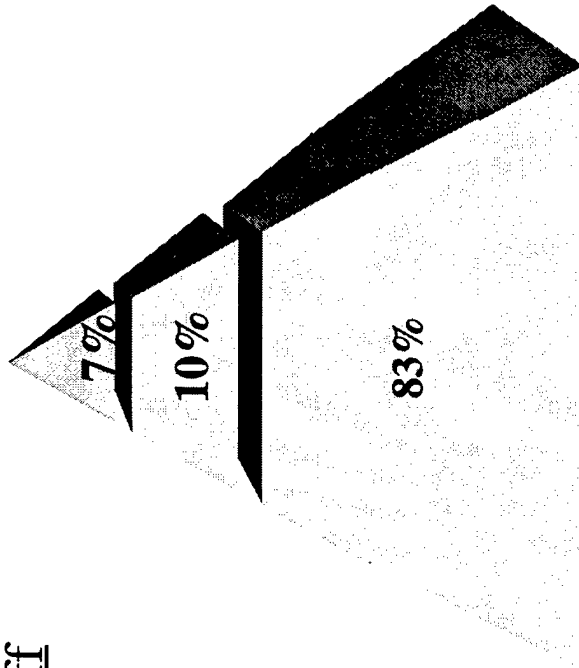

Total HQDA 37,110

Revised FY98 Base

HQ Staff
2,301

SSAs
2,923

FOAs
14,244

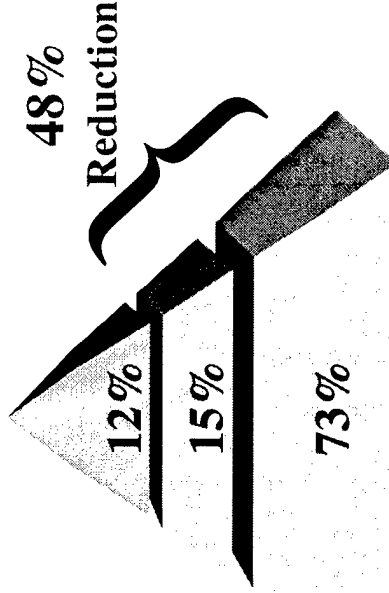

Total HQDA 19,468

HQDA Reduction (net): 17,642
 Transfer to MACOM: 14,392
 Receive from MACOM: 2
 Space Elimination: 3,252
 SSA Reduction: 13 to 5
 FOA Reduction: 58 to 30

Recommendations

THIS PAGE INTENTIONALLY LEFT BLANK

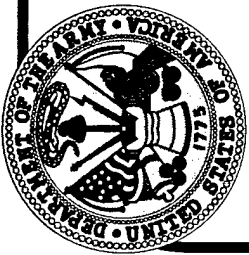

HQDA Redesign Update

March 13, 1996

Recommendations

Section 9 Areas for Additional Study

- A. High Performance Organizations**
- B. Follow on Studies**
- C. New Studies**

Figure:

Areas for Additional Study

Areas for Additional Study

- ◆ Additional Transfers of Operational Functions to MACOMs
- ◆ Advancing HQDA Executive Information Management
- ◆ Integrating Management of Technology Initiatives
- ◆ Consolidation of Operational and Developmental Test & Evaluation
- ◆ PPBES Improvement and Streamlining
- ◆ Expanded look to include MACOM Headquarters and Staff
- ◆ Consolidating and Streamlining Pentagon BASOPS
- ◆ Examine how AGR personnel are distributed and utilized at HQDA

Figure 9-1

Section 9: Areas for Additional Study

A. High Performance Organizations

There is no single yardstick for defining or measuring a high performing headquarters staff. However, organizations which are recognized as "high performance", "world class", or "industry benchmarks" share many common characteristics, regardless of mission or orientation. These characteristics include:

- ◆ Compartmentalization and over specialization are discouraged.
- ◆ Cross functional mechanisms abound; hierarchical (top-down) reporting and decision relationships are de-emphasized.
- ◆ Staff elements are mission, output, or customer oriented rather than skill or discipline oriented
- ◆ Expert or "special" staffs are integrated into line functions.
- ◆ Managers are team leaders whose primary responsibility are as coaches and problem solvers rather than as controllers and directors
- ◆ Attributes of the organization itself are viewed as a primary vehicle for achieving competitive advantage

At first look many, if not all, of these characteristics may appear to be contradictory to the environment of rank, command, and managerial control that is integral to HQDA. However, the adoption of these characteristics by high performance staffs does not mean that the organization abdicates internal methods of control, accountability, or discipline. It does mean that high performing organizations develop new leadership, management, communication, problem solving, and recognition/promotion mechanisms that reward innovative ways of reaching goals and achieving success. This notion is not solely theoretical. Indeed,

Areas for Additional Study

an examination of many of today's high performance staffs indicate that previous to their transitions to process-oriented, flatter organizational designs, they were patterned after more rigid, bureaucratic reporting and decision making models.

How HQDA changes over the next few years to meet the evolving challenges of the next century, depends not only upon the will of its leaders, but also on a myriad of factors beyond their control. Waivers of existing regulations and instructions, resource constraints, legislature changes, the growing importance of the joint requirements process and other changes in the DoD community, will have an impact on how HQDA changes.

What is more certain is the Army's commitment to Reinventing Government precepts, to the implementation of changes which will maximize resources, and to a process of continuous improvement. Future HQDA redesign studies will help meet these commitments.

B. Follow on Studies

Future HQDA redesign studies should build upon the conceptual model, staff assessments and recommendations presented herein. Issues and recommendations developed during Phase I that require continuing work include:

- ◆ ODCSPER and OASA(M&RA) consolidation.
- ◆ Review of ODCSOPS restructure.
- ◆ Review AVCSA operation to make necessary adjustments.
- ◆ Review DUSA(LA) structure to make necessary adjustments.
- ◆ Review DUSA(OR) effort to consolidate analytical support within CAA.
- ◆ Review SARDA plan on downsizing AAESA.

Areas for Additional Study

- ◆ Review of NGB restructure initiatives

C. New Studies

Other potential HQDA effectiveness areas that warrant examination consideration are:

- ◆ **ORGANIZATIONAL STRUCTURE.** Identify organizational structure factors or principles, including:
 - Interrelationships among Political, Military, and Career Civilian Staff elements. Identity lines of responsibility for HQDA's organizational hierarchy. For example: The Offices of Political Appointees should be responsible for establishing policy and helping assess how well the Army meets its stated long-term goals and yearly objectives. Whereas, the Army Staff would provide implementing direction and support the CSA in his unique JCS responsibilities. HQDA essential functions, such as financial management and information management, should operate in a business-like manner. These functional areas would integrate corporate objectives, rather than implement "stove-piped" functional areas of responsibility.
 - Focus of HQDA agencies. HQDA's focus should be on cross-functional integration. The current uni-functional focus of a number of HQDA agencies results in competition. For one to win, another must lose. A more effective model is one in which, broad joint-based requirements are integrated across all functional lines of responsibility. Using a process approach enables functional contributions to be complementary.
 - HQDA as a horizontal organization. Layer reduction and empowerment offer opportunities for organizational improvement. However, the inherent hierarchical design of a military organization and the entwined command and control channels encourages layering and frequently discourages empowerment. Directorates, divisions, branches, and teams are organizational layers. Deputies can also add layers to this decision-making structure. In general, HQDA's corporate business functions should not be organized in layered military fashion. An office setting policy and broad direction

should not develop specific procedures for policy execution. Rather, accountability and internal assessment should replace external control functions.

- Alignment of accountability and customer/supplier interface. Accountability requires defined areas of process responsibility. Identifying key business processes and data flows helps define the business structure and identifies internal process performance measures. A model of the ideal HQDA processes would also show how to identify and best serve external customers and suppliers. The model postulated in this report represents a first step at portraying such a model.

◆ **MANAGING INFORMATION.** Identify ways for advancing HQDA executive information management and use information and process management to better manage the Department of the Army. Opportunities include:

- Integration of information needs across all functions. The Army needs a proponent to ensure identification of decision-making information needs and to integrate collective information sources throughout Army. Ensuring shared and available information will pay dividends in efficiency and effectiveness throughout the Institutional Army and Army supported operations. An integration methodology should include: redundancy reduction; increased consistency of information; and personnel savings due to a decreased need for gathering and displaying disparate data.
- Technology application. A futuristic and analytical review of Army processes is needed. This review should ensure greater application and integration of technology into revised functional processes and refinement of informational decision-making needs.

◆ **OBTAINING RESOURCES.** Make the PPBES more efficient and effective. Opportunities include:

- Better integration of the planning and programming phases of the PPBES. A once-per-cycle prioritization and resource allocation of a single set of joint-based requirements (with all associated resources spanning all functional areas) can save resources by streamlining the PPBES process.
- Shorten the resourcing cycle. The resourcing cycle (PPBS process) is longer than the life-cycle of the improved and emerging technology. This lengthened life-cycle unnecessarily results in antiquated

Areas for Additional Study

technology. Short technology life-cycles dictate short resourcing cycles and greater reprogramming flexibility.

◆ OTHER AREAS.

- Transfer the operational aspects of mobilization to FORSCOM.
 - Consolidate operational and developmental testing and evaluation.
 - Look beyond HQDA at MACOM Headquarters and staff for linkages, overlaps, and common areas for improvement.
 - Consolidate and streamline the Pentagon BASOPS functions and infrastructure.
 - Examine how Active, Guard, and Reserve (AGR) personnel are distributed and utilized at HQDA.
- ◆ **CULTURE CHANGE.** Top-down directed culture changes and paradigm shifts, are the first steps toward improving efficiency and effectiveness of an organization. The following are examples of altered perceptions or support processes that enable or promote analysis and change of management processes.
- Empowerment and Stewardship. Empowerment and stewardship are key enablers of efficiency and effectiveness. Earnest pursuit of them will result in an improved HQDA. The Army should craft a planned and phased implementation plan for them to take root.
 - Management and support systems. Current reward systems can interfere with efficiency and effectiveness improvements. Bureaucracy must encourage appropriate risk, overall good of the government, and conservation of limited resources. A clear focus on appropriate business goals and a discrete delineation of lines of responsibility among staff elements is mandatory (accountability and performance measures). Grades/rank and performance appraisals should be untied from organizational structure and tied to process ownership.

THIS PAGE INTENTIONALLY LEFT BLANK

Section 9 Areas for Additional Study

- A. High Performance Organizations**
- B. Follow on Studies**
- C. New Studies**

Figure:

Areas for Additional Study



Areas for Additional Study

- ◆ Additional Transfers of Operational Functions to MACOMs
- ◆ Advancing HQDA Executive Information Management
- ◆ Integrating Management of Technology Initiatives
- ◆ Consolidation of Operational and Developmental Test & Evaluation
- ◆ PPBES Improvement and Streamlining
- ◆ Expanded look to include MACOM Headquarters and Staff
- ◆ Consolidating and Streamlining Pentagon BASOPS
- ◆ Examine how AGR personnel are distributed and utilized at HQDA

Figure 9-1

Section 9: Areas for Additional Study

A. High Performance Organizations

There is no single yardstick for defining or measuring a high performing headquarters staff. However, organizations which are recognized as "high performance", "world class", or "industry benchmarks" share many common characteristics, regardless of mission or orientation. These characteristics include:

- ◆ Compartmentalization and over specialization are discouraged.
- ◆ Cross functional mechanisms abound; hierarchical (top-down) reporting and decision relationships are de-emphasized.
- ◆ Staff elements are mission, output, or customer oriented rather than skill or discipline oriented
- ◆ Expert or "special" staffs are integrated into line functions.
- ◆ Managers are team leaders whose primary responsibility are as coaches and problem solvers rather than as controllers and directors
- ◆ Attributes of the organization itself are viewed as a primary vehicle for achieving competitive advantage

At first look many, if not all, of these characteristics may appear to be contradictory to the environment of rank, command, and managerial control that is integral to HQDA. However, the adoption of these characteristics by high performance staffs does not mean that the organization abdicates internal methods of control, accountability, or discipline. It does mean that high performing organizations develop new leadership, management, communication, problem solving, and recognition/promotion mechanisms that reward innovative ways of reaching goals and achieving success. This notion is not solely theoretical. Indeed,

Areas for Additional Study

an examination of many of today's high performance staffs indicate that previous to their transitions to process-oriented, flatter organizational designs, they were patterned after more rigid, bureaucratic reporting and decision making models.

How HQDA changes over the next few years to meet the evolving challenges of the next century, depends not only upon the will of its leaders, but also on a myriad of factors beyond their control. Waivers of existing regulations and instructions, resource constraints, legislature changes, the growing importance of the joint requirements process and other changes in the DoD community, will have an impact on how HQDA changes.

What is more certain is the Army's commitment to Reinventing Government precepts, to the implementation of changes which will maximize resources, and to a process of continuous improvement. Future HQDA redesign studies will help meet these commitments.

B. Follow on Studies

Future HQDA redesign studies should build upon the conceptual model, staff assessments and recommendations presented herein. Issues and recommendations developed during Phase I that require continuing work include:

- ◆ ODCSPER and OASA(M&RA) consolidation.
- ◆ Review of ODCSOPS restructure.
- ◆ Review AVCSA operation to make necessary adjustments.
- ◆ Review DUSA(IA) structure to make necessary adjustments.
- ◆ Review DUSA(OR) effort to consolidate analytical support within CAA.
- ◆ Review SARDA plan on downsizing AEESA.

Areas for Additional Study

- ◆ Review of NGB restructure initiatives

C. New Studies

Other potential HQDA effectiveness areas that warrant examination consideration are:

- ◆ **ORGANIZATIONAL STRUCTURE.** Identify organizational structure factors or principles, including:
 - Interrelationships among Political, Military, and Career Civilian Staff elements. Identity lines of responsibility for HQDA's organizational hierarchy. For example: The Offices of Political Appointees should be responsible for establishing policy and helping assess how well the Army meets its stated long-term goals and yearly objectives. Whereas, the Army Staff would provide implementing direction and support the CSA in his unique JCS responsibilities. HQDA essential functions, such as financial management and information management, should operate in a business-like manner. These functional areas would integrate corporate objectives, rather than implement "stove-piped" functional areas of responsibility.
 - Focus of HQDA agencies. HQDA's focus should be on cross-functional integration. The current uni-functional focus of a number of HQDA agencies results in competition. For one to win, another must lose. A more effective model is one in which, broad joint-based requirements are integrated across all functional lines of responsibility. Using a process approach enables functional contributions to be complementary.
 - HQDA as a horizontal organization. Layer reduction and empowerment offer opportunities for organizational improvement. However, the inherent hierarchical design of a military organization and the entwined command and control channels encourages layering and frequently discourages empowerment. Directorates, divisions, branches, and teams are organizational layers. Deputies can also add layers to this decision-making structure. In general, HQDA's corporate business functions should not be organized in layered military fashion. An office setting policy and broad direction

should not develop specific procedures for policy execution. Rather, accountability and internal assessment should replace external control functions.

- Alignment of accountability and customer/supplier interface. Accountability requires defined areas of process responsibility. Identifying key business processes and data flows helps define the business structure and identifies internal process performance measures. A model of the ideal HQDA processes would also show how to identify and best serve external customers and suppliers. The model postulated in this report represents a first step at portraying such a model.

◆ **MANAGING INFORMATION.** Identify ways for advancing HQDA executive information management and use information and process management to better manage the Department of the Army. Opportunities include:

- Integration of information needs across all functions. The Army needs a proponent to ensure identification of decision-making information needs and to integrate collective information sources throughout Army. Ensuring shared and available information will pay dividends in efficiency and effectiveness throughout the Institutional Army and Army supported operations. An integration methodology should include: redundancy reduction; increased consistency of information; and personnel savings due to a decreased need for gathering and displaying disparate data.
- Technology application. A futuristic and analytical review of Army processes is needed. This review should ensure greater application and integration of technology into revised functional processes and refinement of informational decision-making needs.

◆ **OBTAINING RESOURCES.** Make the PPBES more efficient and effective. Opportunities include:

- Better integration of the planning and programming phases of the PPBES. A once-per-cycle prioritization and resource allocation of a single set of joint-based requirements (with all associated resources spanning all functional areas) can save resources by streamlining the PPBES process.
- Shorten the resourcing cycle. The resourcing cycle (PPBS process) is longer than the life-cycle of the improved and emerging technology. This lengthened life-cycle unnecessarily results in antiquated

Areas for Additional Study

technology. Short technology life-cycles dictate short resourcing cycles and greater reprogramming flexibility.

◆ OTHER AREAS.

- Transfer the operational aspects of mobilization to FORSCOM.
- Consolidate operational and developmental testing and evaluation.
- Look beyond HQDA at MACOM Headquarters and staff for linkages, overlaps, and common areas for improvement.
- Consolidate and streamline the Pentagon BASOPS functions and infrastructure.
- Examine how Active, Guard, and Reserve (AGR) personnel are distributed and utilized at HQDA.

◆ **CULTURE CHANGE.** Top-down directed culture changes and paradigm shifts, are the first steps toward improving efficiency and effectiveness of an organization. The following are examples of altered perceptions or support processes that enable or promote analysis and change of management processes.

- Empowerment and Stewardship. Empowerment and stewardship are key enablers of efficiency and effectiveness. Earnest pursuit of them will result in an improved HQDA. The Army should craft a planned and phased implementation plan for them to take root.
- Management and support systems. Current reward systems can interfere with efficiency and effectiveness improvements. Bureaucracy must encourage appropriate risk, overall good of the government, and conservation of limited resources. A clear focus on appropriate business goals and a discrete delineation of lines of responsibility among staff elements is mandatory (accountability and performance measures). Grades/rank and performance appraisals should be untied from organizational structure and tied to process ownership.

THIS PAGE INTENTIONALLY LEFT BLANK



DEPARTMENT OF THE ARMY

WASHINGTON, D.C. 20310

19 July 1996



MEMORANDUM FOR SEE DISTRIBUTION

SUBJECT: Summer Command Plan -- Supplemental Guidance

Consistent with the Vice Chief of Staff and the Assistant Secretary of the Army (Manpower and Reserve Affairs) direction, this memorandum provides guidance concerning implementation of Program Objective Memorandum FY 98-03 adjustments in the Summer Command Plan (CPLAN) process. HQDA message, DAMO-FDF, 121445Z JUN 96, Subject: Summer 1996 Command Plan (CPLAN) Guidance, Message #1, provides preliminary guidance for the Summer 1996 CPLAN and subsequent Tables of Distribution and Allowances (TDA) documentation. Although Institutional Army Functional Area Assessments (FAAs) decisions have not been formally approved, documentation at enclosure 1 provides HQDA and MACOM specific guidance for follow-on action required at this time.

Documenting your FY 98 TDAs should be approached in two phases. First, use this summer's Management of Change (MOC) window as a **planning** opportunity to develop streamlined organizations and propose TDAs. Your organization should be within approved resource levels, consistent with National Performance Review/Defense Performance Review principles, and based on sound organization and position management precepts. The second phase will be to assess, modify, and finalize your proposed FY 98 TDAs for submission in the winter 1997 MOC window.

Concept plans required by enclosure 1 may be abbreviated i.e., one that consists of only an Executive Summary, proposed TDA, and General Order (if necessary). Submit concept plans to HQDA DCSOPS, ATTN: DAMO-FDF, no later than 30 August 1996.

Transfer or elimination of functions dictate that you address personnel rights and concerns with utmost care and sensitivity. Your personal involvement in streamlining is essential in order to develop a fully functional headquarters for the 21st Century.

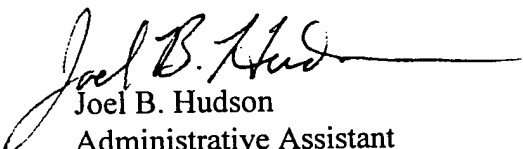
Joel B. Hudson
Administrative Assistant
to the Secretary of the Army

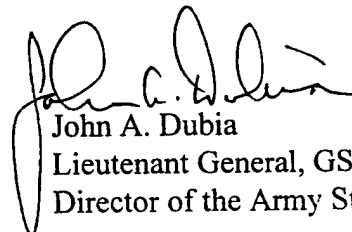
John A. Dubia
Lieutenant General, GS
Director of the Army Staff

Enclosure

DISTRIBUTION:

Assistant Secretary of the Army (Civil Works)
Assistant Secretary of the Army (Financial Management and Comptroller)
Assistant Secretary of the Army (Installations, Logistics, and Environment)
Assistant Secretary of the Army (Manpower and Reserve Affairs)
Assistant Secretary of the Army (Research, Development, and Acquisition)
General Counsel
Director of Information for Command, Control, Communications and Computers
Chief, Legislative Liaison
Chief, Public Affairs
The Auditor General
The Inspector General
Director, Office of Small and Disadvantaged Business Utilization
Deputy Chief of Staff for Personnel
Deputy Chief of Staff for Operations and Plans
Deputy Chief of Staff for Logistics
Deputy Chief of Staff for Intelligence
Assistant Chief of Staff for Installation Management
Chief of Engineers
The Surgeon General
Chief of Chaplains
The Judge Advocate General
Chief, Army Reserve
Director, Army National Guard
Commanders
 US Army Europe and 7th Army
 Eighth US Army
 Forces Command
 US Army Materiel Command
 US Army Training and Doctrine Command
 US Army Corps of Engineers
 US Army Information Systems Command
 US Army Special Operations Command
 US Army Pacific
 Military Traffic Management Command
 US Army Criminal Investigation Command
 US Army Medical Command
 US Army Intelligence and Security Command
 US Army Military District of Washington
 US Army South

CF:

Office, Secretary of the Army
Office, Chief of Staff, Army
Office, Under Secretary of the Army

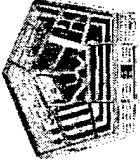

REDESIGN OF THE INSTITUTIONAL ARMY

FUNCTIONAL AREA ASSESSMENT
Phase I

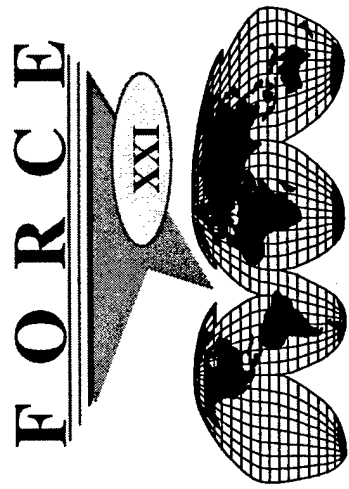

5/21/98



A-1

Issue: 01

Title: Contracting - Consolidation

Proponent: AMC **Sponsor:** ASA(RDA), DCSOPS **Source:** Proponent

Implementation Period: 98-03

Synopsis: FAA identified multiple contracting offices in the same location and recommended local consolidation at five sites (Rock Island, APG, Wash D.C., Huntsville, Huachuca). Indicated additional consolidation opportunities available.

Resource Implications:

	Savings	Costs	Transfers
Military:			
Civilian:	94 TDA spaces		
Dollars:	\$26.35 million		

Army Staff/Command Position:

Concur: AMC, DCSLOG, TRADOC Nonconcur: NGB

Recommendations: Consolidate contracting offices at 5 sites identified by AMC
FAA.

ACTION: AMC - lead; ISC, TRADOC, SSSDC, MDW, DSS-W - assist

Approve **Disapprove** **Fwd to CSA/SA** **Defer to POM 00-05**
for decision **Study by:** _____

Issue: 01

Title: Contracting - Consolidation

Enablers: None

Implementation Guidance:

1. AMC develop concept plan, not later than 30 September 1996, IAW AR 310-49 for consolidating contracting offices at APG, MD (TECOM, ARL, CBDCOM).
2. AMC develop concept plan, not later than 30 September 1996, IAW AR 310-49 for consolidating contracting offices at Rock Island, IL (IOC, TACOM, RI Arsenal).
3. AMC lead, SSSDC assist, develop concept plan, not later than 30 September 1996, IAW AR 310-49 for consolidating four MDW contracting offices and one DSS-W office, in MDW.
4. MDW lead, DSS-W assist, develop concept plan, not later than 1 August 1996, IAW AR 310-49 for consolidating four MDW contracting offices and one DSS-W office, in MDW.
5. TRADOC lead, ISC assist, develop concept plan, not later than 30 September 1996, IAW AR 310-49 for consolidating the TRADOC contracting office with the ISC office at Ft. Huachuca. Coordinate with AMC as ISC has proposed consolidating its contracting functions with CECOM.

Issue: 01

Title: Contracting - Consolidation

PBD Information

Date: PBD#

PBD Title:

Cmd	UIC	MDEP	AMSCO	FY96	FY97	Manpower					
						FY98	FY99	FY00	FY01	FY02	FY03
AMC						-72	-72	-72	-72	-72	-72
MDW						-11	-11	-11	-11	-11	-11
TRADOC						-10	-10	-10	-10	-10	-10
SSDC						-1	-1	-1	-1	-1	-1
Total						-94	-94	-94	-94	-94	-94

TOA (\$ millions)

Cmd	UIC	MDEP	AMSCO	FY96	FY97	FY98	FY99	FY00	FY01	FY02	FY03
MDW						-0.275	-0.55	-0.55	-0.55	-0.55	-0.55
TRADOC						-0.25	-0.50	-0.50	-0.50	-0.50	-0.50
SSDC						-0.25	-0.05	-0.05	-0.05	-0.05	-0.05
Total						-2.6	-4.75	-4.75	-4.75	-4.75	-4.75

Issue: 02

Title: Contracting - Credit Card Use

Proponent: AMC

Sponsor: ASA(RDA), DCSOPS

Source: Proponent

Implementation Period: 98-03

Synopsis: Credit card use for micro purchases reduces purchasing agent time and eliminates the need for a purchase order. Over 68% of the Army's FY95 contracting actions were micro purchases, but only 60% of the eligible actions used credit cards. Mandating credit card use reduces manpower requirements.

Resource Implications:

	Savings	Costs	Transfers
Military:			
Civilian:	105 TDA spaces		
Dollars:	\$26.35 million		

Army Staff/Command Position: NOTE: *-with comment

Concur: TRADOC, FORSCOM, DCSLOG, USAREUR* **Nonconcur:** NGB

Recommendations: ASA(RDA) establish policy to mandate credit card use for 80% of micro purchases (under \$2.5K).

ACTION: ASA(RDA) - lead; AMC, NGB, DSS-W, EUSA, MDW, TRADOC, USACE, USAREUR, USARPAC, USARSO - assist

Approve
 Disapprove
 Fwd to CSA/SA for decision
 Defer to POM 00-05 Study by: _____

Issue: 02

Title: Contracting - Credit Card Use

Enablers: None

Implementation Guidance:

1. ASA(RDA) develop policy, not later than 30 September 1996, with effective date of 1 October 1997, which mandates credit card usage rate of at least 80% for micro purchases.
2. AMC, NGB, DSS-W, EUSA, MDW, TRADOC, USACE, USAREUR, USARPAC, USARSO, reduce contracting spaces as identified in AMC FAA not later than 30 September 1997. Reconcile with manpower and dollar resources withdrawn by Dorn Amendment.

Issue: 02

Title: Contracting - Credit Card Use

PBD Information

PBD#

Date:

PBD Title:

Manpower

Cmd	UIC	MDEP	AMSCO	FY96	FY97	FY98	FY99	FY00	FY01	FY02	FY03
AMC				-13	-13	-13	-13	-13	-13	-13	-13
ARNG				-26	-26	-26	-26	-26	-26	-26	-26
DSS-W				-1	-1	-1	-1	-1	-1	-1	-1
EUSA				-3	-3	-3	-3	-3	-3	-3	-3
MDW				-3	-3	-3	-3	-3	-3	-3	-3
MEDCOM				-10	-10	-10	-10	-10	-10	-10	-10
MRDC				-1	-1	-1	-1	-1	-1	-1	-1
TRADOC				-23	-23	-23	-23	-23	-23	-23	-23
USACE				-27	-27	-27	-27	-27	-27	-27	-27
USAREUR				-6	-6	-6	-6	-6	-6	-6	-6
USARPAC				-2	-2	-2	-2	-2	-2	-2	-2
USARSO				-1	-1	-1	-1	-1	-1	-1	-1
Total				-105	-105	-105	-105	-105	-105	-105	-105

TOA (\$ millions)

Cmd	UIC	MDEP	AMSCO	FY96	FY97	FY98	FY99	FY00	FY01	FY02	FY03
AMC				-0.325	-0.325	-0.325	-0.65	-0.65	-0.65	-0.65	-0.65
ARNG				-0.65	-0.65	-0.65	-1.3	-1.3	-1.3	-1.3	-1.3
DSS-W				-0.025	-0.025	-0.025	-0.05	-0.05	-0.05	-0.05	-0.05
EUSA				-0.075	-0.075	-0.075	-0.15	-0.15	-0.15	-0.15	-0.15
MDW				-0.075	-0.075	-0.075	-0.15	-0.15	-0.15	-0.15	-0.15
MEDCOM				-0.25	-0.25	-0.25	-0.5	-0.5	-0.5	-0.5	-0.5
MRDC				-0.025	-0.025	-0.025	-0.05	-0.05	-0.05	-0.05	-0.05
TRADOC				-0.575	-0.575	-0.575	-1.15	-1.15	-1.15	-1.15	-1.15
USACE				-0.675	-0.675	-0.675	-1.35	-1.35	-1.35	-1.35	-1.35
USAREUR				-0.15	-0.15	-0.15	-0.3	-0.3	-0.3	-0.3	-0.3
USARPAC				-0.05	-0.05	-0.05	-0.1	-0.1	-0.1	-0.1	-0.1
USARSO				-0.025	-0.025	-0.025	-0.05	-0.05	-0.05	-0.05	-0.05
Total				-2.850	-2.850	-2.850	-4.70	-4.70	-4.70	-4.70	-4.70

NOTE: MEDCOM OMA controlled by OSD(HA).

Issue: 03

Title: Contracting - Workload Benchmarks

Proponent: AMC **Sponsor:** ASA(RDA), DCSOPS **Source:** Proponent

Implementation Period: 98-03

Synopsis: Plotting TDA strength versus contracting actions over \$25K and applying regression analysis, inefficient contracting offices were identified. Within each MACOM, implementing best practices in contracting achieves TDA savings.

Resource Implications:

	Savings	Costs	Transfers
Military:			
Civilian:	806 TDA spaces		
Dollars:	\$221.65 million		

Army Staff/Command Position:

Concur: AMC, DCSLOG, TRADOC **Nonconcur:** FORSCOM, USAREUR, NGB

Recommendations: ASA(RDA) establish policy that directs benchmarked best practice implementation; commands implement policy to achieve savings.

ACTION: ASA(RDA) - lead; AMC, NGB, FORSCOM, MDW, TRADOC, USACE, USAREUR, USARPAC, USMA - implement

Approve **Disapprove** **Fwd to CSA/SA for decision** **Defer to POM 00-05**
 Study by: _____

Issue: 03

Title: Contracting - Workload Benchmarks

Enablers: None

Implementation Guidance:

1. ASA(RDA) develop policy, not later than 30 September 1996, with implementation not later than 30 September 1997, directing workload benchmark best business practice implementation.
2. AMC, NGB, FORSCOM, MDW, TRADOC, USACE, USAREUR, USARPAC implement and reduce contracting spaces as identified by AMC FAA not later than 30 September 1997. Reconcile with manpower and dollar resources withdrawn by Dorn Amendment.

Issue: 03

Title: Contracting - Workload Benchmarks

PBD Information

Date: PBD#

PBD Title:

Manpower

Cmd	UIC	MDEP	AMSCO	FY96	FY97	FY98	FY99	FY00	FY01	FY02	FY03
AMC					-392	-392	-392	-392	-392	-392	-392
ARNG					-69	-69	-69	-69	-69	-69	-69
FORSCOM					-18	-18	-18	-18	-18	-18	-18
MDW					-2	-2	-2	-2	-2	-2	-2
MRDC					-20	-20	-20	-20	-20	-20	-20
TRADOC					-32	-32	-32	-32	-32	-32	-32
USACE					-260	-260	-260	-260	-260	-260	-260
USAREUR					-1	-1	-1	-1	-1	-1	-1
USARPAC					-2	-2	-2	-2	-2	-2	-2
USMA					-30	-30	-30	-30	-30	-30	-30
TOTAL					-806	-806	-806	-806	-806	-806	-806

TOA (\$ millions)

Cmd	UIC	MDEP	AMSCO	FY96	FY97	FY98	FY99	FY00	FY01	FY02	FY03
AMC					-9.8	-9.8	-19.6	-19.6	-19.6	-19.6	-19.6
ARNG					-1.725	-1.725	-3.45	-3.45	-3.45	-3.45	-3.45
FORSCOM					-0.45	-0.45	-0.9	-0.9	-0.9	-0.9	-0.9
MDW					-0.05	-0.05	-0.1	-0.1	-0.1	-0.1	-0.1
MRDC					-0.5	-0.5	-1.0	-1.0	-1.0	-1.0	-1.0
TRADOC					-0.8	-0.8	-1.6	-1.6	-1.6	-1.6	-1.6
USACE					-6.5	-6.5	-13.0	-13.0	-13.0	-13.0	-13.0
USAREUR					-0.025	-0.025	-0.05	-0.05	-0.05	-0.05	-0.05
USARPAC					-0.0	-0.0	-0.1	-0.1	-0.1	-0.1	-0.1
USMA					-0.75	-0.75	-1.5	-1.5	-1.5	-1.5	-1.5
TOTAL					-20.15	-20.15	-40.3	-40.3	-40.3	-40.3	-40.3

NOTE: MEDCOM OMA controlled by OSD(HA).

Issue: 04

Title: Central Asset Management

Proponent: AMC

Sponsor: DCSLOG, ASA(ILE) **Source:** Proponent

Implementation Period: 98-03

Synopsis: SARSS-O enables the Corps Materiel Management Center to have visibility of all corps stocks, permitting direction and disposition. Central asset management enables AMC to provide a similar function by absorbing installation stocks into the wholesale stock fund (single stock fund) thereby providing visibility and enhancing Army-wide redistribution. Operation of a single stock fund eliminates a financial system layer and duplication of materiel and financial management functions. An \$83 million investment (an additional FAA issue) addresses potential shortfalls in retail and wholesale stocks for wartime and contingencies. Savings from implementing central asset management accrue through one-time redistribution of excess inventory (\$380 million) and TDA space savings.

Resource Implications:

	Savings	Costs	Transfers
Military:			
Civilian:	203 TDA		
Dollars:	\$436.575 million		

Army Staff/Command Position:

Concur: DCSLOG, AMC, TRADOC **Nonconcur:** FORSCOM, NGB, USMA, MDW

Recommendations: AMC establish Central Asset Management process.

ACTION: AMC - lead; DCSLOG - assist

Approve
 Disapprove
 Fwd to CSA/SA for decision
 Defer to POM 00-05
 Study by: _____

Issue: 04

Title: Central Asset Management

Enablers: None

Implementation Guidance:

1. DA DCSLOG provide results of Executive Steering Group study on Single Stock Fund (SSF), not later than 30 September 1996, for approval by the VCSA.
2. AMC develop concept plan for implementation of SSF, include results of the DA DCSLOG Executive Steering Group study on SSF, not later than 30 September 1996, for approval by VCSA.
3. Initial implementation of SSF to begin not later than 1 November 1996; fielding to be completed by 30 September 1998.
4. Training PEG, in coordination with DA DCSLOG and AMC, will validate/ deconflict savings estimated and adjust the training resource model (TRM) for POM 98-03 accordingly.

Note: The term Central Asset Management was changed by the DCSLOG to Single Stock Fund.

Issue: 04

Title: Central Asset Management

PBD Information

Date:

PBD#

PBD Title:

Manpower

Cmd	UIC	MDEP	AMSCO	FY96	FY97	FY98	FY99	FY00	FY01	FY02	FY03
AMC						-78	-78	-78	-78	-78	-78
FORSCOM						-74	-74	-74	-74	-74	-74
TRADOC						-26	-26	-26	-26	-26	-26
DSSW						-2	-2	-2	-2	-2	-2
MDW						-21	-21	-21	-21	-21	-21
USMA						-2	-2	-2	-2	-2	-2
TOTAL						-203	-203	-203	-203	-203	-203

TOA (\$ millions)

Cmd	UIC	MDEP	AMSCO	FY96	FY97	FY98	FY99	FY00	FY01	FY02	FY03
AMC						-1.95	-3.9	-3.9	-3.9	-3.9	-3.9
FORSCOM						-1.85	-3.7	-3.7	-3.7	-3.7	-3.7
TRADOC						-0.65	-1.3	-1.3	-1.3	-1.3	-1.3
DSSW						-0.05	-0.1	-0.1	-0.1	-0.1	-0.1
MDW						-0.525	-1.05	-1.05	-1.05	-1.05	-1.05
USMA						-0.05	-0.1	-0.1	-0.1	-0.1	-0.1
FORSCOM (inventory)						-10.8	-18	-28.8	-28.8	-28.8	-21.6
USAREUR (inventory)						-4.8	-8	-12.8	-12.8	-12.8	-9.6
EUSA (inventory)						-4.5	-7.5	-12.0	-12.0	-12.0	-9.0
ARNG						-2.7	-4.5	-7.2	-7.2	-7.2	-5.4
AMC						-7.2	-12.0	-19.2	-19.2	-19.2	-14.4
TOTAL						-35.825	-60.15	-90.15	-90.15	-90.15	-70.15

Issue: 05 **Title:** Readiness Based Sparing/Velocity Management (RBS/VM)

Proponent: AMC **Sponsor:** DCSLOG, ASA(ILE) **Source:** Proponent

Implementation Period: 98-03

Synopsis: AMC recommended implementing RBS/VM in POM 98-03 for a one-time inventory reduction savings of \$384M and another \$120 million savings from order-ship-time (OST) reductions. Implementation would require AMC/DA/CASCOM support to MACOMs, corps and divisions to compute and stabilize new stock levels with changes negotiated on an exception basis. SARSS-O, software, other investments reduce net savings. Wartime and contingency support concerns addressed by a separate issue to maintain heavy division, light division, and brigade authorized stockage lists to augment peacetime stocks.

Resource Implications:

	Savings	Costs	Transfers
Military:			
Civilian:			
Dollars:	\$299.9 million		

Army Staff/Command Position:

Concur: DCSLOG, AMC, FORSCOM, TRADOC **Nonconcur:** NGB

Recommendations: Approve RBS/VM implementation for POM 98-03.

ACTION: DCSLOG - lead; AMC, TRADOC (CASCOM) - assist.

Approve
 Disapprove
 Fwd to CSA/SA for decision
 Defer to POM 00-05
 Study by: _____

Issue: 05

Title: Readiness Based Sparring/Velocity Management

Enablers: AR 710-2 policy change: authorized stockage list (ASL) stock add/retain criteria.

Implementation Guidance:

1. DCSLOG develop phased implementation plan, no later than 30 September 1996, and revise AR 710-2.
2. AMC, in coordination with DA DCSLOG and TRADOC (CASCOM), compute and recommend stockage levels for MACOMs not later than 30 September 1996.
3. AMC and MACOMs implement RBS in FY 98.
4. Training PEG, in coordination with DA DCSLOG and AMC, will validate/deconflict savings estimates and adjust the training resource model (TRM) for POM 98-03 accordingly.

Issue: 06 **Title:** Repair Parts Stocks for Wartime/Contingencies

Proponent: AMC **Sponsor:** DCSLOG, ASA(ILE) **Source:** Proponent

Implementation Period: ~~98-03~~ 00-05

Synopsis: Analysis indicates peacetime stockage levels based on OPTEMPO, repair procedures and efficiencies will not provide adequate retail or wholesale stocks for wartime or contingencies. Using NTC, Europe and Korea field experience demand data, a full heavy division ASL, a light division ASL and a separate brigade ASL cost \$83 million for Class IX items. Justification for buying these contingency/war reserve stocks uses the three unit approach. Buying for 10 divisions would break the bank and would receive little support.

Resource Implications:

	Savings	Costs	Transfers
Military:			
Civilian:			
Dollars:		\$83 million	

Army Staff/Command Position:

Concur: DCSLOG, TRADOC **Nonconcur:**

Recommendations: Approve \$83 million investment in additional repair part stocks for wartime/contingencies. DCSLOG determine requirement for Armored Cavalry Regiment (ACR) and Air Assault Division.

ACTION: AMC - lead; DCSLOG - assist

Approve Disapprove Fwd to CSA/SA for decision Defer to POM 00-05 Study by: _____

Issue: 06

Title: Repair Parts Stocks for Wartime/Contingencies

Enablers: None

Implementation Guidance:

1. AMC propose stock levels for the three unit approach no later than October 1996.
2. DCSLOG validate data for three units and determine requirement for Armored Cavalry Regiment and Air Assault Division packages no later than December 1996.
3. AMC present follow-on decision briefing to VCSA, not later than February 1997, for implementation in POM 00-05.

Issue: 06

Title: Repair Parts Stocks for Wartime/Contingencies

PBD Information

Date: **PBD#**

PBD Title:

Cmd	UIC	MDEP	AMSCO	FY96	FY97	FY98	FY99	FY00	FY01	FY02	FY03	Manpower		

TOA (\$ millions)

Cmd	UIC	MDEP	AMSCO	FY96	FY97	FY98	FY99	FY00	FY01	FY02	FY03	TOA (\$ millions)		

AMC +44 +12 +27

Issue: 07 **Title:** Maintenance-Base Shop Test Facility (BSTF)

Proponent: AMC **Sponsor:** DCSLOG, ASA(ILE) **Source:** Proponent

Implementation Period: 98-03

Synopsis: AMSAA analysis of wartime workload indicated only 63 BSTFs were required, but distribution of BSTFs between active divisions, other units and ARNG/USAR would have to be modified. Seventy-nine BSTFs currently procured, with 16 more in POM. TRADOC (Ordnance school) has on-going initiative to modify GS electronic maintenance TOE structure. Sixteen BSTFs would be available to accommodate GS restructure and ARNG and USAR (on a regional basis).

Resource Implications:

Military:

Civilian:

Dollars: \$19.7 million

Savings **Costs** **Transfers**

Army Staff/Command Position:

Concur:

Nonconcur: NGB, TRADOC, DCSLOG

Recommendations: DCSOPS take the lead to resolve the requirement. Brief the VCSA not later than 1 May 1996 for decision.

ACTION: DCSOPS - lead; AMC, TRADOC - assist

Approve Disapprove Fwd to CSA/SA Defer to POM 00-05
for decision for decision Study by: _____

Issue: 07

Title: Maintenance-Base Shop Test Facility (BSTF)

Enablers: None

Implementation Guidance:

1. DCSOPS reconcile the AMSAA analysis of BSTF workload with the TRADOC GS electronic maintenance TOE redesign to determine Army BSTF procurement requirement and fielding plan to support the Total Force.
2. DCSOPS brief the VCSA not later than 30 September 1996 for decision.

Issue: 07

Title: Maintenance-Base Shop Test Facility (BSTF)

PBD Information

Date: **PBD#**

PBD Title:

Cmd	UIC	MDEP	AMSCO	FY96	Manpower					FY03
					FY97	FY98	FY99	FY00	FY01	

TOA (\$ millions)

Cmd	UIC	MDEP	AMSCO	FY96	FY97	FY98	FY99	FY00	FY01	FY02	FY03
OPA						-44.2					
ARNG						+24					
FORSCOM						+0.5					

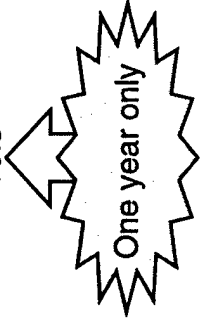

Issue: 08 **Title:** Integrated Sustainment Maintenance (ISM)

Proponent: AMC **Sponsor:** DCSLOG, ASA(ILE) **Source:** Proponent

Implementation Period: 98-03

Synopsis: ISM ultimately places all sustainment maintenance under an integrated management structure owned by AMC. Full implementation not possible in POM 98-03 because of automation, funding and ownership issues, but incremental implementation possible in FY97. Two options, with or without AMC control of regional sustainment maintenance; subject to a 4-star review and CSA decision.

Resource Implications:

Military:	Savings	Costs	Transfers
Civilian:			
Dollars:	\$82 million		

Army Staff/Command Position:

Concur: DCSLOG, AMC, FORSCOM, TRADOC **Nonconcur:**

Recommendations: AMC, FORSCOM, TRADOC implement, starting in FY97, the ISM option approved by CSA.

ACTION: AMC - lead; FORSCOM, TRADOC - assist.

Approve
 Disapprove
 Fwd to CSA/SA for decision
 Defer to POM 00-05 Study by: _____

Issue: 08

Title: Integrated Sustainment Maintenance (ISM)

Enablers: CSA decision.

Implementation Guidance:

1. AMC provide results of 4-star (AMC, FORSCOM, TRADOC) review, through the DA DCSLOG, for approval of VCSA and CSA, not later than 30 September 1996.
2. AMC, with FORSCOM and TRADOC assistance, implement, starting in FY97, the approved option for regional maintenance control.
3. Training PEG, in coordination with DA DCSLOG and AMC, will validate/ deconflict savings estimates and adjust the training resource model (TRM) for POM 98-03 accordingly.

Issue: 08 **Title:** Integrated Sustainment Maintenance (ISM)

PBD Information

Date: **PBD#**

PBD Title:

Cmd	UIC	MDEP	AMSCO	FY96	Manpower			FY00	FY01	FY02	FY03
					FY97	FY98	FY99				

TOA (\$ millions)

Cmd	UIC	MDEP	AMSCO	FY96	FY97	FY98	FY99	FY00	FY01	FY02	FY03
					-4.4	-10.06	-12.8	-15.52	-18.25	-21	

Issue: 09

Title: AMC Materiel Management Privatization

Proponent: AMC **Sponsor:** DCSLOG, ASA(ILE) **Source:** Proponent

Implementation Period: 98-03

Synopsis: Analysis of low risk AMC materiel management functions (cataloging, log transfers, deficiency/discrepancy management) indicated 459 full-time equivalents in AMC MSCs could be privatized. Assuming at least 10% savings, \$2.3M savings/yr in labor costs could be generated.

Resource Implications:

	Savings	Costs	Transfers
Military:			
Civilian:	459		
Dollars:	\$13.8 million		

Army Staff/Command Position:

Concur: DCSLOG, TRADOC **Nonconcur:**

Recommendations: AMC implement in POM 98-03. AMC conduct follow-on study of additional materiel management functions for privatization in POM 00-05.

ACTION: AMC - lead.

Approve Disapprove Fwd to CSA/SA for decision Defer to POM 00-05 Study by: _____

Issue: 09

Title: AMC Materiel Management Privatization

Enablers: A-76 study

Implementation Guidance:

1. AMC implement low risk materiel management privatization in POM 98-03.
2. AMC include additional privatization options in Phase II FAA, February 1997, for example, medium and medium-high risk functions.
3. Training PEG, in coordination with DA DCSLOG and AMC, will validate/ deconflict savings estimates and adjust the training resource model (TRM) for POM 98-03 accordingly.

Issue: 09

Title: AMC Materiel Management Privatization

PBD Information

Date: **PBD#**

PBD Title:

Cmd	UIC	MDEP	AMSCO	FY96	FY97	Manpower				
						FY98	FY99	FY00	FY01	
AMC					-459	-459	-459	-459	FY02	FY03
									-459	-459

TOA (\$ millions)

Cmd	UIC	MDEP	AMSCO	FY96	FY97	FY98	FY99	FY00	FY01	FY02	FY03
AMC					-2.3	-2.3	-2.3	-2.3	-2.3	-2.3	-2.3

Issue: 10

Title: Test & Evaluation - Consolidated Test

Proponent: AMC **Sponsor:** ASA(RDA), DCSOPS **Source:** Proponent

Implementation Period: ~~98-03~~ Deferred

Synopsis: Test and evaluation (T&E) reengineering proposals include, as POM 98-03 feasible, functional realignment (savings 150-300 spaces) followed by consolidating all test functions, operational and developmental, in AMC TECOM (additional 500-700 space savings). With functional realignment, OPTEC's Operational Evaluation Command (OEC) evaluator plans the total system evaluation and integrates the T&E process, and TECOM develops detailed test plans, prepares and executes all tests. Consolidated testing places all test activities under TECOM. Two issues remain: Kwajalein missile range ownership and TEXCOM ownership. Proponent recommended consolidating Kwajalein with TECOM and operation at current POM level (\$130M shortfall over FY97-01 would not be fixed). Proponent recommended OEC as the evaluation integrator, not OPTEC HQ, and TEXCOM be consolidated with TECOM.

Resource Implications:

	Savings	Costs	Transfers
Military:			
Civilian:	600 TDA spaces		
Dollars:	\$165 million		

Army Staff/Command Position:

Concur: AMC, DCSLOG, TRADOC **Nonconcur:** DUSA(OR), SSSDC, OPTEC

Recommendations: AMC implement functional realignment and consolidate test functions in TECOM including Kwajalein and TEXCOM.

ACTION: AMC - lead; OPTEC, SSSDC, DUSA(OR) - assist.

Approve
 Disapprove
 Fwd to CSA/SA for decision
 Defer; requires further review
 Study by: _____

Issue: 10

Title: Test & Evaluation - Consolidated Test

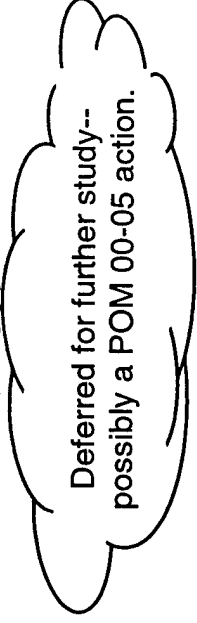

Enablers: None

Implementation Guidance: AMC, with OPTEC and SSDC assistance, present a detailed decision briefing, not later than 3 April 1996, to VCSA. Pending results of the briefing, be prepared to:

1. AMC implement functional realignment. OEC becomes the evaluation integrator for planning, test design, analysis and evaluation. TECOM becomes the single agency lead for detailed test planning, preparation and execution.
2. AMC, with OPTEC and SSDC assistance, develop concept plan IAW AR 310-49 for developing a single test organization, including Kwajalein, TEXCOM and TECOM for execution in FY98.
3. AMC, with OPTEC and DCSOPS assistance, revise T&E funding process through evaluation integrator to achieve a single total system evaluation plan.
4. Retain OPTEC as HQDA FOA until Phase II FAA recommendation for T&E end-state, but right-size reflecting transfer of test functions.
5. AMC provide T&E implementation status in Phase II FAA.

Issue: 10

Title: Test & Evaluation - Consolidated Test

PBD Information

Date:

PBD#

PBD Title:

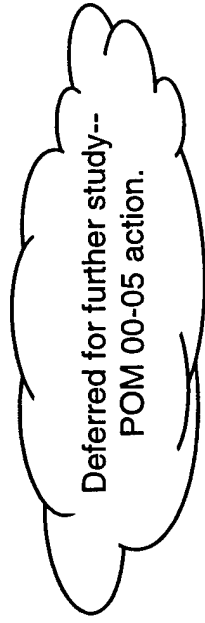

Manpower

Cmd	UIC	MDEP	AMSCO	FY96	FY97	FY98	FY99	FY00	FY01	FY02	FY03
AMC				-150	-150	-150	-150	-150	-150	-150	-150
OPTEC				-385	-385	-385	-385	-385	-385	-385	-385
SSDC				-65	-65	-65	-65	-65	-65	-65	-65
Total				-600	-600	-600	-600	-600	-600	-606	-600

TOA (\$ millions)

Cmd	UIC	MDEP	AMSCO	FY96	FY97	FY98	FY99	FY00	FY01	FY02	FY03
AMC				-3.75	-3.75	-3.75	-7.5	-7.5	-7.5	-7.5	-7.5
OPTEC				-9.625	-9.625	-9.625	-19.25	-19.25	-19.25	-19.25	-19.25
SSDC				-1.625	-1.625	-1.625	-3.25	-3.25	-3.25	-3.25	-3.25
Total				-15	-30	-30	-30	-30	-30	-30	-30

Issue: 11

Title: Test & Evaluation - End State

Proponent: AMC **Sponsor:** ASA(RDA), DCSOPS **Source:** Proponent

Implementation Period: ~~99-03~~ Deferred

Synopsis: Test and evaluation (T&E) reengineering roadmap depicted four options for evaluation ownership in the end-state: a single T&E command under AMC or HQDA; developmental evaluation in AMC; operational evaluation in OPTEC; and all evaluations in OPTEC. DUSA(OR) recommended allowing the already approved functional realignment operation to be continued for a while before making final decision on T&E end-state. Potential savings of 650 TDA spaces.

Resource Implications:

Savings **Costs** **Transfers**

Military:

Civilian:

Dollars:

Army Staff/Command Position:

Concur: AMC, DCSLOG, TRADOC **Nonconcur:**

Recommendations: TEMA conduct T&E end-state study and report out to VCSEA in July 1996 in time to influence mini-POM 99-03.

ACTION: TEMA - lead; AMC, TRADOC, OPTEC, DUSA(OR) - assist

Approve Disapprove Fwd to CSA/SA Defer to POM 00-05
for decision Study by: _____

Issue: 11

Title: Test & Evaluation - End State

Enablers: None

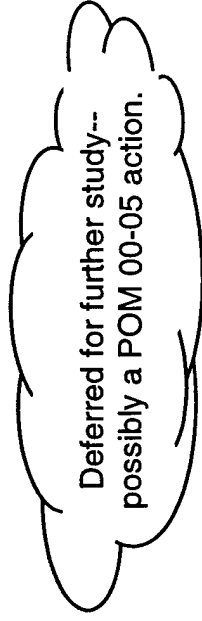

Implementation Guidance:

1. TEMA develop concept plan for T&E end-state for implementation in FY 99.
2. Consider options 3, 4, and 5 (shown below) as proposed by AMC during Equip, Supply, and Maintain (E/S/M) FAA:
 - Option 3: Single test agency and combined force level evaluation
 - Option 4: Single test agency and separate single evaluation activity
 - Option 5: Single consolidated test and evaluation organization

Issue: 12

Title: Contracting - Follow-on Study

Enablers: None

Implementation Guidance:

1. ASA(RDA) conduct follow-on study, not later than 30 September 1996, of the sites recommended by AMC in the Equip/Supply/Maintain FAA as potential sites for consolidation. Report sites selected, potential savings, and lead command for concept plan development to VCSA not later than 30 September 1996. On approval, concept plans to be developed, not later than 30 October 1996, IAW AR 310-49 with FY99 implementation.
2. ASA(RDA) develop and recommend a Force XXI contracting organization, using the four contracting organization alternatives, specified in the E/S/M FAA, as a baseline. Report recommendation in AMC Phase II follow-on FAA, February 1997.
3. ASA(RDA) - lead, ASA(FM&C) assist; conduct study of the costs associated with credit card use and report recommendations in AMC Phase II FAA, February 1997.

Issue: 13

Title: Prescribed Load List (PLL)

Enablers: None

Implementation Guidance:

1. FORSCOM conduct follow-on test and validation of PLL elimination with decision briefing to VCSA not later than December 1996.
2. DCSLOG validate savings associated with PLL elimination for input into mini-POM 99-03.

Issue: 14

Title: DOL Privatization

Proponent: AMC **Sponsor:** DCSLOG, ASA(ILE) **Source:** Proponent

Implementation Period: 00-05

Synopsis: In the Equip/Supply/Maintain FAA look across the total Army maintenance function, DOL privatization with savings of up to \$54M/yr was considered but recommended for review in the Installation Management FAA. The National Provider concept envisions a single logistics system for both supply and sustainment maintenance (GS level) down to the corps rear, including DOLs. Consequently, all maintenance facilities/capabilities must be considered as part of this single system and NOT parceled out to different proponents.

Resource Implications:

Savings **Costs** **Transfers**

Military:

Civilian:

Dollars:

Army Staff/Command Position:

Concur: TRADOC, FORSCOM, DCSLOG **Nonconcur:** NGB

Recommendations: AMC include DOLs in AMC Phase II Supply/Service/Maintain FAA.

ACTION: AMC - lead; FORSCOM, ACSIM - assist

Approve **Disapprove** **Fwd to CSA/SA** **Defer to POM 00-05**
for decision for decision Study by: _____

Issue: 14

Title: DOL Privatization

Enablers: None

Implementation Guidance:

1. AMC coordinate with Installation Management FAA.
2. AMC consider DOLs along with depots, ARNG and USAR facilities/capabilities in study of National Provider concept.
3. AMC include DOL privatization in Phase II FAA, February 1997.

Issue: 15

Title: National Provider

Proponent: AMC

Sponsor: DCSLOG, ASA(ILE)

Source: Umbrella

Implementation Period: 00-05

Synopsis: Equip/Supply/Maintain FAA provided POM 98-03 initiatives that are compatible with National Provider concept but do not fully implement the concept. Consequently, significant potential savings are not generated. Savings include those from consolidating duplicate maintenance facilities (AC, ARNG and USAR) located on or near a post, eliminating redundant maintenance overhead through consolidation and regionalization, DOL privatization, reserve component on-post/off-post support opportunities, full implementation of integrated sustainment maintenance (ISM) and depot privatization. Potential for up to 15,000 space savings.

Resource Implications:

Military:
Civilian:
Dollars:

Savings **Costs** **Transfers**

Army Staff/Cmd Position:

Concur: DCSLOG, TRADOC **Nonconcur:** FORSCOM, OCAR

Recommendations: AMC conduct study and provide implementation plan for POM 00-05; address DOL, ARNG and USAR duplication.

ACTION: AMC - lead; TRADOC, NGB, OCAR - assist

Approve **Disapprove** **Fwd to CSA/SA for decision** **Defer to POM 00-05**
 Study by: _____

Issue: 15

Title: National Provider

Enablers: Legislative enablers required for depot privatization (60/40 rule, \$3M rule, core logistics, OMB circular A-76)

Implementation Guidance:

1. AMC include the following in the Phase II FAA:
 - Impact of a CONUS-based Army National Provider, owning all stocks above direct support (DS) and managing all maintenance above DS, on TOE general support (GS) supply and maintenance structure.
 - NG USP&FO support to active and USAR activities in states without installations.
 - Maximize use of reserve component capabilities.
 - Eliminate redundant overhead through consolidations/regionalization.
 - Recommend DOL privatization, depot privatization, contractor operations as part of a total maintenance structure.
2. ASA(ILE), with AMC assistance, work the legislative enablers permitting depot privatization.

Issue: 16

Title: PM Matrix Support

Proponent: AMC **Sponsor:** ASA(RDA), DCSOPS **Source:** Umbrella

Implementation Period: 00-05

Synopsis: During the Equip/Supply/Maintain FAA, AMC Cdr stated that 11,000 people in the RDECs are being paid by PMs for program support. The Acquisition Executive Support Agency, a field operating agency (FOA) of ASA(RDA) contains 3,167 people. Almost \$1B/yr is spent, of procurement dollars, just for overhead and supervision of a process that is actually accomplished by private contractors, implying extensive duplication/overhead.

Resource Implications:

Military:	Savings	Costs	Transfers
Civilian:			
Dollars:			

Army Staff/Command Position:

Concur: TRADOC, DCSLOG **Nonconcur:** OCAR

Recommendations: ASA(RDA) conduct a Phase II study to reengineer PM matrix support and realize a 25-30% savings in personnel.

ACTION: ASA(RDA)

Approve
 Disapprove
 Fwd to CSA/SA for decision
 Defer to POM 00-05
 Study by: _____

Issue: 16

Title: PM Matrix Support from AMC

Enablers: None

Implementation Guidance: ASA(RDA) conduct study per recommendation, with results to VCSA not later than February 1997. Consider use of Army Science Board.

Issue: 17 **Title:** ARL HQ and RDECs

Proponent: AMC **Sponsor:** ASA(RDA)/DCSOPS **Source:** Umbrella

Implementation Period: 00-05

Synopsis: Army Research Laboratory (ARL) conducts basic and applied research and analysis. Its major customers are AMC's RDECs and PEOs/PMs. ARL provides personnel to TRADOC's Battle Labs, Combat Developments, and Requirements Developers as part of integrated concept teams. ARL has recently been organized under a Federated Lab concept, essentially a partnership between the labs, industry and academia. ARL's principal customer should be the Force Development Command which is responsible for preparing the Army for war in the future. The Force Development Command must direct science and technology (S&T) efforts to ensure evolving technologies/ materiel solutions match developing warfighting concepts.

Resource Implications:

Military:
Civilian:
Dollars:

Savings

Costs

Transfers

Results of a ASA(RDA) quick reaction study, approved by the VCSA on 29 March 1996, removes this issue from further study in Phase II.

Army Staff/Command Position:

Concur: TRADOC **Nonconcur:** AMC, ASA(RDA), DUSA(OR), DCSLOG

Recommendation: ASA(RDA) conduct a study of current process and recommend alternatives thru business process reengineering (BPR) to link S&T to the CBRS process and realize savings.

ACTION: ASA(RDA) - lead; DUSA(OR), AMC, TRADOC - assist

Approve

Disapprove

Fwd to CSA/SA
for decision

Defer to POM 00-05

Study by: ASA(RDA)

Issue: 17

Title: ARL HQ and RDECs

Enablers: None

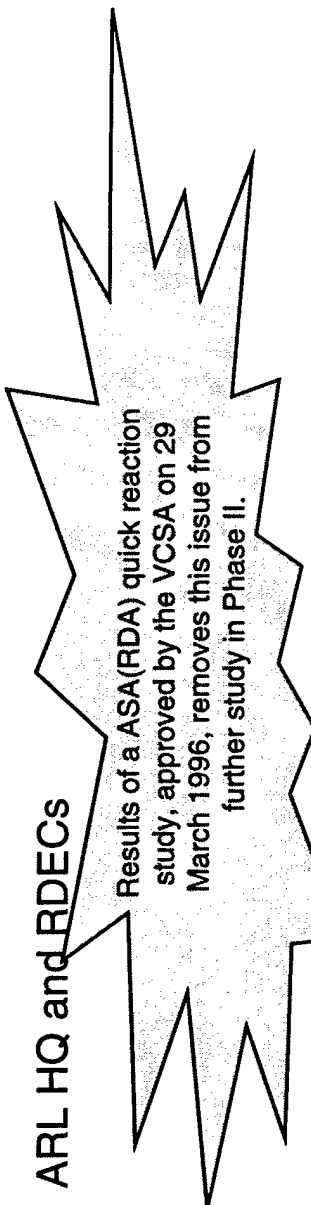

Results of a ASA(RDA) quick reaction study, approved by the VCSA on 29 March 1996, removes this issue from further study in Phase II.

Implementation Guidance:

1. ASA(RDA) study the desirability and feasibility of eliminating ARL Headquarters (the ARL Director, his staff and operations in Adelphi, MD) by assigning all research directorates to AMC RDECs as appropriate and Survivability, Lethality Analysis Directorate (SLAD) to the total test organization, to eliminate a management layer between the directorates (labs) and the RDECs/PMs they support.
2. ASA(RDA) study the desirability and feasibility of contracting out all work done now by the externally focused directorates (advanced simulation/high performance computing, information science and technology, sensors, vehicle propulsion, vehicle structures). As an alternative, contract those directorates with expertise not of fundamentally, central importance to the Army, or where world-class expertise exists in commercial firms, or where there is duplication in the private sector.
3. ASA(RDA) study the desirability and feasibility of realigning ARL directorates with TRADOC to enable a greater, earlier role in the requirements determination process (similar issue in TRADOC's Requirements FAA). Consider use of Army Science Board to: review previous studies of Army laboratory structure to determine if they are still relevant; address the issue of more closely aligning science and technology with concepts development (CBRS) in the future "Develop the Force" command.

Issue: 18

Title: MILCON Streamlining

Enablers: Legislation - relief from Davis-Bacon wages

Implementation Guidance:

1. ACSIM/USACE study MILCON streamlining issue with focus on impacts on construct function.
2. ACSIM/USACE develop concept and implementation plan by 1 October 1996.
3. ACSIM be prepared to develop draft Davis-Bacon legislation package by 1 December 1996.

Issue: 19

Title: Environmental Management/Tech Support

Proponent: USACE **Sponsor:** ASA(ILE)/ACSIM **Source:** Proponent

Implementation Period: 00-05

Synopsis: Environmental management often lags behind in the life cycle of a construct project because environmental expertise is fragmented across organizational lines and districts, and frequently competes for resourcing. The result is that environmental compliance is often addressed too late in the real property development process at additional costs to the process. Simplified access to environmental technical support will result in savings from economies of scale.

Resource Implications:

	Savings	Costs	Transfers
Military:			
Civilian:			
Dollars:			

Army Staff/Command Position:

Concur: USACE, FORSCOM **Nonconcur:** TRADOC, ACSIM, NGB

Recommendation: ACSIM develop policy to integrate environmental management into construct process and conduct an analysis of implementation impacts.

Action: ACSIM - lead; USACE/ASA(ILE) - assist

Approve **Disapprove** **Fwd to CSA/SA for decision** **Defer to POM 00-05**
 Study by: _____

Issue: 19

Title: Environmental Management/Tech Support

Enablers: AR 200-1 changes (priorities for environmental funding)

Implementation Guidance:

1. ACSIM develop regulatory changes to AR 200-1 by 1 December 1996.
2. ACSIM/USACE develop concept and implementation plan for consolidated technical support by 1 February 1997; implement by 30 September 1997.

Issue: 20

Title: Outsourcing Real Property Functions & Facilities

Enablers: None - See note below!

Implementation Guidance:

1. ACSIM develop concept plan for outsourcing facilities by 1 December 1996.
2. MACOMs test concept for outsourcing facilities in FY 00-05.
3. MACOMs/USACE develop concept plan for outsourcing construct function by 1 December 1996.
4. ACSIM/USACE be prepared to draft legislation for changing A-76 and Davis-Bacon by 1 December 1996.
5. ACSIM develop Army position on core facilities.
6. ASA(FM&C) conduct economic analysis to determine potential savings from outsourcing other specific functions determined to be of particular concern to the Army.

Note: Legislative changes that would provide wider tolerances in A-76 rules and relief from Davis-Bacon wages would generate greater savings.

Issue: 22

Title: Single Real Property Disposal Agent

Proponent: USACE **Sponsor:** ASA(ILE)/ACSIM **Source:** Umbrella

Implementation Period: 00-05

Synopsis: The Army is projected to carry approximately 170M square feet of excess facilities (minus surge requirements) into the next century. This represents a considerable cost in terms of minimal maintenance (safety), and lost opportunity in revenue that might be generated by disposing of this excess. The real property management process would be more efficiently managed if a single process owner were designated with the responsibility of expeditious disposition of excess real property.

Resource Implications: **Savings** **Costs** **Transfers**

Military:
Civilian:
Dollars:

Army Staff/Command Position:

Concur: USACE with condition **Nonconcur:** ACSIM

Recommendation: VCSA direct USACE to develop concept for a single excess property disposal agent, as a Phase II study.

Action: USACE - lead; ASA(ILE) - assist

Approve **Disapprove** **Fwd to CSA/SA** **Defer to POM 00-05**
for decision Study by: _____

Issue: 22

Title: Single Real Property Disposal Agent

Enablers:

1. Legislation to permit services to retain and obligate any revenue realized by disposition of excess real property, e.g., sale to the private sector.
2. Legislation to permit Army (DoD) to dispose of excess real property vice GSA (Federal Property and Administrative Services Act of 1949 [63 stat. 377]).
3. Legislation to change Public Benefit Discount authority to transfer responsibility for property from Army when authority is exercised [63 stat. 377].

Implementation Guidance:

1. FORSCOM identify facilities surge requirements for FORCE XXI not later than 1 December 1996.
2. USACE develop a single excess property agent concept not later than 1 March 1997.
3. ASA(ILE), with USACE assist, develop legislative changes to include relief from Public Benefit Discount authorities not later than 1 December 1996.
4. MACOMs revise facilities reduction programs to optimize facilities use and cross level needs not later than 1 December 1997.
5. ACSIM integrate into Installation Management FAA to address installation ownership question.
6. PAE spread dollars and validate through POM/PEG process.

Issue: 23

Title: Installation Construction Authority

Proponent: USACE **Sponsor:** ASA(ILE)/ACSIM **Source:** Umbrella

Implementation Period: 00-05

Synopsis: A significant level of the construction activity at the installation level is under \$1M per project. Increasing the O&MA and RDTE appropriation for construction/modification projects to \$1M (from the current \$300K per project) and Unspecified Minor MCA (UMMCA) to \$3M (from the current \$1M per project), would empower installations with sufficient authority to exercise almost autonomous control over the localized "Acquire and Sustain Facilities" process on a given installation -- a single process owner.

Resource Implications:

Savings	Costs	Transfers
----------------	--------------	------------------

Military:

Civilian:

Dollars:

Army Staff/Command Position:

Concur: USACE, ACSIM

Nonconcur:

Recommendation: ACSIM develop concept plan and legislative package to increase operations and maintenance authority at installation level for construct activities.

Action: ACSIM - lead; ASA(ILE), USACE - assist

Approve **Disapprove**

Fwd to CSA/SA for decision

Defer to POM 00-05 Study by: _____

Issue: 23

Title: Installation Construction Authority

Enablers: Effect statutory changes to PL 104-106, 10 February 96, Annual Authorization Bill and Title 10 USC, para 2805, Unspecified Minor Military Construction Account to change MCA project levels: congressional release of control of MCA \$ affecting projects in the \$300K-\$1M range.

Implementation Guidance:

1. ACSIM develop concept plan with alternative solutions, include consideration of impact on small installations, and incorporation of similar approval levels for construction funded by other appropriations.
2. ACSIM develop draft legislation to increase OMA and UMMCA authorities not later than 1 December 1996.
3. PAE follow up implementation with control measures, integrate resources saved into POM 00-05, e.g., fewer numbers of MCA actions, therefore fewer program management personnel.
4. ACSIM determine resource savings if implemented.

Issue: 24

Title: Power Projection & Power Support Platforms

Enablers: None

Implementation Guidance:

1. DCSOPS officially designate the identified 27 locations as the Army's CONUS Power Projection Platforms (15) and Power Support Platforms (12) not later than 30 September 1996.
2. DCSOPS eliminate mobilization station designation for the following sites: Ft Chaffee, Ft Gordon, Ft Irwin, Ft AP Hill, Ft Sam Houston, Ft McClellan, Ft Pickett, Camp Blanding, Camp Grayling, Camp Ripley. In coordination with owning commands, DCSOPS also determines, not later than 30 September 1996, future status of each site, e.g., training, closure, etc.
3. PAE capture the manpower and dollar savings for this action.

Issue: 24

Title: Power Projection & Power Support Platforms

PBD Information

Date: PBD#

PBD Title:

Cmd	UICMDEP	AMSCO	FY96	FY97	Manpower			FY03
					FY98	FY99	FY00	
FORSCOM	mil				-9	-9	-9	-9
	civ				-6	-6	-6	-6
TRADOC	mil				-9	-9	-9	-9
	civ				-6	-6	-6	-6
MDW	mil				-3	-3	-3	-3
	civ				-2	-2	-2	-2
NGB	mil (AGR)				-9	-9	-9	-9
	civ				-6	-6	-6	-6
AC	mil				-21	-21	-21	-21
RC	mil				-9	-9	-9	-9
	civ				-20	-20	-20	-20

TOA (\$ millions)

Cmd	UICMDEP	AMSCO	FY96	FY97	FY98	FY99	FY00	FY01	FY02	FY03
FORSCOM	Indiantown Gap, Pickett, Irwin				-1.5	-3	-3	-3	-3	-3
TRADOC	Chaffee, McClellan, Gordon				-1.5	-3	-3	-3	-3	-3
MDW	AP Hill			-0.5	-1	-1	-1	-1	-1	-1
NGB	Blanding, Grayling, Ripley				-1.5	-3	-3	-3	-3	-3
					-5	-10	-10	-10	-10	-10

Issue: 25

Title: Deployment Technology Improvement

Proponent: FORSCOM **Sponsor:** ASA(MRA) **DCSOPS Source:** Proponent

Implementation Period: 98-03

Synopsis: Recent deployment experience has identified a significant problem with visibility of deploying assets. To improve visibility and efficiency of deploying supplies, personnel and equipment, HQDA (DCSOPS) should mandate the use of electronic tags and MARC Cards. The Power Projection FAA proposed to continue development of an automated means to measure unit equipment characteristics for deployment processing and developing modular containers for secondary loads.

Resource Implications:

	Savings	Costs	Transfers
Military:	30		
Civilian:	15		
Dollars:	\$12million	\$12million (o/t)	

Army Staff/Command Position: NOTE: * - with comment

Concur: DCSOPS, DISC4*, NGB, TRADOC, OCAR, ASA(MRA)*, FORSCOM * **Nonconcur:**

Recommendation: FORSCOM develop Shed Concept for POM 98-03 and modular containers for POM 00-05. HQDA mandate RF Tag and MARC card use.

ACTION: FORSCOM - lead; DCSOPS, DCSLOG, DCSPER, TRADOC, AMC, ASA(RDA) - assist

Approve
 Disapprove
 Fwd to CSA/SA for decision
 Defer to POM 00-05 Study by: _____

Issue: 25

Title: Deployment Technology Improvement

Enablers: None

Implementation Guidance:

1. FORSCOM coordinate with DCSOPS, DCSLOG and TRADOC in the development of Shed Concept device for deployment and deployment training in POM 98-03.
2. FORSCOM develop the necessary changes to FORMDEPS and the recommended changes for AMOPES and JOPES.
3. HQDA (DCSOPS) mandate the use of RF tags and MARC cards consistent with FORSCOM vision not later than 30 September 1997.

Follow-on

4. FORSCOM, in coordination with DCSOPS, DCSLOG, AMC and ASA(RDA), determine the costs and support the development of modular containers for secondary loads in POM 00-05.

Issue: 25

Title: Deployment Technology Improvement

PBD Information

Date: **PBD#**

PBD Title:

Cmd	UIC	MDEP	AMSCO	FY96	FY97	FY98	FY99	FY00	FY01	FY02	FY03	Manpower		
FORSCOM	mil				-22	-22	-22	-22	-22	-22	-22	-22		
	civ				-11	-11	-11	-11	-11	-11	-11	-11		
TRADOC	mil				-8	-8	-8	-8	-8	-8	-8	-8		
	civ				-4	-4	-4	-4	-4	-4	-4	-4		

TOA (\$ millions)

Cmd	UIC	MDEP	AMSCO	FY96	FY97	FY98	FY99	FY00	FY01	FY02	FY03
OPA costs				+3	+9						
FORSCOM				-1.47	-1.47	-1.47	-1.47	-1.47	-1.47	-1.47	-1.47
TRADOC				-53	-53	-53	-53	-53	-53	-53	-53
				+1	+7	-2	-2	-2	-2	-2	-2

Issue: 26

Title: Mobilize RC Units at Home Station

Proponent: FORSCOM **Sponsor:** ASA(MRA)/DCSOPS **Source:** Umbrella

Implementation Period: 98-03

Synopsis: Currently all RC units must move from home station to mobilization station and then to the port of embarkation. To provide for a more effective and efficient mobilization and deployment, selected early deploying RC CS/CSS units will mobilize and begin strategic movement (deployment) at home station. These units will be prepared for mobilization and deployment and validated for readiness by their GO commands. Concept supports requirement for more CS/CSS units in the first 30 days of a major regional contingency (MRC).

Resource Implications:

Savings	Costs	Transfers
---------	-------	-----------

Military:

Civilian:

Dollars:

Army Staff/Cmd Position: NOTE: * - with comment
Concur: DCSOPS, NGB, TRADOC, OCAR, FORSCOM **Nonconcur:** USAREUR

Recommendation: FORSCOM identify units, test concept and provide recommended changes to AMOPES and FORMDEPS.

ACTION: FORSCOM - lead; DCSOPS, DCSPER, NGB, OCAR - assist

Approve **Disapprove** **Fwd to CSA/SA for decision** **Defer to POM 00-05** **Study by:** _____

Issue: 26

Title: Mobilize RC Units at Home Station

Enablers: AMOPES and FORMDEPS must be changed to reflect this process change for selected CS/CSS units.

Implementation Guidance:

1. FORSCOM in coordination with the NGB and OCAR, not later than 30 October 1996, identify CS/CSS units in FSP1 and FSP2 which will begin strategic movement from home station.
2. FORSCOM leads and DCSOPS assists in making required changes to AMOPES and FORMDEPS, not later than 30 June 1997, to allow selected strategic movement from home station.
3. FORSCOM conducts tests and exercises to validate concept, e.g., include RC units in Sea EDRE.
4. ARNG and USAR initiate action to ensure full POR qualification of "selected" early deploying units at all times, e.g., shots, rifle marksmanship, NBC qualification, power of attorney, etc.

Issue: 27

Title: Reduce RC TDA Structure

Proponent: FORSCOM **Sponsor:** ASA(MRA) /DCSOPS **Source:** Proponent

Implementation Period: 00-05

Synopsis: Some of the existing RC TDA structure in STARCs, RSCs, DIV(IT)s and GSUs is based upon the European conflict scenario. Given the new mobilization requirements, there is a need to reduce structure or regionalize functions of STARCs/RSCs, reduce/remission DIV(IT)s and reduce/realign GSUs. In addition, the size of some STARCs/RSCs appear disproportionate to the size of their peacetime mission; STARC structure should be benchmarked to some standard set of criteria and resources in excess of the benchmark recapitalized.

Resource Implications:

	Savings	Costs	Transfers
Military:			
Civilian:			
Dollars:			

Army Staff/Cmd Position: NOTE: * - with comment
Concur: DCSOPS, TRADOC, OCAR, FORSCOM, USAREUR* **Nonconcur:** NGB*

Recommendation: FORSCOM oversee ARNG and USAR TDA structure; DCSOPS/ASA(MRA) approve proposed benchmark criteria

ACTION: FORSCOM - lead; DCSOPS, NGB, OCAR - assist

Approve **Disapprove** **Fwd to CSA/SA for decision** **Defer to POM 00-05 Study by:** _____

Issue: 27

Title: Reduce RC TDA Structure

Enablers: None

Implementation Guidance:

1. NGB and OCAR, under FORSCOM oversight, conduct studies to determine reductions, realignments, and elimination of RC TDA structure based upon a standardized methodology and/or allocation rules. Brief study findings to VCSA and ASA(MRA) not later than 30 November 1996.
2. NGB and OCAR recommend benchmark criteria for numbers and size of structure.
3. DCSOPS and ASA(MRA) review and approve proposed benchmark criteria.
4. FORSCOM assist NGB and OCAR in applying benchmark criteria, as appropriate and refer results, in coordination with NGB and OCAR to the Organize PEG.
5. PAE review RC resourcing in POM 00-05 accordingly.

Issue: 28 **Title:** Common Mob/Deploy Info Mgmt System

Proponent: FORSCOM **Sponsor:** ASA(MRA) /DCSOPS **Source:** Proponent

Implementation Period: 00-05

Synopsis: The new Global Command and Control System (GCCS) is the communications carrier for mobilization and deployment but does not have all the required applications for mobilization and deployment. This issue suggests that the Army support in joint and Army procurement arenas the need for joint (common) mob/deploy information management applications which will improve the effectiveness and efficiency of power projection.

Resource Implications:

	Savings	Costs	Transfers
Military:			
Civilian:			
Dollars:			

Army Staff/Command Position: **NOTE:** * - with comment

Concur: DISC4*, TRADOC, OCAR, ASA(MRA)*, FORSCOM **Nonconcur:** NGB*

Recommendation: TRADOC conduct a study to determine Army requirements and recommendations for a complete multi-service mob/deploy info management system.

ACTION: TRADOC - lead; FORSCOM, DCSOPS, AMC & DISC4 - assist

Approve **Disapprove** **Fwd to CSA/SA for decision** **Defer to POM 00-05**
 Study by: _____

Issue: 28

Title: Common Mob/Deploy Info Mgmt System

Enablers: JCS/JROC support of GCCS related systems

Implementation Guidance:

1. TRADOC, in coordination with FORSCOM, DCSOPS, DISC4, and AMC, conduct a study, not later than June 1997, based on the Power Projection FAA findings to determine Army input and recommendations for a complete multi-service mob/deploy information management system.
2. FORSCOM assist TRADOC by providing the FAA findings and functional expertise to ensure all aspects of mobilization and deployment are addressed for a common system.
3. DISC4 provide information management oversight for the above study.
4. DCSOPS address requirement for Mob/Deploy information management system in POM 00-05.

Issue: 29

Title: CONUS-Based ASCCs

Enablers: Potential Treaty Negotiations

Implementation Guidance:

1. DCSOPS conduct a study not later than September 1998 that considers multi-focused ASCCs, CONUS based, conceivably one oriented on the eastern hemisphere and one on the western hemisphere.
2. DCSOPS prepare a range of courses of action which address a program of reduced overseas stationing.
3. DCSOPS anticipate and plan accordingly for a changed Unified Command Plan, number of unified commands, et al.
4. DCSOPS develop an exercise scenario where a multiple-missioned ASCC would be required to support more than one combatant command in a given hemisphere, e.g., CENTCOM and SOUTHCOM, concurrently.
5. DCSOPS review and develop proposed alternatives to current treaty organizations requiring forward stationed forces.

Issue: 30

Title: Doctrine Development

Proponent: TRADOC **Sponsor:** ASA(MRA)/DCSOPS **Source:** Proponent

Implementation Period: 98-03

Synopsis: The Army requires a single chief of Army doctrine, able to maintain complete visibility over development of all Army doctrinal products. Under one command, vertical and horizontal integration of doctrinal literature, at all levels and across every functional/mission area, becomes a component of a more cohesive and responsive process. TRADOC considers upgrades to equipment and hardware as a recurring, multi-year cost of \$0.5 million per year.

Resource Implications:

Savings	Costs	Transfers
---------	-------	-----------

Military:

Civilian:

Dollars:

\$0.5 million/yr

Army Staff/Command Position: NOTE: * - with comment

Concur: TRADOC, USAREUR*

Nonconcur: TSG

Recommendations: Designate TRADOC as proponent/process owner for development of Army Doctrine. TRADOC develops Army position on Joint doctrine; HQDA approves.

ACTION: TRADOC - lead; DCSOPS - assist

Approve

Disapprove

Fwd to CSA/SA for decision

Defer to POM 00-05 Study by: _____

Issue: 30

Title: Doctrine Development

Enablers:

1. Upgraded hardware and software.
2. Qualified personnel.
3. Requisite MOUs (interim).

Implementation Guidance:

1. TRADOC becomes Army single process owner for Army doctrine:
 - Assumes oversight of doctrine development.
 - Approves all Army doctrine.
 - Expands doctrine to Institutional Force where appropriate, e.g., LSE (FM 100-7).
2. TRADOC develops and staffs required interim MOUs.
3. TRADOC develops Army position on joint doctrine; HQDA approves and supports VCSA in JROC.

Issue: 30

Title: Doctrine Development

PBD Information

Date: _____ **PBD#** _____

PBD Title: _____

Cmd	UIC	MDEP	AMSCO	FY96	FY97	Manpower			FY02	FY03
						FY98	FY99	FY00		

Cmd	UIC	MDEP	AMSCO	FY96	FY97	TOA (\$ millions)			FY02	FY03
						FY98	FY99	FY00		

TRADOC

+0.5

+0.5

+0.5

+0.5

+0.5

+0.5

Issue: 31

Title: Consolidate Combat Development (CD) Activities

Enablers: None

Implementation Guidance:

1. TRADOC develop concept plan IAW AR 310-49 and submit to ODCSOPS no later than 30 September 1996.
2. INSCOM define CD related resources for transfer to TRADOC no later than 30 September 1996.
3. CIDC define CD related resources for transfer to TRADOC no later than 30 September 1996.

Issue: 31

Title: Consolidate Combat Development (CD) Activities

PBD Information

Date: PBD#

PBD Title:

Cmd	UIC	MDEP	AMSCO	FY96	Manpower			FY00	FY01	FY02	FY03
					FY97	FY98	FY99				
MEDCOM	N/A										
INSCOM											
ISC	See issue #46										
CIDC											
TRADOC											

TOA (\$ millions)

Cmd	UIC	MDEP	AMSCO	FY96	FY97	FY98	FY99	FY00	FY01	FY02	FY03
INSCOM											
ISC	See issue #46										
CIDC											

Issue: 32

Title: Streamline TDA Documentation Process

Enablers:

Implementation Guidance: DCSOPS resolve the issue.

Issue: 33

Title: Protocol Offices

Proponent: DCSPER **Sponsor:** ASA(MRA) **Source:** Proponent

Implementation Period: 98-03

Synopsis: Approximately 49 protocol offices currently exist in the Institutional Force, in some cases more than one exists on a given installation based on the size and nature of tenant organizations. A policy limiting the number of protocol offices to one per garrison, which may be augmented with special duty personnel for limited periods of time to accommodate unusual workload will result in a more cost effective process for performing this service. Deployed operational force units could be supported by RC protocol personnel.

Resource Implications:

	Savings	Costs	Transfers
Military:	19		
Civilian:	14		
Dollars:		\$3.08 million	

Army Staff/Command Position:

Concur: DCSPER, NGB, OCAR, TRADOC **Nonconcur:** MDW

Recommendation: DAS establish HQDA policy of not more than one protocol office per installation.

ACTION: DAS - lead; ASCIM, DCSOPS - assist

Approve
 Disapprove
 Fwd to CSA/SA for decision
 Defer to POM 00-05
 Study by: _____

Issue: 33

Title: Protocol Offices

Enablers: None

Implementation Guidance:

1. Institutional Force
 - DAS develop new Army policy and identify the one remaining protocol office on each installation.
 - PEG determine military/civilian mix for each remaining protocol office.
2. Operational Force
 - DCSOPS, in conjunction with NGB and OCAR, develop/document concept to fulfill MTOE requirement utilizing RC units.

Issue: 33

Title: Protocol Offices

PBD Information

Date:

PBD#

PBD Title:

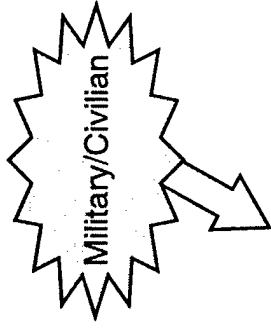

Manpower

Cmd	UIC	MDEP	AMSCO	FY96	FY97	FY98	FY99	FY00	FY01	FY02	FY03
SOUTHCOM					-1/0	-1/0	-1/0	-1/0	-1/0	-1/0	-1/0
USARPAC					-1/-1	-1/-1	-1/-1	-1/-1	-1/-1	-1/-1	-1/-1
MDW					-5/-3	-5/-3	-5/-3	-5/-3	-5/-3	-5/-3	-5/-3
MEDCOM					-5/-1	-5/-1	-5/-1	-5/-1	-5/-1	-5/-1	-5/-1
FORSCOM					-3/-3	-3/-3	-3/-3	-3/-3	-3/-3	-3/-3	-3/-3
TRADOC					-4/-5	-4/-5	-4/-5	-4/-5	-4/-5	-4/-5	-4/-5
AMC					0/-1	0/-1	0/-1	0/-1	0/-1	0/-1	0/-1
TOTAL					-19/-14	-19/-14	-19/-14	-19/-14	-19/-14	-19/-14	-19/-14

TOA (\$ millions)

Cmd	UIC	MDEP	AMSCO	FY96	FY97	FY98	FY99	FY00	FY01	FY02	FY03
USARPAC					-0.02	-0.02	-0.04	-0.04	-0.04	-0.04	-0.04
MDW					-0.065	-0.065	-0.13	-0.13	-0.13	-0.13	-0.13
MEDCOM					-0.02	-0.02	-0.04	-0.04	-0.04	-0.04	-0.04
FORSCOM					-0.065	-0.065	-0.13	-0.13	-0.13	-0.13	-0.13
TRADOC					-0.11	-0.11	-0.22	-0.22	-0.22	-0.22	-0.22
AMC					-0.02	-0.02	-0.04	-0.04	-0.04	-0.04	-0.04
TOTAL					-0.28	-0.28	-0.56	-0.56	-0.56	-0.56	-0.56

5/21/98 Note: MEDCOM OMA controlled by OSD (HA)

Issue: 34

Title: Public Affairs Office

Proponent: DCSPER **Sponsor:** ASA(MRA)

Source: Proponent

Implementation Period: 98-03

Synopsis: The Army has an obligation to keep the public informed of its activities, both world-wide, e.g., Bosnia, and locally, e.g., unit restationing. Public Affairs (PA) offices normally fulfill this obligation. There are over 200 PA offices in the Army. Frequently, several PA offices are located on a given installation. While the PA function in all offices is the same, redundancy results from the diverse operational interests of the tenant organizations. A policy establishing a common PA office, staffed with the requisite skills to represent the interests of the many tenant organizations on a given garrison would reduce redundancies and result in a more consistent quality PA product. Deployed operational force units could be augmented by RC PA support.

Resource Implications:

	Savings	Costs	Transfers
Military:	32		
Civilian:	108		
Dollars:		\$24.2 million	

Army Staff/Command Position:

Concur: CPA (supports TDA concept but recommends further study with MACOM involvement), NGB **Nonconcur:** CPA (must have a nucleus of AC TOE augmented by RC), CIDC

Recommendations: DAS establish HQDA policy of not more than one PA office per installation.

ACTION: DAS - lead; DCSOPS - assist

Approve
 Disapprove
 Fwd to CSA/SA for decision
 Defer to POM 00-05
 Study by: _____

Issue: 34

Title: Public Affairs Office

Enablers: None

Implementation Guidance:

1. DAS establish policy and identify the one remaining PA office on each installation.
2. PEG determine military/civilian mix for each remaining protocol office.
3. Once "losing" units are identified, DCSOPS, in conjunction with NGB and OCAR, develop/document concept to fulfill MTOE requirement utilizing RC units.

Issue: 34

Title: Public Affairs Office

PBD Information

Date:

PBD Title:

PBD#

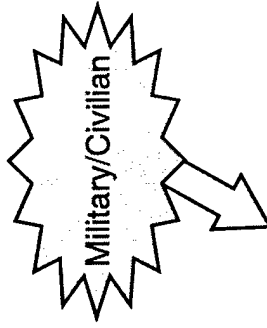

Manpower

Cmd	UIC	MDEP	AMSCO	FY96	FY97	FY98	FY99	FY00	FY01	FY02	FY03
AMC											
MEDCOM											
ISC											
TRADOC											
FORSCOM											
MDW											
SDC											
USAREUR											
USARPAC											
SOUTHCOM											
USACE											
USACIDC											
TOTAL											

TOA (\$ millions)

Cmd	UIC	MDEP	AMSCO	FY96	FY97	FY98	FY99	FY00	FY01	FY02	FY03
AMC											
MEDCOM											
ISC											
TRADOC											
FORSCOM											
MDW											
SDC											
USAREUR											
USARPAC											
SOUTHCOM											
USACE											
USACIDC											
TOTAL											

5/21/98

Note: MEDCOM OMA controlled by OSD (HA)

Issue: 35

Title: Personnel & Finance Groups

Enablers: None

Implementation Guidance:

1. TRADOC develop feasibility study timelines and concept for entry into the FDU 97-1.
2. Incorporate into the current Pay/Per business process reengineering (BPR) study, being conducted jointly by ASA(MRA) and ASA(FMC), and FM 14-100 rewrite scheduled for publication not later than 1997.
3. DCSOPS, if FDU results are approved by the VCSA/CSA, transition the Army to the new force structure design during POM 00-05.
4. USAFISA, if FDU results are approved by the VCSA/CSA, document the new organizational design.
5. No branches will be dissolved and the opportunity to compete for command will be maximized.

Issue: 35

Title: Personnel & Finance Group

PBD Information

Date: **PBD#**

PBD Title:

Cmd	UIC	MDEP	AMSCO	FY96	FY97	FY98	FY99	FY00	FY01	FY02	FY03	Manpower			
TBD															

Cmd	UIC	MDEP	AMSCO	FY96	FY97	FY98	FY99	FY00	FY01	FY02	FY03	TOA (\$ millions)			

Issue: 36

Title: Reduce Attrition

Proponent: DCSPER **Sponsor:** ASA(MRA)

Source: Proponent

Implementation Period: 98-03

Synopsis: Currently 30% of all new active component enlisted soldiers attrite from the force before they reach their initial expiration of term of service (ETS); 12% of all enlisted soldiers before they complete initial entry training (IET). Reduced attrition, or greater retention, would result in fewer soldiers recruited each year, fewer recruiters, a smaller IET cadre, reduced costs on initial clothing issues, reduced TTHS and perhaps other cost avoidance. Alternatively, additional retention may require some investment such as success-oriented training or revised physical conditioning training. The net effect on the process of retaining soldiers would be a greater return on the investment in accessing quality people while maintaining the same produce standard.

Resource Implications:

	Savings	Costs	Transfers
Military:	750		
Civilian:			
Dollars:		\$54 million	

Army Staff/Command Position:

Concur: DCSPER (with comment that TRADOC lead for IET **Nonconcur:** and savings ramp to 4% by FY 99), NGB, OCAR, TRADOC, FORSCOM

Recommendation: DCSPER establish necessary policies to reduce first term attrition.

ACTION: DCSPER - lead; TRADOC - assist

Approve Disapprove

Fwd to CSA/SA for decision

Defer to POM 00-05 Study by: _____

Issue: 36

Title: Reduce Attrition

Enablers: None

Implementation Guidance:

1. DCSPER conduct a study, with TRADOC and TIG assistance, to determine cause of attrition. Present results to VCSA not later than 30 September 1996.
2. DCSPER establish policies to reduce first-term attrition.

Issue: 36

Title: Reduce Attrition

PBD Information

Date: PBD#

PBD Title:

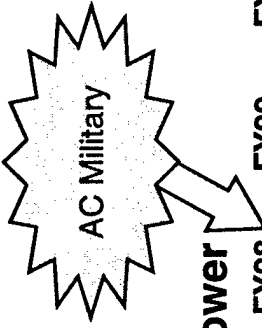

Manpower

Cmd	UIC	MDEP	AMSCO	FY96	FY97	FY98	FY99	FY00	FY01	FY02	FY03
TTHS (IET)/MACOMs (post-IET)											
						-750	-750	-750	-750	-750	-750

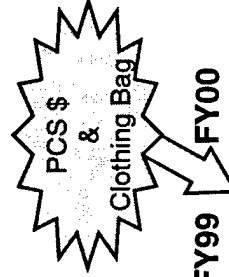

TOA (\$ millions)

Cmd	UIC	MDEP	AMSCO	FY96	FY97	FY98	FY99	FY00	FY01	FY02	FY03
DCSPER						-3.1	-3.1	-3.1	-3.1	-3.1	-3.1
TRADOC						-4.4	-4.4	-4.4	-4.4	-4.4	-4.4
USAREC						-1.5	-1.5	-1.5	-1.5	-1.5	-1.5



Issue: 37

Title: Restructure PERSCOM

Enablers: Capital investment in automation modernization. Consideration of Title

32. Consideration of TJAG special statutory responsibilities (10 USC sections 806 and 3037(c)(2)).

Implementation Guidance:

1. DCSPER develop a concept plan in accordance with AR 310-49, reporting out to ASA(MRA) and the VCSA not later than 30 September 1996, that provides for:
 - a. A multi-component, all branch, all personnel systems PERSCOM to integrate common personnel processes.
 - b. Alignment of PERSINSCOM under PERSCOM.
 - c. Concurrent development of a single, integrated, relational, multi-component personnel database, coinciding with phased implementation of PERSCOM restructuring.
 - d. Transfer of policy currently performed by PERSCOM to HQDA; non-HQ operating functions to responsible MACOMs/installations.
 - e. Alignment of Civilian Personnel Field Agency and Operating Centers to PERSCOM after implementation of regionalization.
2. DCSPER develop PBDs to capture transition costs, capital investment for automation, and savings for mini POM 99-03.
3. Execute plan, accomplishing documentation and transfer of:
 - a. PERSINSCOM not later than 1 October 1996.
 - b. Special Branch personnel not later than 1 June 1996.
 - c. DMO, MBRA and CTED (-) when feasible.
 - d. ARPERCEN not later than 1 June 1999.
 - e. NGB-ARP not later than 1 June 1999.
 - f. Civilian Personnel Field Agency and Operating Centers upon completion of regionalization, not later than 2000.

Issue: 37

Title: Restructure PERSCOM

PBD Information

Date: _____ **PBD#** _____

PBD Title: _____

Cmd	UIC	MDEP	AMSCO	FY96	Manpower							
					FY97	FY98	FY99	FY00	FY01	FY02	FY03	

TOA (\$ millions)

Cmd	UIC	MDEP	AMSCO	FY96	FY97	FY98	FY99	FY00	FY01	FY02	FY03

VCSA approved issue without additional funding.

Issue: 38**Title: Personnel Accessions Command**

Enablers: Capital investment in automation modernization. ASD(FM&P) approval and other Services agreement to move MEPCOM. Consideration of TJAG special statutory responsibilities (10 USC sections 806; 3037(c)(2); and 827(b).

Implementation Guidance:

1. DCSPER, in coordination with ASA(MRA), TRADOC, NGB, OCAR, DCSOPS, PERSCOM, USAREC, TJAG, and OCCH, examine three options for a Personnel/Accessions Command, which includes variations of elements, e.g., PERSCOM, MEPCOM, USAREC, Cadet Command, OCS and WOCS: (1) Army Personnel Command under HQDA, see page 93A; (2) Army Personnel Command under HQDA with Accessions Command and MEPCOM under TRADOC, see page 93B; (3) Army Personnel Command under TRADOC, see page 93C. Options will be briefed to the VCSA not later than 30 September 1996.
2. Based on option approved by senior Army leadership, DCSPER, in coordination with all concerned commands and staff elements, develop a concept plan, not later than 30 October 1996, in accordance with AR 310-49, and obtain leadership approval. Concept plan must address:
 - a. USAREC performance of Total Army recruiting functions--officers, enlisted, active/reserve component, special branches and selected civilians.
 - b. Centralized guidance (e.g., quality standards, DAMPL priorities) for ARNG enlisted accessions from the merged organization with decentralized execution based on individual states' manpower requirements, funding levels, etc.
 - c. Concurrent development of a single, integrated, relational, multi-component personnel database to support the merged organization and link all personnel processes.
 - d. Identification of manpower and dollar savings derived from 15% reduction of accessioning assets.
3. DCSPER include necessary automation support in development of the single, integrated, relational, multi-component personnel database identified in the "Restructure PERSCOM" issue (see issue 37).
4. USAREC, in coordination with other organizations involved (as determined by approved option), conduct proof of principle test, in FY97, not to exceed a cost of \$5M.
5. DCSPER, and other organizations involved (as determined by approved option), develop PBDs to capture transition cost and savings in mini-POM 99-03.
6. DCSPER, and other organizations involved (as determined by approved option), execute plan, accomplishing documentation, transfer of assets and implementation of expanded mission not later than 2000.

Army Personnel Command

(A "Minor" Army Command under HQDA)

Course of Action "A"

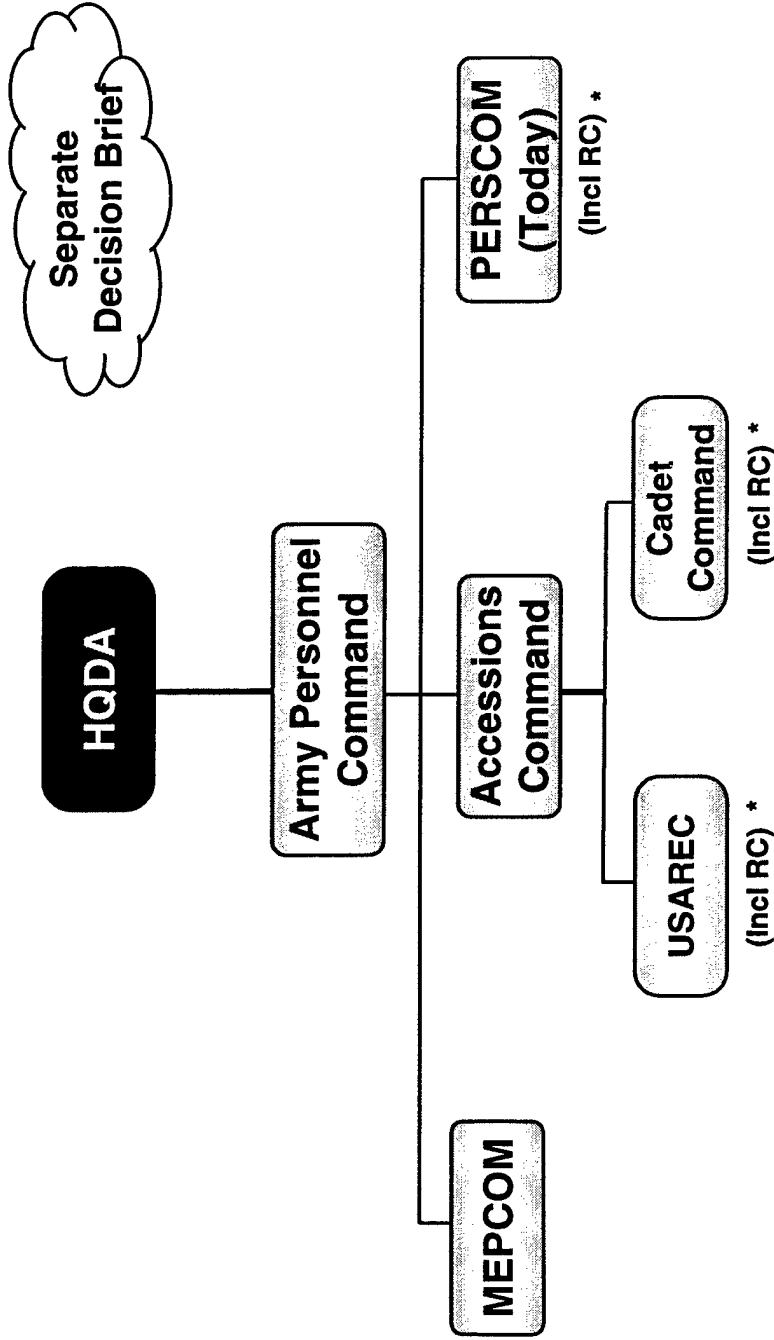

* At End State

Institutional Axis Redesign

Accessions Command

Course of Action "B"

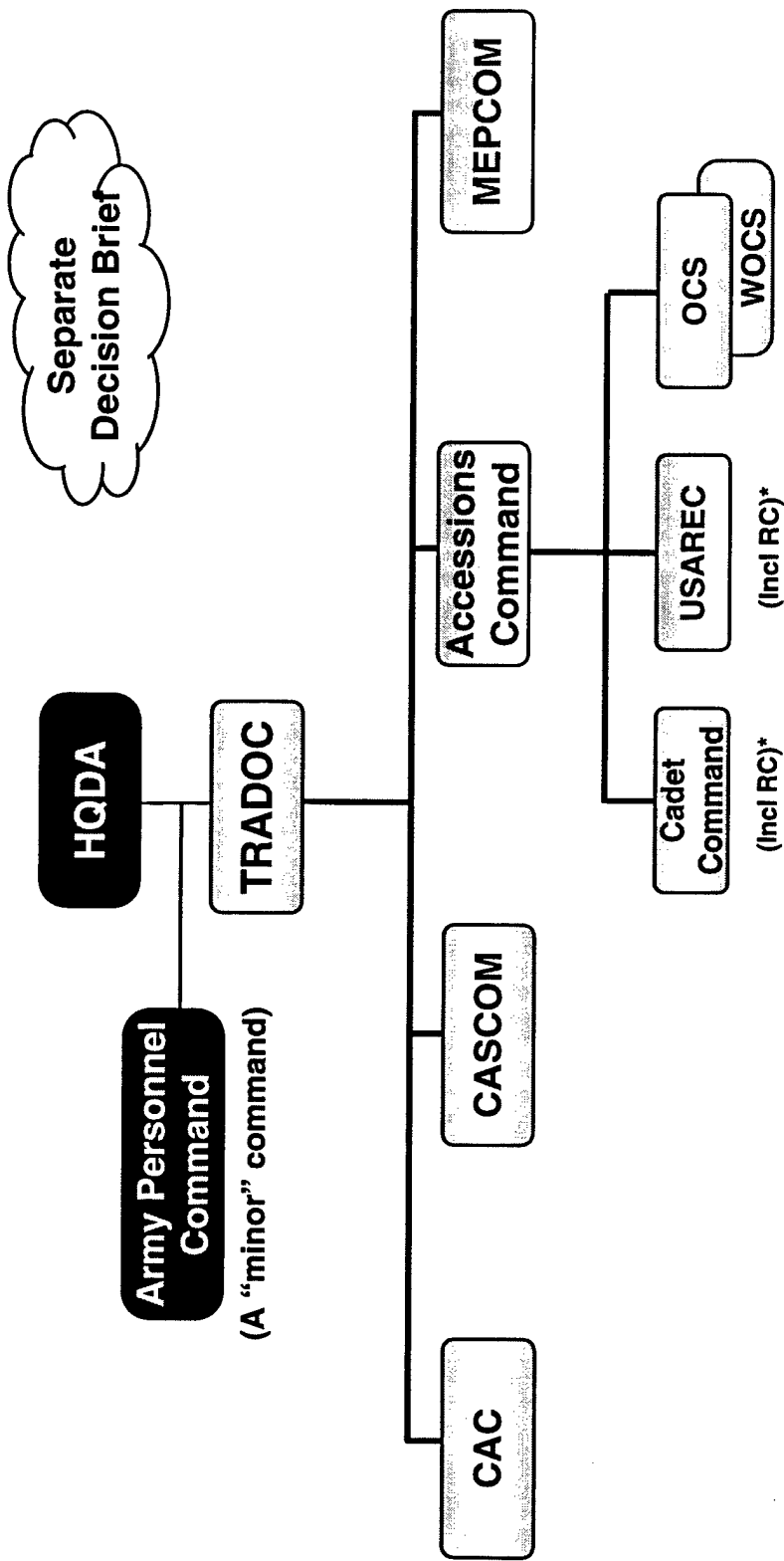

* At End State

Personnel and Accessions Command-- Separate

Course of Action "C"

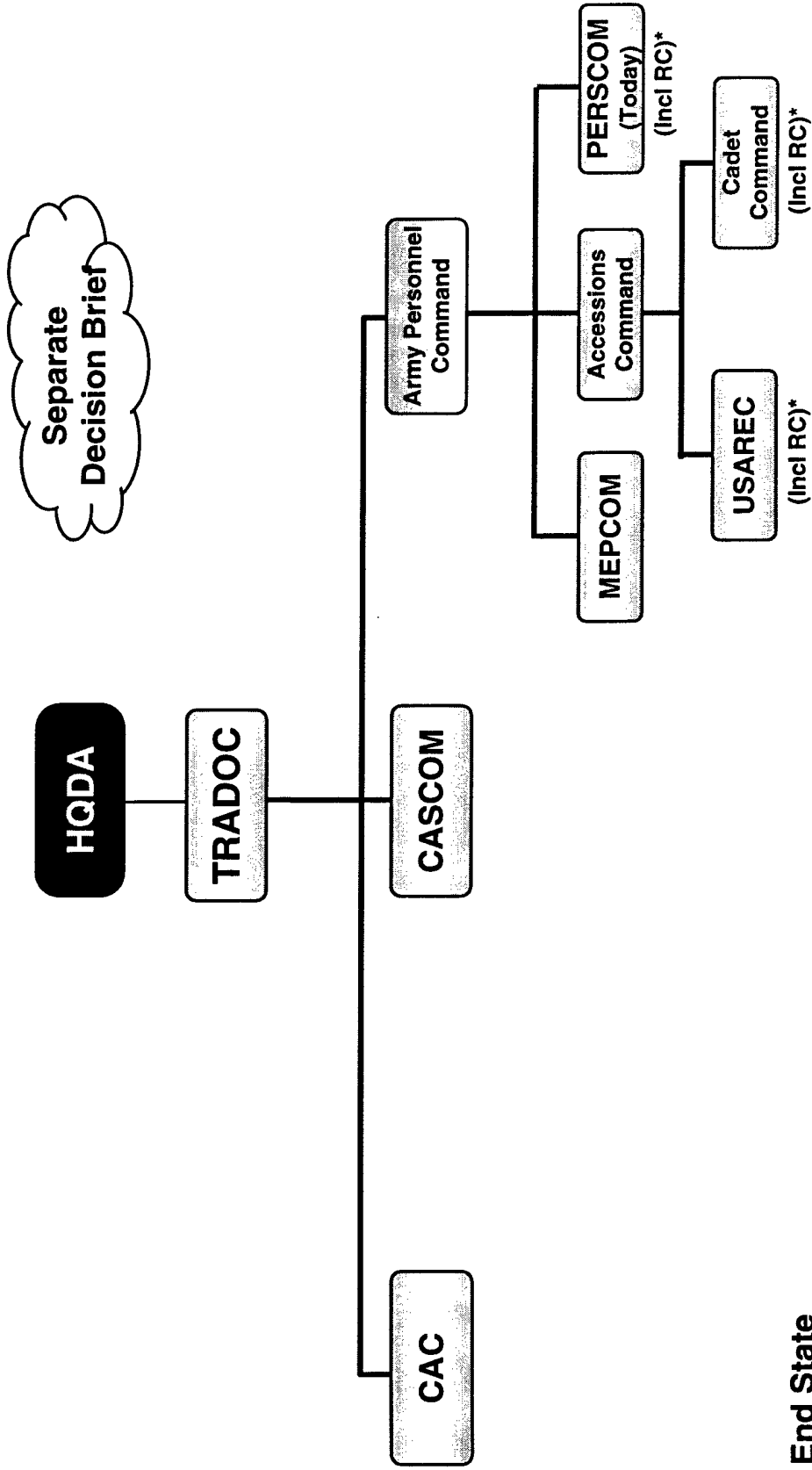

Separate
Decision Brief

* At End State

Issue: 38

Title: Personnel Accessions Command

PBD Information

Date: **PBD#**

PBD Title:

Cmd	UIC	MDEP	AMSCO	FY96	FY97	FY98	FY99	FY00	FY01	FY02	FY03	Manpower		
TBD														

TOA (\$ millions)

Cmd	UIC	MDEP	AMSCO	FY96	FY97	FY98	FY99	FY00	FY01	FY02	FY03	TOA (\$ millions)		
TBD														

Issue: 39

Title: Soldier Support Institute

Proponent: DCSPER

Sponsor: ASA(MRA)

Source: Proponent

Implementation Period: 00-05

Synopsis: Currently the Soldier Support Institute is responsible, within TRADOC, for the full range of combat development, doctrine, organization, system and leader development for the operating force. The personnel service support (PSS) activities are a subset of a complex network referred to collectively as Combat Service Support (CSS) and are therefore integrated into the generic CSS Battlefield Operating System (BOS)/Battlefield Dynamics (TC Pam 525-5) in the Combined Arms Support Command (CASCOM). Because the preponderance of the CSS is logistic in nature, PSS is becoming primarily "service support" and secondarily "personnel." Since "the Army is people" care must be taken to apply appropriate sensitivity to the dominance of PSS vice the more inanimate, logistic-unique service support. The Army should consider alternatives to the current arrangement which preserves TRADOC's role as process owner of the combat development function while applying greater sensitivity to the "personnel" dimensions of PSS activities.

Resource Implications:

Savings **Costs** **Transfers**

Military:

Civilian:

Dollars:

Army Staff/Command Position:

Concur: DCSPER, OCAR, NGB

Nonconcur:

Recommendation: TRADOC, in coordination with DCSPER, resolve issue internally.

ACTION: TRADOC - lead; DCSPER - assist

Approve

Disapprove

Fwd to CSA/SA for decision

Defer to POM 00-05 Study by: _____

Issue: 39

Title: Soldier Support Institute

Enablers: None

Implementation Guidance: DCSPER prepare letter, not later than 30 September 1996, from the VCSA to the Commander, TRADOC requesting issue be addressed in coordination with the DCSPER.

Issue: 41

Title: Senior ROTC Staffing

Proponent: TRADOC **Sponsor:** ASA(MRA)/DCSPER **Source:** Umbrella

Implementation Period: 98-03

Synopsis: Use a combination of active component (AC), reserve component (RC) and/or contracted retired officers and NCOs to manage and execute the ROTC program. RC personnel could be a continued use of full-time and might even include M-day soldiers. Instruction would continue to be conducted at universities. This will release AC officers and NCOs for operational and institutional force requirements.

Resource Implications:

	Savings	Costs	Transfers
Military:	2100		
Civilian:			
Dollars:		\$2 million (FY98 test)	

Army Staff/Command Position:

NOTE: * - with comment

Concur: ASA(MRA), OCAR

Nonconcur: DCSOPS, NGB*, TRADOC*

Recommendation: TRADOC develop plan, conduct test and with goal of implementing in School Year 1999.

ACTION: TRADOC - lead; NGB, OCAR, PAE - assist

Approve Disapprove Fwd to CSA/SA for decision Defer to POM 00-05 Study by: _____

Issue: 41

Title: Senior ROTC Staffing

Enablers: Legislation must be changed to authorize the use of retired personnel (pay restrictions) and more RC personnel. Currently Title 10 limits the use of AGRs as ROTC instructors to 275.

Implementation Guidance:

1. TRADOC develop concept plan, in accordance with AR 310-49, not later than 30 September 1996.
2. TRADOC conduct small scale proof of principle in school year (SY) 1997-1998, not to exceed \$2 million. The test should include a combination of options of: RC, both full-time and M-day soldiers, and AC personnel in a detachment.
3. TRADOC include review of OCAR proposed planned use of reservists. TRADOC plan includes consolidation of contract support.
4. TRADOC, upon successful completion and approval of proof of principle, phase in to coincide with current personnel tour ending dates as follows:
 - 33% in SY 1999
 - 33% in SY 2000
 - 33% in SY 2001

Issue: 41

Title: Senior ROTC Staffing

PBD Information

Date: **PBD#**

PBD Title:

Cmd	UIC	MDEP	AMSCO	FY96	FY97	FY98	FY99	FY00	FY01	FY02	FY03	Manpower		
												FY96	FY97	FY98
TRADOC							-700	-1400	-2100	-2100	-2100			
(mil)														

TOA (\$ millions)

Cmd	UIC	MDEP	AMSCO	FY96	FY97	FY98	FY99	FY00	FY01	FY02	FY03	TOA (\$ millions)		
												FY96	FY97	FY98
TRADOC														

Issue: 42

Title: Reduce TTHS

Proponent: TRADOC **Sponsor:** ASA(MRA)/DCSPER **Source:** Umbrella

Implementation Period: 99-03

Synopsis: The process for providing quality people to the Army includes a large overhead investment. Currently that investment is programmed to be 60,000, that is, 12% of 495,000 active military end strength to be transients, trainees, holdees or students (TTHS) not available for Army units. However, the active TTHS account is actually projected to be approximately 13% resulting in roughly 4,000 negative operating strength - or unmanned billets. Minimally, action is required to eliminate the negative operating strength deviation, and, ideally, develop alternatives to reduce the overhead below the historical level of 12%.

Resource Implications:

Savings	Costs	Transfers
TBD		

Military:
Civilian:
Dollars:

Army Staff/Command Position:

NOTE: * - with comment

Concur: NGB, TRADOC*, OCAR, ASA(MRA)*, DCSPER* **Nonconcur:**

Recommendation: DCSPER develop courses of action to retain TTHS account at 12% or less.

ACTION: DCSPER - lead; TRADOC, DCSOPS - assist

Approve
 Disapprove
 Fwd to CSA/SA for decision
 Defer to POM 00-05
 Study by: _____

Issue: 42

Title: Reduce TTHS

Enablers: None

Implementation Guidance:

1. DCSPER, in coordination with TRADOC and DCSOPS, develop courses of action to retain TTHS account at 12% or less and present in a decision brief to VCSA and CSA not later than 1 October 1996.
2. DCSPER determine savings from above decision not later than 1 December 1996 to be implemented in the mini-POM 99-03.

Issue: 43

Title: Single Leader Development Process Owner

Enablers: None



Movement of the AWC to TRADOC is pending final Secretariat and ARSTAF Coordination

Implementation Guidance:

1. TRADOC develop a concept plan IAW AR 310-49 to consolidate under TRADOC the AMSC and all Federal and State Officer Candidate Schools (OCSs). The concept plan will be briefed to VCSA, not later than 30 October 1996, with a goal of implementing in FY 98.
2. TJAG conduct feasibility study on possible move of JAG School to TRADOC. Report findings to VCSA in 30 September 1996.

Issue: 45 **Title:** Single Automated Training Management System

Proponent: TRADOC **Sponsor:** ASA(MRA)/DCSPER **Source:** Proponent

Implementation Period: 00-05

Synopsis: Currently the Army has several automation systems for training management that cover portions of the requirement but do not include all courses and all military and civilian training. To improve the process of training management, a comprehensive automated training management system is required that documents, schedules, records and resources all institutional training requirements and courses for military and civilian personnel.

Resource Implications:

Savings	Costs	Transfers
---------	-------	-----------

Military:

Civilian:

Dollars:

Army Staff/Command Position: NOTE: * - with comment
Concur: DISC4*, NGB, TRADOC, OCAR, ASA(MRA)*, DCSPER* **Nonconcur:** FORSCOM*

Recommendation: TRADOC conduct study to determine requirements by July 1997 and compete for resources in POM 00-05.

ACTION: TRADOC - lead; DCSPER - assist

Approve **Disapprove** **Fwd to CSA/SA for decision** **Defer to POM 00-05**
 Study by: _____

Issue: 45

Title: Single Automated Training Management System

Enablers: None

Implementation Guidance:

1. TRADOC, complete a study by July 1997, with DCSPER assisting, to determine the requirements of a system that will meet the needs of the Army Training Management and personnel Management communities. The system, a super Army Training Requirements and Resources System (ATRRS), should consider all military (AC/RC) and civilian individual training and leader development activities.
2. TRADOC compete, in POM 00-05, for requisite resources based on the outcome of the above study.

Issue: 46

Title: ISC HQ and Organizational Changes

Proponent: ISC

Sponsor: DCSOPS/DISC4

Source: Proponent

Implementation Period: POM 98-03 and FY97

Synopsis: Refocus ISC as a world-wide operational command, an Army Signal Command subordinate to FORSCOM.

Resource Implications:

	Savings	Costs	Transfers
Military:	16		
Civilian:	45		
Dollars:	\$11.25 million		

Army Staff/Command Position:

Concur: DISC4, TRADOC

Nonconcur: USAREUR, OCAR

Recommendation: Inactivate ISC; remission as Army Signal Command under FORSCOM with responsibility for operational C4/IM.

ACTION: ISC - lead (until transfer to FORSCOM); DISC4, FORSCOM, DCSOPS - assist

Approve

Disapprove

Fwd to CSA/SA
for decision

Defer to POM 00-05
 Study by: _____

Issue: 46

Title: ISC HQ and Organizational Changes

Enablers: None

Implementation Guidance:

1. DCSOPS redesignate ISC as the Army Signal Command (ASC), under current TDA, effective 16 September 1996. ASC transfer to FORSCOM 16 September 1997.
2. FORSCOM designate the ASC commander as the G6, following established signal doctrine, upon assignment of ASC to FORSCOM.
3. ASC retains current relationships with the operational field commands and the MACOMs/CINCs they support.
4. ISC realigns missions and associated resources from ISC as indicated: RDAISA to ASA(RDA), PERSINSCOM to PERSCOM, EAC C4 Combat Developments to the Signal Center, and Technology Applications Office to PEO, STAMIS. Acquisition, procurement and engineering realignments are covered in Issues 48 and 49. Gaining commands and agencies are required to prepare plans for accepting these additional organizations and missions IAW AR 310-49. Gaining and losing commands and agencies must ensure smooth, uninterrupted mission transition.
5. ISC define the ASC technical oversight relationship to DOIMs and the CONUS infrastructure with more precision and submit study/recommendations to DISC4 for approval by 1 December 1996.

Issue: 46

Title: ISC HQ and Organizational Changes

PBD Information

Date: PBD#

PBD Title:

Manpower

Cmd	UIC	MDEP	AMSCO	FY96	FY97	FY98	FY99	FY00	FY01	FY02	FY03
HQ ISC							-61 (16 mil, 45 civ)	-61	-61	-61	-61
C2 TAO					-35	-35	-35	-35	-35	-35	-35
PEO STAMIS					+39	+35	+35	+35	+35	+35	+35
PERSINSCOM					-897	-900	-900	-900	-900	-900	-900
PERSCOM					+897	+900	+900	+900	+900	+900	+900
C2 RDAISA					-97	-97	-97	-97	-97	-97	-97
ASA(RDA)					+97	+97	+97	+97	+97	+97	+97
HQ ISC					-9	-9	-31	-31	-31	-31	-31
TRADOC					+9	+9	+31	+31	+31	+31	+31

TOA (\$ millions)

Cmd	UIC	MDEP	AMSCO	FY96	FY97	FY98	FY99	FY00	FY01	FY02	FY03
ISC							-2.25	-2.25	-2.25	-2.25	-2.25

Issue: 47

Title: Disposition of Non-Core IM Responsibilities

Enablers: Services concurrence with divestiture

Implementation Guidance:

1. DISC4 develop concept/implementation plan not later than 30 September 1996 to:
 - Rely on civilian standards and procedural guidelines for libraries.
 - Divest publications and printing and records management policy to DCSPER.
 - Realign operational aspects of the Army Publications and Printing Command to the Defense Logistics Agency.
 - Complete the consolidation of the Baltimore publications facility into the St. Louis facility in accordance with the BRAC law.
 - Make joint recommendation with DCSPER to ASA(MRA) on realignment of career program 34.
 - Recommend realignment of MACOM, ARNG and USAR library, publications and printing, and records management functions.
2. TRADOC analyze above results to determine impact, if any, on TOE force.
3. DISC4 retains the responsibility to promulgate the architecture and standards for digitization for divested functions.

Issue: 47

Title: Disposition of Non-Core IM Responsibilities

PBD Information

Date: _____ **PBD#** _____

PBD Title: _____

Cmd	UIC	MDEP	AMSCO	FY96	FY97	FY98	FY99	FY00	FY01	FY02	FY03	Manpower		
												FY98	FY03	
C2 APPC				-344		-344	-344	-344	-344	-344	-344	-344		
DISC4				-1		-1	-1	-1	-1	-1	-1	-1		
DLA				+179		+179	+179	+179	+179	+179	+179	+179		
DCSPER				+52		+52	+52	+52	+52	+52	+52	+52		

TOA (\$ millions)

Cmd	UIC	MDEP	AMSCO	FY96	FY97	FY98	FY99	FY00	FY01	FY02	FY03	TOA (\$ millions)		
												FY98	FY03	
ISC (St. Louis facility closure)						+7								
DISC4						-6								

Issue: 48

Title: IM Acquisition Structure

Proponent: ISC

Sponsor: DCSOPS/DISC4

Source: Proponent

Implementation Period: POM 98-03

Synopsis: Information Management FAA recommended eliminating the Information Systems Management Activity (ISMA) by integrating its functions/personnel into PEO, STAMIS and PEO, C3S and CECOM. Elimination streamlines the acquisition process, reduces overhead and enhances interpretability.

Resource Implications:

	Savings	Costs	Transfers
Military:	8		
Civilian:	40		
Dollars:	\$7.9 million		

Army Staff/Command Position:

Concur: DISC4, ASA(RDA), ISC, TRADOC **Nonconcur:**

Recommendation: ISC divest ISMA to PEOs and CECOM

ACTION: ISC - lead; DISC4, ASA(RDA), AMC - assist

Approve
 Disapprove
 Fwd to CSA/SA for decision
 Defer to POM 00-05

 Study by: _____

Issue: 48

Title: IM Acquisition Structure

Enablers: None

Implementation Guidance:

1. ISC realigns, by 1 October 1996, the Program/Product Managers (PM) from ISMA to PEO, C3S and PEO, STAMIS as briefed at the Information Management FAA.
2. ASA(RDA) use the Army Science Board to assess appropriate transfer, all or part, of ISMA to PEOs.
3. ISMA inactivates in FY97 consistent with realignment of its missions.
4. DISC4 ensures realignment of resources (dollars and manpower), including overhead, is consistent with existing PM/PEO business practices and is adequate to provide appropriate matrix support. Such an arrangement will be accomplished through a collaborative effort involving the PEOs, ISC and the DISC4.
5. PEOs and AMC prepare concept plans, IAW AR 310-49, for accepting their additional organizations and missions. Gaining and losing commands and agencies ensure smooth, uninterrupted mission transition.
6. DISC4 examines further consolidation opportunities, such as hardware programs and combat service support programs.

Issue: 48

Title: IM Acquisition Structure

PBD Information

Date: **PBD#**

PBD Title:

Cmd	UIC	MDEP	AMSCO	FY96	Manpower							
					FY97	FY98	FY99	FY00	FY01	FY02	FY03	
C2 ISMA					-252	-249						
C2 HQ					-16	-16						
PEO C3S					+80	+79						
PEO STAMIS					+136	+135						
X8 CECOM					+52	+51						
PEO (C3S/STAMIS)							-24	-32	-42	-48	-48	

TOA (\$ millions)

Cmd	UIC	MDEP	AMSCO	FY96	FY97	FY98	FY99	FY00	FY01	FY02	FY03

Note: OMA & OPA changes between ISMA, CECOM, and PEOs not displayed but available from DISC4.

Issue: 49 **Title:** Streamline IM Procurement and Engineering

Proponent: ISC **Sponsor:** DCSOPS/DISC4 **Source:** Proponent

Implementation Period: POM 98-03

Synopsis: To improve the Information Systems procurement and engineering business process, the proponent recommends consolidating ISC's Info Systems Engineering Command (ISEC), Information Systems Software Center (ISSC) and contracting office in addition to DISC4 FOA (Information Systems Selection and Acquisition Agency), into AMC's CECOM. Consolidation provides a single point for engineering and procurement, eliminates management layering and reduces coordination requirements.

Resource Implications:

	Savings	Costs	Transfers
Military:	39		
Civilian:	18		
Dollars:	\$4-5M		

Army Staff/Command Position:

Concur: DISC4, all ARSTAF, ISC, TRADOC, AMC **Nonconcur:**

Recommendation: ISC divest ISEC, ISSC and contract office to CECOM; DISC4 divest ISSAA FOA to CECOM.

ACTION: ISC, DISC4 - lead; AMC - assist

Approve **Disapprove** **Fwd to CSA/SA** **Defer to POM 00-05**
for decision for decision Study by: _____

Issue: 49

Title: Streamline IM Procurement and Engineering

Enablers: None

Implementation Guidance:

1. ISC/DISC4 transfer all C4/IM contracting to AMC(CECOM) as soon as practicable, but no later than 1 October 1997. OPCON as early as practicable.
2. AMC(CECOM) work follow-on contracting operations and timelines within AMC to implement ultimate contracting end state.
3. ISC realign all C4/IM engineering under AMC(CECOM) less Army Signal Command (ASC) organic support, as soon as practicable, but no later than 16 September 1997. OPCON as soon as practicable.
4. AMC prepare concept plans IAW AR 310-49 for their additional organizations and missions. Gaining and losing commands and agencies must ensure smooth, uninterrupted mission transition.
5. ISC/FORSCOM retain minimal organic engineering element solely for fast reaction, operational requirements.
6. AMC(CECOM), as part of Phase II, increase privatization of software engineering in automated information systems commensurate with privatization software engineering for battlefield C4I systems consistent with legislative constraints.
7. AMC(CECOM), as part of Phase II, assess additional savings possibilities through consolidations, relocations, and privatization consistent with legislative constraints.

PBD Information

Date: 2/9/96

PBD Title:

PBD#

DISC4 working spread of manpower and TOA costing/savings. PEG verify with DISC4.

Cmd	UIC	MDEP	AMSCO	FY96	Manpower					FY03	
					FY97	FY98	FY99	FY00	FY01		FY02
ISCCO					-58		-58	-58	-58	-58	-58
AMC/CECOM							+58	+58	+58	+58	+58
DISC4/ISSAA					-119		-119	-119	-119	-119	-119
AMC/CECOM					+119		+119	+119	+119	+119	+119
ISC (enr)					-1750		-1750	-1750	-1750	-1750	-1750
AMC/CECOM					+1750		+1750	+1750	+1750	+1750	+1750

TOA (\$ millions)

Cmd	UIC	MDEP	AMSCO	FY96	TOA (\$ millions)					FY03	
					FY97	FY98	FY99	FY00	FY01		FY02
ISCCO					-2.626		-2.546	-12.511	-2.545	-2.545	-2.515
AMC/CECOM					+2.626		+2.546	+2.511	+2.545	+2.545	+2.515
DISC4/ISSAA					-5.005		-5.084	-5.024	-5.109	-5.109	-5.109
AMC/CECOM					+5.005		+5.084	+5.024	+5.109	+5.109	+5.109
ISC (OMA)					-56.286		-56.251	-54.181	-55.641	-55.641	-55.641
AMC/CECOM (OMA)					+56.286		+56.251	+54.181	+55.641	+55.641	+55.641
ISC (OPA)					-5.892		-5.188	-5.145	-3.110	-5.11	-5.11
AMC/CECOM (OPA)					+5.892		+5.188	+5.145	+3.110	+5.11	+5.11

Issue: 50

Title: Automation Efficiencies

Proponent: ISC

Sponsor: DCSOPS/DISC4

Source: Proponent

Implementation Period: POM 98-03

Synopsis: To further meet Force XXI goals, DISC4 is undertaking a program to achieve increased automation efficiencies. This will be accomplished by accelerating SINGARS and examining the feasibility of retiring the VRC-12 radio before replacements are available. Additional incentives include validating power projection platform information management systems and requirements, streamlining the automation acquisition and fielding process, increasing oversight of DOIMs, and monitoring MACOM IM procurements with help of Inspector General and Army Audit Agency. Additionally, DISC4 will field a plan to promulgate best business practices across the Army. Projected savings are expected to be \$200-300 million. Savings are included in CSA's efficiencies effort.

Resource Implications:

	Savings	Costs	Transfers
Military:			
Civilian:			
Dollars:	\$200-300M		

Army Staff/Cmd Position:

Concur: DISC4

Nonconcur: NGB

Recommendation: DISC4 develop concept plan to promulgate best business practices; reconcile with efficiencies group to prevent double counting.

ACTION: DISC4 - lead; ISC, ACSIM, DCSOPS - assist

Approve
 Disapprove
 Fwd to CSA/SA for decision
 Defer to POM 00-05
 Study by: _____

Issue: 50

Title: Automation Efficiencies

Enablers: None

Implementation Guidance:

1. DISC4 coordinate with MACOMs and assemble required automation efficiencies data and provide to PAED.
2. PAED coordinate with overall CSA efficiencies effort to avoid double counting savings and enter efficiencies into POM 98-03. Savings from SINGARS acceleration (\$225 million) already taken in budget estimate submission (BES).
3. Do not remove VRC-12 series radios from the RC until suitable replacements are available.

Issue: 50

Title: Automation Efficiencies

PBD Information

Date:

PBD#

DISC4 submit savings under CSA
 efficiencies effort to avoid double counting.
 PEG verify submission with DISC4.

PBD Title:

Manpower

Cmd	UIC	MDEP	AMSCO	FY96	FY97	FY98	FY99	FY00	FY01	FY02	FY03

TOA (\$ millions)

Cmd	UIC	MDEP	AMSCO	FY96	FY97	FY98	FY99	FY00	FY01	FY02	FY03

Issue: 51

Title: Rightsize ISC HQ

Proponent: ISC

Sponsor: DCSOPS/DISC4

Source: Umbrella

Implementation Period: 98-03

Synopsis: Size of ISC HQ size can be reduced based on transfers of missions from ISC to other organizations and subordination to FORSCOM, when the ISC commander becomes the FORSCOM G6. The proponent showed a reduction in the HQ of 116 spaces, 61 as savings and 55 transferring as direct support for missions migrating to other organizations. 44 additional space savings are possible in FY98.

Resource Implications:

Savings	Costs	Transfers
----------------	--------------	------------------

Military:

Civilian: 44 spaces (est)

Dollars: \$13.2 million

Army Staff/Command Position:

Concur: DISC4, TRADOC **Nonconcur:** OCAR

Recommendation: TRADOC develop force design for HQ, Army Signal Command.

ACTION: TRADOC - lead; FORSCOM, ISC, DISC4, DCSOPS - assist

Approve
 Disapprove
 Fwd to CSA/SA for decision
 Defer to POM 00-05 Study by: _____

Issue: 51

Title: Rightsize ISC HQ

Enablers: None

Implementation Guidance:

1. TRADOC, within the FDU process, design the Army Signal Command (ASC) HQs as a deployable TOE headquarters with TDA augmentation based on mission and mission essential task list (METL). Total strength will be less than 394.
2. TOE design for the ASC HQ must be available in time for MTOE documentation EDATE 970916.

Issue: 51

Title: Rightsize ISC HQ

PBD Information

Date: **PBD#**

PBD Title:

Cmd	UIC	MDEP	AMSCO	FY96	FY97	FY98	FY99	FY00	FY01	FY02	FY03	Manpower		
												FY97	FY98	FY99
ISC						-44	-44	-44	-44	-44	-44			

TOA (\$ millions)

Cmd	UIC	MDEP	AMSCO	FY96	FY97	FY98	FY99	FY00	FY01	FY02	FY03	TOA (\$ millions)		
												FY97	FY98	FY99
ISC						-1.1	-2.3	-2.45	-2.45	-2.45	-2.45			

Issue: 52

Title: Army Digitization Office (ADO)

Proponent: ISC

Sponsor: DCSOPS/DISC4

Source: Umbrella

Implementation Period: POM 98-03

Synopsis: ADO was established to coordinate Army battlefield digitization, essentially a forcing function between acquisition and operations to support Force XXI and Joint Venture. Its focus is on the Army XXI and Army Warfighting Experimentation (AWE). After completion of the Applique MS III decision, ADO residual functions should be absorbed by DISC4 eliminating 25 TDA positions.

Resource Implications:

	Savings	Costs	Transfers
Military:	10 spaces		
Civilian:	15 spaces		
Dollars:	\$3M		

Army Staff/Command Position:

Concur: DISC4, TRADOC

Nonconcur:

Recommendation: ASA(RDA) establish a termination date for ADO and reflect in POM 98-03

ACTION: ASA(RDA) - lead; DISC4, DCSOPS - assist

Approve
 Disapprove
 Fwd to CSA/SA
 Defer to POM 00-05

 for decision
 Study by: _____

Issue: 52

Title: Army Digitization Office (ADO)

Enablers: None

Implementation Guidance:

1. Transfer ADO to DISC4, in FY00, at full strength at the beginning of FY00. Begin reducing ADO transfer strength in FY00, taking all 25 spaces by FY01.
2. Army will terminate Federally Funded Research and Development Center and contractor support for the ADO by the end of FY00.

Issue: 52

Title: Army Digitization Office (ADO)

PBD Information

Date: _____ **PBD#** _____

PBD Title: _____

Cmd	UIC	MDEP	AMSCO	FY96	FY97	FY98	FY99	FY00	FY01	FY02	FY03	Manpower		
												FY00	FY01	FY02
ADO								-25	-25	-25	-25			
DISC4								+25	+25	+25	+25			
DISC4								-5	-22	-25	-25			

TOA (\$ millions)

Cmd	UIC	MDEP	AMSCO	FY96	FY97	FY98	FY99	FY00	FY01	FY02	FY03	TOA (\$ millions)		
												FY00	FY01	FY02
ADO								-1.25	-1.25	-1.25	-1.25			
DISC4								+1.25	+1.25	+1.25	+1.25			
DISC4								-0.25	-0.62	-0.71	-0.71			

Issue: 53 **Title:** ISC Three Remaining CONUS DOIMs

Proponent: ISC **Sponsor:** DCSOPS/DISC4 **Source:** Umbrella

Implementation Period: POM 00-05

Synopsis: AMC, FORSCOM and TRADOC DOIMs are part of their commands, responsive to the commander, with standards, architecture and policy from DISC4. ISC operates DOIMs for INSCOM, MDW and West Point. Divesting ISC of this responsibility permits total focus on operational missions in support of FORSCOM. Both INSCOM and MDW DOIMs contain strategic as well as local information systems responsibilities. Separating strategic functions from DOIMs would be necessary before realignment.

Resource Implications:

	Savings	Costs	Transfers
Military:			10 spaces (est)
Civilian:			15 spaces (est)
Dollars:			

Army Staff/Command Position:

Concur: DISC4, TRADOC **Nonconcur:**

Recommendation: DISC4 conduct study to determine appropriate alignment for ISC's three remaining DOIMs.

ACTION: DISC4 - lead; FORSCOM, ISC, MDW, INSCOM, USMA - assist

Approve **Disapprove** **Fwd to CSA/SA** **Defer to POM 00-05**
for decision Study by: _____

Issue: 53

Title: ISC Three Remaining CONUS DOIMs

Enablers: None

Implementation Guidance:

1. DISC4 conduct study to determine appropriate alignment of ISC's three remaining DOIMs including separation of strategic responsibilities from installation operations and determination of the appropriate installation support infrastructure.
2. Submit study results/recommendations to VCSA for approval not later than 30 September 1996.

Issue: 55 **Title:** Office of the Secretary of the Army
Proponent: AA/DAS **Sponsor:** ASA(MRA) **Source:** HQDA Redesign
Implementation Period: POM 98-03

Synopsis: Downsize by 2 (1/1/2).

Resource Implications:

	Savings	Costs	Transfer
Military:		-1	0
Civilian:		-1	0
Dollars:		-.05M	0

Army Staff/Command Position: **Concur:** ASA(MRA) **Nonconcur:**

Recommendation: Implement in POM 98-03

ACTION: OSA.

Approve
 Disapprove
 Fwd to CSA/SA for decision
 Defer to POM 00-05 Study by: _____

Issue: 55 **Title:** Office of the Secretary of the Army

Synopsis: Downsize by 2 (1/1/2).

Enablers: None.

Implementation Guidance:
HQDA Redesign Working Group submit an adjustment to POM 98-03.

Synopsis: Downsize by 2 (1/1/2).

Manpower

Cmd	UIC	MDEP	AMSCO	TYPE	FY97	FY98	FY99	FY00	FY01	FY02	FY03
SA	W00EAA	XMGH	431398000	MIL	-1	-1	-1	-1	-1	-1	-1
XX	WEDGE			MIL	+1	+1	+1	+1	+1	+1	+1
SA	W00EAA	XMGH	431398000	CIV	-1	-1	-1	-1	-1	-1	-1
XX	WEDGE			CIV	+1	+1	+1	+1	+1	+1	+1

TOA (\$ millions)

Cmd	UIC	MDEP	AMSCO	TYPE	FY97	FY98	FY99	FY00	FY01	FY02	FY03
SA	W00EAA	XMGH	431398000	CIV		-.025M	-.05M	-.05M	-.05M	-.05M	-.05M

Issue: 56

Title: Office of the Under Secretary of the Army

Proponent: AA/DAS

Sponsor: ASA(MRA)

Source: HQDA Redesign

Implementation Period: POM 98-03

Synopsis: Downsize by 1 (0/1/1). [Receive Army Studies Program function and spaces from MISMA (0/3/3) (see issue 60).]

Resource Implications:

	Savings	Costs	Transfer
Military:	0	0	0
Civilian:	-1	0	0
Dollars:	-0.05M	0	0

Army Staff/Command Position:

Concur: ASA(MRA)

Nonconcur:

Recommendation: Implement in POM 98-03

ACTION: US of A.

Approve
 Disapprove
 Fwd to CSA/SA for decision
 Defer to POM 00-05 Study by: _____

Issue: 56 **Title:** Office of the Under Secretary of the Army

Synopsis: Downsize by 1 (0/1/1).

Enablers: None.

Implementation Guidance:
HQDA Redesign Working Group submit adjustment to POM 98-03.

Issue: 56

Title: Office of the Under Secretary of the Army

Synopsis: Downsize by 1 (0/1/1).

Manpower

Cmd	UIC	MDEP	AMSCO	TYPE	FY97	FY98	FY99	FY00	FY01	FY02	FY03
SA	W00FAA	XMGH	431398000	CIV	-1	-1	-1	-1	-1	-1	-1
XX	WEDGE			CIV	+1	+1	+1	+1	+1	+1	+1

TOA (\$ millions)

Cmd	UIC	MDEP	AMSCO	TYPE	FY97	FY98	FY99	FY00	FY01	FY02	FY03
SA	W00FAA	XMGH	431398000	CIV	-	-.025M	-.05M	-.05M	-.05M	-.05M	-.05M

Issue: 57

Title: DUSA (International Affairs)

Proponent: AA/DAS

Sponsor: ASA(MRA)

Source: HQDA Redesign

Implementation Period: POM 98-03

Synopsis: Establish a DUSA (IA) to encompass the major Army International Activities (AIA) which transcend the traditional functional area boundaries of acquisition, logistics, intelligence, and operations. Major ARSTAF and Secretariat policy development and management responsibilities migrate to the DUSA (IA). Transfer 80 spaces (29/51/80) to DUSA (IA): SARDA (3/3/6), DCSINT (8/9/17), DCSOPS (8/6/14), DCSOPS Spt Gp (5/9/14), DCSLOG (0/13/13), LEA (1/8/9), TIPA (4/1/5), and AMC (0/2/2). Downsize by 6 (-3/3/6).

Resource Implications:

	Savings	Costs	Transfer
Military:			
		-3	0
Civilian:			
		-3	0
Dollars:			
		-15M	0
			+31
			+51
			+2.55M

Army Staff/Command Position:

Concur: SARDA, DCSINT, DCSLOG

Nonconcur: DCSOPS

Recommendation: Implement in POM 98-03

ACTION: OSA - LEAD; DUSA(IA), ASA(RDA), DCSINT, DCSOPS, DCSLOG, LEA, TIPA, and AMC - ASSIST.

Approve
 Disapprove
 Fwd to CSA/SA
 Defer to POM 00-05
 for decision
 Study by: _____

Issue: 57 **Title:** DUSA (International Affairs)

Synopsis: Establish a DUSA (IA). Transfer 80 spaces (29/51/80) to DUSA (IA): SARDA (3/3/6), DCSINT (8/9/17), DCSOPS (8/6/14), DCSOPS Spt Gp (5/9/14), DCSLOG (0/13/13), LEA (1/8/9), TIPA (4/1/5), and AMC (0/2/2). Downsize by 6 (-3/3/6).

Enablers: None.

Implementation Guidance:

1. HQDA Redesign Working Group submit an adjustment to POM 98-03.
2. DUSA(IA) prepare a concept plan, not later than 30 August 1996, to integrate spaces and functions. ASA(RDA), DCSINT, DCSOPS, DCSLOG, LEA, TIPA, and AMC - ASSIST.

Issue: 57

Title: DUSA (International Affairs)

Synopsis: Establish a DUSA (IA). Transfer 80 spaces (29/51/80) to DUSA (IA): SARDA (3/3/6), DCSINT (8/9/17), DCSOPS (8/6/14), DCSOPS Spt Gp (5/9/14), DCSLOG (0/13/13), LEA (1/8/9) TIPA (4/1/5), and AMC (0/2/2). Downsize by 6 (-3/3/6).

Manpower

Cmd	UIC	MDEP	AMSCO	TYPE	FY97	FY98	FY99	FY00	FY01	FY02	FY03
SA	W1B0AA	XMGH	431398000	MIL	-3	-3	-3	-3	-3	-3	-3
CS	W0Z1AA	XMGH	431398000	MIL	-8	-8	-8	-8	-8	-8	-8
CS	W0Z2AA	XMGH	431398000	MIL	-8	-8	-8	-8	-8	-8	-8
SE	W2VNAA	JDFM	442011000	MIL	-3	-3	-3	-3	-3	-3	-3
SS	W45AAA	XMGH	431498000	MIL	-4	-4	-4	-4	-4	-4	-4
SE	W1YYAA			MIL	-5	-5	-5	-5	-5	-5	-5
SA	W00FAA	XMGH	431398000	MIL	+28	+28	+28	+28	+28	+28	+28
SA	W00FAA	JDFM	442011000	MIL	+1	+1	+1	+1	+1	+1	+1
SA	W00FAA	XMGH	431398000	MIL	-3	-3	-3	-3	-3	-3	-3
XX	WEDGE			MIL	+3	+3	+3	+3	+3	+3	+3
SA	W1B0AA	XMGH	431398000	CIV	-3	-3	-3	-3	-3	-3	-3
CS	W0Z1AA	XMGH	431398000	CIV	-9	-9	-9	-9	-9	-9	-9
CS	W0Z2AA	XMGH	431398000	CIV	-6	-6	-6	-6	-6	-6	-6
CS	W0Z3AA	XMGH	431398000	CIV	-13	-13	-13	-13	-13	-13	-13
SE	W2VNAA	JDFM	442011000	CIV	-6	-6	-6	-6	-6	-6	-6
SE	W2VNAA	JDMA	1082T1000	CIV	-2	-2	-2	-2	-2	-2	-2
SS	W45AAA	XMGH	431498000	CIV	-1	-1	-1	-1	-1	-1	-1
SE	W1YYAA			CIV	-9	-9	-9	-9	-9	-9	-9
	AMC			CIV	-2	-2	-2	-2	-2	-2	-2
SA	W00FAA	JDFM	442011000	CIV	+6	+6	+6	+6	+6	+6	+6
SA	W00FAA	JDMA	1082T1000	CIV	+2	+2	+2	+2	+2	+2	+2
SA	W00FAA	XMGH	442098000	CIV	+13	+13	+13	+13	+13	+13	+13
SA	W00FAA	XMGH	431398000	CIV	+30	+30	+30	+30	+30	+30	+30
SA	W00FAA	XMGH	431398000	CIV	-3	-3	-3	-3	-3	-3	-3
XX	WEDGE			CIV	+3	+3	+3	+3	+3	+3	+3

Issue: 57

Title: DUSA (International Affairs)

Synopsis: Establish a DUSA (IA). Transfer 80 spaces (29/51/80) to DUSA (IA): SARDA (3/3/6), DCSINT (8/9/17), DCSOPS (8/6/14), DCSOPS Spt Gp (5/9/14), DCSLOG (0/13/13), LEA (1/8/9)TIPA (4/1/5), and AMC (0/2/2). Downsize by 6 (-3/3/6).

TOA (\$ millions)

Cmd	UIC	MDEP	AMSCO	TYPE	FY97	FY98	FY99	FY00	FY01	FY02	FY03
SA	W1B0AA	XMGH	431398000	CIV	-.15	-.15	-.15	-.15	-.15	-.15	-.15
CS	W0Z1AA	XMGH	431398000	CIV	-.45	-.45	-.45	-.45	-.45	-.45	-.45
CS	W0Z2AA	XMGH	431398000	CIV	-.3	-.3	-.3	-.3	-.3	-.3	-.3
CS	W0Z3AA	XMGH	442098000	CIV	-.65	-.65	-.65	-.65	-.65	-.65	-.65
SE	W2VNAA	JDFM	442011000	CIV	-.3	-.3	-.3	-.3	-.3	-.3	-.3
SE	W2VNAA	JDMA	1082T1000	CIV	-.1	-.1	-.1	-.1	-.1	-.1	-.1
SS	W45AAA	XMGH	431498000	CIV	-.05	-.05	-.05	-.05	-.05	-.05	-.05
SE	W1YYAA			CIV	-.45	-.45	-.45	-.45	-.45	-.45	-.45
	AMC			CIV	-.1	-.1	-.1	-.1	-.1	-.1	-.1
SA	W00FAA	JDFM	442011000	CIV	+3	+3	+3	+3	+3	+3	+3
SA	W00FAA	JDMA	1082T1000	CIV	+1	+1	+1	+1	+1	+1	+1
SA	W00FAA	XMGH	442098000	CIV	+65	+65	+65	+65	+65	+65	+65
SA	W00FAA	XMGH	431398000	CIV	+1.5	+1.5	+1.5	+1.5	+1.5	+1.5	+1.5
SA	W00FAA	XMGH	431398000	CIV	-.075	-.075	-.075	-.075	-.075	-.075	-.075

Issue: 58 **Title:** Office of Small & Disadvantaged Business Utilization

Proponent: AA/DAS **Sponsor:** ASA(MRA) **Source:** HQDA Redesign

Implementation Period: POM 98-03

Synopsis: Eliminate 2 military spaces (2/0/2).

Resource Implications:

	Savings	Costs	Transfer
Military:		-2	0
Civilian:		0	0
Dollars:		0	0

Army Staff/Command Position: **Concur:** **Nonconcur:** SADBUBU

Recommendation: Implement in POM 98-03.

ACTION: SADBUBU.

Approve
 Disapprove
 Fwd to CSA/SA for decision
 Defer to POM 00-05 Study by: _____

Issue: 58 **Title:** Office of Small & Disadvantaged Business Utilization

Synopsis: Eliminate 2 military spaces (2/0/2).

Enablers: None.

Implementation Guidance:
HQDA Redesign Working Group submits an adjustment to POM 98-03.

Issue: 58

Title: Office of Small & Disadvantaged Business Utilization

Synopsis: Eliminate 2 military spaces (2/0/2).

Manpower

Cmd	UIC	MDEP	AMSCO	TYPE	FY97	FY98	FY99	FY00	FY01	FY02	FY03
SA	W4EBAA	XMGH	431398000	MIL	-2	-2	-2	-2	-2	-2	-2
XX	WEDGE			MIL	+2	+2	+2	+2	+2	+2	+2

TOA (\$ millions)

Cmd	UIC	MDEP	AMSCO	TYPE	FY97	FY98	FY99	FY00	FY01	FY02	FY03
-----	-----	------	-------	------	------	------	------	------	------	------	------

Issue: 59

Title: General Officers Mess

Proponent: AA/DAS

Sponsor: ASA(MRA)

Source: HQDA Redesign

Implementation Period: POM 98-03

Synopsis: Downsize by 2 (2/0/2), transfer (15/0/15) to HQS-W.

Resource Implications:

	Savings	Costs	Transfer
Military:		-2	0
Civilian:		0	0
Dollars:		0	0

15

Army Staff/Cmd Position:

Concur: AA

Nonconcur:

Recommendation: Implement in POM 98-03.

ACTION: AA - LEAD; GO MESS - ASSIST.

- Approve
 Disapprove
 Fwd to CSA/SA for decision
 Defer to POM 00-05 Study by: _____

Issue: 59

Title: General Officers Mess #1

Synopsis: Downsize by 2 (2/0/2), transfer (15/0/15) to HQS-W.

Enablers: None.

Implementation Guidance:

1. HQDA Redesign Working Group submits an adjustment to POM 98-03.
2. Headquarters Services - Washington prepare concept plan, not later than 30 August 1996, to integrate the General Officers Mess, P&ES-W and S&BMS-W functions and personnel into a new organization.

Issue: 59

Title: General Officers Mess #1

Synopsis: Downsize by 2 (2/0/2), transfer (15/0/15) to HQS-W.

Manpower

Cmd	UIC	MDEP	AMSCO	TYPE	FY97	FY98	FY99	FY00	FY01	FY02	FY03
SS	W3X7AA	XMGH	4311498000	MIL	-2	-2	-2	-2	-2	-2	-2
XX	WEDGE			MIL	+2	+2	+2	+2	+2	+2	+2
SS	W3X7AA	XMGH	4311498000	MIL	-15	-15	-15	-15	-15	-15	-15
SJ	W313AA	XMGH	4311498000	MIL	+15	+15	+15	+15	+15	+15	+15

TOA (\$ millions)

Cmd	UIC	MDEP	AMSCO	TYPE	FY97	FY98	FY99	FY00	FY01	FY02	FY03
-----	-----	------	-------	------	------	------	------	------	------	------	------

Issue: 60

Title: US Army Model Improvement & Study Mgt Agency

Proponent: AA/DAS

Sponsor: ASA(MRA)

Source: HQDA Redesign

Implementation Period: POM 98-03

Synopsis: Eliminate and transfer model and simulation management and 3/1/4 spaces to ODCSOPS. Transfer Army Studies Program and 0/7/7 spaces to DUSA (OR).

Resource Implications:

	Savings	Costs	Transfer
Military:	0	0	0
Civilian:	0	0	0
Dollars:	0	0	0
			-3
			-8
			-.4M

Army Staff/Command Position:

Concur: DUSA(OR)

Nonconcur:

DCSOPS

Recommendation: Implement in POM 98-03.

ACTION: DUSA(OR)/DCSOPS - LEAD; MISMA - ASSIST.



Approve



Disapprove



Fwd to CSA/SA

for decision



Defer to POM 00-05



Study by: _____

Issue: 60

Title: US Army Model Improvement & Study Mgt Agency

Synopsis: Eliminate and transfer model and simulation management and 3/1/4 spaces to ODCSOPS. Transfer Army Studies Program and 0/7/7 spaces to DUSA (OR).

Enablers: None.

Implementation Guidance:

1. HQDA Redesign Working Group submits an adjustment to POM 98-03.
2. DUSA(OR) prepare concept plan, not later than 30 August 1996, to integrate the Army Studies Program spaces and functions.
3. DCSOPS prepare concept plan, not later than 30 August 1996, to integrate model and simulation management spaces and functions. DUSA(OR) and MISMA assist.

Issue: 60

Title: US Army Model Improvement & Study Mgt Agency

Synopsis: Eliminate and transfer model and simulation management and 3/1/4 spaces to ODCSOPS. Transfer Army Studies Program and 0/7/7 spaces to DUSA(OR).

		Manpower									
Cmd	UIC	MDEP	AMSCO	TYPE	FY97	FY98	FY99	FY00	FY01	FY02	FY03
SB	W4ZTAA			MIL	-3	-3	-3	-3	-3	-3	-3
CS	W0Z2AA	XMGH	431398000	MIL	+3	+3	+3	+3	+3	+3	+3
SB	W4ZTAA			CIV	-8	-8	-8	-8	-8	-8	-8
CS	W0Z2AA	XMGH	431398000	CIV	+1	+1	+1	+1	+1	+1	+1
SA	W00FAA	XMGH	431398000	CIV	+7	+7	+7	+7	+7	+7	+7

TOA (\$ millions)

Cmd	UIC	MDEP	AMSCO	TYPE	FY97	FY98	FY99	FY00	FY01	FY02	FY03
SB	W4ZTAA			CIV	-4M	-4M	-4M	-4M	-4M	-4M	-4M
CS	W0Z2AA	XMGH	431398000	CIV	+0.05M	+0.05M	+0.05M	+0.05M	+0.05M	+0.05M	+0.05M
SA	W00FAA	XMGH	431398000	CIV	+0.35M	+0.35M	+0.35M	+0.35M	+0.35M	+0.35M	+0.35M

Issue: 61

Title: ASA (CW)

Proponent: AA/DAS

Sponsor: ASA(MRA)

Source: HQDA Redesign

Implementation Period: POM 98-03

Synopsis: Downsize by 10% (0/2/2).

Resource Implications:

	Savings	Costs	Transfer
Military:	0	0	0
Civilian:	-2	0	0
Dollars:	-.1M	0	0

Army Staff/Command Position:

Concur:

Nonconcur:

ASA(CW)

Recommendation: Implement in POM 98-03.

ACTION: ASA(CW).

Approve
 Disapprove
 Fwd to CSA/SA for decision
 Defer to POM 00-05 Study by: _____

Issue: 61

Title:

ASA(CW)

Synopsis: Downsize by 10% (0/2/2).

Enablers: None.

Implementation Guidance:

HQDA Redesign Working Group submit adjustment to POM 98-03.

Issue: 61

Title: ASA(CW)

Synopsis: Downsize by 10% (0/2/2).

Manpower

Cmd	UIC	MDEP	AMSCO	TYPE	FY97	FY98	FY99	FY00	FY01	FY02	FY03
SA	W31SAA	XMGH	431398000	CIV	-2	-2	-2	-2	-2	-2	-2
XX	WEDGE				+2	+2	+2	+2	+2	+2	+2

TOA (\$ millions)

Cmd	UIC	MDEP	AMSCO	TYPE	FY97	FY98	FY99	FY00	FY01	FY02	FY03
SA	W31SAA	XMGH	431398000			-.05M	-.1M	-.1M	-.1M	-.1M	-.1M

Issue: 62

Title: ASA (FM&C)

Proponent: AA/DAS **Sponsor:** ASA(MRA) **Source:** HQDA Redesign

Implementation Period: POM 98-03

Synopsis: ASA(FM&C) receive Pentagon element (2/15/17 spaces) from FINCOM. Downsize by 10% (2/17/19).

Resource Implications:

	Savings	Costs	Transfer
Military:		-2	0
Civilian:		-17	0
Dollars:		-.85M	0
			+2
			+15
			+.75M

Army Staff/Command Position:

Concur:

Nonconcur:

Recommendation: Implement in POM 98-03.

ACTION: ASA(FM&C).

Approve
 Disapprove
 Fwd to CSA/SA for decision
 Defer to POM 00-05
 Study by: _____

Issue: 62

Title: ASA (FM&C)

Synopsis: ASA(FM&C) receive Pentagon element (2/15/17 spaces) from FINCOM. Downsize by 10% (2/17/19).

Enablers: None.

Implementation Guidance:

1. HQDA Redesign Working Group submit adjustment to POM 98-03.
2. ASA(FM&C) prepare concept plan, not later than 30 August 1996, to integrate FINCOM Pentagon element.

Issue: 62

Title: ASA (FM&C)

Synopsis: ASA(FM&C) receive Pentagon element (2/15/17 spaces) from FINCOM. Downsize by 10% (2/17/19).

Manpower

Cmd	UIC	MDEP	AMSCO	TYPE	FY97	FY98	FY99	FY00	FY01	FY02	FY03
SB	W0NRAA	FASS	435212000	MIL	-2	-2	-2	-2	-2	-2	-2
SA	W00GAA	XMGH	431398000	MIL	+2	+2	+2	+2	+2	+2	+2
SA	W00GAA	XMGH	431398000	MIL	-2	-2	-2	-2	-2	-2	-2
XX	WEDGE			MIL	+2	+2	+2	+2	+2	+2	+2
SB	W0NRAA	FASS	435212000	CIV	-15	-15	-15	-15	-15	-15	-15
SA	W00GAA	XMGH	431398000	CIV	+15	+15	+15	+15	+15	+15	+15
SA	W00GAA	XMGH	431398000	CIV	-17	-17	-17	-17	-17	-17	-17
XX	WEDGE			CIV	+17	+17	+17	+17	+17	+17	+17

TOA (\$ millions)

Cmd	UIC	MDEP	AMSCO	TYPE	FY97	FY98	FY99	FY00	FY01	FY02	FY03
SB	W0NRAA	FASS	435212000	CIV		-.375M	-.75M	-.75M	-.75M	-.75M	-.75M
SA	W00GAA	XMGH	431398000	CIV		+.375M	+.75M	+.75M	+.75M	+.75M	+.75M
SA	W00GAA	XMGH	431398000	CIV		-.425M	-.85M	-.85M	-.85M	-.85M	-.85M

Issue: 63

Title: US Army Finance Command

Proponent: AA/DAS

Sponsor: ASA(MRA)

Source: HQDA Redesign

Implementation Period: POM 98-03

Synopsis: Downsize by 10% (1/1/2/3). Redesignate/rename US Army Finance Support Agency. [Transfer Pentagon element (2/15/17 spaces) to ASA(FM&C) (see issue 62).]

Resource Implications:

	Savings	Costs	Transfer
Military:	-1	0	[-2]
Civilian:	-2	0	[-15]
Dollars:	-.1M	0	[-.75M]

Army Staff/Command Position:

Concur:

Nonconcur:

Recommendation: Implement in POM 98-03.

ACTION: ASA(FM&C) - LEAD; FINCOM - ASSIST.

- Approve**
 Disapprove
 Fwd to CSA/SA for decision
 Defer to POM 00-05
 Study by: _____

Issue: 63

Title: US Army Finance Command

Synopsis: Downsize by 10% (1//2/3). Redesignate/rename US Army Finance Support Agency.

Enablers: None.

Implementation Guidance:

1. HQDA Redesign Working Group submit adjustment to POM 98-03.
2. ASA (FM&C) prepare General Order that redesignates and renames the US Army Finance Command the US Army Finance Support Agency. Coordinate with the HQDA Redesign Working Group not later than 30 August 1996.

Issue: 63

Title: US Army Finance Command

Synopsis: Downsize by 10% (1//2/3).

Manpower

Cmd	UIC	MDEP	AMSCO	TYPE	FY97	FY98	FY99	FY00	FY01	FY02	FY03
SB	W0NRRAA	FASS	435212000	MIL	-1	-1	-1	-1	-1	-1	-1
SB	W0NRRAA	FASS	435212000	CIV	-2	-2	-2	-2	-2	-2	-2
XX	WEDGE		MIL		+1	+1	+1	+1	+1	+1	+1
XX	WEDGE		CIV		+2	+2	+2	+2	+2	+2	+2

TOA (\$ millions)

Cmd	UIC	MDEP	AMSCO	TYPE	FY97	FY98	FY99	FY00	FY01	FY02	FY03
SB	W0NRRAA	FASS	435212000	CIV		-.05M	-.1M	-.1M	-.1M	-.1M	-.1M

Issue: 64

Title: US Army Cost & Economic Analysis Center

Proponent: AAD/DAS

Sponsor: ASA(MRA)

Source: HQDA Redesign

Implementation Period: POM 98-03

Synopsis: Downsize by 2/8/10 based on historical fill level.

Resource Implications:

	Savings	Costs	Transfer
Military:		-2	0
Civilian:		-8	0
Dollars:		-.4M	0

Army Staff/Command Position:

Concur:

Nonconcur: ASA(FM&C)

Recommendation: Implement in POM 98-03.

ACTION: ASA(FM&C) - LEAD; CEAC - ASSIST.

- Approve**
 Disapprove
 Fwd to CSA/SA for decision
 Defer to POM 00-05
 Study by: _____

Issue: 64 **Title:** US Army Cost & Economic Analysis Center

Synopsis: Downsize by 2/8/10 based on historical fill level.

Enablers: None.

Implementation Guidance:
HQDA Redesign Working Group submit adjustment to POM 98-03.

Issue: 64

Title: US Army Cost & Economic Analysis Center

Synopsis: Downsize by 2/8/10 based on historical fill level.

Manpower

Cmd	UIC	MDEP	AMSCO	TYPE	FY97	FY98	FY99	FY00	FY01	FY02	FY03
SB	W4PTAA	FACE	435212000	MIL	-2	-2	-2	-2	-2	-2	-2
XX	WEDGE			MIL	+2	+2	+2	+2	+2	+2	+2
SB	W4PTAA	FACE	435212000	CIV	-8	-8	-8	-8	-8	-8	-8
XX	WEDGE			CIV	+8	+8	+8	+8	+8	+8	+8

TOA (\$ millions)

Cmd	UIC	MDEP	AMSCO	TYPE	FY97	FY98	FY99	FY00	FY01	FY02	FY03
SB	W4PTAA	FACE	435212000	CIV	-.4M	-.4M	-.4M	-.4M	-.4M	-.4M	-.4M

Issue: 65

Title: ASA (IL&E)

Proponent: AA/DAS

Sponsor: ASA(MRA)

Source: HQDA Redesign

Implementation Period: POM 98-03

Synopsis: Downsize by 10% (1/3/4). Receive AEPI functions and 0/5/5 spaces (see issue 66).

Resource Implications:

	Savings	Costs	Transfer
Military:	-1	0	0
Civilian:	-3	0	[+5]
Dollars:	-.15M	0	0

Army Staff/Command Position:

Concur: ASA(IL&E)

Nonconcur:

Recommendation: Implement in POM 98-03.

ACTION: ASA(IL&E).



Approve



Disapprove



Fwd to CSA/SA

for decision



Defer to POM 00-05



Study by: _____

Issue: 65

Title: ASA (IL&E)

Synopsis: Downsize by 10% (1/3/4). Receive AEPI functions and 0/5/5 spaces (see issue 66).

Enablers: None.

Implementation Guidance:

1. HQDA Redesign Working Group submit adjustment to POM 98-03.
2. ASA(ILE) prepare concept plan, not later than 30 August 1996, to integrate the AEPE spaces and functions.

Issue: 65

Title: ASA (IL&E)

Synopsis: Downsize by 10% (1/3/4). Receive AEPI functions and 0/5/5 spaces (see issue 66).

Manpower

Cmd	UIC	MDEP	AMSCO	TYPE	FY97	FY98	FY99	FY00	FY01	FY02	FY03
SA	W4P0AA	XMGH	431398000	MIL	-1	-1	-1	-1	-1	-1	-1
XX	WEDGE			MIL	+1	+1	+1	+1	+1	+1	+1
SA	W4P0AA	XMGH	431398000	CIV	-3	-3	-3	-3	-3	-3	-3
XX	WEDGE			CIV	+3	+3	+3	+3	+3	+3	+3

TOA (\$ millions)

Cmd	UIC	MDEP	AMSCO	TYPE	FY97	FY98	FY99	FY00	FY01	FY02	FY03
SA	W4P0AA	XMGH	431398000	CIV	-0.075M	-0.075M	-0.15M	-0.15M	-0.15M	-0.15M	-0.15M

Issue: 66

Title: Army Environmental Policy Institute

Proponent: AA/DAS

Sponsor: ASA(MRA)

Source: HQDA Redesign

Implementation Period: POM 98-03

Synopsis: Eliminate SSA and 0/1/1 spaces. Transfer function and 0/5/5 spaces to ASA(IL&E). ASA(IL&E) establish reimbursement agreements to fund personnel.

Resource Implications:

	Savings	Costs	Transfer
Military:	0	0	0
Civilian:	-1	0	-5
Dollars:	-.3M	0	0

Army Staff/Command Position:

Concur: ASA(ILE)

Nonconcur:

Recommendation: Implement in POM 98-03.

ACTION: ASA(IL&E) - LEAD; AEPI - ASSIST.

Approve
 Disapprove
 Fwd to CSA/SA for decision
 Defer to POM 00-05
 Study by: _____

Issue: 66

Title: Army Environmental Policy Institute

Synopsis: Eliminate SSA and O/1/1 spaces. Transfer function and O/5/5 spaces to ASA(IL&E). ASA(IL&E) establish reimbursement agreements to fund personnel.

Enablers: None.

Implementation Guidance:

1. HQDA Redesign Working Group submit adjustment to POM 98-03.
2. ASA(IL&E) establish reimbursement agreements to fund personnel, effective 1 October 1997. AEPI assist.

Issue: 66

Title: Army Environmental Policy Institute

Synopsis: Eliminate SSA and O/1/1 spaces. Transfer function and O/5/5 spaces to ASA(IL&E). ASA(IL&E) establish reimbursement agreements to fund personnel.

		Manpower									
Cmd	UIC	MDEP	AMSCO	TYPE	FY97	FY98	FY99	FY00	FY01	FY02	FY03
SS	W467AA	XMGH	431898000	CIV	-6	-6	-6	-6	-6	-6	-6
XX	WEDGE			CIV	+1	+1	+1	+1	+1	+1	+1
SA	W4P0AA	XMGH	431398000	CIV	+5	+5	+5	+5	+5	+5	+5

TOA (\$ millions)

Cmd	UIC	MDEP	AMSCO	TYPE	FY97	FY98	FY99	FY00	FY01	FY02	FY03
SS	W467AA	XMGH	431898000	CIV	-0.3	-0.3	-0.3	-0.3	-0.3	-0.3	-0.3
SA	W4P0AA	XMGH	431398000	CIV							

Funding from Reimbursement Sources

Issue: 67

Title: ASA(MRA)

Proponent: AA/DAS

Sponsor: ASA(MRA)

Source: HQDA Redesign

Implementation Period: POM 98-03

Synopsis: Downsize by 10% (2/10/12).

Resource Implications:

	Savings	Costs	Transfer
Military:	-2	0	0
Civilian:	-10	0	0
Dollars:	-.5M	0	0

Army Staff/Command Position:

Concur:

Nonconcur:

Recommendation: Implement in POM 98-03.

ACTION: ASA(MRA).

- Approve**
 Disapprove
 Fwd to CSA/SA for decision
 Defer to POM 00-05
 Study by: _____

Issue: 67

Title: ASA(MRA)

Synopsis: Downsize by 10% (2/10/12).

Enablers: None.

Implementation Guidance:

HQDA Redesign Working Group submit adjustment to POM 98-03.

Issue: 67

Title: ASA(MRA)

Synopsis: Downsize by 10% (2/10/12).

Manpower

Cmd	UIC	MDEP	AMSCO	TYPE	FY97	FY98	FY99	FY00	FY01	FY02	FY03
SA	W00SAA	XMGH	431398000		-2	-2	-2	-2	-2	-2	-2
XX	WEDGE		MIL		+2	+2	+2	+2	+2	+2	+2
SA	W00SAA	XMGH	431398000		-10	-10	-10	-10	-10	-10	-10
XX	WEDGE		CIV		+10	+10	+10	+10	+10	+10	+10

TOA (\$ millions)

Cmd	UIC	MDEP	AMSCO	TYPE	FY97	FY98	FY99	FY00	FY01	FY02	FY03
SA	W00SAA	XMGH	431398000		-	-.25M	-.5M	-.5M	-.5M	-.5M	-.5M

Issue: 68

Title: Civilian Training Education Develop. Student Det.

Proponent: AA/DAS

Sponsor: ASA(MRA)

Source: HQDA Redesign

Implementation Period: POM 98-03

Synopsis: Transfer training and school elements/cadre to TRADOC (0/64/64). Student holding detachment retained as FOA of ASA(MRA). Downsize by 10% (0/108/108) in FY98. Note: Outyear reductions vary due to declining outyear baseline.

Resource Implications:

	Savings	Costs	Transfer
Military:	0	0	0
Civilian:	-108	0	-64
Dollars:	-5.4M	0	-3.2M

Army Staff/Command Position:

Concur: ASA(MRA)

Nonconcur:

Recommendation: Implement in POM 98-03.

ACTION: TRADOC - LEAD; ASA(MRA) - ASSIST.

Approve
 Disapprove
 Fwd to CSA/SA for decision
 Defer to POM 00-05
 Study by: _____

Issue: 68

Title: Civilian Training Education Develop. Student Det.

Synopsis: Transfer training and school elements/cadre to TRADOC (0/64/64). Student holding detachment retained as FOA of ASA(MRA). Downsize by 10% (0/108/108) in FY98. Note: Outyear reductions vary due to declining outyear baseline.

Enablers: None.

Implementation Guidance:

1. HQDA Redesign Working Group submit adjustment to POM 98-03.
2. TRADOC develop concept plan, not later than 30 August 1996, integrate spaces and functions; coordinate with ASA(MRA).

Issue: 68

Title: Civilian Training Education Develop. Student Det.

Synopsis: Transfer training and school elements/cadre to TRADOC (0/64/64). Student holding detachment retained as FOA of ASA(MRA). Downsize by 10% (0/108/108) in FY98. Note: Outyear reductions vary due to declining outyear baseline.

Manpower

Cmd	UIC	MDEP	AMSCO	TYPE	FY97	FY98	FY99	FY00	FY01	FY02	FY03
SF	W4CMAA	TACV	334751000	CIV	-64	-64	-64	-64	-64	-64	-64
TC	TRADOC			CIV	+64	+64	+64	+64	+64	+64	+64
SF	W4CMAA	TACV	334751000	CIV	-108	-108	-8	0	0	0	0
XX	WEDGE			CIV	+108	+108	+8	0	0	0	0

TOA (\$ millions)

Cmd	UIC	MDEP	AMSCO	TYPE	FY97	FY98	FY99	FY00	FY01	FY02	FY03
SF	W4CMAA	TACV	334751000		-1.6M	-1.6M	-3.2M	-3.2M	-3.2M	-3.2M	-3.2M
TC	TRADOC		CIV		+1.6M	+1.6M	+3.2M	+3.2M	+3.2M	+3.2M	+3.2M
SF	W4CMAA	TACV	334751000		-2.7M	-2.7M	-4M	0	0	0	0

Issue: 69

Title: Directed Military Overstrength Detachment

Proponent: AA/DAS

Sponsor: ASA(MRA)

Source: HQDA Redesign

Implementation Period: POM 98-03

Synopsis: Eliminate 200/0/200 spaces and transfer 300/0/300 spaces to PERSCOM. OASA(MRA) retain oversight and approval.

Resource Implications:

	Savings	Costs	Transfer
Military:	-200	0	-300
Civilian:	0	0	0
Dollars:	0	0	0

Army Staff/Command Position:

Concur: ASA(MRA)

Nonconcur:

Recommendation: Implement in POM 98-03.

ACTION: PERSCOM - LEAD; ASA(MRA) - ASSIST.

Approve
 Disapprove
 Fwd to CSA/SA for decision
 Defer to POM 00-05
 Study by: _____

Issue: 69

Title: Directed Military Overstrength Detachment

Synopsis: Eliminate 200/0/200 spaces and transfer 300/0/300 spaces to PERSCOM. ASA(MRA) retain oversight and approval.

Enablers: None.

Implementation Guidance:

1. HQDA Redesign Working Group submit adjustment to POM 98-03.
2. PERSCOM develop concept plan, not later than 30 August 1996, to merge Directed Military Overstrength Detachment; coordinate implementation with ASA(MRA).

Issue: 69

Title: Directed Military Overstrength Detachment

Synopsis: Eliminate 200/0/200 spaces and transfer 300/0/300 spaces to PERSCOM. ASA(MRA) retain oversight and approval.

Manpower

Cmd	UIC	MDEP	AMSCO	TYPE	FY97	FY98	FY99	FY00	FY01	FY02	FY03
DM	W4ZZAA			MIL	-200	-200	-200	-200	-200	-200	-200
XX	WEDGE			MIL	+200	+200	+200	+200	+200	+200	+200
DM	W4ZZAA			MIL	-300	-300	-300	-300	-300	-300	-300
MP	W3VSAA			MIL	+300	+300	+300	+300	+300	+300	+300

TOA (\$ millions)

Cmd	UIC	MDEP	AMSCO	TYPE	FY97	FY98	FY99	FY00	FY01	FY02	FY03
-----	-----	------	-------	------	------	------	------	------	------	------	------

Issue: 70

Title: Army Review Board Agency (ARBA)

Proponent: AA/DAS

Sponsor: ASA(MRA)

Source: HQDA Redesign

Implementation Period: POM 98-03

Synopsis: Consistent with recent study, eliminate 4/14/18 spaces.

Resource Implications:

	Savings	Costs	Transfer
Military:	-4	0	0
Civilian:	-14	0	0
Dollars:	-.7M	0	0

Army Staff/Command Position:

Concur: ASA(MRA)

Nonconcur:

Recommendation: Implement in POM 98-03.

ACTION: ASA(MRA) - LEAD; ARBA - ASSIST.

Approve
 Disapprove
 Fwd to CSA/SA for decision
 Defer to POM 00-05
 Study by: _____

Issue: 70

Title: Army Review Board Agency (ARBA)

Synopsis: Consistent with recent study, eliminate 4/14/18 spaces.

Enablers: None.

Implementation Guidance:

1. HQDA Redesign Working Group submit adjustment to POM 98-03.
2. ARBA prepare personnel reduction plan no later than 15 September 1996; ASA(MRA) assist.

Issue: 70

Title: Army Review Board Agency (ARBA)

Synopsis: Consistent with recent study, eliminate 4/14/18 spaces.

		Manpower										
Cmd	UIC	MDEP	AMSCO	TYPE	FY97	FY98	FY99	FY00	FY01	FY02	FY03	
SB	W336AA	FASS	435212000	MIL	-4	-4	-4	-4	-4	-4	-4	
XX	WEDGE			MIL	+4	+4	+4	+4	+4	+4	+4	
SB	W336AA	FASS	435212000	CIV	-14	-14	-14	-14	-14	-14	-14	
XX	WEDGE			CIV	+14	+14	+14	+14	+14	+14	+14	

TOA (\$ millions)

Cmd	UIC	MDEP	AMSCO	TYPE	FY97	FY98	FY99	FY00	FY01	FY02	FY03
SB	W336AA	FASS	435212000	CIV		-35M	-7M	-7M	-7M	-7M	-7M

Issue: 71

Title: US Army Management Staff College

Proponent: AA/DAS

Sponsor: ASA(MRA)

Source: HQDA Redesign

Implementation Period: POM 98-03

Synopsis: Transfer to TRADOC.

Resource Implications:

	Savings	Costs	Transfer
Military:	0	0	-14
Civilian:	0	0	-38
Dollars:	0	0	-1.9M

Army Staff/Command Position:

Concur: ASA(MRA)

Nonconcur:

Recommendation: Implement in POM 98-03.

ACTION: TRADOC - LEAD; ASA(MRA) - ASSIST.



Approve



Disapprove



Fwd to CSA/SA

for decision



Defer to POM 00-05



Study by: _____

Issue: 71

Title: US Army Management Staff College

Synopsis: Transfer to TRADOC.

Enablers: None.

Implementation Guidance:

1. HQDA Redesign Working Group submit adjustment to POM 98-03.
2. TRADOC develop concept plan, not later than 30 August 1996, to integrate spaces and functions; coordinate implementation with ASA(MRA).

Synopsis: Transfer to TRADOC.

		Manpower									
Cmd	UIC	MDEP	AMSCO	TYPE	FY97	FY98	FY99	FY00	FY01	FY02	FY03
SE	W4YXAA	TACV	334751000	MIL	-14	-14	-14	-14	-14	-14	-14
TC	W4YXAA			MIL	+14	+14	+14	+14	+14	+14	+14
SE	W4YXAA	TACV	334751000	CIV	-33	-33	-33	-33	-33	-33	-33
SE	W4YXAA	TAPE	321731000	CIV	-5	-5	-5	-5	-5	-5	-5
TC	W4YXAA			CIV	+38	+38	+38	+38	+38	+38	+38

TOA (\$ millions)

Cmd	UIC	MDEP	AMSCO	TYPE	FY97	FY98	FY99	FY00	FY01	FY02	FY03
SE	W4YXAA	TACV	334751000	CIV	-	-.825M	-1.65M	-1.65M	-1.65M	-1.65M	-1.65M
SE	W4YXAA	TAPE	321731000	CIV		-.125	-.25	-.25	-.25	-.25	-.25
TC	W4YXAA			CIV		+.95M	+1.9M	+1.9M	+1.9M	+1.9M	+1.9M

Issue: 72

Title: USA Civilian Personnel Field Agency

Proponent: AA/DAS

Sponsor: ASA(MRA)

Source: HQDA Redesign

Implementation Period: POM 98-03

Synopsis: Transfer regional civilian personnel function and spaces to PERSCOM after final regionalization.

Resource Implications:

	Savings	Costs	Transfer
Military:	0	0	0
Civilian:	0	0	-1587
Dollars:	0	0	-79.35M

Army Staff/Command Position:

Concur: ASA(MRA)

Nonconcur:

Recommendation: Implement in POM 98-03 effective FY 02.

ACTION: ASA(MRA) - LEAD; CPFA and PERSCOM - ASSIST.

Approve
 Disapprove
 Fwd to CSA/SA for decision
 Defer to POM 02-07 Study by: _____

Issue: 72

Title: USA Civilian Personnel Field Agency

Synopsis: Transfer regional civilian personnel function and spaces to PERSCOM after final regionalization.

Enablers: None.

Implementation Guidance:

HQDA Redesign Working Group submit adjustment to POM 98-03 effective FY 02-07.

Issue: 72

Title: USA Civilian Personnel Field Agency

Synopsis: Transfer regional civilian personnel function and spaces to PERSCOM after final regionalization.

Manpower											
Cmd	UIC	MDEP	AMSCO	TYPE	FY97	FY98	FY99	FY00	FY01	FY02	FY03
SE	W40WAA	VCPR		CIV						-1587	-1587
MP	W3VSAA			CIV						+1587	+1587

TOA (\$ millions)

Cmd	UIC	MDEP	AMSCO	TYPE	FY97	FY98	FY99	FY00	FY01	FY02	FY03
SE	W40WAA	VCPR		CIV						-79.35M	-79.35M
MP	W3VSAA			CIV						+79.35M	+79.35M

Issue: 73

Title: ASA (RDA)

Proponent: AA/DAS

Sponsor: ASA(MRA)

Source: HQDA Redesign

Implementation Period: POM 98-03

Synopsis: Downsize by 10% (9/6/15). [Transfer International Affairs function and spaces (3/3/6) to DUSA(IA) (see issue 57).]

Resource Implications:

	Savings	Costs	Transfer
Military:	-9	0	0
Civilian:	-6	0	0
Dollars:	-0.3M	0	0

Army Staff/Command Position:

Concur: ASA(RDA) and DUSA(IA)

Nonconcur:

Recommendation: Implement in POM 98-03.

ACTION: ASA(RDA).

Approve
 Disapprove
 Fwd to CSA/SA for decision
 Defer to POM 00-05
 Study by: _____

Issue: 73

Title: ASA (RDA)

Synopsis: Downsize by 10% (7/8/15).

Enablers: None.

Implementation Guidance:

HQDA Redesign Working Group submit adjustment to POM 98-03.

Issue: 73

Title: ASA (RDA)

Synopsis: Downsize by 10% (7/8/15).

Manpower

Cmd	UIC	MDEP	AMSCO	TYPE	FY97	FY98	FY99	FY00	FY01	FY02	FY03
SA	W1B0AA	XMGH	431398000	MIL	-9	-6	-9	-9	-9	-9	-9
SA	W1B0AA	XMGH	431398000	CIV	-6	-6	-6	-6	-6	-6	-6
XX	WEDGE				+9	+9	+9	+9	+9	+9	+9
XX	WEDGE				+6	+6	+6	+6	+6	+6	+6

TOA (\$ millions)

Cmd	UIC	MDEP	AMSCO	TYPE	FY97	FY98	FY99	FY00	FY01	FY02	FY03
SA	W1B0AA	XMGH	431398000	CIV	-0.15M	-0.15M	-0.3M	-0.3M	-0.3M	-0.3M	-0.3M

Issue: 74

Title: Army Acquisition Executive Support Agency

Proponent: AA/DAS

Sponsor: ASA(MRA)

Source: HQDA Redesign

Implementation Period: POM 98-03

Synopsis: Downsize by 104/219/323.

Resource Implications:

	Savings	Costs	Transfer
Military:	-104	-104	0
Civilian:	-219	-219	0
Dollars:	-10.95M	-10.95M	0

Army Staff/Command Position:

Concur: ASA(RDA)

Nonconcur:

Recommendation: Implement in POM 98-03.

ACTION: ASA(RDA) - LEAD; AAESA - ASSIST.

Approve

Disapprove

Fwd to CSA/SA
for decision

Defer to POM 00-05
Study by: _____

Issue: 74 **Title:** Army Acquisition Executive Support Agency

Synopsis: Downsize by 104/219/323).

Enablers: None.

Implementation Guidance:

1. HQDA Redesign Working Group submit adjustment to POM 98-03.
2. ASA (RDA) prepare a personnel reduction plan not later than 15 September 1996.
3. ASA (RDA) comply with policies and procedures of AR 5-10.

Synopsis: Downsize by 104/219/323.

Manpower

Cmd	UIC	MDEP	AMSCO	TYPE	FY97	FY98	FY99	FY00	FY01	FY02	FY03
AE	W27PAA			MIL	-104	-104	-104	-104	-104	-104	-104
XX	WEDGE			MIL	+104	+104	+104	+104	+104	+104	+104
AE	W27PAA			CIV	-219	-219	-219	-219	-219	-219	-219
XX	WEDGE			CIV	+219	+219	+219	+219	+219	+219	+219

TOA (\$ millions)

Cmd	UIC	MDEP	AMSCO	TYPE	FY97	FY98	FY99	FY00	FY01	FY02	FY03
XX	WEDGE			CIV	-5.475	-5.475	-10.95	-10.95	-10.95	-10.95	-10.95

Issue: 75 **Title:** General Counsel

Proponent: AA/DAS **Sponsor:** ASA(MRA) **Source:** HQDA Redesign

Implementation Period: POM 98-03

Synopsis: Downsize by 10% (1/2/3).

Resource Implications:

	Savings	Costs	Transfer
Military:	-1	0	0
Civilian:	-2	0	0
Dollars:	-.1M	0	0

Army Staff/Command Position:

Concur:

Nonconcur: GC

Recommendation: Implement in POM 98-03.

ACTION: OGC.

Approve **Disapprove** **Fwd to CSA/SA**
for decision **Defer to POM 00-05**
 Study by: _____

Issue: 75 **Title:** General Counsel Army

Synopsis: Downsize by 10% (1/2/3).

Enablers: None.

Implementation Guidance:
HQDA Redesign Working Group submit an adjustment to POM 98-03.

Issue: 75

Title: General Counsel

Synopsis: Downsize by 10% (1/2/3).

Manpower

Cmd	UIC	MDEP	AMSCO	TYPE	FY97	FY98	FY99	FY00	FY01	FY02	FY03
SA	W1YMAA	XMGH	431398000	MIL	-1	-1	-1	-1	-1	-1	-1
XX	WEDGE			MIL	+1	+1	+1	+1	+1	+1	+1
SA	W1YMAA	XMGH	431398000	CIV	-2	-2	-2	-2	-2	-2	-2
XX	WEDGE			CIV	+2	+2	+2	+2	+2	+2	+2

TOA (\$ millions)

Cmd	UIC	MDEP	AMSCO	TYPE	FY97	FY98	FY99	FY00	FY01	FY02	FY03
SA	W1YMAA	XMGH	431398000	CIV	-0.05M	-0.05M	-0.1M	-0.1M	-0.1M	-0.1M	-0.1M

Issue: 76

Title: Office of the Administrative Assistant

Proponent: AA/DAS

Sponsor: ASA(MRA)

Source: HQDA Redesign

Implementation Period: POM 98-03

Synopsis: Downsize by (0/4/4);achieve 10% (1/0/1).

Resource Implications:

	Savings	Costs	Transfer
Military:	-1	0	0
Civilian:	-4	0	0
Dollars:	-.2M	0	0

Army Staff/Cmd Position:

Concur:

Nonconcur:

Recommendation: Implement in POM 98-03.

ACTION: AA.

- Approve
 Disapprove
 Fwd to CSA/SA for decision
 Defer to POM 00-05 Study by: _____

Issue: 76

Title: Office of the Administrative Assistant

Synopsis: Downsize by (0/4/4);achieve 10% (1/0/1).

Enablers: None.

Implementation Guidance:

HQDA Redesign Working Group submit adjustment to POM 98-03.

Issue: 76

Title: Office of the Administrative Assistant

Synopsis: Downsize by (0/4/4);achieve 10% (1/0/1).

Manpower

Cmd	UIC	MDEP	AMSCO	TYPE	FY97	FY98	FY99	FY00	FY01	FY02	FY03
SA	W1YSAA	XMGH	431398000	MIL	-1	-1	-1	-1	-1	-1	-1
XX	WEDGE			MIL	+1	+1	+1	+1	+1	+1	+1
SA	W1YSAA	XMGH	431398000	CIV	-4	-4	-4	-4	-4	-4	-4
XX	WEDGE			CIV	+4	+4	+4	+4	+4	+4	+4

TOA (\$ millions)

Cmd	UIC	MDEP	AMSCO	TYPE	FY97	FY98	FY99	FY00	FY01	FY02	FY03
SA	W1YSAA	XMGH	431398000	CIV	-	-.1M	-.2M	-.2M	-.2M	-.2M	-.2M

Issue: 77

Title: Headquarters Services - Washington

Proponent: AA/DAS

Sponsor: ASA(MRA)

Source: HQDA Redesign

Implementation Period: POM 98-03

Synopsis: Downsize by 10% (-1/4/5). [Receive functions and spaces from P&ES-W (61/24/85), see issue 83; S&BMS-W (5/15/20), see issue 84; and the GO Mess (15/0/15), see issue 59. (Note; 9 spaces already cut on P&ES-W & GO Mess transfers)].

Resource Implications:

	Savings	Costs	Transfer
Military:	-1	0	0
Civilian:	-4	0	0
Dollars:	-2M	0	0

Army Staff/Command Position:

Concur:

Nonconcur:

Recommendation: Implement in POM 98-03.

ACTION: AA - LEAD; HQSV-W - ASSIST.



Approve



Disapprove



Fwd to CSA/SA

for decision



Defer to POM 00-05



Study by: _____

Issue: 77 **Title:** Headquarters Services - Washington

Synopsis: Downsize by 1/4/5.

Enablers: None.

Implementation Guidance:

1. HQDA Redesign Working Group submit adjustment to POM 98-03.
2. Headquarters Services - Washington prepare a concept plan, not later than 30 August 1996, to integrate GO MESS, P&ES-W and S&BMS-W functions and personnel into a new organization.

Issue: 77

Title: Headquarters Services - Washington

Synopsis: Downsize by 1/4/5.

Manpower

Cmd	UIC	MDEP	AMSCO	TYPE	FY97	FY98	FY99	FY00	FY01	FY02	FY03
SJ	W313AA	JDSP	435212000	MIL	-1	-1	-1	-1	-1	-1	-1
XX	WEDGE			MIL	+1	+1	+1	+1	+1	+1	+1
SJ	W313AA	JDSP	435212000	CIV	-4	-4	-4	-4	-4	-4	-4
XX	WEDGE			CIV	+4	+4	+4	+4	+4	+4	+4

TOA (\$ millions)

Cmd	UIC	MDEP	AMSCO	TYPE	FY97	FY98	FY99	FY00	FY01	FY02	FY03
SJ	W313AA	JDSP	435212000	CIV		-.1M	-.2M	-.2M	-.2M	-.2M	-.2M

Issue: 78

Title: Safety, Security, and Support Services - Washington

Proponent: AA/DAS

Sponsor: ASA(MRA)

Source: HQDA Redesign

Implementation Period: POM 98-03

Synopsis: Downsize by 10% except GP3I (2/21/23).

Resource Implications:

	Savings	Costs	Transfer
Military:		-2	0
Civilian:		-21	0
Dollars:		-1.05M	0

Army Staff/Command Position:

Concur: AA

Nonconcur:

Recommendation: Implement in POM 98-03.

ACTION: AA - LEAD; S4-W - ASSIST.

Approve

Disapprove

Fwd to CSA/SA for decision

Defer to POM 00-05 Study by: _____

Issue: 78 **Title:** Safety, Security, and Support Services - Washington

Synopsis: Downsize by 10% except GP3I (2/21/23).

Enablers: None.

Implementation Guidance:

1. HQDA Redesign Working Group submit adjustment to POM 98-03.
2. Safety, Security, and Support Services - Washington coordinate with the appropriate personnel office and prepare a personnel reduction plan, not later than 15 September 1996.

Issue: 78

Title: Safety, Security, and Support Services - Washington

Synopsis: Downsize by 10% except GP31 (2/21/23).

Manpower

Cmd	UIC	MDEP	AMSCO	TYPE	FY97	FY98	FY99	FY00	FY01	FY02	FY03
SJ	W06EAA	JDSP	43521200	MIL	-2	-2	-2	-2	-2	-2	-2
SJ	W06EAA	JDSP	43521200	CIV	-21	-21	-21	-21	-21	-21	-21
XX	WEDGE				+2	+2	+2	+2	+2	+2	+2
XX	WEDGE				+21	+21	+21	+21	+21	+21	+21

TOA (\$ millions)

Cmd	UIC	MDEP	AMSCO	TYPE	FY97	FY98	FY99	FY00	FY01	FY02	FY03
SJ	W06EAA	JDSP	43521200	CIV		-.525M	-1.05M	-1.05M	-1.05M	-1.05M	-1.05M

Issue: 79

Title: Defense Supply Service - Washington

Proponent: AA/DAS

Sponsor: ASA(MRA)

Source: HQDA Redesign

Implementation Period: POM 98-03

Synopsis: Downsize by 20 (0/20/20); achieve 10% of direct funded spaces (1/2/3).

Resource Implications:

	Savings	Costs	Transfer
Military:	-1	0	0
Civilian:	-22	0	0
Dollars:	-1.1M	0	0

Army Staff/Command Position:

Concur: AA

Nonconcur:

Recommendation: Implement in POM 98-03.

ACTION: AA - LEAD; DSS-W - ASSIST.

- Approve**
 Disapprove
 Fwd to CSA/SA for decision
 Defer to POM 00-05
 Study by: _____

Issue: 79

Title: Defense Supply Service - Washington

Synopsis: Downsize by 20 (0/20/20); achieve 10% of direct funded spaces (1/2/3).

Enablers: None.

Implementation Guidance:

1. HQDA Redesign Working Group submit adjustment to POM 98-03.
2. Defense Supply Service - Washington coordinate with the appropriate personnel office and prepare a personnel reduction plan, not later than 15 September 1996.

Issue: 79

Title: Defense Supply Service - Washington

Synopsis: Downsize by 20 (0/20/20); achieve 10% of direct funded spaces (1/2/3).

Manpower

Cmd	UIC	MDEP	AMSCO	TYPE	FY97	FY98	FY99	FY00	FY01	FY02	FY03
SJ	W2TZAA	JDSP	435212000	MIL	-1	-1	-1	-1	-1	-1	-1
XX	WEDGE			MIL	+1	+1	+1	+1	+1	+1	+1
SJ	W2TZAA	JDSP	435212000	CIV	-22	-22	-22	-22	-22	-22	-22
XX	WEDGE			CIV	+22	+22	+22	+22	+22	+22	+22

TOA (\$ millions)

Cmd	UIC	MDEP	AMSCO	TYPE	FY97	FY98	FY99	FY00	FY01	FY02	FY03
SJ	W2TZAA		CIV			-.55M	-1.1M	-1.1M	-1.1M	-1.1M	-1.1M

Issue: 80

Title: Information Management Support Center

Proponent: AA/DAS

Sponsor: ASA(MRA)

Source: HQDA Redesign

Implementation Period: POM 98-03

Synopsis: Downsize by (6/4/10); achieve 10% (-0/2/2). Transfer general service and support functions and 5/9/14 spaces to the Pentagon's Single Agency Manager (SAM) for Information Technology Services.

Resource Implications:

	Savings	Costs	Transfer
Military:		-6	0
Civilian:		-6	0
Dollars:		-.3M	0

.45M

Army Staff/Command Position:

Concur:

Nonconcur:

Recommendation: Implement in POM 98-03.

ACTION: AA - LEAD; IMCEN and SAM - ASSIST.



Approve



Disapprove



Fwd to CSA/SA

for decision



Defer to POM 00-05



Study by: _____

Issue: 80

Title: Information Management Support Center

Synopsis: Downsize by (6/4/10); achieve 10% (-0/2/2). Transfer general service and support functions and 5/9/14 spaces to the Pentagon's Single Agency Manager (SAM) for Information Technology Services.

Enablers:

Implementation Guidance:

1. HQDA Redesign Working Group submit adjustment to POM 98-03.
2. AA and Single Agency Manager establish and MOA-type transition plan not later than 1 October 1997.

Issue: 80

Title: Information Management Support Center

Synopsis: Downsize by (6/4/10); achieve 10% (-0/2/2). Transfer general service and support functions and 5/9/14 spaces to the Pentagon's Single Agency Manager (SAM) for Information Technology Services.

Manpower

Cmd	UIC	MDEP	AMSCO	TYPE	FY97	FY98	FY99	FY00	FY01	FY02	FY03
SJ	W06HAA	JDSP	435212000	MIL	-6	-6	-6	-6	-6	-6	-6
XX	WEDGE			MIL	+6	+6	+6	+6	+6	+6	+6
SJ	W06HAA	JDSP	435212000	MIL	-5	-5	-5	-5	-5	-5	-5
SAM				MIL	+5	+5	+5	+5	+5	+5	+5
SJ	W06HAA	JDSP	435212000	CIV	-6	-6	-6	-6	-6	-6	-6
XX	WEDGE			CIV	+6	+6	+6	+6	+6	+6	+6
SJ	W06HAA	JDSP	435212000	CIV	-9	-9	-9	-9	-9	-9	-9
SAM				CIV	+9	+9	+9	+9	+9	+9	+9

TOA (\$ millions)

Cmd	UIC	MDEP	AMSCO	TYPE	FY97	FY98	FY99	FY00	FY01	FY02	FY03
SJ	W06HAA	JDSP	435212000	CIV	-0.15M	-0.15M	-0.3M	-0.3M	-0.3M	-0.3M	-0.3M
SJ	W06HAA	JDSP	435212000	CIV	-0.225M	-0.225M	-0.45M	-0.45M	-0.45M	-0.45M	-0.45M
SAM				CIV	+0.225M	+0.225M	+0.45M	+0.45M	+0.45M	+0.45M	+0.45M

Issue: 81

Title: Resource Services - Washington

Proponent: AA/DAS

Sponsor: ASA(MRA)

Source: HQDA Redesign

Implementation Period: POM 98-03

Synopsis: Downsize by 11 (4/7/11).

Resource Implications:

	Savings	Costs	Transfer
Military:		-4	0
Civilian:		-7	0
Dollars:		-.35M	0

Army Staff/Command Position:

Concur: AA

Nonconcur:

Recommendation: Implement in POM 98-03.

ACTION: AA - LEAD; RS-W - ASSIST.

Approve

Disapprove

**Fwd to CSA/SA
for decision**

**Defer to POM 00-05
Study by: _____**

Issue: 81 **Title:** Resource Services - Washington

Synopsis: Downsize by 11 (4/7/11).

Enablers: None.

Implementation Guidance:
HQDA Redesign Working Group submit adjustment to POM 98-03.

Issue: 81

Title: Resource Services - Washington

Synopsis: Downsize by 11 (4/7/11).

Manpower

Cmd	UIC	MDEP	AMSCO	TYPE	FY97	FY98	FY99	FY00	FY01	FY02	FY03
SJ	W4XEAA	JDSP	435212000	MIL	-4	-4	-4	-4	-4	-4	-4
XX	WEDGE			MIL	+4	+4	+4	+4	+4	+4	+4
SJ	W4XEAA	JDSP	435212000	CIV	-7	-7	-7	-7	-7	-7	-7
XX	WEDGE			CIV	+7	+7	+7	+7	+7	+7	+7

TOA (\$ millions)

Cmd	UIC	MDEP	AMSCO	TYPE	FY97	FY98	FY99	FY00	FY01	FY02	FY03
SJ	W4XEAA	JDSP	435212000	CIV		-.175M	-.35M	-.35M	-.35M	-.35M	-.35M

Issue: 82

Title: US Military Postal Service Agency

Proponent: AA/DAS

Sponsor: ASA(MRA)

Source: HQDA Redesign

Implementation Period: POM 98-03

Synopsis: Eliminate FOA. Downsize by 3 (0/3/3) and transfer function and spaces (10/20/30) to PERSCOM under TAGD.

Resource Implications:

	Savings	Costs	Transfer
Military:	0	0	-10
Civilian:	-3	0	-20
Dollars:	-.15M	0	- 1M

Army Staff/Command Position:

Concur: AA, DCSPER **Nonconcur:**

Recommendation: Implement in POM 98-03.

ACTION: PERSCOM - LEAD; AA - ASSIST.

- Approve** **Disapprove** **Fwd to CSA/SA for decision** **Defer to POM 00-05**
- Study by:** _____

Issue: 82

Title: US Military Postal Service Agency

Synopsis: Eliminate FOA. Downsize by 3 (0/3/3) and transfer function and spaces (10/20/30) to PERSCOM under TAGD.

Enablers: None.

Implementation Guidance:

1. HQDA Redesign Working Group submit adjustment to POM 98-03.
2. PERSCOM prepare a concept plan not later than 30 August 1996.

Issue: 82

Title: US Military Postal Service Agency

Synopsis: Eliminate FOA . Downsize by 3 (0/3/3) and transfer function and spaces (10/20/30) to PERSCOM under TAGD.

Manpower

Cmd	UIC	MDEP	AMSCO	TYPE	FY97	FY98	FY99	FY00	FY01	FY02	FY03
SJ	W4FXAA	JDSP	435212000	MIL	-10	-10	-10	-10	-10	-10	-10
MP	W3VSAA			MIL	+10	+10	+10	+10	+10	+10	+10
SJ	W4FXAA	JDSP	435212000	CIV	-20	-20	-20	-20	-20	-20	-20
MP	W3VSAA			CIV	+20	+20	+20	+20	+20	+20	+20
SJ	W4FXAA	JDSP	435212000	CIV	-1	-1	-1	-1	-1	-1	-1
SJ	W4FXAA	JDSP	435612000	CIV	-2	-2	-2	-2	-2	-2	-2
XX	WEDGE			CIV	+3	+3	+3	+3	+3	+3	+3

TOA (\$ millions)

Cmd	UIC	MDEP	AMSCO	TYPE	FY97	FY98	FY99	FY00	FY01	FY02	FY03
SJ	W4FXAA	JDSP	435212000	CIV	-1M	-1M	-1M	-1M	-1M	-1M	-1M
SJ	W4FXAA	JDSP	435212000	CIV	-.025M	-.025M	-.05M	-.05M	-.05M	-.05M	-.05M
SJ	W4FXAA	JDSP	435612000	CIV	-.05M	-.05M	-.1M	-.1M	-.1M	-.1M	-.1M
MP	W3VSAA			CIV	+1M	+1M	+1M	+1M	+1M	+1M	+1M

Issue: 83

Title: Personnel & Employment Services - Washington

Proponent: AA/DAS

Sponsor: ASA(MRA)

Source: HQDA Redesign

Implementation Period: POM 98-03

Synopsis: Eliminate FOA. Downsize Military Personnel Support spaces (7/0/7). Merge functions and spaces (61/24/85) into HQSV-W.

Resource Implications:

	Savings	Costs	Transfer
Military:	-7	0	-61
Civilian:	0	0	-24
Dollars:	0	0	-1.2M

Army Staff/Cmd Position:

Concur: AA

Nonconcur:

Recommendation: Implement in POM 98-03.

ACTION: AA - LEAD; P&ES-W - ASSIST.



Approve



Disapprove



Fwd to CSA/SA

for decision



Defer to POM 00-05



Study by: _____

Issue: 83

Title: Personnel & Employment Services - Washington

Synopsis: Eliminate FOA. Downsize Military Personnel Support spaces (7/0/7). Merge functions and spaces (61/24/85) into HQSV-W.

Enablers: None.

Implementation Guidance:

1. HQDA Redesign Working Group submit adjustment to POM 98-03.
2. Headquarters Services - Washington prepare a concept plan, not later than 30 August 1996 to integrate GO MESS, P&ES-W and S&BMS-W functions and personnel into new organization.

Synopsis: Eliminate FOA. Downsize Military Personnel Support spaces (7/0/7). Merge functions and spaces (6/24/85 in FY 98--61/23/84 in FY 99) into HQSV-W.

Manpower												
Cmd	UIC	MDEP	AMSCO	TYPE	FY97	FY98	FY99	FY00	FY01	FY02	FY03	
SJ	W310AA	JDSP	435212000	MIL	-7	-7	-7	-7	-7	-7	-7	
XX	WEDGE			MIL	+7	+7	+7	+7	+7	+7	+7	
SJ	W310AA	JDSP	435212000	MIL	-61	-61	-61	-61	-61	-61	-61	
SJ	W313AA	JDSP	435212000	MIL	+61	+61	+61	+61	+61	+61	+61	
SJ	W310AA	QCPO	4351212000	CIV	-24	-24	-23	-23	-23	-23	-23	
SJ	W313AA	QCPO	4351212000	CIV	+24	+24	+23	+23	+23	+23	+23	

TOA (\$ millions)

Cmd	UIC	MDEP	AMSCO	TYPE	FY97	FY98	FY99	FY00	FY01	FY02	FY03
SJ	W310AA	QCPO	4351212000	CIV	-1.2M	-1.2M	-1.15M	-1.15M	-1.15M	-1.15M	-1.15M
SJ	W313AA	QCPO	4351212000	CIV	+1.2M	+1.2M	+1.15M	+1.15M	+1.15M	+1.15M	+1.15M

Issue: 84 **Title:** Space & Building Management Services - Washington

Proponent: AA/DAS **Sponsor:** ASA(MRA) **Source:** HQDA Redesign

Implementation Period: POM 98-03

Synopsis: Eliminate. Transfer function and spaces (5/15/20) to HQSV-W.

Resource Implications:

	Savings	Costs	Transfer
Military:	0	0	0
Civilian:	0	0	0
Dollars:	0	0	0
			-5
			-15
			-.75M

Army Staff/Cmd Position:

Concur: AA **Nonconcur:**

Recommendation: Implement in POM 98-03.

ACTION: AA - LEAD; S&BMS-W - ASSIST.

Approve
 Disapprove
 Fwd to CSA/SA
 Defer to POM 00-05

 for decision

 Study by: _____

Issue: 84 **Title:** Space & Building Management Services - Washington

Synopsis: Eliminate. Transfer function and spaces (5/15/20) to HQSV-W.

Enablers: None.

Implementation Guidance:

1. HQDA Redesign Working Group submit adjustment to POM 98-03.
2. Headquarters Services - Washington prepare a concept plan, not later than 30 August 1996, to integrate GO MESS, P&ES-W and S&BMS-W functions and personnel into new organization.

Issue: 84

Title: Space & Building Management Services - Washington

Synopsis: Eliminate. Transfer function and spaces (5/15/20) to HQSV-W.

Manpower

Cmd	UIC	MDEP	AMSCO	TYPE	FY97	FY98	FY99	FY00	FY01	FY02	FY03
SJ	W242AA	JDSP	435212000	MIL	-5	-5	-5	-5	-5	-5	-5
SJ	W242AA	JDSP	435212000	CIV	-15	-15	-15	-15	-15	-15	-15
SJ	W313AA	JDSP	435212000	MIL	+5	+5	+5	+5	+5	+5	+5
SJ	W313AA	JDSP	435212000	CIV	+15	+15	+15	+15	+15	+15	+15

TOA (\$ millions)

Cmd	UIC	MDEP	AMSCO	TYPE	FY97	FY98	FY99	FY00	FY01	FY02	FY03
SJ	W242AA	JDSP	435212000	CIV	-.75M	-.75M	-.75M	-.75M	-.75M	-.75M	-.75M
SJ	W313AA	JDSP	435212000	CIV	+.75M	+.75M	+.75M	+.75M	+.75M	+.75M	+.75M

Issue: 85 **Title:** Director Information Systems for C4

Proponent: AA/DAS **Sponsor:** ASA(MRA) **Source:** HQDA Redesign

Implementation Period: POM 98-03

Synopsis: Downsize by 10% (5/6/11).

Resource Implications:

	Savings	Costs	Transfer
Military:		-5	0
Civilian:		-6	0
Dollars:		-.3M	0

Army Staff/Command Position:

Concur: **Nonconcur:**

Recommendation: Implement in POM 98-03.

ACTION: DISC4.

Approve **Disapprove** **Fwd to CSA/SA for decision** **Defer to POM 00-05 Study by: _____**

Issue: 85 **Title:** Director Information Systems for C4

Synopsis: Downsize by 10% (5/6/11).

Enablers: None.

Implementation Guidance:
HQDA Redesign Work Group submit adjustment to POM 98-03.

Issue: 85

Title: Director Information Systems for C4

Synopsis: Downsize by 10% (5/6/11).

Manpower

Cmd	UIC	MDEP	AMSCO	TYPE	FY97	FY98	FY99	FY00	FY01	FY02	FY03
SA	W4NJAA	XMGH	431398000	MIL	-5	-5	-5	-5	-5	-5	-5
XX	WEDGE			MIL	+5	+5	+5	+5	+5	+5	+5
SA	W4NJAA	XMGH	431398000	CIV	-6	-6	-6	-6	-6	-6	-6
XX	WEDGE			CIV	+6	+6	+6	+6	+6	+6	+6

TOA (\$ millions)

Cmd	UIC	MDEP	AMSCO	TYPE	FY97	FY98	FY99	FY00	FY01	FY02	FY03
SA	W4NJAA	XMGH	431398000	CIV	-0.15M	-0.15M	-0.3M	-0.3M	-0.3M	-0.3M	-0.3M

Issue: 86

Title: Information Management Support Agency

Proponent: AA/DAS

Sponsor: ASA(MRA)

Source: HQDA Redesign

Implementation Period: POM 98-03

Synopsis: Downsize by 10% (1/6/7).

Resource Implications:

	Savings	Costs	Transfer
Military:		-1	0
Civilian:		-6	0
Dollars:		-0.3M	0

Army Staff/Command Position:

Concur:

Nonconcur:

Recommendation: Implement in POM 98-03.

ACTION: DISC4 - LEAD; IMSA - ASSIST.

- Approve
- Disapprove
- Fwd to CSA/SA for decision
- Defer to POM 00-05
- Study by: _____

Issue: 86 **Title:** Information Management Support Agency

Synopsis: Downsize by 10% (1/6/7).

Enablers: None.

Implementation Guidance:
HQDA Redesign Work Group submit adjustment to POM 98-03.

Issue: 86

Title: Information Management Support Agency

Synopsis: Downsize by 10% (1/6/7).

Manpower

Cmd	UIC	MDEP	AMSCO	TYPE	FY97	FY98	FY99	FY00	FY01	FY02	FY03
SS	W4M7AA	XMGI	431998000	MIL	-1	+1	+1	-1	-1	+1	-1
XX	WEDGE			MIL							
SS	W4M7AA	XMGI	431998000	CIV	-6	-6	-6	-6	-6	-6	-6
XX	WEDGE			CIV	+6	+6	+6	+6	+6	+6	+6

TOA (\$ millions)

Cmd	UIC	MDEP	AMSCO	TYPE	FY97	FY98	FY99	FY00	FY01	FY02	FY03
SS	W4M7AA	XMGI	431998000	CIV	-0.15M	-0.15M	-0.3M	-0.3M	-0.3M	-0.3M	-0.3M

Issue: 87 **Title:** US Army Information Systems Selection & Acquisition Agency

Proponent: AADAS **Sponsor:** ASA(MRA) **Source:** HQDA Redesign

Implementation Period: POM 98-03

Synopsis: Reduce by 20% (3/21/24). Transfer function and spaces (12/83/95) to AMC (Communications and Electronics Command). [See Issue 49.]

Resource Implications:

	Savings	Costs	Transfer
Military:		-3	0
Civilian:		-21	0
Dollars:		-1.05M	0
			-12
			-83
			-4.15M

Army Staff/Command Position:

Concur: DISC4 (transfer only) **Nonconcur:** DISC4 (level t/b transferred)

Recommendation: Implement in POM 98-03.

ACTION: AMC - LEAD; DISC4 - ASSIST.

Approve Disapprove Fwd to CSA/SA for decision Defer to POM 00-05 Study by: _____

Issue: 87

Title: US Army Information Systems Selection & Acquisition Agency

Synopsis: Reduce by 20% (3/21/24). Transfer function and spaces (12/83/95) to AMC (Communications and Electronics Command). [See Issue 49.]

Enablers: None.

Implementation Guidance:

1. HQDA Redesign Work Group submit adjustment to POM 98-03.
2. AMC prepare concept plan, not later than 30 August 1996, to transfer function. DISC4 assist.
3. ISSAA determine impact to customers, submit for approval, and distribute notification to those impacted.

Issue: 87

Title: US Army Information Systems Selection & Acquisition Agency

Synopsis: Reduce by 20% (3/21/24). Transfer function and spaces (12/83/95) to AMC (Communications and Electronics Command). [See Issue 49.]

Manpower

Cmd	UIC	MDEP	AMSCO	TYPE	FY97	FY98	FY99	FY00	FY01	FY02	FY03
SB	W2Y2AA			MIL	-3	-3	-3	-3	-3	-3	-3
XX	WEDGE			MIL	+3	+3	+3	+3	+3	+3	+3
SB	W2Y2AA			MIL	-12	-12	-12	-12	-12	-12	-12
SB	W2Y2AA			CIV	-21	-21	-21	-21	-21	-21	-21
XX	WEDGE			CIV	+21	+21	+21	+21	+21	+21	+21
SB	W2Y2AA			CIV	-83	-83	-83	-83	-83	-83	-83
AMC(CECOM)				MIL	+12	+12	+12	+12	+12	+12	+12
AMC(CECOM)				CIV	+83	+83	+83	+83	+83	+83	+83

TOA (\$ millions)

Cmd	UIC	MDEP	AMSCO	TYPE	FY97	FY98	FY99	FY00	FY01	FY02	FY03
SB	W2Y2AA			CIV	-	-.525M	-1.05M	-1.05M	-1.05M	-1.05M	-1.05
SB	W2Y2AA			CIV	-	-2.075M	-4.15M	-4.15M	-4.15M	-4.15M	-4.15
AMC(CECOM)				CIV		+2.075M	+4.15M	+4.15M	+4.15M	+4.15M	+4.15

Issue: 88 **Title:** US Army Communication-Electronics Services Office

Synopsis: Downsize by 10% (2/4/6).

Enablers: None.

Implementation Guidance:
HQDA Redesign Work Group submit adjustment to POM 98-03.

Issue: 88

Title: US Army Communication-Electronics Services Office

Synopsis: Downsize by 10% (2/4/6).

Manpower

Cmd	UIC	MDEP	AMSCO	TYPE	FY97	FY98	FY99	FY00	FY01	FY02	FY03
SB	W4XFAA	FASS	435212000	MIL	-2	-2	-2	-2	-2	-2	-2
XX	WEDGE			MIL	+2	+2	+2	+2	+2	+2	+2
SB	W4XFAA	FADI	432126000	CIV	-4	-4	-4	-4	-4	-4	-4
XX	WEDGE			CIV	+4	+4	+4	+4	+4	+4	+4

TOA (\$ millions)

Cmd	UIC	MDEP	AMSCO	TYPE	FY97	FY98	FY99	FY00	FY01	FY02	FY03
SB	W4XFAA	FADI	432126000	CIV	-1M	-1M	-2M	-2M	-2M	-2M	-2M

Issue: 89

Title: Office, Chief of Legislative Liaison (OCLL)

Proponent: AA/DAS

Sponsor: ASA(MRA)

Source: HQDA Redesign

Implementation Period: POM 98-03

Synopsis: Downsize by 10% (3/2/5).

Resource Implications:

	Savings	Costs	Transfer
Military:	-3	0	0
Civilian:	-2	0	0
Dollars:	-.1M	0	0

Army Staff/Cmd Position:

Concur:

Nonconcur:

Recommendation: Implement in POM 98-03.

ACTION: OCLL - LEAD; OCSA - ASSIST.

Approve

Disapprove

Fwd to CSA/SA for decision

Defer to POM 00-05

Study by: _____

Issue: 89 **Title:** Chief of Legislative Liaison (OCLL)

Synopsis: Downsize by 10% (3/2/5).

Enablers: None.

Implementation Guidance:

1. HQDA Redesign Working Group submit adjustment to POM 98-03.

Issue: 89

Title: Chief of Legislative Liaison (OCLL)

Synopsis: Downsize by 10% (3/2/5).

Manpower

Cmd	UIC	MDEP	AMSCO	TYPE	FY97	FY98	FY99	FY00	FY01	FY02	FY03
SA	W1BYAA	XMGH	431398000	MIL	-3	+3	-3	-3	-3	-3	-3
XX	WEDGE			MIL			+3	+3	+3	+3	+3
SA	W1BYAA	XMGH	431398000	CIV	-2	-2	-2	-2	-2	-2	-2
XX	WEDGE			CIV	+2	+2	+2	+2	+2	+2	+2

TOA (\$ millions)

Cmd	UIC	MDEP	AMSCO	TYPE	FY97	FY98	FY99	FY00	FY01	FY02	FY03
SA	W1BYAA	XMGH	431398000	CIV		-.05M	-.1M	-.1M	-.1M	-.1M	-.1M

Issue: 90

Title: Congressional Inquiry Division (CID)

Proponent: AA/DAS

Sponsor: ASA(MRA)

Source: HQDA Redesign

Implementation Period: POM 98-03

Synopsis: Downsize by 10% (1/3/4).

Resource Implications:

	Savings	Costs	Transfer
Military:	-1	0	0
Civilian:	-3	0	0
Dollars:	-.15M	0	0

Army Staff/Command Position:

Concur:

Nonconcur:

Recommendation: Implement in POM 98-03.

ACTION: OCLL - LEAD; CID - ASSIST.



Approve



Disapprove



Fwd to CSA/SA
for decision



Defer to POM 00-05



Study by: _____

Issue: 90

Title: Congressional Inquiry Division (CID)

Synopsis: Downsize by 10% (1/3/4).

Enablers: None.

Implementation Guidance:

HQDA Redesign Work Group submit adjustment to POM 98-03.

Issue: 90

Title: Congressional Inquiry Division

Synopsis: Downsize by 10% (1/3/4).

Manpower												
Cmd	UIC	MDEP	AMSCO	TYPE	FY97	FY98	FY99	FY00	FY01	FY02	FY03	
SB	W4CHAA	FASS	435212000	MIL	-1	+1	-1	-1	-1	-1	-1	
XX	WEDGE			MIL	+1	+1	+1	+1	+1	+1	+1	
SB	W4CHAA	FASS	435212000	CIV	-3	-3	-3	-3	-3	-3	-3	
XX	WEDGE			CIV	+3	+3	+3	+3	+3	+3	+3	

TOA (\$ millions)

Cmd	UIC	MDEP	AMSCO	TYPE	FY97	FY98	FY99	FY00	FY01	FY02	FY03	
SB	W4CHAA	FASS	435212000	CIV		-.075M	-.15M	-.15M	-.15M	-.15M	-.15M	

Issue: 91

Title: Office Chief of Public Affairs (CPA)

Proponent: AA/DAS

Sponsor: ASA(MRA)

Source: HQDA Redesign

Implementation Period: POM 98-03

Synopsis: Downsize by 10% (2/1/3).

Resource Implications:

	Savings	Costs	Transfer
Military:	-2	0	0
Civilian:	-1	0	0
Dollars:	-.05M	0	0

Army Staff/Command Position:

Concur:

Nonconcur:

Recommendation: Implement in POM 98-03.

ACTION: OCPA.

Approve
 Disapprove
 Fwd to CSA/SA for decision
 Defer to POM 00-05 Study by: _____

Issue: 91 **Title:** Office Chief of Public Affairs (CPA)

Synopsis: Downsize by 10% (2/1/3).

Enablers: None.

Implementation Guidance:
HQDA Redesign Working Group submit adjustment to POM 98-03.

Issue: 91

Title: Office, Chief of Public Agency (OCPA)

Synopsis: Downsize by 10% (2/1/3).

Manpower

Cmd	UIC	MDEP	AMSCO	TYPE	FY97	FY98	FY99	FY00	FY01	FY02	FY03
SA	W1BZAA	XMGH	431398000	MIL	-2	-2	-2	-2	-2	-2	-2
XX	WEDGE			MIL	+2	+2	+2	+2	+2	+2	+2
SA	W1BZAA	XMGH	431398000	CIV	-1	-1	-1	-1	-1	-1	-1
XX	WEDGE			CIV	+1	+1	+1	+1	+1	+1	+1

TOA (\$ millions)

Cmd	UIC	MDEP	AMSCO	TYPE	FY97	FY98	FY99	FY00	FY01	FY02	FY03
SA	W1BZAA	XMGH	431398000	CIV	-0.025M	-0.025M	-0.05M	-0.05M	-0.05M	-0.05M	-0.05M

Issue: 92

Title: US Army Broadcasting Service (ABS)

Proponent: AAVDAS

Sponsor: ASA(MRA)

Source: HQDA Redesign

Implementation Period: POM 98-03

Synopsis: Pursue transfer of ABS functions and resources to AFIS.

Resource Implications:

	Savings	Costs	Transfer
Military:	0	0	-202
Civilian:	0	0	-129
Dollars:	0	0	- \$6.45 Million

Army Staff/Command Position:

Concur:

Nonconcur:

Recommendation: Pursue transfer of ABS functions and resources to AFIS.

ACTION: OCPA - LEAD; ABS - ASSIST.



Approve



Disapprove



Fwd to CSA/SA

for decision



Defer to POM 00-05



Study by: _____

Issue: 92

Title: US Army Broadcasting Service

Synopsis: Pursue transfer of ABS functions and resources to AFIS.

Enablers: Requires OSD concurrence to transfer ABS to AFIS with 331 spaces.

Implementation Guidance:

1. OCPA pursue transfer to ABS functions and resources (202/129/331) to AFIS, not later than 30 August 1996.
2. HQDA Redesign review issue in Phase II.

Issue: 92

Title: US Army Broadcasting Service

Synopsis: Pursue transfer of ABS functions and resources to AFIS.

Manpower

Cmd	UIC	MDEP	AMSCO	TYPE	FY97	FY98	FY99	FY00	FY01	FY02	FY03

Defer until Phase II

TOA (\$ millions)

Issue: 93

Title: Command Information Unit (CIU)

Proponent: AA/DAS **Sponsor:** ASA(MRA) **Source:** HQDA Redesign

Implementation Period: POM 98-03

Synopsis: Downsize by 10% (4/4/8).

Resource Implications:

	Savings	Costs	Transfer
Military:	-4	0	0
Civilian:	-4	0	0
Dollars:	-.2M	0	0

Army Staff/Command Position:

Concur:

Nonconcur:

Recommendation: Implement in POM 98-03.

ACTION: OCPA - LEAD; CIU - ASSIST.

- Approve**
 Disapprove
 Fwd to CSA/SA for decision
 Defer to POM 00-05 Study by: _____

Issue: 93

Title: Command Information Unit (CIU)

Synopsis: Downsize by 10% (4/4/8).

Enablers: None.

Implementation Guidance:

HQDA Redesign Working Group submit adjustment to POM 98-03.

Issue: 93

Title: Command Information Unit (CIU)

Synopsis: Downsize by 10% (4/4/8).

		Manpower									
Cmd	UIC	MDEP	AMSCO	TYPE	FY97	FY98	FY99	FY00	FY01	FY02	FY03
SB	W06NAA	FASS	435212000	MIL	-4	-4	-4	-4	-4	-4	-4
XX	WEDGE			MIL	+4	+4	+4	+4	+4	+4	+4
SB	W06NAA	FASS	435212000	CIV	-4	-4	-4	-4	-4	-4	-4
XX	WEDGE			CIV	+4	+4	+4	+4	+4	+4	+4

TOA (\$ millions)

Cmd	UIC	MDEP	AMSCO	TYPE	FY97	FY98	FY99	FY00	FY01	FY02	FY03
SB	W06NAA	FASS	435212000	CIV	-1M	-1M	-2M	-2M	-2M	-2M	-2M

Issue: 94

Title: US Army Element-Hometown News Service

Proponent: AA/DAS

Sponsor: ASA(MRA)

Source: HQDA Redesign

Implementation Period: POM 98-03

Synopsis: Eliminate Hometown News Service (HTN). Empower the local commands and installations to forward news releases to the applicable local press. OCPA develops policy and continues oversight responsibilities.

Resource Implications:

	Savings	Costs	Transfer
Military:	0	0	0
Civilian:	0	0	0
Dollars:	0	0	0

Army Staff/Command Position:

Concur:

Nonconcur: OCPA

Recommendation: Defer pending PAO FAA.

ACTION: OCPA - LEAD; HTN - ASSIST.

Approve

Disapprove

Fwd to CSA/SA for decision

Defer to POM 00-05
 Study by: _____

Issue: 94

Title: US Army Element-Hometown News Service

Synopsis: Eliminate Hometown News Service. Empower the local commands and installations to forward news releases to the applicable local press. OCPA develops policy and continues oversight responsibilities.

Enablers: None.

Implementation Guidance:

1. Freeze hiring.
2. OCPA develop concept plan not later than July 1996.
3. Transfer all policy functions to OCPA not later than September 1996. Change policy to empower commands.
4. Transfer military and implement reduction-in-force (RIF) procedures for civilians.

Issue: 94

Title: US Army Element-Hometown News Service

Synopsis: Eliminate Hometown News Service. Empower the local commands and installations to forward news releases to the applicable local press. OCPA develops policy and continues oversight responsibilities.

Manpower

Cmd	UIC	MDEP	AMSCO	TYPE	FY97	FY98	FY99	FY00	FY01	FY02	FY03
SB	W06PAA	FASS	435212000	MIL	-7	-7	-7	-7	-7	-7	-7
XX	WEDGE			MIL	+7	+7	+7	+7	+7	+7	+7
SB	W06PAA	FASS	435212000	CIV	-12	-12	-12	-12	-12	-12	-12
XX	WEDGE			CIV	+12	+12	+12	+12	+12	+12	+12

TOA (\$ millions)

Cmd	UIC	MDEP	AMSCO	TYPE	FY97	FY98	FY99	FY00	FY01	FY02	FY03
SB	W06PAA	FASS	435212000	CIV		-.3M	-.6M	-.6M	-.6M	-.6M	-.6M

Issue: 95

Title: Army Audit Agency (AAA)

Proponent: AADAS

Sponsor: ASA(MRA)

Source: HQDA Redesign

Implementation Period: POM 98-03

Synopsis: Downsize by 49 (1/48/49). Contract for additional audit support.

Resource Implications:

	Savings	Costs	Transfer
Military:	-1	0	0
Civilian:	-48	0	0
Dollars:	-2.4M	+2.4M	0

Army Staff/Cmd Position:

Concur:

Nonconcur: AAA

Recommendation: Implement in POM 98-03.

ACTION: TAG - LEAD; AAA - ASSIST.

Approve
 Disapprove
 Fwd to CSA/SA for decision
 Defer to POM 00-05
 Study by: _____

Issue: 95

Title: Army Audit Agency (AAA)

Synopsis: Downsize by 49 (1/48/49). Contract for additional audit support.

Enablers:. DoD Internal Audit Policy must be changed to allow operational audits to be contracted out.

Implementation Guidance:

1. HQDA Redesign Working Group submit an adjustment to POM 00-05.
2. The Auditor General pursue a change in DoD internal audit policy regarding expanding contractual support services.

Issue: 95

Title: Army Audit Agency (AAA)

Synopsis: Downsize by 49 (1/48/49). Contract for additional audit support.

Manpower

Cmd	UIC	MDEP	AMSCO	TYPE	FY97	FY98	FY99	FY00	FY01	FY02	FY03
AU	WONTAA	FAAA	435212000	MIL				-1	-1	-1	-1
XX	WEDGE			MIL				+1	+1	+1	+1
AU	WONTAA	FAAA	435212000	CIV				-48	-48	-48	-48
XX	WEDGE			CIV				+48	+48	+48	+48

TOA (\$ millions)

Cmd	UIC	MDEP	AMSCO	TYPE	FY97	FY98	FY99	FY00	FY01	FY02	FY03
AU	WONTAA	FAAA	435212000	CIV				0	0	0	0

Issue: 96A

Title: The Inspector General

Proponent: AA/DAS

Sponsor: ASA(MRA)

Source: HQDA Redesign

Implementation Period: POM 98-03

Synopsis: Downsize by 10% (0/1/1). [IGA to absorb reduction.]

Resource Implications:

	Savings	Costs	Transfer
Military:	0	0	0
Civilian:	[-1]	0	0
Dollars:	[-.05M]	0	0

Army Staff/Command Position:

Concur:

Nonconcur:

Recommendation: Implement in POM 98-03.

ACTION: TIG.

- Approve
 Disapprove
 Fwd to CSA/SA for decision
 Defer to POM 00-05 Study by: _____

Issue: 96

Title: The Inspector General Agency

Proponent: AA/DAS

Sponsor: ASA(MRA)

Source: HQDA Redesign

Implementation Period: POM 98-03

Synopsis: Downsize by 10% (8/5/13) plus 0/1/1 space for IG reduction.

Resource Implications:

	Savings	Costs	Transfer
Military:	-8	0	0
Civilian:	-6	0	0
Dollars:	-.3M	0	0

Army Staff/Command Position:

Concur:

Nonconcur:

Recommendation: Implement in POM 98-03.

ACTION: TIG - LEAD; IGA - ASSIST.

Approve **Disapprove** **Fwd to CSA/SA for decision** **Defer to POM 00-05 Study by: _____**

Issue: 96

Title: The Inspector General Agency

Synopsis: Downsize by 10% (8/5/13) plus 0/1/1 space for IG reduction.

Enablers: None.

Implementation Guidance:

HQDA Redesign Working Group submit adjustment to POM 98-03.

Issue: 96

Title: The Inspector General Agency

Synopsis: Downsize by 10% (8/5/13) plus 0/1/1 space for IG reduction.

Manpower

Cmd	UIC	MDEP	AMSCO	TYPE	FY97	FY98	FY99	FY00	FY01	FY02	FY03
SB	W303AA	FAIG	435212000	MIL	-8	-8	-8	-8	-8	-8	-8
XX	WEDGE			MIL	+8	+8	+8	+8	+8	+8	+8
SB	W303AA	FAIG	435212000	CIV	-6	-6	-6	-6	-6	-6	-6
XX	WEDGE			CIV	+6	+6	+6	+6	+6	+6	+6

TOA (\$ millions)

Cmd	UIC	MDEP	AMSCO	TYPE	FY97	FY98	FY99	FY00	FY01	FY02	FY03
SB	W303AA	FAIG	435212000	CIV	-	-.15M	-.3M	-.3M	-.3M	-.3M	-.3M

Issue: 97

Title: Office of the Chief of Staff

Proponent: AA/DAS

Sponsor: ASA(MRA)

Source: HQDA Redesign

Implementation Period: POM 98-03

Synopsis: Stand-up AVCSA. Resource OCSA additional requirements (44/13/57). [Receive TEMA (4/5/9) (see issue 99) and SRIA (5/2/7) (see issue 100) functions/spaces.]

Resource Implications:

	Savings	Costs	Transfer
Military:	0	0	+44
Civilian:	0	0	+13
Dollars:	0	0	+0.65M

Army Staff/Command Position:

Concur:

Nonconcur:

Recommendation: Implement in POM 98-03.

ACTION: OCSA

Approve
 Disapprove
 Fwd to CSA/SA for decision
 Defer to POM 00-05
 Study by: _____

Issue: 97

Title: Office of the Chief of Staff

Synopsis: Stand-up AVCSA. Resource OCSA additional requirements (44/13/57). [Receive TEMA (4/5/9) (see issue 99) and SRIA (5/2/7) (see issue 100) functions/spaces.]

Enablers: None.

Implementation Guidance:

1. HQDA Redesign Working Group submit adjustment to POM 98-03.
2. OCSA develop mission and function statement for AVCSA. ASA(FM)., DCSOPS, and PAED assist.

Issue: 97

Title: Office of the Chief of Staff

Synopsis: Stand-up AVCSA. Resource OCSA additional requirements (44/13/57).
[Receive TEMA (4/5/9) (see issue 99) and SRIA (5/2/7) (see issue 100) functions/
spaces.]

Cmd	UIC	MDEP	AMSCO	TYPE	Manpower							
					FY97	FY98	FY99	FY00	FY01	FY02	FY03	
CS	W0ZUAA	XMGH	431398000	MIL		+44	+44	+44	+44	+44	+44	+44
CS	W0ZUAA	XMGH	431398000	CIV		+13	+13	+13	+13	+13	+13	+13

TOA (\$ millions)

Cmd	UIC	MDEP	AMSCO	TYPE	TOA (\$ millions)							
					FY97	FY98	FY99	FY00	FY01	FY02	FY03	
CS	W0ZUAA	XMGH	431398000	CIV		+325	+65	+65	+65	+65	+65	+65

Issue: 98

Title: Concepts Analysis Agency

Proponent: AA/DAS

Sponsor: ASA(MRA)

Source: HQDA Redesign

Implementation Period: POM 98-03

Synopsis: Redesignate/rename the Center for Army Analysis. Downsize by 18 (5/13/18) spaces. [Receives analysis function and 0/15/15 spaces from the Logistics Evaluation Agency (see issue 125), analysis function and 1/19/20 spaces from Army Research Institute (see issue 111).]

Resource Implications:

	Savings	Costs	Transfer
[+1] Military:		-5	0
[+34] Civilian:		-13	0
[+1.7M] Dollars:		-.65M	0

Army Staff/Command Position:

Concur:

Nonconcur:

Recommendation: Implement in POM 98-03.

ACTION: OCSA - LEAD; DUSA(OR), ODCSLOG, and ODCSPER - ASSIST.

Approve
 Disapprove
 Fwd to CSA/SA for decision
 Defer to POM 00-05
 Study by: _____

Issue: 98

Title: Concepts Analysis Agency

Synopsis: Redesignate/rename the Center for Army Analysis. Downsize by 18 (5/13/18) spaces.

Enablers: None.

Implementation Guidance:

1. HQDA Redesign Working Group submit adjustment to POM 98-03.
2. CAA prepare concept plan not later than 30 August 1996, to integrate functions and spaces. ODCSLOG assist in transition plan and execution.

Issue: 98

Title: Concepts Analysis Agency

Synopsis: Redesignate/rename the Center for Army Analysis. Downsize by 18 (5/13/18) spaces.

Manpower

Cmd	UIC	MDEP	AMSCO	TYPE	FY97	FY98	FY99	FY00	FY01	FY02	FY03
SS	W3WCAA	XMGH	431498000	MIL	-5	-5	-5	-5	-5	-5	-5
XX	WEDGE			MIL	+5	+5	+5	+5	+5	+5	+5
SS	W3WCAA	XMGH	431498000	CIV	-13	-13	-13	-13	-13	-13	-13
XX	WEDGE			CIV	+13	+13	+13	+13	+13	+13	+13

TOA (\$ millions)

Cmd	UIC	MDEP	AMSCO	TYPE	FY97	FY98	FY99	FY00	FY01	FY02	FY03
SS	W3WCAA			CIV		-.325M	-.65M	-.65M	-.65M	-.65M	-.65M

Issue: 99

Title: Test and Evaluation Management Agency

Proponent: AA/DAS

Sponsor: ASA(MRA)

Source: HQDA Redesign

Implementation Period: POM 98-03

Synopsis: Eliminate. Transfer function and resources to OCSA.

Resource Implications:

	Savings	Costs	Transfer
Military:	0	0	- 4
Civilian:	0	0	- 5
Dollars:	0	0	-.25M

Army Staff/Command Position:

Concur:

Nonconcur:

Recommendation: Implement in POM 98-03.

ACTION: OCSA - LEAD; TEMA - ASSIST.

Approve
 Disapprove
 Fwd to CSA/SA for decision
 Defer to POM 00-05
 Study by: _____

Issue: 99 **Title:** Test and Evaluation Management Agency

Synopsis: Eliminate. Transfer function and resources to OCSA.

Enablers: None.

Implementation Guidance:

1. HQDA Redesign Working Group submit adjustment to POM 98-03.
2. OCSA develop concept plan, not later than 30 August 1996, to integrate TEMA functions and spaces. TEMA assist.

Issue: 99

Title: Test and Evaluation Management Agency

Synopsis: Eliminate. Transfer function and resources to OCSA.

Manpower

Cmd	UIC	MDEP	AMSCO	TYPE	FY97	FY98	FY99	FY00	FY01	FY02	FY03
SS	W44SAA	XMGH	431498000	MIL	-4	-4	-4	-4	-4	-4	-4
CS	W0ZUAA	XMGH	431398000	MIL	+4	+4	+4	+4	+4	+4	+4
SS	W44SAA	XMGH	431498000	CIV	-5	-5	-5	-5	-5	-5	-5
CS	W0ZUAA	XMGH	431398000	CIV	+5	+5	+5	+5	+5	+5	+5

TOA (\$ millions)

Cmd	UIC	MDEP	AMSCO	TYPE	FY97	FY98	FY99	FY00	FY01	FY02	FY03
SS	W44SAA	XMGH	431498000	CIV	-.25M	-.25M	-.25M	-.25M	-.25M	-.25M	-.25M
CS	W0ZUAA	XMGH	431398000	CIV	+.25M	+.25M	+.25M	+.25M	+.25M	+.25M	+.25M

Issue: 100 **Title:** US Army Sensitive Records & Information Agency (SRIA)

Enablers: None.

Synopsis: Eliminate. Transfer function and resources to OCSA.

Implementation Guidance:

1. HQDA Redesign Working Group submit adjustment to POM 98-03.
2. OCSA develop concept plan, not later than 30 August 1996, to integrate SRIA functions and spaces.

Issue: 100

Title: US Army Sensitive Records & Information Agency (SRIA)

Synopsis: Eliminate. Transfer function and resources to OCSA.

Manpower

Cmd	UIC	MDEP	AMSCO	TYPE	FY97	FY98	FY99	FY00	FY01	FY02	FY03
SS	W47VAA	XMGH	431498000	MIL	-5	+5	+5	-5	-5	+5	-5
CS	W0ZUAA	XMGH	431398000	MIL	-2	+2	+2	-2	-2	+2	+2

TOA (\$ millions)

Cmd	UIC	MDEP	AMSCO	TYPE	FY97	FY98	FY99	FY00	FY01	FY02	FY03
SS	W47VAA	XMGH	431498000	CIV	-.1M	-.1M	-.1M	-.1M	-.1M	-.1M	-.1M
CS	W0ZUAA	XMGH	431398000	CIV	+.1M	+.1M	+.1M	+.1M	+.1M	+.1M	+.1M

Issue: 101

Title: Space & Strategic Defense Command

Proponent: AA/DAS

Sponsor: ASA(MRA)

Source: HQDA Redesign

Implementation Period: POM 98-03

Synopsis: Downsize by 22/21/43. Designate a stand-alone Army Component Command. GO 17, dated 15 Dec 95, transfers ASPO to SSDC effective FY 97.

Resource Implications:

	Savings	Costs	Transfer
Military:	-22	0	0
Civilian:	-21	0	0
Dollars:	-1.05M	0	0

Army Staff/Command Position:

Concur:

Nonconcur:

Recommendation: Implement downsize in POM 98-03. Designate ACC immediately.

ACTION: OCSA - LEAD; TRADOC - ASSIST.

- Approve**
 Disapprove
 Fwd to CSA/SA for decision
 Defer to POM 00-05
 Study by: _____

Issue: 101 **Title:** Space & Strategic Defense Command

Synopsis: Downsize by 22/21/43. Designate a stand-alone Army Component Command. GO 17, dated 15 Dec 95, transfers ASPO to SSDC effective FY 97.

Enablers: None.

Implementation Guidance:

1. HQDA Redesign Working Group submit adjustment to POM 98-03.

Issue: 101

Title: Space & Strategic Defense Command

Synopsis: Downsize by 22/21/43. Designate a stand-alone Army Component Command. GO 17, dated 15 Dec 95, transfers ASPO to SSSDC effective FY 97.

Manpower

Cmd	UIC	MDEP	AMSCO	TYPE	FY97	FY98	FY99	FY00	FY01	FY02	FY03
SC	W4XQAA			CIV	-21	-21	-21	-21	-21	-21	-21
XX	WEDGE			CIV	+21	+21	+21	+21	+21	+21	+21

TOA (\$ millions)

Cmd	UIC	MDEP	AMSCO	TYPE	FY97	FY98	FY99	FY00	FY01	FY02	FY03
SC	W4XQAA			CIV		-.525M	-1.05M	-1.05M	-1.05M	-1.05M	-1.05M

Issue: 102

Title: Operational Test and Evaluation Command

Proponent: AA/DAS

Sponsor: ASA(MRA)

Source: HQDA Redesign

Implementation Period: POM 98-03

Synopsis: Downsize 10% (130/14/144) and study Test and Evaluation consolidation during phase II.

Resource Implications:

	Savings	Costs	Transfer
Military:	-140	0	0
Civilian:	-14	0	0
Dollars:	-.7M	0	0

Army Staff/Command Position:

Concur:

Nonconcur: DUSA(OR), OPTEC

Recommendation: Implement in POM 98-03.

ACTION: OCSA - LEAD; DUSA(OR), TEMA, and OPTEC - ASSIST.

Approve **Disapprove** **Fwd to CSA/SA for decision** **Defer to POM 00-05 Study by: _____**

Issue: 102

Title: Operational Test and Evaluation Command

Synopsis: Downsize 10% (130/14/144) and study Test and Evaluation consolidation during phase II.

Enablers: None.

Implementation Guidance:

1. HQDA Redesign Working Group submit adjustment to POM 98-03.
2. OPTEC prepare reduction plan and coordinate with TEMA, military and civilian personnel offices and HQDA Redesign Working Group not later than 15 September 1996.
3. OPTEC comply with policies and procedures of AR 5-10.
4. TEMA prepare and monitor a study management plan.
5. OPTEC assist in study plan and execution.

Issue: 102

Title: Operational Test and Evaluation Command

Synopsis: Downsize 10% (130/14/144) and study Test and Evaluation consolidation during phase II.

		Manpower										
Cmd	UIC	MDEP	AMSCO	TYPE	FY97	FY98	FY99	FY00	FY01	FY02	FY03	
SF	W3Q2AA	FACS	121015000	MIL		-130	-130	-130	-130	-130	-130	
XX	WEDGE			MIL		+130	+130	+130	+130	+130	+130	
SF	W3Q2AA	FACS	121015000	CIV		-14	-14	-14	-14	-14	-14	
XX	WEDGE			CIV		+14	+14	+14	+14	+14	+14	

TOA (\$ millions)

Cmd	UIC	MDEP	AMSCO	TYPE	FY97	FY98	FY99	FY00	FY01	FY02	FY03
SF	W3Q2AA	FACS	121015000	CIV		-.35	-.7	-.7	-.7	-.7	-.4

Issue: 103

Title: US Army Safety Center

Proponent: AA/DAS

Sponsor: ASA(MRA)

Source: HQDA Redesign

Implementation Period: POM 98-03

Synopsis: Downsize by 22; retain smaller Office of the Director of Army Safety Program.

Resource Implications:

	Savings	Costs	Transfer
Military:	-11	0	0
Civilian:	-11	0	0
Dollars:	-.55M	0	0

Army Staff/Command Position:

Concur: DAS, ASC

Nonconcur:

Recommendation: Implement in POM 98-03.

ACTION: OCSA - LEAD; ASC - ASSIST.

- Approve
- Disapprove
- Fwd to CSA/SA for decision
- Defer to POM 00-05
- Study by: _____

Issue: 103

Title: US Army Safety Center

Synopsis: Downsize by 22; retain smaller Office of the Director of Army Safety Program.

Enablers: None.

Implementation Guidance:

1. HQDA Redesign Working Group submit adjustment to POM 98-03.
2. Army Safety Center prepare a personnel reduction plan, not later than 15 September 1996; coordinate with military and civilian personnel offices.

Issue: 103

Title: US Army Safety Center

Synopsis: Downsize by 22; retain smaller Office of the Director of Army Safety Program.

Manpower											
Cmd	UIC	MDEP	AMSCO	TYPE	FY97	FY98	FY99	FY00	FY01	FY02	FY03
SE	W0J7AA	FACS	435212000	MIL	-11	-11	-11	-11	-11	-11	-11
XX	WEDGE			MIL	+11	+11	+11	+11	+11	+11	+11
SE	W0J7AA	FACS	435212000	CIV	-11	-11	-11	-11	-11	-11	-11
XX	WEDGE			CIV	+11	+11	+11	+11	+11	+11	+11

TOA (\$ millions)

Cmd	UIC	MDEP	AMSCO	TYPE	FY97	FY98	FY99	FY00	FY01	FY02	FY03
SE	W0J7AA	FACS	435212000	CIV		-.275M	-.55M	-.55M	-.55M	-.55M	-.55M

Issue: 104

Title: US Army Center of Military History

Proponent: AA/DAS

Sponsor: ASA(MRA)

Source: HQDA Redesign

Implementation Period: POM 98-03

Synopsis: Eliminate. Transfer function and 105 spaces to US Army War College. Consider increased contract support.

Resource Implications:

	Savings	Costs	Transfer
Military:	-11	0	-6
Civilian:	-34	0	-99
Dollars:	-1.7M	0	-4.95M

Army Staff/Command Position:

Concur:

Nonconcur:

CMH

Recommendation: Implement in POM 98-03.

ACTION: AWC - LEAD; CMH - ASSIST.

Approve

Disapprove

Fwd to CSA/SA for decision

Defer to POM 00-05 Study by: _____

Issue: 104

Title: US Army Center of Military History

Synopsis: Eliminate. Transfer function and 105 spaces to US Army War College. Consider increased contract support.

Enablers: None.

Implementation Guidance:

1. HQDA Redesign Working Group submit adjustment to POM 98-03.
2. Center of Military History prepare a personnel reduction plan, not later than 15 September 1996; coordinate with military and civilian personnel offices.
3. Army War College prepare concept plan not later than 30 August 1996, to integrate CMH functions and spaces.

Issue: 104

Title: US Army Center of Military History

Synopsis: Eliminate. Transfer function and 105 spaces to US Army War College.
Consider increased contract support.

Manpower

Cmd	UIC	MDEP	AMSCO	TYPE	FY97	FY98	FY99	FY00	FY01	FY02	FY03
SE	W3YUAA	FAOD	435212000	MIL	-11	-11	-11	-11	-11	-11	-11
XX	WEDGE			MIL	+11	+11	+11	+11	+11	+11	+11
SE	W3YUAA			MIL	-6	-6	-6	-6	-6	-6	-6
SF	W2H6AA			MIL	+6	+6	+6	+6	+6	+6	+6
SE	W3YUAA	FAOD	435212000	CIV	-34	-34	-34	-34	-34	-34	-34
XX	WEDGE			CIV	+34	+34	+34	+34	+34	+34	+34
SE	W3YUAA			CIV	-99	-99	-99	-99	-99	-99	-99
SF	W2H6AA			CIV	+99	+99	+99	+99	+99	+99	+99

TOA (\$ millions)

Cmd	UIC	MDEP	AMSCO	TYPE	FY97	FY98	FY99	FY00	FY01	FY02	FY03
SE	W3YUAA	FAOD	435212000	CIV		-.85M	-1.7M	-1.7M	-1.7M	-1.7M	-1.7M
SE	W3YUAA			CIV		-4.95M	-4.95M	-4.95M	-4.95M	-4.95M	-4.95M
SF	W2H6AA			CIV		+4.95M	+4.95M	+4.95M	+4.95M	+4.95M	+4.95M

Issue: 105

Title: DCS for Personnel

Proponent: AA/DAS

Sponsor: ASA(MRA)

Source: HQDA Redesign

Implementation Period: POM 98-03

Synopsis: Downsize by (9/7/16).

Resource Implications:

	Savings	Costs	Transfer
Military:	-9	0	0
Civilian:	-7	0	0
Dollars:	-.35M	0	0

Army Staff/Command Position:

Concur:

Nonconcur:

Recommendation: Implement in POM 98-03.

ACTION: DCSPER

- Approve
- Disapprove
- Fwd to CSA/SA for decision
- Defer to POM 00-05
- Study by: _____

Issue: 105 **Title:** DCSPER

Synopsis: Downsize by (9/7/16).

Enablers: None.

Implementation Guidance:
HQDA Redesign Working Group submit adjustment to POM 98-03.

Issue: 105

Title: DCS Personnel

Synopsis: Downsize by (9/7/16).

Manpower

Cmd	UIC	MDEP	AMSCO	TYPE	FY97	FY98	FY99	FY00	FY01	FY02	FY03
CS	W0ZZAA	XMGH	431398000	MIL	-9	-9	-9	-9	-9	-9	-9
XX	WEDGE			MIL	+9	+9	+9	+9	+9	+9	+9
CS	W0ZZAA	XMGH	431398000	CIV	-7	-7	-7	-7	-7	-7	-7
XX	WEDGE			CIV	+7	+7	+7	+7	+7	+7	+7

TOA (\$ millions)

Cmd	UIC	MDEP	AMSCO	TYPE	FY97	FY98	FY99	FY00	FY01	FY02	FY03
CS	W0ZZAA	XMGH	431398000	CIV	-	-.175M	-.35M	-.35M	-.35M	-.35M	-.35M

Issue: 106

Title: US Army Recruiting Command

Proponent: AA/DAS

Sponsor: ASA(MRA)

Source: HQDA Redesign

Implementation Period: POM 98-03

Synopsis: Transfer mission and resources to TRADOC (8053/1203/9256 spaces in FY 98 -- 8053/1204/9257 in FY 99 and out).

Resource Implications:

	Savings	Costs	Transfer
Military:	0	0	-8053
Civilian:	0	0	-1203
Dollars:	0	0	-60.15M

Army Staff/Command Position:

Concur:

Nonconcur: DCSPER

Recommendation: Implement in POM 98-03.

ACTION: TRADOC - LEAD; DCSPER and USAREC - ASSIST

Approve
 Disapprove
 Fwd to CSA/SA for decision
 Defer to POM 00-05 Study by: _____

Issue: 106

Title: US Army Recruiting Command

Synopsis: Transfer mission and resources to TRADOC (8053/1203/9256 spaces in FY 98 -- 8053/1204/9257 in FY 99 and out).

Enablers: None.

Implementation Guidance:

1. HQDA Redesign Working Group submit adjustment to POM 98-03.
2. TRADOC develop concept plan, not later than 30 August 1996, to integrate functions and spaces.
3. TRADOC coordinate implementation with ASA(MRA) and DCSPER.

Issue: 106

Title: US Army Recruiting Command

Synopsis: Transfer mission and resources to TRADOC (8053/1203/9256 spaces in FY 98 -- 8053/1204/9257 in FY 99 and out).

Manpower

Cmd	UIC	MDEP	AMSCO	TYPE	FY97	FY98	FY99	FY00	FY01	FY02	FY03
RC	VARIOUS			MIL		-8053	-8053	-8053	-8053	-8053	-8053
TC				MIL		+8053	+8053	+8053	+8053	+8053	+8053
RC	VARIOUS			CIV		-1203	-1204	-1204	-1204	-1204	-1204
TC				CIV		+1203	+1204	+1204	+1204	+1204	+1204

TOA (\$ millions)

Cmd	UIC	MDEP	AMSCO	TYPE	FY97	FY98	FY99	FY00	FY01	FY02	FY03
RC	VARIOUS			CIV		-60.15M	-60.2M	-60.2M	-60.2M	-60.2M	-60.2M
TC				CIV		+60.15M	+60.2M	+60.2M	+60.2M	+60.2M	+60.2M

Issue: 107

Title: US Total Army Personnel Command (PERSCOM)

Proponent: AA/DAS

Sponsor: ASA(MRA)

Source: HQDA Redesign

Implementation Period: POM 98-03

Synopsis: Downsize by 10% (58/121/179). [Transfer in (312/1607/1919) from: DMO Det (300/0/300) see issue 69; CPFA (0/1587/1587) in FY 02 see issue 72; MPESA (10/20/30) - see issue 82; Chap Svc Spt Agcy (2/0/2) - see issue 134.] [See issue 108]

Resource Implications:

	Savings	Costs	Transfer
Military:	-58	0	[+312]
Civilian:	-121	0	[+1607]
Dollars:	-6.05M	0	[+80.35M]

Army Staff/Command Position:

Concur:

Nonconcur:

Recommendation: Implement in POM 98-03.

ACTION: DCSPER/PERSCOM - LEAD; ASA(MRA) and OCCH - ASSIST

- Approve
 Disapprove
 Fwd to CSA/SA for decision
 Defer to POM 00-05 Study by: _____

Issue: 107

Title: US Total Army Personnel Command (PERSCOM)

Synopsis: Downsize by 10% (58/121/179).

Enablers: None.

Implementation Guidance:

1. HQDA Redesign Working Group submit adjustment to POM 98-03.
2. DCSPER prepare concept plan, not later than 30 August 1996, to integrate MP&A, DMO Detachment and Chaplain personnel management functions and spaces.
2. DCSPER prepare personnel reduction plan, not later than 15 September 1996; coordinate with military and civilian personnel offices.
3. DCSPER comply with policies and procedures of AR 5-10.

Issue: 107

Title: US Total Army Personnel Command (PERSCOM)

Synopsis: Downsize by 10% (-58/121/179). [Note: full 10% includes ACES spaces reduced in issue 108.]

Manpower

Cmd	UIC	MDEP	AMSCO	TYPE	FY97	FY98	FY99	FY00	FY01	FY02	FY03
MP	W3VSAA		MIL	MIL	-58	-58	-58	-58	-58	-58	-58
XX	WEDGE		MIL	MIL	+58	+58	+58	+58	+58	+58	+58
MP	W3VSAA		CIV	CIV	-121	-121	-121	-121	-121	-121	-121
XX	WEDGE		CIV	CIV	+121	+121	+121	+121	+121	+121	+121

TOA (\$ millions)

Cmd	UIC	MDEP	AMSCO	TYPE	FY97	FY98	FY99	FY00	FY01	FY02	FY03
MP	W3VSAA		CIV	CIV		-3.025M	-6.05M	-6.05M	-6.05M	-6.05M	-6.05M

Issue: 108

Title: Army Continuing Education System/PERSCOM

Proponent: AA/DAS

Sponsor: ASA(MRA)

Source: HQDA Redesign

Implementation Period: POM 98-03

Synopsis: Downsize Education Division of PERSCOM by 0/5/5 to reflect restructure of Army Continuing Education System (ACES). Plan would: (1) automate Functional Academic Skill Training and pre-college instruction; (2) provide worldwide on-line access to Army Transcript Registry Service; and (3) contract soldier and veterans counseling function now performed by PERSCOM Educational Incentive Office. Restructure involves start-up cost of \$17.5M based on purchase of 2710 PC's (10 per Army Learning Center) and software. Projected savings over 6 years = \$4.5M. Personnel reductions listed below reflect payoff from technology initiatives. [Link to issue 107]

Resource Implications:

	Savings	Costs	Transfer
Military:	0	0	0
Civilian:	-5	0	0
Dollars:	-.25M	0	0

Army Staff/Command Position:

Concur: ASA(MRA) Nonconcur:

Recommendation: Implement in POM 98-03.

ACTION: DCSPER/PERSCOM - LEAD; ASA(MRA) - ASSIST

Approve
 Disapprove
 Fwd to CSA/SA for decision
 Defer to POM 00-05
 Study by: _____

Issue: 108

Title: Army Continuing Education System/PERSCOM

Synopsis: Downsize Education Division of PERSCOM by 0/5/5 to reflect restructure of Army Continuing Education System (ACES). Plan would: (1) automate Functional Academic Skill Training and pre-college instruction; (2) provide worldwide on-line access to Army Transcript Registry Service; and (3) contract soldier and veterans counseling function now performed by PERSCOM Educational Incentive Office. Restructure involves start-up cost of \$17.5M based on purchase of 2710 PC's (10 per Army Learning Center) and software. Projected savings over 6 years = \$4.5M. Personnel reductions listed below reflect payoff from technology initiatives. [Link to issue 107]

Enablers: None.

Implementation Guidance:

1. HQDA Redesign Working Group submit adjustment to POM 98-03.
2. DCSPER prepare concept plan, not later than 30 August 1996, to restructure Army Continuing Education System (ACES). Plan must (1) automate Functional Academic Skill Training and pre-college instruction; (2) provide world-wide on-line access to Army Transcript Registry Service; and (3) contract soldier and veterans counseling function now performed by PERSCOM Educational Incentive Office.

Issue: 108

Title: Army Continuing Education System/PERSCOM

Synopsis: Downsize Education Division of PERSCOM by 0/5/5 to reflect restructure of Army Continuing Education System (ACES). Plan would: (1) automate Functional Academic Skill Training and pre-college instruction; (2) provide worldwide on-line access to Army Transcript Registry Service; and (3) contract soldier and veterans counseling function now performed by PERSCOM Educational Incentive Office. Restructure involves start-up cost of \$17.5M based on purchase of 2710 PC's (10 per Army Learning Center) and software. Projected savings over 6 years = \$4.5M. Personnel reductions listed below reflect payoff from technology initiatives.

Manpower

Cmd	UIC	MDEP	AMSCO	TYPE	FY97	FY98	FY99	FY00	FY01	FY02	FY03
MP	W3VSAA			CIV	-5	-5	-5	-5	-5	-5	-5
XX	WEDGE			CIV	+5	+5	+5	+5	+5	+5	+5

TOA (\$ millions)

Cmd	UIC	MDEP	AMSCO	TYPE	FY97	FY98	FY99	FY00	FY01	FY02	FY03
MP	W3VSAA			CIV		-.125M	.25M	.25M	.25M	.25M	.25M

Issue: 109

Title: US Military Academy

Proponent: AA/DAS

Sponsor: ASA(MRA)

Source: HQDA Redesign

Implementation Period: POM 98-03

Synopsis: Downsize by 31 (9/22/31).

Resource Implications:

	Savings	Costs	Transfer
Military:	-9	0	0
Civilian:	-22	0	0
Dollars:	-1.1M	0	0

Army Staff/Command Position:

Concur:

Nonconcur: DCSPER

Recommendation: Implement in POM 98-03.

ACTION: DCSPER - LEAD; USMA - ASSIST

Approve
 Disapprove
 Fwd to CSA/SA for decision
 Defer to POM 00-05 Study by: _____

Issue: 109

Title: US Military Academy

Synopsis: Downsize by 31 (9/22/31).

Enablers: None.

Implementation Guidance:

HQDA Redesign Working Group submit adjustment to POM 98-03.

Issue: 109

Title: US Military Academy

Synopsis: Downsize by 31 (9/22/31).

Manpower

Cmd	UIC	MDEP	AMSCO	TYPE	FY97	FY98	FY99	FY00	FY01	FY02	FY03
MA	W1FBAA	USMA	311721000	MIL	-9	+9	-9	-9	-9	-9	-9
XX	WEDGE			MIL	+9	+9	+9	+9	+9	+9	+9
MA	W1FBAA	USMA	311721000	CIV	-22	-22	-22	-22	-22	-22	-22
XX	WEDGE			CIV	+22	+22	+22	+22	+22	+22	+22

TOA (\$ millions)

Cmd	UIC	MDEP	AMSCO	TYPE	FY97	FY98	FY99	FY00	FY01	FY02	FY03
MA	W1FBAA	USMA	311721000	CIV		-55M	-1.1M	-1.1M	-1.1M	-1.1M	-1.1M

Issue: 110 **Title:** US Military Entrance Processing Command

Synopsis: Transfer to TRADOC (718/1395/2113 spaces).

Enablers: None.

Implementation Guidance:

1. HQDA Redesign Working Group submit adjustment to POM 98-03.
2. TRADOC develop concept plan, not later than 30 August 1996, to realign MEPCOM functions.
3. Coordinate implementation with ASA(MRA) and DCSPER.

Issue: 110

Title: US Military Entrance Processing Command

Synopsis: Transfer to TRADOC (718/1395/2113 spaces).

Manpower

Cmd	UIC	MDEP	AMSCO	TYPE	FY97	FY98	FY99	FY00	FY01	FY02	FY03
PC	VARIOUS			MIL	-718	-718	-718	-718	-718	-718	-718
TC	TRADOC			MIL	+718	+718	+718	+718	+718	+718	+718
PC	VARIOUS			CIV	-1395	-1395	-1395	-1395	-1395	-1395	-1395
TC	TRADOC			CIV	+1395	+1395	+1395	+1395	+1395	+1395	+1395

TOA (\$ millions)

Cmd	UIC	MDEP	AMSCO	TYPE	FY97	FY98	FY99	FY00	FY01	FY02	FY03
PC	VARIOUS			CIV		-69.75M	-69.75M	-69.75M	-69.75M	-69.75M	-69.75M
TC	TRADOC			CIV		+69.75M	+69.75M	+69.75M	+69.75M	+69.75M	+69.75M

Issue: 111

Title: US Army Research Institute

Proponent: AA/DAS

Sponsor: ASA(MRA)

Source: HQDA Redesign

Implementation Period: POM 98-03

Synopsis: Defer pending further review.

Resource Implications:

	Savings	Costs	Transfer
Military:	-10	0	-1
Civilian:	-235	0	-19
Dollars:	-11.75M	0	-.95M

Army Staff/Command Position:

Concur:

Nonconcur:

Recommendation: Implement in POM 98-03.

ACTION: DCSPER - LEAD; ARI and CAA - ASSIST

Approve

Disapprove

**Fwd to CSA/SA
for decision**

**Defer to POM 00-05
Study by: _____**

Issue: 111 **Title:** US Army Research Institute

Synopsis: Eliminate FOA and 245 (10/235/245) spaces, transfer analytical functions and 1/19/20 spaces to CAA. Contract services as required.

Enablers: None.

Implementation Guidance:

1. HQDA Redesign Working Group submit adjustment to POM 98-03.
2. ARI prepare personnel reduction plan; coordinate with personnel offices.
3. ARI comply with policies and procedures of AR 5-10.
4. ARI coordinate implementation with ASA(MRA), DCSPER, CAA and HQDA Redesign Working Group .

Issue: 111

Title: US Army Research Institute

Synopsis: Eliminate FOA and 245 (10/235/245) spaces, transfer analytical functions and 1/19/20 spaces to CAA. Contract services as required.

Manpower

Cmd	UIC	MDEP	AMSCO	TYPE	FY97	FY98	FY99	FY00	FY01	FY02	FY03
SE	W049AA			MIL	-10	-10	-10	-10	-10	-10	-10
XX	WEDGE			MIL	+10	+10	+10	+10	+10	+10	+10
SE	W049AA			MIL	-1	-1	-1	-1	-1	-1	-1
SS	W3WCAA			MIL	+1	+1	+1	+1	+1	+1	+1
SE	W049AA			CIV	-235	-235	-235	-235	-235	-235	-235
XX	WEDGE			CIV	+235	+235	+235	+235	+235	+235	+235
SE	W049AA			CIV	-19	-19	-19	-19	-19	-19	-19
SS	W3WCAA			CIV	+19	+19	+19	+19	+19	+19	+19

TOA (\$ millions)

Cmd	UIC	MDEP	AMSCO	TYPE	FY97	FY98	FY99	FY00	FY01	FY02	FY03
SE	W049AA			CIV	-5.875M	-5.875M	-11.75M	-11.75M	-11.75M	-11.75M	-11.75M
SE	W049AA			CIV	-.475M	-.475M	-.95M	-.95M	-.95M	-.95M	-.95M
SS	W3WCAA			CIV	+.475M	+.475M	+.95M	+.95M	+.95M	+.95M	+.95M

Issue: 112

Title: DCS for Intelligence

Proponent: AA/DAS **Sponsor:** ASA(MRA) **Source:** HQDA Redesign

Implementation Period: POM 98-03

Synopsis: Downsize by 13 (7/6/13). [Transfer 8/9/17 to DUSA(IA) (see issue 57). Receive Intelligence Staff Support Agency function and (24/47/71) spaces (see issue 113).]

Resource Implications:

	Savings	Costs	Transfer
Military:	-7	0	[+16]
Civilian:	-6	0	[+38]
Dollars:	-3M	0	[+1.9M]

Army Staff/Command Position:

Concur:

Nonconcur:

Recommendation: Implement in POM 98-03.

ACTION: DCSINT

Approve
 Disapprove
 Fwd to CSA/SA for decision
 Defer to POM 00-05 Study by: _____

Issue: 112

Title: DCS for Intelligence

Synopsis: Downsize by 13 (7/6/13). [Transfer 8/9/17 to DUSA(IA) (see issue 57). Receive Intelligence Staff Support Agency function and (24/47/71) spaces (see issue 113).]

Enablers: None.

Implementation Guidance:

HQDA Redesign Working Group submit adjustment to POM 98-03.

Issue: 112

Title: DCS for Intelligence

Synopsis: Downsize by 13 (7/6/13). [Transfer 8/9/17 to DUSA(IA) (see issue 57).
Receive Intelligence Staff Support Agency function and (24/47/71) spaces (see issue
113).]

Manpower

Cmd	UIC	MDEP	AMSCO	TYPE	FY97	FY98	FY99	FY00	FY01	FY02	FY03
CS	W0Z1AA	XMGH	431398000	MIL	-7	-7	-7	-7	-7	-7	-7
XX	WEDGE			MIL	+7	+7	+7	+7	+7	+7	+7
CS	W0Z1AA	XMGH	431398000	CIV	-6	-6	-6	-6	-6	-6	-6
XX	WEDGE			CIV	+6	+6	+6	+6	+6	+6	+6

TOA (\$ millions)

Cmd	UIC	MDEP	AMSCO	TYPE	FY97	FY98	FY99	FY00	FY01	FY02	FY03
CS	W0Z1AA	XMGH	431398000	CIV	-.15M	-.15M	-.3M	-.3M	-.3M	-.3M	-.3M

Issue: 113

Title: Intelligence Staff Support Agency

Proponent: AA/DAS

Sponsor: ASA(MRA)

Source: HQDA Redesign

Implementation Period: POM 98-03

Synopsis: Downsize by 10% except GP3I (1/2/3). Eliminate SSA and merge (functions and 24/47/71 spaces) with DCSINT. Transfer Foreign Intelligence Directorate function and spaces (9/9/18) to INSCOM.

Resource Implications:

	Savings	Costs	Transfer
Military:	-1	0	-9
Civilian:	-2	0	-9
Dollars:	-.1M	0	-.45M

Army Staff/Command Position:

Concur:

Nonconcur:

Recommendation: Implement in POM 98-03.

ACTION: INSCOM - LEAD; DCSINT and ISSA - ASSIST



Approve



Disapprove



Fwd to CSA/SA

for decision



Defer to POM 00-05



Study by: _____

Issue: 113

Title: Intelligence Staff Support Agency

Synopsis: Downsize by 10% except GP3I (1/2/3). Eliminate SSA and merge (functions and 24/47/71 spaces) with DCSINT. Transfer Foreign Intelligence Directorate function and spaces (9/9/18) to INSCOM.

Enablers: None.

Implementation Guidance:

1. HQDA Redesign Working Group submit adjustment to POM 98-03.
2. Establish memorandum of understanding between INSCOM and HQDA to support Chief of Staff intel watch.
3. DCSINT prepare concept plan, not later than 30 August 1996, to integrate ISSA functions and spaces. Initiate resource transfer effective FY98.

Issue: 113

Title: Intelligence Staff Support Agency

Synopsis: Downsize by 10% except GP3I (1/2/3). Eliminate SSA and merge (functions and 24/47/71 spaces) with DCSINT. Transfer Foreign Intelligence Directorate function and spaces (9/9/18) to INSCOM.

Manpower											
Cmd	UIC	MDEP	AMSCO	TYPE	FY97	FY98	FY99	FY00	FY01	FY02	FY03
SS	W31XAA	GP3I	411398000	MIL	-9	+9	-9	-9	-9	-9	-9
AS	INSCOM			MIL	+9	+9	+9	+9	+9	+9	+9
SS	W31XAA	XMGH	431498000	MIL	-1	-1	-1	-1	-1	-1	-1
XX	WEDGE			MIL	+1	+1	+1	+1	+1	+1	+1
SS	W31XAA	GP3I	411398000	CIV	-9	-9	-9	-9	-9	-9	-9
AS	INSCOM			CIV	+9	+9	+9	+9	+9	+9	+9
SS	W31XAA	XMGH	431498000	CIV	-2	-2	-2	-2	-2	-2	-2
XX	WEDGE			CIV	+2	+2	+2	+2	+2	+2	+2
SS	W31XAA			MIL	-24	-24	-24	-24	-24	-24	-24
CS	W0Z1AA			MIL	+24	+24	+24	+24	+24	+24	+24
SS	W31XAA			CIV	-47	-47	-47	-47	-47	-47	-47
CS	W0Z1AA			CIV	+47	+47	+47	+47	+47	+47	+47

TOA (\$ millions)

Cmd	UIC	MDEP	AMSCO	TYPE	FY97	FY98	FY99	FY00	FY01	FY02	FY03
SS	W31XAA	GP3I	411398000	CIV	-0.45M	-0.45M	-0.45M	-0.45M	-0.45M	-0.45M	-0.45M
SS	W31XAA	XMGH	431498000	CIV	-0.05M	-0.05M	-0.1M	-0.1M	-0.1M	-0.1M	-0.1M
AS	INSCOM			CIV	+0.45M	+0.45M	+0.45M	+0.45M	+0.45M	+0.45M	+0.45M
SS	W31XAA			CIV	-2.35	-2.35	-2.35	-2.35	-2.35	-2.35	-2.35
CS	W0Z1AA			CIV	+2.35	+2.35	+2.35	+2.35	+2.35	+2.35	+2.35

Issue: 114

Title: DCS Operations and Plans

Proponent: AADAS

Sponsor: ASA(MRA)

Source: HQDA Redesign

Implementation Period: POM 98-03

Synopsis: Implement DCSOPS reorganization plan. Downsize by 43 (27/16/43); receive 1 (Civ) from AMC. [Transfer 14 to DUSA(IA) (see issue 57). Receive 4 from MISMA (see issue 60), 11 from MP Agency (see issue 116), 6 from AWC (LAM) (see issue 117), 9 from USAFISA (see issue 118), 14 from Ops Spt Agency (see issue 122).]

Resource Implications:

	Savings	Costs	Transfer
Military:	-27	0	+0
Civilian:	-16	0	+1
Dollars:	-.8M	0	+.05M

Army Staff/Command Position:

Concur:

Nonconcur:

Recommendation: Implement in POM 98-03.

ACTION: DCSOPS

Approve
 Disapprove
 Fwd to CSA/SA for decision
 Defer to POM 00-05 Study by: _____

Issue: 114 **Title:** DCS Operations and Plans

Synopsis: Implement DCSOPS reorganization plan. Downsize by 43 (27/16/43); receive 1 (Civ) from AMC.

Enablers: None.

Implementation Guidance:

1. HQDA Redesign Working Group submit adjustment to POM 98-03.
2. DCSOPS develop concept plan not later than 30 August 1996 to integrate MISMA, MP Operations Agency, and DCSOPS Spt Agency and elements of AWC(LAM), USAFISA, and AMC functions and spaces into ODCSOPS.

Issue: 114

Title: DCS Operations and Plans

Synopsis: Implement DCSOPS reorganization plan. Downsize by 43 (26/17/44); receive 1 (Civ) from AMC.

Manpower

Cmd	UIC	MDEP	AMSCO	TYPE	FY97	FY98	FY99	FY00	FY01	FY02	FY03
CS	W0Z2AA	XMGH	431398000	MIL	-27	-27	-27	-2.7	-27	-27	-27
XX	WEDGE			MIL	+27	+27	+27	+27	+27	+27	+27
CS	W0Z2AA	XMGH	431398000	CIV	-16	-16	-16	-16	-16	-16	-16
XX	WEDGE			CIV	+16	+16	+16	+16	+16	+16	+16
06	AMC			CIV	-1	-1	-1	-1	-1	-1	-1
CS	W0Z2AA	XMGH	431398000	CIV	+1	+1	+1	+1	+1	+1	+1

TOA (\$ millions)

Cmd	UIC	MDEP	AMSCO	TYPE	FY97	FY98	FY99	FY00	FY01	FY02	FY03
CS	W0Z2AA	XMGH	431398000	CIV	-4M	-4M	-8M	-8M	-8M	-8M	-8M
06	AMC			CIV	-0.025M	-0.025M	-0.05M	-0.05M	-0.05M	-0.05M	-0.05M
CS	W0Z2AA	XMGH	431398000	CIV	+0.025M	+0.025M	+0.05M	+0.05M	+0.05M	+0.05M	+0.05M

Issue: 115

Title: Command and Control Support Agency

Proponent: AA/DAS

Sponsor: ASA(MRA)

Source: HQDA Redesign

Implementation Period: POM 98-03

Synopsis: Downsize by 21 (15/6/21) through contract support. Retain a uniformed crisis action capability.

Resource Implications:

	Savings	Costs	Transfer
Military:	-15	0	0
Civilian:	-6	0	0
Dollars:	-.3M	.3M	0

Army Staff/Command Position:

Concur: DCSOPS

Nonconcur:

Recommendation: Implement in POM 98-03.

ACTION: DCSOPS - LEAD; CCSA - ASSIST

Approve
 Disapprove
 Fwd to CSA/SA for decision
 Defer to POM 00-05 Study by: _____

Issue: 115 **Title:** Command and Control Support Agency

Synopsis: Downsize by 21 (15/6/21) through contract support. Retain a uniformed crisis action capability.

Enablers: None.

Implementation Guidance:
HQDA Redesign Working Group submit adjustment to POM 98-03.

Issue: 115

Title: Command and Control Support Agency

Synopsis: Downsize by 21 (15/6/21) through contract support. Retain a uniformed crisis action capability.

		Manpower									
Cmd	UIC	MDEP	AMSCO	TYPE	FY97	FY98	FY99	FY00	FY01	FY02	FY03
SS	W241AA	XMGH	431B98000	MIL	-15	-15	-15	-15	-15	-15	-15
XX	WEDGE			MIL	+15	+15	+15	+15	+15	+15	+15
SS	W241AA	XMGH	431B98000	CIV	-6	-6	-6	-6	-6	-6	-6
XX	WEDGE			CIV	+6	+6	+6	+6	+6	+6	+6

TOA (\$ millions)

Cmd	UIC	MDEP	AMSCO	TYPE	FY97	FY98	FY99	FY00	FY01	FY02	FY03
SS	W241AA	XMGH	431B98000	CIV	0	0	0	0	0	0	0

Issue: 116

Title: Military Police Operations Agency

Proponent: AA/DAS

Sponsor: ASA(MRA)

Source: HQDA Redesign

Implementation Period: POM 98-03

Synopsis: Eliminate the SSA and 3/2/5 spaces. Transfer essential HQDA level functions and spaces (7/4/11) spaces to DCSOPS.

Resource Implications:

	Savings	Costs	Transfer
Military:	-3	0	-7
Civilian:	-2	0	-4
Dollars:	-.1M	0	-.2M

Army Staff/Command Position:

Concur:

Nonconcur:

Recommendation: Implement in POM 98-03.

ACTION: DCSOPS - LEAD; MPOA - ASSIST

Approve
 Disapprove
 Fwd to CSA/SA for decision
 Defer to POM 00-05 Study by: _____

Issue: 116

Title: Military Police Operations Agency

Synopsis: Eliminate the SSA and 3/2/5 spaces. Transfer essential HQDA level functions and spaces (7/4/11) spaces to DCSOPS.

Enablers: None.

Implementation Guidance:

1. HQDA Redesign Working Group submit adjustment to POM 98-03.
2. ODCSOPS prepare concept plan, not later than 30 August 1996, to transfer functions and spaces.

Issue: 116

Title: Military Police Operations Agency

Synopsis: Eliminate the SSA and 3/2/5 spaces. Transfer essential HQDA level functions and spaces (7/4/11) spaces to DCSOPS.

Manpower

Cmd	UIC	MDEP	AMSCO	TYPE	FY97	FY98	FY99	FY00	FY01	FY02	FY03
SS	W4GQAA	XMGH	431498000	MIL	-3	-3	-3	-3	-3	-3	-3
XX	WEDGE			MIL	+3	+3	+3	+3	+3	+3	+3
SS	W4GQAA	XMGH	431498000	MIL	-7	-7	-7	-7	-7	-7	-7
CS	W0Z2AA	XMGH	431398000	MIL	+7	+7	+7	+7	+7	+7	+7
SS	W4GQAA	XMGH	431498000	CIV	-2	-2	-2	-2	-2	-2	-2
XX	WEDGE			CIV	+2	+2	+2	+2	+2	+2	+2
SS	W4GQAA	XMGH	431498000	CIV	-4	-4	-4	-4	-4	-4	-4
CS	W0Z2AA	XMGH	431398000	CIV	+4	+4	+4	+4	+4	+4	+4

TOA (\$ millions)

Cmd	UIC	MDEP	AMSCO	TYPE	FY97	FY98	FY99	FY00	FY01	FY02	FY03
SS	W4GQAA	XMGH	431498000	CIV	-.2M	-.2M	-.2M	-.2M	-.2M	-.2M	-.2M
SS	W4GQAA	XMGH	431498000	CIV	-.05M	-.05M	-.1M	-.1M	-.1M	-.1M	-.1M
CS	W0Z2AA	XMGH	431398000	CIV	+.2M	+.2M	+.2M	+.2M	+.2M	+.2M	+.2M

Issue: 117

Title: US Army War College

Proponent: AA/DAS

Sponsor: ASA(MRA)

Source: HQDA Redesign

Implementation Period: POM 98-03

Synopsis: Downsize by 48 -- eliminate LAM spaces (25/17/42) and transfer (1/5/6) LAM spaces to DCSOPS. [Receive elements of Center of Military History (CMH) (6/99/105) (see issue 104)]. Further study.

Resource Implications:

	Savings	Costs	Transfer
Military:	-25	0	-1
Civilian:	-17	0	-5
Dollars:	-.85M	0	-.25M

Army Staff/Command Position:

Concur: DCSOPS

Nonconcur:

Recommendation: Implement in POM 98-03.

ACTION: DCSOPS - LEAD; AWC - ASSIST

Approve

Disapprove

Fwd to CSA/SA for decision

Defer to POM 00-05 Study by: _____

Issue: 117

Title: US Army War College

Synopsis: Downsize by 48 -- eliminate LAM spaces (25/17/42) and transfer (1/5/6) LAM spaces to DCSOPS. [Receive elements of Center of Military History (CMH) (6/99/105) (see issue 104)].

Enablers: None.

Implementation Guidance:

1. HQDA Redesign Working Group submit adjustment to POM 98-03.
2. AWC prepare concept plan, not later than 30 August 1996, to transfer CMH functions and spaces. CMH assist.

Synopsis: Downsize by 48 -- eliminate LAM spaces (25/17/42) and transfer (1/5/6) LAM spaces to DCSOPS. [Receive elements of Center of Military History (CMH) (6/99/105) (see issue 104)].

Manpower

Cmd	UIC	MDEP	AMSCO	TYPE	FY97	FY98	FY99	FY00	FY01	FY02	FY03
SF	W2H6AA			MIL	-25	-25	-25	-25	-25	-25	-25
XX	WEDGE			MIL	+25	+25	+25	+25	+25	+25	+25
SF	W2H6AA			MIL	-1	-1	-1	-1	-1	-1	-1
CS	W0Z2AA	XMGH 431398000		MIL	+1	+1	+1	+1	+1	+1	+1
SF	W2H6AA			CIV	-17	-17	-17	-17	-17	-17	-17
XX	WEDGE			CIV	+17	+17	+17	+17	+17	+17	+17
SF	W2H6AA			CIV	-5	-5	-5	-5	-5	-5	-5
CS	W0Z2AA	XMGH 431398000		CIV	+5	+5	+5	+5	+5	+5	+5

TOA (\$ millions)

Cmd	UIC	MDEP	AMSCO	TYPE	FY97	FY98	FY99	FY00	FY01	FY02	FY03
SF	W2H6AA			CIV		-.425M	-.85M	-.85M	-.85M	-.85M	-.85M
SF	W2H6AA			CIV		-.125M	-.25M	-.25M	-.25M	-.25M	-.25M
CS	W0Z2AA	XMGH 431398000		CIV		+.125M	+.25M	+.25M	+.25M	+.25M	+.25M

Issue: 118

Title: US Army Force Integration Agency

Proponent: AA/DAS

Sponsor: ASA(MRA)

Source: HQDA Redesign

Implementation Period: POM 98-03

Synopsis: Downsize by 142 spaces--eliminate 39/94/133 over 3 years (19/48/67) in FY98, 28/65/93 in FY99, 39/94/133 in FY00) and transfer 8/1/9 to DCSOPS.

Resource Implications:

	Savings	Costs	Transfer
Military:	-39	0	-8
Civilian:	-94	0	-1
Dollars:	-4.7M	0	-.05M

Army Staff/Command Position:

Concur: DCSOPS

Nonconcur:

Recommendation: Implement in POM 98-03.

ACTION: DCSOPS - LEAD; USAFISA - ASSIST

- Approve
 Disapprove
 Fwd to CSA/SA for decision
 Defer to POM 00-05 Study by: _____

Issue: 118

Title: US Army Force Integration Agency

Synopsis: Downsize by 142 spaces--eliminate 39/94/133 over 3 years (19/48/67) in FY98, 28/65/93 in FY99, 39/94/133 in FY00) and transfer 8/1/9 to DCSOPS.

Enablers: None.

Implementation Guidance:

1. HQDA Redesign Working Group submit adjustment to POM 98-03.
2. DCSOPS prepare personnel reduction plan, not later than 15 September 1996, coordinate with military and civilian personnel offices. USAFISA assist.
3. DCSOPS comply with policies and procedures of AR 5-10.

Issue: 118

Title: US Army Force Integration Agency

Synopsis: Downsize by 142 spaces--eliminate 39/94/133 over 3 years (19/48/67) in FY98, 28/65/93 in FY99, 39/94/133 in FY00) and transfer 8/1/9 to DCSOPS.

Manpower

Cmd	UIC	MDEP	AMSCO	TYPE	FY97	FY98	FY99	FY00	FY01	FY02	FY03
SE	W4PCAA	FAOB	435212000	MIL	-19	-8	-28	-39	-39	-39	-39
XX	WEDGE			MIL	+19	-8	+28	+39	+39	+39	+39
SE	W4PCAA	FAOB	435212000	MIL	-8	+8	-8	+8	+8	-8	-8
CS	W0Z2AA	XMGH	431398000	MIL	+8	-48	+8	-94	+8	+8	+8
SE	W4PCAA	FAOB	435212000	CIV	-48	+48	-65	+94	-94	-94	-94
XX	WEDGE			CIV	+48	-1	+65	-1	+94	+94	+94
SE	W4PCAA	FAOB	435212000	CIV	-1	+1	-1	+1	-1	-1	-1
CS	W0Z2AA	XMGH	431398000	CIV	+1	+1	+1	+1	+1	+1	+1

TOA (\$ millions)

Cmd	UIC	MDEP	AMSCO	TYPE	FY97	FY98	FY99	FY00	FY01	FY02	FY03
SE	W4PCAA	FAOB	435212000	CIV	-1.2	-3.25	-4.7	-4.7	-4.7	-4.7	-4.7
SE	W4PCAA	FAOB	435212000	CIV	-0.05M	-0.05M	-0.05M	-0.05M	-0.05M	-0.05M	-0.05M
CS	W0Z2AA	XMGH	431398000	CIV	+0.05M	+0.05M	+0.05M	+0.05M	+0.05M	+0.05M	+0.05M

Issue: 119

Title: US Army Aeronautical Services Agency

Proponent: AAVDAS

Sponsor: ASA(MRA)

Source: HQDA Redesign

Implementation Period: POM 98-03

Synopsis: Transfer to TRADOC with 25/17/42 spaces.

Resource Implications:

	Savings	Costs	Transfer
Military:	0	0	-25
Civilian:	0	0	-17
Dollars:	0	0	-.85M

Army Staff/Command Position:

Concur:

Nonconcur: DCSOPS

Recommendation: Implement in POM 98-03.

ACTION: TRADOC - LEAD; ODCSOPS and USAASA - ASSIST



Approve



Disapprove



Fwd to CSA/SA
for decision



Defer to POM 00-05
Study by: _____

Issue: 119 **Title:** US Army Aeronautical Services Agency

Synopsis: Transfer to TRADOC with 25/17/42 spaces.

Enablers: None.

Implementation Guidance:

1. HQDA Redesign Working Group submit adjustment to POM 98-03.
2. TRADOC prepare concept plan, not later than 30 August 1996, to integrate functions and spaces. DCSOPS assist.

Issue: 119

Title: US Army Aeronautical Services Agency

Synopsis: Transfer to TRADOC with 25/17/42 spaces.

Manpower

Cmd	UIC	MDEP	AMSCO	TYPE	FY97	FY98	FY99	FY00	FY01	FY02	FY03
SE	W462AA	QATC	324774000	MIL	-25	+25	-25	-25	-25	-25	-25
TC				MIL	+25	+25	+25	+25	+25	+25	+25
SE	W462AA	QATC	324774000	CIV	-17	-17	-17	-17	-17	-17	-17
TC				CIV	+17	+17	+17	+17	+17	+17	+17

TOA (\$ millions)

Cmd	UIC	MDEP	AMSCO	TYPE	FY97	FY98	FY99	FY00	FY01	FY02	FY03
SE	W462AA			CIV		-.85M	-.85M	-.85M	-.85M	-.85M	-.85M
TC				CIV		+.85M	+.85M	+.85M	+.85M	+.85M	+.85M

Issue: 120

Title: USA Nuclear and Chemical Agency

Proponent: AA/DAS

Sponsor: ASA(MRA)

Source: HQDA Redesign

Implementation Period: POM 98-03

Synopsis: Eliminate. Downsize 5/5/10 spaces. Transfer functions and spaces (13/18/31) to TRADOC.

Resource Implications:

	Savings	Costs	Transfer
Military:	-5	0	-13
Civilian:	-5	0	-18
Dollars:	-.25M	0	-.9M

Army Staff/Command Position:

Concur:

Nonconcur:

Recommendation: Implement in POM 98-03.

ACTION: TRADOC - LEAD; DCSOPS and USANCA ASSIST

Approve
 Disapprove
 Fwd to CSA/SA for decision
 Defer to POM 00-05 Study by: _____

Issue: 120

Title: USA Nuclear and Chemical Agency

Synopsis: Eliminate. Downsize 5/5/10 spaces. Transfer functions and spaces (13/18/31) to TRADOC.

Enablers: None.

Implementation Guidance:

1. HQDA Redesign Working Group submit adjustment to POM 98-03.
2. TRADOC prepare concept plan, not later than 30 August 1996, to transfer functions and spaces. DCSOPS assist.

Issue: 120

Title: USA Nuclear and Chemical Agency

Synopsis: Eliminate. Downsize 5/5/10 spaces. Transfer functions and spaces (13/18/31) to TRADOC.

Manpower

Cmd	UIC	MDEP	AMSCO	TYPE	FY97	FY98	FY99	FY00	FY01	FY02	FY03
SE	W0J5AA	FAOC	435212000	MIL	-5	+5	-5	-5	-5	-5	-5
XX	WEDGE			MIL	+5	-13	+5	+5	+5	+5	+5
SE	W0J5AA	FAOC	435212000	MIL	-13	+13	-13	-13	-13	-13	-13
TC				MIL	+13	-5	+13	+13	+13	+13	+13
SE	W0J5AA	FAOC	435212000	CIV	-5	+5	-5	-5	-5	-5	-5
XX	WEDGE			CIV	+5	-15	+5	+5	+5	+5	+5
SE	W0J5AA	FAOC	435212000	CIV	-15	+15	-15	-15	-15	-15	-15
TC				CIV	+15	-3	+15	+15	+15	+15	+15
SE	W0J5AA	MS4Z	435612000	CIV	-3	+3	-3	-3	-3	-3	-3
TC				CIV	+3	-9M	+3	+3	+3	+3	+3

TOA (\$ millions)

Cmd	UIC	MDEP	AMSCO	TYPE	FY97	FY98	FY99	FY00	FY01	FY02	FY03
SE	W0J5AA	FAOC	435212000	CIV	-.125M	-.75M	-.25M	-.25M	-.25M	-.25M	-.25M
SE	W0J5AA	FAOC	435212000	CIV	-.75M	-.15M	-.75M	-.75M	-.75M	-.75M	-.75M
SE	W0J5AA	MS4Z	435612000	CIV	-.15M	+9M	-.15M	-.15M	-.15M	-.15M	-.15M
TC				CIV	+9M	-9M	+9M	+9M	+9M	+9M	+9M

Issue: 121

Title: USA Special Operations Agency (Pentagon)

Proponent: AA/DAS

Sponsor: ASA(MRA)

Source: HQDA Redesign

Implementation Period: N/A

Synopsis: Change command code to reflect USASOA as an element of USASOC. USASOC maintain liaison office to HQDA.

Resource Implications:

	Savings	Costs	Transfer
Military:	0	0	0
Civilian:	0	0	0
Dollars:	0	0	0

Army Staff/Command Position:

Concur: DCSOPS

Nonconcur:

Recommendation: Implement prior to FY97.

ACTION: USASOC - LEAD; USASOA - ASSIST

Approve

Disapprove

Fwd to CSA/SA for decision

Defer to POM 00-05 Study by: _____

Issue: 121

Title: USA Special Operations Agency

Synopsis: Change command code to reflect USASOA as an element of USASOC. USASOC maintain liaison office to HQDA.

Enablers: None.

Implementation Guidance:

USASOC take necessary action to change command code in force structure and personnel systems. Maintain liaison office to HQDA in the National Capital Region.

Issue: 121

Title: USA Special Operations Agency

Synopsis: Change command code to reflect USASOA as an element of USASOC. USASOC maintain liaison office to HQDA.

Manpower											
Cmd	UIC	MDEP	AMSCO	TYPE	FY97	FY98	FY99	FY00	FY01	FY02	FY03

TOA (\$ millions)

Cmd	UIC	MDEP	AMSCO	TYPE	FY97	FY98	FY99	FY00	FY01	FY02	FY03
-----	-----	------	-------	------	------	------	------	------	------	------	------

Issue: 122

Title: DCSOPS Support Agency

Proponent: AA/DAS

Sponsor: ASA(MRA)

Source: HQDA Redesign

Implementation Period: POM 98-03

Synopsis: Eliminate the FOA. Merge policy functions and spaces (9/5/14) into DCSOPS. [Transfer International Activities functions and spaces (5/9/14) to DUSA(IA) (see issue 57).

Resource Implications:

	Savings	Costs	Transfer
Military:	0	0	-9
Civilian:	0	0	-5
Dollars:	0	0	-.25M

Army Staff/Command Position:

Concur:

Nonconcur:

Recommendation: Implement in POM 98-03.

ACTION: DCSOPS

Approve
 Disapprove
 Fwd to CSA/SA for decision
 Defer to POM 00-05
 Study by: _____

Issue: 122 **Title:** DCSOPS Support Agency

Synopsis: Eliminate the FOA. Merge policy functions and spaces (9/5/14) into DCSOPS.

Enablers: None.

Implementation Guidance:

1. HQDA Redesign Working Group submit adjustment to POM 98-03.
2. DCSOPS prepare concept plan, not later than 30 August 1996, to integrate functions and spaces.

Issue: 122

Title: DCSOPS Support Agency

Synopsis: Eliminate the FOA. Merge policy functions and spaces (9/5/14) into DCSOPS.

Manpower

Cmd	UIC	MDEP	AMSCO	TYPE	FY97	FY98	FY99	FY00	FY01	FY02	FY03
SE	W1YYAA			MIL	-9	-9	-9	-9	-9	-9	-9
CS	W0Z2AA	XMGH	431398000	MIL	+9	+9	+9	+9	+9	+9	+9
SE	W1YYAA			CIV	-5	-5	-5	-5	-5	-5	-5
CS	W0Z2AA	XMGH	431398000	CIV	+5	+5	+5	+5	+5	+5	+5

TOA (\$ millions)

Cmd	UIC	MDEP	AMSCO	TYPE	FY97	FY98	FY99	FY00	FY01	FY02	FY03
SE	W1YYAA			CIV	-.25M	-.25M	-.25M	-.25M	-.25M	-.25M	-.25M
CS	W0Z2AA	XMGH	431398000	CIV	+.25M	+.25M	+.25M	+.25M	+.25M	+.25M	+.25M

Issue: 123

Title: DCS for Logistics

Proponent: AA/DAS

Sponsor: ASA(MRA)

Source: HQDA Redesign

Implementation Period: POM 98-03

Synopsis: Downsize by 22 (8/14/22). [Transfer international affairs function and spaces (0/13/13) to DUSA(IA) (see issue 57).]

Resource Implications:

	Savings	Costs	Transfer
Military:	-8	0	[-0]
Civilian:	-14	0	[-13]
Dollars:	-.7M	0	[-.65M]

Army Staff/Command Position:

Concur:

Nonconcur:

Recommendation: Implement in POM 98-03.

ACTION: DCSLOG

Approve
 Disapprove
 Fwd to CSA/SA for decision
 Defer to POM 00-05 Study by: _____

Issue: 123 **Title:** ODCSLOG

Synopsis: Downsize by 22 (8/14/22).

Enablers: None.

Implementation Guidance:

1. HQDA Redesign Working Group submit adjustment to POM 98-03.
2. DUSA (IA) prepare concept plan, no later than 30 August 1996, to integrate DCSLOG FMS functions and spaces. ODCSLOG assist in transition plan and execution.

Synopsis: Downsize by 22 (8/14/22).

Manpower

Cmd	UIC	MDEP	AMSCO	TYPE	FY97	FY98	FY99	FY00	FY01	FY02	FY03
CS	W0Z3AA	XMGH	431398000	MIL	-8	-8	-8	-8	-8	-8	-8
XX	WEDGE			MIL	+8	+8	+8	+8	+8	+8	+8
CS	W0Z3AA	XMGH	431398000	CIV	-14	-14	-14	-14	-14	-14	-14
XX	WEDGE			CIV	+14	+14	+14	+14	+14	+14	+14

TOA (\$ millions)

Cmd	UIC	MDEP	AMSCO	TYPE	FY97	FY98	FY99	FY00	FY01	FY02	FY03
CS	W0Z3AA	XMGH	431398000	CIV		-.35M	-.7M	-.7M	-.7M	-.7M	-.7M

Issue: 124

Title: Strategic Logistics Agency

Proponent: AA/DAS

Sponsor: ASA(MRA)

Source: HQDA Redesign

Implementation Period: POM 98-03

Synopsis: Eliminate.

Resource Implications:

	Savings	Costs	Transfer
Military:	-5	0	0
Civilian:	-8	0	0
Dollars:	-.4M	0	0

Army Staff/Command Position:

Concur:

Nonconcur:

Recommendation: Implement in POM 98-03.

ACTION: DCSLOG - LEAD; SLA - ASSIST



Approve



Disapprove



Fwd to CSA/SA

for decision



Defer to POM 00-05



Study by: _____

Issue: 124

Title: Strategic Logistics Agency

Synopsis: Eliminate.

Enablers: None.

Implementation Guidance:

HQDA Redesign Work Group submit adjustment to POM 98-03.

Issue: 124

Title: Strategic Logistics Agency

Synopsis: Eliminate.

Manpower

Cmd	UIC	MDEP	AMSCO	TYPE	FY97	FY98	FY99	FY00	FY01	FY02	FY03
SS	W1EEAA	XMGH	431898000	MIL	-5	-5	-5	-5	-5	-5	-5
XX	WEDGE			MIL	+5	+5	+5	+5	+5	+5	+5
SS	W1EEAA	XMGH	431898000	CIV	-8	-8	-8	-8	-8	-8	-8
XX	WEDGE			CIV	+8	+8	+8	+8	+8	+8	+8

TOA (\$ millions)

Cmd	UIC	MDEP	AMSCO	TYPE	FY97	FY98	FY99	FY00	FY01	FY02	FY03
SS	W1EEAA	XMGH	431898000	CIV	-2M	-2M	-4M	-4M	-4M	-4M	-4M

Issue: 125

Title: Logistics Evaluation Agency

Proponent: AA/DAS

Sponsor: ASA(MRA)

Source: HQDA Redesign

Implementation Period: POM 98-03

Synopsis: Downsize by (1/21/22). Transfer logistics analysis function and (0/15/15) spaces to CAA, and transfer (18/84/102) to AMC. [Transfer Foreign Military Sales function and (1/8/9) spaces to DUSC(IA) (see issue 57).]

Resource Implications:

	Savings	Costs	Transfer
Military:	-1	0	-18
Civilian:	-21	0	-99
Dollars:	-1.05M	0	-4.95M

Army Staff/Command Position:

Concur:

Nonconcur:

Recommendation: Implement in POM 98-03.

ACTION: DCSLOG - LEAD; AMC, DUSA(OR), CAA, and LEA - ASSIST

Approve
 Disapprove
 Fwd to CSA/SA for decision
 Defer to POM 00-05
 Study by: _____

Issue: 125

Title: Logistics Evaluation Agency

Synopsis: Downsize by (1/21/22). Transfer logistics analysis function and (0/15/15) spaces to CAA, and transfer (18/84/102) to AMC. [Transfer Foreign Military Sales function and (1/8/9) spaces to DUSC(IA) (see issue 57).]

Enablers: None.

Implementation Guidance:

1. HQDA Redesign Working Group submit adjustment to POM 98-03.
2. DUSA(IA) prepare concept plan, not later than 30 August 1996, to integrate LEA FMS functions and spaces. ODCSLOG assist in transition plan and execution.
3. CAA prepare concept plan, not later than 30 August 1996, to integrate logistics analysis functions and spaces. ODCSLOG assist in transition plan and execution.
4. AMC prepare concept plan, not later than 30 August 1996, to integrate functions and spaces not later than September 1996. ODCSLOG assist in transition plan and execution.

Issue: 125

Title: Logistics Evaluation Agency

Synopsis: Downsize by (1/21/22). Transfer logistics analysis function and (0/15/15) spaces to CAA, and transfer (18/84/102) to AMC. [Transfer Foreign Military Sales function and (1/8/9) spaces to DUSC(IA) (see issue 57).]

Manpower											
Cmd	UIC	MDEP	AMSCO	TYPE	FY97	FY98	FY99	FY00	FY01	FY02	FY03
SE	W2VNAA	FALO	423829000	MIL	-1	-1	-1	-1	-1	-1	-1
XX	WEDGE			MIL	+1	+1	+1	+1	+1	+1	+1
SE	W2VNAA			MIL	-18	-18	-18	-18	-18	-18	-18
AMC				MIL	+18	+18	+18	+18	+18	+18	+18
SE	W2VNAA	FALO	423829000	CIV	-21	-21	-21	-21	-21	-21	-21
XX	WEDGE			CIV	+21	+21	+21	+21	+21	+21	+21
SE	W2VNAA			CIV	-15	-15	-15	-15	-15	-15	-15
SS	W3WCAA	XMGH	431498000	CIV	+15	+15	+15	+15	+15	+15	+15
SE	W2VNAA			CIV	-84	-84	-84	-84	-84	-84	-84
AMC				CIV	+84	+84	+84	+84	+84	+84	+84

TOA (\$ millions)

Cmd	UIC	MDEP	AMSCO	TYPE	FY97	FY98	FY99	FY00	FY01	FY02	FY03
SE	W2VNAA	FALO	423829000	CIV		-.525M	-1.05M	-1.05M	-1.05M	-1.05M	-1.05M
SE	W2VNAA			CIV		-.75M	-.75M	-.75M	-.75M	-.75M	-.75M
SS	W3WCAA	XMGH	431498000	CIV		+.75M	+.75M	+.75M	+.75M	+.75M	+.75M
SE	W2VNAA			CIV		-4.2M	-4.2M	-4.2M	-4.2M	-4.2M	-4.2M
AMC				CIV		+4.2M	+4.2M	+4.2M	+4.2M	+4.2M	+4.2M

Issue: 126

Title: US Army Base Realignment & Closure Office

Proponent: AA/DAS

Sponsor: ASA(MRA)

Source: HQDA Redesign

Implementation Period: POM 98-03

Synopsis: Eliminate. Transfer function and 22 spaces to ISMA.

Resource Implications:

	Savings	Costs	Transfer
Military:	0	0	-11
Civilian:	0	0	-11
Dollars:	0	0	-.55M

Army Staff/Command Position:

Concur: ACSIM

Nonconcur:

Recommendation: Implement in POM 98-03.

ACTION: ACSIM - LEAD; BRACO and ISMA - ASSIST

- Approve
- Disapprove
- Fwd to CSA/SA for decision
- Defer to POM 00-05
- Study by: _____

Issue: 126

Title: US Army Base Realignment & Closure Office

Synopsis: Eliminate. Transfer function and 22 spaces to ISMA.

Enablers: None.

Implementation Guidance:

1. HQDA Redesign Working Group submit adjustment to POM 98-03.
2. ACSIM prepare concept plan, not later than 30 August 1996, to integrate BRACO functions and spaces into ISMA.
3. ACSIM eliminate BRACO spaces (11/11/22) in FY02.

Issue: 126

Title: US Army Base Realignment & Closure Office

Synopsis: Eliminate. Transfer function and 22 spaces to ISMA.

Manpower

Cmd	UIC	MDEP	AMSCO	TYPE	FY97	FY98	FY99	FY00	FY01	FY02	FY03
SS	W454AA	XMGH	431498000	MIL	-11	-11	-11	-11	-11	-11	-11
SE	W4YNAA	FACS	435212000	MIL	+11	+11	+11	+11	+11	0	0
SS	W454AA	XMGH	431498000	CIV	-11	-11	-11	-11	-11	-11	-11
SE	W4YNAA	FACS	435212000	CIV	+11	+11	+11	+11	+11	0	0
XX	WEDGE			MIL	0	0	0	0	0	+11	+11
XX	WEDGE			CIV	0	0	0	0	0	+11	+11

TOA (\$ millions)

Cmd	UIC	MDEP	AMSCO	TYPE	FY97	FY98	FY99	FY00	FY01	FY02	FY03
SS	W454AA	XMGH	431498000	CIV	-0.55M	-0.55M	-0.55M	-0.55M	-0.55M	-0.55M	-0.55M
SE	W4YNAA	FACS	435212000	CIV	+0.55M	+0.55M	+0.55M	+0.55M	+0.55M	0	0

Issue: 127

Title: US Army Environmental Office

Proponent: AA/DAS

Sponsor: ASA(MRA)

Source: HQDA Redesign

Implementation Period: POM 98-03

Synopsis: Eliminate. Transfer functions to OACSIM without resources.

Resource Implications:

	Savings	Costs	Transfer
Military:	0	0	0
Civilian:	-13	0	0
Dollars:	-.65M	0	0

Army Staff/Command Position:

Concur:

Nonconcur:

Recommendation: Implement in POM 98-03.

ACTION: ACSIM - LEAD; AEO - ASSIST

Approve

Disapprove

Fwd to CSA/SA for decision

Defer to POM 00-05 Study by: _____

Issue: 127 **Title:** US Army Environmental Office

Synopsis: Eliminate. Transfer functions to OACSIM without resources.

Enablers: None.

Implementation Guidance:
HQDA Redesign Working Group submit adjustment to POM 98-03.

Issue: 127

Title: US Army Environmental Office

Synopsis: Eliminate. Transfer functions to OACSIM without resources.

Manpower

Cmd	UIC	MDEP	AMSCO	TYPE	FY97	FY98	FY99	FY00	FY01	FY02	FY03
SS	W43YAA	XMGH	431498000	CIV	-13	-13	-13	-13	-13	-13	-13
XX	WEDGE			CIV	+13	+13	+13	+13	+13	+13	+13

TOA (\$ millions)

Cmd	UIC	MDEP	AMSCO	TYPE	FY97	FY98	FY99	FY00	FY01	FY02	FY03
SS	W43YAA	XMGH	431498000	CIV		-.325M	-.65M	-.65M	-.65M	-.65M	-.65M

Issue: 128 **Title:** Community & Family Support Center

Synopsis: Downsize by 70 (8/62/70).

Enablers: None.

Implementation Guidance:

1. HQDA Redesign Working Group submit adjustment to POM 98-03.
2. ACSIM prepare personnel reduction plan, not later than 15 September 1996; coordinate with military and civilian personnel offices. CFSC assist.
3. ACSIM comply with policies and procedures of AR 5-10.

Issue: 128

Title: Community & Family Support Center

Synopsis: Downsize by 70 (8/62/70).

Manpower

Cmd	UIC	MDEP	AMSCO	TYPE	FY97	FY98	FY99	FY00	FY01	FY02	FY03
SE	W4RHAA	XFMU	114092000	MIL	-8	-8	-8	-8	-8	-8	-8
XX	WEDGE			MIL	+8	+8	+8	+8	+8	+8	+8
SE	W4RHAA	FAPC	434710000	CIV	-62	-62	-62	-62	-62	-62	-62
XX	WEDGE			CIV	+62	+62	+62	+62	+62	+62	+62

TOA (\$ millions)

Cmd	UIC	MDEP	AMSCO	TYPE	FY97	FY98	FY99	FY00	FY01	FY02	FY03
SE	W4RHAA	XFMU	114092000	MIL	-8	-8	-8	-8	-8	-8	-8
XX	WEDGE			MIL	+8	+8	+8	+8	+8	+8	+8
SE	W4RHAA	FAPC	434710000	CIV	-62	-62	-62	-62	-62	-62	-62
XX	WEDGE			CIV	+62	+62	+62	+62	+62	+62	+62

All civilian spaces are unfunded.

Issue: 129

Title: US Army Environmental Center

Proponent: AA/DAS

Sponsor: ASA(MRA)

Source: HQDA Redesign

Implementation Period: POM 98-03

Synopsis: Downsize by 57 (0/57/57) and transfer DERA execution functions to USACE without spaces (spaces are reimbursed).

Resource Implications:

	Savings	Costs	Transfer
Military:	0	0	0
Civilian:	-57	0	0
Dollars:	0	0	0

Army Staff/Command Position:

Concur: ACSIM

Nonconcur:

Recommendation: Implement in POM 98-03.

ACTION: ACSIM - LEAD; USACE and AEC - ASSIST

Approve
 Disapprove
 Fwd to CSA/SA for decision
 Defer to POM 00-05 Study by: _____

Issue: 129

Title: US Army Environmental Center

Synopsis: Downsize by 57 (0/57/57) and transfer DERA execution functions to USACE without spaces (spaces are reimbursed).

Enablers: None.

Implementation Guidance:

1. HQDA Redesign Working Group submit adjustment to POM 98-03.
2. ACSIM prepare personnel reduction plan, not later than 15 September 1996; coordinate with military and civilian personnel offices.
3. ACSIM comply with policies and procedures of AR 5-10.

Issue: 129

Title: US Army Environmental Center

Synopsis: Downsize by 57 (0/57/57) and transfer DERA execution functions to USACE without spaces (spaces are reimbursed).

Manpower

Cmd	UIC	MDEP	AMSCO	TYPE	FY97	FY98	FY99	FY00	FY01	FY02	FY03
SE	W3V8AA	ENVR	4930080000	CIV	-10	-23	-35	-56	-57	-57	-57
XX	WEDGE			CIV	+10	+23	+35	+56	+57	+57	+57

TOA (\$ millions)

Cmd	UIC	MDEP	AMSCO	TYPE	FY97	FY98	FY99	FY00	FY01	FY02	FY03
SE	W3V8AA	ENVR	4930080000	CIV							

(spaces are reimbursed)

Issue: 130

Title: Installation Support Management Agency

Proponent: AA/DAS

Sponsor: ASA(MRA)

Source: HQDA Redesign

Implementation Period: POM 98-03

Synopsis: Downsize by 30 (0/30/30). [Receive functions and spaces from BRACO (See issue 126)].

Resource Implications:

	Savings	Costs	Transfer
Military:	0	0	[+11]
Civilian:	-30	0	[+11]
Dollars:	-1.5M	0	[+.55M]

Army Staff/Command Position:

Concur: ACSIM

Nonconcur:

Recommendation: Implement in POM 98-03.

ACTION: ACSIM - LEAD; ISMA - ASSIST

Approve
 Disapprove
 Fwd to CSA/SA
 Defer to POM 00-05
for decision
Study by: _____

Issue: 130 **Title:** Installation Support Management Agency

Synopsis: Downsize by 30 (0/30/30).

Enablers: None.

Implementation Guidance:

1. HQDA Redesign Working Group submit adjustment to POM 98-03.
2. ACSIM eliminate BRACO spaces (11/11/22) in FY 2002.

Issue: 130

Title: Installation Support Management Agency

Synopsis: Downsize by 30 (0/30/30).

Manpower

Cmd	UIC	MDEP	AMSCO	TYPE	FY97	FY98	FY99	FY00	FY01	FY02	FY03
SE	W4YNAA	E3RE	191100000	CIV	-6	-6	-6	-6	-6	-6	-6
XX	WEDGE			CIV	+6	+6	+6	+6	+6	+6	+6
SE	W4YNAA	E3RE	437018000	CIV	-2	-2	-12	-12	-12	-12	-12
XX	WEDGE			CIV	+2	+2	+12	+12	+12	+12	+12
SE	W4YNAA	QMIS	435212000	CIV			-3	-3	-3	-3	-3
XX	WEDGE			CIV			+3	+3	+3	+3	+3
SE	W4YNAA	QMIS	438896000	CIV			-9	-9	-9	-9	-9
XX	WEDGE			CIV			+9	+9	+9	+9	+9

TOA (\$ millions)

Cmd	UIC	MDEP	AMSCO	TYPE	FY97	FY98	FY99	FY00	FY01	FY02	FY03
SE	W4YNAA		CIV			-2M	-9M	-1.5M	-1.5M	-1.5M	-1.5M

Issue: 131

Title: Office of the Chief of Engineers

Proponent: AA/DAS

Sponsor: ASA(MRA)

Source: HQDA Redesign

Implementation Period: POM 98-03

Synopsis: Transfer functions (minus the ARSTAF Chief of Engineers) and 11 spaces to USACE.

Resource Implications:

	Savings	Costs	Transfer
Military:	0	0	-9
Civilian:	0	0	-2
Dollars:	0	0	-.1M

Army Staff/Command Position:

Concur:

Nonconcur: COE

Recommendation: Implement in POM 98-03.

ACTION: COE - LEAD; USACE - ASSIST

Approve
 Disapprove
 Fwd to CSA/SA for decision
 Defer to POM 00-05 Study by: _____

Issue: 131

Title: Office of the Chief of Engineers

Synopsis: Transfer functions (minus the ARSTAF Chief of Engineers) and 11 spaces to USACE.

Enablers: None.

Implementation Guidance:

HQDA Redesign Working Group submit adjustment to POM 98-03.

Issue: 131

Title: Office of the Chief of Engineers

Synopsis: Transfer functions (minus the ARSTAF Chief of Engineers) and 11 spaces to USACE.

Manpower

Cmd	UIC	MDEP	AMSCO	TYPE	FY97	FY98	FY99	FY00	FY01	FY02	FY03
CS	W00MAA	XMGH	431398000	MIL	-9	+9	-9	+9	-9	+9	-9
CE	USACE			MIL							
CS	W00MAA	XMGH	431398000	CIV	-2	+2	-2	+2	-2	+2	-2
CE	USACE			CIV							

TOA (\$ millions)

Cmd	UIC	MDEP	AMSCO	TYPE	FY97	FY98	FY99	FY00	FY01	FY02	FY03
CS	W00MAA	XMGH	431398000	CIV	-0.1M	+0.1M	-0.1M	+0.1M	-0.1M	+0.1M	-0.1M
CE	USACE			CIV							

Issue: 132

Title: The Surgeon General

Proponent: AA/DAS

Sponsor: ASA(MRA)

Source: HQDA Redesign

Implementation Period: POM 98-03

Synopsis: Downsize by 10% (5/5/10).

Resource Implications:

	Savings	Costs	Transfer
Military:	-5	0	0
Civilian:	-5	0	0
Dollars:	-.25M	0	0

Army Staff/Cmd Position:

Concur:

Nonconcur:

Recommendation: Implement in POM 98-03.

ACTION: TSG

- Approve
- Disapprove
- Fwd to CSA/SA for decision
- Defer to POM 00-05
- Study by: _____

Issue: 132

Title: The Surgeon General

Synopsis: Downsize by 10% (5/5/10).

Enablers: None.

Implementation Guidance:

HQDA Redesign Working Group submit adjustment to POM 98-03.

Synopsis: Downsize by 10% (5/5/10).

Manpower

Cmd	UIC	MDEP	AMSCO	TYPE	FY97	FY98	FY99	FY00	FY01	FY02	FY03
CS	W00LAA	XMGH 431398000		MIL	-5	-5	-5	-5	-5	-5	-5
XX	WEDGE			MIL	+5	+5	+5	+5	+5	+5	+5
CS	W00LAA	XMGH 431398000		CIV	-5	-5	-5	-5	-5	-5	-5
XX	WEDGE			CIV	+5	+5	+5	+5	+5	+5	+5

TOA (\$ millions)

Cmd	UIC	MDEP	AMSCO	TYPE	FY97	FY98	FY99	FY00	FY01	FY02	FY03
CS	W00LAA	XMGH 431398000		CIV	-0.125M	-0.125M	-0.25M	-0.25M	-0.25M	-0.25M	-0.25M

Issue: 133

Title: Chief of Chaplains

Proponent: AA/DAS

Sponsor: ASA(MRA)

Source: HQDA Redesign

Implementation Period: POM 98-03

Synopsis: Downsize by 10% (0/4/4). [Integrate US Army Chaplaincy Services Support Agency functions (minus personnel management functions) (4/7/11).]

Resource Implications:

	Savings	Costs	Transfer
Military:	0	0	0
Civilian:	-4	0	0
Dollars:	-.2M	0	0

Army Staff/Command Position:

Concur:

Nonconcur:

Recommendation: Implement effective FY98

ACTION: CCH

Approve
 Disapprove
 Fwd to CSA/SA for decision
 Defer to POM 00-05 Study by: _____

Issue: 133

Title: Chief of Chaplains

Synopsis: Downsize by 10% (0/4/4). [Integrate US Army Chaplaincy Services Support Agency functions (minus personnel management functions) (4/7/11).]

Enablers: None.

Implementation Guidance:

HQDA Redesign Working Group submit adjustment to POM 98-03.

Issue: 133

Title: Chief of Chaplains

Synopsis: Downsize by 10% (0/4/4). [Integrate US Army Chaplaincy Services Support Agency functions (minus personnel management functions) (4/7/11).]

		Manpower									
Cmd	UIC	MDEP	AMSCO	TYPE	FY97	FY98	FY99	FY00	FY01	FY02	FY03
CS	W00CAA	XMGH	431398000	MIL	-4	-4	-4	-4	-4	-4	-4
XX	WEDGE			MIL	+4	+4	+4	+4	+4	+4	+4

TOA (\$ millions)

Cmd	UIC	MDEP	AMSCO	FY 96	FY97	FY98	FY99	FY00	FY01	FY02	FY03
CS	W00CAA	XMGH	431398000	CIV	-1M	-1M	-2M	-2M	-2M	-2M	-2M

Issue: 134

Title: US Chaplaincy Services Support Agency

Proponent: AA/DAS

Sponsor: ASA(MRA)

Source: HQDA Redesign

Implementation Period: POM 98-03

Synopsis: Eliminate FOA and merge personnel management functions with PERSCOM (2/0/2) and integrate remaining functions into the Chief of Chaplains office (4/7/11).

Resource Implications:

	Savings	Costs	Transfer
Military:	0	0	-6
Civilian:	0	0	-7
Dollars:	0	0	-.35M

Army Staff/Command Position:

Concur:

Nonconcur: OCCH

Recommendation: Implement in POM 98-03.

ACTION: CCH - LEAD; USACSSA and PERSCOM - ASSIST

Approve
 Disapprove
 Fwd to CSA/SA for decision
 Defer to POM 00-05 Study by: _____

Issue: 134

Title: US Chaplaincy Services Support Agency

Synopsis: Eliminate FOA and merge personnel management functions with PERSCOM (2/0/2) and integrate remaining functions into the Chief of Chaplains office (4/7/11).

Enablers: None.

Implementation Guidance:

1. HQDA Redesign Working Group submit adjustment to POM 98-03.
2. Chief of Chaplains develop concept plan, not later than 30 August 1996, to integrate functions and spaces.
3. PERSCOM prepare concept plan, not later than 30 August 1996 to integrate the personnel management function. Chief of Chaplains assist.

Issue: 134

Title: US Chaplaincy Services Support Agency

Synopsis: Eliminate FOA and merge personnel management functions with PERSCOM (2/0/2) and integrate remaining functions into the Chief of Chaplains office (4/7/11).

Manpower

Cmd	UIC	MDEP	AMSCO	TYPE	FY97	FY98	FY99	FY00	FY01	FY02	FY03
SE	W062AA	FACB	434716000	MIL	-6	-6	-6	-6	-6	-6	-6
CS	W00CAA	XMGH	431398000	MIL	+4	+4	+4	+4	+4	+4	+4
MP	W3VSAA	FAPM	433709000	MIL	+2	+2	+2	+2	+2	+2	+2
SE	W062AA	FACB	434716000	CIV	-7	-7	-7	-7	-7	-7	-7
CS	W00CAA	XMGH	431398000	CIV	+7	+7	+7	+7	+7	+7	+7

TOA (\$ millions)

Cmd	UIC	MDEP	AMSCO	TYPE	FY97	FY98	FY99	FY00	FY01	FY02	FY03
SE	W062AA	FACB	434716000	CIV	-.35M	-.35M	-.35M	-.35M	-.35M	-.35M	-.35M
CS	W00CAA	XMGH	431398000	CIV	+.35M	+.35M	+.35M	+.35M	+.35M	+.35M	+.35M

Issue: 135

Title: The Judge Advocate General

Proponent: AA/DAS

Sponsor: ASA(MRA)

Source: HQDA Redesign

Implementation Period: POM 98-03

Synopsis: Downsize by 10% (4/3/7).

Resource Implications:

	Savings	Costs	Transfer
Military:	-4	0	0
Civilian:	-3	0	0
Dollars:	-.15M	0	0

Army Staff/Command Position:

Concur:

Nonconcur: TJAG

Recommendation: Implement in POM 98-03.

ACTION: TJAG

- Approve**
 Disapprove
 Fwd to CSA/SA for decision
 Defer to POM 00-05 Study by: _____

Issue: 135

Title: The Judge Advocate General

Synopsis: Downsize by 10% (4/3/7).

Enablers: None.

Implementation Guidance:

HQDA Redesign Working Group submit adjustment to POM 98-03.

Issue: 135

Title: The Judge Advocate General

Synopsis: Downsize by 10% (4/3/7).

		Manpower									
Cmd	UIC	MDEP	AMSCO	TYPE	FY97	FY98	FY99	FY00	FY01	FY02	FY03
CS	W0Z7AA	XMGH	431398000	ML	-4	+4	-4	-4	-4	-4	-4
XX	WEDGE			MIL			+4	+4	+4	+4	+4
CS	W0Z7AA	XMGH	431398000	CIV	-3	-3	-3	-3	-3	-3	-3
XX	WEDGE			CIV	+3	+3	+3	+3	+3	+3	+3

TOA (\$ millions)

Cmd	UIC	MDEP	AMSCO	TYPE	FY97	FY98	FY99	FY00	FY01	FY02	FY03
CS	W0Z7AA	XMGH	431398000	CIV		-.075M	-.15M	-.15M	-.15M	-.15M	-.15M

Issue: 136

Title: USA Legal Services Agency

Proponent: AA/DAS

Sponsor: ASA(MRA)

Source: HQDA Redesign

Implementation Period: POM 98-03

Synopsis: Downsize by 10% (31/19/50). [Receive Army Claims Service functions and spaces (17/55/72) (see issue 138).]

Resource Implications:

	Savings	Costs	Transfer
Military:	-31	0	[+17]
Civilian:	-19	0	[+55]
Dollars:	-.95M	0	[+2.75M]

Army Staff/Command Position:

Concur:

Nonconcur:

TJAG

Recommendation: Implement in POM 98-03

ACTION: TJAG - LEAD; USALSA - ASSIST

Approve
 Disapprove
 Fwd to CSA/SA for decision
 Defer to POM 00-05 Study by: _____

Issue: 136

Title: USA Legal Services Agency

Synopsis: Downsize by 10% (31/19/50).

Enablers: None.

Implementation Guidance:

1. HQDA Redesign Working Group submit adjustment to POM 98-03.
2. TJAG prepare personnel reduction plan, not later than 15 September 1996; coordinate with military and civilian personnel offices.

Issue: 136

Title: USA Legal Services Agency

Synopsis: Downsize by 10% (31/19/50).

Manpower

Cmd	UIC	MDEP	AMSCO	TYPE	FY97	FY98	FY99	FY00	FY01	FY02	FY03
SE	W0KEAA	FAJA	436099000	MIL	-31	-31	-31	-31	-31	-31	-31
XX	WEDGE			MIL	+31	+31	+31	+31	+31	+31	+31
SE	W0KEAA	FAJA	436099000	CIV	-19	-19	-19	-19	-19	-19	-19
XX	WEDGE			CIV	+19	+19	+19	+19	+19	+19	+19

TOA (\$ millions)

Cmd	UIC	MDEP	AMSCO	TYPE	FY97	FY98	FY99	FY00	FY01	FY02	FY03
SE	W0KEAA	FAJA	436099000	CIV		-.475M	-.95M	-.95M	-.95M	-.95M	-.95M

Issue: 137

Title: The Judge Advocate General's School

Proponent: AA/DAS

Sponsor: ASA(MRA)

Source: HQDA Redesign

Implementation Period: POM 98-03

Synopsis: Downsize by 10% (6/3/9).

Resource Implications:

	Savings	Costs	Transfer
Military:	-6	0	0
Civilian:	-3	0	0
Dollars:	-.15M	0	0

Army Staff/Command Position:

Concur:

Nonconcur:

TJAG

Recommendation: Implement in POM 98-03.

ACTION: TJAG - LEAD; TJAG SCHOOL ASSIST

Approve
 Disapprove
 Fwd to CSA/SA for decision
 Defer to POM 00-05 Study by: _____

Issue: 137

Title: The Judge Advocate General's School

Synopsis: Downsize by 10% (6/3/9).

Enablers: None.

Implementation Guidance:

HQDA Redesign Working Group submit adjustment to POM 98-03.

Issue: 137

Title: The Judge Advocate General's School

Synopsis: Downsize by 10% (6/3/9).

Manpower

Cmd	UIC	MDEP	AMSCO	TYPE	FY97	FY98	FY99	FY00	FY01	FY02	FY03
SF	W1ETAA	FAJS	323751000	MIL	-6	+6	-6	-6	-6	-6	-6
XX	WEDGE			MIL			+6	+6	+6	+6	+6
SF	W1ETAA	FAJS	323751000	CIV	-3	-3	-3	-3	-3	-3	-3
XX	WEDGE			CIV	+3	+3	+3	+3	+3	+3	+3

TOA (\$ millions)

Cmd	UIC	MDEP	AMSCO	TYPE	FY97	FY98	FY99	FY00	FY01	FY02	FY03
SF	W1ETAA	FAJS	323751000	CIV		-.075M	-.15M	-.15M	-.15M	-.15M	-.15M

Issue: 138

Title: USA Claims Service

Proponent: AA/DAS

Sponsor: ASA(MRA)

Source: HQDA Redesign

Implementation Period: POM 98-03

Synopsis: Eliminate. Transfer functions and spaces (17/55/72) to the USA Legal Services Agency.

Resource Implications:

	Savings	Costs	Transfer
Military:	0	0	-17
Civilian:	0	0	-55
Dollars:	0	0	-2.75M

Army Staff/Command Position:

Concur: Nonconcur: OTJAG

Recommendation: Implement in POM 98-03.

ACTION: TJAG - LEAD; USA CLAIMS SVC and USALSA ASSIST

Approve
 Disapprove
 Fwd to CSA/SA for decision
 Defer to POM 00-05 Study by: _____

Issue: 138

Title: USA Claims Service

Synopsis: Eliminate. Transfer functions and spaces (17/55/72) to the USA Legal Services Agency.

Enablers: None.

Implementation Guidance:

1. HQDA Redesign Working Group submit adjustment to POM 98-03.
2. TJAG prepare concept plan not later than 30 August 1996, to integrate functions and spaces. USALSA and Claims Service assist in transition plan and execution.

Issue: 138

Title: USA Claims Service

Synopsis: Eliminate. Transfer functions and spaces (17/55/72) to the USA Legal Services Agency.

Manpower

Cmd	UIC	MDEP	AMSCO	TYPE	FY97	FY98	FY99	FY00	FY01	FY02	FY03
SE	W0KFAA			MIL	-17	-17	-17	-17	-17	-17	-17
SE	W0KEAA	FAJA	436099000	MIL	+17	+17	+17	+17	+17	+17	+17
SE	W0KFAA			CIV	-55	-55	-55	-55	-55	-55	-55
SE	W0KEAA	FAJA	436099000	CIV	+55	+55	+55	+55	+55	+55	+55

TOA (\$ millions)

Cmd	UIC	MDEP	AMSCO	TYPE	FY97	FY98	FY99	FY00	FY01	FY02	FY03
SE	W0KFAA		CIV	CIV		-2.75M	-2.75M	-2.75M	-2.75M	-2.75M	-2.75M
SE	W0KEAA	FAJA	436099000	CIV		+2.75M	+2.75M	+2.75M	+2.75M	+2.75M	+2.75M

Issue: 139

Title: Chief of the Army Reserves

Proponent: AA/DAS

Sponsor: ASA(MRA)

Source: HQDA Redesign

Implementation Period: POM 98-03

Synopsis: Downsize by 10% (3/4/7).

Resource Implications:

	Savings	Costs	Transfer
Military:	-3	0	0
Civilian:	-4	0	0
Dollars:	-2M	0	0

Army Staff/Command Position:

Concur: Nonconcur:

Recommendation: Implement in POM 98-03.

ACTION: OCAR

Approve
 Disapprove
 Fwd to CSA/SA for decision
 Defer to POM 00-05 Study by: _____

Issue: 139

Title: Chief of the Army Reserves

Synopsis: Downsize by 10% (3/4/7).

Enablers: None.

Implementation Guidance:

HQDA Redesign Working Group submit adjustment to POM 98-03.

Issue: 139

Title: Chief of the Army Reserves

Synopsis: Downsize by 10% (3/4/7).

Manpower

Cmd	UIC	MDEP	AMSCO	TYPE	FY97	FY98	FY99	FY00	FY01	FY02	FY03
CS	W0Z4AA	XMGH	549998A00	MIL	-3	-3	-3	-3	-3	-3	-3
XX	WEDGE			MIL	+3	+3	+3	+3	+3	+3	+3
CS	W0Z4AA	XMGH	549998A00	CIV	-4	-4	-4	-4	-4	-4	-4
XX	WEDGE			CIV	+4	+4	+4	+4	+4	+4	+4

TOA (\$ millions)

Cmd	UIC	MDEP	AMSCO	TYPE	FY97	FY98	FY99	FY00	FY01	FY02	FY03
CS	W0Z4AA	XMGH	549998A00	CIV	-	-.1M	-.2M	-.2M	-.2M	-.2M	-.2M

Issue: 140

Title: US Army Reserve Personnel Center

Proponent: AA/DAS

Sponsor: ASA(MRA)

Source: HQDA Redesign

Implementation Period: POM 98-03

Synopsis: Downsize by 10% (6/114/120).

Resource Implications:

	Savings	Costs	Transfer
Military:	-6	0	0
Civilian:	-114	0	0
Dollars:	-5.7M	0	0

Army Staff/Command Position:

Concur:

Nonconcur:

Recommendation: Implement in POM 98-03.

ACTION: OCAR - LEAD; ARPERCEN - ASSIST

Approve

Disapprove

**Fwd to CSA/SA
for decision**

**Defer to POM 00-05
Study by: _____**

Issue: 140 **Title:** US Army Reserve Personnel Center

Synopsis: Downsize by 10% (6/114/120).

Enablers: None.

Implementation Guidance:

1. HQDA Redesign Working Group submit adjustment to POM 98-03.
2. OCAR prepare personnel reduction plan, not later than 15 September 1996; coordinate with civilian personnel office.

Issue: 140

Title: US Army Reserve Personnel Center

Synopsis: Downsize by 10% (6/114/120).

		Manpower										
Cmd	UIC	MDEP	AMSCO	TYPE	FY97	FY98	FY99	FY00	FY01	FY02	FY03	
SE	W4M0AA	FAAR	549993000	MIL	-6	-6	-6	-6	-6	-6	-6	
XX	WEDGE			MIL	+6	+6	+6	+6	+6	+6	+6	
SE	W4M0AA	ARFT	549993000	CIV	-114	-114	-114	-114	-114	-114	-114	
XX	WEDGE			CIV	+114	+114	+114	+114	+114	+114	+114	

TOA (\$ millions)

Cmd	UIC	MDEP	AMSCO	TYPE	FY97	FY98	FY99	FY00	FY01	FY02	FY03
SE	W4M0AA	ARFT	549993000	CIV	-2.85M	-2.85M	-5.7M	-5.7M	-5.7M	-5.7M	-5.7M

Issue: 141

Title: Director, Army National Guard

Proponent: AA/DAS

Sponsor: ASA(MRA)

Source: HQDA Redesign

Implementation Period: POM 98-03

Synopsis: Downsize by 10% (4/10/14).

Resource Implications:

	Savings	Costs	Transfer
Military:	-4	0	0
Civilian:	-10	0	0
Dollars:	-.5M	0	0

Army Staff/Command Position:

Concur:

Nonconcur: NGB

Recommendation: Implement in POM 98-03.

ACTION: NGB

Approve
 Disapprove
 Fwd to CSA/SA for decision
 Defer to POM 00-05 Study by: _____

Issue: 141 **Title:** Director, Army National Guard

Synopsis: Downsize by 10% (4/10/14).

Enablers: None.

Implementation Guidance:

1. HQDA Redesign Working Group submit adjustment to POM 98-03.
2. Comply with Title 10, USC 12402 of a 60/40% mix between AC and ARNG US Officers on the NGB TDA.

Issue: 141

Title: Director, Army National Guard

Synopsis: Downsize by 10% (4/10/14).

Manpower

Cmd	UIC	MDEP	AMSCO	TYPE	FY97	FY98	FY99	FY00	FY01	FY02	FY03
CS	W00QAA	XMGH	549898000	MIL	-4	-4	-4	-4	-4	-4	-4
XX	WEDGE			MIL	+4	+4	+4	+4	+4	+4	+4
CS	W00QAA	XMGH	549898000	CIV	-10	-10	-10	-10	-10	-10	-10
XX	WEDGE			CIV	+10	+10	+10	+10	+10	+10	+10

TOA (\$ millions)

Cmd	UIC	MDEP	AMSCO	TYPE	FY97	FY98	FY99	FY00	FY01	FY02	FY03
CS	W00QAA	XMGH	549898000	CIV	-0.25M	-0.25M	-0.5M	-0.5M	-0.5M	-0.5M	-0.5M

Issue: 142

Title: Army National Guard Readiness Center

Proponent: AA/DAS

Sponsor: ASA(MRA)

Source: HQDA Redesign

Implementation Period: POM 98-03

Synopsis: Downsize by 10% (5/29/34). [Receive Army National Guard Finance Center function and spaces (0/6/6)--see issue 146.

Resource Implications:

	Savings	Costs	Transfer
Military:	-5	0	0
Civilian:	-29	0	[+6]
Dollars:	-1.45	0	[+.3M]

Army Staff/Command Position:

Concur:

Nonconcur: NGB

Recommendation: Implement in POM 98-03.

ACTION: NGB - LEAD; DIR, ARNG and ARNGRC - ASSIST

- Approve** **Disapprove** **Fwd to CSA/SA for decision** **Defer to POM 00-05**
- Study by:** _____

Issue: 142 **Title:** Army National Guard Readiness Center

Synopsis: Downsize by 10% (5/29/34).

Enablers: None.

Implementation Guidance:

1. HQDA Redesign Working Group submit adjustment to POM 98-03.
2. NGB prepare concept plan not later than 30 August 1996, to integrate ARNG Finance Center functions and spaces. ARNG Finance Center assist in transition plan and execution.
3. NGB prepare personnel reduction plan, not later than 15 September 1996; coordinate with civilian personnel office.

Issue: 142

Title: Army National Guard Readiness Center

Synopsis: Downsize by 10% (5/29/34).

Manpower

Cmd	UIC	MDEP	AMSCO	TYPE	FY97	FY98	FY99	FY00	FY01	FY02	FY03
GB	W39LAA	FANG	549892000	MIL	-5	-5	-5	-5	-5	-5	-5
XX	WEDGE			MIL	+5	+5	+5	+5	+5	+5	+5
GB	W39LAA	FANG	549892000	CIV	-29	-29	-29	-29	-29	-29	-29
XX	WEDGE			CIV	+29	+29	+29	+29	+29	+29	+29

TOA (\$ millions)

Cmd	UIC	MDEP	AMSCO	TYPE	FY97	FY98	FY99	FY00	FY01	FY02	FY03
GB	W39LAA	FANG	549892000	CIV	-725M	-725M	-1.45M	-1.45M	-1.45M	-1.45M	-1.45M

Issue: 143

Title: Operational Support Airlift Command

Proponent: AA/DAS

Sponsor: ASA(MRA)

Source: HQDA Redesign

Implementation Period: POM 98-03

Synopsis: Downsize by 10% (10/10/20).

Resource Implications:

	Savings	Costs	Transfer
Military:	-10	0	0
Civilian:	-10	0	0
Dollars:	-.5M	0	0

Army Staff/Command Position:

Concur:

Nonconcur: NGB

Recommendation: Implement in POM 98-03.

ACTION: NGB -LEAD; OSACOM - ASSIST

Approve
 Disapprove
 Fwd to CSA/SA for decision
 Defer to POM 00-05
 Study by: _____

Issue: 143 **Title:** Operational Support Airlift Command

Synopsis: Downsize by 10% (10/10/20).

Enablers: None.

Implementation Guidance:
HQDA Redesign Working Group submit adjustment to POM 98-03.

Synopsis: Downsize by 10% (10/10/20).

		Manpower									
Cmd	UIC	MDEP	AMSCO	TYPE	FY97	FY98	FY99	FY00	FY01	FY02	FY03
GB	W36VAA	QATC	549892000	MIL	-10	-10	-10	-10	-10	-10	-10
XX	WEDGE			MIL	+10	+10	+10	+10	+10	+10	+10
GB	W36VAA	NGFB	549892000	CIV	-10	-10	-10	-10	-10	-10	-10
XX	WEDGE			MIL	+10	+10	+10	+10	+10	+10	+10

TOA (\$ millions)

Cmd	UIC	MDEP	AMSCO	TYPE	FY97	FY98	FY99	FY00	FY01	FY02	FY03
GB	W36VAA	NGFB	549892000	CIV		-.25M	-.5M	-.5M	-.5M	-.5M	-.5M

Issue: 144 **Title:** National Guard Professional Education Center

Proponent: AA/DAS **Sponsor:** ASA(MRA) **Source:** HQDA Redesign

Implementation Period: POM 98-03

Synopsis: Transfer (0/7/7) spaces to TRADOC.

Resource Implications:

	Savings	Costs	Transfer
Military:	0	0	0
Civilian:	0	0	-7
Dollars:	0	0	-.35M

Army Staff/Command Position:

Concur: NGB

Nonconcur:

Recommendation: Implement in POM 98-03.

ACTION: TRADOC - LEAD; NGB and ARNGPEC- ASSIST

Approve **Disapprove** **Fwd to CSA/SA for decision** **Defer to POM 00-05 Study by: _____**

Issue: 144 **Title:** National Guard Professional Education Center

Synopsis: Transfer (07/7) spaces to TRADOC.

Enablers: None.

Implementation Guidance:

1. HQDA Redesign Working Group submit adjustment to POM 98-03.
2. TRADOC prepare concept plan, not later than 30 August 1996, to integrate functions and spaces. NGB and ARNG Professional Education Center assist in transition plan and execution.

Issue: 144

Title: National Guard Professional Education Center

Synopsis: Transfer to TRADOC (0/7/7).

Manpower

Cmd	UIC	MDEP	AMSCO	TYPE	FY97	FY98	FY99	FY00	FY01	FY02	FY03
GB	W42TAA	FANG	54989200	CIV	-7	-7	-7	-7	-7	-7	-7
TC		FANG	54989200	CIV	+7	+7	+7	+7	+7	+7	+7

TOA (\$ millions)

Cmd	UIC	MDEP	AMSCO	TYPE	FY97	FY98	FY99	FY00	FY01	FY02	FY03
GB	W42TAA	FANG	54989200	CIV	-0.35M	-0.35M	-0.35M	-0.35M	-0.35M	-0.35M	-0.35M
TC		FANG	54989200	CIV	+0.35M	+0.35M	+0.35M	+0.35M	+0.35M	+0.35M	+0.35M

Issue: 145 **Title:** Project Management Office-RCAS

Proponent: AA/DAS **Sponsor:** ASA(MRA) **Source:** HQDA Redesign

Implementation Period: POM 98-03

Synopsis: Downsize by 10% (0/6/6).

Resource Implications:

	Savings	Costs	Transfer
Military:	0	0	0
Civilian:	-6	0	0
Dollars:	-.3M	0	0

Army Staff/Command Position:

Concur:

Nonconcur: NGB

Recommendation: Implement in POM 98-03.

ACTION: NGB - LEAD; RCAS PM - ASSIST

Approve
 Disapprove
 Fwd to CSA/SA for decision
 Defer to POM 00-05 Study by: _____

Issue: 145 **Title:** Project Management Office-RCAS

Synopsis: Downsize by 10% (0/6/6).

Enablers: None.

Implementation Guidance:
HQDA Redesign Working Group submit adjustment to POM 98-03.

Issue: 145

Title: Project Management Office-RCAS

Synopsis: Downsize by 10% (0/6/6).

Manpower

Cmd	UIC	MDEP	AMSCO	TYPE	FY97	FY98	FY99	FY00	FY01	FY02	FY03
GB	W4VMAA	FANG	54989200	CIV		-6	-6	-6	-6	-6	-6
XX	WEDGE			CIV		+6	+6	+6	+6	+6	+6

TOA (\$ millions)

Cmd	UIC	MDEP	AMSCO	TYPE	FY97	FY98	FY99	FY00	FY01	FY02	FY03
GB	W4VMAA	FANG	54989200	CIV		-.15M	-.3M	-.3M	-.3M	-.3M	-.3M

Issue: 146

Title: ARNG Financial Services Center

Proponent: A/DAS

Sponsor: ASA(MRA)

Source: HQDA Redesign

Implementation Period: POM 98-03

Synopsis: Eliminate the FOA. Transfer the functions and spaces (0/6/6) to ARNG Readiness Center.

Resource Implications:

	Savings	Costs	Transfer
Military:	0	0	0
Civilian:	0	0	-6
Dollars:	0	0	-.3M

Army Staff/Command Position:

Concur: NGB

Nonconcur:

Recommendation: Implement in POM 98-03.

ACTION: NGB - LEAD; ARNGFSC and ARNGRC - ASSIST

Approve

Disapprove

Fwd to CSA/SA for decision

Defer to POM 00-05 Study by: _____

Issue: 146

Title: US ARNG Financial Services Center

Synopsis: Eliminate the FOA. Transfer the functions and spaces (0/6/6) to ARNG Readiness Center.

Enablers: None.

Implementation Guidance:

1. HQDA Redesign Working Group submit adjustment to POM 98-03.
2. NGB prepare concept plan, not later than 30 August 1996, to integrate functions and spaces. ARNG Finance Center assist in transition plan and execution.

Issue: 146

Title: US ARNG Financial Services Center

Synopsis: Eliminate the FOA. Transfer the functions and spaces (0/6/6) to ARNG Readiness Center.

Manpower

Cmd	UIC	MDEP	AMSCO	TYPE	FY97	FY98	FY99	FY00	FY01	FY02	FY03
GB	W4EQAA	FANG	549892000	CIV	-6	-6	-6	-6	-6	-6	-6
GB	W39LAA	FANG	549892000	CIV	+6	+6	+6	+6	+6	+6	+6

TOA (\$ millions)

Cmd	UIC	MDEP	AMSCO	TYPE	FY97	FY98	FY99	FY00	FY01	FY02	FY03
GB	W4EQAA	FANG	549892000	CIV	-0.3M	-0.3M	-0.3M	-0.3M	-0.3M	-0.3M	-0.3M
GB	W39LAA	FANG	549892000	CIV	+0.3M	+0.3M	+0.3M	+0.3M	+0.3M	+0.3M	+0.3M

Issue: 147

Title: Inter-American Defense Board

Proponent: AADAS

Sponsor: ASA(MRA)

Source: HQDA Redesign

Implementation Period: POM 98-03

Synopsis: Transfer administrative support functions and resources to MDW. Remove HQDA FOA status.

Resource Implications:

	Savings	Costs	Transfer
Military:	0	0	-17
Civilian:	0	0	0
Dollars:	0	0	0

Army Staff/Command Position:

Concur: DCSOPS

Nonconcur:

Recommendation: Implement in POM 98-03.

ACTION: DCSOPS - LEAD; MDW - ASSIST

- Approve**
 Disapprove
 Fwd to CSA/SA for decision
 Defer to POM 00-05
 Study by: _____

Issue: 147

Title: Inter-American Defense Board

Synopsis: Transfer administrative support functions and resources to MDW. Remove HQDA FOA status.

Enablers: None.

Implementation Guidance:

1. HQDA Redesign Working Group submit adjustment to POM 98-03.
2. MDW prepare concept plan, not later than 30 August 1996, for the transfer of administrative support functions and resources. DCSOPS assist.

Issue: 147

Title: Inter-American Defense Board

Synopsis: Transfer administrative support functions and resources to MDW. Remove HQDA FOA status.

NOTE: Requires a ROC change; CMD and UIC are unchanged.

Manpower

Cmd	UIC	MDEP	AMSCO	TYPE	FY97	FY98	FY99	FY00	FY01	FY02	FY03
JA	W1BQAA			MIL	-17	-17	-17	-17	-17	-17	-17
JA	W1BQAA			MIL	+17	+17	+17	+17	+17	+17	+17

TOA (\$ millions)

Cmd	UIC	MDEP	AMSCO	TYPE	FY97	FY98	FY99	FY00	FY01	FY02	FY03
-----	-----	------	-------	------	------	------	------	------	------	------	------

Issue: 148

Title: Joint Mexican US Defense Commission

Proponent: AA/DAS

Sponsor: ASA(MRA)

Source: HQDA Redesign

Implementation Period: POM 98-03

Synopsis: Transfer administrative support functions and resources to MDW. Remove HQDA FOA status.

Resource Implications:

	Savings	Costs	Transfer
Military:	0	0	0
Civilian:	0	0	-1
Dollars:	0	0	-.05M

Army Staff/Command Position:

Concur: DCSOPS

Nonconcur:

Recommendation: Implement in POM 98-03.

ACTION: DCSOPS - LEAD; MDW - ASSIST

Approve
 Disapprove
 Fwd to CSA/SA for decision
 Defer to POM 00-05
 Study by: _____

Issue: 148

Title: Joint Mexican US Defense Commission

Synopsis: Transfer administrative support functions and resources to MDW. Remove HQDA FOA status.

Enablers: None.

Implementation Guidance:

1. HQDA Redesign Working Group submit adjustment to POM 98-03.
2. MDW prepare concept plan, not later than 30 August 1996, for the transfer of administrative support functions and resources. DCSOPS assist.

Issue: 148

Title: Joint Mexican US Defense Commission

Synopsis: Transfer administrative support functions and resources to MDW.
Remove HQDA FOA status.

NOTE: Requires a ROC change; CMD and UIC are unchanged.

Manpower

Cmd	UIC	MDEP	AMSCO	TYPE	FY97	FY98	FY99	FY00	FY01	FY02	FY03
JA	W10ZAA			CIV	-1	-1	-1	-1	-1	-1	-1
JA	W10ZAA			CIV	+1	+1	+1	+1	+1	+1	+1

TOA (\$ millions)

Cmd	UIC	MDEP	AMSCO	TYPE	FY97	FY98	FY99	FY00	FY01	FY02	FY03
JA	W10ZAA			CIV	-0.05M	-0.05M	-0.05M	-0.05M	-0.05M	-0.05M	-0.05M
JA	W10ZAA			CIV	+0.05M	+0.05M	+0.05M	+0.05M	+0.05M	+0.05M	+0.05M

UNCLASSIFIED

OPERATIONS
SUPPORT DIRECTORATE

ZYUW RUEADW7454 3070431

PRIORITY

P 030151Z NOV 94

FM DA WASHINGTON DC//DAC-ZA//

TO USCINCEUR USNMR SHAPE BE//ECCC//
CDRFORSCOM FT MCPHERSON GA//FCCC//
CDRTRADOC FT MONROE VA//ATCG//
CINCUSAREUR HEIDELBERG GE//AEACC//
CINCUSCENT MCDILL AFB FL
USCINCSOC MCDILL AFB FL//SOCC//
CINCUNC SEOUL KDR//CC//
USCINCSO QUARRY HEIGHTS PM//CC//
SUPT USMA WEST POINT NY
CDRUSASOC FT BRAGG NC
CDRUSARPAC FT SHAFTER HI//APCG//
CDRUSASSDC WASHINGTON DC
CDRUSAISC FT HUACHUCA AZ
CDROPTC ALEXANDRIA VA//CSTE-ZA//
CDRMTMC FALLS CHURCH VA
CDRINSCOM FT BELVOIR VA
CDRUSASC FTRUCKER AL

CDRAMC ALEXANDRIA VA//AMCG

CDRUSACE WASHINGTON DC

CDRMDW WASHINGTON DC

CDRUSACIDC WASHINGTON DC

CDRUSARSO FT CLAYTON PM

COMDT USAWC CARISLE BKS PA

INFO DA WASHINGTON DC//DACS-ZB/DACS-ZD/
DACS-SM/SAIG-ZA/SAIS-ZA/DAIM -ZA/
SARD-ZB/DASG-ZA/DALO-ZA/DAPE-ZA/DAMO-ZA/
DAAR-ZA/DACS-ADO/SALL/DAIM-ZA/SAPA-ZA/
NGB-ARZ/SAFM-BU/DAJA-ZA/DACH-ZA/DAMO-FDZ/
DAMO-ZM/DACS-DPZ-A/DACS-LM/DACS-DMZ/DAMH-ZA//

UNCLAS SECTION 01 OF 02

PERSONAL FOR GEN JOULWAN, USCINCEUR; GEN REIMER, CDR FORSCOM; GEN HARTZOG, TRADOC; GEN MADDOX, CINCUSAREUR; GEN PEAY, USCINCENTCOM; GEN DOWNING, USCINCSOC; GEN LUCK, CINCUNC; GEN SALOMON, CDR AMC; GEN MCCAFFREY, USCINCSO; LTG GRAVES, SUPT USMA; LTC WILLIAMS, CDR USACE; LTG SCOTT, CDR USASOC; LTG ORD, CDR USARPAC; LTG GARNER, CDR USASSDC; MG GORDEN, CDR MDW; MG LEFFLER, CDR USAISC; MG BERRY, CDR USACIDC; MG ROSENKRANZ, CDR OPTC; MG CROCKER, CDR USARSO; MG THOMPSON, CDR MTMC; BG THOMAS, CDR USAINSCOM; BG CHILCOAT, COMDT USAWC; BG GARRETT, CDR USASC; INFO FOR GEN TILELLI, LTG DOMINY, SMA KIDD, LTG GRIFFITH, MR BORLAND, LTG OWENS, LTG FORSTER, LTG LANOUE, LTG WILSON, LTG STROUP, LTG BLACKWELL, MG BARATZ, MG RIGBY, MG HARRISON, MG LITTLE, MG MCCLAIN, MG HOWARD, MG D'ARAUJO, MG NARNOTTI, MG SHEA, MG ANDERSON, BG(P) COSTELLO, BG HEEBNER, BG OHLE, BG SHANE, COL (P) MOUNTCASTLE.

FROM GENERAL SULLIVAN

SUBJECT: FORCE XXI BOARD OF DIRECTORS' DECISIONS AND GUIDANCE

1. AS LAST WEEK'S AUSA MEETING FADES FROM OUR SCREENS AND WE CONTEMPLATE OUR DELIBERATIONS DURING THE FORCE XXI BOARD OF DIRECTORS' MEETING, I WANT TO PROVIDE YOU MY GUIDANCE FOR

DA WASH DC

30

ACTION DACS/GEN TILELLI/(1) (M)
INFO SAIS/MR BORLAND/ (1) DACS/LTC DOMINY/ (1)
DACS/SMA KIDD/ (1) DACS/MG RIGBY/ (1)
SARD/LTG FORSTER/(1) DASG/LTG LANOUE/ (1)
DAPE/LTG STROUP/(1) DAMO/LTG BLAKWELL/(1)
DAMI/LTG OWENS/ (1) DALO/LTC WILSON/(1)
SAIG/LTG GRIFFITH/ (1) DAAR/MG BARATZ (1)
SALL/MG HARRISON/ (1) DAIM/MG LITTLE/ (1)
SAPA/MG MCCLAIN/ (1) SAFM/MG HOWARD/ CL)
NGB/MG D'ARAUJO/(1) DAJA/MG NARDOTTI/(1)
DACH/MG SHEA/ (1) DAMO/MG ANDERSON/ (1)
DAMO/BG COSTELLO/ (1) DAC/BG HEEBNER/(1)
DACS/EC OHLE/ (1) DACS/BG SHANE/ (1)
DAMH/COL MOUNTCASTLE/ (1) DACS/GEN SULLIVAN/ (2)
DAMO-ZXG/COL LECUYER/ (1) SCB REVIEW (1)

MCN=94307/32732

TOR=94307/0410Z

TAD=94307/1625Z

CDSC=MAL807

ARMY SECTIONAL MSG

UNCLASSIFIED

PAGE 1 OF 3
03015Z NOV 94
02 SECT MSG

UNCLASSIFIED

OPERATIONS SUPPORT DIRECTORATE

SUSTAINING THE MOMENTUM WE HAVE COLLECTIVELY CREATED SINCE MARCH OF THIS YEAR. GENERAL JACK MERRITT PROBABLY SAID IT BEST AT LUNCH ON THURSDAY WHEN HE REMARKED THAT THE MOST REMARKABLE THING ABOUT THIS YEAR'S AUSA MEETING WAS NOT THAT IT WAS THE LARGEST SHOW EVER BUT RATHER THAT YOU COULD FEEL AND SEE FORCE XXI EVERYWHERE YOU WENT --THAT INDUSTRY HAS CLEARLY LISTENED TO AND BOUGHT OUR MESSAGE AND VISION FOR THE FUTURE AND IN MANY DIFFERENT WAYS IS WORKING TO MOVE FORCE XXI THROUGH MANY CONCEPTUAL STAGES INTO REALITY. I FIRMLY BELIEVE THAT OUR MESSAGE IS CREDIBLE AND IS BEING RECEIVED BY THE BROAD SET OF CONSTITUENT AUDIENCES WHO ATTENDED THIS YEAR'S SHOW: CONGRESS, THE WHITE HOUSE. A SKEPTICAL MEDIA, OSD, AND MOST IMPORTANTLY, EVERY ECHELON OF THE FORCE.

2. MY INTENT IS TO MAKE ALL KEY FIELDING AND SUPPORT DECISIONS FOR THE OPERATING FORCE AND OUR TITLE 10 FUNCTIONS BY THE YEAR 2000, ACCELERATING THOSE DECISIONS WHEN PRACTICABLE. INFORMATION-AGE TECHNOLOGY FOR BATTLE COMMAND, BATTLESPACE, DEPTH AND SIMULTANEOUS ATTACK, EARLY ENTRY, AND COMBAT SERVICE SUPPORT WILL UNDERWRITE OUR CAPABILITIES TO PROJECT AND SUSTAIN THE FORCE, PROJECT THE FORCE, WIN THE INFORMATION WAR, CONDUCT PRECISION STRIKES, AND DOMINATE LAND MANEUVER ACROSS THE CONTINUUM OF MILITARY OPERATIONS IN THE 21ST CENTURY.

3. EACH OF US IS FOCUSED ON STRUCTURING OUR PIECE OF THE FORCE XXI PROCESS TO MANAGE AND CONTAIN RISK WHILE BUILDING MOMENTUM FROM ITERATIVE RATHER THAN SEQUENTIAL PROCESSES. WHILE WE MUST AVOID SLOGANS AND BUMPER STICKERS, WE MUST ALSO ACCEPT THE TENSIONS INVOLVED IN PRUDENT RISK-TAKING. FORCE XXI MUST BE CREDIBLE TO THE ARMY AND TO THOSE WHO WILL PROVIDE RESOURCES

4. THE BOARD OF DIRECTORS' MEETING DISCUSSIONS WERE SPIRITED; YOU WERE ENGAGED AND FOCUSED ON PROVIDING ME WITH INSIGHTS TO DEFINE THE PROCESS AND TIMELINES THAT WILL TAKE AMERICA'S ARMY FROM TODAY TO FORCE XXI. SPECIFICALLY, WE MADE CORPORATE DECISIONS FOR THE FOLLOWING AGENDA ITEMS:

A. JOINT VENTURE (REDESIGN OF THE OPERATING FORCE): THE OPERATING FORCE WILL BE KNOWLEDGE-BASED, MODULAR IN DESIGN, AND TAILORABLE IN CAPABILITY AND HAVE IMPROVED LETHALITY, SURVIVABILITY, AND TEMPO.

1.) SELECTED FORCE CAPABILITY ENHANCEMENTS WHOSE IMPROVEMENTS ARE QUANTIFIABLE WILL FOCUS NEAR-TERM JOINT VENTURE EFFORTS. FORCE XXI DESIGNS FOR THE OPERATING FORCE WILL BE INFORMED BY DOCTRINE, DIGITIZATION, EXPERIMENTATION WITH CURRENTLY FIELDED AND EQUIPPED FORCES, AND OPERATIONAL EXPERIENCES.

2.) FY 96 REDESIGN OF AND EXPERIMENTATION WITH A BRIGADE-SIZED TASK FORCE XXI WILL BE BASED ON: TRADOC PAMPHLET 525-5; THE ARMY'S MODERNIZATION GOALS; ATD'S, ACTD'S, AND AWE'S; EXPERIMENTS PRIOR TO FY 95; TWO BATTALION-LEVEL AWE'S IN FY 95 (FOCUSED DISPATCH AND WARRIOR FOCUS); ALREADY FIELDED INFORMATION INFORMATION-BASED IMPROVEMENTS IN MEDICINE INTELLIGENCE, AIR DEFENCE, AND LOGISTICS; & OPERATIONAL EXPERIENCES. BECAUSE WE MUST USE DIGITIZED DIVISION AND CORPS PLUGS TO EXPERIMENT AT THE BRIGADE LEVEL, THE BRIGADE TASK FORCE XXI AWE WILL PROVIDE INSIGHTS INTO DIVISION AND CORPS OPERATIONAL CONCEPTS AND ORGANIZATIONAL DESIGN. WE PLAN TO DIGITIZE THIS FORCE, ENSURE ADEQUATE TRAINING TIME AND THEN EXERCISE IT AT NTC IN FEBRUARY 1997.

3.) BASED ON OUR WORK AT BRIGADE LEVEL, WE WILL CONDUCT A DIVISION AWE IN THE STOW ENVIRONMENT INCORPORATING LIVE SIMULATION WITH BRIGADE XXI, CONSTRUCTIVE SIMULATION OF THE DIVISION BASE AND CORPS PLUGS IN A "BCTP-LIKE" WARFIGHTER, AND TWO BRIGADES IN VIRTUAL SIMULATION IN THE STOW.

B. ROLLING BASELINE: THE OPTEC CONCEPT FOR A ROLLING BASELINE FOR CROSSWALKING THE ELEMENTS OF EVALUATION WITH OUTPUTS FROM OUR ATD'S ACTD'S & AWE'S IS APPROVED FOR FURTHER DEVELOPMENT AND PRESENTATION FOR APPROVAL AT OUR SPRING BOARD OF DIRECTORS' MEETING AS THE ARMY'S ANALYTICAL BASELINE FOR FORCE XXI AND LIFE-CYCLE ANALYTICAL SUPPORT FOR OUR AWE'S

C. THE ADO CAMPAIGN PLAN AND JOINT PLAN WITH CECOM TO TRANSFORM

UNCLASSIFIED

OPERATIONS SUPPORT DIRECTORATE

ATCCS INTO ABCS IS APPROVED FOR PLANNING AND PROGRAMMING.

D. THE ADO-SARDA-DCSOPS CONCEPT FOR SYNCHRONIZING ATD'S ACTD'S, AND AWE'S TO FOCUS ON FORCE XXI INSIGHTS IS APPROVED FOR FURTHER DEVELOPMENT AND PRESENTATION FOR RATIFICATION AS AN INVESTMENT STRATEGY AT THE FY 95 SPRING BOARD OF DIRECTORS' MEETING.

E. TECHNOLOGY INSERTION: ALL COMMUNICATIONS AND DIGITAL TECHNOLOGY CANDIDATES FOR INSERTION INTO THE EXFOR WILL BE CERTIFIED BY THE CECOM DIGITAL INTEGRATION LAB (DIL) AT FT MONMOUTH PRIOR TO FIELDING AND TRAINING.

5. THE SYNTHETIC THEATER OF WAR (STOW) IS AN ESSENTIAL INGREDIENT OF OUR QUEST TO FIELD FORCE XXI. THE LAM STOW EXPERIMENT AT AUSA CLEARLY DEMONSTRATED THAT WE ARE ONLY BEGINNING TO UNDERSTAND THE POTENTIAL OF THIS GREAT TOOL IN ALL OF ITS MANY RAMIFICATIONS FROM TRAINING TO LEADER DEVELOPMENT TO COMBAT DEVELOPMENT ACROSS THE DOTMLS. I HAVE TASKED THE DCSOPS TO REVIEW OUR STRATEGY TO DEVELOP AND EXPLOIT A ROBUST, SEAMLESS, SYNTHETIC ARMY-WIDE CAPABILITY FIELDIED PRIOR TO THE DIVISION XXI AWE AND INFORM YOU OF THE NEXT STEPS BY SEPARATE MESSAGE.

6. WE HAVE EVERY REASON TO CONGRATULATE OURSELVES ON THE RAPID PROGRESS WE HAVE MADE TO DATE. WE HAVE TAKEN A VERY DIVERSE SET OF TECHNOLOGIES, EXPERIENCES, EXPERIMENTS WITH THE OPERATING FORCE AND OUR TITLE 10 RESPONSIBILITIES, AND EXPECTATIONS FOR THE FUTURE AND BEGUN THE DIFFICULT PROCESS OF FOCUSING THEM THROUGH THE LENSES OF
BT

UNCLAS FINAL SECTION OF O2

OUR TITLE 10 RESPONSIBILITIES, AND EXPECTATIONS FOR THE FUTURE AND BEGUN THE DIFFICULT PROCESS OF FOCUSING THEM THROUGH THE LENSES OF SCARCE RESOURCES AND AN INCREASINGLY DANGEROUS GEOSTRATEGIC ENVIRONMENT TO BEGIN TO MAKE FORCE XXI A REALITY -- NOT JUST FOR THE ARMY, BUT FOR THE ROLES AND MISSIONS DEBATE, THE EXPANDED JROC PROCESS, AND ULTIMATELY FOR THE GOOD OF THE NATION. THE DECISIONS FOR THE JOINT VENTURE EFFORT TO REDESIGN THE OPERATING FORCE COUPLED WITH THE GREAT COMPLEXITIES ASSOCIATED WITH REDESIGN OF THE INSTITUTIONAL ARMY AND THE ADO CAMPAIGN PLAN ARE DESIGNED TO CONTAIN RISK AND BUILD MOMENTUM FROM ITERATIVE PROCESSES. WE HAVE SET THE BASELINE FOR JOINT VENTURE AND THE ADO

7. THE DRAFT CAMPAIGN PLAN TO REDESIGN THE INSTITUTIONAL ARMY WILL BE REVIEWED BY THE VICE CHIEF OF STAFF. MY INTENT IS TO GET WELL BEYOND OUR EFFORTS TO DATE BY FOCUSING OUR INTELLECTUAL ENERGIES ON RE-ENGINEERING DEPARTMENTAL PROCESSES AND REDESIGNING ORGANIZATIONAL STRUCTURE TO SUPPORT THE TITLE 10 CORE COMPETENCIES REQUIRED FOR AMERICA'S ARMY IN THE 21ST CENTURY. WE WILL CONFIRM THE ANALYTIC BASELINE OF THE TITLE 10 AXIS NLT 30 NOVEMBER.

8. WE ARE NOT RESTING ON OUR SUCCESS IN TRANSFORMING OURSELVES FROM A COLD-WAR TO A FORCE PROJECTION ARMY IN FOUR SHORT YEARS. WE ARE MOVING OUT TO BECOME A KNOWLEDGE AND CAPABILITIES-BASED ARMY, TRUSTING IN WHAT WE BELIEVE AS A VALUES-BASED INSTITUTION. SECRETARY WEST'S CHALLENGE TO IMAGINE A BETTER ARMY THAN THE WORLD CLASS ARMY WE HAVE TODAY WILL GUIDE OUR EFFORTS. THAT INJUNCTION REFLECTS A CHANGE THAT WE HAVE ADOPTED WITH THE BOARD OF DIRECTORS FORMAT FOR DECISION-MAKING -- A FORMAT WHICH FORCES US COLLECTIVELY TO VIEW DECISION-MAKING IN THE CONTEXT OF THE ARMY AS AN INSTITUTION RATHER THAN IN TERMS OF EACH OF OUR NARROWER COMMAND RESPONSIBILITIES.

I AM CONFIDENT THAT WE WILL SUCCEED WITH FORCE XXI BEYOND ANY OF OUR WILDEST EXPECTATIONS AND IN SO DOING WILL MEET OUR COMMAND AND MORAL RESPONSIBILITIES FOR THE INFORMED STEWARDSHIP OF AMERICA'S MOST PRECIOUS ASSET WHICH HAS BEEN ENTRUSTED TO US -- HER SONS AND DAUGHTERS -- NOT FOR OURSELVES, BUT FOR OUR COUNTRY.

9. AMERICA'S ARMY . . . INTO THE 21ST CENTURY. SULLIVAN BT

REDESIGN OF THE INSTITUTIONAL ARMY

***BOARD OF DIRECTORS
INSTITUTIONAL AXIS UPDATE***

11 July 1995

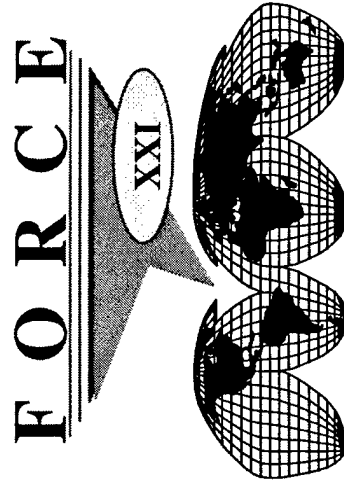

AGENDA

- **Institutional Army - TDA Axis highlights**
- **Army Core Capabilities - update**
- **DA PAM 100-XX - an emerging concept**
- **TDA Axis - the way ahead**

INSTITUTIONAL ARMY REDESIGN CHARTER

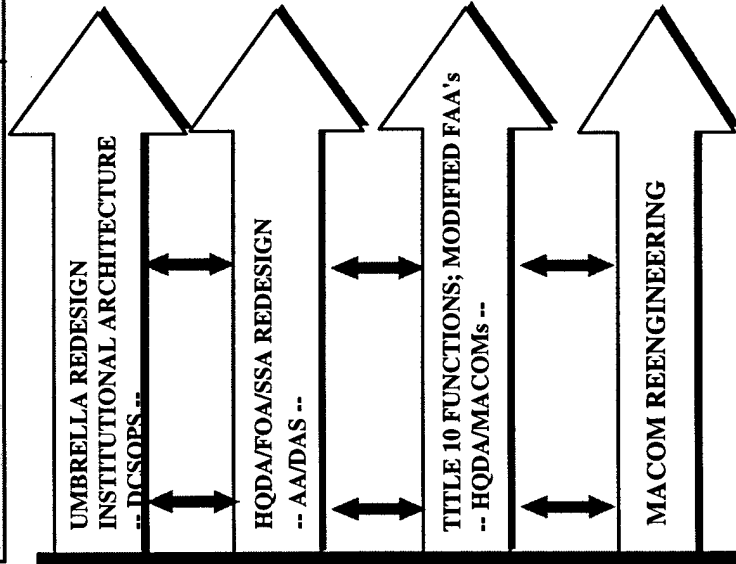
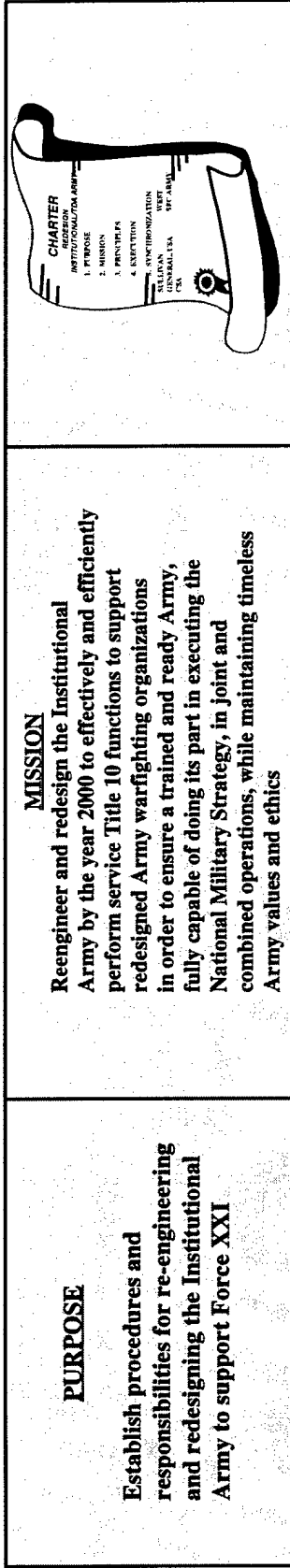

INTEGRATION BY DC SOPS / A S A (M&RA)

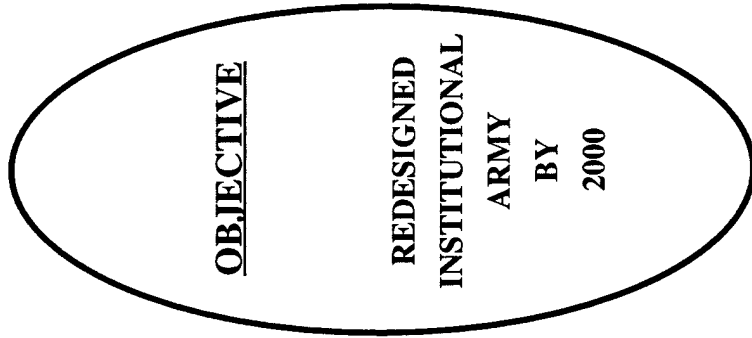

- TITLE 10 FUNCTIONS**
- MACOM PROPONENTS & HQDA SPONSORS -- PARTNERSHIP --
- FORCE**
- PHASED CAMPAIGN**
- I BASELINE ORGANIZATION POM 98-03
 - II REVISED ORGANIZATION BRIGADE XXI POM 00-05
 - III FINAL ORGANIZATION DIVISION XXI POM 02-07

LD

CORE TO THE ARMY



THE ARMY

- Prompt and Sustained Operations on Land

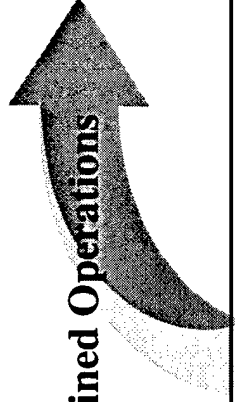

COMPETENCY

CAPABILITY

- Compel
- Defer
- Reassure
- Support

OPERATING FORCES

- Decisive Victory, as the Land Component of the Combatant Commander's Joint/Multinational Force

- Dominate Maneuver
- Conduct Precision Strikes
- Win the Information War
- Protect the Force
- Project and Sustain

INSTITUTIONAL ARMY

- Organize, Train, Equip, Provide and Sustain the Land Component of the Combatant Commander's Joint/Multinational Force
- Direct, Acquire and Resource the Force
- Develop the Force
- Generate and Project the Force
- Sustain the Force

FRAMEWORK FOR REDESIGNING THE INSTITUTIONAL ARMY

Core Capabilities

1. Direct, Acquire and Resource the Force
2. Develop the Force
3. Generate and Project the Force
4. Sustain the Force

Core Processes

1. Plan, Provide Direction; Obtain & Allocate Resources
2. Manage Information
3. Develop Doctrine
4. Develop Requirements
5. Acquire & Sustain People
6. Identify & Develop Leaders
7. Tailor, Mobilize & Project Land Power
8. Support Organizational Training
9. Acquire, Maintain & Sustain Equipments
10. Maintain & Sustain Land Operations
11. Acquire and Sustain Facilities
12. Manage Installations

Army Imperatives

1. Quality People
2. Solid Doctrine
3. Realistic Training
4. Competent Leaders
5. Appropriate Force Mix
6. Continuous Modernization

DA Pam
100-XX

OBJECTIVE
TRAINED, READY,
DEPLOYABLE AND
SUSTAINABLE ARMY

Army Leadership Guidance

- Reengineer Departmental Processes
 - Redesign Organizational Structure
- TO
- Support the Title 10 Core Competencies Required for America's Army in the 21st Century

Institutional Army Core Competency

Organize, Train, Equip, Provide and Sustain the Land Component of the Combatant Commander's Joint/Multinational Force.

Army Vision

America's Army is a Total Force, trained, and ready to fight, serving the Nation at home and abroad . . . a strategic force capable of decisive victory.

Army's Core Competency

Conduct Prompt and Sustained Operations On Land

DA PAM 100-XX

DA Pam 100-XX provides a conceptual framework for the evolutionary design of the Institutional Army to support the Operational Force of the early twenty-first century.

<p>TC Pam 525-5</p> <p>“A concept for the evolution of full-dimensional operations for the Strategic Army of the early twenty-first century”</p> <p>“TC Pam 525-5 represents the baseline in the formulation of more definitive follow-on concepts. . . is not doctrine, rather a document of ideas . . . expressed in a coherent concept lead{ing} the experiments and discovery of needed change”</p>	<p>DA Pam 100-XX</p> <p>“A concept for the evolutionary design of the Institutional Army to support the Operational Force of the early twenty-first century”</p> <p>“DA Pam 100-XX represents a compendium of ideas rooted in a concept, in the information age, of a coherent interface between the supported and supporting, and a subsequent body of thought, or doctrine, common to both...”</p>
--	---

DA Pam 100-XX:

- Acknowledges the strategic backdrop and the future environment.
- Defines the institution’s core capabilities and related processes.
- Postulates institutional design principles and an organizational model of a minimum of three multifunctional major commands in the future.
- Proposes a model for institutional support of two MRCs.
- Provides rationale for eliminating uni-functional MACOMs and MACOM-like FOAs/SSAs.
- Discusses each Institutional Army core process in the context of the 21st Century environment.

FAAS & MACOM RE-ENGINEERING

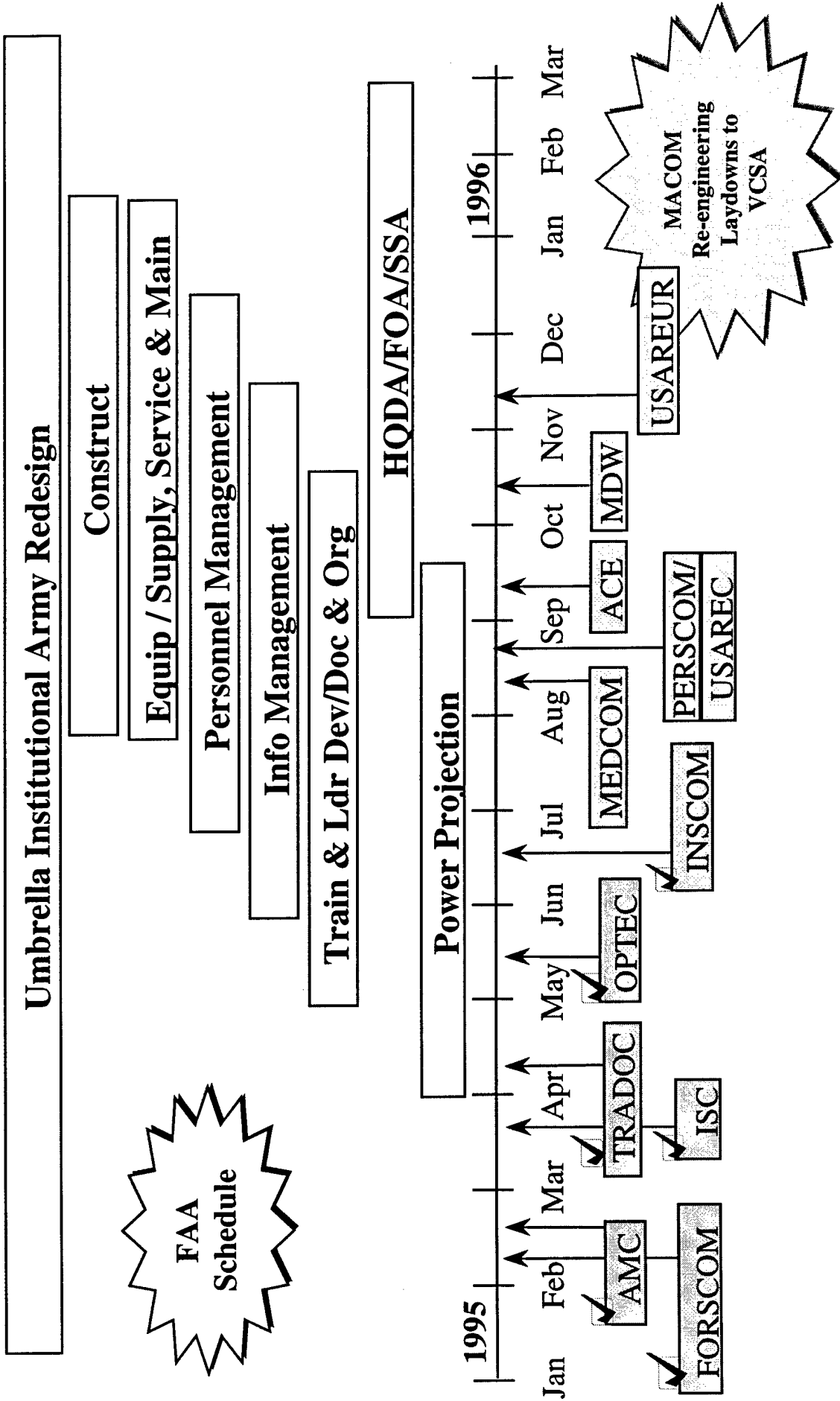

SUMMARY

Charter Signed, 13 Jan 95				
Board of Directors, 1 Mar 95				
Campaign Plan Signed, 21 Mar 95				
Reengineering Briefs to VCSA				
7 Feb 95	✓	FORSCOM	25 Aug 95	PERSCOM/USAREC
27 Feb 95	✓	AMC	8 Sep 95	USACE
23 Mar 95	✓	ISC	11 Oct 95	MDW
10 Apr 95	✓	TRADOC	15 Nov 95	USAREUR
8 May 95	✓	OPTEC	TBD	MEDCOM
28 Jun 95	✓	INSCOM		
Functional Area Assessments to VCSA				
Power Projection (FORSCOM/MTMC)	18 Sep 95	Construct (USACE)	15 Jan 96	
Training/Ldr Dev (TRADOC)	13 Oct 95	Equip (AMC)	26 Jan 96	
Doctrine/Organize (TRADOC)	TBD Oct 95	Supply/Svc/Maintain (AMC)	TBD Jan 96	
Info Mgmt (DISC4)	20 Nov 95	HQDA/FOA/SSA (AA/DAS)	23 Feb 96	
Personnel (DCSPER)	22 Dec 95	Umbrella (DCSOPS)	25 Mar 96	

Institutional Army Core Competency, Capabilities, and Processes

Now Updating Campaign Plan

Reengineering briefs set the stage for beginning the FAAs

FAAs look at the Processes in 21st Century view
DA PAM 100-XX (draft)

GOSC reviews FAA before it goes to the VCSA

FAA recommendations are approved by the BOD and entered into POM 98-03.

BACK UP SLIDES

EMERGING INSIGHTS

- **Establish a National Provider for World-Wide Supply and Maintenance above the DS Level**
 - AMC operates all activities, down to DOL level (and possibly state NG activities), closing redundant and inefficient operations.
 - TOE impact: all GS supply and maintenance units eliminated.
- **Combine all Testing in a Single Process**
 - Eliminate OPTEC; operational and developmental testing done by TECOM (TEXCOM eliminated).
 - OEC part of OPTEC (evaluators) remain.
- **Incorporate Information Management in Command**
 - Disestablish ISC - Bdes to Army components/FORSCOM, developmental mission to CECOM.
 - DISC4 split between SARDA and AMC.
- **Replace CBRS with Battle labs, LAM, and Experiments**
 - Single combat development agency combines research, development and engineering for AMC (RDECs, ARL) with TRADOC combat developers.
 - Acquisition support provided by the new agency.
- **Link Mobilization, Tailoring and Deploying Activities in a Single Process under FORSCOM**
 - MTMC to FORSCOM as deployment MSC augmented with FORSCOM personnel now working the process.
- **Consolidate Real Property, Utilities and Environmental Activities into a Single Facilities Sustainment Process under COE, Executed through Existing Engineer Districts**
 - Eliminate DPW duplication and reduce MACOM staffs.
 - Contract out/credit card maintenance and repair.

CROSSWALK

(Core Processes & FAA)

CORE CAPABILITIES

Develop the Force

Generate and Project
the Force

Sustain the Force

Direct, Acquire &
Resource the Force

CORE PROCESSES

Develop Doctrine

Develop Requirements

Acquire & Sustain People

Identify & Develop Leaders

Tailor, Mobilize & Project Land Power

Support Organizational Training

Manage Installations

Acquire & Sustain Facilities

Maintain & Sustain Land Operations

Acquire, Maintain & Sustain Equipment

Plan, Provide Direction; Obtain & Allocate Resources

Manage Information



FAA

Doctrine/Organize
Doctrine/Organize
Pers Mgmt/Recruit
Train/Ldr Devel

Power Projection
Not in Phase 1 (FORSCOM)

Construct (Facilities Only)
Construct
Equip/Supply/Svc/Maintain
Equip/Supply/Svc/Maintain

HQDA/FOA/SSA
Information Management

CORM and CORE COMPETENCIES

Core Competencies are the set of specific capabilities or activities fundamental to a Service or agency role. They define the Service's or agency's essential contributions to the overall effectiveness of DoD and its unified commands.

CORM View	Operational						Institutional			Notes	
	Army Core Capabilities	Dominant Maneuvers	Precision Strike	Win Info War	Protect the Force	Protect the Force	Develop Forces	Generate & Project Forces	Sustain Forces		Direct, Acquire & Resource Forces
Army											<ul style="list-style-type: none"> Precision Strike is an <i>implied</i> competency related to Army/CORM competencies. It is an <i>explicit</i> (deep attack) Air Force competency. Army's justification, via the JROC et al, to support "precision strike" will be "relative" to its other competencies. Competency for Theater Missile Defense is not aligned with a particular service. Win the Information War is not explicitly addressed in any service competency OOTW not addressed
Mobile Armored Warfare	>										
Airborne Operations	>										
Light Infantry Operations	>										
Sustained Land Operations	>										
Ground Based Area Air Defense	>										
Heavy Engineering											
Supplemental Log Spt											
Air Force											
Air Superiority											
Global Strike/Deep Attack											
Air Mobility											
Navy											
Carrier-Based Air and Amphibious Power Projection			X								
Sea-Based Air and Missile Defense											
Anti-Submarine Warfare											
Marine Corps											
Amphibious Operations											
Over-the-Beach Forced Entry											
Maritime Pre-Positioning										X	

CORE TO THE INSTITUTION

“Process Packages”

- ***Direct, Acquire and Resource***
 - Plan, Provide Direction; Obtain and Allocate Resources
 - Manage Information

- ***Develop the Force***
 - Develop Doctrine
 - Develop Requirements
 - Acquire and Sustain People
 - Identify and Develop Leaders

- ***Generate and Project the Force***
 - Tailor, Mobilize and Project Land Power
 - Support Organizational Training
- ***Sustain the Force***
 - Acquire, Maintain and Sustain Equipment
 - Maintain and Sustain Land Operations
 - Acquire and Sustain Facilities
 - Manage Installations

EFFECT OF HQDA DIVESTITURE

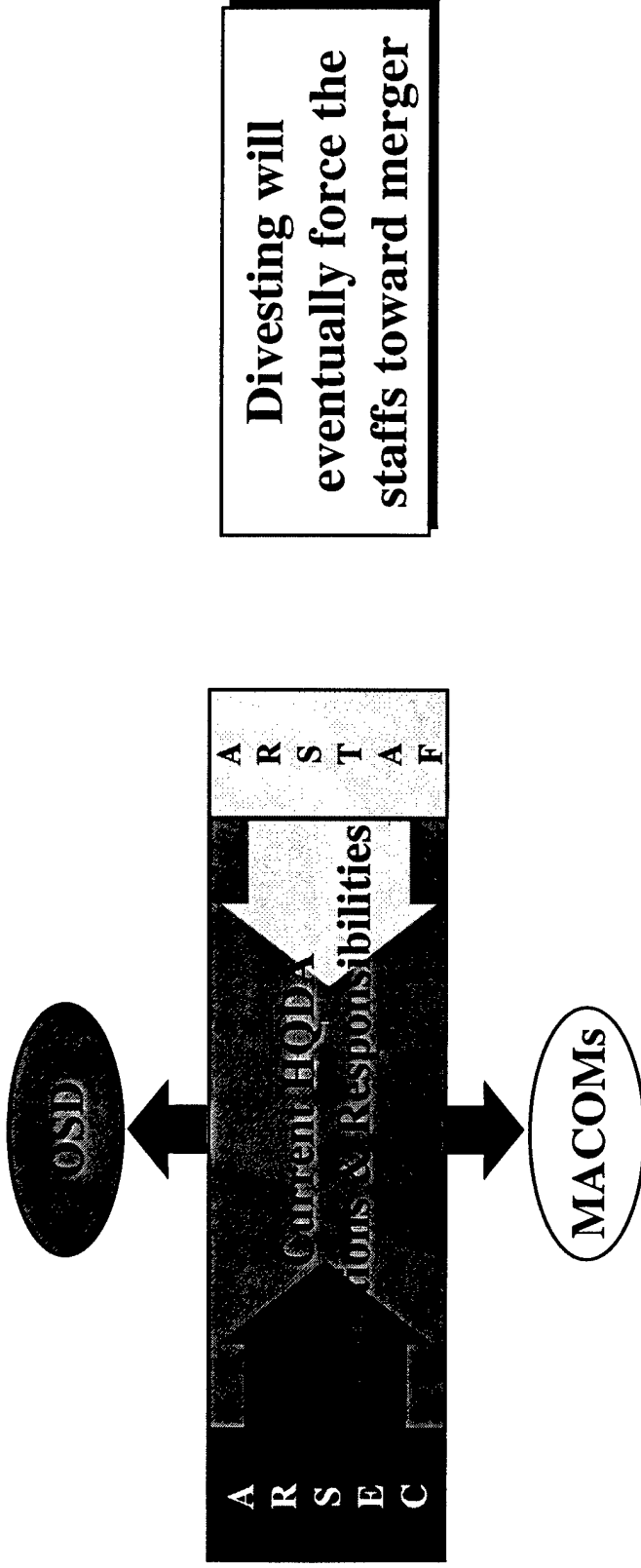

- **Driven to Divest Up or Down, Privatize**
 - By resources
 - By law, NPR
 - By roles and missions
- **TDA Redesign Axis Moves toward an Army Vision of the Future**
 - To accommodate the drivers
 - To be proactive rather than reactive
 - To be long range focused
 - Maintain SA/CSA perspective

INSTITUTIONAL ARMY REDESIGN AXIS

CAMPAIGN PLAN

BASELINE BRIGADE **BASELINE DIVISION** **BASELINE CORPS**

TAA-98-03

TAA 00-05

TAA 02-07

POM '03

POM '05

POM '07

FAA's
(Top Eight)

MACOM
Reengineering

INSTITUTIONAL
ARCHITECTURE
DEVELOPMENT

BRIGADE XXI

DIVISION XXI

BASELINE
ORGANIZATION

FAA's
As Required

REVISED
ORGANIZATION

FINAL
ORGANIZATION

BRAC

FAA's
As Required

PHASE I

PHASE II

PHASE III

Roles & Missions

DPG, NPR, Fiscal

Guidance, Info Tech, Etc

REDESIGNED INSTITUTIONAL ARMY

TIME

DA PAM 100-XX

The Schedule

OUTLINE OF DA PAM 100-XX	TIMETABLE FOR APPROVAL OF DA PAM 100-XX
• Executive Summary	30 JUN 95 Distribute Draft
• Chapter 1 The Future National Security Environment	11 JUL 95 Brief BoD
• Chapter 2 Force XXI Operations	17 JUL 95 1st Draft Comments Due
• Chapter 3 Redesigning the Institutional Army	16 AUG 95 Distribute Final Draft
• Chapter 4 Direct, Acquire and Resource the Force	13 SEP 95 Final Draft Comments Due
• Chapter 5 Develop the Force	15 NOV 95 Publish DA PAM 100-XX
• Chapter 6 Generate and Project the Force	
• Chapter 7 Sustain the Force	
• Chapter 8 Conclusions and Implications	

UMBRELLA GROUP TASKS

- **Independently Develop Institutional Army Design -- 21st Century**
- **Coordinate FAA Process and Re-engineering Briefings (Institutional Army GOSC)**
 - **Format and Schedules**
 - **Provide Other Ideas and Issues**
- **Facilitate Sharing of Ideas**
- **Coordinate and Synchronize Efforts With Joint Venture and ADO**
- **Develop Capstone Manual Force XXI Institutional Army (DA PAM 100-XX)**

FUNCTIONAL AREA ASSESSMENTS

<u>FUNCTION</u>	<u>PROONENT</u>	<u>SPONSOR</u>	<u>START NLT</u>	<u>COMPLETE</u>
MOBILIZE & DEMOBILIZE	FORSCOM	ASA(MRA)/ODCSOPS	APR 95	SEP 95
DEPLOY/REDEPLOY	FORSCOM/MTMC	ASA(ILE)/ODCSOPS		
DOCTRINE & ORGANIZE	TRADOC	ASA(MRA)/ODCSOPS		
TRAIN & LEADER DEVELOPMENT	TRADOC	ASA(MRA)/ODCSOPS	MAY 95	OCT 95
INFORMATION MANAGEMENT	DISC4	DISC4/ODCSOPS	JUN 95	NOV 95
RECRUIT	ODCSPER	ASA(MRA)/ODCSPER		
PERSONNEL MANAGEMENT	ODCSPER	ASA(MRA)/ODCSPER	JUL 95	DEC 95
CONSTRUCT	USACE	ASA(ILE)/ACSIM	AUG 95	JAN 96
EQUIP	AMC	ASA(RDA)/DUSA(OR)/ODCSOPS	AUG 95	JAN 96
SUPPLY, SERVICE & MAINTAIN	AMC	ASA(ILE)/ODCSLOG		
HODA/FOA/SSA	DAS/AA	ASA(MRA)	SEP 95	FEB 96
UMBRELLA REDESIGN	ODCSOPS	ASA(MRA)/DCSOPS	NOW	MAR 96
HEALTH	MEDCOM	ASA(MRA)/OTSG		
INTELLIGENCE	INSCOM/USAIC&FH	OCG/DCSINT		
FINANCE	TRADOC	ASA(FM)		
SECURITY/LAW ENFORCEMENT	TRADOC	ASA(MRA)/ODCSOPS		
CRIMINAL INVESTIGATION	CIDC	ASA(MRA)/ODCSOPS		
INSTALLATION MGMT (BASOPS)	FORSCOM	ASA(ILE)/ASA(MRA)/ACSIM		
JOINT/DEFENSE	ODCSOPS	ASA(MRA)/ODCSOPS		

P H 2
A OR
S 3
E



INSTITUTIONAL ARMY AXIS TIMELINE

PHASE I

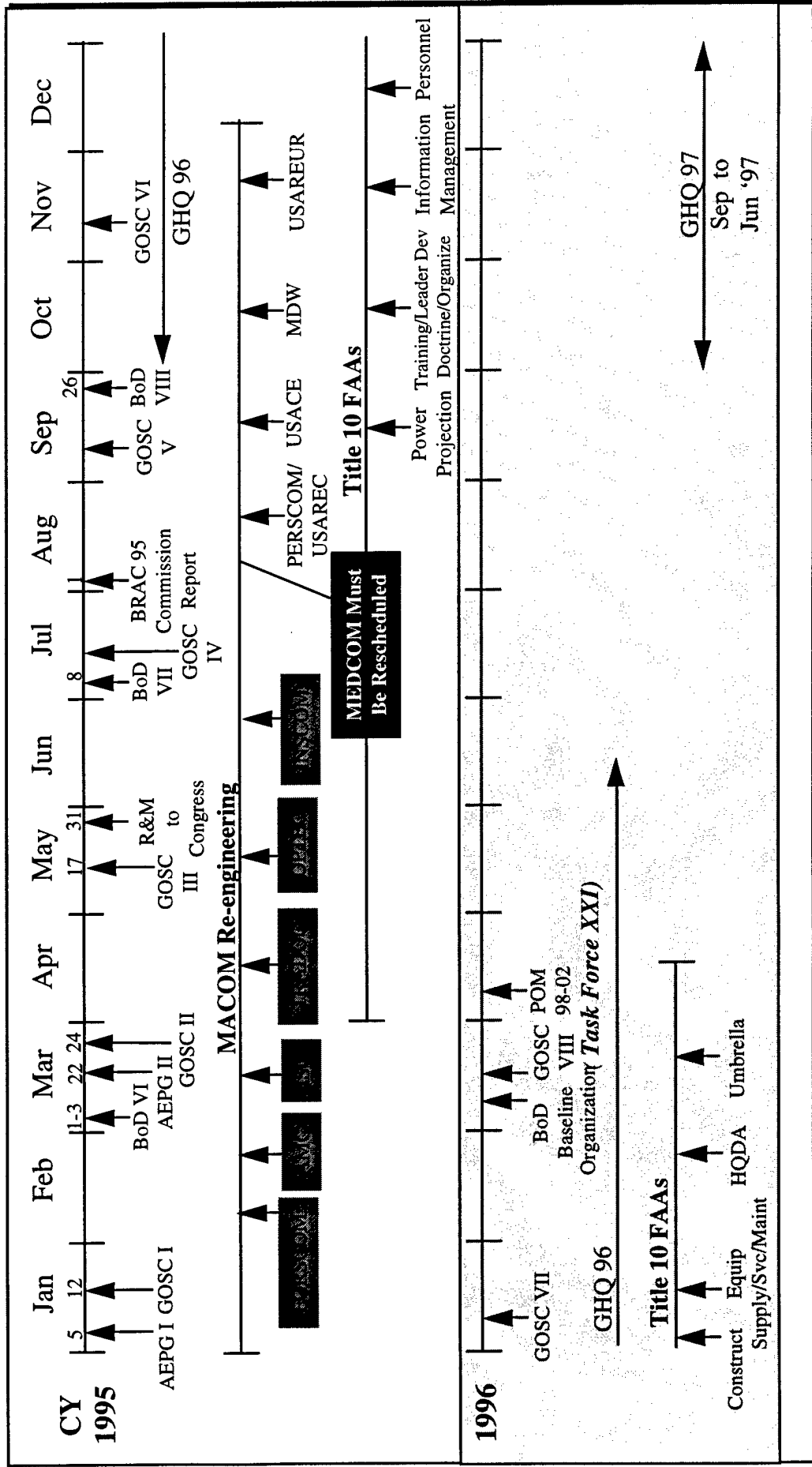

NO. 7

HEADQUARTERS
DEPARTMENT OF THE ARMY
WASHINGTON, DC 1 September 1996

UNIT REDESIGNATION/REASSIGNMENT OF THE
UNITED STATES ARMY INFORMATION SYSTEMS COMMAND

1. Effective 16 September 1996, the UNITED STATES ARMY INFORMATION SYTEMS COMMAND (UIC: W4NHAA), Fort Huachuca, AZ, is redesignated as the UNITED STATES ARMY SIGNAL COMMAND. The UNITED STATES ARMY SIGNAL COMMAND will retain the UIC, missions, personnel, equipment and resources currently assigned to the UNITED STATES ARMY INFORMATION SYSTEMS COMMAND.
2. Effective 1 October 1996, the UNITED STATES ARMY SIGNAL COMMAND (UIC: W4NHAA), Fort Huachuca, AZ; ;less those missions, personnel, equipment and resources associated with publications & printing and records management, is assigned under the command and control of the UNITED STATES ARMY FORCES COMMAND, Fort McPherson, GA. The Commanding General, UNITED STATES ARMY SIGNAL COMMAND, shall also serve as the G-6, UNITED STATES ARMY FORCES COMMAND.
3. Effective 1 October 1996, the UNITED STATES ARMY PUBLICATIONS and PRINTING COMMAND (USAPPC) (UIC: W4XGAA), Alexandria, VA including currently assigned UIC, missions, personnel, equipment and resources is transferred from the UNITED STATES ARMY SIGNAL COMMAND, Fort Huachuca, AZ, to HEADQUARTERS, DEPARTMENT OF THE ARMY, Pentagon, Washington, DC., as a field operating agency of the Office of the Director of Information Systems for Command, Control, Communications and Computers under command code SB.
4. Effective 1 October 1996, records management missions and publications & printing policy missions and personnel currently assigned to HEADQUARTERS, UNITED STATES ARMY SIGNAL COMMAND (UIC: W4NHAA), Fort Huachuca, AZ, are transferred to USAPPC (UIC: W4XGAA), Pentagon, Washington, DC.
5. Effective 1 October 1996, records management missions and personnel associated with the Duplicate Emergency Files Program and currently assigned to the 1111th UNITED STATES ARMY SIGNAL BATTALION (UIC: W65TAA), Fort Ritchie, MD, are transferred from the UNITED STATES ARMY SIGNAL COMMAND, Fort Huachuca, AZ, to USAFFC (UIC: W4XGAA), Pentagon, Washington, DC.
6. Effective 1 October 1996, the DOCUMENT IMAGE SUPPORT DIRECTORATE, UNITED STATES ARMY INFORMATION SYSTEMS SOFTWARE CENTER (UIC: W4FHAA), Ft. Belvoir, VA, including currently assigned missions, personnel, equipment and resources, is transferred from the UNITED STATES ARMY SIGNAL COMMAND, Ft. Huachuca, AZ, to USAPPC (UIC: W4XGAA), Pentagon, Washington, DC.

GO 7

(SAIS-PPP)

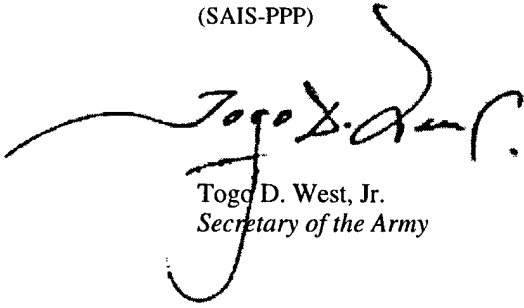
A handwritten signature in black ink, appearing to read "Togo D. West, Jr.", with a large, sweeping flourish extending to the left.

Togo D. West, Jr.
Secretary of the Army

DISTRIBUTION:

Active Army, Army National Guard, and U.S. Army Reserve: To be distributed in accordance with initial distribution number (IDN) 040087, requirements for Department of the Army General Orders.

GENERAL ORDER }
NO. 8 }

HEADQUARTERS
DEPARTMENT OF THE ARMY
WASHINGTON, DC 1 September 1996

ACTIVATION OF THE HEADQUARTERS AND HEADQUARTERS
COMPANY, 9TH ARMY SIGNAL COMMAND

1. Effective 16 September 1997, the UNITED STATES ARMY SIGNAL COMMAND (UIC: W4NHAA), Fort Huachuca, AZ is discontinued. The missions, personnel, and equipment currently assigned to the UNITED STATES ARMY SIGNAL COMMAND are reassigned to the HEADQUARTERS and HEADQUARTERS COMPANY, 9TH ARMY SIGNAL COMMAND (UIC: WCD2AA), Fort Huachuca, AZ.

2. Effective 16 September 1997, the HEADQUARTERS AND HEADQUARTERS COMPANY, 9TH ARMY SIGNAL COMMAND (UIC: WCD2AA), Fort Huachuca, AZ, is activated. The HEADQUARTERS and HEADQUARTERS COMPANY, 9TH ARMY SIGNAL COMMAND is assigned under the command and control of the UNITED STATES ARMY FORCES COMMAND (UIC: W8YBAA), Fort McPherson, GA

(SAIS-PPP)

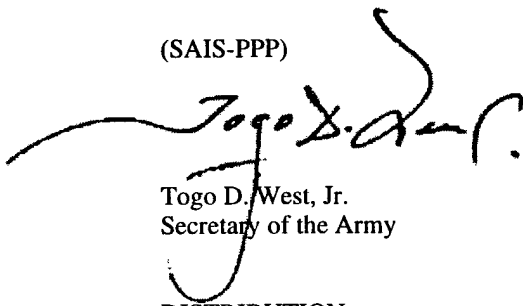

Togo D. West, Jr.
Secretary of the Army

DISTRIBUTION:

Active Army, Army National Guard, and U.S. Army Reserve: To be distributed in accordance with initial distribution number (IDN) 040087, requirements for Department of the Army General Orders.