

INTERNET DOCUMENT INFORMATION FORM

A . Report Title: Report of the NIH PANEL TO Define Principles of Therapy of HIV Infection and Guidelines for the Use of Antiretroviral Agents in HIV-Infected Adults and Adolescents

B. DATE Report Downloaded From the Internet: 17 Jun 98

C. Report's Point of Contact: (Name, Organization, Address, Office Symbol, & Ph #: U.S. Department of Health and Human Services

D. Currently Applicable Classification Level: Unclassified

E. Distribution Statement A: Approved for Public Release

F. The foregoing information was compiled and provided by: DTIC-OCA, Initials: __PM__ Preparation Date: 17 Jun 98

The foregoing information should exactly correspond to the Title, Report Number, and the Date on the accompanying report document. If there are mismatches, or other questions, contact the above OCA Representative for resolution.

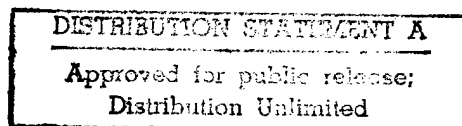

19980618 128



April 24, 1998 / Vol. 47 / No. RR-5

MMWRTM

*Recommendations
and
Reports*

MORBIDITY AND MORTALITY WEEKLY REPORT

**Report of the NIH Panel to Define
Principles of Therapy of HIV Infection
and
Guidelines for the Use of Antiretroviral
Agents in HIV-Infected Adults
and Adolescents**

U.S. DEPARTMENT OF HEALTH AND HUMAN SERVICES
Centers for Disease Control and Prevention (CDC)
Atlanta, Georgia 30333



DTIC QUALITY INSPECTED 1

The *MMWR* series of publications is published by the Epidemiology Program Office, Centers for Disease Control and Prevention (CDC), U.S. Department of Health and Human Services, Atlanta, GA 30333.

SUGGESTED CITATION

Centers for Disease Control and Prevention. Report of the NIH Panel to Define Principles of Therapy of HIV Infection and Guidelines for the Use of Antiretroviral Agents in HIV-Infected Adults and Adolescents. *MMWR* 1998;47(No. RR-5):[Inclusive page numbers].

Centers for Disease Control and Prevention Claire V. Broome, M.D.
Acting Director

The production of this report as an *MMWR* serial publication was coordinated in:

Epidemiology Program Office.....Barbara R. Holloway, M.P.H.
Acting Director

Andrew G. Dean, M.D., M.P.H.
Acting Editor, MMWR Series

Office of Scientific and Health Communications (proposed)

Recommendations and Reports..... Suzanne M. Hewitt, M.P.A.
Managing Editor

Nadine W. Martin
Patricia A. McGee
Project Editors

Peter M. Jenkins
Visual Information Specialist

Contents

Report of the NIH Panel To Define Principles of Therapy of HIV Infection	1
Introduction.....	1
Scientific Principles.....	4
Scientific Background.....	17
References.....	27
Guidelines for the Use of Antiretroviral Agents in HIV-Infected Adults and Adolescents	43
Introduction.....	44
Use of Testing for Plasma HIV RNA Levels and CD4+ T Cell Count in Guiding Decisions for Therapy	45
Established HIV Infection	47
Interruption of Antiretroviral Therapy.....	52
Changing a Failing Regimen.....	52
Acute HIV Infection	56
Considerations for Antiretroviral Therapy in the HIV-Infected Adolescent	58
Considerations for Antiretroviral Therapy in the Pregnant HIV-Infected Woman	59
Conclusion.....	62
References.....	63

Use of trade names and commercial sources is for identification only and does not imply endorsement by the U.S. Department of Health and Human Services.

Copies can be purchased from Superintendent of Documents, U.S. Government Printing Office, Washington, DC 20402-9325. Telephone: (202) 512-1800.

Preface

The past 2 years have witnessed remarkable advances in the development of antiretroviral therapy (ART) for human immunodeficiency virus (HIV) infection, as well as measurement of HIV plasma RNA (viral load) to guide the use of antiretroviral drugs. The use of ART, in conjunction with the prevention of specific HIV-related opportunistic infections (OIs), has been associated with dramatic decreases in the incidence of OIs, hospitalizations, and deaths among HIV-infected persons.

Advances in this field have been so rapid, however, that keeping up with them has posed a formidable challenge to health-care providers and to patients, as well as to institutions charged with the responsibility of paying for these therapies. Thus, the Office of AIDS Research, the National Institutes of Health, and the Department of Health and Human Services, in collaboration with the Henry J. Kaiser Foundation, have assumed a leadership role in formulating the scientific principles (NIH Panel) and developing the guidelines (DHHS/Kaiser Panel) for the use of antiretroviral drugs that are presented in this report. CDC staff participated in these efforts, and CDC and *MMWR* are pleased to be able to provide this information as a service to its readers.

This report is targeted primarily to providers who care for HIV-infected persons, but it also is intended for patients, payors, pharmacists, and public health officials. The report comprises two articles. The first article, *Report of the NIH Panel To Define Principles of Therapy of HIV Infection*, provides the basis for the use of antiretroviral drugs, and the second article, *Guidelines for the Use of Antiretroviral Agents in HIV-Infected Adults and Adolescents*, provides specific recommendations regarding when to start, how to monitor, and when to change therapy, as well as specific combinations of drugs that should be considered. Both articles provide cross-references to each other so readers can locate related information. Tables and figures are included in the Appendices section that follows each article. Although the principles are unlikely to change in the near future, the guidelines will change substantially as new information and new drugs become available.

Copies of this document and all updates are available from the CDC National AIDS Clearinghouse (1-800-458-5231) and are posted on the Clearinghouse World-Wide Web site (<http://www.cdcnac.org>). In addition, copies and updates also are available from the HIV/AIDS Treatment Information Service (1-800-448-0440; Fax 301-519-6616; TTY 1-800-243-7012) and on the ATIS World-Wide Web site (<http://www.hivatis.org>). Readers should consult these web sites regularly for updates in the guidelines.

Report of the NIH Panel To Define Principles of Therapy of HIV Infection**Panel Members**

Charles Carpenter, M.D.

Chair

Brown University

The Miriam Hospital

Providence, RI

Mark Feinberg, M.D., Ph.D.

Executive Secretary

National Institutes of Health

Bethesda, MD

Wade Aubry, M.D.

Blue Cross/Blue Shield Association

San Francisco, CA

Dawn Averitt

Women's Information Service

and Exchange (WISE)

Atlanta, GA

John Coffin, Ph.D.

Tufts University School of Medicine

Boston, MA

David Cooper, M.D.

National Center for HIV Epidemiology

and Clinical Research

Sydney, NSW, Australia

Stephen Follansbee, M.D.

Davies Medical Center

San Francisco, CA

Peggy Hamburg, M.D.

New York City Department of Health

New York, NY

Mark Harrington

Treatment Action Group

New York, NY

Julia Hidalgo, S.C.D.

Center for AIDS Services Planning

and Development

Baltimore, MD

Harold Jaffe, M.D.

Centers for Disease Control

and Prevention

Atlanta, GA

Dan Landers, M.D.

Magee Women's Hospital

Pittsburgh, PA

Henry Masur, M.D.

National Institutes of Health

Bethesda, MD

Philip Pizzo, M.D.

Children's Hospital/Harvard Medical

School

Boston, MA

Douglas Richman, M.D.

University of California, San Diego

La Jolla, CA

Michael Saag, M.D.

University of Alabama, Birmingham

Birmingham, AL

Robert Schooley, M.D.

University of Colorado Health

Sciences Center

Denver, CO

Valerie Stone, M.D., M.P.H.

Brown University School of Medicine

Pawtucket, RI

Melanie Thompson, M.D.
AIDS Research Consortium of Atlanta
Atlanta, GA

Didier Trono, M.D.
The Salk Institute for Biological Studies
La Jolla, CA

Stefano Vella, M.D.
Istituto Superiore di Sanita
Laboratory of Virology
Rome, Italy

Bruce Walker, M.D.
Harvard Medical School
Boston, MA

Patrick Yeni, M.D.
X. Bichat Medical School
Paris, France

The material in this report was prepared for publication by:

Mark B. Feinberg, M.D., Ph.D.
Office of AIDS Research
National Institutes of Health

in collaboration with

Jonathan E. Kaplan, M.D.
Division of AIDS, STD, and TB Laboratory Research
National Center for Infectious Diseases
and
Division of HIV/AIDS Prevention—Surveillance, and Epidemiology
National Center for HIV, STD, and TB Prevention

Report of the NIH Panel To Define Principles of Therapy of HIV Infection*

Summary

Recent research advances have afforded substantially improved understanding of the biology of human immunodeficiency virus (HIV) infection and the pathogenesis of the acquired immunodeficiency syndrome (AIDS). With the advent of sensitive tools for monitoring HIV replication in infected persons, the risk of disease progression and death can be assessed accurately and the efficacy of anti-HIV therapies can be determined directly. Furthermore, when used appropriately, combinations of newly available, potent antiviral therapies can effect prolonged suppression of detectable levels of HIV replication and circumvent the inherent tendency of HIV to generate drug-resistant viral variants. However, as antiretroviral therapy for HIV infection has become increasingly effective, it has also become increasingly complex. Familiarity with recent research advances is needed to ensure that newly available therapies are used in ways that most effectively improve the health and prolong the lives of HIV-infected persons. To enable practitioners and HIV-infected persons to best use rapidly accumulating new information about HIV disease pathogenesis and treatment, the Office of AIDS Research of the National Institutes of Health sponsored the NIH Panel to Define Principles of Therapy of HIV Infection. This Panel was asked to define essential scientific principles that should be used to guide the most effective use of antiretroviral therapies and viral load testing in clinical practice. Based on detailed consideration of the most current data, the Panel delineated eleven principles that address issues of fundamental importance for the treatment of HIV infection. These principles provide the scientific basis for the specific treatment recommendations made by the Panel on Clinical Practices for the Treatment of HIV Infection sponsored by the Department of Health and Human Services and the Henry J. Kaiser Family Foundation. The reports of both of these panels are provided in this publication. Together, they summarize new data and provide both the scientific basis and specific guidelines for the treatment of HIV-infected persons. This information will be of interest to health-care providers, HIV-infected persons, HIV/AIDS educators, public health educators, public health authorities, and all organizations that fund medical care of HIV-infected persons.

INTRODUCTION

The past 2 years have brought major advances in both basic and clinical research on acquired immunodeficiency syndrome (AIDS). The availability of more numerous and more potent drugs to inhibit human immunodeficiency virus (HIV) replication has made it possible to design therapeutic strategies involving combinations of antiretroviral drugs that accomplish prolonged and near complete suppression of

*Information included in these principles may not represent FDA approval or approved labeling for the particular products or indications in question. Specifically, the terms "safe" and "effective" may not be synonymous with the FDA-defined legal standards for product approval.

detectable HIV replication in many HIV-infected persons. In addition, more sensitive and reliable measurements of plasma viral load have been demonstrated to be powerful predictors of a person's risk for progression to AIDS and time to death. They have also been demonstrated to reliably assess the antiviral activity of therapeutic agents.

It is now critical that these scientific advances be translated into information that practitioners and their patients can utilize in making decisions about using the new therapies and monitoring tools to achieve the greatest, most durable clinical benefits. Such information will allow physicians to tailor more effective treatments for their patients and to more closely monitor patients' responses to specific antiretroviral regimens.

A two-track process was initiated to address this pressing need. The Office of AIDS Research of the National Institutes of Health (NIH) sponsored the NIH Panel To Define Principles of Therapy of HIV Infection. This Panel was asked to delineate the scientific principles, based on its understanding of the biology and pathogenesis of HIV infection and disease, that should be used to guide the most effective use of antiretroviral therapy and viral load testing in clinical practice.

The Department of Health and Human Services (HHS) and the Henry J. Kaiser Family Foundation sponsored the Panel on Clinical Practices for the Treatment of HIV Infection. The HHS Panel was charged with developing recommendations, based on the scientific principles, for the clinical use of antiretroviral drugs and laboratory monitoring methods in the treatment of HIV-infected persons. Both documents—the *Report of the NIH Panel To Define Principles of Therapy for HIV Infection*, developed by the NIH Panel, and the *Guidelines for the Use of Antiretroviral Agents in HIV-Infected Adults and Adolescents*, developed by the HHS Panel—are provided in this report.

Together, these two documents summarize new data and provide both the scientific basis and specific guidelines for the treatment of HIV-infected persons. The goal of this report is to assist clinicians and patients in making informed decisions about treatment options so that a) effective antiretroviral therapy is introduced before extensive immune system damage has occurred; b) viral load monitoring is used as an essential tool in determining an HIV-infected person's risk for disease progression and response to antiretroviral therapy; c) combinations of antiretroviral drugs are used to suppress HIV replication to below the limits of detection of sensitive viral load assays; and d) patient adherence to the complicated regimens of combination antiretroviral therapy that are currently required to achieve durable suppression of HIV replication is encouraged by patient-provider relationships that provide education and support concerning the goals, strategies, and requirements of antiretroviral therapy.

The NIH Panel included clinicians, basic and clinical researchers, public health officials, and community representatives. As part of its effort to accumulate the most current data, the Panel held a 2-day public meeting to hear presentations by clinicians and scientists in the areas of HIV pathogenesis and treatment, specifically addressing the following topics: the relationship between virus replication and disease progression; the relative ability of available strategies of antiviral therapy to minimize HIV replication for prolonged periods of time; the relationship between the emergence of drug resistance and treatment failures; the relative ability of available strategies of antiviral therapy to delay or prevent the emergence of drug-resistant HIV variants; and the relationship between drug-induced changes in virus load and improved clinical outcomes and prolonged survival.

Summary of the Principles of Therapy of HIV Infection

1. Ongoing HIV replication leads to immune system damage and progression to AIDS. HIV infection is always harmful, and true long-term survival free of clinically significant immune dysfunction is unusual.
2. Plasma HIV RNA levels indicate the magnitude of HIV replication and its associated rate of CD4+ T cell destruction, whereas CD4+ T cell counts indicate the extent of HIV-induced immune damage already suffered. Regular, periodic measurement of plasma HIV RNA levels and CD4+ T cell counts is necessary to determine the risk for disease progression in an HIV-infected person and to determine when to initiate or modify antiretroviral treatment regimens.
3. As rates of disease progression differ among HIV-infected persons, treatment decisions should be individualized by level of risk indicated by plasma HIV RNA levels and CD4+ T cell counts.
4. The use of potent combination antiretroviral therapy to suppress HIV replication to below the levels of detection of sensitive plasma HIV RNA assays limits the potential for selection of antiretroviral-resistant HIV variants, the major factor limiting the ability of antiretroviral drugs to inhibit virus replication and delay disease progression. Therefore, maximum achievable suppression of HIV replication should be the goal of therapy.
5. The most effective means to accomplish durable suppression of HIV replication is the simultaneous initiation of combinations of effective anti-HIV drugs with which the patient has not been previously treated and that are not cross-resistant with antiretroviral agents with which the patient has been treated previously.
6. Each of the antiretroviral drugs used in combination therapy regimens should always be used according to optimum schedules and dosages.
7. The available effective antiretroviral drugs are limited in number and mechanism of action, and cross-resistance between specific drugs has been documented. Therefore, any change in antiretroviral therapy increases future therapeutic constraints.
8. Women should receive optimal antiretroviral therapy regardless of pregnancy status.
9. The same principles of antiretroviral therapy apply to HIV-infected children, adolescents, and adults, although the treatment of HIV-infected children involves unique pharmacologic, virologic, and immunologic considerations.
10. Persons identified during acute primary HIV infection should be treated with combination antiretroviral therapy to suppress virus replication to levels below the limit of detection of sensitive plasma HIV RNA assays.
11. HIV-infected persons, even those whose viral loads are below detectable limits, should be considered infectious. Therefore, they should be counseled to avoid sexual and drug-use behaviors that are associated with either transmission or acquisition of HIV and other infectious pathogens.

These topics and other data assessed by the Panel in formulating the scientific principles were derived from three primary sources: recent basic insights into the life cycle of HIV, studies of the extent and consequences of HIV replication in infected persons, and clinical trials of anti-HIV drugs.

In certain instances, the Panel based the principles and associated corollaries on clinical studies conducted in relatively small numbers of patients for fairly short periods of time. After carefully evaluating data from these studies, the Panel concluded that the results of several important contemporary studies have been consistent in their validation of recent models of HIV pathogenesis.

The Panel believes that new antiretroviral drugs and treatment strategies, if used correctly, can substantially benefit HIV-infected persons. However, as the understanding of HIV disease has improved and the number of available beneficial therapies has increased, clinical care of HIV-infected patients has become much more complex. Therapeutic success increasingly depends on a thorough understanding of the pathogenesis of HIV disease and on familiarity with when and how to use the more numerous and more effective drugs available to treat HIV infection. The Panel is concerned that even these new potent antiretroviral therapies will be of little clinical utility for treated patients unless they are used correctly and that, used incorrectly, they may even compromise the potential to obtain long-term benefit from other antiretroviral therapies in the future.

The principles and conclusions discussed in this report have been developed and made available now so that practitioners and patients can make treatment decisions based on the most current research results. Undoubtedly, insights into the pathogenesis of HIV disease will continue to accumulate rapidly, providing new targets for the development of additional antiretroviral drugs and even more effective treatment strategies. Thus, the Panel expects that these principles will require modification and elaboration as new information is acquired.

SCIENTIFIC PRINCIPLES

Principle 1. Ongoing HIV replication leads to immune system damage and progression to AIDS. HIV infection is always harmful, and true long-term survival free of clinically significant immune dysfunction is unusual.

Active replication of HIV is the cause of progressive immune system damage in infected persons (1-10). In the absence of effective inhibition of HIV replication by antiretroviral therapy, nearly all infected persons will suffer progressive deterioration of immune function resulting in their susceptibility to opportunistic infections (OIs), malignancies, neurologic diseases, and wasting, ultimately leading to death (11,12).

For adults who live in developed countries, the average time of progression to AIDS after initial infection is approximately 10-11 years in the absence of antiretroviral therapy or with older regimens of nucleoside analog (e.g., zidovudine [ZDV]) monotherapy (11). Some persons develop AIDS within 5 years of infection (20%), whereas others (<5%) have sustained long-term (>10 years) asymptomatic HIV infection without decline of CD4+ T cell counts to <500cells/mm³. Only approximately 2% or less of HIV-infected persons seem to be able to contain HIV replication to extremely low levels and maintain stable CD4+ T cell counts within the normal range for lengthy

periods (>12 years), and many of these persons display laboratory evidence of immune system damage (12). Thus, HIV infection is unusual among human virus infections in causing disease in such a large proportion of infected persons.

Although a very small number of HIV-infected persons do not demonstrate progressive HIV disease in the absence of antiretroviral therapy, there is no definitive way to prospectively identify these persons. Therefore, all persons who have HIV infection must be considered at risk for progressive disease. The goals of treatment for HIV infection should be to maintain immune function in as near a normal state as possible, prevent disease progression, prolong survival, and preserve quality of life by effectively suppressing HIV replication. For these goals to be accomplished, therapy should be initiated, whenever possible, before extensive immune system damage has occurred.

Principle 2. Plasma HIV RNA levels indicate the magnitude of HIV replication and its associated rate of CD4+ T cell destruction, whereas CD4+ T cell counts indicate the extent of HIV-induced immune damage already suffered. Regular, periodic measurement of plasma HIV RNA levels and CD4+ T cell counts is necessary to determine the risk for disease progression in an HIV-infected person and to determine when to initiate or modify antiretroviral treatment regimens.

The rate of progression of HIV disease is predicted by the magnitude of active HIV replication (reflected by so-called viral load) taking place in an infected person (5-10,13-18). Measurement of viral load through the use of quantitative plasma HIV RNA assays permits assessment of the relative risk for disease progression and time to death (5-10,13-18). Plasma HIV RNA measurements also permit assessment of the efficacy of antiretroviral therapies in individual patients (1,2,13,19-25). It is expert opinion that these measurements are necessary components of treatment strategies designed to use antiretroviral drugs most effectively. The extent of immune system damage that has already occurred in an HIV-infected person is indicated by the CD4+ T cell count (11,26-29), which permits assessment of the risk for developing specific OIs and other sequelae of HIV infection. When used in concert with viral load determinations, assessment of CD4+ T cell number enhances the accuracy with which the risk for disease progression and death can be predicted (27). Issues specific for the laboratory assessment of plasma HIV RNA and CD4+ T cell levels in HIV-infected infants and young children are discussed in Principle 9 (14-18,25,30). Important specific considerations regarding laboratory evaluations and HIV-infected persons include the following:

1. In the newly diagnosed patient, baseline plasma HIV RNA levels should be checked in a clinically stable state. Plasma HIV RNA levels obtained within the first 6 months of initial HIV infection do not accurately predict a person's risk for disease progression (31). In contrast, plasma HIV RNA levels stabilize (reach a "set-point") after approximately 6-9 months of initial HIV infection and are then predictive of risk for disease progression (5-10). Following their stabilization, plasma HIV RNA levels may remain fairly stable for months to years in many HIV-infected persons (7,10). However, immunizations and intercurrent infections can lead to transient elevations of plasma HIV RNA levels (32-34). As a result, values obtained within approximately 4 weeks of such episodes may not accurately reflect a person's actual baseline plasma HIV RNA level. For an accu-

- rate baseline, two specimens obtained within 1–2 weeks of each other, processed according to optimal, validated procedures, and analyzed by the same quantitative method are recommended. The use of two baseline measurements serves to reduce the variance in the plasma HIV RNA assays that results from technical and biologic factors (19,22,35,36).
2. Studies of populations of HIV-infected persons indicate that plasma HIV RNA levels gradually increase with time after infection (10). A steeper rate of increase is associated with an increased risk of disease progression. Within individual patients, the actual rate of change of plasma HIV RNA levels is unpredictable but can increase abruptly. Therefore, periodic monitoring of plasma HIV RNA levels is necessary to accurately gauge risk of disease progression. (See Guidelines.)
 3. Studies of the kinetics of HIV replication in infected persons indicate that levels of plasma HIV RNA should measurably decline within days of initiation of effective combination antiretroviral therapy (1,2,20,21,37). In patients in whom cessation of detectable new rounds of HIV infection of CD4+ T cells occurs, plasma HIV RNA levels should fall to approximately 1% of their initial levels within 2 weeks after initiation of therapy, reaching a nadir (ideally below the limit of detection of sensitive plasma HIV RNA assays) within approximately 8 weeks. Persons who have very high initial plasma HIV RNA levels may take longer to reach a nadir of plasma RNA levels following initiation of effective antiretroviral therapy (up to approximately 16 weeks). (See Guidelines.)
 4. Plasma HIV RNA assays provide the best measure of the activity of antiretroviral therapy of HIV-infected persons. Rebound of plasma HIV RNA levels following their suppression by antiretroviral therapy may indicate the outgrowth of drug-resistant HIV variants in a patient adherent to the regimen (see Principle 7 for additional considerations). Should the desired level of suppression of HIV replication be accomplished in treated patients by 16 weeks after initiation or alteration of an antiretroviral regimen, plasma HIV RNA levels should be checked periodically to document the continued activity of the chosen antiretroviral regimen.
 5. HIV RNA levels can vary by approximately threefold ($0.5 \log_{10}$) in either direction, upon repeated measurements (obtained within days or weeks of each other) in clinically stable, HIV-infected persons (19,22,35,36). Changes greater than $0.5 \log_{10}$ usually cannot be explained by inherent biological or assay variability and likely reflect a biologically and clinically relevant change in the level of plasma HIV RNA. It is important to note that the variability of the current plasma HIV RNA assays is greater toward their lower limits of sensitivity. Thus, differences between repeated measures of greater than $0.5 \log_{10}$ may be seen at very low plasma HIV RNA values and may not reflect a substantive biological or clinical change.
 6. CD4+ T cell counts should be obtained for all patients who have newly diagnosed HIV infection (28,29) (See Guidelines).
 7. CD4+ T cell counts are subject to substantial variability due to both biological and laboratory methodologies (26) and can vary up to 30% on repeated measures in the absence of a change in clinical status. Thus, it is important to monitor trends over time rather than base treatment decisions on one specific determination.

8. In patients who are not receiving antiretroviral therapy, CD4+ T cell counts should be checked regularly to monitor patients for evidence of disease progression. (See Guidelines.)
9. In patients receiving antiretroviral therapy, CD4+ T cell counts should be checked regularly to document continuing immunologic benefit and to assess the current degree of immunodeficiency (28,29). (See Guidelines.)
10. It is not yet known whether a given CD4+ T cell level achieved in response to antiretroviral therapy provides an equivalent assessment of the degree of immune system function or has the same predictive value for risk for OIs as do CD4+ T cell levels obtained in the absence of therapy. The potentially incomplete recovery of T cell function and the diversity of antigen recognition, despite CD4+ T cell increases induced by antiretroviral therapy, have raised concerns that patients may remain susceptible to OIs at higher CD4+ T cell levels. Until more data concerning this issue are available, the Panel concurs with recent U.S. Public Health Service/Infectious Diseases Society of America recommendations that prophylactic medications be continued when CD4+ T cell counts increase above recommended threshold levels as a result of initiation of effective antiretroviral therapies (i.e., that the provision of prophylaxis be based on the lowest reliably determined CD4+ T cell count) (28).
11. Measurements of p24 antigen, neopterin, and β -2 microglobulin levels have often been used to assess risk for disease progression. However, these measurements are less reliable than plasma HIV RNA assays and do not add clinically useful prognostic information to that obtained from HIV RNA and CD4+ T cell levels. As such, these laboratory tests need not be included as part of the routine care of HIV-infected patients.

Principle 3. As rates of disease progression differ among HIV-infected persons, treatment decisions should be individualized by level of risk indicated by plasma HIV RNA levels and CD4+ T cell counts.

Decisions regarding when to initiate antiretroviral therapy in an HIV-infected person should be based on the risk for disease progression and degree of immunodeficiency. Initiation of antiretroviral therapy before the onset of immunologic and virologic evidence of disease progression is expected to have the greatest and most durable beneficial impact on preserving the health of HIV-infected persons. When specific viral load or CD4+ T cell levels at which therapy should be initiated are considered, it is important to recognize that the risk for disease progression is a continuous rather than discrete function (5,6,10,27). There is no known absolute threshold of HIV replication below which disease progression will not eventually occur. At present, recommendations for initiation of therapy must be based on the fact that the types and numbers of available antiretroviral drugs are limited. When more numerous, more effective, better tolerated, and more conveniently dosed drugs become available, it is likely that indications for initiation of therapy will change accordingly. Specific considerations regarding treatment include the following:

1. Decisions made by health-care practitioners and HIV-infected patients regarding initiation of antiretroviral therapy should be guided by the patient's plasma HIV RNA level and CD4+ T cell count. (See Guidelines.)

2. Data are not yet available that define the degree of therapeutic benefit in persons who have relatively high CD4+ T cell counts and relatively low plasma HIV RNA levels (e.g., CD4+ T cell count $>500/\text{mm}^3$ and plasma HIV RNA $<10,000$ copies/mL). However, emerging insights into the pathogenesis of HIV disease predict that antiretroviral therapy should be of benefit to such patients. For persons at low risk for disease progression, decisions concerning when to initiate antiretroviral therapy must also include consideration of the potential inconvenience and toxicities of the available antiretroviral drugs. Should the decision be made to defer therapy, regular monitoring of HIV RNA levels and CD4+ T cell counts should be performed as recommended (See Guidelines).
3. Persons who have levels of HIV RNA persistently below the level of detection of currently available HIV RNA assays and who have stable, high CD4+ T cell counts in the absence of therapy are at low risk for disease progression in the near future. The potential for benefit of treatment for these persons is not known. Should the decision be made to defer therapy, regular monitoring of HIV RNA levels and CD4+ T cell counts should be performed as recommended (see Guidelines).
4. Patients who have late-stage disease (as indicated by clinical evidence of advanced immunodeficiency or low CD4+ T cell counts, e.g., <50 cells/ mm^3) have benefited from appropriate antiretroviral therapy as evidenced by decreased risks for further disease progression or death (23,28). In such patients, antiretroviral therapy can be of benefit even when CD4+ T cell increases are not seen. Therefore, discontinuation of antiretroviral therapy in this setting should be considered only if available antiretroviral therapies do not suppress HIV replication to a measurable degree, if drug toxicities outweigh the anticipated clinical benefit, or if survival and quality of life are not expected to be improved by antiretroviral therapy (e.g., terminally ill persons).

Principle 4. The use of potent combination antiretroviral therapy to suppress HIV replication to below the levels of detection of sensitive plasma HIV RNA assays limits the potential for selection of antiretroviral-resistant HIV variants, the major factor limiting the ability of antiretroviral drugs to inhibit virus replication and delay disease progression. Therefore, maximum achievable suppression of HIV replication should be the goal of therapy.

Studies of the biology and pathogenesis of HIV infection have provided the basis for using antiretroviral drugs in ways that yield the most profound and durable suppression of HIV replication. The inherent ability of HIV to develop drug resistance represents the major obstacle to the long-term efficacy of antiretroviral therapy (21). However, recent clinical evidence indicates that the development of drug resistance can be delayed, and perhaps even prevented, by the rational use of combinations of drugs that include newly available, potent agents to suppress HIV replication to levels that cannot be detected by sensitive assays of plasma HIV RNA (23,38-40). Cessation of detectable HIV replication decreases the opportunity for accumulation of mutations that may give rise to drug-resistant viral variants. Furthermore, the extent and duration of inhibition of HIV replication by antiretroviral therapy predicts the magnitude of clinical benefit derived from treatment (9,13,23-25).

The potential toxicities of therapy, as well as the patient's quality of life and ability to adhere to a complex antiretroviral drug regimen, should be balanced with the anticipated clinical benefit of maximal suppression of HIV replication and the anticipated risks of less complete suppression. Specific considerations regarding treatment include the following:

1. Once a decision has been made to initiate antiretroviral therapy, the ideal goal of therapy should be suppression of the level of active HIV replication, as assessed by sensitive measures of plasma HIV RNA, to undetectable levels.
2. If suppression of HIV replication to undetectable levels cannot be achieved, the goal of therapy should be to suppress virus replication as much as possible for as long as possible. Less complete suppression of HIV replication is expected to yield less profound and less durable immunologic and clinical benefits. Higher residual levels of HIV replication during therapy predispose the patient to more rapid development of antiretroviral drug resistance and associated waning of clinical benefit. In the absence of effective suppression of detectable HIV replication, it is currently impossible to identify a precise target level for suppression of HIV replication that will yield predictable clinical benefits. However, recent data indicate that suppression of HIV RNA levels to $<5,000$ copies/mL is likely to yield more greater and more durable clinical benefit than less complete suppression (24).
3. The HIV RNA assays currently available have similar levels of sensitivity (19,41-46; Table). More sensitive versions of each of these assays are currently in development and will likely be commercially available in the future. Once these assays are available, the goal of antiretroviral therapy should be suppression of HIV RNA levels to below detection of these more sensitive assays. Less profound suppression of HIV replication is associated with a greater likelihood of development of drug resistance (23,40).
4. Although suppression of HIV load to levels below the detection limits of sensitive plasma HIV RNA assays indicates profound inhibition of new cycles of virus replication, it does not mean that the infection has been eradicated or that virus replication has been stopped completely (37,47-50). HIV replication may be continuing in various tissues (e.g., the lymphatic tissues and the central nervous system) although it can no longer be detected by plasma HIV RNA assays. Strategies for potential eradication are being pursued in experimental studies, but the likelihood of their success is uncertain (37,51). Recent studies indicate that infectious HIV can still be isolated from CD4+ T cells obtained from infected persons whose plasma HIV RNA levels have been suppressed below detection for prolonged periods (up to 30 months) (49,50). Long-term persistence of HIV infection in such persons who have undetectable levels of plasma HIV RNA appears to be due to the existence of long-lived reservoirs of latently infected CD4+ cells, rather than drug failure (49,50). Continued monitoring of HIV RNA levels is necessary in patients who have achieved antiretroviral drug-induced suppression of HIV RNA to undetectable levels, as this effect may be transient. (See Guidelines.)

Principle 5. The most effective means to accomplish durable suppression of HIV replication is the simultaneous initiation of combinations of effective anti-HIV drugs with which the patient has not been previously treated and that are not cross-resistant with antiretroviral agents with which the patient has been previously treated.

Several issues should be considered regarding the combination of antiretroviral drugs to be used in the treatment of an HIV-infected patient. The efficacy of a given regimen of combination antiretroviral therapy is not simply a function of the number of drugs used. The most effective antiretroviral drugs possess high potency, favorable pharmacologic properties, and require that HIV acquire multiple mutations in the relevant HIV target gene before high-level drug resistance is realized. In addition, drug-resistant HIV variants selected for by treatment with certain antiretroviral drugs may display diminished ability to replicate (decreased "fitness") in infected persons (27). Drugs used in combination should show evidence of additivity or synergy of antiretroviral activity, should lack antagonistic pharmacokinetic or antiretroviral properties, and should possess nonoverlapping toxicities. Ideally, the chosen drugs will display molecular interactions that increase the potency of antiretroviral therapy or delay the emergence of antiretroviral drug resistance. If multiple options are available for combination therapy, specific antiretroviral drugs should be employed so that future therapeutic options are preserved if the initial choice of therapy fails to achieve its desired result. Whenever possible, therapy should be initiated or modified with a rational combination of antiretroviral drugs, a predefined target for the degree of suppression of HIV replication desired, and a predefined alternative antiretroviral regimen to be used should the target goal not be reached. Specific considerations regarding treatment include the following:

1. The combination of antiretroviral drugs used when therapy is either initiated or changed needs to be carefully chosen because it will influence subsequent options for effective antiretroviral therapy if the chosen drug regimen fails to accomplish satisfactory suppression of HIV replication.
2. The best opportunity to accomplish maximal suppression of virus replication, minimize the risk of outgrowth of drug-resistant HIV variants, and maximize protection from continuing immune system damage is to use combinations of effective antiretroviral drugs in persons who have no prior history of anti-HIV therapy.
3. No single antiretroviral drug that is currently available, even the more potent protease inhibitors (PIs), can ensure sufficient and durable suppression of HIV replication when used as a single agent ("monotherapy"). Furthermore, the use of potent antiretroviral drugs as single agents presents a great risk for the development of drug resistance and the potential development of cross-resistance to related drugs. Thus, antiretroviral monotherapy is no longer a recommended option for treatment of HIV-infected persons (see Guidelines). One exception is the use of zidovudine (ZDV) according to the AIDS Clinical Trials Group (ACTG) 076 regimen. This regimen is specifically for the purpose of reducing the risk for perinatal HIV transmission in pregnant women who have high CD4+ T cell counts and low plasma HIV RNA levels and who have not yet decided to initiate antiretroviral therapy based on their own health indications (52-54). This time-limited use of zidovudine by a pregnant woman to prevent perinatal HIV trans-

- mission has important benefits to infants and is not likely to substantially compromise her future ability to benefit from combination antiretroviral therapy.
4. Antiretroviral drugs (e.g., lamivudine [3TC]) or the non-nucleoside reverse transcriptase inhibitors (NNRTIs; e.g., nevirapine and delavirdine), that are potent, but to which HIV readily develops high-level resistance, should not be used in regimens that are expected to yield incomplete suppression of detectable HIV replication.
 5. At present, durable suppression of detectable levels of HIV replication is best accomplished with the use of two nucleoside analog reverse transcriptase (RT) inhibitors combined with a potent PI. In patients who have not been treated with antiretroviral therapy, suppression of detectable HIV replication has also been reported with the use of two nucleoside analog RT inhibitors combined with a NNRTI (e.g., zidovudine, didanosine, and nevirapine [40]). However, the role of this approach as initial antiretroviral therapy needs to be better defined before it can be recommended as a "first-line" treatment strategy. Furthermore, this approach is considerably less effective in persons who have been previously treated with nucleoside analog RT inhibitors (55-57). In the subset of previously treated patients who respond initially to such regimens, suppression of HIV replication is often transient and the associated clinical benefit is limited.
 6. The use of fewer than three antiretroviral drugs in combination may be considered as an option by HIV-infected persons and their physicians. In making this decision, it is important to recognize that no combination of two currently available nucleoside analog RT inhibitors has been demonstrated to consistently provide sufficient and durable suppression of HIV replication. Although the initial decline in HIV RNA levels following treatment with two RT inhibitors may be encouraging, the durability of the response beyond 24-48 weeks in controlled studies has been disappointing (40,56-60). Furthermore, the selection of drug-resistant HIV variants by antiretroviral regimens that fail to suppress HIV replication durably may compromise the range of future treatment options. Even in antiretroviral-drug-naïve patients, the use of NNRTIs is not routinely recommended in combination with one nucleoside analog RT inhibitor, as the risk for selection of NNRTI-resistant HIV variants is high in regimens that fail to achieve suppression of detectable HIV replication (1,61). Certain combinations of two protease inhibitors (without added RT inhibitors) have been reported to provide suppression of detectable HIV replication in pilot studies (62,63); however, given the limited experience available with this approach, it should not be considered as a first-line regimen at the present time. (See Guidelines.)
 7. When a change in therapy is considered in a previously treated patient, a review of the person's prior history of anti-HIV therapy is essential. Drugs chosen as the components of a new antiretroviral regimen should not be cross-resistant to previously used antiretroviral drugs (or share similar patterns of mutations associated with antiretroviral drug resistance). (See Principle 7 for additional considerations.)
 8. When changing a failing regimen, it is important to change more than one component of the regimen. The addition of single antiretroviral agents, even very potent ones, is likely to lead to the development of viral resistance to the new agent. (See Guidelines.)

Principle 6. Each of the antiretroviral drugs used in combination therapy regimens should always be used according to optimum schedules and dosages.

The use of combinations of potent antiretroviral drugs to exert constant, maximal suppression of HIV replication provides the best approach to circumvent the inherent tendency of HIV to generate drug-resistant variants. Specific considerations regarding treatment include the following:

1. Combination therapy should be initiated with all drugs started simultaneously (ideally within 1 or 2 days of each other); antiretroviral therapies should not be added sequentially. Staged introduction of individual antiretroviral drugs increases the likelihood that incomplete suppression of HIV replication will be achieved, thereby permitting the progressive accumulation of mutations that confer resistance to multiple antiretroviral agents. Rather than strive to increase patient acceptance of therapy through the sequential addition of antiretroviral drugs, the Panel believes it is better to counsel and educate patients extensively before the initiation of antiretroviral therapy, even if it means a limited delay in initiating treatment.
2. Whenever possible, combination antiretroviral therapy should be maintained at recommended drug doses. At any time after initiation of therapy, underdosing with any one agent in a combination, or the administration of fewer than all drugs of a combination at any one time, should be avoided. Antiretroviral drug resistance is less likely to occur if *all* antiretroviral therapy is temporarily stopped than if the dosage of one or more components is reduced or if one component of an effective suppressive regimen is withheld. Should antiretroviral drug resistance develop as a result of underdosing or irregular dosing of antiretroviral drugs, subsequent readministration of recommended doses of drugs on a regular schedule is unlikely to accomplish effective suppression of HIV replication.
3. Patient adherence to an antiretroviral regimen is critical to the success of therapy. If antiretroviral drugs are used in inadequate doses or are used only intermittently, the risk for developing drug-resistant HIV variants is greatly increased. Effective adherence to complicated medical regimens requires extensive patient education about the goals and rationale for therapy before it is initiated, as well as an ongoing, active collaboration between practitioner and patient when therapy has been started. Counseling should include careful review of the drug-dosing intervals, the possibility of co-administration of several medications at the same time, and the relationship of drug dosing to meals and snacks.
4. Available effective regimens of combination antiretroviral therapy require that patients take multiple medications at specific times of the day. Persons who have unstable living situations or limited social support mechanisms may have difficulty adhering to the recommended antiretroviral therapy regimens and may need special support from health-care workers to do so effectively. If circumstances impede adherence to the most effective antiretroviral regimens now available, therapy is unlikely to be of long-term benefit to the patient and the risk of selection of drug-resistant HIV variants is increased. Therefore, it is important to ensure that adequate social support is available for patients who are offered combination antiretroviral therapy. Health-care providers should work with HIV-infected patients to assess if they are ready and able to commit to

a regimen of antiviral therapy. Health-care providers should make such assessment on an individual basis and not consider that any specific group of persons are unable to adhere.

Principle 7. The available effective drugs are limited in number and mechanism of action, and cross-resistance between specific drugs has been documented. Therefore, any change in antiretroviral therapy increases future therapeutic constraints.

Decisions to alter therapy will rely heavily on consideration of clinical issues and on the number of available alternative antiretroviral agents. Every decision made to alter therapy may limit future treatment options. Thus, available agents should not be abandoned prematurely. It is not known definitively whether the pathogenic consequences of a measurable level of HIV replication while on therapy are equivalent to those of an equivalent level in an untreated person; however, preliminary data suggest that this is the case. Thus, the level at which HIV replication continues while on an antiretroviral drug regimen that has failed to suppress plasma HIV RNA to below detectable levels should be considered as an indication of the urgency with which an alteration in therapy should be pursued. Specific considerations regarding treatment include the following:

1. Increasing levels of plasma HIV RNA in a person receiving antiretroviral therapy can be caused by several factors. Identification of the responsible factor, wherever possible, is an important goal. Evidence of increased levels of HIV replication may signal the emergence of drug-resistant HIV variants, incomplete adherence to the antiretroviral therapy, decreased absorption of antiretroviral drugs, altered drug metabolism due to physiologic changes or drug-drug interactions, or intercurrent infection.
2. Before the decision is made to alter antiretroviral therapy because of an increase in plasma HIV RNA, it is important to repeat the plasma HIV RNA measurements to avoid unnecessary changes based on misleading or spurious plasma HIV RNA values (e.g., the presence of intercurrent infection or imperfect adherence to therapy).
3. Antiretroviral therapy should be changed when plasma HIV RNA again becomes detectable (repeatedly and in the absence of events such as imperfect adherence to the regimen, immunizations, or intercurrent infections that may lead to transient elevations of plasma HIV RNA levels) and continues to rise in a patient in whom it had been previously suppressed to undetectable levels. In a person whose plasma HIV RNA levels had been previously incompletely suppressed, progressively increasing plasma HIV RNA levels should prompt consideration of a change in antiretroviral therapy. (See Guidelines.)
4. Evidence of antiretroviral drug toxicity or intolerance is also an important reason to consider changes in drug therapy. In certain instances, these manifestations may be transient, and therapy may be safely continued with attention to patient counseling and continuing evaluation. When it is necessary to change therapy for reasons of toxicity or intolerance, alternative antiretroviral drugs should be chosen based on their anticipated efficacy and lack of similar toxicities. In this situation, substitution of one drug (ideally of the same class and possessing equal or greater antiretroviral activity) for another, while continuing the other components of the regimen, is reasonable.

Principle 8. Women should receive optimal antiretroviral therapy regardless of pregnancy status.

The use of antiretroviral treatment in HIV-infected pregnant women raises important, unique concerns (64). HIV counseling and the offer of HIV testing to pregnant women have been universally recommended in the United States and are now mandatory in some states. A greater awareness of issues surrounding HIV infection in pregnant women has resulted in an increased number of women whose initial diagnosis of HIV infection is made during pregnancy. In this circumstance, or when women already aware of their HIV infection become pregnant, treatment decisions should be based on the current and future health of the mother, as well as on preventing perinatal transmission and ensuring the health of the fetus and neonate. Care of the HIV-infected pregnant woman should involve a collaboration between the HIV specialist caring for the woman when she is not pregnant, her obstetrician, and the woman herself. Treatment recommendations for HIV-infected pregnant women are based on the belief that therapies of known benefit to women should not be withheld during pregnancy unless there are known adverse effects on the mother, fetus, or infant that outweigh the potential benefit to the woman (64). There are two separate but interconnected issues regarding antiretroviral treatment during pregnancy: a) use of antiretroviral therapy for maternal health indications and b) use of antiretroviral drugs for reducing the risk of perinatal HIV transmission. Although zidovudine monotherapy substantially reduces the risk of perinatal HIV transmission, appropriate combinations of antiretroviral drugs should be administered if indicated on the basis of the mother's health. In general, pregnancy should not compromise optimal HIV therapy for the mother. Specific considerations regarding treatment of pregnant women include the following:

1. Recommendations regarding the choice of antiretroviral agents in pregnant women are subject to unique considerations, including potential changes in dose requirements due to physiologic changes associated with pregnancy and potential effects of the drug on the fetus and neonate (e.g., placental passage of drug and preclinical data indicating potential for teratogenicity, mutagenicity, or carcinogenicity). (See Guidelines.)
2. No long-term safety studies are available regarding the use of any antiretroviral agents during pregnancy. Because the first trimester of pregnancy (i.e., weeks 1-14) is the most vulnerable time with respect to teratogenicity (particularly the first 8 weeks), it may be advisable to delay, when feasible, the initiation of antiretroviral therapy until 14 weeks' gestational age. However, if clinical, virologic, or immunologic parameters are such that therapy would be recommended for nonpregnant persons, many experts would recommend initiating therapy, regardless of gestational age.
3. Women who are already receiving antiretroviral therapy at the time that pregnancy is diagnosed should continue their therapy. Alternatively, if pregnancy is anticipated or discovered early in the first trimester (before 8 weeks), concern for potential teratogenicity may lead some women to consider stopping antiretroviral therapy until 14 weeks' gestation. Although the effects of all antiretroviral drugs on the developing fetus during the first trimester are uncertain, most experts recommend continuation of a maximally suppressive regimen even during the first trimester. Currently, insufficient data exist to support or refute concerns

- about potential teratogenicity. If antiretroviral therapy is discontinued for any reason during the first trimester, all agents should be discontinued simultaneously. Once they are reinstated, they should be reintroduced simultaneously.
4. Treatment of a pregnant woman with an antiretroviral regimen that does not suppress HIV replication to below detectable levels is likely to result in the development of antiretroviral drug-resistant HIV variants and limit her ability to respond favorably to effective combination therapy regimens in the future. The emergence of drug-resistant HIV variants during incomplete suppression of HIV replication in a pregnant woman may limit the ability of those same antiretroviral drugs to effectively decrease the risk of perinatal transmission if provided intrapartum and/or to the neonate.
 5. Transmission of HIV from mother to infant can occur at all levels of maternal viral loads, although higher viral loads tend to be associated with an increased risk of transmission (53,65). Zidovudine therapy is effective at reducing the risk for perinatal HIV transmission regardless of maternal viral load (53,54). Therefore, use of the recommended regimen of zidovudine alone or in combination with other antiretroviral drugs should be discussed with and offered to all HIV-infected pregnant women, regardless of their plasma HIV RNA level (54).

Principle 9. The same principles of antiretroviral therapy apply to HIV-infected children, adolescents, and adults, although the treatment of HIV-infected children involves unique pharmacologic, virologic, and immunologic considerations.

Most of the data that support the principles of antiretroviral therapy outlined in this document have been generated in studies of HIV-infected adults. Adolescents infected with HIV sexually or through drug use appear to follow a clinical course similar to adults, and recommendations for antiretroviral therapy for these persons are the same as for adults (see Guidelines). However, although fewer data are available concerning treatment of HIV infection in younger persons, it is unlikely that the fundamental principles of HIV disease differ for HIV-infected children. Furthermore, the data that are available from studies of HIV-infected infants and children indicate that the same fundamental virologic principles apply, and optimal treatment approaches are also likely to be similar (14-18,25). Therefore, HIV-infected children, as previously described for HIV-infected adults, should be treated with effective combinations of antiretroviral drugs with the intent of accomplishing durable suppression of detectable levels of HIV replication.

Unfortunately, not all of the antiretroviral drugs that have demonstrated efficacy in combination therapy regimens in adults are available in formulations (e.g., palatable liquid formulations) for infants and young children (particularly for those aged <2 years). In addition, pharmacokinetic and pharmacodynamic studies of some antiretroviral agents have yet to be completed in children. Thus, effective antiretroviral therapies should be studied in children and age-specific pharmacologic properties of these therapies should be defined. Antiretroviral drugs selected to treat HIV-infected children should be used only if their pharmacologic properties have been defined in the relevant age group of the patient. Use of antiretroviral drugs before these properties have been defined may result in undesirable toxicities without virologic or clinical benefit.

Identification of HIV-infected infants soon after delivery or during the first few weeks following their birth provides opportunities for treatment of primary HIV infection and, perhaps, for facilitating the most effective treatment responses (16-18,66). Thus, identification of HIV-infected women through voluntary testing, provision of antiretroviral therapy to the mother and infant to decrease the risk of maternal-infant transmission, and careful screening of infants born to HIV-infected mothers for evidence of HIV infection will provide an effective strategy to ameliorate the risk and consequences of perinatal HIV infection.

The specific HIV RNA and CD4+ T cell criteria used for making decisions about when to initiate therapy in infected adults do not apply directly to newborns, infants, and young children (14-18). As with adults, higher levels of plasma HIV RNA are associated with a greater risk of disease progression and death in infants and young children (14-18). However, absolute levels of plasma HIV RNA observed during the first years of life in HIV-infected children are frequently higher than those found in adults infected for similar lengths of time, and establishment of a post-primary-infection set-point takes substantially longer in infected children (15-18). The increased susceptibility of children to OIs, particularly *Pneumocystis carinii* pneumonia (PCP), at higher CD4+ T cell counts than HIV-infected adults (30) further indicates that the CD4+ T cell criteria suggested as guides for initiation of antiretroviral therapy in HIV-infected adults are not appropriate to guide therapeutic decisions for infected children. In all, the need for and potential benefits of early institution of effective antiretroviral therapy are likely to be even greater in children than adults, suggesting that most, if not all, HIV-infected children should be treated with effective combination antiretroviral therapies.

Principle 10. Persons identified during acute primary HIV infection should be treated with combination antiretroviral therapy to suppress virus replication to levels below the limit of detection of sensitive plasma HIV RNA assays.

Studies of HIV pathogenesis provide theoretical support for the benefits of antiretroviral therapy for persons diagnosed with primary HIV infection, and data that are accumulating from small-scale clinical studies are consistent with these predictions (49,66-73). Results from studies suggest that antiretroviral therapy during primary infection may preserve immune system function by blunting the high level of HIV replication and immune system damage occurring during this period and potentially reducing set-point levels of HIV replication, thereby favorably altering the subsequent clinical course of the infection; however, this outcome has yet to be formally demonstrated (51,73). It has been further suggested that the best opportunity to eradicate HIV infection might be provided by the initiation of potent combination antiretroviral therapy during primary infection (51).

The Panel believes that, although the long-term benefits of effective combination antiretroviral therapy of primary infection are not known, it is a critical topic of investigation. Therefore, enrollment of newly diagnosed patients in clinical trials should be encouraged to help in defining the optimal approach to treatment of primary infection. When this is neither feasible nor desired, the Panel believes that combination antiretroviral therapy with the goal of suppression of HIV replication to undetectable levels should be pursued. The Panel believes that suppressive antiretroviral therapy

for acute primary HIV infection should be continued indefinitely until clinical trials provide data to establish the appropriate duration of therapy.

Principle 11. HIV-infected persons, even those whose viral loads are below detectable limits. Therefore, they should be considered infectious. Therefore, they should be counseled to avoid sexual and drug-use behaviors that are associated with either transmission or acquisition of HIV and other infectious pathogens.

No data are available concerning the ability of HIV-infected persons who have antiretroviral therapy-induced suppression of HIV replication to undetectable levels (assessed by plasma HIV RNA assays) to transmit the infection to others. Similarly, their ability to acquire a multiply resistant HIV variant from another person remains a possibility. HIV-infected persons who are receiving antiretroviral therapy continue to be able to transmit serious infectious diseases to others (e.g., hepatitis B and C and sexually transmitted infections, such as herpes simplex virus, human papillomavirus, syphilis, gonorrhea, chancroid, and chlamydia) and are themselves at risk for infection with these pathogens, as well as others that carry serious consequences for immunosuppressed persons, including cytomegalovirus and human herpes virus 8 (also known as KSHV). Therefore, all HIV-infected persons, including those receiving effective antiretroviral therapies, should be counseled to avoid behaviors associated with the transmission of HIV and other infectious agents. Continued reinforcement that all HIV-infected persons adhere to safe-sex practices is important. If an HIV-infected injecting-drug user is unable or unwilling to refrain from using injection drugs, that person should be counseled to avoid sharing injection equipment with others and to use sterile, disposable needles and syringes for each injection.

SCIENTIFIC BACKGROUND

HIV Infection Leads to Progressive Immune System Damage in Nearly All Infected Persons

Early efforts to synthesize a coherent model of the pathogenic consequences of HIV infection were based on the presumption that few cells in infected persons harbor or produce HIV and that virus replication is restricted during the period of clinical latency. However, early virus detection methods were insensitive, and newer, more sensitive tests have demonstrated that virus replication is active throughout the course of the infection and proceeds at levels far higher than previously imagined. HIV replication has been directly linked to the process of T cell destruction and depletion. In addition, ongoing HIV replication in the face of an active but incompletely effective host antiviral immune response is probably responsible for the secondary manifestations of HIV disease, including wasting and dementia.

Beginning with the first cycles of virus replication within the newly infected host, HIV infection results in the progressive destruction of the population of CD4+ T cells that serve essential roles in the generation and maintenance of host immune responses (1-10). The target cell preference for HIV infection and depletion is determined by the identity of the cell surface molecule, CD4, that is recognized by the HIV envelope (Env) glycoprotein as the virus binds to and enters host cells to initiate

the virus replication cycle (74). Additional cell surface molecules that normally function as receptors for chemokines have recently been identified as essential co-receptors required for the process of HIV entry into target cells (75). Macrophages and their counterparts within the central nervous system, the microglial cells, also express cell surface CD4 and provide targets for HIV infection. As macrophages are more resistant to the cytopathic consequences of HIV infection than are CD4+ T cells and are widely distributed throughout the body, they may play critical roles in persistence of HIV infection by providing reservoirs of chronically infected cells.

Although most of the immunologic and virologic assessments of HIV-infected persons have focused on studies of peripheral blood lymphocytes, these cells represent only approximately 2% of the total lymphocyte population in the body. The importance of the lymphoid organs, which contain the majority of CD4+ T cells, has been highlighted by the finding that the concentrations of virus and percentages of HIV-infected CD4+ T cells are substantially higher in lymph nodes (where immune responses are generated and where activated and proliferating CD4+ T cells that are highly susceptible to HIV infection are prevalent) than in peripheral blood (3,4,48). Thus, although the depletion of CD4+ T cells after HIV infection is most readily revealed by sampling peripheral blood, damage to the immune system is exacted in lymphoid organs throughout the body (3,4). For as yet unidentified reasons, gradual destruction of normal lymph node architecture occurs with time, which probably compromises the ability of an HIV-infected person to generate effective immune responses and replace CD4+ T cells already lost to HIV infection through the expansion of mature T cell populations in peripheral lymphoid tissues. The thymus is also an early target of HIV infection and damage, thereby limiting the continuation of effective T cell production even in younger persons in whom thymic production of CD4+ T cells is active (76,77). Thus, in both adults and children, HIV infection compromises both of the potential sources of T cell production, so the rate of T cell replenishment cannot continue indefinitely to match cell loss. Consequently, total CD4+ T cell numbers may decline inexorably in HIV-infected persons.

After initial infection, the pace at which immunodeficiency develops and the attendant susceptibility to OIs which arise are associated with the rate of decline of CD4+ T cell counts (11,26,27). The rate at which CD4+ T cell counts decline differs considerably from person to person and is not constant throughout all stages of the infection. Acceleration in the rate of decline of CD4+ T cells heralds the progression of disease. The virologic and immunologic events that occur around this time are poorly understood, but increasing rates of HIV replication, the emergence of viruses demonstrating increased cytopathic effects for CD4+ T cells, and declining host cell-mediated anti-HIV immune responses are often seen (12,78). For as yet unknown reasons, host compensatory responses that preserve the homeostasis of total T cell levels (CD4+ plus CD8+ T cells) appear to break down in HIV-infected persons approximately 1-2 years before the development of AIDS, resulting in net loss of total T cells in the peripheral blood, and signaling immune system collapse (79).

Although the progression of HIV disease is most readily gauged by declining CD4+ T cell numbers, evidence indicates that the sequential loss of specific types of immune responses also occurs (80-82). Memory CD4+ T cells are known to be preferential targets for HIV infection, and early loss of CD4+ memory T cell responses is observed in HIV-infected persons, even before there are substantial decreases in total CD4+ T

cell numbers (80,81). With time, gradual attrition of antigen-specific CD4+ T cell-dependent immune recognition may limit the repertoire of immune responses that can be mounted effectively and so predispose the host to infection with opportunistic pathogens (82).

HIV Replication Rates in Infected Persons Can Be Accurately Gauged By Measurement of Plasma HIV Concentrations

Until recently, methods for monitoring HIV replication (commonly referred to as viral load) in infected persons were either hampered by poor sensitivity and reproducibility or were so technically laborious that they could not be adapted for routine clinical practice. However, new techniques for sensitive detection and accurate quantification of HIV RNA levels in the plasma of infected persons provide extremely useful measures of active virus replication (1,2,19,20,37,41-43). HIV RNA in plasma is contained within circulating virus particles or virions, with each virion containing two copies of HIV genomic RNA. Plasma HIV RNA concentrations can be quantified by either target amplification methods (e.g., quantitative RT polymerase chain reaction [RT-PCR], Amplicor HIV Monitor™ assay, Roche Molecular Systems; or nucleic acid sequence-based amplification, [NASBA®], NucliSens™ HIV-1 QT assay, Organon Teknika) or signal amplification methods (e.g., branched DNA [bDNA], Quantiplex™ HIV RNA bDNA assay, Chiron Diagnostics) (42,43). The bDNA signal amplification method (41) amplifies the signal obtained from a captured HIV RNA target by using sequential oligonucleotide hybridization steps, whereas the RT-PCR and NASBA® assays use enzymatic methods to amplify the target HIV RNA into measurable amounts of nucleic acid product (41-43). Target HIV RNA sequences are quantitated by comparison with internal or external reference standards, depending upon the assay used. Versions of both types of assays are now commercially available, and the Amplicor assay was recently approved by the Food and Drug Administration for assessment for risk of disease progression and monitoring of antiretroviral therapy in HIV-infected persons. Target amplification assays are more sensitive (400 copies HIV RNA/mL plasma) than the first generation bDNA assay (10,000 copies HIV plasma), but the sensitivity of the bDNA assay has recently been improved (500 copies HIV RNA/mL plasma). More sensitive versions of each of these assays are currently in development (detection limits 20-100 copies/mL) and will likely be commercially available in the future.

All of the commercially available assays can accurately quantitate plasma HIV RNA levels across a wide range of concentrations (so-called dynamic range). Although the results of the three assays (i.e., the RT-PCR, NASBA®, and bDNA) are strongly correlated, the absolute values of HIV RNA measured in the same plasma sample using two different assays can differ by twofold or more (44-46). Until a common standard is available that can be used to normalize values obtained with different assay methods, it is advisable to choose one assay method consistently when HIV RNA levels in infected persons are monitored for use as a guide in making therapeutic decisions.

The performance characteristics and recommended collection methods for the individual HIV RNA assays are provided (Table). For reliable results, it is essential that the recommended procedures be followed for collection and processing of blood to prepare plasma for HIV RNA measurements. Different plasma HIV RNA assays require

different plasma volumes (an important consideration in infants and in young children). These assays are best performed on plasma specimens prepared from blood obtained in collection tubes containing specific anticoagulants (e.g., ethylenediaminetetraacetic acid [EDTA] or acid-citrate-dextran [ACD]) (Table) (44-46).

Quantitative measurement of plasma HIV RNA levels can be expressed in two ways: a) the number of copies/mL of HIV RNA and b) the logarithm (to the base 10) of the number of copies/mL of HIV RNA. In clinically stable, HIV-infected adults, results obtained by using commercially available plasma HIV RNA assays can vary by approximately threefold ($0.5 \log_{10}$) in either direction on repeated measurements obtained within the same day or on different days (35,36). Factors influencing the variation seen in plasma HIV RNA assays include biological fluctuations and those introduced by the performance characteristics of the particular assay (35,36,44-46). Variability of current plasma HIV RNA assays is greater toward their lower limits of detection and consequently changes greater than $0.5 \log_{10}$ HIV RNA copies can be seen near the assay detection limits without changes in clinical status (35). Differences greater than $0.5 \log_{10}$ copies on repeated measures of plasma HIV RNA likely reflect biologically and clinically relevant changes. Increased variance toward the limit of assay detection presents an important consideration as the recommended target of suppression of HIV replication by antiretroviral therapy is now defined as being HIV RNA levels below the detection limit of plasma HIV RNA assays. Immune system activation (by immunizations or intercurrent infections) can lead to increased numbers of activated CD4+ T cells, and thereby result in increased levels of HIV replication (reflected by significant elevations of plasma HIV RNA levels from their baseline values) that may persist for as long as the inciting stimulus remains (32-34). Therefore, measurements obtained surrounding these events may not reflect a patient's actual steady-state level of plasma HIV RNA. Unlike CD4+ T cell count determinations, plasma HIV RNA levels do not exhibit diurnal variation (26,36). Within the large dynamic range of plasma HIV RNA levels that can be measured (varying over several \log_{10} copies), the observed level of assay variance is low (Table). Measurement of two samples at baseline in clinically stable patients has been recommended as a way of reducing the impact of the variability of plasma HIV RNA assays (19), and recent data support this approach (22).

The level of viremia, as measured by the amount of HIV RNA in the plasma, accurately reflects the extent of virus replication in an infected person (1,2,20,37). Although the lymphoid tissues (e.g., lymph nodes and other compartments of the reticuloendothelial system) provide the major sites of active virus production in HIV-infected persons, virus produced in these tissues is released into the peripheral circulation where it can be readily sampled (3,4,48). Thus, plasma HIV RNA concentrations reflect the level of active virus replication throughout the body, although it is not known whether specific compartments (e.g., the central nervous system [CNS]) represent sites of infection that are not in direct communication with the peripheral pool of virus.

The Magnitude of HIV Replication in Infected Persons Determines Their Rate of Disease Progression

Plasma HIV RNA can be detected in virtually all HIV-infected persons although its concentration can vary widely depending on the stage of the infection (Figure 1) and on incompletely understood aspects of the host-virus interactions. During primary infection in adults when there are numerous target cells susceptible to HIV infection without a countervailing host immune response, concentrations of plasma HIV RNA can exceed 10^7 copies/mL (83). HIV disseminates widely throughout the body during this period, and many newly infected persons display symptoms of an acute viral illness, including fever, fatigue, pharyngitis, rash, myalgias, and headache (84-86). Coincident with the emergence of antiviral immune responses, concentrations of plasma HIV RNA decline precipitously (by 2 to 3 \log_{10} copies or more). After a period of fluctuation, often lasting 6 months or more, plasma HIV RNA levels usually stabilize around a so-called set-point (5,6,10,27,31,86). The determinants of this set-point are incompletely understood but probably include the number of susceptible CD4+ T cells and macrophages available for infection, the degree of immune activation, and the tropism and replicative vigor (fitness) of the prevailing HIV strain at various times following the initial infection, as well as the effectiveness of the host anti-HIV immune response. In contrast to adults, HIV-infected infants often have very high levels of plasma HIV RNA that decline slowly with time and do not reach set-point levels until more than a year after infection (14-18).

Different infected persons display different steady-state levels of HIV replication. When populations of HIV-infected adults are studied in a cross-sectional manner, an inverse correlation between plasma HIV RNA levels and CD4+ T cell counts is seen (87,88). However, at any given CD4+ T cell count, plasma HIV RNA concentrations show wide interindividual variation (87,88). In established HIV infection, persistent concentrations of plasma HIV RNA range from <200 copies/mL in extraordinary persons who have apparently nonprogressive HIV infection to $>10^6$ copies/mL in persons who are in the advanced stages of immunodeficiency or are at risk for very rapid disease progression. In most HIV-infected and untreated adults, set-point plasma HIV RNA levels range between 10^3 and 10^5 copies/mL. Persons who have higher steady-state set-point levels of plasma HIV RNA generally lose CD4+ T cells more quickly, progress to AIDS more rapidly, and die sooner than those with lower HIV RNA set-point levels (5-7,10,27) (Figures 2-4). Once established, set-point HIV RNA levels can remain fairly constant for months to years. However, studies of populations of HIV-infected persons suggest a gradual trend toward increasing HIV RNA concentrations with time after infection (10). Within individual HIV-infected persons, rates of increase of plasma HIV RNA levels can change gradually, abruptly, or hardly at all (10). Progressively increasing plasma HIV RNA concentrations can signal the development of advancing immunodeficiency, regardless of the initial set-point value (10,75).

Plasma HIV RNA levels provide more powerful predictors of risk of progression to AIDS and death than do CD4+ T cell levels; however, the combined measurement of the two values provides an even more accurate method to assess the prognosis of HIV-infected persons (27). The relationship between baseline HIV RNA levels measured in a large cohort of HIV-infected adults and their subsequent rate of CD4+ T cell decline is shown (Figure 3) (27). Progressive loss of CD4+ T cells is observed in all

strata of baseline plasma HIV RNA concentrations, but substantially more rapid rates of decline are seen in persons who have higher baseline levels of plasma HIV RNA (Figure 3) (27). Likewise, a clear gradient in risk for disease progression and death is seen with increasing baseline plasma HIV RNA levels (5,6,10,27) (Figures 2 and 4).

HIV Replicates Actively at All Stages of the Infection

The steady-state level of HIV RNA in the plasma is a function of the rates of production and clearance (i.e., the turnover) of the virus in circulation (1,2,20,21,37). Effective antiretroviral therapy perturbs this steady state and allows an assessment of the kinetic events that underlie it. Thus, virus clearance, the magnitude of virus production, and the longevity of virus-producing cells can all be measured. Recent studies in which measurements of virus and infected-cell turnover were analyzed in this way in persons who had moderate to advanced HIV disease have demonstrated that a very dynamic process of virus production and clearance underlies the seemingly static steady-state level of HIV virions in the plasma (1,2,20,21,37).

Within 2 weeks of initiation of potent antiretroviral therapy, plasma HIV RNA levels usually fall to approximately 1% of their initial values (20,37) (Figure 5). The slope of this initial decline reflects the clearance of virus from the circulation and the longevity of recently infected CD4+ T cells and is remarkably constant among different persons (1,2,20,37). The half-life of virions in circulation is exceedingly short—less than 6 hours. Thus, on average, half of the population of plasma virions turns over every 6 hours or less. Given such a rapid rate of virus clearance, it is estimated that 10^9 to 10^{10} (or more) virions must be produced each day to maintain the steady-state plasma HIV RNA levels typically found in persons who have moderate to advanced HIV disease (20). When new rounds of virus replication are blocked by potent antiretroviral drugs, virus production from the majority of infected cells (approximately 99%) continues for only a short period, averaging approximately 2 days (1,2,20,37). HIV-infected CD4+ T cells are lost, presumably as the result of direct cytopathic effects of virus infection, with an average half-life of an infected cell being approximately 1.25 days (20). The estimated generation time of HIV (the time from release of a virion until it infects another cell and results in the release of a new generation of virions) is approximately 2.5 days, which implies that the virus is replicating at a rate of approximately 140 or more cycles per year in an infected person (20,21). Thus, at the median period between initial infection and the diagnosis of AIDS, each virus genome present in an HIV-infected person is removed by more than a thousand generations from the virus that initiated the infection.

After the initial rapid decline in plasma HIV RNA levels following initiation of potent antiretroviral therapy, a slower decay of the remaining 1% of initial plasma HIV RNA levels is observed (37) (Figure 5). The length of this second phase of virus decay differs among different persons, lasting approximately 8–28 days. Most of the residual viremia is thought to arise from infected macrophages that are lost over an average half-life of about 2 weeks, whereas the remainder is produced following activation of latently infected CD4+ T cells that decay with an average half-life of about 8 days. Within 8 weeks of initiation of potent antiretroviral therapy (in previously untreated patients), plasma HIV RNA levels commonly fall below the level of detection of even the most sensitive plasma HIV RNA assays available (sensitivity of 25 copies HIV

RNA/mL), indicating that new rounds of HIV infection are profoundly suppressed (Figure 5) (37). Fortunately, this level of suppression of HIV replication appears to have been maintained for more than 16 months in most patients who adhere to effective combination antiretroviral drug regimens (39). However, even this marked pharmacologic interference of HIV replication has not yet been reported to eradicate an established infection. Those rare persons who have been studied after having stopped effective combination antiretroviral therapy following months with undetectable levels of plasma HIV RNA have all shown rapid rebounds in HIV replication. Furthermore, infectious HIV can still be isolated from CD4+ T cells obtained from antiretroviral treated persons whose plasma HIV RNA levels have been suppressed to undetectable levels (<50 copies/mL) for 2 years or more (49,50). Viruses recovered from these persons were demonstrated to be sensitive to the antiretroviral drugs used, indicating that a reservoir of latently infected resting CD4+ T cells exists that can maintain HIV infection for prolonged periods even when new cycles of virus replication are blocked. It is not known whether additional reservoirs of residual HIV infection exist in infected persons that can permit persistence of HIV infection despite profound inhibition of virus replication by effective combination antiretroviral therapies (37,47,48). HIV infection within the CNS represents an additional potential sanctuary for virus persistence, as many of the antiretroviral drugs now available do not efficiently cross the blood-brain barrier.

Active HIV Replication Continuously Generates Viral Variants That are Resistant to Antiretroviral Drugs

HIV replication depends on a virally encoded enzyme, RT (an RNA-dependent DNA polymerase) that copies the single-stranded viral RNA genome into a double-stranded DNA in an essential step in the virus life cycle (21). Unlike cellular DNA polymerases used to copy host cell chromosomal DNA during the course of cell replication, RT lacks a 3' exonuclease activity that serves a "proofreading" function to repair errors made during transcription of the HIV genome. As a result, the HIV RT is an "error-prone" enzyme, making frequent errors while copying the RNA into DNA and giving rise to numerous mutations in the progeny virus genomes produced from infected cells. Estimates of the mutation rate of HIV RT predict that an average of one mutation is introduced in every one to three HIV genomes copied (21,89). Additional variation is introduced into the replicating population of HIV variants as a result of genetic recombination that occurs during the process of reverse transcription via template-switching between the two HIV RNA molecules that are included in each virus particle (21,90). Many mutations introduced into the HIV genome during the process of reverse transcription will compromise or abolish the infectivity of the virus; however, other mutations are compatible with virus infectivity. In HIV-infected persons, the actual frequency with which different genetic variants of HIV are seen is a function of their replicative vigor (fitness) and the nature of the selective pressures that may be acting on the existing swarm of genetic variants present (21). Important selective pressures that may exist in HIV-infected persons include their anti-HIV immune responses, the availability of host cells that are susceptible to virus infection in different tissues, and the use of antiretroviral drug treatments.

The rate of appearance of genetic variants of HIV within infected persons is a function of the number of cycles of virus replication that occurs during a person's infection (20,21). That numerous rounds of HIV replication are occurring daily in infected persons provides the opportunity to generate large numbers of variant viruses, including those that display diminished sensitivity to antiretroviral drugs. A mutation is probably introduced into every position of the HIV genome many times each day within an infected person, and the resulting HIV variants may accumulate within the resident virus population with successive cycles of virus replication (21). As a result of the great genetic diversity of the resident population of HIV, viruses harboring mutations that confer resistance to a given antiretroviral drug, and perhaps multiple antiretroviral drugs, are likely to be present in HIV-infected persons *before* antiretroviral therapy is initiated (21). Indeed, mutations that confer resistance to nucleoside analog RT inhibitors, NNRTIs, and PIs have been identified in HIV-infected persons who have never been treated with antiretroviral drugs (61,91,92). Once drug therapy is initiated, the pre-existing population of drug-resistant viruses can rapidly predominate. For drugs such as 3TC and nevirapine (and other NNRTIs), a single nucleotide change in the HIV RT gene can confer 100- to 1,000-fold reductions in drug susceptibility (1,61,93-95). Although these agents may be potent inhibitors of HIV replication, the antiretroviral activity of these drugs when used alone is largely reversed within 4 weeks of initiation of therapy due to the rapid outgrowth of drug-resistant variants (1,61,93-95). The rapidity with which drug-resistant variants emerge in this setting is consistent with the existence of drug-resistant subpopulations of HIV within infected patients before to the initiation of treatment (21,61). Because treatment with many of the available antiretroviral drugs selects for HIV variants that harbor the same or related mutations, specific treatments can select for the outgrowth of HIV variants that are resistant to drugs with which the patient has not been treated (referred to as cross-resistance) (96,97).

Drug-resistant viruses that emerge during drug therapy are predicted to replicate less well (are less fit) than their wild-type counterparts and are expected to attain lower steady-state levels of viral load than are present before the initiation of therapy (21). Evidence for such decreased fitness of drug-resistant viruses has been gleaned from studies of protease-inhibitor-treated or 3TC-treated patients, but this effect has not been apparent in NNRTI-treated patients (e.g., nevirapine or delavirdine) (1,61). Depending on its relative fitness, the drug-resistant variant can persist at appreciable levels even after the antiretroviral therapy that selected for its outgrowth is withdrawn. HIV variants resistant to nevirapine can persist for more than a year after withdrawal of nevirapine treatment (61). Zidovudine-resistant HIV variants and variants resistant to both zidovudine and nevirapine have also been shown to persist in infected persons and to replicate well enough to be transmitted from one person to another (98). Because HIV variants that are resistant to PIs often appear to be less fit than drug-sensitive viruses, their prevalence in patients who develop PI resistance may decline after withdrawal of the drug. However, although such variants may decline after drug withdrawal, they also may persist in patients at higher levels than their original levels and can be rapidly selected for should the same antiretroviral agent (or a PI demonstrating cross-resistance) be used again (97).

The definition of mutations associated with resistance to specific antiretroviral drugs and the advent of genetic methods to detect drug-resistant variants in treated

patients have raised the possibility of screening HIV-infected patients for the presence of HIV variants as a tool to guide therapeutic decisions (92,99). However, this approach must be considered experimental and may prove very difficult to implement because of the complex patterns of mutations that increase resistance to some antiretroviral agents. Furthermore, the prevalence of clinically important populations of drug-resistant variants in many HIV-infected persons is likely to be below the level of detection of the available assays, thus potentially creating falsely optimistic predictions of drug efficacy (21,61).

Combination Antiretroviral Therapy That Suppresses HIV Replication to Undetectable Levels Can Delay or Prevent the Emergence of Drug-Resistant Viral Variants

Current strategies for antiretroviral therapy are much more effective than those previously available, and the efficacy of these approaches confirms predictions emerging from fundamental studies of the biology of HIV infection. Several important principles have emerged from these studies that can be used to guide the application of antiretroviral therapies in clinical practice:

- The likelihood that HIV variants that are resistant to individual drugs (and possibly combinations of drugs) are already present in untreated patients must be appreciated.
- The likelihood that drug-resistant variants are already present in an HIV-infected person decreases as the number of noncross-resistant antiretroviral drugs used in combination is increased.
- The prevalence in untreated patients of HIV variants already resistant to antiretroviral agents that require multiple mutations in the virus target gene to confer high-level drug resistance is also expected to be lower as the number of required mutations increases. For example, high-level resistance to PIs (e.g., ritonavir and indinavir) requires the presence of multiple mutations in the HIV protease gene; some of these mutations affect the actual antiviral action of the drug, whereas others represent compensatory mutations that act to increase the fitness of the drug-resistant HIV variants (96,97,100). The prevalence of HIV variants that already harbor all of the mutations required for high-level resistance to these drugs is expected to be low in untreated patients.
- Antiretroviral drugs that select for partially disabled (less fit) viruses may benefit the host by decreasing the amount of virus replication (and consequent damage) that occurs even after drug-resistant mutants have overgrown drug-sensitive viruses.
- Incomplete suppression of HIV replication (as indicated by the continued presence of detectable levels of plasma HIV RNA) will afford the opportunity for continued accumulation of mutations that confer high-level drug resistance, and thereby facilitate the eventual outgrowth of the resistant virus population during continued therapy (23,39). The more effectively new cycles of HIV infection are suppressed, the fewer opportunities are provided for the accumulation of new

mutations that permit the emergence of drug-resistant variants (97,100). Thus, initiation and maintenance of therapy with optimal doses of combinations of potent antiretroviral drugs with the intent of suppressing HIV replication to levels below the detection limit of sensitive plasma HIV RNA assays provide the most promising strategy to forestall (or prevent) the emergence of drug-resistant viruses and achieve maximum protection from HIV-induced immune system damage.

Antiretroviral Therapy-Induced Inhibition of HIV Replication Predicts Clinical Benefit

As active HIV replication is directly linked to the progressive depletion of CD4+ T cell populations, reduction in levels of virus replication by antiretroviral drug therapy is predicted to correlate with the clinical benefits observed in treated patients. Data from an increasing number of clinical trials of antiretroviral agents provide strong support for this prediction and indicate that greater clinical benefit is obtained from more profound suppression of HIV replication (9,13,23,38-40,56). For example, virologic analyses from ACTG 175 (a study of zidovudine or didanosine monotherapy compared with combination therapy with zidovudine plus either didanosine or zalcitabine) indicate that a reduction in plasma HIV RNA levels to 1.0 log below baseline at 56 weeks after initiation of therapy was associated with a 90% reduction in risk of progression of clinical disease (13). In a pooled analysis of seven different ACTG studies, durable suppression of plasma HIV RNA levels to <5,000 copies of HIV RNA/mL between 1 and 2 years after initiation of treatment was associated with an average increase in CD4+ T cell levels of approximately 90 cells/mm³ (24). Patients whose plasma HIV RNA levels failed to be stably suppressed to <5,000 copies/mL showed progressive decline in CD4+ T cell counts during the same period (24).

Decreases in plasma HIV RNA levels induced by antiretroviral therapy provide better indicators of clinical benefit than CD4+ T cell responses (9,13,24). Furthermore, in patients who have advanced HIV disease, clinical benefit correlates with treatment-induced decreases in plasma HIV RNA levels, even when CD4+ T cell increases are not seen. The failure to observe CD4+ T cell increases in some treated patients despite suppression of HIV replication may reflect irreversible damage to the regenerative capacity of the immune system in the later stages of HIV disease.

The most extensive data on the relationship between the magnitude of suppression of HIV replication induced by antiretroviral therapy and the degree of improved clinical outcome were generated during studies of nucleoside analog RT inhibitors used alone or in combination (9,13,24). These treatments yield less profound and less durable suppression of HIV replication than currently available combination therapy regimens that include potent PIs (and that are able to suppress HIV replication to levels below the detection limits of plasma HIV RNA assays) (23,37,39). Thus, it is likely that the relationship between suppression of HIV replication and clinical benefit will become even more apparent as experience with potent combination therapies accumulates.

Repair of immune system function may be incomplete following effective inhibition of continuing HIV replication and damage by antiretroviral drug therapy.

As discussed in the preceding principles, disease progression in HIV-infected patients results from active virus replication that inflicts chronic damage upon the function of the immune system and its structural elements, the lymphoid tissues. Because of the clonal nature of the antigen-specific immune response, in the absence of generation of immunocompetent CD4+ T cells from immature progenitor cells, it is likely that T cell responses may not be regained once lost, even if new rounds of HIV infection can be stopped by effective antiretroviral therapy (80,82,101). Similarly, it is not known if the damaged architecture of the lymphoid organs seen in persons with moderate to advanced HIV disease can be repaired following antiretroviral drug therapy. Should the residual proliferative potential of CD4+ and CD8+ T cells decline with increased duration of HIV infection and the magnitude of the cumulative loss and regeneration of lymphocyte populations, late introduction of antiretroviral therapy may have limited ability to reconstitute levels of functional lymphocytes. Thus, it is believed that the initiation of antiretroviral therapy before extensive immune system damage has occurred will be more effective in preserving and improving the ability of the HIV-infected person to mount protective immune responses.

Few reliable methods are now available to assess the integrity of immune responses in humans. However, the application of specific methods to the study of immune responses in HIV-infected patients before and after initiation of antiretroviral therapy indicates that immunologic recovery is incomplete even when HIV replication falls to undetectable levels. CD4+ T cell levels do not return to the normal range in most antiretroviral drug-treated patients, and the extent of CD4+ T cell increase is typically more limited when therapy is started in the later stages of HIV disease (82). Recent evidence indicates that the repertoire of antigen-specific CD4+ T cells becomes progressively constricted with declining T cell numbers (82). In persons who have evidence of a restricted T cell repertoire, antiretroviral therapy can increase total CD4+ T cell numbers but fails to increase the diversity of antigen recognition ability (82). It is not yet known if expansion of a constricted CD4+ T cell repertoire of antigen recognition might be seen with longer-term follow-up of such persons.

Reports of OIs occurring in antiretroviral-treated patients at substantially higher CD4+ T cell counts than those typically associated with susceptibility to the specific opportunistic infections raise the concern that restoration of protective immune responses may be incomplete, even when effective suppression of continuing HIV replication is achieved (102). However, other reports describe instances in which the clinical symptoms or signs of preexisting OIs were ameliorated (103-105), or in which new inflammatory responses to preexisting, but subclinical, OIs became manifest following initiation of effective combination antiretroviral therapy (106,107). These observations indicate that some improvement in immune function may be possible, even in patients who have advanced HIV disease, if sufficient numbers of pathogen-specific CD4+ T cells are still present when effective antiretroviral therapy is begun. The extent to which antiretroviral therapy can restore immune function when initiated in persons at varying stages of HIV disease is currently unknown but represents an essential question for future research.

References

1. Wei X, Ghosh SK, Taylor ME, et al. Viral dynamics in human immunodeficiency virus type 1 infection. *Nature* 1995;373:117-22.

2. Ho DD, Neumann AU, Perelson AS, Chen W, Leonard JM, Markowitz M. Rapid turnover of plasma virions and CD4 lymphocytes in HIV-1 infection. *Nature* 1995;373:123-6.
3. Embretson J, Zupancic M, Ribas J, et al. Massive covert infection of helper T lymphocytes and macrophages by HIV during the incubation period of AIDS. *Nature* 1993;362:359-62.
4. Pantaleo G, Graziosi C, Demarest J, et al. HIV infection is active and progressive in lymphoid tissue during the clinically latent stage of disease. *Nature* 1993;362:355-8.
5. Mellors JW, Kingsley LA, Rinaldo CR, et al. Quantitation of HIV-1 RNA in plasma predicts outcome after seroconversion. *Ann Intern Med* 1995; 122:573-9.
6. O'Brien TR, Blattner WA, Waters D, et al. Serum HIV-1 RNA levels and time to development of AIDS in the Multicenter Hemophilia Cohort Study. *JAMA* 1996;276:105-10.
7. Jurriaans S, van Gemen B, Weverling GJ, et al. The natural history of HIV-1 infection: virus load and virus phenotype independent determinants of clinical course? *Virology* 1994;204:223-33.
8. Saksela K, Stevens CE, Rubenstein P, Taylor PE, Baltimore D. HIV-1 messenger RNA in peripheral blood mononuclear cells as an early marker of risk for progression to AIDS. *Ann Intern Med* 1995;123:641-8.
9. O'Brien WA, Hartigan PM, Martin D, et al. Changes in plasma HIV-1 RNA and CD4+ lymphocyte counts and the risk of progression to AIDS. *N Engl J Med* 1996;334:426-31.
10. O'Brien TR, Rosenberg PS, Yellin F, Goedert JJ. Longitudinal HIV-1 RNA levels in a cohort of homosexual men. *J Acquir Immune Defic Syndr Hum Retrovirol* 1998 (in press).
11. Enger C, Graham N, Peng Y, et al. Survival from early, intermediate, and late stages of HIV infection. *JAMA* 1996;275:1329-34.
12. Haynes BF, Pantaleo G, Fauci AS. Toward an understanding of the correlates of protective immunity to HIV infection. *Science* 1996;271:324-8.
13. Katzenstein DA, Hammer SM, Hughes MD, et al. The relation of viral load and immunologic markers to clinical outcomes after nucleoside therapy in HIV-infected adults with 200 to 500 CD4 cells per cubic millimeter. *New Eng J Med* 1996;335:1091-8.
14. Dickover RE, Dillon M, Gillette SG, et al. Rapid increases in load of human immunodeficiency virus correlate with early disease progression and loss of CD4 cells in vertically infected infants. *J Infect Dis* 1994;170:1279-84.
15. McIntosh K, Shevitz A, Zaknun D, et al. Age- and time-related changes in extracellular viral load in children vertically infected by human immunodeficiency virus. *Pediatr Infect Dis J* 1996;15:1087-91.
16. Mofenson LM, Korelitz J, Meyer WA, et al. The relationship between serum human immunodeficiency virus type 1 (HIV-1) RNA level, CD4 lymphocyte percent, and long-term mortality risk in HIV-1-infected children. *J Infect Dis* 1997;175:1029-38.
17. Dickover RE, Dillon M, Leung K-M, et al. Early prognostic indicators in primary perinatal HIV-1 infection: importance of viral RNA and the timing of transmission on long term outcome. *J Infect Dis* 1998 (in press).
18. Shearer WT, Quinn TC, LaRussa P, et al. Viral load and disease progression in infants infected with human immunodeficiency virus type 1. *New Engl J Med* 1997;336:1337-42.
19. Saag MS, Holodniy M, Kuritzkes DR, et al. HIV viral load markers in clinical practice. *Nat Med* 1996;2:625-9.
20. Perelson AS, Neumann AU, Markowitz M, Leonard JM, Ho DD. HIV-1 dynamics in vivo: virion clearance rate, infected cell life-span, and viral generation time. *Science* 1996;271:1582-6.
21. Coffin JM. HIV population dynamics in vivo: implications for genetic variation, pathogenesis, and therapy. *Science* 1995;267:483-9.
22. Raboud JM, Montaner JSG, Rae S, Conway B, Singer J, Schechter MT. Issues in the design of trials of therapies for subjects with human immunodeficiency virus infection that use plasma RNA level as an outcome. *J Infect Dis* 1997;175:576-82.
23. Kempf D, Molla A, Sun E, Danner S, Boucher C, Leonard J. The duration of viral suppression is predicted by viral load during protease inhibitor therapy [Abstract 603]. In: Programs and abstracts of the 4th Conference on Retroviruses and Opportunistic Infections. Washington DC, January 22-26, 1997.
24. DeGruttola V, for the ACTG Cross Protocol Study Group. Prognostic value of CD4 counts and plasma HIV RNA: an ACTG cross protocol analysis. In: Proceedings of the Public Meeting of

- the NIH Panel To Define Principles of Therapy of HIV Infection, November 13–14, 1996. Washington, DC: Office of AIDS Research, NIH.
25. Palumbo PE, Raskino C, Fiscus S, et al. Correlation of HIV plasma RNA levels with clinical outcome in a large pediatric trial (ACTG 152) [Abstract LB14]. In: Program and abstracts of the 4th Conference on Retroviruses and Opportunistic Infections. Washington DC, January 22–26, 1997.
 26. Stein DS, Korvick JA, Vermund SH. CD4+ lymphocyte cell enumeration for prediction of clinical course of human immunodeficiency virus disease: a review. *J Infect Dis* 1992;165:352–63.
 27. Mellors, JW, Muñoz A, Giorgi JV, et al. Plasma viral load and CD4+ lymphocytes as prognostic markers of HIV-1 infection. *Ann Intern Med* 1997;126:946–54.
 28. USPHS/IDSA Prevention of Opportunistic Infections Working Group: 1997 USPHS /IDSA guidelines for the prevention of opportunistic infections in persons infected with human immunodeficiency virus. *MMWR* 1997;46 (No. RR-12).
 29. El-Sadr W, Oleske JM, Agins BD, et al. Evaluation and management of early HIV infection. Clinical practice guideline no. 7. AHCPR publication no. 94–0572. Rockville, MD: Agency for Health Care Policy and Research, Public Health Service, US Department of Health and Human Services, January 1994.
 30. CDC. 1995 Revised guidelines for prophylaxis against *Pneumocystis carinii* pneumonia for children infected with or perinatally exposed to human immunodeficiency virus. *MMWR* 1995;44(No. RR-4).
 31. Schacker T, Hughes J, Shea T, Corey L. Viral load in acute and very early HIV infection does not correlate with disease progression [Abstract 475]. In: Program and abstracts of the 4th Conference on Retroviruses and Opportunistic Infections. Washington DC, January 22–26, 1997.
 32. Staprans SI, Hamilton BL, Follansbee SE, et al. Activation of virus replication after vaccination of HIV-1 infected individuals. *J Exp Med* 1995;182:1727–37.
 33. Stanley SK, Ostrowski MA, Justement JS, et al. Effect of immunization with a common recall antigen on viral expression in patients infected with human immunodeficiency virus type 1. *N Engl J Med* 1996;334:1222–30.
 34. Brichacek B, Swindells S, Janoff EN, Pirruccello S, Stevenson M. Increased plasma human immunodeficiency virus type 1 burden following antigenic challenge with pneumococcal vaccine. *J Infect Dis* 1996;174:1191–9.
 35. Raboud JM, Montaner JSG, Conway B, et al. Variation in plasma RNA levels, CD4 cell counts, and p24 antigen levels in clinically stable men with human immunodeficiency virus infection. *J Infect Dis* 1996;174:191–4.
 36. Deeks SG, Coleman RL, White R, et al. Variance of plasma human immunodeficiency virus type 1 RNA levels measured by branched DNA within and between days. *J Infect Dis* 1997;176:514–7.
 37. Perelson AS, Essunger P, Cao Y, et al. Decay characteristics of HIV-1-infected compartments during combination therapy. *Nature* 1997;387:188–91.
 38. Hammer SM, Squires KE, Hughes MD, et al. A controlled trial of two nucleoside analogues plus indinavir in persons with human immunodeficiency virus infection and CD4 cell counts of 200 per cubic millimeter or less. *N Engl J Med* 1997; 337:725–33.
 39. Gulick RM, Mellors JW, Havlir D, et al. Treatment with indinavir, zidovudine, and lamivudine in adults with human immunodeficiency virus infection and prior antiretroviral therapy. *N Engl J Med* 1997;337:734–9.
 40. Montaner J, Wainberg M, INCAS study results. In: Proceedings of the Public Meeting of the NIH Panel To Define Principles of Therapy of HIV Infection, Nov. 13–14, 1996. Washington, DC: Office of AIDS Research, NIH.
 41. Pachi C, Todd JA, Kern DG, et al. Rapid and precise quantification of HIV-1 RNA in plasma using a branched DNA signal amplification assay. *J Acquir Immune Defic Syndr Hum Retrovirol* 1995;8:446–54.
 42. Mulder J, McKinney N, Christopherson C, Sninsky J, Greenfield L, Kwok S. Rapid and simple PCR assay for quantitation of human immunodeficiency virus type 1 RNA in plasma: application to acute retroviral infection. *J Clin Microbiol* 1994;32:292–300.

43. Vandamme AM, Van Dooren S, Kok W, et al. Detection of HIV-1 RNA in plasma and serum samples using the NASBA amplification system compared to RNA-PCR. *J Virol Methods* 1995;52:121-32.
44. Yen-Lieberman B, Brambilla D, Jackson B, et al. Evaluation of a quality assurance program for quantitation of human immunodeficiency virus type 1 RNA in plasma by the AIDS Clinical Trials Group Virology Laboratories. *J Clin Microbiol* 1996;34:2695-701.
45. Schuurman R, Descamps D, Jan Weverling G, et al. Multicenter comparison of three commercial methods for quantification of human immunodeficiency virus type 1 RNA in plasma. *J Clin Microbiol* 1996;34:3016-22.
46. Revets H, Marissens D, de Wit S, et al. Comparative evaluation of NASBA HIV-1 RNA QT, AMPLICOR-HIV monitor, and QUANTIPLEX HIV RNA assay, three methods for quantification of human immunodeficiency virus type 1 RNA in plasma. *J Clin Microbiol* 1996;34:1058-64.
47. Chun TW, Carruth L, Finzi D, et al. Quantification of latent tissue reservoirs and total body viral load in HIV-1 infection. *Nature* 1997;387:183-8.
48. Cavert W, Notermans DW, Staskus K, et al. Kinetics of response in lymphoid tissues to antiretroviral therapy of HIV-1 infection. *Science* 1997;276:960-4.
49. Wong JK, Hezareh M, Günthard HF, et al. Recovery of replication-competent HIV despite prolonged suppression of plasma viremia. *Science* 1997;278:1291-4.
50. Finzi D, Hermankova M, Pierson T, et al. Identification of a reservoir for HIV-1 in patients on highly active antiretroviral therapy. *Science* 1997;278:1295-8.
51. Ho DD. Time to hit HIV, early and hard. *N Engl J Med* 1995;333:450-1.
52. Connor EM, Sperling RS, Gelber R, et al. Reduction of maternal-infant transmission of human immunodeficiency virus type 1 with zidovudine treatment. *N Engl J Med* 1994;331:1173-80.
53. Sperling RS, Shapiro DE, Coombs RW, et al. Maternal viral load, zidovudine treatment, and the risk of transmission of human immunodeficiency virus type 1 from mother to infant. *New Engl J Med* 1996;335:1621-9.
54. CDC. Public Health Service Task Force recommendations for the use of antiretroviral drugs in pregnant women infected with HIV-1 for maternal health and for reducing perinatal HIV-1 transmission in the United States. *MMWR* 1998;47(RR-2).
55. D'Aquila RT, Hughes MD, Johnson VA, et al. Nevirapine, zidovudine, and didanosine compared with zidovudine and didanosine in patients with HIV-1 infection. *Ann Intern Med* 1996;124:1019-30.
56. CAESAR Coordinating Committee. Randomised trial of addition of lamivudine or lamivudine plus loviride to zidovudine-containing regimens for patients with HIV-1 infection: the CAESAR trial. *Lancet* 1997;349:1413-21.
57. Staszewski S, Loveday C, Picazo JJ, et al. Safety and efficacy of lamivudine-zidovudine combination therapy in zidovudine-experienced patients. *JAMA* 1996;276:111-7.
58. Katlama C, Ingrand D, Loveday C, et al. Safety and efficacy of lamivudine-zidovudine combination therapy in antiretroviral-naïve patients. *JAMA* 1996;276:118-25.
59. Eron JJ, Benoit SL, Jemsek J, et al. Treatment with lamivudine, zidovudine, or both in HIV-positive patients with 200 to 500 CD4+ cells per cubic millimeter. *New Engl J Med* 1995;333:1662-9.
60. Van Leeuwen R, Katlama C, Kitchen V, et al. Evaluation of safety and efficacy of 3TC (lamivudine) in patients with asymptomatic or mildly symptomatic human immunodeficiency virus infection: a phase I/II study. *J Infect Dis* 1995;171:1166-71.
61. Havlir DV, Eastman S, Gamst A, Richman DD. Nevirapine-resistant human immunodeficiency virus: kinetics of replication and estimated prevalence in untreated patients. *J Virol* 1996;70:7894-9.
62. Deeks SG, Smith M, Holodniy M, Kahn JO. HIV-1 protease inhibitors: a review for clinicians. *JAMA* 1997;277:145-53.
63. McDonald CK, Kuritzkes DR. Human immunodeficiency virus type 1 protease inhibitors. *Arch Intern Med* 1997;157:951-9.
64. Minkoff H, Augenbraun M. Antiretroviral therapy for pregnant women. *Am J Obstet Gynecol* 1997;176:478-89.
65. Cao Y, Krogstad P, Korber BT, et al. Maternal HIV-1 viral load and vertical transmission of infection: the Ariel Project for the prevention of HIV transmission from mother to infant. *Nat Med* 1997;3:549-52.

66. Luzuriaga K, Bryson Y, Krogstad P, et al. Combination treatment with zidovudine, didanosine, and nevirapine in infants with human immunodeficiency virus type 1 infection. *New Engl J Med* 1997;336:1343-9.
67. Kinloch-De Loës S, Hirschel BJ, Hoen B, et al. A controlled trial of zidovudine in primary human immunodeficiency virus infection. *N Engl J Med* 1995;333:408-13.
68. Lafeuillade A, Poggi C, Tamalet C, Profizi N, Tourres C, Costes O. Effects of a combination of zidovudine, didanosine, and lamivudine on primary human immunodeficiency virus type 1 infection. *J Infect Dis* 1997;175:1051-5.
69. Hoen B, Harzic M, Fleury H, et al. ANRS053 trial of zidovudine (ZDV), lamivudine (3TC), and ritonavir combination in patients with symptomatic primary HIV-1 infection: preliminary results [Abstract 232]. In: Program and abstracts of the 4th Conference on Retroviruses and Opportunistic Infections. Washington, DC, Jan. 22-26, 1997.
70. Tamalet C, Martin IP, Lafeuillade A. Viral load and genotypic resistance pattern in HIV-1 infected patients treated by a triple combination therapy including nucleoside and protease inhibitors (NIS and PIS) initiated at primary infection (PHI) [Abstract 592]. In: Program and abstracts of the 4th Conference on Retroviruses and Opportunistic Infections. Washington, DC, January 22-26, 1997.
71. Perrin L, Markowitz M, Calandra G, Chung M, and the MRL Acute HIV Infection Study Group. An open treatment study of acute HIV infection with zidovudine, lamivudine and indinavir sulfate [Abstract 238]. In: Program and abstracts of the 4th Conference on Retroviruses and Opportunistic Infections. Washington, DC, January 22-26, 1997.
72. Markowitz M, Cao Y, Vesanan M, et al. Recent HIV infection treated with AZT, 3TC, and a potent protease inhibitor [Abstract LB8]. In: Program and abstracts of the 4th Conference on Retroviruses and Opportunistic Infections. Washington, DC, January 22-26, 1997.
73. Rosenberg ES, Billingsley JM, Caliendo AM, et al. Vigorous HIV-1 specific CD4+ T cell responses associated with control of viremia. *Science* 1997;278:1447-50.
74. Weiss RA. HIV receptors and the pathogenesis of AIDS. *Science* 1996;272:1885-6.
75. Moore, JP, Trkola A, Dragic T. Co-receptors for HIV-1 entry. *Curr Opin Immunol* 1997;9:551-62.
76. Mackall CL, Fleisher TA, Brown MR, et al. Age, thymopoiesis, and CD4+ T-lymphocyte regeneration after intensive chemotherapy. *N Engl J Med* 1995;332:143-9.
77. Darby SC, Weart DW, Giangrande PLF, Spooner RJD, Rizza CR. Importance of age at infection with HIV-1 for survival and development of AIDS in UK haemophilia population. *Lancet* 1996;347:1573-9.
78. Koot M, B van't Wout AB, Kootstra NA, EY de Goede R, Tersmette M, Schuitemaker H. Relation between changes in cellular load, evaluation of viral phenotype, and the clonal composition of virus populations in the course of human immunodeficiency virus type infection. *J Infect Dis* 1996;173:349-54.
79. Margolick JB, Muñoz A, Donnenberg AD, et al. Failure of T-cell homeostasis preceding AIDS in HIV-1 infection. *Nat Med* 1995;7:674-80.
80. Shearer G, Clerici M. Early T-helper cell defects in HIV infection. *AIDS* 1991;5:245-53.
81. Schnittman SM, Lane HC, Greenhouse J, Justement JS, Baseler M, Fauci AS. Preferential infection of CD4+ memory T cells by human immunodeficiency virus type 1: evidence for a role in selective T-cell functional defects observed in infected individuals. *Proc Natl Acad Sci USA* 1990;87:6058-62.
82. Connors M, Kovacs JA, Krevat S, et al. HIV infection induces changes in CD4+ T-cell phenotype and depletions within the CD4+ T-cell repertoire that are not immediately restored by antiviral or immune-based therapies. *Nat Med* 1997;3:533-40.
83. Piatak M Jr, Yang LC, Luk KC, et al. Viral dynamics in primary HIV-1 infection (letter). *Lancet* 1993;341:1099.
84. Tindall B, Cooper DA. Primary HIV infection: host responses and intervention strategies. *AIDS* 1991;5:1-14.
85. Kinloch-de Loës S, de Saussure P, Saurat JH, Stalder H, Hirschel B, Perrin LH. Symptomatic primary infection due to human immunodeficiency virus type 1: review of 31 cases. *Clin Infect Dis* 1993;17:59-65.
86. Schacker T, Collier AC, Hughes J, Shea T, Corey L. Clinical and epidemiologic features of primary HIV infection. *Ann Intern Med* 1996;125:257-64.

87. Piatak M, Saag MS, Yang LC, et al. High levels of HIV-1 in plasma during all stages of infection determined by competitive PCR. *Science* 1993;259:1749-54.
88. Cao Y, Ho DD, Todd J, Kokka R, et al. Clinical evaluation of branched DNA signal amplification for quantifying HIV type 1 in human plasma. *AIDS Res Hum Retroviruses* 1995;11:353-61.
89. Mansky LM, Temin HM. Lower in vivo mutation rate of human immunodeficiency virus type 1 than that predicted from the fidelity of purified reverse transcriptase. *J Virol* 1995;69:5087-94.
90. Moutouh L, Corbeil J, Richman DD. Recombination leads to the rapid emergence of HIV-1 dually resistant mutants under selective drug pressure. *Proc Natl Acad Sci USA* 1996;93:6106-11.
91. de Jong MD, Veenstra J, Stilianakis NI, et al. Host-parasite dynamics and outgrowth of virus containing a single K70R amino acid change in reverse transcriptase are responsible for the loss of human immunodeficiency virus type 1 RNA load suppression by zidovudine. *Proc Natl Acad Sci USA* 1996;93:5501-6.
92. Kozal MJ, Shah N, Shen N, et al. Extensive polymorphisms observed in HIV-1 clade B protease gene using high-density oligonucleotide arrays. *Nat Med* 1996;2:753-9.
93. Schuurman R, Nijhuis M, van Leeuwen R, et al. Rapid changes in human immunodeficiency virus type 1 RNA load and appearance of drug-resistant virus populations in persons treated with lamivudine (3TC). *J Infect Dis* 1995;171:1411-9.
94. Pluda JM, Cooley TP, Montaner JSG, et al. A phase I/II Study of 2'-deoxy-3'-thiacytidine (lamivudine) in patients with advanced human immunodeficiency virus infection. *J Infect Dis* 1995;171:1438-47.
95. Richman DD, Havlir D, Corbeil J, et al. Nevirapine resistance mutations of human immunodeficiency virus type 1 selected during therapy. *J Virol* 1994;68:1660-6.
96. Condra JH, Schleif WA, Blahy OM, et al. In vivo emergence of HIV-1 variants resistant to multiple protease inhibitors. *Nature* 1995;374:569-71.
97. Condra JH, Holder DJ, Schleif WA, et al. Genetic correlates of in vivo viral resistance to indinavir, a human immunodeficiency virus type 1 protease inhibitor. *J Virol* 1996;70:8270-6.
98. Imrie A, Beveridge A, Genn W, et al. Transmission of human immunodeficiency type 1 resistant to nevirapine and zidovudine. *J Infect Dis* 1997;175:1502-6.
99. Holodiny M, Mole L, Margolis D, et al. Determination of human immunodeficiency virus RNA in plasma and cellular viral DNA genotypic zidovudine resistance and viral load during zidovudine-didanosine combination therapy. *J Virol* 1995;69:3510-6.
100. Molla A, Korneyeva M, Gao Q, et al. Ordered accumulation of mutations in HIV protease confers resistance in ritonavir. *Nature Med* 1996;2:760-6.
101. Kelleher AD, Carr A, Zaunders J, Cooper DA. Alterations in the immune response of human immunodeficiency virus (HIV)-infected subjects treated with an HIV-specific protease inhibitor, ritonavir. *J Infect Dis* 1996;173:321-9.
102. Jacobson MA, Zegans M, Pavan PR, et al. Cytomegalovirus retinitis after initiation of highly active antiretroviral therapy. *Lancet* 1997;349:1443-5.
103. Whitcup SM, Fortin E, Nussenblatt RB, et al. Therapeutic effect of combination antiretroviral therapy on cytomegalovirus retinitis (letter). *JAMA* 1997;277:1519-20.
104. Hicks CB, Myers SA, Giner J. Resolution of intractable molluscum contagiosum in a human immunodeficiency virus-infected patient after institution of antiretroviral therapy with ritonavir. *Clin Infect Dis* 1997;24:1023-5.
105. Benhamou Y, Bochet MV, Carriere J, et al. Effects of triple antiretroviral therapies including a HIV protease inhibitor on chronic intestinal cryptosporidiosis and microsporidiosis in HIV-infected patients [Abstract 357]. In: Program and abstracts of the 4th Conference on Retroviruses and Opportunistic Infections. Washington, DC, January 22-26, 1997.
106. Carr A, Cooper DA. Restoration of immunity to chronic hepatitis B infection in HIV-infected patient on protease inhibitor [Letter]. *Lancet* 1997;349:995-6.
107. Phillips P, Zala C, Rouleau D, Montaner JSG. Mycobacterial lymphadenitis: can highly active antiretroviral therapy (HAART) unmask subclinical infection? [Abstract 351]. In: Program and abstracts of the 4th Conference on Retroviruses and Opportunistic Infections. Washington, DC, January 22-26, 1997.

Appendices

TABLE. Characteristics of plasma HIV RNA assays*

Assay	Linear dynamic range [†] (copies/mL)	Observed intra-assay (copies/mL) standard deviation range (log ₁₀) [§]	Preferred anticoagulant
RT-PCR [¶]	4 x 10 ² –10 ^{5.2}	<0.15–0.33	ACD/EDTA**
bDNA ^{††}	5 x 10 ² –1.6 x 10 ⁶	0.08–0.2	EDTA**
NASBA ^{®§§}	4 x 10 ² –4 x 10 ⁷	0.13–0.23	ACD/EDTA/HEP**

* More sensitive versions of each of these assays (detection limits 20–100 HIV RNA copies/mL) are currently in development and will likely be commercially available in the future.

[†] Higher values can be measured with dilution of the specimen into the linear dynamic range for each assay.

[§] Ranges are representative of those obtained in comparative analyses of plasma HIV RNA assays (44–46). Plasma HIV RNA assays tend to be more variable at or near the limit of quantitation. Thus, the significance of changes in HIV RNA levels at the lowest levels of quantitation for a given assay should be evaluated in light of this increased variability.

[¶] Amplicor HIV Monitor™ assay (Roche Molecular Systems, Alameda, CA).

** ACD = acid citrate dextran (citrate; yellow-top tube); EDTA = ethylenediaminetetraacetic acid (purple-top tube); HEP = heparin (green-top tube).

^{††} Quantiplex™ HIV RNA bDNA assay (Chiron Diagnostics, Emeryville, CA).

^{§§} NucliSens™ HIV-1 QT assay (Organon Teknika, Boxtel, The Netherlands).

FIGURE 1. Generalized time course of HIV infection and disease

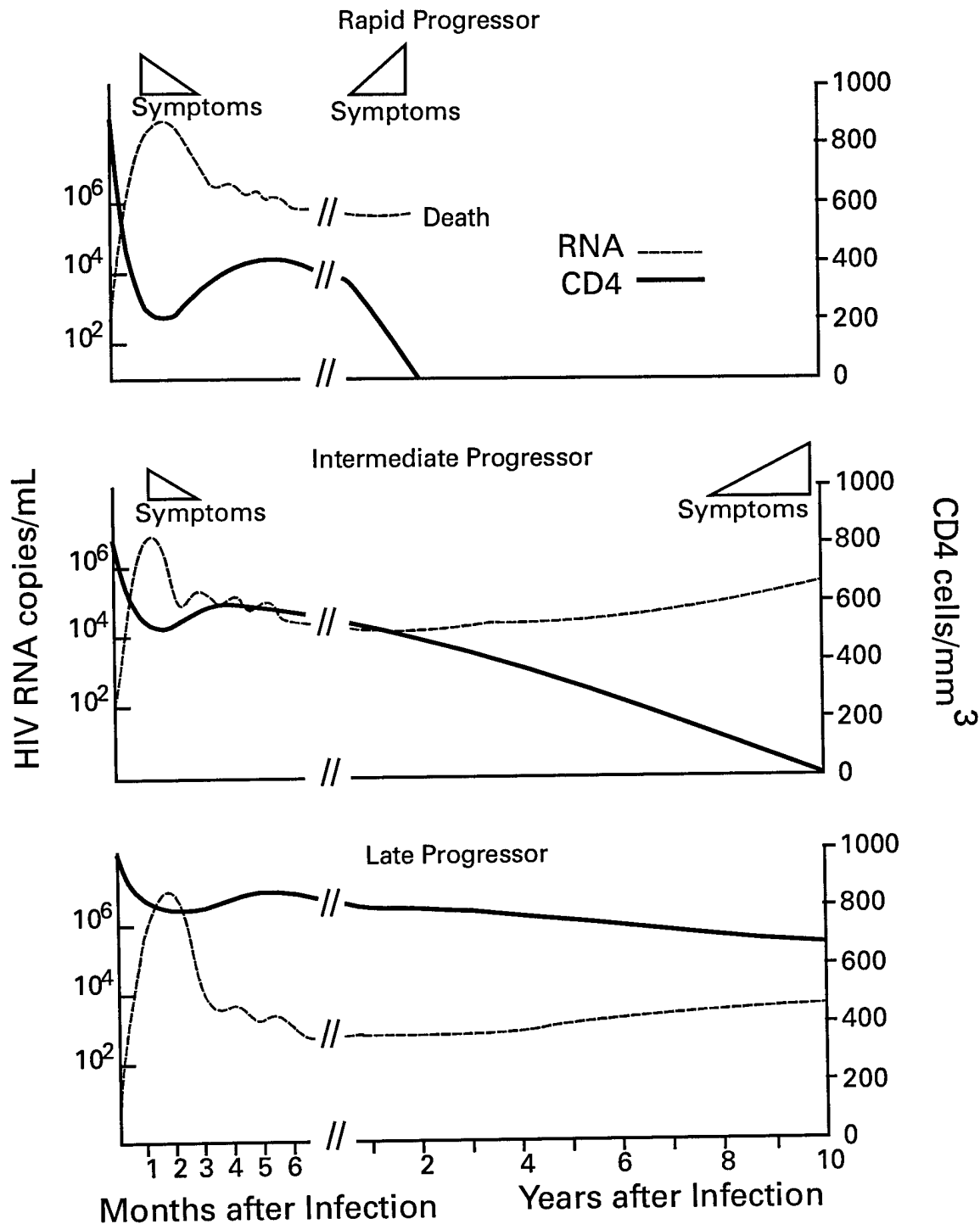

Three different patterns of disease progression: rapid, intermediate, and late progression.

FIGURE 2. AIDS-free survival by baseline plasma HIV RNA and CD4+ T cell levels

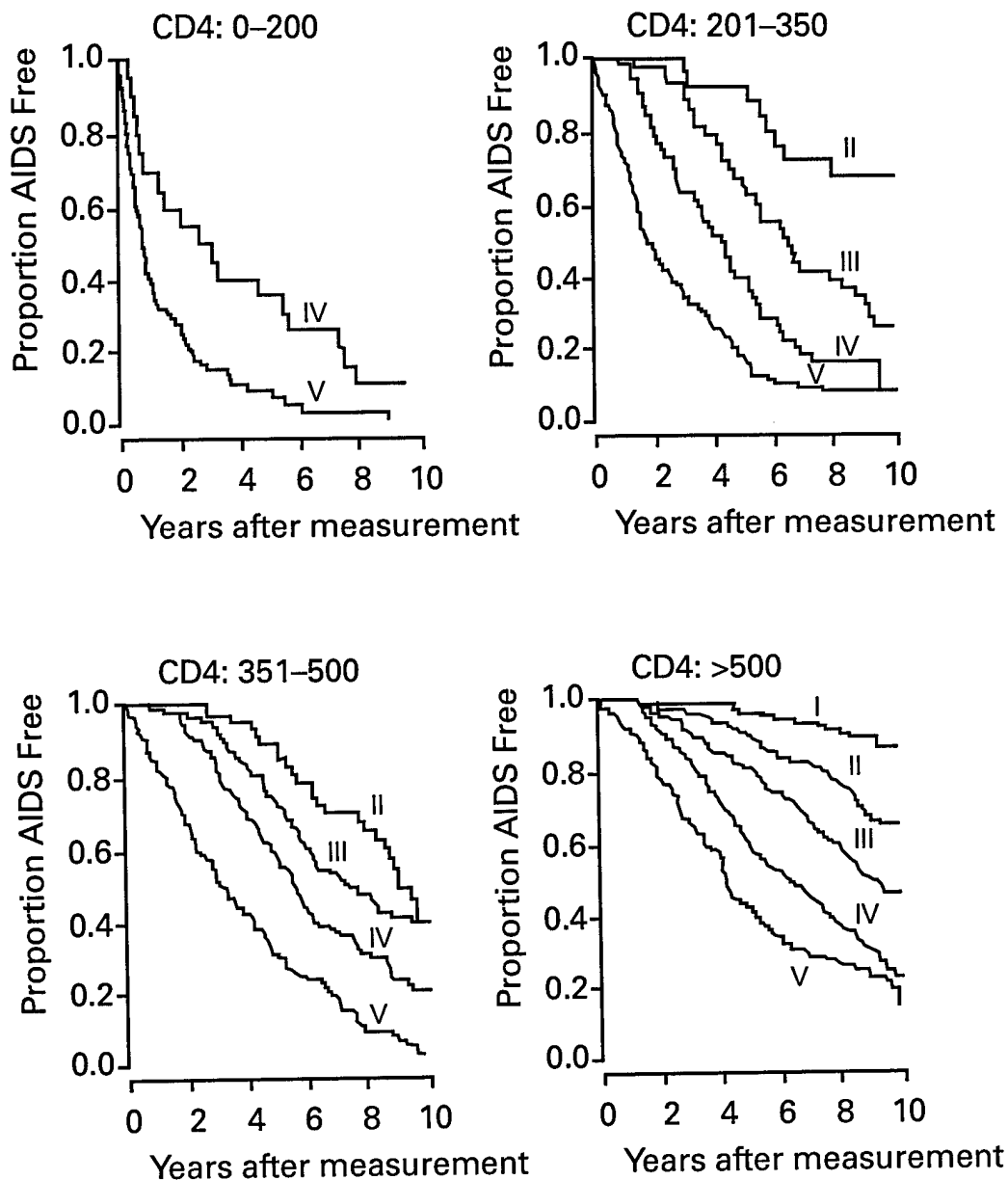

Kaplan-Meier curves showing AIDS-free survival by plasma HIV RNA category among groups of persons with different baseline CD4+ T cell counts who participated in the Multicenter AIDS Cohort Study (MACS) (27). The five categories of baseline HIV RNA levels were (I) ≤ 500 ; (II) 501–3,000; (III) 3,001–10,000; (IV) 10,001–30,000; and (V) $>30,000$ copies/mL. Within each CD4+ T cell category, baseline HIV RNA concentration provided significant discrimination of AIDS-free times ($p < 0.001$) and survival times (27). In the lowest CD4+ T cell category (< 200 cells/ mm^3), there were too few participants with HIV RNA concentrations of $\leq 10,000$ copies/mL to provide reliable estimates for RNA categories I–III. In the next lowest CD4+ T cell categories (201–350 and 351–500 cells/ mm^3), there were too few participants with HIV RNA concentrations of ≤ 500 copies/mL (category I) to provide reliable estimates. Plasma HIV RNA concentrations were measured using the Quantiplex™ HIV RNA bDNA assay.

FIGURE 3. Association between rates of decline of CD4+ T cell counts and baseline plasma HIV RNA level

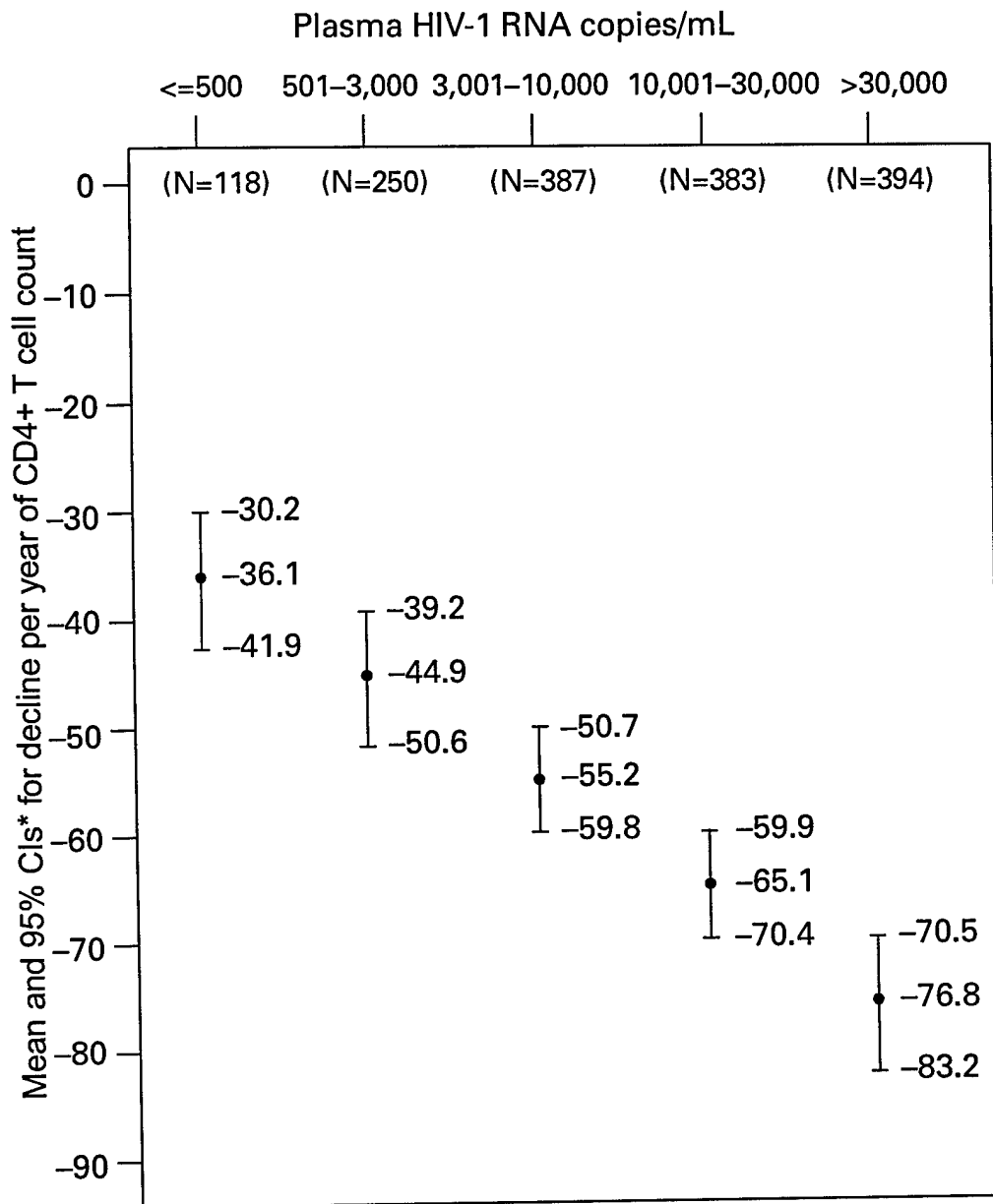

*Confidence intervals.

The relationship between baseline HIV-1 RNA level and the subsequent rate of decline in CD4+ T cells seen in participants of the Multicenter AIDS Cohort Study (MACS) (27). The study population was divided into five categories of plasma HIV-1 RNA defined by baseline concentrations of (I) ≤ 500 ; (II) 501-3,000; (III) 3,001-10,000; (IV) 10,001-30,000; and (V) $>30,000$ copies/mL. The estimated mean slope of decline in CD4+ T cells (number of cells lost per year) and 95% CIs by plasma HIV-1 RNA category are shown. The estimated rates of decline in CD4+ T cell counts are substantially different for each of the five baseline HIV RNA categories and show a monotonic relationship; i.e., the higher the baseline HIV RNA concentration, the greater the rate of decline of CD4+ T cell count. Plasma HIV RNA concentrations were measured using the Quantiplex™ HIV RNA bDNA assay.

FIGURE 4. Probability of AIDS by baseline HIV RNA level and CD4+ T cell count

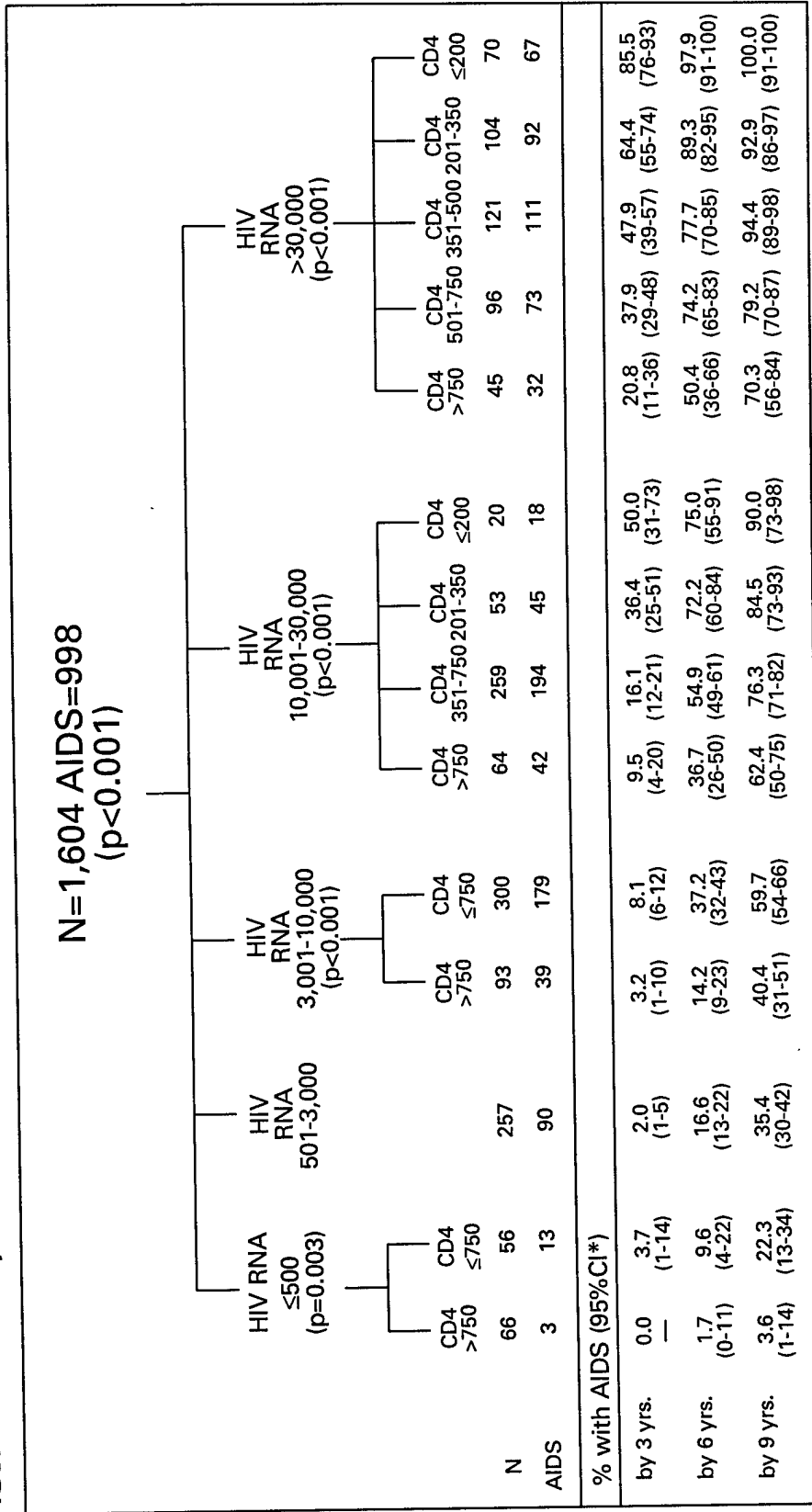

* Confidence interval.
 A regression tree containing 14 distinct categories of risk of progression to AIDS defined among participants in the Multicenter AIDS Cohort Study (MACS) (27). The risk of progression to AIDS can be assessed for many infected persons through the combined analysis of their baseline HIV RNA levels and CD4+ T cell counts. The number of study participants in each group is indicated by "N." AIDS risk with 95% CIs appear at the bottom of the figure. Plasma HIV RNA concentrations were measured using the Quantiplex™ HIV RNA bDNA assay.

FIGURE 5. Rate of decline of plasma HIV RNA concentration after initiation of potent combination antiretroviral therapy

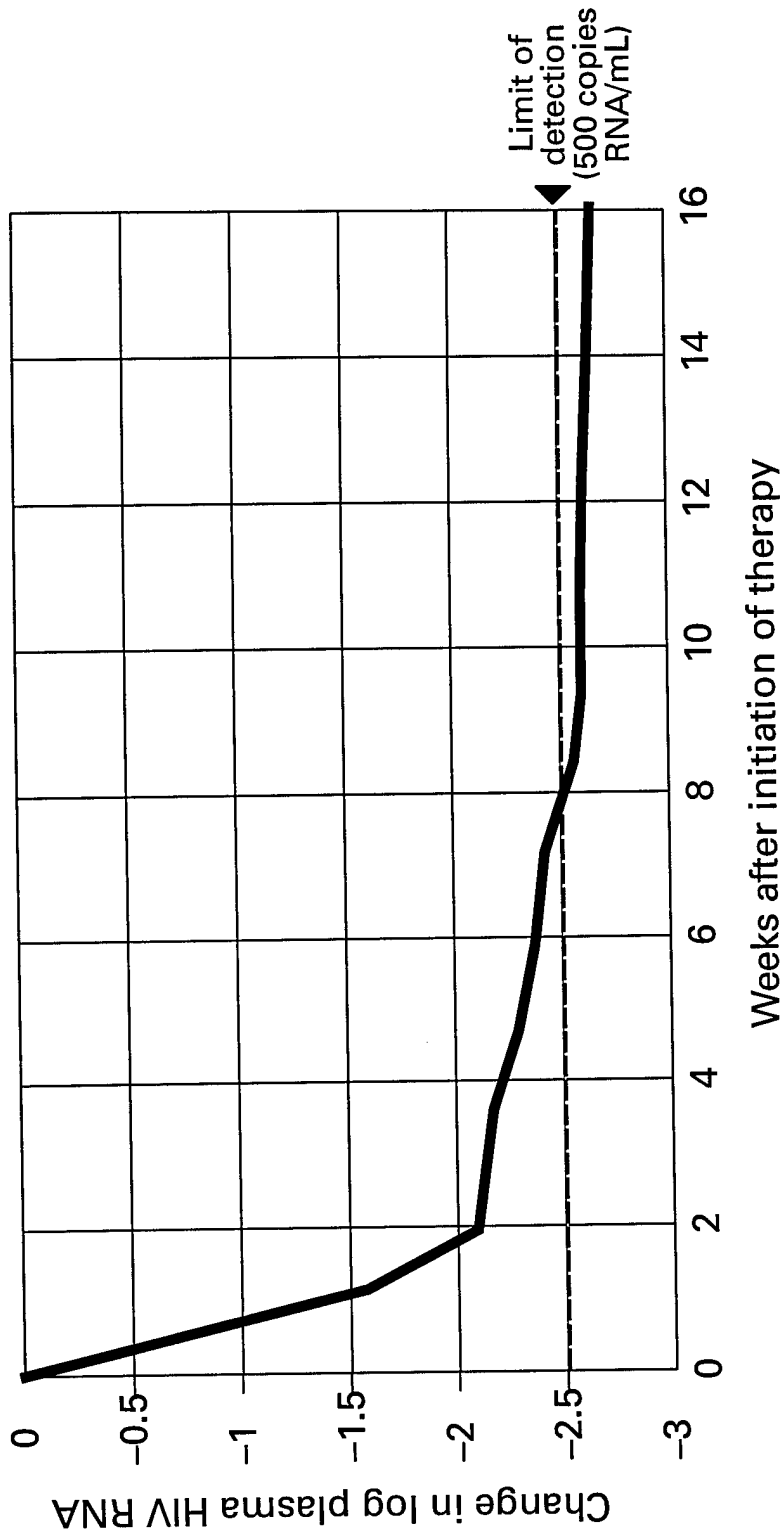

A representative time course of rate of decline in plasma HIV RNA concentration (in \log_{10} copies of RNA/mL) following initiation of a potent regimen of combination antiretroviral therapy (e.g., two nucleoside analog reverse transcriptase inhibitors [such as zidovudine and lamivudine] plus a potent, bioavailable protease inhibitor [such as indinavir, nelfinavir, or ritonavir]). The first phase of decline is a rapid, approximately 2 \log_{10} (100-fold) fall in plasma HIV RNA concentrations. The slope of this first phase of decline in plasma RNA levels is very similar between different persons initiating effective antiretroviral therapies. A second, more gradual phase of decline in plasma HIV RNA levels is seen over subsequent weeks, the slope of which varies between different treated persons. Many effectively treated persons will demonstrate declines in plasma RNA levels to below the limits of assay detection (500 copies RNA/mL) by approximately 8 weeks after initiation of antiretroviral therapy, although some persons may take longer to demonstrate undetectable virus. (37,39). When plasma HIV RNA levels fall below detection, the absolute nadir is unknown. However, plasma HIV RNA levels have decreased below the detection limits of even more sensitive assays (sensitivity of 25 RNA copies/mL) in many effectively treated persons.

The material in this report was prepared for publication by:

Sharilyn K. Stanley, M.D.
*National Institute of Allergy and Infectious Diseases
National Institutes of Health*

in collaboration with

Jonathan E. Kaplan, M.D.
*National Center for Infectious Diseases
Division of AIDS, STD, and TB Laboratory Research
and
National Center for HIV, STD, and TB Prevention
Division of HIV/AIDS Prevention—Surveillance, and Epidemiology*

Members of the Panel on Clinical Practices for Treatment of HIV Infection

- | | |
|---|---|
| Anthony Fauci, M.D. (Co-Chair)
National Institutes of Health
Bethesda, MD | Fred Gordin, M.D.
Veterans Administration Medical Center
Washington, DC |
| John Bartlett, M.D. (Co-Chair)
Johns Hopkins University
Baltimore, MD | Wayne Greaves, M.D.
Howard University
Washington, DC |
| Eric Goosby, M.D. (Convener)
DHHS
Washington, DC | Mark Harrington
Treatment Action Group
New York, NY |
| Mark Smith, M.D. (Co-Convener)
Henry J. Kaiser Family Foundation
Menlo Park, CA | John Henning, Ph.D.
American Medical Association
Chicago, IL |
| Sophia Chang, M.D., M.P.H.
Henry J. Kaiser Family Foundation
Menlo Park, CA | Martin Hirsch, M.D.
Massachusetts General Hospital
Boston, MA |
| Jean Anderson, M.D.
Johns Hopkins University
Baltimore, MD | Richard Marlink, M.D.
Harvard AIDS Institute
Cambridge, MA |
| Rodney Armstead, M.D.
Watts Health Foundation, Inc.
Inglewood, CA | Celia Maxwell, M.D.
AIDS Education and Training Center
Washington, DC |
| A. Cornelius Baker
National Association of People with
AIDS
Washington, DC | John Mellors, M.D.
University of Pittsburgh
Pittsburgh, PA |
| David Barr, J.D.
Forum for Collaborative HIV Research
Washington, DC | David Nash, M.D.
Thomas Jefferson University
Philadelphia, PA |
| Samuel Bozzette, M.D., Ph.D.
SDVA Medical Center
San Diego, CA | Sallie Perryman
New York State Department of Health
New York, NY |
| Spencer Cox
Treatment Action Group
New York, NY | Robert Schooley, M.D.
University of Colorado
Denver, CO |
| Martin Delaney
Project <i>Inform</i>
San Francisco, CA | Renslow Sherer, M.D.
Cook County HIV Primary Care Center
Chicago, IL |

Stephen Spector, M.D.
University of California
San Diego, La Jolla, CA

Paul Volberding, M.D.
University of California
San Francisco, CA

Gabriel Torres, M.D.
St. Vincent's Hospital
New York, NY

Participants from the Department of Health and Human Services

Barbara Brady
Office of HIV/AIDS Policy
Washington, DC

Elaine Daniels, M.D., Ph.D.
Office of HIV/AIDS Policy
Washington, DC

David Feigel, M.D., M.P.H.
U.S. Food and Drug Administration
Bethesda, MD

Mark Feinberg, M.D., Ph.D.
National Institutes of Health
Bethesda, MD

Helene Gayle, M.D., M.P.H.
Centers for Disease Control and
Prevention
Atlanta, GA

T. Randolph Graydon
Health Care Financing Administration
Baltimore, MD

Jonathan Kaplan, M.D.
Centers for Disease Control and
Prevention
Atlanta, GA

Abe Macher, M.D.
Health Resources and Services
Administration
Bethesda, MD

Henry Masur, M.D.
National Institutes of Health
Bethesda, MD

Lynne Mofenson, M.D.
National Institutes of Health
Bethesda, MD

Joseph O'Neill, M.D., M.P.H.
Health Resources and Services
Administration
Rockville, MD

Lucille Perez, M.D.
Substance Abuse and Mental Health
Services Administration
Rockville, MD

Richard Riseberg, J.D.
Office of the Secretary
Department of Health and Human
Services
Rockville, MD

Samuel Shekar, M.D., M.P.H.
Health Care Financing Administration
Rockville, MD

Sharilyn Stanley, M.D.
National Institutes of Health
Bethesda, MD

Guidelines for the Use of Antiretroviral Agents in HIV-Infected Adults and Adolescents*

Summary

With the development and FDA approval of an increasing number of antiretroviral agents, decisions regarding the treatment of HIV-infected persons have become complex; and the field continues to evolve rapidly. In 1996, the Department of Health and Human Services and the Henry J. Kaiser Family Foundation convened the Panel on Clinical Practices for the Treatment of HIV to develop guidelines for the clinical management of HIV-infected persons. This report includes the guidelines developed by the Panel regarding the use of laboratory testing in initiating and managing antiretroviral therapy, considerations for initiating therapy, whom to treat, what regimen of antiretroviral agents to use, when to change the antiretroviral regimen, treatment of the acutely HIV-infected person, special considerations in adolescents, and special considerations in pregnant women. Viral load and CD4+ T cell testing should ideally be performed twice before initiating or changing an antiretroviral treatment regimen. All patients who have advanced or symptomatic HIV disease should receive aggressive antiretroviral therapy. Initiation of therapy in the asymptomatic person is more complex and involves consideration of multiple virologic, immunologic, and psychosocial factors. In general, persons who have <500 CD4+ T cells per mm³ should be offered therapy; however, the strength of the recommendation to treat should be based on the patient's willingness to accept therapy as well as the prognosis for AIDS-free survival as determined by the HIV RNA copy per mL of plasma and the CD4+ T cell count. Persons who have >500 CD4+ T cells per mm³ can be observed or can be offered therapy; again, risk of progression to AIDS, as determined by HIV RNA viremia and CD4+ T cell count, should guide the decision to treat. Once the decision to initiate antiretroviral therapy has been made, treatment should be aggressive with the goal of maximal viral suppression. In general, a protease inhibitor and two non-nucleoside reverse transcriptase inhibitors should be used initially. Other regimens may be utilized but are considered less than optimal. Many factors, including reappearance of previously undetectable HIV RNA, may indicate treatment failure. Decisions to change therapy and decisions regarding new regimens must be carefully considered; there are minimal clinical data to guide these decisions. Patients with acute HIV infection should probably be administered aggressive antiretroviral therapy; once initiated, duration of treatment is unknown and will likely need to continue for several years, if not for life. Special considerations apply to adolescents and pregnant women and are discussed in detail.

*Information included in these guidelines may not represent FDA approval or approved labeling for the particular products or indications in question. Specifically, the terms "safe" and "effective" may not be synonymous with the FDA-defined legal standards for product approval.

INTRODUCTION

These guidelines were developed by the Panel on Clinical Practices for Treatment of HIV Infection, convened by the Department of Health and Human Services (DHHS) and the Henry J. Kaiser Family Foundation. The guidelines contain recommendations for the clinical use of antiretroviral agents in the treatment of adults and adolescents (defined in Considerations for Antiretroviral Therapy in the HIV-Infected Adolescent) who are infected with the human immunodeficiency virus (HIV). Guidance for the use of antiretroviral treatment in pediatric HIV infection is not contained in this report. Although the pathogenesis of HIV infection and the general virologic and immunologic principles underlying the use of antiretroviral therapy are similar for all HIV-infected persons, unique therapeutic and management considerations apply to HIV-infected children. In recognition of these differences, a separate set of guidelines will address pediatric-specific issues related to antiretroviral therapy.

These guidelines are intended for use by physicians and other health-care providers who use antiretroviral therapy to treat HIV-infected adults and adolescents. The recommendations contained herein are presented in the context of and with reference to the first section of this report, Principles of Therapy for HIV Infection, formulated by the National Institutes of Health (NIH) Panel to Define Principles of Therapy of HIV Infection. Together, these reports provide the pathogenesis-based rationale for therapeutic strategies as well as practical guidelines for implementing these strategies. Although the guidelines represent the current state of knowledge regarding the use of antiretroviral agents, this field of science is rapidly evolving, and the availability of new agents or new clinical data regarding the use of existing agents will result in changes in therapeutic options and preferences. The Antiretroviral Working Group, a subgroup of the Panel, will meet several times a year to review new data; recommendations for changes in this document would then be submitted to the Panel and incorporated as appropriate. Copies of this document and all updates are available from the CDC National AIDS Clearinghouse (1-800-458-5231) and are posted on the Clearinghouse World-Wide Web site (<http://www.cdcnac.org>). In addition, copies and updates also are available from the HIV/AIDS Treatment Information Service (1-800-448-0440; Fax 301-519-6616; TTY 1-800-243-7012) and on the ATIS World-Wide Web site (<http://www.hivatis.org>). Readers should consult these web sites regularly for updates in the guidelines. These recommendations are not intended to substitute for the judgment of a physician who is expert in caring for HIV-infected persons. When possible, the treatment of HIV-infected patients should be directed by a physician with extensive experience in the care of these patients. When this is not possible, the physician treating the patient should have access to such expertise through consultations.

Each recommendation is accompanied by a rating that includes a letter and a Roman numeral (Table 1), similar to the rating schemes described in previous guidelines on the prophylaxis of opportunistic infections (OIs) issued by the U.S. Public Health Service and the Infectious Diseases Society of America (1). The letter indicates the strength of the recommendation based on the opinion of the Panel, and the Roman numeral rating reflects the nature of the evidence for the recommendation (Table 1). Thus, recommendations based on data from clinical trials with clinical endpoints are differentiated from recommendations based on data derived from clinical trials with laboratory endpoints (e.g., CD4+ T cell count or plasma HIV RNA levels); when clinical

trial data are not available, recommendations are based on the opinions of experts familiar with the relevant scientific literature. The majority of current clinical trial data regarding the use of antiretroviral agents has been obtained in trials enrolling predominantly young to middle-aged males. Although current knowledge indicates that women may differ from men in the absorption, metabolism, and clinical effects of certain pharmacologic agents, clinical experience and data available to date do not indicate any substantial sex differences that would modify these guidelines. However, theoretical concerns exist, and the Panel urges continuation of the current efforts to enroll more women in antiretroviral clinical trials so that the data needed to re-evaluate this issue can be gathered expeditiously.

This report addresses the following issues: the use of testing for plasma HIV RNA levels (viral load) and CD4+ T cell count; initiating therapy in established HIV infection; initiating therapy in patients who have advanced-stage HIV disease; interruption of antiretroviral therapy; changing therapy and available therapeutic options; the treatment of acute HIV infection; antiretroviral therapy in adolescents; and antiretroviral therapy in the pregnant woman.

USE OF TESTING FOR PLASMA HIV RNA LEVELS AND CD4+ T CELL COUNT IN GUIDING DECISIONS FOR THERAPY

Decisions regarding either initiating or changing antiretroviral therapy should be guided by monitoring the laboratory parameters of both plasma HIV RNA (viral load) and CD4+ T cell count and by assessing the clinical condition of the patient. Results of these two laboratory tests provide the physician with important information about the virologic and immunologic status of the patient and the risk of disease progression to acquired immunodeficiency syndrome (AIDS) (see Principle 2 in the first section of this report). HIV viral load testing has been approved by the U.S. Food and Drug Administration (FDA) only for the RT-PCR assay (Roche) and only for determining disease prognosis. However, data presented at an FDA Advisory Committee for the Division of Antiviral Drug Products (July 14–15, 1997, Silver Spring, MD) provide further evidence for the utility of viral RNA testing in monitoring therapeutic responses. Multiple analyses of more than 5,000 patients who participated in approximately 18 trials with viral load monitoring demonstrated a reproducible dose-response type association between decreases in plasma viremia and improved clinical outcome based on standard endpoints of new AIDS-defining diagnoses and survival. This relationship was observed over a range of patient baseline characteristics, including pretreatment plasma RNA level, CD4+ T cell count, and prior drug experience. The consensus of the Panel is that viral load testing is the essential parameter in decisions to initiate or change antiretroviral therapies. Measurement of plasma HIV RNA levels (viral load), using quantitative methods, should be performed at the time of diagnosis of HIV infection and every 3–4 months thereafter in the untreated patient (AIII) (Table 2). CD4+ T cell counts should be measured at the time of diagnosis and generally every 3–6 months thereafter (AIII). These intervals between tests are merely recommendations, and flexibility should be exercised according to the circumstances of the individual case. Plasma HIV RNA levels also should be measured immediately prior to and again at 4–8 weeks after initiation of antiretroviral therapy (AIII). This second time point allows the clinician to evaluate the initial effectiveness of therapy because in most patients, ad-

herence to a regimen of potent antiretroviral agents should result in a large decrease (~ 0.5 to $0.75 \log_{10}$) in viral load by 4–8 weeks. The viral load should continue to decline over the following weeks, and in most persons it becomes below detectable levels (currently defined as <500 RNA copies/mL) by 12–16 weeks of therapy. The speed of viral load decline and the movement toward undetectable are affected by the baseline CD4+ T cell count, the initial viral load, potency of the regimen, adherence, prior exposure to antiretroviral agents, and the presence of any OIs. These individual differences must be considered when monitoring the effect of therapy. However, the absence of a virologic response of the magnitude previously described (i.e., ~ 0.5 to $0.75 \log_{10}$ by 4–8 weeks and undetectable by 12–16 weeks) should prompt the physician to reassess patient adherence, rule out malabsorption, consider repeat RNA testing to document lack of response, and/or consider a change in drug regimen. Once the patient is on therapy, HIV RNA testing should be repeated every 3–4 months to evaluate the continuing effectiveness of therapy (AII). With optimal therapy, viral levels in plasma at 6 months should be undetectable (i.e., <500 copies of HIV RNA per mL of plasma) (2). If HIV RNA remains above 500 copies/mL in plasma after 6 months of therapy, the plasma HIV RNA test should be repeated to confirm the result, and a change in therapy should be considered according to the guidelines provided in "Considerations for Changing a Failing Regimen" (BIII). More sensitive viral load assays are in development that can quantify HIV RNA down to approximately 50 copies/mL. Preliminary data from clinical trials strongly suggest that lowering plasma HIV RNA to below 50 copies/mL is associated with a more complete and durable viral suppression, compared with reducing HIV RNA to levels between 50–500 copies/mL. However, the clinical significance of these findings is currently unclear.

When deciding whether to initiate therapy, the CD4+ T cell count and plasma HIV RNA measurement ideally should be performed on two occasions to ensure accuracy and consistency of measurement (BIII). However, in patients with advanced HIV disease, antiretroviral therapy should generally be initiated after the first viral load measurement is obtained to prevent a potentially deleterious delay in treatment. Although the requirement for two measurements of viral load may place a substantial financial burden on patients or payers, two measurements of viral load should provide the clinician with the best information for subsequent follow-up of the patient. Plasma HIV RNA levels should not be measured during or within 4 weeks after successful treatment of any intercurrent infection, resolution of symptomatic illness, or immunization (see Principle 2). Because differences exist among commercially available tests, confirmatory plasma HIV RNA levels should be measured by the same laboratory using the same technique to ensure consistent results.

A substantial change in plasma viremia is considered to be a threefold or $0.5 \log_{10}$ increase or decrease. A substantial decrease in CD4+ T cell count is a decrease of $>30\%$ from baseline for absolute cell numbers and a decrease of $>3\%$ from baseline in percentages of cells (3,4). Discordance between trends in CD4+ T cell numbers and plasma HIV RNA levels can occur and was found in 20% of patients in one cohort studied (5). Such discordance can complicate decisions regarding antiretroviral therapy and may be due to several factors that affect plasma HIV RNA testing (see Principle 2). Viral load and trends in viral load are considered to be more informative for guiding decisions regarding antiretroviral therapy than are CD4+ T cell counts; exceptions to this rule do occur, however (see Considerations for Changing a Failing

Regimen); when changes in viral loads and CD4+ T cell counts are discordant, expert consultation should be considered.

ESTABLISHED HIV INFECTION

Patients who have established HIV infection are considered in two arbitrarily defined clinical categories: 1) asymptomatic infection or 2) symptomatic disease (e.g., wasting, thrush, or unexplained fever for ≥ 2 weeks), including AIDS, defined according to the 1993 CDC classification system (6). All patients in the second category should be offered antiretroviral therapy. Considerations for initiating antiretroviral therapy in the first category of patients (i.e., patients who are asymptomatic) are complex and are discussed separately in the following section. However, before initiating therapy in any patient, the following evaluation should be performed:

- Complete history and physical (All)
- Complete blood count, chemistry profile (All)
- CD4+ T cell count (AI)
- Plasma HIV RNA measurement (AI)

Additional evaluation should include routine tests pertinent to the prevention of OIs, if not already performed (i.e., VDRL, tuberculin skin test, toxoplasma IgG serology, and gynecologic exam with Pap smear), and other tests as clinically indicated (e.g., chest radiograph, hepatitis C virus [HCV] serology, ophthalmologic exam) (All). Hepatitis B virus (HBV) serology is indicated for a patient who is a candidate for the hepatitis B vaccine or who has abnormal liver function tests (All); cytomegalovirus (CMV) serology may be useful in certain persons, as discussed in *1997 USPHS/IDSA Guidelines for the Prevention of Opportunistic Infections in Persons Infected With the Human Immunodeficiency Virus (1)* (BIII).

Considerations for Initiating Therapy in the Patient Who Has Asymptomatic HIV Infection

It has been demonstrated that antiretroviral therapy provides clinical benefit in HIV-infected persons who have advanced HIV disease and immunosuppression (7-11). Although there is theoretical benefit to treating patients who have CD4+ T cells >500 cells/mm³ (see Principle 3), no long-term clinical benefit of treatment has yet been demonstrated. A major dilemma confronting patients and practitioners is that the antiretroviral regimens currently available that have the greatest potency in terms of viral suppression and CD4+ T cell preservation are medically complex, are associated with several specific side effects and drug interactions, and pose a substantial challenge for adherence. Thus, decisions regarding treatment of asymptomatic, chronically infected persons must balance a number of competing factors that influence risk and benefit.

The physician and the asymptomatic patient must consider multiple risks and benefits in deciding when to initiate therapy (Table 3) (see Principle 3). Several factors influence the decision to initiate early therapy: the real or potential goal of maximally

suppressing viral replication; preserving immune function; prolonging health and life; decreasing the risk of drug resistance due to early suppression of viral replication with potent therapy; and decreasing drug toxicity by treating the healthier patient. Factors weighing against early treatment in the asymptomatic stable patient include the following: the potential adverse effects of the drugs on quality of life, including the inconvenience of most of the maximally suppressive regimens currently available (e.g., dietary change or large numbers of pills); the potential risk of developing drug resistance despite early initiation of therapy; the potential for limiting future treatment options due to cycling of the patient through the available drugs during early disease; the potential risk of transmission of virus resistant to protease inhibitors and other agents; the unknown durability of effect of the currently available therapies; and the unknown long-term toxicity of some drugs. Thus, the decision to begin therapy in the asymptomatic patient is complex and must be made in the setting of careful patient counseling and education. The factors that must be considered in this decision include the following: 1) the willingness of the individual to begin therapy; 2) the degree of existing immunodeficiency as determined by the CD4+ T cell count; 3) the risk for disease progression as determined by the level of plasma HIV RNA (Table 4; Figure); 4) the potential benefits and risks of initiating therapy in asymptomatic persons, as discussed above; and 5) the likelihood, after counseling and education, of adherence to the prescribed treatment regimen. In regard to adherence, no patient should automatically be excluded from consideration for antiretroviral therapy simply because he or she exhibits a behavior or other characteristic judged by some to lend itself to non-compliance. The likelihood of patient adherence to a complex drug regimen should be discussed and determined by the individual patient and physician before therapy is initiated. To achieve the level of adherence necessary for effective therapy, providers are encouraged to utilize strategies for assessing and assisting adherence that have been developed in the context of chronic treatment for other serious diseases. Intensive patient education regarding the critical need for adherence should be provided, specific goals of therapy should be established and mutually agreed upon, and a long-term treatment plan should be developed with the patient. Intensive follow-up should take place to assess adherence to treatment and to continue patient counseling to prevent transmission of HIV through sexual contact and injection of drugs.

Initiating Therapy in the Patient Who Has Asymptomatic HIV Infection

Once the patient and physician have decided to initiate antiretroviral therapy, treatment should be aggressive, with the goal of maximal suppression of plasma viral load to undetectable levels. Recommendations regarding when to initiate therapy and what regimens to use are provided (Tables 5 and 6). In general, any patient who has <500 CD4+ T cells/mm³ or $>10,000$ (bDNA) or 20,000 (RT-PCR) copies of HIV RNA/mL of plasma should be offered therapy (All). However, the strength of the recommendation for therapy should be based on the readiness of the patient for treatment and a consideration of the prognosis for risk for progression to AIDS as determined by viral load, CD4+ T cell count (Table 4; Figure), and the slope of the CD4+ T cell count decline. The values for bDNA (Table 4; Figure, first column or line) are the uncorrected HIV RNA values obtained from the Multicenter AIDS Cohort Study (MACS). It had previously

been thought that these values, obtained on stored heparinized plasma specimens, should be multiplied by a factor of two to adjust for an anticipated twofold loss of RNA ascribed to the effects of heparin and delayed processing on the stability of RNA. However, more recent analysis suggests that the reduction ascribed to these factors is ≤ 0.2 log, so that no significant correction factor is necessary (Mellors J, personal communication, October 1997). RT-PCR values also are provided (Table 4; Figure); comparison of the results obtained from the RT-PCR and bDNA assays, using the manufacturer's controls, consistently indicates that the HIV-1 RNA values obtained by RT-PCR are approximately twice those obtained by the bDNA assay (12). Thus, the MACS values must be multiplied by approximately 2 to be consistent with current RT-PCR values. A third test for HIV RNA, the nucleic acid sequence based amplification (NASBA[®]), is currently used in some clinical settings. However, formulas for converting values obtained from either branched DNA (bDNA) or RT-PCR assays to NASBA[®]-equivalent values cannot be derived from the limited data currently available.

Currently, there are two general approaches to initiating therapy in the asymptomatic patient: a) a therapeutically more aggressive approach in which most patients would be treated early in the course of HIV infection due to the recognition that HIV disease is virtually always progressive and b) a therapeutically more cautious approach in which therapy may be delayed because the balance of the risk for clinically significant progression and other factors discussed above are considered to weigh in favor of observation and delayed therapy. The aggressive approach is heavily based on the Principles of Therapy, particularly the principle (see Principle 3) that one should begin treatment before the development of significant immunosuppression and one should treat to achieve undetectable viremia; thus, all patients who have < 500 CD4+ T cells/mm³ would be started on therapy as would patients who have higher CD4+ T cell numbers and plasma viral load $> 10,000$ (bDNA) or $20,000$ (RT-PCR) (Table 5). The more conservative approach to the initiation of therapy in the asymptomatic person would delay treatment of the patient who has < 500 CD4+ T cells/mm³ and low levels of viremia and who has a low risk for rapid disease progression (Table 4); careful observation and monitoring would continue. Patients who have CD4+ T cell counts > 500 /mm³ would also be observed, except those who are at substantial risk for rapid disease progression because of a high viral load. For example, the patient who has $60,000$ (RT-PCR) or $30,000$ (bDNA) copies of HIV RNA/mL, regardless of CD4+ T cell count, has a high probability of progressing to an AIDS-defining complication of HIV disease within 3 years (32.6% if CD4+ T cells are > 500 /mm³) and should clearly be encouraged to initiate antiretroviral therapy. Conversely, a patient who has $18,000$ copies of HIV RNA/mL of plasma, measured by RT-PCR, and a CD4+ T cell count of 410 /mm³, has a 5.9% chance of progressing to an AIDS-defining complication of HIV infection in 3 years (Table 4). The therapeutically aggressive physician would recommend treatment for this patient to suppress the ongoing viral replication that is readily detectable; the therapeutically more conservative physician would discuss the possibility of initiation of therapy but recognize that a delay in therapy because of the balance of considerations previously discussed also is reasonable. In either case, the patient should make the final decision regarding acceptance of therapy following discussion with the health-care provider regarding specific issues relevant to his/her own clinical situation.

When initiating therapy in the patient who has never been administered antiretroviral therapy, one should begin with a regimen that is expected to reduce viral replication to undetectable levels (AIII). Based on the weight of experience, the preferred regimen to accomplish this consists of two nucleoside reverse transcriptase inhibitors (NRTIs) and one potent protease inhibitor (PI) (Table 6). Alternative regimens have been employed; these regimens include ritonavir and saquinavir (with one or two NRTIs) or nevirapine as a substitute for the PI. Dual PI therapy with ritonavir and saquinavir (hard-gel formulation), without an NRTI, appears to be potent in suppressing viremia below detectable levels and has convenient twice-daily dosing; however, the safety of this combination has not been fully established according to FDA guidelines. Also, this regimen has not been directly compared with the proven regimens of two NRTIs and a PI; thus, the Panel recommends that at least one additional NRTI be used when the physician elects to use two PIs as initial therapy. Substituting nevirapine for the PI, or using two NRTIs alone, does not achieve the goal of suppressing viremia to below detectable levels as consistently as does combination treatment with two NRTIs and a PI and should be used only if more potent treatment is not possible. However, some experts consider that there currently are insufficient data to choose between a three-drug regimen containing a PI and one containing nevirapine in the patient who has never been administered therapy; further studies are pending. Other regimens using two PIs or a PI and a non-nucleoside reverse transcriptase inhibitor (NNRTI) as initial therapy are currently in clinical trials with data pending. Of the two available NNRTIs, clinical trials support a preference for nevirapine over delavirdine based on results of viral load assays. Although 3TC is a potent NRTI when used in combination with another NRTI, in situations in which suppression of virus replication is not complete, resistance to 3TC develops rapidly (13,14). Therefore, the optimal use for this agent is as part of a three-or-more drug combination that has a high probability of complete suppression of virus replication. Other agents in which a single genetic mutation can confer drug resistance (e.g., the NNRTIs nevirapine and delavirdine) also should be used in this manner. Use of antiretroviral agents as monotherapy is contraindicated (DI), except when no other options exist or during pregnancy to reduce perinatal transmission. When initiating antiretroviral therapy, all drugs should be started simultaneously at full dose with the following three exceptions: dose escalation regimens are recommended for ritonavir, nevirapine, and, in some cases, ritonavir plus saquinavir.

Detailed information comparing the different NRTIs, the NNRTIs, the PIs, and drug interactions between the PIs and other agents is provided (Tables 7–12). Particular attention should be paid to drug interactions between the PIs and other agents (Tables 9–12), as these are extensive and often require dose modification or substitution of various drugs. Toxicity assessment is an ongoing process; assessment at least twice during the first month of therapy and every 3 months thereafter is a reasonable management approach.

Initiating Therapy in Patients Who Have Advanced-Stage HIV Disease

All patients diagnosed as having advanced HIV disease, which is defined as any condition meeting the 1993 CDC definition of AIDS (6), should be treated with an-

tiretroviral agents regardless of plasma viral levels (AI). All patients who have symptomatic HIV infection without AIDS, defined as the presence of thrush or unexplained fever, also should be treated.

Special Considerations in the Patient Who Has Advanced-Stage HIV Disease

Some patients with OIs, wasting, dementia, or malignancy are first diagnosed with HIV infection at this advanced stage of disease. All patients who have advanced HIV disease should be treated with antiretroviral therapy. When the patient is acutely ill with an OI or other complication of HIV infection, the clinician should consider clinical issues (e.g., drug toxicity, ability to adhere to treatment regimens, drug interactions, and laboratory abnormalities) when determining the timing of initiation of antiretroviral therapy. Once therapy is initiated, a maximally suppressive regimen (e.g., two NRTIs and a PI) should be used (Table 6). Advanced-stage patients being maintained on an antiretroviral regimen should not have the therapy discontinued during an acute OI or malignancy, unless concerns exist regarding drug toxicity, intolerance, or drug interactions.

Patients who have progressed to AIDS often are treated with complicated combinations of drugs, and the clinician and patient should be alert to the potential for multiple drug interactions. Thus, the choice of which antiretroviral agents to use must be made with consideration given to potential drug interactions and overlapping drug toxicities (Tables 7–12). For instance, the use of rifampin to treat active tuberculosis is problematic in a patient who is being administered a PI, which adversely affects the metabolism of rifampin but is frequently needed to effectively suppress viral replication in these advanced patients. Conversely, rifampin lowers the blood level of PIs, which may result in suboptimal antiretroviral therapy. Although rifampin is contraindicated or not recommended for use with all of the PIs, the clinician might consider using a reduced dose of rifabutin (Tables 8–11); this topic is discussed in greater detail elsewhere (15). Other factors complicating advanced disease are wasting and anorexia, which may prevent patients from adhering to the dietary requirements for efficient absorption of certain protease inhibitors. Bone marrow suppression associated with ZDV and the neuropathic effects of ddC, d4T and ddI may combine with the direct effects of HIV to render the drugs intolerable. Hepatotoxicity associated with certain PIs may limit the use of these drugs, especially in patients who have underlying liver dysfunction. The absorption and half life of certain drugs may be altered by antiretroviral agents, particularly the PIs and NNRTIs whose metabolism involves the hepatic cytochrome p450 (CYP450) enzymatic pathway. Some of these PIs and NNRTIs (i.e., ritonavir, indinavir, saquinavir, nelfinavir, and delavirdine) inhibit the CYP450 pathway; others (e.g., nevirapine) induce CYP450 metabolism. CYP450 inhibitors have the potential to increase blood levels of drugs metabolized by this pathway. Adding a CYP450 inhibitor can sometimes improve the pharmacokinetic profile of selected agents (e.g., adding ritonavir therapy to the hard-gel formulation of saquinavir) as well as contribute an additive antiviral effect; however, these interactions also can result in life-threatening drug toxicity (Tables 10–12). As a result, health-care providers should inform their patients of the need to discuss any new drugs, including over-the-counter agents and alternative medications, that they may consider taking, and careful attention should be given to the relative risk versus benefits of specific combinations of agents.

Initiation of potent antiretroviral therapy often is associated with some degree of recovery of immune function. In this setting, patients who have advanced HIV disease and subclinical opportunistic infections (e.g., mycobacterium avium intracellulare [MAI] or CMV) may develop a new immunologic response to the pathogen, and, thus, new symptoms may develop in association with the heightened immunologic and/or inflammatory response. This should not be interpreted as a failure of antiretroviral therapy, and these newly presenting OIs should be treated appropriately while maintaining the patient on the antiretroviral regimen. Viral load measurement is helpful in clarifying this association.

INTERRUPTION OF ANTIRETROVIRAL THERAPY

There are multiple reasons for temporary discontinuation of antiretroviral therapy, including intolerable side effects, drug interactions, first trimester of pregnancy when the patient so elects, and unavailability of drug. There are no currently available studies and therefore no reliable estimate of the number of days, weeks or months that constitute a clinically important interruption of one or more components of a therapeutic regimen that would increase the likelihood of drug resistance. If any antiretroviral medication has to be discontinued for an extended time, clinicians and patients should be aware of the theoretical advantage of stopping all antiretroviral agents simultaneously, rather than continuing one or two agents, to minimize the emergence of resistant viral strains (see Principle 4).

CHANGING A FAILING REGIMEN

Considerations for Changing a Failing Regimen

The decision to change regimens should be approached with careful consideration of several complex factors. These factors include recent clinical history and physical examination; plasma HIV RNA levels measured on two separate occasions; absolute CD4+ T cell count and changes in these counts; remaining treatment options in terms of potency, potential resistance patterns from prior antiretroviral therapies, and potential for adherence/tolerance; assessment of adherence to medications; and psychological preparation of the patient for the implications of the new regimen (e.g., side effects, drug interactions, dietary requirements and possible need to alter concomitant medications) (see Principle 7). Failure of a regimen may occur for many reasons: initial viral resistance to one or more agents, altered absorption or metabolism of the drug, multidrug pharmacokinetics that adversely affect therapeutic drug levels, and poor patient adherence to a regimen due to either poor compliance or inadequate patient education about the therapeutic agents. In regard to the last issue, the health-care provider should carefully assess patient adherence before changing antiretroviral therapy; health-care workers involved in the care of the patient (e.g., the case manager or social worker) may be helpful in this evaluation. Clinicians should be aware of the prevalence of mental health disorders and psychoactive substance use disorders in certain HIV-infected persons; inadequate mental health treatment services may jeopardize the ability of these persons to adhere to their medical treatment.

Proper identification of and intervention in these mental health disorders can greatly enhance adherence to medical HIV treatment.

It is important to distinguish between the need to change therapy because of drug failure versus drug toxicity. In the latter case, it is appropriate to substitute one or more alternative drugs of the same potency and from the same class of agents as the agent suspected to be causing the toxicity. In the case of drug failure where more than one drug had been used, a detailed history of current and past antiretroviral medications, as well as other HIV-related medications, should be obtained. Optimally and when possible, the regimen should be changed entirely to drugs that have not been taken previously. With triple combinations of drugs, at least two and preferably three new drugs must be used; this recommendation is based on the current understanding of strategies to prevent drug resistance (see Principles 4 and 5). Assays to determine genotypic resistance are commercially available; however, these have not undergone field testing to demonstrate clinical utility and are not approved by the FDA. The Panel does not recommend these assays for routine use at present.

The following three categories of patients should be considered with regard to a change in therapy: 1) persons who are receiving incompletely suppressive antiretroviral therapy with single or double nucleoside therapy and with detectable or undetectable plasma viral load; 2) persons who have been on potent combination therapy, including a PI, and whose viremia was initially suppressed to undetectable levels but has again become detectable; and 3) persons who have been on potent combination therapy, including a PI, and whose viremia was never suppressed to below detectable limits. Although persons in these groups should have treatment regimens changed to maximize the chances of durable, maximal viral RNA suppression, the first group may have more treatment options because they are PI naive.

Criteria for Changing Therapy

The goal of antiretroviral therapy, which is to improve the length and quality of the patient's life, is likely best accomplished by maximal suppression of viral replication to below detectable levels (currently defined as <500 copies/mL) sufficiently early to preserve immune function. However, this reduction cannot always be achieved with a given therapeutic regimen, and frequently regimens must be modified. In general, the plasma HIV RNA level is the most important parameter to consider in evaluating response to therapy, and increases in levels of viremia that are substantial, confirmed, and not attributable to intercurrent infection or vaccination indicate failure of the drug regimen, regardless of changes in the CD4+ T cell counts. Clinical complications and sequential changes in CD4+ T cell count may complement the viral load test in evaluating a response to treatment. Specific criteria that should prompt consideration for changing therapy include the following:

- *Less than a 0.5–0.75 log reduction in plasma HIV RNA by 4–8 weeks following initiation of therapy (CIII).*
- *Failure to suppress plasma HIV RNA to undetectable levels within 4–6 months of initiating therapy (BIII).* The degree of initial decrease in plasma HIV RNA and the overall trend in decreasing viremia should be considered. For instance, a patient with 10^6 viral copies/mL prior to therapy who stabilizes after 6 months of therapy

at an HIV RNA level that is detectable but <10,000 copies/mL may not warrant an immediate change in therapy.

- *Repeated detection of virus in plasma after initial suppression to undetectable levels, suggesting the development of resistance (BIII).* However, the degree of plasma HIV RNA increase should be considered; the physician may consider short-term further observation in a patient whose plasma HIV RNA increases from undetectable to low-level detectability (e.g., 500–5,000 copies/mL) at 4 months. In this situation, the patient should be monitored closely. However, most patients whose plasma HIV RNA levels become detectable after having been undetectable will subsequently show progressive increases in plasma viremia that will likely require a change in antiretroviral regimen.
- *Any reproducible significant increase, defined as threefold or greater, from the nadir of plasma HIV RNA not attributable to intercurrent infection, vaccination, or test methodology except as noted above (BIII).*
- *Undetectable viremia in the patient who is being administered double nucleoside therapy (BIII).* Patients currently receiving two NRTIs who have achieved the goal of no detectable virus have the option of either continuing this regimen or modifying the regimen to conform to regimens in the preferred category (Table 6). Prior experience indicates that most of these patients on double nucleoside therapy will eventually have virologic failure with a frequency that is substantially greater compared with patients treated with the preferred regimens.
- *Persistently declining CD4+ T cell numbers, as measured on at least two separate occasions (see Principle 2 for significant decline) (CIII).*
- *Clinical deterioration (DIII).* A new AIDS-defining diagnosis that was acquired after the time treatment was initiated suggests clinical deterioration but may or may not suggest failure of antiretroviral therapy. If the antiretroviral effect of therapy was poor (e.g., a less than tenfold reduction in viral RNA), then a judgment of therapeutic failure could be made. However, if the antiretroviral effect was good but the patient was already severely immunocompromised, the appearance of a new opportunistic disease may not necessarily reflect a failure of antiretroviral therapy, but rather a persistence of severe immunocompromise that did not improve despite adequate suppression of virus replication. Similarly, an accelerated decline in CD4+ T cell counts suggests progressive immune deficiency providing there are sufficient measurements to ensure quality control of CD4+ T cell measurements.

A final consideration in the decision to change therapy is the recognition of the still limited choice of available agents and the knowledge that a decision to change may reduce future treatment options for the patient (see Principle 7). This consideration may influence the physician to be somewhat more conservative when deciding to change therapy. Consideration of alternative options should include potency of the substituted regimen and probability of tolerance of or adherence to the alternative regimen. Clinical trials have demonstrated that partial suppression of virus is superior to no suppression of virus. However, some physicians and patients may prefer to suspend treatment to preserve future options or because a sustained antiviral effect

cannot be achieved. Referral to or consultation with an experienced HIV clinician is appropriate when the clinician is considering a change in therapy. When possible, patients who require a change in an antiretroviral regimen but without treatment options that include using currently approved drugs should be referred for consideration for inclusion in an appropriate clinical trial.

Therapeutic Options When Changing Antiretroviral Therapy

Recommendations for changes in treatment differ according to the indication for the change. If the desired virologic objectives have been achieved in patients who have intolerance or toxicity, a substitution should be made for the offending drug, preferably with an agent in the same class with a different toxicity or tolerance profile. If virologic objectives have been achieved but the patient is receiving a regimen not in the preferred category (e.g., two NRTIs or monotherapy), there is the option either to continue treatment with careful monitoring of viral load or to add drugs to the current regimen to comply with preferred treatment regimens. Most experts consider that treatment with regimens not in the preferred category is associated with eventual failure and recommend the latter tactic. At present, few clinical data are available to support specific strategies for changing therapy in patients who have failed the preferred regimens that include PIs; however, several theoretical considerations should guide decisions. Because of the relatively rapid mutability of HIV, viral strains that are resistant to one or more agents often emerge during therapy, particularly when viral replication has not been maximally suppressed. Of major concern is recent evidence of broad cross-resistance among the class of PIs. Evidence indicates that viral strains that become resistant to one PI will have reduced susceptibility to most or all other PIs. Thus, the likelihood of success of a subsequently administered PI + two NRTI regimen, even if all drugs are different from the initial regimen, may be limited, and many experts would include two new PIs in the subsequent regimen.

Some of the most important guidelines to follow when changing a patient's antiretroviral therapy are summarized (Table 13), and some of the treatment options available when a decision has been made to change the antiretroviral regimen are outlined (Table 14). Limited data exist to suggest that any of these alternative regimens will be effective (Table 14), and careful monitoring and consultation with an expert in the care of such HIV-infected patients is desirable. A change in regimen because of treatment failure should ideally involve complete replacement of the regimen with different drugs to which the patient is naive. This typically would include the use of two new NRTIs and one new PI or NNRTI, two PIs with one or two new NRTIs, or a PI combined with an NNRTI. Dose modifications may be required to account for drug interactions when using combinations of PIs or a PI and NNRTI (Table 12). In some persons, these options are not possible because of prior antiretroviral use, toxicity, or intolerance. In the clinically stable patient who has detectable viremia for whom an optimal change in therapy is not possible, it may be prudent to delay changing therapy in anticipation of the availability of newer and more potent agents. It is recommended that the decision to change therapy and design a new regimen should be made with assistance from a clinician experienced in the treatment of HIV infected patients through consultation or referral.

ACUTE HIV INFECTION

Considerations for Treatment of Patients Who Have Acute HIV Infection

Various studies indicate that 50%–90% of patients acutely infected with HIV will experience at least some symptoms of the acute retroviral syndrome (Table 15) and can thus be identified as candidates for early therapy (16–19). However, acute HIV infection is often not recognized in the primary-care setting because of the similarity of the symptom complex with those of the “flu” or other common illnesses. Also, acute primary infection may occur without symptoms. Physicians should maintain a high level of suspicion for HIV infection in all patients with a compatible clinical syndrome (Table 15) and should obtain appropriate laboratory confirmation. Information regarding treatment of acute HIV infection from clinical trials is limited. There is evidence for a short-term effect of therapy on viral load and CD4+ T cell counts (20), but there are as yet no outcome data demonstrating a clinical benefit of antiretroviral treatment of primary HIV infection. Clinical trials completed to date also have been limited by small sample sizes, short duration of follow-up, and often by the use of treatment regimens that have suboptimal antiviral activity by current standards. However, results from these studies generally support antiretroviral treatment of acute HIV infection. Ongoing clinical trials are addressing the question of the long-term clinical benefit of more potent treatment regimens.

The theoretical rationale for early intervention (see Principle 10) is fourfold:

- to suppress the initial burst of viral replication and decrease the magnitude of virus dissemination throughout the body;
- to decrease the severity of acute disease;
- to potentially alter the initial viral “set-point”, which may ultimately affect the rate of disease progression;
- to possibly reduce the rate of viral mutation due to the suppression of viral replication.

The physician and the patient should be aware that therapy of primary HIV infection is based on theoretical considerations, and the potential benefits, described above, should be weighed against the potential risks (see below). Most experts endorse treatment of acute HIV infection based on the theoretical rationale, limited but supportive clinical trial data, and the experience of HIV clinicians.

The risks associated with therapy for acute HIV infection include adverse effects on quality of life resulting from drug toxicities and dosing constraints; the potential, if therapy fails to effectively suppress viral replication, for the development of drug resistance that may limit future treatment options; and the potential need for continuing therapy indefinitely. These considerations are similar to those for initiating therapy in the asymptomatic patient (see Considerations in Initiating Therapy in the Asymptomatic HIV-infected Patient).

Deciding Whom to Treat During Acute HIV Infection

Many experts would recommend antiretroviral therapy for all patients who demonstrate laboratory evidence of acute HIV infection (AII). Such evidence includes HIV RNA in plasma that can be detected by using sensitive PCR or bDNA assays together with a negative or indeterminate HIV antibody test. Although measurement of plasma HIV RNA is the preferable method of diagnosis, a test for p24 antigen may be useful when RNA testing is not readily available. However, a negative p24 antigen test does not rule out acute infection. When suspicion for acute infection is high (e.g., as in a patient who has a report of recent risk behavior in association with suggestive symptoms and signs [Table 15]), a test for HIV RNA should be performed (BII).^{*} Persons may or may not have symptoms of the acute retroviral syndrome. Viremia occurs acutely after infection before the detection of a specific immune response; an indeterminate antibody test may occur when a person is in the process of seroconversion.

Apart from patients who have acute primary HIV infection, many experts also would consider therapy for patients in whom seroconversion has been documented to have occurred within the previous 6 months (CIII). Although the initial burst of viremia in infected adults has usually resolved by 2 months, treatment during the 2–6-month period after infection is based on the likelihood that virus replication in lymphoid tissue is still not maximally contained by the immune system during this time. Decisions regarding therapy for patients who test antibody positive and who believe the infection is recent but for whom the time of infection cannot be documented should be made using the Asymptomatic HIV Infection algorithm mentioned previously (CIII). No patient should be treated for HIV infection until the infection is documented, except in the setting of post-exposure prophylaxis of health-care workers with antiretroviral agents (27)[†]. All patients without a formal medical record of a positive HIV test (e.g., persons who have tested positive by available home testing kits) should be tested by both the ELISA and an established confirmatory test (e.g., the Western Blot) to document HIV infection (AI).

Treatment Regimen for Primary HIV Infection

Once the physician and patient have decided to use antiretroviral therapy for primary HIV infection, treatment should be implemented with the goal of suppressing plasma HIV RNA levels to below detectable levels (AIII). The weight of current experience suggests that the therapeutic regimen for acute HIV infection should include a combination of two NRTIs and one potent PI (AII). Although most experience to date with PIs in the setting of acute HIV infection has been with zidovudine, didanosine or zalcitabine (2,22–24), insufficient data are available to make firm conclusions regarding specific drug recommendations. Potential combinations of agents available are much the same as those used in established infection (Table 6). These aggressive regimens may be associated with several disadvantages (e.g., drug toxicity, large numbers of pills, cost of drugs, and the possibility of developing drug resistance that may limit future options); the latter is likely if virus replication is not adequately suppressed or if the patient has been infected with a viral strain that is already resistant to one or more

^{*}Patients diagnosed with HIV infection by HIV RNA testing should have confirmatory testing performed (Table 2).

[†]Or treatment of neonates born to HIV-infected mothers.

agents. The patient should be carefully counseled regarding these potential limitations and individual decisions made only after weighing the risks and sequelae of therapy against the theoretical benefit of treatment.

Any regimen that is not expected to maximally suppress viral replication is not considered appropriate for treating the acutely HIV-infected person (EIII) because a) the ultimate goal of therapy is suppression of viral replication to below the level of detection, b) the benefits of therapy are based primarily on theoretical considerations, and c) long-term clinical outcome benefit has not been documented. Additional clinical studies are needed to delineate further the role of antiretroviral therapy in the primary infection period.

Patient Follow-up

Testing for plasma HIV RNA levels and CD4+ T cell count and toxicity monitoring should be performed as previously described in Use of Testing for Plasma HIV RNA levels and CD4+ T Cell Count in Guiding Decisions for Therapy, that is, on initiation of therapy, after 4 weeks, and every 3–4 months thereafter (AII). Some experts suggest that testing for plasma HIV RNA levels at 4 weeks is not helpful in evaluating the effect of therapy for acute infection because viral loads may be decreasing from peak viremia levels even in the absence of therapy.

Duration of Therapy for Primary HIV Infection

Once therapy is initiated, many experts would continue to treat the patient with antiretroviral agents indefinitely because viremia has been documented to reappear or increase after discontinuation of therapy (CII). However, some experts would treat for one year and then reevaluate the patient with CD4+ T cell determinations and quantitative HIV RNA measurements. The optimal duration and composition of therapy are unknown, and ongoing clinical trials are expected to provide data relevant to these issues. The difficulties inherent in determining the optimal duration and composition of therapy initiated for acute infection should be considered when first counseling the patient regarding therapy.

CONSIDERATIONS FOR ANTIRETROVIRAL THERAPY IN THE HIV-INFECTED ADOLESCENT

HIV-infected adolescents who were infected through sexual contact or through injecting-drug use during adolescence appear to follow a clinical course that is more similar to HIV disease in adults than in children. In contrast, adolescents who were infected perinatally or through blood products as young children have a unique clinical course that may differ from other adolescents and long-term surviving adults. Currently, most HIV-infected adolescents were infected through sexual contact during the adolescent period and are in a relatively early stage of infection, making them ideal candidates for early intervention.

Puberty is a time of somatic growth and hormonally mediated changes, with females developing more body fat and males more muscle mass. Although theoretically these physiologic changes could affect drug pharmacology, particularly in the case of drugs with a narrow therapeutic index that are used in combination with protein-

bound medicines or hepatic enzyme inducers or inhibitors, no clinically substantial impact of puberty on the use of NRTIs has been observed. Clinical experience with PIs and NNRTIs has been limited. Thus, it is currently recommended that medications used to treat HIV and OIs in adolescents should be administered in a dosage based on Tanner staging of puberty and not specific age. Adolescents in early puberty (Tanner I-II) should receive doses as recommended in the pediatric guidelines, whereas those in late puberty (Tanner V) should receive doses recommended in the adult guidelines. Youth who are in the midst of their growth spurt (Tanner III females and Tanner IV males) should be closely monitored for medication efficacy and toxicity when choosing adult or pediatric dosing guidelines.

CONSIDERATIONS FOR ANTIRETROVIRAL THERAPY IN THE PREGNANT HIV-INFECTED WOMAN

Guidelines for optimal antiretroviral therapy and for initiation of therapy in pregnant HIV-infected women should be the same as those delineated for nonpregnant adults (see Principle 8). Thus, the woman's clinical, virologic, and immunologic status should be the primary factor in guiding treatment decisions. However, it must be realized that the potential impact of such therapy on the fetus and infant is unknown. The decision to use any antiretroviral drug during pregnancy should be made by the woman following discussion with her health-care provider regarding the known and unknown benefits and risks to her and her fetus. Long-term follow-up is recommended for all infants born to women who have received antiretroviral drugs during pregnancy.

Women who are in the first trimester of pregnancy and who are not receiving antiretroviral therapy may wish to consider delaying initiation of therapy until after 10–12 weeks' gestation because this is the period of organogenesis when the embryo is most susceptible to potential teratogenic effects of drugs; the risks of antiretroviral therapy to the fetus during that period are unknown. However, this decision should be carefully considered and discussed between the health-care provider and the patient and should include an assessment of the woman's health status and the potential benefits and risks of delaying initiation of therapy for several weeks. If clinical, virologic, or immunologic parameters are such that therapy would be recommended for nonpregnant persons, many experts would recommend initiating therapy, regardless of gestational age. Nausea and vomiting in early pregnancy, which affect the ability to adequately take and absorb oral medications, may be a factor in deciding whether to administer treatment during the first trimester.

Some women already receiving antiretroviral therapy may have their pregnancy diagnosed early enough in gestation that concern for potential teratogenicity may lead them to consider temporarily stopping antiretroviral therapy until after the first trimester. Insufficient data exist that either support or refute teratogenic risk of antiretroviral drugs when administered during the first 10–12 weeks' gestation. However, a rebound in viral levels would be anticipated during the period of discontinuation, and this rebound could theoretically be associated with increased risk of early in utero HIV transmission or could potentiate disease progression in the woman (25). Although the effects of all antiretroviral drugs on the developing fetus during the first trimester are uncertain, most experts recommend continuation of a maximally sup-

pressive regimen even during the first trimester. If antiretroviral therapy is discontinued during the first trimester for any reason, all agents should be stopped simultaneously to avoid development of resistance. Once the drugs are reinstated, they should be introduced simultaneously for the same reason.

The choice of which antiretroviral agents to use in pregnant women is subject to unique considerations (see Principle 8). Currently, minimal data are available regarding the pharmacokinetics and safety of antiretroviral agents during pregnancy for drugs other than ZDV. In the absence of data, drug choice needs to be individualized based on discussion with the patient and available data from preclinical and clinical testing of the individual drugs. The FDA pregnancy classification for all currently approved antiretroviral agents and selected other information relevant to the use of antiretroviral drugs in pregnancy is provided (Table 16). The predictive value of in vitro and animal-screening tests for adverse effects in humans is unknown. Many drugs commonly used to treat HIV infection or its consequences may have positive findings on one or more of these screening tests. For example, acyclovir is positive on some in vitro assays for chromosomal breakage and carcinogenicity and is associated with some fetal abnormalities in rats; however, data on human experience from the Acyclovir in Pregnancy Registry indicate no increased risk of birth defects to date in infants with in utero exposure to acyclovir (26).

Of the currently approved nucleoside analogue antiretroviral agents, the pharmacokinetics of only ZDV and 3TC have been evaluated in infected pregnant women to date (27,28). Both drugs seem to be well tolerated at the usual adult doses and cross the placenta, achieving concentrations in cord blood similar to those observed in maternal blood at delivery. All the nucleosides except ddI have preclinical animal studies that indicate potential fetal risk and have been classified as FDA pregnancy category C (Table 16); ddI has been classified as category B. In primate studies, all the nucleoside analogues seem to cross the placenta, but ddI and ddC apparently have significantly less placental transfer (fetal to maternal drug ratios of 0.3 to 0.5) than do ZDV, d4T, and 3TC (fetal to maternal drug ratios >0.7) (29).

Of the NNRTIs, only nevirapine administered once at the onset of labor has been evaluated in pregnant women. The drug was well tolerated after a single dose and crossed the placenta and achieved neonatal blood concentrations equivalent to those in the mother. The elimination of nevirapine administered during labor in the pregnant women in this study was prolonged (mean half-life following a single dose, 66 hours) compared with nonpregnant persons (mean half-life following a single dose, 45 hours). Data on multiple dosing during pregnancy are not yet available. Delavirdine has not been studied in Phase I pharmacokinetic and safety trials in pregnant women. In premarketing clinical studies, outcomes of seven unplanned pregnancies were reported. Three of these were ectopic pregnancies, and three resulted in healthy live births. One infant was born prematurely, with a small ventricular septal defect, to a patient who had received approximately 6 weeks of treatment with delavirdine and ZDV early in the course of pregnancy.

Although studies of combination therapy with protease inhibitors in pregnant HIV-infected women are in progress, no data are currently available regarding drug dosage, safety and tolerance during pregnancy. In mice, indinavir has substantial placental passage; however, in rabbits, little placental passage was observed. Ritonavir has been demonstrated to have some placental passage in rats. There are some spe-

cial theoretical concerns regarding the use of indinavir late in pregnancy. Indinavir is associated with side effects (hyperbilirubinemia and renal stones) that theoretically could be problematic for the newborn if transplacental passage occurs and the drug is administered shortly before delivery. These side effects are particularly problematic because the immaturity of the metabolic enzyme system of the neonatal liver would likely be associated with prolonged drug half-life leading to extended drug exposure in the newborn that could lead to potential exacerbation of physiologic neonatal hyperbilirubinemia. Because of immature neonatal renal function and the inability of the neonate to voluntarily ensure adequate hydration, high drug concentrations and/or delayed elimination in the neonate could result in a higher risk for drug crystallization and renal stone development than observed in adults. These concerns are theoretical and such effects have not been reported; because the half-life of indinavir in adults is short, these concerns may only be relevant if drug is administered near the time of labor. Gestational diabetes is a pregnancy-related complication that can develop in some women; administration of any of the four currently available protease inhibitors has been associated with new onset diabetes mellitus, hyperglycemia, or exacerbation of existing diabetes mellitus in HIV-infected patients (30). Pregnancy is itself a risk factor for hyperglycemia, and it is unknown if the use of protease inhibitors will exacerbate this risk for hyperglycemia. Health-care providers caring for infected pregnant women who are being administered PI therapy should be aware of the possibility of hyperglycemia and closely monitor glucose levels in their patients and instruct their patients on how to recognize the early symptoms of hyperglycemia.

To date, the only drug that has been shown to reduce the risk of perinatal HIV transmission is ZDV when administered according to the following regimen: orally administered antenatally after 14 weeks' gestation and continued throughout pregnancy, intravenously administered during the intrapartum period, and administered orally to the newborn for the first 6 weeks of life (31). This chemoprophylactic regimen was shown to reduce the risk for perinatal transmission by 66% in a randomized, double-blind clinical trial, pediatric ACTG 076 (32). Insufficient data are available to justify the substitution of any antiretroviral agent other than ZDV to reduce perinatal HIV transmission; further research should address this question. For the time being, if combination antiretroviral drugs are administered to the pregnant woman for treatment of her HIV infection, ZDV should be included as a component of the antenatal therapeutic regimen whenever possible, and the intrapartum and neonatal ZDV components of the chemoprophylactic regimen should be administered to reduce the risk for perinatal transmission. If a woman is not administered ZDV as a component of her antenatal antiretroviral regimen (e.g., because of prior history of nonlife-threatening ZDV-related severe toxicity or personal choice), intrapartum and newborn ZDV should continue to be recommended; when use of ZDV is contraindicated in the woman, the intrapartum component may be deleted, but the newborn component is still recommended. ZDV and d4T should not be administered together due to potential pharmacologic antagonism. When d4T is a preferred nucleoside for treatment of a pregnant woman, it is recommended that antenatal ZDV not be added to the regimen; however, intrapartum and neonatal ZDV should still be given.

The time-limited use of ZDV alone during pregnancy for chemoprophylaxis of perinatal transmission is controversial. The potential benefits of standard combination antiretroviral regimens for treatment of HIV infection should be discussed with and

offered to all pregnant HIV-infected women. Some women may wish to restrict exposure of their fetus to antiretroviral drugs during pregnancy but still wish to reduce the risk of transmitting HIV to their infant. For women in whom initiation of antiretroviral therapy for treatment of their HIV infection would be considered optional (e.g., CD4+ count $>500/\text{mm}^3$ and plasma HIV RNA $<10,000\text{--}20,000$ RNA copies/mL), time-limited use of ZDV during the second and third trimesters of pregnancy is less likely to induce the development of resistance due to the limited viral replication existing in the patient and the time-limited exposure to the antiretroviral drug. For example, the development of resistance was unusual among the healthy population of women who participated in Pediatric (P)-ACTG 076 (33). The use of ZDV chemoprophylaxis alone during pregnancy might be an appropriate option for these women. However, for women who have more advanced disease and/or higher levels of HIV RNA, concerns about resistance are greater and these women should be counseled that a combination antiretroviral regimen that includes ZDV for reducing transmission risk would be more optimal for their own health than use of ZDV chemoprophylaxis alone.

Monitoring and use of HIV-1 RNA for therapeutic decision making during pregnancy should be performed as recommended for nonpregnant persons. Transmission of HIV from mother to infant can occur at all levels of maternal HIV-1 RNA. In untreated women, higher HIV-1 RNA levels correlate with increased transmission risk. However, in ZDV-treated women this relationship is markedly attenuated (32). ZDV is effective in reducing transmission regardless of maternal HIV RNA level. Therefore, the use of the full ZDV chemoprophylaxis regimen, including intravenous ZDV during delivery and the administration of ZDV to the infant for the first 6 weeks of life, alone or in combination with other antiretrovirals, should be discussed with and offered to all infected pregnant women regardless of their HIV-1 RNA level. Health-care providers who are treating HIV-infected pregnant women are strongly encouraged to report cases of prenatal exposure to antiretroviral drugs (either administered alone or in combinations) to the Antiretroviral Pregnancy Registry. The registry collects observational, nonexperimental data regarding antiretroviral exposure during pregnancy for the purpose of assessing potential teratogenicity. Registry data will be used to supplement animal toxicology studies and assist clinicians in weighing the potential risks and benefits of treatment for individual patients. The registry is a collaborative project with an advisory committee of obstetric and pediatric practitioners, staff from CDC and NIH, and staff from pharmaceutical manufacturers. The registry allows the anonymity of patients, and birth outcome follow-up is obtained by registry staff from the reporting physician. Referrals should be directed to Antiretroviral Pregnancy Registry, Post Office Box 13398, Research Triangle Park, NC 27709-3398; telephone (800) 258-4263.

CONCLUSION

The Panel has attempted to use the advances in current understanding of the pathogenesis of HIV in the infected person to translate scientific principles and data obtained from clinical experience into recommendations that can be used by the clinician and patient to make therapeutic decisions. The recommendations are offered in the context of an ongoing dialogue between the patient and the clinician after having defined specific therapeutic goals with an acknowledgment of uncertainties. It is nec-

essary for the patient to receive a continuum of medical care and services, including social, psychosocial, and nutritional services, with the availability of expert referral and consultation. To achieve the maximal flexibility in tailoring therapy to each patient over the duration of his or her infection, it is imperative that drug formularies allow for all FDA-approved NRTI, NNRTI, and PI as treatment options. The Panel strongly urges industry and the public and private sectors to conduct further studies to allow refinement of these guidelines. Specifically, studies are needed to optimize recommendations for first-line therapy; to define second-line therapy; and to more clearly delineate the reason(s) for treatment failure. The Panel remains committed to revising their recommendations as such new data become available.

Acknowledgment

The Panel extends special appreciation to Charles Carpenter (Brown University School of Medicine, Providence, RI) for his advice in the development of this document and to Gerry Bally (Health Canada) and Anita Rachlis (Sunnybrook Health Science Centre, University of Toronto, Toronto, Canada) for their participation. The Panel acknowledges the special contributions of Sharilyn Stanley, Barbara Brady, and Elaine Daniels in the preparation of this document.

References

1. USPHS/IDSA Prevention of Opportunistic Infections Working Group. 1997 USPHS /IDSA guidelines for the prevention of opportunistic infections in persons infected with human immunodeficiency virus. *MMWR* 1997;46(No. RR-12).
2. Perelson AS, Essunger P, Cao Y, et al. Decay characteristics of HIV-1-infected compartments during combination therapy. *Nature* 1997;387:188-91.
3. Stein DS, Korvick JA, Vermund SH. CD4+ lymphocyte cell enumeration for prediction of clinical course of human immunodeficiency virus disease: a review. *J Infect Dis* 1992;165:352-63.
4. Carpenter CC, Fischl MA, Hammer SM, et al. Antiretroviral therapy for HIV infection in 1997: Updated recommendations of the international AIDS Society—USA panel. *JAMA* 1997;277:1962-9.
5. Raboud JM, Montaner JSG, Conway B, et al. Variation in plasma RNA levels, CD4 cell counts, and p24 antigen levels in clinically stable men with human immunodeficiency virus infection. *J Infect Dis* 1996;174:191-4.
6. CDC. 1993 revised classification system for HIV infection and expanded surveillance case definition for AIDS among adolescents and adults. *MMWR* 1992;41(No. RR-17).
7. Fischl MA, Richman DD, Grieco MH, et al. The efficacy of zidovudine (AZT) in the treatment of patients with AIDS and AIDS-related complex: a double-blind, placebo-controlled trial. *N Engl J Med* 1987;317:185-91.
8. Fischl MA, Richman DD, Hansen N, et al. The safety and efficacy of zidovudine (AZT) in the treatment of subjects with mildly symptomatic human immunodeficiency virus type 1 infection: a double-blind, placebo-controlled trial. *Ann Intern Med* 1990;112:727-37.
9. Volberding PA, Lagakos SW, Koch MA, et al. Zidovudine in asymptomatic human immunodeficiency virus infection: a controlled trial in persons with fewer than 500 CD4-positive cells per cubic millimeter. *N Engl J Med* 1990;322:941-9.
10. Volberding PA, Lagakos SW, Grimes JM, et al. The duration of zidovudine benefit in persons with asymptomatic HIV infection: prolonged evaluation of protocol 019 of the AIDS Clinical Trials Group. *JAMA* 1994;272:437-42.
11. Hammer SM, Katzenstein DA, Hughes MD, et al. A trial comparing nucleoside monotherapy with combination therapy in HIV-infected adults with CD4 cell counts from 200 to 500 per cubic millimeter. *N Engl J Med* 1996;335:1081-90.
12. Mellors JW, Munoz A, Giorgi JV, et al. Plasma viral load and CD4+ lymphocytes as prognostic markers of HIV-1 infection. *Ann Intern Med* 1997;126:946-54.
13. Schuurman R, Nijhuis M, van Leeuwen R, et al. Rapid changes in human immunodeficiency virus type 1 RNA load and appearance of drug-resistant virus populations in persons treated with lamivudine (3TC). *J Infect Dis* 1995;171:1411-9.

14. Keulen W, Back NKT, van Wijk A, et al. Initial appearance of the 184Ile variant in lamivudine-treated patients is caused by the mutational bias of human immunodeficiency virus type 1 reverse transcriptase. *J Virol* 1997;71:3346-50.
15. CDC. Clinical update—impact of HIV protease inhibitors on the treatment of HIV-infected tuberculosis patients with rifampin. *MMWR* 1996;45:921-5.
16. Schacker T, Collier AC, Hughes J, et al. Clinical and epidemiologic features of primary HIV infection. *Ann Intern Med* 1996;125:257-64.
17. Kinloch-de Loës S, de Saussure P, Saurat J, Stalder H, Hirschel B, Perrin, LH. Symptomatic primary infection due to human immunodeficiency virus type 1: review of 31 cases. *Clin Infect Dis* 1993;17:59-65.
18. Tindall B, Cooper D. Primary HIV infection: host responses and intervention strategies. *AIDS* 1991;5:1-14.
19. Niu MJ, Stein D, Schnittman SM. Primary human immunodeficiency virus type 1 infection: review of pathogenesis and early treatment intervention in humans and animal retrovirus infections. *J Infect Dis* 1993;168:1490-501.
20. Lafeuillade A, Poggi C, Tamalet C, Profizi N, Tourres C, Costes O. Effects of a combination of zidovudine, didanosine, and lamivudine on primary human immunodeficiency virus type 1 infection. *J Infect Dis* 1997;175:1051-5.
21. CDC. Update: provisional public health service recommendations for chemoprophylaxis after occupational exposure to HIV. *MMWR* 1996;45:468-72.
22. Hoen B, Harzic M, Fleury HF, et al. ANRS053 trial of zidovudine (ZDV), lamivudine (3TC), and ritonavir combination in patients with symptomatic primary HIV-1 infection: preliminary results [Abstract 232]. In: Program and abstracts of the 4th Conference on Retroviruses and Opportunistic Infections. Washington, DC: January 22-26, 1997.
23. Tamalet C, Poizot Martin IP, Lafeuillade A, et al. Viral load and genotypic resistance pattern in HIV-1 infected patients treated by a triple combination therapy including nucleoside and protease inhibitors (NIS and PIS) initiated at primary infection [Abstract 592]. In: Program and abstracts of the 4th Conference on Retroviruses and Opportunistic Infections. Washington, DC: January 22-26, 1997.
24. Perrin L, Markowitz M, Calandra G, Chung M, and the MRL Acute HIV Infection Study Group. An open treatment study of acute HIV infection with zidovudine, lamivudine and indinavir sulfate [Abstract 238]. In: Program and abstracts of the 4th Conference on Retroviruses and Opportunistic Infections. Washington, DC: January 22-26, 1997.
25. Minkoff H, Augenbraun M: Antiretroviral therapy for pregnant women. *Am J Obstet Gynecol* 1997;176:478-89.
26. CDC. Pregnancy outcomes following systemic prenatal acyclovir exposure—June 1, 1984-June 30, 1993. *MMWR* 1993;42:806-9.
27. O'Sullivan MJ, Boyer PJJ, Scott GB, et al: The pharmacokinetics and safety of zidovudine in the third trimester of pregnancy for women infected with human immunodeficiency virus and their infants: Phase I Acquired Immunodeficiency Syndrome Clinical Trials Group study (protocol 082). *Am J Obstet Gynecol* 1993;168:1510-6.
28. Moodley J, Moodley D, Pillay K, et al: Antiviral effect of lamivudine alone and in combination with zidovudine in HIV-infected pregnant women [Abstract 607]. In: Proceedings of the 4th Conference on Retroviruses and Opportunistic Infections. Washington, DC: January 22-26, 1997
29. Sandberg JA, Slikker W: Developmental pharmacology and toxicology of anti-HIV therapeutic agents: dideoxynucleosides. *FASEB J*. 1995;9:1157-63.
30. FDA Public Health Advisory: Reports of diabetes and hyperglycemia in patients receiving protease inhibitors for the treatment of human immunodeficiency virus (HIV). *JAMA* 1997;278:379.
31. CDC. Public Health Service Task Force recommendations for the use of antiretroviral drugs in pregnant women infected with HIV-1 for maternal health and for reducing perinatal HIV-1 transmission in the United States. *MMWR* 1998;47(RR-2).
32. Sperling RS, Shapiro DE, Coombs RW, et al. Maternal viral load, zidovudine treatment, and the risk of transmission of human immunodeficiency virus type 1 from mother to infant. *N Engl J Med* 1996;335:1621-9.
33. Eastman PS, Shapiro DE, Coombs RW, et al. Maternal genotypic zidovudine (ZDV) resistance and failure of ZDV therapy to prevent mother-child HIV-1 transmission [Abstract 516]. In: Pro-

gram and abstracts of the 4th Conference on Retroviruses and Opportunistic Infections. Washington, DC: January 22-26, 1997.

34. Hammer SM, Squires KE, Hughes MD, et al. A controlled trial of two nucleoside analogues plus indinavir in persons with human immunodeficiency virus infection and CD4 cell counts of 200 per cubic millimeter or less. *N Engl J Med* 1997;337:725-33.
35. Gulick RM, Mellors JW, Havlir D, et al. Treatment with indinavir, zidovudine, and lamivudine in adults with human immunodeficiency virus infection and prior antiretroviral therapy. *N Engl J Med* 1997;337:734-9.
36. de Jong MD, Vella S, Carr A, et al: High-dose nevirapine in previously untreated human immunodeficiency virus type-1-infected persons does not result in sustained suppression of viral replication. *J Infect Dis* 1997;175:966-70.
37. Schapiro JM, Winters MA, Stewart F, et al: The effect of high-dose saquinavir on viral load and CD4+ T-cell counts in HIV-infected patients. *Ann Intern Med* 1996;124:1039-50.
38. Bartlett JG: Protease inhibitors for HIV infection. *Ann Intern Med* 1996;124:1086-8.
39. Eron JT, Benoit SL, Jemsek J, et al: Treatment with lamivudine, zidovudine, or both in HIV-positive patients with 200 to 500 CD4+ cells per cubic millimeter. *N Engl J Med* 1995;333:1662-9.
40. Staszewski S, Loveday C, Picazo JJ, et al: Safety and efficacy of lamivudine-zidovudine combination therapy in zidovudine-experienced patients. *JAMA* 1996;276:111-7.
41. Dubé MP, Johnson DL, Currier JS, Leedom JM. Protease inhibitor-associated hyperglycaemia (letter). *Lancet* 1997;350:713-4.
42. Visnegarwala F, Krause KL, Musher DM. Severe diabetes associated with protease inhibitor therapy (letter). *Ann Intern Med* 1997;127:947.
43. Eastone JA, Decker CF. New-onset diabetes mellitus associated with use of protease inhibitor (letter). *Ann Intern Med* 1997;127:948.
44. Hanson C, Cooper E, Antonelli T, et al: Lack of tumors in infants with perinatal HIV exposure and fetal/neonatal exposure to zidovudine (AZT) [Abstract 304.3]. In: Proceedings of the National Conference on Women and HIV. Pasadena, CA: May 4-7, 1997.

Appendices

FIGURE 1. Likelihood of developing AIDS within 3 years*

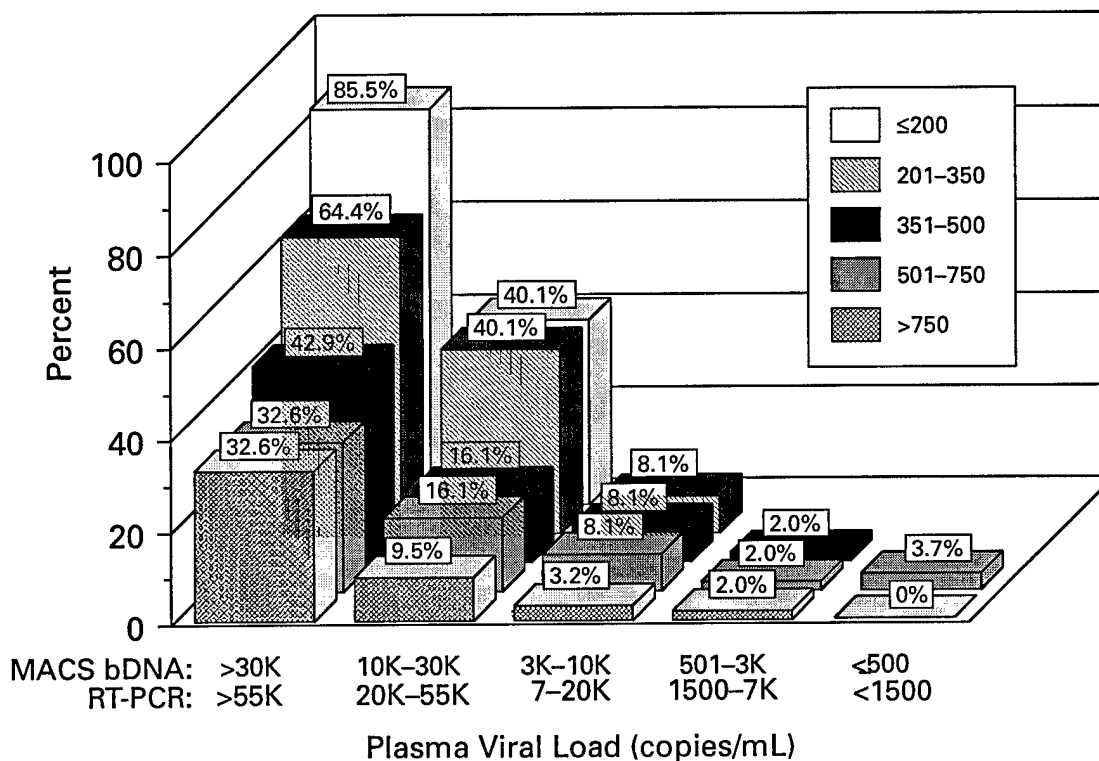

*Viral load values represent the actual data obtained on the specimens from the Multicenter AIDS Cohort Study (MACS) as well as the values showing the equivalent expected RT-PCR values. Values shown in this figure differ slightly from those in Table 4 because better discrimination of outcome was achieved by reanalysis of the data using viral load as the initial parameter for categorization followed by CD4+ T cell stratification of the patients. (Adapted from [12].)

TABLE 1. Rating system for strength of recommendation and quality of evidence supporting the recommendation

Category	Definition
Categories reflecting the strength of each recommendation	
A	Strong; should always be offered
B	Moderate; should usually be offered
C	Optional
D	Should generally not be offered
E	Should never be offered
Categories reflecting the quality of evidence supporting the recommendation	
I	At least one randomized trial with clinical endpoints
II	Clinical trials with laboratory endpoints
III	Expert opinion

TABLE 2. Indications for plasma HIV RNA testing*

Clinical indication	Information	Use
Syndrome consistent with acute HIV infection	Establishes diagnosis when HIV antibody test is negative or indeterminate	Diagnosis [†]
Initial evaluation of newly diagnosed HIV infection	Baseline viral load "set point"	Decision to start or defer therapy
Every 3–4 mos. in patients not on therapy	Changes in viral load	Decision to start therapy
4–8 wks. after initiation of antiretroviral therapy	Initial assessment of drug efficacy	Decision to continue or change therapy
3–4 mos. after start of therapy	Maximal effect of therapy	Decision to continue or change therapy
Every 3–4 mos. in patients on therapy	Durability of antiretroviral effect	Decision to continue or change therapy
Clinical event or significant decline in CD4+ T cells	Association with changing or stable viral load	Decision to continue, initiate, or change therapy

* Acute illness (e.g., bacterial pneumonia, tuberculosis, HSV, PCP) and immunizations can cause increases in plasma HIV RNA for 2–4 wks.; viral load testing should not be performed during this time. Plasma HIV RNA results should usually be verified with a repeat determination before starting or making changes in therapy. HIV RNA should be measured using the same laboratory and the same assay.

[†]Diagnosis of HIV infection determined by HIV RNA testing should be confirmed by standard methods (e.g., Western blot serology) performed 2–4 mos. after the initial indeterminate or negative test.

TABLE 3. Risks and benefits of early initiation of antiretroviral therapy in the asymptomatic HIV-infected patient

Potential Benefits

Control of viral replication and mutation; reduction of viral burden
Prevention of progressive immunodeficiency; potential maintenance or reconstitution of a normal immune system
Delayed progression to AIDS and prolongation of life
Decreased risk of selection of resistant virus
Decreased risk of drug toxicity

Potential Risks

Reduction in quality of life from adverse drug effects and inconvenience of current maximally suppressive regimens
Earlier development of drug resistance
Limitation in future choices of antiretroviral agents due to development of resistance
Unknown long-term toxicity of antiretroviral drugs
Unknown duration of effectiveness of current antiretroviral therapies

TABLE 4. Risk for progression to AIDS-defining illness in a cohort of men who have sex with men, predicted by baseline CD4+ T cell count and viral load*

CD4 ≤350		% AIDS (AIDS-defining complication) [†]			
Plasma viral load (copies/mL) [‡]		No. of patients in study	3 yrs	6 yrs	9 yrs
bDNA	RT-PCR				
≤500	≤1,500	— [¶]	—	—	—
501–3,000	1,501–7,000	30	0	18.8	30.6
3,001–10,000	7,001–20,000	51	8.0	42.2	65.6
10,001–30,000	20,001–55,000	73	40.1	72.9	86.2
>30,000	>55,000	174	72.9	92.7	95.6
CD4 351–500		% AIDS (AIDS-defining complication)			
Plasma viral load (copies/mL)		No. of patients in study	3 yrs	6 yrs	9 yrs
bDNA	RT-PCR				
≤500	≤1,500	—	—	—	—
501–3,000	1,501–7,000	47	4.4	22.1	46.9
3,001–10,000	7,001–20,000	105	5.9	39.8	60.7
10,001–30,000	20,001–55,000	121	15.1	57.2	78.6
>30,000	>55,000	121	47.9	77.7	94.4
CD4 >500		% AIDS (AIDS-defining complication)			
Plasma viral load (copies/mL)		No. of patients in study	3 yrs	6 yrs	9 yrs
bDNA	RT-PCR				
≤500	≤1,500	110	1.0	5.0	10.7
501–3,000	1,501–7,000	180	2.3	14.9	33.2
3,001–10,000	7,001–20,000	237	7.2	25.9	50.3
10,001–30,000	20,001–55,000	202	14.6	47.7	70.6
>30,000	>55,000	141	32.6	66.8	76.3

*Data from the Multicenter AIDS Cohort Study (MACS) (12).

[†]In this study, AIDS was defined according to the 1987 CDC definition and does not include asymptomatic persons who have CD4+ T cells <200/mm³.

[‡]MACS numbers reflect plasma HIV RNA values obtained by bDNA testing. RT-PCR values are consistently 2–2.5-fold higher than bDNA values, as indicated.

[¶]Too few subjects were in the category to provide a reliable estimate of AIDS risk.

TABLE 5. Indications for the initiation of antiretroviral therapy in the chronically HIV-infected patient

Clinical category	CD4+ T cell count and HIV RNA	Recommendation
Symptomatic (i.e., AIDS, thrush, unexplained fever)	Any value	Treat
Asymptomatic	CD4+ T Cells <500/mm ³ or HIV RNA >10,000 (bDNA) or >20,000 (RT-PCR)	Treatment should be offered. Strength of recommendation is based on prognosis for disease-free survival as shown in Table 4 and willingness of the patient to accept therapy.*
Asymptomatic	CD4+ T Cells >500/mm ³ and HIV RNA <10,000 (bDNA) or <20,000 (RT-PCR)	Many experts would delay therapy and observe; however, some experts would treat.

*Some experts would observe patients whose CD4+ T cell counts are between 350–500/mm³ and HIV RNA levels <10,000 (bDNA) or <20,000 (RT-PCR).

TABLE 6. Recommended antiretroviral agents for treatment of established HIV infection

Preferred: Strong evidence of clinical benefit and/or sustained suppression of plasma viral load (2, 34, 35)

One choice each from column A and column B. Drugs are listed in random, not priority, order:

Column A	Column B
Indinavir (AI)	ZDV + ddI (AI)
Nelfinavir (AII)	d4T + ddI (AII)
Ritonavir (AI)	ZDV + ddC (AI)
Saquinavir-SGC* (AII)	ZDV + 3TC [§] (AI)
Ritonavir + Saquinavir-SGC or HGC† (BII)	d4T + 3TC [§] (AII)

Alternative: Less likely to provide sustained virus suppression; (36–38)

1 NNRTI (Nevirapine)[¶] + 2 NRTIs (Column B, above) (BII)

Saquinavir-HGC + 2 NRTIs (Column B, above) (BI)

Not generally recommended: Strong evidence of clinical benefit, but initial virus suppression is not sustained in most patients (39,40)

2 NRTIs (Column B, above) (CI)

Not recommended:** Evidence against use, virologically undesirable, or overlapping toxicities

All monotherapies (DI)

d4T + ZDV (DI)

ddC + ddI^{††} (DII)

ddC + d4T^{††} (DII)

ddC + 3TC (DII)

*Virologic data and clinical experience with saquinavir-sgc are limited in comparison with other protease inhibitors.

†Use of ritonavir 400 mg b.i.d. with saquinavir soft-gel formulation (Fortovase™) 400 mg b.i.d. results in similar areas under the curve (AUC) of drug and antiretroviral activity as when using 400 mg b.i.d. of Invirase™ in combination with ritonavir. However, this combination with Fortovase™ has not been extensively studied and gastrointestinal toxicity may be greater when using Fortovase™.

§High-level resistance to 3TC develops within 2–4 wks. in partially suppressive regimens; optimal use is in three-drug antiretroviral combinations that reduce viral load to <500 copies/mL.

¶The only combination of 2 NRTIs + 1 NNRTI that has been shown to suppress viremia to undetectable levels in the majority of patients is ZDV+ddI+Nevirapine. This combination was studied in antiretroviral-naive persons (36).

**ZDV monotherapy may be considered for prophylactic use in pregnant women who have low viral load and high CD4+ T cell counts to prevent perinatal transmission (see "Considerations for Antiretroviral Therapy in the Pregnant HIV-Infected Woman" on pages 59–62).

††This combination of NRTIs is not recommended based on lack of clinical data using the combination and/or overlapping toxicities.

TABLE 7. Characteristics of nucleoside reverse transcriptase inhibitors (NRTIs)

Generic name	Zidovudine (AZT, ZDV)	Didanosine (ddI)	Zalcitabine (ddC)	Stavudine (d4T)	Lamivudine (3TC)
Trade name	<i>Retrovir</i>	<i>Videx</i>	<i>HIVID</i>	<i>Zerit</i>	<i>Epivir</i>
Dosing recommendations	200 mg t.i.d. or 300 mg b.i.d. or with 3TC as Combivir™, 1 b.i.d.	Tablets >60kg: 200 mg b.i.d. <60 kg: 125 mg b.i.d.	0.75 mg t.i.d.	>60 kg: 40 mg b.i.d. <60 kg: 30 mg b.i.d.	150 mg b.i.d. <50 kg: 2 mg/kg b.i.d. or with ZDV as Combivir™, 1 b.i.d.
Oral bioavailability	60%	Tablet: 40% Powder: 30%	85%	86%	86%
Serum half-life	1.1 hr.	1.6 hr.	1.2 hr.	1.0 hr.	3-6 hrs.
Intracellular half-life	3 hrs.	25-40 hrs.	3 hrs.	3.5 hrs.	12 hrs.
Elimination	Metabolized to AZT glucuronide (GAZT). Renal excretion of GAZT.	Renal excretion 50%	Renal excretion 70%	Renal excretion 50%	Renal excretion unchanged
Adverse events	Bone marrow suppression: anemia and/or neutropenia. Subjective complaints: GI intolerance, headache, insomnia, asthenia.	Pancreatitis; Peripheral neuropathy; Nausea; Diarrhea	Peripheral neuropathy; Stomatitis	Peripheral neuropathy	(Minimal toxicity)

TABLE 8. Non-nucleoside reverse transcriptase inhibitors (NNRTIs)

Generic name	Nevirapine	Delavirdine
<i>Trade name</i>	<i>Viramune</i>	<i>Rescriptor</i>
Form	200 mg tabs	100 mg tabs
Dosing recommendations	200 mg po q.d. x 14 days, then 200 mg po b.i.d.	400 mg po t.i.d. (four 100 mg tabs in ≥ 3 oz. water to produce slurry)
Oral bioavailability	>90%	85%
Serum half-life	25–30 hrs.	5.8 hrs.
Elimination	Metabolized by cytochrome p450; 80% excreted in urine (glucuronidated metabolites, <5% unchanged); 10% in feces	Metabolized by cytochrome p450; 51% excreted in urine (<5% unchanged); 44% in feces
Drug interactions	<p>Induces cytochrome p450 enzymes</p> <ul style="list-style-type: none"> The following drugs have suspected interactions that require careful monitoring if co-administered with nevirapine: rifampin, rifabutin, oral contraceptives, protease inhibitors, triazolam and midazolam. 	<p>Inhibits cytochrome p450 enzymes</p> <ul style="list-style-type: none"> Not recommended for concurrent use: terfenadine, astemizole, alprazolam, midazolam, cisapride, rifabutin, rifampin, triazolam, ergot derivatives, amphetamines, nifedipine, anticonvulsants (phenytoin, carbamazepine, phenobarbital). Delavirdine increases levels of clarithromycin, dapsone, quinidine, warfarin, indinavir, saquinavir. Antacids and didanosine: separate administration by ≥ 1 hr.
Adverse events	Rash; increased transaminase levels; hepatitis	Rash; headaches

TABLE 9. Characteristics of protease inhibitors (PIs)

Generic name	Ritonavir		Saquinavir		Nelfinavir	
	Indinavir <i>Crixivan</i>	<i>Norvir</i>	<i>Invirase</i> TM	<i>Fortovase</i> TM	<i>Viracept</i>	
Form	200-, 400-mg caps	100-mg caps 600 mg/7.5 mL po solution	200-mg caps	200-mg caps	250-mg tablets 50-mg/g oral powder	
Dosing recommendations	800 mg q8h Take 1 hr. before or 2 hrs. after meals; may take with skim milk or low-fat meal.	600 mg q12h* Take with food if possible.	600 mg t.i.d.* Take with large meal.	1,200 mg t.i.d. Take with large meal.	750 mg t.i.d. Take with food (meal or light snack).	
Oral bioavailability	65%	(Not determined)	hard-gel capsule: 4%, erratic	soft-gel capsule (not determined)	20%–80%	
Serum half-life	1.5–2 hrs.	3–5 hrs.	1–2 hrs.	1–2 hrs.	3.5–5 hrs.	
Route of metabolism	P450 cytochrome 3A4	P450 cytochrome 3A4>2D6	P450 cytochrome 3A4	P450 cytochrome 3A4	P450 cytochrome 3A4	
Storage	Room temperature	Refrigerate capsules; refrigeration for oral solution is preferred but not required if used within 30 days.	Room temperature	Refrigerate or store at room temperature (up to 3 mos.).	Room temperature	
Adverse effects	Nephrolithiasis. GI intolerance, nausea. Lab: increased indirect bilirubinemia (inconsequential). Miscellaneous: headache, asthenia, blurred vision, dizziness, rash, metallic taste, thrombocytopenia. Hyperglycemia. (¶)	GI intolerance, nausea, vomiting, diarrhea. Paresthesias (circumoral and extremities). Hepatitis. Asthenia. Taste perversion. Lab: Triglycerides increase >200%, transaminase elevation, elevated CPK and uric acid. Hyperglycemia. (¶)	GI intolerance, nausea and diarrhea. Headache. Elevated transaminase enzymes. Hyperglycemia. (¶)	GI intolerance, nausea, diarrhea, abdominal pain and dyspepsia. Headache. Elevated transaminase enzymes. Hyperglycemia. (¶)	Diarrhea. Hyperglycemia. (¶)	

Drug interactions	Inhibits cytochrome P450 (less than ritonavir). Contraindicated for concurrent use: astemizole, cisapride, triazolam, midazolam, ergot alkaloids. Indinavir levels increased by: ketoconazole [§] , delavirdine. Indinavir levels reduced by: rifampin, juice, grapefruit juice, nevirapine. Didanosine reduces indinavir absorption unless taken >2 hrs apart. Not recommended for concurrent use: rifampin.	Inhibits cytochrome P450 (potent inhibitor). Ritonavir increases levels of multiple drugs that are not recommended for concurrent use [†] . Didanosine: may cause reduced absorption of both drugs; should be taken ≥2 hours apart. Ritonavir decreases levels of ethinyl estradiol, theophylline, sulfamethoxazole and zidovudine. Ritonavir increases levels of clarithromycin and desipramine.	Inhibits cytochrome P450. Saquinavir levels increased by: ritonavir, ketoconazole, grapefruit juice, nefinavir, delavirdine. Saquinavir levels reduced by: rifampin, rifabutin, and possibly the following: phenobarbital, phenytoin, dexamethasone and carbamazepine, nevirapine. Contraindicated for concurrent use: terfenadine, astemizole, cisapride, ergot alkaloids, triazolam and midazolam.	Inhibits cytochrome P450 (less than ritonavir). Nelfinavir levels reduced by rifampin, rifabutin. Contraindicated for concurrent use: triazolam, midazolam, ergot alkaloid, terfenadine, astemizole, cisapride. Nelfinavir decreases levels of ethinyl estradiol and norethindrone. Nelfinavir increases levels of rifabutin, saquinavir, and indinavir. Not recommended for concurrent use: rifampin.

*Dose escalation for ritonavir: Day 1-2: 300 mg b.i.d.; day 3-5: 400 mg b.i.d.; day 6-13: 500 mg b.i.d.; day 14: 600 mg b.i.d. Combination treatment regimen with saquinavir (400-600 mg po b.i.d.) plus ritonavir (400-600 mg po b.i.d.).

[†]Drugs contraindicated for concurrent use with ritonavir: amioderone (Cordonrone), astemizole (Hismanal), bepridil (Vascar), bupropion (Wellbutin), cisapride (Propulsid), clorazepate (Tranxene), clozapine (Clozaril), diazepam (Valium), encainide (Enkaid), estazolam (ProSom), flecainide (Tambocor), flurazepam (Dalmane), meperidine (Demerol), midazolam (Versed), piroxicam (Feldene), propoxyphene (Darvon), propafenone (Rythmol), quinidine, rifabutin, terfenadine (Seldane), triazolam (Halcion), zolpidem (Ambien), ergot alkaloids.

[§]Decrease indinavir to 600 mg q8h.

^{††}Cases of new onset hyperglycemia have been reported in association with the use of all PIs (47-43).

TABLE 10. Drugs that should not be used with protease inhibitors

Drug category	Drugs			Alternatives
	Indinavir	Ritonavir* meperidine propoxyphene	Saquinavir (given as Invirase™ or Fortovase™) Nelfinavir	
Analgesics	(none)	meperidine propoxyphene	(none)	ASA, oxycodon acetaminophen
Cardiac	(none)	amioderone flecainide propafenone quinidine	(none)	limited experience
Antimycobacterial	rifampin	rifabutin†	rifampin rifabutin	For rifabutin (as alternative for MAI treatment): clarithromycin, ethambutol (treatment, not prophylaxis), or azithromycin
Ca ⁺⁺ channel blocker	(none)	bepridil	(none)	limited experience
Antihistamine	astemizole terfenadine	astemizole terfenadine	astemizole terfenadine	loratadine
GI	cisapride	cisapride	cisapride	limited experience
Antidepressant	(none)	bupropion	(none)	fluoxetine, desipramine
Neuroleptic	(none)	clozapine pimozide	(none)	limited experience
Psychotropic	midazolam triazolam	clorazepate, diazepam estazolam, flurazepam midazolam, triazolam zolpidem	midazolam triazolam midazolam triazolam	temazepam, lorazepam
Ergot alkaloid (vasoconstrictor)		dihydroergot-amine (D.H.E. 45), ergotamine§ (various forms)	dihydroergotamine (D.H.E. 45), ergotamine§ (various forms)	

*The contraindicated drugs listed are based on theoretical considerations. Thus, drugs with low therapeutic indices yet with suspected major metabolic contribution from cytochrome P450 3A, CYP2D6, or unknown pathways are included in this table. Actual interactions may or may not occur in patients.

†Reduce rifabutin dose to one fourth of the standard dose.

§This is likely a class effect.

TABLE 11. Drug interactions between protease inhibitors and other drugs; drug interactions requiring dose modifications

	Indinavir	Ritonavir	Saquinavir*	Nelfinavir
Fluconazole	No dose change	No dose change	No data	No dose change
Ketoconazole and itraconazole	Decrease dose to 600 mg q8h	Increases ketoconazole >3-fold; dose adjustment required.	Increases saquinavir levels 3-fold; no dose change [†] .	No dose change
Rifabutin	Reduce rifabutin to one half dose: 150 mg q.d.	Consider alternative drug or reduce dose to one fourth of standard dose.	Not recommended with either Invirase [™] or Fortovase [™] .	Reduce rifabutin to one half dose: 150 mg q.d.
Rifampin	Contraindicated	Unknown [§]	Not recommended with either Invirase [™] or Fortovase [™] .	Contraindicated
Oral contraceptives	Modest increase in Ortho-Novum levels; no dose change.	Ethinyl estradiol levels decreased; use alternative or additional contraceptive method.	No data	Ethinyl estradiol and norethindrone levels decreased; use alternative or additional contraceptive method.
Miscellaneous	Grapefruit juice reduces indinavir levels by 26%.	Desipramine increased 145%; reduce dose; Theophylline levels decreased; increase dose.	Grapefruit juice increases saquinavir levels [†] .	

*Several drug interaction studies have been completed with saquinavir given as Invirase[™] or Fortovase[™]. Results from studies conducted with Invirase[™] may not be applicable to Fortovase[™].

[†]Conducted with Invirase[™].

[§]Rifampin reduces ritonavir 35%. Increased ritonavir dose or use of ritonavir in combination therapy is strongly recommended. The effect of ritonavir on rifampin is unknown. Used concurrently, increased liver toxicity may occur. Therefore, patients on ritonavir and rifampin should be monitored closely.

TABLE 12. Drug interactions: protease inhibitors and non-nucleoside reverse transcriptase inhibitors — effect of drug on levels/dose

Drug affected	Indinavir	Ritonavir	Saquinavir*	Nelfinavir	Nevirapine	Delavirdine
Indinavir (IDV)	—	No data	Levels: IDV no effect; SQV ↑4-7x [§] Dose: no data	Levels: IDV ↑50%; NFV ↑80% Dose: no data	Levels: IDV ↓28% Dose: standard	Levels: IDV ↑40% Dose: IDV 600 mg q8h
Ritonavir (RTV)	No data	—	Levels: RTV no effect; SQV ↑20x ^{†§} or Invirase [™] or Fortovase [™] 400 mg b.i.d. + RTV: 400 mg b.i.d.	Levels: RTV no effect; NFV ↑1.5x Dose: no data	Levels: RTV ↓11% Dose: standard	Levels: RTV ↑70% Dose: no data
Saquinavir (SQV)	Levels: SQV 14-7x; IDV no effect [§] Dose: no data	Levels: SQV ↑20x ^{†§} RTV no effect Dose: Invirase [™] or Fortovase [™] 400 mg b.i.d. + RTV 400 mg b.i.d.	—	Levels: SQV ↑3-5x; NFV ↑20% [§] Dose: standard NFV Fortovase [™] 800 mg t.i.d.	Levels: SQV ↓25% [†] Dose: no data	Levels: SQV ↑5x [†] Dose: standard for Invirase [™] Monitor transaminase levels
Nelfinavir (NFV)	Levels: NFV ↑80% IDV ↑50% Dose: no data	Levels: NFV ↑1.5x RTV no effect Dose: no data	Levels: NFV ↑20%; SQV ↑3-5x [§] Dose: standard NFV Fortovase [™] 800 mg t.i.d.	—	Levels: NFV ↑10% Dose: standard	Levels: NFV ↑2x DLV ↓50% Dose: standard (monitor for neutropenic complications) Do not use together
Nevirapine (NVP)	Levels: IDV ↓28% Dose: standard	Levels: RTV ↓11% Dose: standard	Levels: SQV ↓25% [†] ; Dose: no data	Levels: NFV ↑10% Dose: standard	—	—
Delavirdine (DLV)	Levels: IDV ↑40% Dose: IDV 600 mg q8h	Levels: RTV ↑70% Dose: no data	Levels: SQV ↓5x [†] Dose: standard for Invirase [™] Monitor transaminase levels	Levels: NFV ↑2x DLV ↓50% Dose: standard (monitor for neutropenic complications)	Do not use together	—

* Several drug interaction studies have been completed with saquinavir given as Invirase[™] or Fortovase[™]. Results from studies conducted with Invirase[™] may not be applicable to Fortovase[™].

[†] Conducted with Invirase[™].

[§] Conducted with Fortovase[™].

Table 13. Guidelines for changing an antiretroviral regimen for suspected drug failure

- Criteria for changing therapy include a suboptimal reduction in plasma viremia after initiation of therapy, reappearance of viremia after suppression to undetectable, substantial increases in plasma viremia from the nadir of suppression, and declining CD4 + T cell numbers. Refer to the more extensive discussion of these criteria in "Criteria for Changing Therapy" on pages 53-54.
 - When the decision to change therapy is based on viral load determination, it is preferable to confirm with a second viral load test.
 - Distinguish between the need to change a regimen because of drug intolerance or inability to comply with the regimen versus failure to achieve the goal of sustained viral suppression; single agents can be changed or dose reduced in the event of drug intolerance.
 - In general, do not change a single drug or add a single drug to a failing regimen; it is important to use at least two new drugs and preferably to use an entirely new regimen with at least three new drugs.
 - Many patients have limited options for new regimens of desired potency; in some of these cases, it is rational to continue the prior regimen if partial viral suppression was achieved.
 - In some cases, regimens identified as suboptimal for initial therapy are rational due to limitations imposed by toxicity, intolerance, or nonadherence. This especially applies in late-stage disease. For patients with no rational alternative options who have virologic failure with return of viral load to baseline (pretreatment levels) and a declining CD4+ T cell count, discontinuation of antiretroviral therapy should be considered.
 - Experience is limited with regimens using combinations of two protease inhibitors or combinations of protease inhibitors with nevirapine or delavirdine; for patients with limited options due to drug intolerance or suspected resistance, these regimens provide possible alternative treatment options.
 - There is limited information about the value of restarting a drug that the patient has previously received. The experience with zidovudine is that resistant strains are often replaced with "wild-type" zidovudine sensitive strains when zidovudine treatment is stopped, but resistance recurs rapidly if zidovudine is restarted. Although preliminary evidence indicates that this occurs with indinavir, it is not known if similar problems apply to other nucleoside analogues, protease inhibitors, or NNRTIs, but a conservative stance is that they probably do.
 - Avoid changing from ritonavir to indinavir or vice versa for drug failure, because high-level cross-resistance is likely.
 - Avoid changing from nevirapine to delavirdine or vice versa for drug failure, because high-level cross-resistance is likely.
 - The decision to change therapy and the choice of a new regimen require that the clinician have considerable expertise in the care of persons living with HIV infection. Physicians who are less experienced in the care of persons with HIV infection are **strongly** encouraged to obtain assistance through consultation with or referral to a clinician who has considerable expertise in the care of HIV-infected patients.
-

TABLE 14. Possible regimens for patients who have failed antiretroviral therapy: a work in progress*

Prior regimen	New regimen (not listed in priority order)
2 NRTIs + Nelfinavir (NFV)	2 new NRTIs + RTV; or IDV; or SQV + RTV; or NNRTI [†] + RTV; or NNRTI + IDV [§]
Ritonavir (RTV)	SQV + RTV [§] ; NFV + NNRTI; or NFV + SQV
Indinavir (IDV)	SQV + RTV; NFV + NNRTI; or NFV + SQV
Saquinavir (SQV)	RTV + SQV; or NNRTI + IDV
2 NRTIs + NNRTI	2 new NRTIs + a protease inhibitor
2 NRTIs	2 new NRTIs + a protease inhibitor 2 new NRTIs + RTV + SQV 1 new NRTI + 1 NNRTI + a protease inhibitor 2 protease inhibitors + NNRTI
1 NRTI	2 new NRTIs + a protease inhibitor 2 new NRTIs + NNRTI 1 new NRTI + 1 NNRTI + a protease inhibitor

*These alternative regimens have not been proven to be clinically effective and were arrived at through discussion by the panel of theoretically possible alternative treatments and the elimination of those alternatives with evidence of being ineffective. Clinical trials in this area are urgently needed.

[†]Of the two available NNRTIs, clinical trials support a preference for nevirapine over delavirdine based on results of viral load assays. These two agents have opposite effects on the CYP450 pathway, and this must be considered in combining these drugs with other agents.

[§]There are some clinical trials that have yielded viral burden data to support this recommendation.

TABLE 15. Acute retroviral syndrome: associated signs and symptoms and expected frequency*

● Fever (96%)
● Lymphadenopathy (74%)
● Pharyngitis (70%)
● Rash (70%) Erythematous maculopapular with lesions on face and trunk and sometimes extremities, including palms and soles Mucocutaneous ulceration involving mouth, esophagus, or genitals
● Myalgia or arthralgia (54%)
● Diarrhea (32%)
● Headache (32%)
● Nausea and vomiting (27%)
● Hepatosplenomegaly (14%)
● Thrush (12%)
● Weight Loss
● Neurologic symptoms (12%) Meningoencephalitis or aseptic meningitis Peripheral neuropathy or radiculopathy Facial palsy Guillain-Barré syndrome Brachial neuritis Cognitive impairment or psychosis

*Adapted from reference 19.

TABLE 16. Preclinical and clinical data relevant to use of antiretrovirals during pregnancy

Antiretroviral drug	FDA-defined pregnancy category*	Placental passage [Newborn: maternal drug]	Long-term animal carcinogenicity studies	Rodent teratogen
Zidovudine [†]	C	Yes (human) [0.85]	Positive (rodent, vaginal tumors)	Positive (near lethal dose)
Zalcitabine	C	Yes (rhesus) [0.30–0.50]	Positive (rodent, thymic lymphomas)	Positive (hydrocephalus at high dose)
Didanosine	B	Yes (human) [0.5]	Negative (no tumors, lifetime rodent study)	Negative
Stavudine	C	Yes (rhesus) [0.76]	Not completed	Negative (but sternal bone calcium decreases)
Lamivudine	C	Yes (human)[~1.0]	Negative (no tumors, lifetime rodent study)	Negative
Saquinavir	B	Unknown	Not completed	Negative
Indinavir	C	Yes (rats) ("Significant" in rats; low in rabbits)	Not completed	Negative (but extra ribs in rats)
Ritonavir	B	Yes (rats) [mid-term fetus, 1.15; late-term fetus, 0.15–0.64]	Not completed	Negative (but cryptorchidism in rats) [§]
Nelfinavir	B	Unknown	Not completed	Negative
Neviparine	C	Yes (human) [~1.0]	Not completed	Negative
Delavirdine	C	Yes (rats) [late-term fetus, blood, 0.15; late-term fetus, liver 0.04]	Not completed	Ventricular septal defect

*Food and Drug Administration-defined pregnancy categories are: A = Adequate and well-controlled studies of pregnant women fail to demonstrate a risk to the fetus during the first trimester of pregnancy (and there is no evidence of risk during later trimesters); B = Animal reproduction studies fail to demonstrate a risk to the fetus, and adequate but well-controlled studies of pregnant women have not been conducted; C = Safety in human pregnancy has not been determined, animal studies are either positive for fetal risk or have not been conducted, and the drug should not be used unless the potential benefit outweighs the potential risk to the fetus; D = Positive evidence of human fetal risk based on adverse reaction data from investigational or marketing experiences, but the potential benefits from the use of the drug in pregnant women may be acceptable despite its potential risks; X = Studies in animals or reports of adverse reactions have indicated that the risk associated with the use of the drug for pregnant women clearly outweighs any possible benefit.

[†]Despite certain animal data indicating potential teratogenicity of ZDV when near-lethal doses are given to pregnant rodents, considerable human data are available to date indicating that the risk to the fetus, if any, is extremely small when given to the pregnant mother beyond 14 weeks' gestation. Follow-up for up to age 6 years for 734 infants born to HIV-infected women who had in utero exposure to ZDV has not demonstrated any tumor development (44). However, no data are available with longer follow-up to evaluate for late effects.

[§]These are effects seen only at maternally toxic doses.

MMWR

The *Morbidity and Mortality Weekly Report (MMWR)* Series is prepared by the Centers for Disease Control and Prevention (CDC) and is available free of charge in electronic format and on a paid subscription basis for paper copy. To receive an electronic copy on Friday of each week, send an e-mail message to listserv@listserv.cdc.gov. The body content should read *SUBscribe mmwr-toc*. Electronic copy also is available from CDC's World-Wide Web server at <http://www.cdc.gov> or from CDC's file transfer protocol server at <ftp.cdc.gov>. To subscribe for paper copy, contact Superintendent of Documents, U.S. Government Printing Office, Washington, DC 20402; telephone (202) 512-1800.

Data in the weekly *MMWR* are provisional, based on weekly reports to CDC by state health departments. The reporting week concludes at close of business on Friday; compiled data on a national basis are officially released to the public on the following Friday. Address inquiries about the *MMWR* Series, including material to be considered for publication, to: Editor, *MMWR* Series, Mailstop C-08, CDC, 1600 Clifton Rd., N.E., Atlanta, GA 30333; telephone (888) 232-3228.

All material in the *MMWR* Series is in the public domain and may be used and reprinted without permission; citation as to source, however, is appreciated.