

TECHNOLOGY APPLICATION ANALYSIS

Physical Separation and Acid Leaching

A Demonstration of Small-Arms Range Remediation
at Fort Polk, Louisiana



Prepared for



and



Naval Facilities
Engineering
Service Center

U.S. Army
Environmental
Center

DISTRIBUTION STATEMENT A
Approved for public release;
Distribution Unlimited

19980414 178

Site:
Columbus, Ohio

September 18, 1997

DTIC QUALITY INSPECTED 3

REPORT DOCUMENTATION PAGE

Form Approved
OMB No. 0704-0188

Public reporting burden for this collection of information is estimated to average 1 hour per response, including the time for reviewing instructions, searching existing data sources, gathering and maintaining the data needed, and completing and reviewing the collection of information. Send comments regarding this burden estimate or any other aspect of this collection of information, including suggestions for reducing this burden, to Washington Headquarters Services, Directorate for Information Operations and Reports, 1215 Jefferson Davis Highway, Suite 1204, Arlington, VA 22202-4302, and to the Office of Management and Budget, Paperwork Reduction Project (0704-0188), Washington, DC 20503.

1. AGENCY USE ONLY <i>(Leave blank)</i>		2. REPORT DATE September 18, 1997		3. REPORT TYPE AND DATES COVERED Technology Demonstration, Nov 1995-Sep 1997	
4. TITLE AND SUBTITLE Technology Application Analysis : Physical Separation and Acid Leaching (A Demonstration of Small Arms Range Remediation at Fort Polk, Louisiana)				5. FUNDING NUMBERS	
6. AUTHOR(S) Battelle					
7. PERFORMING ORGANIZATION NAME(S) AND ADDRESS(ES) Battelle 505 King Avenue Columbus, Ohio 43201-2693				8. PERFORMING ORGANIZATION REPORT NUMBER	
9. SPONSORING / MONITORING AGENCY NAME(S) AND ADDRESS(ES) U.S. Army Environmental Center Aberdeen Proving Ground, MD 21010-5401				10. SPONSORING / MONITORING AGENCY REPORT NUMBER SFIM-AEC-ET-CR-97045	
11. SUPPLEMENTARY NOTES					
12a. DISTRIBUTION / AVAILABILITY STATEMENT Approved for Public Release; distribution is unlimited				12b. DISTRIBUTION CODE	
<p>13. ABSTRACT <i>(Maximum 200 words)</i> The U.S. Army Environmental Center in partnership with the Naval Facilities Engineering Services Center and the U.S. Army Engineer Waterways Experiment Station demonstrated Physical Separation/Leaching methods for the remediation of small arms range soils. The demonstration occurred at Fort Polk, Louisiana. After conducting a world-wide search, two vendors were selected to demonstrate two variations of the physical separation/leaching technologies. The first using a process based on acetic (weak) acid chemistry and the second based on hydrochloric (strong) acid chemistry. Following completion of the bench treatability studies, each vendor performed a full scale (5-10 tons per hour, 1000 tons total) demonstration of their respective technologies.</p> <p>This report documents the independent evaluation of the physical separation/acid leaching technology and its application at Fort Polk. The report provides a summary of the performance objectives, site infrastructure and logistics of the demonstration. The report also provides a description of the equipment and processes necessary to accomplish physical separation/acid leaching, the methodology used to evaluate the technologies during the demonstration, lessons learned and the demonstration results to include: effectiveness, applicability, and cost.</p>					
14. SUBJECT TERMS Soil Washing , Heavy Metals, Recycling, Physical Separation, Small Arms Ranges, Technology Demonstration, Acid Leaching, Lead Remediation, Implementation, Maintenance, TCLP, Bench-Scale test, Screening, Attrition Scrubbing				15. NUMBER OF PAGES 52	
				16. PRICE CODE	
17. SECURITY CLASSIFICATION OF REPORT Unclassified		18. SECURITY CLASSIFICATION OF THIS PAGE Unclassified		19. SECURITY CLASSIFICATION OF ABSTRACT Unclassified	
				20. LIMITATION OF ABSTRACT UL	

TECHNOLOGY APPLICATION ANALYSIS

Physical Separation and Acid Leaching

A Demonstration of Small-Arms Range Remediation at Fort Polk, Louisiana

Prepared for



**Naval Facilities Engineering Service Center (NFESC)
Port Hueneme, California**

and



**U.S. Army Environmental Center (USAEC)
Aberdeen Proving Grounds, Maryland**

by

**Battelle
Columbus, Ohio**

September 18, 1997

DTIC QUALITY INSPECTED 3

This report is a work prepared for the United States Government by Battelle. In no event shall either the United States Government or Battelle have any responsibility or liability for any consequences of any use, misuse, inability to use, or reliance on the information contained herein, nor does either warrant or otherwise represent in any way the accuracy, adequacy, efficacy, or applicability of the contents hereof.

Contents

Technology	1
Site.....	1
Site History	1
Demonstration Background.....	1
Heavy Metals of Concern.....	2
Performance Objectives.....	3
Technology Principles	3
Physical Separation	3
Acid Leaching	5
Range Characterization.....	6
Bench Scale Testing	7
Additional Soil and Target Metals Characteristics	8
Site Preparation.....	10
Vendor 1 and the Acetic Acid Plant.....	12
Physical Separation Module.....	13
Acid Leaching Module	13
Vendor 2 and the Hydrochloric Acid Plant	13
Physical Separation Module.....	15
Acid Leaching Module	15
Evaluation Methodology	17
Collecting and Preparing Representative Samples	17
Analytical Methods	19
On-Site XRF Analysis.....	22
Quality Assurance (QA).....	22
Vendor 1 Performance.....	25
Process Efficiency	25
Process Residuals	25
Plant Reliability	28
Vendor 2 Performance.....	29
Process Efficiency	29
Process Residuals	33
Plant Reliability	34
Cost of Application.....	35
Fixed Costs	35
Variable Costs	35
Total and Unit Costs.....	36
Acetic Acid versus Hydrochloric Acid.....	38
Technical and Cost Comparison with Other Technologies	38
Regulatory/Institutional Issues	41
Application at Other Sites.....	42
Technical and Economic Feasibility.....	42
Regulatory Perspective.....	43
Vendor Selection and Contracting.....	43
Process Verification	44
Schedule	45
Lessons Learned	45
Sources	46
Additional References	46
Analysis Preparation.....	47
Certification.....	47

Acknowledgments

Several individuals and organizations participated in this demonstration and provided review, guidance, and information that were valuable to Battelle, Naval Facilities Engineering Service Center (NFESC), and the U.S. Army Environmental Center (USAEC) during the evaluation of the physical separation/acid leaching technology at Fort Polk:

- Gary Sams, Marshall Nay, Bradley Rudd, and Alfred Beckett from BDM Engineering Services Co.
- Richard Kunter from Advanced Sciences, Inc. (ASI)
- Thomas Leggiere and Russell Foyle from ContraCon Northwest, LLC
- Craig Jones from Brice Environmental Corporation (BESCORP)
- John Verner from the Defense Evaluation Support Activity (DESA)
- Mark Bricka from the U.S. Army Corps of Engineers, Waterways Experimental Station
- Jeffrey Marqusee and Alanna Mitchell from Environmental Security Technology Certification Program (ESTCP).

We would like to acknowledge the assistance of Hazen Research, Inc. in providing specialized metallurgical laboratory support and guidance on evaluating mineral beneficiation techniques. Battelle and NFESC appreciate the efforts and support of the Fort Polk administration during the demonstration and on Visitors' Day.

Physical Separation and Acid Leaching

A Demonstration of Small-Arms Range Remediation at Fort Polk, Louisiana

Technology

The technology demonstrated in this project was a combination of physical separation and acid leaching that can be used to remove lead and other heavy metals from small-arms range soils. Physical separation is used to remove particulate metals and acid leaching is used to remove the metals that are present as very fine particulates or molecular/ionic species bound to the soil matrix. These techniques were commonly used for many years in the mining industry for separating metals from ores and, more recently, in the remediation industry for removing target metals by soil washing.

Site

The technology was demonstrated on soils from Range 5 at Fort Polk, an Army Base near Leesville, Louisiana as shown in Figure 1. The demonstration was conducted in an old parking lot approximately 2 miles away from the range by road, in an area called Block 4700. The demonstration site was located some distance from the range to avoid temporarily closing adjacent ranges, whose cones of lethal fire extend into Range 5. Also, the demonstration site was located near an available power supply.

Site History

Range 5 is an active 300-meter small-arms range that has been mainly used for M-16 rifle training. The range has three berms, the last of which runs along the edge of a wetland. Fort Polk was selected for the demonstration because it is environmentally proactive and has active ranges that contain soil and target metals of the type and quantity typically found at several DoD ranges.

Demonstration Background

The separation/leaching technology demonstration at Range 5, Fort Polk was a joint effort between the Naval Facilities Engineering Service Center (NFESC) and U.S. Army Environmental Center (USAEC). Funding for the demonstration was provided by the Environmental Security Technology Certification Program (ESTCP). In anticipation of the demonstration, BDM Engineering Services, Inc. (BDM), the mission support contractor for Fort Polk, prepared the required National Environmental Policy Act (NEPA) documentation that examined potential impacts from the demonstration activities. A Record of Environmental Consideration was approved in April 1996. The field activities related to the demonstration were conducted between August and December 1996. During this period, two vendors demonstrated their variations of the technology. The two vendors were selected after a worldwide search conducted by USAEC and BDM for commercial vendors with the required capabilities. Vendor 1 was requested to use acetic acid leaching and Vendor 2 was requested to use hydrochloric acid leaching. Battelle, under contract to NFESC, conducted the independent evaluation of the technology and its application at Fort Polk, as documented in this report.

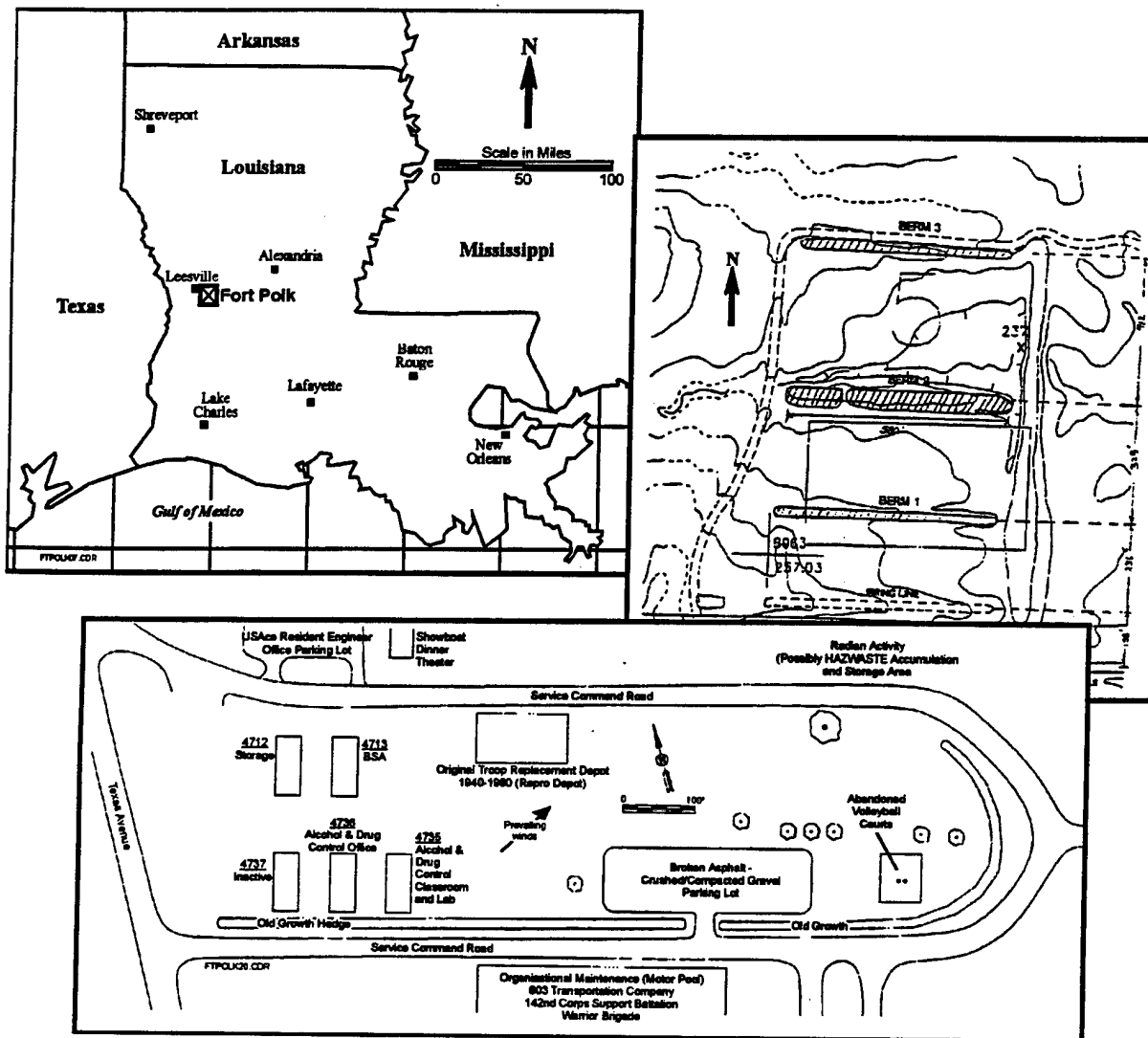

Figure 1. Site location.

Heavy Metals of Concern

Preliminary site characterization indicated that the heavy metals of concern in the bullets were lead (from bullet cores), copper (from bullet casings), zinc, and antimony. Lead is a metal covered under the Resource Conservation and Recovery Act (RCRA). The other metals are not regulated under RCRA, but may be an environmental concern in some states, such as California. Because Range 5 is an active range and the processed soil will be reused in the berm, the processing was conducted as a range maintenance activity rather than as a range remediation activity. According to the U.S. EPA Military Munitions Rule (40 CFR Part 260), range maintenance does not come under RCRA. However, because the technology could be applied for range remediation also, a good faith attempt was made during this demonstration to meet the RCRA-driven Toxicity Characteristic Leaching Procedure (TCLP) target for lead (less than 5 mg/L).

Performance Objectives

The goal of the demonstration was to evaluate a promising new alternative, physical separation and acid leaching, for small-arms range soil processing. This goal was attained by contracting two vendors to conduct a demonstration with the following objectives:

- ❑ Design and mobilize their respective plants at Fort Polk and process up to 1,000 tons of Range 5 soil at an average continuous rate of 5 tons/hr. Each vendor was expected to keep the plant operational for a period of 15 days.
- ❑ Evaluate the efficiencies of two potentially effective acids for leaching. Vendor 1 was asked to use acetic acid leaching and Vendor 2 was asked to use hydrochloric acid leaching.
- ❑ Make a good faith attempt to process the range soil to meet the TCLP criterion of 5 mg/L or less of lead. No criteria were set for other metals, but the removal of copper, zinc, and antimony by the process was also tracked.
- ❑ Achieve the TCLP criterion through metals removal, without the use of stabilization agents. The two vendors were therefore given total metals targets for the processed soil. Vendor 1's target was 1,000 mg/kg. The target was reduced to 500 mg/kg for Vendor 2 to better meet the TCLP criterion.
- ❑ Ensure that the processed soil is physically and chemically suitable for reuse in an active berm.

Technology Principles

The heavy metals removal technology used at Fort Polk had two components — physical separation of particulate metals (bullets and bullet fragments) and acid leaching of metal fines and molecular/ionic metal species.

Physical Separation

Physical separation involves the separation of particles based on their physical properties, such as size, shape, density, or magnetism. Table 1 shows the key attributes of common separation technologies. Other than froth flotation, all the other techniques described in this table were used at Fort Polk in some form or other. Many of these separations are wet processes, that is, the soil and target metals are dispersed in a water medium. Figure 2 shows the jig, a common gravity separation unit, in which water pulsation makes denser particles (metals) settle into the underflow or concentrate, whereas the lighter (soil) particles are carried away in the overflow or tailings. At Fort Polk, the metals recovered by classification and gravity separation were sent to an off-site smelter for recycling of their lead content.

Attrition scrubbers are another commonly used separation element. Some attrition scrubbers are similar to mechanical classifiers (see Figure 3) in that they consist of a basin containing single or multiple shafts with paddles. These units are used to break up soil agglomerates into individual particles, and thus facilitate subsequent classification by particle size. Without this deagglomeration, particles of clay in the Fort Polk soil would stick to each other and accumulate in the oversize fraction during screening or classification. In addition to deagglomeration, attrition scrubbers "scrub" oxide or other coatings from individual particles. Soil scrubbing is accomplished mostly by particle-to-particle attrition, but also by the interaction between the paddles and the particles. Log washers and blade mills are two variations of conventional attrition scrubbers that were used at Fort Polk.

At Fort Polk, physical separation was used to remove as much particulate metal as possible before acid leaching. This allowed the recovery of the majority of the heavy metals through mechanical means and conserved expensive chemical reagents and equipment for the remaining fraction. At some sites, physical separation alone may be enough to meet target criteria. At most sites, especially if the TCLP lead criterion has to be met, leaching will be required to further remove heavy metal fines and molecular/ionic species.

Table 1. Key Attributes of Common Physical Separation Techniques

	Technique				
	Size Separation (Screening)	Hydrodynamic Separation (Classification)	Density (Gravity) Separation	Froth Flotation	Magnetic Separation
Basic Principle	Various diameter openings allow passage of particles with different effective size	Different settling rates due to particle density, size, or shape	Separation due to density differences	Particles are attracted to bubbles due to their surface properties	Magnetic susceptibility
Major Advantage	High-throughput continuous processing with simple, inexpensive equipment	High-throughput continuous processing with simple, inexpensive equipment	High-throughput continuous processing with simple, inexpensive equipment	Very effective for fine particles	Can recover a wide variety of materials when high gradient fields are used
Limitations	Screens can plug; fine screens are fragile; dry screening produces dust	Difficult when high proportions of clay, silt, and humic materials are present	Difficult when high proportions of clay, silt, and humic materials are present	Particulate must be present at low concentration	High capital and operating cost
Typical Implementation	Screens, sieves, or trommels (wet or dry)	Clarifier, elutriator, hydrocyclone	Shaking table, spiral concentrator, jig	Air flotation columns or cells	Electromagnets, magnetic filters

Sources: U.S. EPA, 1995, EPA/540/R-95/512.

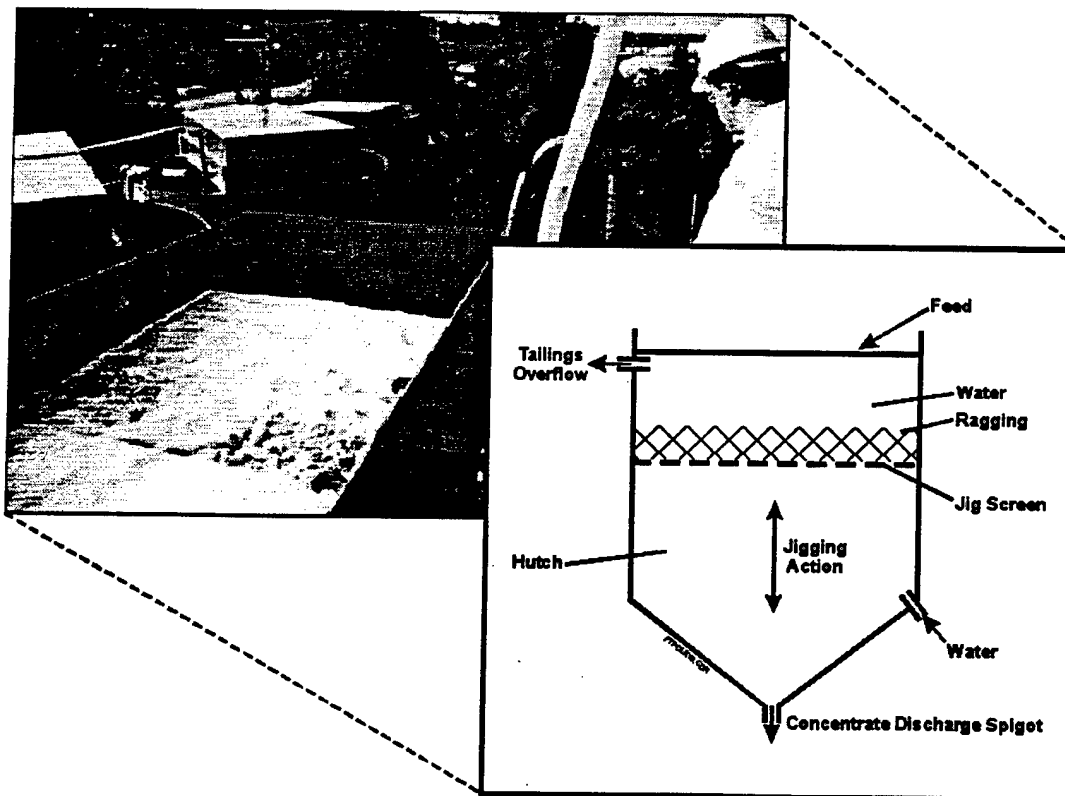

Figure 2. A jig separates out denser metals from soil at Fort Polk.

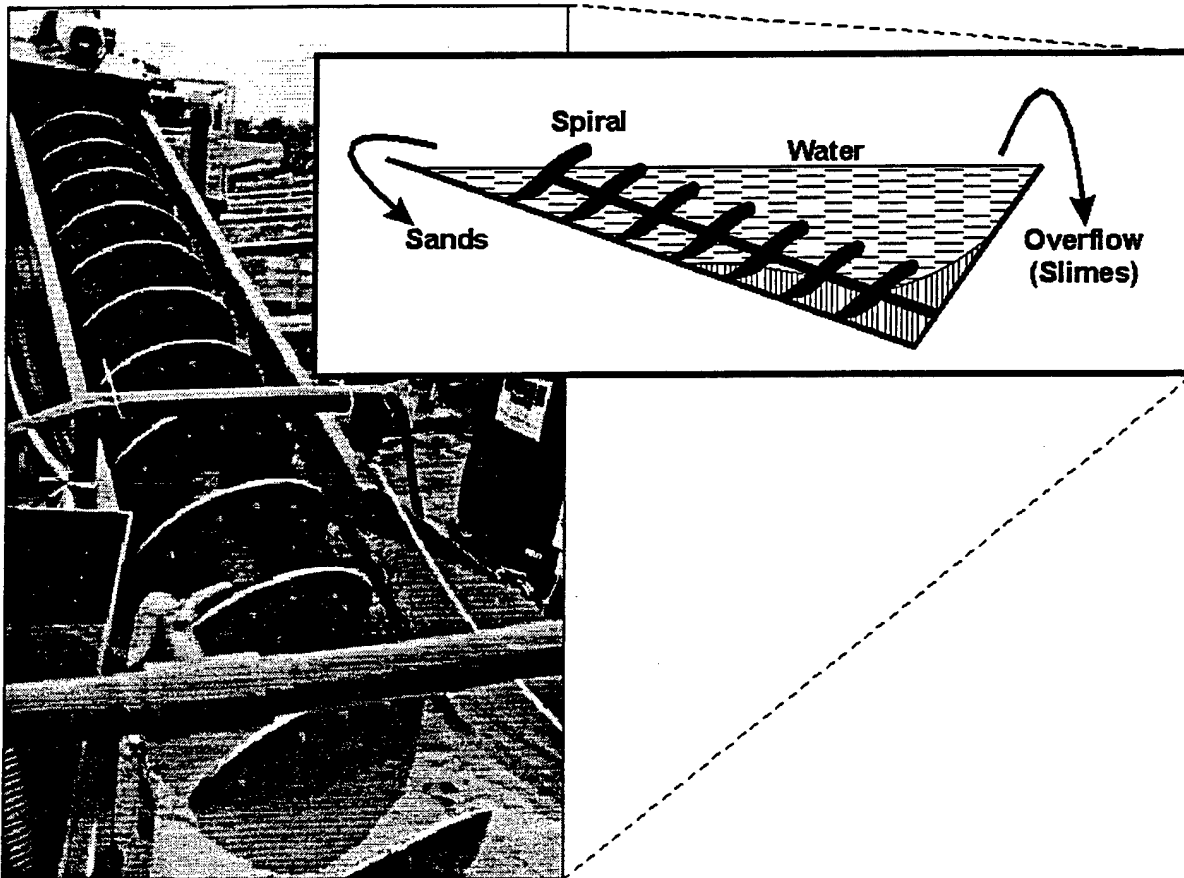

Figure 3. A classifier carries coarse material up the incline during the demonstration.

Acid Leaching

Acid leaching belongs to a group of techniques called soil washing, which tries to mobilize the target metals from the soil into a solution. The solution is then treated to recover the metals in a concentrated form for off-site disposal or recycling. Acid leaching aims to solubilize metals from the soil by changing the pH. Adding acid lowers the pH and increases the supply of H^+ ions. The H^+ ions generated are consumed in a multitude of reactions that increase soluble metal concentrations.

Acid leaching was conducted at Fort Polk as a continuous process involving the following steps:

- Bringing acid and soil into contact in a leaching tank
- Separating the leached soil from the spent leachant
- Regenerating the spent leachant by precipitating the heavy metals.

The precipitated metals were dewatered and the resulting sludge was sent to an off-site smelter for recycling of its lead content. Whereas physical separation is a fast operation in which relatively small equipment is used to obtain high throughput, leaching is relatively slow and requires larger equipment.

Range Characterization

During their history, small-arms range berms often receive fresh additions of soil from various sources. Therefore, berms tend to be very heterogeneous in terms of soil types (gravel, sand, silt, or clay) and metals distribution. Obtaining representative samples of the berm material is important to ensure that bench-scale tests and plant design reflect the material that will be encountered during the field operation. Because of the berm's heterogeneity, several grab samples should be collected from different locations in the berm. These samples can be analyzed separately, or composited, mixed, and split into multiple aliquots suitable for analysis.

Two important range material characteristics for designing an appropriate separation/leaching scheme are the particle sizes of the material and the heavy metal distribution in each size fraction. For example, a higher clay (fines) content will affect the throughput of both the acid leaching process and the solid-liquid separation operations. Other than such mechanical aspects, fine soils tend to bind lead better than coarse soils, thus necessitating more aggressive leaching conditions. Both vendors conducted this type of characterization as part of their bench-scale testing.

Because of the uncertainties involved in analyzing smaller samples of soil, Battelle conducted a detailed characterization on a representative 30-gallon composite sample of berm soil collected from Range 5. Table 2 contains the particle size analysis results obtained from wet screening of the sample. Wet screening is advisable for soil characterization. At Fort Polk, dry screening tended to underestimate the fines content of the soil because balls of fine clay were retained on the coarse screens. Figure 4 shows the results of additional characterization conducted by Battelle to determine the particle size and lead distribution in various fractions and the amenability of the lead in these fractions to physical separation:

- The raw soil from the berm (feed) had a lead assay of almost 0.5%.
- The +10-mesh coarse fraction constituted 2.3% of the berm material, but contained almost 80% of the original lead. Therefore, the majority of the lead in the range soil is recoverable by relatively simple size or gravity separation equipment, such as screens or jigs. About 3% of the lead was amenable to magnetic separation, by virtue of its association with the ferromagnetic fraction.

Table 2. Particle Size Analysis of the Raw Range Soil (30-gallon sample)

Raw Soil (Total Weight = 142.5 kg)			Fraction Weight %		
Mesh size	Micron size	Fraction Weight (kg)	Retained (%)	Cumulative Passing (%)	Cumulative Retained (%)
Organics	N/A	0.08	0.1	99.9	0.1
+10	1,680	3.13	2.2	97.7	2.3
+14	1,190	0.22	0.2	97.6	2.4
+20	841	0.33	0.2	97.4	2.6
+28	595	0.94	0.7	96.7	3.3
+35	425	2.23	1.6	95.1	4.9
+48	297	6.54	4.6	90.6	9.4
+65	210	22.1	15.5	75.0	25.0
+100	149	26.9	18.9	56.2	43.8
+150	105	22.3	15.6	40.5	59.5
+200	74	10.8	7.6	32.9	67.1
-200	-74	46.9	32.9	N/A	N/A

N/A = Not applicable.

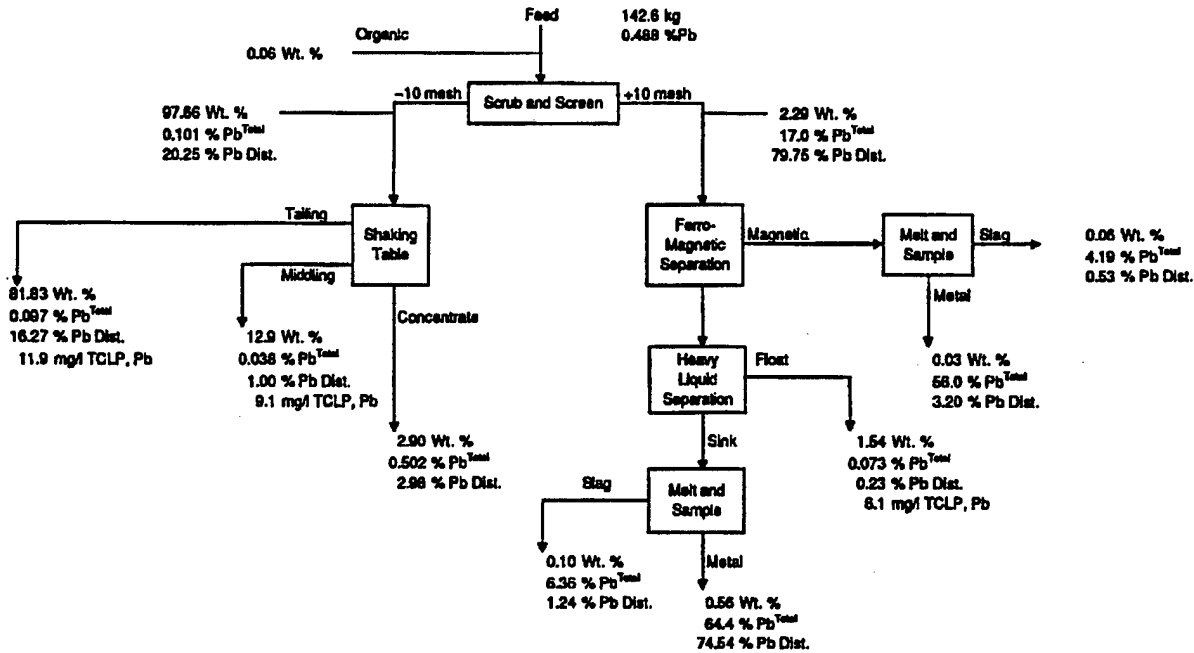

Figure 4. Characterization of a 30-gallon sample of Range 5 soil to evaluate lead distribution and amenability to physical separation (conducted by Hazen Research for Battelle)

- When the coarse fraction was further separated into metals (magnetic and nonmagnetic) and gravel (float), the gravel was found to contain enough leachable lead to fail the TCLP test. This indicates that the coarse fraction also needs to be subjected to some leaching.
- The -10 mesh fraction constituted 98% of the berm material, but contained only 20% of the lead. The -10-mesh fraction was processed on a shaking table to see if this material was amenable to gravity separation. Although gravity separation isolated a concentrate stream that had an assay of 0.5% lead, this constituted less than 3% of the lead in the original range material. The middling and tailing (predominantly soil) fractions retained most of the lead and both streams failed the TCLP test. The -10-mesh fraction did not appear to contain much lead amenable to gravity separation.

Physical separation alone was not sufficient to meet target criteria. The -10-mesh material contained sufficient fine particulate and/or ionic lead that would require removal by leaching.

Bench Scale Testing

The two selected vendors were given samples of the raw soil from Range 5 to use in bench-scale testing and to aid in plant design. Vendor 1, faced with a somewhat aggressive schedule, performed batch tests using acetic acid as the leachant with the following results:

- Attrition washing and screening of the raw range soil removed approximately 87% of the lead, mostly in the form of whole bullets and fragments.
- Organic matter separated during the process had a high lead content and needed to be segregated.

- Gravity separation of the coarse (+100 mesh) soil fraction and acetic acid leaching of the fines (-100 mesh) resulted in additional lead removal that brought the total lead level in the processed soil below the targeted 1,000 mg/kg.
- The individual coarse and fine processed soil fractions, as well as the recombined final processed soil, failed to meet the TCLP lead criterion. This indicated that (a) the coarse fraction would have to be subjected to some mild leaching to remove adsorbed lead, and (b) the fine fraction would need additional leaching or other treatment to address the residual lead.
- Vendor 1 determined that to achieve the TCLP criterion of 5 mg/L lead, the soil would have to be treated to 200 mg/kg total lead or lower. The vendor projected that this would require either a lowering of the pH from 3.5 to 2.5 or an increase in leaching time from 175 to 300 minutes. Both measures would increase processing cost significantly. Because acetic acid is a weak acid, ten times more acid would be required to lower the operating pH from 3.5 to 2.5. On the other hand, it was speculated that the full-scale plant equipment would be able to achieve higher efficiencies of separation and leaching than the simulated equipment used in the bench-scale testing.
- Proprietary precipitants and flocculants were used to precipitate out the heavy metals and regenerate the spent leachant, but this aspect of the process was not adequately evaluated.

Vendor 2 conducted bench-scale tests on a sample of soil from Range 5 using hydrochloric acid as the leachant. Vendor 2 had the benefit of longer preparation time and conducted a more thorough bench-scale testing effort with the following results:

- Screening separated out the gravel (+4 mesh) which contained mostly bullets and fragments. Some rock present in this fraction showed only 100 mg/kg of lead.
- The entire sands fraction (-4+200 mesh) contained over 700 mg/kg of total lead. About 23% of this lead could be removed by gravity separation. However, the resulting soil fraction still required some leaching to remove leachable lead. A higher percentage of the total lead in the coarse fraction appeared to be leachable compared with the percentage in the fines fraction.
- The fines fraction (-200 mesh) contained 2,000 to 2,800 mg/kg of lead. Leaching at a pH of 1.5 enabled this fraction, when combined with the coarse fraction, to pass the TCLP criterion. The total lead in the final recombined processed soil had to be around 250 mg/kg to pass TCLP.
- The spent leachant was regenerated by precipitation with sodium hydroxide. A pH range of 7 to 9.5 was found to be effective. Flocculation, separation, and dewatering of the precipitate were also tested and the results were used to design the full-scale process.

Additional Soil and Target Metals Characteristics

With a strong acid, such as hydrochloric, knowledge of the particle size distribution and heavy metal concentrations in the various size fractions was found to be sufficient to determine suitable separation and leaching operating parameters for the performance targets to be met. However, if performance targets are significantly more stringent (as may be the case in certain states, such as California) or when a weak acid, such as acetic, is used there may be some benefit in analyzing additional soil and target metals properties, with the goal of improving leaching efficiency.

Some soil properties that are important to know and that were measured relatively inexpensively for the Fort Polk soil are listed in Table 3:

Table 3. Other Range 5 Raw Soil Characteristics

Parameter	Measured Value
Soil description	Silt-sand
Moisture content	8%
pH	4.0 to 5.5
Total organic carbon	7,710 mg/kg
Iron	12,115 mg/kg
Manganese	50.7 mg/kg
Cation exchange capacity (CEC)	4.5 meq/100 g

- ❑ The raw soil pH determines how much acid is required to reach the desired leaching pH.
- ❑ The cation exchange capacity (CEC) indicates the capability of the soil to bind lead in an exchangeable form. Generally, clayey soils tend to have higher CEC than sandy soils. This is one reason why clayey soils are more difficult to leach.
- ❑ The total organic carbon indicates the amount of organic matter present in the soil. Lead complexed with organic matter is difficult to remove by leaching.
- ❑ The iron and manganese levels indicate the presence of iron and manganese oxides that can adsorb lead. These soil minerals tend to bind lead very strongly. Also, iron may leach out along with the other heavy metals, thus consuming additional chemicals in the leaching and precipitation steps.

These parameters provide some indication of difficulties that may be encountered during leaching. The leachant selection and optimization process can be further focused, if required, by determining heavy metal speciation and binding mechanisms in the soil. These are expensive analyses and may not be required at most sites.

Heavy metals speciation indicates the types of chemical compounds the metals are present as. In many small-arms range soils that contain native alkalinity, lead is present predominantly as elemental lead and carbonate minerals (cerussite, hydrocerussite). Lead carbonate is easier to leach, whereas elemental lead is leached only very slowly. Both vendors concluded during their bench tests that to improve leaching efficiency, they had to first get as much of the elemental lead out as possible by physical separation. Lead oxide and lead sulfate are other lead compounds that may occur under certain conditions and are difficult to leach. Determining heavy metal speciation requires the use of relatively expensive analysis, such as x-ray diffraction (XRD) and scanning electron microscopy (SEM). At Fort Polk, preliminary site characterization efforts by the site indicated that lead occurred mainly in the form of carbonate minerals. The soil was therefore considered to be amenable to leaching with a weak acid, namely acetic.

Another aspect of the soil-metal matrix that is useful to know is the metal-soil binding mechanisms. A sequential extraction procedure was developed and tested in a separate study on soils from seven industrial sites by Van Benschoten et al. (1997). Depending on the amount of lead recovered by a series of leachants, the lead species can be classified by this procedure as follows:

- ❑ Water soluble
- ❑ Ion exchangeable
- ❑ Silver displaceable
- ❑ Carbonate
- ❑ Easily reducible (bound to manganese oxides)
- ❑ Organically complexed

- Adsorbed on iron oxides
- Sulfide
- Residual.

Generally, the further down the list the metal occurs, the harder it is to remove by leaching. Based on this classification, appropriate leachants can be selected and optimized to achieve desired targets for the site. This sequential extraction procedure is somewhat expensive and generally used only if initial bench-scale tests with common leachants, such as acetic acid and hydrochloric acid, do not provide the required heavy metals removal. The sequential extraction procedure was not conducted on Fort Polk soils, but it could be a useful tool at some sites.

Site Preparation

Site preparation for the demonstration was conducted by BDM Engineering Services, Inc., the site support contractor for Fort Polk. Before the start of the demonstration, BDM built an asphalt pad (see Figures 5 and 6) on which each vendor's plant was installed in turn. Because most of the plant incorporates wet processes, spills and leaks are inevitable. To provide secondary containment and facilitate drainage, the pad was built with bermed sides and graded so that rainwater or process water overflow would run off to the far end into a containment pond. Both vendors were asked to reuse this water as much as possible. The water in this pond was periodically discharged after testing to either a sewer leading to the local water treatment plant or to off-site disposal, depending on the level of dissolved metals in the water.



Figure 5. Asphalt pad with bermed sides built to house the vendors' plants. The pad was graded into a containment pond at the far end. Processed soil storage bins are on the left, and pole transformers are on the right.

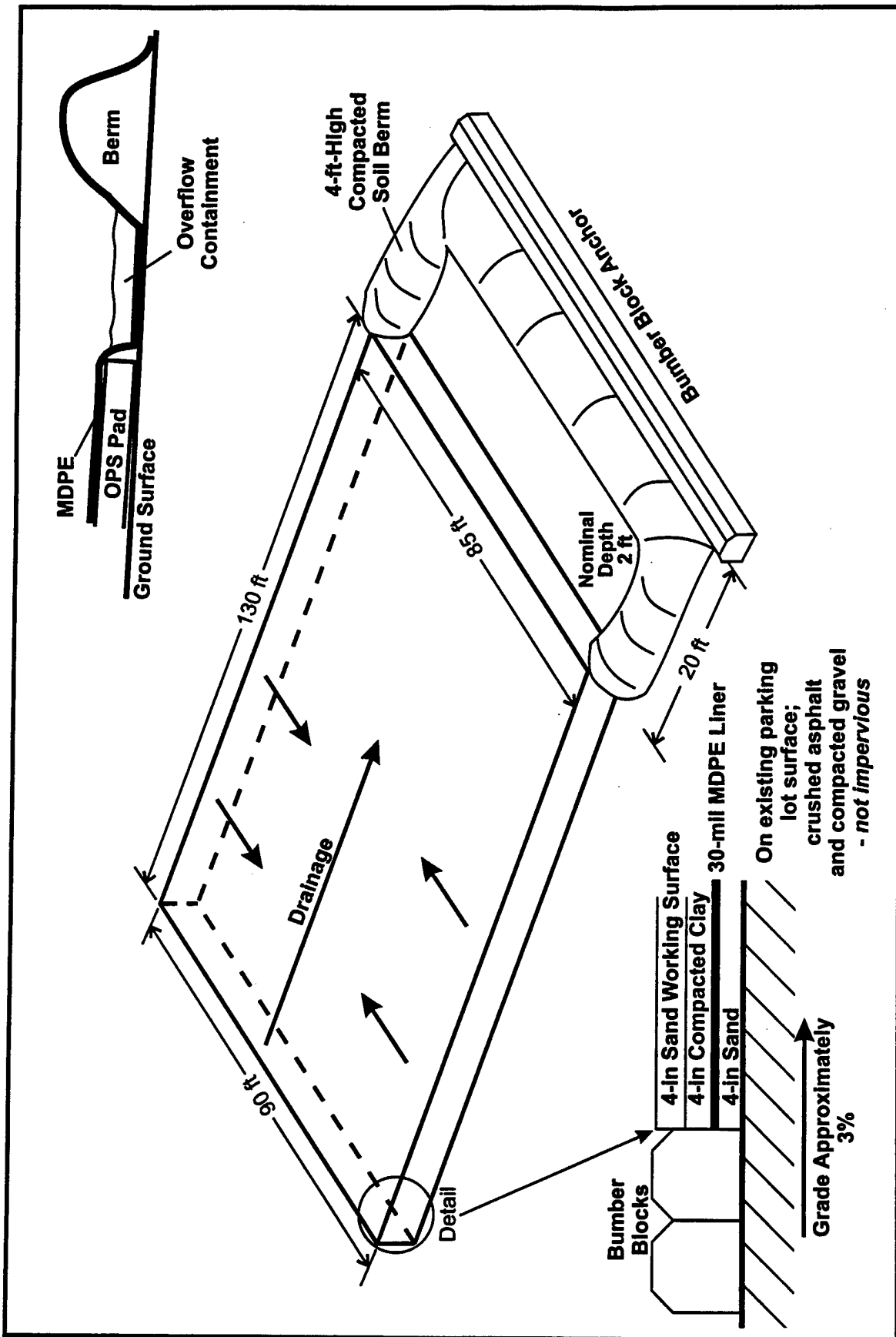

Figure 6. New asphalt pad with overflow containment features built by BDM for the demonstration.

Arrangements were made to supply power for each vendor's plant through three transformers, each with 300 kVA capacity. However, more power was required for the demonstration than planned. The vendors and Battelle rented diesel generators to make up the deficit. Process water was provided by channeling the base water supply through a backflow prevention tank.

A locked office/laboratory trailer was set up to house sample preparation equipment, an on-site x-ray fluorescence (XRF) analyzer, laptop computers, telephones, restroom, and other office support. A small covered area outside the trailer was prepared to house large sample preparation equipment, such as the ovens, crusher, etc. The entire demonstration site was enclosed by a 6-foot-high chain link fence.

Before field operations commenced, BDM prepared a Health and Safety Plan that covered the demonstration activities. During the demonstration, BDM conducted air monitoring for lead dust and the vendor monitored acid fumes. No significant hazards were encountered during the demonstration, and on-site personnel wore level D personal protective equipment (PPE). There was one brief period when sampling personnel had to wear respirators when excess acetic acid fumes were temporarily generated from the treated soil.

Vendor 1 and the Acetic Acid Plant

Figure 7 shows an overview of Vendor 1's plant for implementing physical separation and acetic acid leaching.

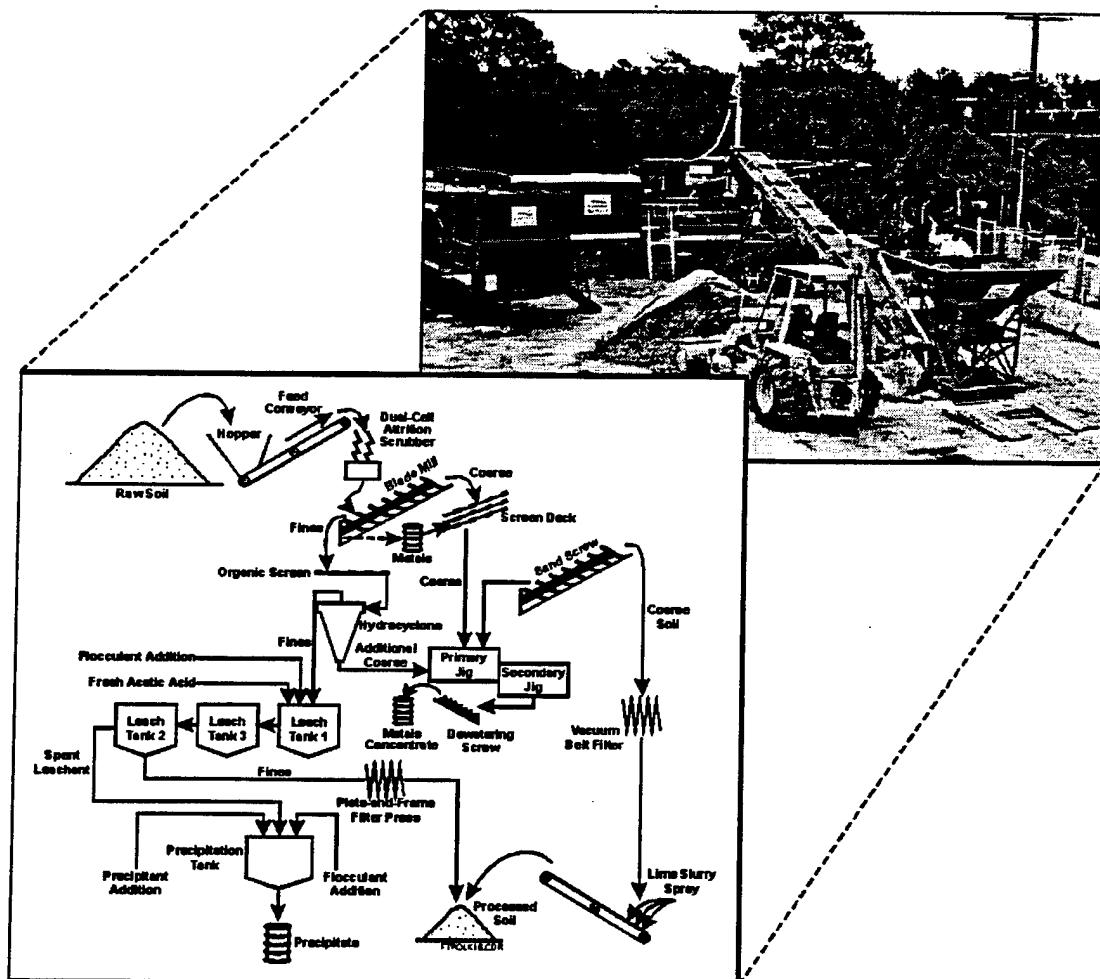

Figure 7. Vendor 1's plant and the acetic acid process.

Physical Separation Module

As shown in Figure 8, the raw soil (U) was first deagglomerated in an attrition scrubber to facilitate subsequent classification and screening. Classification separated the raw soil into coarse (+175 mesh) and fine (-175 mesh) soil fractions. Screening removed bullets, large metal fragments, and some gravel from the coarse fraction. The coarse fraction was then subjected to gravity separation in a jig in an effort to separate out smaller metal fragments (M). Acetic acid was used as the wash solution in the physical separation processes so that the coarse fraction could be subjected to a brief leaching to remove any adsorbed heavy metals.

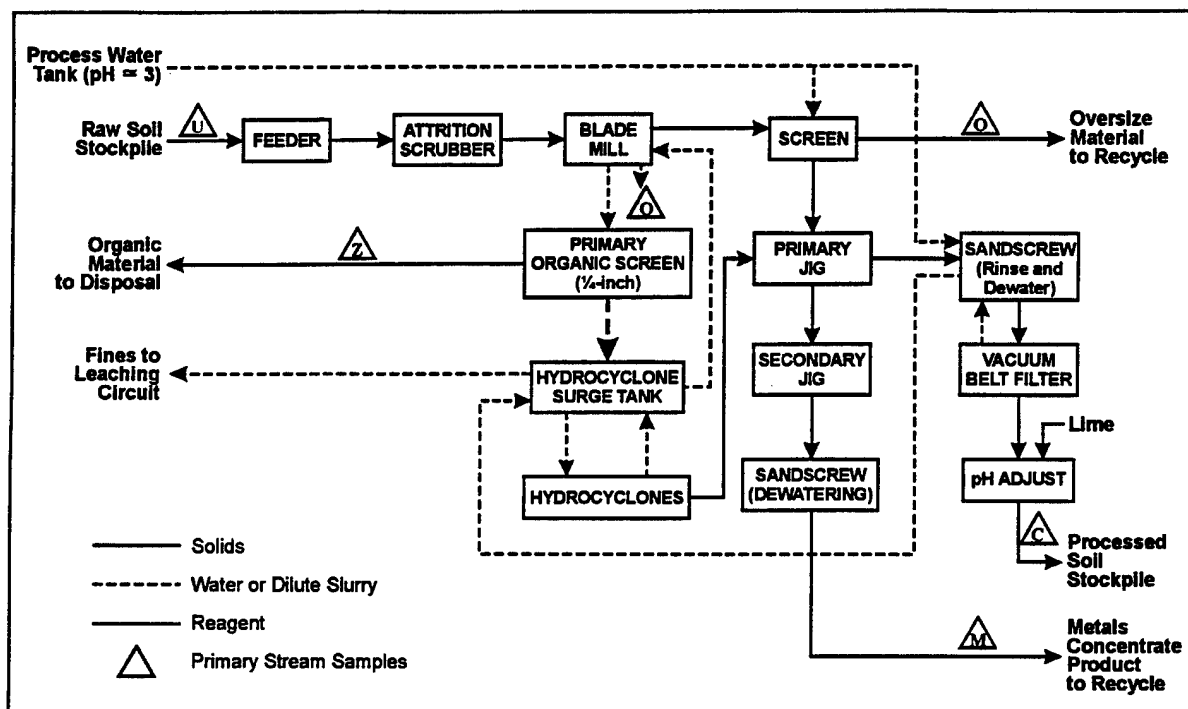

Figure 8. Physical separation module (Vendor 1).

Acid Leaching Module

Acid leaching was conducted as shown in Figure 9 on the fines fraction (L) from the physical separation module. These fines probably contained a combination of fine metal particulates and molecular/ionic metal species bound to the soil. The pH in the leaching tanks (see Figure 10) was maintained at 3.2. The spent leachant was treated with a proprietary precipitant, ThioRed®, which converts the soluble metals into insoluble thiocarbonates. Unfortunately, the dosage and operating pH range of this precipitant had not been adequately evaluated at bench-scale and the vendor's on-site process control mechanism could not properly evaluate the efficiency of the precipitation step. The precipitation step in the field operation appears to have been conducted at a pH below 3.6, which may not have been high enough to precipitate metals (P) out efficiently. Therefore, dissolved heavy metals continued to build up in the regenerated leachant (Q) as the demonstration progressed.

Vendor 2 and the Hydrochloric Acid Plant

Figure 11 shows the plant assembled by Vendor 2 for demonstration of physical separation and hydrochloric acid leaching.

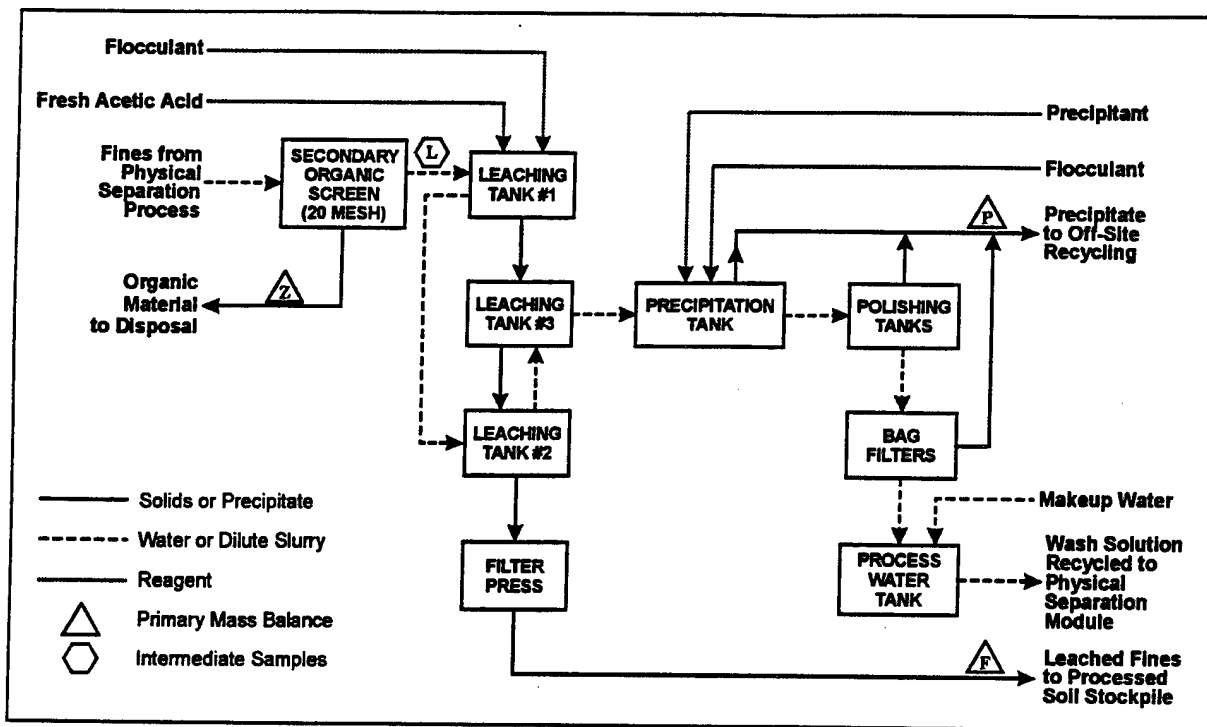

Figure 9. Leaching module (Vendor 1).

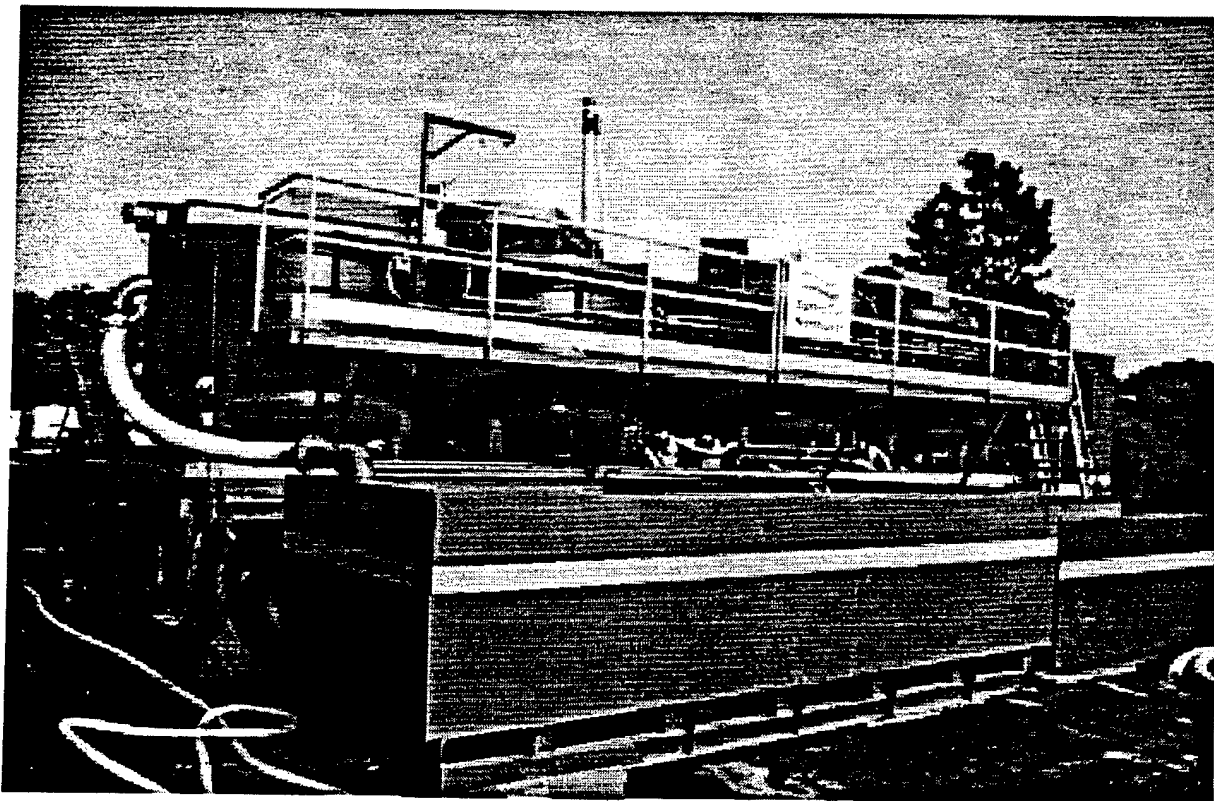

Figure 10. Leaching and precipitation tanks and clarifiers that were part of Vendor 1's plant.

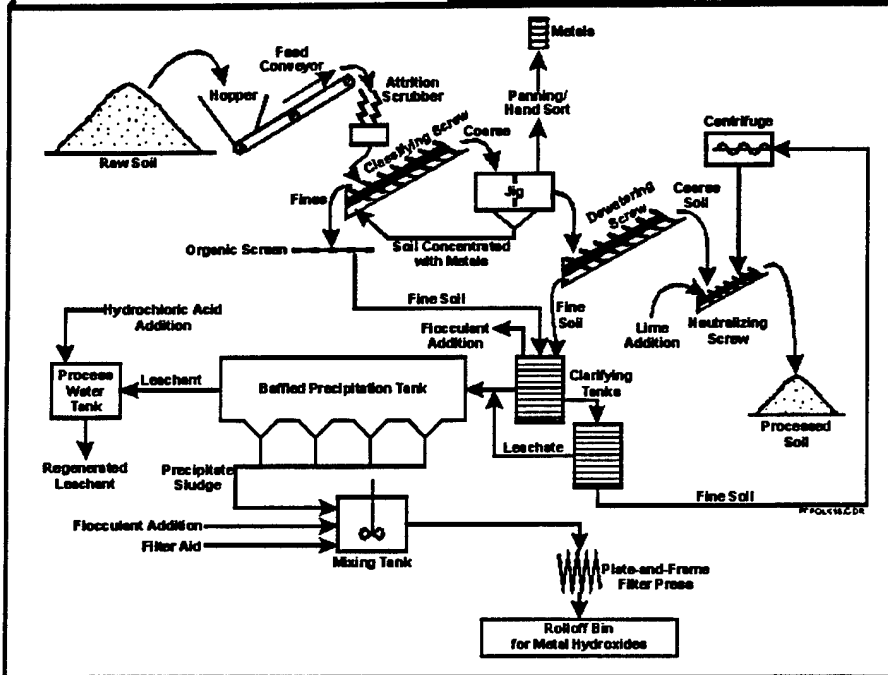

Figure 11. Vendor 2's plant and the hydrochloric acid process.

Physical Separation Module

As seen in Figure 12, the physical separation module in Vendor 2's plant had many of the same elements as Vendor 1's plant. The raw soil (U) was first classified into coarse (+200 mesh) and fine (-200 mesh) fractions. The coarse fraction (K) was processed by gravity separation in a jig in an effort to remove smaller metal fragments (M). Hydrochloric acid was used as the wash solution in these processes so that the coarse fraction could be subjected to a brief leaching to remove any adsorbed lead.

Acid Leaching Module

The classified fines (L) were sent to the leaching module (see Figure 13) where they were brought into contact with hydrochloric acid at a pH of 1.5. The leached fine fraction (F) was dewatered in a centrifuge and recombined with the processed coarse fraction (C) to obtain the final processed soil (T). The processed soil was returned to the range following neutralization with lime to a pH of about 5.5. The spent leachant was regenerated successfully by adding sodium hydroxide and raising the pH above 7 in the

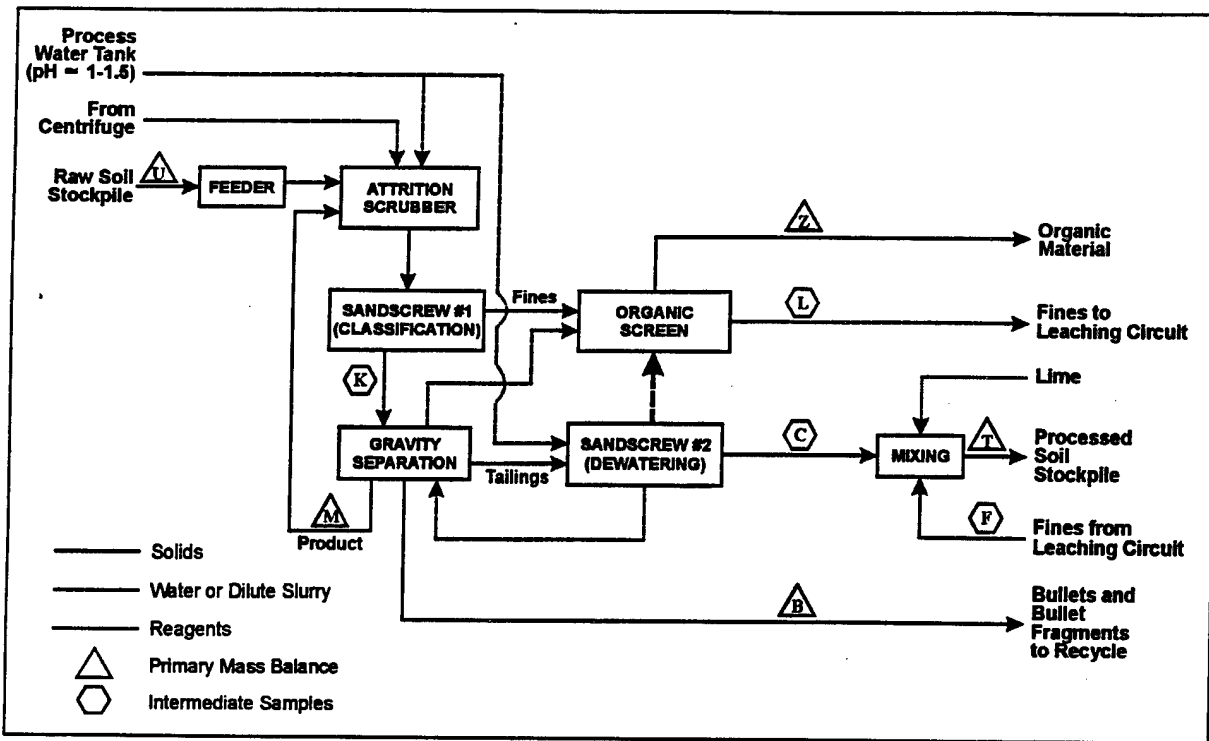

Figure 12. Physical separation module (Vendor 2).

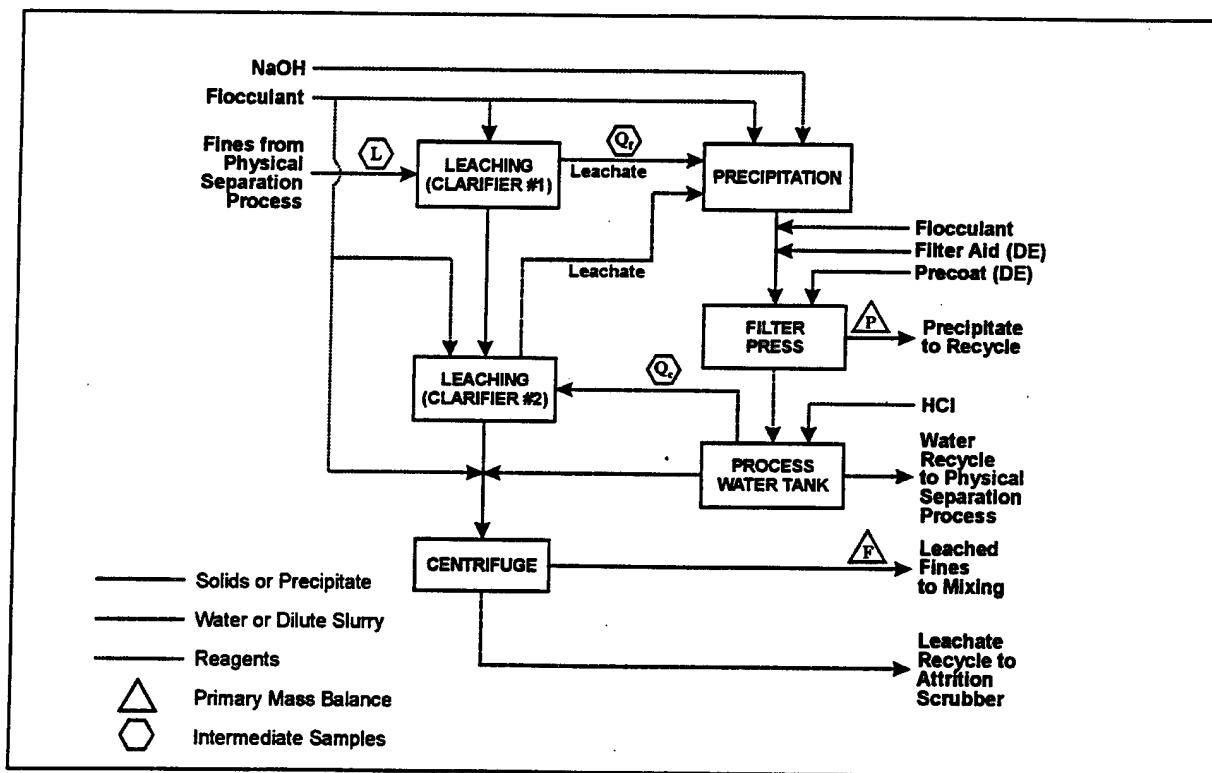

Figure 13. Leaching circuit (Vendor 2).

precipitation tank shown in Figure 14. The metals recovered in the oversize (O) and precipitate (P) were sent to an off-site smelter to recycle the lead content.

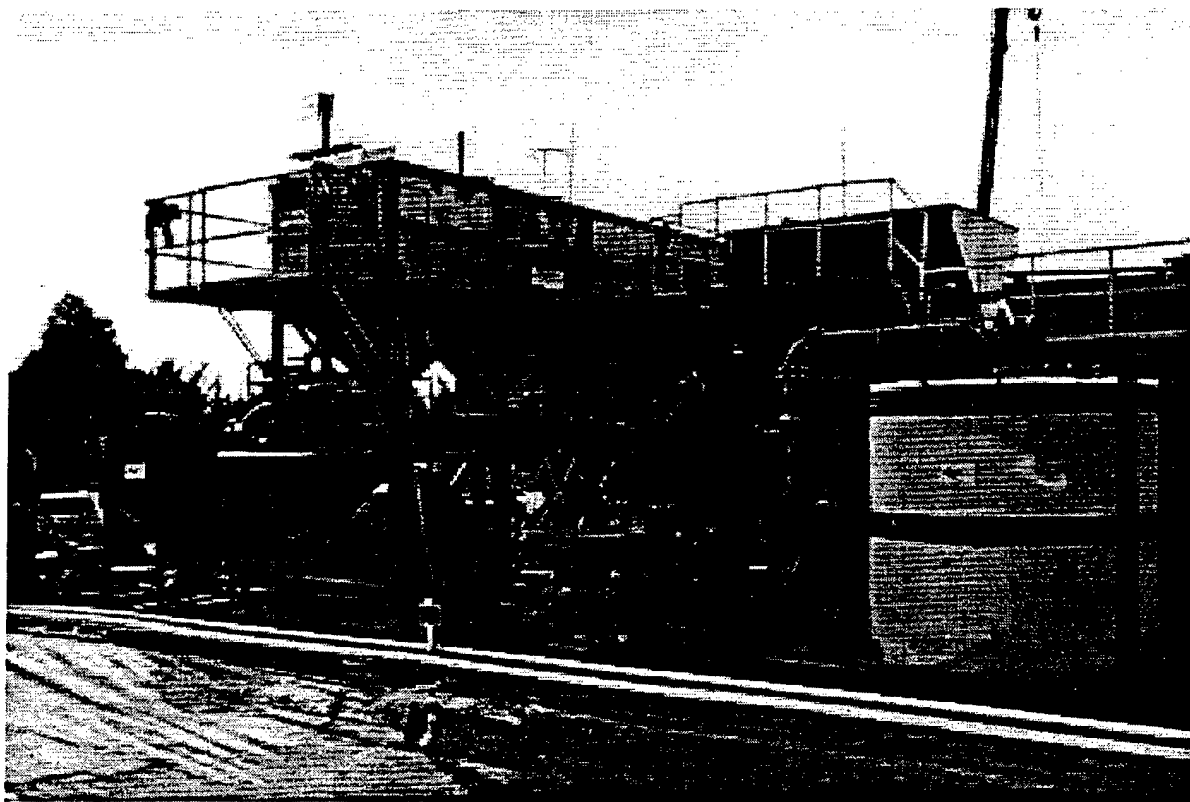

Figure 14. Baffled precipitation and settling tank on left forms part of Vendor 2's plant.

Evaluation Methodology

Evaluation of the separation/leaching technology and its application at Fort Polk was conducted by Battelle through field observations, sampling and analysis of process streams, and discussions with the two vendors and site support personnel. Figure 15 shows the key input and output process streams sampled during the demonstration. At the outset of the demonstration, Battelle prepared a technology demonstration plan (Battelle, 1996) that outlined the evaluation methodology.

Collecting and Preparing Representative Samples

The main challenge during the evaluation was collecting and analyzing representative samples of the raw and processed soil, as well as other process streams. The presence of particulate metals in the soil precludes the use of standard EPA sampling and analysis methods that involve the collection and analysis of a few grams of soil. The difficulty is due to what is known in the mining industry as the "nugget" effect. Depending on whether a particle of metal is collected or left out of the sample, the metal concentration measured in the sample could vary considerably. The larger the size of the metal particle encountered in the matrix, the greater is its ability to bias the analytical result. Previous studies and field demonstrations have been hampered by high variability in the results that made evaluation of removal efficiency difficult (Fristad et al., 1996).

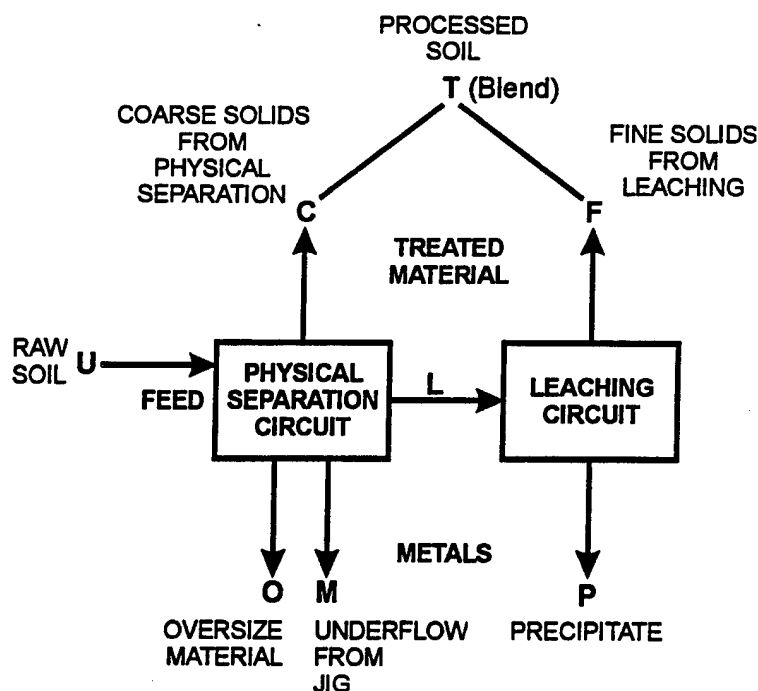

Figure 15. General schematic of process showing input and output streams.

Battelle considered two ways to overcome the matrix variability and obtain representative samples and analyses. One way was to collect a large number of replicates so that the variability between individual samples could be averaged out. In this approach, although metal concentrations in small individual samples collected from a process stream or pile of soil vary considerably, the average is still expected to be relatively close to the true concentration. The other approach considered was the one used by the mining industry to analyze metal concentrations in ores. Table 4 shows the mass of mineral ore or soil containing metals that is required for a given size of metal particle. Thus if 0.375-inch fragments of metal are expected in the soil (as might be expected in small-arms ranges), then between 75 to 3,200 lbs of sample needs to be collected, depending on the metal distribution in the material, to obtain a 99% confidence in the analysis result. The implication is that at this sample size, the analytical result is not significantly affected by whether a 0.375-inch metal particle is collected in or stays out of a sample.

After considerable method development, the sample collection and preparation procedure outlined in Figure 16 was implemented. What this procedure accomplishes is that, once a representative composite sample (of a size determined by Table 4) is collected, the particle size of the material is successively reduced so that representative subsamples of appropriate size are collected at each step. Initially, as much as 300 lbs of material per composite sample was collected for some of the process streams (see Figure 17). Subsequent sample preparation steps successively reduced the large composite to representative 8-gram aliquots that could be conveniently analyzed by digestion and inductively coupled plasma (ICP). At several steps, duplicate or triplicate subsamples were collected and analyzed to increase the level of confidence in the analysis.

The composite usually consisted of multiple grab samples that encompassed 1 day of processing or one pile of soil delivered from the range. Large sample processing equipment was assembled to handle the large sample volumes on site, as shown in Figure 18. These included a 7-foot oven for drying the wet sample, a vibrating screen for size separation, a rolls crusher for size reduction, a sample splitter for

Table 4. Mass (in Pounds) of Composite Required to Obtain Representative Samples

Diameter of Largest Piece			Mass (lb) of Composite for Different Soil Grades				
Inches	mm	Mesh	Very-low-	Low-grade or	Medium ores		Rich or
			grade or very uniform ores	uniform ores			spotty ores
8	-	-	19,200	64,00	-	-	-
6	-	-	10,800	36,000	80,000	-	-
5	-	-	7,500	25,000	55,550	-	-
4	-	-	4,800	16,000	35,556	80,000	-
33	-	-	2,700	9,000	20,000	45,000	-
2.5	-	-	1,875	6,250	13,888	31,250	80,000
2	-	-	1,200	4,000	8,889	20,000	51,200
1.5	-	-	675	2,250	5,000	44,580	28,800
1.25	-	-	496	1,536	3,472	7,813	20,000
1	-	-	300	1,000	2,222	5,000	12,800
0.75	-	-	169	536	1,250	2,813	7,200
0.625	-	-	117	391	868	1,953	5,000
0.500	-	-	75	250	556	1,250	3,200
0.375	-	-	42	141	313	704	1,800
0.3125	-	-	29	98	217	488	1,250
0.250	-	-	19	63	139	313	800
0.1875	-	-	10.5	35	78	176	450
0.131	3.327	6	5.15	17.2	38.1	86	220
0.093	2.362	8	2.6	8.65	19.2	43	111
0.065	1.651	10	1.29	4.3	9.5	21.5	55
0.046	1.168	14	0.65	2.16	4.8	10.75	28
0.0328	0.833	20	0.322	1.075	2.37	5.38	13.76
0.0232	0.589	28	0.162	0.539	1.20	2.69	6.90
0.0165	0.417	35	0.081	0.269	0.59	1.345	3.44
0.0116	0.295	48	0.041	0.135	0.30	0.673	1.73
0.0082	0.208	65	0.020	0.067	0.15	0.336	0.86
0.0058	0.147	100	0.010	0.034	0.075	0.168	0.43
0.0041	0.104	150	0.005	0.017	0.038	0.084	0.215
0.0029	0.074	200	0.0025	0.009	0.019	0.042	0.107

Adapted from Taggart, 1945.

collecting representative subsamples. Because of the limited storage space available on the operations pad for the processed soil and the need for process verification before returning the soil to the range, reliability was built into the sample collection and preparation chain by duplicating every piece of mechanical equipment. Including the final analysis at the off-site Battelle laboratory, analytical results for the processed soil were always reported to the site in three days.

Analytical Methods

The off-site analytical laboratory at Battelle had to develop special procedures to handle the unusual matrix. EPA Standard Method 3051 calls for the microwave digestion of 2-gram aliquots of the final prepared sample. The aliquot size was increased to 8 grams, which is the maximum that method development efforts showed the digester cups would handle. In addition to nitric acid, hydrochloric acid was used for digestion to improve the recovery of antimony. The digestates were analyzed by ICP according to EPA Standard Method 6010.

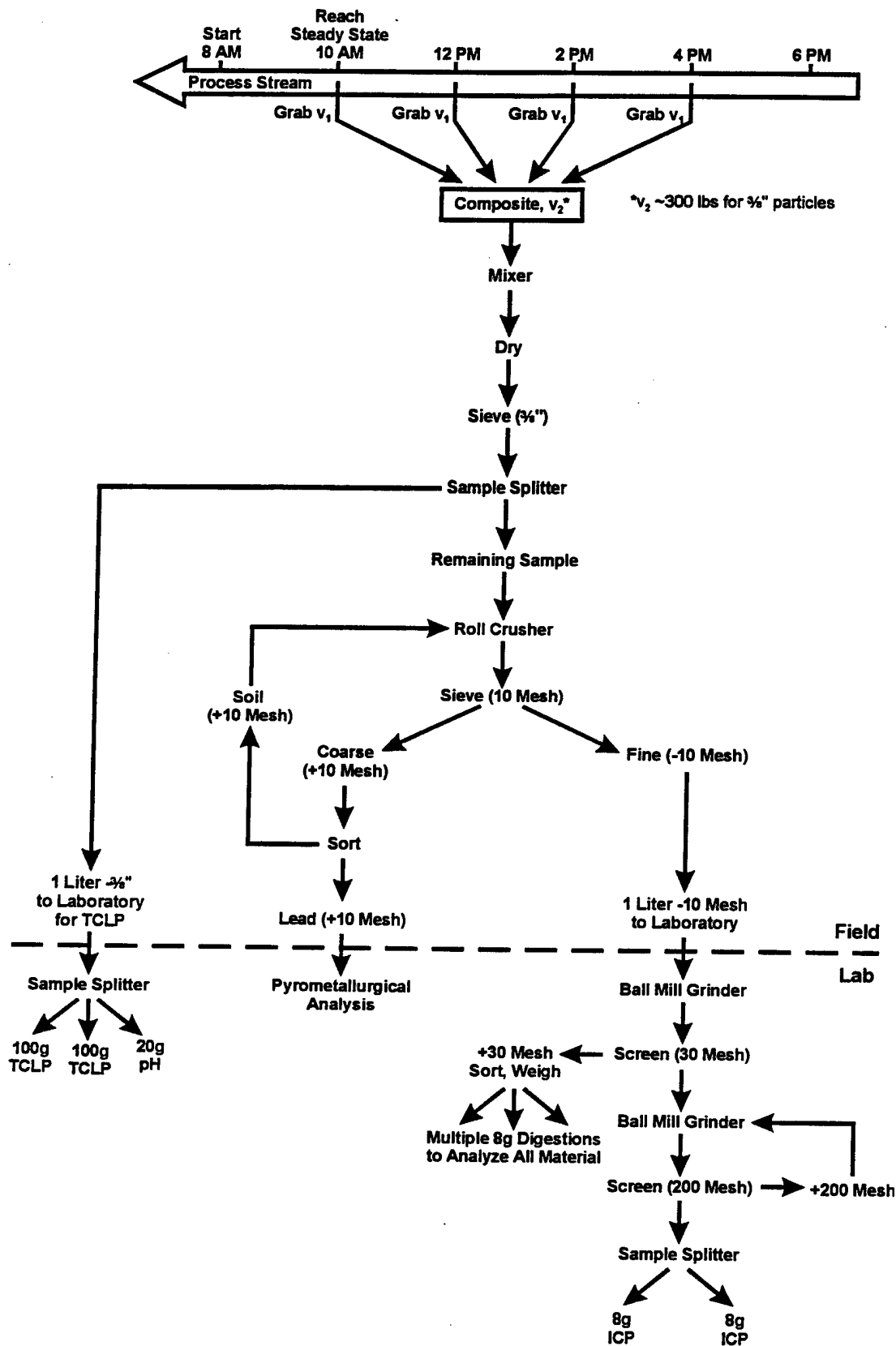

Figure 16. Collecting and preparing representative samples of raw and processed soil for process verification.

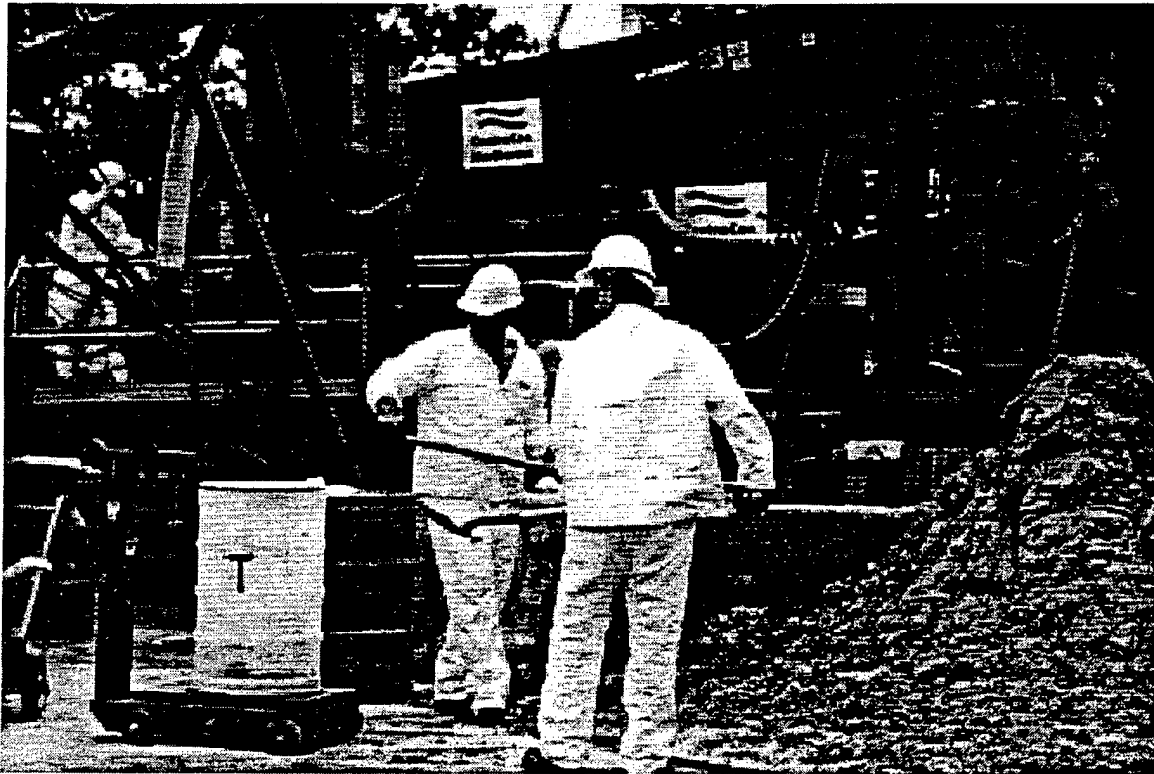

Figure 17. Collecting a 150- to 300-lb sample of processed soil (T) for verifying process efficiency.



Figure 18. Covered sample preparation area with ovens, crusher, vibrating screen, and sample splitter.

The final total metals concentration reported for each composite sample consisted of a weighted average of the concentrations in the following fractions (see Figure 16):

- The +10-mesh oversize material. This fraction consisted mostly of whole bullets, casings, and some gravel. The metals content of this fraction was determined by splitting and sending three aliquots of material to an off-site metallurgical laboratory, where the metals were identified and measured by a combination of special pyrometallurgical and analytical techniques.
- The +30-mesh fraction. This size fraction resulted from the fact that the contents of the 1-liter sample bottle could not be completely ground to -200 mesh in any reasonable amount of time. A small fraction of the material (mostly malleable lead and copper metal fragments) flattens out and refuses to be ground below 30 mesh. This fraction was therefore isolated during sample preparation and analyzed separately by digesting multiple 8-gram aliquots.
- The -200-mesh fraction. This represents the final ground material that was split, digested in multiple 8-gram aliquots, and analyzed by ICP.

TCLP metals analysis was done strictly by EPA Method 1311. For the TCLP analysis, the sample was ground no further than $\frac{3}{8}$ -inch as required by the standard method. The standard method calls for extraction, digestion, and analysis of a 100-gram aliquot of the sample material. As seen in Table 4, at $\frac{3}{8}$ - (0.375)-inch particle size, at least 42-lb subsamples would need to be analyzed to obtain a representative analysis. This was not practical for the study. Therefore, the standard TCLP test as it is designed is inherently nonrepresentative for this matrix. To overcome this limitation while still adhering to the standard method, multiple (two or three) 1-liter subsamples of the $\frac{3}{8}$ -inch material were collected by passing the entire composite sample through a sample splitter in the field. Each 1-liter subsample was further split by the off-site laboratory until two 100-gram aliquots were obtained. These aliquots were then subjected to the TCLP test. The final TCLP result reported for the composite sample was an average of four or six replicate analyses. Any expected variability between the subsamples was averaged out by this method.

On-Site XRF Analysis

An attempt was made during the demonstration to use an on-site XRF analyzer (see Figure 19) to screen soil samples for heavy metals content so that some initial indication of process performance could be obtained in the field. Samples were analyzed wet or dry depending on how fast the analysis was required on site. Dry samples were ground in a small grinder before analysis. As may be expected, XRF analysis had a better correlation with the full-fledged sample preparation and ICP analysis procedures when the sample was collected from relatively homogeneous streams with no coarse metals particles, such as processed soil (T), soil fines (F), and precipitate (P). When samples were collected from streams that were heterogeneous and had coarse metal particulates, such as the raw soil (U), XRF data had a poor correlation with the regular analysis. This is because metal particles tend to shield each other and the concentration is underestimated. As a screening tool, the XRF did provide some early indications of expected total metals levels in the processed soil. But, not enough confidence was generated during the sporadic use of this instrument at Fort Polk for the XRF unit to perform as an on-site decision-making tool. The on-site AA analyzer brought to the site by the vendors appeared to be a better tool for process verification and control.

Quality Assurance (QA)

Most of the special sample collection and analysis procedures described above relate to QA issues such as representativeness, metal recovery (accuracy), and reproducibility (precision). Additional QA measures to ensure field sampling and analysis validity involved field blanks, calibrations, method blanks, matrix spikes, and duplicates. The QA results are summarized as follows:



Figure 19. On-site XRF analyzer in use at Fort Polk.

- Field blanks were collected by running clean sand through the sample collection and preparation equipment during each vendor's operation. As seen in Table 5, the level of metals in the blanks were insignificant compared with the levels in the raw and processed soils, indicating that there was no cross-contamination. The sampling team routinely ran clean sand through all the sampling equipment between samples.

Table 5. Field Blanks Processed During the Demonstration

Field Blank Sampling Date	Blank Matrix	Lead Result (mg/kg)	Copper Result (mg/kg)	Zinc Result (mg/kg)	Antimony Result (mg/kg)
October 5	Sand	2.70	11.60	7.29	0.31
December 3	Sand	6.58	6.19	6.25	1.09

- The precision of the sample preparation procedures for total metals concentrations, as measured by the variability between replicate 1-liter subsamples of soil (see Figure 16) was well within the predetermined target of 25% relative standard deviation (RSD) as shown in Figure 20. Only one sample had a slightly higher RSD.
- The precision of the total metals analytical procedures, as measured by the variability between multiple 8-gram aliquots (see Figure 16) was consistently within the 25% target as shown in Figure 20.

(a) Processed Soil - Vendor 1

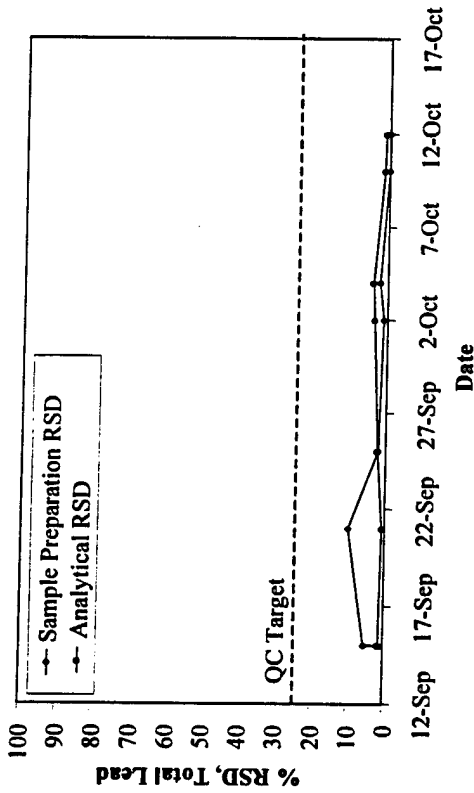

(b) Raw Soil - Vendor 1

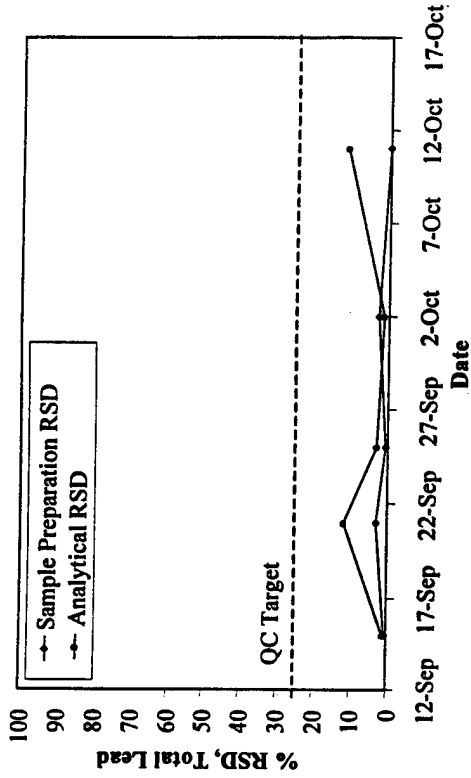

(c) Processed Soil - Vendor 2

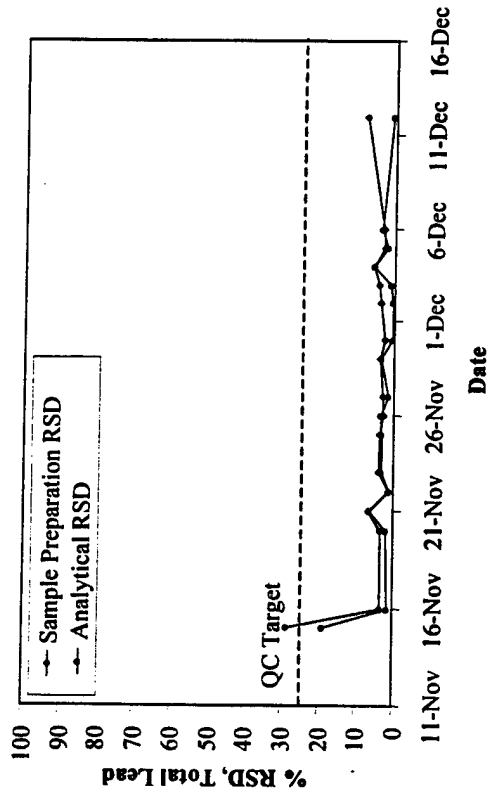

(d) Raw Soil - Vendor 2

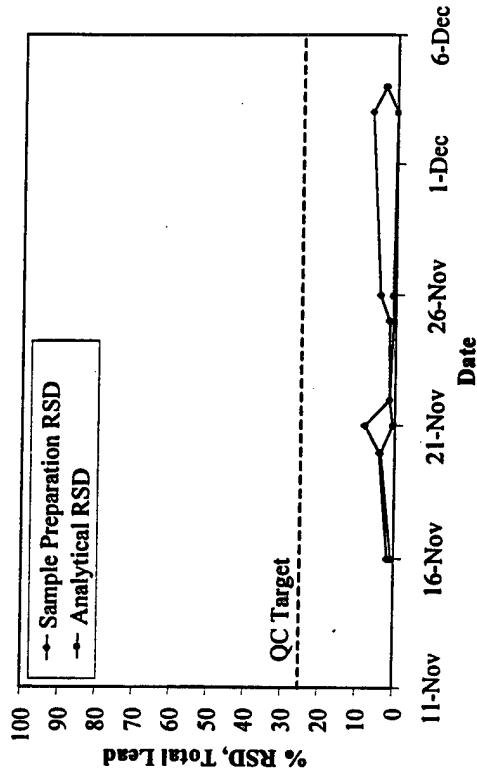

Figure 20. Precision evaluation for total lead analysis.

- The precision of the TCLP analysis was within limits for most of the processed soil analysis (as seen in Figure 21). Three of the samples during Vendor 2's operation showed somewhat higher variability between replicates, possibly due to isolated metal fragments in one of the aliquots. The RSD for the raw soil was outside the target range for many samples because of the unrepresentative aliquot size required by the standard method. Multiple aliquots were analyzed for each composite sample to average out this variability.
- The accuracy evaluation of the total and TCLP lead analysis for soil is shown in Figure 22. Except for two samples in which lead was over-recovered, the matrix spike recoveries were within the target limits of 75 to 125%.
- Several method blanks were routinely analyzed to ensure that the background and any other analytical interferences were minimal. In all cases, method blank results were below method detection limits, except one blank which contained about 1 mg/L of lead, which is well below any measured value in the raw or processed streams.
- Instruments were calibrated daily by running initial and continuing calibration check standards, for which recoveries were within 85 to 115%.

Vendor 1 Performance

Vendor 1 assembled an on-site plant and processed 263 tons of Range 5 soil by physical separation and acetic acid leaching.

Process Efficiency

Table 6 shows the results of Vendor 1's processing. On the first day of processing the processed soil met the total and TCLP lead targets. Approximately 93% of the total lead, 93% of the total copper, 77% of the total zinc, and 70% of the total antimony were removed during this initial processing effort, indicating that acetic acid has the potential to remove heavy metals to target levels. Subsequently however, both total and leachable lead levels rose incrementally. This decline was due to a buildup of lead in the regenerated leachant caused by inadequate precipitation.

Table 7 shows the lead assays and pH ranges of various process streams in the plant. Most of the oversize material (O) accumulated in the basin of the blade mill rather than on the screen and was collected at the end of the demonstration. The jig concentrate (M) did not contain much lead, indicating that the coarse soil fraction may not have contained a size fraction of lead amenable to jiggling. Organic matter (Z) collected in the process contained high levels of lead, but this stream was very small in volume. Both coarse (C) and fine (F) processed fractions individually failed the TCLP test. This was because inadequate precipitation caused dissolved lead to build up in the regenerated leachant (Q), at times reaching levels as high as 627 mg/L. The pH levels of the regenerated leachant (Q) and precipitate (P) indicate that the precipitation step was being implemented at a very low pH, at which most precipitants may be expected to be inefficient. One reason the vendor did not raise the pH in the precipitation tank was the cost concern about the large amount of acetic acid that would be required in the next step to return the regenerated leachant to a lower pH.

Process Residuals

Table 8 shows the residuals generated from the processing and their ultimate disposition. The first batch of processed soil that passed TCLP was returned to the range. The processed soil that did not pass TCLP was sent to a landfill. In addition to its inability to meet the TCLP target, the processed soil appeared to be unsuitable for return to the range because of inadequate dewatering and neutralization of the leached soil. At times, there was so much excess acid in the processed soil pile that field personnel had to wear

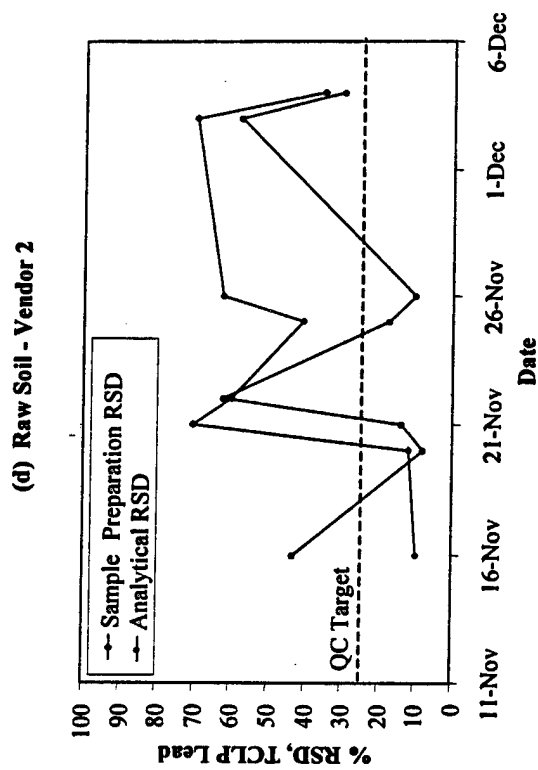
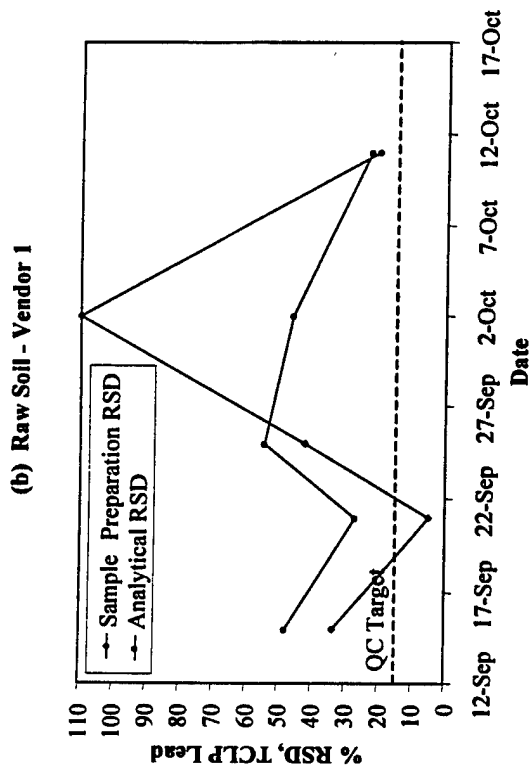
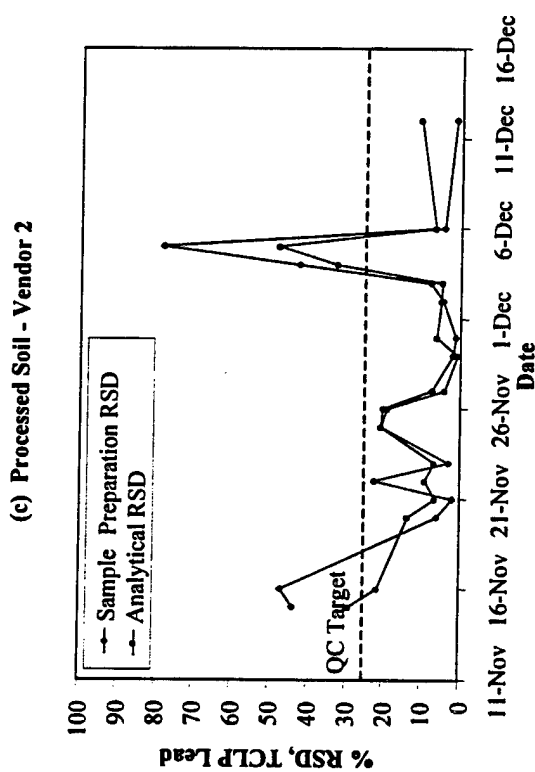
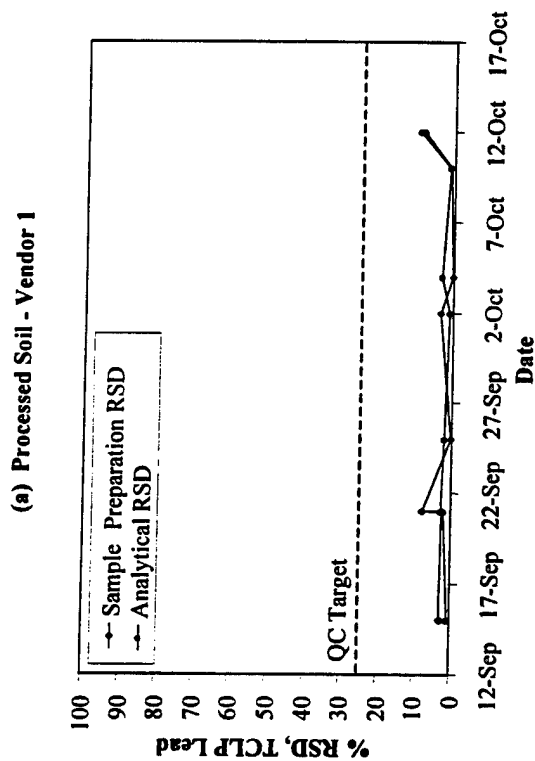

Figure 21. Precision evaluation for TCLP lead analysis.

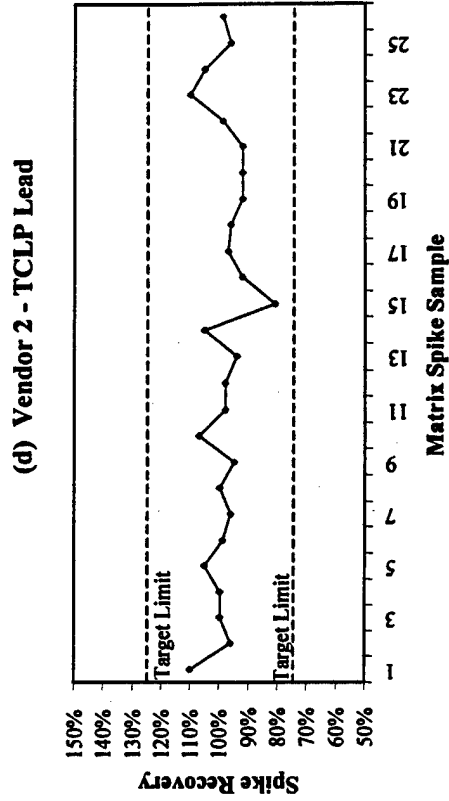
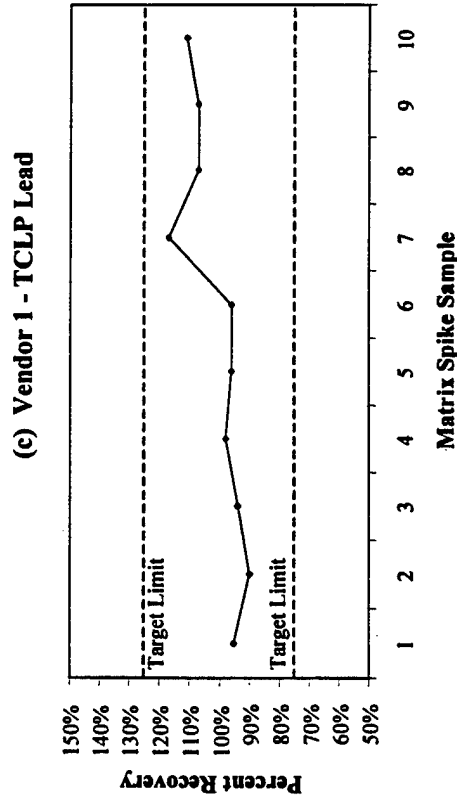
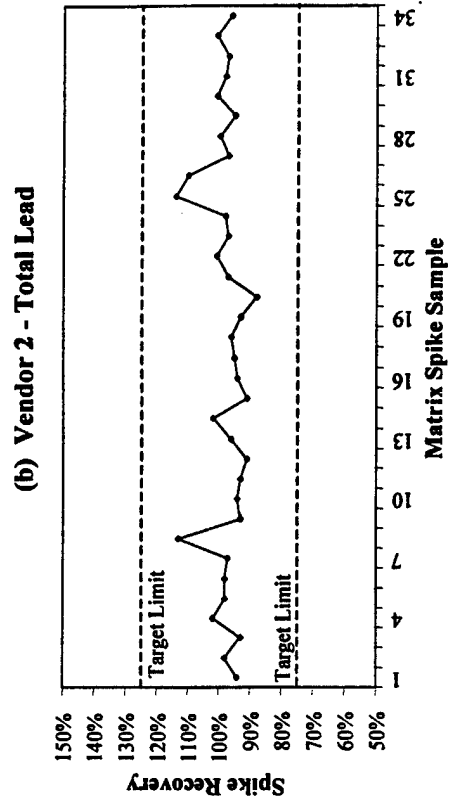
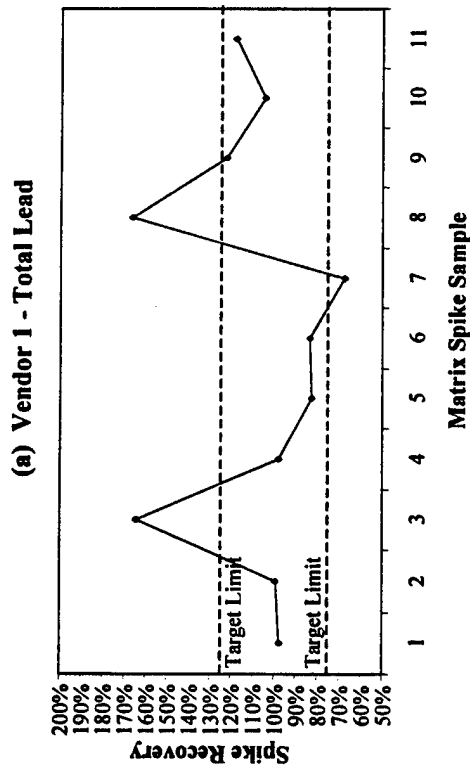

Figure 22. Accuracy evaluation of lead analysis of processed soil.

Table 6. Overall Removal of Total and Leachable Lead with the Acetic Acid Process

Date	Total Lead			TCLP Lead	
	Raw Soil (mg/kg)	Processed Soil (mg/kg)	Removal (%)	Raw Soil (mg/L)	Processed Soil (mg/L)
15-Sep	1,854	122	93	34.6	3.07
21-Sep	1,407	208	85	21.0	5.99
25-Sep	3,347	330	90	22.0	10.3
2-Oct	2,741	404	85	40.5	11.2
4-Oct ^(a)	208 - 330	269 ^(b)	None	5.99 - 10.3	7.80 ^(b)
10-Oct	4,789	839	82	106	21.7
12-Oct	4,789	1,443	70	106	48.0
Statistics					
n	5	N/A	N/A	5	N/A
Avg.	2,828	N/A	N/A	45	N/A
Std. Dev.	1,331	N/A	N/A	35	N/A
80% C.I.	2,828±792	N/A	N/A	45±21	N/A

(a) This sample is a combination of the processed samples from September 21 and 25 that failed TCLP testing.

(b) These sampling data are the results of reprocessing of soil that failed TCLP on September 21 and 25.

N/A = Not applicable. The process did not reach steady state and the distribution is not normal.

C.I. = confidence interval.

n = Number of independent measurements.

Table 7. Distribution of Lead in Acetic Acid Process

Process Stream	Stream Description	PH Range	Total Lead Result (mg/kg)			TCLP Lead Result (mg/L)			Avg. Total Lead Conc. (mg/kg)
			Sep. 15	Oct. 1-3	Oct. 7-11	Sep. 15	Oct. 1-3	Oct. 7-11	
U	raw soil	4.0-4.8	1,854	2,741	4,789	34.6	40.5	106	2,828
T	processed soil	4.1-4.9	122	404	839	3.07	11.2	21.7	722
M	jig concentrate	4.8	N/A	484	N/A	N/A	17.6	N/A	484
O	oversize fraction	5.2	N/A	N/A	239,000	N/A	N/A	N/A	239,000
P	precipitate sludge	3.2-3.6	N/A	N/A	11,990	N/A	N/A	321	11,990
Z	organic matter	N/A	6,457	N/A	N/A	11.1	N/A	N/A	6,457
C	coarse processed fraction	4.9-5.5	N/A	252	N/A	N/A	6.49	N/A	252
F	fine processed fraction	4.0-4.3	N/A	947	N/A	N/A	15.1	N/A	947
L	leach circuit feed	4.4	832	5,347	N/A	21.3	49.9	N/A	3,090
Q ^(a)	regenerated leachant	2.9-3.3	N/A	627	29.3	N/A	N/A	N/A	328

(a) Leachant concentration measured in units of mg/L.

N/A = Not applicable/available.

respirators (PPE upgrade from Level D to Level C) during sampling of the processed soil. The process solution circulating in the plant, the jig concentrate, and the organic matter separated in the process were also hauled to a landfill. The particulate metals recovered in the attrition scrubber basin were sent to an off-site smelter for recycling.

Plant Reliability

In general, plant reliability was relatively low. Mobilization took 14 days, not including transportation to the site. During the next 24 working days, the plant was operational for a total of 139.5 hrs (or 65% of the time). The plant was considered operational whenever it was receiving raw soil feed, regardless of any difficulties or intermediate material accumulation encountered downstream. A total of 263 tons of raw

Table 8. Residuals Disposal for the Vendor 1 Demonstration

Process Stream	Stream Description	Average Lead Concentration (mg/Kg)	Hazardous/ Nonhazardous	Disposal Method	Mass of Stream (kg) ^(a)	Unit Cost (\$)	Total Cost (\$)
T	Processed soil	722 ^(b)	Hazardous	Landfill	146,058	\$0.30	\$43,496
T	Processed soil	122	Nonhazardous	Returned to range	29,937	\$0.00	\$0
P ^(c)	Precipitate sludge	11,990	Hazardous	Landfill	19,731	\$1.41	\$27,782
Q ⁽¹⁾	Process solution	328 mg/L	Hazardous	Landfill	39,000 gal	\$1.25	\$48,750
Q ⁽²⁾	Pad runoff	< 5 mg/L	Nonhazardous	Discharged to POTW	60,000 gal	\$0.00	\$0
Z	Organic matter	6,457	Hazardous	Landfill	1,240 ^(d)	\$0.77	\$958
M	Jig concentrate	484 ^(b)	Hazardous	Landfill	4,082	\$1.53	\$6,260
M'	Metals from screen and blade mill	239,000	Hazardous	Recycled	4,715 ^(e)	\$0.53	\$2,495

(a) Total mass of process streams is on a wet weight basis.

(b) This material was classified as hazardous waste because the TCLP analyses for lead were greater than 5.0 mg/L.

(c) Mass of material in this stream includes the spent bag filters.

(d) Mass of material in this stream was estimated to be 1% of the total raw soil processed; moisture content was approximately 85%.

(e) Mass of material in this stream was estimated from the weights of the drums reported by the off-site recycling facility.

soil were processed by Vendor 1 at an average rate of 2.8 tons/hr. Demobilization was completed on site in 10 days.

The following factors contributed to the low plant reliability and inability to meet processing targets:

- Inadequate bench-scale testing. At bench-scale itself, Vendor 1 was unable to optimize the separation/leaching processes to attain the TCLP lead target. Precipitation efficiency was not optimized during the bench-scale tests and key operating parameters, such as precipitant dosage and effective pH range, were not adequately evaluated.
- Inadequate process control. The problem with the buildup of lead in the leachant could not be identified and corrected in time during the demonstration because there was insufficient instrumentation to provide reliable on-site process verification. Vendor 1 also appeared to be short handed, perhaps due to budget constraints. Additional operators (including an on-site process chemist) would have speeded up plant operation and provided better process control.
- Problems with material handling and equipment sizing. Various material handling problems were encountered in the feed hopper, plate feeder, soil deagglomerator, sand screw, vacuum belt filter, and plate-and-frame filter press. These difficulties caused frequent bottlenecks and downtime.

Vendor 2 Performance

Vendor 2 assembled an on-site plant and processed 835 tons of Range 5 soil by physical separation and hydrochloric acid leaching.

Process Efficiency

As seen in Table 9, the processed soil from Vendor 2's plant consistently met total and TCLP lead targets. Total lead was reduced from an average of 4,117 mg/kg in the raw soil to an average of 165 mg/kg in the processed soil. Leachable lead levels as measured by TCLP were reduced to an average of 2 mg/L. Figure 23 shows the daily total metals removal performance of the process. Processing removed an

Table 9. Overall Removal of Total and Leachable Lead with Vendor 2's Hydrochloric Acid Process

Date	Total Lead			TCLP Lead	
	Raw Soil (mg/kg)	Processed Soil (mg/kg)	Removal (%)	Raw Soil (mg/L)	Processed Soil (mg/L)
15-Nov	4,819	143	97	18.4	3.07
16-Nov	4,819	178	96	18.4	1.83
20-Nov	4,152	125	97	20.7	0.958
21-Nov	3,567	134	96	37.3	1.32
22-Nov	4,068	115	97	33.5	0.56
23-Nov	5,194	232	96	31.9	1.75
25-Nov	5,194	235	95	31.9	2.15
26-Nov	5,040	181	96	36.3	1.97
27-Nov	5,040	165	97	36.3	2.84
29-Nov	5,040	230	95	36.3	3.44
30-Nov	3,351	233	93	40.4	2.53
2-Dec	3,351	177	95	40.4	1.85
3-Dec	3,351	132	96	40.4	1.36
4-Dec	2,743	113	96	13.7	2.35
5-Dec	2,743	127	95	13.7	3.06
6-Dec	2,743	123	96	13.7	0.757
Statistics					
n	8	16	16	8	16
Avg.	4,117	165	96	29	2.0
Std. Dev.	869	46	1.0	10	0.86
80% C.I.	4,117±435	165±15	96±0.34	29±5.0	2.0±0.29

C.I. = confidence interval.

n = number of independent measurements.

average of 96% total lead, 97% total copper, 89% total zinc, and 60% total antimony from the range soil. Figure 24 shows the daily TCLP metals removal performance of the process.

Figure 25 shows the lead assays of the various process streams. Most of the metals that were removed by the process were collected in the jig bed (M') and in the precipitate sludge (P). The organic matter separated from the classifier overflow showed high concentrations of lead. This organic matter was blended with the final processed soil, although in the future, this stream may be best blended with the precipitate for off-site disposal.

The metals collected in the jig bed (M') were an unexpected process stream that resulted from on-site modifications made to the plant by the vendor. Because of difficulties encountered in screening the raw soil, Vendor 2 eliminated the screening unit and the coarse material jig from the planned plant configuration. Instead, the raw soil was sent directly to the attrition scrubber and classifier. The coarse fraction from the classifier was sent to the fine material jig. In this jig, the metal fragments, instead of sinking into the jig concentrate, were retained on the 1/8-inch slotted punch plate. These metal fragments were hand-sorted and removed by an operator at the end of each day.

As seen in Figure 25, both coarse (C) and fine (F) processed fractions contained low levels of lead. These two fractions were combined to form the final processed soil (T) that was neutralized and returned to the range. The processed soil had a loose texture and appeared to be suitable for reuse in the active berm at Range 5. Precipitation was conducted efficiently at a pH of around 7.7 by adding sodium hydroxide. Precipitation reduced the lead content from 96 mg/L in the spent leachant (Q_f) to 11.5 mg/L in the regenerated leachant (Q_c).

(a) Field Demonstration Total Metals Pb Concentrations for Processed and Raw Soil

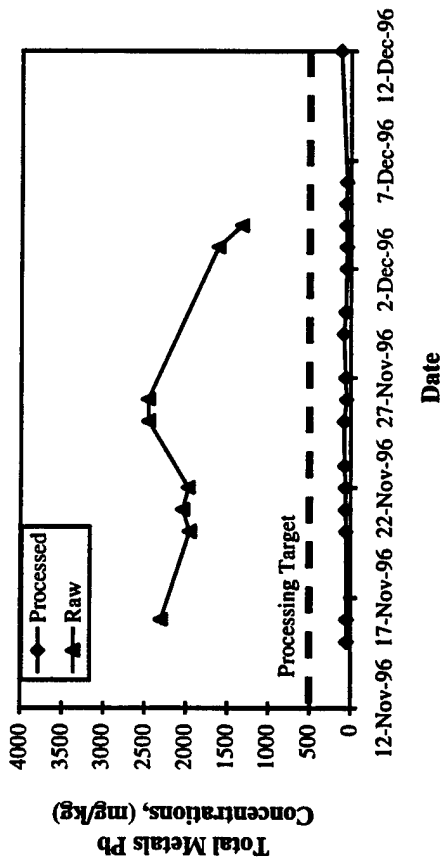

(b) Field Demonstration Total Metals Cu Concentration for Processed and Raw Soil

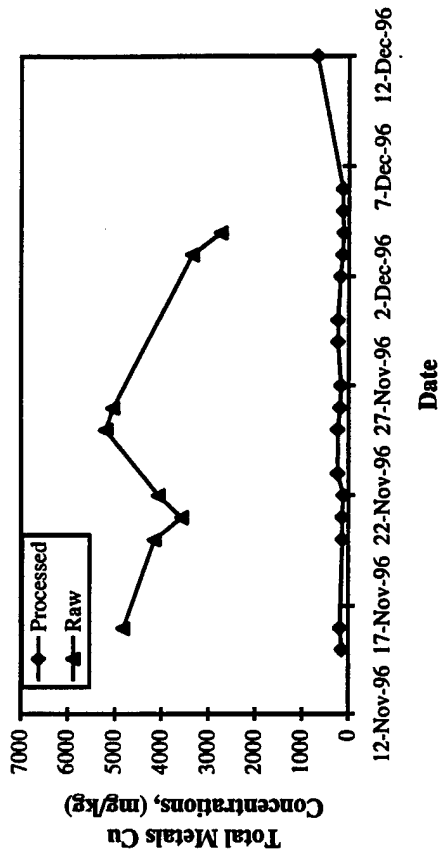

(c) Field Demonstration Total Metals Sb Concentrations for Processed and Raw Soil

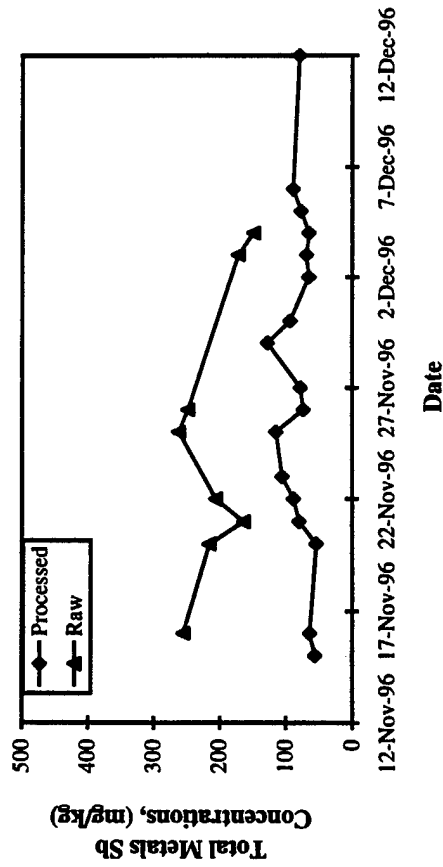

(d) Field Demonstration Total Metals Zn Concentrations for Processed and Raw Soil

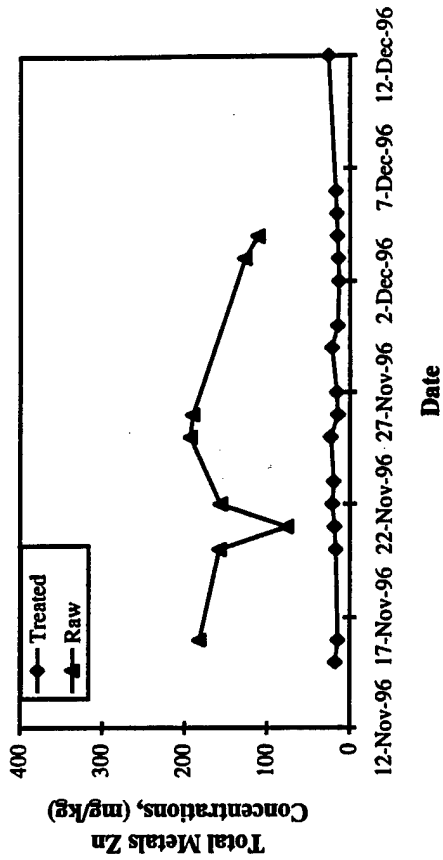
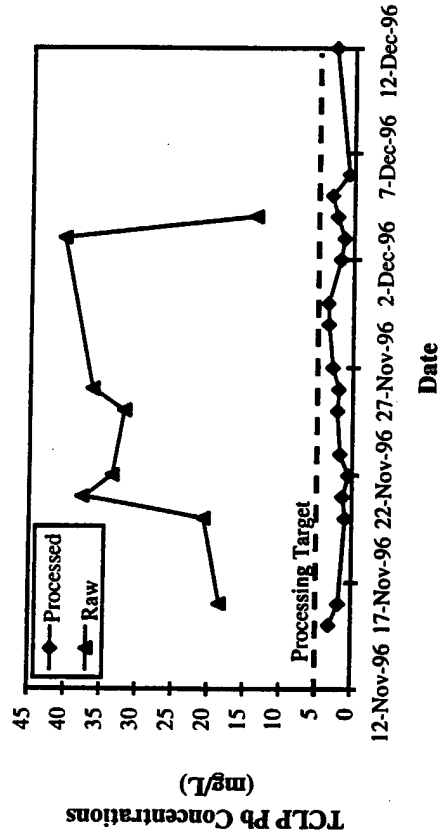
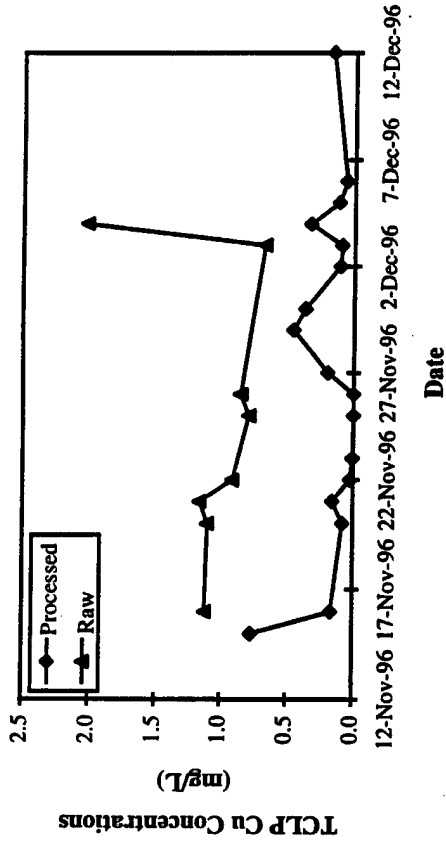

Figure 23. Total metals removed during the hydrochloric acid demonstration at Fort Polk.

(a) Hydrochloric Acid Field Demonstration
TCLP Pb Concentrations for Processed
and Raw Soil



(b) Hydrochloric Acid Field Demonstration
TCLP Cu Concentrations for
Processed and Raw Soil



(c) Hydrochloric Acid Field Demonstration
TCLP Sb Concentrations for Processed
and Raw Soil

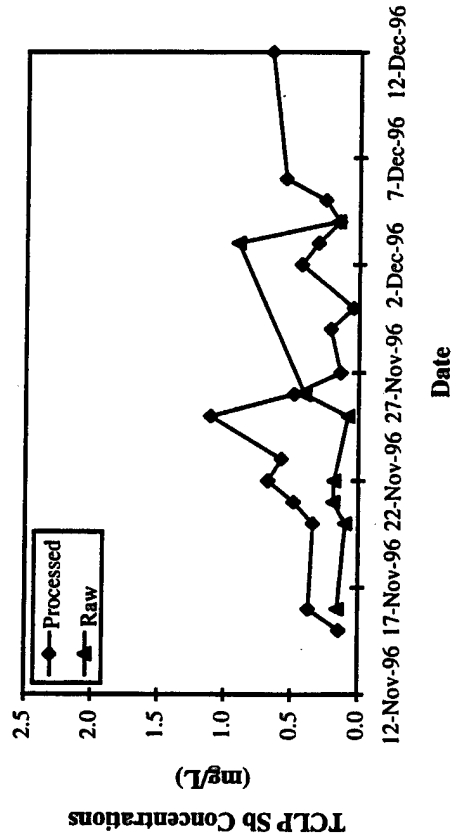

(d) Hydrochloric Acid Field Demonstration
TCLP Zn Concentrations for Processed
and Raw Soil

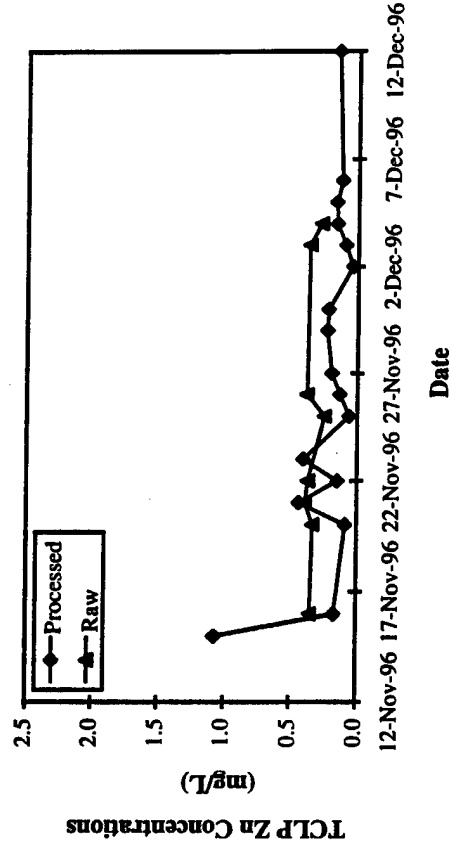

Figure 24. TCLP performance during the hydrochloric acid demonstration at Fort Polk.

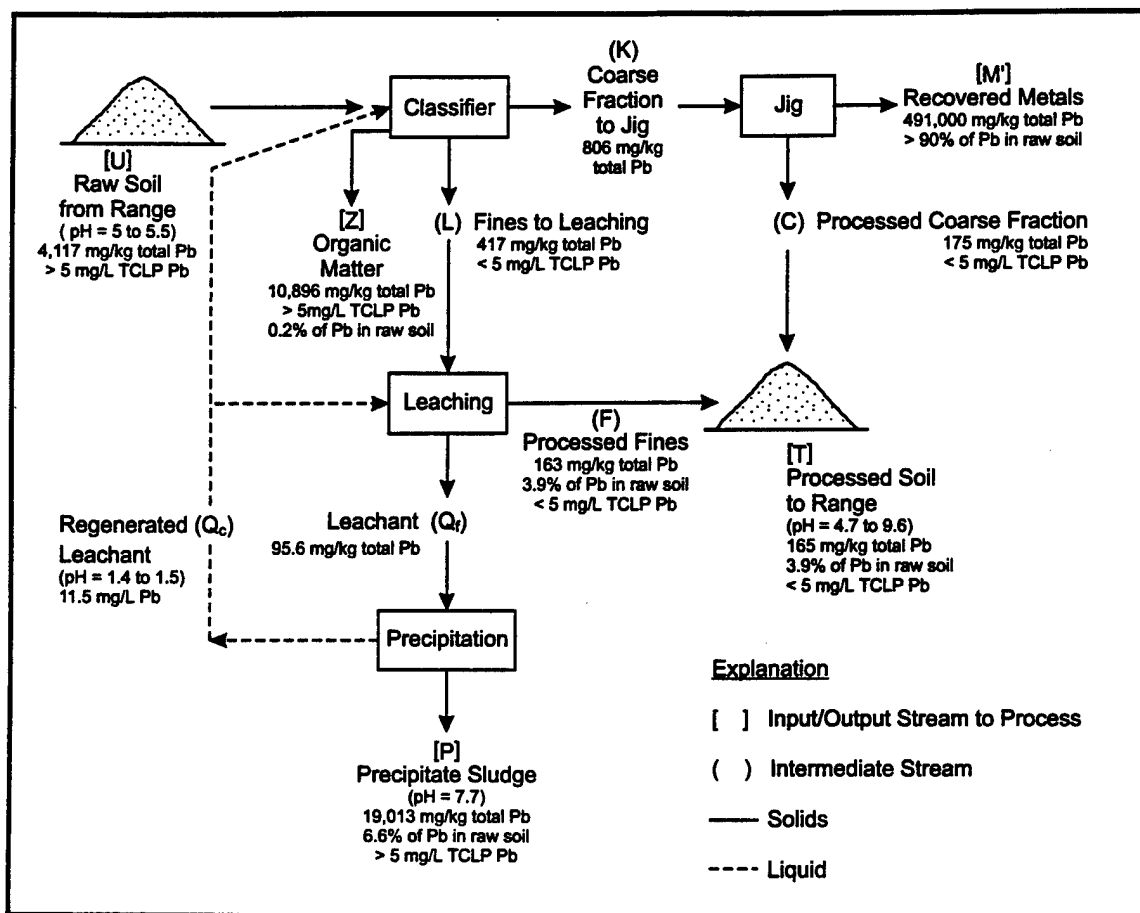

Figure 25. Distribution of lead in various process streams in Vendor 2's plant using hydrochloric acid leaching.

The mass distribution of lead in the input and output streams in the plant is summarized in Table 10. Most of the lead was collected in the jig bed rather than in the jig concentrate, and this suggests some form of size separation. About 7% of the lead was collected in the precipitate sludge. The organic matter isolated from the soil contained a high concentration of lead but its mass was not significant. About 4% of the lead in the raw soil was residual in the processed soil. The mass balance is skewed mainly by the high variability of the lead concentration in the jig bed metals (M'). The lead content of this stream was estimated by analyzing three grab samples of the oversize material, which contained whole bullets, bullet fragments, bullet casing, and gravel. These three grab samples were analyzed by special pyrometallurgical techniques to obtain average lead, copper, zinc, and antimony contents that were used as an estimate of the metals in this fraction for all the samples during the demonstration.

Process Residuals

The residuals from Vendor 2's processing are shown in Table 11. Both the jig bed metals (M') and the precipitate (P) were sent to an off-site smelter for recycling of their lead content. The smelter did charge a recycling fee for accepting the material.

The processed soil was loose textured and suitable for absorbing bullet impacts. This soil was returned to the active berm. The site support contractor applied three types of grass seeds to this soil. Indications are that revegetation is progressing as desired.

Table 10. Mass Distribution of Lead in Various Process Streams for Vendor 2

Process Stream	Stream Description	Moisture Content (%)	Mass of Process Stream (kg) ^(a)	Average Lead Concentration (mg/kg)	Mass of Lead (kg)	Mass Percentage of Lead (%) ^(b)
U	raw soil	9.1	757,507	4,117 ^(c)	2,836	100
T	processed soil	22.8	868,825	165	111	3.9
P	precipitate sludge	62.9	26,672	19,013	188	6.6
Z	organic matter	40.0	800 ^(d)	10,896	5.2	0.2
M ^(e)	jig bed metals	5.0 ^(e)	7,859 ^(f)	491,900 ^(g)	3,673	129.5 ^(h)

- (a) Total mass of process streams are on a wet weight basis.
- (b) Overall balance equation : U = T + P + Z + Metals.
- (c) Concentration of total lead in the raw soil varied considerably from day-to-day.
- (d) Mass of material in this stream was estimated to be 1 % of the total feed.
- (e) This stream contained particulate metals collected from the jig bed and a small amount of soil; moisture content was assumed to be 5 %.
- (f) Mass of material in this stream was estimated from the weights of the drums reported by the off-site recycling facility.
- (g) Concentration of lead in the recovered metals stream was measured by pyrometallurgical analysis conducted on three samples collected from this stream.
- (h) This number has the highest uncertainty because of the high variability of this stream and the limitations of the analytical methods.

Table 11. Residuals Disposal for the Vendor 2 Demonstration

Process Stream	Stream Description	Average Lead Concentration (mg/kg)	Hazardous/ Nonhazardous	Disposal Method	Mass of Stream (kg) ^(a)	Unit Cost (\$)	Total Cost (\$)
T	Processed soil	165	Nonhazardous	Returned to range	745,968	\$0.00	\$0
P	Precipitate sludge	19,013	Hazardous	Recycled	26,672	\$0.18	\$4,850
Q _c	Process solution	< 5 mg/L ^(b)	Nonhazardous	Discharged to POTW	22,000 gal	\$0.00	\$0
Z	Organic matter	10,896	Hazardous	Reblended with process soil ^(c)	800 ^(d)	\$0.00	\$0
M'	Particulate metals	491,900	Hazardous	Recycled	7,859 ^(e)	\$0.53	\$4,158

- (a) Total mass of process streams are on a wet weight basis.
- (b) The lead concentration measured during the demonstration was 11 mg/L. The final concentration measured prior to discharge was less than 5 mg/L due to additional processing of the discharge by the vendor and the influx of rainwater into the containment pond.
- (c) In the future, this stream should be reblended with the precipitate sludge, or disposed of as hazardous waste.
- (d) The mass of material in this stream was estimated to be 1% of the total feed.
- (e) Mass of material in this stream was estimated from the weights of the drums reported by the off-site recycling facility.

Plant Reliability

Vendor 2 completed plant mobilization (not including transportation to the site) in 14 days and demobilization in 10 days. During 18 days available for processing, the plant was operational 98% of the time. About 2 hrs of down time were incurred for minor plant adjustments. A total of 835 tons of soil were processed at an average rate of 6.3 tons/hr. The plant operated at steady state during the entire demonstration and consistently met total and TCLP lead targets. Vendor 2 benefited from longer preparation time available for bench tests and plant design, as well as from the lessons learned during Vendor 1's processing. However, the following factors also contributed to the smooth operation:

- A comprehensive bench-scale study. Vendor 2 thoroughly evaluated every element of the process, including physical separation, leaching, precipitation, and dewatering. Operating

parameters for the process such as pH, contact time, solid-liquid ratios, precipitant dosage, etc., were tested and established in advance of the field operation.

- Material handling considerations in the design. Scale-up was done with attention to material handling aspects in anticipation of a feed material (range soil) that varied in fines content and metals concentrations. Much of the equipment was oversized and this prevented bottlenecks and provided flexibility to increase residence times if required to handle higher fines or metal content.
- Adequate field process control. An on-site process chemist with an AA analyzer provided constant verification and feedback to other plant operators, thus facilitating on-site decision making and plant adjustments. The plant appeared to be adequately staffed to enable efficient operation.

Cost of Application

The cost of processing small-arms range soil with the physical separation and leaching technology was determined by estimating fixed and variable cost elements:

- Fixed or capital cost is the cost incurred independent of the amount of soil processed, and includes items such as permitting, site preparation, bench-scale testing, engineering and administration, plant lease (vendor), transportation, mobilization, and demobilization. Fixed costs may be expected to remain approximately the same at most sites for any berm size. For estimation purposes, equipment (depreciation) cost is assumed to be fixed, because both vendors indicated that they plan to depreciate the plant by a fixed amount at each site.
- Variable or operating cost depends on the amount of soil processed, and includes items such as chemicals, utilities (power and water), plant labor, sampling and analysis, soil excavation and hauling, and residuals disposal. Variable costs will vary from site to site based on the amount of soil available for processing.

Tables 12 and 13 show the fixed and variable costs incurred by each vendor during the demonstration.

Fixed Costs

The major items of fixed cost for either plant appeared to be equipment leasing, transportation of the plant to the site, site preparation, and vendor selection/contracting. Some items, such as permitting and transportation, may cost less or more at other sites.

Variable Costs

Variable costs for Vendor 1 should be interpreted with caution because difficulties during processing resulted in inefficient use of chemicals (acid, precipitant, and flocculant), utilities (power and water), plant labor, sampling and analysis support, and residuals disposal. Also, most of the processed soil did not meet the desired targets for total and TCLP lead. In spite of this inefficiency, it appears that using acetic acid is likely to be more expensive than using hydrochloric acid. First, the unit price of acetic acid (over \$5/gal) is significantly higher than that of hydrochloric acid (\$0.60/gal). Second, the quantity of acetic acid required to attain a comparable pH is significantly higher than that for hydrochloric acid.

Variable costs incurred by Vendor 2 are probably more representative of the operational costs in this type of processing. The "Normal Processing Costs" column in Table 13 reflects some adjustments to account for the differences between the costs incurred in a demonstration versus the normally expected costs for a typical full-scale operation.

Table 12. Costs Incurred During the Acetic Acid Demonstration

Item	Basis	Demonstration Costs 263 tons
Fixed Costs		
Permitting and Regulatory (Site)	NEPA, HASP, & other permitting	\$73,199
Site Characterization (Site)	Planning, sampling, and analyses	\$56,171
Vendor Selection (Site)	Selection and contracting, plan preparation	\$135,686
Bench-Scale Testing (Vendor)	1 representative sample	\$17,739
Site Preparation and Support (Site)	Pad construction and accessory rentals	\$150,839
Engineering and Administrative (Vendor)	Administrative and assessment	\$45,000
Transportation (Vendor)	Plant and personnel mobilization	\$79,200
On-Site Mobilization (Vendor)	Equipment procurement and shakedown	\$63,000
Equipment (Vendor)	25% depreciation over 4 cleanups	\$105,800
Decontamination and Demobilization (Vendor)	Disassembly, decontamination, and demobilization	\$47,600
Total - Fixed Costs		\$774,234
Variable Costs		
Site Excavation & Hauling (Vendor)	Backhoe equipment, excavation & hauling	\$12,419
Labor (Site)	1 site superintendent for 420 hours	\$25,200
	1 health and safety officer for 420 hours	\$21,000
Utilities (Site)	Electricity, 5,000 kWh/month @ \$0.075/kWh	\$750
	Water, 51,250 gal @ \$8.07/kgal	\$414
	Phone, \$220/month	\$440
Labor (Vendor)	1 supervisor for 420 hours	\$119,800
	1 operator for 420 hours	
	1 safety officer for 420 hours	
	4 technicians for 420 hours each	
Chemicals (Vendor)	Acetic acid, 9,415 gal @ \$5.17/gal	\$48,635
	ThioRed®, 1,210 gal @ \$10.91/gal	\$13,201
	Diatomaceous earth, 0 lb @ \$0.53/lb	\$0
	Flocculant, 110 gal @ \$3.31/gal	\$364
	Hydrated lime, 2,000 lb @ \$0.40/lb	\$800
Consumables / Supplies (Vendor)	PPE, gloves, tarps, accessories	\$10,394
Sampling & Analyses (Site)	Accessories, other equipment rentals	\$19,983
- Labor (Site)	1 supervisor for 420 hours	\$25,200
	2 technicians for 420 hours each	\$25,200
- Analyses (Site)	219, sample prep & TCLP analysis	\$50,000
	233, sample prep & total metals analysis	
Residuals, Waste Shipping/Handling (Vendor)	Bulk solid waste & recovered metals credit	\$80,991
Effluent Treatment (Site)	Wastewater, 19,000 gal @ \$1.25/gal	\$48,750
Total - Variable Costs		\$503,541
Total - Project Costs		\$1,277,775
Total - Cost/ton of soil processed		\$4,858

Total and Unit Costs

The total cost for each vendor's processing is the sum of the respective fixed and variable costs. The unit cost of processing is the total cost divided by the number of tons of soil processed (263 tons by Vendor 1 and 835 tons by Vendor 2). Again, the total and unit costs for Vendor 1 represent operating inefficiencies that make interpretation difficult.

Table 13. Demonstration-Incurred and Routine Maintenance Costs of the Hydrochloric Acid Processing

Item	Basis	Demonstration Costs 835 tons	Normal Processing Costs 835 tons
Fixed Costs			
Permitting and Regulatory (Site)	NEPA, HASP, & other permitting	\$73,199	\$73,199
Site Characterization (Site)	Planning, sampling, and analyses	\$56,171	\$56,171
Vendor Selection (Site)	Selection and contracting, plan preparation	\$135,686	\$135,686
Bench-Scale Testing (Vendor)	1 representative sample	\$17,739	\$17,739
Site Preparation & Support (Site)	Pad construction and accessory rentals	\$150,839	\$150,839
Engineering & Administrative (Vendor)	Administrative and assessment	\$41,571	\$41,571
Transportation (Vendor)	Plant and personnel mobilization	\$173,692	\$173,692
On-site Mobilization (Vendor)	Equipment procurement and shakedown	\$23,825	\$23,825
Equipment (Vendor)	25% depreciation over 4 cleanups	\$233,075	\$233,075
Decontamination and Demobilization (Vendor)	Disassembly, decontamination, and demobilization	\$20,000	\$20,000
Total - Fixed Costs		\$925,797	\$925,797
Variable Costs			
Soil Excavation/Hauling (Vendor)	Backhoe equipment, excavation/hauling	\$12,419	\$12,419
Labor (Site)	1 site superintendent for 300 hours	\$18,000	\$18,000
	1 health and safety officer for 300 hours	\$15,000	\$15,000
Utilities (Site)	Electricity, 5,000 kWh/month @ \$0.075/kWh	\$750	\$750
	Water, 49,300 gal @ \$8.07/kgal	\$398	\$398
	Phone, \$220/month	\$440	\$440
Labor (Vendor)	1 supervisor for 300 hours	\$51,845	\$34,563
	2 engineers for 300 hours each ^(a)		
	1 chemist for 300 hours		
	5 technicians for 300 hours each ^(a)		
Chemicals (Vendor)	HCl acid, 5,200 gal @ \$0.60/gal	\$3,141	\$3,141
	NaOH, 5,850 gal @ \$0.60/gal	\$3,517	\$3,517
	Diatomaceous earth, 11,300 lb @ \$0.53/lb	\$6,044	\$6,044
	Flocculant, 1,000 gal @ \$3.31/gal	\$3,311	\$3,311
	Hydrated lime, 1,275 lb @ \$0.40/lb	\$510	\$510
Consumables / Supplies (Vendor)	PPE, gloves, tarps, accessories	\$8,235	\$8,235
Sampling & Analyses (Site)	Accessories, other equipment rentals	\$19,983	\$16,383
- Labor (Site)	1 supervisor for 300 hours	\$18,000	\$18,000
	2 technicians for 300 hours each ^(a)	\$18,000	\$9,000
- Analyses (Site)	240, sample prep & TCLP analyses	\$57,000	\$14,280
	529, sample prep & total metals analysis		
Residuals, Waste Shipping/Handling (Vendor)	Bulk solid waste & recovered metals credit	\$9,008	\$9,200
Effluent Treatment (Site)	Wastewater, 0 gal @ \$1.25/gal ^(a)	\$0	\$27,500
Total - Variable Costs		\$245,601	\$200,693
Total - Project Costs		\$1,171,398	\$1,126,490
Total - Cost/ton of soil		\$1,402	\$1,349

(a) These costs have been changed for the normal processing estimate.

Vendor 2's costs are a better indicator of the cost of applying this type of technology. In Table 13, the second column of costs represents slight adjustments made to the flagged cost items to adjust for the higher cost of these items during a demonstration rather than a routine range maintenance operation. For example, routine range maintenance may not require as extensive a sampling and analysis effort as during the demonstration. The total cost is driven mainly by the high fixed cost of preparing the site and obtaining the plant. This is typical of many on-site technologies. The high fixed cost component implies that, on a pure monetary basis, the cost effectiveness of this technology will be greater at larger ranges or at sites with multiple ranges.

Table 14 shows the projected costs for processing a larger, 10,000-ton site. Implicit in the projection is the assumption that the same plant will be used at a maximum speed of 10 tons/hr, which is the quoted capacity of the plant. Also implicit is the assumption that the processing targets are the same (less than 500 mg/kg total lead and 5 mg/l TCLP lead). The unit cost for the 10,000-ton site is approximately \$170/ton compared with about \$1,400/ton for the 835-ton site. The technology becomes more cost effective for larger sites because the fixed costs are spread over a larger volume of soil.

Acetic Acid versus Hydrochloric Acid

Acetic acid and hydrochloric acid have been commonly used to address lead contamination because both acids produce water-soluble salts with lead. Given the importance of low pH in enhancing solubilization, a strong acid, such as hydrochloric, can be expected to be a more efficient leachant compared with acetic acid. This was the case at Fort Polk, where much more acetic acid was required to maintain a low pH compared with hydrochloric acid. As shown in Table 15, more acetic acid is required to reach a certain low pH than hydrochloric acid. The reason for this is that acetic acid is a weak acid that dissociates only partially, whereas hydrochloric acid is a strong acid that is almost fully dissociated at any molarity.

Acetic acid is expected to be effective at sites where lead is mostly in the form of carbonate minerals, and where processing targets can be achieved at moderately low pH (around 3.0). At small-arms range sites, lead carbonates are formed from the weathering of elemental lead in the presence of native soil alkalinity. Other forms of lead, such as lead dioxide and lead sulfate, are more recalcitrant to solubilization by acetic acid. A strong acid, such as hydrochloric, may be better able to address these species by achieving lower pH (below 2.0).

Hydrochloric acid is a more aggressive leachant compared with acetic acid, and hence may be expected to be more efficient. However, hydrochloric acid is also more aggressive on the soil structure and process equipment. During Vendor 2's demonstration, very high concentrations of iron were noticed in the precipitate sludge. Although part of this iron originated in the soil, some of it could have been dissolved from the equipment itself. Hydrochloric acid is likely to wear out the plant faster, unless expensive stainless steel equipment is used.

Technical and Cost Comparison with Other Technologies

Off-site landfilling and on-site stabilization are the two technologies most commonly considered for addressing elevated metal levels in active and inactive small-arms ranges. From a short-term perspective both these technologies have demonstrated effectiveness in reducing the hazard associated with the metals. Landfilling achieves hazard reduction by removing the hazard (metals-bearing soil) from the site. Stabilization achieves it by immobilizing the metals in the soil. In the long term, however, the heavy metals stay with the soil and the potential for liability remains. With separation/leaching on the other hand, heavy metals are removed from the soil and recycled in an off-site smelter. From a long-term perspective, therefore, separation/leaching is the preferred option.

Table 14. Costs of the Hydrochloric Acid Process at a Larger Site (10,000 tons of soil)

Item	Basis	Costs 10,000-ton site
Fixed Costs		
Permitting and Regulatory (Site)	NEPA, HASP, other permitting	\$73,199
Site Characterization (Site)	Planning, sampling, and analyses	\$56,171
Vendor Selection (Site)	Selection and contracting	\$135,686
Bench-Scale Treatability Tests (Vendor)	1 representative sample	\$17,739
Site Preparation and Support (Site)	Pad construction and accessory rentals	\$150,839
Engineering and Administrative (Vendor)	Administrative and assessment	\$41,571
Transportation (Vendor)	Plant and personnel mobilization	\$173,692
On-site Mobilization (Vendor)	Equipment procurement and shakedown	\$23,825
Equipment (Vendor)	25% depreciation over 4 cleanups	\$233,075
Decontamination and Demobilization (Vendor)	Disassembly, decontamination and demobilization	\$20,000
Total - Fixed Costs		\$925,797
Variable Costs		
Site Excavation / Hauling (Vendor)	Backhoe equipment, excavation & hauling	\$124,190
Labor (Site)	1 Superintendent/HSO for 480 hours	\$28,800
Utilities (Site)	Electricity, 5,000 kWh/month @ \$0.075/kWh	\$1,125
	Water, 80,000 gal @ \$8.07/kgal	\$646
	Phone, \$220/month	\$660
	Labor (Vendor)	1 supervisor for 480 hours
Chemicals (Vendor)	1 engineer for 480 hours each	
	1 chemist for 480 hours	
	3 technicians for 480 hours each	
	HCl acid, 62,275 gal @ \$0.35/lb	\$21,796
	NaOH, 70,060 gal @ \$0.44/lb	\$30,826
Consumables / Supplies (Vendor)	Diatomaceous earth, 50 tons @ \$800/ton	\$40,000
	Flocculant, 7,200 gal @ \$2.20/gal	\$26,347
	Hydrated lime, 8 tons @ \$89/ton	\$712
	PPE, gloves, tarps, accessories	\$50,994
	Accessories, other equipment rentals	\$34,873
Sampling & Analyses (Site)	1 supervisor for 480 hours	\$28,800
	1 technician for 480 hours	\$14,400
- Labor (Site)	360, sample prep & TCLP analysis	\$86,040
	800, sample prep & total metals analysis	
Residuals, Waste Shipping / Handling (Vendor)	Bulk solid waste & recovered metals credit	\$110,180
Effluent Treatment (Site)	Wastewater, 22,000 gal @ \$1.25/gal	\$27,500
Total - Variable Costs		\$762,289
Total - Project Costs		\$1,688,086
Total - Cost/ton of soil processed		\$168

Table 15. Strengths of Various Molar Concentrations of Acetic and Hydrochloric Acid

HCl Solution	pH	Acetic Acid Solution	pH
0.100M	1.00	0.100M	2.87
0.0100M	2.00	0.0100M	3.37
0.00100M	3.00	0.00100M	3.90

Figure 26 provides a cost comparison of the three technologies for different size sites. The costs used for landfilling and stabilization were adapted from R.S. Means Environmental Restoration Unit Cost Books (Means, 1996) for the same quantity of soil. The costs for separation/leaching were projected on the basis of the Fort Polk experience with Vendor 2, as described in Tables 13 and 14. Fixed (capital) costs were assumed to remain fixed over the range of soil volumes (500 to 15,000 tons) covered. Implicit in these costs is the assumption that the soil will be processed to meet the same targets as at Fort Polk (500 mg/kg total and 5 mg/L TCLP lead in the processed soil).

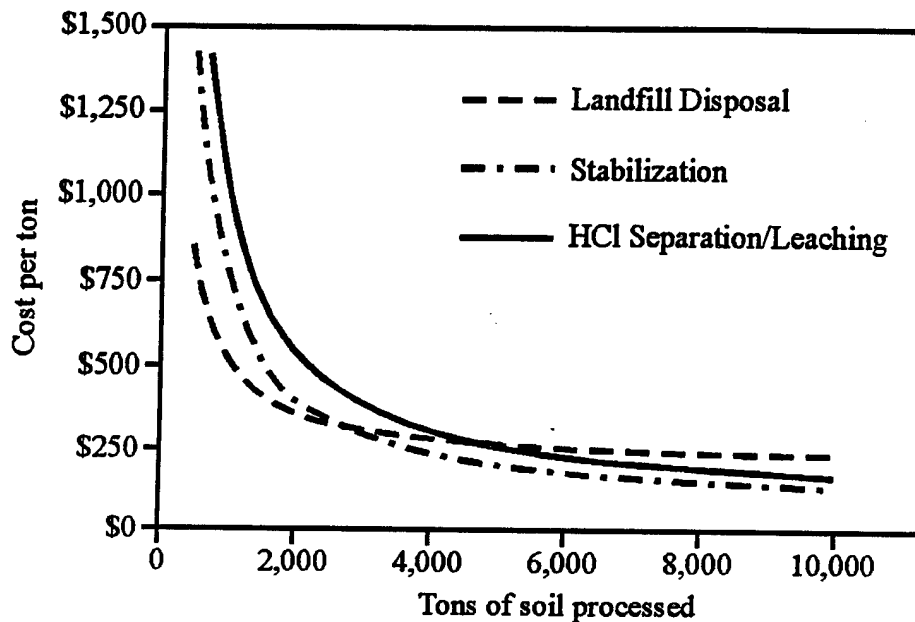

Figure 26. Cost comparison of competitive technologies.

At smaller sites (with less than about 2,600 tons of soil), landfilling is always cheaper than stabilization or separation/leaching. The reason for this is that for smaller soil volumes, an off-site option that does not generate the high fixed costs associated with on-site technologies is always cheaper. When the site is bigger than about 2,600 tons, on-site technologies, such as stabilization and separation/leaching, are cheaper. Stabilization is always cheaper than separation/leaching because it involves relatively simple equipment (lower fixed cost) and faster processing (lower operating cost). If a true cost-benefit analysis is conducted, however, the physical separation and acid leaching option provides the following benefits that would merit serious consideration at most small-arms range sites, regardless of the soil volume:

- Unlike stabilization, separation/leaching removes the heavy metal hazard from the soil. The restored range can then be put to many more beneficial uses than would be possible with stabilized soil which still contains the metals.
- Unlike landfilling or stabilization, separation/leaching reduces the potential for long-term liability by removing and recycling the heavy metals.
- Several commercial vendors are available who can be contracted to assemble and operate the required separation/leaching plant with off-the-shelf equipment. Processing is relatively fast and an active range need not be shut down for long. With a 10-ton/hr plant, a 10,000-ton site could be processed in around two months, assuming two shifts per day, seven days per week of operation.

Regulatory/Institutional Issues

A number of regulatory issues apply to range maintenance or remediation operations:

- ❑ National Environmental Policy Act (NEPA). NEPA applies to any maintenance or remediation activity associated with active or inactive small-arms ranges. However, because of the limited scope of many range maintenance or remediation projects, it may be possible (as at Fort Polk) to fulfill NEPA requirements by applying a Categorical Exclusion (CATEX) with a Record of Environmental Consideration (REC), as described in Chapter 4 of Army Regulation (AR) 200-2.
- ❑ Resource Conservation and Recovery Act (RCRA). Both the final US EPA Military Munitions rule and the DoD Military Range Rule indicate that if range maintenance activities occur on site at an active range, the soil is not considered a RCRA hazardous waste. For such maintenance activities, regulatory-driven processing targets may not apply. Some concern still remains whether all the states will recognize this. Remediation of inactive ranges may fall under RCRA. In either case, some RCRA waste may be generated during processing for either type of range. Examples of such wastes during the Fort Polk demonstration include PPE, metal-bearing organic matter, and process solutions remaining at the end of processing.
- ❑ Emergency Planning and Community Right-to-Know Act (EPCRA). EPCRA requires the reporting of hazardous materials that exceed threshold planning quantities (TPQs). At Fort Polk, the acids used required reporting under EPCRA.
- ❑ Clean Water Act (CWA). BDM, the site support contractor, prepared a Solid Waste Pollution Prevention (SWPP) Plan and a Spill Prevention, Control, and Countermeasures (SPCC) Plan, which were in effect during the demonstration. The vendors' plants incorporated secondary containment for spills. The bermed asphalt pad and containment pond provided additional back up. The water from the containment pond was discharged to the sanitary sewer leading to the local wastewater treatment plant after being tested to ensure that it met the treatment plant's requirements.
- ❑ Clean Air Act (CAA) and Occupational Health and Safety Act (OSHA). BDM prepared a Health and Safety Plan for the maintenance activity and conducted air sampling and monitoring to evaluate lead dust. No lead dust hazard was noticed, but occasionally during Vendor 1's operation, acetic acid fumes were observed near the processed soil pile. Field personnel, who generally wore Level D PPE, switched to Level C, when sampling the processed soil on these occasions.

The Fort Polk installation commander, through his Environmental Management staff, was the authorized line of communication to all environmental regulatory agencies. The installation had an active Environmental Quality Control Committee (EQCC) that met monthly. In addition, the installation held Remediation Advisory Board (RAB) meetings in which the local community and regulatory officials participated.

As part of the demonstration, Battelle organized the following activities designed to facilitate technology transfer:

- ❑ A Visitors' Day was held on December 12, 1996, while Vendor 2 was operating, to allow potential users in the DoD community a chance to see the plant in operation.
- ❑ Two brochures outlining the demonstration activities and results were prepared and distributed widely.
- ❑ Two video films showing the plants in operation and the results of the processing were prepared for use in training seminars.

- This report and a more detailed Technology Evaluation Report describing the technical performance and cost effectiveness of the technology were prepared for distribution.

Application at Other Sites

Technical and Economic Feasibility

The physical separation and acid leaching technology is potentially applicable at most small-arms range sites, both active and inactive. Different types of soil and heavy metal species encountered at different sites may not be a significant limitation in meeting the TCLP lead criterion, if a strong acid, such as hydrochloric, is used at a sufficiently low pH (less than 2.0). At Fort Polk, the suspected lead species were mostly carbonates, which are relatively easy to leach. However, in a separate bench-scale study reported by Van Benschoten et al. (1997), hydrochloric acid leaching (at a pH of 1.0) was successfully applied to seven different soils with various lead species (carbonates, oxides, sulfates) and soil-metal binding mechanisms (exchangeable, adsorbed on iron and manganese oxides, etc.). All seven leached soils in this study met the TCLP lead criterion. In terms of soil texture too, Fort Polk, with its relatively high clay content, probably represented one of the more difficult small-arms range sites that could be encountered.

If the use of a weak acid, such as acetic, is desired, there may be limitations based on the speciation of the heavy metals and the soil-metal binding mechanisms. At Fort Polk, where the lead was suspected to occur mostly as carbonates, acetic acid leaching succeeded in meeting the TCLP lead target, at least on the first day, before the processing was hampered by plant problems. However, in separate bench-scale studies by Igwe et al. (1994) and Krishnamurthy (1992), acetic acid was found to be effective only on the more easily leachable forms of lead. Given the large amounts of acetic acid required to reach moderately low pH (around 3.0) and the high unit price of acetic acid, the use of acetic acid is likely to incur higher processing costs. Bench-scale treatability studies should be conducted on a site-specific basis to select an appropriate leachant and to determine the ability of the technology to achieve the required processing targets.

The processing targets set for the maintenance or remediation are an important consideration when evaluating the technical and economic feasibility of the technology. At Fort Polk, the total and leachable lead targets (500 mg/kg and 5 mg/L TCLP) were easily met by the hydrochloric acid process. However, some states may have more stringent requirements, especially for remediation of inactive ranges. For example, in California, the processed soil may be evaluated by the Waste Extraction Test (WET), which is more aggressive than the TCLP. Although not a requirement for this demonstration, two samples of the processed soil from Vendor 2's demonstration were subjected to the WET. As seen in Table 16, both samples easily met the TCLP criterion but did not meet the WET criterion for lead. In California, copper, zinc, and antimony are regulated metals.

Table 16. Leachable Lead Concentrations

Sample No.	U.S. EPA TCLP (mg/L)				California WET (STLC) (mg/L)			
	Lead	Copper	Zinc	Antimony	Lead	Copper	Zinc	Antimony
Nov. 22, processed soil	0.47	0.022	0.15	0.68	9.4	2.5	<1	5.1
Nov. 30, processed soil replicate	3.6	0.38	0.30	0.036	19	3.1	<1	2.1
California Limit	5.0	N/A	N/A	N/A	5.0	25	250	15

Meeting more demanding targets may be possible with separation/leaching, but will probably incur higher processing costs. One option would be to remove as much of the heavy metals from the soil by separation/leaching as is possible and economically viable, and then add a suitable stabilization agent to the processed soil to reach the desired leachability target. Phosphate would be a good option as a stabilization agent that is effective over a wide range of pH and is relatively benign from an environmental perspective. At the other end of the spectrum, there may be sites where physical separation alone may be sufficient to meet a processing target such as TCLP. Again, comprehensive bench-scale testing would be the best tool to evaluate and optimize a suitable processing scheme.

Regulatory Perspective

At most active ranges, maintenance is not expected to come under RCRA, and the site may be able to choose economically viable processing targets. At inactive ranges, remediation may have to be conducted under RCRA, in which case, at a minimum, the TCLP criterion for lead will have to be met. Some states may require more stringent processing targets, and these may engender the technical and cost effects discussed above. In any case, prospective sites should initiate regulatory involvement as early in the decision-making process as possible.

Vendor Selection and Contracting

Because several commercial vendors have the equipment and capability to implement separation/leaching processes, prospective sites need not build or operate their own plant. Based on the Fort Polk experience, the following guidance is suggested for vendor selection and contracting:

- Vendors should have prior mining or remediation experience with separation/leaching type technologies.
- Candidate vendors should be given a representative sample of the range soil for characterization and bench-scale testing. A 30-gallon drum of soil composited from several grab samples collected strategically from the berm should provide a representative quantity.
- Bench-scale testing should simulate all elements of the proposed process, including separation, leaching, precipitation, leachant regeneration, dewatering, and neutralization.
- The selected vendor should be asked to provide a complete process flow diagram indicating all input, output, and intermediate streams. This diagram should include both solid and liquid flows. Supporting information should include estimated material flow and particle size composition for each stream.
- The design should demonstrate the plant's capability to handle variability in feed soil texture and metals concentration. Generally, some excess capacity in the process equipment is desirable to provide the flexibility to increase residence times and avoid bottlenecks. Any anticipated material handling difficulties should be identified and addressed.
- The vendor should provide information on site preparation needs and utilities support required from the site. On its part, it may be advisable for the site to overdesign site support facilities (such as power, water, pad size, etc.) to some extent to allow the vendor some flexibility in adding or changing equipment during the operation.
- The vendor should demonstrate that provisions have been made for adequate and appropriate operator support in terms of number of operators and qualifications. At least one of the operators should have enough knowledge of process chemistry to be able to make on-site adjustments.
- The vendor should demonstrate that adequate process control has been built into the plant to allow verification and adjustment of key operating parameters, such as pH, contact time, metals

concentrations, etc. An on-site AA analyzer proved especially useful at Fort Polk in verifying lead levels in key process streams.

Process Verification

To obtain reliable verification of the process efficiency and effectiveness of individual process elements, extensive sampling and analysis involving special methods were conducted during the demonstration. Routine range maintenance or remediation projects may need to conduct less frequent sampling. With the general goal of collecting, preparing, and analyzing representative samples, sites may be able to implement less expensive adaptations of the sampling and analysis methods described in this report (Figure 16). Towards this end, Battelle evaluated an alternative sampling scheme during the demonstration.

In both schemes, a large composite sample (150 to 300 lbs) was initially collected from the processed soil pile in a 30-gal drum. In the first method the entire contents of the drum were processed by the regular scheme described in Figure 16. This involved the use of special large on-site equipment for drying, grinding, and splitting the large volume of material. In the alternative method, 1-liter (or 3- to 4-lb) grab subsamples were collected directly from the drum containing the wet composite sample without prior preparation. These grab subsamples were taken with a soil corer, so that an entire column of material was obtained in each grab subsample. These grab subsamples were placed in 1-liter bottles and sent to the off-site laboratory. Beyond this point, these grab subsamples were treated in the same fashion as the other 1-liter subsamples obtained from the regular method (see Figure 16), except that the 1-liter samples from the alternative method had to be dried in the off-site laboratory. In both sampling methods, the 1-liter subsamples were further processed at the off-site laboratory until representative 100-gram or 8-gram aliquots could be collected for TCLP or total metals analyses, respectively.

A comparison of the results of the two sampling schemes is shown in Table 17. The average total and TCLP lead concentrations by either method were almost exactly the same, although the alternative method of collecting grab samples from the composite drum showed a much higher variability between replicates, as measured by the relative standard deviation (RSD).

Table 17. Comparison of the Analytical Data from Regular and Alternative Sample Preparation Methods

Sample ID	Sampling Method	Total Lead Result (mg/kg)	TCLP Lead Result (mg/L)
September 15, A	Regular (Figure 16)	N/A	3.11
September 15, B	Regular	N/A	2.98
September 15, C	Regular	N/A	3.10
September 15, D	Regular	123.3	N/A
September 15, E	Regular	120.3	N/A
Average	Regular	121.8	3.06
Percent RSD	Regular	1.74%	2.36%
September 15, X	Alternative	114.2	3.18
September 15, Y	Alternative	116.9	3.04
September 15, Z	Alternative	125.6	3.01
Average	Alternative	118.9	3.08
Percent RSD	Alternative	2.95%	5.01%

N/A = Not applicable/available.

In both methods, once the initial composite is collected by combining several grabs from the processed soil pile or from the processed soil conveyor, the problem of accurately sampling an 80-ton soil pile is reduced to one of sampling 150 to 300 lbs of soil from a drum that is a reasonably good representation of the original pile. In the regular method used at Fort Polk, the variability in the drum is blended away by drying and grinding the entire contents. In the alternative method, the variability in the drum is averaged out by collecting a sufficient number of small replicates (three in this case). The alternative method provides reasonably good estimates without the need for expensive on-site equipment and preparation. If desired, the original large composite can be mixed in a small cement mixer before the 1-liter grabs are collected.

Schedule

Table 18 shows the schedule of activities conducted as part of this demonstration.

Table 18. Schedule of Activities for the Demonstration at Fort Polk

Activity	Start Date	End Date
Project Start/End	9/29/94	9/30/97
Vendor Selection/Contracting (BDM)	10/20/94	5/31/95
Permitting/Safety Plans (BDM)	2/12/95	5/15/95
Site Characterization (BDM)	11/15/95	12/14/95
Technology Demonstration Plan (Battelle)	6/21/96	8/21/96
Bench-Scale Testing (Vendors)	6/3/96	10/2/96
Site Preparation (BDM)	5/30/96	8/9/96
Vendor 1 Mobilization	7/22/96	8/30/96
Vendor 1 Processing	9/2/96	10/21/96
Vendor 1 Demobilization	10/21/96	10/25/96
Vendor 2 Mobilization	10/3/96	11/8/96
Vendor 2 Processing	11/11/96	12/10/96
Vendor 2 Demobilization	1/8/97	1/28/97
Visitors' Day	12/12/96	12/12/96
Site Demobilization (BDM)	1/30/97	2/26/97
Draft-Final Technology Evaluation Report (Battelle)	2/15/97	6/15/97
Final Technology Evaluation Report (Battelle)	9/1/97	9/30/97

Lessons Learned

All the interpretations, conclusions, and recommendations arising from the demonstration were discussed in the appropriate sections of this report so that each topic could be fully addressed in one place. In summary, the following lessons were learned from the demonstration:

- The physical separation and acid leaching technology is a viable alternative for processing small-arms range soils at most sites.
- With a strong acid such as hydrochloric acid, different heavy metal speciation and soil-metal binding mechanisms at different sites may not be a significant limitation in achieving the TCLP lead target. With a weak acid, such as acetic, metal speciation and soil-metal binding mechanisms at some sites may impose limitations in meeting the TCLP lead target. This conclusion was based partly on the Fort Polk experience and partly on the results of other studies (Van Benschoten et al., 1997; Igwe et al., 1994; and Krishnamurthy, 1992).

- Acetic acid leaching is costlier than hydrochloric acid leaching because of the higher unit price and higher concentration requirements of acetic acid. However, acetic acid is expected to be relatively more benign on the soil structure and process equipment.
- Technical and economic feasibility of the technology at a given site will depend on the processing targets assigned for the project. For inactive ranges, some states may require more stringent processing criteria than meeting TCLP. The feasibility of the technology at such sites should be evaluated through bench-scale tests.
- Bench-scale studies are the most important tool for assessing technical feasibility and cost effectiveness of the technology on a site-specific basis. A comprehensive bench-scale study that tests every element of the process, including physical separation, leaching, precipitation, and dewatering is a major contributor to success in the field.
- Plant design should be flexible enough to handle the expected variability in the texture and metals content of the soil. Adequate process control should be built into the testing plant to enable personnel to verify that operating parameters established during bench-scale testing are being met in the field.

Sources

Battelle. 1996. *Technology Demonstration Plan for Joint Small-Arms Range Remediation at Fort Polk, Louisiana*. Prepared by Battelle Columbus Operations for Naval Facilities Engineering Service Center and U.S. Army Environmental Center, October 14.

Fristad, W.E., D.K. Elliott, and M.D. Royer. 1996. "EPA Site Emerging Technology Program: Cognis Terramet® Lead Extraction Process." *Air & Waste Manage Assoc.*, 46:470-480.

Igwe, G.J., P.D. Walling, Jr., and D. Johnson. 1994. "Physical and Chemical Characterization of Lead-Contaminated Soil." *1994 Innovative Solutions for Contaminated Site Management*. The Water Environment Federation conference, Miami, FL. March 6.

Krishnamurthy, S. 1992. "Extraction and Recovery of Lead Species from Soil." *Environmental Progress*, 11(4):256-260.

Means, R.S. 1996. *Softbooks™ – Environmental Restoration Cost Books*. ECHOS, LLC.

Taggart, A.F. 1945. *Handbook of Mineral Dressing, Ores and Industrial Minerals*. John Wiley & Sons, New York, NY.

U.S. Environmental Protection Agency. 1995. *Contaminants and Remedial Options at Selected Metal-Contaminated Sites*. EPA/540/R-95/512. Office of Research and Development, Washington, DC.

Van Benschoten, J.E., M.R. Matsumoto, and W.H. Young. 1997. "Evaluation and Analysis of Soil Washing for Seven Lead-Contaminated Soils." *Journal of Environmental Engineering*, 123(3):217-224.

Additional References

Battelle. 1997a. *Physical Separation and Acid Leaching: A Demonstration of Small-Arms Range Remediation at Fort Polk, Louisiana*. Final report prepared for Naval Facilities Engineering Service Center and U.S. Army Environmental Center. July.

Battelle. 1997b. *Physical Separation and Acid Leaching: A Demonstration of Small-Arms Range Remediation at Fort Polk, Louisiana, Implementation Guidance Handbook*. Prepared for Naval Facilities Engineering Service Center and U.S. Army Environmental Center. August.

BDM. 1997. *Demonstration of Physical Separation/Leaching Methods for the Remediation of Heavy Metals-Contaminated Soils at Small-Arms Ranges*. Prepared for U.S. Army Environmental Center and Naval Facilities Engineering Service Center. June.

BDM. 1996. *Worldwide Search Report*. Prepared for U.S. Army Environmental Center. February 7.

Lead Industries Association. 1992. *Lead Recycling – 1992 Directory*. Lead Industries Association, New York, NY.

U.S. Environmental Protection Agency. 1991. *Superfund Engineering Issue – Treatment of Lead-Contaminated Soils*. EPA/540/2-91/009. Office of Solid Waste and Emergency and Remedial Response, Washington, DC; and Office of Research and Development, Risk Reduction Engineering Laboratory, Cincinnati, OH.

U.S. Environmental Protection Agency. 1992. *Engineering Bulletin: Selection of Control Technologies for Remediation of Lead Battery Recycling Sites*. EPA/540-S-02/011. Office of Emergency and Remedial Response, Washington, DC.

U.S. Environmental Protection Agency. 1994. *VISITT C Vendor Information System for Innovative Treatment Technologies*. EPA/542/R-94/003 (with update to Version 4.0). Office of Solid Waste and Emergency Response, Washington, DC.

Analysis Preparation

The on-site evaluation and this analysis of the demonstration was conducted by:

Battelle
505 King Avenue
Columbus, Ohio 43201

Project Leader: Arun Gavaskar (614) 424-3403

Certification

This analysis was reviewed by:

Naval Facilities Engineering Service Center
1100 23rd Street
Port Hueneme, California

U.S. Army Environmental Center
Building E-4430
Aberdeen Proving Ground, Maryland 21010

Project Officer: Barbara Nelson
Phone: (805) 982-1668

Project Officers: Richard O'Donnell
Phone: (410) 612-6850

Lisa Miller
Phone: (410) 612-6843