

DISTRIBUTION STATEMENT A

Approved for public release;
Distribution Unlimited

Unexploded Ordnance (UXO) Reference Manual October 1996

DANGER

EXTREMELY HAZARDOUS
UNEXPLODED AMMUNITION
DO NOT GET OFF ROAD
BETWEEN HERE AND
MACHINE GUN ROAD



19980325 046

Unexploded Ordnance Reference Manual

October 1996

DTIC QUALITY INSPECTED 2

Distribution Unlimited; Approved for Public Release

TABLE OF CONTENTS

1.0	BACKGROUND INFORMATION	1-1
2.0	ORDNANCE GUIDE	
2.1	OVERVIEW OF UXO	2-1
2.2	TYPES OF UXO	2-1
2.3	GLOSSARY	2-9
3.0	TABLES	
3.1	PRIVATE INDUSTRY	3-1
3.2	GOVERNMENT AGENCIES	3-32
3.3	UNIVERSITIES	3-40
4.0	BIBLIOGRAPHY	4-1

FOREWARD

This document has been prepared for the Federal Advisory Committee for the Development of Innovative Technologies, in cooperation with:

Department of Defense Explosives Safety Board
Naval Explosive Ordnance Disposal Technology Division
United States Army Environmental Center
PRC Environmental Management, Inc.

The Committee is comprised of representatives from the Western Governors' Association, Department of Defense, Department of Energy, Environmental Protection Agency, and Department of the Interior.

SECTION 1

**BACKGROUND
INFORMATION**

1.0 BACKGROUND INFORMATION

More than 11 million acres of U.S. government property across the country contain some form of unexploded ordnance (UXO) as a result of weapons system testing and troop training activities conducted over the past century at Department of Defense (DoD) sites. After a worldwide study in 1994, the United Nations declared UXO to be the second leading cause of preventable death in the world, estimating that 20,000 civilians lose their lives each year as a result of encountering some form of UXO.

DoD is responsible for the management of thousands of military installations and other defense sites throughout the United States and overseas. The downsizing of DoD and the closure of military bases over the past decades have yielded about 1,900 formerly used defense (FUD) sites and 130 base realignment and closure (BRAC) sites. DoD installations now face many unique environmental problems, one of which is the presence of UXO. UXO is unique because it poses immediate or imminent danger of explosion and loss of life and property.

The problems associated with UXO are compounded by other factors. For example, the topography, geology, and current uses of UXO sites vary greatly, as do the quantities and types of UXO present. Many FUD and BRAC sites are being used as farmlands, others are wildlife refuges, and still others have been developed for residential and other public and private uses. Additionally, many active DoD installations are conducting installation restoration programs to eliminate or minimize UXO hazards. Many active and formerly used installations include rugged terrain as well as areas that are heavily concentrated not only with UXO, but with natural and manmade debris that makes UXO characterization and remediation difficult.

The scope of the UXO problem and the associated hazards to DoD personnel and the public have created the need for advanced UXO identification, characterization, and remediation technologies. According to the 1994 Tri-Service Strategic Plan, each service ranked UXO compliance problems among their highest priorities.

DoD has become increasingly aware of the need to accurately and reliably assess areas containing UXO and to economically characterize and remediate these areas before their reuse. The current technique for UXO characterization typically involves conducting visual surface sweeps. This technique is labor-intensive, costly, and dangerous, and has been statistically proven to detect only about 40 percent of the UXO actually present. Available clearance options are limited by personnel safety concerns.

In November 1994, the U.S. Army Environmental Center (USAEC) sponsored a meeting for those who use UXO clearance technology to better define tri-service needs and priorities. The principal conclusions drawn at the meeting were as follows:

- Proven technology is needed to address surface and subsurface UXO.
- An interaction of various technologies (sensors, sensor platforms, and navigation and data analysis techniques) are needed for complete, accurate, and reliable site characterization.

- UXO discrimination algorithms need to be enhanced, field-tested, validated, and implemented.
- New techniques and technologies are needed for UXO remediation; remote or autonomous systems are desirable to minimize hazards to personnel and improve remediation efficiency.
- Underwater UXO detection, identification, mapping, and remediation systems are needed.
- Automated, standard methods need to be employed to track (from deployment through cleanup to disposal) and document all UXO-related information.

The purpose of this publication is to: (1) outline the scope of the UXO problem; (2) present the basic types, characteristics, deployment methods, and hazards associated with UXO that may be found in the U.S.; (3) provide a resource directory of selected private, federal, and academic organizations that may provide UXO-related equipment and services; and (4) provide a limited list of UXO-related publications and conferences. This information is intended to facilitate communication between interested parties so that resources may be shared and the problems associated with UXO clearance can be better addressed.

SECTION 2

**ORDNANCE
GUIDE**

2.0 ORDNANCE GUIDE

2.1 OVERVIEW OF UXO

DoD defines "explosive ordnance" as any munition, weapon delivery system, and ordnance item that contains explosives, propellants, and chemical agents. UXO consists of these same items after they (1) are armed or otherwise prepared for action, (2) are launched, placed, fired, or released in a way that they cause hazards, and (3) remain unexploded either through malfunction or design.

A person's ability to recognize a UXO is the first and most important step in reducing the risk posed by a UXO hazard. This section presents information on the most common types of UXO and how it may be found in the field.

2.2 TYPES OF UXO

In the past century, all shapes, sizes, and types of explosive ordnance have been used in the U.S. for weapons system testing and troop training activities. The following types of UXO are most likely to be encountered on active DoD sites and FUD and BRAC sites:

- Small arms munitions
- Hand grenades
- Projectiles
- Mortars
- Projected grenades
- Rifle grenades
- Submunitions
- Bombs
- Guided missiles
- Rockets

Ordnance is color-coded during manufacturing for identification purposes. However, color markings cannot be relied upon to identify UXO—markings can be altered or removed by weather or exposure to the environment. The following sections describe the basic features and characteristics associated with each general type of UXO. Additional information can be found in *Unexploded Ordnance (UXO) Procedures* (U.S. Army 1994).

SMALL ARMS MUNITIONS

Small arms munitions contain projectiles that are 0.5 inches or less in caliber and no longer than approximately 4 inches. They are fired from various sizes of weapons, such as pistols, carbines, rifles, automatic rifles, shotguns, and machine guns. Generally, the shell casings of small arms munitions are made from brass or steel and contain lead, steel, depleted uranium, incendiary material, or tracer material. Small arms munitions contain projectiles that are typically copper or lead. Although the hazards associated with these UXO are much less than for other munitions, unexploded small arms munitions may explode if thrown into a fire or struck with a sharp object such as a nail. Figure 1 illustrates various small arms munitions.

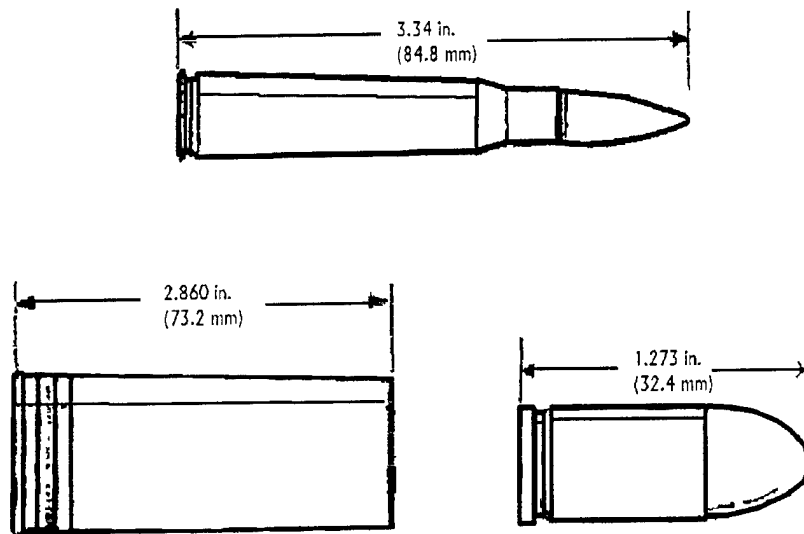

Figure 1 Various small arms munitions

HAND GRENADES

Hand grenades are classified according to type, use, and function. They may be encountered because of their small size and frequent use. Grenades may be used as antipersonnel, antitank, smoke, incendiary, chemical, target practice, and illumination weapons. All hand grenades have three main parts: a body, a fuze with a pull ring and safety clip assembly, and a filler. They are small explosive- or chemical-type munitions that are designed to be thrown at short range. Figures 2 and 3 show various types of grenades.

Fragmentation grenades are the most common type of grenade used. They have a metal or plastic body filled with an explosive material. When the filler explodes, the body of the grenade or a metal fragmentation sleeve breaks into small, lethal, high-velocity fragments. These grenades use a pyrotechnic delay fuze that functions 3 to 5 seconds after the safety lever is released. Other grenades may be made of metal, plastic, cardboard, or rubber and may contain explosives, white phosphorus, chemical agents, or illumination flares, depending on their intended use. Most use a burning delay fuze that functions 3 to 5 seconds after the safety lever is released, but some are activated instantly when the lever is released (smoke grenades).

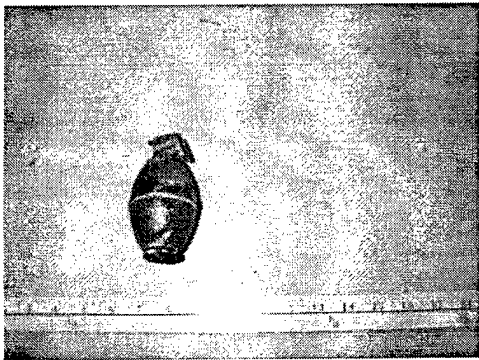

Figure 2 High-explosive (HE) fragmentation grenade



Figure 3 Various hand grenades

PROJECTILES

Projectiles range from 0.8 inches (or less than 1 inch) to 16 inches in diameter and from 2 inches to 4 feet in length. Fillers may include antipersonnel munitions, high-explosive, high-explosive antitank, high-explosive plastic, high-explosive ejection, illuminating, smoke, and white phosphorus. All projected ordnance is fired from some type of launcher or gun tube. Projected ordnance falls into the following subgroups: artillery projectiles, mortars, rockets, guided missiles, rifle grenades, and drill ammunition (drill ammunition is assembled with inert materials and is used as a training device or for testing only).

Projectile fuzes can be located in the nose or in the base. Like rockets, projectiles may be stabilized during flight by fins or bands fixed around the circumference of the projectile. Figures 4 through 7 show various types of projectiles. Projectiles such as riot-control agents, illumination, and high-explosive ejection, will produce empty shells once their canister, illumination flare, or shrapnel has been expended.



Figure 4 Various spin-stabilized projectiles

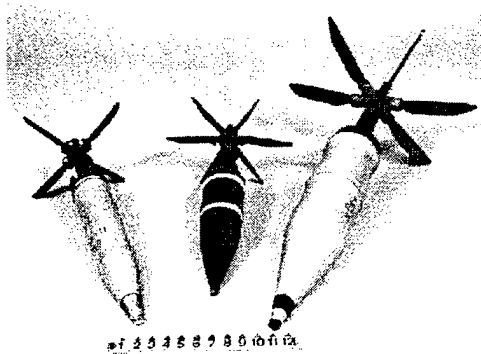

Figure 6 Folding-fin stabilized high-explosive antitank (HEAT) projectiles

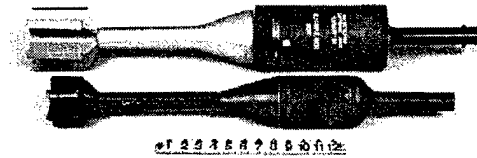

Figure 5 Fin-stabilized projectiles: 90mm (front) and 120mm high-explosive antitank (HEAT) (rear)

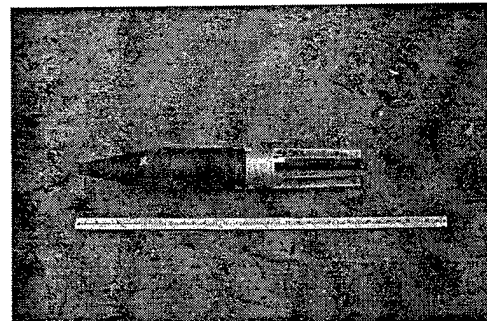

Figure 7 106mm high-explosive antitank (HEAT) recoilless rifle projectile

MORTARS

Mortars range from approximately 1 inch to 11 inches in diameter and can be filled with explosives, toxic chemicals, white phosphorus, or illumination flares. Mortars generally have thinner metal casing than projectiles, but use the same types of fuzing and stabilization. Figures 8 through 10 show various types of mortars.



Figure 8 Various fin-stabilized mortars: 60mm and below

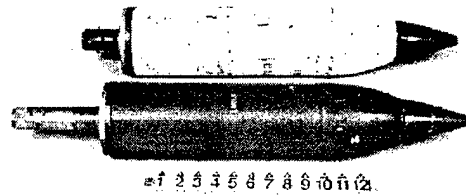

Figure 9 Spin-stabilized mortars

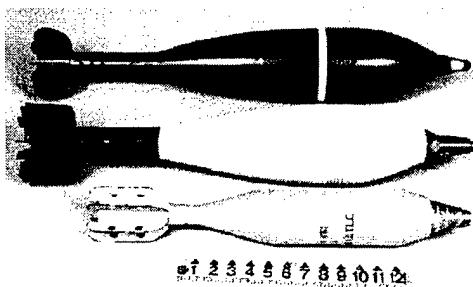

Figure 10 Fin-stabilized mortars: 81mm and 120mm

PROJECTED GRENADES

The most commonly used projected grenade is the 40 millimeter (40mm) grenade. This grenade is also among the most commonly found UXO items. The 40mm grenade is about the same size and shape as a chicken egg, as shown in Figure 11. The 40mm grenade contains high explosives and uses a variety of fuzes, including some of the most sensitive internal impact fuzing systems. Because of their relatively small size, 40mm grenades are easily concealed by vegetation. They are extremely dangerous and can explode if moved or handled.



Figure 11 40mm high-explosive (HE) projected grenade

RIFLE GRENADES

Rifle grenades look like mortars and range from about 9 to 17 inches in length. They may be filled with high explosives, high-explosive antitank (shaped charge), white phosphorus, riot-control agent, illumination flares, or chemicals that produce colored smoke. Rifle grenades are fired from standard infantry rifles. They have an opening at the far end of a tube near the fin assembly that allows the rifle grenade to be placed on the barrel of a rifle. Rifle grenades rely on impact fuzing, which is located on the nose or internally behind the warhead. Figures 12 and 13 show various types of rifle grenades.



Figure 12 M9A1 high-explosive antitank (HEAT) rifle grenade



Figure 13 Various rifle grenades

SUBMUNITIONS

Submunitions include bomblets, grenades, and mines filled with explosives or chemical agents. They may be antipersonnel, antimateriel, antitank, dual-purpose, incendiary, or chemical submunitions. Submunitions are typically spread over a large area by aircraft dispensers, missiles, rockets, or artillery projectiles. Each of these delivery systems disperses the submunitions while still in flight, scattering the submunitions over an area.

Submunitions are activated in a variety of ways, depending on their intended use. Some are activated by pressure, impact, movement, or disturbance. Others are activated in flight or when they come near metallic objects. Some submunitions contain a self-destruct fuze as a backup. The self-destruct time can vary from a couple of hours to several days. Warning: Submunitions are extremely hazardous because even very slight disturbances can cause them to explode. Some types of submunitions require stabilization to hit the target straight on. Stabilization can be provided through an arming ribbon, parachute, or fin assembly. Figures 15 through 17 show a variety of submunitions.

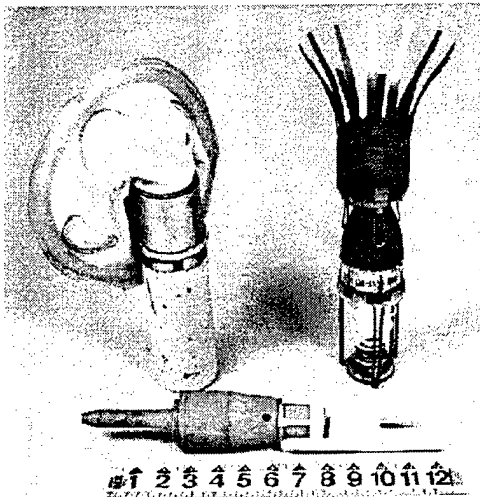

Figure 15 Antimateriel (AMAT)/antitank (AT) submunitions (conventional)

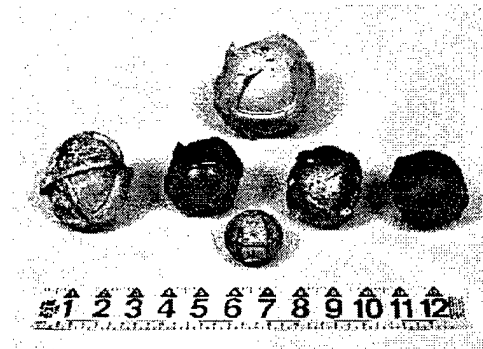

Figure 16 Antipersonnel (APERS)/antimateriel (AMAT) submunitions

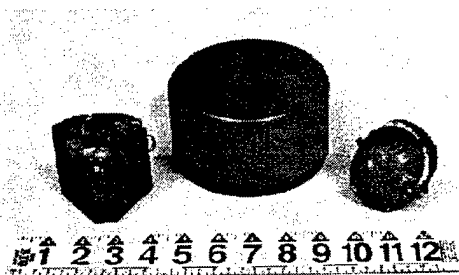

Figure 17 Area-denial submunitions: area-denial artillery munition (ADAM) (left), remote antiarmor mine system (RAAMS) (middle), and bomb live unit (BLU)-54/B (right)



Figure 18 Antipersonnel (APERS)/antimateriel (AMAT) submunitions (conventional)

BOMBS

Bombs range in weight from 1 to 3,000 pounds and in length from 3 to 10 feet. Generally, all bombs have the same components -- a metal container, a fuze with a booster, and a stabilizing device. The metal container, or bomb body, holds the explosive or chemical filler and may consist of one piece or multiple pieces. Bombs are divided into four principle groups: high-explosive, fire and incendiary, dispenser and cluster, and special-purpose weapons. They also come as practice bombs that are used for pilot training and contain inert materials and spotting charges. Figures 19 through 21 show various types of bombs.

Bombs use either mechanical or electrical fuzes, typically located in the nose or tail section, either internally or externally. Mechanical fuzes are generally armed by some type of arming vane. The arming vane operates like a propeller to line up all the fuze parts and thus arm the fuze. The fuzes may be configured as impact, proximity, or delay. Bombs are stabilized during flight by fin or parachute assemblies attached to the rear section of the bomb. These assemblies often detach from the bomb after impact.



Figure 19 Various general purpose (GP) bombs

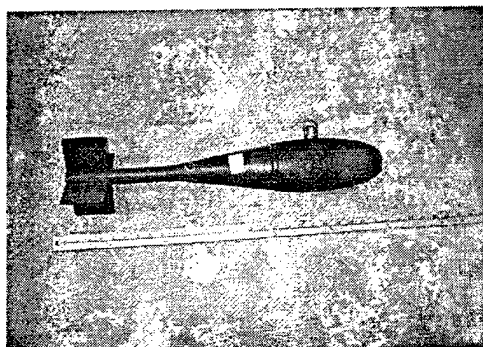

Figure 21 Bomb dummy unit (BDU)-33, 25-lb practice bomb (may contain a spotting charge)

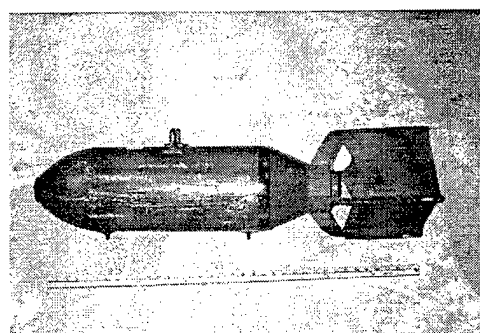

Figure 20 Old style bomb, 1930 to 1960s (boxed fins)

ROCKETS

A rocket uses gas pressure from rapidly-burning material (propellant) to transport a payload (warhead) to a desired location. Rockets can range from 37 to more than 380 millimeters in diameter (approximately 1½ to 15 inches), and they can vary from 1 foot to over 9 feet in length. All rockets consist of a warhead section, a motor section, and a fuze. They are unguided after launch and are stabilized during flight by canted nozzles at the base of the motor or fins attached to the motor. Figures 22 and 23 show various types of rockets.

The warhead section of the rocket is the portion that produces the intended effect; it can be filled with explosives, toxic chemicals, white phosphorus, submunitions, riot-control agent, or illumination flares. Fuzes may be located in the nose of the rocket or internally between the warhead and motor. The fuzing on rockets can be impact, time-delay, or proximity fuzing. Impact fuzes function when they hit the target. Delay fuzes contain an element that delays explosion for a fixed time after impact. Proximity fuzes are intended to function when the rockets reach a predetermined distance from the target. *Caution: Do not approach —proximity fuzing may activate, causing the rocket warhead to explode.* Also, fired rockets may still contain residual propellant that could ignite and burn violently.

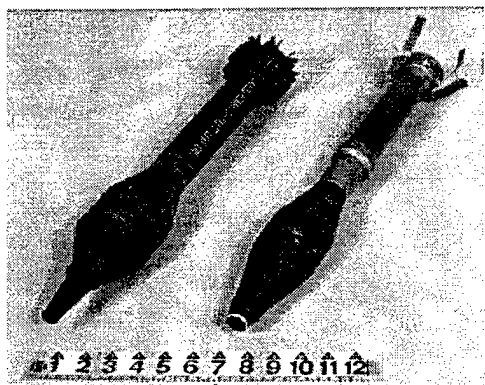

Figure 22 Fin-stabilized high-explosive antitank (HEAT) rockets

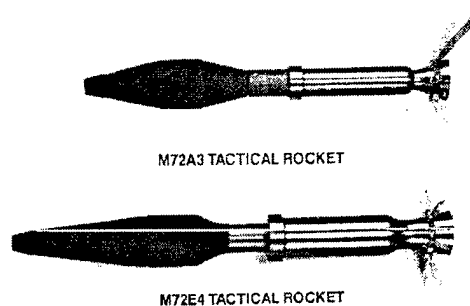

Figure 23 Lightweight multipurpose assault weapons

GUIDED MISSILES

Guided missiles are similar to rockets (see Figures 24 and 25); however, they are guided to their target by various guidance systems. Some are wire-guided, and others are guided by internal or external radar or video. Guided missiles are usually stabilized by fins controlled by internal electronics. Internal proximity fuzes are used in guided missiles, which makes approaching them extremely dangerous. *Also, fired guided missiles may still contain residual propellant that could ignite and burn violently.*

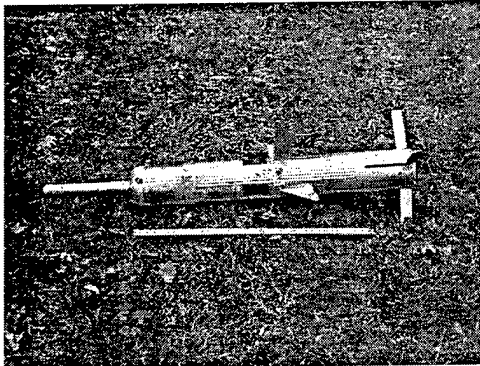

Figure 24 Tube-launched, optically-tracked, wire-guided (TOW) guided missile

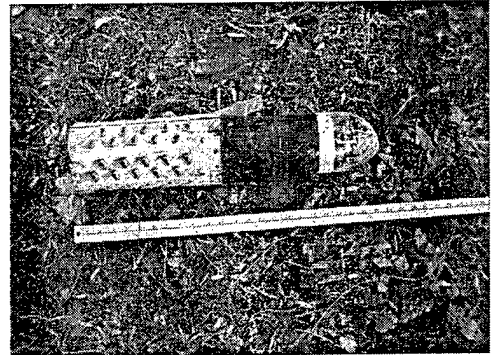

Figure 25 Dragon guided missile

2.3 GLOSSARY OF ORDNANCE-RELATED TERMS

This glossary defines ordnance-related terms.

antimateriel: A weapon system or ordnance item designed specifically to destroy equipment or materials other than personnel.

antipersonnel: A weapon system or ordnance item designed specifically to destroy or disrupt personnel.

artillery: A complete projectile-firing weapon consisting of cannon or missile launcher on suitable carriage or mount. Field artillery cannons are classified according to caliber as light, medium, heavy, and very heavy.

antitank: A weapon system or ordnance item designed to be used against tanks.

bomb: 1. Explosive or other lethal agent, together with its container or holder, which may be planted or thrown by hand, dropped from an aircraft, or projected by some other slow-speed device and used to destroy, damage, injure, or kill. 2. Anything similar to this object in appearance, operation, or effect, as a leaflet bomb, smoke bomb, or photoflash bomb. 3. Bomb designed to be dropped from an aircraft, carrying either a high-explosive or other agent, and normally detonated on contact or by a timing device.

booster: 1. A high-explosive element sufficiently sensitive so as to be actuated by small explosive elements in a fuze or primer and powerful enough to cause detonation of the main explosive filling. 2. An auxiliary or initial propulsion system which travels with a missile or aircraft and which may or may not separate from the parent craft when its impulse has been delivered.

caliber: The diameter of a projectile, gun bore, or launching tube; usually expressed in millimeters or inches.

casing: The fabricated outer part of ordnance designed to hold an explosive charge and the mechanism required to fire this charge.

canister: A special, short-range antipersonnel projectile consisting of a light sheet-metal casing that is loaded with preformed submunitions such as small steel balls. The casing is designed so that rotation causes it to open at, or just beyond, the muzzle of the gun, dispersing submunitions in a cone shape.

cartridge-actuated device: See "propellant-actuated device." A device that employs the gases produced by burning propellants to perform a mechanical action other than the propelling of a projectile. These devices are compact packages that can be mechanically, electrically, or gas triggered. They usually have self-contained power sources which supply mechanical energy in the form of recilinear or rotary motion; the power source is frequently in the form of a special cartridge.

deflagrate: To burn rapidly with intense heat and sparks being generated.

detonation: Classified as an explosion. It is a chemical reaction that propagates with such rapidity that the rate of advance of the reaction zone into the unreacted material exceeds that velocity of sound in the unreacted material.

dispenser: An item designed to be mounted, but not permanently fixed, on aircraft to carry and eject small ordnance.

electromagnetic induction: Transfer of electrical power from one circuit to another by varying the magnetic linkage.

electromagnetic radiation: Consists of waves of electrical energy at radio transmission frequencies. These waves are radiated in a line-of-sight from the antennas of electronic devices that transmit radio, radar, television, or other communication or navigation radio frequency signals. The energy is usually equally radiated in all directions; however, certain types of antennas focus the energy, transmitting it in a single direction or sector.

explosive: See "detonation." A substance or mixture of substances that may be made to undergo a rapid chemical change without an outside supply of oxygen, with the liberation of large quantities of energy generally accompanied by the evolution of hot gases. Explosives are divided into two classes: high explosives and low explosives, according to their rate of reaction in normal usage.

explosive ordnance disposal: The detection, identification, field evaluation, rendering safe, recovery, evacuation, and disposal of explosive ordnance that has been fired, dropped, launched, projected, or placed in such a manner as to constitute a hazard to operations, installations, personnel, or materiel. It also includes the rendering safe and/or disposal of ordnance that has become hazardous or unserviceable by damage or deterioration when the disposal of such ordnance is beyond the capabilities of personnel normally assigned to the responsibility for routine disposition.

flare: 1. A pyrotechnic designed to produce a single source of intense light for illumination.
2. A pyrotechnic designed to produce infrared radiation of greater intensity than that produced by jet engine exhaust for a sufficient time to decoy and direct enemy heat-seeking missiles.

fragmentation: Term applied to ordnance indicating that it is primarily intended to produce a fragmentation effect.

fuze: 1. A device with explosive components designed to initiate a train of fire or detonation in ordnance by an action such as hydrostatic pressure, electrical energy, chemical, impact, mechanical time, or a combination of these. 2. A nonexplosive device designed to initiate an explosion in ordnance.

fuze, delay: Any impact fuze incorporating a means of delaying its action after contact with the target. Delay fuzes are classified to the length of time of the delay as follows: long, medium, and short delay.

fuze, impact: A fuze in which detonation is initiated by the force of impact and that usually functions instantaneously or after a short delay.

fuze, proximity: A fuze wherein primary initiation occurs by remotely sensing the presence, distance, and/or direction of the target through the characteristics of the target itself or its environment.

fuze, self-destruct: A fuze designed to burst a projectile before the end of its flight.

gradiometer: Magnetometer for measuring the rate of change of a magnetic field.

grenade: Small fragmentation (defensive) or blast (offensive) ordnance, originally designed to be thrown by hand, but also designed to be projected from rifles, special launchers, and dispensing munitions.

high explosive: An explosive compound that normally detonates rather than deflagrates or burns and produces a pressure/shock wave.

high-explosive ejection: Ordnance (usually a projectile or rocket) that contains a submunitions payload.

high-explosive incendiary: Ordnance that contains both an explosive compound and a flammable agent. The incendiary filler intensifies that level of fire and the thermal effects.

igniter: 1. Specially arranged charge of ready-burning composition used to assist the initiation of a propelling charge. 2. Device containing such a composition which is used to amplify the initiation of a primer in the functioning of a fuze.

illuminating: Indicates that the ordnance is intended primarily for providing light of high intensity. Such ordnance usually contains a flare and may contain a parachute for suspension in the air.

impact: The striking of an object against another, as the striking of a projectile or bomb on the target or surface.

incendiary: Any flammable material that is used as a filler in ordnance intended to destroy a target by fire.

inert: Descriptive of the condition of ordnance, or components thereof, which contains no explosive, pyrotechnic, or chemical agent.

live ordnance: Ordnance containing explosives or active chemicals as distinguished from inert or drill ordnance.

materiel: All items necessary for the equipment, maintenance, operation, and support of military activities without distinction as to their application for administrative or combat purposes; excludes ships or naval aircraft.

misfire: Failure to fire or explode properly or failure of a primer or the propelling charge of a projectile to function, wholly or in part.

mortar: A muzzle-loading, indirect fire weapon with either a rifled or smooth bore. It usually has a shorter range than a howitzer and employs a higher angle of fire.

munition: 1. Ordnance. 2. Any and all supplies and equipment required to conduct warfare.

ordnance: 1. Military weapons collectively, along with ammunition and the equipment to keep them in good repair. 2. Explosives, chemicals, pyrotechnics, and similar stores, e.g., bombs, guns and ammunition, flares, smoke, napalm.

projectile: An object projected by an applied exterior force and continuing in motion by virtue of its own inertia, as a bullet, bomb, shell, or grenade. This also applied to rockets and to guided missiles.

propellant: An agent such as an explosive powder or fuel that can be made to provide the necessary energy for propelling ordnance.

propellant-actuated device: See "cartridge-actuated device." A device that employs the gases produced by burning propellants to perform a mechanical action other than the propelling of a projectile. These devices are compact packages that can be mechanically, electrically, or gas triggered. They usually have self-contained power sources that supply mechanical energy in the form of rectilinear or rotary motion; the power source is frequently in the form of a special cartridge. For this reason, the devices were formerly known as cartridge-actuated devices.

pyrotechnic: A mixture of chemicals when ignited is capable of reacting exothermically to produce light, heat, smoke, sound or gas, and may also be used to introduce a delay into an explosive train because of its known burning time. The term excludes propellants and explosives.

render safe procedure: That portion of an explosive ordnance disposal procedure that is designed to preclude the detonation or functioning of explosive ordnance, and which involves the application of special EOD techniques and tools to interrupt functions or separate essential components of the ordnance.

rocket: Unmanned, self-propelled ordnance, with or without a warhead, designed to travel above the surface of the earth and whose trajectory or course cannot be controlled during flight. Excludes guided missiles and the like whose trajectory or course during flight can be controlled remotely by homing systems, or by inertia and/or programmed guidance from within.

shaped charge: A charge shaped so as to concentrate its explosive force in a particular direction.

shell: 1. A hollow metal projectile designed to be projected from a weapon, containing or intended to contain a high-explosive, chemical, atomic, or other charge. 2. A shotgun cartridge or cartridge for artillery or small arms.

shrapnel: Small lead or steel balls contained in a shell with a small bursting charge that, when functioned by a fuze, projects or scatters the balls. This is also applied to ordnance fragments.

smoke: 1. Suspension of small liquid or solid particles in air. 2. Filling for ordnance. 3. Intended to produce smoke used for cover or concealment.

spotting charge: An explosive filler that produces a flash and smoke when detonated. This filler is often used in practice bombs so that observers have a visual reference for each impact location.

submunition/missile: Bombs, grenades, mines, and other small miscellaneous munition items that are dispensed from cluster bombs, cluster bomb unit (CBU) systems, modular weapon systems, and artillery dispensing rounds.

target practice: Ordnance used for training purposes. The ordnance item may contain either small amounts of explosives or a small spotting charge.

tracer: A device that fits into or is attached to ordnance. It normally contains a starting mixture and illuminant and leaves a trail of flame or smoke to show the trajectory of the ordnance.

training device: A device or item of ordnance, etc., designed or modified for use by a trainee in training.

unarmed: 1. Condition of a fuze (or other firing device) in which the necessary steps to put it in condition to function have not been taken. 2. Condition of the fuze when it is safe for handling, storage, and transportation.

unexploded ordnance: Explosive ordnance that has been primed, fuzed, armed, or otherwise prepared for action, and that has been fired, dropped, launched, projected, or placed in such a manner as to constitute a hazard to operations, installations, personnel, or material and remains unexploded either by malfunction or design or for any other cause.

warhead: That part of a missile, projectile, torpedo, rocket, or other munition that contains the explosive system, chemical or biological agents, or inert materials intended to inflict damage.

white phosphorous: A chemical that when exposed to air, burns spontaneously, producing dense clouds of white smoke.

SECTION 3

TABLES

PRIVATE INDUSTRY

(The information contained herein was provided by the entities listed.)

PRIVATE INDUSTRY

Company Name	Point of Contact	Street Address, Telephone and Facsimile Numbers, and E-Mail Address	Background Information and Description of UXO-Related Activities
Aerodat Inc.	T. Jeffrey Gamey, Manager - Environmental Services	3883 Nashua Drive Mississauga, Ontario Canada L4V 1R3 (905) 671-2446 (905) 671-8160 (fax)	Aerodat Inc. specializes in mineral prospecting and is equipped with several fixed- and rotary-wing aircraft for this purpose. Aerodat also has experience in airborne UXO detection using a six-sensor gradiometer array. This array provides three-component magnetic data necessary for accurate anomaly targeting.
Airborne Environmental Surveys; ERA Aviation	Doug Strahl	14505 Mount Anderson Drive Reno, NV 89506 (702) 677-4200 (702) 677-8864 (fax)	Airborne Environmental Surveys (AES) uses a rotary-wing aircraft equipped with airborne ground-penetrating radar (GPR) for UXO detection. AES combines GPR data with an imaging spectrometer to achieve target identification.
Alliant Techsystems; Global Naval Systems Division	Ronald B. McGough, Director - UXO and Sensor Systems	6500 Harbour Heights Parkway Mukilteo, WA 98275 (206) 356-3224 (206) 356-3186 (fax) ron_mcgough.atk.com	Alliant Techsystems, Global Naval Systems Division (Alliant GNS), has extensive experience in the design, manufacture, and testing of sensing and signal processing systems. Alliant GNS has expertise in signal processing for acoustic and electromagnetic sensors, including ground-penetrating radar, electromagnetic induction, magnetometers, side-looking sonar and synthetic aperture sonar. Alliant GNS also has experience in data processing, antenna beamforming, filtering, detection, localization, classification, false alarm reduction, transmit waveform design, and the Global Positioning System.

PRIVATE INDUSTRY

Company Name	Point of Contact	Street Address, Telephone and Facsimile Numbers, and E-Mail Address	Background Information and Description of UXO-Related Activities
Arete' Engineering Technologies Corporation	Thomas H. Bell, Ph.D., Vice President	1725 Jefferson Davis Highway Suite 707 Arlington, VA 22202 (703) 413-0500 (703) 413-0505 (fax) tbell@va.aetc.com	Arete Engineering Technologies Corporation (AETC) specializes in data processing systems for unexploded ordnance (UXO) survey planning, analysis, and interpretation. AETC is experienced with magnetometers and electromagnetic induction sensors in land and marine applications. AETC data processing systems are employed in the Multisensor Towed Array Detection System developed by the U.S. Naval Research Laboratory and in the Subsurface Ordnance Characterization System developed by the Naval Explosive Ordnance Disposal Technology Division.
Australian Defence Industries Limited	Timothy J. Pippett, Manager - Subsurface Imaging	7918 Jones Branch Drive Suite 600 McLean, VA 22102 (703) 918-4948 (703) 821-9251 (fax)	The Subsurface Imaging Branch within Australian Defence Industries Limited applies geophysical techniques to detect environmental contamination. The branch also has expertise in operating and interpreting other geophysical techniques, including electromagnetic conductivity, ground-penetrating radar, seismic refraction and reflection, and resistivity profiling.
Battelle; Applied Physics Laboratory	Larry Lazofson	505 King Avenue Columbus, OH 43201 (614) 424-7977 lazofson@battelle.org	In Phase I of the UXO Advanced Technology Demonstrations at Jefferson Proving Ground, Madison, Indiana, Battelle Applied Physics Laboratory (Battelle), in conjunction with the Ohio State University ElectroScience Laboratory and Center for Mapping (OSUCFM), demonstrated airborne ground-penetrating radar (GPR). This GPR was originally developed for detecting plastic utility pipes and near-surface land mines. The system has been modified for buried UXO detection. Battelle and OSUCFM also demonstrated a vehicle-towed GPR.

PRIVATE INDUSTRY

Company Name	Point of Contact	Street Address, Telephone and Facsimile Numbers, and E-Mail Address	Background Information and Description of UXO-Related Activities
BEAR, Inc.	Peter Boissier, President and Chief Executive Officer	2815 Broadbent Parkway Suite E Albuquerque, NM 87107-1625 (505) 342-2020	Bear, Inc., supplies integrated products and services, including the development, manufacture, and operation of complete, remote, robotic excavation and retrieval systems, and application engineering services designed to deliver new robotic hardware and software for customer applications. Bear, Inc. remote robotic systems are exceptionally suited for remedial tasks, such as UXO excavation and retrieval and hazardous materials. Bear, Inc. systems have extensive field experience, including UXO retrieval, excavation and inspection of compressed gas bottles, and inspection of unknown chemical agents.
Benthos, Inc.	Kevin McCarthy	49 Edgerton Drive North Falmouth, MA 02556-2826 (800) 446-1222 (508) 563-6444 (fax)	Benthos, Inc. (Benthos) is experienced in the design, development, manufacture, and sales of remotely-operated vehicle systems, subsystems, sensors. Benthos developed the Remote Dig-It System that incorporates sensors and other devices to provide UXO localization and excavation.
Blackhawk Geosciences	Dr. Pieter Hoekstra, Vice President and General Manager	301 Commercial Road Suite B Golden, CO 80401 (303) 278-8700 (303) 278-0789 (fax) pieterhoekstra@mail.crc.com	Blackhawk Geosciences (Blackhawk) specializes in geophysical services for detection and location of UXO and explosive ordnance waste. Blackhawk performs routine surveys on impacted lands, as well as research and development to further improve detection and discrimination capabilities. Under a research and development contract with the Naval Explosive Ordnance Disposal Technology Division, Blackhawk is currently enhancing the state-of-the-art of time-domain electromagnetic sensors.

PRIVATE INDUSTRY

Company Name	Point of Contact	Street Address, Telephone and Facsimile Numbers, and E-Mail Address	Background Information and Description of UXO-Related Activities
BOWAS-Group - BCU	Martina Schneider, Engineer and Technical Project Manager	Moehlstrasse 22 Munich, Germany 81675 49/89/98 66 40 49/89/98 14 71 (fax) 100752.3532@compuserve.com	The BOWAS-Group's (BOWAS) international activities include consulting, engineering, and equipment supply. BOWAS also has experience in startup operations of complete plants for the production of explosives, disposal of munitions and UXO, and treatment of soils contaminated with explosives. During the last 40 years, Bowas has worked jointly with other German firms on a variety of projects for UXO detection and remediation.
Bristol Aerospace Limited	Bob Palmer, Business Development Manager, Targets and Unmanned Vehicles	P. O. Box 874 660 Berry Street Winnipeg, Manitoba Canada R3C 2S4 (204) 788-2952 (204) 775-7494 (fax)	Bristol Aerospace Limited (Bristol), has worked in the UXO field since 1991, focusing on vehicle robotics and autonomous control, sensor data interface, and data reduction. Bristol was awarded license rights to the Canadian Forces-developed JINGOSS system, which was initially designed for robotic mine detection purposes, together with ANCEOUS, which was the control and data link connection. Bristol participated in the second phase of the UXO Advanced Technology Demonstration Program in 1995 and has since incorporated numerous improvements to its system, including the adaptation of different sensor packages.

PRIVATE INDUSTRY

Company Name	Point of Contact	Street Address, Telephone and Facsimile Numbers, and E-Mail Address	Background Information and Description of UXO-Related Activities
CHEMRAD Tennessee Corporation	<p>Robert Selfridge, Senior Geophysicist, P.G. and UXO Project Manager</p> <p>Michael Blair, Vice President - Product Development, E.E. and Director - UXO Research and Development</p>	<p>739 Emory Valley Road Oak Ridge, TN 37830 (615) 481-2511 (615) 483-9528 (fax) 75362.3142@compuserve.com</p>	<p>CHEMRAD manufactures the Advanced Ordnance Locator (AOL) that was recently developed under funding support from the Naval Explosive Ordnance Disposal Technology Division. The AOL interfaces with any UXO detector to provide high-accuracy, high-density, position-correlated data at rates up to 10 times per second in order to yield detailed images of anomalies.</p>
CMS Environmental, Inc.	<p>John Chionchio, Director of Environmental Restoration</p>	<p>4904 Eisenhower Boulevard Suite 310 Tampa, FL 33634 (813) 882-4477 (813) 884-1876 (fax)</p>	<p>CMS Environmental, Inc. (CMS), is an experienced, fully-qualified ordnance and explosives (OE) investigation and remediation firm. CMS applies advanced technologies to detect, identify, and remediate subsurface UXO, including land mines. CMS is currently performing OE removal activities at Base Realignment and Closure and Formerly-Used Defense sites for the U.S. Army Corps of Engineers, Army Engineering and Support Center - Huntsville, Alabama.</p>

PRIVATE INDUSTRY

Company Name	Point of Contact	Street Address, Telephone and Facsimile Numbers, and E-Mail Address	Background Information and Description of UXO-Related Activities
Coleman Research Corporation	Mark Patz, Senior Systems Engineer	5950 Lakehurst Drive Orlando, FL 32819-8343 (407) 352-3700, ext. 1545 (407) 345-8616 (fax) mark_patz@mail.crc.com	Coleman Research Corporation (CRC) developed and demonstrated man-portable and vehicular-mounted systems that incorporate ground-penetrating radar (GPR), pulsed electromagnetic (EM) metal detectors, and/or infrared camera sensors to provide non-intrusive detection and identification of subsurface UXO and miscellaneous objects. CRC has extensive experience in design and assembly, data collection, data processing, and object identification. CRC demonstrated its Towed Multi-Sensor Array System (with GPR and pulsed EM sensors) during the UXO Advanced Technology Demonstrations at Jefferson Proving Ground and Eglin Air Force Base. CRC also has expertise in metallic and nonmetallic mine detection using hand-held mine detectors with GPR sensors, and a vehicle-mounted mine detector with infrared and GPR sensors. CRC is also experienced in identification of subsurface objects using an earth-penetrating radar imaging system.

PRIVATE INDUSTRY

Company Name	Point of Contact	Street Address, Telephone and Facsimile Numbers, and E-Mail Address	Background Information and Description of UXO-Related Activities
COMARCO Engineering Services Division	<p>Dan Kedzie, Quality Resources Branch Manager</p> <p>Patricia Herndon, Environmental Management Resource Manager</p> <p>Bart Barthold, Senior Engineering Technician</p>	<p>Rural Route 6 P.O. Box 28 Bloomfield, IN 47424 (812) 384-3587 (812) 384-3744 (fax) comarco esd@viduct.custom.net</p>	<p>COMARCO Engineering Services Division (COMARCO), is staffed by ordnance, environmental, and quality assurance engineers and specialists, together with health and safety professionals, technical writers, and former military master explosive ordnance disposal technicians. With this diverse background, COMARCO can provide ordnance engineering oversight of plans and programs involving quality assurance and quality control, health and safety and environmental management, as well as site inspections, assessments, investigations, and removal and remediation oversight.</p>
Concept Engineering Group, Inc.	<p>Jerome Apt., Jr., P.E. and Senior Engineer</p>	<p>610 William Pitt Way Pittsburgh, PA 15238-1332 (412) 826-3191 (412) 826-3193 (fax) 72124.1273@compuserve.com</p>	<p>Concept Engineering Group, Inc. (CEG), is an engineering-based company specializing in the development and sale of safe excavation equipment, including prototype systems adapted to meet a customer's specific needs. CEG's proprietary safe excavation technology uses a combination of high-flow, pneumatic vacuum transport, and supersonic air jets to safely dislodge and remove soil. This technology is particularly suited for excavation of any buried object where great care must be taken, such as UXO, hazardous waste, archaeological artifacts, or underground utility pipes or cables. CEG recently demonstrated this technology in the UXO Advanced Technology Demonstration Program at Jefferson Proving Ground in Madison, Indiana.</p>

PRIVATE INDUSTRY

Company Name	Point of Contact	Street Address, Telephone and Facsimile Numbers, and E-Mail Address	Background Information and Description of UXO-Related Activities
Defence Test & Evaluation Organisation; Demilitarisation & Security Systems	Captain Ian Moore, Project Manager	New Ranges Blackgate Road Shoeburyness, Essex England SS3 9SR (1702) 292271, ext. 3252 (1702) 292868	The Defence Test & Evaluation Organisation (DTEO), offers design, test, and evaluation of techniques and equipment used in UXO clearance and disposal programs. DTEO's most recent development is an explosive ordnance disposal, hydro-abrasive, jet-cutting system known as MARLIN.
Dynamic Systems, Inc.; Optical Technologies	Robert Einzig	635 Slaters Lane #100 Alexandria, VA 22314-1177 (703) 684-4060	Dynamic Systems, Inc. is an engineering and management support services firm specializing in management, procurement, and logistics analysis in the areas of mine warfare and torpedoes. Optical Technologies, a division of Dynamic Systems, Inc., designs, develops, and manufactures fiber-optic sensors and sensor systems.
El Dorado Engineering, Inc.	R. Glenn Roberts, Manager - Engineering Programs	2964 West 4700 South Suite 109 Salt Lake City, UT 84118-2554 (801) 966-8288 (801) 966-8499 (fax)	El Dorado Engineering, Inc. (El Dorado), is a high-technology, small business specializing in explosives and UXO recovery and disposal. El Dorado's experience includes recovery of potential chemical warfare material, ordnance explosive waste, and conventional munitions-related items.

PRIVATE INDUSTRY

Company Name	Point of Contact	Street Address, Telephone and Facsimile Numbers, and E-Mail Address	Background Information and Description of UXO-Related Activities
Electronic Mapping System, Inc.	Gerry Turley, President	12125 Popes Head Road Fairfax, VA 22030 (703) 968-3549 (703) 968-4489 (fax) emapps@aol.com	Electronic Mapping System, Inc. (E-MAPS), provides custom map digitization, customized database development, site management support, personnel, training, and technical systems support. E-MAPS has extensive experience with the Geographic Information System in the following areas: initial orientation, project planning, on-site employee orientation, integration with the global positioning system (GPS), electronic data transfer for real-time reporting, and preparation of final reports. In addition, E-MAPS provides accurate maps and reports, custom documentation, compatibility with existing software, worldwide GPS mapping services, on-site support, residual risk assessment, and cost savings.
Engineered Air Systems, Inc.	Ronald W. Davis, Vice President - Marketing	1270 North Price Road St. Louis, MO 63132 (314) 993-5880 (314) 567-4052 (fax)	Engineered Air Systems, Inc., is the U.S. representative for Aardvark Clearmine, Ltd. (Aardvark). Aardvark manufactures a mine flail and "Sifter" that is ideal for UXO ground clearance. The flail is used to break up or explode ordnance and may be used in conjunction with the Sifter, which follows behind the flail to pick up debris. Both of these systems were successfully used after Desert Storm for mine removal and cleanup.
ENSCO, Inc.	David W. A. Taylor, Ph.D., L.G. and Director - Environmental Programs	P.O. Box 41107 Greensboro, NC 27404 (910) 632-1200 (910) 632-1225 (fax) taylord@ensco.com	ENSCO, Inc., provides geophysical surveying, sensor development, and automated data analysis for UXO detection, location, and characterization. ENSCO, Inc., has extensive experience in geophysics and sensor development, applying the full range of geophysical tools, including magnetics, electromagnetics, ground-penetrating radar, and multispectral imaging.

PRIVATE INDUSTRY

Company Name	Point of Contact	Street Address, Telephone and Facsimile Numbers, and E-Mail Address	Background Information and Description of UXO-Related Activities
EnSys Environmental Products, Inc.	Deborah Levitt Smith, Technical Sales Manager - Southeast Region	P.O. Box 14063 Research Triangle Park, NC 27709 (919) 941-5509, ext. 151 (919) 941-5519 (fax)	EnSys Environmental Products, Inc., developed and manufactures a TNT and RDX wet chemistry, nonimmunoassay, field-compatible analytical test kit. The testing method was originally developed by Dr. Thomas F. Jenkins with the Cold Regions Research and Engineering Laboratory and funded by the U.S. Army Environmental Center.
EnTech Engineering, Inc.	Gary J. Weil, P.E., CPIM	1846 Craig Park Court St. Louis, MO 63146 (314) 434-5255 (314) 434-3270 (fax) weilgj.aol.com	EnTech Engineering, Inc. (EnTech), is a professional design and engineering company specializing in nondestructive testing. EnTech has experience in designing infrared thermographic electro-optical and ground-penetrating radar systems designed to locate buried objects, such as landmines and other UXO and hazardous waste. EnTech has designs pending for man-portable, vehicle-mounted, and helicopter or fixed-wing, aircraft-mounted landmine detection systems.
Environmental Chemical Corporation	Richard Posey, Director - UXO Division Chuck Welk, UXO Project Manager David Briggs, International Marketing	UXO Division 4909 Murphy Canyon Road Suite 405 San Diego, CA 92123 (619) 576-0107 (619) 576-1329 (fax) eccuxo@adnc.com	Environmental Chemical Corporation (ECC) specializes in ordnance explosives and hazardous, toxic, and radiological waste (HTRW) remediation and analytical services, and is comprised of three divisions: UXO, HTRW, and analytical. ECC's UXO Division specializes in UXO avoidance, investigation, removal, mapping, and demining activities.

PRIVATE INDUSTRY

Company Name	Point of Contact	Street Address, Telephone and Facsimile Numbers, and E-Mail Address	Background Information and Description of UXO-Related Activities
Environmental Hazards Specialists International, Inc.	Charles E. Wharton, Sr., President	Route 1 P.O. Box 232 Belvidere, NC 27919 (919) 297-2991 (919) 297-2992 (fax)	Environmental Hazards Specialists, International, Inc. (EHSI), is an experienced, fully-qualified, ordnance and explosive (OE) investigation and remediation firm. EHSI applies advanced technologies to detect, identify, and remediate subsurface UXO, including land mines. EHSI is the United States representative and distributor for Foerster Instruments, offering state-of-the-art training and subsurface detection instruments (DLM-93) with datalogging and data analysis capabilities and a proven track record for UXO detection.
EOD World Services	James J. Witte, Vice President	P.O. Box 355 Fort Walton Beach, FL 32549-0355 (904) 664-0616 (904) 664-5650 (fax) eodws@aol.com hf mixer @ compuserve 70650,221	EOD World Services (EOD) was the prime explosive ordnance disposal subcontractor for UXO removal operations in the American sector of Kuwait following the Gulf War. Since the conclusion of that project, EOD has concentrated on humanitarian demining efforts, advanced technology development and demonstrations, and U.S. Army Corps of Engineers projects.
EODT Technology, Inc.	Paul Greene	10511 Hardin Valley Road Knoxville, TN 37932 (615) 690-6061	EODT Technology, Inc. (EODT) develops specialized equipment, technology, and procedures in support of explosive ordnance disposal and UXO ordnance- and explosive waste-related services. EODT maintains two geophysical surveying test sites for development and testing of geophysical surveying equipment.

PRIVATE INDUSTRY

Company Name	Point of Contact	Street Address, Telephone and Facsimile Numbers, and E-Mail Address	Background Information and Description of UXO-Related Activities
ERA Aviation	O. R. Palmer	6160 South Airpark Drive Anchorage, AK 99502 (713) 621-7800	ERA Aviation is the parent company of Airborne Environmental Surveys, and owns and operates a patented airborne ground-penetrating radar system used for geological surveys and UXO detection.
ERA Technology Ltd.	Peter Mallinson, Sales Manager - Radar Systems	Cleeve Road Leatherhead, Surrey England KT2 7SA 44 (0) 1372 367000 44 (0) 1372 367102 (fax) peter.mallinson@era.co.uk	ERA Technology Ltd. (ERA) has developed and currently produces ground-penetrating radar equipment suitable for UXO detection. Equipment developed by ERA was used for mine clearance during the Falklands war and includes a variety of off-the-shelf radar systems. ERA can also develop special equipment in response to specific customer requirements.
Explosives and Ammunition Technologies Pty Ltd.	Grahame Crane, Director	3 Mac Donald Road Peachester Queensland Australia 4519 61-74-949-724 61-74-949-406	Explosives and Ammunition Technologies (EXAT) specializes in ordnance remediation. EXAT has worldwide experience including location, identification, remediation, and disposal of explosive ordnance and ordnance explosive waste; personnel training for explosive ordnance disposal operations; and maintenance of secure working environments. In addition, EXAT has extensive experience in environmental impact and community awareness programs; siting, planning, and design of ammunition explosive facilities; and all aspects of licensing and safeguarding of explosive facilities. EXAT staff is highly-qualified and experienced in control, safety, and security within ammunition storage facilities; and classification, movement, warehousing, and storage of ammunition and explosives.

PRIVATE INDUSTRY

Company Name	Point of Contact	Street Address, Telephone and Facsimile Numbers, and E-Mail Address	Background Information and Description of UXO-Related Activities
Explosive Countermeasures International, Inc.	Edward J. Seuter	4923 Americana Drive Suite 207 Annandale, VA 22003 (703) 256-1569 (703) 256-0953 (fax) eseuter@dc.infi.net	Explosive Countermeasures International, Inc. (ECI), maintains a vast open-source library and offers comprehensive technical data reports on a variety of munitions not easily accessible elsewhere. ECI can accommodate most word processing and graphic formats, and turn-around time from request to report averages 4 hours.
Foerster Instruments, Inc.	Myles Capen	140 Industry Drive Pittsburgh, PA 15275-1028 (412) 788-8976 (412) 788-8984 (fax)	In Phase I of the UXO Advanced Technology Demonstrations at Jefferson Proving Ground in Madison, Indiana, Foerster Instruments, Inc. demonstrated the Vehicle Mounted Differential Global Positioning System Controlled Combined Shallow/Deep Search Survey System. The system was equipped with an array of FEREX and MINEX sensors mounted on a towed platform for UXO detection.
GDE Systems Inc.	Ray Garriott, Project Manager - Mine Detection Gus Tricoles, Project Manager - Unexploded Ordnance	P.O. Box 509009 San Diego, CA 92150-9009 (619) 675-2818 (619) 675-1999 (fax)	GDE Systems Inc. (GDE) is experienced in UXO detection. GDE demonstrated a towed, vehicular, microwave imaging system in 1994 and 1995 during the UXO Advanced Technology Demonstrations at Jefferson Proving Ground in Madison, Indiana. GDE also develops hand-held radio-wave devices for buried land mine detection; these devices have been demonstrated in several U.S. Army projects.

PRIVATE INDUSTRY

Company Name	Point of Contact	Street Address, Telephone and Facsimile Numbers, and E-Mail Address	Background Information and Description of UXO-Related Activities
Geo-Centers, Inc.	Frank Finch, P.E.; U.S. Army - Retired	6116 Executive Boulevard 120 Rockville, MD 20852-4920 (301) 231-6144 (301) 816-8647 (fax) ffinch@ops.geo-centers.com	Geo-Centers, Inc., provides conventional and innovative technology for UXO detection and remediation. The Geo-Centers' approach brings together a unique, custom-designed, man-portable, Global Positioning System (GPS)-synchronized, dual total-field magnetometer, and a vehicular, GPS-synchronized, total-field magnetometer array, combined with an array of electromagnetic pulsed induction sensors. This system produces same-day, on-site, Geographic Information System-compatible area and target maps.
Geometrics, Inc.	Douglas Groom, Project Manager	395 Java Drive Sunnyvale, CA 94089 (408) 734-4616 (408) 745-6131 (fax)	Geometrics, Inc., manufactures, markets, and sells seismographs, geoelectric instruments, and magnetometers used to characterize and image subterranean regions. This equipment has applications in UXO detection, construction, environmental remediation, infrastructure siting, and natural resource location. Geometrics offers a full line of magnetometers, including land, airborne, and marine models.
Geonics Limited	Frank Snelgrove	1745 Meyerside Drive Mississauga, Ontario Canada L5T 1C6 (905) 670-9580 (905) 670-9204 (fax)	Geonics Limited manufactures the EM61 electromagnetic metal detector, which is used for UXO detection.

PRIVATE INDUSTRY

Company Name	Point of Contact	Street Address, Telephone and Facsimile Numbers, and E-Mail Address	Background Information and Description of UXO-Related Activities
Geophex, Ltd.	Dean Keiswetter, Ph.D., Geophysics Division - Deputy Manager	605 Mercury Street Raleigh, NC 27603 (919) 839-8515 (919) 839-8528 (fax)	Geophex, Ltd., provides environmental and engineering services and conducts research and development for new geophysical instrument development. Geophex personnel use advanced Geophex sensors and commercially-available instruments to locate and characterize subsurface conditions, including trenches, landfills, drums, tanks, and UXO.
GeoPotential	Ralph Soule, President	437 Northeast Liberty Avenue Gresham, OR 97030 (503) 665-7520 (503) 492-4404 (fax) geopotential@ortel.org	GeoPotential uses magnetics, electromagnetics, and ground-penetrating radar to locate UXO. GeoPotential has located UXO for the Port of Portland and participated in the 1995 UXO Advanced Technology Demonstrations at Jefferson Proving Ground in Madison, Indiana.
GeoRadar Inc.	Doug Crice	19623 Via Escuela Drive Saratoga, CA 95070 (408) 867-3792 (408) 867-4900 (fax) 71774.1572@compuserve.com	GeoRadar Inc. is a commercial manufacturer of stepped-frequency modulated ground-penetrating radar systems. These systems offer imaging capabilities with digital control, and can be used stand-alone or integrated into imaging systems.
Georadar Research Pty Ltd.	Richard J. Yelf, Managing Director	412 Eastbank Road Coramba New South Wales Australia 2450 61-66-54-4162 61-66-54-4043 (fax) yelf@midcoast.com.au	Georadar Research Pty Ltd. (Georadar) has extensive experience with ground-penetrating radar (GPR), including projects in Australia, southeast Asia, and the Pacific area. Georadar offers specialized GPR services and contract research and development in the following areas: geotechnical engineering, road/pavement inspection, soil and fill profiling, mineral exploration, mine planning, utility location, pipeline routing, and archaeology, environmental, and landfill sites.

PRIVATE INDUSTRY

Company Name	Point of Contact	Street Address, Telephone and Facsimile Numbers, and E-Mail Address	Background Information and Description of UXO-Related Activities
Geo-Services International (UK) Ltd.; Geo-Services International (SA) Ltd.	Asger S. Eriksen, Ph.D., Managing Director	No. 5 Des Roches Square Witan Way Witney, Oxon United Kingdom OX8 6BE 01993 706707 01993 773040 (fax) 100074.1622@compuserve.com	Geo-Services International (UK) Ltd. and Geo-Services International (SA) Ltd. (Geo-Services), use high-resolution geophysical methods for UXO detection in Europe and Africa. Methods utilized include cesium vapor gradient magnetometry (arrays and single), time-domain electromagnetic profiling, ground-penetrating radar (ground- and air-coupled), and airborne thermal infrared linescanning. Geo-Services also provides proprietary, spatial-relational, database software for UXO data management.
Geosoft, Inc.	Angela Lennox, Environmental Account Representative	Suite 500 204 Richmond Street West Toronto, Ontario Canada M5V 1V6 (416) 971-7700 (416) 971-7520 (fax) http://www.geosoft.com	Geosoft, Inc. developed and markets a comprehensive software package, the UXO Analysis System. The system allows interactive viewing and interpretation of electromagnetic (EM61) and magnetic survey datasets to extract quantitative and qualitative information about buried manmade targets. The system automatically selects targets for quick evaluation of EM61 depth information and magnetic depth and weight information. Geosoft, Inc. also developed and markets a suite of Earth Science Software products.

PRIVATE INDUSTRY

Company Name	Point of Contact	Street Address, Telephone and Facsimile Numbers, and E-Mail Address	Background Information and Description of UXO-Related Activities
Glacier Engineering, P.C.	Alan T. Frohberg, P.E., President and Project Manager	104 2nd Street, South Suite 300 Great Falls, MT 59401 (406) 727-3748	Glacier Engineering, P.C. (Glacier), is a consulting firm that provides innovative and cost-efficient geophysical investigative services for UXO and explosive waste detection and remediation. In addition, Glacier provides geological, water resource, and environmental engineering services for the investigation, containment, and cleanup of hazardous waste-impacted soils and groundwater, and the design of hazardous materials transport, storage, and disposal facilities. Glacier has worked closely with military personnel to investigate the presence of UXO at nonmilitary-owned training sites that were being returned to public use.
Golden West Products International	Joseph L. Trocino, President	15233 Ventura Boulevard Penthouse 8 Sherman Oaks, CA 91403 (818) 981-6400 (818) 501-6181 (fax)	Golden West Products International provides LEXFOAM, a foam explosive, for UXO neutralization. LEXFOAM has a shaving cream consistency, is available for "blow-in-place" applications, and has shown 100% field-proven reliability for UXO neutralization, as well as buried, surface, and above-ground placed landmines.
W.L. Gore & Associates, Inc.	Mark J. Wrigley, P.G., Product Specialist	101 Lewisville Road P.O. Box 1100 Elkton, MD 21922-1100 (410) 996-3406 (410) 996-3325 (fax)	W.L. Gore & Associates, Inc., performs passive soil gas surveys that can determine relative distribution of compounds associated with explosives, shells, and munitions. The survey methods used are highly sensitive to volatile and semivolatile organic compounds, and have been successful in difficult applications, including clay and saturated soils and groundwater.

PRIVATE INDUSTRY

Company Name	Point of Contact	Street Address, Telephone and Facsimile Numbers, and E-Mail Address	Background Information and Description of UXO-Related Activities
Hydro-Innovations Inc.	Herb McGrath, Business Development Manager	5 Harrison Avenue Buckeye Mount Vernon, OH 43050 (614) 392-4643 (614) 392-4513 (fax)	Hydro-Innovations, Inc. (HII), operates mobile, ultra-high pressure, waterjet systems for nonsparking cold cutting, cleaning, and coatings removal applications. The self-contained systems can be remotely operated at pressures up to 40,000 pounds per square inch. HII's experience includes cutting live rocket propellants, removing specialty coatings from bomb exteriors, and cleaning high-explosive materials from munitions. Research and development assistance is available.
International Technology Corporation	Jim Pastorick, UXO Project Manager	302 North Alfred Street Alexandria, VA 22314 (703) 548-5300 (703) 548-5350 (fax)	International Technology Corporation (IT) has provided comprehensive hazardous materials remediation and management services for over 75 years. IT's UXO Division was formed to support IT's increasing workload for active and former Department of Defense facilities. The IT UXO Division is comprised of full-time UXO specialists who perform UXO safety escort and remediation services, including UXO detection, excavation, removal, and disposal for the U.S. Army, Navy, Air Force, and Department of Energy.
ISSI Unexploded Ordnance Inc.	Robert T. Faye, Sr., Senior Vice President	P.O. Box 11 Huntsville, AL 35804-0011 (205) 247-7050 (205) 247-7030 (fax)	ISSI Unexploded Ordnance Inc. (ISSI) provides UXO, chemical warfare materiel (CWM), and explosive safety training, as well as master explosive ordnance disposal personnel for government, environmental, and engineering firms. It performs UXO CWM surveys and investigations; access and ordnance avoidance; range clearance and maintenance; and hazard feasibility and evaluation. ISSI specializes in evaluating explosive safety requirements and providing quality safety training.

PRIVATE INDUSTRY

Company Name	Point of Contact	Street Address, Telephone and Facsimile Numbers, and E-Mail Address	Background Information and Description of UXO-Related Activities
Jaycor	Frank C. Robbins	9775 Towne Centre Drive San Diego, CA 92121 (619) 543-6580 (619) 546-9428 (fax)	Jaycor is a diversified advanced technology company with experience in the areas of telecommunications engineering, defense sciences, systems development, environmental services, information technology services, applied technology, and strategic programs and analysis.
Kaman Science Corporation	Michael A. King, Project Manager	P. O. Box 7463 Colorado Springs, CO 80933 (719) 599-1500 (719) 599-1942 (fax)	Kaman Sciences Corporation (Kaman) is a research and development company that applies science and technology to national defense issues, other government-funded areas of research, and commercial customers. Kaman has experience in surface, subsurface, and submarine object detection, including UXO, using both ground and airborne ground-penetrating radar.
Mac J. International, Ltd.	Jon M. Mc Nerney, President	P. O. Box 629 Alexandria, VA 22313-0629 (703) 836-9304 (703) 836-9307 (fax) mjil@crels.com	Mac J. International, Ltd. (MJIL), conducts evaluations of government UXO sites, assesses UXO remediation feasibility, and provides cost assessments. MJIL also provides assessments of emerging detection technologies, and conducts research, development, testing, and evaluation for UXO and improvised explosive device neutralization.
MAC Technical Services Company	James Dew	3756 West 17th Street Idaho Falls, ID 83402 (303) 273-5092	MAC Technical Services Company (MAC) offers a wide range of environmental and technical support services, including corporate management consulting, maintenance management, nuclear plant operations, fuel management, waste management, permitting, and operational certification.

PRIVATE INDUSTRY

Company Name	Point of Contact	Street Address, Telephone and Facsimile Numbers, and E-Mail Address	Background Information and Description of UXO-Related Activities
Management Technology Associates, Inc.	Michael J. Moran, P.E., Chief - Environmental Engineering Division	688 Discovery Drive Huntsville, AL 35806 (205) 922-1110 (205) 922-1888 (fax) mta@iquest.com	Management Technology Associates, Inc. (MTA), is an engineering firm with expertise in remediation of ordnance explosive waste and chemical warfare materials (CWM). MTA has extensive experience in conventional interim removal actions, CWM surface investigations, and conventional ordnance waste remediation.
Metratek, Inc.	Ed Stapel, Program Manager	12330 Pinecrest Road Reston, VA 22091 (703) 620-9500 (703) 620-9696 (fax)	Metratek, Inc., has developed and demonstrated a mixed-technology, multi-sensor, UXO detection system. This system employs high-performance sensors, and provides rapid, comprehensive, and economical coverage of suspected UXO-contaminated areas in diverse terrain, vegetation, and climate. Metratek's multi-sensor platform includes ground-penetrating radar and electromagnetic sensors for UXO detection, and a high-performance, real-time, Kinematic Differential Global Positioning System for navigation and UXO target location. After data is downloaded from the multi-sensor arrays, proprietary software is used for data collection, real-time display, and storage for on-site and post-survey processing.
Military International Limited	Ron Quigley, President and Sales and Marketing Stuart Henley, Vice President - R & D Engineering	3601 72nd Avenue, Southeast Calgary, Alberta Canada T2C 0G6 (403) 236-2431 (403) 236-1831 (fax)	Military International Limited (MIL) is a NATO-listed defense manufacturer specializing in mine detection and mechanical clearance technologies. MIL has experience with a variety of metal detection coils and arrays, trace explosive detection, and ground-penetrating radar. MIL mechanical clearance projects include mini-flails, South African mine-resistant vehicles, rollers, surface plows, and soil mills.

PRIVATE INDUSTRY

Company Name	Point of Contact	Street Address, Telephone and Facsimile Numbers, and E-Mail Address	Background Information and Description of UXO-Related Activities
Milsearch Pty Ltd	Ronald Furze, Director Operations	191-203 Anktell Street Unit 4, Level 2 Tuggeranong, Australian Capital Territory Australia 2901	Milsearch Pty Ltd (Milsearch) remediates land contaminated by military activities, and remediation is tailored to the land's end use. Milsearch conducts UXO surveys utilizing the TM-4 Digital Imaging Magnetometer system, as well as standard analogue magnetometers, ground-penetrating radar, and EM-61 and handheld metal detectors for surface and subsurface military contamination. Milsearch removes and disposes of all munitions encountered.
Montgomery Watson	Gary Enloe, Project Manager	4525 South Wasatch Boulevard Suite 200 Salt Lake City, UT 84124 (801) 272-1900 (801) 272-0430 (fax) gary.enloe@us.mw.com	Montgomery Watson (Montgomery), provides comprehensive investigation and remediation services for UXO and chemical warfare materiel (CWM) sites. Montgomery is currently performing these services for the military under a number of regional Department of Defense contracts. Montgomery has extensive experience in the following areas: conducting geophysical surveys for subsurface UXO detection, conducting engineering evaluations and cost analyses for UXO and CWM sites, performing remedial investigations to determine environmental impacts from open burning/open detonation areas, preparing UXO or CWM remedial designs, utilizing Geographic Information System technologies for mapping and archiving site data, and CWM remediation.
Naeco Associates, Inc.	E. Stack Gately, President	1925 North Lynne Street Suite 900 Arlington, VA 22209 (703) 524-4551 (703) 525-4266 (fax)	Naeco Associates, Inc., represents Scintrex, and products include cesium magnetometers and explosive detection equipment.

PRIVATE INDUSTRY

Company Name	Point of Contact	Street Address, Telephone and Facsimile Numbers, and E-Mail Address	Background Information and Description of UXO-Related Activities
Nova Research, Inc.	Russell A. Jeffries, Project Manager	1900 Elkin Street Suite 230 Alexandria, VA 22308 (703) 360-3900 (703) 360-3911 (fax)	Nova Research, Inc. (Nova), is a high-technology small business, specializing in technology demonstrations and field test programs. Currently, Nova is evaluating and assisting in the development of chemical sensing instrumentation for detection of energetic materials. This instrumentation will be used for site characterization and remediation.
OAO Corporation	Joseph W. Foley, Director - Robotics	7500 Greenway Center Greenbelt, MD 20770 (301) 220-7134 (301) 345-9669 (fax) jfoley@oao.com	OAO Corporation (OAO) is a full-service engineering company that provides teleoperated solutions to UXO handling and remediation. OAO produces a variety of remote-controlled, teleoperated vehicles and systems for use in hazardous environments. OAO has configured vehicles for numerous explosive ordnance disposal applications, including land mine removal and missile test range clearance. The vehicles range in size from 100-pound platforms to teleoperated excavators.
Oilton, Inc.	Zeno Leiter, Vice President - Corporate Business Development	1821 University Avenue West Suite 461G St. Paul, MN 55104 (612) 646-5747 (612) 646-5303 (fax)	Oilton, Inc. (Oilton), provides advanced technology services, including location and mapping of subsurface petroleum pipeline leaks and surface or buried UXO munitions. Using an airborne sensor platform, Oilton's Advanced Infrared Detection System combines multi-sensor technology with unique image enhancement software, yielding multi-spectral data.

PRIVATE INDUSTRY

Company Name	Point of Contact	Street Address, Telephone and Facsimile Numbers, and E-Mail Address	Background Information and Description of UXO-Related Activities
ORINCON Corporation	Harry Keane	9363 Towne Centre Drive San Diego, CA 92121-3017 (619) 455-5530, ext. 271 (619) 455-5026 (fax) harry@orincon.com http://orincon.com	ORINCON Corporation (ORINCON) is a high-technology research and development firm that provides signal processing, data fusion, and tracking expertise. Using fluxgate gradiometer sensors and advanced signal processing techniques, ORINCON developed an inexpensive, remotely-operated platform for the detection of buried ferrous metal objects. The platform uses differential global positioning system localization to produce a magnetic anomaly map.
Pacific Synergetics Incorporated	John Jordan, Project Coordinator Garth Barrett, Project Manager	P. O. Box 309 San Clemente, CA 92674-0309 (714) 492-0804 (714) 498-6877	Pacific Synergetics Incorporated (PSI) provides consulting services and special equipment to the government and the private sector. PSI has expertise in the use of unmanned airborne and ground-based vehicles in UXO and mine detection and clearance operations.
Parsons Engineering Science, Inc.	Robert A. Menke, P.E., Project Manager	10521 Rosehaven Street Fairfax, VA 22031 (703) 591-7575 (703) 591-1305 (fax)	Parsons Engineering Science, Inc. (Parsons), is a full-service consulting firm devoted exclusively to environmental engineering and the environmental sciences. Parsons provides subsurface UXO detection, location, and differentiation using electromagnetic induction metal detectors.

PRIVATE INDUSTRY

Company Name	Point of Contact	Street Address, Telephone and Facsimile Numbers, and E-Mail Address	Background Information and Description of UXO-Related Activities
Polestar Technologies, Inc.	Karen Carpenter, President	79 Maynard Road Sudbury, MA 01776 (508) 443-8125 (508) 443-2302 (fax)	Polestar Technologies, Inc. (Polestar), specializes in sensor development for environmental measurements. Polestar is a sensor subcontractor to the Naval Research Laboratory in its development efforts for the Multi-Sensor Towed Array Detection System (MTADS). The MTADS is designed to detect buried UXO, hazardous toxic and radiological waste, and other subsurface environmental hazards. Polestar also has experience in sensor development, integration, and data processing and analysis.
Power Spectra Inc.	Jeffrey Oicles, Director - New Business Development	919 Hermosa Court Sunnyvale, CA 94086-4103 (408) 737-7977 (408) 732-1832 (fax) oicles@netcom.com	Power Spectra Inc. is developing a ground-penetrating impulse radar (GPR), with spacial resolution of about 3 centimeters. The GPR will be optimized for real-time imaging of small land mines, and the sensor platform will be mounted on a low-flying helicopter. For UXO detection and identification, resolution quality may be sacrificed for penetration depth.
PRC Environmental Management, Inc.	Joe Dauchy, Project Manager	330 South Executive Drive Suite 203 Brookfield, WI 53005 (414) 821-5894 (414) 821-5946 (fax) dauchyj@aol.com miprcall@aol.com	PRC Environmental Management, Inc. (PRC), is currently assisting the U.S. Naval Explosive Ordnance Disposal Technology Division and the U.S. Army Environmental Center, with conducting and managing the comprehensive UXO Clearance Technology Program. The program includes evaluation and enhancement of UXO detection, identification, remediation, and information management technologies.

PRIVATE INDUSTRY

Company Name	Point of Contact	Street Address, Telephone and Facsimile Numbers, and E-Mail Address	Background Information and Description of UXO-Related Activities
Protech Armored Products	Albert A. Lafontaine, Technical Advisor and Ballistician	158 Hubbard Avenue Pittsfield, MA 01201 (413) 684-3104 (800) 234-3104 (413) 684-4166 (fax)	Protech Armored Products is an original equipment manufacturer of protective garments for explosive ordnance disposal (EOD) operations. The Protech product line extends from EOD search suits to full bomb apparel, and includes blast deflection shields, helmets, and faceshields. Customized garments may be designed at the client's request.
Reactive & Explosive Materials Training Corporation	Fred Hoverkamp	133 Route 206 Branchville, NJ 07826 (201) 948-0270 (201) 948-5972 (fax)	Reactive & Explosive Materials Training Corporation (REMTC) owns and operates explosive containment chambers, reactive chemical containment chambers, and a portable incinerator for the disposal or stabilization of explosives, dangerous cylinders, and reactive chemicals. REMTC also offers a variety of training related to energetic materials.
Rockwell International Corporation	Dr. Charles P. Frahm, Senior Scientist - Special Projects	3370 Miraloma Avenue Anaheim, CA 92803-3105 (714) 762-0837 (714) 762-0528 (fax) cprahm@anet.rockwell.com	Rockwell International Corporation's Autonetics and Missile Systems Division (AMS) is developing a new high-performance, passive, magnetic search system that may be applied to UXO detection. The system will integrate an array of state-of-the-art, low- noise, high-sensitivity, three-axis, fluxgate magnetometers with a high-precision positioning system and sophisticated signal processing. Its extra-wide survey path may result in cost savings, since less pre-survey site preparation and actual survey time is required.

PRIVATE INDUSTRY

Company Name	Point of Contact	Street Address, Telephone and Facsimile Numbers, and E-Mail Address	Background Information and Description of UXO-Related Activities
RSP Inc.	Ronald Patrick Warren, President and Project Manager	P.O. Box 858 Indian Head, MD 20640 (301) 753-9751 (301) 743-5965 (fax) pwarren@vais.net	RSP Inc. is a consulting firm with expertise in explosive ordnance disposal, UXO, ordnance, explosive, and hazardous waste material. RSP Inc. also has extensive experience in site preparation, clearance rates, health and safety, site survey, classification, cleanup technologies, equipment, and remediation.
Sage Earth Science	Glen Carpenter	2300 North Yellowstone Highway Suite 206 Idaho Falls, ID 83401 (208) 522-5049 (208) 523-1049 (fax) ses@srv.net	Sage Earth Science (Sage), is a technology "spin-off" company of the Department of Energy's Idaho National Engineering Laboratory. Sage performs a variety of geophysical investigation services for environmental and engineering applications. The company has unique capability and experience in UXO characterization through the Rapid Geophysical Surveyor (RGS) technology, licensed from the Department of Energy. With the RGS system, Sage is able to create high-fidelity magnetic field maps at lower cost and in a wider variety of site conditions than competing systems.
Science Applications International Corporation	Nicholas P. Trentacoste, Senior Vice President - Corporate Development	11251 Roger Bacon Drive Reston, VA 22090 (703) 318-4516 (703) 709-1045 (fax)	Science Applications International Corporation (SAIC) has extensive experience in weapons system design, development, and demilitarization. SAIC developed sensors for underground and underwater munitions detection and an innovative UXO risk assessment model. In addition, SAIC supplies the U.S. Army with x-ray systems for remote inspection of munitions on the production line and is the U.S. Army's integration contractor for the destruction of chemical weapons stockpiled in the U.S. Finally, SAIC provides a broad range of environmental technologies to mitigate the residues from the storage, disposal, and destruction of conventional and chemical munitions.

PRIVATE INDUSTRY

Company Name	Point of Contact	Street Address, Telephone and Facsimile Numbers, and E-Mail Address	Background Information and Description of UXO-Related Activities
Scintrex	Brian Markle, Senior Design Engineer	222 Snidercroft Concord, Ontario Canada L4K 1B5 (905) 669-2280 (905) 669-6403 (fax)	Scintrex is a major instrumentation supplier for the world's mineral, oil, and groundwater exploration markets, as well as the security, analytical, atmospheric, environmental, and nucleonics markets. Scintrex maintains a strong research and development presence with emphasis in exploration and the environment. The Scintrex SMARTMAG, a cesium-vapor magnetometer and processor, has been used for UXO detection.
SciTech Services, Inc.	Robert Metzger, Project Manager	1311 Continental Drive Suite G Abingdon, MD 21009 (410) 671-7104 (410) 676-2304 (fax) bmetzger@scitechinc.com	SciTech Services, Inc. (SciTech) specializes in detailed historical surveys of military operations involving chemical, biological, and radiological UXO. SciTech has conducted numerous surveys of Department of Defense sites to determine munitions type and quantity, location of disposal sites and contamination, and the potential for contaminate migration.
Security Management International, Inc.	Arthur "Mick" Donahue, President	801 North Pitt Street Suite 102 Alexandria, VA 22314 (703) 836-8304 (703) 836-9307 (fax)	Security Management International, Inc. (SMI), has extensive experience in conducting mine placement, chemical materiel (CM), and explosive ordnance detection and improvised explosive device (IED) neutralization training for U.S. personnel and foreign nationals. SMI also has expertise in evaluating chemical materiel, boobytrap, and improvised explosive device technologies for U.S. government agencies.
Security Search Product Sales	Ronald A. Hitchler, Managing Director	7 Amaranth Drive Littleton, CO 80127-2611 (303) 933-7955 (303) 933-7955 (fax) tacarms@aol.com	Security Search Product Sales is the U.S. distributor and representative for Vallon GmbH. Vallon GmbH manufactures detection instruments for UXO, ordnance and explosive waste, mines, and weapons.

PRIVATE INDUSTRY

Company Name	Point of Contact	Street Address, Telephone and Facsimile Numbers, and E-Mail Address	Background Information and Description of UXO-Related Activities
Sensors & Software Inc.	Peter Annan, Project Manager	1091 Brevik Place Mississauga, Ontario Canada L4W 3R7 (905) 624-8909 (905) 624-9365 (fax) radar@senssoft.on.ca	Sensors & Software Inc. (S&S) manufactures the pulse EKKO family of ground-penetrating radar (GPR) systems. Pulse EKKO systems cover a frequency range of 10 to 1,200 MHz. These lightweight systems are readily adapted to man-portable or vehicle-mounted applications. Open data structure permits melding of GPR data with other mapping sensors and positioning systems for use with artificial intelligence and fuzzy logic target discrimination schemes.
SNC Industrial Technologies Inc.	Adrian Albon, Project Manager	170 Laurier Avenue West Suite 1100 Ottawa, Ontario Canada K1P 5V5 (613) 567-7019 (613) 567-5509	SNC Industrial Technologies Inc. (SNC) specializes in ordnance explosives waste decontamination, as well as the manufacture of a wide range of conventional ammunition for defense purposes. SNC has also developed a wide range of small-caliber training ammunition marketed under the name Simunition™. In addition, SNC has expertise in the following areas: electronic survey and project assessment; ordnance clearance (surface, subsurface, and underwater); explosive ordnance disposal; explosive safety programs and related training; technical consulting and translation; ammunition facility and range management; small arms range decontamination; and demilitarization.

PRIVATE INDUSTRY

Company Name	Point of Contact	Street Address, Telephone and Facsimile Numbers, and E-Mail Address	Background Information and Description of UXO-Related Activities
SOREQ Nuclear Research Center	<p>Dr. Hovav Zafrir, Project Manager</p> <p>Dr. Yuri Bregman, Researcher</p>	<p>SOREQ Nuclear Research Center Applied Radiation Technology Division P.O. Box 239 Yavne, Israel 81800 972-8-9437267 972-8-9434403 (fax)</p>	<p>SOREQ Nuclear Research Center (SOREQ), an Israeli governmental institute, has extensive experience in the application of magnetic, electromagnetic, optic, and nuclear technology. SOREQ conducts airborne, ground, and marine surveys and detects and maps subsurface objects. SOREQ is currently conducting a research and development project to detect, identify, and map UXO. The technology consists of an unmanned all-terrain platform equipped with sensors capable of locating UXO to a depth of a few feet below ground surface, and producing a location map.</p>
SQM Technology, Inc.	<p>Dr. Walter Podney, President and Project Manager</p>	<p>P.O. Box 2225 San Diego, CA 92038-2225 (619) 481-7182 (619) 481-6482 (fax)</p>	<p>SQM Technology, Inc., has developed a superconductive electromagnetic instrument for detection of subsurface UXO. The hand-held instrument is designed to locate and classify UXO.</p>
SRI International	<p>David Buseck</p>	<p>333 Ravenswood Avenue Menlo Park, CA 94025 (415) 859-4714 (415) 859-5149 (fax)</p>	<p>SRI International (SRI) has designed and fielded ground-penetrating radar equipment for a wide variety of platforms and a large number of applications, including archaeology, natural resource location, topographic mapping, and most recently, imaging of military and other targets. SRI has experience in UXO detection using a fixed-wing aircraft equipped with airborne ground-penetrating radar.</p>

PRIVATE INDUSTRY

Company Name	Point of Contact	Street Address, Telephone and Facsimile Numbers, and E-Mail Address	Background Information and Description of UXO-Related Activities
TEAM Consulting, Incorporated	Steven A. Downes	Capitol I Office Building Suite 205 5515 Cherokee Avenue Alexandria, VA 22312 (703) 256-6661 (703) 256-3810 (fax) tteam@ix.netcom.com	TEAM Consulting, Incorporated (TEAM), provides research, data management, training, and program management support to the Defense Environmental Network and Information Exchange (DENIX) program for the Office of the Under Secretary of Defense for Environmental Security. TEAM also provides DENIX training for the Defense Environmental Security Corporate Information Management office.
Technology Marketing	James T. Ferguson, Sr., President	P.O. Box 987 Millersville, MD 21108-0987 (410) 987-9111 or (301) 621-9480 (410) 987-6392 (fax)	Technology Marketing (TM) provides business development, marketing, partnering, teaming, proposal preparation and review, and consultation services to organizations in the scientific and engineering disciplines. TM has worked extensively with several branches of the military.
Tomographic Technologies Inc.	Robert W. Hess John Geiger Warren P. Stark	120 Cameron Street Suite 205 Alexandria, VA 22314 (703) 836-6678 (703) 836-6678 (fax) Geiger: (415) 383-8907 (415) 389-9102 (fax) Stark: (805) 966-7115 (805) 966-7445 (fax)	Tomographic Technologies, Inc., is developing an ultra-wide tomographic system for UXO detection, including land mines. The system incorporates significant advancements in antenna and receiver design and data processing, and provides three-dimensional tomographic images of subsurface objects.

PRIVATE INDUSTRY

Company Name	Point of Contact	Street Address, Telephone and Facsimile Numbers, and E-Mail Address	Background Information and Description of UXO-Related Activities
UXB International, Inc.	Dr. Richmond H. Dugger, President Kevin Lombardo, Project Manager	21641 Beaumeade Circle Suite 301 Ashburn, VA 22011 (703) 729-9600 drdugger@uxb.com krlombardo@uxb.com	UXB International, Inc. (UXB), is an explosive ordnance disposal service specializing in ordnance and explosives detection and identification, removal and disposal of conventional UXO, and the detection and neutralization of chemical warfare materials. In addition, UXB has extensive experience in hazard assessment, hazardous materials transportation, the Geographic Information System, and land survey computer-automated drafting and design mapping. UXB provides range maintenance services, road construction, and civil engineering. Underwater capabilities include deep sea salvage and repair, port inspections, and equipment supply.
Vallon GmbH; c/o Security Search Product Sales	Ronald Hitchler, Owner - Security Search Product Sales	7 Amaranth Drive Eagles Point KC Littleton, CO 80127-2611 (303) 933-7955 (303) 933-7955 (fax)	Vallon GmbH (Vallon) has extensive experience in the design and development of specialized instruments for UXO and mine detection. Vallon developed the Multi-Sensor Vehicle to survey large areas for UXO detection, and has recently added a differential global positioning system capability to the system.
Roy F. Weston	Sharon Frye, Vice President - Program Development	1 Weston Way Westchester, PA 19380-1499 (610) 701-3000 (610) 701-3186 (fax)	Roy F. Weston (Weston), in conjunction with Israel Aircraft Industries, Ltd. and ISORAD, developed an unmanned, robotic, sensor-mounted ground vehicle for detection, identification, and mapping of hazardous objects, including UXO and its remnants.

GOVERNMENT AGENCIES

(The information contained herein was provided by the entities listed.)

GOVERNMENT AGENCIES

Governmental Agency Name	Point of Contact	Street Address, Telephone and Facsimile Numbers, and E-Mail Address	Background Information and Description of UXO-Related Activities
Aberdeen Proving Ground	Joseph D. Craten, Director - Safety, Health, and Environment	ATTN: STEAP-SH Aberdeen Proving Ground, MD 21005-5001 (410) 278-7685 (410) 278-8759 (fax) jcraten@apg-9.apg.army.mil	Since 1918, Aberdeen Proving Ground has engaged in research, development, testing, evaluation, and manufacture of conventional and chemical weapons. These activities have resulted in unexploded ordnance (UXO) contamination on land and water ranges, both active and closed. UXO clearance is required for most excavations, and chemical and conventional UXO are routinely located and recovered by civilian explosive ordnance disposal contractors and the U.S. Army Technical Escort Unit. UXO clearance is planned for the installation boundaries beginning in 1996.
Argonne National Laboratory; Center for Cost Engineering	Jerry Gillette, Project Manager Steve Lake, ITD	9700 South Cass Avenue Building 900 Argonne, IL 60439 (708) 252-7475 (708) 252-6073 (fax) jgillette@anl.gov smtplink.anl.gov	The Center for Cost Engineering (CCE) can apply cost engineering principles to evaluate the cost, benefit, and scheduling impacts of using new UXO clearance technologies. The principles that can be used in the evaluation process include benchmarking, cost estimating, cost effectiveness, life-cycle analysis, and cost and schedule control. CCE has expertise in each of these areas and has applied them in projects for both United States government and private sector sponsors.
Canadian Department of National Defence; Defence Research Establishment Suffield	John R. Evans, Head - Military Engineering Section	P. O. Box 4000 Medicine Hat, Alberta Canada T1A 8K6 (403) 544-4724 (403) 544-4704 (fax) jevans@dres.dnd.ca	The Defence Research Establishment Suffield (DRES) is an organization within the Canadian Department of National Defence (DND). DRES is investigating subsurface UXO detection and identification. The techniques researched include advanced electromagnetic induction and magnetometry, ground-penetrating radar, millimeter wave and infrared radiometry, thermal neutron activation, and trace element detection. DRES is also researching mechanical and explosive neutralisation of mines and mine fields.
Department of the Air Force; Aeronautical Systems Center	Joseph Jenus, Jr., Manager - USAF Explosive Hazard Reduction Program	ASC/LIW (EHR) Building 40; Suite 104 314 W. Choctawhatchee Avenue Eglin Air Force Base, FL 32542-5717 (904) 882-4685 (904) 882-9381 (fax)	The U.S. Air Force is currently implementing the Explosive Hazard Reduction (EHR) Program. Under the program, technology test projects are conducted to reduce munitions hazards. The EHR Program funded a project to enhance ground-penetrating radar capabilities for range cleanup assistance.

GOVERNMENT AGENCIES

Governmental Agency Name	Point of Contact	Street Address, Telephone and Facsimile Numbers, and E-Mail Address	Background Information and Description of UXO-Related Activities
Department of Defense Explosives Safety Board	Colonel W.P. Wright	Hoffman Building Room 856C 2461 Eisenhower Avenue Alexandria, VA 22331-0600 (703) 325-0152 (703) 325-6227 (fax) wright@ddesh.acq.osd.mil	The Department of Defense Explosives Safety Board (DDESB) provides guidance to the Security of Defense and Service Secretaries on the cradle-to-grave use of ammunition and explosives. The DDESB establishes explosives safety standards for the Department of Defense (DoD) and serves as DoD's interface with the international explosives safety community. The DDESB's mission is to conduct explosives safety surveys, research, development, and testing programs, and review and approve all clearance plans for leasing, transfer, or disposal of DoD real property and site and construction plans.
Lockheed Martin Energy Systems, Inc.	James K. Kulesz, Manager - Ordnance and Demilitarization	P. O. Box 2003 Oak Ridge, TN 37831-7606 (423) 435-3219 (423) 435-3699 (fax) kuleszj@ornl.gov	The Ordnance and Demilitarization area, a business unit within the Department of Energy's Hazardous Waste Remediation Actions Program, provides explosive disposal compliance guidance; UXO detection, characterization, and removal; and chemical and munitions demilitarization.
Los Alamos National Laboratory	Donald J. Rej, Program Coordinator - Physics Division	MS-D434 Los Alamos, NM 87545 (505) 665-1883 (505) 665-8520 (fax) drej@lanl.gov	Los Alamos National Laboratory (Los Alamos) has resources that can be used to solve problems associated with UXO detection problems. Los Alamos can provide multidisciplinary capabilities in a variety of science and technology programs, including defense, nonproliferation, energy, and healthcare. Some of these capabilities may contribute to UXO detection, such as inexpensive, biologically-inspired robotics; electromagnetic sensors for plastic mine detection; Superconducting Quantum Interference Device magnetometry; nuclear and chemical assaying; adaptive processing; and sensor fusion methods.

GOVERNMENT AGENCIES

Governmental Agency Name	Point of Contact	Street Address, Telephone and Facsimile Numbers, and E-Mail Address	Background Information and Description of UXO-Related Activities
Naval Explosive Ordnance Disposal Technology Division	Gerard Snyder	2008 Stump Neck Road Code 30U, Building 2172 Indian Head, MD 20640-5070 (301) 743-6850, ext. 289 (301) 743-6946 (fax) snyder.eodtc@eodimgate.navysea.navy.mil	The Naval Explosive Ordnance Disposal Technology Division (NAVEODTECHDIV) is responsible for the research, development, and logistic support of specialized equipment, tools, techniques, and procedures required to support operational Army, Navy, Marine Corps, and Air Force explosives ordnance disposal (EOD) units in the location, identification, render safe, removal, exploitation, and/or disposal of all types of surface, air, and underwater ordnance. Additionally, NAVEODTECHDIV provides EOD technical support to other federal agencies as required to counter the threat of UXO.
Naval Facilities Engineering Service Center	Captain John P. Collins, CEC, USN, Commanding Officer	1100 23rd Avenue Port Hueneme, CA 93043-4370 (805) 982-1393 (805) 982-4429 (fax) jcollim@nfesc.navy.mil	The Naval Facilities Engineering Service Center (NFESC), is experienced in site preparation for UXO technology demonstrations and remediation of UXO-related hazardous waste. The NFESC installs and operates a transportable UXO range comprised of more than 250 inert ordnance items, ranging from 20mm rounds to 1,000-pound bombs. NFESC engineers precisely place targets using a differential global position system and ultra-short baseline acoustics, and produce both quick-look and detailed reports of detection system performance. NFESC engineers have developed bioremediation techniques for neutralizing certain types of UXO-related hazardous waste.
Sandia National Laboratories; Sandia Corporation	Richard S. Harding, Jr., Manager - Advanced Geophysical Technology Department 6114	MS-0705 P.O. Box 5800 Organization 6114 Albuquerque, NM 87185-0705 (505) 844-0780 (505) 844-0240 (fax) rshardi@sandia.gov	Under a cooperative research and development agreement, Sandia National Laboratories and Raton Technology Research (RTR) have been developing a continuous-wave ground-penetrating radar (GPR). The GPR is operable from 5kHz to 5MHz, and incorporates beam-steering and a range-to-target algorithm. RTR may be contacted at P.O. Box 428, Raton, NM, 87740.

GOVERNMENT AGENCIES

Governmental Agency Name	Point of Contact	Street Address, Telephone and Facsimile Numbers, and E-Mail Address	Background Information and Description of UXO-Related Activities
U.S. Air Force Wright Laboratory Airbase Technology Branch	Captain Walter M. Waltz	WL/FIVCF 139 Barnes Drive Suite 2 Tyndall AFB, FL 32403-5323 (904) 283-3725/6 (904) 283-9710 (fax)	The U.S. Air Force Wright Laboratory Airbase Technology Branch performs civil engineering research in the areas of fire protection and crash rescue, pavement and structures, energy, and construction automation and robotics. The Construction Automation and Robotics Group, which is also part of the Office of Secretary of Defense Joint Robotics Project, supports agencies in development and fielding of unmanned vehicles for use in UXO remediation, mine countermeasures, and other hazardous missions.
U.S. Army Technical Center for Explosives Safety	Melvin L. Colberg, Chief - Logistics Explosives Safety Division	ATTN: SIOAC-ESL Savanna, IL 61074-9639 (815) 273-8801 (815) 273-8731 (fax) stioacesl@savanna-emhl.army.mil	The U.S. Army Technical Center for Explosives Safety (USATCES) reviews and approves Army safety submissions for ordnance explosives removal from real property no longer in Department of Defense control as a result of Base Realignment and Closure actions. USATCES also provides Army technical review of safety submissions at Formerly-Used Defense sites. USATCES assists major Army commands and installations in explosives preparation and chemical safety submissions for ordnance explosives removal and subsequent land disposals. USATCES teams with the U.S. Army Corps of Engineers (USACE) on ordnance explosives projects by conducting historical records searches, performing site inspections, and preparing summary reports for USACE.
U.S. Army Corps of Engineers; Huntsville Division	C. David Douthat, P.E. and Director - Ordnance and Explosives Team	ATTN: CEHNC-OE P.O. Box 1600 Huntsville, AL 35807-4301 (205) 895-1510 (205) 895-1178 (fax) douthatd@smtp.hnd.usace.army.mil	The U.S. Army Corps of Engineers, Huntsville Division (CEHND) is the Corps of Engineers' Ordnance and Explosives Mandatory Center of Expertise. CEHND is responsible for evaluating the remedial actions needed to eliminate or reduce any imminent danger to the public posed by abandoned ordnance and explosives at current or formerly-used defense sites.

GOVERNMENT AGENCIES

Governmental Agency Name	Point of Contact	Street Address, Telephone and Facsimile Numbers, and E-Mail Address	Background Information and Description of UXO-Related Activities
<p>U.S. Army Corps of Engineers; Cold Regions Research and Engineering Laboratory</p>	<p>Gary Koh</p>	<p>72 Lyme Road Hanover, NH 03755-1290 (603) 646-4282 (603) 646-4397 (fax) gkoh@crrel41.crrel.usace.army.mil</p>	<p>The Cold Regions Research and Engineering Laboratory (CRREL), has lead a 6-year investigation and remediation of Eagle River Flats in Fort Richardson, Alaska. Eagle River Flats is an active impact area containing a high level of UXO. CRREL has also participated in cold region mine detection; specifically, snow-covered mines.</p>
<p>U.S. Army Corps of Engineers; Rock Island District</p>	<p>Daniel Holmes, P.E., Chief - Ordnance and Explosives Engineering</p>	<p>ATTN: CENCR-ED-DO P.O. Box 2004 Rock Island, IL 61201 (309) 794-6080 (309) 794-6050 (fax) daniel.j.holmes@usace.army.mil</p>	<p>The U.S. Army Corps of Engineers (USACE) performs archive searches and related ordnance and explosive investigations, and is partnered with the U.S. Army Defense Ammunition Center and School. USACE has performed extensive analyses and evaluations on hundreds of ordnance production and range sites, and has provided cleanup strategies and scopes of work. USACE also has extensive experience in explosive ordnance disposal and joint military munitions operations. USACE has expertise in UXO detection and clearance methods and provides computer-automated drafting and design/Geographic Information System mapping and database support and internet ordnance and explosives project information on the Internet (http://dogbert.ncr.usace.army.mil).</p>
<p>U.S. Army Defense Ammunition Center and School; Ammunition Technical Training Department</p>		<p>ATTN: SIOAC-ASC Savannah, IL 61074-9639 (815) 273-8845 (815) 273-8788 (fax) sioacasc@savanna-emhl.army.mil</p>	<p>The Ammunition Technical Training Department (ATTD) develops curricula and provides training for unexploded ordnance identification, explosive safety, and environmental considerations during ammunition operations. ATTD provides training to military, civilian, and contractor personnel in residence at the Savannah, Illinois, campus and on site as requested. The Registrar can be reached at (815) 273-8934, or (815) 273-6022 (fax), for schedule and fee information.</p>

GOVERNMENT AGENCIES

Governmental Agency Name	Point of Contact	Street Address, Telephone and Facsimile Numbers, and E-Mail Address	Background Information and Description of UXO-Related Activities
U.S. Army Defense Ammunition Center and School; Logistics Review and Assistance Office	Daniel R. Civis, Logistics Management Specialist	ATTN: SIOAC-AV Savanna, IL 61074-9639 (815) 273-8058 (815) 273-6172 (fax) dcivis@savanna-emhl.army.mil	The Logistics Review and Assistance Office (LRAO) provides a wide range of ammunition technical assistance to activities, commands, installations, and units worldwide. LRAO assistance is available by telephone consultation or on a temporary duty basis. LRAO is currently consulting with the Naval Explosive Ordnance Disposal Technology Division on its Kaho'olawe Island project.
U.S. Army Environmental Center	Kelly Rigano, Project Engineer - UXO Technology Demonstration and Transfer	SFIM-AEC-ETD Building E4430 Aberdeen Proving Ground, MD 21010-5401 (410) 612-6868 (410) 612-6836 (fax) karigano@aec1.apgea.army.mil	The U.S. Army Environmental Center (USAEC) provides centralized management, oversight, coordination, and execution of Army Environmental Compliance, Conservation, Restoration, Technology Demonstration and Transfer, and Environmental Information Management Programs. Within the technology demonstration and transfer areas, USAEC manages a comprehensive program for testing and evaluating technologies that can be used for UXO characterization and remediation.
U.S. Army Project Manager for Non-Stockpile Chemical Materiel	Wayne Jennings Steve Bird	ATTN AMCPM-NS Aberdeen Proving Ground, MD 21010-5401 (410) 671-4577	The U.S. Army Project Manager for Non-Stockpile Chemical Materiel provides centralized management and direction for disposal of non-stockpile chemical materiel in a safe, environmentally-sound, and cost-effective manner.
U.S. Department of Energy; AlliedSignal Federal Manufacturing & Technologies, Inc.	Michael Johnson	Federal Manufacturing & Technologies NC-135 Area Truman Gate Kirtland Air Force Base Albuquerque, NM 87106-3219 (505) 844-3754 (505) 844-3751 (fax) mjohnson@kcp.com	AlliedSignal Federal Manufacturing & Technologies, Inc. (AlliedSignal), has unique signal and data processing capabilities that can produce a high-speed data processing architecture to perform signal conditioning, signal preprocessing, feature extraction, and sensor/data fusion. These capabilities may be used with existing Department of Defense sensors or sensor platforms to detect, locate, and identify UXO, including land mines, or other buried waste. AlliedSignal has participated in the U.S. Army's Minefield Reconnaissance and Detector Platform and the On-Route Mine Detection System, and has experience in site characterization.

GOVERNMENT AGENCIES

Governmental Agency Name	Point of Contact	Street Address, Telephone and Facsimile Numbers, and E-Mail Address	Background Information and Description of UXO-Related Activities
<p>U.S. Department of Energy; Savannah River Technology Center</p>	<p>Vid Deksheniaks - Technical Business Development</p>	<p>227 Gateway Drive Aiken, SC 29803 (800) 228-3843 (803) 652-1865 (803) 652-1898 (fax) vid.deksheniaks@srs.gov</p>	<p>The Savannah River Technology Center (SRTC) is an applied research and development laboratory operated by Westinghouse Savannah River Company at the Department of Energy's Savannah River Site near Aiken, South Carolina. SRTC's scientists and engineers have expertise in sensor and robotics systems and environmental remediation techniques, and apply that expertise to unexploded ordnance issues.</p>
<p>U.S. Department of Energy; Special Technologies Laboratory</p>	<p>Steve Koppenjan Tricia Lewallen</p>	<p>5520 Ekwil Street Suite B Santa Barbara, CA 93111 Koppenjan: (805) 681-2453 (805) 681-2471 (fax) Koppensk@nv.doe.gov Lewallen: (805) 681-2446 (805) 681-2471 (fax) Lewallt@nv.doe.gov</p>	<p>Special Technologies Laboratory (STL) is a U.S. Department of Energy research laboratory managed by Bechtel Nevada. STL developed frequency-modulated, continuous-wave, ground-penetrating radar (GPR) and a hand-held mine detector for use in UXO detection. STL is currently developing several state-of-the-art technologies for UXO clearance.</p>
<p>U.S. Department of the Interior; Bureau of Land Management</p>	<p>Dwight J. Hempel, Project Manager</p>	<p>1849 C Street, Northwest Suite 1000LS Washington, D.C. 20240 (202) 452-7778 dhempel@wo0033wp.wo.blm.gov</p>	<p>The Bureau of Land Management (BLM) manages more than 5.4 million acres in the western United States, which are known or suspected to contain UXO. Public and employee safety is our main concern and, therefore, our focus is on risk management and compatible reuse of this land. The BLM works closely with the U.S. Army Corps of Engineers and the joint military for UXO clearance and emergency response actions on public lands.</p>

GOVERNMENT AGENCIES

Governmental Agency Name	Point of Contact	Street Address, Telephone and Facsimile Numbers, and E-Mail Address	Background Information and Description of UXO-Related Activities
U.S. Army Research Laboratory	Michael A. Kolodny, Chief - Advanced Concepts Branch	ATTN: AMSRL-SE-RC 2800 Powder Mill Road Adelphi, MD 20783-1197 (301) 394-3110 (301) 394-4605 (fax) mkolodny@arl.mil	The U.S. Army Research Laboratory (ARL) performs innovative research in sensor and aided-target recognition (ATR) technologies that may be applied to UXO detection and discrimination. Specific technologies include low-frequency, ultra-wideband synthetic aperture radar (SAR); laser radar; SAR ATR; and multi-sensor fusion ATR. ARL is the technical executing agent for the Defense Intelligence Agency's Central MASINT Office's Steel Crater Ground-Penetrating Radar (GPR) Program. The objective of this program is to define the target types detectable by airborne GPR, and to determine the location and frequency at which GPR can successfully detect these targets. ARL is also responsible for defining the technical requirements for UXO remediation at active test and training ranges.
U.S. Army Waterways Experiment Station; EWES-EE-S	Hollis H. (Jay) Bennett, Jr.	3909 Halls Ferry Road U.S. Army EWES-EE-S Vicksburg, MS 39180-6199 (601) 634-3924	In Phase I of the UXO Advanced Technology Demonstrations at Jefferson Proving Ground, Madison, Indiana, the U.S. Army Waterways Experiment Station demonstrated a helicopter-mounted sensing and processing system, the Remote Minefield Detection System. The system was originally designed for airborne minefield detection, but is now used as a tool for detecting surface UXO.
Western Governors' Association	Jim Lehr	600 17th Street Suite 1705 South Tower Denver, CO 80202 (303) 623-9378, ext. 116 (303) 534-7309 (fax)	The Western Governors' Association (WGA) identifies and addresses policy and governance issues involving natural resources, the environment, human services, economic development, international relations, and public management. As a part of this activity, the WGA joined the U.S. Departments of Energy, Defense, and the Interior and the Environmental Protection Agency to establish a committee to develop on-site innovative technologies (DOIT). The DOIT Committee provides advice on cooperative approaches to speed the cleanup of federal waste sites.

UNIVERSITIES

(The information contained herein was provided by the entities listed.)

UNIVERSITIES

University Name	Point of Contact	Street Address, Telephone and Facsimile Numbers, and E-Mail Address	Background Information and Description of UXO-Related Activities
Ohio State University; ElectroScience Laboratory	Dr. Leon Peters, Jr., Project Manager	1320 Kinnear Road Columbus, OH 43212-1156 (614) 292-6153 (614) 292-7297 (fax) lpj@brewster.eng.ohio-state.edu	The ElectroScience Laboratory (ESL) at Ohio State University, has expertise in ground-penetrating radar (GPR). Recently, ESL applied GPR to UXO detection and identification, using complex natural resonances as a signature. ESL has designed a special GPR antenna and used it to detect and identify UXO at Jefferson Proving Ground and Tyndall Air Force Base.
University of Arizona; Department of Mining and Geological Engineering	Dr. Ben K. Sternberg, Department Head Professor and Director of Laboratory for Advanced Subsurface Imaging	College of Engineering & Mines Building #12 Tucson, AZ 85721 (520) 621-2439 (520) 621-8330 (fax) bks@mge.arizona.edu	For the last several years, the Laboratory for Advanced Subsurface Imaging (LASI) at the University of Arizona has been researching high-resolution imaging of near-surface targets. LASI has developed several highly successful systems in frequency ranges from tens of Hertz to Gigahertz. These systems incorporate novel data acquisition and processing features, as well as new data interpretation methods based primarily on neural networks.
University of Mississippi; Department of Physics & Astronomy	Dr. Gordon Baird, Professor of Physics & Astronomy	University, MS 38677 (601) 232-7048 (601) 232-7494 (fax)	The National Center for Physical Acoustics (NCPA), located at the University of Mississippi, developed procedures and instrumentation to locate and image buried objects using combined acoustic and optics technologies. Sound is used to excite surface vibrations that can be detected with an LDV. This procedure has been applied to a number of test plots containing target types buried at various depths.
University of Nebraska - Lincoln; Department of Electrical Engineering	Ram M. Narayanan, Project Manager	209 North Walter Scott Engineering Center Lincoln, NE 68588-0511 (402) 472-5141 (402) 472-4732 (fax) rmarayanan@unl.edu	The University of Nebraska's (UN) research in UXO detection technology combines the use of active radar and laser with passive radiometric sensing techniques. Currently, UN is developing polarimetric radar systems with high depth and azimuth resolution for probing subsurface regions. UN is developing techniques to synergistically integrate multiple sensor system output for subsurface target detection and identification.

UNIVERSITIES

University Name	Point of Contact	Street Address, Telephone and Facsimile Numbers, and E-Mail Address	Background Information and Description of UXO-Related Activities
<p>University of New England; Geophysical Research Institute</p>	<p>Peter J. Clark, Manager - Environmental Services John M. Stanley, Director</p>	<p>Armidale, New South Wales Australia 2351 61 67 73 2617 61 67 73 3307 (fax) info@gri.une.edu.au jstanle2@metz.une.edu.au</p>	<p>The Geophysical Research Institute (GRI) is a subsurface detection and mapping technology service. GRI developed the TM-4 magnetic UXO detection and quality assurance data processing system, which has been successfully employed at many UXO contaminated sites worldwide. GRI provides complete ferrous UXO detection at quantifiable insurable levels of quality assurance; a unique and highly efficient methodology for large-scale site assessment; and a suite of magnetic, electromagnetic, and ground-penetrating radar technologies.</p>
<p>University of Washington; Applied Physics Laboratory</p>	<p>Peter Kaczowski, Ph.D., Senior Electrical Engineer, Program Manager - UXO Remediation Technology</p>	<p>1013 Northeast 40th Street Seattle, WA 98105-6698 (206) 543-1300 (206) 543-6785 (fax) peter@apl.washington.edu</p>	<p>Applied Physics Laboratory, in collaboration with Alliant Techsystems in Mukilteo, Washington, applied Pulsed Electromagnetic Induction (PEMI) to unexploded ordnance (UXO) detection and identification. This project, funded by the U.S. Army Environmental Center and the Naval Explosive Ordnance Disposal Technology Division (NAVEODTECHDIV), included developing a full set of models and data processing software, assembling a suitable PEMI data acquisition system, conducting multi-phased experiments for model validation, measuring responses from inert UXO, and conducting a field demonstration at the NAVEODTECHDIV test range. Project results indicate that PEMI holds promise for accurate location and characterization of subsurface UXO, and APL is currently enhancing PEMI to provide a more effective and efficient tool for UXO remediation.</p>

SECTION 4

**BIBLIOGRAPHY:
PUBLICATIONS**

4.0 BIBLIOGRAPHY: PUBLICATIONS

- Aerospace Ordnance Handbook*. Frank Pollard Bowles. Prentice Hall. Englewood Cliffs, New Jersey. 1966.
- "Air Force Designing Air Base Recovery Robots." Military Robotics Sourcebook. L&B Limited. ISSN: 0896-0348. December 1990.
- "Annotated Bibliography on Unexploded Ordnance Detection and Clearance." Tactical Warfare Simulation and Technology Information Analysis Center. Columbus, Ohio. Report No. 1-93-174. November 1993.
- Arms and Armaments*. United States Air Force, Pacific Air Forces. Undated.
- Armour and Artillery*. Jane's Yearbook. Edited by Christopher F. Foss. Undated.
- Army Countermine Science, Technology, and Equipment Response to the Landmine Threat in Bosnia*. Prepared Statement of Brigadier General Roy E. Beauchamp, Deputy Chief of Staff for Research, Development, and Engineering, U.S. Army Materiel Command. Presented to the House Committee on National Security, Subcommittee on Military Procurement. United States Army Materiel Command (USAMC). Federal News Service Group, Inc. Washington, DC. January 1996.
- Army Ordnance Report*. U. S. Department of the Army. Washington, D.C. 1943 through 1945.
- "Army Seeks Unexploded Ordnance Technologies." Defense Cleanup. Pasha Publications, Inc. ISSN: 0083-9735. September 1994.
- "Base Realignment and Closure Act Cleanup Costly, Slow." Defense Cleanup. Pasha Publications, Inc. ISSN: 0083-9735. March 1995.
- "Blowup Over Bomb Rules." Engineering News Record. McGraw-Hill Companies Inc. ISSN: 0013-807X. December 1995.
- "British Army Equipment Exhibition: Alarm, Signal, and Security Detection." Military Technology. Information Access Company. ISSN: 0722-3226. June 1984.
- "Chance for Unexploded Ordnance Demos Offered." Defense Cleanup. Pasha Publications, Inc. ISSN: 0083-9735. October 1993.
- "Clearance of Unexploded Ordnance from Weapons Ranges." Central Studies Establishment. Great Britain. DST 431/7/158. May 1981.
- "Computer Simulation of Anomalies Created by an Array of Ferrous Objects in the Earth's Magnetic Field." R.W. Hemrich. Defense Research Establishment Suffield. Ralston, Alberta, Canada. Report No. DRES-MEMO-29/76. November 1976.

“Congressional Budget Office Calls for Deferring Tougher Cleanups.” *Defense Cleanup*. Pasha Publications, Inc. ISSN: 0083-9735. March 1995.

“Corps Wants Unexploded Ordnance Research.” *Defense Cleanup*. Pasha Publications, Inc. ISSN: 0083-9735. July 1992.

Defense Environmental Cleanup Program Annual Report to Congress for Fiscal Year 1993. U.S. Department of Defense. Government Reports Announcements & Index. Issue 20. 1994.

Defense Environmental Restoration Program. Bruce G. Karolle. Micronesian Area Research Center. University of Guam. 1985.

Demonstrator Performance at the Unexploded Ordnance Advanced Technology Demonstration at Jefferson Proving Ground (Phase I) and Implications for Unexploded Ordnance Clearance. Naval Explosive Ordnance Disposal Technology Division (NAVEODTECHDIV) in conjunction with the U. S. Army Environmental Center, (USAEC). Report No. IDA-P-3114. ADA No. 306273. Available through the Defense Technical Information Center (DTIC) at 703/767-8274 (telephone) or (703) 767-9070 (facsimile). October 1995.

Department of Defense Ammunition and Explosives Safety Standards. Chapter 12. “Real Property Contaminated with Ammunition, Explosives, or Chemical Agents.” U.S. Department of Defense 6033.9. March 1, 1995.

Detection and Discrimination Techniques for Total Field Magnetometers and Multi-Axis Gradiometers. Final Report. NAVTECHDIV in conjunction with USAEC. Report No. SFIM-AEC-ET-CR-95093. ADA No. 303274. Available through DTIC at 703/767-8274 (telephone) or 703/767-9070 (facsimile). November 1995.

“Detection and Disposal of Buried Bombs.” Khosrow Bakhtar and Fan-Nian Kong. ASC-TR-95-1001. April 1995.

Elements of Armament Engineering. U.S. Army Materiel Command (USAMC). Washington, DC. 1963.

“Enhanced Signal Processing Algorithms for Buried Unexploded Ordnance Detection and Location Estimation with Magnetometer and Electromagnetic Induction Measurements.” A. Witten. Oak Ridge National Laboratory, Tennessee. Report No. ORNL/TM-12478. Order No. DE94001844. September 1993.

Environment: Mines and Other Unexploded Ordnance. “Unexploded Ordnance Disposal in Kuwait; Report to the Secretary-General on the Scope and Nature of Damage Inflicted on Kuwaiti Infrastructure during the Iraqi Occupation.” Parts 197-199. Aristarchus Knowledge Industries. Source: 93H-48382. United Nations. September 1991.

Evaluation of Individual Demonstrator Performance at the Unexploded Ordnance Advanced Technology Demonstration Program at Jefferson Proving Ground (Phase I). NAVEODTECHDIV in collaboration with USAEC. Report No. SFIM-AEC-ET-CR-95033. ADA No. 294935. Available through DTIC at 703/767-8274 (telephone) or 703/767-9070 (facsimile). December 1994.

Evaluation of Individual Demonstrator Performance at the Unexploded Ordnance Advanced Technology Demonstration Program at Jefferson Proving Ground (Phase I). NAVEODTECHDIV in conjunction with USAEC. Report No. SFIM-AEC-ET-CR-95033. ADA No. 295074. Available through DTIC 703/767-8274 (telephone) or 703/767-9070 (facsimile). March 1995.

Evaluation of the Geophysical Survey Systems, Inc., Radar for the Detection of Unexploded Ordnance. Melvin H. Friedman. U.S. Army Mobility Equipment Research and Development Command. Fort Belvoir, Virginia. Report No. MERADCOM-2322. March 1981.

Evaluation of the Ordnance Detection Expert Support Application (ODESA). NAVEODTECHDIV in conjunction with USAEC. Report No. SFIM-AEC-ET-CR-95084. ADA No. 302912. Available through DTIC at 703/767-8274 (telephone) or 703/767-9070 (facsimile). October 1995.

Explosive Ordnance Disposal Procedures. NAVEODTECHDIV. Indian Head, Maryland. Technical Manual 60A-1-1-15. April 4, 1994.

Ground Penetrating Radar for Ordnance-Contaminated Site Restoration. NAVEODTECHDIV in conjunction with USAEC. Report No. SFIM-AEC-ET-CR-95041. ADA No. 295153. Available through DTIC at 703/767-8274 (telephone) or 703/767-9070 (facsimile). March 1995.

Guns, Mortars & Rockets. J.W. Ryan. Brassey's Publishers. New York, New York; Oxford, England. 1982.

Handbook: Approaches for the Remediation of Federal Facility Sites Contaminated with Explosive or Radioactive Wastes. Eastern Research Group, Inc., Lexington, Massachusetts. Report No. PB-94-144656/XAB. September 1993.

History of U.S. Navy Bomb Disposal. Naval Explosive Ordnance Disposal Association. Virginia Beach, Virginia. 1992.

"House to Appropriate 26% Less for the Defense Environmental Restoration Account." Defense Cleanup. Pasha Publications, Inc. ISSN: 0083-9735. September 1993.

Imaging Algorithms for Synthetic Aperture Ultra-Wideband Radar. E.M. Johansson, J.E. Mast. Lawrence Livermore National Laboratory. California. Report No. UCRL-53868-93. Order No. DE94014210. May 1994.

Improvised Munitions Systems. James J. Glackin. Paladin Press. Newfoundland, New Jersey. 1976.

Infantry Weapons. Jane's Yearbook. Edited by Ian V. Hogg. Undated.

"Kaho'olawe Draft Issued." Defense Cleanup. Pasha Publications, Inc. November 1995.
ISSN: 0083-9735.

"Kuwait Bomb Disposal Gets Off to an Explosive Start." Miriam Amie. 32 Mideast Markets.
American Banker-Bond Buyer. February 1992.

"Managing Unexploded Ordnance on Federal Lands: Oversight Hearing." Before the Committee on
Natural Resources. House of Representatives, One Hundred Third Congress, Second Session.
House Committee on Natural Resources. Seaside, California. U.S. Government Printing
Office. Washington, DC. May 2, 1994.

"Military Bases: Environmental Impact at Closing Installations." General Accounting Office.
GAO/NSIAD-85-70. February 1995.

"Military Robotics." Robotic Digest. L&B Limited. ISSN: 0896-0348. September 1992.

"Mine Detection in Dry Soils Using Radar." J.V. Hanson and others. U.S. Army Topographic
Engineering Center. Report No. R-163. March 17, 1992.

"Navy Begins to Clean Up Kaho'olawe Island." Defense Cleanup. Pasha Publications, Inc.
ISSN: 0083-9735. August 1995.

"Navy Wants Autonomous Underwater Vehicle." Military Robotics Sourcebook. L&B Limited.
ISSN: 0896-0348. March 1989.

Need for Unexploded Ordnance Remediation Technology. Institute for Defense Analysis.
C.T. Ackerman and C.M. Jordan. Report No. IDA-D-1527. Alexandria, Virginia.
October 1994.

New Weapons Technologies: Debate and Directions. Richard Burt. International Institute for Strategic
Studies. London, England. 1976.

"No 'Silver Bullet' Technology Found for Clearing Land Mines." Federal Technology Report.
McGraw-Hill Companies Inc. ISSN: 1042-9158/9. February 1996.

Notes on the Selection and Use of Metals in Ordnance Design. U.S. Department of Defense,
Metallurgical Board. U.S. Government Printing Office. Washington, DC. November 1924.

"OEW Site Mitigation Prioritization." Final Report, Version D. QuantiTech, Inc. Technical Report
93R004vD. 1994.

Ordnance Basic Research, 1956-60. Peregrine White. U.S. Army Office of Ordnance Research.
Durham, North Carolina. 1960.

Ordnance Corps; Pamphlet. U.S. Army Ordnance Corps. U.S. Government Printing Office. Washington, DC. Undated.

Ordnance; Government-Owned Inventions Available for License. U.S. Patents Board. U.S. Department of Commerce. Washington, DC. 1954.

Pulsed Electromagnetic Induction (PEMI). Final Report. NAVEODTECHDIV in conjunction with USAEC. November 1995. Report No. SFIM-AEC-ET-CR-95092. ADA No. 305557. Available through DTIC at 703/767-8274 (telephone) or 703/767-9070 (facsimile). November 1995.

"Range Clearance -- An Economic Model. Final Report. NAVEODTECHDIV. Indian Head, Maryland. May 1985.

"Range Clearance Technology Assessment. Final Report. NAVEODTECHDIV. Indian Head, Maryland. Report No. AD-B146-002. March 1990.

"Rapid Area Clearance of Explosives. Abstract. Patent No. US 5223661; Class No. 089001130. Zeinab A. Sabri. U. S. Patent Office. Washington, D.C. 1993.

"Recycling & Recovery: Useful Material from Aging Explosives." Waste Treatment Technology News. Business Communications Company, Inc. ISSN: 0885-0003. March 1994.

Remote Detection of Unexploded Ordnance -- Ground Penetrating Radar. Geo-Centers, Inc., Newton Upper Falls, Massachusetts. Report No. NAVEODTECHCEN-308. November 1990.

"Report to the President from the Defense Base Closure and Realignment Commission." U.S. Department of Defense. 1993.

"Response to the Landmine Threat in Bosnia." Prepared Statement by Dr. Claude Manley, Technical Director, Navy Managed Joint Service Activity, NAVEODTECHDIV. Presented to the House National Security Committee, Military Procurement Subcommittee, and Research and Development Subcommittee. NAVEODTECHDIV. Indian Head, Maryland. Federal News Service Group, Inc. Washington, DC. January 1996.

"Response to the Landmine Threat in Bosnia." Prepared Statement by George T. Singley, III, Deputy Director, Defense Research and Engineering. Presented to the House National Security Committee, Subcommittee on Military Procurement, and Subcommittee on Military Research and Development. U.S. Department of Defense, Defense Research and Engineering. Federal New Service Group, Inc. Washington, DC. January 1996.

"Response to the Landmine Threat in Bosnia." Prepared Statement by John K. Reingruber, Office of the Assistant Secretary of Defense, Special Operations and Low-Intensity Conflict. Presented to the House National Security Committee, Research and Development Subcommittee, and the Procurement Subcommittee. United States Department of Defense. Federal News Service Group, Inc. Washington, DC. January 1996.

- "Retainer for Grenade Body Loading Assemblies for Demolition of Unexploded Ordnance." Abstract. U.S. Patent Office. Patent No. US 4993324; Class No. 102275120. David Stefanye. Washington, DC. 1991.
- "Review of Unexploded Ordnance Detection Methods." J.E. McFee and Y. Das. Suffield Report 292. September 1981.
- "Rising to the Challenge in Military Site." Battelle Memorial Institute. Timothy Moore. Ray-Vin Publishing Company. New Brunswick, New Jersey. May to June 1995.
- "Risk Assessment: Unexploded Ordnance." Major N. Lantzer and others. Point paper prepared for NAVEODTECHDIV. August 1995.
- "Robotics for Airborne Recovery Program Unmanned Ground Vehicle." Military Robotics Sourcebook. L&B Limited. January 1991.
- "Rule Proposed for Hazardous Waste Munitions." Haznews. Profitastrol, Ltd. ISSN: 0953-5357. January 1996.
- "Sensor Technology Assessment for Ordnance and Explosive Waste Detection and Location." U.S. Army Corps of Engineers. March 1, 1995.
- Surface Explosive Ordnance Disposal.* U.S. Army. Washington, DC. 1961.
- "Surface Towed Ordnance Locator System Scientific and Technical Report." NAVEODTECHDIV in conjunction with USAEC. Report No. SFIM-AEC-ET-CR-95042. ADA No. 295232. Available through DTIC at 703/767-8274 (telephone) or 703/767-9070 (facsimile). February 1995.
- "Sweden - Rapid Disposal of Buried Unexploded Ordnance." Canadian Defence Quarterly. Information Access Company. ISSN: 0315-3495. 1982.
- "System/Design Trade Study Report for the Navigation of the Airborne, Ground Vehicular and Man-Portable Platforms in Support of the Buried Ordnance Detection, Identification, and Remediation Technology." NAVEODTECHDIV in conjunction with USAEC. Report No. SFIM-AEC-ET-CR-95043. ADA No. 295760. Available through DTIC at 703/767-8274 (telephone) or 703/767-9070 (facsimile). March 1995.
- "Talon Team Would Recycle Munitions." Defense Cleanup. Pasha Publications, Inc. ISSN:0083-9735. October 1992.
- "The Federal Advisory Committee to Develop On-Site Innovative Technologies Picks 13 Projects." Defense Cleanup. Pasha Publications, Inc. ISSN: 0083-9735. February 1994.
- "The Greening of U.S. Military Bases." Pritchard, Charles G. International Defence Review . Jane's Information Group. January 1991.

The Story of Ordnance in the World War. Sevellon Brown. James William Bryan Press.
Washington, DC. 1920.

Two Centuries of Weapons, 1776-1976. Carroll B. Colby. Coward, McCann & Geoghegan.
New York, New York. 1975.

Undex Site Survey Report. Final Report. NAVEODTECHDIV in conjunction with the Army Toxic
and Hazardous Materials Agency. Report No. NAVEODTECHDIV TR 303. September
1991.

“Unexploded Ordnance: A Coordinated Approach to Detection and Clearance is Needed.” Report to
Committee on National Security, United States House of Representatives. U.S. General
Accounting Office, National Security and International Affairs Division. Washington, DC.
GAO/NSIAD-95-197. September 1991.

*Unexploded Ordnance Advanced Technology Demonstration Program at Jefferson Proving Ground
(Phase I).* NAVEODTECHDIV. Indian Head, Maryland. December 1994.

*Unexploded Ordnance Advanced Technology Demonstration Program at Jefferson Proving Ground
(Phase II).* NAVEODTECHDIV. Indian Head, Maryland. June 1996.

“Unexploded Ordnance, Agent Cleanups Excluded from the Defense Environmental Restoration Act.”
Defense Cleanup. Pasha Publications, Inc. ISSN: 0083-9735. December 1995.

“Unexploded Ordnance and Explosive Residuals on Military Ranges -- Is the Remediation Cure Worse
than the Ailment?” K. Heckelman. May 12, 1995.

*Unexploded Ordnance Assessment of U.S. Military Ranges in Panama: Empire, Balboa West, and
Pina Ranges.* PRC Environmental Management, Inc. April 1996.

“Unexploded Ordnance Cleanup Uncoordinated.” Defense Cleanup. Pasha Publications, Inc.
ISSN: 0083-9735. October 1995.

*Unexploded Ordnance Detection, Identification, and Remediation Advanced Technology
Demonstrations: Demonstrator Information.* NAVEODTECHDIV. Indian Head, Maryland.
1994.

Unexploded Ordnance in Kuwait: The EOD Operator's Pocket Book. UK EOD CELL (Kuwait).
1991.

“Unexploded Ordnance (UXO) Procedures.” U.S. Department of the Army. Field Manual
No. 21-16. Fleet Marine Force Manual No. 13-8-1. August 1994.

*Unexploded Ordnance Standoff Detection and Classification System using HTS Superconducting
Quantum Interference Device Sensors.* Brian D. Glance. U.S. Navy, Office of Naval
Research. Knight-Ridder Information. Issue No. PSA-1561. March 1996.

"Unexploded Ordnance: U.S. Army Finishes Evaluation of Bomb-Finding Technologies." Report on Defense Plant Wastes. Business Publishers, Inc. ISSN: 1043-268X. December 1994.

Weapon Systems. Jane's Yearbook. Edited by Ronald T. Pretty. Undated.

Weapons and Equipment Recognition Guide: Southeast Asia. U.S. Army. Washington, DC. 1966.

Weapons and Equipment Recognition Handbook, Middle East. U.S. Army. Washington, DC. 1958.

Weapons of War. Philip Ellaby Cleator. Hale. London, England. 1967.

BIBLIOGRAPHY: CONFERENCES PUBLICATIONS

Conference of Arsenal Mathematicians: Transactions. Conference Proceedings. Office of Ordnance Research, Ordnance Corps, U.S. Army. Durham, North Carolina. Undated.

Conference for the Reduction and Limitation of Armaments, Geneva, 1932-1934: Documents 1-4. Conference Proceedings. General Commission Drafting Committee Concerning Material. Geneva, Switzerland. 1933.

Electromagnetic Detection, Location, and Identification of Unexploded Ordnance for Environmental Cleanup. Conference Proceedings. Electromagnetic Environments and Consequences; Proceedings of the European Electromagnetics International Symposium on Electromagnetic Environment and Consequences, EUROEM 94. Bordeaux, France. Authors: A.E. Hooper, C.D. Brown, and P.A. Tennant, U.S. Army Test & Evaluation Command. Aberdeen Proving Ground, Maryland. EUROEM, Gramat, France. May to June 1994.

Environmental Restoration at Formerly Used Defense Sites. Conference Proceedings. Hazardous Materials Control/Superfund 92: 13th Annual Conference and Exhibition. Washington, DC. Report No. CONF-921235. 1992.

Evaluation of Methods for Detection, Identification, and Remediation of Buried Unexploded Ordnance. Superfund XV Conference Proceedings. Washington, DC. Authors: K.O. Thomsen, PRC Environmental Management, Inc., Chicago, Illinois; K.A. Rigano, USAEC, Aberdeen Proving Ground, Maryland; G.R. Snyder, NAVEODTECHDIV, Indian Head, Maryland; J.R. Bellinger, PRC, Inc., Indian Head, Maryland; W.D. Rowe, Automation Research Systems, Ltd., Alexandria, Virginia; and L.M. Seigel, PRC Environmental Management, Inc., McLean, Virginia. U.S. Hazardous Materials Control Resources Institute, Rockville, Maryland. Report No. CONF-941189. ISBN: 1-56590-016-2. November to December 1994.

First Tutorial Seminar on P/M in Ordnance. Conference Proceedings. Philadelphia, Pennsylvania. 1971.

- Ground-Penetrating Radar Applications for Hazardous Waste Detection.* Conference Proceedings. Underground and Obscured-Object Imaging and Detection. Orlando, Florida. Authors: Michael Bashforth and Steven Koppenjan, Special Technologies Laboratory, Santa Barbara, California. 1993.
- Ground-Penetrating Radar Target Classification Via Complex Natural Resonances.* Conference Proceedings. IEEE Antenna and Propagation Society International Symposium. Newport Beach, California. Authors: Chi-Chih Chen, L. Peters, Jr., and W.D. Burnside, ElectroScience Laboratory, Ohio State University, Columbus, Ohio. IEEE. New York, New York. Material Identity No. XX95-02116. 1995.
- Human Factors Evaluation; the Explosive Ordnance Disposal/Automated Information Retrieval and Expert System.* Conference Proceedings. Human Factors Society 34th Annual Meeting. Orlando, Florida. Authors: Adam E. Krass, Robert F. Miller, and Jock O. Grynovicki, U.S. Army, Fort Monmouth, New Jersey. 1990.
- Innovative and Cost-Effective Approach for Unexploded Ordnance Detection Using Geographic Information System: Setting a New Standard.* Conference Proceedings. Symposium on the Application of Geophysics to Engineering and Environmental Problems. Orlando, Florida. Authors include: C. Heaton, R. Menke, and M. Gifford. Environmental and Engineering Geophysical Society. Engelwood, Colorado. April 1995.
- Integrated Approach for Measuring and Processing Geophysical Data for the Detection of Unexploded Ordnance.* Conference Proceedings. Symposium on the Application of Geophysics to Engineering and Environmental Problems. Orlando, Florida. Authors: J. Pawlowski, R. Lewis, T. Dobush, and N. Valleau. Environmental and Engineering Geophysical Society. Engelwood, Colorado. April 1995.
- Martha's Vineyard - An Explosive Situation; Dune Restoration after Removal of Unexploded Ordnance.* Conference Proceedings. Coastal Zone '89: Proceedings of the Sixth Symposium on Coastal and Ocean Management. Charleston, South Carolina. Authors: Catherine J. Demos and Judith L. Johnson. 1989.
- Multispectral Infrared Signature Polarimetry for Detection of Mines and Unexploded Ordnance.* Conference Proceedings. Detection Technologies for Mines and Minelike Targets; Proceedings of the Meeting. Orlando, Florida. Authors: Malcolm A. LeCompte and Frank J. Iannarilli, Aerodyne Research, Inc., Billerica, Massachusetts; Davis B. Nichols and Robert R. Keever, Boeing Defense and Space Group, Seattle, Washington. AIAA. Order No. A95-43164. 1995.
- Telerobotic Excavation System for Unexploded Ordnance Retrieval.* Conference Proceedings. Department of Defense 26th Explosives Safety Seminar. Miami, Florida. Authors: B.L. Burks, S.M. Killough, and D.H. Thompson, Oak Ridge National Laboratory, Tennessee; and R.A. Rossi. Office of the Project Manager for Ammunition Logistics, Picatinny Arsenal, New Jersey. Report No. CONF-9408136-3. Order No. DE95006738. August 1994.

Titanium Symposium. Conference Proceedings. Watertown Arsenal. Watertown, Massachusetts. 1952.

Unexploded Ordnance Risk Assessment Framework. Conference Proceedings. Unexploded Ordnance Forum. Williamsburg, Virginia. Authors: R.J. Mulvihill and others. April 1996.

COMMENTS AND SUGGESTIONS

Comments, recommendations, and suggested changes are being solicited so that this document can be revised for future distribution. Please note your comments and recommendations below and send them to:

Naval Explosive Ordnance Disposal Technology Division
UXO Countermeasures Department
Code 30U
2008 Stump Neck Road
Indian Head, Maryland 20640-5070

For your convenience, the back of this page is self-addressed for mailing purposes.

Name: _____

Address: _____

Daytime Phone: _____

Comments and Suggestions:

If you would like to be added to future publications of the UXO Reference Book, please send a 3- to 4-sentence description of your organization's experience as it relates to UXO, along with an appropriate project manager's name, address, telephone number, facsimile number, and e-mail address, to the address listed on the reverse side of this page.

(Fold)

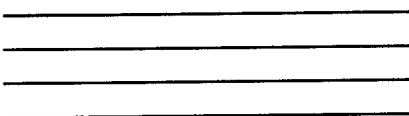

Naval Explosive Ordnance Disposal Technology Division
UXO Countermeasures Department
Code 30U
2008 Stump Neck Road
Indian Head, Maryland 20640-5070