



## Effects of low-frequency water-borne sound on divers: Open water trial

*C. C. Steevens, MD*  
*R. Sylvester*  
*J. Clark*

19971121 017

Released by  
M. T. Wooster, CAPT, MSC, USN  
Commanding Officer  
Naval Submarine Medical Research Laboratory

DTIC QUALITY INSPECTED 3

Effects of low-frequency water-borne sound on divers:  
Open water trial

C. C. Steevens and R. Sylvester  
Naval Submarine Medical Research Laboratory

J. Clark  
Naval Aerospace Medical Research Laboratory

Naval Submarine Medical Research Laboratory  
Report 1208

Space and Naval Systems Warfare Command Task

Naval Medical Research and Development Command  
Research Work nit 63747N-5503

Approved and Released by



M. T. Wooster  
Commanding Officer  
NavSubMedRschLab

**DTIC QUALITY INSPECTED 3**

Approved for public release; distribution unlimited

## Summary Page

### The Problem:

Divers may be exposed to intense underwater sound. Previous research in this area has been conducted in enclosed environments only, characterized by standing wave acoustics. The effects on divers of low-frequency water-borne sound in the open water remains unknown.

### The Findings:

There is no indication that low-frequency water-borne sound exposures in the open water present any additional risk compared to similar exposures in enclosed environments.

### The Application:

The results of this study have been used in establishing recommendations for safe exposure of divers to low-frequency sonar transmissions.

## Administrative Information

This research was carried out under a Space and Naval Systems Warfare Command Task, 63747N-5503, Low Frequency Active Sonar, and the Naval Medical Research and Development Command. The views expressed in this report are those of the authors and do not reflect the official policy or position of the Department of the Navy, the Department of Defense, or the US Government. It was approved for publication on 7 Oct 97 and designated as NSMRL Report 1208.

## Abstract

Navy divers may be exposed to active sonar transmissions while underwater. Previous manned experiments to determine safe levels of exposure have all been conducted in enclosed settings characterized by standing wave sound fields. The purpose of this experiment was to determine if plane wave (open water) acoustics alters the physiological or subjective responses of exposed divers compared to standing wave exposures. 54 manned exposures to two low-frequency underwater acoustic signals were performed at depths of 30 and 60 feet in a fresh water spring. Two projectors were used to create a plane progressive traveling acoustic wave. Divers were exposed in both helmeted and unhelmeted diving rigs. Effects on hearing, vestibular function, cardiac rhythm, and a key-insertion task were measured. Subjective responses were also recorded. In addition, the effects of neoprene wet suits on sound attenuation were measured. Slight decrements in hearing acuity were detected, but these results were confounded by circumstances unrelated to the underwater sound exposures, such as ear squeezes from diving, and microphone feedback noise. No adverse effects in vestibular function, cardiac rhythm, or key insertion performance were detected. Subjective responses revealed that divers were moderately annoyed by the underwater sound, but overall found the exposures tolerable. Neoprene wet suits generally act to attenuate low-frequency sound exposures, but under certain circumstances may also accentuate a sound exposure, possibly through a resonance effect. There is no indication from the results of this study that low-frequency water-borne sound exposures in the open water present any additional risk to divers compared to similar exposures in enclosed environments.

[Blank Page]

Effects of low-frequency water-borne sound on divers:  
Open water trial

Navy divers may be exposed to active sonar transmissions while underwater. Anecdotal reports from divers have indicated that such transmissions can be felt as well as heard. One such report from a diver exposed to low-frequency water-borne sonar consisted of a sensation of numbness for two hours following the exposure, thus raising concerns regarding the potential health risks to divers who may be in the area of these transmissions (P.F. Smith, Personal Communication, "Interview with a Diver Exposed to Intense Low-Frequency Water-Borne Sound," 25 Feb 1993). Consequently, recent efforts have been focused on defining in greater detail the effects on divers of underwater sound, particularly low-frequency transmissions in the frequency range of 160 to 320 Hz, and in the process determining levels of safe exposure.<sup>1</sup>

The current experiment is the final phase of a two year study addressing the effects of low-frequency water-borne sound on divers. The study progress to this point may be summarized as follows:

*Thermal Effects:*

Mathematical modeling concluded that the temperature increase produced by exposure to underwater sound at a frequency less than 1000 Hz, and a sound pressure level less than 160 dB will produce a temperature rise of less than 1 °C, and therefore not result in a significant thermal effect on human tissue (Nyborg, 1993).

*Bubble Growth:*

Further mathematical modeling concluded that underwater sound exposure at all low frequencies (any frequency less than an order of hundreds of kilohertz) and sound pressure levels in excess of 210 dB can be expected to result in significant micro-bubble growth (bubbles with initial radii from 1-10 mm) by the process of rectified diffusion, and therefore divers exposed to these conditions may be at increased risk of such effects as decompression sickness (Crum and Mao, 1994). For sound pressure levels below about 190 dB, however, significant bubble growth is unlikely.

*Lung Response:*

Modeling of wave propagation within the airways resulting from sound pressure applied at the chest wall concluded that there can be considerable amplification of pressure within the airways in response to frequencies surrounding 250 Hz (Suki, Habib, & Jackson, 1994). Due to limitations of the model, however, the magnitude of the pressure amplification, and the level of exposure for which barotrauma might be expected could not be determined.

Lung vibration studies (n = 5 subjects) using an experimental non-invasive vibration amplitude measurement system (NIVAMS) showed a lung resonance for humans between 100 and 200 Hz at the surface which was reduced in amplitude with subjects at a depth of 10 feet (Rogers, Caille, & Lewis, 1994). Determining lung resonance in divers is impor-

---

1 NOTE: All notations regarding underwater sound levels are specified in decibels (dB) referenced to 1  $\mu$ Pa unless otherwise noted.

tant for establishing thresholds of injury, because for a given level of low frequency excitation, the vibration of the lungs (and hence the risk of damage) will be highest at resonance. Exposures during these studies consisted of approximately 30, 4-6 second pulses using frequencies between 50 and 500 Hz at levels of approximately 130 dB.

Experiments on three pigs at depths of 6-10 feet exposed to underwater sound for up to 35 minutes total exposure time (using 5-minute intervals of continuous exposure) at frequencies between 100 and 400 Hz and intensity levels ranging from 161 to 177 dB showed no detectable damage to lungs or abdominal viscera as a result of the sound exposure (Lehner, 1994). However, due to initial problems with anesthesia in the totally submerged pig, results from 10 additional sound exposed pigs were inconclusive.

#### *Tactile Perception:*

Experiments at NSMRL (n = 4 divers) and Syracuse University (n = 3 subjects) showed that vibrotactile sensitivity is not significantly affected by ambient pressure and water immersion, suggesting that vibrations resulting from underwater sound present no additional risk, compared to similar vibrations in air, with regards to the cutaneous sensory system (Verrillo, Bolanowski, Baran, & Smith, 1994). Further, mathematical calculations concluded that for underwater sound at 250 Hz, the sound intensity required to induce mild discomfort through the cutaneous sensory system would need to be at least three orders of magnitude greater than the auditory pain threshold as determined in air (an equivalent of approximately 220 dB underwater) (Bolanowski, 1994).

#### *Auditory Effects:*

Hearing experiments conducted at Roosevelt Roads, Puerto Rico with bare-headed SCUBA divers at 30 FSW showed

that four-minute exposures to continuous warble tones (+/- 5% of center frequency) with center frequencies of 125 Hz (n = 9 divers) and 250 Hz (n = 10 divers) produced no temporary threshold shifts in hearing greater than 15 dB for exposure levels up to 161 dB (Smith, Sylvester, Baran, & Steevens, 1994). It was concluded that such exposures do not present a significant risk to diver hearing. During these same studies, divers did report various symptoms including joint pains, dizziness, alterations in visual fields, and headaches, but these symptoms were only in response to higher frequency transmissions (500-4000 Hz). Intensities for the higher frequency exposures extended up to 196 dB.

#### *Vital Organ Function:*

Experiments conducted at SUBASE NLON found that divers (n = 22) whose torsos were intermittently exposed to 250 Hz (+/- 12.5 Hz) warble tone signals for a total of 15 minutes at levels up to 160 dB experienced no significant measurable effects on performance or vital organ function (Steevens, Schlichting, et al., 1994).

Experiments conducted at the Naval Experimental Diving Unit (NEDU) (n = 18 divers, 33 dives) using intermittent 5-minute exposures for a total of 15 minutes at 33 FSW (simulated depth in a hyperbaric wet pot facility) to 240 Hz (+/- 80 Hz) warble tone signals at levels up to 160 dB also revealed no measurable effects on vital organs (Steevens, Knafelc, et al., 1994).

A second set of experiments conducted at NEDU (n = 22, 156 dives), with exposure to three different representative low-frequency water-borne sound waveforms (a 240 +/- 80 Hz warble tone signal, a pure tone sweep signal from 160 to 260 Hz, and a pure tone sweep signal from 230 to 320 Hz) using 100 second exposures with a 50% duty cycle for a cumulative exposure of 15 minutes per dive,

at various depths and using various rigs resulted in no events compromising the divers (Russell and Knafelc, 1995). In these experiments, a "compromised event" was defined as one in which a diver could become a casualty or burden to others in an operational setting as a result of the sound exposure. Tests of vestibular function were also performed during this study, and although minor changes were seen, the clinical significance of such changes remains uncertain.

#### *Subjective Responses:*

Results of the tests referred to above at Roosevelt Roads (n = 19), SUBASE (n = 22), and NEDU (n = 30) showed that most subjects felt vibrations at 130 dB and higher, described such sensations as mildly to moderately annoying but tolerable, and suffered no lasting aftereffects of those exposures. The frequencies covered in these experiments consisted of 3 separate warble tone signals, and 2 pure tone sweep signals ranging from 100 to 320 Hz (see above).

Reports from three subjects, however, remain topics of concern. One subject reported numbness for 2 hours after an unknown exposure in the open sea (P.F. Smith, Personal Communication, "Interview with a Diver Exposed to Intense Low-Frequency Water-Borne Sound," 25 Feb 1993). The sensations disappeared, with no apparent after-effects. One report of knee pain was received from a subject whose knees were exposed to a warble tone signal (250 +/- 12.5 Hz) at 160 dB intermittently for about 15 minutes (Steevens, Schlichting, et al., 1994). The knee pain resolved completely within 18-24 hours after the sound exposure ended. This subject had prior knee surgery with retained hardware in the affected knee, raising the issue of possible predisposing factors increasing one's susceptibility for adverse effects of water-borne sound. During tests at NEDU, one subject at 60 FSW using a US Navy MK-20 underwater

breathing apparatus (full face mask, no helmet, with surface supplied air) reported lightheadedness, dizziness, not feeling awake and alert, and being unable to concentrate after about 12 minutes into a planned 15 minute continuous exposure to a warble tone signal (240 Hz +/- 80 Hz) at 160 dB (Steevens, Russell, et al., 1994). The subject maintained a level of consciousness which allowed him to remove himself from the water safely without assistance. The acute symptoms initially resolved after approximately 26 minutes post-dive, but the subject experienced two similar recurrences within a 36 hour period following the sound exposure. Medical evaluation of this subject was inconclusive, and his symptoms appeared to have resolved without any measurable persistent deficits. However, during an interview approximately one year after the exposure, the subject reported persistent impairment which he subjectively attributed to the sound exposure; specifically, a decrease in hand steadiness, increased irritability, insomnia, and impaired memory function. He declined any further neuropsychological evaluation at that time. Nineteen months after the exposure, he developed symptoms consistent with a seizure disorder. Further workup was again non-diagnostic, but he is currently receiving anti-seizure and antidepressant therapy. This subject had received a longer duration of continuous exposure within the 160-320 Hz frequency range than any other experimental subject.

Table I summarizes the above results.

The manned exposures described above were all conducted in enclosed settings where the sound field was characterized by a standing wave field that varied in a deterministic manner in response to the changing signal characteristics. Although the sound pressure levels in these experiments were controlled to reflect potential open water (occupational) exposures, the phase relationship between



Table 1  
*Studies of Low Frequency Underwater Sound*

Author	Method	Frequencies	Max SPL	Time of Exposure	Adverse Effects
Nyborg	Modeling	< 1000 Hz	< 160 dB	Minutes	None
Crum and Mao	Modeling	< 1000 Hz	<190 dB	Minutes	None
Suki et al.	Modeling	250 Hz	not specified	Minutes	Elevation of intra-airway pressure
Rogers et al.	Human exp. (n=5)	50-500 Hz	130 dB	4-6 sec x 30	None
Lehner et al.	Pig exp. 6-10 (FSW (n=3))	100-400 Hz	161-177 dB	5 min. x 7	None
Verrillo et al.	Human exp. (n=6) + Modeling	250 Hz	<180 dB	Minutes	None
Smith et al.	Human exp. (n=9)	125 Hz (warble +/-5%)	161 dB	4 minutes	None
Smith et al.	Human exp. (n=10)	250 Hz (warble +/-5%)	161 dB	4 minutes	None
Steevens et al.	Human exp head out (n = 22)	250 Hz (warble +/-5%)	160 dB	5-10 min. (cont.) + 30-60 sec. x 5	Knee pain in subject
Steevens et al.	Human exp. 33 FSW (n = 18)	240 Hz (warble +/-33%)	160 dB	5 minutes	None
Steevens et al.	Human exp. 60 FSW (n = 1)	240 Hz (warble +/-33%)	160 dB	15 minutes	somnolent, light-headed, dizzy, unable to concentrate
Russell et al.	Human exp. 33,60,66,99, 130 FSW (n = 24)	160-320 Hz (3 varying signals)	160 dB	100 sec. x 9	None

pressure and acoustic particle velocity was different from that expected in an open water setting. That is, in the open water one would expect a plane progressive traveling acoustic wave where pressure and particle velocity are in phase, as opposed to the out of phase relationship seen in the enclosed laboratory facilities. While it has been hypothesized that pressure, not particle velocity, is the fundamental variable likely to cause physiological responses from underwater sound exposures,

and therefore, controlling sound pressure levels is deemed an adequate representation of open water exposures, this has not been tested empirically. Furthermore, this hypothesis is based largely on the assumption that compressible tissues, such as the lung, are most vulnerable to underwater acoustical damage, when in fact, the most significant effects thus far observed seem to be either central nervous or vestibular system effects. The mechanism for these effects, and thus the relevance of

plane wave acoustics, remains essentially unknown.

Acoustical engineers at the Naval Research Laboratory (NRL) in Orlando, FL. have designed a method to simulate open water acoustics in a relatively enclosed facility (thereby maintaining appropriate experimental control) by using a second source projector to create the purely resistive field present in a plane progressive traveling acoustic wave (Forsythe and Van Buren, 1995). We used this method to expose 6 subjects to low-frequency waterborne sound. Apart from the differences in wave mechanics, the signals used in this experiment were identical to signals used in the most recent NEDU experiment (Russell and Knafelc, 1995). That is, the same frequency characteristics (warble and sweep signals varying from 160-320 Hz), duration of exposures (9, 100 second intervals per dive), duty cycles (50%), and estimated sound pressure level (160 dB) were used. Therefore, some direct comparisons between responses to plane

waves and standing waves can be made.

## METHOD

### *Research Set-up*

This experiment took place at Bugg Spring, FL. Bugg Spring is a funnel shaped spring with top diameter of 130 m and depth of 53 m. Water temperature in the spring (below about 5 m) is constant at 22°C at all depths at all times of the year. The spring is leased by the Navy, isolated from recreational activity, and routinely used for underwater sonar testing. Dense vegetation surrounding the spring and its somewhat isolated location in a rural area contribute to the low noise levels in the spring. The ambient noise level is usually below sea-state-zero on an extrapolated Knudsen curve. Measured sound speed in the spring is 1488 m/sec at a depth of 15 meters. Figure 1 is a hydrographic map of the spring.

All diving took place off a barge located approximately in the center of the spring. Divers entered the water through a central open-

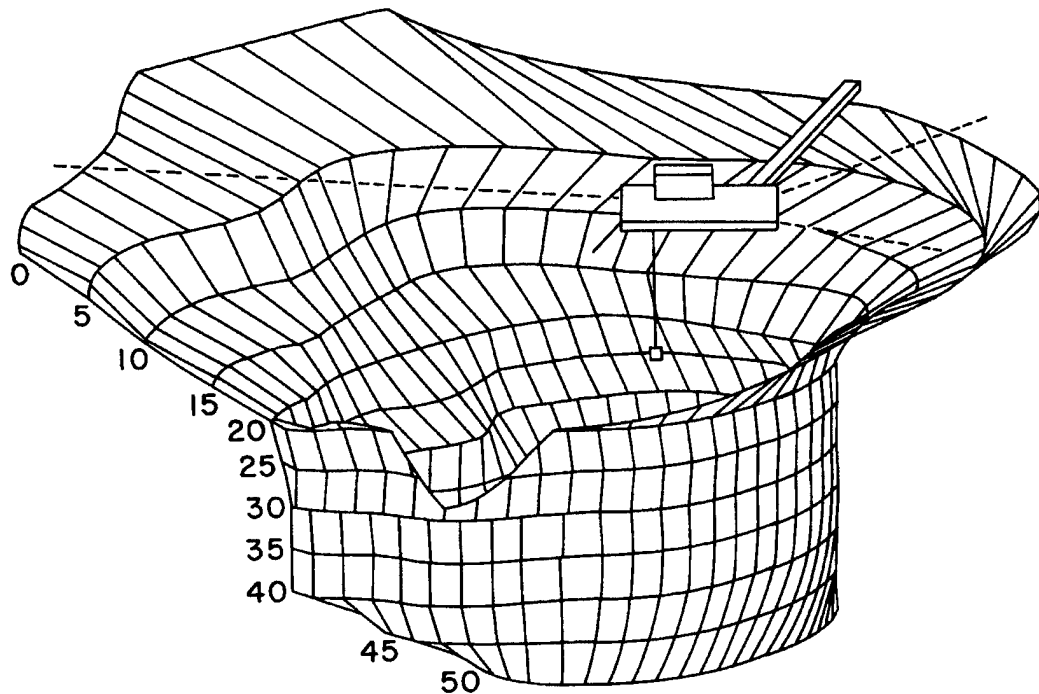

*Figure 1.* A hydrographic map of Bugg Spring. Indicated depths are in meters. The diving platform was located over the deepest portion of the spring.

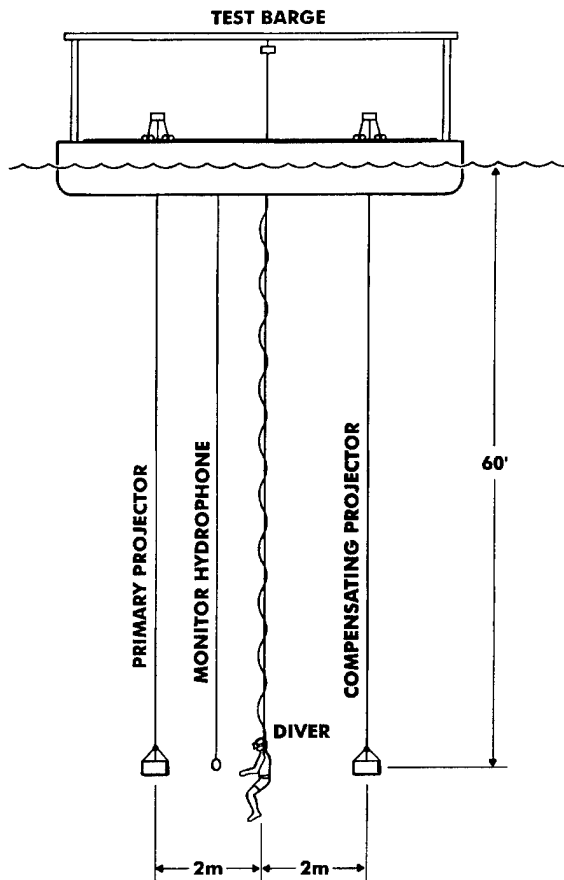

Figure 2. Schematic representation of the diving set-up. Subjects dove through a central opening in the test barge. Sound projectors were located directly in front of and behind the subject when in position for sound exposure testing.

ing in the barge, and were situated with sound transducers located approximately 2 meters in front of and behind them (Figure 2). A trapeze with harnesses was used to maintain the divers position and control his depth (Figure 3).

### Subjects

The subject population consisted of 8 active-duty US Navy divers (6 experimental subjects and 2 controls), possessing Diver Second Class qualification or higher. Divers were medically qualified for experimental diving as determined by review of medical records by the principal investigator (a qualified Diving Medical Officer). All subjects were healthy males (not undergoing medical evaluation or treatment, and without chronic unresolved

medical disability) between the ages of 24 and 35.

### Test Conditions

All underwater sound exposures were conducted using a fixed sound pressure level of 160 dB. The sound pressure level was determined at the diver location without the diver present (Appendix A is a description of the sound field production and monitoring methods). Each of the six primary diver-subjects completed one sound exposure dive per day for 9 test days. The first exposure dive for all subjects was conducted at a depth of 30 ft. All remaining exposures were conducted at 60 ft. The purpose of the 30 ft. dive was to orient the subject to the sound exposure at a shallower depth before proceeding with eight

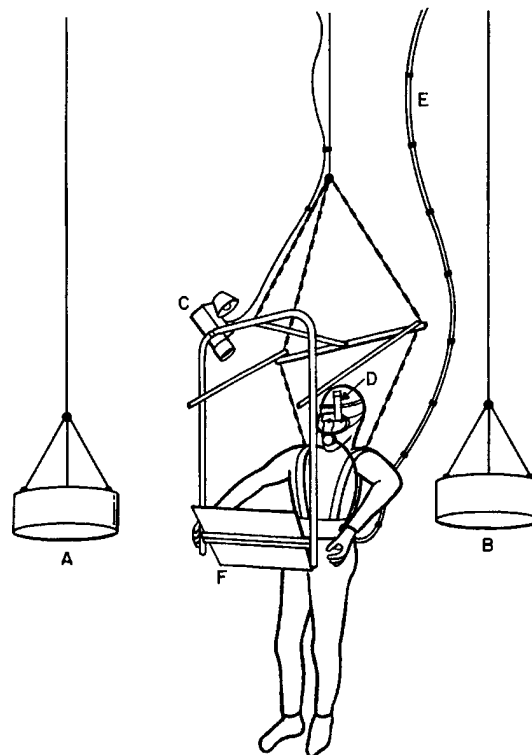

Figure 3. Schematic representation of diving trapeze set-up. A,B: primary and compensating sound sources; C: Osprey video camera for visualization of the diver during testing; D: nystagmus monitoring camera mounted to the diver's face mask; E: diver/medical umbilical (gas supply and ECG electrode wiring); F: SINDBAD reaction time testing tray.

Table 2  
*Experimental Design*

Unhelmeted				Helmeted			
Signal 1		Signal 2		Signal 1		Signal 2	
e1	e2	e1	e2	e1	e2	e1	e2

experimental dives at the single depth of 60 ft. Two transmission sequences were used, a warble tone signal at 240 +/- 80 Hz (using a 5 Hz warble rate), and a slow sweep signal from 230 to 320 Hz. The diving rigs used were grouped into two categories: helmeted, and unhelmeted. The helmeted diving rig for all subjects was a USN MK-21. The unhelmeted diving rig for four of the experimental subjects and the two control subjects was a USN MK-20. For the remaining two experimental subjects, a USN MK-16 (a closed circuit diving rig) was used in the unhelmeted condition. For the eight 60 ft. dives each subject was exposed under 4 conditions with 2 exposures per condition in a repeated measures design as shown in Table 2, where "e 1" represents ex-

posure number 1 for each condition, and "e 2" represents exposure number 2 (the repeated measure).

In order to separate a cumulative exposure effect from an effect of a specific condition, the sequence of exposure conditions were counterbalanced between subjects (Table 3).

Transmission sequences were delivered as 9 successive continuous sound intervals of 100 seconds each. Each sound interval was followed by an equal time inter-pulse interval during which no sound was transmitted. Thus, subjects received a cumulative underwater sound exposure of 15 minutes per dive.

Table 3  
*Diving Schedule*

Date	Diver						
	Day	D1	D2	D3	D4	D5	D6
17-Jul-95	30 ft. orientation dive for all divers						
18-Jul-95	1	S1	S2	S3	S4	S2	S3
19-Jul-95	2	S2	S1	S4	S2	S3	S2
20-Jul-95	3	S3	S4	S2	S1	S1	S4
21-Jul-95	4	S4	S3	S1	S3	S4	S1
24-Jul-95	5	S4	S3	S1	S3	S4	S1
25-Jul-95	6	S3	S4	S2	S1	S1	S4
26-Jul-95	7	S2	S1	S4	S2	S3	S2
27-Jul-95	8	S1	S2	S3	S4	S2	S3

S1 = Unhelmeted, Signal 1  
S2 = Unhelmeted, Signal 2

S3 = Helmeted, Signal 1  
S4 = Helmeted, Signal 2

For each dive, the following schedule was used:

- (1) Establish and verify sound signals and levels.
- (2) Diver enters water, surface checks performed, begins descent.
- (3) Diver reaches bottom, signals ready.
- (4) Signal turned on for 100 seconds. Diver performs testing during the sound exposure (see below).
- (5) Signal turned off for 100 seconds. Directed conversation with diver. Diver asked if ready to proceed with next exposure.
- (6) If diver OK, repeat steps 4 and 5 for a total of 9 exposures.
- (7) End of ninth exposure. Diver leaves bottom.
- (8) At surface, diver removes diving rig, ECG leads, and wet suit, then is immediately turned over to medical personnel for post-exposure testing.

The two control subjects completed one 30 ft. dive (unhelmeted), and eight 60 ft. dives (4 helmeted, 4 unhelmeted) without sound exposure. All divers wore 1/4-1/2 inch wet suits including hoods, gloves, and booties.

The diving operations for this experiment were conducted in strict accord with the US Navy Diving Manual (1993). A standby diver was present during each dive (ready to enter the water to assist a compromised diver). An underwater video camera was used to maintain visual contact with the diver at all times during exposures. Verbal communication be-

tween topside personnel and the diver was also maintained throughout the dive, with line pull signals used as backup. On site access to a dry treatment recompression chamber was provided. A Diving Medical Officer and a Diving Medical Technician were on site at all times during diving operations. Appendix B is a copy of the dive protocol.

#### *Assessment of health and performance*

Before and after the dive series, each diver-subject completed the following:

- (1) General medical history and review of systems with emphasis on vestibular and neurological history, and physical examination with emphasis on neurological examination.
- (2) Pulmonary function testing (Appendix C).
- (3) Two clinical audiograms.
- (4) Neuropsychometric testing (Appendix D).
- (5) Electroencephalogram (EEG), brain mapping (Appendix D).
- (6) Quantitative oculomotor performance battery; Micromedical Technology VORTEQ system (Appendix D).
- (7) Balance platform performance, Neurocom Pro Balance Master (dynamic posturography) as modified by Naval Aerospace Medical Research Laboratory (NAMRL) (Appendix D).

All baseline tests were performed within 1 week prior to the first underwater sound exposure. Baseline tests were performed for comparative purposes in the event of a symptomatic response from the sound exposures. All post study testing was performed within 1 week following the final sound exposure to es-

establish the divers well being at the end as compared to the beginning of the study.

Prior to and immediately after each dive, diver-subjects completed the following:

- (1) Fitness to dive physical examination, as indicated by history.
- (2) Dynamic visual acuity testing (DVAT) (Appendix D).
- (3) Balance platform testing, Neurocom Pro Balance Master (dynamic posturography) as modified by Naval Aerospace Medical Research Laboratory (NAMRL) (Appendix D).
- (4) Audiogram for hearing thresholds at 250, 500, 1000, 2000, 4000, and 8000 Hz (Appendix E).

Pre and post-exposure testing was designed to efficiently assess the diver's acute response to the underwater sound exposures with emphasis on possible auditory, vestibular, and central nervous system effects.

During each dive, diver-subjects were monitored using the following:

- (1) Systematic Investigation of Navy Diving Behavior at Depth (SINDBAD) sustained performance key insertion test for the initial 60 seconds of each 100 second sound exposure (Appendix F).
- (2) Real time in water videooculography (VOG) during the final 30 seconds of each 100 second sound exposure using a Mini B&W camera, model UWC-120, Outland Technology Inc.; ISCAN pupillary reflection eye tracking system; and Video time based corrector (Appendix D).

- (3) Continuous electrocardiograms (ECG).
- (4) A symptoms survey during each sound exposure (Appendix G).

These tests were designed to monitor the subjects responses during the actual sound exposure for early detection of compromise, or other adverse effects.

All testing, with the exception of one of the clinical audiograms and the neuropsychometric testing, was conducted at the test site using portable equipment, and trained technicians under the supervision of qualified medical officers. All subjects received pre and post study audiograms at the Naval Medical Clinic in Orlando, as well as at the test site. Neuropsychometric testing took place at the Naval Aerospace Medical Institute (NAMI) in Pensacola.

#### *Dive Termination Criteria*

The following termination criteria were used during the underwater sound exposures:

- (1) upon request by the subject for any reason,
- (2) as video nystagmus monitoring abnormalities indicate when correlated with subjective symptoms,
- (3) presence of any significant discomfort or pain,
- (4) as determined by the diving officer, diving supervisor, diving medical officer, or principal investigator,
- (5) cessation of the SINDBAD test during an exposure for no known reason,
- (6) Loss of video, and/or voice communication.

Because the possible effects of the sound exposure are wide and varied, continued exposures were based on the determination of a “compromised diver” rather than a particular symptomatology.

A “compromised diver” was defined as any diver whom, in the opinion of the diver, diving officer, diving supervisor, diving medical officer, or principal investigator could become a casualty or burden to others in an operational setting as a result of the sound exposure.

If the “compromised diver” had symptomatology that was self-limiting, spontaneously recovered after the sound was turned off, resulted in no subjective or objective after-effects, and was without risk for harm to the diver in the controlled setting of the experiment, then this was considered a “minor” compromise.

A “major” compromise was defined as a diver with symptomatology that required supportive measures for recovery from the insult, required prolonged recovery time, or resulted in minor after-effects (as determined by the medical monitor).

A “catastrophic” compromise was defined as a diver whose symptomatology resulted in risk of “life or limb,” or major after-effects (as determined by the medical monitor).

A flow chart of continued testing in the event of a compromised diver is presented in Appendix H. A major compromise would result in termination of testing at 160 dB. Testing would resume at 154 dB. Two minor compromises were required before testing was terminated at 160 dB and then continued at 154 dB.

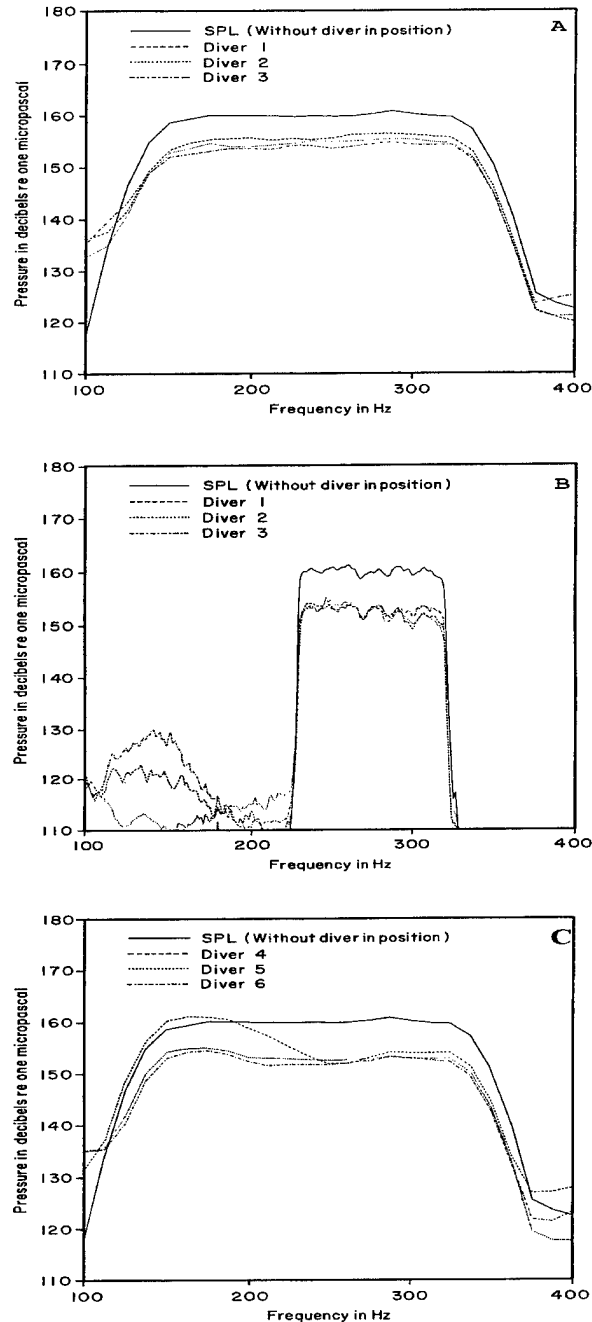

Figure 4. Sound pressure level diagrams showing sound pressure as a function of frequency with and without divers present for both warble tone (A and C), and sweep tone (B) signals. Note that the typical response to the presence of a diver in the sound field was an attenuation of the sound pressure level by 5-10 dB (A and B). However, diver 4 had an effect of actually increasing the sound pressure level for the lower frequency component of the warble tone (C). See text for explanation.

## RESULTS

### *Sound field characteristics*

Figures 4A and B are sound pressure level diagrams for the warble and sweep tone signals, respectively, with and without divers present in the field. These measurements were taken from a hydrophone located approximately 40 cm to the left of where the diver was during an exposure. As can be seen, the sound pressure level for both signals was nearly constant at 160 dB without the diver present. The transducer output was set at this level and unaltered during exposures of the divers (see Appendix A for details). With a typical diver-subject present during an exposure, the sound pressure level is attenuated some 5-10 dB by the presence of the diver. This was seen with both signals, both helmeted and unhelmeted diving rigs, and at both 30 and 60 ft. depths. However, one subject (as seen in Figure 4C) had the effect of increasing the sound pressure level for the lower frequency component of the warble tone signal at 60 ft. This effect was not seen at 30 ft., but was seen in both the helmeted and unhelmeted diving rigs. Further inquiry revealed that this subject was wearing different wet suit material than the other subjects. Specifically, he wore 1/8" thinsulate with lycra undergarment covered by 1/8" neoprene for a total of 1/4" wet suit material, while the remainder of subjects wore 1/4" neoprene nitrogen blown closed cell rubatex in two pieces (a "farmer john" for legs and chest, and a hooded jacket for arms, head, and chest, resulting in 1/2" neoprene over the chest area).

After all subject exposures had been completed, the effect of the wet suit materials alone (without the diver present) on the sound field was tested. Figures 5A and B show the effect of the 1/4" neoprene worn by most divers. The result is an attenuation of 8-10 dB. Therefore, the attenuation seen with the divers present was essentially accounted for by the

wet suit material alone. Likewise, when the 1/8" thinsulate/lycra plus 1/8" neoprene was tested, the same response seen for the diver represented in figure 4C was observed (Figures 6A and B). That is, there was an increase in intensity of the low-frequency component of the warble tone signal. Separating the thinsulate/lycra from the neoprene revealed that the effect was the result of the 1/8" neoprene

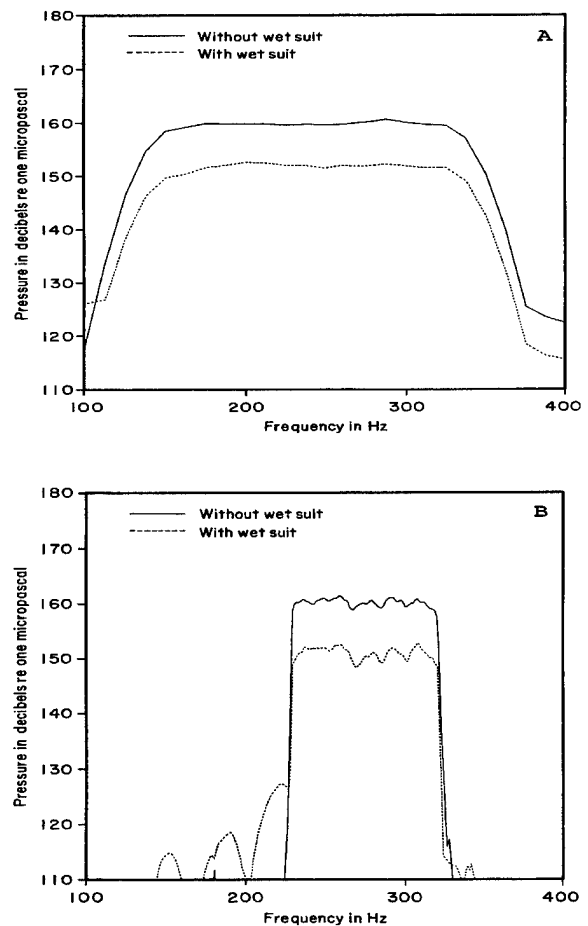

*Figure 5.* Sound pressure level diagrams with and without 1/4" neoprene nitrogen blown closed cell rubatex two piece wet suit alone (no diver) for both warble tone (A), and sweep tone (B) signals. This is the wet suit material worn by the divers represented in Figures 4A and B. Note that the 5-10 dB attenuation of sound pressure level seen in Figures 4A and B with divers present in the field is accounted for by the wet suit material alone.



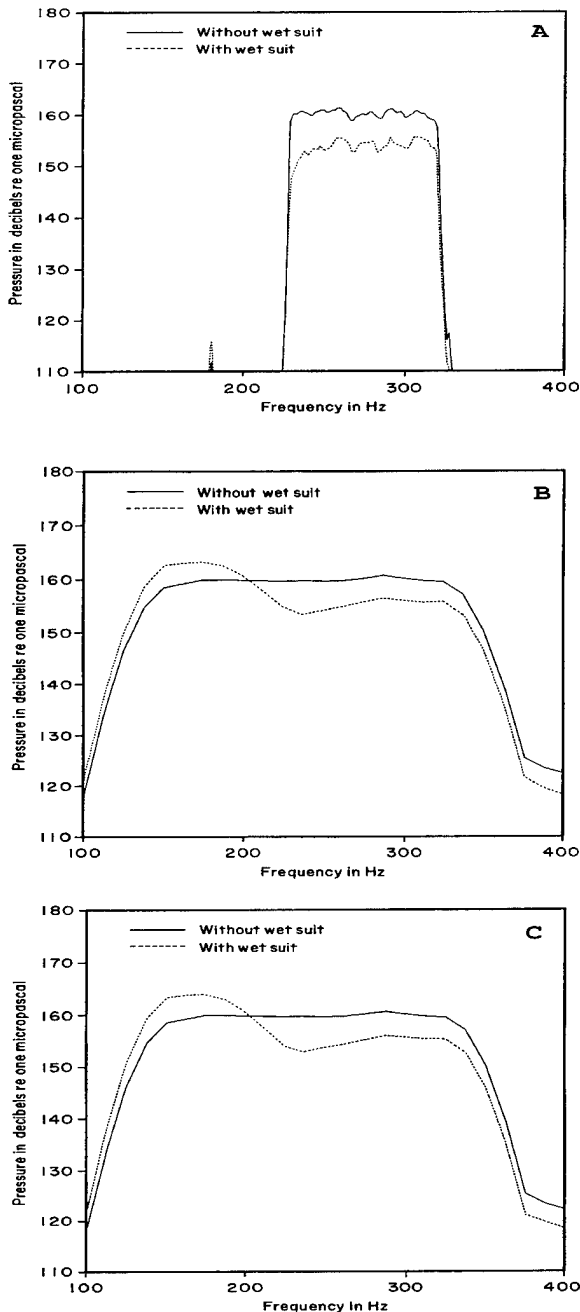

Figure 6. Sound pressure level diagrams with and without 1/8" thinsulate with lycra undergarment covered by 1/8" neoprene wet suit (no diver) for both sweep tone (A) and warble tone (B) signals. This is the wet suit material worn by "diver 4" in Figure 4C. The effect of the 1/8" neoprene without the undergarment is also shown (C). Note that, again, both the attenuating and enhancing effects seen in Figure 4C are accounted for by the neoprene wet suit material alone.

alone (Figure 6C). The tentative interpretation is that at 60 ft. a bubble-like resonance of approximately 160-180 Hz is stimulated in the 1/8" neoprene wet suit material.

#### Effects on Divers

Fifty four manned dive exposures were completed using six subjects. In addition, eighteen manned dives without sound exposure were completed using two subjects. An initial eight manned dives without sound exposure were also completed using all eight subjects prior to the first sound exposure dive. At no time during these dives was a "compromised diver," as defined above, identified. There were no dives terminated early due to effects of the sound exposures.

#### Pre- and Post-study Testing:

Pre- and post-study audiograms obtained at the Naval Medical clinic in Orlando were judged not to be of clinical quality (250 and 8000 Hz frequencies were not tested, and several subjects complained that background ambient noise and inadequate facilities interfered with testing). Therefore, effects on hearing were assessed from on-site audiometric measurements only (see below).

Medical monitors did not note any clinically relevant changes in physical examinations of subjects post-study compared to pre-study. In particular, neurological exams were unchanged.

No decrements in pulmonary function were detected post-study (mean FEV1/FVC=78.2%) compared to pre-study (mean FEV1/FVC=77.3%;  $p=.266$  for a paired sample t-test of the two means).

Appendix I is a summary of pre- and post-study test results for electroencephalogram (EEG) and vestibular function (dynamic platform posturography and quantitative oculomotor performance battery) testing. For EEG

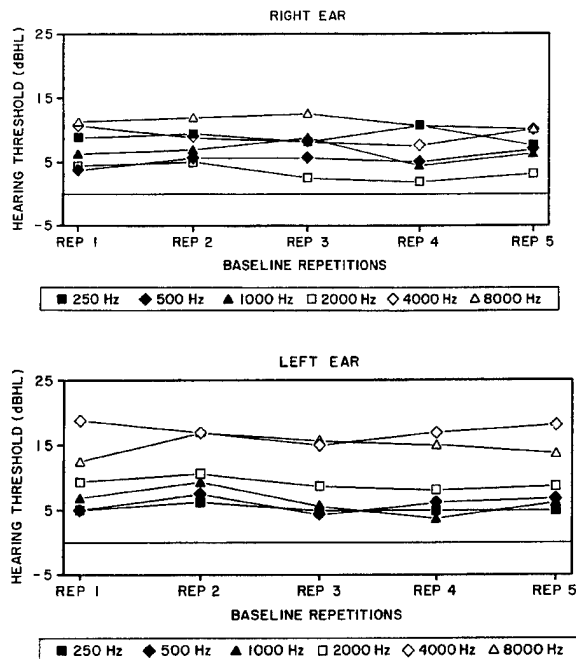

Figure 7. Results of five repeated audiograms used to establish a baseline level of hearing threshold. Depicted is the mean threshold level across eight subjects for the six frequencies used in audiogram testing for both right and left ears. Note that there is very little variation between repeated test results, indicating good test to test reliability in audiogram measurements.

testing, all pre- and post-study measurements were within clinically normal limits. No changes were observed during the running memory task portion of EEG testing, but three of the six experimental subjects did show some increase in alpha wave activity in temporal/parietal areas during the resting state post-study compared to pre-study. This effect was not observed in either of the control subjects. However, since the post-study results were still within normal limits, the clinical significance of these changes is uncertain. The trend for all subjects (experimental and control) in both dynamic platform posturography and quantitative oculomotor performance battery testing was toward improvement in vestibular function during post-study testing compared to pre-study testing. This may represent a modest learning effect for the vestibular

function testing procedures during the course of the experiment (see below).

Appendix J is a summary of pre- and post-study neuropsychological assessments. All statistically significant changes were in the direction of improvement for post-study scores compared to pre-study scores.

#### Pre and Post-exposure Testing:

For audiogram and balance platform testing, training sessions were used to limit the effects of learning during the exposure trials. All subjects had performed audiograms in the past (during prior experiments involving audiogram testing, and/or during physical exams for diving qualifications). Therefore, it was anticipated that minimal training (two practice sessions) would be required to eliminate a learning effect. The results of five baseline audiograms (means across subjects) following the two practice audiograms are shown in Figure 7. As evidenced by the flat-

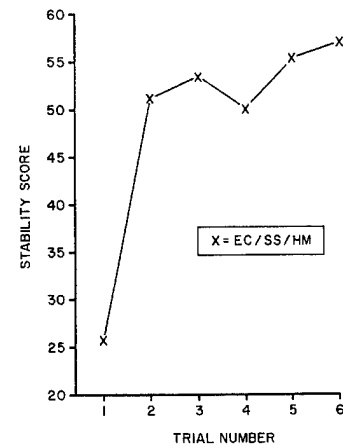

Figure 8. Results (means across eight subjects) of six repeated balance platform tests during subject training sessions. The test depicted is the most difficult of the balance platform maneuvers with eyes closed, a sway platform, and head movements (EC/SS/HM). Scores indicate % of maximum stability, with a score of 100 representing perfect stability, and a score of 0 representing a fall. Note that test performance is highly dependent of familiarization training, but that the greatest learning effect occurs between the first and second practice trials, with relative flattening of the learning curve thereafter.

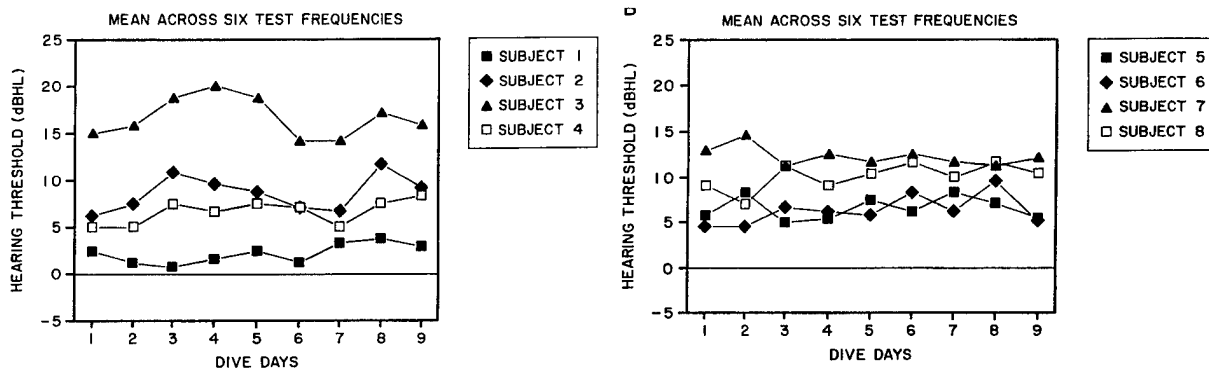

Figure 9. Pre-exposure trend for audiogram testing. Day to day variation in pre-sound exposure hearing thresholds (means across the six test frequencies) for each subject are shown. The relative flatness of the curves indicates that repetitive testing had little effect on audiogram results.

ness of these curves, there appeared to be no learning effect during these five trials. In contrast, since none of the subjects had prior familiarization in balance platform testing, it was anticipated that a greater degree of training (an estimated minimum of five training sessions) would be needed to reach a level of peak performance on the balance platform. Figure 8 shows the results (means across subjects) of 6 training trials for the most difficult of the balance platform tests (eyes closed, head movement, sway platform); the test showing the greatest learning effect. Although a clear learning effect is demonstrated, the most significant improvement occurred between the first and second trials with the mean score increasing from 25.6 to 51.1 (scores indicate % of maximum stability, with a score of 100 representing perfect stability, and a score of 0 representing a fall). Between the second through sixth trials, however, there was considerably less variation with a low mean score of 50.1 occurring during the fourth trial, and a high mean score of 57.1 during the sixth trial. There were no direct training sessions for the dynamic visual acuity test (DVAT), although similar testing was included as part of the pre-study quantitative oculomotor performance battery.

The trend of pre-exposure test results was analyzed for learning effects and test re-test reliability. Figure 9 shows the day to day pre-exposure hearing threshold (mean across frequencies) for each of the eight subjects. The  $R^2$  correlation statistics for these curves are less than 0.1 indicating that the audiogram results were relatively independent of the test days on which they were completed. The trend of pre-exposure results for the balance platform tests are represented in figures 10A, 10B, 10C, and 10D. Figure 10A and 10B represents the trend for the easiest test (eyes open, no head movement, stable platform). The  $R^2$  correlation statistic was less than 0.01, again illustrating that the test result was independent of the test day. For the most difficult balance platform test (eyes closed, head movement, sway platform) a slight trend of improvement is seen (figures 10C and 10D). The  $R^2$  correlation statistic for this test was 0.14. This may represent some degree of continued learning throughout the experiment for the more difficult balance platform maneuvers. This effect is, however, relatively small in relation to clinically significant differences in performance. Figures 11A, 11B, 11C, and 11D show the pre-exposure trends for two of the DVAT tests used in this experiment (the easiest, 0 d/s head movement, and the most difficult, 200 d/s head movement). In general,

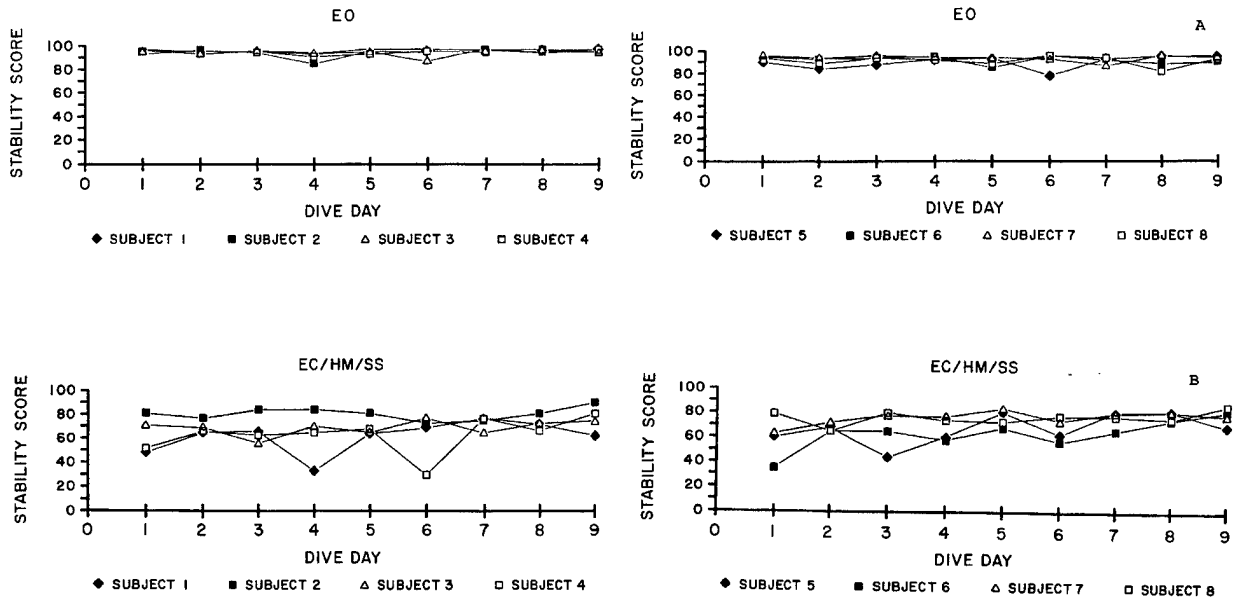

Figure 10. Pre-exposure trend for balance platform testing. Day to day variation of subjects' pre-sound exposure stability scores for the easiest (A) and most difficult (B) balance platform tests are shown. The day to day variability was greater for the more difficult test, but overall, subjects scores remained relatively consistent throughout the experiment. EO: eyes open, no head movement, stable platform; EC/HM/SS: eyes closed, head movement, sway platform.

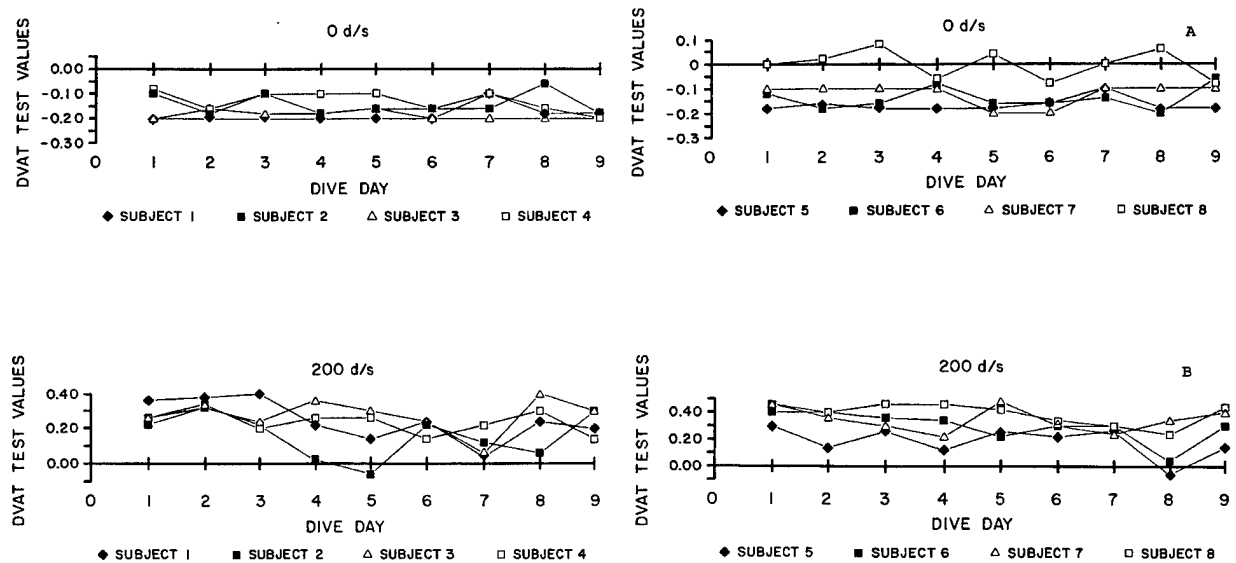

Figure 11. Pre-exposure trend for dynamic visual acuity testing (DVAT). Day to day variation of subjects' pre-sound exposure test results for the easiest (A) and the most difficult (B) DVAT tests are shown. Similar to the balance platform results, day to day variability was greater for the more difficult test, but, again, the repetitive testing design did not appear to greatly influence test results. d/s: degrees per second of head rotation.

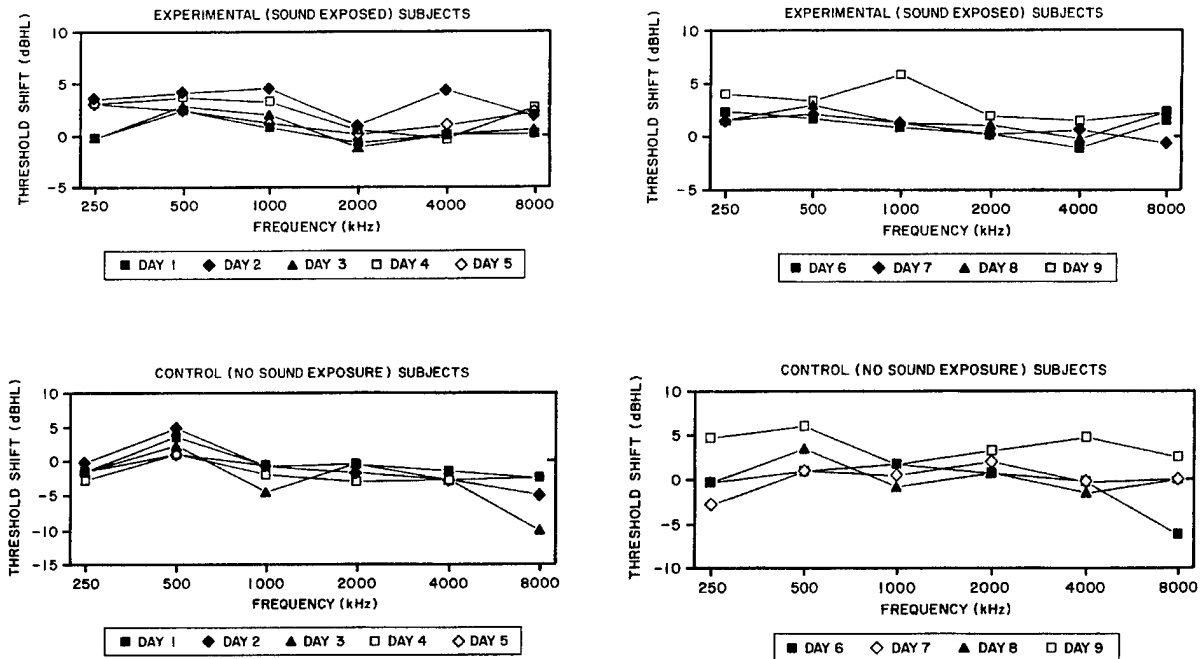

Figure 12. Hearing threshold shifts (means across subjects) calculated from post-exposure audiograms for experimental (A) and control (B) subjects. The different curves represent the nine sound exposure test days.

these plots show a slight day to day improvement in DVAT scores indicative of some continued learning throughout the study, but again  $R^2$  is less than 0.1 for all DVAT tests, and thus the effect was relatively small.

Figures 12A and B show mean hearing threshold shifts (post vs. pre exposure audiogram results) for experimental and control subjects, respectively. Repeated measures ANOVAs with three factors were conducted. Factors included diving rig (helmeted or un-helmeted), sound characteristics (warble or sweep tone), and time (pre- or post-exposure). There were no main effects for diving rig or sound characteristics, and no significant interactions. For the experimental subjects, thresholds were significantly higher post-exposure compared to pre-exposure for the left ear at 250 ( $p=.028$ ), 500 ( $p=.048$ ), and 1000 Hz ( $p=.045$ ), and for the right ear at 4000 Hz ( $p=.031$ ). Although statistically significant, these threshold shifts were small (5 dB or

less), and thus the clinical significance of such changes is questionable. Furthermore, confounding factors apart from the sound exposures may have contributed to these differences. Specifically, three experimental subjects experienced ear squeezes during the course of the study, and one subject was exposed to very loud microphone feedback during a dive. The two control subjects showed no significant changes between pre- and post-exposure hearing thresholds.

Figures 13-15 show the pre- and post-exposure results for balance platform and DVAT testing. Three factor (diving rig, sound characteristics, and time) repeated measures ANOVAs were conducted. For the overall balance platform score, there were no significant main effects, but there was a significant sound characteristic and time interaction ( $p=.018$ ). For the warble tone, there was a greater degree of improvement in post-exposure scores (compared to pre-exposure scores) than for the

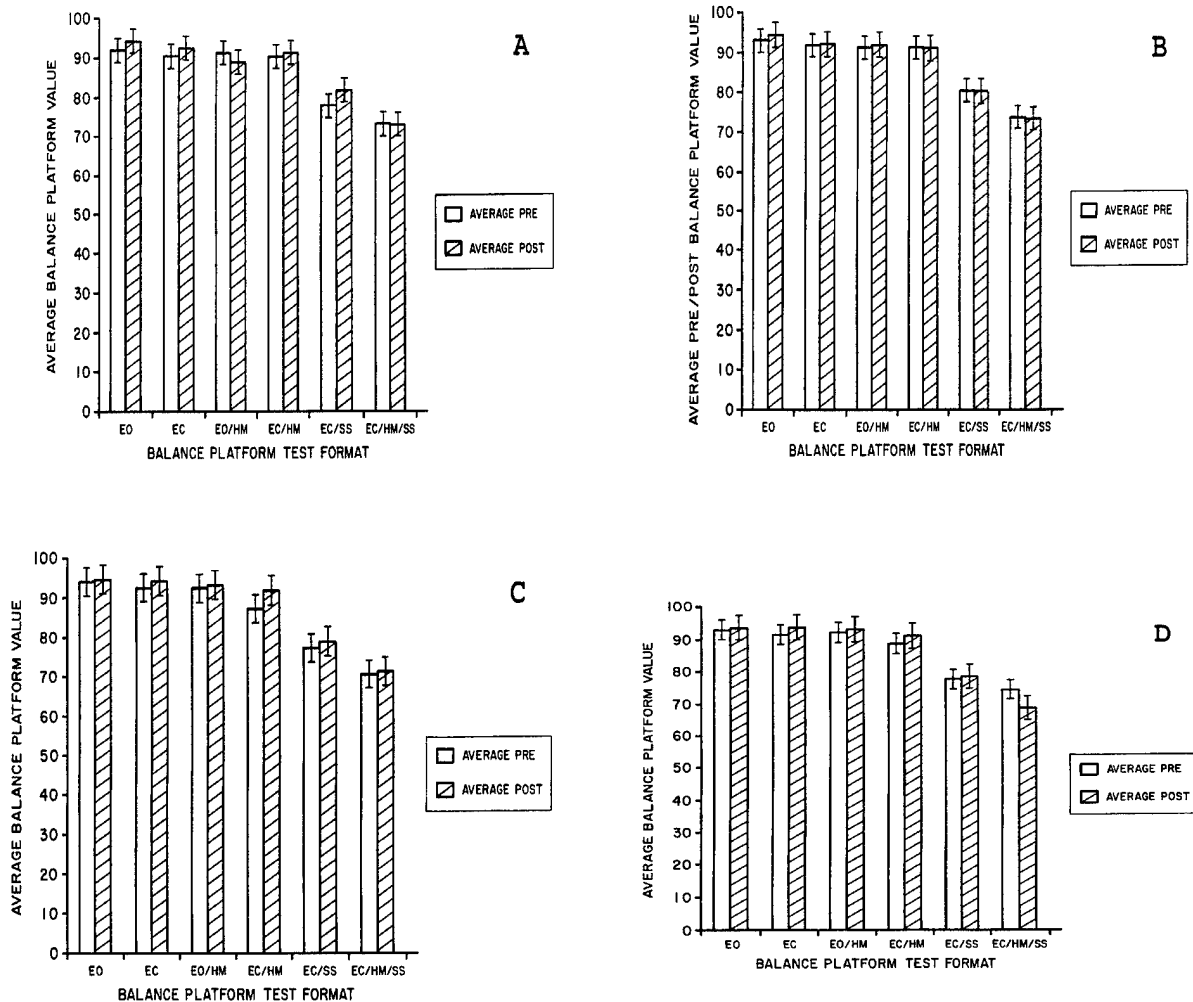

Figure 13. Comparison of pre- and post-exposure balance platform scores (mean across subjects) for experimental (sound exposed) subjects under the four diving conditions. (A) Condition 1 - unhelmeted, warble signal; (B) Condition 2 - unhelmeted, sweep signal; (C) Condition 3 - helmeted, warble signal; (D) Condition 4 - helmeted, sweep signal. EO: eyes open, no head movement, stable platform; EC: eyes closed, no head movement, stable platform; EO/HM: eyes open, head movement, stable platform; EC/HM: eyes closed, head movement, stable platform; EC/SS: eyes closed, no head movement, sway platform; EC/HM/SS: eyes closed, head movement, sway platform.

sweep tone signal. For the individual balance platform tests, the two least difficult (no head movement and a stable platform with eyes open, and eyes closed), and the two most difficult (eyes closed and an unstable platform with head movements, and without head movements) showed no significant main effects and no significant interactions. For the two mid level difficulty tests (head movement and a stable platform with eyes open, and

eyes closed), however, both showed statistically significant results. For the eyes open with head movement test, significant effects for diving rig ( $p=.019$ ), and time ( $p=.005$ ) were observed with no significant interactions. Post-exposure scores were improved compared to pre-exposure scores, and scores following the unhelmeted condition were higher than those for the helmeted condition. For the eyes closed with head movement test,

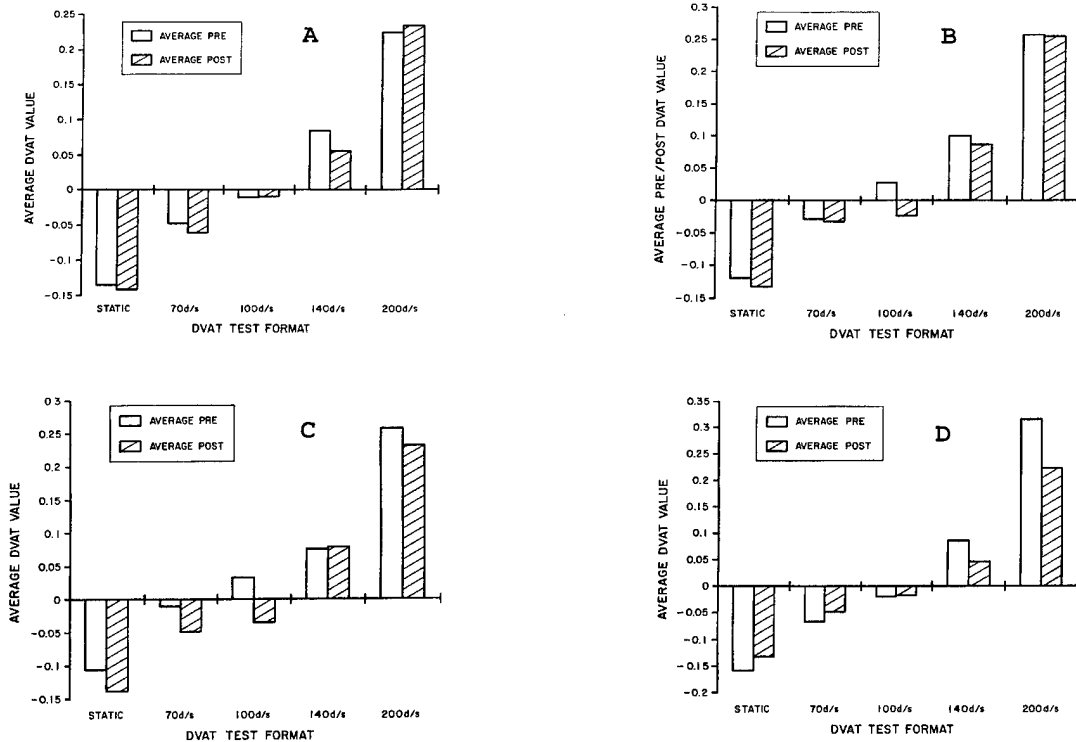

Figure 14. Comparison of pre- and post-exposure dynamic visual acuity scores (mean across subjects) for experimental (sound exposed) subjects under the four diving conditions. (A) Condition 1 - unhelmeted, warble signal; (B) Condition 2 - unhelmeted, sweep signal; (C) Condition 3 - helmeted, warble signal; (D) Condition 4 - helmeted, sweep signal. d/s: degrees/second of head rotation.

there were no significant main effects for diving rig or sound characteristic, but there was a significant effect for time ( $p=.034$ ). In addition there were significant diving rig and time, and sound characteristic and time interactions ( $p=.022$ , and  $p=.034$ , respectively). Again, post-exposure scores were improved compared to pre-exposure scores. The time effect was greater for the helmeted condition compared to the unhelmeted condition, and for the warble tone compared to the sweep tone.

For the DVAT test, there were no significant main effects for diving rig, sound characteristic, or time. In addition, apart from one significant diving rig and sound interaction for the 70 degree/second test ( $p=.036$ ), there were no significant interactions.

The two control subjects showed no statistically significant changes in balance platform or DVAT testing.

To summarize the pre- and post-exposure vestibular testing results, very little change in vestibular function was observed. The changes that were seen were in the direction of improved function following the sound exposure dives.

#### During Exposure Testing:

The videooculography revealed no evidence of nystagmus in response to the sound exposures. Appendix K is an abstract summarizing these results.

Results of the SINDBAD key insertion test are summarized in Figures 16A and B. Subjects were given 9 practice trials prior to test-

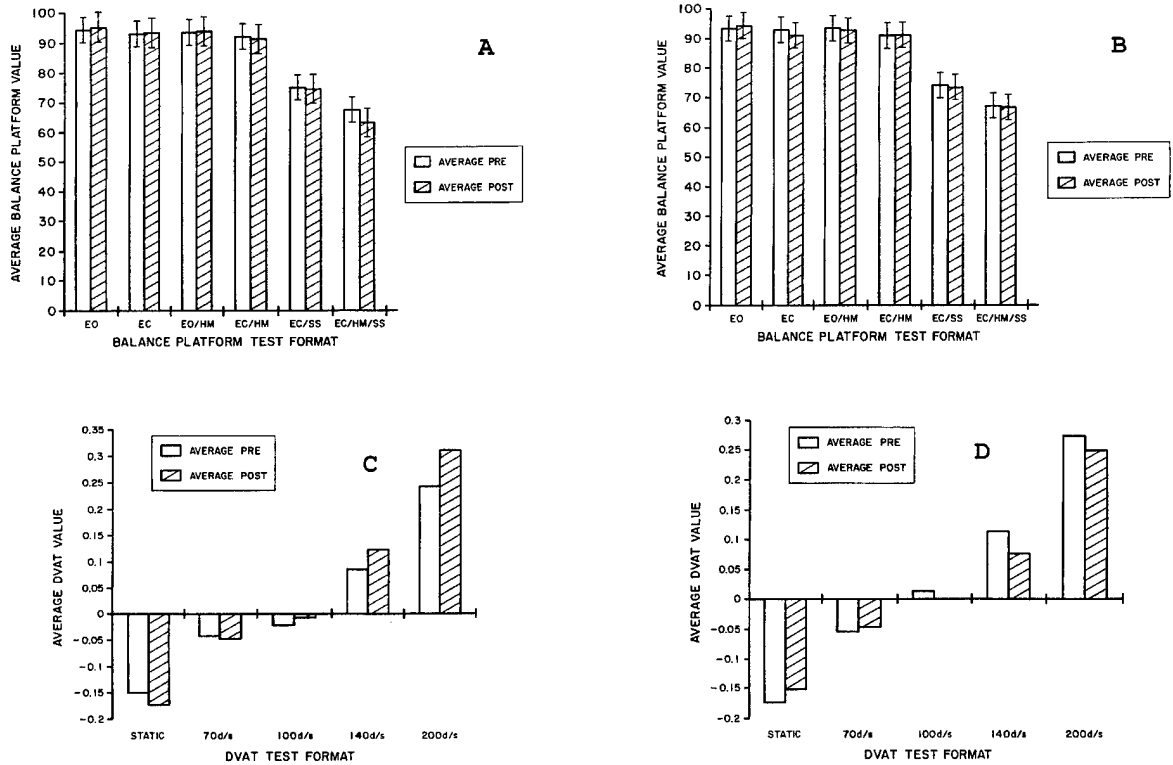

Figure 15. Comparison of pre- and post-exposure balance platform and dynamic visual acuity scores (mean across subjects) for control (no sound exposure) subjects. (A) Balance platform, unhelmeted; (B) Balance platform, helmeted; (C) Dynamic visual acuity, unhelmeted; (D) Dynamic visual acuity, helmeted. EO: eyes open, no head movement, stable platform; EO/HM: eyes open, head movement, stable platform; EC/HM: eyes closed, head movement, stable platform; EC/SS: eyes closed, no head movement, sway platform; EC/HM/SS: eyes closed, head movement, sway platform. d/s: degrees/second of head rotation.

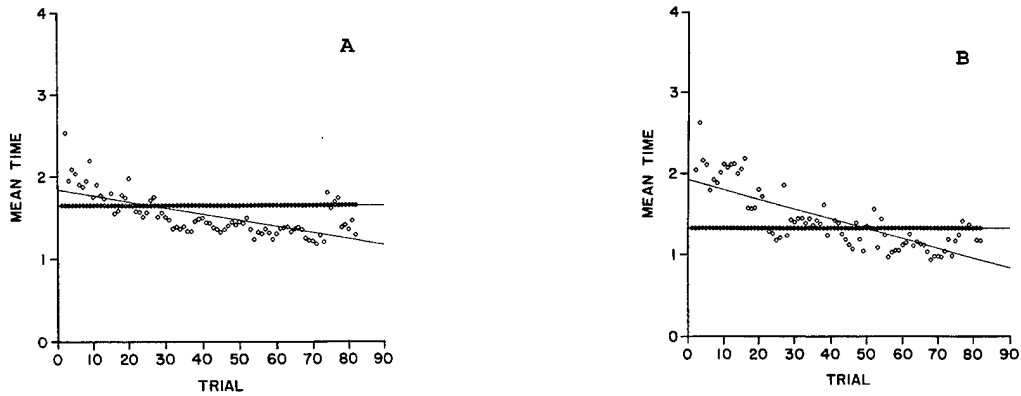

Figure 16. SINDBAD results. Depicted are reaction times (mean across subjects) of experimental (A), and control (B) subjects. The horizontal line of each diagram represents the mean reaction time across subjects for the final practice trial. This time was used as a baseline for comparison during the sound exposure dives. Each subject performed 9 test trials during each of the 9 sound exposure dives for a total of 81 test trials. Note the gradual improvement in reaction times for both experimental and control subjects with the increase in the number of test trials performed. This improvement, however, was offset in both experimental and control subjects by a corresponding increase in the number of errors made during testing (not shown)



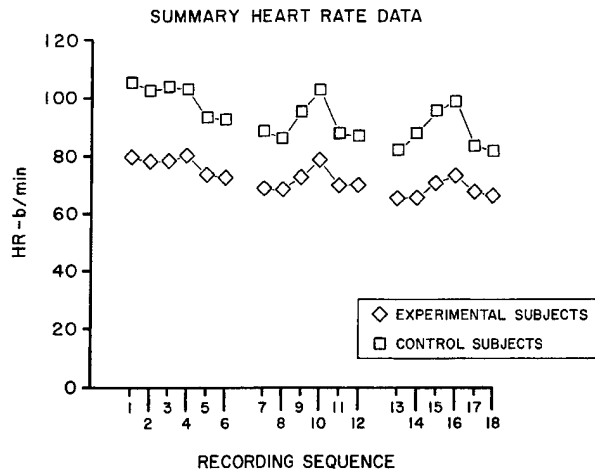

Figure 17. Summary heart rate data for experimental and control subjects. Heart rates were recorded at six separate times (two before sound, three during sound, and one after sound) for three of the nine sound exposure sequences during each dive. The curves represent the mean heart rates for experimental and control subjects. The peaks in each of the curves corresponds to the SINDBAD reaction time testing. The sound exposures did not appear to affect heart rate.

ing. The final score of the practice trials was used as a baseline for comparison. Subjects (both controls and experimental) showed a gradual improvement in response time throughout the study. However, this improvement in response time was offset by a corresponding gradual increase in the number of incorrect responses where the key was not properly inserted. The likely explanation for these results is that subjects, to offset the monotony of the testing procedure, used the SINDBAD test to compete with each other. Since the major feedback given to the subjects was response time, their efforts were concentrated on doing the test as fast as possible resulting in improved times, but with more mistakes being made. Overall, the sound exposure had no noticeable effect on SINDBAD testing.

ECG monitoring revealed no direct effects of the sound on heart rate or rhythm. However, a predictable elevation of heart rate was observed corresponding to the SINDBAD testing during each sound exposure. Heart rates were recorded around 3 of the 9 sound exposures of each dive (the first, the fourth, and the seventh). For each of these exposures heart rates were recorded at six separate points (two before the exposure, three during the exposure, and one after the exposure). Heart rates increased at the beginning of the sound exposure (also the beginning of the SINDBAD testing), peaked at the 40 second point during the exposure (sound on, performing SINDBAD), and returned to baseline at the 80 second point in the exposure (sound on, but not performing SINDBAD). This heart rate response also occurred in the two controls who were not exposed to the sound. Figure 17 is a summary of the heart rate data.

Appendix G is a copy of the symptoms survey with a modified Borg scale used during each exposure. Responses with scores greater than 0 were given only for questions 1, 4, 6, 10, 11, and 12. All subjects gave a positive response to questions 1 and 4 (sensation of vibration). Scores for vibration sense ranged from 0 to 3 (moderate sensation), and were located primarily in the extremities and chest region, with a few isolated responses of sensations in the head and neck region. Only one diver reported not feeling wide awake and alert (question 6) during a sound exposure. This diver responded with a 1 (very slight) on three occasions during two dives (during the fifth exposure of one dive and during the eighth and ninth exposures of a second dive). He also reported that the sound seemed to contribute to the symptom. This same diver was also the only subject to give a non-"0" score to question 10 (inability to concentrate). He gave a .5 to 1 (very, very to very slight) response for the last two to four exposures of four separate dives. Again, the sound seemed

to contribute to the symptom. Two divers reported brief unusual sensations (question 11). One diver reported a 2 (slight) for a sensation of turning to the left while looking down during a sound exposure. The sensation was a slow 90° rotation over approximately 5 seconds, and was broken by looking up. This occurred during this diver's orientation exposure at 30 ft., but not during his 8 subsequent dives with sound exposure at 60 ft. Another subject reported a sensation of gastrointestinal gas build-up associated with sound exposures during one dive. Finally, four of the divers reported .5 to 3 (very, very slight to moderate) to question 12 (annoyance). In general, the annoyance scores were higher and more frequent for the sweep signal in the unhelmeted diving rig.

#### *Underwater Breathing Apparatus Performance*

There were no reports of problems with any of the rigs during the sound exposures. In addition, post dive procedures did not reveal any mechanical defects in the diving rigs following the sound exposures.

#### Conclusions

Fifty-four manned exposures (6 orientation dives, and 48 test dives) to two low-frequency underwater acoustic signals were performed. Both helmeted and unhelmeted diving rigs were used. The primary depth of exposure was 60 ft.

There were no sound related events during the dive series compromising the diver's health or safety. Pre and post-study examinations of subjects also revealed no clinically significant detrimental effects resulting from exposure to low-frequency water-borne sound under the conditions of this experiment.

Pre and post-exposure audiograms show some slight decrements in hearing, but these

results are confounded by circumstances unrelated to the water-borne sound exposures, such as ear squeezes from diving. Pre and post-exposure vestibular testing showed that vestibular function in subjects exposed to water-borne sound under the conditions of this experiment is not adversely affected.

During exposures, videooculography, ECG monitoring, and SINDBAD performance revealed no adverse effects of the sound exposures. Symptoms surveys during exposures showed that divers may become moderately annoyed by such exposures, but overall found the exposures tolerable. Annoyance was slightly greater in the unhelmeted condition with the sweep tone signal.

Sound field testing revealed that neoprene wet suits generally act to attenuate low-frequency sound exposures, but under certain circumstances may also accentuate a sound exposure. This may be due to resonance effects within the wet suit material.

There is no indication from the results of this study that low-frequency water-borne sound exposures (using the sound wave characteristics as described in this experiment) in the open water (plane wave acoustics) present any additional risk compared to similar exposures in enclosed environments (standing wave acoustics), such as the ocean simulation facility at the Navy Experimental Diving Unit.

#### References

- Bolanowski, S. J. (1994). *Assessment of the effects of 250 Hz vibratory stimuli applied to the cutaneous sensory system as they relate to sensation, pain, and discomfort*. Syracuse, NY: Syracuse University, Institute for Sensory Research.

- Crum, L. A. & Mao, Y. (1996). Acoustically enhanced bubble growth at low frequencies and its implications for human diver and marine mammal safety. *Journal of the Acoustical Society of America*, 99(5), 2898-207.
- Forsythe, S. E. & Van Buren, A. L. (1995). *Proposed experiment to produce a region of low-frequency plane wave using two spherical projectors*. (Report submitted to NSMRL, Feb 94).
- Lehner, N. D. M. (1994). *Response of the lungs to low frequency underwater sound: swine studies*. (Report submitted to NSMRL).
- Nyborg, W. L. (1993). Estimates of limits to temperature rise. Appendix In F. M. Pestorius (Au), *Effects of low frequency waterborne sound on divers* (Tech Report ARL-TR-96-5). Austin, Texas: University of Texas at Austin, Applied Research Laboratory.
- Rogers, P. H., Caille, G. W., & Lewis, T. N. (1994). *Response of the lungs to low frequency underwater sound* (Presentation at NSMRL meeting, Effects of low-frequency water-borne sound on divers: Summary Meeting, 29 Jun 94). Groton, CT: Naval Submarine Medical Research Laboratory.
- Russell, K. L. & Knafelc, M. E. (1995). *Low frequency water-borne sound manned dive series* (Technical Report No. 10-95). Panama City, FL: Navy Experimental Diving Unit.
- Smith, P. F. (1993). Interview with a diver exposed to intense low-frequency waterborne sound (NSMRL Memo dtd 25 Feb 93). Groton, CT: Naval Submarine Medical Research Laboratory.
- Smith, P. F., Sylvester, R., Baran, F., & Steevens, C. C. (1996). *Development of a general hearing conservation standard for diving operations: Experiment I - Comparison of temporary auditory threshold shifts induced by intense tones in air and water* (NSMRL Report 1203). Groton, CT: Naval Submarine Medical Research Laboratory.
- Steevens, C. C., Knafelc, M. E., & Clarke, J. (1994). *Effects of low-frequency waterborne sound on divers: Physiological monitoring during immersion at depth*. Manuscript in preparation.
- Steevens, C. C., Russell, K. L., Knafelc, M. E., Dutka, A. J., Hopkins, E. W., & Smith, P. F. (1997). *Neuropsychological disturbances in divers exposed to intense waterborne sound: Two case reports*. Manuscript submitted for publication.
- Steevens, C. C., Schlichting, C. L., & Baran, F. (1994). *Effects of low-frequency waterborne sound on divers: physiological monitoring during torso immersion*. Manuscript in preparation.
- Suki, B., Habib, R. H., & Jackson, A. C. (1994). *Effects of low frequency ( $f < 300$  Hz) waterborne sound on divers: Wave propagation in the airways* (Presentation at NSMRL meeting, Effects of low-frequency water-borne sound on divers, 29 Jun 94). Groton, CT: Submarine Medical Research Laboratory.
- Naval Sea Systems Command. (1993). *US Navy Diving Manual Volume 1 (air diving) and Volume 2 (mixed-gas diving)* (NAVSEA 0994-LP-001-9010 and 0994-LP-001-9020, Revision 3, dtd 15 Feb 93). Washington, DC: Naval Sea Systems Command.

Verillo, R. T., Bolanowski, S. J., Baran, F. & Smith, P. F. (1996). The effects of underwater environmental conditions on vibrotactile thresholds. *Journal of the Acoustical Society of America*, 100(1), 651-658.

[Blank Page]

OPEN WATER TRIALS  
APPENDICES

- Appendix A Sound Exposure Setup and Calibration.  
Fig. A1. Signal chain for transmitting and receiving equipment  
Fig. A2. Grounding scheme  
Fig. A3. Graphical representation of the cancellation effect in polar coordinates.  
Fig. A4. Measurement points in the diver test area.  
Fig. A5. Pressure gradient required for compensation transducer.
- Appendix B The Dive Protocol.
- Appendix C Spirometry Testing.
- Appendix D Neuropsychological/Neurological Testing Procedures.
- Appendix E Procedure for Administering Audiograms.  
Fig. E1. Equipment Setup.
- Appendix F SINDBAD Sustained Attention Test.
- Appendix G Symptoms Survey.
- Appendix H Continued Testing.  
Fig. H1. Flow Chart
- Appendix I Neurological Testing. Pre/Post Study Test Results.
- Appendix J Neuropsychological Testing. Pre/Post Study Test Results.
- Appendix K Abstract Summarizing Results of Videoculography.

[Blank Page]

## APPENDIX A

### SOUND EXPOSURE SETUP AND CALIBRATION

#### *Transmitting setup*

The two signals for the sound exposure were recorded on digital tapes in advance, and then played on a TCD-D3 Sony digital analog tape player (DAT) during the experiment. The warble tone ( $240\text{Hz} \pm 80\text{Hz}$ ) was designated tape S1, and the 100 second sweep ( $230 - 320\text{ Hz}$ ) was designated tape S0. The description of the signals is detailed elsewhere in the report. The output of the DAT was connected to the input of a 5435 Kay Electronics attenuator, which was used to control the SPL during sound checks and calibration (Refer to the schematic of the equipment setup in Figure A1). The output of the attenuator was con-

nected to input (J1) of the Supplemental Fail-Safe Cutoff (SFC) circuit. The SFC reduced the power amplifiers input to zero when the SPL exceeded a predetermined level. In addition, the SFC would sound an alarm indicating an excessive SPL had occurred. A more thorough description of the SFC circuit is outlined in the safety section. To detect the SPL near the diver during the exposures, a H56 monitor hydrophone was installed 61 cm from the diver at chest level. The output of this hydrophone was connected to an external pre-amplifier, which in turn was connected to input (J2) of the SFC.

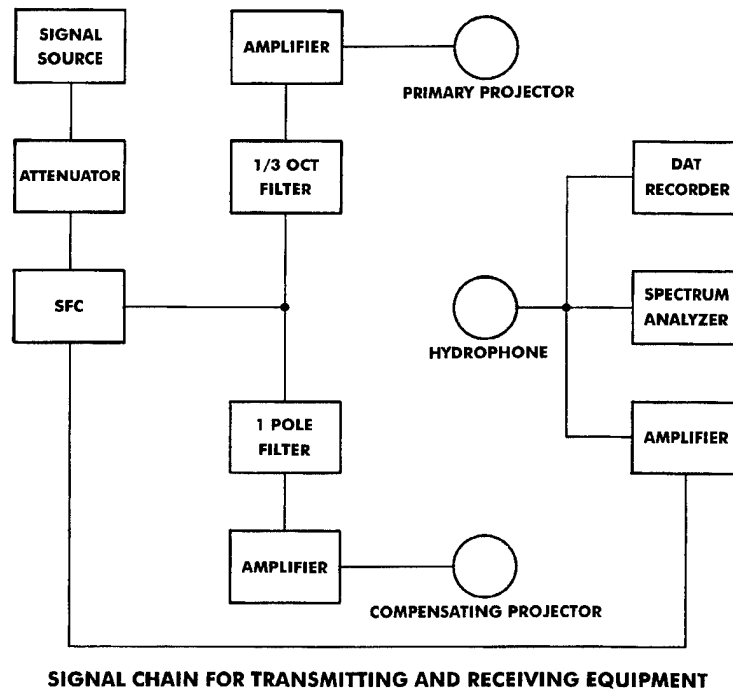

Figure A1. Signal chain for transmitting and receiving equipment



The exposure signal from the SFC output was routed to both the primary and secondary transducers. The primary route was first connected to the GE 30 1/3 Octave Graphic Equalizer. The Equalizer was used in the calibration process to compensate for the projector frequency response and flatten the spectrum. The output of the Equalizer connected to the Instruments Inc. LD1-3 Kilowatt Amplifier which powered the J11/3 (primary transducer). The secondary route was fed to an SR560 Stanford low pass filter and preamplifier. The low pass filter was used to correct the drive response of the compensating transducer by filtering out the frequency components above 300 Hz. The output of the filter was connected to the Kron-Hite 7500 Amplifier which powers the J15/1 (compensating transducer). The role of the compensating transducer is described in detail in the calibration section.

### Sound Receiving Setup

An H56 hydrophone was used to monitor

the SPL at the diver location. The output of the H56 was connected to three different devices: The first device, a Sony DAT, was used to record all SPL information while the divers were at depth. The second device, a 3562A Dynamic Signal Analyzer, was used to analyze the sound pressure and particle velocity during the calibration procedures and exposure dives. The third device connected to the output of the H56 was the SFC described above.

### Safety Precautions

NOTE: All sound levels are specified in decibels referenced to 1 micro Pascal (dB re 1 $\mu$ Pa).

The projectors and amplifiers, described in the transmitting section above, were configured such that the amplifier outputs were floating with the instrument cases tied to ground. A schematic of this grounding scheme is shown in Figure A2. The power cables feeding the projectors were sheathed in copper

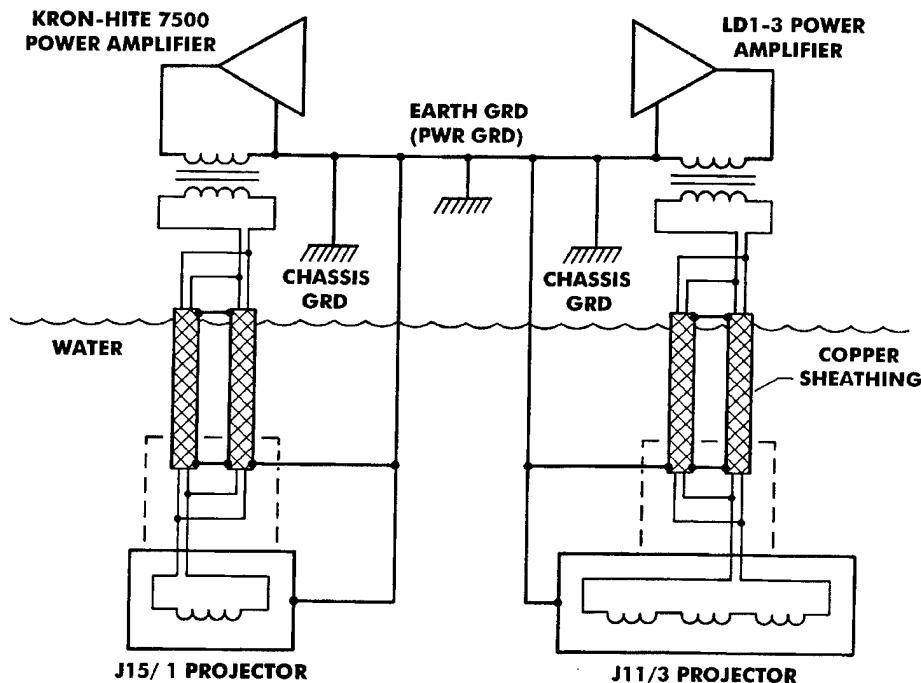

Figure A2. Grounding scheme

screening and then connected to each projector housing . A 10 gage wire was connected to the housing of the projectors and then brought to the surface ground. The surface ground was connected to "earth ground", a forty foot, four inch diameter steel grounding rod. The resistance between any ground point on the test barge and the grounding rod was less than 1 ohm when certified. The resistance from the signal leads, to the projector housing, was greater than 20 Megaohms for both projectors. This was checked on a daily basis during the testing period.

In addition to the grounding precautions, the cables of the J11/3 and J15/1 were also checked with a megaohm meter daily to prevent excessive levels of leakage current. On June 30, 1995 the resistance's of the J11/3 and J15/1 cables were measured at 1G (500 volts between pairs) and 100 M (100 volts between pairs) respectively. These values were well above safety levels, but if they fell below safety levels the projector was replaced and rechecked before continuing the experiment.

To guard against a subject being exposed to a SPL in excess of 163 dB during the experiment a supplemental Fail-Safe Cutoff (SFC) circuit was installed between the attenuator output and power amplifiers input. The H56 hydrophone, which monitored the SPL near the diver, was connected to the J2 jumper on the SFC. For normal SPL (less than 163 dB), the SFC is a unity-gain inverting amplifier. An input signal of up to 2 volts RMS can pass through the SFC with only a 180° phase inversion. If the signal at J2 exceeds 2 volts RMS, corresponding to a 163 dB or greater SPL, the signal to the amplifier is cut off ( the signal to the power amplifiers is reduced to zero) and the SFC sounds an alarm. This condition is latched and can only be cleared by cycling the SFC power off and back on.

### *Calibration of Sound Field*

The objective of the calibration was to create a sound field in which a diver can be exposed to the same pressure and impedance conditions found in open water (the far field), over the frequency range of 160 to 320 Hz. To simulate a far field condition in the near field the pressure wave must act as a plane progressive wave in the diver test location. The characteristic property of plane waves is that each acoustic variable (particle displacement, density, pressure, etc.) has constant amplitude on any given plane perpendicular to the direction of wave propagation. Therefore, a rc match is achieved when the ratio of total pressure (pressures from the projector add as scalars) to total velocity (velocities add as vectors) matches  $p / v$  at every point in the test area. When this match is achieved the result is a plane progressive wave in the test area with a specific acoustic impedance ( $Z_{ac}$ ) of:  $Z_{ac} = p / v = rc$ .

The reactive components present in a near field condition must be canceled out in

order to attain a rc match. The equation for impedance in the near field can be written:

$$Z_{ac} = rc [ R(kr) + jX(kr) ]$$

where  $R(kr)$  represents the resistive (or real) component, and  $jX(kr)$  represents the reactive (or imaginary) component of the impedance. The  $k$  in the  $(kr)$  term represents the free field wavenumber, and  $r$  indicates the distance from the source. To accomplish the impedance match, a J11/3 transducer (primary projector) is driven at the desired SPL, and a J15/1 transducer (compensating projector) is placed symmetrically about the test area and driven out of phase with the primary transducer at a significantly lower amplitude. The amplitude, phase and frequency response of the two projectors are set such that the im-

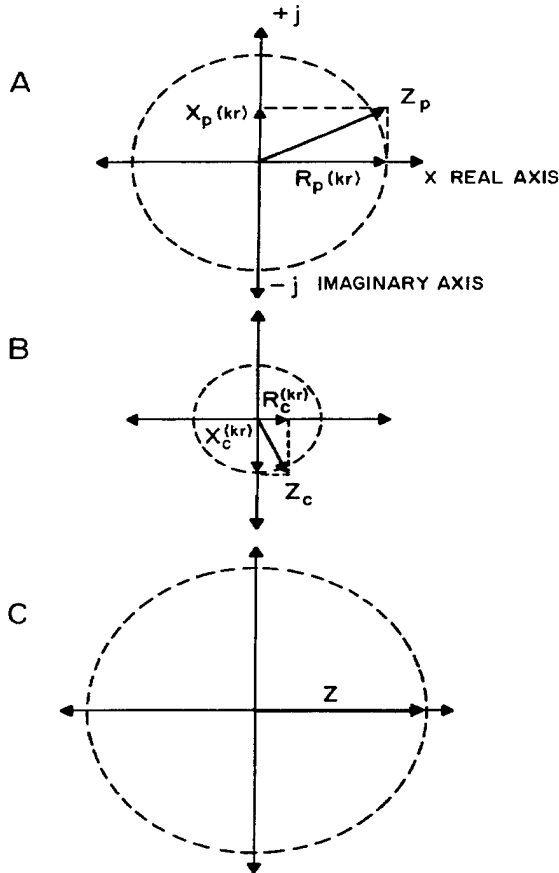

Figure A3. Graphical representation of the cancellation effect in polar coordinates

pedance match is obtained, and a free field condition exists in the test area. The procedure for obtaining this free field condition is outlined in the calibration procedure below. A graphical representation in polar coordinates of the cancellation effect is shown in Figure A3. Figure A3a represents the approximate amplitude and phase of the specific acoustic impedance ( $Z_p$ ) when the primary projector is operating alone, and A3b represents the specific acoustic impedance ( $Z_c$ ) when the compensating projector is operating alone. When the projectors are operating together the resultant impedance ( $Z_{ac}$ ) of the compensating projector is almost purely reactive, and the amplitude is much lower than that of the primary projector. In fact, the actual correction amplitude of the compensating projector was approximately 20 dB lower than that of the primary projector. Figure A3 does

not represent the actual impedance characteristics, but gives an approximation for illustrative purposes.

#### Calibration Procedure for Attaining the PC Match

The particle velocity is the parameter chosen for calibration purposes because the  $Z_{ac}$  is the ratio of acoustic pressure ( $p$ ) to particle velocity ( $v$ ) for a plane progressive wave. To measure the particle velocity a pressure gradient hydrophone is used because pressure gradient is proportional to particle velocity. Pressure gradient measurements are made at positions -40, -20, 0, 20, and 40 cm on the Z axis as shown in Figure A4, and an H56 hydrophone is used to measure the pressure at the same locations. Measurements are taken along the x and y axis to verify the sound field after the calibration is completed.

First, the band levels on the 1/3 octave filter are varied until a flat pressure response is achieved at the center point of the test area,

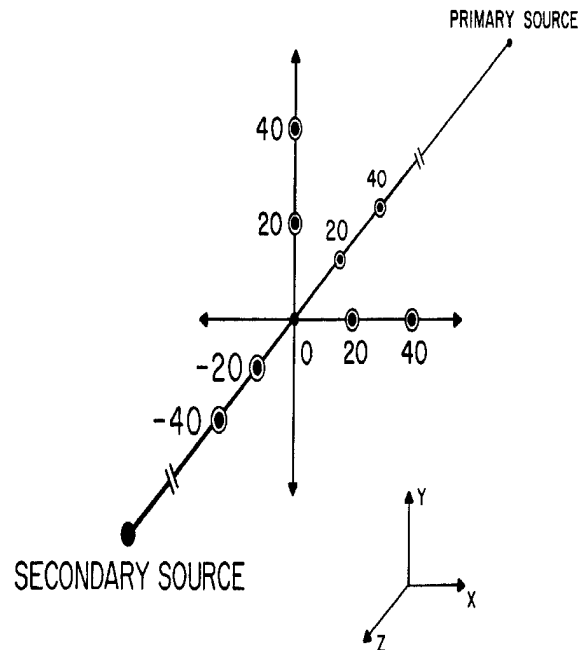

Figure A4. Measurement points in the diver test area.

with only the primary projector being driven. Second, the compensating projector is turned on and the high frequency cutoff of the 1 pole filter is set to approximately 300 Hz. This value is chosen because the lower frequencies require more correction than the higher frequencies. This is illustrated in Figure A5 where it shows the pressure gradient correction required at 160 Hz is approximately 2 dB, and at 300 Hz is approximately 0.5 dB. The third step is to achieve a plane wave condition, a rc match. The pressure and the pressure gradient are monitored at the center of the test area. The amplitude of the compensating amplifier, and the frequency cutoff of the 1-pole filter are fine tuned until the pressure and the pressure gradient indicate a rc match, while maintaining a SPL of 160 dB between 160 and 320 Hz.

The next step is to move the pressure gradient hydrophone to the 40 cm point on the z

axis and repeat the frequency response measurement. If the difference between the center spectra and 40 cm point measurement concur within 2 dB at the frequencies of concern, the 40 cm point is checked. If it does not, the filter settings, and amplitude of the compensating amplifier are adjusted until the criteria are met at the 40 cm point. The center point is rechecked, and fine adjustments to the two parameters (SPL and filter cutoff frequency) are again made to meet the criteria. This procedure is repeated until the variation from the -40 cm to the 40 cm point is no greater than  $\pm 2$  dB in all directions, while maintaining the rc match and the 160 dB SPL. Finally, measurements are taken along the x, y, and z axes to verify that the sound field is balanced about the center point. The center point (0) is the diver location (the diver's chest)

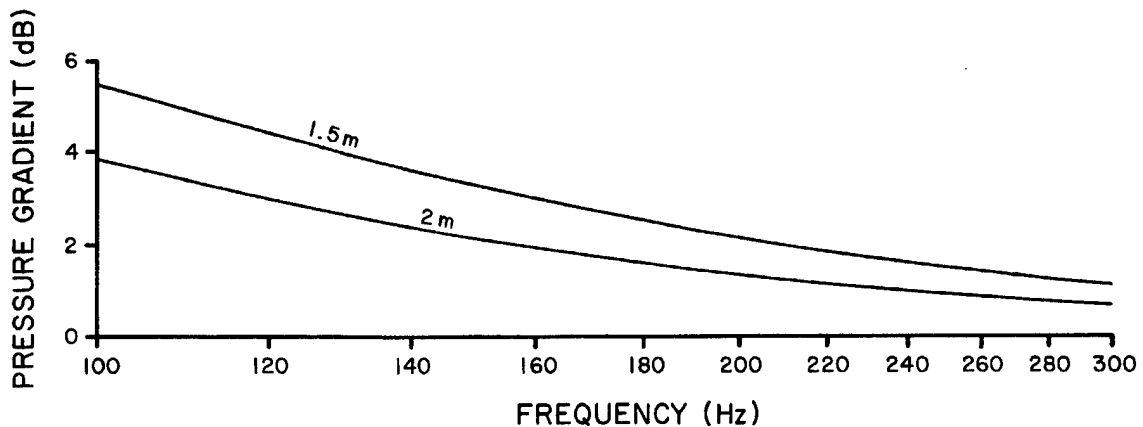

Figure A5. Pressure gradient required for compensation transducer

[Blank Page]

## APPENDIX B

### DIVE PROTOCOL

1. Objective: The purpose of this experiment is to determine the effects on divers of exposure to underwater active sonar. The basic design consists of exposing divers to underwater sonar at a level which they may be exposed to during a working dive, and determine their tolerance based on subjective responses, medical monitoring, and performance tests. In the present experiment, exposure to a narrow range of low frequencies (pitches) will be tested. The signals used will simulate an actual active sonar system. Previous experiments in enclosed laboratory environments suggest that such exposures should be well tolerated. However, differences exist between open water and closed tank acoustics. This experiment is designed to determine if these differences significantly affect a diver's tolerance to underwater sound.

2. Medical Examinations: All of the measurements administered during these experiments are established clinical measures. Divers will be given thorough physical exams including a complete neurological exam and neuropsychological assessment. These exams may also include routine blood, urine, and fecal sampling, and a chest x-ray. Additional measures include electroencephalography (EEG), videooculography, audiometry, spirometry, electrocardiography (ECG), balance platform testing, dynamic visual acuity testing, a sustained attention test (SAT), and a symptoms survey. Thorough physicals, audiometry, spirometry, and EEG will be conducted before and after complete participation in the study. ECG, videooculography, symptoms survey, and the SAT will be conducted at the dive site (during each dive) before, during, and after each exposure. Balance platform testing, dynamic visual acuity testing, and additional audiometry will be conducted at the dive site before and after each dive.

Prior to and immediately after each dive, diver subjects will also be examined by the Principal Investigator (PI) who is a diving medical officer. The PI or the dive watch medical officer (DWMO) may order additional measurements after any exposure if a change in the state of the diver subject is suspected.

### 3. Watch Section Duties:

Dive Supervisor: A senior diver, E6 or higher, will directly oversee all diving operations. He will have control over all scheduling and safety of the diver test subjects. The Dive Supervisor may appoint an alternate qualified Dive Supervisor during his absence.

Principal Investigator (PI): LT Christopher C. Steevens, MC, USNR, Biomedical Sciences Department, Naval Submarine Medical Research Laboratory has overall responsibility for the conduct of the experiment. He will schedule all activities with the Dive Supervisor and the test facility manager. The PI will maintain all experimental logs.

Recorder: This function will be performed by a diver-subject under control of the Dive Supervisor. The Dive Supervisor will maintain dive duty logs as required by standard Navy practice.

Surface Tender, Communicator, and Standby Diver: These functions will be designated by the Dive Supervisor. Two-way voice communication will be maintained using a standard Navy Communication system. The surface tender will also communicate with the subject by line pull as needed. In addition, the subject will be monitored by a video camera attached to the diver support structure. The video monitor will be located topside to be viewed by a member of the crew designated by the Dive Supervisor. The standby diver will be fully suited at all times and be prepared to enter the water to assist the subject in the event of an emergency.

Medical Monitor: LT Robert Harris, MC, USN, Biomedical Sciences Department, Naval Submarine Medical Research Laboratory will act as medical monitor. He will consult with the PI and Dive Supervisor regarding any medical aspects of the dives or the experiment.

4. Subjects: There will be 6 primary subjects and 4 alternates. The subject population will consist of active-duty US Navy divers, possessing Diver Second Class qualification or higher. Divers will be medically qualified for diving as determined by a US Navy Diving Medical Officer. There are no restrictions as to age or sex of the diver.
5. Dive Records and Logs: A dive log will be kept by the Dive Supervisor. Ancillary logs are not required. Experimental logs including data will be kept by the PI.
6. Compression phase: Compression/Decompression rates are under the control of the diver subject, his tender, and dive supervisor in accordance with standard practice.
7. Depth Control: Divers will be suspended from a diver support structure which will be maintained at the desired depth for each dive. While the depth will be fixed for each individual dive, it will vary between dives. Depths to be used will be 30 and 60 ft.
8. Excursion Procedures: None.
9. Atmosphere Control: Surface supplied compressed air will be used for dives using MK-20 and MK-21 diving rigs. Air diluent will be used for the MK-16 diving rig.
10. Emergency Breathing Gas: None required. However, umbilical gas supply will be used via the MK-20 FFM for MK-16 dives (waiver required).
11. Contaminated Gases: Standard U.S. Navy Diving Manual Procedures for surface supplied air, and closed circuit rebreathers will be followed to ensure gas purity.
12. Termination Criteria: Each subject may terminate any dive for any reason. Subjects will be instructed to terminate any dive if they feel pain or excessive discomfort from noise exposures.

The Dive Supervisor, PI, and medical monitor may also terminate any dive. Guidelines for continued exposure to underwater sound are covered in the main protocol.

13. Abort Procedures: Standard dive surfacing techniques.

14. Decompression Phase: For dives requiring decompression, in water decompression will be conducted according to U.S. Navy decompression tables. At the Master Diver's preference, surface decompression using oxygen may be used. Bottom times for all dives will be limited to 40 minutes.

15. Decompression Sickness (DCS), Arterial Gas Embolism (AGE) Diagnosis and Treatment: Any casualties will be evaluated by an on-site DMO, and treated at an on-site recompression chamber and/or local hospital as needed.



[Blank Page]

## APPENDIX C

### Spirometry Testing

Spirometry was performed using a hand held portable SpiroSense spirometer. All subjects underwent baseline testing prior to any experimental diving. The baseline test used in this study was the Flow/Volume Loop. The Flow/Volume Loop is a Forced Vital Capacity (FVC) maneuver followed by a maximal inhalation maneuver. The test requires that the subject fill his lungs maximally, then exhale forcefully as long and as hard as possible through the spirometer flow sensor, then complete the loop by inhaling maximally through the flow sensor. Subject understanding and cooperation is necessary for an acceptable test. A trained pulmonary technician was present to coach the subjects through each maneuver. In addition, subjects were able to view a real time graph of the flow loop giving them visual as well as audio incentive. The SpiroSense automatically determines the end of test, and comments on the quality and reproducibility of each maneuver. The pulmonary technician and principal investigator reviewed each test for acceptability. Each subject performed three acceptable maneuvers during baseline testing.

Following the series of experimental dives, subjects repeated Flow/Volume Loop testing. Again, each subject performed three acceptable maneuvers. These results were compared with the results of baseline testing to determine whether a restrictive or obstructive airway disorder was induced by underwater sound exposures.

[Blank Page]

## APPENDIX D

### Neuropsychological/Neurological Testing Procedures

#### Neuropsychological Assessment

##### Test Battery

Group Administered:	Cognitive Behavior Rating Scale, Beck Anxiety Inventory, Beck Depression Inventory and Shipley Scale.
Computer Administered:	COGSCREEN and Non-Verbal Selective Reminding.
Individually Administered:	Wisconsin Card Sorting, California Verbal Learning (Forms 1 and 2), Continuous Visual Memory (Forms 1 and 2), Paced Auditory Serial Addition, Reitan Train Making, Symbol-Digit Modalities, Reitan Finger Tapping, Grooved Pegboard, Grip Strength, Controlled Oral Word Association and Stroop Color/Word Interference.

##### Description

The four-hour pre-dive neuropsychological battery included measures of intelligence (abstract sequence completion and multiple-choice vocabulary), concept formation, memory (verbal and visuospatial), reaction time (simple and choice), divided attention, focused attention, mental flexibility, coding speed, verbal fluency (word-list generation), manual skills (finger tapping, dexterity and grip strength), mental calculation, digit span, right-left orientation, visual matching-to-sample, and dual task performance. All measures were repeated following the dive, except the measures of intelligence and concept formation. Each subject also rated their current levels of anxiety, depression, memory impairment and other cognitive difficulties before and after the low-frequency water-borne sound dives.

## Neurological Assessment

### Pre/Post Study

Comprehensive neurologic tests to evaluate subjects at study entrance (beginning) and exit (end).

### Test: **Electroencephalography (EEG)/Brain Electrical Activity Mapping (BEAM)**

#### Test equipment

Bio-Logic ® Brain Analysis System.

#### Test length

Set up and subject preparation: 20 minutes.

Recording: 20 minutes.

Analysis time: 30 minutes.

#### Test protocol

Subject's electrocortical brain activity recorded from scalp electrodes using standard bipolar montage.

Patient is awake and resting, and undergoes brief period (3 minutes) of hyperventilation.

#### Test Analysis

Raw EEG electrocortical brain activity reviewed for abnormalities and artifacts.

Digitized electrocortical brain activity analyzed using Fast Fourier Transformation (FFT) after artifacts deselected.

Data compared pre/post study (within subjects) and compared to population normals (between subjects).

#### Data storage

250 MB Tape, Hard drive, printed summary of Spectral Plot, relative and absolute power.

### Pre/Post Study

Comprehensive neurologic tests to evaluate subjects at study entrance (beginning) and exit (end).

### Test: **Quantitative Oculomotor Performance Battery**

#### Test equipment

Micromedical Technology ® VORTEQ system.

Neurokinetics ® Contraves rotational chair system.

#### Test length

Setup and subject preparation: 5 minutes.

Recording: 30 minutes.

Analysis time: 20 minutes.

### Test protocol

Standard electrooculography (EOG) electrodes applied to subject.  
EOG calibration conducted prior to recording.  
For the standard test series, the subject is seated and secured in rotational chair.  
For the Vestibular Autorotation Tests, the subject wears yaw (side to side) axis angular rate sensor secured on headband.

### Test series

Oculomotor Tests (each test records 30-60 seconds of EOG)..  
Spontaneous and Gaze Evoked Nystagmus (1 trial).  
Saccade (fast) eye movement (2 trials).  
Pursuit (slow) eye movement (3 trials).  
Visual Vestibular Interaction Tests (each test records 30-120 sec of EOG)  
Optokinetic Nystagmus (OKN) (2 trials)  
Vestibular Ocular Reflex (VOR)  
Sinusoidal Harmonic Acceleration (5 trials)  
Impulse Acceleration (2 trials)  
Visual Vestibular Ocular Reflex (VVOR) (1 trial).  
Vestibular Ocular Reflex Suppression (Ocular Fixation) (1 trial)  
Off Vertical Rotation Nystagmus (OVR) (2 trials)  
Tilt Suppression of Post Rotatory Nystagmus (PRN) (2 trials)  
Optokinetic After Nystagmus (OKAN) (2 trials)  
Vestibular Autorotation Tests (each test records 15 seconds of EOG)  
Vestibular Ocular Reflex (VOR) (1 trial)  
Visual Vestibular Ocular Reflex (VVOR) (1 trial)  
Vestibular Ocular Reflex Suppression (Ocular Fixation ) (1 trial)

### Test analysis

Digitized eye and head position and eye velocity, latency and accuracy scores analyzed and reviewed for abnormalities.  
Gain refers to peak or maximum eye slow phase velocity (SPV) to head SPV.  
Gains compared pre/post study (within subjects) and compared to population normals (between subjects).

### Test descriptions

#### Nystagmus Test

Test description:

Subject sits in dark room with eyes open.  
EOG recorded while subject is staring forward (primary position) and 20 degrees left or right (secondary position).

Significance:

- 1) Nystagmus in primary position is usually vestibular in origin, may be congenital.
- 2) Nystagmus in secondary position is gaze evoked, may be vestibular.

### Saccade (Fast eye movement) Test

Saccade system used to move eye to acquire targets located off the visual axis (peripheral vision).

Saccade system supplements smooth pursuit, maintaining retinal image stability, when targets move faster than 100 deg/sec (constant velocity) or 150 deg/sec (sinusoidal motion).

#### Test description:

Subject in stationary chair in dark room instructed to track rapidly moving laser target

Two trials (rhythmic and random)

Target moves rhythmically (0-10 deg) and randomly (0-30 deg) left or right of center results in fast eye movement that closely matches target position and velocity.

#### Significance:

- 1) Reduced saccade latency may indicate frontal lobe dysfunction
- 2) Impaired saccade accuracy or velocity indicates brainstem oculomotor dysfunction

### Smooth Pursuit (SP) / Slow eye movements Test

Maintains retinal image stability for slow objects moving at < 100 degrees/sec

#### Description:

Subject in stationary chair in dark room instructed to track slowly moving laser target.

Target moves 30 deg left and right of center at 3 test frequencies (0.1, 0.2, 0.3 Hz).

Results in slow eye movement that closely matches target movement.

#### Significance:

- 1) No pursuit eye movements (only catch-up saccades), indicates cerebellar dysfunction.
- 2) Reduced pursuit when target moves toward one side indicates parietal lobe (cerebral) hemisphere dysfunction (ipsilateral)
- 3) Reduced pursuit gain in both directions seen with altered mental state (alcohol, medication, fatigue, or inattention)

### Optokinetic Nystagmus (OKN) Test

Eye movements induced by moving 360° visual field surround (retinal slip stimulus) enables retinal image stability of object of regard while ignoring competing motion signals results in nystagmus with slow phase in same direction of OKN stripe rotation.

#### Test description:

Subject seated in stationary chair (earth vertical axis).

Rotating OKN stripes projected onto wall, then stripes off in darkened room.

#### OKN visual stimulus:

Projector generated vertical regular black/white stripes

Stripes extend 45 degrees above and below horizon

Stripes project around full visual field (360 degrees horizontally)

OKN stripes rotated horizontally at 60 deg/sec  
OKN stripes rotated 1 trial clockwise, 1 trial counterclockwise  
OKN stripes projected for 60-120 seconds

Significance:

- 1) Reduced OKN slow phase component indicates ipsilateral parietal lobe dysfunction
- 2) Reduced OKN fast phase component indicates contralateral frontal lobe dysfunction

Vestibular Ocular Reflex Test

Maintains ocular stability during head motion by generating compensatory eye movement opposite to head movement

Test description:

Subject sits in rotating chair in darkened room

Results in nystagmus with slow phase in opposite direction of movement stimulus

Gain measured (peak or maximum eye slow phase velocity (SPV) to head SPV)

Stimulus profiles:

- 1) Sinusoidal Harmonic Acceleration (SHA)  
Test Profile: 1-67 cycles at 0.01, 0.02, 0.04, 0.08, 0.16 Hz at 60 deg/sec
- 2) Step Velocity  
Test Profile: 1 trial clockwise, 1 trial counterclockwise  
Rotated 60-120 seconds at 100 deg/sec

Significance:

- 1) Unilateral vestibular dysfunction  
Reduced gain at lower rotation frequencies  
Larger phase advance (phase lead) at higher frequencies
- 2) Bilateral vestibular lesion has lower gain than unilateral lesion

Visual Vestibular Ocular Reflex (VVOR) Test

Maintains ocular stability during head motion by generating compensatory eye movement opposite to head movement, with visual feedback present.

VVOR gain is higher (more accurate) than VOR gain.

Test description:

Subject sits in rotating chair (earth vertical) in room

Subject viewing stationary visual stimulus while rotating

Projector generated vertical regular black/white stripes

Stripes extend 45 degrees above and below horizon and 360 degrees around

Results in nystagmus with slow phase in opposite direction of rotation

Stimulus Profile

Sinusoidal Harmonic Acceleration (SHA) for 1-6 cycles at 0.04 Hz at 60 deg/sec

Significance:

Reduced gain at lower rotation frequencies indicates parietal and vestibular dysfunction



Reduced gain at higher frequencies indicates unilateral vestibular dysfunction  
Absent gain at higher frequencies indicates bilateral vestibular dysfunction

#### VOR Suppression (VOR-S) Test

VOR-S is the ability to voluntarily override the VOR to allow ocular tracking of object moving with head (head fixed target), effective at lower head oscillations (0.1-1.0 Hz).

##### Test description:

Subject in rotating chair in dark room instructed to track laser target moving with chair.

##### Stimulus Profile:

Sinusoidal Harmonic Acceleration for 1-6 cycles at 0.04 Hz at 60 deg/sec  
Chair fixed laser target moves left and right with subject, normally results in no eye movement as target does not move relative to subject

##### Significance:

- 1) Presence of VOR nystagmus (impaired VOR-S) when target moves toward one side indicates ipsilateral parietal lobe (cerebral) hemisphere dysfunction.
- 2) Presence of VOR nystagmus (impaired VOR-S) in both directions seen with altered mental state (alcohol, medication, fatigue, or inattention).
- 3) VOR-S is similar to smooth pursuit system.

#### Optokinetic After Nystagmus (OKAN) Test

Test of otolith/semicircular canal interaction (otolith modulation of VOR).

OKAN and PRN are opposite in direction, cancel each other, stabilizing retinal image.

##### Test description:

Subject seated in stationary chair (earth vertical axis).  
Rotating OKN stripes projected onto wall, then stripes turned off.

##### Stimulus:

OKN stripe profile: 1 trial clockwise, 1 trial counterclockwise.  
OKN stripes projected for 40-60 seconds and rotated at 50 deg/sec.  
Once OKN nystagmus reaches peak SPV, OKN stripes extinguished, and subject keeps eyes open in darkened room.

##### Significance:

Following sufficient OKN stimulus (40 deg/sec for 40 seconds), OKAN nystagmus persists after visual stimulus removed (room darkened).  
Initial OKAN I: follows OKN, same direction as OKN, then OKAN II, which follows OKAN I, is in opposite direction of OKN.  
Bilateral labyrinth damage, OKN unchanged, OKAN absent permanently.  
Unilateral labyrinth damage, OKAN reduced toward affected side.

#### Vestibular Autorotation Tests (each test records 15 seconds of EOG)

This test sequence uses active (subject generated) horizontal head rotation.

Subject turns head 10-20 degrees right and left at 0.5-4.0 Hz.

Subject wears headband with velocity rate sensor.

- Vestibular Ocular Reflex (VOR)
  - Subject in dark room, no visual feed back
  - Same significance as VOR rotational chair series
- Visual Vestibular Ocular Reflex (VVOR)
  - Subject in dark room fixates on earth fixed target light
  - Same significance as VVOR rotational chair series
- Vestibular Ocular Reflex Suppression (Ocular Fixation)
  - Subject in dark room fixates on head fixed target light
  - Same significance as VOR-S rotational chair series

#### Data Storage

Hard drive, 3.5 inch disk, 250 Megabyte tape backup, printed summary.

#### Pre/Post Study

Test: **Dynamic Platform Posturography**

#### Test equipment

- Neurocom® Pro Balance Master (dynamic posturography).
- Polhemus® Head Tracker System.
- Labview® data acquisition system.
- Audio system with background (pink noise) generator and communication.
- Video camera and recorder to view subject.

#### Test length

- Setup and subject preparation: 1-2 minutes.
- Recording: 30 minutes.
- Analysis time: 10 minutes.

#### Test protocol

- Subject wears safety harness secured to safety bar.
- Subject wears pitch - roll axis position sensor secured on head band.
- Subject wears headset connected to background noise generator and audio comm system.
- During Sensory Organization Tests (SOT), the subject maintains best balance for 20 seconds of the test condition.
- During Dynamic Stability Test, the subject shifts weight to match the designated indicator, out to a target location at a percentage of the subject's calculated maximum limit of stability (LOS), based on height and weight.

#### Sequence of test conditions (22 trials conducted)

- (Series One) Standard Sensory Organization Test
  - Eyes open (EO)/No Head Movements/ Stable Platform (1 trial).
  - Eyes closed (EC)/No Head Movements/ Stable Platform (1 trial).
  - Eyes open (EO)/No Head Movements/ Unstable Platform (3 trials).
  - Eyes closed (EC)/No Head Movements/ Unstable Platform (3 trials).

(Series Two) Dynamic Stability Test

Center Target - maintain static position (1 trial).

Rhythmic Weight Shift L/R - target moving left and right to 50% LOS at 3 speeds (1 trial).

Rhythmic Weight Shift F/B - target moving forward and backward to 50% LOS at 3 speeds (1 trial).

Limit of Stability Shift - shift position from the center to of 8 predictable targets at 90% LOS and back (1 trial).

Random Limit of Stability Shift - shift position from the center to 1 of 8 random targets at 90% LOS and back (1 trial).

(Series Three) NAMRL Modified Sensory Organization Test.

Eyes open (EO)/Head Movements/ Stable Platform (3 trials).

Eyes closed (EC)/Head Movements/ Stable Platform (3 trials).

Eyes closed (EC)/Head movements/ Unstable Platform (3 trials).

Test Analysis

Balance and sway path distance scores reviewed for change pre/ post study scores compared pre/ post study (within subjects) and compared to population normals (between subjects).

Analyze video tape of instability pattern or fall.

Data Storage

250 MB Tape, Hard drive, printed summary.

VHS tape of subjects during balance test.

Pre/Post Exposure Tests

Rapid screening tests of Neuro-otologic Function administered before and after each LFA exposure.

Test: **Dynamic Visual Acuity Test**

Test equipment

Micromedical Technology ® VORTEQ system

Test length

Setup and subject preparation: 1 minute

Recording: 4 minutes

Analysis time: 2 minutes

Test protocol

Subject wears yaw axis angular rate sensor secured on headband.

Subject reads computer generated eye chart at 10 foot distance while turning head side to side at specific head velocities and frequencies.

Computer displays computer generated eye chart when subject turns head at selected velocity.

Operator encourages best visual acuity from subject.

Five test conditions

static (0 velocity)

0.7 Hz/ 70n deg/ sec

1.0 Hz/ 100 deg/ sec

1.4 Hz, 140 deg/ sec

2.0 Hz/ 200 deg/ sec

Each test condition takes 20-40 sec to administer.

#### Test Analysis

Operator scores visual acuity at each test frequency using log Mean Angle Resolvable (log MAR) scale.

Scores are reviewed for change pre/ post exposure.

#### Data Storage

Hard drive, 3.5 inch disk, printed summary.

#### Pre/ Post Exposure Tests

Rapid screening tests of Neuro-otologic Function administered before and after each LFA exposure.

#### Test: **NAMRL Modified Sensory Organization Test**

##### Test Equipment

Neurocom® Pro Balance Master (dynamic posturography).

Polhemus® Head Tracker System.

Labview® data acquisition system.

Audio system with background (pink noise) generator and communication.

Video recorder to view subject.

##### Test length

Setup and subject preparation: 1-2 minutes.

Recording: 5 minutes.

Analysis time: 1 minute.

##### Test protocol

Subject wears safety harness secured to safety bar.

Subject wears pitch - roll axis position sensor secured on headband.

Subject wears headset connected to background noise generator and audio comm system.

Patient maintains best balance.

### Test conditions

12 trials conducted, each trial measures balance over 20 seconds  
NAMRL modified Sensory Organization Test  
Eyes open (EO)/ No Head Movements/ Stable Platform (1 trial).  
Eyes closed (EC)/ No Head Movements/ Stable Platform (1 trial)  
Eyes open (EO)/ Head Movements/ Stable Platform (2 trials)  
Eyes closed (EC)/ Head Movements/ Stable Platform (2 trials)  
Eyes closed (EC)/ No Head Movements/ Unstable Platform (3 trials)  
Eyes closed (EC)/ Head Movements/ Unstable Platform (3 trials)

### Test Analysis

Balance scores reviewed for change pre/ post exposure  
Scores compared pre/ post study (within subjects) and compared to population normals (between subjects)  
Video tape of instability or fall

### Data Storage

250 MB Tape, Hard drive, printed summary  
VHS tape of subjects during balance test

## Test: **Real time in water videooculography (VOG)**

### Test Equipment

Water proof video camera.  
Standard VCR recorder.  
ISCAN ® pupillary reflection eye tracking system.  
Video Time Based Corrector.  
Labview ® data acquisition system.

### Test length

Setup and subject preparation: 5 minute.  
Recording: during descent, in water exposure, and ascent.  
Analysis time: variable, can be real time.

### Test protocol

Subject wears waterproof video camera on helmet with adjustable mount.  
Operator adjusts power supply to camera and infrared lights to obtain optimal video signal.  
Subject adjusts camera angle and distance with feedback from operator.  
Operator adjusts ISCAN unit to obtain centered eye pupil cross hair.

### Test analysis

Operator correlates VOG eye movements with audio and full field video.

Monitor subject head and eye position, body movement, and visual stimuli.  
Operator interprets significance of eye movements.  
Eye movement analyzed and reviewed for abnormalities (spontaneous primary  
position nystagmus, particularly vertical or torsional nystagmus).

### **Incident Evaluation**

Clinical evaluation to include history and examination with specific focus to  
complaints and organ system involvement.

Neuro-otologic Functions Tests (from Pre/Post Study or exposure tests) as indicated.

[Blank Page]

## APPENDIX E

### Procedure for administering audiograms

A GSI 16 audiometer with TDH-50 headphones were used to administer all audiograms performed during the experiment. Figure E1 shows a block diagram of the audiometry, and calibration equipment. A B&K type 2636 Measuring Amplifier and a type 1617 Third Octave filter were used in conjunction with a B&K type 4152 artificial ear coupler to calibrate the ear phones. The coupler microphone was calibrated with a B&K type 4220 Piston Phone calibrator and double checked with a B&K type 4230 pocket size calibrator. The audiometry equipment was calibrated on a daily basis before the morning audiograms were performed. In addition, the audiogram booth was tested to insure that it met with the ANSI standards for administering clinical audiograms.

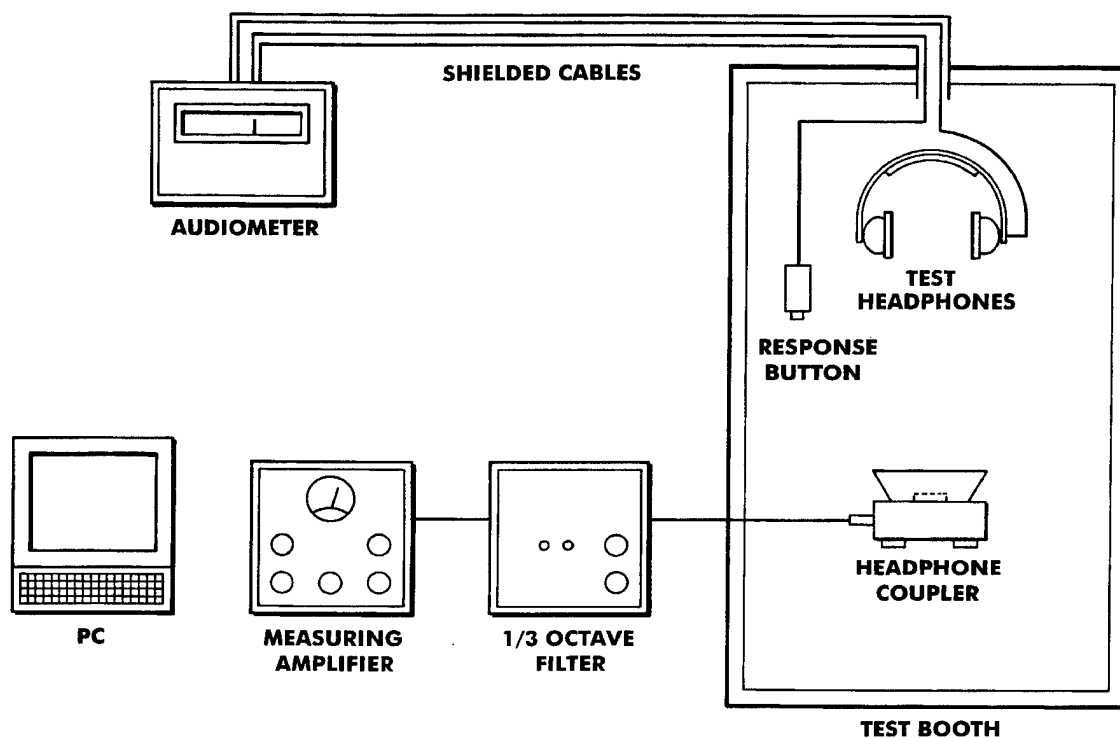

*Figure E1. Equipment Setup*

Each subject had two practice audiograms before receiving five baseline audiograms over a three day period. The audiograms covered the test frequencies of 250, 500, 1000, 2000, 4000, and 8000 Hz. During the exposure days the subjects received a pre-dive audiogram first thing in the morning and a post dive audiogram between one and three hours after the dive. The audiograms were immediately entered into a spread-sheet and compared with the subjects baseline. If a shift of 10dB or greater was found at any one of the test frequencies, the audiogram was repeated and the subjects ears were



examined by a medical monitor on site. A post exposure audiogram was administered to each subject the day after the final exposure.

In addition to the audiograms explained above, each subject received a clinical audiogram at the Orlando Navy Hospital prior to, and after the experiment. The audiograms were administered by a certified technician and covered the frequencies of 500, 1000, 2000, 3000, 4000., and 6000 Hz.

#### Daily calibration procedure

1. Check the calibration of the equipment by placing the B&K type 4220 Piston Phone calibrator on the microphone and coupler.
2. Set the 1/3 octave filter to the 1000 Hz band and read the level on the Measuring amplifier. If the level doesn't read 93dB, adjust the calibration screw until it does. Check the Measuring amplifier settings if the reading is off by more than 3dB, and repeat the measurement with the second calibrator.
3. Screw the coupler back together and fit the right earphone snugly into the coupler, and place the weight bag on top of the earphone.
4. Set the audiometer to 70dBHL, and dial in the first test frequency. Set the filter to the Band level which concurs with the test frequency and record the SPL in the table. Compare the level with the previous day's calibration levels. If they are not within 1dB check the earphone placement in the coupler, and verify that all instrument settings are correct.
5. Repeat this for all the test frequencies in the left and right earphones, and record the results in the computer.
6. Replace the earphones in the headset and check that the response button is working correctly.

## APPENDIX F

SINDBAD sustained attention test (Manual Dexterity Task): A special "key" is used by the subject in this task. The key is square shaped on one end and round or cylindrically shaped on the other end. The square and round ends of the key were alternately inserted into matching shaped target areas on the response panel for 60 sec. The score was the total number of key insertions. The following instructions were presented to the subject prior to initiating the task:

### MANUAL DEXTERITY TASK

THIS IS A TEST TO SEE HOW QUICKLY YOU CAN MANIPULATE A SMALL OBJECT. PICK UP THE SMALL KEY INSERTION DEVICE DURING THIS TEST. YOU ARE TO USE ONLY YOUR PREFERRED HAND TO MANIPULATE THIS DEVICE. DO NOT ASSIST THIS HAND WITH THE OTHER HAND. THROUGHOUT THE TEST, YOU ARE TO ALTERNATE TWO DIFFERENT RESPONSES: FIRST, INSERT THE ROUND END OF THE DEVICE INTO THE LIGHTED ROUND CELL MARKED WITH AN 'ASTERISK;' SECOND, INSERT THE SQUARE END OF THE DEVICE INTO THE LIGHTED SQUARE CELL BESIDE THE ASTERISK. ALTERNATE THESE TWO RESPONSES AS RAPIDLY AS YOU CAN FOR THE FULL ONE MINUTE OF THE TEST.

A RESPONSE WILL COUNT TOWARD YOUR SCORE ONLY IF THE RESPONSE DEVICE IS INSERTED ALL OF THE WAY INTO THE PANEL CELL. ALSO, ONLY ALTERNATED RESPONSES WILL COUNT TOWARD YOUR SCORE: THAT IS, REPEATED INSERTIONS INTO THE SAME CELL DO NOT COUNT. START IMMEDIATELY AFTER THE FIVE SECOND COUNTDOWN ON THE TOP NUMBERS. KEEP WORKING RIGHT UP TO THE END OF THE TEST, MARKED BY NINES SHOWN ON THESE SAME NUMBERS.

REMEMBER, USE ONLY YOUR PREFERRED HAND AND WORK AS FAST AS YOU CAN. DO YOU UNDERSTAND WHAT YOU ARE TO DO? READY.

When subject is ready, press a key.

[Blank Page]

## APPENDIX G

### Symptoms Survey

While you are in the water, you will be frequently asked the following series of questions. The intensity of a symptom should be rated on a scale of 0 to 10 as follows:

#### MODIFIED BORG SCALE

0	5
Nothing at all	Severe
0.5	6
Very, Very Slight	
1	7
Very Slight	Very Severe
2	8
	Slight
3	9
Moderate	Very, Very Severe
4	10
Somewhat Severe	Maximal

1. DO YOU HAVE A SENSATION OF VIBRATION OR NUMBNESS ANYWHERE ON YOUR BODY? IF SO, WHERE?
2. DO YOU HAVE ANY PAIN?
3. ARE YOU SHORT OF BREATH?
4. DO YOU FEEL VIBRATION IN YOUR CHEST?
5. DO YOUR EARS ACHE OR HURT?
6. DO YOU FEEL WIDE AWAKE AND ALERT?
7. IS YOUR VISION DIM?
8. DO YOU FEEL LIGHTHEADED?

9. DO YOU HAVE A HEADACHE?

10. COULD YOU FULLY CONCENTRATE UNDER THESE CONDITIONS?

11. ARE YOU EXPERIENCING ANY OTHER UNUSUAL SENSATIONS?

12. DO YOU FIND THE SOUND ANNOYING?

This survey will be given during each 100 second sound exposure. Questions for which positive responses were given (or negative responses in the case of questions 6 and 10) will be repeated with the sound off. Prior to repeating each 100 second sound exposure, you will also be asked:

13. ARE YOU READY FOR THE NEXT SOUND EXPOSURE?

If you respond "No", the next exposure will be postponed or terminated at your request.

In addition to the above questions, as a diver-subject, you are encouraged to let topside personnel know of any other sensation or problem you might have. Your participation is voluntary, and each exposure is performed only with your approval.

APPENDIX H  
Flow Chart of continued testing

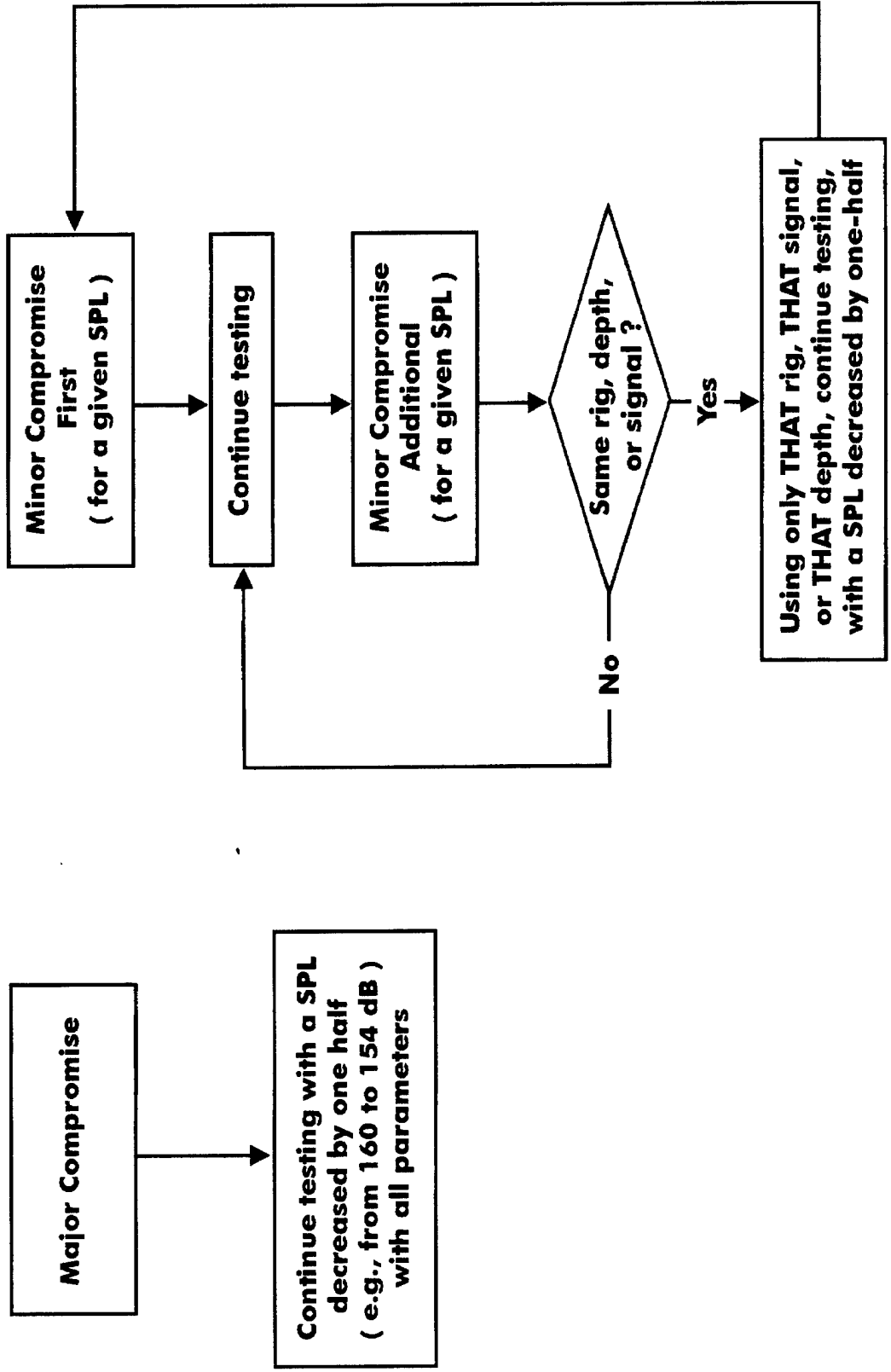

[Blank Page]

Appendix H-2

APPENDIX I

Neurological Testing: Pre/Post Study Test Results Summary

EEG Brain Electrical Activity Mapping (BEAM) Fast Fourier Transformation (FFT)								
Diver Number	5	6	7	8	9	10	11	12
Subject (S)/Control (C)	S	S	S	S	S	S	C	C
Running Memory Task								
Spectral Plot	0	0	0	0	0	0	0	0
Relative Power	0	0	0	0	0	0	0	0
Absolute Power	0	0	0	0	0	0	0	0
Resting State								
Spectral Plot	0	0	0	0	0	0	0	0
Relative Power	+	0	+	+	0	0	0	0
Absolute Power	0	0	0	0	0	0	0	0
Test: Dynamic Platform Posturography								
Diver Number	5	6	7	8	9	10	11	12
Subject / Control	S	S	S	S	S	S	C	C
Standard Sensory Organization Test								
EO/NoHM/Stable(S1)	0	0	+	0	-	0	+	0
EC/NoHM/Stable(S2)	0	0	-	-	0	0	+	0
EO/NoHM/Unstable(S4)	+	+	+	+	0	-	+	0
EC/NoHM/Unstable(S5)	+	+	0	+	0	+	+	0
NAMRL Modified Sensory Organization Test								
EO/HM/Stable(N1)	+	0	+	+	+	0	+	0
EC/HM/Stable(N2)	+	0	+	+	0	+	+	0
EC/HM/Unstable(N5)	+	+	+	+	+	+	+	+
Test: Quantitative Oculomotor Performance Battery								
Diver Number	5	6	7	8	9	10	11	12
Subject/Control	S	S	S	S	S	S	C	C
Saccade Velocity	0	0	+	0	+	+	+	+
Pursuit gain	0	-	+	0	0	0	+	+
Visual Vestibular Interaction								
Optokinetic OKN) gain	+	+	+	0	+	+	+	+
After Nystagmus (OKAN)	-	0	+	+	+	0	+	0
VOR Suppression	0	0	0	-	+	0	-	0
Visual VOR (VVOR) gain	0	+	+	+	+	+	+	+
Vestibular Reflex (VOR)								
Sinusoid	+	+	+	+	+	+	+	+
Impulse	0	0	0	0	0	0	0	-
Active Head Rotation								
Visual VOR (VVOR) gain	0	+	0	+	-	0	+	0
Trends: - is downward trend from pre to post study 0 is no change from pre to post study + is an upward trend from pre to post study								



[Blank Page]

Appendix J

Neuropsychological Testing  
Pre/Post Study Test Results Summary

(scores are means for all subjects.

There were no significant differences between experimental subjects and controls)

MEMORY PERFORMANCE				
Variable	Pre	Post	t-value	p-value
CVLT				
Trial 1	7.4	7.4	0.00	1.000
Trial 5	14.9	15.0	-0.24	.818
Total	62.0	59.7	0.60	.569
Short Delay Recall	13.4	14.6	-1.29	.244
Long Delay Recall	14.3	14.4	-0.18	.864
Recognition	15.9	15.6	1.00	.356
CVMT				
Hits	39.8	37.5	2.39	.048
False Alarms	14.3	9.9	3.24	.014
D-Primed	2.3	2.3	-0.03	.977
Total	79.5	81.6	-1.22	.263
Recognition	5.3	4.9	0.81	.442

(Alternate forms used for CVLT and CVMT)

MOTOR + GRAPHOMOTOR PERFORMANCE				
Variable	Pre	Post	t-value	p-value
Grip Strength				
Dominant	61.9	61.0	0.46	.660
Non-Dom	59.4	58.0	1.23	.258
Pegboard				
Dominant	66.0	62.0	5.57	* .001
Non-Dom	68.0	62.3	5.24	* .001
Finger Tapping				
Dominant	55.3	55.3	0.00	1.000
Non-Dom	48.1	49.9	- 1.94	.093
Symbol-Digits				
Oral	67.5	73.6	- 1.70	.133
Written	55.4	57.0	- 1.23	.259
Trail Making				
Part A	18.8	18.3	0.34	.741
Part B	47.5	47.1	0.11	.919

\* Significant Improvement

ATTENTION / CONCENTRATION PERFORMANCE				
Variable	Pre	Post	t-value	p-value
Verbal Fluency				
Letter C	16.4	14.8	1.11	.303
Letter F	14.0	12.9	0.95	.375
Letter L	13.5	12.5	0.78	.461
Total	42.6	40.1	0.60	.565
PASAT				
Trl 1 errors	7.8	4.0	1.56	.163
Trl 2 errors	12.4	6.5	3.51	* .010
Trl 3 errors	16.1	9.9	3.28	.014
Trl 4 errors	21.8	15.0	3.71	* .008
Optime	58.0	35.4	4.32	* .003
Avertime	2.3	1.8	2.88	.024
	2.7	2.2	3.41	.011
Stroop				
Words	104.0	100.6	1.44	.193
Colors	73.4	76.9	- 1.71	.131
Colors-Words	46.3	46.3	0.00	1.000

\* Significant Improvement

COGSCREEN Performance				
Variable	Pre	Post	t-value	p-value
ASCACC	93.8	97.5	- 0.89	.402
DATIPRE	6.8	4.8	2.04	.081
DATIRTC	293.8	322.5	- 2.18	.066
DTTAHIT	0.5	0.3	0.51	.626
MATHACC	70.0	72.5	- 0.20	.844
MTSRTC	1315.0	1292.5	0.18	.864
SATDACC	56.5	74.5	- 4.57	* .003
SATNRTC	680.0	766.3	- 0.92	.389
VSCRTC	2445.0	2396.3	0.20	.846

\* Significant Improvement

SUBJECTIVE COGNITIVE / EMOTIONAL RATINGS				
Variable	Pre	Post	t-value	p-value
Beck Scales				
Anxiety	2.3	1.1	1.01	.344
Depression	2.6	1.3	2.11	.073
CBRS				
Language Deficit	21.4	17.3	4.51	.003*
Apraxia	6.5	6.0	1.32	.227
Disorientation	6.3	5.6	1.00	.351
Agitation	6.6	6.1	0.94	.381
Need for Routine	8.0	7.3	1.43	.197
Depression	30.6	25.4	1.35	.220
Higher Cognitive Deficits	23.0	20.3	2.92	.022
Memory Disorder	29.4	23.5	1.70	.132
Dementia	29.8	26.8	1.83	.109

\* Significant Improvement

[Blank Page]

## APPENDIX K

### ASSESSMENT OF EYE MOVEMENTS DURING HIGH INTENSITY UNDERWATER SOUND EXPOSURES IN U.S. NAVY DIVERS

ELIZABETH A. FERREIRA  
BRADEN J. McGRATH  
JONATHAN B. CLARK

Naval Aerospace Medical Research Laboratory  
Naval Air Station  
Pensacola, FL

#### INTRODUCTION

Divers exposed to high-intensity underwater sound have experienced symptoms attributed to vestibular stimulation. An underwater video oculography (VOG) system was developed to monitor divers' eye movements, particularly torsion, during exposure to underwater sonar signals.

#### MATERIALS & METHODS

Six Navy divers were exposed to 240-320 Hz underwater sound @ 160 dB (re 1 mPa) for 15 minutes daily cumulative exposure for 10 days. Testing was in open water at a depth of 60 ft. An underwater camera was attached to the divers soft hooded mask or hard helmet over the diver's right eye. Waterproof power and video cables were attached to diver's umbilical cable that relayed the video image to a surface control room. Eye movements were continuously monitored and recorded in a surface control room. A torsional "calibration" was performed where divers were cued to perform head tilts to be sure the system was capable of capturing torsional eye movements. Off-site, a NASA developed torsion analysis system was used on the data.

##### Torsional Analysis Protocol

1. Pupil edge is detected.
2. Center of the pupil is calculated by determining the center of the pupil shape detected in step 1.
3. Horizontal and vertical eye movements are measured by recording the pupil center calculated in step 2.
4. Iris landmarks are selected FROM FEATURES IN THE IRIS.
- 5: Pattern recognition is used to track the iris landmarks and measure torsional eye movements.

#### RESULTS

During each 100 second sound exposure, eye movements were analyzed for abnormalities while divers looked straight ahead. No spontaneous nystagmus, torsional or linear, was detected.

## CONCLUSIONS

This experiment was the first successful attempt to record and analyze eye movements under water. No sound induced nystagmus, resulting from exposure to 160 dB underwater sound, was detected in any diver.

**UNCLASSIFIED**

SECURITY CLASSIFICATION OF THIS PAGE

<b>REPORT DOCUMENTATION PAGE</b>				<i>Form Approved OMB No. 074-0188</i>	
1a. REPORT SECURITY CLASSIFICATION <b>UNCLASSIFIED</b>			1b. RESTRICTIVE MARKINGS		
2a. SECURITY CLASSIFICATION AUTHORITY			3. DISTRIBUTION/AVAILABILITY OF THE REPORT <b>Approved for public release; Distribution unlimited</b>		
2b. DECLASSIFICATION/DOWNGRADING SCHEDULE			4. PERFORMING ORGANIZATION REPORT NUMBER(S) <b>NSMRL Report 1208</b>		
5. MONITORING ORGANIZATION REPORT NUMBER(S) <b>NA</b>			6a. NAME OF PERFORMING ORGANIZATION <b>Naval Submarine Medical Research Laboratory</b>		
6b. OFFICE SYMBOL <i>(If Applicable)</i>			7a. NAME OF MONITORING ORGANIZATION <b>Naval Medical Research and Development Command</b>		
6c. ADDRESS <i>(City, State, Zip Code)</i> <b>Box 900, Naval Submarine Base NLON, Groton, CT 06349-5900</b>			7b. ADDRESS <i>(City, State, Zip Code)</i> <b>8901 Wisconsin Avenue Bethesda, MD 20889-5606</b>		
8a. NAME OF FUNDING/SPONSORING ORGANIZATION <b>Space &amp; Naval Systems Warfare Cmd</b>		8b. OFFICE SYMBOL <i>(If Applicable)</i>		9. PROCUREMENT INSTRUMENT IDENTIFICATION NUMBER	
8c. ADDRESS <i>(City, State, Zip Code)</i>		10. SOURCE OF FUNDING NUMBERS			
		PROGRAM ELEMENT NO. <b>63747N</b>	PROJECT NO.	TASK NO. <b>5503</b>	WORK UNIT ACCESSION NO.
11. TITLE <i>(Include Security Classification)</i> <b>Effects of low-frequency water-borne sound on divers: Open water trial</b>					
12. PERSONAL AUTHOR(S) <b>C.C. Steevens, R. Sylvester, J. Clark</b>					
13a. TYPE OF REPORT <b>Interim</b>		13b. TIME COVERED FROM _____ TO _____		14. DATE OF REPORT <i>(Year, Month, Day)</i> <b>1997 October 07</b>	
15. PAGE COUNT <b>24</b>					
16. SUPPLEMENTARY NOTATION					
17. COSATI CODES			18. SUBJECT TERMS <i>(Continue on reverse if necessary and identify by block number)</i>		
FIELD	GROUP	SUB-GROUP	<b>Sound; Underwater; Plane waves; Standing waves; Divers; Safety; Hearing; Vestibular function; Performance; Tolerance</b>		
19. ABSTRACT <i>(Continue on reverse if necessary and identify by block number)</i> <p>Navy divers may be exposed to active sonar transmissions while underwater. Previous manned experiments to determine safe levels of exposure have all been conducted in enclosed settings characterized by standing wave sound fields. The purpose of this experiment was to determine if plane wave (open water) acoustics alters the physiological or subjective responses of exposed divers compared to standing wave exposures. 54 manned exposures to two low-frequency underwater acoustic signals were performed at depths of 30 and 60 feet in a fresh water spring. Two projectors were used to create a plane progressive traveling acoustic wave. Divers were exposed in both helmeted and unhelmeted diving rigs. Effects on hearing, vestibular function, cardiac rhythm, and a key-insertion task were measured. Subjective responses were also recorded. In addition, the effects of neoprene wet suits on sound attenuation were measured. Slight decrements in hearing acuity were detected, but these results were confounded by circumstances unrelated to the underwater sound exposures, such as ear squeezes from diving, and microphone feedback noise. No adverse effects in vestibular function, cardiac rhythm, or key insertion performance were detected. Subjective responses revealed that divers were moderately annoyed by the underwater sound, but overall found the exposures tolerable. Neoprene wet suits generally act to attenuate low-frequency sound exposures, but under</p>					
20. DISTRIBUTION/AVAILABILITY OF ABSTRACT <input checked="" type="checkbox"/> UNCLASSIFIED/UNLIMITED <input type="checkbox"/> SAME AS REPORT <input type="checkbox"/> DTIC USERS			21. ABSTRACT SECURITY CLASSIFICATION		
22a. NAME OF RESPONSIBLE INDIVIDUAL <b>S. D. Monty, Editor</b>			22b. TELEPHONE <i>(Include Area Code)</i> <b>(203) 449-3967</b>		22c. OFFICE SYMBOL



**UNCLASSIFIED**

SECURITY CLASSIFICATION OF THIS PAGE

19. cont.

certain circumstances may also accentuate a sound exposure, possibly through a resonance effect. There is no indication from the results of this study that low-frequency water-borne sound exposures in the open water present any additional risk to divers compared to similar exposures in enclosed environments.