

**THE EFFECT OF SUPERFINISHING ON GEAR  
TOOTH PROFILE**

**Sponsors: US Army Research Development &  
Standardisation Group UK London  
Contract Number N68171-96-C-9043**

**FINAL REPORT**

R W Snidle H P Evans M P Alanou

Report No 2284

June 1997

---

**Division of Mechanical Engineering  
and Energy Studies**

---

# Engineering

**DISTRIBUTION STATEMENT A**

Approved for public release;  
Distribution Unlimited

19970728 140



**THE EFFECT OF SUPERFINISHING ON GEAR  
TOOTH PROFILE**

**Sponsors: US Army Research Development &  
Standardisation Group UK London  
Contract Number N68171-96-C-9043**

**FINAL REPORT**

R W Snidle H P Evans M P Alanou

Report No 2284

June 1997

DTIC QUALITY INSPECTED 4

**DISTRIBUTION STATEMENT A**

Approved for public release;  
Distribution Unlimited

**Research Project "The effect of superfinishing on gear tooth profile"**  
**Sponsors: US Army Research Development & Standardisation Group UK London**  
**Contract Number N68171-96-C-9043**

## **FINAL REPORT**

R W Snidle H P Evans M P Alanou  
School of Engineering  
University of Wales Cardiff  
Cardiff CF2 3TA, UK

## **SUMMARY**

The report describes the results of a project carried out to determine the effect of superfinishing of gears on the profile and surface finish of the teeth. A batch of fourteen NASA 3.5 inches reference diameter spur test gears were prepared in the usual way by grinding. The gears were inspected for profile and lead quality and surface profiles taken. The gears were then superfinished by the "Abral" process. Following superfinishing the gears were again inspected and surface profiles taken. It was found that typically the surface finish improved from about 0.4 $\mu$ m roughness average (Ra) to better than 0.1 $\mu$ m Ra. Results of gear metrology inspection showed that the quality of the gears in terms of profile and lead was not affected by this process. It was concluded that approximately 2.5 $\mu$ m had been removed from the tooth surfaces as a result of superfinishing.

For further information please contact:

Dr R W Snidle  
Division of Mechanical Engineering  
University of Wales Cardiff  
PO Box 925  
Cardiff CF2 3TA  
UK

Tel: (01222) 874273 Fax: (01222) 874317 E-mail: SnidleR@cardiff.ac.uk

Research Project "The effect of superfinishing on gear tooth profile"  
Sponsors: US Army Research Development & Standardisation Group UK London  
Contract Number N68171-96-C-9043

## FINAL REPORT

R W Snidle H P Evans M P Alanou  
School of Engineering  
University of Wales Cardiff  
Cardiff CF2 3TA, UK

### 1. INTRODUCTION

The objectives of this project were summarised in the *STATEMENT OF WORK* included in the contract document as follows:

*OBJECTIVES: The overall aim of the proposed research is to improve the durability of gears used in helicopter transmissions. The two primary questions to be addressed are as follows:*

- a. *Will the superfinishing process adversely affect gear tooth shape?*
- b. *What is the relationship between gear tooth surface roughness and gear life, especially for superfinished gears?*

The project carried out at University of Wales School of Engineering was mainly concerned with objective (a); the second objective (b) is to be completed at NASA-Lewis Research Center where fatigue testing of the superfinished gears supplied by the University is now taking place (June 1997).

In order to accomplish task (a) arrangements were made for a batch of 14 standard NASA test gears (28 teeth, 8DP, 6.35 mm facewidth) to be delivered to University of Wales. The gears had been finished by grinding in the usual way. On arrival the gears were inspected to determine the initial accuracy and surface finish. They were then superfinished and re-inspected to determine the effect of superfinishing on accuracy and surface finish. Detailed results of the project are given as follows.

### 2. INITIAL INSPECTION

#### 2.1 Gear metrology

Four gears were randomly selected for detailed inspection from the batch of 14 supplied. These were already stamped with serial numbers as follows:

AMS6260 #11  
" #15  
" #20  
" #23

The four gears were sent to the UK National Gear Metrology Laboratory at Newcastle University. The following parameters were measured on each gear:

- lead and profile errors on four teeth, left and right flanks, spaced at 90 degree intervals;
- adjacent and cumulative pitch errors on all teeth, left and right flanks;
- radial runout of the tooth space;
- mean circular tooth thickness.

A reference tooth ("tooth 1") on each gear was marked so that re-examination could be carried out on the same teeth following superfinishing. Four teeth (Teeth 1, 8, 15, 22) were used in the gear metrology tests. This initial metrology showed that the gears were generally to DIN grade 5 or better on profile and lead. A copy of the metrology report on the gears as received (dated August 1996) is shown in Appendix 1.

## 2.2 Surface finish

In order to show the detailed effects of superfinishing it was decided to take "re-located" profiles from the gear teeth before and after finishing. This was achieved by use of a special stepper motor-driven profilometer with which it was possible to take a profile or series of profiles at a precisely known location on a gear tooth. The principle of relocation was based on detection of the edges of the gear tooth by running the profilometer stylus in the axial direction of the gear to detect the side of the tooth and radially to detect the tooth tip. Three profiles were taken from both sides of two teeth (teeth 1 and 15) on each gear (i.e. a total of 12 profiles from each gear). Two of the three profiles on each gear flank were located 1mm from each side edge and the third profile was on the centre line as illustrated in Figure 1. Profile data was taken up to and slightly beyond the tip of the teeth as a direct means of verifying the accuracy of relocation in every case. Figure 2(a) shows a typical profile obtained in this way. It should be noted that the profiles are measured relative to a nominal circular-arc datum and the long wavelength undulations do not indicate any deviation of the profile from the desired involute but simply the deviation of the gear tooth profile from a nominal circular arc. All profiles were processed using a standard phase-corrected digital filter with a cut off of 0.08 mm. The length of the raw profile which appears in the filtered data is shown in Figure 2 (b) and the same length of profile after filtering is shown in Figure 2 (c). All Roughness Average (Ra) and ten-point height parameters (Rz) values quoted in this report are calculated from profiles filtered with the above cut off.

The centre profile ( $y=3.175$  mm) from each flank of the two teeth examined on all four of the gears as supplied are shown in Appendix 2 for reference. The remaining profiles taken at 1mm from each edge of the flanks ( $y=1$ mm and  $y=5.35$  mm) are not shown for reasons of space, but are available if required.

## 3. INSPECTION AFTER FIRST PHASE OF SUPERFINISHING

### 3.1 Gear metrology

Following initial inspection the gears were superfinished using the *Abral* process at Westland Engineering of Yeovil, England. In this process the gears are immersed in bed of small zinc chips, water and aluminium oxide powder. The container (a rubber-lined open tank) is vibrated for a period of several hours and the grade of the oxide powder is increased in fineness in several stages. In the first attempt at finishing the gears were clamped together and mounted along with several other gears of different types that were being handled at the time

by Westland Engineering. Although the NASA gears appeared at first sight to be suitably superfinished it was subsequently found on detailed inspection that a further stage of treatment was needed in order to achieve the finish ( $Ra < 0.1\mu\text{m}$ ) that was expected on the basis of previous work. The gears were, however, checked at this un-planned "intermediate" stage and this proved to give a good quantitative measure of the rate of surface removal in the process.

Gear metrology was again performed at Newcastle where it was found that there was no significant change in the profile of the teeth. It was concluded from the metrology work that an average of approximately  $1\mu\text{m}$  of stock had been removed from the tooth flanks. The inspectors also commented that the initial grinding marks were visible on some of the teeth. The full report (dated December 1996) corresponding to this "intermediate" stage of finishing is given in appendix 3.

### 3.2 Surface finish

The above comments by the metrology inspectors were confirmed at Cardiff by relocated surface roughness profiles. Figure 3, for example shows relocated profiles from two teeth diametrically opposed on gear #11 (i.e. teeth 1 and 15). Comparison of profiles before and after finishing of tooth 1 (Figures 3(a) and 3(b)) show a significant degree of surface improvement, but recognisable deep valley features are still present. These features are indicated with small arrows in both profiles as shown. From this comparison we can see that about  $2\mu\text{m}$  of metal has been removed from the surface. On the opposite tooth (tooth 15), however, there is less evidence of polishing and comparison of Figures 3(c) and 3(d), which are profiles from this tooth, suggests that about  $1\mu\text{m}$  or less has been removed. This uneven and incomplete finishing of the teeth was judged to be unsatisfactory and it was decided to carry out a second stage of finishing by repeating the process.

In order to promote an even finishing during the repeat run the gears were clamped together on their own separate mandrel which could circulate freely in the vibrating finishing tank. The mandrel had "dumb-bell" ends to prevent contact between the gears and the sides and bottom of the tank. A run of the finishing process was devoted to the gears and they were the only parts in the tank. A photograph of the gears clamped on their mandrel is shown in Figure 4. The gears were processed for the standard run time as before. After this second stage of processing the gears were found to have a superb mirror finish and visual inspection showed no signs of the initial grinding marks.

## 4. INSPECTION AFTER SECOND STAGE OF SUPERFINISHING

### 4.1 Gear metrology

The gears were again checked at Newcastle University and were found to be DIN grade 5 or better on both profile and lead as before. The report (dated March 1997, see Appendix 4) concludes:

*"The measurement results and a visual examination of the measurement traces shows that there is very little difference between the initial flank geometry and the final flank geometry. The superfinishing process has still not changed the basic flank form error but the grinding feed marks have been removed on all the teeth. The normal circular tooth thickness measurements*

*show that after the results are corrected for the probe datum error, an average of approximately 2.5  $\mu\text{m}$  of stock has been removed from each flank”*

#### **4.2 Surface finish**

Following the second stage of superfinishing the four sample gears were again inspected. Three profiles from both sides of two teeth on each of the four selected gears were taken. Typical comparisons of the initial ground finish, the intermediate finish and the final superfinished surface are shown in Figure 5. Again, the profile taken after the first stage of finishing shows persistence of identifiable grinding marks. These have almost completely disappeared from the profile taken after the second stage (Figure 5 (c)) although there are still faint signs of some particularly deep marks. One such mark is indicated with an arrow on all three profiles. Comparison of such features with the initial profile suggests that about 2-3  $\mu\text{m}$  has been removed from the surface. This estimate taken from surface profilometry agrees well with the estimate obtained from the gear metrology measurements.  $R_a$  and  $R_z$  values for all profiles from all the sample gears before finishing and after the second stage of superfinishing are shown in Tables 1-8. It should be noted that the profiles were digitally filtered with a cut off of 0.08 mm.

The centre profiles ( $y=3.175$  mm) from each flank of the two teeth examined on all four of the finally finished gears are shown in Appendix 5 for reference. The remaining profiles taken at 1mm from each edge of the flanks ( $y=1$ mm and  $y=5.35$  mm) are not shown for reasons of space, but are available if required.

Typical three-dimensional surface plots from ground and superfinished surfaces are shown in Figures 6 and 7, respectively. Note that the two surfaces are plotted to the same vertical scale for comparison.

It should be noted that the profile data from the right flank of tooth 1 of gear #15 after superfinishing were badly affected by vibration during data acquisition; the  $R_a$  and  $R_z$  values for the three profiles affected should therefore be ignored. These profiles are not shown in Appendix 5.

**Table 1. Roughness Average (Ra) results ( $\mu\text{m}$ ), Gear AMS6260 #11**

Tooth	Flank	Position	Ra as ground	Ra after superfinish
<b>1</b>	left	y=1mm	0.434	0.0558
		y=3.175mm	0.425	0.0529
		y=5.35mm	0.417	0.0607
	right	y=1mm	0.351	0.0805
		y=3.175mm	0.358	0.0962
		y=5.35mm	0.346	0.0753
<b>15</b>	left	y=1mm	0.432	0.0884
		y=3.175mm	0.450	0.0707
		y=5.35mm	0.433	0.0674
	right	y=1mm	0.322	0.0458
		y=3.175mm	0.320	0.0674
		y=5.35mm	0.350	0.0608

**Table 2. Roughness Average (Ra) results ( $\mu\text{m}$ ), Gear AMS6260 #15**

Tooth	Flank	Position	Ra as ground	Ra after superfinish
<b>1</b>	left	y=1mm	0.484	0.0912
		y=3.175mm	0.513	0.1008
		y=5.35mm	0.477	0.0926
	right	y=1mm	0.358	0.1322*
		y=3.175mm	0.366	0.1366*
		y=5.35mm	0.348	0.1454*
<b>15</b>	left	y=1mm	0.476	0.0620
		y=3.175mm	0.471	0.0525
		y=5.35mm	0.470	0.0658
	right	y=1mm	0.333	0.0583
		y=3.175mm	0.335	0.0552
		y=5.35mm	0.341	0.0676

\* Vibration during acquisition of these three superfinished profiles



**Table 3. Roughness Average (Ra) results ( $\mu\text{m}$ ), Gear AMS6260 #20**

Tooth	Flank	Position	Ra as ground	Ra after superfinish
<b>1</b>	left	y=1mm	0.415	0.0723
		y=3.175mm	0.458	0.0759
		y=5.35mm	0.471	0.0972
	right	y=1mm	0.372	0.0429
		y=3.175mm	0.364	0.0575
		y=5.35mm	0.350	0.0600
<b>15</b>	left	y=1mm	0.394	0.0763
		y=3.175mm	0.415	0.0785
		y=5.35mm	0.435	0.0735
	right	y=1mm	0.351	0.0518
		y=3.175mm	0.341	0.0590
		y=5.35mm	0.335	0.0598

**Table 4. Roughness Average (Ra) results ( $\mu\text{m}$ ), Gear AMS6260 #23**

Tooth	Flank	Position	Ra as ground	Ra after superfinish
<b>1</b>	left	y=1mm	0.400	0.0711
		y=3.175mm	0.402	0.0629
		y=5.35mm	0.418	0.0553
	right	y=1mm	0.270	0.0683
		y=3.175mm	0.275	0.0642
		y=5.35mm	0.259	0.0659
<b>15</b>	left	y=1mm	0.343	0.0976
		y=3.175mm	0.343	0.1062
		y=5.35mm	0.355	0.0879
	right	y=1mm	0.268	0.0623
		y=3.175mm	0.275	0.0730
		y=5.35mm	0.267	0.0615

**Table 5. Ten-point parameter (Rz) results ( $\mu\text{m}$ ), Gear AMS6260 #11**

Tooth	Flank	Position	Rz as ground	Rz after superfinish
<b>1</b>	left	y=1mm	3.75	0.61
		y=3.175mm	3.64	0.55
		y=5.35mm	5.50	0.73
	right	y=1mm	3.03	1.07
		y=3.175mm	3.24	1.56
		y=5.35mm	3.08	0.86
<b>15</b>	left	y=1mm	3.69	1.20
		y=3.175mm	4.01	0.88
		y=5.35mm	3.63	0.63
	right	y=1mm	2.72	0.50
		y=3.175mm	2.63	1.06
		y=5.35mm	2.65	0.68

**Table 6. Ten-point parameter (Rz) results ( $\mu\text{m}$ ), Gear AMS6260 #15**

Tooth	Flank	Position	Rz as ground	Rz after superfinish
<b>1</b>	left	y=1mm	3.84	1.36
		y=3.175mm	4.08	1.55
		y=5.35mm	3.90	1.48
	right	y=1mm	3.73	1.23*
		y=3.175mm	4.01	0.84*
		y=5.35mm	3.88	1.30*
<b>15</b>	left	y=1mm	4.13	0.93
		y=3.175mm	4.30	0.71
		y=5.35mm	3.93	1.20
	right	y=1mm	3.77	0.77
		y=3.175mm	3.84	1.04
		y=5.35mm	3.57	1.08

\* Vibration during acquisition of these three superfinished profiles

**Table 7. Ten-point parameter (Rz) results ( $\mu\text{m}$ ), Gear AMS6260 #20**

Tooth	Flank	Position	Rz as ground	Rz after superfinish
1	left	y=1mm	3.78	1.14
		y=3.175mm	4.38	1.00
		y=5.35mm	4.69	1.38
	right	y=1mm	3.38	0.49
		y=3.175mm	4.03	0.64
		y=5.35mm	3.35	0.68
15	left	y=1mm	3.54	1.35
		y=3.175mm	3.61	1.14
		y=5.35mm	3.46	1.11
	right	y=1mm	3.49	0.59
		y=3.175mm	3.34	0.63
		y=5.35mm	3.72	0.59

**Table 8. Ten-point parameter (Rz) results ( $\mu\text{m}$ ), Gear AMS6260 #23**

Tooth	Flank	Position	Rz as ground	Rz after superfinish
1	left	y=1mm	3.44	1.00
		y=3.175mm	3.34	0.95
		y=5.35mm	3.92	0.82
	right	y=1mm	3.05	0.84
		y=3.175mm	2.86	0.73
		y=5.35mm	2.56	0.79
15	left	y=1mm	3.01	1.16
		y=3.175mm	2.98	1.39
		y=5.35mm	3.00	1.20
	right	y=1mm	2.47	0.68
		y=3.175mm	2.66	0.86
		y=5.35mm	2.80	0.67

## 5.. DISCUSSION AND CONCLUSIONS

As a result of careful gear metrology and surface profilometry it was found that the amount of surface metal removed during the standard process as implemented by Westland Engineering was relatively small and did not have any adverse effect on the gear tooth geometry or profile. The test gears as supplied were found to comply to DIN grade 5 or better and they were still within this grade after finishing. One cycle of the standard process was found to leave witness traces of the initial grinding, and in order to achieve the best possible finish a second cycle of the process was applied. After two cycles of finishing it was concluded on the basis of both metrology and surface profile measurements that about 2.5µm of surface metal had been removed from the gear flanks. This would appear to be about the minimum required to remove all traces of the initial grinding marks for gears with an initial nominal finish of 0.4 µm Ra. The final surface finish of the gear flanks was in the range 0.05-0.1 µm Ra. In conclusion, therefore, the answer to the question "*Will the superfinishing process adversely affect gear tooth shape?*" is: no, the process as presently implemented gives minimum metal removal and ensures the integrity of the tooth profile. This conclusion assumes, of course, careful control of the process.

## 6. ACKNOWLEDGEMENTS

We are grateful to Mr Graham Wilkie and Mr Paul Fisher of Westland Engineering for their careful finishing of the gears and to Mr Rob Frazer of Newcastle University Design Unit for his equally careful gear metrology.

## 7. FURTHER INFORMATION

For further information please contact:

Dr R W Snidle  
Division of Mechanical Engineering  
University of Wales Cardiff  
PO Box 925  
Cardiff CF2 3TA  
UK

Tel: (01222) 874273 Fax: (01222) 874317 E-mail: SnidleR@cardiff.ac.uk

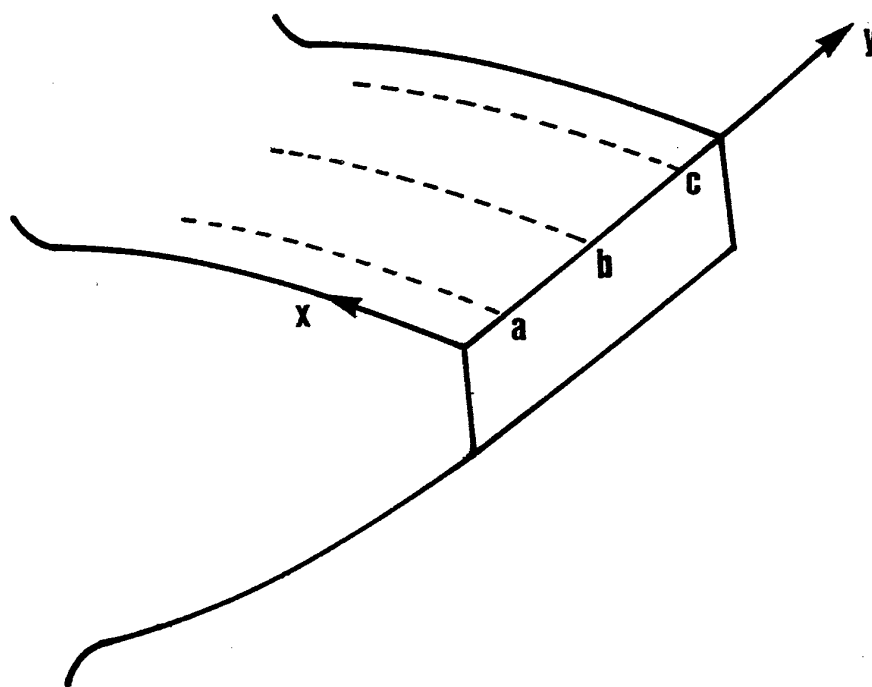
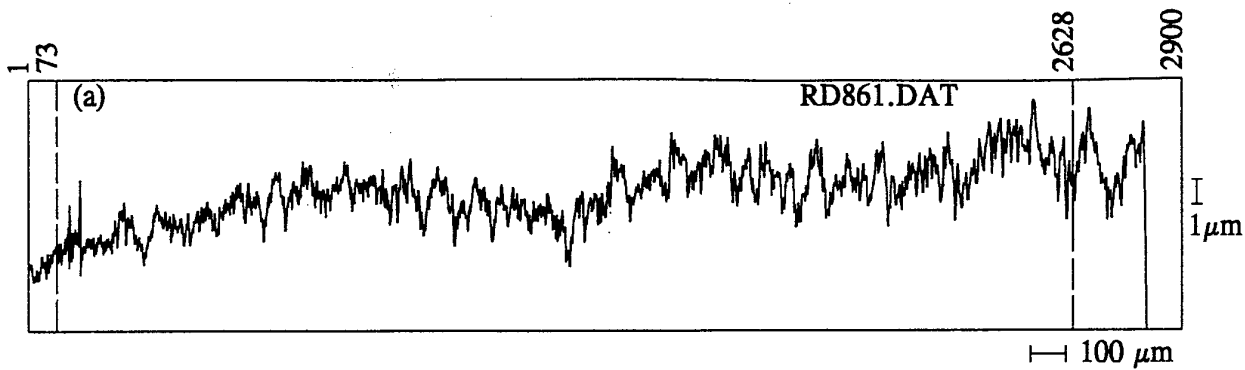

Figure 1. Illustration of gear tooth showing  $x, y$  coordinates and location of the three profiles (shown as broken lines) taken from both sides of two teeth from each gear. The  $y$ -coordinates of the profiles shown are:

- (a)  $y=1$  mm
- (b)  $y=3.175$  mm
- (c)  $y=5.35$  mm

Start and end  $x$ -coordinates of raw profiles are  $x=3.097$  mm and  $x=-0.1$  mm, respectively. (The negative end coordinate ensures that tip of tooth is detected as a check on relocation of profiles in  $x$ -direction.)



NASA gear #11 (ground), tooth 1/left,  $x = -.1\text{mm}$   $y = 3.175\text{mm}$

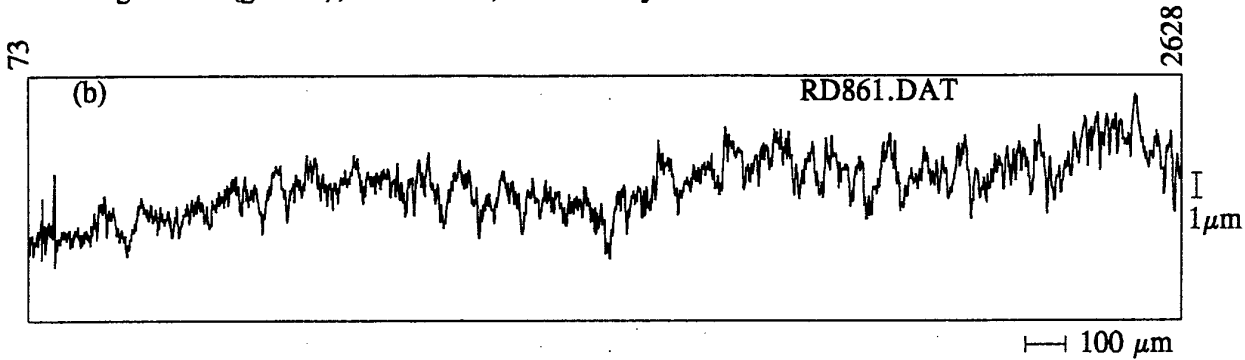

NASA gear #11 (ground), tooth 1/left,  $x = -.1\text{mm}$   $y = 3.175\text{mm}$

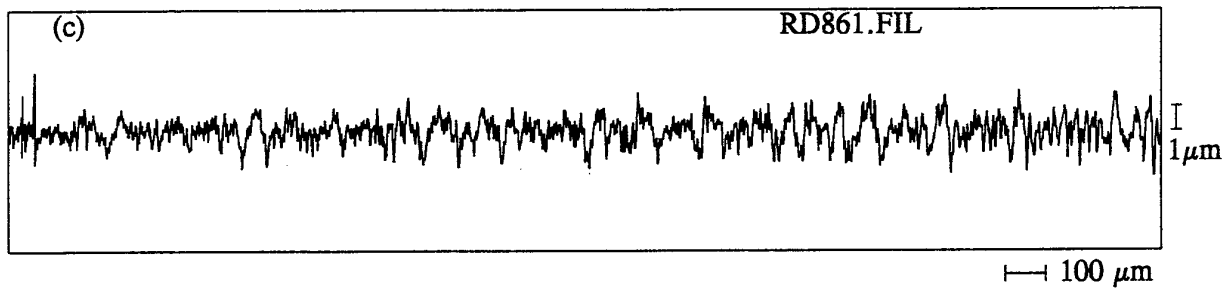

NASA gear #11 (ground), tooth 1/left,  $x = -.1\text{mm}$   $y = 3.175\text{mm}$  (filtered:  $R_a = 0.425\mu\text{m}/0.08\text{mm}$  cutoff)

Figure 2. Showing (a) typical raw surface profile from ground test gear as acquired; (b) length of raw profile that appears in filtered data file; (c) profile after digital filtering (cut off = 0.08 mm).

Figures above graphs (a) and (b) are the digitally stored ordinate numbers of the data. Filtered data file contains ordinates 73-2628 from the raw data. Ordinate spacing =  $1.102\mu\text{m}$ ; total length of filtered profile =  $2.82\text{mm}$ . Note that tip of tooth is detected as a check on relocation, and is shown on profile (a) as the sharp drop at the right hand end of the profile.

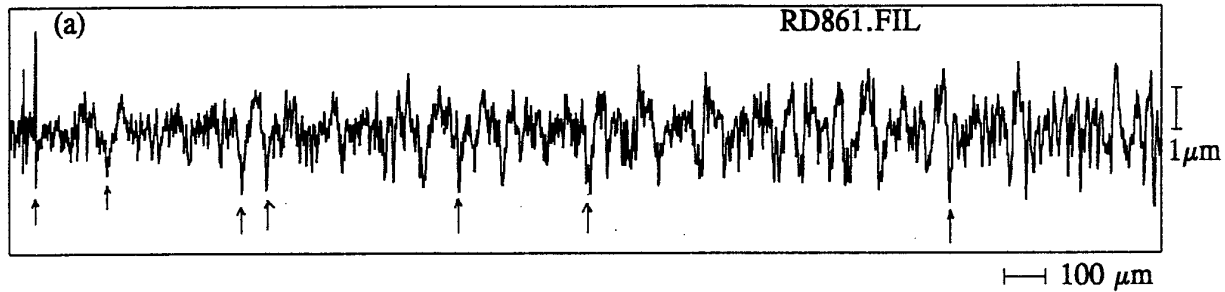

NASA gear #11 (ground), tooth 1/left,  $x = -.1\text{mm}$   $y = 3.175\text{mm}$  (filtered:  $R_a = 0.425\mu\text{m}/0.08\text{mm}$  cutoff)

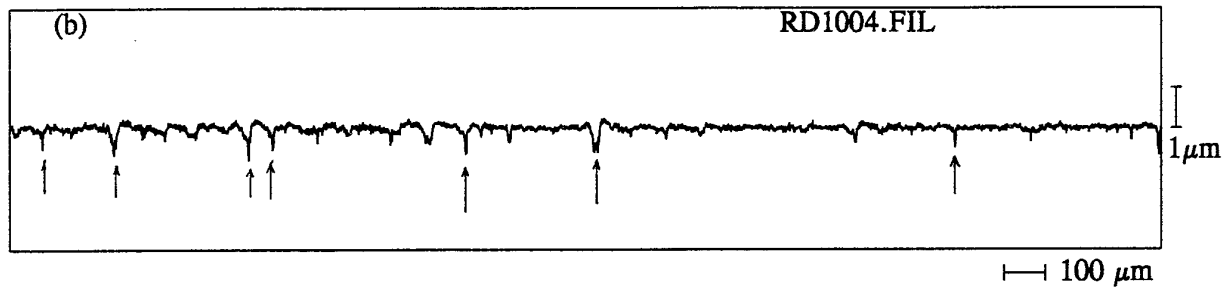

NASA gear #11 (polished), tooth 1/left,  $x = -.1\text{mm}$ ,  $y = 3.175\text{mm}$  (filtered:  $R_a = 0.071\mu\text{m}/0.08\text{mm}$  cutoff)

Figure 3. (a) typical profile from ground gear before finishing; (b) re-located profile from same tooth after first stage of superfinishing. Note persistence of identifiable deep valley features as indicated on both profiles.

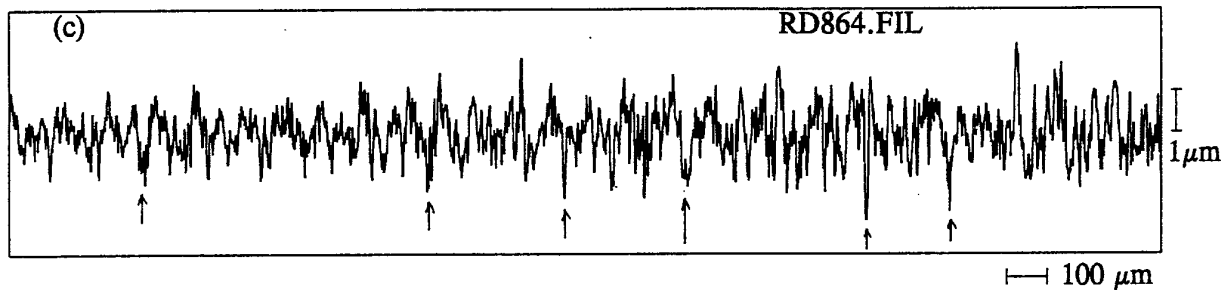

NASA gear #11 (ground), tooth 15/left,  $x = -.1\text{mm}$ ,  $y = 3.175\text{mm}$  (filtered:  $R_a = 0.450\mu\text{m}/0.08\text{mm}$  cutoff)

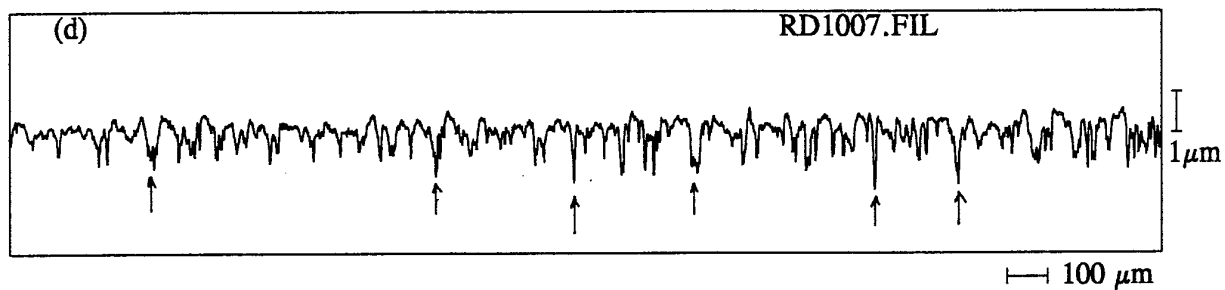

NASA gear #11 (polished), tooth 15/left,  $x = -.1\text{mm}$ ,  $y = 3.175\text{mm}$  (filtered:  $R_a = 0.229\mu\text{m}/0.08\text{mm}$  cutoff)

Figure 3 (continued). (c) typical profile from ground gear before finishing; (c) re-located profile from same tooth after first stage of superfinishing. Note persistence of identifiable deep valley features as indicated on both profiles. Note that the profiles shown in (c) and (d) are from a tooth diametrically opposite the tooth shown in Figure 3 (a) and (b).



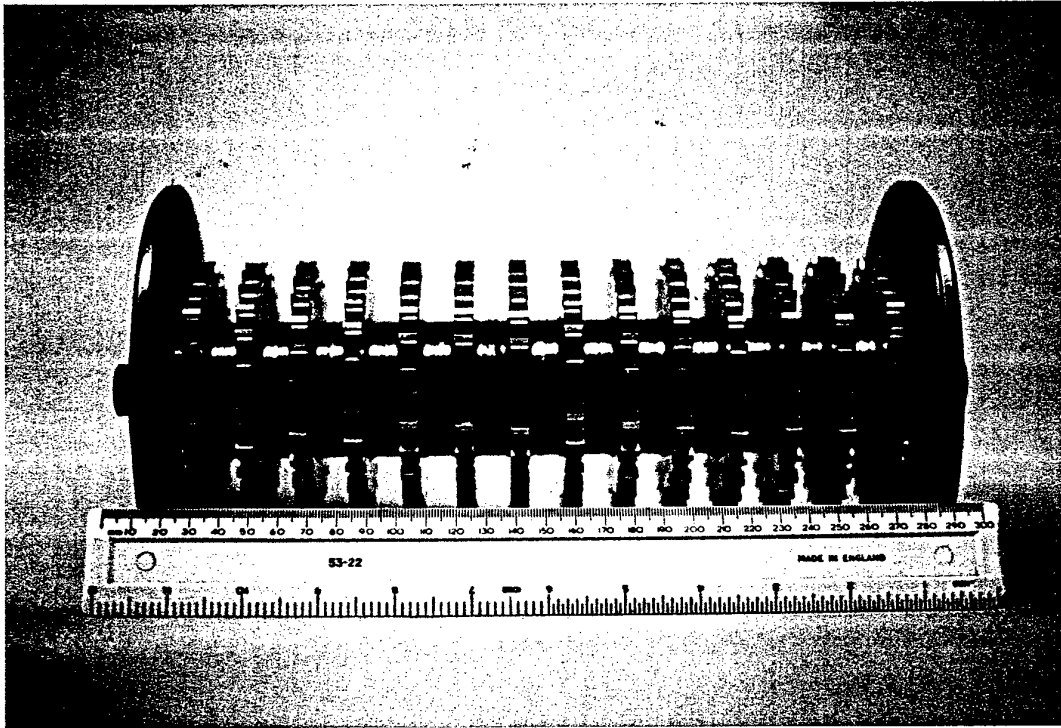
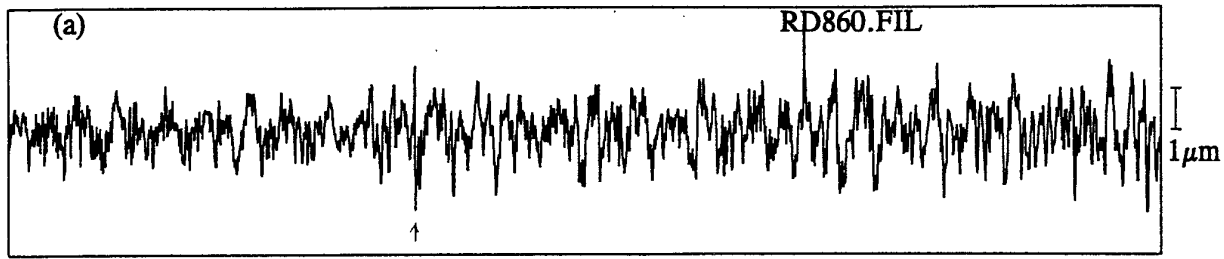
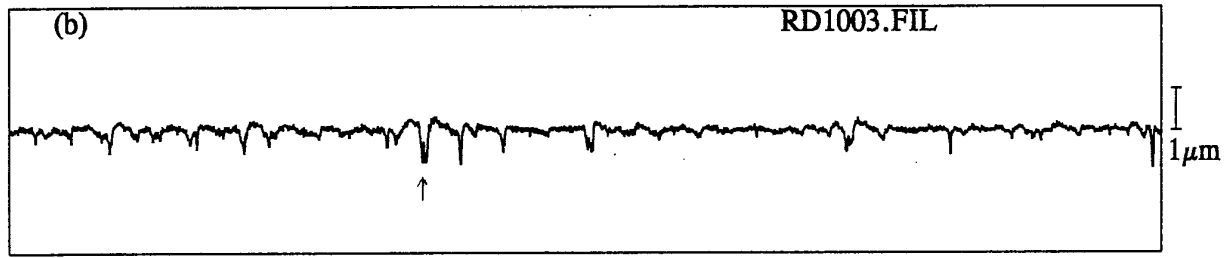

Figure 4. Photograph showing test gears clamped on mandrel used for superfinishing



NASA gear #11 (ground), tooth 1/left,  $x = -.1\text{mm}$ ,  $y = 1\text{mm}$  (filtered:  $R_a = 0.434\mu\text{m}/0.08\text{mm}$  cutoff)



NASA gear #11 (polished), tooth 1/left,  $x = -.1\text{mm}$ ,  $y = 1\text{mm}$  (filtered:  $R_a = 0.083\mu\text{m}/0.08\text{mm}$  cutoff)

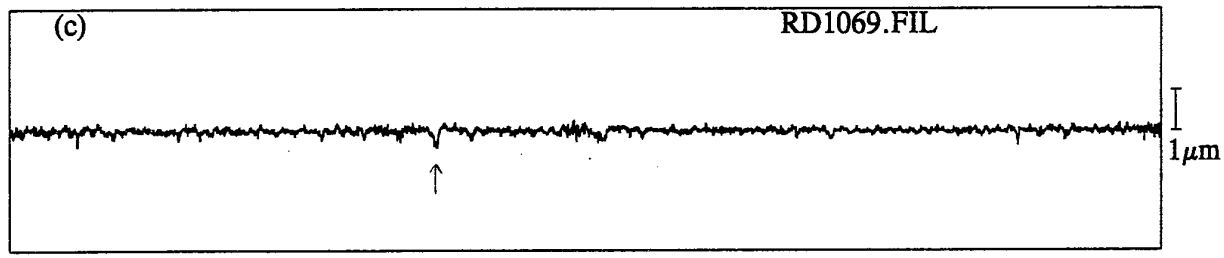

NASA gear #11 (polished) tooth 1/left,  $x = -.1\text{mm}$ ,  $y = 1\text{mm}$  (filtered:  $R_a = 0.056\mu\text{m}/0.08\text{mm}$  cutoff)

Figure 5. Re-located profiles from (a) ground tooth surface; (b) same tooth surface after the first stage of superfinishing; (c) same tooth after second (final) stage of superfinishing. Note that initial finish is apparently removed but there is evidence of slight persistence of the deepest grinding marks as indicated, this indicates that about  $2.5\mu\text{m}$  has been removed from the surface.

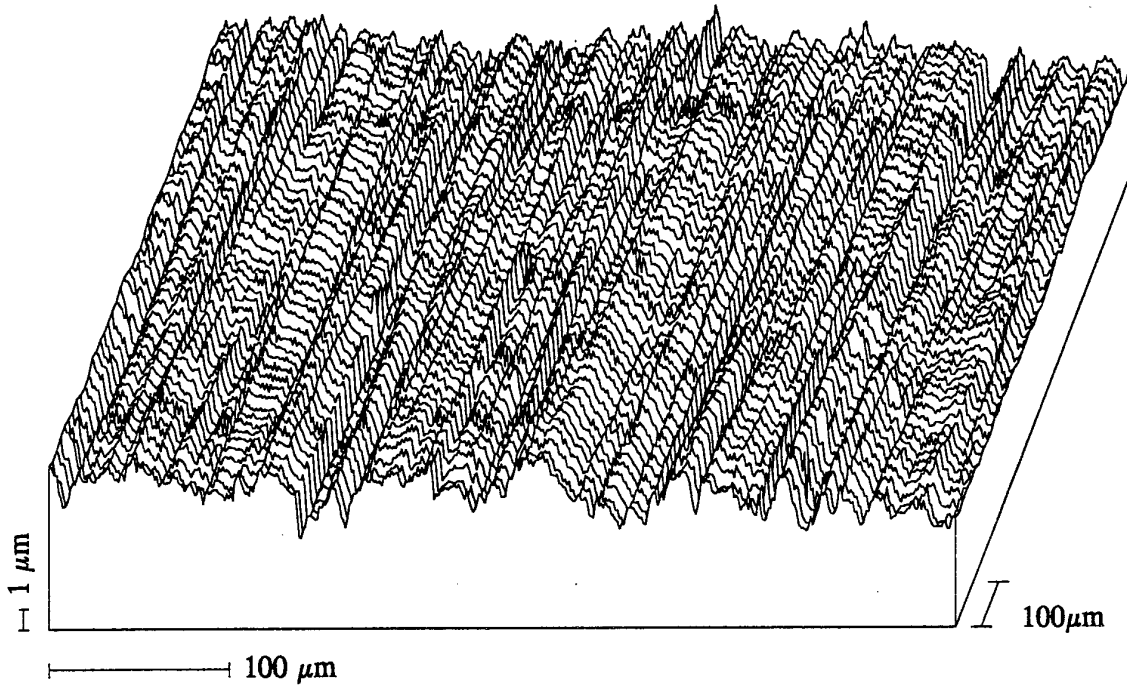

NASA gear #23 (ground) tooth 1/left, xdim=0.50 mm, ydim=0.99 mm  
08-30-1996 file: 3D28.DAT No of profiles= 45 ; ordinates/profile= 452  
YSCALE= .7633588

Figure 6. Typical three-dimensional surface plot from ground gear (before superfinishing).

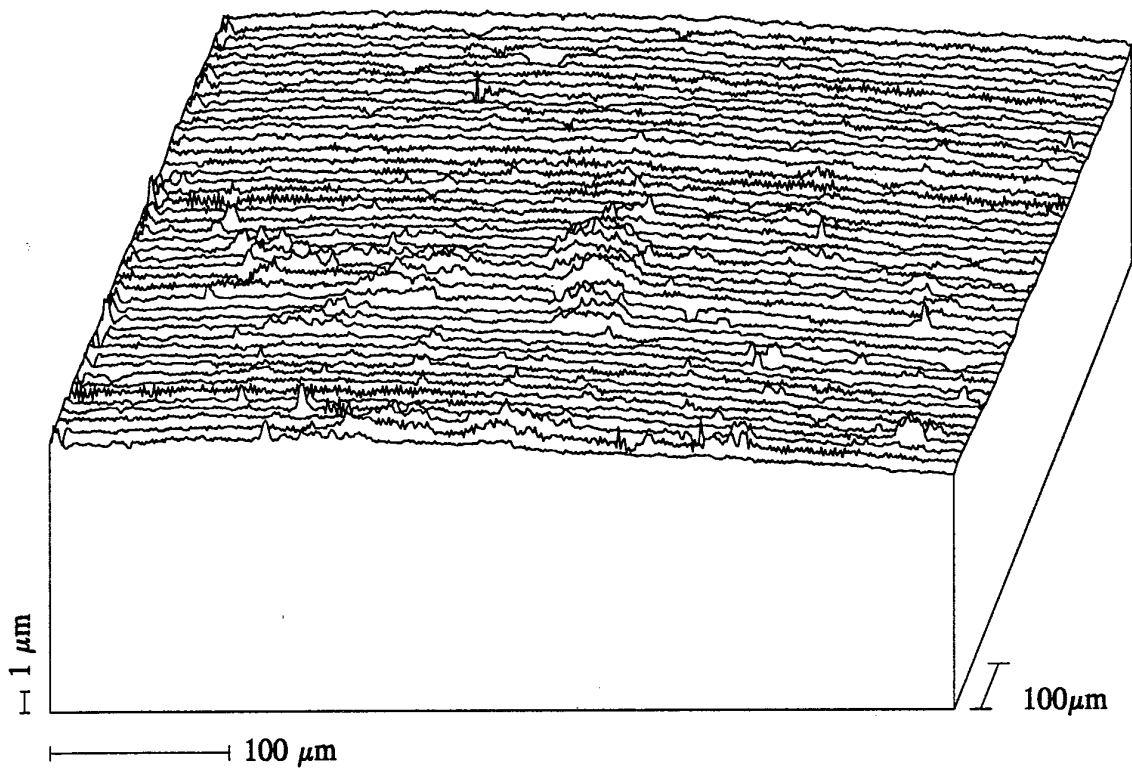

NASA gear 11 (polished) tooth 14/right, xdim=0.50 mm, ydim=0.99 mm  
03-20-1997 file: 3D56.DAT No of profiles= 45 ; ordinates/profile= 452  
Surface is relocated: x=2.00 mm, y=1.00 mm  
YSCALE= .7633588

Figure 7. Typical three-dimensional surface plot from superfinished gear.

**APPENDIX 1**

**INITIAL METROLOGY INSPECTION OF GEARS**

AMS6260	#11
"	#15
"	#20
"	#23

University of Newcastle upon Tyne

Department of Mechanical  
Materials & Manufacturing Engineering  
Stephenson Building  
Newcastle upon Tyne NE1 7RU

PROJECT GM. 373/1

7th August 1996

SUPERFINISHING INVESTIGATION :-INITIAL MEASUREMENT

**For:** Cardiff School of Engineering  
University of Wales  
Queens Buildings  
The Parade  
PO Box 917  
Cardiff  
CF2 1XH

**Gear Reference:** AMS 6260

**Samples Checked:** No. 11, 15, 20 & 23

**Parameters Measured:**

The following parameters were measured on each gear:

1. Lead and profile errors on 4 teeth, left and right flanks, spaced at 90° intervals.
2. Adjacent and cumulative pitch errors on all teeth, left and right flanks.
3. Radial runout of the tooth space.
4. Mean circular tooth thickness.

**Results:**

Record sheets for each of the gears are included in this report. A full analysis will be carried out after the gears have been superfinished.

Refer to Appendix A for assistance with interpreting the record sheets.

**GEAR MEASUREMENT SUMMARY SHEET**

Client: *University of Wales*

DU Reference: *GM1373*

Gear Drawing: *- AMS 6260*

Gear Reference: *REF N°S 11, 15, 20 & 23*

Manufactured By :

Parameters Measured : *Lead / Profile / Pitch / Runout / Tooth thickness / runout of reference bands.*

Runout of Reference Bands : *not checked*

*- mounted on an expanding mandrel  
with etched details at the top.*

Accuracy requirements :

Results :

PARAMETERS	TOLERANCE ( $\mu\text{m}$ )	MAX. ERROR ( $\mu\text{m}$ )	COMMENTS
LEAD			
PROFILE			
ADJ. PITCH			
CUM. PITCH			
RUNOUT			
PITCH DIFF.			
THICKNESS			

General comments :

1. Gears have been measured in accordance with the code of practice DUCOP.03 for Involute Gear Measurement.

2. *TOOTH N°S 1, 8, 15 & 22 (have been checked - see attached sheet for position).*

3. *TOOTH N° 1 WITH DET ETCHED AT TOP FACE.*

Equipment: Machine: *HOFLER EM12 632* Probe: *Ø 1.2*

All measurements were carried out on traceably calibrated equipment in the UK National Gear Metrology Laboratory ( NAMAS Accreditation number 0250 ).

Measured by: *RC Hayes*

Date: *6 - Aug 96*

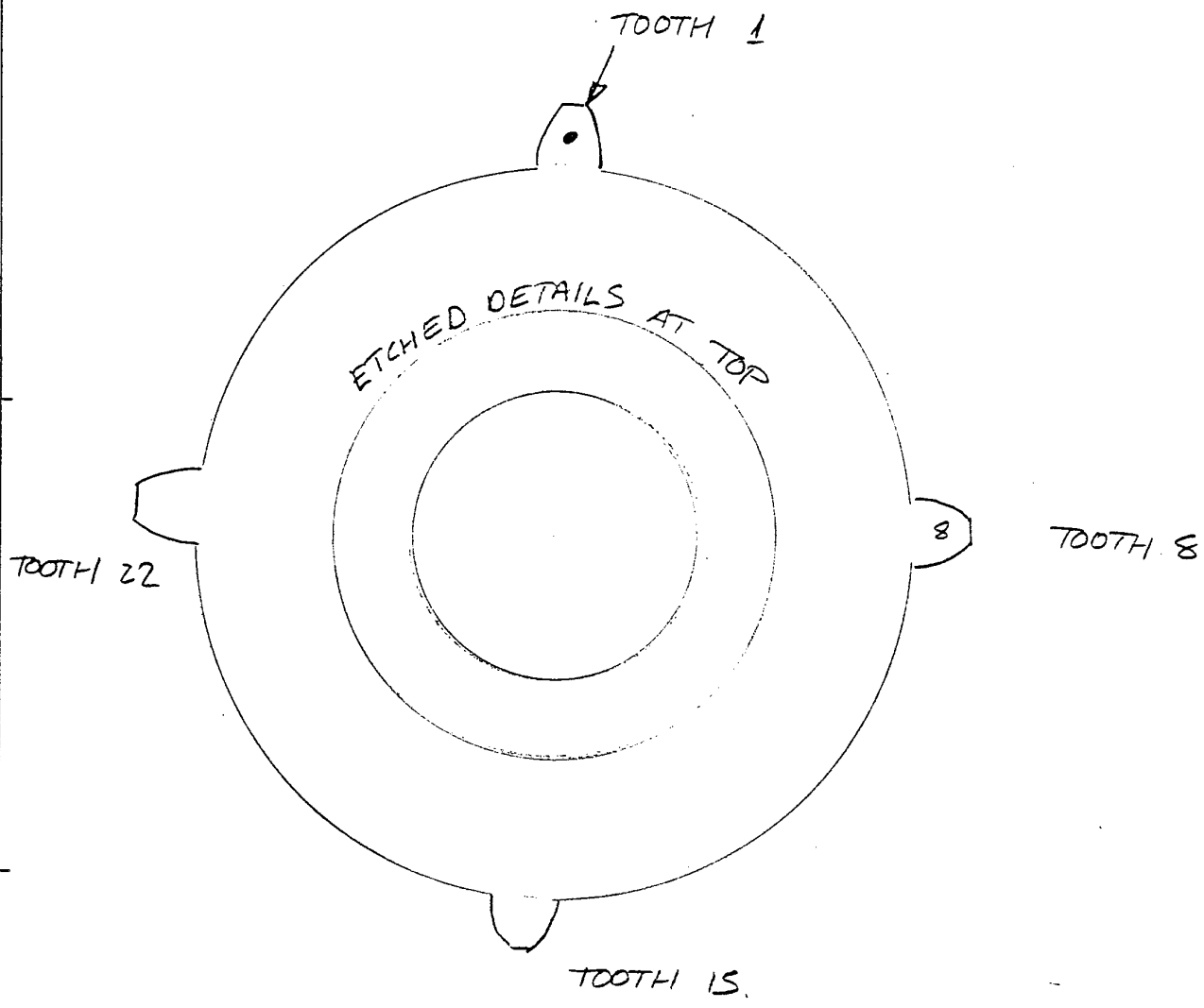

Calculated by		Checked by		Calculation Title		
 DESIGN UNIT				Project No.	Date	Item / Sheet No.
University of Newcastle upon Tyne						



DESIGN UNIT

# Lead + Profile Test

Quality levels to DIN 3962 / AGMA 390.03  
Values in  $\mu\text{m}$ /Ten-Thousands of an Inch

Date: 06.08.1996 16:53

NATIONAL GEAR METROLOGY LABORATORY  
Inspector: RCF  
EMZ 632

**HOFER**  
Fpb 018-4/3E

Designation:	$m_n$ 3.175 mm	$b$ 6.35 mm
Part No.: AMS6260/./.	$z$ 28	$L_\beta$ 90 %
REMARKS: REF 11-1ST	$\alpha_n$ 20°0'0''	$d_h$ 83.539 mm
	$\beta$ 0°0'0''	
	$\beta_b$	

Quality	Reqd.Pr: 5 / Le: 5	Act.Pr: 5. / Le: 2	Reqd.Pr: 5 / Le: 5	Act.Pr: 5 / Le: 2
---------	--------------------	--------------------	--------------------	-------------------

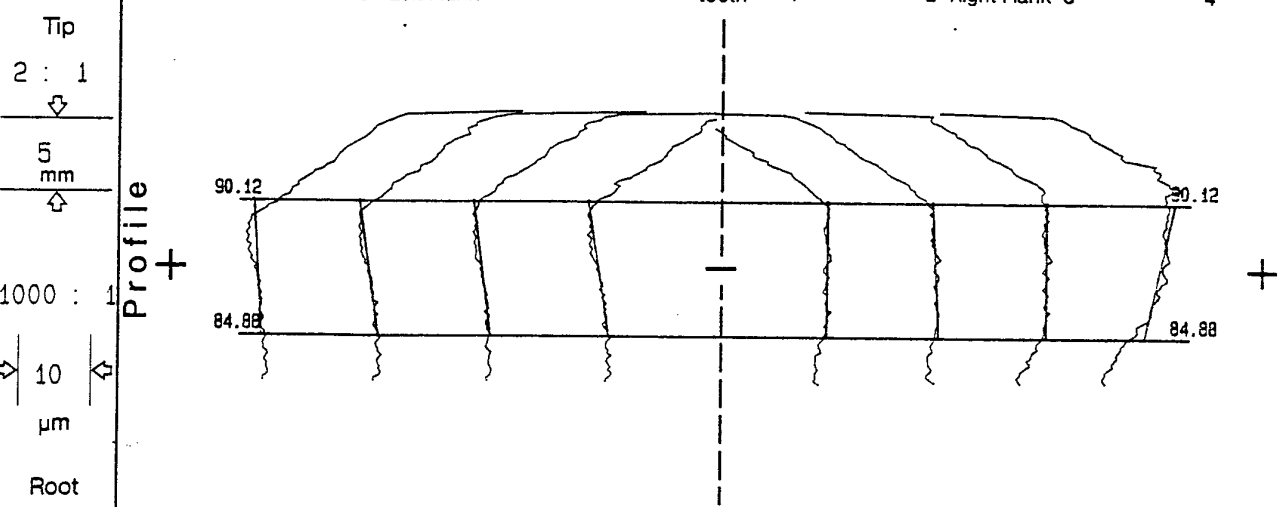

Limit Value	4	3	2	1	Limit Value	1	2	3	4
$F_a 0/7$	4.5	3.2	2.8	3.2	0/7	1.2	1.9	1.4	5.8
$f_{ra} 0/6$	4.8	2.7	1.6	2.0	0/6	1.2	1.5	1.4	3.5
$f_{H\alpha} -4.5$	1.1	2.7	2.4	2.9	+4.5	1	-1.0	0.0	4.3

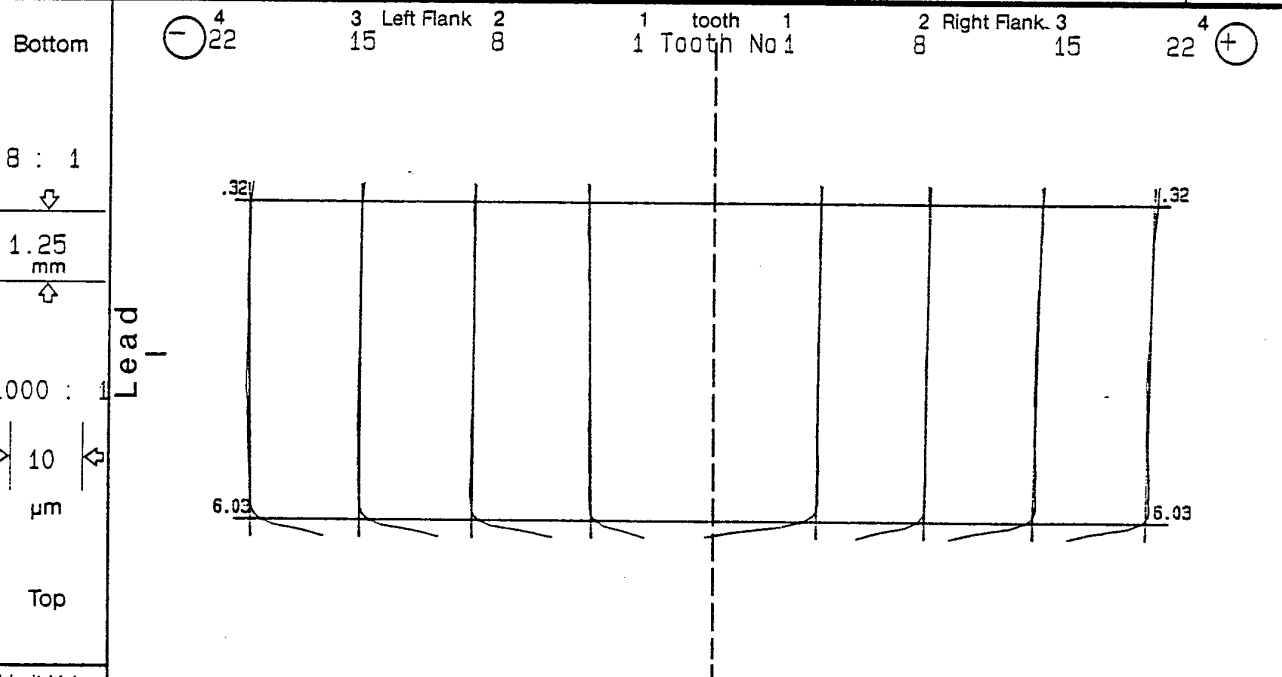

Limit Value	4	3	2	1	Limit Value	1	2	3	4
$F_b 0/7$	2.0	1.5	1.1	1.2	0/7	2.3	1.5	2.3	2.1
$f_{pb} 0/4.5$	1.9	1.6	1.1	1.9	0/4.5	2.1	1.1	1.2	1.0
$f_{H\beta} -6$	-3	2	3	-4	+6	6	7	1.1	1.1

DESIGN UNIT

PITCH + RUNOUT TEST

Part No.: AMSG260/./.

REMARKS: REF 11-1ST

z = 28    m = 3.175 mm    β = 0°0'0" R    d = 88.900 mm    Date/Insp.: 06.08.1996/RCF

Reqd. Qual. Limit Value Act. Value Act. Qual.	Left Flank	$f_p$	$f_u$ *	$F_p$	$F_{pz}/8$	Right Flank	$f_p$	$f_u$ *	$F_p$	$F_{pz}/8$	$F_r$	Values in $\mu m$
		5	5	5	5		5	5	5	5		
		5.0	6.0	20.0	12.0		5.0	6.0	20.0	12.0	5	14.0
		2.1	2.3	10.1	5.7		1.6	2.6	6.7	4.6	5.6	5.6
		2	1	3	3		2	3	2	3	3	3

Quality levels to DIN 3962 / AGMA 390.03  
Values in  $\mu m$  / Ten-Thousands of an Inch

MAX. T. NO.: 3    \*    TOOTH THICK:    NOM. VAL.: 4.987    Min.: 0    Max.: 0    MEAS. VAL: 4.871

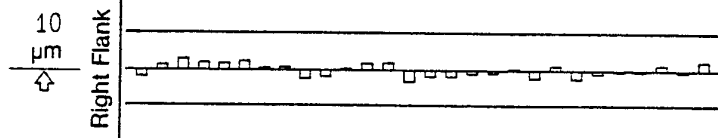

$f_p$   MIN. T. NO.: 14  
 MIN. T. NO.: 13    \*

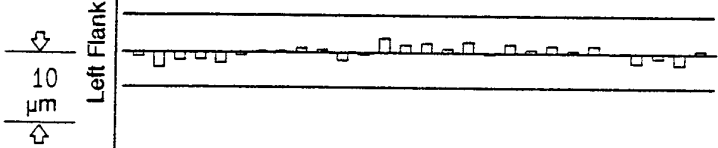

MAX. T. NO.: 2

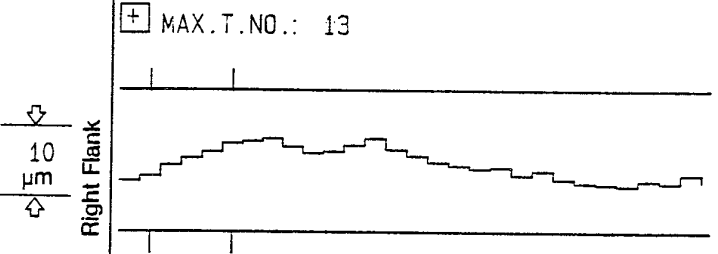

$F_p$   MIN. T. NO.: 25  
 MIN. T. NO.: 13

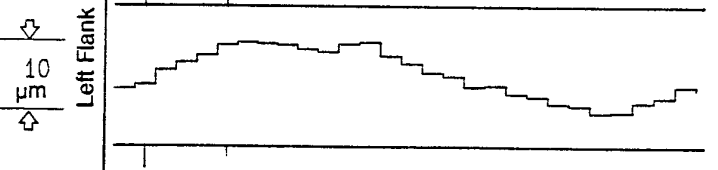

MAX. T. NO.: 24

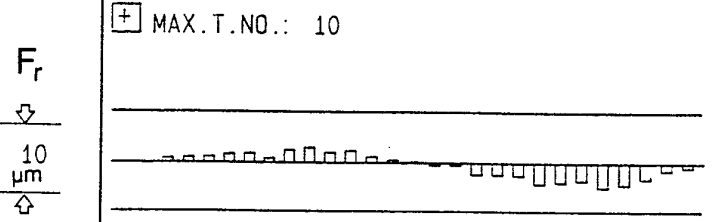

MAX. T. NO.: 10  
 MIN. T. NO.: 24

NATIONAL GEAR METROLOGY LABORATORY

TR pb 014-4E →



DESIGN UNIT

PITCH + RUNOUT TEST

Part No.: AMS6260/./.

REMARKS: REF 15-1ST

z = 28 m = 3.175 mm β = 0°0'0" R d = 88.900 mm Date/Insp: 06.08.1996/RCF

Reqd. Qual.	Left Flank	$f_p$	$f_u$ *	$F_p$	$F_{pz}/8$	Right Flank	$f_p$	$f_u$ *	$F_p$	$F_{pz}/8$	$F_r$	Values in $\mu m$
		Limit Value	Act. Value	Act. Qual.	Limit Value		Act. Value	Act. Qual.	Limit Value	Act. Value	Act. Qual.	
		5	5	5	5		5	5	5	5	5	
		5.0	6.0	20.0	12.0		5.0	6.0	20.0	12.0	14.0	
		1.8	2.2	4.4	3.7		1.9	1.5	6.7	4.2	8.8	
		2	1	1	2		2	1	2	2	4	

TOOTH THICK:  MAX. T. NO.: 28 \* NOM. VAL. 4.987 Min. 0 Max. 0 MEAS. VAL 4.863

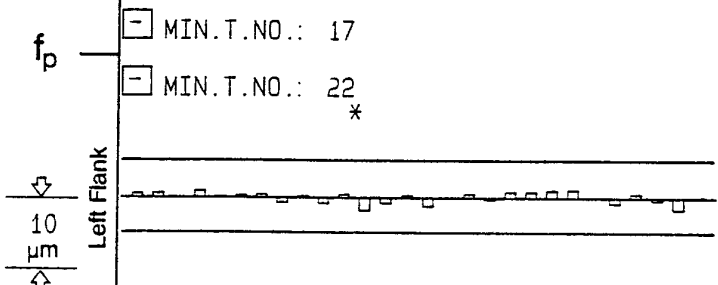
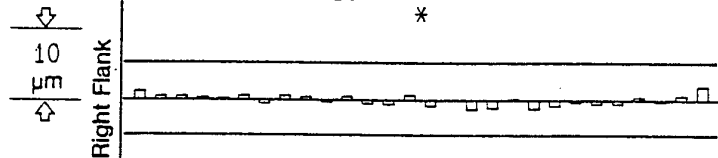

MAX. T. NO.: 12

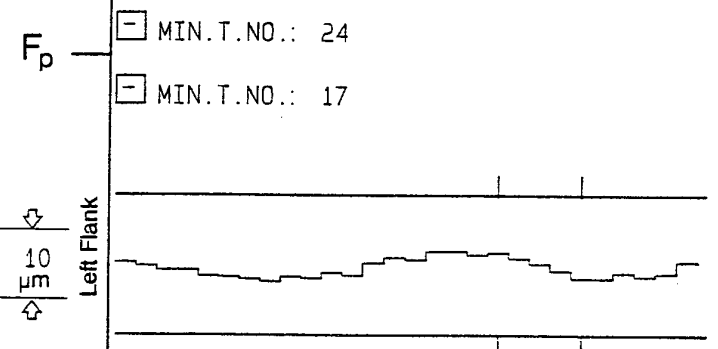
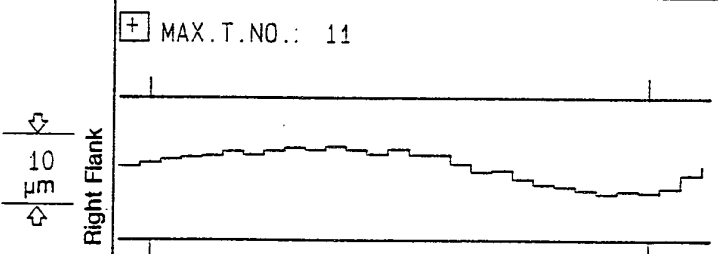

MAX. T. NO.: 8

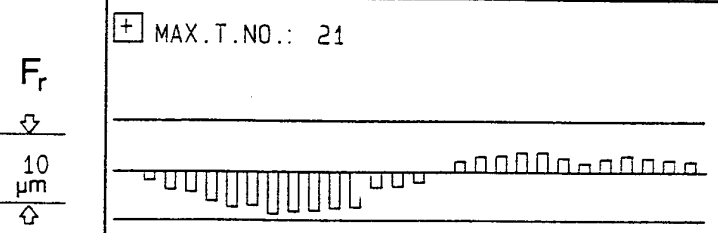

MIN. T. NO.: 6

NATIONAL GEAR METROLOGY LABORATORY  
 Quality levels to DIN 3962 / AGMA 390.03  
 Values in  $\mu m$  / Ten-Thousands of an inch  
 TR pb 014-4 E →

DESIGN UNIT

# Lead + Profile Test

Designation:	$m_n$ 3.175 mm	$b$ 6.35 mm
Part No.: AMS6260/. /. .	$z$ 28	$L_\beta$ 90 %
REMARKS: REF 20-1ST	$\alpha_n$ 20°0'0''	$d_h$ 83.539 mm
	$\beta$ 0°0'0''	
	$\beta_b$	

Quality	Reqd. Pr: 5 / Le: 5	Act. Pr: 5 / Le: 5	Reqd. Pr: 5 / Le: 5	Act. Pr: 3 / Le: 1
	4	3 Left Flank 2	1 tooth 1	2 Right Flank 3 4

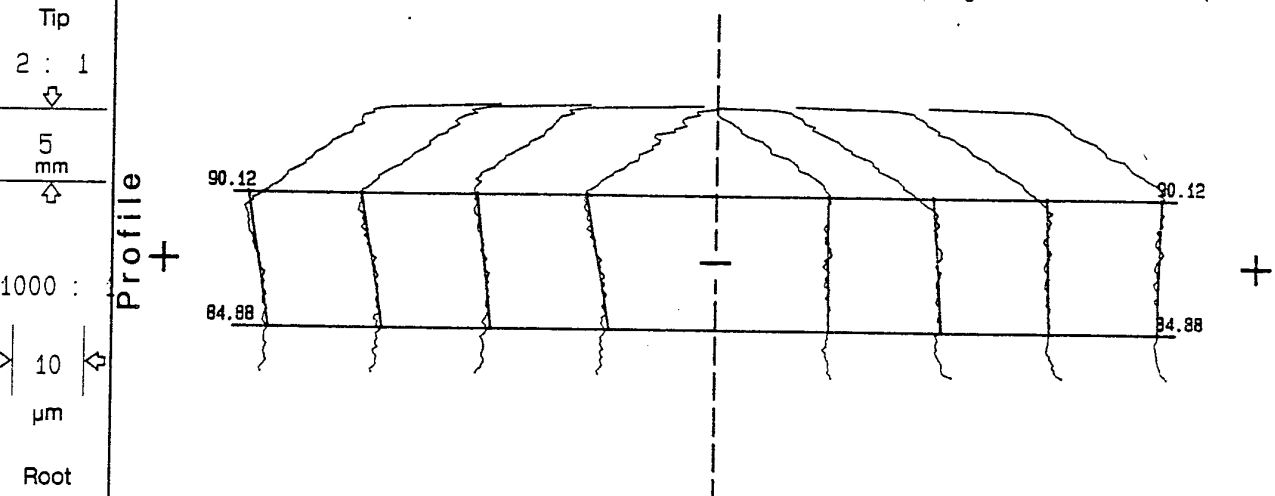

Limit Value	4	3	2	1	Limit Value	1	2	3	4
$F_a$ 0/7	3.5	3.3	2.4	3.2	0/7	1.4	3.4	1.8	1.5
$f_{ra}$ 0/6	2.7	1.7	1.8	1.6	0/6	1.4	2.9	1.8	1.4
$f_{Ha}$ +-4.5	3.0	3.1	2.1	3.3	+-4.5	-2	-1.3	-5	5

Bottom	4 22	3 Left Flank 15	2 8	1 tooth 1	1 Tooth No 1	2 Right Flank 8	3 15	4 22
--------	------	-----------------	-----	-----------	--------------	-----------------	------	------

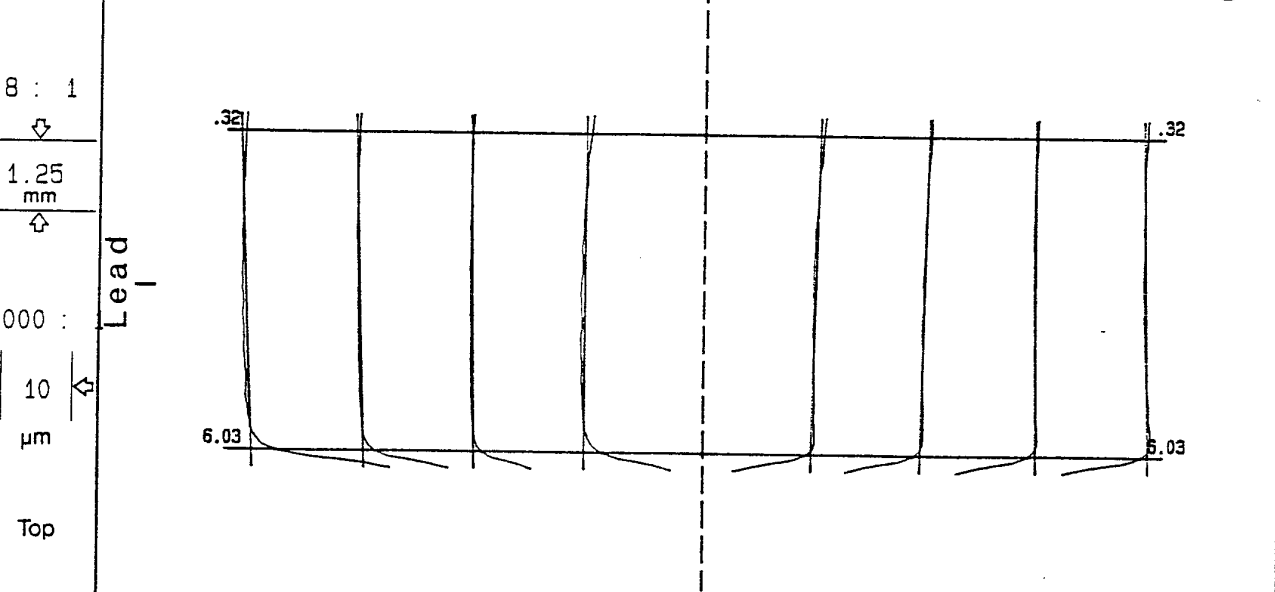

Limit Value	4	3	2	1	Limit Value	1	2	3	4
$F_\beta$ 0/7	5.1	2.8	1.9	3.0	0/7	2.5	2.2	1.4	1.3
$f_{f\beta}$ 0/4.5	4.2	2.1	1.6	3.0	0/4.5	1.5	1.2	1.5	1.4
$f_{H\beta}$ +-6	-1.7	-1.2	-6	0.0	+-6	1.0	1.0	-3	-8

Quality levels to DIN 3902 / AGMA 390.03  
Values in  $\mu\text{m}$ /Ten-Thousands of an Inch

Date: 07.08.1996 08:24

NATIONAL GEAR METROLOGY LABORATORY

Inspector: RCF

EMZ 632

**HOFLER**

Fpb 018-4/3E

DESIGN UNIT

PITCH + RUNOUT TEST

Part No.: AMS6260/./.

REMARKS: REF 20-1ST

z = 28    m = 3.175 mm    β = 0°0'0" R    d = 88.900 mm    Date/Insp.: 06.08.1996/RCF

Reqd. Qual. Limit Value Act. Value Act. Qual.	Left Flank	$f_p$	$f_u$ *	$F_p$	$F_{pz}/8$	Right Flank	$f_p$	$f_u$ *	$F_p$	$F_{pz}/8$	$F_r$	Values in $\mu\text{m}$
		5	5	5	5		5	5	5	5	5	
		5.0	6.0	20.0	12.0		5.0	6.0	20.0	12.0	14.0	
		2.7	3.8	8.5	4.1		1.1	2.0	4.5	2.8	5.6	
		4	4	3	2		1	1	1	1	3	

TOOTH THICK:    NOM. VAL.    Min.    Max.    MEAS. VAL.  
4.987    0    0    -    4.863

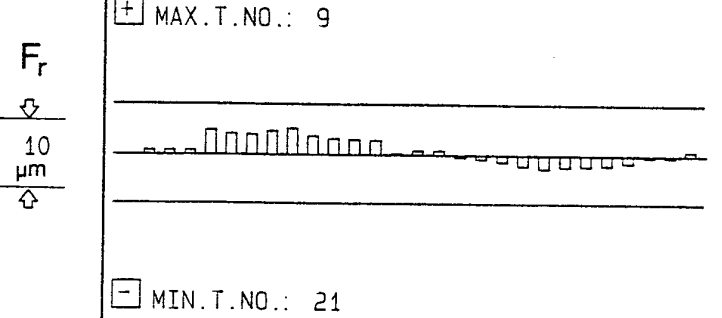
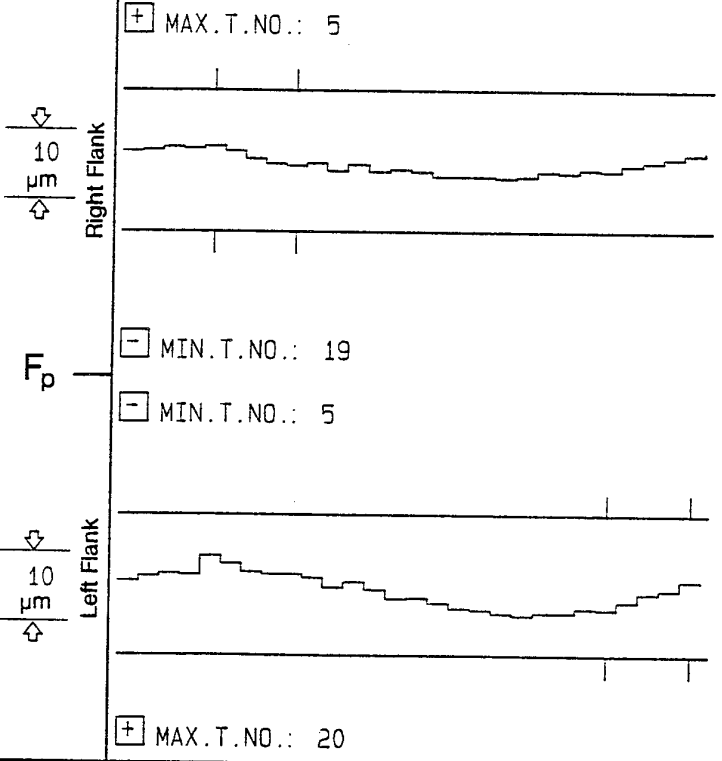
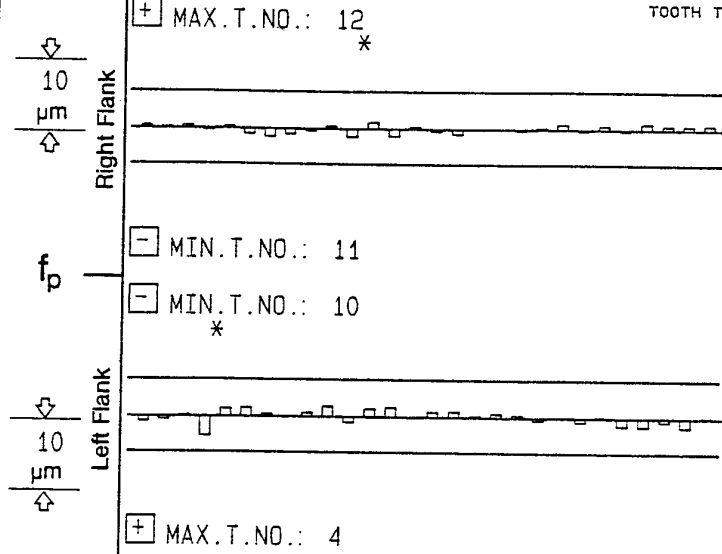

Quality levels to DIN 3962 / AGMA 390.03  
Values in  $\mu\text{m}$ /Ten-Thousands of an Inch  
TR pb 014-4E



DESIGN UNIT

PITCH + RUNOUT TEST

Part No.: AMS6260/./.

REMARKS: REF 23-1ST

z = 28    m = 3.175 mm    β = 0°0'0" R    d = 88.900 mm    Date/Insp: 07.08.1996/RCF

Reqd. Qual. Limit Value Act. Value Act. Qual.	Left Flank	$f_p$	$f_u^*$	$F_p$	$F_{pz}/8$	Right Flank	$f_p$	$f_u^*$	$F_p$	$F_{pz}/8$	$F_r$	Values in $\mu m$
		5	5	5	5		5	5	5	5		
		5.0	6.0	20.0	12.0		5.0	6.0	20.0	12.0	14.0	
		2.2	3.1	11.8	6.4		2.6	2.0	10.4	6.0	4.8	
		2	3	4	3		4	1	3	3	2	

Quality levels to DIN 3962 / AGMA 390.03  
Values in  $\mu m$ /Ten-Thousands of an Inch

TOOTH THICK:    NOM. VAL.    Min.    Max.    MEAS. VAL  
\*    4.987    0    0    -    4.884

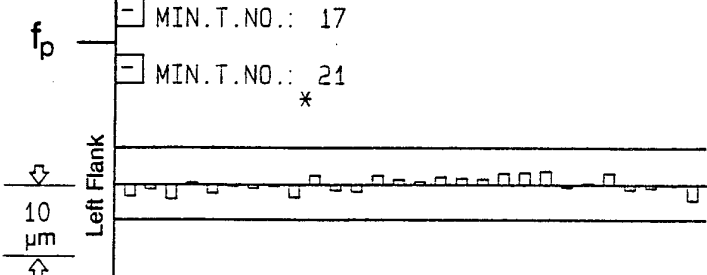
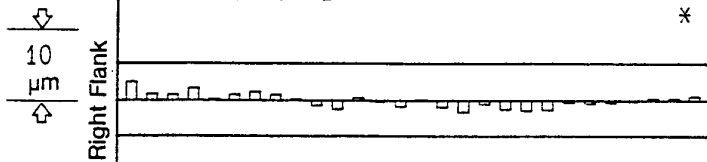

MAX. T. NO.: 28

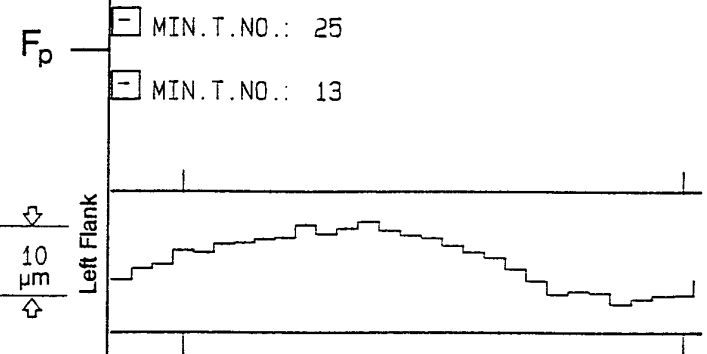
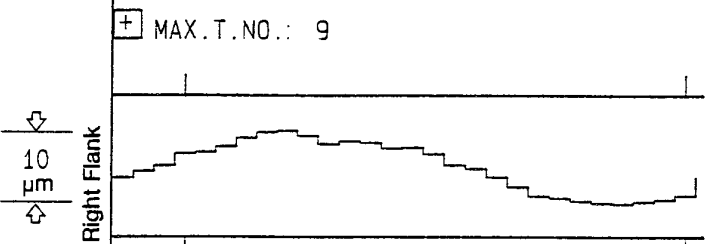

MAX. T. NO.: 25

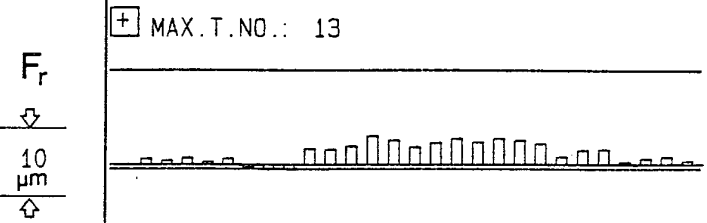

MIN. T. NO.: 9

NATIONAL GEAR METROLOGY LABORATORY

HOFER TR pb 014-4 E



# APPENDIX A

## INTERPRETATION OF GEAR MEASUREMENT RESULT SHEETS.

### GENERAL.

The gear measurement results in this report are from CNC measuring machines in the UK National Gear Metrology Laboratory, which is run by Design Unit. The measuring machines used are traceably calibrated to National Standards using a range of master gears and gear artefacts which have been calibrated at the European National Laboratory, PTB, in Germany. Gears have been measured in accordance with procedures layed down in DUCOP.03, a code of practice for Involute Gear Measurement, which is issued by Design Unit and BGA ( British Gear Association ).

It is the policy of the laboratory to measure :

- a. lead and profile errors on 4 teeth equally spaced at 90 degree intervals. Both left and right flanks are measured.
- b. adjacent and cumulative pitch errors on all teeth on left and right flanks.
- c. radial runout of the tooth space.
- d. tooth thickness.
- e. radial runout of the reference bands on the gear measuring machine.

Measured errors are interpreted strictly in accordance with the specified standards. It is the policy of the laboratory to evaluate errors in accordance with DIN 3962 if the accuracy requirements are not fully specified.

The following sections show how to interpret the result sheets and define the parameters which are measured and evaluated.

## THE DEFINITION OF LEFT & RIGHT FLANKS.

A definition of left and right flanks in accordance with ISO 1328 ( Technical Reports ) is given in Figure.1. Note that it is important to know which way up the gear was mounted on the measuring machine for the correct interpretation of the measurement records.

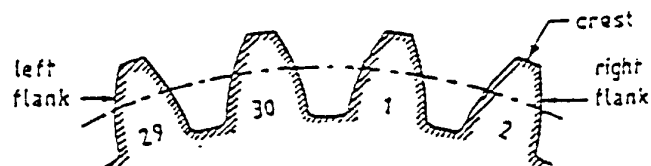

A1 Definition of left and right flanks on an external gear and tooth numbering

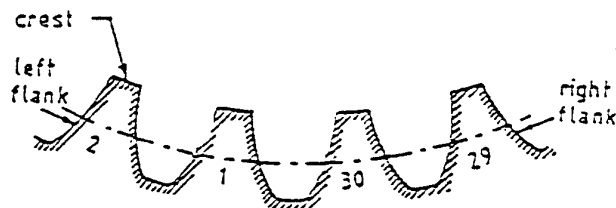

A2 Definition of left and right flanks on an internal gear and tooth numbering

Figure 1. The definition of left and right flanks.

## PROFILE ERRORS.

Profile errors are measured to define the difference between a true involute form and the actual measured profile. Although the involute is a curve, the difference between the true involute form and the measured form is given as a deviation from a straight line. See figure.2.

Profile errors are usually measured at mid face width unless specified otherwise. The profile error curve is evaluated between lines, one of which is the start of active profile and the second is specified as 8% of the total active length of the profile.

The measured results are compared to the DIN standard and the accuracy grade of the gear is determined. The largest error measured determines the accuracy grade of the gear.

All errors are measured in the transverse plane.

Errors are analysed in accordance with DIN 3962, which specifies 3 parameters :

- $f_{\alpha}$  profile form errors
- $f_{H\alpha}$  profile slope errors
- $F_{\alpha}$  total profile error

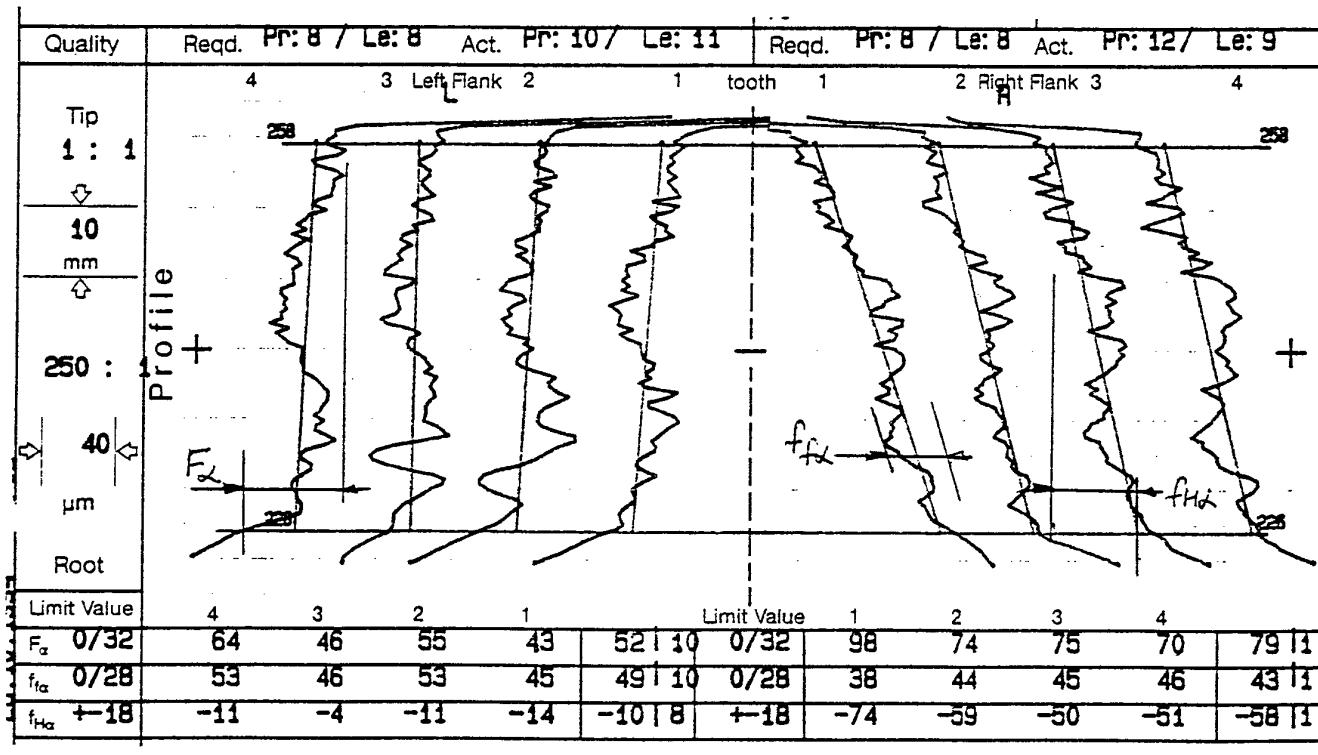

Figure 2. Profile error parameters.

# LEAD ERRORS.

Lead or tooth alignment errors are measured at the pitch circle diameter of the gear assuming that the gear is mating with its basic rack. Lead errors are evaluated over 90% of the facewidth unless stated on the drawing.

Deviations from the true helix of the gear are plotted as errors from a straight line.

All lead errors are measured in the transverse plane.

The parameters which are evaluated in accordance with DIN 3962 are :

- $f_{fB}$  lead form error.
- $f_{H\beta}$  lead error slope.
- $F_{\beta}$  total lead error.

An example of these parameters are given in figure.3.

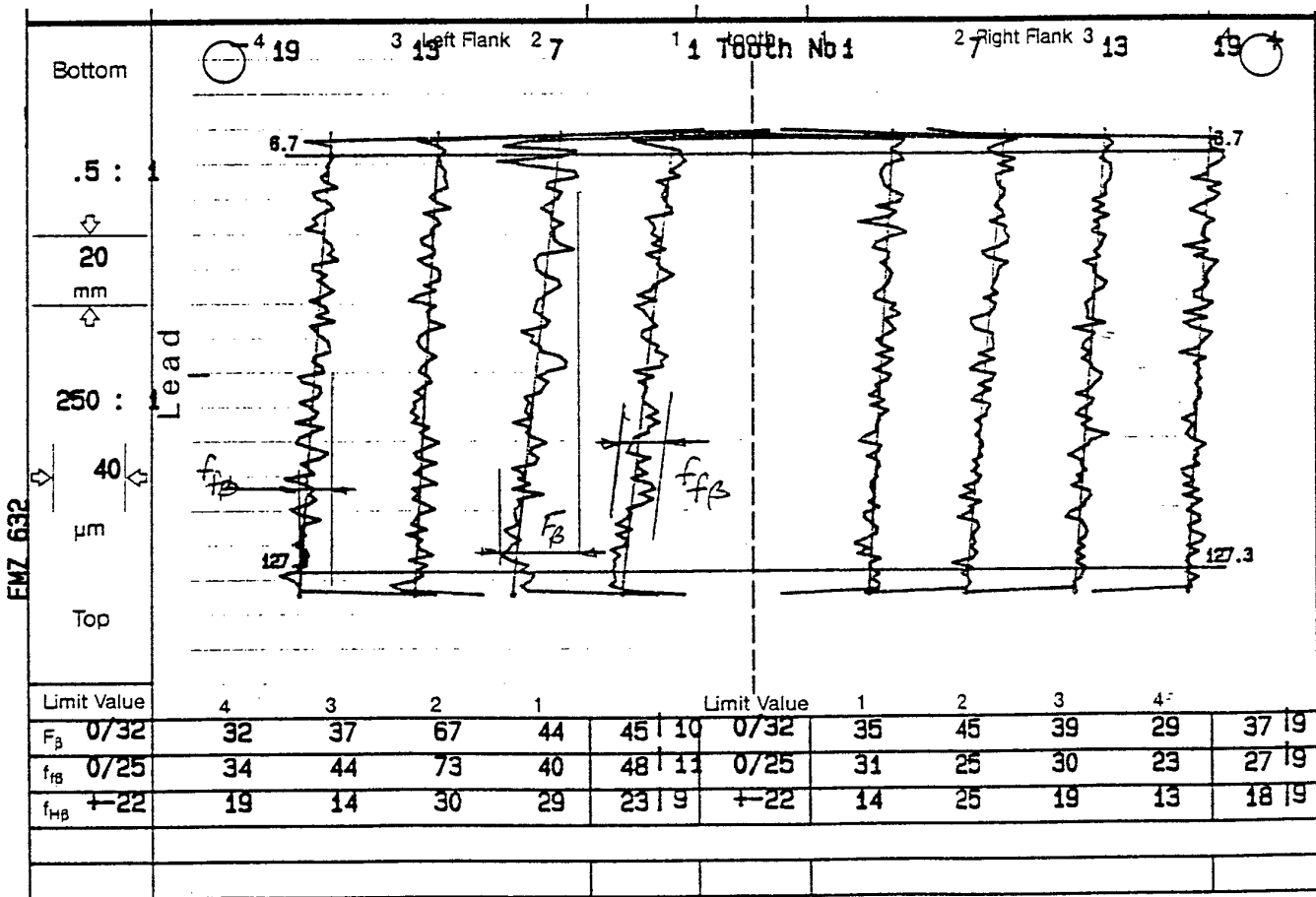

Figure 3. Lead error parameters.

## PITCH ERRORS.

Pitch or spacing errors are measured on all teeth, both left and right flanks. Errors are measured at mid face width and at the lead measuring diameter unless specified otherwise.

Adjacent pitch errors ( errors between adjacent pairs of teeth ) are plotted on the record sheet and the largest error is printed out and compared to the DIN Standard.

Cumulative pitch errors are calculated by summing the adjacent pitch errors and calculating the total range of errors. Again the value of the error is compared to the DIN Standard.

Radial runout of the tooth space is calculated by computing the radial position that a ball would sit in the tooth space. The total variation in radial position is the radial runout error.

Examples of the parameter calculated is given in Figure 4.

The parameters evaluated are :

$f_p$	adjacent pitch error
$F_p$	cumulative pitch error
$F_r$	radial runout of the toothgap

# PITCH + RUNOUT TEST

Part No.:

REMARKS: \*

z = 24	m = 10	mm	β = 0°0'0" R	d = 240.000	mm	Date/Insp. 28.10.1994/
Reqd. Qual.	$f_b$	$f_u$ *	$F_p$	$F_{pz}/8$		
Limit Value	8	8	8	8		
Act. Value	20	25	71	45		
Act. Qual.	30	37	68	36		
	10	10	8	8		

Quality levels to DIN 3962 / AGMA 390.03  
Values in μm/Ten-Thousands of an Inch

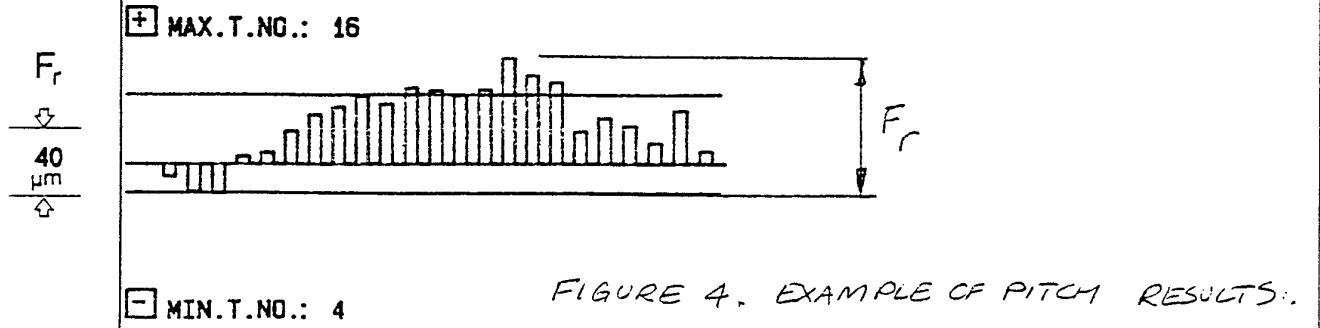
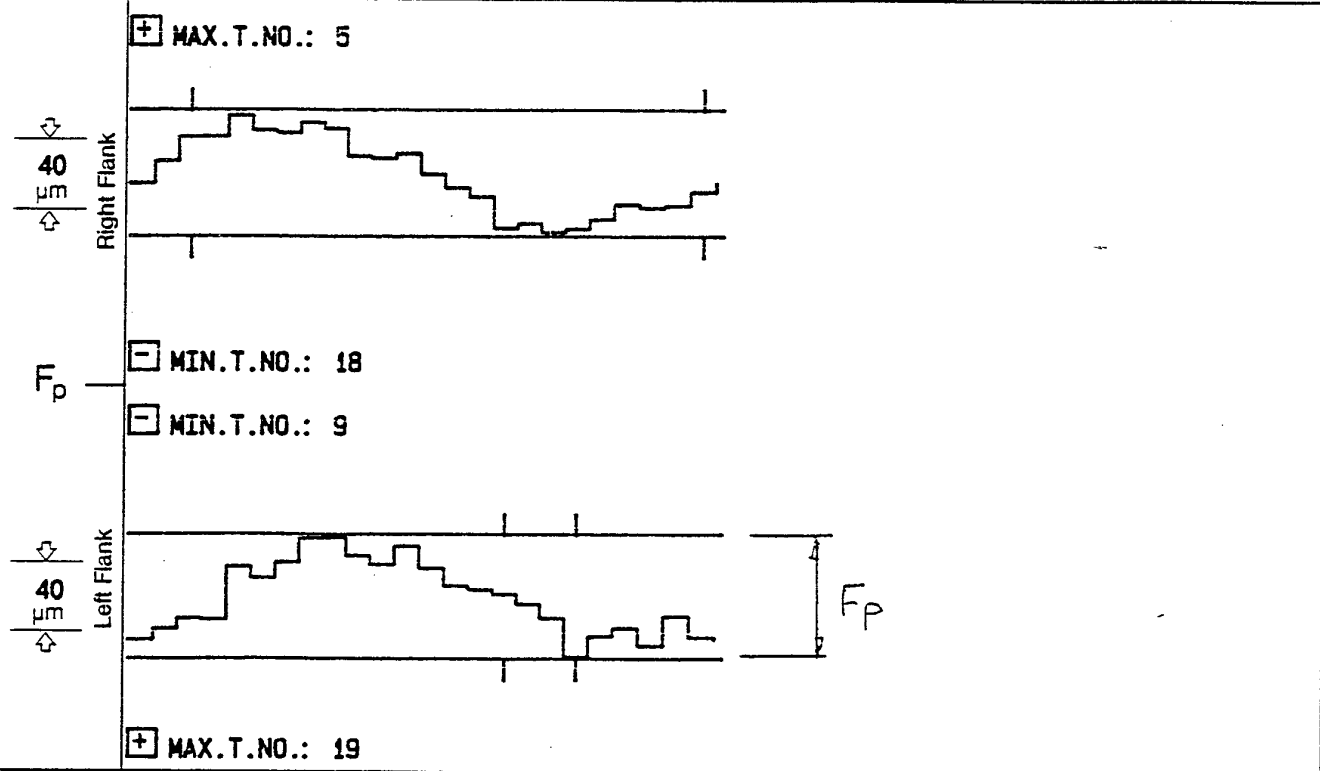
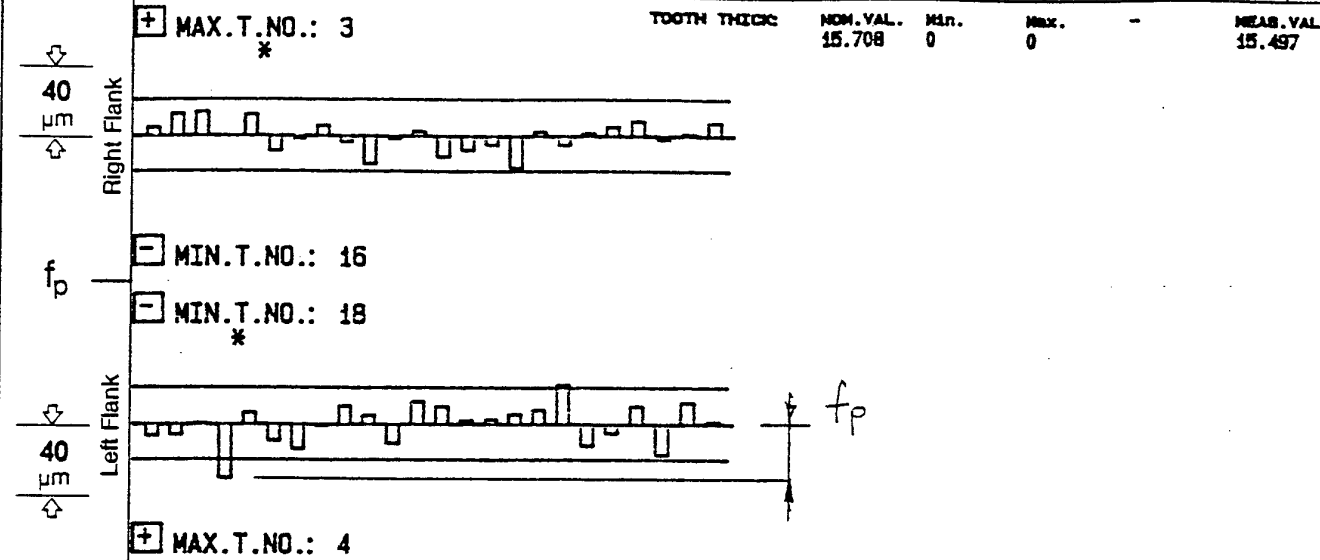

MIN.T.NO.: 4

FIGURE 4. EXAMPLE OF PITCH RESULTS.

TR pb 014-4-E →

## APPENDIX 2

### INITIAL SURFACE PROFILES OF GEARS

AMS6260	#11
"	#15
"	#20
"	#23



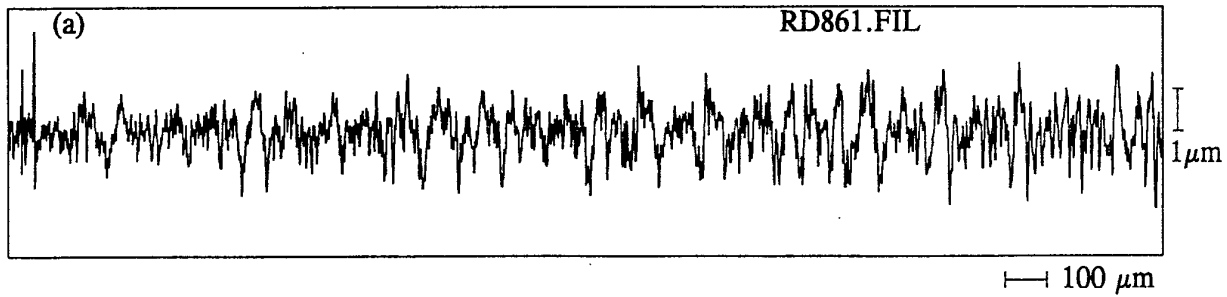

NASA gear #11 (ground), tooth 1/left,  $x = -.1\text{mm}$   $y = 3.175\text{mm}$  (filtered:  $R_a = 0.425\mu\text{m}/0.08\text{mm}$  cutoff)

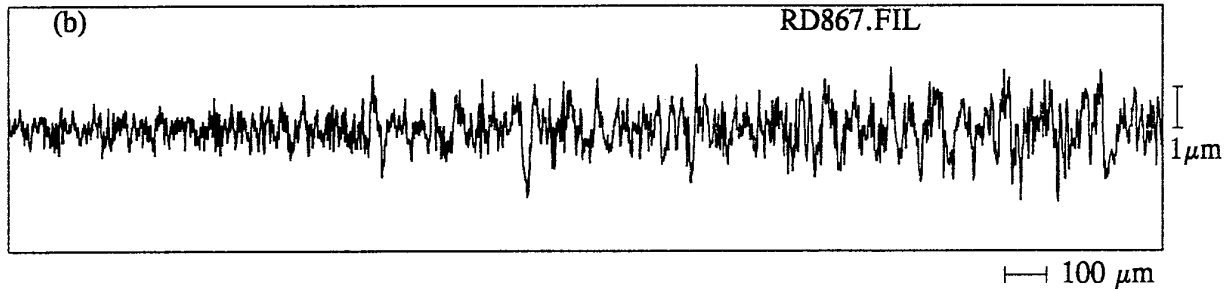

NASA gear #11 (ground) tooth 1, right,  $x = -.1\text{mm}$   $y = 3.175\text{mm}$  (filtered:  $R_a = 0.358\mu\text{m}/0.08\text{mm}$  cut)

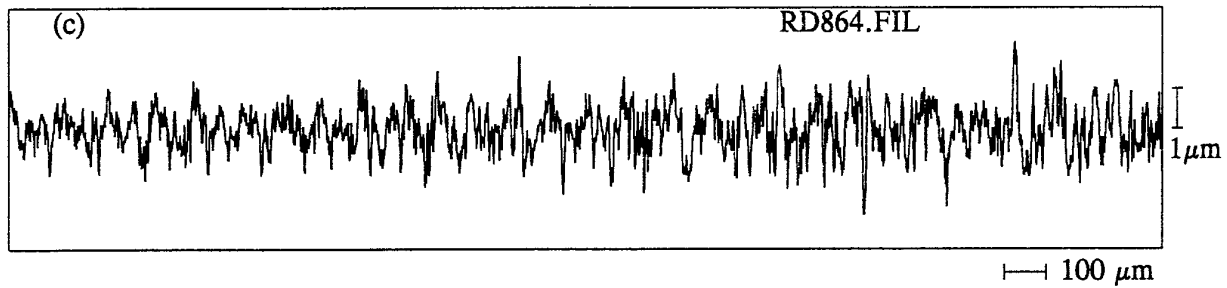

NASA gear #11 (ground), tooth 15/left,  $x = -.1\text{mm}$   $y = 3.175\text{mm}$  (filtered:  $R_a = 0.450\mu\text{m}/0.08\text{mm}$  cutoff)

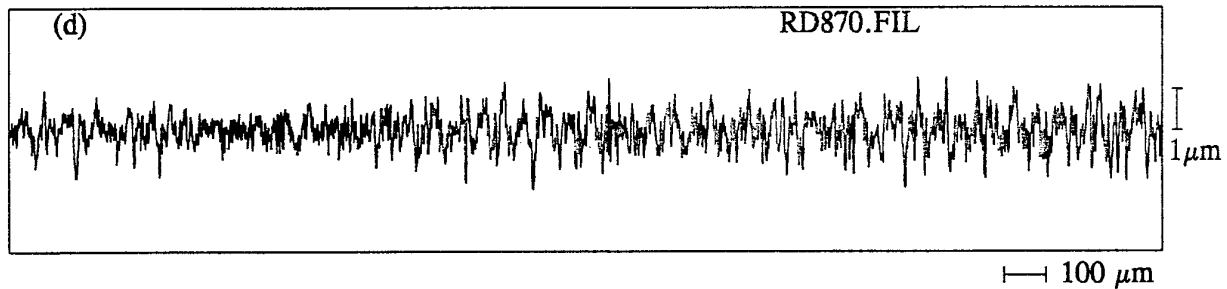

NASA gear #11 (ground), tooth 15/right,  $x = -.1\text{mm}$ ,  $y = 3.175\text{mm}$  (filtered:  $R_a = 0.320\mu\text{m}/0.08\text{mm}$  c)

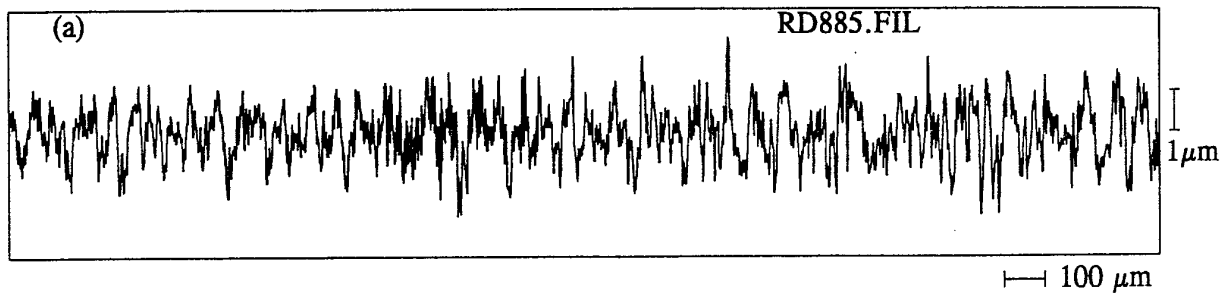

NASA gear #15 (ground) tooth 1/left,  $x = -.1\text{mm}$ ,  $y = 3.175\text{mm}$  (filtered:  $R_a = 0.513\mu\text{m}/0.08\text{mm}$  cut)

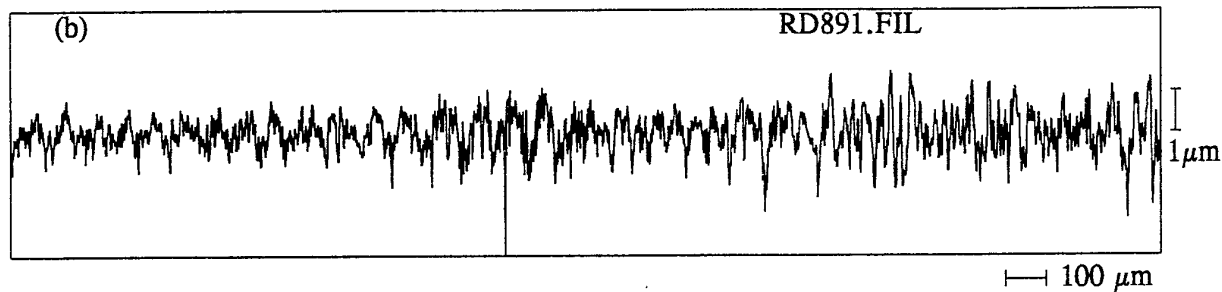

NASA gear #15 (ground) tooth 1/right,  $x = -.1\text{mm}$ ,  $y = 3.175\text{mm}$  (filtered:  $R_a = 0.366\mu\text{m}/0.08\text{mm}$  cut)

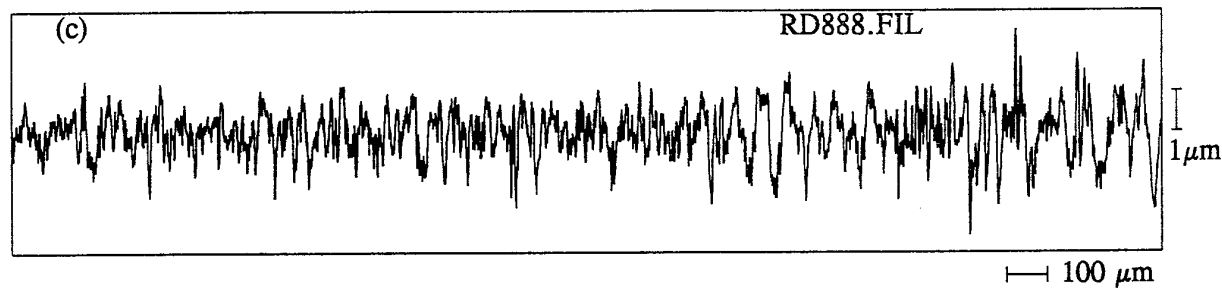

NASA gear #15 (ground) tooth 15/left,  $x = -.1\text{mm}$ ,  $y = 3.175\text{mm}$  (filtered:  $R_a = 0.471\mu\text{m}/0.08\text{mm}$  cut)

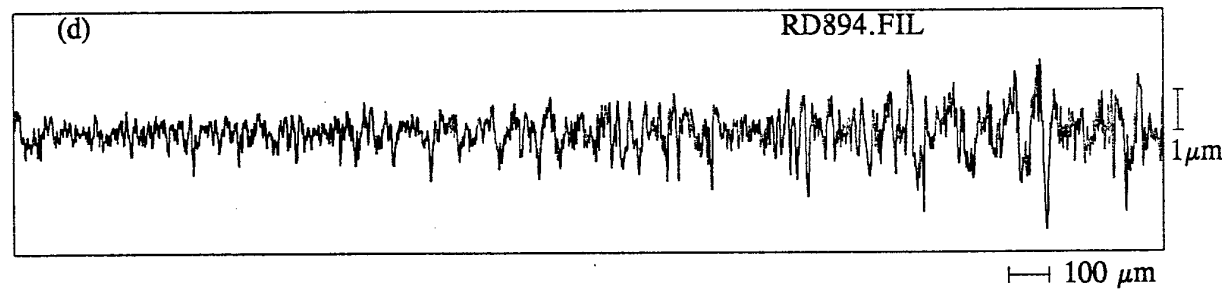

NASA gear #15 (ground) tooth 15/right,  $x = -.1\text{mm}$ ,  $y = 3.175\text{mm}$  (filtered:  $R_a = 0.335\mu\text{m}/0.08\text{mm}$  cut)

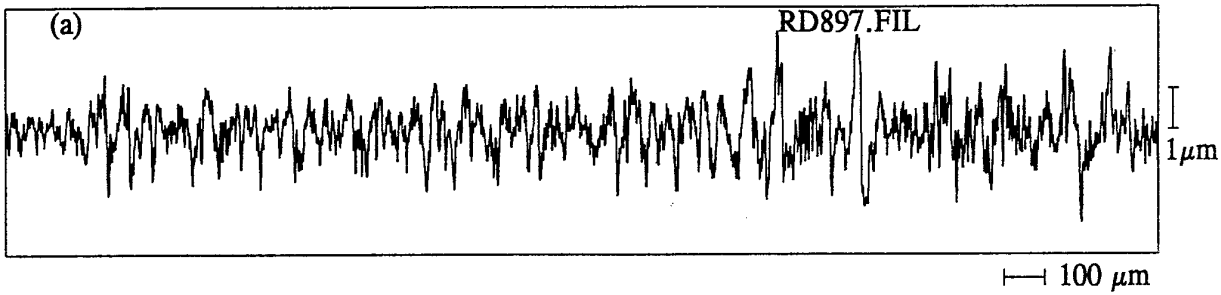

NASA gear #20 (ground) tooth 1/left,  $x = -.1\text{mm}$ ,  $y = 3.175\text{mm}$  (filtered:  $R_a = 0.458\mu\text{m}/0.08\text{mm}$  cut)

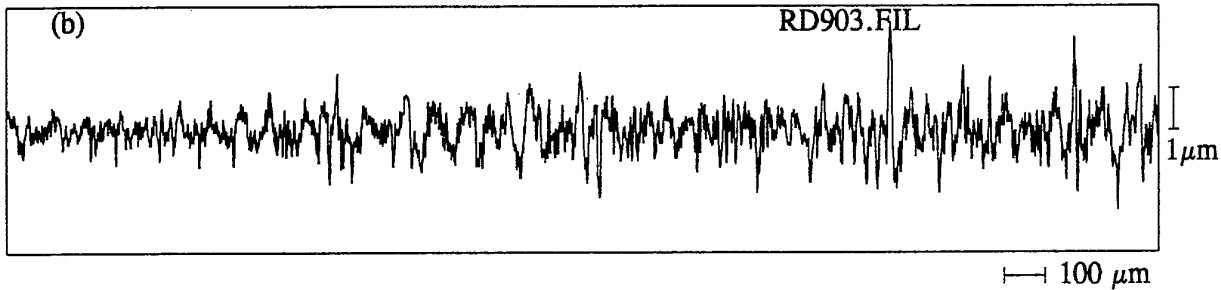

NASA gear #20 (ground) tooth 1/right,  $x = -.1\text{mm}$ ,  $y = 3.175\text{mm}$  (filtered:  $R_a = 0.364\mu\text{m}/0.08\text{mm}$  cut)

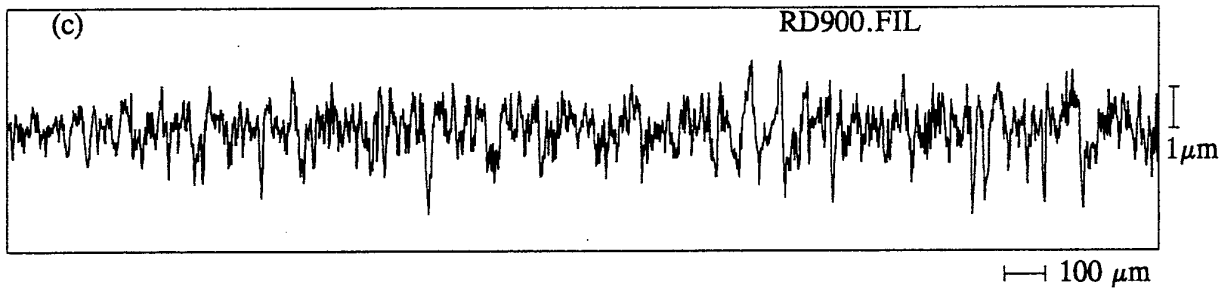

NASA gear #20 (ground) tooth 15/left,  $x = -.1\text{mm}$ ,  $y = 3.175\text{mm}$  (filtered:  $R_a = 0.415\mu\text{m}/0.08\text{mm}$  cut)

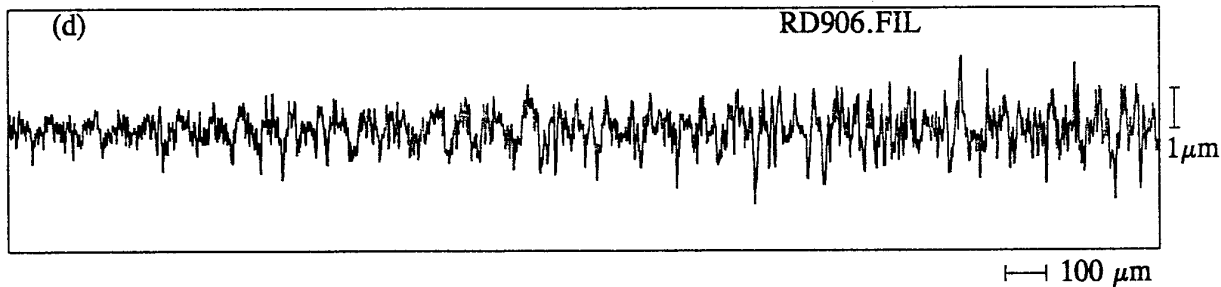

NASA gear #20 (ground) tooth 15/right,  $x = -.1\text{mm}$ ,  $y = 3.175\text{mm}$  (filtered:  $R_a = 0.341\mu\text{m}/0.08\text{mm}$  cut)

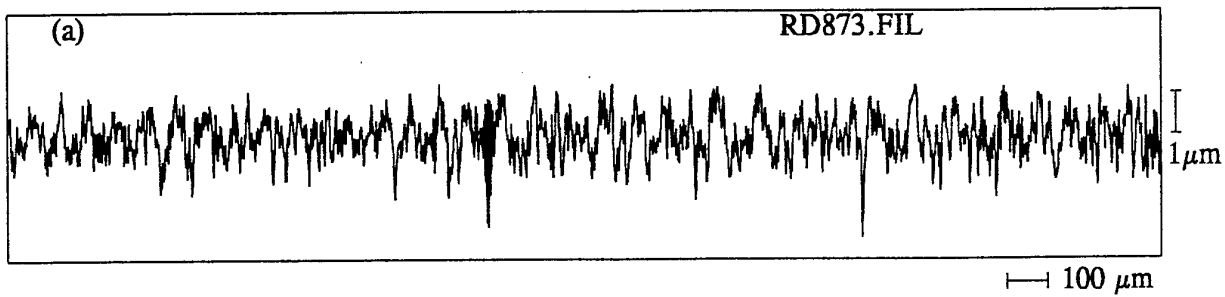

NASA gear #23 (ground) tooth 1/left,  $x = -.1\text{mm}$ ,  $y = 3.175\text{mm}$  (filtered:  $R_a = 0.402\mu\text{m}/0.08\text{mm}$  cut)

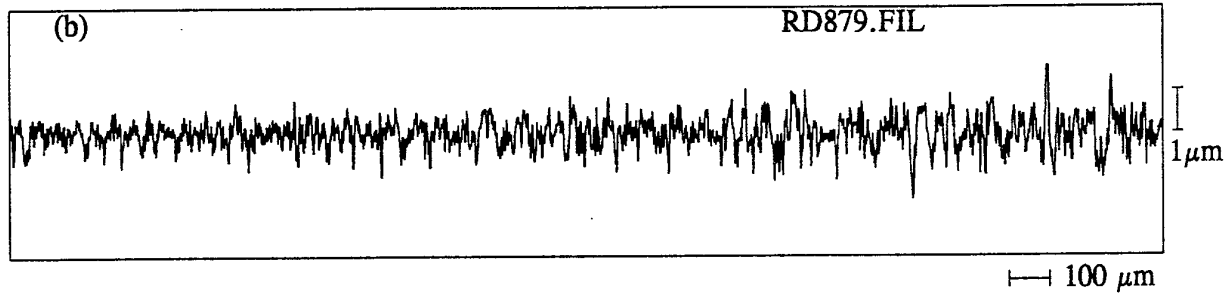

NASA gear #23 (ground) tooth 1/right,  $x = -.1\text{mm}$ ,  $y = 3.175\text{mm}$  (filtered:  $R_a = 0.275\mu\text{m}/0.08\text{mm}$  cut)

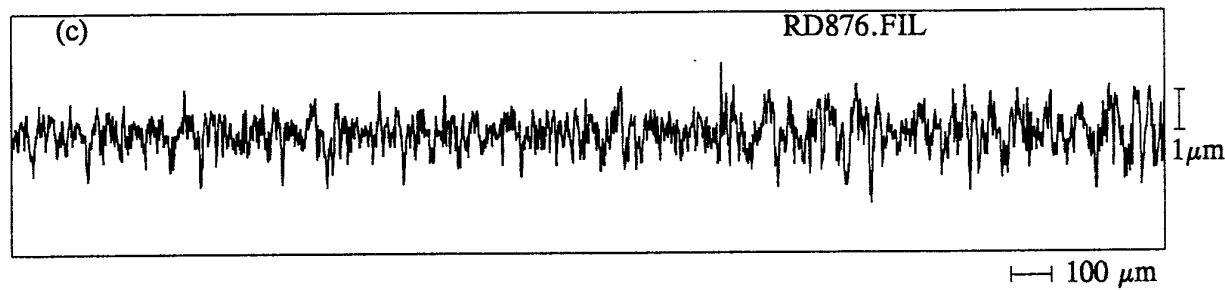

NASA gear #23 (ground) tooth 15/left,  $x = -.1\text{mm}$ ,  $y = 3.175\text{mm}$  (filtered:  $R_a = 0.343\mu\text{m}/0.08\text{mm}$  cut)

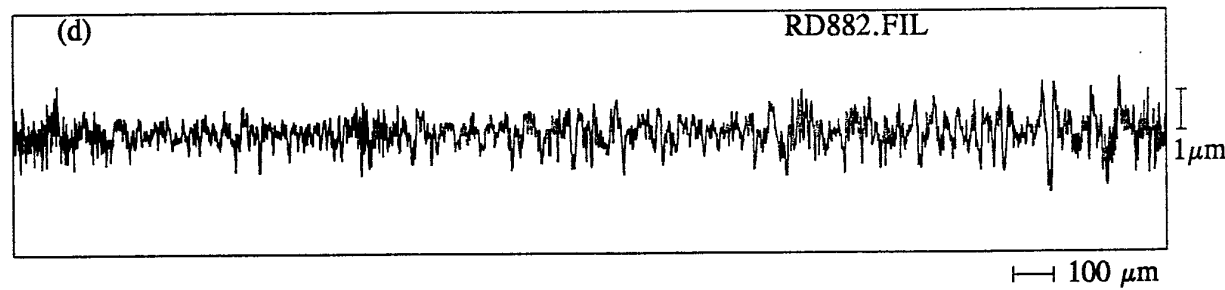

NASA gear #23 (ground) tooth 15/right,  $x = -.1\text{mm}$ ,  $y = 3.175\text{mm}$  (filtered:  $R_a = 0.275\mu\text{m}/0.08\text{mm}$  cut)

### APPENDIX 3

#### INTERMEDIATE METROLOGY INSPECTION OF GEARS

AMS6260	#11
"	#15
"	#20
"	#23

4 December 1996

Project GM 373/2

**Superfinishing Investigation  
Final Measurement Results**

**Client:** Cardiff School of Engineering,  
University of Wales,  
Queens Buildings,  
The Parade,  
P.O. Box 97,  
CARDIFF  
CF2 1XH

**Gear Reference:** AMS 6260

**Samples Checked:** N<sup>o</sup>. 11, 15, 20 and 23 (see GM 373/1 for the initial measurement results).

**Parameters Measured:**

The following parameters were measured on each gear:

1. Lead and profile errors on 4 teeth, left and right flanks, spaced at 90° intervals.
2. Adjacent and cumulative pitch errors on all teeth, left and right flanks.
3. Radial runout of the tooth space.
4. Mean circular tooth thickness.

**Results:**

The measurement record sheets for each gear after superfinishing are included at the end of this report. Please refer to report GM 373/1 of 7th August 1996 for the original result sheets.

An examination of the record sheets show that there is very little difference in measured errors between initial and final results. The differences in total error parameters ( $F_{\alpha}$  and  $F_{\beta}$ ) and mean error slope ( $f_{H\alpha}$  and  $f_{H\beta}$ ) are predominantly caused by slight differences in mounting error during measurement. Therefore, for this analysis, the average form error

parameters for left and right flank  $f_{f\alpha}$  (profile form error) and  $f_{f\beta}$  (lead form error) have been used for comparison together with the average normal circular tooth thickness measured ( $S_n$ ). A summary of the results is given in table 1.

### Discussion of Results:

The measurement results in table 1 and a visual examination of the measurement traces shows that there is very little difference between the initial flank geometry and the final flank geometry. The superfinishing process has not changed the basic flank form. (This is supported by a visual examination of the gears which show that on most of the tooth flanks, the grinding feed marks are still visible).

The normal circular tooth thickness measurements show that after the results are corrected for the probe datum error, an average of approximately  $1\mu\text{m}$  of stock has been removed from each flank.

A visual examination of the gears shows that stock removal is uneven: some teeth are highly polished but on others the grinding marks and ground 'dull' finish still predominates the flanks. In this test, we must conclude that process was not correctly controlled.

Sample	Flank	Initial Results			Final Results		
		$f_{f\alpha}$	$f_{f\beta}$	$S_n$	$f_{f\alpha}$	$f_{f\beta}$	$S_n$
11	LF	$2.8\mu\text{m}$	$1.4\mu\text{m}$	4.871mm	$2.9\mu\text{m}$	$1.8\mu\text{m}$	4.868mm
	RF	$1.9\mu\text{m}$	$1.4\mu\text{m}$	-	$1.8\mu\text{m}$	$1.8\mu\text{m}$	-
15	LF	$3.5\mu\text{m}$	$0.9\mu\text{m}$	4.883mm	$3.6\mu\text{m}$	$1.2\mu\text{m}$	4.881mm
	RF	$2.8\mu\text{m}$	$0.7\mu\text{m}$	-	$3.0\mu\text{m}$	$0.7\mu\text{m}$	-
20	LF	$2.0\mu\text{m}$	$2.7\mu\text{m}$	4.863mm	$1.7\mu\text{m}$	$2.8\mu\text{m}$	4.860mm
	RF	$1.9\mu\text{m}$	$1.4\mu\text{m}$	-	$2.1\mu\text{m}$	$1.6\mu\text{m}$	-
23	LF	$2.5\mu\text{m}$	$1.6\mu\text{m}$	4.884mm	$2.5\mu\text{m}$	$1.9\mu\text{m}$	4.880mm
	RF	$1.9\mu\text{m}$	$2.1\mu\text{m}$	-	$1.8\mu\text{m}$	$2.3\mu\text{m}$	-

Table 1: Summary of Results

Note: The difference in probe diameter, calibration size is  $1.2\mu\text{m}$  (i.e. the probe calibrated  $+1.2\mu\text{m}$  during the final measurements). This will reduce the nominal measured tooth thickness in the final results by  $1.2\mu\text{m}$  compared to the initial results.

GEAR MEASUREMENT SUMMARY SHEET

Client: *University of Wales*

DU Reference: *GM373/2*

Gear Drawing: *AMS 6260*

Gear Reference: *REF NOS 11, 15, 20 & 23*

Manufactured By:

Parameters Measured: Lead / Profile / Pitch / Runout / Tooth thickness / runout of reference bands.

Runout of Reference Bands:

*mounting: expanding mandrel with etched details at the top.*

Accuracy requirements:

Results:

PARAMETERS	TOLERANCE ( $\mu\text{m}$ )	MAX. ERROR ( $\mu\text{m}$ )	COMMENTS
LEAD			
PROFILE			
ADJ. PITCH			
CUM. PITCH			
RUNOUT			
PITCH DIFF.			
THICKNESS			

General comments:

1. Gears have been measured in accordance with the code of practice DUCOP.03 for Involute Gear Measurement.

2. *Measurement details are identical to GM373/1*

Equipment: Machine: *Hofler G12 632*

Probe:  *$\phi 1.2$*

All measurements were carried out on traceably calibrated equipment in the UK National Gear Metrology Laboratory (NAMAS Accreditation number 0250).

Measured by: *R. C. Frazer*

Date: *3 Dec 96*





DESIGN UNIT

# Lead + Profile Test

Designation:	$m_n$ 3.175 mm	$b$ 6.35 mm
Part No.: AMS6260/./.	$z$ 28	$L_\beta$ 90 %
REMARKS: REF 15-2ND	$\alpha_n$ 20°0'0''	$d_b$ 83.539 mm
	$\beta$ 0°0'0''	
	$\beta_b$	

Quality levels to DIN 3962 / AGMA 390.03  
Values in  $\mu\text{m}$ /Ten-Thousands of an Inch

Date: 03.12.1996 16:37

NATIONAL GEAR METROLOGY LABORATORY  
Inspector: RCF  
EMZ 632  
Fpb 018-4/3E

Quality	Reqd.Pr: 5 / Le: 5	Act.Pr: 6 / Le: 2	Reqd.Pr: 5 / Le: 5	Act.Pr: 5 / Le: 1
---------	--------------------	-------------------	--------------------	-------------------

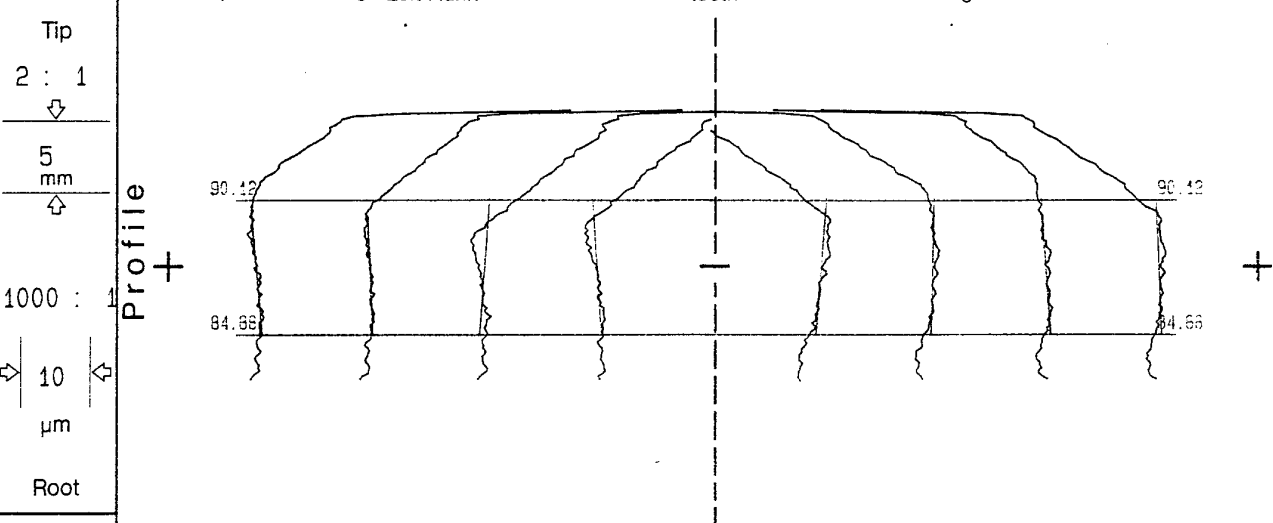

Limit Value	4	3	2	1	Limit Value	1	2	3	4		
$F_a$ 0/7	2.5	1.7	6.5	4.4	3.8   5	0/7	3.7	2.4	2.0	3.9	3.0   3
$f_{te}$ 0/6	1.6	1.9	6.1	4.7	3.6   6	0/6	4.3	2.2	1.9	3.6	3.0   5
$f_{H\alpha}$ -4.5	1.7	.8	-1.4	1.2	.6   3	+4.5	1.5	.4	-1.4	-8	-1   2

Bottom	4 22	3 15	2 8	1 1	1 Tooth No 1	1 8	2 15	3 22	4 22
--------	---------	---------	--------	--------	-----------------	--------	---------	---------	---------

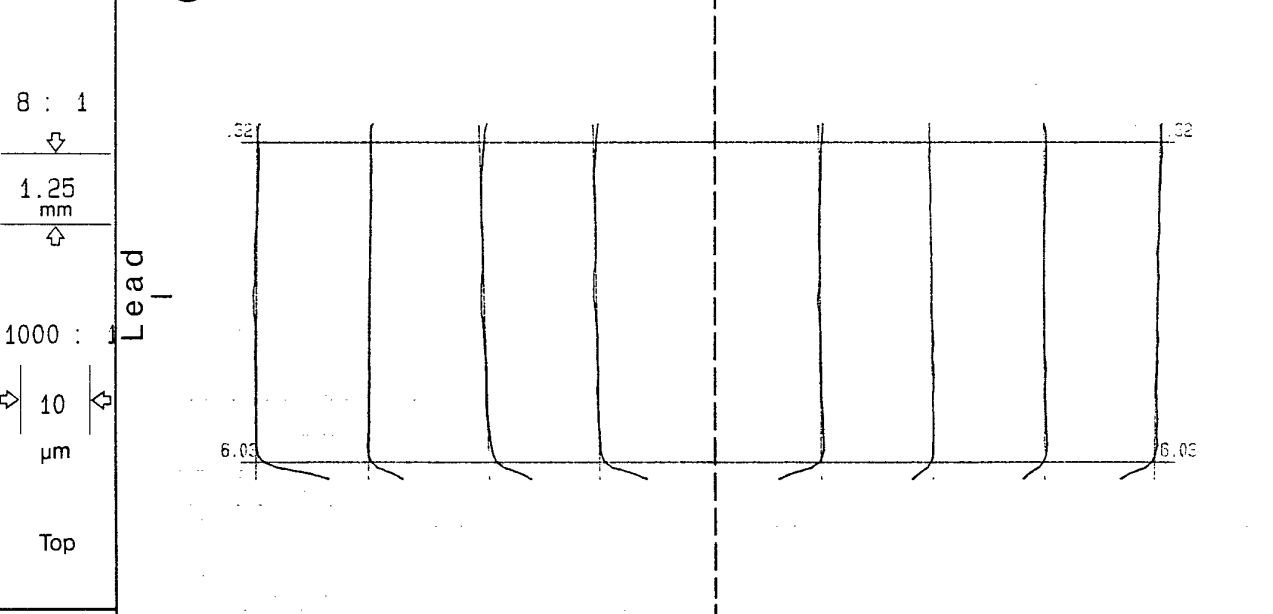

Limit Value	4	3	2	1	Limit Value	1	2	3	4		
$F_\beta$ 0/7	1.5	.5	2.2	1.6	1.5   1	0/7	9	7	6	1.5	9   1
$f_{f\beta}$ 0/4.5	1.6	.5	1.6	1.1	1.2   2	0/4.5	1.0	.6	.5	.8	7   1
$f_{H\beta}$ -6	2	.4	-1.3	-9	-.4   1	+6	-5	-6	-1	.8	-1   1

DESIGN UNIT

PITCH + RUNOUT TEST

Part No.: AMS6260/./.

REMARKS: REF 11-2ND

z = 28    m = 3.175mm    β = 0°0'0" R    d = 88.900 mm    Date/Insp.: 03.12.1996/RCF

Reqd. Qual. Limit Value Act. Value Act. Qual.	Left Flank	$f_p$	$f_u$ *	$F_p$	$F_{pz/8}$	Right Flank	$f_p$	$f_u$ *	$F_p$	$F_{pz/8}$	$F_r$	Values in $\mu m$
		5	5	5	5		5	5	5	5		
		5.0	6.0	20.0	12.0		5.0	6.0	20.0	12.0	14.0	
		2.7	2.5	14.3	7.3		2.4	2.8	12.5	6.6	6.2	
		4	3	4	4		2	3	4	4	3	

Quality levels to DIN 3962 / AGMA 390.03  
Values in  $\mu m$  / Ten-Thousands of an inch

TOOTH THICK:    NOM. VAL.    Min.    Max.    MEAS. VAL.  
4.987    0    0    -    4.868

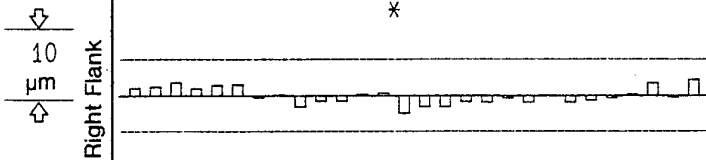

$f_p$

MIN. T. NO.: 14

MIN. T. NO.: 13 \*

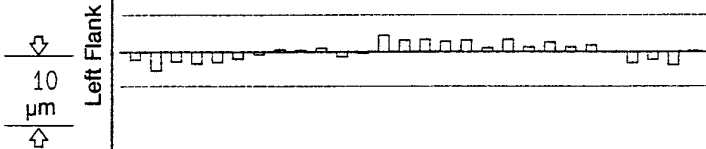

MAX. T. NO.: 2

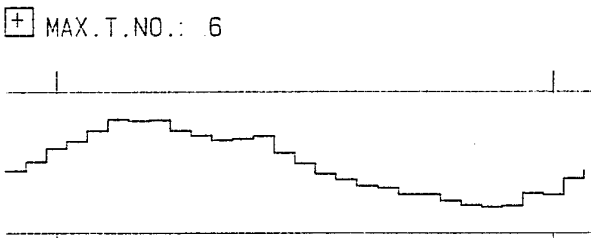

$F_p$

MIN. T. NO.: 24

MIN. T. NO.: 8



MAX. T. NO.: 25

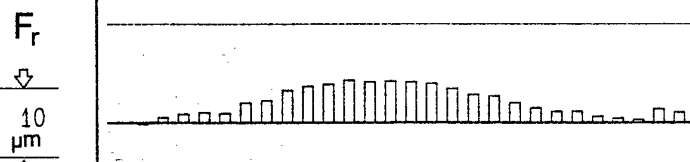

MAX. T. NO.: 12

MIN. T. NO.: 2

NATIONAL GEAR METROLOGY LABORATORY

**HOFLER**  
TR pb 014-4 E →

DESIGN UNIT

PITCH + RUNOUT TEST

Part No.: AMS6260/./.

REMARKS: REF 15-2ND

z = 28 m = 3.175mm β = 0°0'0" R d = 88.900 mm Date/Insp.: 03.12.1996/RCF

Reqd. Qual. Limit Value Act. Value Act. Qual.	Left Flank	$f_p$	$f_u$ *	$F_p$	$F_{pz}/8$	Right Flank	$f_p$	$f_u$ *	$F_p$	$F_{pz}/8$	$F_r$	Values in $\mu m$
		5	5	5	5		5	5	5	5	5	
		5.0	6.0	20.0	12.0		5.0	6.0	20.0	12.0	14.0	
		1.9	2.8	10.4	6.1		1.1	1.1	3.5	2.3	10.2	
		2	3	3	3		1	1	1	1	4	

MAX. T.NO.: 13 TOOTH THICK: NOM. VAL. 4.987 Min. 0 Max. 0 MEAS. VAL. 4.881

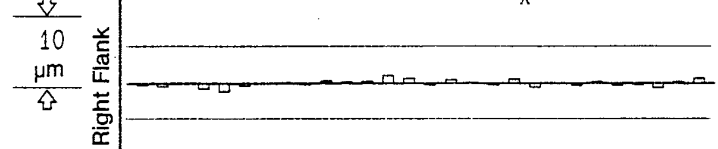

MIN. T.NO.: 5  
 MIN. T.NO.: 4 \*

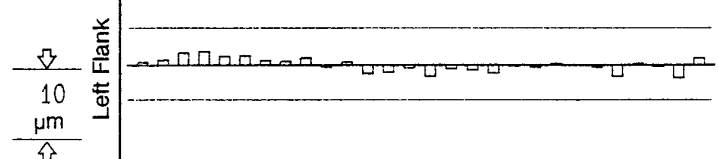

MAX. T.NO.: 27

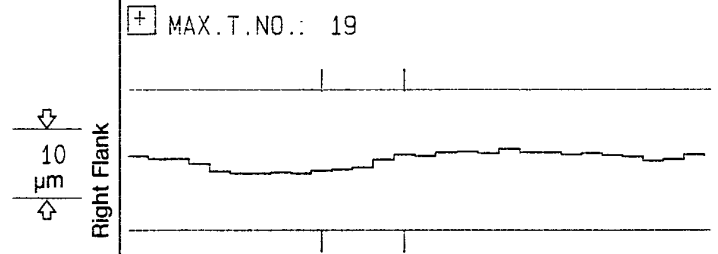

MIN. T.NO.: 9  
 MIN. T.NO.: 28

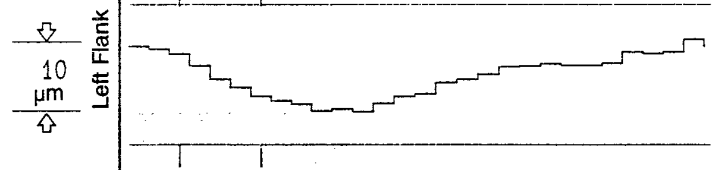

MAX. T.NO.: 12

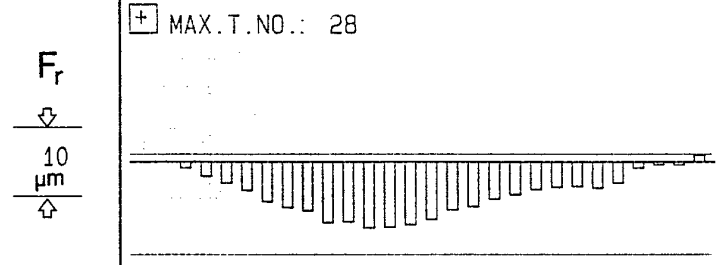

MIN. T.NO.: 12

Quality levels to DIN 3962 / AGMA 390.03  
Values in  $\mu m$ /Ten-Thousands of an Inch

NATIONAL GEAR METROLOGY LABORATORY

DESIGN UNIT

# Lead + Profile Test

Designation:	$m_n$ 3.175 mm	$b$ 6.35 mm
Part No.: AMS6260/./.	$z$ 28	$L_\beta$ 90 %
REMARKS: REF 20-2ND	$\alpha_n$ 20°0'0''	$d_b$ 83.539 mm
	$\beta$ 0°0'0''	
	$\beta_b$	

Quality levels to DIN 3962 / AGMA 390.03  
Values in  $\mu\text{m}$ /ten-Thousands of an inch

Date: 03.12.1996 16:29

NATIONAL GEAR METROLOGY LABORATORY  
Inspector: RCF  
EMZ 632  
Fpb 018-4/3E

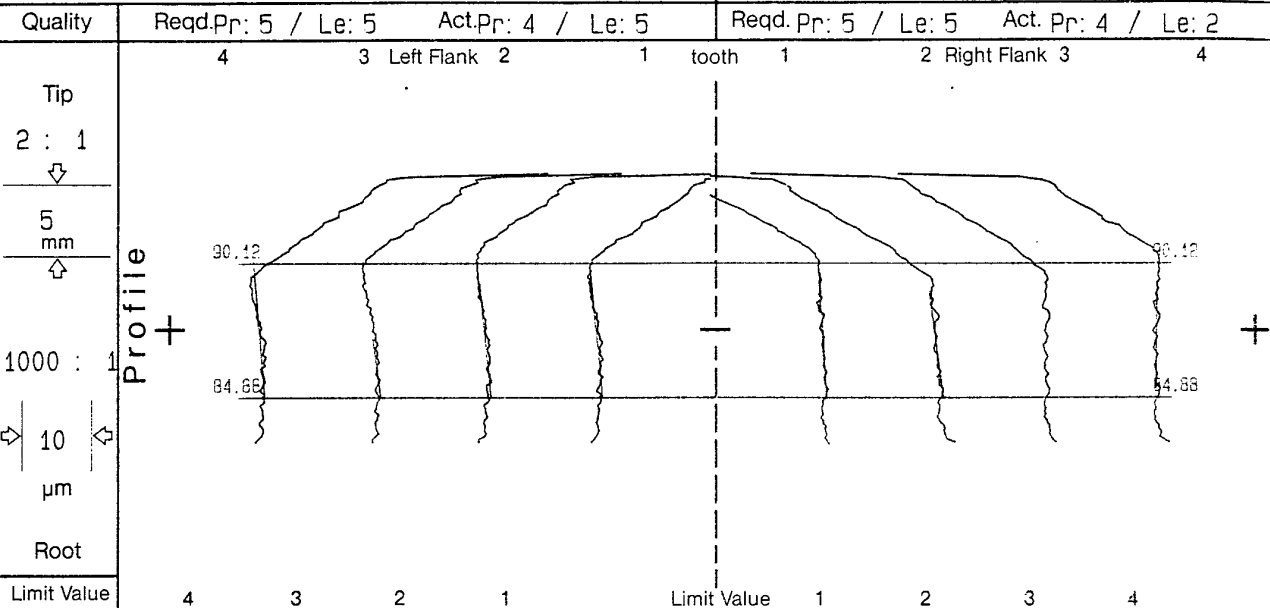

Quality	Reqd.Pr: 5 / Le: 5				Act.Pr: 4 / Le: 5				Reqd.Pr: 5 / Le: 5				Act.Pr: 4 / Le: 2																																							
	4				3 Left Flank 2				1 tooth 1				2 Right Flank 3				4																																			
Tip																																																				
2 : 1																																																				
5 mm																																																				
1000 : 1																																																				
10 $\mu\text{m}$																																																				
Root																																																				
Limit Value	4				3				2				1				Limit Value				1				2				3				4																			
$F_a$ 0/7	2.4				2.5				2.0				2.3				2.3				2				0/7				1.7				4.8				2.8				1.4				2.7				4			
$f_{ra}$ 0/6	2.7				1.2				1.2				1.6				1.7				3				0/6				1.1				3.1				2.6				1.4				2.1				4			
$f_{H\alpha}$ -4.5	1.6				2.6				2.0				2.0				2.0				4				+-4.5				-1.2				-2.5				-5				.2				-1.0				4			

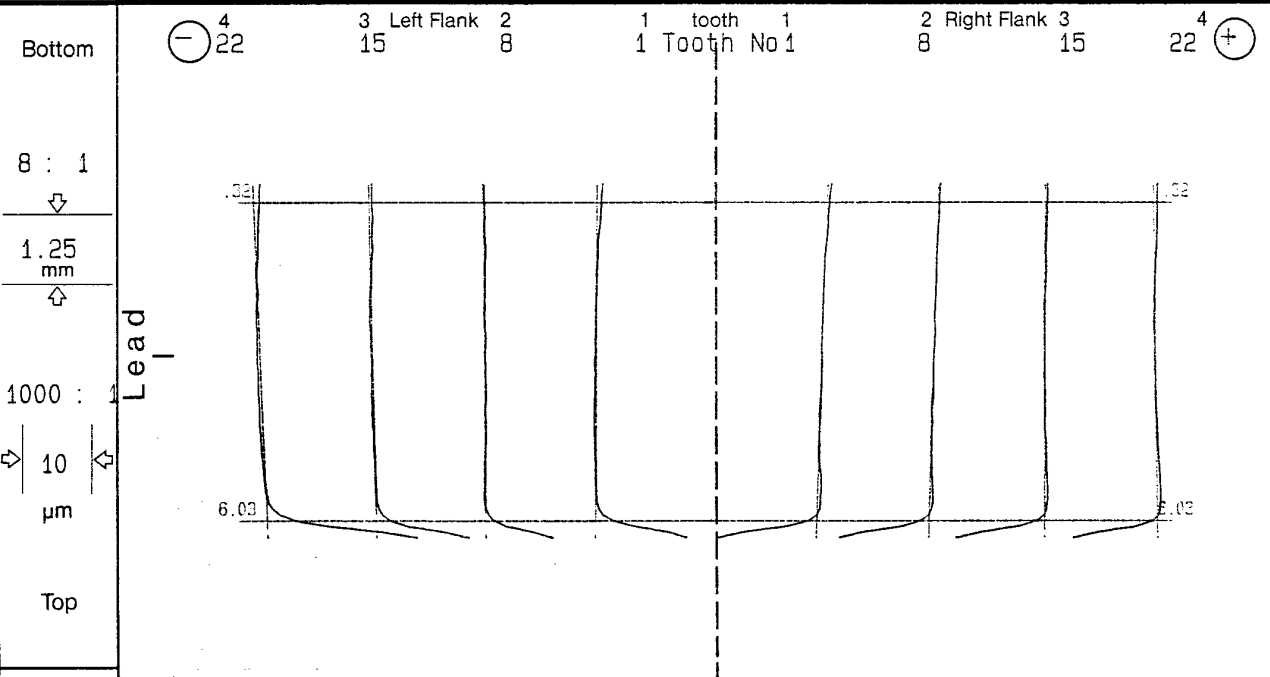

Bottom	4 22				3 Left Flank 15				2 8				1 tooth 1				1 Tooth No 1				2 Right Flank 8				3 15				4 22																							
8 : 1																																																				
1.25 mm																																																				
1000 : 1																																																				
10 $\mu\text{m}$																																																				
Top																																																				
Limit Value	4				3				2				1				Limit Value				1				2				3				4																			
$F_\beta$ 0/7	5.4				2.9				1.5				2.7				3.1				4				0/7				3.4				2.9				1.6				1.2				2.3				2			
$f_{f\beta}$ 0/4.5	4.5				2.3				1.4				2.8				2.8				5				0/4.5				1.8				1.6				1.6				1.3				1.6				2			
$f_{H\beta}$ -6	-1.9				-1.0				-2				.3				-7				1				+-6				1.6				1.4				.1				-5				7				1			

Date: 03.12.1996 17:14

Quality levels to DIN 3962 / AGMA 390.03  
 Values in  $\mu\text{m}$ /Ten-Thousands of an inch

DESIGN UNIT		Lead + Profile Test			
Designation:		$m_n$ 3.175	mm	b 6.35	mm
Part No.:	AMS6260/./.	z 28		$L_\beta$ 90	%
REMARKS:	REF 23-2ND	$\alpha_n$ 20°0'0''		$d_b$ 83.539	mm
		$\beta$ 0°0'0''			
		$\beta_b$			

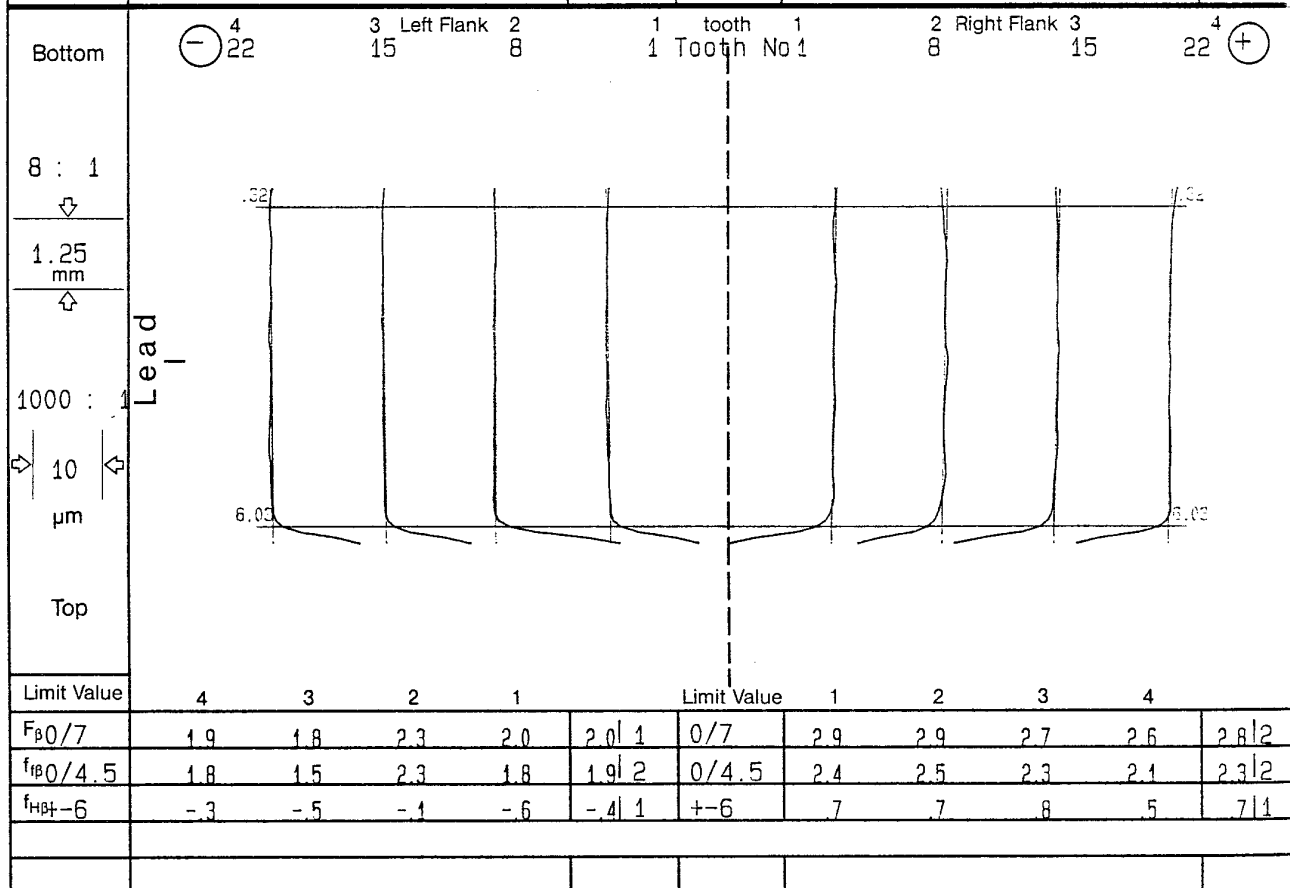
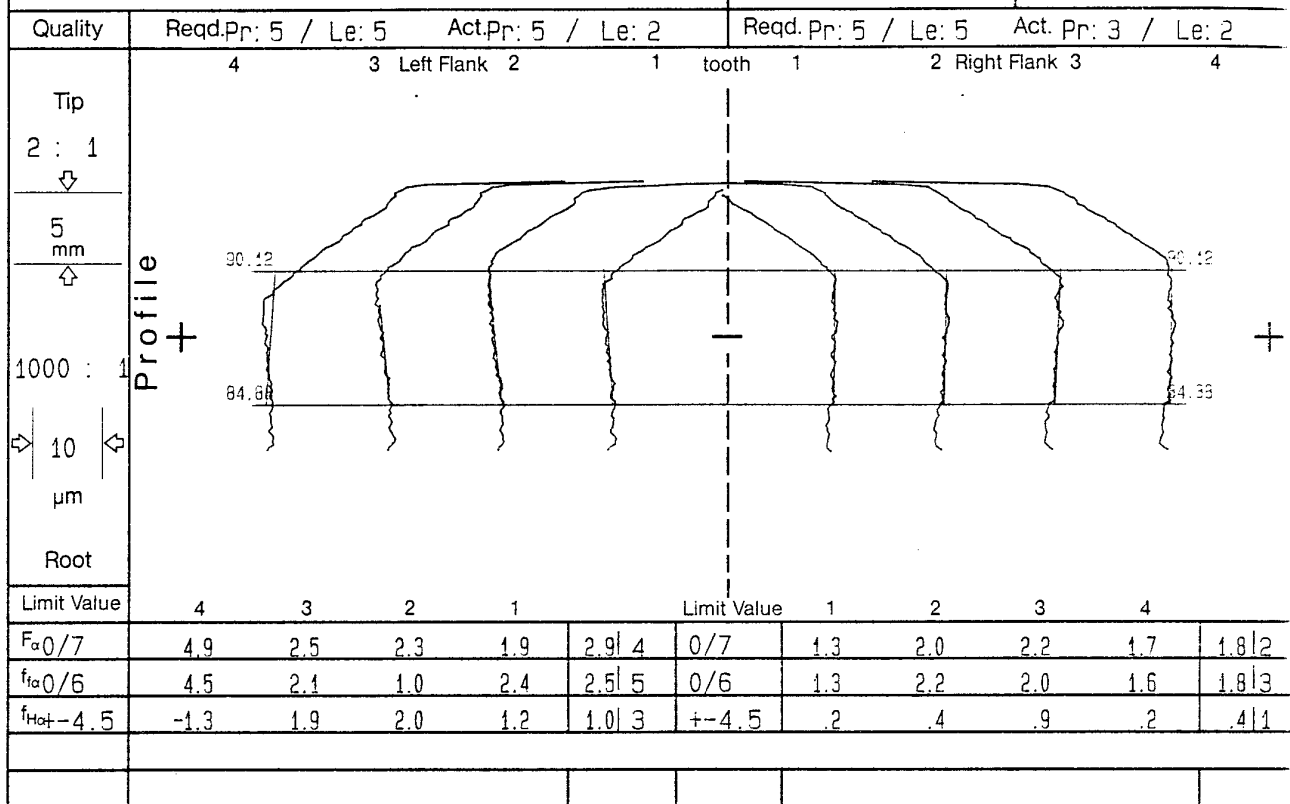

DESIGN UNIT

# PITCH + RUNOUT TEST

Part No.: AMS6260/./.

REMARKS: REF 20-2ND

z = 28    m = 3.175mm    β = 0°0'0" R    d = 88.900 mm    Date/Insp.: 03.12.1996/RCF

Reqd. Qual. Limit Value Act. Value Act. Qual.	Left Flank	$f_p$	$f_u$ *	$F_p$	$F_{pz}/8$	Right Flank	$f_p$	$f_u$ *	$F_p$	$F_{pz}/8$	$F_r$	Values in $\mu m$
		5 5.0 2.5 4	5 6.0 2.6 3	5 20.0 9.4 3	5 12.0 5.2 3		5 5.0 1.4 1	5 6.0 2.1 1	5 20.0 6.6 2	5 12.0 3.7 2	5 14.0 5.8 3	

TOOTH THICK:    NOM. VAL.    Min.    Max.    MEAS. VAL.  
 4.987    0    0    -    4.86

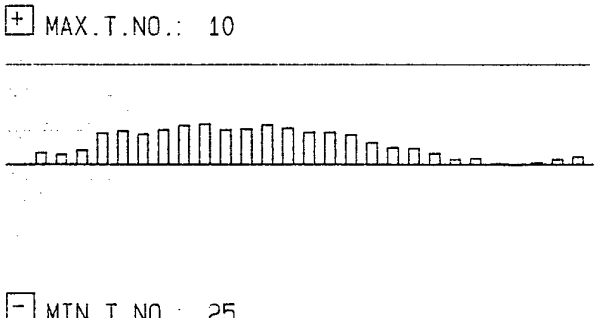
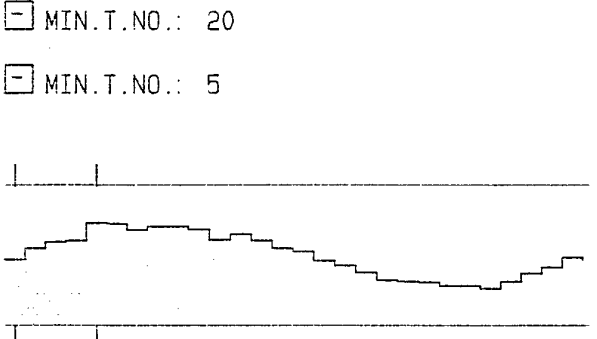
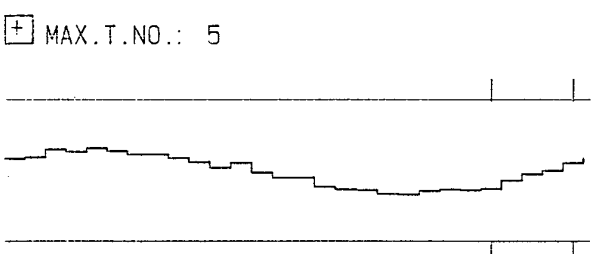
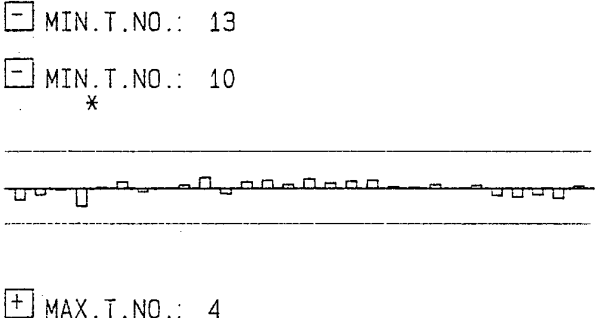
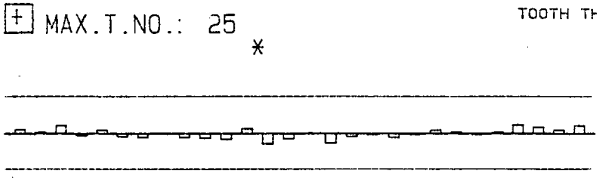

Quality levels to DIN 3962 / AGMA 390.03  
Values in  $\mu m$  / Ten-Thousands of an Inch

NATIONAL GEAR METROLOGY LABORATORY

**HDFLER**  
TR pb 014-4 E →

DESIGN UNIT

PITCH + RUNOUT TEST

Part No.: AMS6260/./.

REMARKS: REF 23-2ND

z = 28    m = 3.175 mm    β = 0°0'0" R    d = 88.900 mm    Date/Insp: 03.12.1996/RCF

Reqd. Qual. Limit Value Act. Value Act. Qual.	Left Flank	$f_p$	$f_u \%$	$F_p$	$F_{pz}/8$	Right Flank	$f_p$	$f_u \%$	$F_p$	$F_{pz}/8$	$F_r$	Values in $\mu m$
		5	5	5	5		5	5	5	5	5	
		5.0	6.0	20.0	12.0		5.0	6.0	20.0	12.0	14.0	
		2.3	3.2	12.7	6.9		2.1	2.1	10.9	6.1	5.6	
		2	3	4	4		2	1	4	3	3	

Quality levels to DIN 3962 / AGMA 390.03  
Values in  $\mu m$ /Ten-Thousands of an Inch

MAX. T. NO.: 1    TOOTH THICK:    NOM. VAL.    Min.    Max.    MEAS. VAL  
\*    4.987    0    0    4.88

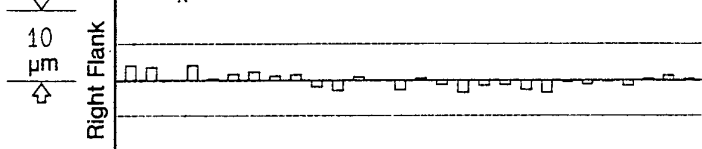

Right Flank

$f_p$   MIN. T. NO.: 21  
 MIN. T. NO.: 20 \*

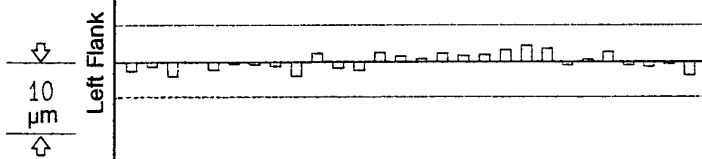

Left Flank

MAX. T. NO.: 3

MAX. T. NO.: 9

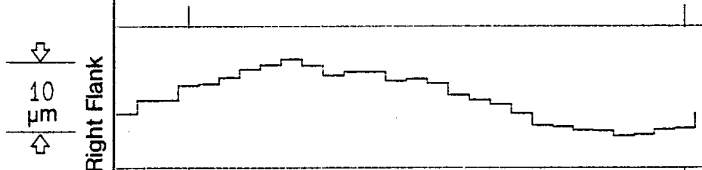

Right Flank

$F_p$   MIN. T. NO.: 25  
 MIN. T. NO.: 13

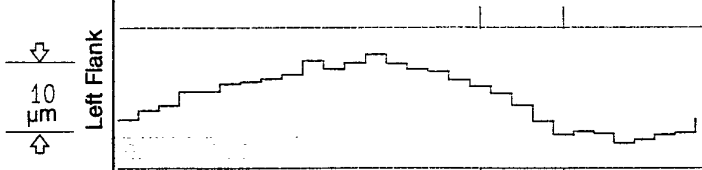

Left Flank

MAX. T. NO.: 25

MAX. T. NO.: 14

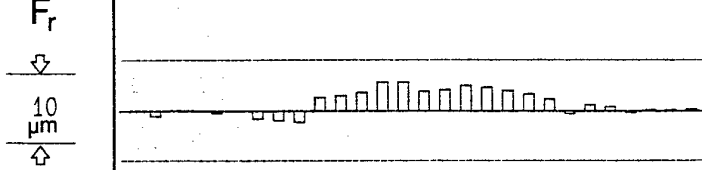

Right Flank

MIN. T. NO.: 9

NATIONAL GEAR METROLOGY LABORATORY

**HDFLER**  
TR pb 014-4 E →



## APPENDIX 4

### FINAL METROLOGY INSPECTION OF GEARS

AMS6260	#11
"	#15
"	#20
"	#23

13 March 1997

Project GM 373/3

**Superfinishing Investigation  
Final Measurement Results**

**Client:** Cardiff School of Engineering,  
University of Wales,  
Queens Buildings,  
The Parade,  
P.O. Box 97,  
CARDIFF  
CF2 1XH

**Gear Reference:** AMS 6260

**Samples Checked:** N<sup>o</sup>. 11, 15, 20 and 23 (see GM 373/1 and GM 373/2 for the previous measurement results).

**Note:** The 4 sample gears have been superfinished for a second time because stock removal after the first attempt was uneven.

**Parameters Measured:**

The following parameters were measured on each gear:

1. Lead and profile errors on 4 teeth, left and right flanks, spaced at 90° intervals.
2. Adjacent and cumulative pitch errors on all teeth, left and right flanks.
3. Radial runout of the tooth space.
4. Mean circular tooth thickness.

**Results:**

The measurement record sheets for each gear after superfinishing are included at the end of this report. Please refer to report GM 373/1 of 7th August 1996 for the original result sheets and GM 373/2 for the second set of result sheets.

An examination of the record sheets show that there is very little difference in measured

errors between initial and final results. The differences in total error parameters ( $F_\alpha$  and  $F_\beta$ ) and mean error slope ( $f_{H\alpha}$  and  $f_{H\beta}$ ) are predominantly caused by slight differences in mounting error during measurement. Therefore, for this analysis, the average form error parameters for left and right flank  $f_{f\alpha}$  (profile form error) and  $f_{f\beta}$  (lead form error) have been used for comparison together with the average normal circular tooth thickness measured ( $S_n$ ). A summary of the results is given in table 1.

#### Discussion of Results:

The measurement results in table 1 and a visual examination of the measurement traces shows that there is very little difference between the initial flank geometry and the final flank geometry. The superfinishing process has still not changed the basic flank form error but the grinding feed marks have been removed on all the teeth.

The normal circular tooth thickness measurements show that after the results are corrected for the probe datum error, an average of approximately  $2.5\mu\text{m}$  of stock has been removed from each flank.

Sample	Flank	Initial Results			Final Results		
		$f_{f\alpha}$	$f_{f\beta}$	$S_n$	$f_{f\alpha}$	$f_{f\beta}$	$S_n$
11	LF	$2.8\mu\text{m}$	$1.4\mu\text{m}$	$4.871\text{mm}$	$3.1\mu\text{m}$	$2.0\mu\text{m}$	$4.865\text{mm}$
	RF	$1.9\mu\text{m}$	$1.4\mu\text{m}$	-	$1.9\mu\text{m}$	$2.3\mu\text{m}$	-
15	LF	$3.5\mu\text{m}$	$0.9\mu\text{m}$	$4.883\text{mm}$	$3.6\mu\text{m}$	$1.6\mu\text{m}$	$4.877\text{mm}$
	RF	$2.8\mu\text{m}$	$0.7\mu\text{m}$	-	$3.0\mu\text{m}$	$1.3\mu\text{m}$	-
20	LF	$2.0\mu\text{m}$	$2.7\mu\text{m}$	$4.863\text{mm}$	$1.8\mu\text{m}$	$3.1\mu\text{m}$	$4.857\text{mm}$
	RF	$1.9\mu\text{m}$	$1.4\mu\text{m}$	-	$1.7\mu\text{m}$	$2.3\mu\text{m}$	-
23	LF	$2.5\mu\text{m}$	$1.6\mu\text{m}$	$4.884\text{mm}$	$2.7\mu\text{m}$	$2.3\mu\text{m}$	$4.877\text{mm}$
	RF	$1.9\mu\text{m}$	$2.1\mu\text{m}$	-	$1.8\mu\text{m}$	$2.5\mu\text{m}$	-

Table 1: Summary of Results

Note: The difference in probe diameter, calibration size is  $1.2\mu\text{m}$  (i.e. the probe calibrated  $+1.2\mu\text{m}$  during the final measurements). This will reduce the nominal measured tooth thickness in the final results by  $1.2\mu\text{m}$  compared to the initial results.

DESIGN UNIT

# Lead + Profile Test

Designation:		$m_n$ 3.175 mm	$b$ 6.35 mm
Part No.: AMS6260/./.		$z$ 28	$L_p$ 90 %
REMARKS: REF. 11 3RD		$\alpha_n$ 20°0'0''	$d_b$ 83.539 mm
		$\beta$ 0°0'0''	
		$\beta_b$	

Quality levels to DIN 3962 / AGMA 390.03  
Values in  $\mu\text{m}$ /Ten-Thousands of an Inch

Date: 07.03.1997 05:17

Inspector: RCF

EMZ 632

NATIONAL GEAR METROLOGY LABORATORY

**HOFLER**

Fpb 018-4/3E

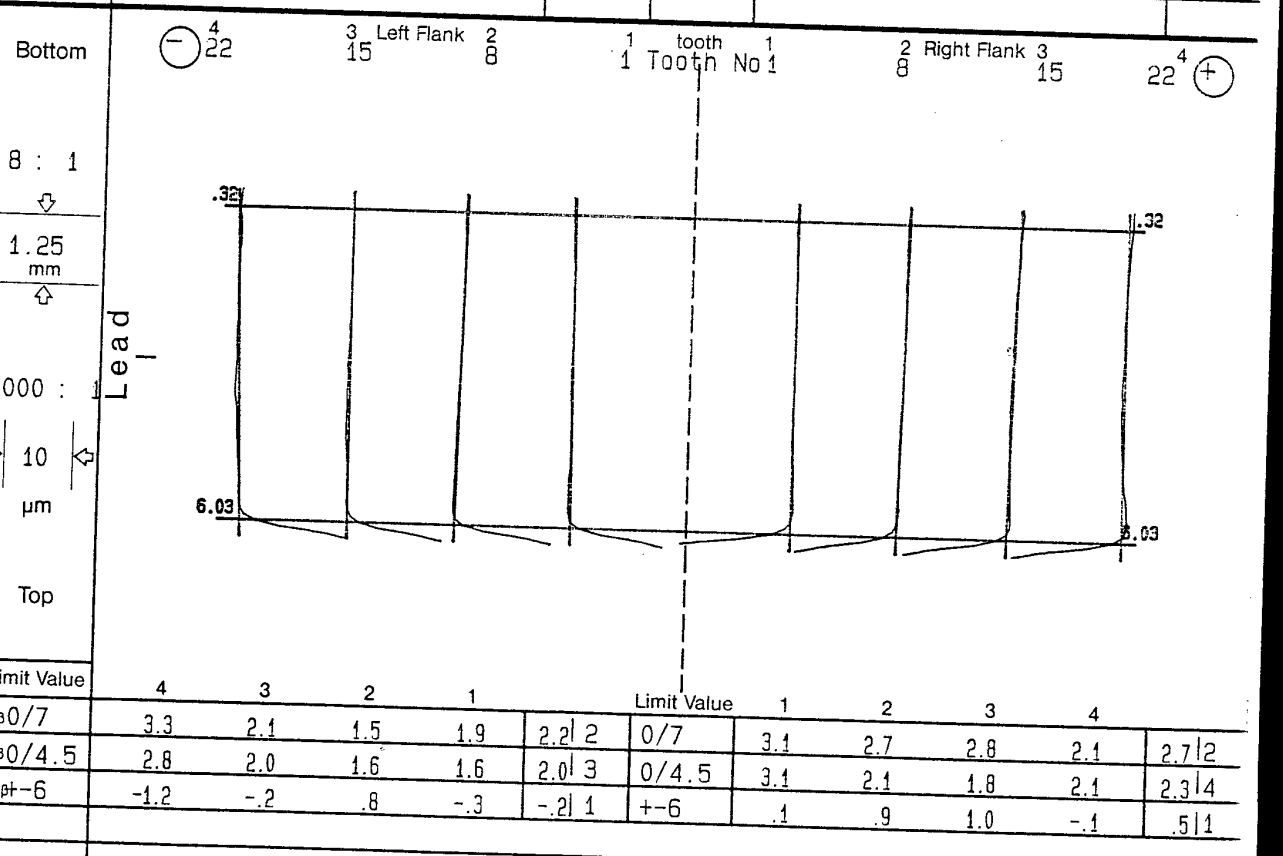
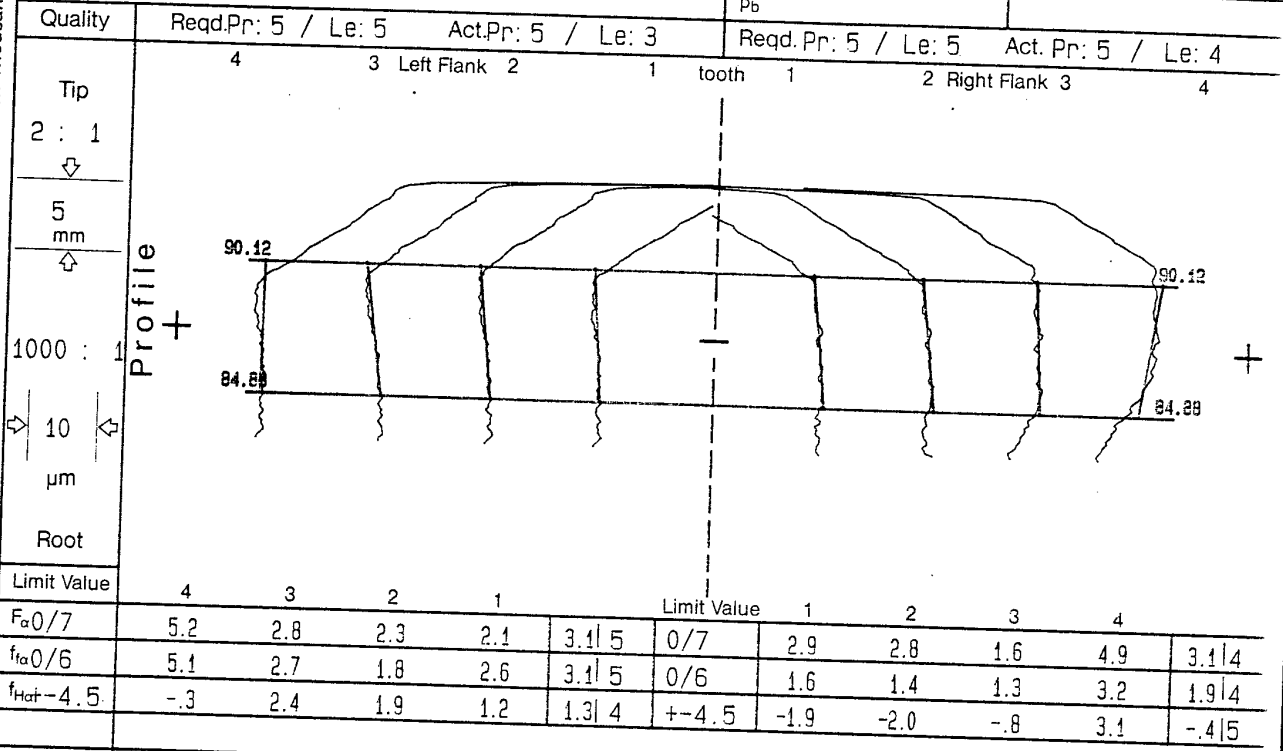

DESIGN UNIT

PITCH + RUNOUT TEST

4

Part No.: AMS6260/./.

REMARKS: REF. 11 3RD

z = 28    m = 3.175 mm    β = 0°0'0" R    d = 88.900 mm    Date/Insp.: 07.03.1997/RCF

Reqd. Qual. Limit Value Act. Value Act. Qual.	Left Flank	$f_p$	$f_u$ *	$F_p$	$F_{pz}/8$	Right Flank	$f_p$	$f_u$ *	$F_p$	$F_{pz}/8$	$F_r$	Values in $\mu m$
		5	5	5	5		5	5	5	5	5	
		5.0	6.0	20.0	12.0		5.0	6.0	20.0	12.0	14.0	
		2.4	2.6	15.7	7.8		2.5	2.7	13.9	7.0	7.7	
		2	3	5	4		4	3	4	4	4	

TOOTH THICK:    NOM. VAL.    Min.    Max.    MEAS. VAL.  
 4.987    0    0    -    4.865

MAX. T. NO.: 3    \*

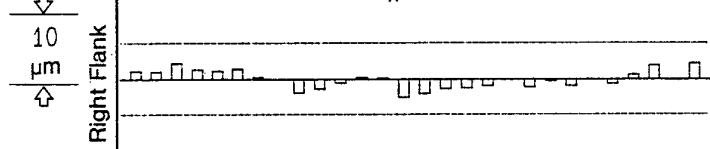

MIN. T. NO.: 14  
 MIN. T. NO.: 15    \*

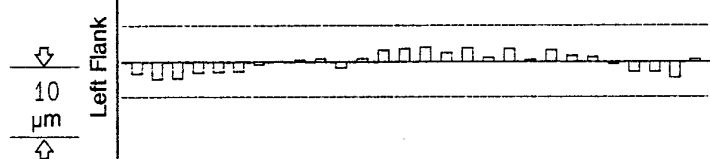

MAX. T. NO.: 2

MAX. T. NO.: 8

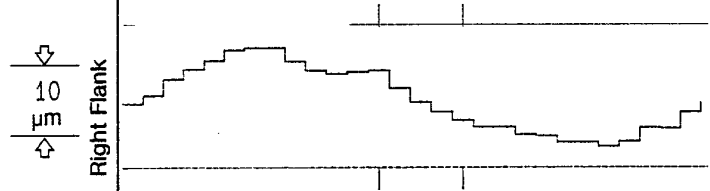

MIN. T. NO.: 24  
 MIN. T. NO.: 8

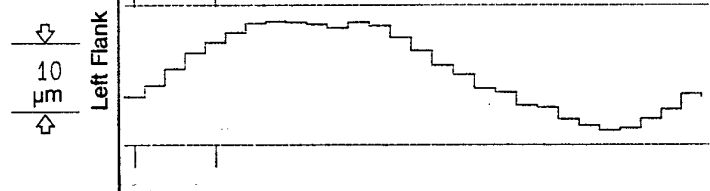

MAX. T. NO.: 24

MAX. T. NO.: 15

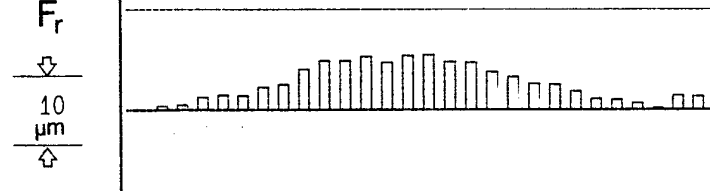

MIN. T. NO.: 1

Quality levels to DIN 3962 / AGMA 390.03  
 Values in  $\mu m$ /Ten-Thousands of an Inch

NATIONAL GEAR METROLOGY LABORATORY

DESIGN UNIT		Lead + Profile Test			
Designation: .		$m_n$ 3.175	mm	b 6.35	mm
Part No.: AMS6260/./.		z 28		$L_\beta$ 90	%
REMARKS: REF. 15 3RD		$\alpha_n$ 20°0'0''		$d_b$ 83.539	mm
		$\beta$ 0°0'0''			
		$\beta_b$			

Quality levels to DIN 3962 / AGMA 390.03  
Values in um/Ten-Thousands of an Inch

Date: 07.03.1997 05:33

NATIONAL GEAR METROLOGY LABORATORY  
Inspector: RCF  
EMZ 632  
Fpb 018-4/3E

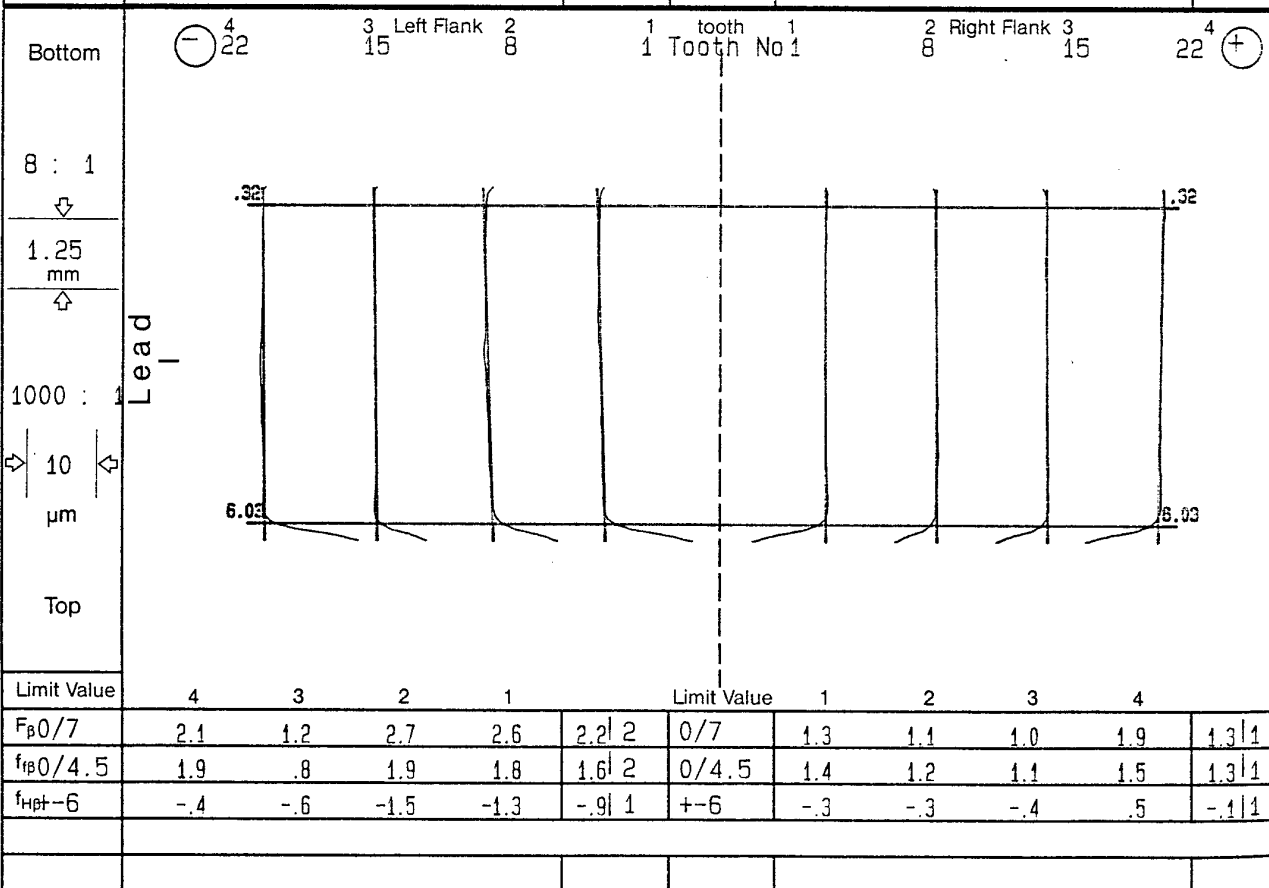
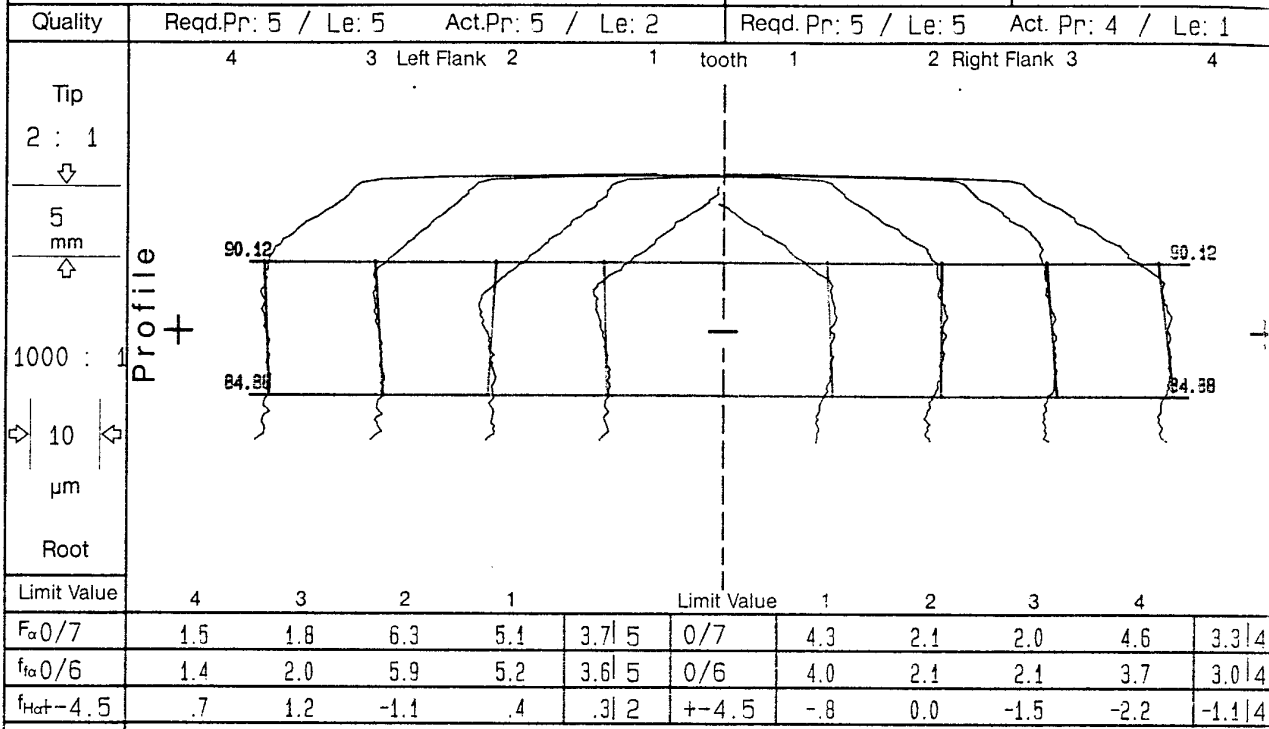

DESIGN UNIT

PITCH + RUNOUT TEST

6

Part No.: AMS6260/./.

REMARKS: REF. 15 3RD

z = 28    m = 3.175 mm    β = 0°0'0" R    d = 88.900 mm    Date/Insp.: 07.03.1997/RCF

Reqd. Qual. Limit Value Act. Value Act. Qual.	Left Flank	$f_p$	$f_u$ *	$F_p$	$F_{pz}/8$	Right Flank	$f_p$	$f_u$ *	$F_p$	$F_{pz}/8$	$F_r$	Values in $\mu\text{m}$
		5	5	5	5		5	5	5	5	5	
		5.0	6.0	20.0	12.0		5.0	6.0	20.0	12.0	14.0	
		1.6	2.3	4.4	3.4		1.6	1.6	5.5	3.5	8.0	
		2	1	1	1		2	1	2	2	4	

TOOTH THICK:    NOM. VAL.    Min.    Max.    MEAS. VAL.  
 \*    4.987    0    0    4.877

MAX. T. NO.: 28

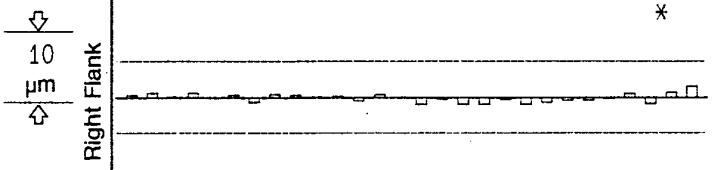

MIN. T. NO.: 15

MIN. T. NO.: 3

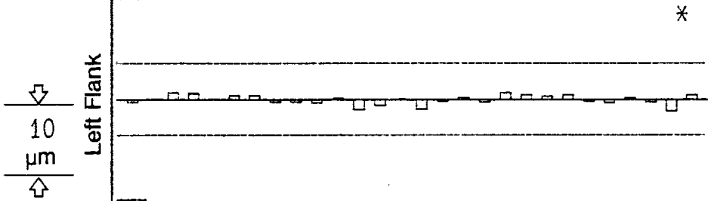

MAX. T. NO.: 27

MAX. T. NO.: 14

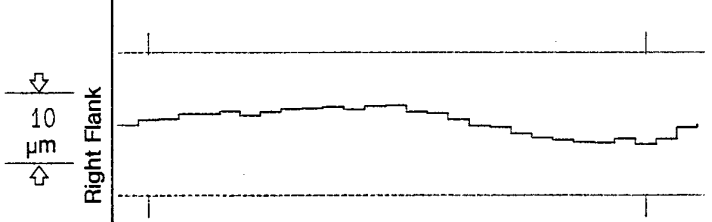

MIN. T. NO.: 26

MIN. T. NO.: 19

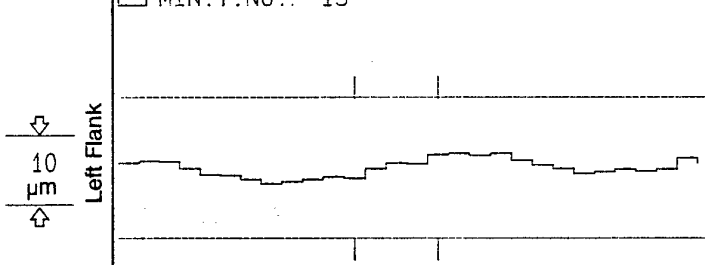

MAX. T. NO.: 8

MAX. T. NO.: 19

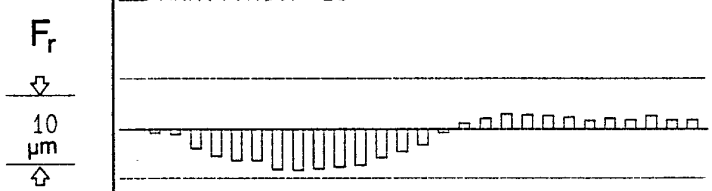

MIN. T. NO.: 9

Quality levels to DIN 3962 / AGMA 390.03  
 Values in  $\mu\text{m}$  / Ten-Thousands of an Inch

NATIONAL GEAR METROLOGY LABORATORY

Quality levels to DIN 3962 / AGMA 390.03  
Values in um/Ten-Thousands of an inch

Date: 07.03.1997 05:25

NATIONAL GEAR METROLOGY LABORATORY  
Inspector: PCF  
EMZ 632  
Fbb 018-4/3E

DESIGN UNIT		Lead + Profile Test			
Designation:		$m_n$ 3.175	mm	b 6.35	mm
Part No.:	AMS6260/./.	z 28		$L_\beta$ 90	%
REMARKS:	REF. 20 3RD	$\alpha_n$ 20°0'0''		$d_b$ 83.539	mm
		$\beta$ 0°0'0''			
		$\beta_b$			

Quality	Reqd.Pr: 5 / Le: 5 Act.Pr: 5 / Le: 6				Reqd.Pr: 5 / Le: 5 Act.Pr: 5 / Le: 3						
	4	3	2	1	1	2	3	4			
	Left Flank				tooth	Right Flank					
Tip											
2 : 1											
5 mm											
1000 : 1											
10 μm											
Root											
Limit Value	4	3	2	1	Limit Value	1	2	3	4		
$F_\alpha 0/7$	2.9	3.0	1.9	1.9	2.4   2	0/7	2.6	5.8	2.0	1.2	2.9   5
$f_\alpha 0/6$	3.2	1.2	1.4	1.5	1.8   4	0/6	1.1	3.1	1.6	1.1	1.7   4
$f_{H\alpha} -4.5$	1.6	3.1	1.7	1.3	1.9   5	+4.5	-2.3	-3.7	-7	-2	-1.7   5

Bottom											
8 : 1											
1.25 mm											
1000 : 1											
10 μm											
Top											
Limit Value	4	3	2	1	Limit Value	1	2	3	4		
$F_\beta 0/7$	6.5	3.3	2.0	3.1	3.7   5	0/7	3.6	3.6	2.3	1.9	2.9   3
$f_\beta 0/4.5$	4.9	2.5	1.9	3.0	3.1   6	0/4.5	2.7	2.2	2.0	2.1	2.3   3
$f_{H\beta} -6$	-2.7	-1.4	-3	-2	-1.2   3	+6	.9	1.4	.3	-1.3	.3   1



DESIGN UNIT

PITCH + RUNOUT TEST

8

Part No.: AMS6260/./.

REMARKS: REF. 20 3RD

z = 28

m = 3.175 mm

$\beta = 0^{\circ}0'0''$  R

d = 88.900 mm

Date/Insp.: 07.03.1997/RCF

Reqd. Qual. Limit Value Act. Value Act. Qual.	Left Flank	$f_p$	$f_u$ *	$F_p$	$F_{pz}/8$	Right Flank	$f_p$	$f_u$ *	$F_p$	$F_{pz}/8$	$F_r$	Values in $\mu$ m
		5	5	5	5		5	5	5	5	5	
		5.0	6.0	20.0	12.0		5.0	6.0	20.0	12.0	14.0	
		3.0	3.3	13.9	6.9		2.0	1.3	11.7	5.7	9.6	
		4	3	4	4		2	1	4	3	4	

TOOTH THICK: NOM. VAL. 4.987 Min. 0 Max. 0 MEAS. VAL. 4.857

MAX. T. NO.: 26 \*

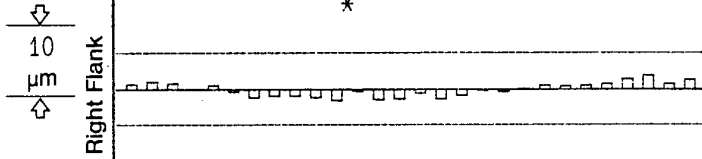

MIN. T. NO.: 11  
MIN. T. NO.: 15 \*

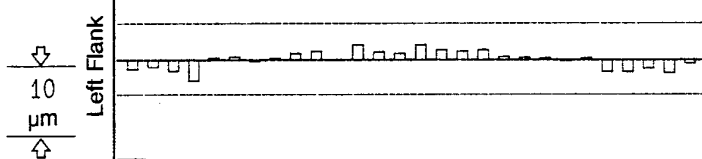

MAX. T. NO.: 4

MAX. T. NO.: 5

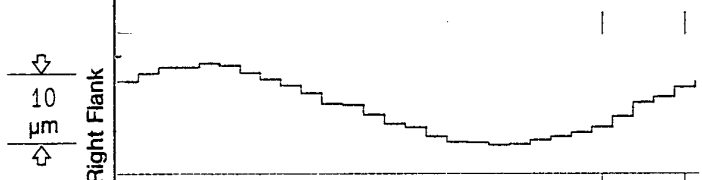

MIN. T. NO.: 19  
MIN. T. NO.: 5

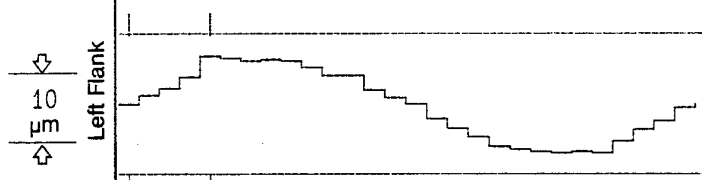

MAX. T. NO.: 24

MAX. T. NO.: 12

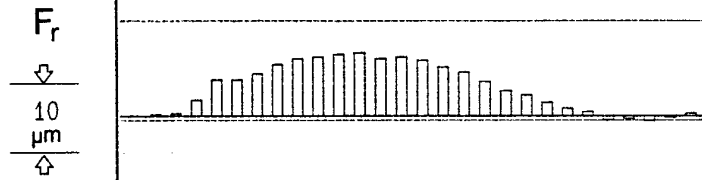

MIN. T. NO.: 26

Quality levels to DIN 3962 / AGMA 390.03  
Values in  $\mu$ m/Ten-Thousands of an Inch

NATIONAL GEAR METROLOGY LABORATORY

HDFLER  
TR pb 014-4 E

DESIGN UNIT

# Lead + Profile Test

9

Designation: .	$m_n$ 3.175 mm	$b$ 6.35 mm
Part No.: AMS6260/./.	$z$ 28	$L_\beta$ 90 %
REMARKS: REF. 23 3RD	$\alpha_n$ 20°0'0''	$d_b$ 83.539 mm
	$\beta$ 0°0'0''	
	$\beta_b$	

Quality	Reqd.Pr: 5 / Le: 5	Act.Pr: 5 / Le: 3	Reqd.Pr: 5 / Le: 5	Act.Pr: 3 / Le: 3
---------	--------------------	-------------------	--------------------	-------------------

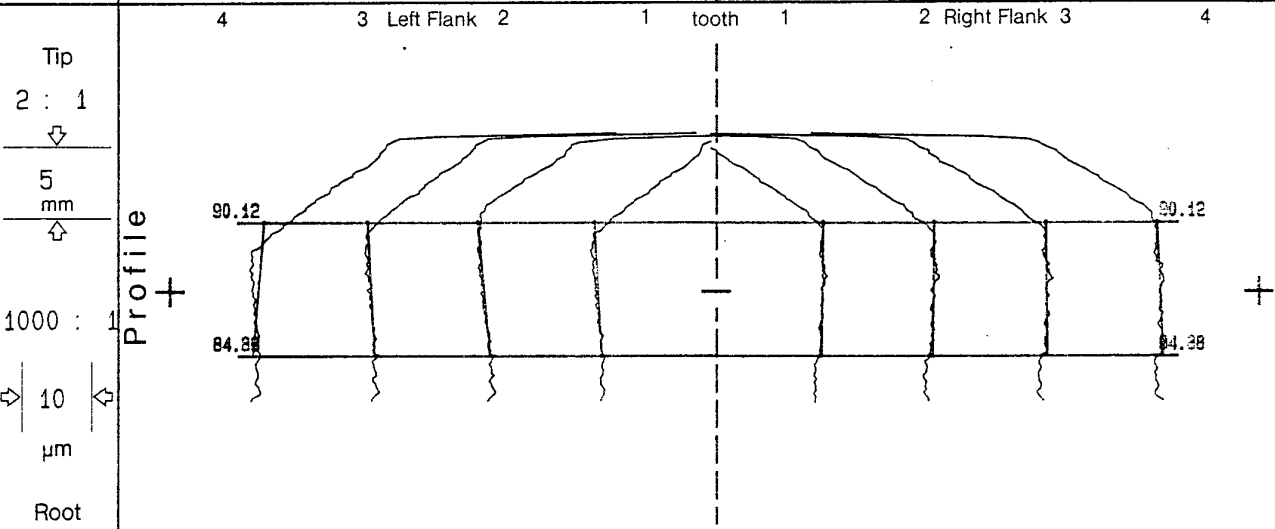

Limit Value	4	3	2	1	Limit Value	1	2	3	4		
$F_a$ 0/7	5.3	1.9	2.1	2.7	3.0 5	0/7	1.3	2.1	2.4	1.5	1.8 2
$f_{ta}$ 0/6	4.7	2.3	1.0	2.9	2.7 5	0/6	1.2	2.2	2.3	1.3	1.8 3
$f_{Htot}$ -4.5	-1.7	1.1	1.8	1.0	.6 3	+4.5	.3	.2	-.2	-.9	-.2 1

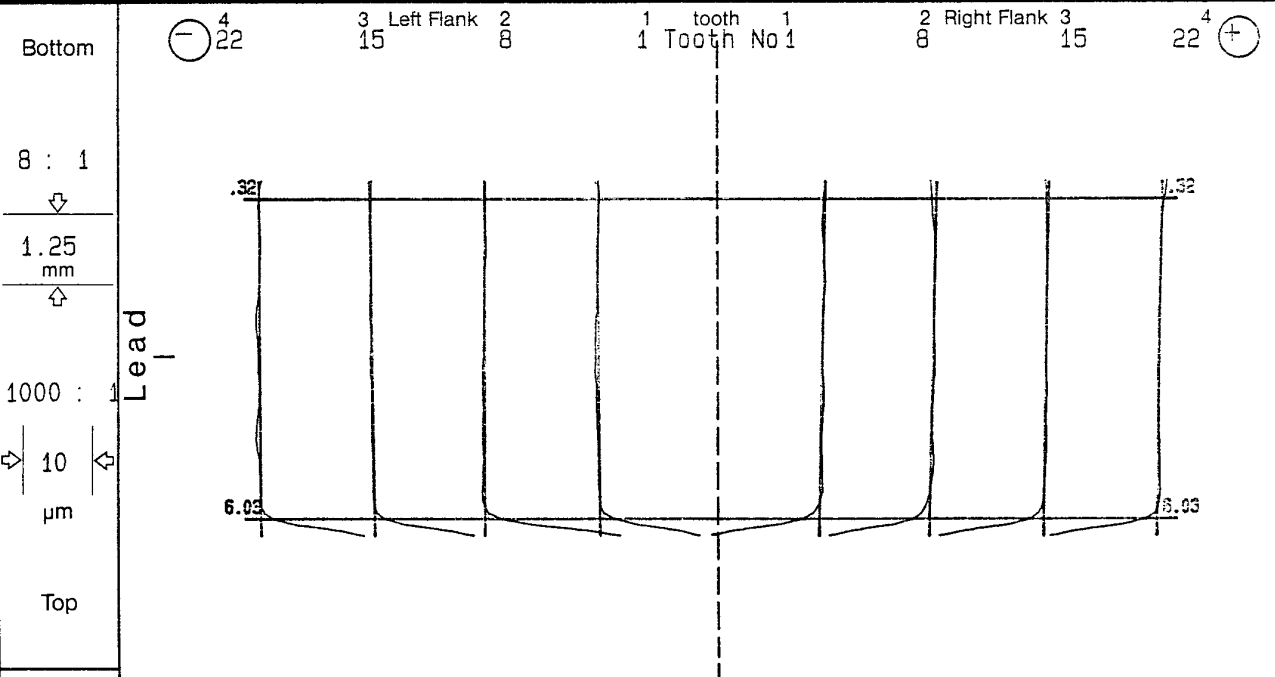

Limit Value	4	3	2	1	Limit Value	1	2	3	4		
$F_b$ 0/7	2.4	2.1	2.7	2.7	2.5 2	0/7	3.3	3.2	2.4	3.1	3.0 2
$f_{tb}$ 0/4.5	2.3	1.8	2.7	2.5	2.3 3	0/4.5	2.7	2.7	2.2	2.3	2.5 3
$f_{Hbt}$ -6	-.2	-.6	.1	-.4	-.3 1	+6	.9	1.0	.7	.8	.9 1

Quality levels to DIN 3962 / AGMA 390.03  
Values in um/Ten-Thousands of an inch

Date: 07.03.1997 05:04

NATIONAL GEAR METROLOGY LABORATORY  
Inspector: RCF  
EMZ 632

HOFLER  
Fpb 018-4/3E

Part No.: AMS6260/. /.

REMARKS: REF. 23 3RD

z = 28    m = 3.175 mm    β = 0°0'0" R    d = 88.900 mm    Date/Insp.: 07.03.1997/RCF

Reqd. Qual. Limit Value Act. Value Act. Qual.	Left Flank	$f_p$	$f_u$ *	$F_p$	$F_{pz}/8$	Right Flank	$f_p$	$f_u$ *	$F_p$	$F_{pz}/8$	$F_r$	Values in $\mu m$
		5	5	5	5		5	5	5	5	5	
		5.0	6.0	20.0	12.0		5.0	6.0	20.0	12.0	14.0	
		2.3	3.2	10.3	5.6		1.9	2.2	10.4	5.2	5.5	
		2	3	3	3		2	1	3	3	2	

Quality levels to DIN 3962 / AGMA 390.03  
Values in  $\mu m$ /Ten-Thousands of an inch

TOOTH THICK:    NOM. VAL.    Min.    Max.    MEAS. VAL.  
4.987    0    0    -    4.877

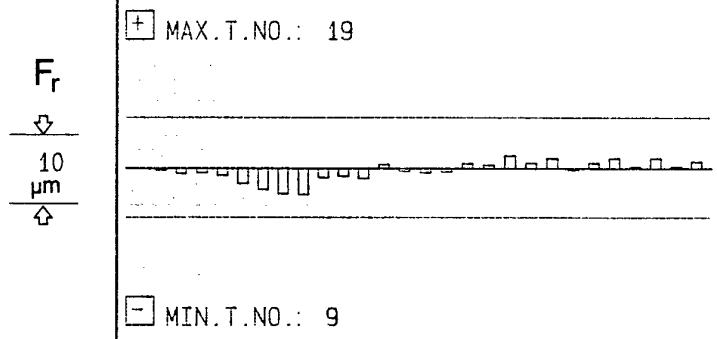
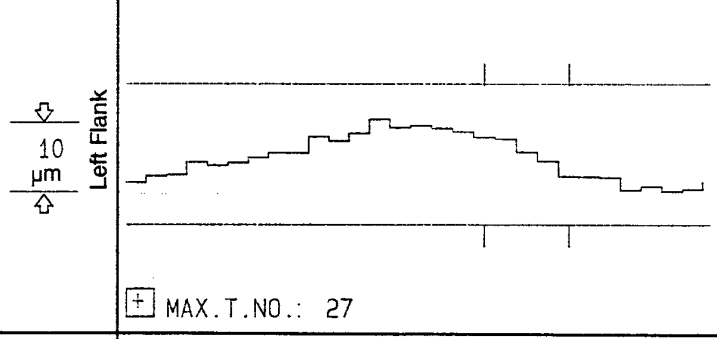
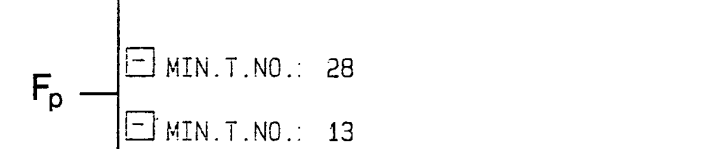
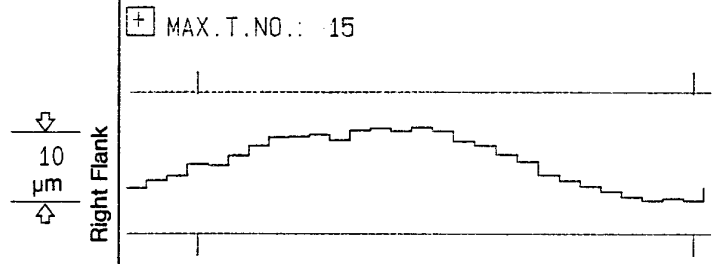
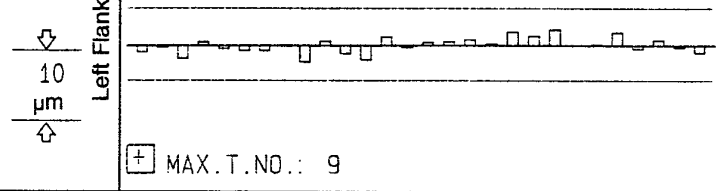
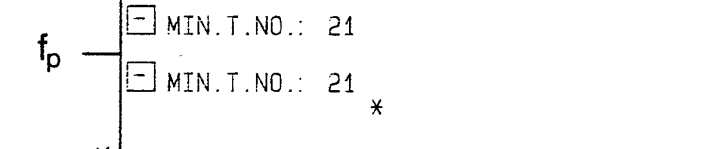
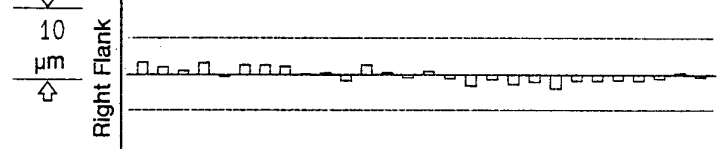

NATIONAL GEAR METROLOGY LABORATORY

HOFLER  
TR pb 014-4 E →

-----  
RESULTS OF THE CALIBRATION  
=====

7 Mar 1997  
04:15:24

PROBE NUMBER 10

PROBE ORIENTATION Y-

CENTER OF THE MACHINE

Xm = -.6566  
Ym = -.1989  
Zm = 197.3903

REAL STYLUS DIAMETER

1.2

MEASURED PROBE DIAMETER

D\_x= 1.2002  
D\_y= 1.2000  
D\_z= 1.2002

PRELOAD

.15

-----  
CALIBRATION FACTOR

X : ( + ) : 1.0106  
      ( - ) : 1.0027  
Y : ( + ) : .9973  
      ( - ) : .9973  
Z : ( + ) : 1.0464  
      ( - ) : 1.0394  
-----

## APPENDIX 5

### FINAL SURFACE PROFILES OF GEARS

AMS6260	#11
"	#15
"	#20
"	#23

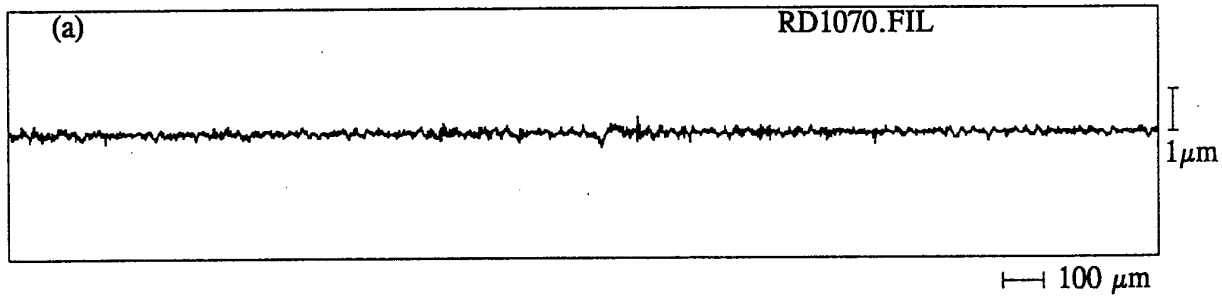

NASA gear #11 (polished) tooth 1/left,  $x = -.1\text{mm}$ ,  $y = 3.175\text{mm}$  (filtered:  $R_a = 0.053\mu\text{m}/0.08\text{mm}$  cut)

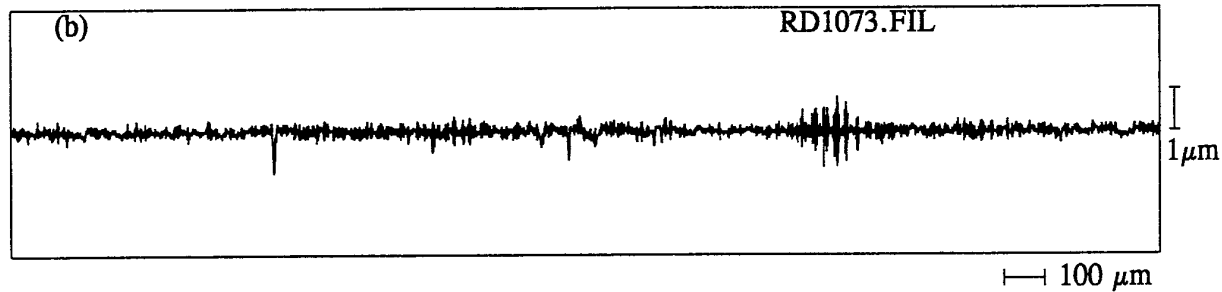

NASA gear #11 (polished) tooth 1/right,  $x = -.1\text{mm}$ ,  $y = 3.175\text{mm}$  (filtered:  $R_a = 0.096\mu\text{m}/0.08\text{mm}$  cut)

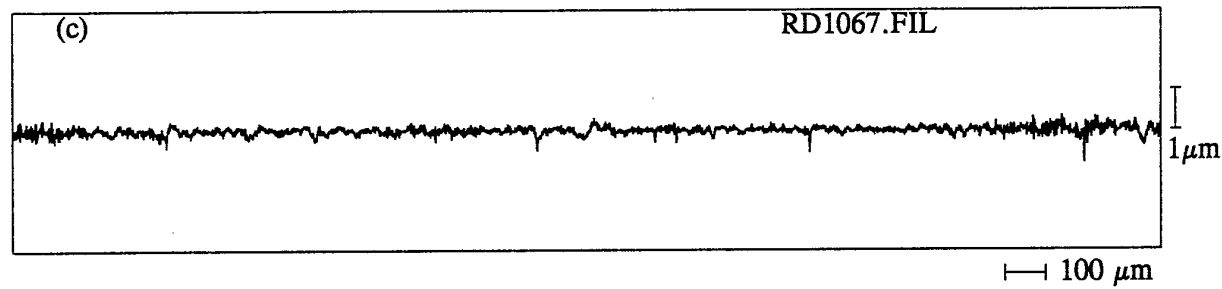

NASA gear #11 (polished) tooth 15/left,  $x = -.1\text{mm}$ ,  $y = 3.175\text{mm}$  (filtered:  $R_a = 0.071\mu\text{m}/0.08\text{mm}$  cut)

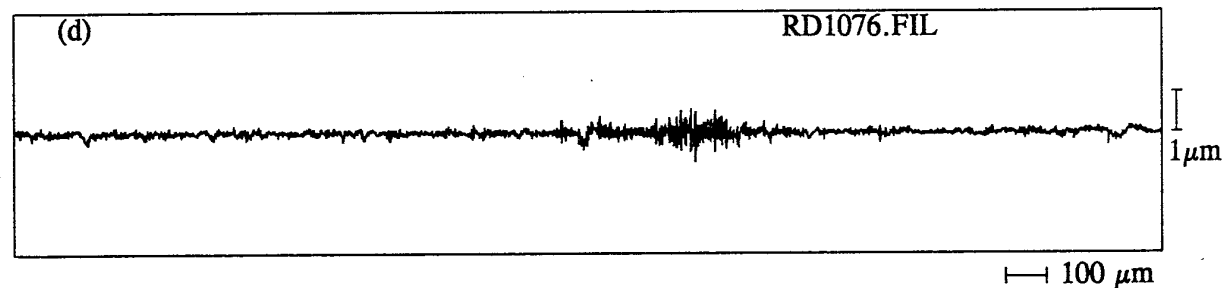

NASA gear #11 (polished) TOOTH 15/right,  $x = -.1\text{mm}$ ,  $y = 3.175\text{mm}$  (filtered:  $R_a = 0.067\mu\text{m}/0.08\text{mm}$  cut)

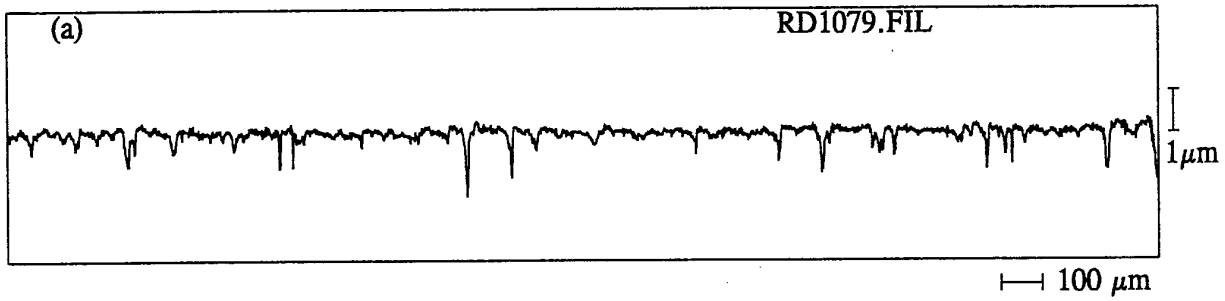

NASA gear #15 (polished) tooth 1/left,  $x = -.1\text{mm}$ ,  $y = 3.175\text{mm}$  (filtered:  $R_a = 0.101\mu\text{m}/0.08\text{mm}$  cut

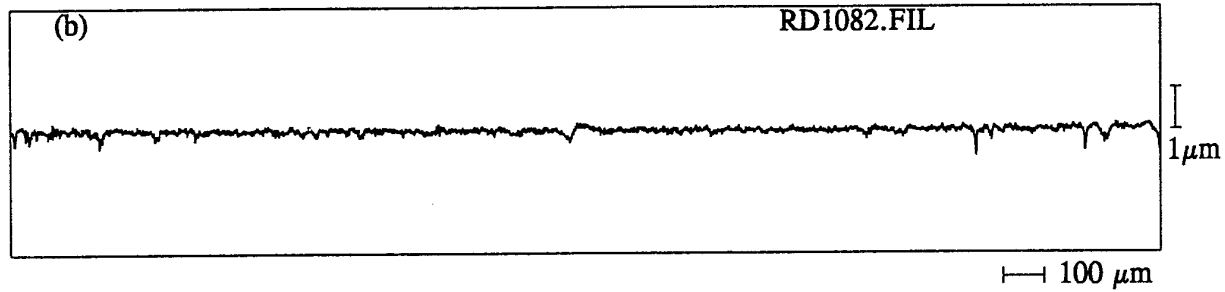

NASA gear #15 (polished) tooth 15/left,  $x = -.1\text{mm}$ ,  $y = 3.175\text{mm}$  (filtered:  $R_a = 0.053\mu\text{m}/0.08\text{mm}$  cu

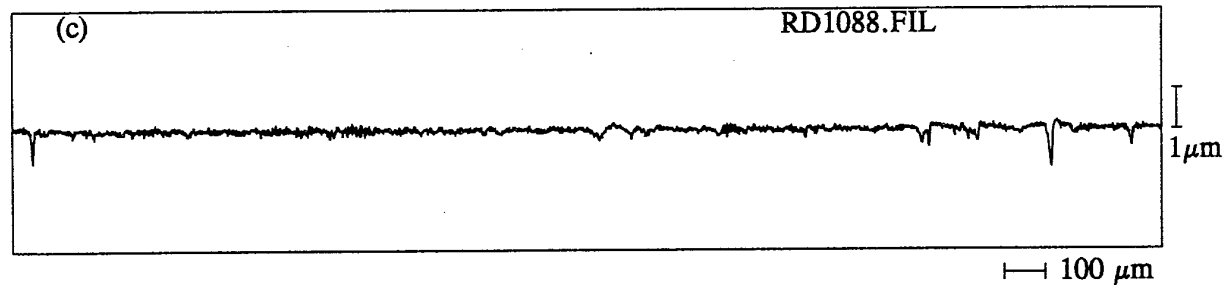

NASA gear #15 (polished) tooth 15/right,  $x = -.1\text{mm}$ ,  $y = 3.175\text{mm}$  (filtered:  $R_a = 0.055\mu\text{m}/0.08\text{mm}$  c

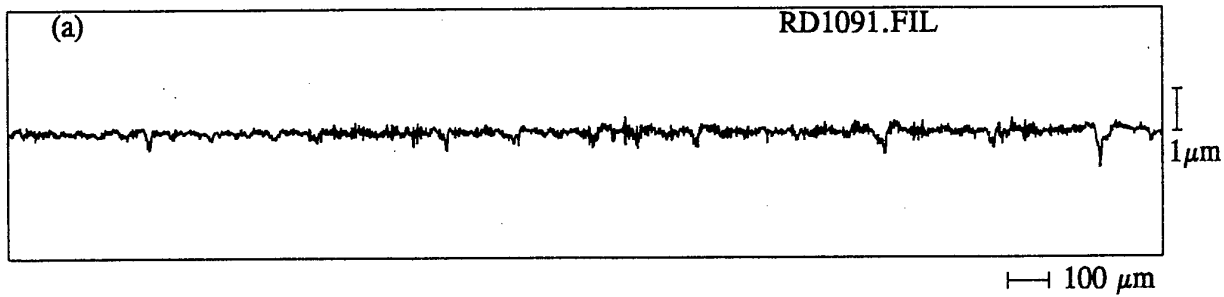

NASA gear #20 (polished) tooth 1/left,  $x = -.1\text{mm}$ ,  $y = 3.175\text{mm}$  (filtered:  $R_a = 0.076\mu\text{m}/0.08\text{mm}$  cut)

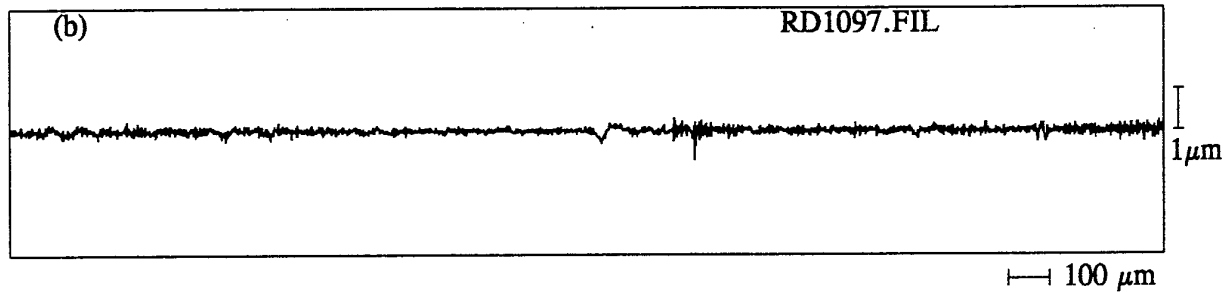

NASA gear #20 (polished) tooth 1/right,  $x = -.1\text{mm}$ ,  $y = 3.175\text{mm}$  (filtered:  $R_a = 0.057\mu\text{m}/0.08\text{mm}$  cut)

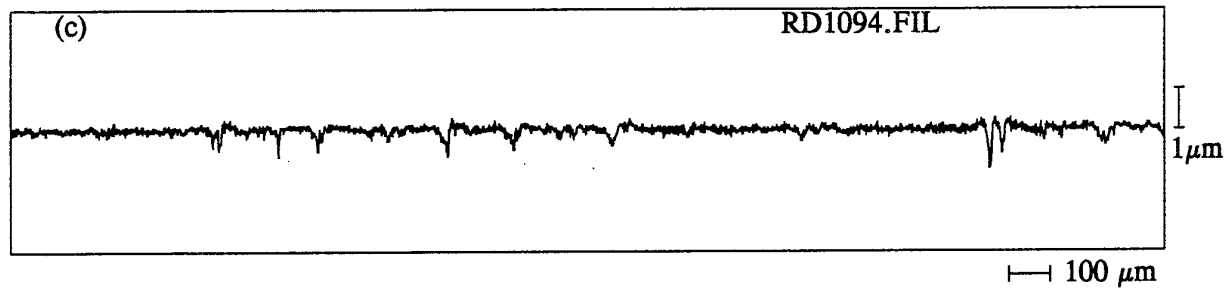

NASA gear #20 (polished) tooth 15/left,  $x = -.1\text{mm}$ ,  $y = 3.175\text{mm}$  (filtered:  $R_a = 0.078\mu\text{m}/0.08\text{mm}$  cut)

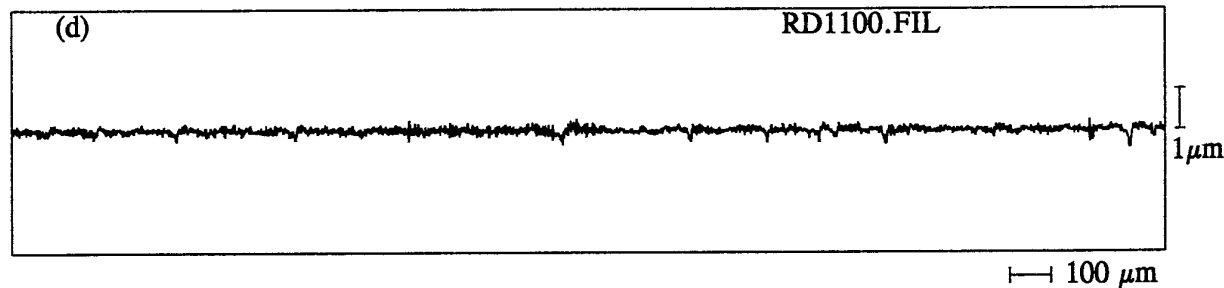

NASA gear #20 (polished) tooth 15/right,  $x = -.1\text{mm}$ ,  $y = 3.175\text{mm}$  (filtered:  $R_a = 0.059\mu\text{m}/0.08\text{mm}$  cut)



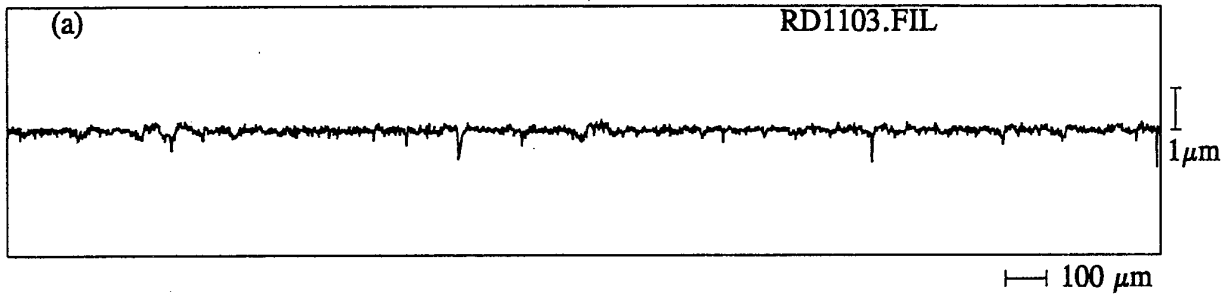

NASA gear#23 (polished) tooth1/left,  $x=-.1\text{mm}$ ,  $y= 3.175\text{mm}$  (filtered:  $R_a=0.063\mu\text{m}/0.08\text{mm}$  cutoff)

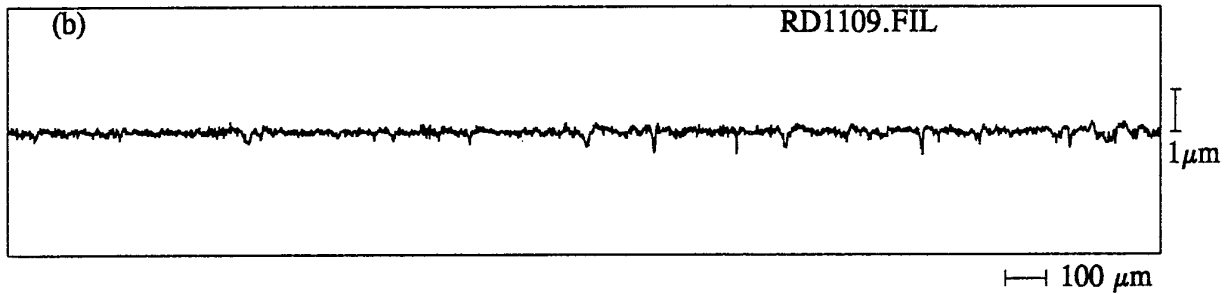

NASA gear #23 (polished) tooth 1/right,  $x=-.1\text{mm}$ ,  $y= 3.175\text{mm}$  (filtered:  $R_a=0.064\mu\text{m}/0.08\text{mm}$  cutoff)

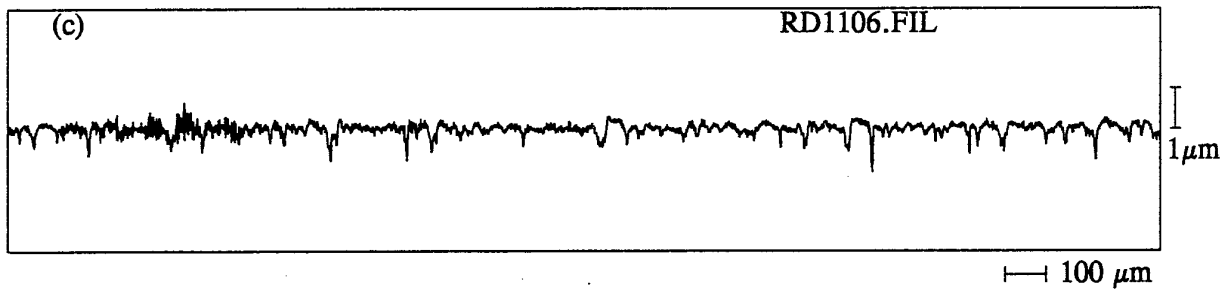

NASA gear #23 (polished) tooth15/left,  $x=-.1\text{mm}$ ,  $y= 3.175\text{mm}$  (filtered:  $R_a=0.106\mu\text{m}/0.08\text{mm}$  cutoff)

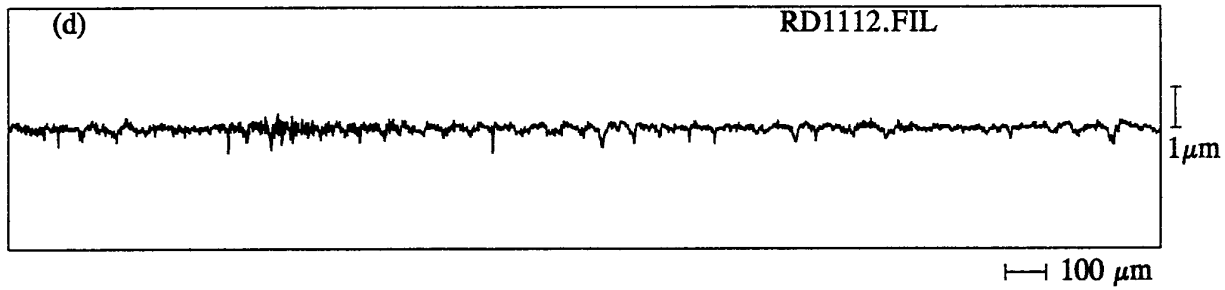

NASA gear #23 (polished) tooth15/right,  $x=-.1\text{mm}$ ,  $y= 3.175\text{mm}$  (filtered:  $R_a=0.073\mu\text{m}/0.08\text{mm}$  cutoff)