

A HARD AND DEEPLY BURIED TARGET DEFEAT CONCEPT

Nancy F. Swinford*
Dean A. Kudlick†

Lockheed Martin Missiles & Space
Sunnyvale, CA 94088

19961213 060

Abstract

A Mission Need Statement (MNS) written by the United States Strategic Command and the Air Force's Air Combat Command (Reference 1) has generated the current study of a Hard and Deeply Buried Target Defeat Capability, which combines target construction and purpose with weapon technologies and capabilities to determine cost-effective solutions for hardened target defeat. A promising solution consists of a conventional Submarine Launched Ballistic Missile (SLBM) that delivers a modified, existing reentry body (RB) aeroshell encasing a unitary penetrator. The accuracy is controlled by a tightly coupled Global Positioning Satellite receiver and Inertial Measurement Unit (GPS/IMU) system.

This paper examines the benefits and challenges of the SLBM-delivered RB. The selected control system is discussed relative to the performance requirements imposed by the aeroshell size and packaging constraints. One of the major challenges for an SLBM system is slowing down to meet the penetrator constraints. Current RB aerodynamic performance capabilities, trajectory shaping required to meet the penetrator impact conditions, and the control system concept are reviewed. Finally, future areas to be investigated are discussed.

Introduction

Penetration efficiency is basically dictated by two penetrator parameters: the ratio of total weight to cross-sectional area and the impact

velocity. Air dropped penetrators can reach velocities in the range of 1500-1650 fps, and boosted penetrators can reach approximately 2500 fps. Boosting to higher velocities is possible, but the percentage of the weapon system devoted to propellant starts to become unattractive.

Faster penetration, with impact velocities greater than can be achieved via air drop, translates directly to dramatic increases in penetration depth without the need for larger and heavier weapons. This is appealing for SLBM-delivered penetrators, where higher velocities are inherent and penetrator size is a constraint.

The current study consists of a SLBM that delivers a modified aeroshell encasing a unitary penetrator warhead. The aeroshell is based on an existing, fully developed and proven RB design. Use of existing hardware helps reduce the system cost, and accuracy is obtained by using a tightly coupled GPS/IMU system during reentry to provide navigation for correction of boost errors. This concept employs technologies which are currently available or require minimum development time and integrates these technologies into a system which is compatible with missile packaging constraints and aeroshell environmental requirements. The intention of the concept is to increase penetrator impact velocity and resulting penetration depth, with minimum cost and modifications to the original RB.

The existing aeroshell is modified by increasing the length with an aft extension. The extension is used to house the control system, while allowing the penetrator length to be

* Aerodynamics Engineer, AIAA Member

† Aerodynamics Staff Engineer, AIAA Member

DISTRIBUTION STATEMENT A

Approved for public release
Distribution Unlimited

maximized. To reduce the cost of the avionics package, a low performance IMU with GPS updates is incorporated. A GPS-augmented guidance package provides significant improvement in accuracy at relatively low cost.

SLBM delivery measurably improves penetrator system performance compared to other typical weapon systems. Measures of this improvement include delivery at long range, high penetrator impact velocities, smaller required penetrator size, use of existing hardware, and fast response time. This increased performance allows for a broader application of this concept. High penetrator impact velocities translate into requirements for smaller and lighter penetrators with increased penetration depths, and fast response time is desirable in any situation.

Delivery System

Constraints

The SLBM delivery system imposes various constraints on the aeroshell and the penetrator, and these constraints limit the capabilities of the concept in various ways. The MNS also imposes constraints on the concept. It is not a new or unusual challenge in the SLBM field to begin a concept with given volume constraints on the weapon and work backwards to maximize the resulting concept capabilities.

The SLBM payload volume limits the size of the aeroshell, and the aeroshell volume limits the size of the penetrator. The aeroshell base diameter and length is limited by SLBM nose fairing shape and dynamic clearances. Hence, the maximum allowable volume is fixed.

To survive the impact against a hardened target the penetrator must be delivered within specific parameters for impact angle-of-obliquity (AoO), angle-of-attack (AoA), and velocity. Penetrator design constraints must take into consideration the dimensions, center of gravity, and packaging constraints of the RB and all other guidance and control components. Reference 2 provides details for using a design selection tool developed by Lockheed Martin Missiles and Space (LMMS) to address the requirements and constraints of the penetrator design process.

Depth of penetration is based on two primary parameters; weight to cross section area ratio and impact velocity. For a constant velocity, the more weight for a small cross section, the deeper the penetration. Also, the more force against a small cross section area, the deeper the penetration. Recent testing with small penetrators shows increased penetration efficiency at impact velocities of up to 4000 fps in 5000 psi reinforced concrete. Above 4000 fps there is high risk of penetrator failure from case erosion.

Impact AoO (angle measured from the velocity vector to a line perpendicular to the target) of 20 degrees is recognized as a nominal limit for high velocity impact. When combined with an AoA (angle measured from the velocity vector to the axis of the warhead) of up to 2 degrees, the 20 degree AoO places severe bending loads on the warhead and severe lateral acceleration loads on the fuzing system.

To meet the MNS requirements, the penetrator impact velocity must be no less than 3000 fps and penetrator material constraints limit it to approximately 4000 fps. However, as close as possible to 4000 fps is the desirable impact velocity. The minimum required penetrator range is 2000 NM, however 3000 NM is the goal.

The existing RB aeroshell is modified by increasing the length with a 4 degree half-cone angle, 12 inch aft extension (Figure 1). This extension is used to house the control system and accommodate the longest possible penetrator. The modified aeroshell is within the length and base diameter limitations imposed by the SLBM; however, an increase in individual RB weight dictates that four, instead of eight, RBs can now be delivered by the SLBM.

Aeroshell Control System

The goals of the control system chosen for the RB are to provide the impact conditions required for the penetrator warhead and provide adequate vehicle control, while minimizing the complexity and weight of the system. The most critical parameters affecting the control system performance are: control system weight, response time, technical risk, and aerothermal survivability. In general, aerodynamic controls

experience aerodynamic drag, aerothermal heating, and erosion due to contaminants such as rain or dust in the atmosphere. Because of their sensitivity to dynamic pressure, control system operation is limited to within the endoatmosphere for control effectiveness.

Aerodynamic controls such as airvanes, retractable/extendable/linear flaps, spoilers, ram air, swivel-noses, jet interaction (JI), and canards were considered (Figure 2). Based on the drag enhancement, control effectiveness, simplicity, survivability, and the favorable aerodynamic characteristics, an extended body flap control system was selected. Various options exist regarding the number of flaps; however, for this study, a six flap drag brake control system (DBCS) was selected. The DBCS generates adequate control to slow the RB to within the desired penetrator impact velocities and provides sufficient drag and control for trajectory shaping and roll control. The DBCS control surfaces must be stowed during boost in order to fit on the missile. The windward and leeward flaps are movable and are used for trim, roll, and drag control. The side flaps, which provide additional drag, are locked in place and receive the highest heating.

Aerodynamic Properties

Because an existing aeroshell is used for this concept, the aerodynamic properties cannot be optimally tailored for the concept mission. An ideal design would incorporate characteristics that would allow the vehicle to experience small changes in the static margin with respect to changes in Mach number and AoA. Once the trajectory condition used to determine the center of gravity location for minimum stability is established, any change in static margin at other conditions means that the RB is flying with more stability than required. The greater the static margin shift, the greater the excess stability during the other segments of the trajectory. Lower stability allows the vehicle to be controlled more easily, so large static margin changes will require a larger control system.

Generally, biconic configurations exhibit less center of pressure shift with Mach number and AoA than conical configurations. Since only slight modifications can be made to the existing

aeroshell, the extension must be used to create a biconic vehicle. A half-cone angle extension that is larger than the existing aeroshell provides more stability, but is more sensitive to changes in Mach number than a smaller half-cone angle extension. The 4 degree half-cone angle extension was selected to maximize volume within the booster constraints, but it also produces less static margin change than would be seen with a larger half-cone angle.

The aerodynamic properties also vary with respect to the nosetip shape that is used. Sharp and blunt nosetip shapes were compared for use on the RB.

The advantages of using a sharp nosetip include reduced sensitivity of the static margin with respect to changes in Mach number and AoA and reduced static margin which allows greater DBCS effectiveness. With a sharp nosetip, there are fewer losses behind the bow shock, and the shock near the body is at a shallower angle. These characteristics translate to higher dynamic pressures near the surface, which subsequently translate to higher effectiveness of the DBCS. A sharp nosetip also mitigates plasma, which causes LOS to occur at a lower altitude than if a blunt nosetip were used.

The disadvantage of using a sharp nosetip is that it produces less vehicle drag than a blunt nose. High drag is required in order to adequately slow the RB, and any velocity reduction not produced by body drag must be obtained by maneuvering.

It is not known whether the benefits of using a sharp nosetip, which produces higher dynamic pressures on the vehicle and causes the DBCS to be more effective, outweigh the benefits of using a blunt nosetip, which produces higher drag on the vehicle as a whole. Some initial studies indicate that the sharp nose requires smaller control surfaces primarily due to the fact that it can operate over more of the trajectory at lower static margin. This is because it has less static margin shift with Mach number and AoA.

Trajectory Shaping

The capabilities of the concept are based on the trajectories that can be flown which result in

successfully meeting the required penetrator impact conditions. In order to understand the maneuvering requirements, first consider performance from the standpoint of the ballistic RB relative to a reentry V - γ map (Figure 3). This figure shows reentry velocity as a function of reentry flight path angle. The dashed lines indicate ranges in thousands of nautical miles. The light solid line indicates the reentry conditions of an RB that will ballistically impact at an angle of 70 degrees, or 20 degrees AoO. Below and to the left of this line, steeper impact angles occur. The two heavier solid lines show the reentry conditions where the impact velocity requirement is met ballistically. It can be seen that there is only a very small region at short ranges where both impact constraints are met.

Changing the ballistic coefficient (β) alone does not place the RB on the left side of the V - γ map, where the higher ranges are realized. For an RB with a lower β , the impact velocity lines will occur at higher reentry angles, but the impact angle curve will shift only slightly. This has the effect of moving the area of acceptable impact conditions up and to the right on the V - γ map. The right side of the map has shorter ranges, so a ballistic RB, even with lower β , will not achieve the range objective. For this reason, using the flaps as drag brakes alone will not meet the range requirements. While the drag brakes will expand the area on the V - γ map that reach the impact conditions (because changing brake deployment changes the effective β), the operational area will be below the required range.

Flaps to Brake and Maneuver

As previously discussed, there are two impact requirements imposed on the RB: a steep impact angle and a low impact velocity. If the RB flies at a shallow gamma, it will impact at an acceptable velocity but the impact gamma will be too shallow. If the RB flies at a steep gamma, it will come in at an acceptable impact gamma but at a short range.

A pull-down (PD) maneuver controls the impact angle (Figure 4). A PD allows the RB to reenter the atmosphere at a shallow gamma. Using the drag flaps to pull the vehicle down, the

impact angle is increased during the course of the trajectory to meet the required AoO.

A pull-up (PU) maneuver controls the impact velocity. A PU allows the RB to reenter the atmosphere at a higher velocity. Using the drag flaps to pull the vehicle up, the impact velocity is decreased during the course of the trajectory. However, the RB is limited as to how high the reentry velocity can be because of the surface area of the drag flaps. At the higher velocities and steeper gammas, the drag brakes may not have a large enough surface area to turn the RB enough to slow it down before impact.

A pull-down maneuver controls the impact angle, and a pull-up maneuver controls the impact velocity. Therefore, a pull-up pull-down (PUPD) maneuver controls both the impact angle and the impact velocity (Figure 5). A PUPD maneuver theoretically allows the RB to fly anywhere on the V - γ map while meeting the required impact conditions, provided the RB has the required control capability and can withstand the large lateral accelerations. The pull-up segment places the RB in the atmosphere for longer periods of time. This causes the RB to experience shallow gamma trajectory conditions, thereby slowing the RB to the required impact velocity conditions. The pull-down segment allows the RB to meet the impact gamma conditions. The trajectory requirements can be met by incorporating a PUPD, which can be achieved using a six flap control system.

Reentry Gamma

A shallow reentry gamma requires less slowing and more turning, whereas a steep reentry gamma requires more slowing and less turning, to achieve the desired RB impact conditions. However, if a PUPD maneuver is required for the steep trajectory, the pull up will shallow the flight gamma and the advantage of the steep initial reentry gamma will be lost. Therefore, less maneuvering is required for shallow reentry angles than steep ones. However, the more shallow the trajectory, the longer the flight time. A longer flight time translates to higher heating loads on the RB. It is also difficult for the missile to achieve a very shallow trajectory, so there is a practical limit as to how shallow the initial reentry angle can be. There is an optimum reentry angle for a given

concept that minimizes downtime and maneuvering requirements.

Drag Brakes

The advantages associated with using drag brakes in combination with a PD or PUPD maneuver include a reduction in time of flight to impact and a reduction in the necessary trim AoA. Drag brakes reduce the flight time by requiring a shorter pull up maneuver. A shorter flight time is advantageous to the heat shield, because the less time the RB is in flight, the less time the RB is exposed to a high heating environment. The existing RB heat shield is determined to adequately perform with drag brakes, but it fails if drag brakes are not used.

A smaller required trim AoA is beneficial in three areas: drag brake size, thermal heating, and lateral acceleration. If less trim is required, a smaller control surface, or drag brake area, is needed. Because the RB is at a smaller AoA, less trim produces lower thermal heating of the aeroshell. Finally, less required trim decreases the lateral g's experienced by the RB structure and electronics. This is especially important to the performance of the IMU, which is highly sensitive to the magnitude of the lateral g's. An inexpensive IMU is more sensitive to lateral g's than a more costly IMU, and high lateral g's may render an inexpensive IMU useless.

Control System Concept - Six Flaps

The control system consists of a six flap drag brake design (Figure 6). The two flaps on the sides act purely as drag brakes, and the other four flaps are used for trim and roll control. Six flaps provide zero AoA at impact, as well as more drag control flexibility. The six flaps are approximately the same size, however the shape may be optimized for drag or pitch and roll control. The six flaps are stowed to begin with and are deployed after separation of the RB from the missile bus. Deploying the flaps may be delayed until later in the trajectory to avoid excessive thermal heat soak.

Maximum trim occurs when two of the trim control flaps are completely deployed, and two are completely stowed. There are two ways to provide intermediate trim control to allow the RB to go from maximum trim to zero AoA: either the

flaps that are initially deployed are stowed, or the flaps that are initially stowed are deployed. The first method minimizes the heating on the windward flaps, which simplifies the thermal problems of ablation and heat soak to the flaps. Ablation decreases the flap size, which requires the initial flap size to be either larger in surface area or to extend deeper into the RB such that more flap material can be deployed as it is ablated during flight. Thermal heat soak is a problem because the flaps are made from carbon-carbon, which has a very high thermal conductivity. This requires that the internal components be sufficiently insulated against the high temperatures experienced by the flaps. The second method provides maximum drag with less maneuvering of the RB. The second trim control method is the preferred method of the two, provided the thermal issues can be resolved, for most of the V- γ map where maximum slow-down is required.

Maneuvering RBs are typically designed with extra heat shield material on the windward ray of the body. Ballistic bodies spin during flight and have no preferential AoA; therefore, except for asymmetries that occur during flight, heating is essentially uniform on the body. Consequently, all sides of a ballistic body have the same thickness of insulation. Since the concept incorporates an existing ballistic aeroshell, there is no extra insulation on a particular side of the body.

The RB will be pulling sizable trim angles and will have high heating on one side of the body. Maneuvering the RB increases the time in flight, which also increases the heating on the body. However, it is desirable to heat both sides of the body evenly. The two sets of pitch flaps allow the windward ray to be changed 180 degrees. This can be achieved by switching the tasks of the four flaps that are used for trim control. The two flaps that are used for drag become the control brakes, and the two flaps that are used for control become the drag brakes. This switches the side that receives the highest heat soak by 180 degrees. This can most easily be accomplished during the switch from the PU maneuver to the PD maneuver, since the trim direction is changed by 180 degrees at this time.

In the cases that have been analyzed, if the windward ray is not changed, the aeroshell temperature exceeds the capability of the heat shield which will subsequently fail. However, if the windward ray is shifted at the transition from pull-up to pull-down and the side flaps are used as drag brakes, the existing aeroshell is adequate to complete the mission.

such as increasing the weight to cross sectional area, increasing the effectiveness of the defeat mechanism against the target, investigation of new materials that will enable higher velocities without nose erosion or case failure, and control of the trajectory of the warhead as it travels through the target's protective covering of concrete, rock, or earth.

Future Areas to be Investigated

A number of areas need to be investigated before this concept can proceed. The major areas where work is required are: the control system, GPS reception with plasma reduction techniques, tightly coupled GPS/IMU performance under high g loading, and high impact velocity penetrator performance.

More analyses of the drag flaps are required to optimize the control system design and achieve the best performance for the lowest cost. The flap shapes need to be optimized and thermal insulation and control actuator designs developed. Also, steering laws need to be designed to provide the required control to satisfy the impact constraints for the penetrator and still meet the accuracy objectives. Ground and flight tests will be required to verify the design solutions.

The advantage of the sharp nosetip for reduced plasma attenuation during reentry has already been flight tested. It has demonstrated the capability of maintaining GPS lock to lower altitudes. More work is required to further reduce the altitude of LOS. Also, the effect of the drag flaps on GPS reception needs to be investigated.

Flight experiments are already planned to examine the navigation accuracy of a tightly coupled GPS/IMU system under reentry environments. However, these initial flights will be basically ballistic, and more tests will be required to evaluate the capability of this system under high lateral g loadings. The ability to maintain GPS lock while maneuvering will be an important consideration.

To keep pace with the ever increasing target hardening by potential adversaries, advances in penetrator technology must address key areas

References

1. "Hard and Deeply Buried Target Defeat Capability", SECRET, CASMNS 317-92, May 1994.
2. Huang, J.T. and Phillips, J.S., "Penetrator Design Optimization Method", Lockheed Missiles & Space Co., Inc., Sunnyvale, CA, H04126 AIAA.

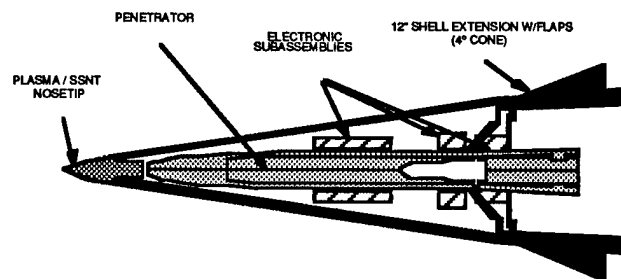

*DRAWING NOT TO SCALE

Figure 1. Modified Aeroshell Configuration

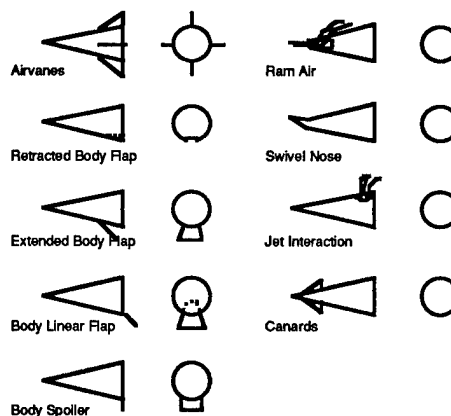

Figure 2. Control System Configurations

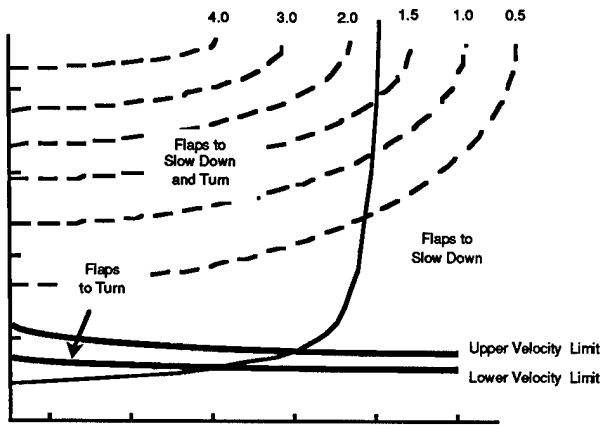

Figure 3. V- γ Map Constraints

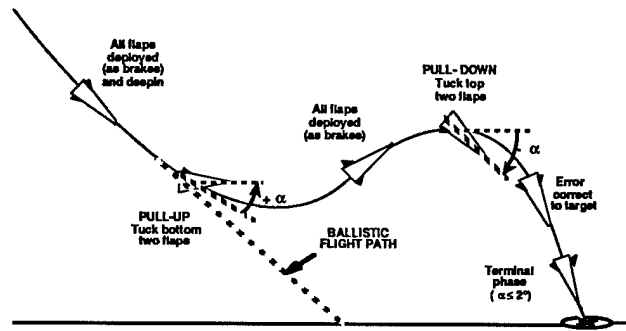

Figure 5. Pull-Up, Pull-Down (PUPD) Maneuver

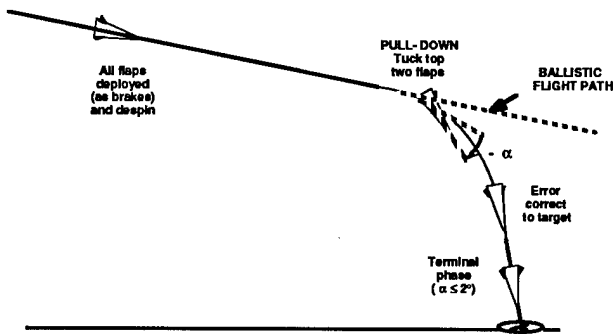

Figure 4. Pull-Down (PD) Maneuver

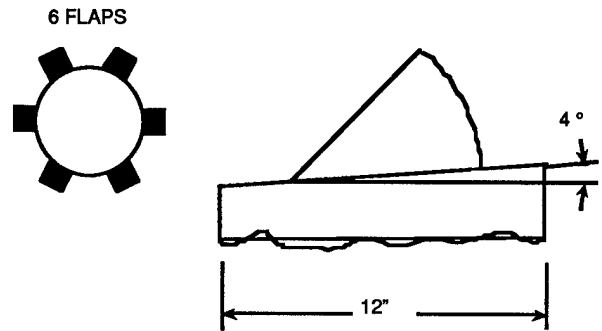
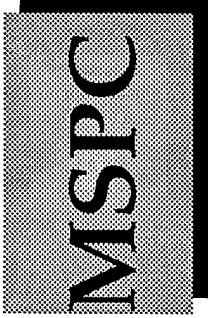

Figure 6. Six Flap Drag Brake Control System (DBCS)



A Hard and Deeply Buried Target Defeat Concept

AIAA MISSILE SCIENCES CONFERENCE

Nancy Swinford
Dean Kudlick

5 Dec 1996

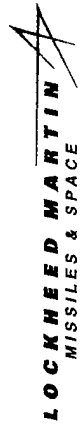

MSPC

Advantages of Concept

- **Delivery at Long Range**
- **High Penetrator Impact Velocities**
 - **Smaller and Lighter Penetrators**
 - **Increased Penetration Depths**
- **Use of Existing Hardware**
- **Fast Response Time**

MSPC

Modified Aeroshell Configuration

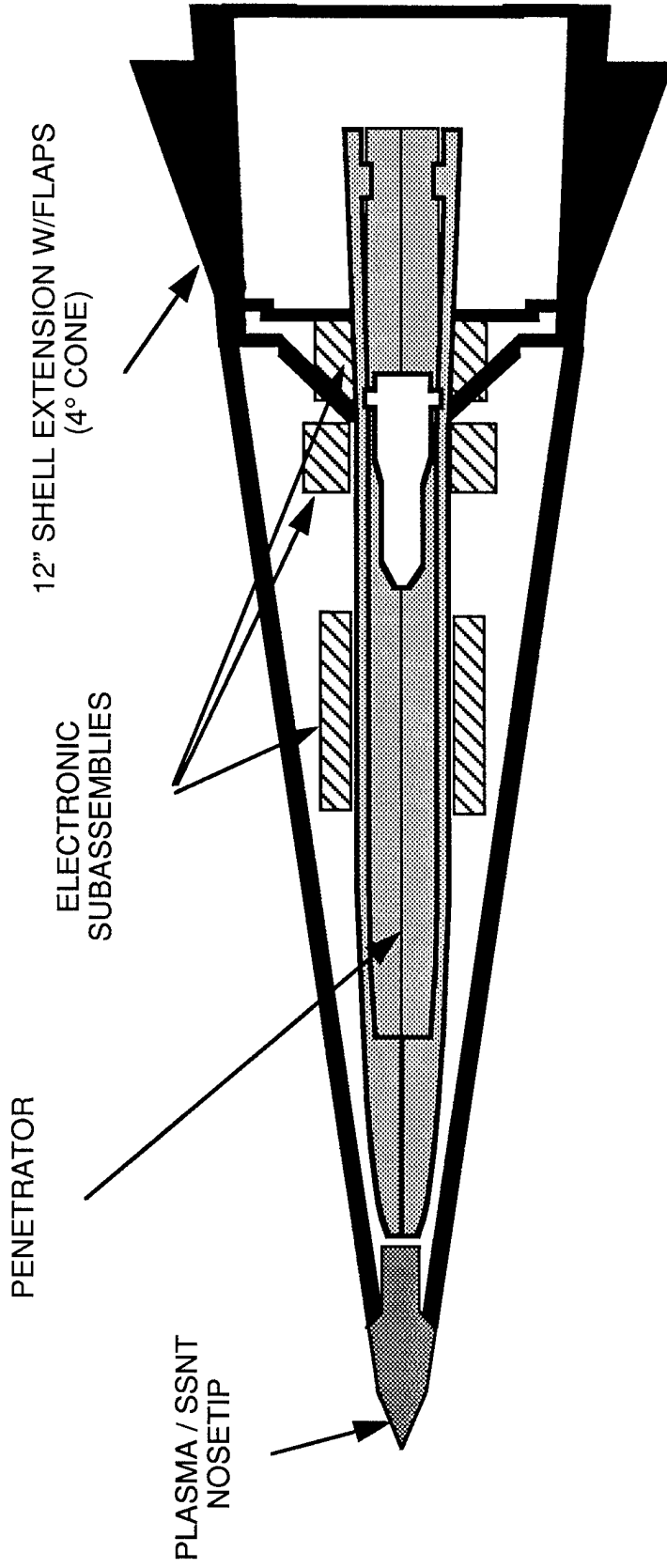

* DRAWING NOT TO SCALE

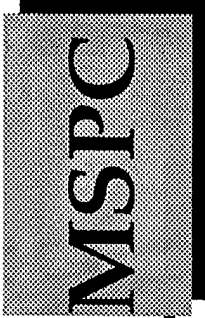

Control System Configurations

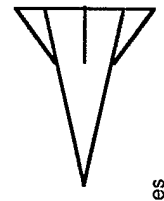

Airvanes

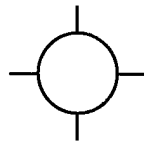

Ram Air

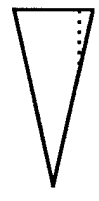
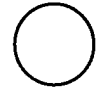

Retracted Body Flap

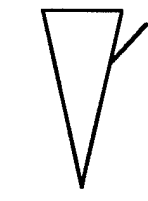

Extended Body Flap



Swivel Nose

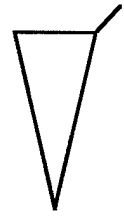

Body Linear Flap

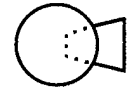

Jet Interaction

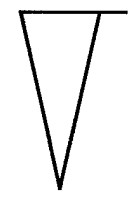
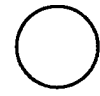

Body Spoiler

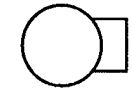

Canards



MSPC

V-γ Map Constraints

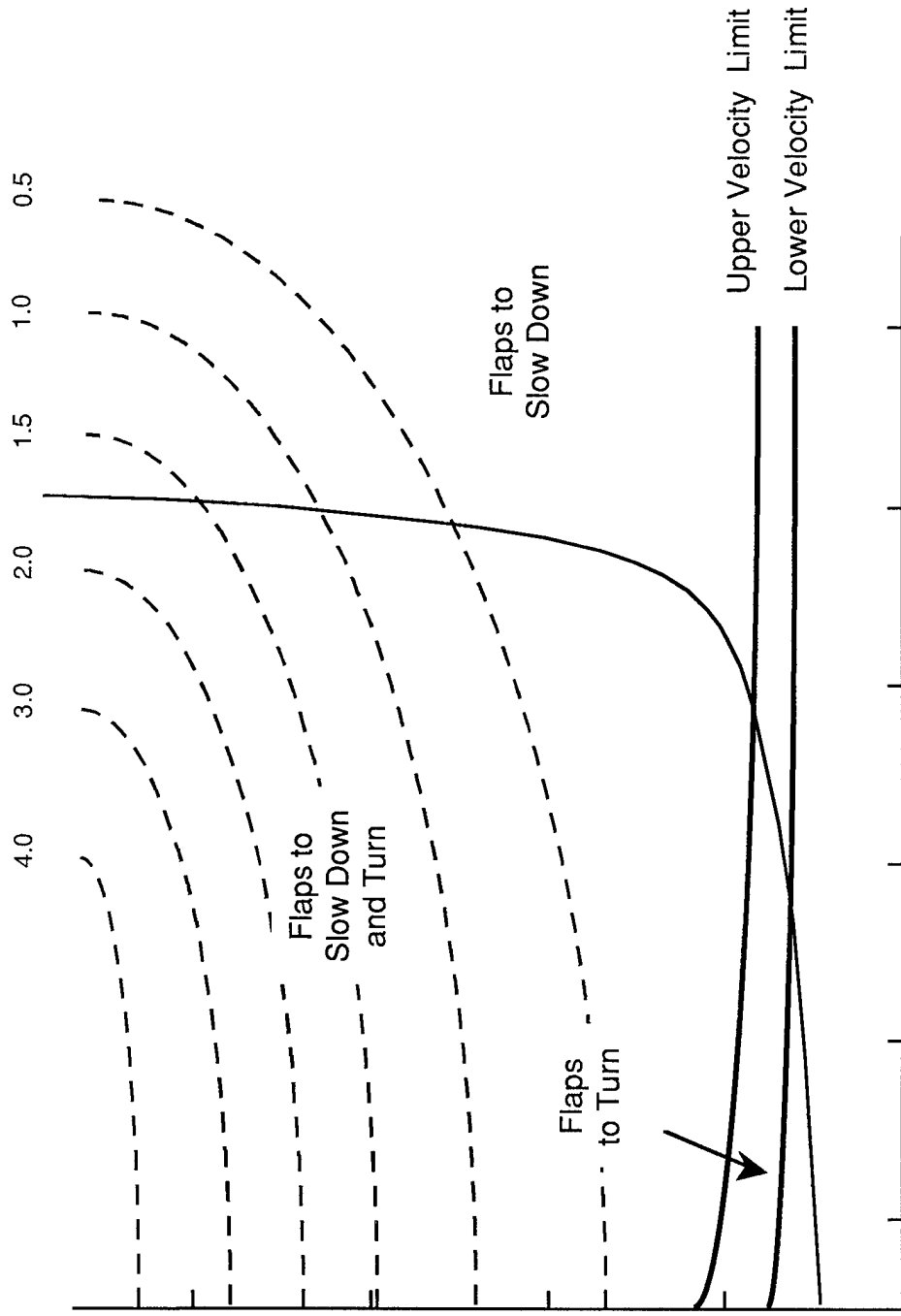

MSPC

Pull Down (PD) Description

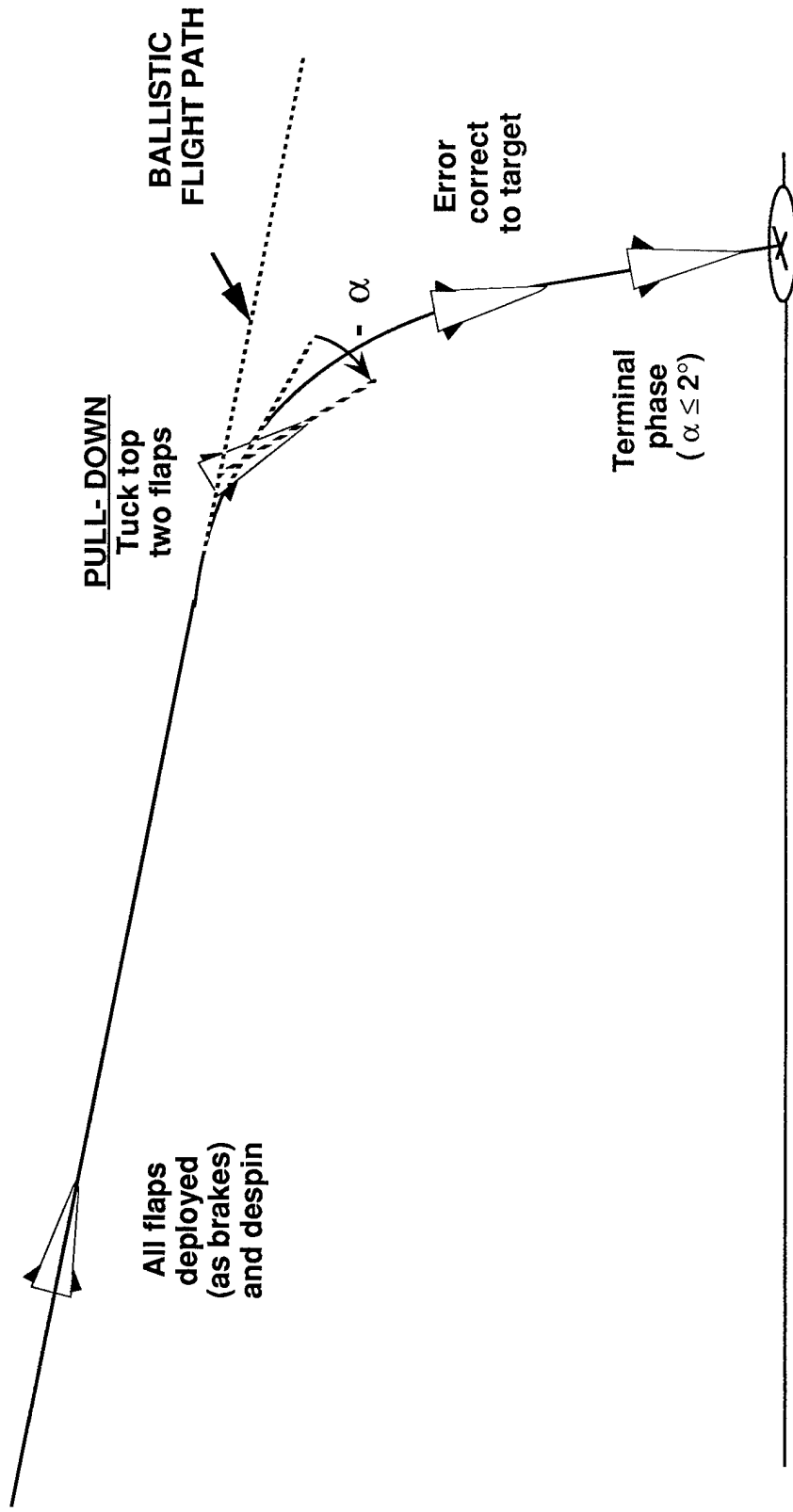

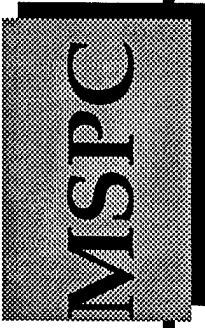

Pull Up, Pull Down (PUPD) Description

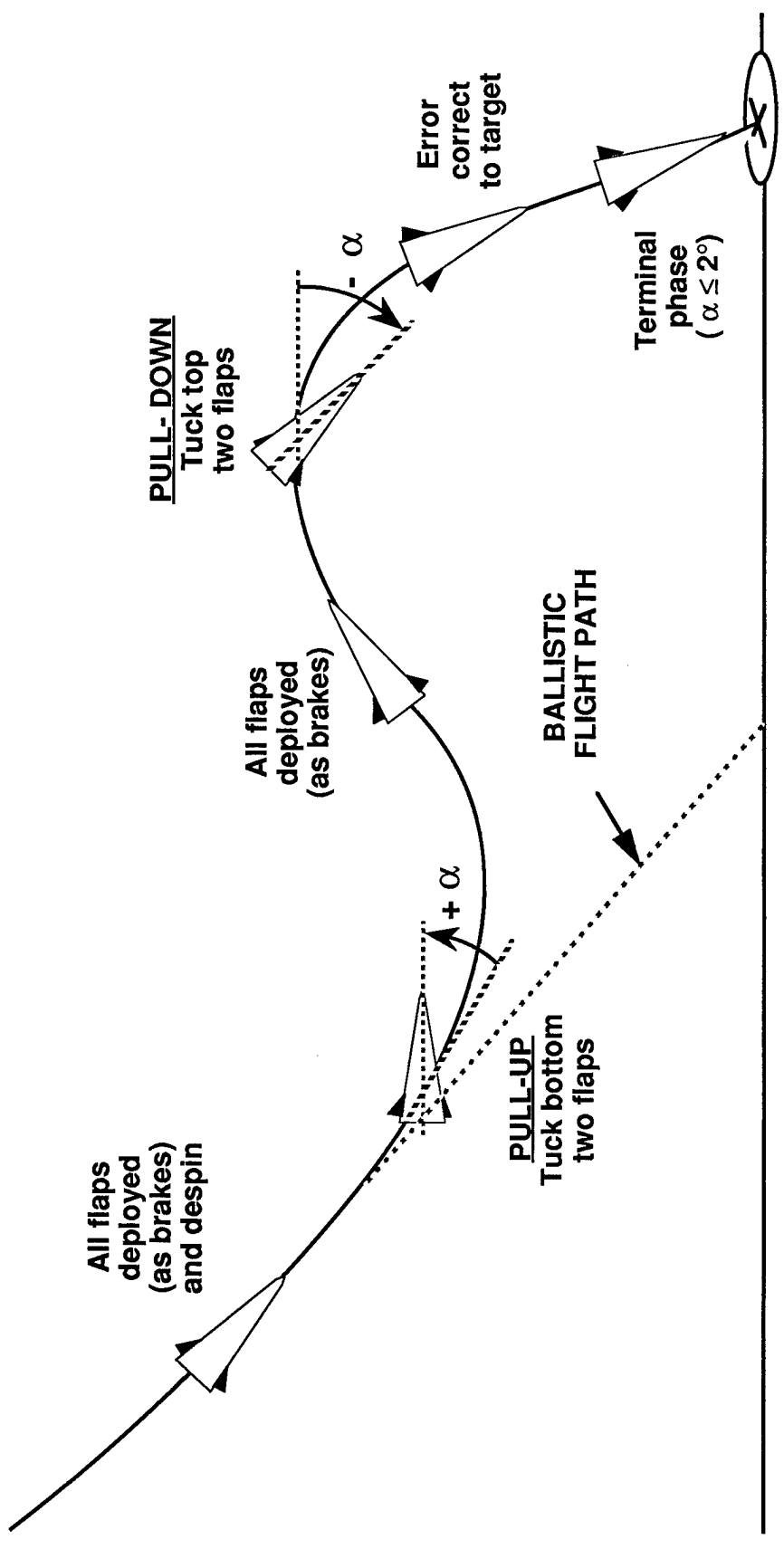

MSPC

Six Flap Drag Brake Control System (DBCS)

6 FLAPS

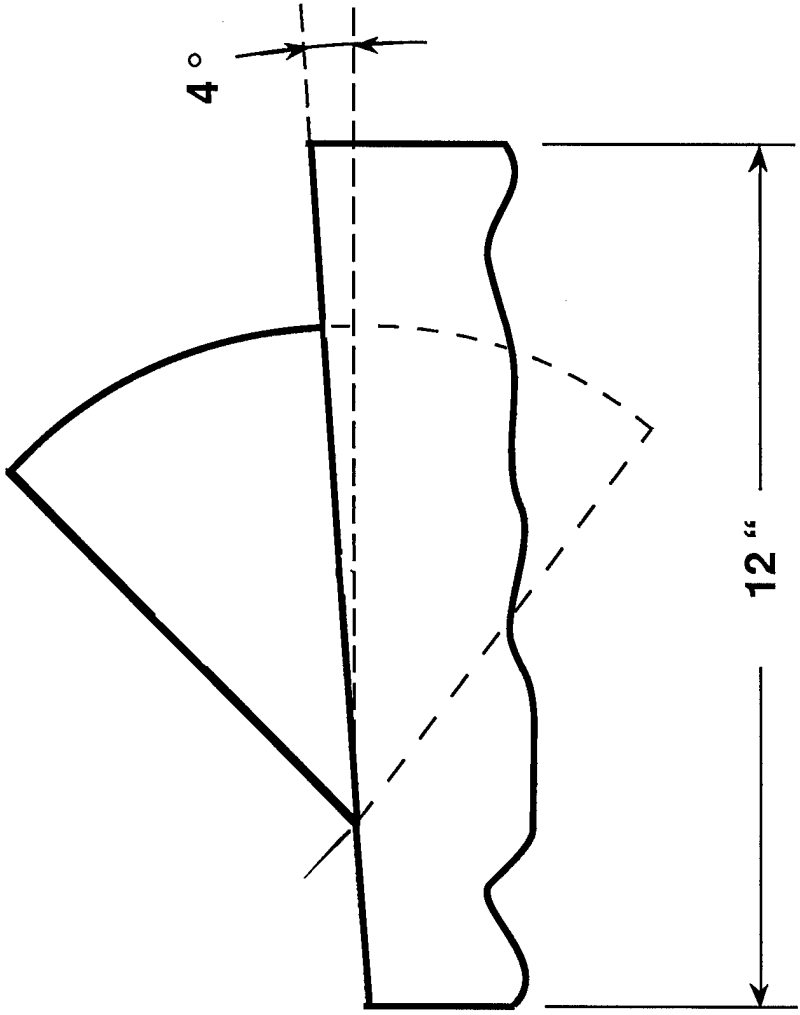
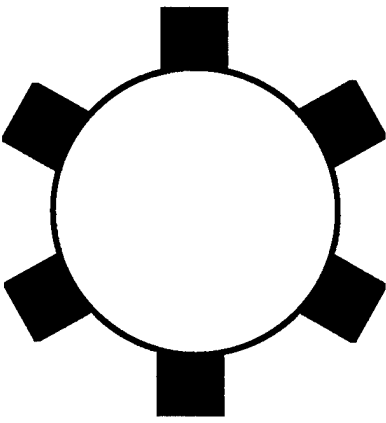

LOCKHEED MARTIN
MISSILES & SPACE

Future Areas to be Investigated

- **Control System**
 - Drag Flap Optimization
- **GPS Reception with Plasma Reduction Techniques**
- **Tightly Coupled GPS/IMU Performance Under High g Loadings**
- **High Impact Velocity Penetrator Performance**
 - Increase Weight to Cross Sectional Area
 - Effectiveness of Ordnance Options
 - New Materials

PLEASE CHECK THE APPROPRIATE BLOCK BELOW:

M97-03-2054

_____ copies are being forwarded. Indicate whether Statement A, B, C, D, E, F, or X applies.

DISTRIBUTION STATEMENT A:
APPROVED FOR PUBLIC RELEASE: DISTRIBUTION IS UNLIMITED

DISTRIBUTION STATEMENT B:
DISTRIBUTION AUTHORIZED TO U.S. GOVERNMENT AGENCIES ONLY; (Indicate Reason and Date). OTHER REQUESTS FOR THIS DOCUMENT SHALL BE REFERRED TO (Indicate Controlling DoD Office).

DISTRIBUTION STATEMENT C:
DISTRIBUTION AUTHORIZED TO U.S. GOVERNMENT AGENCIES AND THEIR CONTRACTORS; (Indicate Reason and Date). OTHER REQUESTS FOR THIS DOCUMENT SHALL BE REFERRED TO (Indicate Controlling DoD Office).

DISTRIBUTION STATEMENT D:
DISTRIBUTION AUTHORIZED TO DOD AND U.S. DOD CONTRACTORS ONLY; (Indicate Reason and Date). OTHER REQUESTS SHALL BE REFERRED TO (Indicate Controlling DoD Office).

DISTRIBUTION STATEMENT E:
DISTRIBUTION AUTHORIZED TO DOD COMPONENTS ONLY; (Indicate Reason and Date). OTHER REQUESTS SHALL BE REFERRED TO (Indicate Controlling DoD Office).

DISTRIBUTION STATEMENT F:
FURTHER DISSEMINATION ONLY AS DIRECTED BY (Indicate Controlling DoD Office and Date) or HIGHER DOD AUTHORITY.

DISTRIBUTION STATEMENT X:
DISTRIBUTION AUTHORIZED TO U.S. GOVERNMENT AGENCIES AND PRIVATE INDIVIDUALS OR ENTERPRISES ELIGIBLE TO OBTAIN EXPORT-CONTROLLED TECHNICAL DATA IN ACCORDANCE WITH DOD DIRECTIVE 5230.25, WITHHOLDING OF UNCLASSIFIED TECHNICAL DATA FROM PUBLIC DISCLOSURE, 6 Nov 1984 (Indicate date of determination). CONTROLLING DOD OFFICE IS (Indicate Controlling DoD Office).

This document was previously forwarded to DTIC on _____ (date) and the AD number is _____.

In accordance with the provisions of DoD instructions, the document requested is not supplied because:

It is TOP SECRET.

It is excepted in accordance with DoD instructions pertaining to communications and electronic intelligence.

It is a registered publication.

It is a contract or grant proposal, or an order.

It will be published at a later date. (Enter approximate date, if known.)

Other. (Give Reason.)

Print or Typed Name

Authorized Signature Date

Telephone Number

#10
a hard and deeply buried target defeat
concept.