

NASA
Technical Memorandum 107330

Army Research Laboratory
Technical Report ARL-TR-1101

A New Technique for Compensating Joint Limits in a Robot Manipulator

Jonathan Litt
Vehicle Propulsion Directorate
U.S. Army Research Laboratory
Lewis Research Center
Cleveland, Ohio

André Hickman
Morehouse College
Atlanta, Georgia

Ten-Huei Guo
Lewis Research Center
Cleveland, Ohio

October, 1996



National Aeronautics and
Space Administration

DISTRIBUTION STATEMENT A

Approved for public release;
Distribution Unlimited

DTIC QUALITY INSPECTED 3



19961105 037

A New Technique for Compensating Joint Limits in a Robot Manipulator

by

Jonathan Litt
Vehicle Propulsion Directorate
U.S. Army Research Laboratory
Lewis Research Center
Cleveland, OH 44135

André Hickman
Morehouse College
Atlanta, GA 30314

Ten-Huei Guo
National Aeronautics and Space Administration
Lewis Research Center
Cleveland, OH 44135

ABSTRACT

A new robust, optimal, adaptive technique for compensating rate and position limits in the joints of a six degree-of-freedom elbow manipulator is presented. In this new algorithm, the unmet demand as a result of actuator saturation is redistributed among the remaining unsaturated joints. The scheme is used to compensate for inadequate path planning, problems such as joint limiting, joint freezing, or even obstacle avoidance, where a desired position and orientation are not attainable due to an unrealizable joint command. Once a joint encounters a limit, supplemental commands are sent to other joints to best track, according to a selected criterion, the desired trajectory.

INTRODUCTION

A standard six degree-of-freedom elbow manipulator (figure 1) has six independently controlled joints. The position and orientation of the end effector, each of which is described in three dimensions, are fully determined by the angles of the joints. As long as the appropriate joint angles are achievable, the desired position and orientation can be obtained. However, when the specified joint trajectories cannot be followed due to a command beyond the range of the actuator, positions and orientations downstream from the limited joint will all be affected, causing in some cases extreme deviations from the expected values. The Windup Feedback scheme [1] is an ideal solution candidate for this problem. It was designed to compensate for actuator saturation in a multivariable system by supplementing the commands to the remaining actuators to produce the desired effect on the output, in this case the gripper position and orientation. For each joint which saturates, a degree of freedom is lost, but the remaining joints can be used to track the desired path within the physical limits of the manipulator.

MATHEMATICAL BACKGROUND FOR ROBOT JOINT CALCULATIONS

An overview of the mathematical descriptions used for robot joint calculations will be presented in this section. For a more thorough presentation, the reader is referred to [2].

In order to describe the position and orientation of a robot's end effector in space, we will define six Cartesian (x, y, z) coordinate frames, one at each joint. The main reference frame is fixed such that the base of the robot is at the origin, as shown in figure 1. The five other reference frames are each attached to one of the other joints. Thus the position and orientation of the end effector with respect to any joint is known. A transformation from one reference frame to another, consisting of rotations and translations, can be described by the 4×4 transformation matrix

$$T = {}^i T_j = \begin{bmatrix} n_x & o_x & a_x & p_x \\ n_y & o_y & a_y & p_y \\ n_z & o_z & a_z & p_z \\ 0 & 0 & 0 & 1 \end{bmatrix}$$

where i refers to the original coordinate frame and j refers to the transformed coordinate frame. The orthonormal n -, o -, and a -vectors describe the orientation as shown in figure 1 while the p -vector provides the position information. In a robot manipulator, a transformation matrix ${}^j T_{j+1}$ can be defined to describe the rotation and translation required to get from the j th to the $j+1$ st joint using the convention that the motion of the j th link is along the z -axis of the j th joint if it is translational, and around the z -axis of the j th joint if it is rotational. Multiplying the matrices describing sequential joint transformations will give a new transformation matrix from the first joint in the series to the last. Thus, in a six-jointed manipulator, ${}^0 T_6$ is the transformation from the base to the gripper in base coordinates, i.e., ${}^0 T_6$ represents the position and orientation of the end effector in base coordinates.

Finally, in order to see what effect a differential change in any joint (dq_i) has on the gripper position and orientation, a 6×6 matrix known as the *Jacobian* is defined. The Jacobian, J , can be used to compute differential changes in position (d_i) and orientation (δ_i) based on differential changes in joint translations and angles as

$$D = \begin{bmatrix} d_x \\ d_y \\ d_z \\ \delta_x \\ \delta_y \\ \delta_z \end{bmatrix} = J \begin{bmatrix} dq_1 \\ dq_2 \\ dq_3 \\ dq_4 \\ dq_5 \\ dq_6 \end{bmatrix} = J dq \quad (1)$$

where the vector dq corresponds to differential joint movements, either translational or rotational, and D represents their corresponding effects at the gripper. The Jacobian is the first derivative of the equations of motion with respect to each joint. A first-order approximation of the Jacobian is easily obtained from the transformation matrices from each joint to the gripper (${}^0T_6, {}^1T_6, \dots, {}^5T_6$) using the equations

$$\begin{aligned} d_x &= n \cdot ((\delta \times p) + d) \\ d_y &= o \cdot ((\delta \times p) + d) \\ d_z &= a \cdot ((\delta \times p) + d) \\ \delta_x &= n \cdot \delta \\ \delta_y &= o \cdot \delta \\ \delta_z &= a \cdot \delta \end{aligned}$$

where d and δ indicate translational and rotational movement of the joint, respectively. They are defined as $d = (0,0,1)$, $\delta = (0,0,0)$ for prismatic joints and $d = (0,0,0)$, $\delta = (0,0,1)$ for rotational joints. Using these relationships, the Jacobian can be computed as

$$J = \begin{bmatrix} (n \cdot ((\delta \times p) + d))_0 & \dots & (n \cdot ((\delta \times p) + d))_5 \\ (o \cdot ((\delta \times p) + d))_0 & \dots & (o \cdot ((\delta \times p) + d))_5 \\ (a \cdot ((\delta \times p) + d))_0 & \dots & (a \cdot ((\delta \times p) + d))_5 \\ (n \cdot \delta)_0 & \dots & (n \cdot \delta)_5 \\ (o \cdot \delta)_0 & \dots & (o \cdot \delta)_5 \\ (a \cdot \delta)_0 & \dots & (a \cdot \delta)_5 \end{bmatrix}$$

where the subscripts from 0 through 5 use the values from the transformation matrices 0T_6 through 5T_6 .

MATHEMATICAL DEVELOPMENT OF THE WINDUP FEEDBACK SCHEME

The Windup Feedback scheme is an algorithm developed to take advantage of underutilized actuators to compensate for saturated actuators such that the output of the system optimally tracks the output of a similar system without actuator limits.

In a robot manipulator, saturation can occur when a command to a joint is too large to be accommodated, either in position or rate, such as a request to rotate a joint to 110° when it is restricted to lie within the $\pm 90^\circ$ range, or a request to move 110° in one second when the rate limit is 90° per second. In a situation where each joint angle is computed and commanded based on a desired position and orientation, a joint which cannot track its command will prevent the gripper from reaching its desired position. By using other joints to compensate for the saturated one, the desired gripper position can be nearly matched and the robot manipulator might be able

to perform its task as if no joint reached its limit. Figure 2 depicts a robotic system with joint commands altered by Windup Feedback gains so that the position and orientation of the end effector track their ideal counterparts even during position and rate limits. In figure 2, q is the vector of ideal joint commands, and Δq is the vector of the difference between the desired joint commands and the achievable commands. When at least one joint is at its limit, q^* is the vector of optimized supplemental commands to compensate the saturated joint commands. If Δq is relatively small, it approximates dq from (1). Using the definitions from the previous section, we can derive the Windup Feedback scheme as applied to manipulator systems.

The Windup Feedback scheme tries to minimize the difference between the desired and achievable end effector position and orientation in an optimal sense. At every control interval, a command is given to each joint with the goal of moving the gripper along a desired trajectory. If a desired command is not achievable because it would force a joint to move beyond its limit, the Windup Feedback scheme will try to utilize other, unsaturated joints to maneuver the effector to the desired position and orientation at the current time step. Thus, the quadratic performance index, PI , for this optimization procedure is defined as

$$PI = \frac{1}{2} \{ [J(\Delta q - I^* I^{*T} q^*)]^T Q [J(\Delta q - I^* I^{*T} q^*)] + q^{*T} I^* I^{*T} R I^* I^{*T} q^* \} \quad (2)$$

As shown in figure 2, Δq is the vector of unmet demand, i.e. the difference between the desired joint commands and the achievable commands when a joint is at its limit. Thus, $J\Delta q$ approximates the differential change in gripper position and orientation, D , from (1), required to move to the desired location based on the ideal commands. The vector q^* consists of the optimized supplemental commands to compensate the saturated joint commands as shown in figure 2. The diagonal weighting matrix Q allows more importance to be given to selected variables, such as position over orientation. The diagonal weighting matrix R penalizes the use of particular joints for compensation, and I^* is a matrix which restricts the supplemental joint commands to be distributed over the unsaturated joints. I^* is created by taking the identity matrix of dimension equal to the number of joints and deleting each column which corresponds to a command greater than the joint's limit. This way, whenever a limit is encountered, I^* is computed to be the dimension of the total number of joints by the total number of unlimited joints. In the objective function (2) above, the formulation using two quadratic terms, corresponding to Q and R , provides a great advantage over the strict least squares formulation (Q only), as will be shown.

The Windup Feedback gains are obtained by minimizing (2) with respect to q^* (see Appendix A for the derivation) to produce the solution

$$q^* = I^* (I^{*T} J^T Q J I^* + I^{*T} R I^*)^{-1} I^{*T} J^T Q J \Delta q \quad (3)$$

The elements of q^* are the supplemental control commands which, when added to the commands to the unlimited joints, bring the end effector closer to the desired position and orientation. The unmet demand, Δq , can be represented as

$$\Delta q = \sum_i e_i e_i^T \Delta q$$

where e_i is a column vector of zeroes with a 1 in the i th location. The breaking up of the vector of unmet demand into its individual components allows each saturated joint to be compensated individually. Thus, if a single joint encounters its limit, a single column of the Windup Feedback matrix can be computed using (3) with an I^* matrix equal to the identity matrix with the appropriate column deleted. If, after the addition of the supplemental q^* terms, another joint saturates, the overdemand is again redistributed among the remaining unsaturated actuators through a second column of the Windup Feedback matrix determined using a new I^* equal to the previous I^* with a second column deleted. This process can continue as long as at least one joint is not fully utilized. Thus, the ability to break up the Δq vector into its components permits individual columns of the feedback matrix to be computed as needed. Using this technique, the computed columns correspond only to the saturated joints and allow redistribution only to the unsaturated joints, while the gains are continuously, optimally updated. This promotes the smooth flow of compensation between joint commands because, immediately after a joint saturates, the overdemand to it is small so, as it grows, the supplemental commands fed to the unsaturated joints are smooth, continuous signals.

As stated earlier, the inclusion of the weighting matrix R in the objective function benefits the solution greatly. Even though the addition of the R term means that the solution obtained will not be strictly the best achievable match in a least squares sense to the desired solution, it forces the supplemental commands to stay close to their nominal values and thereby limits severe jumps and sign changes in the computed gains, effectively acting as a smoothing filter for the time-varying gains and resulting in a potentially much less erratic set of supplemental commands. Perhaps more importantly from an implementation standpoint, the inclusion of R guarantees the invertibility of the matrix in (3). Using only the weighting matrix Q ($R=0 \times I_6$), the invertibility of the matrix is not guaranteed as the manipulator moves through its workspace, even if Q is invertible. When joints are lined up along an axis, such as when the robot arm is straight, the Jacobian, J , may become rank-deficient or at least have an unreliable numerical inverse. Using the above formulation, with the inclusion of the matrix R , the matrix to invert is in the Modified form [3], and in this special case it is nonsingular since R is invertible; it does not depend upon the rank of J . See Appendix B for a derivation of this result.

EXAMPLES

A six-jointed elbow manipulator, such as that shown in figure 1, is used in two examples to demonstrate the Windup Feedback Algorithm. The first illustrates rate limit compensation, the second features position limit compensation. All joints' position and rate limits are displayed in Table I.

Table I. ELBOW MANIPULATOR MOTION LIMITS

JOINT	POSITION RANGE	RATE LIMIT
θ_1	-90° through 90°	90°/second
θ_2	0° through 180°	90°/second
θ_3	-90° through 90°	90°/second
θ_4	-90° through 90°	90°/second
θ_5	0° through 180°	90°/second
θ_6	-90° through 90°	90°/second

The path planning algorithm used here simply interpolates from starting point to ending point by incrementing each joint's command by an amount related to the distance from the nearest endpoint. This gives a bell-shaped velocity profile (stopped at the beginning, fastest in the middle, stopped at the end). From figure 2 it is clear that the Windup Feedback algorithm is applied to the joint commands only, not to the actual, measured joint angles. The purpose of this scheme is to provide admissible joint commands, i.e. commands which the joints can physically follow which will result in the desired position and orientation. Therefore, the way the limit checking is incorporated is significant because that determines whether the joints will truly be able to track the commands. For these examples, the rate limit checking was implemented by determining the maximum angle the joint can rotate through in one time step based on the maximum angular velocity listed in Table I, not taking acceleration into account, and allowing a command change of not more than that amount. The use of a more sophisticated rate limit checking computation utilizing acceleration limits and current velocity would not change the Windup Feedback algorithm in any way. The weighting matrix Q should be chosen depending on the task, but usually the position is compensated at the expense of the orientation, since most tasks will allow a larger error in approach than in position. The weighting matrix R should be chosen such that it is a diagonal matrix with all elements positive. Beyond that, the Windup Feedback gains are relatively insensitive to large changes in R as long as it is of the form $R=k \times I_6$ with $k>0$. In cases where all diagonal elements of R are not the same, the potential exists to significantly alter the results by heavily penalizing the use of effective joints over ineffective ones for compensation. Unwise choices of R aside, its inclusion should have very little effect on the compensated position and orientation. The weighting matrices used in the following examples are $Q=diag(100,100,100,1,1,1)$ and $R=10 \times I_6$. The total movement in each example takes one second with the commands updated at a frequency of 50 Hz.

In the first example, the objective is to move from the initial position and orientation to the final position and orientation which are specified as

$$T_{initial} = \begin{bmatrix} 0 & -.64 & -.77 & -8.02 \\ 1 & 0 & 0 & 0 \\ 0 & -.77 & .64 & 32.11 \\ 0 & 0 & 0 & 1 \end{bmatrix} \quad T_{final} = \begin{bmatrix} 0 & -.94 & .34 & 25.32 \\ 1 & 0 & 0 & 0 \\ 0 & .34 & .94 & 22.77 \\ 0 & 0 & 0 & 1 \end{bmatrix}$$

Table II contains the joint angles corresponding to those endpoints.

Table II. JOINT ANGLES FOR ENDPOINTS IN RATE LIMIT EXAMPLE

JOINT	INITIAL ANGLE	FINAL ANGLE
θ_1	0°	0°
θ_2	40°	0°
θ_3	70°	10°
θ_4	30°	60°
θ_5	90°	90°
θ_6	0°	0°

In the first example, a rate limit is encountered by the third joint about one third of the way through the run. The unmet demand is redirected to other, unsaturated joints through the Windup Feedback gains computed using (3) and an I^* matrix created by removing the third column from a 6x6 identity matrix. After several control intervals, the supplemental command added to the already rapidly changing command to the second joint causes it to rate limit also. Thus, a second column of the Windup Feedback matrix is computed using (3) but a new I^* : a 6x6 identity matrix with both the second and third columns removed. The second joint comes off its limit about two thirds of the way through the run, as the rate of change of the commands decreases, leaving only the third joint saturated. This joint also comes off its limit near the end of the run, again aligning the compensated and ideal trajectory commands. Figure 3 shows in three dimensions the paths of the three cases: desired, limited without compensation, and limited with Windup Feedback. The projections show that the error is limited to the x - z -plane. This view depicts the trajectories through space without any reference to time. Thus a different example could have been concocted where the saturated curve is perfectly overlaid on the ideal curve. For this reason, figure 4 displays the three curves with respect to time, clearly demonstrating how the saturated case lags behind the other two as the rate-limited joint is unable to track the demand. Figure 5 depicts the supplemental command vector, q^* , used to compensate the saturated command. Figure 6 contains plots of the joint commands for the three cases. In the θ_3 trace, the rate-limited command cannot track the ideal command, resulting in the immediate divergence of the other, compensated joint commands from the ideal case to maintain the end effector in its desired trajectory. The other uncompensated commands track the ideal commands exactly. The

compensation is accomplished essentially with the second and fourth joints, but when the second joint command also hits its rate limit, the other joints temporarily play a more prominent role. Figure 7 compares the error in gripper position of the saturated and compensated cases. The compensated case is significantly better than the saturated case which is not surprising since the supplemental commands were optimized to maintain position. Figure 8 compares the error in approach (the direction of the vector a from figure 1, corresponding to the direction in which the gripper is pointing) for the two cases. Since orientation was not heavily weighted in this example, the fact that the compensated case is much better is not significant, but it shows that orientation is not markedly sacrificed to maintain position.

In the second example, the objective is to move from the initial position and orientation to the final position and orientation which are specified as

$$T_{initial} = \begin{bmatrix} .61 & .50 & .61 & 28.07 \\ .71 & 0 & -.71 & -4.24 \\ -.35 & .87 & -.35 & 0.95 \\ 0 & 0 & 0 & 1 \end{bmatrix} \quad T_{final} = \begin{bmatrix} .30 & .91 & .30 & 17.32 \\ .71 & 0 & -.71 & -4.24 \\ -.64 & .42 & -.64 & -8.90 \\ 0 & 0 & 0 & 1 \end{bmatrix}$$

Table III contains the joint angles corresponding to those endpoints.

Table III. JOINT ANGLES FOR ENDPOINTS IN POSITION LIMIT EXAMPLE

JOINT	INITIAL ANGLE	FINAL ANGLE
θ_1	0°	0°
θ_2	45°	45°
θ_3	-75°	-110°
θ_4	0°	0°
θ_5	45°	45°
θ_6	0°	0°

Since the final desired value for the third joint is unrealizable, every succeeding joint, even if it has achieved its commanded angle, will not be at its desired position and orientation. In this example, the third joint encounters its position limit at nearly half way through its desired swing. The unachievable command is redistributed through the Windup Feedback gains to other joints. In doing so, a large enough supplement is added to the fourth joint that it rides its rate limit for several control intervals while the ideal command is changing at its fastest rate. This causes a second column of the Windup Feedback matrix to be computed, redistributing this unmet command among the other four joints. Once the rate of command change has decreased enough,

the fourth joint comes off its limit while continuing to accommodate the unmet command to the third joint. Figure 9 shows the three-dimensional path the end effector follows. The compensated path lies nearly along the desired trajectory while the uncompensated path comes to a dead stop after saturation and never gets near its final destination. Figure 10 shows the x -, y -, and z -positions of the gripper versus time for the three paths. The compensated path tracks the desired closely in both x and z while paying a small penalty in y as compared to the uncompensated path which diverges from the other two in both x and z after saturation. Figure 11 depicts the supplemental commands used to compensate the saturated joint commands. Figure 12 displays ideal, compensated, and saturated commands with respect to time. The uncompensated curves exactly follow the ideal commands, except for the saturated θ_3 curve, which is the only one that shows on the trace. The compensated θ_4 command's constant, steep slope reveals that it is rate limited for a short time initially. Figure 13 compares the error in gripper position of the compensated and saturated cases. A great improvement is achieved through the use of Windup Feedback as the error is reduced to about 5% of that in the uncompensated case even though a position limit was encountered. Figure 14 compares the error in approach of the two cases. Here again, orientation in the compensated case is not significantly sacrificed to maintain position and is, in fact, better than in the uncompensated case.

CONCLUSIONS

The Windup Feedback scheme is a robust, optimal adaptive algorithm which has been shown to significantly improve the tracking of the desired end effector trajectory for a six-degree-of-freedom elbow manipulator under unexpected rate and position constraints. The scheme is especially suitable for applications which include some variability so that unusual situations, such as joint saturations, are likely to occur. The weighting matrix Q should be chosen depending upon the task, to appropriately emphasize position or orientation. The inclusion of the weighting matrix R gives a solution which is not the best fit, in a least squares sense, to the desired. However, the resulting difference in position and orientation between the optimal solution obtained using R and the least squares solution should be negligible and the compensation variables should vary more smoothly than when R is not included. The Windup Feedback gains are simple to compute and adapt online in real time which makes this scheme practical.

APPENDIX A: DERIVATION OF WINDUP FEEDBACK GAINS

The objective function is defined as

$$PI = \frac{1}{2} \left\{ [J(\Delta q - I^* I^{*T} q^*)]^T Q [J(\Delta q - I^* I^{*T} q^*)] + q^{*T} I^* I^{*T} R I^* I^{*T} q^* \right\}$$

with variables as show in figure 2. I^* is created by taking the identity matrix of dimension equal to the number of joints and deleting each column which corresponds to a command greater than the joint's limit. This way, whenever a limit is encountered, I^* is computed to be the dimension of the total number of joints by the total number of unlimited joints. Therefore, I^* has more rows than columns and each column has exactly one 1 in it. It is clear that $I^{*T} I^*$ is a diagonal matrix of zeroes and ones and $I^{*T} I^*$ is the identity matrix.

Example:

$$I^* = \begin{bmatrix} 1 & 0 \\ 0 & 0 \\ 0 & 1 \end{bmatrix}, \quad I^* I^{*T} = \begin{bmatrix} 1 & 0 \\ 0 & 0 \\ 0 & 1 \end{bmatrix} \begin{bmatrix} 1 & 0 & 0 \\ 0 & 0 & 1 \end{bmatrix} = \begin{bmatrix} 1 & 0 & 0 \\ 0 & 0 & 0 \\ 0 & 0 & 1 \end{bmatrix}, \quad I^{*T} I^* = \begin{bmatrix} 1 & 0 & 0 \\ 0 & 0 & 1 \\ 0 & 0 & 1 \end{bmatrix} \begin{bmatrix} 1 & 0 \\ 0 & 0 \\ 0 & 1 \end{bmatrix} = \begin{bmatrix} 1 & 0 \\ 0 & 1 \end{bmatrix}$$

PI is easily minimized as follows.

$$\begin{aligned} \frac{\partial PI}{\partial q^*} &= -(J\Delta q - JI^* I^{*T} q^*)^T Q JI^* I^{*T} + q^{*T} I^* I^{*T} R I^* I^{*T} = 0 \\ &\rightarrow -I^* I^{*T} J^T Q (J\Delta q - JI^* I^{*T} q^*) + I^* I^{*T} R I^* I^{*T} q^* = 0 \end{aligned}$$

Therefore,

$$\begin{aligned} I^* I^{*T} J^T Q J\Delta q &= (I^* I^{*T} J^T Q JI^* I^{*T} + I^* I^{*T} R I^* I^{*T}) q^* \\ I^{*T} I^* I^{*T} J^T Q J\Delta q &= (I^{*T} I^* I^{*T} J^T Q JI^* I^{*T} + I^{*T} I^* I^{*T} R I^* I^{*T}) q^* \\ I^{*T} J^T Q J\Delta q &= (I^{*T} J^T Q JI^* I^{*T} + I^{*T} R I^* I^{*T}) q^* \\ &= (I^{*T} J^T Q JI^* + I^{*T} R I^*) I^{*T} q^* \end{aligned}$$

As long as $I^{*T} J^T Q JI^* + I^{*T} R I^*$ is full rank, it can be inverted, thus

$$(I^{*T} J^T Q JI^* + I^{*T} R I^*)^{-1} I^{*T} J^T Q J\Delta q = I^{*T} q^*$$

which, using the identity property of I^* , leads to

$$q^* = I^* (I^{*T} J^T Q JI^* + I^{*T} R I^*)^{-1} I^{*T} J^T Q J\Delta q$$

APPENDIX B: PROOF OF INVERTIBILITY

By definition, a matrix A is said to be positive semidefinite (p.s.d.) if and only if $x^T A x \geq 0$ for any vector x . In the case where equality holds only when x is uniquely the zero vector, A is said to be positive definite (p.d.) [4]. The eigenvalues of a positive semidefinite matrix are all nonnegative. The eigenvalues of a positive definite matrix are all positive. Consequently, p.d. matrices are also p.s.d. but they are always invertible since all of their eigenvalues are nonzero.

The inclusion of the diagonal weighting matrix R in the objective function (2) changes the matrix

to be inverted in (3) from being positive semidefinite to being positive definite and thus always invertible. This is easily shown as follows.

The matrix to be inverted is:

$$I^T J^T Q J I^* + I^T R I^* \quad (4)$$

The weighting matrix Q is diagonal positive semidefinite (it may have some diagonal terms equal to zero) and R is diagonal positive definite. Note that a matrix A is p.s.d. if there exists a matrix T such that $A=T^T T$ [5]. Clearly both terms of (4) meet this condition, therefore they are both p.s.d. Additionally, the second term is p.d. because, independent of the number of columns of I^* , it is a diagonal matrix with all elements greater than zero since they are merely selected diagonal elements of the original R matrix. Pre- and postmultiplying (4) by an arbitrary nonzero vector x gives

$$x^T (I^T J^T Q J I^* + I^T R I^*) x = x^T I^T J^T Q J I^* x + x^T I^T R I^* x$$

which, by the definition of a p.s.d. matrix, produces a scalar greater than or equal to zero for the first term plus a scalar greater than zero for the second term. Thus, the sum is greater than zero for any nonzero vector x . Therefore, the matrix is p.d. and consequently always invertible.

REFERENCES

1. Litt, J. S., and Roulette, G., "A Method for Exploiting Redundancy to Accommodate Actuator Limits in Multivariable Systems," NASA TM 106859, December 1995.
2. Paul, Richard P., Robot Manipulators: Mathematics, Programming, and Control, The MIT Press, Cambridge, MA, 1981.
3. Householder, A. S., The Theory of Matrices in Numerical Analysis, Dover Publications, Inc., New York, NY, 1975, p. 123.
4. Brogan, W. J., Modern Control Theory, Quantum Publishers, New York, NY, 1974, p.133.
5. Kailath, T., Linear Systems, Prentice-Hall, Inc., Englewood Cliffs, NJ, 1980, p. 667.

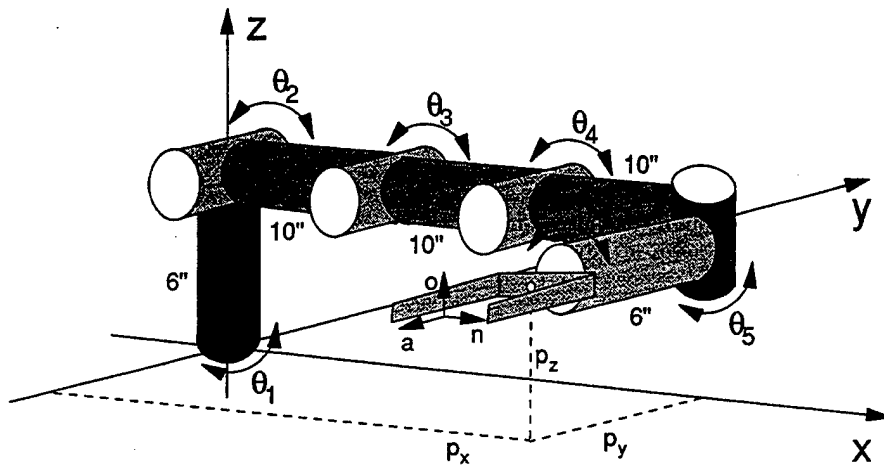

Figure 1. Six degree-of-freedom elbow manipulator.

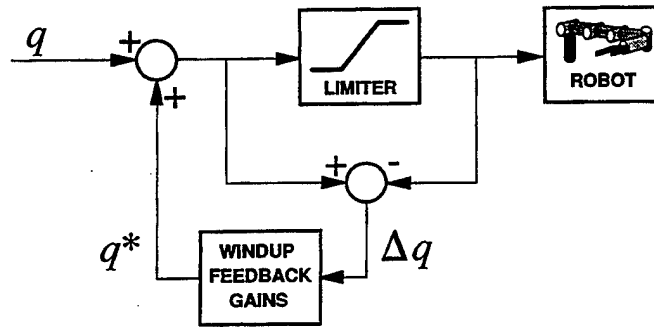

Figure 2. Robot joint commands with Windup Feedback compensation.

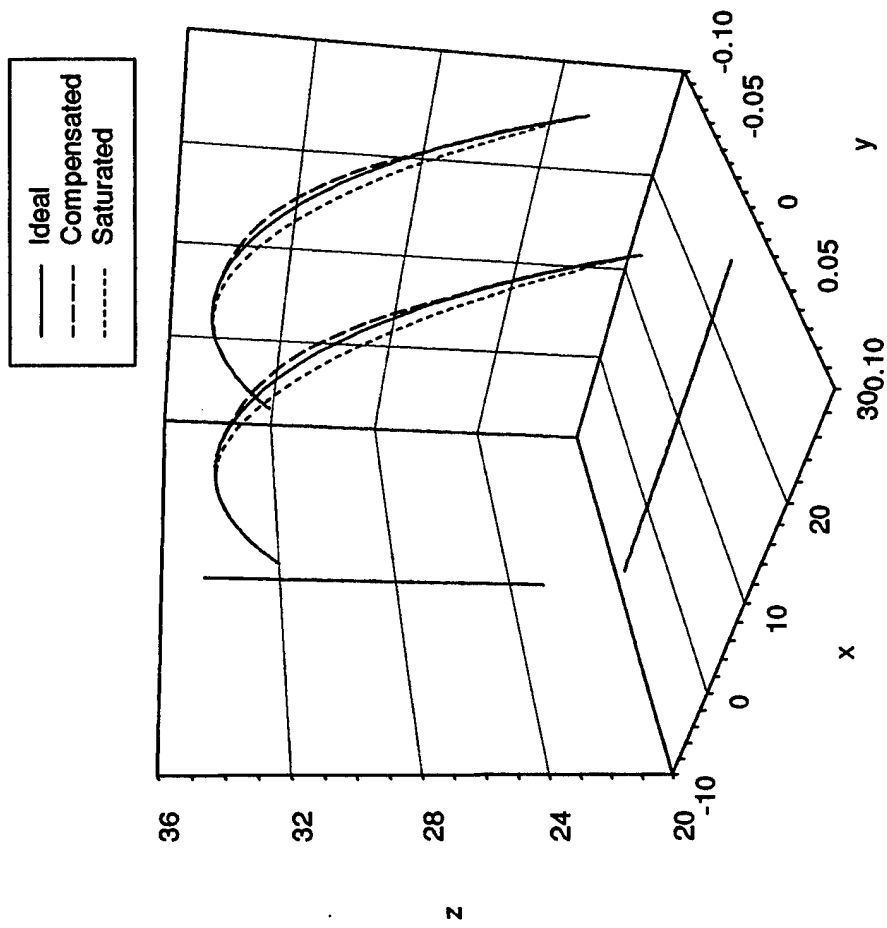

Figure 3. Three-dimensional view with projections, for the rate-limited example.

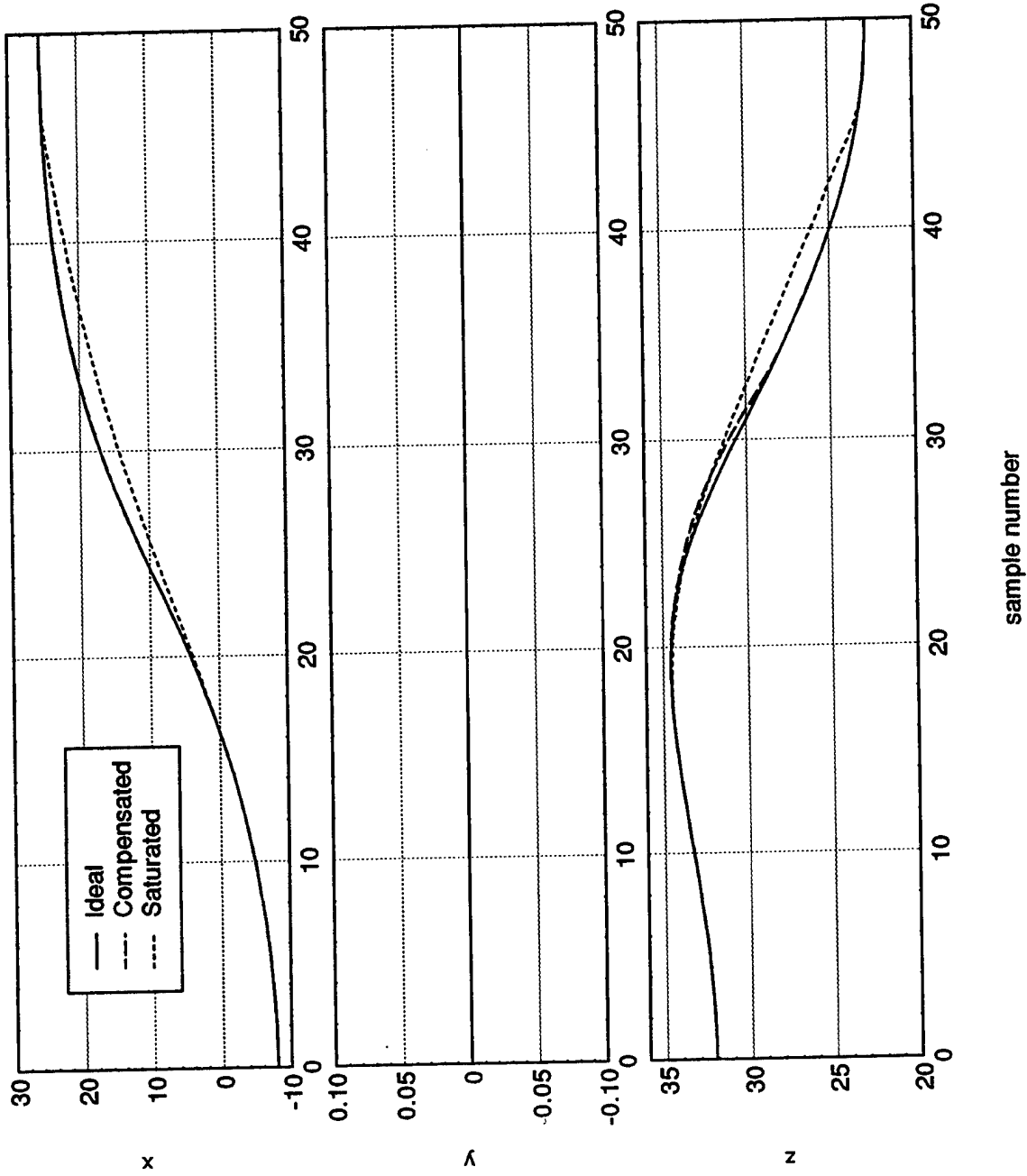

Figure 4. Gripper position in inches vs. sample number for rate-limited example.

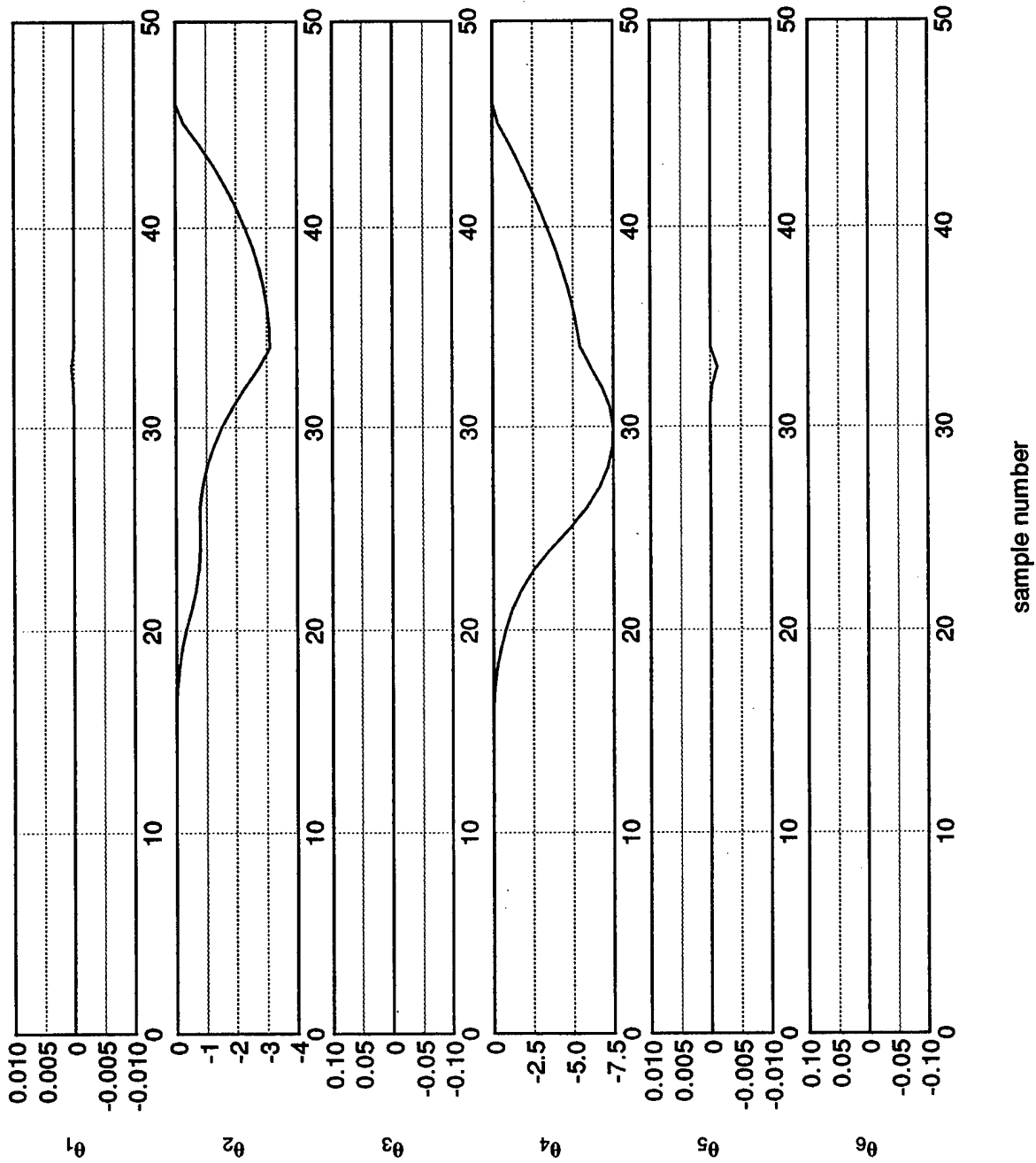

Figure 5. Supplemental commands in degrees vs. sample number for rate-limited example.

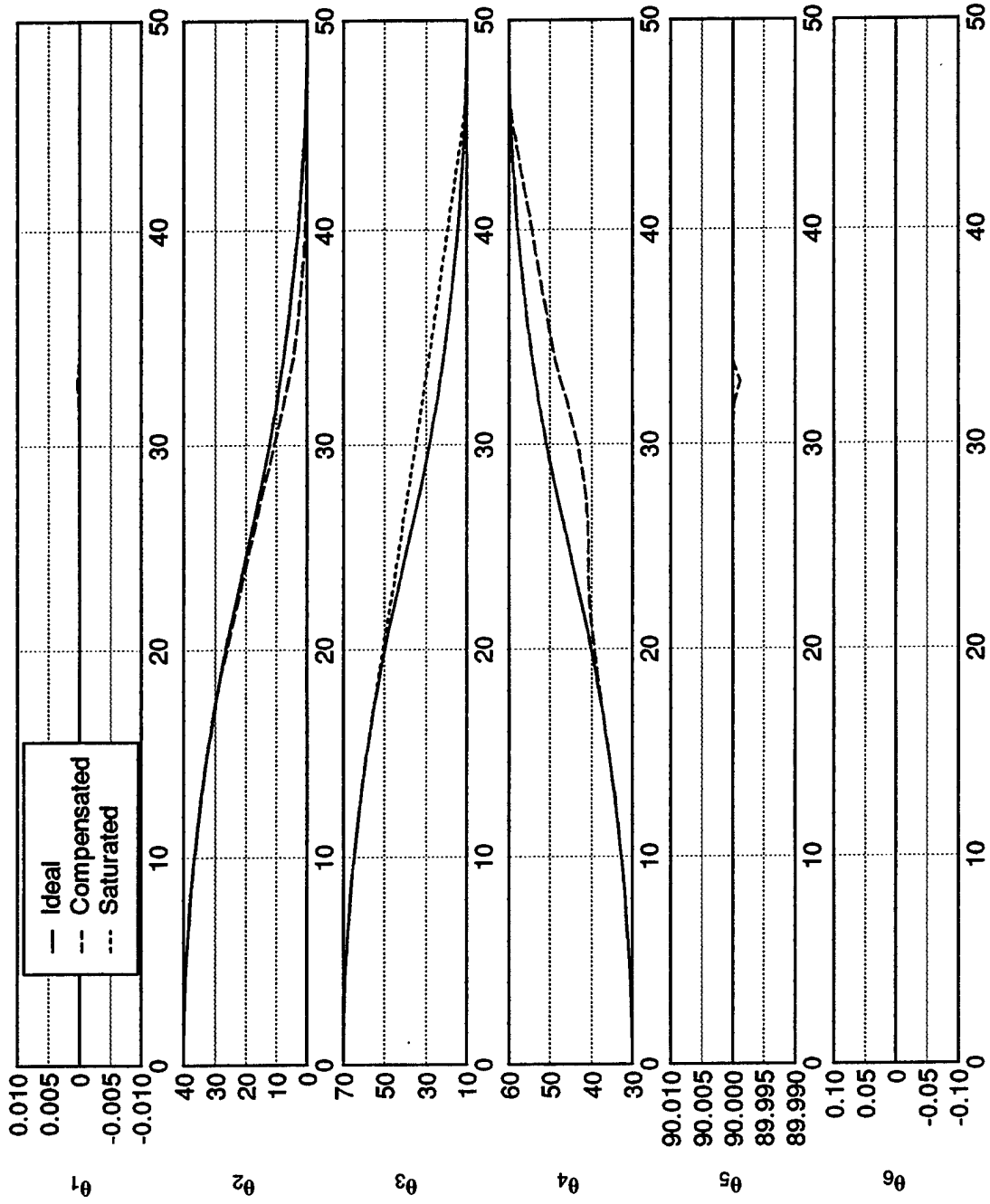

Figure 6. Ideal, compensated, and saturated commands in degrees vs. sample number for rate-limited example.

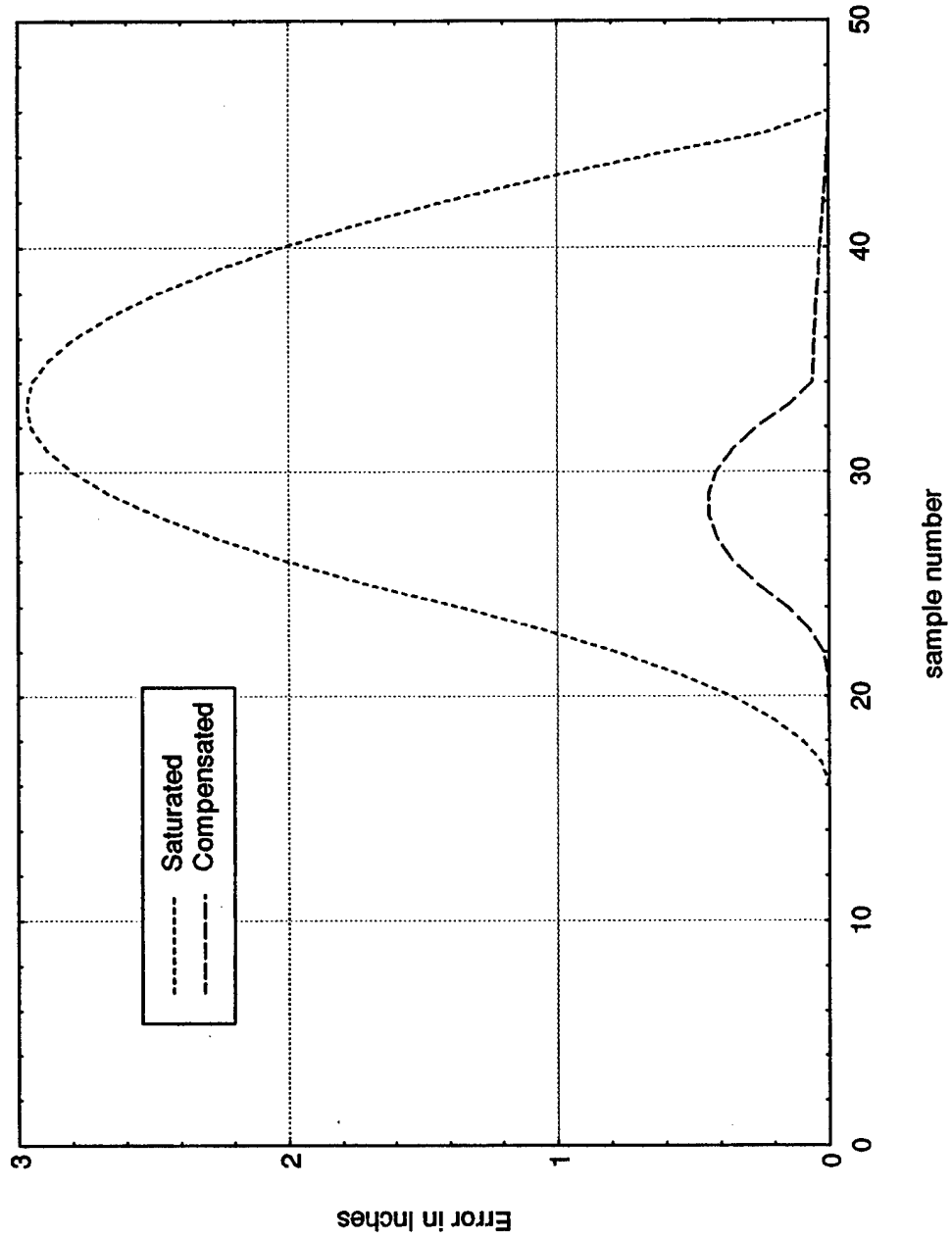

Figure 7. Error in gripper position vs. sample number for rate-limited example.

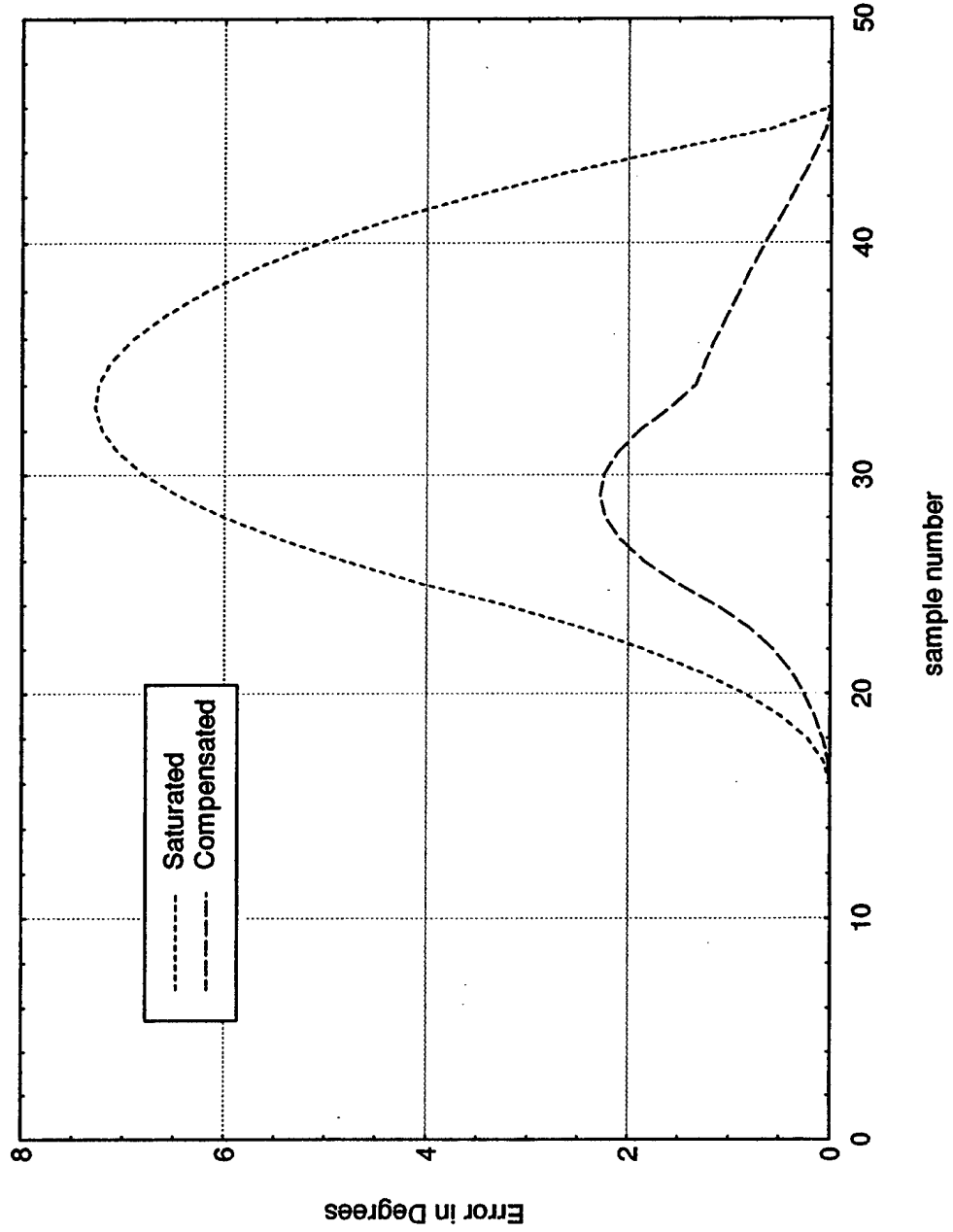

Figure 8. Angle error in approach vs. sample number for rate-limited example.

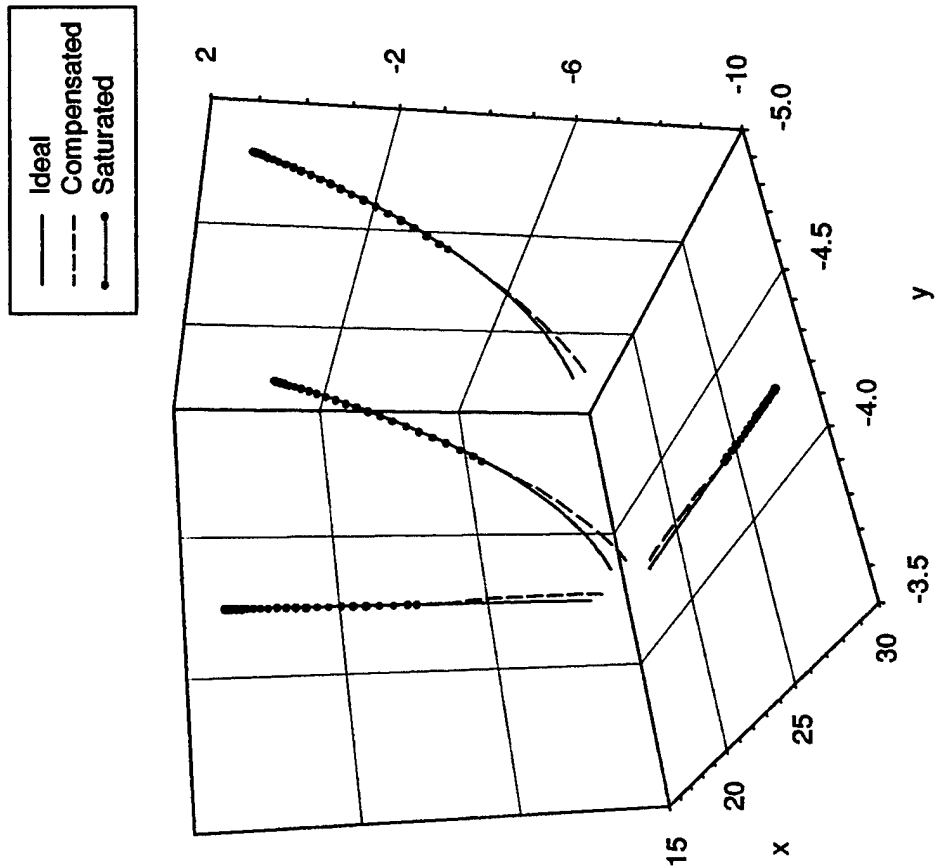

Figure 9. Three-dimensional view with projections, for the position-limited example.

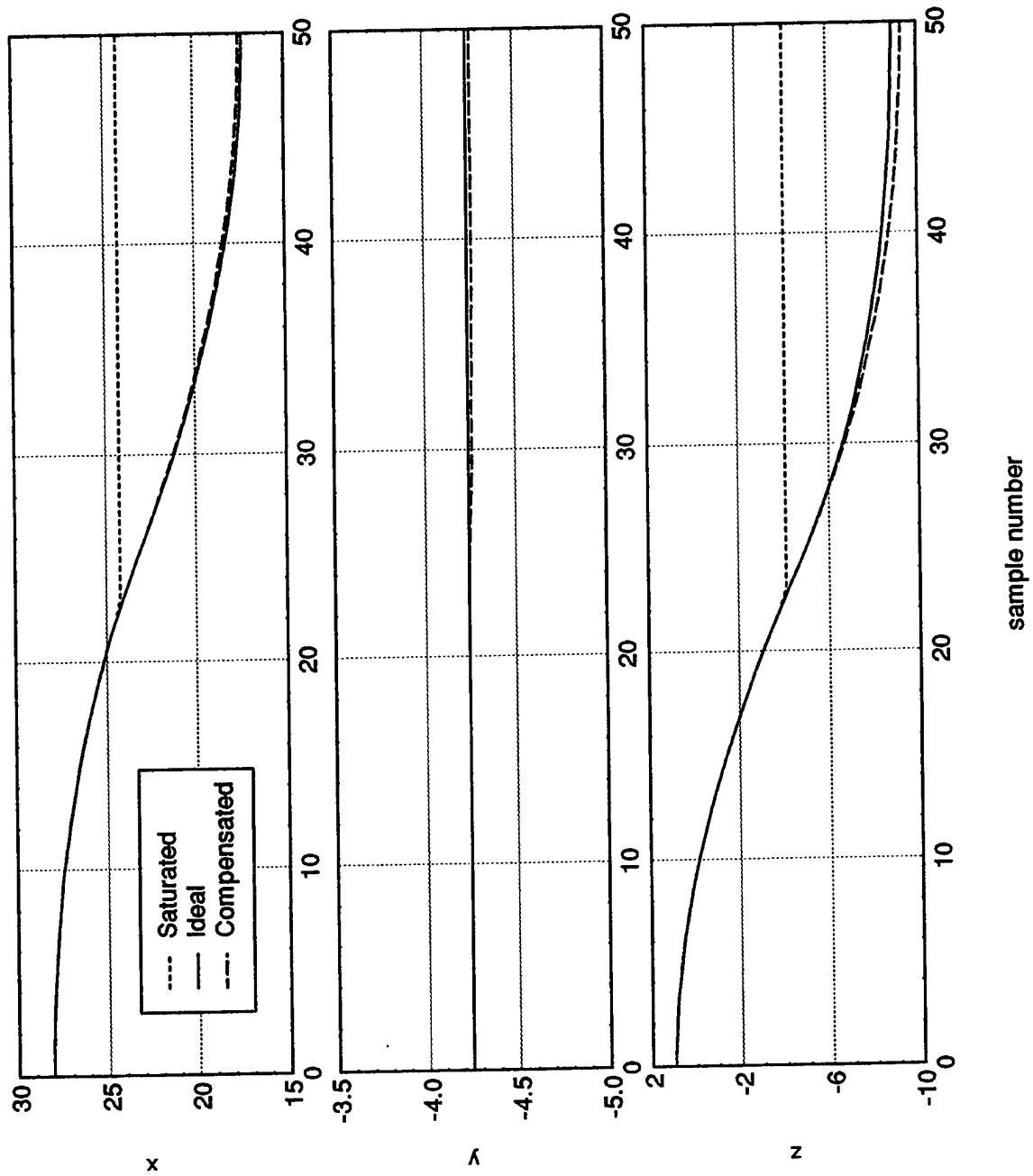

Figure 10. Gripper position in inches vs. sample number for position-limited example.

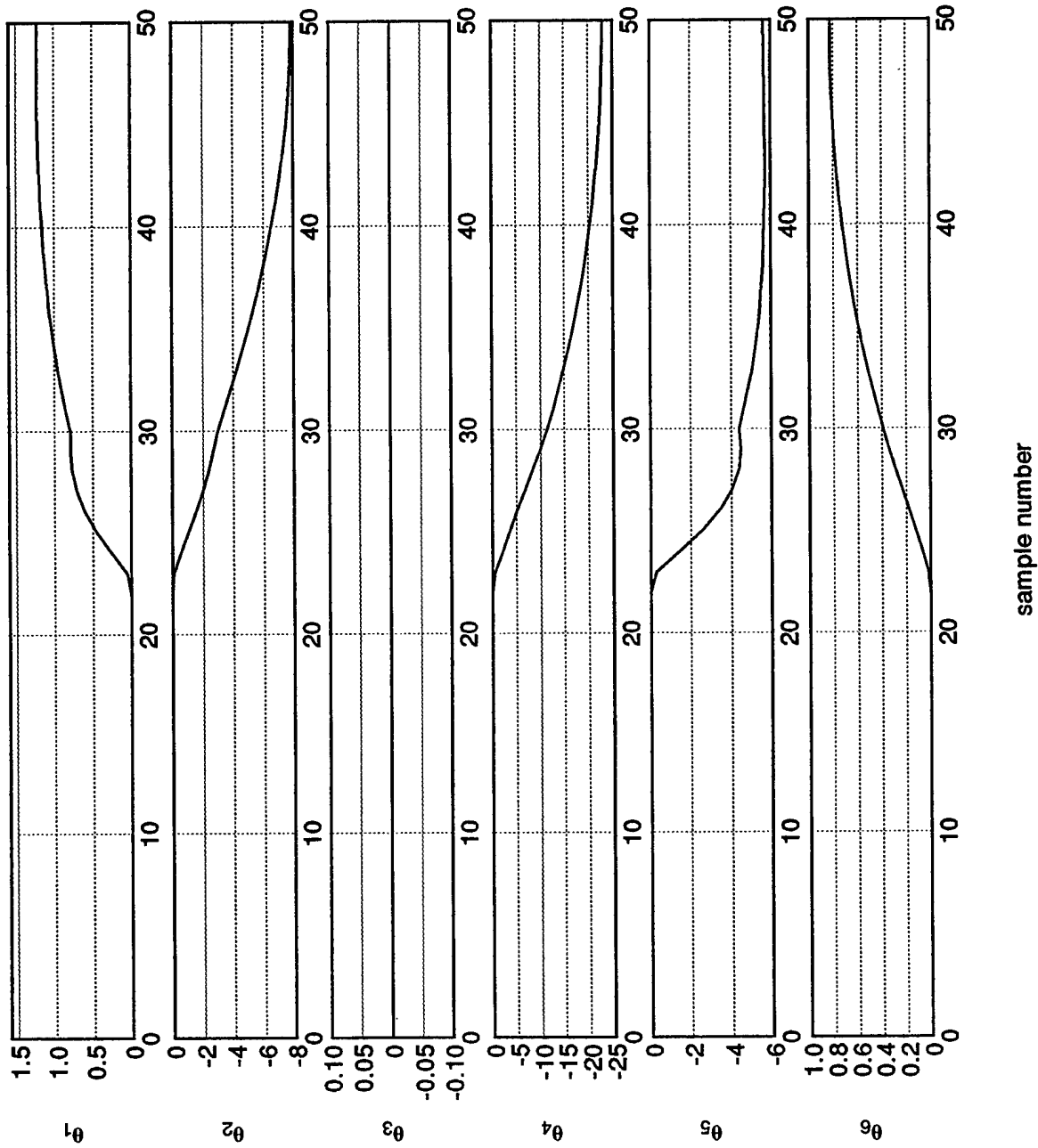

Figure 11. Supplemental commands in degrees vs. sample number for position-limited example.

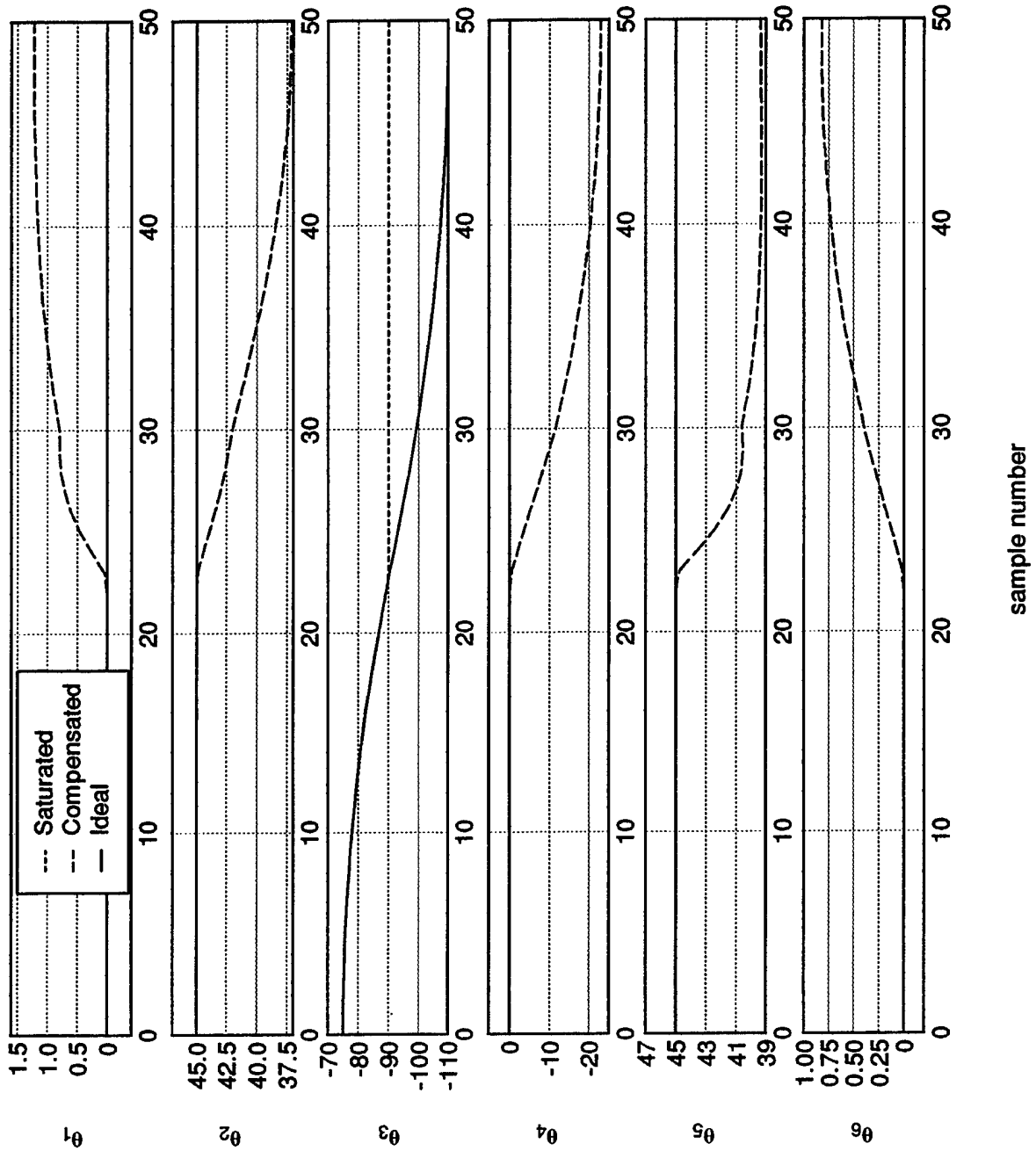

Figure 12. Ideal, compensated, and saturated commands in degrees vs. sample number for position-limited example.

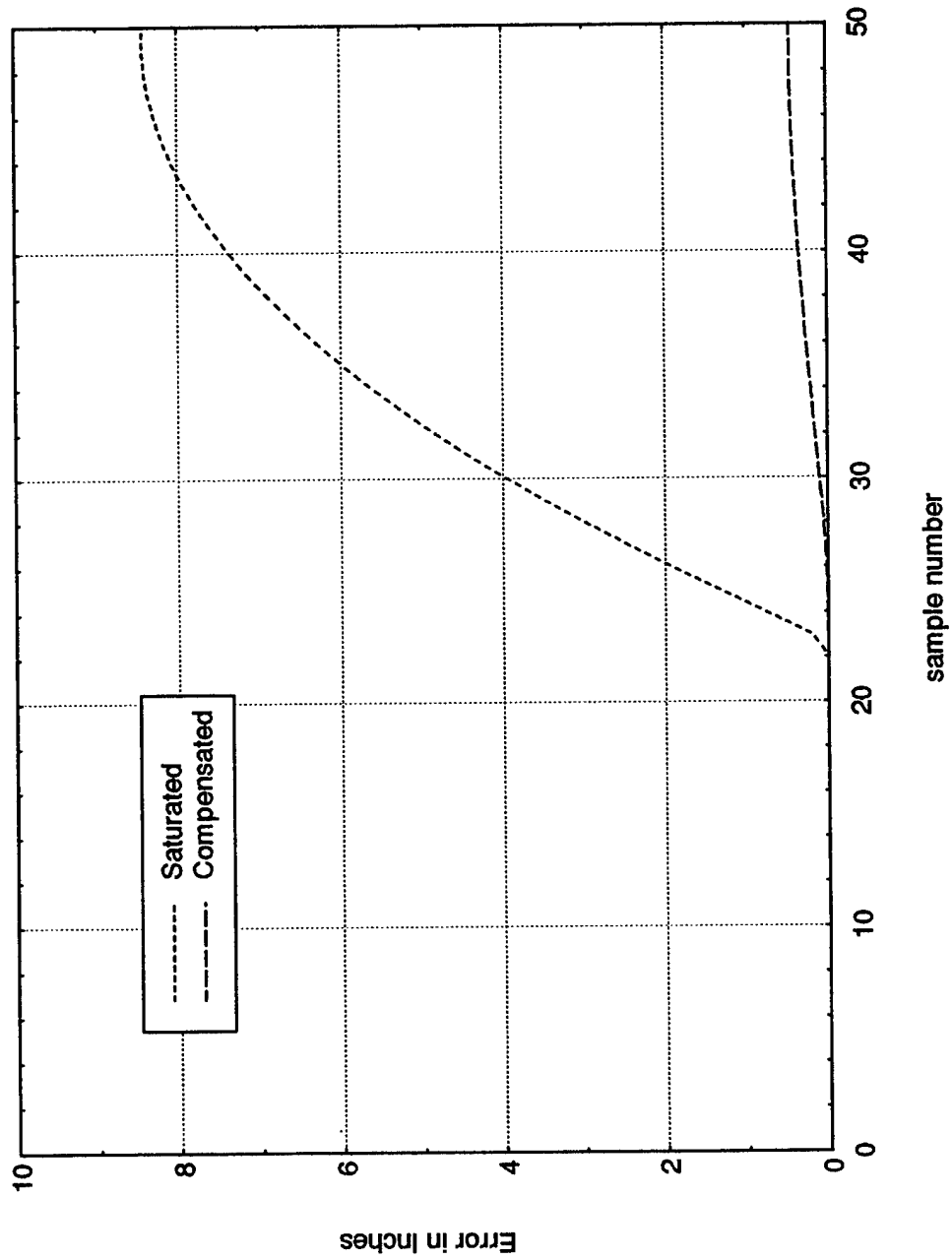

Figure 13. Error in gripper position vs. sample number for position-limited example.

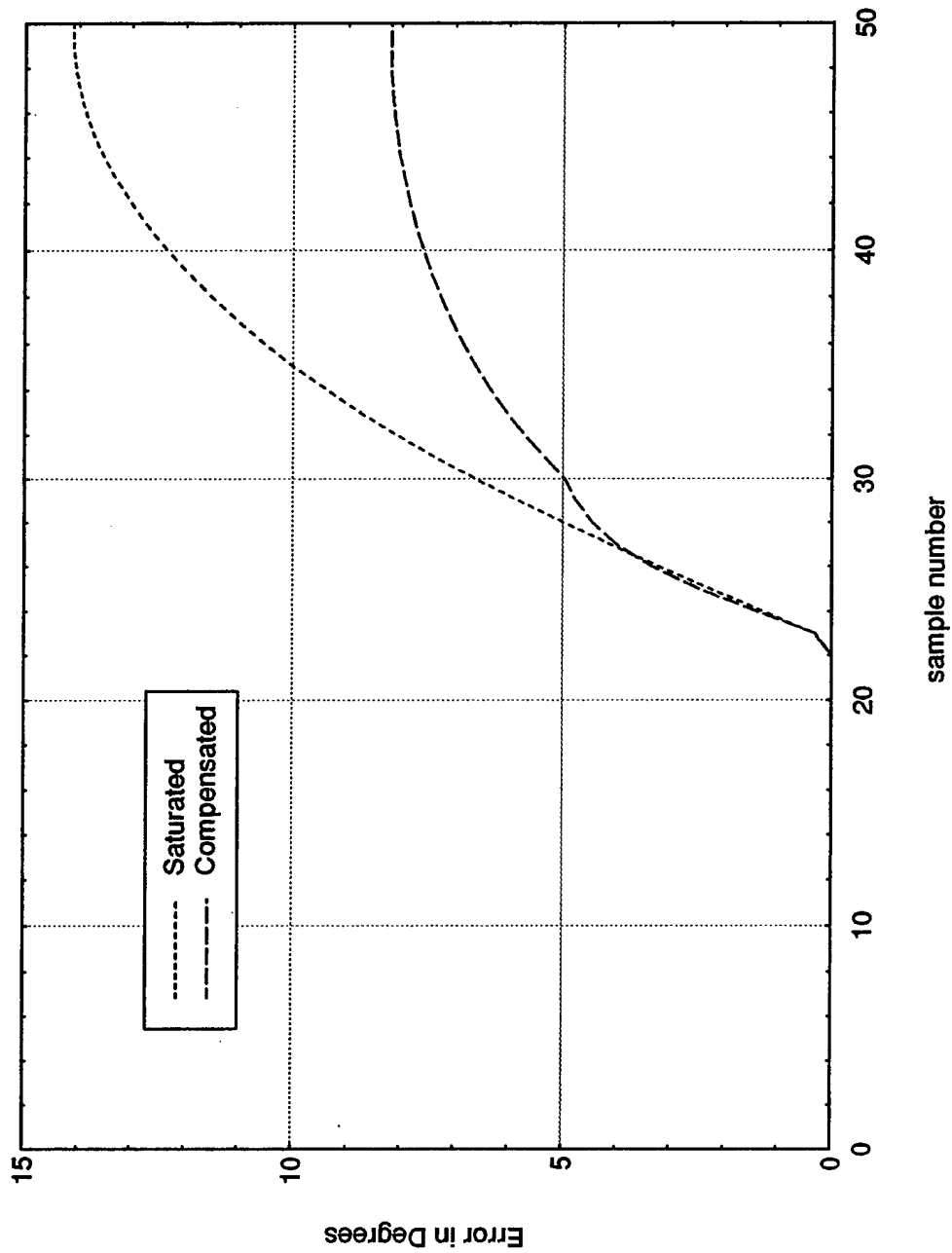

Figure 14. Angle error in approach vs. sample number for position-limited example.

REPORT DOCUMENTATION PAGE

Form Approved
OMB No. 0704-0188

Public reporting burden for this collection of information is estimated to average 1 hour per response, including the time for reviewing instructions, searching existing data sources, gathering and maintaining the data needed, and completing and reviewing the collection of information. Send comments regarding this burden estimate or any other aspect of this collection of information, including suggestions for reducing this burden, to Washington Headquarters Services, Directorate for Information Operations and Reports, 1215 Jefferson Davis Highway, Suite 1204, Arlington, VA 22202-4302, and to the Office of Management and Budget, Paperwork Reduction Project (0704-0188), Washington, DC 20503.

1. AGENCY USE ONLY (Leave blank)	2. REPORT DATE October 1996	3. REPORT TYPE AND DATES COVERED Technical Memorandum	
4. TITLE AND SUBTITLE A New Technique for Compensating Joint Limits in a Robot Manipulator		5. FUNDING NUMBERS WU-505-62-50 1L161102AH45	
6. AUTHOR(S) Jonathan Litt, André Hickman, and Ten-Huei Guo		8. PERFORMING ORGANIZATION REPORT NUMBER E-10451	
7. PERFORMING ORGANIZATION NAME(S) AND ADDRESS(ES) NASA Lewis Research Center Cleveland, Ohio 44135-3191 and Vehicle Propulsion Directorate U.S. Army Research Laboratory Cleveland, Ohio 44135-3191		10. SPONSORING/MONITORING AGENCY REPORT NUMBER NASA TM-107330 ARL-TR-1101	
9. SPONSORING/MONITORING AGENCY NAME(S) AND ADDRESS(ES) National Aeronautics and Space Administration Washington, D.C. 20546-0001 and U.S. Army Research Laboratory Adelphi, Maryland 20783-1145		11. SUPPLEMENTARY NOTES Jonathan Litt, Vehicle Propulsion Directorate, U.S. Army Research Laboratory, Lewis Research Center; André Hickman, Morehouse College, Atlanta, Georgia 30314; Ten-Huei Guo, Lewis Research Center. Responsible person, Jonathan Litt, organization code 0300, (216) 433-3738.	
12a. DISTRIBUTION/AVAILABILITY STATEMENT Unclassified - Unlimited Subject Category 63 This publication is available from the NASA Center for AeroSpace Information, (301) 621-0390.		12b. DISTRIBUTION CODE	
13. ABSTRACT (Maximum 200 words) A new robust, optimal, adaptive technique for compensating rate and position limits in the joints of a six degree-of-freedom elbow manipulator is presented. In this new algorithm, the unmet demand as a result of actuator saturation is redistributed among the remaining unsaturated joints. The scheme is used to compensate for inadequate path planning, problems such as joint limiting, joint freezing, or even obstacle avoidance, where a desired position and orientation are not attainable due to an unrealizable joint command. Once a joint encounters a limit, supplemental commands are sent to other joints to best track, according to a selected criterion, the desired trajectory.			
14. SUBJECT TERMS Robotics; Actuator saturation; Adaptive control; Optimal control; Fault compensation		15. NUMBER OF PAGES 26	
17. SECURITY CLASSIFICATION OF REPORT Unclassified		16. PRICE CODE A03	
18. SECURITY CLASSIFICATION OF THIS PAGE Unclassified	19. SECURITY CLASSIFICATION OF ABSTRACT Unclassified	20. LIMITATION OF ABSTRACT	