

NAVAL POSTGRADUATE SCHOOL MONTEREY, CALIFORNIA



THESIS

**THE USE OF PATROL CRAFT IN LOW
INTENSITY CONFLICT OPERATIONS:
AN ALTERNATIVE MODEL FOR THE
EMPLOYMENT OF THE
CYCLONE-CLASS (PC-1)**

by
Michael A. Polidoro

December, 1995

Thesis Advisor:

Wayne P. Hughes, Jr.

19960329 099

Approved for public release; distribution is unlimited.

DTIC QUALITY INSPECTED 1

REPORT DOCUMENTATION PAGE

Form Approved OMB No. 0704-0188

Public reporting burden for this collection of information is estimated to average 1 hour per response, including the time for reviewing instruction, searching existing data sources, gathering and maintaining the data needed, and completing and reviewing the collection of information. Send comments regarding this burden estimate or any other aspect of this collection of information, including suggestions for reducing this burden, to Washington Headquarters Services, Directorate for Information Operations and Reports, 1215 Jefferson Davis Highway, Suite 1204, Arlington, VA 22202-4302, and to the Office of Management and Budget, Paperwork Reduction Project (0704-0188) Washington DC 20503.

1. AGENCY USE ONLY (Leave blank)	2. REPORT DATE December 1995	3. REPORT TYPE AND DATES COVERED Master's Thesis	
4. TITLE AND SUBTITLE - THE USE OF PATROL CRAFT IN LOW INTENSITY CONFLICT OPERATIONS: AN ALTERNATIVE MODEL FOR THE EMPLOYMENT OF THE CYCLONE-CLASS (PC-1) (UNCLASSIFIED)		5. FUNDING NUMBERS	
6. AUTHOR(S) Michael A. Polidoro		8. PERFORMING ORGANIZATION REPORT NUMBER	
7. PERFORMING ORGANIZATION NAME(S) AND ADDRESS(ES) Naval Postgraduate School Monterey CA 93943-5000		10. SPONSORING/MONITORING AGENCY REPORT NUMBER	
9. SPONSORING/MONITORING AGENCY NAME(S) AND ADDRESS(ES)		11. SUPPLEMENTARY NOTES The views expressed in this thesis are those of the author and do not reflect the official policy or position of the Department of Defense or the U.S. Government.	
12a. DISTRIBUTION/AVAILABILITY STATEMENT Approved for public release; distribution is unlimited.		12b. DISTRIBUTION CODE	
13. ABSTRACT (maximum 200 words) The post-Cold War era has posed a significant challenge to the U.S. Navy. The absence of a major, blue-water, naval threat has allowed the Navy to shift its focus toward the littoral arena and to develop strategies and tactics for operations close to shore. While it is hard to dispute the need for the combat power of a carrier battle group in wartime, its firepower is less necessary or applicable in low intensity conflict (LIC) operations. Patrol craft, particularly the Cyclone-class (PC-1), are ideally suited for LIC. These "niche" craft offer a valuable contribution to the close-in, coastal patrol and interdiction mission and to naval special warfare support. Unfortunately for the PCs, the institutional bias of the U.S. Navy favors multi-mission capable "big ships" and small craft programs are often deemed non-competitive and are ignored. The thesis examines this problem through the lens of bureaucratic politics theory and uses it to compare the similarity of arguments for and against the PHM and PC programs. In an attempt to create an alternative model for PC employment, based on the mother ship/scout-fighter concept, the thesis also investigates how foreign coastal navies employ their patrol craft. The study concludes with a recommendation to more heavily involve the PCs in LIC and contingency operations and make them part of the Navy's forward presence mission.			
14. SUBJECT TERMS Patrol Craft - Cyclone-class - Pegasus-class - Low Intensity Conflict - Littoral Warfare - Mother Ship - Scout-fighter - Bureaucratic Politics			15. NUMBER OF PAGES 121
17. SECURITY CLASSIFICATION OF REPORT Unclassified			16. PRICE CODE
18. SECURITY CLASSIFICATION OF THIS PAGE Unclassified	19. SECURITY CLASSIFICATION OF ABSTRACT Unclassified	20. LIMITATION OF ABSTRACT UL	

Approved for public release; distribution is unlimited.

**THE USE OF PATROL CRAFT IN LOW INTENSITY CONFLICT
OPERATIONS: AN ALTERNATIVE MODEL FOR THE
EMPLOYMENT OF THE CYCLONE-CLASS (PC-1)**

Michael A. Polidoro
Lieutenant, United States Navy
B.S., United States Naval Academy, 1990

Submitted in partial fulfillment
of the requirements for the degree of

MASTER OF ARTS IN NATIONAL SECURITY AFFAIRS

from the

NAVAL POSTGRADUATE SCHOOL

December 1995

Author:



Michael A. Polidoro

Approved by:

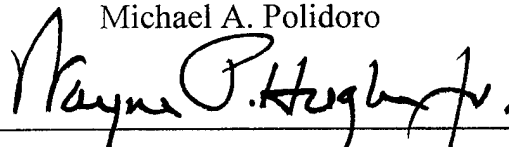

Wayne P. Hughes, Jr., Thesis Advisor

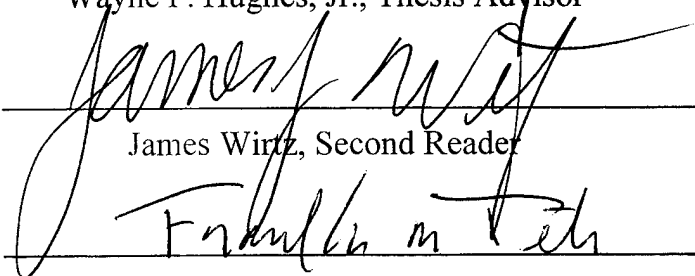

James Wirtz, Second Reader

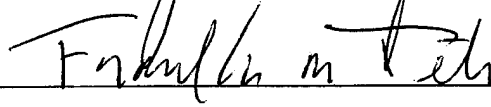

Frank Teti, Chairman

Department of National Security Affairs

ABSTRACT

The post-Cold War era has posed a significant challenge to the U.S. Navy. The absence of a major, blue-water, naval threat has allowed the Navy to shift its focus toward the littoral arena and to develop strategies and tactics for operations close to shore. While it is hard to dispute the need for the combat power of a carrier battle group in wartime, its firepower is less necessary or applicable in low intensity conflict (LIC) operations. Patrol craft, particularly the *Cyclone*-class (PC-1), are ideally suited for LIC. These "niche" craft offer a valuable contribution to the close-in, coastal patrol and interdiction mission and to naval special warfare support.

Unfortunately for the PCs, the institutional bias of the U.S. Navy favors multi-mission capable "big ships" and small craft programs are often deemed non-competitive and are ignored. The thesis examines this problem through the lens of bureaucratic politics theory and uses it to compare the similarity of arguments for and against the PHM and PC programs. In an attempt to create an alternative model for PC employment, based on a mother ship/scout-fighter concept, the thesis also investigates how foreign coastal navies employ their patrol craft. The study concludes with a recommendation to more heavily involve the PCs in LIC and contingency operations and make them part of the Navy's forward presence mission.

TABLE OF CONTENTS

I.	INTRODUCTION.....	1
A.	THE PROBLEM.....	1
B.	RELEVANCE.....	2
C.	METHODOLOGY.....	6
II.	THE <i>SURFACE WARFARE VISION 2030</i> FORCE.....	15
A.	BACKGROUND.....	15
B.	MOTHER SHIP (LX)/SCOUT-FIGHTER (SFX) COMBINATION....	16
1.	Concept of Operations.....	16
2.	Characteristics and Potential Missions.....	22
a.	Mother Ship (LX).....	22
b.	Scout-Fighter Vehicles (SFX).....	26
3.	Conclusions.....	32
III.	PATROL CRAFT EMPLOYMENT IN COASTAL NAVIES.....	35
A.	STRATEGY.....	35
B.	MISSIONS.....	37
1.	Non-Wartime Patrol Craft Missions.....	38
a.	Fisheries Protection/EEZ Patrol.....	38
b.	Internal Waters/Riverine Patrols.....	39
c.	Non-Wartime Coastal Patrol & Interdiction (CP&I).....	40
2.	Wartime Patrol Craft Missions.....	41
a.	Checkpoint Control and Defense.....	41
b.	Close Blockade.....	42
c.	Picket Boat Duty/Harbor Defense.....	43
d.	Support of Land Forces.....	43
e.	Special Operations.....	44
f.	Wartime Coastal Patrol & Interdiction.....	44
C.	PROBLEMS WITH PATROL CRAFT.....	44
1.	Forward Basing Requirements.....	45
2.	Limited Endurance.....	45
3.	Platform Instability.....	46
4.	Vulnerability to Air Attack.....	46
D.	CURRENT TRENDS.....	47
IV.	<i>PEGASUS</i> AND <i>CYCLONE</i>	51

A.	THE <i>PEGASUS</i> -CLASS (PHM-1).....	51
1.	History.....	51
2.	Description.....	57
3.	Roles and Missions.....	60
4.	Debate and Controversy.....	63
a.	Limited Mission Tasking.....	63
b.	Cost.....	65
c.	Vulnerability to Air Attack.....	66
d.	Limited Endurance and Seakeeping.....	67
e.	The Need for Speed.....	69
f.	MLSG Dependency.....	70
B.	THE <i>CYCLONE</i> -CLASS (PC-1).....	71
1.	History.....	71
2.	Description.....	74
3.	Roles and Missions.....	77
4.	Debate and Controversy.....	78
a.	Limited Endurance and Seakeeping.....	79
b.	Cannot Defend Itself.....	81
c.	MST Dependency.....	82
d.	Neither Community Wants Them.....	83
V.	MOTHER SHIP (LX)/PATROL CRAFT, COASTAL (PC) ALTERNATIVE MODEL.....	87
VI.	CONCLUSION.....	93
	BIBLIOGRAPHY.....	97
	INITIAL DISTRIBUTION LIST.....	103

LIST OF FIGURES

1. Vision 2030 Mother Ship (LX).....	23
2. Amphibious Transport Dock Ship (LPD-17).....	25
3. Vision 2030 Scout-Fighter, Small (SFS).....	27
4. Vision 2030 Scout-Fighter, Large (SFL).....	27
5. Multi-Mission Deployable Vehicle, Surface Effect Ship (MDV-SES).....	31
6. Multi-Mission Deployable Vehicle, Hybris Hydrofoil (MDV-HH).....	31
7. <i>Pegasus</i> -class, Patrol Missile Hydrofoil (PHM).....	58
8. <i>Cyclone</i> -class, Patrol Craft, Coastal (PC).....	75
9. Mk V Special Operations Craft (SOC).....	85

LIST OF TABLES

1. Weekly <i>Cyclone</i> -class Rotation Cycle.....	88
2. Squadron Personnel Requirements.....	90

I. INTRODUCTION

A. THE PROBLEM

The post-Cold War era has posed a significant challenge to the U.S. Navy. The absence of a major, blue-water, naval threat has allowed the Navy to shift its focus toward the littoral arena and to develop strategies and tactics for operations close to shore. While the amphibious ready group (ARG) has always trained for such missions, the carrier battle group (CVBG) is confronting the limitations and hazards of operating near the beach. The 1992 *...From the Sea* and the 1994 *Forward...From the Sea* white papers explore and redefine the traditional roles and missions of the Navy and Marine Corps in light of the fall of the Soviet Union. *Forward...From the Sea* outlines the continued importance of naval forces in United States foreign policy:

Most fundamentally, our naval forces are designed to fight and win wars. Our most recent experiences, however, underscore the premise that the most important role of naval forces in situations short of war is to be engaged in forward areas, with the objectives of preventing conflicts and controlling crises. Naval forces thus are the foundation of peacetime forward presence operations and overseas response to crisis.¹

Contingency operations call upon the Navy and Marine Corps to fulfill maritime sanctions enforcement, humanitarian relief and/or peacekeeping roles. These missions consume a disproportionate amount of the yearly operating budgets. Whether the crisis has the potential to escalate into a major regional conflict (MRC), as with Iraq and Bosnia, or to remain at the low intensity conflict (LIC) level, as with Liberia, Somalia, Haiti and Cuba, does not seem to matter -- the standard Administration response is to deploy a CVBG or ARG to the region to signal U.S. interest. Once on station, this naval

¹ *Forward...From the Sea*, Washington D.C.: Department of the Navy, 1994: 2.

show of force is expected to influence events and to project power ashore to prevent further conflict escalation. While it is hard to dispute the need for the combat power of a CVBG in wartime, its firepower is less necessary or applicable in LIC operations (where the maritime threat is most often low to non-existent). Neither the high-tech *Ticonderoga*-class (CG-47) cruisers, *Arleigh Burke*-class (DDG-51) destroyers nor the *Spruance*-class (DD-963) destroyers that accompany the CVBG are ideally suited for such a low, maritime threat environment. Designed as multi-mission platforms for war on the open ocean, it is unlikely that their surface-to-air or surface-to-surface missiles will ever be needed in support of LIC operations. Limited to their 5" guns and 25 mm chain guns as their most useful armaments for LIC, it is hardly cost-effective to use billion dollar warships for gunboat and picket duty.

B. RELEVANCE

The Navy is slowly adapting to littoral and LIC mission requirements. While high profile littoral programs, like theater ballistic missile defense, will undoubtedly pay off in future MRCs or the next superpower confrontation, these advances do little to enhance naval operations in LIC. A force which is trained and equipped to fight a major conventional war is not necessarily equally ready to fight a low intensity conflict.² Obviously, this research and development is still necessary to maintain the Navy's ability to "fight and win wars"; however, attention needs to be focused today on developing the

² Andrew F. Krepinevich's book, *The Army and Vietnam*, Baltimore: Johns Hopkins University Press, 1986, outlines this concept. The U.S. Army viewed the Vietnam War as a conventional war between the armies of North and South Vietnam. The U.S. Army strategy was to secure the borders of South Vietnam to prevent the main force, NVA units from coming south. The Viet Cong were seen as North Vietnamese lackies and their insurgency was more of a nuisance than a threat. In reality, according to Krepinevich, the Viet Cong were the real threat; a counter-insurgency (LIC) strategy was needed in lieu of a conventional one. The United States lost because its military and foreign policy leaders failed to understand this fact until it was too late.

doctrine and platforms required for the low intensity conflicts which consume so much of the Navy's time and money. This lack of focus is caused partly by the definition of the "littoral region," as set forth in the Department of the Navy's recent maritime strategy white papers.

As a general concept, ...*From the Sea* defines the littoral region as comprising two segments of the battlespace:

Seaward: The area from the open ocean to the shore which must be controlled to support operations ashore.

Landward: The area inland from shore that can be *supported and defended* directly from the sea. [emphasis added] ³

Forward...From the Sea expands on the definition, stating that the littoral is comprised of, "...those areas adjacent to the oceans and seas that are *within direct control of and vulnerable* to the striking power of sea-based forces." [emphasis added]⁴ The 1994 white paper widens the scope of the littoral region to include areas "vulnerable" to naval strikes. Accordingly, the definition becomes a function of the maximum striking range of naval forces (currently 650 nm using conventional Tomahawk Land Attack Missiles). Over time, as technology improves the range of the Navy's cruise missiles and attack aircraft, the littoral region will extend even farther inland. Defined in these terms, the littoral encompasses almost all land regions on the planet except for the frozen tundras of Siberia and North America, the heart of deepest Africa and the central hinterland of South America.⁵ This definition is far too broad and is driving the Navy to adopt weapon systems and platforms designed to make the Navy a more active participant in the fight on land mainly because there is no maritime power left to fight at sea.

³ ...*From the Sea: Preparing the Naval Service for the 21st Century*, Washington D.C.: Department of the Navy, 1992: 6.

⁴ *Forward...From the Sea*, 1.

⁵ ...*From the Sea*, 6.

Prior to ...*From the Sea*, the littoral region referred to the seashore and coastal waterways. It was a region too shallow for blue-water combatant ships and was relegated to the green and brown-water navies and coast guards of the world. Now it seems that littoral operations are synonymous with deep-strike, power projection operations, a mission more suitable to the capabilities of our larger combatants. Using *Forward...From the Sea's* definition, the entire World War II Pacific campaign and most of the North African and European campaigns qualify as littoral operations; a ridiculous idea to say the least. Deep strike missions should be left to the Air Force. Littoral should be defined in such a way as to tie it back to the coastal region - 650 nm inland is not considered coastal by any stretch of the imagination. The crux of the definition should be the phrase "supported and defended directly from the sea," as originally stated in ...*From the Sea*. Just because the Navy can hit targets hundreds of miles inland, does not mean it can support and defend that area in the same way that ground forces can. It takes ground forces to occupy and control ground, navies should not be advertised as being equally capable of doing so. The definition would be better served if it was limited in scope to the same area of influence ashore afforded to the Marine Corps

The Navy has not been completely off-the-mark in adapting to littoral operations, particularly in the realm of LIC. The *Cyclone*-class coastal patrol craft (PCs) are a case in point. Unfortunately, what was conceived of as a good idea has evolved into a controversial program which is receiving mixed reviews. The PCs were originally intended for use by Naval Special Warfare Command (NAVSPECWARCOM) as platforms for SEAL team operations. They were supposed to be replacements for Naval Special Warfare's aging fleet of small boats and were never intended to become so large that they warranted commissioning. For a variety of reasons, to be explored later in the thesis, the boats became ships. When the PCs were finally commissioned, they were the

product of bureaucratic compromise between the Special Operations and Surface Warfare communities, no longer satisfying the original requirements of either.⁶ The PCs are currently owned by US Special Operations Command (USSOCOM) but have been relegated to the sidelines by both communities. Each branch is struggling to find suitable employment for the craft. They are shunned by the special operations community because of the bureaucratic "baggage" that accompanies their commissioned status and because the craft can only accommodate half of a SEAL platoon with barely enough room for their equipment. The surface navy regards the *Cyclone*-class as too small, too poorly armed and too mission limited for blue-water operations and is reluctant to allow them to travel far from home.⁷ When the PCs do manage to deploy to a theater of operations, they are assigned to the senior, surface commander and are frequently tasked with odd jobs and "busy work" while the rest of the battle force worries about the big picture.

The *Cyclone*-class is in danger of suffering the same fate which befell the recently decommissioned *Pegasus*-class PHMs, only in reverse. While the PHMs struggled for integration and acceptance of a coastal patrol craft in the blue-water *Maritime Strategy*, the PCs are fighting to carve a coastal patrol niche in the littoral ...*From the Sea* strategy. General Carl Mundy, USMC, former Commandant of the Marine Corps, best describes this littoral environment in a recent article:

Operations in the often compressed battlespace of littoral regions hinder a multilayered defense.... The broad array of military threats, air and surface traffic congestion, and natural forces complicate littoral force employment, especially command and

⁶ Orr Kelly, *Brave Men - Dark Waters*, Novato, CA: Presidio, 1992: 248-49.

⁷ This reluctance is gradually being overcome in the 2nd and 6th Fleets. PCs have successfully deployed to the Mediterranean and Baltic Seas for combined operations. The PCs based on the West Coast have yet to find support for a trans-Pacific crossing.

control.... Moreover, [weapons] employment is likely to be in congested littoral areas, with crowded shipping lanes and civilian air corridors, combined with problems of uncharted shallows.⁸

This environment is exactly the type of setting for which patrol craft are best suited to operate. For reasons of cost and strategy, it is understandable why the PHMs failed to fit into the forward presence doctrine advocated in the *Maritime Strategy*. These same reasons, however, do not apply to the PC, especially when all attention is now focused on naval operations in the littoral. To understand the resistance of the Navy to the PCs, an examination of the bureaucratic politics and institutional biases of the Navy is necessary.

C. METHODOLOGY

The central thesis of this study is that patrol craft, particularly the *Cyclone*-class PCs, have a valuable and often overlooked potential for enhancing U.S. Navy operations in littoral warfare, especially when responding to LIC contingencies. Currently, the PCs are being under-employed and misused, deployed in pairs on bi-lateral exercises and diplomatic port visits. There is a fundamental lack of understanding in the U.S. Navy of small craft tactics and missions, stemming from long-standing institutional and cultural biases in favor of big ships. As Robert O'Connell points out, since Teddy Roosevelt's Great White Fleet of 1908, the U.S. Navy has dedicated its resources toward becoming a blue-water, maritime power and a "cult of the battleship" mentality has reigned supreme in the minds of the senior, surface line officers.⁹

A review of the bureaucratic politics literature explains much of the U.S. Navy's resistance to patrol craft and small craft in general. Graham Allison introduced his conception of bureaucratic politics in 1971. In an effort to understand how policy

⁸ Carl E. Mundy Jr., GEN, USMC, "Thunder and Lightning: Joint Littoral Warfare," *Joint Forces Quarterly*, Spring 1994: 47.

⁹ Robert L. O'Connell, *Sacred Vessels*, New York: Oxford University Press, 1991: 124.

decisions were made by institutions, he developed three models: Model I (Rational Actor), Model II (Organizational Process), and Model III (Bureaucratic Politics). Allison concluded that policy decisions are the result of the interaction between various bureaucratic players whose parochial interests and organizational position dictate their perceptions (Model III). This concept challenged the dominant belief that states acted as unitary, rational actors in formulating decisions. Allison demonstrated that parochial interests are a prime factor in shaping policy.¹⁰ Applying Model III to the U.S. Navy, the traditional "big ship" mentality is the result of the leadership's need to protect its vested interests. In the face of budget cuts, draw downs and interservice competition for missions, the capital ships have always been protected by the admirals even when they became obsolete. The battleship is an excellent example of this phenomenon, being decommissioned, reconfigured and dragged out of retirement multiple times.

Morton Halperin expanded on Allison's Model III. Arguing that "an action by one government, which looks...like a deliberate and calculated attempt to influence the behavior of another government, in fact is likely to have emerged from the process of hauling and pulling [between individuals in government organizations]."¹¹ Parochial interests and shared images of society combine to determine the outcome of foreign policy decisions. Halperin also stated that an organization's "essence" is the view held by the dominant group of what the roles and missions of the organization should be.¹² Organizations resist efforts to take away certain functions which are considered vital to the essence of the organization. Additionally, the organization will be indifferent to

¹⁰ Graham Allison, *Essence of Decision*, Boston: Little, Brown, 1971.

¹¹ Morton H. Halperin, *Bureaucratic Politics and Foreign Policy*, Washington, D.C.: Brookings Institution, 1974: 312.

¹² *Ibid.*, 28.

functions that are not deemed as part of its essence and tend not to pursue or advance them even when new technology makes them feasible.¹³

This is a significant point and accurately applies to the patrol craft programs in the U.S. Navy. When they are "sold" by their advocates, they are often hyped as equivalent or marginally better replacements for existing platforms. Pursuing this strategy is a risky endeavor. As will be shown later, the PHM program died trying to prove that it was multi-mission capable. The blue-water Navy was skeptical of the PHM program's boast that they were capable of performing CVBG-related missions like screening, ASW barrier patrol and ASUW/AAW picket. All of these missions threatened the role of the cruisers, destroyers and frigates and were rejected outright. The one mission that the PHM was ideally suited for, choke point interdiction, was lost in the haze of all the other potential missions and completely ruled out when the cost of the PHMs made them too expensive to use for such a high risk mission. The essence of the U.S. Navy centers on the CVBGs and ballistic missile submarines which underpin the sea control, forward presence and deterrence strategies of the blue-water fleet. The PC program, if it is to become a part of the Navy's "essence," must sell itself as a platform capable of doing a "niche" mission not already performed by battle group assets. Coastal patrol & interdiction (inside the 5 fathom curve) and naval special warfare insertion/extraction are obvious choices. The PC proponents must resist the temptation to "sell" their ships for other missions or they will suffer the same fate as the PHMs.

Carl Builder agrees with Halperin's arguments. He claims that the Navy's force mixture drives its strategy: "The qualities of U.S. military forces are determined more by cultural and institutional preferences for certain kinds of military forces than by the

¹³ Ibid., 39.

'threat'.¹⁴ Relying heavily on the parochial interest argument, Builder asserts that institutions have enduring personalities which govern their behavior in planning, strategy formulation and analysis. These personalities are motivated by traditions and cultural preferences adhered to by the senior officers. Builder is particularly critical of the Navy. He views the Navy's maritime strategy as, "...a carefully woven fabric of sub-strategies that more clearly serves the Navy's institutional interests in rationalizing its existing force mix than it does the U.S. national strategy or security interests."¹⁵ Despite Builder's own parochialism in favor of the Army, his arguments are basically sound (i.e., when stripped of his obvious disdain for the Navy).

With today's emphasis on LIC and littoral warfare, the Navy should be striving to build its amphibious forces and restore the "Gator Navy's" tarnished image. The surface warfare officer community has long been divided by the cruiser/destroyer (CRUDES) and amphibious/combat logistics force (CLF) rivalry. The emphasis placed on the CVBG ensured that the CRUDES community was continually taken care of, their ships upgraded with the latest systems to better protect the carrier. Aegis Combat Systems and gas turbine technology are two of the improvements that worked their way into the escort combatants. The amphibious ships were subordinated in importance to the CRUDES ships. A commonly held belief by the surface community was that once you served on an amphibious ship, you were stuck in that community for life. For a career-minded officer, the amphibious navy was not on the fast-track to command. Even today, few Aegis-qualified officers will risk their careers by "going Gator," despite assurances otherwise from their assignment officers. Although the surface navy pays lip service to the renewed

¹⁴ Carl H. Builder, *The Masks of War: American Military Styles in Strategy and Analysis*, Baltimore: John Hopkins University Press, 1989: 6.

¹⁵ *Ibid.*, 85.

importance of the "Gator Navy" and can point to the new LHD-1 and LPD-17 classes, surface warfare officers still worship at alter of the Aegis gods.

Edward Rhodes advanced the bureaucratic politics debate one iteration further by testing Allison's Model III on U.S. Navy policy decisions for budgets, procurement and force mixture. His basic hypothesis is that the Navy is the most parochial of the services and its most senior officer, the Chief of Naval Operations (CNO), steers policy decisions in favor of the parochial interests of the warfare community (either surface, air or submarine) from which he originated. Contrary to Allison, Halperin and Builder, Rhodes' findings dispel the notion that bureaucratic politics are purely interest-driven, despite the fact that the players *believe* that they are:

That bureaucratic politics exist is beyond question. The issue, rather, is whether bureaucratic politics *matter* - whether we need to take them into account to understand state behavior and whether knowledge of the intragovernmental games being played will allow us to predict actual state actions.¹⁶

Based on his findings, Rhodes concludes that organizational behavior is not based on parochial self-interest but rather on the influence of particular sets of widely shared beliefs.¹⁷ He offers an idea-driven model as an alternative to Allison's interest-driven Model III. Rhodes tests this using the hypothesis that commonly held images of naval warfare and foreign policy combine to influence naval procurement and force mixture.

In naval warfare's case, the theories of Alfred Thayer Mahan still reign supreme. Mahan's advocacy of a strong capital ship program made battleships and carriers "essential" and prevented them from being cut when drawdowns occurred. Conversely, those ships and programs not identified as "essential" were often sacrificed to protect the

¹⁶ Edward Rhodes, "Do Bureaucratic Politics Matter? Some Disconfirming Findings from the Case of the U.S. Navy," *World Politics* 47:1 October 1994: 39-40.

¹⁷ *Ibid.*, 41.

cardinal assets.¹⁸ Foreign policy images affect force structure in a similar manner, Rhodes cites the Vietnam War as an example. After the Vietnam War experience, American public opinion shied away from the concept of U.S. military intervention in the Third World. As a result, programs which were designed for the support of intervention missions, such as the amphibious navy, suffered a drastic cut in funding for new construction.¹⁹ This point is almost identical to Halperin's essence argument against the amphibious community. "Luxury" ships, those not identified as "essential," like mine warfare craft, PHMs and PCs, are caught in a Catch-22. They will always suffer in times of fiscal austerity, being sacrificed to maintain the vital sea control ships. In times when the Navy's war chest is full, during the Reagan years for example, the "luxury" ships risk abandonment if they encroach too far on missions normally assigned to the "essential" ships.²⁰

As bureaucratic politics illustrate, whether due to interest or idea-driven policies, the U.S. Navy has a hard time determining the role of patrol craft in a forward presence-oriented, blue-water fleet. Patrol craft are strange creatures; while operating on the tactical offensive, their limited range and endurance makes them strategically defensive platforms. Historically, patrol craft are used to defend the coast and vital choke points of the homeland. WWII and Vietnam are notable exceptions to this rule and demonstrate that given several years to perfect combat operations, the Navy can produce a strong and strategically offensive small boat program. However, in each case, as soon as the war ended, both programs were immediately discontinued.²¹ The LICs of today do not afford the luxury of building up a small boat program. The often short and intense nature of

¹⁸ Ibid., 34-35.

¹⁹ Ibid., 36-37.

²⁰ Ibid., 35.

²¹ Reinforcing the Halperin and Rhodes arguments.

contingency operations dictates that the program must already be up and running prior to the Navy's intervention. For these reasons, the Navy needs to re-examine the role of patrol craft as a potential supplement to low intensity conflict and contingency operations.

This thesis seeks to dispel the idea that patrol craft are restricted to home waters. It also seeks to find an alternative method for integration of patrol craft into the forward presence/contingency response missions of the U.S. Navy's new littoral strategy. While studying WWII and Vietnam may prove helpful in understanding the war time tactics of patrol boats, it would shed little light on the littoral LIC problem facing the Navy today. To best understand how patrol craft should be employed in LIC, attention must be directed toward conceptual studies and toward the coastal navies. The examination of concept studies and coastal navy employment doctrine allows the investigation to distance itself (as much as is possible) from the institutional and cultural biases of the "big ship" mentality common to the U.S. Navy. With these goals, this thesis will hopefully renew interest in the patrol craft program and offer a viable alternative employment for the *Cyclone*-class in order to prevent its premature demise.

The concept study, *Surface Warfare Vision 2030*, is used as a stepping off point for the thesis. Chapter II examines the Vision 2030 basic concepts and ideas, particularly focusing on the mother ship (LX)/scout-fighter (SFX) combination. Although controversial and hotly contested, the study is an excellent framework from which to build the alternative *Cyclone*-class employment model. Chapter III explores the strategy and doctrine of the world's coastal navies. Their doctrine is quite different in practice and scope than the blue-water strategy of the U.S. Navy and is worth understanding. The chapter also reviews the roles and missions of patrol craft in these navies, as well as their common problems and current design trends. Chapter IV investigates the similarity of

debate between the *Cyclone* and *Pegasus*-classes. Valuable lessons learned are derived from the comparison and the investigation highlights the U.S. Navy's institutional bias against the small boat navy. Chapter V proposes the alternative model for the employment of the *Cyclone*-class. The concept centers on the use of patrol squadrons, operating from a mother ship and supported by helicopter gunships, as an inshore supplement to the naval forces responding to a contingency or low intensity conflict. Their ability to operate close to shore, taking advantage of the coastal islands, shoals and inlets, and the sheer number of individual craft would afford the squadron much greater survivability and area of influence than the few combatants that arrive with a carrier battle group or amphibious ready group. Chapter VI offers the study's conclusions.

II. THE SURFACE WARFARE VISION 2030 FORCE

A. BACKGROUND

Written by the Naval Surface Warfare Center in 1990, *Surface Warfare Vision 2030* is a conceptualization of what surface forces will look like 40 years into the post-Cold War era. It has three objectives: to focus on the war fighting needs and goals, to formulate future concepts of operation and force structure, and to support the development of future ships and combat systems. The study assumes that the geopolitical situation of 2030 will be multipolar, with states clustering in economic blocs. Conflict will be caused by economic rivalry, nationalism and religious fundamentalism; environmental and overpopulation problems will act as catalysts to these conflicts. The gap between the developed and undeveloped worlds is expected to widen. While global conventional war is considered unlikely, LIC and limited wars will increase in frequency and intensity as the "have not" states struggle to survive. The study concludes that LIC and limited wars will require the U.S. to reshape its military forces to strike a "better balance between those structured for global war and those able to perform effectively at the lower end of the spectrum of violence."²²

Working from this foundation, *Surface Warfare Vision 2030* outlines a maritime strategy for the U.S. Navy to meet the threats associated with the realignment of the world states. The Navy would continue in its primary role as a sea control force but stronger emphasis will be placed on regional power projection assets. These assets must be capable of carrying out the naval missions most often associated with littoral operations, such as amphibious warfare, mine warfare, coastal patrol and interdiction,

²² Victor A. Meyer, CAPT, USN (Ret.), *Surface Warfare Vision 2030*, Dahlgren, VA: Naval Surface Warfare Center, December 1990: 4.

shallow water anti-submarine warfare (ASW), and special operations.²³ The study describes several future ship types designed to fulfill the requirements of the 2030 maritime strategy. For example, the next generation nuclear aircraft carrier (CVN) will look similar to the *Nimitz*-class CVN; however, its signature will be reduced considerably in all spectrums to make it indistinguishable from the other ships in the battle group.²⁴ The Battle Force Combatant (BFC II) will replace the destroyers and cruisers and the Sea Control Ship (SCV) will become the follow-on to the amphibious helicopter carriers, battleships, and command & control ships. The Mother Ship (LX) will replace amphibious transport ships and repair ships while airborne and seaborne Scout-Fighter Vehicles (SFX), operating from the LX, will act as mine countermeasure ships, patrol boats, amphibious assault boats, and helicopter gunships.²⁵ Various combinations of CVNs, BFC IIs, SCVs and LXs will form the core of future battle and ready groups. Because of its clear role in LIC, the mother ship/scout-fighter concept warrants further exploration.

B. MOTHER SHIP (LX)/SCOUT-FIGHTER (SFX) COMBINATION

1. Concept of Operations

The shallow, congested and high risk waters of the littoral require small craft specially outfitted for operations in the amphibious operating area (AOA). Minesweepers, assault craft, and patrol boats in WWII were the early ancestors of scout-fighters. The *Surface Warfare Vision 2030* concept not only expands the role and

²³ Ibid., 12.

²⁴ Ibid., 28.

²⁵ Brian J. Hopkins and Victor A. Meyer, CAPT, USN (Ret.), *Conceptual Ship Characteristics and Capabilities*, Dahlgren, VA: Naval Surface Warfare Center, 1991: IV- 4.

function of scout-fighters in the AOA but also incorporates them into the screening force.²⁶

The first-stage, mother ship carries the second-stage, scout-fighter vehicles in its well deck, or hangar for airborne scout-fighters, and transports them to the operating area. During transit the LX relies on the battle group to provide protection and escort.²⁷ Once near the operating area, the mother ship deploys its scout-fighters to expand the screen and probe for enemy weaknesses.²⁸ Each SFX is designed to be small, inexpensive, maneuverable and capable of performing a limited, single mission, like ASW or fire support. "Technological advances in the size, weight, cost, and effectiveness of weapons, sensors, and advanced naval vehicles have the potential to revolutionize the capability of the scout-fighters."²⁹ Using the principles of maneuver warfare,³⁰ the LX/SFX combination will conduct operations to keep the enemy off-balance, maneuvering, striking and withdrawing before the enemy can counterattack. By disrupting, harassing and forcing the enemy to reposition his forces, opportunities are created for decisive strikes by the main force CVNs, BFCs and SCVs.³¹

The advantage of the scout-fighters lies in their small size, the adaptability of the LX/SFX force mixture and most importantly, their numbers. Low observability is

²⁶ It is here that that concept runs into direct conflict with the CRUDES navy. The Halperin and Rhodes arguments once again apply. The SFX screening mission threatens to take away functions assigned to destroyers and cruisers or future BFCs. Based on bureaucratic politics, the LX/SFX concept will never be adopted by the Navy if it challenges the traditional roles and missions of the "essential" ships.

²⁷ This assumes the LX has the speed required to keep up with a CVBG. A more likely option would be attaching the LX to an ARG, which often steams without CRUDES escorts. The SFX screening mission would have a much better chance of surviving.

²⁸ Meyer, 18.

²⁹ Ibid., 24.

³⁰ Maneuver warfare is more than maneuverability. Maneuver warfare is often synonymous with amphibious warfare. It involves maneuvering the enemy rather than just maneuvering *to* the enemy. Paralysis, not annihilation is the goal. See Robert J. Kelsey's article, "Maneuver Warfare At Sea." *Naval Institute Proceedings* September 1982: 30-38.

³¹ Meyer, 18.

essential for the SFX. It is also easier to achieve due to their inherently small size and continued success with "stealth" engineering designs. Observability for the LX is not as important because it is expected to operate at a relatively "safe" distance from the threat area. Its role is more similar to that of an aircraft carrier than to that of the tank landing ships (LSTs) and amphibious transport docks (LPDs) that it was designed to replace. Using the two-stage concept, the LX will let its second-stage do all of the fighting much the same as a CV uses its aircraft to fight the battle. The LX, like the CV, stays in the rear of the battle area to provide support and resupply to its second-stage platforms.

Adaptability is another key factor for the LX/SFX team. The well deck and flight deck of the LX are built to accommodate many different types of scout-fighter designs. The well deck can handle the normal assortment of amphibious and patrol craft plus the more exotic designs like surface effect craft, hybrid hydrofoils and air cushion vehicles. The flight deck and hangar are equally versatile, equipped to support helicopters, VSTOL aircraft, remote piloted vehicles (RPVs) and unmanned autonomous vehicles (UAVs). This adaptability is achieved through modularization of hardware and software of the SFX and LX. "Conceptually, the missions of the mother ship are limited only by the type of scout-fighter vehicle available as a modular payload."³² An appropriate SFX force mixture will be embarked and tailored for contingency missions so that the LX arrives with a force suited for local operations. This is more optimal than the usual policy of responding with a nearby CVBG to a LIC contingency. The CVBG arrives equipped to wage war and to establish control of the battle space. In most LICs, however, the scenario does not require the launching of air strikes or even a battle for air, surface and subsurface superiority. The LIC realm spans the spectrum from

³² Ibid., 25.

humanitarian relief to peacekeeping to counterinsurgency; although the CVBG can still play a useful role in LIC, it was not intended for such missions and is not optimized to meet the often nebulous requirements associated with LIC.

This policy is gradually changing. The latest contingency mission in Haiti, Operation Support Democracy, embarked Army Rangers and aviation units on the CVs instead of the normal Navy air wing. While this idea was revolutionary and worked well in operation, I believe it was more of an aberration than a real change in doctrine. The swap occurred primarily because of the luxury afforded by the unusually long lead-time prior to the deployment and invasion. In addition, due to the relative proximity of Haiti to the United States, the carriers were sortied from their home ports and were not already on deployment. It is hard to believe that a similar swap of a carrier air wing for Army helicopters will occur if the contingency is half way around the world. The typically explosive ignition of contingency missions requires a quick response, usually handled by locally deployed battle groups. There would be no time for a carrier to return home, or to be brought out of its repair and work-up cycle, to embark Army aviation units before responding to the crisis.

This fact raises the question about permanently devoting one or two carriers to supporting Army aviation. Due to the already diminished number of aircraft carriers, but with no corresponding decrease in forward presence commitments, it would be impossible to spare even one carrier without severely impacting the deployment cycles and areas of coverage necessary to support the forward presence mission. The 1995 deployment of the *Theodore Roosevelt* CVBG is instructive. The battle group initially deployed to the Adriatic Sea in support of the presence mission required off of Bosnia. It was quickly shifted to the Persian Gulf in response to Iraq's aggressive posturing. Once that situation settled, the CVBG rushed back to the Adriatic to conduct NATO ordered air

strikes on Bosnian-Serb positions.³³ This flexibility is demanded of all carrier battle groups and the Navy is pressed to meet the demand with only 12 carriers. Besides, the helicopter carrier function is already fulfilled by the amphibious assault ships (LHA, LPH and LHDs) for the Marine air wings and there is little need to replicate it for the Army.

Lastly, the success of the SFX relies upon the large number of scout-fighters which arrive on scene. Numbers matter substantially in the LX/SFX concept. A variety of studies have been conducted which demonstrate that staying power, the ability of a force to absorb damage and to continue fighting, is most readily improved by increasing the number of assets brought to the fight.³⁴ While this idea may sound obvious, it runs counter to the Navy's procurement program. For a variety of reasons, monetary and conceptual, the post-WWII Navy has adhered to the policy of quality over quantity. Building and maintaining a navy is an expensive undertaking and the "600-Ship Navy," which was considered by many to be *too small* for the Soviet threat, collapsed under its own weight in 1989 when the Soviet threat could no longer be justified. Much research and development goes into creating multi-mission ships designed to "do more with less" and the quantity argument does not mean to imply that this is a bad idea. By building fewer ships, but making them multi-mission capable, the Navy has been able to maintain a force adequate to meet the country's national tasking needs. By the same token, with this procurement policy, there is an almost instinctual and institutional resistance toward

³³ Victor A. Meyer, CAPT, USN (Ret.) Interview, 5 December 1995.

³⁴ On the advantage of numbers, see K.R. Crawford, M.T. Hatton, and A.W. Melton, "Where Are the Littoral Warfare Fast-Attack Craft?" *Naval Institute Proceedings* (April 1995), Trevor N. Dupuy, COL, USA (Ret.), *Numbers, Predictions and War: Using History to Evaluate Combat Factors and Predict the Outcomes of Battles*, Indianapolis: Bobbs-Merrill, 1979, Wayne J. Hopkins, *Combat Effectiveness of Mother Ship/Scout Fighter Combinations Relative to Battle Force Combatant*, presented at the 60th Military Operations Research Symposium, June 1992, and Wayne P. Hughes, Jr., CAPT, USN (Ret.), *Fleet Tactics: Theory and Practice*, Annapolis: Naval Institute Press, 1986.

building a flotilla of *anything* that is not multi-mission capable. It is on this premise, however, that the LX/SFX combination works.

An operations analysis study, conducted by Wayne Hopkins, compares the combat effectiveness of the LX/SFX combination against the BFC in conditions of a superpower confrontation and in contingency and limited objective (CALO) missions. Looking past the same mistake of directly challenging the blue-water surface navy to a roles and missions battle, the study offers valuable incite into how the advantage of numbers works to the benefit of the SFX. Hopkins concludes that:

The mother ship and scout fighter groupings can offer combat effectiveness superior to an equal cost cruiser/destroyer [BFC II] under some conditions more often found in CALO warfare. Although the cruiser/destroyer offers superior sensors and weapons for all warfare areas, as well as superior endurance and seakeeping, it cannot be in more than one place at the same time, whereas the four or five ships of the [LX/SFX] grouping can. The SFX also offer the advantage of stealth. These advantages of multi-location and stealth provide a greater combat effectiveness for the LX and SFX groupings during: blockade enforcement, bad water ASW and stealth strike [missions].³⁵

Although the individual SFX are single-mission units, the number and variety of SFX employed makes the *combined force* multi-mission capable. Not only are costs kept low with small, large production run scout-fighters but the sheer number of craft provides mission redundancy and force staying power. In the high-risk, littoral AOA where anti-ship cruise missiles (ASCMs), shore batteries and mines are anticipated, casualties are to be expected in a forced entry, amphibious operation. The loss of several scout-fighters, while not preferable, costs less in blood and treasure than the damage or loss of one or more of the bigger warships. In terms of mission effectiveness, the loss of one of the

³⁵ Wayne J. Hopkins, *Combat Effectiveness of Mother Ship/Scout Fighter Combinations Relative to Battle Force Combatant*. Presented at the 60th Military Operations Research Symposium. June 1992: 20.

large, multi-mission combatants would have a greater effect over several mission areas.³⁶ The loss of an SFX causes little impact on the overall mission and can be cheaply replaced with another similarly equipped SFX.

2. Characteristics and Potential Missions

Surface Warfare Vision 2030 speculates on the ship design requirements and characteristics necessary to make the mother ship/scout-fighter concept work. What follows is an overview of the ships envisioned for operations circa 2030:

a. Mother Ship (LX)

The LX design centers on it being an affordable, first-stage carrier of scout-fighter vehicles using a well deck and an aviation deck (see Figure 1). Basically, the LX is a seagoing "truck" that can be configured alternatively for amphibious warfare, mine warfare, naval special warfare, or shore fire support roles.³⁷ It is capable of carrying two Landing Craft, Air Cushion vehicles (LCACs), or four SFX in its well deck. On the flight deck, the LX can spot four LAMPS helicopters or six helicopter gunships. Six UAVs can be stored in lieu of one helicopter.³⁸ The LX can also function in a fleet repair variant, serving as a tender or repair ship for forward deployed surface ships and submarines. It requires sufficient command and control systems to coordinate the actions of its SFX. Due to the protection afforded by the main force units, the LX need only be equipped with a self-defense system composed of a 32-cell, vertical launch system, two Close-In Weapon System (CIWS) mounts and various "soft-kill" systems.³⁹ Offensive firepower depends on the SFX load out for each particular contingency. Based

³⁶ The same argument can be made regarding the vulnerability of the mother ship. If the LX gets hit, all of the SFX which operate from it are temporarily "soft killed" until they can find another platform to operate from.

³⁷ Meyer, *Surface Warfare Visions 2030*, 33.

³⁸ Hopkins and Meyer, III-9.

³⁹ Meyer, *Surface Warfare Visions 2030*, 33.

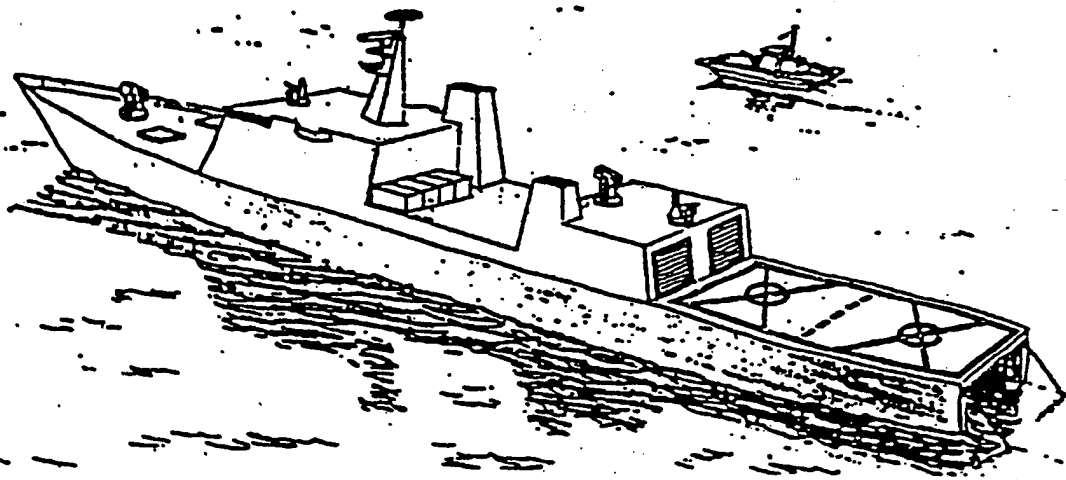

- SINGLE, TAILORED MISSION
- EMBARKS SCOUT FIGHTERS AND OTHER MODULAR PAYLOADS
- CONFIGURED ALTERNATIVELY FOR AMPHIBIOUS LIFT, MCM/MINING, NAVAL SPECIAL WARFARE, SHORE FIRE SUPPORT, FLEET REPAIR

Figure 1. Vision 2030 Mother Ship (LX)

on these mission demands, the LX design is estimated to require a displacement of 20,000 long tons. The ship's dimensions are 650 feet long, 90 feet at the beam with a draft of 23 feet. It has a maximum speed of 23 kts and fuel endurance for 6,000 nm.⁴⁰ The study estimates the LX to cost \$550 million per ship (in FY91 dollars).

The LX "vision ship" became a reality in late 1993 when it was designated as the LPD-17 Amphibious Transport Dock (see Figure 2). It is the functional replacement for the LPD-4, LST-1179, LSD-36 and LKA-113 classes scheduled for decommissioning by 2010.⁴¹ The LPD-17 is 684 feet long and 105 feet at the beam. It draws 23 feet and displaces 25,000 long tons. Its four diesel engines allow a sustained speed of 22 kts.⁴² Its well deck can carry two LCACs and it has 25,000 square feet of vehicle area and 25,000 cubic feet of cargo capacity. It is also equipped to carry 720 combat troops. The flight deck can spot two CH-53 Sea Stallion or four CH-46 Sea Knight or AH-1 Cobra helicopters. The LPD-17 has an advanced air defense system composed of 64 Evolved Sea Sparrow Missiles (ESSM) "quad-packed" into a 16-cell vertical launcher, two Rolling Air Frame point defense missile launchers and two CIWS mounts. The ship design also incorporates a reduced radar cross section and multiple "soft kill" defensive systems, including chaff and electronic counter measures.⁴³ The procurement contract calls for 12 ships to be constructed at an average unit cost of less than \$700 million (FY98 dollars).⁴⁴

⁴⁰ Hopkins and Meyer, III-8.

⁴¹ Howard Fireman, Jim Fowler, John McIntire, and Jim Wilkins, CDR, USN, "LPD-17: In the Midst of Reform," *Naval Engineers Journal* 107:3 May 1995: 267.

⁴² *Ibid.*, 270.

⁴³ *Ibid.*, 267.

⁴⁴ *Ibid.*, 282.

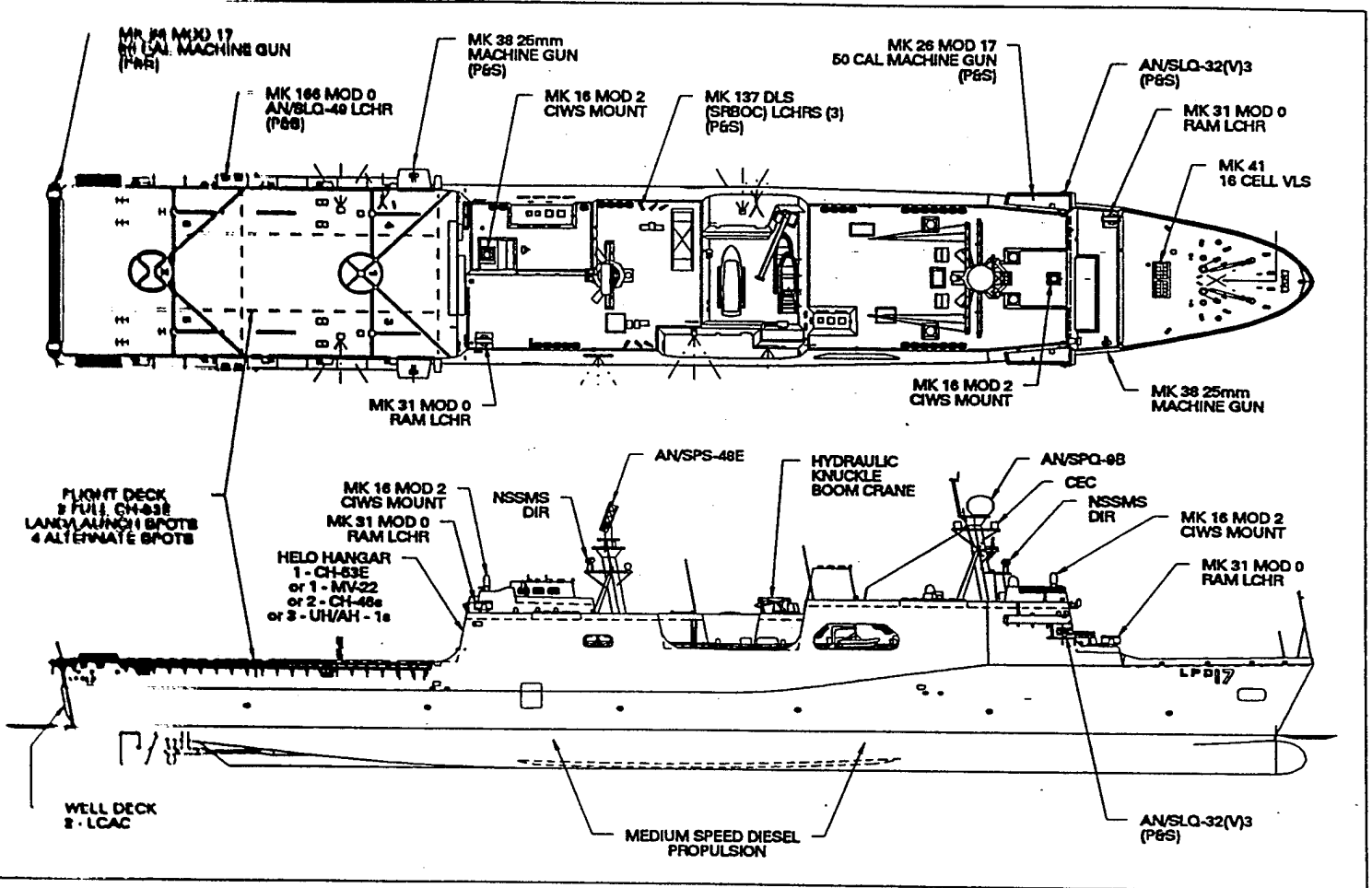

Figure 2. Amphibious Transport Dock Ship (LPD-17)

b. Scout-Fighter Vehicles (SFX)

The second-stage SFX are small, single mission platforms which rely on their size, stealth, shallow draft, high speed, maneuverability and modular payload to accomplish task force operations. According to the study,

They are heavily oriented toward surveillance and offensive missions and would have only a minimum self-defense weapon suite. They are constructed as simply and inexpensively as possible so that they may be affordable in the numbers needed to be effective and to minimize the political risk should one be lost.⁴⁵

The missions suitable for SFX employment are: mine countermeasures/laying, naval special warfare insertion/extraction and reconnaissance, surface fire support, amphibious assault, force deception, shallow water ASW, combat search and rescue, logistics support, and coastal patrol & interdiction.⁴⁶

The specific design of the SFX varies and is rather flexible (see Figures 3 and 4). Large scout-fighters (SFLs), such as patrol craft or even corvette-sized vessels, will receive services alongside the LX and transit independently to the operating area. Small scout-fighters (SFSs), like helicopters, smaller surface craft, mini-sub, UAVs or RPVs, will receive services and transit inside the well deck or hangar of the mother ship.⁴⁷ The *Surface Warfare Vision 2030* study suggests that the SFX designs should to be as flexible as a helicopter and have the maintenance requirements of a patrol boat. Design modularity permits innovative acquisition strategies, like non-developmental and commercial off-the-shelf items, to ensure that the latest technology is incorporated in a timely and affordable manner. Care must be taken, however, to ensure that the SFX is not so

⁴⁵ Meyer, *Surface Warfare Visions 2030*, 35.

⁴⁶ *Ibid.*, 36.

⁴⁷ Hopkins, 1.

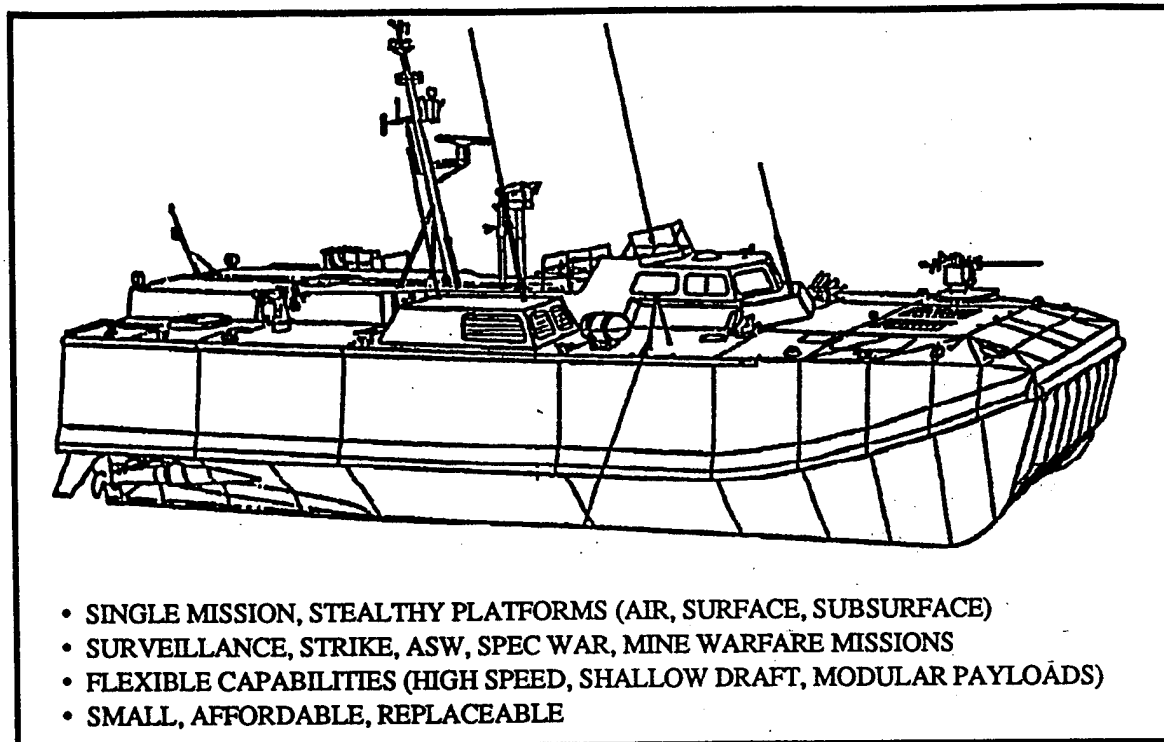

Figure 3. Vision 2030 Scout-Fighter, Small (SFS)

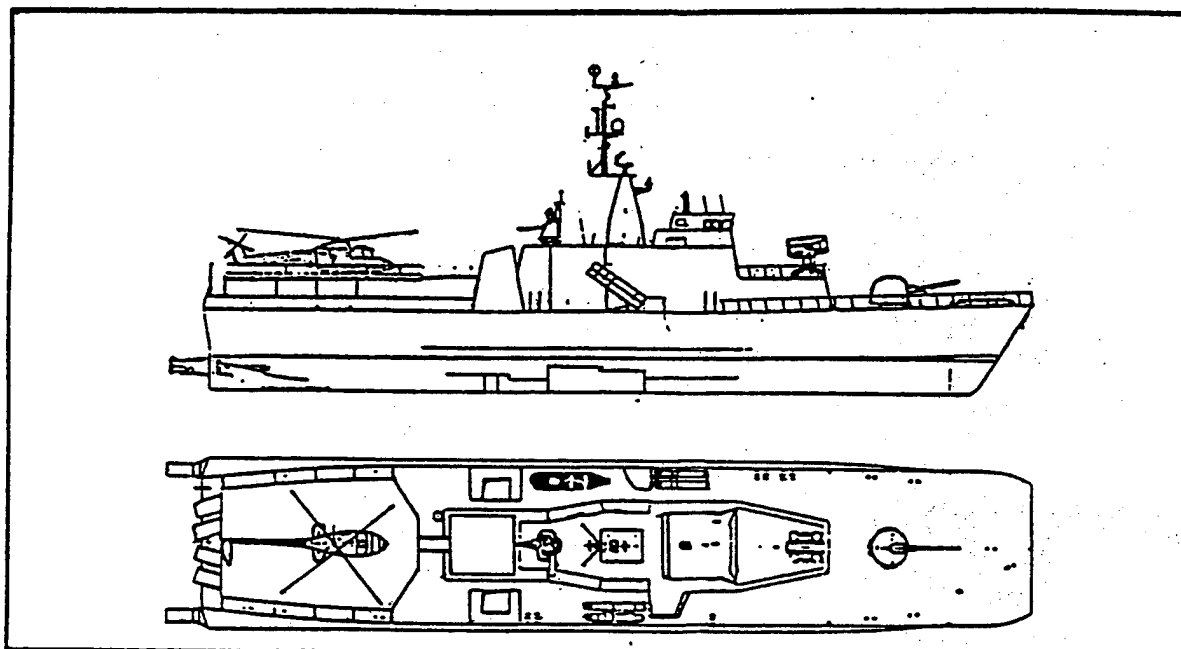

Figure 4. Vision 2030 Scout-Fighter, Large (SFL)

constrained by support systems that it cannot be replaced as new technology becomes available.⁴⁸

Presently, there is strong debate as to whether the role of the SFX can be better satisfied by surface vessels or aircraft. The standard, anti-small boat arguments are made by the critics. They are too heavily impacted by bad weather and are limited in crew endurance and payload. The aircraft proponents assert that certain types of all-weather attack aircraft, particularly helicopters, can accomplish many of the same missions assigned to small boats with the added advantage of being faster. The small boat navy counters that surface vessels can stay on station longer than aircraft and are necessary for critical LIC missions such as boarding operations and mine clearance. The answer lies somewhere in the middle; a mixture of surface and air scout-fighters will be required depending on the scenario. To argue for the "one proper" design which satisfies most of the SFX requirements demonstrates a failure to understand the concept.

The SFX vision requires single mission craft, each mission must govern the appropriate SFX design. If a particular design satisfies two or even three missions, that is an added bonus but it should not be a requirement. Recalling Builder's argument, for the SFX program to be credible and accepted, the missions should drive the platform construction, not vice-versa. The key point is that, whatever forms the SFX take, the designs must be modular and supportable from the mother ship. Certain SFX missions, such as surface fire support and special operations, can be performed by the same craft simply by swapping out basic, man portable weapon systems, like precision guided mortars or anti-tank weapons, from inside the well deck of the LX. Other missions, like mine countermeasures or ASW, which require larger support and weapon systems would

⁴⁸ Meyer, *Surface Warfare Visions 2030*, 35.

not be so interchangeable.⁴⁹ The idea of building one hullform or airframe and modularizing all of the mission packages to fit it is unrealistic, brings us back to the multi-mission argument and would cause a massive increase in unit cost, thereby defeating the purpose of the SFX concept.

Currently there are no specific SFX designs in the procurement cycle. The Navy is looking at various candidates but few have made it beyond the conceptual prototype phase. Two versions the LCAC show some promise: a mine countermeasure (MCAC) version, and a surface fire support (FSAC) version. The MCAC would install off-the-shelf sweep gear and the FSAC would install the Army's Multiple Launch Rocket System (MLRS).⁵⁰ Other attempts are not worth considering too seriously, such as the Multi-mission Deployable Vehicle (MDV). The MDV has two prototype designs: a surface effect ship (MDV-SES) and a hybrid hydrofoil (MDV-HH). Conceived at the David Taylor Research Center, the MDV was initially designed as a "deployable vehicle that has better seakeeping for its size than a displacement craft, more speed than a ship, more payload than an airplane and more endurance than an airplane."⁵¹ Four missions were envisioned for modularization on the MDV:

- 1) ASW - One package for open ocean and another for shallow water.
- 2) AAW decoy - One package of deception electronic counter measures (ECM).
- 3) LCAC escort and naval surface fire support (NSFS) - One package of gun and rocket enhancements.
- 4) Peacetime search and rescue (SAR), maritime patrol and drug interdiction. One package of boats and fuel.

⁴⁹ Meyer, interview, 5 December 1995.

⁵⁰ Ibid.

⁵¹ Scott Black, Michael Bosworth, CDR, USN, and John R. Meyer, "Well Deck Deployable Naval Combatants," *Naval Engineers Journal* 106:1 January 1994: 110.

Mission definition mandates that the MDV candidates must be able to operate 150 nm in advance of the main force on three to five day missions with a 2,000 nm self-deployment range. In addition, the MDVs have to be helicopter capable and equipped with modular mission payloads that can be changed out in the well deck of a mother ship.⁵²

The MDV prototype designs outlined several vehicles with differing strengths and weaknesses but both capable of meeting the mission definition requirements. The MDV-SES (see Figure 5) is 175 feet long, 45 feet at the beam with a draft of only 2 feet when in surface effect mode and 8 feet when hullborne. It has an overall displacement of 454 long tons and a speed of 53 kts in Sea State 0 (<30 kts in Sea State 5). Per unit cost, in FY90 dollars, is approximately \$98 million for the first ship, \$60 million for the next and \$52 million by the eighth ship.⁵³ The MDV-HH (see Figure 6) is 130 feet long, 45 feet at the beam with a 9 foot draft when foilborne and 21 feet when hullborne. Displacing 416 long tons, the MDV-HH can achieve speeds of 45 kts in Sea State 0 (42 kts in Sea State 5). Its costs, in FY90 dollars, are slightly lower at \$80 million for the lead ship, \$48 million for the second and \$43 million for the eighth.⁵⁴

There are several drawbacks to these MDV prototypes. First, starting with the name, the program is already off to a bad start. The contract requirement that the vehicle must be multi-mission capable in ASW, AAW, ECM, NSFS, SAR, CP&I and helicopter operations makes it a target for the programs that it threatens. Even though the multi-mission requirement was probably envisioned as a "selling point," bureaucratic politics will kill the program if it cannot demonstrate its superiority in the missions it is trying to take over. The more missions it takes on, the more potential enemies it will

⁵² Ibid., 111.

⁵³ Ibid., 115, 121.

⁵⁴ Ibid., 119, 121.

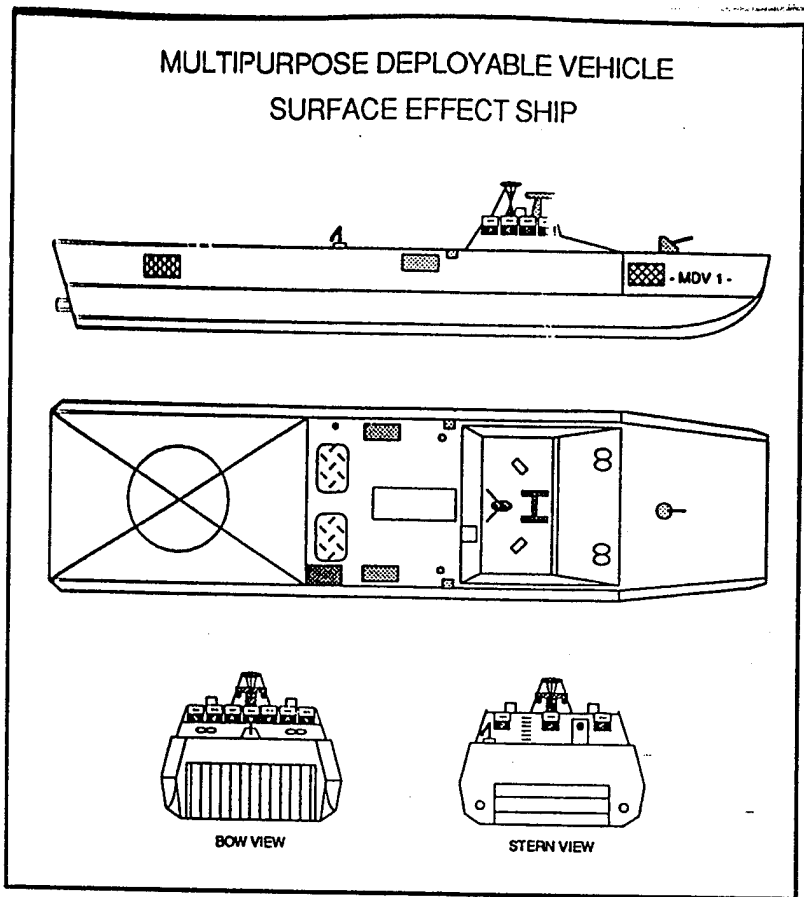

Figure 5. Multi-Mission Deployable Vehicle, Surface Effect Ship (MDV-SES)

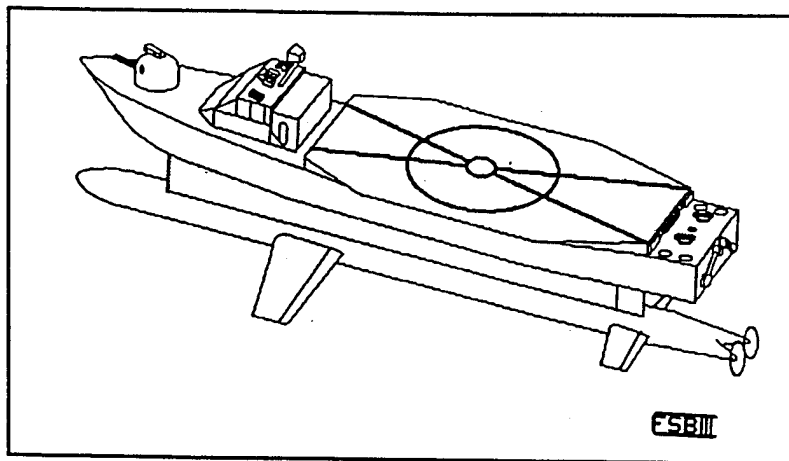

Figure 6. Multi-Mission Deployable Vehicle, Hybrid Hydrofoil (MDV-HH)

have to overcome. The second major drawback to the MDV is cost. The exotic hullform technology and the modularization of mission payloads is expensive. The helicopter support mission increases the cost due to the incorporation of a flight deck in the design of the vehicle. The added cost of outfitting the MDV with all the necessary equipment for flight operations, raises the issue of dropping the helicopter support mission. A third problem with the MDV focuses on logistics. Space must be set aside in the well deck to store the different mission modules. This may pose a potential problem when the LX is combat loaded. In addition, the MDV-HH also requires a specially constructed LX with a well deck that can accommodate the lower hull and strut of the craft.

3. Conclusions

Surface Warfare Vision 2030 has much to offer to the debate on the next generation of warships and fighting concepts as long as the reader keeps the bureaucratic politics of the Navy in mind. The vision proposed by Victor Meyer is founded on realistic and valid (at least over the first six years) assumptions of the geopolitical situation at the beginning of the next century. President Bush's "New World Order" quickly gave way to a "New World Disorder" and the United States and its allies were given a series of refresher courses in the intricacies of low intensity conflict operations. Somalia made the U.S. military painfully aware that a handful of low-tech, urban guerrillas could inflict enough damage to shake the foundations of the army which decimated Iraq. The Navy was dealt a similar blow in Haiti, when a few cars full of machete-wielding thugs prevented an LST from disembarking its troops at a pier and forced it to return to sea in front of CNN cameras and the world. None of the contingencies in Liberia, Somalia, Rwanda, Haiti, or Cuba were as taxing on the military as the MRC with Iraq, but the political, military and social consequences of those missions left a mark on future U.S. military operations.

Based on the validity of the study's geopolitical "vision," strategic implications require a serious consideration of its accompanying maritime "vision." The concepts and ship designs put forth by the study make sense in the context of the types of MRC and LIC mission requirements anticipated circa 2030. While global war remains the biggest threat to U.S. security and must still be prepared for, its occurrence is highly unlikely unless there is a return to the bi-polar, Cold War antagonism of the past four decades. MRCs will require the CVNs, BFCs and SCVs of the future. Limited wars of this magnitude will demand the attention of multiple battle groups and army divisions but the real "bread and butter" missions will be the brush-fire LICs. These contingencies will drive the military's operational and training requirements well into the next century. It is with the LICs that the LX and SFX offer the greatest contribution and can play a significant role when supplementing the contingency response forces. Additionally, the mother ship/scout-fighter concept forces the Navy to reverse the quality over quantity debate, at least in the area of amphibious and littoral operations. Staying power is increased and multi-mission capability is retained, at a lower cost, by bringing more single-mission assets to the battle instead of sending in fewer, high value, multi-mission platforms. The overwhelming advantage of numbers drives the LX/SFX concept.

In an effort to contribute further to the Navy's ability to respond to LIC, employing the *Cyclone*-class as a special operations scout-fighter is worth studying. Before this model can be fully developed, it must first be understood how patrol craft were historically and are currently employed. Chapter III will examine how small, coastal navies use their patrol craft.

III. PATROL CRAFT EMPLOYMENT IN COASTAL NAVIES

This chapter explores how patrol boats are used by coastal navies and illustrates their application and employment potential for the U.S. Navy. It focuses on the overall strategy of the coastal state and the missions that follow from this strategy. It also examines the problems and current trends in patrol boat employment.

A. STRATEGY

When examining the use of patrol craft in coastal navies, their missions must first be understood within the context of the overall strategy of the coastal state and its navy. A coastal state, according to Jacob Borresen, draws a significant portion of its wealth and political influence from its ability to exploit the resources in its economic zones, continental shelf and/or coastal waterways. The coastal state does not have the resources, or has chosen not to dedicate them, to support a blue-water capable navy.⁵⁵ The navy is usually a subordinate service to a much larger army. Large-scale missions, such as open ocean sea control, power projection and forward presence are not requirements for coastal navies. The coastal navy's main purpose is to operate on the strategic defensive by maintaining state sovereignty in territorial waters and exclusive economic zone (EEZ) and by protecting against sea-based attack. Their maritime strategy is contingent upon the threat and whether it is another regional, coastal navy or a blue-water, naval power. If it is a coastal challenger, the possibility exists to maintain control of the adjacent waters, go on the strategic offensive and defeat the enemy at sea. If the threat is a major naval power, then the strategy shifts from offense to defense and the coastal navy attempts to

⁵⁵ Jacob Borresen, "The Seapower of the Coastal State," *Seapower Theory and Practice*, Annapolis: Naval Institute Press, 1990: 149.

harass or delay the enemy's projection of power ashore. The coastal navy will not seek a decisive sea battle with the blue-water, main force ships but will badger the enemy, skirmish with his units and raise the cost of invasion. Argentina's tactics against the British invasion fleet during the 1982 Falklands War are illustrative of this coastal navy strategy.⁵⁶ The coastal navy will use terrain and local navigational skill to its advantage, operating with the support of land-based aircraft, behind minefields or under the cover of shore batteries. As Borresen points out:

In coastal waters, defense is a relatively stronger form of combat than it is on the open ocean. The battle for the first salvo matters less. Moreover, a naval power opposed to a coastal state will usually not have developed weapon systems and tactics that are optimized for operations in coastal waters. And weapons technology has made it possible to pack enough firepower into small units for them to threaten the most powerful units of the naval power, without themselves representing suitable targets for the primary weapons of such an opponent.⁵⁷

ASCMs, like Exocet and Harpoon, have proliferated throughout the world. These stand-off, fire and forget missiles are the great equalizer in the naval warfare. 66 countries possess ASCMs, over 43 of these countries belong to the Third World. 220 ASCMs have been fired in anger since 1967 resulting in 56 ships damaged and 31 ships sunk. Of these totals, 39 of the ships damaged and 19 of ships sunk were warships.⁵⁸

When operating in the littoral, tactics and operations are radically different than when operating on the open ocean. At sea, the blue-water navy seeks to extend its forces in a screen to protect its high-value units by engaging the enemy at a range outside of the opponent's weapons range. When blue-water warships enter the confined waters of the

⁵⁶ Admiral Sandy Woodward's book, *One Hundred Days: The Memoirs of the Falklands Battle Group Commander*, Annapolis: Naval Institute Press, 1992, is an excellent account of the Argentine tactics.

⁵⁷ Borresen, 150.

⁵⁸ Data taken from John C. Schulte's, *An Analysis of the Historical Effectiveness of Anti-Ship Cruise Missiles in Littoral Warfare*, Thesis, Monterey, CA: Naval Postgraduate School, 1994.

littoral arena, defense-in-depth is lost and the fundamental relationships of maneuverability and firepower are upset. In the near-shore littoral operation, ships are forced to operate inside of the radius of coastal missile batteries and land-based aircraft.⁵⁹ Terrain becomes a factor. Ships adopt a tightly packed, defensive posture in the hope that all of their sensors and weapon systems combine to detect and defeat the shore-based, air threat. During the Falklands War, Argentine aircraft, using Exocets and iron bombs, inflicted heavy damage on the British ships operating in support of the invasion force. The British were ill-equipped with point defense weapon systems and lacked airborne early warning aircraft to give the ships advance notice of incoming raids. Despite technological advances in weapon systems and the presence of continuous airborne early warning, during Operation Desert Storm on 25 February 1991, coalition ships were surprised and unable to respond effectively to two Iraqi Silkworm ASCMs fired at them. The first missile missed and the second was shot down by two snap-fired British Sea Darts, but not before it had thrown the coalition defenses into confusion and turmoil.

B. MISSIONS

Patrol craft are used by coastal navies for a variety of non-wartime and wartime missions. Non-wartime, in used instead of peacetime, because many of these coastal states, while not at war with another state, are not at peace either. Guerrillas, drug lords and bandits must constantly be kept in check and the coastal navy's missions are more closely aligned with police and coast guard functions. At war, their missions are similar to those performed by destroyers and frigates of blue-water navies.

⁵⁹ Yedidia Ya'ari, "The Littoral Arena: A Word of Caution," *Naval War College Review* 48:2 Spring 1995: 7-8.

1. Non-Wartime Patrol Craft Missions

The following three missions are the main function of coastal navy patrol craft when not at war:

a. Fisheries Protection/EEZ Patrol

Over half of the world's senior naval officers, responding to a 1995 survey, stated that the protection of their country's maritime resources was a primary mission for their respective navies.⁶⁰ With the UN Convention on the Law of the Sea of 1982 giving increased sovereignty and jurisdictional control out to 200 miles, coastal states are depending more on ocean-going patrol craft to conduct fishery patrols. Migrating fish stocks cause accidental and deliberate poaching by foreign fishing fleets and require near constant enforcement efforts in vital fishing grounds. Norway's chief of naval operation considers the problem serious enough to warrant hostilities:

The use of flags of convenience and the numerous conflicts over international fishing rights also...worrisome signs. The Norwegian Navy's Coast Guard has fired more shots in anger during the last year than the Navy did during four years of neutrality guard operations in World War I.... Threats or challenges against [Norway's] right to protect these resources, therefore, will be considered threats or challenges to Norway's central security interests.⁶¹

The UN Convention on the Law of the Sea of 1982 allows states the right to enforce a catch limit in its EEZ; states can declare certain fish stocks as off-limits due to over fishing. It also governs rights concerning environmental protection and preservation and

⁶⁰ The results of the survey were published in the article, "The Commanders Respond," *Naval Institute Proceedings*, March 1995. The question posed to the world's navy commanders was, "With the Cold War over, many are questioning the value of military forces in general and naval forces in particular. What makes your navy relevant today?"

⁶¹ Kjell A. Prytz, RADM, RNN, "The Commanders Respond," *Naval Institute Proceedings* March 1995: 38.

allows states to establish sovereignty on their continental shelf for resource exploration and exploitation.

b. Internal Waters/Riverine Patrols

Of particular value to the Central and South American navies, patrol craft are ideally suited for operations on the thousands of miles of internal waterways. Peru has 5,500 miles of navigable rivers to patrol.⁶² The Uruguayan Navy is charged with jurisdiction over a total surface area of 54,811 square miles (79% of Uruguayan territory);⁶³ the Colombians assign 1118 miles of waterways and 23,000 square miles of land to their navy.⁶⁴ These waterways are efficient highways for transportation of people and goods through the vast, impenetrable jungles that characterize the region. They are also the major supply routes for narcotic and guerrilla operations. The U.S. military assists these countries in waging their war on drugs. In an article by U.S. Marine Corps Captain Darren Pitts, an advisor to the Colombian marines, he outlines the problems posed by the geography of the region:

The vast majority of precursor chemicals...travel predominantly along Colombia's 3,800 miles of navigable rivers. On countless occasions, ferry boats are seized while transporting coca leaves, cocaine base and crystalline cocaine. The problems associated with controlling drug traffic along the rivers are immense. Colombia has four major river systems that branch out into 24 others. In addition, four of Colombia's borders are rivers that provide at least 20 entry points into the country's interior.⁶⁵

⁶² Alfredo Arnaiz Ambrossiani, ADM, PN, "The Commanders Respond," *Naval Institute Proceedings* March 1995: 28.

⁶³ James Coates Rovira, VADM, UN, "The Commanders Respond," *Naval Institute Proceedings* March 1995: 31.

⁶⁴ Holdan Delgado Villamil, VADM, CN, "The Commanders Respond," *Naval Institute Proceedings* March 1995: 31.

⁶⁵ Darren Pitts, CAPT, USMCR, "Fighting Drugs at the Source," *Naval Institute Proceedings* July 1994: 53.

Whether conducting security patrols, counter-narcotic raids, or fighting guerrilla forces, the requirements for river patrol craft are essentially the same. They must be quick, of shallow draft, heavily armed and capable of calling in artillery or air support. The Colombians developed 15 Riverine Combat Elements (RCE), with the assistance of the U.S. Marine Corps. These RCE's are comprised of a command group and a boat section made up of three 22-foot Boston Whaler *Piranha*-class patrol boats and one 35-foot Riverine Assault Craft. Each *Piranha* has a three man crew and nine combat loaded marines. Typically armed with one .50 caliber and two 7.62 mm machine guns, these boats provide fire support to the marines who offload for the patrols and raids. The Riverine Assault Craft is similarly armed with the addition of a 40mm-grenade launcher.⁶⁶

c. Non-Wartime Coastal Patrol & Interdiction (CP&I)

CP&I is used primarily as a law enforcement mission. Coastal patrols regulate maritime shipping traffic, ensure compliance with navigational regulations, conduct customs and safety inspections, and interdict drug runners, pirates, smugglers and illegal immigrants. The interdiction component requires the most time and resources and serves as the driving force behind the CP&I mission. The crews are trained in visit, boarding, search and seizure techniques. The craft used for these missions are fast, sea worthy up to Sea State 4-5 and armed heavily enough to disable merchant ships and out gun drug runners.

⁶⁶ Mark Freitas, MAJ, USMC and Brad Treadway, LT, USN, *Stygian Myth: US Riverine Operations Against the Guerrilla*, Thesis, Naval Postgraduate School, December 1994: 92.

2. Wartime Patrol Craft Missions

The following six patrol craft missions fit the strategically defensive nature of coastal navies. Although they operate as part of the coastal state's strategic defense, patrol craft are best used when they fight on the tactical offensive.

a. Chokepoint Control and Defense

The principal task for patrol craft in wartime is chokepoint control. The use of geography or mines to funnel the enemy into a designated killing ground is an ancient tactic and small, fast attack craft are ideally suited for the role. Ambushes and hit and run tactics launched from island coves and fjords favor the patrol craft. Simple and inexpensive patrol gun boats can deny enemy merchant shipping in restricted waters. Armed with torpedoes or fire-and-forget ASCMs, the patrol craft threat is particularly lethal to blue-water ships forced to transit these chokepoints.

If the patrol craft can retreat up a river or around the corner of a fjord, it will become almost impossible for the ship to engage the attacker. Airpower or escort patrol craft would be required to continue pursuit. Radar-directed gunfire and radar-guided ASCMs fired back at these craft will have great difficulty discriminating the target against the background clutter of land and sea return. Hiding among coastal fisherman and merchants will further complicate the targeting solution by providing multiple targets to decoy the missile, making an ASCM response a poor choice especially if rules of engagement (ROE) are restrictive with regard to civilian casualties. If the engagement occurs at night, the complexity of the problem increases even further despite the advent of night vision technology. Imagine a night torpedo attack in a chokepoint. With no tell-tale missile plumes or radar seekers to tip off the defenses, chances are very good that the ships will be surprised. Assuming their sonar detects the torpedoes, there is little the ships can do to defeat them except drop decoys and maneuver wildly - a risky proposal in

a mine field or navigationally restricted waters. The ship's defensive maneuvering has the potential to do more harm than the torpedoes.

b. Close Blockade

The employment of maritime sanctions is a common practice to underscore diplomatic pressure on a country. In wartime, these sanctions are often applied in the form of a blockade to strangle the maritime component of the economy. Blockades are also used to prevent the enemy fleet from getting in or out of its ports, as the UN maritime force in the Adriatic is doing to the Serbian Navy. But wartime blockades are dangerous to enforce. Blockading ships often operate inside the range of shore-based weapons and aircraft, in potentially mined waters if they are to effectively stop all forms of coastal traffic and shipping. While the Coalition navies during Operation Desert Shield and Desert Storm sealed off Iraq from merchant shipping, they failed to cut off the coastal traffic in Iraqi and Kuwaiti waters. Despite complete naval and air superiority, the mine hazard prevented the frigates and destroyers from getting close enough to interdict the small, blockade runners. Precisely because of its shallow draft, light construction and high speed, the patrol craft is an ideal platform for working in these hazardous waters. Its maneuverability allows it to avoid contact mines, and influence mines will probably be set to wait for larger, higher value units. Christopher Abel and Herbert Black, advocates of patrol craft, point out: "If an influence mine is detonated, a fast patrol boat's speed may already have taken it out of the blast area and, if not, its light, specialized construction decreases the likelihood of it sustaining a fatal hit."⁶⁷ Especially with friendly air superiority, patrol craft could operate close-in to the shore, shutting down all coastal traffic in their area of operations. This is critical when

⁶⁷ Christopher A. Abel, LT, USCG and Herbert A. Black, LT, USCG, "Missing the Boat," *Naval Institute Proceedings* September 1988: 57-58.

many countries rely heavily on coastal shipping. For example, more than 95% of Peru's international trade and internal fuel distribution flows along the coast.⁶⁸

c. Picket Boat Duty/Harbor Defense

Patrol craft are used by coastal and blue-water navies alike for port security and for providing rapid reaction, ASW defense inside harbors. During the Cold War, Norwegian and Swedish patrol craft had extensive experience chasing suspected, Soviet submarines out of their territorial waters and harbors. As picket boats providing security for anchored task groups, patrol craft can protect the vulnerable, bigger ships from small boat attack. The multinational force off of Beirut in 1983 was particularly concerned with this problem and had to resort to using landing craft and Seafox-boats to provide security.⁶⁹

d. Support of Land Forces

Coastal navies train extensively to support army operations. For the majority of coastal countries, the cross border land threat is more significant than the potential for amphibious invasion; amphibious invasions require more assets than most countries have in their entire navy. As a result, the Army has a greater share in the defense budget and the Navy exists primarily to support the Army. Naval operations center on securing the flank and rear of the Army. They also provide the Army with amphibious and sealift capacity and work to deny the enemy from doing the same.⁷⁰ Properly equipped, patrol craft are capable escorts for amphibious landing craft. Due to their shallow draft, they can guide and flank the landing craft all the way to the beach, providing protection from enemy patrol craft and close-range covering fire for the landing

⁶⁸ Ambrossiani, 28.

⁶⁹ Abel and Black, 58.

⁷⁰ Borresen, 156.

force. They are also well suited for rescue of disabled landing craft, downed aviators and friendly casualties in the landing zone.⁷¹

e. Special Operations

Patrol craft are an integral part of naval special forces in all of the world's navies. Primarily used for insertion and extraction missions, patrol craft allow the commandos to approach close to the beach or, in some instances, far upriver before disembarking. The boats carry the supplies necessary for the mission and serve as a mobile fire support platform usually equipped with mortars, small caliber cannon and machine guns. Their speed, shallow draft, low radar cross-section and muffled engine capability are essential for covert operations.

f. Wartime Coastal Patrol & Interdiction

The outbreak of general hostilities allows for the interdiction of enemy shipping. Patrol craft can interrupt enemy sea lines of communications by raiding their unescorted merchant and auxiliary fleet, sinking or capturing the vessels as prizes of war. Should the merchants be escorted, the escorts must be contended with first. An engagement similar to the chokepoint night action described earlier is envisioned. World War II motor-torpedo boat (PT) actions in the Pacific and the English Channel serve best as examples of patrol craft serving in this wartime anti-shipping capacity.⁷²

C. PROBLEMS WITH PATROL CRAFT

There are four primary drawbacks associated with patrol craft in general: logistics and repair entail forward basing or a support ship, they lack the endurance necessary for

⁷¹ Abel and Black, 60.

⁷² W.L. White's, *They Were Expendable*, New York: Harcourt, Brace and Company, 1942, and Edward I. Farley's book, *PT Patrol*, New York: Exposition Press, 1957, are great reading and offer detailed descriptions of WWII PT boat operations.

open ocean operations, they are subject to platform instability and they are vulnerable to air attack.

1. Forward Basing Requirements

Due to limited fuel and ammunition capacity, small crews and minimal stowage for repair parts, patrol craft require an extensive support organization. Patrol craft, in general, must leave the operations area and return to harbor to repair equipment casualties or battle damage. In addition, small craft engines have fewer running hours between maintenance periods than the propulsion plants of larger vessels. This results in many more hours [pierside] per sailing hour for the FPB compared to the frigate.⁷³

The base or mother ship must be located in a secure area, preferably out of harm's way but not so far as to inhibit the patrol craft from operating against the enemy. The base provides logistical support in the form of crew rest, refueling, rearming and resupply. Other "hotel services" like laundry and billeting are also found at the base. All major repairs, many of the minor ones, and some of the more labor-intensive preventive maintenance jobs are handled by the base repair facilities. Obviously, the base or mother ship is the Achilles' Heel for the patrol craft squadron. If it is destroyed, the squadron cannot sustain operations in the area unless another base is quickly established.

2. Limited Endurance

Although their small size is of great tactical value, their size also serves as a major operational hindrance in two ways: low endurance for ship and crew and less fuel capacity. The smaller the craft, the rougher the ride in higher sea states. Most patrol craft experience mission degradation in Sea States 4 (8-10 foot seas) and higher due to the strain on the crew's endurance. Constant, heavy pounding at high speeds and

⁷³ Borresen, 172.

wallowing at low speeds breaks equipment and rapidly takes its toll on the crew. Minimal manning and a steady watch rotation contributes to crew exhaustion. Limited fuel capacity makes it necessary to refuel far more often than larger combatants. A frigate or destroyer can operate at ranges over 6000 nm at 12 kts for weeks at a time without refueling. In comparison, the 450 ton Russian *Tarantul* has a range of 2300 nm at 15 kts, roughly worth 10 days of steaming. The 480 ton Israeli *Sa'ar 4.5* can travel 3000 nm at 16 kts over a 12 day period.⁷⁴

3. Platform Instability

As a weapons platform, patrol craft are often too small to accommodate stabilized, large caliber gun and missile systems. The violent motion of a patrol craft at speed limits the effectiveness of point-fire weapons. "The boats potential need to take evasive action at any stage of its attack," Abel and Black argue, "[necessitates] the use of fire-and-forget missiles and torpedoes."⁷⁵ Many of the smaller craft are armed with nothing heavier than .50 caliber machine guns. Those that are more heavily armed, with 25 mm chain guns or 40 mm grenade launchers, still suffer from the same problems associated with firing from an unstable platform.

4. Vulnerability to Air Attack

Operation Desert Storm confirmed what naval historians already learned from the lessons of World War II; surface ships are easy targets for airpower. The Iraqi Navy was completely devastated by Coalition air forces, unable to defend itself from fixed-wing and helicopter attacks. By staying out of the range of the FAC's [fast attack craft] defensive systems, the helicopters attacked with relative ease. The Iraqi FAC's either had

⁷⁴ Kenneth Brower and James Kehoe, CAPT, USN (Ret), "Fast Attack Craft - A Comparative Analysis," *Naval Engineers Journal* May 1993: 234-35.

⁷⁵ Abel and Black, 57.

no effective soft or hard kill countermeasures against the missiles once locked on and airborne, or (in the case of the captured Kuwaiti vessels) they lacked the skilled crews needed to operate their defensive systems.⁷⁶ The quick annihilation of the Iraqi Navy made other coastal navies shudder at the prospect of their own patrol fleet's demise without the benefit of friendly air superiority or better anti-air weapons (AAW) and countermeasures. The conflict spurred various anti-patrol craft comments, some analysts claiming that the craft were obsolete. These valid criticisms exacerbated the downward trend in patrol craft acquisition by many navies. The number of modern missile-armed FAC's entering service decreased from 112 between 1982-1986 down to only 33 from 1987-1992.⁷⁷

D. CURRENT TRENDS

In the post-Desert Storm years, coastal navies are continuing to operate patrol craft of all sizes but some trends show an attempt to overcome the problems highlighted earlier (i.e., forward basing requirements, limited endurance, instability, and vulnerability to air attack.)

Boat design is tending toward larger craft with "stealth" architecture. This helps to reduce all four of the problems encountered by small patrol craft. Increased size leads to greater fuel capacity and greater "legs."⁷⁸ It also increases the available storage space on board for repair parts and supplies, helping to reduce base dependency. The boat will

⁷⁶ "Fast Attack Craft: Adapting the Art of Hit and Run," *Jane's Defence Weekly* 24 October 1992: 27.

⁷⁷ *Ibid.*, 27.

⁷⁸ Experimental concepts have been proposed to extend the range of patrol craft, such as external "drop tank" fuel containers attached to the stern with a quick-release mechanism. The patrol craft could draw fuel from the drop tank as it proceeded to station, thereby increasing its loiter time once it arrived in its operations area. The quick-release mechanism would allow for the craft to shed the tank before engaging the enemy.

ride better in rough seas and will allow the crew to operate more effectively. The larger size can also accommodate larger weapon systems and sensors and their related stabilizing equipment. The "stealth" features help offset the increased radar cross section which accompanies larger ship designs.

Much research is being directed toward developing better point defense, hard-kill AAW systems, like Rafael's Barak vertically launched surface-to-air missile (SAM) and the Sigaaal Goalkeeper 30 mm Close-In Weapon System (CIWS) for patrol craft.⁷⁹ Even so, defensive systems will always lag behind the advances in offensive technology. Multiple seeker heads, improved sea-skimming ability and terminal maneuvers threaten to defeat the most advanced hard-kill system. New advances in ASCM guidance and targeting, like laser-beam riders and optical guidance systems require a new genre of defensive systems. Understandably, soft-kill, electronic countermeasure systems are under heavy pressure to continually improve. Israeli Rear Admiral Yedidia Ya'ari believes that:

Uncertainties regarding the actual performance of defensive suites in a full-blown modern engagement are cause for concern. Even limited experience has established, however, that whereas for the offense a mistake or malfunction means the loss of a missile, for the defense it means at least the disablement, and probably the loss, of a ship.⁸⁰

This conclusion has merit, added emphasis is being placed on upgrading the communications and tactical suites for patrol craft. The Iraqi's contributed to their own defeat by lacking effective command and control in combat. The coastal navies apparently learned from that mistake and are purchasing systems to enhance their tactical

⁷⁹ "Fast Attack Craft: Adapting the Art of Hit and Run," 27-8.

⁸⁰ Ya'ari, 11.

and operational awareness, such as the TACTICOS combat management system.⁸¹ Better command and control will enhance the offensive and defensive potential of coastal patrol craft.

The FAC is increasingly returning in larger numbers on the acquisition lists of coastal navies. Singapore's *Victory*-class, China's *Houxin* and *Huang*-class and Israel's *Sa'ar 5* are all highly capable fast attack craft. Outfitted with fire-and-forget weapon systems like Harpoon, Exocet, C-801 Jing Yi or Gabriel ASCMs, advanced air defense, communications and ECM suites, they are in essence, mini-corvettes.⁸²

⁸¹ "Fast Attack Craft: Adapting the Art of Hit and Run," 27.

⁸² *Ibid.*, 27-8.

IV. PEGASUS AND CYCLONE

A. THE PEGASUS-CLASS (PHM-1)

The patrol missile hydrofoil was designed for offensive, anti-surface warfare (ASUW) missions. It was to be forward deployed to European waters to help contain and destroy the Warsaw Pact navies as they tried to surge past the strategic chokepoints which kept the Soviet Fleet bottled up. Intended to be inexpensive and expendable yet highly lethal, the PHMs were supposed to operate on the tactical offensive while NATO's larger warships prepared to defend the Atlantic and Mediterranean's vital sea lines of communication (SLOC). At \$100 million a copy, their excessive price tag, 300% cost growth and limited production run put an end to those visions of combat glory. They spent their remaining years roaming the Florida Straits and participating in counter narcotic operations.

1. History

The *Pegasus*-class was a response to the success of the 1967 Egyptian missile boat attack on the Israeli destroyer *Eilat*. Firing Styx ASCMs from just outside of their harbor, the missile boats disabled and sunk the unsuspecting destroyer in a matter of minutes. Their attack revolutionized naval warfare and demonstrated that warships were vulnerable to even the smallest missile-armed patrol craft. Blue-water navies took note and realized that the naval balance had shifted. A coastal navy could threaten a blue-water power with a small flotilla of missile boats and ASCM shore batteries. In 1969, NATO drafted a mission needs document and directed a study group to focus on the missile boat threat. The NATO Naval Armaments Group (NNAG) determined that the number of warships based in the Mediterranean had to increase in order to account for the attrition of ASCM combat. The study concluded that a new NATO naval platform was

needed which was inexpensive and survivable without much outside support. These two goals produced a description of a small ship which would defend itself using speed and maneuverability and would attack using ASCMs and a small, main gun with a high rate of fire. Design specifications required a minimum displacement of 228 tons. According to Stephen Chapin, "This relatively small displacement allowed the NNAG to consider hydrofoils and ultimately to determine that a 'PHM with fully submerged foils was the answer to the operational requirements of a common, fast patrol boat, capable of carrying surface-to-surface missiles.'"⁸³

The PHM concept ran into problems from the beginning; politics and technology hampered the program from the outset. As a NATO multinational development effort, the first major obstacle was getting the different countries to agree on a specific design and provide funding. In addition, hydrofoil technology was still relatively new and a significant amount of research and development was necessary. By 1971, most of NATO had lost interest in the project due to the potential high cost of the PHM program. Three countries remained active, the United States, Italy and West Germany. They signed a Memorandum of Understanding in 1972 to build two prototypes. The United States would fund the majority of the research and development involved with building the lead ship and Italy and West Germany would contribute their share to complete the project. The memorandum stipulated that the United States would retain the two prototypes and Italy and West Germany would receive a production data package containing blueprints, drawings and technical data to build their own PHMs.⁸⁴

⁸³ Stephen R. Chapin, ENS, USN, "The History of the PHM," *Naval Institute Proceedings* September 1986: 80.

⁸⁴ *Ibid.*, 80.

The contract was awarded to the Boeing Corporation for the production of thirty PHMs.⁸⁵ Boeing borrowed heavily from other projects to reduce the cost of development. The Harpoon ASCM planned for the P-3 Orion antisubmarine patrol aircraft was adapted as a surface-to-surface missile for the PHM. The main gun design was a combination of the lightweight Mk 92 fire control system from the *USS Talbot* (DEG-4)⁸⁶ and the Italian Mk 75, a 76 mm gun from their *Swordfish*-class patrol craft. The hydrofoil design was borrowed from the *USS Tucumcari* (PGH-2), a hydrofoil gunboat prototype built previously by Boeing Corporation and used extensively in coastal operations off of Vietnam. For propulsion, the LM-2500 gas turbine aircraft engine was installed and coupled with a hydraulic system originally designed for the Boeing 747. The radar was Italian and the gyroscope, environmental control system and the auxiliary diesels were West German. Given the international composition of the program, all measurements and specifications for the first prototype ship, *Pegasus*, were metric.⁸⁷

The Italians backed out of co-production plans in 1974 but agreed to maintain funding to receive the production design package for possible future use. West Germany, fearing a collapse of the project, indicated that it would be unable to afford production if the U.S. Navy failed to procure the ships at the end of the research and development phase. By late 1976, the PHM program was endorsed by the U.S. Navy and a request for funding was submitted. After some political wrangling between the Defense System Acquisition Review Council (DSARC) and the Office of the Assistant Secretary

⁸⁵ Leroy G. Williams, Jr., LCDR, USN, "Employing the PHM's," *Naval Institute Proceedings* September 1986: 80.

⁸⁶ *Pegasus* (PHM-1) was outfitted with the Signaal-built Mk 94 fire control system. It is the Dutch version of the MK 92.

⁸⁷ Chapin, 80-81.

of Defense for International Security Affairs (ISA),⁸⁸ the PHM program was supported by the Secretary of Defense.

In 1977, politics almost brought the PHM project to an early demise. In January, President Jimmy Carter's administration took over and the newly appointed Secretary of Defense, Harold Brown, took the PHM program "under advisement" and funding was canceled for the PHM squadron support ship, *USS Wood County* (LST-1178). In April, funding for the entire project was cut off and the project was canceled. West Germany declared that it could no longer afford production and permanently shelved its plan to order eight PHMs from Boeing. Because Congress had already approved funding for the program, the National Budget Impoundment Act of 1974 required that the President submit a Memorandum of Recision to Congress to abrogate the approved funds.⁸⁹ Secretary Brown, via President Carter, sent the memorandum to Congress and a Bill of Recision was drafted. While the House Appropriations Committee (HAC) was somewhat hostile to the PHM program for earlier cost overruns, there were two key individuals who pulled the program off of the chopping block, Congressman Norman D. Dicks (D - WA), in whose district Boeing planned to build the PHMs, and Secretary of the Navy W. Graham Claytor. Prior to the decision to cancel the program, Claytor had sent two memos to Brown encouraging support for the PHMs. After the final decision was made to kill the project, Claytor was bound by loyalty to support his senior's testimony before Congress. His memos, however, found their way to

⁸⁸ DSARC did not support the program on the basis of its lack of a clear mission. ISA argued that the international shipbuilding effort was worth supporting for intra-NATO cooperation purposes more than anything else. The PHM Program Coordinator, CDR George Jenkins, believed that DSARC challenged the project not because of its lack of merit but due to personality conflicts between DSARC and the PHM Program Office.

⁸⁹ This requires a Bill of Recision, which is essentially an amendment to the appropriated act. If no action is taken by the House in 45 legislative days, the President must spend the money for its originally appropriated purpose.

the HAC and were read into the record before Claytor's testimony was heard. The HAC voted nine to one, rejecting the rescission bill and Carter was forced to continue funding for the PHM program.⁹⁰

Given this reprieve, the program began anew but not without a heavy price. Increased costs, high inflation, contract delays and technological problems prevented Boeing from benefiting from an economy of scale on the production run. The "fly-before-buy" contract policy of building a prototype before pursuing full production was costing the Navy and Boeing much more than they had anticipated. Because production followed research "in series" rather than "in parallel," the amount of time required to build all vessels was significantly longer than the more typical "parallel" production run. As Chapin notes:

The inherent technological difficulties associated with the hydrofoil's development...easily [caused] the price of research and development to fluctuate \$2 million beyond initial projections. Thus the "fly-before-buy" program, which required an extended time span, was particularly affected by political constraints.⁹¹

Any change in the cost of the program in excess of \$2 million annually required the approval of four congressional committees. Changes in political support between administrations affected the overall price by dragging out the production timeline eight additional months.

In addition, the program lacked senior sponsorship. Although Admiral Elmo Zumwalt was the source and impetus behind the PHM program, after he retired as CNO in 1976, the program became an orphan without his strong advocacy. No other senior naval officer really claimed overall responsibility for *Pegasus* after Zumwalt.⁹² Initially

⁹⁰ Chapin, 82.

⁹¹ Ibid., 83.

⁹² Wayne P. Hughes, Jr., CAPT, USN (Ret.), Interview, 11 December 1995.

stationed with the 3rd Fleet on the West Coast, there was always an intention to shift homeport to the East Coast. The move was delayed and rescheduled six times. Not until June 1979 did the *Pegasus* reach the Atlantic Fleet, the fleet ultimately responsible for the program's development. Little was accomplished during the project's tenure on the West Coast. There was a reluctance to spend money on a program that would eventually become a 2nd Fleet asset.⁹³ Adding to the monetary problems, labor and material costs increased faster than projected and the delays added \$15 million to the PHM price tag. Because this overrun money was not forecast in the budget, the *USS Gemini* (PHM-6) was delivered to the Navy in 1982 without a weapons suite. It was not outfitted with Harpoons, its gun or its fire control system until a year after commissioning. Funding for these components came from other defense appropriations, forcing the Navy to shuffle funds at the expense of other programs.

Despite all the monetary problems caused by the cost overrun, the most serious blow to the program had yet to come. Congress, unimpressed with the soaring costs of the PHM project, reduced the original goal of 30 PHMs to a meager six,⁹⁴ forcing production to cease after *Gemini*. This action conferred a "white elephant" status on the ships. With only six vessels total, one built to metric standards (PHM-1) and the remaining five built to English-unit equivalents, the tiny PHM squadron was a large-scale logistics nightmare. The squadron had to have two different sets of everything, from training to spare parts.⁹⁵ Due to the specialized nature of the craft and the low production numbers, the massive Navy supply system would routinely experience log

⁹³ Alan D. Zimm, LCDR, USN, "PHM's: Unique Ships, Unique Problems," *Naval Institute Proceedings* February 1982: 90.

⁹⁴ Chapin, 83.

⁹⁵ Zimm, 93.

jams, particularly when the uniquely metric *Pegasus* required parts for its foreign-made components.

2. Description

The six *Pegasus*-class PHMs (see Figure 7) were homeported in Key West, Florida. 132.5 feet long and 28 feet wide at the beam, the hydrofoils displaced 256 tons when hullborne. The PHM had a draft of 9 feet when foilborne. Hullborne, with foils lowered, the draft increased to 23 feet, but the deep foils and low silhouette combined to give the PHM much greater stability than one would expect of a vessel of similar size. Hullborne, with foils retracted, the draft was 6 feet. For main propulsion, the vessels had the LM-2500 gas turbine engine and two auxiliary diesel engines. Using the gas turbine, the foilborne PHMs could attain speeds of 40-45 knots in waves up to 13 feet (Sea State 6). Powered by the diesel engines alone, the water jet propulsion system allowed for a maximum speed of 11 knots. Speeds between 11 and 40 knots were not achievable due to the engineering constraint of having to operate one or the other method of propulsion; the PHMs could only operate in the "extremes" of low-speed cruising (0-11 kts) or high-speed sprints (40-45 kts).⁹⁶

Pegasus had a hullborne range of 1700 nm at 10 kts and a foilborne range of 700 nm at 45 kts. A PHM would require refueling every 14 hours if operating on foils continuously. Regardless of refueling requirements, the hydrofoils were further restricted in endurance by the size of their crew.

⁹⁶ Stephen R. Chapin, LTJG, USN, "Countering Guerrillas in the Gulf," *Naval Institute Proceedings* January 1988: 66.

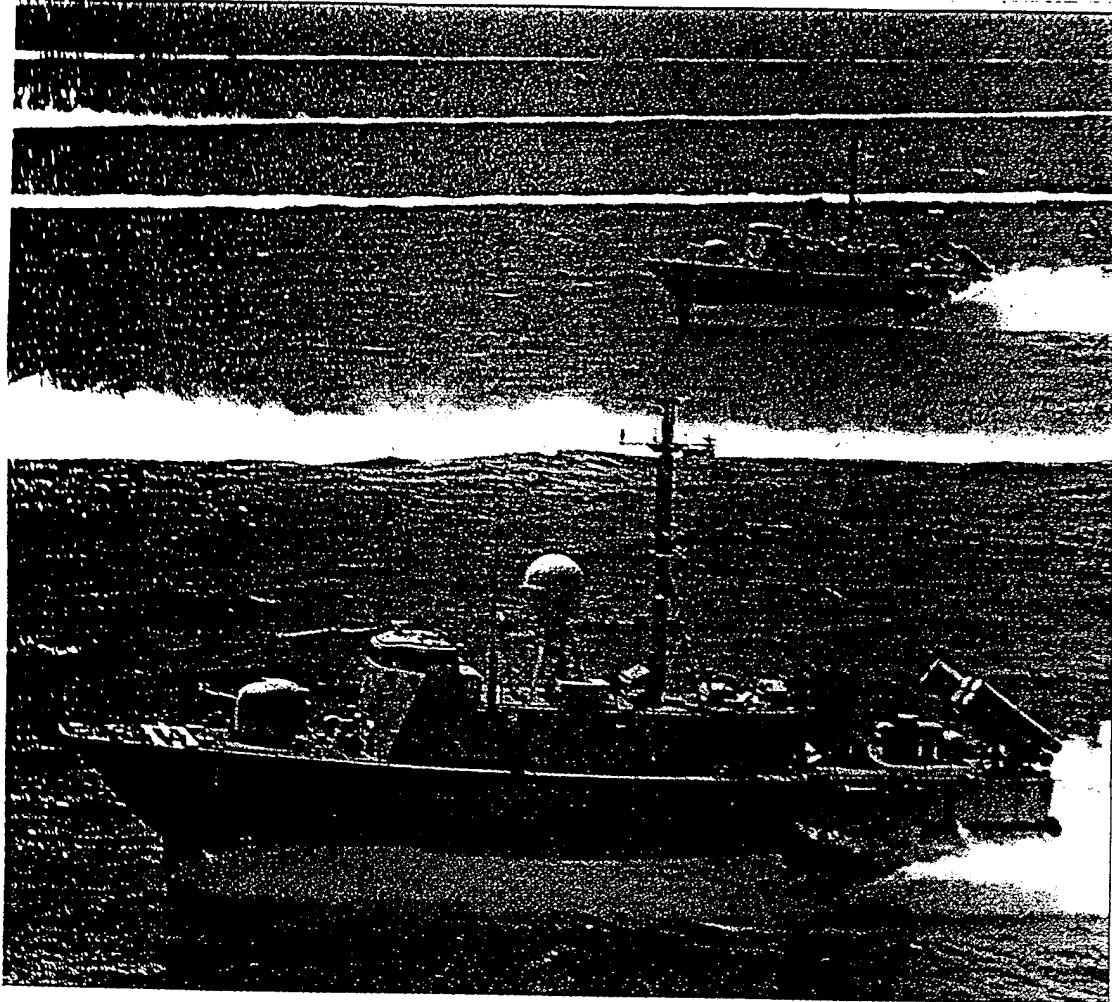

Figure 7. *Pegasus*-class, Patrol Missile Hydrofoil (PHM)

Leroy Williams argues that, with four officers and 17 enlisted men,

...the PHMs were designed to support a five-day mission, with most of the crew standing watch-on/watch-off. After five days, the crew routinely requires two days rest. This cycle can be repeated three times before maintenance requirements dictate a two-week stand-down.⁹⁷

Williams also assumes that wartime operations would require missions of approximately ten days duration with two days rest.⁹⁸ The PHMs never had the opportunity to test this assumption.

The small size of the crew and the ship dictated that the PHMs rely on outside support for maintenance and upkeep. The Mobile Logistics Support Group (MLSG) augmented the ship's crew by providing assistance for all but the most routine preventive and corrective maintenance. The MLSG also supplied the administrative, clerical, medical, and supply support personnel for the PHM squadron. The MLSG operated out of 24 vans or container express (CONEX) boxes which were transportable by plane, ship or truck.⁹⁹ A detachment from the MLSG would accompany PHMs deployed out of area for extended periods of time, acting as a temporary supply base for the hydrofoils. The MLSG detachment could be based on land or onboard a mother ship -- often times an *Oliver Hazard Perry*-class frigate (FFG-7) would serve in this capacity. The FFG was chosen because it had two helicopter hangars, one could handle the MLSG vans leaving the other hangar for a helicopter. Additionally, the FFG shared many of the same systems as the PHMs: the Mk 92 fire control system, the Mk 75 76 mm gun, the Harpoon weapon system and the LM-2500 gas turbine engine.¹⁰⁰

⁹⁷ Williams, 80.

⁹⁸ Ibid., 85.

⁹⁹ Ibid., 80-81.

¹⁰⁰ Chapin, "Countering Guerrillas...", 66.

3. Roles and Missions

The *PHM-1 Class Tactical Manual* (NWP 65-1-22) states that the mission of the PHM was, "in peacetime, to conduct surveillance, screening and special operations; in wartime, to operate offensively against major surface combatants and other surface craft."¹⁰¹ Equipped with the SPS-63 surface search radar, limited electronic support measures and the Mk 92 fire control system, the PHM could actively or passively track multiple surface contacts. Armed with eight Harpoon ASMs and a 76 mm gun, capable of firing 80 rounds per minute, these small hydrofoils packed enough firepower to disable, if not sink, the largest Soviet combatant ships.

With its primary mission of ASUW, many tactical uses for the PHM were envisioned:

- 1) Geographic area surveillance (coastal, straits, narrow seas)
- 2) Choke point interdiction
- 3) Barrier patrol
- 4) Coastal SLOC protection
- 5) Surveillance of potentially hostile forces (Tattletale)
- 6) Detecting and attacking enemy forces
- 7) Screening coastal convoys against surface attacks
- 8) Screening large convoys during arrival/departure
- 9) Special operations

Of these missions, the PHMs were ideal for choke point interdiction, coastal SLOC protection, and screening operations.¹⁰²

The PHM was best suited for the choke point interdiction. This mission capitalized on the PHM's strengths and minimized its weaknesses. Its shallow draft, high

¹⁰¹ Although intended for ASUW missions, the PHM was also given a secondary mission of AAW. As an AAW platform, the *Pegasus*-class was adequate at best. Barely able to defend itself against an air attack, the ship offered no protection for any vessels that it was escorting. Relying primarily on its speed and maneuverability, a PHM could use rapid blooming onboard chaff (RBOC) to distract or seduce incoming missiles and aircraft. If these efforts failed, the Mk 92 and the 76 mm gun combination were capable of shooting down some "expected" missiles.

¹⁰² Williams, 84.

speed and stand-off attack capability would allow it to dominate the narrow waters of a choke point. Depending on the size of the choke point, a detachment of hydrofoils would be assigned to patrol and deny its use by the enemy. They would also serve as escort protection for friendly shipping transiting the straits.¹⁰³ Choke point "denial" operations would be relatively easy to accomplish with only PHMs; however, choke point "control" would require the addition of air and submarine assets to effectively command a particular stretch of water.

The location of the choke point also determined the type of tactics that the PHMs would use. If the choke point was under friendly control, the hydrofoils would have the luxury of operating under the protective umbrella of friendly air cover. They would also be able to take advantage of airborne spotters and warning aircraft. This would allow the PHMs to shut down their radars and operate in emission controlled silence (EMCON). While in EMCON, the PHMs could track and target the enemy using data passed from the aircraft. They could also utilize their passive electronic support measures (ESM) gear to get lines of bearing to the target. A coordinated Harpoon attack could be executed with the assistance of the airborne warning aircraft.

In enemy controlled waters, the PHM was vulnerable without the protection afforded by air cover or larger friendly combatants in the area. Forced to rely on its speed and small silhouette to give it "stealth," the PHMs would be tasked with quick

¹⁰³ PHMs would have been ideal for escorting merchants transiting the Straits of Hormuz during the Iran-Iraq War. Iranian Revolutionary Guard (*Pasdaran*) boats conducted rocket propelled grenade and machine gun attacks on passing oil tankers in order to shut down Iraqi oil trade. The Navy did not have patrol craft in theater to deal with the threat. Congress debated whether to send 110-foot US Coast Guard *Island*-class patrol boats or the Navy's *Pegasus*-class PHMs. The War Powers Act and domestic concerns kept the Coast Guard from being sent. The Navy, however, did not follow through and send the PHMs despite their eagerness to be assigned the escort mission. It is only speculation, but perhaps the accidental shoot down of the Iranian Airbus could have been avoided if PHMs had been there to respond to the *pasdaran* attack instead of the *Ticonderoga*-class cruiser, *USS Vincennes*.

strike missions to harass and interdict the enemy's use of the choke point. Operations would be conducted from an advanced base. On station time would be maximized by patrolling at the most economical hullborne speed, slowly drifting and hugging the coastal terrain.¹⁰⁴ When the opportunity for a strike existed, the PHMs would go foilborne, launch their Harpoons and flee the area in order to minimize their exposure to counterattack and increase the complexity and size of the enemy's search area. The scenario would become even more favorable if the PHMs were teamed up with a FFG mother ship. Since the range of the Harpoon is quite a bit greater than that of the PHM's active and passive sensors, the FFG's helicopter, with a 160 nm radar picture, would make the PHM/FFG combination into a formidable striking force.¹⁰⁵

Coastal SLOC protection missions, not open ocean SLOC patrols, and screening operations were also a PHM-tailored mission. Close-in sea lanes allow the squadron to operate from a home base, maximizing their coverage and effectiveness. An overlapping barrier of PHM patrol sectors would provide coverage for the coastal shipping lanes. Moving barrier screens could also be assigned for coastal convoy escort missions. The PHMs main function would be to provide protection from a surface threat. The submarine threat, the one most likely to be encountered in coastal home waters, would be handled by land-based maritime patrol aircraft or "pouncer" helicopters. This would free up the limited and valuable surface warships for open ocean SLOC missions.¹⁰⁶

¹⁰⁴ Williams, 84.

¹⁰⁵ Thomas H. Berns, CDR, USN, "Some Tactical Considerations," *Naval Institute Proceedings* September 1986: 84.

¹⁰⁶ Williams, 85.

4. Debate and Controversy

The PHM was one of the most controversial warships ever built by the U.S. Navy. Heated debate surrounded the class from its earliest design days to its eventual decommissioning. Some of the more prevalent arguments concerned:

a. Limited Mission Tasking

One of the biggest arguments centered on the fact that the PHM could not operate with the carrier battle group. PHMs, with their limited fuel capacity and high rate of fuel consumption when foilborne, would require daily underway replenishment. If an economical fuel consumption rate was desired, the PHM would have to remain hullborne, thereby limiting the battle group's speed of advance (SOA) to an unacceptable 11 kts. Most CVBGs traveled with SOAs 15 kts or more. Regular flight operations required the carrier to increase speed to achieve 25 kts of relative wind over the flight deck, further burdening the escort ships with high speed sprints to maintain sector assignments. The PHMs would constantly be shifting from hull to foils and back again just to maintain station. These sprint and drift cycles would burn a considerably higher percentage of fuel compared to the other escorts.

Pegasus proponents argued that the PHM could operate with the battle group if used as a forward sector screen or on picket duty. The PHMs would sortie ahead of the carrier force, along the intended track or down the expected threat axis. Their mission would be to investigate surface contacts and "sanitize" the assigned area. Working in shifts, PHMs would alternate between this forward position and being back with the battle group for replenishment and supply. PHMs were also offered as a Soviet battle group "tattletale," used to shadow enemy formations prior to the outbreak of hostilities. Should conflict erupt, the PHMs would conduct Harpoon attacks and use their foils to make good an escape. Advocates even considered outfitting the PHMs with

mine sweeping gear and antisubmarine warfare sensors and weapons in order to make them more useful for battle group operations.¹⁰⁷

None of these ideas were readily accepted, and the mission for which the PHM was designed, choke point interdiction against Soviet surface forces, never materialized. Additionally, all of the missions devised could be equally or better performed by carrier-based aircraft or larger surface escorts. One particularly harsh critic stated:

After an anti-surface strike, a P-3...can be reconfigured for antisubmarine warfare for the long-term campaign against submarines. PHMs cannot be configured for anything, and after airpower has eliminated the surface targets in the first few hours, the single mission PHMs will have nothing to do.¹⁰⁸

P-3 aircraft, armed with Harpoons, could fly a 1,500 mile strike in less than five hours while PHMs would require thirty three hours foilborne plus time to slow down and refuel twice. The PHM had many enemies who argued that the platform did not fit into the battle group-centered *Maritime Strategy*.

Due to the PHM's unique and limited missions, the program also suffered from a lack of conceptual doctrine and tactical development. The Surface Warfare Development Group (SWDG) devoted little time or effort in developing tactics for PHM employment. Alan Zimm, a former PHM executive officer, laments, "what little quality work did come out of SWDG relative to the PHM tactics was mainly the product of an outside contractor who, with ample coaching from the PHM officers, managed to generate a few TacMemos."¹⁰⁹ Doctrinal development progressed slowly and little

¹⁰⁷ Bruce R. Linder, "Pegasus: Winner or Also-ran?," *Naval Institute Proceedings* September 1981: 42-43.

¹⁰⁸ Jan Paul Hope, "Fighting the PHMs: Rebuttal," *Naval Institute Proceedings* August 1989: 30.

¹⁰⁹ Zimm, 90.

original thought emerged. Contributions to PHM doctrine were often inadequate and plagiarized from other platform TacMemos. Zimm continues in his criticism, "there [was] nothing on choke-point tactics, screening, PHMs operating together against individual ships or enemy surface action groups, strategic employment, or any of the other defined and identified PHM missions."¹¹⁰ Participation in battle group exercises was "canned," with the PHMs playing the role of the "Orange Force" aggressors. Almost always, the scenarios were devised to maximize the battle group's strengths and minimize the advantages of the PHMs. The hydrofoils were never given the opportunity to demonstrate their potential and many naval commanders deployed, falsely confident that their battle groups could handle a fast patrol boat or missile boat threat.

b. Cost

PHM supporters argued that high technology cost money and the PHMs were on the cutting edge of naval architectural design. Inflation, which was severe during construction, and its corresponding increase in labor and material costs also affected all other weapon and shipbuilding programs at the time. Despite the \$100 million price tag for the *Pegasus*, it was still one-third the cost of the next lowest priced American naval escort in production, the FFG. Bruce Linder makes the argument, "For this 'low-mix' cost, the Navy gets a vessel that is...invulnerable to torpedoes and contains the firepower to neutralize even the largest Soviet fleet units."¹¹¹ Moreover, because of the small crew size, the operation and manning costs of recruiting, training, berthing and paying personnel were significantly less for a PHM than for an FFG or other combatant.

The detractors disputed these assertions. If the original reason these craft were built was to satisfy a requirement for numerous, small, and inexpensive missile

¹¹⁰ Ibid., 91.

¹¹¹ Linder, 40-41.

boats, then the six PHMs, costing \$600 million in construction costs alone, were not the answer. Similar, foreign-built missile boats cost two and three times less than the PHM, allowing them to be mass produced cheaply. The cost of repairs and specialized maintenance support from the MLSG drove the price tag for the PHM squadron above \$1 billion. Contributing to this fiscal embarrassment, the uniquely metric and foreign-made components of *Pegasus* required expensive, foreign technical support. Zimm points out the repair problems he experienced as XO of the *Pegasus*:

The *Pegasus* has only one fire control system, the Signaal-built Mk 94. It is a good system and the American version (Mk 92) is used extensively in the fleet. Unfortunately, the Mk 94 is not the Mk 92. Parts and training are not compatible. [The] technical manuals are poorly translated, the modification instructions are in Dutch, and it takes a foreign technical representative to make repairs at \$10,000 a week.¹¹²

With lots of money set aside to repair the foreign equipment but none allocated to replace it with the standard Navy systems used on the five other PHMs, the program spent exorbitant sums of money just to keep *Pegasus* operational. In time, the cost of repairs and downtime for the Mk 94 exceeded the cost to replace the system.¹¹³ This example of bureaucratic inflexibility and neglect typified and haunted the PHM program.

c. Vulnerability to Air Attack

Both sides agreed that the PHM was vulnerable to air attack, particularly from a well-targeted ASCM. Modifications were never made, due to design limitations, to incorporate a defensive, close-in weapons system, like Phalanx or Sea Sparrow. The PHM had to depend on other platforms to provide AAW protection. Although possessing many inherent defensive characteristics like a small, radar cross-section, speed and

¹¹² Zimm, 92.

¹¹³ *Ibid.*, 92.

agility, without air cover, the *Pegasus*-class was left with its 76 mm gun, its chaff and, hopefully, a little luck.¹¹⁴ In a conventional bomb attack or strafing run, the PHM's speed and maneuverability made it a difficult target for fixed-wing aircraft; the PHM could maneuver inside the turning radius of most attack aircraft. Against a helicopter, however, this agility advantage was lost.

d. Limited Endurance and Seakeeping

The PHM's comparatively small size sparked debate about its ability to stay on-station. It was generally assumed that rough weather would make it impossible for PHMs to go to sea. Actually, the hydrofoils had the capacity to "fly" even in moderate seas (up to Sea State 6); the foils automatically maintained the hull a set height above the water. In heavier seas, with the foils extended under the hull during hullborne operations, the PHM would ride quite well. The extended foils acted as a massive keel board, lowering the center of gravity of the vessel and damping the effects of hull motion. A comparison study of the ride response of a 300-ton conventional PB, a 3,000 ton frigate and a PHM concluded that the PHM crew could retain their working proficiency in high sea states for the longest period of time.¹¹⁵ While some disputed the validity of the study, all agreed that heavy weather made crews seasick, regardless of the size of the vessel. Even if the crew managed to avoid fatigue in heavy seas, rarely did the ship's equipment fair as well. The constant pounding and buffeting of the vessel inevitably broke components and gear. Because of these problems, Michael Szablak states, "The PHM [was] best suited for operations near a base or a mother ship of some type to provide the necessary crew and maintenance support."¹¹⁶

¹¹⁴ One PHM officer joked that the best defense against an incoming ASCM was to come crashing down off the foils at high speed, creating a huge splash as the PHM temporarily submerged below the surface.

¹¹⁵ Linder, 39-40.

¹¹⁶ Williams, 80.

Endurance was another issue heavily debated. PHMs had one-third the "legs" of other escort ships. Their smaller fuel and stores capacity severely affected operational and logistical planning, especially when operating in-company with larger combatants. As mentioned earlier, advocates proposed picket stations and forward sector screens to minimize the impact caused by their need for daily replenishment. One even suggested using small drop tanks attached to the stern with a quick release mechanism. The PHM would draw fuel from the drop-tank while in transit to patrol station and drop it when enemy action was imminent.¹¹⁷ When tasked to operate at a strategic chokepoint, doctrine called for an advanced base to be established or a mother ship to be assigned to provide fuel and logistical support. The 1977 cancellation of the *USS Wood County* (LST-1178) killed the prospects for a dedicated PHM support ship.

Endurance arguments also focused on crew endurance. The small crew size increased the burden of watch-standing and finite interior space restricted crew activity and diminished shipboard habitability. The five-day on/two-day off operational cycle was primarily established out of concerns for crew endurance. Several former PHM commanding officers argued heavily with the policy. The commissioning CO of *USS Taurus* (PHM-3), W. Scott Slocum, took his ship to sea for 11 days specifically to challenge the assumptions. In a rebuttal article, Slocum argues:

...these ships have remarkable stability for their size. Those foils are heavy, deep keels when hullborne. Crew fatigue was not an issue, only fuel constrained us from staying out longer.¹¹⁸

Despite the attempts to prove otherwise, the peacetime operational cycle of the PHMs remained relatively close to the five-day on/two-day off rotation.

¹¹⁷ Michael Szablak, "Employing the PHMs: Rebuttal." *Naval Institute Proceedings* December 1986: 26.

¹¹⁸ W. Scott Slocum, CDR, USN, "Employing the PHMs: Rebuttal," *Naval Institute Proceedings* February 1987: 76.

e. The Need for Speed

The opponents of the PHM found little utility for the hydrofoil's speed. A common argument was that an ASCM traveling a Mach 1.8 would perceive no difference in a target traveling at 15 kts or 45 kts. To the missile, the target was basically motionless. They wondered why spend millions of dollars on a missile boat that could "fly" when a conventional missile boat would do the same mission for significantly less money. PHM supporters disagreed. They lived by the maxim, "Speed is life." The targeting problem was not as simple as the opponents made it appear to be. A target maneuvering at high speed dramatically complicated an over-the-horizon engagement, especially if the down-range targeting information was infrequently updated.¹¹⁹ The area of uncertainty (AOU)¹²⁰ increased more rapidly with a higher speed target.

Maneuverability, as the classic element of surprise, has always been tactically desirable. Except in cases of short-range ASCM engagements or continuous down-range targeting support, speed could also be used defensively in surviving an attack.¹²¹ Offensively, a high-speed naval vessel, such as a PHM, could react quickly to the enemy's attempts to maneuver; the PHM could reposition itself for the optimal attack geometry. It could also cover a far greater area of ocean and, to an extent, control the time, place and aspect of an engagement. High speed was important in attack as well as in retirement; it minimized the exposure of the PHM to counterattack. High speed also allowed for quick reaction against a time-urgent target.¹²² The PHM need not loiter on

¹¹⁹ Linder, 39.

¹²⁰ AOU is a circle whose radius equals the target's speed multiplied by the time delay between target sighting (datum) and weapon arrival time. The longer the time lag or the faster the target speed, the greater possible distance the target could have traveled away from initial datum.

¹²¹ Ibid., 39.

¹²² Norman Friedman, "Speed in Modern Warships," *Naval Institute Proceedings* May 1979: 158.

station, exposed to attack, if it could quickly move in and strike a target already identified by airborne spotter or another platform.

f. MLSG Dependency

Critics cited the almost total dependency of the PHM squadron on their Mobile Logistic Support Group. Viewed as an "Achilles Heel," the ships could not travel very far without the support provided by the MLSG. In wartime, if the PHMs were operating out of an advanced base, the MLSG would be vulnerable to enemy attack and a tempting target; destroying it would force the PHMs to leave the area of operations. Transporting the MLSG vans to the theater of operations was another potential problem. If a large deployment was planned, outside assets were needed to bring the MLSG to the theater. When the PHM squadron deployed to Grenada in 1988 to support the invasion, a Military Sealift vessel was rerouted to Key West to transfer the MLSG. Marvin Butcher, the former CO of *USS Aquila* (PHM-4), states that, "In the event of a major crisis requiring numerous sealift assets, the PHMs might be unable to participate because of higher priority shipping requirements."¹²³ Another problem when the PHMs deployed, was the large "footprint" ashore created by the MLSG. In politically sensitive countries where the United States wanted to maintain ties without appearing too dominant in the region, bilateral exercises with a detachment of patrol hydrofoils was considered politically feasible. Unfortunately, experience had shown that the MLSG "baggage" that accompanied the PHMs often times made the U.S. presence ashore extremely high profile.

PHM advocates argued that the MLSG was no more an Achilles Heel to the squadron than the oilers and ammunition ships were to the CVBG. Obviously, it

¹²³ Marvin E. Butcher, LCDR, USN, "Fighting the PHMs," *Naval Institute Proceedings* April 1989: 104.

would have to be intelligently located in a secure area to avoid enemy attack but there are no guarantees in wartime. The PT boat support bases of WWII came under repeated attack but the PT boats continued to operate -- so too would the PHMs. Others took offense to the "total dependency" line of thinking used by the opponents. Slocum counters the critics:

All the original commanding officers worked hard to develop self-sufficiency in their PHM crews....The MLSG shared our goal and provided superb maintenance support only in situations that required at least one of the three following characteristics: labor intensive efforts, unique skills found only in the MLSG, or test equipment not carried by the PHMs.¹²⁴

To counter the footprint statement, supporters pointed out that three PHMs had routinely deployed to Puerto Rico and other Caribbean islands with only a ten man, two van MLSG accompanying them.¹²⁵ The footprint was neither huge nor cumbersome.

B. THE *CYCLONE*-CLASS (PC-1)

1. History

The *Cyclone*-class came into being after the 1987 tanker escort mission, Operation Earnest Will. Iranian Revolutionary Guard boats, usually 12-24 foot Boston Whalers armed with machine guns and rocket propelled grenade launchers, were attacking commercial shipping in and near the Straits of Hormuz. The United States re-flagged several Kuwaiti oil tankers in order to protect them from attack and keep the oil flowing to the United States. Patrol boats were needed to escort the tankers and to ward off any Iranian boats which ventured too close to the convoys. The escort mission required the use of an aging flotilla of special operations patrol boats: the 65 foot Mk III and the 68

¹²⁴ Slocum, 76.

¹²⁵ Anthony Gurnee, LT, USN, "Some Tactical Considerations: Rebuttal," *Naval Institute Proceedings* January 1987: 25.

foot Mk IV *Sea Spectre* patrol boats (PBs). The PBs were successful at deterring the *pasdaran* raiders but the operating conditions took their toll on the boats and the crews. Forced to operate under conditions for which they were not designed, the PBs required constant upkeep. An article by three key members of the PC program explains the problem:

The overloaded conditions and operations in severe sea states forced the PBs out of the water and into cradles on barges that were used as "mother ships" to repair engine casualties and battered structures. In addition to being capable of operations up to Sea State 4, the crew endurance on the PBs was limited by the availability of potable water on occasions due to the hot arid climate....The resulting habitability conditions severely impacted the effectiveness of the crew.¹²⁶

A larger patrol boat was needed to handle the higher sea states, longer on-station time, crew habitability and significantly heavier weapons and ammunition requirements of Persian Gulf operations. It was designated as the Patrol Craft, Coastal (PCC).

During roughly the same time period, the Naval Special Warfare Command was searching for a replacement for the *Sea Spectres* operating in the Caribbean Sea. The SEALs required a craft capable of making the long range transits throughout the region and able to travel at moderately high speeds in Sea State 3.¹²⁷ SEAL operations in the Caribbean centered on coastal patrol & interdiction (CP&I) missions in the war against the drug cartels. Their new craft was designated the Special Warfare Craft, Coastal (SWCC) and plans for its construction were begun in earnest.

¹²⁶ Dennis Doyle, Joseph Mayer and Frank N. McCarthy, "The Patrol Coastal CYCLONE Class: A Description of the Newest Addition to the U.S. Navy," Abstract 1993: 3.

¹²⁷ *Ibid.*, 4.

The Coast Guard's 110 foot *Island*-class patrol boat was considered as a potential candidate to meet the specifications of the SWCC design. Naval Sea Systems Command (NAVSEA) tasked the Naval Surface Warfare Center to conduct a feasibility study to determine if a modified *Island*-class patrol boat could meet the SWCC requirements. The study concluded that the modifications would be too extensive and not worth the effort. Since the SWCC would have to be a new procurement, as was the PCC, the Deputy Chief of Naval Operations, Surface Warfare (OP-03), recognized that the two craft were similar enough that separate procurements were not warranted.¹²⁸ The SWCC and PCC requirements were combined and the new vessel was called the Patrol Boat, Coastal (PBC). A total of 16 PBCs were requested. In order to minimize development costs and avoid the time required to develop a prototype (as occurred with the *Pegasus*), the Chief of Naval Operations (CNO) directed that the PBC contract be a Non-Developmental Item (NDI) procurement. An NDI procurement is intended to be a cost effective approach for meeting the program requirements by obtaining an already developed product, that with minimal modification, will suit the needs of the program.¹²⁹

The contract was awarded in August, 1990 to Bollinger Machine Shop & Shipyard, Inc. in Lockport, Louisiana. It specified the construction of eight PBCs with the option for five additional craft. Bollinger had worked closely with Vosper Thornycraft in designing and building 49 *Island*-class PBs and relied on Vosper for help with the NDI design for the PBC. The Vosper 170 foot, Egyptian *Ramadan*-class patrol craft was modified to meet the specifications for the contract.¹³⁰

¹²⁸ Ibid., 4.

¹²⁹ Dennis J. Doyle and Joseph C. Mayer, "The Evolution of Patrol Boat Coastal From Boat to Ship," *Association of Scientists and Engineers 29th Annual Technical Symposium*, 28 May 1992: 2.

¹³⁰ Doyle, Mayer and McCarthey, 5.

In January 1991, the size of the PBC design led the CNO to ask if these vessels should be commissioned. The craft were destined to belong to USSOCOM and not the Navy. NAVSPECWARCOM owned the Special Boat Squadrons and would act as the PBC Type Commander. Although patrol boats were nothing new to the SEAL community, none of the previous PBs were this large nor were they commissioned. The act of commissioning carried with it multiple implications regarding command at sea, sovereignty issues, immunity to search and seizure, exemption from foreign taxes and regulation, and exclusive control over passengers and crew.¹³¹ The decision to commission was placed under review and construction began in February 1991. The Secretary of the Navy decided in favor of commissioning the PBC in June 1991 and the CNO renamed the class, Patrol Coastal (PC), removing the "boat" reference.¹³²

The first craft of the class, *USS Cyclone* (PC-1), was completed and delivered in February 1993. The last vessel of the class, *USS Shamal* (PC-13), was commissioned in November 1995. Four of the PCs are homeported in San Diego, California with Special Boat Squadron One and the remaining nine are located at Little Creek, Virginia with Special Boat Squadron Two.¹³³

2. Description

The 331 ton *Cyclone*-class is 170 feet long, 25 feet wide at the beam and has a draft of 8 feet (see Figure 8). It has a cruising range of 2000 nm at 12 kts and is capable of making 35 kts in Sea State 1. The ship is designed to operate in seas up to Sea State 4 and to survive Sea State 5. The PC has four shafts, driven by four diesel engines. It carries enough stores, potable water and supplies for an endurance of 10 days underway.

¹³¹ Doyle and Mayer, 3.

¹³² Doyle, Mayer and McCarthy, 5.

¹³³ Ibid., 5.



Figure 8. *Cyclone*-class, Patrol Craft, Coastal (PC)

Ship's company is 30 (four officers, two chief petty officers and 24 enlisted) plus nine embarked SEALs.¹³⁴

Its main armament consists of fore and aft, Mk 38 25 mm chain guns. The Mk 38s are unstabilized mounts which make them highly inaccurate in rough seas.¹³⁵ It is also equipped with pintel mounts for two .50 caliber and two M-60 machine guns. In addition, pintels exist for two Mk 19 40 mm grenade launchers. For close-in air defense, the PCs carry six Stinger, shoulder fired anti-air missiles. The Mk 52 Decoy Chaff System is installed for added defense against ASCM attack.¹³⁶ Its aluminum hull and superstructure vary in thickness from 3 to 5 mm, although the pilothouse, communications center and engine control station are protected by lightweight armor plating.¹³⁷

For special operations, the PCs can carry two Combat Rubber Raiding Craft (CRRCs) and a 6 meter Rigid Hull Inflatable Boat (RHIB). A stern davit is used to raise and lower the RHIB. The CRRCs and RHIB are used for insertion and extraction missions and to carry boarding parties on CP&I missions. The ship has accommodations for nine SEALs and their associated gear (although the SEALs will disagree with the amount of stowage space). The aft end of the ship contains a dive locker, swimmer showers and a swimmer platform.

For major maintenance requirements, the PCs rely on their Maintenance Support Team (MST) in much the same way as the PHMs used their MLSG. The MST possesses the supplies, spare parts and requisite maintenance equipment and personnel to keep the

¹³⁴ Ibid., 2.

¹³⁵ Currently, there is a program to replace the aft mount with a stabilized Mk 96 gun mount, which incorporates the 25 mm chain gun and a MK 19 40 mm grenade launcher. The gunner sits to the left of the weapons on a stabilized platform that helps to eliminate ship pitch and roll.

¹³⁶ Doyle, Mayer and McCarthey, 2.

¹³⁷ Ibid., 11.

PCs operational. The support team also handles the administrative, postal and logistic issues for the ships. When a detachment deploys, usually comprised of two PCs, an MST detachment also follows. The MST will take along three vans, one to use as a workshop and the other two to carry the spare parts and equipment for each PC. Three C-130 cargo planes are required to airlift the three vans.

3. Roles and Missions

The *Cyclone* is tasked with a primary mission of Coastal Patrol & Interdiction and a secondary mission of Naval Special Warfare Operations. It can perform both missions equally well but it is slightly better suited for its CP&I role than for Special Operations.¹³⁸ The *Cyclones* operate in pairs in mutually supporting roles. CP&I requires vessels that have good seakeeping ability, on-station endurance and speed. Interdiction missions are characterized by long periods of low speed cruising and patrolling and short bursts of high speed to identify and intercept surface contacts. Once a suspect craft is intercepted and a boarding decision is authorized, the PC must remain close by in order to launch and recover the RHIB and to provide fire support should the vessel resist search and seizure. Frank McCarthy, the Assistant Project Manager for the PC program, further elaborates on the boarding requirements:

In order to efficiently prosecute the CP&I mission, a craft needs a good relative speed advantage over the ship/craft to be intercepted to minimize the intercept time. Additionally, a clear deck area for boat handling and suitably arranged weapons mounts are required to provide adequate coverage of the boarding evolution without interfering with the launch and recovery operations of the RHIB.¹³⁹

¹³⁸ In 1994, during the initial phases of Operation Support Democracy in Haiti, the warships participating in the maritime sanctions enforcement operations were unable to shut down coastal smuggling traffic. A smuggler in a tugboat was able to outrun an FFG by heading for shallower water. The FFG, unable to pursue and not authorized to sink the tug, had to break off pursuit. Once a detachment of PCs arrived, within a period of 24 hours, the coastal CP&I gap was effectively closed.

¹³⁹ Carl Casamassina and Frank N. McCarthy, "Patrol Coastal Program - Requirements Definition to

The *Cyclone* weapons configuration provides sufficient firepower and coverage for support of most hostile boarding scenarios.

Competing with the CP&I mission requirements for design priority was the Naval Special Warfare secondary mission. This mission is rather broad in scope but mostly entails delivering SEAL teams to a drop off point, withdrawing and waiting for the SEALs to return and extracting them from the objective area. The SEALs would perform a variety of missions ranging from hydrographic surveys of surf zones to strategic reconnaissance ashore or quick strike, direct action raids on enemy positions. The teams could be inserted via CRRC or RHIB or they could deploy via the swimmers platform and swim ashore. These Special Warfare tasks require the PC design to have reduced radar, thermal, electronic and acoustic signatures and to have a high burst speeds for the insertion and extraction phases of the operation.¹⁴⁰ It must also possess adequate suppressive fire potential should either phase of the insertion or extraction turn into a fire fight. The *Cyclone* silhouette is low and sleek, comprised of obtuse angles and sloping sides to reduce radar cross-section. Radar absorbent materials are also used to enhance its "stealth" profile. Thermal and acoustic signatures are reduced using muffled, side and underwater exhaust ports rather than conventional topside stacks.¹⁴¹

4. Debate and Controversy

Much of the PC debate is similar to the arguments often voiced concerning any small boat program. Furthermore, the *Cyclone* has managed to avoid one of the main

Contract Award," Technical Proceedings "From the Sea to the Future" of the Small Boats Symposium '93, Norfolk, VA. May 1993: 4.

¹⁴⁰ Ibid., 4.

¹⁴¹ Doyle, Mayer and McCarthy, 12.

controversies which killed the PHM program - cost; PCs cost less than \$20 million.¹⁴²

The PC debate centers on the following points.

a. Limited Endurance and Seakeeping

Using an almost identical argument as the one found in the PHM debate, PC critics contend that the 170 foot ship is not seaworthy enough to deploy safely across the ocean or that moderately heavy weather will force them to head for port. The lack of ballast or sea water compensation systems also makes the PC vulnerable to heavy pitching and rolling. Limited crew endurance due to fatigue is a concern. Seasickness and shipboard habitability problems, like lack of laundry facilities and minimal berthing accommodations, are factors which must be considered when assigning PCs to an operations area. Their 2,000 nm range requires them to travel in the company of a larger escort ship from which to refuel. Further complicating matters, the PCs are designed and best suited for astern refueling -- a procedure not often practiced by a surface navy more comfortable with alongside refueling. This unique refueling requirement necessitates the use of a Fleet Reserve oiler or a special refueling rig carried by the combatant escorting the PCs.

PC officers agree that the *Cyclone*-class is a rough ride in foul weather but the PCs are not merely "fair weather" craft. The small craft skippers have a healthy respect for the weather, probably more so than their combatant counterparts, and practice heavy weather avoidance at all times. The PCs request OTSR reports (weather avoidance routes) each time before they get underway. In the event that they cannot avoid the bad weather, an active fin stabilization system helps to counter the effects of wave motion

¹⁴² George R. Worthington, RADM, USN (Ret), "Combatant Craft Have a Role in Littoral Warfare," *Naval Institute Proceedings* August 1994: 25.

and is optimized for speeds of 15 - 20 kts.¹⁴³ Additionally, the craft requires a minimal amount of watch standers to operate, two on the bridge and two in the engineering plant. The PC was designed to be run from the bridge and a considerable amount of automation assists in its operation. An automatic pilot is almost always used to steer and the engine throttles and Halon fire protection system controls are also located in the pilot house. The engine rooms do not have to be manned, although they normally are when underway. If heavy weather has forced a significant portion of the crew "out of commission," theoretically, only one person is needed to drive the ship.

With respect to the ship's endurance, the PC can carry 10 days worth of stores for the crew; fuel endurance is subject to speed and mission profile. Although the astern refueling method is not preferred by the Fleet, it is the only real option for the *Cyclone*; several different refueling methods were attempted, all with little success. Alongside refueling was too manpower intensive and too dangerous underway; the massive hydrodynamic forces created by the larger ship's motion threatened to capsize or suck the PC into a collision. Dead-in-the-water (DIW) alongside refueling required almost flat seas or the PC would repeatedly be smashed into the side of the refueling ship. Minimal success was achieved using the Helicopter In-Flight Refueling (HIFR) rig from an FFG, with the PC taking station off the port quarter and slightly astern of the frigate while both proceeded at bare steerageway. Unfortunately, the small size of the HIFR hose significantly increased the time needed to complete the evolution. The best option remains the astern refueling method.

¹⁴³ Doyle, Mayer and McCarthy, 15.

b. Cannot Defend Itself

The *Cyclone*-class is lightly armed when compared to foreign patrol boats of similar size. Opponents of the PC believe it is at a serious disadvantage if confronted by anything equal to or larger than a gunboat. It would also run into trouble during boarding operations if the suspect vessel resisted with any large caliber, crew-served weapon.¹⁴⁴ Lacking a gun with greater stand-off range, the PC would be compelled to abort the boarding and call for air support or a larger surface combatant to engage the vessel. If the boarding party was caught in the RHIB or, worse yet, were forced to jump ship when hostilities broke out, the PC would sustain heavy damage while trying to rescue the boarding team members. The lack of an integrated, AAW defensive weapon system is also cited as a major weakness, particularly after Desert Storm had demonstrated the vulnerability of patrol boats to air attack.

Cyclone's proponents offer the counterpoint that the PC was originally intended to be a "niche" mission ship. There was a conscious effort during the design process to avoid the temptation of adding torpedoes, bigger guns and Harpoon missiles on to the patrol craft.¹⁴⁵ Turning it into a multi-mission, mini-corvette would only complicate matters and would not contribute to its original naval special warfare mission. The *Cyclone's* weapons combination was chosen primarily to support CP&I and special operations, not the gunboat/anti-shipping missions typically assigned to foreign PBs. It would be ridiculous to outfit it with bigger weapon systems "just in case" the PC ran into

¹⁴⁴ During WWII, Germany lost several U-boats to British Q-ships, small gunboats disguised as coastal merchants, when the submarines surfaced to sink the "merchants" with gunfire rather than waste a torpedo on such a small target.

¹⁴⁵ The NAVSEA PC Project Managers encountered this problem repeatedly, "Many people, from operators to arm-chair warriors wanted to arm the PC as if it were the U.S. Navy's premier ship-of-the-line. 'What if you come up against the XYZ class?', was a constant question. We had to continually resist this argument if the PC was to remain cost effective and to meet the need of our customer to...fill the niche he had intended in the littoral and low-intensity conflict arena." Doyle, Mayer and McCarthey, 17.

an enemy gunboat or submarine. Due to the "big ship" orientation of the U.S. Navy, the PCs will never be allowed to operate alone in waters that are openly contested by hostile naval and air power, even if they were equipped with appropriate weapons. In the unlikely event that the PCs are involved in an engagement with the enemy, the PCs can call for air support or call in warships that will be operating close by.

c. MST Dependency

An argument wrongly drawn from the PHM debate is the PCs dependence on the Maintenance Support Team. Critics refer to the lack of storage space onboard for spare parts and repair equipment and to the need for containerized storage vans. They also mention that specialized or manpower intensive maintenance requirements demand the uniquely qualified personnel of the MST. Although their points are factual true, it is incorrect to assume that the MST is as critical to PC operations as the MLSG was to the PHMs. In maintenance demands, the *Cyclone*-class is nowhere near the level of complexity of the *Pegasus*-class; much of the repair work is relatively simple and can be conducted by the crew. Since the PCs travel in pairs, they can share parts from one van; the MST need only bring a workshop van and one parts van, instead of two.¹⁴⁶ The biggest difficulty for the PCs occurs when the MST deploys *with* them. Experience has shown that ordering parts, especially crucial CASREP items, becomes much more difficult. Because the MST takes its supply clerks with it, there is no one back at the base able to do the face-to-face liaison necessary to keep track of and expedite shipment of critical parts. Moreover, on deployments, the MST is often made to set up camp at non-U.S. and non-Navy facilities, further complicating the logistics supply line.

¹⁴⁶ *USS Squall* (PC-7) and *USS Zephyr* (PC-8) found this arrangement to work well in a recent cruise to Alaska.

d. Neither Community Wants Them

Perhaps the most publicized point of the PC debate, it focuses on the bureaucratic politics, intraservice rivalry and compromise that both communities, Special Operations and Surface Warfare, had to make to get a patrol boat into the Fleet. It is also a mixture of all the other controversies of the PC program.

The most often voiced complaint is that the SEALs dislike the *Cyclone*-class and prefer the 82 foot, 57 ton Mk V Special Operations Craft (SOC), ironically named *Pegasus* (see Figure 9). They are faster, capable of 50 kts, and can be airlifted via C-5 transport aircraft. Operated by a five man crew, the Mk V SOC's primary mission is to insert and extract 16 fully equipped SEALs into "a low to medium threat (offshore/coastal) environment."¹⁴⁷ Its secondary mission is limited CP&I. The shift in mission priority with the Mk V SOC particularly pleases the SEALs. It reflects what they originally wanted when NAVSPECWARCOM submitted its request for a replacement boat back in 1987. Additionally, the Mk V SOC is not commissioned and, as such, does not have the "strings attached" to the surface navy like the PC.

The surface community also has complaints, mainly directed at the PC's perceived inability to operate far from home waters and its weak firepower. Most conventional surface line officers have no background and little comprehension of patrol boat or special operations. Viewing the small PCs with an eye toward battle group or amphibious ready group operations, it is easy to understand why they are skeptical of the PC's applicability. The "cult of the battleship" mentality remains in effect and some of the PC's most ardent critics are the blue-water, line officers unimpressed with the Coast Guard-like qualities of the *Cyclone*-class. Special Boat Squadron One, based out of San

¹⁴⁷ *Mk V Special Operations Craft (Standardized Information Document)*, U.S. Special Operations Command, Tampa, FL 1995: 1.

Diego, has been unable to deploy to the Western Pacific for exercises with various Pacific Rim navies. Despite the fact that USSOCOM owns them and Commander, Naval Forces, Japan (CNFJ) wanted to exercise with them, CINCPACFLT refused to let the PCs make the transit. Resistance to the proposed deployment has centered on the vast size of the Pacific Ocean compared to the small size of the PC and its lack of open ocean seaworthiness and low endurance. One PC officer noted that the PCs seem to have the greatest latitude in operations when a non-naval officer is the Joint Task Force commander. Until the *Cyclone*-class has been given the opportunity to demonstrate its potential as a capable "niche mission" ship, it will continue to encounter biases against its employment.

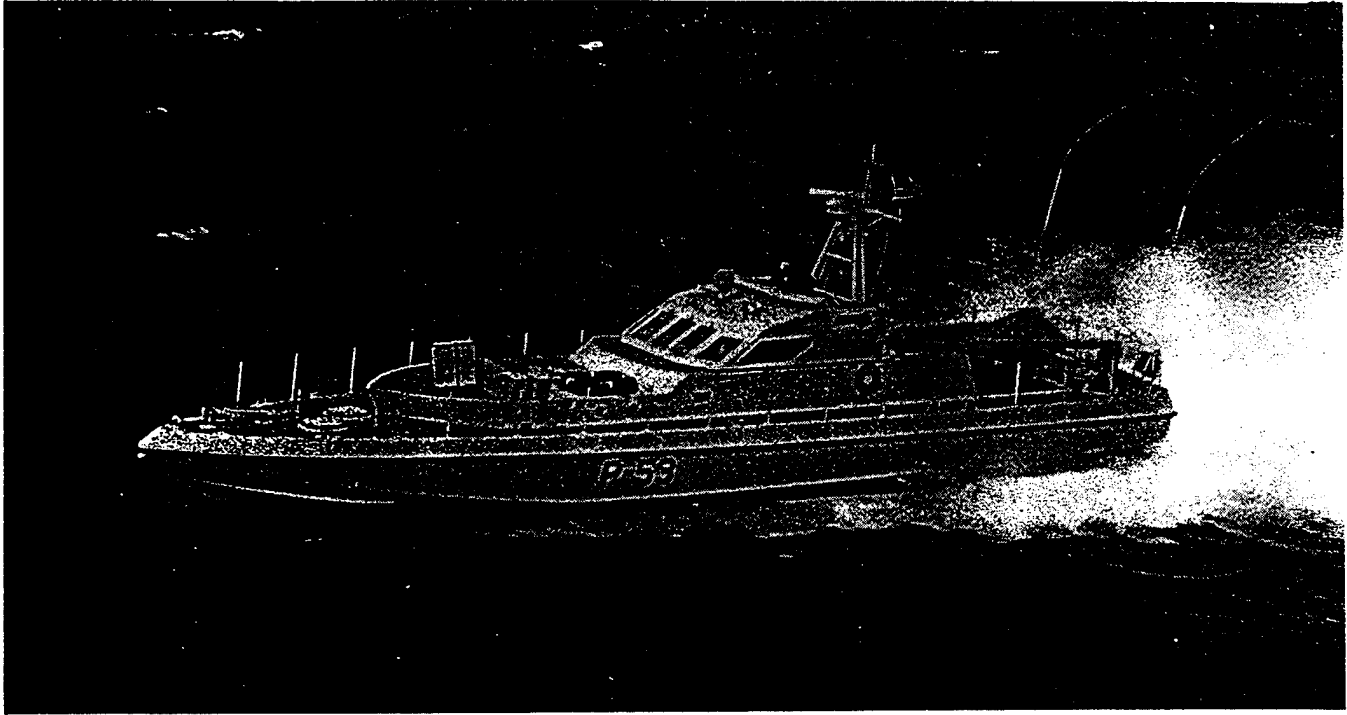

Figure 9. Mk V Special Operations Craft (SOC)

V. MOTHER SHIP (LX)/PATROL CRAFT, COASTAL (PC) ALTERNATIVE MODEL

Contingency operation and low intensity conflict require missions which include, but are not limited to: coastal patrol & interdiction, special operations, naval surface fire support and internal water/riverine patrols. Although *Surface Warfare Vision 2030* deals primarily with future naval operations in the context of a major regional conflict, its LX/SFX concept is adapted to create a model for operations in LIC environments. The following chapter offers an alternative for *Cyclone*-class employment in contingency operations or operations other than war.

First and foremost, it must be reiterated that the *Cyclone*-class is a "niche mission" patrol craft and it should be used in that manner. Its primary missions are coastal patrol and interdiction and naval special warfare support. The PCs need to operate in detachments of at least four ships and have a helicopter-capable mother ship dedicated to their support. The helicopter detachment would be supplied by the USSOCOM's 160th Special Operations Aviation Regiment or by Marine Corps aviation units. A minimum of two attack helos and two medium/heavy lift helos should be provided. The helicopter gunships will act as pouncer aircraft if the PCs encounter heavy resistance. Helos can also be used to helocast SEAL boarding teams on to uncooperative vessels which refuse to stop for the PCs. Additionally, two to four Mk V SOC should operate per squadron as high-speed insertion/extraction and interceptor boats.

As Norman Mosher and Andrew Nelson, naval officers with extensive Operation Market Time experience point out, "For thorough coastal coverage and to allow for overhaul/upkeep time, there should be an average of about one [craft] per ten miles of

coastline."¹⁴⁸ The current policy of deploying PCs two at a time to the theater of operations is not sufficient. If one becomes disabled due to unforeseen problems, like running aground, or due to combat or equipment casualties, the remaining PC will be unable to cover all of the missions that require two craft to accomplish.¹⁴⁹ At a minimum, close in CP&I capability will degrade by 50 percent. Four PCs allow for a weekly rotation cycle where at least three craft per day are on patrol or ready reserve status (see Table 1.) The exception to this rule occurs on Day 5 when two of the PCs are in crew rest and maintenance and there are no craft standing by in ready reserve; however, this does not necessarily mean that they would be unavailable if needed.

	DAY 1	DAY 2	DAY 3	DAY 4	DAY 5	DAY 6	DAY 7
PC-1	Patrol	Patrol	Patrol	Patrol	Rest	Rest	Reserve
PC-2	Rest	Reserve	Patrol	Patrol	Patrol	Patrol	Rest
PC-3	Patrol	Rest	Rest	Reserve	Patrol	Patrol	Patrol
PC-4	Patrol	Patrol	Patrol	Rest	Rest	Reserve	Patrol

Table 1. Weekly *Cyclone*-class Rotation Cycle

Each ship spends four days on station, patrolling its assigned sector and conducting routine CP&I. They are available for special warfare tasking, supporting SEAL teams on strategic reconnaissance, direct action, unconventional warfare, counter-terrorism and foreign internal defense missions. On their two days of stand down, the crew can recover from the rigors of patrol duty. Resupply, repairs and maintenance, with the assistance of the mother ship's support department, will also be performed during these two days. The day prior to returning on patrol is the PC's ready reserve day. It is

¹⁴⁸ Norman G. Mosher and Andrew G. Nelson, "Proposed: A Counterinsurgency Task Force," *Naval Institute Proceedings*, June 1966: 45.

¹⁴⁹ *USS Monsoon* (PC-4) ran aground off Haiti and was stuck for almost a day until the tide rose and another vessel could help ease her off the shoal.

still used for crew rest but all critical maintenance and repairs need to have been completed. The ready reserve ship must be prepared to deploy immediately to cover the break down, damage or loss of a PC on patrol. It can also be used as a reinforcement if operations warrant extra coverage.

The crew of the PCs live on board the mother ship during the three days not on patrol. The mother ship must be capable of providing all the repair and support services necessary to maintain the squadron, with the exception of dry docking facilities.¹⁵⁰ It also needs to have a well deck to shelter the MK V SOCs as well as a flight deck and hangar for the squadron's helicopter assets. Since the mother ship serves as a command and control ship for the squadron, it requires appropriately sized communications, operations and intelligence centers. It must also provide berthing and facilities for all of the squadron's crew, support and staff members, numbering roughly 272 personnel. These numbers are broken down in Table 2.

The LPD-17 class would work particularly well as a mother ship. If these ships were unavailable due to Marine Corps requirements, an LST slated for decommissioning would work until a newer mother ship could be developed. LSTs were converted into ARLs (Landing Craft Repair ships) during Vietnam and were used as tenders for mine sweepers (MSB, MSC and MSOs) and patrol boats. The *USS Krishna* (ARL-38) is an example. It served as a base ship for 16 U.S. Navy and Coast Guard patrol boats participating in Market Time coastal patrol operations. A 60-ton derrick, and 25 and 10-ton booms were added for hoist capability. The well deck was converted into electrical, instrument and machinery repair shops. The ship's ballast tanks were converted into fresh

¹⁵⁰ If repairs require dry docking the PC, a floatable dry dock can be towed to the operations area (although this requires significant transit time) or the PC may be sent to a nearby port. Another option is to heavy-lift a replacement PC to the operations area and use the same ship to bring the damaged PC home.

water and fuel tanks, almost doubling the ship's capacity. The *Krishna's* medical department provided care not only for U.S. military personnel but also made weekly sick calls to the local villages, a valuable trust building measure that helped provide local intelligence about Viet Cong infiltration routes.¹⁵¹

	Number		Personnel		
PCs	4	x	30	=	120
PC Maintenance Support	2	x	15	=	30
Mk V SOCs	4	x	5	=	20
Mk V Maintenance Support	2	x	8	=	16
PC/Mk V Staff	1	x	10	=	10
SEAL Platoons	3	x	16	=	48
Helicopters	4	x	2	=	8
Helo Maintenance Support	2	x	10	=	20
					Total 272

Table 2. Squadron Personnel Requirements

Radar picket escort destroyers (DERs) were also used as tactical mother ships in Operation Market Time. The DER, accompanying 82 foot Coast Guard cutters (WPB) or 50 foot Navy Swift boats (PCFs), would stop and search all junks its sector of operations. DER commanding officers had broad guide lines governing how they carried out their missions and how they employed their patrol craft. The CO of *USS Lowe* (DER-325) often took, "two PCF crews and one PCF...with the DER, with the [DER] providing the lodging and logistics to allow the PCF to remain away from her home base for extended periods."¹⁵² For short periods of time, a *Spruance* DD or *Oliver Hazard Perry* FFG could serve as a tactical mother ship for a PC or two. This combination

¹⁵¹ William R. Harris, LCDR, USN, "Market Time Mother Ship," *Naval Institute Proceedings*, December 1966.

¹⁵² W.J. Moredock, LCDR, USN, "The DER in Market Time," *Naval Institute Proceedings*, February 1967: 138.

would work well if operations required a CP&I mission outside of the main area of operations where the bigger mother ship was located.

VI. CONCLUSION

Patrol craft, particularly the *Cyclone*-class offer much potential in low intensity conflict and contingency response operations in the littoral. Unfortunately, bureaucratic politics and cultural biases against small craft, in general, make it a hard case to sell to the U.S. Navy. In the fiscally constrained years of today, every program is concerned with its share of the defense budget, and none would be willing to sacrifice roles and missions considered vital to their survival. The alternative model proposed in this thesis threatens existing forces. The question that must be asked is whether these current forces are the proper tools for the LIC arena. I argue that they are not; close-in coastal patrol and interdiction is inadequately performed by today's Navy and the *Cyclone*-class is ideally suited for such a mission. The standard concerns that the ships are too small to deploy and adversely affected by foul weather are absurd. The PCs have already proven that they can cross the Atlantic Ocean and operate in the Mediterranean and Baltic Seas. In the Pacific Ocean, PCs have made the trip from San Diego to Alaska with no difficulty. Those critics still skeptical of the PCs ability to make the open ocean transit could be placated by forward deploying the craft to Sasebo, Japan or Gaeta, Italy or Bahrain. Regardless of their homeport, if the weather in theater is so bad as to hamper PC operations, it will likewise hamper blockade runner and smuggler operations.

Another institutional hurdle which must be overcome is the mind set that patrol craft are defensive in nature, to be used to protect the home coast like the Coast Guard. WWII and Vietnam prove that patrol craft can be employed on the strategic as well as tactical offensive. Lacking forward basing, the PCs can equally be utilized on the offensive with the assistance of a mother ship. If the LIC scenario permits, CP&I

operations can be staged out of a harbor or port under U.S. control. If the situation is openly hostile or working up to a regional conflict, then the mother ship would be critical.

This thesis has shown the advantage of numbers in coastal operations. The more ships, the better force coverage and survivability. In a large-scale CP&I campaign, like Operation Market Time, thousands of boardings per month are conducted. Over 50,000 registered vessels and innumerable junks plied the coastal waters of South Vietnam. In an effort to control the South Vietnamese coastline from the shore out to 40 nm, Operation Market Time required 17 combatants, four LSTs, 14 off-shore patrol ships, 84 PCFs, 26 WPBs and continuous maritime patrol aircraft surveillance.¹⁵³ In smaller-scale operations, like Operation Support Democracy, the Navy boarded and searched over 1,100 coastal and merchant ships in the first six months of the campaign.¹⁵⁴ 13 PCs are not enough to fulfill all the close-in CP&I requirements for the Navy. The alternative model, as designed, would be able to create three squadrons out of the 13 PCs currently in existence. If the squadrons are forward deployed, a minimum of 12 PCs per coast are necessary to handle the 6-month deployment rotations.

Recently, statements have been made in Washington by the surface navy, that they were considering taking over the PCs from USSOCOM, equipping them with ASCMs and turning them into coastal missile craft (PCMs). This would be a tragic mistake. The craft were not designed for such a mission and it would leave the close-in CP&I mission unfilled once again. More importantly, the PCs would probably wither and die in the surface navy due to the traditional "big ship is better" mentality. The

¹⁵³ R.L. Schreadley, "The Naval War in Vietnam," *Naval Institute Proceedings, Naval Review* 1971, March 1971: 188,191.

¹⁵⁴ Frederick C. Smith, "Department of Defense's Role in Supporting the Administration's Haiti Policy," Speech, *Federal News Service*, 28 June 1994.

lessons learned from the PHM program and Desert Storm apply; coastal missile ships are not needed by the U.S. Navy and aircraft are much better at ASUW missions than PHMs or PCs. *Cyclone*-class PCs are best suited for close-in CP&I and naval special warfare support. Improvements and modifications to the PCs should be made to enhance those missions and not to turn them into "can do everything" ships.

BIBLIOGRAPHY

Books

- Allison, Graham. *Essence of Decision*. Boston: Little, Brown. 1971.
- Barnett, Frank R., Shultz, Richard H., and Tovar, B. Hugh eds. *Special Operations in U.S. Strategy*. Washington D.C.: National Defense University Press. 1984.
- Booth, Ken. "The Role of Navies in Peacetime: The Influence of Future History on Sea Power," in Hugh Smith and Anthony Bergin, eds., *Naval Power in the Pacific: Toward the Year 2000*. Boulder: Lynne Rienner. 1993.
- Borresen, Jacob. "The Seapower of the Coastal State." *Seapower Theory and Practice*. Annapolis: Naval Institute Press. 1990.
- Builder, Carl H. *The Masks of War: American Military Styles in Strategy and Analysis*. Baltimore: John Hopkins University Press. 1989.
- Cutler, Thomas J. *Brown Water, Black Beret*. Annapolis: Naval Institute Press. 1988.
- Dupuy, Trevor N., COL, USA (Ret.). *Numbers, Predictions and War: Using History to Evaluate Combat Factors and Predict the Outcomes of Battles*. Indianapolis: Bobbs-Merrill. 1979.
- Farley, Edward I. *PT Patrol*. New York: Exposition Press. 1957.
- George, James L. *The U.S. Navy in the 1990's*. Annapolis: Naval Institute Press. 1992.
- Halperin, Morton H. *Bureaucratic Politics and Foreign Policy*. Washington, D.C.: Brookings Institution. 1974.
- Hughes, Wayne P., Jr., CAPT, USN (Ret.). *Fleet Tactics: Theory and Practice*. Annapolis: Naval Institute Press. 1986.
- Kelly, Orr. *Brave Men - Dark Waters: The Untold Story of the Navy SEALs*. Novato, CA: Presidio Press. 1992.
- Koburger, Charles W., Jr. *Naval Warfare in the Baltic, 1939-1945*. London: Praeger. 1994.
- Krepinevich, Andrew, Jr. *The Army and Vietnam*. Baltimore: Johns Hopkins University Press. 1986.
- Levert, Lee J. *Fundamentals of Naval Warfare*. New York: Macmillan Company. 1947.
- Mayer, Kenneth R. *The Political Economy of Defense Contracting*. New Haven: Yale University Press. 1991.
- O'Connell, Robert L. *Sacred Vessels*. New York: Oxford University Press. 1991.
- Pratt, Fletcher. *Night Work*. New York: Henry Holt and Co. 1946.
- Scott, Peter, LCDR, RNVR. *The Battle for the Narrow Seas*. New York: Scribner's. 1946.
- Vego, Milan N. *Soviet Naval Tactics*. Annapolis: Naval Institute Press. 1992.
- Watson, Bruce W. *The Changing Face of the World's Navies: 1945 to the Present*. New York: Brassey's (US). 1991
- White, W.L. *They Were Expendable*. New York: Harcourt, Brace and Company. 1942.
- Wolfert, Ira. *Battle for the Solomons*. Cambridge: Riverside Press. 1943.

Woodward, Sandy, ADM, RN. *One Hundred Days: The Memoirs of the Falklands Battle Group Commander*. Annapolis: Naval Institute Press. 1992.

Periodicals

- Abel, Christopher A. and Black, Henry A. "Missing the Boat." *Naval Institute Proceedings* (September 1988).
- Adler, Ronald E. "In the Navy's Future: the Small, Fast Surface Ship." *Naval Institute Proceedings* (March 1978).
- Berns, Thomas H. "Some Tactical Considerations." *Naval Institute Proceedings* (January 1988).
- Black, Scott, Bosworth, Michael, CDR, USN, and Meyer, John R. "Well Deck Deployable Naval Combatants." *Naval Engineers Journal* 106:1 (January 1994).
- Brower, Kenneth S. and Kehoe, James W. "Fast Attack Craft - A Comparative Analysis." *Naval Engineering Journal* 105:3 (May 1993).
- "Budget Cuts Delay Patrol Ship Upgrade; CYCLONE Class Coastal Patrol Ships." *Defense Daily* 183:48 (June 1994).
- Burnett, Robin. "Offshore Protection Vessels - Large and Small." *The Naval Architect* (July/August 1995).
- Butcher, Marvin E. "Fighting the PHM's." *Naval Institute Proceedings* (April 1989).
- Chapin, Stephen R. "Countering Guerrillas in the Gulf." *Naval Institute Proceedings* (January 1988).
- "The History of the PHM." *Naval Institute Proceedings* (September 1986).
- Crawford, K.R., Hatton, M.T., and Melton, A.W. "Where Are the Littoral Warfare Fast-Attack Craft?" *Naval Institute Proceedings* (April 1995).
- Croizat, Victor J. "Naval Forces in River War." *Naval Institute Proceedings* (October 1966).
- "Fast Attack Craft: Adapting the Art of Hit and Run." *Jane's Defence Weekly* (24 October 1992).
- Fireman, Howard, Fowler, Jim, McIntire, John and Wilkins, Jim, CDR, USN. "LPD 17: In the Midst of Reform." *Naval Engineers Journal* 107:3 (May 1995).
- Friedman, Norman. "Speed in Modern Warships." *Naval Institute Proceedings* (May 1979).
- Gurnee, Anthony. "Some Tactical Considerations: Rebuttal." *Naval Institute Proceedings* (January 1987).
- Harris, William R., LCDR, USN. "Market Time Mother Ship." *Naval Institute Proceedings* (December 1966).
- Hope, Jan Paul. "Fighting the PHM's: Rebuttal." *Naval Institute Proceedings* (August 1989).
- Hughes, Wayne P., Jr., CAPT, USN. "Fast Attack Craft in Littoral Warfare." *Naval Institute Proceedings* (May 1995).
- Jacobs, R.D. "In Search of ... Patrol Combatants." *Naval Institute Proceedings* (September 1983).

- Kelsey, Robert J. "Maneuver Warfare At Sea." *Naval Institute Proceedings* (September 1982).
- Libbey, Miles A., III. "The Missing Link." *Naval Institute Proceedings* (July 1982).
- Linder, Bruce R. "Pegasus: Winner or Also-ran?" *Naval Institute Proceedings* (September 1981).
- Meyer, Victor A., CAPT, USN (Ret.). "Naval Special Warfare Future Concepts: The Case for Operational Mobility." *Naval Engineering Journal* 106:3 (May 1994).
- Moredock, W.J., LCDR, USN. "The DER in Market Time." *Naval Institute Proceedings* (February 1967).
- Mosher, Norman G. and Nelson, Andrew G. "Proposed: A Counterinsurgency Task Force." *Naval Institute Proceedings* (June 1966).
- "Pegasus' Wins U.S. Special Operations Command Competition to be Next Generation Mark V." *Naval Engineering Journal* 107:1 (January 1995).
- Pitts, Darren. "Fighting Drugs at the Source." *Naval Institute Proceedings* (July 1994).
- Rhodes, Edward. "Do Bureaucratic Politics Matter? Some Disconfirming Findings from the Case of the U.S. Navy." *World Politics* 47:1 (October 1994).
- Schreadley, R.L. "The Naval War in Vietnam." *Naval Institute Proceedings, Naval Review* 1971 (March 1971).
- Slocum, W. Scott. "Employing the PHM's: Rebuttal." *Naval Institute Proceedings* (February 1987).
- Szablak, Michael J. "Employing the PHM's: Rebuttal." *Naval Institute Proceedings* (December 1986).
- Thompson, Warner K. "Small Craft Firepower in Vietnam: Rebuttal." *Naval Institute Proceedings* (April 1966).
- Tishel, Uzi. "Designing the Sa'ar V." *Naval Institute Proceedings* (March 1992).
- Truver, Scott C. "Tomorrow's Fleet: Part II." *Naval Institute Proceedings* (July 1995).
- Vego, Milan N. "Tactical Employment of Soviet FPBs: Part 1." *Naval Institute Proceedings* (June 1980).
- "Tactical Employment of Soviet FPBs: Part 2." *Naval Institute Proceedings* (July 1980).
 - "The Potential Influence of Third World Navies on Ocean Shipping." *Naval Institute Proceedings* (May 1981).
- Wells, Alexander W. "Small Craft Firepower in Vietnam." *Naval Institute Proceedings* (April 1966).
- Williams, Leroy G., Jr. "Employing the PHM's." *Naval Institute Proceedings* (September 1986).
- Worthington, George R. "Combatant Craft Have a Role in Littoral Warfare." *Naval Institute Proceedings* (August 1994).
- Ya'ari, Yedidia. "The Littoral Arena: A Word of Caution." *Naval War College Review* 48:2 (Spring 1995).
- Zimm, Alan D. "PHM's: Unique Ships, Unique Problems." *Naval Institute Proceedings* (February 1982).

Documents

- Bosworth, Michael, LCDR, USN *An Alternative Surface Battle Force Architecture*. Annapolis, MD: David Taylor Research Center. 20 November 1990.
- Casamassina, Carl and McCarthy, Frank N. "Patrol Coastal Program - Requirements Definition to Contract Award" in Technical Proceedings *"From the Sea to the Future"* of the Small Boats Symposium '93. Norfolk, VA. May 1993.
- Downing, Wayne A., GEN, USA. "Formation of USSOCOM in 1987." Speech. *Federal News Service*. 2 March 1994.
- Doyle, Dennis J. and Mayer, Joseph C. "The Evolution of Patrol Boat Coastal from Boat to Ship" in *Association of Scientists and Engineers 29th Annual Technical Symposium*. 28 May 1992.
- Doyle, Dennis J., Mayer, Joseph C., and McCarthy, Frank N. "The Patrol Coastal CYCLONE Class: A Description of the Newest Addition to the U.S. Navy." 1993.
- Forward...From the Sea*. Washington D.C.: Department of the Navy. 1994.
- Freitas, Mark and Treadway, Braddock W. *Stygian Myth: U.S. Riverine Operations Against the Guerrilla*. Thesis. Monterey, CA: Naval Postgraduate School. 1994.
- ...From the Sea: Preparing the Naval Service for the 21st Century*. Washington D.C.: Department of the Navy. 1992.
- Hopkins, Wayne J. *Combat Effectiveness of Mother Ship/Scout Fighter Combinations Relative to Battle Force Combatant*. Presented at the 60th Military Operations Research Symposium. June 1992.
- Hopkins, Brian J. and Meyer, Victor A., CAPT, USN (Ret.). *Conceptual Ship Characteristics and Capabilities*. Dahlgren, VA: Naval Surface Warfare Center. 1991.
- Hughes, Wayne, P., Jr., CAPT, USN (Ret.). *Naval Forces in Joint Littoral Warfare*. Presented at the 61st Military Operations Research Symposium. June 1993.
- Lewis, Winston B. and Mustin, Henry A. *The Battles of Savo Island (9 August, 1942) and the Eastern Solomons (23-25 August, 1942)*. Washington D.C.: Naval Historical Center. 1994.
- Meyer, Victor A., CAPT, USN (Ret.). *Combat System Concepts for Scout-Fighters*. Memorandum. 22 January 1992.
- *Surface Warfare Vision 2030*. Dahlgren, VA: Naval Surface Warfare Center. December 1990.
- MK V Special Operations Craft (Standardized Information Document)*. Tampa, FL: U.S. Special Operations Command. 1995.
- National Military Strategy: A Strategy of Flexible and Selective Engagement*. Washington D.C.: Department of Defense. 1994.
- Naval Doctrine Publication 1: Naval Warfare*. Washington D.C.: Department of the Navy. 1994.
- Naval Ship's Technical Manual (NSTM S9PCO-AA-SIB-010/PC-1)* from the ATIS CD-ROM Disks GB0001 & GB0002. 1995.

- Schulte, John C. *An Analysis of the Historical Effectiveness of Anti-Ship Cruise Missiles in Littoral Warfare*. Thesis. Monterey, CA: Naval Postgraduate School. 1994.
- Smith, Frederick C. "Department of Defense's Role in Supporting the Administration's Haiti Policy." Speech. *Federal News Service*. 28 June 1994.
- Smith, Steven G., CAPT, USN. *Naval Operations in the Third World*. Paper. Newport, RI: Naval War College. 13 May 1991.
- Ware, Leonard. *The Landing in the Solomons (7-8 August, 1942)*. Washington D.C.: Naval Historical Center. 1994.

INITIAL DISTRIBUTION LIST

	No. Copies
1. Defense Technical Information Center 8725 John J. Kingman Rd. Ste 09442 Fort Belvoir, VA 22060-6218	2
2. Library, Code 13 Naval Postgraduate School Monterey, CA 93943-5002	2
3. Dr. Frank Teti Chairman, National Security Affairs (NS/Te) Naval Postgraduate School Monterey, CA 93943	1
4. Superintendent ATTN: Professor Gordon H. McCormick (Code NS/Mc) Naval Postgraduate School Monterey, CA 93943-5000	1
5. Superintendent ATTN: Professor Wayne P. Hughes, Jr. (Code OR/Hi) Naval Postgraduate School Monterey, CA 93943-5000	1
6. Superintendent ATTN: Professor James Wirtz (Code NS/Wz) Naval Postgraduate School Monterey, CA 93943-5000	2
7. Superintendent ATTN: Professor Jan Breemer (Code NS/Be) Naval Postgraduate School Monterey, CA 93943-5000	1

- | | | |
|-----|---|---|
| 8. | Superintendent
ATTN: CAPT Mike Dunaway
Senior Military Advisor, National Security Affairs
(Code NS/Du)
Naval Postgraduate School
Monterey, CA 93943-5000 | 1 |
| 9. | GEN Wayne A. Downing, USA
Commander in Chief
US Special Operations Command
MacDill AFB, FL 33608-6001 | 1 |
| 10. | United States Special Operations Command
Joint Special Operations Forces Institute
Fort Bragg, NC 28307-5000 | 1 |
| 11. | Jennifer Duncan
Center for the Study of Political Violence
Naval Postgraduate School
Monterey, CA 93943-5000 | 5 |
| 12. | The Honorable H. Allen Holmes
Assistant Secretary of Defense for SO/LIC
The Pentagon, RM 2E258
Washington, DC 20301-2500 | 1 |
| 13. | The JCS Staff
J-3 Special Operations Division
Washington, DC 20318-3000 | 1 |
| 14. | Commander
Joint Special Operations Command
ATTN: J-3
P.O. Box 70239
Ft. Bragg, NC 28307-6001 | 1 |
| 15. | Commander, Naval Special Warfare Command
NAB Coronado
San Diego, CA 92155 | 1 |
| 16. | Commander Naval Special Warfare Development Group
FCTCL Dam Neck
Virginia Beach, VA 23461-5200 | 1 |

- | | | |
|-----|--|---|
| 17. | Commander, Naval Special Warfare Group One
NAB Coronado
San Diego, CA 92155 | 1 |
| 18. | Commander, Naval Special Warfare Group Two
NAB Little Creek
Norfolk, VA 23521 | 1 |
| 19. | Library
Naval War College
Newport, RI 02840 | 1 |
| 20. | Strategic Studies Group (SSG)
Naval War College
Newport, RI 02840 | 1 |
| 21. | Department of Military Strategy
National War College (NWMS)
Ft. Leslie J. McNair
Washington, DC 20319-6111 | 1 |
| 22. | Hurlburt Base Library
16SVS/SVRL
ATTN: Susan Whitson
410 Cody Ave
Hurlburt Fld, FL 32544-5417 | 1 |
| 23. | USASOC
Directorate of History and Museums
ATTN: AOHS-Dr Stewart
Ft Bragg, NC 28307-5200 | 2 |
| 24. | Office of the Chief of Naval Operations
Fleet CINC Liaison (Code N839)
The Pentagon, RM 4C652
Washington, D.C. 20350-2000 | 1 |
| 25. | CDR William McCraven
Commanding Officer
SEAL Team Three
NAB Coronado
San Diego, CA 91255 | 1 |

26. CDR Joseph Bouchard 1
Office of the Chief of Naval Operations (Code N513)
The Pentagon, RM 4E514
Washington, D.C. 20350
27. U.S. Army Center for Military History 1
1099 14th St. NW
Washington, D.C. 20005-3402
28. Major John Viehe 1
U.S. Special Operations Command
ATTN: AOFI-ST
Fort Bragg, NC 28307-5200
29. U.S. Army Command & General Staff College 2
Concepts and Doctrine Directorate
ATTN: Mr. John B. Hunt
Ft. Leavenworth, KS 66027-6900
30. U.S. Military Academy 1
ATTN: Department of Military History
West Point, NY 10966
31. U.S. Naval Academy 1
ATTN: Chester Nimitz Library
Annapolis, MD 21412
32. Marquat Memorial Library 1
U.S. Army John F. Kennedy Special Warfare Center & School
Rm. C287, Bldg. D 3915
ATTN: Mr. Fred Fuller
Ft. Bragg, NC 28307-5000
33. Defense and Arms Control Studies Program 1
Massachusetts Institute of Technology
292 Main Street (E38-603)
Cambridge, MA 02139
34. Harvard University 1
JFK School of Government
Cambridge, MA 02138

- | | | |
|-----|--|---|
| 35. | Hoover Institution for War & Peace
Palo Alto, CA 94306 | 1 |
| 36. | Library
Air War College
Maxwell, AFB, AL 36112-6428 | 1 |
| 37. | CAPT Larry Nelms
1855 Citadel Court
Chula Vista, CA 91913 | 1 |
| 38. | CAPT Steven Smith
9517 Draycot Court
Burke, VA 22015 | 1 |
| 39. | LT Joe Kirby
2233 Baylakes Rd
Virginia Beach, VA 23455 | 1 |
| 40. | LT Michael Polidoro
244 Worden Street
Portsmouth, RI 02871 | 2 |
| 41. | Dr. Jack Polidoro
105 Route 13
Brookline, NH 03033 | 1 |
| 42. | Mrs. Jane Conley
2805 Corrie Way
Tampa, FL 33618 | 1 |
| 43. | U.S. Special Operations Command, Pacific
J-5 Office
Camp Smith, HI 96861
ATTN: LT Ellington | 1 |
| 44. | U.S. Special Operations Command
J-5C
MacDill AFB, FL 33606-6001
ATTN: MAJ Steve Cox | 1 |

45. Commander, Naval Doctrine Command
Dr. James Tritten
8952 First Street, Suite 200
Norfolk, VA 23511-3790

1