

Strain Rate, Temperature, and Humidity Influences on Strength and Moduli of a Graphite/Epoxy Composite

J. M. Lifshitz

DEPARTMENT OF DEFENSE
ELASTICS TECHNICAL EVALUATION CENTER
ARRADCOM, DOVER, N. J. 07808

DTIC QUALITY INSPECTED

January 1981

19960312 075

NASA
National Aeronautics and
Space Administration

DISTRIBUTION STATEMENT A
Approved for public release;
Distribution Unlimited

19960312 075

Strain Rate, Temperature, and Humidity Influences on Strength and Moduli of a Graphite/Epoxy Composite

J. M. Lifshitz, Ames Research Center, Moffett Field, California

NASA

National Aeronautics and
Space Administration

Ames Research Center
Moffett Field, California 94035

*J. M. Lifshitz*¹

STRAIN RATE, TEMPERATURE, AND HUMIDITY INFLUENCES
ON STRENGTH AND MODULI OF A GRAPHITE/EPOXY COMPOSITE

ABSTRACT: Results of an experimental study of the influence of strain rate, temperature, and humidity on the mechanical behavior of a graphite/epoxy fiber composite are presented. Three principal strengths (longitudinal, transverse, and shear) and four basic moduli (E_1 , E_2 , G_{12} , and ν_{12}) of a unidirectional graphite/epoxy (T300/5208) composite were followed as a function of strain rate, temperature, and humidity. Each test was performed at a constant tensile strain rate in an environmental chamber providing simultaneous temperature and humidity control. Prior to testing, specimens were given a moisture preconditioning treatment at 60°C.

Values for the matrix-dominated moduli and strength were significantly influenced by both environmental and rate parameters, whereas the fiber-dominated moduli were not. However, the longitudinal strength was significantly influenced by temperature and moisture content. A qualitative explanation for these observations is presented.

KEY WORDS: composite material, graphite fiber, epoxy, temperature, humidity, strain rate, strength, moduli

¹NASA Ames Research Center, Moffett Field, Calif. 94035, senior NRC associate on sabbatical leave from Technion - Israel Institute of Technology, Haifa, Israel.

Matrix-controlled mechanical behavior of graphite/epoxy fiber composites can be significantly influenced by externally applied parameters such as strain rate, temperature, and humidity. Because many composite structural components are exposed to these parameters, it is essential to define and understand their influence on mechanical behavior. Such an understanding is required; first, to supply designers with accurate data on material behavior under conditions similar to service life, and second, to develop a methodology which can be used to predict long-term behavior of material under one set of environmental conditions from short-term tests under other conditions.

Much work has been done on effects of temperature and moisture on composite materials. Some investigators [1-3] have used the diffusion equation to describe the sorption of moisture by composite materials. Early papers dealt with a constant coefficient of diffusion and, initially, with dry material exposed to constant surface moisture. Later work included time-dependent diffusion coefficients [4] and varying moisture boundary conditions [5]. Some mechanical properties were predicted from micromechanics analysis by calculating thermal and swelling stresses around fibers [6]. Some experiments on thermal and moisture effects on strength and moduli of unidirectional fiber-reinforced lamina were done [7, 8], but, in many cases, moisture control of the specimen during testing (particularly at high temperatures) was insufficient. Facilities having better control of simultaneous temperature and moisture application during mechanical tests are found in the aerospace industry, but their tests lack generality. Unfortunately, most test only laminates of fiber orientation and stacking sequence identical to the laminates to be used in the final product. Additionally, environmental parameters are determined to fit specific conditions the part is expected to experience. The resulting data are too specific for use in designing other products.

This paper presents results of an investigation of the basic mechanical behavior of a unidirectional lamina loaded at various temperatures, moisture contents, and strain rates, under closely controlled conditions. These results suggest the possibility of developing constitutive relations, including effects of time, temperature, and moisture content.

Experimental

Specimen Preparation and Conditioning

The material selected for this program was a graphite/epoxy composite material (Union Carbide T300 fibers in a Narmco 5208 matrix). The specimens were manufactured by Lockheed Missiles and Space Co. from unidirectional prepreg tape. Three types of specimens were tested in this program; longitudinal $(0^\circ)_8$, transverse $(90^\circ)_{16}$, and $(\pm 45^\circ)_{2S}$ angle ply.

The longitudinal and angle ply specimens were cut from panels of 8 layers of prepreg tape, while the transverse specimens were cut from 16-layer panels. A typical 8-layer specimen is shown in Fig. 1. In all cases the fiber volume fraction was 64.6% with a standard deviation of 0.21%; and the void content was 0.51% with a standard deviation of 0.05%.

Upon receipt, the specimens were dried in a vacuum oven at 100°C for 72 hours, followed by oven cooling (under vacuum) for 24 hours. This established the base-line condition of a dry specimen. Specimens were then placed in an environmental chamber at a relative humidity of 98% and 60°C . The observed relative moisture pickup (M), where $M = (\text{wt gain} \times 100) / \text{dry specimen wt}$, as a function of exposure time, is shown in Fig. 2.

The diffusivity (D) of the material can be obtained from the initial straight portion of the graph in Fig. 2, using the relation [2]

$$D = \pi \left(\frac{h}{4M_m} \right)^2 \left(\frac{M_b - M_a}{\sqrt{t_b} - \sqrt{t_a}} \right)^2 \quad (1)$$

where h is specimen thickness, M_m is maximum moisture content attainable under the given environmental conditions, and M_a and M_b are moisture contents at times t_a and t_b , respectively. The assumed value of M_m was 1.22%, and the diffusivity of the material through the specimen thickness was found to be $D = 3.05 \times 10^{-7} \text{ mm}^2/\text{sec}$. These results were obtained by solving the one-dimensional Fick equation with constant diffusivity (D) for the moisture concentration (c)

$$\frac{\partial c}{\partial t} = D \frac{\partial^2 c}{\partial x^2} \quad (2)$$

The initial and boundary conditions were:

$$\text{and } \left. \begin{array}{l} \text{at } t \leq 0 \quad c = c_i \quad \text{for } -\frac{h}{2} \leq x \leq \frac{h}{2} \\ \text{at } t > 0 \quad c = c_m \quad \text{for } x = \pm \frac{h}{2} \end{array} \right\} \quad (3)$$

To determine variations of mechanical properties as a function of moisture content, it is essential that moisture distribution throughout the specimen be as uniform as possible. Time required to yield a uniform distribution was determined as a series solution of Eq. 2 with the boundary conditions given in Eq. 3 [9]. In the case of initially dry specimens, the solution becomes

$$\frac{c(x,t)}{c_m} = \sum_{n=1}^{\infty} (-1)^{n+1} \left\{ \operatorname{erfc} \frac{(2n-1) - 2x/h}{2\sqrt{t^*}} + \operatorname{erfc} \frac{(2n-1) + 2x/h}{2\sqrt{t^*}} \right\} \quad (4)$$

where t^* is a nondimensional time parameter given by

$$t^* = \frac{4Dt}{h^2} \quad (5)$$

Equation 4 was evaluated numerically and the result for an 8-ply specimen is shown in Fig. 3. Beyond 16 days of moisture conditioning, the moisture distribution is nearly constant throughout the specimen thickness. Nevertheless, all 8-ply specimens were given at least a 30-day conditioning prior to testing. When Eq. 4 was evaluated for 16-ply specimens, the time to reach nearly uniform moisture distribution was 4 times as long, or about 2 months.

The results shown in Figs. 2 and 3 were used to establish conditioning procedures. Specimens given the 30-day conditioning contained a very high moisture content, M_2 , equal to 1.15%. This is almost the maximum moisture the material is capable of absorbing, even if placed indefinitely in water. Another moisture content, M_1 , equal to 0.7% was obtained by conditioning the specimens for 1 week at 60°C and 98% relative humidity and then transferring them to another chamber kept at 60°C and 60% relative humidity. Specimens needed 2 weeks in the second chamber to reach a fairly uniform moisture distribution through the thickness, but all were conditioned for at least 1 month. The third moisture condition used in the program was the base-line dry condition, M_0 , equal to 0.1%. The dry specimens were kept inside a desiccator at room temperature until time for testing.

Test Arrangement and Program

All specimens were tested to failure in tension at constant strain rates. Tests were performed inside an environmental chamber, using a servohydraulic mechanical test machine. Both temperature and humidity were controlled during the entire test period, such that the moisture distribution inside the specimen remained unchanged. The applied load, longitudinal strain, and transverse strain were recorded continuously during the test. Strains were measured using an axial and a diametral extensometer.

The test program included 3 strain rates, 3 temperatures, and 3 levels of moisture content. The values of these parameters are

Strain rates: $R_0 = 2000 \times 10^{-6} \text{ sec}^{-1}$
 $R_1 = 50 \times 10^{-6} \text{ sec}^{-1}$
 $R_2 = 1 \times 10^{-6} \text{ sec}^{-1}$

Temperatures: $T_0 = 24^\circ\text{C} (75^\circ\text{F})$
 $T_1 = 74^\circ\text{C} (165^\circ\text{F})$
 $T_2 = 96^\circ\text{C} (205^\circ\text{F})$

Moisture contents: $M_0 = 0.1\%$
 $M_1 = 0.7\%$
 $M_2 = 1.15\%$

Longitudinal specimens, $(0^\circ)_8$, with fibers parallel to loading direction (Fig. 1) were used to obtain the longitudinal modulus (E_1), the major Poisson's ratio (ν_{12}), and the longitudinal tensile strength (X). Transverse specimens, $(90^\circ)_{16}$, with fibers perpendicular to the loading direction were used to obtain the transverse modulus (E_2) and transverse tensile strength (Y). The $(\pm 45^\circ)_{28}$ angle-ply specimens with fibers oriented at $\pm 45^\circ$ to the loading direction were used to obtain the axial shear modulus (G_{12}) and to provide an approximate value for the axial shear strength (S).

Initial testing verified that the applied tensile load was evenly distributed over the cross section of the specimens. Strain distribution across the specimen width on its front and back faces was measured using strain gages bonded to a longitudinal specimen. The results proved satisfactory.

Results and Discussion

Longitudinal Properties

The stress-strain curve of the longitudinal specimens, $(0^\circ)_8$, was close to a straight line, except for a slight increase in slope as the load increased.

A similar effect was observed by Sendeckyj et al. [10] but there has been no conclusive explanation for it. Possibly during manufacture of the laminates, fibers are not under constant tension and, as a result, are slightly warped in the cured specimen. When the tensile load is applied, some of the fibers are not fully active as load carrying elements until they are stretched and become straight. This increase in the value of the modulus seems to be more pronounced at higher temperatures and higher moisture contents. Except for this small variation, the longitudinal modulus (E_1) does not appear to depend on temperature, moisture content, or strain rate.

Major Poisson's ratio (ν_{12}) also does not appear to depend on temperature, moisture content, or strain rate. The observed values were scattered between 0.33 and 0.36, with some tendency toward a slight decrease as load was increased. These values are somewhat higher than values found in the literature (usually about 0.30), but the large number of tests, the reproducibility of the results, and the method of measuring the transverse strain give us confidence in the present results.

The most interesting result of tests on longitudinal specimens was that the longitudinal tensile strength (X) increased with both test temperature and moisture content, as shown in Fig. 4. This property is thought to be primarily fiber controlled and would not be expected to depend on temperature, moisture content, or strain rate. Variation in strain rate did not cause statistically significant changes in X .

One explanation for this observation is that an uneven stress distribution may exist across the specimens and that this leads to failure of some fibers at an early stage of the loading process. At low temperatures and in dry specimens, the matrix material is more brittle and, thus, more sensitive to stress concentrations about broken fibers. This would result in the lower

observed laminate strength and increased scatter. At high temperatures and high moisture contents, the matrix material is more ductile and less sensitive to stress concentrations around broken fibers. The result is that the observed strength is closer to the "true" strength of the composite material. The scatter of the results would also be less, as is indicated in Fig. 4 by the standard deviation (in parentheses). Every point in Fig. 4 represents results of at least 6 tests.

Transverse Properties

The influence of temperature and moisture content on the transverse modulus (E_2) is shown in Fig. 5. The values of E_2 shown are initial values, as the modulus was observed to decrease up to about 10% as the load approached failure. As shown, there appears to be a slight temperature dependence, as well as some effect of moisture; however, more tests are needed to establish conclusive trends.

The transverse strength (Y), as shown in Fig. 6, is more sensitive to temperature and moisture content. This property is matrix (and interface) controlled. As seen, transverse strength decreases as temperature or moisture content is increased.

Axial Shear Properties

As expected, the property that is most sensitive to temperature, moisture content, and strain rate is the axial shear modulus (G_{12}). Typical stress-strain curves under 2 extremely different sets of environmental conditions are shown in Fig. 7. The dry specimen (M_0) tested at room temperature (T_0) and at high strain rate (R_0) is much stiffer and stronger than the saturated specimen (M_2) tested at an elevated temperature (T_2) and at a medium strain rate (R_1).

Additionally, G_{12} is strongly dependent upon the level of applied stress. A common way to quantify this nonlinear shear behavior is to determine the tangent modulus of the axial shear stress-strain curve and use these values to calculate stress distribution in laminates using incremental loading [11, 12]. The tangent moduli (G_T) of the 2 curves in Fig. 7 are shown in Fig. 8. From practical considerations, we are not interested in the high shear strain range. The values of G_T are, therefore, given for axial shear values of less than 2.5%. It has also been shown [12] that at these low levels of shear strain the prediction of axial shear behavior from testing of $(\pm 45^\circ)_S$ angle-ply specimens is quite reliable.

Figures 9, 10, and 11 summarize the influence of temperature, moisture content, and strain rate, respectively, on the tangent shear modulus. The trend of the influence in all 3 figures is as expected of polymeric materials, namely, decreasing stiffness with increasing temperature and moisture content and increasing stiffness with increasing strain rate.

The similarity of the curves in Figs. 9, 10, and 11 suggests the possibility of predicting changes in shear behavior under one set of environmental conditions by conducting tests under other conditions. For example, the effect of increasing strain rate at T_0 and M_0 (Fig. 11) is the same as the effect of decreasing moisture content at T_0 and R_0 (Fig. 10). These effects have to be quantified in such a way that, in addition to the well-known time/temperature superposition principle for polymeric materials, we will have an equivalent time/temperature/humidity superposition principle.

The last property presented is the axial shear strength (S). A previous paper [12] that dealt with glass/epoxy composite material showed that $(\pm 45^\circ)_S$ angle-ply specimens did not provide true shear strength values because the stress state at failure was far from being a pure shear. For graphite/epoxy

the ($\pm 45^\circ$)_s orientation gives more nearly pure shear than it did for the glass/epoxy. Nevertheless, the measured value of the shear strength is somewhat lower than the true shear strength. The 2 curves in Fig. 7 indicate the magnitude of variation in this property when environmental conditions are changed.

Conclusions

Matrix controlled mechanical properties of fiber reinforced composites are influenced by temperature, moisture content, and strain rate. The strongest influence is on the axial shear behavior. The effects of the 3 applied parameters appear to be similar, suggesting that an equivalence between them could be established.

Fiber controlled modulus and Major Poisson's ratio (E_1, ν_{12}) are not influenced by temperature, moisture content, or strain rate. The value of Poisson's ratio, however, is higher than normally reported in the literature.

The longitudinal strength, accepted as a fiber controlled property, was influenced appreciably by temperature and moisture content. This is attributed to uneven tension on fibers and the behavior of the matrix material near broken fibers.

References

- [1] Hertz, J., "Investigation into the High-Temperature Strength Degradation of Fiber-Reinforced Resin Composite During Ambient Aging," General Dynamics/Convair Aerospace Division Rept. GDCA-DBG73-005, Contract NAS8-27435, June 1973.
- [2] Shen, C. H. and Springer, G. S., *Journal of Composite Materials*, Vol. 10, Jan. 1976, pp. 2-20.
- [3] McKague, E. L., Jr., Reynolds, J. D., and Halkias, J. E., *ASME Journal of Engineering Materials and Technology*, Jan. 1976, pp. 92-95.
- [4] Weitsman, Y., *Journal of Composite Materials*, Vol. 10, July 1976, pp. 193-204.
- [5] Springer, G. S., *Journal of Composite Materials*, Vol. 11, Jan. 1977, pp. 107-122.
- [6] Miller, A. K. and Adams, D. F., "Micromechanical Aspects of the Environmental Behavior of Composite Materials," Univ. of Wyoming, Dept. of Mechanical Engineering, Report UWME-DR-70-11111, Jan. 1978.
- [7] Shen, C. H. and Springer, G. S., *Journal of Composite Materials*, Vol. 11, Jan. 1977, pp. 2-16.
- [8] Browning, C. E., Husman, G. E., and Whitney, J. M., *Moisture Effects in Epoxy Matrix Composites*, STP 617, American Society for Testing and Materials, 1977.
- [9] Luikov, A. V., *Analytical Heat Diffusion Theory*, Academic Press, 1968.
- [10] Sendekyj, G. P., Richardson, M. D., and Pappas, J. E., *Fracture Behavior of Thornel 300/5208 Graphite/Epoxy Laminates - Part 1: Unnotched Laminates*, STP 580, American Society for Testing and Materials, 1975.

- [11] Petit, P. H., *A Simplified Method of Determining Inplane Shear Stress-Strain Response of Unidirectional Composites*, STP 460, American Society for Testing and Materials, 1969.
- [12] Lifshitz, J. M. and Gilat, A., *Experimental Mechanics*, Dec. 1979, pp. 444-449.

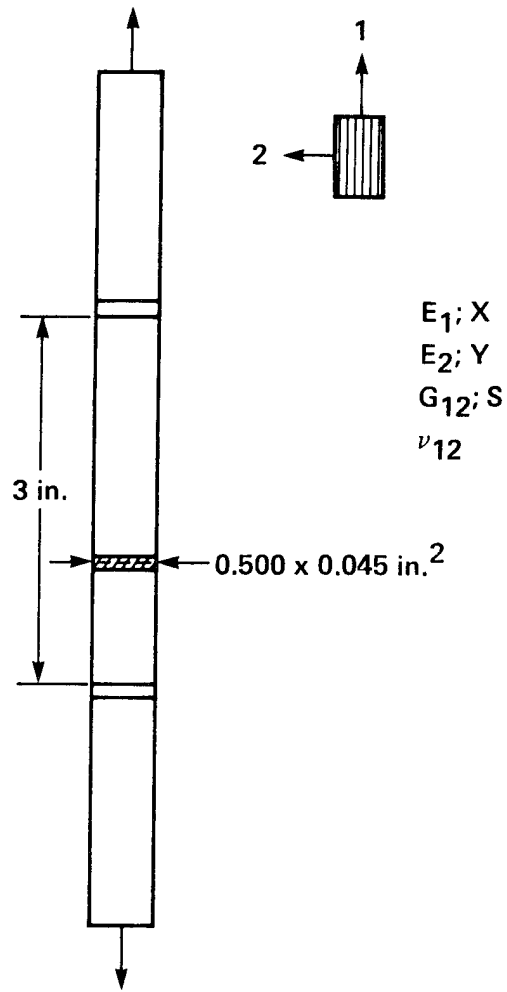

Figure 1.- Test specimen.

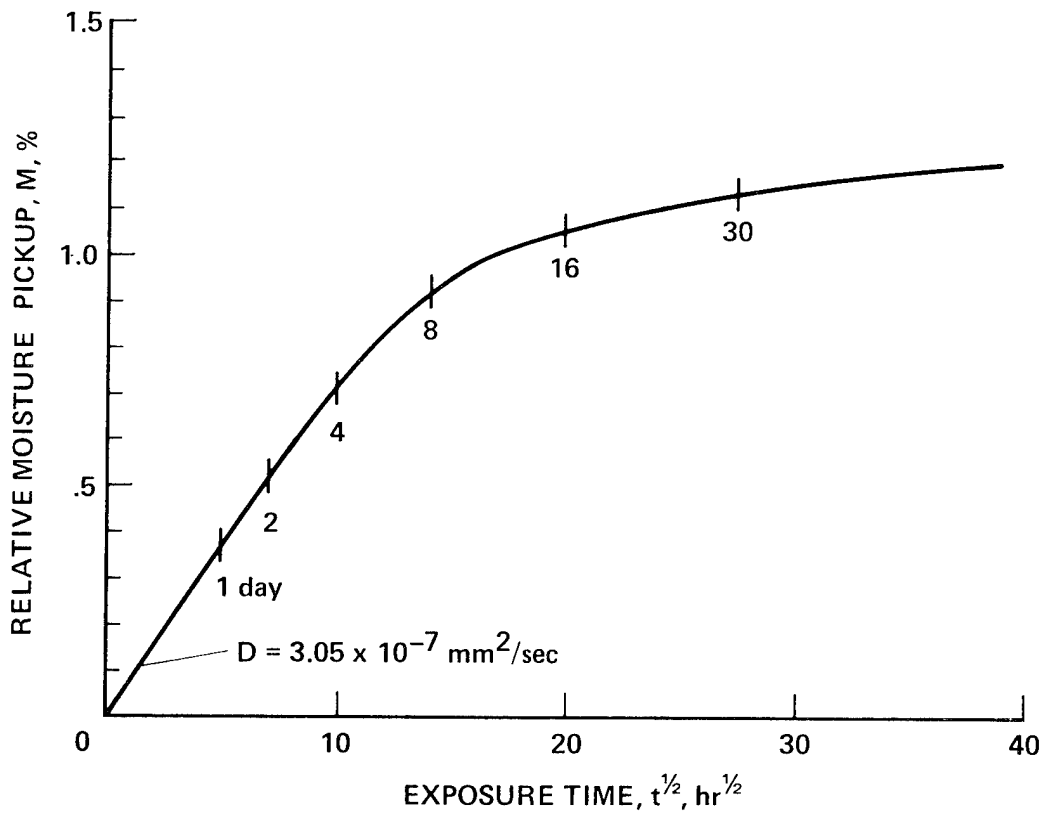

Figure 2.- Moisture absorption in 8-ply T300/5208 conditioned at 60° C and 98% R.H.

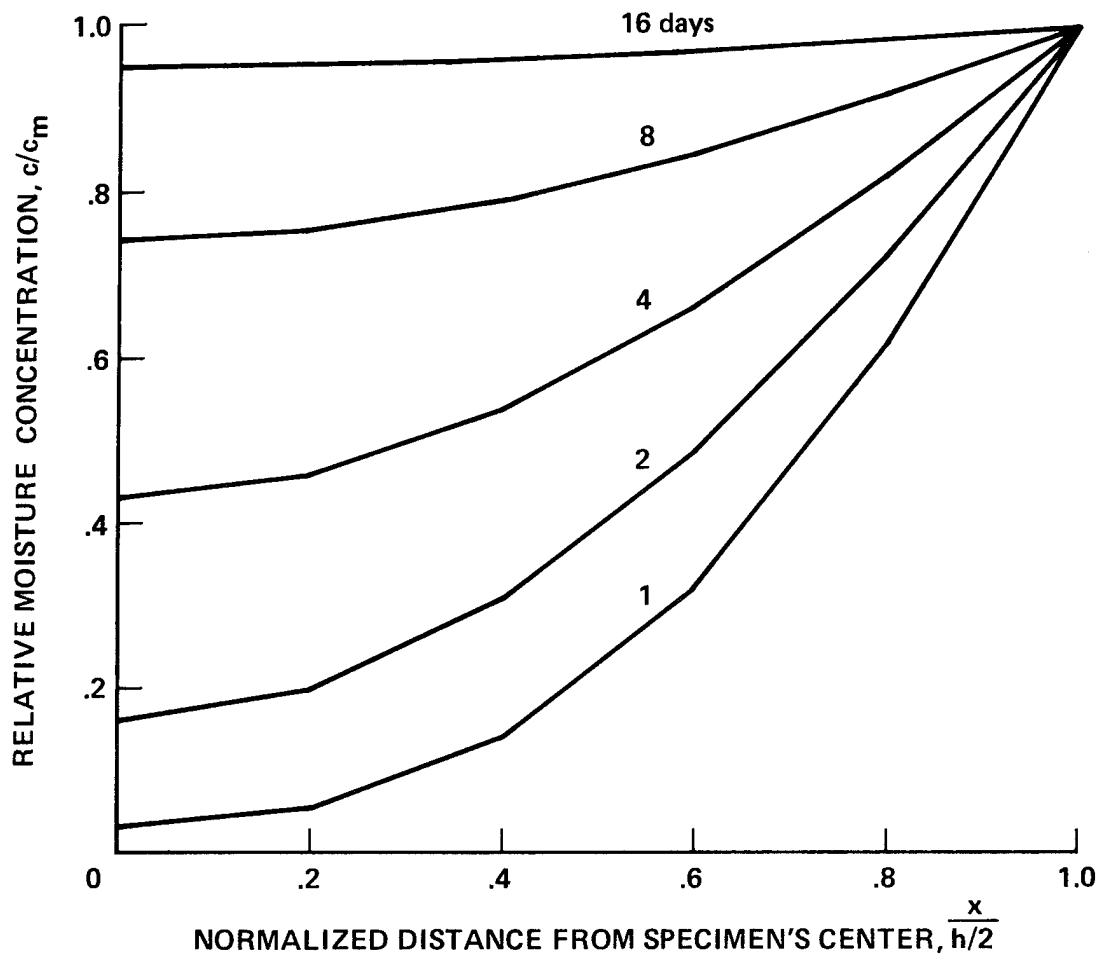

Figure 3.- Moisture distribution in 8-ply T300/5208 conditioned at 60° C and 98% R.H.

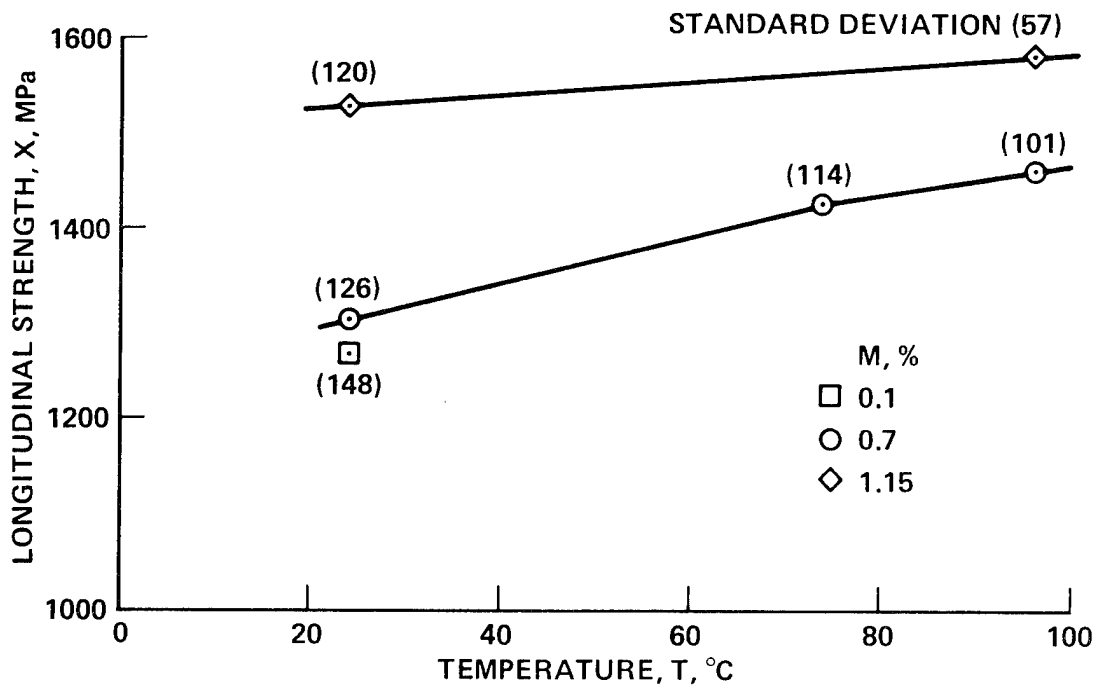

Figure 4.- Variation of axial strength (X) with temperature and moisture content.

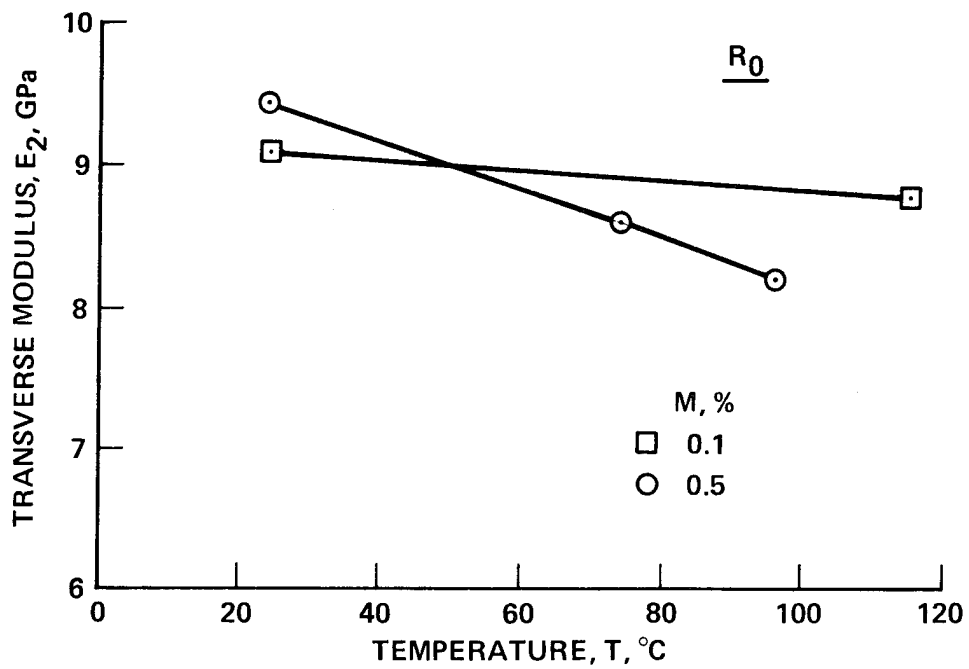

Figure 5.- Variation of transverse modulus (E_2) with temperature and moisture content.

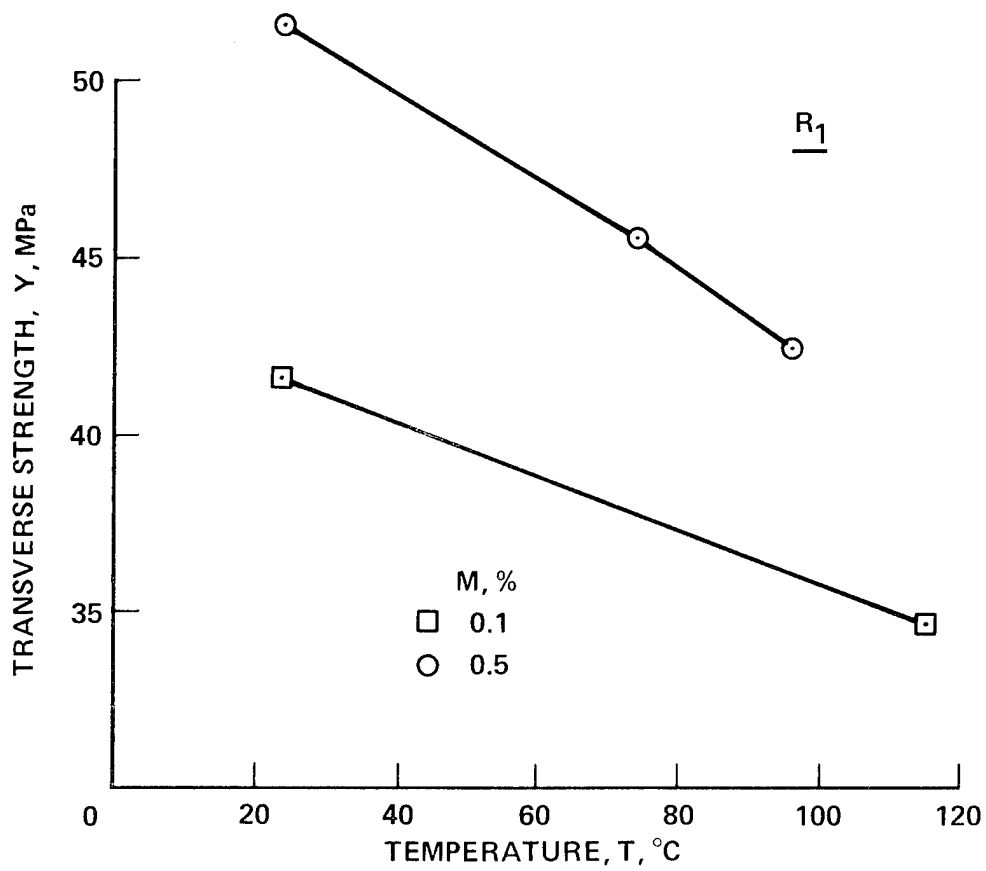

Figure 6.- Variation of transverse strength (Y) with temperature and moisture content.

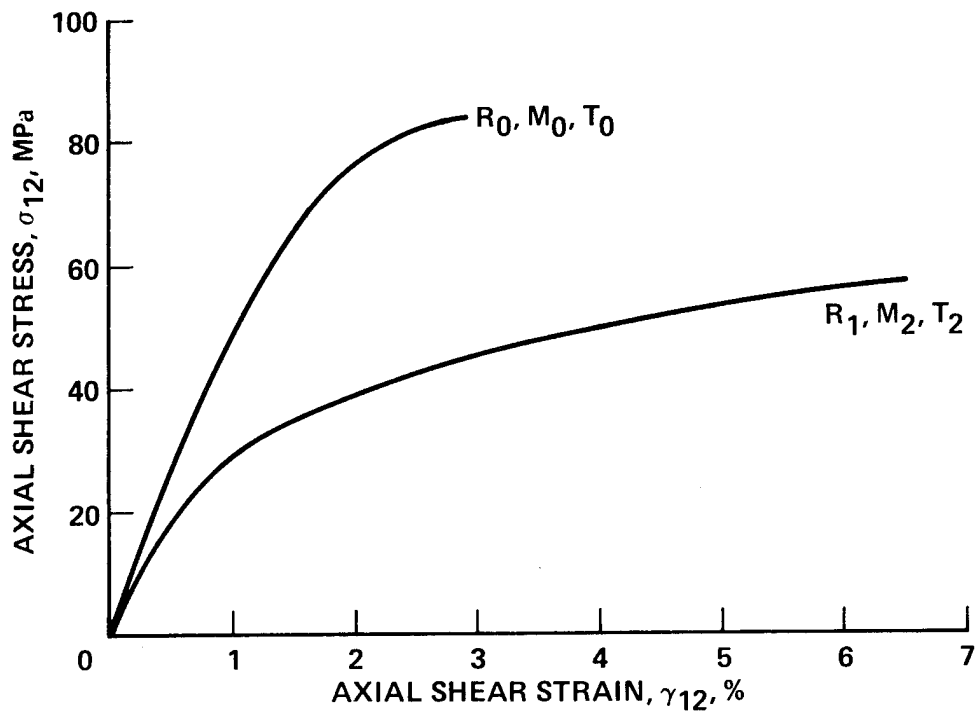

Figure 7.- Axial shear stress-strain curves for two extreme loading conditions.

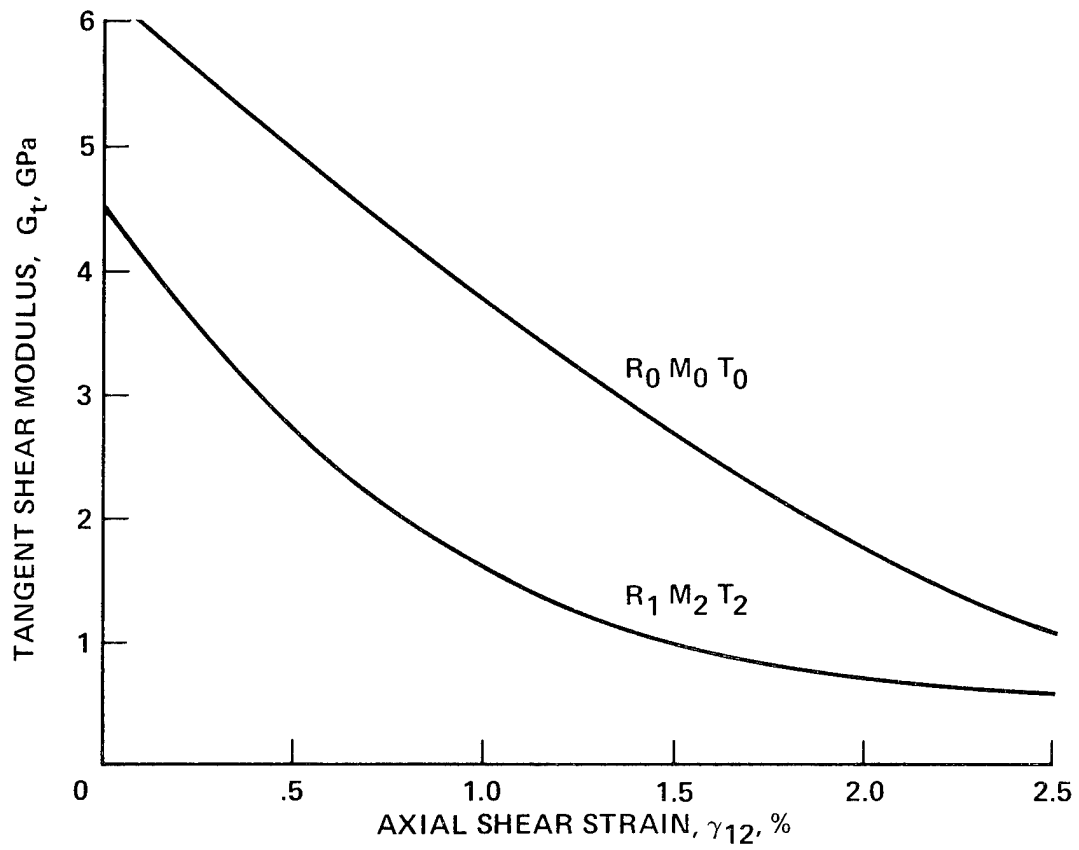

Figure 8.- Tangent shear modulus for two extreme loading conditions.

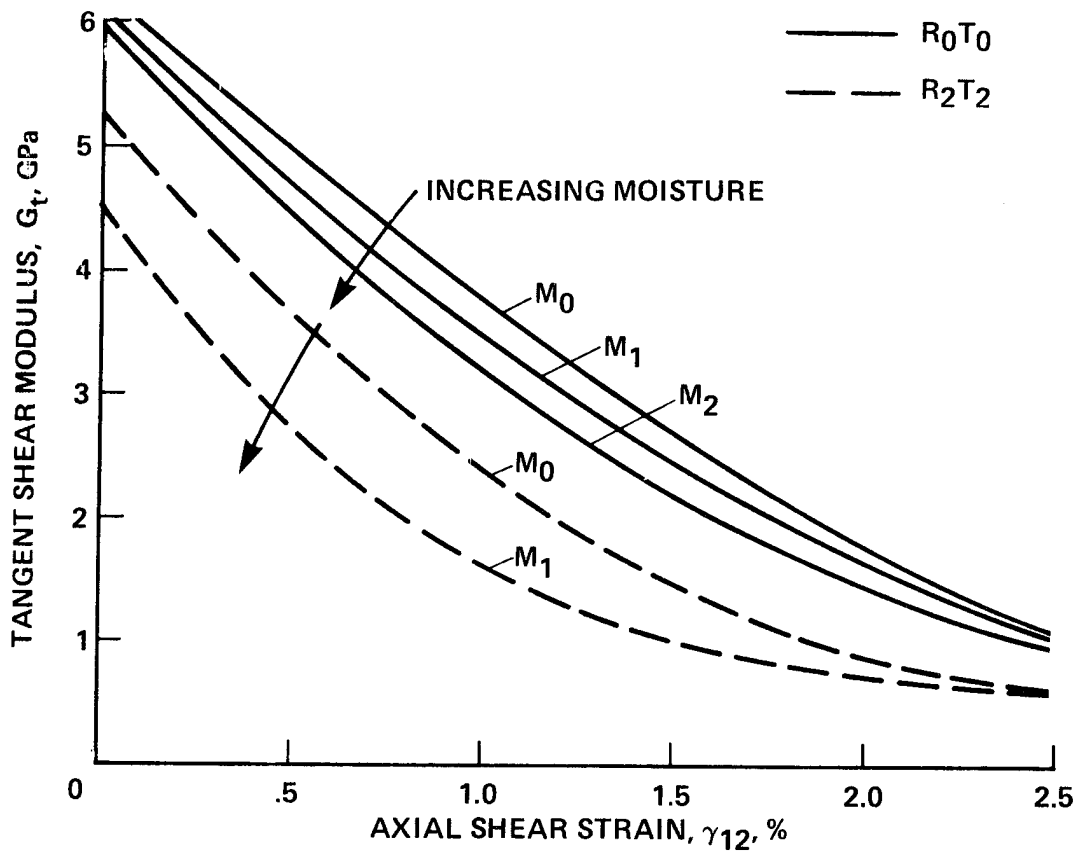

Figure 9.- Temperature effects on tangent shear modulus.

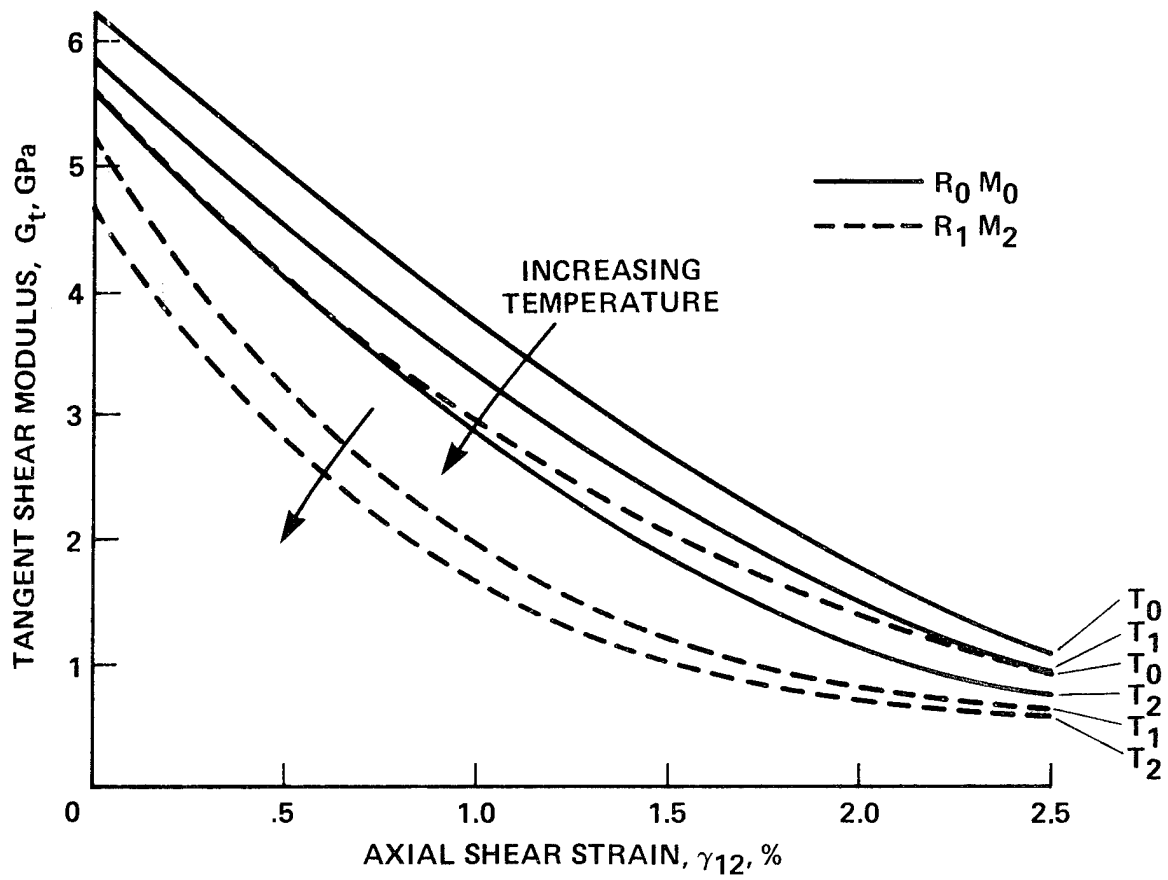

Figure 10.- Moisture effects on tangent shear modulus.

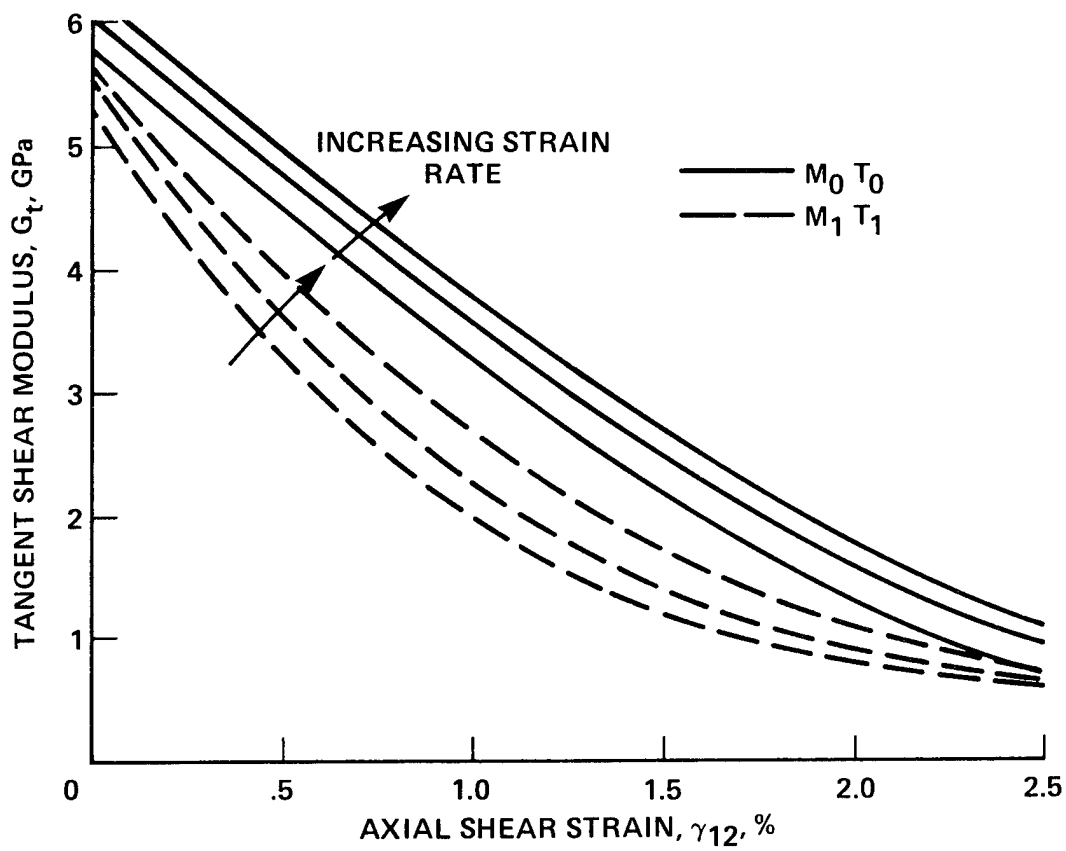

Figure 11.- Rate effects on tangent shear modulus.

1. Report No. NASA TM- 81247		2. Government Accession No.		3. Recipient's Catalog No.	
4. Title and Subtitle STRAIN RATE, TEMPERATURE, AND HUMIDITY INFLUENCES ON STRENGTH AND MODULI OF A GRAPHITE/EPOXY COMPOSITE			5. Report Date January 1981		
			6. Performing Organization Code		
7. Author(s) J. M. Lifshitz			8. Performing Organization Report No. A-8381		
9. Performing Organization Name and Address NASA Ames Research Center Moffett Field, Calif. 94035			10. Work Unit No. 505-33-21		
			11. Contract or Grant No.		
12. Sponsoring Agency Name and Address National Aeronautics and Space Administration Washington, D.C. 20546			13. Type of Report and Period Covered Technical Memorandum		
			14. Sponsoring Agency Code		
15. Supplementary Notes J. M. Lifshitz is a senior National Research Council Associate on sabbatical leave from Technion -- Israel Institute of Technology, Haifa, Israel.					
16. Abstract Results of an experimental study of the influence of strain rate, temperature, and humidity on the mechanical behavior of a graphite/epoxy fiber composite are presented. Three principal strengths (longitudinal, transverse, and shear) and four basic moduli (E_1 , E_2 , G_{12} , and ν_{12}) of a unidirectional graphite/epoxy (T300/5208) composite were followed as a function of strain rate, temperature, and humidity. Each test was performed at a constant tensile strain rate in an environmental chamber providing simultaneous temperature and humidity control. Prior to testing, specimens were given a moisture preconditioning treatment at 60°C. Values for the matrix-dominated moduli and strength were significantly influenced by both environmental and rate parameters, whereas the fiber-dominated moduli were not. However, the longitudinal strength was significantly influenced by temperature and moisture content. A qualitative explanation for these observations is presented.					
17. Key Words (Suggested by Author(s)) Composite material Graphite fiber Epoxy Temperature Strain rate			18. Distribution Statement Unlimited STAR Category - 24		
19. Security Classif. (of this report) Unclassified		20. Security Classif. (of this page) Unclassified		21. No. of Pages 25	22. Price* \$5.00