



SOCIETY OF AUTOMOTIVE ENGINEERS, INC.  
400 Commonwealth Drive, Warrendale, Pa. 15096

DEFINITION STANDARD  
Approved for public release  
Distribution Unlimited

# PLASTIC MATERIALS SELECTION GUIDE

Paul F. Kusy  
Scientist  
Materials Applications Dept.  
Deere & Company  
Moline, Illinois

DEPARTMENT OF DEFENSE  
PLASTICS TECHNICAL EVALUATION CENTER  
ARRADCOM, DOVER, N. J. 07801

SOCIETY OF AUTOMOTIVE ENGINEERS

Off-Highway Vehicle Meeting  
Milwaukee, Wisconsin  
Sept. 13-16, 1976

760663

DTIC QUALITY INSPECTED 3

19951226 027

PLASTEC 34873

\*\*\*OTIC DOES NOT HAVE THIS ITEM\*\*\*

-- 1 - AD NUMBER: D409472  
-- 2 - UNCLASSIFIED TITLE: PLASTIC MATERIALS SELECTION GUIDE,  
-- 10 - PERSONAL AUTHOR: KUSY, P. F. J.  
-- 11 - REPORT DATE: SEP 10, 1976  
-- 12 - PAGINATION: 32P  
-- 14 - REPORT NUMBER: SAE PAPER NO. 760663  
-- 20 - REPORT CLASSIFICATION: UNCLASSIFIED  
-- 21 - SUPPLEMENTARY NOTE: PRESENTED AT: OFF-HIGHWAY VEHICLE MEETING,  
-- 13-16 SEP 76, MILWAUKEE, WI. SPONSORED BY SOCIETY OF AUTOMOTIVE  
-- ENGINEERS. PAPER NO. 760663.  
-- 22 - LIMITATIONS (ALPHA): APPROVED FOR PUBLIC RELEASE; DISTRIBUTION  
-- UNLIMITED. AVAILABILITY: SOCIETY OF AUTOMOTIVE ENGINEERS, INC., 400  
-- COMMONWEALTH DRIVE, WARRENDALE, PA. 15096. NO. 760663.  
-- 33 - LIMITATION CODES: 1 24

\*\*\*\*\*  
-- END OF DISPLAY LIST

(ENTER NEXT COMMAND)

010-E TOR HELPS ANSI 3 BDK 3 3 LOG CLOSED 3 PRINT OFF 3 PARITY

760663

# PLASTIC MATERIALS SELECTION GUIDE

Paul F. Kusy  
Scientist  
Materials Applications Dept.  
Deere & Company  
Moline, Illinois

THE JOB OF SELECTING plastic materials for applications is usually looked on by users as laborious and bordering on the impossible. Many view plastics as a single type material because they are not aware of all the materials available to them.

The need has long existed to aid potential plastics users to search through the thousands of materials in order to select the best one available to meet their specific needs. In today's high-cost business climate it is important that the most suitable, economical, and easily processable material be selected the first time. This is unlikely unless users have at their disposal a procedure to guide them through the maze of materials and molding processes available.

Numerous techniques have been devised to aid in selecting plastic materials; however, most were developed by specific material suppliers and are primarily aimed at using their materials only. Most selection systems of which we are aware today presuppose that a potential plastic user knows he wants or needs to use a plastic. This is often not so.

This selection guide uses a three-step process aimed at aiding potential users to determine if plastics should be considered, selecting the most logical plastic, and then analyzing fabrication methods and costs. Available information from various literature sources and material suppliers is used. It can be updated easily and is also designed to use data developed in our laboratories.

---

## ABSTRACT

---

A technique to guide users in selecting plastic materials has been developed. It encompasses a screening procedure to determine if plastic materials should be considered and a material selection procedure for evaluating tooling and

processing costs. Some guidelines are provided to allow general use of the data given in the literature.

Copyright © Society of Automotive Engineers, Inc. 1976  
All rights reserved.

## SPECIAL MATERIAL CONSIDERATIONS

For the user of a selection guide to fully utilize the data available, it is desirable to develop a familiarity with the physical and mechanical behavior of plastics. An understanding of the general mechanical behavior of plastics is most important. B. S. Benjamin [1]\* lists nine important points to consider.

1. The stress/strain curve of plastics is not usually linear up to yield. In some cases the yield may be very slight or not at all.
2. The modulus of elasticity in tension of plastics is not necessarily the same as that in compression.
3. The modulus of elasticity of plastics is very low compared to metals.
4. Plastics can exhibit anisotropic behavior.
5. The mechanical behavior of plastics is affected by the rate of straining of the material.
6. The mechanical behavior of plastics is affected by temperature and time.
7. Compared to metals, plastics creep considerably under load with time.
8. Plastics show a reduction in ultimate strengths with time, even under static loading.
9. The properties of plastics can be affected by environmental conditions.

In addition, the effects of heat, fillers and glass reinforcements must be thoroughly understood and used when specifying properties.

Where long-term heat resistance is a problem, it is important to search material supplier data for long-term properties or to develop them through testing.

Use of fillers and glass reinforcements in plastics further compounds the problem; because there is an infinite number of possible mixtures, it is impossible to list all of the various materials. In general, with increasing glass or filler content, the effects upon the properties of

any plastic are as follows:

- Higher tensile strength.
- Lower elongation.
- Poorer wear resistance. Some fillers in bearing materials tend to improve wear resistance. Glass usually reduces wear resistance because of the abrasiveness of the glass once exposed to the wearing surface.
- Higher flexural strength.
- Impact strength is affected variably.
- Higher heat deflection temperature.
- Lower thermal expansion.
- Becomes more opaque.

Glass fibers and fillers have little or no effect on the following properties.

- Hardness — unless very highly filled.
- Electrical properties.
- Chemical resistance.
- Weatherability.

## MATERIAL SELECTION PROCEDURE

The material selection procedure includes three steps:

- I — APPLICATION SCREENING
- II — GENERIC FAMILY AND SPECIFIC GRADE IDENTIFICATION
- III — PROCESS SELECTION AND COST ANALYSIS

### STEP I — APPLICATION SCREENING

The first step in using the plastic material selection guide is to determine if plastics should be

---

\*Numbers appearing in brackets refer to references at end of this report.

considered for the application. This is a screening process which is accomplished by developing a set of simple functional requirements which the component should meet, determining the component category, and evaluating the component requirements against an End Use Requirement Check List.

When establishing component functional requirements, consideration should be given to the following factors, and the influences of the possible variations within each factor upon satisfactory performance of the component under consideration.

- Structural
- Performance
- Environmental
- Design Criteria
- Economics Factors
- Manufacturing Processes

Within the structural requirements it is important to concern oneself with special physical abuses, including those associated with assembly and shipping as well as those the customer is expected to give it. In the performance requirements, any standards such as Federal, SAE, ASAE, or U.L. should be considered.

Table 1 shows a typical list of functional requirements for a cab roof innerliner. In the early stages of component development a designer usually does not have sufficient data to specify all the material property requirements precisely. By listing those things which are important, if only in a word description and by numerical values where possible, the screening analysis can be made.

Once these requirements have been set down, an End Use Requirement Check List, Table 2, is consulted to determine conformance. The check list is divided into property categories depending upon the type of component being designed. The component categories are based on like type applications (2) which typically use

**TABLE 1. CAB ROOF INNERLINER FUNCTIONAL REQUIREMENTS**

PROPERTIES REQUIRED	PROPERTIES AND CHARACTERISTICS DESIRED
<ul style="list-style-type: none"> <li>● Self-supporting - flexural modulus about <math>1 \times 10^6</math> psi (6.9 G Pa)</li> <li>● Multiple Function               <ul style="list-style-type: none"> <li>● air conditioning ducts</li> <li>● mount air conditioning coils</li> <li>● air conditioner evaporates areas (corrosion resistant)</li> </ul> </li> <li>● Weatherability - exposed to interior and exterior of cab - not in direct sunlight</li> <li>● Fatigue resistant relatively low load</li> <li>● Good dimensional control (molding)</li> <li>● Light weight</li> <li>● Good property retention over service temperature range of -40 to +200 F (-40 to +93°C)</li> <li>● Accept mechanical fasteners</li> </ul>	<ul style="list-style-type: none"> <li>● Integral color (black)</li> <li>● Sound deadening</li> <li>● Make in one piece</li> <li>● Paintable (reconditioning)</li> </ul>

TABLE 2. COMPONENT CATEGORY — END USE REQUIREMENT CHECK LIST

END USE REQUIREMENT	REQUIREMENT FOR EACH COMPONENT CATEGORY <sup>1</sup>					ADDITIONAL COMMENTS
	A	B	C	D	E	
Stiffness (flexural modulus) 10 <sup>5</sup> psi (GPa)	25 (17.2)	33 (22.8)	41 (28.3)	7 (4.8)	33 (22.8)	Reinforcement and/or filler required above 6x10 <sup>5</sup> (4.1 GPa) Fillers reduce light transmission in Category D.
Service temperature range F (°C)	400 to -80 (204 to -62)	550 to -450 (288 to -268)	550 to -450 (288 to -268)	300 to -80 (149 to -62)	680 to -450 (360 to -268)	Most materials are usable from -30 to +300 (-34 to +149). Most material in Category D are amorphous & soften over wide temp. range.
Thermal insulation is required	Yes	Yes	Yes	Yes	Yes	All plastics are relatively poor conductors of heat.
Static loads, 10 <sup>3</sup> psi (MPa) Ultimate Compressive	40 (276)	40 (276)	40 (276)	25 (172)	40 (276)	Creep is more likely cause of failure. Creep resistance of plastics is low.
Ultimate Tensile	5-30 (3.4-207)	30 (207)	30 (207)	10 (69)	50 (345)	Highly variable, speed and/or temperature dependent.
Fatigue resistance (flexural endurance limit) 10 <sup>3</sup> psi (MPa)	12 (83) @ 10 <sup>7</sup> cycles	4 (28) @ 10 <sup>7</sup> cycles	4 (28) @ 10 <sup>7</sup> cycles	1 (7) @ 2.5x 10 <sup>6</sup> cycles	4 (28) @ 10 <sup>7</sup> cycles	Consult fatigue data on each material. Most transparent materials have low fatigue resistance.
Impact resistance is required (up to no break)	Yes	Yes	Yes	Yes	Yes	Highly variable—depends on elastic deformation of specific materials.
Dimensional control (fabrication tolerance) %	.3	.3	.3	.3	.3	
Dimensional stability 10 <sup>-3</sup> % / °C	1.5	0.8	0.8	0.8	0.8	
Abrasion resistance is required	Yes	Yes	Yes	No	Yes	
Low friction is required (coefficient)	Yes	40 dry .25 lubricated	40 dry .25 lubricated	Yes	40 dry .25 lubricated	Very difficult to correlate. May require field evaluation. Can be achieved on some mat'ls by use of clear silicate coating?
Weatherability is required	Yes	Yes	Yes	Yes	Yes	PV values below 50,000. (1750 k Pa m/s). Specialty mat'ls available.
Paintability is required	Yes	Yes	Yes	Yes	Yes	Acrylic, PVC, & fiberglass-polyester are good. Others require pigmentation and/or UV stabilizers. Black is good. Colors are poor.
Decorative surface is required	Yes	Yes	Yes	Yes	Yes	Painting may affect surface or surface may require treatment to make paint adhere.
Corrosion resistance is required	Yes	Yes	Yes	Yes	Yes	Can be molded in, hot stamped, or attained on sheet prior to forming.
Flame resistance is required	No	No	No	No	No	Plastics are generally good but variable. Depends upon chemical make-up of plastic.
Chemical resistance is required	Yes	Yes	Yes	Yes	Yes	All plastics will burn or decompose in a flame. Highly variable.

TABLE 2. COMPONENT CATEGORY — END USE REQUIREMENT CHECK LIST (continued)

END USE REQUIREMENT	REQUIREMENT FOR EACH COMPONENT CATEGORY <sup>1</sup>					ADDITIONAL COMMENTS
	A	B	C	D	E	
Electrical resistance is required	Yes	Yes	Yes	Yes	Yes	All are good. Some excellent.
Translucency is required	Yes	Yes	No	NA <sup>3</sup>	No	Limited to a few materials.
Transparency is required	Yes	Yes	No	Yes	No	Colors can be molded in, but may affect other properties.
Integral color is required	Yes	Yes	Yes	Yes	Yes	Plastics generally reduce noise levels in operation. All are good — varies with hardness and if formed.
Sound deadening is required (noise reduction)	Yes	Yes	Yes	Yes	Yes	All materials can be made self-extinguishing.
Self-extinguishing is required	Yes	Yes	Yes	Yes	Yes	All plastics are comparatively light in weight. All plastics have low specific gravity.
Light weight (specific gravity 3)	Yes	Yes	Yes	Yes	Yes	Most are from .2 to .5 Cal/°C/gm (RT) <sup>4</sup>
Specific heat is low	Yes	Yes	Yes	Yes	Yes	Many materials require no external lubrication.
Self lubricating is required	No	Yes	Yes	No	No	Many materials can operate satisfactorily in a dirty environment.
Dirty environmental operation is required	Yes	Yes	Yes	No	Yes	Check creep data on individual compounds.
Resistance to creep is low	Yes	Yes	Yes	Yes	Yes	Nylon and polyethylene exhibit slip-stick.
Slip-stick resistance is required	No	Yes	Yes	No	No	PV values vary with speed—consult manufacturer's data for each material.
PV (pressure x velocity) psi x ft./min. (kPa x m/s)		<50,000 (1750)	>50,000 (1750)	NA	<500V/mil	Most materials between 300 & 400 V/mil.
Dielectric strength	NA	NA	NA	NA	>10 <sup>8</sup> ohm-cm	Most materials between 6.6x10 <sup>8</sup> to 2.1 x 10 <sup>16</sup> .
Volume resistivity (50% RH <sup>5</sup> @23°C)	NA	NA	NA	NA	<.35	Better materials between .0009 to .18 @ 60 Hz.
Dissipation factor @ 60 Hz	NA	NA	NA	NA	Yes	Materials available from tracking to 360 sec.
Arc resistance, sec. no tracking is required.	NA	NA	NA	NA		

NOTES: 1. Property values given are the maximum or minimum that can be expected for the materials most often used for that category.  
 2. DuPont Abcite coated acrylic greatly improves abrasion resistance. Rohm & Haas abrasion resistant Plexiglass sheet 7304, 7305.  
 3. NA — Not Applicable.  
 4. RT — Room Temperature.  
 5. RH — Relative Humidity.

similar types of plastic materials. The categories follow.

CATEGORY	TYPE OF COMPONENTS
A	Housings, shrouds, containers, ducts and light duty components.
B	Gears, cams, racks, couplings, rollers and other mechanical and structural components.
C	Bearings, bushings, slides, guides, and wear surfaces.
D	Light transmission and glazing.
E	Electro-structural components.

In most cases it will be a simple matter to determine into which category the component fits. There may be some instances, however, where there is a crossover between specific categories. In those cases, it will usually suffice to search both categories at the same time, using the highest or lowest value which corresponds to the specific requirement.

The information given in the End Use Requirement Check List is the maximum or the minimum value, as the case may be, of those materials most often used for the applications in each component category. The comment column in the table alerts users to potential problems and should aid in searching supplier literature for additional information.

If through this screening process it appears that appropriate plastic materials can be found, a full analysis should be made and the best material selected by following Step II.

**NOTE: Although plastics may be indicated at this point, it is possible that no totally suitable plastic material is available. In this case, other materials or plastics in conjunction with other materials should be considered.**

#### STEP II — GENERIC FAMILY AND SPECIFIC GRADE IDENTIFICATION

In this portion of the Selection Guide, the generic family or families and specific grades of plastics within the families are identified for the component under investigation. When the

analysis has been completed, the most promising material or materials should be tested to determine full suitability in the application being considered.

**COMPONENT PROPERTY REQUIREMENTS** — An "Analysis of Application Requirements" Form (Form 1) is used for listing all of the requirements of the component. As shown, the form is filled out to illustrate the example of the cab roof innerliner screened in Step I.

Because data available in the literature is usually given as ultimate values, it is necessary to use some safety factors in specifying mechanical property requirements. In Table 3 are some safety factor guidelines which should be used when establishing mechanical property requirements for searching materials.

**TABLE 3. FACTORS OF SAFETY**

TYPE OF LOAD	FACTOR (MINIMUM)
Static short-term loads	2
Static long-term loads	4
Variable or changing loads	4
Repeated loads	5
Fatigue or load reversal	5
Impact loads	10

It is important to remember that material selections can only be as good as the information used on which the selections are based. Good engineering estimates should serve as the basis for judgment when no actual data is available.

**MATERIAL STIFFNESS** — Since most users are unfamiliar with the stiffness values (flexural modulus) of plastic materials, aid is probably needed to demonstrate this property. A small flexural modulus demonstrator utilizing injection-molded tensile bar specimens of varying stiffness can be used to guide users in establishing the proper range of stiffness of material to search. Suitable specimens ranging from



# FORM 1. ANALYSIS OF APPLICATION REQUIREMENTS

Date Prepared 14 SEPT, 1976

## GENERAL

Part name CAB ROOF INNER LINER  
 Part number 3-123456  
 Used on TRACTOR CAB  
 Annual requirement 10,000  
 Tools available NO  
 Min. tolerance range .....  
 Date parts needed .....  
 Spec. No. ....

## MECHANICAL

\* Tensile strength 6,000 PSI (40 MPa)  
 Elongation .....  
 Tensile modulus .....  
 \* Compressive strength 15,000 PSI (105 MPa)  
 Flexural strength .....  
 \* Impact strength 3 LB-FT (4.5 Nm)  
 Hardness (See Hardness Conversion Table 4) .....  
 \* Flexural modulus 1 x 10<sup>6</sup> PSI (6.9 GPa)  
 Compressive modulus .....  
 Wear resistance .....  
 Creep resistance .....  
 Vibration resistance .....  
 \* Frictional coefficient .....  
 Fatigue resistance YES, LOW LOAD  
 \* PV pressure, dry .....  
 (psi x velocity ft/min) (kPa x m/s) .....  
 Other .....

## ELECTRICAL

Volume resistivity .....  
 Dielectric strength .....  
 Dielectric constant .....  
 Dissipation factor .....  
 Arc resistance .....  
 Tracking resistance .....

## CHEMICAL

Water absorption max. ....  
 Acid resistance .....  
 Alkali resistance .....  
 Organic solvent resistance GOOD  
 Oil resistance GOOD  
 Degreasing resistance .....  
 Other PAINTABLE W/O PRIMER

## OPTICAL

Refractive index .....  
 Clarity - transparent, translucent, opaque .....  
 Transmittence .....  
 Haze .....  
 Colorability BLACK  
 Appearance .....  
 Gloss 60° - 30  
 Other .....

\*Corresponds to Bar Chart

## ENVIRONMENTAL

Flame resistant .....  
 Sunlight resistant .....  
 Weatherability resistant GOOD  
 Yellowing resistant .....  
 Fade resistant YES  
 Fungus resistant .....  
 Humidity resistant .....  
 Vibration resistant .....  
 Permeability .....  
 Indoor use .....  
 Outdoor use YES  
 Used in scaled enclosure .....  
 In contact with other plastics POSSIBLE  
 State plastics PVC, ABS  
 Non-bleeding .....  
 Other .....

## THERMAL

Max. op. temp. 220°F (105°C) PAINT OVEN  
 Min. op. temp. -40°F (-40°C)  
 Thermal conductivity .....  
 Specific heat .....  
 Thermal expansion .....  
 \* Continuous temp. 200°F (93°C)  
 Heat deflection temp. ....  
 (at 264 or 66 psi)  
 Intermittent temp. ....  
 Thermal shock .....  
 Insulating ability .....  
 Other .....

## ASSEMBLY

Heat sealing .....  
 Ultrasonic bonding .....  
 Ultrasonic staking .....  
 Solvent bonding .....  
 Adhesive bonding .....  
 Accept self-tapping screws YES  
 Force fit insertion .....

## MANUFACTURE

Molding qualities .....  
 Compression moldable .....  
 Injection moldable .....  
 Mold linear shrinkage .....  
 Machining qualities .....  
 Transfer moldable .....  
 Extrudable .....  
 Vacuum formable .....  
 Blow moldable .....  
 Castable .....  
 Very low flash produced .....  
 Deflashing ability .....  
 Potting suitability .....  
 Other HAIR (ELL ONE SIDE)

## MISCELLANEOUS

Specific gravity (density) .....  
 Specific volume .....  
 Other MATERIAL COST 64/IN<sup>2</sup> MAX

$2 \times 10^4$  psi (.138 G Pa) to  $1 \times 10^6$  psi (6.9 G Pa) flexural modulus will demonstrate this property nicely. Such an exhibit should be used to help select the approximate flexural modulus value that will provide the required stiffness. The use of this technique requires judgment and knowledge of the effect of thickness on the stiffness. Since modulus can change with long-term loading, it is important to consider this in the final design. Data on long-term creep is shown in the suppliers' literature and in the Modern Plastics Encyclopedia (5).

The Hardness Conversion Table (Table 4) is provided to aid in establishing which hardness should be specified when necessary in the material selection. The table is based on comparison to Brinell hardness. For most materials people there is a good understanding of the relationship of Rockwell hardness to Brinell. It is evident that the Rockwell hardnesses of plastics are considerably lower than for metals. Barcol is a special method used primarily for fiberglass reinforced polyesters and for aluminum.

Following completion of the Analysis of Application Requirements Form (Form 1), the next task is to determine which generic family or families of plastics have the properties which meet or exceed the requirements. Bar Charts (Charts 1 - 7) and a Qualitative Material Environmental Ratings Table (Table 5) provide the data to match the properties of various plastics families against the requirements specified on Form 1. The generic families of plastics in the bar charts cover those 30 families of plastics most often used for component manufacture. Data used to develop the bar charts was taken from Modern Plastics Encyclopedia (5).

The matches from Charts 1 - 7 are tabulated on Form 2, Work Sheet for Selecting Material Family. The first seven columns on Form 2 correspond to the material property bar charts and the eighth column is provided for tabulating material costs (Chart 9).

Form 3, Work Sheet for Tabulating Qualitative Material Environmental Ratings, is used to tabulate and rate the data from Table 5. Only those materials still under consideration after tabulating the mechanical and thermal requirements and recording the cost data on Form 2 need be evaluated further.

Using the values for the five basic requirements specified on Form 1 for the cab roof innerliner, an analysis made using Bar Charts 1 - 5 and Chart 9 is shown tabulated on Form 2. It is immediately evident from Chart 1 that glass or other fillers are required to obtain the stiffness required for this component. All subsequent tabulations from Bar Charts 2 - 5 and Chart 9 must then be made on glass or filled materials. It is important not to cross filled and unfilled materials in the tabulation.

The analysis based on Bar Charts 1 - 5 shows thirteen material families with properties meeting the five basic requirements. Following the cost analysis from Chart 9, several materials can immediately be dropped from further consideration due to high material cost alone. A line has been drawn through those materials whose minimum cost is above 6 cents per cubic inch (16.4 cubic centimeters). This then leaves eight material families having specific materials which should meet these minimum requirements.

With the recent rapid fluctuation in prices of plastic materials, it is difficult to keep price information current. Periodically, Chart 9 must be revised and dated to show the price ranges at that time. It is important that cost quotations be solicited from vendors since material prices are also subject to quantity pricing. The prices shown are for the largest volumes which are usually 20,000 to 40,000 lbs. (9,000 to 18,000 kg) quantities.

Price ranges are for natural and/or black-colored materials. Specialty items such as matched colors, fire retardant and special lubricated types (teflon or molybdenum disulfide filled) also will increase cost. When specialty items are required in small quantities, 5,000 lbs. (2,300 kg) or less, the cost increase can be substantial.

On Form 3 the remaining eight material families from Form 2 are evaluated for those environmental properties considered important. Here several more materials fail to meet the painting and oil resistance requirements specified on Form 1, which leaves only five generic families still under consideration.

**TABLE 4. HARDNESS CONVERSIONS (APPROXIMATE) [3]**

BRINELL	ROCKWELL							BARCOL
	A	B	C	D	E	M	R	
1000								
900								
800	85		65	75				
700			60	70				
600	80		55	65				
500	75		50	60				
400	70		45	50				
300	65		40	50				
200	60	100	30	40				
		90	20					
		80			100			90
		70						
100					90			80
90					80			
80					80			
70								70
60					70	140		
50					60	120		60
40					50			
					40	100		50
30					30			
						80		40
20						60		
10						40	130	
9							120	
8								
7						20	100	
6							80	
5							60	
4								
3								
2								
1								

PLASTICS

FORM 2. WORK SHEET FOR SELECTING MATERIAL FAMILY

MATERIAL FAMILY	FLEXURAL MODULUS	RESISTANCE TO HEAT	COMPRESSIVE STRENGTH	TENSILE STRENGTH	IMPACT STRENGTH	COEFFICIENT OF FRICTION	PV <sup>1</sup> RATING DRY	COST PER IN <sup>3</sup>
ABS <sup>1</sup>	X GF <sup>2</sup>	X	X	X	O			
ACETAL	X GF	X	X	X	O			
ACRYLIC								
<del>ALYL</del>	<del>X GF</del>	<del>X</del>	<del>X</del>	<del>X</del>	<del>X</del>			<del>9-15</del>
ASA <sup>1</sup>								
CELLULOSIC								
<del>EPOXY</del>	<del>X GF</del>	<del>X</del>	<del>X</del>	<del>X</del>	<del>X</del>			<del>7-14</del>
FLUOROPLASTIC	X GF	X	O	X	X			
MELAMINE-FORMALDEHYDE	X GF	X	X	X	X			4-15
NYLON	X GF	X	X	X	X			4-7
PHENOL-FORMALDEHYDE	X GF	X	X	X	X			4-16
POLY(AMIDE-IMIDE)	X GF	X	X	X	O			
POLYARYLETHER								
POLYBUTADIENE	X GF	X	?	X	X			
POLYCARBONATE	X GF	X	X	X	X			4.5-8
POLYESTER (TP) <sup>1</sup>	X GF	X	O	X	O			
POLYESTER-FIBERGLASS (TS) <sup>1</sup>	X GF	X	X	X	X			3.5-10
POLYETHYLENE								
<del>POLYIMIDE</del>	<del>X GF</del>	<del>X</del>	<del>X</del>	<del>X</del>	<del>X</del>			<del>3-10</del>
POLYPHENYLENE OXIDE	X GF	X	X	X	X			4.5-6.5
POLYPHENYLENE SULFIDE	X GF	X	X	X	O			
POLYPROPYLENE								
POLYSTYRENE	X GF	X	X	X	X			2-4
<del>POLYSULFONE</del>	<del>X GF</del>	<del>X</del>	<del>X</del>	<del>X</del>	<del>X</del>			<del>4.5-13</del>
POLYURETHANE (TS) (TP) <sup>1</sup>								
SAN <sup>1</sup>	X GF	X	X	X	X			2-4.5
<del>SILICONE</del>	<del>X GF</del>	<del>X</del>	<del>X</del>	<del>X</del>	<del>X</del>			<del>20-74</del>
STYRENE BUTADIENE								
UREA FORMALDEHYDE	X GF	O	O	X	O			
VINYL								

NOTE: 1. See Appendix for definitions of abbreviations  
 2. GF - Glass Filled

X - Meets requirement from Form 1  
 O - Does not meet requirement from Form 1



CHART 1. FLEXURAL MODULUS (ELASTIC)

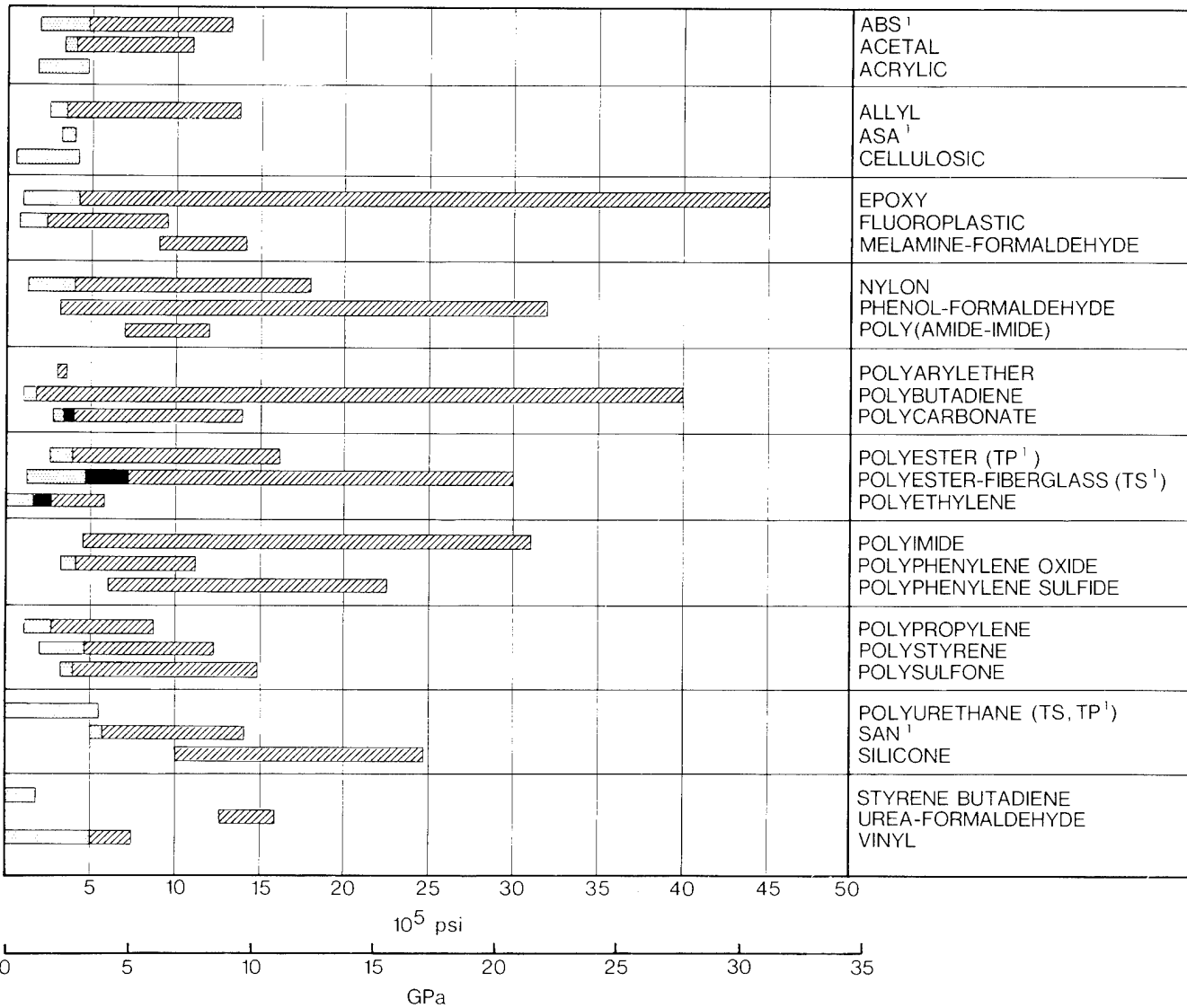



- Unreinforced.
- Unreinforced and reinforced.
- Reinforced.

NOTE: 1. See Appendix for definitions.

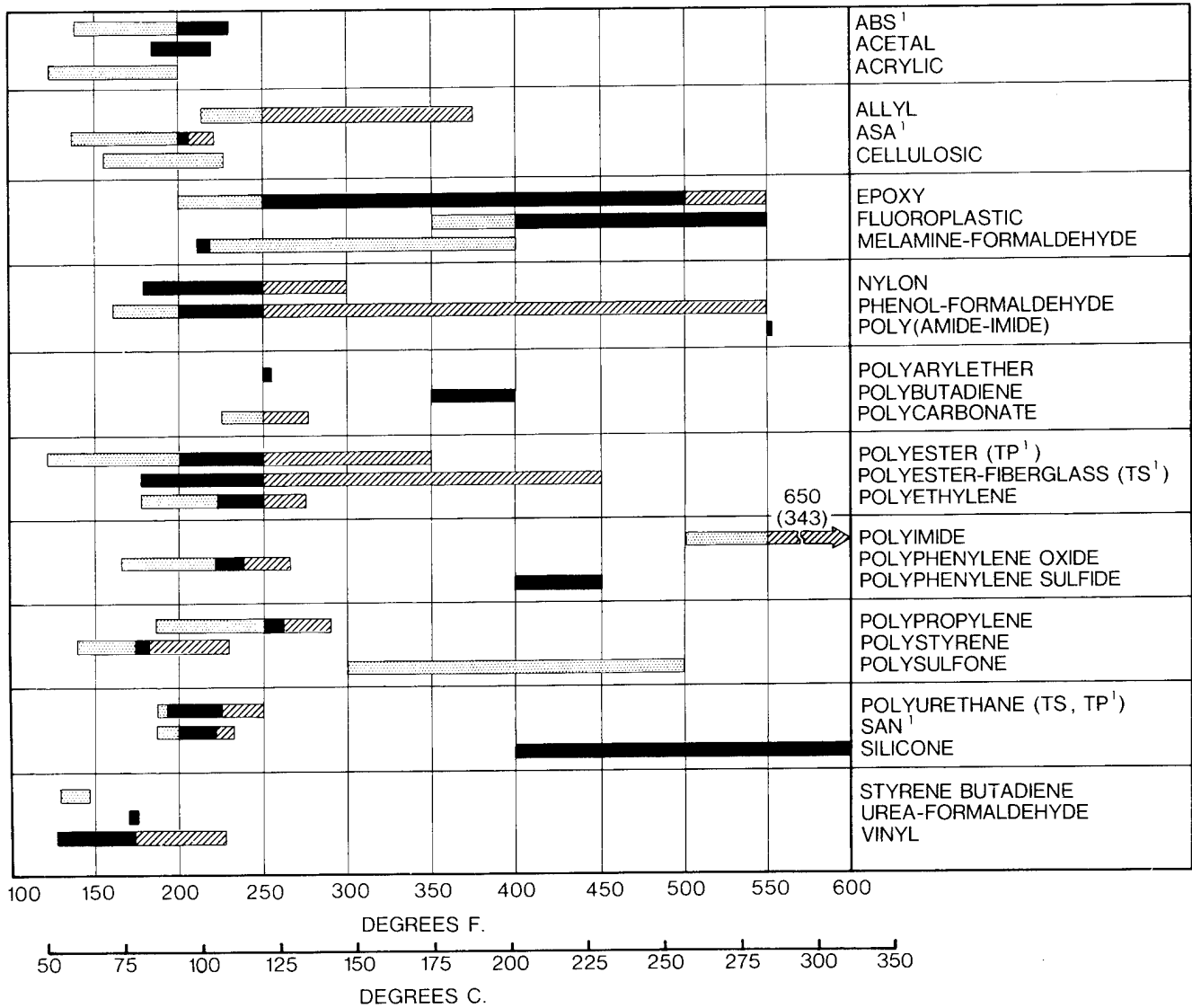
CHART 2. RESISTANCE TO HEAT (CONTINUOUS — NO LOAD)





 Unreinforced.  
 Unreinforced and reinforced.  
 Reinforced.

NOTE: 1. See Appendix for definitions.

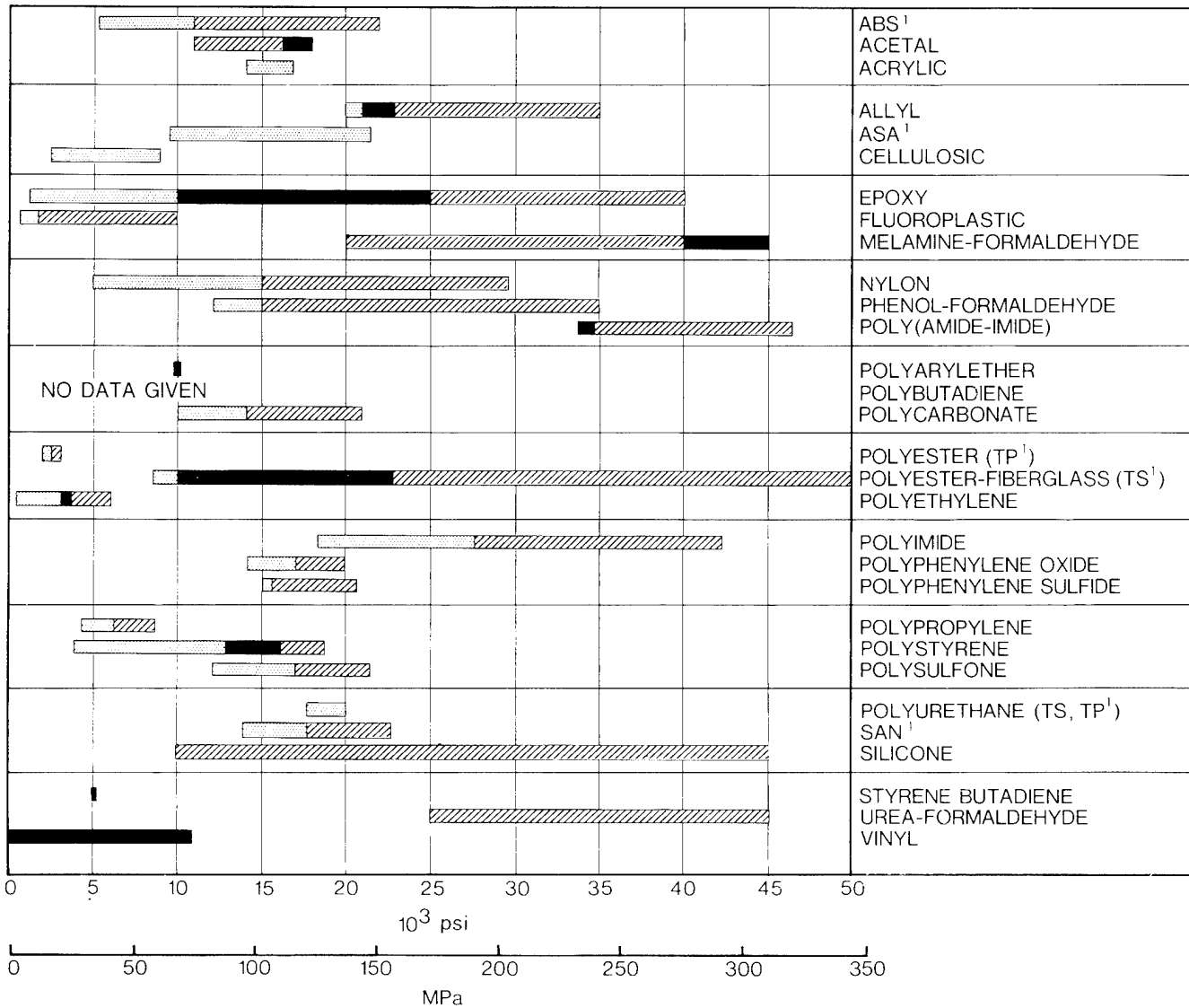
**CHART 3. COMPRESSIVE STRENGTH (ULTIMATE)**







 Unreinforced.  
 Unreinforced and reinforced.  
 Reinforced.

NOTE: 1. See Appendix for definitions.

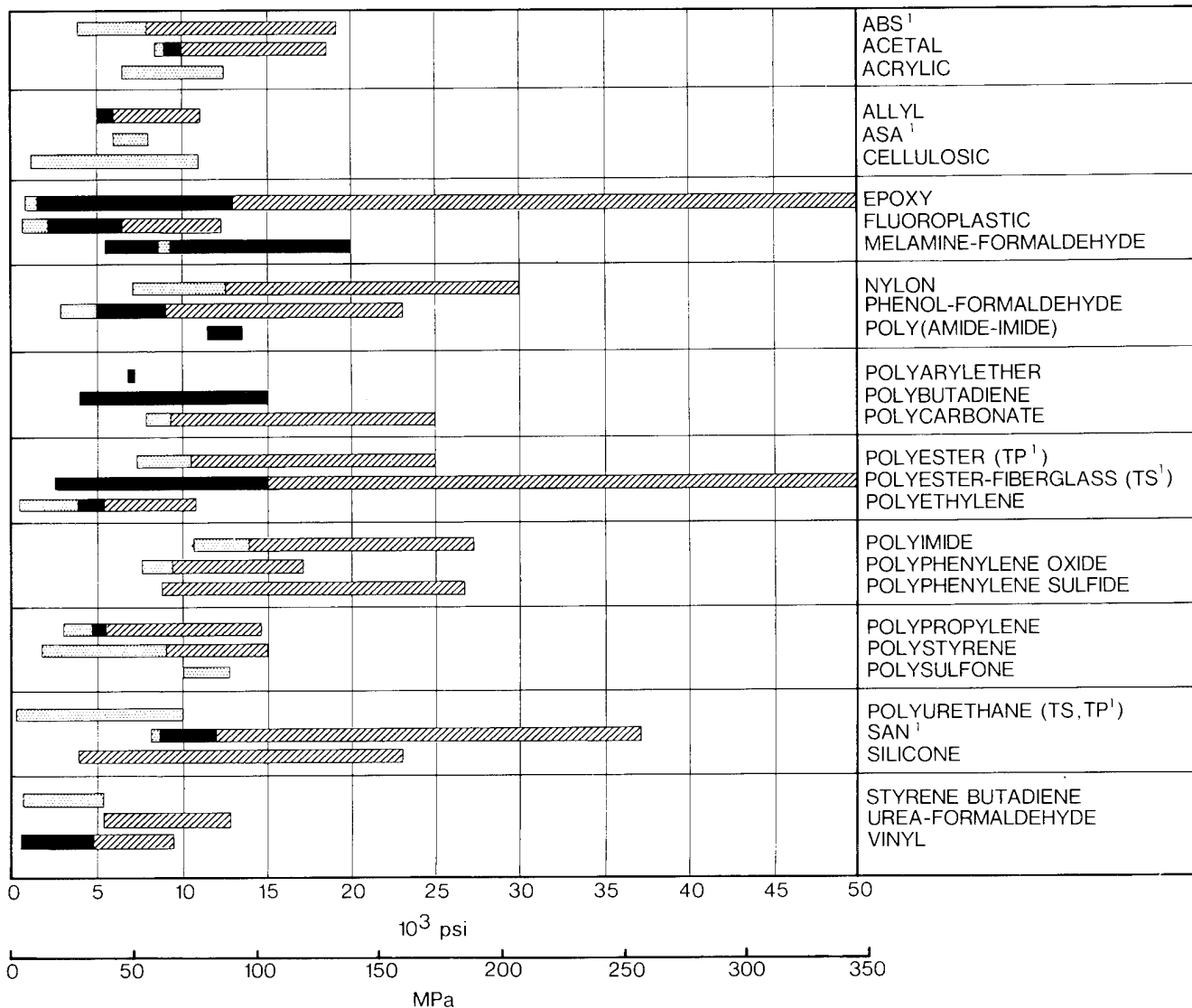

CHART 4. TENSILE STRENGTH (ULTIMATE)



 Unreinforced.  
 Unreinforced and reinforced.  
 Reinforced.

NOTE: 1. See Appendix for definitions.

CHART 5. IZOD IMPACT STRENGTH AT 73 F (23°C)

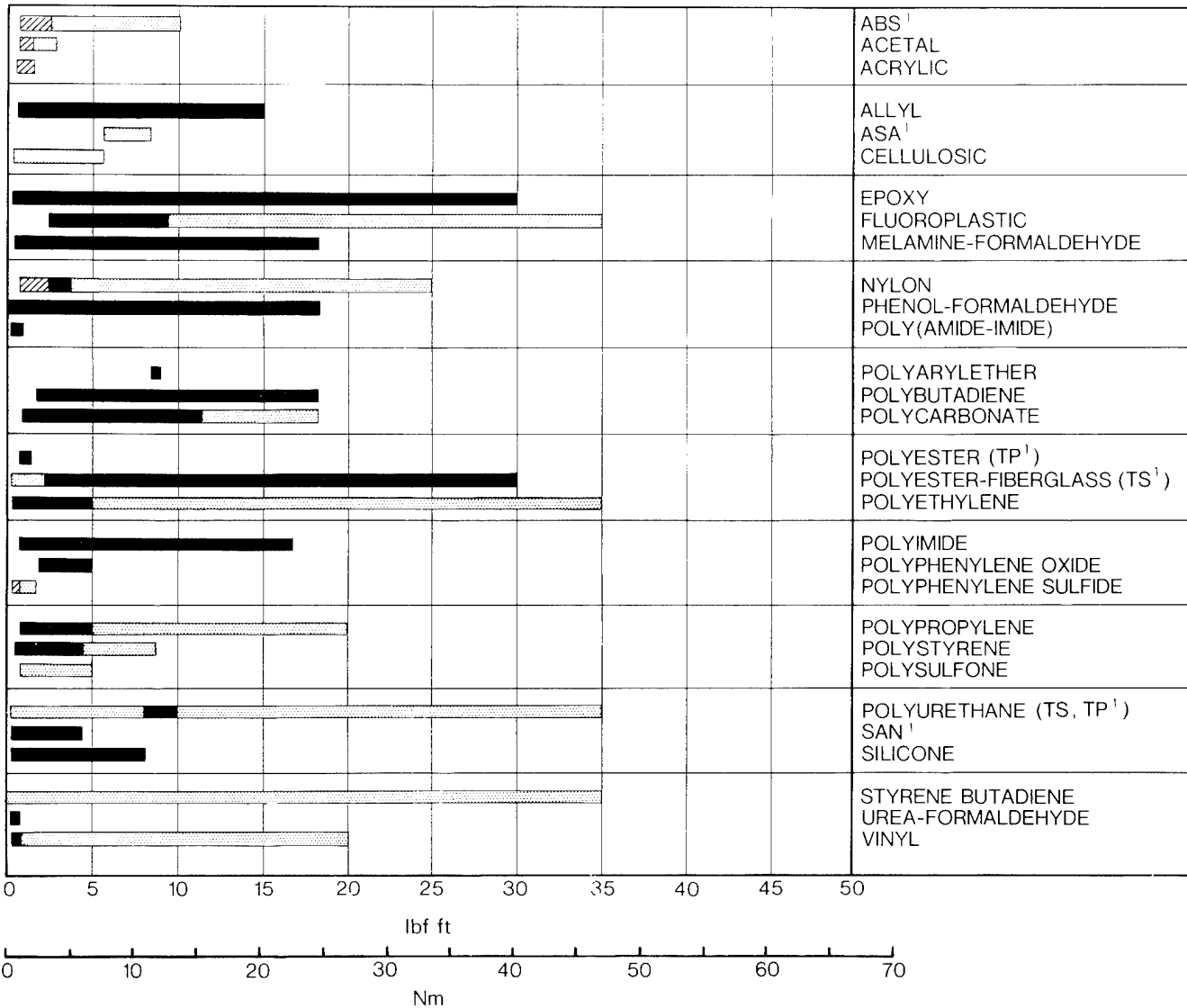



Unreinforced.  
 Unreinforced and reinforced.  
 Reinforced.

NOTE: 1. See Appendix for definitions.

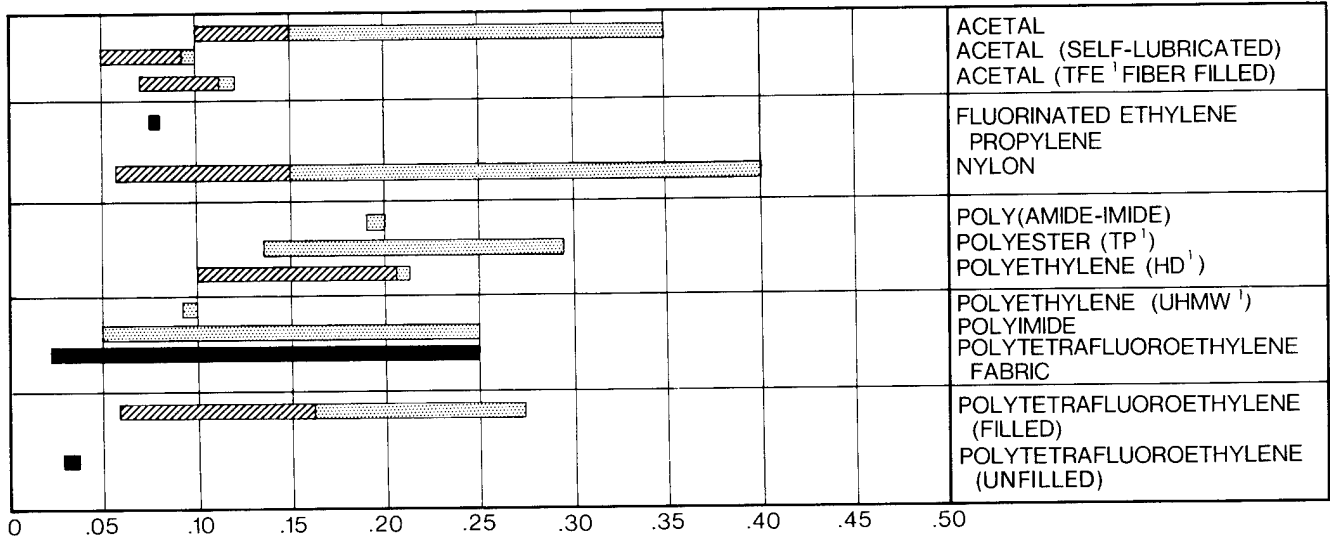
**CHART 6. COEFFICIENT OF FRICTION**



 Dry.  
 Dry and lubricated.  
 Lubricated.

NOTE: 1. See Appendix for definitions.

**CHART 7. PV<sup>1</sup> RATING, DRY**

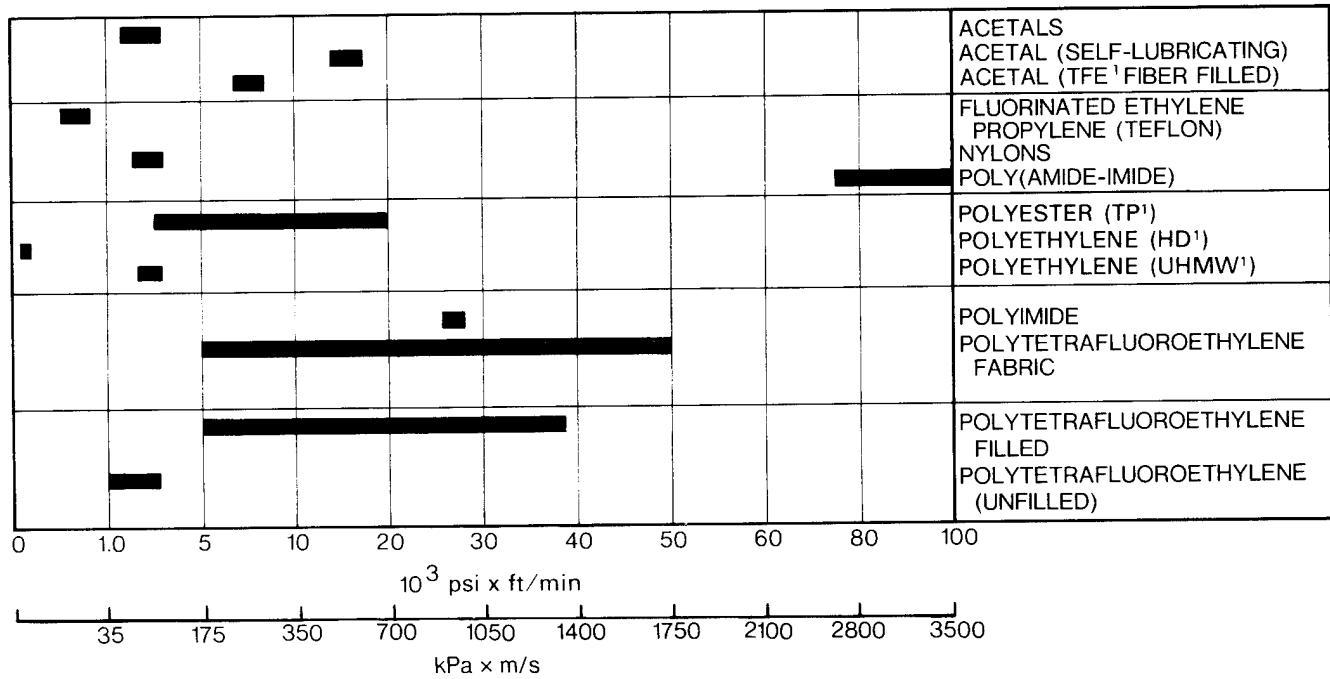

NOTE: 1. See Appendix for definitions.

**QUALITATIVE SELECTION CHART** — In those instances where a designer is unable to establish specific material requirements, the Qualitative Selection Chart (4) (Chart 8) is used to determine those materials which fit certain categories of toughness, strength and flexibility. Those materials along the top of the chart are considered the toughest, while those near the bottom are considered to be more brittle. The materials along the left edge are more rigid, while those along the right edge are more flexible.

To use the chart, one identifies the area of use required for the application and evaluates the properties of these materials in the data banks to determine if they meet the qualitative requirements.

Some information such as izod impact strength and heat resistance, may be determined by reviewing the generic family values shown in Bar Charts 1 - 7. Additional qualitative information on abrasive resistance, weatherability, paintability, transparency, translucency and chemical resistance can be determined from Table 5.

**GENERIC NAME AND SUB-GROUPS** — Once the best generic family or families have been identified by either the bar chart or the qualitative selection method (the five materials remaining on Form 3), it is necessary to make still a further sort into sub-groups. This procedure identifies the specific type of material or materials which will meet the requirements. This sub-group sort is conducted by reviewing the data bank in the Modern Plastics Encyclopedia (5). Using the same properties as searched on the bar charts, and on other key requirements, the generic families are viewed to identify specific sub-groups meeting the requirements.

For those five generic families still under consideration on Form 3, the sub-groups for each generic family shown in Table 6 most likely will contain specific compounds which should satisfy the requirements. Of note, however, is the polyphenylene oxide which, upon close analysis, is borderline in meeting the requirements.

Once the specific sub-groups have been identified, material supplier literature is searched to determine specific grades which meet the requirements.

A list of suppliers of specific material types is shown in the Modern Plastics Encyclopedia. Although there are variations of similar materials from different suppliers, in most cases it is possible to use those materials interchangeably. It is of value to develop a suitable library of suppliers' data so that it can be searched. In addition to the basic information on material properties, data on creep, fatigue, specific solvent resistance, long-term exposure to heat, radiation and permeability are often given. The suppliers further give specific data on design recommendations for their materials.

When materials have been selected, the final part of the selection system, Step III — Process Selection, is performed.

In order to fully demonstrate use of the tooling and process selection, we can assume that all the material types shown in Table 6 are still under consideration for the cab roof innerliner example.

### STEP III — PROCESS SELECTION AND COST ANALYSIS

The remaining step establishes the most logical method(s) of fabrication and the relative tooling and molding costs. Final cost of the component will, of course, be based on a combination of the material selected, the type of fabrication used and the size of the tooling, e.g., single or multiple cavities. Part thickness also affects molding machine time.

Completion of this step should provide a specific material candidate or candidates for the application. These are ultimately designed and tested to assure complete conformance to requirements.

There is an interdependence of material and shape to molding or fabricating processes. All must be considered in order to make the process analysis. It is therefore necessary to establish which materials and which shapes fit certain processes. By matching the materials still under consideration to the applicable processes, then determining if that shape can be made by that process, the process and tooling analysis can be made.

**TABLE 5. QUALITATIVE MATERIAL ENVIRONMENTAL RATINGS**

MATERIAL FAMILY	ABRASION RESISTANCE	WEATHER-ABILITY <sup>8</sup> (NATURAL)	PAINT-ABILITY	TRANS PARENT	TRANS LUCENT <sup>2</sup>	CHEMICAL RESISTANCE						
						ACID		ALKALI		SOLVENTS	OILS	FUELS
						S <sup>9</sup>	W <sup>10</sup>	S	W			
ABS <sup>1</sup>	F	F-P	NO <sup>6</sup>	YES	YES	P	G	G	G	P	P	P
ACETAL	G	F	NO <sup>6</sup>		YES	P	G	E	E	E	E	E
ACRYLIC	P	G	NO <sup>6</sup>	YES		P	G	P	F	P	F	P
ALLYL	G	F	NO <sup>6</sup>			G	E	G	F	E	E	E
ASA <sup>1</sup>	F	P	NO <sup>6</sup>		YES	P	G	G	G	P	P	P
CELLULOSIC	F-P	F-G	NO <sup>6</sup>	YES		P	P	P	P	F	G	F-P
EPOXY	G	F	YES	YES		F	G	G	G	VG	VG	VG
FLUOROPLASTIC	G	E	NO <sup>6</sup>		YES	E	E	E	E	E	E	E
MELAMINE-FORMALDEHYDE	G	F-G	YES		YES	P	G	P	G	E	E	E
NYLON	G	F-P	YES		YES	P-G	F-P	G	G	G	G	G
PHENOL-FORMALDEHYDE	G	G	YES		YES	P	G	P	F	G	G	G
POLY (AMIDE-IMIDE)	VG	F	NO <sup>6</sup>		YES	G	G	P	F	G	G	G
POLYARYLETHER	G	F	NO <sup>6</sup>		YES	G	E	E	E	F	G	G
POLYBUTADIENE	G	F-G	NO <sup>6</sup>			E	E	E	E	G	G	G
POLYCARBONATE	F	F	NO <sup>6</sup>	YES		P	G	P	P	P	G	F-P
POLYESTER (TP) <sup>1</sup>	G	F	NO <sup>6</sup>	YES	YES	P	G	P	F	G	G	G
POLYESTER-FIBERGLASS (TS) <sup>1</sup>	G	G	YES	YES <sup>3</sup>	YES	F	G	P	F	G	G	G
POLYETHYLENE	G	P	NO <sup>7</sup>		YES	F	G	G	G	G <sup>4</sup>	G	G <sup>4</sup>
POLYIMIDE	VG	F-P	NO <sup>7</sup>			G	G	F	G	G	G	G
POLYPHENYLENE OXIDE	G	F-G	YES			G	G	G	G	F	G	G
POLYPHENYLENE SULFIDE	G	G	NO <sup>6</sup>			P	G	G	G	E	E	E
POLYPROPYLENE	G	F-P	NO <sup>6 7</sup>		YES	F	G	G	G	G-F	G-F	G-F
POLYSTYRENE	P	F-P	NO <sup>6</sup>	YES		P	F	G	G	P	F	P
POLYSULFONE	G	F-P	NO <sup>6</sup>	YES		G	G	G	G	P-G <sup>5</sup>	G	P-G <sup>5</sup>
POLYURETHANE (TS) (TP) <sup>1</sup>	VG	E-G	NO <sup>6</sup>		YES	P	P	P	P	F-G	G	G
SAN <sup>1</sup>	F	F	NO <sup>6</sup>	YES	YES	P	F	G	G	P	F	P
SILICONE	F	VG	NO <sup>6</sup>	YES	YES	P	G	P	F	F	F	F
STYRENE BUTADIENE	G	G	NO <sup>6</sup>	YES		F	G	G	P	P	P	P
UREA FORMALDEHYDE	G	F	YES			P	F	P	P	G	G	G
VINYL	G	G	NO <sup>6</sup>	YES		G	VG	VG	VG	G	G	G

- NOTES: 1. See Appendix for definitions.  
 2. In natural color only; also affected by thickness.  
 3. Can be made nearly transparent but with slight glass pattern.  
 4. Subject to environmental stress cracking in some organic liquids.  
 5. Soluble in aromatic solvents.  
 6. Requires special paint or primer.  
 7. Requires special prepaint surface preparation.  
 8. Addition of ultraviolet inhibitor and/or blackpigment improves weatherability of all except vinyl where light colors weather best.  
 9. Strong.  
 10. Weak.

**RATINGS KEY:** E - Excellent      VG - Very Good      G - Good      F - Fair      P - Poor

CHART 8. QUALITATIVE SELECTION CHART

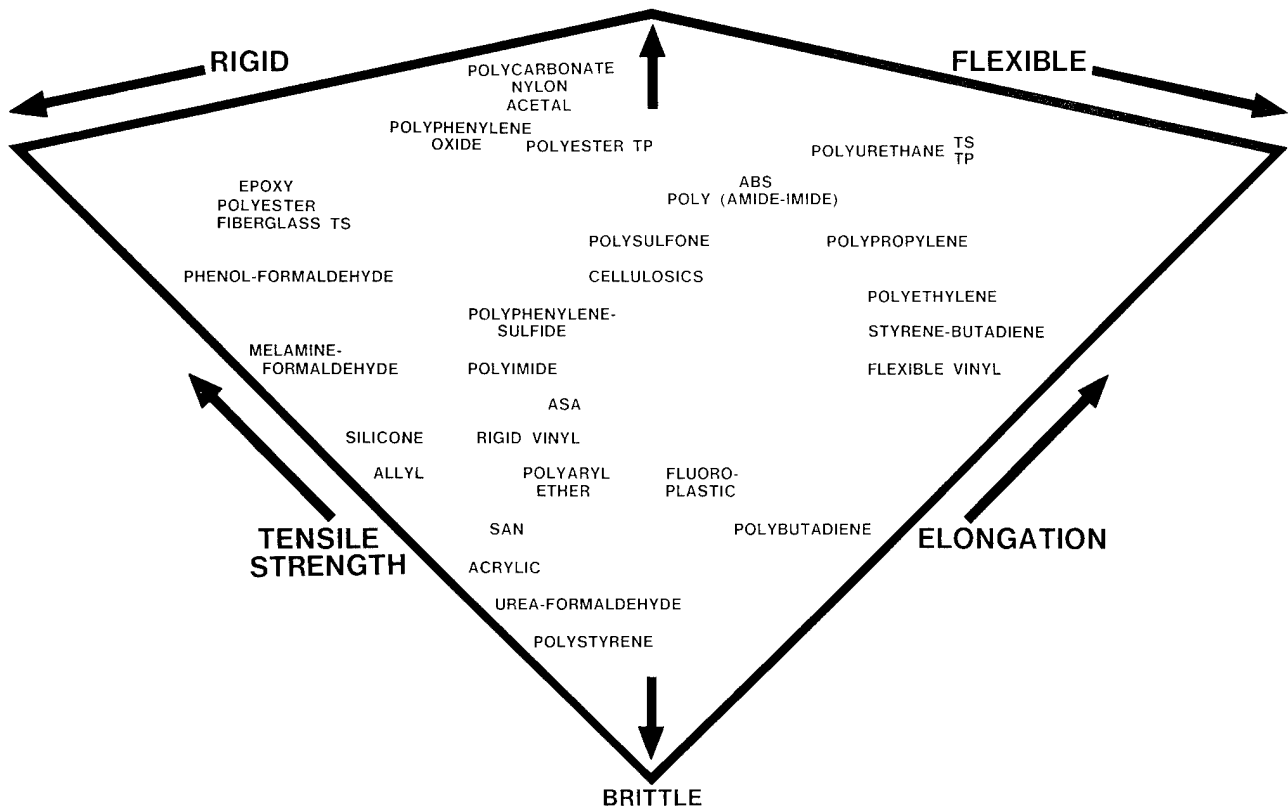

**TABLE 6. GENERIC FAMILY SUB-GROUPS AND MOLDING PROCESSES FOR CAB ROOF INNERLINER**

GENERIC FAMILY	MATERIAL SUB-GROUP	APPLICABLE MOLDING PROCESSES
Melamine-formaldehyde (Thermoset)	Glass fiber filled (including nodular)	Compression
Nylon (Thermoplastic)	Type 6 — 30-35% glass reinforced	Injection
	Type 6/10 — 30-35% glass reinforced	Injection
Phenol-formaldehyde (Thermoset)	Asbestos filled	Compression, Injection
	Glass fiber filled	Compression, Injection
	Macerated fabric and cord filled	Compression, Injection
Polyester-fiberglass (Thermoset)	Preformed chopped roving	Compression
	Premix chopped glass	Compression
	Woven cloth	Compression
	Sheet molding compound	Compression
	Low-shrink compound	Compression
Polyphenylene oxide (Thermoplastic)	20-30% glass reinforced 20-30% glass reinforced	Injection

**SHAPE CLASSIFICATION** — The shape classification number which most closely corresponds to the shape of the component under consideration is selected from Table 7. Drawings of the shapes are shown to aid in selecting the most representative classification for that shape.

Shape 4 matches the cab roof innerliner shape type in the example.

Molding Processes Applicable to Plastic Materials, Table 8, is consulted to determine the process by which the materials selected can be processed. Some judgment will be required in process selection since the component size and shape are also factors in selecting the best process for the material selected.

**TABLE 7. SHAPE CLASSIFICATION (6)**

CLASS. NUMBER	SHAPE CLASSIFICATION
1	Solid Concentric
2	Hollow Concentric
3	Cone or Cup Concentric
4	Cup, Disk, or Cone — Non-Concentric
5	Hollow or Solid Non-Concentric
6	Spirals — Repetitive Irregular Concentric
7	Flanged and Flat
8	Complex Miscellaneous
9	Tanks or Closed Tubes

TABLE 8. MOLDING PROCESSES APPLICABLE TO PLASTIC MATERIALS

MATERIAL FAMILY	INJECTION	COMPRESSION	TRANSFER	CASTING	COLD MOLDING	COATING	STRUCTURAL FOAM	EXTRUSION	LAMINATION	SHEET FORMING	RP MOLDING FRP	FILAMENT	DIP & SLUSH	BLOW	ROTATIONAL
ABS <sup>1</sup>	X						X	X		X					
Acetal	X						X	X		X				X	X
Acrylic	X			X		X		X	X	X					
Allyl		X	X	X		X			X			X			
ASA <sup>1</sup>	X						X	X		X					
Cellulosic	X						X	X	X	X				X	X
Epoxy		X	X	X	X	X			X			X			
Fluoroplastic	X	X	X		X	X		X		X					X
Melamine-Formaldehyde	X	X	X	X		X			X						
Nylon	X			X		X	X	X						X	X
Phenol-Formaldehyde	X	X	X	X	X	X			X						
Poly (Amide-Imide)	X	X	X					X							
Polyarylether	X							X							
Polybutadiene	X		X					X							
Polycarbonate	X	X					X	X		X				X	X
Polyester (TP) <sup>1</sup>	X							X							X
Polyester-Fiberglass (TS) <sup>1</sup>		X	X				X	X	X		X				X
Polyethylene	X	X				X	X	X	X	X				X	X
Polyimide	X	X				X		X (TP) <sup>1</sup>							
Polyphenylene Oxide	X						X	X							X
Polyphenylene Sulfide	X	X				X									
Polypropylene	X						X	X		X				X	X
Polystyrene	X						X	X		X				X	X
Polysulfone	X	X						X		X					
Polyurethane (TS) (TP) <sup>1</sup>	X	X	X	X		X	X	X (TP) <sup>1</sup>	X	X					X
San <sup>1</sup>	X						X	X	X	X					X
Silicone		X		X				X							
Styrene Butadiene	X					X		X	X						
Urea Formaldehyde		X							X						
Vinyl	X	X				X	X	X	X	X			X	X	X

NOTE: 1. See Appendix for definitions.



**TABLE 9. PROCESS ANALYSIS FOR CAB ROOF INNERLINER**

PROCESSES	MATERIALS	MATERIAL WASTE	RELATIVE COST		
			TOOLING	LABOR	MOLDING (10,000) PIECES
Injection (Thermoplastic)	Nylon Polyphenylene oxide	Very low	Very high	Moderately low	Moderately low
Injection (Thermoset)	Phenol-formaldehyde Polyester-fiberglass	EQUIPMENT NOT LARGE ENOUGH TO MOLD THE PART — 200 OZ. MAX. CAP.			
Compression (Thermoset)	Melamine-formaldehyde Phenol-formaldehyde Polyester-fiberglass	Moderate	Very high	Moderate	Very low

**CHART 9. MATERIAL COST<sup>1</sup>**

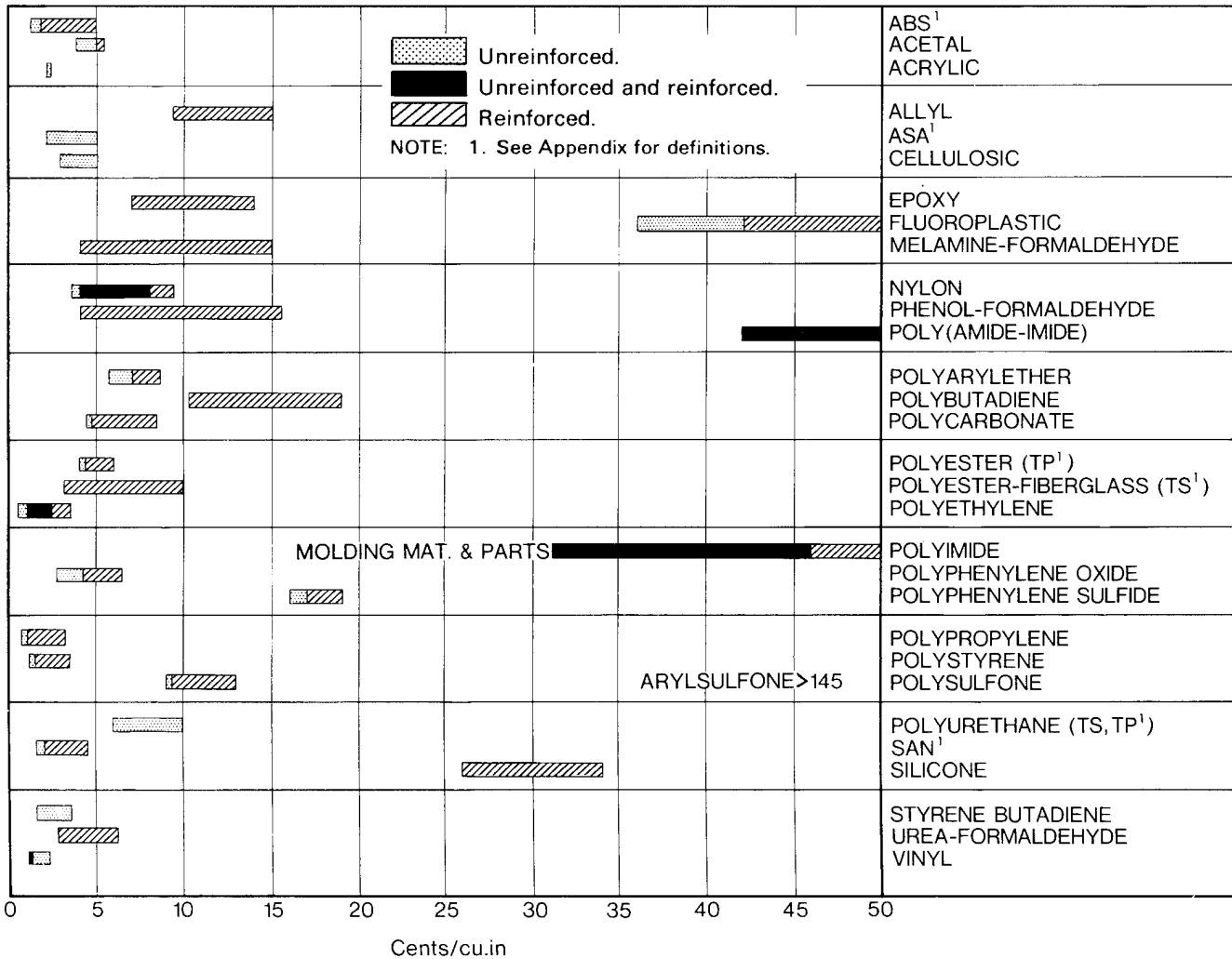

**CHART 10. PROCESS & TOOLING [6]**

SHAPE CLASSIFICATION	PROCESS	COMMENTS	RAW MATERIAL	MAXIMUM SIZE	MINIMUM SIZE	GENERAL TOLERANCE	SURFACE FINISH (RMS)	PIECES PER/HOUR
1 4 7 2 5 8 3 6	Injection Molding (Thermoplastic)	Thermoplastic	Granules Pellets Powders	700 ounces	Less than 1 ounce	±002 up to 1" dim ±008 up to 6" dim ±010 +004 in/in over 6 inch dim	4 and better	3-12 cycles/min
1 4 7 2 5 8 3 6	Injection Molding (Thermosetting)	Thermosetting	Granules Pellets Powders	200 ounce	Less than 1 ounce	±002 up to 1" dim ±006 up to 6" dim ±010 +003 in/in over 6 inch dim	4 and better	3-4 cycles/min
1 4 7 2 5 8 3 6	Compression Molding	Almost entirely Thermosetting	Pellets Powders Preforms	35 pounds 18 inches deep	1/8 inch x 1/8 inch	±002 up to 1" dim ±005 up to 6" dim ±006 +002 in/in over 6 inch dim	4 and better	20-140 cycles/hr
1 4 7 2 5 8 3 6	Transfer Molding	Thermosetting	Pellets Powders Preforms	35 pounds 18 inches deep	1/8 inch x 1/8 inch	±002 up to 1" dim ±006 up to 6" dim ±010 +003 in/in over 6 inch dim	4 and better	20-140 cycles/hr
1 4 7 2 5 8 3 6	Casting	Thermosetting and Thermoplastic	Liquids	2000 pounds 24 inches thick	1/4 inch x 1/4 inch x 1/4 inch	±1/32 ±002 (special handling)	16 and better	Low
1 4 7 2 5 8 3 6	Cold Molding	Non-Refractory - Bitumen or Phenolic Base Refractory - Inorganic Binders	Powders Fillers	-----	1/4 inch	±003	63 and better	3500-4000 cycles/hr
1 2 3	Coating	Thermosetting and Thermoplastic	Liquids Powders	-----	-----	±002	4 and better	Short cycle
1 4 7 2 5 8 3	Cellular Plastics (foam - expanded)	Thermosetting and Thermoplastic	Granules Pellets, Liquids Powders	20 ft. dia.	No Limit	±005	varies greatly	Spray-on (high) molded (medium)
2 5 8 6	Extrusion	Thermoplastic and Thermosetting	Granules Powders	72 inches wide 6 inches wide	.0015 film 1/4 x 1/4 inch	±002 or better	16 and better	6 - 300 lbs/hr
2 5 8 3 9	Laminating (high pressure)	Thermosetting and Thermoplastic	Liquid Resins and Fillers	Sheet 3'x6'x8" thick. Tube 3'x 6" dia. Rod 3'x 3-7/8" dia.	Sheet 3'x6'x.010" thick. Tube 3'x 1/8" dia. Rod 3'x 1/4" dia.	±005	4 and better	Low
4 7 2 5 3	Sheet Forming	Thermoplastic	Sheet	60 inch x 80 inch	1 inch x 1 inch	±1/16 normal ±1/32 special ±010 thk of mat	4 and better	medium to high
4 7 2 8 3 6 9	RP Molding (Reinforced Plastics)	Thermosetting Resin and Filler, Usually Glass	Liquids, Glass Fibers or Glass Cloth	Up to 80 ft. x 80 ft. x 10 ft.	4 inch x 4 inch	±1/32 to ±1/4	125 and better	Usually low Dependent on Method
2 3 9	Filament Winding	Thermosetting Resin and Glass strand Roving	Liquids and glass strands	15 ft. x 40 ft.	12 inch x 3/4 inch	±1/16	63 and better	multi-spindle up to 60/hr
4 2 3 9	Dip & Slush Molding	Thermoplastic	Powders	-----	-----	±1/32	125 and better	Low
4 2 3 9	Blow Molding	Thermoplastic	Granules Pellets Powders	34 inches long 144 sq. in cross-section	1/2 inch long	±003 O.D.	4 and better	300-1200
4 7 2 8 3 9	Rotational Molding	Thermoplastic	Powders	12 ft. x 12 ft. x 12 ft.	-----	±1/32 to ±1/4	16 and better	12-20 cycles/hr

NOTE: 1. Courtesy, Value Analysis, Inc.



The tabulation for the applicable molding processes for each material selected for the cab roof innerliner example are shown in Table 6.

**PROCESS AND TOOLING** — To use the process and tooling chart (Chart 10) one must understand what the position and width of the shaded bars mean. Placement of the bar to the far left means that the relative cost for that process is low. Placement of the bar to the far right means that the relative cost is high. Intermediate costs are indicated by placement in between the far left and far right. The bar width indicates the range of the relative cost. It should be remembered that the relative cost for the number of pieces is the relative molding cost and does not include material costs.

Other pertinent information such as minimum size, general tolerances and surface finish will remain relatively constant. Maximum size and pieces per hour are continually being upgraded due to innovations in molding equipment and molding materials.

The shape classification number in the left-hand column of Chart 10 is then matched to the applicable molding process in the second column from the left. For the cab roof innerliner example, the processes which match shape classification 4 are first reviewed to determine if the part size can successfully be handled on available equipment. In this case, the injection thermoset process does not have large enough sized equipment to handle the component; it therefore drops from further consideration (Table 9).

An evaluation of the relative tooling, labor and manufacturing costs for the number of pieces required is then made for each material still under consideration to determine the least costly ones. This results in an indication of the least expensive combination of tooling and processing.

From the analysis of the cab roof innerliner shown in Table 9, and made using Chart 10, it is evident that there are trade-offs from process to process, depending upon the material being used. While the injection molding process for nylon and polyphenylene oxide based resins has a low labor cost, the relative manufacturing cost for 10,000 pieces is only moderately low.

The compression molding process for melamine-formaldehyde, phenol-formaldehyde and polyester fiberglass compounds, on the other hand, have slightly higher labor cost and material waste, but the relative manufacturing cost for 10,000 pieces is lower.

On the basis of the analysis, it then appears worthwhile to solicit tooling and price quotations from molders to obtain firm costs on several materials and processes.

In reality the melamine-formaldehyde and phenol-formaldehyde materials do not lend themselves to this type component, and the material cost would be somewhat higher than the polyester fiberglass preformed chopped roving, sheet molding, low shrink and premix chopped glass compounds. The woven cloth polyester fiberglass is a high performance, high cost material unnecessary for this application. Although the glass reinforced nylons may be higher in material cost, the lower cost and material waste may make these materials competitive. This will be dependent upon the complexity of the tooling and the ultimate molding cycle. Because a hair cell textured surface was specified on Form 1, the polyester fiberglass, sheet molding and low shrink compounds would be the most logical choices. Likewise, it would be difficult to obtain a satisfactory surface using preformed chopped roving or premix chopped glass compounds.

When this step has been completed, the entire process for selection of material, tooling, and processing is complete. At this point, the manufacturers' literature should again be consulted to determine the best designs for the process selected. Designs should be generated using this information and, ultimately, prototypes constructed and tested.

Machined prototypes usually do not perform overall as well as molded components. If the machined component tests out satisfactorily, then molded parts should be acceptable provided they are molded properly, e.g., proper gating, no internal shrinkage, etc.

CLASS. 1 — SOLID CONCENTRIC

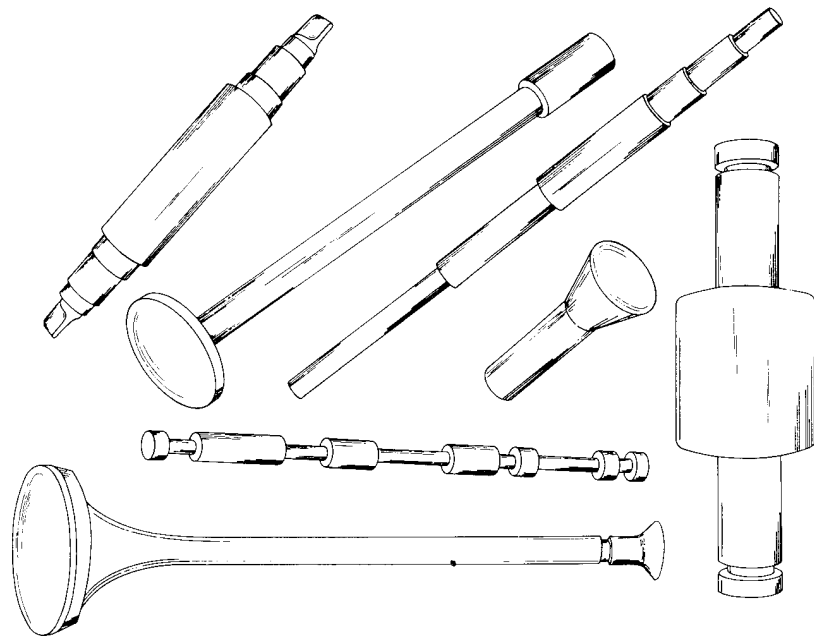

NOTE 1. Courtesy: Value Analysis, Inc.

CLASS. 2 — HOLLOW CONCENTRIC

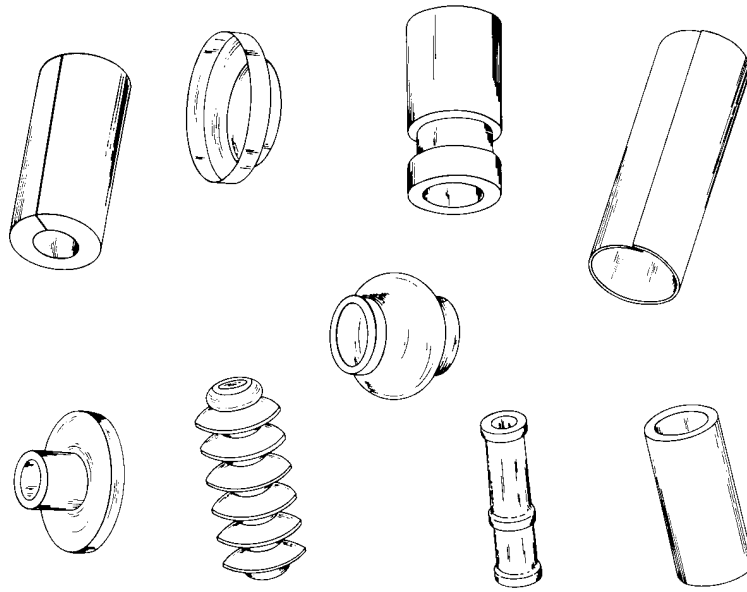

NOTE 1. Courtesy: Value Analysis, Inc.



**CLASS. 5 — HOLLOW OR SOLID NON-CONCENTRIC**

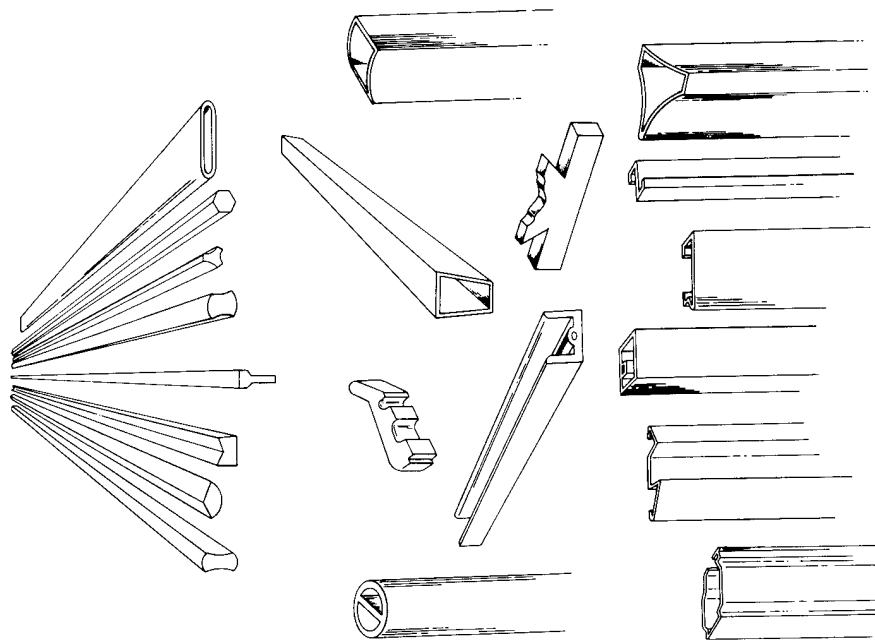

NOTE 1. Courtesy: Value Analysis, Inc.

**CLASS. 6 — SPIRALS — REPETITIVE IRREGULAR CONCENTRIC**

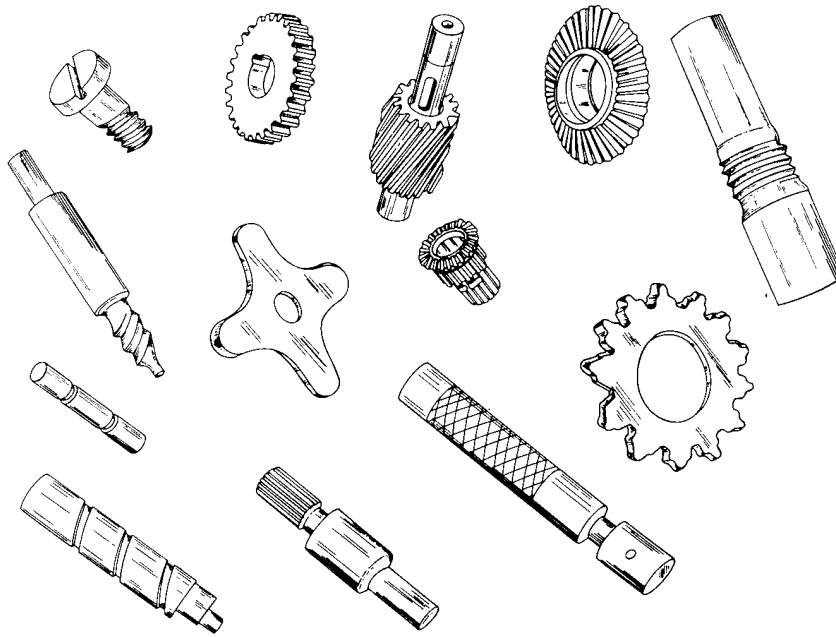

NOTE 1. Courtesy: Value Analysis, Inc.

CLASS. 7 — FLANGED AND FLAT

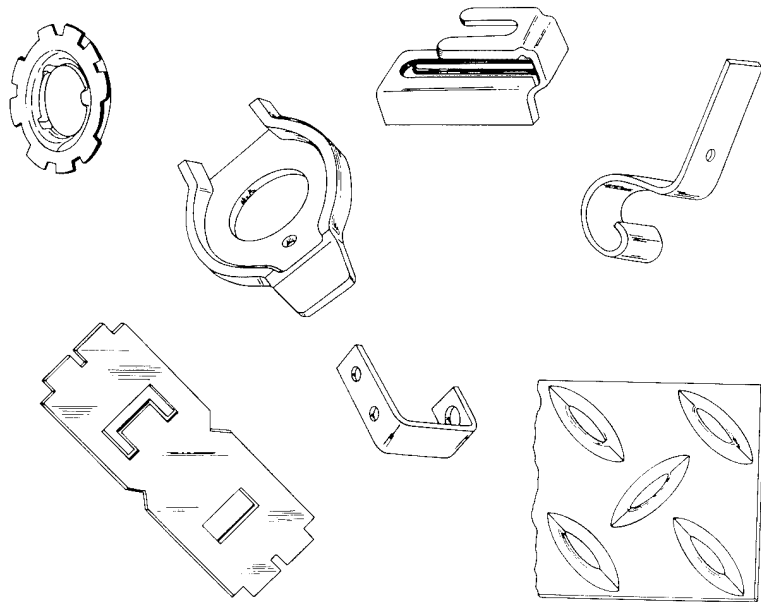

NOTE 1. Courtesy: Value Analysis, Inc.

CLASS. 8 — COMPLEX MISCELLANEOUS

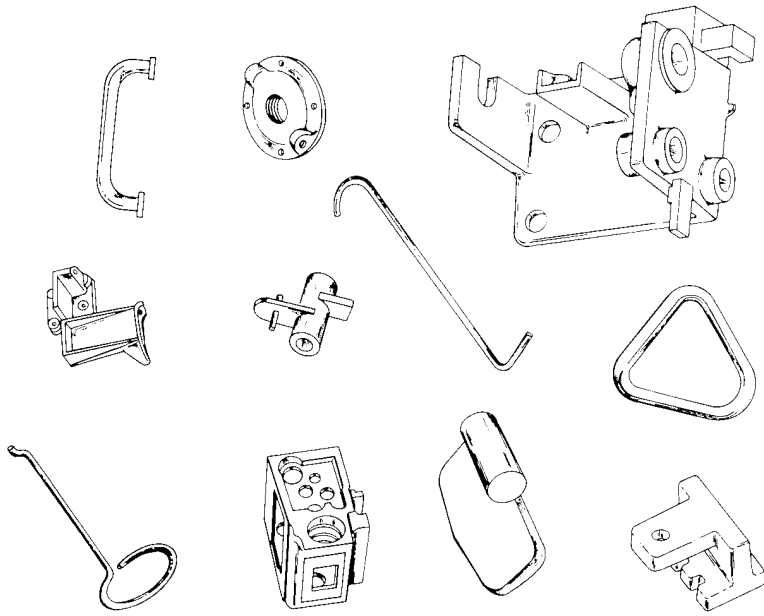

NOTE 1. Courtesy: Value Analysis, Inc.



**CLASS. 9 — TANKS OR CLOSED TUBES —  
CONCENTRIC OR NON-CONCENTRIC**

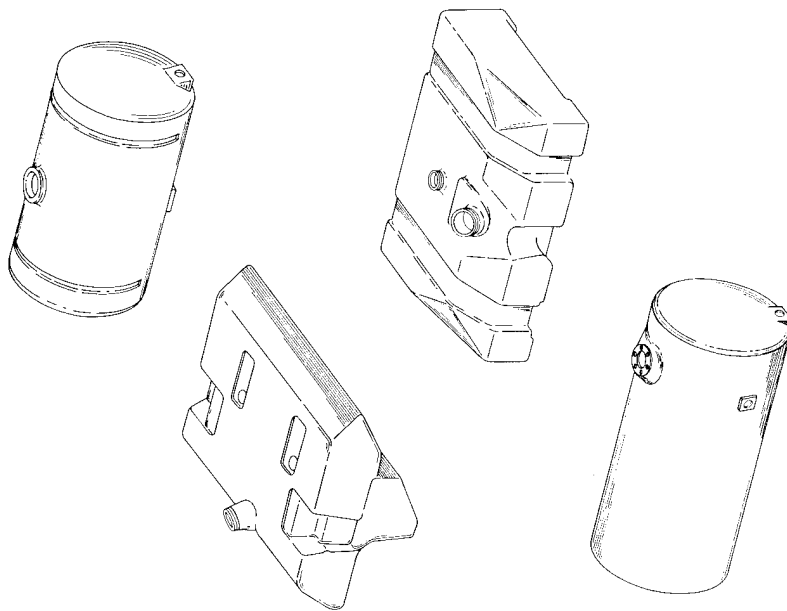

## CONCLUSIONS

This type of guide should simplify the problem of plastic material selection and lead to improved use of the materials to satisfy design requirements. It should also lead to shorter development and test time, resulting in reduced development costs and provide the lowest cost components with the desired reliability level.

Perhaps the most important consideration of a systematic material selection system is that the availability of a good data file causes the plastic user to analyze the problem at hand in a scientific manner rather than the empirical method formerly used. The time has come to get rid of the hit-or-miss approach to plastic material selection.

## APPENDIX COMMON ABBREVIATIONS ASSOCIATED WITH PLASTIC MATERIALS

ABS*	Acrylonitrile-Butadiene-Styrene	PA	Polyallomer
AF	Teflon Filled Acetal	PFA	Polyfluoroacrylate
ASA*	Acrylonitrile-Styrene-Acrylic	PPO	Polyphenylene Oxide
CL	Cross Linked	PTMT	Polytetramethyleneterephthlate
CTFE	Polychlorotrifluoro Ethylene	PTP	Polyterephthalate
E-CTFE	Ethylene Chlorotrifluoro Ethylene	PV*	Pressure X Velocity (Rating)
EEA	Ethylene Ethylacrylate	PVC*	Poly Vinyl Chloride
ETFE	Ethyl Tetrafluoroethylene	PVF	Poly Vinylidene Fluoride
EVA	Ethylene Vinyl Acetate	RP*	Reinforced Plastics
FEP	Fluorinated Ethylene Propylene	SAN*	Styrene Acrylonitrile
FRP*	Fiberglass Reinforced Polyester	TFE*	Poly Tetra Fluoroethylene
H. D.*	High Density	TP*	Thermoplastic
L.D.	Low Density	TS*	Thermoset
M.D.	Medium Density	UHMW*	Ultra High Molecular Weight
MMA	Methyl Methacrylate		

\*Used in text.

## REFERENCES

1. B. S. Benjamin, *"Structural Design with Plastics,"* Van Nostrand-Reinhold, 1961.
2. William S. Miller, Ed., *"Machine Design,"* No. 41, Volume 45, Penton Publishing Company, February 15, 1973.
3. R. T. Wimber, *"A Preliminary Materials Selection Guide,"* Paper 760139 presented at SAE Automotive Engineering Congress and Exposition, February 1976.
4. Ronald D. Beck, *"Plastic Product Design,"* Van Nostrand-Reinhold, 1970.
5. Sidney Gross, Ed., *"Modern Plastics Encyclopedia,"* Volume 51, No. 10A, McGraw-Hill, New York, 1974-1975.
6. J. K. Fowlkes, *"Value Control Design Guide,"* Value Analysis, Inc., California, 1970.



This paper is subject to revision. Statements and opinions advanced in papers or discussion are the author's and are his responsibility, not the Society's; however, the paper has been edited by SAE for uniform styling and format. Discussion will be printed with the paper if it is published

**Society of Automotive Engineers, Inc.**  
400 COMMONWEALTH DRIVE, WARRENDALE, PA. 15096

in SAE Transactions. For permission to publish this paper in full or in part, contact the SAE Publications Division.

Persons wishing to submit papers to be considered for presentation or publication through SAE should send the manuscript or a 300 word abstract of a proposed manuscript to: Secretary, Engineering Activities Board, SAE.

32 page booklet.

Printed in U.S.A.