

Report No. CG-D-17-95

**Coast Guard Mission Data Recorder (MDR)
for the 47-FT Motor Lifeboat - Phase 2**

Bert N. Macesker
Robert C. Desruisseau
Thomas J. Brion

U.S. Coast Guard
Research and Development Center
1082 Shennecossett Road
Groton, CT 06340-6096



FINAL REPORT
MAY 1995

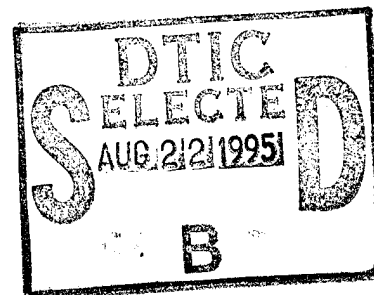

This document is available to the U.S. public through the
National Technical Information Service, Springfield, Virginia 22161

Prepared for:

U.S. Department of Transportation
United States Coast Guard
Office of Engineering, Logistics, and Development
Washington, DC 20593-0001

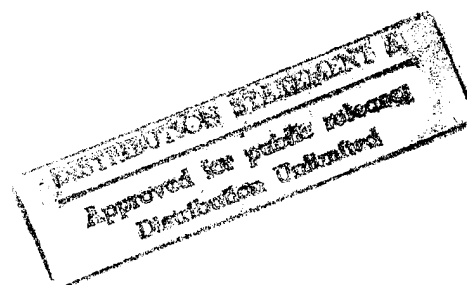

19950822 023

NOTICE

This document is disseminated under the sponsorship of the Department of Transportation in the interest of information exchange. The United States Government assumes no liability for its contents or use thereof.

The United States Government does not endorse products or manufacturers. Trade or manufacturers' names appear herein solely because they are considered essential to the object of this report.

The contents of this report reflect the views of the Coast Guard Research & Development Center. This report does not constitute a standard, specification, or regulation.



G. T. Gunther
Technical Director, Acting
United States Coast Guard
Research & Development Center
1082 Shennecossett Road
Groton, CT 06340-6096

Technical Report Documentation Page

1. Report No. CG-D-17-95		2. Government Accession No.		3. Recipient's Catalog No.	
4. Title and Subtitle Coast Guard Mission Data Recorder (MDR) for the 47-FT Motor Lifeboat - Phase 2				5. Report Date May 1995	
				6. Performing Organization Code	
7. Author(s) Bert N. Macesker, Robert C. Desruisseau, and Thomas J. Brion				8. Performing Organization Report No. R&DC 08/95	
9. Performing Organization Name and Address U.S. Coast Guard Research and Development Center 1082 Shennecossett Road Groton, CT 06340-6096				10. Work Unit No. (TRAI5)	
				11. Contract or Grant No.	
12. Sponsoring Agency Name and Address Department of Transportation U.S. Coast Guard Office of Engineering, Logistics, and Development Washington, D.C. 20593-0001				13. Type of Report and Period Covered Final Report - Phase 2 June 1994 through March 1995	
				14. Sponsoring Agency Code Commandant (G-NRS) U.S. Coast Guard Headquarters Washington, D.C. 20593-0001	
15. Supplementary Notes					
16. Abstract A Mission Data Recorder (MDR) was designed and built by the Coast Guard R&D Center to support the Operational Test and Evaluation (OT&E) of the 47-FT Motor Lifeboat (MLB). The purpose of the MDR was to collect both short-term event data and long-term vessel motions data in an autonomous manner, similar to an aircraft flight data recorder. Phase 1 results were published in "Coast Guard Mission Data Recorder (MDR) for the 47-FT Motor Lifeboat," Report No. CG-D-20-94. Phase 2 follow-on data collection includes the recording of one significant event which was recorded during a towing operation. Statistics data for the Phase 2 period of June 1994 to March 1995 were collected and analyzed. Heave acceleration and roll frequency distribution curves were developed for each boat. The MDRs will remain onboard the 47-FT MLBs for an additional year to continue monitoring for significant motion events and to collect data on how the boats will be used following the close scrutiny of the OT&E.					
17. Key Words motor lifeboat 47-FT MLB motion statistics			18. Distribution Statement Document is available to the U.S. public through the National Technical Information Service, Springfield, Virginia 22161		
19. Security Classif. (of this report) UNCLASSIFIED		20. SECURITY CLASSIF. (of this page) UNCLASSIFIED		21. No. of Pages	22. Price

METRIC CONVERSION FACTORS

Approximate Conversions to Metric Measures

Symbol	When You Know	Multiply By	To Find	Symbol
LENGTH				
in	inches	* 2.5	centimeters	cm
ft	feet	30	centimeters	cm
yd	yards	0.9	meters	m
mi	miles	1.6	kilometers	km
AREA				
in ²	square inches	6.5	square centimeters	cm ²
ft ²	square feet	0.09	square meters	m ²
yd ²	square yards	0.8	square meters	m ²
mi ²	square miles	2.6	square kilometers	km ²
	acres	0.4	hectares	ha
MASS (WEIGHT)				
oz	ounces	28	grams	g
lb	pounds	0.45	kilograms	kg
	short tons (2000 lb)	0.9	tonnes	t
VOLUME				
tsp	teaspoons	5	milliliters	ml
tbsp	tablespoons	15	milliliters	ml
fl oz	fluid ounces	30	milliliters	ml
c	cups	0.24	liters	l
pt	pints	0.47	liters	l
qt	quarts	0.95	liters	l
gal	gallons	3.8	liters	l
ft ³	cubic feet	0.03	cubic meters	m ³
yd ³	cubic yards	0.76	cubic meters	m ³
TEMPERATURE (EXACT)				
°F	Fahrenheit temperature	5/9 (after subtracting 32)	Celsius temperature	°C

* 1 in = 2.54 (exactly).

Approximate Conversions from Metric Measures

Symbol	When You Know	Multiply By	To Find	Symbol
LENGTH				
mm	millimeters	0.04	inches	in
cm	centimeters	0.4	inches	in
m	meters	3.3	feet	ft
m	meters	1.1	yards	yd
km	kilometers	0.6	miles	mi
AREA				
cm ²	square centimeters	0.16	square inches	in ²
m ²	square meters	1.2	square yards	yd ²
km ²	square kilometers	0.4	square miles	mi ²
ha	hectares (10,000 m ²)	2.5	acres	
MASS (WEIGHT)				
g	grams	0.035	ounces	oz
kg	kilograms	2.2	pounds	lb
t	tonnes (1000 kg)	1.1	short tons	
VOLUME				
ml	milliliters	0.03	fluid ounces	fl oz
l	liters	0.125	cups	c
l	liters	2.1	pints	pt
l	liters	1.06	quarts	qt
l	liters	0.26	gallons	gal
m ³	cubic meters	35	cubic feet	ft ³
m ³	cubic meters	1.3	cubic yards	yd ³

TEMPERATURE (EXACT)

°C	Celsius temperature	9/5 (then add 32)	Fahrenheit temperature	°F
----	---------------------	-------------------	------------------------	----

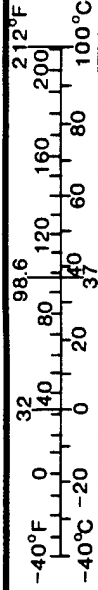

TABLE OF CONTENTS

	<u>Page</u>
INTRODUCTION.....	1
BACKGROUND.....	1
Mission Data Recorder Objectives.....	1
Summary of Phase 1 Results.....	2
DISCUSSION	2
Events Recorded.....	2
Crew Interviews.....	3
Area of Recorded Operations (AROs).....	6
Engine RPM Analysis.....	7
Motion Statistics Analysis.....	9
MDR Functional Overview.....	15
MDR Data Off-Loading	16
CONCLUSIONS/RECOMMENDATIONS.....	16
REFERENCES	19
APPENDIX A - 47201 DATA RESULTS.....	A-1
APPENDIX B - 47202 DATA RESULTS.....	B-1
APPENDIX C - 47203 DATA RESULTS.....	C-1
APPENDIX D - 47204 DATA RESULTS.....	D-1
APPENDIX E - 47205 DATA RESULTS.....	E-1
APPENDIX F - 47200 DATA RESULTS.....	F-1

Accession For	
NTIS GRA&I	<input checked="" type="checkbox"/>
DTIC TAB	<input type="checkbox"/>
Unannounced	<input type="checkbox"/>
Justification	
By	
Distribution/	
Availability Codes	
Dist	Avail and/or Special
A-1	

DTIC QUALITY INSPECTED 2,

LIST OF ILLUSTRATIONS

<u>Figure</u>		<u>Page</u>
1	Event Summary Plot Key.....	4
2	Key to Interpretation of Virtual Instruments.....	5
3	Area of Recorded Operation (ARO) Plot Key.....	8
4	Composite Engine Usage Profile for Proproduction MLBs.....	10
5	47205 Low Speed Towing Mission.....	11
6	47205 Low Speed Towing Mission.....	12
7	47204 Low Speed Towing Mission.....	13
8	47204 Low Speed Towing Mission.....	14

LIST OF TABLES

<u>Table</u>		<u>Page</u>
1	Summary of Statistics Data Collected.....	17

ACKNOWLEDGMENTS

The cooperation of each of the five stations tasked with testing the preproduction 47-FT Motor Lifeboats is gratefully acknowledged. This includes the crew of the 47200 which has recently been outfitted with a mission data recorder (MDR). Although a nearly autonomous MDR device was developed, some additional responsibility had to be given to each station (on top of their already busy work schedule) to support the MDR data collection. Appreciation is expressed to the Program Sponsors (G-NRS) including CDR Lewandowski and LTJG Popiel for their guidance and support.

EXECUTIVE SUMMARY

A Mission Data Recorder (MDR) was designed and built by the Coast Guard R&D Center to support the Operational Test and Evaluation (OT&E) of the 47-FT Motor Lifeboat (MLB).

The OT&E was conducted by Commandant (G-NRS), Coast Guard Headquarters, to evaluate the effectiveness and suitability of five 47-FT MLBs placed at various stations under operation by standard Coast Guard (CG) crews as opposed to the prototype, which had a special Test Team.

The purpose of the MDR was to collect both short-term event data and long-term vessel motions data in an autonomous manner, similar to an aircraft flight data recorder. Phase 1 results were published in Report No. CG-D-20-94, "Coast Guard Mission Data Recorder (MDR) for the 47-FT Motor Lifeboat." Phase 1 contains detailed descriptions of the MDR development and discussions of roll-events recorded during the period of SEPTEMBER 1993 to JUNE 1994.

The work in this report represents Phase 2 follow-on data collection and event analysis. Only one significant event was recorded during Phase 2 that was in the course of a towing operation rather than rough seas. Statistical data for the Phase 2 period of JUNE 1994 to MARCH 1995 were collected and analyzed. Both heave acceleration and roll frequency distribution curves were developed from the MDR statistics collected on each boat. Engine usage profiles were also developed for each boat.

INTRODUCTION

The 47-FT Motor Lifeboat (MLB) design was developed by the U.S. Coast Guard and Textron Marine Systems. The 47-FT MLB is designed as a heavy weather rescue boat with self-righting capabilities. The self-righting capability of a 47-FT MLB is essential since it can expect to encounter violent motions in the surf with an occasional severe roll or even 360 degree rollover in the course of conducting operations.

The Coast Guard is planning to replace the aging 44-FT MLBs with these 47-FT MLBs. Prior to full-scale production, five preproduction boats underwent an Operational Test & Evaluation (OT&E). The five Coast Guard stations involved with the OT&E were:

Station Cape May, Cape May, NJ	47201
Station Oregon Inlet, Rodanthe, NC	47202
Station Tillamook, Garibaldi, OR	47203
Station Umpqua River, Reedsport, OR	47204
Station Gloucester, Gloucester, MA	47205

The objective of the OT&E as defined in the OT&E Plan [1] was to evaluate the *effectiveness* and *suitability* of the Coast Guard 47-FT MLB. The results of the OT&E were presented to the Coast Guard Acquisition Review Council (CGARC) in Reference [2].

The R&D Center was tasked to develop a Mission Data Recorder (MDR) to autonomously record operating hours, motion environment, operational profile, and capture any significant events such as a boat rollover. The task of developing an MDR, which addresses one of the six OT&E evaluation components [1], was presented in Reference [3].

BACKGROUND

Mission Data Recorder Objectives

Two main objectives were established from the start of this project to collect motions data on the 47-FT MLB. They were as follows:

- o The primary objective for the MDR is to have the ability to reconstruct a severe dynamic event such as a rollover when an established threshold is exceeded.
- o The secondary objective for the MDR is to collect data to develop motion and underway time histories.

These objectives apply to both phases of MDR data collection, Phase 1 and Phase 2. The MDR was developed to function like an aircraft flight recorder "black box." The concept is to use a self-contained sensor package and data-logger to record the

motions and control settings on the 47-FT MLB when threshold conditions are exceeded. The recorded data is played back after an incident to help reconstruct the actual event.

Summary of Phase 1 Results

A total of nine significant motion events were recorded during the first six-month OT&E period, Phase 1. The MDR roll thresholds ranged from 30 to 45 degrees on the preproduction boats. A few exceptional events were recorded including a 137 degree roll on the 47202, a 53 degree roll and 35 degree pitch event on the 47201, and a 72 degree roll experienced by the 47203. The first two boats are located on the East Coast at Station's Oregon Inlet (47202) and Cape May (47201). The last boat is located on the West Coast at Station Tillamook. Permanent records of these events were obtained, showing roll, pitch, yaw, engine RPM, and rudder angle. On two occasions where a severe roll occurred, the engine on the side toward the roll stalled and was restarted in about one-minute. A computer screen animation capability was developed called BOATVU and assisted in debriefing the crew.

Areas of Recorded Operations (AROs) were developed for each station using the Coast Guard Electronic Engineering Center's program, Geographical Display Operations Computer (GDOC). Motion statistics collected in Phase 1 were reduced and presented by a monthly basis.

It was stated in the Phase 1 report in Reference [3] that the R&D Center would continue to collect motion events and statistics with the MDR in Phase 2. In addition the R&D Center would conduct informal interviews with coxswains by presenting the animations and data on events recorded to develop an improved picture of what happened for notable events. The interviews were intended to uncover whether or not the R&D Center should reevaluate the MDR's definition of an event. There could be a need to capture other more important boat maneuvering concerns that the coxswains had experienced.

In Reference [2] Commandant G-NRS recommended proceeding with the production phase of the 47-FT MLB Acquisition Project while continuing to evaluate the MLBs in heavy weather and surf operations.

DISCUSSION

Events Recorded

It was intended that the MDRs have a roll threshold set to 60 degrees in Phase 2 data collection. It was generally believed that more severe events would be captured during the winter Search and Rescue (SAR) season, especially for small boat stations on the West Coast.

An Event was captured on the 47202 at Station Oregon Inlet with the roll threshold set to 45 degrees. This represents the only significant event captured. The 47202 experienced a 50 degree roll event on 23 February 1995. The data collected on this event are presented in Table B-1 and Figures B-5 through B-14 in Appendix B. Figures 1 and 2 are presented from Reference [3] to provide plot keys for interpreting data in the Appendix. Figures B-7 and B-8 demonstrate that the boat was heeled to starboard for most of the captured 12 minutes. Figure B-8 indicates that the boat experienced a quick roll to starboard in a couple of seconds and experienced a similar roll 15 seconds later. It is apparent from Figures B-5, B-6, and B-9 that the boat was predominantly in a bow up position throughout the 12 minutes. It was later determined through a conversation with the coxswain from that day that they had experienced a sharp starboard roll during a towing case. The 47202 pulled the M/V CAPT WEDDELL, a 74-FT 69 ton vessel, off a sand bar. The towing of a vessel explains the constant stern down position of the 47202. RPM readings were not available for the starboard engine as shown in Figure B-10. During an R&D Center visit to the 47202 the starboard optical tach was found to be pointing away from the shaft. This was probably the result of someone inadvertently stepping on the tach fixture.

A computer-based animation was developed using data from this event. The roll, pitch, and heave data were low-pass filtered around 1 Hz. A 1 Hz second order Butterworth Filter was used to eliminate unwanted noise while retaining sufficient rigid-body motion information. The filtering had the effect of slightly reducing the amplitudes of these data as illustrated in Figure B-11 but was necessary for importation into the animation routine called BOATVU. Figures B-12 through B-14 present snapshots from this animation.

Crew Interviews

It was observed by crew members on both the 47203 and 47204 that splitting the throttles, i.e., quickly shifting one engine in reverse, at high speed to improve the turn radius could cause the engine to stall. This is what caused the one engine to stall on 3 March 1994 when the 47201 experienced a 53 degree roll. This was reported in detail in Reference [3]. Recent discussions with the coxswain revealed that they were operating the 47201 in 12 foot swells at a cruising speed of 2000 RPM. The 47201 went up the back of a swell, crested the swell, and rapidly accelerated down the face of it as the boat turned left and came abeam to the swell. The boat quickly rolled to starboard 53 degrees and also pitched to 35 degrees. The starboard engine stalled immediately after the coxswain moved the starboard throttle past reverse. It took 53 seconds to bring the starboard engine back on line.

Event Summary Plot Key:

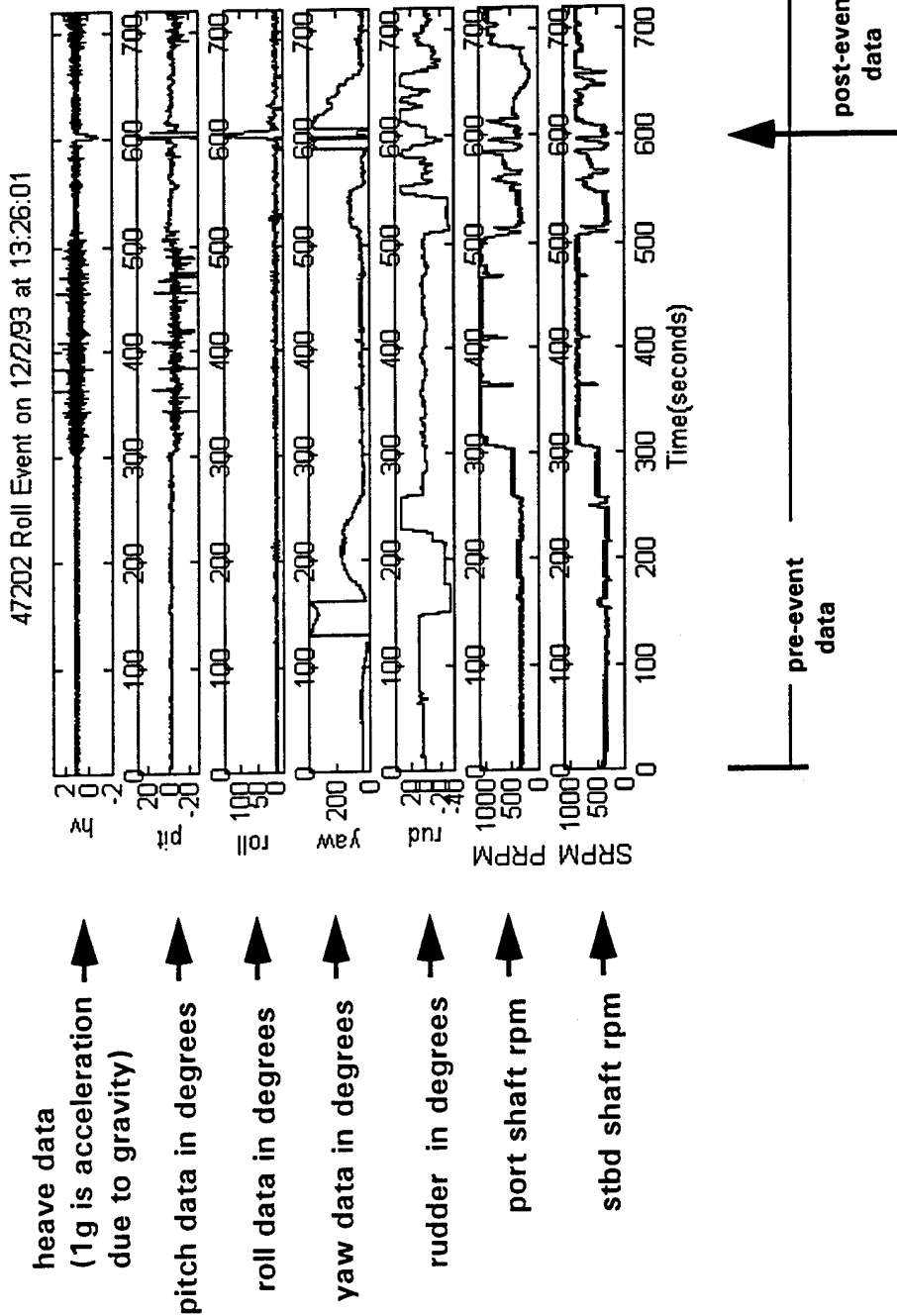

Figure 1. EVENT SUMMARY PLOT KEY

Animation Snapshot Plot Key:

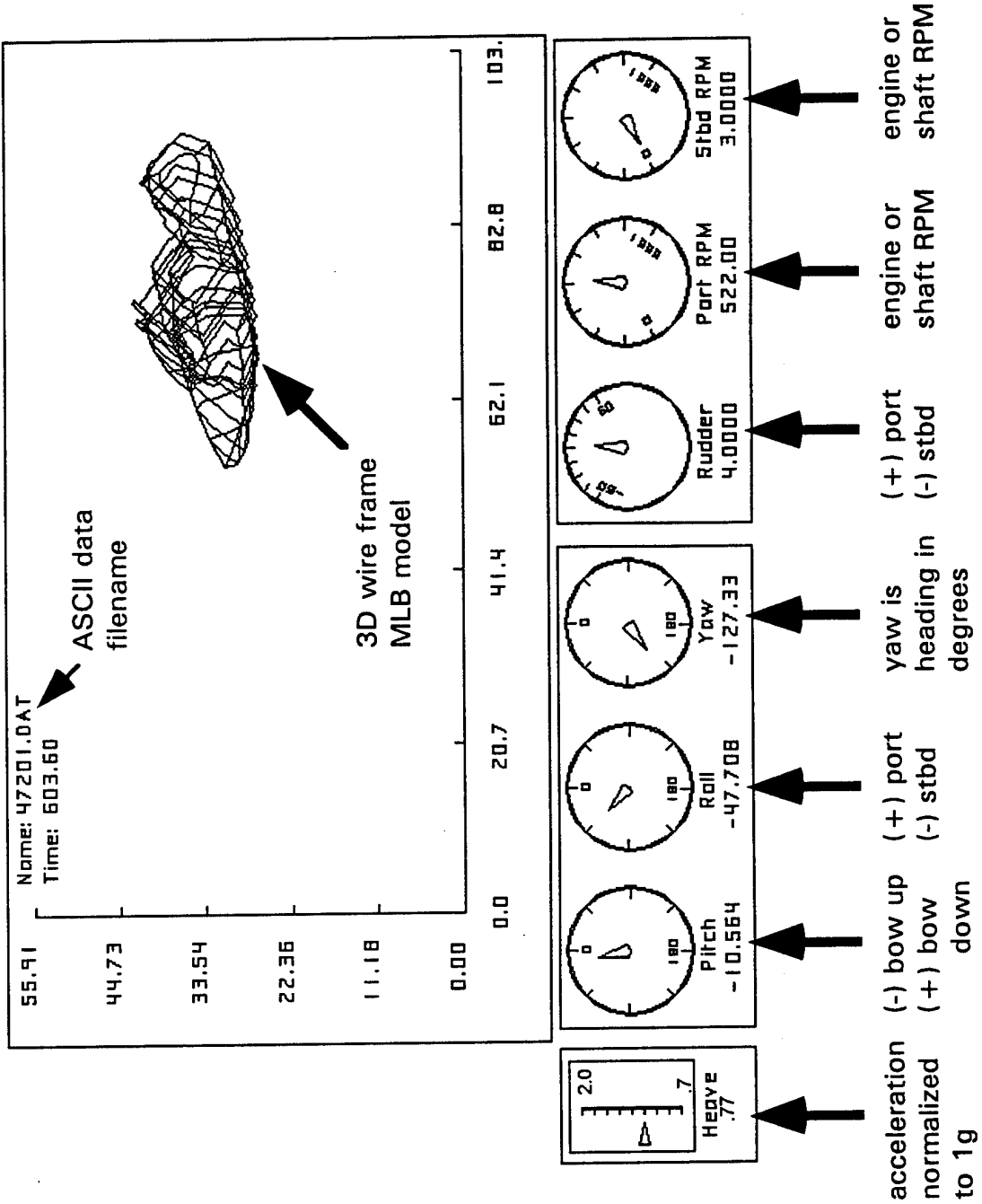

Figure 2. KEY TO INTERPRETATION OF VIRTUAL INSTRUMENTS

Another instance of a stalled engine after a roll of 137 degrees occurred on the 47202. There does not appear to be any correlation between these two instances. The 47202's port engine was not throttled through reverse but maintained levels just below clutch speed. A final determination of why the 47202 engine stalled in this event has not been made.

The OT&E Report in Reference [2] includes Station Reports that provided detailed narratives of the most significant events including the 47203 72 degree roll on 12 June 1994 and the 47202 137 degree roll on 2 December 1993. These discussions are consistent with the data collected with the MDR. The only anomaly in the data captured on the 47203 roll event was the MDR tach data which demonstrated RPM levels out of synchronization. This was confirmed in Phase 2 by the crew's explanation that the boat had to be run at different RPM settings. This could be due to a variety of reasons including rudder misalignment or a skewed hull.

The 47-FT MLB crews were asked if they had encountered any unusual boat behavior in rough seas such as pitch poling close calls, broaching in following seas, or general controllability problems. Only one chine riding incident was indicated. This occurred on the 47203 and involved the 47-FT MLB losing helm control in attempting to turn in following seas. According to the crew member the boat heeled to one side and held a steady course, as if riding on the chine. This is similar to problems encountered in DT&E testing of the 47200 in Reference [4]. The MDR could be modified to trigger on a combination of rudder and yaw rates to capture similar events. However, this appears to have been an isolated case.

The crews were asked about possible engine related parameters that might be affected after a severe roll, such as loss of fuel suction, engine air deprivation, and water entry through the fuel tank vent. The crew members interviewed did not believe any of these items would present a problem during a roll. Although, some felt that the engines in general may not be getting enough ventilation.

It has not been determined why the 47202 engine stalled after its 137 degree roll. The MDR could be modified to collect other engine parameters such as engine room pressure as a function of time. Alternatively, the MDR could trigger the DDEC computer to take a snapshot of the engine parameters after a triggered roll event. The R&D Center is exploring the level of difficulty in interfacing the MDR with the DDEC computer.

Area of Recorded Operations (AROs)

The Area of Recorded Operations (AROs) is defined as the latitude and longitude locations recorded by the MDR for the purposes of this report. This is not to be confused with Areas of

Responsibility (AORs). The MDR records position fixes every 10 minutes when the MLBs are underway. The navigational information is decoded from the LORAN set in the enclosed bridge.

A front-end conversion program was written to manipulate the MDR ASCII output to be compatible for import into the Geographical Display Operations Computer (GDOC). Figure 3 provides a key to the interpretation of the MDR ARO plots.

The AROs are presented in the Appendices of the respective MLB. A perimeter was drawn around the recorded position data to indicate the bounds to each boat's underway locations. Some scatter in the data may be evident in the ARO plots. This may be due to the LORAN receiver not locking up on the signal properly. The overview plots are not very informative except in indicating the MLB's range of operations and where the MLB's coverage would overlap with other small boat stations. However, increasing the view of the MLB operating areas using GDOC demonstrate definite tracks that the MLBs tend to cruise. The GDOC files are available upon request.

Engine RPM Analysis

A concern under the Maintainability Critical Operational Issue (COI) identified in Reference [2] involved the Mean Time Between Overhaul (MTBO) of the preproduction boat engines. An engine usage profile can be developed from the MDR data over a long period of time. Presently, the MDR collects an average RPM value on the port engine every 10 minutes. These data can be sorted into RPM bins to generalize the boat's usage. Engine usage profiles were developed for underway hours for the five preproduction boats. The results are presented in the Appendices in Figures A-2, B-2, C-2, D-2, and E-2 for each boat. A frequency sort was used to compute the numbers and proportions of observations falling into specific RPM ranges. These data do not give a complete picture of engine use, e.g., throttling transients, etc. However, they do present a view of engine usage that could be used in the construction of future engine life test procedures.

The engine usage profiles can be used by selecting specific RPM operating ranges of interest. For example, Station Cape May's 47201, Figure A-2, operates its engines between 1850-2000 RPM 19.34% of the time underway.

It is apparent that the West Coast MLBs (47203 and 47204) operate at lower RPM ranges compared to the East Coast MLBs (47202 and 47201). The 47201 and 47202 demonstrated more distinctive usage at either low RPM (650-800) or higher RPM (2000-2150). The 47205 at Station Gloucester stands apart in its engine usage profile. The 47205 exhibits 43% of its underway time as being in an RPM range of 650-800 RPM. This is roughly a speed of 5-7 knots and might be indicative of many towing cases.

Area of Recorded Operations (AROs) using the Geographical Display Operations Computer (GDOC) Summary Plot Key:

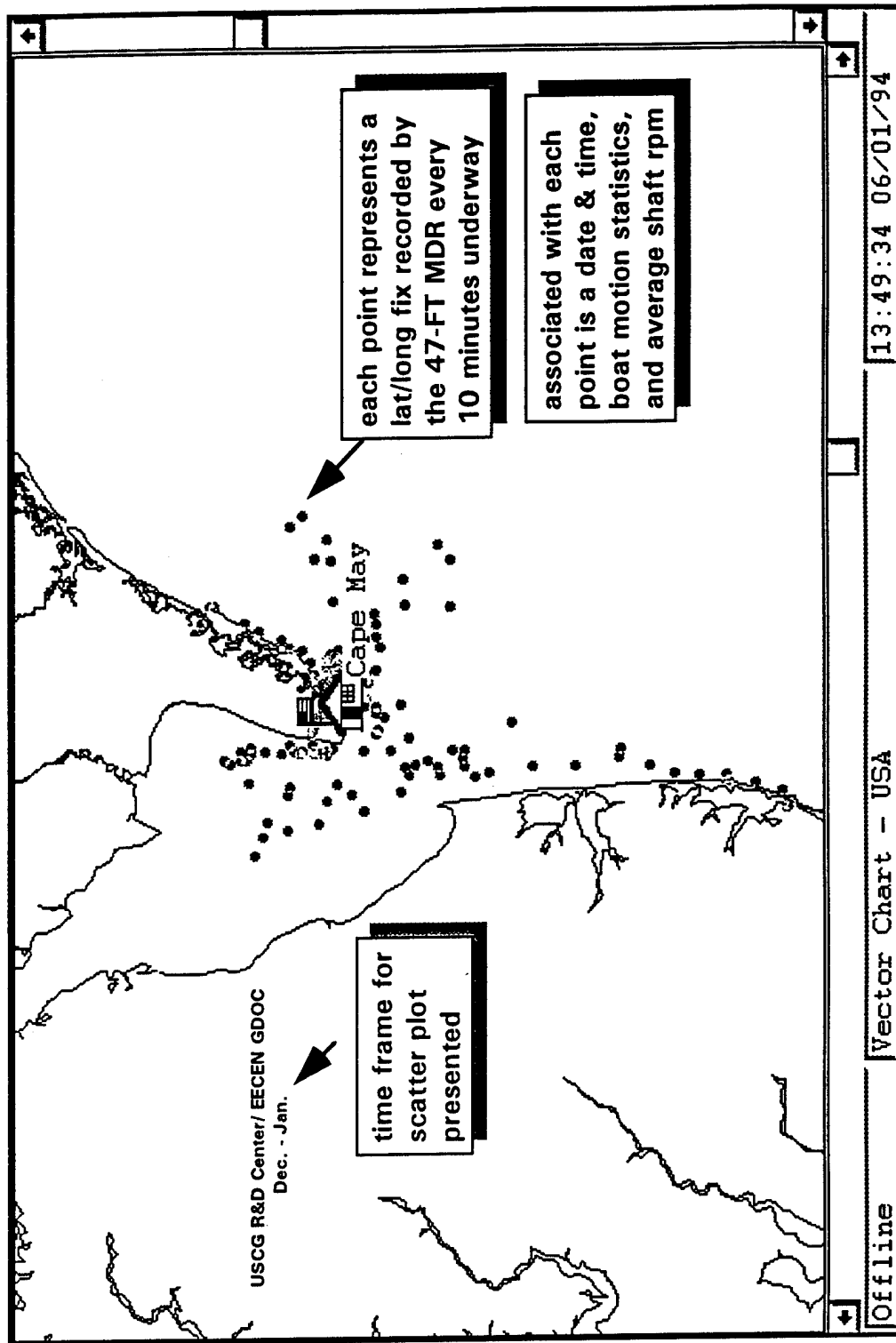

Figure 3. AREA OF RECORDED OPERATION (ARO) PLOT KEY

A composite engine usage profile was developed which includes data from all of the preproduction 47-FT MLBs. This is presented in Figure 4.

Engine usage could also be correlated to mission type. The MDR can not distinguish low speed towing operations from other slow speed operations. However, specific towing missions could be selected and cross-correlated to MDR statistics for that time frame. Two arbitrary cases are presented in Figures 5 through 8 from East and West Stations. The 47205 performed a stern tow of a 78-FT fishing vessel at roughly 6 knots in 5 foot seas on 3 January, Figures 5 and 6. The 47204 performed a tow on a 75 foot shrimp boat on 23 September, Figures 7 and 8. The shrimp boat was towed from offshore Station Umpqua River to Coos Bay at roughly 5 knots. Information like this would be more useful if it could be tied to engine load.

Motion Statistics Analysis

Appendices A through F contain the results of the data analysis for the 47201, 47202, 47203, 47204, 47205, and 47200, respectively.

Heave acceleration frequency distribution curves were developed for each boat. These data are presented in the Appendices in Figures A-3, B-3, C-3, D-3, and E-3. These data are referenced to $1g$ (32 ft/sec^2) or simply stated, the boat experiences $1g$ at rest with no heave motions. Heave values collected with RPM readings of less than 200 RPM were not included in this analysis. Using heave data associated with 200 RPM readings and higher insure that the heave distribution curves are representative of underway motions. The data can be used by selecting a heave acceleration range of interest. For example, Station Cape May's 47201, Figure A-3, will experience a range of 1.7 to 1.8 g 's of acceleration 1.32% of the time it is underway.

Roll frequency distributions are presented in the Appendices for each boat in Figures A-4, B-4, C-4, D-4, and E-4. The graphs were developed by sorting observed high roll values into 2 degree ranges starting at a lower bound of 2 degrees (upper bound of 42 degrees). Rolls less than 2 degrees were not included because they could be representative of motions of the boat when docked. The West Coast 47203 and 47204 roll frequency distributions are similar. The East Coast 47201, 47202, and 47205 roll distributions are similar to each other as well. The West Coast MLBs do exhibit more roll in the 4-12 degree range. It is apparent from the figures that the MLBs will experience 32-34 degree rolls no more than one percent of the time while underway.

The motion statistics data can be processed on a average daily basis which may provide a better "flavor" for the different levels of motions recorded by the boats at different geographical locations. These data are available upon request. Pitch frequency distributions are available upon request.

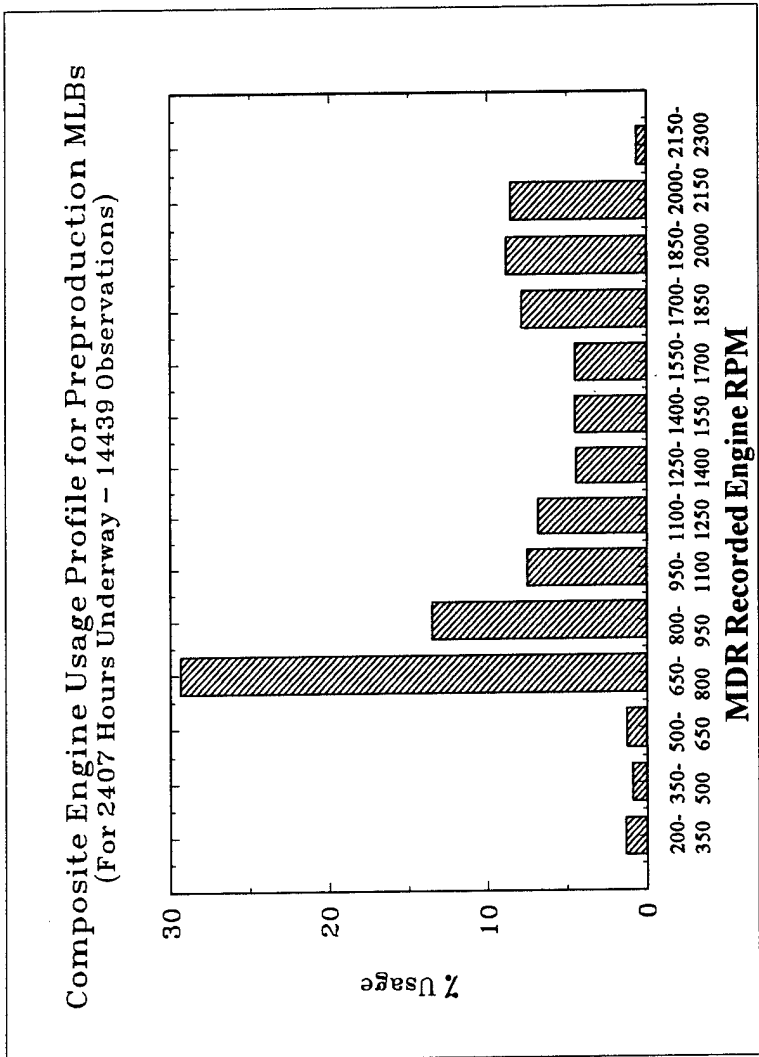

Figure 4. COMPOSITE ENGINE USAGE PROFILE FOR PREPRODUCTION MLBs

47205 Towing Mission of 78 FT F/V Morning Star
Stern Tow (1/3/95)

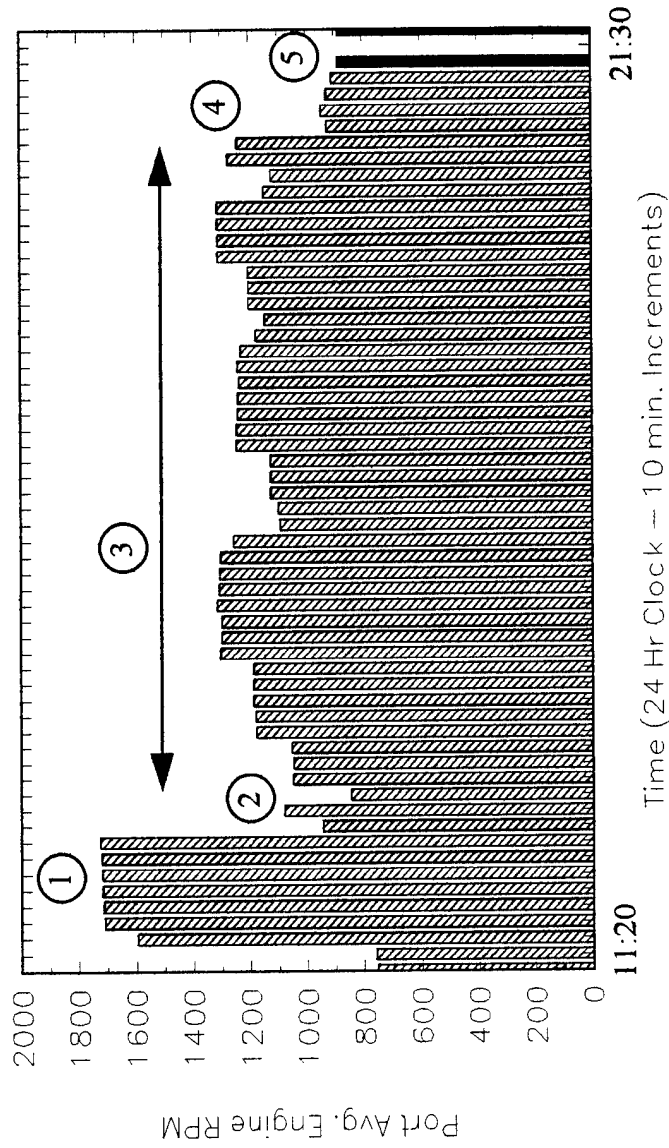

Figure 5. 47205 LOW SPEED TOWING MISSION

1. Transit to F/V Morning Star (approx. 118 GT) from Station Gloucester
2. On-scene attaching stern tow
3. Underway tow at roughly 6 knots in approximately 5 FT seas
4. Switch to side tow and vessel moored
5. Return to Station Gloucester

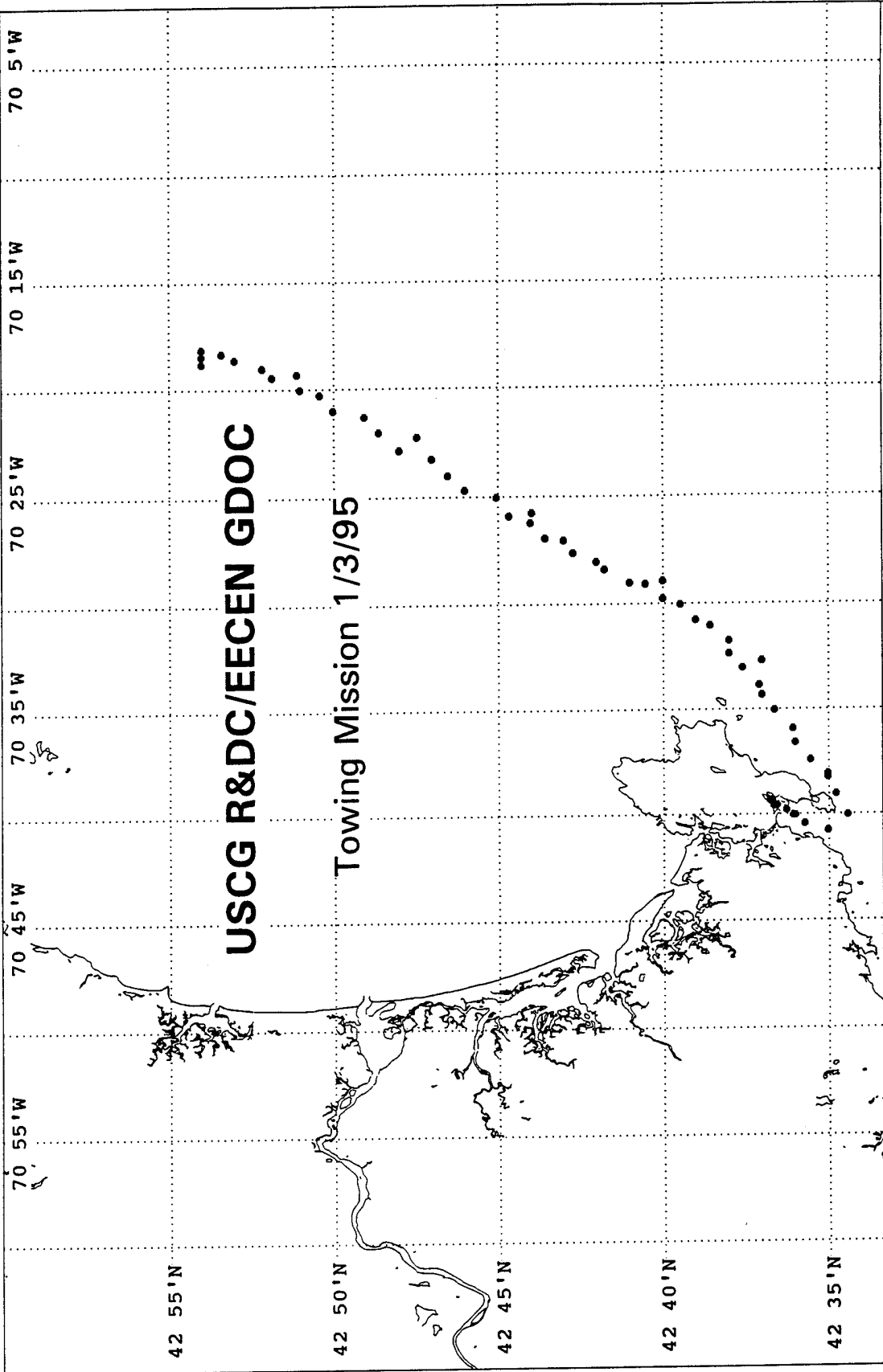

Figure 6. 47205 LOW SPEED TOWING MISSION

47204 Towing Mission of 75 FT Shrimp Boat
Stern Tow (9/23/94)

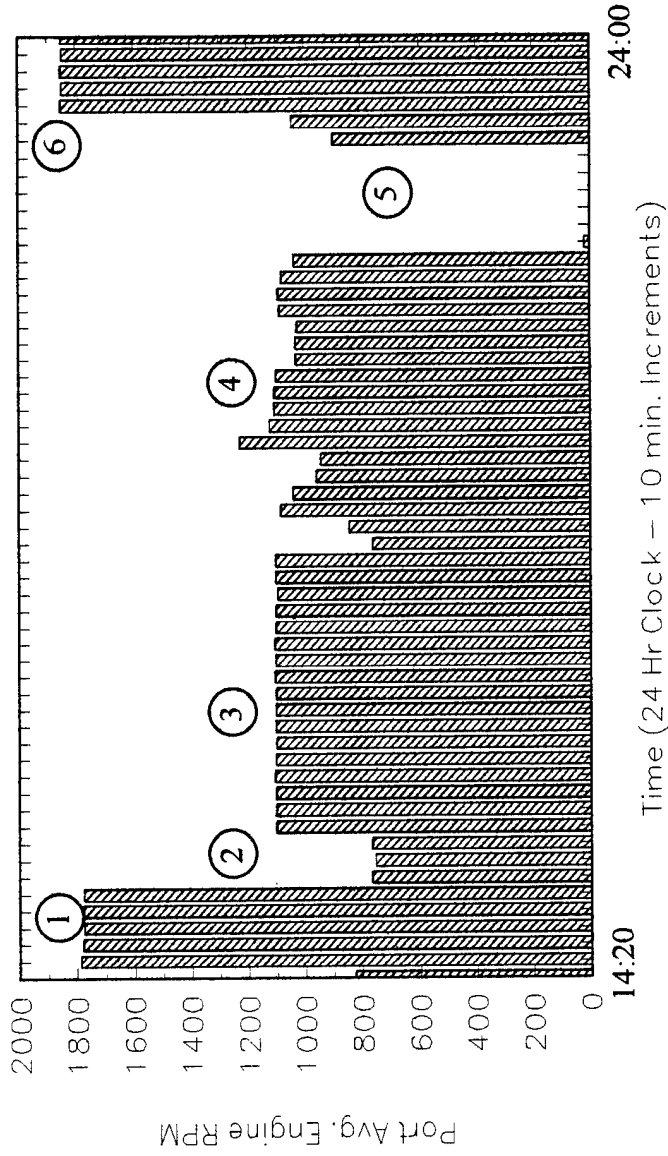

Figure 7. 47204 LOW SPEED TOWING MISSION

1. Transit to fishing vessel from Station Umpqua River
2. Attaching stern tow
3. Underway tow at roughly 5 knots
4. Maneuvering tow with 44-FT and 52-FT MLB's assistance to Coos Bay marina
5. Late breakfast at Station Coos Bay
6. Return transit to Station Umpqua River

Untitled

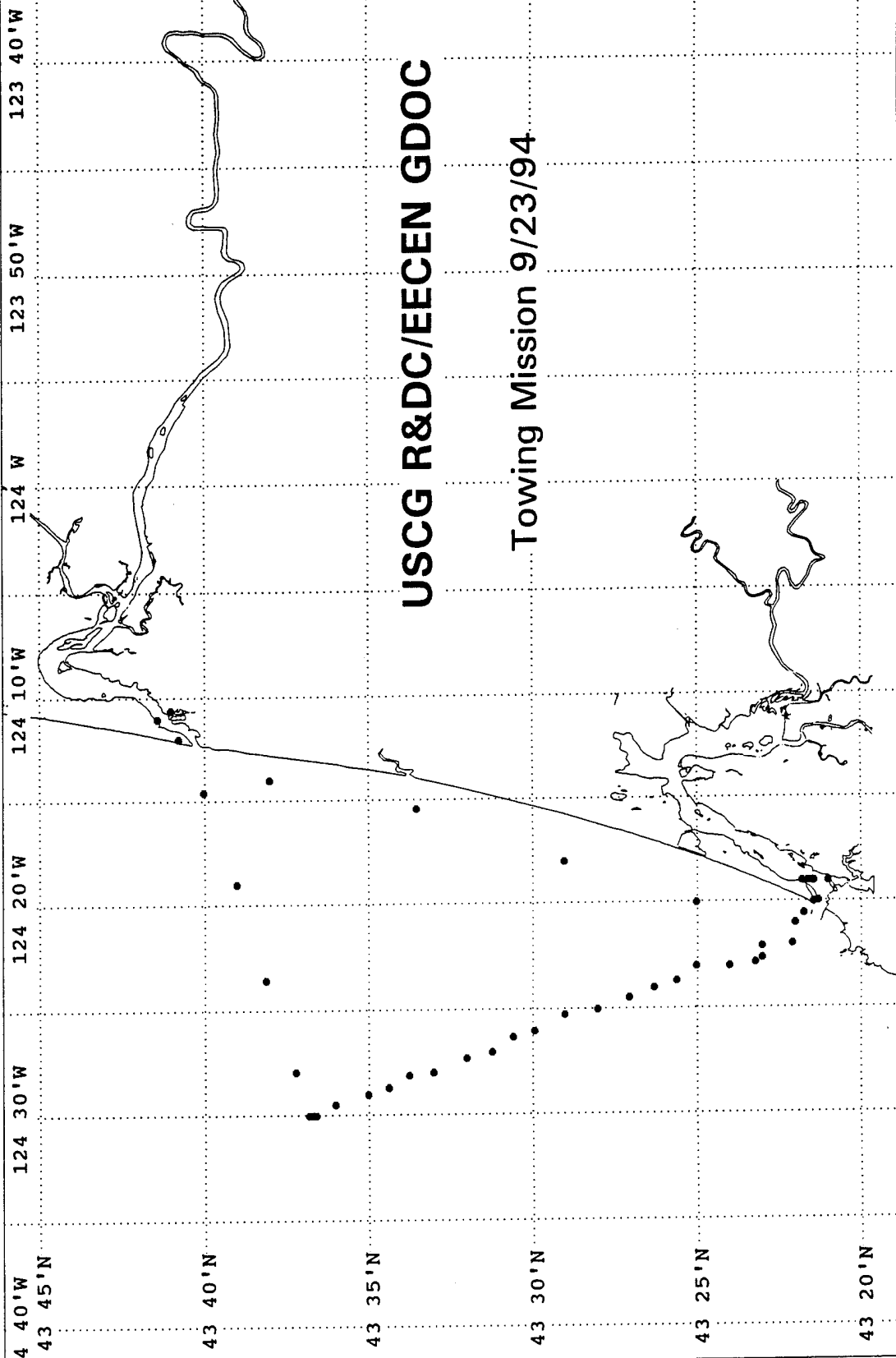

Figure 8. 47204 LOW SPEED TOWING MISSION

MDR Functional Overview

The MDR was designed to operate autonomously with minimal crew participation. The MDR remains in a low power "stand-by-mode" and charges up its battery when the 47-FT MLB is on shore-tie. After a relay detects a shore-tie power disconnect, it turns on and begins data collection. The shore-tie is normally disconnected just before the boat gets underway. This enables the MDR to monitor the boat's motions from the moment it leaves the dock until it returns. After the shore-tie is reconnected the MDR resumes its low power "stand-by mode" and charges up its battery for the next mission.

The MDR houses the computer board, 2 Mbyte expanded memory board, battery charger, and 12V6Ah gell cell battery. The MDR has four internal sensors. Two electronic, pendulum-type sensors are used to measure roll and pitch angles of motion. A 4g accelerometer measures heave motions and a fluxgate compass is used to measure yaw angle.

The MDR economizes storage space by recording data continuously in a revolving buffer at a 20 Hz sampling rate. When the MDR is on, the program collects 10 channels of information for a cycle of 10 minutes. During the 10-minute cycle, the MDR program continuously checks the roll sensor and determines if a threshold has been exceeded or not. If no event has been detected after the 10-minute cycle expires, the memory pointer goes to the beginning of the buffer and begins to collect new data. However, if an event is detected, the 10 minutes of information is saved as pre-event data. The program's progressive memory pointer moves to a different location and stores an additional two minutes of post-event data. A threshold software filter was added to eliminate the possibility of triggering on an artificial event such as a spurious voltage spike or extreme vertical acceleration.

The data in the 10 minute buffer is statistically reduced before the buffer is overwritten in the case of a non-event, saving the following:

- ◆ date and time
- ◆ heave RMS, heave average, highest heave value detected, lowest heave value detected
- ◆ pitch RMS, pitch average, highest pitch value detected, lowest pitch value detected
- ◆ roll RMS, roll average, highest roll value detected, lowest roll value detected
- ◆ average port shaft RPM
- ◆ ships position (lat/long)

If the shore-tie disconnect is not replaced and the internal 12V battery falls below 8.5 Volts, the system assumes a "sleep-mode"

to retain recorded data. When this occurs, the MDR data can only be recovered by executing a hard reset. The internal MDR battery will collect three to five days of continuous data acquisition without recharging. Further details, including MDR schematics and program listings, can be found in References [3] and [5].

MDR Data Off-Loading

In both Phase 1 and the early part of Phase 2 data collection, MDR data were off-loaded by a portable computer (HP95LX w/4 Mbyte PCMCIA card) sent to the stations. This required a crew member to attach the computer to the RJ-11 interface box in the Survivor's Compartment and run a batch communications program. This worked well except in a few instances where both operator and communication program errors occurred which jeopardized the integrity of the data. The portable computer is not being employed anymore. R&D Center personnel are now performing East and West Coast maintenance visits to off-load the data and to check MDR sensors. This is done every two to three months.

Table 1 provides an accounting of MDR data coverage for Phase 1 and Phase 2. The table provides a quick reference as to what type of MDR data were collected. It is apparent from this table that there are some gaps in MDR coverage. This is due to a number of reasons such as:

- o boat repairs away from shore-tie power for more than four days - a complete power drain on the MDR causes a memory purge
- o crew neglecting to periodically check the data status of the MDR

It is not clear why LORAN data collection had more gaps than the motion statistics unless the LORAN in the enclosed bridge was not always turned on. A couple of instances were detected where settings on the LORAN's interface were inadvertently changed so that Port 2 settings were no longer in the NEMA 183 format required by the MDR.

CONCLUSIONS/RECOMMENDATIONS

It was expected that more events would be collected during the winter SAR season in Phase 2. The roll thresholds on all of the boats had been set to 60 degrees except for the 47202. It is recommended that the thresholds on all of the boats be reset to 45-50 degrees so that a larger database of events can be captured and analyzed.

The splitting of throttles is probably what caused the 47201 starboard engine to stall on 3 March 1994. The ability to split throttles on a planing boat would be a desirable attribute in that it could enhance maneuverability especially in instances of

TABLE 1. SUMMARY OF STATISTICS DATA COLLECTED

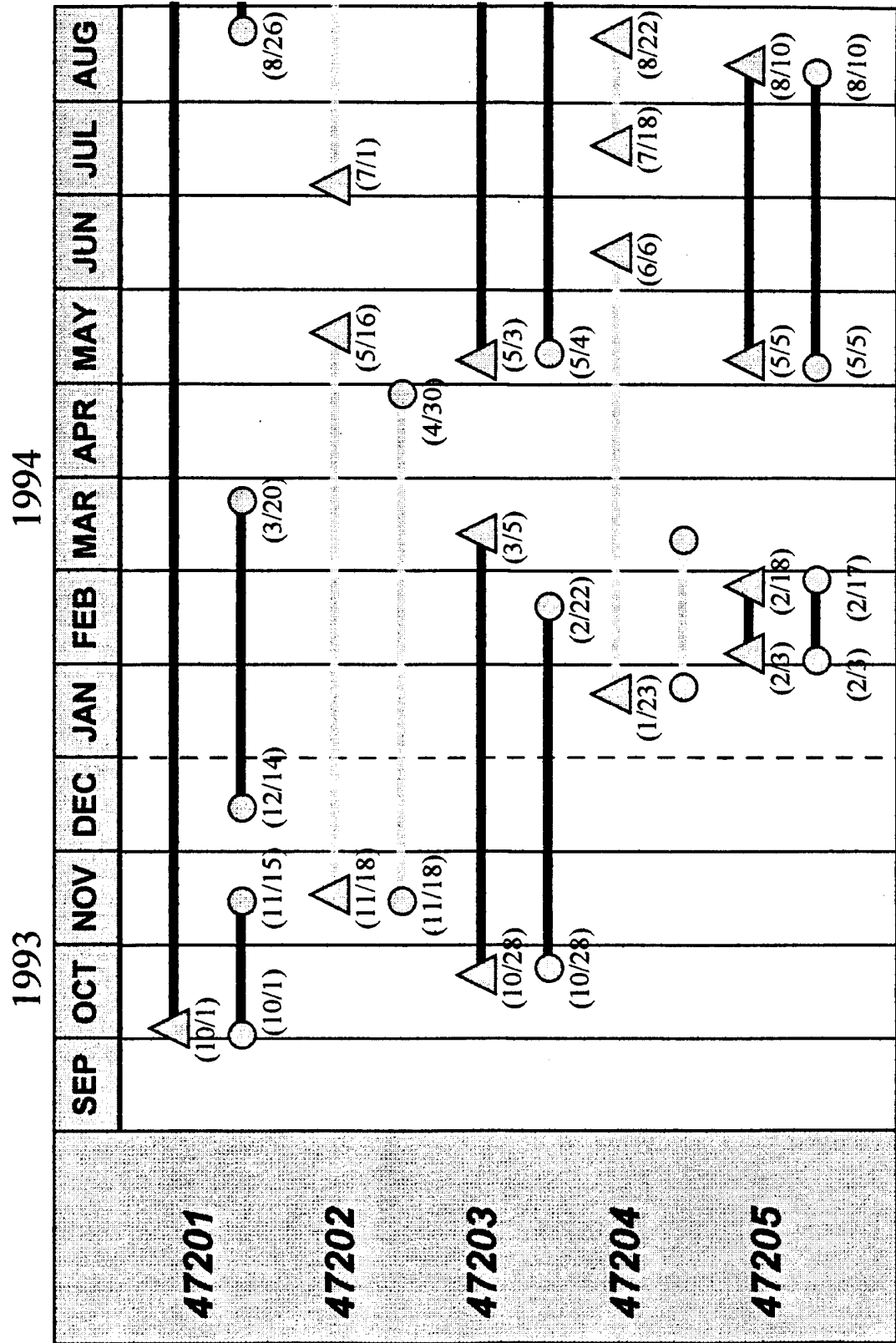
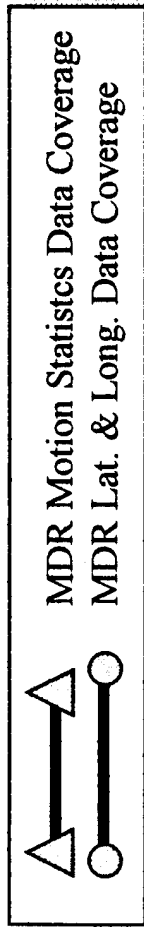
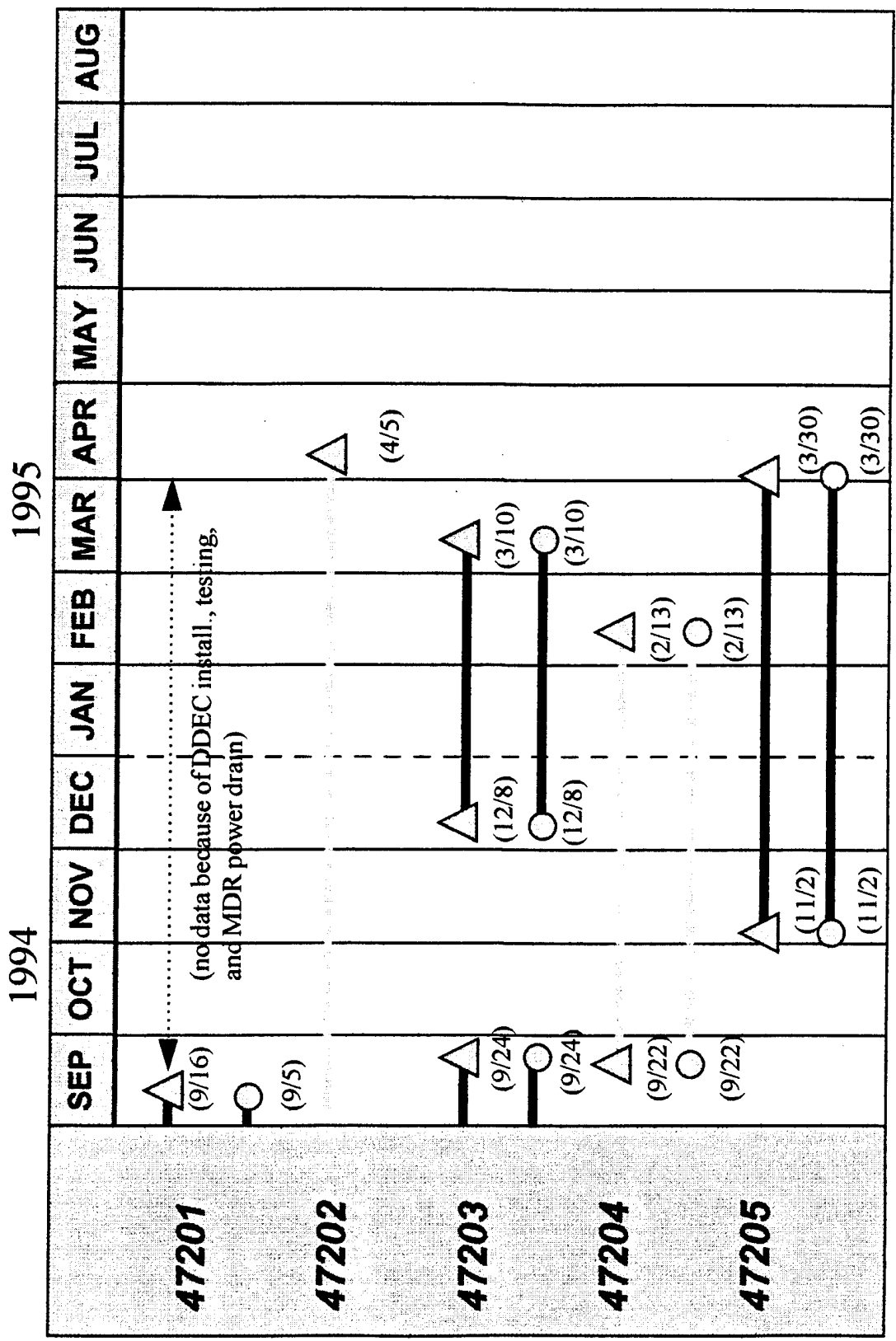
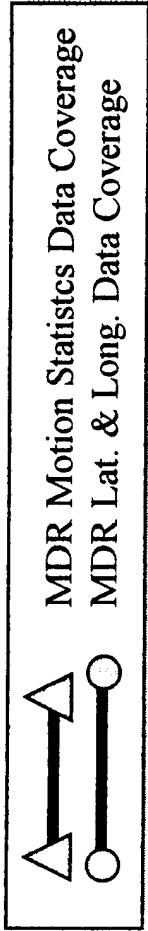

TABLE 1. SUMMARY OF STATISTICS
DATA COLLECTED (continued)



avoiding a potentially dangerous wave. Asking the coxswains to take precautionary steps to avoid throttle splitting in a dangerous situation where instincts take over is unrealistic. The new Detroit Diesel electronic throttles installed on the 47201 should prevent engine stalls of this nature but it is unclear if this an acceptable trade-off for less maneuverability. It is recommended that maneuvering tests, i.e., advance and transfer measurements, be done on the 47201 to determine any differences to the 47200 documented data collected in 1990. The 47200 data represent the only documented maneuvering data on the 47-FT MLB.

Engine load should be captured with RPM data over a long period of time to develop representative engine usage data to design future test procedures. This could be done with the DDEC computer on the 47201 or with a combination of DDEC input and the MDR.

REFERENCES

- [1] Operational Test and Evaluation Plan for the 47' Motor Lifeboat
- [2] Operational Test and Evaluation (OT&E) Report 47' Motor Lifeboat of the Motor Lifeboat Acquisition Program, December 1994
- [3] Coast Guard Mission Data Recorder (MDR) for the 47-FT Motor Lifeboat, Report No. CG-D-20-94
- [4] Technical Characteristics Verification of the Prototype 47-FT MLB, Coast Guard R&DC Final Report No. CG-D-02-92, October 1991
- [5] 47' Motor Lifeboat Mission Data Recorder Development Manual - Version 2, R&D Center Unpublished Document, Available Upon Request

APPENDIX A
47201 DATA RESULTS

ARO for 47201 : CAPE.VU

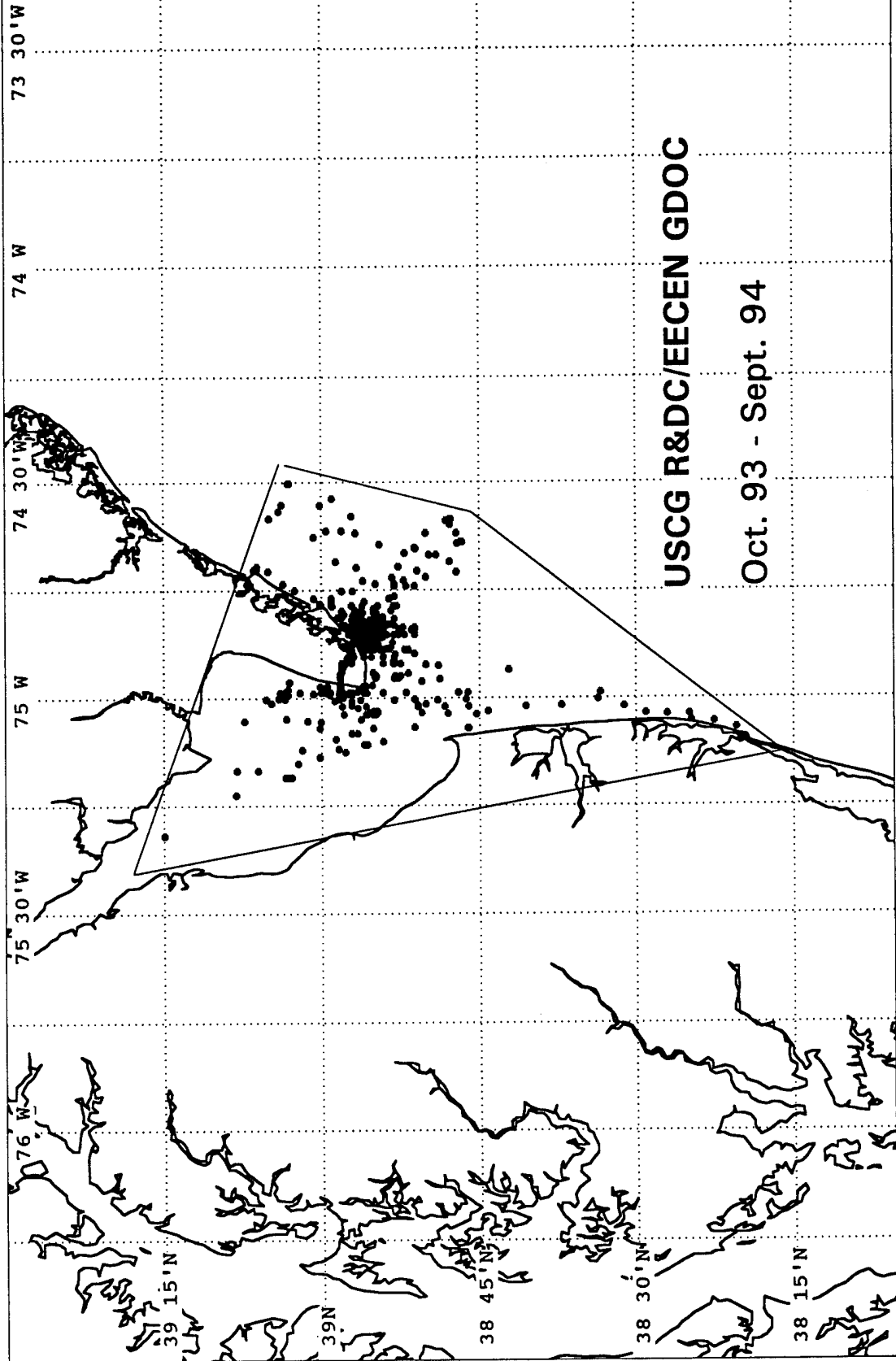

Figure A-1. AREA OF RECORDED OPERATIONS FOR 47201

47201 Engine Usage Profile
Out of 392 Recorded Hours Underway

RPM:	% Usage
200-350	1.02
350-500	1.07
500-650	0.94
650-800	21.39
800-950	19.13
950-1100	9.46
1100-1250	8.90
1250-1400	5.28
1400-1550	4.01
1550-1700	1.87
1700-1850	2.22
1850-2000	19.34
2000-2150	5.37
2150-2300	0.00

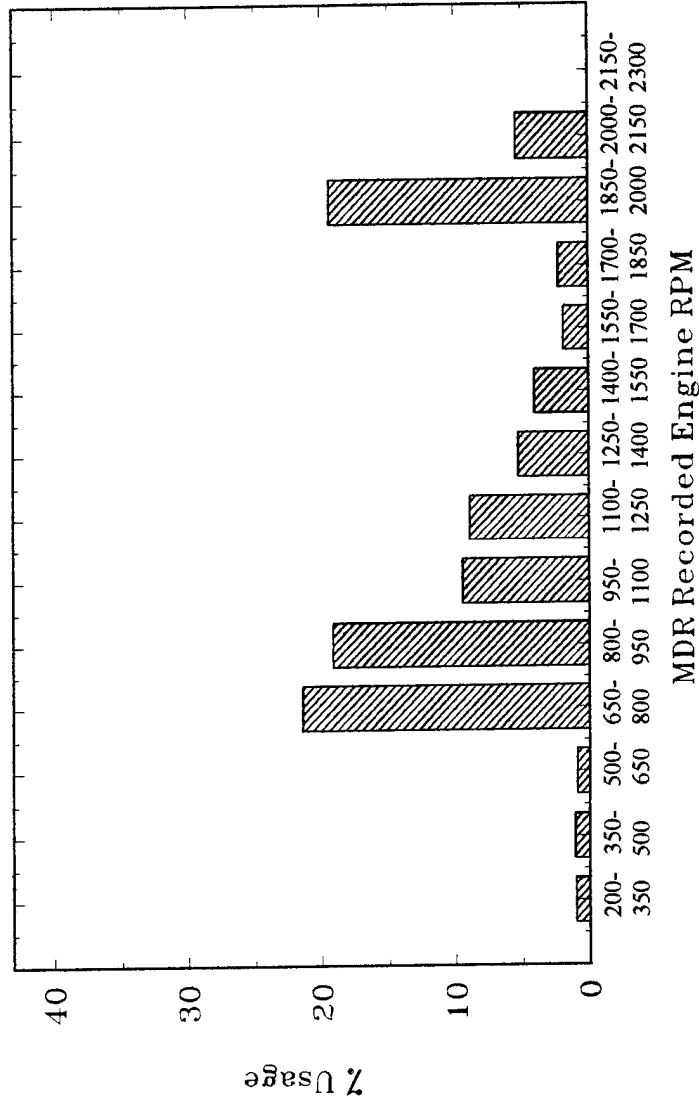
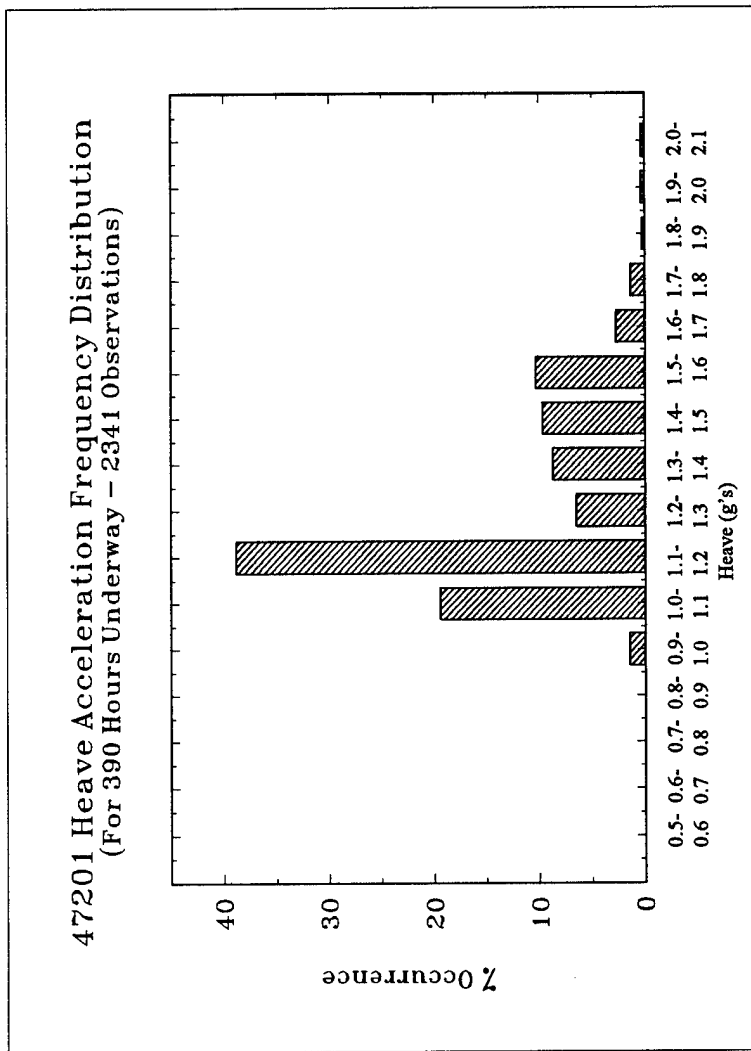

Figure A-2. 47201 ENGINE USAGE PROFILE



Heave Range	% Occurrence
0.5-0.6	0.00
0.6-0.7	0.00
0.7-0.8	0.00
0.8-0.9	0.00
0.9-1.0	1.45
1.0-1.1	19.44
1.1-1.2	38.83
1.2-1.3	6.49
1.3-1.4	8.71
1.4-1.5	9.74
1.5-1.6	10.34
1.6-1.7	2.73
1.7-1.8	1.32
1.8-1.9	0.26
1.9-2.0	0.34
2.0-2.1	0.34

[values outside sort range -
2.38, 2.38, 2.38, 2.28, 2.28, 2.18]

Figure A-3. 47201 HEAVE ACCELERATION FREQUENCY DISTRIBUTION

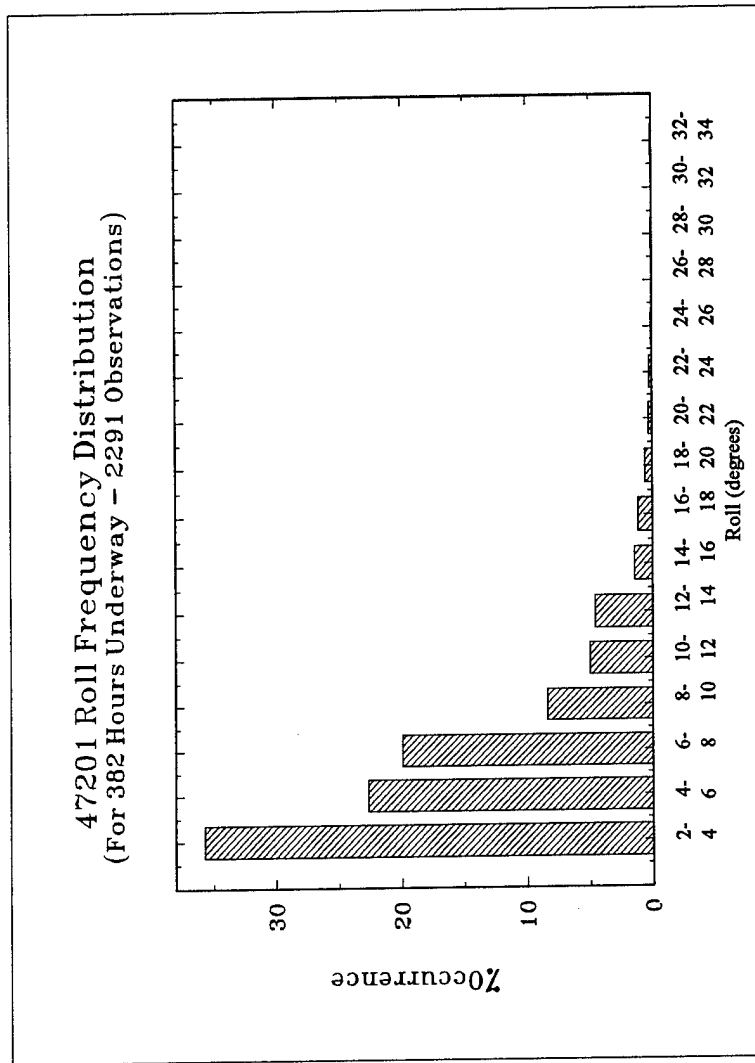

Figure A-4. 47201 ROLL FREQUENCY DISTRIBUTION

APPENDIX B
47202 DATA RESULTS

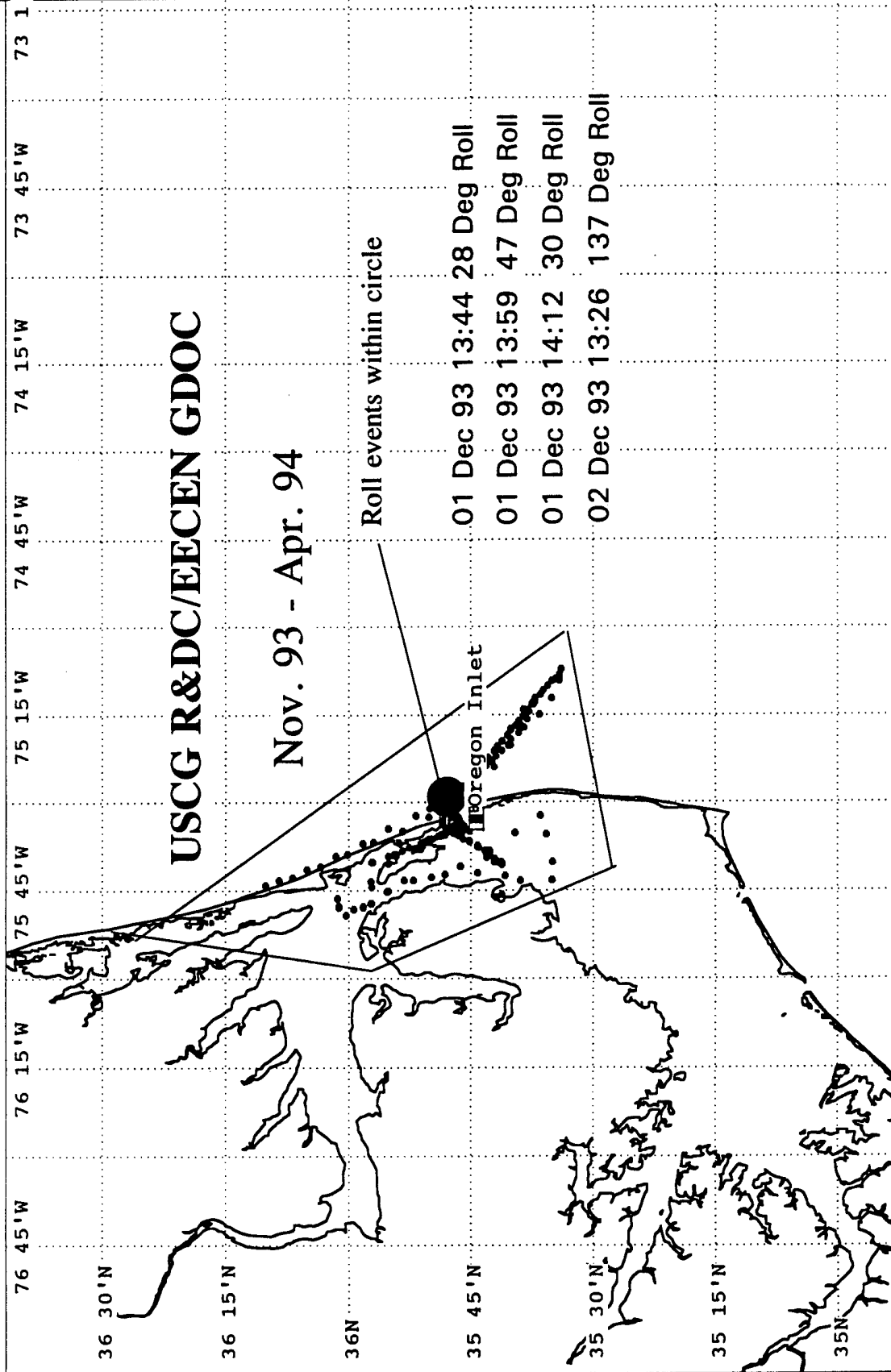
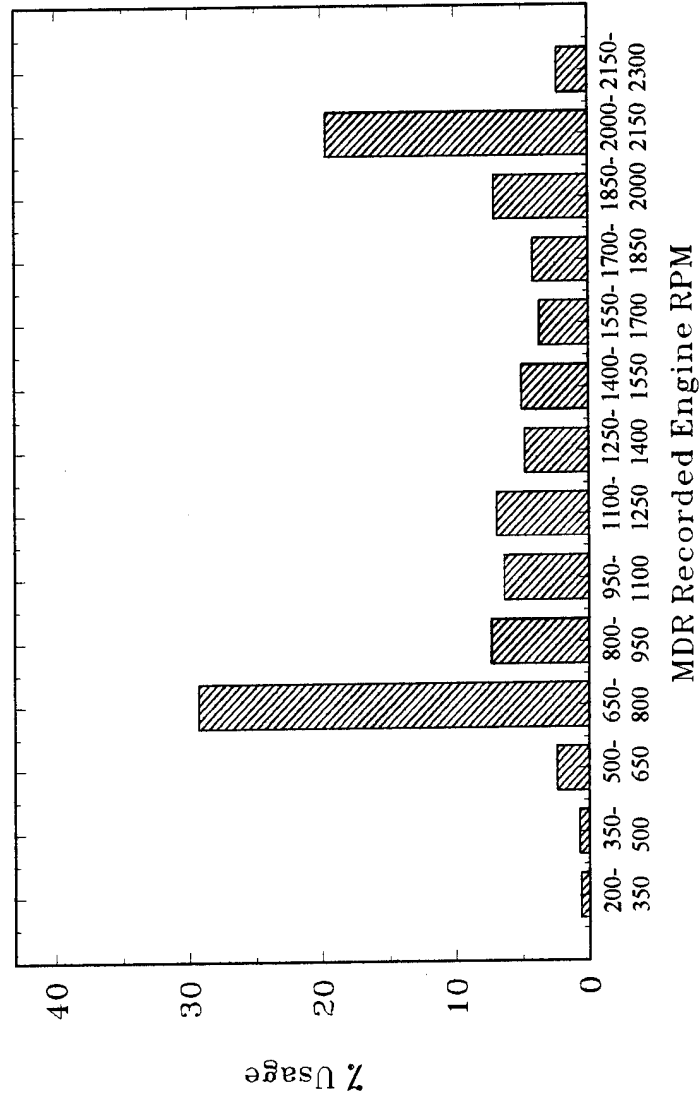

Figure B-1. Area of Recorded Operations for 47202

47202 Engine Usage Profile
Out of 637 Recorded Hours Underway



RPM:	% Usage
200-350	0.58
350-500	0.71
500-650	2.38
650-800	29.27
800-950	7.28
950-1100	6.36
1100-1250	6.89
1250-1400	4.77
1400-1550	5.00
1550-1700	3.67
1700-1850	4.11
1850-2000	7.07
2000-2150	19.64
2150-2300	2.28

Figure B-2. 47202 ENGINE USAGE PROFILE

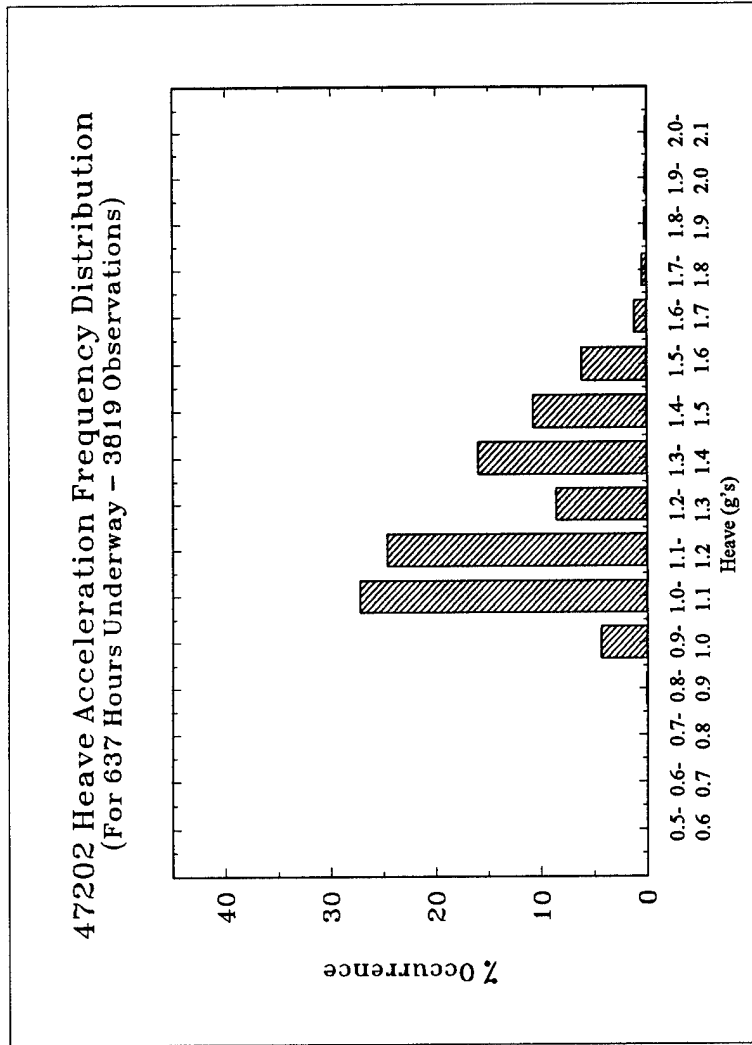

Figure B-3. 47202 HEAVE ACCELERATION FREQUENCY DISTRIBUTION

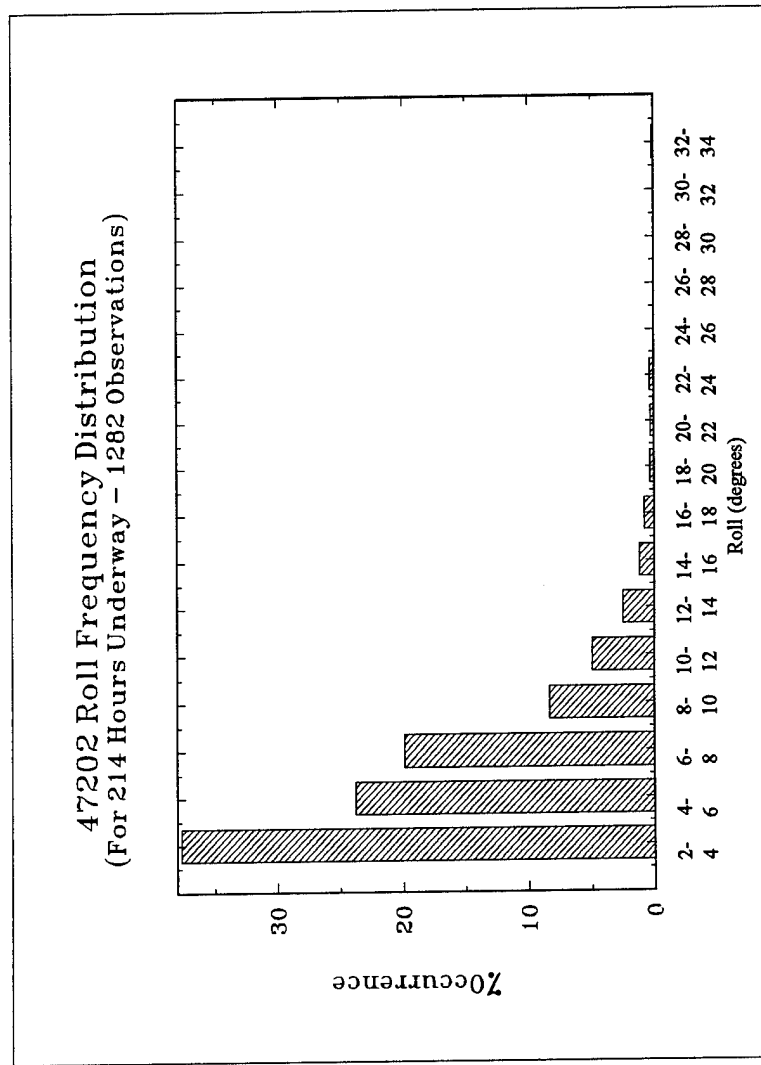

Figure B-4. 47202 ROLL FREQUENCY DISTRIBUTION

TABLE B-I. 47202 EVENT SUMMARY TABLE
Summary of Data Collected with the MDR

Boat: 47202
Date: 23 FEB 95
Dock Departure (Shore-tie Disconnected): 12:28
Time of Event: 15:47:36
Location: No LORAN fix available
Maximum Roll Angle Detected: APPROXIMATE 50 degrees *
Time Spent Past 90 Degrees: N.A.

* This event occurred in the course of towing operations.

47202 Roll Event on 2/23/95 at 15:47:36

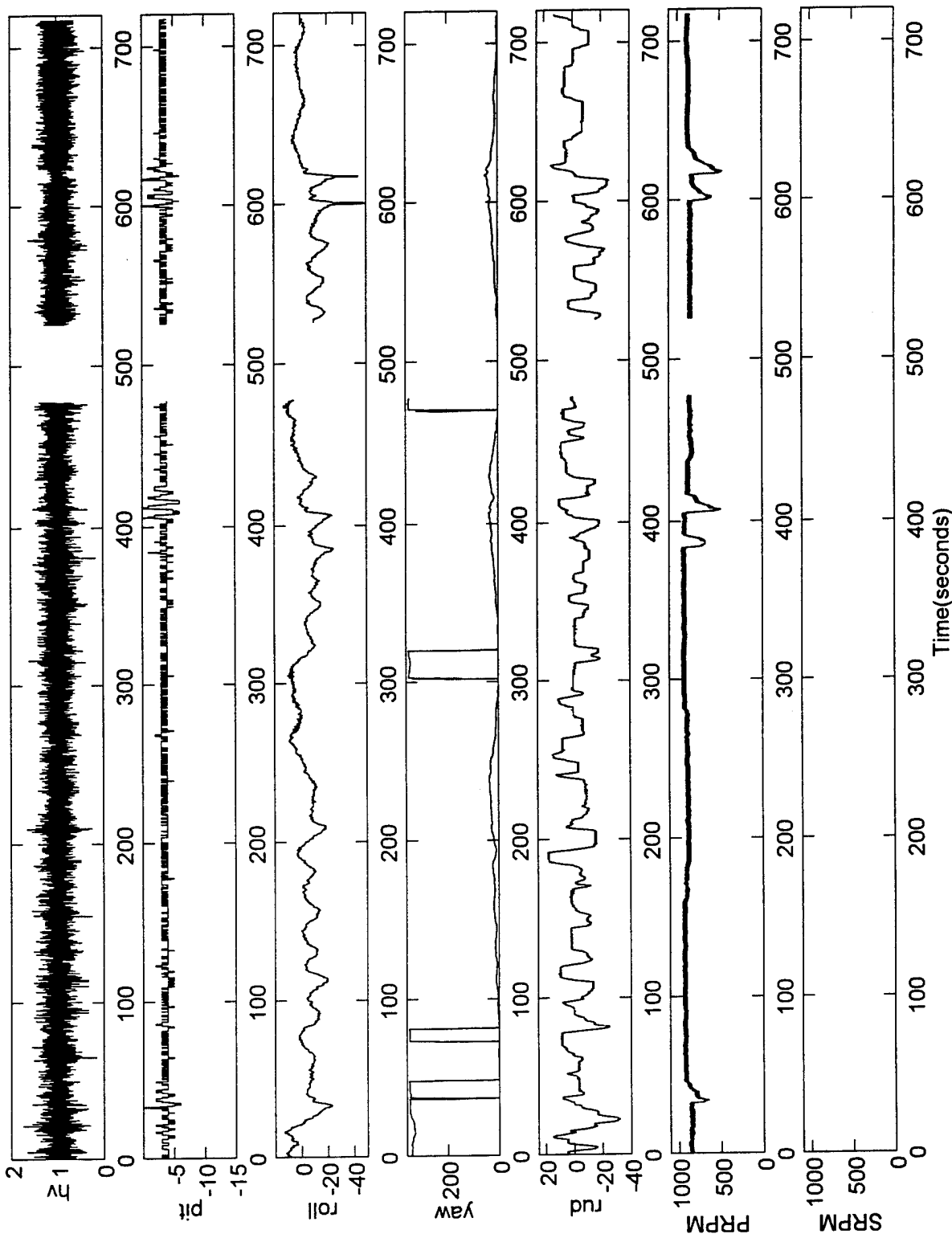

Figure B-5. 47202 EVENT SUMMARY PLOT (12 MINUTES)

47202 Roll Event on 2/23/95 at 15:47:36

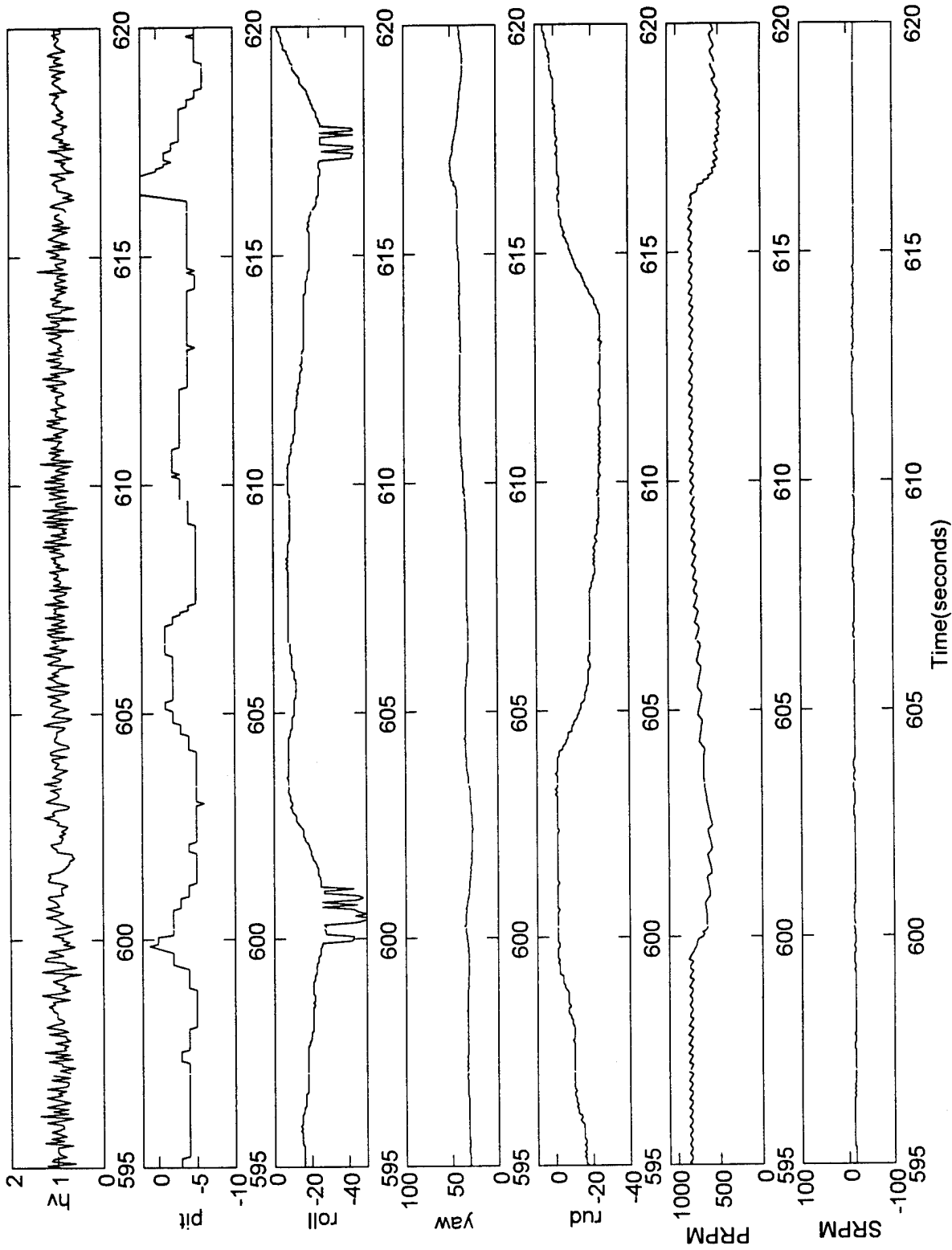

Figure B-6. 47202 EVENT SUMMARY PLOT (25 SECONDS)

47202 Roll Event on 2/23/95 at 15:47:36 (12 minutes)

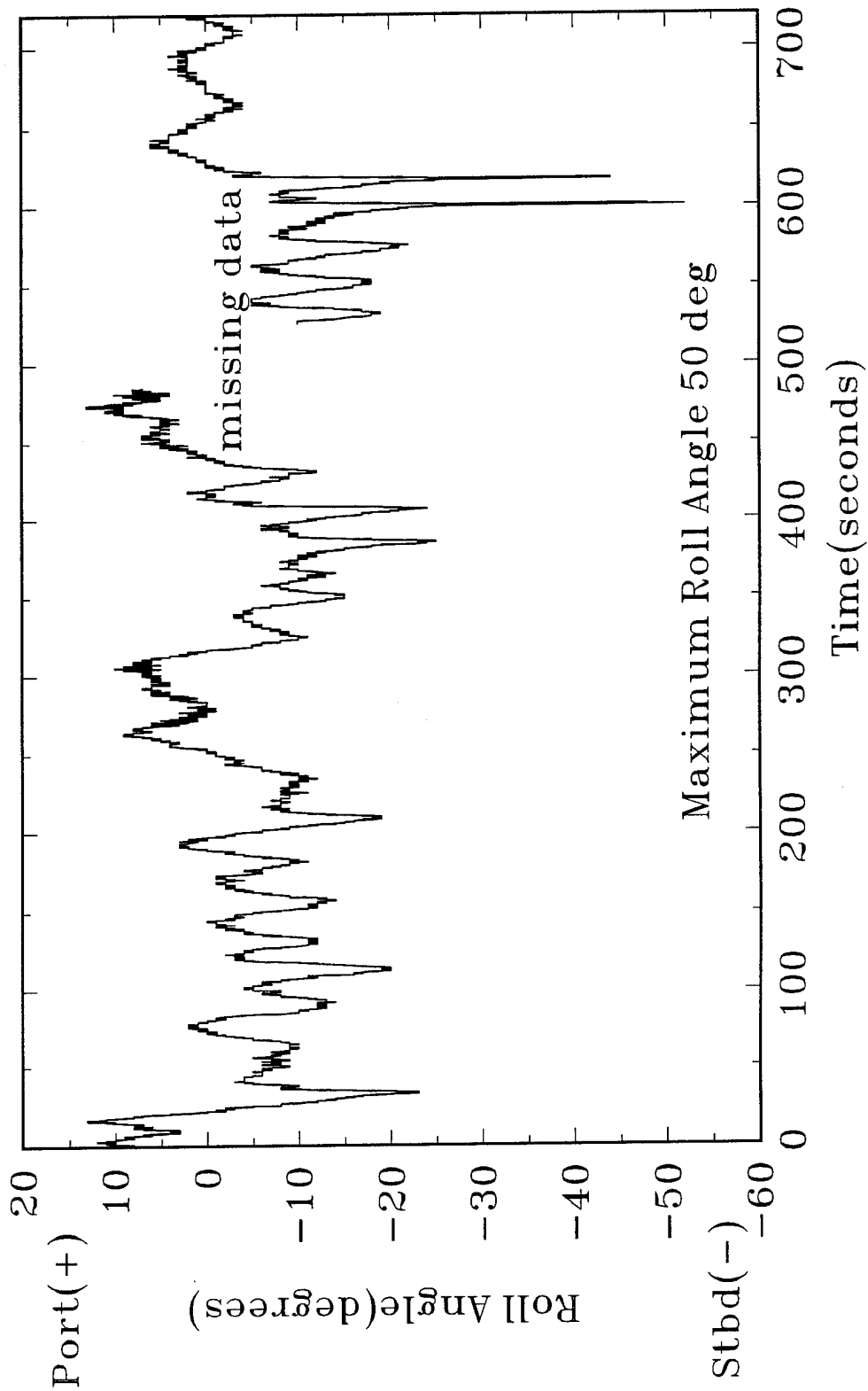

Figure B-7. 47202 ROLL DATA (12 MINUTES)

47202 Roll Event on 2/23/95 at 15:47:36 (25 seconds)

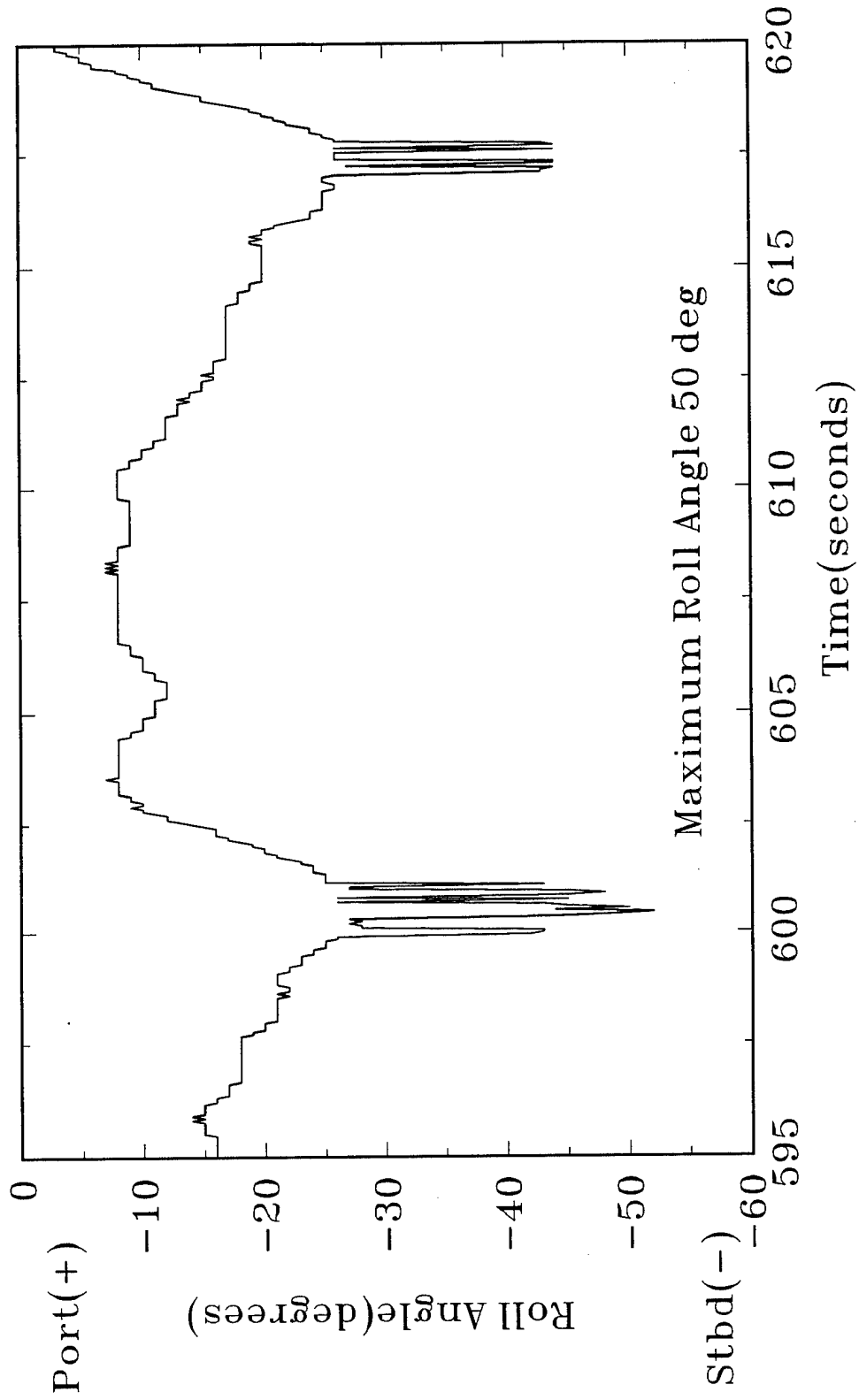

Figure B-8. 47202 ROLL DATA (25 SECONDS)

47202 Roll Event on 2/23/95 at 15:47:36 (12 minutes)

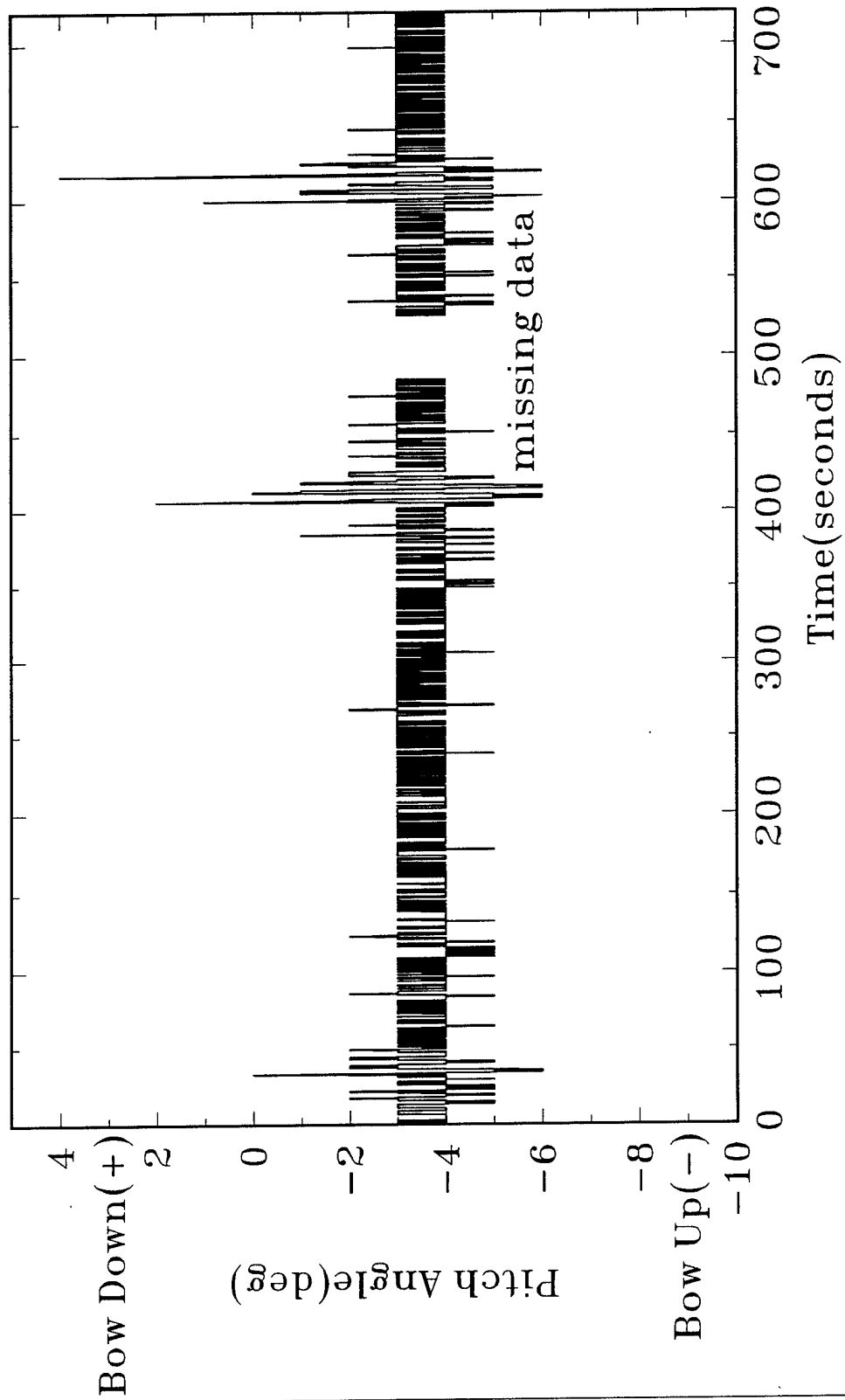

Figure B-9. 47202 PITCH DATA (12 MINUTES)

47202 Roll Event on 2/23/95 at 15:47:36 (12 minutes)

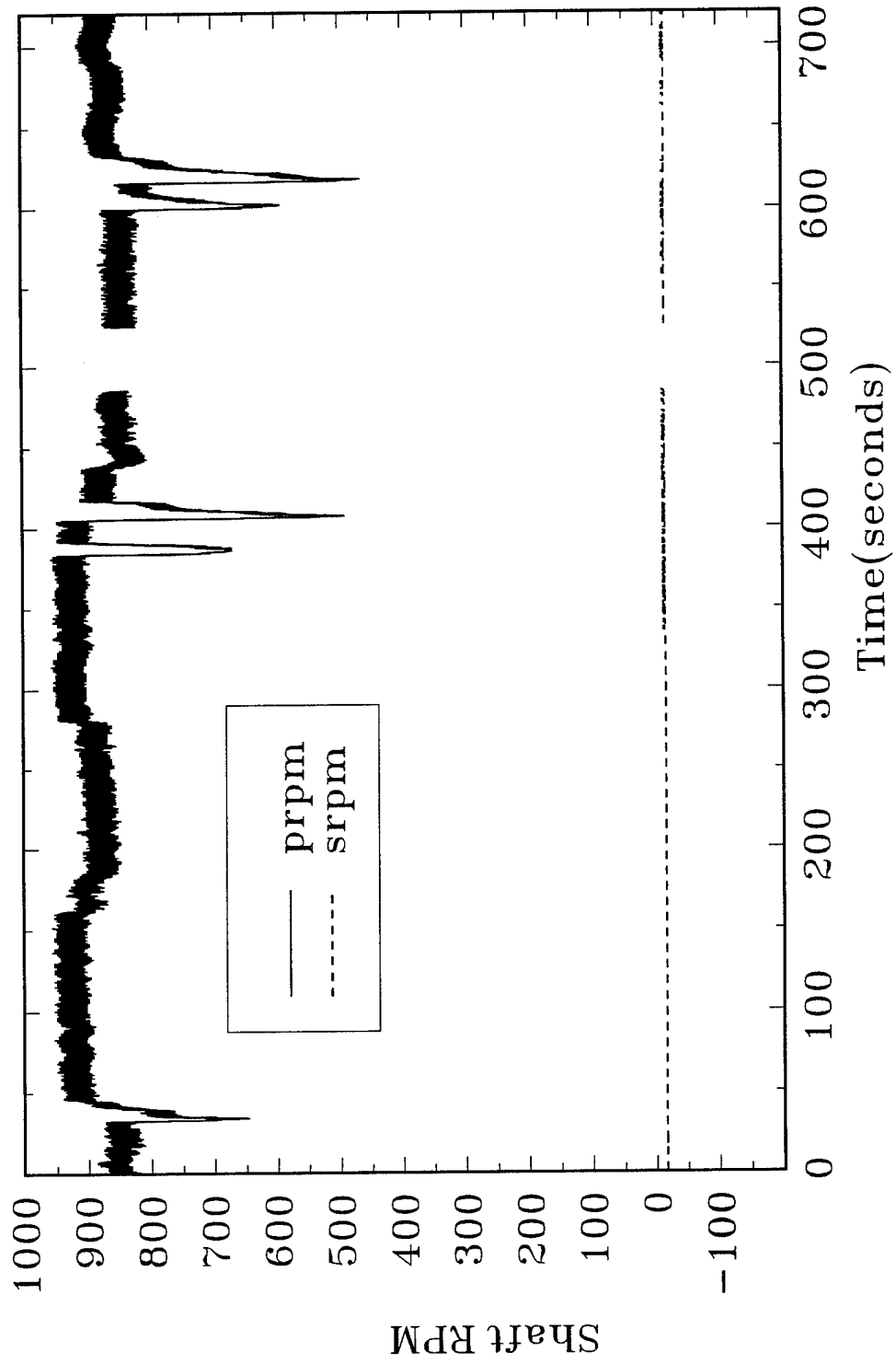

Figure B-10. 47202 PORT AND STARBOARD SHAFT RPM

47202 2/23/95 Event

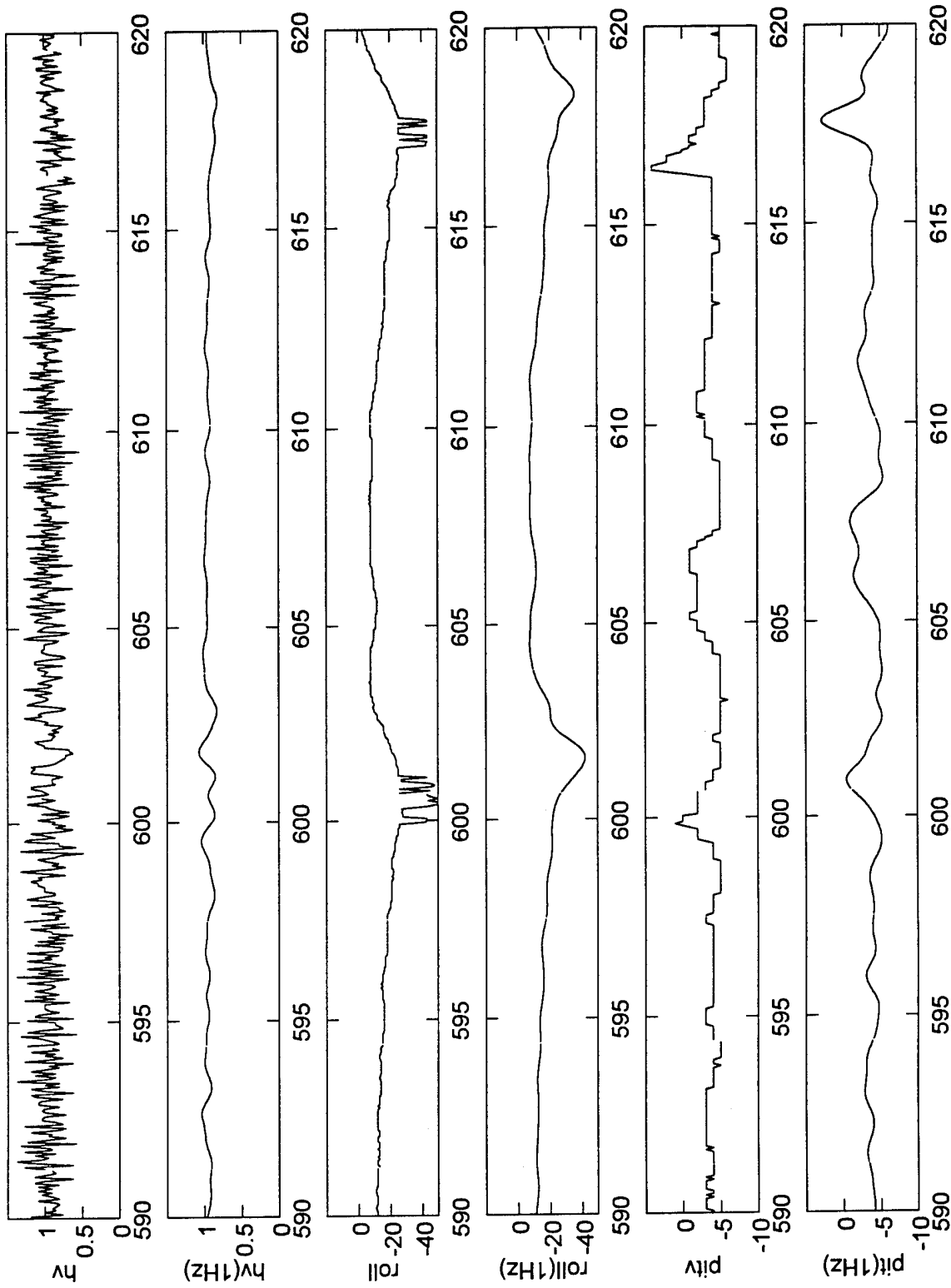
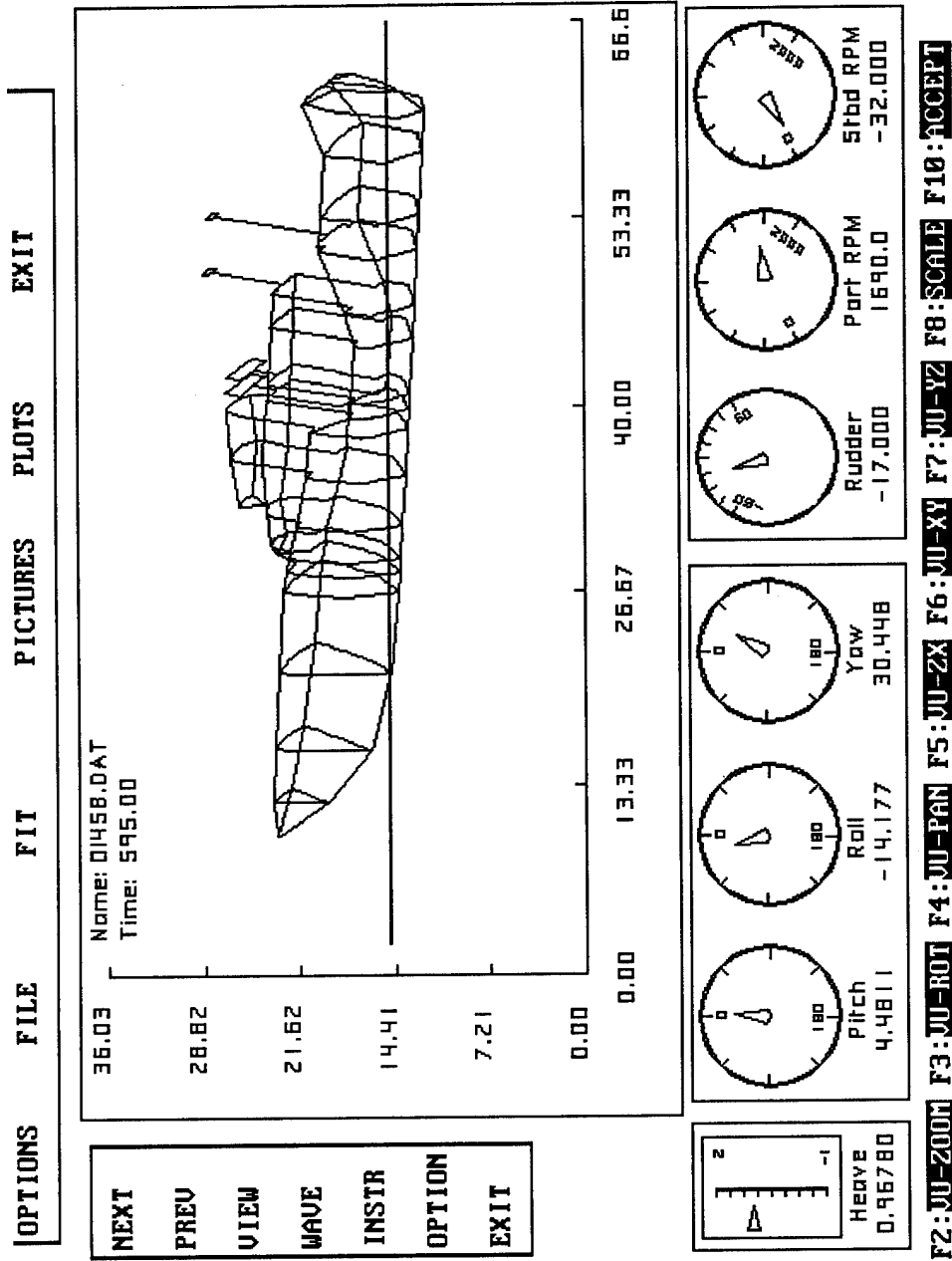

Figure B-11. FILTERED ROLL, PITCH, AND HEAVE DATA

47202 Roll Event on 2/23/95 (-5 seconds)



At 5 seconds before the event the stern is down by 4 degrees (the stern is down for most of the captured 12 minutes). The port engine is operating around 1700 RPM.

Figure B-12. 47202 ROLL EVENT (-5 SECONDS)

47202 Roll Event on 2/23/95 (-5 seconds)

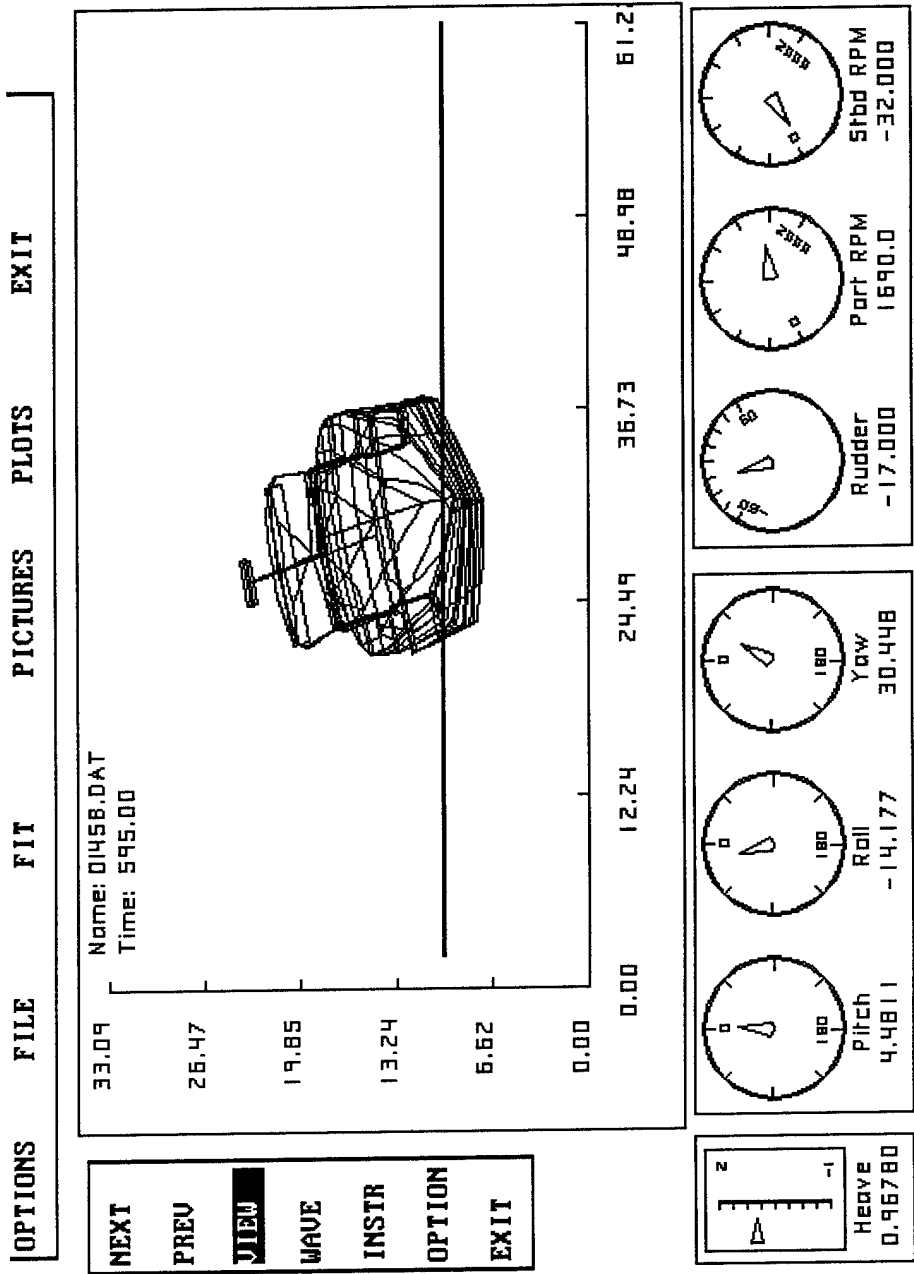

F3: Set Time F4: Wave-on/off F5: Move F6: Instrument-on/off F7: Continuous

At 5 seconds before the event the boat has a roll oscillation of approximately +/- 5 degrees about a heel angle of around 15 degrees.

Figure B-13. 47202 ROLL EVENT (-5 SECONDS)

47202 Roll Event on 2/23/95 (+1.5 seconds after event detection)

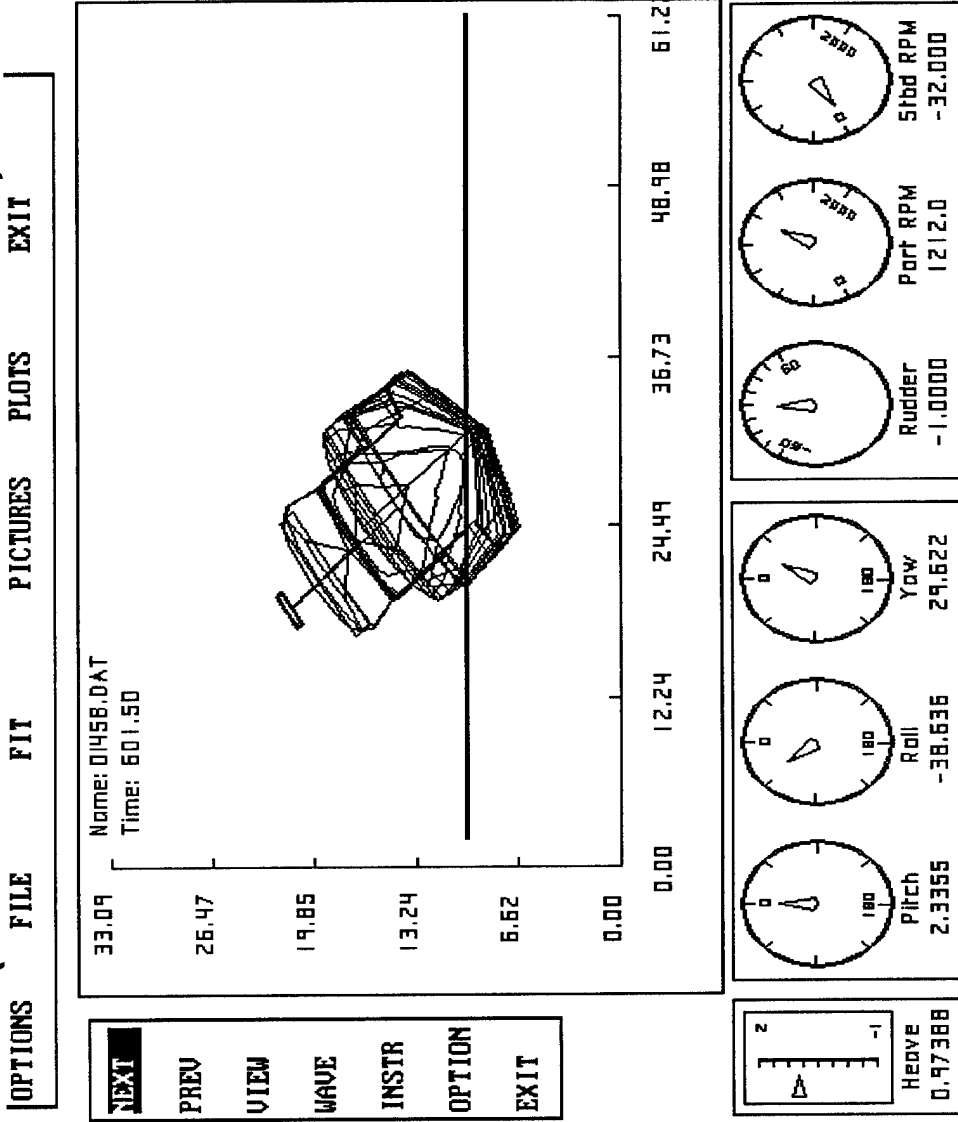

F3: Set Time **F4: Wave-on/off** **F5: Wave** **F6: Instrument-on/off** **F7: Continuous**

At the event trigger (threshold was set to 45 degrees) the 47202 rolls to starboard to a maximum of 50 degrees (note that roll, pitch, and heave data were low-pass filtered to 1 Hz for this animation). The port engine RPM levels drop quickly and then return.

Figure B-14. 47202 ROLL EVENT (+1.5 SECONDS)

APPENDIX C
47203 DATA RESULTS

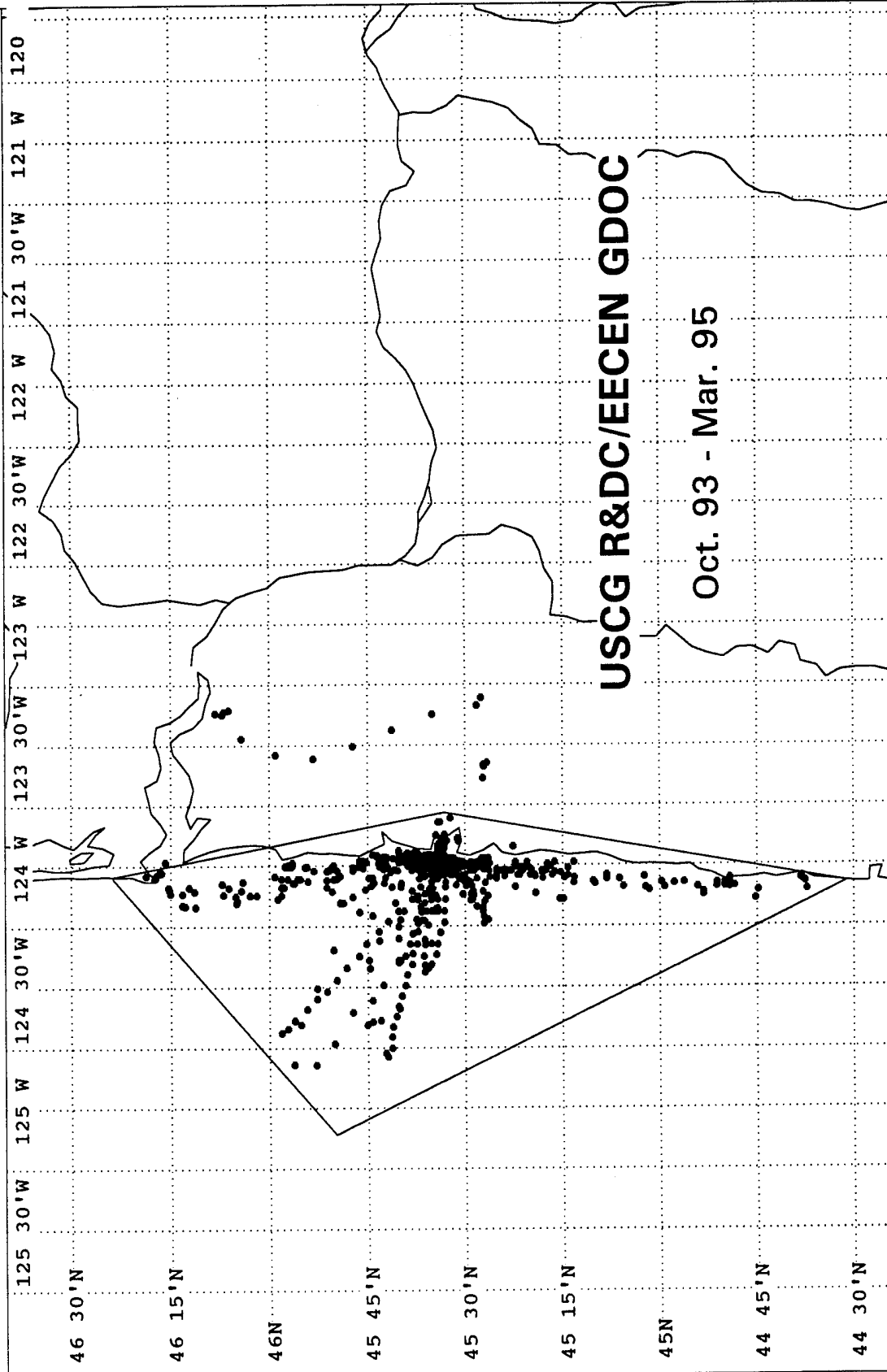
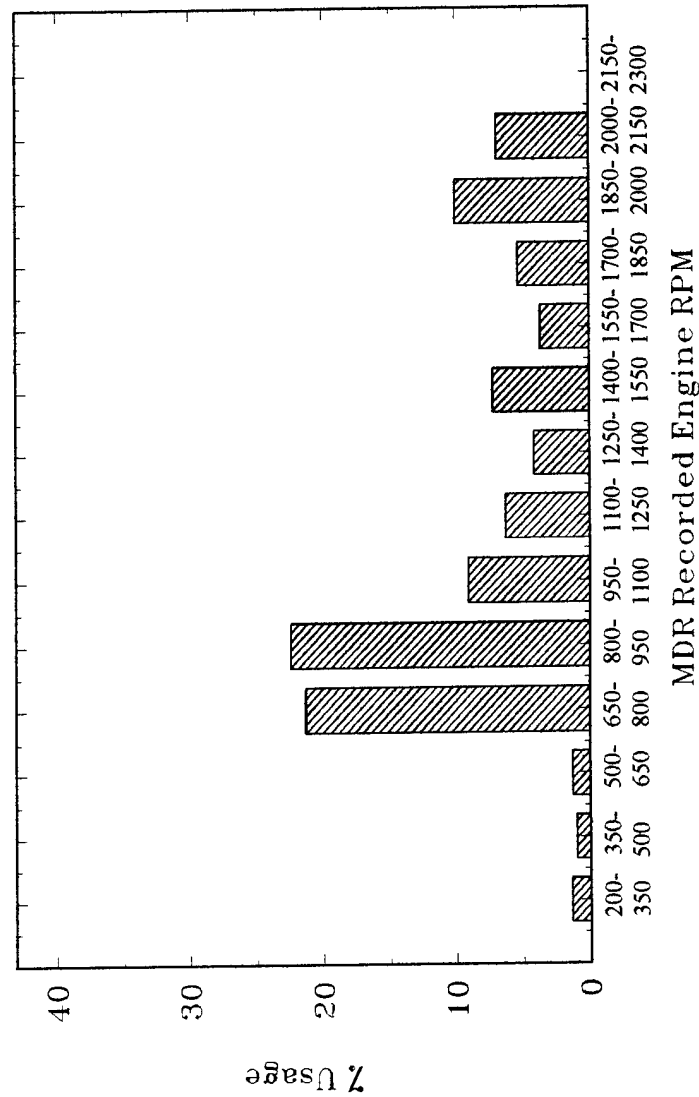

Figure C-1. AREA OF RECORDED OPERATIONS FOR 47203

47203 Engine Usage Profile
Out of 519 Recorded Hours Underway



RPM:	% Usage
200-350	1.38
350-500	1.03
500-650	1.29
650-800	21.30
800-950	22.43
950-1100	9.09
1100-1250	6.27
1250-1400	4.11
1400-1550	7.20
1550-1700	3.66
1700-1850	5.33
1850-2000	10.03
2000-2150	6.88
2150-2300	0.00

Figure C-2. 47203 ENGINE USAGE PROFILE

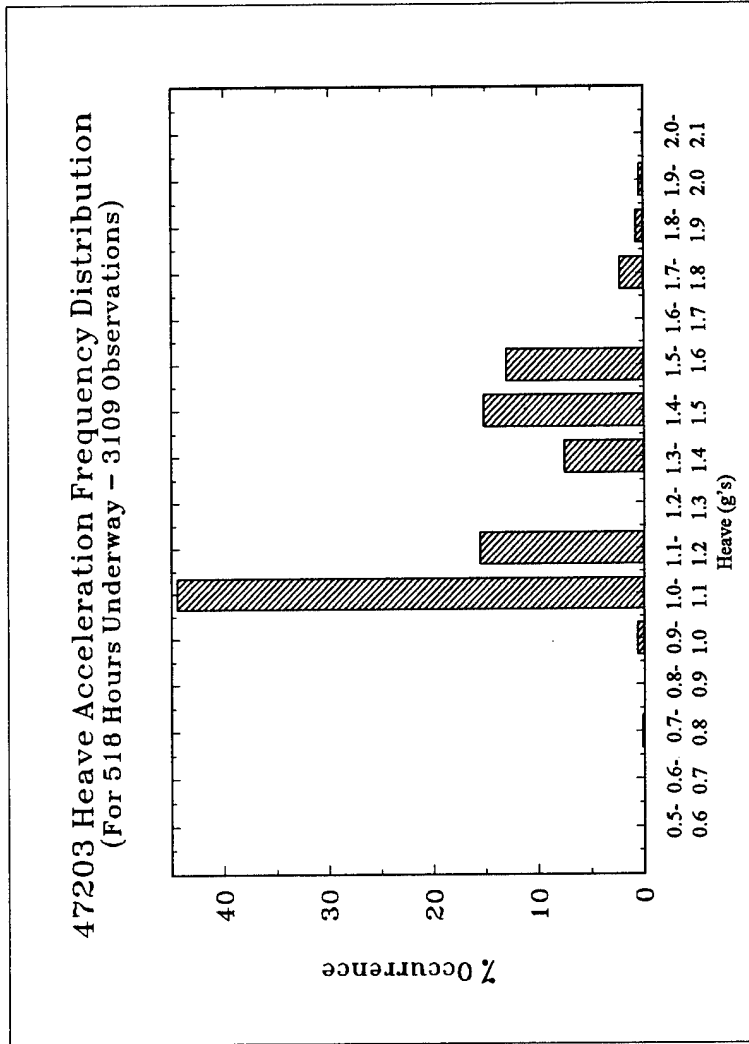

Figure C-3. 47203 HEAVE ACCELERATION FREQUENCY DISTRIBUTION

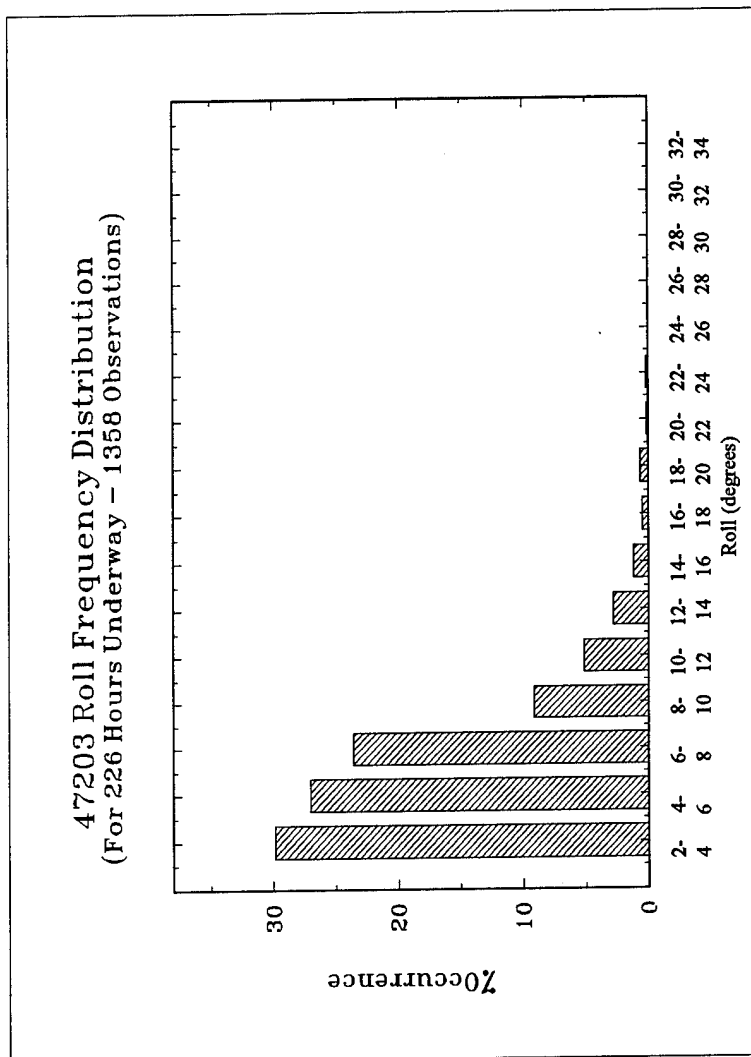

Figure C-4. 47203 ROLL FREQUENCY DISTRIBUTION

Roll(deg)	% Occurrence
2-4	29.90
4-6	27.03
6-8	23.56
8-10	9.13
10-12	5.15
12-14	2.80
14-16	1.18
16-18	0.44
18-20	0.59
20-22	0.07
22-24	0.15
24-26	0.00
26-28	0.00
28-30	0.00
30-32	0.00
32-34	0.00

APPENDIX D
47204 DATA RESULTS

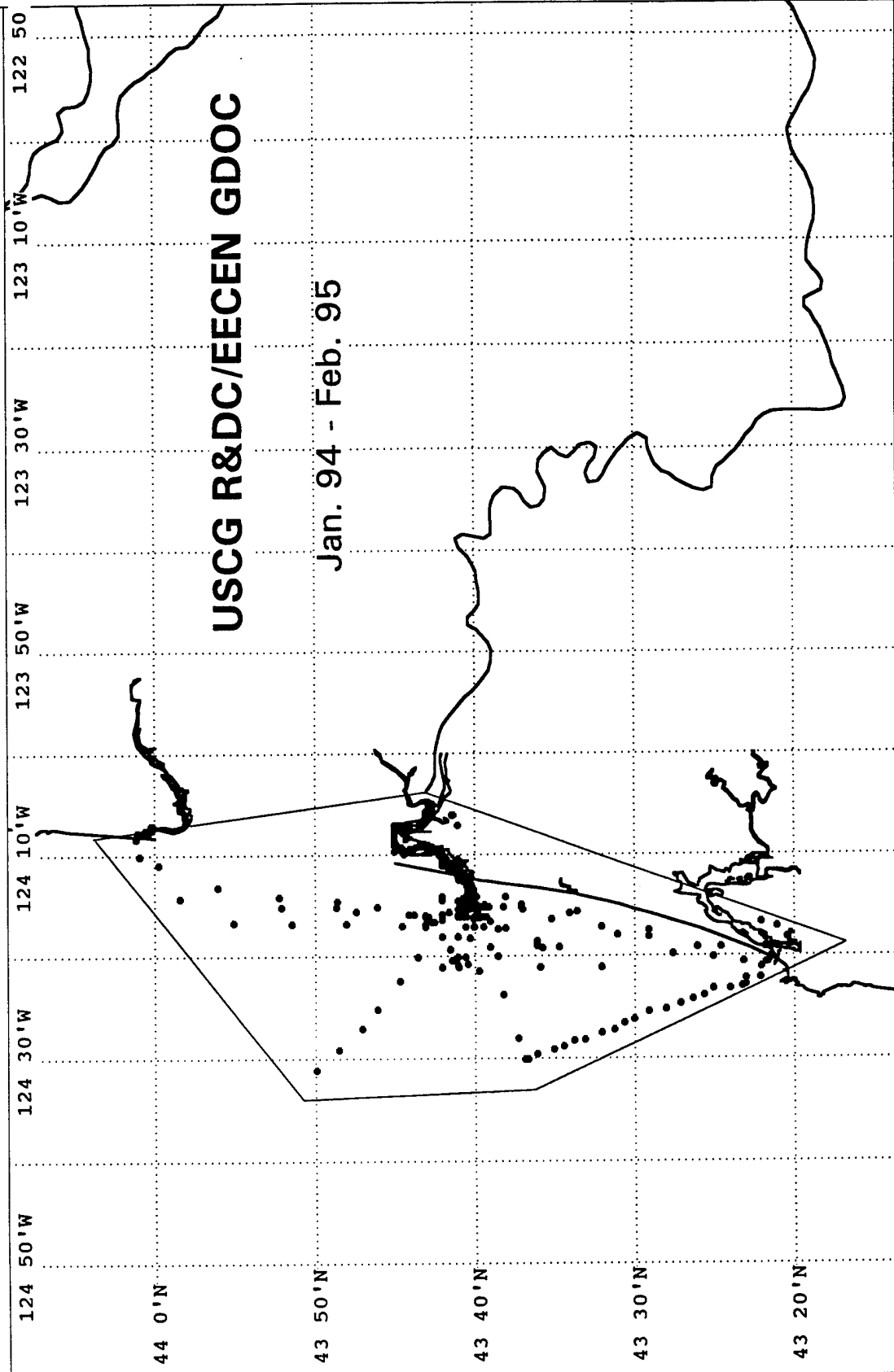

Figure D-1. AREA OF RECORDED OPERATIONS FOR 47204

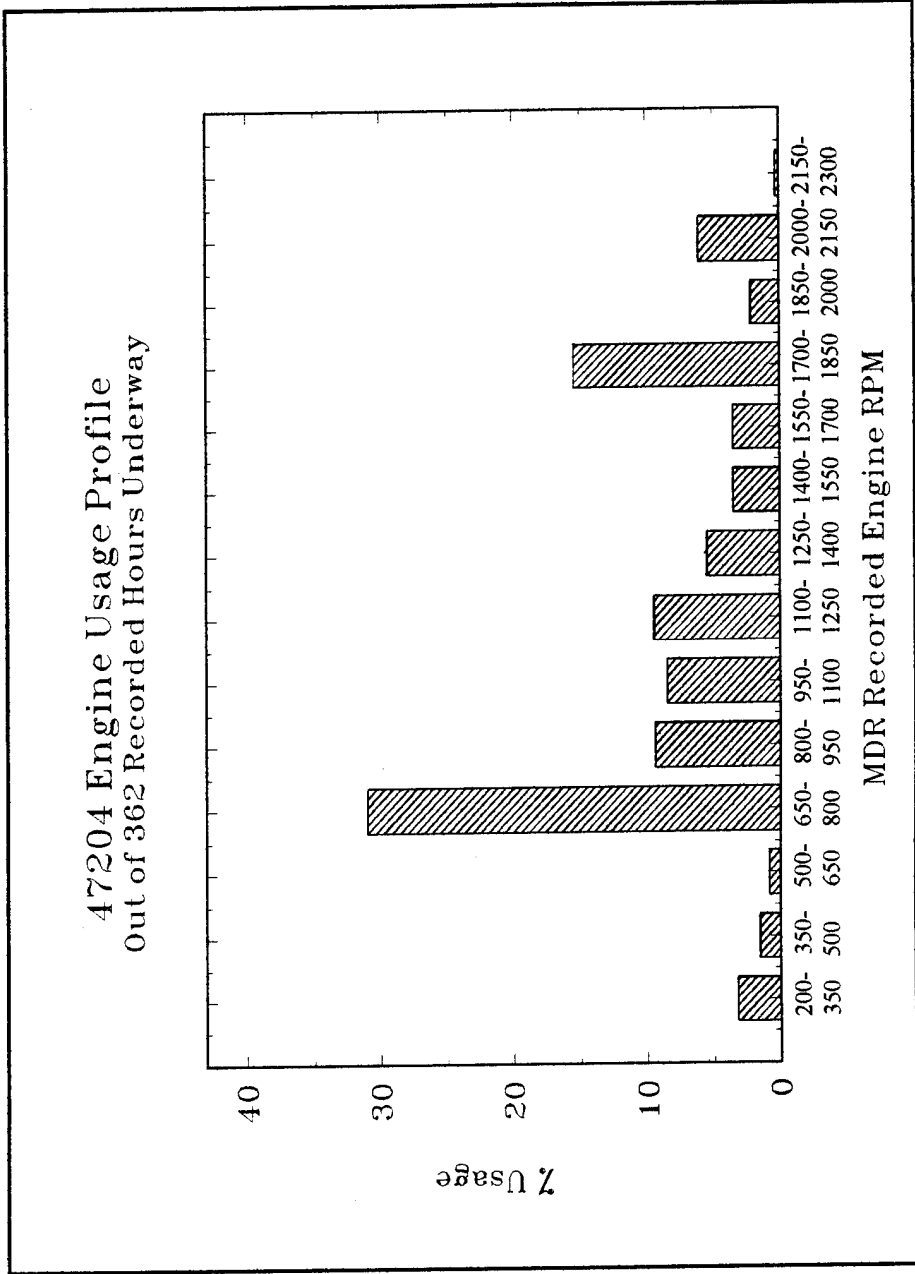

Figure D-2. 47204 ENGINE USAGE PROFILE

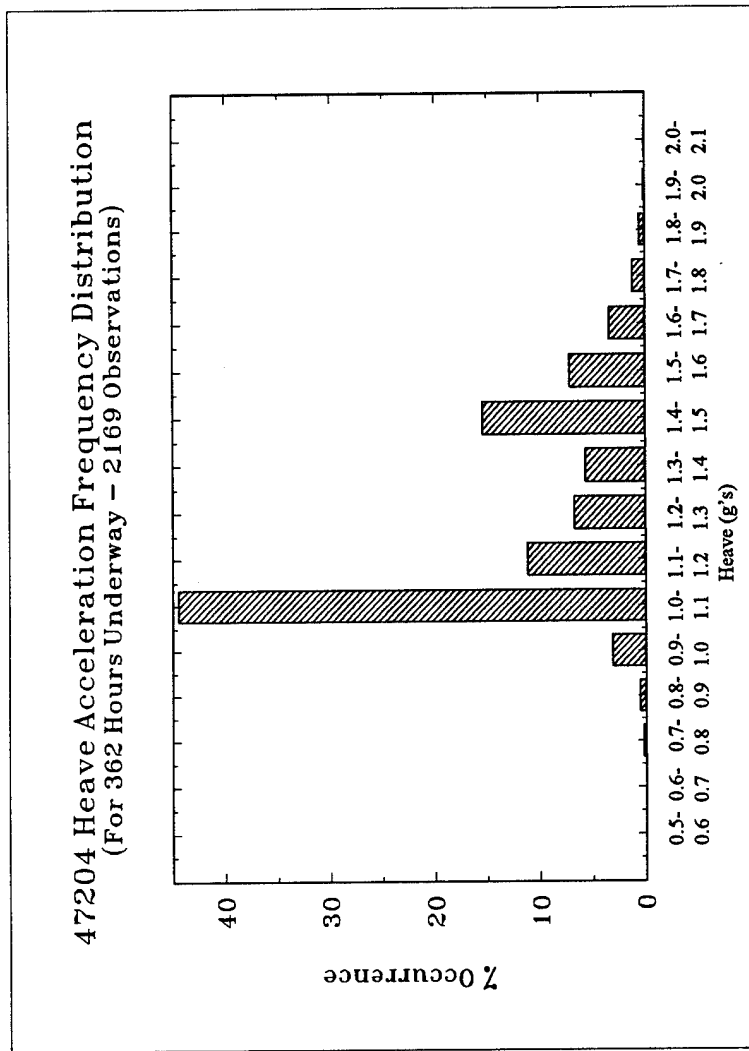
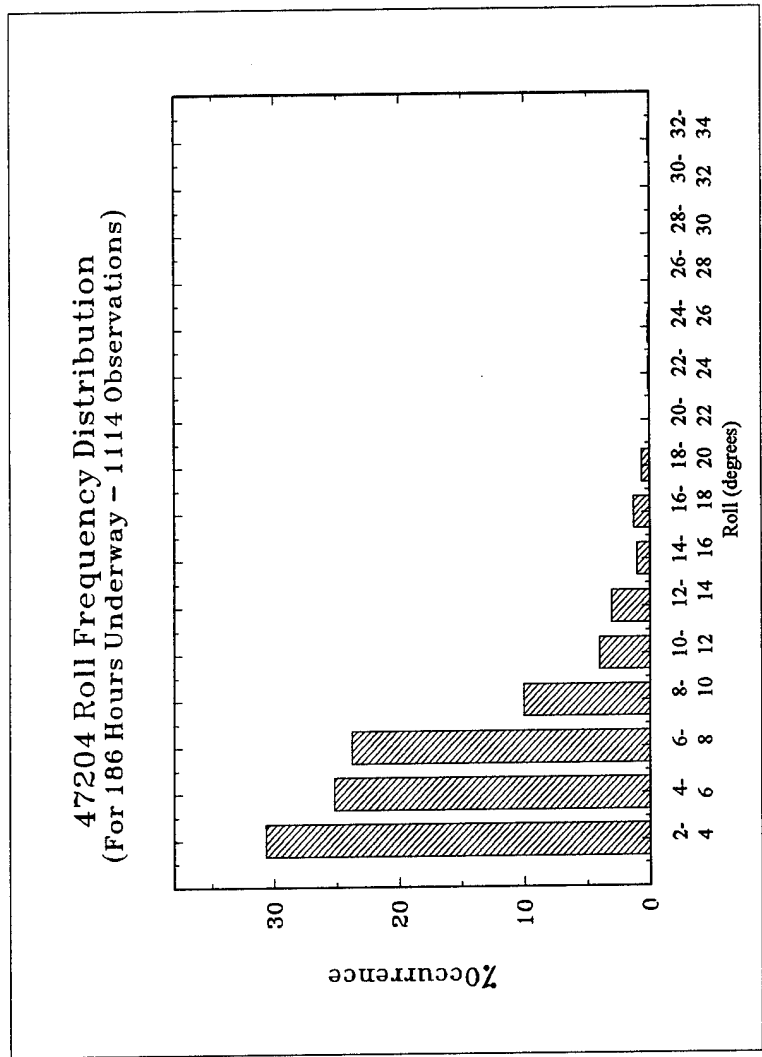

Figure D-3. 47204 HEAVE ACCELERATION FREQUENCY DISTRIBUTION



Roll(deg)	% Occurrence
2-4	30.70
4-6	25.22
6-8	23.79
8-10	10.05
10-12	4.04
12-14	3.05
14-16	0.99
16-18	1.26
18-20	0.63
20-22	0.00
22-24	0.09
24-26	0.09
26-28	0.00
28-30	0.00
30-32	0.00
32-34	0.09

Figure D-4. 47204 ROLL FREQUENCY DISTRIBUTION

APPENDIX E
47205 DATA RESULTS

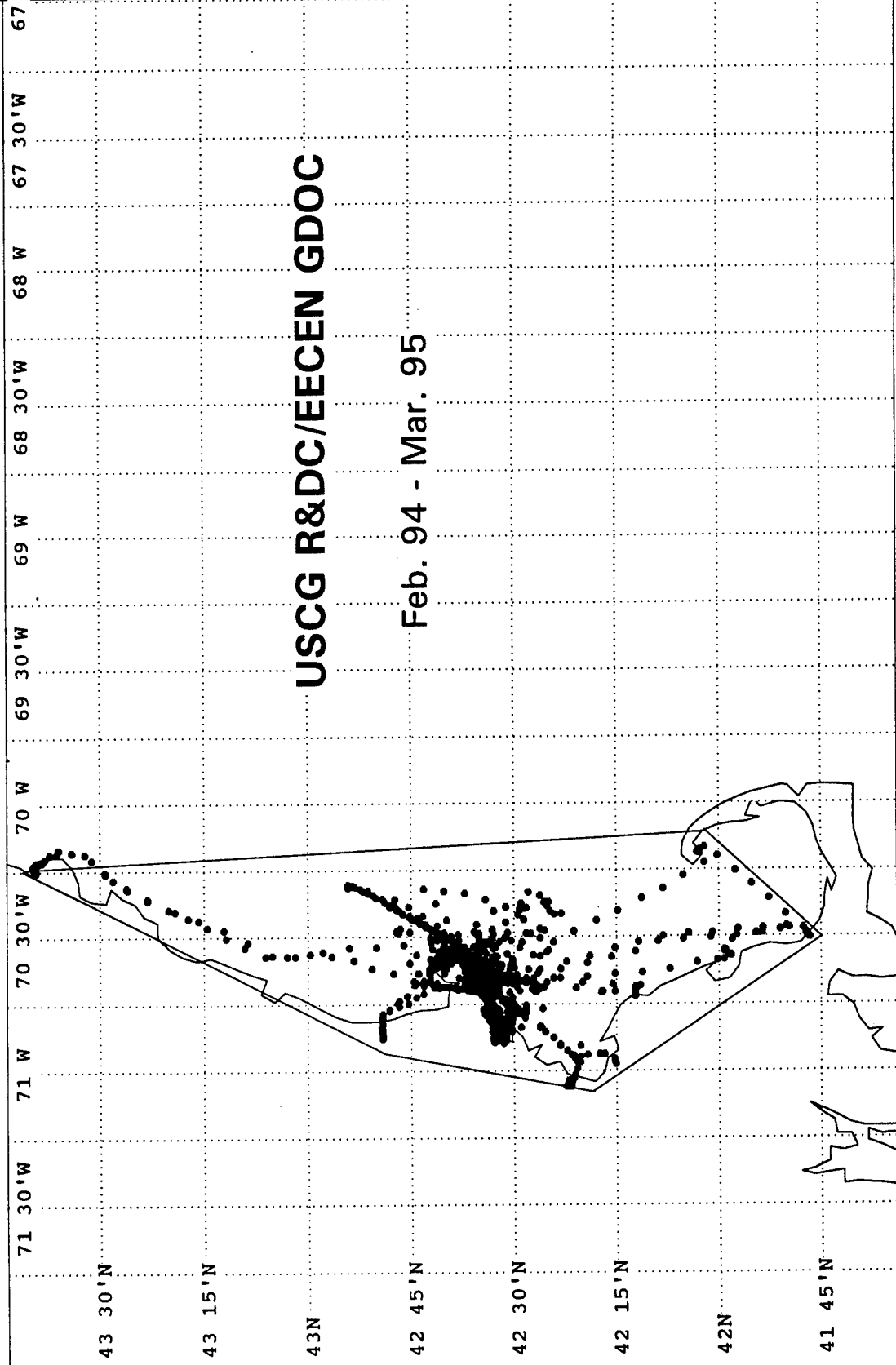
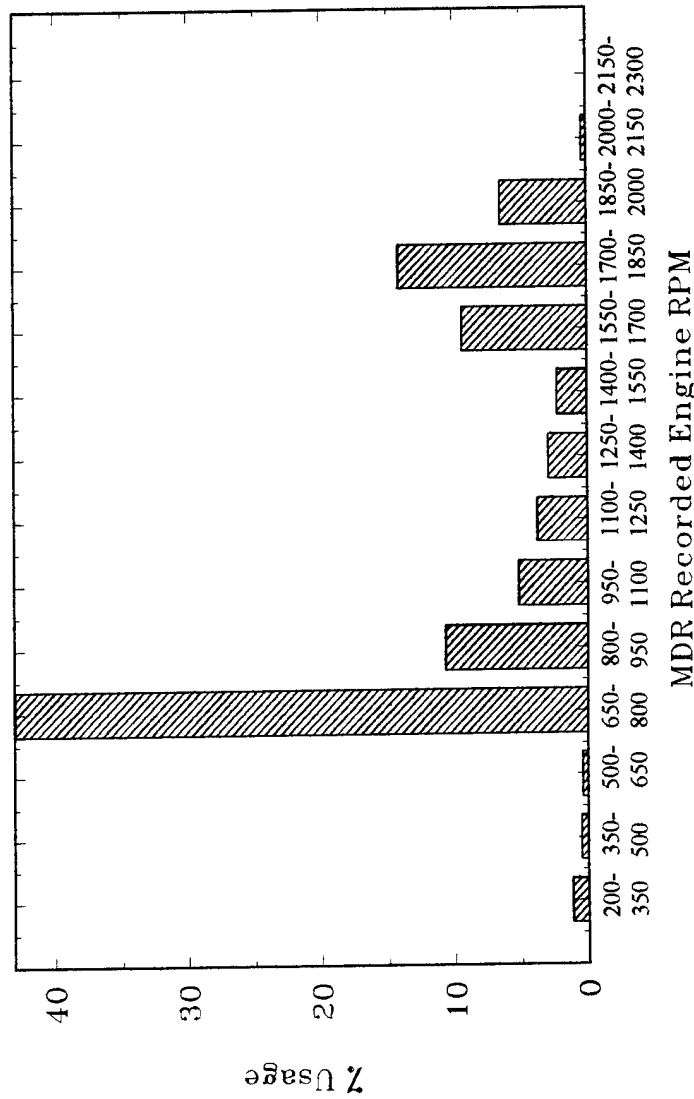

Figure E-1. AREA OF RECORDED OPERATIONS FOR 47205

47205 Engine Usage Profile
 Out of 499 Recorded Hours Underway



RPM:	% Usage
200-350	1.14
350-500	0.47
500-650	0.40
650-800	42.96
800-950	10.67
950-1100	5.15
1100-1250	3.74
1250-1400	2.88
1400-1550	2.24
1550-1700	9.39
1700-1850	14.14
1850-2000	6.49
2000-2150	0.33
2150-2300	0.00

Figure E-2. 47205 ENGINE USAGE PROFILE

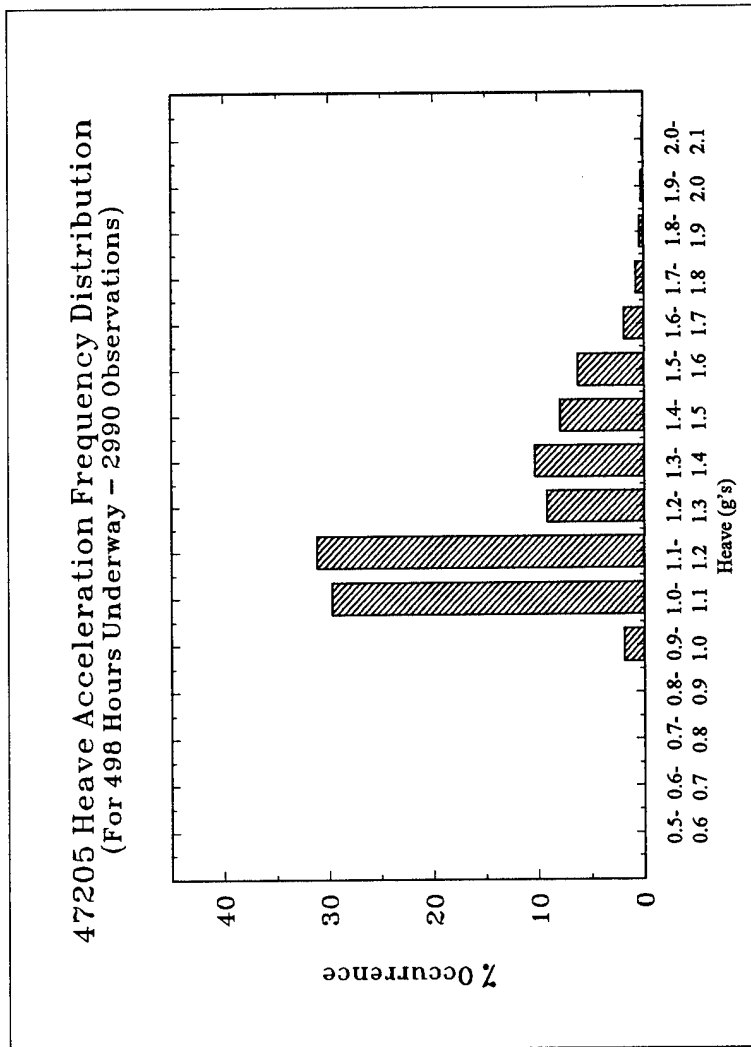

Figure E-3. 47205 HEAVE ACCELERATION FREQUENCY DISTRIBUTION

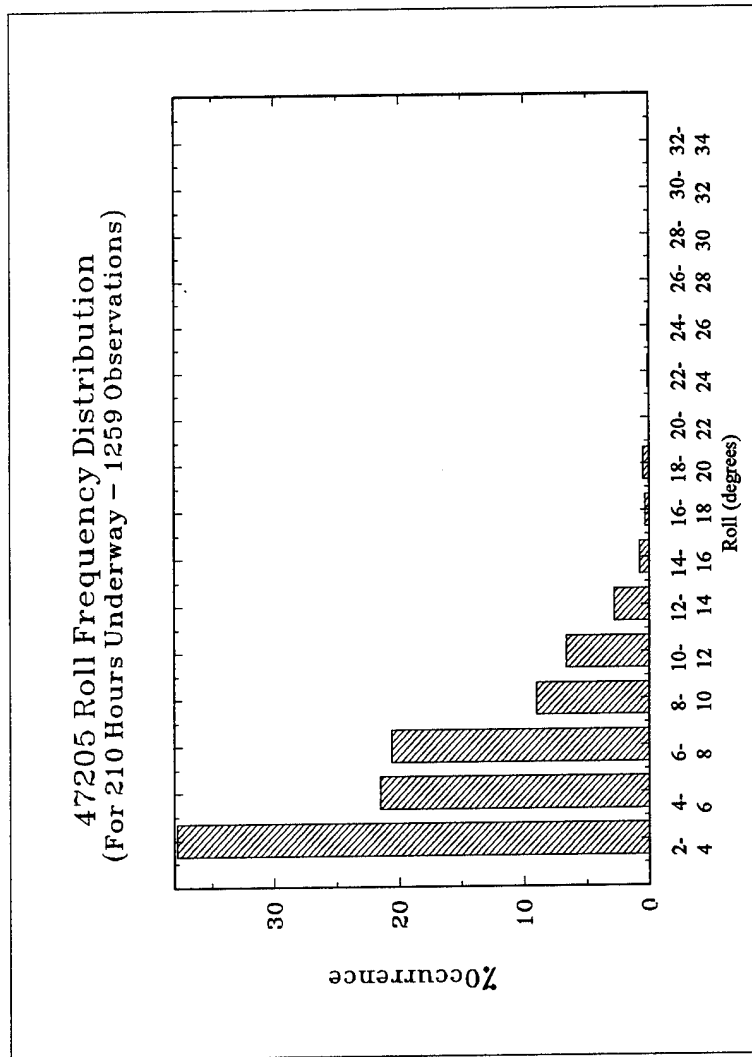

Figure E-4. 47205 ROLL FREQUENCY DISTRIBUTION

APPENDIX F

47200 DATA RESULTS

(Data was not collected on the 47200
during this phase of the evaluation)