

ate technical note techn

# Mode S Beacon System Terminal Configuration Performance Test Report

Raymond J. Alimenti



**DISTRIBUTION STATEMENT A**  
Approved for public release  
Distribution Unlimited

May 1995

DOT/FAA/CT-TN95/7

Document is on file at the Technical Center Library,  
Atlantic City International Airport, N.J. 08405



U.S. Department of Transportation  
Federal Aviation Administration  
Technical Center  
Atlantic City Airport, NJ 08405

19950629 046

DTIC QUALITY INSPECTED 5

#### **NOTICE**

**This document is disseminated under the sponsorship of the U.S. Department of Transportation in the interest of information exchange. The United States Government assumes no liability for the contents or use thereof.**

**The United States Government does not endorse products or manufacturers. Trade or manufacturers' names appear herein solely because they are considered essential to the objective of this report.**

1. Report No. DOT/FAA/CT-TN95/7	2. Government Accession No.	3. Recipient's Catalog No.	
4. Title and Subtitle Mode S Beacon System Terminal Configuration Performance Test Report		5. Report Date May 1995	6. Performing Organization Code
7. Author(s) Raymond J. Alimenti, ACW-100		8. Performing Organization Report No. DOT/FAA/CT-TN95/7	
9. Performing Organization Name and Address U.S. Department of Transportation Federal Aviation Administration Technical Center Atlantic City International Airport, NJ 08405		10. Work Unit No. (TRAIS)	11. Contract or Grant No.
12. Sponsoring Agency Name and Address U.S. Department of Transportation Federal Aviation Administration Technical Center Atlantic City International Airport, NJ 08405		13. Type of Report and Period Covered Technical Note	
15. Supplementary Notes		14. Sponsoring Agency Code	
16. Abstract This document reports the findings of the performance tests conducted on the terminal configuration of the Mode S Beacon System. The tests were conducted at the FAA Technical Center using the first article system from the Mode S production contract. The Mode S system under test was a fully configured dual channel system having all required external interfaces connected to actual NAS equipment. A combination of live aircraft and simulated targets were used in the test conduct and data collection.  The tests were conducted in accordance with the Mode S Master Test Plan (DOT/FAA/CT-88/28) and the Mode S Performance Test Plan (DOT/FAA/CT-TN 90/24). The test goals are to characterize the performance of the Mode S system in key areas and to establish a baseline from which to evaluate future changes.			
17. Key Words Mode S Beacon System Monopulse Data Link		18. Distribution Statement Document is on file at the Technical Center Library, Atlantic City International Airport, NJ 08405	
19. Security Classif. (of this report) Unclassified	20. Security Classif. (of this page) Unclassified	21. No. of Pages 140	22. Price

# TABLE OF CONTENTS

	Page
EXECUTIVE SUMMARY	ix
1. SCOPE	1
2. REFERENCE DOCUMENTS	1
3. BACKGROUND	2
4. TEST AND EVALUATION	3
4.1 Test 1: IBI/ATCBI-5 - Comparison	3
4.2 Test 2: IBI Performance Monitoring	9
4.3 Test 3: Surveillance Baseline - Pd/Pfa	12
4.4 Test 4: Surveillance Baseline - Report Parameters	19
4.5 Test 5: Surveillance Baseline - Conflict Situations	33
4.6 Test 6: Data Link Baseline	38
4.7 Test 7: Mode S Sensor Coverage	45
4.8 Test 8: Mode S Reflection Analysis	56
4.9 Test 9: Sensor Accuracy	63
4.10 Test 10: Sensor Resolution	71
4.11 Test 11: Mode S Stochastic Acquisition	76
5. DEFINITION OF TERMS AND ACRONYMS	80

## APPENDIXES

- A - Formal Test SPRs
- B - Directory Structure and Naming Convention
- C - List of Files Created During Data Extraction
- D - Files Created During Data Reduction
- E - Directory SAP and Scenario Definitions

Accession For	
NTIS CRA&I	<input checked="" type="checkbox"/>
DTIC TAB	<input type="checkbox"/>
Unannounced	<input type="checkbox"/>
Justification .....	
By .....	
Distribution /	
Availability Codes	
Dist	Avail and/or Special
A-1	

## LIST OF ILLUSTRATIONS

Figure		Page
4.1-1	IBI/ATCBI-5 Comparison	4
4.1-2	IBI/ATCBI-5 Comparison	6
4.1-3	Splits and Ring Around Comparison	6
4.1-4	Filtered Splits and Ring Around	7
4.3-1	Surveillance Baseline Pd/Pfa	13
4.3-2	Probability of Detection for ATCRBS Mode S Targets	15
4.3-3	Average Pd Versus Fruit Level	17
4.3-4	Average Pfa Versus Fruit Level	17
4.4-1	Surveillance Baseline-Report Parameters	20
4.4-2	Beacon Probability of Detection Data	25
4.4-3	Effective Probability of Detection Data	25
4.4-4	ID Code Validity Data	25
4.4-5	Altitude Code Validity Data	26
4.4-6	False Target Due to Splits and Fruit Data	27
4.4-7	Re-Interrogation Rate Versus Scenario Type	28
4.4-8	Re-Interrogation Rate Versus Fruit Level	29
4.4-9	Beacon Probability of Detection Degradation as a Function of Fruit Level	30
4.4-10	Effective Probability of Detection Degradation as a Function of Fruit Level	30
4.4-11	ID Code Validity Degradation as a Function of Fruit Level	31
4.4-12	Altitude Code Validity Degradation as a Function of Fruit Level	31

LIST OF ILLUSTRATIONS (continued)

Figure		Page
4.4-13	False Targets Due to Splits and Fruit Degradation as a Function of Fruit Level	31
4.5-1	Surveillance Baseline - Conflict Situations	34
4.6-1	Data Link Baseline	39
4.6-2	Test 6 Versus Test 4 and Test 7	44
4.7-1	Mode S Sensor Coverage	47
4.7-2a	ATCRBS Surveillance Parameters	49
4.7-2b	Mode S Surveillance Parameters	49
4.7-2c	ATCRBS Splits	50
4.7-3	Subtest 6, Range Versus Azimuth	52
4.7-4	Subtest 6, Range Versus Altitude	52
4.7-5	Subtest 8, Range Versus Azimuth	53
4.7-6	Subtest 8, Range Versus Altitude	53
4.7-7	Subtest 7, Range Versus Azimuth	54
4.7-8	Subtest 7, Range Versus Altitude	55
4.8-1	Mode S Reflection Analysis	57
4.9-1	Sensor Accuracy	64
4.9-2a	Orbital Flightpaths	65
4.9-2b	Radial Flightpaths	65
4.10-1	Sensor Resolution	71
4.11-1	Stochastic Acquisition	77

## LIST OF TABLES

Table		Page
4.1-1	Surveillance Parameters-IBI Results Versus IBI Limits	8
4.1-2	False Target Parameters-IBI Results Versus IBI Limits	8
4.1-3	Surveillance Parameters-IBI Results Versus IBI Limits	9
4.1-4	False Target Parameters-IBI Results Versus IBI Limits	9
4.2-1	Objective Summary	11
4.3-1	Probability of Detection	15
4.3-2	Probability of False Alarm for -70 DBM Target	16
4.3-3	Pd/Pfa Baseline	16
4.3-4	Objective Summary	18
4.4-1	Beacon and Effective Pd Data	23
4.4-2	ID and Altitude Validity Data	24
4.4-3	False Targets Due to Splits and Fruit	26
4.4-4	Re-Interrogation Rate Versus Range (NMI)	28
4.4-5	Probability of Detection Data Versus Fruit Level	29
4.4-6	Surveillance Parameter Data Versus Fruit Level	30
4.4-7	Objective Summary	32
4.5-1	Track Swap Percentages	37
4.5-2	Objective Summary	37
4.6-1	Mode S Capacity Scenario Results	42
4.6-2	Mixed Capacity Scenario Results	42
4.6-3	Radar Reinforced, Capacity Scenario Results	42
4.6-4a	Surveillance Performance	43

LIST OF TABLES (continued)

Table	Page	
4.6-4b	Surveillance Performance	43
4.6-5	Test 6 Versus Test 4 and Test 7	43
4.6-6	Objective Summary	44
4.7-1	Test Description Summary	48
4.7-2	Test 7 Versus Test 4, Surveillance Parameter	51
4.7-3	Test 7 Versus Test 4, Azimuth Splits	51
4.8-1	False Target Identification, Mode S Sensor Versus False Target Summary	60
4.8-2	Subtest Two Reflector Characteristics	60
4.8-3	Report Level Probability of Detection	61
4.8-4	Objective Summary	62
4.9-1	CPME Error Data	67
4.9-2	Accuracy Analysis Data	68
4.9-3	DR Nine Point Data	70
4.10-1	Resolution Percentage	74
4.10-2	Test 10 Versus Test 4 Comparison	75
4.11-1	Target Positions	77
4.11-2	SAP Changes	78



## EXECUTIVE SUMMARY

This report discusses the results of Mode S Performance testing conducted at the Federal Aviation Administration (FAA) Technical Center, Atlantic City International Airport, New Jersey, from June 29 to October 15, 1993, and subsequent regression testing completed by February 1994.

Testing was accomplished in order to verify performance of the Mode S Sensor and to provide early identification of problem areas that require further investigation.

Mode S Performance testing was composed of 11 separate tests to provide a performance baseline for the Mode S terminal configuration. Tests were conducted in accordance with standardized test procedures outlined in the Mode S Performance Test Plan (PTP). A combination of live aircraft and simulated target scenarios were used during the test effort.

Test results as viewed at the completion of the regression tests, using Mode S terminal software TR21.3x, were generally acceptable. One section of testing, Mode S stochastic acquisition, was not completed. This activity will be reported on in the Mode S Operational Test and Evaluation (OT&E) report. Some of the Mode S accuracy data fell outside the limits of the specification but are not considered serious. The surveillance, datalink, and resolution capability of the Mode S sensor exceeded established thresholds and the sensor performance is captured as baseline data for future reference.

## 1. SCOPE.

This report discusses the results of Mode S Performance testing conducted at the Federal Aviation Administration (FAA) Technical Center, Atlantic City International Airport, New Jersey, from June 29 to October 15, 1993, using software version TR21.2. This report also includes data from regression tests run in January and February 1994, with software version TR21.3 which included a number of corrections to the Mode S software tested in the June to October 1993 period. The tests described in this report were performed using a terminal Mode S sensor configuration. For this reason, objectives relating to enroute sensors are not considered. This report includes recommendations, conclusions, and identifies additional regression testing where needed.

## 2. REFERENCE DOCUMENTS.

The following documents are referenced in this report:

### SPECIFICATIONS

FAA-E-2716	Mode Select Beacon System (Mode S) Sensor, Amendment 2, Changes 1-24, SCN #18 as changed by Mod 32 and Mod 38 contract.
NAS-SS-1000	NAS System Specification, Functional and Performance Requirements for the National Airspace System

### STANDARDS

FAA-STD-024a	Preparation of Test and Evaluation Documentation, August 17, 1987
--------------	---

### FAA ORDERS

Order 1810.4B	FAA NAS Test and Evaluation Program
---------------	-------------------------------------

### PLANS

DOT/FAA/CT-TN 88/28	Mode S Master Test Plan
DOT/FAA/CT-TN 89/24	Mode S Performance Test Plan

### USER'S MANUALS

Analysis Program User's Manuals for Mode S Performance, Integration, and Operational Testing;  
Volume 1 - RTADS Data Reduction (TDR) Programs  
Volume 2 - Mode S Data Reduction (DR) Programs

### 3. BACKGROUND.

The Mode S Operational Test and Evaluation (OT&E) effort was conducted at the FAA Technical Center from June 29 to October 15, 1993, with regression tests completed by February 1994. The Mode S system tested was configured for a terminal field configuration. This configuration is the one now being delivered to field sites. The terminal configuration allows for coverage of up to 60 nautical miles (nmi), a target load of 400 aircraft, and is capable of accepting digitized radar surveillance data from the Air Surveillances Radar (ASR)-9.

Some of the Mode S data collected was taken using the Real Time Aircraft Display System (RTADS). This hardware and software package can display and record disseminated target data.

RTADS collections are reduced using TRACS Data Reduction (TDR). TDR was developed to support Mode S testing and to replace older radar analysis programs. It allows the user to analyze the recorded output of the common digitizer, ASR-9, and the Mode S sensor.

Other data collections were accomplished by using the Mode S Analysis and Recording Display Environment (MARDE). The MARDE was used as a replacement for the tape drives that were formally used to extract Mode S sensor data. Instead of using magnetic tape to record sensor data, the MARDE enables users to collect the data on a personal computer-based hard disk drive. This eliminates the need for converting the data from one format to another prior to performing analysis.

MARDE collections are reduced using a set of Data Reduction (DR) programs located on the SUN and MASSCOMP systems at the FAA Technical Center.

Each of the 11 tests reported on in this document is addressed individually. The section for each test explains the purpose of the test and how it was conducted. Then the type and amount of data collected during the testing is explained. Next the methods of analysis used to reduce the data are detailed. Finally, the results of the test are given, failures or anomalies are highlighted, and conclusions are advanced.

This document also contains several appendices. Appendix A lists the SPR's referred to in the document. Appendix B explains the directory structure and naming conventions used to archive the computer files created during testing. This includes files created during data extractions and files created during analysis. The names of the extraction files created appear in appendix C. A list of all the files created during analysis is given in appendix D. A directory of SAPs and scenario definitions is included in appendix E.

#### 4. TEST AND EVALUATION.

In the sections that follow, each of the 11 tests which constitute the Mode S Performance Test is discussed separately. The results of the testing are given, and failures or problems related to each test are identified.

##### 4.1 TEST 1: IBI/ATCBI-5 COMPARISON

###### PURPOSE

The purpose of this test was to verify that the sensor's performance in Interim Beacon Interrogator (IBI) operation meets or exceeds that of the Air Traffic Control Beacon Interrogator (ATCBI)-5 for the parameters defined in the objectives below.

###### TEST OBJECTIVES

The objectives for this test were as follows:

1. To verify that the IBI Beacon Probability of Detection meets or exceeds that of the ATCBI-5.
2. To verify that the IBI Mode 3/A validity and reliability meets or exceeds that of the ATCBI-5.
3. To verify that the IBI Altitude validity and reliability meets or exceeds that of the ATCBI-5.
4. To verify that the IBI Beacon ring around rate is equal to or less than that of the ATCBI-5.
5. To verify that the IBI Beacon split rate is equal to or less than that of the ATCBI-5.
6. To verify that the IBI Mode 3/A code 0000 rate is equal to or less than that of the ATCBI-5.

## TEST CONFIGURATION

Figure 4.1-1 depicts the configuration for this test.

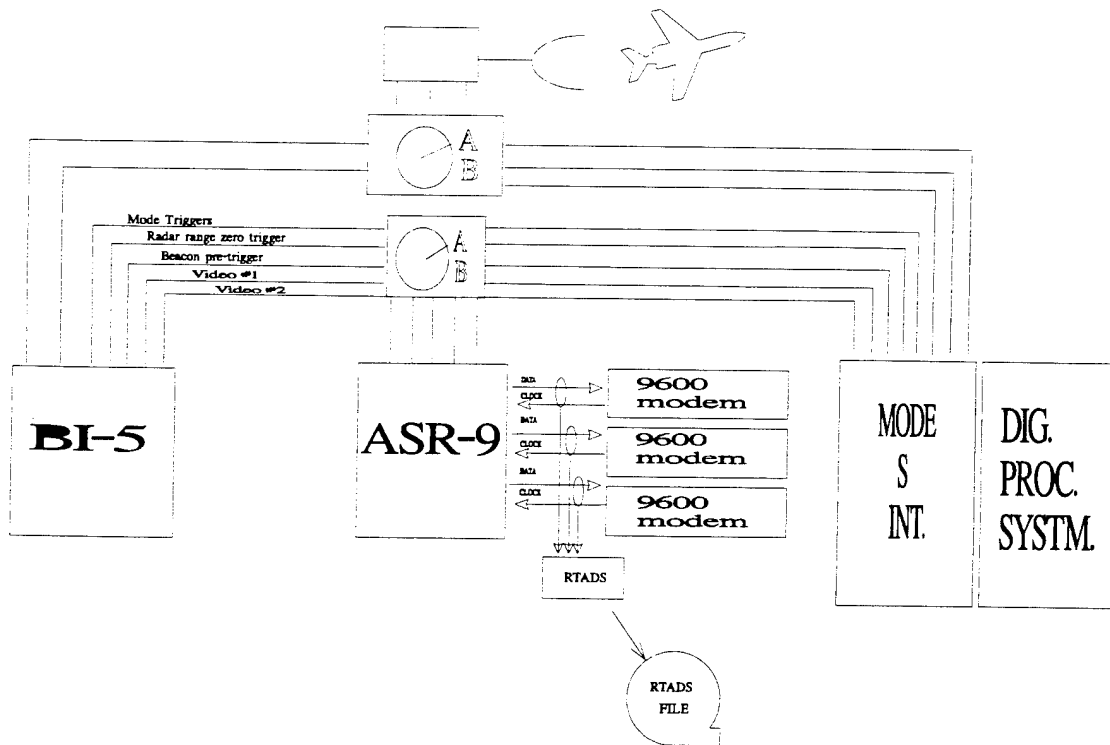

FIGURE 4.1-1. IBI/ATCBI-5 COMPARISON

Note: In figure 4.1-1, the A/B switches were used to go from IBI to ATCBI-5 operation.

## TEST DESCRIPTION

A beacon test set and the peak power meter were used to perform preliminary measurements. Comparisons of data collected using live targets of opportunity, ATCBI-5 versus IBI, were made.

To make these comparisons accurate, the transmit power levels between the ATCBI-5 and the IBI were matched before the tests began.

The IBI and the ATCBI-5 were connected to the ASR-9 radar via a video/trigger switch and to the antenna via radio frequency (RF) switching relays. This allowed the systems to be switched quickly enough for the live environment to remain similar between subtests. The test was broken into 40 subtests to provide a sample large enough to be considered statistically valid. Over 10 hours of data was collected and analyzed. For each subtest, data was collected until an RTADS file of 1 megabyte (MB) was recorded.

To ensure that the IBI and ATCBI-5 collections were done under similar conditions, IBI and ATCBI-5 collections were made alternately. An equal number of subtests were conducted using Side Lobe Suppression (SLS) and Improved Side Lobe Suppression (ISLS).

This test was composed of 40 subtests. To obtain the collections indicated they were organized as follows:

- \* 10 live world collections on the Mode S IBI (SLS): subtests 2 through 20 even.
- \* 10 live world collections on the ATCBI-5 (SLS): subtests 1 through 19 odd.
- \* 10 live world collections on the Mode S IBI (ISLS): subtests 22 through 40 even.
- \* 10 live world collections on the ATCBI-5 (ISLS): subtests 22 through 40 odd.

All of the IBI data was collected using Channel A. The Mode S sensor was loaded with the S1 Site Adaptable Parameters (SAPs) configuration identical to that used during the first performance test. Beacon video and triggers were fed to the ASR-9 radar for target processing by the Beacon Target Extractor. The digital surveillance data was disseminated over three 9600 baud modem lines and received by the ASR-9 Remote Surveillance and Communication Interface Processor (SCIP). No sensor alarms that could skew the test results were observed during the testing.

### DATA ANALYSIS

An RTADS extraction file containing all disseminated data types was recorded for each of the 40 subtests. Reduction and analysis were performed on each of the RTADS extraction files using the TDR Beacon False Target Summary and Surveillance Analysis programs. Surveillance Analysis provided the Beacon Probability of Detection, Mode 3/A validity and reliability, and Altitude validity and reliability statistics used to verify objectives one through three. The output of the Beacon False Target Summary program provided the statistics on ring around rate, split rate, and code 0000 rate used to verify objectives four through six. When required, filtering was done on the RTADS extraction file using the TDR Filter program. This allowed for easier analysis of particular targets or areas of the coverage map.

### TEST RESULTS

There were six Test Objectives to be verified. These objectives state that the sensor's performance in IBI operation should meet or exceed ATCBI-5 performance.

The data for objectives one through three is summarized in figure 4.1-2. Note from figure 4.1-2 that on the parameters where ATCBI-5 outperformed IBI, the differences were on the order of two-tenths of a percentage point or less. Although back-to-back collective periods were performed to have similar conditions, each of the ten collections

were unique with a certain randomness resulting in the summary data. Differences of a few tenths of a percent should be concluded as equal since they exceed the minimum system requirements by an order of magnitude.

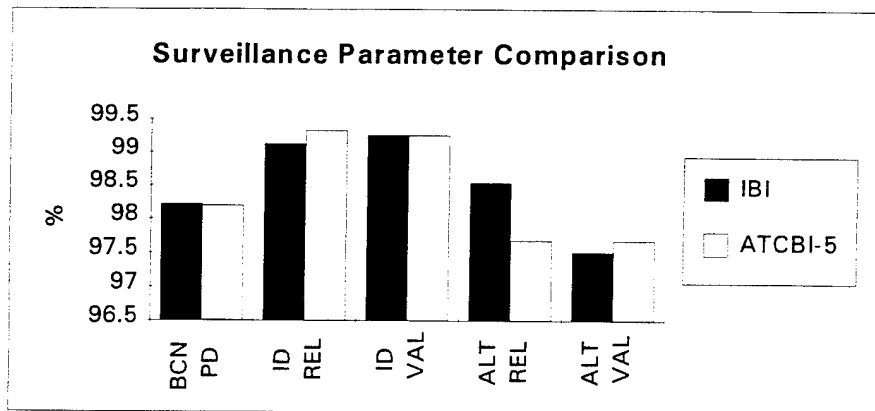

FIGURE 4.1-2. IBI / ATCBI-5 COMPARISON

The data for objectives four through six is shown in graphical form in figure 4.1-3 below.

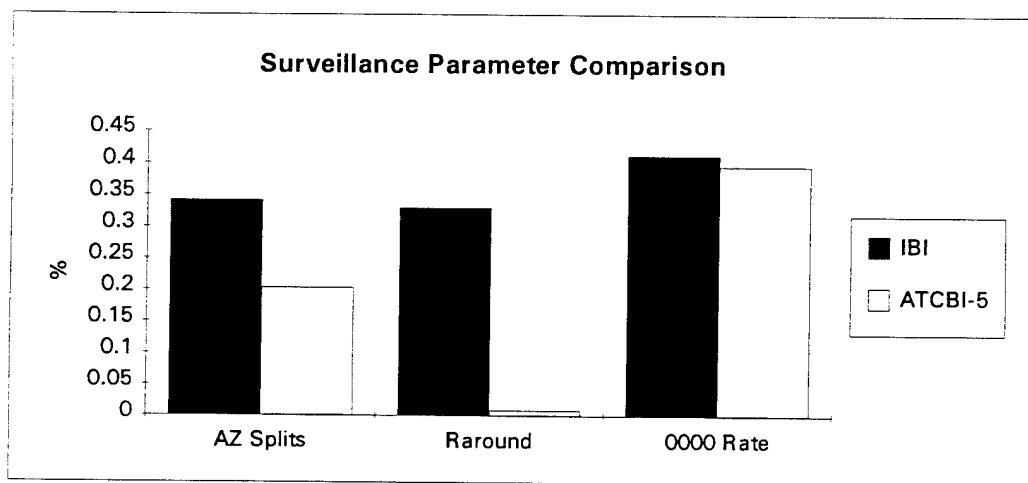

FIGURE 4.1-3. SPLITS AND RING AROUND COMPARISON

The higher Beacon Split rate for IBI operation shown in figure 4.1-3 was caused by pulse stretching associated with the log beacon video employed by the IBI (the ATCBI-5 uses linear video). Bench tests revealed that transponders whose frequency was outside of the allowable band ( $1090 \pm 3$  megahertz (MHz)), caused significant pulse stretching in the receiver. This pulse stretching caused multiple splits to occur on targets whose transponder frequencies were out of tolerance. An System Problem Report (SPR) was written on this problem (FC93-00501). This pulse stretching is the cause of objective 5 not being verified. When filtering was used it was determined that there were as many as

141 splits associated with a single target during one IBI collection. This same target had no Beacon Splits associated with it during the ATCBI-5 collections before and after the IBI collection. In the same way, as many as 224 Ring around errors were associated with a single target during an IBI collection. Again this target registered no Ring around faults during the ATCBI-5 collections before or after the IBI collection. The fact that objective 6 was not verified is also due to the pulse stretching problem. Filtering out the targets associated with multiple Beacon Split and/or Ring around errors resulted in the data shown in figure 4.1-4.

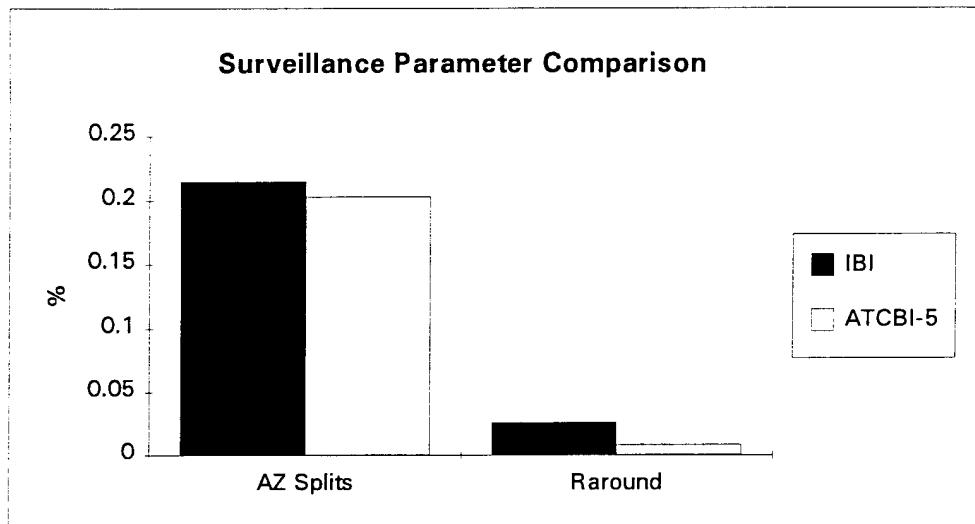

FIGURE 4.1-4. FILTERED SPLITS AND RINGAROUND

After filtering, the IBI and ATCBI-5 numbers for Beacon Splits and Ringarounds were much more comparable and the differences could be considered negligible. The filtered value for IBI Beacon Splits was 0.212 percent. This is only 0.009 percent different from the ATCBI-5 value of 0.203 percent. The filtered value for IBI Ringarounds was 0.026 percent. This is 0.017 percent greater than the ATCBI-5 value of 0.009 percent.

#### SLS Versus ISLS for IBI Operations

The sensor's performance using SLS was very similar to that observed using ISLS. Surveillance parameters were generally slightly better with SLS, but the differences were less than 0.16 percent. Such differences are so slight as to be considered negligible. The data comparing IBI performance using SLS and ISLS with regard to surveillance parameters is presented in table 4.1-1.



TABLE 4.1-1. SURVEILLANCE PARAMETERS- IBI RESULTS VERSUS IBI LIMITS

	BCN PD	ID REL	ID VAL	ALT. REL	ALT. VAL
IBI (SLS)	98.30%	99.18%	99.27%	98.59%	97.52%
IBI (ISLS)	98.14%	99.08%	99.24%	98.48%	97.50%
DIFFERENCE	0.16%	0.10%	0.03%	0.11%	0.02%

ISLS performed better with regard to false targets. Splits were 1.49 times more likely to occur with SLS than with ISLS. Ring around occurred 1.17 times more often with SLS. The split and Ring around statistics listed in table 4.1-2 do not take into account the targets with multiple splits and Ring arounds caused by log beacon video pulse stretching. The number of targets with multiple splits and Ring arounds caused by log beacon video pulse stretching was not equally distributed between tests using SLS and ISLS. For this reason a comparison of the SLS and ISLS results for these parameters should not have been considered statistically valid. It is fair to say, however, that ISLS performance with regard to false targets appears to be slightly better than SLS performance. The data comparing IBI performance using SLS and ISLS for false target parameters is presented in table 4.1-2.

TABLE 4.1-2. FALSE TARGET PARAMETERS- IBI RESULTS VERSUS IBI LIMITS

	AZ. SPLITS	RING-A-ROUND	0000 RATE
IBI (SLS)	0.257%	0.028%	0.402%
IBI (ISLS)	0.172%	0.024%	0.461%
DIFFERENCE	0.085%	0.004%	0.059%

IBI Performance versus National Standard for Performance

Tables 4.1-3 and 4.1-4 shown below compare the IBI (including SLS and ISLS data) performance observed during testing to the IBI nominal limits. The limits cited were taken from the Mode S Beacon System Airway Facilities Maintenance Handbook (document #6360.xx).

TABLE 4.1-3. SURVEILLANCE PARAMETERS-  
IBI RESULTS VERSUS IBI LIMITS

	BCN PD	ID REL	ID VAL	ALT. REL	ALT. VAL
IBI RESULTS	98.220%	99.128%	99.254%	98.535%	97.506%
IBI LIMITS	>97.0%	>97.0%	>97.0%	>97.0%	>96.0%
LIMITS MET?	YES	YES	YES	YES	YES

Table 4.1-4. FALSE TARGET PARAMETERS-  
IBI RESULTS VERSUS IBI LIMITS

	AZ. SPLITS	RING-A- ROUND	0000 RATE
IBI RESULTS	0.2145%	0.0260%	0.412%
IBI LIMITS	<0.20%	<1.0%	<1.0%
LIMITS MET?	NO	YES	YES

Note that all limits were met easily except for the Azimuth Split limit of 0.20 percent. The observed value of 0.2145 percent exceeds the limit by only 7.25 percent.

### CONCLUSIONS

The data indicates that the ATCBI-5 and the Mode S IBI performance is essentially the same. The ATCBI-5 did perform better than the IBI in the area of Azimuth Splits. This was due to problems in log receiver stretching for ATCRBS transponder whose frequency is out-of-tolerance (1090±3 MHz) and was documented as SPR# FC93-00501.

### 4.2 TEST 2: IBI PERFORMANCE MONITORING

#### PURPOSE

The purpose of this test was to (a) verify the accuracy of the forward power monitoring circuits, (b) test the accuracy of the Voltage Standing Wave Ratio (VSWR) monitoring circuits, and (c) test the monitoring alarm points of four key performance parameters of the IBI sensor; Directional Forward Power, Directional VSWR, Omni Forward Power, and Omni VSWR. The power alarms were tested to verify that they are sent to the Air Traffic Control (ATC) remote terminal.

## TEST OBJECTIVES

The objectives for this test were as follows:

- a. To verify that the IBI remote monitoring conforms to the IBI statement of work.
- b. To verify that the IBI power and VSWR alarms occur at the correct power levels.

## TEST CONFIGURATION

The test configuration consisted of the Mode S sensor, the local terminal, and a peak power meter. Since this test basically consisted of measuring power levels and comparing them with the local terminal, no Aircraft Reply and Interference Environmental Simulator (ARIES) scenarios were needed. This test required that the sensor be operated with the antenna rather than into a dummy load. This was done so that all cable losses in the signal path from the antenna would be included in the power measurements.

## TEST DESCRIPTION

For the purposes of this test, the sensor was operated in the IBI mode. The sum power was set to +52.0 decibels above 1 milliwatt (dBm) in both channels, and the omni power was set to +55.0 dBm in both channels. The sum and omni alarm threshold SAPs were set to indicate a yellow code for a power level 1 dBm lower and a red code for a power level 3 dBm lower than the power levels. All these limits were tested by reducing the power and verifying the appropriate response.

In place of section 4.2.5.1.3 of the Mode S Performance Test Procedure, Procedure 161 (sections A-E) from the Mode Select Beacon System Airway Facilities Maintenance Handbook was executed. Procedure 161 was considered an up-to-date version of section 4.2.5.1.3 of the Mode S Performance Test Procedure.

The power offset SAPs were adjusted on Channel A and Channel B so that the omni and sum powers on the local terminal measured 55 dBm and 52 dBm, respectively. This portion of the test verified the effectiveness of the power offset SAPs.

Power levels were adjusted on Channel A and Channel B to ensure that the yellow and red alarms occurred at the proper levels.

Next, the VSWR was measured at the sum and omni couplers. SAPs were adjusted so that the local terminal VSWR values displayed matched the measured VSWR values measured at the couplers. This was accomplished using Procedure 161 discussed above.

Finally, the VSWR and power alarm SAPs were tested and verified. The VSWR limit for a yellow code is 1.5. The limit for a red code is 2.0. These two limits are defined by SAP settings. The alarm performance was verified by first setting the alarm threshold

SAP to the measured VSWR and verifying that there is no alarm. Then the alarm threshold SAP was moved to 0.1 under the measured VSWR resulting in a yellow alarm. This procedure was repeated for yellow and red alarms in Channel A and Channel B.

### DATA ANALYSIS

Data analysis was performed immediately by observing the measurements and alarms on the local terminal. No data analysis programs were used; all analysis was completed by observation.

### TEST RESULTS

There were two Test Objectives to be verified.

Objective 1 states that the IBI remote monitoring conforms to the IBI statement of work. The test results verified this test objective.

Objective 2 states that the IBI power and VSWR alarms occur at the correct power levels. This objective was also verified. All alarms occurred at exactly the appropriate levels and the VSWR portion of the test was also successful.

### CONCLUSIONS

No deficiencies were identified during execution or analysis. The objectives for this test and their verification status are summarized in table 4.2-1.

TABLE 4.2-1. OBJECTIVE SUMMARY

OBJECTIVE	VERIFIED?
1. Verify that IBI remote monitoring conforms to the IBI statement of work	Yes
2. Verify that the IBI power and VSWR alarms occur at the correct power levels	Yes

### 4.3 TEST 3: SURVEILLANCE BASELINE-PD/PFA

#### PURPOSE

This test measured the Mode S probability of detection (Pd) and probability of false alarm (Pfa), both as a function of RF signal level and fruit level. This section includes the results and analysis of data observed using no fruit, moderate fruit and heavy fruit scenarios.

#### TEST OBJECTIVES

The objectives for this test were as follows:

- a. To verify that the Mode S Pd and the ATCRBS Pd rates exceed 99 percent for a received power of -76 dBm in the absence of fruit. References PTP Category 1, paragraph 4.1.1.1 and PTP TVRTM 1200
- b. To verify that the Mode S Pfa and the ATCRBS Pfa are less than  $10^{-6}$ , while detecting targets as per objective 1. References PTP Category 1, paragraph 4.1.1.1 and PTP TVRTM 1200
- c. To establish a baseline of Pd/Pfa versus selected RF signal levels and fruit levels. Reference PTP Category 1, paragraph 4.1.1.1

#### TEST CONFIGURATION

Figure 4.3-1 depicts the configuration for this test.

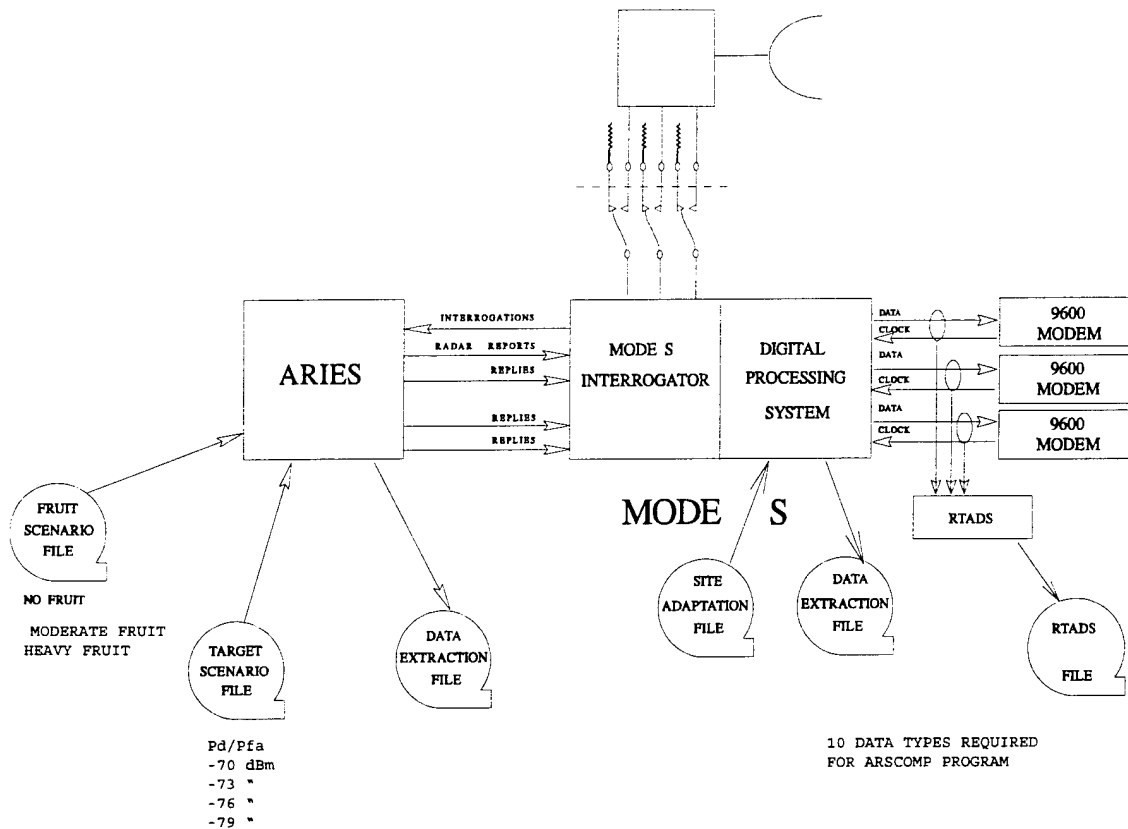

FIGURE 4.3-1. SURVEILLANCE BASELINE Pd/Pfa

TEST DESCRIPTION.

It was necessary to calibrate the ARIES to validate the received reply power levels -70, -73, -76, and -79 dBm for use in this test. The sensor was operated with a dummy load, rather than the antenna, for this test.

Each subtest executed an ARIES scenario with ATRBS and Mode S targets using a single received power level and one fruit level. There were four different received power levels and three different fruit levels, no fruit, moderate fruit (4k/sec), and heavy fruit (40K/sec). It required 12 subtests to run every combination of received power level and fruit level.

The S2 SAP configuration was used with the following modifications:

```

mode_s_roll_call_stc = 0,
mode_s_all_call_stc = 0,
atcrbs_stc = 0, and
auxiliary_stc = 0

```

Each of the ARIES scenarios started with a ring of 32 targets equally spaced, 11.25° apart at a range of 5 nmi from the sensor. There were 16 ATCRBS and 16 Mode S targets, alternating ATCRBS target, Mode S target, ATCRBS target, Mode S target, and so forth around the ring until it was complete.

Each scenario started with each target moving at a constant clockwise rotation rate, about the sensor, with its range increasing at a constant rate, and an approximate ground speed of 240 nmi per hour. The scenario ended after 10 minutes. At the end, each target was at a sensor range of 45 nmi, and had rotated 5.625° clockwise from its starting location.

### DATA ANALYSIS

ARIES and sensor data extraction files were saved from each subtest. These data files were reduced with the ARIES/Mode S Compare program which computed sample size, Probability of Detection (also called blip/scan ratio), Identity reliability, Altitude reliability, number of uncorrelated reports, and the number of replies per report.

RTADS data extraction files were also saved from each subtest. These data files were used by the Surveillance Analysis program to compute sample size, blip/scan ratio, and code reliability. The same data files were used by the Beacon False Target Summary to compute the number of false targets, which is in turn used to compute the Pfa.

### TEST RESULTS

The data presented was generated by processing the Mode S sensor, ARIES, and RTADS data extraction files using the DR and the Transportable Radar Analysis System TDR programs. Specifically, the DR option ARIES/Mode S Compare was used to process the sensor and ARIES extraction data, and the TDR Beacon False Target Summary and Surveillance Analysis were used to process the RTADS extraction data.

**Objective 1** required that the Pd for Mode S and ATCRBS targets exceed 99 percent for received reply power of -76 dBm (in the absence of fruit). All subtests passed. These results are shown in table 4.3-1.

TABLE 4.3-1. PROBABILITY OF DETECTION

Subtest	Pd Mode S (%)	Pd ATCRBS (%)
1a	100.00	99.86
2	100.00	100.00
3	100.00	99.71
Average	100.00	99.56
Pd Limits	>99.00	>99.00
Limits Met?	Yes	Yes

Figure 4.3-2 details the sensor's Pd performance as a function of decreasing received power levels and increasing fruit levels. Note from this figure that Mode S performance is virtually unaffected by the adverse conditions while ATCRBS performance is significantly degraded.

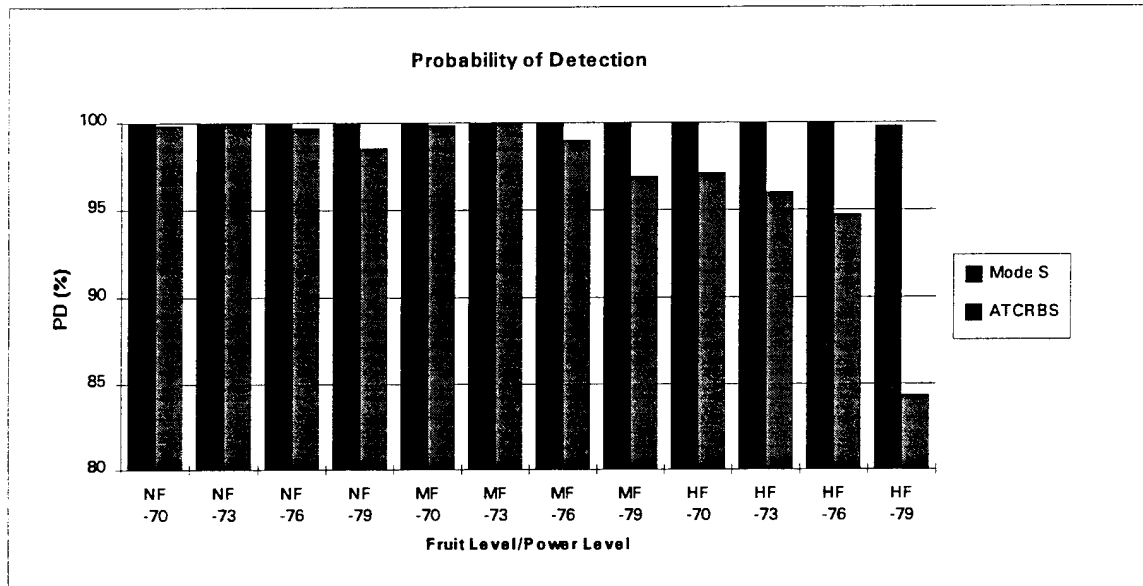

Figure 4.3-2. PROBABILITY OF DETECTION FOR ATCRBS / MODE S TARGETS

Note: The following legend applies to all figures related to this test.

**Legend**

NF=No Fruit MF=Moderate Fruit (4k/sec ATCRBS, 50/sec Mode S)  
 HF=Heavy Fruit (40k/sec ATCRBS, 200/sec Mode S)  
 Power levels are expressed in dBm



**Objective 2** required that the Pfa for Mode S and ATCRBS targets be less than  $10^{-6}$ . The Pfa values for all -70 dBm subtests are shown in table 4.3-2. This objective was verified for all subtests.

TABLE 4.3-2. PROBABILITY OF FALSE ALARM FOR -70 DBM TARGETS

Subtest Number	Pfa	
	Mode S	ATCRBS
1a (no fruit)	$7.852 \times 10^{-9}$	$0.4891 \times 10^{-9}$
5(moderate fruit)	$7.852 \times 10^{-9}$	0.0
9 (heavy fruit)	$8.803 \times 10^{-9}$	$15.65 \times 10^{-9}$
Pfa limit	$<10^{-6}$	$<10^{-6}$
Limit met?	YES	YES

The target report false alarm rate was significantly lower than the requirement of  $10^{-6}$  for both Mode S and ATCRBS, even at the 40K fruits levels

**Objective 3** required the establishment of a baseline of Pd operational values for a selected range of receiver power and fruit levels. The test results shown in table 4.3-3 fulfills this objective.

TABLE 4.3-3. Pd/Pfa BASELINE

Subtest	Probability of Detection (%)		Scenario Information (dBm)	
	Mode S	ATCRBS	Fruit Level	Power Level
1a	100.00	99.86	None	-70
2	100.00	100.00	None	-73
3	100.00	99.71	None	-76
4a	100.00	98.56	None	-79
5	100.00	99.85	Moderate	-70
6	100.00	100.00	Moderate	-73
7	100.00	98.99	Moderate	-76
8	100.00	96.92	Moderate	-79
9	100.00	97.10	Heavy	-70
10	100.00	96.00	Heavy	-73
11	100.00	94.73	Heavy	-76
12	99.80	84.34	Heavy	-79

Figures 4.3-3 and 4.3-4 give the ATCRBS and Mode S data for these tests as a function of fruit level. The data in these figures is an average of all the data collected at each fruit level. The data is presented in this fashion to highlight the fact that Mode S performance is stable regardless of fruit level tested while ATCRBS performance is degraded by increasing fruit levels. This trend is present in both the Pd and Pfa results.

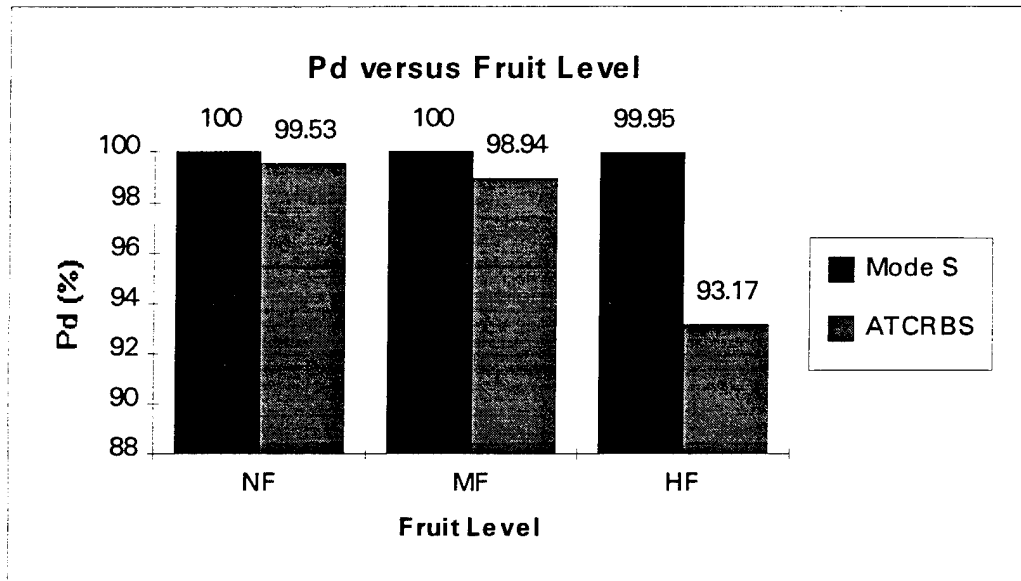

FIGURE 4.3-3. AVERAGE Pd VERSUS FRUIT LEVEL

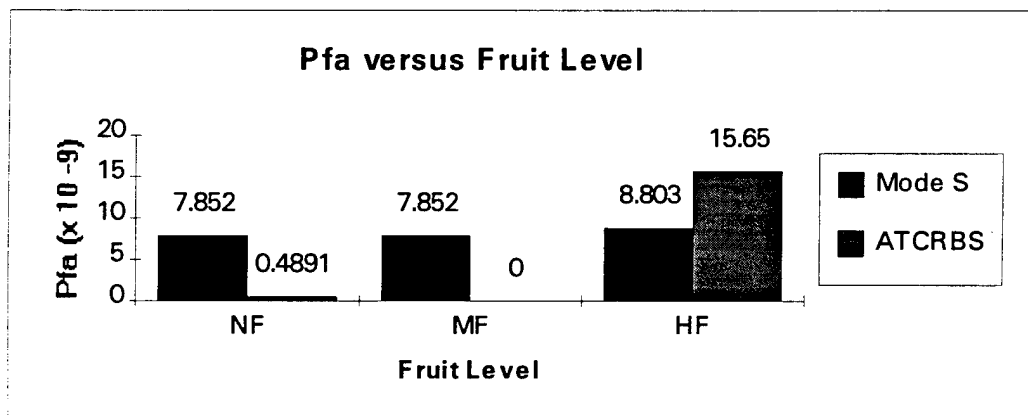

FIGURE 4.3-4. AVERAGE Pfa VERSUS FRUIT LEVEL

CONCLUSIONS

All objectives for this test were verified. The Pd and Pfa objectives were met, and the Pd/Pfa operational Baseline was established.

The sensor's performance was generally better with Mode S targets than with ATCRBS. Specifically, there was less degradation in the Pd and the Pfa due to decreasing received signal power levels or increasing fruit levels. For both parameters, ATCRBS performance degraded significantly in adverse conditions while Mode S performance held stable.

A summation of the results as they relate to each objective follows in table 4.3-4.

TABLE 4.3-4. OBJECTIVE SUMMARY

OBJECTIVE	VERIFIED?
1. ATCRBS and Mode S Pd > 99% for received power -76 dBm in the absence of fruit.	YES
2. ATCRBS and Mode S Pfa < 10 <sup>-6</sup>	YES
3. Establish a baseline of PD/Pfa versus RF signal levels and fruit levels.	YES

## 4.4 TEST 4: SURVEILLANCE BASELINE-REPORT PARAMETERS

### PURPOSE

This test evaluated Mode S surveillance performance under typical target load and capacity situations. The following surveillance report data was collected and analyzed:

- a. beacon blip/scan ratio,
- b. effective blip/scan ratio (includes radar substitution),
- c. ID code validity,
- d. altitude code validity,
- e. false targets due to splits and fruit,
- f. Mode S interrogation rate, and
- g. Mode S re-interrogation rate.

### TEST OBJECTIVES

The objectives for this test were as follows:

1. To verify that the beacon blip/scan ratio for Mode S exceeds 98 percent and that the beacon blip/scan ratio for ATCRBS exceeds 97 percent. Reference PTP Category 1, paragraph 4.1.1.1.
2. To verify that the effective blip/scan ratio (including radar substitution) exceeds 99 percent for both Mode S and ATCRBS. Reference PTP Category 1, paragraph 4.1.1.1.
3. To verify that the ID code validity exceeds 97 percent for ATCRBS and 99.9 percent for Mode S. Reference PTP Category 1, paragraph 4.1.1.1.
4. To verify that the Altitude code validity exceeds 95 percent for ATCRBS and 99.9 percent for Mode S. Reference PTP Category 1, paragraph 4.1.1.1.
5. To verify that false reports due to splits and fruit are less than 0.3 percent for ATCRBS and less than 0.1 percent for Mode S. Reference PTP Category 1, paragraph 4.1.1.1.
6. To verify that an ATCRBS/Mode S All-Call can be generated. References PTP Category 1, paragraph 4.1.1.1 and PTP TVRTM 1300.
7. To verify that a Mode S Role-Call can be generated. References PTP Category 1, paragraph 4.1.1.1 and PTP TVRTM 1340.
8. To verify that the average Mode S re-interrogation rate is less than 0.10 re-interrogations per target report. References PTP Category 1, paragraph 4.1.1.1.

## TEST CONFIGURATION

Figure 4.4-1 depicts the configuration for this test.

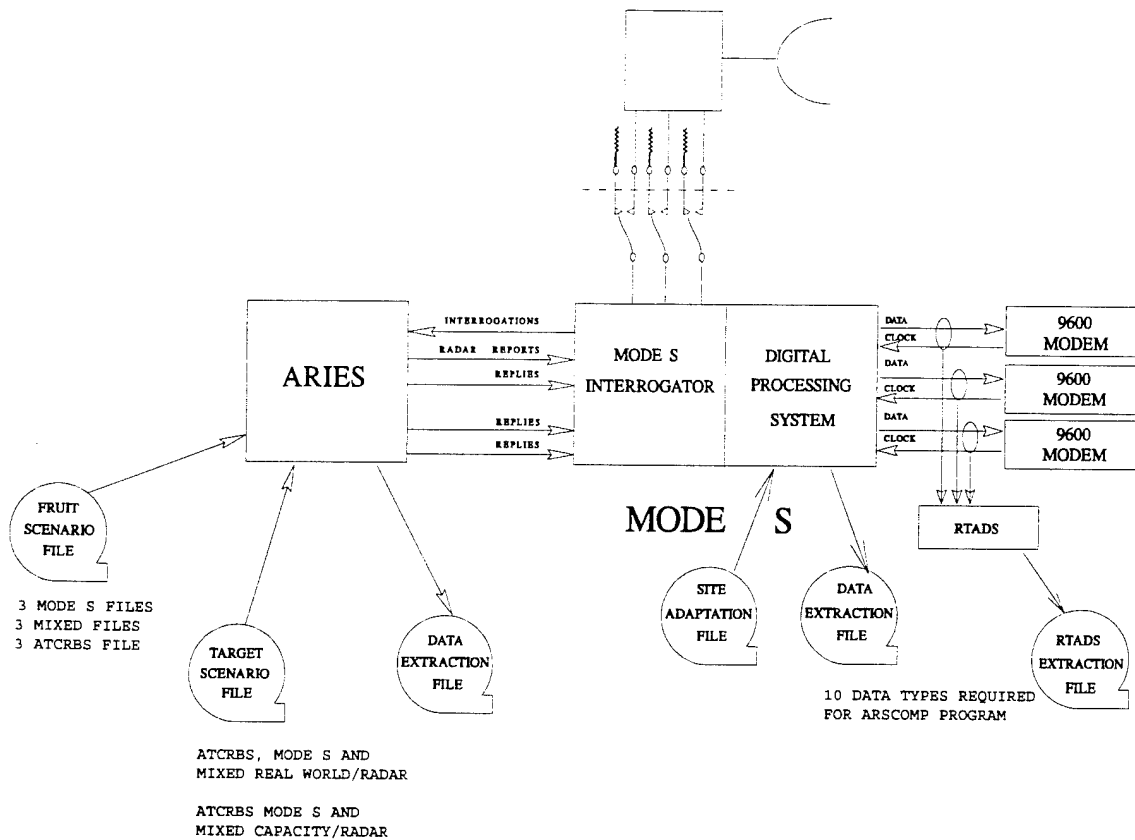

**FIGURE 4.4-1. SURVEILLANCE BASELINE - REPORT PARAMETERS**

## TEST DESCRIPTION

The sensor was operating with a dummy load rather than the antenna. Eighteen subtests were executed using ARIES target scenarios and fruit scenarios. Two types of ARIES target scenarios were used:

1. Real world scenarios (derived from data recorded at operational sites)
2. Capacity scenarios with a maximum of 400 targets

Both the real world and capacity scenarios were executed using only ATCRBS targets, only Mode S targets, and an equal mixture of ATCRBS and Mode S targets. Each scenario was executed using no fruit, moderate fruit ( 4K/sec ATCRBS and 50/sec Mode S), or heavy fruit ( 40K/sec ATCRBS and 200 Mode S/sec) scenarios. Twenty-five percent of the fruit was mainbeam fruit.

For these tests, the sensor was loaded with the S2 SAP configuration with the following changes:

```
radar_type = 1,  
sds_surv_installed = 1,  
surv_data_selector_mode = 1,  
surv_destination_control = 1, and  
ntry = 0.
```

To enable the 80 percent radar reinforcement, it was necessary to install ARIES Radar Report cables into Mode S communications junction box. The cables from ports J49, J50, J69, J70 were unplugged. The ARIES cable for Channel A was plugged into J49, and the ARIES cable for Channel B was plugged into J50.

### DATA ANALYSIS

The data presented was produced using Mode S Sensor, ARIES, and RTADS extraction files generated during test execution. The TDR Beacon False Target Summary, TDR Surveillance Analysis, DR Channel Management Statistics, and DR ARIES Compare data reduction programs were run on the data collected for each subtest.

### TEST RESULTS

The data as it relates to each objective is presented below.

**Objective 1** of the Performance Test Procedure required that the beacon blip/scan ratio (i.e., Pd) for Mode S exceed 98 percent and that the beacon blip/scan ratio (Pd) for ATCRBS exceed 97 percent. The data for all subtests exceeded the limits. Note that sensor performance was generally better with Mode S targets than it was with ATCRBS targets.

**Objective 2** of the Performance Test Procedure required that the effective beacon blip/scan ratio (Pd) (including radar substitution) exceed 99 percent for both Mode S and ATCRBS. The effective blip/scan ratios (Pd) for the Mode S, ATCRBS and Mixed scenarios exceed 99.65 percent in every case. The data for Pd, and Effective Pd is given in table 4.1-1 shown below. Note that Mode S performance was superior to ATCRBS performance for both of these parameters. The conditions field of table 4.4-1 defines the scenario type, fruit level, and target mix.

TABLE 4.4-1. BEACON AND EFFECTIVE PD DATA

Subtest	Beacon Pd (%)		Effective Pd (%)		Conditions
	ATCRBS	Mode S	ATCRBS	Mode S	
1	99.69	N/A	99.74	N/A	RW/NF/A
2	N/A	99.63	N/A	99.72	RW/NF/S
3	99.73	99.81	99.79	99.85	RW/NF/M
4	99.63	N/A	99.71	N/A	RW/MF/A
5	N/A	99.64	N/A	99.71	RW/MF/S
6	99.65	99.71	99.71	99.84	RW/MF/M
7	*	N/A	*	N/A	RW/HF/A
8	N/A	99.68	N/A	99.73	RW/HF/S
9	99.42	99.72	99.65	99.85	RW/HF/M
10	99.77	N/A	99.91	N/A	CP/NF/A
11	N/A	100.00	N/A	100.00	CP/NF/S
12	99.76	100.00	99.94	100.00	CP/NF/M
13	99.73	N/A	99.95	N/A	CP/MF/A
14	N/A	100.00	N/A	100.00	CP/MF/S
15	99.77	100.00	99.77	100.00	CP/MF/M
16	99.34	N/A	99.73	N/A	CP/HF/A
17	N/A	100.00	N/A	100.00	CP/HF/S
18	99.54	100.00	99.84	100.00	CP/HF/M
Average	99.62	99.85	99.79	99.89	N/A
Limits	>97.0	>98.0	>99.0	>99.0	N/A
Limits Met?	YES	YES	YES	YES	N/A

Note: The following legend applies to all of the tables for Test #4.

**Legend**

- |                          |   |
|--------------------------|---|
| A = ATCRBS Targets       | N/A = Not Applicable  |
| S = Mode S Targets       | NF = No Fruit Scenario                                      |
| M = Mixed Targets        | MF = Moderate Fruit Scenario (4k/sec ATCRBS, 50/sec Mode S) |
| RW = Real World Scenario | HF = High Fruit Scenario (40k/sec ATCRBS, 200/sec Mode S)   |
| CP = Capacity Scenario   | * = Not Executed  |



**Objective 3** of the Performance Test Procedure required that the ID code validity exceed 97 percent for ATCRBS targets and 99.9 percent for Mode S targets. The limits for ATCRBS targets were met on all subtests. The ID code validity for Mode S targets in subtests 2, 5, and 8 was slightly below the limit. Subtest 2 had the lowest reading, 99.81 percent. The average ID code validity for Mode S targets was 99.95 percent, above the limit of 99.9 percent. Given this and the fact that the worst failure was only 0.09 percent below the limit, this objective is considered verified. The lowest value of ID code validity observed for ATCRBS targets was 99.48 percent in subtest 16.

**Objective 4** of the Performance Test Procedures required the Altitude code validity exceeds 95 percent for ATCRBS and 99.9 percent for Mode S. All subtests exceeded the limit for ATCRBS targets, however subtests 2, 5, and 8, failed for Mode S targets. As the worst case failure (subtest 2) was only 0.14 percent low, and the average of all subtests exceeded the limit, these failures were not significant. Note that the sensor performed better with Mode S targets than it did with ATCRBS targets. The ID and Altitude Validity data are given in table 4.4-2 shown below.

TABLE 4.4-2. ID AND ALTITUDE VALIDITY DATA

Subtest	ID Validity (%)		Altitude Code Validity (%)		Conditions
	ATCRBS	Mode S	ATCRBS	Mode S	
1	99.97	N/A	99.59	N/A	RW/NF/A
2	N/A	99.81	N/A	99.76	RW/NF/S
3	99.98	99.98	99.63	99.90	RW/NF/M
4	99.93	N/A	99.46	N/A	RW/MF/A
5	N/A	99.82	N/A	99.77	RW/MF/S
6	99.92	99.93	99.35	99.93	RW/MF/M
7	*	N/A	*	N/A	RW/HF/A
8	N/A	99.87	N/A	99.83	RW/HF/S
9	99.66	99.95	95.93	99.93	RW/HF/M
10	99.87	N/A	99.32	N/A	CP/NF/A
11	N/A	100.00	N/A	100.00	CP/NF/S
12	99.98	99.99	99.77	99.99	CP/NF/M
13	99.85	N/A	99.91	N/A	CP/MF/A
14	N/A	100.00	N/A	100.00	CP/MF/S
15	99.97	100.00	99.63	100.00	CP/MF/M
16	99.48	N/A	95.21	N/A	CP/HF/A
17	N/A	99.99	N/A	99.99	CP/HF/S
18	99.77	100.00	95.89	100.00	CP/HF/M
Average	99.84	99.95	98.20	99.94	N/A
Limits	>97.0	>99.9	>95.0	>99.9	N/A
Limits Met?	YES	YES	YES	YES	N/A

Figures 4.4-2, 4.4-3, 4.4-4, and 4.4-5 present the average value of each parameter as a function of fruit level. Note that Mode S performance is generally superior to ATCRBS performance. In addition, Mode S performance is much less subject to degradation with increasing levels of fruit.

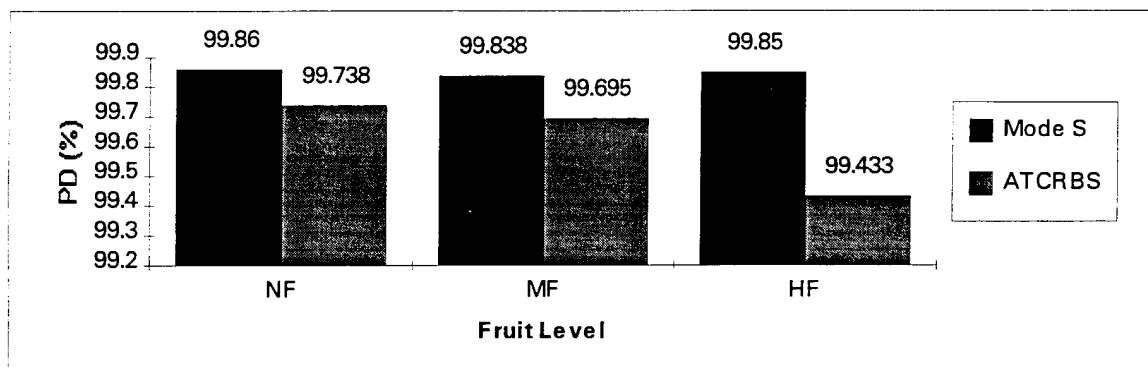

FIGURE 4.4-2. BEACON PROBABILITY OF DETECTION DATA

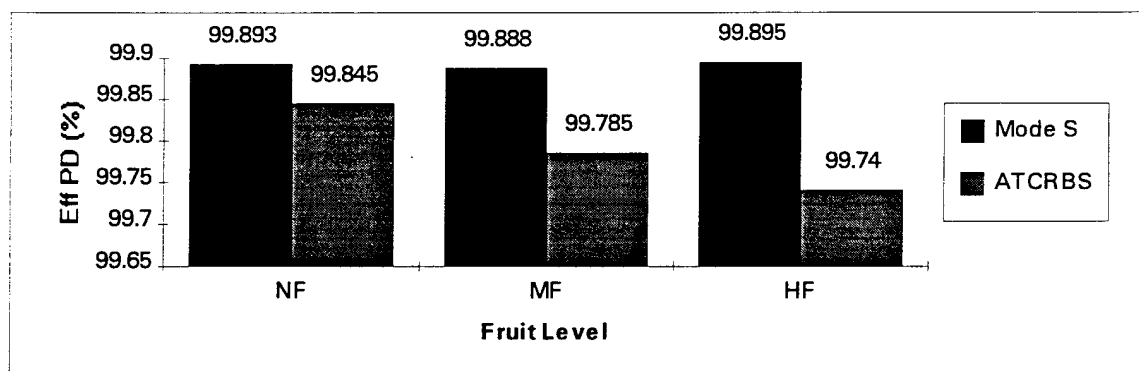

FIGURE 4.4-3. EFFECTIVE PROBABILITY OF DETECTION DATA

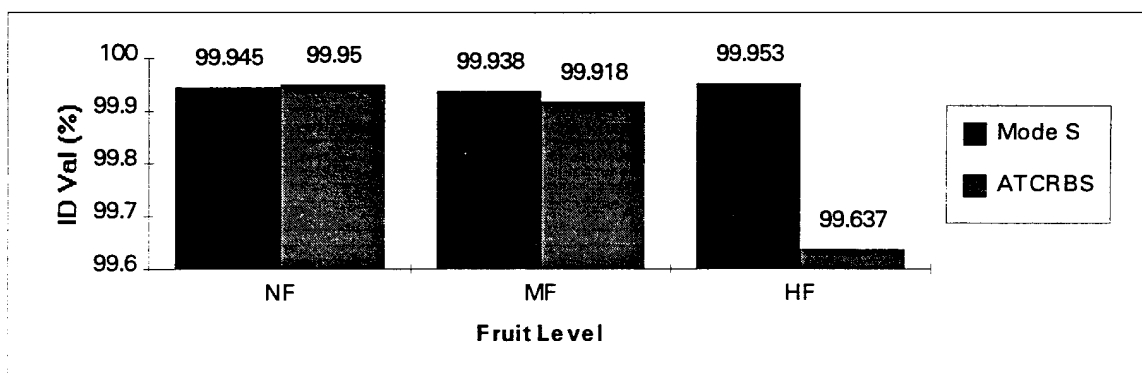

FIGURE 4.4-4. ID CODE VALIDITY DATA

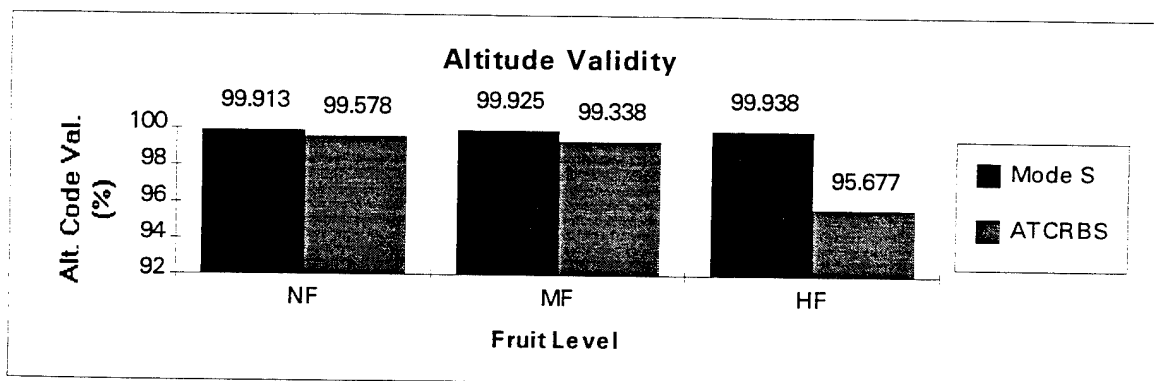

FIGURE 4.4-5. ALTITUDE CODE VALIDITY DATA

**Objective 5** of the Performance Test Procedure required that false reports due to splits and fruit were less than 0.3 percent for ATRCBS and less than 0.1 percent for Mode S. All of the subtests easily passed this requirement, both on ATRCBS and Mode S targets. Table 4.4-3 and figure 4.4-6 summarize the False Targets due to splits and fruit data for these tests.

TABLE 4.4-3. FALSE TARGETS DUE TO SPLITS AND FRUIT

Subtest	Splits (%)		Conditions
	ATCRBS	Mode S	
1	0.02	N/A	RW/NF/A
2	N/A	0.04	RW/NF/S
3	0.01	0.01	RW/NF/M
4	0.03	N/A	RW/MF/A
5	N/A	0.04	RW/MF/S
6	0.02	0.02	RW/MF/M
7	*	N/A	RW/HF/A
8	N/A	0.04	RW/HF/S
9	0.05	0.0	RW/HF/M
10	0.02	N/A	CP/NF/A
11	N/A	0.0	CP/NF/S
12	0.0	0.0	CP/NF/M
13	0.01	N/A	CP/MF/A
14	N/A	0.0	CP/MF/S
15	0.01	0.01	CP/MF/M
16	0.13	N/A	CP/HF/A
17	N/A	0.0	CP/HF/S
18	0.04	0.0	CP/HF/M
Average	0.036	0.01	N/A
Limits	<0.3	<0.1	N/A
Limits Met?	YES	YES	N/A

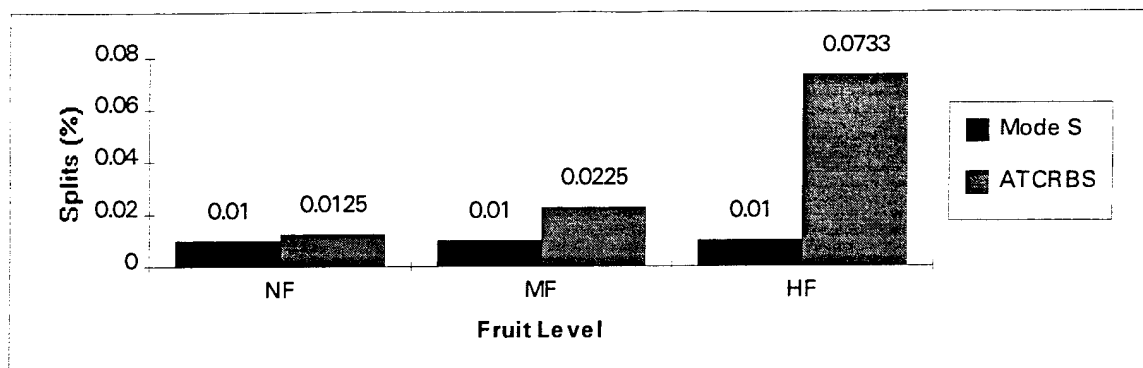

FIGURE 4.4-6. FALSE TARGETS DUE TO SPLITS AND FRUIT DATA

**Objective 6** of the Performance Test Procedure required verification that ATCRBS and Mode S All-Calls were generated. The fact that all ATCRBS and Mode S subtests, using capacity scenarios executed successfully (except for excessive re-interrogation rates), according to the Performance Test Procedure, verifies that multiple ATCRBS and Mode S All-Calls were successfully generated.

**Objective 7** of the Performance Test Procedure required verification that Mode S Roll-Calls were generated. The fact that all Mode S and Mixed subtests, using capacity scenarios executed successfully (except for excessive re-interrogation rates), according to the Performance Test Procedure, verifies that multiple Mode S Roll-Calls were successfully generated.

**Objective 8** of the Performance Test Procedure required that the average Mode S re-interrogation rate was less than 0.10 re-interrogations per target report. This objective was not verified. The re-interrogation rate for each target was dependent on its range. Targets close to the sensor had a higher re-interrogation rate than those further away. The data reduction tool Channel Management Statistics, filtered on range, was used to determine how re-interrogation rate changes as a function of range. The greatest variations in re-interrogation rate were observed in the range interval of 0 to 20 nmi. In the interval 20 to 60 nmi, the re-interrogation rate was relatively constant. For this reason, the analysis was done by dividing the coverage map into six range bands. The ranges included in each band are shown below;

- |                               |                                |
|-------------------------------|--------------------------------|
| 1. $0 \leq \text{range} < 4$  | 4. $12 \leq \text{range} < 16$ |
| 2. $4 \leq \text{range} < 8$  | 5. $16 \leq \text{range} < 20$ |
| 3. $8 \leq \text{range} < 12$ | 6. $20 \leq \text{range} < 60$ |

The Channel Management Statistics program was executed once for every range band of each subtest.

The results of the analysis are given in table 4.4-4. This table shows how re-interrogation rate varies with range during these tests. Note from figure 4.4-7 that the re-interrogation rate for real world and capacity scenarios generally drops off as range increases. The lowest value of re-interrogation rate observed was for targets with ranges

between 16 and 20 nmi in subtests 3 and 6. The re-interrogation rate of 0.05 in this interval was the only instance of data that fell below the 0.10 limit.

TABLE 4.4-4. RE-INTERROGATION RATE VERSUS RANGE (nmi)

Re-interrogation Rate versus Range (nmi)							
Subtest	0≤R≤4	4≤R≤8	8≤R≤12	12≤R≤16	16≤R≤20	20≤R≤60	Scenario Type
2	0.82	0.38	0.26	0.17	0.15	0.14	RW/NF
3	0.83	0.37	0.22	0.16	0.05	0.14	RW/MF
5	0.82	0.38	0.25	0.18	0.15	0.14	RW/NF
6	0.83	0.38	0.22	0.19	0.05	0.15	RW/MF
8	0.82	0.41	0.24	0.19	0.14	0.14	RW/HF
9	0.84	0.39	0.23	0.22	0.11	0.21	RW/HF
11	0.84	0.54	0.33	0.24	0.33	0.17	CP/NF
12	0.83	0.54	0.30	0.24	0.35	0.17	CP/MF
14	0.83	0.49	0.27	0.23	0.32	0.17	CP/NF
15	0.83	0.48	0.28	0.22	0.34	0.17	CP/MF
17	0.83	0.48	0.26	0.23	0.33	0.17	CP/HF
18	0.83	0.49	0.27	0.24	0.36	0.22	CP/HF
RW. Average	0.827	0.385	0.237	0.185	0.108	0.153	RW
CP. Average	0.832	0.503	0.285	0.233	0.338	0.182	CP
Overall Average	0.829	0.444	0.261	0.209	0.223	0.168	RW
Limit	<0.10	<0.10	<0.10	<0.10	<0.10	<0.10	CP
Limit Met?	NO	NO	NO	NO	NO	NO	N/A

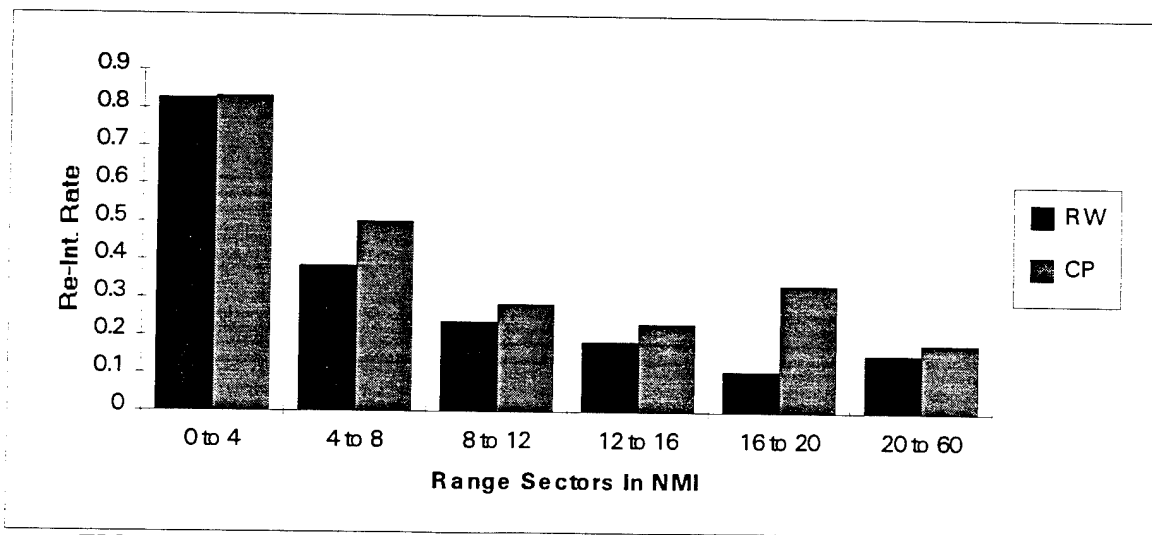

FIGURE 4.4-7. RE-INTERROGATION RATE VERSUS SCENARIO TYPE

Re-interrogation rate appears to be independent of the level of fruit present. This is shown in figure 4.4-8.

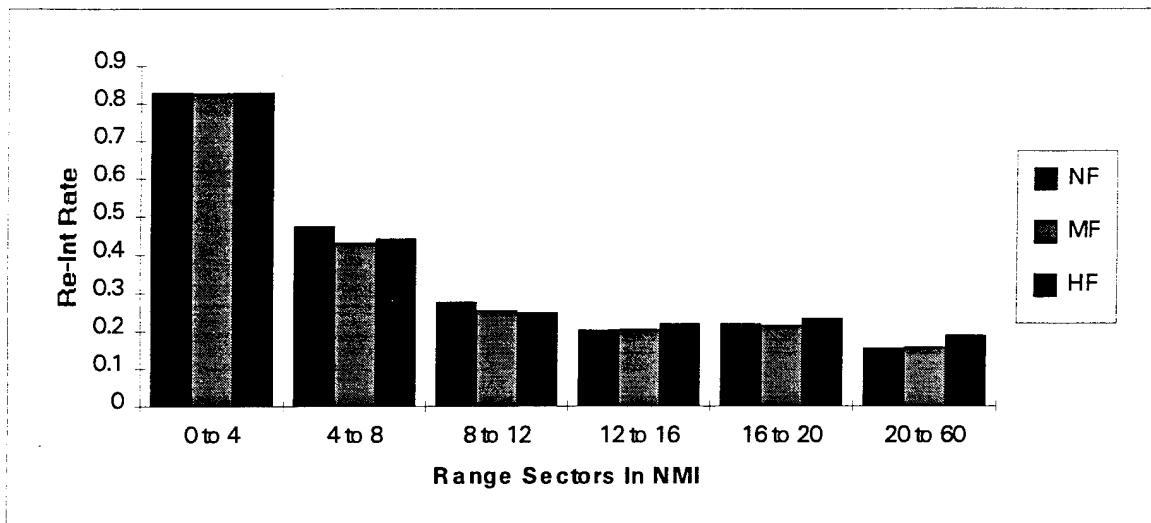

FIGURE 4.4-8. RE-INTERROGATION RATE VERSUS FRUIT LEVEL

Since the high re-interrogation rates shown in table 4.4-4 could not be explained, an SPR (FC93-30910) was written to document the problem. In general, the re-interrogation rate increases with increasing reply processing load on the sensor.

It is interesting to look at how the sensor's performance varies with changing fruit levels. Tables 4.4-5 and 4.4-6 present the average value for each surveillance parameter as a function of fruit level. Note that in all cases the performance with Mode S targets is virtually constant. Also note that ATCRBS performance degrades steadily in the presence of increasing fruit. This is especially true in regard to Altitude Code Validity and Splits. There are no instances of performance being degraded below the specification requirement for a given level of fruit.

TABLE 4.4-5. PROBABILITY OF DETECTION DATA VERSUS FRUIT LEVEL

	Beacon PD		Effective PD	
	ATCRBS	MODE S	ATCRBS	MODE S
No Fruit	99.738	99.860	99.845	99.893
Moderate Fruit	99.695	99.838	99.785	99.888
Heavy Fruit	99.433	99.850	99.740	99.895
Average	99.622	99.849	99.790	99.892
Limit	>97.0	>98.0	>99.0	>99.0

TABLE 4.4-6. SURVEILLANCE PARAMETER DATA VERSUS FRUIT LEVEL

	ID Code Val.		Alt. Code Val.		Splits	
	ATCRBS	MODE S	ATCRBS	MODE S	ATCRBS	MODE S
No Fruit	99.950	99.945	99.578	99.913	0.0125	0.0100
Moderate Fruit	99.918	99.938	99.338	99.925	0.0225	0.0100
Heavy Fruit	99.637	99.923	95.677	99.938	0.0733	0.0100
Average	99.835	99.935	98.198	99.925	0.0361	0.0100
Limit	>97.0	>99.9	>95.0	>99.9	<0.3	<0.1

Figures 4.4-9 through 4.4-13 present the data from tables 4.4-5 and 4.4-6 in the form of graphs. These graphs show even more clearly the superior noise immunity of the Mode S interrogations and replies.

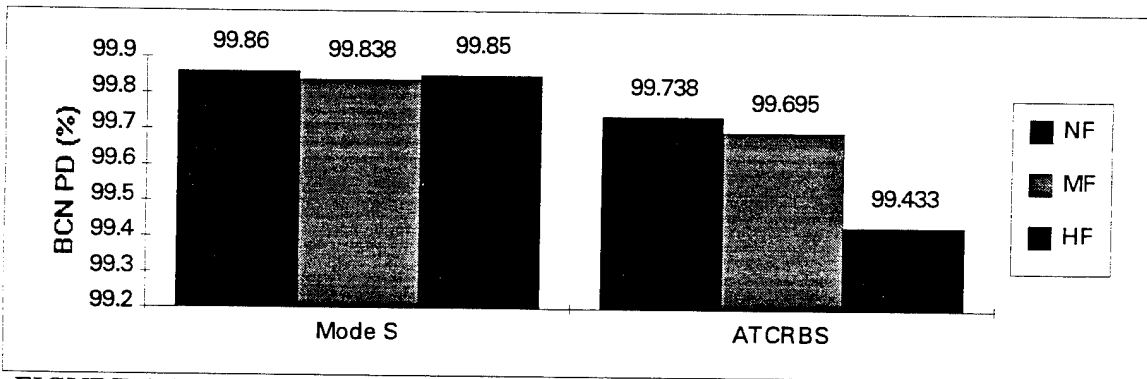

FIGURE 4.4-9. BEACON PROBABILITY OF DETECTION DEGRADATION AS A FUNCTION OF FRUIT LEVEL

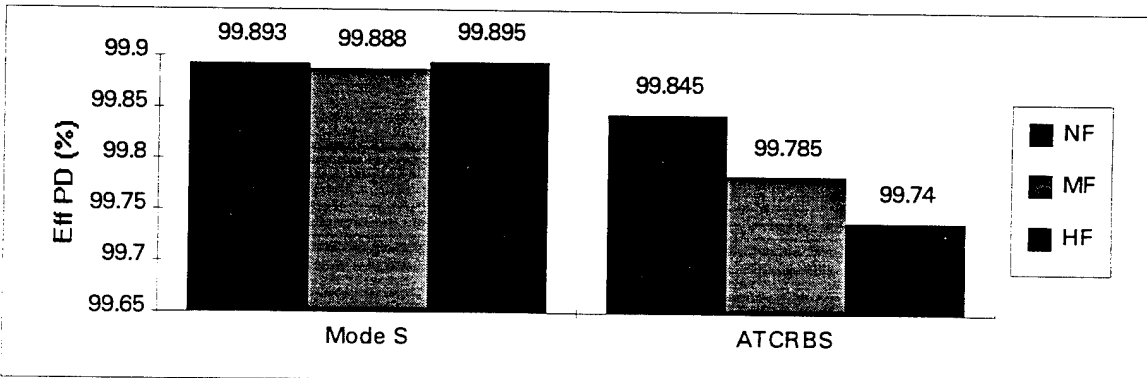

FIGURE 4.4-10. EFFECTIVE PROBABILITY OF DETECTION DEGRADATION AS A FUNCTION OF FRUIT LEVEL

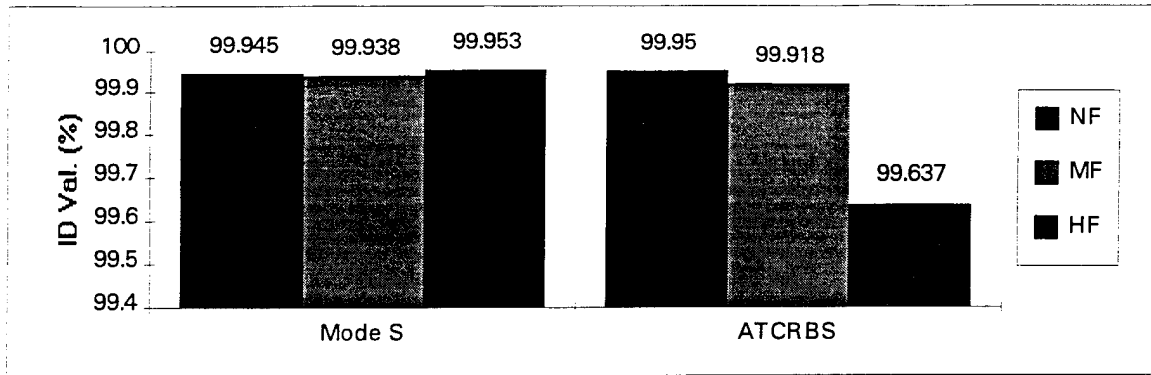

FIGURE 4.4-11. ID CODE VALIDITY DEGRADATION AS A FUNCTION OF FRUIT LEVEL

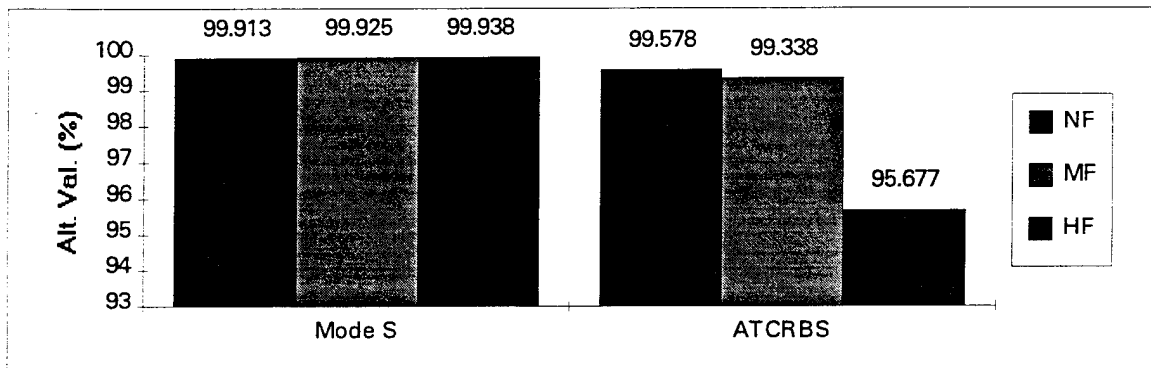

FIGURE 4.4-12. ALTITUDE CODE VALIDITY DEGRADATION AS A FUNCTION OF FRUIT LEVEL

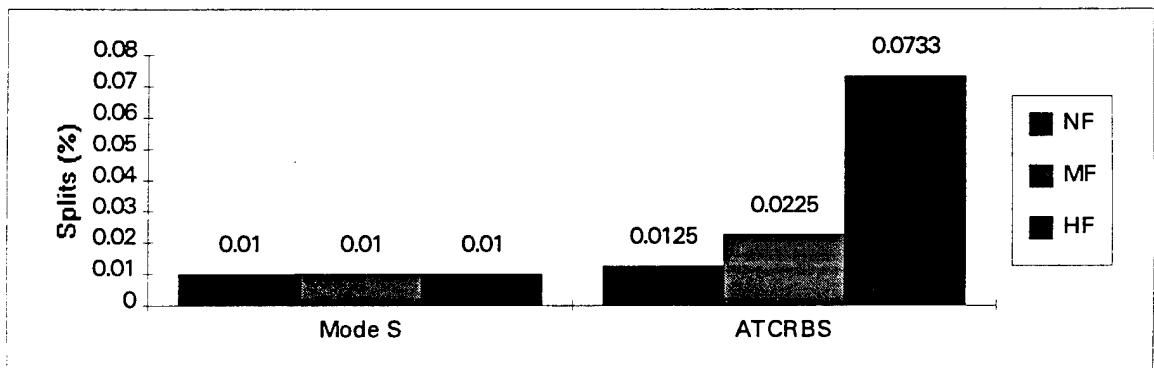

FIGURE 4.4-13. FALSE TARGETS DUE TO SPLITS AND FRUIT DEGRADATION AS A FUNCTION OF FRUIT LEVEL

## CONCLUSIONS

All the objectives for surveillance performance as measured using the ARIES simulation environment were met except for Re-interrogation rate. The Re-interrogation Rate (objective 8) limit of less than 0.10 was not met for any subtest. The re-interrogation rate is highest closest to the sensor and decreases with increasing range. After a range of approximately 20 nmi is reached, the rate remains relatively constant to the limits of the



coverage. An SPR (FC93-30910) was written concerning this issue. No resolution of this SPR has been forthcoming. Further testing will be required when a solution to the SPR is proposed.

The objectives for this test and whether or not they have been verified by the testing to date is summarized in table 4.4-7.

TABLE 4.4-7. OBJECTIVE SUMMARY

OBJECTIVE	VERIFIED?
1. Mode S blip/scan >98%, ATCRBS blip/scan >97%	YES
2. Effective blip/scan >99% for Mode S and ATCRBS	YES
3. Mode S ID code validity >99.9%, ATCRBS code validity >97%	YES
4. Mode S Altitude code validity >99.9%, ATCRBS code validity >95%	YES
5. False reports due to splits and fruit <0.1% for Mode S, <0.03% for ATCRBS	YES
6. A Mode S/ATCRBS All Call can be generated	YES
7. A Mode S/ATCRBS Roll Call can be generated	YES
8. Average Mode S re-interrogation rate <0.10	NO

## 4.5 TEST 5: SURVEILLANCE BASELINE-CONFLICT SITUATIONS

### PURPOSE

These tests provided statistics to evaluate Mode S sensor performance relative to track swaps and garble when interrogating simulated Air Traffic Control Beacon Interrogator (ATCRBS) and Mode S targets. The tracking performance was primarily concerned with the sensor's ability to maintain correct tracks on simulated targets whose paths come into close proximity to one another. The test was also concerned with examining garble reduction due to the Mode S interrogation. The ARIES provided the fruit environments and simulated target scenarios to generate well-defined target crossing and conflict patterns.

### TEST OBJECTIVES

The objectives for this test were as follows:

1. To verify that ATCRBS track swaps are less than 1 percent. Reference PTP Category 1, paragraph 4.1.1.1.
2. To establish a baseline of ATCRBS track swaps data. Reference PTP Category 1, paragraph 4.1.1.1.
3. To verify that Mode S reduces garble by use of Mode S aircraft interrogation ability. Reference PTP Category 1, paragraph 4.1.1.3, NAS-SS-1000 (1120).

## TEST CONFIGURATION

Figure 4.5-1 depicts the configuration for this test.

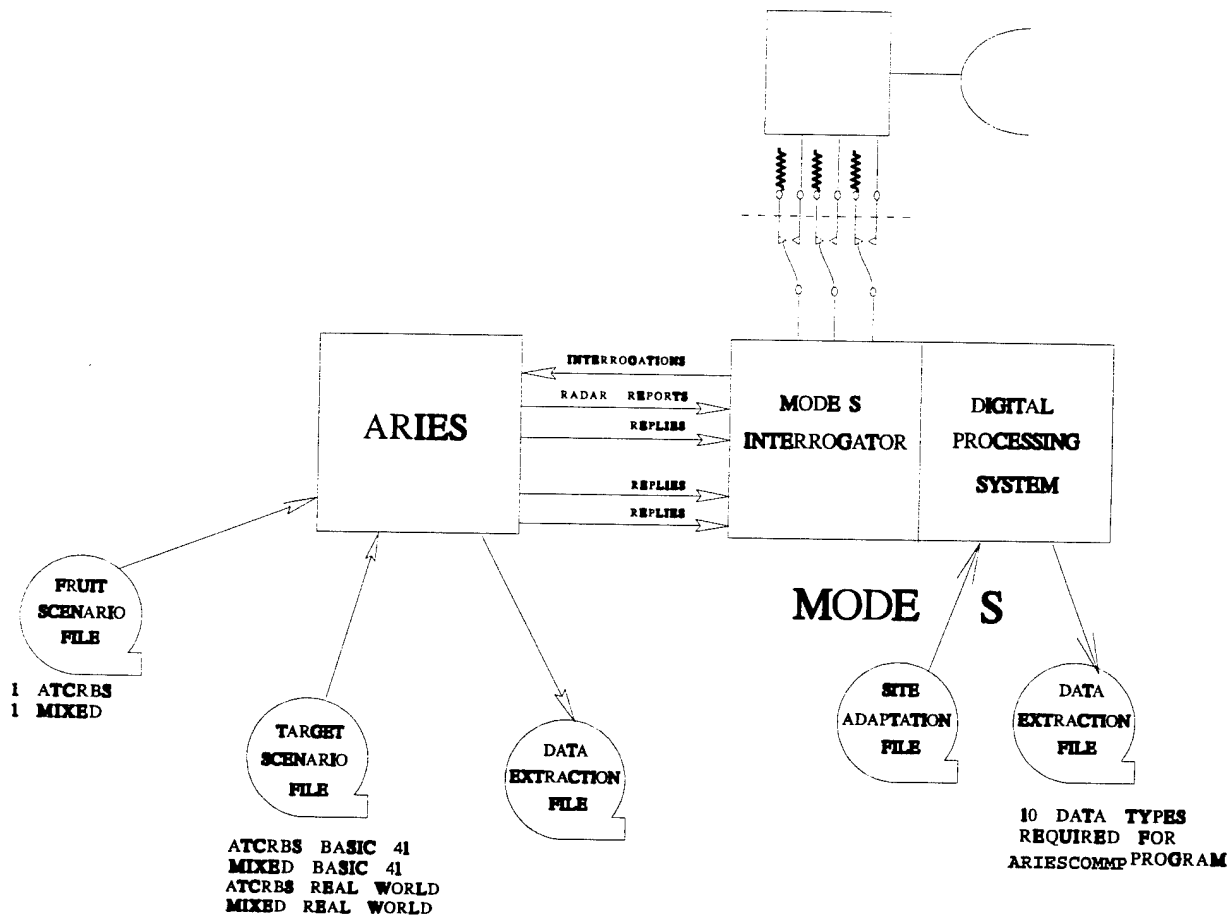

FIGURE 4.5-1. SURVEILLANCE BASELINE -  
CONFLICT SITUATIONS

## TEST DESCRIPTION

For these tests, the sensor was operated with the dummy load rather than the antenna. This was done because targets were provided by ARIES rather than live targets. Targets for the four subtests that make up this test were generated using ARIES. The Basic 41 and real world scenarios were used. The Basic 41 scenarios simulate various stresses and conflict situations. The real world scenarios are based on data extractions from airports around the country.

Subtest 1 used the ATCRBS version of the Basic 41 scenario. Subtest 2 used the Mixed (ATCRBS and Mode S) version of Basic 41. The Basic 41 scenarios features 41 aircraft with flight which present test cases which stress surveillance functions. See appendix E for a description of the Basic 41 target scenario. By keeping the aircraft closely spaced in range, azimuth, and altitude for long periods of time these scenarios provide a stress situation with regard to maintaining tracks correctly. These scenarios simulate 13 conflict situations that the test is designed to evaluate.

Subtests 3 and 4 used the ATCRBS and Mixed versions of the Real World scenario, respectively. The Real World scenarios are similar to the Basic 41 scenarios in that they provide the conflict situations needed to test the sensor. However, the Real World scenarios have many more targets and conflicts than the Basic 41 scenarios. Where a Basic 41 scenario provides only 13 conflicts for analysis, the Real World scenarios provide over 100. Because of this, these real world scenarios provide a clearer picture of how the sensor will perform in the field.

The sensor was loaded with the S2 SAP configuration for all subtests. An RTADS, ARIES, and Mode S extraction file were collected for each subtest. All of the subtests were executed using the appropriate moderate fruit scenario.

#### DATA ANALYSIS

Reduction and analysis were performed on the extraction files using the TDR and DR family of programs. The TDR program Conflict Analysis was run on each subtest using the RTADS extraction file. This program was used to identify the conflicts to be analyzed for each subtest. For the purposes of this test, a conflict was defined as two or more targets within 2 nmi and 4° of each other. These are the limits given in the test procedure.

The DR Surveillance Analysis and Surveillance File Analysis programs were run on the Mode S extraction file for each subtest. Surveillance Analysis was used to provide parameters such as Beacon Pd, ID code reliability and validity, and Altitude reliability and validity for the targets. Surveillance File Analysis was used to obtain scan-by-scan information on the target's ID and position in space. This information was needed to determine whether a track swap had occurred. To help analyze complex conflicts, the Surveillance File Analysis program was used with the time, slant range, and azimuth limits of each particular conflict. Doing this limited the targets shown in the program's output to the targets involved in the conflict, greatly reducing the number of targets to be analyzed.

The DR ARIES Compare program was run once for each subtest using the appropriate ARIES and Mode S extraction files. This program provided much of the same information as the Surveillance Analysis program, but ARIES Compare provides that information at the Reply, Report, and Disseminated levels. As garbled replies are not used in reports, the differences between data at the various levels give a measure of garble.

## TEST RESULTS

There were three Test Objectives to be verified.

**Objective 1** states that ATCRBS swaps be less than 1 percent. On average this was the case. The average ATCRBS swap percentage was 0.867 percent.

**Objective 2** states that a baseline of ATCRBS track swap data will be established. This was done.

**Objective 3** states that the Mode S must reduce garble by use of Mode S aircraft interrogation ability. There were no track swaps involving Mode S targets, and garble problems were less numerous in subtests involving Mode S targets.

The results of each subtest are presented individually. Although the primary interest is in track swaps, problems relating to garble, ID errors, and altitude errors are noted when they occurred. Problems are referenced by their conflict number from the TDR Conflict Analysis program. The tracks defined within a conflict are related to their surveillance file numbers from the DR Surveillance File Analysis program. No references are made to conflicts that have no problems. The track swap percentage is defined as the number of track swaps, divided by the number of tracks listed by the DR Surveillance Analysis program, multiplied by 100.

### Subtest 1: ATCRBS, Basic 41

The DR Surveillance Analysis program identified 46 tracks, with one swap this indicates a track swap percentage of 2.17 percent. This is more than double the 1.0 percent test specification. To verify whether or not this problem was repeatable, this subtest was repeated.

In the second run there were 47 tracks. With one track swap this indicated a track swap percentage of 2.13 percent. Again, this was well above the 1.0 percent limit of Objective 1.

The Basic 41 scenario used for this subtest presents the sensor with multiple stress situations well above the percentage in normal live traffic environments. Because of the small number of tracks in the scenario, even one track swap will cause the 1.0 percent limit to be exceeded. For these reasons, the fact that swaps occurred and the limit was exceeded both times this scenario was used is not viewed as a cause for concern. The test is valuable in that results are to a limited extent repeatable and can be used for later software version comparisons.

### Subtest 2: Mixed (ATCRBS and Mode S), Basic 41

There were no significant problems to report with this subtest. There were no track swaps, and no tracks that coasted and were dropped during a conflict.

Subtest 3: ATRCBS, Real World

With a total of 216 tracks and 1 track swap the track swap percentage is 0.463 percent. This is under the 1.0 percent track swap limit, indicating that Objective 1 was met for this subtest.

Subtest 4: Mixed (ATCRBS and Mode S), Real World

There were two track swaps in this subtest. With 220 tracks this indicates a track swap percentage of .909 percent. This is just under the 1.0 percent limit of Objective 1.

CONCLUSIONS

All of the subtests passed the 1.0 percent track swap limit of Objective 1 with the exception of subtest one. The total track swap percentage for all the subtests was 0.867 percent. Since this is below the limit, Objective 1 is considered verified. The track swap data percentages for these tests are presented in table 4.5-1 shown below.

TABLE 4.5-1. TRACK SWAP PERCENTAGES

SUBTEST	1	1B	2	3	4	TOTAL
NO. TRACKS	46	47	48	216	220	577
NO. SWAPS	1	1	0	1	2	5
PERCENTAGE	2.17%	2.13%	0.0%	0.463%	0.909%	0.867%
LIMIT MET?	NO	NO	YES	YES	YES	YES

The data in this table can be used to establish a baseline for track swap percentage, satisfying Objective 2.

There were no track swaps involving Mode S targets, and garble problems were less numerous in the subtests that involved Mode S targets. Also garble problems were more likely to occur during conflicts involving only ATRCBS targets than they were when the conflict included a Mode S target. This shows that the Mode S interrogation reduces garble, verifying Objective 3.

All of the objectives defined for this procedure have been met, and there are no deficiencies to report. A summary of the objectives and their verification is given in table 4.5-2 shown below.

TABLE 4.5-2. OBJECTIVE SUMMARY

OBJECTIVE	VERIFIED?
1. ATRCBS track swaps <1%	YES
2. Establish a baseline of ATRCBS track swap data	YES
3. Verify that Mode S reduces garble by using the Mode S aircraft interrogation ability	YES

## 4.6 TEST 6: DATA LINK BASELINE.

### PURPOSE

This test measured the ability of the Mode S sensor to correctly transmit uplink messages and to correctly process downlink messages. The Mode S Terminal Configuration Software has a reduced target and data link from 700 targets to 400 targets. The objectives for this test have been scaled accordingly. Baseline data included uplink message delay, downlink message delay, uplink and downlink message storage capacity, and message completion's classified by priority. The test was executed using the ARIES and the Communications Interface Driver (CID) to simulate real world and capacity communications scenarios. This addendum contains the results of the initial and regression testing. Three fruit levels were used; no-fruit, moderate fruit, and heavy fruit.

### TEST OBJECTIVES

The objectives for this test were as follows:

1. To verify that the sensor does not delay uplink messages more than 1/16 of a scan. Reference: PTP Category 1, par 4.1.1.2, NAS-SS-1000, (1400).
2. To verify that the sensor does not delay downlink messages more than 1/16 of a scan. Reference: PTP Category 1, par 4.1.1.2, NAS-SS-1000, (1410).
3. To verify that the sensor prioritizes message transmissions per the Mode S specification. Reference: PTP Category 1, par 4.1.1.2, NAS-SS-1000, (1500, 1510).
4. To verify that the sensor can receive or output data link messages for 400 Mode S equipped aircraft per scan. Reference: PTP Category 1, par 4.1.1.2, NAS-SS-1000, (1610).
5. To verify that the sensor can receive or output data link messages for the following per scan target capacity scenarios:
  - a. Any mixture of 400 Mode S and ATCRBS beacon targets.
  - b. 700 primary radar target reports.
  - c. Nonuniform beacon target distribution of:
    - (1) 250 targets within a 90° quadrant.
    - (2) 50 targets within a 11.25° sector for up to four consecutive sectors.
    - (3) 24 targets within a 2.4° wedge.

Reference: PTP Category 1, par 4.1.1.2.

6. To verify that the sensor efficiently utilizes the data channel under the conditions listed in the peaking scenario described in the TVRTM, table 3.2.1.1.6.2.13-1. Reference: PTP Category 1, par 4.1.1.2, NAS-SS-1000, (1630).
7. To verify that the sensor can store up to 4800 uplink messages. Reference: PTP Category 1, par 4.1.1.2, NAS-SS-1000, (1700).
8. To verify that the sensor can store up to 1100 downlink messages. Reference: PTP Category 1, par 4.1.1.2, NAS-SS-1000, (1710).

## TEST CONFIGURATION

Figure 4.6-1 depicts the configuration for this test.

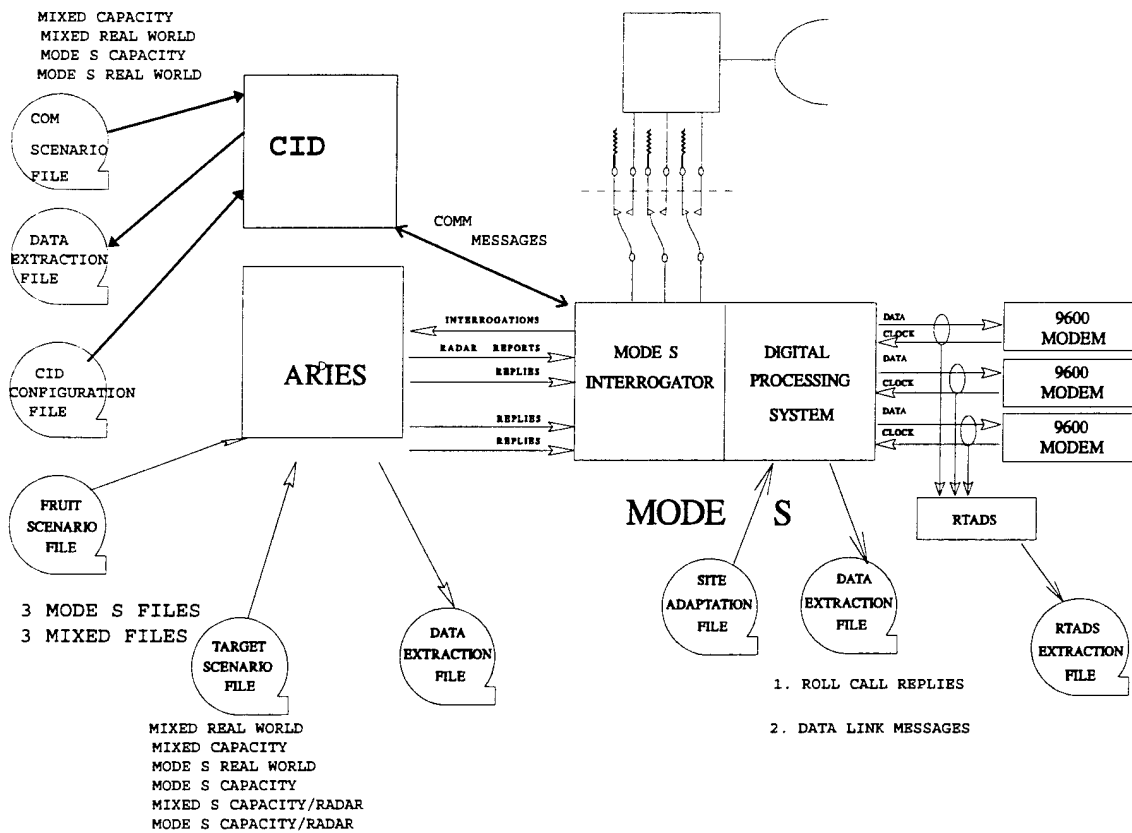

FIGURE 4.6-1. DATA LINK BASELINE



## TEST DESCRIPTION

For this test the Mode S sensor was operated using the dummy load. The ARIES and CID scenarios were used to generate simulated targets and their associated communications messages. Three fruit scenarios were used: no fruit, moderate fruit, and heavy fruit. Data extractions were made from the output of the ARIES, CID, Mode S sensor, and RTADS.

The test called for the use of two types of ARIES scenarios, real world and capacity. For each of the scenarios there is an ATCRBS version, a Mode S version and a mixed version (ATCRBS and Mode S).

The real world scenarios were designed to provide realistic simulated targets for surveillance and data link testing. The scenarios were derived from data recordings of operational air traffic. Separate data files were developed for the Mode S only scenarios and the mixed ATCRBS/Mode S scenarios.

The capacity scenarios were designed to test the Mode S sensor's ability to process 400 targets per scan. Again, separate data files were developed for Mode S only and mixed ATCRBS/Mode S scenarios.

## DATA ANALYSIS

Reduction and analysis were performed on the extractions identified above using the DR "Data Link Statistics" program and the TDR "Surveillance Analysis" program. These programs were run once for each subtest using the appropriate extraction file.

## TEST RESULTS

There were eight Test Objectives to be verified.

**Objective 1** states that the sensor must not delay uplink messages more than 1/16 of a scan. The objective was verified during the Sensor Design Qualification #5 (SDQ5) Formal Acceptance Test. The sensor software level tested was Release 16.2, consisting of the Interrogator Software Version 19 and the DPS Software version Mode S 1.1. The Sensor Design Qualification #5 Test Report documents the verification of these objectives (TM-PA-0018/624/00, dated June 8, 1992, CLIN 16E3e).

**Objective 2** states that the sensor must not delay downlink messages more than 1/16 of a scan. The objective was verified during the Sensor Design Qualification #5 (SDQ5) Formal Acceptance Test. The Sensor Design Qualification #5 Test Report documents the verification of these objectives (TM-PA-0018/624/00, dated June 8, 1992, CLIN 16E3e).

**Objective 3** states that the sensor prioritizes message transmissions per the Mode S specification. This objective was verified during the Real Time Formal Qualification

Test 2 (Data Link). The software under test was at the cset of build 1.1.13.7. The Software Test Report, Real Time FQT2 Data Link, discusses the verification of this objective (TM-PA-0018/756/01, dated July 24, 1991, CLIN 16f7-3H).

**Objective 4** states that the sensor must be capable of receiving or transmitting data link messages for 400 Mode S equipped aircraft per scan. This release of Mode S software requires that the sensor be able to handle messages for 400 Mode S equipped aircraft per scan. This objective was tested and met.

**Objective 5** states that the sensor must be capable of receiving or transmitting data link messages for the following target capacity scenarios:

- a. Any mixture of 400 Mode S and ATCRBS beacon targets.
- b. 700 primary radar target reports.
- c. Non-uniform beacon target distribution of:
  1. 250 targets within a 90° quadrant.
  2. 50 targets within a 11.25° sector for up to four consecutive sectors.
  3. 24 targets within a 2.4° wedge.

This objective was met.

**Objective 6** states that the sensor must efficiently utilize the data channel under the conditions listed in the peaking scenario described in the TVRTM, table 3.2.1.1.6.2.13-1. Efficient usage of the data channel resulted in a high delivery rate of messages. This objective was verified.

**Objective 7** states that the sensor must store up to 4800 uplink messages. The objective was verified during the Sensor Design Qualification #5 (SDQ5) Formal Acceptance Test. The Sensor Design Qualification #5 Test Report documents the verification of these objectives (TM-PA-0018/624/00, dated June 8, 1992, CLIN 16E3e).

**Objective 8** states that the sensor can store up to 1100 downlink messages. This objective was verified during the Sensor Design Qualification #5 (SDQ5) Formal Acceptance Test. The Sensor Design Qualification #5 Test Report documents the verification of these objectives (TM-PA-0018/624/00, dated June 8, 1992, CLIN 16E3e).

The data accumulated indicates that the sensor is performing up to specifications. For the six subtests executed an average of 99.57 percent of the messages was delivered. An average of 0.38 percent expired, 0.05 percent were rejected, and 0.17 percent were delayed.

Table 4.6-1 illustrates the test results when the Mode S capacity scenario was executed. An average of 99.6 percent of the messages was delivered even in the presence of moderate and heavy fruit levels.

TABLE 4.6-1. MODE S CAPACITY SCENARIO RESULTS

Subtest	Delivered (%)	Rejected (%)	Delayed (%)	Expired (%)	Fruit Level
10	99.7	0.1	0.0	0.2	None
11	99.7	0.0	0.0	0.3	MF
12	99.4	0.1	0.9	0.5	HF
Average	99.6	0.07	0.33	0.33	N/A

The following legend applies to tables 4.6-2 and 4.6-3, as well as table 4.6-1.

Legend

MF = Moderate fruit scenario (4k/sec ATCRBS, 50/sec Mode S).

HF = Heavy fruit scenario (40k/sec ATCRBS, 200/sec Mode S).

Table 4.6-2 summarizes the data for the mixed capacity scenarios.

TABLE 4.6-2. MIXED CAPACITY SCENARIO RESULTS

Subtest	Delivered (%)	Rejected (%)	Delayed (%)	Expired (%)	Fruit Level
4	99.8	0.0	0.0	0.2	None
5	99.8	0.0	0.0	0.2	MF
Average	99.8	0.00	0.0	0.2	N/A

The radar reinforced data (subtests 13 and 14) is consistent with the other subtests executed. The percentage of messages delivered is an acceptable 99.8 percent. The percentage of expired messages is also within acceptable limits and consistent with other data. This data is detailed in table 4.6-3 shown below.

TABLE 4.6-3. RADAR REINFORCED, CAPACITY SCENARIO RESULTS

Subtest	Delivered (%)	Rejected (%)	Delayed (%)	Expired (%)	Fruit Level
13	99.7	0.0	0.0	0.2	MF
14	99.6	0.1	0.03	0.3	MF
Average	99.65	0.05	0.02	0.25	N/A

This test also verified that data link activity did not affect surveillance performance by the Mode S. The following tables illustrates Mode S surveillance performance while the data link is in use.

TABLE 4.6-4a. SURVEILLANCE PERFORMANCE

Subtest	Beacon Pd		ID Reliability		ID Validity	
	ATCRBS	Mode S	ATCRBS	Mode S	ATCRBS	Mode S
4	99.82	99.99	99.96	100.00	99.99	100.00
5	99.83	100.00	99.94	100.00	99.98	100.00
10	N/A	99.96	N/A	99.99	N/A	99.98
11	N/A	99.96	N/A	100.00	N/A	100.00
12	N/A	99.47	N/A	99.99	N/A	99.99
13	99.80	100.00	99.92	100.00	99.96	100.00
14	N/A	99.75	N/A	99.99	N/A	99.98
Average	99.82	99.86	99.94	99.99	99.98	99.99

TABLE 4.6-4b. SURVEILLANCE PERFORMANCE

Subtest	Alt. Reliability		Alt. Validity	
	ATCRBS	Mode S	ATCRBS	Mode S
4	99.70	99.99	99.73	100.00
5	99.48	100.00	99.53	100.00
10	N/A	99.99	N/A	100.00
11	N/A	100.00	N/A	100.00
12	N/A	99.96	N/A	99.99
13	99.54	100.00	99.57	100.00
14	N/A	99.96	N/A	99.98
Average	99.57	99.99	99.61	99.99

Table 4.6-5 and figure 4.6-2 compare the surveillance data observed in this test with the data from Test 4 (Surveillance Baseline-Report Parameters) and Test 7 (Sensor Coverage). Test 4 used simulated targets generated by ARIES, while Test 7 used live targets. Neither Test 4 nor Test 7 used the data link. Consideration of the data in table 4.6-5 and figure 4.6-2 shows that the sensor's performance with regard to surveillance parameters was not significantly degraded by using the data link.

TABLE 4.6-5. TEST 6 VERSUS TEST 4 AND TEST 7

	BEACON PD (%)		ID VALIDITY (%)		ALT. VALIDITY (%)	
	MODE S	ATCRBS	MODE S	ATCRBS	MODE S	ATCRBS
TEST 6	99.86	99.82	99.99	99.98	99.99	99.61
TEST 4	99.71	99.65	99.98	99.92	99.90	99.29
TEST 7	99.68	97.76	99.96	99.74	99.92	99.02
TEST 4 LIMIT	>99.0	>97.0	>99.0	>97.0	>99.9	>95.00
LIMIT MET?	NO	YES	YES	YES	NO	YES

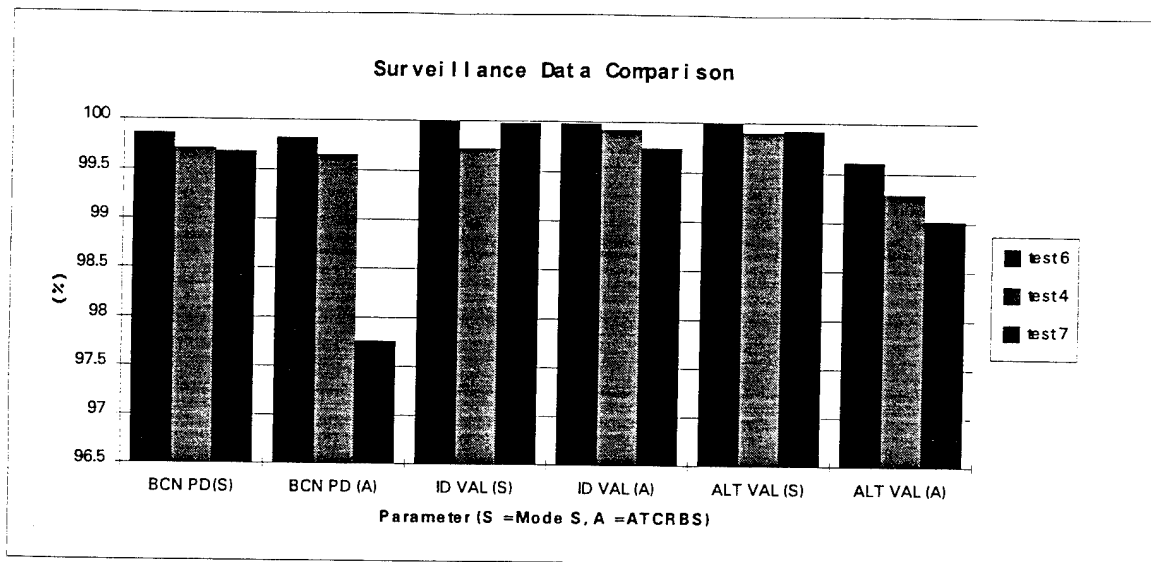

FIGURE 4.6-2. TEST 6 VERSUS TEST 4 AND TEST 7

CONCLUSIONS

All of the objectives for this test were met. Some of the objectives were verified during this test, other were met during Sensor Design Qualification #5 (SDQ5) Formal Acceptance Test. The objectives for this test and their verification to date are summarized in table 4.6-6 shown below.

TABLE 4.6-6. OBJECTIVE SUMMARY

OBJECTIVE	VERIFIED?
1. Uplink message delay <1/16 of a scan	YES
2. Downlink message delay <1/16 of a scan	YES
3. Messages prioritized as per Mode S specification	YES
4. Sensor can receive or output 400 messages per scan	YES
5. Sensor can receive or output messages using capacity target distributions	YES
6. Sensor efficiently utilizes the data channel under peaking conditions	YES
7. Verify that the sensor can store up to 4800 uplink messages	YES
8. Verify that the sensor can store up to 1100 downlink messages	YES

## 4.7 TEST 7: MODE S SENSOR COVERAGE.

### PURPOSE

These tests measured the coverage volume of the sensor as well as the following surveillance parameters; (1) blip/scan, (2) ID code validity, (3) altitude code validity, and (4) false targets due to splits and fruit. The values of the surveillance parameters listed above were recorded for live targets. The results of the live world testing were compared with the simulated target data gathered in Test 4 (Surveillance Baseline-Report Parameters).

### TEST OBJECTIVES

The objectives for this test were as follows;

1. To compare the beacon blip/scan ratio for ATCRBS and Mode S targets against the baseline data of Test 4 (Surveillance Baseline-Report Parameters). Reference: PTP Category 1, paragraph 4.1.1.3.
2. To compare the ID code validity for ATCRBS and Mode S targets against the baseline data of Test 4 (Surveillance Baseline-Report Parameters). Reference: PTP Category 1, paragraph 4.1.1.3.
3. To compare the Altitude code validity for ATCRBS and Mode S targets against the baseline data of Test 4 (Surveillance Baseline-Report Parameters). Reference: PTP Category 1, paragraph 4.1.1.3.
4. To compare the false reports due to splits for ATCRBS and Mode S targets against the baseline data of Test 4 (Surveillance Baseline-Report Parameters). Reference: PTP Category 1, paragraph 4.1.1.3.
5. To verify that the slant range coverage for the terminal sensor is 0.5 nmi to 55 nmi. Reference: PTP Category 1, paragraph 4.1.1.3, NAS-SS-1000, (1800).
6. To verify that the slant range coverage for the enroute sensor is 0.5 nmi to 255 nmi. Reference: PTP Category 1, paragraph 4.1.1.3, NAS-SS-1000, (1810).
7. To verify that the azimuth coverage is 360°. Reference: PTP Category 1, paragraph 4.1.1.3, NAS-SS-1000, (1820).
8. To verify that the altitude coverage shall be to 100,00 ft. Reference: PTP Category 1, paragraph 4.1.1.3, NAS-SS-1000, (1830).
9. To verify that the elevation coverage is 0.5° to 45°. Reference: PTP Category 1, paragraph 4.1.1.3, NAS-SS-1000, (1800).

10. To verify that the sensor detects all transponder equipped aircraft at a rate identical with that of the associated primary radar. Reference: PTP Category 1, paragraph 4.1.1.3, NAS-SS-1000, (1250).
11. To verify that the Mode S terminal sensor updates surveillance reports on all targets within the detection envelope every antenna scan. Reference: PTP Category 1, paragraph 4.1.1.3, NAS-SS-1000, (1900).
12. To verify that the Mode S enroute sensor updates surveillance reports on all targets within the detection envelope twice per antenna scan when operating with a back-to-back beacon antenna. Reference: PTP Category 1, paragraph 4.1.1.3, NAS-SS-1000, (1910).
13. To verify that the Mode S enroute sensor detects all transponder equipped aircraft with the detection envelope at a rate of 12 seconds, +1.33 or -1.09 seconds. Reference: PTP Category 1, par 4.1.1.3, NAS-SS-1000, (1260).

Objectives 6, 12, and 13 are concerned with enroute sensor performance. Because this report deals with a terminal sensor exclusively, these objectives are beyond the scope of the report and will not be considered.

## TEST CONFIGURATION

Figure 4.7-1 depicts the configuration for this test.

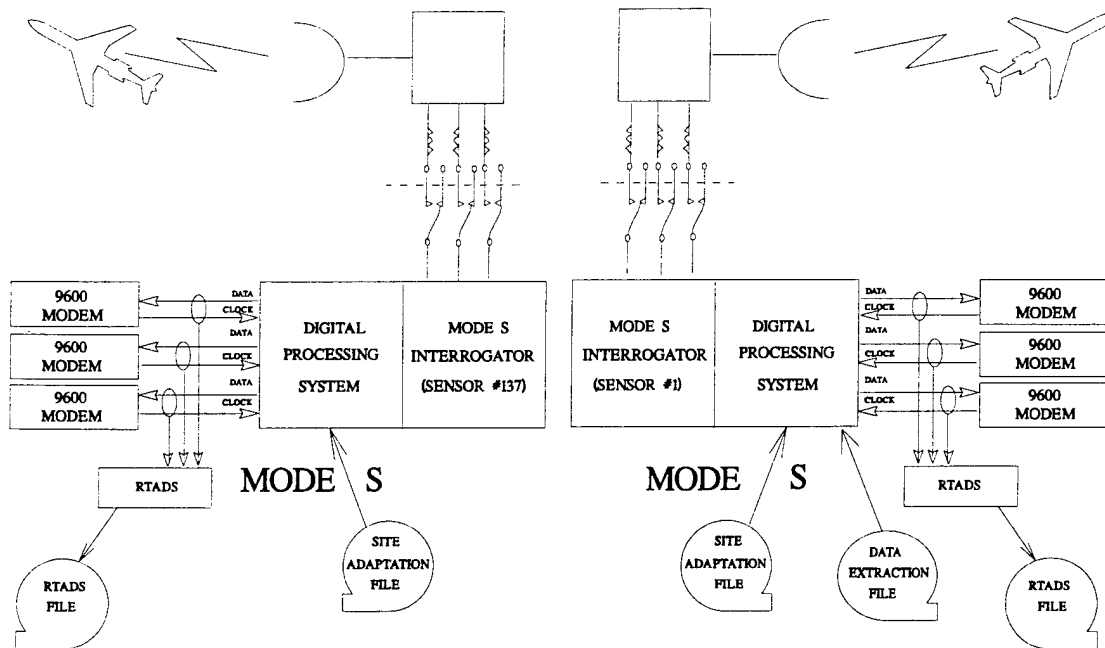

FIGURE 4.7-1. MODE S SENSOR COVERAGE

### TEST DESCRIPTION

The tests involving live targets sensor #1 and sensor #137 were operated into their antennas to interrogate all targets within the coverage area. Both sensors were operated in the site address lockout mode. For the tests involving simulated targets, only sensor # 1 was used. Because ARIES was providing the targets for these tests, the sensor was operated with the dummy load rather than the antenna.

This test was made up of eight subtests. The first five subtests involved live data collection at sensor #1 and at sensor #137. Both sensors were operated in the site address lockout mode. The data collected in these subtests was compared to the results obtained in Test 4 (Surveillance Baseline-Report Parameters). For the live world subtests sensor #1, was loaded with the S7 SAP configuration. Sensor #137 was loaded with the S1 SAP configuration.

Subtests 6, 7, and 8 used sensor #1 only. These subtests used ARIES scenarios designed to test the 100,000 ft. altitude, 360° azimuth coverage, and 0.5° to 45° elevation angle



coverage limits as defined in the test procedure. These subtests were run using the "no fruit" fruit scenario. Subtests 6, 7, and 8 were executed with sensor # 1 being loaded with a modified version of the S2 SAPs. The modification consisted of changing the beacon elevation angle SAP in the NM\_TABLE from its normal value of 34° to 60°. This was done in order that the sensor not lose the targets in the zenith cone. No ARIES errors or MIOP alarms that could skew the test results were observed during testing.

Table 4.7-1 summarizes the test description data presented above.

TABLE 4.7-1. TEST DESCRIPTION SUMMARY

SUBTESTS	SENSOR NO(S).	SAPs	RELATED OBJECTIVES
1 - 5	1 and 137	S7 (Sensor 1) S1 (Sensor 137)	1, 2, 3, 4, 10, 11
6 - 8	1	S2 (MODIFIED)	5, 7, 8, 9

Extractions were made from the RTADS and Mode S sensor for all subtests at sensor # 1. The Mode S extractions do not provide any data required for this test. They are recorded for use in Test 8 (Mode S Reflection Analysis). For subtests 6, 7, and 8 an ARIES extraction was also taken at sensor #1. RTADS extractions were taken at sensor #137 for subtests 1 through 5.

#### DATA ANALYSIS

Reduction and analysis were performed on the extraction files using the TDR family of programs. For subtests 1 through 5, the TDR Surveillance Analysis, Beacon False Target Summary, and Surveillance Print and Plot programs were run on each RTADS extraction file from sensor # 1. Surveillance Analysis provided the statistics on blip/scan ratio, ID code and Altitude code validity needed to verify Objectives 1 through 3. Beacon False Target Summary furnished the split data needed to verify Objective 4. Surveillance Print and Plot was used to create plot files to display the data.

For subtests 6, 7, and 8 the Surveillance Analysis and Surveillance Print and Plot TDR programs were run on the RTADS files. Surveillance Analysis provided statistics on blip/scan ratio, ID code validity and reliability, Altitude code validity and reliability, range error, and azimuth error. These statistics were used to verify Objectives 5, 7, 8, and 9. The Surveillance Print and Plot program was used to create plot files to display the data.

#### TEST RESULTS

Objectives 1 through 4 required that the Beacon Probability of Detection, ID Validity, Altitude Code Validity, and Azimuth Splits data be compared to the baseline data recorded in Test 4 (Surveillance Baseline-Report Parameters). In this way data observed

using live targets (Test 7, subtests 1 - 5) will be compared to data observed using simulated targets (Test 4). To make the comparison as accurate as possible, the data from these tests was compared to the data collected using a "Real World" mixed (ATCRBS and Mode S) scenario and a "Moderate Fruit" scenario. This corresponds to subtest 6 of Test 4. The average values of subtests 1 through 5 from Test 7 were used for the comparison. Results of the testing are shown below in figures 4.7-2a, 4.7-2b, and 4.7-2c.

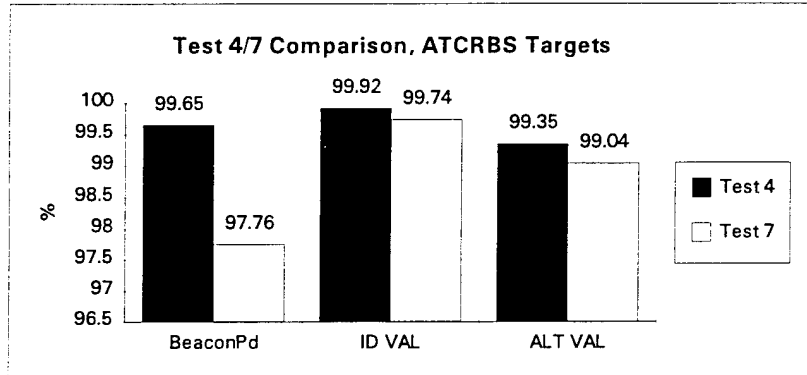

FIGURE 4.7-2a. ATCRBS SURVEILLANCE PARAMETERS

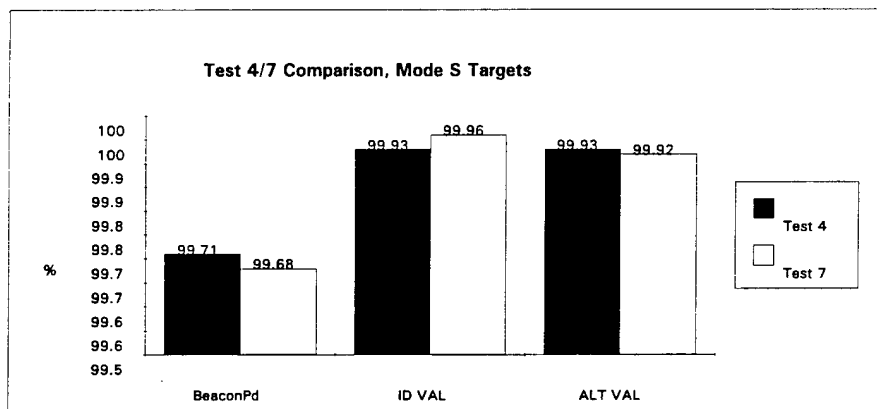

FIGURE 4.7-2b. MODE S SURVEILLANCE PARAMETERS

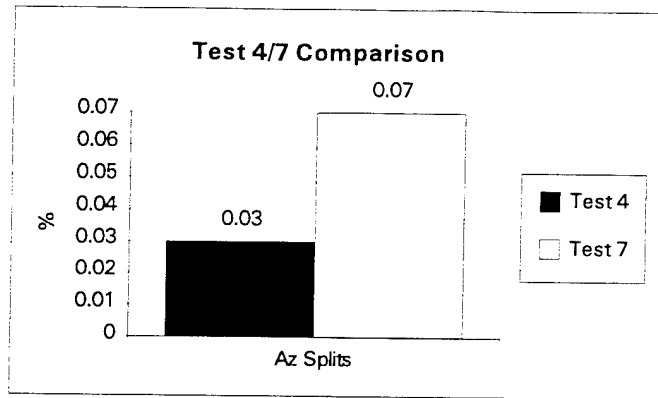

FIGURE 4.7-2c. ATCRBS SPLITS

As shown in the figures, the live target results of Test 7 were very close to the simulated target results of Test 4. This is very much as expected. In general, the ATCRBS results were slightly lower for Test 7, while the Mode S results were virtually identical. The differences for the blip/split ratio, and ID and Altitude code validity surveillance parameters are on the order of tenths of a percentage point or less for both ATCRBS and Mode S targets. In all cases, the limits established in Test 4 were met.

A summation of the results as they relate to each objective follows.

**Objective 1** required a comparison of the blip/split ratio (Beacon Pd) data to the baseline data of Test 4. The largest difference between the data from Tests 7 and 4 was observed in Beacon Pd for ATCRBS targets. The 97.76 percent detection for real ATCRBS targets is 1.89 percent lower than that for simulated targets. The ATCRBS detection limit set forth in Objective 1 of Test 4 is 97.0 percent. The value for real targets is lower, but it still meets this limit.

**Objective 2** required a comparison of the ID code validity data to the baseline data of Test 4. For ATCRBS targets, the code validity was 99.35 percent in Test 4, and 99.74 percent in Test 7. For Mode S targets, the values were 99.93 percent and 99.74 percent for Tests 4 and 7, respectively. The values observed using real and simulated targets are less than 0.20 percent apart.

**Objective 3** required a comparison of the Altitude code validity data to the baseline data of Test 4. ATCRBS targets had an Altitude code validity of 99.35 percent in Test 4 and 99.04 percent in Test 7. The Mode S target value was 99.93 percent for Test 4 and 99.92 percent for Test 7. The real target data from Test 7 was within 0.31 percent of the simulated target data from Test 4.

**Objective 4** required a comparison of the false targets due to splits data to the baseline data of Test 4. In Splits from ATCRBS targets, the results of Test 7 were significantly worse than those observed in Test 4. In fact, the Split rate in Test 7 is 2.50 times greater than that of Test 4. However, the observed value of 0.07 percent is well below the 0.3 percent limit for splits on ATCRBS targets established in Objective 5 of Test 4. There

were no splits associated with Mode S targets in either Test 7 or Test 4.

The comparison of Test 7 and Test 4 data is summarized in form in tables 4.7-2 and 4.7-3 shown below.

TABLE 4.7-2. TEST 7 VERSUS TEST 4, SURVEILLANCE PARAMETERS

	BEACON PD		ID VALIDITY		ALT. CODE VALIDITY	
	MODE S	ATCRBS	MODE S	ATCRBS	MODE S	ATCRBS
TEST 7	99.68%	97.76%	99.96%	99.74%	99.92%	99.02%
TEST 4	99.71%	99.65%	99.98%	99.92%	99.90%	99.29%
TEST 4 LIMIT	>99.0%	>97.0%	>99.0%	>97.0%	>99.9%	>95.0%
LIMIT MET?	YES	YES	YES	YES	YES	YES

TABLE 4.7-3. TEST 7 VERSUS TEST 4, AZIMUTH SPLITS

	AZIMUTH SPLITS	
	MODE S	ATCRBS
TEST 7	0.0%	0.07%
TEST 4	0.0%	0.03%
TEST 4 LIMIT	<0.10%	<0.30%
LIMIT MET?	YES	YES

**Objective 8** was to verify altitude coverage to 100,000 feet. Subtest 6 had multiple Mode S targets moving away from the sensor at a constant altitude of 105,000 feet. These targets began at the point where an elevation angle of 45° meets the 105,000 feet altitude plane (24 nmi). The maximum range of any target is 60 nmi. This test verified Objective 8. The sensor tracked these targets very well. Beacon Pd, ID Validity and Reliability, and Altitude Validity and Reliability were all 100.0 percent for this subtest. The overall Range Error was 0.011 nmi, and the overall Azimuth Error was .071°. Plots of range versus azimuth and altitude versus range from the TDR Surveillance Print and Plot file for this subtest follow in figures 4.7-3 and 4.7-4.

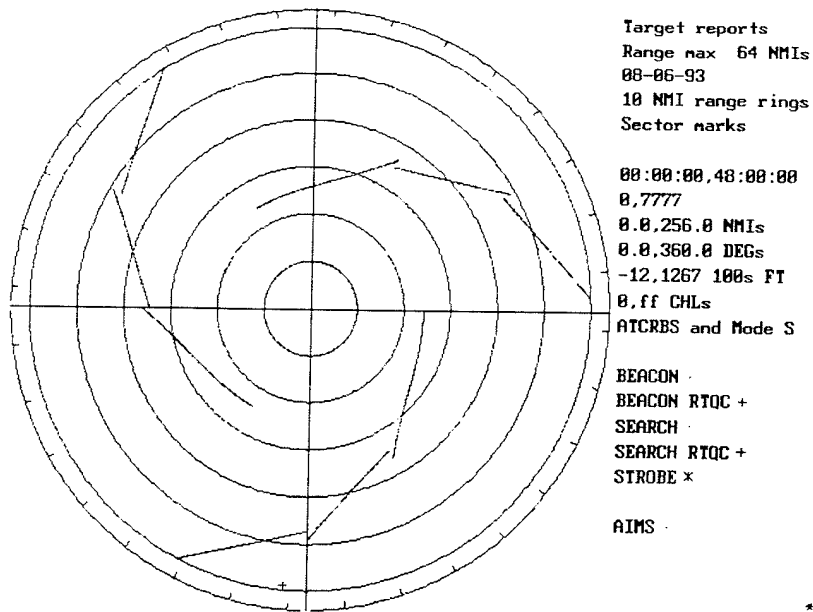

FIGURE 4.7-3. SUBTEST 6, RANGE VERSUS AZIMUTH

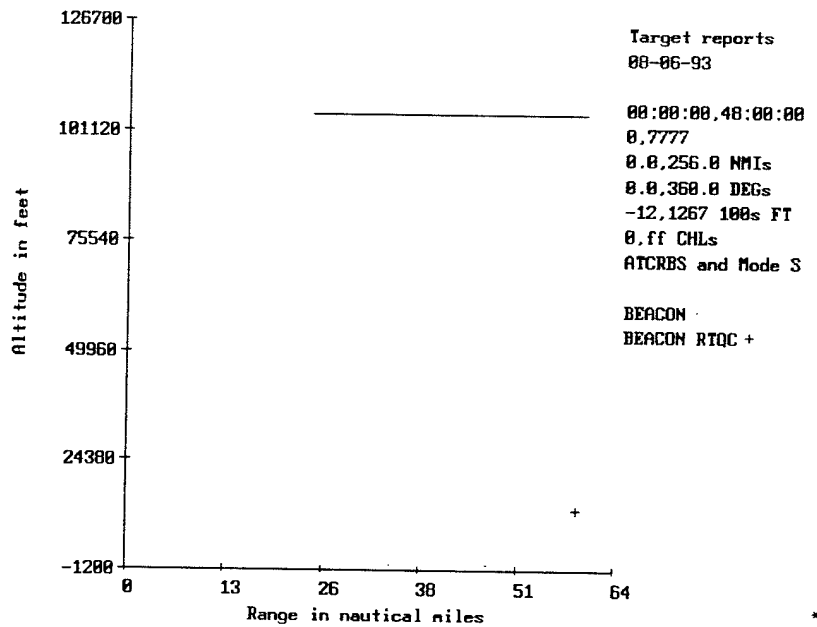

FIGURE 4.7-4. SUBTEST 6, RANGE VERSUS ALTITUDE

Subtests 7 and 8 were used to verify Objectives 5, 7, and 9. Subtest 8 had multiple Mode S targets moving away from the sensor while their altitude increases at a rate that corresponds to a one-half degree elevation angle. The targets nearest to the sensor begin at a range of 0.5 nmi, the maximum range is 60 nmi. This subtest verified the lower limit of Objective 9 (0.5° to 45° elevation angle coverage). The sensor tracked these targets very well. A TDR Surveillance Analysis file run from the RTADS extraction for this

subtest showed that the Beacon Pd, Altitude Reliability and Validity, and ID Reliability and Validity for all targets were 100 percent. The Range Error was 0.010 nmi, and the Azimuth Error was 0.075°. Plots of range versus azimuth, and range versus altitude taken from the TDR Surveillance Print and Plot file for this subtest follow in figures 4.7-5 and 4.7-6.

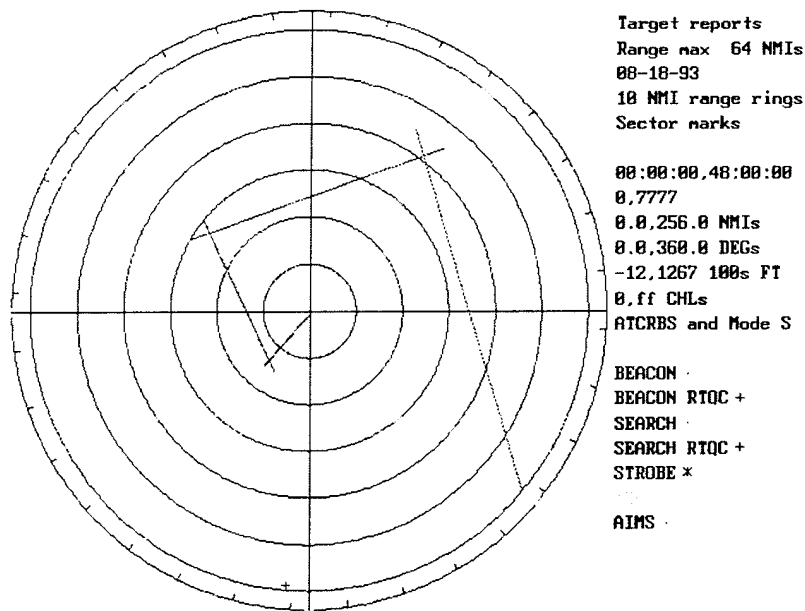

FIGURE 4.7-5. SUBTEST 8, RANGE VERSUS AZIMUTH

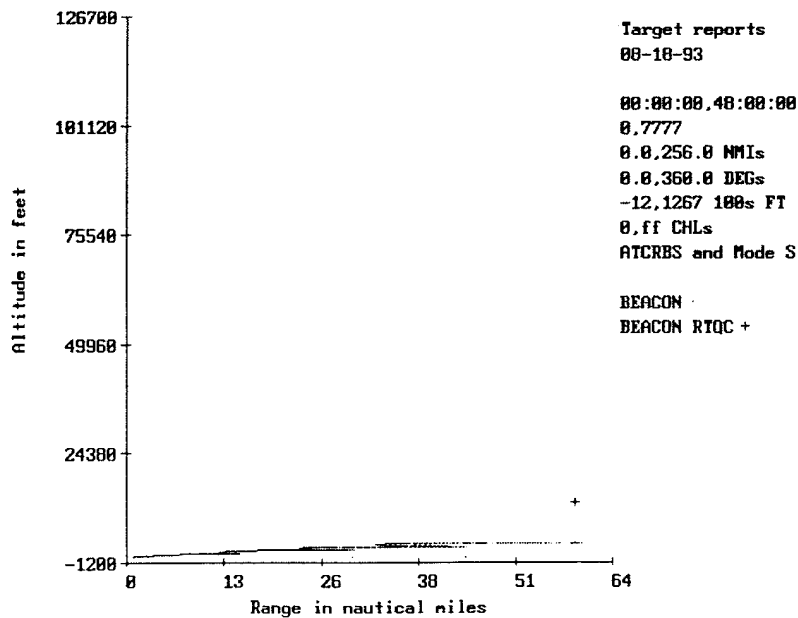

FIGURE 4.7-6. SUBTEST 8, RANGE VERSUS ALTITUDE

Subtest 7 verified the upper limit of Objective 9 and Objective 7 (360° coverage). This test had multiple Mode S targets moving out from the sensor as their altitude increases at a rate that corresponds to a 45° elevation angle. The range of the closest targets is 0.5 nmi. The targets furthest from the sensor reached an altitude of 104,000 feet, their range at this point is 25 nmi. The sensor tracked these targets faultlessly. Execution of the TDR Surveillance Analysis program showed that the Beacon Pd, Altitude Reliability and Validity, and ID Reliability and Validity for all targets were 100 percent. The Range Error was 0.011 nmi, and the Azimuth Error was 0.086°. Note from figures 4.7-3, 4.7-5, and 4.7-7 that the sensor tracked targets throughout the full 360° azimuth range. This verifies Objective 9. Plots of range versus azimuth, and range versus altitude taken from the TDR Surveillance Print and Plot files for this subtest follows in figures 4.7-7 and 4.7-8.

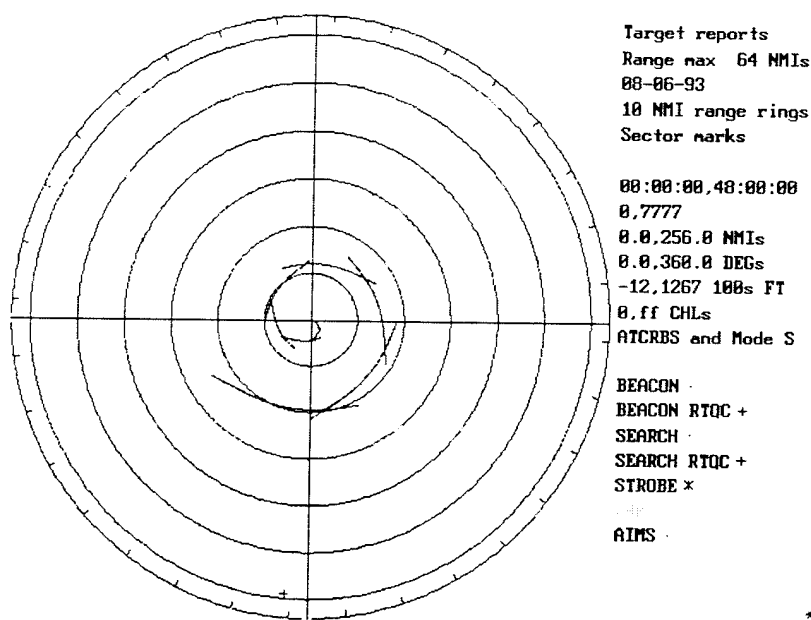

FIGURE 4.7-7. SUBTEST 7, RANGE VERSUS AZIMUTH

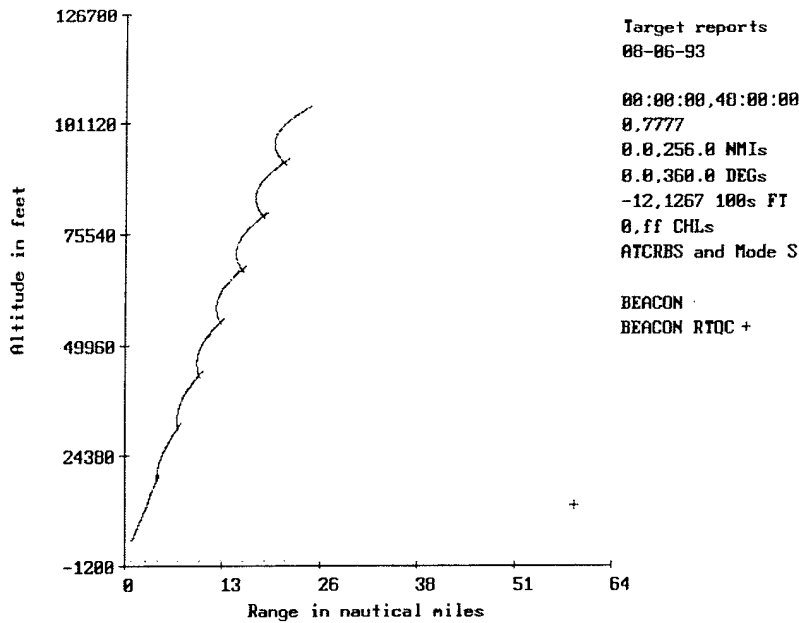

FIGURE 4.7-8. SUBTEST 7, RANGE VERSUS ALTITUDE

### CONCLUSIONS

The sensor performed equally well with "live world" targets and simulated targets. In general, performance for ATCRBS targets was slightly degraded in Real World situations, while that for Mode S targets was almost identical. This was attributed to poor low angle coverage of the site of primarily general aviation aircraft. The Mode S targets are typically commercial aircraft flying at altitudes. However, the sensor's performance with Mode S transponder equipped targets was virtually the same with real or simulated targets. The data for surveillance parameters and false targets observed in this test exceeded the limits established by the objective of Test 4 (Surveillance Baseline-Report Parameters). All of the sensor coverage limits were verified. All of the applicable objectives listed in the Test Procedure have been verified, and there are no deficiencies to report for this procedure.



## 4.8 TEST 8: MODE S REFLECTION ANALYSIS.

### PURPOSE

This test measured the sensor's ability to identify reflected false target reports correctly. The test used simulated targets provided by ARIES scenarios, as well as real targets of opportunity, to test the reflection algorithms. The real target data came from the live world collection taken during Test 7 (Mode S Sensor Coverage). Testing was also done relative to adaptive thresholding. Adaptive thresholding is used to reduce false targets caused by in-beam ground-bounce reflections.

### TEST OBJECTIVES

The objectives for this test were as follows:

1. To measure the amount of reduction of reflected false targets. Reference: PTP Category 1, paragraph 4.1.1.3.
2. To determine if there are any adverse effects due to the reflection elimination process. Reference: PTP Category 1, paragraph 4.1.1.3.
3. To verify that Mode S reduces false target reports that result from multipath effects. Reference: PTP Category 1, paragraph 4.1.1.3, NAS-SS-1000, (1100).

## TEST CONFIGURATION

Figure 4-8.1 depicts the configuration for this test.

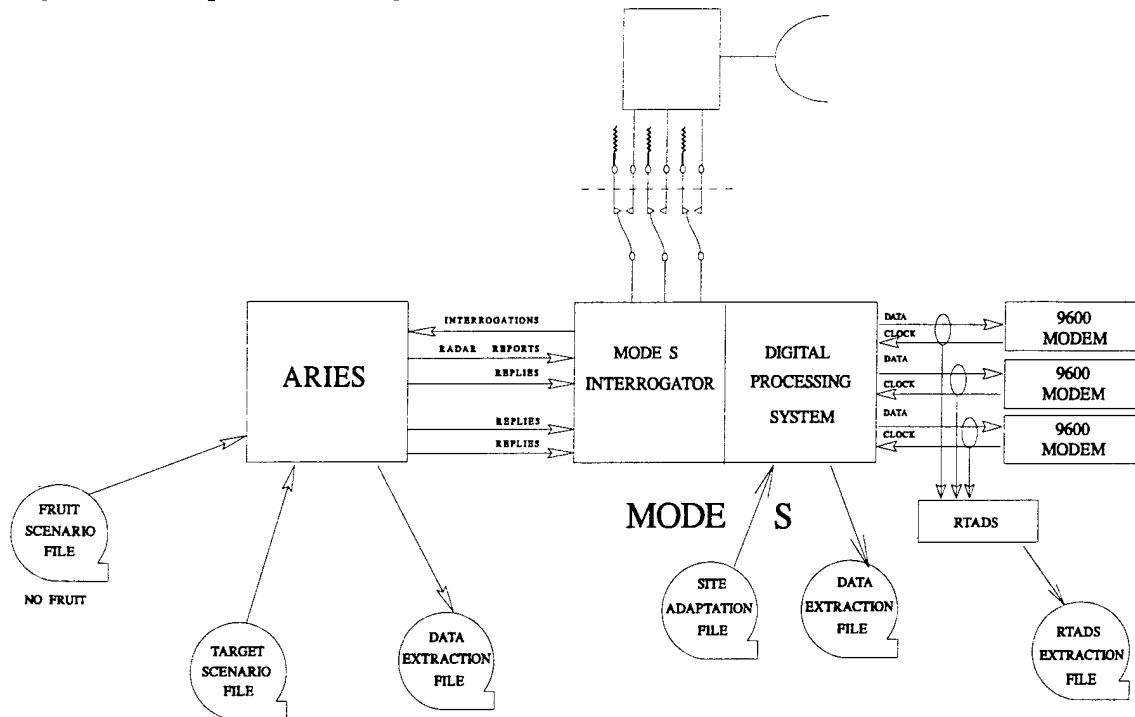

FIGURE 4.8-1. MODE S REFLECTION ANALYSIS

### TEST DESCRIPTION

This test consisted of 14 subtests. The subtests were grouped into four different sets. Each set of subtests addressed a different aspect of Mode S performance.

Subtest one was executed to verify that the reflector algorithms work properly under a variety of situations. The ARIES scenario used for this subtest was the uplink reflection scenario. The uplink reflection scenario was designed specifically to test the sensor's reflection algorithms. The scenario consists of 16 pairs of targets. Each pair consists of a reflected target and a true target. The location and orientation of the 16 reflecting surfaces that could cause reflections were calculated. A reflector map containing the range, orientation, and azimuth of the 16 reflectors was loaded into the sensor.

The sensor was loaded with the S2 SAP configuration for subtest 1. A reflector file corresponding to the reflectors embedded within the scenario was also loaded. Given that the targets were simulated by ARIES, the sensor was switched to dummy load for test execution.

ARIES, RTADS, and sensor extractions were collected during test execution. No ARIES or sensor errors or alarms were observed during execution.

Subtests 2 through 6 used the live data collected during Test 7 (Mode S Sensor Coverage). This was required in order to determine if the reflector algorithms work properly in a live environment.

During the site acceptance testing, a site adapted reflector file was established for the Mode S sensor, based on Beacon False Target Summary data. The reflectors contained in this file were loaded into the sensor at the time of test execution.

Subtests 2 through 6 were executed using a modified S7 SAP configuration. The following changes were made to the S7 SAPs:

- st\_addrd\_lockout\_md = 1
- na\_pds = 13
- ext\_sensor\_id = 1
- sensor\_id = 15

RTADS and sensor extractions were collected during test execution. No sensor alarms were observed during execution.

The test procedure requires that an ARIES scenario with a large number of targets be used during subtests 7, 8, and 9. This scenario would have determined the effect false target tests have on the surveillance performance. The required scenario was unavailable at the time of test execution. Sub Subtests 7, 8, and 9 were not conducted.

Subtests 10 through 14 used an ARIES ground-bounce scenario, to determine whether adaptive thresholds reduce multipath false targets. The downlink reflection scenario was used. The downlink reflection scenario simulates ground bounce replies and is designed to test the sensor's adaptive threshold circuitry. Pairs of moving targets were generated with the same azimuth but different ranges. The range difference of each pair was varied from completely separated to fully overlapped. Replies from the true targets were 20 decibels (dB) greater than the ground bounce reply.

This set of subtests was executed using the S2 SAP configuration with the following changes:

- mdS\_rc\_stc\_crv\_ref = 0
- mdS\_ac\_stc\_crv\_ref = 0
- atcr\_stc\_crv\_ref = 0
- aux\_stc\_crv\_ref = 0

RTADS, ARIES and Mode S sensor data extractions were collected.

## DATA ANALYSIS

The data reduction effort used the RTADS files as an input for the TDR Beacon False Target Summary (BFTS) program. TDR BFTS provided listings of all false targets as well as the calculated positions of the reflectors causing reflected false targets.

The BFTS and Surveillance File Analysis DR programs were used to identify the number of times that a false target was identified as false in its surveillance file.

The ARIES/Mode S Compare program was used to identify missing reports, incorrect codes, or false targets for the ground-bounce multipath analysis.

For subtest 1, the DR Beacon False Target Summary, TDR Beacon False Target Summary, and DR Surveillance File Analysis programs were executed to determine if all of the reflected targets were identified by the sensor. The summary data from each BFTS and Surveillance File Analysis listing was entered onto the data sheet and analyzed.

For subtests 2 through 6, the reduction and analysis effort included executing DR and TDR BFTS programs, and the DR Surveillance File Analysis program on the five sets of data collected during Test 7 (Mode S Sensor Coverage). The summary data was entered onto the data sheets. The corresponding Surveillance File Analysis data from Test 7 was also transferred to a data sheet. The reflectors identified by data analysis were compared to the reflectors already identified in the site adapted parameters.

For subtests 10 through 14, the ARIES/Mode S Compare program was executed. As the ground-bounce scenario was executed for this set of subtests, the ARIES/Mode S Compare program was used to determine how the reflected and real targets were tracked as the site adaptable parameters varied.

## TEST RESULTS

There were three Test Objectives to be verified.

**Objective 1** states that the amount of reduction of reflected false targets must be measured. The sensor successfully identified all reflected false targets.

**Objective 2** states that any adverse effects due to the reflection elimination process must be determined. It was determined that no adverse effects resulted from the adaptive thresholding algorithm.

**Objective 3** states that Mode S must reduce false target reports that result from multipath effects. This was accomplished. A 37.93 percent detection of reflected false targets due to multipath was measured using the adaptive thresholding algorithm.

Subtest 1 used the uplink reflection scenario to determine if the reflected targets generated by ARIES were correctly identified by the sensor.

A beacon message, that is flagged as a reflection by the Mode S sensor, is a false alarm, if the BFTS identifies the target that it came from as real. There were no false alarms identified for this subtest. The Mode S sensor and the Beacon False Target Summary program agreed completely on which beacon messages were true, and which were false. This information is summarized in table 4.8-1 shown below.

TABLE 4.8-1. FALSE TARGET IDENTIFICATION,  
MODE S SENSOR VS. BEACON FALSE TARGET SUMMARY

Subtest	Uplink Reflections According to the Sensor	Uplink Reflections According to BFTS	False Beacon Responses According to Sensor	False Beacon Responses According to BFTS
2	133	131	108	107
3	53	53	39	39
4	55	54	39	39
5	31	31	17	17
6	8	8	2	2

Subtests 2 through 6 proved that the sensor identified false targets quite well using the site adapted reflector file. In subtest 2, a reflector was identified by the Mode S sensor that was not part of the reflector file in the SAPs. The characteristics of this reflector are given in table 4.8-2.

TABLE 4.8-2. SUBTEST TWO REFLECTOR CHARACTERISTICS

Range (nmi)	.562
Azimuth (degree)	250.84
Orientation	174.451
Minimum Azimuth	250.840
Maximum Azimuth	250.840
Count	1

Given that the reflection was identified only once and only at one point in space, it is likely that this reflector was created by a plane at the Atlantic City International Airport. The range and azimuth of the reflector also make this plausible. Subtest 2 was the only subtest to identify this reflector. Given that the other subtests occurred later in time, this suggests the reflector may have moved.

Subtests 10 through 14 revealed the effect of the adaptive threshold circuitry. Adaptive thresholding works by comparing the detection threshold to the amplitude of the last pulse detected. In analyzing subtests 10 through 14, it was important to ensure that the

real targets were tracked, and the reflected ones were not (depending on the adaptive thresholding value). This was partially verified.

For this portion of the test, the Sensitivity Time Constant (STC) curves were set to zero to eliminate their effect. This step was actually redlined into the procedure, after the subtests were executed the first time.

The reported Pd for the reflected targets was 37.93 percent, when the adaptive thresholding was set to 15. Since the reflected targets were 20 dB lower than the real targets in the scenario, the report Pd, for the reflected targets, should have been zero or close to it. The adaptive thresholding was not completely effective.

The table 4.8-3 shows the Pd data (as observed at the report level) for real and reflected targets as the adaptive threshold was varied. When the adaptive threshold was set to 20, a much lower value for the Pd was expected because the reflected targets were 20 dB lower than the real targets.

TABLE 4.8-3. REPORT LEVEL PROBABILITY OF DETECTION

Adaptive Threshold SAP	Real Target PD (%)	False Target PD (%)
15	100.00	37.93
20	99.84	95.82
25	100.00	97.72
30	100.00	98.86
NONE	100.00	98.20

## CONCLUSIONS

The first subtest successfully proved that the reflector algorithms work properly under a variety of situations. The sensor correctly identified the reflected beacon targets using the reflector file in the site adaptable parameters. In accordance with Objective 1, a reduction in the number of reflected false targets was measured.

The second set of subtests (i.e., Numbers 2 through 6) verified that the reflector algorithms worked properly in a live environment. False targets were correctly identified by the Beacon False Target Summary program.

The third set of subtests (i.e., subtests 7 through 9) was supposed to use a capacity-like scenario to determine whether the additional workload of reflection analysis, or adaptive thresholding, caused any degradation in the surveillance performance. There was no capacity-like scenario with reflectors available.

The fourth set of subtests (i.e., numbers 10 through 14) identified a problem with the adaptive thresholding. Adaptive thresholding is only partially effective. SPR FC93-30902 was written to address this problem. One thing that is known is that real targets are unaffected by the adaptive thresholding feature. Further investigation is needed to identify the reason adaptive thresholding is only partially effective.

The third objective was to verify that the Mode S reduces the number of false target reports that result from multipath effects. This was verified, but the intent of the test was not realized. The reduction of false target reports was not as great as expected.

The objectives for this test and their verification are summarized in table 4.8-4.

TABLE 4.8-4. OBJECTIVE SUMMARY

OBJECTIVE	VERIFIED?
1. Measure amount of reduction of reflected false targets	Yes
2. Determine any adverse effects due to the reflection elimination process	Yes
3. Verify that Mode S reduces false target reports due to multipath effects	Yes

## 4.9 TEST 9: SENSOR ACCURACY.

### PURPOSE

These tests measured the accuracy of Mode S position reporting, for both moving and stationary targets. The Mode S sensors Calibration and Performance Monitoring Equipment (CPME) was used as a source of Mode S and ATRBS replies to evaluate accuracy at a low angle (less than 2°), stationary position. Since the Mode S specification specifies that bias errors are measured at low angles, and due to the fact that many aircraft transponders delay times vary as a function of time and temperature, the CPME was used for all bias measurements.

A test aircraft, tracked by both the Mode S sensor and a precision tracker, flew pre-planned routes to gather data about range and azimuth jitter. The differences between the tracker position reports and the Mode S position reports were analyzed.

### TEST OBJECTIVES

The objectives for this test were as follows:

1. To verify that the sensor-only range errors for Mode S reports do not exceed  $\pm 30$  ft. bias and 25 ft. root mean square (rms.) jitter. Reference: PTP Category 1, paragraph 4.1.1.3, NAS-SS-1000, (1210).
2. To verify that the sensor-only range errors for ATRBS reports do not exceed  $\pm 30$  ft. bias and 25 ft. root mean square (rms.) jitter. Reference: PTP Category 1, paragraph 4.1.1.3, NAS-SS-1000, (1220).
3. To verify that the long term combined sensor plus antenna azimuth errors for Mode S reports do not exceed:
  - a. A bias of  $\pm 0.033^\circ$  for elevation angles less than  $2^\circ$  (exclusive of antenna wind load)
  - b. Jitter less than  $0.060^\circ$  (one standard deviation), for elevation angles less than  $20^\circ$ .

Reference: PTP Category 1, paragraph 4.1.1.3, NAS-SS-1000, (1230).

4. To verify that the long term combined sensor plus antenna azimuth errors for ATRBS reports do not exceed:
  - a. A bias of  $\pm 0.033^\circ$  for elevation angles less than  $2^\circ$  (exclusive of antenna wind load)
  - b. Jitter less than  $0.060^\circ$  (one standard deviation), for elevation angles less than  $20^\circ$ .

Reference: PTP Category 1, paragraph 4.1.1.3, NAS-SS-1000, (1240).



## TEST CONFIGURATION

Figure 4.9-1 depicts the configuration for this test.

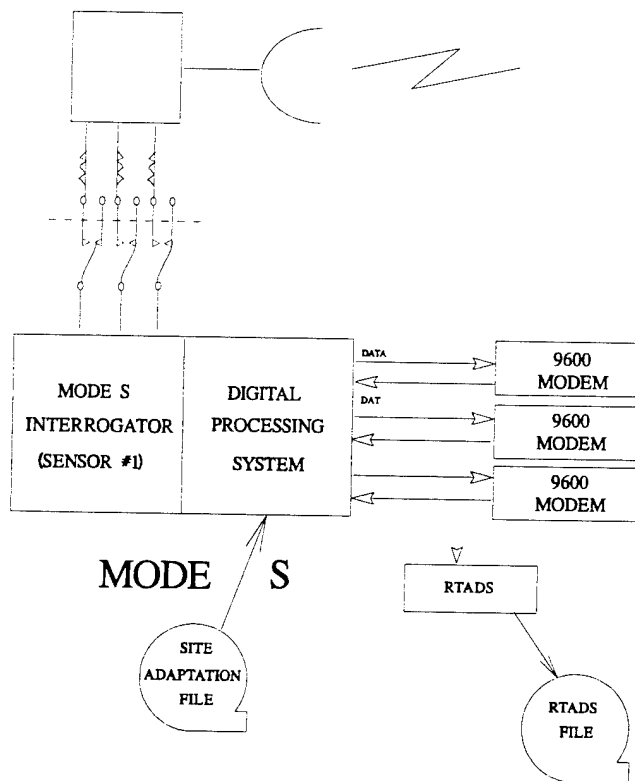

FIGURE 4.9-1. SENSOR ACCURACY

### TEST DESCRIPTION

During this test a single aircraft flew preplanned flight paths while being tracked by the sensor and a precision tracker. The precision tracker used was a NIKE tracking system with a published accuracy of 9 feet in range and 0.1 milliradians in azimuth. The pilots received instructions via radio as to where to position the aircraft and which transponder (ATCRBS or Mode S) to use. This test consisted of 18 subtests. Nine subtests used Mode S transponders, and nine used ATCRBS transponders. The subtests can be further broken down into two main categories; tests in which the target flew an orbital flight path around the sensor, and those in which the target flew a radial flight path.

In the orbital subtests, the target aircraft transcribed a 90° arc (195°-285°) about the sensor at a slant range of 13 nmi. Each subtest consisted of a run in the clockwise

direction and one in the counter clockwise direction. An equal number of subtests were conducted with ATCRBS and Mode S transponders. Half of the subtests involved aircraft flying at 6,000 feet; the other half had aircraft at 27,000 feet. Figure 4.9-2a and 4.9-2b depicts the orbital flightpaths for these tests.

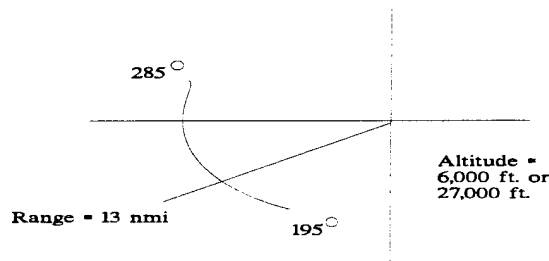

FIGURE 4.9-2A. ORBITAL FLIGHTPATHS

The radial tests consisted of having the aircraft transverse a range of 5 to 55 nmi while keeping a constant 241° azimuth. Each subtest had one run from 5 to 55 nmi followed by a run from 55 to 5 nmi. The subtests were equally divided between ATCRBS and Mode S transponders. All targets in the radial testing flew at an altitude of 17,400 feet.

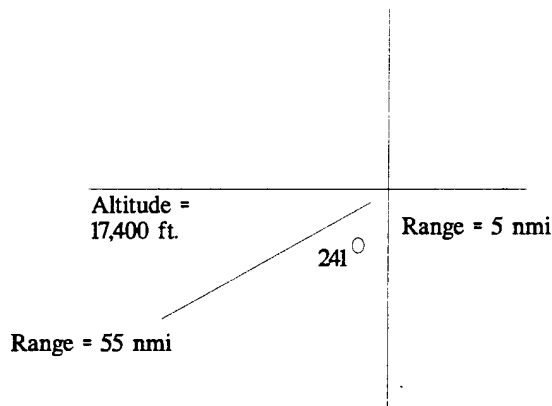

FIGURE 4.9-2B. RADIAL FLIGHTPATHS

While the aircraft were flying their preplanned flight paths data from the sensors two CPMEs was also collected. Each scan of the antenna provided data from the CPMEs which was used to determine the sensors range and azimuth accuracy at low elevation angles. The reported positions of the CPMEs was compared to their surveyed position.

The sensor was loaded with the R1 SAP configuration for these tests.

### DATA ANALYSIS

Two DR programs were used to reduce and analyze the data from these tests. The DR "Accuracy Analysis" program was run using the extractions from the Mode S Sensor and the Precision Tracker for each subtest. This program compares the range and azimuth reported by the sensor to that reported by the precision tracker and returns an error value for each parameter. The Accuracy Analysis program was run using report level data (as opposed to reply level or disseminated level) from the sensor extraction tape.

The DR "Nine Point" programs was also used. These programs provide information on range and azimuth errors, but they do not use an external tracking radar for comparison. Instead these programs consider the targets current position and its position over the past four scans and four scans into the future. These "nine points" are then used to construct a curve. The difference between the current position predicted by the curve fitting process and the current position reported by the sensor was considered to be the position error. The DR Nine Point program operates at the report level.

### TEST RESULTS

The DR Accuracy Analysis program was used to calculate the sensor's errors with regard to the CPMEs. The output of the program was the difference between the range and azimuth reported by the sensor and the surveyed range and azimuth of the CPMEs. Since each CPME provides ATCRBS and Mode S replies, this method of analysis gives an indication of how accurately the sensor reports each target type. One of the CPMEs used is mounted on building 70 at the FAA Technical Center. The other CPME is mounted on a tower in McKee City, New Jersey. The data presented in table 4.9-1 was obtained using the CPME reports on the Mode S extraction tapes recorded during testing. Since these reports are present throughout the testing, time filtering was not used to exclude periods when the test aircraft were not flying their planned routes. For this reason, the results are not organized by subtest. Instead the results are presented by test pattern (orbital or radial), target type (ATCRBS or Mode S), and altitude in thousands of feet for the orbital subtests.

While some individual data runs indicate values which exceed the specification limits the overall numbers are well below the established limits for both range and azimuth bias and jitter.

TABLE 4.9-1. CPME ERROR DATA

CPME, Target Type	RANGE (FT.)		AZIMUTH (DEG.)		Flight
	MEAN ERROR	STD. DEV.	MEAN ERROR	STD. DEV.	Pattern Info
Bldg #70, ATRBS	8.9	17.9	-0.031	0.019	rad/a
Bldg #70, Mode S	9.0	14.0	-0.022	0.045	rad/a
McKee City, ATRBS	10.5	18.7	0.038	0.017	rad/a
McKee City, Mode S	1.6	6.9	0.032	0.032	rad/a
Bldg #70, ATRBS	8.2	16.9	0.022	0.019	rad/s
Bldg #70, Mode S	8.9	14.0	0.016	0.039	rad/s
McKee City, ATRBS	12.8	18.0	0.042	0.018	rad/s
McKee City, Mode S	1.8	7.1	0.040	0.045	rad/s
Bldg #70, ATRBS	13.3	18.5	0.024	0.017	orb/a/27
Bldg #70, Mode S	30.5	2.4	0.026	0.025	orb/a/27
McKee City, ATRBS	7.2	18.4	0.012	0.015	orb/a/27
McKee City, Mode S	16.2	15.4	0.006	0.022	orb/a/27
Bldg #70, ATRBS	10.1	18.3	0.020	0.018	orb/s/27
Bldg #70, Mode S	30.5	2.2	0.012	0.027	orb/s/27
McKee City, ATRBS	14.3	9.3	0.007	0.015	orb/s/27
McKee City, Mode S	16.0	17.2	-0.010	0.177	orb/s/27
Bldg #70, ATRBS	N/A	N/A	N/A	N/A	orb/a/6
Bldg #70, Mode S	7.0	13.0	0.020	0.014	orb/a/6
McKee City, ATRBS	N/A	N/A	N/A	N/A	orb/a/6
McKee City, Mode S	0.3	2.9	0.011	0.012	orb/a/6
Bldg #70, ATRBS	15.1	18.1	0.039	0.019	orb/s/6
Bldg #70, Mode S	8.7	13.9	0.045	0.042	orb/s/6
McKee City, ATRBS	11.3	16.8	0.036	0.015	orb/s/6
McKee City, Mode S	6.2	12.3	0.042	0.047	orb/s/6
Average, ATRBS	11.18	18.09	0.0271	0.0172	N/A
Average, Mode S	11.39	10.11	0.0235	0.0441	N/A
Limits	±30.0	±25.0	±0.033	±0.060	N/A

A summary of the Accuracy Analysis data for the test aircraft are listed below in table 4.9-2. The flight data contains the number of samples, the mean error and the standard deviation with the exception that the mean range error data is not presented. This was omitted due to varying transponder delay characteristics incurred during the flights due to temperature and power level variations.

TABLE 4.9-2. ACCURACY ANALYSIS DATA

Transponder Type and Flight Pattern	SAMPLE SIZE	RANGE STD. DEV. (ft)	AZ Mean Error (deg)	AZ STD. DEV. (deg)
MODE S CW ORBITALS	430	15.8	-0.145	0.080
ATCRBS CW ORBITALS	412	32.0	-0.088	0.041
MODE S CCW ORBITALS	402	15.7	-0.017	0.069
ATCRBS CCW ORBITALS	404	29.0	-0.091	0.040
MODE S INBOUND RADIALS	415	97.2	-0.073	0.091
ATCRBS INBOUND RADIALS	417	27.5	-0.046	0.043
MODE S OUTBOUND RADIALS	394	57.0	-0.077	0.092
ATCRBS OUTBOUND RADIALS	356	46.9	-0.051	0.048

MODE S ORBITALS	832	15.8	-0.127	0.077
ATCRBS ORBITALS	816	30.7	-0.089	0.041
MODE S RADIALS	809	82.8	-0.075	0.092
ATCRBS RADIALS	773	40.1	-0.048	0.046
MODE S (ALL)	1641	61.5	-0.101	0.088
LIMIT	NONE	±25.0	±0.060 *	±0.060
ATCRBS (ALL)	1589	37.0	-0.069	0.048
LIMIT	NONE	±25.0	±0.060 *	±0.060

Note: In all of the Accuracy Analysis and Nine Point results tables presented here, CW indicates clockwise rotation and CCW indicates counterclockwise rotation.

\* Beam widening effects of antenna pattern with increased elevation angle can add an additional 0.007 ° bias per degree elevation increase.

The standard deviation of the measured range difference ( Mode S position - Nike position) for ATCRBS targets was 37 feet. For the Mode S transponder the standard deviation was 61 feet. The established limit in the specification is a maximum of 25 feet jitter. The standard deviation of the azimuth data for ATCRBS is  $.048^\circ$ , and  $.088^\circ$  for Mode S. The specification limits for azimuth mean error is  $.060^\circ$ . In addition to the allowed system level biases, antenna pattern changes must be accounted for as a function of target elevation angle. The variation of angular offset from boresight to crossover increases nominally  $0.070^\circ$  with every  $10^\circ$  increase in elevation angle. Complete analysis of mean azimuth data to account for beam widening affects would require a much more sophisticated tool than was available. For the purposes of this test, since the aircraft elevation angles varied from  $3^\circ$  to  $35^\circ$ , an additional  $0.007$  to  $0.231^\circ$  error, respectively, would be allowable depending on the target elevation. The ATCRBS data is better than the Mode S data, due to antenna beam edge effects. The ATCRBS azimuth is determined by the two replies closest to boresight in most cases. For Mode S targets a single reply near the leading edge of the antenna beam is normally used to determine the target azimuth.

The Nine Point accuracy program was also used to analyze the controlled target data. This data is presented in table 4.9-3. Again only the sample size and the standard deviation of the error data is presented. This analysis produced a different result, with the standard deviation of the Mode S range data equal to 16 feet and the ATCRBS data 22 feet. The Mode S and ATCRBS azimuth deviation numbers were  $.027^\circ$  and  $.022^\circ$ , respectively. The Nine Point accuracy data may look better in part because there are no calibration errors ( as there are between NIKE and Mode S) and the inherent errors of the NIKE ( 9 feet range and  $.1$  milliradians) do not exist.

TABLE 4.9-3. DR NINE POINT DATA

	SAMPLE SIZE	STD. DEV.	STD. DEV.
MODE S CW ORBITALS	390	20.3	0.025
ATCRBS CW ORBITALS	344	23.9	0.017
MODE S CCW ORBITALS	358	18.8	0.023
ATCRBS CCW ORBITALS	359	23.0	0.018
MODE S INBOUND RADIALS	300	9.7	0.028
ATCRBS INBOUND RADIALS	248	20.7	0.025
MODE S OUTBOUND RADIALS	389	11.5	0.030
ATCRBS OUTBOUND RADIALS	356	21.9	0.028
MODE S ORBITALS	748	19.6	0.024
ATCRBS ORBITALS	703	23.5	0.017
MODE S RADIALS	689	10.8	0.029
ATCRBS RADIALS	604	21.4	0.027
ALL MODE S	1437	16.0	0.027
LIMIT	NONE	±25.0	±0.060
ALL ATCRBS	1307	22.5	0.022
LIMIT	NONE	±25.0	±0.060

### CONCLUSIONS

The accuracy of the Mode S sensor when using a controlled transponder at a low elevation angle is extremely good and meets all the requirements of the specification.

The accuracy achieved when comparing a NIKE tracker to the Mode S sensor for a test aircraft at higher elevation angles is not always within the specification limits. Some of the measured range error is probably due to variability in the transponder delay time as a function of time, temperature, and power level. These variables were impossible to eliminate completely. The azimuth data from the flight tests indicated that the ATCRBS errors were less than the amount allowed in the specification. The Mode S azimuth error was  $.088^\circ$  compared to a limit of  $.060$ . This error can be reduced by using replies closer to bore sight for Mode S targets. This would necessitate more Mode S interrogations and replies or waiting until later in the beam to start interrogating. Both of these options would have an adverse effect on data link capacity. Since the accuracy is very close to the specification limit and much better than the existing ATC system, no change is recommended to the Mode S sensor.

## 4.10 TEST 10: SENSOR RESOLUTION.

### PURPOSE

These tests verified the ability of the Mode S sensor to detect and resolve two aircraft closely spaced in range and azimuth. This procedure was only concerned with obtaining and comparing resolution data from two ATCRBS transponders. The Mode S sensor has no resolution conflict in the Mode S mode. The resolution data obtained will be used to establish a baseline for Mode S performance.

### TEST OBJECTIVES

The objectives for this test were as follows:

- a. Determine the sensor's ability to resolve two targets flying in close proximity.  
Reference: PTP Category 1, paragraph 4.1.1.3.
- b. Verify that Mode S reduces garble by use of monopulse beacon operations.  
Reference: PTP Category 1, paragraph 4.1.1.3, NAS-SS-1000, (1110).

### TEST CONFIGURATION

Figure 4.10-1 depicts the configuration for this test.

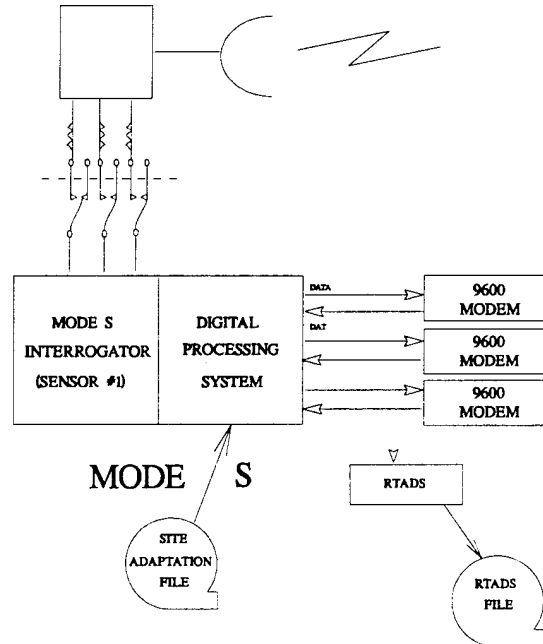

FIGURE 4.10-1. SENSOR RESOLUTION



## TEST DESCRIPTION

These tests measured the ability of the sensor to accurately report the positions of two aircraft closely spaced in slant range and azimuth. An ATCRBS reply has a duration of 20.3  $\mu$ sec. This corresponds to 1.64 nmi. The antenna beamwidth is 3.6°. When two targets are separated by less than 1.64 nmi and 3.6°, the result is ATCRBS replies that overlap.

These tests required that the Mode S sensor be operated into the antenna to interrogate all ATCRBS targets within its coverage range. A pair of test aircraft, flying planned routes, were tracked by the Mode S sensor as well as by two precision tracking units. Each aircraft was equipped with an ATCRBS transponder as well as a transponder for use by the precision tracker. The sensor was loaded with the R1 SAP configuration for these tests.

The two test aircraft flew radial flight paths at a nominal azimuth of 242°. The planes maintained a constant altitude difference of 500 feet, flying at 11,200 feet and 11,700 feet, respectively. Ranges varied from 3 nmi to 45 nmi. The aircraft started their flights at slightly different ranges and slightly different airspeeds. During the course of each test run one plane would slowly overtake and pass the other one. This ensured that they would maintain a close proximity in range throughout the testing. Six test runs were made, and each run consisted of an inbound and an outbound leg. These six runs were grouped into three different azimuth separations; 0°, 1°, and 2°. Two test runs were made at each azimuth separation. Keeping azimuth separation relatively constant while varying the range separation allowed for data collection at a large number of points within the 1.64 nmi/3.6° separation area of interest. Executing 12 test runs ensured that the data sample would be large enough to be statistically valid.

## DATA ANALYSIS

The data was reduced using the DR Resolution Analysis program and the TDR Surveillance Analysis program. In accordance with the Test Procedure, the Resolution Analysis program was run using ATCRBS Reports (as opposed to Replies or Disseminated Reports) as an input. The targets are considered resolved if there is one and only one report from each of the targets on the Mode S extraction file and the error between the report position and the position recorded by the appropriate tracker is below the accuracy limit. The default accuracy limits of 2,500 feet and 6.8° were used for these tests. The results of each test run were considered separately, and then the results of all the runs were merged. When surveillance parameters for this test were considered, the data observed in Test 4 (Surveillance Baseline-Report Parameters) was used for comparison.

## TEST RESULTS

A summation of the results as they relate to each objective follows.

Objective 1 was to determine the sensor's ability to resolve targets in close proximity. The second objective was to verify that Mode S reduces garble by using monopulse beacon operations. The sensor performed well in regard to both of these objectives. For a graphical representation of the data, the reader is referred to table 4.10-1 (Resolution Percentage) on the following page. This table displays resolution percentage as a function of range separation and azimuth separation. Each block in the table represents a particular interval of range and azimuth separation. For example, the block in the lower right hand corner of the table covers separations of 1.8 nmi to 2.0 nmi and 0.0° to 0.4°. The resolution in this block was 100.0 percent, and the data is based on a sample size of 13. The rows of numbers above the table are the totals of resolution percentage and sample size for each range separation interval. In the same manner, the numbers along the right hand edge of the table are the azimuth interval totals. The overall resolution percentage was 90.1 percent and is based on 1146 data points.

The worst case for resolution was for separations of 0.0 nmi to 0.2 nmi and 0.4° to 0.8°. In this interval the resolution was 71.4 percent. As would be expected, resolution percentage decreases as range and azimuth separation decrease. The worst case performance as a function of azimuth interval is 80.4 percent in the interval 0.0° to 0.4°. The worst case performance as a function of range occurs in the interval of 0.0 nmi to 0.2 nmi. In this interval the resolution percentage was 82.1 percent. Again, this is as expected. The closer the targets the more they overlap, and the more likely it is that there will be a resolution problem. However, even these "worst case" numbers are acceptable. This data satisfies the objective of providing a baseline of the sensor's ability to resolve targets in close proximity.

**TABLE 4.10-1 RESOLUTION PERCENTAGE**

% NO.	82.1 117	90.3 113	90.1 121	86.2 123	87.7 162	91.6 154	94.4 124	95.9 98	95.5 67	92.5 67	90.1% 1146
4.0°			100.0 5	100.0 7	80.0 5	100.0 5	100.0 4	100.0 2	100.0 1		96.6 29
3.6°		100.0 6	100.0 3	100.0 1	100.0 11	100.0 6	100.0 5	100.0 4		100.0 4	100.0 40
3.2°	100.0 1	100.0 3		100.0 2	100.0 5	100.0 6	100.0 7	100.0 3	100.0 5	100.0 1	100.0 33
2.8°	100.0 5			100.0 2	100.0 2	100.0 10	100.0 15	94.1 17	100.0 4	100.0 6	98.4 61
2.4°	83.3 6	100.0 5	100.0 8	100.0 14	100.0 10	100.0 12	90.9 11	100.0 5	100.0 1	100.02	97.3 74
2.0°	100.0 17	100.0 12	100.0 13	100.0 5	100.0 6	91.7 12	95.2 21	100.0 4	75.0 8	100.0 7	96.2 105
1.6°	80.0 10	87.5 8	100.0 4	71.4 7	94.1 17	100.0 21	100.0 21	100.0 16	92.3 13	80.0 10	92.9 127
1.2°	84.6 26	100.0 33	93.8 32	78.6 28	83.3 18	88.9 18	90.9 11	92.9 14	100.0 16	86.7 15	90.0 211
0.8°	71.4 14	90.0 10	100.0 20	100.0 21	85.4 48	87.2 39	83.3 12	100.0 8	100.0 5	88.9 9	89.2 186
0.4°	73.7 38	75.0 36	72.2 36	75.0 36	80.0 40	80.0 25	88.2 17	92.0 25	100.0 14	100.0 13	80.4 280
0	0.2	0.4	0.6	0.8	1.0	1.2	1.4	1.6	1.8	2.0	

RANGE SEPARATION IN NMI

TABLE 4.10-2. TEST 10 VERSUS TEST 4 COMPARISON

	BEACON PD (%)	TOTAL PD (%)	ID VAL. (%)	ALT. VAL. (%)	FALSE TARGET (%)
TEST 10 VALUE	99.15	99.61	99.97	95.30	0.10
TEST 4 LIMIT	>97.0	>99.0	>97.0	>95.0	<0.30
LIMIT MET?	YES	YES	YES	YES	YES

All of the objectives for this procedure were verified. The sensor's ability to resolve two ATRBS targets in close proximity has been established as a function of range separation and azimuth separation.

CONCLUSIONS

This test can be considered successful. All of the objectives outlined in the Test Procedures have been met. The sensor performed very much as expected, and there were no significant anomalies in the data.

## 4.11 TEST 11: MODE S STOCHASTIC ACQUISITION.

### PURPOSE

These tests measured the ability of the sensor to acquire Mode S tracks using the stochastic acquisition process. The tests used three colocated ground mounted Mode S transponders to establish garble situations.

### TEST OBJECTIVES

The objectives for this test were as follows;

1. To verify the Mode S initial acquisition process. Reference: PTP Category 1, paragraph 4.1.1.3.
2. To verify the Mode S adaptive acquisition process. Reference: PTP Category 1, paragraph 4.1.1.3.
3. To establish the stochastic acquisition baseline. Reference: PTP Category 1, paragraph 4.1.1.3.
4. To verify that the sensor can generate a Mode S only All-Call interrogation. Reference: PTP Category 1, paragraph 4.1.1.1, NAS-SS-1000, (1330).

### TEST CONFIGURATION

Figure 4.11-1 depicts the configuration for this test.

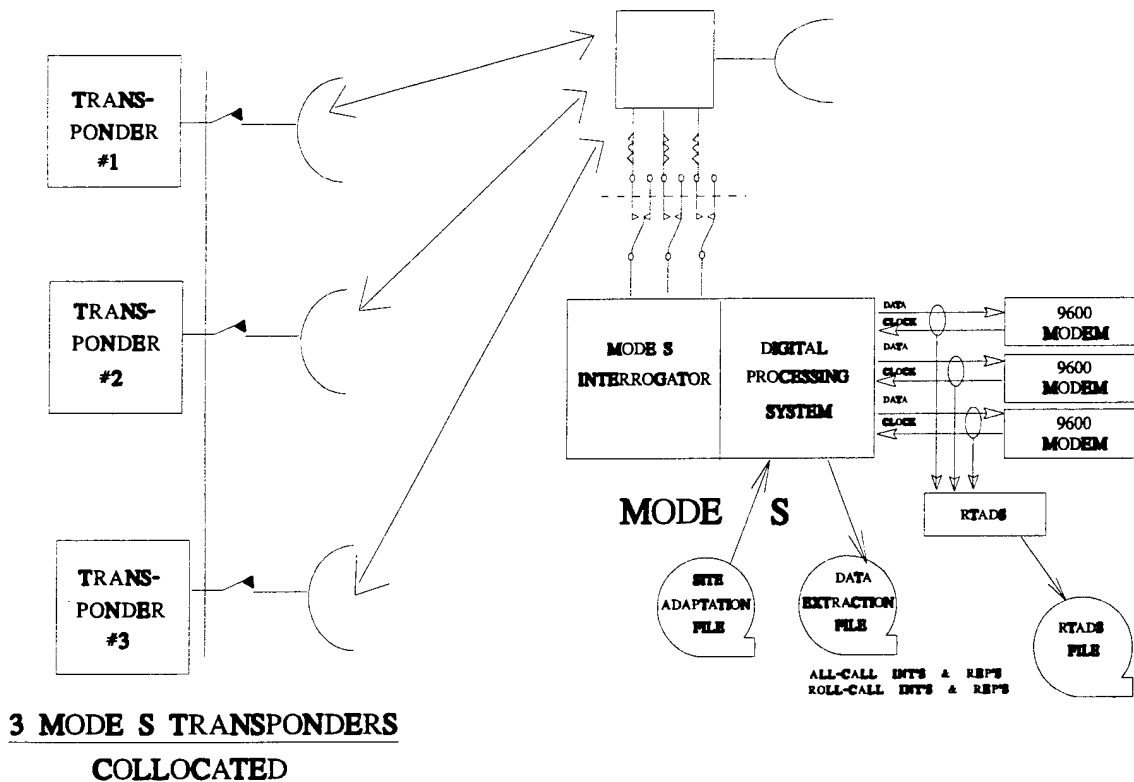

FIGURE 4.11-1. STOCHASTIC ACQUISITION

TEST DESCRIPTION

To establish the garble condition needed for the test, three targets were arranged on the runway closely spaced in range and azimuth. The positions of the targets are detailed in table 4.11-1 shown below.

TABLE 4.11-1. TARGET POSITIONS

MODE S ID/ (ATCRBS ID)	RANGE IN NMI	AZIMUTH IN DEG.
a4aa47/(0201)	0.44	125.684°
a480ee/(0206)	0.25	125.771°
ac9451/(0211)	0.33	125.420°

The targets used for the testing consisted of two aircraft equipped with Mode S transponders and a van with a Mode S transponder mounted in it. To make sure that the van was not screened out by the much larger aircraft, it was positioned closest to the

sensor. For the same reason, the largest aircraft was positioned furthest from the sensor. The pilots received instructions via radio on where to position the targets and when to turn their transponders on and off.

Stochastic acquisition can be broken into two broad areas, initial acquisition and adaptive acquisition. For each subtest the initial and adaptive portions of the tests were executed consecutively. The initial acquisition portions of the test verify the sensor's ability to acquire targets in garble conditions after the sensor has been reset. During initial acquisition, the sensor had to acquire all the targets in its coverage area after a reset.

In the adaptive acquisition portions of the test, the sensor was not reset. The transponders of the three targets were turned off and left off for several minutes to assure that the targets were dropped from the roll call. Then all three transponders were turned on simultaneously. This tests the ability of the sensor to acquire targets in garble conditions, and add them to the roll call.

The sensor was loaded with a modified S1 SAP configuration for these tests. Twelve subtests were executed. For all of the subtests, the same changes were made to the S1 configuration. The changes were:

```
rpt_trk_num_in_mode2_flg=1
k_thta_acq_mds_trk=1
```

The starting value of the reply probability and the number of scans for which the probability is maintained are controlled by the reply\_prob and sai\_scans SAPs, respectively. Using the reply\_prob SAP the value of the probability of reply bits in the interrogator message can be set to 1/16, 1/8, 1/4, 1/2, or 1. The initial probability of reply doubles after a predetermined number of scans until a probability of reply of one is achieved. The number of scans a given probability is held for is controlled by the sai\_scans SAP. In initial acquisition, these SAPs make sure that the sensor is not overloaded by all the targets in the coverage area replying to All Calls at the same time. These SAPs were varied throughout the test in an effort to determine which combination yielded the best results. The value of these SAPs for each subtest is detailed in table 4.11-2 shown below.

TABLE 4.11-2. SAP CHANGES

Subtests	Reply_Prob	Sai_Scans
1-5	2	1
6-8	2	3
9-12	4	3

Extractions were made at the RTADS and Mode S sensor for both initial and adaptive acquisition tests.

## TEST RESULTS

Problems in the Mode S system software prevented the collection and analysis of data necessary to confirm proper operation of the stochastic acquisition process. A problem report was prepared and a solution implemented with in the sensor. Lack of transponder and aircraft resources prevented the retest of this function. This testing will be completed as part of the OT&E of the Mode S sensors.



## 5. DEFINITION OF TERMS AND ACRONYMS.

ARIES	Aircraft Reply and Interference Environmental Simulator
ASR-9	Air Surveillance Radar
ATC	Air Traffic Control
ATCBI-5	Air Traffic Control Beacon Interrogator
ATCRBS	Air Traffic Control Radar Beacon System
Azimuth splits	Azimuth splits occur when beacon replies of a target are interrupted and two targets are declared
Azimuthal reflections	When a target is displayed at an azimuth that is significantly different from that of the true target, it is called an azimuthal reflection.
Basic 41 scenario	A series of three scenarios (ATCRBS only, Mode S only, and mixed) that simulate stress situations. Each scenario contains 41 targets.
Blip/scan ratio (Probability of Detection)	The ratio of blips (the number of times a target was detected) to scans (the number of times the target should have been detected) is expressed as a percentage. The blip/scan ratio is an important figure for evaluating radar performance. For example, if the blip/scan value falls to 60percent, the probability is greater that tracks will go into the coast mode much more frequently.
CID	Communications Interface Driver
Conflict	When two or more targets are within 2 nmi and 4 degrees of each other.
dBm	The loss in decibels is ten times the logarithm of the power ratio, where the reference power level is 1 milliwatt.
DR	Data Reduction
False target reports	Any discrete beacon code report determined by software analysis to be split in azimuth, split in range, or a reflected target report.
Fruit	Non synchronous replies, such as those caused by interrogation of the transponders by other interrogators, are called fruit.

Fruit rate	Fruit is transponder replies to interrogators other than the interrogator of interest. Fruit replies appear asynchronous to the interrogator of interest. Fruit levels are given in the following table: <table border="0" style="margin-left: 40px;"> <thead> <tr> <th style="text-decoration: underline;">Level</th> <th style="text-decoration: underline;">ATCRBS</th> <th style="text-decoration: underline;">Mode S</th> </tr> </thead> <tbody> <tr> <td>Moderate</td> <td>4,000</td> <td>50</td> </tr> <tr> <td>Heavy</td> <td>40,000</td> <td>200</td> </tr> </tbody> </table>	Level	ATCRBS	Mode S	Moderate	4,000	50	Heavy	40,000	200
Level	ATCRBS	Mode S								
Moderate	4,000	50								
Heavy	40,000	200								
Garble	The sensor condition where replies from different targets overlap									
Garbled replies	When two aircraft are located at approximately the same slant range and azimuth, their beacon replies can overlap. Overlapped replies that cannot be separated in time are processed as garbled replies.									
IBI	Interim Beacon Interrogator									
ISLS	Improved side lobe suppression.									
MARDE	Mode S Analysis and Recording Display Environment									
Mode S	Mode Select									
Orientation	Orientation of an azimuthal or back-lobe reflector is the angle measured from true north to the face of the reflecting surface. Orientation of a downlink reflector is the angle measured between the plane of the reflector and a line perpendicular to the antenna tower.									
Pd	Probability of Detection (see blip/scan ratio)									
Pfa	Probability of False Alarm									
PTP	Performance Test Plan									
Range split	Range splits occur when beacon replies of a target are interrupted and two targets are declared.									
Radar Reinforced (R/R)	The radar reinforced value is the ratio of the number of beacon messages with the reinforced bit set to the total number of beacon messages received, expressed as a percentage.									
Reflections	A discrete beacon code report within one scan interval of a second report determined to be the true report. The true report is considered to be the report from the target that was present during previous scans.									
RF	Radio Frequency									
Ring around	Side lobe replies and ring around are considered to be equivalent terms, and are used to describe the appearance of false targets that are caused by side lobe replies.									

RTADS	Real-Time Aircraft Display System
SCIP	Surveillance and Communication Interface Processor
Side lobe replies	A side lobe target is displayed at the same range as the true target, but at a different azimuth. These side lobe replies are detected as multiple targets by the data processing equipment.
SLS	Side Lobe Suppression.
SPR	System Problem Report
STC	Sensitivity Time Constant
Target reliability	The probability that the transponder will reply to an interrogation is called target reliability or round reliability.
Target splits	A target split occurs when one target is displayed as multiple targets.
TDR	Transportable Radar Analysis Computer System (TRACS) Data Reduction Program
track swap	This is a condition where two or more targets come into close proximity (usually a conflict), and this causes a misassignment at least one target ID for the duration of that track.
TRACS	Transportable Radar Analysis System
TVRTM	Test Verification Requirements Traceability Matrix
VSWR	Voltage Standing Wave Ratio

APPENDIX A.  
FORMAL TEST SPRs

The table shown below lists the SPR's referred to in the report and which tests they apply to.

SPR number	Problem	Related Tests
FC93-00501	Beacon log video pulse stretching	Test 1 (IBI/ATCBI-5 Comparison)
FC93-21409	Sensor not operational using Heavy Fruit	Test 3 (Surveillance Baseline-Pd/Pfa), Test 4 (Surveillance Baseline-Report Parameters), Test 6 (Data Link)
FC93-30910	High reinterrogation rate	Test 4 (Surveillance Baseline-Report Parameters)
FC93-30902	Adaptive Thresholding Partially Ineffective	Test 8 (Reflection Analysis)
FC93-22106	Mode S targets simultaneously on Roll- Call and responding to All-Calls	Test 11 (Stochastic Acquisition)

APPENDIX B

DIRECTORY STRUCTURE AND NAMING CONVENTION

## DIRECTORY STRUCTURE

All of the files for these tests reside under the /PERF/f1 directories on the SUN. PERF represents "performance test," and f1 represents "formal, run 1." Under the f1 directory there is a directory for each test. These directories are named t1 for Test 1, t2 for Test 2, and so on. Under the directory for each test there are directories for extraction files, DR files, and TDR files. The names of these directories are de, dr, tdr, respectively. For example, an extraction file for test 11 would be under PERF/f1/t11/de. Similarly a TDR file for test 4 would be under PERF/f1/t4/tdr.

## NAMING CONVENTION

There are two naming conventions used for these files. One convention applies to extraction files, and the other applies to DR and TDR files.

The naming convention for extraction files is the more simple of the two. Consider the template shown below.

(test #)(extraction type)(subtest #).(date)

Test number is the number of the test the extraction is related to. This parameter can be one or two characters as required. The extraction type is one character in length and identifies whether the extraction is from the Mode S Sensor, ARIES, or CID. The allowable values for extraction type are m for Mode S, a for ARIES, and c for CID. The subtest number identifies which subtest the extraction is related to. If a subtest is executed more than once, the subtest number is followed by a letter. For instance, the second execution of subtest four would be termed "4a." The three character extension represents the date. The first character represents the month as an integer, and the next two characters specify the day. Months that would require more than one decimal digit are expressed in hexadecimal. As an example, the Mode S extraction file from test 8, subtest 1, executed on July 15, would be named 8m1.715. If an ARIES extraction file for the third execution of subtest 7 from test 4 was made on November 8, the file would be named 4a7b.b08.

The naming convention for DR and TDR files is somewhat more involved. Consider the template shown below.

(test #)(test tool)(subtest #).(extension)

The test number and subtest number are exactly as defined for the extraction files. The three-character extension has only two allowable values in this convention. For plot files the extension is ".plt," for listing files ".lst" is used. Anything that is not a plot file is defined as a listing.

The confusion here is with the naming convention for the "test tool" parameter. This identifies which DR or TDR program was used to create the file. Since some programs exist in both DR and TDR versions (Surveillance Analysis, for example), it is possible for two different files to have the same name. This problem is rectified by the directory structure used. TDR files reside in the appropriate tdr directories and DR files reside in dr directories. The table below identifies all of the test tools used in these tests, whether they are DR or TDR programs, and the abbreviation used in for the tool in the naming convention.

ABBREVIATION	TEST TOOL NAME	DR/TDR
aa	Accuracy Analysis	DR
aam	Accuracy Analysis Merge	DR
ac	ARIES Compare	DR
bf	Beacon False Target Summary	DR and TDR
bfm	Beacon False Target Summary Merge	TDR
ca	Conflict Analysis	DR
cm	Channel Management Statistics	DR
dl	Data Link Statistics	DR
fltr	Filter	TDR
misc	Miscellaneous Print	DR
np	Nine Point	DR and TDR
npm	Nine Point Merge	DR and TDR
pp	Surveillance Print and Plot	TDR
res	Resolution Analysis	DR
resm	Resolution Analysis Merge	DR
sa	Surveillance Analysis	DR and TDR
sam	Surveillance Analysis Merge	TDR
sf	Surveillance File Analysis	DR
sl	Mode S List	DR
sp	Surveillance Print	DR
sum	Scan Summary	DR

All of the files created during these tests are archived on magnetic tape using the directory structure and naming convention detailed above. Lists of the names of these files organized by test number appear in appendices D and E of this document. Any departure from the naming convention will be detailed where it occurs.



APPENDIX C

LIST OF FILES CREATED DURING DATA EXTRACTION

This appendix contains the names of all the data extraction files created during testing. The types of files included are Mode S extractions, ARIES extractions, RTADS extractions, and CID extractions. Unless otherwise noted, all of these files conform to the naming convention of appendix C. The files for each test are presented as a group. Files that were created but not used due to data corruption, incorrect execution of the test, or any other reason will be identified as they appear.

**TEST 1 (ATCBI/IBI COMPARISON) EXTRACTIONS**

The files in the table below were extracted and reduced, but not used in the report. It was discovered that the ATCBI/IBI power level matching done prior to the testing was incorrect, rendering any results based on these extractions suspect.

SUBTEST NUMBER	RTADS FILE NAME	SUBTEST NUMBER	RTADS FILE NAME
1	1r1.723	21	1r21.724
2	1r2.723	22	1r22.724
3	1r3.723	23	1r23.724
4	1r4.723	24	1r24.724
5	1r5.723	25	1r25.724
6	1r6.723	26	1r26.724
7	1r7.723	27	1r27.724
8	1r8.724	28	1r28.724
9	1r9.724	29	1r29.724
10	1r10.724	30	1r30.724
11	1r11.724	31	1r31.724
12	1r12.724	32	1r32.724
13	1r13.724	33	1r33.724
14	1r14.724	34	1r34.724
15	1r15.724	35	1r35.724
16	1r16.724	36	1r36.724
17	1r17.724	37	1r37.724
18	1r18.724	38	1r38.724
19	1r19.724	39	1r39.724
20	1r20.724	40	1r40.724

The files in the table below contain the names of the files that were reduced and analyzed to produce the conclusions that appear in this report.

SUBTEST NUMBER	RTADS FILE NAME	SUBTEST NUMBER	RTADS FILE NAME
1a	1r1a.823	21a	1r21a.826
2a	1r2a.823	22a	1r22a.826
3a	1r3a.823	23a	1r23a.826
4a	1r4a.823	24a	1r24a.826
5a	1r5a.823	25a	1r25a.826
6a	1r6a.823	26a	1r26a.826
7a	1r7a.823	27a	1r27a.826
8a	1r8a.823	28a	1r28a.826
9a	1r9a.823	29a	1r29a.826
10a	1r10a.823	30a	1r30a.826
11a	1r11a.823	31a	1r31a.826
12a	1r12a.823	32a	1r32a.826
13a	1r13a.823	33a	1r33a.827
14a	1r14a.823	34a	1r34a.827
15a	1r15a.823	35a	1r35a.827
16a	1r16a.826	36a	1r36a.827
17a	1r17a.826	37a	1r37a.830
18a	1r18a.826	38a	1r38a.830
19a	1r19a.826	39a	1r39a.830
20a	1r20a.724	40a	1r40a.830

**TEST 2 (IBI PERFORMANCE MONITORING) EXTRACTIONS**

This test did not require the creation of any extraction files.

**TEST 3 (SURVEILLANCE BASELINE-PD/PFA) EXTRACTIONS**

SUBTEST NUMBER	RTADS FILE NAME	MODE S FILE NAME	ARIES FILE NAME
1	3r1.819	3m1.819	3a1.819
1a	3r1a.820	3m1a.820	3a1a.820
2	3r2.819	3m2.819	3a2.819
3	3r3.819	3m3.819	3a3.819
4	3r4.819	3m4.819	3a4.819
4a	3r4a.820	3m4a.820	3a4a.820
5	3r5.820	3m5.820	3a5.820
6	3r6.820	3m6.820	3a6.820
7	3r7.820	3m7.820	3a7.820
8	3r8.820	3m8.820	3a8.820
9	3r9.b16	3m9.b16	3a9.b16
10	3r10.b16	3m10.b16	3a10.b16
11	3r11.b16	3m11.b16	3a11.b16
12	3r12.b16	3m12.b16	3a12.b16

Due to sensor yellow codes observed during the execution the files from subtests 1 and 3 extracted on August 19, 1993, were not used. The files included in the statistics in the report are 1a and 3a files extracted on August 20, 1993.

**TEST 4 (SURVEILLANCE BASELINE-REPORT PARAMETERS)  
EXTRACTIONS**

SUBTEST	RTADS FILE NAME	MODE S FILE NAME	ARIES FILE NAME
1	4r1.629	4m1.629	4a1.629
1a	4r1a.707	4m1a.707	4a1a.707
1b	4r1b.917	4m1b.917	4a1b.917
2	4r2.629	4m2.629	4a2.629
2a	4r2a.707	4m2a.707	4a2a.707
3	4r3.629	4m3.629	4a3.629
3a	4r3a.707	4m3a.707	4a3a.707
4	4r4.630	4m4.630	4a4.630
5	4r5.630	4m5.630	4a5.630
6	4r6.630	4m6.630	4a6.630
7	4r7.810	4m7.810	4a7.810
8	4r8.810	4m8.810	4a8.810
8b	4r8b.903	4m8b.903	4a8b.903
8c	4r8c.b16	4m8c.b16	4a8c.b16
9	4r9.810	4m9.810	4a9.810
9a	4r9a.c15	4m9a.c15	4a9a.c15
10	4r10.629	4m10.629	4a10.629
10a	4r10a.708	4m10a.708	4a10a.708
11	4r11.629	4m11.629	4a11.629
11a	4r11a.708	4m11a.708	4a11a.708
12	4r12.629	4m12.629	4a12.629
12a	4r12a.708	4m12a.708	4a12a.708
13	4r13.630	4m13.630	4a13.630
14	4r14.701	4m14.701	4a14.701
15	4r15.701	4m15.701	4a15.701
16	4r16.c15	4m16.c15	4a16.c15
17	4r17.810	4m17.810	4a17.810
17b	4r17b.903	4m17b.903	4a17b.903
17c	4r17c.c15	4m17c.c15	4a17c.c15
18	4r18.c15	4m18.c15	4a18.c15
rein	4rrein.719	4mrein.719	4arein.719
rein a	4rreina.728	4mreina.728	4areina.728

The "latest" file listed in this table is always the file used for the statistics in this report. For example, 4r17b.903 was used rather than 4r17.810. The reader will note that there is no 4r17a.xxx file. This is due to problems executing scenarios that involve the use of heavy or intermediate fruit scenarios. During the execution of many of these tests the sensor shut down with red codes prior to the conclusion of the test. The extractions

from these executions were of little use, so they were not saved. However, if an attempt was made the run number was incremented.

The files listed under "rein" are extractions related to an ARIES scenario that was created to help determine the re-interrogation rate as a function of range.

### **TEST 5 (CONFLICT SITUATIONS) EXTRACTIONS**

Subtest 1 required a regression test as explained in the body of this document. The first regression (run "1a") contained a shift in azimuth in the disseminated data. The extractions from this file were not used. The extractions from the second regression (run "1b") were used for the statistics in the report.

SUBTEST	RTADS FILE NAME	MODE S FILE NAME	ARIES FILE NAME
1	5r1.701	5m1.701	5a1.701
1a	5r1a.903	5m1a.903	5a1a.903
1b	5r1b.917	5m1b.917	5a1b.917
2	5r2.701	5m2.701	5a2.701
3	5r3.701	5m3.701	5a3.701
4	5r4.701	5m4.701	5a4.701

### **TEST 6 (DATA LINK BASELINE) EXTRACTIONS**

SUBTEST	RTADS FILE NAME	MODE S FILE NAME	ARIES FILE NAME	CID FILE NAME
4	6r4.816	6m4.816	6a4.816	6c4.816
5	6r5.816	6m5.816	6a5.816	6c5.816
6	6r6.816	6m6.816	6a6.816	6c6.816
10	6r10.816	6m10.816	6a10.816	6c10.816
11	6r11.816	6m11.816	6a11.816	6c11.816
12	6r12.816	6m12.816	6a12.816	6c12.816
13	6r13.903	6m13.903	6a13.903	6c13.903
14	6r14.903	6m14.903	6a14.903	6c14.903

### **TEST 7 (MODE S SENSOR COVERAGE) EXTRACTIONS**

The table below contains the names of all the files created during tests using live targets. As explained in the body of this report, the RTADS extractions from sensor 137 were not usable due to the lack of TOY time updates on the files.

SUBTEST	SENSOR 1 RTADS FILE NAME	SENSOR 137 RTADS FILE NAME	SENSOR 1 MODE S FILE NAME
1	7r1.806	7r1_137.806	7m1.806
2	7r2.806	7r2_137.806	7m2.806
3	7r3.806	7r3_137.806	7m3.806
4	7r4.806	7r4_137.806	7m4.806
5	7r5.806	7r5_137.806	7m5.806

The next table contains the names of all the files created during the tests that used targets generated by ARIES. The extraction from "run b" of subtest 8 were the ones used to generate the data that appears in this report.

SUBTEST	RTADS FILE NAME	MODE S FILE NAME	ARIES FILE NAME
6	7r6.806	7m6.806	7a6.806
7	7r7.806	7m7.806	7a7.806
8	7r8.806	7m8.806	7a8.806
8a	7r8a.813	7m8a.813	7a8a.813
8b	7r8b.820	7m8b.820	7a8b.820

### **TEST 8 (MODE S REFLECTION ANALYSIS) EXTRACTIONS**

Subtests 10 through 14 were originally executed with the wrong values loaded in the STC curve SAPs. When this was discovered these subtests were rerun with the correct SAPs. The files labeled 10a through 14a were used to generate the statistics that appear in this report.

SUBTEST	RTADS FILE NAME	MODE S FILE NAME	ARIES FILE NAME
1	8r1.728	8m1.728	8a1.728
7	8r7.728	8m7.728	8a7.728
10	8r10.806	8m10.806	8a10.806
10a	8r10a.A04	8m10a.A04	8a10a.A04
11	8r11.806	8m11.806	8a11.806
11a	8r11a.A04	8m11a.A04	8a11a.A04
12	8r12.806	8m12.806	8a12.806
12a	8r12a.A04	8m12a.A04	8a12a.A04
13	8r13.806	8m13.806	8a13.806
13a	8r13a.A04	8m13a.A04	8a13a.A04
14	8r14.806	8m14.806	8a14.806
14a	8r14a.A04	8m14a.A04	8a14a.A04

### TEST 9 (SENSOR ACCURACY) EXTRACTION

Because the extractions for this test were created in conjunction with another test group (OT&E), they do not conform to the naming convention of appendix C. The first letter identifies whether the file is an RTADS (r) or Mode S (s) extraction. The next two characters (g1) identify the test name that the OT&E group uses. The next number is the OT&E test number. The next character indicates the type of transponder used in the test; a for ATRBS, m for Mode S. The last two characters before the extension indicate the run number. For example, r2 would be the second run of a given test. The three letter extension is the date of the extraction.

SUBTEST	RTADS FILE	MODE S FILE
1	rg17aar1.708	mg17aar1.708
2	rg18aar1.708	mg18aar1.708
3	rg19aar1.708	mg19aar1.708
4	rg17mar1.709	mg17mar1.709
5	rg18mar1.709	mg18mar1.709
6	rg19mar1.709	mg19mar1.709
7	rg14mar1.803	mg14aar1.803
8	rg15mar1.803	mg15aar1.803
9	rg16mar1.803	mg16aar1.803
10	rg14aar1.803	mg14aar1.803
11	rg15aar1.803	mg15aar1.803
12	rg16aar1.803	mg16aar1.803
13	rg11aar1.706	mg11aar1.706
14	rg12aar1.706	mg12aar1.706
15	rg13aar1.706	mg13aar1.706
16	rg11mar1.706	mg11mar1.706
17	rg12mar1.706	mg12mar1.706
18	rg13mar1.706	mg13mar1.706



## TEST 10 (SENSOR RESOLUTION) EXTRACTIONS

As was the case with Test 9, these files do not conform to the naming convention of appendix C. The first letter identifies whether the file is an RTADS (r) or Mode S (s) extraction. The next two characters (g1) identify the test name that the OT&E group uses. The next number is the OT&E test number. The next character indicates the type of transponder used in the test; a for ATCRBS, m for Mode S. The last two characters before the extension indicate the run number. For example, r3 would be the third run of a given test. The three letter extension is the date of the extraction.

SUBTEST	RTADS FILE	MODE S FILE
1	rg_1rr1.727	mg_1rr1.727
2	rg_1rr1.727	mg_1rr1.727
3	rg_1rr1.727	mg_1rr1.727
4	rg_1rr1.727	mg_1rr1.727
5	rg_1rr1.727	mg_1rr1.727
6	rg_1rr1.727	mg_1rr1.727
7	rg_1rr1.727	mg_1rr1.727
8	rg_1rr1.727	mg_1rr1.727

## TEST 11 (STOCHASTIC ACQUISITION) EXTRACTIONS

The first attempt to execute this test was done with an incorrect SAP configuration loaded into the sensor. Because of this the data files created that day were not used for the statistics included in this report. The names of these files appear in the table below.

SUBTEST	RTADS FILE NAME	MODE S FILE NAME
1	11r1.707	11m1.707
2	11r2.707	11m2.707
3	11r3.707	11m3.707
4	11r4.707	11m4.707
5	11r5.707	11m5.707
6	11r6.707	11m6.707
7	11r7.707	11m7.707
8	11r8.707	11m8.707
9	11r9.707	11m9.707
10	11r10.707	11m10.707

Another set of extraction was made with the correct SAP configuration. These are the files used to generate the statistics that appear in this report. The names of these files are given in the table below. The filtered RTADS files contain disseminated information only from targets in the area of the runway where the testing was conducted. All other targets were filtered out of these files.

SUBTEST	RTADS FILE NAME	FILTERED RTADS FILE NAME	MODE S FILE NAME
1a	11r1a.813	11r1af.813	11m1a.813
2a	11r2a.813	11r2af.813	11m2a.813
3a	11r3a.813	11r3af.813	11m3a.813
4a	11r4a.813	11r4af.813	11m4a.813
5a	11r5a.813	11r5af.813	11m5a.813
6a	11r6a.813	11r6af.813	11m6a.813
7a	11r7a.813	11r7af.813	11m7a.813
8a	11r8a.813	11r8af.813	11m8a.813
9a	11r9a.813	11r9af.813	11m9a.813
10a	11r10a.813	11r10af.813	11m10a.813
11a	11r11a.813	11r11af.813	11m11a.813
12a	11r12a.813	11r12af.813	11m12a.813

APPENDIX D

FILES CREATES DURING DATA REDUCTION

This appendix contains lists of all the files created during data reduction and analysis. All of the files from each test are grouped together. Unless otherwise noted all of the file names conform to the naming convention of appendix C. Files that were created but not used to generate the statistics in this report will be identified as they appear.

### **TEST 1 (ATCBI-5/IBI COMPARISON) REDUCTION FILES**

There are three tables of files in this section. Due to mismatched ATCBI-5 and IBI power levels, the files from the first execution of this test were considered invalid and not used. The names of these files appear in the first table. After the power levels were matched, the tests were re-executed and the data reduced. These files are shown in the second table. All of the files from the second run of tests have an "a" appended to the subtest number. The third table contains files that were generated during the process of filtering out targets that were associated with multiple splits or ringarounds. These files have an "f" appended to the file name to indicate that they are a filtered file. All of these files were generated under TDR as opposed to DR.

SUBTEST NUMBER	TDR FILE NAME	TDR FILE NAME
1	1bf1.lst/1bf1.plt	1sa1.lst/1sa1.plt
2	1bf2.lst/1bf2.plt	1sa2.lst/1sa2.plt
3	1bf3.lst/1bf3.plt	1sa3.lst/1sa3.plt
4	1bf4.lst/1bf4.plt	1sa4.lst/1sa4.plt
5	1bf5.lst/1bf5.plt	1sa5.lst/1sa5.plt
6	1bf6.lst/1bf6.plt	1sa6.lst/1sa6.plt
7	1bf7.lst/1bf7.plt	1sa7.lst/1sa7.plt
8	1bf8.lst/1bf8.plt	1sa8.lst/1sa8.plt
9	1bf9.lst/1bf9.plt	1sa9.lst/1sa9.plt
10	1bf10.lst/1bf10.plt	1sa10.lst/1sa10.plt
11	1bf11.lst/1bf11.plt	1sa11.lst/1sa11.plt
12	1bf12.lst/1bf12.plt	1sa12.lst/1sa12.plt
13	1bf13.lst/1bf13.plt	1sa13.lst/1sa13.plt
14	1bf14.lst/1bf14.plt	1sa14.lst/1sa14.plt
15	1bf15.lst/1bf15.plt	1sa15.lst/1sa15.plt
16	1bf16.lst/1bf16.plt	1sa16.lst/1sa16.plt
17	1bf17.lst/1bf17.plt	1sa17.lst/1sa17.plt
18	1bf18.lst/1bf18.plt	1sa18.lst/1sa18.plt
19	1bf19.lst/1bf19.plt	1sa19.lst/1sa19.plt
20	1bf20.lst/1bf20.plt	1sa20.lst/1sa20.plt
21	1bf21.lst/1bf21.plt	1sa21.lst/1sa21.plt
22	1bf22.lst/1bf22.plt	1sa22.lst/1sa22.plt
23	1bf23.lst/1bf23.plt	1sa23.lst/1sa23.plt
24	1bf24.lst/1bf24.plt	1sa24.lst/1sa24.plt
25	1bf25.lst/1bf25.plt	1sa25.lst/1sa25.plt
26	1bf26.lst/1bf26.plt	1sa26.lst/1sa26.plt
27	1bf27.lst/1bf27.plt	1sa27.lst/1sa27.plt
28	1bf28.lst/1bf28.plt	1sa28.lst/1sa28.plt
29	1bf29.lst/1bf29.plt	1sa29.lst/1sa29.plt
30	1bf30.lst/1bf30.plt	1sa30.lst/1sa30.plt
31	1bf31.lst/1bf31.plt	1sa31.lst/1sa31.plt
32	1bf32.lst/1bf32.plt	1sa32.lst/1sa32.plt
33	1bf33.lst/1bf33.plt	1sa33.lst/1sa33.plt
34	1bf34.lst/1bf34.plt	1sa34.lst/1sa34.plt
35	1bf35.lst/1bf35.plt	1sa35.lst/1sa35.plt
36	1bf36.lst/1bf36.plt	1sa36.lst/1sa36.plt
37	1bf37.lst/1bf37.plt	1sa37.lst/1sa37.plt
38	1bf38.lst/1bf38.plt	1sa38.lst/1sa38.plt
39	1bf39.lst/1bf39.plt	1sa39.lst/1sa39.plt
40	1bf40.lst/1bf40.plt	1sa40.lst/1sa40.plt

SUBTEST NUMBER	TDR FILE NAME	TDR FILE NAME
1a	1bf1a.lst/1bf1a.plt	1sa1a.lst/1sa1a.plt
2a	1bf2a.lst/1bf2a.plt	1sa2a.lst/1sa2a.plt
3a	1bf3a.lst/1bf3a.plt	1sa3a.lst/1sa3a.plt
4a	1bf4a.lst/1bf4a.plt	1sa4a.lst/1sa4a.plt
5a	1bf5a.lst/1bf5a.plt	1sa5a.lst/1sa5a.plt
6a	1bf6a.lst/1bf6a.plt	1sa6a.lst/1sa6a.plt
7a	1bf7a.lst/1bf7a.plt	1sa7a.lst/1sa7a.plt
8a	1bf8a.lst/1bf8a.plt	1sa8a.lst/1sa8a.plt
9a	1bf9a.lst/1bf9a.plt	1sa9a.lst/1sa9a.plt
10a	1bf10a.lst/1bf10a.plt	1sa10a.lst/1sa10a.plt
11a	1bf11a.lst/1bf11a.plt	1sa11a.lst/1sa11a.plt
12a	1bf12a.lst/1bf12a.plt	1sa12a.lst/1sa12a.plt
13a	1bf13a.lst/1bf13a.plt	1sa13a.lst/1sa13a.plt
14a	1bf14a.lst/1bf14a.plt	1sa14a.lst/1sa14a.plt
15a	1bf15a.lst/1bf15a.plt	1sa15a.lst/1sa15a.plt
16a	1bf16a.lst/1bf16a.plt	1sa16a.lst/1sa16a.plt
17a	1bf17a.lst/1bf17a.plt	1sa17a.lst/1sa17a.plt
18a	1bf18a.lst/1bf18a.plt	1sa18a.lst/1sa18a.plt
19a	1bf19a.lst/1bf19a.plt	1sa19a.lst/1sa19a.plt
20a	1bf20a.lst/1bf20a.plt	1sa20a.lst/1sa20a.plt
21a	1bf21a.lst/1bf21a.plt	1sa21a.lst/1sa21a.plt
22a	1bf22a.lst/1bf22a.plt	1sa22a.lst/1sa22a.plt
23a	1bf23a.lst/1bf23a.plt	1sa23a.lst/1sa23a.plt
24a	1bf24a.lst/1bf24a.plt	1sa24a.lst/1sa24a.plt
25a	1bf25a.lst/1bf25a.plt	1sa25a.lst/1sa25a.plt
26a	1bf26a.lst/1bf26a.plt	1sa26a.lst/1sa26a.plt
27a	1bf27a.lst/1bf27a.plt	1sa27a.lst/1sa27a.plt
28a	1bf28a.lst/1bf28a.plt	1sa28a.lst/1sa28a.plt
29a	1bf29a.lst/1bf29a.plt	1sa29a.lst/1sa29a.plt
30a	1bf30a.lst/1bf30a.plt	1sa30a.lst/1sa30a.plt
31a	1bf31a.lst/1bf31a.plt	1sa31a.lst/1sa31a.plt
32a	1bf32a.lst/1bf32a.plt	1sa32a.lst/1sa32a.plt
33a	1bf33a.lst/1bf33a.plt	1sa33a.lst/1sa33a.plt
34a	1bf34a.lst/1bf34a.plt	1sa34a.lst/1sa34a.plt
35a	1bf35a.lst/1bf35a.plt	1sa35a.lst/1sa35a.plt
36a	1bf36a.lst/1bf36a.plt	1sa36a.lst/1sa36a.plt
37a	1bf37a.lst/1bf37a.plt	1sa37a.lst/1sa37a.plt
38a	1bf38a.lst/1bf38a.plt	1sa38a.lst/1sa38a.plt
39a	1bf39a.lst/1bf39a.plt	1sa39a.lst/1sa39a.plt
40a	1bf40a.lst/1bf40a.plt	1sa40a.lst/1sa40a.plt

SUBTEST NUMBER	TDR FILE NAME	TDR FILE NAME
1a	1bf1af.lst/1bf1af.plt	1sa1af.lst/1sa1af.plt
3a	1bf3af.lst/1bf3af.plt	1sa3af.lst/1sa3af.plt
7a	1bf7af.lst/1bf7af.plt	1sa7af.lst/1sa7af.plt
9a	1bf9af.lst/1bf9af.plt	1sa9af.lst/1sa9af.plt
11a	1b11faf.lst/1bf11af.plt	1sa11af.lst/1sa11af.plt
13a	1bf13af.lst/1bf13af.plt	1sa13af.lst/1sa13af.plt
15a	1bf15af.lst/1bf15af.plt	1sa15af.lst/1sa15af.plt
19a	1bf19af.lst/1bf19af.plt	1sa19af.lst/1sa19af.plt
23a	1bf23af.lst/1bf23af.plt	1sa23af.lst/1sa23af.plt
27a	1bf27af.lst/1bf27af.plt	1sa27af.lst/1sa27af.plt
29a	1bf29af.lst/1bf29af.plt	1sa29af.lst/1sa29af.plt
31a	1bf31af.lst/1bf31af.plt	1sa31af.lst/1sa31af.plt
33a	1bf33af.lst/1bf33af.plt	1sa33af.lst/1sa33af.plt
35a	1bf35af.lst/1bf35af.plt	1sa35af.lst/1sa35af.plt
37a	1bf37af.lst/1bf37af.plt	1sa37af.lst/1sa37af.plt

### **TEST 2 (IBI PERFORMANCE MONITORING) REDUCTION FILES**

No reduction files were created for this test.

### **TEST 3 (SURVEILLANCE BASELINE-PD/PFA) REDUCTION FILES**

SUBTEST NUMBER	TDR SA FILE NAME	TDR BFTS FILE NAME
1a	3sa1a.lst/3sa1a.plt	3bf1a.lst/3bf1a.plt
2	3sa2.lst/3sa2.plt	3bf2.lst/3bf2.plt
3	3sa3.lst/3sa3.plt	3bf3.lst/3bf3.plt
4a	3sa4a.lst/3sa4a.plt	3bf4a.lst/3bf4a.plt
5	3sa5.lst/3sa5.plt	3bf5.lst/3bf5.plt
6	3sa6.lst/3sa6.plt	3bf6.lst/3bf6.plt
7	3sa7.lst/3sa7.plt	3bf7.lst/3bf7.plt
8	3sa8.lst/3sa8.plt	3bf8.lst/3bf8a.plt
9	3sa9.lst/3sa9.plt	3bf9.lst/3bf9.plt
10	3sa10.lst/3sa10.plt	3bf10.lst/3bf10.plt
11	3sa11.lst/3sa11.plt	3bf11.lst/3bf11.plt
12	3sa12.lst/3sa12.plt	3bf12.lst/3bf12.plt

SUBTEST NUMBER	DR FILE NAME
1a	3ac1a.lst
2	3ac2.lst
3	3ac3.lst
4a	3ac4a.lst
5	3ac5.lst
6	3ac6.lst
7	3ac7.lst
8	3ac8.lst
9	3ac9.lst
10	3ac10.lst
11	3ac11.lst
12	3ac12.lst

**TEST 4 (SURVEILLANCE BASELINE-REPORT PARAMETERS) REDUCTION FILES**

The next two tables contain the files generated during the reduction and analysis for this test. In cases where a subtest was executed more than once, the latest run was used for the report statistics. That is to say that given there are runs 1, 1a, and 1b, the data from run 1b was used in the report.



SUBTEST NUMBER	DR FILE NAME	DR FILE NAME
1a	4ac1a.lst	4cm1a.lst/4cm1.plt
1b	4ac1b.lst	4cm1b.lst/4cm1b.plt
2	4ac2.lst	4cm2.lst/4cm2.plt
2a	4ac2a.lst	4cm2a.lst/4cm2a.plt
3a	4ac3a.lst	4cm3a.lst/4cm3a.plt
4	4ac4.lst	4cm4.lst/4cm4.plt
5	4ac5.lst	4cm5.lst/4cm5.plt
6	4ac6.lst	4cm6.lst/4cm6.plt
8	4ac8.lst	4cm8.lst/4cm8.plt
8b	4ac8b.lst	4cm8b.lst/4cm8b.plt
8c	4ac8c.lst	4cm8c.lst/4cm8c.plt
9	4ac9.lst	4cm9.lst/4cm9.plt
9a	4ac9a.lst	4cm9a.lst/4cm9a.plt
10a	4ac10a.lst	4cm10a.lst/4cm10a.plt
11a	4ac11a.lst	4cm11a.lst/4cm11a.plt
12a	4ac12a.lst	4cm12a.lst/4cm12a.plt
13	4ac13.lst	4cm13.lst/4cm13.plt
14	4ac14.lst	4cm14.lst/4cm14.plt
15	4ac15.lst	4cm15.lst/4cm15.plt
16	4ac16.lst	4cm16.lst/4cm16.plt
17	4ac17.lst	4cm17.lst/4cm17.plt
17b	4ac17b.lst	4cm17b.lst/4cm17b.plt
17	4ac17c.lst	4cm17c.lst/4cm17c.plt
18	4ac18.lst	4cm18.lst/4cm18.plt

SUBTEST NUMBER	TDR FILE NAME	TDR FILE NAME
1	4bf1.lst/4bf1.plt	4sa1.lst/4sa1.plt
1a	4bf1a.lst/4bf1a.plt	4sa1a.lst/4sa1a.plt
1b	4bf1b.lst/4bf1b.plt	4sa1b.lst/4sa1b.plt
2	4bf2.lst/4bf2.plt	4sa2.lst/4sa2.plt
2a	4bf2a.lst/4bf2a.plt	4sa2a.lst/4sa2a.plt
3	4bf3.lst/4bf3.plt	4sa3.lst/4sa3.plt
3a	4bf3a.lst/4bf3a.plt	4sa3a.lst/4sa3a.plt
4	4bf4.lst/4bf4.plt	4sa4.lst/4sa4.plt
5	4bf5.lst/4bf5.plt	4sa5.lst/4sa5.plt
6	4bf6.lst/4bf6.plt	4sa6.lst/4sa6.plt
8	4bf8.lst/4bf8.plt	4sa8.lst/4sa8.plt
8b	4bf8b.lst/4bf8b.plt	4sa8b.lst/4sa8b.plt
8c	4bf8c.lst/4bf8c.plt	4sa8c.lst/4sa8c.plt
9	4bf9.lst/4bf9.plt	4sa9.lst/4sa9.plt
9a	4bf9a.lst/4bf9a.plt	4sa9a.lst/4sa9a.plt
10	4bf10.lst/4bf10.plt	4sa10.lst/4sa10.plt
10a	4bf10a.lst/4bf10a.plt	4sa10a.lst/4sa10a.plt
11	4bf11.lst/4bf11.plt	4sa11.lst/4sa11.plt
11a	4bf11a.lst/4bf11a.plt	4sa11a.lst/4sa11a.plt
12	4bf12.lst/4bf12.plt	4sa12.lst/4sa12.plt
12a	4bf12a.lst/4bf12a.plt	4sa12a.lst/4sa12a.plt
13	4bf13.lst/4bf13.plt	4sa13.lst/4sa13.plt
14	4bf14.lst/4bf14.plt	4sa14.lst/4sa14.plt
15	4bf15.lst/4bf15.plt	4sa15.lst/4sa15.plt
16	4bf16.lst/4bf16.plt	4sa16.lst/4sa16.plt
17	4bf17.lst/4bf17.plt	4sa17.lst/4sa17.plt
17b	4bf17b.lst/4bf17b.plt	4sa17b.lst/4sa17b.plt
17c	4bf17c.lst/4bf17c.plt	4sa17c.lst/4sa17c.plt
18	4bf18.lst/4bf18.plt	4sa18.lst/4sa18.plt

The next table contains the names of files that were generated using the re-interrogation scenario.

DR RE-INTERROGATION SCENARIO FILE NAMES	
4csrein1.lst/4csrein1.plt	4csreind.lst/4csreind.plt
4csrein2.lst/4csrein2.plt	4csrer1.lst/4csrer1.plt
4csrein3.lst/4csrein3.plt	4csrer2.lst/4csrer2.plt
4csreina.lst/4csreina.plt	4csrer3.lst/4csrer3.plt
4csreinb.lst/4csreinb.plt	4csrer4.lst/4csrer4.plt
4csreinc.lst/4csreinc.plt	
TDR RE-INTERROGATION SCENARIO FILE NAMES	
4bfre6.lst/4bfre6.plt	4bfre18.lst/4bfre18.plt
4bfre10.lst/4bfre10.plt	4bfre20.lst/4bfre20.plt
4bfre15.lst/4bfre15.plt	

The table shown below contains files generated when using the DR program Channel Management Statistics and filtering on range. The naming convention for these files is that the number after the underscore indicates the range of the filtering in the following manner:

\_1,  $0 \leq \text{range} \leq 4$     \_4,  $12 \leq \text{range} \leq 16$   
 \_2,  $4 \leq \text{range} \leq 8$     \_5,  $16 \leq \text{range} \leq 20$   
 \_3,  $8 \leq \text{range} \leq 12$     \_6,  $20 \leq \text{range} \leq 60$

SUBTEST NUMBER	DR FILE NUMBER	DR FILE NAME
2a	4cm2a_1.lst/4cm2a_1.plt	4cm2a_2.lst/4cm2a_2.plt
2a	4cm2a_3.lst/4cm2a_3.plt	4cm2a_4.lst/4cm2a_4.plt
2a	4cm2a_5.lst/4cm2a_5.plt	4cm2a_6.lst/4cm2a_6.plt
3a	4cm3a_1.lst/4cm3a_1.plt	4cm3a_2.lst/4cm3a_2.plt
3a	4cm3a_3.lst/4cm3a_3.plt	4cm3a_4.lst/4cm3a_4.plt
3a	4cm3a_5.lst/4cm3a_5.plt	4cm3a_6.lst/4cm3a_6.plt
5	4cm5_1.lst/4cm5_1.plt	4cm5_2.lst/4cm5_2.plt
5	4cm5_3.lst/4cm5_3.plt	4cm5_4.lst/4cm5_4.plt
5	4cm5_5.lst/4cm5_5.plt	4cm5_6.lst/4cm5_6.plt
6	4cm6_1.lst/4cm6_1.plt	4cm6_2.lst/4cm6_2.plt
6	4cm6_3.lst/4cm6_3.plt	4cm6_4.lst/4cm6_4.plt
6	4cm6_5.lst/4cm6_5.plt	4cm6_6.lst/4cm6_6.plt
8c	4cm8c_1.lst/4cm8c_1.plt	4cm8c_2.lst/4cm8c_2.plt
8c	4cm8c_3.lst/4cm8c_3.plt	4cm8c_4.lst/4cm8c_4.plt
8c	4cm8c_5.lst/4cm8c_5.plt	4cm8c_6.lst/4cm8c_6.plt
9a	4cm9a_1.lst/4cm9a_1.plt	4cm9a_2.lst/4cm9a_2.plt
9a	4cm9a_3.lst/4cm9a_3.plt	4cm9a_4.lst/4cm9a_4.plt
9a	4cm9a_5.lst/4cm9a_5.plt	4cm9a_6.lst/4cm9a_6.plt
11a	4cm11a_1.lst/4cm11a_1.plt	4cm11a_2.lst/4cm11a_2.plt
11a	4cm11a_3.lst/4cm11a_3.plt	4cm11a_4.lst/4cm11a_4.plt
11a	4cm11a_5.lst/4cm11a_5.plt	4cm11a_6.lst/4cm11a_6.plt
12a	4cm12a_1.lst/4cm12a_1.plt	4cm12a_2.lst/4cm12a_2.plt
12a	4cm12a_3.lst/4cm12a_3.plt	4cm12a_4.lst/4cm12a_4.plt
12a	4cm12a_5.lst/4cm12a_5.plt	4cm12a_6.lst/4cm12a_6.plt
14	4cm14_1.lst/4cm14_1.plt	4cm14_2.lst/4cm14_2.plt
14	4cm14_3.lst/4cm14_3.plt	4cm14_4.lst/4cm14_4.plt
14	4cm14_5.lst/4cm14_5.plt	4cm14_6.lst/4cm14_6.plt
15	4cm15_1.lst/4cm14_1.plt	4cm15_2.lst/4cm14_2.plt
15	4cm15_3.lst/4cm15_3.plt	4cm15_4.lst/4cm15_4.plt
15	4cm15_5.lst/4cm15_5.plt	4cm15_6.lst/4cm15_6.plt
17c	4cm17c_1.lst/4cm17c_1.plt	4cm17c_2.lst/4cm17c_2.plt
17c	4cm17c_3.lst/4cm17c_3.plt	4cm17c_4.lst/4cm17c_4.plt
17c	4cm17c_5.lst/4cm17c_5.plt	4cm17c_6.lst/4cm17c_6.plt
18	4cm18_1.lst/4cm18_1.plt	4cm18_2.lst/4cm18_2.plt
18	4cm18_3.lst/4cm18_3.plt	4cm18_4.lst/4cm18_4.plt
18	4cm18_5.lst/4cm18_5.plt	4cm18_6.lst/4cm18_6.plt

## TEST 5 (CONFLICT SITUATIONS) REDUCTION FILES

The files listed below for run "1a" were not used in the report due to an azimuth shift in the extraction files.

SUBTEST NUMBER	TDR FILE NAME	DR FILE NAME	DR FILE NAME	DR FILE NAME
1	5ca1.lst	5ac1.lst	5sa1.lst/5sa1.plt	5sf1.lst
1a	5ca1a.lst	5ac1a.lst	5sa1a.lst/5sa1a.plt	5sf1a.lst
1b	5ca1b.lst	5ac1b.lst	5sa1b.lst/5sa1b.plt	5sf1b.lst
2	5ca2.lst	5ac2.lst	5sa2.lst/5sa2.plt	5sf2.lst
3	5ca3.lst	5ac3.lst	5sa3.lst/5sa3.plt	5sf3.lst
4	5ca4.lst	5ac4.lst	5sa4.lst/5sa4.plt	5sf4.lst

The files listed in the table below do not conform to the naming convention of appendix C. These are Surveillance File Analysis files created to help in the analysis of individual conflicts within a given subtest. As an example of the naming convention for these files, 5sf3\_3.lst represents a file run from DR Surveillance File Analysis on subtest 3, conflict 3. Similarly 5sf4\_6.lst represents subtest 4, conflict 6.

SURVEILLANCE FILE ANALYSIS FILES FOR INDIVIDUAL CONFLICTS			
5sf3_1.lst	5sf3_2.lst	5sf3_3.lst	5sf3_4.lst
5sf3_5.lst	5sf3_6.lst	5sf3_7.lst	5sf3_8.lst
5sf3_9.lst	5sf3_10.lst	5sf3_22.lst	5sf3_44.lst
5sf3_58.lst	5sf3_73.lst	5sf3_80.lst	5sf3_125.lst
5sf3_130.lst	5sf3_133.lst	5sf3_144.lst	5sf3_161.lst
5sf3_167.lst	5sf3_171.lst	5sf4_0.lst	5sf4_1.lst
5sf4_1a.lst	5sf4_1b.lst	5sf4_3.lst	5sf4_4.lst
5sf4_5.lst	5sf4_6.lst	5sf4_7.lst	5sf4_12.lst
5sf4_22.lst	5sf4_51.lst	5sf4_57.lst	5sf4_58.lst
5sf4_70.lst	5sf4_82.lst	5sf4_97.lst	5sf4_111.lst
5sf4_118.lst	5sf4_134.lst	5sf4_137.lst	5sf4_138.lst
5sf4_140.lst	5sf4_142.lst	5sf4_146.lst	5sf4_147.lst
5sf4_164.lst	5sf4_169.lst	5sf4_174.lst	5sf4_175.lst
5sf4_178.lst	5sf4_182.lst	5sf4_184.lst	5sf4_186.lst
5sf1b1.lst	5sf1b2.lst	5sf1b3.lst	5sf1b4.lst
5sf4_188.lst	5sf4_s.lst	5sf4_misc.lst	5sf4_135.lst

## TEST 6 (DATA LINK) REDUCTION FILES

SUBTEST NUMBER	DR FILE NAME	TDR FILE NAME
4	6dl4.lst	6sa4.lst/6sa4.plt
5	6dl5.lst	6sa5.lst/6sa5.plt
6	6dl6.lst	6sa6.lst/6sa6.plt
7	6dl7.lst	6sa7.lst/6sa7.plt
10	6dl10.lst	6sa10.lst/6sa10.plt
11	6dl11.lst	6sa11.lst/6sa11.plt
12	6dl12.lst	6sa12.lst/6sa12.plt
13	6dl13.lst	6sa13.lst/6sa13.plt
14	6dl14.lst	6sa14.lst/6sa14.plt

## TEST 7 (MODE S SENSOR COVERAGE) REDUCTION FILES

The scenarios needed to run subtests 6, 7, and 8 were created during the course of the testing. Because of this, multiple test runs were needed to test the scenarios themselves before they could be used for testing the sensor. The files that were used to generate the statistics in this report come from runs 6a, 7a, and 8b. All of the other files from these subtests were not included.

SUBTEST NUMBER	TDR FILE NAME	TDR FILE NAME
1	7sa1.lst/7sa1.plt	7bf1.lst/7bf1.plt
2	7sa2.lst/7sa2.plt	7bf2.lst/7bf2.plt
3	7sa3.lst/7sa3.plt	7bf3.lst/7bf3.plt
4	7sa4.lst/7sa4.plt	7bf4.lst/7bf4.plt
5	7sa5.lst/7sa5.plt	7bf5.lst/7bf5.plt
6	7sa6.lst/7sa6.plt	7bf6.lst/7bf6.plt
6a	7sa6a.lst/7sa6a.plt	7bf6a.lst/7bf6a.plt
7	7sa7.lst/7sa7.plt	7bf7.lst/7bf7.plt
7a	7sa7a.lst/7sa7a.plt	7bf7a.lst/7bf7a.plt
8	7sa8.lst/7sa8.plt	7bf8.lst/7bf8.plt
8a	7sa8a.lst/7sa8a.plt	7bf8a.lst/7bf8a.plt
8b	7sa8b.lst/7sa8b.plt	7bf8b.lst/7bf8b.plt

SUBTEST NUMBER	TDR FILE NAME
6	7pp6.lst/7pp6.plt
6a	7pp6a.lst/7pp6a.plt
7	7pp7.lst/7pp7.plt
7a	7pp7a.lst/7pp7a.plt
8	7pp8.lst/7pp8.plt
8a	7pp8a.lst/7pp8a.plt
8b	7pp8b.lst/7pp8b.plt

**TEST 8 (REFLECTION ANALYSIS) REDUCTION FILES**

SUBTEST NUMBER	DR FILE NAME	DR FILE NAME
1	8sa1.lst/8sa1.plt	8bf1.lst/8bf1.plt
2	8sa2.lst/8sa2.plt	8bf2.lst/8bf2.plt
3	8sa3.lst/8sa3.plt	8bf3.lst/8bf3.plt
4	8sa4.lst/8sa4.plt	8bf4.lst/8bf4.plt
5	8sa5.lst/8sa5.plt	8bf5.lst/8bf5.plt
6	8sa6.lst/8sa6.plt	8bf6.lst/8bf6.plt

SUBTEST NUMBER	TDR FILE NAME
1	8bf1.lst/8bf1.plt
2	8bf2.lst/8bf2.plt
3	8bf3.lst/8bf3.plt
4	8bf4.lst/8bf4.plt
5	8bf5.lst/8bf5.plt
6	8bf6.lst/8bf6.plt

SUBTEST NUMBER	DR FILE NAME	SUBTEST NUMBER	DR FILE NAME
10	8ac10.lst	12a	8ac12a.lst
10a	8ac10a.lst	13	8ac13.lst
11	8ac11.lst	13a	8ac13a.lst
11a	8ac11a.lst	14	8ac14.lst
12	8ac12.lst	14a	8ac14a.lst

SUBTEST NUMBER	DR FILE NAME	SUBTEST NUMBER	DR FILE NAME
1	8sf1.lst	7	8sf7.lst
2	8sf2.lst	10	8sf10.lst
3	8sf3.lst	11	8sf11.lst
4	8sf4.lst	12	8sf12.lst
5	8sf5.lst	13	8sf13.lst
6	8sf6.lst	14	8sf14.lst

SUBTEST NUMBER	DR FILE NAME	SUBTEST NUMBER	DR FILE NAME
1	8sa1.lst/8sa1.plt	4	8sa4.lst/8sa4.plt
2	8sa2.lst/8sa2.plt	5	8sa5.lst/8sa5.plt
3	8sa3.lst/8sa3.plt	6	8sa6.lst/8sa6.plt

### **TEST 9 (SENSOR ACCURACY) REDUCTION FILES**

The next four tables list the files created for this test using the DR Accuracy Analysis, DR Nine Point, TDR Surveillance Analysis and TDR Nine Point programs.

SUBTEST NUMBER	DR FILE NAME	SUBTEST NUMBER	DR FILE NAME
1	9aa1.lst/9aa1.plt	19	9aa19.lst/9aa19.plt
2	9aa2.lst/9aa2.plt	20	9aa20.lst/9aa20.plt
3	9aa3.lst/9aa3.plt	21	9aa21.lst/9aa21.plt
4	9aa4.lst/9aa4.plt	22	9aa22.lst/9aa22.plt
5	9aa5.lst/9aa5.plt	23	9aa23.lst/9aa23.plt
6	9aa6.lst/9aa6.plt	24	9aa24.lst/9aa24.plt
7	9aa7.lst/9aa7.plt	25	9aa25.lst/9aa25.plt
8	9aa8.lst/9aa8.plt	26	9aa26.lst/9aa26.plt
9	9aa9.lst/9aa9.plt	27	9aa27.lst/9aa27.plt
10	9aa10.lst/9aa10.plt	28	9aa28.lst/9aa28.plt
11	9aa11.lst/9aa11.plt	29	9aa29.lst/9aa29.plt
12	9aa12.lst/9aa12.plt	30	9aa30.lst/9aa30.plt
13	9aa13.lst/9aa13.plt	31	9aa31.lst/9aa31.plt
14	9aa14.lst/9aa14.plt	32	9aa32.lst/9aa32.plt
15	9aa15.lst/9aa15.plt	33	9aa33.lst/9aa33.plt
16	9aa16.lst/9aa16.plt	34	9aa34.lst/9aa34.plt
17	9aa17.lst/9aa17.plt	35	9aa35.lst/9aa35.plt
18	9aa18.lst/9aa18.plt	36	9aa36.lst/9aa36.plt



SUBTEST NUMBER	DR FILE NAME	SUBTEST NUMBER	DR FILE NAME
1	9np1.lst/9np1.plt	19	9np19.lst/9np19.plt
2	9np2.lst/9np2.plt	20	9np20.lst/9np20.plt
3	9np3.lst/9np3.plt	21	9np21.lst/9np21.plt
4	9np4.lst/9np4.plt	22	9np22.lst/9np22.plt
5	9np5.lst/9np5.plt	23	9np23.lst/9np23.plt
6	9np6.lst/9np6.plt	24	9np24.lst/9np24.plt
7	9np7.lst/9np7.plt	25	9np25.lst/9np25.plt
8	9np8.lst/9np8.plt	26	9np26.lst/9np26.plt
9	9np9.lst/9np9.plt	27	9np27.lst/9np27.plt
10	9np10.lst/9np10.plt	28	9np28.lst/9np28.plt
11	9np11.lst/9np11.plt	29	9np29.lst/9np29.plt
12	9np12.lst/9np12.plt	30	9np30.lst/9np30.plt
13	9np13.lst/9np13.plt	31	9np31.lst/9np31.plt
14	9np14.lst/9np14.plt	32	9np32.lst/9np32.plt
15	9np15.lst/9np15.plt	33	9np33.lst/9np33.plt
16	9np16.lst/9np16.plt	34	9np34.lst/9np34.plt
17	9np17.lst/9np17.plt	35	9np35.lst/9np35.plt
18	9np18.lst/9np18.plt	36	9np36.lst/9np36.plt

SUBTEST NUMBER	TDR FILE NAME	SUBTEST NUMBER	TDR FILE NAME
1	9sa1.lst/9sa1.plt	19	9sa19.lst/9sa19.plt
2	9sa2.lst/9sa2.plt	20	9sa20.lst/9sa20.plt
3	9sa3.lst/9sa3.plt	21	9sa21.lst/9sa21.plt
4	9sa4.lst/9sa4.plt	22	9sa22.lst/9sa22.plt
5	9sa5.lst/9sa5.plt	23	9sa23.lst/9sa23.plt
6	9sa6.lst/9sa6.plt	24	9sa24.lst/9sa24.plt
7	9sa7.lst/9sa7.plt	25	9sa25.lst/9sa25.plt
8	9sa8.lst/9sa8.plt	26	9sa26.lst/9sa26.plt
9	9sa9.lst/9sa9.plt	27	9sa27.lst/9sa27.plt
10	9sa10.lst/9sa10.plt	28	9sa28.lst/9sa28.plt
11	9sa11.lst/9sa11.plt	29	9sa29.lst/9sa29.plt
12	9sa12.lst/9sa12.plt	30	9sa30.lst/9sa30.plt
13	9sa13.lst/9sa13.plt	31	9sa31.lst/9sa31.plt
14	9sa14.lst/9sa14.plt	32	9sa32.lst/9sa32.plt
15	9sa15.lst/9sa15.plt	33	9sa33.lst/9sa33.plt
16	9sa16.lst/9sa16.plt	34	9sa34.lst/9sa34.plt
17	9sa17.lst/9sa17.plt	35	9sa35.lst/9sa35.plt
18	9sa18.lst/9sa18.plt	36	9sa36.lst/9sa36.plt

SUBTEST NUMBER	TDR FILE NAME	SUBTEST NUMBER	TDR FILE NAME
1	9np1.lst/9np1.plt	19	9np19.lst/9np19.plt
2	9np2.lst/9np2.plt	20	9np20.lst/9np20.plt
3	9np3.lst/9np3.plt	21	9np21.lst/9np21.plt
4	9np4.lst/9np4.plt	22	9np22.lst/9np22.plt
5	9np5.lst/9np5.plt	23	9np23.lst/9np23.plt
6	9np6.lst/9np6.plt	24	9np24.lst/9np24.plt
7	9np7.lst/9np7.plt	25	9np25.lst/9np25.plt
8	9np8.lst/9np8.plt	26	9np26.lst/9np26.plt
9	9np9.lst/9np9.plt	27	9np27.lst/9np27.plt
10	9np10.lst/9np10.plt	28	9np28.lst/9np28.plt
11	9np11.lst/9np11.plt	29	9np29.lst/9np29.plt
12	9np12.lst/9np12.plt	30	9np30.lst/9np30.plt
13	9np13.lst/9np13.plt	31	9np31.lst/9np31.plt
14	9np14.lst/9np14.plt	32	9np32.lst/9np32.plt
15	9np15.lst/9np15.plt	33	9np33.lst/9np33.plt
16	9np16.lst/9np16.plt	34	9np34.lst/9np34.plt
17	9np17.lst/9np17.plt	35	9np35.lst/9np35.plt
18	9np18.lst/9np18.plt	36	9np36.lst/9np36.plt

The next four tables list the "merge" files created using the files from the individual subtests listed above. There is an addition to the normal naming convention for these files. After the two letter test designation comes an "s" for Mode S targets or an "a" for ATCRBS. Next comes a description of the tests that were merged for the particular file. The naming convention for the descriptions is as follows;

- cw: clockwise orbitals
- ccw: counter clockwise orbitals
- in: inbound radials
- out: outbound radials
- orb: all orbitals
- rad: all radials
- all: all subtests

DR ACCURACY ANALYSIS FILES	
9aascw.lst/9aascw.plt	9aaaout.lst/9aaaout.plt
9aaaccw.lst/9aaaccw.plt	9aasorb.lst/9aasorb.plt
9aascw.lst/9aascw.plt	9aaaorb.lst/9aaaorb.plt
9aaacw.lst/9aaacw.plt	9aasrad.lst/9aasrad.plt
9aasin.lst/9aasin.plt	9aaarad.lst/9aaarad.plt
9aaain.lst/9aaain.plt	9aasall.lst/9aasall.plt
9aasout.lst/9aasout.plt	9aaaall.lst/9aaaall.plt

DR NINE POINT MERGE FILES	
9npccw.lst/9npccw.plt	9npaout.lst/9npaout.plt
9npaccw.lst/9npaccw.plt	9npsorb.lst/9npsorb.plt
9npscw.lst/9npscw.plt	9npaorb.lst/9npaorb.plt
9npacw.lst/9npacw.plt	9npsrad.lst/9npsrad.plt
9npsin.lst/9npsin.plt	9nparad.lst/9nparad.plt
9npain.lst/9npain.plt	9npsall.lst/9npsall.plt
9npsout.lst/9npsout.plt	9npaall.lst/9npaall.plt

TDR NINE POINT MERGE FILES	
9npccw.lst/9npccw.plt	9npaout.lst/9npaout.plt
9npaccw.lst/9npaccw.plt	9npsorb.lst/9npsorb.plt
9npscw.lst/9npscw.plt	9npaorb.lst/9npaorb.plt
9npacw.lst/9npacw.plt	9npsrad.lst/9npsrad.plt
9npsin.lst/9npsin.plt	9nparad.lst/9nparad.plt
9npain.lst/9npain.plt	9npsall.lst/9npsall.plt
9npsout.lst/9npsout.plt	9npaall.lst/9npaall.plt

TDR SURVEILLANCE ANALYSIS MERGE FILES	
9sasccw.lst/9sasccw.plt	9saaout.lst/9saaout.plt
9saaccw.lst/9saaccw.plt	9sasorb.lst/9sasorb.plt
9sascw.lst/9sascw.plt	9saaorb.lst/9saaorb.plt
9saacw.lst/9saacw.plt	9sasrad.lst/9sasrad.plt
9sasin.lst/9sasin.plt	9saarad.lst/9saarad.plt
9saain.lst/9saain.plt	9sasall.lst/9sasall.plt
9sasout.lst/9sasout.plt	9saaall.lst/9saaall.plt

### **TEST 10 (SENSOR RESOLUTION) REDUCTION FILES**

Because the extraction files used to generate these files did not conform to the naming convention of appendix C, neither do the reduction files. The extraction file for each subtest contains data for both the inbound and outbound legs of the flight. This means that some distinction must be made between the reduction files for the inbound and outbound legs. For the DR Resolution Analysis files this was done by appending an \_1 to indicate an inbound flight and an \_2 to indicate an outbound flight after the subtest number. A similar convention was used for the TDR files. The DR file "rsmerge.lst" is the result of running the DR Resolution Analysis Merge program to get summary information on all the subtests. Merge files were also created using the TDR Surveillance Analysis and Beacon false Target Summary files.

SUBTEST NUMBER	DR FILE NAME	DR FILE NAME
11	10rs11_1.lst	10rs11_2.lst
12	10rs12_1.lst	10rs12_2.lst
13	10rs13_1.lst	10rs13_2.lst
14	10rs14_1.lst	10rs14_2.lst
15	10rs15_1.lst	10rs15_2.lst
16	10rs16_1.lst	10rs16_2.lst
MERGE	rsmerge.lst	N/A

SUBTEST NUMBER	TDR FILE NAME	TDR FILE NAME
11	10sa11_1.lst/10sa11_1.plt	10sa11_2.lst/10sa11_2.plt
11	10bf11_1.lst/10bf11_1.plt	10bf11_2.lst/10bf11_2.plt
12	10sa12_1.lst/10sa12_1.plt	10sa12_2.lst/10sa12_2.plt
12	10bf12_1.lst/10bf12_1.plt	10bf12_2.lst/10bf12_2.plt
13	10sa13_1.lst/10sa13_1.plt	10sa13_2.lst/10sa13_2.plt
13	10bf13_1.lst/10bf13_1.plt	10bf13_2.lst/10bf13_2.plt
14	10sa14_1.lst/10sa14_1.plt	10sa14_2.lst/10sa14_2.plt
14	10bf14_1.lst/10bf14_1.plt	10bf14_2.lst/10bf14_2.plt
15	10sa15_1.lst/10sa15_1.plt	10sa15_2.lst/10sa15_2.plt
15	10bf15_1.lst/10bf15_1.plt	10bf15_2.lst/10bf15_2.plt
16	10bf16_1.lst/10bf16_1.plt	10bf16_2.lst/10bf16_2.plt
16	10sa16_1.lst/10sa16_1.plt	10sa16_2.lst/10sa16_2.plt
MERGE	10samtg.lst/10samrg.plt	10bfmrg.lst/10bfmrg.plt

### **TEST 11 (STOCHASTIC ACQUISITION) REDUCTION FILES**

The next three tables contain files created with extractions from the first the first execution of the test. None of these files were used to generate the statistics included in the report.

SUBTEST NUMBER	DR FILE NAME	DR FILE NAME
1	11sp1.lst	11ml1.lst
2	11sp2.lst	11ml2.lst
3	11sp3.lst	11ml3.lst
4	11sp4.lst	11ml4.lst
5	11sp5.lst	11ml5.lst
6	11sp6.lst	11ml6.lst
7	11sp7.lst	11ml7.lst
8	11sp8.lst	11ml8.lst
9	11sp9.lst	11ml9.lst
10	11sp10.lst	11ml10.lst

SUBTEST NUMBER	TDR FILE NAME	SUBTEST NUMBER	TDR FILE NAME
1	11sa1.lst/11sa1.plt	6	11sa6.lst/11sa7.plt
2	11sa2.lst/11sa2.plt	7	11sa7.lst/11sa7.plt
3	11sa3.lst/11sa3.plt	8	11sa8.lst/11sa8.plt
4	11sa4.lst/11sa4.plt	9	11sa9.lst/11sa9.plt
5	11sa5.lst/11sa5.plt	10	11sa10.lst/11sa10.plt

TDR "FILTERED" FILES		
SUBTEST NUMBER	TDR FILE NAME	TDR FILE NAME
4	11sa4.lst/11sa4.plt	11fltr4.lst
5	11sa5.lst/11sa5.plt	11fltr5.lst
7	11sa7.lst/11sa7.plt	11fltr7.lst
9	11sa9.lst/11sa9.plt	11fltr9.lst
10	11sa10.lst/11sa10.plt	11fltr10.lst

The next two tables contain the names of the files created using the extractions from run "1a." These are the file used to generate the statistics that appear in the report.

RUN "1a" DR FILES	
11bf2a.lst/11bf2a.plt	11sa2a.lst/11sa2a.plt
11cm2a.lst/11cm2a.plt	11sl2a.lst
11cm2a1.lst/11cm2a1.plt	11sl2af.lst
11cm3a.lst/11cm3a.plt	11sf2af.lst
11cm4a.lst/11cm4a.plt	11sl3a.lst
11cm5a.lst/11cm5a.plt	11sl5a.lst
11dl2a.lst	11sp2a.lst
11misc2a.lst	11sp2af.lst
11sp3a.lst	11sp2af2.lst
11sum2a.lst	11sp2af3.lst

The TDR files that follow are filtered on the area of the runway where the targets were parked. An "af" indicates that the filtering was on all Mode S targets in that area during the course of the entire test. An "fi" indicates filtering on all Mode S targets in the area during the time of the initial acquisition testing only. In the same manner, an "fa" indicates filtering on the time of the adaptive acquisition testing.

RUN "1a", "FILTERED" TDR FILES

SUBTEST NUMBER	TDR FILE NAME	TDR FILE NAME
1a	11bf1fi.lst/11bf1fi.plt	11sa1fi.lst/11sa1fi.plt
1a	11bf1fa.lst/11bf1fa.plt	11sa1fa.lst/11sa1fa.plt
1a	11bf1af.lst/11bf1af.plt	11sa1af.lst/11sa1af.plt
2a	11bf2fi.lst/11bf2fi.plt	11sa2fi.lst/11sa2fi.plt
2a	11bf2fa.lst/11bf2fa.plt	11sa2fa.lst/11sa2fa.plt
2a	11bf2af.lst/11bf2af.plt	11sa2af.lst/11sa2af.plt
3a	11bf3fi.lst/11bf3fi.plt	11sa3fi.lst/11sa3fi.plt
3a	11bf3fa.lst/11bf3fa.plt	11sa3fa.lst/11sa3fa.plt
3a	11bf3af.lst/11bf3af.plt	11sa3af.lst/11sa3af.plt
4a	11bf4fi.lst/11bf4fi.plt	11sa4fi.lst/11sa4fi.plt
4a	11bf4fa.lst/11bf4fa.plt	11sa4fa.lst/11sa4fa.plt
4a	11bf4af.lst/11bf4af.plt	11sa4af.lst/11sa4af.plt
5a	11bf5fi.lst/11bf5fi.plt	11sa5fi.lst/11sa5fi.plt
5a	11bf5fa.lst/11bf5fa.plt	11sa5fa.lst/11sa5fa.plt
5a	11bf5af.lst/11bf5af.plt	11sa5af.lst/11sa5af.plt
6a	11bf6fi.lst/11bf6fi.plt	11sa6fi.lst/11sa6fi.plt
6a	11bf6fa.lst/11bf6fa.plt	11sa6fa.lst/11sa6fa.plt
6a	11bf6af.lst/11bf6af.plt	11sa6af.lst/11sa6af.plt
7a	11bf7fi.lst/11bf7fi.plt	11sa7fi.lst/11sa7fi.plt
7a	11bf7fa.lst/11bf7fa.plt	11sa7fa.lst/11sa7fa.plt
7a	11bf7af.lst/11bf7af.plt	11sa7af.lst/11sa7af.plt
8a	11bf8fi.lst/11bf8fi.plt	11sa8fi.lst/11sa8fi.plt
8a	11bf8fa.lst/11bf8fa.plt	11sa8fa.lst/11sa8fa.plt
8a	11bf8af.lst/11bf8af.plt	11sa8af.lst/11sa8af.plt
9a	11bf9fi.lst/11bf9fi.plt	11sa9fi.lst/11sa9fi.plt
9a	11bf9fa.lst/11bf9fa.plt	11sa9fa.lst/11sa9fa.plt
9a	11bf9af.lst/11bf9af.plt	11sa9af.lst/11sa9af.plt
10a	11bf10fi.lst/11bf10fi.plt	11sa10fi.lst/11sa10fi.plt
10a	11bf10fa.lst/11bf10fa.plt	11sa10fa.lst/11sa10fa.plt
10a	11bf10af.lst/11bf10af.plt	11sa10af.lst/11sa10af.plt
11a	11bf11fi.lst/11bf11fi.plt	11sa11fi.lst/11sa11fi.plt
11a	11bf11fa.lst/11bf11fa.plt	11sa11fa.lst/11sa11fa.plt
11a	11bf11af.lst/11bf11af.plt	11sa11af.lst/11sa11af.plt
12a	11bf12fi.lst/11bf12fi.plt	11sa12fi.lst/11sa12fi.plt
12a	11bf12fa.lst/11bf12fa.plt	11sa12fa.lst/11sa12fa.plt
12a	11bf12af.lst/11bf12af.plt	11sa12af.lst/11sa12af.plt

APPENDIX E

DIRECTORY SAP AND SCENARIO DEFINITIONS



## Mode S #001 SAP Configurations

### **IBIMODE**

Radar Mode R1 w/ forced ATCBI

### **Configuration ID**

I1

### **RADAR MODE**

Operational/No Comm

R1

Non Operational/No Comm

R2

Operational/DLP Comm

R3

Non-Operational/Full Comm

R4

Operational/CID ATC/Non-ATC Comm

R5

Non-Operational/CID ATC/Non-ATC Comm

R6

R7

R8

R9

### **SURVEILLANCE MODE**

Operational/No Comm

S1

Non Operational/No Comm

S2

Operational/DLP Comm

S3

Operational/CID ATC/Non-ATC Comm

S4

Non-Operational/CID ATC/Non-ATC Comm

S5

Non-Operational/CID ATC Comm

S6

Operational/No Comm

S7

S8

S9

## Scenario Descriptions

### **BASIC 41**

This scenario consists of 41 dynamic targets performing various types of maneuvers including straight line tracks, turning tracks, overtaking patterns, and crossing tracks. The purpose of this scenario is to gather baseline data on the sensor's ability to maintain tracking in many complex situations.

### **CAPACITY**

This scenario begins as a light load and gradually builds to a 700 target per scan capacity load. The targets then move to the distribution defined in the FAA-E-2716 Specification, Section 3.3.2.5. and 3.3.2.5.1. It also incorporates the data link peaking scenario defined in NAS-SS-1000 section 3.2.1.1.6.3.13. The purpose of this scenario is to gather data on the sensor's ability to handle a capacity situation.

### **PROBABILITY of DETECTION**

These scenarios generate the simulated targets for the Pd/Pfa measurements. They will be used to establish the probability of detection baseline as a function of signal strength for no-fruit and capacity fruit conditions. The terminal scenarios are each available for four different signal levels; -70, -73, -76, and -79 dbm.

(Terminal Version)

The scenario begins as a ring of 32 targets equally spaced every 11.25 degrees at a range of 5 nautical miles (nm). As the scenario begins, the targets start moving slightly clockwise (cw) and further in range at an approximate ground speed of 240 nm/hr. The scenario ends after 10 minutes with each target at a range of 45 nm, and 5.625 degrees cw from original position. Of the 32 targets, 16 are discrete ATCRBS targets and 16 are Mode S targets. The ATCRBS and Mode S targets alternate every 11.25 degrees.

REAL WORLD

These scenarios are designed to duplicate the flight parameters of aircraft in actual terminal or enroute environment. The data used to generate the scenarios will be extracted at selected operational TRACON and ARTCC facilities. The purpose of these scenarios is to determine the sensor's surveillance and data link performance, using realistic simulations.

UPLINK REFLECTION

The uplink reflection scenario is designed to test the sensor's reflection algorithms. The scenario consists of 16 pairs of targets, each pair consists of a reflected target and a true target. The 16 reflecting surfaces that could cause the reflections have been calculated. A reflector map, containing the range, orientation, and azimuth of the 16 reflected target quadrant and true target quadrant are tested.

DOWNLINK REFLECTION

The downlink reflection scenario simulates ground bounce replies and is designed to test the sensor's adaptive threshold circuitry. Pairs of moving targets will be generated (same azimuth but different range). The range difference of each pair will be varied from completely separated to fully overlapped. The true reply's intensity will be 20 db greater than that of the ground bounce reply.