



User's Guide for SWOE Treetherm A 3-D Thermal Model for Single Trees

James R. Jones

SPARTA, Inc.
Lexington, Ma



PL-TR-91-2109

DTIC QUALITY INSPECTED 3

SWOE Report 91-12

31 May 1991

19950111 075



***User's Guide for SWOE Treetherm
A 3-D Thermal Model for Single Trees***

James R. Jones

SPARTA, Inc.
Lexington, Ma

PL-TR-91-2109

SWOE Report 91-12
31 May 1991

Approved for public release;
distribution unlimited

FOREWORD

SWOE Report 91-12, 31 May 1991, was prepared by J.R. Jones of SPARTA, Inc., Lexington, Massachusetts.

This report is a contribution to the Smart Weapons Operability Enhancement (SWOE) Program. SWOE is a coordinated, Army, Navy, Marine Corps, Air Force and DARPA program initiated to enhance performance of future smart weapon systems through an integrated process of applying knowledge of the broadest possible range of battlefield conditions.

Performance of smart weapons can vary widely, depending on the environment in which the systems operate. Temporal and spatial dynamics significantly impact weapon performance. Testing of developmental weapon systems has been limited to a few selected combinations of targets and environment conditions, primarily because of the high costs of full-scale field tests and limited access to the areas or events for which performance data are required.

Performance predictions are needed for a broad range of background environmental conditions and targets. Meeting this need takes advantage of significant DoD investments by Army, Navy, Marine Corps and Air Force in 1) basic and applied environmental research, data collection, analysis, modeling and rendering capabilities, 2) extensive target measurement capabilities and geometry models, and 3) currently available computational capabilities. The SWOE program takes advantage of these DoD investments to produce an integrated process.

SWOE is developing, validating, and demonstrating the capability of this integrated process to handle complex target and background environment interactions for a world-wide range of battlefield conditions. SWOE is providing the DoD smart weapons and autonomous target recognition (ATR) communities with a validated capability to integrate measurement, information base, modeling and scene rendering techniques for complex environments. The result of a DoD-wide partnership, this effort works in concert with both advanced weapon system developers and major weapon system test and evaluation programs.

The SWOE program started in FY89 under Balanced Technology Initiative (BTI) sponsorship. Present sponsorship is by the U.S. Army Corps of Engineers (lead service), the individual services, and the Joint Test and Evaluation (JT&E) program of the Office of the Director of Defense Research and Engineering (DDR&E), Office of the Secretary of Defense (OSD).

The Program Director is Dr. L.E. Link, Technical Director of the U.S. Army, Cold Regions Research and Engineering Laboratory (CRREL). The Program Manager is Dr. J.P. Welsh, CRREL. The Integration Manager is Mr. Richard Palmer, CRREL. The task areas and their managers are as follows: Modeling Task Area, LTC George G. Koenig, USAF, Geophysics Laboratory (GL), of the Air Force Phillips Laboratories; Information Bases Task Area, Mr. Harold W. West, PE, U.S. Army Engineer, Waterways Experiment Station (WES); Scene Rendering Task Area, Mr. Mike Hardaway, Corps of Engineers, Topographic Engineering Center (TEC); Validation Task Area, Dr. Jon Martin, Atmospheric Sciences Laboratory (ASL) of the Army Materiel Command.

Accession For	
NTIS GRA&I	<input checked="" type="checkbox"/>
DTIC TAB	<input type="checkbox"/>
Unannounced	<input type="checkbox"/>
Justification _____	
By _____	
Distribution/_____	
Availability Codes	
Dist	Avail and/or Special
A-1	

PL-TR-91-2109

USER'S GUIDE FOR TREETHERM:
A 3-D THERMAL MODEL FOR SINGLE TREES

James R. Jones

SPARTA, Inc.
24 Hartwell Avenue
Lexington, MA 02173

31 March 1991

Scientific Report No. 9

Approved for Public Release; Distribution Unlimited

PHILLIPS LABORATORY
AIR FORCE SYSTEMS COMMAND
HANSCOM AIR FORCE BASE, MASSACHUSETTS 01731-5000

Contents

1	INTRODUCTION	1
1.1	Purpose of Report	1
1.2	Organization of Report	2
2	OVERVIEW OF TREETHERM	2
2.1	Overview of Numerical Method	2
2.2	Basic TREETHERM Terminology	4
2.3	Executing The Code	4
3	INPUT REQUIREMENTS	6
3.1	Single Tree Segment Option	6
3.2	Multiple Tree Segment Option	13
3.3	Leaf Properties File Format	14
3.4	Meteorological File Format	14
3.5	Property File Format	22
4	OUTPUT FORMAT	29
5	TREETHERM MODEL EXAMPLES	32
5.1	Example 1: Single Segment Option	32
5.2	Example 2: Multiple Segment Option With No Leaves	35
5.3	Example 3: Multiple Tree Segments With Leaves	37
6	MODEL ASSUMPTIONS AND LIMITATIONS	42
6.1	Branched Connections – Longitudinal Conduction Effects	42

6.2	Ray Casting	45
6.3	Convection	45
6.4	Infrared Flux	50
6.5	Solar Flux	51
6.6	Tree Segments Resolution	51
6.7	Phase Change	51
6.8	Connections At A Node	51
6.9	Radiation Interchange	52
	References	53

Figures

1	Flowchart of Tree Model Code Execution	3
2	TREETHERM Model Global Coordinate System	3
3	Side View Example of a Tree Segment (Outlined With Dashed Lines) and a Leaf Cluster With an Outer Diameter of 2 m	5
4	Cross Section of Tree Component Detailing the Element Numbering Scheme and the Ring Diameters	5
5	Input Requirements When Specifying the Single Tree Segment Option	7
6	Example Input File for a Calculation Using the Single Tree Segment Option	12
7	Input Requirements for Multiple Tree Segment Option	13
8	Example of an Input File for the Multiple Tree Segment Option	21
9	Example of the Types of Tree Element Connections for the Multiple Tree Segment Option	22
10	Example of a Leaf Property File Used by the Leaf Energy Budget Model in TREETHERM	23
11	Example of the Meteorological File Used by TREETHERM	25
12	Example of a Tree Material Property File	28
13	Example of the Temperature History Output Produced by TREETHERM	29
14	Example Output at Meteorological Data Intervals	31
15	Model Input File for Example 1, a Single Tree Segment Calculation	33
16	Tree Material Properties for Example 1, a Single Tree Segment Calculation	34
17	Surface Temperature History at Cardinal Points from Example 1 Using the Single Segment Option	35
18	Model Input File for Multiple Segment Option, Example 2	36
19	Comparison of Temperature Histories at Three Locations to Demonstrate Shading Effects for the Multiple Segment Option, Example 2	37
20	Input File for Example 2 for a Multiple Tree Segment Calculation With Shading Not Considered	38
21	Input File for Example 3 With Self Shading Not Considered	39
22	Input File for Example 3 for With Shading Considered, Including Shading by Leaf Clusters	40

23	Comparison of Temperature History Results From Example 3 With and Without Self-Shading by Branches and Leaf Clusters Considered	41
24	(a.) Typical Branch Connection and (b.) Cross Sectional View of Section 1-1	43
25	(a.) Three Segment Tree Model and (b.) Location of Surface Elements Used to Study Impact of Longitudinal Conductivity	44
26	Temperature of Element 21 (OD = 0.15 m) as a Function of Time for Three Different Segment Lengths	46
27	Temperature of Element 22 (OD = 0.15 m) as a Function of Time for Three Different Segment Lengths	46
28	Temperature of Element 23 (OD = 0.15 m) as a Function of Time for Three Different Segment Lengths	47
29	Temperature of Element 24 (OD = 0.15 m) as a Function of Time for Three Different Segment Lengths	47
30	Temperature of Element 21 (OD = 0.6 m) as a Function of Time for Three Different Segment Lengths	48
31	Temperature of Element 22 (OD = 0.6 m) as a Function of Time for Three Different Segment Lengths	48
32	Temperature of Element 23 (OD = 0.6 m) as a Function of Time for Three Different Segment Lengths	49
33	Temperature of Element 24 (OD = 0.6 m) as a Function of Time for Three Different Segment Lengths	49
34	Subdivision of Normal Ray Casting Grid Unit for Element Resolution	50

Tables

1	Format of Input Section 1 for the Single Tree Segment Option Used to Specify Model Options and Boundary Conditions	8
2	Format of Input Section 2 for the Single Tree Segment Option Used to Specify the Required Material Properties Files	9
3	Format of Input Section 3 for the Single Tree Segment Option Used to Specify the Geometry of the Calculation	9
4	Format of Input Section 4 for the Single Tree Segment Option Used to Specify the Nodal Coordinates	10
5	Format of Input Section 5 for the Single Tree Segment Option Used to Provide the Temperature Initialization	10
6	Format of Input Section 6 for the Single Tree Segment Option Used to Control the Output From the Calculation	11
7	Format of Input Section 1 for the Multiple Tree Segment Option Used to Specify Model Options and Boundary Conditions	15
8	Format of Input Section 2 for the Multiple Tree Segment Option Used to Specify the Required Material Properties Files	16
9	Format of Input Section 3 for the Multiple Tree Segment Option Used to Specify the Nodal Coordinates	16
10	Format of Input Section 4 for the Multiple Tree Segment Option Used to Specify the Types of Tree Elements	17
11	Format of Input Section 5 for the Multiple Tree Segment Option Used to Specify the Geometry of the Tree Elements	18
12	Format of Input Section 6 for the Multiple Tree Segment Option Used to Provide the Temperature Initialization	19
13	Format of Input Section 7 for the Multiple Tree Segment Option Used to Control the Output From the Calculation	20
14	Leaf Property File Format	23
15	Meteorological File Format	24
16	Description of Required Cloud Cover Information	24
17	Description of Input Values in a Tree Material Property File	26

User's Guide for TREETHERM: A 3-D Thermal Model for Single Trees

1 INTRODUCTION

TREETHERM is a three dimensional thermal code that models a single tree's response to environmental boundary conditions. Written in the C programming language, the model includes heat transfer due to conduction, solar absorption, surface convection due to wind, infrared absorption and surface reradiation. The model allows the user to disable the various boundary conditions in order to perform sensitivity studies. The model also includes an option to allow the shading effects and attenuation effects due to leaves.

1.1 Purpose of Report

This report is a User's Guide to the operation of the code. Descriptions of the various code options and how to implement them are provided. Also given are descriptions of the data files that are required to operate the code. Detailed descriptions of the physics used in developing the model are provided in the companion technical report.¹

¹ Hummel, J.R., Jones, J.R., Longtin, D.R., Paul, N.L., (1991) "Development of a 3-D Tree Thermal Response for Energy Budget and Scene Simulation Studies," Phillips Laboratory, Hanscom AFB, Massachusetts, PL-TR-91-2108, 15 March.

1.2 Organization of Report

Section 2 provides an overview of the model including a description of the coordinate system and basic terminology. Section 3 describes the input requirements for the model. Section 4 describes the output provided by the code. Section 5 provides some examples from the model. Finally, Section 6 discusses some of the assumptions made in the development of the code and their limitations.

2 OVERVIEW OF TREETHERM

There are two versions of the model available for the user. The first version models a single tree element like a tree trunk. The second version allows a user to model a tree consisting of many segments.

The single segment version includes greater spatial resolution than the multiple segment version and is useful for studying the detailed thermal structure in a tree element. The multiple segment version models the interactions between tree elements and can include shading and solar attenuation due to leaves.

2.1 Overview of Numerical Method

The code uses an electrical analog to the general heat balance equation for heterogeneous, anisotropic materials as given as²

$$\rho c \frac{\partial T}{\partial t} = \frac{\partial}{\partial x} \left(k_x \frac{\partial T}{\partial x} \right) + \frac{\partial}{\partial y} \left(k_y \frac{\partial T}{\partial y} \right) + \frac{\partial}{\partial z} \left(k_z \frac{\partial T}{\partial z} \right) + Q_{x,y,z,t} \quad (1)$$

where ρ is density of the tree material in kg/m^3 , c is the specific heat in J/kg-K , T is the temperature in K , t is the time in seconds, k_x, k_y, k_z are the conductivities in the x, y, z directions in W/m-K , and $Q_{x,y,z,t}$ is the total surface flux. The partial derivatives are approximated with finite differences using the Crank-Nicolson method. The model is divided into a set of elements whose calculated temperatures are assumed constant over an element's spatial boundaries. A more detailed description of the implementation of the energy balance is contained in the thermal response section of the report this User's Guide accompanies. A flow chart of the code execution is shown in Figure 1.

The tree model global coordinate system is based on a Cartesian system. In this approach, the X-axis is north, the Y-axis is west, and the Z-axis is vertical, as shown in Figure 2.

² Duncan, T. C., Farr, J.L., Wassel, T., and Curtis, R. J., Satellite Laser Vulnerability Model, Thermal Model User's Guide, Air Force Weapons Laboratory, (Software Documentation).

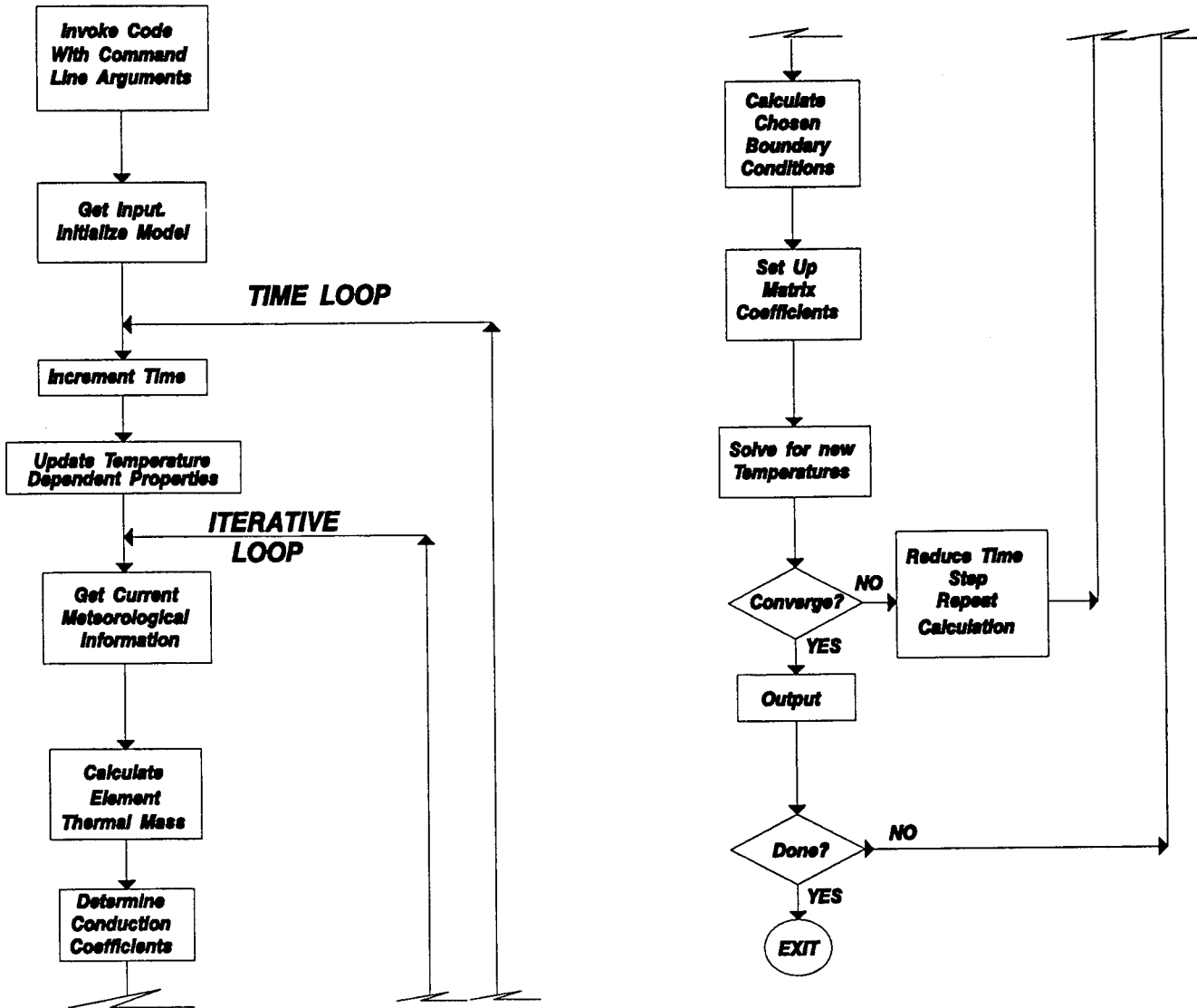

Figure 1. Flowchart of Tree Model Code Execution

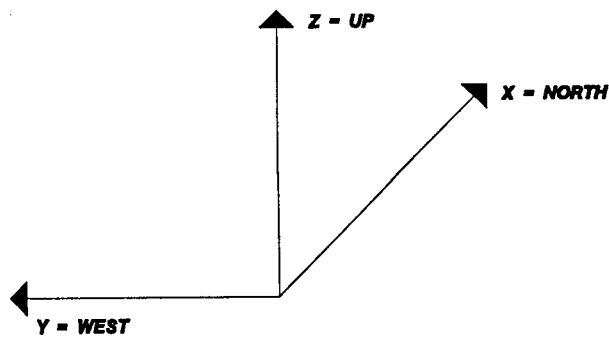

Figure 2. TREETHERM Model Global Coordinate System

2.2 Basic TREETHERM Terminology

The overall tree model is composed of cylindrical sections termed tree segments or tree elements. The limits of these tree segments are defined by input nodal coordinates and segment outer diameter. The segments are divided into rings and these rings are then sectioned. These are called calculation elements. Each ring may have a different material property. A tree segment may have a leaf cluster around it. In Figures 3 and 4, tree element 9 is defined as from node 8 to node 9. It has a leaf cluster diameter of 2 meters. In this example it is composed of three rings which may have different material properties. The outer diameters of these rings are 0.25, 0.50, 0.75 meters. The inner ring is composed of calculation elements 73, 74, 75, and 76.

The starting or *from* node should be the closest in a path along tree segments towards the root node. The sense of the *from-to* direction is away from main segments towards the ends of the tree model.

Internally, the tree segment has a local coordinate system defined as positive local z in the *from-to* direction. The local X-axis is parallel to the model global XY plane and is determined by a cross product as follows:

$$\hat{X}_L = \hat{Z}_L \times \hat{Z}_G \quad (2)$$

The local Y-axis is given by

$$\hat{Y}_L = \hat{Z}_L \times \hat{X}_L. \quad (3)$$

In the above, \hat{X}_L , \hat{Y}_L , and Z_L are the unit vectors parallel to the tree segment's local x, y, z axes, respectively, and \hat{Z}_G is the unit vector parallel to the model global Z -axis. The calculation elements are numbered consecutively, starting in the inner ring in the first quadrant (local system), then counterclockwise (CCW) around the ring, then to the next ring. The local system definition and calculation numbering scheme is required to choose output for a specific calculation element.

2.3 Executing The Code

The current version of TREETHERM is executed from the command line with a set of command line arguments as follows:

```
prompt > TREETHERM inputfile echofile modeltype outputfile1 outputfile2
```

where

TREETHERM : Name of the executable code
inputfile : Name of the user designated input file
echofile : Name of the user designated echo file of *inputfile*
modeltype : Model type option. This is a case sensitive character

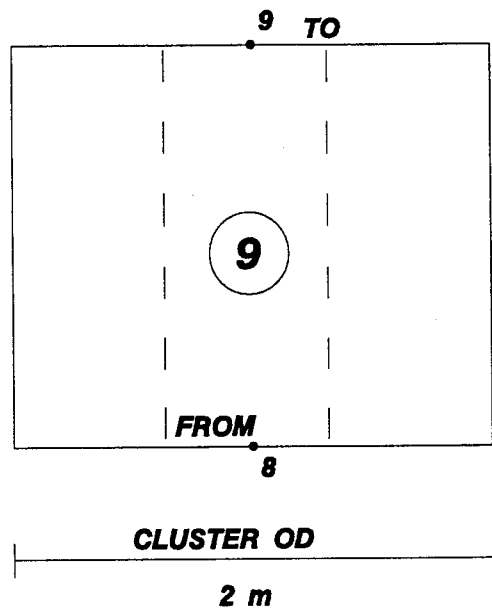

Figure 3. Side View Example of a Tree Segment (Outlined With Dashed Lines) and a Leaf Cluster With an Outer Diameter of 2 m

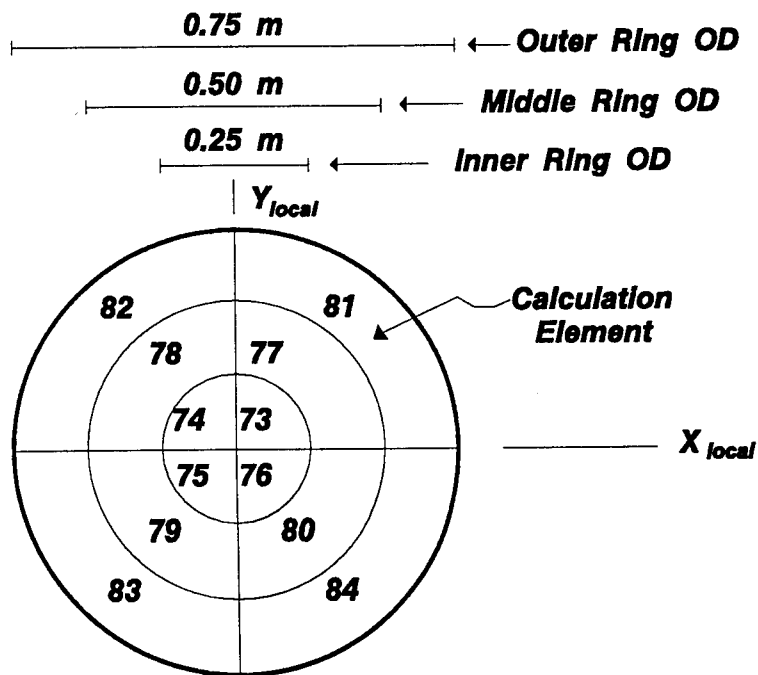

Figure 4. Cross Section of Tree Component Detailing the Element Numbering Scheme and the Ring Diameters

string. Allowed strings are: TREE, OneTreeSegment
outputfile1 : Name of the user designated output file 1
outputfile2 : Name of the user designated output file 2

The file names have to be compatible with the target operating system. The user is cautioned that TREETHERM does not check to see if the specified output files exist or not, *i.e.*, existing files will be overwritten.

Model types "TREE" and "OneTreeSegment" invoke the tree model multiple and single tree segment options, respectively. For the specified tree model option, the selected calculation element temperature history output is placed in *outputfile2*. The temperatures of surface calculation elements or all calculation elements of selected segments are available at the time intervals of the meteorological data. This output is put in *outputfile1*.

3 INPUT REQUIREMENTS

This section deals with the format of the main input file and the material property files for the different model options. In general, related input is grouped in sections. For each section of data, there will be a header line of description strings, and the data section will be terminated by a closing end statement. In between the header and closing end statement, the input format is generally a set of descriptive strings followed by the input value.

3.1 Single Tree Segment Option

Figure 5 shows the input requirements for a calculation using the single tree segment model. The data are grouped into sections that contain data of different types. Table 1 to 6 describe the data contained in each of the input sections for the single tree segment model option.

Table 1 describes the data required to specify the various model options. These data specify the type of model calculation (single or multiple tree segment), the number of internal tree elements, the sources of the input data files, the surface boundary conditions being considered, the location of the tree, and temperature units. Table 2 describes the data required to specify the material properties. Table 3 describes the data required to specify the geometry for the calculations with a single tree segment. This section of data specifies how the tree is being divided into calculation elements. The section inputs how many rings, their diameters, the material properties associated with the rings, and how many segments. Table 4 describes the data required to specify the nodal geometries. These data specify where in 3-D space the nodes are located. Table 5 describes the data required to initialize the temperature calculations. Finally, Table 6 describes the input

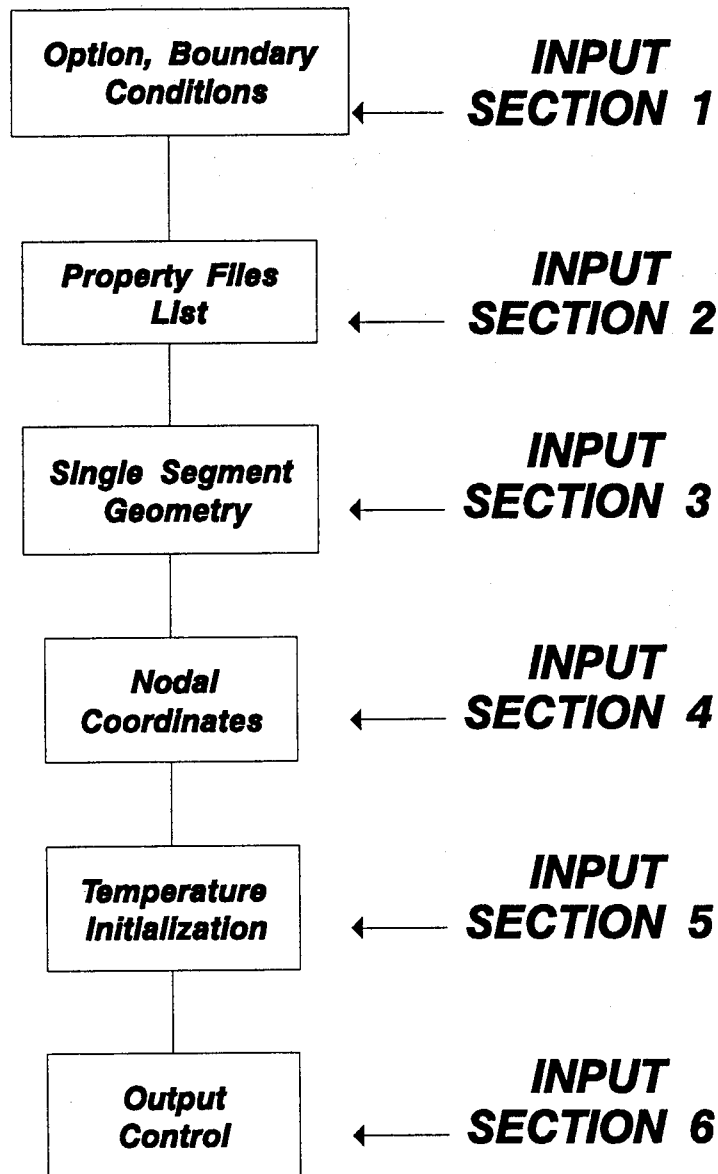

Figure 5. Input Requirements When Specifying the Single Tree Segment Option

required to control the output produced by the model. These data specify for what elements output is produced. TREETHERM produces voluminous output, and these parameters help the user to produce only those output results required.

In the Tables, the input format for each line of data is given along with examples, the data type, and some additional comments. All of this input data must be contained in the same input file. The input filename is referenced as an argument in the command line (see Section 2.3). Figure 6 gives an example of the data that would be used for a calculation with the single tree element option.

Table 1. Format of Input Section 1 for the Single Tree Segment Option Used to Specify Model Options and Boundary Conditions

LINE #	REQUIRED DESCRIPTIVE STRING(S)	EXAMPLE VALUE(S)	DATA TYPE†	COMMENTS
1	MODEL TYPE TREE	N/A	N/A	Header statement for input section.
2	NUMBER OF NODES	2	I	Number of calculation nodes. Valid Range: 2
3	NUMBER TREE ELEMENTS	1	I	Number of tree segments. Valid Range: 1
4	METEOROLOGICAL DATA FILE	hunt262	S	Name of data file containing meteorological data.
5	SURFACE BOUNDARY CONDITIONS SOLAR IR CONVECTION NONE	None	S	Surface boundary conditions. Enter the string of choice or NONE.
6	IR	DATA	S	String describing source of infrared data. Valid Strings: DATA, ESTIMATE
7	SOLAR	DATA	S	String describing source of solar data. Valid Strings: DATA, ESTIMATE
8	NUMBER TREE PROPERTY FILES	6	I	Number of data files containing material properties. Valid Range: 1 - 10
9	TIME ZONE	8	I	Number identifying the time zone. Positive values west of Greenwich. Valid Range: 0 - 24
10	LATITUDE	36 DEG 0 MIN 0.0 SEC	I,I,F	Latitude
11	LONGITUDE	121 DEG 19 MIN 0.0 SEC	I,I,F	Longitude
12	INPUT TEMPERATURES	KELVIN	S	Temperature units of input data.† Choices: KELVIN or CELSIUS
13	OUTPUT TEMPERATURES	KELVIN	S	Temperature units of output data.† Choices: KELVIN or CELSIUS
14	LEAF PROPERTY FILE	NONE	S	NONE for single tree option.
15	END	N/A	N/A	Closing statement for input section.

† I = Integer F = Float S = String

‡ Applies to meteorological data file and initial temperature profile in Input Section 5.

Table 2. Format of Input Section 2 for the Single Tree Segment Option Used to Specify the Required Material Properties Files

LINE #	REQUIRED DESCRIPTIVE STRING(S)	EXAMPLE VALUE(S)	DATA TYPE†	COMMENTS
1	PROPERTY FILES	N/A	N/A	Header statement for the input section
2		hlprop.inp tree.prp	S	The number of strings required is given in Line 8 of the Section 1 input
3	END	N/A	N/A	Closing statement for the input section

Table 3. Format of Input Section 3 for the Single Tree Segment Option Used to Specify the Geometry of the Calculation

LINE #	REQUIRED DESCRIPTIVE STRING(S)	EXAMPLE VALUE(S)	DATA TYPE†	COMMENTS
1	TREE SINGLE SEGMENT	N/A	N/A	Header statement for the input section
2	NUMBER RINGS	5	I	Number of rings modeled. Valid Range: 3 - 20
3	NUMBER SEGMENTS	36	I	Number of segments modeled. Valid range: 4 - 36
4	OUTER RING RADII	0.1 0.2 0.3 0.4 0.5	F	Radii given in ascending order, inner to outer ring. Number of values must match the number on Line 2.
5	RING MATERIAL NUMBER	1 1 1 1 2	I	Material index for each ring
6	END	N/A	N/A	Closing statement for the input section

† I = Integer F = Float S = String

Table 4. Format of Input Section 4 for the Single Tree Segment Option Used to Specify the Nodal Coordinates

LINE #	REQUIRED DESCRIPTIVE STRING(S)	EXAMPLE VALUE(S)	DATA TYPE†	COMMENTS
1	TREE NODAL COORDINATES	N/A	N/A	Header statement for the input section
2	ROTATE Z value DEG	90.0	F	Rotate the following coordinates about the model global Z-axis
3		1 : 0.0 0.0 0.0	I,S,F,F,F	Node index #, a delimiter, and X,Y,Z position in m.
4		2 : 0.0 0.0 1.0	I,S,F,F,F	Node index #, a delimiter and X,Y,Z position in m.
5	END	N/A	N/A	Closing statement for the input section

Table 5. Format of Input Section 5 for the Single Tree Segment Option Used to Provide the Temperature Initialization

LINE #	REQUIRED DESCRIPTIVE STRING(S)	EXAMPLE VALUE(S)	DATA TYPE†	COMMENTS
1	VERTICAL TEMPERATURE PROFILE	N/A	N/A	Header statement for the input section
2	NENTRY	2	I	Number of entries in the temperature-height profile table. Valid Range: 2 - 10
3	HEIGHT	0.0 100.0	F	Height values in m.
4	TEMPERATURE	13.0 13.0	F	Initial temperatures at the heights given from line 3. Units are °C or K based on option set in line 12, Input Section 1.
5	END	N/A	N/A	Closing statement for the input section

† I = Integer F = Float S = String

Table 6. Format of Input Section 6 for the Single Tree Segment Option Used to Control the Output From the Calculation

LINE #	REQUIRED DESCRIPTIVE STRING(S)	EXAMPLE VALUE(S)	DATA TYPE†	COMMENTS
1	TREE OUTPUT CONTROL	N/A	N/A	Header statement for the input section.
2	NUMBER OF TEMPERATURE HISTORY	5	I	Number of calculation elements printed in temperature history output list. Valid Range: 0 - 200
3	TEMPERATURE HISTORY ELEMENTS	1 20 75 100	I	List of index numbers of calculation elements for which temperatures will be output.
4	NUMBER TREE SURFACE ELEMENTS‡	1	I	Number of surface elements for which output is desired. Valid Range: 0 or 1
5	TREE ELEMENT	1	I	List of indices of tree surface elements. The number of elements must match the number in Line# 4.
6	NUMBER TREE ELEMENT‡	1	I	Number of tree segments for which output is desired.
7	TREE ELEMENTS	1	I	List of the index numbers for tree segments. The number of indices must match the number in Line# 6.
8	END	N/A	N/A	Closing statement for the input section.

† I = Integer F = Float S = String

‡ Output given at the time interval of the meteorological data.

```

MODEL TYPE TREE
NUMBER NODES          2
NUMBER TREE ELEMENTS  1
METEOROLOGICAL DATA FILE  hunt262
SURFACE BOUNDARY CONDITIONS  SOLAR  IR  CONVECTION  NONE
IR                    ESTIMATE
SOLAR                 ESTIMATE
NUMBER TREE PROPERTY FILES  1
TIME ZONE             8
LATITUDE              36 DEG  0 MIN  0.0 SEC
LONGITUDE             121 DEG 19 MIN  0.0 SEC
INPUT TEMPERATURES   CELCIUS
OUTPUT TEMPERATURES CELCIUS
LEAF PROPERTY FILE   NONE
END

PROPERTY FILES
  hltree.prop
END

TREE SINGLE SEGMENT
NUMBER RINGS          6
NUMBER SEGMENTS       36
OUTER RING RADII     .02 .04 .06 .08 .1 .12
RING MATERIAL NUMBER 1 1 1 1 1 1
END

TREE NODAL COORDINATES
  ROTATE Z 0.0 DEG
  1 : 0.0 0.0 0.0
  2 : 0.0 0.0 1.0
END

VERTICAL TEMPERATURE PROFILE
  NENTRY 2
  HEIGHT      0.0 50.0
  TEMPERATURE 13.0 13.0
END

TREE OUTPUT CONTROL
  NUMBER TEMPERATURE HISTORY  8
    TEMPERATURE HISTORY ELEMENTS 185 194 203 212
                                  1 10 19 28
  NUMBER TREE SURFACE ELEMENTS  1
    TREE ELEMENTS                1
  NUMBER TREE ELEMENTS          1
    TREE ELEMENTS                1
END

```

} Input Section 1
See Table 1

} Input Section 2
See Table 2

} Input Section 3
See Table 3

} Input Section 4
See Table 4

} Input Section 5
See Table 5

} Input Section 6
See Table 6

Figure 6. Example Input File for a Calculation Using the Single Tree Segment Option

3.2 Multiple Tree Segment Option

Figure 7 shows the input flow for the multiple tree segment option. Tables 7 to 13 correspond to the input sections labeled in Figure 7. All this information must be contained in the same file which is referenced as a command line argument. (See Executing Code Section 2.3.)

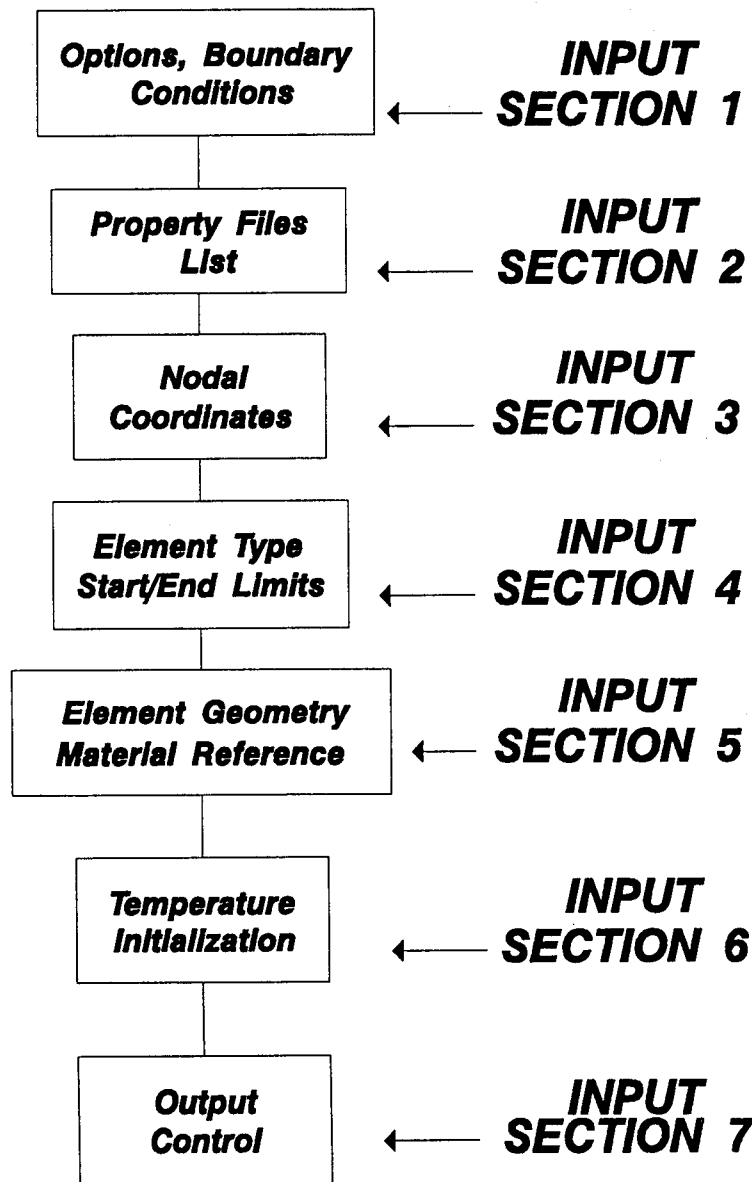

Figure 7. Input Requirements for Multiple Tree Segment Option

The data requirements for the Multiple Tree Segment Option are similar to those for the Single Tree Segment Option. The primary differences between the two options is that the user must now specify the nodal coordinates of the individual tree components (in Input Section 3), the type of each tree element and where they start and stop (in Input Section 4), and the diameters and material property references of the elements (in Input Section 5). Figure 8 shows an example input file for the Multiple Tree Segment option.

Figure 9 shows the relations between the tree element physical connection and the description of a connection type that is required as input for the multiple tree segment option. The connection type description is input in Input Section 4 of the multiple tree segment option. Table 10 contains the format for that input section.

3.3 Leaf Properties File Format

TREETHERM includes a separate leaf energy budget model¹ that can be turned on and off depending on the user's requirements. Leaves are only available when the Multiple Tree Segment Option is invoked. Self-shading from the branches and leaf clusters can also be included, via the use of a ray-tracing routine,¹ by including shading in the boundary conditions by adding the string SHADING in Line 5 of Input Section 1 of the Multiple Tree Segment option. The calculation of leaf temperatures is performed via the addition of a valid leaf property file name in Line 14 of the Input Section 1, Table 7). Table 14 gives the input format for the leaf property file and Figure 10 lists a sample leaf property file. It is noted that the user can calculate leaf temperatures without invoking the self-shading option, which is very computationally intensive.

3.4 Meteorological File Format

The meteorological file name is read in as Line# 4 of Input Section 1 (see Tables 1 and 7). The meteorological data file consists of 19 columns of data, which are described in Table 15. The maximum time interval for the meteorological data is currently set at one hour (3600 secs). The meteorological data file used by TREETHERM is the same as that used in the Interim Thermal Model (ITM).³

Both TREETHERM and the ITM can either utilize data of solar and infrared fluxes or calculate those values using the Preliminary Atmospheric Radiation Package.³ The latter choice is selected via the use of the character string ESTIMATE in Input Section 1. If this option is selected, one can account for the effects of clouds. Table 16 describes the cloud types that can be accounted for.

³ Hummel, J.R., Longtin, D.R., Paul, N.R., and Jones, J.R. (1991) "Development of the Smart Weapons Operability Enhancement Interim Thermal Model," Phillips Laboratory, Hanscom AFB, Massachusetts, PL-TR-91-20073, March.

Table 7. Format of Input Section 1 for the Multiple Tree Segment Option Used to Specify Model Options and Boundary Conditions

LINE #	REQUIRED DESCRIPTIVE STRING(S)	EXAMPLE VALUE(S)	DATA TYPE†	COMMENTS
1	MODEL TYPE TREE	N/A	N/A	Header statement for section.
2	NUMBER OF NODES	200	I	Number of calculation nodes. Valid Range: 2 - 300
3	NUMBER TREE ELEMENTS	199	I	Number of tree segments. Valid Range: 1 - 299
4	METEOROLOGICAL DATA FILE	hunt262	S	Name of data file containing meteorological data.
5	SURFACE BOUNDARY CONDITIONS SOLAR IR CONVECTION SHADING	None	S	Surface boundary conditions. Enter the string of choice or NONE.
6	IR	DATA	S	String describing source of infrared data. Valid Strings: DATA, ESTIMATE*
7	SOLAR	DATA	S	String describing source of solar data. Valid Strings: DATA, ESTIMATE*
8	NUMBER TREE PROPERTY FILES	6	I	Number of data files containing material properties. Valid Range: 1 - 10
9	TIME ZONE	8	I	Time zone. Positive west of Greenwich. Valid Range: 0 - 24
10	LATITUDE	36 DEG 0 MIN 0.0 SEC	I,I,F	Latitude
11	LONGITUDE	121 DEG 19 MIN 0.0 SEC	I,I,F	Longitude
12	INPUT TEMPERATURES	KELVIN	S	Temperature units.† Choices: KELVIN or CELSIUS
13	OUTPUT TEMPERATURES	CELSIUS	S	Temperature units.† Choices: KELVIN or CELSIUS
14	LEAF PROPERTY FILE	NONE	S	NONE for single tree option.
15	END	N/A	N/A	Closing statement for section.

† I = Integer F = Float S = String † Applies to meteorological data file & initial temperature profile (Input Section 5). * Invokes Internal Code Routines

Table 8. Format of Input Section 2 for the Multiple Tree Segment Option Used to Specify the Required Material Properties Files

LINE #	REQUIRED DESCRIPTIVE STRING(S)	EXAMPLE VALUE(S)	DATA TYPE†	COMMENTS
1	PROPERTY FILES	N/A	N/A	Header statement for the input section
2		hprop.inp tree.prp	S	File names of material properties. The number of strings required is given in Line 8 of the Section 1 input
3	END	N/A	N/A	Closing statement for the input section

Table 9. Format of Input Section 3 for the Multiple Tree Segment Option Used to Specify the Nodal Coordinates

LINE #	REQUIRED DESCRIPTIVE STRING(S)	EXAMPLE VALUE(S)	DATA TYPE†	COMMENTS
1	TREE NODAL COORDINATES	N/A	N/A	Header statement for the input section
2	ROTATE Z value DEG	90.0 DEG	F	Rotate the following coordinates about the model global Z-axis
3‡		1 : 0.0 0.0 0.0	I,S,F,F,F	Node index #, a delimiter, and X,Y,Z position in m.
N*	END	N/A	N/A	Closing statement for the input section

† I = Integer F = Float S = String

‡ Repeat for the number of nodes specified in Line 2 of Section 1

* N = Number of nodes + 2

Table 10. Format of Input Section 4 for the Multiple Tree Segment Option Used to Specify the Types of Tree Elements

LINE #	REQUIRED DESCRIPTIVE STRING(S)	EXAMPLE VALUE(S)	DATA TYPE†	COMMENTS
1	TREE ELEMENT CONFIGURATION	N/A	N/A	Header statement for the input section
2‡		1 TRUNK M 1 2	I,S,S,I,I	See Note Below
N*	END	N/A	N/A	Closing statement for the input section

† I = Integer F = Float S = String

‡ Repeat for all tree elements (see Line 3, Input Section 1)

* N = Number of tree elements + 2

Note: The format for Line 2 is

$Tree_Element_No$ Segment_ID Connection_Type From_Node To_Node

where

$Tree_Element_No$ = Tree Element Index, Valid Range: 1 - Number tree elements

$Segment_ID$ = String describing the type of tree element. Valid strings are:
TRUNK, LIMB, BRANCH, or TWIG
Currently, the resolution geometry is the same.

$Connection_Type$ = String that identifies the type of connection at From_Node. Valid strings are: M, B, S where

B = first branch off of a main element

M = a normal axial (longitudinal connections)

S (Reserved for future use)

(See Figure 9 for pictorial representation of connection types)

$From_Node$ = Starting node number

To_Node = Ending node number

Table 11. Format of Input Section 5 for the Multiple Tree Segment Option Used to Specify the Geometry of the Tree Elements

LINE #	REQUIRED DESCRIPTIVE STRING(S)	EXAMPLE VALUE(S)	DATA TYPE†	COMMENTS
1	TREE ELEMENT DESIGNATION	N/A	N/A	Header statement for the input section
2‡		1 : 0.15 0.25 0.3 0.0 : 1 1 1 I,S,F,F,F,F,S,I,I		See Note Below
N*	END	N/A	N/A	Closing statement for the input section

† I = Integer F = Float S = String

‡ Repeat for all tree elements (see Line 3, Input Section 1)

* N = Number of tree elements + 1

Note: Format of line 2 is

Tree_El_No Delimiter OD1 OD2 OD3 LCD Delimiter Mat1 Mat2 Mat3

where

Tree_El_No = Tree element number

Range = 1 - Number tree elements

Delimiter = : (Use spaces around delimiter)

OD1, OD2, OD3 = Inner, middle, outer diameters (meters) of element rings

LCD = Leaf cluster outer diameter (meters). Use 0.0 if no leaves are assumed.

Delimiter = : (Use spaces around delimiter)

Mat1, Mat2, Mat3 = Material index number corresponding to the material property files (see Table 8 Line# 2.) Corresponds to inner, middle, and outer rings of material.

Table 12. Format of Input Section 6 for the Multiple Tree Segment Option Used to Provide the Temperature Initialization

LINE #	REQUIRED DESCRIPTIVE STRING(S)	EXAMPLE DATA		COMMENTS
		VALUE(S)	TYPE†	
1	VERTICAL TEMPERATURE PROFILE	N/A	N/A	Header statement for the input section.
2	NENTRY	2	I	Number of entries in the temperature-height profile table. Valid Range: 2 - 10
3	HEIGHT	0.0 100.0	F	Height values in m.
4	TEMPERATURE	13.0 13.0	F	Initial temperatures at the heights given from line 3. Units are °C or K, based on option set in line 12, Input Section 1.
5	END	N/A	N/A	Closing statement for the input section.

† I = Integer F = Float S = String

Table 13. Format of Input Section 7 for the Multiple Tree Segment Option Used to Control the Output From the Calculation

LINE #	REQUIRED DESCRIPTIVE STRING(S)	EXAMPLE VALUE(S)	DATA TYPE†	COMMENTS
1	TREE OUTPUT CONTROL	N/A	N/A	Header statement for the input section.
2	NUMBER OF TEMPERATURE HISTORY	5	I	Number of calculation elements printed in temperature history output list. Valid Range: 0 - 200
3	TEMPERATURE HISTORY ELEMENTS	1 20 75 100	I	List of index numbers of calculation elements for which temperatures will be output.
4	NUMBER TREE SURFACE ELEMENTS‡	1	I	Number of surface elements for which output is desired.
5	TREE ELEMENT	1	I	List of indices of tree surface elements. The number of elements must match the number in Line# 4.
6	NUMBER TREE ELEMENT‡	1	I	Number of tree segments for which output is desired.
7	TREE ELEMENTS	1	I	List of the index numbers for tree segments. The number of indices must match the number in Line# 6.
8	END	N/A	N/A	Closing statement for the input section.

† I = Integer F = Float S = String

‡ Output given at the time interval of the meteorological data.

```

MODEL TYPE TREE
NUMBER NODES          4
NUMBER TREE ELEMENTS  3
METEOROLOGICAL DATA FILE hunt262
SURFACE BOUNDARY CONDITIONS SOLAR NONE NONE NONE
IR                    ESTIMATE
SOLAR                 DATA
NUMBER TREE PROPERTY FILES  2
TIME ZONE             8
LATITUDE              36 DEG  0 MIN  0.0 SEC
LONGITUDE             121 DEG 19 MIN  0.0 SEC
INPUT TEMPERATURES   CELCIUS
OUTPUT TEMPERATURES CELCIUS
LEAF PROPERTY FILE   NONE
END

PROPERTY FILES
hltree.prop hl2.prop
END

TREE NODAL COORDINATES
ROTATE Z 0.0 DEG
  1 : 0.0 0.0 0.0
  2 : 0.0 0.0 1.0
  3 : 0.0 0.0 2.0
  4 : 0.0 0.0 3.0
END

TREE ELEMENT CONFIGURATION
  1 TRUNK M  1 2
  2 TRUNK M  2 3
  3 TRUNK M  3 4
END

TREE ELEMENT DESIGNATION
  1 : 0.15 0.25 0.30 0.0 : 1 1 1
  2 : 0.15 0.25 0.30 0.0 : 2 2 2
  3 : 0.15 0.25 0.30 0.0 : 1 1 1
END

VERTICAL TEMPERATURE PROFILE
NENTRY 2
HEIGHT      0.0 50.0
TEMPERATURE 12.8 12.8
END

TREE OUTPUT CONTROL
NUMBER TEMPERATURE HISTORY 12
TEMPERATURE HISTORY ELEMENTS  9 10 11 12
                              21 22 23 24
                              33 34 35 36
NUMBER TREE SURFACE ELEMENTS  3
TREE ELEMENTS                 1 2 3
NUMBER TREE ELEMENTS          1
TREE ELEMENTS                 1
END

```

} Input Section 1
See Table 7

} Input Section 2
See Table 8

} Input Section 3
See Table 9

} Input Section 4
See Table 10

} Input Section 5
See Table 11

} Input Section 6
See Table 12

} Input Section 7
See Table 13

Figure 8. Example Input File for Multiple Tree Segment Option

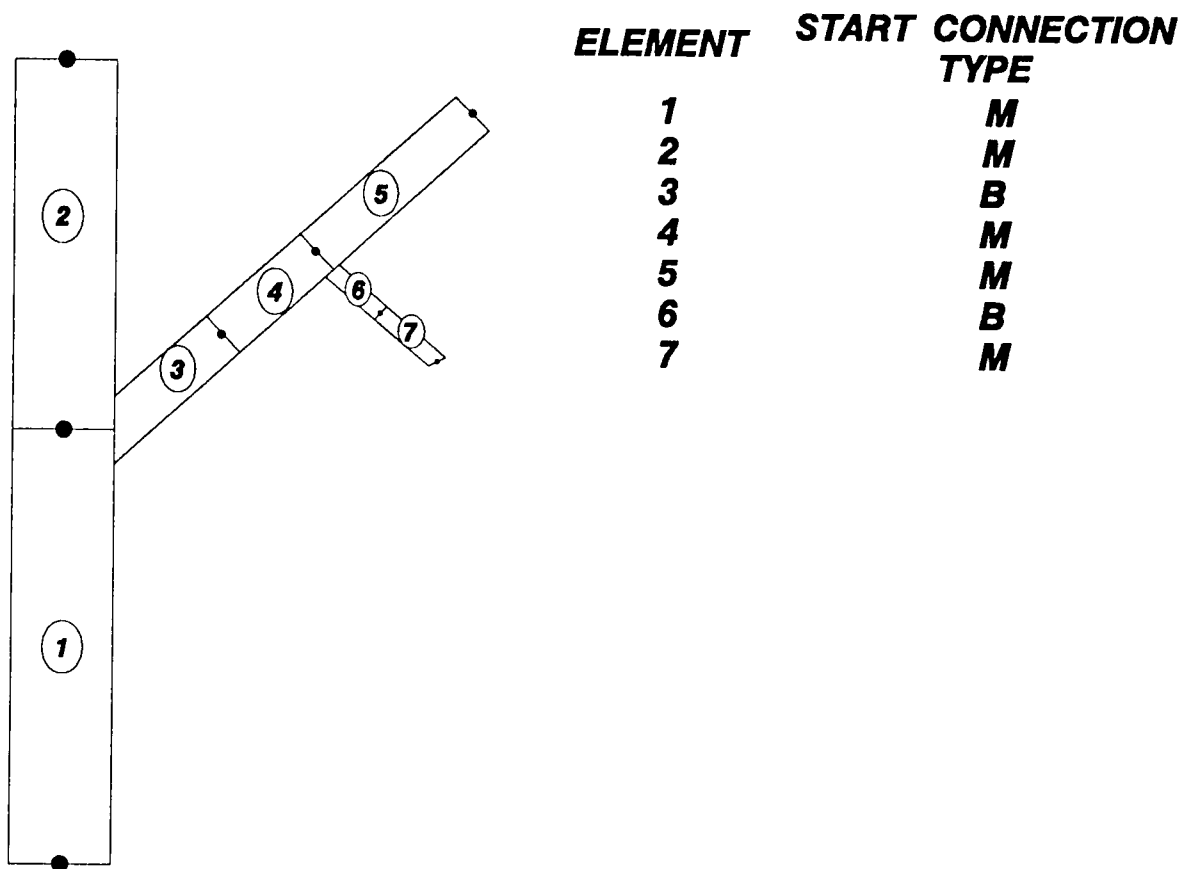

Figure 9. Example of the Types of Tree Element Connections for the Multiple Tree Segment Option

Figure 11 is an example of the meteorological data required by TREETHERM. This example is of data from Hunter-Liggett, California.

3.5 Property File Format

Material properties are required to describe the thermal properties of the different materials assumed in the tree. Table 17 describes the individual input values required in the tree property file.

Material properties can be temperature independent or dependent. To use constant temperature properties throughout, set the variable CONSTANTPROPS to 1. If one or more properties are temperature dependent, set CONSTANTPROPS to 0. To use a constant temperature property (Lines 4-9 of Table 17) along with tempera-

Table 14. Leaf Property File Format

LINE #	REQUIRED DESCRIPTIVE STRING(s)	EXAMPLE VALUE(s)	DATA TYPE [†]	COMMENTS
1	LEAF INPUT PARAMETERS	N/A	N/A	Header statement for the input section.
2	NUMBER DENSITY	98.0	F	Number of leaves per cluster
3	AREA	0.0030591	F	Area of individual leaf (m)
4	TRANSMISSIVITY	0.50	F	Shortwave transmissivity of leaf
5	ABSORPTIVITY	0.25	F	Shortwave absorptivity of leaf
6	REFLECTIVITY	0.25	F	Shortwave reflectivity of leaf
7	DIFFUSE REFLECTIVITY	0.25	F	Shortwave diffuse reflectivity of leaf
8	IR EMISSIVITY	0.90	F	Infrared emissivity of leaf
9	IR ABSORPTIVITY	0.90	F	Infrared absorptivity of leaf
10	WIDTH	0.05	F	Width of leaf (m) based on assumption of circular leaf
11	DIFFUSION RESISTANCE	1.0	F	Diffusion resistance of leaf (sec/m)
12	SURFACE ALBEDO	0.15	F	Surface albedo of underlying surface
13	END	N/A	N/A	Closing statement for the input section.

[†] I = Integer

F = Float

S = String

```

LEAF INPUT PARAMETERS
NUMBER DENSITY      500.0
AREA                0.0030591
TRANSMISSIVITY      0.5
ABSORPTIVITY        0.25
REFLECTIVITY        0.60
DIFFUSE REFLECTIVITY 0.60
IR EMISSIVITY       0.97
IR ABSORPTIVITY     0.97
WIDTH               0.05
DIFFUSION RESISTANCE 6.0
SURFACE ALBEDO      0.15
END
    
```

Figure 10. Example of a Leaf Property File Used by the Leaf Energy Budget Model in TREETHERM

Table 15. Meteorological File Format

COLUMN#	DESCRIPTION	DATA TYPE	COMMENTS
1	Year	I	Last 2 digits of year
2	Julian Day	I	
3	Hour of Day	I	0 = Midnight
4	Minute	I	
5	Pressure	F	mb
6	Air Temperature	F	C or K [†]
7	Relative Humidity	F	%
8	Wind Speed	F	m/s
9	Wind Direction	F	deg
10	Total Solar	F	W/m ^{2†}
11	Directed Solar	F	W/m ^{2†}
12	Diffuse Solar	F	W/m ²
13	Downward IR*	F	W/m ²
14	Fractional Cloud Cover High Layer	I	Range: 0 - 1
15	Cloud Type for High Cloud Layer	I	See Table 16
16	Fractional Cloud Cover Middle Layer	F	Range: 0 - 1
17	Cloud Type for Middle Cloud Layer	I	See Table 16
18	Fractional Cloud Cover Low Layer	F	Range: 0 - 1
19	Cloud Type for Low Cloud Layer	I	See Table 16

† Must correspond to units specified in Input Section 1 (Table 1 or 7)

† Assumed on horizontal surface. Code resolves magnitude and vector of incident solar.

* If value = 0 surfaces will radiate to the background air temperature unless the string ESTIMATE is included in Line# 6 of Input Section 1

Table 16. Description of Required Cloud Cover Information

CLOUD TYPE CODE	LAYER	CLOUD TYPE
1	High	Thin Cirrus
2	High	Thick Cirrus
3	Middle	Middle Cloud
4	Low	Stratus
5	Low	Cumulus or Cumulonimbus

89 261 22 0	969.0	13.0	70.0	0.44	135.2	0.0	0.0	0.0	0.0	281.8	0.0	0	0.0	0	0.0	0
89 261 23 0	969.0	11.5	80.0	0.37	131.6	0.0	0.0	0.0	0.0	277.6	0.0	0	0.0	0	0.0	0
89 262 0 0	969.0	10.8	89.0	0.30	128.0	0.0	0.0	0.0	0.0	276.8	0.0	0	0.0	0	0.0	0
89 262 1 0	968.8	10.6	89.0	0.31	128.0	0.0	0.0	0.0	0.0	275.8	0.0	0	0.0	0	0.0	0
89 262 2 0	969.2	10.5	90.0	0.67	76.0	0.0	0.0	0.0	0.0	275.5	0.0	0	0.0	0	0.0	0
89 262 3 0	969.2	9.4	90.0	0.05	76.0	0.0	0.0	0.0	0.0	269.9	0.0	0	0.0	0	0.0	0
89 262 4 0	969.4	9.5	91.0	0.21	91.0	0.0	0.0	0.0	0.0	270.7	0.0	0	0.0	0	0.0	0
89 262 5 0	969.0	8.9	89.0	0.01	160.0	0.0	0.0	0.0	0.0	267.1	0.0	0	0.0	0	0.0	0
89 262 6 0	969.0	8.3	92.0	0.01	160.0	13.4	6.6	6.8	6.8	264.9	0.0	0	0.0	0	0.0	0
89 262 7 0	969.0	10.6	89.0	0.01	160.0	189.7	135.9	53.8	53.8	275.8	0.0	0	0.0	0	0.0	0
89 262 8 0	969.0	13.3	77.0	0.01	160.0	416.9	346.3	70.5	70.5	286.0	0.0	0	0.0	0	0.0	0
89 262 9 0	969.0	16.7	61.0	0.01	160.0	626.6	547.7	79.0	79.0	297.6	0.0	0	0.0	0	0.0	0
89 262 10 0	969.0	17.2	58.0	3.00	160.0	780.3	690.4	90.0	90.0	298.9	0.0	0	0.0	0	0.0	0
89 262 11 0	969.0	18.9	45.0	1.00	190.0	869.7	769.8	99.9	99.9	301.1	0.0	0	0.0	0	0.0	0
89 262 12 0	969.0	20.6	44.0	2.00	240.0	862.3	719.3	143.0	143.0	319.3	0.0	0	0.0	0	0.13	5
89 262 13 0	969.0	22.8	41.0	1.00	140.0	829.9	689.0	140.9	140.9	329.5	0.0	0	0.0	0	0.13	5
89 262 14 0	969.0	23.3	39.0	2.00	170.0	734.4	599.8	134.7	134.7	330.8	0.0	0	0.0	0	0.13	5
89 262 15 0	969.0	23.9	40.0	1.00	160.0	576.9	452.2	124.7	124.7	335.0	0.0	0	0.0	0	0.13	5
89 262 16 0	969.0	24.3	41.0	0.92	156.5	407.6	337.4	70.2	70.2	328.2	0.0	0	0.0	0	0.0	0
89 262 17 0	969.0	22.8	44.0	0.84	152.9	181.0	128.5	52.5	52.5	321.8	0.0	0	0.0	0	0.0	0
89 262 18 0	969.0	20.6	48.0	0.76	149.4	8.3	4.0	4.3	4.3	312.1	0.0	0	0.0	0	0.0	0
89 262 19 0	969.0	18.9	53.0	0.68	145.8	0.0	0.0	0.0	0.0	305.6	0.0	0	0.0	0	0.0	0
89 262 20 0	969.0	17.5	59.0	0.60	142.3	0.0	0.0	0.0	0.0	301.0	0.0	0	0.0	0	0.0	0
89 262 21 0	969.0	16.0	65.0	0.52	138.7	0.0	0.0	0.0	0.0	295.6	0.0	0	0.0	0	0.0	0
89 262 22 0	969.0	13.0	70.0	0.44	135.2	0.0	0.0	0.0	0.0	281.8	0.0	0	0.0	0	0.0	0
89 262 23 0	969.0	11.5	80.0	0.37	131.6	0.0	0.0	0.0	0.0	277.6	0.0	0	0.0	0	0.0	0
89 263 0 0	969.0	10.8	89.0	0.30	128.0	0.0	0.0	0.0	0.0	276.8	0.0	0	0.0	0	0.0	0

Figure 11. Example of the Meteorological File Used by TREETHERM. This example is for Hunter-Liggett, California

ture dependent properties, set the corresponding input value for the number of table entries (parameters NCP, NKX, NKY, NKZ, NEMIS, and NABS in Table 17) to 0 and do not input the applicable table values (Lines 17-40) in the property file. If temperature dependent properties are used, each calculation element has to update each temperature dependent property (via interpolation) at each time step. This will significantly increase the code computational time, especially as the model becomes more complex.

When the HOMOGENEOUS flag is input as 1, the model assumes there will be no variations in the conductivities. Therefore, the k_x conductivity will be used for the k_y and k_z conductivities. This can reduce computation time for models of homogeneous material with temperature dependent conductivity. Figure 12 is an example of a tree property file. Each of the different materials in the tree must have such a file.

Table 17. Description of Input Values in a Tree Material Property File

LINE#	REQUIRED DESCRIPTIVE STRING(s)	EXAMPLE VALUE(s)	TYPE†	COMMENTS
1	CONSTANTPROPS	0	I	1 = Constant Temperature 0 = Temperature Dependent
2	HOMOGENEOUS	0	I	0 = Use x, y, z conductivities 1 = Use x conductivity
3	RHO	900.0	F	Density (kg/m^3)
4	CP	2900.0	F	Specific Heat (J/kg-K)
5	XK	0.15	F	x Conductivity
6	YK	0.30	F	y Conductivity
7	ZK	0.30	F	z Conductivity
8	EMIS	0.80	F	Surface Emissivity
9	ABS	0.55	F	Solar Surface Absorptivity
10	IRABS	1.0	F	IR Surface Absorptivity
Following Lines are Optional. Read if CONSTANTPROPS = 0				
11	NCP	2	I	# of Entries in $C_p(T)$ Table
12	NKX	2	I	# of Entries in $k_x(T)$ Table
13	NKY	2	I	# of Entries in $k_y(T)$ Table
14	NKZ	2	I	# of Entries in $k_z(T)$ Table
15	NEMIS	2	I	# of Entries in $\epsilon(T)$ Table
16	NABS	2	I	# of Entries in $\alpha(T)$ Table
Following Lines are Optional. Read if CONSTANTPROPS = 0 and NCP, NKX, NKY, NKZ, NEMIS, or NABS > 0				
17	CPTAB			Section Header for Table
18		200 400	F	Temperature for $C_p(T)$ (K)
19		2600 2700	F	$C_p(T)$ (J/kg-K)
20	END			Closing Statement
21	KXTAB			Section Header for Table
22		200 400	F	Temperature for $k_x(T)$ (K)
23		0.15 0.16	F	$k_x(T)$ (W/m-K)
24	END			Closing Statement
25	KYTAB			Section Header for Table
26		200 400	F	Temperature for $k_y(T)$ (K)
27		0.31 0.32	F	$k_y(T)$ (W/m-K)
28	END			Closing Statement
29	KZTAB			Section Header for Table
30		200 400	F	T for $k_z(T)$ (K)
31		0.33 0.36	F	$k_z(T)$ (W/m-K)
32	END			Closing Statement

† I = Integer F = Float S = String

Table 17. Tree Material Property File (Continued)

LINE#	REQUIRED DESCRIPTIVE STRING(s)	EXAMPLE VALUE(s)	TYPE [†]	COMMENTS
33	EMISTAB			Section Header for Table
34		200 400	F	Temperature for $\epsilon(T)$ (K)
35		0.9 0.9	F	$\epsilon(T)$
36	END			Closing Statement
37	ABSTAB			Section Header for Table
38		200 400	F	Temperature for $\alpha(T)$ (K)
39		0.55 0.60	F	$\alpha(T)$
40	END			Closing Statement

[†] I = Integer F = Float S = String

Notes Concerning Tree Material Property File

- Maximum temperature dependent table length is 10 items
- The temperature dependent conductivities, $k_x(T)$, $k_y(T)$, $k_z(T)$ in the tree model correspond to radial, circumferential, and longitudinal directions
- $\epsilon(T)$ Temperature dependent emissivity
- $\alpha(T)$ Temperature dependent solar absorptivity
- T Temperature

```
CONSTANTPROPS 1
HOMOGENEOUS 0
RHO 900.0
CP 2900.0
XK 0.15
YK 0.3
ZK 0.3
EMIS 0.80
ABS 0.55
IRABS 1.00

NCP 2
NKX 2
NKY 2
NKZ 2
NEMIS 2
NABS 2

CPTAB
100 200
2900 2900
END

KXTAB
100 200
0.15 0.15
END

KYTAB
100 300
0.30 0.30
END

KZTAB
100 400
0.30 0.30
END

EMISTAB
100 200
1.0 1.0
END

ABSTAB
100 200
1.0 1.0
END
```

Figure 12. Example of a Tree Material Property File

4 OUTPUT FORMAT

TREETHERM is rich in output possibilities. As implied by the output choices made in the Input Section 6, for the Single Tree Element Option, and Input Section 7, for the Multiple Tree Element Option, the user can study the temperature history of any or all computational elements. Due to the voluminous amounts of output possible, especially for the Multiple Tree Segment Option, the user is urged to carefully consider what types of output to request.

Two primary types of output are available. The first is the detailed temperature history of the selected tree elements at all time steps. The second is the temperature history at only the time intervals in the meteorological data file. The former is useful for studying the detailed thermal response of the woody material of the tree to changes in the energy balance while the latter is useful for general simulation studies.

Figure 13 is an example of the detailed temperature history output for a calculation element. This first column is the model time in seconds. The model time is initialized to the first time in the meteorological data file, expressed in seconds. All subsequent timesteps are incremented by the calculation time step. It is noted that the calculation timestep is not constant.¹ The second is the air temperature, echoed from the meteorological data file. The third is a representative leaf temperature if leaf properties are input. If leaves are not included, which is the case for the Single Tree Option or if the string NONE is included in line 14 of the Multiple Tree Option Input Section 1, then column 3 contains the temperature of the first tree element selected for temperature history output. The rest of the columns are the temperatures for the elements selected in the output control section of the input. (Tables 6 or 13, Line 3.) This type of output is available when a detailed temperature history is required for the selected calculation elements.

79205.000	13.00	13.00	13.00	13.00	13.00	13.00	13.00	13.00	13.00
79210.500	13.00	13.00	13.00	13.00	13.00	13.00	13.00	13.00	13.00
79216.547	13.00	13.00	13.00	13.00	13.00	13.00	13.00	13.00	13.00
79223.203	12.99	12.99	12.99	12.99	13.00	13.00	13.00	13.00	13.00
79230.523	12.99	12.99	12.99	12.99	13.00	13.00	13.00	13.00	13.00
79238.578	12.99	12.99	12.99	12.99	13.00	13.00	13.00	13.00	13.00
79247.438	12.99	12.99	12.99	12.99	13.00	13.00	13.00	13.00	13.00
79257.180	12.98	12.98	12.98	12.98	13.00	13.00	13.00	13.00	13.00
79267.898	12.98	12.98	12.98	12.98	13.00	13.00	13.00	13.00	13.00
79279.688	12.98	12.98	12.98	12.98	13.00	13.00	13.00	13.00	13.00
79292.656	12.97	12.97	12.97	12.97	13.00	13.00	13.00	13.00	13.00
79306.922	12.97	12.97	12.97	12.97	13.00	13.00	13.00	13.00	13.00
79322.617	12.96	12.96	12.96	12.96	13.00	13.00	13.00	13.00	13.00
79339.875	12.96	12.96	12.96	12.96	13.00	13.00	13.00	13.00	13.00
79358.859	12.95	12.95	12.95	12.95	13.00	13.00	13.00	13.00	13.00

Figure 13. Example of the Temperature History Output Produced by TREETHERM

Figure 14 is a reduced example of the output available at the meteorological time data intervals. The time and the current meteorological parameters are printed out. Although not shown in Figure 14 a representative leaf temperature is available at the meteorological data intervals if leaf properties are input. Then, calculation element temperatures for the selected tree elements are printed out. The format for an individual calculation element is:

$$EL \quad x_g \quad y_g \quad z_g \quad x_\ell \quad y_\ell \quad z_\ell \quad T$$

where

EL: Calculation element number

x_g, y_g, z_g: Model global coordinates (m) where calculation takes place

x_ℓ, y_ℓ, z_ℓ: For tree element local coordinates (m) where calculation takes place

T: Temperature (°C or K)

The output shown in Figure 14 represents the model state at a snapshot in time. This output is available when the spatial variations in the temperature predictions are required.

```

.....
START OUTPUT
YEAR = 89 DAY= 262  HOUR= 6  MINUTE = 0
Pressure= 969.0 mb  Air Temperature= 8.3 Deg C  RH= 92.0
Wind Speed = 0.0 m/s  Wind Direction= 135.2 Deg
Solar= 13.4 w/m^2 Direct= 6.6 w/m^2 Diffuse= 6.8 w/m^2 IR= 265.0 w/m^2
Cloud Layer-> 0 Type 0 Cover 0.00
Cloud Layer-> 1 Type 0 Cover 0.00
Cloud Layer-> 2 Type 0 Cover 0.00

Tree Element 1. Surface Calculation Elements->
181 3.138e-01 2.745e-02 5.000e-01 3.138e-01 2.745e-02 0.000e+00 8.279
182 3.043e-01 8.153e-02 5.000e-01 3.043e-01 8.153e-02 0.000e+00 8.279
183 2.855e-01 1.331e-01 5.000e-01 2.855e-01 1.331e-01 0.000e+00 8.279
184 2.580e-01 1.807e-01 5.000e-01 2.580e-01 1.807e-01 0.000e+00 8.279
185 2.227e-01 2.227e-01 5.000e-01 2.227e-01 2.227e-01 0.000e+00 8.279
186 1.807e-01 2.580e-01 5.000e-01 1.807e-01 2.580e-01 0.000e+00 8.279
187 1.331e-01 2.855e-01 5.000e-01 1.331e-01 2.855e-01 0.000e+00 8.279
188 8.153e-02 3.043e-01 5.000e-01 8.153e-02 3.043e-01 0.000e+00 8.279
189 2.745e-02 3.138e-01 5.000e-01 2.745e-02 3.138e-01 0.000e+00 8.279
190 -2.745e-02 3.138e-01 5.000e-01 -2.745e-02 3.138e-01 0.000e+00 8.279
191 -8.153e-02 3.043e-01 5.000e-01 -8.153e-02 3.043e-01 0.000e+00 8.279
.
.
.
214 2.855e-01 -1.331e-01 5.000e-01 2.855e-01 -1.331e-01 0.000e+00 8.279
215 3.043e-01 -8.153e-02 5.000e-01 3.043e-01 -8.153e-02 0.000e+00 8.279
216 3.138e-01 -2.745e-02 5.000e-01 3.138e-01 -2.745e-02 0.000e+00 8.279
Tree Element 1. Calculation Elements->
1 2.490e-02 2.179e-03 5.000e-01 2.490e-02 2.179e-03 0.000e+00 13.000
2 2.415e-02 6.470e-03 5.000e-01 2.415e-02 6.470e-03 0.000e+00 13.000
3 2.266e-02 1.057e-02 5.000e-01 2.266e-02 1.057e-02 0.000e+00 13.000
4 2.048e-02 1.434e-02 5.000e-01 2.048e-02 1.434e-02 0.000e+00 13.000
5 1.768e-02 1.768e-02 5.000e-01 1.768e-02 1.768e-02 0.000e+00 13.000
6 1.434e-02 2.048e-02 5.000e-01 1.434e-02 2.048e-02 0.000e+00 13.000
7 1.057e-02 2.266e-02 5.000e-01 1.057e-02 2.266e-02 0.000e+00 13.000
.
.
.
213 2.580e-01 -1.807e-01 5.000e-01 2.580e-01 -1.807e-01 0.000e+00 8.279
214 2.855e-01 -1.331e-01 5.000e-01 2.855e-01 -1.331e-01 0.000e+00 8.279
215 3.043e-01 -8.153e-02 5.000e-01 3.043e-01 -8.153e-02 0.000e+00 8.279
216 3.138e-01 -2.745e-02 5.000e-01 3.138e-01 -2.745e-02 0.000e+00 8.279
END OUTPUT for YEAR = 89 DAY= 262. HOUR= 6 MINUTE = 0
.....

```

Figure 14. Example Output at Meteorological Data Intervals. Single tree segment option of 6 rings of 36 segments

5 TREETHERM MODEL EXAMPLES

Some of the tree model options will be demonstrated by example cases. The meteorological data to be used is from a data set associated with Fort Hunter-Liggett, California, the site of the second year SWOE demonstration. (See Figure 11 for a list of the data.) Three examples will be discussed. The first is a Single Segment Option calculation, the second a Multiple Segment Option without leaves considered, and the third a Multiple Segment Option with leaves. (These examples and their required data files are included with the source code.)

5.1 Example 1: Single Segment Option

The tree model input file for this case is shown in Figure 15. The example is 1 meter long in the model global Z-direction. The actual length is arbitrary as long as it is a finite value. Only the orientation is important for the single segment option.

The boundary conditions modeled included incoming solar and infrared radiation and surface convection considered. The solar and infrared fluxes were calculated internally using the Preliminary Atmospheric Radiation Package³ as a result of the string ESTIMATE being included. (The solar and infrared data in the meteorological input file are ignored in this example.) The shading option is not available for the single tree segment option. As there are no leaves present, no leaf properties are required.

The single segment is divided into 6 rings of 36 circular segments. The outer ring radii in ascending order are: 0.02, 0.04, 0.06, 0.08, 0.10, and 0.12 meters, respectively. The input temperatures chosen are in degrees Celsius to match the meteorological data and the model initialization temperatures. Only one material property is used and the values used are given in Figure 16. Note that temperature dependent properties are not used (or read) since CONSTANTPROPS equals 1. The model will use different conductivities for the radial and circumferential directions since HOMOGENEOUS is set to 0.

The model is initialized to the air temperature at the beginning of the calculation. In the absence of tree temperature data, any calculation should be "thermally loaded" before the output times of specific interest. How long is dependent on many parameters including element resolution, relative changes in the meteorological data and material properties. The model should cycle through one full day's environmental conditions. This is a guideline only and each model's requirements are different.

Temperature histories were output for surface elements near the cardinal compass points. These are plotted in Figure 17.

The changing solar position and intensity is evident in the temperatures for the east and south locations. The temperatures from the southern element rise and then

```

MODEL TYPE TREE
NUMBER NODES                2
NUMBER TREE ELEMENTS        1
METEOROLOGICAL DATA FILE   hunt.met
SURFACE BOUNDARY CONDITIONS SOLAR  IR  CONVECTION  NONE
IR                            ESTIMATE
SOLAR                         ESTIMATE
NUMBER TREE PROPERTY FILES   1
TIME ZONE                     8
LATITUDE                     36 DEG   0 MIN   0.0 SEC
LONGITUDE                    121 DEG  19 MIN   0.0 SEC
INPUT TEMPERATURES           CELSIUS
OUTPUT TEMPERATURES          CELSIUS
LEAF PROPERTY FILE           NONE
END

PROPERTY FILES
  htree.prop
END

TREE SINGLE SEGMENT
NUMBER RINGS                 20
NUMBER SEGMENTS              36
OUTER RING RADII             .015 .030 .045 .060 .075 .090 .105 .120 .135 .150
                              .165 .180 .195 .210 .225 .240 .255 .270 .285 .300
RING MATERIAL NUMBER 1 1 1 1 1 1 1 1 1 1 1 1 1 1 1 1 1 1 1 1 1 1
END

TREE NODAL COORDINATES
  ROTATE Z 0.0 DEG
  1 : 0.0  0.0  0.0
  2 : 0.0  0.0  1.0
END

VERTICAL TEMPERATURE PROFILE
  NENTRY 2
  HEIGHT      0.0 50.0
  TEMPERATURE 13.0 13.0
END

TREE OUTPUT CONTROL
  NUMBER TEMPERATURE HISTORY 4
    TEMPERATURE HISTORY ELEMENTS 685 694 703 712
  NUMBER TREE SURFACE ELEMENTS 1
    TREE ELEMENTS 1
  NUMBER TREE ELEMENTS 1
    TREE ELEMENTS 1

```

Figure 15. Model Input File for Example 1, a Single Tree Segment Calculation

```

CONSTANTPROPS  1
HOMOGENEOUS    0
RHO            900.0
CP            2900.0
XK            0.15
YK            0.3
ZK            0.3
EMIS          0.80
ABS           0.55
IRABS        1.00

NCP           2
NKX           2
NKY           2
NKZ           2
NEMIS        2
NABS         2

CPTAB
100 200
2900 2900
END

KXTAB
100 200
0.15 0.15
END

KYTAB
100 300
0.30 0.30
END

KZTAB
100 400
0.30 0.30
END

EMISTAB
100 200
1.0 1.0
END

ABSTAB
100 200
1.0 1.0
END

```

Figure 16. Tree Material Properties for Example 1, a Single Tree Segment Calculation

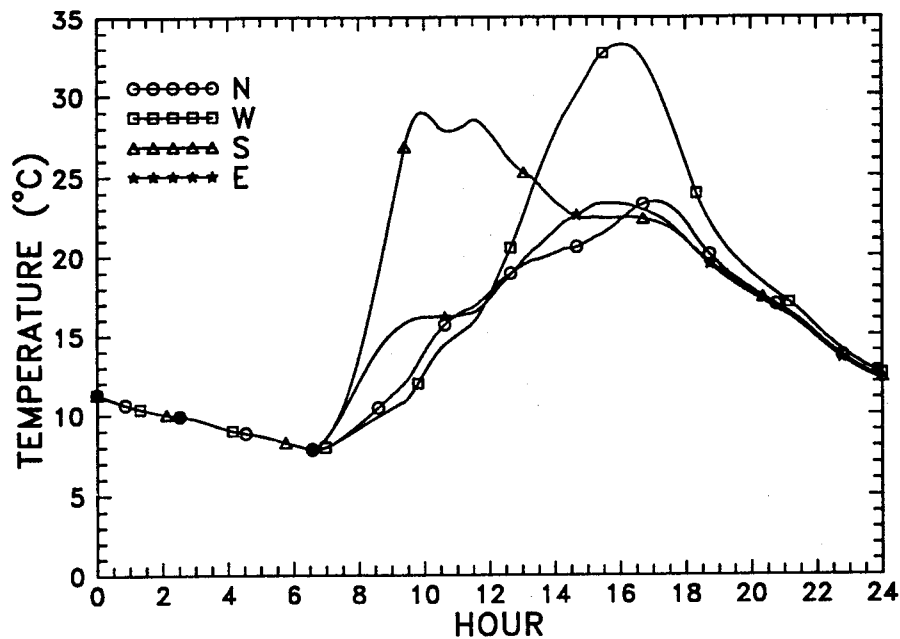

Figure 17. Surface Temperature History at Cardinal Points from Example 1 Using the Single Segment Option

fall off as a function of time as a result of the changes in solar position. The drop in the temperature of the southern surface element in the mid-morning is due to an abrupt increase in the wind speed at 1100 hours (see Figure 11).

5.2 Example 2: Multiple Segment Option With No Leaves

This example is for a tree with six parts, four main trunk elements and two branch elements. Each tree component contain three rings. The tree model input file for this example is shown in Figure 18. The boundary conditions modeled are incident solar and infrared radiation, surface convection, and shading due to branches only. No leaves were included (accomplished by giving the leaf property file name the case sensitive string NONE.) The material properties used are the same as for Example 1.

Figure 19 shows a comparison of the temperatures for three surface calculation elements. Elements # 9 and # 45 are in the same relative position, northwest, and in similar sized tree segments. Element # 45 is located 0.275 m above element # 9. Element # 10 is located in the same plane (and tree segment) as element # 9 but its relative position is in the southwest.

Figure 19 shows the temperature histories of the elements with and without the self shading option. (The input for the no shade option is shown in Figure 20.) Note that for no shading, the curves are the same for elements # 9 and # 45 since the model geometric representation is the same. Element 10 reaches a higher temperature than element # 9 or # 45 for both the no shade and shade since it receives

```

MODEL TYPE TREE
NUMBER NODES          7
NUMBER TREE ELEMENTS  6
METEOROLOGICAL DATA FILE  hunt262
SURFACE BOUNDARY CONDITIONS  SOLAR SHADING IR CONVECTION
IR                    ESTIMATE
SOLAR                 ESTIMATE
NUMBER TREE PROPERTY FILES  1
TIME ZONE             8
LATITUDE              36 DEG   0 MIN   0.0 SEC
LONGITUDE             121 DEG  19 MIN   0.0 SEC
INPUT TEMPERATURES   CELSIUS
OUTPUT TEMPERATURES  CELSIUS
LEAF PROPERTY FILE    NONE
END

PROPERTY FILES
hltree.prop
END

TREE NODAL COORDINATES
ROTATE Z 0.0 DEG
  1 : 0.0  0.0  0.0
  2 : 0.0  0.0  0.125
  3 : 0.0  0.0  0.20
  4 : -0.20 -0.20  0.20
  5 : -0.20  0.20  0.20
  6 : 0.0  0.0  0.275
  7 : 0.0  0.0  0.40
END

TREE ELEMENT CONFIGURATION
  1 TRUNK M  1  2
  2 TRUNK M  2  3
  3 TRUNK M  3  6
  4 TRUNK M  6  7
  5 TRUNK B  3  5
  6 TRUNK B  3  4
END

TREE ELEMENT DESIGNATION
  1 : 0.05 0.10 0.15 .0 : 1 1 1
  2 : 0.05 0.10 0.15 .0 : 1 1 1
  3 : 0.05 0.10 0.15 .0 : 1 1 1
  6 : 0.05 0.10 0.15 .0 : 1 1 1
  5 : 0.05 0.10 0.15 .0 : 1 1 1
  4 : 0.05 0.10 0.15 .0 : 1 1 1
END

VERTICAL TEMPERATURE PROFILE
NENTRY 2
HEIGHT      0.0 50.0
TEMPERATURE 13.0 13.0
END

TREE OUTPUT CONTROL
NUMBER TEMPERATURE HISTORY  8
TEMPERATURE HISTORY ELEMENTS  9 10 11 12 45 46 47 48
NUMBER TREE SURFACE ELEMENTS  4
  TREE ELEMENTS      1 2 3 4
NUMBER TREE ELEMENTS      0
  TREE ELEMENTS
END

```

Figure 18. Model Input File for Multiple Segment Option, Example 2

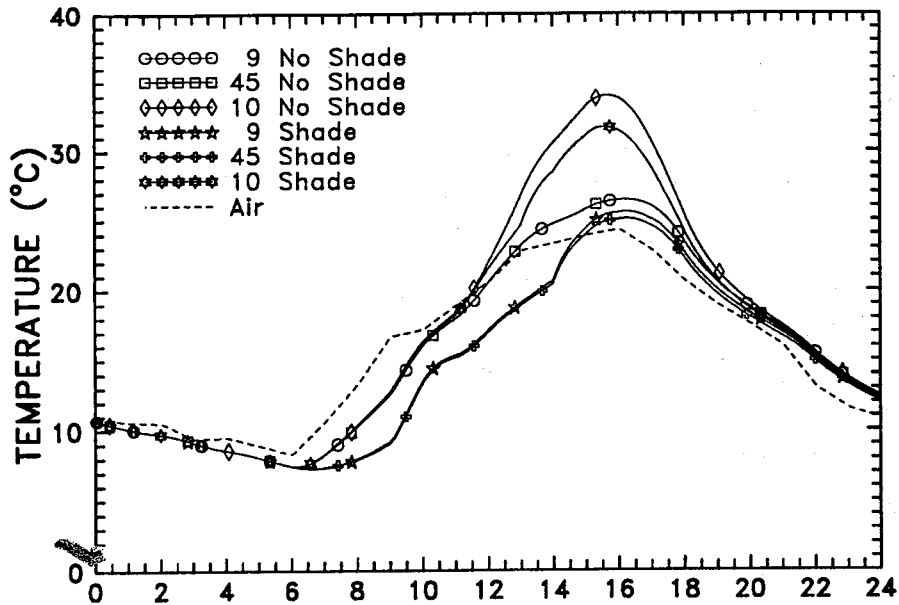

Figure 19. Comparison of Temperature Histories at Three Locations to Demonstrate Shading Effects for the Multiple Segment Option, Example 2

more solar energy. Element # 9 and element # 45 have similar temperatures for the shading case since the shading branches (at vertical height $Z=0.2$ m) do not effectively shade those locations when the solar intensity peaks for element # 9 and # 45. The effect of shading, though, is evident in the comparison of element # 10's temperature history for the shading and the no shade case. One of the shading branches is oriented towards the southwest and its effect on the prediction of element # 10's temperature for the shading case can be seen starting about 1200 hours.

5.3 Example 3: Multiple Tree Segments With Leaves

This example uses the same meteorological data file in examples 1 and 2. The leaf properties used are those shown in Figure 10. Two multiple tree segment models were run to demonstrate the effects of shading by leaf clusters on the temperature history of a tree element. Figures 21 and 22 show the input files for the no shading case and the self shading case with leaves included.

Figure 23 shows a comparison of the temperature history of a tree element with and without self-shading considered. Also, shown on the Figure are the calculated leaf temperatures and the air temperature. The geometries used were to demonstrate the impact of the self-shading by leaf clusters. For this example, the self-shading by leaf clusters resulted in a maximum difference of about 5°C in the temperature of the surface elements.

```

MODEL TYPE TREE
NUMBER NODES          7
NUMBER TREE ELEMENTS  6
METEOROLOGICAL DATA FILE hunt262
SURFACE BOUNDARY CONDITIONS SOLAR SHADING IR CONVECTION
IR ESTIMATE
SOLAR ESTIMATE
NUMBER TREE PROPERTY FILES 1
TIME ZONE             8
LATITUDE              36 DEG  0 MIN  0.0 SEC
LONGITUDE             121 DEG 19 MIN  0.0 SEC
INPUT TEMPERATURES   CELSIUS
OUTPUT TEMPERATURES CELSIUS
LEAF PROPERTY FILE   NONE
END

PROPERTY FILES
  hltree.prop
END

TREE NODAL COORDINATES
  ROTATE Z 0.0 DEG
    1 : 0.0  0.0  0.0
    2 : 0.0  0.0  0.125
    3 : 0.0  0.0  0.20
    4 : -0.20 -0.20  0.20
    5 : -0.20  0.20  0.20
    6 : 0.0  0.0  0.275
    7 : 0.0  0.0  0.40
  END

TREE ELEMENT CONFIGURATION
  1 TRUNK M  1 2
  2 TRUNK M  2 3
  3 TRUNK M  3 6
  4 TRUNK M  6 7
  5 TRUNK B  3 5
  6 TRUNK B  3 4
  END

TREE ELEMENT DESIGNATION
  1 : 0.05 0.10 0.15 .0 : 1 1 1
  2 : 0.05 0.10 0.15 .0 : 1 1 1
  3 : 0.05 0.10 0.15 .0 : 1 1 1
  6 : 0.05 0.10 0.15 .0 : 1 1 1
  5 : 0.05 0.10 0.15 .0 : 1 1 1
  4 : 0.05 0.10 0.15 .0 : 1 1 1
  END

VERTICAL TEMPERATURE PROFILE
  NENTRY 2
  HEIGHT      0.0 50.0
  TEMPERATURE 13.0 13.0
  END

TREE OUTPUT CONTROL
  NUMBER TEMPERATURE HISTORY 8
  TEMPERATURE HISTORY ELEMENTS 9 10 11 12 45 46 47 48
  NUMBER TREE SURFACE ELEMENTS 4
    TREE ELEMENTS      1 2 3 4
  NUMBER TREE ELEMENTS 0
    TREE ELEMENTS
  END

```

Figure 20. Input File for Example 2 for a Multiple Tree Segment Calculation With Shading Not Considered

```

MODEL TYPE TREE
NUMBER NODES                3
NUMBER TREE ELEMENTS        2
METEOROLOGICAL DATA FILE    hunt262
SURFACE BOUNDARY CONDITIONS  SOLAR NONE IR CONVECTION
IR                            ESTIMATE
SOLAR                         ESTIMATE
NUMBER TREE PROPERTY FILES    1
TIME ZONE                     8
LATITUDE                      36 DEG   0 MIN   0.0 SEC
LONGITUDE                    121 DEG  19 MIN   0.0 SEC
INPUT TEMPERATURES           CELSIUS
OUTPUT TEMPERATURES          CELSIUS
LEAF PROPERTY FILE           leaf.example
END

PROPERTY FILES
hltree.prop
END

TREE NODAL COORDINATES
ROTATE Z 0.0 DEG
  1 : 0.0  0.0  0.0
  2 : 0.0  0.0  2.00
  3 : -2.00 0.0  4.00
END

TREE ELEMENT CONFIGURATION
  1 TRUNK M  1 2
  2 TRUNK M  2 3
END

TREE ELEMENT DESIGNATION
  1 : 0.05 0.10 0.15 .0 : 1 1 1
  2 : 0.05 0.10 0.15 .20 : 1 1 1
END

VERTICAL TEMPERATURE PROFILE
NENTRY 2
HEIGHT      0.0 50.0
TEMPERATURE 13.0 13.0
END

TREE OUTPUT CONTROL
NUMBER TEMPERATURE HISTORY 8
TEMPERATURE HISTORY ELEMENTS 9 10 11 12 21 22 23 24
NUMBER TREE SURFACE ELEMENTS 1
TREE ELEMENTS                2
NUMBER TREE ELEMENTS          1
TREE ELEMENTS                 2

```

Figure 21. Input File for Example 3 With Self Shading Not Considered

```

MODEL TYPE TREE
NUMBER NODES          3
NUMBER TREE ELEMENTS  2
METEOROLOGICAL DATA FILE hunt262
SURFACE BOUNDARY CONDITIONS SOLAR SHADING IR CONVECTION
IR                    ESTIMATE
SOLAR                 ESTIMATE
NUMBER TREE PROPERTY FILES 1
TIME ZONE             8
LATITUDE              36 DEG  0 MIN  0.0 SEC
LONGITUDE             121 DEG 19 MIN  0.0 SEC
INPUT TEMPERATURES   CELSIUS
OUTPUT TEMPERATURES CELSIUS
LEAF PROPERTY FILE   leaf.example

END

PROPERTY FILES
hltree.prop
END

TREE NODAL COORDINATES
ROTATE Z 0.0 DEG
1 : 0.0 0.0 0.0
2 : 0.0 0.0 2.00
3 : -2.00 0.0 4.00
END

TREE ELEMENT CONFIGURATION
1 TRUNK M 1 2
2 TRUNK M 2 3
END

TREE ELEMENT DESIGNATION
1 : 0.05 0.10 0.15 .0 : 1 1 1
2 : 0.05 0.10 0.15 .20 : 1 1 1
END

VERTICAL TEMPERATURE PROFILE
NENTRY 2
HEIGHT      0.0 50.0
TEMPERATURE 13.0 13.0
END

TREE OUTPUT CONTROL
NUMBER TEMPERATURE HISTORY 8
TEMPERATURE HISTORY ELEMENTS 9 10 11 12 21 22 23 24
NUMBER TREE SURFACE ELEMENTS 1
TREE ELEMENTS                2
NUMBER TREE ELEMENTS          1
TREE ELEMENTS                 2

```

Figure 22. Input File for Example 3 for With Shading Considered, Including Shading by Leaf Clusters

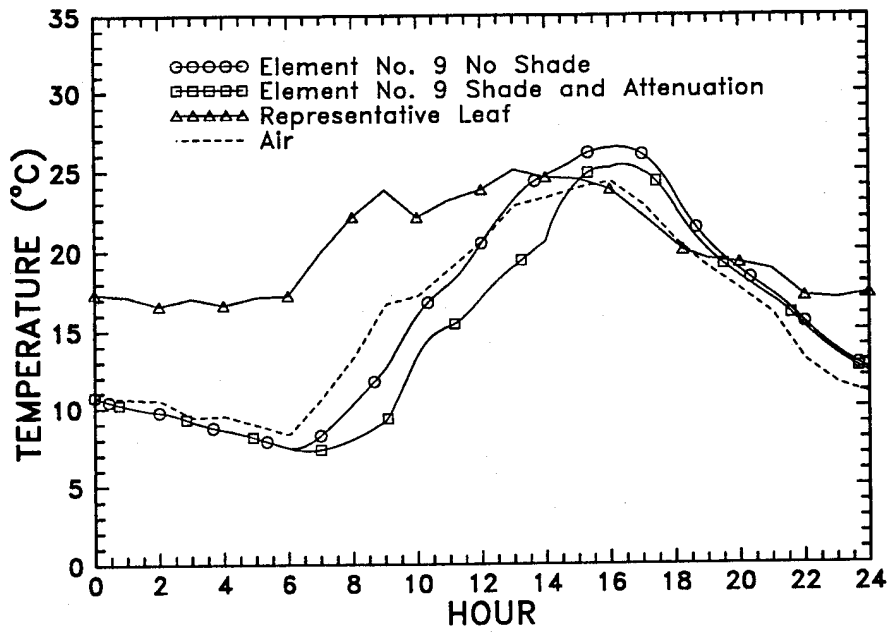

Figure 23. Comparison of Temperature History Results From Example 3 With and Without Self-Shading by Branches and Leaf Clusters Considered

6 MODEL ASSUMPTIONS AND LIMITATIONS

This section examines the impact of various models assumptions on the current version of the tree model. Also, limitations in the model are discussed.

6.1 Branched Connections – Longitudinal Conduction Effects

The initial implementation of the tree model considered provisions for additional element attachments at branch (non-longitudinal directions) connections above the normal allowed amounts (six). This was more of a geometric consideration rather than an appreciation of the conduction effects at connections of long thin cylindrical segments. In the example shown in Figure 24, the branch segment #3 is defined by the nodal points *A* and *B*. The thermal calculations over this segment are done along plane 1-1 and at the radial mid-point of the calculation elements for a tree model. In most cases, the effects at *B* from the longitudinal conduction contributions from end connections at *C* and *A* will not be significant in comparison to the radial and circumferential conduction effects. This assumes length \overline{AB} to be “long” in comparison to its diameter.

From a computational as well as a modeling input viewpoint, any reduction in element attachment requirements is welcomed. To demonstrate the effects of longitudinal conduction on thermal response, a set of representative calculations were made. For these calculations, three segments of cylindrical shape were modeled, as shown in Figure 25. Segments #1 and #3 were subjected to a temporally and spatially varying heat flux corresponding to a typical solar variation and the temperature history of the surface elements in segment #2 studied. No other boundary conditions were applied.

Calculations were performed using two values for the outer diameters of the segments, 0.15 and 0.60 m. Figures 26 to 29 show the temperatures of the surface elements as a function of time for the calculations made with an outer diameter of 0.15 m and Figures 30 to 33 show the results for an outer diameter of 0.6 m. In each case, results are given for segments with three different lengths.

The salient point of these figures is the relative temperature rise which arises due to longitudinal conduction. These show that if the calculation location (Section 1-1, point B in Figure 25) is more than ~ 0.25 to 0.5 m from the connection interface, longitudinal conductivity effects are not that significant. The conclusion drawn from these calculations that longitudinal conduction effects are significantly reduced as the calculation location becomes further from the connection interfaces will be applied to the first branch segment off main elements (for example, a branch to a trunk). Since most branch lengths modeled are significantly greater than the effective longitudinal conduction lengths determined, it is reasonable to assume no net heat exchange occurs at the interface between branch calculation elements and main elements. This will only apply to first branched connection off

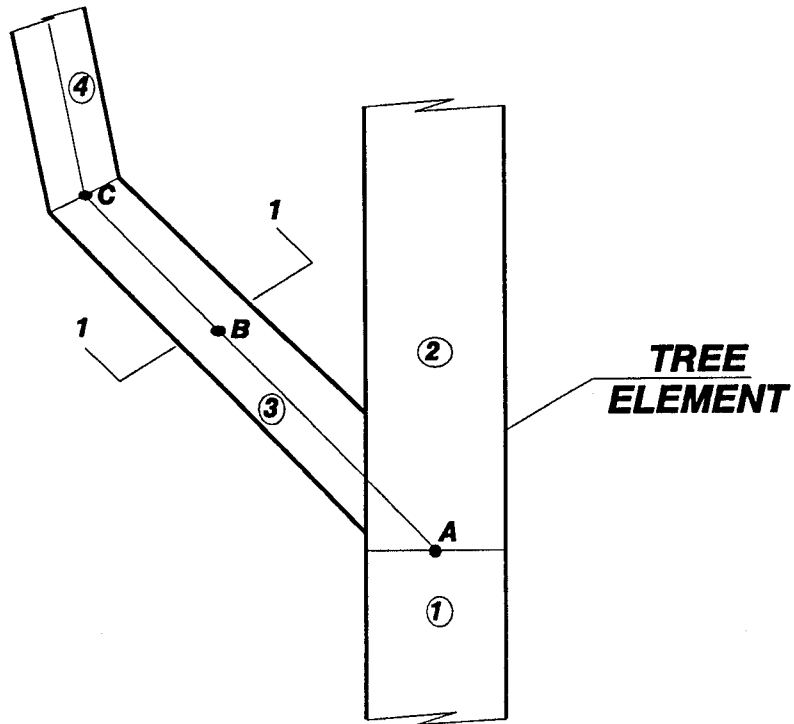

(a.)

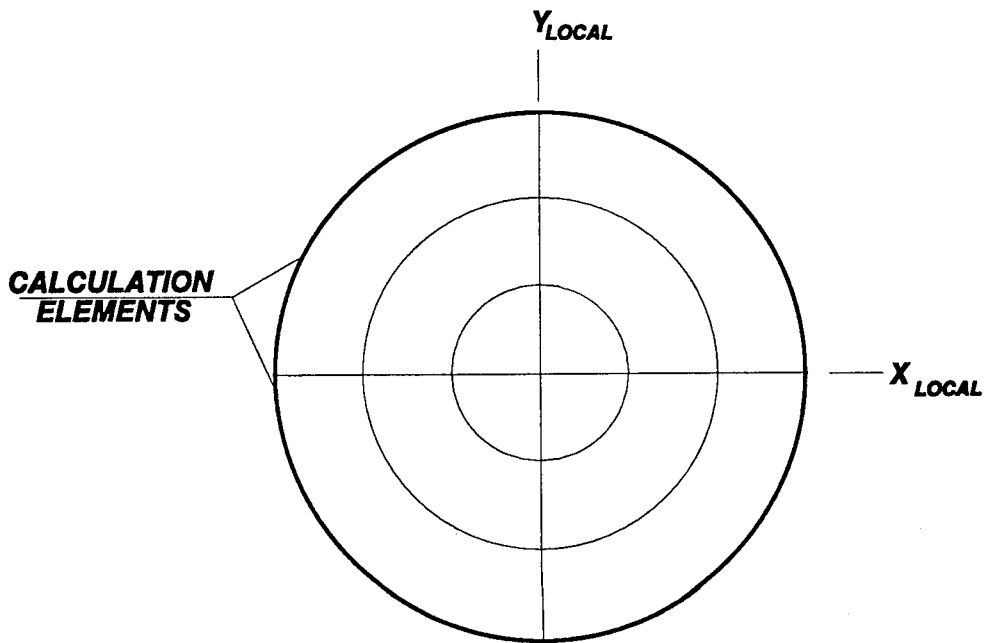

(b.)

Figure 24. (a.) Typical Branch Connection and (b.) Cross Sectional View of Section 1-1

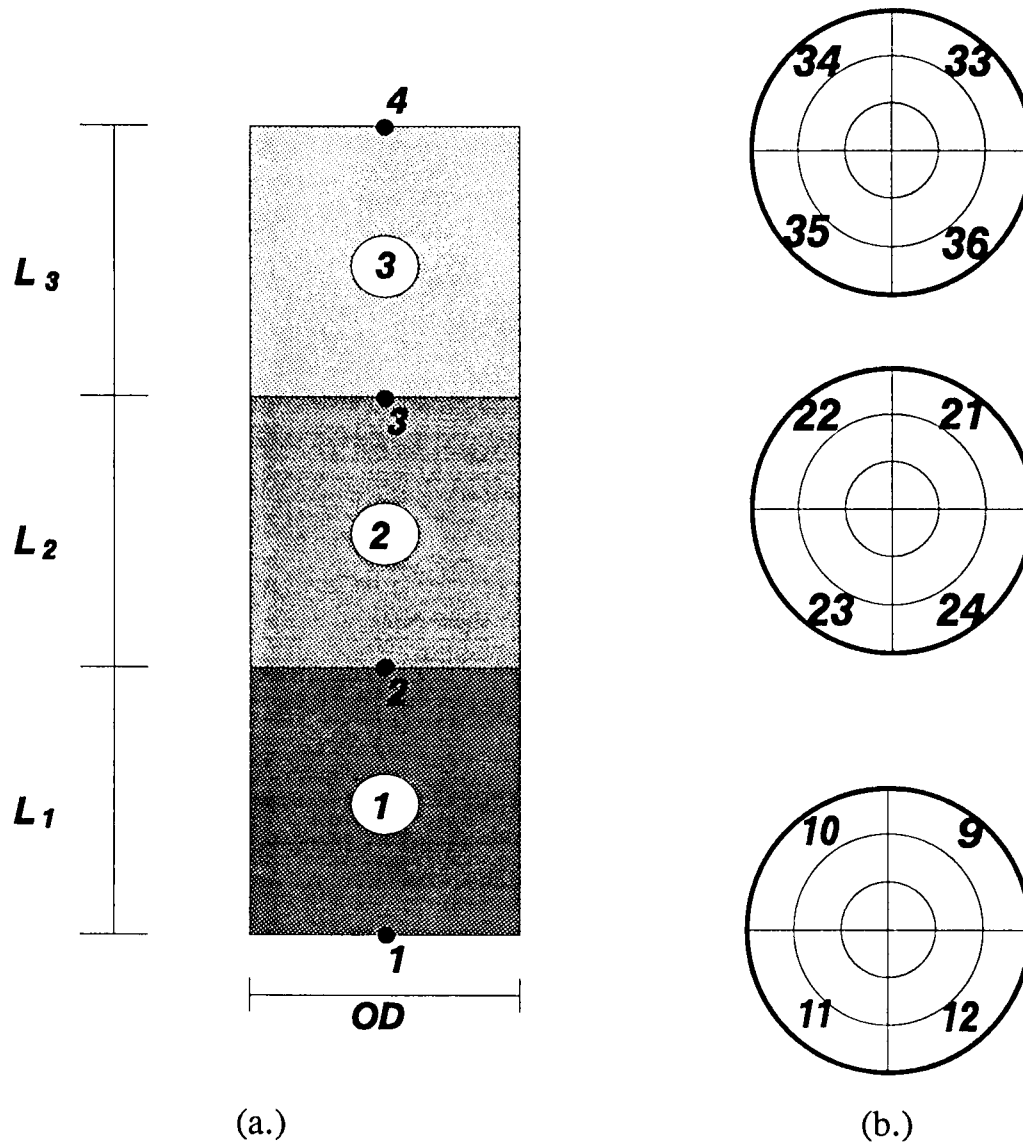

Figure 25. (a.) Three Segment Tree Model and (b.) Location of Surface Elements Used to Study Impact of Longitudinal Conductivity

a main element and not at subsequent normal axial connections. The assumption that no net heat exchange occurs at the interface of the first branch connection off a main element allowed a significant reduction in geometric modeling development and will reduce the computational expense of complex models. Note that if mass transport of moisture is required for a subsequent tree model, geometric connection information will be needed at these interfaces.

There may be combinations of geometries and material properties where the assumption that longitudinal conduction effects at the first branch interface are not significant is no longer valid. In general, the assumption that no net heat exchange due to conduction between a main element and the first branch element off it will

hold for the range of tree geometries and properties expected.

6.2 Ray Casting

The ray casting scheme is used to calculate the area of a tree element illuminated by the direct solar component and modified by any attenuation due to leaf effects. Each ray has an associated grid area as shown in Figure 34. The grid resolution is currently a fixed value. However, if a tree element is smaller than the grid resolution, that associated grid area may be subdivided into sub-grid areas. More rays can then be cast within the normal grid element.

The number of sub-grids is also a fixed value. However, elements below a certain size can be ignored.

As the model becomes more complex and the relative diameters of the elements becomes more diverse, so does the computational burden of the ray casting procedure. There is no best combination of grid resolution, number of sub-grids allowed and which size elements to ignore. Each model will have its own requirements. Smaller elements may be in an area of interest but including them may make the computation effort unfeasible. Not including them will negate their shading effect.

It is possible to model the tree without shading to identify the locations of interest. Then a subset of the full tree could be analyzed with the shading included.

The variables defining grid and subgrid spacing as well as the minimum size (diameter) of tree segments should be input variables, as the grid requirements will change with model configuration. These variables are identified in routine *sol_tree* as *gridres*, *limit* and *TEMP*. They should be changed to suit each tree model's requirements.

The point of this section is to state that the single most computationally intensive procedure in modeling the tree is the shading/attenuation implemented by the ray casting scheme. The user should invoke this option with care on complex models.

6.3 Convection

The surface convective term is derived from a correlation of data on cylinders in a cross-flow. It does not yet account for wind direction or the incidence angle from the wind vector to the cylinder longitudinal axis. Also, the free convective term has not been implemented for this model version.

Some determination of the effects of surface roughness should be made. Most test data for convective coefficient correlation of cylinders is done for a constant wall temperature or uniform heating rate. A tree segment will have non-uniform heating due to the solar intensity and spatial variation leading to varying surface temperatures.

The convective term will vary longitudinally as well as circumferentially due

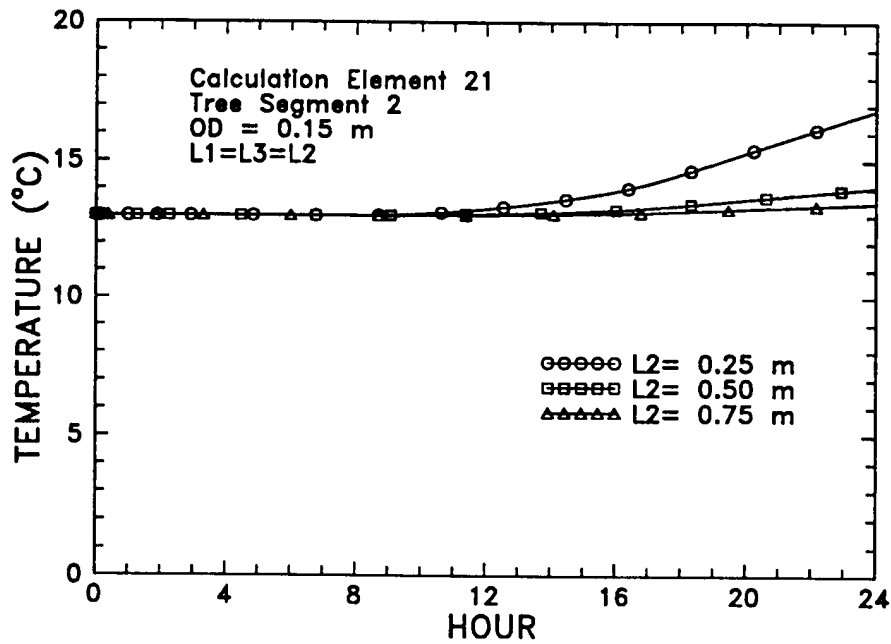

Figure 26. Temperature of Element 21 (OD = 0.15 m) as a Function of Time for Three Different Segment Lengths

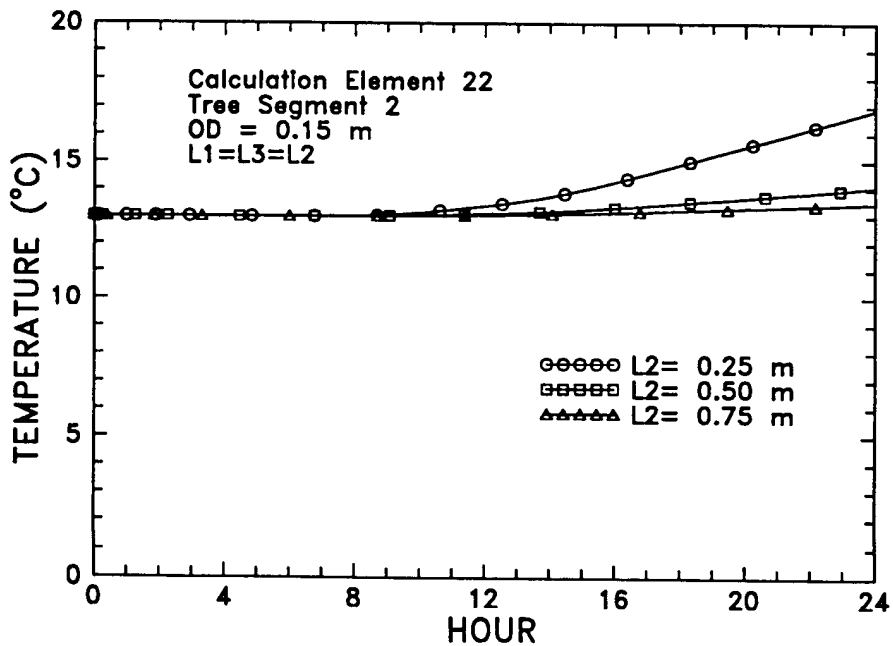

Figure 27. Temperature of Element 22 (OD = 0.15 m) as a Function of Time for Three Different Segment Lengths

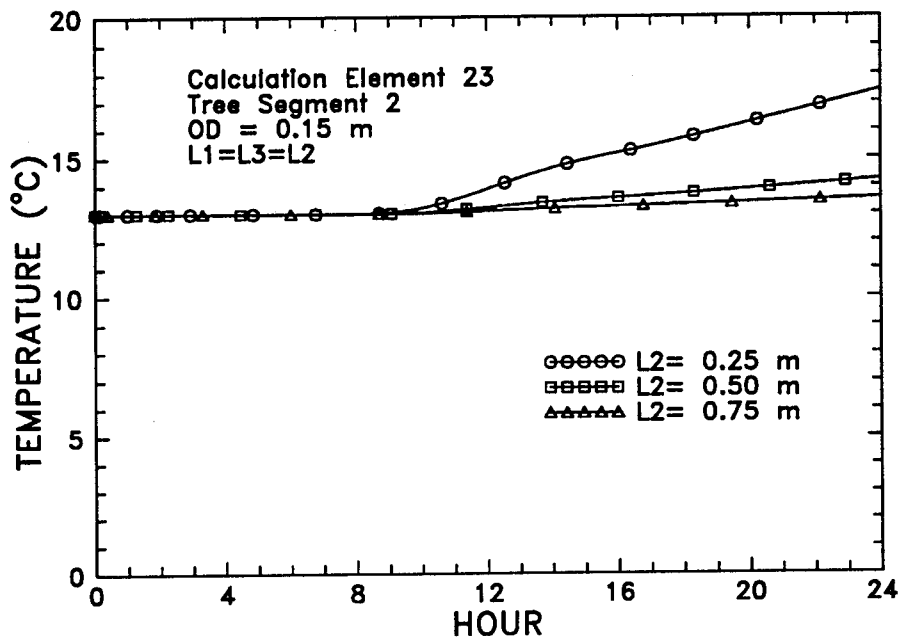

Figure 28. Temperature of Element 23 (OD = 0.15 m) as a Function of Time for Three Different Segment Lengths

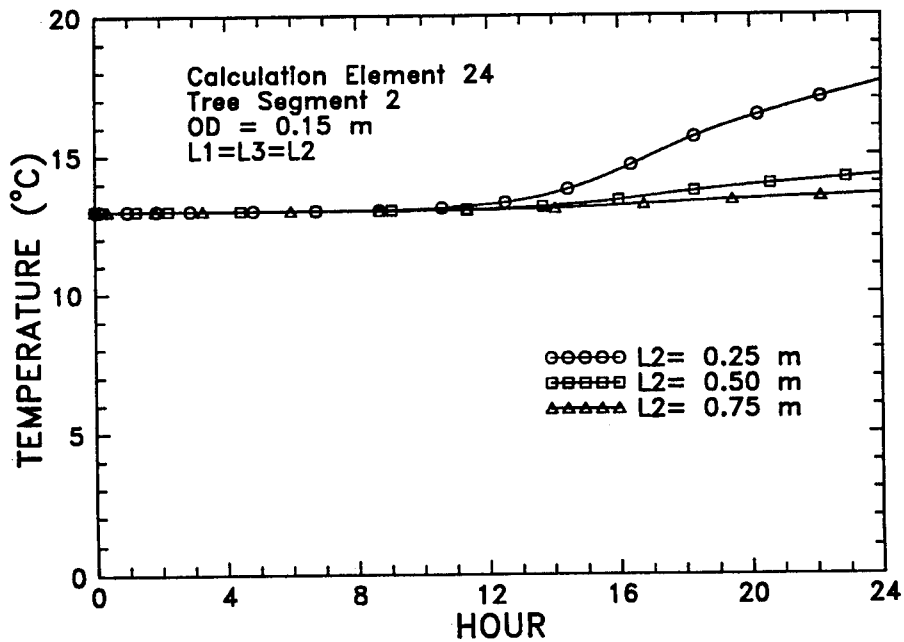

Figure 29. Temperature of Element 24 (OD = 0.15 m) as a Function of Time for Three Different Segment Lengths

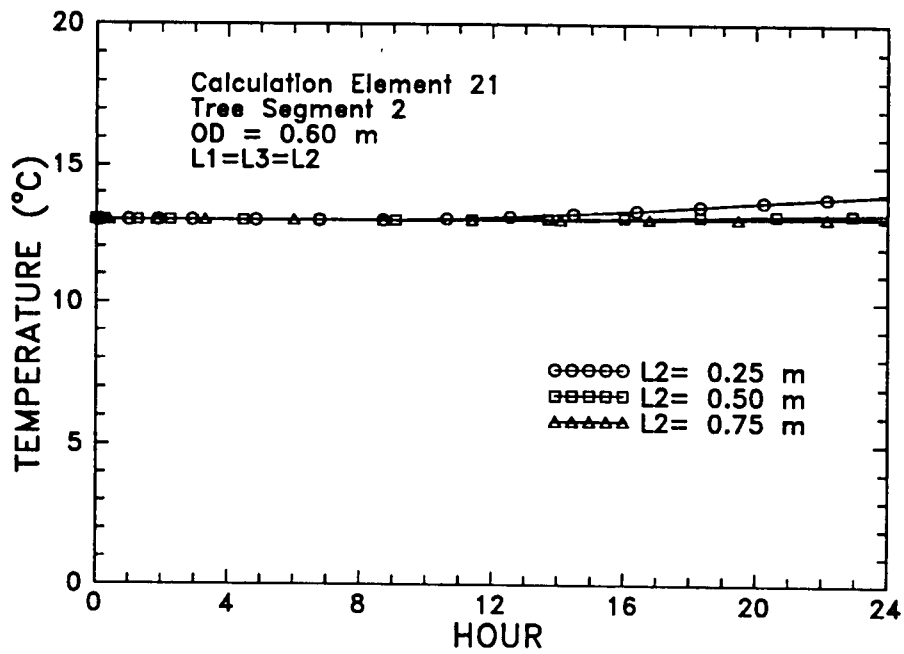

Figure 30. Temperature of Element 21 (OD = 0.6 m) as a Function of Time for Three Different Segment Lengths

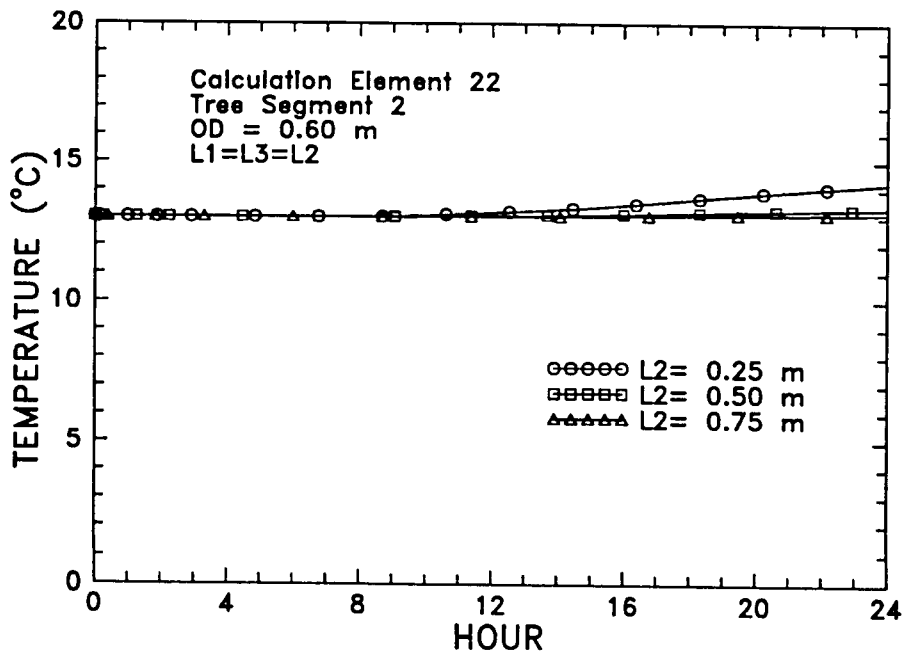

Figure 31. Temperature of Element 22 (OD = 0.6 m) as a Function of Time for Three Different Segment Lengths

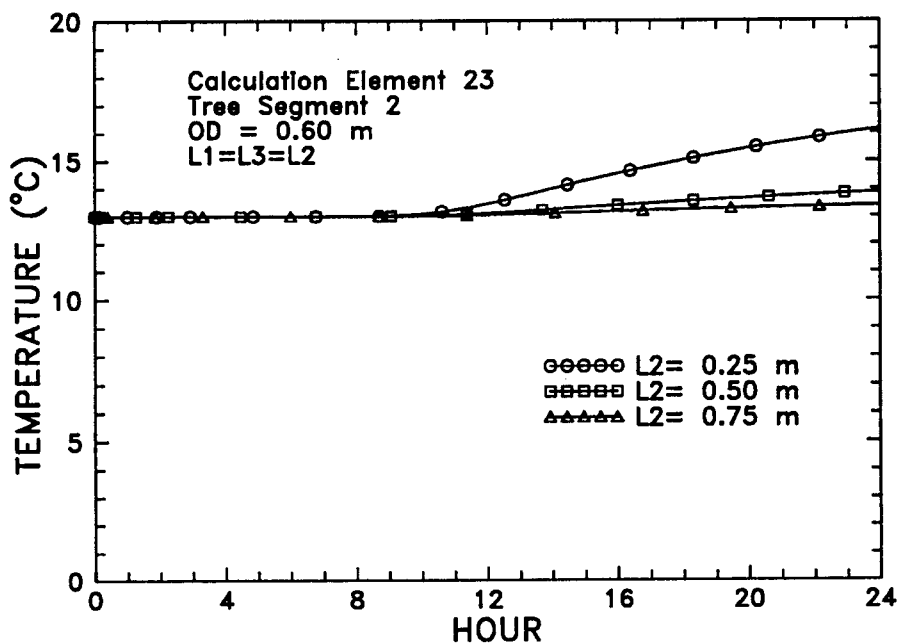

Figure 32. Temperature of Element 23 (OD = 0.6 m) as a Function of Time for Three Different Segment Lengths

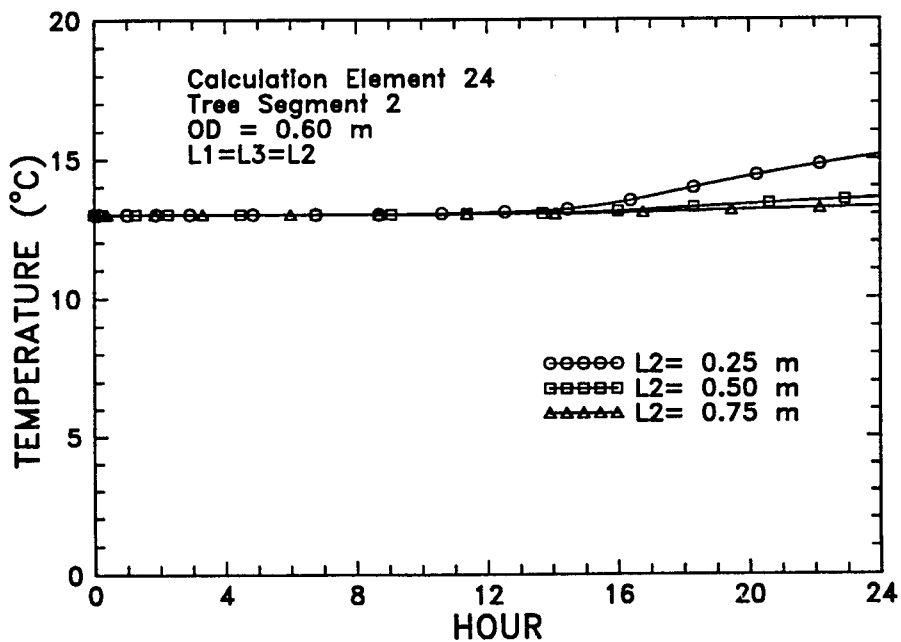

Figure 33. Temperature of Element 24 (OD = 0.6 m) as a Function of Time for Three Different Segment Lengths

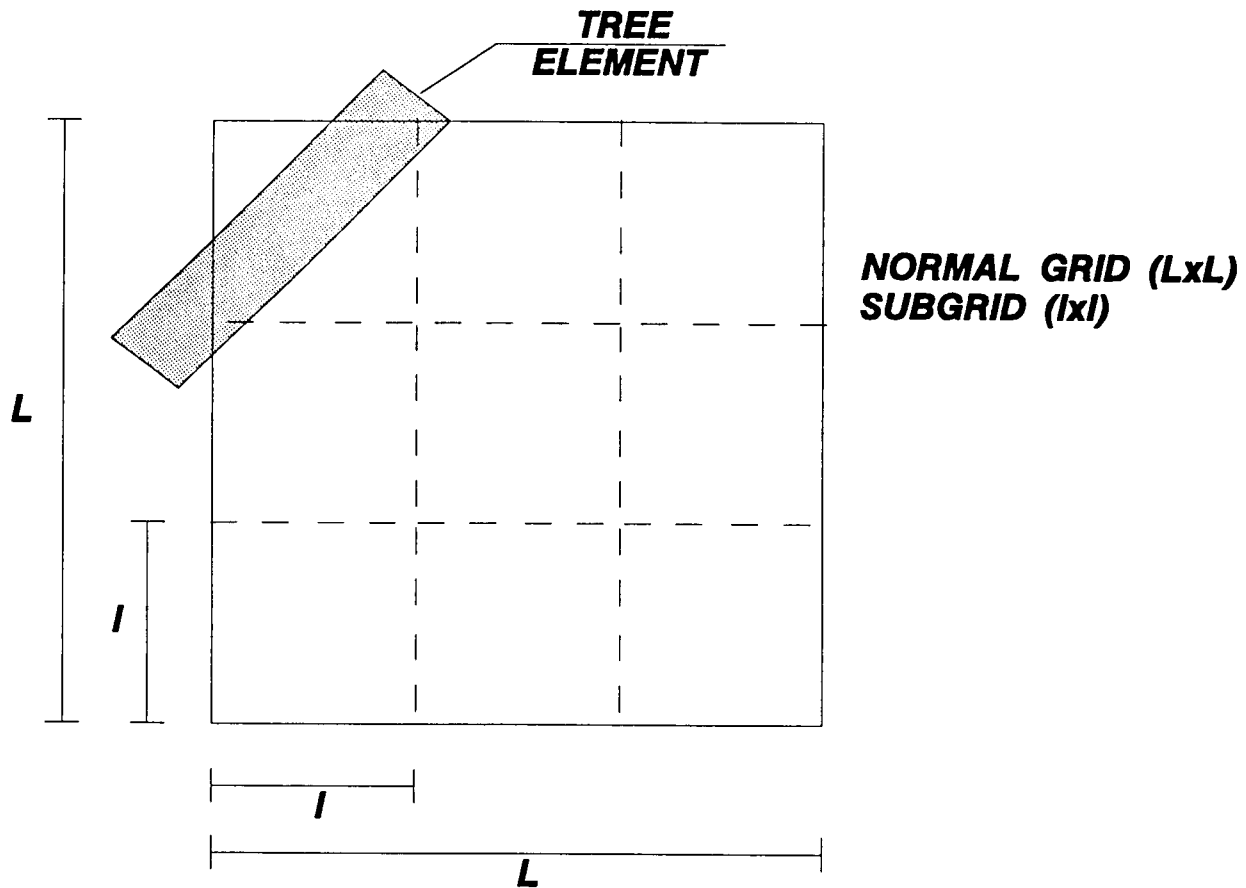

Figure 34. Subdivision of Normal Ray Casting Grid Unit for Element Resolution

to the change in tree cross-sections. The model assumes a constant cross-section for a given tree element.

6.4 Infrared Flux

In the present version of TREETHERM, the downward infrared flux value is assumed to be spherically symmetric. A separate term for the upwelling infrared flux from the underlying ground is not modeled. It is being proposed to incorporate upwelling infrared radiation in the next version of TREETHERM¹ but, seeing that this will require the coupling of TREETHERM to a surface thermal model, such as the SWOETHRM³, and the inclusion of the impact of tree shading on the ground energy budget, this task was beyond the scope of the current effort. However, the neglect of upwelling surface infrared radiation on the tree energy budget is not considered to be a major deficiency in the model.

6.5 Solar Flux

When the shading option is invoked, the ray casting scheme is implemented at the mid-point of the meteorological data time interval. The calculated illuminated area is assumed constant over that interval. Reflections from within or without the tree model are not included in this version.

6.6 Tree Segments Resolution

The multiple segment version of the tree model has the current cross-section resolution of 3 rings of 4 circular segments. The thickness of the rings can vary and each ring may have a different set of material properties. This resolution is not intended as a limit or a guideline, but as a starting point. It was picked as the minimum amount that could show the time and spatial effects of the solar position.

It is intended as the model evolves to allow each tree segment to vary its resolution based on size, material makeup, and expected temperature distribution. This, however, while having more flexibility will require more input preparation.

An option to the tree model is the single tree segment. This option can be used to help determine bounds for cross-sectional model resolution. It currently allows a range of 3 to 20 rings and 4 to 36 circular segments per ring. Each ring can be a different material. Varying the cross-section element layout for this option, along with the range of the material properties expected will point to the resolutions required in the multiple segment model. This will allow higher cross-section resolution in the areas of interest, while keeping the overall model geometry in place.

6.7 Phase Change

Currently, no phase change is considered in the model. Implementing a constant temperature freeze/thaw cycle would only require a modification to the conduction parameters and a tracking of the net energy at the elements undergoing freeze/thaw.

An alternative to this is to put the effects into the temperature dependent specific heat table over a finite temperature range. Some method of insuring that no temperature change skipped over this interval would be necessary. Any evaporative or gaseous diffusion within tree segments (trunk, branch, etc.) would require a mass balance scheme.

6.8 Connections At A Node

There is a current limit of 3 connections at a node. This is an arbitrary limit whose original purpose has been circumvented by the conclusion from the study of longitudinal conduction effects (see Section 6.1). Increasing this limit will require some minor code modification.

6.9 Radiation Interchange

Radiant heat transfer between other objects was not implemented in this version of the tree model. Since the ground infrared and interaction between leaves and branches were not considered, this feature is not yet required. The framework for this item exists in the current code but is not currently invoked. Generating the surface view factors for this implementation will be the most costly in terms of development time.

References

1. Hummel, J.R., Jones, J.R., Longtin, D.R., Paul, N.L., (1991) "Development of a 3-D Tree Thermal Response for Energy Budget and Scene Simulation Studies," Phillips Laboratory, Hanscom AFB, Massachusetts, PL-TR-91-2108, 15 March.
2. Duncan, T. C., Farr, J.L., Wassel, T., and Curtis, R. J., Satellite Laser Vulnerability Model, Thermal Model User's Guide, Air Force Weapons Laboratory, (Software Documentation).
3. Hummel, J.R., Longtin, D.R., Paul, N.R., and Jones, J.R. (1991) "Development of the Smart Weapons Operability Enhancement Interim Thermal Model," Phillips Laboratory, Hanscom AFB, Massachusetts, PL-TR-91-20073, March.

REPORT DOCUMENTATION PAGE

Form Approved
OMB No. 0704-0188

Public reporting burden for this collection of information is estimated to average 1 hour per response, including the time for reviewing instructions, searching existing data sources, gathering and maintaining the data needed, and completing and reviewing the collection of information. Send comments regarding this burden estimate or any other aspect of this collection of information, including suggestions for reducing this burden, to Washington Headquarters Services, Directorate for Information Operations and Reports, 1215 Jefferson Davis Highway, Suite 1204, Arlington, VA 22202-4302, and to the Office of Management and Budget, Paperwork Reduction Project (0704-0188), Washington, DC 20503.

1. AGENCY USE ONLY (Leave blank)		2. REPORT DATE 31 MAR 91	3. REPORT TYPE AND DATES COVERED SCIENTIFIC REPORT 9, 1 JUL 90 - 31 DEC 90	
4. TITLE AND SUBTITLE USER'S GUIDE FOR TREETHERM: A 3-D THERMAL MODEL FOR SINGLE TREES			5. FUNDING NUMBERS Contract- F19628-88-C-0038 PE- 62101F PR- 7670 TA- 15 WU- AP	
6. AUTHOR(S) J. R. JONES			8. PERFORMING ORGANIZATION REPORT NUMBER LTR91-003	
7. PERFORMING ORGANIZATION NAME(S) AND ADDRESS(ES) SPARTA, Inc. 24 Hartwell Avenue Lexington, MA 02173			10. SPONSORING / MONITORING AGENCY REPORT NUMBER PL-TR-91-2109	
9. SPONSORING / MONITORING AGENCY NAME(S) AND ADDRESS(ES) PHILLIPS LABORATORY HANSCOM AFB, MA 01731-5000 Contact: ROBERT BELAND			11. SUPPLEMENTARY NOTES	
12a. DISTRIBUTION / AVAILABILITY STATEMENT APPROVED FOR PUBLIC RELEASE: DISTRIBUTION UNLIMITED			12b. DISTRIBUTION CODE	
13. ABSTRACT (Maximum 200 words) Energy budget modeling of vegetated surfaces is complicated by the extreme variability that can be encountered in the species that are present. A three dimensional thermal model of trees, TREETHERM, has been developed to understand the thermal properties of trees. The model has been developed for leafed and leafless conditions. This report presents a User's Guide for TREETHERM. Descriptions of the input requirements for the code are presented as well as examples of how to use the code.				
14. SUBJECT TERMS BTI/SWOE, TREETHERM, User's Guide			15. NUMBER OF PAGES	
17. SECURITY CLASSIFICATION OF REPORT UNCLASSIFIED			16. PRICE CODE	
18. SECURITY CLASSIFICATION OF THIS PAGE UNCLASSIFIED		19. SECURITY CLASSIFICATION OF ABSTRACT UNCLASSIFIED		20. LIMITATION OF ABSTRACT