

AD-A285 226



①

0291-01-001

**REPLACEMENTS FOR OBSOLETE SECONDARY ITEMS
20-TON ROUGH TERRAIN CRANE PROGRAM**

Scientific and Technical Report

Jerry C. Schuessler
Lester C. Via

Vitro Corporation

1994



U. S. Army
Mobility Technology Center - Belvoir
Fort Belvoir, Virginia 22060-5606

Distribution Statement A. Approved for public release; distribution is unlimited.

94-31155



94 0 00 00 2

REPORT DOCUMENTATION PAGE

Form Approved
OMB No. 0704-0188

Public reporting burden for this collection of information is estimated to average 1 hour per response, including the time for reviewing instructions, searching existing data sources, gathering and maintaining the data needed, and completing and reviewing the collection of information. Send comments regarding this burden estimate or any other aspect of this collection of information, including suggestions for reducing this burden, to Washington Headquarters Services, Directorate for Information Operations and Reports, 1215 Jefferson Davis Highway, Suite 1204, Arlington, VA 22202-4302, and to the Office of Management and Budget, Paperwork Reduction Project (0704-0188), Washington, DC 20503.

1. AGENCY USE ONLY (Leave blank)	2. REPORT DATE AUG 1994	3. REPORT TYPE AND DATES COVERED FINAL
---	-----------------------------------	--

4. TITLE AND SUBTITLE Replacements For Obsolete Secondary Items 20-TON Rough Terrain Crane Program	5. FUNDING NUMBERS C DAAK70-92-D-0002
--	---

6. AUTHOR(S) Jerry C. Schuessler Lester C. Via	
---	--

7. PERFORMING ORGANIZATION NAME(S) AND ADDRESS(ES) VITRO Corporation 45 N. Gude Drive Building B Rockville, MD 20850	8. PERFORMING ORGANIZATION REPORT NUMBER 0291-01-001
---	--

9. SPONSORING / MONITORING AGENCY NAME(S) AND ADDRESS(ES) Mobility Technology Center-Belvoir ATTN: AMSTA-RBMT 10115 Gridley Rd, Suite 128 Fort Belvoir, VA 22060-5843	10. SPONSORING / MONITORING AGENCY REPORT NUMBER
--	---

11. SUPPLEMENTARY NOTES

12a. DISTRIBUTION AVAILABILITY STATEMENT Distribution Statement A. Approved for Public release; Distribution is unlimited	12b. DISTRIBUTION CODE
---	-------------------------------

13. ABSTRACT (Maximum 200 words) From a list of hard to procure secondary items needed as spares for the Army's 20-Ton Rough Terrain Crane Program, the government had identified two items as being obsolete. These obsolete items were: a Steering Mode Selector Hydraulic Valve for the M2380 Model Cranes and the Front Axle for the M2380 and M2385 Model Cranes. Vitro Corporation was tasked to locate replacement parts, purchase the items, perform modifications, test the cranes, and document their effort. During the task, the Department of the Army (DA) made a program decision to discontinue support for the M2380 & M2385 cranes. Because of the DA decision, all on-going efforts were stopped. This report documents the replacement valve and axle efforts.
--

DTIC QUALITY INSPECTION

14. SUBJECT TERMS Crane, Rough Terrain Crane, Axle, Hydraulic Valve, Steering, M2380, M2385, Obsolete Replacement Parts, Front Axle, Steering Mode Selector Hydraulic Valve	15. NUMBER OF PAGES 78
16. PRICE CODE	

17. SECURITY CLASSIFICATION OF REPORT UNCLASSIFIED	18. SECURITY CLASSIFICATION OF THIS PAGE UNCLASSIFIED	19. SECURITY CLASSIFICATION OF ABSTRACT UNCLASSIFIED	20. LIMITATION OF ABSTRACT UL
--	---	--	---

0291-01-001

**REPLACEMENTS FOR OBSOLETE SECONDARY ITEMS
20-TON ROUGH TERRAIN CRANE PROGRAM**

Scientific and Technical Report

Prepared by:

**Jerry C. Schuessler
Lester C. Via**

**Vitro Corporation
Lorton, VA 22079**

August 1994

**Contract DAAK70-92-D-0002
Vitro Corporation
Rockville, MD 20850-1160**

Prepared for:

**U. S. Army
Mobility Technology Center
AMSTA-RBMT
Fort Belvoir, VA 22060-5606**

DTIC QUALITY INSPECTED 3

TABLE OF CONTENTS

<u>Section</u>	<u>Page</u>
1.0 INTRODUCTION	1
2.0 HYDRAULIC VALVE	2
2.1 <u>Engineering Analysis</u>	2
2.2 <u>Modification Effort</u>	3
2.3 <u>Documentation</u>	4
3.0 FRONT AXLE	5
3.1 <u>Engineering Analysis</u>	5
3.2 <u>Technical Data Issues</u>	8
4.0 MODEL 2380 CRANE RESTORATION EFFORT	10
5.0 CHRONOLOGY OF TASK ORDER MILESTONES AND EVENTS	10

Appendix A. Engineering Analysis of the Steering Mode Selector Valve Requirements for the Model 2380 Crane

 Tab A. Hydraulic Valve, NSN 4820-00-945-5348, Flow Characteristics

 Tab B. Recommended Replacement Hydraulic Valve Data Sheets

Appendix B. Test Report of Cross AD Series Steering Mode Selector Valve

Appendix C. Hydraulic Valve Test Procedure TP3212.013

Appendix D. Hydro-Mechanical Systems, Inc. Front Axle Price Quotation

Appendix E. Clark Axle Specifications Form

Appendix F. Verification Test Results of Restored M2380 Crane

Accession For	
NTIS	<input checked="" type="checkbox"/>
DTIC TAB	<input type="checkbox"/>
Unannounced	<input type="checkbox"/>
Justification	
By _____	
Distribution _____	
Availability Codes	
Dist	Special
A-1	

1.0 INTRODUCTION

From a list of hard-to-procure secondary items needed as spares for the Army's 20-ton Rough Terrain Crane Program, the government had identified two items as being obsolete. These obsolete items were: Steering Mode Selector (SMS) Hydraulic Valve (Drawing 97403-13208E6430) for the M2380 model cranes; and Front Axle (Drawing 97403-13213E9493-2) for the M2380 and M2385 model cranes.

A task order was issued to Vitro Corporation under Contract DAAK70-92-D-0002 to locate potential replacements for the obsolete valve and front axle and identify the modifications required to install them on the crane. Following government approval, Vitro was to purchase the items, perform the necessary modifications, install the items on government furnished cranes, and test the cranes. Following successful testing Vitro would prepare the necessary technical documentation for the government to continue competitively procuring repair parts without compromising quality or reliability.

Approximately seven months after task award, the Department of Army (DA) made a program decision to discontinue support for the M2380 and M2385 models. This left only the M320 model rough terrain crane in the active Army fleet. At that point, the replacement valve and associated hardware had been identified, a sample procured and bench tested; mounting brackets and panel modifications had been designed, fabricated, and the components assembled for installation and verification testing in the M2380 crane. As a result of Vitro's inquiries on the front axle, Clark-Hurth, the original axle manufacturer, had proposed to the Army that they go back into production, subject to a minimum buy agreement.

Because of the DA program decision, however, all on-going task efforts were stopped. The task order was modified to return the M2380 crane to its unmodified condition - or as close thereto as possible, the M2380 and M2385 model cranes were

to be returned to government control, all completed efforts were to be documented, and remaining resources were to be focused on other obsolete or difficult to procure items associated with the M320 model cranes.

This report documents the replacement valve and axle efforts and is organized as follows: Section 1 provides an introductory overview, Section 2 summarizes the SMS valve effort; Section 3, the front axle effort; Section 4, the M2380 restoration effort; and Section 5 provides a chronology of task order milestones and events.

2.0 HYDRAULIC VALVE

2.1 Engineering Analysis

A detailed engineering analysis was performed to determine the characteristics of an optimum replacement valve from the standpoint of performance, availability, and cost. The analysis consisted of evaluating the obsolete valve as to form, fit, and function; and identifying its specific operational characteristics. Since the operating characteristics of the obsolete valve were not specified on Drawing 97403-13208E6430, a functioning valve was removed from a M2380 crane and subjected to hydraulic bench tests to determine its characteristics. With this information, alternative commercial valves were analyzed for their suitability as a replacement. The results of the engineering analysis with a recommendation for a replacement valve were documented in a report provided to the government. A copy of this report is provided as Appendix A and includes a comparison of hydraulic flow characteristics for both the obsolete and recommended replacement valves. The recommended replacement was a Cross, AD series, hydraulic valve.

During the analysis of valve requirements, a severe oscillation was noted in the M2380 crane steering system. The oscillation appears to be inherent in the design and is attributed to the use of two hydraulic servoloops in series such that a 180 phase

reversal occurs, producing a hydraulic oscillation whenever the loop gain exceeds unity. A suggestion for eliminating this condition is provided in Section 9.0 of Appendix A, Engineering Analysis of the Steering Mode Selector Valve Requirements.

2.2 Modification Effort

The planned modification effort was to consist of:

- a) Engineering design and preparation of detail fabrication drawings for new mounting brackets, panel, and interlock assembly for the mode selector lever; and installation drawings for new components and configurations of the hydraulic lines, associated couplings, and hardware.
- b) Procurement of replacement valve and associated parts required for installation.
- c) Bench testing of replacement valve to confirm flow and pressure characteristics.
- d) Fabrication of modified mounting brackets, panel, and interlock assembly in accordance with detail drawings.
- e) Assembly and installation of valve, panel, mounting brackets, interlock assembly, hydraulic lines, and associated hardware in the GFE crane.
- f) Verification testing of the installed components for proper functioning of the mode selector valve and vehicle steering assembly on a stationary vehicle.
- g) Functional testing of the modified vehicle while operating on a test track.

The replacement hydraulic valve was procured, and a bench test conducted in

accordance with Vitro Corporation Test Procedure TP 3212.013. A copy of this Test Procedure is provided as Appendix B. The results of hydraulic bench testing of the obsolete and replacement valves were documented in a Test Report, and a copy is provided as Appendix C.

Engineering design and fabrication drawings for the mounting brackets, panel, and interlock assembly were completed and released for fabrication. Purchase orders were released to procure associated parts. Fabricated and procured items were inspected upon receipt for conformance with drawings and purchase order specifications. Pre-installation assembly of valve, mounting brackets, panel, interlock assembly, and miscellaneous components was completed, and on-vehicle installation was scheduled.

2.3 Documentation

Completed documentation for the valve effort consists of:

- Hydraulic Valve Test Plan.

The Test Plan describes the hydraulic bench tests to be performed on the replacement valve and the valve verification and functional tests to be performed after installation in the M2380 Crane.

- Hydraulic Valve Test Procedure.

The test procedure, Vitro TP3212.013, specifies the detailed test steps to be performed for conducting the hydraulic valve bench tests, verification tests and functional tests, and the acceptance limits for each type of test.

- Installation Instructions for Hydraulic Valve Draft Modification Work Order (MWO).

The installation instructions for a Draft MWO, to be published by

the government, describes the item to be modified, purpose of the modification, parts to be replaced or changed, parts and tools required, and detailed installation instructions for performing the modification.

3.0 FRONT AXLE

3.1 Engineering Analysis

During the first phase of engineering analysis, the existing axle was evaluated for form, fit, and function; and its specific operational requirements were identified. The analysis also included an investigation of the front axle ancillary parts and their interface requirements with the front axle. These parts included the vehicle front axle support cradle, steering linkage, front propeller shaft, steering cylinders, wheels (rims), and axle off-set input drive shaft. Pertinent information required for this effort was obtained from technical manuals: TM 5-3810-232-12 and TM 3810-232-34P; front axle source control drawing (SCD) D13213E9493-2 (Clark Equipment Company, Part Number FDS29500-2, Drawing Number 190172); and applicable M2385 crane drawings.

The second phase of the engineering analysis consisted of soliciting axle manufacturers to quote on a replacement axle that would meet the specified load and operational requirements of SCD D13213E9493-2. The plan was to: a) identify potential axle candidates, b) determine the extent of modifications required to install each candidate, and c) recommend the candidate which represented the most cost effective solution.

Four Request for Quotations (RFQs) were developed and submitted to various axle/transmission manufacturers as follows:

RFQ No. 1 - Item 1 of this RFQ specified a standard planetary drive steer axle in accordance with the loading and operational requirements of SCD D13213E9493. Item 2 of this RFQ specified the same axle with a built-in dropbox which locates the input drive shaft centerline approximately 6-7 inches below the axle centerline (same as the existing axle design). The axle manufacturers' response to this RFQ was:

<u>Company</u>	<u>Response</u>
- Rockwell International Corporation	No Bid
- Eaton	No Bid ⁽¹⁾
- Clark-Hurth	No Response
- Dana Corporation	No Bid ⁽²⁾
- Truck Gears Incorporated	No Response
- Caterpillar	No Response
- Franklin Equipment Company	No Bid
- John Deer	No Bid
- Ford New Holland	No Bid ⁽²⁾
- Hydro-Mechanical Systems, Inc.	No Response

Notes:

- (1) Makes only planetary drive units.
- (2) Units do not meet load ratings.

RFQ No. 2 - This RFQ specified operational requirements for a separate dropbox to be used in conjunction with the standard planetary drive steer axle specified by Item 1 of RFQ No. 1. The following manufacturers submitted "No Bids" to RFQ No. 2:

- Dana Corp./Spicer
- Eaton
- Regal-Beloit/Durst
- Fairfield Manufacturing Co.
- Oshkosh Truck Corp.
- FABCO Automotive

The reasons given for "No Bid" by the manufacturers were that modification of their standard line units to meet the specified operational and 6-7 inch offset

requirements was not feasible and they did not want to develop a special unit of limited quantity.

RFQ No. 3 - RFQ No. 3 specified refurbishment efforts for the original crane axle supplied by Clark-Hurth (Clark drawing number 190172). During Vitro's initial inquiries, and prior to releasing this RFQ, Clark's east coast distributor, Hydro-Mechanical System, Inc., (HMS) originally proposed providing refurbishment services for the cranes' axles which would include replacement of all bearings and seals and replacement of the air brake components. However, HMS "No Bid" this RFQ due to the potential for indeterminable axle costs and spare parts availability.

RFQ No. 4 - RFQ No. 4 specified the original crane planetary drive steer front axle, Clark part number FDS29500-2, drawing number 190172. A positive response for supply of the original axle was received from Clark's distributor, Hydro-Mechanical Systems, Inc. (see Appendix D). The HMS quote, dated 9 February 1993, indicated that production of Clark-Hurth axle, drawing number 190172, would be reactivated upon receipt of a purchase order for a minimum quantity of 20 axles.

The results of the engineering analysis effort for the replacement front axle, including HMS'/Clark's offer to reactivate production, were presented to the Government on 17 February 1993. The U.S. Army Tank-Automotive Command, who has logistical support responsibility for these vehicles, was considering Clark's quotation when the DA decision to eliminate the M2380 and M2385 models from the active Army inventory obviated the decision.

3.2 Technical Data Issues

Differences between the government's technical data and the manufacturer's axle data were noted during Vitro's analysis. The documentation resolving these differences could not be reconstructed. The differences are provided to complete the record.

During discussions with HMS prior to receiving their quotation, Vitro pointed out that the axle load rating specified on the government's source control drawing 13213E9493, Revision G, is 36,000 pounds. HMS was somewhat surprised since they thought the Clark axle, drawing number 190172, supplied to American Hoist & Derrick was load rated at only 29,000 pounds. Subsequent to receiving HMS's quotation, Vitro requested documentation from HMS stating the operational requirements/specifications of the Clark axle, drawing number 190172, supplied to American Hoist & Derrick. This information was requested for comparison with the axle specifications depicted on SCD D13213E9493. HMS responded to Vitro's request by sending a copy of Clark's standard inquiry specifications form, "Specifications for Axle, Transmission and Torque Converter Installation", which had been prepared and submitted by American Hoist & Derrick Company on 1 April 1968. The form also depicts Clark's receipt of document and the axles Clark recommended to meet the form's requirements. A copy of this specifications form is provided in Appendix E.

In comparing the axle source control drawing to the specifications form, the following is noted:

- a) The specifications form states that the front axle shall meet the requirements of SCD D13213E9493-1, Revision D, Clark Number 190164. During discussions with Clark, they indicated that the

190164 axle was never produced, but that the 190172 (SCD D13213E9493-2) front axle was produced starting in 1968. The only difference between the 190164 and 190172 axles, as indicated on SCD D13213E9493, Revision G, is the size of the input shaft companion flange.

- b) The specifications form states the vehicle speed as 30 MPH, maximum, and the speed of the axles as 34.3 MPH at zero resistance. SCD D13213E9493, Revision G, specifies the axle traveling speed as 38 MPH, maximum.
- c) The specifications form states the vehicle maximum gross weight as 62,000 pounds. This is in agreement with the vehicle specifications of Technical Manual TM 5-3810-232-12 for the M2380 and M2385 cranes, which also indicates that the vehicle weight is distributed equally between the two axles (approximately 31,000 pounds each). SCD D13213E9493, Revision G, specifies the front axle travel loading as 36,000 pounds and the static single wheel loading as 90,000 pounds. No specific loading specifications for the 190172 axle have been provided by Clark/HMS as requested other than the general information on the specifications form. Thus, it can only be assumed that the 190172 axle meets the axle/wheel loading requirements of SCD D13213E9493, Revision G, since the crane test requirements specified by Military Specification MIL-C-52341E for the M2380 and M2385 cranes do not specify tests that will provide verification of the axle/wheel load ratings specified by the SCD.

4.0 MODEL 2380 CRANE RESTORATION EFFORT

The restoration effort on the M2380 crane involved refurbishing the original valve support panel. This panel had been removed from the crane and modified to house the new Cross replacement SMS valve. Restoration involved cutting and welding pieces of sheet metal to the modified support panel, followed by grinding and painting, to restore it to the original configuration, as depicted on American Hoist & Derrick Company drawing 02280-781038. The original interlock assembly, which had been removed and retained, was reinstalled on the reworked support panel.

The restored support panel/interlock assembly was reinstalled in the M2380 crane utilizing the original hydraulic hose assemblies and SMS valve. The crane was then subjected to verification tests to demonstrate that the performance characteristics of the restored M2380 crane matched those of the crane when delivered to Vitro as GFE. These tests were performed in accordance with Vitro test procedure TP3212.013, Section 2, modified as follows:

- a) Paragraph 2.3 tests were performed at approximately 1500 RPM (idle speed) in lieu of 2800 RPM.
- b) Paragraph 2.4 tests a. through h. were performed in lieu of tests a. through p. at idle speed.

The testing verified that the operation of the steering mode selector valve, operating lever, and interlock assembly were the same as the unmodified condition. The results of the restored M2380 crane verification tests are presented in Appendix F.

5.0 CHRONOLOGY OF TASK ORDER MILESTONES AND EVENTS

18 Sep 1992 Task order awarded.

6 Oct 1992 First of numerous inquires to Clark Axle Division requesting

- technical information and quote on supply of a replacement axle including the Clark Model 16S1841 recommended by the VSE Corporation report.
- 19 Oct 1992 Submitted replacement SMS valve test plan, CDRL A188.
- 3 Nov 1992 CDRL A188 approved by Government.
- 4 Nov 1992 First of numerous contacts with Hydro-Mechanical Systems, Inc., Clark's east coast distributor. Clark requested all replacement axle inquiries be handled through HMS.
- 9 Dec 1992 Clark announced that it will quote on supplying the original front axle, part number FDS 29500-2, in accordance with drawing 190172.
- 21 Dec 1992 Submitted replacement SMS valve engineering analysis report.
- 22 Dec 1992 Received Government approval to procure recommended replacement SMS valve.
- 22 Jan 1993 The Government requested a status review meeting of the replacement front axle effort since an axle source had not been identified within schedule. The meeting was scheduled for 17 February 1993.
- 9 Feb 1993 HMS formally quoted on supplying the Clark 190172 front axle.
- 17 Feb 1993 A meeting was held with BRDEC and TACOM representatives at Vitro's Newington facility. A review of the SMS valve effort and the status of the replacement front axle effort were presented. Vitro reported that the detailed engineering analysis for the replacement front axle had been completed with the identification of an axle source. The Government requested Vitro to suspend further task order effort on the axle pending a decision on the HMS quotation.
- 17 Mar 1993 The Cross AD Series replacement SMS valve was received from the

- vendor and successfully bench tested in accordance with Vitro test procedure TP3212-013.
- 12 Apr 1993 Fabrication of parts for the replacement SMS valve installation effort was completed.
- 14 Apr 1993 The Government issued a stop work order on Delivery Order 0001 for a period not to exceed 60 days.
- 3 Jun 1993 Delivery Order 0001 was modified to delete the SMS valve and front axle replenishment efforts for the M2380/M2385 cranes and restore the M2380 crane as close to its original condition as possible (reinstall original SMS valve) and verify the original steering performance characteristics of the crane.
- 15 Jul 1993 Delivery Order 0001 was amended to modify the requirements for the Scientific and Technical Report to include the results of the M2380 crane (SMS valve) restoration effort.
- 26 Jul 1993 Restoration of the M2380 crane, including verification testing, was completed.

APPENDIX A

ENGINEERING ANALYSIS

OF THE

STEERING MODE SELECTOR VALVE REQUIREMENTS

FOR THE

MODEL 2380 CRANE

ENGINEERING ANALYSIS
OF THE
STEERING MODE SELECTOR VALVE REQUIREMENTS
FOR THE
MODEL M2380 CRANE

16 December 1992
Revised 23 December 1992

Contract DAAK70-92-D-0002
Task Order 0001

Prepared by
Vitro Corporation
14000 Georgia Avenue
Silver Spring, Maryland

1.0 SCOPE - This report documents the engineering analysis supporting the selection of a new steering mode selector valve for the Model 2380 Rough Terrain Crane. The original valve is no longer manufactured and is not available from any known source.

2.0 ANALYSIS OF VALVE REQUIREMENTS - The functional requirements of the steering mode selector valve are met by a hydraulic valve usually described as a 4-way, 3-position, directional control valve with a motoring spool. One unusual requirement, however, is the steering mode selector valve could experience pressures as high as 650 psi on its return/tank port. Most directional control valve applications do not result in significant pressure on the return/tank port and the maximum pressure that would be permitted on this port is rarely specified by valve manufacturers. Back pressure on the return/tank port places pressure on the valve seals. Based on this information and the fact that the obsolete valve also exposes its "O"-ring seals to pressure on its return/tank port, the lack of a maximum specified back pressure will not eliminate a valve from being considered for use as a replacement for the obsolete valve. Suitability of the selected valve for use with back-pressures as high as 650 psi will be demonstrated by analysis of the dimensions of the "O"-ring gland and by bench tests.

3.0 CHARACTERISTICS OF OBSOLETE VALVE - The flow characteristics of the obsolete valve are the most important specification needed for selecting a suitable replacement valve. No information describing the flow characteristics of the obsolete valve was available. This information had to be obtained by flow measurements performed on a valve removed from the Model 2380 crane provided by the government for modification. This effort was subcontracted to Transmission Technology, Inc, Alexandria, VA and was performed at the Vitro facility in Newington, VA. Results of the hydraulic tests performed on the obsolete valve are summarized below. Actual test data and graphs derived from it are presented in Tab A. The graphs in Tab A also show flow curves derived from the recommended replacement valve manufacturer's data sheets. The valve's resistance to flow is much greater than similar valves available today.

The valve pressure drop data in Tab A includes both the pressure drop across the valve and the pressure drop occurring in the line returning to the hydraulic reservoir (backpressure). Backpressure measurements were taken at various flow rates to permit the determination of the actual pressure drop across the valve. A graphical representation of the backpressure data is also included in Tab A and may be subtracted from the pressures obtained from the graphs of the obsolete valve's flow characteristics if more accurate flow characteristics are desired. The pressure corrections will not alter the test results in the sense that the selected replacement valve has significantly less restriction to flow than the obsolete valve.

The fluid used for the flow tests, Texaco RANDO Oil HD 32, was selected because its viscosity is very close to the same viscosity as the fluid used by most valve manufacturers to specify their valves flow characteristics. This is also very close to the typical MIL-L-2104F, type 10W oils used in the crane's hydraulic system. This allowed direct comparison of flow characteristics between the obsolete valve flow measurements, the typical valve manufacturer's flow data, and the calculated flow characteristics of the crane's hydraulic system without correcting for viscosity differences. Tab A contains a graphical representation of the viscosity versus temperature characteristics of these fluids.

4.0 REPLACEMENT VALVES CONSIDERED - The following valve manufacturer's product lines were researched for suitable replacement valves:

- (a) American Barmag Corp.
- (b) Amot Controls Corp.
- (c) Aro Corp./Fluid Power Products
- (d) Barworth Inc.
- (e) Bosch (Robert) Corp./Racine Fluid Power Inc.
- (f) * Burton Hydraulics Inc.
- (g) * Commercial Intertech
- (h) * Continental Hydraulics

- (g) * Cross Manufacturing Inc.
- (h) Danfoss Inc.
- (i) Dukes Fluid Power
- (j) Dynamco Inc.
- (k) * Energy Manufacturing Inc.
- (l) Fluid Regulators Corp.
- (m) * Gresen Manufacturing Company
- (n) Honeywell Inc./Skinner Valve Division
- (o) IFP Hydraulics
- (p) IMO Industries/Boston Gear Division
- (q) ISI Manufacturing Inc./ISI Fluid Power Inc.
- (r) Lehigh Fluid Power Inc.
- (s) Magna-Pow'r Inc./Hydreco Inc.
- (t) MC Industries Inc./Victor Fluid Power Inc.
- (u) Metro Machine & Engineering Corp./Metro Hydraulics Div.
- (v) * Parker Hannifin Corp/Fluidpower Products/Hydraulic Valve Div.
- (w) * Trinova Corp/Vickers Division.

Specifications were obtained for any manufacturer providing a valve that would meet the functional requirements of the steering mode selector valve. Those manufacturers are noted by the asterisks in the above list. A comparison of these manufacturer's valves to the existing valve is depicted in Figure 1.

5.0 VALVE SELECTION CRITERIA - Since all valves considered were the functional equivalents of the obsolete valve, the selection criteria was an economic one - the extent of the modification to the crane and the cost of the valve itself. Unfortunately, there is no known available valve that is a bolt-in replacement for the obsolete valve. The use of any of the valves being considered requires that the redesign of the valve support panel, NSN 2530-00-427-4004, be included as part of the crane modification. The other alternative, to design a custom valve as a bolt-in replacement, was also considered but rejected as a far more costly approach. The redesigned panel is required to allow changing the valve location which is necessary to accommodate any of the replacement valves found. The removal of the obsolete valve requires removal of the support panel; thus its replacement with the new panel will not require any additional installation effort. One replacement valve investigated, the single spool version of the Cross AD series, is the recommended replacement valve because of its slightly smaller size and because it can be obtained with all port openings on the same side which makes it easier to interface with the existing hydraulic lines in the limited space available. The Parker Hannifin VDP11 series valve which is basically the same size and configuration as the Cross AD series valve was not selected as the replacement valve because:

- a. It is more expensive than the Cross unit (\$283 versus \$150, unit quantities).
- b. The valve with all ports located on the same side is not a standard stock item. It is a special order item requiring longer delivery time.
- c. Due to the physical design of the valve, a complete new handle assembly would have to be designed and fabricated in lieu of modifying the existing handle assembly.

A description of the recommended Cross AD series valve and its specifications are included in Tab B. Figure 2 illustrates the obsolete valve's (item 10) position in the crane's cab while Figure 3 illustrates the existing panel (item 57) and hydraulic components. The recommended new panel layout is depicted in Figure 4.

**FIGURE 1
COMPARISON OF THE VALVES BEING CONSIDERED**

MANUFACTURER	MODEL NO.	PORTS ON SAME SIDE	RATED FLOW (GPM)	LENGTH	WIDTH	HEIGHT	REMARKS
BURTON HYDRAULICS	OD4	NO	20	9.31	3.50	3.19	
COMMERCIAL INTERTECH	KA18	NO	20	9.11	4.89	3.62	Stacked valve
CONTINENTAL HYDRAULICS	VM12M	YES	12	7.06	2.75	3.50	Baseplate mounting only
CROSS MANUFACTURING	AD	YES	15	8.62	4.10	3.00	
ENERGY MANUFACTURING	2000	NO	20	9.22	3.75	3.00	
GRESEN MANUFACTURING	400	NO	16	8.69	4.00	3.48	
PARKER HANNIFIN	VDP11	YES	20	8.62	4.19	3.00	
TRINOVA/VICKERS	SV-20	YES	20				Requires extensive modification

6.0 FLOW CHARACTERISTICS OF RECOMMENDED REPLACEMENT VALVE - The flow characteristics of the recommended Cross AD series valve are significantly different than the measured characteristics of the obsolete valve. The obsolete valve has much higher resistance to flow than the recommended Cross valve. These differences are graphically depicted in Tab A for each flow path. These differences were expected since the obsolete valve's spool travel is much smaller than any of the valves being considered for use as the replacement. In most applications, however, a decreased resistance to flow is considered beneficial.

7.0 ANALYSIS OF VALVE DIFFERENCES - The improved flow characteristics of the recommended replacement valve will shorten the dynamic response time of the rear wheel steering system. The obsolete valve's resistance to flow is comparable to the estimated resistance to flow provided by the hydraulic lines to the rear steering control cylinder, thus the improved flow characteristics of the recommended valve should cut the total resistance to flow in this hydraulic circuit in half. The end effect will be to reduce by one half any delay in the rear wheels to track steering changes. This is not expected to cause any problems since no noticeable delays in the crane's steering system were evident while observing the steering system in operation.

8.0 REPLACEMENT VALVE MODIFICATION REQUIREMENTS - The following modifications to the crane are required to utilize the recommended replacement valve:

- a. The replacement of two existing short rigid hydraulic lines with longer lines.
- b. The addition of two new hydraulic lines to extend existing lines that would be difficult to replace.
- c. The replacement of the existing valve support panel with a redesigned panel.

FIGURE 2

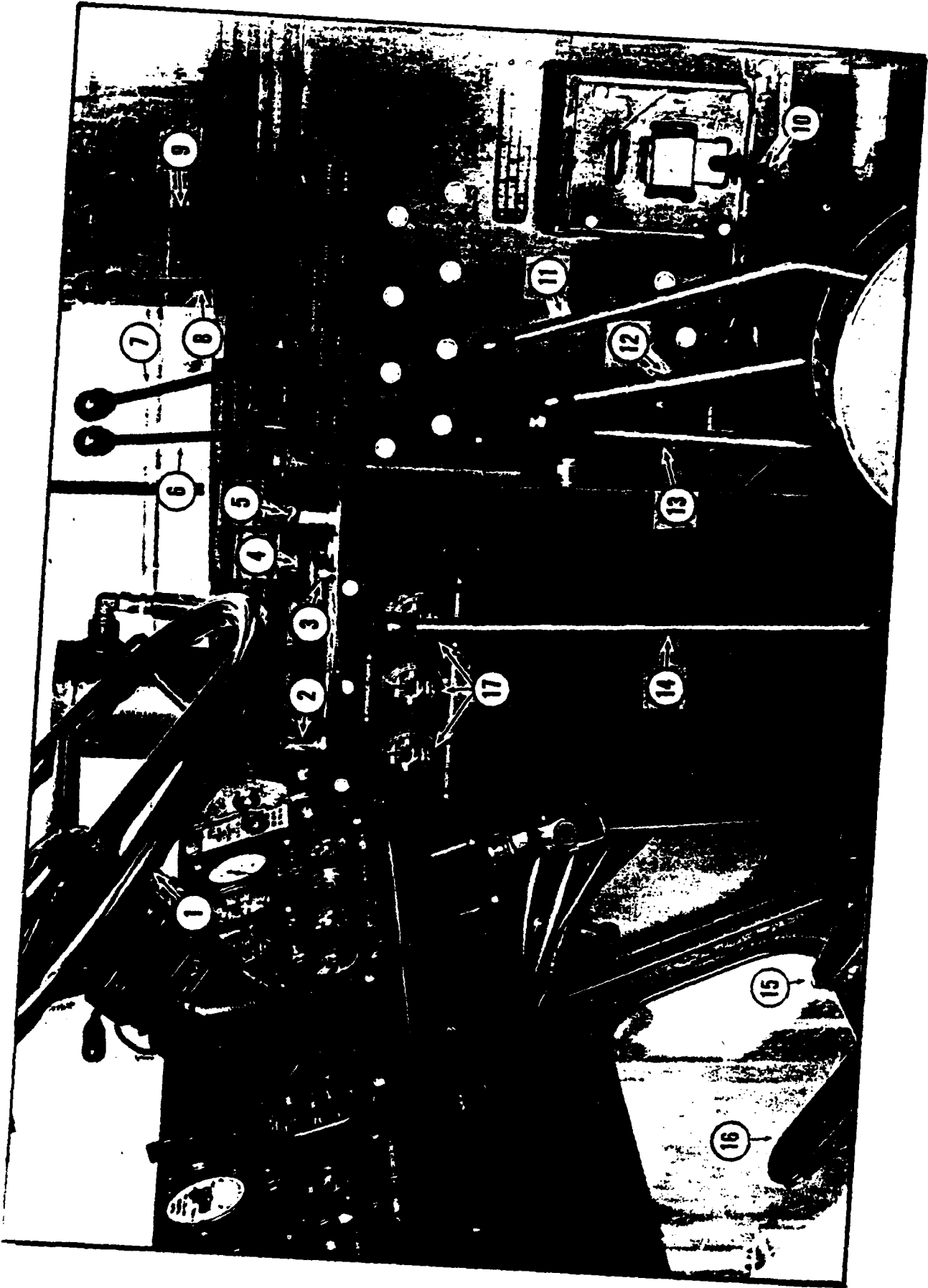
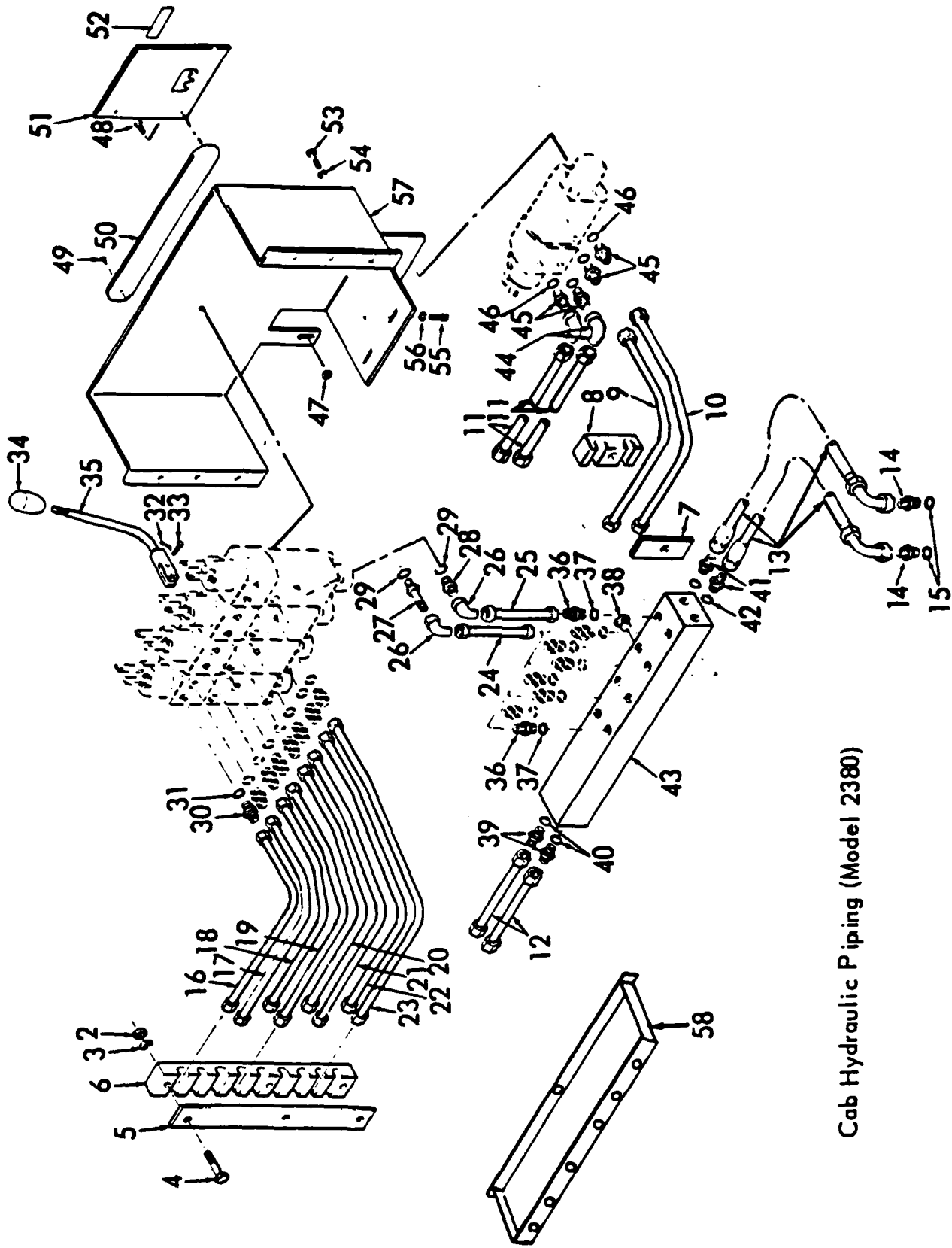
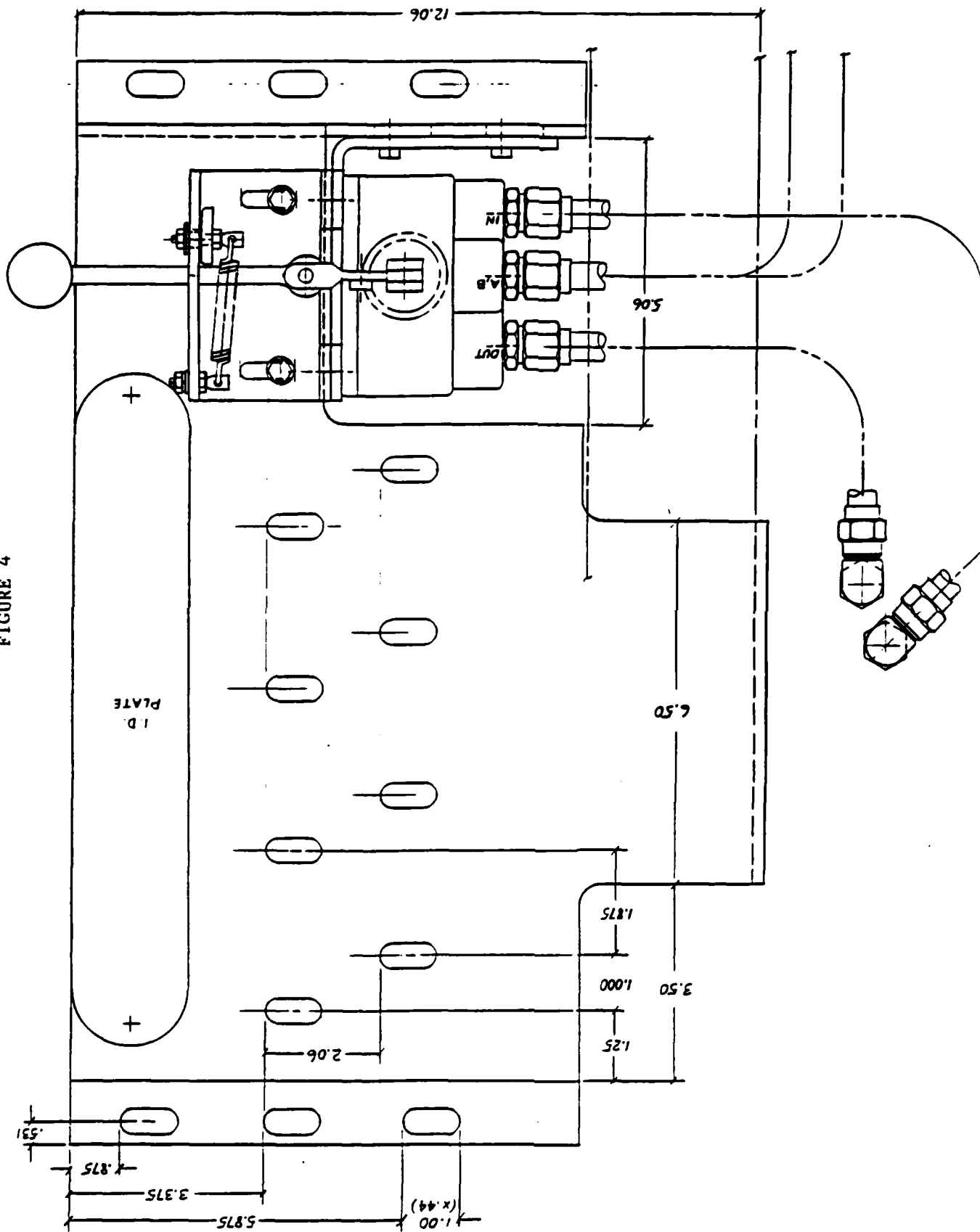

FIGURE 3



Cab Hydraulic Piping (Model 2380)

FIGURE 4



9.0 RISKS AND CONCERNS - One risk associated with the recommended Cross valve is the lack of a specified maximum back-pressure on its return/tank port. The risk of significant back-pressure causing any problems with the selected replacement valve such as fluid leakage, however, appears to be small since the obsolete valve was used under the same conditions and its seal design is virtually the same as the replacement valve. Additionally the manufacturer claims one of their customers is using the valve without problems at much higher back-pressures than will be experienced in the crane steering system, although, that customer does use a harder seal material than the standard part. We also plan to purchase the harder seals as spare parts for the valve. If any problems are experienced with the standard seals during the bench testing phase, the valve will be subjected to additional bench tests with the harder seals installed.

Another risk associated with the improved flow characteristics of the Cross AD series valve is the possibility that an undesirable change in the dynamic response of the rear steering system could occur. If such an effect occurs during testing, it can be eliminated easily by the insertion of an inexpensive flow restrictor in the hydraulic flow path.

As part of the initial analysis of the steering mode selector valve requirements, the crane steering system was operated to observe any dynamic steering characteristics that might be affected by the use of a valve with different flow characteristics. Of particular interest was whether the front and rear wheels appeared to track each other as they moved in response to a sudden change in steering wheel position. During these tests a severe oscillation in the front steering system was evident as the front wheel position was changing. The oscillation appears to be inherent in the crane's steering system design and is attributed to the use of two hydraulic servo-loops in series with the positional feedback for the first stage being provided by the output of the second stage. Since each stage will shift the phase of the higher frequency components in position error hydraulic signal by 90 degrees, the two stages in series result in a 180 degree phase shift changing the intended negative feedback to positive feedback. The result is a hydraulic oscillator whenever the loop gain at these higher frequencies exceeds unity. It may be possible to eliminate the oscillation by providing the feedback to the draglink mounted steering control valve from the position of the front steering control cylinder rather than the front steering cylinders (front wheel position). This inherent oscillation problem was not investigated any further since it is outside the scope of our task order.

TAB A
TO APPENDIX A

FLOW CHARACTERISTICS OF

HYDRAULIC VALVE

NSN 4820-00-945-5348

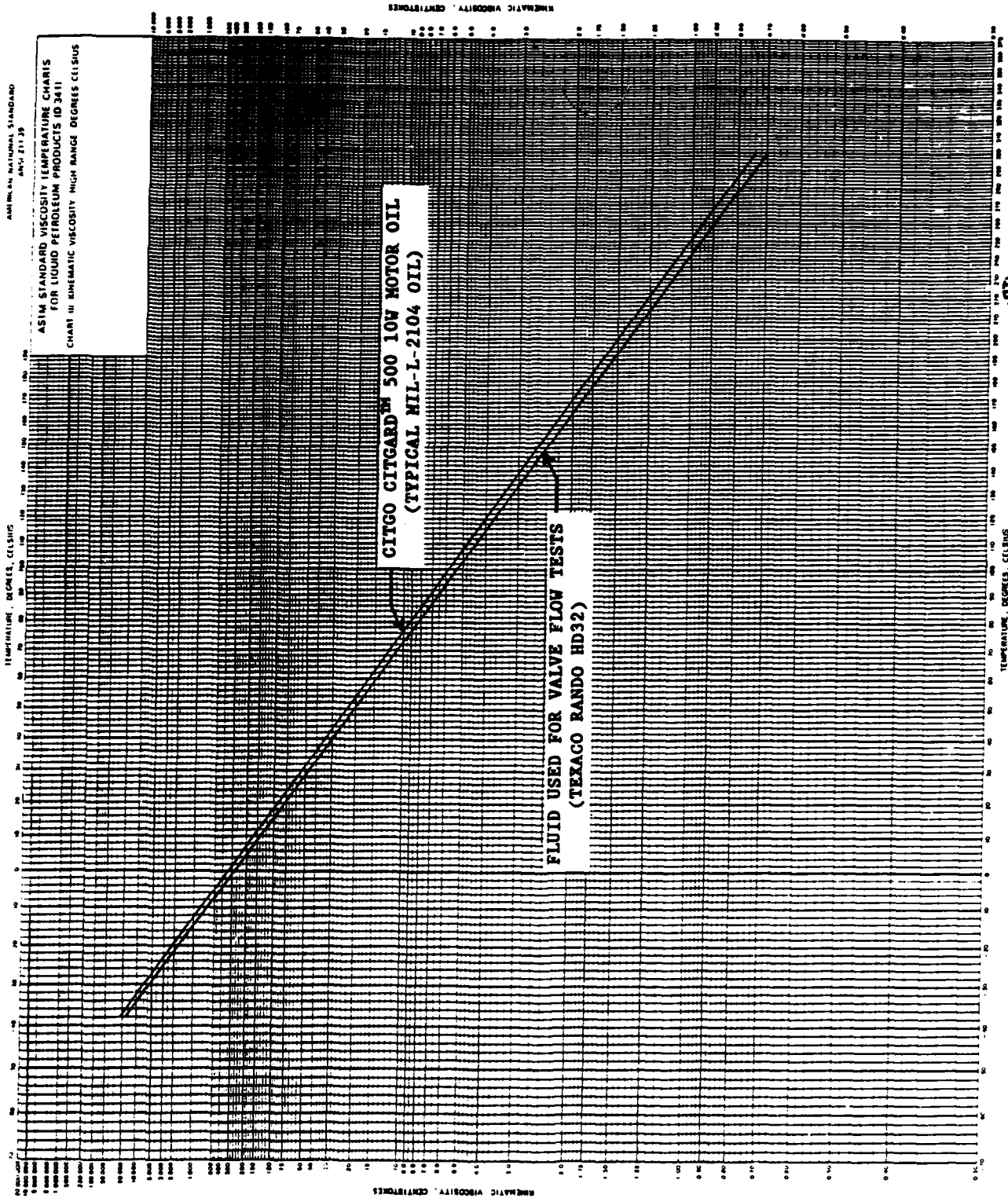

AMERICAN SOCIETY FOR TESTING AND MATERIALS
1916 RACI ST. PHILADELPHIA PA 19103
PCA 17-00513 17

FIGURE 1
VISCOSITY COMPARISON OF THE FLUID USED FOR VALVE
FLOW TESTS AND A TYPICAL MIL-L-2104D FLUID

FIGURE 2
BACKPRESSURE VS FLOW

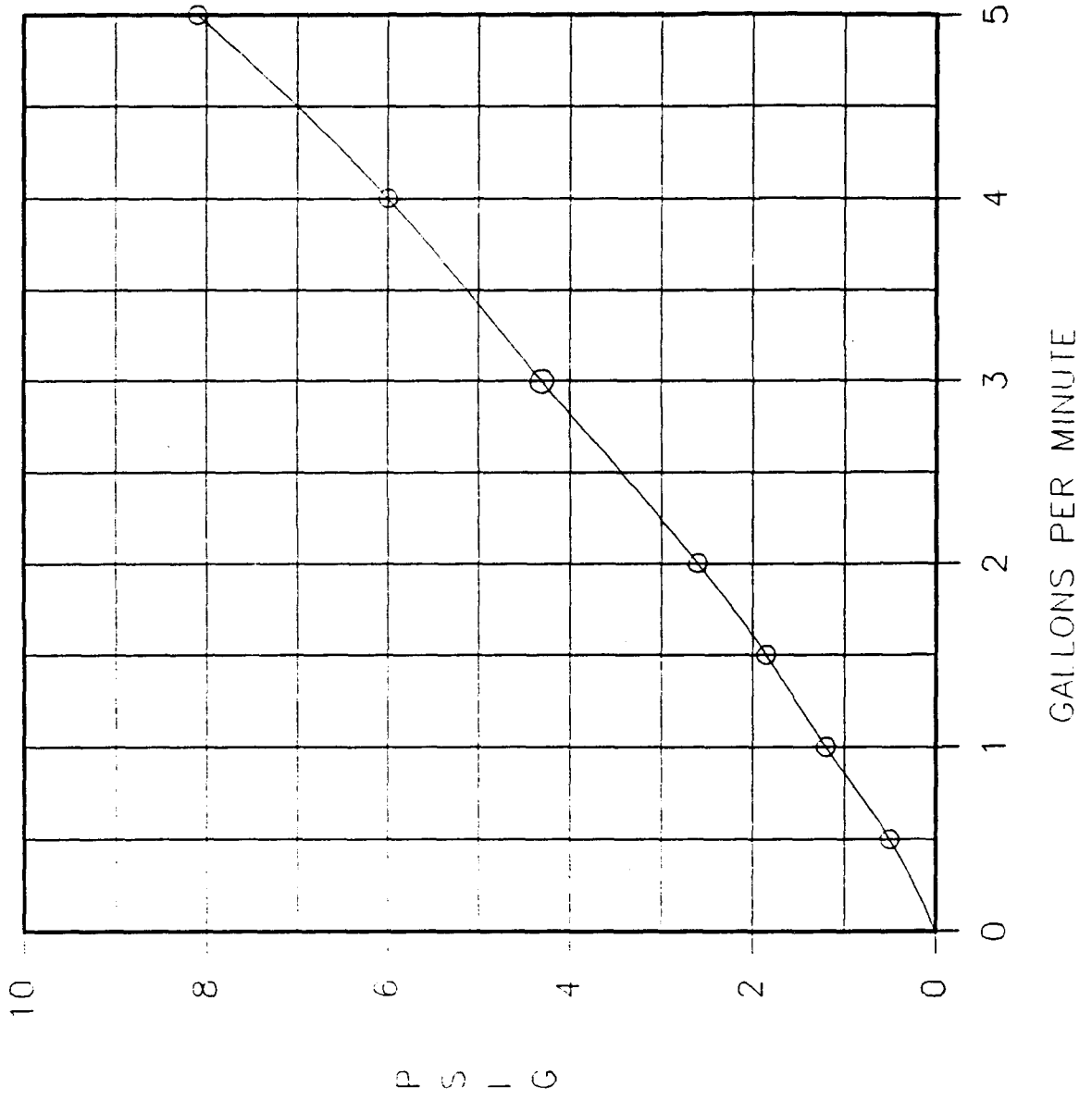

FIGURE 3

COMPARISON OF FLOW CHARACTERISTICS

SPOOL CENTERED (FLOW FROM PORT A TO PORTS T&B)

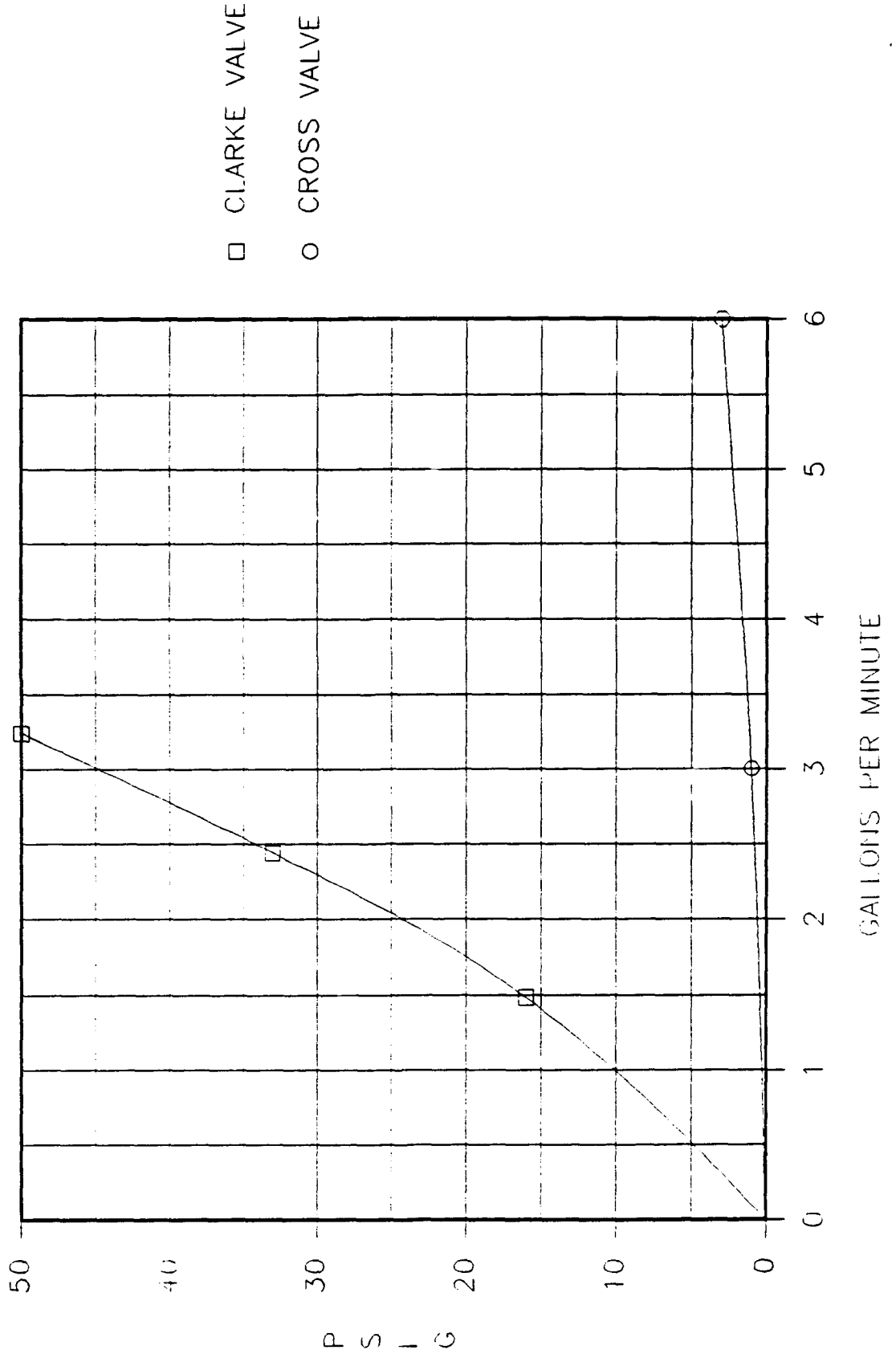

FIGURE 4

COMPARISON OF FLOW CHARACTERISTICS

SPool Cleared (Flow from Port B to Ports T&A)

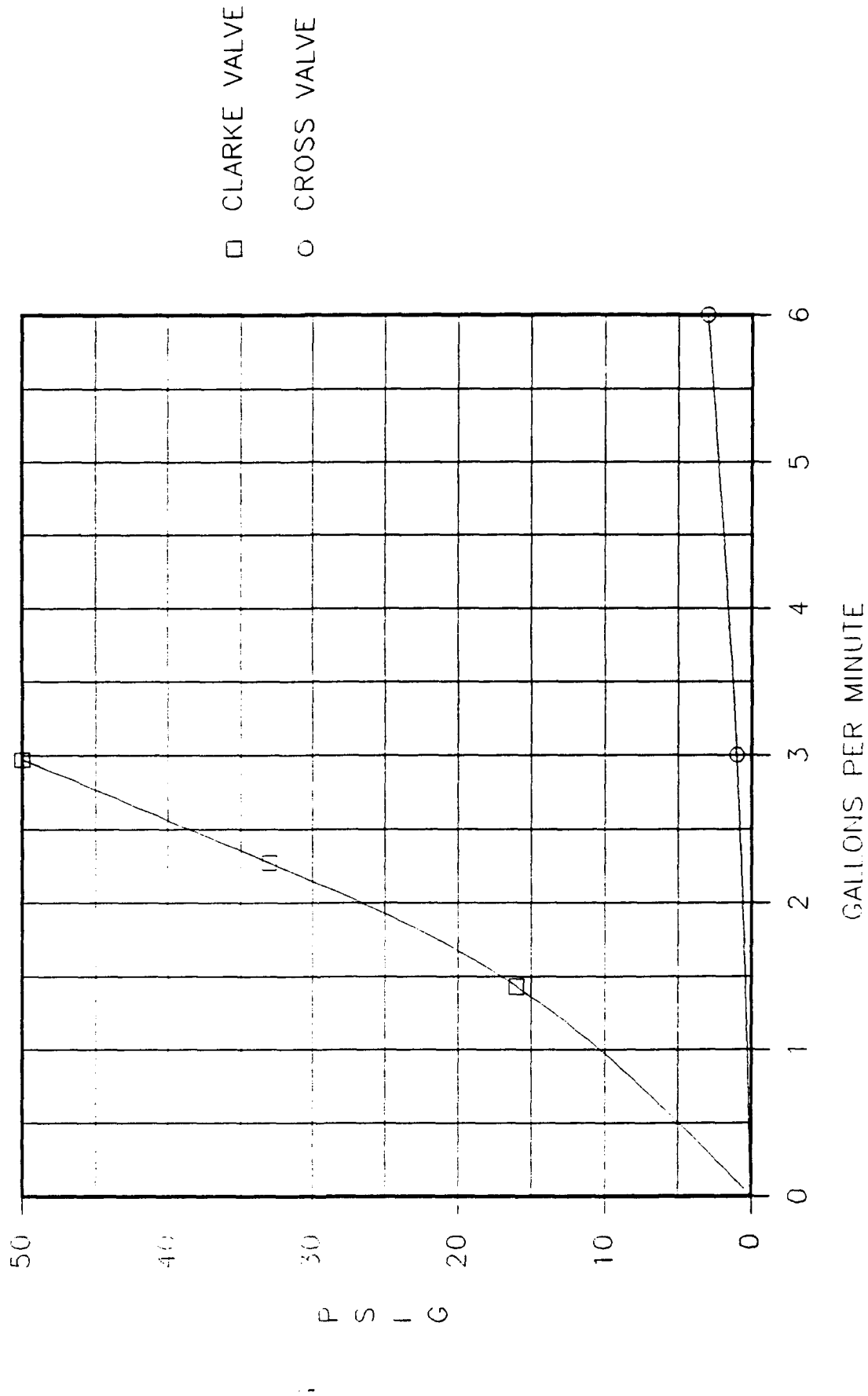

FIGURE 5

COMPARISON OF FLOW CHARACTERISTICS

SPOOL CENTERED (FLOW FROM PORT T TO PORTS A&B)

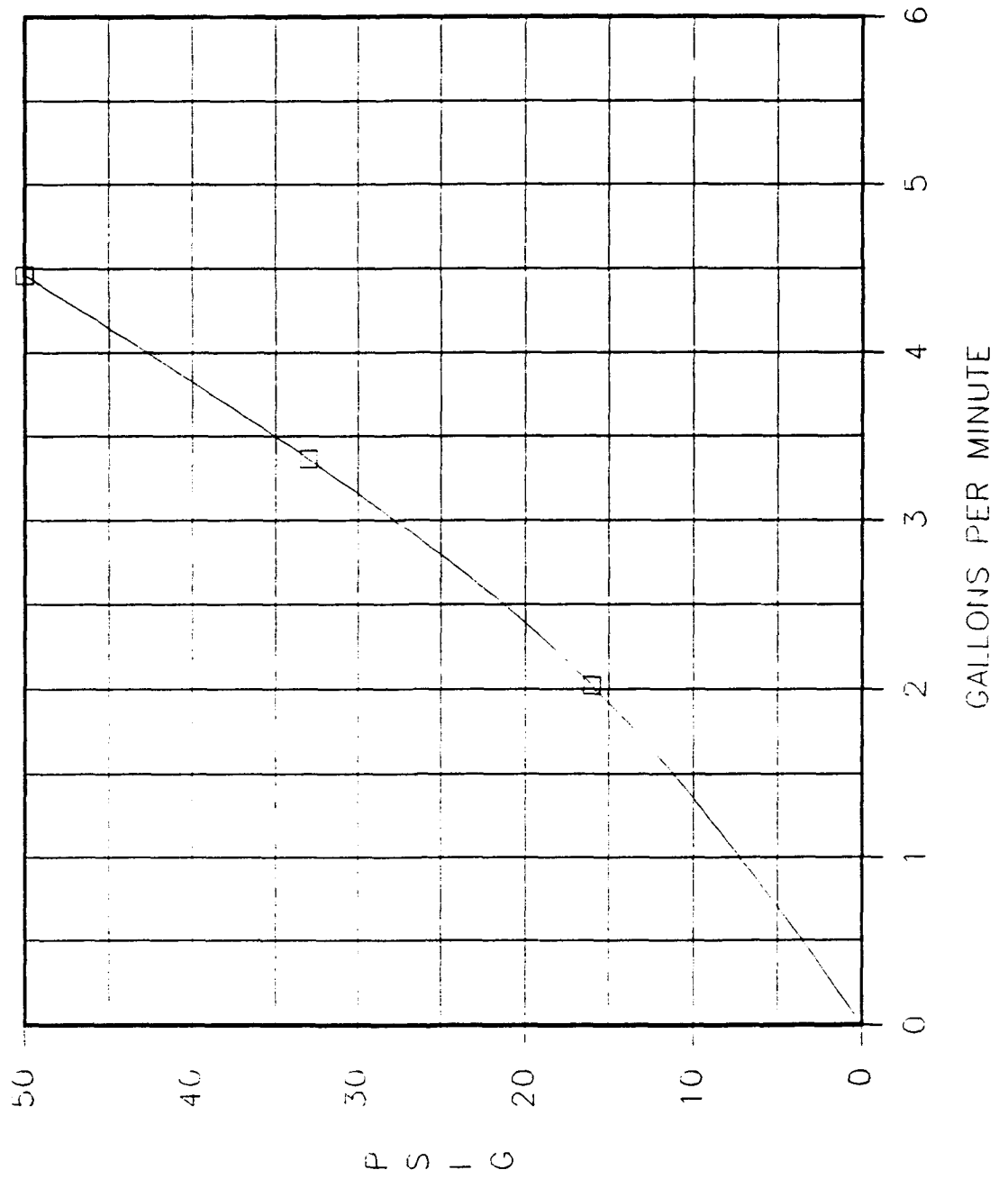
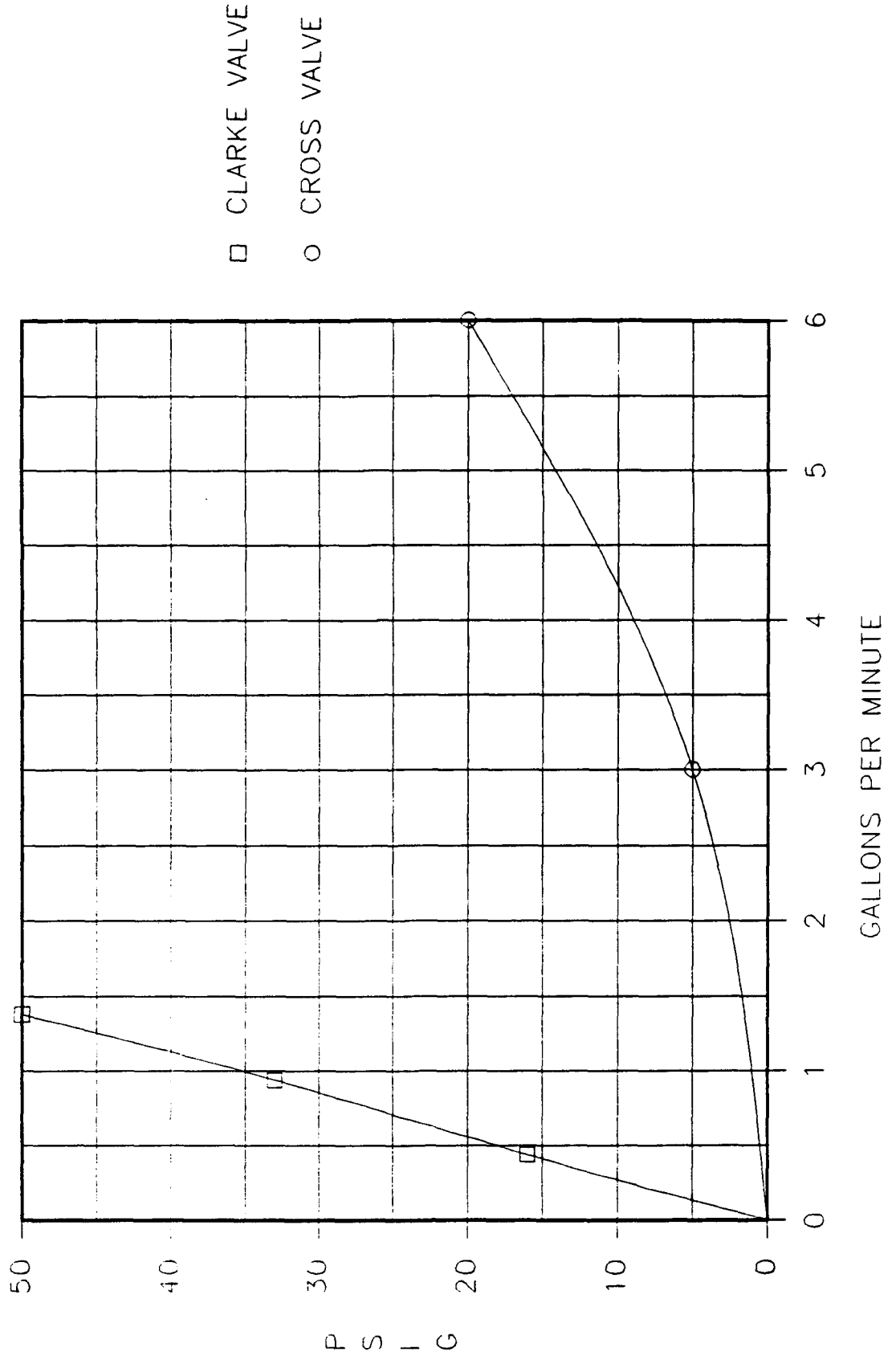

FIGURE 6

COMPARISON OF FLOW CHARACTERISTICS

SPOOL OUT (FLOW FROM PORT P TO PORT B)



□ CLARKE VALVE
○ CROSS VALVE

FIGURE 7

COMPARISON OF FLOW CHARACTERISTICS

SPOOL OUT (FLOW FROM PORT B TO PORT P)

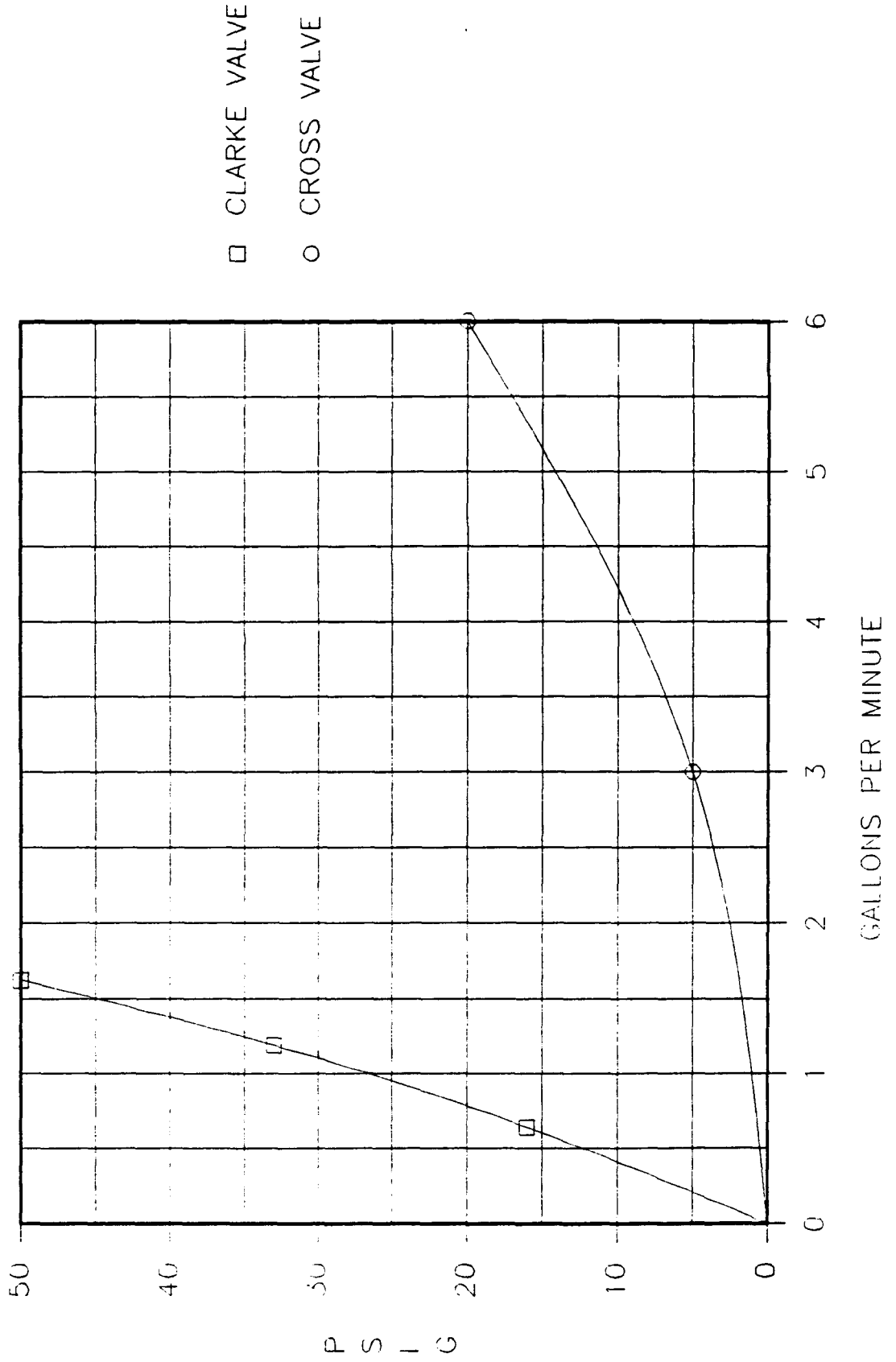

FIGURE 8

COMPARISON OF FLOW CHARACTERISTICS

SPOOL OUT (FLOW FROM PORT A TO PORT T)

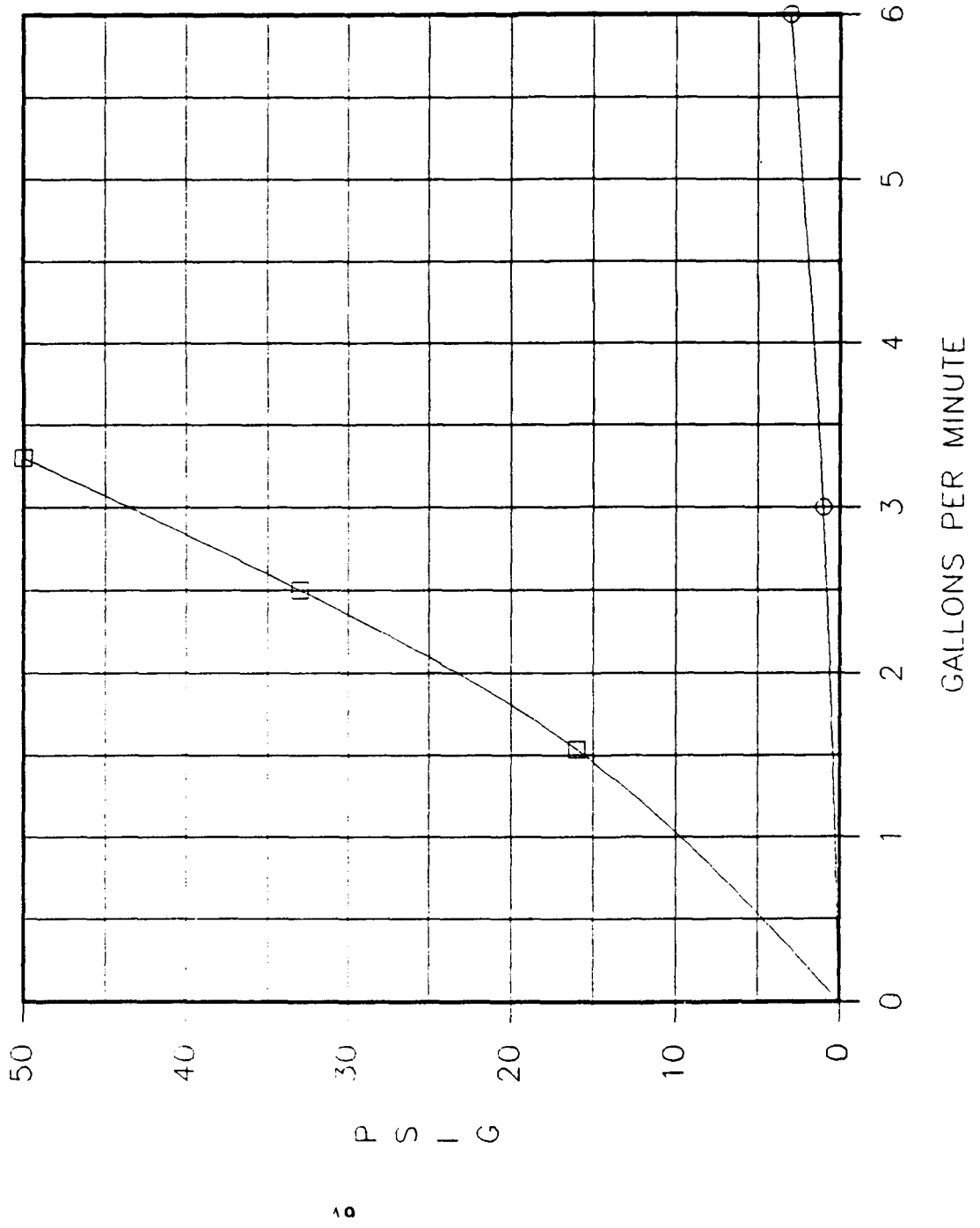

FIGURE 9

COMPARISON OF FLOW CHARACTERISTICS

SPOOL OUT (FLOW FROM PORT T TO PORT A)

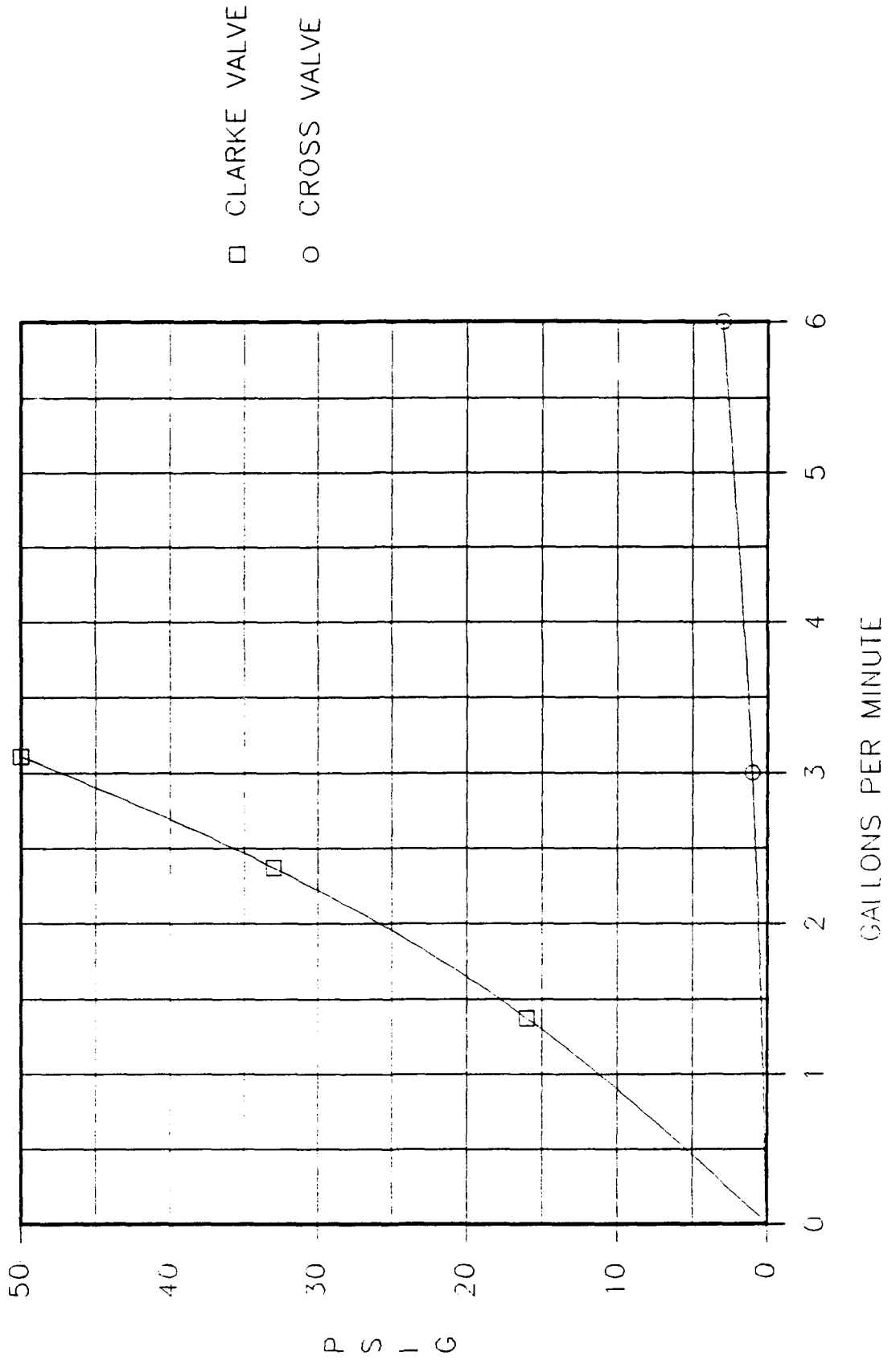

FIGURE 10
COMPARISON OF FLOW CHARACTERISTICS
SPOOL IN (FLOW FROM PORT P TO PORT A)

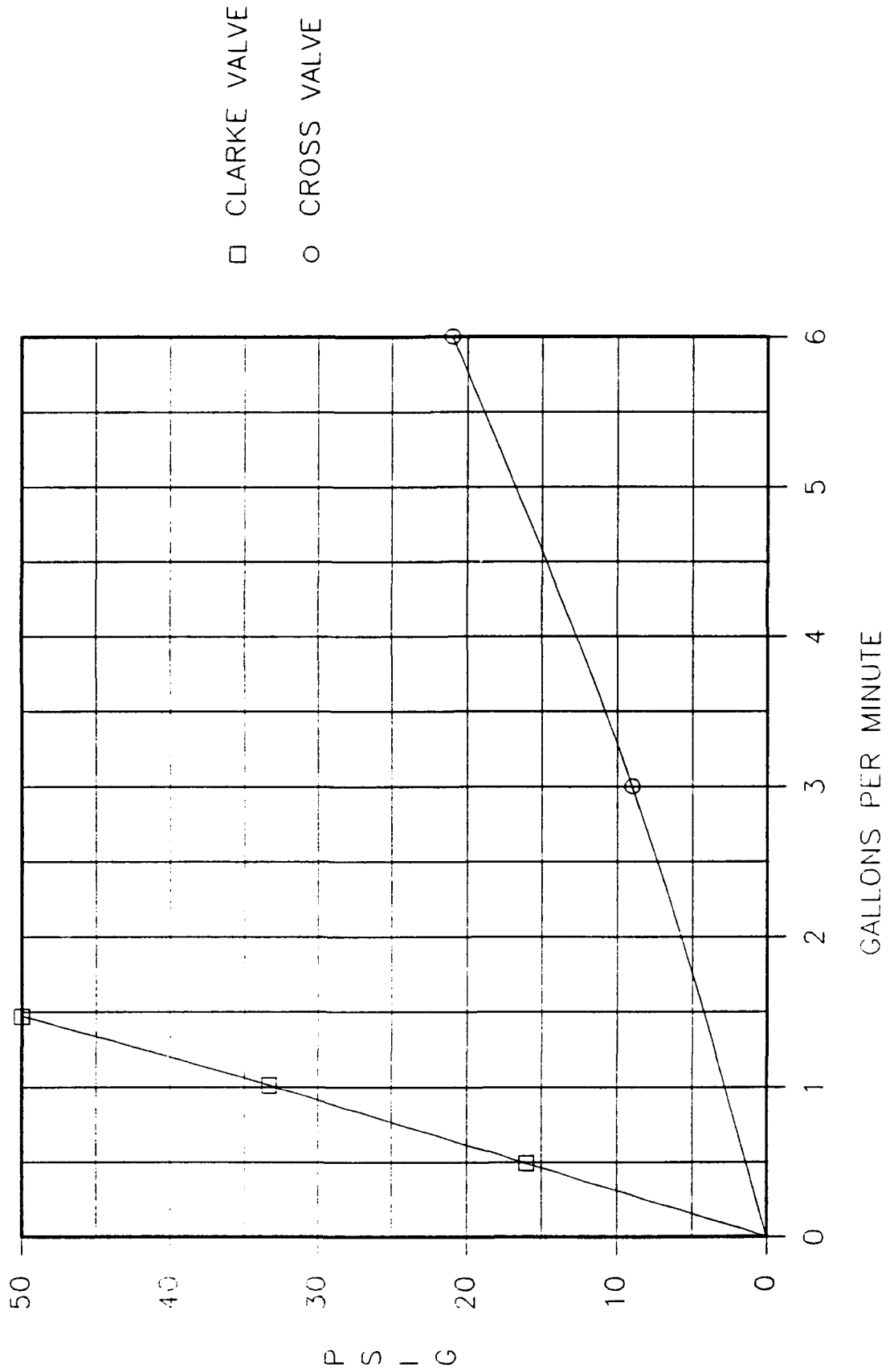

FIGURE 11

COMPARISON OF FLOW CHARACTERISTICS

SPOOL IN (FLOW FROM PORT A TO PORT P)

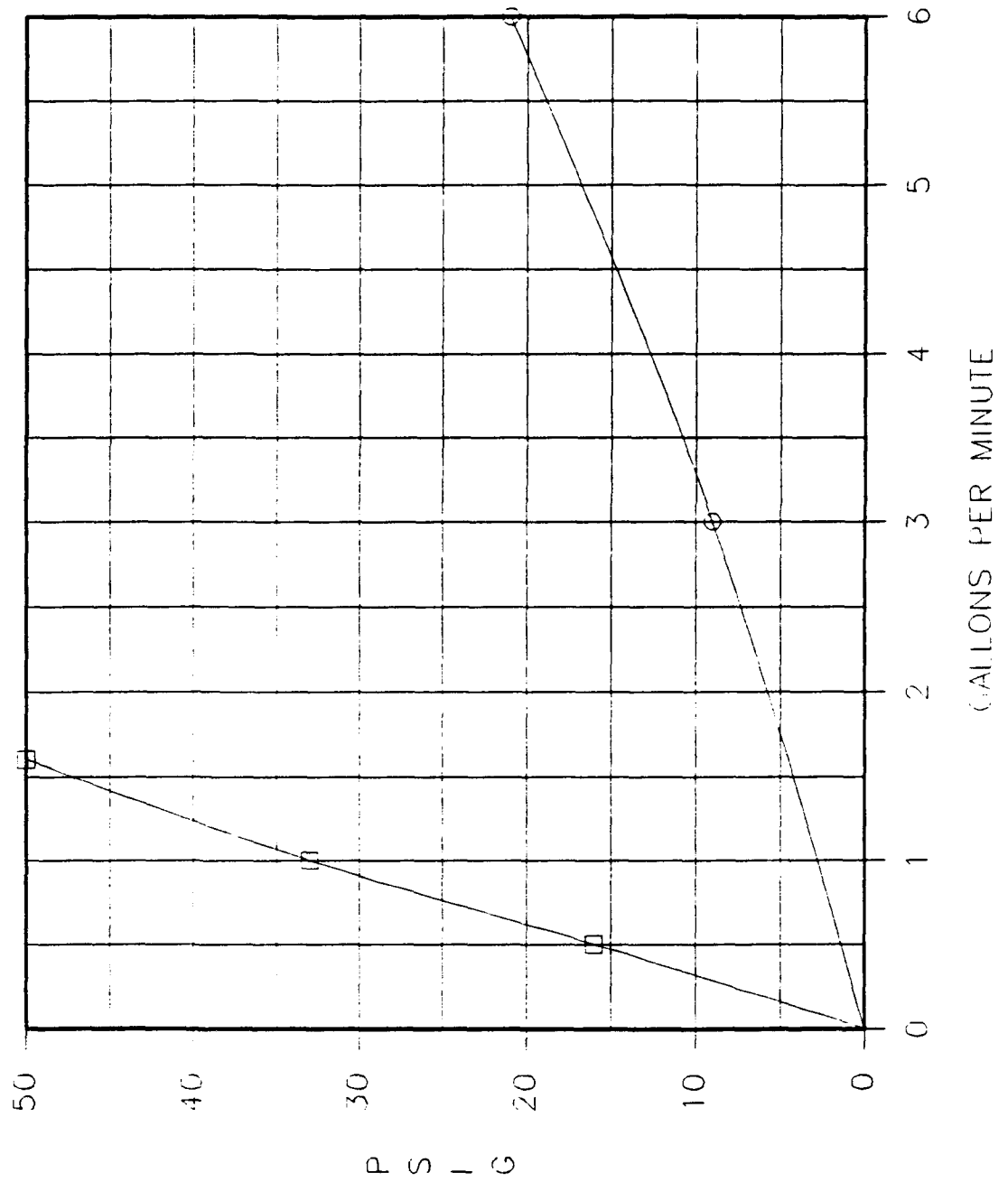

FIGURE 12

COMPARISON OF FLOW CHARACTERISTICS

SPOOL IN (FLOW FROM PORT T TO PORT B)

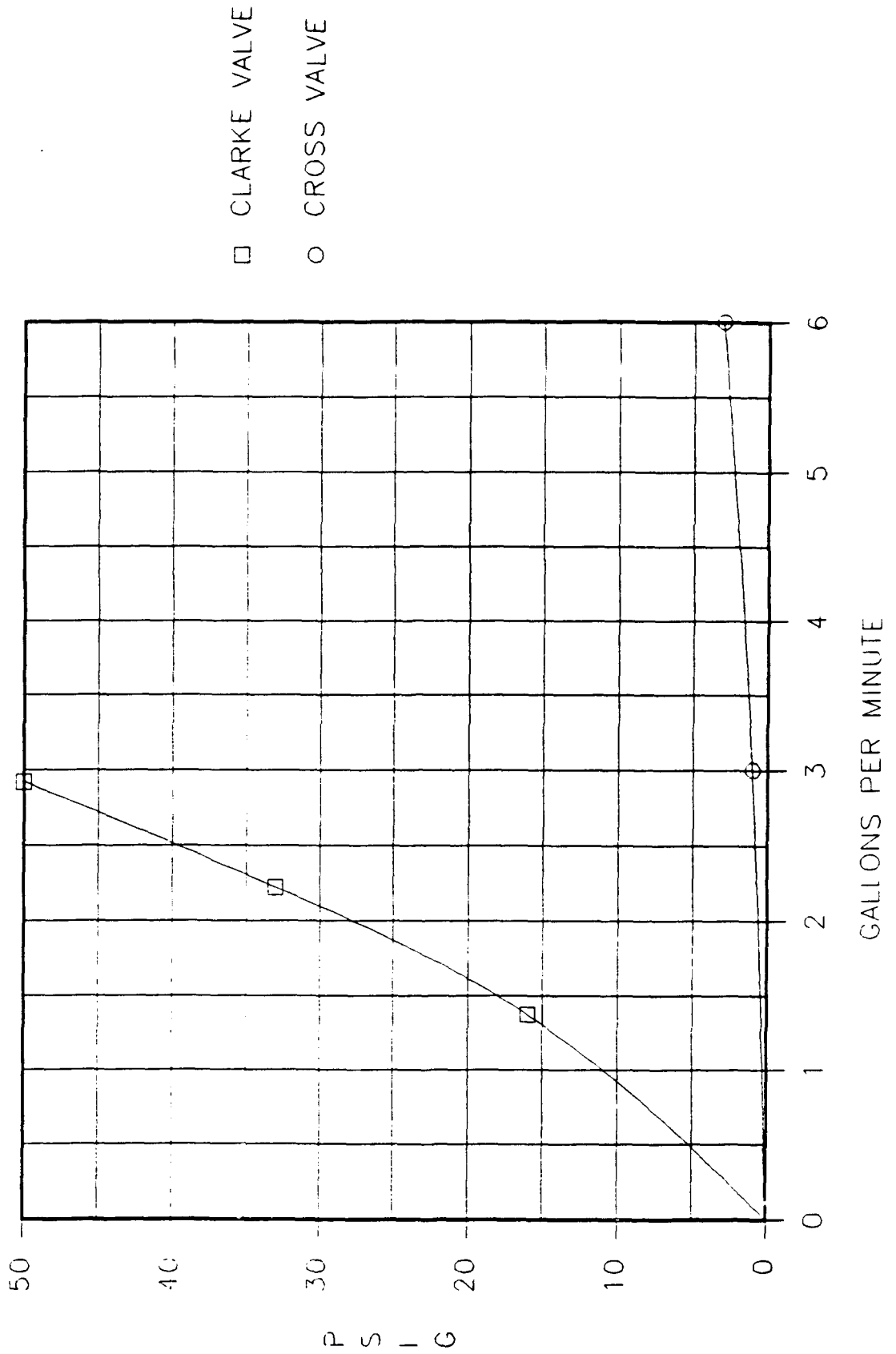
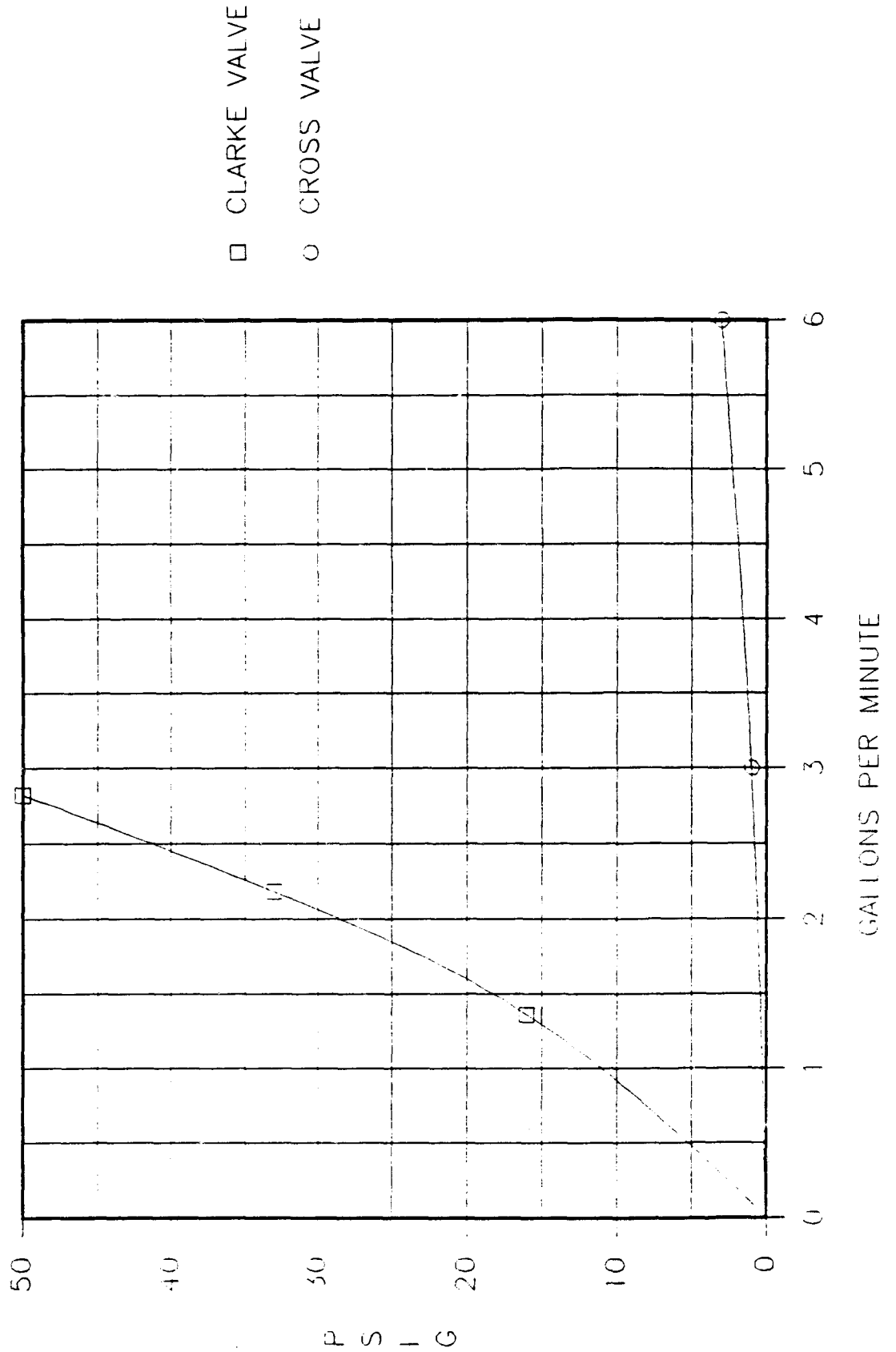

FIGURE 13
 COMPARISON OF FLOW CHARACTERISTICS
 SPOOL IN (FLOW FROM PORT B TO PORT T)



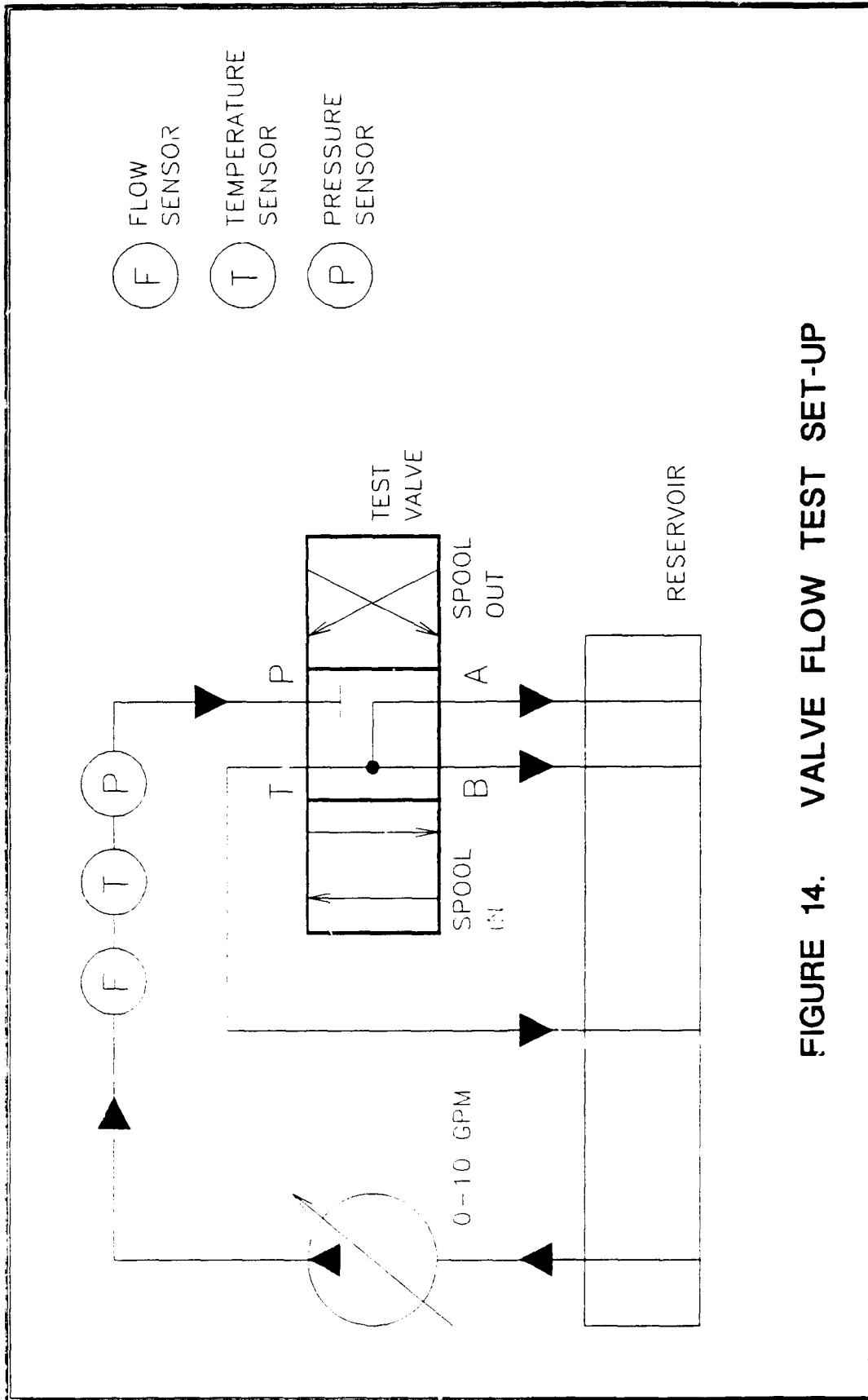

FIGURE 14. VALVE FLOW TEST SET-UP

TAB B
TO APPENDIX A

HYDRAULIC VALVE DATA SHEETS

RECOMMENDED REPLACEMENT



HYDRAULIC VALVES

DIRECTIONAL CONTROL AD SERIES Specification Sheet



AD 1



AD 2

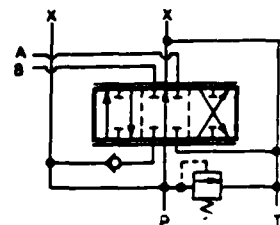

The Cross series AD directional control valves provide good metering characteristics and long dependable service life. Optimum versatility is provided due to the many standard and optional features. Balanced spools are select-fit for minimum leakage and load holding checks prevent load drop when shifting. Parallel flow path permits spools to be operated independently or simultaneously.

GENERAL SPECIFICATIONS

Number of spools	One, two
Maximum working pressure	3000 psi (206 bar)
Maximum shock and surge pressure	4000 psi (276 bar)
Maximum flow capacity	15 gpm (57 l/m)
Maximum spool leakage (at 1000 psi w/100 SUS oil at 120° F)	16 cc/min.
Mounting, any position	Two mounting holes for 1/4" dia. bolts
Weight	1 spool: 8 lbs. (3.6 Kg.) 2 spool: 10 lbs. (4.5 Kg)

MATERIAL SPECIFICATIONS

Body	High tensile strength cast iron
Spools	Ground, plated and polished steel alloy
Seals	Buna N

STANDARD FEATURES

- Integral load holding check valves (prevent reverse flow through valve when shifting)
- Integral differential poppet type relief valve, adjustable (set at 2000 psi, 10 gpm)
- Balanced, select-fit spools (provide minimum leakage, smooth operation)
- External spool seals (permit easy replacement, reduced maintenance cost)
- SAE#10 (5/8") 7/8 - 14 inlet and outlet ports: SAE#8 (1/2") 3/4 - 16 work ports
- Complete handle assembly

OPTIONAL FEATURES AVAILABLE

- Open or closed center positions, 3-way or 4-way operation, 3-position or 4-position (float position), full open center (motoring spool) and other spool options
- Power beyond (permits use of neutral flow at system pressure); also permits field conversion from closed center to open center (tandem) operation

NOTE: Refer to CROSS Valve Technical/Service Sheet for recommendations and limitations.



DIMENSIONAL DATA in inches

ONE SPOOL

TWO SPOOL

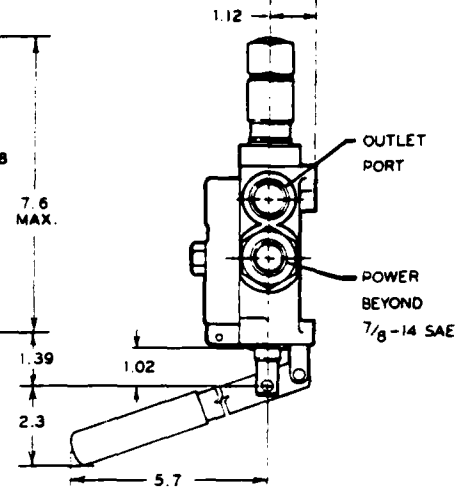
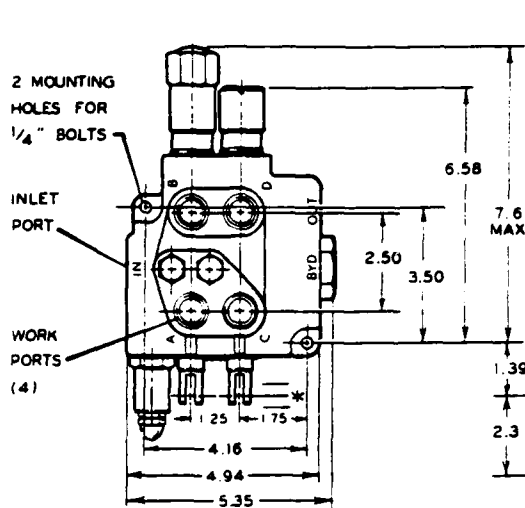
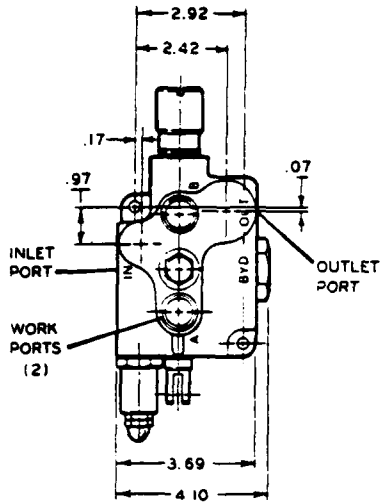

* SPOOL TRAVEL: .22" EACH WAY FROM NEUTRAL. (.375 FOR FLOAT)

SPOOL OPTIONS

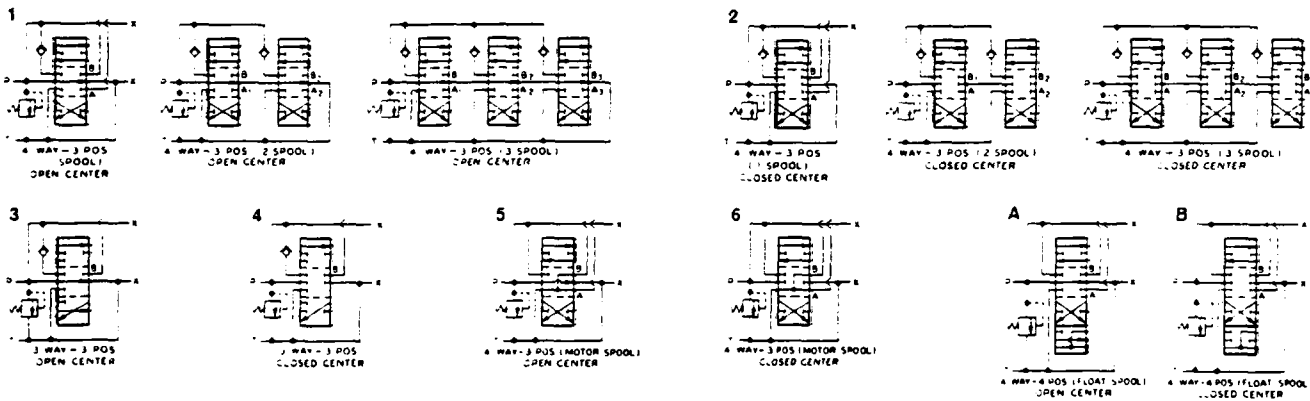

ACTUATOR OPTIONS

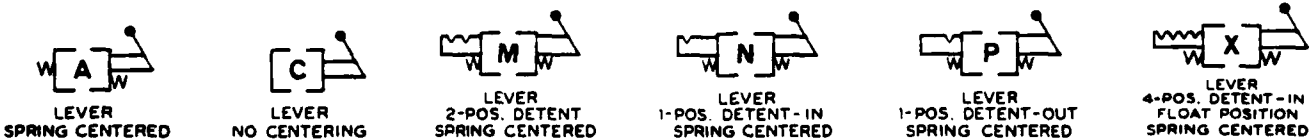



HYDRAULIC VALVES

DIRECTIONAL CONTR.
AD SERIES
 Specification Sheet

TYPICAL PERFORMANCE DATA

PRESSURE DROP (with 100 SUS oil at 120° F. SAE#10 in and out, #8 work ports.)

AD 1

FLOW GPM			PSI		
	P-A	P-B	A-T	B-T	P-T
3	9	5	1	1	2
6	21	20	3	3	5
9	42	40	10	11	11
12	65	63	21	20	20
15	90	87	34	32	32

FLOW GPM	FLOAT	PSI	
		P-A-B-T	P-A-B-T
3	12	10	11
6	23	27	29
9	43	53	60
12	65	88	100
15	90	125	140

TO CONVERT	INTO	MULTIPLY BY
GALLONS	LITERS	3.7853
PSI	BAR	0.0690

AD 2

FLOW GPM			PSI			
	P-T	P-A	P-B	P-C	P-D	
3	4	20	18	20	20	
6	12	38	34	40	36	
9	28	62	54	72	58	
12	46	96	82	110	88	
15	71	138	114	156	122	

FLOW GPM	A-T	B-T	PSI		FLOAT	
			C-T	D-T	A-B	B-A
3	4	4	4	4	10	10
6	12	12	10	10	32	30
9	24	26	22	20	70	64
12	40	44	36	34	118	108
15	60	66	54	50	180	164

FLOW GPM	PSI			
	PABT	PBAT	PCDT	PDCT
3	24	24	24	24
6	52	52	54	48
9	94	88	98	84
12	146	134	158	130
15	212	192	228	286

TYPICAL PERFORMANCE DATA

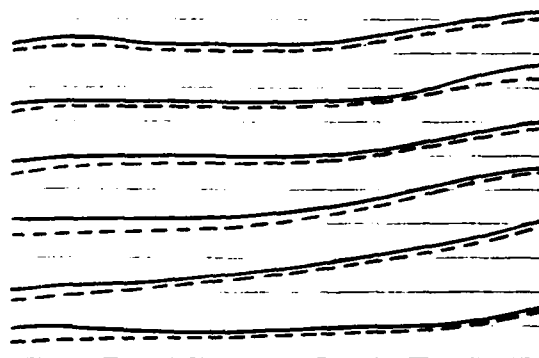

100 SSU oil at 120° F

Opening
 Closing



ORDERING INFORMATION

MODEL NO	NO OF SPOOLS	SPOOL TYPE	SPOOL ACTION (ACTUATOR OPTIONS)	RELIEF VALVE	POWER BEYOND	OUTLET PORT LOCATION	PORT SIZE & TYPE	HANDLE
AD	1 Single	1 4-way 3-position open center	A 3-position Spring Centered	A 2000 psi	O None	O End Outlet	O SAE#10	O Complete Handle Assembly
	2 Double	2 4-way 3-position closed center	C manual-no detent no centering spring	B 1500 psi	2 3/16-18 SAE # 6	P ² Top inlet & outlet	O SAE#8 3/8-16 Work Ports	1 Less Complete Handle Assembly
		3 ¹ 3-way 3-position open center	M 2-position detent in & out spring center	C 2000 psi				
	3 ¹	4 ¹ 3-way 3-position closed center	N 1-position detent in only spring center	D None	3 Conversion plug	H ² Top inlet	1 1/2" NPTF inlet & Outlet 3/8" NPTF Work Ports	2 Less Handle Only (link pins & bracket included)
		5 4-way 3-position open center w/motoring spool	P 1-position detent out only spring center	E Other	4 3/8-14 SAE#10			
	6	6 4-way 3-position closed center w/motoring spool	X 4-pos sprg ctr to neutral. Detent in float position	F Adjustable 500-1500 psi set at 1000 psi	5 Closed ctr plug	R Rear 3/8" NPTF	3 Other	
		A 4-way 4-position open center Detent float position	A Adjustable 1500-3500 psi (Set at 2000 psi)	G				
	B	B 4-way 4-position closed center Detent float position				T Top outlet		

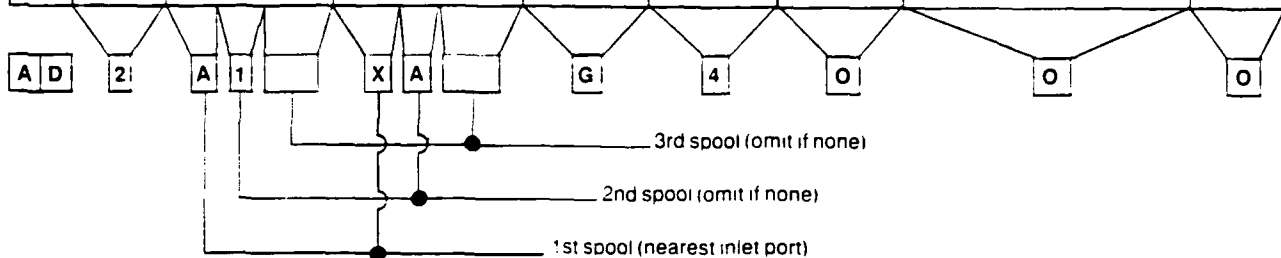

When this spool in the second spool of a two spool valve is shifted to gravity return, no pressure may be built on A or B port of the first spool.

¹ Available only on single spool model.

EXAMPLE: AD2A1XAG4000 is an AD manually operated double spool valve, the first spool being 4-way, 4-position, open center, spring centered with detent in float position; the second spool being 4-way, 3-position, open centered, spring centered. The adjustable relief valve is set at 2000 psi. Power beyond sleeve port with 3/8 - 14 SAE thread. Inlet and outlet ports SAE#10, 3/8 - 14 Work ports SAE#8, 3/4 - 16. Complete handle assembly.



APPENDIX B

TEST REPORT

CROSS AD SERIES
STEERING MODE SELECTOR VALVE

**TEST REPORT
OF CROSS AD SERIES
STEERING MODE SELECTOR VALVE TESTS**

This report documents tests performed on a hydraulic valve being considered as a replacement steering mode selector valve in an American Hoist and Derrick model 2380A Rough Terrain Crane. Similar tests were also performed on the original steering mode selector valve which is now obsolete. The original valve was manufactured by the Hydraulics Component Division of the Clark Equipment Company. The selected replacement valve is a type AD Series directional control valve manufactured by Cross Manufacturing, Inc of Lewis Kansas. The flow characteristics of the obsolete valve were not documented and were determined by these tests to allow selecting a suitable substitute. Both valves were measured using the same equipment and test set up.

The steering mode selector valve is a 4-way 3-position hydraulic valve used to control the rear wheel steering mode of the crane's carrier. A simplified diagram of the crane's steering system is depicted in Figure 1.

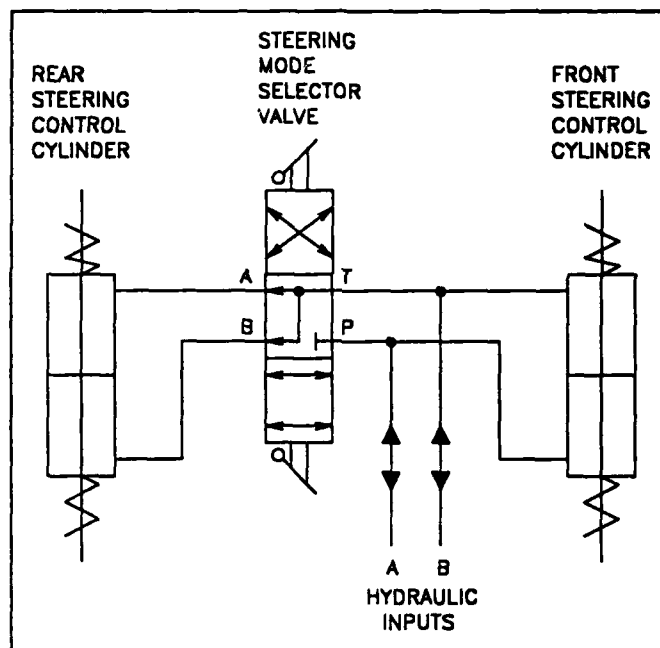

**Figure 1
SIMPLIFIED STEERING SYSTEM DIAGRAM**

With the steering mode selector valve in the center position as shown, hydraulic pressure applied to inputs A or B will cause the front steering control cylinder to move. This cylinder contains self centering springs resulting in the requirement that continual hydraulic pressure be supplied by the steering system to hold the steering control cylinder in the desired position. When pressure is applied to hydraulic inputs A or B of Figure 1 the rear steering control cylinder remains centered since the same pressure is applied to both ends of the cylinder. When the steering mode selector valve is in either of the other two positions, the rear wheel steering modes, the hydraulic pressure is also applied to the rear steering control cylinder. It also is a self centering cylinder with return springs identical to the front steering control cylinder causing its position to track any position changes of the front steering control cylinder. The two rear wheel steering modes, OBLIQUE and REAR STEER, connect the hydraulic lines to the rear steering control cylinder differently. In the OBLIQUE mode the front and rear wheels turn the

same direction while in the REAR STEER mode the rear wheels turn opposite of the front. These rear wheel steering modes provide the crane carrier with additional maneuverability when needed. The maximum system hydraulic pressure is 650 PSIG, however, this pressure will never be imposed continually on any of the valve ports. These functional requirements will generally be met by a 3-position, 4-way valve with a spool designed to control a hydraulic motor.

In addition to the functional requirements just described there is a proof pressure requirement of 2000 PSIG and a requirement that the valve be easy to operate. The ease of operation was quantitatively defined by measuring the force required to move the obsolete valve's handle when 650 PSIG was applied to the pressure port (P) and the remaining ports returned to the tank. If the force required to move the replacement valve's handle was not substantially greater than the obsolete valve's handle we would consider it acceptable.

The flow measurements and handle force measurements were done using the test set-up shown in figure 2. The 2000 PSIG proof pressure test was done by applying 2000 PSIG to all valve ports simultaneously.

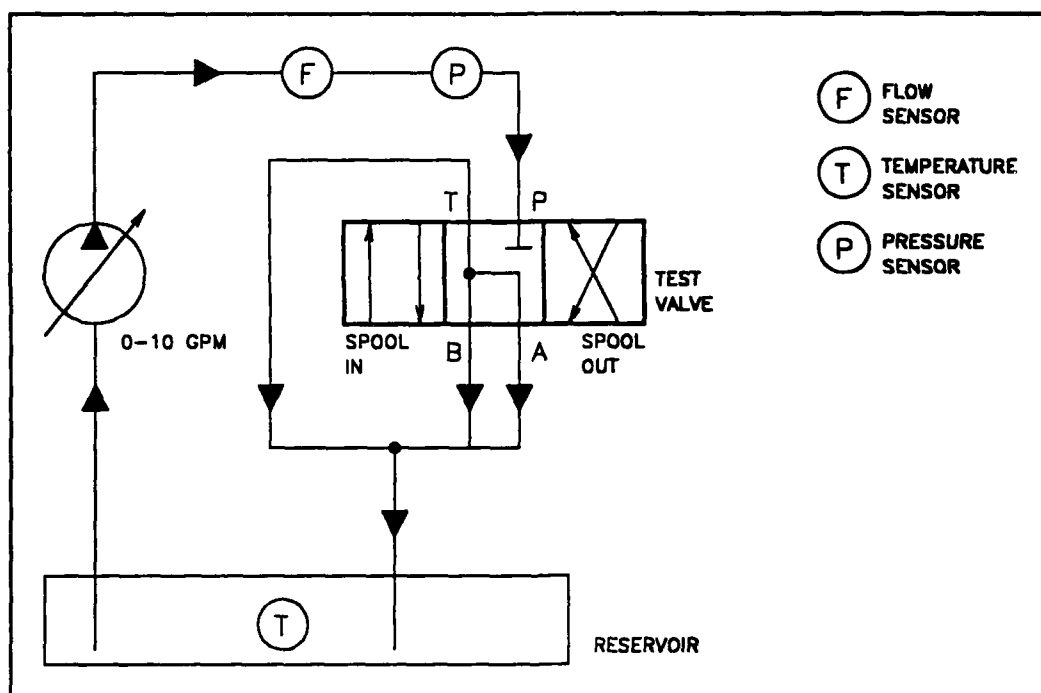

Figure 2
HYDRAULIC FLOW TEST SET-UP

During the flow tests it was discovered that the Cross valve had an internal poppet type check valve preventing backflow out the pressure (P) port. This prevented the valve from providing the needed functional characteristics and was removed. The poppet and an associated spring are easily removed. It was verified that the previous flow measurements were not significantly affected by the check valves presence and the flow testing was completed.

The flow test data is graphically depicted in Figure 3 through Figure 13 showing the measured characteristics of both valves for comparison on the same graph for each fluid flow path. The data shown by these graphs includes the backpressure drop through the hoses returning the hydraulic fluid to the reservoir. If the actual valve pressure drop is desired the backpressure, graphically depicted in Figure 14, should be subtracted from the pressures shown in the valve flow measurement graphs.

The flow tests show the replacement valve's resistance to flow in the two 4-wheel steering modes is significantly less than the obsolete valve. This is expected to result in a faster dynamic response time of the rear wheel steering system. This is not expected to cause any undesirable steering characteristics. The flow tests also show the replacement valve's resistance to flow at the rear steering control cylinders is significantly higher than the obsolete valve when the valve is in the front steering mode. No fluid flow occurs when steering mode selector valve is in its center position except when the valve is returned to center with the rear wheels turned. When this occurs, fluid must flow between ports A and B until the self centering rear steering control cylinder has returned to its center position. The increased resistance to flow under these conditions will slow the return of the rear wheels to their center position. This should be of little consequence.

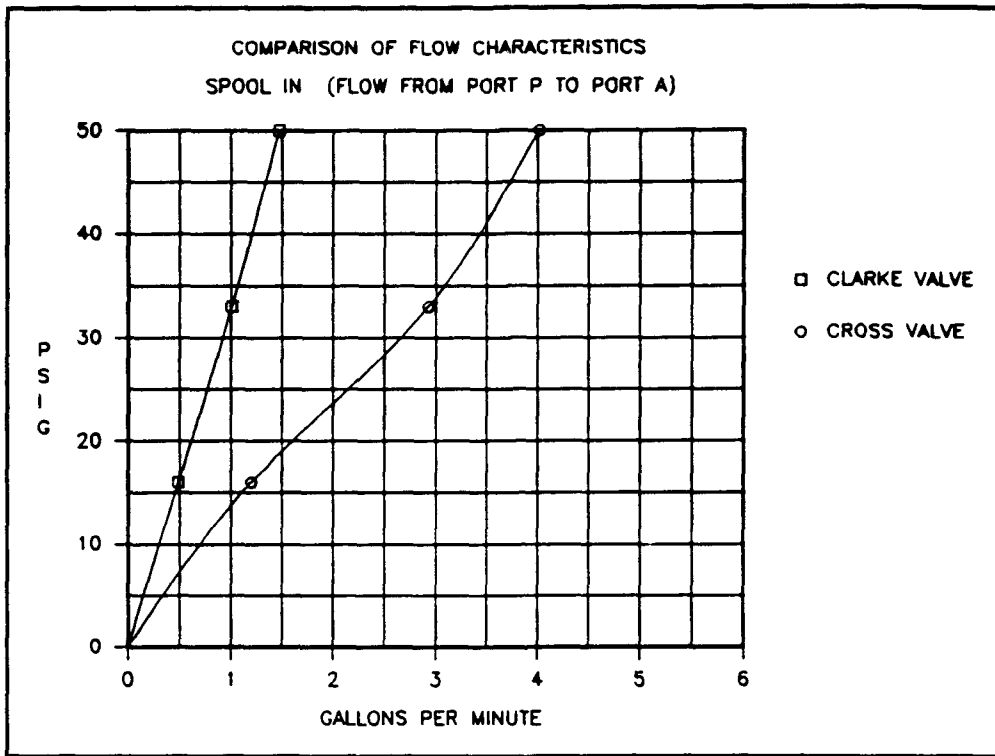

Figure 3

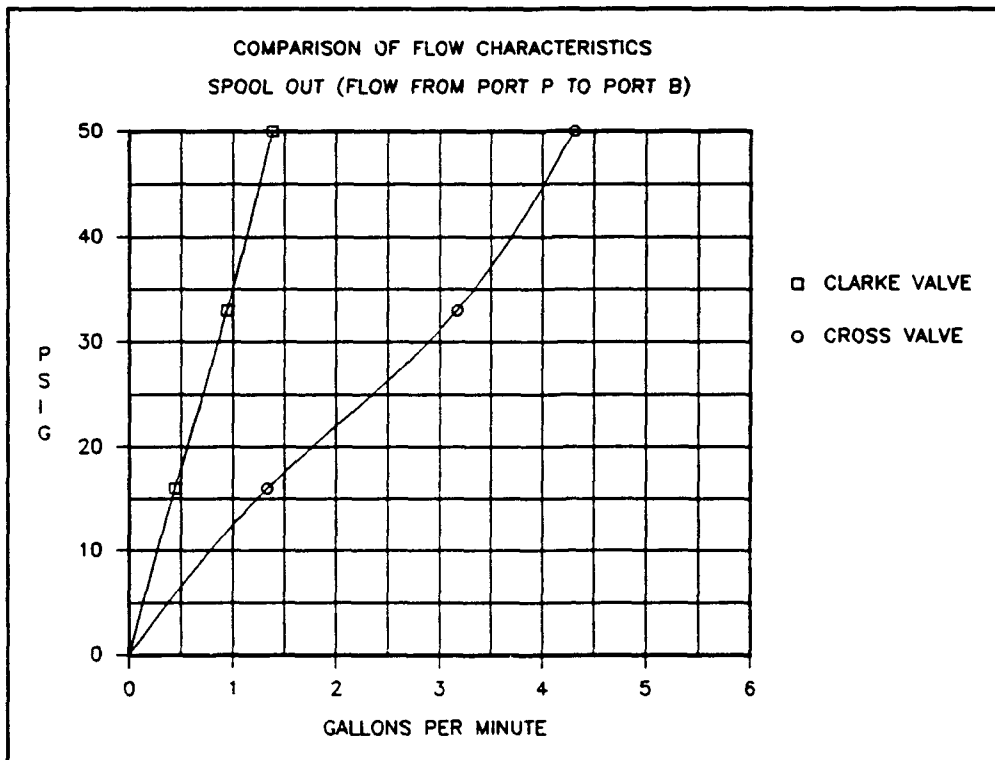

Figure 4

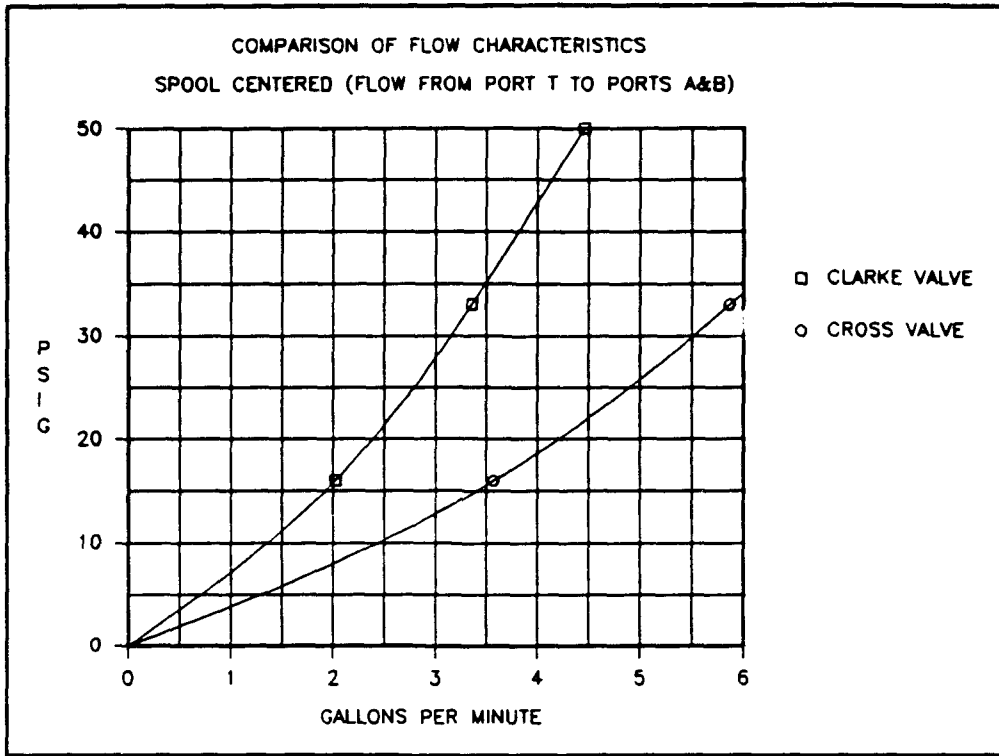

Figure 5

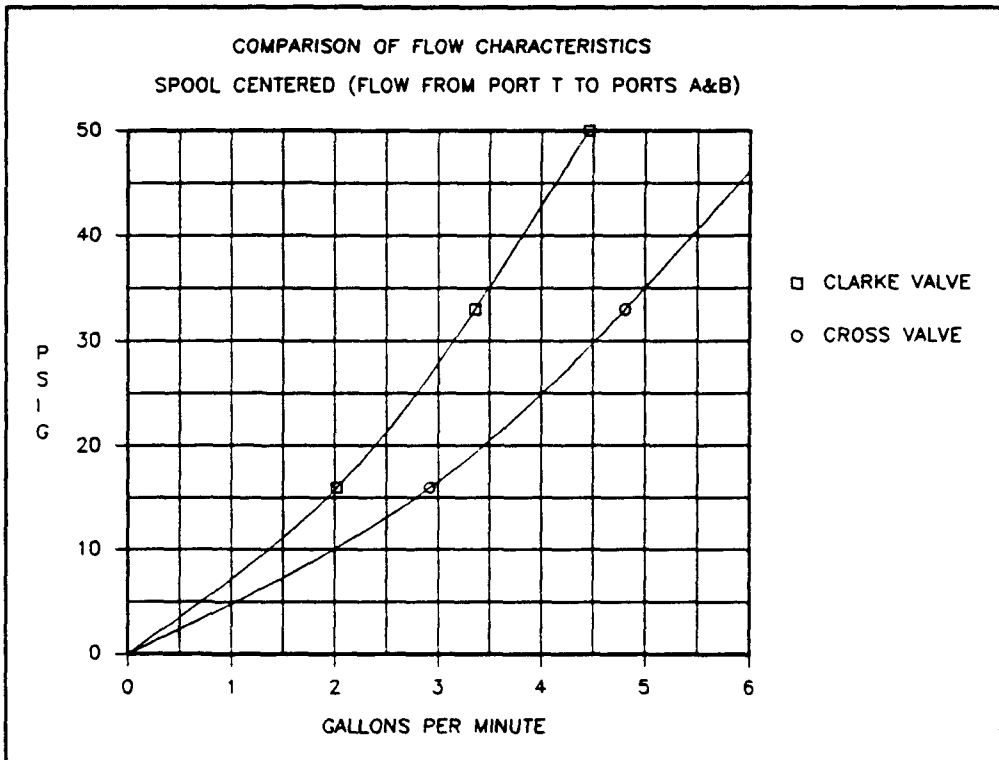

Figure 6

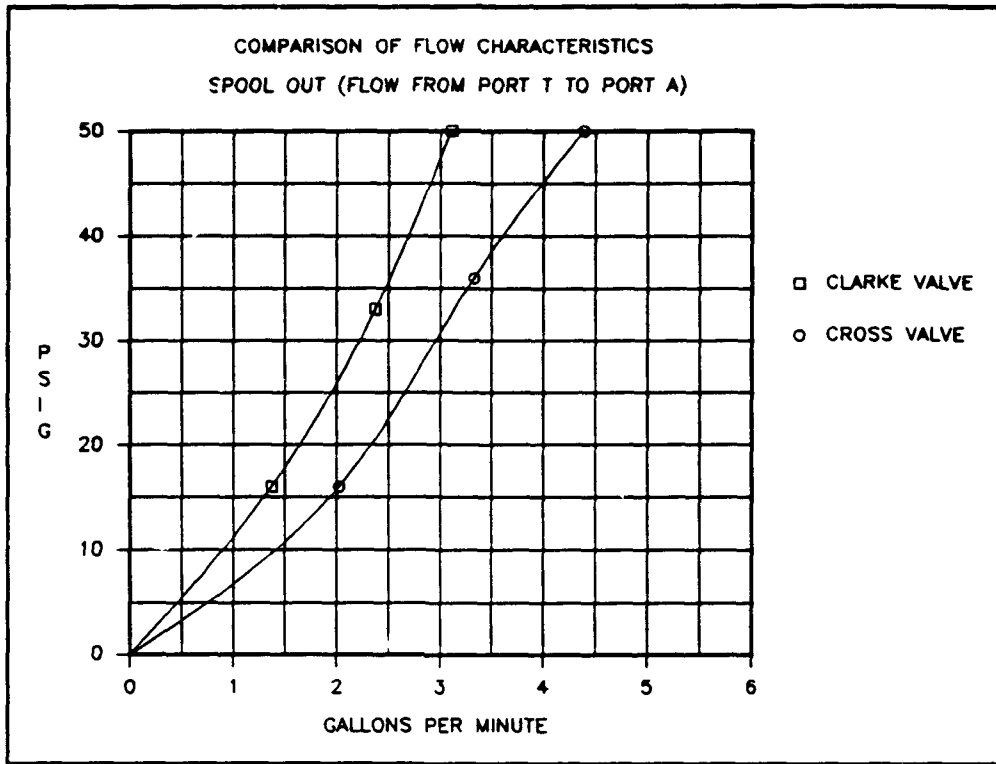

Figure 7

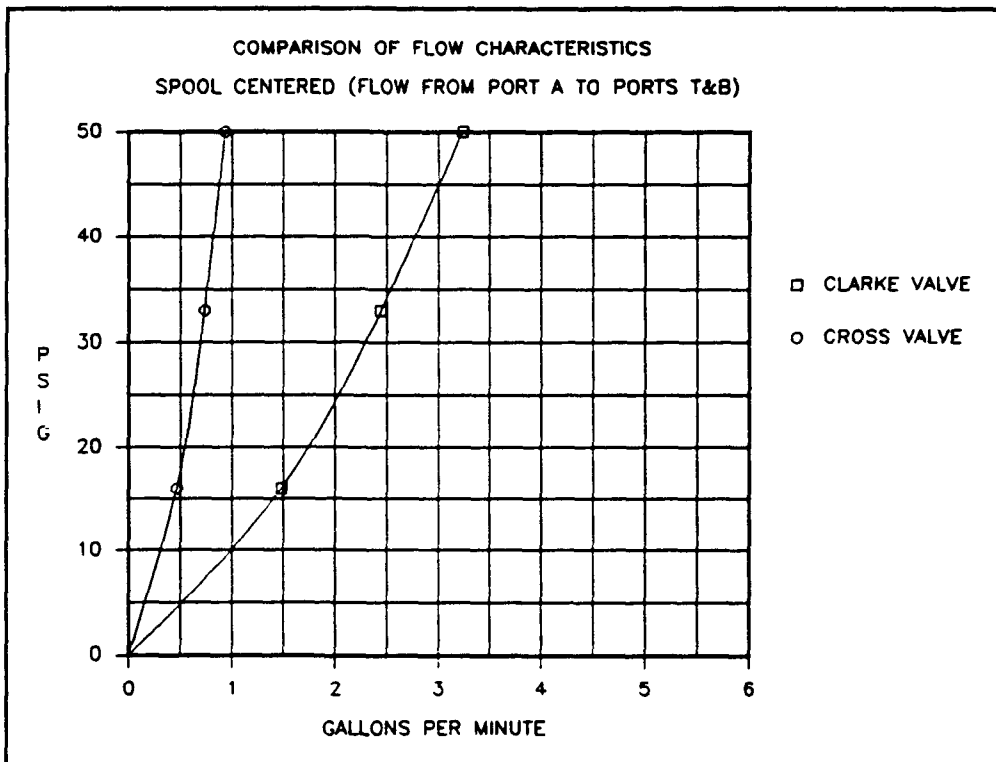

Figure 8

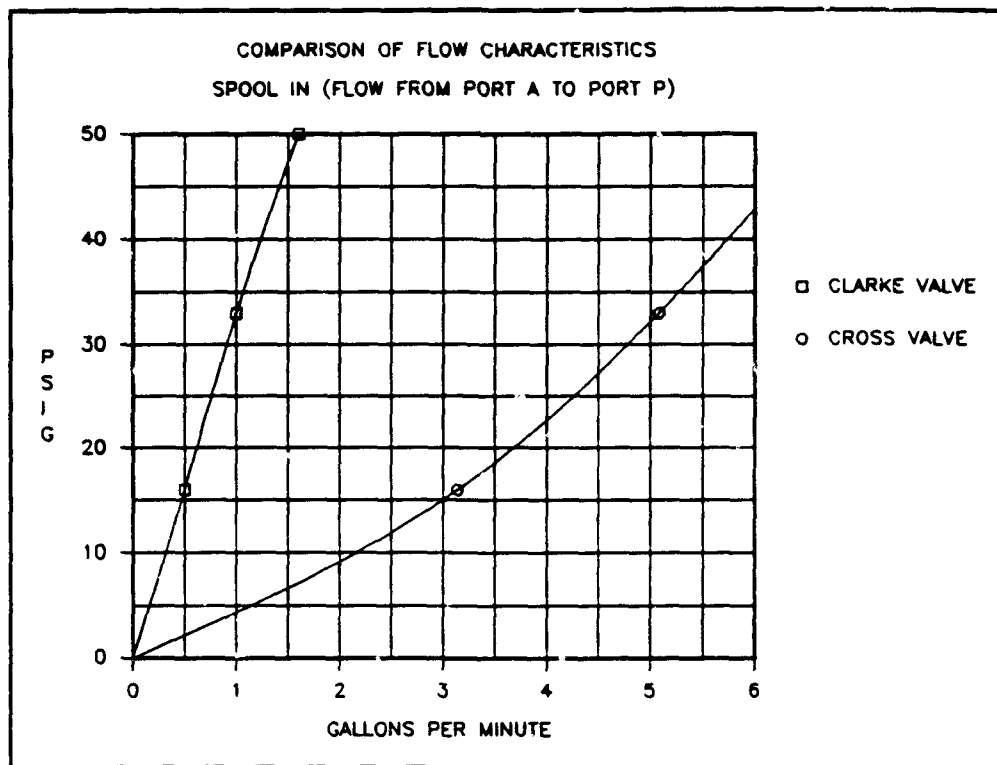

Figure 9

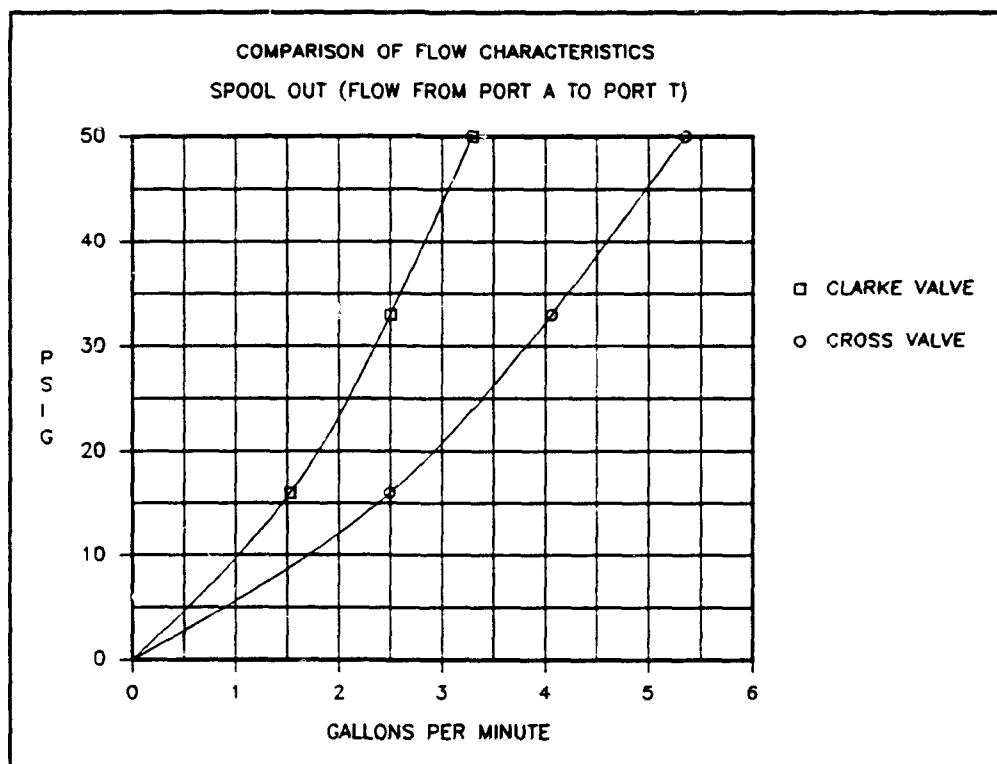
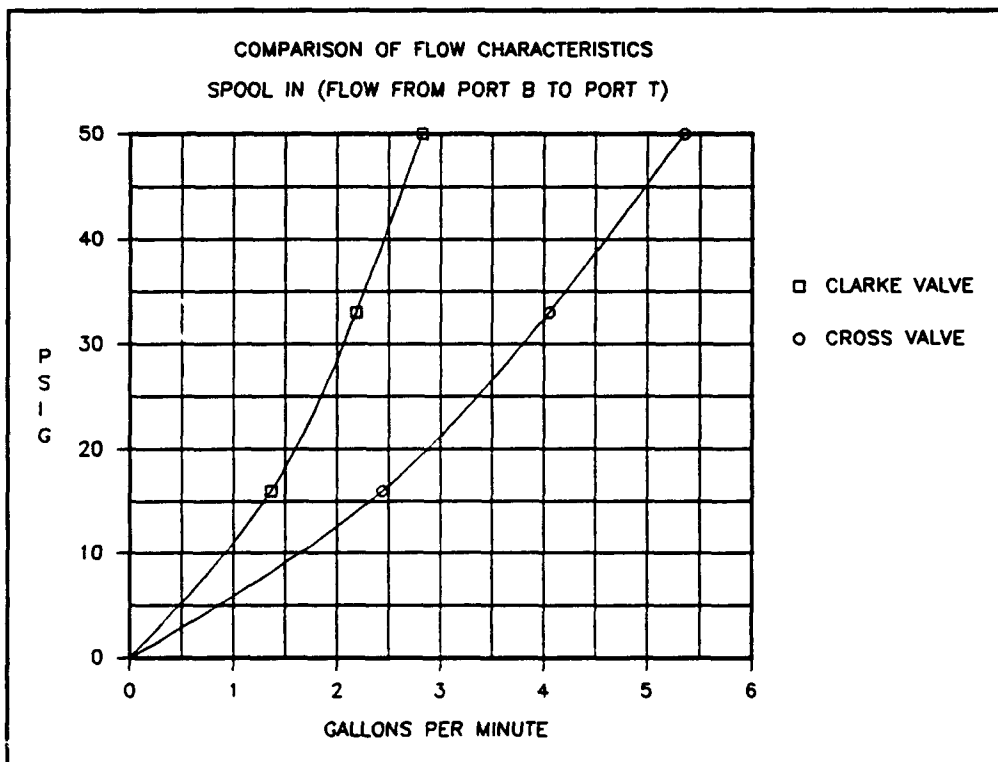
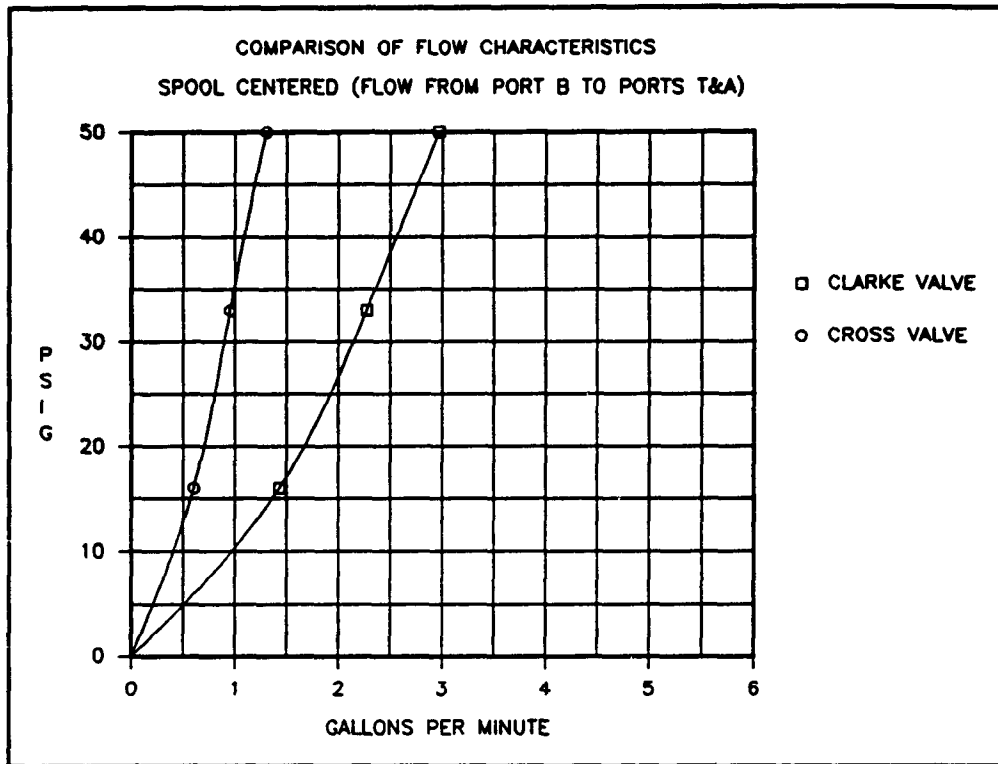

Figure 10



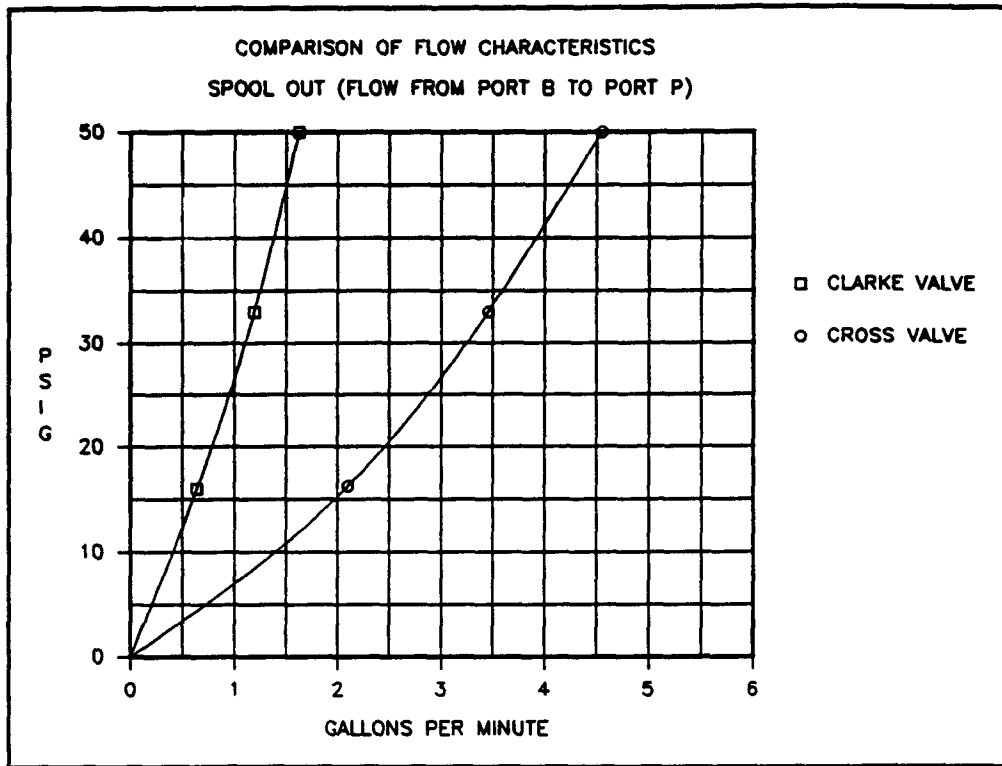

Figure 13

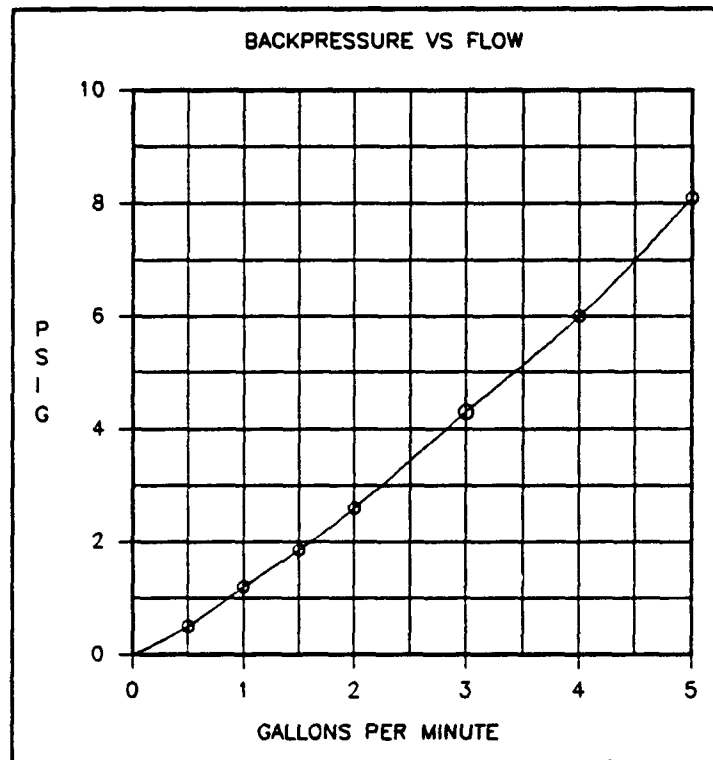

Figure 14

HYDRAULIC VALVE BENCH TEST DATA SHEET

TEST PERFORMED BY L.C. VIA & C. WHITTON

DATE 3-11-93
3-12-93
3-17-93

HYDRAULIC FLUID USED:

MANUFACTURER Texaco PRODUCT DESIGNATION RANDO 32
NOMINAL VISCOSITY: 100 DEG F 155 SUS 210 DEG F 44 SUS

EQUIPMENT USED FOR MEASUREMENTS TRACEABLE TO N.I.S.T

0-50 PSIG PRESSURE MEASUREMENT DEVICE:

MFR. HEISE MODEL H21954 CALIBRATION DATE 11-20-92 ASSET NO. _____

0-2000 PSIG PRESSURE MEASUREMENT DEVICE:

MFR. ASHCRAFT MODEL 0-5000 CALIBRATION DATE 11-20-92 ASSET NO. _____

FLUID FLOW MEASUREMENT DEVICE:

MFR. WEBSTER MODEL HC125 CALIBRATION DATE 11-24-92 ASSET NO. _____

FLUID TEMPERATURE MEASUREMENT DEVICE:

MFR. OMEGA MODEL 450AK7 CALIBRATION DATE 11-23-92 ASSET NO. _____

FORCE MEASUREMENT DEVICE:

MFR. TOLEDO MODEL 8140 CALIBRATION DATE 11-24-92 ASSET NO. _____

FLOW TEST DATA

1.4.1.1 PRESSURE AT PORT P, SPOOL IN, FLOW P to A:

	(a)	(b)	(c)
FLOW	<u>4.01</u> GPM	<u>2.93</u> GPM	<u>1.20</u> GPM
PRESSURE	<u>50</u> PSIG	<u>33</u> PSIG	<u>16</u> PSIG
TEMPERATURE	<u>95</u> DEG F	<u>96</u> DEG F	<u>96</u> DEG F

1.4.1.2 PRESSURE AT PORT P, SPOOL OUT, FLOW P to B:

	(a)	(b)	(c)
FLOW	<u>4.31</u> GPM	<u>3.17</u> GPM	<u>1.33</u> GPM
PRESSURE	<u>50</u> PSIG	<u>33</u> PSIG	<u>16</u> PSIG
TEMPERATURE	<u>97</u> DEG F	<u>98</u> DEG F	<u>98</u> DEG F

SIZE

FSCM NO.

A

99789

TP3212.013



4000 GEORGIA AVENUE
SILVER SPRING, MARYLAND 20908-2972
(301) 221-1000

1.4.1.3 PRESSURE AT PORT T, SPOOL CENTERED, FLOW T to A&B:

	(a)	(b)	(c)
FLOW	<u>2.62</u> GPM	<u>5.86</u> GPM	<u>3.57</u> GPM
PRESSURE	<u>50</u> PSIG	<u>33</u> PSIG	<u>16</u> PSIG
TEMPERATURE	<u>98</u> DEG F	<u>98</u> DEG F	<u>99</u> DEG F

HYDRAULIC VALVE TEST DATA SHEET (CONT'D)

1.4.1.4 PRESSURE AT PORT T, SPOOL IN, FLOW T to B:

	(a)	(b)	(c)
FLOW	<u>6.31</u> GPM	<u>4.81</u> GPM	<u>2.92</u> GPM
PRESSURE	<u>50</u> PSIG	<u>33</u> PSIG	<u>16</u> PSIG
TEMPERATURE	<u>100</u> DEG F	<u>100</u> DEG F	<u>100</u> DEG F

1.4.1.5 PRESSURE AT PORT T, SPOOL OUT, FLOW T to A:

	(a)	(b)	(c)
FLOW	<u>4.39</u> GPM	<u>3.33</u> GPM	<u>2.02</u> GPM
PRESSURE	<u>50</u> PSIG	<u>33</u> PSIG	<u>16</u> PSIG
TEMPERATURE	<u>102</u> DEG F	<u>102</u> DEG F	<u>102</u> DEG F

1.4.1.6 PRESSURE AT PORT A, SPOOL CENTERED, FLOW A to T&B:

	(a)	(b)	(c)
FLOW	<u>0.93</u> GPM	<u>0.73</u> GPM	<u>0.46</u> GPM
PRESSURE	<u>50</u> PSIG	<u>33</u> PSIG	<u>16</u> PSIG
TEMPERATURE	<u>104</u> DEG F	<u>104</u> DEG F	<u>104</u> DEG F

1.4.1.7 PRESSURE AT PORT A, SPOOL IN, FLOW A to P:

	(a)	(b)	(c)
FLOW	<u>6.64</u> GPM	<u>5.08</u> GPM	<u>3.14</u> GPM
PRESSURE	<u>50</u> PSIG	<u>33</u> PSIG	<u>16</u> PSIG
TEMPERATURE	<u>104</u> DEG F	<u>104</u> DEG F	<u>104</u> DEG F

1.4.1.8 PRESSURE AT PORT A, SPOOL OUT, FLOW A to T:

	(a)	(b)	(c)
FLOW	<u>5.35</u> GPM	<u>4.16</u> GPM	<u>2.49</u> GPM
PRESSURE	<u>50</u> PSIG	<u>33</u> PSIG	<u>16</u> PSIG
TEMPERATURE	<u>105</u> DEG F	<u>105</u> DEG F	<u>105</u> DEG F

1.4.1.9 PRESSURE AT PORT B, SPOOL CENTERED, FLOW B to T&A:

	(a)	(b)	(c)
FLOW	<u>1.30</u> GPM	<u>0.95</u> GPM	<u>0.60</u> GPM
PRESSURE	<u>50</u> PSIG	<u>33</u> PSIG	<u>16</u> PSIG
TEMPERATURE	<u>96</u> DEG F	<u>97</u> DEG F	<u>97</u> DEG F



14000 GEORGIA AVENUE
SILVER SPRING, MARYLAND 20908-2972
(301) 231-1000

SIZE

A

FSCM NO.

99789

TP3212.013

REV

PAGE 6

HYDRAULIC VALVE TEST DATA SHEET (CONT'D)

1.4.1.10 PRESSURE AT PORT B, SPOOL IN, FLOW B to T:

	(a)	(b)	(c)
FLOW	<u>5.35</u> GPM	<u>4.05</u> GPM	<u>2.43</u> GPM
PRESSURE	<u>50</u> PSIG	<u>33</u> PSIG	<u>16</u> PSIG
TEMPERATURE	<u>98</u> DEG F	<u>98</u> DEG F	<u>98</u> DEG F

1.4.1.11 PRESSURE AT PORT B, SPOOL OUT, FLOW B to P:

	(a)	(b)	(c)
FLOW	<u>4.55</u> GPM	<u>3.46</u> GPM	<u>2.10</u> GPM
PRESSURE	<u>10</u> PSIG	<u>33</u> PSIG	<u>16</u> PSIG
TEMPERATURE	<u>99</u> DEG F	<u>99</u> DEG F	<u>100</u> DEG F

1.4.2 LEVER FORCE TESTS

(a) LEVER MOVEMENT FROM SPOOL-CENTERED TO SPOOL-IN: 1.5 LBS MAX
 (b) LEVER MOVEMENT FROM SPOOL-CENTERED TO SPOOL OUT: 1.0 LBS MAX

1.4.3 2000 PSIG PROOF PRESSURE TEST

VERIFY NO VALVE DAMAGE

PASS FAIL



14229 GEORGIA AVENUE
 SILVER SPRING, MARYLAND 20908-2972
 (301) 221-1000

SIZE

A

FSCM NO.

99789

TP3212.013

APPENDIX C

HYDRAULIC VALVE TEST PROCEDURE

VITRO TP3212.013

REVISIONS

LTR	DESCRIPTION	DATE	APVD

REV STATUS	REV	-	-	-	-	-	-	-	-	-	-	-	-	-	-	-	-	-	-	-	-	-	-	-	-	-	-	-	-	-	-	-	-	-			
OF SHEETS	SHEET	1	2	3	4	5	6	7	8	9	10	11	12	13	14	15	16	17	18	19	20	21	22	23	24	25											

CONTRACT
DAAK70-92-D-0002

1400 GEORGIA AVENUE
SILVER SPRING, MARYLAND 20910-0972
(301) 591-1000

CORPORATION

QA-133 (REV 2-87)

APPROVAL

ENGR/CHKR.	L.C. VIA	12/9/92
ROJ. MGR.	<i>[Signature]</i>	12/9/92
QA. SUPV.		

HYDRAULIC VALVE TEST PROCEDURE

APPROVED
[Signature] 12/30/1992

SIZE	FSCM NO.	
A	99789	TP3212.013

1.0 HYDRAULIC VALVE BENCH TEST

1.1 PURPOSE The purpose of this test is to measure the flow characteristics of a 4-way, 3-position, manually operated hydraulic valve that has been selected to replace an obsolete valve which was similarly tested. These measurements will be compared to the measurement data obtained from the obsolete valve and any significant differences analyzed to determine their impact on the system's performance.

1.2 HYDRAULIC TEST SYSTEM REQUIREMENTS

- a. 0-10 GPM adjustable flow rate with pressure up to 50 psig.
- b. Capable of proving a 3 GPM flow while pressure limited to 650 psig.
- c. Capable of performing a 2000 psig proof pressure test.
- d. Flow measurement accuracy of +/- 0.3 GPM from 0 to 10 GPM.
- e. Pressure measurement accuracy of +/- 0.5 psig from 0 to 50 psig.
- f. Pressure measurement accuracy of +/- 20 psig from 650 to 2000 psig.
- g. Hydraulic fluid temperature measurement accuracy +/- 2 deg F at 100 F.
- h. Hydraulic fluid nominal viscosity approximately 100 SUS at deg 120 F.

1.3 FORCE MEASUREMENT DEVICE REQUIREMENTS

- a. Capable of measuring the maximum force required to move the test valves lever to an accuracy of +/- 0.5 lbs over the range of 0-10 lbs.

1.4 HYDRAULIC TESTS

1.4.1 FLOW TESTS Prior to measuring the valve flow characteristics the temperature of the hydraulic test system's fluid temperature shall be increased to 100 +/- 5 deg. F and maintained within this temperature range during the flow tests.

NOTE: Continuous pressure vs flow curves may be substituted for the following groups of three flow measurement points (a,b, & c) for each flow path, provided the accuracy of the plotted curves meets the pressure and flow measurement accuracy stated in 1.2.(d) and 1.2.(e) and the fluid temperature is recorded with the plotted curves.



14000 GEORGIA AVENUE
SILVER SPRING, MARYLAND 20906-2972
(301) 231-1000

SIZE	FSCM NO.	TP3212.013
A	99789	
		REV -
		SHEET 2

1.4.1.1 Connect the hydraulic test system output including the pressure, flow and temperature sensors to the pressure input (port P) of the valve being tested and return all other valve ports to the reservoir (see Figure 1). Place the valve spool in the spool-in position, then slowly increase the hydraulic flow through the valve until the fluid pressure at port P is 50 psig $\pm 10\%$ or the fluid flow is 10 GPM $\pm 10\%$ whichever occurs first. Record the flow rate, pressure, and fluid temperature on the test data sheet as 1.4.1.1.(a). Decrease the flow rate until the pressure at port P decreases to 2/3 the pressure recorded in 1.4.1.1.(a). Record the flow rate, pressure and fluid temperature on the test data sheet as 1.4.1.1.(b). Decrease the flow rate until the pressure at port P is 1/3 the reading recorded as 1.4.1.1.(a) and record the flow rate, pressure, and temperature on the test data sheet as 1.4.1.1.(c).

1.4.1.2 Repeat the procedure of 1.4.1.1 with the valve spool in the spool-out position except use the initial pressure measured with the spool out [recorded on the data sheet as 1.4.1.2.(a)] as the basis for the flow measurements at 2/3 and 1/3 of this initial pressure measurement. Record these measurements on the test data sheet as 1.4.1.2.(b) and 1.4.1.2.(c) respectively.

1.4.1.3 Repeat the procedure of 1.4.1.1 and 1.4.1.2 with the output of the hydraulic test system connect to port T and all other ports (including port P) connected to the reservoir, measuring the flow in all three spool positions as shown in Table 1. Repeat this measurement process using each of the valve work ports, A & B, as the pressure input as shown in Table 1. Record all measurement data on the test data sheet as 1.4.1.3 through 1.4.1.11 as indicated by Table 1.

1.4.2 VALVE LEVER FORCE TESTS Set the hydraulic test system to provide a flow of 3 GPM with pressure limited to 650 psig using a bypass pressure relief valve. Connect the test valve's pressure port to the hydraulic test system output, energize the test system with the test valve spool centered (flow into valve blocked) and measure and record the maximum force required to pull (or push) the manual lever to the spool-in position. Repeat the procedure to measure the force required to move the spool from the centered to the spool-out position.

1.4.3 2000 PSIG PROOF PRESSURE TEST Connect all valve ports to the hydraulic test system output. With the valve spool centered, apply 2000 psig, minimum, for a duration of at least 10 seconds. Reduce the pressure to zero, remove the valve from test set up, and verify no damage to the valve has occurred.

Vitro
CORPORATION

14289 GEORGIA AVENUE
SILVER SPRING, MARYLAND 20906-2972
(301) 231-1000

SIZE

A

FSCM NO.

99789

TP3212.013

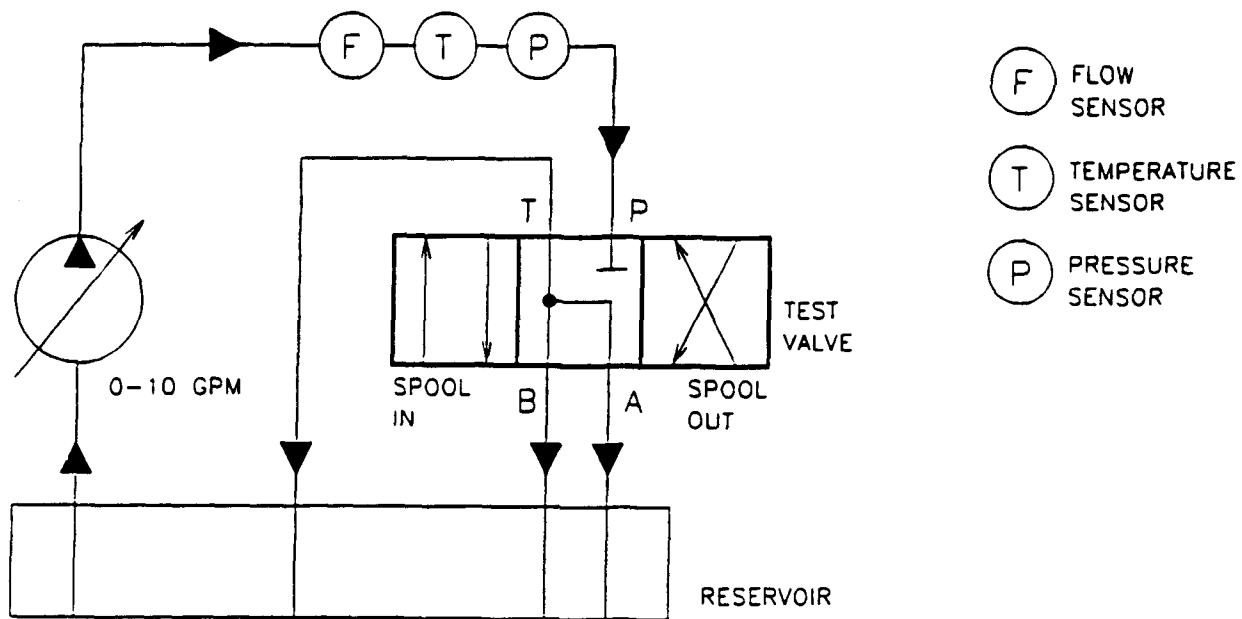

FIGURE 1. TEST SET-UP

TABLE 1. FLOW PATH MEASUREMENTS

PRESSURE APPLIED TO PORT	FLOW PATH MEASURED		
	SPOOL CENTERED	SPOOL IN	SPOOL OUT
P	————	P to A	P to B
T	T to A&B	T to B	T to A
A	A to T&B	A to P	A to T
B	B to T&A	B to T	B to P

HYDRAULIC VALVE BENCH TEST DATA SHEET

TEST PERFORMED BY _____ DATE _____

HYDRAULIC FLUID USED:

MANUFACTURER _____ PRODUCT DESIGNATION _____

NOMINAL VISCOSITY: 100 DEG F _____ SUS 210 DEG F _____ SUS

EQUIPMENT USED FOR MEASUREMENTS TRACEABLE TO N.I.S.T

0-50 PSIG PRESSURE MEASUREMENT DEVICE:

MFR. _____ MODEL _____ CALIBRATION DATE _____ ASSET NO. _____

0-2000 PSIG PRESSURE MEASUREMENT DEVICE:

MFR. _____ MODEL _____ CALIBRATION DATE _____ ASSET NO. _____

FLUID FLOW MEASUREMENT DEVICE:

MFR. _____ MODEL _____ CALIBRATION DATE _____ ASSET NO. _____

FLUID TEMPERATURE MEASUREMENT DEVICE:

MFR. _____ MODEL _____ CALIBRATION DATE _____ ASSET NO. _____

FORCE MEASUREMENT DEVICE:

MFR. _____ MODEL _____ CALIBRATION DATE _____ ASSET NO. _____

FLOW TEST DATA

1.4.1.1 PRESSURE AT PORT P, SPOOL IN, FLOW P to A:

	(a)	(b)	(c)
FLOW	_____ GPM	_____ GPM	_____ GPM
PRESSURE	_____ PSIG	_____ PSIG	_____ PSIG
TEMPERATURE	_____ DEG F	_____ DEG F	_____ DEG F

1.4.1.2 PRESSURE AT PORT P, SPOOL OUT, FLOW P to B:

	(a)	(b)	(c)
FLOW	_____ GPM	_____ GPM	_____ GPM
PRESSURE	_____ PSIG	_____ PSIG	_____ PSIG
TEMPERATURE	_____ DEG F	_____ DEG F	_____ DEG F



SIZE	FSCM NO.	TP3212.013
A	99789	
REV		SHEET 5

1.4.1.3 PRESSURE AT PORT T, SPOOL CENTERED, FLOW T to A&B:

	(a)	(b)	(c)
FLOW	_____ GPM	_____ GPM	_____ GPM
PRESSURE	_____ PSIG	_____ PSIG	_____ PSIG
TEMPERATURE	_____ DEG F	_____ DEG F	_____ DEG F

HYDRAULIC VALVE TEST DATA SHEET (CONT'D)

1.4.1.4 PRESSURE AT PORT T, SPOOL IN, FLOW T to B:

	(a)	(b)	(c)
FLOW	_____ GPM	_____ GPM	_____ GPM
PRESSURE	_____ PSIG	_____ PSIG	_____ PSIG
TEMPERATURE	_____ DEG F	_____ DEG F	_____ DEG F

1.4.1.5 PRESSURE AT PORT T, SPOOL OUT, FLOW T to A:

	(a)	(b)	(c)
FLOW	_____ GPM	_____ GPM	_____ GPM
PRESSURE	_____ PSIG	_____ PSIG	_____ PSIG
TEMPERATURE	_____ DEG F	_____ DEG F	_____ DEG F

1.4.1.6 PRESSURE AT PORT A, SPOOL CENTERED, FLOW A to T&B:

	(a)	(b)	(c)
FLOW	_____ GPM	_____ GPM	_____ GPM
PRESSURE	_____ PSIG	_____ PSIG	_____ PSIG
TEMPERATURE	_____ DEG F	_____ DEG F	_____ DEG F

1.4.1.7 PRESSURE AT PORT A, SPOOL IN, FLOW A to P:

	(a)	(b)	(c)
FLOW	_____ GPM	_____ GPM	_____ GPM
PRESSURE	_____ PSIG	_____ PSIG	_____ PSIG
TEMPERATURE	_____ DEG F	_____ DEG F	_____ DEG F

1.4.1.8 PRESSURE AT PORT A, SPOOL OUT, FLOW A to T:

	(a)	(b)	(c)
FLOW	_____ GPM	_____ GPM	_____ GPM
PRESSURE	_____ PSIG	_____ PSIG	_____ PSIG
TEMPERATURE	_____ DEG F	_____ DEG F	_____ DEG F

1.4.1.9 PRESSURE AT PORT B, SPOOL CENTERED, FLOW B to T&A:

	(a)	(b)	(c)
FLOW	_____ GPM	_____ GPM	_____ GPM
PRESSURE	_____ PSIG	_____ PSIG	_____ PSIG
TEMPERATURE	_____ DEG F	_____ DEG F	_____ DEG F



1400 GEORGIA AVENUE
SILVER SPRING, MARYLAND 20908-2872
13011 231-1000

SIZE

FSCM NO.

A 99789

TP3212.013

HYDRAULIC VALVE TEST DATA SHEET (CONT'D)

1.4.1.10 PRESSURE AT PORT B, SPOOL IN, FLOW B to T:

	(a)	(b)	(c)
FLOW	_____ GPM	_____ GPM	_____ GPM
PRESSURE	_____ PSIG	_____ PSIG	_____ PSIG
TEMPERATURE	_____ DEG F	_____ DEG F	_____ DEG F

1.4.1.11 PRESSURE AT PORT B, SPOOL OUT, FLOW B to P:

	(a)	(b)	(c)
FLOW	_____ GPM	_____ GPM	_____ GPM
PRESSURE	_____ PSIG	_____ PSIG	_____ PSIG
TEMPERATURE	_____ DEG F	_____ DEG F	_____ DEG F

1.4.2 LEVER FORCE TESTS

(a) LEVER MOVEMENT FROM SPOOL-CENTERED TO SPOOL-IN: _____ LBS MAX
 (b) LEVER MOVEMENT FROM SPOOL-CENTERED TO SPOOL OUT: _____ LBS MAX

1.4.3 2000 PSIG PROOF PRESSURE TEST

VERIFY NO VALVE DAMAGE PASS _____ FAIL _____

2.0 HYDRAULIC VALVE VERIFICATION TEST

2.1 PURPOSE The purpose of this test is to evaluate the operational performance of a new type of steering mode selector valve being considered as a replacement for the obsolete type used in a 20 Ton Rough Terrain Crane, Model M2380. The test is intended to demonstrate operational performance of the new valve being installed in the Model M2380 crane as well as expose any unpredicted crane steering system deficiencies resulting from the use of the new type valve. Performance of this verification test will ensure acceptable valve results when the modified crane is subjected to the contractually required functional test. All of the below tests are performed with the crane carrier transmission in neutral position.

2.2 INITIAL LEAKAGE TESTS Prior to starting the crane carrier engine, place the steering mode selector in the FRONT STEER mode. Start the crane carrier engine and allow the engine to idle for one minute while observing the steering mode selector valve for fluid leakage. If any leakage is observed shut down the engine and repair the leak before proceeding. Repeat this step if a leak was repaired.

Place the steering mode selector in the OBLIQUE STEER mode and allow the engine to idle for one minute while observing the steering mode selector valve for fluid leakage. If any leakage is observed shut down the engine and repair the leak before proceeding. Repeat this step if a leak was repaired.

With the carrier engine at idle, observe the steering mode selector valve for signs of leakage while purging the hydraulic system of air by alternately turning the carrier steering system to its left and right limits at least four time in each direction. If any leakage is observed shut down the engine and repair the leak before proceeding. Repeat this step if a leak was repaired. Verify that the rear wheels move in the same direction as the front wheels.

VERIFY NO LEAKAGE OCCURS PASS ____ FAIL ____

VERIFY CORRECT REAR WHEEL MOTION PASS ____ FAIL ____

2.3 FULL PRESSURE LEAKAGE TEST With the steering mode selector valve in the 4-WHEEL STEER position and the steering system near its left turn limit verify the rear wheels have moved in the direction opposite the front wheels. Increase the engine speed to full throttle (2800 RPM). Allow the engine to continue at 2800 RPM for one minute while observing the steering mode selector valve for signs of fluid leakage. Return the engine speed to idle and place the steering system near its right turn limit. Increase the engine RPM to 2800 for one minute while observing the steering mode selector valve for leakage.

VERIFY CORRECT REAR WHEEL MOTION PASS ____ FAIL ____

VERIFY NO LEAKAGE OCCURS PASS ____ FAIL ____

Vitro
CORPORATION

14000 GEORGIA AVENUE
SILVER SPRING, MARYLAND 20908-2872
(301) 221-1000

SIZE

A

FSCM NO.

99789

TP3212.013

DEV

PAGE 8

2.4 STEERING MODE SWITCHING TESTS With the steering mode selector in the FRONT STEER position and the steering system in the hard right position, increase the engine speed to a nominal 2800 RPM as indicated by the crane tachometer. Change the steering mode selector to the 4-WHEEL STEER position while maintaining the 2800 engine RPM. Verify rear wheel position change specified, then return the engine speed to idle. Repeat this procedure for each of the conditions b. through p. shown below.

	FRONT STEERING POSITION	STEERING MODE CHANGE		REAR WHEEL CHANGE	
		FROM	TO	FROM	TO
a.	HARD RIGHT	FRONT STEER	4-WHEEL STEER	STRAIGHT	HARD LEFT___
b.	HARD RIGHT	4-WHEEL STEER	FRONT STEER	HARD LEFT	STRAIGHT___
c.	HARD LEFT	FRONT STEER	4-WHEEL STEER	STRAIGHT	HARD RIGHT___
d.	HARD LEFT	4-WHEEL STEER	FRONT STEER	HARD RIGHT	STRAIGHT___
e.	HARD LEFT	FRONT STEER	OBLIQUE STEER	STRAIGHT	HARD LEFT___
f.	HARD LEFT	OBLIQUE STEER	FRONT STEER	HARD LEFT	STRAIGHT___
g.	HARD RIGHT	FRONT STEER	OBLIQUE STEER	STRAIGHT	HARD RIGHT___
h.	HARD RIGHT	OBLIQUE STEER	FRONT STEER	HARD RIGHT	STRAIGHT___
i.	HARD RIGHT	FRONT STEER	4-WHEEL STEER	STRAIGHT	HARD LEFT___
j.	HARD RIGHT	4-WHEEL STEER	FRONT STEER	HARD LEFT	STRAIGHT___
k.	HARD LEFT	FRONT STEER	4-WHEEL STEER	STRAIGHT	HARD RIGHT___
l.	HARD LEFT	4-WHEEL STEER	FRONT STEER	HARD RIGHT	STRAIGHT___
m.	HARD LEFT	FRONT STEER	OBLIQUE STEER	STRAIGHT	HARD LEFT___
n.	HARD LEFT	OBLIQUE STEER	FRONT STEER	HARD LEFT	STRAIGHT___
o.	HARD RIGHT	FRONT STEER	OBLIQUE STEER	STRAIGHT	HARD RIGHT___
p.	HARD RIGHT	OBLIQUE STEER	FRONT STEER	HARD RIGHT	STRAIGHT___

After completion of these tests inspect the valve for evidence of leakage.

VERIFY NO LEAKAGE OCCURS

PASS ___ FAIL ___



14000 GEORGIA AVENUE
SILVER SPRING, MARYLAND 20906-2972
(301) 231-1000

QA-134 (REV 2-87)

SIZE

A

FSCM NO.

99789

TP3212.013

REV

SHEET 9

3.0 HYDRAULIC VALVE FUNCTIONAL TEST

3.1 PURPOSE The purpose of this test is to perform the contractually required functional test which will demonstrate the acceptable performance of the replacement steering mode selector valve installed on the 20-Ton Rough Terrain Crane, Model M2380. The valve has been selected to replace the original equipment steering mode selector valve which is no longer manufactured.

3.2 VALVE TEST REQUIREMENT The contractual requirement governing this test is documented in the statement of work (SOW) paragraph 3.2.c on contract no. DAAK70-92-D-0002, task order no. 0001, Prototyping/Engineering Services For 20-Ton Rough Terrain Crane. The SOW requirement is:

"The hydraulic valve functional test shall be conducted after the hydraulic valve is installed on the vehicle and shall consist of the vehicle being driven in forward first gear at full throttle while switching into each rear steering mode. The test will last about 15 minutes during which time, the rear steer mode will be changed about every minute. The valve would then be inspected for leakage."

3.3 TEST SITE PREPARATION A level area, clear of obstructions and at least 500 feet by 200 feet, is required to provide adequate space to maneuver the crane and allow it to move at full throttle in the oblique steering mode for period of one minute. Place two 40-foot radius half circles of 5 pylons approximately 32 feet apart as shown in Figure 2. Place 4 additional pylons approximately 45 ft from the ends of the half circles as shown in Figure 2.

3.4 TEST PROCEDURE Position the crane with its steering centered on the test track at the starting position shown in Figure 2. Place steering mode selector valve in the OBLIQUE STEER position. Place the transmission in forward first gear and drive the crane at full throttle. When sufficiently clear of pylon A, steer to the left on a path that will allow the crane to pass to the left of pylon B. Upon reaching pylon B, center the steering and switch to the 4-WHEEL STEER mode while in the 45 foot straight section. Then follow the right semicircular path defined by the pylons. While in the straight section approaching pylon C, center the steering and switch to the OBLIQUE steering mode. After clearing pylon C, steer to the right following a path that will pass to the right of pylon D. Upon reaching pylon D, center the steering and switch to the 4-WHEEL STEER mode. Follow the left semicircular path defined by the pylons. Then, while in the 45 foot straight section approaching the starting point, switch back to the OBLIQUE STEER mode. Continue past the starting point and make three additional complete circuits following the procedure just described. After completing the forth circuit, stop the crane and allow the engine to cool at idle for at least 5 minutes. After shutting down the engine, inspect the steering mode selector valve for signs of fluid leakage.

VERIFY NO LEAKAGE PASS FAIL



14000 GEORGIA AVENUE
SILVER SPRING, MARYLAND 20908-2972
(301) 231-1000

SIZE	FSCM NO.	TP3212.013
A	99789	
	REV	SHEET 10

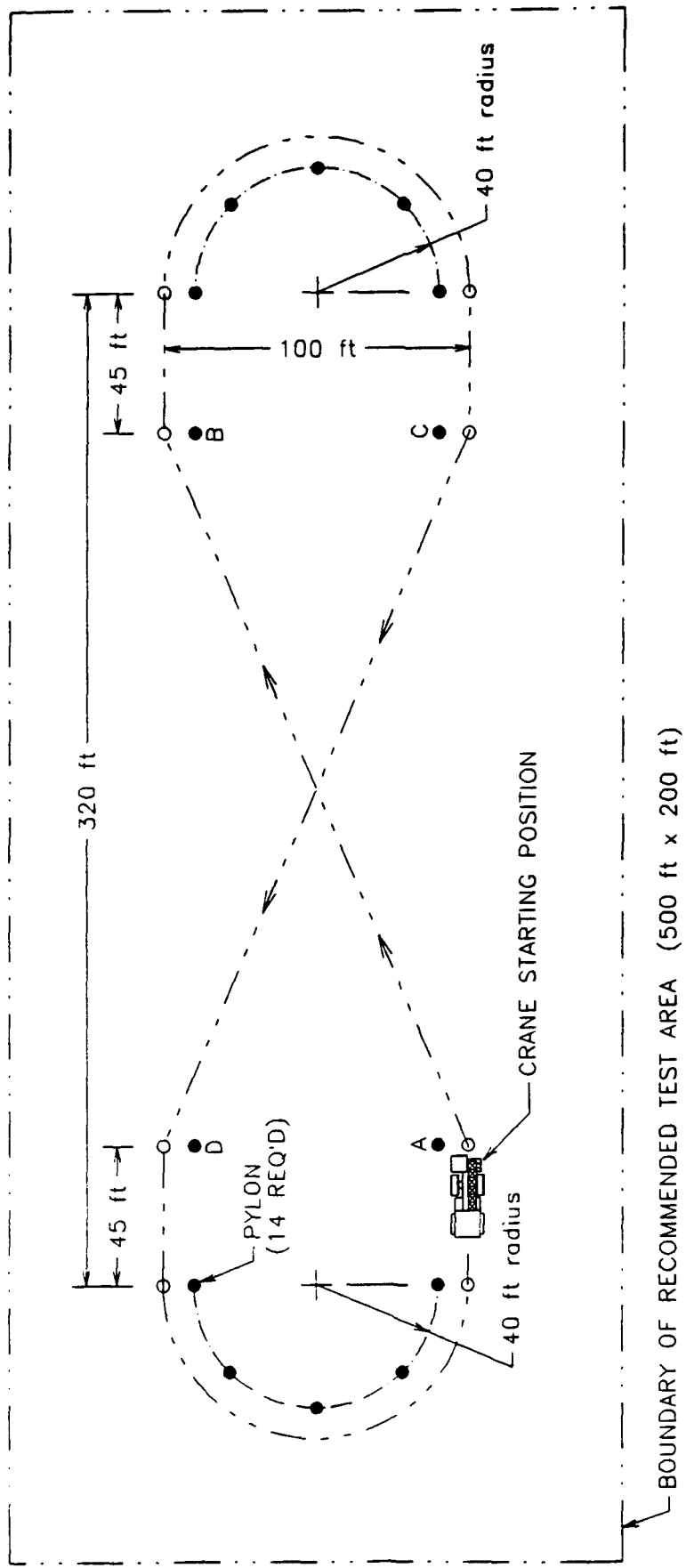

TEST TRACK CIRCUIT PLAN FOR STEERING MODE SELECTOR VALVE TEST
 FIGURE 2

APPENDIX D

HYDRO-MECHANICAL SYSTEMS, INC.
FRONT AXLE PRICE QUOTATION

HYDRO-MECHANICAL SYSTEMS, INC.

P. O. Box 62

611 DELSEA DRIVE - BLDG. #8
WESTVILLE, NEW JERSEY 08093

(609) 848-8888

9 February 1993

Mr. Jeff Klein
Department of the Army
Belvoir Research, Development and Engineering Center
Fort Belvoir, VA 22060-5606

Dear Jeff:

We have finalized our evaluation of the military's request to reactivate and service Clark-Hurth part number 190172. This is a DSD-33650 model axle supplied to American Hoist several years ago. Many of the part numbers used to build this axle are obsolete and are no longer available currently.

Our initial review, shows that Clark-Hurth can and will reactivate this axle provided a minimum quantity of twenty (20) axles are purchased initially. The axle part number and the service parts will then remain active as long as we continue to receive requirements for each of the part numbers for any quantity within the subsequent two-year period. Any part number without activity within that two-year period will remain available but under revised quantity and price buy volumes.

The price to the Army (TACOM) for the axle will be ~~838,379.00~~ each F.O.B. Westville, NJ with delivery in 180 days. Once again, if the program is reactivated then all service parts will remain active as long as there are requirements within the two-year period. One of the main underlying reasons for reinstating this axle package is parts serviceability and complete axle refurbishment in the future. This will subsequently prove to be far less costly than complete axle replacement.

Payment of 60% of the purchase price is required at time order is placed and the balance due 30 days after shipment.

We along with Clark-Hurth will start working on this project as soon as we receive an order. We will also have reactivated all the service part numbers and establish parts prices at that time.

If you have questions, please give me a call at 609-848-8888.

Respectfully,



Steven M. Rosenbloom
Director of Special Projects

APPENDIX E

CLARK AXLE SPECIFICATIONS FORM

Book

3-10-68 16:48 CLARK STATESVILLE NC-
SPECIFICATIONS FOR AXLE, TRANSMISSION AND TORQUE
CONVERTER INSTALLATION

609 848 607118 2
APR 3 1968
Buckner
Lusk
381-8094

CLARK EQUIPMENT COMPANY

Please send Axle Information to Buchanan, Missouri
Please send Transmission and Torque Converter Information to
(Falshee Road)
USE SEPARATE SHEET FOR EACH VEHICLE

SPECIFICATION SHEET No.

Firm Name American Hoist & Derrick
Address Fort Wayne, Indiana
Information Furnished by Owen Delude
Title Ch. Military Engr. Date 4/1/68
Sales Rep _____ Date _____

Clark Units Recommended
#19016-4 FDS-29500-1
#19017-2 FDS-29500-2
#19016-5 FDS-29500-1
Signed C. Lusk
Date 13 MAY 68
Space to be filled in by Clark Equipment

COMMENT ON PERMISSIBLE DEVIATIONS OR SHOW
RANGE ON ITEMS MARKED WITH ASTERISK (*)

Est. Yearly Machine Production 3 1st Yr. 3 2nd Yr. 160 3rd Yr. 41
Beginning Date 3 Pre-Prod Jan. 69 & Prod. Sept.
Prototype Req. YES Quantity 3 Date JAN. 69 69
Military Specifications to Be Met MIL-C-52341B and as modified by IFB
DAAK01-68-B-2463 with Amendment
Model No. of Equipment 2380 Production X Being Developed _____
General Use and Type Service Military Rough Terrain Crane - with light
duty dozer blade. Forging for unloading landing craft.

Max. Gross Weight 62,000 Front Axle(s) _____ Rear Axle(s) _____
Curb Weight 62,000 Front Axle(s) _____ Rear Axle(s) _____
Wheel Base _____ Max. Speed* 30 MPH Frontal Area _____ No. of Driving Axles _____
Front & Rear Axle Loading Changes Under Different Conditions (over-end, over-side, tip, crowd, etc. as applicable)
34.3 MPH AT ZERO RESISTANCE

Gross Train Weight 30 MPH @ GTW 62,000 Outriggers Available Yes
ENGINE
Make and Model No. Used Cummins V8265 Fuel Diesel Flywheel Housing SAE No. 1
Governed RPM Full Load 2600 Governed RPM No Load 2860 Cubic Inch Displacement _____
Maximum Gross Torque and RPM _____ Maximum Net Torque and RPM 237HP@2600
Gross Torque Governed RPM _____ G.M. Injector Size _____
Amb. Airtemp _____ Alt. _____ Eng. Acc. H.P. _____
Accessories Driven by Engine _____
Additional Veh. Acc. _____ Veh. Acc. H.P. _____

TRANSMISSION

Make and Model Used 5420 Clark Model Suggested _____
Number of Forward Gears 4 Reverse 2 Type Control Req'd. Hydraulic H. or LH _____
PTO to Be Used No PTO Output Torque Req. _____
Clutch Housing SAE No. _____ Low Gear Ratio 5.33 High Gear Ratio .72
Min. Hrs. Life Req. in Low Gear _____ in Reverse _____ Other Gears _____
Operating Cycle _____
Will Shifts Be Made While in Motion Yes Speedometer Gear Ratio Yes Flange Size: In 7C Out 8 & 9
Clutch Make and Model _____ Clutch Release Parts Req'd. _____ Trans. Brake Required No
Remarks Disconnect to front, SAE A size emergency str. pump on re

AUXILIARY TRANSMISSION OR TRANSFER CASE

Make & Model Used NONE Clark Model Suggested _____
No. of Forw'd Gears _____ Reverse _____ Low Ratio _____ High Ratio _____ Flange Size: In _____ Out _____

APPENDIX F

VERIFICATION TEST RESULTS

OF

RESTORED M2380 CRANE

2.0 HYDRAULIC VALVE VERIFICATION TEST

2.1 PURPOSE The purpose of this test is to evaluate the operational performance of a new type of steering mode selector valve being considered as a replacement for the obsolete type used in a 20 Ton Rough Terrain Crane, Model M2380. The test is intended to demonstrate operational performance of the new valve being installed in the Model M2380 crane as well as expose any unpredicted crane steering system deficiencies resulting from the use of the new type valve. Performance of this verification test will ensure acceptable valve results when the modified crane is subjected to the contractually required functional test. All of the below tests are performed with the crane carrier transmission in neutral position.

2.2 INITIAL LEAKAGE TESTS Prior to starting the crane carrier engine, place the steering mode selector in the FRONT STEER mode. Start the crane carrier engine and allow the engine to idle for one minute while observing the steering mode selector valve for fluid leakage. If any leakage is observed shut down the engine and repair the leak before proceeding. Repeat this step if a leak was repaired.

Place the steering mode selector in the OBLIQUE STEER mode and allow the engine to idle for one minute while observing the steering mode selector valve for fluid leakage. If any leakage is observed shut down the engine and repair the leak before proceeding. Repeat this step if a leak was repaired.

With the carrier engine at idle, observe the steering mode selector valve for signs of leakage while purging the hydraulic system of air by alternately turning the carrier steering system to its left and right limits at least four time in each direction. If any leakage is observed shut down the engine and repair the leak before proceeding. Repeat this step if a leak was repaired. Verify that the rear wheels move in the same direction as the front wheels.

VERIFY NO LEAKAGE OCCURS PASS X FAIL
 VERIFY CORRECT REAR WHEEL MOTION PASS X FAIL

2.3 FULL PRESSURE LEAKAGE TEST With the steering mode selector valve in the 4-WHEEL STEER position and the steering system near its left turn limit verify the rear wheels have moved in the direction opposite the front wheels. Increase the engine speed to full throttle (2800 RPM). Allow the engine to continue at 2800 RPM for one minute while observing the steering mode selector valve for signs of fluid leakage. Return the engine speed to idle and place the steering system near its right turn limit. Increase the engine RPM to 2800 for one minute while observing the steering mode selector valve for leakage.

VERIFY CORRECT REAR WHEEL MOTION * PASS X FAIL
 VERIFY NO LEAKAGE OCCURS * PASS X FAIL

* TESTED AT IDLE SPEED

*HW Reynolds
7-26-93*



14000 GEORGIA AVENUE
SILVER SPRING, MARYLAND 20908-2872
(301) 231-1000

SIZE	FSCM NO.
A	99789

TP3212.013

REV

SHEET 8

2.4 STEERING MODE SWITCHING TESTS * With the steering mode selector in the FRONT STEER position and the steering system in the hard right position, increase the engine speed to a nominal 2800 RPM as indicated by the crane tachometer. Change the steering mode selector to the 4-WHEEL STEER position while maintaining the 2800 engine RPM. Verify rear wheel position change specified, then return the engine speed to idle. Repeat this procedure for each of the conditions b. through p. shown below.

	FRONT STEERING POSITION	STEERING MODE CHANGE		REAR WHEEL CHANGE	
		FROM	TO	FROM	TO
a.	HARD RIGHT	FRONT STEER	4-WHEEL STEER	STRAIGHT	HARD LEFT <u>X</u>
b.	HARD RIGHT	4-WHEEL STEER	FRONT STEER	HARD LEFT	STRAIGHT <u>X</u>
c.	HARD LEFT	FRONT STEER	4-WHEEL STEER	STRAIGHT	HARD RIGHT <u>X</u>
d.	HARD LEFT	4-WHEEL STEER	FRONT STEER	HARD RIGHT	STRAIGHT <u>X</u>
e.	HARD LEFT	FRONT STEER	OBLIQUE STEER	STRAIGHT	HARD LEFT <u>X</u>
f.	HARD LEFT	OBLIQUE STEER	FRONT STEER	HARD LEFT	STRAIGHT <u>X</u>
g.	HARD RIGHT	FRONT STEER	OBLIQUE STEER	STRAIGHT	HARD RIGHT <u>X</u>
h.	HARD RIGHT	OBLIQUE STEER	FRONT STEER	HARD RIGHT	STRAIGHT <u>X</u>
i.	HARD RIGHT	FRONT STEER	4-WHEEL STEER	STRAIGHT	HARD LEFT <u>X</u>
j.	HARD RIGHT	4-WHEEL STEER	FRONT STEER	HARD LEFT	STRAIGHT <u>X</u>
k.	HARD LEFT	FRONT STEER	4-WHEEL STEER	STRAIGHT	HARD RIGHT <u>X</u>
l.	HARD LEFT	4-WHEEL STEER	FRONT STEER	HARD RIGHT	STRAIGHT <u>X</u>
m.	HARD LEFT	FRONT STEER	OBLIQUE STEER	STRAIGHT	HARD LEFT <u>X</u>
n.	HARD LEFT	OBLIQUE STEER	FRONT STEER	HARD LEFT	STRAIGHT <u>X</u>
o.	HARD RIGHT	FRONT STEER	OBLIQUE STEER	STRAIGHT	HARD RIGHT <u>X</u>
p.	HARD RIGHT	OBLIQUE STEER	FRONT STEER	HARD RIGHT	STRAIGHT <u>X</u>

After completion of these tests inspect the valve for evidence of leakage.

VERIFY NO LEAKAGE OCCURS * PASS X FAIL

* ALL TESTS AT IDLE SPEED

*HW Reynolds
7-26-93*



14288 GEORGIA AVENUE
SILVER SPRING, MARYLAND 20905-3972
(301) 221-1000

SIZE

A

FSCM NO.

99789

TP3212.013