

AD-A285 001



S DTIC
SELECTE
SEP 29 1994
F

**COST AND SCHEDULE BENCHMARKS
FOR DEFENSE ACQUISITION CONTRACTS**

THESIS

**Glenn W. Buchfeller, Captain, USAF
Donald E. Kehl, GS-12, USA**

AFIT/GCA/LAS/94S-2

**This document has been approved
for public release and sale; its
distribution is unlimited.**

**DEPARTMENT OF THE AIR FORCE
AIR UNIVERSITY**

AIR FORCE INSTITUTE OF TECHNOLOGY

Wright-Patterson Air Force Base, Ohio

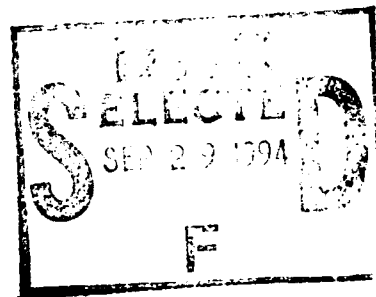

**COST AND SCHEDULE BENCHMARKS
FOR DEFENSE ACQUISITION CONTRACTS**

THESIS
Glenn W. Buchfeller, Captain, USAF
Donald E. Kehl, GS-12, USA

AFIT/GCA/LAS/94S-2

| | |
|---------------------|-------------------------------------|
| Accession For | |
| NTIS CRA&I | <input checked="" type="checkbox"/> |
| DTIC TAB | <input type="checkbox"/> |
| Unannounced | <input type="checkbox"/> |
| Justification | |
| By | |
| Distribution / | |
| Availability Codes | |
| Dist | Avail and/or Special |
| A-1 | |

DTIC QUALITY INSPECTED 3

Approved for public release; distribution unlimited

94 9 28 184

1338/94-31135

The views expressed in this thesis are those of the authors and do not reflect the official policy or position of the Department of Defense or the U.S. Government.

AFIT/GCA/LAS/94S-2

**COST AND SCHEDULE BENCHMARKS
FOR DEFENSE ACQUISITION CONTRACTS**

THESIS

**Presented to the Faculty of the Graduate School of Logistics
and Acquisition Management of the Air Force Institute of
Technology
Air University**

**In Partial Fulfillment of the
Requirements for the Degree of
Master of Science in Cost Analysis**

**Glenn W. Buchfeller, B.B.A.
Captain, USAF**

**Donald E. Kehl, B.S.
GS-12, USA**

September 1994

Approved for public release; distribution unlimited

Preface

The purpose of this research was to generate cost and schedule benchmarks in percent for Department of Defense contracts for 48 collectively exhaustive and mutually exclusive categories of contracts. Cost and schedule variance benchmarks that are tailored to specific categories of contracts are needed to assist program managers in determining the cost and schedule performance of their current programs.

Hypothesis testing was accomplished across categories of contracts to determine if various benchmarks were statistically significantly different. If a given cost or schedule benchmark was found to be statistically representative of a specific category of contract then that benchmark would provide program managers with a sound historical standard against which they could evaluate their current programs.

Special thanks to our primary thesis advisor, Dr. Dave Christensen, for his advice and guidance throughout the entire process. In addition, we greatly appreciated the many hours that Professor Dan Reynolds unselfishly spent counseling us on the finer points of ANOVA nested analyses.

Glenn Buchfeller and Donald Kehl

Table of Contents

| | Page |
|--|------|
| Preface..... | ii |
| List of Figures..... | vi |
| List of Tables..... | vii |
| Abstract..... | viii |
| I. Introduction..... | 1 |
| General Issue..... | 1 |
| Background..... | 3 |
| Specific Problem..... | 4 |
| Investigative Questions..... | 5 |
| The Primary Hypotheses Tested..... | 6 |
| Scope/Limitations/Assumptions..... | 7 |
| Thesis Overview..... | 8 |
| II. Literature Review..... | 10 |
| Overview of Literature Review..... | 10 |
| General Factors Affecting Cost Overruns and Schedule Slippages..... | 12 |
| Woodward Thesis..... | 13 |
| Cost/Schedule Control Systems Criteria..... | 14 |
| Defense Acquisition Executive Summary (DAES) Database..... | 16 |
| Christensen Article..... | 18 |
| Abba's C/SCSC White Paper..... | 19 |
| Knepp and Stroble Thesis..... | 20 |
| Terry and Vanderburgh Thesis..... | 21 |
| Beach Report..... | 22 |
| Investigative Question Answered..... | 23 |
| Conclusion and Overview..... | 24 |
| III. Methodology..... | 25 |
| Introduction..... | 25 |
| Overview of Benchmark Calculations..... | 25 |
| Statement of Hypotheses..... | 25 |
| Relevance of Hypotheses Testing..... | 27 |
| The DAES Database..... | 27 |
| Population & Sample..... | 28 |
| Data Collection Instrument..... | 29 |
| Data Collection Plan..... | 29 |
| Data Preparation..... | 30 |
| Benchmark Calculations..... | 32 |

| | Page |
|---|--------|
| Flowchart of the Analysis | 32 |
| Analysis of Variance (ANOVA) | 32 |
| Overview | 32 |
| ANOVA Terminology | 34 |
| Type of study | 34 |
| Factors | 34 |
| Factor Levels | 34 |
| Multifactor Study | 35 |
| Type of Factors | 35 |
| Dependent Variables | 35 |
| Treatments | 35 |
| ANOVA Fixed Factor Level Model | 37 |
| ANOVA Nested Design | 37 |
| Testing the Primary Assumptions of ANOVA | 37 |
| Determination of Normality | 37 |
| Analysis of Nonconstancy of Error Variance | 38 |
| Independence of the Error Terms | 39 |
| Hypotheses Testing | 39 |
| Three Steps in the Analysis | 41 |
| Step 1 Determining if Any Groups Contain Statistically Significantly Different Means | 41 |
| Step 2 Analyzing Which Groups Contain Statistically Significantly Different Means | 42 |
| Step 3 Comparison of Specific Means | 43 |
| IV. Analysis | 46 |
| Calculation of Cost and Schedule Variance Means | 46 |
| Testing the ANOVA Assumption of Normality | 46 |
| Testing the ANOVA Assumption of Equality of the Error Variance for the Entire Data Set | 48 |
| Overall Assessment of the ANOVA Assumptions | 49 |
| Running the Nested ANOVA Model (Step 1) | 49 |
| F-test on Military Service Factor Levels for Schedule Variance (Step 2) | 52 |
| Additional Testing of the ANOVA Assumption of Equality of the Error Variances | 53 |
| Comparison of Means Within Groups Identified as Containing Statistically Significantly Different Means (Step 3) | 54 |
| Analytical Summary | 55 |
| V. Conclusions | 56 |
| Discussion | 56 |
| Limitation | 57 |
| Conclusions | 57 |

| | Page |
|---|--------|
| How Cost and Schedule Benchmarks Can be Used by Program Managers | 58 |
| Recommendations for Further Research | 59 |
| Appendix A: Definition of Terms | A-1 |
| Appendix B: Data Used in the ANOVA Nested Models | B-1 |
| Appendix C: Cost Variance SAS Programs and SAS Outputs | C-1 |
| Appendix D: Schedule Variance SAS Programs and SAS Outputs | D-1 |
| Appendix E: Bartlett Test Results and Related Scatter Plots | E-1 |
| Bibliography | BIB-1 |
| Vitas | VITA-1 |

List of Figures

| Figure | Page |
|---|------|
| 1. Flowchart..... | 33 |
| 2. Four Factor Nested Design with Managing Service as the Treatment..... | 36 |

List of Tables

| Table | Page |
|---|------|
| 1. Summary Of Literature Review..... | 11 |
| 2. Benchmarks for Cost and Schedule Variances..... | 47 |
| 3. ANOVA Model Results with Cost Variance in Percent as the Dependent Variable..... | 50 |
| 4. ANOVA Model Results with Schedule Variance in Percent as the Dependent Variable..... | 50 |
| 5. F-Test Summary Table for Alpha = .05 (Step 1)..... | 51 |
| 6. Results of F-Test Analyzing Groups of Means (Step 2).... | 52 |
| 7. Bartlett Test Results for Equality of Error Variance for Groups of Means with Statistically Significant Differences..... | 53 |
| 8. Results of the Tukey-Kramer Test Between Statistically Significantly Different Treatment Means (Step 3)..... | 55 |

Abstract

Managers of Department of Defense programs would benefit from having cost and schedule benchmarks that are based on the historical performance of similar programs. This research generated cost and schedule variance in percent benchmarks for 48 collectively exhaustive and mutually exclusive categories of DoD contracts.

The analysis of variance (ANOVA) nested design methodology was used to compare these cost and schedule benchmarks across related categories of contracts to determine if the benchmarks were statistically significantly different. Such statistical difference would ensure program managers had a very specific tool tailored to their unique needs.

Due to some relatively small sample sizes in the study, along with the rather large standard deviations associated with those samples, the majority of benchmarks did not prove to be statistically significantly different. As a result, most benchmarks do not uncategorically describe one, and only one, category of contract. Thus, program managers must exercise caution when drawing conclusions about how the cost and schedule performance of their current programs compares to the historical average.

A few years from now, as the number of contracts included in the DAES database grows larger, a greater number

of cost and schedule benchmarks that test statistically significantly different should be able to be calculated.

**COST AND SCHEDULE BENCHMARKS
FOR DEFENSE ACQUISITION CONTRACTS**

I. Introduction

General Issue

In recent years the United States military services have experienced numerous and significant cost and schedule overruns on their major weapon systems contracts. For example, as early as December 1990, the C-17 transport aircraft was experiencing substantial cost overruns (Smith, 1990:36-39). The C-17 cost and schedule overruns have not abated. In fact, "The Defense Department revealed Nov. 12 [1993] that the C-17 Globemaster III is experiencing a new wave of schedule setbacks and cost overruns" (Watkins, 1993:2). Also, the B-2 bomber aircraft has had huge cost overruns and schedule delays (Velocci, 1993:29).

Cost and schedule problems are not restricted to the few high profile weapon systems identified above. In fact, "the average cost overrun on a weapon system has been around 40 percent" (Gansler, 1989:4). Severe cost overruns and schedule delays may be due, at least partly, to not expeditiously determining when a contractor begins to have significant difficulty meeting a contract's schedule and/or cost constraints. An analogy can be made to a small hole in

a dike. If the leak is realized early it can be easily repaired. However, if the leak is left unchecked for too long the leak grows severe and it becomes very difficult to correct the problem.

Obviously, methods that can allow a more timely means of identifying when potentially serious cost and schedule overruns *begin* to occur would be beneficial. This would aid weapon system program managers in identifying potential problems earlier when there are more alternatives available to correct the situation. One approach to address this issue is to develop quantitative cost and schedule *benchmarks* (benchmark is defined as, "a point of reference from which measurements of any sort may be made" (Webster's, 1971:203)) to assist decision makers in identifying potential problems before they become serious. Cost and schedule benchmarks in the context of this thesis should not be construed to mean standards of excellence. They are simply descriptive indicators of past cost and schedule performance.

Identifying when a contract is "exceeding" cost and schedule goals is not as simple as it may sound since so many contracts experience some degree of cost and/or schedule overrun. The challenge is determining when a cost or schedule overrun is significant enough to warrant close management scrutiny. Due to limited personnel resources, program managers cannot afford to investigate every cost and schedule deviation.

Deviations from a cost and schedule plan are known as cost and schedule variances. Cost and schedule benchmarks represent the mean cost and schedule variances on past contracts. These benchmarks can be used to evaluate the overall cost and schedule status of ongoing contracts. Cost and schedule benchmarks, along with their associated standard deviations, can assist decision makers in determining what contracts warrant closer management attention by providing early cost and schedule trend information. Then, program managers can focus their limited investigative and managerial resources on selected contracts.

Background

In an attempt to gain better control over major weapons programs, the government, in 1967, designed standards to encourage contractors to focus on their internal cost and schedule management control systems. These standards, called Cost/Schedule Control Systems Criteria (C/SCSC), enable the government to obtain timely and auditable data from the contractor that are used to determine contract status.

The primary vehicles for reporting contract data is the Cost Performance Report (CPR) and the Cost Schedule Status Report (C/SSR) (AFMCP 173-5, 1987:2-1). Information from the CPR or C/SSR is summarized in the Defense Acquisition Executive Summary (DAES) report and then it is entered into a centralized database called the DAES database (DODI 5000.2M, 1991:part 11). This database gives DoD decision makers

access to the information they need in determining the status of major DoD acquisition programs.

The DAES database, which contains detailed information on over 500 military contracts, contains the quantitative information necessary to create cost and schedule benchmarks. These benchmarks can then be used throughout the life of the military contract to monitor the program by comparing the current status of the contract to a historical reference. If a contract's cost and schedule status varies significantly from the established benchmark, when considering the associated standard deviation, program managers can commit their limited resources to investigate what is causing this deviation.

The difference between *benchmarks* and *benchmarking* needs to be emphasized. Benchmarks, as used in this study, are indicators of cost and schedule performance based on historical data which can be used to gauge future performance. In contrast, "Benchmarking is the continuous process of measuring products, services, or activities against the best levels of performance that may be found either inside or outside the organization" (Horngren, 1994:7). Thus, the term *benchmarks* is clearly not synonymous with the concept of *benchmarking*.

Specific Problem

The primary purpose of this research is to calculate and document quantitative cost and schedule measures of

performance, based on historical data, at various stages of military contracts. This will provide program managers with benchmarks with which to determine if the status of their contract is different from past contracts.

A secondary purpose of this research is to compare the benchmarks produced in the primary stage of the analysis across categories of contracts to determine if there is a statistically significant difference. Identifying statistically significant differences between cost and/or schedule variances on contracts categorized by contract type, program phase, and military service might lead to improvements in contract management and lower cost and schedule variances.

Investigative Questions

The following questions were used to direct the focus of this research:

1. What general circumstances have historically caused cost overruns and schedule slippages?
2. What are the historical cost and schedule variances for the 12 categories of contracts at selected stages?
3. Given program phase, contract type, and contract stage, are there statistically significant cost or schedule differences across the three military services (Air Force, Army, and Navy)?
4. Given contract type, managing service, and contract stage, are there statistically significant cost or schedule

differences between the two program phases (development and production)?

5. Given program phase, managing service, and contract stage, are there statistically significant cost or schedule differences between the two contract types (cost reimbursable and fixed price)?

6. How can cost and schedule benchmarks be used to assist program managers in determining the status of on-going contracts?

The Primary Hypotheses Tested

1. Tested a null hypothesis (H_0) that given program phase, contract type, and contract stage, there is no statistically significant difference among the cost or schedule variances of contracts managed by the Air Force, Army, and Navy.

2. Tested a null hypothesis (H_0) that given contract type, managing service, and contract stage there is no statistically significant difference among the cost or schedule variances between the two program phases (development and production).

3. Tested a null hypothesis (H_0) that given program phase, contract type, and contract stage there is no statistically significant difference among the cost or schedule variances between the two contract types (fixed price and cost reimbursable).

Scope/Limitations/Assumptions

This research is confined to the military contracts contained in the DAES database. Contracts which are excluded from the database include contracts classified as "black" programs for national security reasons, contracts completed prior to 1972, and contracts not meeting established reporting thresholds. In addition, contracts in the full DAES database that had missing data considered essential to this analysis were eliminated. The refinements made to the database in order to tailor it to this study are discussed in detail in the methodology section.

The "refined" DAES database only contains contracts that have comprehensive cost and schedule data. Thus, a judgment sample was used for statistical analysis. Because the DAES database is a non-random sampling of the population of all military contracts, caution should be used when making inferences concerning the population. As a result, the inferential statistics produced in this study can only be reliably applied to those contracts with the same attributes as those currently included in the DAES database.

The calculated benchmarks are limited by the accuracy of the information in the DAES database. Inaccurate data can result from human error in either completing the cost performance report or entering the data into the database. Also, in rare situations it is possible that the data reported on the CPR were erroneous. Given the size of the

sample in the study (462 contracts), errors in the data should not have a material effect on the results of the analysis.

Although cost overruns and schedule problems are often rooted in the contractor's performance, this thesis should not be interpreted as faulting the contractor for all cost overruns and schedule slippages. Due to time and resource limitations it was not possible to determine all of the factors that might have adversely impacted every specific program's cost and schedule status. General situations that adversely impact cost and schedule are discussed in the literature review section. The program manager/decision maker must determine what, if any, other factors are adversely impacting the program before focusing on the contractor as the cause of the overruns.

Thesis Overview

This thesis utilizes the DAES database to calculate benchmarks for determining the cost and schedule status of current contracts as compared to past contracts.

The Literature Review, Chapter Two, summarizes past efforts in the areas of:

1. The factors that adversely impact cost and schedule
2. How Cost/Schedule Control Systems Criteria apply to the collection and documentation of contract data

3. The informational structure of the DAES database and how that information might be used to determine contract status

4. What the level of need is for additional tools to evaluate contract status

The Methodology section, Chapter Three, presents how the data were analyzed and what specific steps were followed in answering the investigative questions and testing the hypotheses.

The Analysis section, Chapter Four, presents the quantitative results of the statistical analysis. The hypotheses were tested using the analysis of variance (ANOVA) approach and the significant results were discuss and summarized.

Conclusions based on the analysis are drawn in Chapter Five. In addition, recommendations on how the results of this study could be utilized to improve contract management are included. Basically, the cost and schedule benchmarks could be used to monitor contract status throughout the life of a military contract.

II. Literature Review

The review of the existing literature identifies and discusses pertinent articles, theses, reports and other published works related to four areas:

1. The factors that adversely impact cost and schedule performance
2. How C/SCSC applies to collecting and documenting performance data
3. How the DAES database is structured and how it can be used to determine how a contract is progressing
4. What level of need exists for additional tools to evaluate contract status.

Overview of Literature Review

Ten published works were reviewed. Table 1 on the following page contains a summary of these published works. The first one (Woodward, 1983) was chosen because it thoroughly covered the risk and uncertainty factors that influence cost and schedule performance. Several authoritative references on C/SCSC were written by Messrs. Fleming (1988), Christensen (1993), and Abba (1986). These readings were selected because of their thorough explanation of the C/SCSC process. Information pertaining to the DAES database was gathered from Christensen's articles. His writings explained the nature of the DAES database and how this database is useful for performance measurement

calculations. The Beach Report (1990) highlights the need for more accurate and timely cost and schedule status information. Mr. Beach clearly points out the consequence (the cancellation of a major program) resulting from inadequate cost and schedule monitoring. Lastly, two AFIT theses detailing some alternative cost and schedule performance indicators were examined. These were selected because they were pertinent to the topic of cost and schedule performance benchmarks.

Table 1
Summary Of Literature Review

| AUTHOR/YEAR | TOPIC | CONCLUSIONS |
|--------------------------|--|--|
| Woodward/1983 | Risk and Uncertainty | Numerous causes of cost overruns |
| Fleming/1988 | C/SCSC | N/A |
| Christensen/1993 | C/SCSC | N/A |
| AFMCP 173-5/1987 | C/SCSC | N/A |
| Christensen/1992 | Control & Analysis of Performance Measurement Data | N/A |
| Christensen/1993 | Cost Overruns | Use performance measurement data for timely identification of overruns |
| Abba/1986 | C/SCSC | Take corrective actions for cost and schedule deviations early |
| Knepp & Stroble/1993 | S-curves for cost control | S-curves couldn't be used |
| Terry & Vanderburgh/1993 | EAC Indices | SCI-based EAC is accurate |
| Beach/1990 | A-12 Aircraft | Need to recognize cost overruns earlier |

General Factors Affecting Cost Overruns and Schedule Slippages

There are many factors that affect the cost and schedule status of defense acquisition systems. Although inefficiencies in the contractor's operation can cause cost overruns and schedule slippages, other factors often play a part.

Gansler points out that the procurement system "encourages a great deal of "optimism" in bidding and in budgeting" (Gansler, 1989:177). Because the contract is often awarded to the lowest bidder, it behooves a contractor to bid the lowest possible amount for the contract. This is not to imply the contractor is purposely understating the actual cost of fulfilling the contract. Indeed, the whole concept of risk analysis and probability distributions implies there are a great number of possibilities over what the contract will really cost. Some of these probabilities are small but are non-the-less possibilities.

Another reason for cost overruns is a greater government priority on minimizing development time regardless of the cost consequences (Peck, 1962:438). This is not necessarily always bad. When the United States is on the verge of war it is important to get the weapon systems fielded as soon as possible in order to increase the advantage over the enemy and reduce casualties by minimizing the duration of the conflict. In this situation cost ramifications become secondary. Expediting development time at the expense of

controlling costs becomes poor management when there are no clear cut national priorities for doing so except just a desire to get the system on-line sooner.

Woodward Thesis

Factors that Woodward noted in his 1983 thesis, An Analysis of the Management of Funds for Risk and Uncertainty in the Department Of Defense, include:

1. Not adequately budgeting for risk and uncertainty (particularly during the relatively high risk R&D phase)
2. Unexpected high inflation
3. Supply and demand factors
4. Poor resource allocation
5. Managerial inefficiency
6. Technological uncertainty
7. System requirements uncertainty
8. Less than perfect cost estimating techniques
9. The budget process involving risk in congressional appropriations

The adverse impact that uncertainty in the congressional appropriations process can have on a major weapons program can be readily seen in the acquisition of the Air Force's next generation air superiority fighter. A recent \$163 million congressional cut in the development phase of the F-22 could "translate into at least \$400 million in added development costs for the F-22 and stretch-out development by five months" (Cole, 1994:A-3). The author went on to state,

Every time F-22 funding for a given year is cut, the total cost of developing the plane actually escalates. When the funding is cut in the short term, development must be slowed, meaning work with lots of fixed-overhead costs is stretched out over more time. The higher price invariably gives political opponents more ammunition for cutting the program further. Gen. Merrill McPeak, Chief of Staff of the Air Force, warned in an interview that the F-22 was in danger of being pushed into 'the same old death spiral we always get into on these programs.'

Woodward concluded his research by stating, "Further research should be done in the management control of risk and uncertainty, as well as *cost and schedule variances* within government programs" (italics added) (Woodward, 1983:108). As previously stated, calculating and analyzing cost and schedule variances with the objective of designing cost and schedule benchmarks is the objective of this thesis.

It must be emphasized that there are many reasons why program costs and schedules can be adversely affected. The program manager needs to carefully analyze the various influences on the program before concluding the root cause lies in the contractor's performance. Fortunately, major defense programs are governed by Cost/Schedule Control Systems Criteria designed to facilitate identifying programs experiencing difficulty meeting cost and schedule goals.

Cost/Schedule Control Systems Criteria

The Cost/Schedule Control Systems Criteria were developed in 1967 to address fundamental deficiencies in the management of defense acquisition programs. Prior to implementation of C/SCSC contract performance data were often

incomplete, inconsistent, and inaccurate. The 35 criteria, or standards, contained in C/SCSC were designed to standardize performance data reporting and provide decision makers with thorough, accurate and reliable information.

When a contractor configures their management control systems in accordance with the 35 criteria, they are certified as C/SCSC compliant by the government. Thereafter, the government places high confidence in the data the contractor reports on contracts under their control. It must be emphasized that contractors are not required to design any one specific system to become certified. However, they must ensure their systems are C/SCSC compliant.

The government realizes that no one management control system is perfect for every contractor given the diverse nature of DoD acquisitions. As a result, contractors have wide latitude in designing management control systems to meet their unique needs provided the system satisfies the 35 criteria needed to ensure accurate and reliable cost and schedule information.

Contractors use the Cost Performance Report (CPR) or the Cost/Schedule Status Report (C/SSR) to report cost and schedule information on their contracts. According to Department of Defense Cost/Schedule Control Systems Criteria Joint Implementation Guide, the CPR contains data that must:

1. relate time-phased budgets to specific contract tasks and/or statements of work;
2. indicate work progress;

3. properly relate cost, schedule and technical accomplishment;
4. be valid, timely, and auditable;
5. supply DoD managers with information at a practical level of summarization; and
6. be derived from the same internal management control systems used by the contractor to manage the contract. (AFMCP 173-5, 1987:1-1)

Key information from the CPR is entered into the DAES report and then into a summary database to allow decision makers rapid access to determine the cost and schedule performance status of current and/or completed major defense contracts.

Defense Acquisition Executive Summary (DAES) Database

The Defense Acquisition Executive Summary (DAES) database is a compilation of cost and performance data on over 500 Department of Defense (DoD) contracts. The information in the database covers most of the major weapon systems contracted for development or production by the DoD since 1972.

Data from the CPRs and C/SSRs are summarized and sent, on a quarterly basis, to the Office of the Undersecretary of Defense for Acquisition (OUSDA) (Christensen, 1993) (DODI 5000.2M, 1991:part 11). This summary is called the Defense Acquisition Executive Summary (DAES). Data from this summary are entered into the database. Information in the database is proprietary, therefore, information that could be used to identify the contractor or a specific weapon system will not appear in this thesis. Specific responsibilities for all

participants in the reporting process are detailed in DoD Manual 5000.2M, part 11.

The database is quite detailed; it contains over 50 fields of data. The current database has over 7,000 lines of data representing completed and on-going contracts from the early 1970's to date.

Some of the fields in the database used in determining the status of cost overruns and schedule problems are:

(note: formal definitions of these terms are in Appendix A)

1. Cumulative Budgeted Cost of Work Scheduled (BCWS). This figure is also known as *planned value*. It is the value of the work the contractor had *planned* to complete by the reporting date. If the contractor had completed an amount of work equal to this figure he would be on schedule (i.e. zero schedule variance)

2. Cumulative Budgeted Cost of Work Performed (BCWP). This figure is also known as *earned value*. This amount represents the amount of the contract the contractor has actually *earned*. If BCWP does not equal BCWS then the contractor did not complete the exact amount of work he had planned to complete; he would have completed more work or less work than what was planned. Differences between planned and actual work completed is known as a schedule variance (SV) and is calculated as:

$$\text{Schedule Variance (SV)} = \text{BCWP} - \text{BCWS} \quad (1)$$

Significant schedule variances, either positive or negative, are cause for concern since the work would not be progressing according to the plan.

3. Cumulative Actual Cost of Work Performed (ACWP).

This amount represents the actual cost of the work performed as of the time the CPR was submitted. If ACWP does not equal BCWP then the contractor spent more or less money than what was planned for the amount of work actually performed. A difference between planned costs and actual costs is known as a cost variance (CV) and is calculated as:

$$\text{Cost Variance (CV)} = \text{BCWP} - \text{ACWP} \quad (2)$$

This variance will be positive if the contractor spent less than budgeted for the actual work performed or negative if he spent more than budgeted for the actual work performed. Significant cost variances, either positive or negative, are cause for concern since costs are not close to what was anticipated when the budget was drafted.

The equations for determining cost and schedule variances were taken from Control and Analysis of Performance Measurement Data (Christensen, 1992:20).

Christensen Article

David S. Christensen published an analysis of cost overruns on DoD acquisition contracts. In his discussion, he stresses that "timely management attention to adverse cost

variances can reduce them. . .the problem has been a failure to use performance measurement data proactively"

(Christensen, 1993:44-45). This research addresses Christensen's concerns regarding the timely use of performance measurement data by providing cost and schedule benchmarks which program managers can use to assess the severity of potential problems early in the program. This may allow additional time to take appropriate intervening action. Christensen concludes by stating:

Without more realistic estimates [of cost and/or schedule variances], senior management may be lulled into a false sense of security about their programs and fail to take appropriate action to correct problems. (Christensen, 1993:47)

Abba's C/SCSC White Paper

Mr. Wayne Abba, of the Office of the Under Secretary of Defense for Acquisition, prefaced the Cost/Schedule Control Systems Criteria Joint Implementation Guide, by addressing the importance of C/SCSC. He advocates using C/SCSC for collecting and tracking both cost and schedule data to assess contractors' performance. He emphasizes, "Real improvements in contract management can be achieved by top-level attention to developing and using good cost and schedule management control systems and by taking timely corrective action when a problem is identified" (AFMCP 173-5, 1986:viii).

Knepp and Stroble Thesis

Richard Knepp and Michael Stroble in their 1993 thesis Development of Standardized S Curves for the Evaluation of Major Department of Defense Purchases investigated using S-curves to describe how costs react over time for typical major weapons programs (Knepp and Stroble, 1993). They also used the DAES database in their analysis. They used 317 contracts in their study. They had hoped to provide program managers with a cost-based S-curve created from historical data. Program managers could then use this S-curve to help gauge the status of their contracts.

Knepp and Stroble theorized that weapon system contracts would exhibit a familiar trend in costs as the contract is completed. Basically, they hypothesized costs are slow to increase in the early stages of a contract and then increase fairly rapidly in the middle stages of the contract before tailing off toward the end of the contract; thus exhibiting an "S" shape. Unfortunately, they discovered the pattern of costs with respect to percent complete was often more linear than S-shaped. However, even though a distinctive S-curve was not always evident, the reference line might have still proved useful to program managers to gauge the status of their current contracts except for a key point, the spread of the aggregated cost variance.

The aggregated cost variance in the study was spread over a large area (i.e. the standard deviation was very

large). For example, given a contract that was 50% complete, the expected cost, plus or minus one standard deviation, was predicted to be between approximately 42% and 72% of total contract cost. Basically, this is indicating that, based on historical data, a contract is "in the window" if cumulative costs were between 42% and 72% of total contract costs at the 50% completion point.

It appears that due to the large size of the "window," program managers would have difficulty using this information to determine how their contracts are performing relative to a historical reference. Unless the cumulative costs greatly exceeded the historical norm, decision makers would have to conclude the contracts are within cost boundaries.

Terry and Vanderburgh Thesis

In 1993, Mark Terry and Mary Vanderburgh performed an analysis of estimate at completion (EAC) models utilizing the DAES database. In their thesis, An Analysis of Estimate at Completion Models Utilizing the Defense Acquisition Executive Summary Database they focused on using various indices to estimate a floor and ceiling for the final cost of a contract. The three indices they used in their analysis were the Cost Performance Index (CPI), the Schedule Cost Index (SCI), and the Schedule Performance Index (SPI). By identifying a floor and ceiling for the estimated costs of a contract, they might be able to predict realistic cost bounds for a given contract.

Terry and Vanderburgh used 321 contracts from the DAES database in their analysis. They concluded that the CPI-based estimate at completion (EAC) represents a valid floor for a contract's final cost estimate. Although they expected the SCI-based EAC would be a valid cost ceiling, they discovered the actual cost at completion (CAC) exceeded the SCI-based EAC. However, of the EACs they analyzed, the SCI-based EAC was the most accurate predictor of final contract cost.

In summary, Terry and Vanderburgh analyzed the appropriateness of using various performance indices to predict contract costs at completion and had positive results. They recommended that "a more detailed statistical analysis of the DAES database would be very useful for future research." Analyzing the DAES database with the goal of producing descriptive statistical cost and schedule benchmarks is a logical extension of their work.

Beach Report

Navy Inquiry Officer, Chester Paul Beach Jr., issued a memorandum on the status of the A-12 aircraft program for the Secretary of the Navy on 28 Nov 1990 (Beach, 1990). Forty days later, Defense Secretary Cheney formally canceled the A-12 program.

Beach's report highlighted many problems with the A-12 program, including the fact that the program manager's office did not formally recognize that the A-12 contract was in

trouble until it was in such serious difficulty that the Secretary of Defense had to step in to terminate it. The problems of the A-12 program have helped focus the attention of the defense contracting community on the need for tools that program managers can use to assess the viability of their weapon or material programs. The benchmarks this thesis calculates are intended to be one of these assessment tools. Beach's conclusions concerning the A-12 aircraft program validate the need for cost and schedule benchmarks.

Investigative Question Answered

There are numerous reasons why cost overruns and schedule slippages occur (investigative question #1). These reasons include: poor contractor performance, not properly accounting for risk and uncertainty when budgeting funds for the contract, not properly managing the contract to discover when cost and schedule problems are occurring, and congressional budget cuts in the middle of the contract that cause unexpected and short notice schedule slips.

Given that cost and schedule problems are occurring in a large percentage of contracts, there is a need for a means of identifying cost and schedule deviations at the earliest possible time. Cost and schedule benchmarks should prove useful to the program manager by providing early indications of when a contract is exceeding historical average cost and schedule variances.

Conclusion and Overview

Although the C/SCSC management control system is designed to minimize cost and schedule overruns, problems in these areas remain. Studies have explored ways to address cost and schedule issues with limited success. The next chapter presents the specific methodology used in the analysis.

III. Methodology

Introduction

This section specifies the methodology used in this analysis. A refined DAES database of 290 military contracts was used to calculate benchmarks for cost and schedule variances (in percent) of contracts. This study employs secondary data. It uses quantitative analysis producing inferential statistics. In addition, Analysis of Variance (ANOVA) is used to analyze the data.

Overview of Benchmark Calculations

Benchmarks are simply the mean cost and schedule variances (in percent) for designated categories. The cost and schedule variances calculated from the DAES database were grouped into 48 categories. These categories were derived from the three military services under analysis (Air Force, Army or Navy), the two possible phases of a contract (development or production), the two general types of contracts (cost reimbursable or fixed price), and the four stages of a contract (0-25% complete, 25-50% complete, 50-75% complete, or 75-100% complete). This breakout resulted in 48 cost variance and 48 schedule variance benchmarks ($3*2*2*4=48$).

Statement of Hypotheses

The six hypotheses are:

1. Given the contract phase, contract type and contract stage, there is no statistically significant difference in the cost variance percentages of the three military services. The null and alternative hypotheses are:

$$H_0: CV\%_{\mu_{\text{Air Force}}} = CV\%_{\mu_{\text{Army}}} = CV\%_{\mu_{\text{Navy}}}$$

$$H_a: \text{not all three means are equal}$$

2. Given the contract phase, contract type and contract stage, there is no statistically significant difference in the *schedule* variance percentages of the three military services. The null and alternative hypotheses are:

$$H_0: SV\%_{\mu_{\text{Air Force}}} = SV\%_{\mu_{\text{Army}}} = SV\%_{\mu_{\text{Navy}}}$$

$$H_a: \text{not all three means are equal}$$

3. Given the military service, contract type and contract stage, there is no statistically significant difference in the cost variance percentages of the two contract phases. The null and alternative hypotheses are:

$$H_0: CV\%_{\mu_{\text{Development}}} = CV\%_{\mu_{\text{Production}}}$$

$$H_a: CV\%_{\mu_{\text{Development}}} \neq CV\%_{\mu_{\text{Production}}}$$

4. Given the military service, contract type and contract stage, there is no statistically significant difference in the *schedule* variance percentages of the two contract phases. The null and alternative hypotheses are:

$$H_0: SV\%_{\mu_{\text{Development}}} = SV\%_{\mu_{\text{Production}}}$$

$$H_a: SV\%_{\mu_{\text{Development}}} \neq SV\%_{\mu_{\text{Production}}}$$

5. Given the military service, contract phase and contract stage, there is no statistically significant

difference in the cost variance percentages of the two contract types. The null and alternative hypotheses are:

$$H_0: CV\%_{\mu_{\text{Cost Reimbursable}}} = CV\%_{\mu_{\text{Fixed Price}}}$$

$$H_a: CV\%_{\mu_{\text{Cost Reimbursable}}} \neq CV\%_{\mu_{\text{Fixed Price}}}$$

6. Given the military service, contract phase and contract stage, there is no statistically significant difference in the schedule variance percentages of the two contract types. The null and alternative hypotheses are:

$$H_0: SV\%_{\mu_{\text{Cost Reimbursable}}} = SV\%_{\mu_{\text{Fixed Price}}}$$

$$H_a: SV\%_{\mu_{\text{Cost Reimbursable}}} \neq SV\%_{\mu_{\text{Fixed Price}}}$$

Relevance of Hypotheses Testing

A benchmark may be affected by the following categories: program phase, contract type, and branch of military service. Matching the characteristics of an ongoing contract with the benchmarks would be appropriate if the benchmark does in fact depend on these categories. Therefore, hypothesis testing is necessary to determine if statistically significant differences between benchmarks truly exist.

The DAES Database

The DAES database is the principal cost performance reporting database for the three military services and is comprised of quarterly cost and schedule reports which are submitted by the program managers (Beach, 1990:2).

Companies with large military contracts must comply with the government's Cost/Schedule Control Systems Criteria

(C/SCSC) and normally report detailed cost and schedule information to the program managers throughout the life of the contract. The Cost Performance Report (CPR) or the Cost/Schedule Status Report (C/SSR) are used for reporting this data. Program managers then summarize the information the contractor submitted for insertion into the DAES database via the DAES report.

Population & Sample

The population is DoD military contracts contained in the Defense Acquisition Executive Summary (DAES) database. For this analysis, a judgment sample was extracted from the DAES database.

The database was refined by eliminating those contracts which could not be specifically categorized into either the production or development phase, or into cost reimbursable or fixed price type of contracts. Contracts with blank fields identifying the phase or type of contract were eliminated. Individual contracts which listed both development and production and/or cost reimbursable and fixed price were not considered since they did not conform to the collectively exhaustive and mutually exclusive categories in the study.

Additionally, contracts that had missing data or clearly incorrect data due to input errors in fields considered essential to this study (ACWP, BCWP and BCWS) were eliminated. Thus, the sample consists of those contracts for which there are valid and complete data. "Complete"

contracts are defined as those contracts having entries in these fields: Military Service, Contract Phase, Contract Type, Final Budget at Completion (FBAC), BCWS, BCWP and ACWP.

Data Collection Instrument

The data for the DAES database were collected through detailed Cost Performance Reports (CPR) and the Cost/Schedule Status Report (C/SSR) and are maintained in the DAES database as historical data (AFMCP 173-5, 1987:2-1) (DODI 5000.2M, 1991:16-1 to 16-7 and 20-1 to 20-9). These documents lay out the specific criteria with which contractors must comply on military research, development, or test and evaluation contracts over \$60 million and any procurement contract over \$250 million in FY90 constant dollars. Due to the detailed C/SCSC contractor performance reporting standards and the presence of military representatives at the contracting sites, the data in the DAES database are assumed valid for this study.

Data Collection Plan

The data used in this study had previously been collected by a third source. The DAES database was provided to the researchers by David S. Christensen of the Air Force Institute of Technology. Mr. Christensen originally received the database from the Office of the Under Secretary of Defense for Acquisition. The cost and schedule data are

ratio data with zero dollars and zero time being the absolutes.

The data were appropriately categorized for this research. Some examples of categories are: contract number (a numeric identifier), branch of service (Air Force, Army or Navy), program phase (development or production), type of contract (cost reimbursable or fixed price), budgeted cost of work scheduled (BCWS), budgeted cost of work performed (BCWP), and actual cost of work performed (ACWP).

Data Preparation

There were 5 steps taken to prepare the data for analysis.

1. Each contract was separated into four stages prior to calculating the actual cost and schedule variances in percent. These stages were selected to provide program managers with an appropriate level of detailed information. The variances were categorized using the following definitions where Percent Complete (PC) is defined as Budgeted Cost of Work Performed (BCWP) divided by Final Budget at Completion (FBAC) (note: Final BAC was used in lieu of BAC since BAC will fluctuate throughout the life of a contract as modifications to the contract produce changes in the cost of the contract--using FBAC more realistically reflects the actual completion status of the contract):

$$\text{Percent Complete (PC)} = \text{BCWP} + \text{FBAC} \quad (3)$$

Stage 1 = contracts between 0% and 25% complete

Stage 2 = contracts between 25.1% and 50% complete

Stage 3 = contracts between 50.1% and 75% complete

Stage 4 = contracts between 75.1% and 100% complete.

2. The cost and schedule variances were computed using the following formulas:

$$\text{Cost Variance (CV)} = \text{BCWP} - \text{ACWP} \quad (4)$$

$$\text{Schedule Variance (SV)} = \text{BCWP} - \text{BCWS} \quad (5)$$

Similarly, mean schedule variances were calculated.

3. The cost and schedule variances in percentages for each entry/row in the database were computed using the following formulas:

$$\% \text{ Cost Variance (CV\%)} = (\text{CV} + \text{BCWP}) * 100 \quad (6)$$

$$\% \text{ Schedule Variance (SV\%)} = (\text{SV} + \text{BCWS}) * 100 \quad (7)$$

4. For each contract the number (n) of cost variance in percent entries in each stage were summed (an entry is generated each time a contractor reports cost or schedule information to the government). This summed value was divided by n to calculate a mean cost variance in percent for each stage of each contract using the formula:

$$\text{CV\%}\mu_{(\text{by stage by contract})} = \left(\sum \text{CV\%}_{(\text{by stage by contract})} \right) + n \quad (8)$$

Variances are converted into percentages to normalize the data for analysis. By converting to percentages, contracts that are monetarily large do not have excessive influence on the analytical results.

5. Each contract was identified by service, phase, type and stage. This resulted in 48 distinct groupings. The resulting 969 lines of data from the above steps are listed in Appendix B.

Benchmark Calculations

The mean of each of the 48 cost variance and 48 schedule variance groupings was computed by summing the number (n) of cost or schedule variances in each category and dividing by n, as follows:

$$\mu CV\%(\text{by category}) = (\sum CV\%(\text{by category})) + n \quad (9)$$

$$\mu SV\%(\text{by category}) = (\sum SV\%(\text{by category})) + n \quad (10)$$

The benchmarks are in the Analysis Section (chapter IV).

Flowchart of the Analysis

The flowchart on the following page depicts the core decision steps used in the analysis (Figure 1).

Analysis of Variance (ANOVA)

Overview. The ANOVA approach was used to test the hypotheses to determine whether there is a statistically significant difference between related groupings. The ANOVA

Figure 1
Flowchart

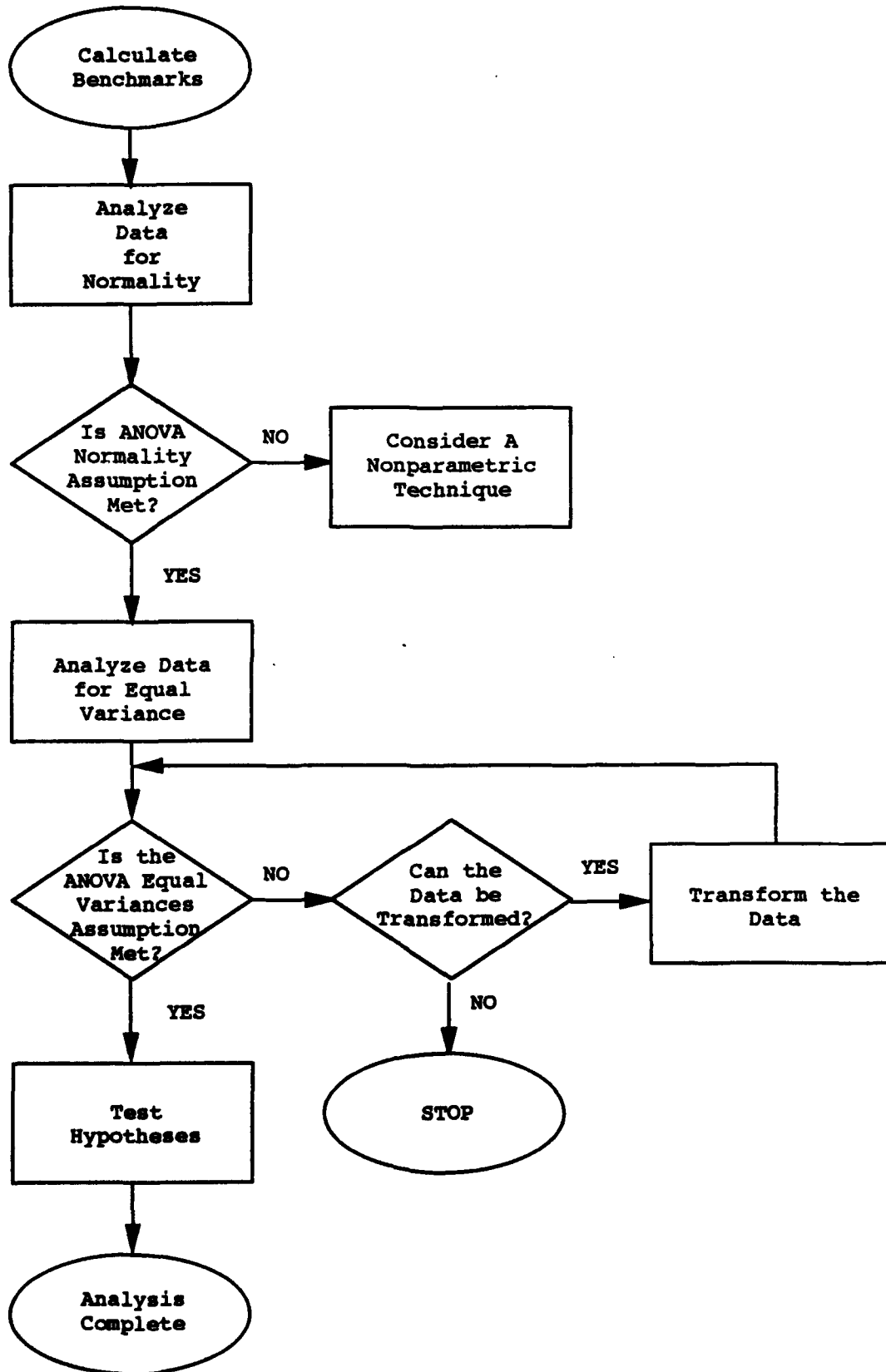

design appropriate for this study is the fixed factor level ANOVA model (Neter and others, 1990:528).

This study incorporates a four factor nested design. It is an unbalanced design (unequal sample sizes) with one category containing no data points (the Air Force, Production, Cost Reimbursable, 1st Stage category). The nested design explicitly considers the interrelationships of the multiple factors in the analysis.

ANOVA Terminology. The following discussion relates the standard ANOVA terminology to the attributes of this study (Neter and others, 1990:522-525).

Type of study. This study is based on observational data from the DAES database. As a consequence, the factors under analysis may be called *classification factors*.

Factors. There are four factors (independent variables) in the study. They are: 1) the branch of military service, 2) the phase the contract applies to, 3) the type of contract and 4) the stage of the contract.

Factor Levels. Each of the four factors in the study are divided into the appropriate number of collectively exhaustive and mutually exclusive factor levels. The branch of military service factor is divided into three factor levels consisting of, Air Force, Army or Navy. The phase the contract applies to is divided into two levels, development or production. The type of contract is divided into two

levels, cost reimbursable or fixed price. The stage of the contract is divided into four levels, 1st quarter, 2nd quarter, 3rd quarter or 4th quarter. Figure 2 is an example of a four factor nested design with multiple factor levels as described above.

Multifactor Study. This is a *multifactor* study containing the four factors (independent variables) previously discussed. A diagram of one of the nested designs used in these analyses is included on the following page (Figure 2).

Type of Factors. The four factors in this study are *qualitative* and nominal in nature.

Dependent Variables. There are two dependent variables in this study, cost variance (in percent) and schedule variance (in percent).

Treatments. The *treatments* are those "buckets" appearing at the bottom of the nested design. Each treatment is a unique combination of the factor levels above it. The effect each treatment has on the dependent variable will be analyzed. In this four factor study, with factor levels consisting of three, two, two and four categories (reference factor level discussion beginning on the previous page), the total number of treatments in the bottom factor will equal 48 ($3*2*2*4=48$) for cost variance in percent and another 48 for schedule variance in percent.

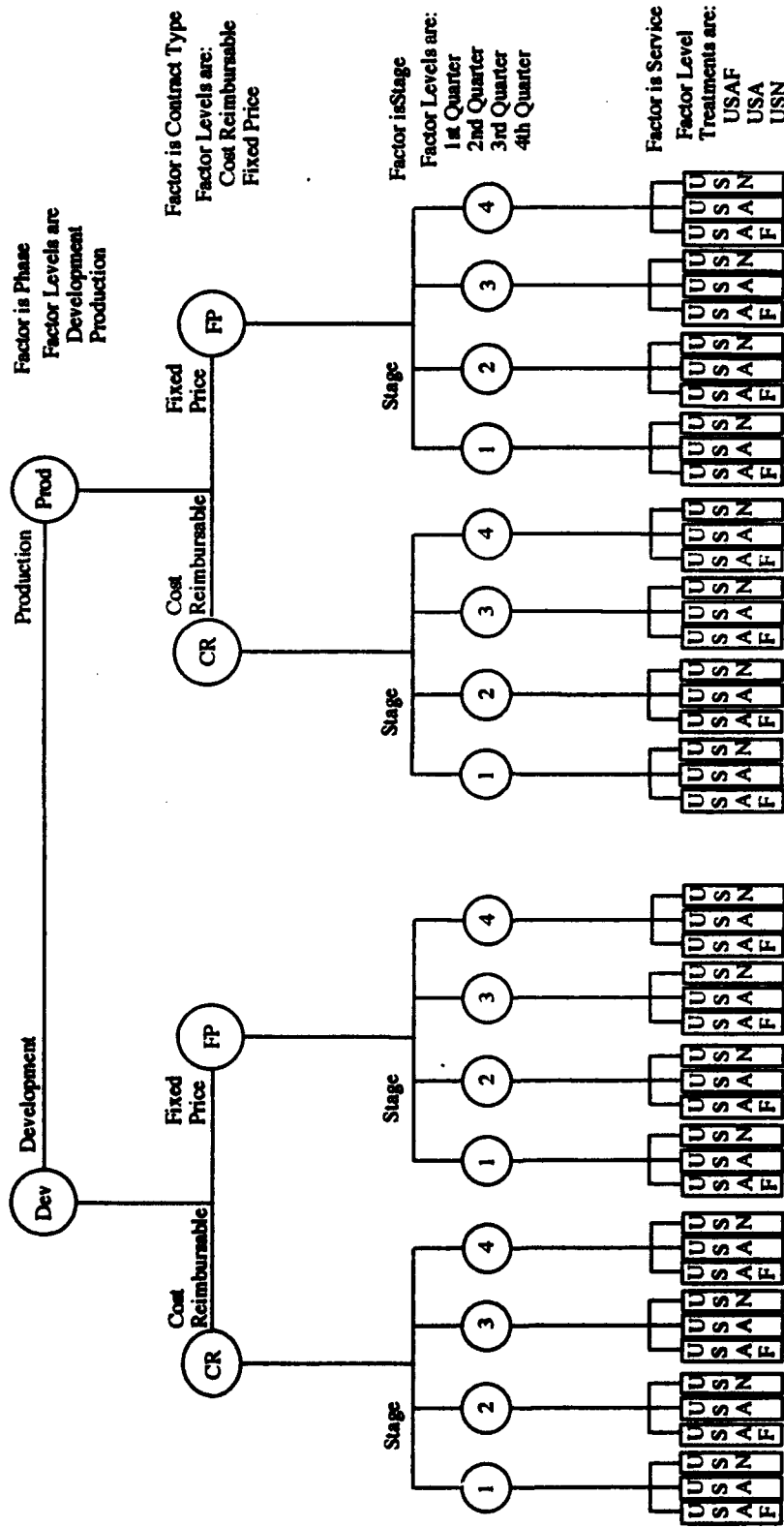

Figure 2. Four Factor Nested Design with Managing Service as the Treatment

ANOVA Fixed Factor Level Model. The reason the ANOVA fixed factor level model is appropriate for this study is because the interest is in the specific factor levels contained in the analysis. This is in contrast to a random factor level model where inferences are desired for factor levels not included in the model. For example, if the objective of this study was to make inferences not of just Air Force, Army and Navy contracts but of, say, NASA, Department of Energy and Department of Commerce contracts, then the random factor level model would be appropriate. The ANOVA fixed factor level model is very robust against certain departures from the assumptions of the model such as normality and constant error variance (Neter and others, 1990:607, 623).

ANOVA Nested Design. This is a nested design since a given cost or schedule variance (in percent) is associated with a *specific combination* of factor levels (service, phase of contract, type of contract and stage of contract). This is in contrast to the other major type of design, the crossed design, where a given treatment could be associated with *any combination* of factor levels (Neter and others, 1990:970-973).

Testing the Primary Assumptions of ANOVA

Determination of Normality. Initially the Shapiro-Wilk statistical test was used to determine the degree of normality of the data. In addition, the normal probability

plot was created and visually analyzed bearing in mind the ANOVA fixed factor level model is a robust model and is valid for moderate departures from normality (Neter and others, 1990:623).

Analysis of Nonconstancy of Error Variance. The Bartlett statistical test is appropriate for testing the degree of constancy of the error variance when the sample sizes are unequal. The Bartlett test was applied in two stages. First, the entire data set was tested for equality of error variance. Second, for each group of means for which the ANOVA F-test indicated statistically significant differences, the test was applied to the means in that group to further explore the constancy of the error variance.

First, the Bartlett test was applied to the entire data set to examine the overall constancy of the error variances. In addition, a plot of the residuals was analyzed. "When the error variance is constant, these residual plots should show about the same extent of scatter of the residuals around 0 for each factor level" (Neter and others, 1990:610). The plot of the residuals indicates if heteroscedasticity is present in the data. As with departures from normality, the ANOVA fixed factor level model is a robust model and is valid even for a moderate degree of unequal error variance.

Second, for those groups containing statistically significantly different means, the Bartlett test was applied to that specific group of means. This more detailed analysis

of the error variance is necessary when interpreting the results of the analysis. If the error variances are not equal, then the probability of a type I error is increased. Thus, if heteroscedasticity is present and if a result is "borderline" (indicating the null hypothesis should be rejected--but just barely), then caution must be exercised before concluding the null hypothesis should indeed be rejected.

Independence of the Error Terms. Since this study is not based on time series data, the error terms are assumed to be independent and a test of their independence is unnecessary.

Hypotheses Testing

The ANOVA design was nested each of three different ways during the study to get the appropriate treatment under analysis at the bottom of the design. After the first nesting produced the factor military service at the bottom of the nest, the test of the hypothesis associated with testing among military services was conducted (reference the beginning of this chapter for a description of the six hypotheses in this study). The nesting in the design was restructured two more times to allow testing between groups of means categorized by contract type and then by program phase. Thus, this analysis tested means three different ways through three variations of the nested design, as follows:

1. Holding program phase, contract type, and contract stage constant the branch of military service was analyzed. Means were calculated and tested to determine whether they had statistically significant differences. For example, the mean for production, fixed price contracts from the first quarter in the Air Force was tested against the mean for production, fixed price contracts from the first quarter in the Army.

If the null hypothesis is rejected, there are statistically significant differences between the cost and/or schedule variance means in percent for contracts managed by the various services.

2. Similarly, holding military service, program phase, and contract stage constant, the contract type was varied and means were calculated and tested.

If the null hypothesis is rejected, there are statistically significant differences between the percentage cost and/or schedule variance means for the two contract types.

3. Lastly, holding military service, contract type and contract stage constant, program phase was varied and means were calculated and tested.

If the null hypothesis is rejected, there are statistically significant differences between the percentage cost and/or schedule variance means for the two program phases.

Three Steps in the Analysis. There are three specific steps in the ANOVA analysis, as follows:

1. The first step is to determine if there are any groups that contain means that have statistically significant differences. The ANOVA F-test is used to make this determination.

2. The second step is to determine which groups of means contain the means that are statistically significantly different. An ANOVA F-test is used via the SAS CONTRAST statement to pinpoint the groups of means requiring further analysis.

3. The third step is to determine the specific means in each group that had been identified as containing statistically significantly different means. The SAS ESTIMATE statement is used as part of this analysis. The Tukey-Kramer multiple comparison of means method is used in this final step.

Step 1 Determining if Any Groups Contain Statistically Significantly Different Means. This ANOVA F-test is the first step in the three step process in determining where statistically significant differences between means lie. The F-test was performed to indicate if there is a statistically significant difference among any of the groups of treatments in any of the factor levels. The ANOVA F-test eliminates the need to test *each and every*

treatment in the factor level to determine if statistically significant differences among the means exists.

Since the treatments contained in the factor level at the bottom of the nest are of interest in this study, the F-test result for that factor level was analyzed to see if a more detailed analysis was necessary. The F-test only indicates if there is a statistical difference among any of the groups of means at the bottom of the nest. It does not indicate which of the means are different. A more specific comparison of means would need to be conducted to determine which groups of means are different.

If the F-test result was not significant, a more detailed analysis was not necessary and steps two and three were not accomplished. The alpha value used to determine statistical differences was .05. Thus, if the F-test for the bottom factor level in the nest produced a p-value greater than .05, there was not a statistically significant difference in any of the groups of means in that factor level and no further analysis was accomplished.

However, if the F-test for the bottom factor level in the nest produced an p-value equal to or less than .05, then further analysis was needed to determine *which* of the groups of means contains individual means which have statistically significant differences.

Step 2 Analyzing Which Groups Contain Statistically Significantly Different Means. Based on

the results of the ANOVA F-test in step 1 a comparison of means may be warranted. If the first F-test indicated there was a statistically significant difference somewhere in the groups of means at the bottom of the nest, every group of means was analyzed to see *which* group(s) of means contained the statistically significant difference. This is the second step of the three stage process to locate the means which have statistically significant differences.

Again, the F-test was used to pinpoint the group(s) of means requiring further analysis. The CONTRAST statement in SAS was used to analyze the group of means in each factor level. An F-ratio, and associated p-value, was produced for each group of means. As with the F-test results for the factor as a whole (discussed in step 1), a p-value equal to or less than .05 was used to indicate statistically significant differences among some of the means in that group.

If the F-test results indicated statistically significant differences among some of the means in a group, a comparison of the individual means within each group was accomplished. Thus, the third and final step was to determine which individual means within a group have statistically significant differences.

Step 3 Comparison of Specific Means. If the F-test in step 2 indicated the factor level contained statistically significant differences between two or more

means, a comparison between each applicable mean/treatment was made. The ESTIMATE statement in SAS was used to pinpoint the *specific* means that have statistically significant differences. This ESTIMATE statement produced a T-value for each pair of means.

The Tukey-Kramer multiple comparison method was used to determine which means are statistically significantly different. This variation of the basic Tukey method was used because of the unequal sample sizes. The Tukey-Kramer method provides protection against the inferences in cases where more than two treatment means are being compared. Specifically, when comparing the means associated with the three military services a three-way multiple comparison is necessary.

The T-values produced using the SAS ESTIMATE command were compared to a critical value to determine if a significant statistical difference exists between the means. This critical value was extracted from a Percentiles of the Studentized Range Distribution table (Neter and others, 1990:1149). Since this study uses $\alpha = .05$, the table containing critical values associated with a .95 family confidence level was used.

There are two entering arguments for the Percentiles of the Studentized Range Distribution table: 1) the number of means to compare (r) and 2) the number of error degrees of freedom (v). The value of r will be 2 or 3 depending on the

number of means being compared ($r = 2$ when means associated with program phase or contract type are being studied and $r = 3$ when the means associated with military service is being studied). The value of v is 922 as reflected in the ANOVA table. Given this rather large v value, the critical value extracted from the table is 3.31.

Any T -value resulting from a comparison of means that is greater than 3.31 indicates a significant statistical difference exists between those means.

The results of the above procedure are contained in Chapter IV.

IV. Analysis

tion of Cost and Schedule Variance Means

data from the DAES database were divided into 48
es. Cost and schedule variance means were calculated
ibed in Chapter III. This created the 96 benchmarks
d in Table 2 on the next page. Information in the
broken down by military service, phase of contract,
contract and stage of contract. The number of
s in each category/treatment, the mean cost and
e variances in percent, and the standard deviation
ed with each mean is presented. This quick reference
an be used by program managers to compare historical
performance with their specific program's
ance.

the ANOVA Assumption of Normality

e results of the Shapiro-Wilk statistical test were
or the cost variance in percent and .8507 for the
e variance in percent. Although these results
e the distributions are not exactly normal, the
are strong enough to conclude the ANOVA assumption
mality is being met.

e assumption of normality was discussed with Professor
E. Reynolds, a resident statistician at the Air Force
te of Technology. Professor Reynolds stated when
with a large sample (969 in this case) the Shapiro-

COPY AVAILABLE TO DTIC DOES NOT PERMIT FULLY LEGIBLE REPRO

Table 2
Benchmarks
for
Cost and Schedule Variances

| Branch of Military Service | Phase of Program | Type of Contract | Stage of Contract | Number of Contracts | Mean Cost Variance % | Cost Variance % Std. Dev. | Mean Schedule Variance % | Schedule Variance % Std. Dev. |
|----------------------------|------------------|-------------------|-------------------|---------------------|----------------------|---------------------------|--------------------------|-------------------------------|
| Air Force | Development | Cost Reimbursable | 1st Quarter | 8 | -3.93 | 7.83 | -6.29 | 5.33 |
| Air Force | Development | Cost Reimbursable | 2nd Quarter | 9 | -4.14 | 10.68 | -4.35 | 5.98 |
| Air Force | Development | Cost Reimbursable | 3rd Quarter | 14 | -0.42 | 10.05 | -1.86 | 1.74 |
| Air Force | Development | Cost Reimbursable | 4th Quarter | 15 | -0.57 | 5.45 | -0.57 | 0.97 |
| Air Force | Development | Fixed Price | 1st Quarter | 21 | 1.57 | 8.29 | -8.42 | 9.37 |
| Air Force | Development | Fixed Price | 2nd Quarter | 29 | -4.13 | 11.91 | -8.96 | 6.66 |
| Air Force | Development | Fixed Price | 3rd Quarter | 31 | -6.24 | 13.16 | -6.92 | 5.76 |
| Air Force | Development | Fixed Price | 4th Quarter | 33 | -9.67 | 16.19 | -3.32 | 3.06 |
| Air Force | Production | Cost Reimbursable | 1st Quarter | 0 | N/A | N/A | N/A | N/A |
| Air Force | Production | Cost Reimbursable | 2nd Quarter | 2 | 0.83 | 1.67 | -2.05 | 2.89 |
| Air Force | Production | Cost Reimbursable | 3rd Quarter | 1 | -4.96 | N/A | -8.24 | N/A |
| Air Force | Production | Cost Reimbursable | 4th Quarter | 3 | -4.74 | 10.43 | -2.47 | 1.47 |
| Air Force | Production | Fixed Price | 1st Quarter | 45 | 4.32 | 6.41 | -9.62 | 17.15 |
| Air Force | Production | Fixed Price | 2nd Quarter | 58 | 1.37 | 11.23 | -8.94 | 12.74 |
| Air Force | Production | Fixed Price | 3rd Quarter | 66 | -2.68 | 11.61 | -7.00 | 7.90 |
| Air Force | Production | Fixed Price | 4th Quarter | 71 | -4.86 | 11.83 | -3.24 | 2.81 |
| Army | Development | Cost Reimbursable | 1st Quarter | 11 | 2.15 | 12.05 | -7.27 | 7.30 |
| Army | Development | Cost Reimbursable | 2nd Quarter | 14 | -2.06 | 12.80 | -5.56 | 5.90 |
| Army | Development | Cost Reimbursable | 3rd Quarter | 19 | -4.49 | 13.72 | -6.08 | 4.68 |
| Army | Development | Cost Reimbursable | 4th Quarter | 19 | -9.69 | 16.20 | -3.31 | 3.06 |
| Army | Development | Fixed Price | 1st Quarter | 4 | 10.26 | 14.24 | -11.75 | 7.91 |
| Army | Development | Fixed Price | 2nd Quarter | 5 | 1.39 | 9.99 | -9.71 | 8.30 |
| Army | Development | Fixed Price | 3rd Quarter | 5 | -5.54 | 11.50 | -9.74 | 6.78 |
| Army | Development | Fixed Price | 4th Quarter | 6 | -9.41 | 14.96 | -3.18 | 1.98 |
| Army | Production | Cost Reimbursable | 1st Quarter | 6 | -16.44 | 35.46 | -4.31 | 8.17 |
| Army | Production | Cost Reimbursable | 2nd Quarter | 6 | 2.78 | 7.92 | -11.08 | 6.01 |
| Army | Production | Cost Reimbursable | 3rd Quarter | 7 | -7.23 | 23.82 | -10.51 | 4.55 |
| Army | Production | Cost Reimbursable | 4th Quarter | 7 | -11.11 | 16.63 | -4.81 | 2.81 |
| Army | Production | Fixed Price | 1st Quarter | 29 | -1.92 | 12.67 | -12.63 | 18.35 |
| Army | Production | Fixed Price | 2nd Quarter | 31 | -4.43 | 11.25 | -21.13 | 15.29 |
| Army | Production | Fixed Price | 3rd Quarter | 31 | -7.86 | 12.33 | -16.45 | 10.43 |
| Army | Production | Fixed Price | 4th Quarter | 33 | -11.45 | 13.85 | -5.44 | 2.80 |
| Navy | Development | Cost Reimbursable | 1st Quarter | 13 | -6.70 | 28.47 | -10.38 | 13.96 |
| Navy | Development | Cost Reimbursable | 2nd Quarter | 24 | -5.87 | 6.59 | -8.32 | 7.91 |
| Navy | Development | Cost Reimbursable | 3rd Quarter | 30 | -5.64 | 6.36 | -5.64 | 4.98 |
| Navy | Development | Cost Reimbursable | 4th Quarter | 34 | -6.53 | 7.42 | -3.11 | 2.95 |
| Navy | Development | Fixed Price | 1st Quarter | 1 | 16.25 | N/A | 0.00 | N/A |
| Navy | Development | Fixed Price | 2nd Quarter | 3 | -2.48 | 25.62 | -4.00 | 21.69 |
| Navy | Development | Fixed Price | 3rd Quarter | 3 | -9.94 | 24.09 | -11.17 | 11.00 |
| Navy | Development | Fixed Price | 4th Quarter | 4 | -13.95 | 29.07 | -3.71 | 3.54 |
| Navy | Production | Cost Reimbursable | 1st Quarter | 7 | -10.12 | 16.42 | -6.29 | 7.75 |
| Navy | Production | Cost Reimbursable | 2nd Quarter | 8 | -6.54 | 14.84 | -10.48 | 6.39 |
| Navy | Production | Cost Reimbursable | 3rd Quarter | 8 | -8.84 | 17.38 | -8.23 | 5.30 |
| Navy | Production | Cost Reimbursable | 4th Quarter | 10 | -9.97 | 20.92 | -3.39 | 3.20 |
| Navy | Production | Fixed Price | 1st Quarter | 28 | 2.93 | 16.04 | 8.09 | 33.09 |
| Navy | Production | Fixed Price | 2nd Quarter | 47 | -2.79 | 10.64 | -3.60 | 15.01 |
| Navy | Production | Fixed Price | 3rd Quarter | 54 | -4.50 | 11.15 | -4.41 | 8.65 |
| Navy | Production | Fixed Price | 4th Quarter | 55 | -8.14 | 16.46 | -3.63 | 3.21 |

Wilk test will rarely uncategorically indicate the data are strongly normally distributed. The adverse impact that a large sample size had on the results of the normality test dictated judgment be exercised in determining whether the assumption of normality was satisfied. The ANOVA model, particularly the fixed factor level model, is robust against departures from normality (Neter and others, 1990: 607).

Normal probability plots of the residuals for cost variance in percent and for schedule variance in percent were created to provide a visual indication of the distribution of the data. Analyses of these plots indicated the data did not seriously depart from normality, and therefore the normality assumption was satisfied (Neter and others, 1990:613-614). The normal probability plots for cost and schedule variance in percent are contained in Appendices C and D, respectively.

Testing the ANOVA Assumption of Equality of the Error Variance for the Entire Data Set

When applied to the entire data set, the results of the Bartlett statistical test for equality of the error variances for cost variance in percent and schedule variance in percent were 4.55 and 18.98, respectively. Unfortunately, the Bartlett test is sensitive to even small departures from normality. Thus, the more the data depart from perfect normality the less conclusive are the results of the Bartlett test. In this case, a better way of analyzing the equality of error variances is by using a plot of the residuals.

The assumption of constant error variance for all factor levels was tested by plotting the residuals against their predicted values for cost variance in percent and for schedule variance in percent. The analysis of these plots indicated that the error terms have nearly constant variance, therefore, this ANOVA assumption is also satisfied (Neter and others, 1990:609-611). The constant error variance plots of the residuals for cost and schedule variance in percent are in Appendices C and D, respectively.

Overall Assessment of the ANOVA Assumptions

Based on the statistical test results and a visual analysis of the plots, the normality assumption and the constant error variance assumption have been adequately met.

Running the Nested ANOVA Model (Step 1)

The ANOVA model was run six different times to test the six null hypotheses (three times for cost variance in percent and three times for schedule variance in percent). The ANOVA statistical results with *cost* variance in percent as the dependent variable and *schedule* variance in percent as the dependent variable are summarized in Tables 3 and 4, respectively (note: the overall statistical results for the entire model are presented followed by the statistical results for each of the three ways the model was nested--of critical importance is the p-value associated with the last factor in each of the nested models).

Table 3

ANOVA Model Results with
Cost Variance in Percent as the Dependent Variable

| Source of Variation | Degrees of Freedom | Sum of Squares | Mean Squares | F-Value | P-Value |
|---------------------|--------------------|----------------|--------------|---------|---------|
| Model | 46 | 18,204 | 395.7 | 2.34 | 0.0001 |
| Error | 922 | 156,144 | 169.4 | | |
| Total | 968 | 174,348 | | | |
| Phase | 1 | 310 | 310 | 1.83 | 0.1766 |
| Type | 2 | 688 | 344 | 2.03 | 0.1317 |
| Quarter | 12 | 9,948 | 829 | 4.90 | 0.0001 |
| Service | 31 | 5,934 | 191 | 1.13 | 0.2866 |
| Type | 1 | 425 | 425 | 2.51 | 0.1133 |
| Service | 4 | 544 | 136 | 0.80 | 0.5229 |
| Quarter | 18 | 8,714 | 484 | 2.86 | 0.0001 |
| Phase | 23 | 4,380 | 190 | 1.12 | 0.3106 |
| Phase | 1 | 175 | 175 | 1.03 | 0.3095 |
| Service | 4 | 916 | 229 | 1.35 | 0.2485 |
| Quarter | 18 | 5,635 | 313 | 1.85 | 0.0168 |
| Type | 23 | 4,892 | 213 | 1.26 | 0.1881 |

Table 4

ANOVA Model Results with
Schedule Variance in Percent as the Dependent Variable

| Source of Variation | Degrees of Freedom | Sum of Squares | Mean Squares | F-Value | P-Value |
|---------------------|--------------------|----------------|--------------|---------|---------|
| Model | 46 | 22,869 | 497.2 | 4.32 | 0.0001 |
| Error | 922 | 106,170 | 115.2 | | |
| Total | 968 | 129,039 | | | |
| Phase | 1 | 66 | 66 | 0.57 | 0.4497 |
| Type | 2 | 118 | 59 | 0.51 | 0.5980 |
| Quarter | 12 | 5,896 | 491 | 4.27 | 0.0001 |
| Service | 31 | 17,272 | 557 | 4.84 | 0.0001 |
| Type | 1 | 113 | 113 | 0.98 | 0.3217 |
| Service | 4 | 1,901 | 475 | 4.13 | 0.0025 |
| Quarter | 18 | 4,465 | 248 | 2.15 | 0.0035 |
| Phase | 23 | 1,476 | 64 | 0.56 | 0.9546 |
| Phase | 1 | 82 | 82 | 0.71 | 0.3991 |
| Service | 4 | 2,394 | 598 | 5.20 | 0.0004 |
| Quarter | 18 | 4,088 | 227 | 1.97 | 0.0091 |
| Type | 23 | 3,641 | 158 | 1.37 | 0.1122 |

Summary F-statistics are shown in Table 5 and describe the overall assessment of statistical difference in the means contained in the most deeply nested factor in each one of the six ANOVA models. These F-statistics pertain to the first step in the three sequence step to determine which means, among groups of means, are statistically different.

Table 5

F-Test Summary Table for Alpha = .05 (Step 1)

| | | -----Factor----- | | |
|------|-----------------------|------------------|---------------|---------------|
| | | Service | Phase | Type |
| CV % | p-value | 0.2866 | 0.3106 | 0.1881 |
| | Ho: All μ s Equal | Cannot Reject | Cannot Reject | Cannot Reject |
| SV % | p-value | 0.0001 | 0.9546 | 0.1122 |
| | Ho: All μ s Equal | Reject | Cannot Reject | Cannot Reject |

Statistically significant differences among the means only exists in the schedule variance in percent model with military service as the bottom factor in the nest (the p-value associated with the F-ratio was 0.0001 which is smaller than the .05 alpha level used in the study). The other p-values were greater than .05 which indicated a statistically significant difference does not exist within the groups of means. Thus, Step 2 of the analysis was only performed on each of the 16 factor levels (groups of means) at the bottom of the nested design where military service is the factor. Figure 2 illustrates this nested design.

F-test on Military Service Factor Levels for Schedule Variance (Step 2)

This is the second step in the three step sequence to determine where the statistically significant differences in the means lie. This step is necessitated by the first F-test indicating there is a statistical difference *somewhere* in the military services factor for schedule variance. The CONTRAST statement in SAS was used to produce the F-ratios, and the associated p-values, for each factor level. Thus, each of the 16 factor levels were analyzed to pinpoint which group(s) of means are statistically significantly different. The results for the 16 factor levels are in Table 6 below.

Table 6

Results of F-Test Analyzing Groups of Means (Step 2)

| Phase of Contract | Type of Contract | Stage of Contract | P-Value |
|-------------------|-------------------|-------------------|---------|
| Development | Cost Reimbursable | 1st Quarter | 0.6473 |
| | | 2nd Quarter | 0.5672 |
| | | 3rd Quarter | 0.4744 |
| | | 4th Quarter | 0.7051 |
| | Fixed Price | 1st Quarter | 0.6088 |
| | | 2nd Quarter | 0.7273 |
| | | 3rd Quarter | 0.7201 |
| | | 4th Quarter | 0.9969 |
| Production | Cost Reimbursable | 1st Quarter | 0.7403 |
| | | 2nd Quarter | 0.5605 |
| | | 3rd Quarter | 0.9147 |
| | | 4th Quarter | 0.9408 |
| | Fixed Price | 1st Quarter | 0.0001 |
| | | 2nd Quarter | 0.0001 |
| | | 3rd Quarter | 0.0001 |
| | | 4th Quarter | 0.6141 |

Additional Testing of the ANOVA Assumption of Equality of the Error Variances

For the groups of means with statistically significantly different means, the Bartlett test was applied to each group to evaluate the extent of any heteroscedasticity that might be present. If a significant amount of heteroscedasticity is present the results must be interpreted with caution. The results of the Bartlett test for specific group means are contained in Table 7 below. The test results along with the plots of the raw data illustrating the dispersion about each mean are in Appendix E.

Table 7

Bartlett Test Results for Equality of Error Variance for Groups of Means with Statistically Significant Differences

| Program Phase | Type of Contract | Stage of Contract | Bartlett Test Result | Equal Error Variances? |
|----------------------|-------------------------|--------------------------|-----------------------------|-------------------------------|
| Production | Fixed Price | 1st Quarter | 0.00013 | NO |
| | | 2nd Quarter | 0.39518 | YES |
| | | 3rd Quarter | 0.18788 | YES |

Since the Bartlett test did not indicate the error variances for production, fixed price, 1st quarter contracts were equal, an analysis of the associated scatter plot is warranted. Analysis of the scatter plot indicated, with the exception of one outlier Navy contract, the data are homoscedastic. Thus, the assumption of the equality of the error variance is satisfied.

Comparison of Means Within Groups Identified as Containing Statistically Significantly Different Means (Step 3)

Based on the results of the F-test of military service factor levels for schedule variance (Table 4), there are three groups that contain statistically significantly different means (p-value equal to or less than .05). Thus, an actual comparison of the means within each of those groups was warranted using the Tukey-Kramer multiple comparison test. This is the third step in the three step analysis previously discussed.

The ESTIMATE command in SAS produced *T*-values for each of the possible combinations of means within each treatment group identified as containing statistically significantly different means. Each *T*-value was compared to the critical value of 3.31. This value was extracted from the appropriate Percentiles of the Studentized Range Distribution table as previously discussed in the Methodology Chapter.

The specific means that are statistically significantly different are identified in Table 8 on the following page. Although the critical value used in the study was 3.31 ($\alpha = .05$), two other critical values associated with other alpha levels are presented for reference only when interpreting the overall significance of the results in Table 8, as follows: 1) the critical value at $\alpha = .01$ is 4.12 and, 2) the critical value at $\alpha = .10$ is 2.90.

Table 8.

Results of the Tukey-Kramer Test Between Statistically
Significantly Different Treatment Means (Step 3)

| Category | Treatments | Absolute T-value | Reject Ho given a 3.31 critical value? |
|--|-----------------------------|---------------------|---|
| Production Fixed Price 1st Quarter | Air Force Versus Army | 1.18 | NO |
| Production Fixed Price 1st Quarter | Air Force Versus Navy | 6.89 | YES |
| Production Fixed Price 1st Quarter | Army Versus Navy | 7.29 | YES |
| Production Fixed Price 2nd Quarter | Air Force Versus Army | 5.11 | YES |
| Production Fixed Price 2nd Quarter | Air Force Versus Navy | 2.53 | NO |
| Production Fixed Price 2nd Quarter | Army Versus Navy | 7.06 | YES |
| Production Fixed Price 3rd Quarter | Air Force Versus Army | 4.05 | YES |
| Production Fixed Price 3rd Quarter | Air Force Versus Navy | 1.31 | NO |
| Production Fixed Price 3rd Quarter | Army Versus Navy | 4.98 | YES |

Analytical Summary

Of the 96 cost and schedule variance means (in percent) benchmarks that were analyzed, six tested statistically significantly different. The six means (in percent) that tested different were confined to the production, fixed price category.

V. Conclusions

Discussion

This thesis used data in the DAES database to calculate 96 benchmarks. These benchmarks can be used by Department of Defense Program Managers for comparison when evaluating the cost and schedule status of their program contracts.

The 96 benchmarks are comprised of 48 cost variance percentage means and 48 schedule variance percentage means. These 48 categories of cost/schedule variance percentage means are a result of classifying each data point in the refined DAES database into the following collectively exhaustive, mutually exclusive categories:

1. As supporting either the development phase of a program or the production phase of a program
2. As either a cost reimbursable type contract or a fixed price type contract
3. As representing contract data from the 1st quarter, 2nd quarter, 3rd quarter, or the 4th quarter of the contract
4. As managed by the Air Force, Army, or Navy.

The two program phases times the two contract types times the four contract stages/quarters times the three managing services equals 48 cost and 48 schedule benchmarks.

These benchmarks were nested using the ANOVA fixed factor model. The cost and schedule means in each of the three various nested designs were tested for statistically significant differences between treatments.

Limitation

The sample data did not test to be exactly normally distributed nor test to have exactly constant error variance. Thus, judgment was exercised to conclude the population was normally distributed with constant error variance to the degree required by the ANOVA fixed-factor level model.

Conclusions

Not one of the statistical tests of cost variance means (in percent) yielded statistically significant differences. Only six of the 48 schedule variance means (in percent) yielded statistically significant differences. The small number of statistically significant differences between the means was partly due to the somewhat small sample sizes in the study and the rather large variances which yielded large confidence intervals.

Large standard deviations impacted the S-curves that Knepp and Stroble produced in their thesis (reference the literature review in chapter two). Knepp and Stroble found that, given the large variances/standard deviations in the data, their tailored S-curves had limited applicability.

Similarly, the large standard deviations surrounding the data dictate using caution when applying the tailored cost and schedule benchmarks. Program managers must consider the associated standard deviation when using a benchmark in gauging the status of their programs.

Conclusions relating to the individual factors are:

1. When tested across *program phases*, it was determined there are no statistically significant differences between the cost variance percentages of development contracts and production contracts. Similarly, there are no statistically significant differences between the *schedule variance* percentages of development contracts and production contracts.

2. When tested across *contract type*, it was also determined there are no statistically significant differences between the cost variance percentages of cost reimbursable contracts and fixed price contracts. Likewise, there are no statistically significant differences between the *schedule variance* percentages of cost reimbursable contracts and fixed price contracts.

3. However, when tested across *military service*, there were a total of six treatments that were statistically significantly different in their *schedule* variances in percent.. Basically, the statistically significant differences between the military services are confined to the production phase, fixed price type contracts in the first, second and third stages/quarters.

How Cost and Schedule Benchmarks Can be Used by Program Managers

Program managers should use the cost and schedule benchmarks that this study produced for reference only.

Statistical testing of the benchmarks indicated the vast majority of them were not statistically significantly different from one another (primarily due to the comparatively large standard deviation associated with the benchmarks). Thus, program managers should not use these cost and schedule benchmarks to conclude the status of their current program is categorically above or below the historical average of similar contracts. However, by considering the historical cost and schedule benchmarks for similar contracts (caveated by the standard deviations) program managers can get a ballpark idea of how their programs are performing.

Recommendations for Further Research

The following suggestions for future research are made:

1. Since some categories of benchmarks have statistically significant differences in the means, it is recommended that further study be done to try to determine the reasons for these differences. Determining why one military service has historically had different cost and schedule variances than other military services might benefit DoD. An example of a benefit might be the sharing of managerial techniques found conducive to minimizing cost and schedule variances.

2. Since some categories of data have very few data points (and one has none--Air Force, production, cost reimbursable, 1st quarter category), it is recommended that a

follow-up study be done in a few years after the DAES database has accumulated more data to yield larger sample sizes. Additional data points in each category might narrow the confidence intervals around the individual benchmarks, and could affect the results of the hypothesis testing for statistically significant differences.

Appendix A: Definition of Terms

1. **Actual Cost of Work Performed (ACWP).** "The cost incurred and recorded in accomplishing the work performed within a given time period" (DoD Instruction 5000.2, 1991:11-B-2-1).

2. **Benchmark.** "A point of reference from which measurements of any sort may be made" (Webster's, 1971:203).

3. **Budgeted Cost of Work Performed (BCWP).** "The sum of the budgets for completed work packages and completed portions of open work packages, plus the applicable portion of the budgets for level of effort and apportioned effort" (DoD Instruction 5000.2, 1991:11-B-2-1).

4. **Budgeted Cost of Work Scheduled (BCWS).** "The sum of budgets for all work packages, planning packages, etc., scheduled to be accomplished (including in-process work packages) plus the amount of level-of-effort and apportioned effort scheduled to be accomplished within a given time period" (DoD Instruction 5000.2, 1991:11-B-2-1).

5. **Cost Overrun.** "The amount by which a contractor exceeds (a) the estimated cost and/or (b) the final limitation (ceiling) of his contract" (DoD DSMC, 1991:B-23).

6. **Contract Budget Base (CBB).** "The negotiated contract cost plus the estimated cost of authorized unpriced work" (DoD Instruction 5000.2, 1991:11-B-2-2).

7. Cost Performance Report (CPR). "A monthly DoD report generated by the contractor to obtain cost and schedule status information for program management. The CPR is intended to provide early identification of problems having significant cost impact, effects of management actions and program status information for use in making and validating management decisions" (Fleming, 1988:507).

8. Cost/Schedule Control Systems Criteria (C/SCSC). "Government established standards which a contractor's internal management system must meet in order to insure the government of effective planning and control of contract work" (Fleming, 1988:507).

9. Cost Variance. "Budgeted Cost of Work Performed minus Actual Cost of Work Performed. A negative cost variance is an unfavorable condition and indicates a cost overrun. A positive cost variance indicates a cost underrun" (Christensen, 1992:20).

10. Defense Acquisition Executive Summary (DAES). "Defense Acquisition Executive's principle mechanism for tracking programs between milestone reviews. Includes programs subject to the Selected Acquisition Report (SAR), and any non-SAR programs subject to review by the Defense Acquisition Board" (DoD DSMC, 1991:B-27).

11. Judgment Sampling. This is a non-random sampling method which relies on the judgment and intuition of the

analyst to ensure the sample accurately reflects the population.

12. **Program Manager (PM).** "A military or civilian official who is responsible for managing an acquisition program" (DoD Instruction 5000.2 1991:15-14). PMs are the Air Force, Army, and Navy organizational managers responsible for guiding the research, development, production, testing and fielding of a new weapon system.

13. **Schedule Slippages.** These occur when milestones are not met on time and the program is delayed.

14. **Total Allocated Budget (TAB).** "The sum of all budgets allocated to the contract. Total allocated budget consists of the performance measurement baseline and all management reserve. The total allocated budget will reconcile directly to the contract budget base. Any differences will be documented as to quantity and cause" (DoD Instruction 5000.2, 1991:11-B-2-3).

15. **Unfavorable Cost or Schedule Variances.** A variance is unfavorable when incurred costs exceed planned costs at a given point or the contract is behind the planned schedule.

16. **Weapon or Materiel System.** These systems are generally defined as any research, development, or test and evaluation contract over \$60 million and any procurement contract over \$250 million.

Appendix B: Data Used in the ANOVA Nested Models

| Managing Service | Contract Type | Program Phase | Stage/Quarter | Avg C.V. % | Avg S.V. % |
|-------------------------|----------------------|----------------------|----------------------|-------------------|-------------------|
| Air Force | Fixed Price | Production | 1 | 0.00 | 10.00 |
| Air Force | Fixed Price | Production | 1 | 2.13 | -4.08 |
| Air Force | Fixed Price | Production | 1 | -2.44 | -2.09 |
| Air Force | Fixed Price | Production | 1 | -2.56 | -3.83 |
| Army | Fixed Price | Production | 1 | -21.09 | 1.69 |
| Army | Cost Reimbursable | Production | 1 | 10.71 | 6.94 |
| Army | Fixed Price | Production | 1 | -1.68 | -18.51 |
| Army | Fixed Price | Production | 1 | -5.47 | -10.30 |
| Army | Fixed Price | Production | 1 | -5.64 | 9.33 |
| Army | Cost Reimbursable | Production | 1 | -25.57 | 4.96 |
| Army | Cost Reimbursable | Production | 1 | -84.25 | -8.20 |
| Army | Cost Reimbursable | Development | 1 | 3.90 | -17.20 |
| Army | Cost Reimbursable | Development | 1 | -5.67 | -7.22 |
| Army | Cost Reimbursable | Production | 1 | 1.37 | -10.48 |
| Army | Fixed Price | Production | 1 | 20.33 | -17.32 |
| Army | Fixed Price | Production | 1 | 16.33 | -26.61 |
| Army | Fixed Price | Production | 1 | 0.00 | -19.17 |
| Army | Fixed Price | Production | 1 | 31.25 | -5.00 |
| Navy | Fixed Price | Production | 1 | -1.67 | -1.41 |
| Army | Cost Reimbursable | Production | 1 | -4.76 | -12.12 |
| Army | Fixed Price | Production | 1 | 7.14 | -15.71 |
| Air Force | Fixed Price | Development | 1 | 0.00 | 0.00 |
| Air Force | Cost Reimbursable | Development | 1 | -21.19 | -13.08 |
| Navy | Fixed Price | Production | 1 | 1.47 | -5.16 |
| Air Force | Fixed Price | Production | 1 | -6.88 | -7.65 |
| Air Force | Fixed Price | Production | 1 | 0.93 | 1.30 |
| Air Force | Cost Reimbursable | Development | 1 | -4.12 | -3.21 |
| Air Force | Fixed Price | Production | 1 | 6.45 | 5.79 |
| Air Force | Fixed Price | Production | 1 | 0.92 | 1.59 |
| Navy | Fixed Price | Production | 1 | 37.70 | -3.71 |
| Air Force | Fixed Price | Development | 1 | -0.47 | -5.67 |
| Navy | Fixed Price | Production | 1 | 3.58 | -8.92 |
| Navy | Cost Reimbursable | Development | 1 | -0.76 | -0.64 |
| Army | Fixed Price | Production | 1 | 7.83 | 0.10 |
| Army | Fixed Price | Production | 1 | -3.75 | -5.65 |
| Navy | Cost Reimbursable | Production | 1 | -25.00 | -6.67 |
| Army | Cost Reimbursable | Development | 1 | 33.33 | 0.00 |
| Army | Cost Reimbursable | Development | 1 | 5.21 | -15.04 |
| Navy | Cost Reimbursable | Development | 1 | 0.79 | 0.00 |
| Navy | Cost Reimbursable | Development | 1 | 6.27 | -3.33 |
| Air Force | Fixed Price | Production | 1 | 2.38 | 2.50 |
| Air Force | Fixed Price | Development | 1 | 10.23 | 12.50 |
| Navy | Fixed Price | Production | 1 | -4.93 | -9.31 |
| Army | Cost Reimbursable | Development | 1 | -17.32 | -14.52 |
| Navy | Cost Reimbursable | Development | 1 | 0.00 | -7.14 |
| Navy | Fixed Price | Production | 1 | -7.78 | -22.48 |
| Army | Fixed Price | Development | 1 | 29.76 | 0.00 |
| Army | Fixed Price | Production | 1 | -11.94 | -8.02 |
| Army | Fixed Price | Production | 1 | 0.00 | -12.28 |
| Army | Fixed Price | Production | 1 | 0.00 | 0.00 |

| | | | | | |
|-----------|-------------------|-------------|---|--------|--------|
| Army | Cost Reimbursable | Development | 1 | 0.00 | 0.00 |
| Navy | Fixed Price | Production | 1 | 0.00 | -8.33 |
| Navy | Fixed Price | Production | 1 | -25.00 | 14.29 |
| Navy | Cost Reimbursable | Production | 1 | -40.00 | -16.67 |
| Navy | Cost Reimbursable | Production | 1 | 7.11 | 3.27 |
| Army | Fixed Price | Production | 1 | 3.22 | -19.27 |
| Army | Fixed Price | Production | 1 | -0.76 | -59.77 |
| Army | Fixed Price | Production | 1 | -11.01 | -63.20 |
| Army | Fixed Price | Production | 1 | 0.00 | 21.43 |
| Army | Fixed Price | Production | 1 | 0.00 | -3.13 |
| Army | Fixed Price | Production | 1 | -11.67 | -22.22 |
| Army | Cost Reimbursable | Development | 1 | 0.00 | 0.00 |
| Army | Cost Reimbursable | Development | 1 | 0.00 | -16.67 |
| Army | Cost Reimbursable | Production | 1 | 3.89 | -6.97 |
| Army | Cost Reimbursable | Development | 1 | 4.17 | -2.63 |
| Army | Fixed Price | Production | 1 | -19.43 | -11.23 |
| Army | Fixed Price | Production | 1 | -8.37 | -22.43 |
| Army | Fixed Price | Production | 1 | -16.96 | -1.68 |
| Army | Fixed Price | Production | 1 | 0.00 | -10.71 |
| Army | Fixed Price | Production | 1 | -33.33 | -39.92 |
| Army | Fixed Price | Production | 1 | 0.00 | -14.81 |
| Army | Cost Reimbursable | Development | 1 | 0.00 | 0.00 |
| Navy | Fixed Price | Production | 1 | 11.60 | 22.45 |
| Navy | Fixed Price | Production | 1 | 3.20 | 23.97 |
| Navy | Fixed Price | Production | 1 | -0.54 | 52.59 |
| Navy | Fixed Price | Production | 1 | 6.20 | -6.09 |
| Navy | Fixed Price | Production | 1 | -1.26 | 8.05 |
| Air Force | Fixed Price | Production | 1 | -6.97 | -23.91 |
| Air Force | Fixed Price | Production | 1 | 6.91 | 4.93 |
| Air Force | Fixed Price | Production | 1 | 8.44 | -1.85 |
| Air Force | Fixed Price | Production | 1 | 4.00 | 0.00 |
| Air Force | Fixed Price | Production | 1 | 2.35 | -0.58 |
| Air Force | Fixed Price | Development | 1 | 1.39 | 0.00 |
| Air Force | Fixed Price | Production | 1 | 3.33 | -16.67 |
| Air Force | Fixed Price | Production | 1 | 7.49 | -4.46 |
| Air Force | Fixed Price | Production | 1 | 4.35 | -1.90 |
| Navy | Fixed Price | Production | 1 | 8.75 | -13.07 |
| Navy | Cost Reimbursable | Development | 1 | 1.39 | -24.17 |
| Navy | Fixed Price | Production | 1 | -1.51 | 19.36 |
| Navy | Cost Reimbursable | Development | 1 | 7.79 | -10.65 |
| Navy | Cost Reimbursable | Production | 1 | -5.73 | -7.31 |
| Navy | Cost Reimbursable | Production | 1 | -3.38 | -13.47 |
| Navy | Cost Reimbursable | Production | 1 | -3.83 | -7.28 |
| Navy | Cost Reimbursable | Production | 1 | 0.00 | 4.09 |
| Navy | Cost Reimbursable | Development | 1 | 10.70 | -1.34 |
| Navy | Fixed Price | Production | 1 | -2.04 | -3.92 |
| Navy | Fixed Price | Production | 1 | 6.20 | -6.09 |
| Air Force | Fixed Price | Development | 1 | 0.00 | -29.17 |
| Air Force | Fixed Price | Production | 1 | 0.00 | -5.88 |
| Air Force | Fixed Price | Production | 1 | 12.50 | -46.43 |
| Air Force | Fixed Price | Production | 1 | 4.08 | 19.51 |
| Navy | Cost Reimbursable | Development | 1 | -9.35 | -13.25 |
| Navy | Fixed Price | Production | 1 | 12.35 | -5.74 |
| Navy | Fixed Price | Production | 1 | 0.00 | -23.79 |
| Navy | Fixed Price | Production | 1 | -1.00 | -13.73 |
| Navy | Fixed Price | Production | 1 | 28.70 | 5.81 |

| | | | | | |
|-----------|-------------------|-------------|---|--------|--------|
| Navy | Cost Reimbursable | Development | 1 | 0.00 | 0.00 |
| Air Force | Fixed Price | Development | 1 | 0.72 | -7.51 |
| Air Force | Fixed Price | Production | 1 | -12.98 | -24.88 |
| Air Force | Fixed Price | Production | 1 | 6.18 | -50.78 |
| Air Force | Fixed Price | Development | 1 | 14.65 | -13.97 |
| Air Force | Fixed Price | Production | 1 | 1.37 | 0.00 |
| Army | Fixed Price | Development | 1 | -0.69 | -14.90 |
| Army | Fixed Price | Development | 1 | 11.98 | -17.26 |
| Navy | Cost Reimbursable | Development | 1 | -2.38 | -10.64 |
| Navy | Fixed Price | Production | 1 | -4.53 | 133.52 |
| Navy | Fixed Price | Production | 1 | -6.08 | 27.84 |
| Navy | Fixed Price | Production | 1 | 1.19 | 17.81 |
| Navy | Fixed Price | Production | 1 | 50.83 | 8.33 |
| Air Force | Fixed Price | Production | 1 | 5.26 | -32.14 |
| Air Force | Fixed Price | Production | 1 | 16.67 | -18.18 |
| Air Force | Fixed Price | Production | 1 | 16.67 | -20.00 |
| Air Force | Fixed Price | Production | 1 | 10.71 | -1.39 |
| Air Force | Fixed Price | Production | 1 | 4.57 | -14.58 |
| Air Force | Fixed Price | Production | 1 | -1.11 | -3.71 |
| Air Force | Fixed Price | Production | 1 | 7.63 | 0.00 |
| Air Force | Fixed Price | Production | 1 | 5.00 | 25.00 |
| Air Force | Fixed Price | Production | 1 | 10.00 | -9.09 |
| Air Force | Fixed Price | Production | 1 | 0.00 | -7.14 |
| Air Force | Fixed Price | Production | 1 | -3.45 | 16.00 |
| Air Force | Fixed Price | Production | 1 | 13.03 | -13.75 |
| Air Force | Fixed Price | Production | 1 | 17.78 | -43.33 |
| Air Force | Fixed Price | Production | 1 | 0.00 | -9.09 |
| Air Force | Fixed Price | Production | 1 | 13.54 | -30.75 |
| Air Force | Fixed Price | Production | 1 | 4.76 | 0.00 |
| Air Force | Fixed Price | Production | 1 | 11.05 | -47.54 |
| Air Force | Fixed Price | Production | 1 | 1.39 | -19.84 |
| Air Force | Cost Reimbursable | Development | 1 | -2.27 | -5.71 |
| Air Force | Cost Reimbursable | Development | 1 | -7.84 | -8.93 |
| Air Force | Fixed Price | Production | 1 | 11.67 | -17.71 |
| Air Force | Fixed Price | Production | 1 | 5.87 | -38.57 |
| Air Force | Fixed Price | Development | 1 | -3.57 | -13.39 |
| Air Force | Cost Reimbursable | Development | 1 | -1.45 | -8.00 |
| Air Force | Fixed Price | Development | 1 | 6.06 | -10.81 |
| Air Force | Fixed Price | Development | 1 | 15.74 | -17.53 |
| Air Force | Fixed Price | Development | 1 | 3.36 | -9.59 |
| Air Force | Fixed Price | Development | 1 | -3.33 | -6.25 |
| Air Force | Fixed Price | Development | 1 | 0.00 | -12.82 |
| Air Force | Fixed Price | Development | 1 | 15.97 | -28.30 |
| Air Force | Fixed Price | Development | 1 | -8.33 | -8.75 |
| Air Force | Fixed Price | Development | 1 | 2.27 | -7.50 |
| Air Force | Fixed Price | Production | 1 | 5.91 | -3.19 |
| Navy | Fixed Price | Production | 1 | 0.00 | -40.00 |
| Navy | Fixed Price | Production | 1 | 0.00 | -2.29 |
| Navy | Fixed Price | Development | 1 | 16.25 | 0.00 |
| Navy | Cost Reimbursable | Development | 1 | -1.52 | -13.78 |
| Navy | Cost Reimbursable | Development | 1 | 0.00 | 0.00 |
| Air Force | Fixed Price | Development | 1 | -20.00 | 0.00 |
| Air Force | Fixed Price | Development | 1 | -1.85 | -4.56 |
| Air Force | Fixed Price | Development | 1 | -5.08 | -4.50 |
| Air Force | Fixed Price | Development | 1 | 0.00 | 0.00 |
| Air Force | Cost Reimbursable | Development | 1 | 4.03 | 0.00 |

| | | | | | |
|-----------|-------------------|-------------|---|--------|--------|
| Air Force | Fixed Price | Production | 1 | 0.00 | -4.17 |
| Air Force | Fixed Price | Development | 1 | 5.26 | -8.93 |
| Air Force | Cost Reimbursable | Development | 1 | 0.00 | -12.50 |
| Army | Fixed Price | Development | 1 | 0.00 | -14.84 |
| Army | Fixed Price | Production | 1 | 2.28 | -1.47 |
| Army | Fixed Price | Production | 1 | 7.08 | -2.98 |
| Army | Fixed Price | Production | 1 | 0.00 | 12.50 |
| Air Force | Fixed Price | Production | 1 | 0.00 | 0.00 |
| Navy | Fixed Price | Production | 1 | -33.33 | 66.67 |
| Air Force | Cost Reimbursable | Development | 1 | 1.39 | 1.10 |
| Army | Cost Reimbursable | Development | 1 | 0.00 | -6.67 |
| Air Force | Fixed Price | Production | 2 | 0.00 | 3.85 |
| Air Force | Fixed Price | Production | 2 | 0.00 | -2.62 |
| Air Force | Fixed Price | Production | 2 | 6.30 | -6.41 |
| Air Force | Fixed Price | Production | 2 | 0.00 | -4.35 |
| Air Force | Fixed Price | Production | 2 | -1.68 | 2.37 |
| Air Force | Fixed Price | Production | 2 | 0.00 | -5.78 |
| Army | Cost Reimbursable | Development | 2 | 10.23 | -7.41 |
| Army | Fixed Price | Production | 2 | -1.67 | -2.19 |
| Army | Cost Reimbursable | Production | 2 | 11.92 | -14.02 |
| Army | Fixed Price | Production | 2 | -2.39 | -19.16 |
| Army | Fixed Price | Production | 2 | -0.35 | -16.99 |
| Army | Fixed Price | Production | 2 | 0.08 | -8.01 |
| Army | Cost Reimbursable | Production | 2 | 3.75 | -4.76 |
| Army | Cost Reimbursable | Production | 2 | -4.90 | -4.67 |
| Army | Cost Reimbursable | Development | 2 | -0.45 | -5.82 |
| Army | Cost Reimbursable | Development | 2 | -4.69 | -5.57 |
| Army | Cost Reimbursable | Production | 2 | 5.02 | -9.17 |
| Army | Cost Reimbursable | Development | 2 | 9.09 | 0.00 |
| Army | Cost Reimbursable | Development | 2 | -32.59 | -11.43 |
| Army | Fixed Price | Production | 2 | 19.19 | -19.15 |
| Army | Fixed Price | Production | 2 | -4.32 | -51.92 |
| Army | Fixed Price | Production | 2 | 7.14 | -17.65 |
| Army | Fixed Price | Production | 2 | 7.14 | -14.58 |
| Navy | Cost Reimbursable | Development | 2 | -6.96 | -3.58 |
| Navy | Cost Reimbursable | Development | 2 | 3.33 | -12.33 |
| Navy | Fixed Price | Production | 2 | -32.08 | -17.19 |
| Navy | F | Production | 2 | -4.55 | -24.14 |
| Navy | Cost Reimbursable | Development | 2 | -17.83 | -6.91 |
| Army | Cost Reimbursable | Production | 2 | -8.33 | -20.00 |
| Army | Fixed Price | Production | 2 | 0.00 | -25.64 |
| Air Force | Fixed Price | Development | 2 | 4.17 | -9.40 |
| Air Force | Cost Reimbursable | Development | 2 | 0.96 | -1.93 |
| Navy | Fixed Price | Production | 2 | -0.53 | -5.62 |
| Navy | Fixed Price | Production | 2 | -2.45 | -2.40 |
| Air Force | Cost Reimbursable | Production | 2 | 1.65 | -4.09 |
| Air Force | Fixed Price | Production | 2 | 0.51 | 10.04 |
| Air Force | Cost Reimbursable | Development | 2 | 4.55 | 0.00 |
| Air Force | Cost Reimbursable | Production | 2 | 0.00 | 0.00 |
| Air Force | Fixed Price | Production | 2 | 3.64 | -3.51 |
| Air Force | Cost Reimbursable | Development | 2 | -4.58 | -3.04 |
| Air Force | Fixed Price | Production | 2 | 5.48 | 1.90 |
| Air Force | Fixed Price | Production | 2 | 0.36 | 1.37 |
| Air Force | Fixed Price | Production | 2 | -10.05 | -3.76 |
| Navy | Fixed Price | Production | 2 | 5.72 | -16.56 |
| Air Force | Fixed Price | Development | 2 | -6.38 | -12.62 |

| | | | | | |
|-----------|-------------------|-------------|---|--------|--------|
| Navy | Fixed Price | Production | 2 | -1.19 | -10.81 |
| Navy | Fixed Price | Production | 2 | 0.00 | -17.14 |
| Navy | Fixed Price | Production | 2 | -19.30 | -4.27 |
| Navy | Cost Reimbursable | Development | 2 | -0.72 | -1.25 |
| Army | Fixed Price | Production | 2 | 8.86 | -5.20 |
| Army | Fixed Price | Production | 2 | -11.97 | -18.86 |
| Army | Fixed Price | Production | 2 | -12.15 | -17.99 |
| Navy | Cost Reimbursable | Production | 2 | -42.86 | -22.22 |
| Army | Cost Reimbursable | Development | 2 | 17.14 | 0.00 |
| Army | Cost Reimbursable | Development | 2 | -5.42 | -10.80 |
| Navy | Cost Reimbursable | Development | 2 | 0.00 | -10.71 |
| Navy | Cost Reimbursable | Development | 2 | -6.90 | -1.91 |
| Navy | Cost Reimbursable | Development | 2 | -13.79 | -9.38 |
| Navy | Cost Reimbursable | Development | 2 | -4.55 | -10.71 |
| Navy | Cost Reimbursable | Development | 2 | -7.69 | 0.00 |
| Navy | Cost Reimbursable | Development | 2 | -14.51 | -23.00 |
| Air Force | Fixed Price | Production | 2 | 3.51 | -0.16 |
| Air Force | Fixed Price | Production | 2 | -40.97 | -31.93 |
| Air Force | Fixed Price | Development | 2 | -9.94 | -9.04 |
| Navy | Fixed Price | Development | 2 | -31.83 | -25.17 |
| Navy | Fixed Price | Production | 2 | -3.32 | -9.05 |
| Navy | Cost Reimbursable | Development | 2 | -11.53 | -1.96 |
| Navy | Fixed Price | Production | 2 | -10.81 | -7.68 |
| Navy | Fixed Price | Production | 2 | -13.95 | -15.60 |
| Navy | Fixed Price | Production | 2 | -12.50 | -5.88 |
| Navy | Fixed Price | Production | 2 | -2.97 | 22.69 |
| Army | Fixed Price | Development | 2 | 8.49 | -2.22 |
| Army | Fixed Price | Production | 2 | -2.04 | -5.07 |
| Army | Fixed Price | Production | 2 | 2.38 | -2.33 |
| Army | Fixed Price | Production | 2 | 0.00 | -12.50 |
| Army | Cost Reimbursable | Development | 2 | 2.78 | -5.87 |
| Navy | Fixed Price | Production | 2 | 1.96 | -3.34 |
| Navy | Fixed Price | Production | 2 | -16.32 | 4.65 |
| Navy | Fixed Price | Production | 2 | -3.78 | -7.24 |
| Navy | Fixed Price | Production | 2 | -3.70 | -21.01 |
| Navy | Fixed Price | Production | 2 | 4.88 | 0.00 |
| Navy | Cost Reimbursable | Development | 2 | -16.67 | -33.33 |
| Navy | Fixed Price | Production | 2 | -10.34 | 0.00 |
| Navy | Fixed Price | Production | 2 | 7.50 | -10.79 |
| Navy | Fixed Price | Production | 2 | -3.90 | -4.01 |
| Navy | Cost Reimbursable | Production | 2 | -2.12 | -5.79 |
| Navy | Cost Reimbursable | Production | 2 | -0.65 | -4.97 |
| Army | Fixed Price | Production | 2 | -1.09 | -11.54 |
| Army | Fixed Price | Production | 2 | -15.52 | -46.30 |
| Army | Fixed Price | Production | 2 | -41.24 | -27.93 |
| Army | Fixed Price | Production | 2 | -8.88 | -9.05 |
| Army | Fixed Price | Production | 2 | -7.14 | -6.67 |
| Army | Fixed Price | Production | 2 | -8.62 | -33.30 |
| Army | Fixed Price | Development | 2 | 11.11 | 0.00 |
| Army | Cost Reimbursable | Development | 2 | 0.00 | 8.33 |
| Army | Cost Reimbursable | Development | 2 | -16.82 | -12.16 |
| Army | Fixed Price | Production | 2 | -2.81 | -47.95 |
| Army | Cost Reimbursable | Production | 2 | 9.24 | -13.85 |
| Army | Cost Reimbursable | Development | 2 | 6.25 | -5.88 |
| Army | Fixed Price | Production | 2 | 3.75 | -27.93 |
| Army | Fixed Price | Production | 2 | -19.71 | -42.54 |

| | | | | | |
|-----------|-------------------|-------------|---|--------|--------|
| Army | Fixed Price | Production | 2 | -26.35 | -31.56 |
| Army | Fixed Price | Production | 2 | 1.97 | -20.09 |
| Army | Fixed Price | Production | 2 | -10.80 | -55.00 |
| Army | Fixed Price | Production | 2 | -9.13 | -8.58 |
| Army | Cost Reimbursable | Development | 2 | 0.00 | 0.00 |
| Navy | Fixed Price | Production | 2 | 14.81 | -0.61 |
| Navy | Fixed Price | Production | 2 | 14.75 | 4.06 |
| Navy | Fixed Price | Production | 2 | 7.63 | 13.41 |
| Navy | Fixed Price | Production | 2 | -2.87 | -0.83 |
| Navy | Fixed Price | Production | 2 | 1.30 | -2.43 |
| Navy | Fixed Price | Production | 2 | 0.49 | -7.01 |
| Navy | Fixed Price | Production | 2 | 2.88 | -0.95 |
| Navy | Fixed Price | Production | 2 | 9.19 | -8.32 |
| Navy | Fixed Price | Production | 2 | -5.97 | 9.84 |
| Air Force | Fixed Price | Production | 2 | -11.16 | -14.11 |
| Air Force | Fixed Price | Development | 2 | -7.28 | -23.13 |
| Air Force | Fixed Price | Production | 2 | 1.88 | 1.34 |
| Air Force | Fixed Price | Production | 2 | 4.11 | -8.79 |
| Air Force | Fixed Price | Production | 2 | 3.20 | 21.36 |
| Air Force | Fixed Price | Production | 2 | 5.00 | -4.18 |
| Air Force | Fixed Price | Development | 2 | 2.31 | -0.20 |
| Air Force | Fixed Price | Development | 2 | 1.84 | -3.06 |
| Air Force | Fixed Price | Development | 2 | 4.14 | -2.79 |
| Air Force | Fixed Price | Production | 2 | 1.84 | -2.40 |
| Air Force | Fixed Price | Production | 2 | 0.00 | -11.15 |
| Air Force | Fixed Price | Production | 2 | 0.75 | -9.97 |
| Air Force | Fixed Price | Production | 2 | 3.08 | -5.43 |
| Navy | Fixed Price | Production | 2 | 2.26 | -3.61 |
| Navy | Cost Reimbursable | Development | 2 | -9.83 | -10.09 |
| Navy | Fixed Price | Production | 2 | 0.68 | 3.27 |
| Navy | Cost Reimbursable | Development | 2 | -0.09 | -10.52 |
| Navy | Cost Reimbursable | Production | 2 | -4.43 | -5.19 |
| Navy | Cost Reimbursable | Production | 2 | -2.27 | -15.38 |
| Navy | Cost Reimbursable | Production | 2 | -0.73 | -14.02 |
| Navy | Cost Reimbursable | Production | 2 | 3.19 | -11.33 |
| Navy | Cost Reimbursable | Production | 2 | -2.42 | -4.93 |
| Navy | Fixed Price | Production | 2 | -2.27 | 46.67 |
| Navy | Cost Reimbursable | Development | 2 | 0.00 | 0.00 |
| Navy | Cost Reimbursable | Development | 2 | 3.50 | -1.03 |
| Navy | Fixed Price | Production | 2 | 0.24 | -7.21 |
| Navy | Fixed Price | Production | 2 | 9.19 | -8.32 |
| Air Force | Fixed Price | Development | 2 | 0.00 | -24.29 |
| Air Force | Fixed Price | Production | 2 | 0.00 | -17.65 |
| Air Force | Fixed Price | Production | 2 | 0.00 | -21.41 |
| Air Force | Fixed Price | Production | 2 | 10.90 | -36.63 |
| Air Force | Fixed Price | Production | 2 | 5.26 | -17.99 |
| Air Force | Fixed Price | Production | 2 | 2.15 | -19.98 |
| Air Force | Fixed Price | Production | 2 | 0.80 | -7.98 |
| Army | Cost Reimbursable | Development | 2 | -16.16 | -12.24 |
| Navy | Cost Reimbursable | Development | 2 | -7.56 | -5.03 |
| Navy | Fixed Price | Production | 2 | -4.00 | -27.32 |
| Navy | Fixed Price | Production | 2 | -9.89 | -22.84 |
| Navy | Fixed Price | Production | 2 | 0.00 | -15.69 |
| Air Force | Fixed Price | Development | 2 | -26.67 | -11.76 |
| Navy | Fixed Price | Production | 2 | 6.70 | 0.19 |
| Navy | Cost Reimbursable | Development | 2 | 0.00 | -1.66 |

| | | | | | |
|-----------|-------------------|-------------|---|--------|--------|
| Air Force | Fixed Price | Development | 2 | -8.47 | -7.58 |
| Air Force | Fixed Price | Production | 2 | -12.56 | -30.69 |
| Air Force | Fixed Price | Production | 2 | -48.55 | -37.07 |
| Air Force | Fixed Price | Development | 2 | 6.84 | -22.03 |
| Air Force | Fixed Price | Production | 2 | 1.85 | 0.00 |
| Air Force | Fixed Price | Production | 2 | 0.00 | -10.00 |
| Air Force | Fixed Price | Production | 2 | -0.60 | -1.33 |
| Army | Fixed Price | Development | 2 | -1.29 | -11.19 |
| Army | Fixed Price | Development | 2 | 2.92 | -17.42 |
| Navy | Cost Reimbursable | Development | 2 | -10.00 | -16.67 |
| Navy | Fixed Price | Production | 2 | -44.24 | 6.70 |
| Navy | Fixed Price | Production | 2 | -9.35 | 45.68 |
| Navy | Fixed Price | Production | 2 | 2.56 | 6.11 |
| Navy | Fixed Price | Production | 2 | -2.19 | 5.45 |
| Navy | Fixed Price | Production | 2 | 9.13 | -21.32 |
| Air Force | Fixed Price | Production | 2 | 4.04 | -5.20 |
| Air Force | Fixed Price | Production | 2 | 10.00 | -11.91 |
| Air Force | Fixed Price | Production | 2 | 14.76 | -19.31 |
| Air Force | Fixed Price | Production | 2 | -2.70 | -5.13 |
| Air Force | Fixed Price | Production | 2 | 3.56 | -23.57 |
| Air Force | Fixed Price | Production | 2 | 3.30 | -10.00 |
| Air Force | Fixed Price | Production | 2 | 7.00 | -5.90 |
| Air Force | Fixed Price | Production | 2 | 3.21 | -1.14 |
| Air Force | Fixed Price | Production | 2 | 2.89 | 11.64 |
| Air Force | Fixed Price | Production | 2 | 4.87 | 7.56 |
| Air Force | Fixed Price | Production | 2 | 3.59 | 0.41 |
| Air Force | Fixed Price | Production | 2 | -2.63 | 4.64 |
| Air Force | Fixed Price | Production | 2 | 7.86 | -11.30 |
| Air Force | Fixed Price | Production | 2 | 0.00 | -4.88 |
| Air Force | Fixed Price | Production | 2 | 1.52 | -4.48 |
| Air Force | Fixed Price | Production | 2 | 9.94 | -26.41 |
| Air Force | Fixed Price | Production | 2 | 40.00 | -16.67 |
| Air Force | Fixed Price | Production | 2 | 0.00 | -10.59 |
| Air Force | Fixed Price | Production | 2 | 12.13 | -44.86 |
| Air Force | Fixed Price | Production | 2 | 4.27 | -26.22 |
| Air Force | Fixed Price | Development | 2 | -4.17 | -3.85 |
| Air Force | Cost Reimbursable | Development | 2 | 1.06 | -4.52 |
| Air Force | Fixed Price | Development | 2 | -2.41 | -5.17 |
| Air Force | Cost Reimbursable | Development | 2 | -1.89 | -3.75 |
| Air Force | Fixed Price | Production | 2 | 1.43 | -17.95 |
| Air Force | Fixed Price | Production | 2 | 11.91 | -23.11 |
| Air Force | Fixed Price | Development | 2 | -7.38 | -9.88 |
| Air Force | Cost Reimbursable | Development | 2 | 1.48 | -7.11 |
| Air Force | Fixed Price | Development | 2 | 0.64 | -7.96 |
| Air Force | Fixed Price | Development | 2 | 9.52 | -5.13 |
| Air Force | Fixed Price | Development | 2 | 3.00 | -9.05 |
| Air Force | Fixed Price | Development | 2 | -4.01 | -7.18 |
| Air Force | Fixed Price | Development | 2 | -3.24 | -5.41 |
| Air Force | Fixed Price | Development | 2 | -0.22 | -6.35 |
| Air Force | Fixed Price | Development | 2 | 12.14 | -17.16 |
| Air Force | Fixed Price | Development | 2 | 0.00 | -7.14 |
| Air Force | Fixed Price | Development | 2 | -2.30 | -7.22 |
| Air Force | Fixed Price | Production | 2 | 0.00 | 0.00 |
| Navy | Fixed Price | Production | 2 | -7.69 | -27.78 |
| Navy | Fixed Price | Production | 2 | 2.65 | 5.61 |
| Navy | Fixed Price | Production | 2 | -5.66 | -6.77 |

| | | | | | |
|-----------|-------------------|-------------|---|--------|--------|
| Navy | Fixed Price | Development | 2 | 15.38 | 18.18 |
| Navy | Cost Reimbursable | Development | 2 | -11.80 | -11.45 |
| Navy | Cost Reimbursable | Development | 2 | -9.91 | -7.67 |
| Army | Cost Reimbursable | Development | 2 | 1.85 | -9.05 |
| Navy | Cost Reimbursable | Development | 2 | 0.00 | 0.00 |
| Air Force | Fixed Price | Development | 2 | -50.00 | -20.00 |
| Air Force | Fixed Price | Development | 2 | -19.72 | -11.95 |
| Air Force | Fixed Price | Development | 2 | -10.96 | -1.32 |
| Air Force | Fixed Price | Development | 2 | -3.25 | 0.00 |
| Air Force | Cost Reimbursable | Development | 2 | 0.36 | 0.00 |
| Air Force | Fixed Price | Development | 2 | -2.49 | -4.19 |
| Navy | Fixed Price | Development | 2 | 9.02 | -5.00 |
| Navy | Cost Reimbursable | Development | 2 | 0.07 | -9.39 |
| Air Force | Fixed Price | Production | 2 | 3.65 | -1.00 |
| Air Force | Fixed Price | Development | 2 | 4.50 | -5.06 |
| Air Force | Cost Reimbursable | Development | 2 | -30.77 | -18.75 |
| Army | Fixed Price | Development | 2 | -14.26 | -17.70 |
| Army | Fixed Price | Production | 2 | -1.40 | -22.23 |
| Army | Fixed Price | Production | 2 | 5.71 | -28.57 |
| Army | Fixed Price | Production | 2 | -5.91 | 1.43 |
| Air Force | Fixed Price | Production | 2 | 0.00 | 0.00 |
| Navy | Cost Reimbursable | Development | 2 | 2.50 | -11.11 |
| Air Force | Cost Reimbursable | Development | 2 | -8.43 | -0.06 |
| Air Force | Cost Reimbursable | Development | 3 | -2.80 | -2.19 |
| Air Force | Fixed Price | Production | 3 | -0.23 | -4.09 |
| Air Force | Fixed Price | Production | 3 | 0.90 | -4.31 |
| Air Force | Fixed Price | Production | 3 | 0.56 | -1.73 |
| Air Force | Fixed Price | Production | 3 | -1.06 | -2.62 |
| Air Force | Fixed Price | Production | 3 | 0.92 | 1.05 |
| Air Force | Fixed Price | Production | 3 | -2.34 | -7.61 |
| Army | Cost Reimbursable | Development | 3 | 8.42 | -8.29 |
| Army | Fixed Price | Production | 3 | 1.88 | -8.61 |
| Army | Cost Reimbursable | Production | 3 | 12.46 | -9.57 |
| Army | Fixed Price | Production | 3 | 0.60 | -13.44 |
| Army | Fixed Price | Production | 3 | 0.25 | -12.63 |
| Army | Fixed Price | Production | 3 | -1.99 | -4.75 |
| Army | Cost Reimbursable | Production | 3 | 4.91 | -7.22 |
| Army | Cost Reimbursable | Production | 3 | -8.96 | -7.59 |
| Army | Cost Reimbursable | Development | 3 | -2.13 | -1.29 |
| Army | Cost Reimbursable | Development | 3 | -10.91 | -7.69 |
| Army | Cost Reimbursable | Production | 3 | 4.73 | -5.67 |
| Army | Fixed Price | Production | 3 | 0.00 | 0.00 |
| Army | Cost Reimbursable | Development | 3 | 1.96 | -6.61 |
| Army | Cost Reimbursable | Development | 3 | -47.92 | -8.68 |
| Army | Fixed Price | Production | 3 | 12.69 | -16.40 |
| Army | Fixed Price | Production | 3 | -20.00 | -43.18 |
| Army | Fixed Price | Production | 3 | 0.00 | -24.00 |
| Army | Fixed Price | Production | 3 | 7.14 | -12.50 |
| Navy | Cost Reimbursable | Development | 3 | -4.55 | -1.49 |
| Navy | Cost Reimbursable | Development | 3 | -1.96 | -1.88 |
| Navy | Cost Reimbursable | Development | 3 | -4.90 | -7.55 |
| Navy | Fixed Price | Production | 3 | -36.28 | -8.21 |
| Navy | Fixed Price | Production | 3 | 0.00 | -7.94 |
| Army | Cost Reimbursable | Development | 3 | 0.71 | -3.17 |
| Navy | Cost Reimbursable | Development | 3 | -15.79 | -2.56 |
| Army | Cost Reimbursable | Production | 3 | -2.80 | -18.77 |

| | | | | | |
|-----------|-------------------|-------------|---|--------|--------|
| Army | Fixed Price | Production | 3 | -15.35 | -7.47 |
| Air Force | Fixed Price | Development | 3 | -3.85 | -7.45 |
| Air Force | Cost Reimbursable | Development | 3 | 1.19 | -0.70 |
| Navy | Fixed Price | Production | 3 | -1.15 | -2.96 |
| Air Force | Cost Reimbursable | Production | 3 | -4.96 | -8.24 |
| Air Force | Fixed Price | Production | 3 | -12.84 | 6.91 |
| Air Force | Fixed Price | Production | 3 | -5.49 | -5.20 |
| Air Force | Fixed Price | Production | 3 | -18.07 | -21.84 |
| Air Force | Cost Reimbursable | Development | 3 | 15.24 | 0.00 |
| Air Force | Fixed Price | Production | 3 | -1.63 | -1.17 |
| Air Force | Cost Reimbursable | Development | 3 | -1.67 | -1.68 |
| Air Force | Fixed Price | Production | 3 | 2.62 | 0.25 |
| Air Force | Fixed Price | Production | 3 | -0.28 | 0.53 |
| Air Force | Fixed Price | Production | 3 | -7.88 | -7.54 |
| Air Force | Fixed Price | Production | 3 | -3.46 | -1.55 |
| Navy | Fixed Price | Production | 3 | -7.06 | -22.02 |
| Air Force | Fixed Price | Development | 3 | -5.42 | -7.53 |
| Air Force | Fixed Price | Production | 3 | -2.21 | -8.13 |
| Navy | Fixed Price | Production | 3 | 1.39 | 0.00 |
| Navy | Fixed Price | Production | 3 | -3.98 | -6.40 |
| Navy | Fixed Price | Production | 3 | 8.05 | -3.25 |
| Navy | Fixed Price | Production | 3 | -25.18 | -3.32 |
| Navy | Cost Reimbursable | Development | 3 | -0.67 | -3.41 |
| Army | Fixed Price | Production | 3 | 8.52 | -8.23 |
| Army | Fixed Price | Production | 3 | -8.54 | -17.27 |
| Army | Fixed Price | Production | 3 | -21.22 | -15.56 |
| Navy | Cost Reimbursable | Production | 3 | -50.95 | -17.91 |
| Army | Cost Reimbursable | Development | 3 | 20.13 | -2.78 |
| Army | Cost Reimbursable | Development | 3 | -14.94 | -8.02 |
| Navy | Cost Reimbursable | Development | 3 | -12.12 | -0.76 |
| Navy | Cost Reimbursable | Development | 3 | -15.38 | -7.14 |
| Navy | Cost Reimbursable | Development | 3 | 0.00 | -20.00 |
| Navy | Cost Reimbursable | Development | 3 | -8.39 | 0.00 |
| Navy | Cost Reimbursable | Development | 3 | -19.30 | -12.15 |
| Air Force | Fixed Price | Production | 3 | -1.27 | 1.27 |
| Air Force | Fixed Price | Production | 3 | -51.32 | -32.14 |
| Air Force | Fixed Price | Development | 3 | -16.10 | -6.47 |
| Navy | Fixed Price | Development | 3 | -37.41 | -22.71 |
| Navy | Fixed Price | Production | 3 | -0.35 | -6.21 |
| Army | Cost Reimbursable | Development | 3 | 0.34 | -2.49 |
| Navy | Cost Reimbursable | Development | 3 | -7.73 | -10.77 |
| Navy | Fixed Price | Production | 3 | -18.15 | -8.55 |
| Navy | Fixed Price | Production | 3 | -21.78 | -9.18 |
| Navy | Fixed Price | Production | 3 | -1.15 | 0.00 |
| Navy | Fixed Price | Production | 3 | -4.06 | -3.47 |
| Navy | Fixed Price | Production | 3 | -7.41 | -3.57 |
| Navy | Fixed Price | Production | 3 | -1.84 | -6.01 |
| Navy | Fixed Price | Production | 3 | -12.39 | -3.28 |
| Army | Fixed Price | Development | 3 | 7.87 | -9.91 |
| Army | Fixed Price | Production | 3 | -2.33 | -7.02 |
| Army | Fixed Price | Production | 3 | 0.75 | -4.66 |
| Army | Fixed Price | Production | 3 | -13.33 | -11.69 |
| Army | Cost Reimbursable | Development | 3 | -5.77 | -4.48 |
| Navy | Fixed Price | Production | 3 | 4.05 | -2.94 |
| Navy | Fixed Price | Production | 3 | -17.76 | 4.89 |
| Navy | Fixed Price | Production | 3 | -9.90 | -8.24 |

| | | | | | |
|-----------|-------------------|-------------|---|--------|--------|
| Navy | Cost Reimbursable | Development | 3 | -9.07 | -1.44 |
| Navy | Fixed Price | Production | 3 | -5.66 | -7.03 |
| Navy | Fixed Price | Production | 3 | 6.95 | 0.00 |
| Navy | Cost Reimbursable | Development | 3 | -8.57 | -17.79 |
| Navy | Fixed Price | Production | 3 | -4.00 | -8.54 |
| Navy | Fixed Price | Production | 3 | -3.30 | -4.21 |
| Navy | Fixed Price | Production | 3 | -2.66 | -4.29 |
| Navy | Cost Reimbursable | Production | 3 | -6.69 | -7.67 |
| Army | Fixed Price | Production | 3 | -11.11 | -11.11 |
| Army | Fixed Price | Production | 3 | -24.31 | -20.34 |
| Army | Fixed Price | Production | 3 | -45.35 | -20.37 |
| Army | Fixed Price | Production | 3 | -10.42 | -4.00 |
| Army | Fixed Price | Production | 3 | -4.55 | -12.00 |
| Army | Fixed Price | Production | 3 | -27.66 | -27.41 |
| Army | Fixed Price | Development | 3 | 0.00 | 0.00 |
| Army | Cost Reimbursable | Development | 3 | 2.31 | 0.00 |
| Army | Cost Reimbursable | Development | 3 | -17.83 | -15.09 |
| Army | Fixed Price | Production | 3 | 0.40 | -37.78 |
| Army | Cost Reimbursable | Production | 3 | -1.98 | -10.74 |
| Army | Cost Reimbursable | Development | 3 | 3.25 | -3.62 |
| Army | Cost Reimbursable | Production | 3 | -58.95 | -14.04 |
| Army | Fixed Price | Production | 3 | -2.54 | -23.46 |
| Army | Fixed Price | Production | 3 | -22.09 | -31.45 |
| Army | Fixed Price | Production | 3 | -4.27 | -23.85 |
| Army | Fixed Price | Production | 3 | -10.57 | -17.07 |
| Army | Fixed Price | Production | 3 | -3.33 | -33.04 |
| Army | Fixed Price | Production | 3 | -17.35 | -9.05 |
| Army | Cost Reimbursable | Development | 3 | -2.48 | 0.00 |
| Navy | Fixed Price | Production | 3 | 14.91 | -5.40 |
| Navy | Fixed Price | Production | 3 | -12.56 | -2.88 |
| Navy | Fixed Price | Production | 3 | 16.39 | -7.30 |
| Navy | Fixed Price | Production | 3 | 5.09 | 15.11 |
| Navy | Fixed Price | Production | 3 | -5.94 | 0.99 |
| Navy | Fixed Price | Production | 3 | 0.85 | -2.98 |
| Navy | Fixed Price | Production | 3 | 1.68 | -3.29 |
| Navy | Fixed Price | Production | 3 | 4.34 | 0.82 |
| Navy | Fixed Price | Production | 3 | 8.56 | -8.53 |
| Navy | Fixed Price | Production | 3 | -6.98 | 2.65 |
| Air Force | Fixed Price | Production | 3 | -8.57 | -6.39 |
| Air Force | Fixed Price | Development | 3 | -15.06 | -17.85 |
| Air Force | Fixed Price | Production | 3 | 1.03 | 0.82 |
| Air Force | Fixed Price | Production | 3 | 2.23 | -1.77 |
| Air Force | Fixed Price | Production | 3 | 1.50 | 5.79 |
| Air Force | Fixed Price | Production | 3 | -2.95 | -3.94 |
| Air Force | Fixed Price | Production | 3 | 2.96 | -6.06 |
| Air Force | Fixed Price | Development | 3 | 2.99 | -0.15 |
| Air Force | Fixed Price | Development | 3 | 2.58 | -2.06 |
| Air Force | Fixed Price | Development | 3 | 2.21 | -1.78 |
| Air Force | Fixed Price | Development | 3 | 0.00 | 0.00 |
| Air Force | Fixed Price | Production | 3 | 3.47 | -11.60 |
| Air Force | Fixed Price | Production | 3 | 0.70 | -10.69 |
| Air Force | Fixed Price | Production | 3 | -6.61 | -9.19 |
| Air Force | Fixed Price | Production | 3 | 0.37 | -4.57 |
| Air Force | Fixed Price | Production | 3 | 2.28 | -4.49 |
| Navy | Fixed Price | Production | 3 | -1.43 | -14.38 |
| Navy | Cost Reimbursable | Development | 3 | -2.40 | -6.53 |

| | | | | | |
|-----------|-------------------|-------------|---|--------|--------|
| Air Force | Cost Reimbursable | Development | 3 | 16.60 | 0.00 |
| Navy | Fixed Price | Production | 3 | 1.26 | -0.93 |
| Navy | Cost Reimbursable | Production | 3 | 0.00 | 0.00 |
| Navy | Cost Reimbursable | Development | 3 | -1.30 | -3.98 |
| Navy | Cost Reimbursable | Development | 3 | -8.44 | -2.04 |
| Navy | Cost Reimbursable | Production | 3 | -6.20 | -5.47 |
| Navy | Cost Reimbursable | Production | 3 | -6.56 | -11.52 |
| Navy | Cost Reimbursable | Production | 3 | 1.72 | -9.94 |
| Navy | Cost Reimbursable | Production | 3 | 1.44 | -8.75 |
| Navy | Cost Reimbursable | Production | 3 | -3.45 | -4.58 |
| Navy | Fixed Price | Production | 3 | -1.32 | 22.58 |
| Navy | Cost Reimbursable | Development | 3 | -1.24 | -0.44 |
| Navy | Cost Reimbursable | Development | 3 | 1.74 | -0.39 |
| Navy | Fixed Price | Production | 3 | 1.68 | -3.29 |
| Navy | Fixed Price | Production | 3 | 8.56 | -8.53 |
| Air Force | Fixed Price | Production | 3 | 6.23 | 0.00 |
| Air Force | Fixed Price | Development | 3 | 1.32 | -10.74 |
| Air Force | Fixed Price | Production | 3 | -8.73 | -10.59 |
| Air Force | Fixed Price | Production | 3 | -2.13 | -13.77 |
| Air Force | Fixed Price | Production | 3 | -5.88 | -14.32 |
| Air Force | Fixed Price | Production | 3 | 1.50 | -11.16 |
| Air Force | Fixed Price | Production | 3 | -2.55 | -22.12 |
| Army | Cost Reimbursable | Development | 3 | -9.80 | -6.27 |
| Navy | Cost Reimbursable | Development | 3 | -3.60 | -3.63 |
| Navy | Fixed Price | Production | 3 | -5.26 | -19.49 |
| Navy | Fixed Price | Production | 3 | -13.88 | -25.52 |
| Navy | Fixed Price | Production | 3 | -1.58 | -15.83 |
| Navy | Cost Reimbursable | Development | 3 | -8.26 | -6.25 |
| Air Force | Cost Reimbursable | Development | 3 | -2.88 | -2.06 |
| Air Force | Fixed Price | Development | 3 | -15.63 | -5.88 |
| Navy | Fixed Price | Production | 3 | -24.26 | -12.79 |
| Navy | Fixed Price | Production | 3 | 3.03 | -16.10 |
| Navy | Cost Reimbursable | Development | 3 | 1.21 | -1.52 |
| Air Force | Fixed Price | Development | 3 | -21.97 | -9.59 |
| Air Force | Fixed Price | Production | 3 | -44.47 | -21.26 |
| Air Force | Fixed Price | Production | 3 | -38.45 | -20.48 |
| Air Force | Fixed Price | Development | 3 | -2.23 | -24.70 |
| Air Force | Fixed Price | Production | 3 | 0.71 | -3.95 |
| Air Force | Fixed Price | Production | 3 | -9.53 | -8.55 |
| Air Force | Fixed Price | Production | 3 | -5.74 | -6.59 |
| Air Force | Fixed Price | Production | 3 | 1.35 | -5.37 |
| Air Force | Fixed Price | Production | 3 | -1.61 | 0.00 |
| Army | Fixed Price | Development | 3 | -5.09 | -7.09 |
| Army | Fixed Price | Development | 3 | -7.15 | -17.74 |
| Navy | Cost Reimbursable | Development | 3 | -13.81 | -9.38 |
| Navy | Fixed Price | Production | 3 | -42.65 | -9.92 |
| Navy | Fixed Price | Production | 3 | -9.26 | 11.29 |
| Navy | Fixed Price | Production | 3 | 0.00 | 18.87 |
| Navy | Fixed Price | Production | 3 | 0.62 | -4.10 |
| Navy | Fixed Price | Production | 3 | 7.83 | -11.31 |
| Navy | Fixed Price | Production | 3 | -4.27 | -3.37 |
| Air Force | Fixed Price | Production | 3 | 4.74 | -0.89 |
| Air Force | Fixed Price | Production | 3 | 12.00 | -21.88 |
| Air Force | Fixed Price | Production | 3 | -2.89 | 0.39 |
| Air Force | Fixed Price | Production | 3 | -3.15 | -15.42 |
| Air Force | Fixed Price | Production | 3 | 3.57 | -14.29 |

| | | | | | |
|-----------|-------------------|-------------|---|--------|--------|
| Air Force | Fixed Price | Production | 3 | -3.61 | -3.49 |
| Air Force | Fixed Price | Production | 3 | 0.00 | -1.84 |
| Air Force | Fixed Price | Production | 3 | 2.43 | -0.76 |
| Air Force | Fixed Price | Production | 3 | 3.92 | 8.51 |
| Air Force | Fixed Price | Production | 3 | 4.55 | -1.49 |
| Air Force | Fixed Price | Production | 3 | -19.90 | 0.74 |
| Air Force | Fixed Price | Production | 3 | 2.50 | -4.76 |
| Air Force | Fixed Price | Production | 3 | 0.00 | -9.09 |
| Air Force | Fixed Price | Production | 3 | 6.26 | -20.30 |
| Air Force | Fixed Price | Production | 3 | 31.09 | -4.51 |
| Air Force | Fixed Price | Production | 3 | 0.95 | -6.25 |
| Air Force | Fixed Price | Production | 3 | 1.04 | -23.81 |
| Air Force | Fixed Price | Production | 3 | 6.25 | -12.96 |
| Air Force | Fixed Price | Development | 3 | -2.96 | 0.00 |
| Air Force | Cost Reimbursable | Development | 3 | -0.07 | -2.51 |
| Air Force | Fixed Price | Development | 3 | -1.87 | -5.44 |
| Air Force | Cost Reimbursable | Development | 3 | -4.80 | -1.30 |
| Air Force | Fixed Price | Production | 3 | 1.75 | -9.52 |
| Air Force | Fixed Price | Production | 3 | 4.05 | -12.94 |
| Air Force | Fixed Price | Development | 3 | -6.05 | -7.18 |
| Air Force | Cost Reimbursable | Development | 3 | 0.93 | -5.68 |
| Air Force | Fixed Price | Development | 3 | -2.35 | -7.08 |
| Air Force | Fixed Price | Development | 3 | 4.34 | -3.57 |
| Air Force | Fixed Price | Development | 3 | -0.10 | -4.45 |
| Air Force | Fixed Price | Development | 3 | -7.63 | -6.41 |
| Air Force | Fixed Price | Development | 3 | -3.55 | -4.51 |
| Air Force | Fixed Price | Development | 3 | -5.04 | -5.33 |
| Air Force | Fixed Price | Development | 3 | 4.57 | -15.09 |
| Air Force | Fixed Price | Development | 3 | 0.00 | -5.42 |
| Air Force | Fixed Price | Development | 3 | -8.19 | -6.54 |
| Air Force | Fixed Price | Production | 3 | 1.12 | -1.58 |
| Army | Cost Reimbursable | Development | 3 | 0.00 | 0.00 |
| Navy | Fixed Price | Production | 3 | -7.69 | -10.34 |
| Navy | Fixed Price | Production | 3 | -0.19 | 3.45 |
| Navy | Fixed Price | Production | 3 | -14.87 | 1.01 |
| Navy | Fixed Price | Development | 3 | 0.00 | -10.00 |
| Navy | Fixed Price | Production | 3 | -2.08 | -3.95 |
| Navy | Cost Reimbursable | Development | 3 | -1.52 | -6.67 |
| Navy | Cost Reimbursable | Development | 3 | -8.26 | -4.93 |
| Navy | Cost Reimbursable | Development | 3 | 0.00 | -4.76 |
| Army | Cost Reimbursable | Development | 3 | -13.17 | -13.35 |
| Army | Cost Reimbursable | Development | 3 | 0.00 | -12.50 |
| Navy | Cost Reimbursable | Development | 3 | 0.00 | 0.00 |
| Air Force | Fixed Price | Development | 3 | -65.72 | -15.02 |
| Air Force | Fixed Price | Development | 3 | -19.10 | -17.34 |
| Air Force | Cost Reimbursable | Development | 3 | -0.39 | -0.61 |
| Air Force | Fixed Price | Development | 3 | 0.75 | -1.94 |
| Air Force | Fixed Price | Development | 3 | 3.50 | -3.95 |
| Air Force | Cost Reimbursable | Development | 3 | 4.12 | -0.60 |
| Air Force | Cost Reimbursable | Development | 3 | 5.90 | -2.75 |
| Air Force | Fixed Price | Development | 3 | -12.85 | -4.53 |
| Navy | Fixed Price | Development | 3 | 7.60 | -0.81 |
| Navy | Cost Reimbursable | Development | 3 | -0.46 | -6.44 |
| Air Force | Fixed Price | Development | 3 | 0.00 | -1.47 |
| Air Force | Fixed Price | Production | 3 | 4.48 | -2.90 |
| Air Force | Fixed Price | Development | 3 | 0.00 | -4.94 |

| | | | | | |
|-----------|-------------------|-------------|---|--------|--------|
| Air Force | Cost Reimbursable | Development | 3 | -21.64 | -5.10 |
| Army | Fixed Price | Development | 3 | -23.31 | -13.95 |
| Army | Fixed Price | Production | 3 | 4.96 | -23.42 |
| Army | Fixed Price | Production | 3 | -14.58 | -8.26 |
| Air Force | Fixed Price | Production | 3 | -17.66 | -8.89 |
| Air Force | Fixed Price | Production | 3 | 0.00 | -10.59 |
| Air Force | Fixed Price | Production | 3 | -4.33 | -5.21 |
| Navy | Cost Reimbursable | Development | 3 | -2.48 | -7.75 |
| Navy | Cost Reimbursable | Development | 3 | 5.88 | -10.53 |
| Air Force | Cost Reimbursable | Development | 3 | -15.56 | -0.90 |
| Army | Cost Reimbursable | Development | 3 | 2.50 | -11.11 |
| Navy | Cost Reimbursable | Development | 3 | -17.86 | -7.11 |
| Air Force | Fixed Price | Production | 4 | 0.00 | 0.00 |
| Air Force | Cost Reimbursable | Development | 4 | -7.06 | -0.89 |
| Air Force | Fixed Price | Production | 4 | -2.85 | -1.58 |
| Air Force | Fixed Price | Production | 4 | -2.23 | -1.23 |
| Air Force | Fixed Price | Production | 4 | -0.41 | -0.82 |
| Air Force | Fixed Price | Production | 4 | -0.58 | -0.46 |
| Air Force | Fixed Price | Production | 4 | 1.56 | -0.28 |
| Air Force | Fixed Price | Production | 4 | -3.61 | -5.15 |
| Army | Cost Reimbursable | Development | 4 | 3.83 | -3.39 |
| Army | Fixed Price | Production | 4 | 4.46 | -6.42 |
| Army | Cost Reimbursable | Production | 4 | 10.76 | -3.23 |
| Army | Fixed Price | Production | 4 | 4.43 | -4.59 |
| Army | Fixed Price | Production | 4 | 0.66 | -5.36 |
| Army | Fixed Price | Production | 4 | -5.39 | -3.66 |
| Army | Cost Reimbursable | Production | 4 | -4.98 | -5.80 |
| Army | Cost Reimbursable | Production | 4 | -17.05 | -4.48 |
| Army | Cost Reimbursable | Development | 4 | -2.85 | -1.21 |
| Army | Cost Reimbursable | Development | 4 | -14.28 | -1.56 |
| Army | Cost Reimbursable | Production | 4 | 5.39 | -2.44 |
| Army | Fixed Price | Production | 4 | 0.00 | 0.00 |
| Army | Fixed Price | Production | 4 | 0.00 | 0.00 |
| Army | Cost Reimbursable | Development | 4 | -2.18 | -1.95 |
| Army | Cost Reimbursable | Development | 4 | -52.26 | -5.39 |
| Army | Fixed Price | Production | 4 | 3.25 | -8.99 |
| Army | Fixed Price | Production | 4 | -27.18 | -7.76 |
| Army | Fixed Price | Production | 4 | -2.61 | -7.10 |
| Army | Fixed Price | Production | 4 | 0.91 | -4.07 |
| Navy | Cost Reimbursable | Development | 4 | -9.98 | -1.38 |
| Navy | Cost Reimbursable | Development | 4 | -5.43 | -1.82 |
| Navy | Cost Reimbursable | Development | 4 | -3.46 | -3.71 |
| Navy | Fixed Price | Production | 4 | -38.74 | -3.86 |
| Army | Cost Reimbursable | Development | 4 | 0.38 | -1.35 |
| Navy | Cost Reimbursable | Development | 4 | -13.79 | -3.08 |
| Army | Cost Reimbursable | Production | 4 | -14.64 | -8.74 |
| Army | Fixed Price | Production | 4 | -30.66 | -3.60 |
| Air Force | Fixed Price | Development | 4 | -11.83 | -4.83 |
| Air Force | Cost Reimbursable | Development | 4 | -3.24 | -0.64 |
| Navy | Fixed Price | Production | 4 | -0.58 | -1.22 |
| Navy | Fixed Price | Production | 4 | -0.89 | -1.25 |
| Air Force | Cost Reimbursable | Production | 4 | -6.45 | -4.16 |
| Air Force | Fixed Price | Production | 4 | -18.34 | -3.79 |
| Air Force | Fixed Price | Production | 4 | -2.51 | -1.92 |
| Air Force | Fixed Price | Production | 4 | -10.13 | -8.78 |
| Air Force | Cost Reimbursable | Development | 4 | 3.75 | 0.00 |

| | | | | | |
|-----------|-------------------|-------------|---|--------|--------|
| Air Force | Cost Reimbursable | Production | 4 | -14.21 | -1.80 |
| Air Force | Fixed Price | Production | 4 | -2.47 | -0.39 |
| Air Force | Cost Reimbursable | Development | 4 | -2.84 | -0.06 |
| Air Force | Fixed Price | Production | 4 | 1.00 | 0.22 |
| Air Force | Fixed Price | Production | 4 | -0.88 | 0.88 |
| Air Force | Fixed Price | Production | 4 | -4.84 | -1.74 |
| Air Force | Fixed Price | Production | 4 | -15.60 | -5.31 |
| Air Force | Fixed Price | Production | 4 | -5.08 | -2.31 |
| Navy | Fixed Price | Production | 4 | -3.91 | -9.46 |
| Air Force | Fixed Price | Development | 4 | -5.91 | -2.42 |
| Air Force | Fixed Price | Production | 4 | -1.23 | -5.87 |
| Navy | Fixed Price | Production | 4 | 2.50 | 0.53 |
| Navy | Fixed Price | Production | 4 | -5.62 | -2.40 |
| Navy | Fixed Price | Production | 4 | 7.55 | 0.25 |
| Navy | Fixed Price | Production | 4 | -20.13 | -0.46 |
| Navy | Cost Reimbursable | Development | 4 | -2.02 | -0.51 |
| Army | Fixed Price | Production | 4 | 4.66 | -2.53 |
| Army | Fixed Price | Production | 4 | -5.07 | -7.33 |
| Army | Fixed Price | Production | 4 | -30.14 | -2.44 |
| Navy | Cost Reimbursable | Production | 4 | -67.11 | -11.60 |
| Army | Cost Reimbursable | Development | 4 | 21.45 | -3.28 |
| Army | Cost Reimbursable | Development | 4 | -17.97 | -4.24 |
| Navy | Cost Reimbursable | Development | 4 | -4.33 | -1.40 |
| Navy | Cost Reimbursable | Development | 4 | -8.65 | -5.06 |
| Navy | Cost Reimbursable | Development | 4 | -23.63 | -4.15 |
| Navy | Cost Reimbursable | Development | 4 | 0.00 | -8.74 |
| Navy | Cost Reimbursable | Development | 4 | -11.72 | 0.00 |
| Navy | Cost Reimbursable | Development | 4 | -19.21 | -6.88 |
| Air Force | Fixed Price | Production | 4 | -4.81 | -2.62 |
| Air Force | Fixed Price | Production | 4 | -28.95 | -8.49 |
| Air Force | Fixed Price | Development | 4 | -30.73 | -4.38 |
| Navy | Fixed Price | Development | 4 | -56.57 | -8.70 |
| Navy | Fixed Price | Production | 4 | -2.28 | -3.26 |
| Army | Cost Reimbursable | Development | 4 | -3.80 | -1.13 |
| Navy | Cost Reimbursable | Development | 4 | -6.23 | -3.93 |
| Navy | Fixed Price | Production | 4 | -28.47 | -3.68 |
| Navy | Fixed Price | Production | 4 | -26.39 | -4.73 |
| Navy | Fixed Price | Production | 4 | 1.10 | 0.00 |
| Navy | Fixed Price | Production | 4 | -8.17 | -2.52 |
| Navy | Cost Reimbursable | Development | 4 | -7.73 | -1.52 |
| Navy | Fixed Price | Production | 4 | -13.25 | -4.02 |
| Navy | Fixed Price | Production | 4 | -5.87 | -3.64 |
| Navy | Fixed Price | Production | 4 | -10.86 | -3.98 |
| Army | Fixed Price | Development | 4 | 4.38 | -5.69 |
| Army | Fixed Price | Production | 4 | -10.20 | -4.82 |
| Army | Fixed Price | Production | 4 | -1.91 | -1.28 |
| Army | Fixed Price | Production | 4 | -27.14 | -4.65 |
| Army | Cost Reimbursable | Development | 4 | -19.37 | -3.11 |
| Navy | Fixed Price | Production | 4 | 5.38 | -1.51 |
| Navy | Fixed Price | Production | 4 | -19.35 | 0.76 |
| Navy | Fixed Price | Production | 4 | -4.42 | -4.17 |
| Navy | Cost Reimbursable | Development | 4 | -1.69 | -1.02 |
| Navy | Fixed Price | Production | 4 | -23.33 | -6.51 |
| Navy | Fixed Price | Production | 4 | 2.15 | -1.06 |
| Navy | Cost Reimbursable | Development | 4 | -11.01 | -7.83 |
| Navy | Fixed Price | Production | 4 | -5.32 | -5.06 |

| | | | | | |
|-----------|-------------------|-------------|---|--------|--------|
| Navy | Fixed Price | Production | 4 | -7.89 | -4.80 |
| Navy | Fixed Price | Production | 4 | 1.67 | -2.82 |
| Navy | Cost Reimbursable | Production | 4 | -15.24 | -1.18 |
| Navy | Cost Reimbursable | Production | 4 | -4.48 | -1.94 |
| Army | Fixed Price | Production | 4 | -6.81 | -2.98 |
| Army | Fixed Price | Production | 4 | -24.53 | -9.29 |
| Army | Fixed Price | Production | 4 | -39.22 | -7.65 |
| Army | Fixed Price | Production | 4 | -10.64 | -2.42 |
| Army | Fixed Price | Production | 4 | -1.54 | -5.41 |
| Army | Fixed Price | Production | 4 | -35.79 | -6.83 |
| Army | Fixed Price | Development | 4 | 4.76 | 0.00 |
| Army | Cost Reimbursable | Development | 4 | 1.06 | 0.00 |
| Army | Cost Reimbursable | Development | 4 | -28.91 | -11.88 |
| Army | Fixed Price | Production | 4 | -14.35 | -3.35 |
| Army | Cost Reimbursable | Production | 4 | -18.36 | -7.86 |
| Army | Cost Reimbursable | Development | 4 | -2.71 | -1.68 |
| Army | Cost Reimbursable | Production | 4 | -38.87 | -1.14 |
| Army | Fixed Price | Production | 4 | -17.51 | -9.62 |
| Army | Fixed Price | Production | 4 | -17.01 | -5.53 |
| Army | Fixed Price | Production | 4 | 1.62 | -9.17 |
| Army | Fixed Price | Production | 4 | -21.84 | -7.11 |
| Army | Fixed Price | Production | 4 | 1.28 | -10.26 |
| Army | Fixed Price | Production | 4 | -17.07 | -4.66 |
| Army | Cost Reimbursable | Development | 4 | -1.81 | 0.00 |
| Navy | Fixed Price | Production | 4 | 12.72 | -7.75 |
| Navy | Fixed Price | Production | 4 | -17.01 | -5.79 |
| Navy | Fixed Price | Production | 4 | 14.27 | -8.63 |
| Navy | Fixed Price | Production | 4 | 1.28 | -1.79 |
| Navy | Fixed Price | Production | 4 | -10.66 | -0.51 |
| Navy | Fixed Price | Production | 4 | -0.37 | -0.73 |
| Navy | Fixed Price | Production | 4 | 2.11 | -1.97 |
| Navy | Fixed Price | Production | 4 | 5.53 | -2.66 |
| Navy | Fixed Price | Production | 4 | 4.81 | -2.33 |
| Navy | Fixed Price | Production | 4 | -10.57 | -2.48 |
| Air Force | Fixed Price | Production | 4 | -7.40 | -2.95 |
| Air Force | Fixed Price | Development | 4 | -21.99 | -5.50 |
| Air Force | Fixed Price | Production | 4 | -1.63 | -0.40 |
| Air Force | Fixed Price | Production | 4 | -1.86 | -1.05 |
| Air Force | Fixed Price | Production | 4 | 1.42 | -1.26 |
| Air Force | Fixed Price | Production | 4 | -8.37 | -1.70 |
| Air Force | Fixed Price | Production | 4 | 0.41 | -6.51 |
| Air Force | Fixed Price | Development | 4 | 1.64 | -0.41 |
| Air Force | Fixed Price | Development | 4 | 2.43 | -0.25 |
| Air Force | Fixed Price | Development | 4 | 2.81 | -0.60 |
| Air Force | Fixed Price | Development | 4 | 0.89 | -0.89 |
| Air Force | Fixed Price | Production | 4 | 1.55 | -1.44 |
| Air Force | Fixed Price | Production | 4 | 1.51 | -3.42 |
| Air Force | Fixed Price | Production | 4 | -10.15 | -2.99 |
| Air Force | Fixed Price | Production | 4 | 1.00 | -1.65 |
| Air Force | Fixed Price | Production | 4 | 2.17 | -0.26 |
| Navy | Fixed Price | Production | 4 | -10.38 | -5.66 |
| Navy | Cost Reimbursable | Development | 4 | -15.10 | -12.85 |
| Air Force | Cost Reimbursable | Development | 4 | 10.61 | 0.00 |
| Navy | Fixed Price | Production | 4 | 3.96 | -1.61 |
| Navy | Cost Reimbursable | Production | 4 | 0.00 | 0.00 |
| Navy | Cost Reimbursable | Development | 4 | -1.65 | -0.99 |

| | | | | | |
|-----------|-------------------|-------------|---|--------|--------|
| Navy | Cost Reimbursable | Production | 4 | 5.54 | -3.59 |
| Navy | Cost Reimbursable | Development | 4 | -0.38 | -1.34 |
| Navy | Cost Reimbursable | Development | 4 | -10.31 | -0.73 |
| Navy | Cost Reimbursable | Production | 4 | -8.61 | -2.44 |
| Navy | Cost Reimbursable | Development | 4 | -9.74 | -2.12 |
| Navy | Cost Reimbursable | Production | 4 | -7.22 | -3.19 |
| Navy | Cost Reimbursable | Production | 4 | 2.17 | -1.97 |
| Navy | Cost Reimbursable | Production | 4 | -1.36 | -2.84 |
| Navy | Cost Reimbursable | Production | 4 | -3.37 | -5.19 |
| Navy | Fixed Price | Production | 4 | -1.43 | 1.28 |
| Navy | Cost Reimbursable | Development | 4 | -1.09 | 0.00 |
| Navy | Cost Reimbursable | Development | 4 | -0.49 | -0.16 |
| Navy | Fixed Price | Production | 4 | 2.18 | -1.68 |
| Navy | Fixed Price | Production | 4 | 4.81 | -2.33 |
| Air Force | Fixed Price | Production | 4 | 5.12 | 0.00 |
| Air Force | Fixed Price | Development | 4 | -2.94 | -1.72 |
| Air Force | Fixed Price | Production | 4 | -14.52 | -6.44 |
| Air Force | Fixed Price | Production | 4 | -10.78 | -3.91 |
| Air Force | Fixed Price | Production | 4 | -17.31 | -3.08 |
| Air Force | Fixed Price | Production | 4 | -10.61 | -4.36 |
| Air Force | Fixed Price | Production | 4 | -18.82 | -6.14 |
| Air Force | Fixed Price | Production | 4 | -4.00 | -1.11 |
| Army | Cost Reimbursable | Development | 4 | -12.64 | -3.72 |
| Navy | Cost Reimbursable | Development | 4 | -2.93 | -1.89 |
| Navy | Fixed Price | Production | 4 | -8.85 | -4.00 |
| Navy | Fixed Price | Production | 4 | -27.55 | -13.94 |
| Navy | Fixed Price | Production | 4 | -1.55 | -7.04 |
| Navy | Cost Reimbursable | Development | 4 | -5.50 | -2.16 |
| Air Force | Cost Reimbursable | Development | 4 | -0.42 | -0.40 |
| Air Force | Fixed Price | Development | 4 | -24.19 | -3.11 |
| Navy | Fixed Price | Production | 4 | -36.30 | -6.04 |
| Navy | Fixed Price | Production | 4 | 2.15 | -11.33 |
| Navy | Cost Reimbursable | Development | 4 | 1.16 | -1.15 |
| Air Force | Fixed Price | Development | 4 | -45.90 | -3.58 |
| Air Force | Fixed Price | Production | 4 | -50.50 | -5.50 |
| Air Force | Fixed Price | Production | 4 | -47.73 | -9.42 |
| Air Force | Fixed Price | Development | 4 | -13.81 | -8.69 |
| Air Force | Fixed Price | Production | 4 | -7.10 | -4.30 |
| Air Force | Fixed Price | Production | 4 | -15.28 | -5.17 |
| Air Force | Fixed Price | Production | 4 | -7.40 | -4.59 |
| Air Force | Fixed Price | Production | 4 | -3.52 | -6.47 |
| Air Force | Fixed Price | Production | 4 | -1.63 | -1.76 |
| Air Force | Cost Reimbursable | Production | 4 | 6.43 | -1.46 |
| Army | Fixed Price | Development | 4 | -9.49 | -2.71 |
| Army | Fixed Price | Development | 4 | -20.47 | -3.36 |
| Navy | Cost Reimbursable | Development | 4 | -23.47 | -4.48 |
| Navy | Fixed Price | Production | 4 | -53.10 | -9.34 |
| Navy | Fixed Price | Production | 4 | -5.55 | 1.49 |
| Navy | Fixed Price | Production | 4 | 5.23 | -1.25 |
| Navy | Fixed Price | Production | 4 | 0.41 | -2.37 |
| Navy | Fixed Price | Production | 4 | 9.97 | -3.74 |
| Navy | Fixed Price | Production | 4 | -7.21 | -2.05 |
| Air Force | Fixed Price | Production | 4 | 2.24 | 0.52 |
| Air Force | Fixed Price | Production | 4 | 6.24 | -2.74 |
| Air Force | Fixed Price | Production | 4 | 9.29 | -5.17 |
| Air Force | Fixed Price | Production | 4 | 2.74 | 0.00 |

| | | | | | |
|-----------|-------------------|-------------|---|--------|--------|
| Air Force | Fixed Price | Production | 4 | -13.30 | -8.02 |
| Air Force | Fixed Price | Production | 4 | -11.17 | -9.75 |
| Air Force | Fixed Price | Production | 4 | -13.27 | -2.42 |
| Air Force | Fixed Price | Production | 4 | -4.30 | -1.32 |
| Air Force | Fixed Price | Production | 4 | 6.54 | -1.19 |
| Air Force | Fixed Price | Production | 4 | 8.27 | -0.21 |
| Air Force | Fixed Price | Production | 4 | 9.80 | -0.03 |
| Air Force | Fixed Price | Production | 4 | -21.86 | -1.72 |
| Air Force | Fixed Price | Production | 4 | -3.62 | -2.89 |
| Air Force | Fixed Price | Production | 4 | -1.96 | -2.97 |
| Air Force | Fixed Price | Production | 4 | -0.87 | -0.60 |
| Air Force | Fixed Price | Production | 4 | -4.55 | -5.16 |
| Air Force | Fixed Price | Production | 4 | 37.50 | 0.00 |
| Air Force | Fixed Price | Production | 4 | -4.92 | -2.26 |
| Air Force | Fixed Price | Production | 4 | -5.43 | -10.42 |
| Air Force | Fixed Price | Production | 4 | 2.43 | -5.10 |
| Air Force | Fixed Price | Development | 4 | -4.24 | -0.98 |
| Air Force | Cost Reimbursable | Development | 4 | -1.62 | -0.86 |
| Air Force | Fixed Price | Development | 4 | -8.63 | -3.92 |
| Air Force | Cost Reimbursable | Development | 4 | -5.51 | -1.01 |
| Air Force | Fixed Price | Production | 4 | -1.88 | -5.41 |
| Air Force | Fixed Price | Production | 4 | 0.98 | -4.15 |
| Air Force | Fixed Price | Development | 4 | -4.83 | -2.67 |
| Air Force | Cost Reimbursable | Development | 4 | -6.63 | -3.56 |
| Air Force | Fixed Price | Development | 4 | -3.51 | -4.15 |
| Air Force | Fixed Price | Development | 4 | 0.58 | -3.20 |
| Air Force | Fixed Price | Development | 4 | -0.58 | -2.86 |
| Air Force | Fixed Price | Development | 4 | -14.57 | -4.11 |
| Air Force | Fixed Price | Development | 4 | -6.16 | -3.14 |
| Air Force | Fixed Price | Development | 4 | -5.35 | -3.14 |
| Air Force | Fixed Price | Development | 4 | 1.81 | -5.93 |
| Air Force | Fixed Price | Development | 4 | -1.37 | -2.83 |
| Air Force | Fixed Price | Development | 4 | -16.40 | -6.35 |
| Air Force | Fixed Price | Production | 4 | -1.26 | -2.92 |
| Army | Cost Reimbursable | Development | 4 | 0.00 | 0.00 |
| Navy | Fixed Price | Production | 4 | -1.20 | -5.70 |
| Navy | Fixed Price | Production | 4 | -3.94 | -4.23 |
| Navy | Fixed Price | Production | 4 | -34.53 | -2.70 |
| Navy | Fixed Price | Development | 4 | -5.91 | -3.40 |
| Navy | Fixed Price | Production | 4 | -6.16 | -9.87 |
| Navy | Cost Reimbursable | Development | 4 | -4.24 | -3.98 |
| Navy | Cost Reimbursable | Development | 4 | -10.04 | -1.72 |
| Navy | Cost Reimbursable | Development | 4 | 5.22 | 0.00 |
| Army | Cost Reimbursable | Development | 4 | -30.56 | -6.36 |
| Army | Cost Reimbursable | Development | 4 | -20.71 | -8.45 |
| Navy | Cost Reimbursable | Development | 4 | 0.00 | -7.70 |
| Air Force | Fixed Price | Development | 4 | -73.31 | -9.22 |
| Air Force | Fixed Price | Development | 4 | -29.28 | -14.51 |
| Air Force | Cost Reimbursable | Development | 4 | 0.91 | 0.46 |
| Air Force | Fixed Price | Development | 4 | -0.71 | -0.60 |
| Air Force | Fixed Price | Development | 4 | 5.26 | -2.15 |
| Air Force | Cost Reimbursable | Development | 4 | 3.13 | 0.00 |
| Air Force | Cost Reimbursable | Development | 4 | 9.52 | 0.00 |
| Air Force | Fixed Price | Development | 4 | -4.02 | -0.67 |
| Air Force | Fixed Price | Development | 4 | -1.50 | -0.14 |
| Air Force | Cost Reimbursable | Development | 4 | -0.37 | -0.20 |

| | | | | | |
|-----------|-------------------|-------------|---|--------|--------|
| Air Force | Fixed Price | Development | 4 | -1.47 | -0.54 |
| Navy | Fixed Price | Development | 4 | -1.97 | -0.46 |
| Navy | Fixed Price | Development | 4 | 8.65 | -2.27 |
| Navy | Cost Reimbursable | Development | 4 | -0.26 | -1.69 |
| Air Force | Fixed Price | Development | 4 | -0.76 | -0.89 |
| Air Force | Fixed Price | Production | 4 | 6.35 | -2.21 |
| Air Force | Fixed Price | Development | 4 | -0.59 | -1.25 |
| Air Force | Cost Reimbursable | Development | 4 | -6.47 | -1.36 |
| Army | Fixed Price | Development | 4 | -2.59 | -2.54 |
| Army | Fixed Price | Development | 4 | -33.07 | -4.75 |
| Army | Fixed Price | Production | 4 | -11.60 | -4.65 |
| Army | Fixed Price | Production | 4 | -0.88 | -6.04 |
| Army | Fixed Price | Production | 4 | -40.11 | -10.02 |
| Air Force | Fixed Price | Production | 4 | -19.00 | -8.20 |
| Air Force | Fixed Price | Production | 4 | 3.21 | -2.81 |
| Air Force | Fixed Price | Production | 4 | -5.58 | -7.71 |
| Navy | Cost Reimbursable | Development | 4 | -2.51 | -5.94 |
| Navy | Cost Reimbursable | Development | 4 | 6.36 | -4.34 |
| Navy | Fixed Price | Production | 4 | -75.88 | -3.86 |
| Air Force | Cost Reimbursable | Development | 4 | -2.26 | 0.00 |
| Army | Cost Reimbursable | Development | 4 | -0.77 | -4.23 |
| Navy | Cost Reimbursable | Development | 4 | -18.25 | -1.56 |

Appendix C: Cost Variance SAS Programs and SAS Outputs

```
options linesize = 78;
* options pagesize = 26;

data thesis;
input type phase service quarter cv sv;
%include buckdon;

proc glm;
class phase type quarter service;

model cv = phase
        type(phase)
        quarter(type phase)
        service(quarter type phase);

means phase
        type(phase)
        quarter(type phase)
        service(quarter type phase);

output out=check p=cvhat student=sresid;

proc plot data=check;
plot sresid*cvhat;

proc univariate data=check plot normal;
var sresid;
run;
```

The SAS System

09:39 Monday, June 20, 1994¹

General Linear Models Procedure
Class Level Information

| Class | Levels | Values |
|---------|--------|---------|
| PHASE | 2 | 1 2 |
| TYPE | 2 | 1 2 |
| QUARTER | 4 | 1 2 3 4 |
| SERVICE | 3 | 1 2 3 |

Number of observations in data set = 969

The SAS System

09:39 Monday, June 20, 1994²

General Linear Models Procedure

Variable: CV

| DF | Sum of Squares | Mean Square | F Value | Pr > F |
|-----------|----------------|-------------|---------|--------|
| 46 | 18203.66065 | 395.73175 | 2.34 | 0.0001 |
| 922 | 156144.44308 | 169.35406 | | |
| Total 968 | 174348.10373 | | | |

| R-Square | C.V. | Root MSE | CV Mean |
|----------|-----------|----------|-----------|
| 0.104410 | -314.6066 | 13.01361 | -4.136471 |

| DF | Type III SS | Mean Square | F Value | Pr > F | |
|------------|-------------|-------------|------------|--------|--------|
| 1 | 309.677037 | 309.677037 | 1.83 | 0.1766 | |
| 2 | 688.136306 | 344.068153 | 2.03 | 0.1317 | |
| ASE*TYPE) | 12 | 9948.103437 | 829.008620 | 4.90 | 0.0001 |
| TYPE*QUAR) | 31 | 5934.360860 | 191.430995 | 1.13 | 0.2866 |

Plot of SRESID*CVHAT. Legend: A = 1 obs, B = 2 obs, etc.

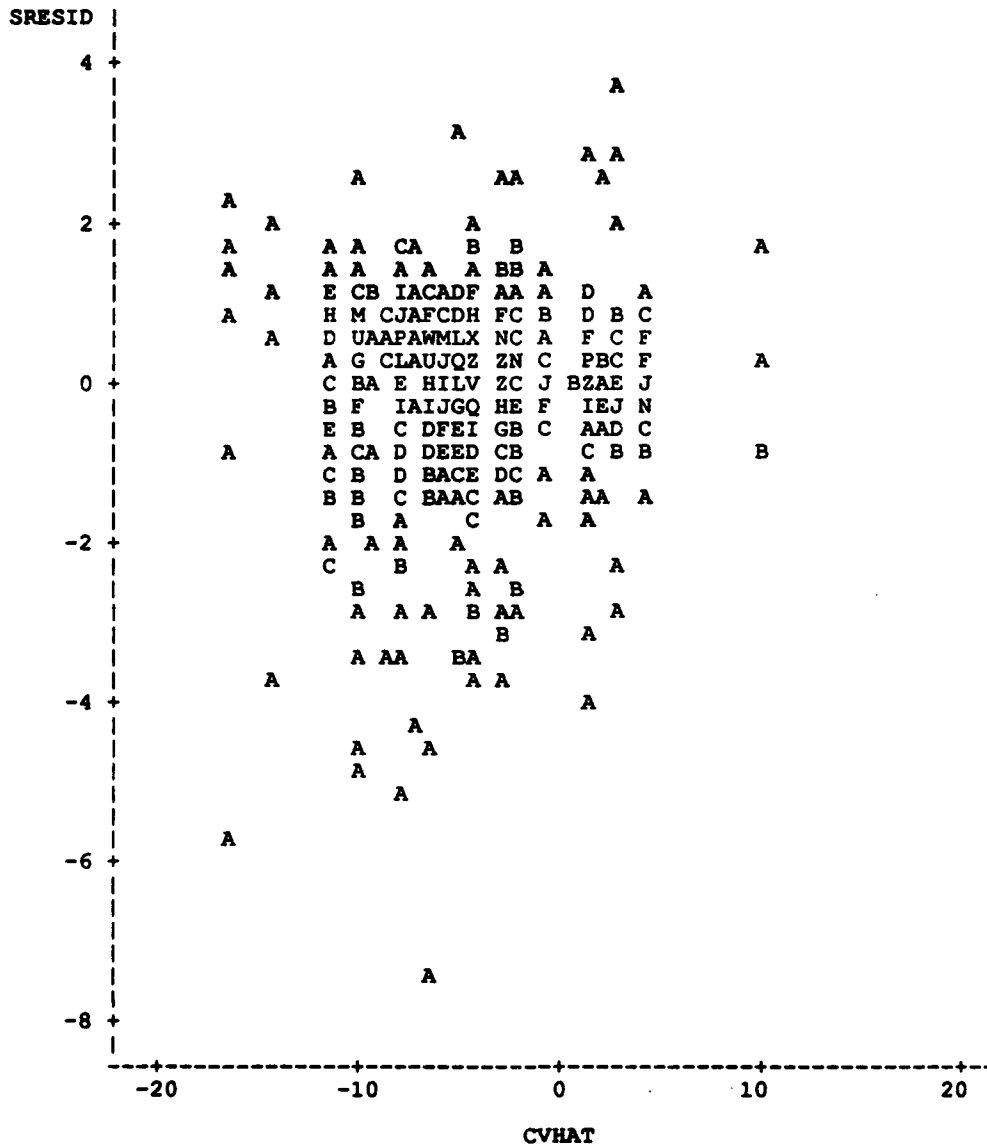

NOTE: 2 obs had missing values. 31 obs hidden.

Univariate Procedure

Variable=SRESID

Moments

| | | | |
|----------|----------|----------|----------|
| N | 967 | Sum Wgts | 967 |
| Mean | 0 | Sum | 0 |
| Std Dev | 1.010013 | Variance | 1.020126 |
| Skewness | -1.81509 | Kurtosis | 7.948211 |
| USS | 985.442 | CSS | 985.442 |
| CV | . | Std Mean | 0.03248 |
| T:Mean=0 | 0 | Pr> T | 1.0000 |
| Num ^= 0 | 967 | Num > 0 | 581 |
| M(Sign) | 97.5 | Pr>= M | 0.0001 |
| Sgn Rank | 39633 | Pr>= S | 0.0001 |
| W:Normal | 0.868986 | Pr<W | 0.0001 |

Quantiles (Def=5)

| | | | |
|----------|----------|-----|----------|
| 100% Max | 3.748137 | 99% | 2.016404 |
| 75% Q3 | 0.511385 | 95% | 1.151745 |
| 50% Med | 0.153875 | 90% | 0.916663 |
| 25% Q1 | -0.30439 | 10% | -1.05064 |
| 0% Min | -7.46235 | 5% | -1.69244 |
| | | 1% | -3.76635 |
| Range | 11.21049 | | |
| Q3-Q1 | 0.815772 | | |
| Mode | -0.10645 | | |

Extremes

| Lowest | Obs | Highest | Obs |
|-----------|------|-----------|------|
| -7.46235(| 54) | 2.614778(| 621) |
| -5.70846(| 11) | 2.720679(| 30) |
| -5.25297(| 966) | 2.994102(| 363) |
| -4.96597(| 938) | 3.277905(| 904) |
| -4.64623(| 655) | 3.748137(| 120) |

| | |
|---------------|------|
| Missing Value | . |
| Count | 2 |
| % Count/Nobs | 0.21 |

Univariate Procedure

Variable=SRESID

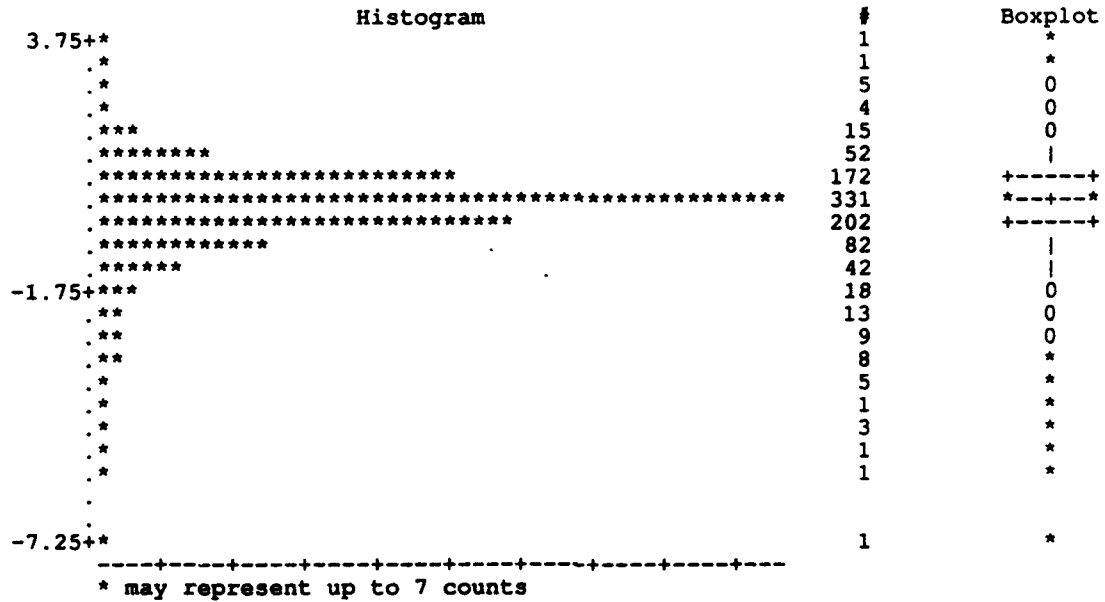

Univariate Procedure

Variable=SRESID

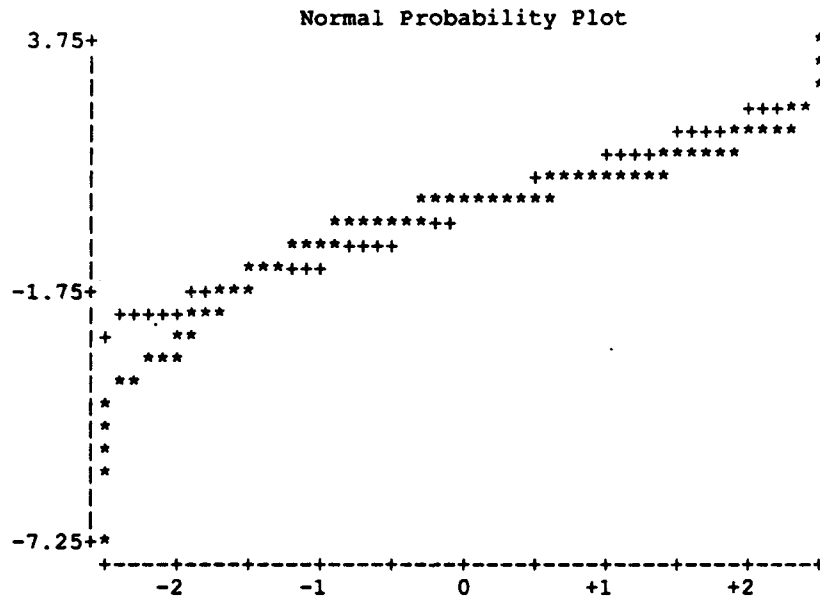

```
options linesize = 78;  
* options pagesize = 26;  
  
data thesis;  
input type phase service quarter cv sv;  
%include buckdon;  
  
proc glm;  
class type service quarter phase;  
  
model cv = type  
service(type)  
quarter(service type)  
phase(quarter service type);  
  
run;
```

The SAS System

09:40 Monday, June 20, 1994¹

General Linear Models Procedure
Class Level Information

| Class | Levels | Values |
|---------|--------|---------|
| TYPE | 2 | 1 2 |
| SERVICE | 3 | 1 2 3 |
| QUARTER | 4 | 1 2 3 4 |
| PHASE | 2 | 1 2 |

Number of observations in data set = 969

The SAS System

09:40 Monday, June 20, 1994²

General Linear Models Procedure

Dependent Variable: CV

| Source | DF | Sum of Squares | Mean Square | F Value | Pr > F |
|-----------------|-----|----------------|-------------|---------|--------|
| Model | 46 | 18203.66065 | 395.73175 | 2.34 | 0.0001 |
| Error | 922 | 156144.44308 | 169.35406 | | |
| Corrected Total | 968 | 174348.10373 | | | |

| R-Square | C.V. | Root MSE | CV Mean |
|----------|-----------|----------|-----------|
| 0.104410 | -314.6066 | 13.01361 | -4.136471 |

| Source | DF | Type III SS | Mean Square | F Value | Pr > F |
|-----------------------|----|-------------|-------------|---------|--------|
| TYPE | 1 | 425.363211 | 425.363211 | 2.51 | 0.1133 |
| SERVICE (TYPE) | 4 | 544.405475 | 136.101369 | 0.80 | 0.5229 |
| QUARTE (TYPE*SERVICE) | 18 | 8713.911259 | 484.106181 | 2.86 | 0.0001 |
| PHAS (TYPE*SERV*QUAR) | 23 | 4380.110461 | 190.439585 | 1.12 | 0.3106 |

```
options linesize = 78;
* options pagesize = 26;

data thesis;
  input type phase service quarter cv sv;
  %include buckdon;

proc glm;
  class phase service quarter type;

  model cv = phase
          service(phase)
          quarter(service phase)
          type(quarter service phase);

run;
```

The SAS System

09:41 Monday, June 20, 1994¹

General Linear Models Procedure
Class Level Information

| Class | Levels | Values |
|---------|--------|---------|
| PHASE | 2 | 1 2 |
| SERVICE | 3 | 1 2 3 |
| QUARTER | 4 | 1 2 3 4 |
| TYPE | 2 | 1 2 |

Number of observations in data set = 969

The SAS System

09:41 Monday, June 20, 1994²

General Linear Models Procedure

Dependent Variable: CV

| Source | DF | Sum of Squares | Mean Square | F Value | Pr > F |
|-----------------|-----|----------------|-------------|---------|--------|
| Model | 46 | 18203.66065 | 395.73175 | 2.34 | 0.0001 |
| Error | 922 | 156144.44308 | 169.35406 | | |
| Corrected Total | 968 | 174348.10373 | | | |

| R-Square | C.V. | Root MSE | CV Mean |
|----------|-----------|----------|-----------|
| 0.104410 | -314.6066 | 13.01361 | -4.136471 |

| Source | DF | Type III SS | Mean Square | F Value | Pr > F |
|-----------------------|----|-------------|-------------|---------|--------|
| PHASE | 1 | 175.130787 | 175.130787 | 1.03 | 0.3095 |
| SERVICE (PHASE) | 4 | 916.420171 | 229.105043 | 1.35 | 0.2485 |
| QUARTE (PHASE*SERVIC) | 18 | 5634.590389 | 313.032799 | 1.85 | 0.0168 |
| TYPE (PHAS*SERV*QUAR) | 23 | 4892.459283 | 212.715621 | 1.26 | 0.1881 |

**Appendix D: Schedule Variance
SAS Programs and SAS Outputs**

```
options linesize = 78;  
* options pagesize = 26;  
  
data thesis;  
  input type phase  service  quarter  cv sv;  
%include buckdon;  
  
proc glm;  
  class phase type quarter service;  
  
  model sv = phase  
          type(phase)  
          quarter(type phase)  
          service(quarter type phase);  
  
  means phase  
         type(phase)  
         quarter(type phase)  
         service(quarter type phase);  
  
  output out=check p=svhat student=sresid;  
  
  proc plot data=check;  
  plot sresid*svhat;  
  
  proc univariate data=check plot normal;  
  var sresid;  
run;
```

The SAS System

09:38 Monday, June 20, 1994¹

General Linear Models Procedure
Class Level Information

| Class | Levels | Values |
|---------|--------|---------|
| PHASE | 2 | 1 2 |
| TYPE | 2 | 1 2 |
| QUARTER | 4 | 1 2 3 4 |
| SERVICE | 3 | 1 2 3 |

Number of observations in data set = 969

General Linear Models Procedure

Dependent Variable: SV

| Source | DF | Sum of Squares | Mean Square | F Value | Pr > F |
|-----------------|----------|----------------|-------------|---------|-----------|
| Model | 46 | 22869.39862 | 497.16084 | 4.32 | 0.0001 |
| Error | 922 | 106169.86957 | 115.15170 | | |
| Corrected Total | 968 | 129039.26820 | | | |
| | R-Square | C.V. | Root MSE | | SV Mean |
| | 0.177228 | -166.4754 | 10.73088 | | -6.445924 |

| Source | DF | Type III SS | Mean Square | F Value | Pr > F |
|-----------------------|----|-------------|-------------|---------|--------|
| PHASE | 1 | 65.85931 | 65.85931 | 0.57 | 0.4497 |
| TYPE (PHASE) | 2 | 118.47127 | 59.23563 | 0.51 | 0.5980 |
| QUARTER (PHASE*TYPE) | 12 | 5895.80977 | 491.31748 | 4.27 | 0.0001 |
| SERV (PHAS*TYPE*QUAR) | 31 | 17271.74601 | 557.15310 | 4.84 | 0.0001 |

Univariate Procedure

Variable=SRESID

Moments

| | | | |
|----------|----------|----------|----------|
| N | 967 | Sum Wgts | 967 |
| Mean | 0 | Sum | 0 |
| Std Dev | 0.99672 | Variance | 0.99345 |
| Skewness | 1.471944 | Kurtosis | 25.2061 |
| USS | 959.673 | CSS | 959.673 |
| CV | . | Std Mean | 0.032052 |
| T:Mean=0 | 0 | Pr> T | 1.0000 |
| Num ^= 0 | 967 | Num > 0 | 538 |
| M(Sign) | 54.5 | Pr>= M | 0.0005 |
| Sgn Rank | 16916 | Pr>= S | 0.0515 |
| W:Normal | 0.85069 | Pr<W | 0.0001 |

Quantiles (Def=5)

| | | | |
|----------|----------|-----|----------|
| 100% Max | 11.90275 | 99% | 2.538876 |
| 75% Q3 | 0.36208 | 95% | 1.188916 |
| 50% Med | 0.058465 | 90% | 0.84024 |
| 25% Q1 | -0.32099 | 10% | -0.97795 |
| 0% Min | -4.79576 | 5% | -1.55868 |
| | | 1% | -3.17607 |
| Range | 16.69851 | | |
| Q3-Q1 | 0.683075 | | |
| Mode | 0.054789 | | |

Extremes

| Lowest | Obs | Highest | Obs |
|-----------|------|-----------|------|
| -4.79576(| 59) | 4.222568(| 76) |
| -4.56414(| 154) | 4.642425(| 343) |
| -4.47046(| 58) | 4.73568(| 312) |
| -3.878(| 111) | 5.558747(| 172) |
| -3.84291(| 54) | 11.90275(| 117) |

| | |
|---------------|------|
| Missing Value | . |
| Count | 2 |
| % Count/Nobs | 0.21 |

Univariate Procedure

Variable=SRESID

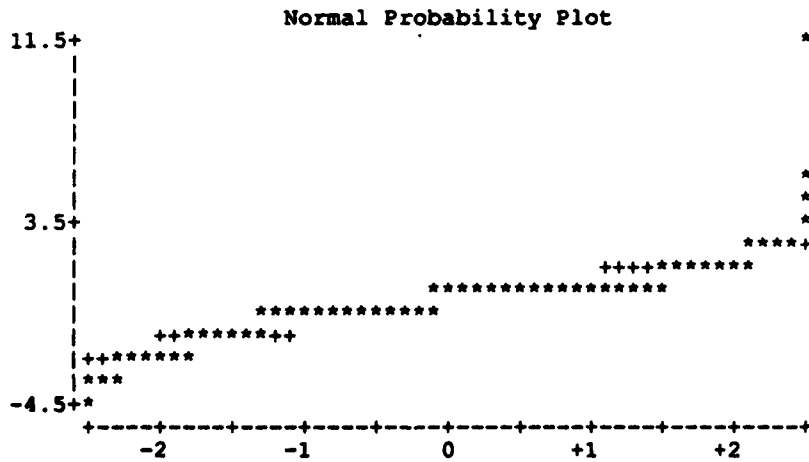
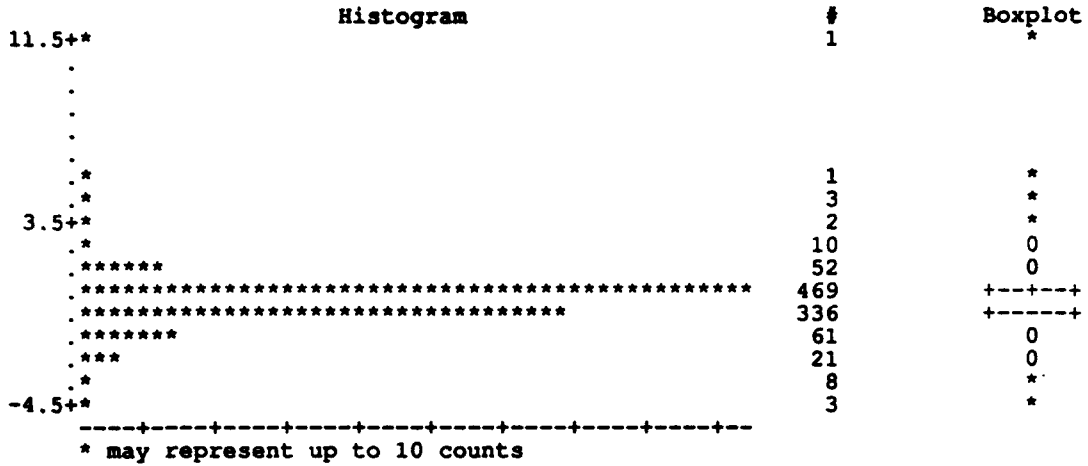

```
options linesize = 78;
* options pagesize = 26;

data thesis;
  input type phase service quarter cv sv;
  %include buckdon;

proc glm;
  class type service quarter phase;

  model sv = type
          service(type)
          quarter(service type)
          phase(quarter service type);

run;
```

The SAS System

09:39 Monday, June 20, 1994 ¹

General Linear Models Procedure
Class Level Information

| Class | Levels | Values |
|---------|--------|---------|
| TYPE | 2 | 1 2 |
| SERVICE | 3 | 1 2 3 |
| QUARTER | 4 | 1 2 3 4 |
| PHASE | 2 | 1 2 |

Number of observations in data set = 969

The SAS System

09:39 Monday, June 20, 1994 ²

General Linear Models Procedure

Dependent Variable: SV

| Source | DF | Sum of Squares | Mean Square | F Value | Pr > F |
|-----------------|----------|----------------|-------------|---------|-----------|
| Model | 46 | 22869.39862 | 497.16084 | 4.32 | 0.0001 |
| Error | 922 | 106169.86957 | 115.15170 | | |
| Corrected Total | 968 | 129039.26820 | | | |
| | R-Square | C.V. | Root MSE | | SV Mean |
| | 0.177228 | -166.4754 | 10.73088 | | -6.445924 |

| Source | DF | Type III SS | Mean Square | F Value | Pr > F |
|-----------------------|----|-------------|-------------|---------|--------|
| TYPE | 1 | 113.207600 | 113.207600 | 0.98 | 0.3217 |
| SERVICE (TYPE) | 4 | 1901.304449 | 475.326112 | 4.13 | 0.0025 |
| QUARTE (TYPE*SERVICE) | 18 | 4465.144698 | 248.063594 | 2.15 | 0.0035 |
| PHAS (TYPE*SERV*QUAR) | 23 | 1476.324084 | 64.188004 | 0.56 | 0.9546 |

```
options linesize = 78;
* options pagesize = 26;

data thesis;
  input type phase service quarter cv sv;
  %include buckdon;

proc glm;
  class phase service quarter type;

  model sv = phase
          service(phase)
          quarter(service phase)
          type(quarter service phase);

run;
```

The SAS System

09:40 Monday, June 20, 1994 ¹

General Linear Models Procedure
Class Level Information

| Class | Levels | Values |
|---------|--------|---------|
| PHASE | 2 | 1 2 |
| SERVICE | 3 | 1 2 3 |
| QUARTER | 4 | 1 2 3 4 |
| TYPE | 2 | 1 2 |

Number of observations in data set = 969

The SAS System

09:40 Monday, June 20, 1994 ²

General Linear Models Procedure

Dependent Variable: SV

| Source | DF | Sum of Squares | Mean Square | F Value | Pr > F |
|-----------------|----------|----------------|-------------|---------|-----------|
| Model | 46 | 22869.39862 | 497.16084 | 4.32 | 0.0001 |
| Error | 922 | 106169.86957 | 115.15170 | | |
| Corrected Total | 968 | 129039.26820 | | | |
| | R-Square | C.V. | Root MSE | | SV Mean |
| | 0.177228 | -166.4754 | 10.73088 | | -6.445924 |

| Source | DF | Type III SS | Mean Square | F Value | Pr > F |
|-----------------------|----|-------------|-------------|---------|--------|
| PHASE | 1 | 81.942356 | 81.942356 | 0.71 | 0.3991 |
| SERVICE (PHASE) | 4 | 2393.578465 | 598.394616 | 5.20 | 0.0004 |
| QUARTE (PHASE*SERVIC) | 18 | 4088.334459 | 227.129692 | 1.97 | 0.0091 |
| TYPE (PHAS*SERV*QUAR) | 23 | 3641.672129 | 158.333571 | 1.37 | 0.1122 |

```

options linesize = 78;
* options pagesize = 26;

data thesis;
  input type phase service quarter cv sv;
  %include buckdon;

proc glm;
  class phase type quarter service;
  model sv = phase
          type(phase)
          quarter(type phase)
          service(quarter type phase);

  contrast 'Dev, Cost Reimb, Q1'
    service(quarter type phase) 1 -1 0,
    service(quarter type phase) 1 0 -1;

  contrast 'Dev, Cost Reimb, Q2'
    service(quarter type phase) 0 0 0 1 -1 0,
    service(quarter type phase) 0 0 0 1 0 -1;

  contrast 'Dev, Cost Reimb, Q3'
    service(quarter type phase) 0 0 0 0 0 0 1 -1 0,
    service(quarter type phase) 0 0 0 0 0 0 1 0 -1;

  contrast 'Dev, Cost Reimb, Q4'
    service(quarter type phase) 0 0 0 0 0 0 0 0 1 -1 0,
    service(quarter type phase) 0 0 0 0 0 0 0 0 1 0 -1;

  contrast 'Dev, Fixed Price, Q1'
    service(quarter type phase) 0 0 0 0 0 0 0 0 0 0 0 0
    1 -1 0,
    service(quarter type phase) 0 0 0 0 0 0 0 0 0 0 0 0
    1 0 -1;

  contrast 'Dev, Fixed Price, Q2'
    service(quarter type phase) 0 0 0 0 0 0 0 0 0 0 0 0
    0 0 0 1 -1 0,
    service(quarter type phase) 0 0 0 0 0 0 0 0 0 0 0 0
    0 0 0 1 0 -1;

  contrast 'Dev, Fixed Price, Q3'
    service(quarter type phase) 0 0 0 0 0 0 0 0 0 0 0 0
    0 0 0 0 0 0 1 -1 0,
    service(quarter type phase) 0 0 0 0 0 0 0 0 0 0 0 0
    0 0 0 0 0 0 1 0 -1;

  contrast 'Dev, Fixed Price, Q4'
    service(quarter type phase) 0 0 0 0 0 0 0 0 0 0 0 0
    0 0 0 0 0 0 0 0 0 1 -1 0,
    service(quarter type phase) 0 0 0 0 0 0 0 0 0 0 0 0
    0 0 0 0 0 0 0 0 0 1 0 -1;

  contrast 'Prod, Cost Reimb, Q1'
    service(quarter type phase) 0 0 0 0 0 0 0 0 0 0 0 0
    0 0 0 0 0 0 0 0 0 0 0 0
    1 -1;

  contrast 'Prod, Cost Reimb, Q2'
    service(quarter type phase) 0 0 0 0 0 0 0 0 0 0 0 0
    0 0 0 0 0 0 0 0 0 0 0 0
    0 0 1 -1 0,
    service(quarter type phase) 0 0 0 0 0 0 0 0 0 0 0 0
    0 0 0 0 0 0 0 0 0 0 0 0
    0 0 1 0 -1;

```

```

contrast 'Prod, Cost Reimb, Q3'
  service(quarter type phase) 0 0 0 0 0 0 0 0 0 0 0 0
                                0 0 0 0 0 0 0 0 0 0 0 0
                                0 0 0 0 0 1 -1 0,
  service(quarter type phase) 0 0 0 0 0 0 0 0 0 0 0 0
                                0 0 0 0 0 0 0 0 0 0 0 0
                                0 0 0 0 0 1 0 -1;

contrast 'Prod, Cost Reimb, Q4'
  service(quarter type phase) 0 0 0 0 0 0 0 0 0 0 0 0
                                0 0 0 0 0 0 0 0 0 0 0 0
                                0 0 0 0 0 0 0 0 1 -1 0,
  service(quarter type phase) 0 0 0 0 0 0 0 0 0 0 0 0
                                0 0 0 0 0 0 0 0 0 0 0 0
                                0 0 0 0 0 0 0 0 1 0 -1;

contrast 'Pro, Fixed Price, Q1'
  service(quarter type phase) 0 0 0 0 0 0 0 0 0 0 0 0
                                0 0 0 0 0 0 0 0 0 0 0 0
                                0 0 0 0 0 0 0 0 0 0 0 0
                                1 -1 0,
  service(quarter type phase) 0 0 0 0 0 0 0 0 0 0 0 0
                                0 0 0 0 0 0 0 0 0 0 0 0
                                0 0 0 0 0 0 0 0 0 0 0 0
                                1 0 -1;

contrast 'Pro, Fixed Price, Q2'
  service(quarter type phase) 0 0 0 0 0 0 0 0 0 0 0 0
                                0 0 0 0 0 0 0 0 0 0 0 0
                                0 0 0 0 0 0 0 0 0 0 0 0
                                0 0 0 1 -1 0,
  service(quarter type phase) 0 0 0 0 0 0 0 0 0 0 0 0
                                0 0 0 0 0 0 0 0 0 0 0 0
                                0 0 0 0 0 0 0 0 0 0 0 0
                                0 0 0 1 0 -1;

contrast 'Pro, Fixed Price, Q3'
  service(quarter type phase) 0 0 0 0 0 0 0 0 0 0 0 0
                                0 0 0 0 0 0 0 0 0 0 0 0
                                0 0 0 0 0 0 0 0 0 0 0 0
                                0 0 0 0 0 0 1 -1 0,
  service(quarter type phase) 0 0 0 0 0 0 0 0 0 0 0 0
                                0 0 0 0 0 0 0 0 0 0 0 0
                                0 0 0 0 0 0 0 0 0 0 0 0
                                0 0 0 0 0 0 1 0 -1;

contrast 'Pro, Fixed Price, Q4'
  service(quarter type phase) 0 0 0 0 0 0 0 0 0 0 0 0
                                0 0 0 0 0 0 0 0 0 0 0 0
                                0 0 0 0 0 0 0 0 0 0 0 0
                                0 0 0 0 0 0 0 0 0 1 -1 0,
  service(quarter type phase) 0 0 0 0 0 0 0 0 0 0 0 0
                                0 0 0 0 0 0 0 0 0 0 0 0
                                0 0 0 0 0 0 0 0 0 0 0 0
                                0 0 0 0 0 0 0 0 0 1 0 -1;

```

run;

The SAS System

09:41 Monday, June 20, 1994 ¹

General Linear Models Procedure
Class Level Information

| Class | Levels | Values |
|---------|--------|---------|
| PHASE | 2 | 1 2 |
| TYPE | 2 | 1 2 |
| QUARTER | 4 | 1 2 3 4 |
| SERVICE | 3 | 1 2 3 |

Number of observations in data set = 969

General Linear Models Procedure

Dependent Variable: SV

| Source | DF | Sum of Squares | Mean Square | F Value | Pr > F |
|-----------------|----------|----------------|-------------|---------|-----------|
| Model | 46 | 22869.39862 | 497.16084 | 4.32 | 0.0001 |
| Error | 922 | 106169.86957 | 115.15170 | | |
| Corrected Total | 968 | 129039.26820 | | | |
| | R-Square | C.V. | Root MSE | | SV Mean |
| | 0.177228 | -166.4754 | 10.73088 | | -6.445924 |

| Source | DF | Type III SS | Mean Square | F Value | Pr > F |
|-----------------------|----|-------------|-------------|---------|--------|
| PHASE | 1 | 65.85931 | 65.85931 | 0.57 | 0.4497 |
| TYPE (PHASE) | 2 | 118.47127 | 59.23563 | 0.51 | 0.5980 |
| QUARTER (PHASE*TYPE) | 12 | 5895.80977 | 491.31748 | 4.27 | 0.0001 |
| SERV (PHAS*TYPE*QUAR) | 31 | 17271.74601 | 557.15310 | 4.84 | 0.0001 |
| Contrast | DF | Contrast SS | Mean Square | F Value | Pr > F |
| Dev, Cost Reimb, Q1 | 2 | 100.230436 | 50.115218 | 0.44 | 0.6473 |
| Dev, Cost Reimb, Q2 | 2 | 130.658553 | 65.329277 | 0.57 | 0.5672 |
| Dev, Cost Reimb, Q3 | 2 | 171.897253 | 85.948626 | 0.75 | 0.4744 |
| Dev, Cost Reimb, Q4 | 2 | 80.516299 | 40.258149 | 0.35 | 0.7051 |
| Dev, Fixed Price, Q1 | 2 | 114.354968 | 57.177484 | 0.50 | 0.6088 |
| Dev, Fixed Price, Q2 | 2 | 73.368823 | 36.684412 | 0.32 | 0.7273 |
| Dev, Fixed Price, Q3 | 2 | 75.644503 | 37.822251 | 0.33 | 0.7201 |
| Dev, Fixed Price, Q4 | 2 | 0.713842 | 0.356921 | 0.00 | 0.9969 |
| Prod, Cost Reimb, Q1 | 1 | 12.662862 | 12.662862 | 0.11 | 0.7403 |
| Prod, Cost Reimb, Q2 | 2 | 133.407473 | 66.703736 | 0.58 | 0.5605 |
| Prod, Cost Reimb, Q3 | 2 | 20.525829 | 10.262914 | 0.09 | 0.9147 |
| Prod, Cost Reimb, Q4 | 2 | 14.064525 | 7.032263 | 0.06 | 0.9408 |
| Pro, Fixed Price, Q1 | 2 | 7428.654220 | 3714.327110 | 32.26 | 0.0001 |
| Pro, Fixed Price, Q2 | 2 | 5826.269202 | 2913.134601 | 25.30 | 0.0001 |
| Pro, Fixed Price, Q3 | 2 | 2976.429772 | 1488.214886 | 12.92 | 0.0001 |
| Pro, Fixed Price, Q4 | 2 | 112.347453 | 56.173727 | 0.49 | 0.6141 |

```

options linesize = 78;
* options pagesize = 26;

data thesis;
input type phase service quarter cv sv;
%include buckdon;

proc glm;
class phase type quarter service;
model sv = phase
      type(phase)
      quarter(type phase)
      service(quarter type phase);

contrast 'Dev, Cost Reimb, Q1'
      service(quarter type phase) 1 -1 0,
      service(quarter type phase) 1 0 -1;

contrast 'Dev, Cost Reimb, Q2'
      service(quarter type phase) 0 0 0 1 -1 0,
      service(quarter type phase) 0 0 0 1 0 -1;

contrast 'Dev, Cost Reimb, Q3'
      service(quarter type phase) 0 0 0 0 0 0 1 -1 0,
      service(quarter type phase) 0 0 0 0 0 0 1 0 -1;

contrast 'Dev, Cost Reimb, Q4'
      service(quarter type phase) 0 0 0 0 0 0 0 0 1 -1 0,
      service(quarter type phase) 0 0 0 0 0 0 0 0 1 0 -1;

contrast 'Dev, Fixed Price, Q1'
      service(quarter type phase) 0 0 0 0 0 0 0 0 0 0 0
      1 -1 0,
      service(quarter type phase) 0 0 0 0 0 0 0 0 0 0 0
      1 0 -1;

contrast 'Dev, Fixed Price, Q2'
      service(quarter type phase) 0 0 0 0 0 0 0 0 0 0 0
      0 0 0 1 -1 0,
      service(quarter type phase) 0 0 0 0 0 0 0 0 0 0 0
      0 0 0 1 0 -1;

contrast 'Dev, Fixed Price, Q3'
      service(quarter type phase) 0 0 0 0 0 0 0 0 0 0 0
      0 0 0 0 0 0 1 -1 0,
      service(quarter type phase) 0 0 0 0 0 0 0 0 0 0 0
      0 0 0 0 0 0 1 0 -1;

contrast 'Dev, Fixed Price, Q4'
      service(quarter type phase) 0 0 0 0 0 0 0 0 0 0 0
      0 0 0 0 0 0 0 0 0 1 -1 0,
      service(quarter type phase) 0 0 0 0 0 0 0 0 0 0 0
      0 0 0 0 0 0 0 0 0 1 0 -1;

contrast 'Prod, Cost Reimb, Q1'
      service(quarter type phase) 0 0 0 0 0 0 0 0 0 0 0
      0 0 0 0 0 0 0 0 0 0 0
      1 -1;

contrast 'Prod, Cost Reimb, Q2'
      service(quarter type phase) 0 0 0 0 0 0 0 0 0 0 0
      0 0 0 0 0 0 0 0 0 0 0
      0 0 1 -1 0,
      service(quarter type phase) 0 0 0 0 0 0 0 0 0 0 0
      0 0 0 0 0 0 0 0 0 0 0
      0 0 1 0 -1;

```

```

contrast 'Prod, Cost Reimb, Q3'
  service(quarter type phase) 0 0 0 0 0 0 0 0 0 0 0 0
                                0 0 0 0 0 0 0 0 0 0 0 0
                                0 0 0 0 0 1 -1 0,
  service(quarter type phase) 0 0 0 0 0 0 0 0 0 0 0 0
                                0 0 0 0 0 0 0 0 0 0 0 0
                                0 0 0 0 0 1 0 -1;

contrast 'Prod, Cost Reimb, Q4'
  service(quarter type phase) 0 0 0 0 0 0 0 0 0 0 0 0
                                0 0 0 0 0 0 0 0 0 0 0 0
                                0 0 0 0 0 0 0 0 1 -1 0,
  service(quarter type phase) 0 0 0 0 0 0 0 0 0 0 0 0
                                0 0 0 0 0 0 0 0 0 0 0 0
                                0 0 0 0 0 0 0 0 1 0 -1;

contrast 'Pro, Fixed Price, Q1'
  service(quarter type phase) 0 0 0 0 0 0 0 0 0 0 0 0
                                0 0 0 0 0 0 0 0 0 0 0 0
                                0 0 0 0 0 0 0 0 0 0 0 0
  service(quarter type phase) 1 -1 0,
                                0 0 0 0 0 0 0 0 0 0 0 0
                                0 0 0 0 0 0 0 0 0 0 0 0
                                0 0 0 0 0 0 0 0 0 0 0 0
                                1 0 -1;

estimate 'USAF vs USA, 1st Qtr'
  service(quarter type phase) 0 0 0 0 0 0 0 0 0 0 0 0
                                0 0 0 0 0 0 0 0 0 0 0 0
                                0 0 0 0 0 0 0 0 0 0 0 0
  service(quarter type phase) 1 -1 0;

estimate 'USAF vs USN, 1st Qtr'
  service(quarter type phase) 0 0 0 0 0 0 0 0 0 0 0 0
                                0 0 0 0 0 0 0 0 0 0 0 0
                                0 0 0 0 0 0 0 0 0 0 0 0
  service(quarter type phase) 1 0 -1;

estimate 'USA vs USN, 1st Qtr'
  service(quarter type phase) 0 0 0 0 0 0 0 0 0 0 0 0
                                0 0 0 0 0 0 0 0 0 0 0 0
                                0 0 0 0 0 0 0 0 0 0 0 0
  service(quarter type phase) 0 1 -1;

contrast 'Pro, Fixed Price, Q2'
  service(quarter type phase) 0 0 0 0 0 0 0 0 0 0 0 0
                                0 0 0 0 0 0 0 0 0 0 0 0
                                0 0 0 0 0 0 0 0 0 0 0 0
  service(quarter type phase) 0 0 0 1 -1 0,
                                0 0 0 0 0 0 0 0 0 0 0 0
                                0 0 0 0 0 0 0 0 0 0 0 0
                                0 0 0 0 0 0 0 0 0 0 0 0
                                0 0 0 1 0 -1;

estimate 'USAF vs USA, 2nd Qtr'
  service(quarter type phase) 0 0 0 0 0 0 0 0 0 0 0 0
                                0 0 0 0 0 0 0 0 0 0 0 0
                                0 0 0 0 0 0 0 0 0 0 0 0
  service(quarter type phase) 0 0 0 1 -1 0;

estimate 'USAF vs USN, 2nd Qtr'
  service(quarter type phase) 0 0 0 0 0 0 0 0 0 0 0 0
                                0 0 0 0 0 0 0 0 0 0 0 0
                                0 0 0 0 0 0 0 0 0 0 0 0
  service(quarter type phase) 0 0 0 1 0 -1;

estimate 'USA vs USN, 2nd Qtr'

```



```

service(quarter type phase) 0 0 0 0 0 0 0 0 0 0 0 0
0 0 0 0 0 0 0 0 0 0 0 0
0 0 0 0 0 0 0 0 0 0 0 0
0 0 0 0 1 -1;

contrast 'Pro, Fixed Price, Q3'
service(quarter type phase) 0 0 0 0 0 0 0 0 0 0 0 0
0 0 0 0 0 0 0 0 0 0 0 0
0 0 0 0 0 0 0 0 0 0 0 0
0 0 0 0 0 0 1 -1 0,
service(quarter type phase) 0 0 0 0 0 0 0 0 0 0 0 0
0 0 0 0 0 0 0 0 0 0 0 0
0 0 0 0 0 0 0 0 0 0 0 0
0 0 0 0 0 0 1 0 -1;

estimate 'USAF vs USA, 3rd Qtr'
service(quarter type phase) 0 0 0 0 0 0 0 0 0 0 0 0
0 0 0 0 0 0 0 0 0 0 0 0
0 0 0 0 0 0 0 0 0 0 0 0
0 0 0 0 0 0 1 -1 0;

estimate 'USAF vs USN, 3rd Qtr'
service(quarter type phase) 0 0 0 0 0 0 0 0 0 0 0 0
0 0 0 0 0 0 0 0 0 0 0 0
0 0 0 0 0 0 0 0 0 0 0 0
0 0 0 0 0 0 1 0 -1;

estimate 'USA vs USN, 3rd Qtr'
service(quarter type phase) 0 0 0 0 0 0 0 0 0 0 0 0
0 0 0 0 0 0 0 0 0 0 0 0
0 0 0 0 0 0 0 0 0 0 0 0
0 0 0 0 0 0 0 1 -1;

contrast 'Pro, Fixed Price, Q4'
service(quarter type phase) 0 0 0 0 0 0 0 0 0 0 0 0
0 0 0 0 0 0 0 0 0 0 0 0
0 0 0 0 0 0 0 0 0 0 0 0
0 0 0 0 0 0 0 0 0 1 -1 0,
service(quarter type phase) 0 0 0 0 0 0 0 0 0 0 0 0
0 0 0 0 0 0 0 0 0 0 0 0
0 0 0 0 0 0 0 0 0 0 0 0
0 0 0 0 0 0 0 0 0 1 0 -1;

* output out=check p=cvhat student=sresid;
*
* proc plot data=check;
* plot sresid*cvhat;
*
* proc univariate data=check plot normal;
* var sresid;
run;

```

The SAS System

09:42 Monday, June 20, 1994¹

General Linear Models Procedure
Class Level Information

| Class | Levels | Values |
|---------|--------|---------|
| PHASE | 2 | 1 2 |
| TYPE | 2 | 1 2 |
| QUARTER | 4 | 1 2 3 4 |
| SERVICE | 3 | 1 2 3 |

Number of observations in data set = 969

General Linear Models Procedure

Dependent Variable: SV

| Source | DF | Sum of Squares | Mean Square | F Value | Pr > F |
|-----------------|----------|----------------|-------------|---------|-----------|
| Model | 46 | 22869.39862 | 497.16084 | 4.32 | 0.0001 |
| Error | 922 | 106169.86957 | 115.15170 | | |
| Corrected Total | 968 | 129039.26820 | | | |
| | R-Square | C.V. | Root MSE | | SV Mean |
| | 0.177228 | -166.4754 | 10.73088 | | -6.445924 |

| Source | DF | Type III SS | Mean Square | F Value | Pr > F |
|-----------------------|----|-------------|-------------|---------|--------|
| PHASE | 1 | 65.85931 | 65.85931 | 0.57 | 0.4497 |
| TYPE (PHASE) | 2 | 118.47127 | 59.23563 | 0.51 | 0.5980 |
| QUARTER (PHASE*TYPE) | 12 | 5895.80977 | 491.31748 | 4.27 | 0.0001 |
| SERV (PHAS*TYPE*QUAR) | 31 | 17271.74601 | 557.15310 | 4.84 | 0.0001 |
| Contrast | DF | Contrast SS | Mean Square | F Value | Pr > F |
| Dev, Cost Reimb, Q1 | 2 | 100.230436 | 50.115218 | 0.44 | 0.6473 |
| Dev, Cost Reimb, Q2 | 2 | 130.658553 | 65.329277 | 0.57 | 0.5672 |
| Dev, Cost Reimb, Q3 | 2 | 171.897253 | 85.948626 | 0.75 | 0.4744 |
| Dev, Cost Reimb, Q4 | 2 | 80.516299 | 40.258149 | 0.35 | 0.7051 |
| Dev, Fixed Price, Q1 | 2 | 114.354968 | 57.177484 | 0.50 | 0.6088 |
| Dev, Fixed Price, Q2 | 2 | 73.368823 | 36.684412 | 0.32 | 0.7273 |
| Dev, Fixed Price, Q3 | 2 | 75.644503 | 37.822251 | 0.33 | 0.7201 |
| Dev, Fixed Price, Q4 | 2 | 0.713842 | 0.356921 | 0.00 | 0.9969 |
| Prod, Cost Reimb, Q1 | 1 | 12.662862 | 12.662862 | 0.11 | 0.7403 |
| Prod, Cost Reimb, Q2 | 2 | 133.407473 | 66.703736 | 0.58 | 0.5605 |
| Prod, Cost Reimb, Q3 | 2 | 20.525829 | 10.262914 | 0.09 | 0.9147 |
| Prod, Cost Reimb, Q4 | 2 | 14.064525 | 7.032263 | 0.06 | 0.9408 |
| Pro, Fixed Price, Q1 | 2 | 7428.654220 | 3714.327110 | 32.26 | 0.0001 |
| Pro, Fixed Price, Q2 | 2 | 5826.269202 | 2913.134601 | 25.30 | 0.0001 |
| Pro, Fixed Price, Q3 | 2 | 2976.429772 | 1488.214886 | 12.92 | 0.0001 |
| Pro, Fixed Price, Q4 | 2 | 112.347453 | 56.173727 | 0.49 | 0.6141 |

| Parameter | Estimate | T for H0: Parameter=0 | Pr > T | Std Error of Estimate |
|----------------------|-------------|--------------------------|---------|--------------------------|
| USAF vs USA, 1st Qtr | 3.0119790 | 1.18 | 0.2368 | 2.54441471 |
| USAF vs USN, 1st Qtr | -17.7150776 | -6.89 | 0.0001 | 2.57213115 |
| USA vs USN, 1st Qtr | -20.7270567 | -7.29 | 0.0001 | 2.84311610 |

General Linear Models Procedure

Dependent Variable: SV

| Parameter | Estimate | T for H0: Parameter=0 | Pr > T | Std Error of Estimate |
|----------------------|-------------|--------------------------|---------|--------------------------|
| USAF vs USA, 2nd Qtr | 12.1921969 | 5.11 | 0.0001 | 2.38745581 |
| USAF vs USN, 2nd Qtr | -5.3339802 | -2.53 | 0.0115 | 2.10604140 |
| USA vs USN, 2nd Qtr | -17.5261771 | -7.06 | 0.0001 | 2.48286272 |
| USAF vs USA, 3rd Qtr | 9.4537732 | 4.05 | 0.0001 | 2.33651317 |
| USAF vs USN, 3rd Qtr | -2.5875589 | -1.31 | 0.1891 | 1.96905096 |
| USA vs USN, 3rd Qtr | -12.0413321 | -4.98 | 0.0001 | 2.41805913 |

**Appendix E: Bartlett Test Results
and Related Scatter Plots**

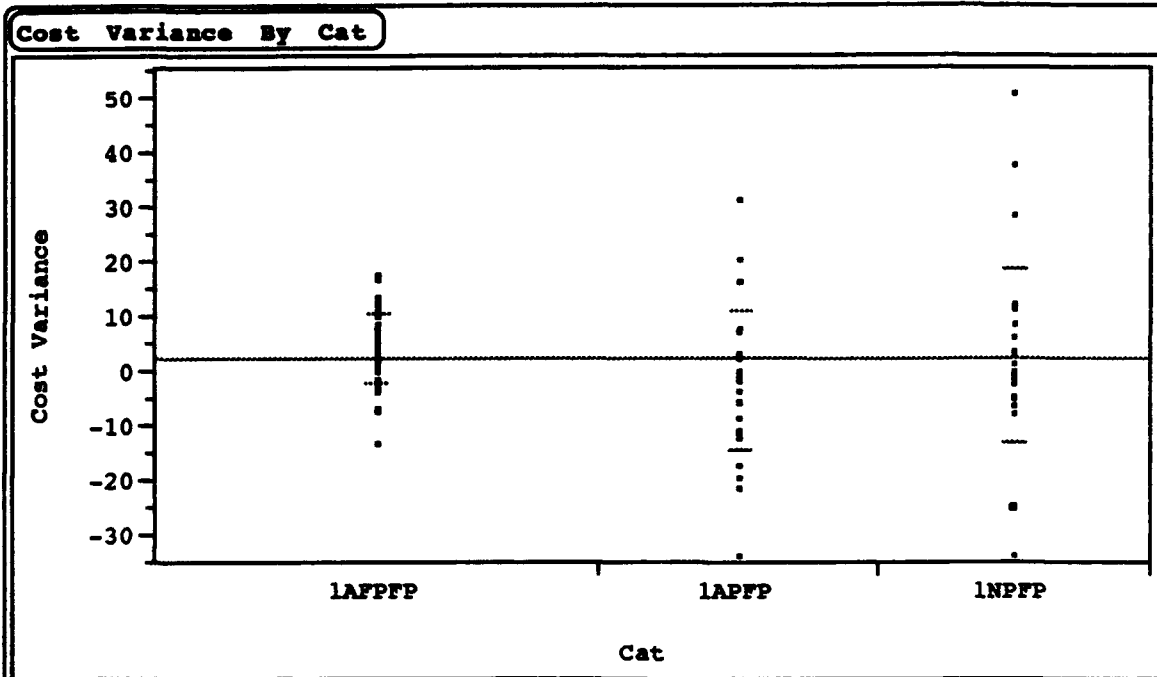

Tests that the Variances are Equal

| Level | Count | Std Dev | MeanAbsDif to Mean | MeanAbsDif to Median |
|--------|-------|----------|--------------------|----------------------|
| 1AFPPF | 46 | 6.40591 | 4.911957 | 4.911957 |
| 1APFP | 29 | 12.67427 | 8.796908 | 8.502069 |
| 1NFPF | 28 | 16.03863 | 9.984898 | 9.337143 |

| Test | F Ratio | DF Num | DF Den | Prob>F |
|----------------|---------|--------|--------|-----------|
| O'Brien[.5] | 3.7198 | 2 | 100 | 0.0276557 |
| Brown-Forsythe | 2.6112 | 2 | 100 | 0.0784510 |
| Levene | 3.6981 | 2 | 100 | 0.0282189 |
| Bartlett | 14.6636 | 2 | . | 0.0000004 |

Welch Anova testing Means Equal, allowing Std's Not Equal

| F Ratio | DF Num | DF Den | Prob>F |
|---------|--------|--------|--------|
| 2.9995 | 2 | 44.718 | 0.0599 |

1AFPPF means 1st Quarter, Air Force, Production, Fixed Price

1APFP means 1st Quarter, Army, Production, Fixed Price

1NFPF means 1st Quarter, Navy, Production, Fixed Price

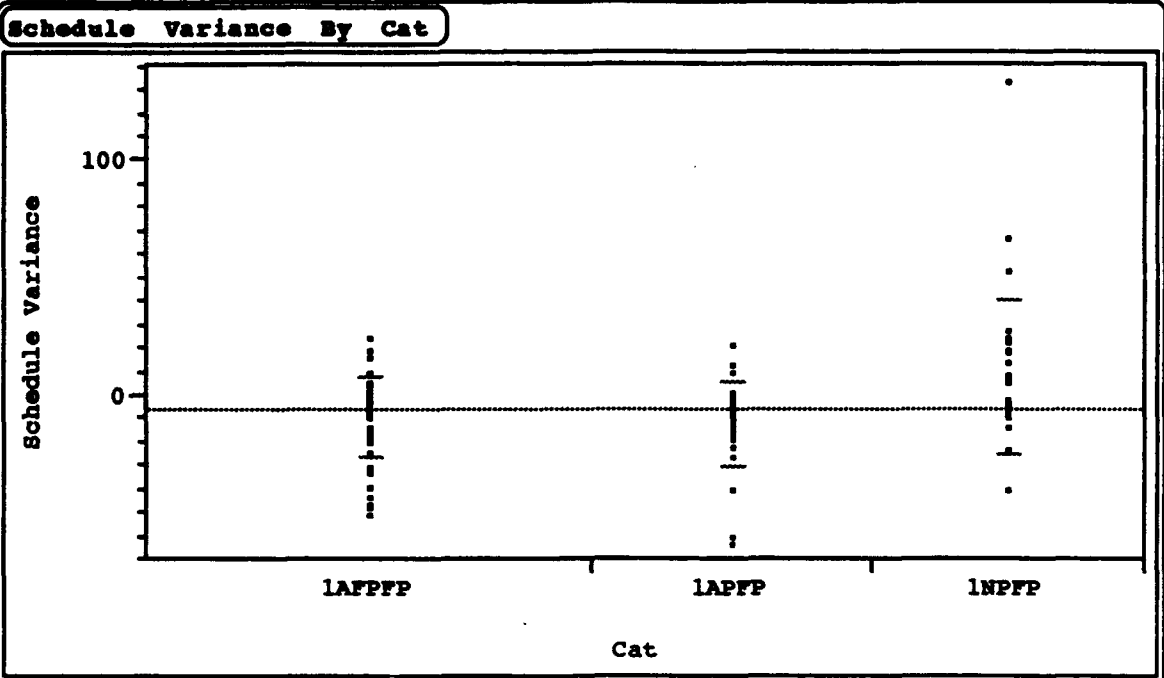

Tests that the Variances are Equal

| Level | Count | Std Dev | MeanAbsDif to Mean | MeanAbsDif to Median |
|--------|-------|----------|--------------------|----------------------|
| 1AFPPF | 46 | 17.14911 | 13.26665 | 12.40304 |
| 1APFP | 29 | 18.35469 | 12.92076 | 12.74759 |
| 1NPFP | 28 | 33.08671 | 21.84883 | 20.26179 |

| Test | F Ratio | DF Num | DF Den | Prob>F |
|----------------|---------|--------|--------|-----------|
| O'Brien[.5] | 2.1662 | 2 | 100 | 0.1199581 |
| Brown-Forsythe | 1.7987 | 2 | 100 | 0.1708218 |
| Levene | 2.9917 | 2 | 100 | 0.0547128 |
| Bartlett | 8.9397 | 2 | . | 0.0001311 |

| Welch Anova testing Means Equal, allowing Std's Not Equal | | | | |
|---|--------|--------|--------|--|
| F Ratio | DF Num | DF Den | Prob>F | |
| 4.2796 | 2 | 52.678 | 0.0190 | |

1AFPPF means 1st Quarter, Air Force, Production, Fixed Price
 1APFP means 1st Quarter, Army, Production, Fixed Price
 1NPFP means 1st Quarter, Navy, Production, Fixed Price

Cost Variance By Cat

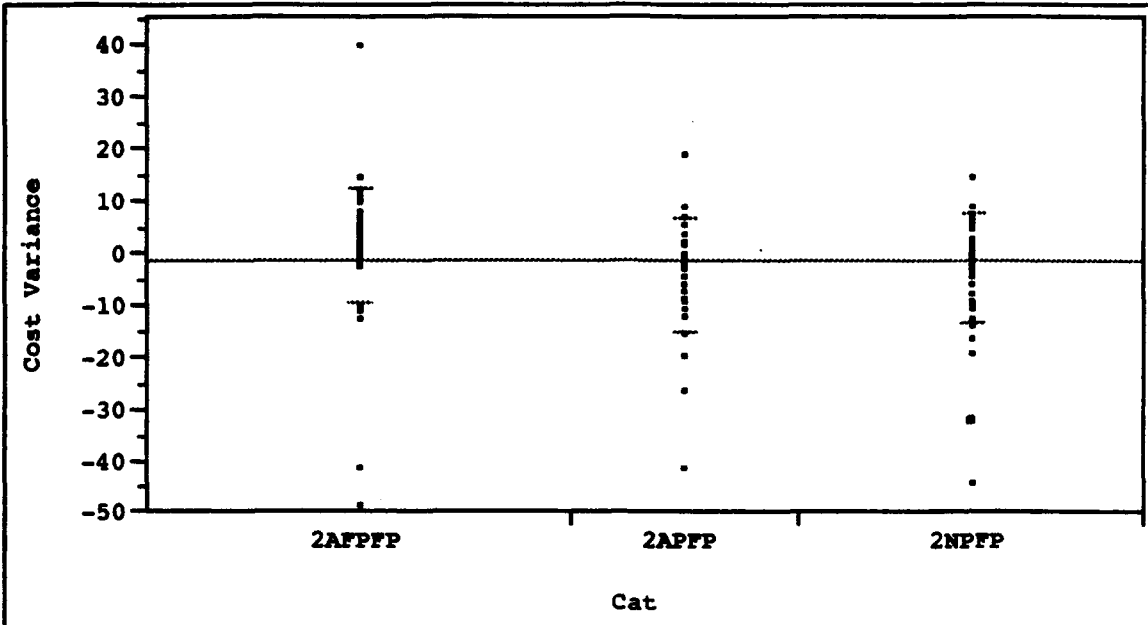

Tests that the Variances are Equal

| Level | Count | Std Dev | MeanAbsDif to Mean | MeanAbsDif to Median |
|-------|-------|----------|--------------------|----------------------|
| 2AFPP | 58 | 11.23464 | 5.614203 | 5.574655 |
| 2APFP | 31 | 11.24569 | 8.018273 | 7.709677 |
| 2NPFP | 47 | 10.64134 | 7.171236 | 7.123191 |

| Test | F Ratio | DF Num | DF Den | Prob>F |
|----------------|---------|--------|--------|-----------|
| O'Brien[.5] | 0.0198 | 2 | 133 | 0.9803550 |
| Brown-Forsythe | 0.7179 | 2 | 133 | 0.4896406 |
| Levene | 0.8860 | 2 | 133 | 0.4147157 |
| Bartlett | 0.0877 | 2 | | 0.9160201 |

Welch Anova testing Means Equal, allowing Std's Not Equal

| F Ratio | DF Num | DF Den | Prob>F |
|---------|--------|--------|--------|
| 3.2644 | 2 | 76.094 | 0.0436 |

2AFPP means 2nd Quarter, Air Force, Production, Fixed Price

2APFP means 2nd Quarter, Army, Production, Fixed Price

2NPFP means 2nd Quarter, Navy, Production, Fixed Price

Bibliography

- Abba, Wayne. "Cost/Schedule Control Systems Criteria White Paper," Program Manager, 15: 45-47 (November-December 1986).
- Beach, Chester Paul Jr. Inquiry Officer. Memorandum for the Secretary of the Navy, Subj: A-12 Administrative Inquiry. Department of the Navy, Washington DC, 28 November 1990.
- Christensen, David S. "An Analysis of Cost Overruns on Defense Acquisition Contracts," Project Management Journal XXIV: 43-48, September 1993.
- Christensen, David S. Control and Analysis of Performance Measurement Data. Department of System Acquisition Management, Air Force Institute of Technology (AU), Wright-Patterson AFB OH, January 1992.
- Cole, Jeff. "New F-22 Funding Cuts May Increase Jet Fighter's Final Tab by \$700 Million," The Wall Street Journal, 4 January 1994, sec. A:3.
- Department of the Air Force. Cost/Schedule Control Systems Criteria Joint Implementation Guide. AFMCP 173-5. Washington: HQ USAF, 1 October 1987.
- Department of the Air Force, Air Force Institute of Technology. Compendium of Authenticated Systems and Logistics Terms, Definitions and Acronyms. Wright-Patterson AFB OH, April 1981.
- Department of Defense, Defense Systems Management College. Glossary of Defense Acquisition Acronyms and Terms (Fifth Edition). Fort Belvoir VA, September 1991.
- Department of Defense, Defense Acquisition Management Policies and Procedures. DoD Instruction 5000.2. Washington: GPO, 23 February 1991.
- Fleming, Quentin W. Cost/Schedule Control Systems Criteria. Chicago IL: Probus Publishing Company, 1988.
- Gansler, Jacques S. Affording Defense. Cambridge MA: The MIT Press, 1989.

- Horngren, Charles T., George Foster, and Srikant M. Datar. Cost Accounting: A Managerial Emphasis. Englewood Cliffs NJ: Prentice Hall, 1994.
- Keyes, W. Noel. Keyes Encyclopedic Dictionary of Contract and Procurement Law (Fourth Edition). New York: Oceana Publications, Inc., March 1987.
- Knepp, Richard E. and Michael E. Stroble. Development of Standardized S Curves for the Evaluation of Major Department of Defense Purchases MS thesis, AFIT/GCA/LAS/93S-7 School of Systems and Logistics, Air Force Institute of Technology (AU), Wright-Patterson AFB OH, September 1993. (AD-A273963).
- Peck, Merton J. and Frederic M. Scherer. The Weapons Acquisition Process: An Economic Analysis. Boston MA: Harvard University, 1962.
- SAS Institute. JMP Statistics and Graphics Guide. Cary NC: SAS Institute. Inc., 1994
- Scherer, Frederic M.. The Weapons Acquisition Process: Economic Incentives. Boston MA: Harvard University, 1964.
- Shapiro, S. S. and M. B. Wilk. "An Analysis of Variance Test for Normality (complete samples)," Biometrika, 52: 591-611.
- Smith, Bruce A. "Douglas Clears Final Hurdles for Completing C-17 Transport," Aviation Week & Space Technology, 133: 36-39 (3 December 1990).
- Terry Mark F. and Mary M. Vanderburgh. An Analysis of Estimate at Completion Models Utilizing the Defense Acquisition Executive Summary Database. MS thesis, AFIT/GCA/LAS/93S-9. School of Systems and Logistics, Air Force Institute of Technology (AU), Wright-Patterson AFB OH, September 1993. (AD-A275914).
- Velocci, Anthony L. "C-17 Termination Could be Mixed Blessing for Builder," Aviation Week & Space Technology, 138: 39 (22 March 1993).
- Watkins, Steven. "C-17 has more problems," Air Force Times, 17: 2 (29 November 1993).
- Websters's Third New International Dictionary (Unabridged). Springfield MA: G. & C. Merriam, 1971.

Wilson, Brian D. An Analysis of Contract Cost Overruns and Their Impacts. MS thesis, AFIT/GCA/LSY/92S-8. School of Systems and Logistics, Air Force Institute of Technology (AU), Wright-Patterson AFB OH, September 1992. (AD-A258422)

Woodward, Peter L. An Analysis of the Management of Funds for Risk and Uncertainty in the Department of Defense MS thesis, AFIT/LSH School of Systems and Logistics, Air Force Institute of Technology (AU), Wright-Patterson AFB OH, September 1983. (AD-A134409).

Vita

Captain Glenn "Buck" Buchfeller was born on 13 July 1958 in Allentown, Pennsylvania. He graduated from Parkland High School in Orefield, Pennsylvania in 1976. He enlisted into the United States Air Force (USAF) in 1977 attaining the rank of Staff Sergeant before being honorably discharged in 1981.

He entered Pennsylvania State University in 1981 and graduated with honors in 1984 after earning a Bachelors of Business Administration degree with majors in accounting and finance. After completing Officer Training School in 1985 he was commissioned as a second lieutenant in the USAF and entered Specialized Undergraduate Navigator Training (SUNT) at Mather AFB, California.

Captain Buchfeller holds a senior navigator rating with over 1000 hours of flying experience and has held instructor qualifications in both the F-4E and T-43 aircraft. In addition, he was a distinguished graduate from both SUNT in 1986 and instructor training school at SUNT in 1989.

He entered the School of Logistics and Acquisition Management, Air Force Institute of Technology, in 1993. After receiving his Master of Science in Cost Analysis degree in September 1994, he will be assigned to the National Aerospace Plane System Program Office at Wright-Patterson Air Force Base, Ohio.

Permanent Address: 1275 Timberwyck Court
Spring Valley, Ohio 45370

Vita

Donald E. Kehl was born in Sheldon, New York on 22 June 1944. He attended St. John Fisher College in Rochester, New York. In 1966 he enlisted in the United States Marine Corps and served four years as a radar technician for the F-4B aircraft. After his military service, he attended the State University of New York at Geneseo and graduated in 1972 with a Bachelor of Science degree in Education (Mathematics). During the next twelve years he taught secondary Mathematics and worked in commercial banking. In 1984 he started work with the United States Army as an Operations Research Analyst in the Cost Analysis field. For the next nine years he worked for the Army Materiel Command at Fort Monmouth, New Jersey and White Sands Missile Range, New Mexico. In May 1993, he entered the Graduate Cost Analysis Program at the Air Force Institute of Technology. Upon graduation he will join the U.S. Army Cost and Economic Analysis Center in Falls Church, Virginia.

Permanent Address: 13911 Deviar Drive
Centerville, VA 22020

REPORT DOCUMENTATION PAGE

Form Approved
OMB No. 0704-0188

Public reporting burden for this collection of information is estimated to average 1 hour per response, including the time for reviewing instructions, searching existing data sources, gathering and maintaining the data needed, and completing and reviewing the collection of information. Send comments regarding this burden estimate or any other aspect of this collection of information, including suggestions for reducing this burden, to Washington Headquarters Services, Directorate for Information Operations and Reports, 1215 Jefferson Davis Highway, Suite 1204, Arlington, VA 22202-4302, and to the Office of Management and Budget, Paperwork Reduction Project (0704-0188), Washington, DC 20503.

| | | | | |
|--|---|--|---|--|
| 1. AGENCY USE ONLY (Leave blank) | | 2. REPORT DATE September 1994 | 3. REPORT TYPE AND DATES COVERED Master's Thesis | |
| 4. TITLE AND SUBTITLE COST AND SCHEDULE BENCHMARKS FOR DEFENSE ACQUISITION CONTRACTS | | | 5. FUNDING NUMBERS | |
| 6. AUTHOR(S) Glenn W. Buchfeller, Captain, USAF Donald E. Kehl, GS-12, USA | | | | |
| 7. PERFORMING ORGANIZATION NAME(S) AND ADDRESS(ES) Air Force Institute of Technology, WPAFB OH 45433-6583 | | | 8. PERFORMING ORGANIZATION REPORT NUMBER AFIT/GCA/LAS/94S-2 | |
| 9. SPONSORING / MONITORING AGENCY NAME(S) AND ADDRESS(ES) Wayne Abba, Senior Analyst OUSD(A) API/PM Rm 3E1025 3020 Defense Pentagon Washington DC 20330-3000 | | | 10. SPONSORING / MONITORING AGENCY REPORT NUMBER | |
| 11. SUPPLEMENTARY NOTES | | | | |
| 12a. DISTRIBUTION / AVAILABILITY STATEMENT Approved for public release; distribution unlimited | | | 12b. DISTRIBUTION CODE | |
| 13. ABSTRACT (Maximum 200 words) Managers of Department of Defense programs would benefit from having cost and schedule benchmarks that are based on the historical performance of similar programs. This research generated cost and schedule variance in percent benchmarks for 48 collectively exhaustive and mutually exclusive categories of DoD contracts. The ANOVA nested design methodology was used to compare these cost and schedule benchmarks across related categories of contracts to determine if the benchmarks were statistically significantly different. Such statistical difference would ensure program managers had a very specific tool tailored to their unique needs. Due to some relatively small sample sizes in the study, along with the rather large standard deviations associated with those samples, the majority of benchmarks did not prove to be statistically significantly different. As a result, most benchmarks do not unambiguously describe one, and only one, category of contract. Thus, program managers must exercise caution when drawing conclusions about how the cost and schedule performance of their current programs compares to the historical average. A few years from now, as the number of contracts included in the DAES database grows larger, a greater number of cost and schedule benchmarks that test statistically significantly different should be able to be calculated. | | | | |
| 14. SUBJECT TERMS Benchmark, Benchmarks, Cost Variance, Schedule Variance, Analysis of Variance (ANOVA) | | | 15. NUMBER OF PAGES 132 | |
| | | | 16. PRICE CODE | |
| 17. SECURITY CLASSIFICATION OF REPORT Unclassified | 18. SECURITY CLASSIFICATION OF THIS PAGE Unclassified | 19. SECURITY CLASSIFICATION OF ABSTRACT Unclassified | 20. LIMITATION OF ABSTRACT UL | |