

AD-A282 210



# Semiautomated Methodology for Measurement of Field-of-View, Magnification, and Distortion of Night Vision Devices as Defined in MIL-A-49425(CR)

By

John S. Martin  
Howard H. Beasley  
Robert W. Vernona

UES, Incorporated

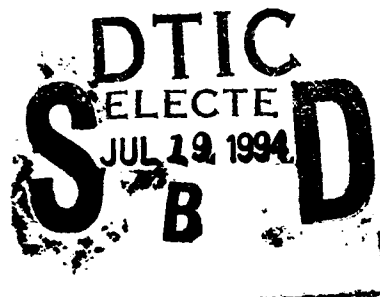

and

Clarence E. Rash

94-22461



SAPX

Aircrew Health and Performance Division

May 1994

94 7 18 015

DTIC QUALITY INSPECTED 1

Approved for public release; distribution unlimited.

United States Army Aeromedical Research Laboratory  
Fort Rucker, Alabama 36362-0577

Notice

Qualified requesters

Qualified requesters may obtain copies from the Defense Technical Information Center (DTIC), Cameron Station, Alexandria, Virginia 22314. Orders will be expedited if placed through the librarian or other person designated to request documents from DTIC.

Change of address

Organizations receiving reports from the U.S. Army Aeromedical Research Laboratory on automatic mailing lists should confirm correct address when corresponding about laboratory reports.

Disposition

Destroy this document when it is no longer needed. Do not return it to the originator.

Disclaimer

The views, opinions, and/or findings contained in this report are those of the author(s) and should not be construed as an official Department of the Army position, policy, or decision, unless so designated by other official documentation. Citation of trade names in this report does not constitute an official Department of the Army endorsement or approval of the use of such commercial items.

Human use

Human subjects participated in these studies after giving their free and informed voluntary consent. Investigators adhered to AR 70-25 and USAMRDC Reg 70-25 on Use of Volunteers in Research.

Reviewed:

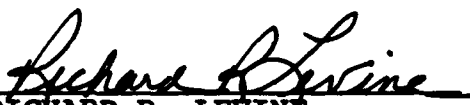
  
RICHARD R. LEVINE  
LTC, MS  
Director, Aircrew Health and Performance Division

Released for publication:

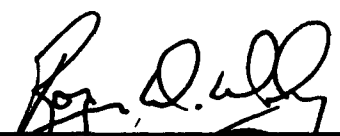
  
ROGER W. WILEY, G.D., Ph.D.  
Chairman, Scientific  
Review Committee

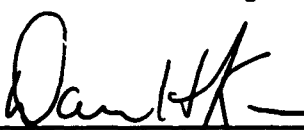
  
DAVID H. KARNEY  
Colonel, MC, SFS  
Commanding

Unclassified

SECURITY CLASSIFICATION OF THIS PAGE

**REPORT DOCUMENTATION PAGE**

Form Approved  
OMB No. 0704-0188

1a. REPORT SECURITY CLASSIFICATION <b>Unclassified</b>		1b. RESTRICTIVE MARKINGS	
2a. SECURITY CLASSIFICATION AUTHORITY		3. DISTRIBUTION/AVAILABILITY OF REPORT Approved for public release; distribution unlimited	
2b. DECLASSIFICATION/DOWNGRADING SCHEDULE			
4. PERFORMING ORGANIZATION REPORT NUMBER(S)  USAARL Report No. 94-25		5. MONITORING ORGANIZATION REPORT NUMBER(S)	
6a. NAME OF PERFORMING ORGANIZATION U.S. Army Aeromedical Research Laboratory	6b. OFFICE SYMBOL (if applicable) SRGD-UAS-VS	7a. NAME OF MONITORING ORGANIZATION U.S. Army Medical Research, Development, Acquisition and Logistics Command(Provisional)	
6c. ADDRESS (City, State, and ZIP Code) P.O. Box 620577 Fort Rucker, AL 36362-0577		7b. ADDRESS (City, State, and ZIP Code) Fort Detrick Frederick, MD 21702-5012	
8a. NAME OF FUNDING/SPONSORING ORGANIZATION	8b. OFFICE SYMBOL (if applicable)	9. PROCUREMENT INSTRUMENT IDENTIFICATION NUMBER	
8c. ADDRESS (City, State, and ZIP Code)		10. SOURCE OF FUNDING NUMBERS	
		PROGRAM ELEMENT NO. 0602787A	PROJECT NO. 3E1672 787A879
		TASK NO. BG	WORK UNIT ACCESSION NO. 164
11. TITLE (Include Security Classification) Semiautomated Methodology for Measurement of Field-of-View, Magnification, and Distortion of Night Vision Devices as Defined in MIL-A-49425 (CR)			
12. PERSONAL AUTHOR(S) John S. Martin, Howard H. Beasley, Robert W. Verona, and Clarence E. Rash			
13a. TYPE OF REPORT Final	13b. TIME COVERED FROM _____ TO _____	14. DATE OF REPORT (Year, Month, Day) 1994 May	15. PAGE COUNT 50
16. SUPPLEMENTARY NOTATION			
17. COSATI CODES		18. SUBJECT TERMS (Continue on reverse if necessary and identify by block number)	
FIELD	GROUP	Testing, image intensification, NVG, ANVIS	
20	06		
17	05		
19. ABSTRACT (Continue on reverse if necessary and identify by block number)			
<p>As new and improved designs for night vision imaging systems based on the principle of image intensification are produced, it is advantageous to have a system which can accurately and quickly assess the performance of various configurations of intensifiers and associated optics. Parameters which define system performance include field-of-view (FOV), magnification, and distortion. The availability of precision positioners and personal computers enable the measurement of performance as specified in Military Specification MIL-A-49425 (CR), <u>Aviator's Night Vision Imaging System AN/AVS-6(V)1, AN/AVS-6(V)2</u>, with a high degree of accuracy and repeatability. A measurement system which provides high flexibility in the evaluation of image intensification devices is described.</p>			
20. DISTRIBUTION/AVAILABILITY OF ABSTRACT <input checked="" type="checkbox"/> UNCLASSIFIED/UNLIMITED <input type="checkbox"/> SAME AS RPT. <input type="checkbox"/> DTIC USERS		21. ABSTRACT SECURITY CLASSIFICATION Unclassified	
22a. NAME OF RESPONSIBLE INDIVIDUAL Chief, Scientific Information Center		22b. TELEPHONE (Include Area Code) 205-255-6907	22c. OFFICE SYMBOL SGRD-UAX-SI

## Table of contents

	Page
List of figures . . . . .	1
List of tables . . . . .	2
Introduction . . . . .	3
MIL-A-49425(CR) requirements . . . . .	4
Methodology . . . . .	4
Test apparatus . . . . .	4
Control program . . . . .	10
Measurement procedure . . . . .	23
Performance data . . . . .	26
Discussion . . . . .	29
References . . . . .	30
Appendixes	
Appendix A - List of manufacturers . . . . .	31
Appendix B - Control program source code . . . . .	32
Appendix C - Test reports . . . . .	45

## List of figures

Figure	Page
1. Aviator's Night Vision Imaging System (ANVIS) . . . . .	3
2. MIL-A-49425(CR) test setup for measuring field-of-view . . . . .	5
3. MIL-A-49425(CR) test setup for measuring magnification . . . . .	5
4. Block diagram of semiautomated measurement system . . . . .	6
5. Photograph of full semiautomated test setup . . . . .	6
6. Large rotary table used to mount the device under test for FOV and magnification measurements . . . . .	7
7. The small (2-inch diameter) rotary table used to mount the minidioptrimeter for magnification measurements . . . . .	8
8. The gunsight used as a target for field-of-view and magnification measurements . . . . .	9

List of figures (Continued)

9.	AN/AVS-6(V)1 mount used to attach ANVIS unit to the test setup and to apply power to ANVIS . . . . .	9
10.	Attachment of a sample test system . . . . .	10
11.	Exploded view of test setup . . . . .	12
12.	Simplified program control flow chart . . . . .	14
13.	Sample screen for identification menu . . . . .	15
14.	Sample screen for setup menu . . . . .	15
15.	Sample screen for function menu . . . . .	17
16.	Sample screen for field-of-view measurement . . . . .	17
17.	Sample screen for center of field-of-view . . . . .	18
18.	Sample screen for minidioptometer installation . . . . .	18
19.	Sample screen for minidioptometer alignment . . . . .	20
20.	Sample screen #1 for magnification and distortion testing . . . . .	20
21.	Sample screen #2 for magnification and distortion testing . . . . .	21
22.	Sample test results output . . . . .	22
23.	Distortion (in percent) as a function of angular position across the tube . . . . .	27

List of tables

Table		Page
1.	List of components . . . . .	13
2.	Repeatability performance data . . . . .	28
3.	Distortion values (in percent) . . . . .	28
4.	Distortion data analysis . . . . .	29

## Introduction

Night vision image intensification devices have become a critical technology for U.S. Army aviation. New system designs for the AN/AVS-6 Aviators Night Vision Imaging System (ANVIS) [Figure 1], as well as other image intensification (I<sup>2</sup>) based imaging systems, are constantly being considered for use. As these proposed devices approach their test and evaluation phases, it is critical that methodology be available which can evaluate their performance in a timely and cost effective manner. This paper describes an enhanced integrated test system and methodology which can evaluate compliance with specific sections of MIL-A-49425(CR), Aviator's Night Vision Imaging System AN/AVS-6(V)1, AN/AVS-6(V)2. This system automates most of the procedural steps, providing increased efficiency and accuracy in the measurement of system field-of-view, magnification, and distortion parameters with a high degree of repeatability.

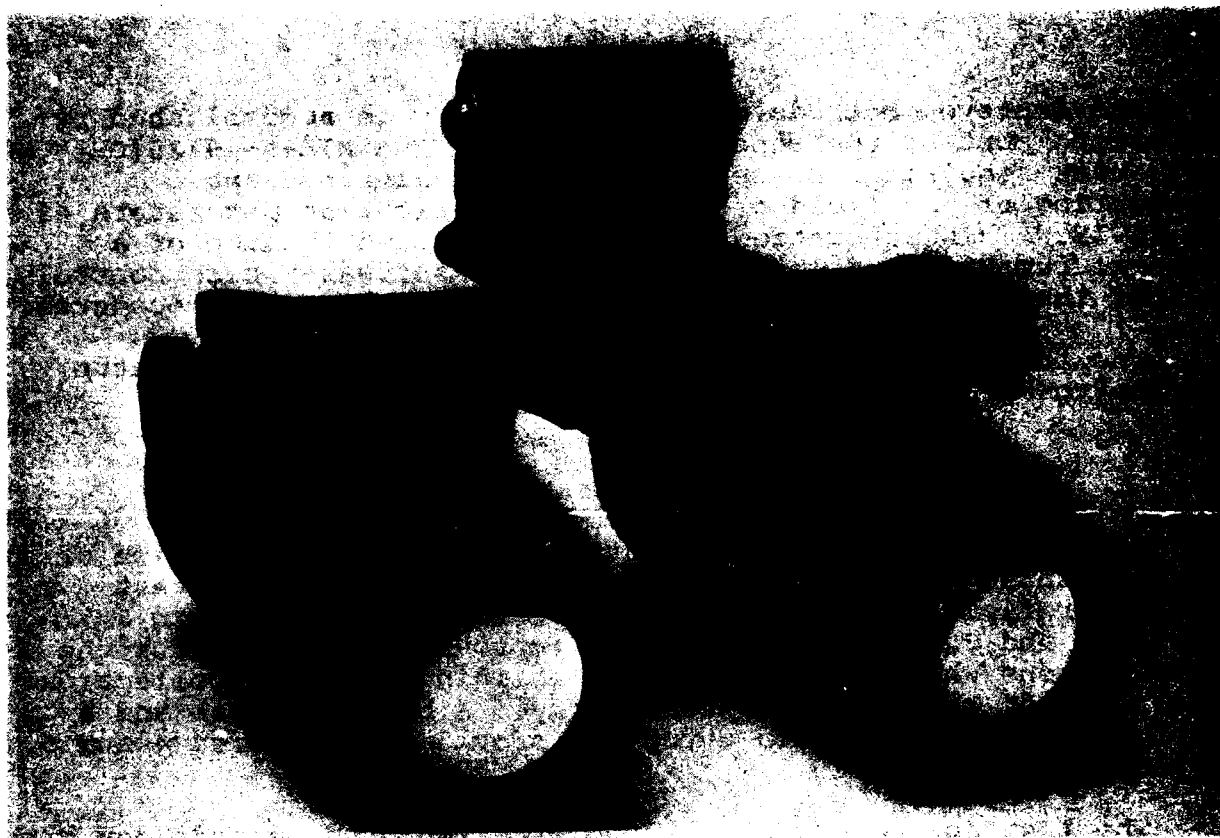

Figure 1. Aviator's Night Vision Imaging System (ANVIS).

Distribution/36	
Availability Codes	
Dist	Avail and/or Special
A-1	

## MIL-A-49425(CR) requirements

The basic test methodologies and requirements for measurement of field-of-view, magnification, and distortion for ANVIS are provided in Military Specification MIL-A-49425(CR), Aviator's Night Vision Imaging System AN/AVS-6(V)1, AN/AVS-6(V)2. Other I<sup>2</sup> devices may have different criteria.

ANVIS field-of-view acceptance criteria and measurement procedures are given in Sections 3.6.1 and 4.6.1 of MIL-A-49425(CR), respectively. The field-of-view is required to be 40 degrees (circular) with a tolerance of +1 to -2 degrees. Magnification criteria and procedures are given in Sections 3.6.2 and 4.6.2, respectively. Magnification is required to be unity (1X) with a + 5 percent tolerance. Distortion criteria and procedures are given in Sections 3.6.3 and 4.6.3, respectively. Distortion is not to be greater than 4 percent across the total field-of-view.

### Methodology

The improved methodology described here is accomplished by automating most of the repetitive steps in the MIL-A-49425(CR) procedures required for the positioning, measuring, and documenting of the field-of-view and magnification parameters of the ANVIS. This automation is achieved through the use of a personal computer and specially developed software which controls most of the repetitive movements involved in the test procedures.

The following sections describe the test apparatus, setup, and control program comprising this new methodology.

### Test apparatus

The test setup described in this paper is an adaptation of that presented in MIL-A-49425(CR). The MIL-A-49425(CR) test setups for field-of-view and magnification are depicted in Figures 2 and 3, respectively. The improved setup reflects the modifications which automate the positioning and data collection procedures of the required methodology. A block diagram and a photograph of the improved setup are provided in Figures 4 and 5, respectively.

The test apparatus designed for the improved methodology can be divided into three functional classifications: automation control, mechanical positioning and mounting, and optical viewing.

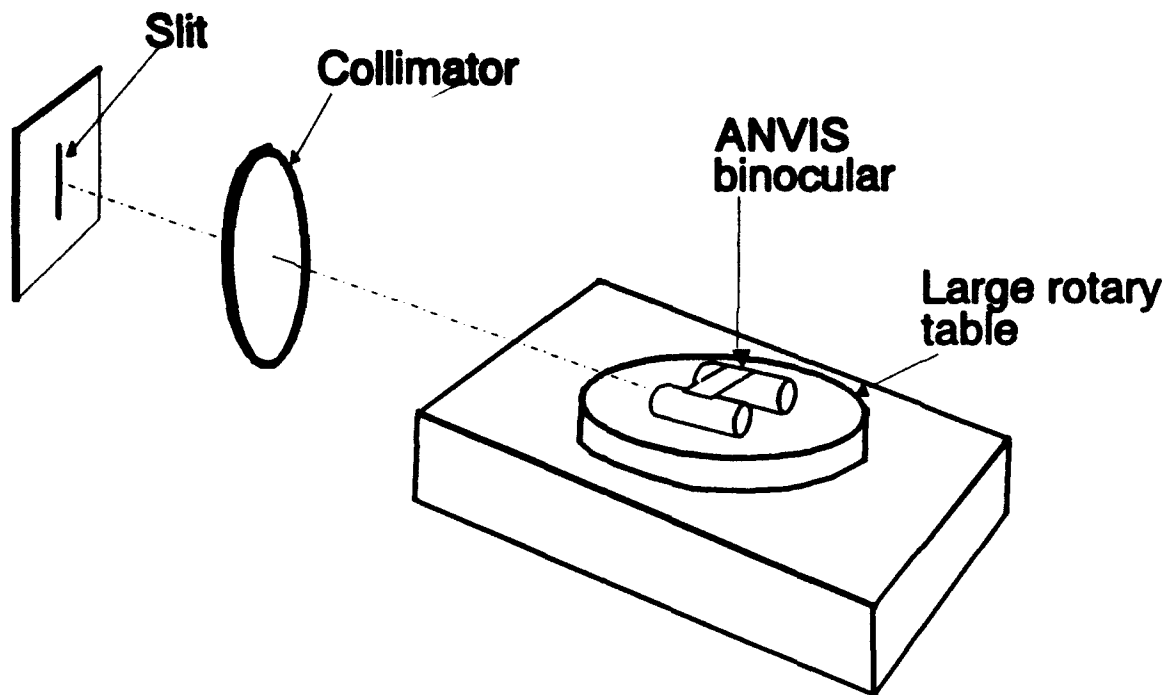

Figure 2. MIL-A-49425(CR) test setup for measuring field-of-view.

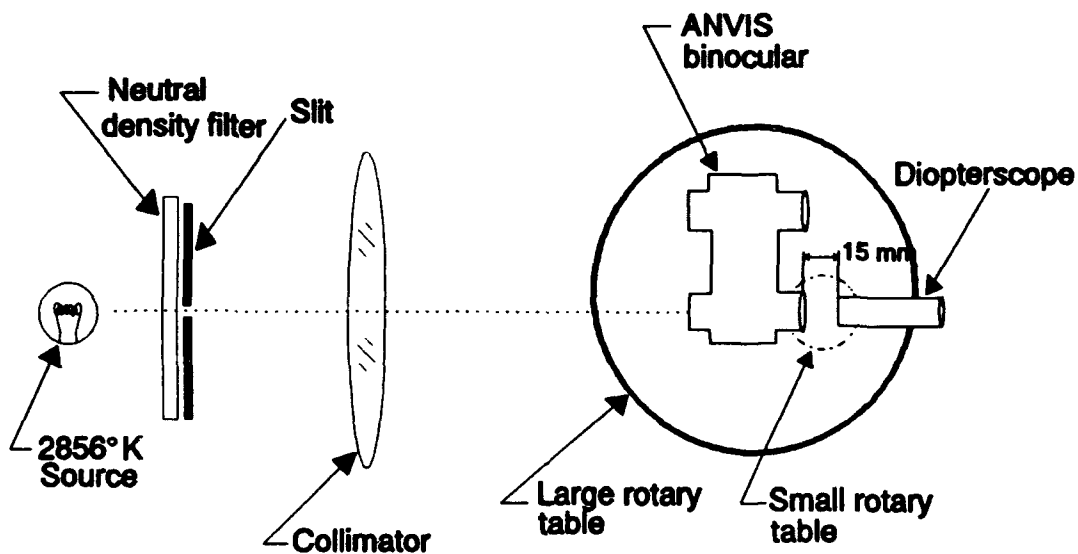

Figure 3. MIL-A-49425(CR) test setup for measuring magnification.



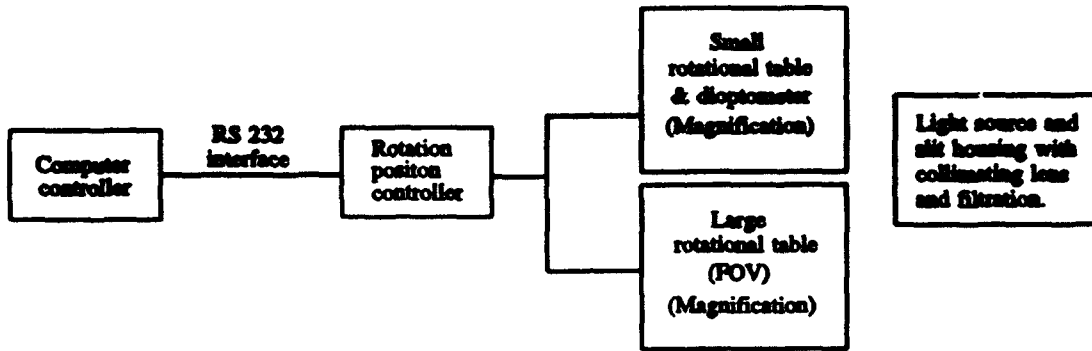

Figure 4. Block diagram of semiautomated measurement system.

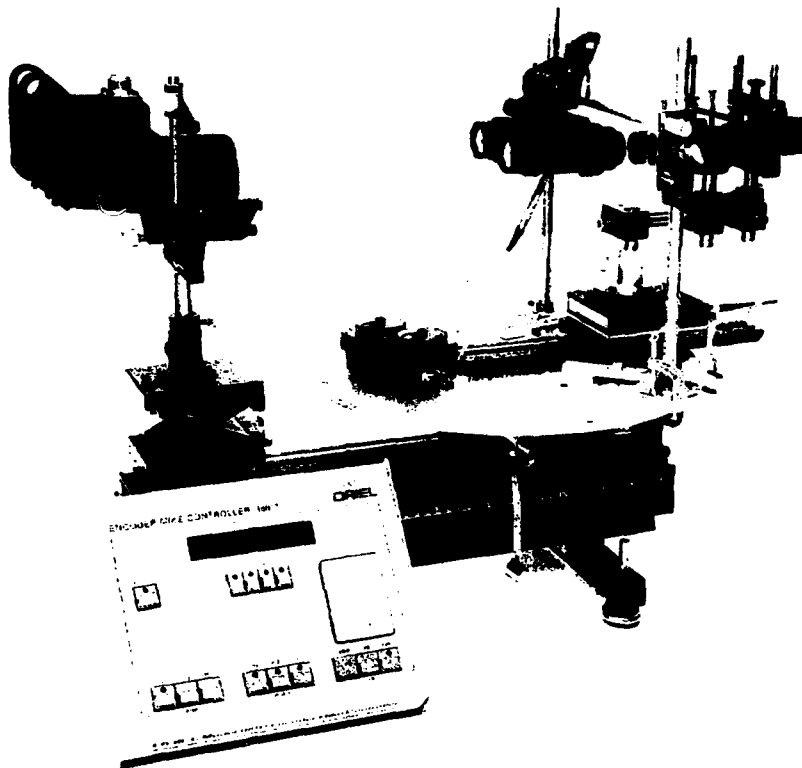

Figure 5. Photograph of full semiautomated test setup.

The automation components consist of a Dell\* system 310 computer using an Intel\* 80386 microprocessor operating in a MicroSoft(MS)\* DOS Version 5.0 environment. The computer is connected via a RS-232 interface to an Oriel Corporation\* encoder Mike™ controller which provides control of stepping motors (Figure 5).

The mechanical mounting and positioning components consist of various motors, rods, rod holders, carriers, jacks, and rails mounted on specially fabricated rotary tables which are attached to an optical bench. Two encoder DC motors are used to position the rotary tables for the required measurements. The large (14.25-inch diameter) rotary table holds the device under test and is used for both field-of-view and magnification measurements (Figure 6). The small (2-inch diameter) rotary table holds the minidiometer and is used for magnification measurements only (Figure 7).

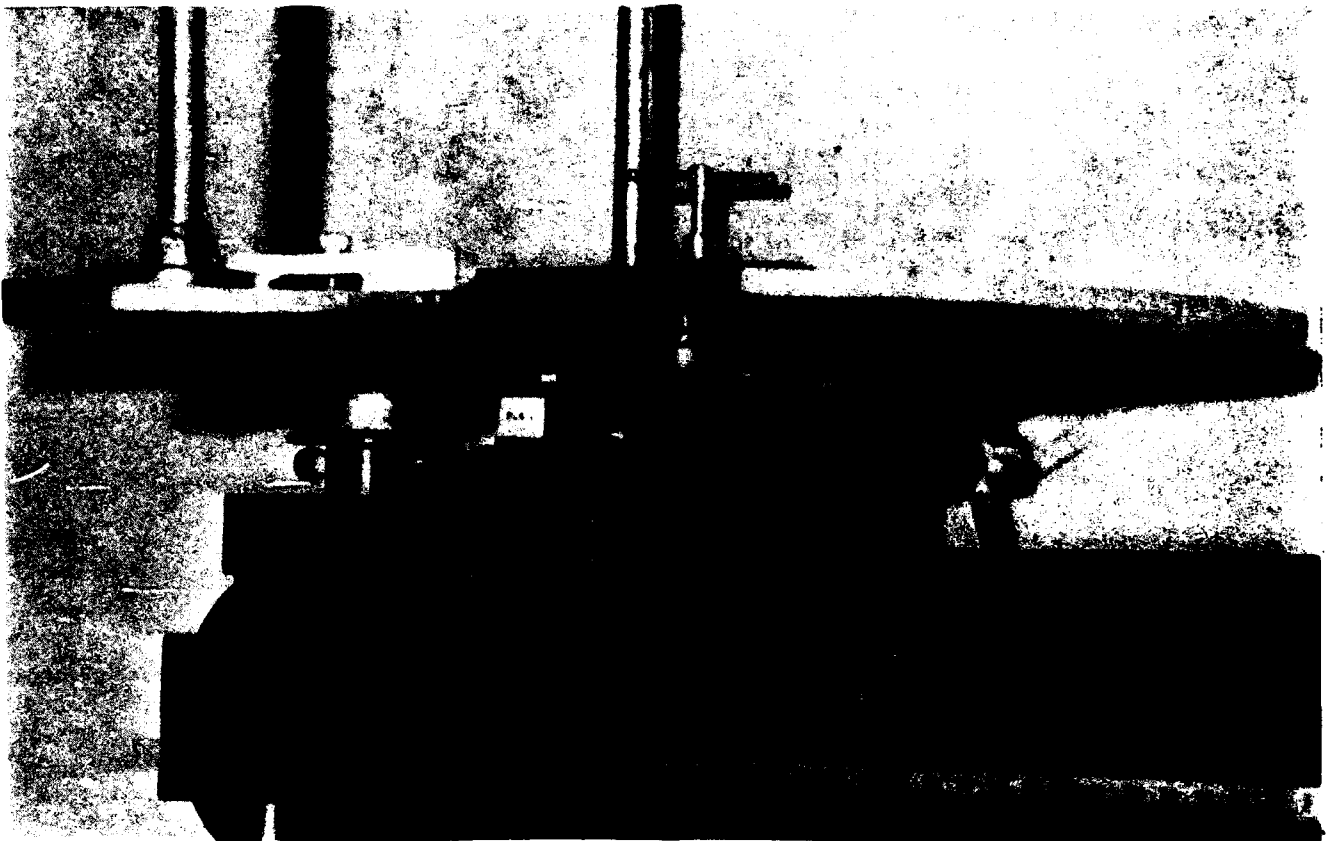

Figure 6. Large rotary table used to mount the device under test for FOV and magnification measurements.

-----  
\* See Appendix A.

Optical viewing is accomplished using a model N-3C aircraft gunsight and minidiometer. The gunsight, consisting of a tungsten filament lamp, 0.025 mm X 7 mm slit, collimating lens, and attenuating filter, serves as the stationary target for field-of-view and magnification measurements (Figure 8). Any collimated source could be used as a replacement for the gunsight.

When ANVIS systems are under test, an AN/AVS-6(V)1 mount is used to attach the ANVIS unit to the test setup and apply power (Figure 9). Figure 10 shows the attachment of a sample test system.

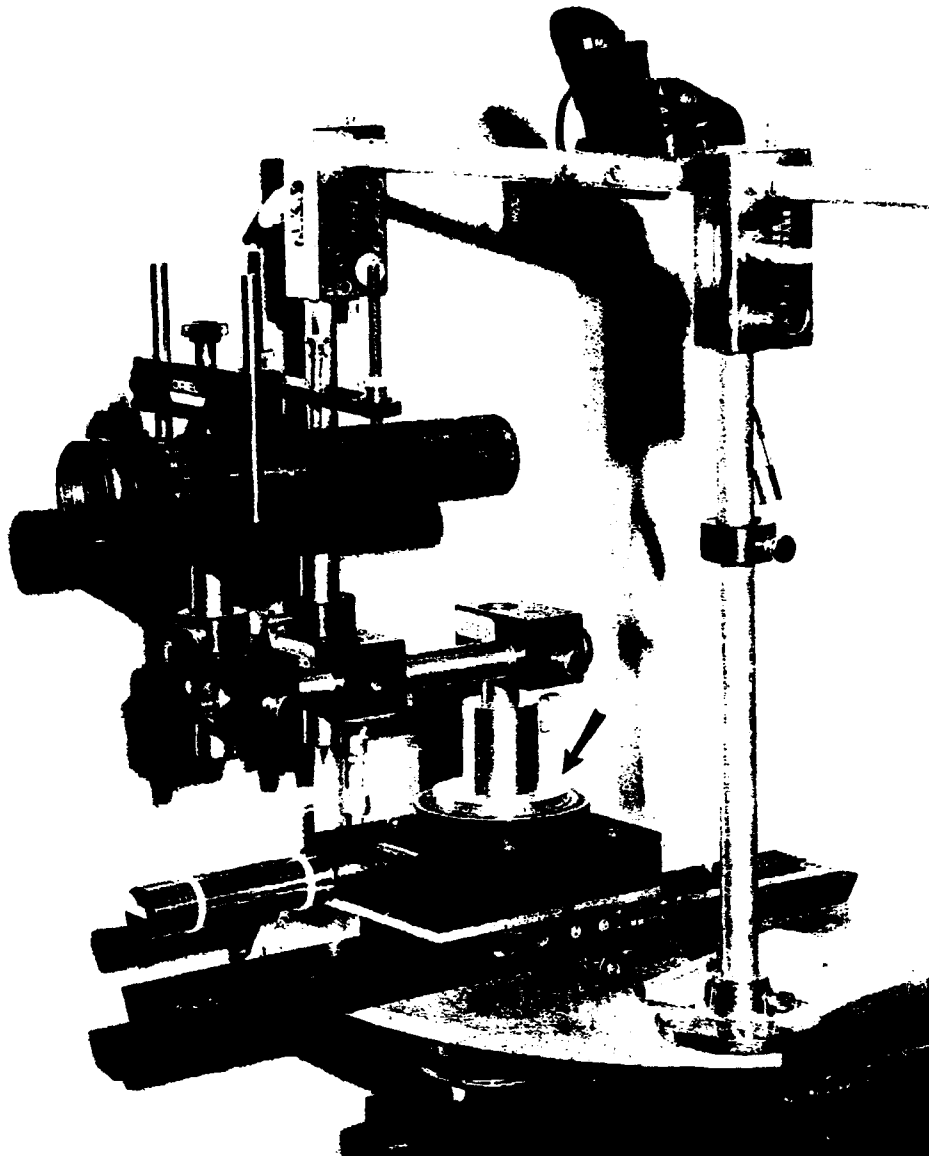
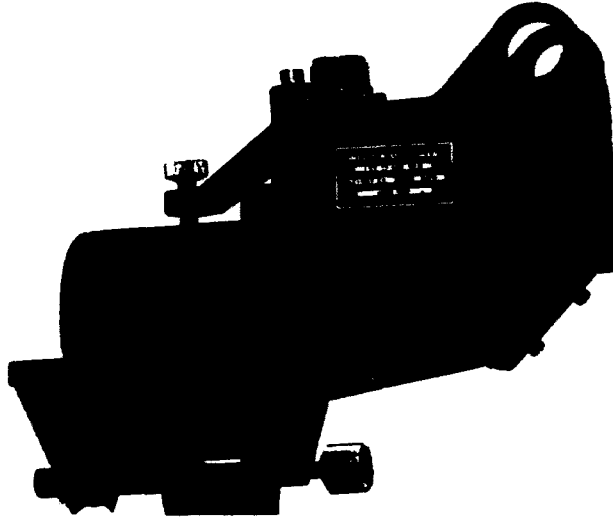
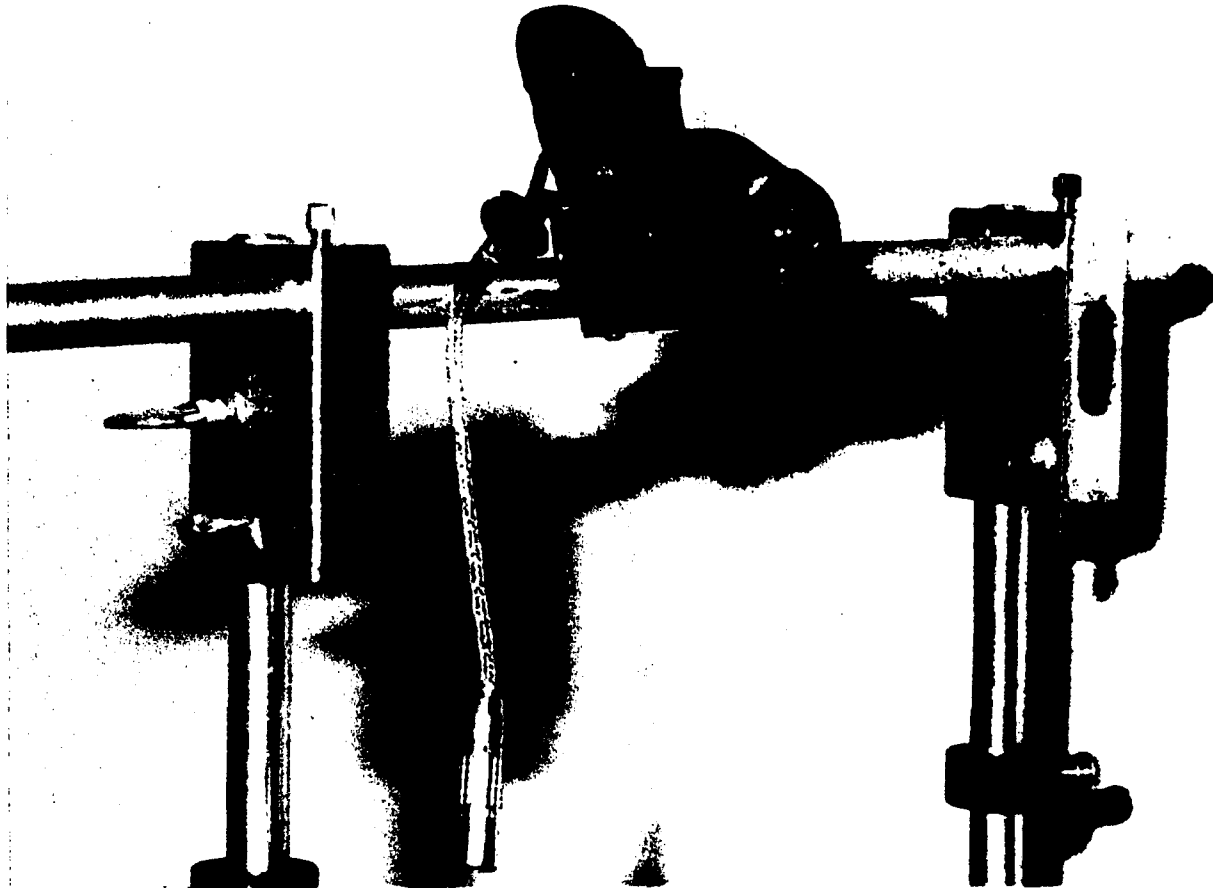

Figure 7. The small (2-inch diameter) rotary table used to mount the minidiometer for magnification measurements.



**Figure 8.** The gunsight used as a target for field-of-view and magnification measurements.



**Figure 9.** AN/AVS-6(V)1 mount used to attach ANVIS unit to the test setup and to apply power to ANVIS.

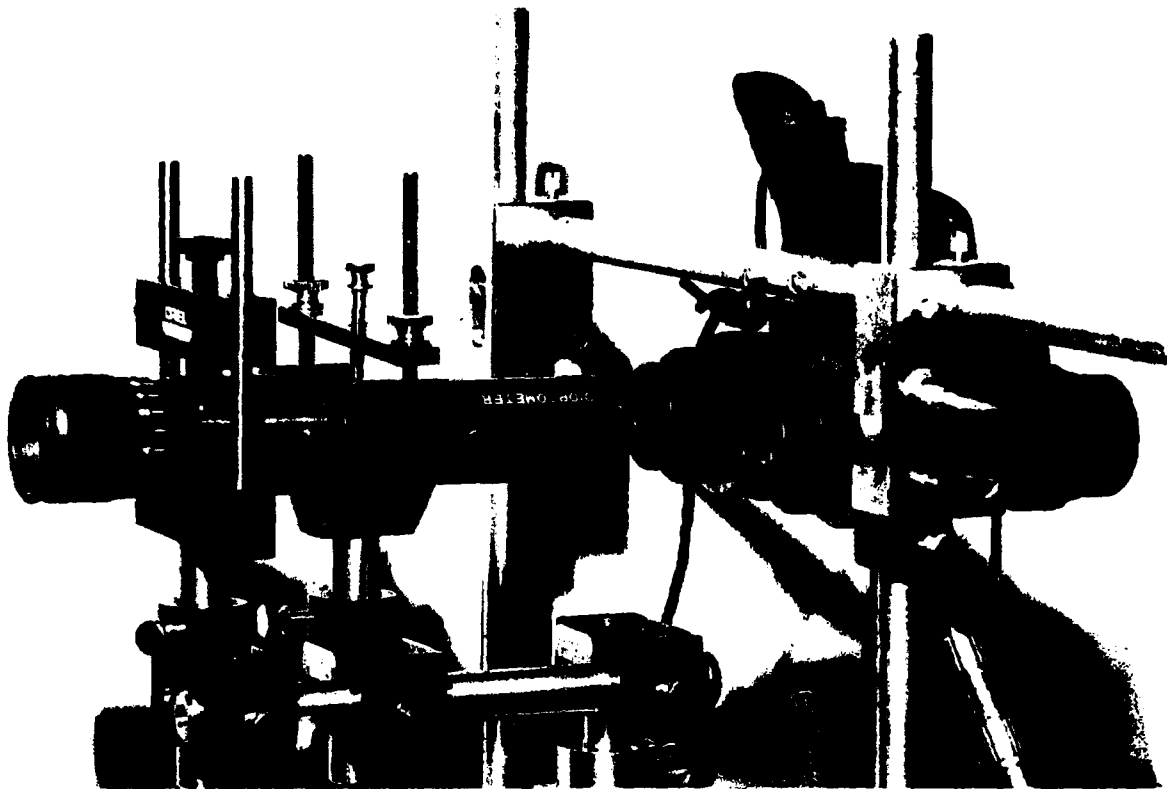

Figure 10. Attachment of a sample test system.

A full listing of the components used in the described configuration, and their manufacturers, is provided in Table 1. This listing is not intended to be exclusive; functionally comparable components may be substituted as required. An exploded view of the test setup is depicted in Figure 11.

#### Control program

The control program for this methodology is written in GW-Basic and, in our laboratory, runs on a Dell system 310, 80386 DX computer operating at 33 MHz. (Note: This program will execute properly on any MS-DOS based system with GW-Basic.) There are four main objectives of the control program:

1. To provide accurate control of the alignment, positioning, and movement of the rotary tables.
2. To perform all mathematical operations required for the calculation of field-of-view, magnification, and distortion values.
3. To provide hard copy output that summarizes test results.

4. To achieve high reliability in the measurement of field-of-view and magnification.

The control program consists of seven basic elements. These are: instruction option, test item identification, setup and alignment, field-of-view measurement, magnification measurement, distortion calculation, and test results output. A simplified operational flow chart of the program is presented in Figure 12. A complete listing of the program is provided in Appendix B.

#### Instruction option

Initiating the program results in an option for a review of the test operating instructions. A 'YES' response will display a series of tutorial graphics and text screens which provide rudimentary training to the user. Successive screens depict images simulating the view of the illuminated slit through an ANVIS type device along with text describing the process. Examples are provided of the various positions of rotation along with descriptions to ensure proper alignment. The instruction section can be bypassed with a 'NO' response at the prompt.

#### Test item identification

The program prompts the user to provide test item identification data (Figure 13). These data include the type of device under test, the serial number, and an indication of optical channel (left, right, or n/a). In addition, field-of-view parameter requirements are requested. This allows for testing of nonstandard devices which may have field-of-view requirements that differ from ANVIS. An option for a NOTE line also is included to allow the entry of additional descriptive information. All of these data appear in the printed output of the performance results.

#### Setup and alignment

Following entry of identification data, the control program performs steps which establish alignment and initial settings. RS-232 communication is established via a null modem cable between the computer and the Oriel Encoder Mike controller. Once this is successful, the setup menu (Figure 14) displays the current settings for the active motor: motor speed, absolute and relative positions, and degree reference from relative zero. System status, BUSY or IDLE, is indicated also.

The setup menu offers a selection of seven options. The first five options allow selection and adjustment of motors as

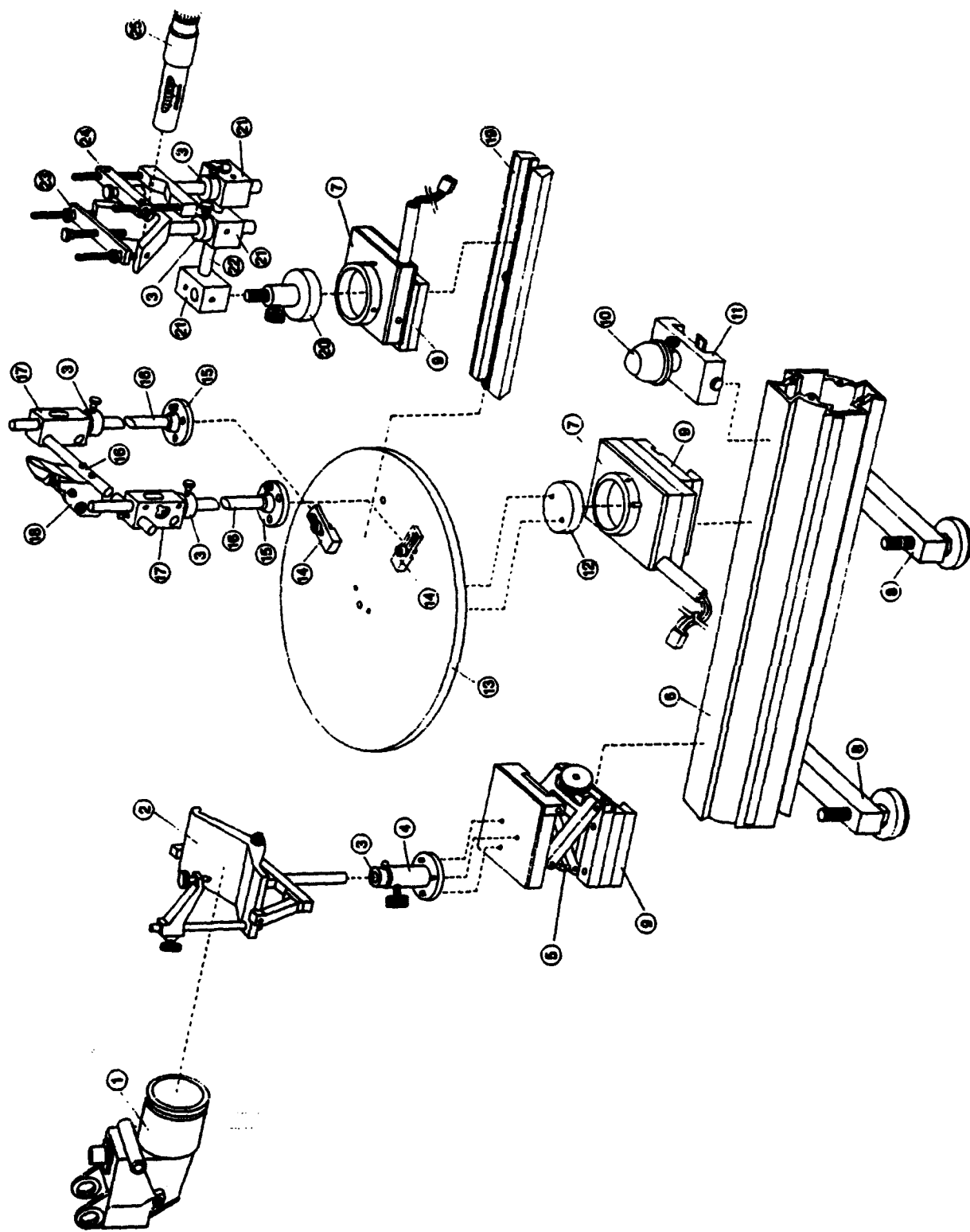

Figure 11. Exploded view of test setup.

Table 1.

List of components.

Component description	Qty	Source	Figure reference
<b>Automation control</b>			
Computer, model 310	1	Dell Computer Corp.	Not shown
Encoder Mike controller, model 18011	1	Oriel Corp.	Not shown
<b>Mechanical mounting and positioning</b>			
Optical bench, tubular, model 10810	1	Oriel Corporation	6
Encoder DC motor, model 13038	2	Oriel Corporation	7
Universal carrier, model 11620	3	Oriel Corporation	9
Universal carrier, model 11621	1	Oriel Corporation	11
Mounting foot bar, model 10720	2	Oriel Corporation	8
Table rail, precision, model 11422	1	Oriel Corporation	19
Vee holder, model 13860	1	Oriel Corporation	23
Vee holder, model 13870	1	Oriel Corporation	2
Rod connector, 90-degree, model 14300	3	Oriel Corporation	21
Rod collar, model 12510	2	Oriel Corporation	3
Optical mount, model 12625	1	Oriel Corporation	24
Jack, standard, model 17271	1	Oriel Corporation	5
Rod holder, model 12410	1	Oriel Corporation	4
Optical rod, model 12320	3	Oriel Corporation	22
Rod, 0.5-inch diameter, 12-inch length	3	Oriel Corporation	16
Rod base adapter	2	Fisher Scientific Co.	15
Rod connector, 90 degrees	2	Fisher Scientific Co.	17
Rotary table (large), aluminum, 0.25-inch thick, 14.25-in. diameter	1	Fabricated	13
Rotary table (small), aluminum, 2-in. dia.	1	Fabricated	20
Roller ball, support	1	Fabricated	10
Adapter, aluminum, 2-inch diameter	1	Fabricated	12
Clamp, aluminum	2	Fabricated	14
ANVIS mount	1	U.S. Army	18
<b>Optical viewing</b>			
Minidioptometer	1	Seiler Instrument and Manufacturing Co.	25
Gun sight, model N-3C, 0.025 x 7 mm slit, opal glass filter, and tungsten lamp	1	Military surplus	1



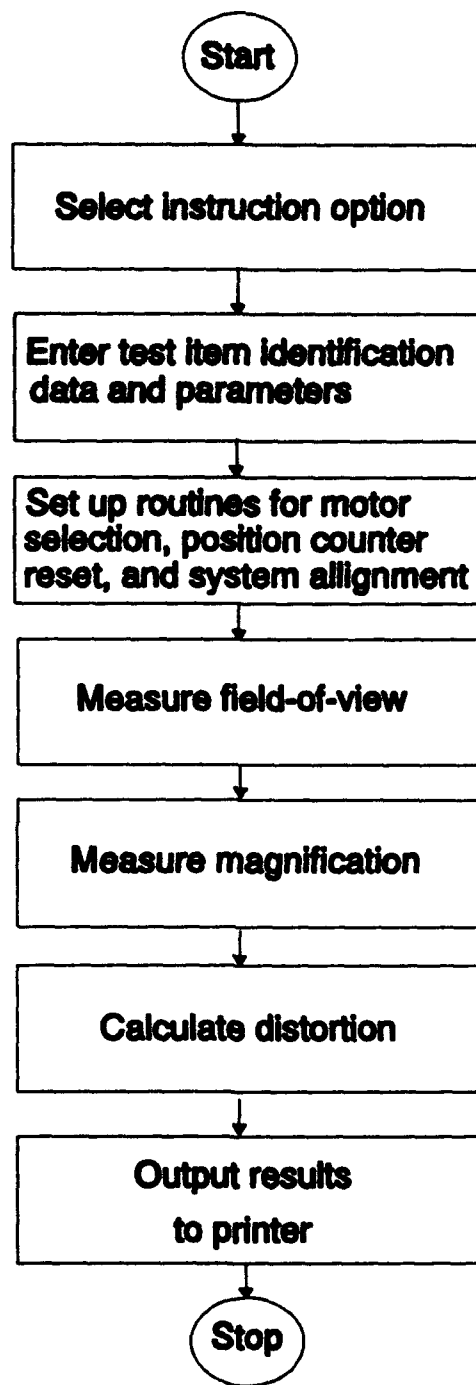

Figure 12. Simplified program control flow chart.

**CONTROL AND DATA COLLECTION PROGRAM FOR  
FOV, MAGNIFICATION, & DISTORTION MEASUREMENTS**

ACTIVE MOTOR

MOTOR SPEED

ABS Position

REL Position

Degrees from  
Relative 0

<<< SYSTEM STATUS >>>

**IDENTIFICATION FOR TESTED DEVICE**

TYPE DEVICE: ?

SERIAL #:

LEFT/RIGHT or N/A:

FOV Specification limits

Lower Limit:                      Upper Limit:

NOTE:

Figure 13. Sample screen for identification menu.

**CONTROL AND DATA COLLECTION PROGRAM FOR  
FOV, MAGNIFICATION, & DISTORTION MEASUREMENTS**

ACTIVE MOTOR

MOTOR SPEED

ABS Position

REL Position

Degrees from  
Relative 0

<<< SYSTEM STATUS >>>

\*\*<<< SET UP MENU >>>\*\*\*

1. SELECT MOTOR
2. RESET ABSOLUTE ZERO
3. RESET RELATIVE ZERO
4. SET MOTOR SPEED
5. MOVE TO A POSITION
6. GOTO FUNCTION MENU
7. EXIT PROGRAM

Figure 14. Sample screen for setup menu.

well as setting of absolute and relative zero positions. Option 1 allows selection between motor #1, which controls the large rotary table holding the device under test, and motor #2, which controls the small rotary table holding the mini-dioptometer. Option 2 allows the current position of the active motor to be defined as the absolute zero reference position. This absolute zero position is used as a straight ahead reference for equipment alignment. Option 3 provides for the setting of the relative zero position, allowing independent field-of-view measurements without altering the absolute zero setting. Option 4 provides setting of the motor speed between 50 to 200 microns per second. Option 5 allows movements of the motor either a set distance and direction or to a specific location. Moving a set distance requires input of direction, LEFT or RIGHT, and distance, entered in units of microns. (Note: 485 microns corresponds to approximately 1 degree of rotation.) Moving to a specific location requires input of location position in microns. In addition, direct movement to absolute or relative zero position is provided.

Upon completion of all the alignments, the position counter resets, and the speed control settings, option 6, GOTO FUNCTION MENU, is provided to begin actual testing. Option 7 is provided to exit the control program.

### Field-of-view measurement

From the function menu (Figure 15), FIELD-OF-VIEW MEASUREMENT must be selected first, as the procedures for the other tests are dependent upon the field-of-view limits. At the field-of-view menu (Figure 16), the tester optically aligns the slit at the right and left extremes of the field-of-view. This is accomplished by movements of the large rotary table (motor #1). Rotation to the left is performed first to find one edge of the field-of-view. Once this edge is positioned, option 3 (RESET RELATIVE ZERO) is used to identify the starting point for the measurement. Rotation to the right then is required to locate the other edge of the field-of-view. Option 4 then is used to record the actual field-of-view into the program.

Movement to the center of the field-of-view is accomplished with option 5 which calculates the field-of-view and center of the field-of-view in both microns and degrees (Figure 17). At this point, selection of submenu option 1 will move the large table to the center of the calculated field-of-view and reset the relative position to zero.

This resetting of the relative scale to the center of the field-of-view is necessary for subsequent testing of magnification and distortion. At the conclusion of this movement

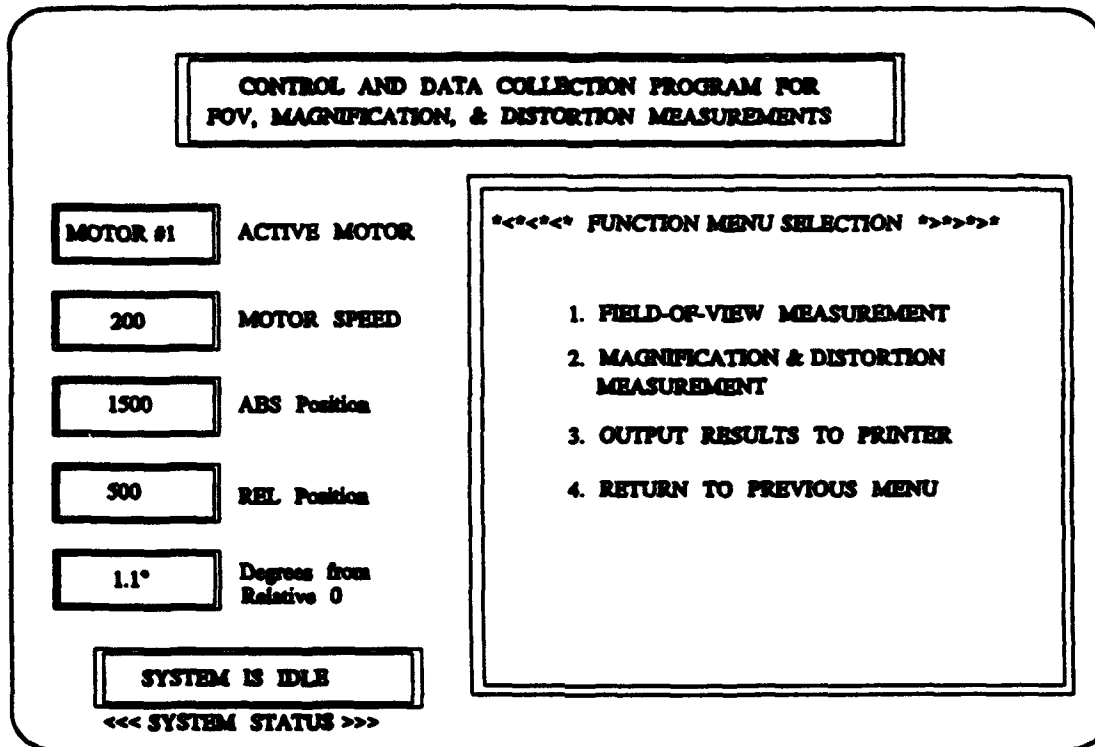

Figure 15. Sample screen for function menu.

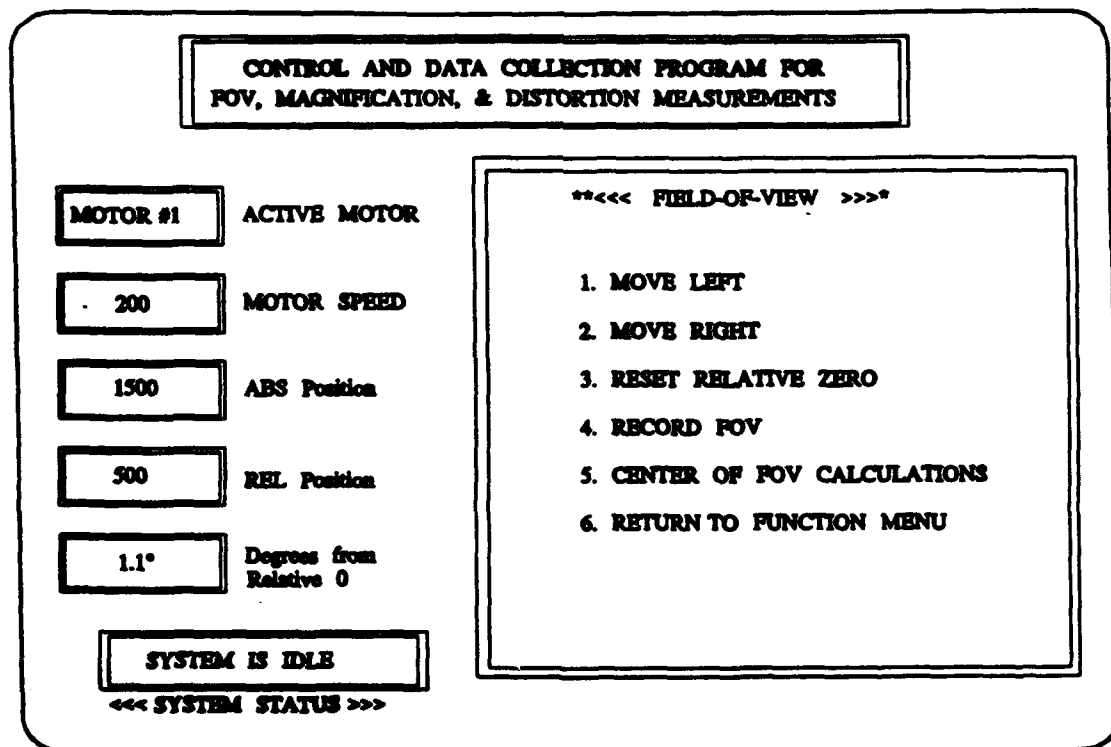

Figure 16. Sample screen for field-of-view measurement.

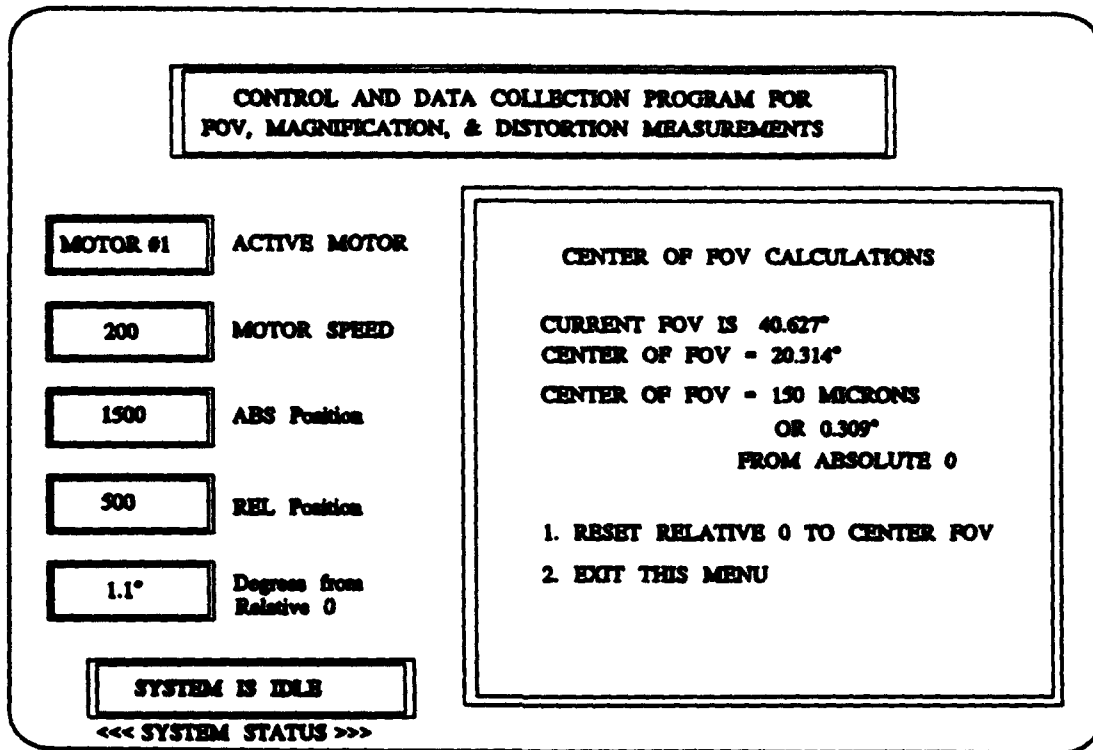

Figure 17. Sample screen for center of field-of-view.

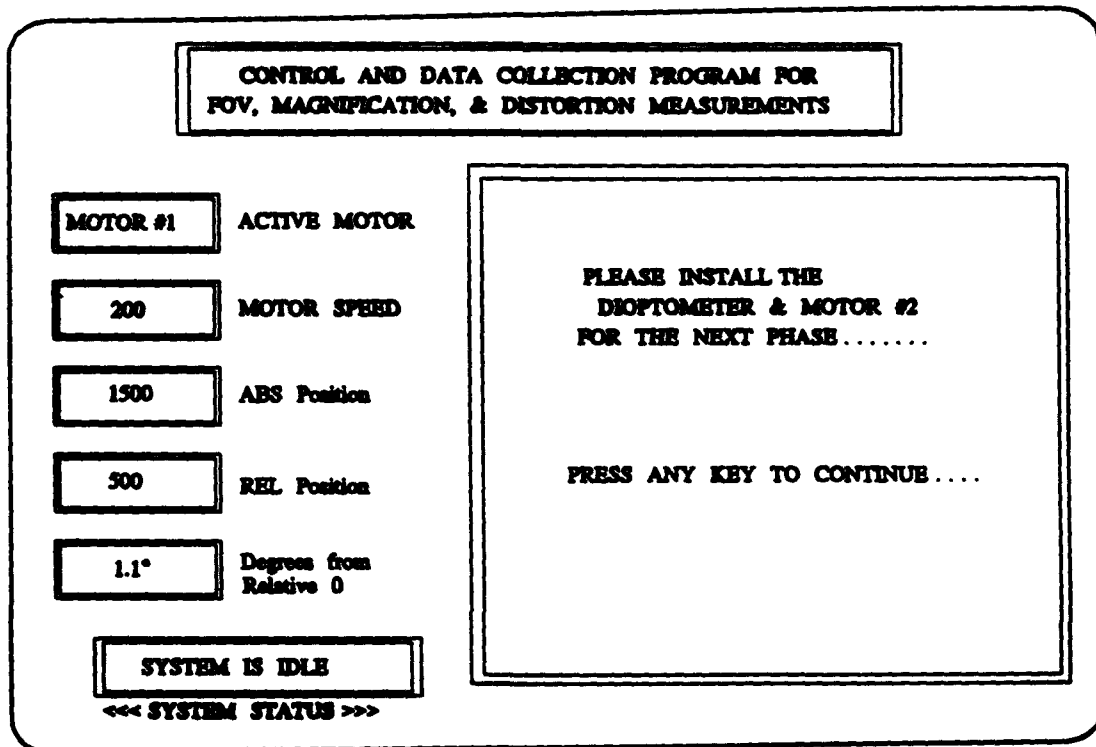

Figure 18. Sample screen for minidiopmeter installation.

to the field-of-view center, the user will be prompted to install the minidiometer that is mounted on motor #2 (Figure 18). With these items in place, the control program automatically will select motor #2 as the active motor and move into the minidiometer alignment submenu. Left and right movement of motor #2 will be necessary to align the crosshairs of the minidiometer to the slit (Figure 19). Once this position is identified, the relative scale for motor #2 must be reset to zero as its starting reference, using option 3 from this menu. These steps complete the field-of-view measurement portion and all necessary preparations for the subsequent magnification testing.

### Magnification measurement

The magnification test procedure begins with the selection of the desired number of data point pairs (n), up to 20 pairs (Figure 20). Data are to be collected at corresponding angles on both sides of the optical axis. Rotation to the edge of the field-of-view sets the first point of data collection with each additional point recorded progressively through one rotation of the table to the other edge of the field-of-view. [Note: Only data obtained at the largest angle, i.e., full field-of-view, are used to calculate magnification. Data for intermediate angles are used in the distortion calculation.]

The control program calculates the angular size of the steps based on the number of data point pairs requested and the range of the field-of-view. The large table is rotated automatically first to each point along the measurement region. The small rotational table holding the minidiometer then is rotated automatically to the approximate corresponding angle after which small adjustments of the small table are required to align the crosshairs (Figure 21). When the alignment is achieved, the data point is recorded with a menu option. Subsequent movements to the remaining positions occur automatically until the last point is recorded.

When the last data pair measurements are completed, the calculation of system magnification is performed using the following formula:

$$M = \overline{\tan \phi_n} / \overline{\tan \theta_n}$$

where

$$\overline{\tan \phi_n} = (\tan \phi_n + \tan \phi_n') / 2, \quad \overline{\tan \theta_n} = (\tan \theta_n + \tan \theta_n') / 2$$

n = 1, denoting the semifield angle,

$\phi_n$  and  $\phi_n'$  are the angles associated with the real image rotations within the magnification procedure, and

$\theta_n$  and  $\theta_n'$  are the large rotary table angles associated with the point pair positions.

### Distortion calculation

Calculations for distortion are performed immediately following the magnification calculations. Distortion calculations are based on the theory presented in Section 4.6.3 of MIL-A-49425(CR). Calculations are performed using the data from the magnification procedure. The distortion at any point is calculated as:

$$D = (\overline{\tan \phi_n} - M \tan \theta_n) / M \tan \theta_n \times 100$$

where M = the system magnification

and n = respective point pairs.

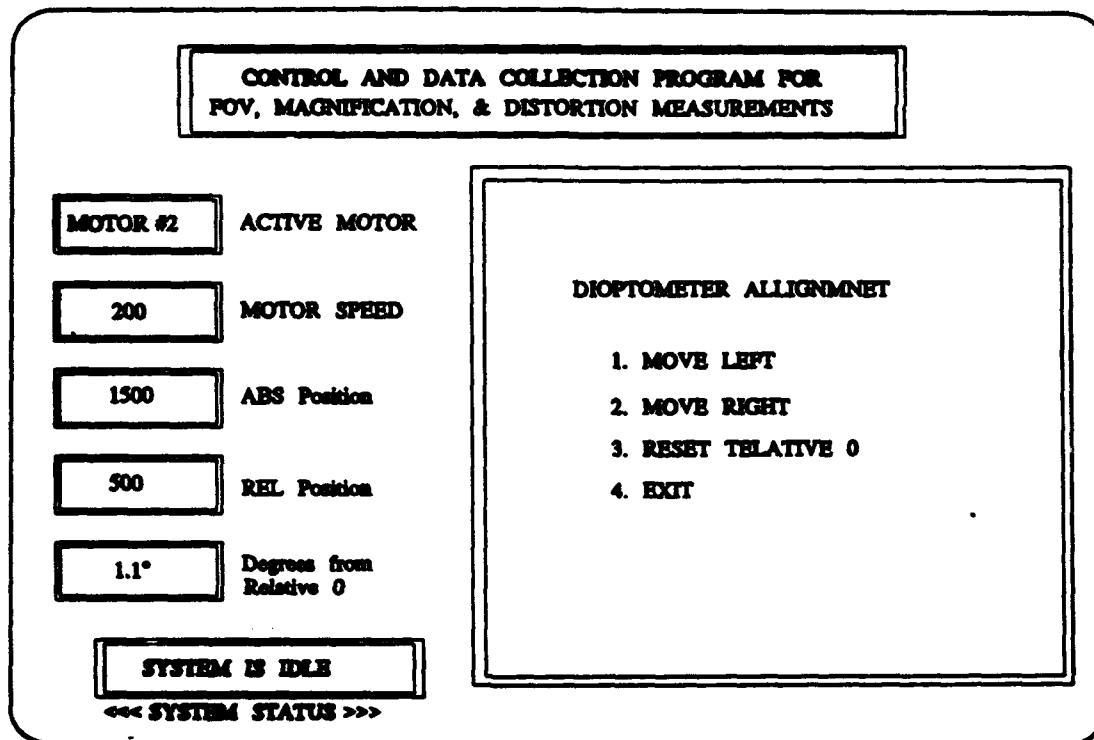

Figure 19. Sample screen for minidiometer alignment.

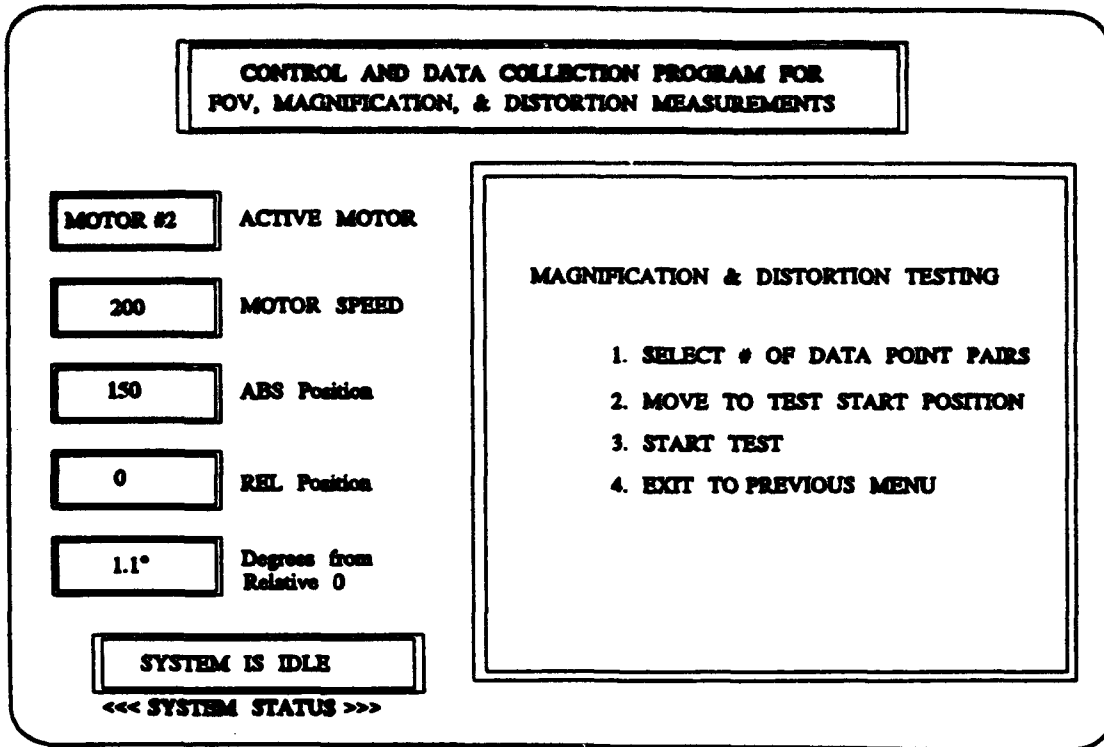

Figure 20. Sample screen #1 for magnification and distortion testing.

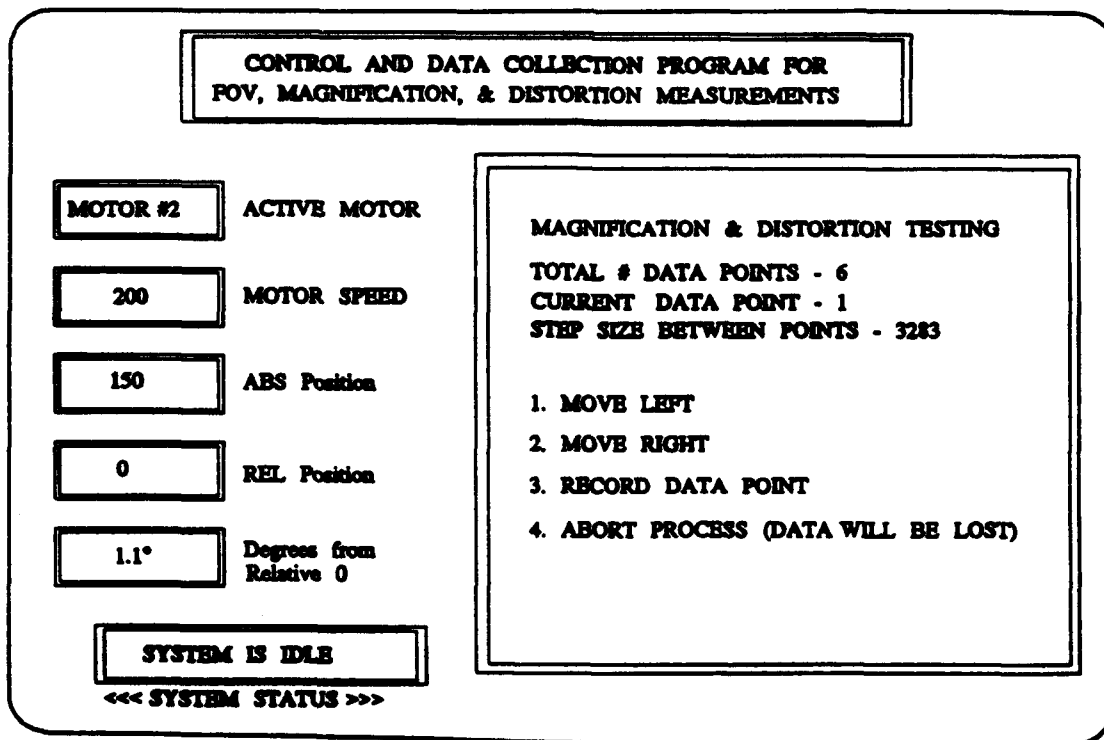

Figure 21. Sample screen #2 for magnification and distortion testing.



## Output of results

The program control returns to the function menu (Figure 15), where option 3 sends the test results to the printer. A test data output form (Figure 22) reports the test item identification data, the measured system field-of-view and magnification values, and the percent distortion values for all test points. PASSED/FAILED notation is used to indicate field-of-view and magnification test results.

Option 4, RETURN TO PREVIOUS MENU, exits to the original setup menu (Figure 14) for realignment of the rotational motors to their zero position. The program should be restarted at this point for subsequent testing. This allows for the input of new identification data and clearing of all variables, arrays, counters, etc.

DEVICE TYPE = AN/AVS-6(V)1 TEST DATE = 11-22-1993 Time: 14:29:05  
SERIAL# = 960A TUBE = RIGHT

RUN #1 HHB

FOV Specification Limits: 38 - 41 Degrees  
FIELD-OF-VIEW = 40.401 degrees - PASSED -  
MAGNIFICATION = 1.020X - PASSED -

Center of FOV is 345 microns  
or .7114957 degrees  
right of Absolute zero

DISTORTION DATA:  
MAGNIFICATION VALUE FOR GRAPH TRIAL = 1.0197680

Position in degrees	% Distortion
20.2003	-0.0333 %
16.8346	-0.5742 %
13.4689	-0.6206 %
10.1032	-1.2331 %
6.7376	-1.2718 %
3.3719	-2.1188 %
3.3595	-1.7575 %
6.7252	-1.0885 %
10.0909	-1.1095 %
13.4565	-0.5258 %
16.8222	-0.4967 %
20.1879	0.0333 %

Figure 22. Sample test results output.

## Measurement procedure

Prior to beginning of the test procedures, the physical setup of the test hardware and optics must be aligned. With this achieved, the three test procedures are performed in the sequence of field-of-view, magnification, and distortion. Each subsequent test is dependent upon data from the previous measurement. Field-of-view and magnification require physical measurements; distortion is calculated using the magnification data. Detailed steps in performing the alignment tests are as follows:

### Physical equipment setup and alignment

- Step 1 Perform vertical alignment of target (gunsight), vee-mount, and vertical jack.
- Step 2 Rotate large table to visually align mounting bar on large table to target (gunsight).
- Step 3 Turn on tungsten filament lamp and adjust luminance to approximately 1E-1 footlambert.
- Step 4 Mount device to be tested onto the large table.

### Measurement program

- Step 1 Apply power to motor controller and initiate control program.
- Step 2 At instruction prompt, enter Y to review instructions or enter N to bypass instructions.

### Test item identification

- Step 3 Enter name of device under test, followed by <CR>, at 'TYPE DEVICE' prompt. This entry is limited to 20 characters.
- Step 4 Enter serial # of device under test, followed by <CR>, at 'SERIAL #' prompt. This entry is limited to 20 characters.
- Step 5 For dual tube devices, enter LEFT or RIGHT to indicate the tube under test. For single tube systems, enter N/A. Follow entry with <CR>.

- Step 6 Enter the lower and upper design specifications, in degrees, for system field-of-view. For ANVIS, the lower limit is 39 and the upper limit is 41. Follow each entry with <CR>.
- Step 7 At 'NOTE:' prompt, enter up to 20 characters which further describe the device under test. Follow entry with <CR>.
- Step 8 If the entered test item identification data is correct, enter Y. If corrections are required, enter N and repeat steps 3-7.

#### Setup and alignment

- Step 9 At motor prompt, select the large table motor by pressing 1.
- Step 10 At SETUP menu, press 2 to reset absolute zero.
- Step 11 Press 3 to reset relative zero.
- Step 12 Press 4 to set the motor speed. Enter 200, followed by <CR>.

Note: If a previous measurement has been made, option 5 may need to be selected at this point to return the motor to absolute zero.

- Step 13 Press 6 to advance to FUNCTION MENU.
- Step 14 At this menu screen press 1 to select field-of-view measurement.

#### Field-of-view measurement

- Step 15 Looking through one monocular, rotate the platform to the left until the edge of the field is located. This is accomplished by pressing 1 and entering the desired number of micron steps to be moved, followed by <CR>. For ANVIS, this entry will be approximately 10,000.
- Step 16 By alternating between right (2) and left (1) motor movements, in decreasing size, position the slit on the extreme right edge of the field-of-view.

- Step 17 Press 3, which sets the relative zero position.
- Step 18 Rotate the table to the right by pressing 2 and repeating bracketing procedure until the slit is aligned with the left edge of the field-of-view.
- Step 19 Press 4 to record the measured field-of view value.
- Step 20 Press 5 to position the large table at the center of the measured field-of-view. At this point, measured values for the FOV and center of FOV will be displayed.
- Step 21 Press 1 to reset relative zero to the center of the measured FOV.
- Step 22 At the dioptometer installation prompt, set the dioptometer to infinity, position the dioptometer 15 mm behind the test device ocular, and press <any key> to continue. Motor #2 is selected automatically.

### Magnification

- Step 23 To align the dioptometer crosshairs with the slit, select 1 and/or 2 to make the necessary motor movements.
- Step 24 When alignment is achieved, press 3 to reset the relative zero position of motor #2.
- Step 25 Press 4 to exit the DIOPTOMETER ALIGNMENT menu and return to the CENTER OF FOV CALCULATIONS menu. Press 2 to exit this menu and return to the FUNCTION menu.
- Step 26 Press 2 to begin magnification measurement.
- Step 27 Select the number of measurement pairs by pressing 1 and entering the desired value up to 20 (40 data points). An entry of 4 (8 data points) is recommended for ANVIS systems.

- Step 28 Press 2 to move to the starting position. This results in the large table moving to the first data point position and the small table moving to an approximate corresponding position.
- Step 29 Press 3 to begin the measurement.
- Step 30 Use 1 and/or 2 to completely align the dioptometer crosshairs with the illuminated slit. When alignment is achieved, press 3 to record the data point. Movement to the next data point is automatic.
- Step 31 Repeat 30 until each data point measurement is recorded. After the last data point measurement is completed, the program calculates magnification and distortion and returns to the FUNCTION menu.
- Step 32 To output the test results, press 3.
- Step 33 Press 4 to return to the SETUP menu.
- Step 34 From the SETUP menu, press 1 for the motor selection, press 1 to select large rotary table motor, and press 5 followed by 1 to move to absolute zero. Press 3 to reset the relative zero position.
- Step 35 From the SETUP menu, press 1 for motor selection, press 2 to select small rotary table motor, press 5 followed by 1 to move to absolute zero. Press 3 to reset relative zero position.

Note: Steps 34 and 35 realign the test apparatus to its physical center for subsequent tests. It is recommended that the control program be halted and restarted before each test. This clears all program variables, flags, and data arrays.

#### Performance data

To assess the reliability of the improved test methodology, a randomly selected ANVIS tube was repeatedly measured five times. For each test trial the tube was removed completely, remounted, and realigned. Six point pairs were used to obtain the distortion values. The five data reports are provided in Appendix C.

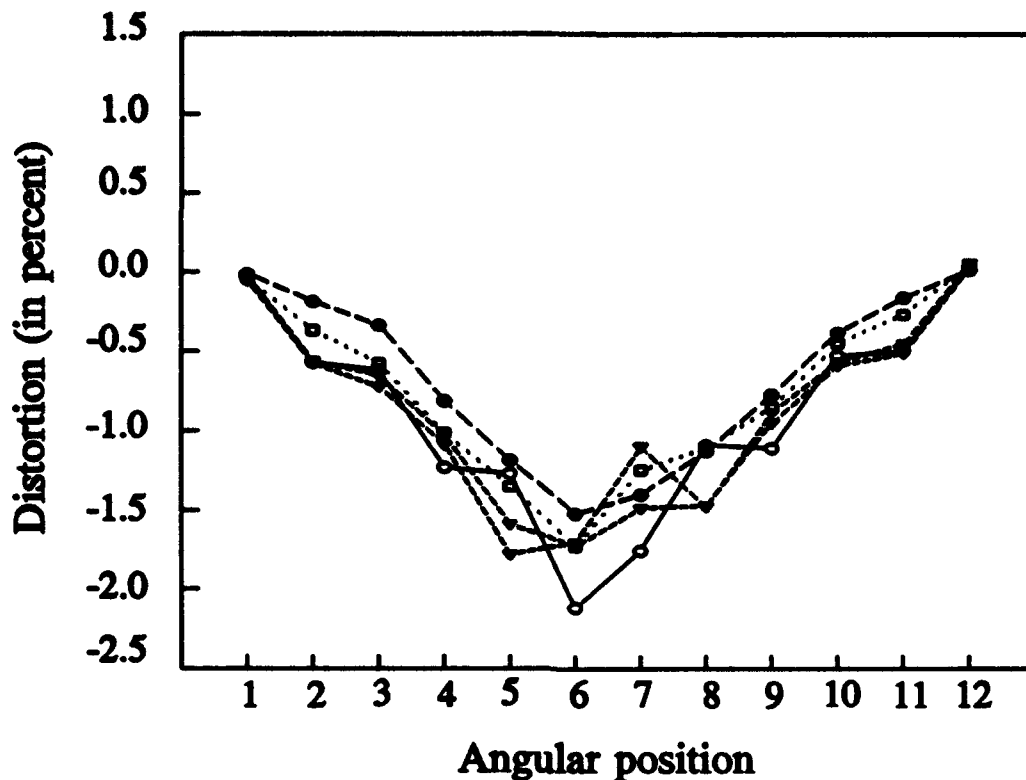

Figure 23. Distortion (in percent) as a function of angular position across the tube.

Table 2 lists the field-of-view and magnification values for these trials. Table 3 lists the calculated distortion values for each point. These values are plotted as a function of the angular position of the point pairs in Figure 23.

The repeatability of the distortion data is investigated in Table 4, where means and standard deviations for the values at each angular position for the five trials are presented. In the strictest sense, the five separate trials do not provide distortion values for the exact same points. This is a result of the control program's method of determining distortion measurement points. Equally spaced points within the measured field-of-view are determined based upon the field-of-field measurement. Since there is variation within the field-of-view measurements across trials (Table 2), each trial produces slightly different distortion measurement positions. However, due to the high repeatability in the FOV measurement, we consider these differences to be very small.

Table 2.

Repeatability performance data.

Trial #	FOV (in degrees)	Magnification
1	40.401	1.020X
2	40.370	1.016X
3	40.359	1.019X
4	40.349	1.020X
5	40.380	1.017X
Mean	40.372	1.018X
SD	0.020	0.002

Table 3.

Distortion values (in percent).

Position	Trial #				
	1	2	3	4	5
1	-0.0333	-0.0111	-0.0556	-0.0222	-0.0444
2	-0.5742	-0.1890	-0.5828	-0.5666	-0.3702
3	-0.6206	-0.3401	-0.7273	-0.6562	-0.5791
4	-1.2331	-0.8157	-1.0919	-1.0330	-1.0174
5	-1.2718	-1.1903	-1.7839	-1.5948	-1.3544
6	-2.1188	-1.5258	-1.7094	-1.7328	-1.7337
7	-1.7575	-1.4047	-1.1031	-1.4908	-1.2494
8	-1.0885	-1.1292	-1.4793	-1.4729	-1.1099
9	-1.1095	-0.7742	-0.8851	-0.9503	-0.8520
10	-0.5258	-0.3084	-0.5692	-0.5930	-0.4525
11	-0.4967	-0.1630	-0.4534	-0.5149	-0.2666
12	0.0333	0.0111	0.0556	0.0222	0.0445

**Table 4.**

**Distortion data analysis.**

<b>Angular position</b>	<b>Mean</b>	<b>SD</b>
1	-0.0333	0.0176
2	-0.4566	0.1738
3	-0.5846	0.1471
4	-1.0382	0.1507
5	-1.4390	0.2450
6	-1.7641	0.2165
7	-1.4011	0.2484
8	-1.2560	0.2015
9	-0.9142	0.1263
10	-0.4898	0.1146
11	-0.3789	0.1558
12	0.0333	0.0176

**Discussion**

These system components and software were assembled to speed up the process of data collection and increase the accuracy level of the measurements. Using a microprocessor to control the angular positioning of the tested device through the Mike encoder motors assures accuracy well within the required tolerances. The computer, through software, collects the data directly from the encoder positioner control interface and performs the required mathematical calculations and functions. This greatly reduces potential for human error and accelerates completion of the measurement task.



Reference

Department of Defense. 1989. Military specification: Aviator's  
Night Vision Imaging System AN/AVS-6(V)1, AN/AVS-6(V)2.  
Washington, DC: Department of Defense. MIL-A-49425 (CR)

Appendix A.

List of manufacturers

Dell Computer Corporation  
9505 Arboretum Blvd  
Austin, TX 78759-7299

Fisher Scientific Company  
4901-TW Lemoyne Ave  
Chicago, IL 60651

Intel Corporation  
3065-T Bowers Ave  
Santa Clara, CA 95051

MicroSoft Corporation  
15220 Greenbrier Parkway  
Beaverton, OR 97006-9937

Oriel Corporation  
250 Long Beach Blvd  
P.O. Box 872  
Stratford, CT 06497

Appendix B.

Control program source code.

```

10 REM * * * * *
20 REM * *           THIS PROGRAM IS DESIGNED FOR USE           * *
30 REM * * WITH ORIEL MICRO POSITIONER EQUIPMENT USING A       * *
40 REM * * NULL MODEM CABLE AND COM PORT 2 ON AN IBM-AT      * *
50 REM * * SYSTEM. WRITTEN BY J.S. MARTIN - 1992              * *
60 REM * *           Revision date 17 Feb 1993                 * *
70 REM * * THIS VERSION IS FOR COMBINED FOV / MAGNIFICATION / * *
80 REM * * AND DISTORTION / USING 2 AXIS ROTATIONAL MOTORS    * *
85 REM * *           ON THE BEASLEY TABLE SETUP               * *
90 REM * * * * *
100 CLS:KEY OFF:SCREEN 9:COLOR 15,1,1
101 LOCATE 10,20:PRINT" DO YOU WANT INSTRUCTIONS...(Y/N)?"
102 V$=INKEY$:IF V$="" THEN 102
103 IF V$= "Y" OR V$= "y" THEN GOSUB 9000:GOTO 110
105 CLS
110 REM *** variable declaration
120 U1=0:U2=0:D1=0:F1=0:F2=0:F3=0:F4=0:M=0:PI=22/7:M1$="Motor
#1":M2$="Motor #2"
122 TD$=DATE$:C$=""
123 REM *** U1 & U2 = Spec limits for test item FOV ***
125 DIM P1(30),P2(30),Q1(30),Q2(30),R1(30),R2(30),D(30) 'Dimension
arrays
130 X1=85:X2=515:Y1=5:Y2=50:B=1:B1=12
140 GOSUB 610:O1=1:B1=14:GOSUB 610:O1=2:B1=12:GOSUB 610:O1=0
150 X1=10:X2=100:Y1=65:Y2=90:B=1:B1=14
160 GOSUB 610:O1=1:B1=10:GOSUB 610:O1=0
170 X1=10:X2=100:Y1=105:Y2=130:B=1:B1=14
180 GOSUB 610:O1=1:B1=10:GOSUB 610:O1=0
190 X1=10:X2=100:Y1=147:Y2=172:B=1:B1=14
200 GOSUB 610:O1=1:B1=10:GOSUB 610:O1=0
210 X1=10:X2=100:Y1=190:Y2=215:B=1:B1=14
220 GOSUB 610:O1=1:B1=10:GOSUB 610:O1=0
230 X1=10:X2=100:Y1=230:Y2=255:B=1:B1=14
240 GOSUB 610:O1=1:B1=10:GOSUB 610:O1=0
250 X1=27:X2=228:Y1=272:Y2=303:B=1:B1=14
260 GOSUB 610:O1=1:B1=12:GOSUB 610:O1=2:B1=14:GOSUB 610:O1=0
270 X1=250:X2=610:Y1=63:Y2=330:B1=10
280 GOSUB 610:O1=1:GOSUB 610:O1=2:GOSUB 610:O1=0
285 COLOR 14
290 LOCATE 2,13:PRINT" CONTROL AND DATA COLLECTION PROGRAM FOR "
295 COLOR 10
300 LOCATE 3,13:PRINT" FOV, MAGNIFICATION, & DISTORTION MEASUREMENTS"
305 COLOR 15
310 LOCATE 6,15:PRINT"ACTIVE MOTOR"
315 LOCATE 9,15:PRINT"MOTOR SPEED"
320 LOCATE 12,15:COLOR 12:PRINT"ABS Position"
325 LOCATE 15,15:COLOR 14:PRINT"REL Position"
330 LOCATE 17,15:COLOR 10:PRINT"Degrees from"
335 LOCATE 18,15:PRINT"Relative 0":COLOR 11
340 LOCATE 23,6:PRINT"<<< SYSTEM STATUS >>>":COLOR 15
345 GOSUB 2500

```

```

350 REM *** SET-UP MENU ***
355 CLS:COLOR 15:COLOR 14:LOCATE 6,34:PRINT"          ***<<< SET UP
MENU >>>***:COLOR 15
360 LOCATE 9,42:PRINT"1. SELECT MOTOR"
370 LOCATE 11,42:PRINT"2. RESET ABSOLUTE ZERO"
375 LOCATE 13,42:PRINT"3. RESET RELATIVE ZERO"
380 LOCATE 15,42:PRINT"4. SET MOTOR SPEED"
390 LOCATE 17,42:PRINT"5. MOVE TO A POSITION"
400 LOCATE 19,42:PRINT"6. GOTO FUNCTION MENU"
410 LOCATE 21,42:PRINT"7. EXIT PROGRAM"
420 IF M=0 THEN GOSUB 820:GOTO 350
430 GOSUB 630:GOSUB 910:GOSUB 800
440 V$=INKEY$:IF V$="" THEN 440
450 IF V$="1"THEN GOSUB 820:GOTO 350
460 IF V$="2"THEN GOSUB 1000:GOTO 350
470 IF V$="3"THEN GOSUB 1060:GOTO 350
480 IF V$="4"THEN GOSUB 1140:GOTO 350
490 IF V$="5"THEN GOSUB 1180:GOTO 350
500 IF V$="6"THEN GOSUB 2000:GOTO 350
510 IF V$="7"THEN GOSUB 1500:GOTO 350
520 BEEP:GOTO 440
600 END
610 REM *** View port draw routine ***
620 VIEW (X1+01,Y1+01)-(X2-01,Y2-01),B,B1:RETURN
630 REM * * OPEN COM PORT * * *
640 OPEN "COM2:4800,N,8,1" AS #1
650 GOSUB 670:GOSUB 710
660 PRINT#1,"R":GOSUB 730:B$="":RETURN
670 LOCATE 21,7:PRINT"          "
680 RETURN
690 LOCATE 21,7:COLOR 14:PRINT" SYSTEM IS IDLE          "
:COLOR 15:GOSUB 998
700 RETURN
710 LOCATE 21,7:COLOR 10:PRINT"SYSTEM BUSY-> WAIT...":COLOR 15
720 RETURN
730 REM * * / READ POSITIONER OUTPUT * * *
740 FOR X=0 TO 1200:NEXT X
750 WHILE NOT EOF(1)
760 A$=INPUT$(LOC(1),#1)
770 B$=B$+A$
780 WEND
790 RETURN
800 REM * * * CLOSE COM PORT * * *
810 PRINT#1,"L":GOSUB 730:B$="":CLOSE:GOSUB 670:GOSUB 690:RETURN
820 CLS:LOCATE 6,45:COLOR 14:PRINT"* * SELECT MOTOR * * "
830 LOCATE 9,46:COLOR 15:PRINT"1. SELECT MOTOR #1"
840 LOCATE 11,46:PRINT"2. SELECT MOTOR #2"
845 GOSUB 995
850 V$=INKEY$:IF V$="" THEN 850
860 IF V$="1" THEN 890
870 IF V$="2" THEN 900

```

```

880 BEEP:GOTO 850
890 GOSUB 630:GOSUB 730:PRINT#1,"M1":M=1:LOCATE 6,3:PRINT M1$
:GOSUB 910:GOSUB 800:RETURN

900 GOSUB 630:GOSUB 730:PRINT#1,"M2":M=2:LOCATE 6,3:PRINT M2$
:GOSUB 910:GOSUB 800:RETURN
910 REM * * READ POSITION DATA * *
920 B$="":PRINT#1,"A":GOSUB 730:A=VAL(B$):B$="":PRINT#1,"P"
:GOSUB 730:R=VAL(B$):B$=""
930 LOCATE 12,3:PRINT " " " ":LOCATE 12,3:PRINT A
940 LOCATE 15,3:PRINT " " " ":LOCATE 15,3:PRINT R
950 LOCATE 18,3:PRINT " " " ":LOCATE 18,3:R1=R/484.894:PRINT
USING "###.###";R1;:PRINT CHR$(248)
960 B$="":PRINT#1,"I":GOSUB 730:S=VAL(MID$(B$,7,3)):LOCATE 9,3:PRINT"
" :LOCATE 9,5:PRINT S:RETURN
970 REM * * * Check System for BUSY signal * * *
980 B$="":PRINT#1,"Z":GOSUB 730:IF B$<>"a" THEN 980
990 RETURN
995 SOUND 450,7:SOUND 350,5.5:RETURN
998 FOR X=1 TO 3:SOUND 475,.8:FOR Z=0 TO 650:NEXT Z:NEXT X:RETURN
1000 CLS:LOCATE 9,53:PRINT"Ready to ":COLOR 14:LOCATE 10,50:PRINT
"RESET ABSOLUTE ";:COLOR 15:LOCATE 11,50:PRINT"counter to zero"
1010 LOCATE 13,48:COLOR 10:PRINT"ARE YOU SURE Y/N ?":COLOR 15
1020 V$=INKEY$:IF V$="" THEN 1020
1030 IF V$="Y"OR V$="y" THEN 1120
1040 IF V$="N"OR V$="n" THEN RETURN
1050 BEEP:GOTO 1020
1060 CLS:LOCATE 9,53:PRINT"Ready to ":COLOR 14:LOCATE 10,50:PRINT
"RESET RELATIVE ";:COLOR 15:LOCATE 11,50:PRINT"counter to zero"
1070 LOCATE 13,48:COLOR 10:PRINT"ARE YOU SURE Y/N ?":COLOR 15
1080 V$=INKEY$:IF V$="" THEN 1080
1090 IF V$="Y"OR V$="y" THEN 1130
1100 IF V$="N"OR V$="n" THEN RETURN
1110 BEEP:GOTO 1080
1120 CLS:GOSUB 630:PRINT#1,"CA":GOSUB 730:B$="":GOSUB 910
:GOSUB 800:RETURN
1130 CLS:GOSUB 630:PRINT#1,"CR":GOSUB 730:B$="":GOSUB 910
:GOSUB 800:RETURN
1140 CLS:LOCATE 13,45:PRINT"Enter new SPEED value":LOCATE
14,45:PRINT"BETWEEN (.5 <-> 200)"
1150 LOCATE 17,48:INPUT "New Speed";S
1160 IF S< .5 OR S>200 THEN 1150
1170 GOSUB 630:PRINT#1,"V";S:GOSUB 910:GOSUB 800:RETURN
1180 REM *** Move the motors routine ***
1190 CLS:V$="":LOCATE 6,45:COLOR 14:PRINT"<< MOVEMENT MENU >>"
:COLOR 15
1200 LOCATE 9,42:PRINT"1. MOVE TO ABSOLUTE ZERO"
1210 LOCATE 11,42:PRINT"2. MOVE TO RELATIVE ZERO"
1220 LOCATE 13,42:PRINT"3. MOVE TO SPECIFIC POSITION"
1230 LOCATE 15,42:PRINT"4. MOVE SET DISTANCE & DIRECTION"
1240 LOCATE 17,42:PRINT"5. RETURN TO PREVIOUS MENU"

```

```

1250 V$=INKEY$:IF V$="" THEN 1250
1260 IF V$="1" THEN GOSUB 1320:GOTO 1180
1270 IF V$="2" THEN GOSUB 1350:GOTO 1180
1280 IF V$="3" THEN GOSUB 1380:GOTO 1180
1290 IF V$="4" THEN GOSUB 1450:GOTO 1180
1300 IF V$="5" THEN V$="":RETURN
1310 BEEP:GOTO 1250
1320 REM * * * MOVE TO ABSOLUTE ZERO * * *
1330 CLS:LOCATE 13,44:COLOR 12:PRINT "MOVING TO ABSOLUTE ZERO"
:COLOR 15
1340 GOSUB 630:PRINT #1,"G 0":GOSUB 970:B$="":GOSUB 910
:GOSUB 800:RETURN
1350 REM * * * MOVE TO RELATIVE ZERO * * *
1360 CLS:LOCATE 13,44:COLOR 12:PRINT "MOVING TO RELATIVE ZERO"
:COLOR 15
1370 GOSUB 630:IF R<0 THEN J=ABS(R) ELSE J=R-(R*2)
1372 PRINT #1,"T";J:GOSUB 970:B$="":GOSUB 910:GOSUB 800:RETURN
1380 REM * * * MOVE TO SPECIFIC POSITION"
1390 CLS:LOCATE 9,42:PRINT"ENTER THE ";:COLOR 14:PRINT"ABSOLUTE
";:COLOR 15:PRINT"POSITION"
1400 LOCATE 10,46:PRINT"TO MOVE TO"
1410 LOCATE 12,42:PRINT"Include Neg (-) sign as appropriate"
1420 LOCATE 15,42:INPUT"< -999999 to 999999 >";N
1430 IF N< -999999! OR N> 999999! THEN LOCATE 15,41:PRINT "
":BEEP:GOTO 1420
1440 GOSUB 630:GOSUB 730:B$="":PRINT #1,"G";N:GOSUB 970:B$="
":GOSUB 910:GOSUB 800:RETURN
1450 REM *** MOVE DIRECTION & DISTANCE ***
1455 CLS:LOCATE 9,42:PRINT"LEFT OR RIGHT MOVEMENT (L/R)"
1460 V$=INKEY$:IF V$="" THEN 1460
1465 IF V$="R" OR V$="r" THEN 1470
1466 IF V$="L" OR V$="l" THEN 1480
1468 BEEP:GOTO 1450
1470 CLS:COLOR 14:LOCATE 11,40:PRINT"ENTER # STEP TO MOVE R-I-G-H-T"
1475 LOCATE 13,45:INPUT N:GOSUB 1490:RETURN
1480 CLS:COLOR 14:LOCATE 11,40:PRINT"ENTER # STEP TO MOVE L-E-F-T"
1485 LOCATE 13,45:INPUT N:N=N-N*2:GOSUB 1490:RETURN
1490 GOSUB 630:GOSUB 730:B$="":PRINT #1,"T";N:GOSUB 970:B$="":GOSUB
910:GOSUB 800:RETURN
1500 CLS:LOCATE 12,43:PRINT"ARE YOU SURE (Y/N)?"
1510 V$=INKEY$:IF V$="" THEN 1510
1520 IF V$="y" OR V$="Y" THEN 1540
1530 IF V$="n" OR V$="N" THEN RETURN
1540 VIEW:CLS:SCREEN 0:ON ERROR GOTO 0:END
2000 REM *** FUNCTION MENU SELECTION ***
2010 CLS:COLOR 14:LOCATE 6,35:PRINT" *<*<* FUNCTION MENU SELECTION
*>*>":COLOR 15
2020 LOCATE 9,42:PRINT"1. FIELD-OF-VIEW MEASUREMENT"
2030 LOCATE 11,42:PRINT"2. MAGNIFICATION & DISTORTION"
2040 LOCATE 12,51:PRINT"MEASUREMENTS"
2050 LOCATE 14,42:PRINT"3. OUTPUT RESULTS TO PRINTER"

```

```

2060 LOCATE 16,42:PRINT"4. RETURN TO PREVIOUS MENU"
2070 V$=INKEY$:IF V$="" THEN 2070
2080 IF V$="1" THEN GOSUB 3000:GOTO 2010
2090 IF V$="2" THEN GOSUB 4000:GOTO 2010
2100 IF V$="3" THEN GOSUB 7000:GOTO 2010
2110 IF V$="4" THEN V$="":RETURN
2120 BEEP:GOTO 2070
2500 REM *** GET ID DATA FOR TESTED DEVICE ***
2510 CLS:LOCATE 6,35:PRINT"IDENTIFICATION FOR TESTED DEVICE"
2520 LOCATE 9,40:PRINT"TYPE DEVICE:"
2530 LOCATE 11,40:PRINT"SERIAL #:"
2540 LOCATE 13,40:PRINT"LEFT/RIGHT or N/A:"
2545 LOCATE 15,40:PRINT"FOV Specification limits "
2546 LOCATE 16,33:PRINT"Lower Limit:":LOCATE 16,55:PRINT "Upper
Limit:"
2550 LOCATE 9,52:INPUT D$
2560 LOCATE 11,50:INPUT S1$
2565 LOCATE 13,59:INPUT T2$
2568 LOCATE 16,45:INPUT U1
2570 LOCATE 16,67:INPUT U2
2575 LOCATE 19,35:PRINT "NOTES: "
2576 LOCATE 19,42:INPUT C$
2580 CLS:LOCATE 6,35:COLOR 14:PRINT"TEST ID DATA:"
2590 LOCATE 9,40:PRINT"DEVICE TYPE IS: ";:COLOR 15:PRINT D$:COLOR 14
2600 LOCATE 11,40:PRINT"SERIAL # IS: ";:COLOR 15:PRINT S1$:COLOR 14
2610 LOCATE 13,40:PRINT"SELECTED TUBE IS: ";:COLOR 15:PRINT T2$
:COLOR 14
2611 LOCATE 15,35:PRINT"FOV Specification Limits:":COLOR 15:PRINT
U1;"-";U2:COLOR 14
2615 LOCATE 17,45:PRINT "NOTES:":COLOR 15:LOCATE 18,35:PRINT C$
2620 LOCATE 20,35:PRINT"IS THIS CORRECT? (Y/N)"
2630 V$=INKEY$:IF V$="" THEN 2630
2640 IF V$="N" OR V$="n" THEN 2500
2650 IF V$="Y" OR V$="y" THEN RETURN
2660 BEEP:GOTO 2630
3000 REM *** FOV MENU ***
3010 CLS:COLOR 14:LOCATE 6,35:PRINT" <-<-<- FIELD-OF-VIEW
->->->":COLOR 15
3020 LOCATE 9,42:PRINT"1. MOVE LEFT"
3030 LOCATE 11,42:PRINT"2. MOVE RIGHT"
3040 LOCATE 13,42:PRINT"3. RESET RELATIVE"
3050 LOCATE 15,42:PRINT"4. RECORD FOV"
3060 LOCATE 17,42:PRINT"5. CENTER OF FOV CALCULATIONS"
3070 LOCATE 19,42:PRINT"6. RETURN TO FUNCTION MENU"
3080 V$=INKEY$:IF V$="" THEN 3080
3090 IF V$="1" THEN GOSUB 3200:GOTO 3010
3100 IF V$="2" THEN GOSUB 3300:GOTO 3010
3110 IF V$="3" THEN GOSUB 1060:A4=A:GOTO 3010
3120 IF V$="4" THEN GOSUB 3400:GOTO 3010
3130 IF V$="5" THEN GOSUB 3500:GOTO 3010
3140 IF V$="6" THEN RETURN

```



```

3150 BEEP:GOTO 3080
3200 REM * * * MOVE LEFT * * *
3210 CLS:COLOR 14:LOCATE 11,40:PRINT"ENTER # STEP TO MOVE L-E-F-T"
3220 LOCATE 13,45:INPUT N:N=N-N*2:GOSUB 1490:RETURN
3300 REM * * * MOVE RIGHT * * *
3310 CLS:COLOR 14:LOCATE 11,40:PRINT"ENTER # STEP TO MOVE R-I-G-H-T"
3320 LOCATE 13,45:INPUT N:GOSUB 1490:RETURN
3400 REM *** RECORD FIELD OF VIEW MEASUREMENT ***
3410 CLS:LOCATE 6,34:PRINT"RECORD FIELD-OF-VIEW MEASUREMENT"
3420 LOCATE 9,40:PRINT"THE CURRENT FOV IS: ";:PRINT USING "###.###";
R1;:PRINT CHR$(248)
3430 LOCATE 12,42:COLOR 12:PRINT"IS THIS CORRECT (Y/N)"
3440 V$=INKEY$:IF V$="" THEN 3440
3450 IF V$="N" OR V$="n" THEN RETURN
3460 IF V$="Y" OR V$="y" THEN 3480
3470 BEEP:GOTO 3440
3480 F1=R1:F2=R:F4=A:RETURN
3500 REM *** CENTER OF FOV CALCULATIONS ***
3510 CLS:LOCATE 6,40:COLOR 14:PRINT"CENTER OF FOV CALCULATIONS"
3520 LOCATE 8,35:PRINT"CURRENT FOV IS ";:PRINT USING "###.###";F1;
:PRINT CHR$(248)
3530 D=(F2*.5)-F4:R3=F2*.5:R3=FIX(R3)
3540 LOCATE 10,35:PRINT"CENTER OF FOV =";:PRINT USING "###.###";
(.5*F2)/484.894;:PRINT CHR$(248)
3560 LOCATE 12,35:PRINT"CENTER OF FOV IS ";D;"MICRONS "
3570 LOCATE 13,49:PRINT"OR";:PRINT USING "###.###";D/484.894;:PRINT
CHR$(248)
3580 LOCATE 14,48:PRINT"FROM ABSOLUTE 0":COLOR 15
3590 LOCATE 16,35:PRINT"1. RESET RELATIVE 0 TO CENTER FOV"
3600 LOCATE 18,35:PRINT"2. EXIT THIS MENU"
3610 V$=INKEY$:IF V$="" THEN 3610
3620 IF V$="1" THEN GOSUB 3700:F3=1:RETURN
3630 IF V$="2" THEN RETURN
3640 BEEP:GOTO 3610
3700 REM *** MOVE TO HALF FOV ***
3710 CLS:LOCATE 6,35:COLOR 12:PRINT"THIS PROCESS WILL TAKE A FEW
MINUTES"
3711 LOCATE 7,35:PRINT"PLEASE WAIT ....."
3712 LOCATE 10,40:COLOR 14:PRINT"MOVING TO CENTER OF FOV...."
3713 GOSUB 630:GOSUB 730:B$="":D2=R3-(R3*2):PRINT #1,"T";D2:
GOSUB 970:B$=""
3714 LOCATE 10,40:COLOR 14:PRINT"RESETTING RELATIVE 0....."
3715 PRINT #1,"CR":GOSUB 730:B$="":GOSUB 910:GOSUB 800
3716 FOR X=1 TO 2000:NEXT X
3718 GOSUB 995:CLS:LOCATE 7,35:PRINT"PLEASE INSTALL THE "
3719 LOCATE 8,40:PRINT"DIOPTRIC & MOTOR #2"
3720 LOCATE 9,38:PRINT"FOR THE NEXT PHASE.....":GOSUB 995
3721 LOCATE 13,35:PRINT"PRESS ANY KEY TO CONTINUE ..."
3722 V$=INKEY$:IF V$="" THEN 3722
3725 GOSUB 900
3726 CLS:LOCATE 6,35:COLOR 14:PRINT"DIOPTRIC ALIGNMENT":COLOR 15

```

```

3730 LOCATE 9,42:PRINT"1. MOVE LEFT"
3735 LOCATE 11,42:PRINT"2. MOVE RIGHT"
3740 LOCATE 13,42:PRINT"3. RESET RELATIVE 0"
3745 LOCATE 15,42:PRINT"4. EXIT"
3750 V$=INKEY$:IF V$="" THEN 3750
3760 IF V$="1" THEN GOSUB 3200:GOTO 3726
3765 IF V$="2" THEN GOSUB 3300:GOTO 3726
3770 IF V$="3" THEN GOSUB 1060:GOTO 3726
3775 IF V$="4" THEN RETURN
3780 BEEP:GOTO 3750
4000 REM *** MAGNIFICATION & DISTORTION MEASUREMENTS ***
4010 CLS:IF F3 THEN 4030
4020 LOCATE 9,35:PRINT"FIELD-OF-VIEW MEASUREMENTS MUST BE "
4022 LOCATE 11,35:PRINT"COMPLETED BEFORE THIS PROCESS"
4023 LOCATE 13,35:PRINT"CAN BE ACCOMPLISHED"

4025 LOCATE 15,35:COLOR 14:PRINT"PRESS ANY KEY TO CONTINUE....."
":COLOR 15
4026 GOSUB 995
4027 V$=INKEY$:IF V$="" THEN 4027
4028 RETURN
4030 LOCATE 6,35:COLOR 14:PRINT"MAGNIFICATION & DISTORTION
MEASUREMENTS":COLOR 15
4040 LOCATE 9,40:PRINT"1. SELECT # OF DATA POINT PAIRS"
4050 LOCATE 11,40:PRINT"2. MOVE TO TEST START POSITION"
4060 LOCATE 13,40:PRINT"3. START TEST"
4065 LOCATE 15,40:PRINT"4. EXIT TO PREVIOUS MENU"
4070 V$=INKEY$:IF V$="" THEN 4070
4080 IF V$="1" THEN GOSUB 4500:GOTO 4000
4090 IF V$="2" THEN GOSUB 4800:GOTO 4000
4100 IF V$="3" THEN GOSUB 5000:RETURN
4110 IF V$="4" THEN RETURN
4120 BEEP:GOTO 4070
4500 REM *** get number of data point pairs ***
4510 CLS:LOCATE 9,35:PRINT"Enter the number of data point pairs"
4520 LOCATE 10,35:PRINT"for Magnification & Distortion testing:"
4525 LOCATE 12,37:PRINT"MAX POSSIBLE IS 20"
4530 LOCATE 14,40:INPUT NP
4540 CLS:LOCATE 9,35:PRINT"You have selected";NP;"DATA POINT PAIRS"
4550 S1=FIX(R3/NP):LOCATE 11,35:PRINT"This will be";NP*2;"data
points"
4555 LOCATE 13,35:PRINT"Step size between data points "
4560 LOCATE 14,35:PRINT"will be";S1;"microns or";:PRINT USING
"###.###";S1/484.894;:PRINT CHR$(248)
4570 NS=NP-1:LOCATE 16,35:PRINT"There will be";NS+1;"data points on "
4580 LOCATE 17,35:PRINT"each side of center"
4590 LOCATE 20,40:PRINT"Is this correct (Y/N)?"
4600 V$=INKEY$:IF V$="" THEN 4600
4610 IF V$="Y" OR V$="y" THEN 4650
4620 IF V$="N" OR V$="n" THEN 4500
4630 BEEP:GOTO 4600

```

```

4650 D1=1:RETURN
4800 REM *** Move to Magnification / Distortion test starting Point
4805 CLS:IF D1=0 THEN 4870
4810 LOCATE 8,35:COLOR 14:PRINT"READY to MOVE to TEST START POSITION"
4820 LOCATE 10,49:PRINT"(Y/N)":COLOR 15
4830 V$=INKEY$:IF V$="" THEN 4830
4840 IF V$="Y" OR V$="y" THEN 4900
4850 IF V$="N" OR V$="n" THEN RETURN
4860 BEEP:GOTO 4830
4870 LOCATE 8,35:COLOR 14:PRINT "Number of data point must be "
4875 LOCATE 9,35:PRINT"entered before movement"
4880 LOCATE 11,40:PRINT"PRESS ANY KEY TO CONTINUE...":COLOR 15
:GOSUB 998
4885 V$=INKEY$:IF V$="" THEN 4885
4890 RETURN
4900 REM *** move to start position ***
4910 GOSUB 890:GOSUB 630:PRINT #1,"T";R3:GOSUB 970:B$=""
:GOSUB 910:GOSUB 800

4920 GOSUB 900:X1=R3-(R3*2):GOSUB 630:PRINT #1,"T";X1:GOSUB 970:
B$="":GOSUB 910 :GOSUB 800:GOSUB 995
4990 D4=1:RETURN
5000 REM *** start test for magnification ***
5010 CLS:IF D1=0 THEN 5020 ELSE 5040
5020 LOCATE 9,35:COLOR 14:PRINT"Number of DATA POINT PAIRS"
5025 LOCATE 10,35:PRINT"must be selected before TESTING can begin"
:COLOR 15
5027 LOCATE 13,35:PRINT "PRESS ANY KEY TO CONTINUE":GOSUB 998
5030 V$=INKEY$:IF V$="" THEN 5030
5035 RETURN
5040 IF D4=0 THEN 5042 ELSE 5050
5042 LOCATE 9,35:COLOR 14:PRINT"LARGE TABLE MUST BE AT START
POSITION"
5043 LOCATE 10,35:PRINT"BEFORE TESTING CAN BEGIN.....":COLOR 15
5044 LOCATE 13,35:PRINT"PRESS ANY KEY TO CONTINUE":GOSUB 998
5045 V$=INKEY$:IF V$="" THEN 5045
5046 RETURN
5050 CLS:LOCATE 14,35:PRINT"SETTING UP... PLEASE WAIT":GOSUB 900
5053 FOR K=1 TO NP*2
5055 CLS:LOCATE 6,35:COLOR 14:PRINT"MAGNIFICATION & DISTORTION
TESTING":COLOR 15
5060 LOCATE 8,35:PRINT"TOTAL # DATA POINTS -";NP*2
5070 LOCATE 9,35:PRINT"CURRENT DATA POINT -"
5080 LOCATE 10,35:PRINT"STEP SIZE BETWEEN POINTS -";S1
5090 LOCATE 12,35:PRINT "1. MOVE LEFT"
5100 LOCATE 14,35:PRINT "2. MOVE RIGHT"
5110 LOCATE 16,35:PRINT "3. RECORD DATA POINT"
5120 LOCATE 18,35:PRINT "4. ABORT PROCESS (DATA WILL BE LOST)"
5130 LOCATE 9,55:PRINT K
5140 V$=INKEY$:IF V$="" THEN 5140
5150 IF V$="1" THEN GOSUB 3200:GOTO 5055

```

```

5160 IF V$="2" THEN GOSUB 3300:GOTO 5055
5170 IF V$="3" THEN GOSUB 5500:IF K<(NP*2) THEN NEXT K ELSE 5600
5180 IF V$="4" THEN GOSUB 6000:GOTO 5055
5190 BEEP:GOTO 5140
5500 REM *** RECORD DATA POINT AND MOVE ON ***
5510 R2(K)=ABS(R1)
5520 GOSUB 890
5530 R1(K)=ABS(R1)
5535 IF K=NP*2 THEN 5590
5540 IF K=NP THEN S2=S1*2 ELSE S2=S1
5550 CLS:LOCATE 14,35:PRINT"MOVING TO NEXT POINT... PLEASE WAIT"
5560 GOSUB 630:GOSUB 730:B$="":S2=S2-S2*2:PRINT #1,"T";S2:
GOSUB 970:B$="":GOSUB 910:GOSUB 800
5570 GOSUB 900
5580 GOSUB 630:GOSUB 730:B$="":S2=S2-S2*2:PRINT #1,"T";S2:
GOSUB 970:B$="":GOSUB 910:GOSUB 800
5590 V$=INKEY$:IF V$<>" " THEN 5590
5595 RETURN
5600 REM *** BACK FILL THE ARRAYS - CALCULATIONS AND EXIT PROCESS ***
5610 FOR X=1 TO NP:P1(X)=R1(X):P2(X)=R2(X):NEXT X
5615 J=0
5620 FOR X=NP*2 TO NP+1 STEP -1:J=J+1:Q1(J)=R1(X):Q2(J)=R2(X):NEXT X
5622 REM *** MAGNIFICATION CALCULATIONS ***
5625 X=1
5630 LP=TAN(P2(X)*PI/180):LQ=TAN(Q2(X)*PI/180):L=(LP+LQ)/2
5635 BP=TAN(P1(X)*PI/180):BQ=TAN(Q1(X)*PI/180):B=(BP+BQ)/2
5640 MX=L/B
5650 REM *** DISTORTION CALCULATIONS ***
5700 FOR X=1 TO NP
5705 LP=TAN(P2(X)*PI/180):LQ=TAN(Q2(X)*PI/180)
5710 L(X)=(LP+LQ)/2
5715 NEXT X
5720 J=0:FOR X=1 TO NP
5725 J=J+1:B=MX*(TAN(R1(X)*PI/180))
5730 D(X)=((L(J)-B)/B)*100
5735 NEXT X
5736 J=0:FOR X=NP*2 TO NP+1 STEP -1
5737 J=J+1:B=MX*(TAN(R1(X)*PI/180))
5738 D(X)=((L(J)-B)/B)*100
5740 NEXT X
5999 RETURN
6000 CLS:LOCATE 14,35:PRINT "ABORT THE PROCESS...."
6005 LOCATE 16,35:PRINT "ARE YOU SURE (Y/N) ?"
6010 V$=INKEY$:IF V$="" THEN 6010
6020 IF V$="Y" OR V$="y" THEN 4000
6030 IF V$="N" OR V$="n" THEN RETURN
6040 BEEP:GOTO 6010
7000 REM *** OUTPUT DATA TO PRINTER ***
7005 ON ERROR GOTO 8000
7010 LPRINT"DEVICE TYPE =";D$;"          TEST DATE =";DATE$;"
Time:";TIME$

```

```

7020 LPRINT"SERIAL# =" ;S1$;"      TUBE =" ;T2$
7030 LPRINT:LPRINT C$:DD=ABS(D):IF D< 0 THEN LR$="left" ELSE
LR$="right"
7035 LPRINT:LPRINT"FOV Specification Limits: " ;U1;"-" ;U2;"Degrees"
7040 LPRINT"FIELD-OF-VIEW = " ;:LPRINT USING "###.###";F1;:LPRINT"
degrees";
7042 IF F1 < U1 OR F1> U2 THEN LPRINT"- FAILED -" ELSE LPRINT"-
PASSED -"
7045 LPRINT"MAGNIFICATION =" ;:LPRINT USING "###.###";MX;:LPRINT"X";
7046 IF MX <.95 OR M>1.05 THEN LPRINT"- FAILED -" ELSE LPRINT "-
PASSED -"
7047 LPRINT:LPRINT"Center of FOV is";DD;"Microns or";:LPRINT USING
"###.###";DD/484.894;"DEGREES " ;LR$;" OF ABSOLUTE ZERO"
7048 LPRINT:LPRINT"DISTORTION DATA:
7049 LPRINT "MAGNIFICATION VALUE FOR GRAPH TRIAL =" ;:LPRINT USING
"###.###";MX
7050 LPRINT:LPRINT"Position in degrees      ‡ Distortion"
7055 FOR X=1 TO NP*2:AK=R1(X)
7060 LPRINT USING "###.###";AK;:LPRINT"                ";:LPRINT
USING "###.###";D(X);:LPRINT" ‡"
7070 NEXT X
7110 LPRINT CHR$(12):RETURN
8000 REM *** ERROR TRAPPING FOR PRINTER OFF LINE CONDITION ***
8010 CLS:LOCATE 14,35:PRINT"P R I N T E R   E R R O R  !!"
8020 LOCATE 16,35:PRINT"CHECK ON-LINE SETTING &/OR POWER SWITCH..."
8030 GOSUB 995:LOCATE 19,35:PRINT "PRESS ANY KEY TO
CONTINUE..." :GOSUB 995
8040 V$=INKEY$:IF V$="" THEN 8040
8050 RESUME 7000
9000 CLS:KEY OFF:SCREEN 9:COLOR 4:GOTO 9430
9010 REM *** center slit ***
9020 LINE (295,70)-(305,70),2
9030 LINE (295,220)-(305,220),2
9040 LINE (295,220)-(295,70),2
9050 LINE (305,70)-(305,220),2
9060 PAINT (300,100),2,2
9070 RETURN
9080 REM *** edge slit ***
9090 LINE (177,70)-(187,70),2
9100 LINE (177,220)-(187,220),2
9110 LINE (177,220)-(177,70),2
9120 LINE (187,70)-(187,220),2
9130 PAINT (180,100),2,2
9140 RETURN
9150 REM *** circle draw
9160 CIRCLE (300,150),130,8,,,1
9170 CIRCLE (300,150),120,8,,,1
9180 PAINT (183,200),8,8
9190 RETURN
9200 REM *** crosshair draw edge ***
9210 LINE (135,150)-(225,150),15

```

```

9220 LINE (180,100)-(180,200),15
9230 RETURN
9240 REM *** crosshair draw mid point ***
9250 LINE (200,150)-(290,150),15
9260 LINE (245,100)-(245,200),15
9270 RETURN
9280 REM *** crosshair draw center ***
9290 LINE (255,150)-(345,150),15
9300 LINE (300,100)-(300,200),15
9310 RETURN
9320 REM *** slit at mid point ***
9330 LINE (240,70)-(250,70),2
9340 LINE (240,220)-(250,220),2
9350 LINE (240,70)-(240,220),2
9360 LINE (250,70)-(250,220),2
9370 PAINT (245,100),2,2
9380 RETURN
9390 LOCATE 1,24:PRINT"PRESS ANY KEY TO CONTINUE..."
9400 V$=INKEY$:IF V$="" THEN 9400
9410 LOCATE 1,24:PRINT" "
9420 RETURN
9430 CLS:COLOR 2
9440 LOCATE 20,15:PRINT "This is a brief instructional outline to
describe"
9450 LOCATE 21,15:PRINT"what to look for while doing the
Field-of-View,"
9460 LOCATE 22,15:PRINT"Magnification & Distortion testing "
9470 GOSUB 9390
9480 CLS:GOSUB 9150:GOSUB 9010
9490 COLOR 10
9500 LOCATE 21,15:PRINT"The initial view through the ANVIS will be
that of"
9510 LOCATE 22,15:PRINT"a slit of light in the approximate center "
9520 GOSUB 9390
9530 CLS:GOSUB 9080:GOSUB 9150
9540 COLOR 2
9550 LOCATE 21,15:PRINT"Field-of-View will be measured first by
rotating"
9560 LOCATE 22,15:PRINT"the large table, (motor #1), until the slit
appears "
9570 LOCATE 23,15:PRINT"to be halved by the edge of the ANVIS tube "
9580 GOSUB 9390
9590 COLOR 7
9600 LOCATE 21,15:PRINT"Move left or right as needed with the
computer controls"
9610 LOCATE 22,15:PRINT"to align the image. Once completed record
the position"
9620 LOCATE 23,15:PRINT"at the computer, then repeat for the opposite
side"
9630 GOSUB 9390
9640 CLS:GOSUB 9150:GOSUB 9010

```

```
9650 COLOR 15
9660 LOCATE 21,15:PRINT"With the FOV recorded, the system should be
reset "
9670 LOCATE 22,15:PRINT"to the center of the FOV and the Dioptrimeter
will be "
9680 LOCATE 23,15:PRINT"added to the configuration for the
magnification measurements."
9690 GOSUB 9390
9700 GOSUB 9280
9710 COLOR 14
9720 LOCATE 21,15:PRINT"You now move the small table, (motor #2),
left/right "
9730 LOCATE 22,15:PRINT"with the computer controls to align the
crosshair of"
9740 LOCATE 23,15:PRINT"the Dioptrimeter with the center of the slit."
9750 GOSUB 9390
9760 CLS:GOSUB 9080:GOSUB 9150
9770 COLOR 3
9780 LOCATE 21,15:PRINT"Data will then be collected for Magnification
and"
9790 LOCATE 22,15:PRINT"Distortion at selected points. The first and
last"
9800 LOCATE 23,15:PRINT"points will again be at the extremes of the
FOV."
9810 GOSUB 9390
9820 GOSUB 9200:COLOR 11
9830 LOCATE 21,15:PRINT"When aligning the crosshair at these extremes
use"
9840 LOCATE 22,15:PRINT"the EDGE of the TUBE not the center of the
remaining"
9850 LOCATE 23,15:PRINT"portion of the slit."
9860 GOSUB 9390
9870 CLS:GOSUB 9150:GOSUB 9320:GOSUB 9240
9880 COLOR 11
9890 LOCATE 21,15:PRINT"For data points other than the extremes use
the center"
9900 LOCATE 22,15:PRINT"of the slit to align the crosshair.
9910 GOSUB 9390
9920 COLOR 14:CLS
9930 LOCATE 16,15:PRINT"Please insure that the Oriel Controller is
turned on"
9940 LOCATE 18,15:PRINT"before continuing....."
9950 GOSUB 9390
9960 CLS:SCREEN 9:COLOR 15,1,1:RETURN
```

Appendix C.

Test reports.



DEVICE TYPE =AN/AVS-6(V)1 TEST DATE =11-22-1993 Time:14:29:05  
SERIAL# =960A TUBE =RIGHT

RUN #1 HHB

FOV Specification Limits: 38 - 41 Degrees  
FIELD-OF-VIEW = 40.401 degrees- PASSED -  
MAGNIFICATION = 1.020X- PASSED -

Center of FOV is 345 Microns  
or .7114957 degrees  
right of Absolute zero

DISTORTION DATA:  
MAGNIFICATION VALUE FOR GRAPH TRIAL = 1.0197680

Position in degrees	% Distortion
20.2003	-0.0333 %
16.8346	-0.5742 %
13.4689	-0.6206 %
10.1032	-1.2331 %
6.7376	-1.2718 %
3.3719	-2.1188 %
3.3595	-1.7575 %
6.7252	-1.0885 %
10.0909	-1.1095 %
13.4565	-0.5258 %
16.8222	-0.4967 %
20.1879	0.0333 %

DEVICE TYPE =AN/AVS-6(V)1      TEST DATE =11-22-1993      Time:15:18:00  
SERIAL# =960A      TUBE =RIGHT

RUN #2 HHB

FOV Specification Limits: 38 - 41 Degrees  
FIELD-OF-VIEW = 40.370 degrees- PASSED -  
MAGNIFICATION = 1.016X- PASSED -

Center of FOV is 287.5 Microns  
                  or           .5929131 degrees  
right of Absolute zero

DISTORTION DATA:  
MAGNIFICATION VALUE FOR GRAPH TRIAL = 1.0164300

Position in degrees	% Distortion
20.1838	-0.0111 %
16.8202	-0.1890 %
13.4565	-0.3401 %
10.0929	-0.8157 %
6.7293	-1.1903 %
3.3657	-1.5258 %
3.3616	-1.4047 %
6.7252	-1.1292 %
10.0888	-0.7742 %
13.4524	-0.3084 %
16.8160	-0.1630 %
20.1797	0.0111 %

DEVICE TYPE =ANAVS-6(V)1      TEST DATE =11-22-1993      Time:16:15:08  
SERIAL# =960A      TUBE =RIGHT

RUN #3 HHB

FOV Specification Limits: 38 - 41 Degrees  
FIELD-OF-VIEW = 40.359 degrees- PASSED -  
MAGNIFICATION = 1.019X- PASSED -

Center of FOV is 175 Microns  
or .3609036 degrees  
right of Absolute zero

DISTORTION DATA:  
MAGNIFICATION VALUE FOR GRAPH TRIAL = 1.0189510

Position in degrees	% Distortion
20.1797	-0.0556 %
16.8181	-0.5828 %
13.4565	-0.7273 %
10.0950	-1.0919 %
6.7334	-1.7839 %
3.3719	-1.7094 %
3.3512	-1.1031 %
6.7128	-1.4793 %
10.0744	-0.8851 %
13.4359	-0.5692 %
16.7975	-0.4534 %
20.1590	0.0556 %

DEVICE TYPE =AN/AVS-6(V)1      TEST DATE =11-22-1993      Time:16:54:02  
SERIAL# =960A      TUBE =RIGHT

RUN #4 HHB

FOV Specification Limits: 38 - 41 Degrees  
FIELD-OF-VIEW = 40.349 degrees- PASSED -  
MAGNIFICATION = 1.020X- PASSED -

Center of FOV is 127.5 Microns  
                  or           .2629441 degrees  
right of Absolute zero

DISTORTION DATA:  
MAGNIFICATION VALUE FOR GRAPH TRIAL = 1.0195090

Position in degrees	% Distortion
20.1735	-0.0222 %
16.8119	-0.5666 %
13.4504	-0.6562 %
10.0888	-1.0330 %
6.7272	-1.5948 %
3.3657	-1.7328 %
3.3574	-1.4908 %
6.7190	-1.4729 %
10.0806	-0.9503 %
13.4421	-0.5930 %
16.8037	-0.5149 %
20.1652	0.0222 %

DEVICE TYPE =AN/AVS-6(V)1      TEST DATE =11-23-1993      Time:09:36:44  
SERIAL# =960A      TUBE =RIGHT

RUN #5 HHB

FOV Specification Limits: 38 - 41 Degrees  
FIELD-OF-VIEW = 40.380 degrees- PASSED -  
MAGNIFICATION = 1.017X- PASSED -

Center of FOV is 360 Microns  
or .7424303 degrees  
right of Absolute zero

DISTORTION DATA:  
MAGNIFICATION VALUE FOR GRAPH TRIAL = 1.0167090

Position in degrees	% Distortion
20.1900	-0.0444 %
16.8264	-0.3702 %
13.4627	-0.5791 %
10.0991	-1.0174 %
6.7355	-1.3544 %
3.3719	-1.7337 %
3.3554	-1.2494 %
6.7190	-1.1099 %
10.0826	-0.8520 %
13.4462	-0.4525 %
16.8099	-0.2666 %
20.1735	0.0445 %

**Initial distribution**

**Commander, U.S. Army Natick Research,  
Development and Engineering Center  
ATTN: SATNC-MIL (Documents  
Librarian)  
Natick, MA 01760-5040**

**Library  
Naval Submarine Medical Research Lab  
Box 900, Naval Sub Base  
Groton, CT 06349-5900**

**Chairman  
National Transportation Safety Board  
800 Independence Avenue, S.W.  
Washington, DC 20594**

**Executive Director, U.S. Army Human  
Research and Engineering Directorate  
ATTN: Technical Library  
Aberdeen Proving Ground, MD 21005**

**Commander  
10th Medical Laboratory  
ATTN: Audiologist  
APO New York 09180**

**Commander  
Man-Machine Integration System  
Code 602  
Naval Air Development Center  
Warminster, PA 18974**

**Naval Air Development Center  
Technical Information Division  
Technical Support Detachment  
Warminster, PA 18974**

**Commander  
Naval Air Development Center  
ATTN: Code 602-B  
Warminster, PA 18974**

**Commanding Officer, Naval Medical  
Research and Development Command  
National Naval Medical Center  
Bethesda, MD 20814-5044**

**Commanding Officer  
Armstrong Laboratory  
Wright-Patterson  
Air Force Base, OH 45433-6573**

**Deputy Director, Defense Research  
and Engineering  
ATTN: Military Assistant  
for Medical and Life Sciences  
Washington, DC 20301-3080**

**Director  
Army Audiology and Speech Center  
Walter Reed Army Medical Center  
Washington, DC 20307-5001**

**Commander, U.S. Army Research  
Institute of Environmental Medicine  
Natick, MA 01760**

**Commander/Director  
U.S. Army Combat Surveillance  
and Target Acquisition Lab  
ATTN: SFAE-IEW-JS  
Fort Monmouth, NJ 07703-5305**

Director  
Federal Aviation Administration  
FAA Technical Center  
Atlantic City, NJ 08405

Commander, U.S. Army Test  
and Evaluation Command  
ATTN: AMSTE-AD-H  
Aberdeen Proving Ground, MD 21005

Naval Air Systems Command  
Technical Air Library 950D  
Room 278, Jefferson Plaza II  
Department of the Navy  
Washington, DC 20361

Director  
U.S. Army Ballistic  
Research Laboratory  
ATTN: DRXBR-OD-ST Tech Reports  
Aberdeen Proving Ground, MD 21005

Commander  
U.S. Army Medical Research  
Institute of Chemical Defense  
ATTN: SGRD-UV-AO  
Aberdeen Proving Ground,  
MD 21010-5425

Commander  
USAMRDALC  
ATTN: SGRD-RMS  
Fort Detrick, Frederick, MD 21702-5012

Director  
Walter Reed Army Institute of Research  
Washington, DC 20307-5100

HQ DA (DASG-PSP-O)  
5109 Leesburg Pike  
Falls Church, VA 22041-3258

Harry Diamond Laboratories  
ATTN: Technical Information Branch  
2800 Powder Mill Road  
Adelphi, MD 20783-1197

U.S. Army Materiel Systems  
Analysis Agency  
ATTN: AMXSU-PA (Reports Processing)  
Aberdeen Proving Ground  
MD 21005-5071

U.S. Army Ordnance Center  
and School Library  
Simpson Hall, Building 3071  
Aberdeen Proving Ground, MD 21005

U.S. Army Environmental  
Hygiene Agency  
ATTN: HSHB-MO-A  
Aberdeen Proving Ground, MD 21010

Technical Library Chemical Research  
and Development Center  
Aberdeen Proving Ground, MD  
21010-5423

Commander  
U.S. Army Medical Research  
Institute of Infectious Disease  
ATTN: SGRD-UIZ-C  
Fort Detrick, Frederick, MD 21702

Director, Biological  
Sciences Division  
Office of Naval Research  
600 North Quincy Street  
Arlington, VA 22217

Commander  
U.S. Army Materiel Command  
ATTN: AMCDE-XS  
5001 Eisenhower Avenue  
Alexandria, VA 22333

**Commandant  
U.S. Army Aviation  
Logistics School ATTN: ATSQ-TDN  
Fort Eustis, VA 23604**

**Headquarters (ATMD)  
U.S. Army Training  
and Doctrine Command  
ATTN: ATBO-M  
Fort Monroe, VA 23651**

**IAF Liaison Officer for Safety  
USAF Safety Agency/SEFF  
9750 Avenue G, SE  
Kirtland Air Force Base  
NM 87117-5671**

**Naval Aerospace Medical  
Institute Library  
Building 1953, Code 03L  
Pensacola, FL 32508-5600**

**Command Surgeon  
HQ USCENCOM (CCSG)  
U.S. Central Command  
MacDill Air Force Base, FL 33608**

**Air University Library  
(AUL/LSE)  
Maxwell Air Force Base, AL 36112**

**U.S. Air Force Institute  
of Technology (AFIT/LDEE)  
Building 640, Area B  
Wright-Patterson  
Air Force Base, OH 45433**

**Henry L. Taylor  
Director, Institute of Aviation  
University of Illinois-Willard Airport  
Savoy, IL 61874**

**Chief, National Guard Bureau  
ATTN: NGB-ARS  
Arlington Hall Station  
111 South George Mason Drive  
Arlington, VA 22204-1382**

**Commander  
U.S. Army Aviation and Troop Command  
ATTN: AMSAT-R-ES  
4300 Goodfellow Bouvelard  
St. Louis, MO 63120-1798**

**U.S. Army Aviation and Troop Command  
Library and Information Center Branch  
ATTN: AMSAV-DIL  
4300 Goodfellow Boulevard  
St. Louis, MO 63120**

**Federal Aviation Administration  
Civil Aeromedical Institute  
Library AAM-400A  
P.O. Box 25082  
Oklahoma City, OK 73125**

**Commander  
U.S. Army Medical Department  
and School  
ATTN: Library  
Fort Sam Houston, TX 78234**

**Commander  
U.S. Army Institute of Surgical Research  
ATTN: SGRD-USM  
Fort Sam Houston, TX 78234-6200**

**AAMRL/HEX  
Wright-Patterson  
Air Force Base, OH 45433**



**Product Manager**  
Aviation Life Support Equipment  
ATTN: SFAE-AV-LSE  
4300 Goodfellow Boulevard  
St. Louis, MO 63120-1798

**Commander and Director**  
USAE Waterways Experiment Station  
ATTN: CEWES-IM-MI-R,  
CD Department  
3909 Halls Ferry Road  
Vicksburg, MS 39180-6199

**Commanding Officer**  
Naval Biodynamics Laboratory  
P.O. Box 24907  
New Orleans, LA 70189-0407

**Assistant Commandant**  
U.S. Army Field Artillery School  
ATTN: Morris Swott Technical Library  
Fort Sill, OK 73503-0312

**Mr. Peter Seib**  
Human Engineering Crew Station  
Box 266  
Westland Helicopters Limited  
Yeovil, Somerset BA20 2YB UK

**U.S. Army Dugway Proving Ground**  
Technical Library, Building 5330  
Dugway, UT 84022

**U.S. Army Yuma Proving Ground**  
Technical Library  
Yuma, AZ 85364

**AFFTC Technical Library**  
6510 TW/TSTL  
Edwards Air Force Base,  
CA 93523-5000

**Commander**  
Code 3431  
Naval Weapons Center  
China Lake, CA 93555

**Aeromechanics Laboratory**  
U.S. Army Research and Technical Labs  
Ames Research Center, M/S 215-1  
Moffett Field, CA 94035

**Sixth U.S. Army**  
ATTN: SMA  
Presidio of San Francisco, CA 94129

**Commander**  
U.S. Army Aeromedical Center  
Fort Rucker, AL 36362

**Strughold Aeromedical Library**  
Document Service Section  
2511 Kennedy Circle  
Brooks Air Force Base, TX 78235-5122

**Dr. Diane Damos**  
Department of Human Factors  
ISSM, USC  
Los Angeles, CA 90089-0021

**U.S. Army White Sands**  
Missile Range  
ATTN: STEWS-IM-ST  
White Sands Missile Range, NM 88002

**U.S. Army Aviation Engineering**  
Flight Activity  
ATTN: SAVTE-M (Tech Lib) Stop 217  
Edwards Air Force Base, CA 93523-5000

**Ms. Sandra G. Hart**  
Ames Research Center  
MS 262-3  
Moffett Field, CA 94035

**Commander  
USAMRDALC  
ATTN: SGRD-UMZ  
Fort Detrick, Frederick, MD 21702-5009**

**Commander  
U.S. Army Health Services Command  
ATTN: HSOP-SO  
Fort Sam Houston, TX 78234-6000**

**U. S. Army Research Institute  
Aviation R&D Activity  
ATTN: PERI-IR  
Fort Rucker, AL 36362**

**Commander  
U.S. Army Safety Center  
Fort Rucker, AL 36362**

**U.S. Army Aircraft Development  
Test Activity  
ATTN: STEBG-MP-P  
Cairns Army Air Field  
Fort Rucker, AL 36362**

**Commander  
USAMRDALC  
ATTN: SGRD-PLC (COL R. Gifford)  
Fort Detrick, Frederick, MD 21702**

**TRADOC Aviation LO  
Unit 21551, Box A-209-A  
APO AE 09777**

**Netherlands Army Liaison Office  
Building 602  
Fort Rucker, AL 36362**

**British Army Liaison Office  
Building 602  
Fort Rucker, AL 36362**

**Italian Army Liaison Office  
Building 602  
Fort Rucker, AL 36362**

**Directorate of Training Development  
Building 502  
Fort Rucker, AL 36362**

**Chief  
USAHEL/USAAVNC Field Office  
P. O. Box 716  
Fort Rucker, AL 36362-5349**

**Commander, U.S. Army Aviation Center  
and Fort Rucker  
ATTN: ATZQ-CG  
Fort Rucker, AL 36362**

**Chief  
Test & Evaluation Coordinating Board  
Cairns Army Air Field  
Fort Rucker, AL 36362**

**Canadian Army Liaison Office  
Building 602  
Fort Rucker, AL 36362**

**German Army Liaison Office  
Building 602  
Fort Rucker, AL 36362**

**French Army Liaison Office  
USAAVNC (Building 602)  
Fort Rucker, AL 36362-5021**

**Australian Army Liaison Office  
Building 602  
Fort Rucker, AL 36362**

**Dr. Garrison Rapmund  
6 Burning Tree Court  
Bethesda, MD 20817**

**Commandant, Royal Air Force  
Institute of Aviation Medicine  
Farnborough, Hampshire GU14 6SZ UK**

**Defense Technical Information  
Cameron Station, Building 5  
Alexandria, VA 22304-6145**

**Commander, U.S. Army Foreign Science  
and Technology Center  
AIFRTA (Davis)  
220 7th Street, NE  
Charlottesville, VA 22901-5396**

**Commander  
Applied Technology Laboratory  
USARTL-ATCOM  
ATTN: Library, Building 401  
Fort Eustis, VA 23604**

**Commander, U.S. Air Force  
Development Test Center  
101 West D Avenue, Suite 117  
Eglin Air Force Base, FL 32542-5495**

**Aviation Medicine Clinic  
TMC #22, SAAF  
Fort Bragg, NC 28305**

**Dr. H. Dix Christensen  
Bio-Medical Science Building, Room 753  
Post Office Box 26901  
Oklahoma City, OK 73190**

**Commander, U.S. Army Missile  
Command  
Redstone Scientific Information Center  
ATTN: AMSMI-RD-CS-R  
/ILL Documents  
Redstone Arsenal, AL 35898**

**Director  
Army Personnel Research Establishment  
Farnborough, Hants GU14 6SZ UK**

**U.S. Army Research and Technology  
Laboratories (AVSCOM)  
Propulsion Laboratory MS 302-2  
NASA Lewis Research Center  
Cleveland, OH 44135**

**Commander  
USAMRDALC  
ATTN: SGRD-ZC (COL John F. Glenn)  
Fort Detrick, Frederick, MD 21702-5012**

**Dr. Eugene S. Channing  
166 Baughman's Lane  
Frederick, MD 21702-4083**

**U.S. Army Medical Department  
and School  
USAMRDALC Liaison  
ATTN: HSMC-FR  
Fort Sam Houston, TX 78234**

**Dr. A. Kornfield, President  
Biosearch Company  
3016 Revere Road  
Drexel Hill, PA 29026**

**NVESD  
AMSEL-RD-NV-ASID-PST  
(Attn: Trang Bui)  
10221 Burbeck Road  
Fort Belvoir, VA 22060-5806**

**CA Av Med  
HQ DAAC  
Middle Wallop  
Stockbridge, Hants S020 8DY UK**

**Dr. Christine Schlichting**  
Behavioral Sciences Department  
Box 900, NAVUBASE NLON  
Groton, CT 06349-5900

**Commander, HQ AAC/SGPA**  
Aerospace Medicine Branch  
162 Dodd Boulevard, Suite 100  
Langley Air Force Base,  
VA 23665-1995

**Commander**  
Aviation Applied Technology Directorate  
ATTN: AMSAT-R-TV  
Fort Eustis, VA 23604-5577

**Director**  
Aviation Research, Development  
and Engineering Center  
ATTN: AMSAT-R-Z  
4300 Goodfellow Boulevard  
St. Louis, MO 63120-1798

**Commander**  
USAMRDALC  
ATTN: SGRD-ZB (COL C. Fred Tyner)  
Fort Detrick, Frederick, MD 21702-5012

**Director**  
Directorate of Combat Developments  
ATTN: ATZQ-CD  
Building 515  
Fort Rucker, AL 36362