

①

AD-A279 690

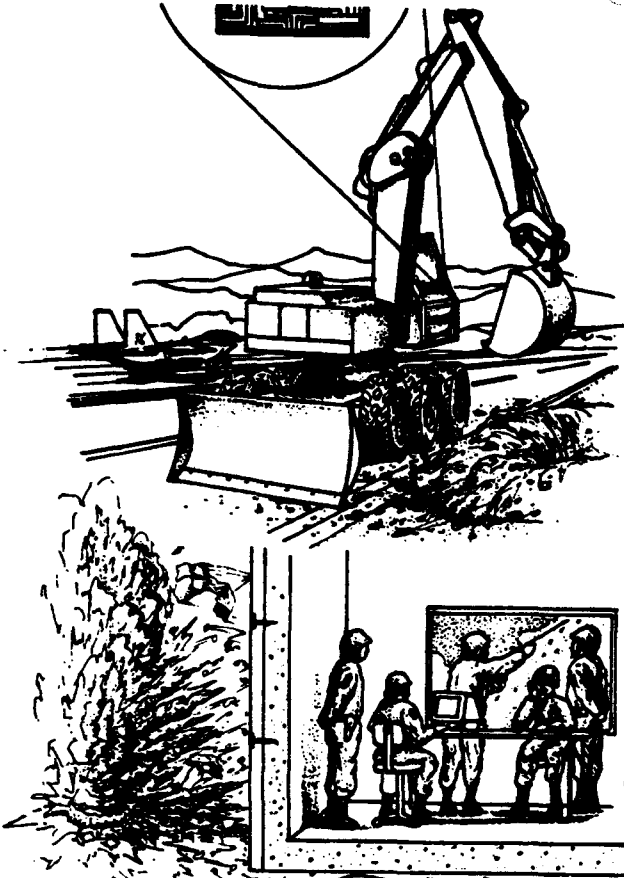

ESL-TR-92-26



**AIRBASE STRUCTURAL FACILITY
POSTATTACK RECOVERY - FOAL
EAGLE DEMONSTRATION**

**D.H. MERKLE, D.L. READ,
R.A. REID, J.M. UNDERWOOD,
N.F. KARASZEWSKI**

**APPLIED RESEARCH ASSOCIATES
P.O. BOX 40128
TYNDALL AFB FL 32403**



APRIL 1993

FINAL REPORT

SEPTEMBER 1991 - MARCH 1992

**DTIC
ELECTE
MAY 27 1994
S G D**

94-16001



**APPROVED FOR PUBLIC RELEASE
DISTRIBUTION UNLIMITED**



**ENGINEERING RESEARCH DIVISION
Air Force Civil Engineering Support Agency
Civil Engineering Laboratory
Tyndall Air Force Base, Florida 32403**



94 5 26 171 DTIC QUALITY INSPECTED 1

NOTICE

PLEASE DO NOT REQUEST COPIES OF THIS REPORT FROM HQ AFCESA/RA (AIR FORCE CIVIL ENGINEERING SUPPORT AGENCY). ADDITIONAL COPIES MAY BE PURCHASED FROM:

**NATIONAL TECHNICAL INFORMATION SERVICE
5285 PORT ROYAL ROAD
SPRINGFIELD, VIRGINIA 22161**

FEDERAL GOVERNMENT AGENCIES AND THEIR CONTRACTORS REGISTERED WITH DEFENSE TECHNICAL INFORMATION CENTER SHOULD DIRECT REQUESTS FOR COPIES OF THIS REPORT TO:

**DEFENSE TECHNICAL INFORMATION CENTER
CAMERON STATION
ALEXANDRIA, VIRGINIA 22314**

REPORT DOCUMENTATION PAGE

Form Approved
OMB No. 0704-0188

1a. REPORT SECURITY CLASSIFICATION UNCLASSIFIED			1b. RESTRICTIVE MARKINGS			
2a. SECURITY CLASSIFICATION AUTHORITY			3. DISTRIBUTION / AVAILABILITY OF REPORT Approved for public release Distribution Unlimited			
2b. DECLASSIFICATION / DOWNGRADING SCHEDULE			5. MONITORING ORGANIZATION REPORT NUMBER(S) CEL-TR-92-26			
4. PERFORMING ORGANIZATION REPORT NUMBER(S)			7a. NAME OF MONITORING ORGANIZATION Air Force Civil Engineering Support Agency			
6a. NAME OF PERFORMING ORGANIZATION Applied Research Associates		6b. OFFICE SYMBOL (if applicable) ARA	7b. ADDRESS (City, State, and ZIP Code) HQ AFCESA/RACS Tyndall AFB, FL 32403			
6c. ADDRESS (City, State, and ZIP Code) P.O. Box 40128 Tyndall AFB, FL 32403			9. PROCUREMENT INSTRUMENT IDENTIFICATION NUMBER F08635-88-C-0067			
8a. NAME OF FUNDING / SPONSORING ORGANIZATION HQ AFCESA		8b. OFFICE SYMBOL (if applicable) RACS	10. SOURCE OF FUNDING NUMBERS			
8c. ADDRESS (City, State, and ZIP Code) Tyndall AFB, FL 32403			PROGRAM ELEMENT NO.	PROJECT NO.	TASK NO.	WORK UNIT ACCESSION NO.
11. TITLE (Include Security Classification) Airbase Structural Facility Postattack Recovery - FOAL EAGLE Demonstration						
12. PERSONAL AUTHOR(S) Merkle, D.H.; Read, D.L.; Reid, R.A.; Underwood, J.M.; Karaszewski, N.F.; Purcell, M.R.						
13a. TYPE OF REPORT Final		13b. TIME COVERED FROM Sept 9 TO Mar 92		14. DATE OF REPORT (Year, Month, Day) April 1993		15. PAGE COUNT 150
16. SUPPLEMENTARY NOTATION						
17. COSATI CODES			18. SUBJECT TERMS (Continue on reverse if necessary and identify by block number)			
FIELD	GROUP	SUB-GROUP	Facility Recovery Base Recovery After Attack			
			Damage Assessment FOAL EAGLE			
			Expedient Repair			
19. ABSTRACT (Continue on reverse if necessary and identify by block number) The RACS Facility Recovery Demonstration, accomplished during the airbase ground defense exercise FOAL EAGLE at Osan AB, Republic of Korea from 2-6 November 1991, included both damage assessment and expedient repair systems. The postattack damage assessment (POST-DAM) system has three major subsystems; 1. An expert system, installed on a field portable laptop or hand-held computer, which sends previously stored expedient repair strategies to the BCE Damage Control Center (DCC) when fed damage information at the damage scene; 2. A resource database manager, installed on a host microcomputer in the DCC, which receives expedient repair strategies from the expert system, then compares repair resources required versus those available, to determine whether a repair is possible; and 3. A project scheduler, also installed on the host computer, which schedules possible repairs when approved by the Survival/Recovery Center (SRC) commander. Four airbase structural facility expedient repair systems were demonstrated:						
20. DISTRIBUTION / AVAILABILITY OF ABSTRACT <input checked="" type="checkbox"/> UNCLASSIFIED/UNLIMITED <input type="checkbox"/> SAME AS RPT. <input type="checkbox"/> DTIC USERS				21. ABSTRACT SECURITY CLASSIFICATION UNCLASSIFIED		
22a. NAME OF RESPONSIBLE INDIVIDUAL Richard A. Reid			22b. TELEPHONE (Include Area Code) (904) 283-4912		22c. OFFICE SYMBOL RACS	

19. ABSTRACT Continued:

1. A column splinting system, which resists further relative displacement of two portions of a fractured but otherwise intact reinforced concrete column;
2. A column shoring system, which replaces a badly damaged reinforced concrete column with a wood or light-gage steel column;
3. An earth berm, ground-level wall breach repair system, consisting of a tilt-up Rapid Runway Repair concrete slab and an earth berm, which shield a ground-level wall breach against shrapnel and/or airblast from another attack; and
4. A fiber-reinforced, high-early-strength shotcrete wall breach repair system, for repairing breaches in a reinforced concrete wall at either ground or second-story level.

Each expedient repair system was demonstrated in less than 30 minutes, under realistic conditions which were part of the FOAL EAGLE exercise scenario.

Accession For	
NTIS CRA&I	<input checked="" type="checkbox"/>
DTIC TAB	<input type="checkbox"/>
Unannounced	<input type="checkbox"/>
Justification	
By	
Distribution /	
Availability Codes	
Dist	Avail and/or Special
A-1	

EXECUTIVE SUMMARY

A. OBJECTIVE

The objective of the tests described herein was to demonstrate airbase structural facility postattack recovery (damage assessment and expedient repair) methods developed by AFCESA/RACS from 1 December 1987 through 31 August 1991, to convince MAJCOM civil engineers that the methods are ready for Engineering and Manufacturing Development by AFCESA/RAAE.

B. BACKGROUND

Modern warfare grants no safe haven. A few years ago an air base well behind the front line was considered immune from the threat of death and destruction characterizing an infantry battlefield. Now there is no front line, and the lethality of the battlefield threatens every major overseas air base. This is because the range, accuracy, and destructive power of modern weapons pose the same threat to an airbase command post as to a tank. That situation mandates that Air Force civil engineers anticipate the nature, extent, and mission capability consequences of facility damage, and develop strategies to recover from it.

In 1985 at Spangdahlem AB, Germany the NATO airbase survivability exercise SALTY DEMO dramatically underscored the need for reliable postattack communications and a facility recovery plan. The Air Base Operability (ABO) concept evolved from SALTY DEMO. Its five phases are defense, survival, recovery, aircraft sortie generation, and sortie support. This report deals with the recovery phase of ABO, called Base Recovery After Attack (BRAAT), and specifically with rapid assessment of damage to mission-critical structural facilities, and expedient repair of those facilities, using preplanned methods and prepositioned resources.

To meet the above threat, AFCESA/RACS developed a computer-based, expert system-assisted, postattack facility damage assessment system for air bases, and expedient repair methods for bomb-damaged, mission-critical structural

facilities. Taken together, facility damage assessment and expedient repair are called facility recovery (1).

Of the numerous expedient repair methods developed and evaluated, four were selected for demonstration during FOAL EAGLE because of expected frequency of occurrence and structural consequences of the corresponding damage, and because of the flexibility and originality of the repair methods. Extensive still photo and video coverage was obtained of all repair tests, and execution times were measured.

C. SCOPE

The FOAL EAGLE Facility Recovery Demonstration included both damage assessment and expedient repair systems.

The postattack damage assessment (POST-DAM) system has three major subsystems:

1. An expert system, installed on a field portable laptop or hand-held computer, which sends previously stored expedient repair strategies to the BCE Damage Control Center (DCC) when fed damage information at the damage scene;

2. A resource database manager, installed on a host microcomputer in the DCC, which receives expedient repair strategies from the expert system, then compares repair resources required versus those available, to determine whether a repair is possible; and

3. A project scheduler, also installed on the host computer, which schedules possible repairs when approved by the Survival/Recovery Center (SRC) commander.

Four airbase structural facility expedient repair systems were demonstrated:

1. A column splinting system, which resists further relative displacement of two portions of a fractured but otherwise intact reinforced concrete column;

2. A column shoring system, which replaces a badly damaged reinforced concrete column with a wood or light-gage steel column;

3. An earth berm, ground-level wall breach repair system, consisting of a tilt-up Rapid Runway Repair concrete slab and an earth berm, which shield a ground-level wall breach against shrapnel and/or airblast from another attack; and

4. A fiber-reinforced, high-early strength shotcrete wall breach repair system, for repairing breaches in a reinforced concrete wall at either ground or second-story level.

Each expedient repair system was demonstrated in less than 30 minutes, under realistic conditions which were part of the FOAL EAGLE exercise scenario.

D. METHODOLOGY

The airbase structural facility postattack damage assessment system demonstrated during Exercise FOAL EAGLE at Osan AB, Republic of Korea on 2 November 1991 was developed by RACS under Subtasks 2.02, 2.02.1, and 2.02.2 of RAC SETA Contract F08635-88-C-0067, and is described in a nine-volume final technical report (2) and an article (3).

The four airbase structural facility postattack expedient repair systems demonstrated on 5 and 6 November 1991 were developed by RACS under RAC SETA Subtasks 2.01, 2.01.1, 2.01.2, 2.00 (2.08), and 2.08.1, and are described in four final technical reports (4-7), and two papers (8 and 9), and this report. The expedient repair system development described in this report is that of the light-gage steel column shoring system, developed in the Fall of 1991 to meet unique FOAL EAGLE requirements.

The idea of demonstrating recently developed facility recovery systems during Exercise FOAL EAGLE originated with Colonels Frank Gallagher, the Civil Engineering Laboratory Director, and Virgil Carr, the Seventh Air Force Staff Civil Engineer, during a Society of American Military Engineers' Peninsula Conference at Yongsan Army Base and Osan Air Base, Republic of Korea in February 1991. Colonel Gallagher gave an Air Force Civil Engineering Science and Technology presentation at the conference, which included facility recovery, and which sparked discussions leading to the idea of a FOAL EAGLE facility recovery demonstration.

A telephone conversation between Lieutenant Colonels Fravel, Civil Engineering Division Chief, and Rose, Yongsan AB Exercise Branch Chief, in late April 1991 led to a message from Captain Reid of RACS to Captain Zuercher of 7AF/DEX, plus several phone calls from Dr. Merkle to Captain Zuercher, stating RACS's desire to participate in FOAL EAGLE. This precipitated a briefing by Captain Reid to Lieutenant General Ronald R. Fogleman, 7AF/CC, at Hurlburt Field, Florida on 17 July 1991, at which time General Fogleman approved the demonstration. That led to an invitation to Mr. Strickland, Captain Reid, and Dr. Merkle to participate in a FOAL EAGLE planning conference at Yongsan AB on 9 September 1991, after which they travelled to Osan AB to do a site survey and begin detailed preparations with the help of Captain Rey Tagorda, Captain Zuercher's replacement. Following that trip, Dr. Merkle specified the shotcrete utility support requirements (electrical power, compressed air, and water) in detail, to be sure the shotcrete demonstration would not be delayed because of system/utility incompatibility.

To prepare for the FOAL EAGLE test series, each demonstration was performed at either the Tyndall AFB 9700 Area or the Sky X test site (10). The POST-DAM damage assessment system was demonstrated on 13 September 1991. The column splint, column shoring, and earth berm wall breach repairs were demonstrated on 24 September 1991, and the shotcrete wall breach repair was demonstrated on 27 September 1991. All demonstrations went smoothly. However, because the Osan AB FOAL EAGLE site survey on 10 September 1991 had identified a much taller column to be shored than any used during the previous development effort, it was decided

to replace the shoring jack and glued laminated timber (glulam) repair column by a light-gage steel column recently developed to brace concrete formwork (11).

E. TEST DESCRIPTION

Demonstration of the POST-DAM system during exercise FOAL EAGLE at Osan AB, Republic of Korea took place on the afternoon of 2 November 1991 at the DCC. Demonstration of the earth berm/precast slab and shotcrete wall replacement systems took place on the morning of 5 November 1991. Demonstration of column splint and column shore (replacement) systems took place in the morning and early afternoon of 6 November 1991.

F. RESULTS

The RACS FOAL EAGLE facility recovery demonstration conducted at Osan AB, Republic of Korea from 2-6 November 1991 was a complete success. The computer-assisted damage assessment, column splinting, column shoring, earth berm wall breach repair, and shotcrete wall breach repair demonstrations were each executed as planned, with no significant difficulty. All demonstrations were accomplished by active duty military personnel. The Osan AB BCE, Colonel McPherson, witnessed the demonstration, and afterward sent an enthusiastic support letter to HQ PACAF/DE, who in turn sent an equally enthusiastic support message to AFCESA.

G. CONCLUSIONS

Both Colonel McPherson's letter and the HQ PACAF/DE message are included in Appendix E. The RACS facility recovery methods demonstrated during FOAL EAGLE are now ready for Engineering and Manufacturing Development (EMD) by RAA.

H. RECOMMENDATIONS

EMD of the RACS facility recovery methods successfully demonstrated during FOAL EAGLE should begin immediately. The column splint and earth berm wall breach repair methods require little if any additional engineering prior to fielding. The column shoring method needs a small amount of additional

engineering to design an effective lateral bracing arrangement. The shotcrete wall breach repair method needs additional engineering to produce a single, self-propelled, self-contained shotcrete system, which includes material storage, feeder, hopper, gun, power source, compressed air source, water source, remotely-controlled robotic nozzle, and an operator cab with control panel. In addition, the long-term storage characteristics of the rapid-strength gaining shotcrete mix need to be determined as the basis for a material purchase and storage plan.

Specially tailored damage assessment software to perform the resource availability determination and repair scheduling functions was completed in February 1992. The first step in damage assessment EMD should be to integrate POST-DAM with other BCE damage assessment systems for rapid runway repair, fire protection and crash rescue, and utilities. Also, POST-DAM should be expanded to include facility utility services.

Operational Requirements Documents (ORDs) for both facility damage assessment and facility expedient repair are needed to initiate the facility recovery EMD process.

PREFACE

This report was prepared by Applied Research Associates, Inc., P.O. Box 40128, Tyndall Air Force Base, FL 32403, under Scientific and Engineering Technical Assistance (SETA) Contract FO8635-88-C-0067 with the Air Force Civil Engineering Support Agency, Engineering Research Division (AFCEA/RAC), 139 Barnes Drive, Tyndall Air Force Base, FL 32403. The work was performed between September 1991 and March 1992.

Capt. Richard A. Reid was the HQ AFCEA/RACS Project Officer.

This technical report has been reviewed by the Public Affairs Office and is releasable to the National Technical Information Service (NTIS). At NTIS, it will be available to the general public, including foreign nations.

This technical report has been reviewed and is approved for publication.



JON B. ANDERSON, GS-13
Chief, Air Base Survivability
Branch

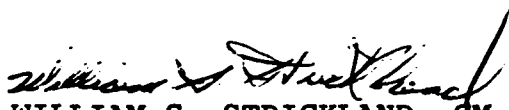

WILLIAM S. STRICKLAND, GM-14
Chief, Engineering Research
Division



RICHARD A. REID, Capt, USAF
Project Officer



FRANK P. GALLAGHER III, Col, USAF
Director, Air Force Civil
Engineering Laboratory

(The reverse of this page is blank.)

TABLE OF CONTENTS

Section	Title	Page
I	INTRODUCTION.....	1
	A. OBJECTIVE.....	1
	B. BACKGROUND.....	1
	C. SCOPE.....	2
	D. APPROACH.....	3
II	DEMONSTRATION PRACTICE AT TYNDALL AFB.....	6
	A. OVERVIEW.....	6
	B. POST-DAM SYSTEM PRACTICE.....	6
	1. POST-DAM System Overview.....	6
	2. Prototype System Description.....	7
	3. POST-DAM Demonstration Scripts.....	12
	C. ERSF SYSTEM PRACTICE.....	13
	1. Column Splint.....	13
	2. Column Replacement.....	22
	3. Earth Berm/Precast Concrete Slab Wall Breach Repair.....	31
	4. Shotcrete Wall Breach Repair.....	35
	D. CONCLUSIONS.....	42
III	SEVENTH AIR FORCE SUPPORT.....	48
	A. FOAL EAGLE PLANNING CONFERENCE AND SITE SURVEY.....	48
	B. 7AF/DE SUPPORT.....	49
IV	LOGISTIC ACTIONS.....	50
	A. AIR SHIPMENT TO OSAN AB.....	50
	B. PREPARATION AT OSAN AB.....	51
	C. RETURN AIR SHIPMENT FROM OSAN AB.....	51
	D. RECOMMENDATION.....	52
V	DEMONSTRATION TRAINING AT OSAN AB.....	53
	A. OVERVIEW.....	53
	B. COLUMN SPLINT TRAINING.....	53
	C. COLUMN SHORE (REPLACEMENT) TRAINING.....	54
	D. EARTH BERM WALL REPLACEMENT REPAIR TRAINING....	55
	E. SHOTCRETE WALL REPLACEMENT REPAIR TRAINING.....	56

TABLE OF CONTENTS (CONCLUDED)

Section	Title	Page
VI	FOAL EAGLE DEMONSTRATION.....	59
	A. OVERVIEW.....	59
	B. POST-DAM DEMONSTRATION.....	59
	1. System Description.....	59
	2. Demonstration.....	59
	3. Integrated Resource Manager And Repair Scheduler.....	60
	C. EARTH BERM/PRECAST SLAB WALL REPLACEMENT DEMONSTRATION.....	62
	D. SHOTCRETE WALL REPLACEMENT DEMONSTRATION.....	64
	E. COLUMN SPLINT DEMONSTRATION.....	65
	1. Hospital Column Splint.....	65
	2. 7AF Headquarters Column Splint.....	69
	F. COLUMN SHORE (REPLACEMENT) DEMONSTRATION.....	71
VII	CONCLUSIONS AND RECOMMENDATIONS.....	75
	A. CONCLUSIONS.....	75
	B. RECOMMENDATIONS.....	75
	REFERENCES.....	77
 APPENDIX		
A	POST-DAM FOAL EAGLE DEMONSTRATION SCRIPTS.....	79
B	FOAL EAGLE FACILITY RECOVERY DEMONSTRATION 7AF/DE SUPPORT REQUEST SUMMARY.....	115
C	FOAL EAGLE FACILITY RECOVERY DEMONSTRATION TEST PLAN.....	121
D	DEMONSTRATION SCHEDULE.....	145
E	PACAF SUPPORT DOCUMENTS.....	147

LIST OF FIGURES

Figure	Title	Page
1	Line Drawing Floor Plan - Building 138 (Bitburg AB)..	9
2	Detail Of Column Splint Plate.....	14
3	Side Elevation Of Column Splint.....	15
4	Plan View Of Column Splint.....	16
5	Cracked Column Used For Column Splint Practice.....	23
6	Completed Column Splint Repair.....	24
7	Glued-Laminated (Glulam) Timber Column.....	25
8	Partially Assembled Box Section (Super Stud*).....	26
9	Completed Glulam Column Replacement Repair.....	30
10	Wall Breach Used For Earth Berm Wall Replacement Practice.....	33
11	Earth Berm Wall Replacement Repair In Progress.....	34
12	Shotcrete And Support Equipment Setup.....	39
13	Penthouse Opening In NATO Structure.....	41
14	Penthouse Shotcrete Repair In Progress.....	43
15	Wall Breach Used For Shotcrete Repair.....	44
16	Backing Breach With Plywood.....	45
17	Filling Breach With Shotcrete.....	46
18	Lining Drainage Ditch With Shotcrete.....	57
19	POST-DAM Expert System Being Used In The Field.....	61
20	Completed Earth Berm Wall Replacement Repair During The FOAL EAGLE Exercise.....	63
21	View 1 Of Shotcrete Wall Replacement Repair During The FOAL EAGLE Exercise.....	66
22	View 2 Of Shotcrete Wall Replacement Repair During The FOAL EAGLE Exercise.....	67
23	Completed Shotcrete Wall Replacement Repair During The FOAL EAGLE Exercise.....	68
24	Completed Column Splint Repair At Base Hospital During The FOAL EAGLE Exercise.....	70
25	Completed Column Splint Repair At 7AF Headquarters During The FOAL EAGLE Exercise.....	72
26	Completed Column Replacement Repair During The FOAL EAGLE Exercise.....	74

LIST OF TABLES

Table	Title	Page
1	POST-DAM STRUCTURAL ELEMENT NUMBERING SYSTEM.....	10
2	HQ AFCEA FOAL EAGLE FACILITY RECOVERY DEMONSTRATION RESOURCE REQUIREMENTS.....	17
3	ALIVA SPRAY BOOM 80 MAJOR SPECIFICATIONS.....	37
4	ALIVA 260 SHOTCRETE GUN SPECIFICATIONS.....	38
5	SUMMARY OF COLUMN SPLINT TRAINING RESULTS AT OSAN AB.	53
6	SUMMARY OF COLUMN REPLACEMENT TRAINING RESULTS AT OSAN AB.....	54
7	SUMMARY OF EARTH BERM WALL REPLACEMENT TRAINING RESULTS AT OSAN AB.....	55
8	SUMMARY OF EARTH BERM WALL REPLACEMENT DEMONSTRATION RESULTS.....	62
9	SUMMARY OF SHOTCRETE WALL REPLACEMENT DEMONSTRATION RESULTS.....	65
10	SUMMARY OF COLUMN SPLINT DEMONSTRATION RESULTS AT BASE HOSPITAL.....	69
11	SUMMARY OF COLUMN SPLINT DEMONSTRATION RESULTS AT 7AF HEADQUARTERS.....	71
12	SUMMARY OF COLUMN REPLACEMENT DEMONSTRATION RESULTS..	73

SECTION I

INTRODUCTION

A. OBJECTIVE

The objective of the tests described herein was to demonstrate airbase structural facility postattack recovery (damage assessment and expedient repair) methods developed by AFCESA/RACS from 1 December 1987 through 31 August 1991, to convince MAJCOM civil engineers that the methods are ready for Engineering and Manufacturing Development (EMD) by AFCESA/RAAE. Test results were judged based on repair stability and/or execution time. All demonstrations were successfully conducted on 2, 5, and 6 November 1991, during the airbase ground defense exercise FOAL EAGLE at Osan AB, Republic of Korea. In addition, the peacetime utility of the shotcrete repair method was demonstrated by lining a badly eroded drainage ditch as a training exercise. MAJCOM support was then sought for Operational Requirement Documents (ORDs) to obtain EMD funding.

B. BACKGROUND

Modern warfare grants no safe haven. A few years ago an air base well behind the front line was considered immune from the threat of death and destruction characterizing an infantry battlefield. Now there is no front line, and the lethality of the battlefield threatens every major overseas air base. This is because the range, accuracy, and destructive power of modern weapons pose the same threat to an airbase command post as to a tank. That situation mandates that Air Force civil engineers anticipate the nature, extent, and mission capability consequences of facility damage, and develop strategies to recover from it.

In 1985 at Spangdahlem AB, Germany the NATO airbase survivability exercise SALTY DEMO dramatically underscored the need for reliable postattack communications and a facility recovery plan. The Air Base Operability (ABO) concept evolved from SALTY DEMO. Its five phases are defense, survival, recovery, aircraft sortie generation, and sortie support. This report deals with

the recovery phase of ABO, called Base Recovery After Attack (BRAAT), and specifically with rapid assessment of damage to mission-critical structural facilities, and expedient repair of those facilities, using preplanned methods and prepositioned resources.

To meet the above threat, AFCESA/RACS developed a computer-based, expert system-assisted, postattack facility damage assessment system for air bases, and expedient repair methods for bomb-damaged, mission-critical structural facilities. Taken together, facility damage assessment and expedient repair are called facility recovery (1).

Of the numerous expedient repair methods developed and evaluated, four were selected for demonstration during FOAL EAGLE because of expected frequency of occurrence and structural consequences of the corresponding damage, and because of the flexibility and originality of the repair methods. Extensive still photo and video coverage was obtained of all repair tests, and execution times were measured.

C. SCOPE

The FOAL EAGLE Facility Recovery Demonstration included both damage assessment and expedient repair systems.

The postattack damage assessment (POST-DAM) system has three major subsystems:

1. An expert system, installed on a field portable laptop or hand-held computer, which sends previously stored expedient repair strategies to the BCE Damage Control Center (DCC) when fed damage information at the damage scene;

2. A resource database manager, installed on a host microcomputer in the DCC, which receives expedient repair strategies from the expert system, then compares repair resources required versus those available, to determine whether a repair is possible; and

3. A project scheduler, also installed on the host computer, which schedules possible repairs when approved by the Survival/Recovery Center (SRC) commander.

Four airbase structural facility expedient repair systems were demonstrated:

1. A column splinting system, which resists further relative displacement of two portions of a fractured but otherwise intact reinforced concrete column;

2. A column shoring system, which replaces a badly damaged reinforced concrete column with a wood or light-gage steel column;

3. An earth berm, ground-level wall breach repair system, consisting of a tilt-up Rapid Runway Repair concrete slab and an earth berm, which shield a ground-level wall breach against shrapnel and/or airblast from another attack; and

4. A fiber-reinforced, high-early-strength shotcrete wall breach repair system, for repairing breaches in a reinforced concrete wall at either ground or second-story level.

Each expedient repair system was demonstrated in less than 30 minutes, under realistic conditions which were part of the FOAL EAGLE exercise scenario.

D. APPROACH

The airbase structural facility postattack damage assessment system demonstrated during Exercise FOAL EAGLE at Osan AB, Republic of Korea on 2 November 1991 was developed by RACS under Subtasks 2.02, 2.02.1, and 2.02.2 of RAC SETA Contract F08635-88-C-0067, and is described in a nine-volume final technical report (2) and an article (3).

The four airbase structural facility postattack expedient repair systems demonstrated on 5 and 6 November 1991 were developed by RACS under RAC SETA Subtasks 2.01, 2.01.1, 2.01.2, 2.00 (2.08), and 2.08.1, and are described in four final technical reports (4-7), and two papers (8 and 9), and this report. The expedient repair system development described in this report is that of the light-gage steel column shoring system, developed in the Fall of 1991 to meet unique FOAL EAGLE requirements.

The idea of demonstrating recently developed facility recovery systems during Exercise FOAL EAGLE originated with Colonels Frank Gallagher, the Civil Engineering Laboratory Director, and Virgil Carr, the Seventh Air Force Staff Civil Engineer, during a Society of American Military Engineers' Peninsula Conference at Yongsan Army Base and Osan Air Base, Republic of Korea in February 1991. Colonel Gallagher gave an Air Force Civil Engineering Science and Technology presentation at the conference, which included facility recovery, and which sparked discussions leading to the idea of a FOAL EAGLE facility recovery demonstration.

A telephone conversation between Lieutenant Colonels Fravel, Civil Engineering Division Chief, and Rose, Yongsan AB Exercise Branch Chief, in late April 1991 led to a message from Captain Reid of RACS to Captain Zuercher of 7AF/DEX, plus several phone calls from Dr. Merkle to Captain Zuercher, stating RACS's desire to participate in FOAL EAGLE. This precipitated a briefing by Captain Reid to Lieutenant General Ronald R. Fogleman, 7AF/CC, at Hurlburt Field, Florida on 17 July 1991, at which time General Fogleman approved the demonstration. That led to an invitation to Mr. Strickland, Captain Reid, and Dr. Merkle to participate in a FOAL EAGLE planning conference at Yongsan AB on 9 September 1991, after which they travelled to Osan AB to do a site survey and begin detailed preparations with the help of Captain Rey Tagorda, Captain Zuercher's replacement. Following that trip, Dr. Merkle specified the shotcrete utility support requirements (electrical power, compressed air, and water) in detail, to be sure the shotcrete demonstration would not be delayed because of system/utility incompatibility.

To prepare for the FOAL EAGLE test series, each demonstration was performed at either the Tyndall AFB 9700 Area or the Sky X test site. The POST-DAM damage assessment system was demonstrated on 13 September 1991. The column splint, column shoring, and earth berm wall breach repairs were demonstrated on 24 September 1991, and the shotcrete wall breach repair was demonstrated on 27 September 1991. All demonstrations went smoothly. However, because the Osan AB FOAL EAGLE site survey on 10 September 1991 had identified a much taller column to be shored than any used during the previous development effort, it was decided to replace the shoring jack and glued laminated timber (glulam) replacement column by a light-gage steel column recently developed to brace concrete formwork (11).

Upon completion of the FOAL EAGLE facility recovery demonstration, the Osan AB BCE, Colonel McPherson, wrote an enthusiastic endorsement of the demonstrated methods to the PACAF Civil Engineer, Colonel Allen. In turn, Colonel Allen's office sent a message to AFCESA expressing their strong support for the methods. Both are included in Appendix E. The demonstration objective was accomplished.

SECTION II

DEMONSTRATION PRACTICE AT TYNDALL AFB

A. OVERVIEW

Prior to demonstrating the POST-DAM system and Expedient Repair of Structural Facilities (ERSF) systems (column splint, column replacement, earth berm wall breach repair, and shotcrete wall breach repair) during the FOAL EAGLE exercise at Osan AB, Republic of Korea, demonstration practice sessions were held at Tyndall AFB, Florida in late September 1991 (10). For ERSF systems, since the personnel used during the practice sessions were not the same as used in Korea, the primary purpose of the practice was to evaluate repair procedures, equipment, and supplies, and make modifications to the systems when necessary. For the POST-DAM system, the same personnel used during practice at Tyndall AFB were also used during FOAL EAGLE to operate the system. Consequently, the purpose of the POST-DAM practice at Tyndall AFB was to train personnel on the use of the system, to check out computer hardware and software, and to develop a detailed, step-by-step script for the demonstration at Osan AB.

POST-DAM and ERSF system practice sessions at Tyndall AFB, Florida are described below.

B. POST-DAM SYSTEM PRACTICE

1. POST-DAM System Overview

In prototype form, the POST-DAM system consists of three individual software components that work together as follows. An expert system (Component 1) residing on a portable computer or similar piece of hardware, is taken to a damaged facility by a Damage Assessment and Response Team (DART). The expert system is used by the DART to assess the damage to the facility and develop recommended repair procedures, including required supplies, materials, manpower, and equipment. This information is then sent to a host computer at the BCE Damage Control Center (DCC) using the Survivable Base Recovery After Attack

(BRAAT) Communication System (SBCS), or some other base-wide communication system.

Residing on the host computer are the other two components of the POST-DAM system: a resource manager (Component 2) and a repair scheduler (Component 3). Using the information received from the expert system about the damaged facility and recommended expedient repair(s), the resource manager checks to ensure that the supplies, materials, manpower, and equipment required to accomplish the repair(s) are available, and if so, allocates them to the repair(s). If some of the required resources are not available, the resource manager highlights the shortfalls, and if possible, allows resource substitutions to be made so the repair(s) can be carried out. Resources can be allocated between repairs at a facility, and between different damaged facilities, based on priorities set by the DCC.

Once resources have been allocated, the repair scheduler is used to schedule repairs based on the priorities set by the DCC. The schedule can be updated as repairs are completed, and/or when additional damage assessments are received at the DCC from the DARTs. If desired, a completely new schedule can be generated if many new damage assessments are received, or if priorities change. Once repairs have been scheduled, damage repair teams are sent to damaged facilities by the DCC with the resources required to accomplish the scheduled repairs.

2. Prototype System Description

The POST-DAM system used for demonstration practice at Tyndall AFB, Florida in late September 1991, and for the actual demonstration during the FOAL EAGLE exercise at Osan AB, Republic of Korea in early November 1991 was a prototype. As described above, this prototype POST-DAM system consisted of three individual software components. Each of these software components, and associated hardware, are briefly described below. For more detailed information on the prototype POST-DAM system see Reference 2.

a. Expert System

The first POST-DAM component is the expert system, which resides on a 386SX IBM compatible portable computer. The expert system is written in the C Language Production System (CLIPS). CLIPS is an artificial intelligence (AI) language developed by the National Aeronautics and Space Administration (NASA). At a damaged facility, the expert system prompts the DART for information on the type and extent of damage for each identified damage mode, i.e., breached wall, destroyed column, etc. The DART uses line drawing floor plans, such as shown in Figure 1, to indicate to the expert system which structural element of the facility is damaged. As seen in Figure 1, a three-digit number is assigned to each structural element. The element numbering system used by the expert system is given in Table 1.

Based on the information provided by the DART, the expert system recommends a repair method for each identified damage mode, and generates files listing the equipment, supplies, materials, and manpower required to carry out the repair(s). These files are then sent to the POST-DAM host computer. For practice at Tyndall AFB, Florida, and for the actual demonstration of POST-DAM at Osan AB, a direct communication link between the portable computer and the host computer was used to transfer the necessary data files. The direct link simulated a communication system such as SBCS.

b. Host Computer

The host computer was a 386 desk-top IBM compatible computer. Residing on the host computer are the resource manager and the repair scheduler software packages described below.

(1) Resource Manager

Via the direct communication link already described, the data files generated by the expert system are transferred to the host computer. The host computer operator then uses the resource manager, written in R:BASE[®] by Microfirm, to compare the supplies, materials, manpower, and equipment listed in

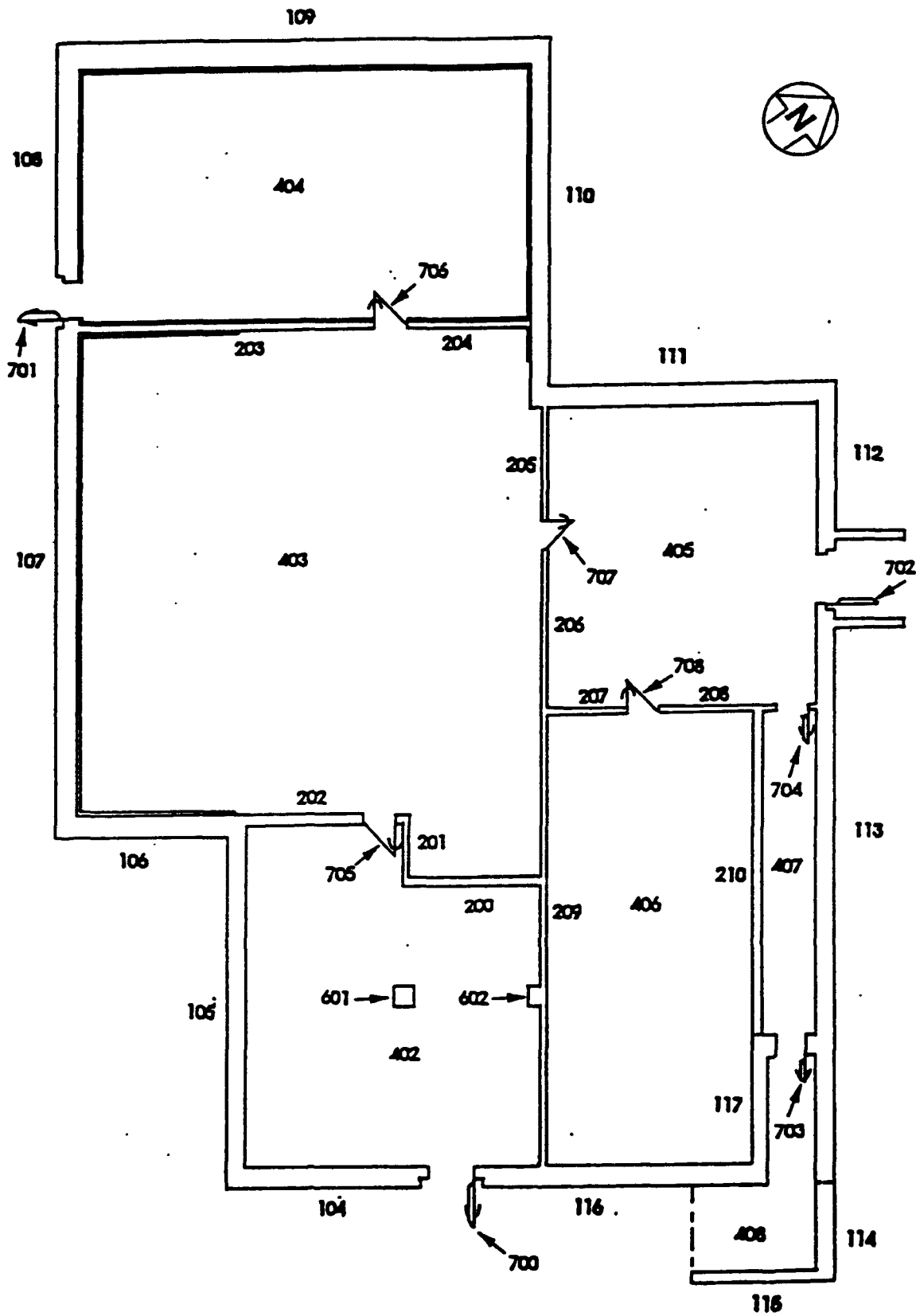

Figure 1. Line Drawing Floor Plan - Building 138 (Bitburg AB).

TABLE 1. POST-DAM STRUCTURAL ELEMENT NUMBERING SYSTEM.

ELEMENT TYPE	ELEMENT NUMBER SEQUENCE
EXTERIOR WALL	100 - 199
INTERIOR WALL	200 - 299
ROOF	300 - 399
FLOOR	400 - 499
BEAM	500 - 599
COLUMN	600 - 699
DOOR	700 - 799
MISCELLANEOUS	800 - 899

the files as being required to conduct each repair, against the resource manager's database of available supplies, materials, manpower, and equipment. If the necessary supplies, materials, manpower, and equipment are available, the host computer operator allocates them to the repair using the resource manager, and updates the resource database to reflect what has been used. If there is a resource shortfall for a particular repair, the resource manager highlights it, allowing the host computer operator to substitute some other resource, if possible, so the repair can be carried out.

(2) Repair Scheduler

The repair scheduler used in the prototype POST-DAM system was written using Harvard Project Manager[®] by Software Publishing Corporation (SPC). The purpose of the repair scheduler is to schedule repairs, after resources have been allocated, based on priorities set by the host computer operator. Repair durations, including setup and cleanup, come from the data files transferred from the expert system to the host computer. The scheduler then adds travel time to the repair duration to obtain the total repair time.

During practice with the repair scheduler at Tyndall AFB, Florida, it was determined that the scheduler did not operate smoothly enough to be demonstrated during the FOAL EAGLE exercise. The user interface was too cumbersome and difficult to use, insufficient error trapping was built into the program, and data transfer between the scheduler and resource manager was difficult. Consequently, practice with the scheduler was terminated.

AFCESA/RACS was already aware that the repair scheduler, in its current form, was difficult to use, and that passing data between the scheduler and the resource manager was cumbersome. To overcome these problems, AFCESA/RACS had initiated an effort to develop a tailored software package that integrated the resource manager and repair scheduler functions into a single menu/dialog box-driven system. The user interface shell of this new software package, showing the pull-down menus and dialog boxes, but not containing the repair scheduler and resource manager, had been developed in time for FOAL EAGLE. AFCESA/RACS decided to demonstrate the interface shell during FOAL EAGLE, instead

of the repair scheduler, to show how the prototype POST- DAM system was being improved.

3. POST-DAM Demonstration Scripts

The POST-DAM demonstration scripts used during the FOAL EAGLE exercise were developed during practice with the prototype POST- DAM system at Tyndall AFB. The scripts were based on Bitburg AB Building 138, described in the Field Manual Of Mission-Critical Facilities For Use With The Prototype Post-Dam System (Reference 2, Volume IX). This field manual contains line drawing floor plans, with corresponding three-digit structural element codes, for mission-critical facilities at Bitburg AB, Germany. The ground floor plan for Building 138 (525th Squadron Operations Building), shown in Figure 1, was used to develop the scripts. Building 138 is a semihardened facility used for command, control, and communications (C³). It has a C2 priority code, which means it is critical for launch and recovery during the 72 hour period following an attack.

Three damage modes were selected to develop the scripts: (1) a 5- by 5-foot breach in an exterior wall (Element Number 106), (2) a destroyed 10-foot long column (Element Number 602), and (3) a cracked column (Element Number 601). The scripts for the expert system and the resource manager, based on the damage scenario described above, are given in Appendix A. The scripts show the computer screen prompt for each stage of the expert system and resource manager, along with the appropriate response from the DART (expert system) and host computer operator (resource manager). The response to each prompt is highlighted in the scripts. The scripts are used in sequence. First, the expert system script was used to generate the data files describing the procedures and required resources to repair the specified damage. These files were then transferred by a direct link to the host computer, where the resource manager script was used to allocate the required materials, supplies, manpower, and equipment to the three repairs. The materials, supplies, manpower, and equipment database in the resource manager was configured so no resource shortfall would occur.

The scripts given in Appendix A were used by AFCESA/RACS personnel to demonstrate the prototype POST-DAM system to PACAF personnel during the FOAL

EAGLE ABO exercise at OSAN AB, Republic of Korea on 2 November 1991.

C. ERSF SYSTEM PRACTICE

Practice sessions were conducted for four ERSF systems during September 1991 at Tyndall AFB, Florida. The four systems were: (1) column splint for a cracked concrete column, (2) column replacement for a destroyed concrete column, (3) precast concrete slab/earth berm repair for a ground floor, exterior wall breach, and (4) rapid-setting, dry-mix shotcrete repair for an upper story, exterior wall breach.

Practice with each of these ERSF systems at Tyndall AFB, Florida is described below. The debris removal step described below during discussions of ERSF systems was, in large part, not required during practice at Tyndall AFB nor during the FOAL EAGLE exercise. At Tyndall AFB this was because the damaged areas had been used during past testing. As a result, the repair areas were, for the most part, already prepared. At Osan AB, damage was simulated, so debris removal was not necessary. The debris removal step is included in the following discussions of ERSF systems for completeness.

For additional information on ERSF system development and use see References 4 through 10.

1. Column Splint

a. Repair Process

When a reinforced concrete column is cracked, but still able to carry some load, a column splint can be used to repair, i.e., shore, the column. A column splint, shown in Figures 2 to 4, consists of two steel plates with slots in each corner, four threaded rods, and washers and nuts. The repair process, using such a splint, is briefly described below. A list of supplies, materials, and equipment required to carry out the repair during practice at Tyndall AFB, and during the FOAL EAGLE exercise, is listed in Table 2.

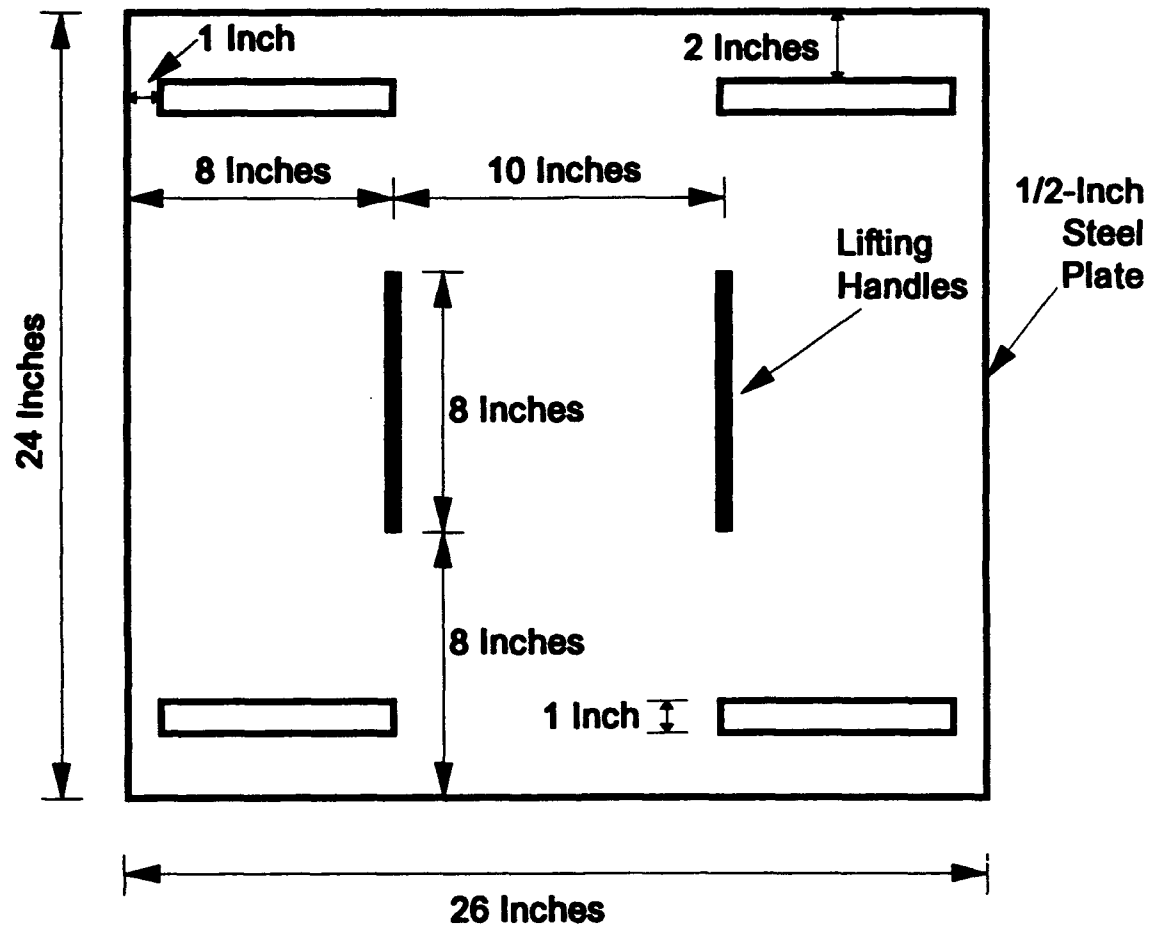

Figure 2. Detail Of Column Splint Plate.

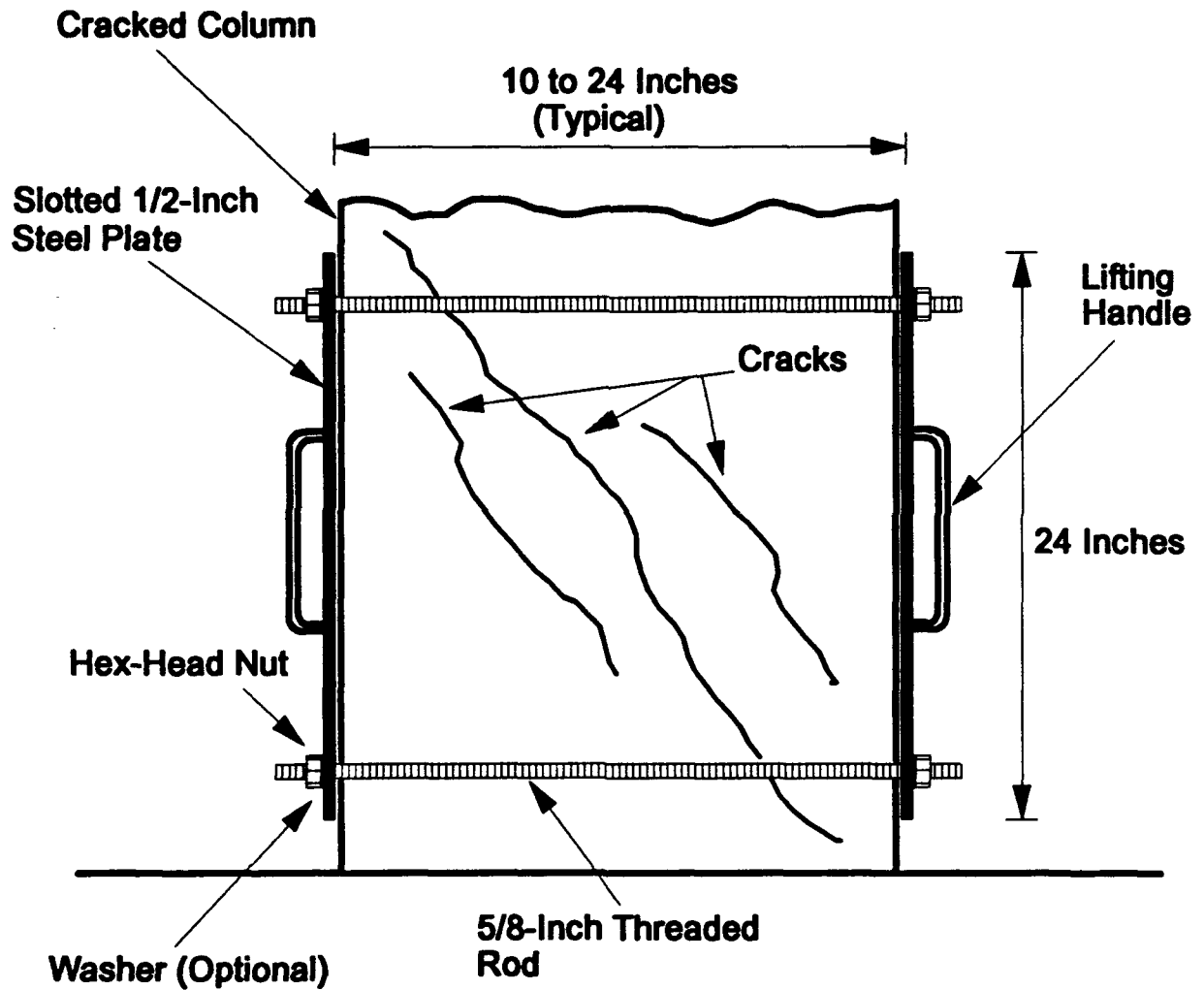

Figure 3. Side Elevation Of Column Splint.

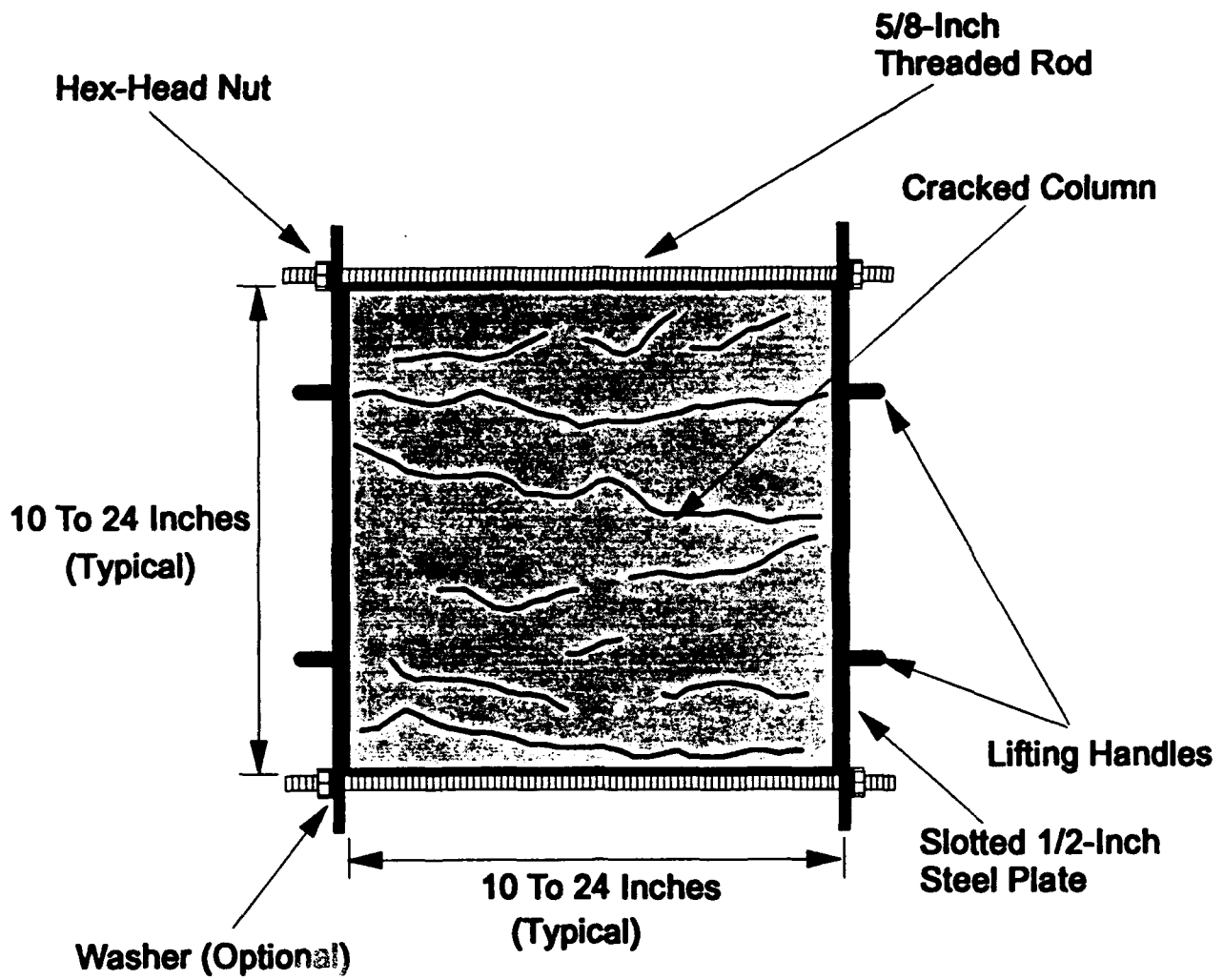

Figure 4. Plan View Of Column Splint.

TABLE 2. HQ AFCESA FOAL EAGLE FACILITY RECOVERY DEMONSTRATION
RESOURCE REQUIREMENTS

10/03/91

<u>ACTION</u>	<u>PERSONNEL</u>	<u>NO</u>	<u>ITEM</u>	<u>AFCESA</u>	<u>7AF</u>
<u>PREDEMO STORAGE</u>					
transport equipment from Osan AB air freight terminal to 51 CSG/DE storage area	3	(1)	flat-bed tractor/ trailer		X
		(1)	forklift		X
<u>SHOTCRETE WALL BREACH REPAIR</u>					
clear debris	3	(1)	six-pax truck		X
		(1)	front-end loader		X
		(1)	bolt cutter	X	
		(1)	sledge hammer	X	
		(2)	coal shovels	X	
		(1)	regular broom	X	
		(1)	push broom	X	
fabricate plywood backing	2	(1)	hand-held, 8" diam. elect. circular saw	X	
		(1)	110V, 1 phase, 60Hz electric power outlet		X
		(1)	100' extension chord with 3/2 adapter		X
		(1)	crosscut saw	X	
		(1)	rip saw	X	
		(1)	12' carpenter's steel tape	X	
		(1)	carpenter's square	X	
		(2)	carpenter's hammers	X	
		(1)	marker	X	
		(2)	sawhorses		X
		(7)	4'x8'x3/8" plywood sheets		X
		(18)	2"x4"x8' boards		X
		(200)	8d nails	X	
(200)	16d nails	X			
install plywood backing	3	(2)	8' stepladders		X
		(1)	ramset stud gun	X	
		(200)	ramset cartridges	X	
		(100)	ramset studs	X	
		(20pr)	ear plugs		X
		(7)	ear protectors		X

**TABLE 2. HQ AFCEA FOAL EAGLE FACILITY RECOVERY DEMONSTRATION
RESOURCE REQUIREMENTS (CONTINUED)**

<u>ACTION</u>	<u>PERSONNEL</u>	<u>NO</u>	<u>ITEM</u>	<u>AFCEA</u>	<u>ZAF</u>
position shotcrete equipment	5	(1)	shotcrete gun	X	
		(1)	shotcrete hose	X	
		(1)	shotcrete nozzle	X	
		(1)	robotic arm, with hydraulic pump and electric motor	X	
		(1)	15' chain with hook		X
		(1)	step-up transformer	X	
		(1)	all-terrain forklift		X
		(1)	air compressor, 600 CFM @ 100 psi		X
		(1)	air compressor hose	X	
		(1)	water buffalo		X
		(1)	water heater	X	
		(1)	water pump, 10 GPM at 90 psi		X
		(1)	110V, 1 phase, 60Hz electric power outlet		X
		(1)	100' extension chord with 3/2 adapter		X
		(1)	water flow meter	X	
		(1)	water hose	X	
		(5)	1 CY shotcrete super-sacks	X	
		(1)	front-end loader		X
(1)	480V, 3 phase, 60Hz, 25KW electric power		X		
apply shotcrete	5		No additional equipment		
<u>EARTH BERM WALL BREACH REPAIR</u>					
clear debris	3	(1)	six-pax truck		X
		(1)	front-end loader		X
		(1)	bolt cutter	X	
		(1)	sledge hammer	X	
		(2)	coal shovels	X	
		(1)	regular broom	X	
		(1)	push broom	X	
fabricate plywood backing	2	(1)	hand-held, 8" diam. elect. circular saw	X	
		(1)	110V, 1 phase, 60Hz, electric power outlet		X
		(1)	100' extension chord with 3/2 adapter		X

TABLE 2. HQ AFCEA FOAL EAGLE FACILITY RECOVERY DEMONSTRATION
RESOURCE REQUIREMENTS (CONTINUED)

<u>ACTION</u>	<u>PERSONNEL</u>	<u>NO</u>	<u>ITEM</u>	<u>AFCEA</u>	<u>7AF</u>
		(1)	crosscut saw	X	
		(1)	rip saw	X	
		(1)	12' carpenter's steel tape	X	
		(1)	carpenter's square	X	
		(2)	carpenter's hammers	X	
		(1)	marker	X	
		(2)	sawhorses		X
		(7)	4'x8'x3/8" plywood sheets		X
		(18)	2"x4"x8' boards		X
		(200)	8d nails	X	
		(200)	16d nails	X	
install plywood backing	3	(2)	8' stepladders		X
		(1)	ramset stud gun	X	
		(200)	ramset cartridges	X	
		(100)	ramset studs	X	
		(20pr)	ear plugs		X
		(7)	ear protectors		X
load, transport, and position R/C tiltup slab	2	(1)	3 mx3 m precast R/C slab with lift eyes/hooks		X
		(2)	slab lifting frame and cable or chain		X
		(1)	front-end loader		X
form earth berm	1	(1)	No additional equipment		
<u>COLUMN REPLACEMENT REPAIR</u>					
clear debris	3	(1)	six-pax truck		X
		(1)	front-end loader		X
		(1)	bolt cutter	X	
		(1)	sledge hammer	X	
		(2)	coal shovels	X	
		(1)	regular broom	X	
		(1)	push broom	X	
erect shoring tower	5	(2)	8"x8"x6' timbers		X
		(1)	EFCO 12' tower	X	
		(1)	all-terrain forklift		X
		(2)	8' stepladders		X
		(1)	measuring rod	X	

TABLE 2. HQ AFCESA FOAL EAGLE FACILITY RECOVERY DEMONSTRATION
RESOURCE REQUIREMENTS (CONTINUED)

<u>ACTION</u>	<u>PERSONNEL</u>	<u>NO</u>	<u>ITEM</u>	<u>AFCESA</u>	<u>ZAF</u>
		(1)	12' carpenter's steel tape	X	
		(4)	crescent wrenches	X	
		(2)	ball peen hammers		X
<u>COLUMN SPLINT REPAIR</u>					
clear debris	3	(1)	six-pax truck		X
		(1)	front-end loader		X
		(1)	bolt cutter	X	
		(1)	sledge hammer	X	
		(2)	coal shovels	X	
		(1)	regular broom	X	
		(1)	push broom	X	
position & attach splint plates	2	(1)	12' carpenter's steel tape	X	
		(1)	carpenter's square	X	
		(1)	marker	X	
		(1)	crosscut saw	X	
		(1)	50' coil clothesline	X	
		(4)	2"x4"x6' boards		X
		(2)	splint plates	X	
		(4)	threaded rods	X	
		(8)	extra heavy washers	X	
		(8)	nuts	X	
		(2)	crescent wrenches	X	

(1) Debris Clearance

If necessary, use brooms and shovels to remove loose debris from around the column to provide a clear working area. If necessary, remove loose debris from the cracked area(s) of the column.

(2) Position Steel Plates

Position the two steel plates on opposite sides of the column, so they will apply a compressive force component against (normal to) the crack surface(s). Use 2- by 4-inch boards to support the plates at the correct height. Trim the boards to the correct height, and bind them to the sides of the column with rope. Place the plates on top of the boards, and against the sides of the column.

(3) Placement Of Threaded Rods

Thread a nut with a washer on one end of each of the four threaded rods. Run a threaded rod through each slot in one plate, and through the corresponding slot in the opposite plate. Thread a second nut with a washer on the free end of each rod. Slide each rod in the slots until the rod contacts the side of the column, as shown in Figure 3. Hand tighten all eight nuts to snug the plates to the sides of the column.

(4) Tighten Nuts

Use a crescent wrench or a ratcheted socket wrench to tighten each nut in an alternating sequence, to ensure the plates are in even and firm contact with the sides of the column. If desired, after tightening the nuts the bracing lumber can be removed.

b. Column Splint Practice

The cracked column shown in Figure 5 was used to practice the column splint repair. This column is located in the NATO structure at the SKY X Explosive Test Range, Tyndall AFB, Florida. The column was damaged during explosive testing at the range.

Column splint repair practice took place on 24 September 1991. Two personnel were used to carry out the repair. Following the procedures outlined above, a column splint repair was accomplished in 7 minutes 29 seconds. No problem was encountered during the repair process. Consequently, no system modification was required. Figure 6 shows the completed column splint repair.

2. Column Replacement

When a reinforced concrete column is damaged to the point that it can no longer be considered a structural member, it should be replaced. Three ERSF methods were developed by AFCESA/RACS to replace a destroyed reinforced concrete column. The first uses a glued laminated (glulam) timber, wedged and braced next to the destroyed column, to carry a portion of the destroyed column's design load. The second uses a shoring jack, jacked and braced next to the destroyed column. The third uses an assembled, lightweight, steel box section, called a "Super Stud"[™] (11), placed next to the destroyed column. The first and third methods were practiced at Tyndall AFB, Florida. Figure 7 shows a glulam column, while Figure 8 shows a partially assembled box section "Super Stud"[™] with a screw extender at one end.

a. Repair Process

(1) Glulam Timber Column Replacement

A glulam timber column replacement is accomplished using the steps described below. A list of the supplies, materials, and equipment required to carry out the repair during practice at Tyndall AFB is given in Table 2.

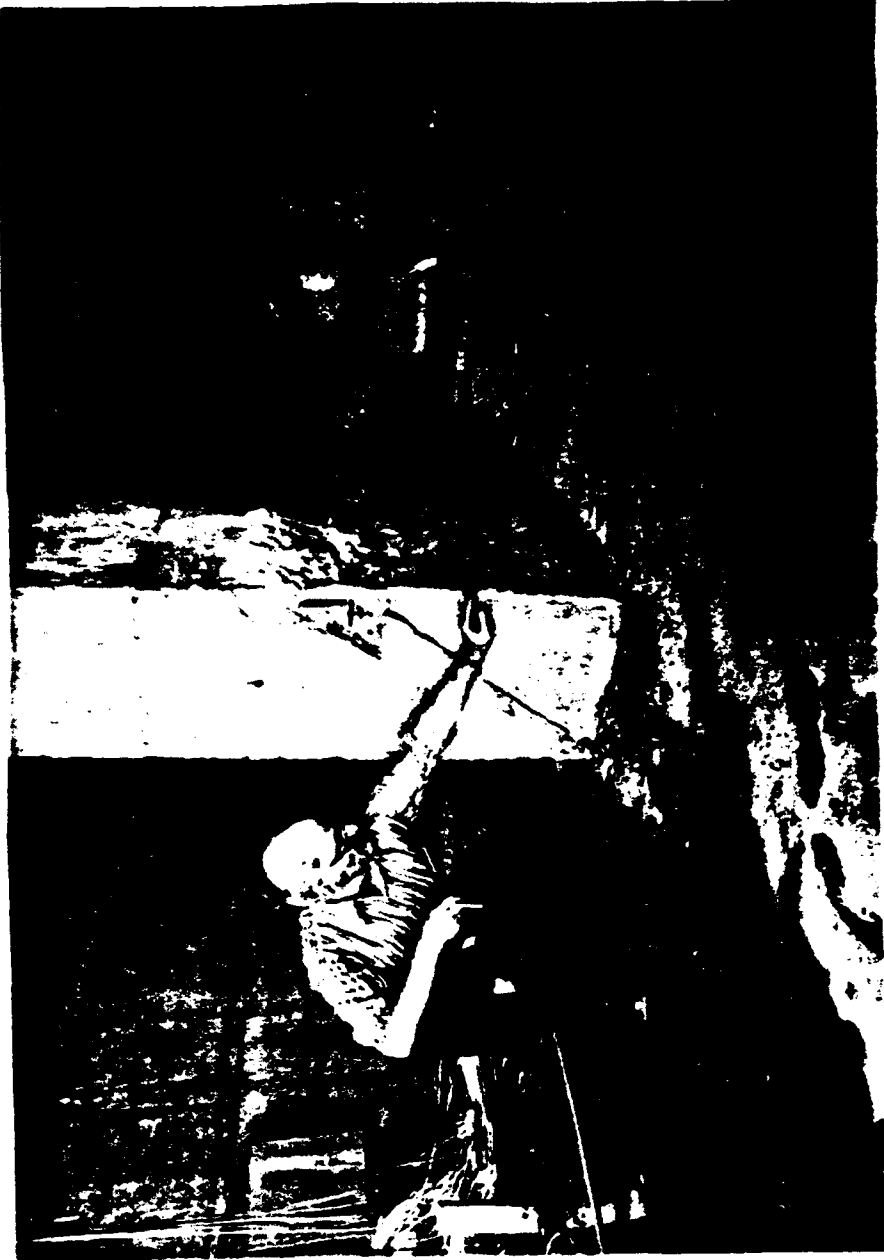

Figure 5. Cracked Column Used For Column Splint Practice.

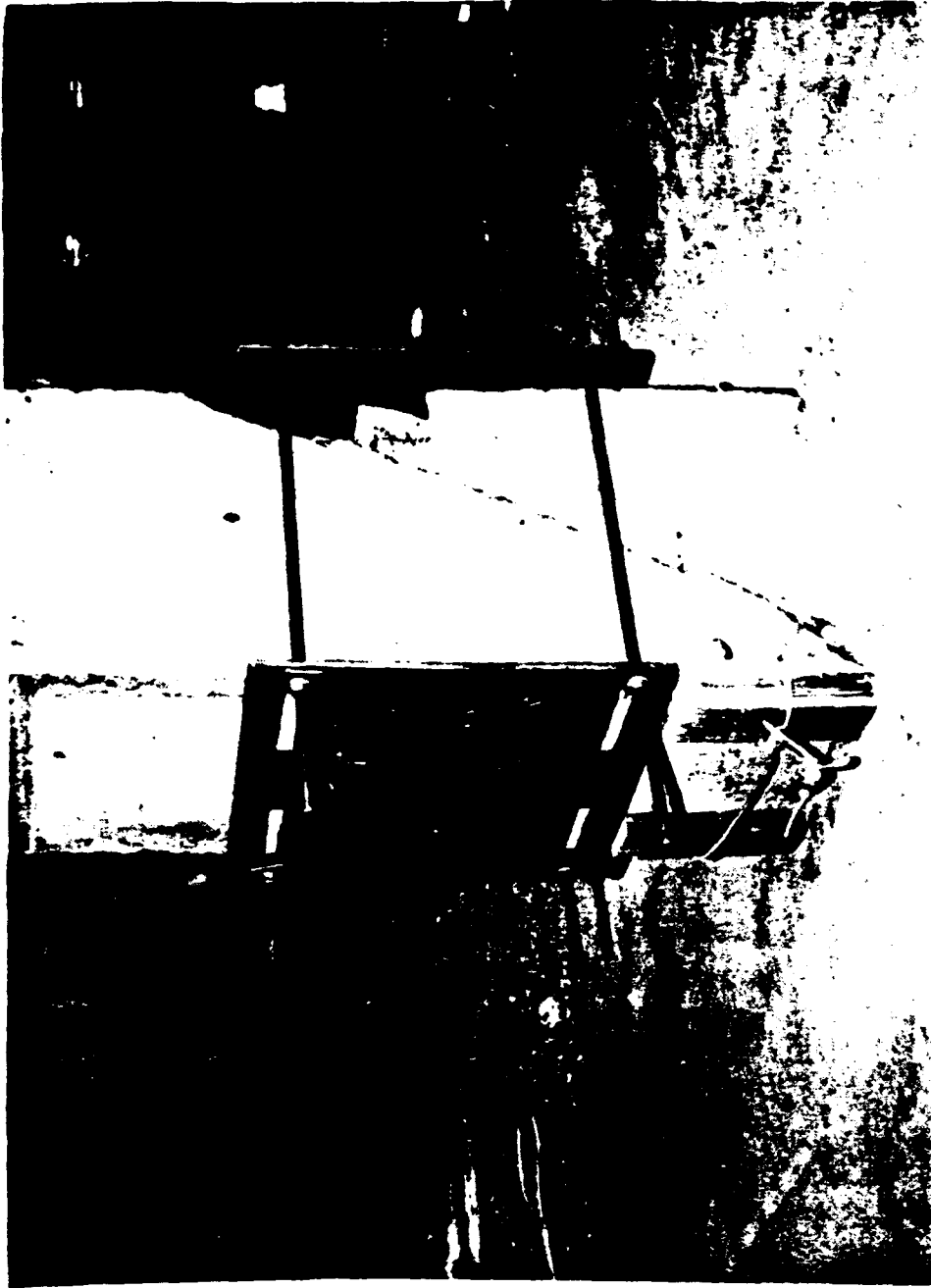

Figure 6. Completed Column Splint Repair.



Figure 7. Glued-Laminated (Glulam) Timber Column.



Figure 8. Partially Assembled Box Section (Super Stud[™]).

(a) Debris Clearance

If necessary, use brooms and shovels to remove loose debris from the repair area. If necessary, remove interfering concrete and protruding rebar to provide a level surface at the floor and ceiling locations where the replacement column will be inserted.

(b) Trim Column

Measure the distance between the floor and ceiling beam next to the damaged column. Using this measurement as a reference, trim the column to the correct length with a chain saw. The column should be trimmed so the diagonal will be 1/2 inch shorter than the distance between the floor and the ceiling beam. Once the glulam column is tilted into position, wooden wedges will be placed in the gap to secure the column in position.

(c) Jack Structure

Place a mechanical shoring jack close to where the replacement column will go. Extend the jack until its capacity is reached or it meets refusal, whichever comes first.

(d) Position Column

Tilt the glulam column upward into position next to the damaged column. Hammer as many wooden wedges as necessary into the gap between the glulam column and the ceiling beam to secure the glulam column in position.

(e) Jack Removal

Once the glulam column is wedged into position, remove the shoring jack. By removing the jack, its load is transferred to the glulam column.

(f) Brace Column

Attach bracing lumber to the glulam column with hammer and nails. Attach the bracing lumber with hammer and nails to wooden sills, secured to the floor around the column with ramset studs. If possible, the column should be braced in the "x" and "y" directions.

(2) Box Section ("Super Stud") Column Replacement

A box section ("Super Stud") column replacement is accomplished using the steps given below. A list of the supplies, materials, and equipment required to carry out the repair at Tyndall AFB, and during the FOAL EAGLE exercise in the Republic of Korea, is given in Table 2.

(a) Debris Clearance

See Subsection II-C.2.a.(1)(a) for details on debris clearance.

(b) Assemble Box Section

Measure the distance between the floor and ceiling beam next to the damaged column. Using this measurement as a reference, assemble the box section with a screw extender at one end, so as the box section is being raised to a vertical position it will clear the ceiling beam by 1 inch.

(c) Position Box Section

Maneuver the box section next to the damaged column. Tilt the box section upward until it is upright with its screw extender slightly below the ceiling beam.

(d) Extend Screw Extender

By hand, rotate the screw extender until its base

plate comes in contact with the ceiling beam. Then using a large crescent wrench continue to rotate the extender until the box section is tightly wedged into position.

(e) Brace Column (Optional)

Attach wood bracing members to the box section with nuts and bolts. Attach the wood bracing with hammer and nails to wooden sills, secured to the floor around the box section with ramset studs. If possible, the box section should be braced in the "x" and "y" directions.

b. Column Replacement Practice

(1) Glulam Timber Column Replacement Practice

A glulam column replacement repair was conducted on 24 September 1991 using a doorway in the southern wall of the NATO structure at the SKY X test range, Tyndall AFB, Florida, to simulate a floor and roof beam. The repair team consisted of four personnel. The repair team used the procedures described above to carry out the glulam timber column replacement. The column replacement took 16 minutes and 43 seconds to complete. No problem was encountered during the repair process. The completed glulam column replacement repair is shown in Figure 9.

(2) Box Section Column Replacement Practice

A complete box section column replacement repair was not conducted at Tyndall AFB, Florida. Instead, sections of various lengths, with screw extenders on both ends, were assembled to become familiar with the device. Assembly of a 10-foot long section, with a screw extender on one end, on average, took approximately 10 minutes. The "Super Stud"™ system was found to be very simple and easy to use.

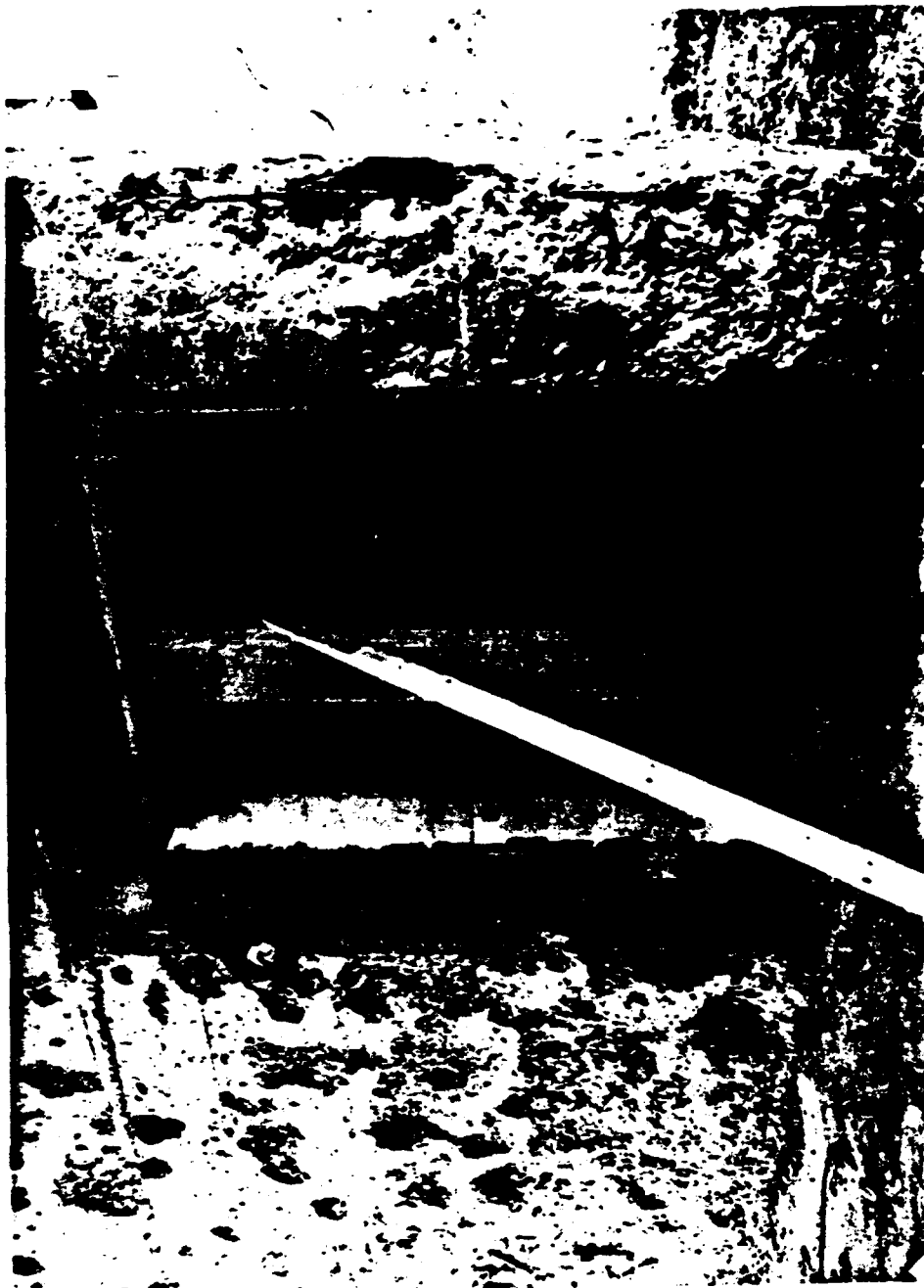

Figure 9. Completed Glulam Column Replacement Repair.

At Osan AB, a simulated column replacement repair was carried out using a column in the emergency entrance to the base hospital (see Section VI-C.5.). The height of the column was 10 feet 9 inches, which was too great to use a glulam column because of weight and safety constraints. Consequently, only the "Super Stud"™ column replacement method was demonstrated during FOAL EAGLE.

3. Earth Berm/Precast Concrete Slab Wall Breach Repair

a. Repair Process

An earth berm can be used to repair a breached, ground floor, exterior structural wall. The earth berm repair is accomplished following the steps given below. A list of the supplies, material, and equipment required to carry out such a repair during practice at Tyndall AFB, and during the FOAL EAGLE exercise, is given in Table 2.

(1) Debris Clearance

If required, remove parts of the damaged wall and surrounding members that are still attached to the structure and would interfere with repair operations. Use brooms and shovels to remove loose debris from the repair area to provide a clean and level working surface.

(2) Place Backing

(a) Plywood

Measure the breach, and cut and join plywood sections together using 2- by 4-inch boards and hammer and nails, to back the breach from behind. Secure the plywood backing behind the breach with ramset studs, driven through the plywood and boards into the adjacent, firm concrete. Brace the backing using 2- by 4- inch diagonal bracing lumber, attached to the backing and to wooden sills secured to the floor behind the backing with ramset studs.

(b) Precast Slab Backing

Using a front-end loader, lean precast slabs against the outside of the structure to cover the breach. Use as many slabs as necessary to completely cover the breach.

(3) Form Berm

Use a front-end loader to mound soil against the precast slabs to form a berm. The length of the berm perpendicular to the slab needed to obtain the necessary height to completely cover the breach will depend on the angle of repose of the material used to form the berm. The lower the angle of repose, the greater the required berm length.

b. Earth Berm Practice

The 5-foot diameter wall breach at ground level, shown in Figure 10, was used to practice an earth berm repair. This wall breach is in the southern wall of the NATO structure at the SKY X Explosive Test Range, Tyndall AFB, Florida.

Earth berm repair practice took place on 24 September 1991. Four personnel were used to carry out the repair. Following the procedure outlined above, the plywood backing portion of the repair took 28 minutes and 33 seconds, placement of one precast slab with a front-end loader took 9 minutes 57 seconds, and forming the earth berm with a front-end loader took 15 minutes 12 seconds. Total repair time was 53 minutes 42 seconds. Figure 11 shows the earth berm repair in progress.

Two problems were encountered during the earth berm repair. The ramset stud gun used to secure the plywood backing behind the breach was old and worn out. Consequently, the charge cartridges stuck in the gun firing chamber after the charge had been fired. After each shot, it took several minutes to remove the spent cartridge before another could be inserted. Additionally, the stud gun often would not fire, even though its barrel was



Figure 10. Wall Breach Used For Earth Berm Wall Replacement Practice.

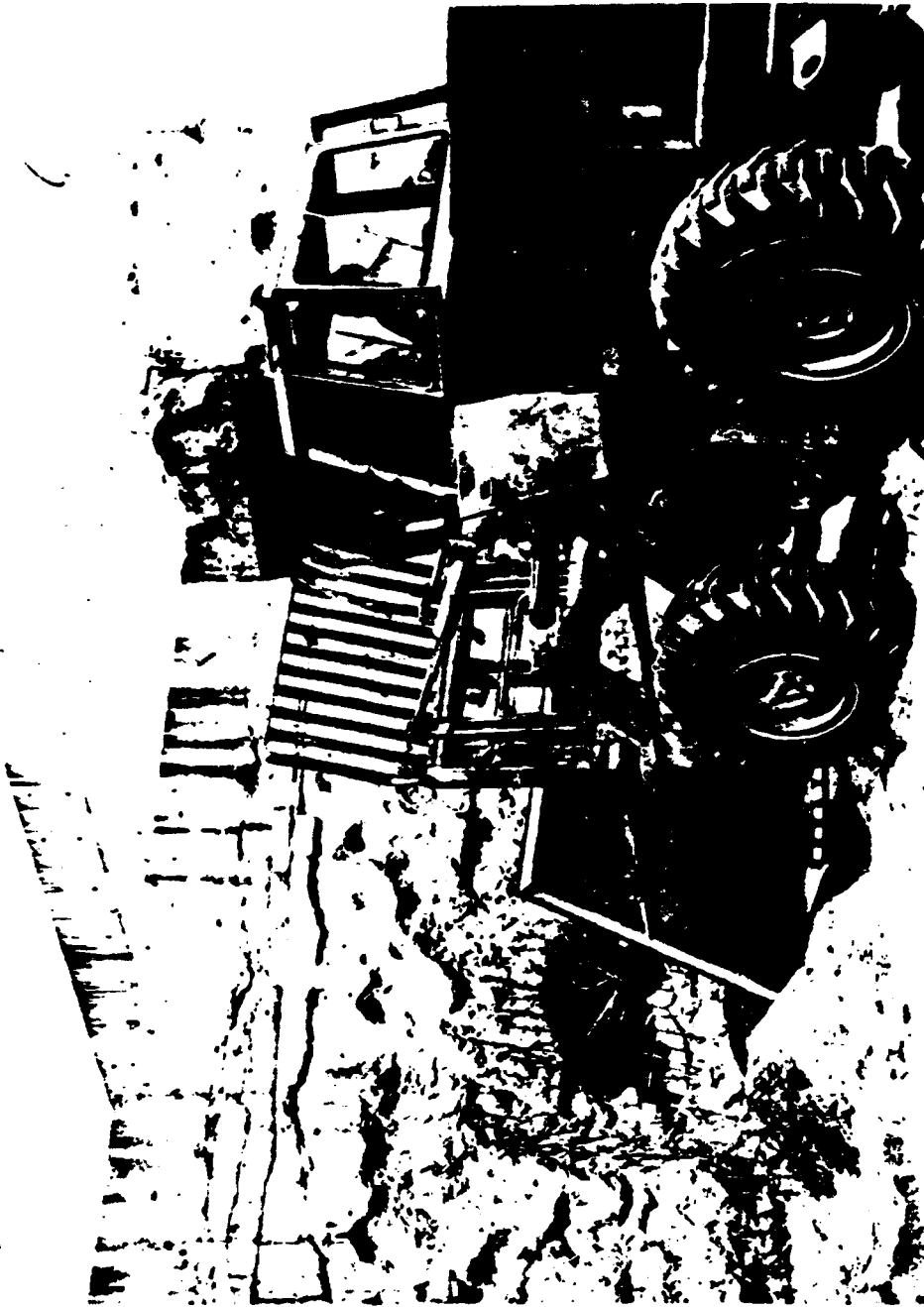

Figure 11. Earth Berm Wall Replacement Repair In Progress.

firmly pressed against the plywood backing to disengage the safety mechanism. Another problem occurred during slab placement against the outside structure to cover the breach. It proved difficult and time-consuming to use the forks of the front-end loader to lean the slab against the structure to cover the breach. It was difficult to center the slab over the breach and obtain the correct lean angle.

To overcome the problems with the stud gun, a new one was purchased for use during the FOAL EAGLE demonstration in the Republic of Korea. To position the slab, it was decided to use a lifting harness with hooked eyelets passing through keyways in the slab, to move and position the slab against a structure with a front-end loader.

4. Shotcrete Wall Breach Repair

a. Shotcrete Overview

In the simplest form of the shotcrete repair process, dry-mix shotcrete is sprayed onto a plywood backing placed behind the repair area, using a shotcrete gun, hoses, and a hand-held spray nozzle. Hoses are required to carry water, compressed air, and shotcrete material. The gun consists of a hopper, beneath which is a cylinder (rotor) which revolves about a vertical axis and has several axial holes (chambers). The diameter and length of the rotor, along with the number and size of the chambers, control the gun output.

In the dry-mix shotcrete process, dry shotcrete material is fed into the hopper, then passes through the revolving rotor chambers to a hose attached to the gun. Compressed air propels the dry shotcrete material through the hose to a hand-held nozzle. At the nozzle, water mixes with the dry shotcrete material, and the wet shotcrete is then sprayed onto a backing, guided by the nozzle operator. In addition to the equipment just described, all that is needed for the system to work are: (1) a water source of sufficient flow rate and pressure; (2) an electrical source of sufficient voltage and power, having the correct frequency and number of phases; (3) compressed air of sufficient flow rate and pressure; and (4) shotcrete material.

The basic system described above needs only one person to control the spray nozzle. In a shotcrete-based ERSF system, the spray nozzle is attached to a remotely controlled robotic boom, which reduces crew fatigue, allows higher material output rates because a person is not providing the reaction force at the nozzle, and makes it possible to cover a much larger area without moving the equipment.

For more detailed descriptions of the shotcrete process and associated equipment, see References 4 through 8.

b. Equipment

The shotcrete and support equipment used for practice at Tyndall AFB, and for the demonstration at Osan AB, consisted of the following: (1) an Aliva Spray Boom 80 with remotely controlled nozzle (specifications given in Table 3), (2) an Aliva 260 shotcrete gun (specifications given Table 4), (3) an air compressor providing 600 cubic feet per minute (CFM) at 125 psi, (4) a 60 kilowatt (KW) generator set providing 480 volt/three phase/60 cycle power, and (5) a water source providing 10 gallons per minute (GPM) at 90 psi. Figure 12 shows the shotcrete and support equipment setup used for practice at Tyndall AFB, Florida.

c. Repair Process

A shotcrete wall breach repair is accomplished following the steps given below. A list of the supplies, material, and equipment required to carry out the repair during practice at Tyndall AFB, and during the FOAL EAGLE exercise in the Republic of Korea, is given in Table 2.

(1) Debris Clearance

See Subsection II-C.3.a.(1) for details on debris clearance.

TABLE 3. ALIVA SPRAY BOOM 80 MAJOR SPECIFICATIONS.

Power Source	Pneumatic Motor
Max. Height	12.32 feet*
Min. Height	1.00 feet
Max. Reach	15.50 feet
Min. Reach	4.45 feet
Weight	3,860.0 lb**
Cost on 4/15/91 (Approx.)	\$60,000.00***

* - Does not include lift height of forklift carrying the boom.

** - Weight of boom without forklift.

*** - Cost of boom only (estimated).

TABLE 4. ALIVA 260 SHOTCRETE GUN SPECIFICATIONS.

Power Source	Electric Motor IEC three-phase 600 Volt, 60 Hz 7.5 kW @ 1460 rpm 5.5 kW @ 950 rpm
Compressed Air Source	353 to 670 CFM @ 100 PSI
Water Source	10 GPM @ 90 PSI
Cylinder (Rotor) Capacity	0.56 ft³
Hose Diameter	2.56 to 3.35 inches
Conveying Line Diameter	2.56 to 2.95 inches
Material Output Capacity	7.85 to 11.77 yd³/hour
Aggregate Size normal/max.	0.63 inches / 0.98 inches
Conveying Distance	
Horizontal	985 feet
Vertical	328 feet
Cost on 4/15/91 (Approx.)	\$35,000.00



Figure 12. Shotcrete And Support Equipment Setup.

(2) Place Plywood Backing

See Subsection II-C.3.a.(2)(a) for details on the placement of plywood backing.

(3) Rebar Placement (Optional)

Placement of rebar is optional, and should be considered only if repair time need not be minimized and/or the strength of the repair must be maximized. If rebar is used, trim and tie lengths of Number 4 rebar to fit the repair area. For more details on placing rebar within the repair area see Reference 5.

(4) Place Shotcrete Material

Set up the shotcrete equipment next to the breach. Load material into the shotcrete gun hopper, then begin spraying shotcrete material mixed with water onto the plywood backing behind the breach until the repair reaches the desired thickness. For more details on placing shotcrete material to repair a wall breach see References 5 and 6.

d. Shotcrete Wall Breach Repair Practice

Two shotcrete practice sessions took place at Tyndall AFB on 26 and 27 September 1991. Each practice session is briefly described below. For additional information on shotcrete practice sessions at Tyndall AFB see Reference 6.

(1) Penthouse Opening (26 and 27 September)

On 26 September 1991 a penthouse opening in the east wall of the NATO structure (Figure 13) was repaired with shotcrete. Prior to the repair, the opening had been backed with plywood so that the repair thickness, when the opening was completely filled in, would be 10 inches.



Figure 13. Penthouse Opening In NATO Structure.

When repair of the penthouse opening was started, an insufficient water supply was available for the shotcrete equipment. Insufficient water caused the shotcrete material to be too dry to build up on the plywood backing. Consequently, the repair process was suspended until an adequate water source could be found. A water truck capable of providing the required 10 gallons per minute at 90 psi was found, and the repair process resumed on 27 September. With an adequate water source, repair of the penthouse opening went smoothly, with a rapid buildup of shotcrete material on the plywood backing. The repair process was stopped after 20 minutes, when the average repair thickness was approximately 7 to 8 inches. Figure 14 shows the penthouse opening repair in progress.

(2) Wall Breach (27 September)

On 27 September 1991 the elevated wall breach in the south wall of the NATO structure (Figure 15) was repaired with shotcrete. The wall breach was approximately 5 feet in diameter, with the center of the breach 15 feet above ground level. The wall thickness around the breach was 26.5 inches. Backing the breach with plywood (Figure 16) took 32 minutes 16 seconds. Filling the breach with shotcrete (Figure 17) took 16 minutes 17 seconds. The repair process went smoothly, with the only trouble caused, as with the earth berm repair, by the ramset stud gun used to place the backing behind the breach.

D. CONCLUSIONS

Four significant problems were encountered during POST-DAM and ERSF system practice sessions at Tyndall AFB, Florida. Each problem, and the solution, is briefly described below. The first problem was the unsatisfactory performance of the POST-DAM repair scheduler. It was decided not to demonstrate this portion of POST-DAM during FOAL EAGLE, because it was being replaced. Instead, the user interface shell of a new software package being developed to improve the performance of the scheduler and make passing data between the scheduler and resource manager easier was demonstrated during FOAL EAGLE. This shell is the user interface of a software package that integrates the repair scheduler and resource manager together in a menu/dialog box-driven system.



Figure 14. Penthouse Shotcrete Repair In Progress.

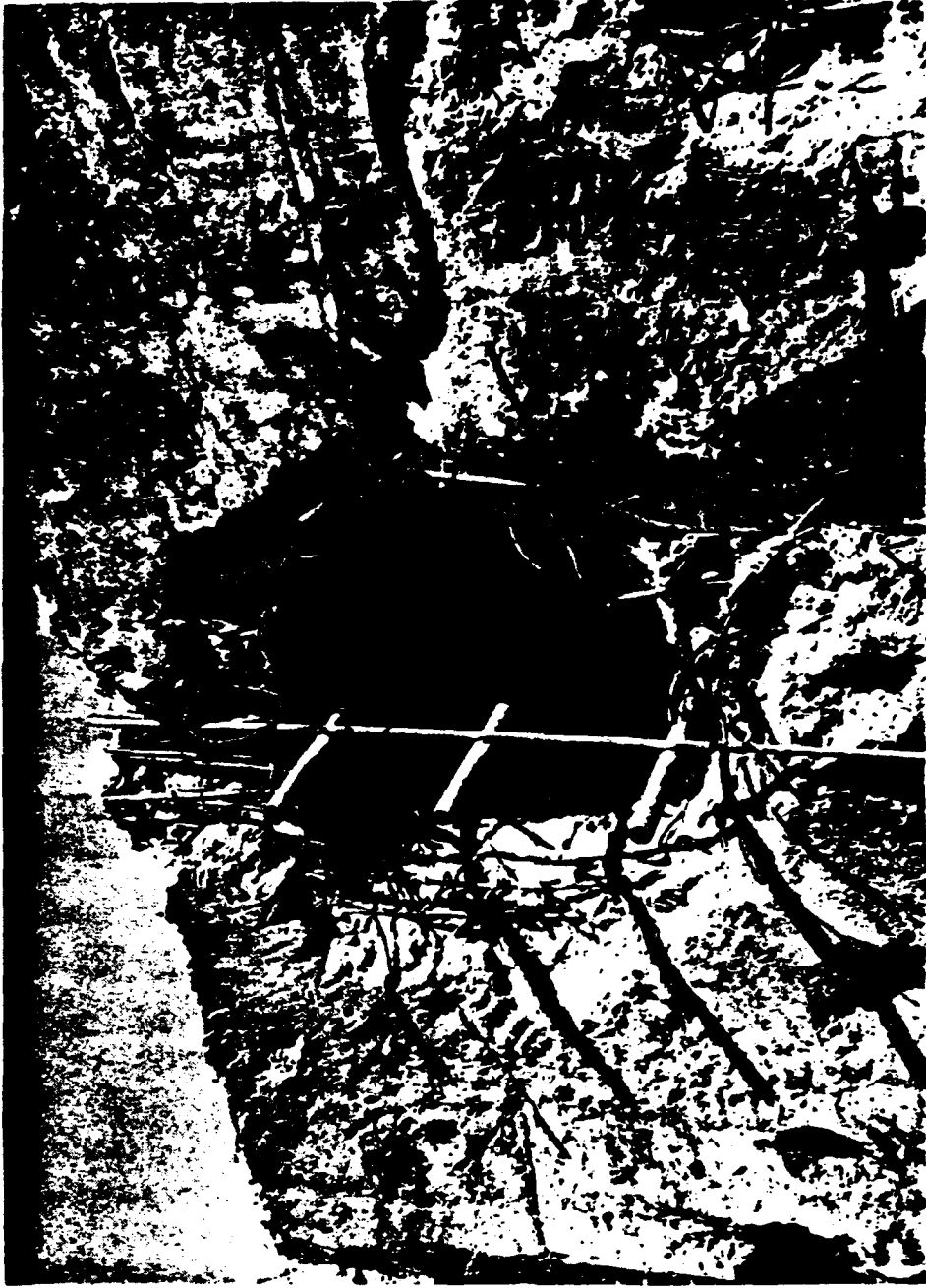

Figure 15. Wall Breach Used For Shotcrete Repair.



Figure 16. Backing Breach With Plywood.



Figure 17. Filling Breach With Shotcrete.

The second problem was the unsatisfactory performance of the old, worn out ramset stud gun used to secure plywood backing behind the earth berm and shotcrete wall breach repairs. To overcome this problem, a new stud gun was purchased.

The third problem was the difficulty in positioning and leaning the precast slab against the NATO structure with the forks of an all-terrain forklift, to cover the wall breach. It was decided to use a lifting harness to move and position precast slabs during FOAL EAGLE.

The final problem encountered during the practice sessions involved the shotcrete water source. The initial water source used during the repair process did not provide the required 10 GPM at 90 psi. Consequently, the shotcrete material was too dry to build up on the plywood backing behind the breach. Once an adequate water source was used, the repair process went smoothly. Adequate water, electrical, and compressed air sources are critical to a successful shotcrete repair.

SECTION III

SEVENTH AIR FORCE SUPPORT

A. FOAL EAGLE PLANNING CONFERENCE AND SITE SURVEY

Section I.D summarizes the events leading to Mr. Strickland's and Captain Reid's attendance at the 9 September 1991 FOAL EAGLE planning conference at Yongsan AB. The principal RACS accomplishment at that conference was that the FOAL EAGLE planning staff agreed to include the RACS facility recovery demonstrations in the exercise script.

Dr. Merkle arrived in Seoul on the evening of the 9th, and the RACS demonstration planning team was driven to Osan AB by Major Mike Stephens and Captain Lisa Witt of 7AF/DEX. The Osan AB site survey, and engineering and logistical planning occupied the next three days. Excellent sites were found for all the demonstrations:

Damage Assessment - BCE Damage Control Center (Building 416)

Column Splint - Base Hospital (Building 777), and Seventh Air Force Headquarters (Building 933)

Column Shoring - Base Hospital (Building 777)

Earth Berm Wall Breach Repair - burned out laundry (Building 414)

Shotcrete Wall Breach Repair - burned out laundry (Building 414)

Finding the burned-out laundry on which to perform the earth berm and shotcrete repair demonstrations was a stroke of good luck, because it meant no structural modification would be required for any repair demonstration. In addition, Colonel McPherson, the Osan AB BCE, had the fire debris around Building 414 removed and the area cleaned up, thus creating an ideal demonstration site.

The hospital basement-level emergency entrance column to be shored proved to be considerably taller (10 feet 9 inches) than the Eglin AFB column and Tyndall AFB door opening on which the glulam column shoring repair method had been developed and rehearsed. It was clear that a modification of the column shoring method was needed, to allow the replacement column to be safely positioned by hand. Fortunately, Dr. Merkle had spotted an Engineering News-Record advertisement several months earlier for light-gage steel columns used to brace concrete formwork. The product, called "Super-Stud"™ and manufactured by the Economy Forms Corporation (EFCO), of Des Moines, IA, turned out to be a very practical solution. Engineering for the method was quickly accomplished when the RACS team returned to Tyndall AFB. The light-gage steel columns and associated hardware, including easy-to-handle screw jacks, were available off-the-shelf, and were ordered and received at Tyndall AFB just in time to ship to Osan AB for FOAL EAGLE.

B. 7AF/DE SUPPORT

Shortly after the RACS site survey, Colonel Cardinale, 7AF/DE, issued a staff summary sheet listing FOAL EAGLE facility recovery demonstration support requirements (Appendix B). The staff summary sheet included a talking paper and three support requirement summaries prepared by the RACS team while at Osan AB.

After returning to Tyndall AFB, the RACS team refined their support requirements, sent them to 7AF/DEX, and developed the light-gage steel column shoring method. They then prepared a detailed Test Plan (Appendix C) finalizing all support requirements.

When all demonstration preparations and training had been accomplished, Captain Tagorda, 7AF/DEX, issued a demonstration schedule (Appendix D), announcing the date, time and location of each FOAL EAGLE facility recovery demonstration.

SECTION IV

LOGISTIC ACTIONS

A. AIR SHIPMENT TO OSAN AB

The logistic support provided for FOAL EAGLE was divided into three parts: obtaining equipment, transporting equipment, and preparing equipment. The column shoring equipment, shotcrete machine and shotcrete material were received at Tyndall AFB one week prior to air shipment to the Republic of Korea. The shotcrete machine was prepared for shipment by ARA technicians, and palletized by the Air Freight Section of the Transportation Management Office (TMO). TMO is best prepared to palletize, weigh, and determine overall dimensions. That information is required before air shipment can be accomplished. The equipment had just been tested with shotcrete material prior to having TMO palletize the shipment. The machinery had to be thoroughly cleaned of all dirt and oil before TMO would accept it for air shipment. Additionally, the machinery was banded by ARA, and loose items were secured. Once everything had been prepared for shipment, TMO arranged for a Red Ball shipment to Travis AFB. (Red Ball is a term used to denote a priority, non-stop, surface shipment). ARA arranged for a personal representative (air cargo courier) to meet the equipment at Travis, to ensure that everything moved via aircraft to Osan AB on time.

The shipment was met at Travis, and shipping documents were prepared to move all the equipment in accordance with Code 999 (priority air). Six bags of shotcrete material had been shipped from Seattle, WA and were also met by the ARA air cargo courier. The equipment had been ready for air shipment the day before, but was intentionally delayed to ensure the whole package went over on one aircraft. This was important because not all aircraft use the same routing. There was a possibility that the shipment might be split, and part of the cargo "bumped" by a higher priority shipment at one of the enroute stops. To avoid this, the air cargo courier worked closely with Air Traffic Operation Control (ATOC) to use a single aircraft that flew nonstop to Osan AB. By not splitting the shipment, everything was ensured of arriving on time. This priority movement was prearranged through 22nd Air Force. Three to four weeks were allowed for

this type of air shipment to be processed. Also, it was important the shipment not be combined with hazardous materials, as this would have delayed the processing time. If hazardous materials had been shipped, six weeks would have been necessary for processing the request.

B. PREPARATION AT OSAN AB

Upon arrival at Osan Air Base and delivery of the equipment to the 51st Civil Engineer Squadron, plans were made to protect the shotcrete material from rain. Prior to shipment, arrangements had been made for 51 CES to furnish a 600 CFM, 100 psi air compressor and a 220/440 VAC generator. However, the air compressor was not available, so ARA arranged with the 554th Red Horse Squadron to obtain a suitable substitute. Unfortunately, the air lines and fittings were not compatible with the substitute air compressor and shotcrete machine, so on-the-spot modifications were required. A full stock of air lines and fittings should be on hand for future operations.

Transportation of the equipment at Osan was a problem. Initially the shotcrete equipment was moved by forklift, and the shotcrete material by 10 ton dump truck. While this operation worked well for the short distance required for the test, moving the equipment longer distances around the base by forklift would have been unsafe. The ideal solution would be to provide a 40-foot Low-Boy, and have all equipment and material on it, plus a dedicated forklift for unloading and loading.

C. RETURN AIR SHIPMENT FROM OSAN AB

Air shipment of equipment back to Tyndall and Seattle was routine. Again, the ARA air cargo courier worked with military personnel from TMO and ATOC. The column shoring equipment was returned directly to Tyndall AFB, and the shotcrete machinery was flown into Travis. Upon its arrival at Travis, the ARA representative arranged for Red Ball shipment of the shotcrete machine to the manufacturer's site at Seattle, WA.

D. RECOMMENDATION

FOAL EAGLE was the second test in little more than a year that required air shipment of equipment by AFCESA. In both cases it was quite evident that use of an air cargo courier was the only way to ensure that critical shipments arrived on time. The courier must be fully knowledgeable of hazardous cargo, compatibility waivers, palletization, and types of aircraft for load planning.

Although every possible detail was considered before the trip, it was obvious that "Murphy" was alive and full of spunk. Lack of a compressed air source, incompatible coupling tubes, bad weather, and confusion of CE personnel to be trained all required quick changes at the last moment. Part of the confusion was due to CE management understanding the needs but not passing the information to their shops. During future pretest meetings, it would be advisable to meet with people who will actually do the work. Also important is meeting the person who controls supply sources.

SECTION V

DEMONSTRATION TRAINING AT OSAN AB

A. OVERVIEW

ERSF system training at Osan AB, Republic of Korea was conducted using 51 CES and 92 CES personnel during the week of 28 October 1991. The trainees were taught to use the column splint, column shore (replacement), earth berm/precast slab wall replacement, and shotcrete wall replacement ERSF systems. Each ERSF system training session is described below.

B. COLUMN SPLINT TRAINING

Column splint training took place on 31 October 1991. A 20-inch square column located in a mechanical room in the basement of the base hospital was used to conduct the training session. The repair team consisted of two 51 CES personnel. Two repairs were conducted, following the repair procedure described in Subsection II.C.1.a of this report. Results from each practice column splint repair are summarized below in Table 5.

TABLE 5. SUMMARY OF COLUMN SPLINT TRAINING RESULTS AT OSAN AB.

	Repair Clock Time (min:sec)*	
Repair Task	Repair-1	Repair-2
Position Boards to Support Plates	0:40	0:30
Position/Align Plates	3:30	2:20
Place/Tighten Threaded Rods/Bolts	4:30	3:55
Remove Boards	Not Done	4:25

* - Elapsed clock time starting at 0:00.

Both column splint repair practices went well, with no significant problem encountered during the process. Both repair team members felt comfortable with the repair process and associated hardware. With both repairs taking less than 5 minutes to complete, the repair team was ready for the actual demonstration, scheduled to take place on 6 November 1991.

C. COLUMN SHORE (REPLACEMENT) TRAINING

Column replacement training took place on 31 October 1991. A 25-inch diameter, 10-foot 9 inch tall circular column located in the emergency entrance to the base hospital was used to conduct the training session. The repair team consisted of four 51 CES personnel. The repair was conducted following the procedure described in Subsection II.C.2.a (2) of this report. Results from the practice column replacement repair are summarized below in Table 6.

TABLE 6. SUMMARY OF COLUMN REPLACEMENT TRAINING RESULTS AT OSAN AB.

Repair Task	Repair Clock Time*
Assess Damage To Column	0:15
Position "Super Stud"™ Column Parts	0:45
Measure Column Height/Assemble Column	2:35
Position Column Next To Damaged Column	2:50
Extend Jack Extender	3:45
Remove Ladder	4:16
Attach Bracing Members	Not Done

* - Elapsed clock time starting at 0:00.

Column splint repair practice went well. No significant problem was encountered during the process, and the four repair team members felt comfortable with the repair process and associated hardware. The repair team was ready for

the actual demonstration, scheduled to take place on 6 November 1991.

D. EARTH BERM WALL REPLACEMENT REPAIR TRAINING

Earth berm wall replacement training took place on 31 October 1991. A burned-out, single-story, laundry building located behind the base civil engineering equipment yard was used to conduct the practice session. A door opening in the structure was repaired using the earth berm repair procedure described in Subsection II.C.3.a of this report. The repair team consisted of five 51 CES personnel. One repair was conducted. Results from the practice earth berm repair are summarized below in Table 7.

TABLE 7. SUMMARY OF EARTH BERM WALL REPLACEMENT TRAINING RESULTS AT OSAN AB.

Repair Task	Repair Clock Time*
Place Plywood Backing In Door Opening	9:50
Position Precast Slab Against Structure	15:00
Form Berm With Soil	19:40

* - Elapsed clock time starting at 0:00.

During the earth berm repair, a problem arose due to the weakened structural condition of the burned-out laundry building. All that was left standing of the building were masonry walls. The roof was completely gone. The masonry walls could not resist a significant lateral load. This was especially true for the wall used for earth berm repair practice. This wall was only connected to the building along one side, with no wall connected to it from behind in the perpendicular direction to provide out-of-plane support. It was essentially cantilevered from the rest of the building. As a result of its weakened and cantilevered condition, when the precast slab was leaned against the wall, a visible lateral deflection occurred. To prevent collapse of the wall, only a partial berm was formed against the slab to minimize the lateral load imparted to the wall. The berm covered approximately two-thirds of the

slab. To alleviate this problem during the actual demonstration, the masonry wall was braced from behind with lumber to increase its lateral strength.

Except for the problem described in the preceding paragraph, the earth berm wall repair practice went well. The five repair team members felt comfortable with the repair process and associated hardware. With the repair taking less than 20 minutes to complete, even when great care had to be taken not to collapse the wall, the repair team was ready for the actual demonstration, scheduled to take place on 6 November 1991.

E. SHOTCRETE WALL REPLACEMENT REPAIR TRAINING

The main purpose of the shotcrete wall replacement practice was to familiarize 51 CES personnel with the use and maintenance of the shotcrete and support equipment. Additionally, one person was trained to use the remote, hand-held, control panel to operate the robotic shotcrete spray boom/nozzle. An actual wall replacement repair was not attempted during training. Instead, a base drainage ditch, which had erosion problems, was lined with shotcrete on 1 November 1991. See Subsection II.C.4.b of this report for a list of required shotcrete and support equipment. Subsection II.C.4.c. describes the shotcrete wall replacement process. A view of the ditch-lining process is shown in Figure 18. The lining process took approximately 2.5 hours to complete.

Two significant problems were encountered while lining the ditch. The first involved control of the water flow rate to the shotcrete nozzle, which in turn controlled the water content of the shotcrete material. If the water flow rate is too high, the shotcrete material becomes too wet and sloughs off instead of building up on the repair surface. If the water flow rate is too low, the material is too dry and will not stick to the repair surface. It took approximately 30 minutes to troubleshoot the water supply system and obtain the correct flow rate in a reliable manner.

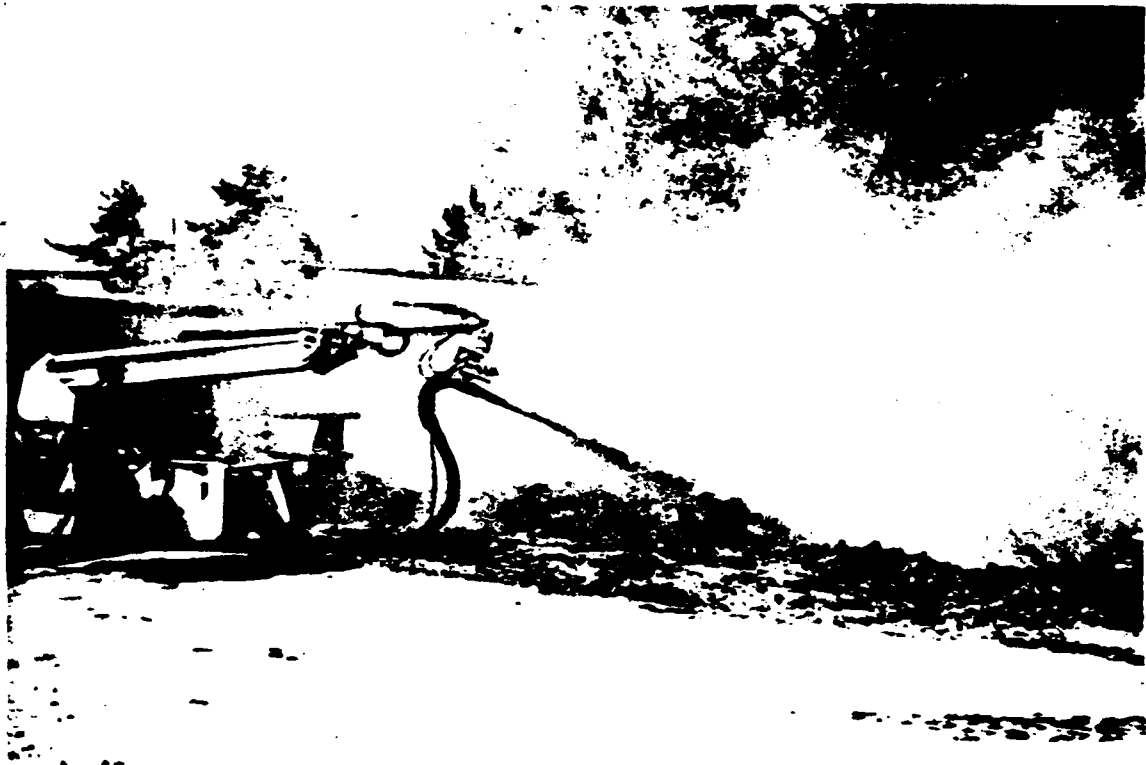

Figure 18. Lining Drainage Ditch With Shotcrete.

The second problem involved supplying shotcrete material to the shotcrete gun hopper. The material was supplied in supersacks, which are plastic-lined bags with four lifting loops on top and a drawstring funnel at the bottom. Each sack contains 3,500 pounds of material, which when mixed with water makes 1 cubic yard of shotcrete. To supply material to the shotcrete gun hopper while lining the ditch, a lifting harness was placed through the loops in the top of the supersack. The harness was then secured to the forks of an all-terrain forklift, which then lifted the supersack over the hopper. The funnel at the bottom of the bag was opened, and the shotcrete material flowed into the hopper. Once, during this process, the lifting harness was not secured to the forklift forks. When the supersack was lifted, the harness slid off the forks, and the supersack fell to the ground and ruptured. The material then had to be fed into the hopper by hand with shovels. This oversight, in addition to slowing down the ditch-lining process, posed a safety hazard. Subsequently, while completing the lining of the drainage ditch, and during the actual shotcrete wall replacement demonstration the following week, great care was taken to ensure the lifting harness was securely fastened to the forks of the forklift.

Except for the two problems described above, shotcrete training went well. The five-man repair team felt comfortable with the repair process and associated equipment. The repair team was ready for the actual demonstration, scheduled to take place on 7 November 1991.

SECTION VI FOAL EAGLE DEMONSTRATION

A. OVERVIEW

Demonstration of the POST-DAM system during exercise FOAL EAGLE at Osan AB, Republic of Korea took place on the afternoon of 2 November 1991 at the DCC. Demonstration of the earth berm/precast slab and shotcrete wall replacement ERSF systems took place on the morning of 5 November 1991. Demonstration of the column splint and column shore (replacement) ERSF systems took place on the morning and early afternoon of 6 November 1991. Each demonstration is described below.

B. POST-DAM DEMONSTRATION

1. System Description

See Subsection II.B of this report for descriptions of the hardware, software, and operation of the POST-DAM system. Additionally, files generated by the POST-DAM system are described, along with the communication links between the different components of the POST-DAM system.

2. Demonstration

Demonstration of the POST-DAM expert system and resource manager software components took place at the DCC. The audience consisted of the BCE along with other DCC personnel. The scripts in Appendix A were used to conduct the demonstration. First, the expert system was demonstrated, using the damage scenario described in Subsection II.B.3 of this report. This scenario consists of three damage modes: a damaged column requiring a column splint, a damaged column requiring replacement, and a destroyed exterior wall requiring replacement.

TSgt Bruce W. Callahan of 51 CES provided input to the expert system, prompted by LT Jim Underwood (USN) of RACS. Then the data files

generated by the expert system, describing damage to the building and recommended repair procedures, were transferred by direct communication link to the host computer, on which the resource manager resided. The resource manager was then demonstrated by LT Underwood. Resources were allocated to each repair, and the resource database updated as resources were used for each repair. The resource database had been configured so no resource shortfalls would occur.

The POST-DAM demonstration, which took approximately 30 minutes, went very well. No problem was encountered during the demonstration. The audience appeared interested in the POST-DAM system, and how its capabilities could enhance the performance of the DCC in a postattack environment.

In addition to the POST-DAM demonstration described above, the expert system was used in the field by 51 CES personnel immediately prior to the earth berm/precast slab wall replacement demonstration on 5 November 1991. Figure 19 shows the expert system being used in the field. No problem was encountered during this process.

3. Integrated Resource Manager And Repair Scheduler

As described in Subsection II.C.2.b (2) of this report, problems existed with the original repair scheduler component of the POST-DAM system because of commercial software incompatibilities. Consequently, the scheduler was not demonstrated during FOAL EAGLE. To overcome these problems, AFCESA/RACS had already initiated an effort to develop a new integrated resource manager and repair scheduler software package to reside on the DCC host computer. The user interface shell of the new software package, which uses pull-down menus and dialog boxes for input and output functions, was available to be demonstrated during the FOAL EAGLE exercise.

The user interface shell was demonstrated immediately after the POST-DAM system demonstration on 2 November 1991. LT Underwood conducted the demonstration, and all went well, with DCC personnel stating the package looked user-friendly and easy to use.



Figure 19. POST-DAM Expert System Being Used In The Field.

C. EARTH BERM/PRECAST SLAB WALL REPLACEMENT DEMONSTRATION

The earth berm wall replacement demonstration took place on the morning of 5 November 1991. The burned out laundry building behind the civil engineering equipment yard described in Subsection V.D of this report was used to conduct the repair. The same wall used for earth berm repair training was used for the demonstration. The wall had been braced to increase its lateral strength (see Subsection V.D). The plywood backing placed in the door opening in the wall during earth berm training had not been removed, and was used for the demonstration.

The repair was accomplished using the repair procedure described in Subsection II.C.3.a of this report. The repair team consisted of SRA Christopher Berens and SRA Ronald F. Snider, both from 92 CES, and AIC Curtis W. J. Stewart from 51 CES. One repair was conducted. Results from the earth berm wall replacement demonstration are summarized below in Table 8.

TABLE 8. SUMMARY OF EARTH BERM WALL REPLACEMENT DEMONSTRATION RESULTS.

Repair Task	Repair Clock Time*
Place Plywood Backing In Window Opening	Not Required
Position Precast Slab Against Structure	2:30
Form Berm With Dirt	5:42

* - Elapsed clock time starting at 0:00.

Even with bracing, the wall was still weak laterally. Consequently, only a partial berm was formed against the precast slab to minimize the lateral load imparted to the wall. Overall the repair went very well, with no significant problem encountered. The completed earth berm repair is shown in Figure 20.



Figure 20. Completed Earth Berm Wall Replacement Repair During The FOAL EAGLE Exercise.

D. SHOTCRETE WALL REPLACEMENT DEMONSTRATION

The shotcrete wall replacement demonstration took place immediately after the earth berm wall replacement demonstration. A door opening in a wall of the burned out laundry building, previously backed with plywood, was used to conduct the demonstration. Repair thickness was 8 inches. The wall used for the shotcrete demonstration was different from the one used for the earth berm demonstration. No lateral bracing was attached to the wall prior to the shotcrete demonstration.

The repair was accomplished using the repair procedure described in Subsection II.C.4.c of this report. Shotcrete and support equipment are described in Subsection II.C.4.b of this report. The repair team consisted of SSgt Karl T. Apsey (remotely-controlled shotcrete nozzle operator), and AIC Curtis W. J. Stewart of 51CES, and SRA Christopher Berens and SRA Ronald F. Snider of 92CES. Two representatives from Surecrete, Inc., the firm from which the shotcrete equipment used during the demonstration was leased, were on hand to provide technical assistance. The representatives were Mr. Fred Sherrill, an expert on the shotcrete process, and Mr Andrew Smith, an expert on the shotcrete equipment. One repair was conducted. Results from the shotcrete wall replacement demonstration are summarized below in Table 9.

The delays in the repair process due to insufficient water flow were caused by a piece of plastic sheeting in the water supply system. The piece of plastic was initially in the water truck tank. As water was sprayed from the shotcrete nozzle, pieces of the plastic sheet passed through the water truck pump, through the water line to the shotcrete nozzle. Pieces of the plastic clogged the nozzle water spray holes. As a result, insufficient water flow was available, and the sprayed shotcrete material was too dry to stick to the plywood backing. After the nozzle had been taken apart, the plastic debris removed from the nozzle water spray holes, and the nozzle reassembled, the correct water flow rate was quickly obtained. Then the sprayed shotcrete material rapidly built up on the plywood backing in the door opening to the desired thickness of 8 inches.

TABLE 9. SUMMARY OF SHOTCRETE WALL REPLACEMENT DEMONSTRATION RESULTS.

Repair Task	Repair Clock Time*
Position Supersack Over Hopper	1:00
Charge Hopper With Shotcrete Material	1:47
Begin Water Spray From Nozzle Onto Backing	7:40
Delay Due To Insufficient Water Flow	10:30
Begin Water Spray Again	11:00
Begin Spray Pattern Onto Backing	12:00
Begin Spraying Shotcrete Onto Backing	15:00
Delay Due To Insufficient Water Flow	16:30
Complete Spraying Shotcrete Onto Backing	20:55

* - Elapsed clock time starting at 0:00

Overall the shotcrete wall replacement demonstration went very well, with no significant problem encountered. SSgt Apsey, after the training he received lining the drainage ditch on 1 November (see Subsection V.E), easily operated the control panel that remotely controlled the shotcrete spray nozzle. Views of the shotcrete wall replacement process are shown in Figures 21 and 22. The completed shotcrete repair is shown in Figure 23.

E. COLUMN SPLINT DEMONSTRATION

Two column splint demonstrations took place during the FOAL EAGLE exercise. Each splint demonstration is discussed below.

1. Hospital Column Splint

The first column splint demonstration took place on the morning of 6 November 1991. A 20-inch square column located in a mechanical room in the



Figure 21. View 1 of Shotcrete Wall Replacement Repair During The FOAL EAGLE Exercise.



Figure 22. View 2 of Shotcrete Replacement Repair During
The FOAL EAGLE Exercise.



Figure 23. Completed Shotcrete Wall Replacement Repair During
The FOAL EAGLE Exercise.

basement of the base hospital was used to conduct the demonstration.

The repair team consisted of two 51 CES personnel: SSgt Karl T. Apsey and AIC Curtis W. J. Stewart. The splint repair was conducted following the repair procedure described in Subsection II.C.1.a of this report. Results from this column splint demonstration are summarized below in Table 10.

TABLE 10. SUMMARY OF COLUMN SPLINT DEMONSTRATION RESULTS AT BASE HOSPITAL.

Repair Task	Repair Clock Time*
Position Boards To Support Plates	1:53
Position/Align Plates	2:10
Place/Tighten Threaded Rods/Bolts	6:29
Remove Boards	Not Done

* - Elapsed clock time starting at 0:00.

This column splint demonstration went well. No problem was encountered during the process. This completed column splint repair is shown in Figure 24.

2. 7AF Headquarters Column Splint

The second column splint demonstration took place on the afternoon of 6 November 1991. A 14-inch square column located at the front entrance to the 7AF headquarters building was used to conduct the demonstration. The repair team consisted of two 92 CES personnel: SRA Christopher Berens and SRA Ronald F. Snider. The splint repair was conducted following the repair procedure described in Subsection II.C.1.a of this report. Results from this column splint demonstration are summarized below in Table 11.

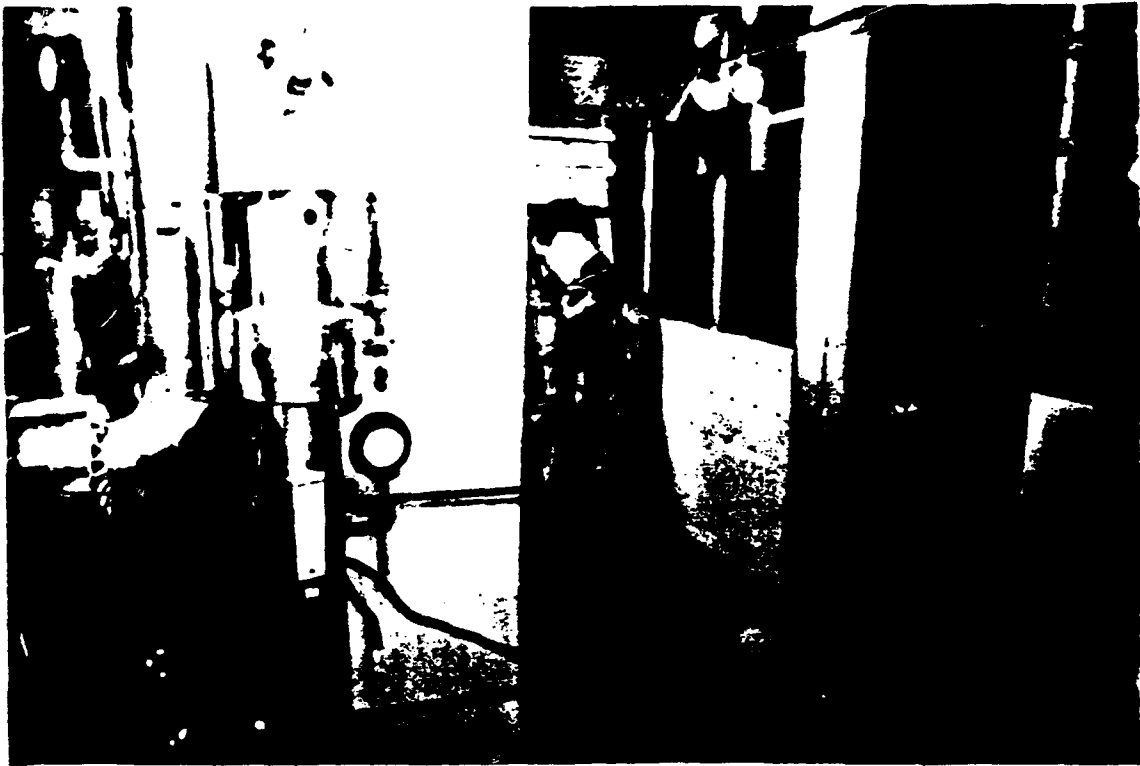

Figure 24. Completed Column Splint Repair At Base Hospital During The FOAL EAGLE Exercise.

TABLE 11. SUMMARY OF COLUMN SPLINT DEMONSTRATION RESULTS AT 7AF HEADQUARTERS.

Repair Task	Repair Clock Time*
Position Boards To Support Plates	1:08
Position/Align Plates	1:27
Place/Tighten Threaded Ruds/Bolts	6:37
Remove Boards	Not Done

* - Elapsed clock time starting at 0:00.

This column splint demonstration went well. No problem was encountered during the process. This completed column splint repair is shown in Figure 25.

F. COLUMN SHORE (REPLACEMENT) DEMONSTRATION

The column replacement demonstration took place in mid-morning of 6 November 1991. A 10-foot 9-inch tall, 25-inch diameter circular column located in the emergency entrance to the base hospital was used to conduct the demonstration. The repair team consisted of SSgt Karl T Apsey, SRA Dean D. Berube, and A1C Curtis W. J. Stewart of 51 CES, and SSgt David D. Lott of 92 CES. One repair was conducted, following the repair procedure described in Subsection II.C.2.a (2) of this report. Results from the column replacement demonstration are summarized in Table 12.

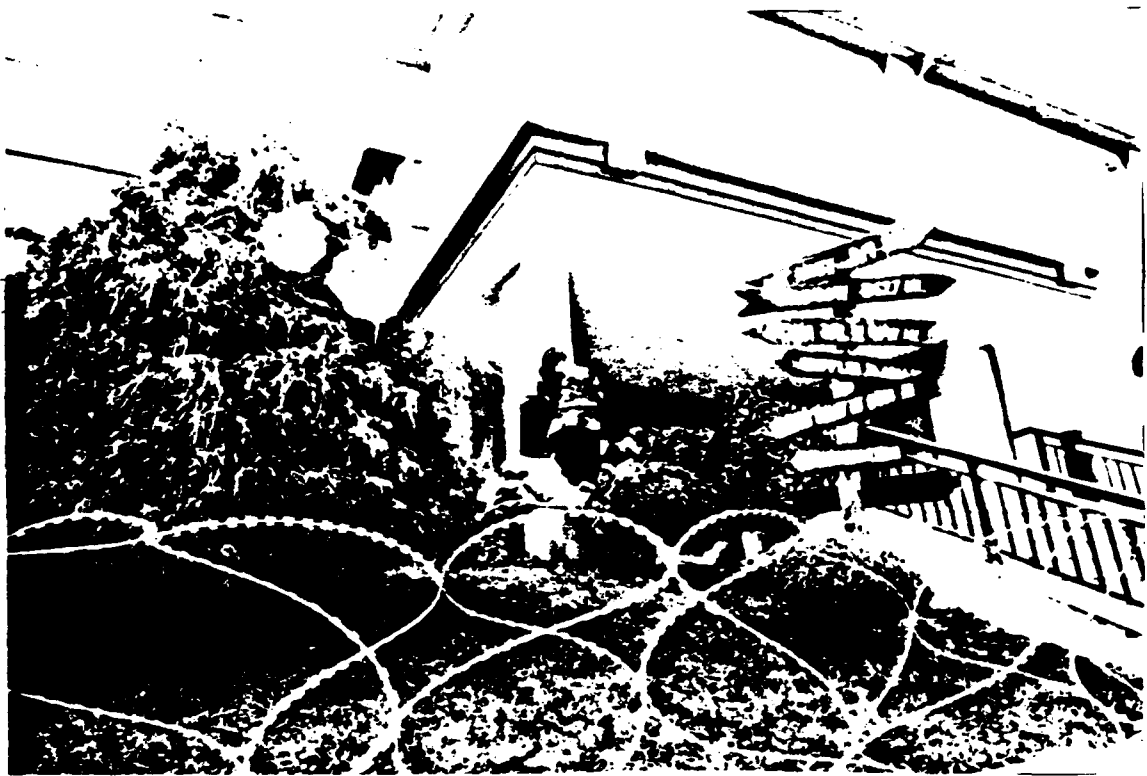

Figure 25. Completed Column Splint Repair At 7AF Headquarters During The FOAL EAGLE Exercise.

TABLE 12. SUMMARY OF COLUMN REPLACEMENT DEMONSTRATION RESULTS.

Repair Task	Repair Clock Time*
Assess Damage To Column	0:15
Position "Super Stud" [™] Column Parts	0:45
Measure Column Height/Assemble Column	2:20
Position Column Next To Damaged Column	2:50
Extend Jack Extender	3:38
Remove Ladder	3:50
Attach Bracing Members	Not Done

* - Elapsed clock time starting at 0:00.

The column replacement demonstration went well. No significant problem was encountered during the process. The completed column shoring repair is shown in Figure 26.

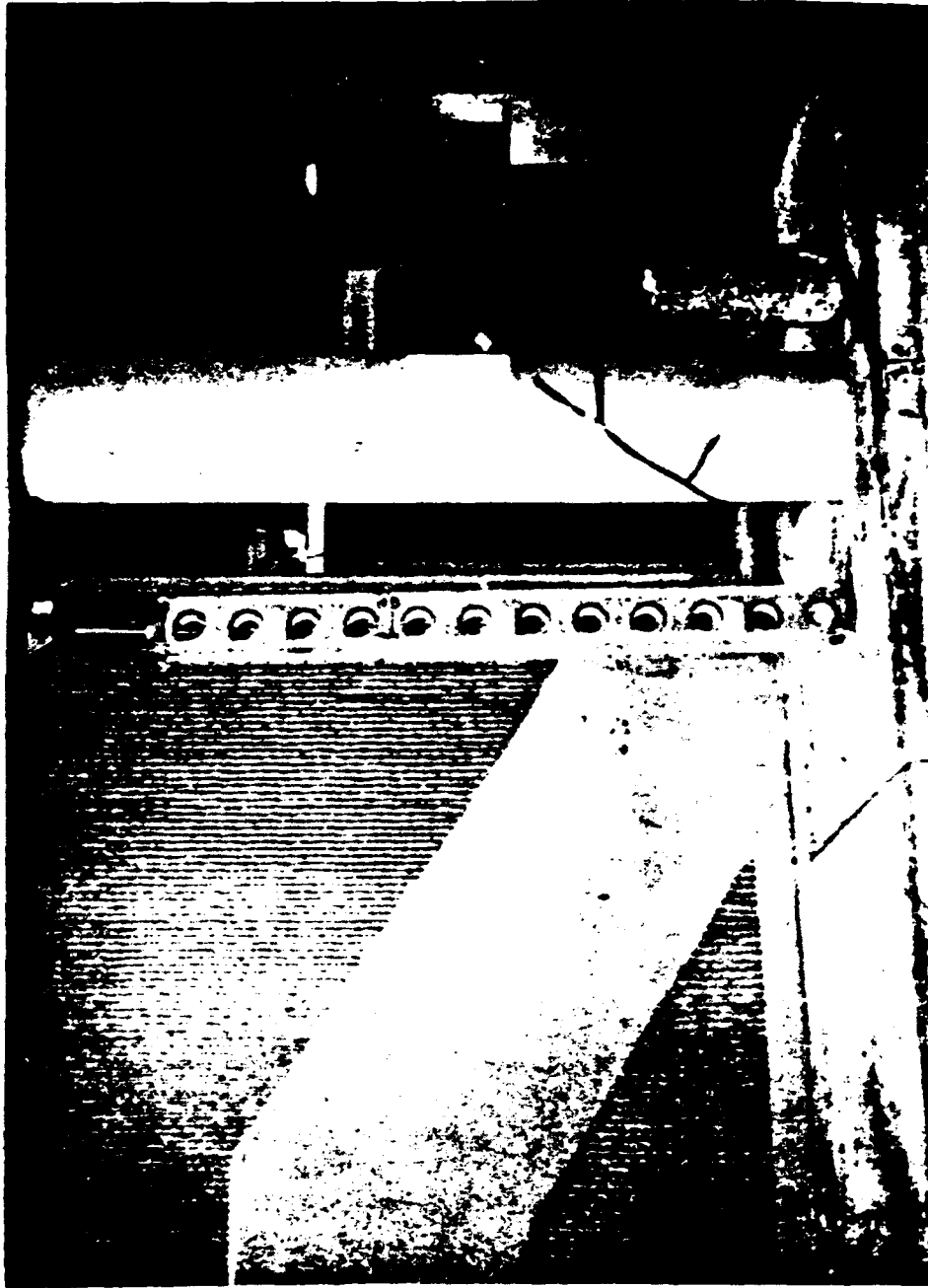

Figure 26. Completed Column Replacement Repair During The FOAL EAGLE Exercise.

SECTION VII

CONCLUSIONS AND RECOMMENDATIONS

A. CONCLUSIONS

The RACS FOAL EAGLE facility recovery demonstration conducted at Osan AB, Republic of Korea from 2-6 November 1991 was a complete success. The computer-assisted damage assessment, column splinting, column shoring, earth berm wall breach repair and shotcrete wall breach repair demonstrations were each executed as planned, with no significant difficulty. All demonstrations were accomplished by active duty military personnel. The Osan AB BCE, Colonel McPherson witnessed the demonstration, and afterward sent an enthusiastic support letter to HQ PACAF/DE, who in turn sent an equally enthusiastic support message to AFCESA. Both Colonel McPherson's letter and the HQ PACAF/DE message are included in Appendix E. The RACS facility recovery methods demonstrated during FOAL EAGLE are now ready for Engineering and Manufacturing Development (EMD) by RAA.

B. RECOMMENDATIONS

EMD of the RACS facility recovery methods successfully demonstrated during FOAL EAGLE should begin immediately. The column splint and earth berm wall breach repair methods require little if any additional engineering prior to fielding. The column shoring method needs a small amount of additional engineering to design an effective lateral bracing arrangement. The shotcrete wall breach repair method needs additional engineering to produce a single, self-propelled, self-contained shotcrete system, which includes material storage, feeder, hopper, gun, power source, compressed air source, water source, remotely-controlled robotic nozzle, and an operator cab with control panel. In addition, the long-term storage characteristics of the rapid-strength gaining shotcrete mix need to be determined as the basis for a material purchase and storage plan.

Specially tailored damage assessment software to perform the resource availability determination and repair scheduling functions was completed in February 1992. The first step in damage assessment EMD should be to integrate

POST-DAM with other BCE damage assessment systems for rapid runway repair, fire protection and crash rescue, and utilities. Also, POST-DAM should be expanded to include facility utility services.

Operational Requirements Documents (ORDs) for both facility damage assessment and facility expedient repair are needed to initiate the facility recovery EMD process.

SECTION VIII

REFERENCES

1. Merkle, D.H., Howard, J.J., Read, D.L., Reid, R.A., Underwood, J.M., and Warren, T.L., "Postattack Airbase Facility Recovery," 5. Internationales Symposium Interaktion Konventioneller Munition mit Schutzbauten, Mannheim, Germany, 22-26 April 1991, pp. 4-10.
2. Warren, T.L., Howard, J.J., and Merkle, D.H., The POST-DAM System, 9 Volumes, Applied Research Associates, Inc., Final Report to the Air Force Civil Engineering Support Agency, ESL-TR-91-22, 21 December 1990 to 1 March 1991.
3. Merkle, D.H., Read, D.L., Rochefort, M.A., Underwood, J.M., and Warren, T.L., "Expert Systems for Airbase Damage Assessment," The Military Engineer, Vol. 82, No. 537, August 1990, pp. 38-41.
4. Anderson, M., Shotcrete for Expedient Repair of Bomb-Damaged Structures, Applied Research Associates, Inc., Final Report to the Air Force Engineering and Services Center, ESL-TR-90-14, 25 October 1989.
5. Read, D.L., and Merkle, D.H., Expedient Repair of Structural Facilities (ERSF); Volume I: ERSF System Development, March 1991; Volume II: ERSF System Requirements and User's Guide, 25 June 1991; Applied Research Associates, Inc., Final Report to the Air Force Civil Engineering Support Agency, ESL-TR-91-13.
6. Read, D.L., Automated Shotcrete Equipment for Expedient Repair of Structural Facilities (ERSF), Applied Research Associates, Inc., Final Report to the Air Force Civil Engineering Support Agency, CEL-TR-92-04, 29 November 1991.
7. Muszynski, L.C. and Rochefort, M.A., Fibrous Concrete for Expedient Repair of Structures, Applied Research Associates, Inc., Final Report to the Air Force Civil Engineering Support Agency, ESL-TR-91-53, December 1991.

8. Muszynski, L.C., "High Early Strength Shotcrete for Expedient Repair of Bomb-Damaged Structures," presented at the Symposium on Shotcrete for the 21st Century, ACI Annual Meeting, Boston, 21 March 1991.
9. Muszynski, L.C., and Rochefort, M.A., "Fibrous Concrete for Expedient Repair of Structures," 5. Internationales Symposium, Interaktion Konventioneller Munition mit Schutzbauten, Mannheim, Germany, 22-26 April 1991, pp. 294-300.
10. Howard, J.J., Read, D.L., and Merkle, D.H., RACS Facility Recovery Demonstration Test Plan, Applied Research Associates, Inc., Report to the Air Force Civil Engineering Support Agency, 23 August 1991, 86 pp.
11. Economy Forms Corporation (EFCO), Forming Systems Catalog-Steel Forms for Concrete Construction, EFC 682, July 1991, 88 pp.

APPENDIX A
POST-DAM FOAL EAGLE DEMONSTRATION SCRIPTS

EXPERT SYSTEM SCRIPT

```

*****
*
*          POST-DAM EXPERT SYSTEM
*          (PDES)
*
*****

```

OPTION	DESCRIPTION
1	CONTINUE POST-DAM EXPERT SYSTEM
2	QUIT POST-DAM EXPERT SYSTEM
3	MODIFY OPTIONAL UTILITY CONFIGURATION

SELECT OPTION 1 TO 3 : 1

```

*****
*
*          POST-DAM
*
*****

```

DAMAGED FACILITY NUMBER QUERY

OPTION	DESCRIPTION
1	ENTER DAMAGED FACILITY NUMBER
2	HELP
3	RETURN TO PREVIOUS MENU
4	QUIT POST-DAM

SELECT OPTION 1 TO 4 : 1

```

*****
*
*          POST-DAM
*
*****

```

DAMAGED FACILITY NUMBER QUERY

OPTION	DESCRIPTION
1	ENTER DAMAGED FACILITY NUMBER
2	HELP
3	RETURN TO PREVIOUS MENU
4	QUIT POST-DAM

SELECT OPTION 1 TO 4 : 1

FACILITY NUMBER : 138

```

*****
*                                     POST-DAM                                     *
*****
* INPUT DATA:
*   BUILDING NUMBER           : 138
*
* GENERAL INFORMATION:
*   BUILDING DESCRIPTION      : HARDENED RC STRUCTURE
*   BUILDING FUNCTION         : 525 SQ OPS
*   DAMAGE ASSESSMENT NUMBER  : 1
*****

```

ASSESSMENT OF DAMAGED FACILITY

IS THIS FACILITY A CANDIDATE FOR EXPEDIENT REPAIR?

OPTION	DESCRIPTION
1	YES
2	NO
3	RETURN TO PREVIOUS MENU
4	QUIT ASSESSMENT OF PRESENT FACILITY

SELECT OPTION 1 TO 4 : 1

```

*****
*                                     POST-DAM                                     *
*****
* INPUT DATA:
*   BUILDING NUMBER           : 138
*
* GENERAL INFORMATION:
*   BUILDING DESCRIPTION      : HARDENED RC STRUCTURE
*   BUILDING FUNCTION         : 525 SQ OPS
*   DAMAGE ASSESSMENT NUMBER  : 1
*****

```

SELECT DAMAGED ELEMENT CATEGORY

OPTION	DESCRIPTION	OPTION	DESCRIPTION
1	EXTERIOR WALL	7	COLUMN
2	INTERIOR WALL	8	DOOR
3	ROOF	9	MISCELLANEOUS
4	FLOOR	10	RETURN TO PREVIOUS MENU
5	BEAM		QUIT ASSESSMENT OF CURRENT FACILITY

SELECT AN OPTION 1 THROUGH 10 : 1

```

*****
*                                     POST-DAM                                     *
*****
* INPUT DATA:
*   BUILDING NUMBER           : 138
*   ELEMENT DESCRIPTION       : EXTERIOR WALL
*
* GENERAL INFORMATION:
*   BUILDING DESCRIPTION      : HARDENED RC STRUCTURE
*   BUILDING FUNCTION         : 525 SQ OPS
*   DAMAGE ASSESSMENT NUMBER  : 1
*****

```

DAMAGED ELEMENT NUMBER QUERY

OPTION	DESCRIPTION
1	ENTER DAMAGED ELEMENT NUMBER
2	HELP
3	RETURN TO PREVIOUS MENU
4	QUIT ASSESSMENT OF PRESENT FACILITY

SELECT OPTION 1 TO 4 : 1

```

*****
*                                     POST-DAM                                     *
*****
* INPUT DATA:
*   BUILDING NUMBER           : 138
*   ELEMENT DESCRIPTION       : EXTERIOR WALL
*
* GENERAL INFORMATION:
*   BUILDING DESCRIPTION     : HARDENED RC STRUCTURE
*   BUILDING FUNCTION        : 525 SQ OPS
*   DAMAGE ASSESSMENT NUMBER : 1
*****

```

DAMAGED ELEMENT NUMBER QUERY

OPTION	DESCRIPTION
1	ENTER DAMAGED ELEMENT NUMBER
2	HELP
3	RETURN TO PREVIOUS MENU
4	QUIT ASSESSMENT OF PRESENT FACILITY

SELECT OPTION 1 TO 4 : 1
 ENTER DAMAGED ELEMENT NUMBER : 106

```

*****
*                                     POST-DAM                                     *
*****
* INPUT DATA:
*   BUILDING NUMBER           : 138
*   ELEMENT NUMBER           : 106
*   ELEMENT DESCRIPTION       : EXTERIOR WALL
*
* GENERAL INFORMATION:
*   BUILDING DESCRIPTION     : HARDENED RC STRUCTURE
*   BUILDING FUNCTION        : 525 SQ OPS
*   DAMAGE ASSESSMENT NUMBER : 1
*****

```

DAMAGE MODE ASSESSMENT

OPTION	DESCRIPTION	OPTION	DESCRIPTION
1	EXCESSIVE CRACKING	4	OTHER
2	SMALL HOLE (less than 3' x 7')	5	BEYOND EXPEDIENT REPAIR
3	WALL BREACH (greater than 3' x 7')	6	RETURN TO PREVIOUS MENU
		7	QUIT ASSESSMENT OF CURRENT ELEMENT

ENTER OPTION 1 TO 7 : 3

```

*****
*                                     POST-DAM                                     *
*****
* INPUT DATA:
*   BUILDING NUMBER           : 138
*   ELEMENT NUMBER           : 106
*   ELEMENT DESCRIPTION       : EXTERIOR WALL
*   DAMAGE MODE               : WALL BREACH
*
* GENERAL INFORMATION:
*   BUILDING DESCRIPTION     : HARDENED RC STRUCTURE
*   BUILDING FUNCTION        : 525 SQ OPS
*   DAMAGE ASSESSMENT NUMBER : 1
*****

```

ENTER APPROXIMATE DIMENSION(S) (in feet) OF THE DAMAGED AREA:

WIDTH = 5
 HEIGHT = 5

```

*****
*                                     POST-DAM                                     *
*****
*
* INPUT DATA:
* BUILDING NUMBER           : 138
* ELEMENT NUMBER           : 106
* ELEMENT DESCRIPTION       : EXTERIOR WALL
* DAMAGE MODE               : WALL BREACH
* WIDTH                     : 5.0
* HEIGHT                    : 5.0
*
* GENERAL INFORMATION:
* BUILDING DESCRIPTION      : HARDENED RC STRUCTURE
* BUILDING FUNCTION         : 525 SQ OPS
* DAMAGE ASSESSMENT NUMBER : 1
*****

```

IS THE INPUT INFORMATION GIVEN ABOVE CORRECT ?
 ENTER < yes > OR < no > : yes

```

*****
*                                     POST-DAM                                     *
*****
*
* INPUT DATA:
* BUILDING NUMBER           : 138
* ELEMENT NUMBER           : 106
* ELEMENT DESCRIPTION       : EXTERIOR WALL
* DAMAGE MODE               : WALL BREACH
* WIDTH                     : 5.0
* HEIGHT                    : 5.0
*
* GENERAL INFORMATION:
* BUILDING DESCRIPTION      : HARDENED RC STRUCTURE
* BUILDING FUNCTION         : 525 SQ OPS
* DAMAGE ASSESSMENT NUMBER : 1
*****

```

IS THE INPUT INFORMATION GIVEN ABOVE CORRECT ?
 ENTER < yes > OR < no > : yes

ENTER ANY APPLICABLE REMARKS ABOUT THIS ASSESSMENT
 (or hit < enter > to continue): broken gas main in area

```

*****
*                                     POST-DAM                                     *
*****
*
* INPUT DATA:
* BUILDING NUMBER           : 138
* ELEMENT NUMBER           : 106
* ELEMENT DESCRIPTION       : EXTERIOR WALL
* DAMAGE MODE               : WALL BREACH
* WIDTH                     : 5.0
* HEIGHT                    : 5.0
*
* GENERAL INFORMATION:
* BUILDING DESCRIPTION      : HARDENED RC STRUCTURE
* BUILDING FUNCTION         : 525 SQ OPS
* DAMAGE ASSESSMENT NUMBER : 1
*
* OUTPUT DATA:
* REPAIR STRATEGY           : SHOTCRETE
*****

```

POST-DAM HAS SELECTED THE ABOVE REPAIR STRATEGY.

HIT < enter > TO CONTINUE.

```

*****
*
* POST-DAM
*
* INPUT DATA:
*   BUILDING NUMBER           : 138
*
* GENERAL INFORMATION:
*   BUILDING DESCRIPTION      : HARDENED RC STRUCTURE
*   BUILDING FUNCTION         : 525 SQ OPS
*   DAMAGE ASSESSMENT NUMBER : 2
*****

```

SELECT DAMAGED ELEMENT CATEGORY

OPTION	DESCRIPTION	OPTION	DESCRIPTION
1	EXTERIOR WALL	6	COLUMN
2	INTERIOR WALL	7	DOOR
3	ROOF	8	MISCELLANEOUS
4	FLOOR	9	RETURN TO PREVIOUS MENU
5	BEAM	10	QUIT ASSESSMENT OF CURRENT FACILITY

SELECT AN OPTION 1 THROUGH 10 : 6

```

*****
*
* POST-DAM
*
* INPUT DATA:
*   BUILDING NUMBER           : 138
*   ELEMENT DESCRIPTION       : COLUMN
*
* GENERAL INFORMATION:
*   BUILDING DESCRIPTION      : HARDENED RC STRUCTURE
*   BUILDING FUNCTION         : 525 SQ OPS
*   DAMAGE ASSESSMENT NUMBER : 2
*****

```

DAMAGED ELEMENT NUMBER QUERY

OPTION	DESCRIPTION
1	ENTER DAMAGED ELEMENT NUMBER
2	HELP
3	RETURN TO PREVIOUS MENU
4	QUIT ASSESSMENT OF PRESENT FACILITY

SELECT OPTION 1 TO 4 : 1

```

*****
*
* POST-DAM
*
* INPUT DATA:
*   BUILDING NUMBER           : 138
*   ELEMENT DESCRIPTION       : COLUMN
*
* GENERAL INFORMATION:
*   BUILDING DESCRIPTION      : HARDENED RC STRUCTURE
*   BUILDING FUNCTION         : 525 SQ OPS
*   DAMAGE ASSESSMENT NUMBER : 2
*****

```

DAMAGED ELEMENT NUMBER QUERY

OPTION	DESCRIPTION
1	ENTER DAMAGED ELEMENT NUMBER
2	HELP
3	RETURN TO PREVIOUS MENU
4	QUIT ASSESSMENT OF PRESENT FACILITY

SELECT OPTION 1 TO 4 : 1
 ENTER DAMAGED ELEMENT NUMBER : 601

```

*****
*                                     POST-DAM                                     *
*****
*
* INPUT DATA:
*   BUILDING NUMBER           : 138
*   ELEMENT NUMBER           : 601
*   ELEMENT DESCRIPTION       : COLUMN
*
* GENERAL INFORMATION:
*   BUILDING DESCRIPTION      : HARDENED RC STRUCTURE
*   BUILDING FUNCTION         : 525 SQ OPS
*   DAMAGE ASSESSMENT NUMBER : 2
*****

```

DAMAGE MODE ASSESSMENT

OPTION	DESCRIPTION	OPTION	DESCRIPTION
1	SPALLING	5	OTHER
2	CRACKING/STEEL DEBONDING	6	BEYOND EXPEDIENT REPAIR
3	MAJOR DAMAGE/MISSING	7	RETURN TO PREVIOUS MENU
4	CONNECTION FAILURE	8	QUIT ASSESSMENT OF CURRENT ELEMENT

ENTER OPTION 1 TO 8 : 2

```

*****
*                                     POST-DAM                                     *
*****
*
* INPUT DATA:
*   BUILDING NUMBER           : 138
*   ELEMENT NUMBER           : 601
*   ELEMENT DESCRIPTION       : COLUMN
*   DAMAGE MODE               : CRACKING/STEEL DEBONDING
*
* GENERAL INFORMATION:
*   BUILDING DESCRIPTION      : HARDENED RC STRUCTURE
*   BUILDING FUNCTION         : 525 SQ OPS
*   DAMAGE ASSESSMENT NUMBER : 2
*****

```

IS THE INPUT INFORMATION GIVEN ABOVE CORRECT ?
 ENTER < yes > OR < no > : yes

```

*****
*                                     POST-DAM                                     *
*****
*
* INPUT DATA:
*   BUILDING NUMBER           : 138
*   ELEMENT NUMBER           : 601
*   ELEMENT DESCRIPTION       : COLUMN
*   DAMAGE MODE               : CRACKING/STEEL DEBONDING
*
* GENERAL INFORMATION:
*   BUILDING DESCRIPTION      : HARDENED RC STRUCTURE
*   BUILDING FUNCTION         : 525 SQ OPS
*   DAMAGE ASSESSMENT NUMBER : 2
*****

```

IS THE INPUT INFORMATION GIVEN ABOVE CORRECT ?
 ENTER < yes > OR < no > : yes

ENTER ANY APPLICABLE REMARKS ABOUT THIS ASSESSMENT
 (or hit < enter > to continue): great deal of debris in area

```

*****
*                                     POST-DAM                                     *
*****
* INPUT DATA:                                                                 *
*   BUILDING NUMBER                   : 138                                   *
*   ELEMENT NUMBER                    : 601                                   *
*   ELEMENT DESCRIPTION                : COLUMN                               *
*   DAMAGE MODE                       : CRACKING/STEEL DEBONDING             *
*                                     *                                     *
* GENERAL INFORMATION:                                                         *
*   BUILDING DESCRIPTION              : HARDENED RC STRUCTURE                 *
*   BUILDING FUNCTION                 : 525 SQ OPS                             *
*   DAMAGE ASSESSMENT NUMBER         : 2                                     *
*                                     *                                     *
* OUTPUT DATA:                                                                *
*   REPAIR STRATEGY                  : COLUMN SPLINT                         *
*****
POST-DAM HAS SELECTED THE ABOVE REPAIR STRATEGY.
HIT < enter > TO CONTINUE.

```

```

*****
*                                     POST-DAM                                     *
*****
* INPUT DATA:                                                                 *
*   BUILDING NUMBER                   : 138                                   *
*                                     *                                     *
* GENERAL INFORMATION:                                                         *
*   BUILDING DESCRIPTION              : HARDENED RC STRUCTURE                 *
*   BUILDING FUNCTION                 : 525 SQ OPS                             *
*   DAMAGE ASSESSMENT NUMBER         : 3                                     *
*****
SELECT DAMAGED ELEMENT CATEGORY

```

OPTION	DESCRIPTION	OPTION	DESCRIPTION
1	EXTERIOR WALL	6	COLUMN
2	INTERIOR WALL	7	DOOR
3	ROOF	8	MISCELLANEOUS
4	FLOOR	9	RETURN TO PREVIOUS MENU
5	BEAM	10	QUIT ASSESSMENT OF CURRENT FACILITY

SELECT AN OPTION 1 THROUGH 10 : 6

```

*****
*                                     POST-DAM                                     *
*****
* INPUT DATA:                                                                 *
*   BUILDING NUMBER                   : 138                                   *
*   ELEMENT DESCRIPTION                : COLUMN                               *
*                                     *                                     *
* GENERAL INFORMATION:                                                         *
*   BUILDING DESCRIPTION              : HARDENED RC STRUCTURE                 *
*   BUILDING FUNCTION                 : 525 SQ OPS                             *
*   DAMAGE ASSESSMENT NUMBER         : 3                                     *
*****
DAMAGED ELEMENT NUMBER QUERY

```

OPTION	DESCRIPTION
1	ENTER DAMAGED ELEMENT NUMBER
2	HELP
3	RETURN TO PREVIOUS MENU
4	QUIT ASSESSMENT OF PRESENT FACILITY

SELECT OPTION 1 TO 4 : 1

```

*****
*                                     POST-DAM                                     *
*****
*
* INPUT DATA:
*   BUILDING NUMBER           : 138
*   ELEMENT DESCRIPTION       : COLUMN
*
* GENERAL INFORMATION:
*   BUILDING DESCRIPTION     : HARDENED RC STRUCTURE
*   BUILDING FUNCTION        : 525 SQ OPS
*   DAMAGE ASSESSMENT NUMBER : 3
*****

```

DAMAGED ELEMENT NUMBER QUERY

- | OPTION | DESCRIPTION |
|--------|-------------------------------------|
| 1 | ENTER DAMAGED ELEMENT NUMBER |
| 2 | HELP |
| 3 | RETURN TO PREVIOUS MENU |
| 4 | QUIT ASSESSMENT OF PRESENT FACILITY |

SELECT OPTION 1 TO 4 : 1
 ENTER DAMAGED ELEMENT NUMBER : 602

```

*****
*                                     POST-DAM                                     *
*****
*
* INPUT DATA:
*   BUILDING NUMBER           : 138
*   ELEMENT NUMBER           : 602
*   ELEMENT DESCRIPTION       : COLUMN
*
* GENERAL INFORMATION:
*   BUILDING DESCRIPTION     : HARDENED RC STRUCTURE
*   BUILDING FUNCTION        : 525 SQ OPS
*   DAMAGE ASSESSMENT NUMBER : 3
*****

```

DAMAGE MODE ASSESSMENT

- | OPTION | DESCRIPTION | OPTION | DESCRIPTION |
|--------|--------------------------|--------|------------------------------------|
| 1 | SPALLING | 5 | OTHER |
| 2 | CRACKING/STEEL DEBONDING | 6 | BEYOND EXPEDIENT REPAIR |
| 3 | MAJOR DAMAGE/MISSING | 7 | RETURN TO PREVIOUS MENU |
| 4 | CONNECTION FAILURE | 8 | QUIT ASSESSMENT OF CURRENT ELEMENT |

ENTER OPTION 1 TO 8 : 3

```

*****
*                                     POST-DAM                                     *
*****
*
* INPUT DATA:
*   BUILDING NUMBER           : 138
*   ELEMENT NUMBER           : 602
*   ELEMENT DESCRIPTION       : COLUMN
*   DAMAGE MODE               : MAJOR DAMAGE / MISSING
*   HEIGHT                    : 10.0
*
* GENERAL INFORMATION:
*   BUILDING DESCRIPTION     : HARDENED RC STRUCTURE
*   BUILDING FUNCTION        : 525 SQ OPS
*   DAMAGE ASSESSMENT NUMBER : 3
*****

```

IS THE INPUT INFORMATION GIVEN ABOVE CORRECT ?
 ENTER < yes > OR < no > : yes

```

*****
*
* POST-DAM
*
* INPUT DATA:
* BUILDING NUMBER : 138
* ELEMENT NUMBER : 602
* ELEMENT DESCRIPTION : COLUMN
* DAMAGE MODE : MAJOR DAMAGE / MISSING
* HEIGHT : 10.0
*
* GENERAL INFORMATION:
* BUILDING DESCRIPTION : HARDENED RC STRUCTURE
* BUILDING FUNCTION : 525 SQ OPS
* DAMAGE ASSESSMENT NUMBER : 3
*****

```

IS THE INPUT INFORMATION GIVEN ABOVE CORRECT ?
 ENTER < yes > OR < no > : yes

ENTER ANY APPLICABLE REMARKS ABOUT THIS ASSESSMENT
 (or hit < enter > to continue): none

```

*****
*
* POST-DAM
*
* INPUT DATA:
* BUILDING NUMBER : 138
* ELEMENT NUMBER : 602
* ELEMENT DESCRIPTION : COLUMN
* DAMAGE MODE : MAJOR DAMAGE / MISSING
* HEIGHT : 10.0
*
* GENERAL INFORMATION:
* BUILDING DESCRIPTION : HARDENED RC STRUCTURE
* BUILDING FUNCTION : 525 SQ OPS
* DAMAGE ASSESSMENT NUMBER : 3
*
* OUTPUT DATA:
* REPAIR STRATEGY : COLUMN SHORE
*****

```

POST-DAM HAS SELECTED THE ABOVE REPAIR STRATEGY.

HIT < enter > TO CONTINUE.

```

*****
*
* POST-DAM
*
* INPUT DATA:
* BUILDING NUMBER : 138
*
* GENERAL INFORMATION:
* BUILDING DESCRIPTION : HARDENED RC STRUCTURE
* BUILDING FUNCTION : 525 SQ OPS
* DAMAGE ASSESSMENT NUMBER : 4
*****

```

SELECT DAMAGED ELEMENT CATEGORY

OPTION	DESCRIPTION	OPTION	DESCRIPTION
1	EXTERIOR WALL	6	COLUMN
2	INTERIOR WALL	7	DOOR
3	ROOF	8	MISCELLANEOUS
4	FLOOR	9	RETURN TO PREVIOUS MENU
5	BEAM	10	QUIT ASSESSMENT OF CURRENT FACILITY

SELECT AN OPTION 1 THROUGH 10 : 10

POST-DAM COMMUNICATION SYSTEM

ZMODEM file transfer in progress

Waiting to begin transfer...

Press Ctrl-Break to cancel

Transferring PDES .OUT files

DIR_LINK

0:00:52

RESOURCE MANAGER SCRIPT

~~Resource Data Base~~

- (1) Transfer Data Files
- (2) Compute Possible Repairs From Materials
- (3) Compute Possible Repairs From Equipment
- (4) Remove And Edit Data In Materials Tables
- (5) Remove And Edit Data In Equipment Tables
- (6) View And Print Tables
- (7) View Or Print Repair Strategy Files
- (8) Exit

~~Remove And Edit Material Data~~

- (1) Delete All Rows In The Required Materials Table
- (2) Delete All Rows In The Materials Supply Table
- (3) Delete All Rows In The Materials Compute Table
- (4) Load Rows In The Required Materials Table
- (5) Load Rows In The Materials Supply Table
- (6) Edit Rows In The Required Materials Table
- (7) Edit Rows In The Materials Supply Table
- (8) Exit

~~Remove And Edit Material Data~~

- (1) Delete All Rows In The Required Materials Table
- (2) Delete All Rows In The Materials Supply Table
- (3) Delete All Rows In The Materials Compute Table
- (4) Load Rows In The Required Materials Table
- (5) Load Rows In The Materials Supply Table
- (6) Edit Rows In The Required Materials Table
- (7) Edit Rows In The Materials Supply Table
- (8) Exit

~~Remove And Edit Material Data~~

- (1) Delete All Rows In The Required Materials Table
- (2) Delete All Rows In The Materials Supply Table
- (3) Delete All Rows In The Materials Compute Table
- (4) Load Rows In The Required Materials Table
- (5) Load Rows In The Materials Supply Table
- (6) Edit Rows In The Required Materials Table
- (7) Edit Rows In The Materials Supply Table
- (8) Exit

~~Remove And Edit Equipment Data~~

- (1) Delete Rows In The Required Equipment Table
- (2) Delete Rows In The Equipment Supply Table
- (3) Delete Rows In The Equipment Compute Table
- (4) Load Rows In The Required Equipment Table
- (5) Load Rows In The Equipment Supply Table
- (6) Edit Rows In The Required Equipment Table
- (7) Edit Rows In The Equipment Supply Table
- (8) Exit

~~Resource Data Base~~

- (1) Transfer Data Files
- (2) Compute Possible Repairs From Materials
- (3) Compute Possible Repairs From Equipment
- (4) Remove And Edit Data In Materials Tables
- (5) Remove And Edit Data In Equipment Tables
- (6) View And Print Tables
- (7) View Or Print Repair Strategy Files
- (8) Exit

~~Remove And Edit Equipment Data~~

- (1) Delete Rows In The Required Equipment Table
- (2) Delete Rows In The Equipment Supply Table
- (3) Delete Rows In The Equipment Compute Table
- (4) Load Rows In The Required Equipment Table
- (5) Load Rows In The Equipment Supply Table
- (6) Edit Rows In The Required Equipment Table
- (7) Edit Rows In The Equipment Supply Table
- (8) Exit

~~Remove And Edit Equipment Data~~

- (1) Delete Rows In The Required Equipment Table
- (2) Delete Rows In The Equipment Supply Table
- (3) Delete Rows In The Equipment Compute Table
- (4) Load Rows In The Required Equipment Table
- (5) Load Rows In The Equipment Supply Table
- (6) Edit Rows In The Required Equipment Table
- (7) Edit Rows In The Equipment Supply Table
- (8) Exit

~~Remove And Edit Equipment Data~~

- (1) Delete Rows In The Required Equipment Table
- (2) Delete Rows In The Equipment Supply Table
- (3) Delete Rows In The Equipment Compute Table
- (4) Load Rows In The Required Equipment Table
- (5) Load Rows In The Equipment Supply Table
- (6) Edit Rows In The Required Equipment Table
- (7) Edit Rows In The Equipment Supply Table
- (8) Exit

Remove And Edit Material Data

- (1) Delete All Rows In The Required Materials Table
- (2) Delete All Rows In The Materials Supply Table
- (3) Delete All Rows In The Materials Compute Table
- (4) Load Rows In The Required Materials Table
- (5) Load Rows In The Materials Supply Table
- (6) Edit Rows In The Required Materials Table
- (7) Edit Rows In The Materials Supply Table
- (8) Exit

Resource Data Base

- (1) Transfer Data Files
- (2) Compute Possible Repairs From Materials
- (3) Compute Possible Repairs From Equipment
- (4) Remove And Edit Data In Materials Tables
- (5) Remove And Edit Data In Equipment Tables
- (6) View And Print Tables
- (7) View Or Print Repair Strategy Files
- (8) Exit

Transfer Data Files

- (1) Input Required Materials Files
- (2) Input Required Equipment Files
- (3) Input Materials Supply File
- (4) Input Equipment Supply File
- (5) Output Materials Supply File
- (6) Exit

Volume in drive C has no label
Directory of C:\PDAM\

B9999	MAT	243	8-14-91	1:54p
B1	MAT	431	5-21-90	1:50p
B10	MAT	243	9-20-91	9:58a
B138	MAT	243	10-10-91	9:06a

4 File(s) 2056192 bytes free

B(NUMBER).mat

Enter The Facility NUMBER: 138

Transfer Data Files

- (1) Input Required Materials Files
- (2) Input Required Equipment Files
- (3) Input Materials Supply File
- (4) Input Equipment Supply File
- (5) Output Materials Supply File
- (6) Exit

Volume in drive C has no label
Directory of C:\PDAM\

B9999	EQP	299	8-14-91	1:54p
B1	EQP	399	5-21-90	1:50p
B10	EQP	299	9-20-91	9:58a
B138	EQP	299	10-10-91	9:06a

4 File(s) 2056192 bytes free

B(NUMBER).eqp

Enter The Facility NUMBER: 138

~~Transfer Data Files~~

- (1) Input Required Materials Files
- (2) Input Required Equipment Files
- (3) Input Materials Supply File
- (4) Input Equipment Supply File
- (5) Output Materials Supply File
- (6) Exit

~~Transfer Data Files~~

- (1) Input Required Materials Files
- (2) Input Required Equipment Files
- (3) Input Materials Supply File
- (4) Input Equipment Supply File
- (5) Output Materials Supply File
- (6) Exit

~~Transfer Data Files~~

- (1) Input Required Materials Files
- (2) Input Required Equipment Files
- (3) Input Materials Supply File
- (4) Input Equipment Supply File
- (5) Output Materials Supply File
- (6) Exit

Resource Data Base

- (1) Transfer Data Files
- (2) Compute Possible Repairs From Materials
- (3) Compute Possible Repairs From Equipment
- (4) Remove And Edit Data In Materials Tables
- (5) Remove And Edit Data In Equipment Tables
- (6) View And Print Tables
- (7) View Or Print Repair Strategy Files
- (8) Exit

Compute Possible Repairs From Equipment

- (1) Load Equipment Into The Compute Table
- (2) Delete Repairs That Are Not Possible
- (3) Write The Required Equipment Table To EQP.DAT
- (4) Write The Equipment Supply Table To ESUP.DAT
- (5) Exit

Compute Possible Repairs From Equipment

- (1) Load Equipment Into The Compute Table
- (2) Delete Repairs That Are Not Possible
- (3) Write The Required Equipment Table To EQP.DAT
- (4) Write The Equipment Supply Table To ESUP.DAT
- (5) Exit

Resource Data Base

- (1) Transfer Data Files
- (2) Compute Possible Repairs From Materials
- (3) Compute Possible Repairs From Equipment
- (4) Remove And Edit Data In Materials Tables
- (5) Remove And Edit Data In Equipment Tables
- (6) View And Print Tables
- (7) View Or Print Repair Strategy Files
- (8) Exit

View And Print Tables

- (1) View Or Print The Required Materials Table
- (2) View Or Print The Materials Supply Table
- (3) View Or Print The Materials Compute Table
- (4) View Or Print The Required Equipment Table
- (5) View Or Print The Equipment Supply Table
- (6) View Or Print The Equipment Compute Table
- (7) Exit

View And Print Tables

- (1) View Or Print The Required Materials Table
- (2) View Or Print The Materials Supply Table
- (3) View Or Print The Materials Compute Table
- (4) View Or Print The Required Equipment Table
- (5) View Or Print The Equipment Supply Table
- (6) View Or Print The Equipment Compute Table
- (7) Exit

Select Print Routing

Printer Screen Both

- (1) View Or Print The Required Materials Table □
 - (2) View Or Print The Materials Supply Table □
 - (3) View Or Print The Materials Compute Table □
 - (4) View Or Print The Required Equipment Table □
 - (5) View Or Print The Equipment Supply Table □
 - (6) View Or Print The Equipment Compute Table □
 - (7) Exit □
- ~~~~~
 ~~~~~Select Print Routing~~~~~  
 □ Printer Screen Both □

EQUIPMENT COMPUTE TABLE

DATE: 10/10/91 TIME: 13:30:24 PAGE: 1

| Repair # | Required Equipment | Needed | On Hand | Total | Flag |
|----------|--------------------|--------|---------|-------|------|
| 1        | sc machine         | 1.     | 4.      | 3.    | y    |
| 1        | ramset             | 2.     | 5.      | 3.    | y    |
| 1        | repair team        | 1.     | 5.      | 4.    | y    |
| 2        | ramset             | 2.     | 5.      | 3.    | y    |
| 2        | shoring jack       | 1.     | 6.      | 5.    | y    |
| 2        | chainsaw           | 1.     | 5.      | 4.    | y    |
| 2        | repair team        | 1.     | 5.      | 4.    | y    |
| 3        | repair team        | 1.     | 5.      | 4.    | y    |

Press any key to continue

View And Print Tables

- (1) View Or Print The Required Materials Table
- (2) View Or Print The Materials Supply Table
- (3) View Or Print The Materials Compute Table
- (4) View Or Print The Required Equipment Table
- (5) View Or Print The Equipment Supply Table
- (6) View Or Print The Equipment Compute Table
- (7) Exit

Resource Data Base

- (1) Transfer Data Files
- (2) Compute Possible Repairs From Materials
- (3) Compute Possible Repairs From Equipment
- (4) Remove And Edit Data In Materials Tables
- (5) Remove And Edit Data In Equipment Tables
- (6) View And Print Tables
- (7) View Or Print Repair Strategy Files
- (8) Exit

Compute Possible Repairs From Materials

- (1) Load Materials Into The Compute Table
- (2) Delete Repairs That Are Not Possible
- (3) Delete Repairs That Are Not Wanted
- (4) Allocate Materials To A Repair
- (5) Write The Required Materials Table To MAT.DAT
- (6) Write The Materials Supply Table To MSUP.DAT
- (7) Exit

Compute Possible Repairs From Materials

- (1) Load Materials Into The Compute Table
- (2) Delete Repairs That Are Not Possible
- (3) Delete Repairs That Are Not Wanted
- (4) Allocate Materials To A Repair
- (5) Write The Required Materials Table To MAT.DAT
- (6) Write The Materials Supply Table To MSUP.DAT
- (7) Exit

Resource Data Base

- (1) Transfer Data Files
- (2) Compute Possible Repairs From Materials
- (3) Compute Possible Repairs From Equipment
- (4) Remove And Edit Data In Materials Tables
- (5) Remove And Edit Data In Equipment Tables
- (6) View And Print Tables
- (7) View Or Print Repair Strategy Files
- (8) Exit

```

View And Print Tables
(1) View Or Print The Required Materials Table
(2) View Or Print The Materials Supply Table
(3) View Or Print The Materials Compute Table
(4) View Or Print The Required Equipment Table
(5) View Or Print The Equipment Supply Table
(6) View Or Print The Equipment Compute Table
(7) Exit

```

```

View And Print Tables
(1) View Or Print The Required Materials Table
(2) View Or Print The Materials Supply Table
(3) View Or Print The Materials Compute Table
(4) View Or Print The Required Equipment Table
(5) View Or Print The Equipment Supply Table
(6) View Or Print The Equipment Compute Table
(7) Exit

```

```

Select Print Routing
Printer Screen Both

```

```

(1) View Or Print The Required Materials Table
(2) View Or Print The Materials Supply Table
(3) View Or Print The Materials Compute Table
(4) View Or Print The Required Equipment Table
(5) View Or Print The Equipment Supply Table
(6) View Or Print The Equipment Compute Table
(7) Exit
Select Print Routing
Printer Screen Both

```

MATERIALS COMPARISON

| DATE: 10/10/91             | TIME: 13:40:20 | NEEDED | ONHAND | PAGE: TOTAL | 1 FLAG |
|----------------------------|----------------|--------|--------|-------------|--------|
| REP# RESOURCE              |                |        |        |             |        |
| 1 2x4 16ft                 |                | 1.     | 20391. | 20390.      | y      |
| 1 plywood 4x8 .5in         |                | 2.     | 13000. | 12998.      | y      |
| 1 wire mesh                |                | 25.    | 8540.  | 8515.       | y      |
| 1 shotcrete                |                | 3.     | 1000.  | 997.        | y      |
| 1 water                    |                | 88.9   | 1000.  | 911.1       | y      |
| 2 glulam column 12x12 10ft |                | 1.     | 100.   | 99.         | y      |
| 3 column splint            |                | 1.     | 100.   | 99.         | y      |

Press any key to continue

~~View And Print Tables~~

- (1) View Or Print The Required Materials Table
- (2) View Or Print The Materials Supply Table
- (3) View Or Print The Materials Compute Table
- (4) View Or Print The Required Equipment Table
- (5) View Or Print The Equipment Supply Table
- (6) View Or Print The Equipment Compute Table
- (7) Exit

~~Resource Data Base~~

- (1) Transfer Data Files
- (2) Compute Possible Repairs From Materials
- (3) Compute Possible Repairs From Equipment
- (4) Remove And Edit Data In Materials Tables
- (5) Remove And Edit Data In Equipment Tables
- (6) View And Print Tables
- (7) View Or Print Repair Strategy Files
- (8) Exit

~~Compute Possible Repairs From Materials~~

- (1) Load Materials Into The Compute Table
- (2) Delete Repairs That Are Not Possible
- (3) Delete Repairs That Are Not Wanted
- (4) Allocate Materials To A Repair
- (5) Write The Required Materials Table To MAT.DAT
- (6) Write The Materials Supply Table To MSUP.DAT
- (7) Exit

Enter The Repair Number: 1

Enter The Repair Number: 1

For Another Repair, Go To (1) And Re-load  
The Materials Compute Table  
(Hit Enter To Continue)

Compute Possible Repairs From Materials

- (1) Load Materials Into The Compute Table
- (2) Delete Repairs That Are Not Possible
- (3) Delete Repairs That Are Not Wanted
- (4) Allocate Materials To A Repair
- (5) Write The Required Materials Table To MAT.DAT
- (6) Write The Materials Supply Table To MSUP.DAT
- (7) Exit



- Compute Possible Repairs From Materials
- (1) Load Materials Into The Compute Table
  - (2) Delete Repairs That Are Not Possible
  - (3) Delete Repairs That Are Not Wanted
  - (4) Allocate Materials To A Repair
  - (5) Write The Required Materials Table To MAT.DAT
  - (6) Write The Materials Supply Table To MSUP.DAT
  - (7) Exit

Enter The Repair Number: 2

Enter The Repair Number: 2

For Another Repair, Go To (1) And Re-load  
The Materials Compute Table  
(Hit Enter To Continue)

- Compute Possible Repairs From Materials
- (1) Load Materials Into The Compute Table
  - (2) Delete Repairs That Are Not Possible
  - (3) Delete Repairs That Are Not Wanted
  - (4) Allocate Materials To A Repair
  - (5) Write The Required Materials Table To MAT.DAT
  - (6) Write The Materials Supply Table To MSUP.DAT
  - (7) Exit

- Compute Possible Repairs From Materials
- (1) Load Materials Into The Compute Table
  - (2) Delete Repairs That Are Not Possible
  - (3) Delete Repairs That Are Not Wanted
  - (4) Allocate Materials To A Repair
  - (5) Write The Required Materials Table To MAT.DAT
  - (6) Write The Materials Supply Table To MSUP.DAT
  - (7) Exit

Enter The Repair Number: 3

Enter The Repair Number: 3

For Another Repair, Go To (1) And Re-load  
The Materials Compute Table  
(Hit Enter To Continue)

- Compute Possible Repairs From Materials
- (1) Load Materials Into The Compute Table
  - (2) Delete Repairs That Are Not Possible
  - (3) Delete Repairs That Are Not Wanted
  - (4) Allocate Materials To A Repair
  - (5) Write The Required Materials Table To MAT.DAT
  - (6) Write The Materials Supply Table To MSUP.DAT
  - (7) Exit

- Compute Possible Repairs From Materials
- (1) Load Materials Into The Compute Table
  - (2) Delete Repairs That Are Not Possible
  - (3) Delete Repairs That Are Not Wanted
  - (4) Allocate Materials To A Repair
  - (5) Write The Required Materials Table To MAT.DAT
  - (6) Write The Materials Supply Table To MSUP.DAT
  - (7) Exit

Resource Data Base

- (1) Transfer Data Files
- (2) Compute Possible Repairs From Materials
- (3) Compute Possible Repairs From Equipment
- (4) Remove And Edit Data In Materials Tables
- (5) Remove And Edit Data In Equipment Tables
- (6) View And Print Tables
- (7) View Or Print Repair Strategy Files
- (8) Exit

View Or Print Repair Strategy Files

- (1) View Repair Strategy Files
- (2) Print Repair Strategy Files
- (3) Exit

Volume in drive C has no label  
Directory of C:\PDAM\

|       |     |      |          |       |
|-------|-----|------|----------|-------|
| B9999 | OUT | 4532 | 8-14-91  | 1:54p |
| B1    | OUT | 2949 | 12-11-90 | 8:08a |
| B2    | OUT | 1638 | 3-20-90  | 7:29a |
| B10   | OUT | 4520 | 9-20-91  | 9:58a |
| B138  | OUT | 4520 | 10-10-91 | 9:06a |

5 File(s) 2033664 bytes free

b(NUMBER).out

Enter The Facility NUMBER: 138

POST-ATTACK DAMAGE ASSESSMENT OF  
FACILITY NUMBER 138  
BITBURG AIR BASE, GERMANY

---

I.) GENERAL FACILITY INFORMATION

Function : "525 SQ OPS"  
Priority : 2  
Description : "HARDENED RC STRUCTURE"

II.) DAMAGE ASSESSMENTS

Damage Assessment Number : 1

A.) General Element Information

More output follows - press [ESC] to quit, any key to continue

A.) General Element Information

More output follows - press [ESC] to quit, any key to continue

Element Number : 107  
Element Description : EXTERIOR WALL  
Damage Mode : WALL BREACH  
Damage Width : 5.0 ft.  
Damage Height : 5.0 ft.  
Repair Strategy : SHOTCRETE

B.) Repair Strategy Information

1.) Required Materials :

Grade A 2x4 : 10.4 ft.  
Grade A Plywood : 49.0 sq. ft.  
Wire Mesh : 25.0 sq. ft.  
Shotcrete Material : 3.0 cubic yards  
Water : 88.9 gallons

2.) Required Equipment :

Shotcrete Unit w/ Accessories : 1

More output follows - press [ESC] to quit, any key to continue

- 2.) Required Equipment :
- Shotcrete Unit w/ Accessories : 1  
 More output follows - press [ESC] to quit, any key to continue  
 Ramset w/ Stud : 2
- 3.) Estimated Manpower/Time :
- Repair Team(s) : 1  
 Repair Team Hours : 2.50
- 4.) Remarks :
- broken gas line in area
- 5.) Repair Schedule :
- Start Repair :  
 Finish Repair :

More output follows - press [ESC] to quit, any key to continue

More output follows - press [ESC] to quit, any key to continue

POST-ATTACK DAMAGE ASSESSMENT OF  
 FACILITY NUMBER 138  
 BITBURG AIR BASE, GERMANY  
 (continue)

Damage Assessment Number : 2

A.) General Element Information

Element Number : 601  
 More output follows - press [ESC] to quit, any key to continue

A.) General Element Information

Element Number : 601  
 More output follows - press [ESC] to quit, any key to continue  
 Element Description : COLUMN  
 Damage Mode : MAJOR DAMAGE / MISSING  
 Damage Height : 10.0 ft.  
 Repair Strategy : COLUMN SHORE

B.) Repair Strategy Information

1.) Required Materials :

Glulam Column : 10.0 feet

2.) Required Equipment :

Ramset w/ Stud : 2  
 Shoring Jack : 1  
 Chain saw : 1

3.) Estimated Manpower/Time :

Repair Team(s) : 1  
 More output follows - press [ESC] to quit, any key to continue

3.) Estimated Manpower/Time :

Repair Team(s) : 1  
More output follows - press [ESC] to quit, any key to continue  
Repair Team Hours : 1.25

4.) Remarks :

none

5.) Repair Schedule :

Start Repair :  
Finish Repair :

More output follows - press [ESC] to quit, any key to continue

More output follows - press [ESC] to quit, any key to continue

POST-ATTACK DAMAGE ASSESSMENT OF  
FACILITY NUMBER 138  
BITBURG AIR BASE, GERMANY  
(continue)

---

More output follows - press [ESC] to quit, any key to continue

(continue)

More output follows - press [ESC] to quit, any key to continue

Damage Assessment Number : 3

A.) General Element Information

Element Number : 602  
Element Description : COLUMN  
Damage Mode : CRACKING/STEEL DEBONDING  
Repair Strategy : COLUMN SPLINT

B.) Repair Strategy Information

1.) Required Materials :

Column Splint Kit : 1

2.) Required Equipment :

3.) Estimated Manpower/Time :

More output follows - press [ESC] to quit, any key to continue

View Or Print Repair Strategy Files

- (1) View Repair Strategy Files
- (2) Print Repair Strategy Files
- (3) Exit

Resource Data Base

- (1) Transfer Data Files
- (2) Compute Possible Repairs From Materials
- (3) Compute Possible Repairs From Equipment
- (4) Remove And Edit Data In Materials Tables
- (5) Remove And Edit Data In Equipment Tables
- (6) View And Print Tables
- (7) View Or Print Repair Strategy Files
- (8) Exit



APPENDIX B  
FOAL EAGLE FACILITY RECOVERY DEMONSTRATION  
7AF/DE SUPPORT REQUEST SUMMARY

**STAFF SUMMARY SHEET**

|   | TO | ACTION    | SIGNATURE (Surname), GRADE AND DATE |  | TO | ACTION | SIGNATURE (Surname), GRADE AND DATE |
|---|----|-----------|-------------------------------------|--|----|--------|-------------------------------------|
|   | 1  | ICSG/DE   | Coor                                |  | 6  | 7AF/CS | Info                                |
| 2 |    | 51TFW/LGT | Coor                                |  | 7  | 7AF/CV | Info                                |
| 3 |    | 51TFW/SG  | Coor                                |  | 8  | 7AF/CC | Info                                |
| 4 |    | 7AF/DO    | Coor                                |  | 9  |        |                                     |
| 5 |    | 7AF/LG    | Coor                                |  | 10 |        |                                     |

|                                                      |                   |                   |                          |               |
|------------------------------------------------------|-------------------|-------------------|--------------------------|---------------|
| SURNAME OF ACTION OFFICER AND GRADE<br>Tagorda, Capt | SYMBOL<br>7AF/DEX | PHONE<br>784-6826 | TYPIST'S INITIALS<br>RVT | SUSPENSE DATE |
|------------------------------------------------------|-------------------|-------------------|--------------------------|---------------|

|                                                                                         |                   |
|-----------------------------------------------------------------------------------------|-------------------|
| SUBJECT<br>AF Civil Engineering Support Agency (AFCESA) Facility Recovery Demonstration | DATE<br>18 Sep 91 |
|-----------------------------------------------------------------------------------------|-------------------|

**SUMMARY**

1. The purpose of this staff summary is to provide the results of the AFCESA personnel site visit to Csan AB. During their visit, they coordinated the logistics for their demonstration of expedient facility damage repair techniques currently under development.

2. The AFCESA personnel were TDY in Korea from 7 to 14 Sep '91. 7 AF/DEX was the OPR for their visit and arranged meetings with pertinent organizations. The advon team worked with 7AF SPX and DOX to tie the demonstration into the overall Foal Eagle '91 scenario. Their logistic requirements are listed in Attachment 1 of the Talking Paper at Tab 1. 51 CSG/DE agreed to support their logistic requirements. Per Mr. Strickland, AFCESA, funds are available for items that cannot be borrowed, and therefore, must be purchased or fabricated. ICSG/DE also agreed to support their personnel requirements (Attachments 2 & 3). 51 TFW/LGT agreed to support their vehicle requirements (Attachment 1). The proposed demonstration sites were coordinated with pertinent organizations. The demonstrations at buildings 933, 7AF headquarters, and 777, hospital, will not alter the existing structure. If any surface damage occurs, repairs will be made immediately after. Additionally, the demonstrations at those two buildings will minimally interfere with daily operations.

**RECOMMENDATION**

3. None. For information only.

*Richard O. Cardinale*  
 RICHARD O. CARDINALE, Colonel, USAF  
 DCS, Engineering and Services

1 Tab  
 Talking Paper for Air Force Civil  
 Engineering Support Agency Facility  
 Recovery Demonstration

TALKING PAPER FOR  
AIR FORCE CIVIL ENGINEERING SUPPORT AGENCY  
FACILITY RECOVERY DEMONSTRATION

**BACKGROUND:**

- 7AF/CC approved AFCEA demonstration of advanced technology expedient damage repair techniques in conjunction with Foal Eagle 91
- The purposes of the demonstration are to involve users in research and development process, obtain MAJCOM inputs, and acquire support to generate requirement documents for full scale development

**SCOPE:**

- Demonstrate structural damage assessment expert system program
- Demonstrate expedient repair methods to include shotcrete repair, column replacement, column splinting and slab/berm repair

**PROPOSED DEMONSTRATION SITES:**

- 51CSG/DE Damage Control Center, Bldg 416, for damage assessment system software
- Remnants of Bldg 414 for shotcrete and slab/berm repair demonstration
- Hospital emergency room entrance, and mechanical rooms, Bldg 777, for column replacement
- Entrance to Bldg 933, 7AF HQ, for column splinting

**LOGISTICS SUPPORT:**

- Storage, utilities, heavy equipment, supplies (See Attachment 1)
  - AFCEA funds are available for items that cannot be borrowed, and therefore, must be purchased or fabricated

**PERSONNEL SUPPORT:**

- Five civil engineering craftsmen (See Attachment 2)
  - 51CSG/DE agreed to support personnel requirements

**PROPOSED DEMONSTRATION DATES:**

- Days 3 and 4 of Foal Eagle 91 exercise (See Attachment 3)
  - Tied to Foal Eagle 91 scenario
- Project officer to work details on logistics and personnel support requirements is 7AF/DEX, Capt Tagorda, Ext. 784-6826

Capt Tagorda/DEX/4-6826/jag/2 Oct 91

**AFCEA FOAL EAGLE Facility Recovery Demonstration**

**7AF Logistics Support Requirements**

**Utilities**

| <b><u>ITEM</u></b>                                                                   | <b><u>CAPACITY</u></b> |
|--------------------------------------------------------------------------------------|------------------------|
| elec power in vicinity<br>of Bldgs 414 & 777 + 200' power<br>chord                   | 110v                   |
| or                                                                                   |                        |
| 1 ea portable elec generator + 100' power<br>chord                                   | 110v                   |
| fire hydrant in vicinity<br>of Bldg 414 + 200' hose w/ coupling<br>to shotcrete hose | GPM [TBD]              |
| or                                                                                   |                        |
| 1 ea water buffalo + 100' hose w/<br>coupling to shotcrete hose                      | GAL [TBD]              |

| <b><u>ITEM</u></b>                   | <b><u>CAPACITY</u></b> |
|--------------------------------------|------------------------|
| <b>B. VEHICLES</b>                   |                        |
| 1 ea front end loader                | 5 CUYD                 |
| 1 ea crane                           | 5 TON                  |
| 1 ea all-terrain forklift            | 10K                    |
| 1 ea 6 PAX w/ pintal hook            |                        |
| 1 ea mobile air compressor           | CFM [TBD]              |
| 1 ea water buffalo                   | 500 GAL                |
| 1 ea exterior electric line<br>truck | 10KW                   |
| 1 ea tractor/trailer                 | 10 TON                 |
| 1 ea 5 ton dump truck                | 5 ton                  |

Attachment 1

C. EQUIPMENT/SUPPLIES/TOOLS

| <u>ITEM</u>                                                                                                                                                        | <u>CAPACITY</u> |
|--------------------------------------------------------------------------------------------------------------------------------------------------------------------|-----------------|
| 1 ea 2m x 2m reinforced concrete slab (9" thick)                                                                                                                   |                 |
| 1 ea elec circular saw +<br>extra blade + 100' power chord                                                                                                         |                 |
| 1 ea gas powered chain saw +<br>extra chain                                                                                                                        |                 |
| 1 ea 55 gal drum                                                                                                                                                   |                 |
| 1 ea elec junction box                                                                                                                                             |                 |
| 2 ea 12' step ladder                                                                                                                                               |                 |
| 2 ea coal shovels                                                                                                                                                  |                 |
| 1 ea bolt cutter                                                                                                                                                   |                 |
| 1 ea sledge hammer                                                                                                                                                 |                 |
| 1 ea ram set stud gun w/ cartridge                                                                                                                                 |                 |
| 1 ea regular broom                                                                                                                                                 |                 |
| 1 ea push broom                                                                                                                                                    |                 |
| 2 ea carpenter's hammer                                                                                                                                            |                 |
| 1 ea carpenter's square                                                                                                                                            |                 |
| 1 ea 12' steel tape                                                                                                                                                |                 |
| 2 ea saw horses                                                                                                                                                    |                 |
| 1 ea rubber head mallet                                                                                                                                            |                 |
| 1 ea crosscut saw                                                                                                                                                  |                 |
| 100' rope                                                                                                                                                          |                 |
| 1 ea 10' x 10' x 8' R/C<br>till-up slab w/ pickup eyes +<br>lifting cable & spread bar<br>nails (for joining 3/8 plywood<br>to 2 x 4, and for joining 2 ea 2 x 4s) |                 |

Attachment 1

7AF PERSONNEL SUPPORT REQUIREMENTS

A. Personnel

| <u>AFSC</u> | <u>NOMENCLATURE</u> | <u>NO. REQUIRED</u> |
|-------------|---------------------|---------------------|
| 35270       | Carpenter           | 1 ea                |
| 35230       | Carpenter           | 2 ea                |
| 55151       | Equipment Operators | 2 ea                |
|             |                     | -----               |
| TOTAL       |                     | 5 ea                |

Note: 551X1's must be proficient in the operation of 5 ton dump truck, 10K front end loader at forklift/loader, 5 ton crane, and air compressor.

7AF PERSONNEL SUPPORT REQUIREMENT

|                |         |                                                               |
|----------------|---------|---------------------------------------------------------------|
| Oct 31 - 1 Nov | All day | shotcrete machine familiarization                             |
| 4 Nov          | AM      | column splint training                                        |
|                | PM      | shotcrete & earth berm training                               |
| 5 Nov          | AM/PM   | shotcrete repair hands on training<br>and site preparation    |
| 6 Nov (Day 3)  | AM      | shotcrete demo                                                |
|                | PM      | column splint demo, prepare<br>shotcrete machine for shipping |
| 7 Nov (Day 4)  | AM      | earth berm repair                                             |
|                | PM      | column replacement                                            |
| Nov            | AM      | restoration, clean-up                                         |

Note: Need entire team 4 - 8 Nov and 2 551X1's on 31 Oct - 1 Nov.

APPENDIX C  
FOAL EAGLE FACILITY RECOVERY DEMONSTRATION  
TEST PLAN





**RACS FOAL EAGLE FACILITY RECOVERY DEMONSTRATION TEST PLAN**

by

**Douglas H. Merkle  
David L. Read  
Norman F. Karaszewski  
Michael R. Purcell**

**Applied Research Associates, Inc.  
P.O. Box 40128  
Tyndall Air Force Base, FL 32403**

**18 October 1991**

**Prepared for  
Airbase Survivability Branch  
Engineering Research Division  
Civil Engineering Laboratory  
Air Force Civil Engineering Support Agency  
AFCESA/RACS  
Tyndall Air Force Base, FL 32403**

**Under**

**Scientific and Engineering Technical Assistance (SETA)  
Contract Number F08635-88-C-0067**

Scientific and Engineering Technical Assistance (SETA)  
Contract Number F08635-88-C-0067

TABLE OF CONTENTS

| Section | Title                            | Page |
|---------|----------------------------------|------|
| I       | OBJECTIVES.....                  | 1    |
| II      | SCHEDULE.....                    | 1    |
| III     | ENGINEERING INFORMATION.....     | 1    |
| IV      | RESOURCES REQUIRED.....          | 1    |
| V       | DATA ACQUISITION.....            | 18   |
| VI      | DATA REDUCTION AND ANALYSIS..... | 18   |
| VII     | SAFETY.....                      | 18   |
| VIII    | ENVIRONMENTAL IMPACT.....        | 20   |
| IX      | EXTERNAL COORDINATION.....       | 20   |

## I. INTRODUCTION

Since 1988, RACS has been developing airbase postattack facility recovery (damage assessment and expedient repair) techniques, which SALTY DEMO showed were much needed throughout PACAF and USAFE. These techniques are now ready for full-scale development by AFCESA/RAA, but require MAJCOM support to obtain FSD funding. FOAL EAGLE, a PACAF ABO exercise to be staged at Osan AB, ROK in November 91, is an ideal opportunity for RACS to demonstrate its facility recovery techniques, and thus gain needed MAJCOM support.

ARA developed the following facility recovery techniques under the RAC SETA contract:

- computer-assisted damage assessment (POST-DAM)
- column splint
- column shoring
- earth berm wall breach repair
- shotcrete wall breach repair

This test plan describes when and how the above techniques will be demonstrated during FOAL EAGLE.

## II. SCHEDULE

Table 1 lists the sequence of events to prepare for and execute the RACS FOAL EAGLE Facility Recovery Demonstration.

## III. ENGINEERING INFORMATION

Figures 1 through 6 are engineering sketches and drawings pertaining to the column shoring repair; Figures 7 and 8 pertain to the shotcrete wall repair.

## IV. RESOURCES REQUIRED

Table 2 details the personnel, equipment and material resources required for the RACS FOAL EAGLE Facility Expedient Repair Demonstration, and the organization supplying each equipment and material resource item. Labor will be supplied by 51 CSG/DEM. RACS will supply all video and photo equipment.

TABLE 1. HO AFCESA FOAL EAGLE FACILITY RECOVERY DEMONSTRATION SCHEDULE

10/17/91

Friday, 11 Oct 91

RACS demo equipment shipment departs Tyndall for Travis via TMO/commercial truck (CLHM).

Wednesday, 16 Oct 91

RACS demo equipment shipment arrives at Travis.

Purcell meets equipment shipment at Travis, expedites transfer to and processing through MAC airlift receiving office.

Friday, 18 Oct 91

Shotcrete supersacks and waterheater arrive at Travis.

Purcell expedites supersack and waterheater transfer to and processing through MAC airlift receiving office.

Saturday, 19 Oct 91

RACS demo equipment departs Travis for Osan via MAC airlift.

Tuesday, 22 Oct 91

Reid and Karaszewski depart Panama City for Portland.

Purcell joins Reid and Karaszewski at Portland.

Reid, Karaszewski, and Purcell depart Portland for Seoul.

Wednesday, 23 Oct 91

Reid, Karaszewski, and Purcell arrive at Seoul.

Reid, Karaszewski, and Purcell rent car, drive to Osan.

Video and photo equipment arrive at Tyndall (to be carried as personal baggage by Reid, Karaszewski, Merkle, Read, and Underwood).

Thursday, 24 Oct 91

Reid contacts 7AF/DEX (Tagorda) to confirm demo arrangements.

Reid confirms VOQ reservations for all: (Reid, Underwood, Merkle, Read, Karaszewski, Purcell, Sherrill, Smith).

Reid and Karaszewski contact 51 CSG/DEM (Kessler, Wackowski) to confirm availability of requested repair resources, dimensions of columns to be repaired, and DCC availability for POST-DAM demo; identify 51 CSG/DEM craftsman labor, and set training schedule; confirm availability of vehicles to transfer shotcrete equipment and material from MAC terminal to 51 CSG/DEM storage area.

Purcell contacts MAC terminal to confirm RACS demo equipment shipment arrival date and time; initiates RACS demo equipment MAC airlift return shipment paperwork.

Reid sends status FAX to RACS.

Friday, 25 Oct 91

Reid contacts FOAL EAGLE exercise team to confirm schedule, scenarios, moulaging, asset fencing and fenced asset identification.

Purcell and Karaszewski receive RACS demo equipment at MAC terminal, inventory same, transport it to 51 CSG/DEM storage area, and perform equipment condition visual survey.

Merkle, Read, and Underwood depart Panama City for Portland.

Merkle, Read, and Underwood arrive at Portland.

Merkle, Read, and Underwood depart Portland for Seoul.

Saturday, 26 Oct 91

Karaszewski and 51 CSG/DEM team assemble and check out shotcrete equipment.

Karaszewski and 51 CSG/DEM team arrange repair demo equipment in kit groups for training and fast response.

Merkle, Read, and Underwood arrive at Seoul.

Merkle, Read, and Underwood RON at Yongsan.

Reid calls Merkle at Crown Hotel (Phone # 792-8224).

Sunday, 27 Oct 91

Merkle, Read, and Underwood rent car, drive to Osan.

Team Conference: (1500 at Osan Officers' Club) review all demo preparations, adjust demo scenario as necessary.

Monday, 28 Oct 91

Karaszewski and 51 CSG/DEM team assemble all demo materials supplied by 51 CSG/DEM.

Purcell completes RACS demo equipment MAC airlift return shipment paperwork.  
Read and Underwood set up POST-DAM equipment in DCC.  
Read and Underwood rehearse POST-DAM demo script.  
Merkle and Reid contact 7AF/DEX and arrange for demo audience, briefings.

Tuesday, 29 Oct 91

Merkle, Karaszewski, and Reid update repair training schedule and syllabus.  
Purcell arranges for video positioning equipment.  
Read and Underwood adjust POST-DAM demo scenarios as needed.

Wednesday, 30 Oct 91

Karaszewski trains shotcrete nozzle operator (dry).

Thursday, 31 Oct 91

Karaszewski trains shotcrete nozzle operator (water only).

Friday, 1 Nov 91

Merkle, Karaszewski, and Read train column splint team.  
Merkle, Karaszewski, and Read train column shoring team.  
Karaszewski trains shotcrete nozzle operator (water only).

Saturday, 2 Nov 91

Read and Underwood demonstrate POST-DAM.

Sunday, 3 Nov 91

Sherrill and Smith depart Portland for Seoul.

Monday, 4 Nov 91

Merkle, Karaszewski, and Read train earth berm team.  
Merkle, Karaszewski, and Read train shotcrete team (water only).  
Sherrill and Smith arrive at Seoul, are met by RACS team.  
RACS team drives Sherrill and Smith to Osan.

Tuesday, 5 Nov 91

Merkle, Karaszewski, Read, Sherrill and Smith oversee site preparation and shotcrete practice repair.

Wednesday, 6 Nov 91

Shotcrete Demo (AM)

Earth Berm Demo (PM)

Karaszewski and RED HORSE team prepare shotcrete equipment for return shipment.

Thursday, 7 Nov 91

Column Splint Demo (AM) (7AF HQ; HOSP)

Column Shoring Demo (PM)

Karaszewski and RED HORSE team prepare splint and shoring kits for return shipment.

Friday, 8 Nov 91

Restoration and cleanup.

Saturday, 9 Nov 91

Depart Osan for Seoul.

Fly from Seoul to Portland.

Fly from Portland to Panama City.

2.08.1

9/18/91  
DRTT

1/2

FOAL EAGLE Exercise

Osan AB, Korea

November 1991

Building 777 - Base Hospital.

25"  $\phi$  R/C Column, ~ 12' high

Scenario - repair by shoring

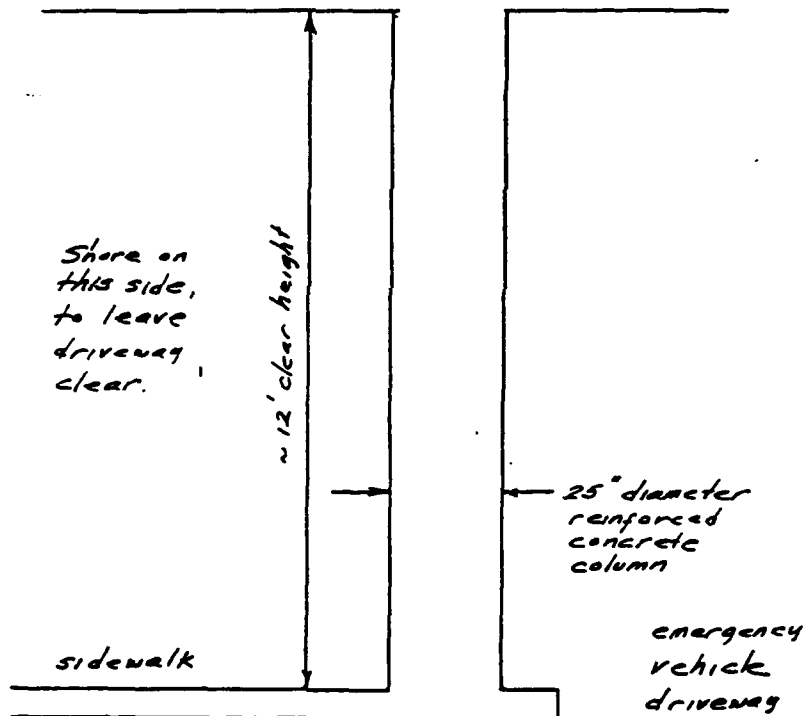

ELEVATION

48-102 100 SHEETS  
10/1/91  
DRTT



2.08.1

7/19/91  
DTR

2/2

42-100 100 SHEETS  
MAY 1988

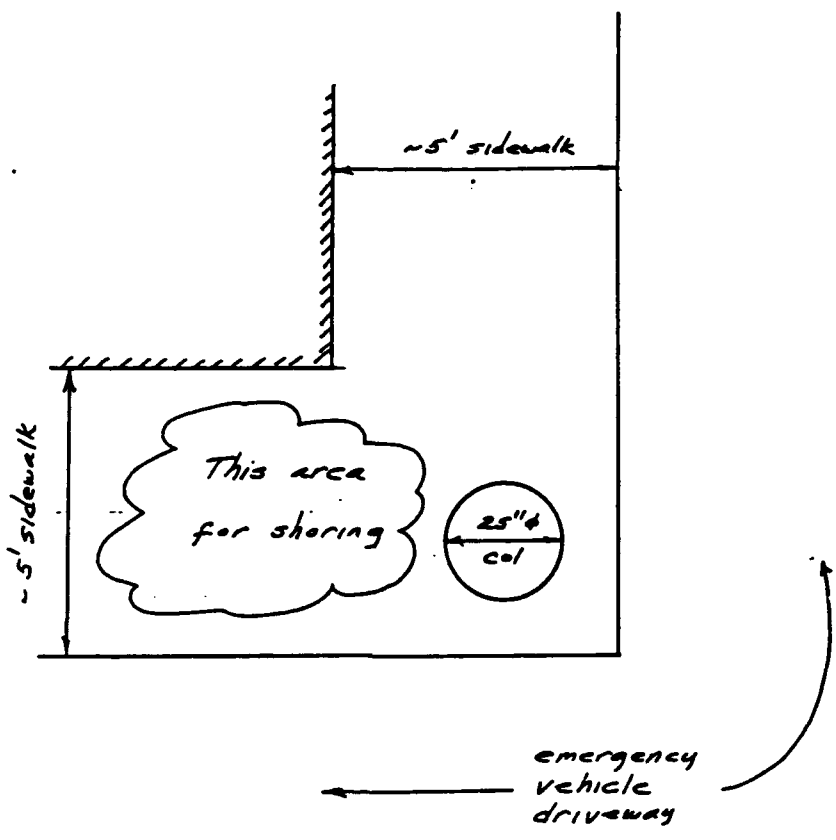

PLAN



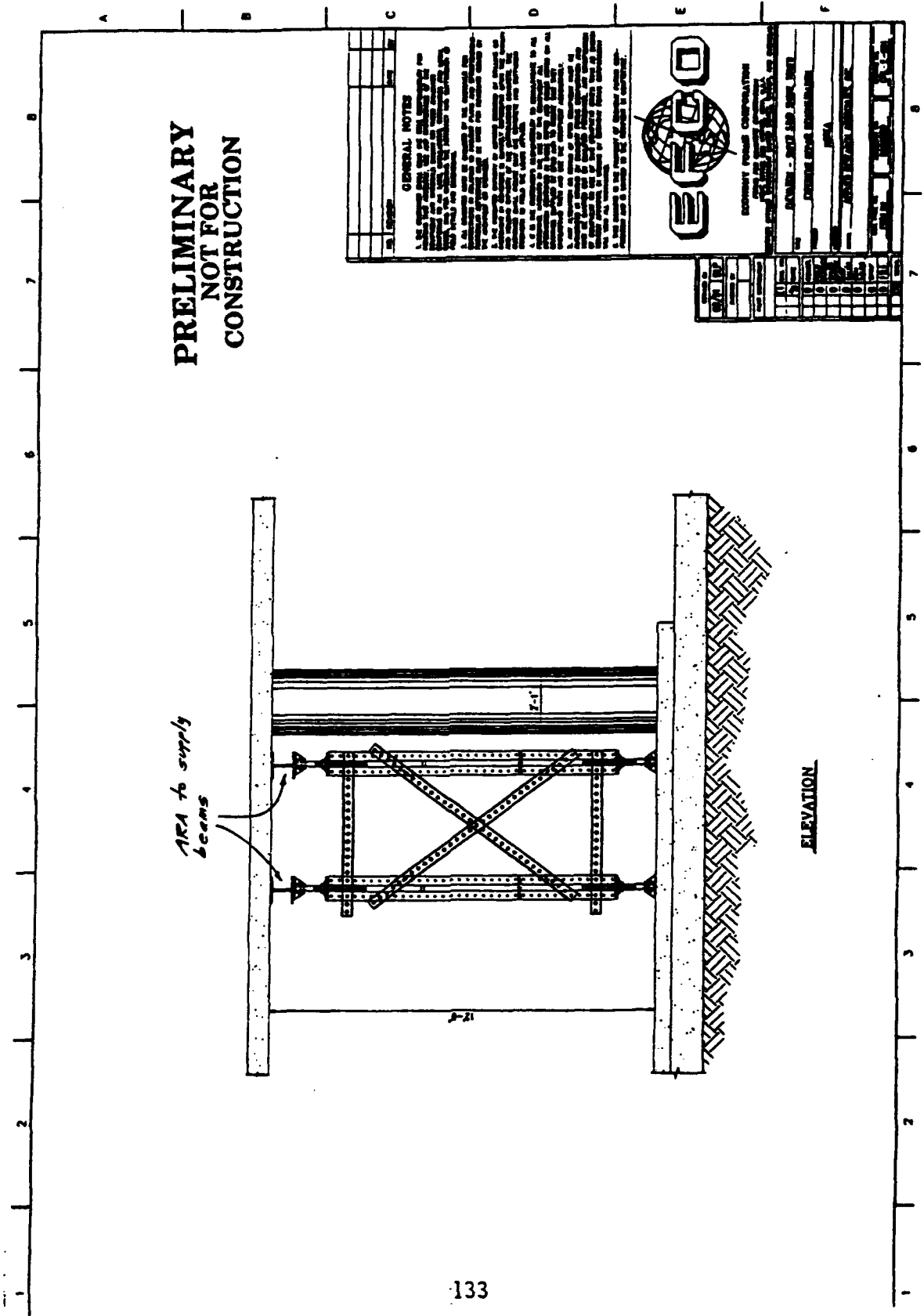

**PRELIMINARY  
NOT FOR  
CONSTRUCTION**

**GENERAL NOTES**

1. ALL STEEL SHALL BE A36 UNLESS OTHERWISE NOTED.

2. ALL CONNECTIONS SHALL BE WELDED UNLESS OTHERWISE NOTED.

3. ALL DIMENSIONS SHALL BE IN FEET AND INCHES UNLESS OTHERWISE NOTED.

4. ALL DIMENSIONS SHALL BE TO THE CENTERLINE UNLESS OTHERWISE NOTED.

5. ALL DIMENSIONS SHALL BE TO THE FACE UNLESS OTHERWISE NOTED.

6. ALL DIMENSIONS SHALL BE TO THE CENTERLINE UNLESS OTHERWISE NOTED.

7. ALL DIMENSIONS SHALL BE TO THE FACE UNLESS OTHERWISE NOTED.

8. ALL DIMENSIONS SHALL BE TO THE CENTERLINE UNLESS OTHERWISE NOTED.

9. ALL DIMENSIONS SHALL BE TO THE FACE UNLESS OTHERWISE NOTED.

10. ALL DIMENSIONS SHALL BE TO THE CENTERLINE UNLESS OTHERWISE NOTED.



**EFCO**

STEEL FABRICATING CORPORATION

1000 WEST 10TH AVENUE, SUITE 1000  
DENVER, COLORADO 80202

TELEPHONE (303) 733-1000

FAX (303) 733-1001

WWW.EFCO.COM

| NO. | DESCRIPTION | QTY. | UNIT |
|-----|-------------|------|------|
| 1   | ...         | ...  | ...  |
| 2   | ...         | ...  | ...  |
| 3   | ...         | ...  | ...  |
| 4   | ...         | ...  | ...  |
| 5   | ...         | ...  | ...  |
| 6   | ...         | ...  | ...  |
| 7   | ...         | ...  | ...  |
| 8   | ...         | ...  | ...  |
| 9   | ...         | ...  | ...  |
| 10  | ...         | ...  | ...  |





FOAL EAGLE Facility Recovery Demonstration

Room AB, ROK Building 414 - Mosaic Repair

West Wall @ SW Corner

2.08.1

9/25/91  
 DRY

1/2

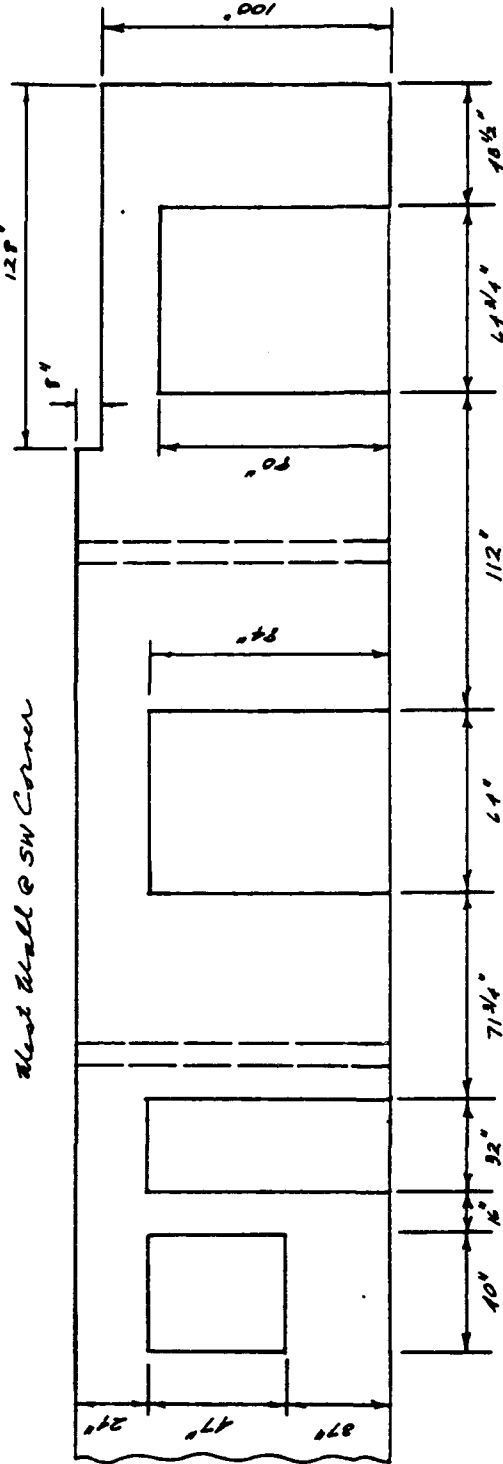

8" x 8" x 16" cinder block

ELEVATION

1" = 50"

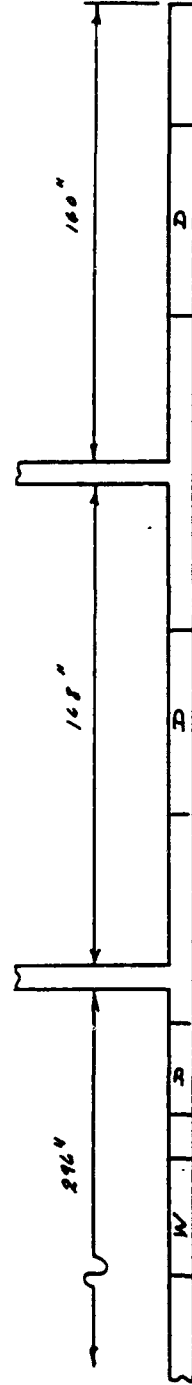

PLAN

2.08.1

9/25/91  
BTT

3/2

AS 152 100 SHEETS  
PROFESSIONAL  
REGISTERED

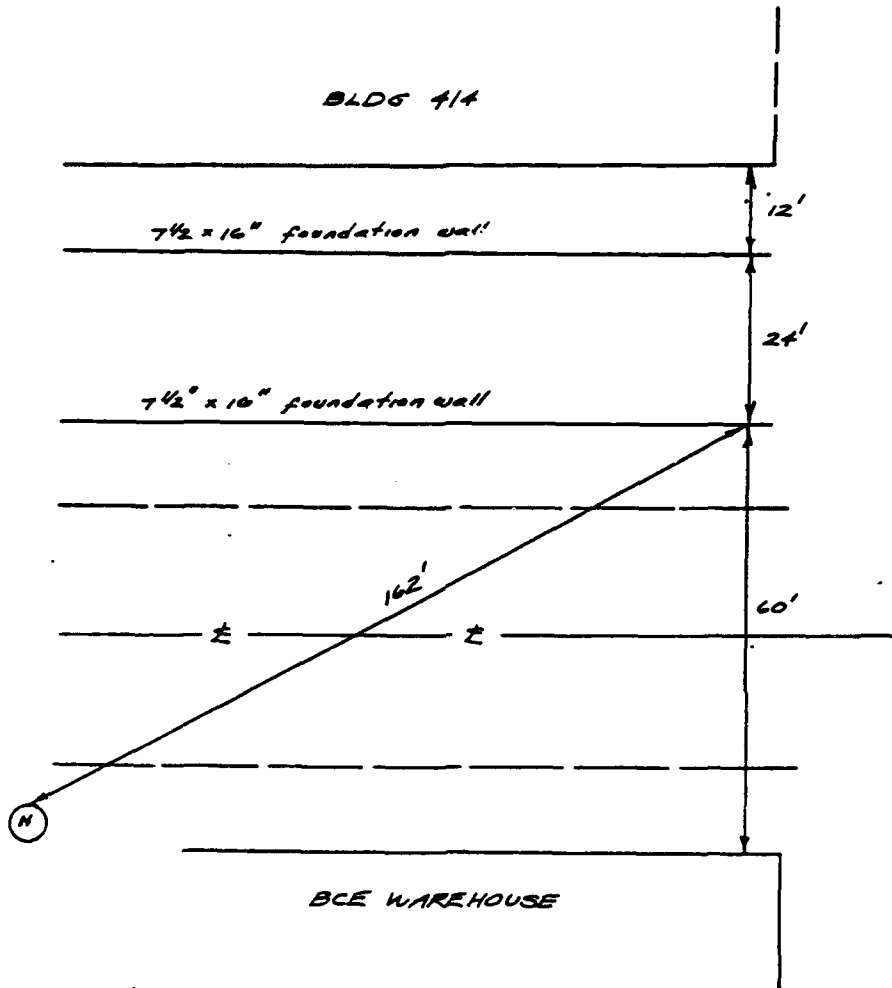

~180' from hydrant to furthest point on Bldg 414

Abstruse Volume

$40 \times 47 \times 8 = 15,040$

$32 \times 84 \times 8 = 21,504$

$64 \times 54 \times 8 = 43,008$

$65 \times 80 \times 8 = 41,600$

$121,152 / 1728 = 70.11 \text{ CF}$

$= 2.60 \text{ CY}$

∴ Use 5 CY

TABLE 2. HQ AFCESA FOAL EAGLE FACILITY RECOVERY DEMONSTRATION  
RESOURCE REQUIREMENTS

10/03/91

| <u>ACTION</u>                                                                               | <u>PERSONNEL</u> | <u>NO</u> | <u>ITEM</u>                                  | <u>AFCESA</u> | <u>ZAF</u> |
|---------------------------------------------------------------------------------------------|------------------|-----------|----------------------------------------------|---------------|------------|
| <u>PRE-DEMO STORAGE</u>                                                                     |                  |           |                                              |               |            |
| transport equipment<br>from Osan AB air<br>freight terminal to<br>51 CSG/DE storage<br>area | 3                | (1)       | flat bed tractor/<br>trailer                 |               | X          |
|                                                                                             |                  | (1)       | forklift                                     |               | X          |
| <u>SHOTCRETE WALL BREACH REPAIR</u>                                                         |                  |           |                                              |               |            |
| clear debris                                                                                | 3                | (1)       | six-pax truck                                |               | X          |
|                                                                                             |                  | (1)       | front end loader                             |               | X          |
|                                                                                             |                  | (1)       | bolt cutter                                  | X             |            |
|                                                                                             |                  | (1)       | sledge hammer                                | X             |            |
|                                                                                             |                  | (2)       | coal shovels                                 | X             |            |
|                                                                                             |                  | (1)       | regular broom                                | X             |            |
|                                                                                             |                  | (1)       | push broom                                   | X             |            |
| fabricate plywood<br>backing                                                                | 2                | (1)       | hand held, 8" diam.<br>elect. circular saw   | X             |            |
|                                                                                             |                  | (1)       | 110V, 1 phase, 60Hz<br>electric power outlet |               | X          |
|                                                                                             |                  | (1)       | 100' extension chord<br>with 3/2 adapter     |               | X          |
|                                                                                             |                  | (1)       | crosscut saw                                 | X             |            |
|                                                                                             |                  | (1)       | rip saw                                      | X             |            |
|                                                                                             |                  | (1)       | 12' carpenter's steel<br>tape                | X             |            |
|                                                                                             |                  | (1)       | carpenter's square                           | X             |            |
|                                                                                             |                  | (2)       | carpenter's hammers                          | X             |            |
|                                                                                             |                  | (1)       | marker                                       | X             |            |
|                                                                                             |                  | (2)       | sawhorses                                    |               | X          |
|                                                                                             |                  | (7)       | 4'x8'x3/8" plywood<br>sheets                 |               | X          |
|                                                                                             |                  | (18)      | 2"x4"x8' boards                              |               | X          |
|                                                                                             |                  | (200)     | 8d nails                                     | X             |            |
|                                                                                             |                  | (200)     | 16d nails                                    | X             |            |
| install plywood<br>backing                                                                  | 3                | (2)       | 8' step ladders                              |               | X          |
|                                                                                             |                  | (1)       | ramset stud gun                              | X             |            |
|                                                                                             |                  | (200)     | ramset cartridges                            | X             |            |
|                                                                                             |                  | (100)     | ramset studs                                 | X             |            |
|                                                                                             |                  | (20pr)    | ear plugs                                    |               | X          |
|                                                                                             |                  | (7)       | ear protectors                               |               | X          |



TABLE 2. HQ AFCEA FOAL EAGLE FACILITY RECOVERY DEMONSTRATION  
RESOURCE REQUIREMENTS (CONTINUED)

| <u>ACTION</u>                        | <u>PERSONNEL</u> | <u>NO</u> | <u>ITEM</u>                                               | <u>AFCEA</u> | <u>ZAF</u> |
|--------------------------------------|------------------|-----------|-----------------------------------------------------------|--------------|------------|
| position shotcrete<br>equipment      | 5                | (1)       | shotcrete gun                                             | X            |            |
|                                      |                  | (1)       | shotcrete hose                                            | X            |            |
|                                      |                  | (1)       | shotcrete nozzle                                          | X            |            |
|                                      |                  | (1)       | robotic arm, with<br>hydraulic pump and<br>electric motor | X            |            |
|                                      |                  | (1)       | 15' chain with hook                                       |              | X          |
|                                      |                  | (1)       | step-up transformer                                       | X            |            |
|                                      |                  | (1)       | all-terrain forklift                                      |              | X          |
|                                      |                  | (1)       | air compressor,<br>600 CFM @ 100 psi                      |              | X          |
|                                      |                  | (1)       | air compressor hose                                       | X            |            |
|                                      |                  | (1)       | water buffalo                                             |              | X          |
|                                      |                  | (1)       | water heater                                              | X            |            |
|                                      |                  | (1)       | water pump, 10 GPM<br>at 90 psi                           |              | X          |
|                                      |                  | (1)       | 110V, 1 phase, 60Hz<br>electric power outlet              |              | X          |
|                                      |                  | (1)       | 100' extension chord<br>with 3/2 adapter                  |              | X          |
|                                      |                  | (1)       | water flow meter                                          | X            |            |
|                                      |                  | (1)       | water hose                                                | X            |            |
|                                      |                  | (5)       | 1 CY shotcrete super-<br>sacks                            | X            |            |
|                                      |                  | (1)       | front end loader                                          |              | X          |
|                                      |                  | (1)       | 480V, 3 phase, 60Hz,<br>25KW electric power               |              | X          |
| apply shotcrete                      | 5                |           | No additional equipment                                   |              |            |
| <u>EARTH BERM WALL BREACH REPAIR</u> |                  |           |                                                           |              |            |
| clear debris                         | 3                | (1)       | six-pax truck                                             |              | X          |
|                                      |                  | (1)       | front end loader                                          |              | X          |
|                                      |                  | (1)       | bolt cutter                                               | X            |            |
|                                      |                  | (1)       | sledge hammer                                             | X            |            |
|                                      |                  | (2)       | coal shovels                                              | X            |            |
|                                      |                  | (1)       | regular broom                                             | X            |            |
|                                      |                  | (1)       | push broom                                                | X            |            |
| fabricate plywood<br>backing         | 2                | (1)       | hand held, 8" diam.<br>elect. circular saw                | X            |            |
|                                      |                  | (1)       | 110V, 1 phase, 60Hz,<br>electric power outlet             |              | X          |
|                                      |                  | (1)       | 100' extension chord<br>with 3/2 adapter                  |              | X          |
|                                      |                  | (1)       | crosscut saw                                              | X            |            |

TABLE 2. HQ AFCEA FOAL EAGLE FACILITY RECOVERY DEMONSTRATION  
RESOURCE REQUIREMENTS (CONTINUED)

| <u>ACTION</u>                                       | <u>PERSONNEL</u> | <u>NO</u> | <u>ITEM</u>                                       | <u>AFCEA</u> | <u>7AF</u> |
|-----------------------------------------------------|------------------|-----------|---------------------------------------------------|--------------|------------|
|                                                     |                  | (1)       | rip saw                                           | X            |            |
|                                                     |                  | (1)       | 12' carpenter's steel<br>tape                     | X            |            |
|                                                     |                  | (1)       | carpenter's square                                | X            |            |
|                                                     |                  | (2)       | carpenter's hammers                               | X            |            |
|                                                     |                  | (1)       | marker                                            | X            |            |
|                                                     |                  | (2)       | sawhorses                                         |              | X          |
|                                                     |                  | (7)       | 4'x8'x3/8" plywood<br>sheets                      |              | X          |
|                                                     |                  | (18)      | 2"x4"x8' boards                                   |              | X          |
|                                                     |                  | (200)     | 8d nails                                          | X            |            |
|                                                     |                  | (200)     | 16d nails                                         | X            |            |
| install plywood<br>backing                          | 3                | (2)       | 8' step ladders                                   |              | X          |
|                                                     |                  | (1)       | ramset stud gun                                   | X            |            |
|                                                     |                  | (200)     | ramset cartridges                                 | X            |            |
|                                                     |                  | (100)     | ramset studs                                      | X            |            |
|                                                     |                  | (20pr)    | ear plugs                                         |              | X          |
|                                                     |                  | (7)       | ear protectors                                    |              | X          |
| load, transport,<br>and position<br>R/C tiltup slab | 2                | (1)       | 3mx3m precast R/C<br>slab with lift<br>eyes/hooks |              | X          |
|                                                     |                  | (2)       | slab lifting frame<br>and cable or chain          |              | X          |
|                                                     |                  | (1)       | front end loader                                  |              | X          |
| form earth berm                                     | 1                | (1)       | No additional equipment                           |              |            |
| <u>COLUMN REPLACEMENT REPAIR</u>                    |                  |           |                                                   |              |            |
| clear debris                                        | 3                | (1)       | six-pax truck                                     |              | X          |
|                                                     |                  | (1)       | front end loader                                  |              | X          |
|                                                     |                  | (1)       | bolt cutter                                       | X            |            |
|                                                     |                  | (1)       | sledge hammer                                     | X            |            |
|                                                     |                  | (2)       | coal shovels                                      | X            |            |
|                                                     |                  | (1)       | regular broom                                     | X            |            |
|                                                     |                  | (1)       | push broom                                        | X            |            |
| erect shoring tower                                 | 5                | (2)       | 8"x8"x6' timbers                                  |              | X          |
|                                                     |                  | (1)       | EFCO 12' tower                                    | X            |            |
|                                                     |                  | (1)       | all-terrain forklift                              |              | X          |
|                                                     |                  | (2)       | 8' step ladders                                   |              | X          |
|                                                     |                  | (1)       | measuring rod                                     | X            |            |
|                                                     |                  | (1)       | 12' carpenter's steel<br>tape                     | X            |            |
|                                                     |                  | (4)       | crescent wrenches                                 | X            |            |

TABLE 2. HQ AFCESA FOAL EAGLE FACILITY RECOVERY DEMONSTRATION  
RESOURCE REQUIREMENTS (CONTINUED)

| <u>ACTION</u>                      | <u>PERSONNEL</u> | <u>NO</u> | <u>ITEM</u>                   | <u>AFCESA</u> | <u>ZAF</u> |
|------------------------------------|------------------|-----------|-------------------------------|---------------|------------|
|                                    |                  | (2)       | ball peen hammers             |               | X          |
| <u>COLUMN SPLINT REPAIR</u>        |                  |           |                               |               |            |
| clear debris                       | 3                | (1)       | six-pax truck                 |               | X          |
|                                    |                  | (1)       | front end loader              |               | X          |
|                                    |                  | (1)       | bolt cutter                   | X             |            |
|                                    |                  | (1)       | sledge hammer                 | X             |            |
|                                    |                  | (2)       | coal shovels                  | X             |            |
|                                    |                  | (1)       | regular broom                 | X             |            |
|                                    |                  | (1)       | push broom                    | X             |            |
| position & attach<br>splint plates | 2                | (1)       | 12' carpenter's steel<br>tape | X             |            |
|                                    |                  | (1)       | carpenter's square            | X             |            |
|                                    |                  | (1)       | marker                        | X             |            |
|                                    |                  | (1)       | crosscut saw                  | X             |            |
|                                    |                  | (1)       | 50' coil clothesline          | X             |            |
|                                    |                  | (4)       | 2"x4"x6' boards               |               | X          |
|                                    |                  | (2)       | splint plates                 | X             |            |
|                                    |                  | (4)       | threaded rods                 | X             |            |
|                                    |                  | (8)       | extra heavy washers           | X             |            |
|                                    |                  | (8)       | nuts                          | X             |            |
|                                    |                  | (2)       | crescent wrenches             | X             |            |

Table 3 shows the tasks assigned to each demonstration team member.

V. DATA ACQUISITION

In addition to video and photo coverage of each demonstration, the time required for each demonstration phase will be recorded together with all significant observations, using the following format:

RACS FOAL EAGLE FACILITY RECOVERY DEMO  
DATA SHEET

DEMO \_\_\_\_\_

DATE \_\_\_\_\_

BLDG \_\_\_\_\_

TEMP \_\_\_\_\_

WEATHER CONDITIONS \_\_\_\_\_

| <u>DEMO PHASE</u> | <u>START</u> | <u>STOP</u> | <u>DURATION</u> | <u>REMARKS</u> |
|-------------------|--------------|-------------|-----------------|----------------|
|-------------------|--------------|-------------|-----------------|----------------|

VI. DATA REDUCTION AND ANALYSIS

Data reduction will consist of developing and editing the video and photo coverage. Data analysis will consist of a qualitative discussion of how well each demonstration went, and how the demonstrated method might be improved during full-scale development by RAA.

VII. SAFETY

Safety concerns for the expedient repair demonstrations, and how they will be addressed are listed below.

| <u>REPAIR</u> | <u>CONCERN</u>             | <u>HOW ADDRESSED</u>     |
|---------------|----------------------------|--------------------------|
| column splint | head injury<br>foot injury | hard hat<br>safety boots |

TABLE 3. RACS FOAL EAGLE FACILITY RECOVERY DEMONSTRATION TEAM TASKS.

| <u>NAME</u>                          | <u>TASKS</u>                                                                                                                                                                                            |
|--------------------------------------|---------------------------------------------------------------------------------------------------------------------------------------------------------------------------------------------------------|
| Dr. Douglas Merkle                   | (ARA) SETA Principal Investigator (designed POST-DAM basic architecture and all four expedient repair techniques); engineering supervision; record expedient repair demo data; brief 7AF demo audience. |
| Mr. David Read                       | (ARA) train expedient repair teams; execute POST-DAM demo; record expedient repair demo data.                                                                                                           |
| Mr. Norm Karaszewski                 | (ARA) expedient repair demo Training Chief (has personally performed all expedient repair demos at Tyndall AFB); supervise expedient repair demo; record expedient repair demo data.                    |
| Mr. Mike Purcell                     | (ARA) arrange and supervise demo equipment shipment from Tyndall AFB to Osan AB and back; record demo video data.                                                                                       |
| Mr. Fred Sherrill & Mr. Andrew Smith | (Surecrete, Inc.) supervise shotcrete equipment set up, checkout, and repair (if necessary); consult on shotcrete material placement as affected by environmental conditions.                           |
| LT James Underwood                   | (RACS) POST-DAM Project Officer; execute POST-DAM demo; record expedient repair demo still photo data.                                                                                                  |
| Capt Rich Reid                       | (RACS) Expedient Repair Project Officer; interface with 7AF/DEM and                                                                                                                                     |

51CSG/DEX supporting organizations;  
 record POST-DAM demo still photo  
 data; record expedient repair demo  
 data; help brief 7AF audience.

|                |                                                                                                |                                                                                                               |
|----------------|------------------------------------------------------------------------------------------------|---------------------------------------------------------------------------------------------------------------|
| column shoring | head injury<br>foot injury<br>back injury<br><br>falling<br>ear injury                         | hard hat<br>safety boots<br>forklift to lift<br>heavy items<br>safety belts/ropes<br>ear plugs                |
| earth berm     | head injury<br>foot injury                                                                     | hard hat<br>safety shoes                                                                                      |
| shotcrete      | head injury<br>foot injury<br>chemical burns<br>lung injury<br>ear injury<br>ramset stud wound | hard hat<br>safety shoes<br>gloves<br>face mask<br>ear plugs<br>stand clear from<br>ramset stud<br>trajectory |

VIII. ENVIRONMENTAL IMPACT

The demonstrations will have no permanent adverse environmental impact.

IX. EXTERNAL COORDINATION

The following organizations and individuals have been contacted in preparation for the RACS FOAL EAGLE facility recovery demonstration:

| <u>ORGANIZATION</u> | <u>NAME</u>            | <u>PHONE</u>     |
|---------------------|------------------------|------------------|
| 7AF/CC              | Lt Gen Ronald Fogleman |                  |
| 7AF/DE              | Col Richard Cardinale  |                  |
| 7AF/DEX             | Maj Mike Stevens       | DSN 315-784-6826 |
| 7AF/DEX             | Capt Rey Tagorda       | DSN 315-784-6826 |
| 7AF/DEX             | Capt Lisa Witt         | DSN 315-784-6826 |
| 7AF/DEX             | MSgt Tim Thomas        | DSN 315-784-6723 |
| 7AF/DOX             | Capt Kevin Hawkins     | DSN 315-784-5230 |
| 51CSG/DE            | Col Mike McPherson     |                  |
| 51CSG/DEM           | Maj Lillimon           |                  |
| 51CSG/DEM           | Lt Patricia Kessler    | DSN 315-784-6462 |
| 51CSG/DEM           | SMSgt Alan Wackowski   | DSN 315-784-6461 |

**APPENDIX D**  
**DEMONSTRATION SCHEDULE**



DEPARTMENT OF THE AIR FORCE  
 HEADQUARTERS SEVENTH AIR FORCE (PACAF)  
 APO SAN FRANCISCO 96570-5000

01 NOV 1991

REPLY TO  
 ATTN OF: DE

SUBJECT: AF Civil Engineering Support Agency (AFCESA) Facility Recovery Demonstration

TO: 7AF/CC/CV/CS/DO/SG                      51CSG/DE                      51MED GP/SG                      51RMG/LGT

1. Reference 18 Sept 91 staff summary sheet, same subject.
2. All interested parties are invited to witness the following AFCESA facility recovery demonstrations (damage assessment and expedient repair), at the dates, times, and locations shown below:

| <u>DATE</u> | <u>TIME</u> | <u>BUILDING</u> | <u>ROOM</u>    | <u>DEMONSTRATION</u>                         |
|-------------|-------------|-----------------|----------------|----------------------------------------------|
| 2 Nov 91    | 1400        | 416             | DCC            | Computer-assisted facility damage assessment |
| 5 Nov 91    | 1000        | 414             | ---            | Earth berm wall breach repair                |
| 5 Nov 91    | 1030        | 414             | ---            | Shotcrete wall breach repair                 |
| 6 Nov 91    | 1130        | 777             | LE11           | Column splint repair                         |
| 6 Nov 91    | 1200        | 777             | LH16           | Column shoring repair                        |
| 6 Nov 91    | 1300        | 933             | Front Entrance | Column splint repair                         |

3. The computer-assisted damage assessment (POST-DAM) demonstration will be performed by AFCESA personnel. The expedient facility repair demonstrations will be performed by 51CSG/DEM and Fairchild AFB Prime BEEF personnel, trained by AFCESA.

4. Both still photo and video coverage of all five demonstrations will be obtained by AFCESA and will be made available to requesting organizations through 7AF/DEX (Capt Tagorda) or by contacting:

HQ AFCESA/RACS  
 ATTN: Capt Richard A. Reid  
 Tyndall AFB, FL 32403  
 DSN 523-2918/4912

5. Our POC for the AFCESA demonstration is Capt Tagorda at 784-2459.

  
 REYNOLD V. TAGORDA, Capt, USAF  
 Director, Plans and Exercises



APPENDIX E  
PACAF SUPPORT DOCUMENTS

c/c



DEPARTMENT OF THE AIR FORCE  
HEADQUARTERS 51ST COMBAT SUPPORT GROUP (PACAF)  
APO SAN FRANCISCO 96370-5000

REPLY TO: 51 CES/DE  
ATTN OF:

06 NOV 1991

SUBJECT: Facility Recovery

HQ PACAF/DE

TO

1. During exercise FOAL EAGLE I and several of my staff witnessed an impressive demonstration of postattack facility damage assessment and expedient repair techniques developed by the Air Force Civil Engineering Support Agency (AFCESA). We watched a personal computer-assisted facility damage assessment system called POST-DAM, compatible with the Survivable BRAAT Communication System (SBCS), easily handle the same kind of detailed structural damage and repair information that gridlocked the Spangdahlem AB Damage Control Center (DCC) during exercise SALTY DEMO in 1985. We saw blue-suit craftsmen from 51 CSG/DEM and 92 CES/DEMR splint two reinforced concrete columns and shore a third. We also saw them repair a wall breach using a tilt-up, rapid runway repair (RRR) concrete slab and an earth berm, and fill another wall breach with fiber-reinforced, rapid-setting shotcrete (concrete sprayed from a hose by high pressure air), using a remotely-controlled nozzle arm commonly used in tunnel construction. Each of the four repairs was completed in less than 21 minutes on site.

2. This is exactly the practical technology I and Air Force BCES throughout PACAF need, to put muscle into our Contingency Response Plan and make our Base Recovery After Attack program robust. I urge PACAF/DE to support the Facility Recovery Operational Requirements Document (ORD) now being written by AFCESA, so the vital technology we witnessed can proceed through Full-Scall Development at AFCESA and out to the field.

3. The AFCESA point of contact for ORD preparation is:

Mr. William S. Strickland  
HQ AFCESA/RACS  
Tyndall AFB, FL 32403  
DSN 523- 2918/4912

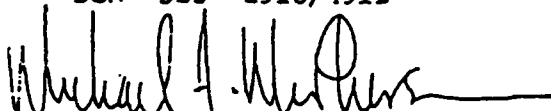
  
MICHAEL F. MCPHERSON, Colonel, USAF  
Director of Civil Engineering

UNCLASSIFIED

01 02 141213Z MAY 92 RR UUUU RACS

NO

HQ PACAF HICKAM AFB HI//DE//

RUCIPGA/AFCEA TYNDALL AFB FL//CC//

INFO RUDWAAH/7AF OSAN AB KOR//DE//

RUAKDPB/51CSG OSAN AB KOR//DE//

RJHVPA/CINCPACAF HICKAM AFB HI//CS//

BT

MSGID/SYS RRM/PACOPS DEMR//

AMPN/SUBJ FACILITY RECOVERY DEMONSTRATION AT OSAN

AB//

REF/A/LTR/51CSG-DE/6NOV91 NOT TO ALL//

RMKS/

UNCLAS

6. RECENTLY, YOUR STAFF CONDUCTED A DEMONSTRATION AT OSAN AB, DURING EXERCISE FOAL EAGLE 91, ON EXPEDIENT REPAIR TECHNIQUES AND POSTATTACK FACILITY DAMAGE ASSESSMENT. COL MCPHERSON, 51CES/CC, WITNESSED THE DEMONSTRATION AND STRONGLY SUPPORTS THESE TECHNOLOGIES (REF A). WE ALSO SUPPORT AND WILL WORK WITH YOUR STAFF TO DEVELOP THE FACILITY RECOVERY OPERATIONAL REQUIREMENTS

PAGE 02 RUHVAAB1745 UNCLAS

DOCUMENT (ORD) FOR THESE TECHNOLOGIES.

BISHOP, GS-04 SEC, RACS, 2918  
CRC:

149

UNCLASSIFIED

141213ZMAY92

UNCLASSIFIED

02 02 141213Z MAY 92 RR UUUU RACS

NO

2. TO GET THESE TECHNOLOGIES QUICKLY TO THE FIELD, WE SEE A NEED TO SPLIT THE FACILITY EXPEDIENT REPAIR TECHNIQUES AND THE POSTATTACK FACILITY DAMAGE ASSESSMENT INTO SEPARATE REQUIREMENTS.

A. WE RECOMMEND THE FACILITY EXPEDIENT REPAIR TECHNIQUES SHOULD BE HANDLED ALONG THE SAME LINES AS THE RAPID UTILITY REPAIR KITS (CRURKS).

A FACILITY REPAIR KIT SHOULD BE DEVELOPED UTILIZING AFFORDABLE OFF-THE-SHELF OR MODIFIED COMMERCIAL PRODUCTS WHICH CAN BE FIELDDED QUICKLY AND AFFORDABLY.

B. THE REQUIREMENT FOR THE POSTATTACK FACILITY DAMAGE ASSESSMENT CLEARLY EXISTS. HOWEVER, A COORDINATED EFFORT ON SOFTWARE DEVELOPMENT HAS TO BE DONE OF THE VARIOUS PRODUCTS (CBAM, CRISIS, SBCS, CTIS, ETC.) BEING DEVELOPED. SBCS MUST BE COMPATIBLE WITH WCCS. WE NEED TO LOOK AT ALL THE SYSTEMS, DEFINE THE REQUIREMENTS, TAKE THE BEST FROM EACH, AND DEVELOP INTERACTION WHERE NECESSARY. WE WILL WORK WITH YOUR STAFF TO HELP RESOLVE THIS ISSUE.

3. POC IS CAPT PETRYSYN, DEMR, DSN 448-0476.// BT #1745

BISHOP, GS-04 SEC, RACS, 2918  
CRC:

150

UNCLASSIFIED

141213ZMAY92